



> Book a test drive



> Find a Retailer



> View the Range Guide

B-Class

Electric Drive



now electric!

Effective from 1 December 2015.

Mercedes-Benz





> Book a test drive



> Find a Retailer



> View the Range Guide

Contents

Model prices	7	Executive package	20	Technical data	34
Model lines	8	Premium package	21	Road Fund Licence	36
Standard equipment	12	Pricing summary for Executive and Premium packages	22	Services and insurance	37
Wheels	16	Optional equipment	23	Mercedes me	38
Driving Assistance package	17	Genuine Accessories	26	Mercedes-Benz Finance	40
Energy Assist package	18	Colours and materials	30		
Exclusive package	19				



> Book a test drive



> Find a Retailer



> View the Range Guide

The hard facts to melt your heart

At Mercedes-Benz we appreciate the importance of detail. Over the following pages you'll find model prices and a breakdown of standard and optional equipment, as well as details of the comprehensive services and benefits that are available to every Mercedes-Benz driver.

Of course, some things have to be experienced to be truly appreciated, such as the qualities that set a Mercedes-Benz apart. Which is why we'd like to invite you for a test drive at your local Mercedes-Benz Retailer. Alternatively, you can make arrangements by visiting www.mercedes-benz.co.uk/testdrive

For more information visit www.mercedes-benz.co.uk or call 0333 222 0500.



> Book a test drive



> Find a Retailer



> View the Range Guide

4



Some of the model features, optional extras and colours shown may not be available, or may only be available in a different specification.



> Book a test drive



> Find a Retailer



> View the Range Guide



Some of the model features, optional extras and colours shown may not be available, or may only be available in a different specification.



> Book a test drive



> Find a Retailer



> View the Range Guide

6



Some of the model features, optional extras and colours shown may not be available, or may only be available in a different specification.



Model prices

Engine	Model line	Transmission	CO ₂	Basic RRP excl. VAT (£)	Total RRP incl. VAT (£)	Road Fund Licence (£) ¹	Rec. OTR price (£) ²	P11D value (£)	Rec. OTR with PICG (£) ³	BiK tax rate 2015/16 (%)
B-Class Electric Drive Asynchronous motor – lithium-ion battery, 28 kWh, 179 hp/132 kW	Sport	Single speed	0	26,370.83	31,645.00	0.00	32,275.00	32,220.00	27,775.00	5
	Electric Art	Single speed	0	26,616.67	31,940.00	0.00	32,570.00	32,515.00	28,070.00	5

¹A different first year rate of Vehicle Excise Duty (Road Fund Licence) applies for new cars. Please refer to page 36 for the relevant rate for the second and subsequent years.

²Recommended on-the-road price: these prices reflect the Road Fund Licence applicable to the standard model plus £630.00 additional costs necessary to put your car on the road.

Included are a standard UK delivery charge (£540.00 incl. VAT), new vehicle registration fee (£55.00), number plates (£25.00 incl. VAT) and a battery charge (£10.00 incl. VAT). VAT is calculated at the standard rate of 20%.

³PICG (Plug-in car grant) is a £4,500.00 discount from the government. The amount of your grant will be automatically deducted from the price of your B-Class Electric Drive when you purchase it.

Your authorised Mercedes-Benz Retailer will complete all the paperwork for you.



> Book a test drive



> Find a Retailer



> View the Range Guide

8

B-Class Sport



Optional metallic paint finish and Premium package shown





True to its name, the Sport's dynamic styling includes a radiator grille in iridium silver with chrome inserts and 17" multi-spoke alloy wheels in himalaya grey. A choice between black, sahara beige or crystal grey ARTICO leather¹ upholstery combined with a sail pattern dashboard trim sets the tone for the interior. The door armrests feature contrast topstitching, and the 3-spoke multi-function leather steering wheel comes with a perforated

grip area. THERMOTRONIC luxury automatic climate control with dual zone adjustment and ambient lighting also add to your sense of wellbeing. Plus, for your in-car entertainment and information, there is the 8-inch colour display and the Audio 20 CD multimedia system with pre-installation for the optional Garmin® MAP PILOT navigation system.

Exterior

- 17" multi-spoke alloy wheels painted in himalaya grey
- Beltline trim strip in chrome
- Exterior mirrors – body coloured with integrated LED indicators and aspherically curved mirror glass
- Radiator grille with two louvres painted in iridium silver with chrome inserts
- Reversing camera with dynamic guidelines on central display

Interior

- Ambient lighting (single colour) with indirect illumination of interior door handles at front and rear and door trim elements
- Cruise control with SPEEDTRONIC variable speed limiter
- Folding tables on rear of driver and front passenger seat backrests

- Footwell lighting in front and rear
- Instrument cluster with 4.5-inch TFT colour multi-function display, silver-coloured dials and red needles
- THERMOTRONIC – luxury automatic climate control (two-zone)

Trim and Upholstery

Sail pattern	ARTICO leather ¹ – black
	
ARTICO leather ¹ – crystal grey	ARTICO leather ¹ – sahara beige
	

¹Man-made leather



> Book a test drive



> Find a Retailer



> View the Range Guide

10

B-Class Electric Art



Optional Premium package and privacy glass shown



You'll recognise the Electric Art model by its cirrus white or south seas blue paint finish with exterior door mirrors and a radiator grille with two louvres in contrasting paintwork. 18" multi-spoke alloy wheels in matt black are also exclusive to this model line. The stylish interior is fitted with black

ARTICO leather¹ upholstery with blue contrast stitching and sail pattern trim, combined with a black roof liner. On the velour floor mats, you'll notice 'Electric Drive' lettering and blue contrast topstitching.

Exterior

- 18" multi-spoke alloy wheels painted in matt black with a high-sheen finish
- Beltline trim strip in chrome
- Exterior mirrors in cirrus white or south seas blue (in contrast to body colour) with integrated LED indicators and aspherically curved mirror glass
- Radiator grille with two louvres painted in cirrus white or south seas blue (in contrast to body colour) with chrome inserts
- Reversing camera with dynamic guidelines on central display

Interior

- Ambient lighting (single colour) with indirect illumination of interior door handles at front and rear and door trim elements
- Folding tables on rear of driver and front passenger seat backrests

- Footwell lighting in front and rear
- Instrument cluster with 4.5-inch TFT colour multi-function display, silver-coloured dials and red needles
- THERMOTRONIC - luxury automatic climate control (two-zone)
- Velour floor mats with blue contrast topstitching and 'Electric Drive' lettering

Trim and Upholstery

- Sail pattern ARTICO leather¹ - black with contrast topstitching



¹Man-made leather



Standard equipment

Item	Sport	Electric Art
Transmission and Suspension		
Cruise control with SPEEDTRONIC variable speed limiter	●	●
ESP® Curve Dynamic Assist	●	●
Suspension – comfort suspension	●	●
Steering		
Power steering – with speed-sensitive servo assistance	●	●
Steering column manually adjustable for height and reach	●	●
Steering wheel – 3-spoke leather 12-button multi-function steering wheel with silver chrome trim and perforated grip area	●	●
Driving modes		
ECO+ mode – 70 kW available	●	●
ECO mode – 100 kW available, with additional 32 kW on kick-down	●	●
Sport mode – 132 kW available, with sharper throttle response	●	●
Exterior		
Beltline strips – chrome	●	●
Brakes – disc brakes all round (internally ventilated at the front)	●	●
Bumpers – body-coloured	●	●

Item	Sport	Electric Art
Bumpers – rear bumper with short chrome trim strip	●	●
Charging cable for household socket (mode 2) – 4 m, 13 A, coiled	●	●
Charging cable for wallbox and public charging stations (mode 3) – 4 m, 16 A, non-coiled	●	●
Door handles – body-coloured	●	●
Door mirrors – exterior mirror housings in body colour with integrated LED indicators and aspherically curved mirror glass	●	–
Door mirrors – exterior mirror housings in cirrus white with integrated LED indicators and aspherically curved mirror glass	–	△
Door mirrors – exterior mirror housings in south seas blue with integrated LED indicators and aspherically curved mirror glass	–	△
Lights – halogen headlamps including integral LED daytime running lamps	●	●
Lights – Headlamp Assist, automatic headlamp activation in dark conditions	●	●
Lights – high-level third brake light, LED technology	●	●
Lights – rear lights with LED fibre-optic tail lamps and LED brake lights	●	●
Radiator grille – two louvres painted in cirrus white with chrome inserts	–	△
Radiator grille – two louvres painted in iridium silver with chrome inserts	●	–
Radiator grille – two louvres painted in south seas blue with chrome inserts	–	△
Wiper system – heated windscreen washer system (heated windscreen wiper nozzles and heated washer fluid hoses)	●	●
Wiper system – rear windscreen wiper with intermittent wipe and automatic activation when reversing	●	●



Item	Sport	Electric Art
Interior		
12 V socket in luggage compartment	●	●
Air conditioning – air vents with surround and cruciform nozzle in silver chrome	●	●
Air conditioning – THERMOTRONIC luxury automatic climate control (two-zone)	●	●
Armrest – armrest on centre console with stowage compartment beneath	●	●
Armrest – door armrests with contrast topstitching	●	●
Armrest – rear armrest, folding, including through-loading function and cup holder	●	●
Door sills – front door sill panels with ‘Mercedes-Benz’ lettering in front	●	●
Floor mats – velour floor mats with blue contrast topstitching and ‘Electric Drive’ lettering	–	●
High-gloss black light switch with ring in silver chrome	●	●
Instrument cluster – 4.5-inch TFT colour multi-function display, silver-coloured dials and red needles	●	●
Instrument cluster – electronic service interval indicator ASSYST	●	●
Instrument cluster – outside temperature display	●	●
Instrument cluster – upper control panel with galvanised switches in silver chrome	●	●
Instrument cluster – warning indicators for fuel, oil, coolant and washer fluid levels and brake wear	●	●
Interior lighting – ambient lighting (single colour) with indirect illumination of interior door handles at front and rear and door trim elements	●	●

Item	Sport	Electric Art
Interior lighting – courtesy (white) and warning (red) lights in front doors and boot lid	●	●
Interior lighting – footwell lighting in front and rear	●	●
Interior lighting – rear interior lighting with integral reading lamps and locator lighting	●	●
Interior lighting – sun visor with illuminated vanity mirror for driver and front passenger	●	●
Mirrors – rear-view mirror with additional lighting	●	●
Non-Smoker package, including 12 V socket and stowage compartment in the front	●	●
Seats – front seats, height adjustable	●	●
Seats – front seats with adjustable seat cushion angle	●	●
Seats – rear seat backrests, split-folding (1/3:2/3)	●	●
Stowage – boxes under driver’s and front passenger’s seats	●	●
Stowage – compartments in front doors	●	●
Stowage – compartment with retractable cover in centre console	●	●
Stowage – double cup holder in centre console	●	●
Stowage – folding tables on rear of driver and front passenger seat backrests	●	●
Stowage – load-securing rings in luggage compartment	●	●
Stowage – nets in front passenger footwell	●	●
Stowage – nets on rear of driver and front passenger seat backrests	●	●



Item	Sport	Electric Art
Interior (continued)		
Stowage - retractable load compartment cover	●	●
Stowage - sunglasses compartment in overhead console	●	●
Windows - electric windows (4)	●	●
Paint, Trim and Upholstery		
Paint - non-metallic	●	●
Roof lining - black	△	●
Roof lining - grey	△	-
Trim - dashboard, sail pattern	●	●
Upholstery - ARTICO leather ¹	●	-
Upholstery - ARTICO leather ¹ in black with blue contrast topstitching	-	●

Item	Sport	Electric Art
Communications and In-Car Entertainment		
Audio 20 CD multimedia system including pre-installation for Garmin® MAP PILOT navigation system	●	●
Bluetooth® interface with HD voice-capable hands-free function and audio streaming for playing music files, cover flow and cover art for displaying album covers, SMS display function, and internet capability. (Bluetooth® features are phone-dependent)	●	●
CD player (MP3, WMA, AAC, WAV-compatible)	●	●
Controller on centre console (remote operation of audio and communication system)	●	●
Media display - 8-inch tablet-style CENTRAL MEDIA DISPLAY	●	●
Mercedes me connect (Remote Online) Onboard use of the remote and location services, e.g. geographic vehicle monitoring, vehicle location, remote door locking and unlocking, remote interrogation of the vehicle status. Remote Online subscription services are limited to three years from the initial registration, and can be extended at an additional cost	●	●
Mercedes me connect (standard services) Including emergency call system (eCall), accident recovery, breakdown and maintenance management	●	●
Radio with twin tuner and traffic information decoder (TP/TA)	●	●
SD card slot	●	●
Two USB connections in centre armrest for external audio devices and storage media (compatible with iPod® and iPhone®, access via vehicle operating system)	●	●



Item	Sport	Electric Art
Safety and Assistance Systems		
Anti-Theft Protection package including anti-theft alarm system with tow-away protection and interior monitoring system	●	●
Acceleration Skid Control (ASR)	●	●
Airbags – automatic front passenger airbag deactivation	●	●
Airbags – for driver and front passenger	●	●
Airbags – kneebag for driver	●	●
Airbags – sidebags for driver and front passenger (combined thorax/pelvis bag)	●	●
Airbags – windowbags	●	●
ATTENTION ASSIST – alerts the driver to increasing fatigue and inattention	●	●
Braking – adaptive Brake Assist with HOLD function and Hill Start Assist	●	●
Braking – adaptive brake lamps (flash under emergency braking)	●	●
Braking – anti-lock braking system (ABS)	●	●
Braking – Brake Assist (BAS) with brake servo assistance when emergency braking is detected	●	●
Braking – electric parking brake	●	●

Item	Sport	Electric Art
Childproof rear doors (manually operated) and rear electric windows (electrically operated)	●	●
COLLISION PREVENTION ASSIST PLUS	●	●
Crash-responsive emergency lighting – automatic activation of interior lighting in the event of an accident	●	●
Electronic immobiliser	●	●
Emergency call system (eCall)	●	●
First-aid kit and warning triangle	●	●
Locking – remote central locking with interior switch, speed-dependent automatic locking (can be deactivated) and crash sensor with emergency opening function	●	●
Parking – reversing camera with dynamic guidelines on central display	●	●
Seats – height-adjustable head restraints (5)	●	●
Seat belts – status display for rear seat belts in instrument cluster	●	●
Seat belts – three-point seat belts (5)	●	●
Tyres – TIREFIT with tyre inflation compressor	●	●
Tyres – tyre pressure monitoring system (with tyre pressure display in instrument cluster)	●	●



> Book a test drive



> Find a Retailer



> View the Range Guide

16

Wheels

A revolution in style

Item	Notes		69R	●	-	Basic RRP excl. VAT (£)	Total RRP incl. VAT (£)
Wheels			Sport	Electric Art			
17" alloy wheels (4) – multi-spoke design painted in himalaya grey 225/50 tyres						-	-
18" alloy wheels (4) – multi-spoke design painted in matt black with a high-sheen finish 225/45 tyres			04R	-	●	-	-

● Standard ○ Optional - Not available



Driving Assistance package



Blind Spot Assist



Lane Keeping Assist

Safety is at the heart of this package. It features the renowned Mercedes-Benz PRE-SAFE® anticipatory safety system which offers extensive all-round protection. Blind Spot Assist alerts you to unseen obstacles behind you, while Lane Keeping Assist warns you if you unintentionally stray out of the lane.

Driving Assistance package (code DP2) – designed and priced as a package, including items as listed below. **Total incl. VAT £875.00**

Driving Assistance package comprises:

Blind Spot Assist

Visible warning in exterior mirrors if vehicle is detected in the blind spot. Audible warning if indicating to move out of lane when a vehicle is detected in the blind spot

Lane Keeping Assist

Vibrates the steering wheel when detecting unintentional drifting out of lane

PRE-SAFE® anticipatory safety system

If the system detects a critical driving situation, preventive occupant protection measures are initiated, including reversible seat belt tensioning, adjustment of passenger seat positions (if Memory package is fitted)



Energy Assist package



Acoustic presence indicator



Privacy glass



Radar-based regeneration



Range Plus

The Energy Assist package comes with heated windscreen and a radar-based regeneration, ensuring a more efficient drive. Range Plus adds another 18 miles of range thanks to further efficiency measures including additional insulation and all-round privacy glass. As part of acoustic presence indicator, pedestrians and cyclists can be warned of the car's presence at speeds up to 18 mph.

Energy Assist package (code DP9) – designed and priced as a package, including items as listed below. **Total incl. VAT £945.00**

Energy Assist package comprises:

Acoustic presence indicator

Emits audible warning up to 18 mph alerting pedestrians/cyclists of car's presence.
Warning inaudible from interior of the vehicle

Heated windscreen

Good visibility restored quickly even if the windscreen is iced up – with no scraping required

Privacy glass

Heat-insulating dark-tinted glass all round from B-pillars to keep cabin cool in hot conditions and reduce heat from escaping in cold temperatures

Radar-based regeneration

The recuperation power is automatically adjusted to the current traffic situation, leading to more efficient driving, lower consumption and a higher range

Range Plus

Provides an additional 18 miles of range taking the total to 142 miles during the next charge cycle



Exclusive package



Leather upholstery – lava black

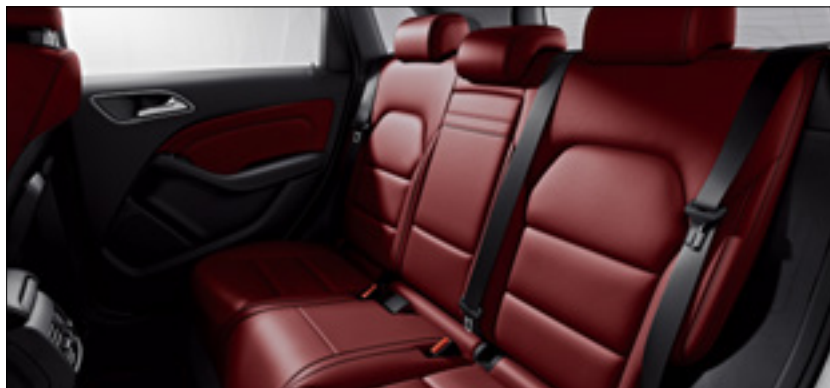

Leather upholstery – cranberry red

For an added touch of luxury, the Exclusive package includes leather upholstery in a choice of three elegant colours, as well as floor mats with matching colour edging. The Exclusive package is available only in conjunction with Executive or Premium package.

Exclusive package (code P34) – designed and priced as a package, including items as listed below.

Electric Art

Total incl. VAT £895.00

Exclusive package comprises:

Floor mats with edging in upholstery colour

Leather upholstery – lava black, hazelnut brown or cranberry red

Trim – brown open-pore eucalyptus wood or high-gloss black ash wood

Exclusive package upholstery and trim

Lava black

Hazelnut brown

Cranberry red



Brown open-pore eucalyptus wood

High-gloss black ash wood





Executive package



Active Parking Assist including PARKTRONIC



Heated front seats



Garmin® SD navigation system

This package is designed to add yet more comfort to your journey. It comes with Active Parking Assist including PARKTRONIC for effortless parking, heated front seats and the Garmin® SD navigation system complete with 8-inch colour display.

Executive package (code DP3) – designed and priced as a package, including items as listed below. **Total incl. VAT £995.00**

Executive package comprises:

Active Parking Assist including PARKTRONIC

Active Parking Assist helps find appropriate parking slots and can also automatically manoeuvre the car in and out of perpendicular and parallel parking spaces.

PARKTRONIC monitors front and rear while vehicle is being manoeuvred and warns the driver if risk of collision is detected

Garmin® SD navigation system

Heated front seats



Premium package



Ambient lighting



Bi-xenon headlamps



Electrically folding exterior mirrors

If you want to increase the level of comfort, this package includes the same items as the Executive package, plus bi-xenon headlamps for increased visibility and electrically folding exterior mirrors to assist with manoeuvring and parking in small spaces, as well as auto-dimming rear view and driver's exterior mirrors – a handy feature for dazzle-free night time driving.

Premium package (code DP0) – designed and priced as a package, including items as listed below. **Total incl. VAT £1,695.00**

Premium package comprises:

Active Parking Assist including PARKTRONIC

Active Parking Assist helps find appropriate parking slots and can also automatically manoeuvre the car in and out of perpendicular and parallel parking spaces.

PARKTRONIC monitors front and rear while vehicle is being manoeuvred and warns the driver if risk of collision is detected

Ambient lighting (12-colour)

Auto-dimming rear view and driver's exterior mirrors

Bi-xenon headlamps with headlamp wash

Electrically folding exterior mirrors

Heated front seats



Pricing summary for Executive and Premium packages

Engine	Model line	Transmission	Recommended OTR price (£) ¹			Recommended OTR price with PICG (£) ²		
			Base model	Executive	Premium	Base model	Executive	Premium
B-Class Electric Drive	Sport	Single speed	32,275.00	32,270.00	33,970.00	27,775.00	28,775.00	29,470.00
	Electric Art	Single speed	32,570.00	33,575.00	34,275.00	28,070.00	29,065.00	29,765.00

¹Recommended on-the-road price: these prices reflect the Road Fund Licence applicable to the standard model plus £630.00 additional costs necessary to put your car on the road.

Included are a standard UK delivery charge (£540.00 incl. VAT), new vehicle registration fee (£55.00), number plates (£25.00 incl. VAT) and a battery charge (£10.00 incl. VAT). VAT is calculated at the standard rate of 20%.

²PICG (Plug-in car grant) is a £4,500.00 discount from the government. The amount of your grant will be automatically deducted from the price of your B-Class Electric Drive when you purchase it.

Your authorised Mercedes-Benz Retailer will complete all the paperwork for you.



Optional equipment

Item	Notes		Sport	Electric Art	Basic RRP excl. VAT (£)	Total RRP incl. VAT (£)
Exterior						
Headlamps – Intelligent Light System Bi-xenon headlamps with LED daytime running lamps, Adaptive Highbeam Assist, cornering light function, headlamp wash and LED rear lamps	Only in conjunction with Premium package (code DP0)	621	<input type="radio"/>	<input type="radio"/>	362.50	435.00
Privacy glass	Included in Energy Assist package (code DP9)	840	<input type="radio"/>	<input type="radio"/>	216.67	260.00
Interior						
Memory package Electrically adjustable driver and front passenger seats with three individually selectable settings Four-way lumbar support for driver and front passenger		275	<input type="radio"/>	<input type="radio"/>	412.50	495.00
Four-way lumbar support	Included in Exclusive package (code P34)	U22	<input type="radio"/>	<input type="radio"/>	133.33	160.00
KEYLESS-GO – keyless locking, unlocking and start of the vehicle		889	<input type="radio"/>	<input type="radio"/>	354.17	425.00
Rear dividing net – restricts movement of items from luggage compartment to passenger compartment		U40	<input type="radio"/>	<input type="radio"/>	104.17	125.00
Paint, Trim and Upholstery						
Paint – metallic		'	<input type="radio"/>	<input type="radio"/>	479.17	575.00



Item	Notes		Sport	Electric Art	Basic RRP excl. VAT (£)	Total RRP incl. VAT (£)
Communications and In-Car Entertainment						
COMAND Online system ¹ 8-inch high-resolution colour display, hard disk drive (HDD) navigation with 3D map display, Live Traffic Information and European map data updates free of charge for the first three years. Smartphone integration, single CD/DVD and LINGUATRONIC voice control. Access to internet sites when vehicle is stationary, plus unrestricted use of Mercedes-Benz apps (internet-enabled mobile phone required). Integrated WLAN hotspot for onboard access of WLAN-enabled devices	In conjunction with Executive package (code DP3) and Premium package (code DP0)	531	<input type="radio"/>	<input type="radio"/>	829.17	995.00
DAB digital radio tuner	Not in conjunction with Energy Assist package (code DP9)	537	<input type="radio"/>	<input type="radio"/>	358.33	430.00
Garmin® MAP PILOT navigation system 8-inch high-resolution colour display. SD card navigation with instructions on screen and displayed in the instrument cluster. SD card inserted in centre armrest compartment next to USB ports. Includes 3D views with exact visualisation of roads and buildings as well as junction and lane assistants making it easy for drivers to orientate themselves. Operation via controller or voice control. Spoken instructions are emitted through the vehicle's built-in speakers. Software and maps can be updated via the internet	Included in Executive package (code DP3) and Premium package (code DP0)	357	<input type="radio"/>	<input type="radio"/>	412.50	495.00
Smartphone integration Comprising Apple CarPlay™. Compatible iPhones (iPhone 5 and newer) can be integrated into the vehicle via Apple CarPlay™. Please check on www.apple.com/uk/ios/carplay/ for compatibility and approved apps. Certain features and apps require a 3G or 4G data connection. Control of features available through voice control and controller on centre console	Included with COMAND Online system (code 531)	14U	<input type="radio"/>	<input type="radio"/>	208.33	250.00



Item	Notes	Sport Electric Art	Basic RRP excl. VAT (£)	Total RRP incl. VAT (£)
Communications and In-Car Entertainment (continued)				
Surround sound system – Harman Kardon® Logic 7® with Dolby Digital 5.1 and DTS 11 high-performance speakers and additional amplifiers	Only in conjunction with COMAND Online system (code 531). Removes stowage compartment beneath load compartment floor	810 <input type="radio"/> <input type="radio"/>	566.67	680.00
Service Package				
Service Care Service Care allows you to spread the cost of servicing your new car in the Mercedes-Benz Retailer network. Taking out a Service Care plan ensures your servicing needs are taken care of by fully trained Mercedes-Benz Technicians with the added benefit of a Mercedes-Benz service history	Price is based on a monthly rate. Example given is for two services taken over 24 months, three services over 36 months or four services over 48 months. Further payment options are available. New Service Care prices apply only to vehicles up to 12 months old prior to first service	' <input type="radio"/> <input type="radio"/>	20.00	24.00



Genuine Accessories

We've developed a range of Accessories you can add to help personalise and enhance your B-Class. Your local Mercedes-Benz Retailer can advise on fitting costs of Accessories, where applicable. Further information on our full range of Genuine Accessories can be found on the Mercedes-Benz UK website.



01 | Shallow boot tub

The boot tub is suitable for transporting shopping. The tub shape with its slightly raised edge is precision-tailored to the load area. Made from impact-resistant, non-split polypropylene, its structured surface holds the separately available stowage crate in place. Deep boot tub also available.

Basic RRP £72.50 (excl. VAT) **Total RRP £87.00 (incl. VAT)**

02 | Stowage crate

A secure hold for items which are prone to tip over or slide around, e.g. shopping bags. Adjustable partitioning elements allow crate to be divided into max. four sections. Optimum functionality only in conjunction with shallow boot tub.

Basic RRP £71.67 (excl. VAT) **Total RRP £86.00 (incl. VAT)**



> Book a test drive



> Find a Retailer



> View the Range Guide

03 | All-season floor mats

Robust, washable synthetic material, designed for heavy use. Latest design with recessed areas and raised edge. With distinctive Mercedes-Benz star logo. Price for front and rear mats.

Basic RRP £84.17 (excl. VAT) **Total RRP £101.00 (incl. VAT)**

04 | Concertina load sill protector

Protects the rear of the car from scratches when you're loading the vehicle and prevents dirt on the car from getting onto your clothes. Practical design – can be connected to reversible mat, shallow boot tub or deep boot tub.

Basic RRP £32.50 (excl. VAT) **Total RRP £39.00 (incl. VAT)**



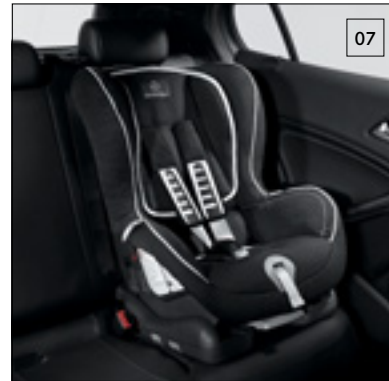
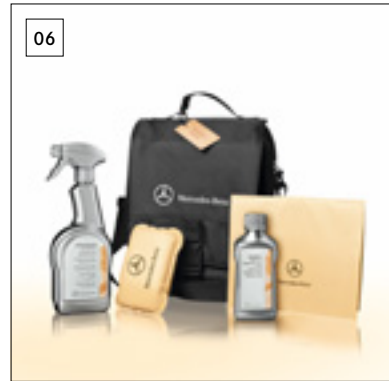
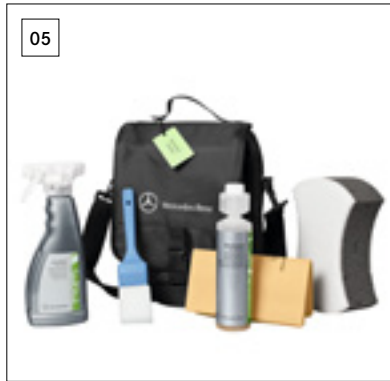

05 | Exterior Car Care Kit

The Mercedes-Benz Exterior Car Care Kit is a four-piece collection to keep the exterior of your car looking like it's come straight from the showroom. The bag contains car shampoo, wheel cleaner, sponge and polishing cloth. Basic RRP £20.83 (excl. VAT) **Total RRP £25.00 (incl. VAT)**

06 | Interior Car Care Kit

The Mercedes-Benz Interior Car Care Kit is a four-piece collection enabling you to maintain a spotless showroom finish inside your car. The bag contains cabin care spray, interior glass cleaner, interior glass sponge and car cloth. Basic RRP £20.83 (excl. VAT) **Total RRP £25.00 (incl. VAT)**

07 | DUO plus child seat, with ISOFIX and automatic child seat recognition

Optimum safety for children between the ages of around 8 months and 4 years (9 to 18 kg). Fitted as standard with top tether, an additional belt for securing the head section, a height-adjustable harness, ventilation channels and ISOFIX attachment points. With automatic child seat recognition. Adjustable tilt. Also available for ages 0+ (1 to 13 kg) and 3.5 to 12 years (15 to 36 kg). Basic RRP £428.33 (excl. VAT) **Total RRP £449.75 (incl. VAT)**

08 | Coolbox

Not only cools but warms too. Cools to up to 20° C below ambient temperature, to max. -2° C. Can be switched to warming function. Robust, highly insulated hard case with fabric cover, outside pockets and padded shoulder strap. Capacity: 24 litres. Can be connected to 12V socket in vehicle or to 230V power source via separately available rectifier. Basic RRP £140.00 (excl. VAT) **Total RRP £168.00 (incl. VAT)**



> Book a test drive



> Find a Retailer



> View the Range Guide

09 | Mercedes-Benz roof box, 400 litres

Multi-purpose box. Compact length, impressive amount of space. Capacity approx. 400 litres. Opens on both sides. Single lock system. Gas-filled struts for easy opening and closing of lid. Straps to hold contents in place. Maximum load capacity 75 kg. Available in matt silver or metallic black.

Basic RRP £341.67 (excl. VAT) **Total RRP £410.00 (incl. VAT)**

10 | Alustyle Quickfix carrier bars

Aluminium carrier bars, precision-tailored to the body of your B-Class – the perfect basis for a range of Mercedes-Benz transport solutions: ski and snowboard rack, bicycle rack or roof boxes.

Basic RRP £182.50 (excl. VAT) **Total RRP £219.00 (incl. VAT)**





Colours and materials

Non-metallic paints

Standard



589 jupiter red¹

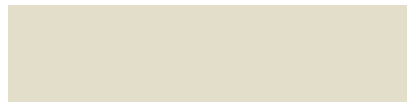

650 cirrus white

Metallic paints

Optional



162 south seas blue



191 cosmos black¹



787 mountain grey¹



175 elbaite green²



761 polar silver¹

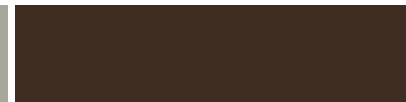

990 orient bronze¹



Upholstery

Sport

ARTICO leather¹



111 black



105 sahara beige



118 crystal grey

Trim

Sport



H81 sail pattern

Electric Art

ARTICO leather¹



121 black with blue contrast topstitching

Electric Art

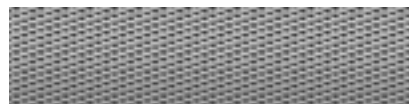

H81 sail pattern

Exclusive package (Electric Art)

Leather



201 lava black

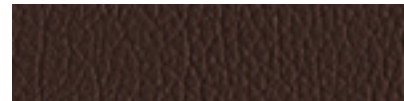

204 hazel nut brown



207 cranberry red

Exclusive package (Electric Art)



734 brown open-pore eucalyptus wood



736 high-gloss black ash wood

¹Man-made leather



Trim and upholstery combinations

	Sport			Electric Art
	ARTICO leather ¹			ARTICO leather ¹
	sahara beige (105)	black (111)	crystal grey (118)	black with blue contrast topstitching (121)
Dashboard				
Steering wheel	black	black	black	black
Upper dashboard trim	black	black	black	black
Lower dashboard trim	black	black	crystal grey	black
Seats				
Seat cushion centre section	sahara beige	black	crystal grey	black
Side bolster trim	sahara beige	black	crystal grey	black
Head restraint	sahara beige	black	crystal grey	black
Seat belt	black	black	black	black
Doors				
Door pocket	black	black	crystal grey	black
Door trim	sahara beige	black	crystal grey	black
Roof lining	black	black	grey	black
Floor covering				
Front and rear	black	black	black	black
Boot	black	black	black	black

¹Man-made leather



Combination options

		ARTICO leather ¹ Sport				ARTICO leather ¹ Electric Art				
		black	sahara beige	crystal grey		black with blue contrast topstitching	Leather (Exclusive package) Electric Art			
							lava black	hazelnut brown	cranberry red	
Non-metallic paints (standard)										
	589 jupiter red	●	△	○	-	-	-	-	-	
	650 cirrus white	●	●	○	●	●	●	●	●	
Metallic paints (optional)										
	162 south seas blue	●	●	●	●	●	●	△	△	
	175 elbaite green	●	●	●	-	-	-	-	-	
	191 cosmos black	●	●	○	-	-	-	-	-	
	761 polar silver	●	△	●	-	-	-	-	-	
	787 mountain grey	●	△	●	-	-	-	-	-	
	990 orient bronze	●	○	●	-	-	-	-	-	



Technical data

Model	Electric motor	
	B-Class Electric Drive	
Engine		
Battery type	lithium-ion high-voltage	
Electric motor type	asynchronous	
Battery capacity	kWh	28.0
Power ¹	hp (kW) at rpm	179 ² (132)/9,900-12,500
Torque ¹	Nm	340
Transmission		
Single-speed	●	
Performance	auto.	
Acceleration 0-62 mph	sec	7.9
Top speed	mph	99.5
Charging time ³ - AC outlet (230 V/13 A)		9.1-21.4
Wallbox (400 V/16 A)	hr	3.0-4.4
Electric power consumption - NEDC ⁴	kWh/100 km	approx. 16.6*
Electric range - NEDC ⁴	m	124

Model	Electric motor	
	B-Class Electric Drive	
Performance (continued)	auto.	
Emissions standard	EU6	
CO ₂ emissions	g/km	0
Weights and capacities	auto.	
Tyre size - Sport (front/rear)	225/50 R 17	
Electric Art (front/rear)	225/45 R 18	
Boot capacity ⁵ (seats down)	l	approx. 1,456
Turning circle	m	11.0
Kerb weight	kg	1,725
Perm. Gross Vehicle Weight	kg	2,170
Insurance		
Group rating	15	
Insurance ratings may vary depending on model line and specification. Please refer to http://www.thatcham.org/abigrouprating/ for further details		

¹Figures for rated output and rated torque according to Regulation (EC) No. 595/2009 in the currently applicable version. ²Peak power; continuous power 65 kW. ³Specified voltage and current values refer to network infrastructure and can be limited by the vehicle. Times are from 20-100% charge using a wallbox (3-phase) or standard socket (single-phase). ⁴New European Driving Cycle. The figures shown were obtained in accordance with the prescribed measuring process (Sec. 2, Nos. 5, 6, 6a of the German Ordinance on Fuel Consumption Labelling for Cars [Pkw-EnVKV] in the applicable version). The figures are not based on an individual vehicle. They are provided solely for the purpose of comparing different vehicle models.

⁵Figures according to Directive 70/156/EEC as amended by 2000/40/EC.

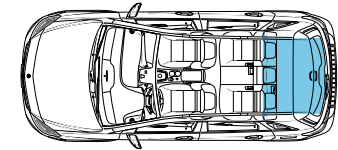
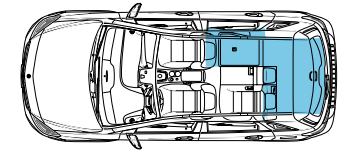
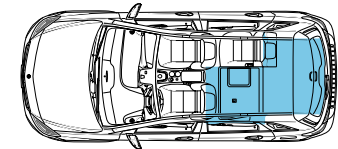
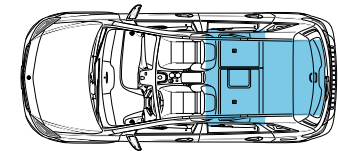
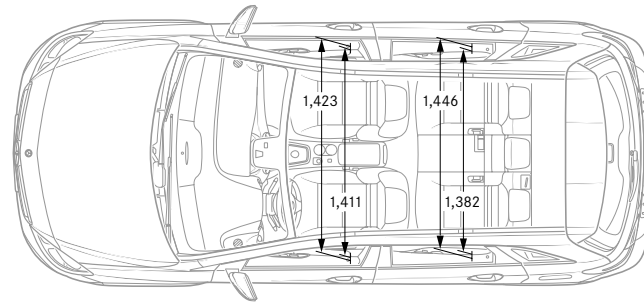
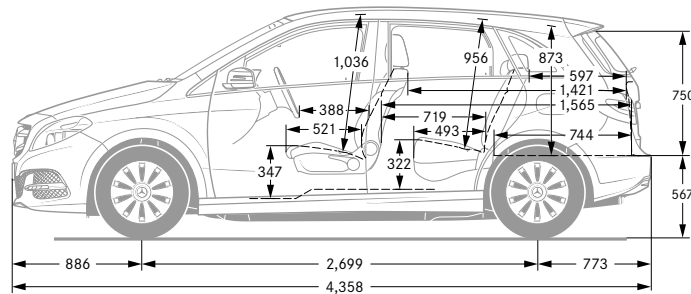
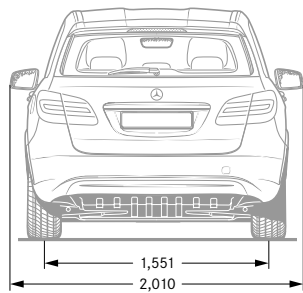
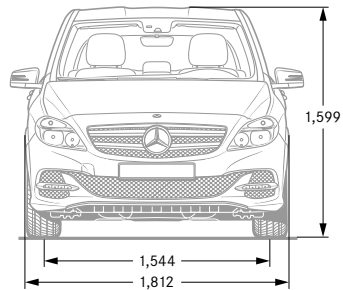

*The manufacturer's stated fuel consumption figures are based on the legally prescribed NEDC test cycle, which is performed in a laboratory. These are the only figures we are allowed to publish.

It is common that differences occur in real driving conditions compared with these certified laboratory values. They result primarily from conditions different from the legally-prescribed laboratory conditions, for example when ambient temperatures differ (the weather is hot, cold, windy, wet), the vehicle is operated under different loads and many other factors.

For several years, Mercedes-Benz has fully and actively supported the early introduction of the WLTP (Worldwide Harmonised Light Vehicles Test Procedure) and the measuring procedure for Real Driving Emissions (RDE). This procedure is designed to supersede the NEDC, with the goal of bringing standardised and real-world consumption closer together.

All measurements in millimetres. The dimensions shown are mean values and apply to standard-specification, unladen vehicles. Dimensions may vary slightly depending on the engine. Please consult your Retailer for further information.

The figures on pages 34-35 are correct at time of going to print. Please refer to the government website for latest data - <http://carfueldata.direct.gov.uk/>



Road Fund Licence



All road vehicle registrations are subject to Vehicle Excise Duty (Road Fund Licence), which varies in accordance with the vehicle's CO₂ emissions. A first year rate of Vehicle Excise Duty applies to new cars on their first year of registration. For the second and subsequent years a standard rate for each taxation band will apply.¹ The table below shows the bands (A–M) created by the DVLA and the corresponding Road Fund Licence. CO₂ emissions are listed in the technical data on page 34, and the relevant Excise Duty is reflected in the on-the-road prices on page 7.

Band	CO ₂ emissions	Petrol/Diesel		Electric/Hybrid	
		First year rate (£)	Standard rate (£)	First year rate (£)	Standard rate (£)
A	up to 100 g/km	0.00	0.00	0.00	0.00
B	101–110 g/km	0.00	20.00	0.00	10.00
C	111–120 g/km	0.00	30.00	0.00	20.00
D	121–130 g/km	0.00	110.00	0.00	100.00
E	131–140 g/km	130.00	130.00	120.00	120.00
F	141–150 g/km	145.00	145.00	135.00	135.00
G	151–165 g/km	180.00	180.00	170.00	170.00
H	166–175 g/km	295.00	205.00	285.00	195.00
I	176–185 g/km	350.00	225.00	340.00	215.00
J	186–200 g/km	490.00	265.00	480.00	255.00
K	201–225 g/km	640.00	290.00	630.00	280.00
L	226–255 g/km	870.00	490.00	860.00	480.00
M	over 255 g/km	1,100.00	505.00	1,090.00	495.00

¹For further information on vehicle taxation please refer to <http://carfueldata.direct.gov.uk/>



Services and insurance

Mercedes-Benz Service Care

We believe that servicing costs should be as flexible and affordable as possible for your B-Class Electric Drive, which is why we offer Service Care, an easy way to budget for all your servicing costs. It spreads your bills into manageable payments based on whether you have a new or used Mercedes-Benz.

With Service Care we guarantee the price of parts and labour for up to four services and safeguard against further inflation. It also covers the cost of all recommended service items including brake fluid and screen wash for your B-Class Electric Drive.

You can choose either to add your servicing costs into your monthly spend or pay the full amount in a one-off payment, giving you peace of mind that they are taken care of for the period of the plan.

To receive a personalised Service Care plan recommendation visit the Service Care Calculator at servicecarerates.mercedes-benz.co.uk

Warranty and breakdown cover

Every Mercedes-Benz comes with a three-year unlimited mileage warranty against manufacturing or material defects¹ and up to 30 years warranty against perforation due to corrosion from the inside out.² What's more, it's also covered by Mercedes-Benz Roadside Assistance – a unique package comprising up to 30 years pan-European breakdown assistance.²

Insurance

Since our name is synonymous with reliability, who better to trust with your motor insurance? Mercedes-Benz Insurance provides a motor insurance policy specifically designed to give you the cover you would expect from Mercedes-Benz. For a motor insurance quotation, call **0345 600 2180**.*



> Book a test drive



> Find a Retailer



> View the Range Guide

38

The Mercedes that thinks and acts for you.

Imagine if...

...you could connect with your Mercedes-Benz?

With Mercedes me connect, you can; with Remote Online services¹ that include trip planning, maintenance management and vehicle tracking, plus more.

Getting connected is easy. Just set up your Mercedes me account and get in touch with your Mercedes-Benz Retailer to connect your vehicle to your profile to access your Mercedes me connect services.

...you knew beforehand that you need to stop for fuel?

Simply check the fuel level and mileage range from your phone wherever you are. You can also check tyre pressure and washer fluid level. (For electric cars, you can check battery charge state.)

...your Mercedes could tell you where it's parked?

You no longer need to ask yourself where you left your car; with Mercedes me connect you can locate your car from your smartphone or tablet within a mile radius.



- 1. PARKED VEHICLE LOCATOR
- 2. VEHICLE TRACKER

- 3. REMOTE RETRIEVAL OF VEHICLE STATUS
- 4. PRE-ENTRY CLIMATE CONTROL FOR ELECTRIC DRIVE AND PLUG-IN HYBRID



> Book a test drive



> Find a Retailer



> View the Range Guide

...you could lock your Mercedes, even if you're miles away?

The uncertainty of whether you've forgotten to lock the car is only human. To make sure your Mercedes-Benz is safe and secure, you can simply lock the car remotely via your PC/Mac, tablet or smartphone.

...your Mercedes told you when your service is due?

Being connected means essential data is constantly sent to your Mercedes-Benz Retailer so they know when it is time for a service. Your Retailer can then contact you with a tailor-made service quote.

...your Retailer already knows which parts need replacing?

As surprising as this sounds, with telediagnosics your Retailer can recognise remotely if certain parts are due for replacement, contacting you to book an appointment and making sure the relevant parts are in stock when you arrive, getting you back on the road as quickly as possible.

...you could just push a button to deal with a breakdown?

Should your car break down, with a simple press of the button everything is taken care of – from breakdown assistance to vehicle recovery.

...your Mercedes called for help?

Your Mercedes comes with an SOS button. Press it if you need urgent help and you will be contacted by the emergency response centre.² In the event of an accident where airbags or seatbelt tensioners have been activated, a call is placed automatically. Your GPS position is sent to the response teams to initiate rescue efforts.³

The Mercedes that thinks and acts for you.

Contact your Retailer to get connected, or go to www.mercedes.me for more details.

¹This is available as an option in conjunction with Audio 20 CD, and standard with COMAND Online. Remote Online is standard with electric drive and plug-in hybrid. Use of the Remote Online equipment option is limited to three years from first registration of the vehicle and can then be extended at extra cost.

²A call is placed via the car's sim card, rather than the customer relying on their mobile phone.

³This feature is still available to customers without Mercedes me connect services. The customer is not required to accept the terms and conditions on the portal to activate this feature. For all other features the customer will have to accept terms and conditions on the portal to activate them.



Mercedes-Benz Finance

Why should you finance with Mercedes-Benz?

At Mercedes-Benz we believe a great driving experience should be matched by an equally great ownership experience. That is why we put just as much thought, time and effort into designing our finance options, our service plans and our insurance cover as we do into our vehicles.

We are not in the business of simply providing a loan to fund the purchase of your dream vehicle. We look on it as a journey that we take with you, from the moment you choose your new Mercedes-Benz, to helping you in choosing your next one.

If you would like to find out more about any of our current offers, simply call into your local Mercedes-Benz Retailer where one of our Business Managers will be more than happy to talk you through anything you need to know.

Helping you find the right solution.

You should find our finance packages are more convenient than a traditional personal loan because:

- Funds are immediately available – no waiting for cheques or loans to clear.
- There is no security required – either against your home or other assets.
- We have clear and transparent rates – the APR we quote is the APR you get.
- We have friendly Business Managers – experts in vehicle finance who can talk you through all of your plans in detail.

One of our most popular finance products is Mercedes-Benz Agility (our Personal Contract Purchase product). We also offer Contract Hire, Operating Lease and Hire Purchase solutions. If you would like to find out more about these speak to your Retailer or visit www.mercedes-benz.co.uk/fandi.

Mercedes-Benz Agility (our PCP product).

At the start of an Agility agreement, you put down a deposit and decide the term of your agreement and your annual mileage. You will be advised of the Guaranteed Future Value, which offers you the reassurance of knowing exactly what you will need to pay to own the vehicle outright in the future (this is known as the Optional Purchase Payment).

Throughout your agreement you simply pay your agreed monthly payments and when the agreement comes to an end you either purchase, hand back or part-exchange your vehicle.





Agility features:

- Fixed regular payments mean you can easily budget.
- Payments are based only on a proportion of the vehicle's value, keeping your monthly payments lower.
- Our Guaranteed Future Value avoids the risk of unplanned depreciation of your vehicle.
- You defer your ownership decision until the end of the agreement.

At the end of your agreement you have three options to choose from.

Option 1: Purchase your Mercedes-Benz.

Purchase your Mercedes-Benz by paying the Optional Purchase Payment and Purchase Activation Fee.¹ This will complete the purchase of your Mercedes-Benz, leaving you free to simply enjoy your vehicle.

Option 2: Hand back your Mercedes-Benz.

If you decide to return your vehicle to us, it must be in line with our Vehicle Return Standards,^{*} as vehicle condition, excess mileage and other charges may be payable.

Option 3: Part-Exchange for a new vehicle.

Purchase your Mercedes-Benz by paying the Optional Purchase Payment and Purchase Activation Fee.¹ This will complete the purchase of your Mercedes-Benz, leaving you free to part-exchange for a new vehicle.

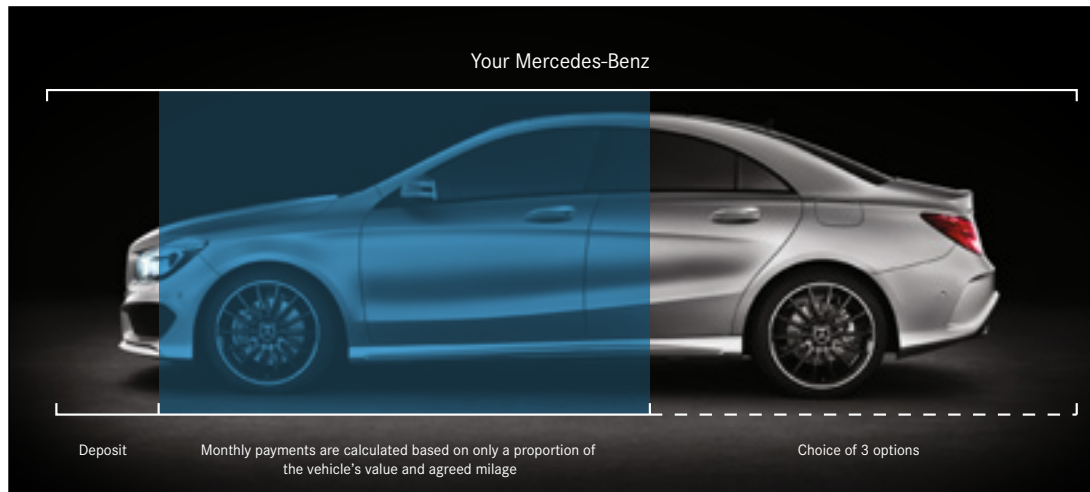

¹Please note the 'Purchase Activation Fee' of £10 will be debited from your account *To find out more information about our Vehicle Return Standards please visit <http://mercedes-benz.co.uk/vrs>



> Book a test drive





> Find a Retailer





> View the Range Guide

Follow us on the following social media channels:

 <https://www.facebook.com/MercedesBenzUk>

 <https://twitter.com/mercedesbenzuk>

 <https://www.youtube.com/mercedesbenzuk>

 <https://instagram.com/mercedesbenzuk>

Effective from 1 December 2015. Information correct at time of going to print.

Prices and specifications are subject to change without prior notice.

MBW242PL/1215

Mercedes-Benz UK Ltd, Tongwell, Milton Keynes, MK15 8BA www.mercedes-benz.co.uk



Mixed Sources

Product group from well-managed forests, controlled sources and recycled wood or fibre
www.fsc.org Cert no. SGS-COC-004556
©1996 Forest Stewardship Council

