



**The Audi Q5 and SQ5**  
Pricing and Specification Guide  
Valid from January 2016



## Personalising your Audi Q5

This guide has been designed to help you tailor and price your Audi Q5 quickly and logically. At the back, you will find information on CO2 emissions-based taxation and services offered with your Audi, including Finance and Insurance. You can also configure your Audi Q5 online at [audi.co.uk](http://audi.co.uk)



**Get more from this brochure with the free Audi Vision app.**

Audi Vision brings our brochures to life through Augmented Reality. It works by recognising images on a page through your device's camera. Suitable for compatible phones or tablets, download it for free from the App Store or Google Play. Once downloaded, simply open the app and scan the cover of your guide. Then look out for any page with the Audi Vision logo, you can then hold your device over the page and watch as you get exclusive access to extra images, information and video content.



The images featured in this guide are for illustrative purposes only. They may feature left-hand drive vehicles and include equipment that is not UK specification.

### The Audi Q5

Engines	12
Transmissions	13
Efficiency	14
quattro	16

### Model details and prices

SE model equipment	20
S line model equipment	22
S line Plus model equipment	24
SQ5 model equipment	26
SQ5 plus model equipment	28

Model prices	30
--------------	----

<b>Audi exclusive</b>	32
-----------------------	----

### Colour and upholstery

Paint	36
Upholstery	40
Seats	47
Colour and trim guide	48

<b>Inlays</b>	54
---------------	----

### Options

Wheels, tyres and suspension	58
Packages	64
Audio and communication	68
Interior equipment	70
Exterior equipment	74
Safety and security	76
Steering wheels	77

### Looking after your Audi

Audi Complete and Warranty	78
Accessories	81
Merchandise	82
Audi Difference	83

### Technical details

Off-road capabilities	84
Technical data	86
Dimensions	90
Pricing and Additional information	92





## Vorsprung durch Technik

Three words that express the very essence of Audi – Vorsprung durch Technik. It's not just a slogan, it's our way of seeing the world and the driving force behind our history of innovation that continues into the 21st century. Indeed, many technologies that have become synonymous with Audi remain in our cars today. Some are milestones in the history of the motorcar. From our beginnings in 1899, to the Auto Union team's Grand Prix successes in the 1930s and our more recent wins at Le Mans, we have always been at the forefront of the motor industry.

Vorsprung durch Technik makes us who we are. To see more of its influence, just read on.





## The streamlined Audi Q5

The Audi Q5 combines the design and elegance of a coupé with the practicality and space of a SUV. It also offers the exceptional grip of quattro all-wheel-drive, 18" alloy wheels and some other features you might not expect. There's a choice of direct-injection TDI and TFSI engines, a five-link front suspension and optional S tronic or tiptronic transmission.











## **Audi Q5 interior story**

We've introduced a number of finishing touches to the Audi Q5 interior to make your driving experience both comfortable and unique. You'll find an impressive attention to detail in everything from the luxurious leather seating to our optional customised stitching, which means that every journey you make will be a personal one.

# Engines

## Petrol

TFSI direct-injection technology that includes supercharging, which combines FSI technology with forced induction – giving cars an extra injection of power and torque. It also delivers enhanced fuel efficiency as precisely the right amount of fuel and air are injected into the combustion chambers, enabling the engine to 'breathe' more easily. It results in reduced heat loss and increased output.

## Diesel

We introduced TDI to the roads in 1989, and since then, we've continuously refined it, including developing common-rail technology. With this system, a series of piezo injectors use electrical charge to precisely control the amount of fuel injected into the engine. As well as reducing noise, this allows combustion to happen at a lower temperature, with less oxygen. The recently introduced bi-turbo diesel engine in the SQ5 plus is our most powerful six-cylinder diesel engine to date, capable of 340PS and a combined mpg of 42.8 (Urban 36.2mpg, Extra Urban 47.9mpg).\*



# Transmissions

## **S tronic**

Driving is all about thinking ahead, which is just what the S tronic dual-clutch transmission does. It works almost as two separate systems, one engaging the odd-numbered and the other the even-numbered gears. So when you're accelerating in second, it has third gear waiting for you. And once you make the switch, it's already thinking about fourth. With two clutches working together, you can change gears almost instantly while experiencing smooth, virtually uninterrupted power.

## **tiptronic**

The 8-speed tiptronic transmission system converts high-torque engine power into enhanced performance and operating convenience, with crisp, fast gear changes and an optimised gear-shift strategy. More spontaneous gear changes are a particular benefit and in the 'D' (Drive) and 'S' (Sport) programmes, the electronics used in tiptronic respond efficiently to every driver input.



## Efficiency

We've incorporated a number of technologies into the Audi Q5 aimed to enhance your drive and improve efficiency.

### Recuperation

When a vehicle brakes, the discs convert the kinetic energy into thermal energy, which is wasted as it cannot be used. With a recuperation system like the one in the Audi Q5, the kinetic energy is converted into useful electrical energy. The way it works is simple. While the car is coasting or braking, the alternator voltage is raised above the level of the basic electrical system, which enables the alternator to generate electrical energy and store it temporarily in the battery. When the vehicle accelerates, this energy is used to relieve the load on the alternator, resulting in a fuel saving of up to 3%.





### **Aerodynamics**

A car's shape can have a big impact on its efficiency. It's why we've worked to make the Audi Q5 as aerodynamic as possible.

### **Automatic Start-Stop function**

In heavy traffic, your car still uses fuel and releases CO<sub>2</sub>, even when it's stationary. The automatic Start-Stop function counteracts this problem by switching off the engine when your car comes to a standstill. As soon as you touch the clutch, the car restarts.

## quattro

It's the technology that has been synonymous with Audi ever since it was first introduced over 30 years ago – a technology that helps deliver greater traction on all surfaces.

It's called quattro permanent all-wheel-drive. The principle is simple: in the same way that four brakes ensure better deceleration, four permanently-driven wheels aid acceleration and road-holding by distributing power to each individual wheel as necessary.

The result is a dynamic driving experience in all conditions.

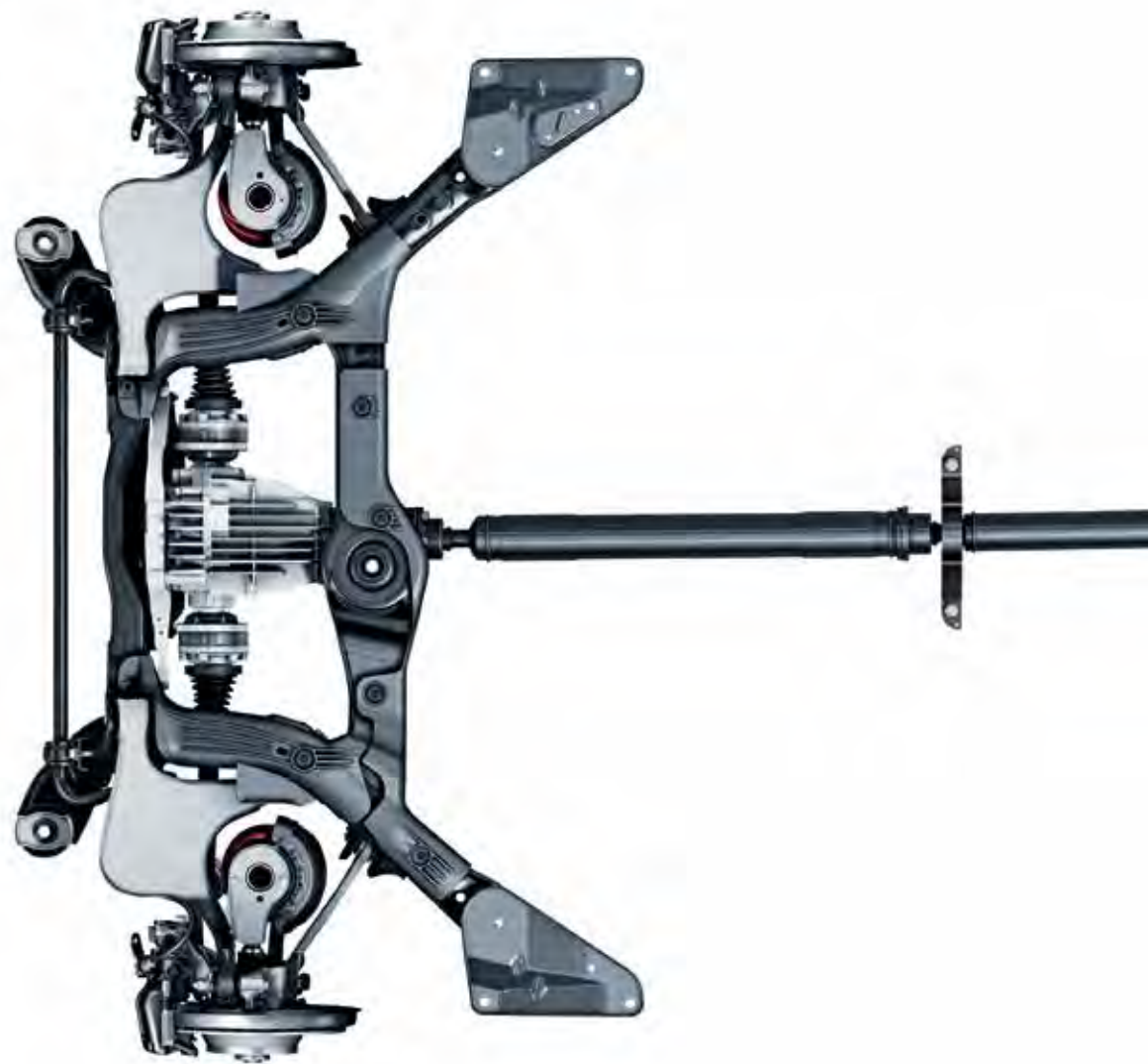



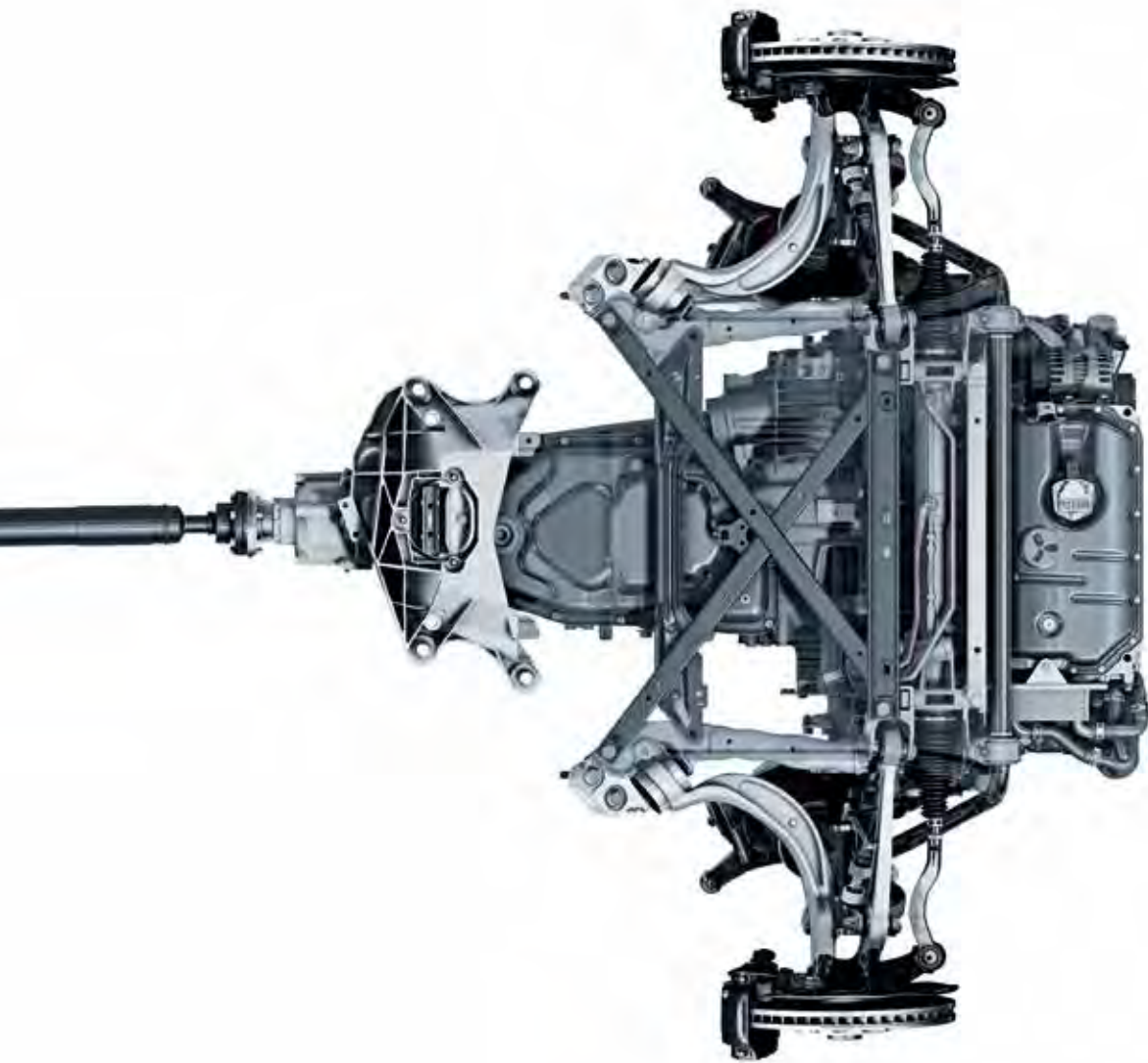

It means that the Audi Q5 can sense changes in the surface beneath the wheels and adjusts their grip accordingly. So when conditions get a little more demanding – in particular, when you go off-road – quattro adapts, putting all the force of the Audi Q5's engine precisely where it's needed to handle the change in terrain.





# SE model equipment

All Audi Q5 models have the following items of standard equipment

## Engine

Automatic Start-Stop function

Recuperation for optimal energy utilisation

Misfuelling inhibition for diesel models

## Wheels, tyres and suspension

18" x 8J '5-arm-star' design alloy wheels with 235/60 R18 low rolling resistance tyres and locking wheel bolts

Electromechanical power steering

Tyre repair kit

## Audio and communication

Audi Concert radio which includes:

- Single CD drive and SDHC memory card reader which are MP3, WMA and AAC compatible
- 6.5" colour centre display with MMI operating logic
- AUX-IN connection
- TP memo – automatically saves traffic news when driving

Audi sound system – 10 high-performance loudspeakers (180 watts) and 6-channel amplifier

DAB digital radio reception – integrated into MMI, receives digitally-transmitted radio stations in addition to the range of analogue stations. Displays music track, artist and radio program. Capable of 'DAB slideshow' where transmitted. Reception dependent on local digital network. Automatic switch from DAB to FM reception if the network signal is not strong enough

Bluetooth interface – for mobile phone and software version compatibility, please visit your Audi Centre or [audi.co.uk/phonecompatibility](http://audi.co.uk/phonecompatibility)

## Interior equipment

4-spoke multi-function leather steering wheel (with gear-shift paddles for automatic models)

## Aluminium Satellite inlays

Cruise control – maintains any speed above 18mph, provided the engine power output and engine braking effect permit it; operated via separate steering column stalk. The set speed is displayed in the Driver's Information System

Deluxe 3-zone climate control with separate air distribution and digital display for the driver and front passenger. System includes air-conditioning controls in rear centre console for passenger compartment

Colour Driver's Information System – shows the radio station or track title, telephone control, menu and other display information from the infotainment system such as navigation (if fitted). Also includes an on-board trip computer with short and long-term memory, outside temperature display, digital speedometer and door or boot open warning

## Front and rear electric windows

## Front and rear floor mats

Front centre armrest including 12-Volt socket



18" x 8J '5-arm Star' design alloy wheels



4-spoke multi-function leather steering wheel



Deluxe 3-zone climate control

## Safety and security

Auto-dimming rear-view mirror

Thatcham Category 1 alarm

**Rest recommendation system** – analyses driving behaviour based on steering, pedal and gear lever movements. If the system detects a change in driving patterns it can, via audio and visual effects, notify the driver of the possible need to take a rest

**Light and rain sensor** – automatically switches the dipped beam headlights and windscreen wipers on/off depending on the light and rain conditions. Also includes coming home/leaving home function which delays the deactivation of the front and rear lights after locking and automatic activation of the lights when unlocking

**Electromechanical parking-brake** – includes parking brake function when stationary, drive-off assistance function through automatic release when driving away and emergency braking function whilst driving, acting on all 4 wheels

**Tyre pressure loss indicator** – visual and acoustic warning if the pressure drops in one or more tyres

First-aid kit

Front and rear fog lights

**ISOFIX child seat mounting** – for front passenger (with airbag deactivation) and outer rear seats. Including Top Tether attachment point for the outer rear seats

**Halogen headlights** with daytime-running lights

**Hill descent assist** (please see page 84 for further information) with off-road Electronic Stability Programme (ESP)

Front side airbags

**Rear parking sensors** – aids parking by acoustically indicating the distance to obstacles; measurement is by ultrasonic sensors integrated discreetly into the bumper

Tool kit and car jack

Warning triangle

**Seats**

**3-point seat belt** with belt-force limiters for all 5 seats

Milano leather upholstery

Split-folding rear seat

## Exterior equipment

**Aluminium roof rails** with roof bar detection (automatically adjusts the Electronic Stability Control (ESC) to react to the higher centre of gravity when roof bars are in place)

**Aluminium window trims** framing the exterior side windows

**Chrome-trimmed, flat-bottom design exhaust pipe** – 2.0 TDI engines have a single exhaust pipe on the left-hand side, 2.0 TFSI and 3.0 TDI have one exhaust pipe on either side

**Door mirrors** – electrically adjustable and heated

**Double-glazed windscreen and front side windows** (only on 6-cylinder models)

Full body-coloured bumpers

Highly polished black grille with vertical chrome struts

Provision for towing equipment

Rear spoiler

Roof bars and storage bag

Chrome door handles and chrome tailgate strip



Halogen headlights with daytime-running lights



Aluminium roof rails



Door mirrors – electrically adjustable and heated

# S line model equipment

In addition to SE model equipment

Total RRP inc VAT\*  
£2,400.00

## Wheels, tyres and suspension

19" x 8J '5-spoke' design alloy wheels with 235/55 R19 tyres and locking wheel bolts

Standard suspension (S line Sport suspension available with no additional charge)

## Seats

Front Sport seats in Fine Nappa leather with electric lumbar support (S line embossed)

## Interior equipment

Black headlining

Matt-brushed aluminium inlays

S line 3-spoke leather multi-function steering wheel (with gear-shift paddles for automatic models)

S line sill plates and aluminium loading strip for the boot

## Exterior equipment

Diffuser in Platinum grey

## Rear LED lights

S line exterior styling package including:

- S line badges on front wings
- S line front bumper
- S line rear diffuser
- S line side skirts
- S line grille with chrome vertical bars

Xenon headlights with automatic headlight-range adjustment, headlight washers and LED daytime-running lights



19" x 8J '5-spoke' design alloy wheels



Matt-brushed aluminium inlays



Rear LED lights



Xenon headlights



Image shows the Audi Q5 S line model with optional Floret silver, metallic paint (L5) and Technology package (WB7).

# S line Plus model equipment

## In addition to S line model equipment

Total RRP inc VAT\*  
£2,500.00

### Wheels, tyres and suspension

20" x 8.5J '5-segment-spoke' design alloy wheels with 255/45 R20 tyres

### Audio and communication

**Audi Music Interface.** Universal connection for use with stereo audio sources, USB and MP3 devices including Apple iPod generation 4 onwards (iPod, iPod classic, iPod nano, iPod photo, iPod video, iPod touch). The interface provides charging function (dependent on device). Includes cable to connect your iPod or USB MP3 player device

### Interior equipment

**MMI Navigation system plus.** Hard disk navigation with topographical map display, places of interest and town models in 3D, with high-resolution 7" colour TFT display. The system offers three alternative routes, with the ability to scroll along the selected route and manoeuvre within the map. Uses 7-digit postcode recognition. Includes split-screen mode for route information, dynamic route guidance (TMC), intersection zoom function, motorway exits and lane recommendations in Driver's Information System (DIS). Includes two SD card readers, single CD/DVD player, 40GB hard drive and Jukebox (20GB) for storing and managing music files in WMA and MP3 format. Includes European navigation data (where digitised). Additional functionality is available when combined with optional Mobile telephone preparation - High with Audi Connect (9ZW). For more details please see option 9ZW, featured in the options section of the guide

### Exterior equipment

**Audi Parking System Plus.** Acoustic and visual front and rear parking system with MMI screen display; measurement is by ultrasonic sensors concealed in the bumpers

**Power-operated tailgate**

**Metallic paint**

**Privacy glass**



20" x 8.5J '5-segment-spoke' design alloy wheels



Audi Music Interface

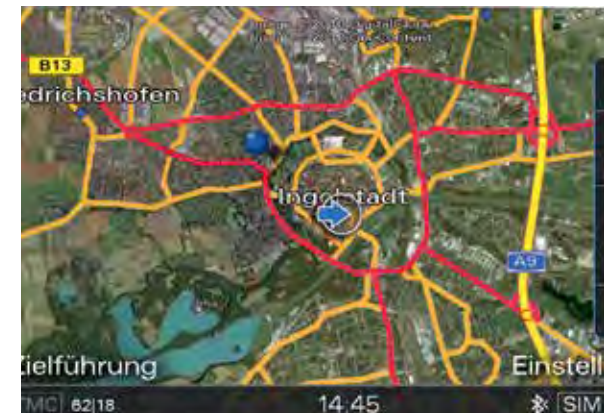

MMI Navigation system plus





Image shows the Audi Q5 S line Plus model with optional 20" '10-Y-spoke' design alloy wheels (PQ1).

## SQ5 model equipment

In addition to SE model equipment

### Wheels, tyres and suspension

20" x 8.5J '5-parallel-spoke' design alloy wheels with 255/45 R20 tyres. Includes small wheel arch extensions  
'S' Sport suspension (30mm lower than SE suspension)

### Interior equipment

LED interior light package  
3-spoke 'S' Sport multi-function leather steering wheel with paddle shift and contrast stitching  
Matt-brushed aluminium inlays  
'S' instrument dials  
Aluminium scuff plates with SQ5 logo

### Seats

Electrically-adjustable front seats with SQ5 embossing. Includes adjustment for height, forwards and backwards position, backrest angle and lumbar support  
Fine Nappa leather upholstery  
Leather door armrests

### Exterior equipment

Xenon headlights with automatic headlight-range adjustment, headlight washers and LED daytime-running lights  
Rear LED lights  
Aluminium-effect door mirror housings  
'S' radiator grille with SQ5 logo finished in platinum grey  
Front black painted brake calipers with 'S' logo  
'S' body styling  
Exhaust pipes – two oval tailpipes on left and right-hand side in chrome rolled finish  
Active Sound exhaust system  
Chrome door handles\*



20" x 8.5J '5-parallel-spoke' design alloy wheels



SQ5 grille with horizontal double chrome struts



Dual oval tailpipes



Image shows the Audi SQ5 model with optional Sepang blue, pearl effect paint (E9) and 21" '5-twin-spoke Star' design alloy wheels in titanium look with a high-gloss finish (PQ8).

## SQ5 plus model equipment

### In addition to SQ5 model equipment

#### Wheels, tyres and suspension

21" x 8.5J '5-twin-spoke Star' design alloy wheels in titanium look with a high gloss finish with 255/40 R21 tyres. Includes small wheel arch extensions

**quattro permanent all-wheel-drive with Sport differential.** The electronically regulated Sport differential distributes variable amounts of driving force to each rear wheel, improving stability and agility especially when cornering. It ensures better direct steering characteristics and, thanks to less steering effort, more agile handling

#### Audio and communication

**Audi Music Interface.** Universal connection for use with stereo audio sources, USB and MP3 devices including Apple iPod generation 4 onwards (iPod, iPod classic, iPod nano, iPod photo, iPod video, iPod touch). The interface provides charging function (dependent on device and cable). Includes cable to connect your iPod or USB MP3 player device

#### Interior equipment

**MMI Navigation system plus.** Hard disk navigation with topographical map display, places of interest and town models in 3D, with high-resolution 7" colour TFT display. The system offers three alternative routes, with the ability to scroll along the selected route and manoeuvre within the map. Uses 7-digit postcode recognition. Includes split-screen mode for route information, dynamic route guidance (TMC), intersection zoom function, motorway exits and lane recommendations in Driver's Information System (DIS). Includes two SD card readers, single CD/DVD player, 40GB hard drive and Jukebox (20GB) for storing and managing music files in WMA and MP3 format. Includes European navigation data (where digitised). Additional functionality is available when combined with optional Mobile telephone preparation - High with Audi Connect (9ZW). For more details please see option 9ZW, featured in the options section of the guide

#### Seats

**Fine Nappa seats with diamond stitching**

**Rear bench seat plus.** Allows both the 1/3 and 2/3 sections of the rear bench seat to be independently adjusted by 100mm forwards and backwards. Also includes a through-load facility with an integral centre armrest containing two cup holders

#### Exterior equipment

**Audi Parking System Plus.** Acoustic and visual front and rear parking system with MMI screen display; measurement is by ultrasonic sensors concealed in the bumpers

**Black styling pack** consisting of black roof rails, black window surrounds, radiator grille frame in gloss black, radiator grille in matt black, number plate and fog light surround in high-gloss black

**Black exterior mirror housings**

**Rear spoiler in black**

**Door handles partially finished in high-gloss black**

**Power-operated tailgate**

**Metallic paint**

**Privacy glass**

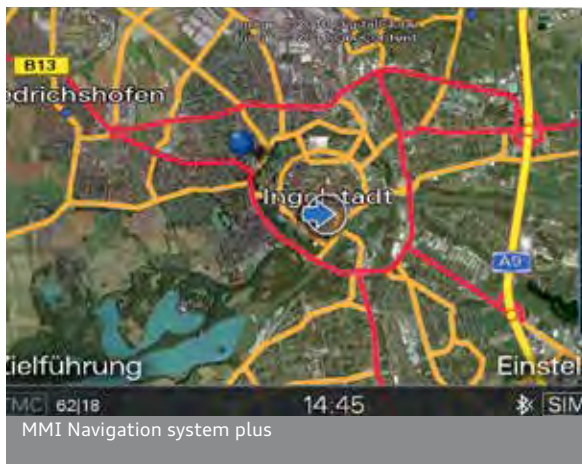



Image shows a SQ5 plus with optional Sepang blue, pearl effect paint (E9), 21" x 8.5J '5-twin-spoke Star' design alloy wheel in gloss black, with a high-gloss finish (PQI) and Red brake calipers (PC2)

## Audi Q5 SE

Engines	Power	Transmissions	CO <sub>2</sub> g/km*	Total RRP inc VAT <sup>^</sup>	Recommended OTR <sup>†</sup>
2.0 TFSI quattro	230PS	6-speed manual	173	£32,275.00	£33,255.00
2.0 TFSI quattro	230PS	8-speed tiptronic	169	£33,825.00	£34,805.00
2.0 TDI quattro	150PS	6-speed manual	147	£31,300.00	£32,130.00
2.0 TDI quattro	190PS	6-speed manual	148	£32,275.00	£33,105.00
2.0 TDI quattro	190PS	7-speed S tronic	152	£33,825.00	£34,690.00
3.0 TDI quattro	258PS	7-speed S tronic	158	£37,925.00	£38,790.00

## Audi Q5 S line

Engines	Power	Transmissions	CO <sub>2</sub> g/km*	Total RRP inc VAT <sup>^</sup>	Recommended OTR <sup>†</sup>
2.0 TFSI quattro	230PS	6-speed manual	179	£34,675.00	£35,710.00
2.0 TFSI quattro	230PS	8-speed tiptronic	172	£36,225.00	£37,205.00
2.0 TDI quattro	150PS	6-speed manual	150	£33,700.00	£34,530.00
2.0 TDI quattro	190PS	6-speed manual	151	£34,675.00	£35,540.00
2.0 TDI quattro	190PS	7-speed S tronic	154	£36,225.00	£37,090.00
3.0 TDI quattro	258PS	7-speed S tronic	161	£40,325.00	£41,190.00

**\*Please note:** CO<sub>2</sub> emissions can change if a different size alloy is ordered onto the vehicle. This may also lead to a change to the VED amount payable. Please refer to pages 60, 61, 87, 88 and 93 for more information. <sup>\*</sup>Values based on standard EU test figures for comparative purposes and may not reflect real driving results.

**Please note:** The maximum power output figures are quoted in PS (or Pferdestärke, which is the metric equivalent of brake horsepower). To convert to brake horsepower, divide the PS figure by 1.0139.

<sup>^</sup>Total RRP inc VAT – Recommended Retail Price including VAT which is calculated at 20%. This may alter to reflect any change in the applicable VAT rate.

**\*Recommended On-The-Road (OTR) retail prices include:** delivery charge, half a tank of fuel, number plates at £630.00 (inc. VAT), Road Fund Licence (which may vary depending on model/transmission – see page 93 for details) and first registration fee at £55.00. Vehicle Excise Duty correct at time of going to print, but this may alter to reflect any change in the applicable VED rate.

## Audi Q5 S line Plus

Engines	Power	Transmissions	CO <sub>2</sub> g/km*	Total RRP inc VAT <sup>^</sup>	Recommended OTR <sup>†</sup>
2.0 TFSI quattro	230PS	6-speed manual	181	£37,175.00	£38,210.00
2.0 TFSI quattro	230PS	8-speed tiptronic	174	£38,725.00	£39,705.00
2.0 TDI quattro	150PS	6-speed manual	152	£36,200.00	£37,065.00
2.0 TDI quattro	190PS	6-speed manual	153	£37,175.00	£38,040.00
2.0 TDI quattro	190PS	7-speed S tronic	157	£38,725.00	£39,590.00
3.0 TDI quattro	258PS	7-speed S tronic	163	£42,825.00	£43,690.00

## Audi SQ5

Engines	Power	Transmissions	CO <sub>2</sub> g/km*	Total RRP inc VAT <sup>^</sup>	Recommended OTR <sup>†</sup>
3.0 BiTDI quattro	326PS	8-speed tiptronic	174	£44,495.00	£45,475.00

## Audi SQ5 plus

Engines	Power	Transmissions	CO <sub>2</sub> g/km*	Total RRP inc VAT <sup>^</sup>	Recommended OTR <sup>†</sup>
3.0 BiTDI quattro	340PS	8-speed tiptronic	174	£50,865.00	£51,845.00







## Audi exclusive

For that special touch, you can specify your Audi Q5 with options from Audi exclusive. Whether you want a unique, custom-mixed paint colour or seats in a combination of complementary shades, Audi exclusive will enable you to drive the car you've always imagined.

Both the exclusive and standard options can be found on the following pages.





## Audi exclusive line

There are a number of ways to customise your car's interior with the Audi exclusive range. And if you'd like us to help you choose, we've put the most popular elements of the range together into one harmonious package – the Audi exclusive line.

With experience spanning more than 20 years, our expert designers understand which elements work well together. From high-quality Fine Nappa leather seats to Audi exclusive door sill trims, every detail has been chosen to truly enhance your experience.



# Paint

We believe that every part of your car should have a personal touch. Which is why you can choose from a wide range of paint colours, from solid paint to metallic and pearl effect finishes.

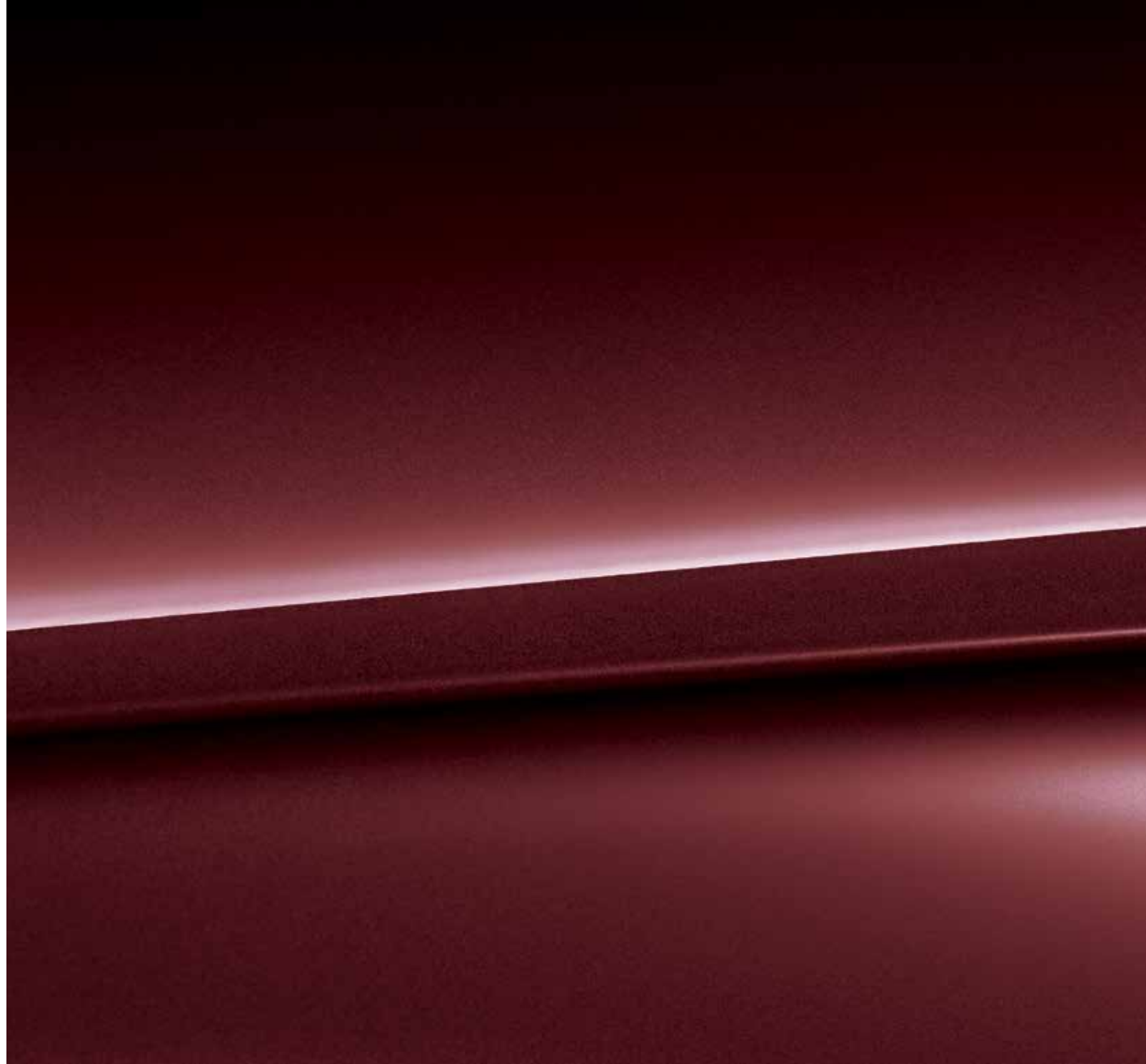

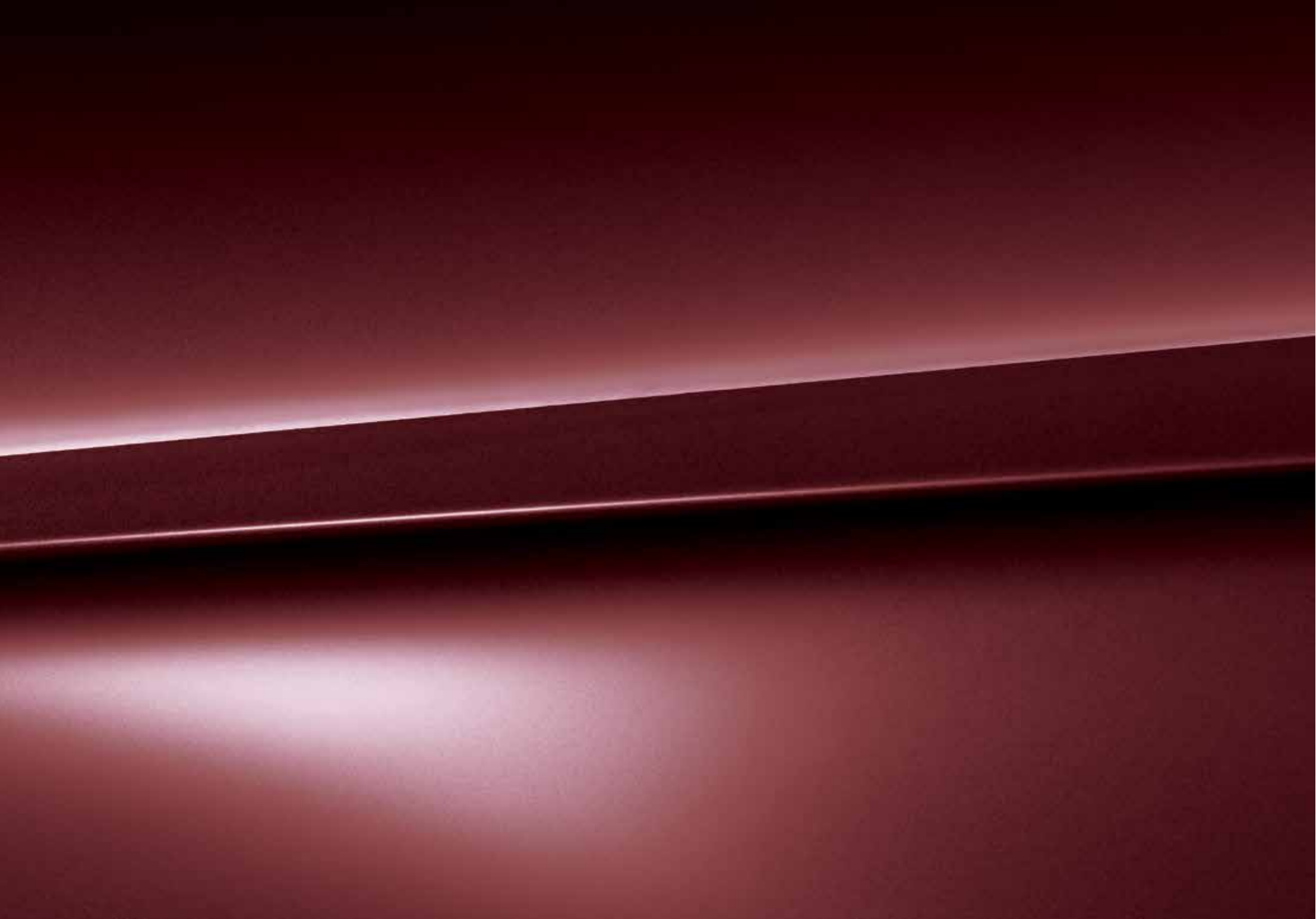

# Paint

You can select one of the standard colours shown opposite or, for a different look, choose from a range of optional finishes.

Options are subject to availability and may extend time taken for delivery.

All the colour swatches on this page are matched as accurately as possible to the actual paint colours used. However, due to print processes, Audi UK cannot guarantee that colours shown are 100% accurate.

Visit your local Audi Centre for a more accurate colour swatch.

\*Not available on SQ5 or SQ5 plus.

\*\*On S line Plus and SQ5 plus trim the metallic and pearl effect optional colours have no additional charge.

\*\*\*Only available in combination with the Extended Black Styling Package.

^Also available on S line Plus models if ordering the optional Extended Black Styling Package.

\*Total RRP inc VAT – Recommended Retail Price including VAT which is calculated at 20%. This may alter to reflect any change in the applicable VAT rate.

## Standard colours



Ibis white – T9

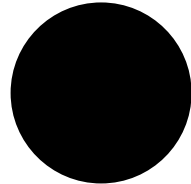

Brilliant black – A2

## Optional colours

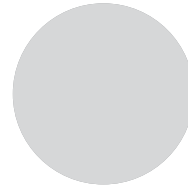

Floret silver, metallic – L5



Glacier white, metallic – 2Y

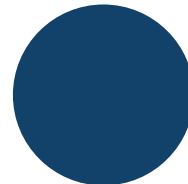

Scuba blue, metallic – S9\*

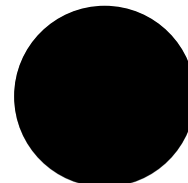

Lava grey, pearl effect – 1R

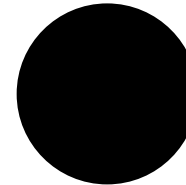

Mythos black, metallic – OE

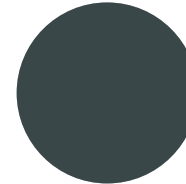

Monsoon grey, metallic – 0C

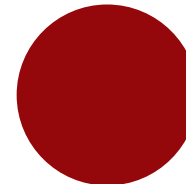

Volcano red, metallic – 1G

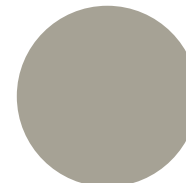

Cuvée silver, metallic – 0D\*

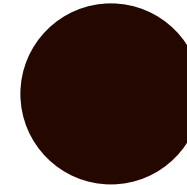

Teak brown, metallic – 4U\*

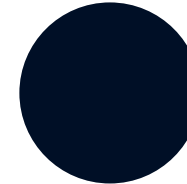

Moonlight blue, metallic – W1

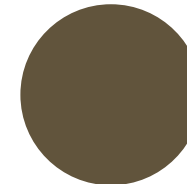

Maya brown, metallic – G4\*

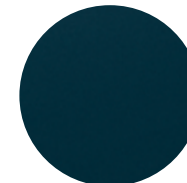

Utopia blue, metallic – D2\*

## S line colours

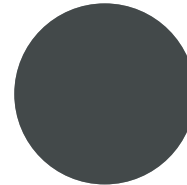

Daytona grey, pearl effect – 6Y\*

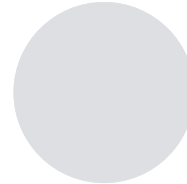

Suzuka grey, metallic – M1\*\*\*

### Optional colours\*\*

Metallic and Pearl effect

Total RRP inc VAT<sup>†</sup>  
£645.00

### SQ5 colours

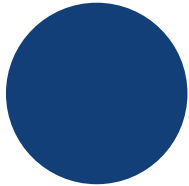

Sepang blue, pearl effect - E9^

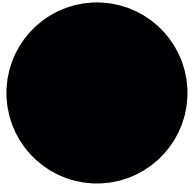

Panther black, crystal effect - H8

**Optional colours**  
**Crystal effect**  
**SQ5**  
**Total RRP inc VAT<sup>†</sup>**  
 £865.00  
**SQ5 Plus**  
**Total RRP inc VAT<sup>†</sup>**  
 £220.00

## Paint

### Audi exclusive

Everyone has a favourite colour. No matter what yours is, Audi exclusive provides a range of unique colours that have been designed to set your car apart. Choose from the swatches here, or specify any other paint colour in the Audi range - the choice is yours.\*

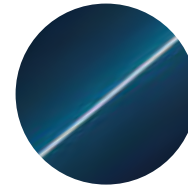

Palace blue, pearl effect

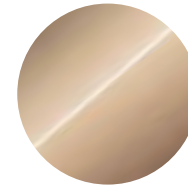

Sand beige, pearl effect

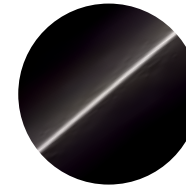

Saddle brown, pearl effect

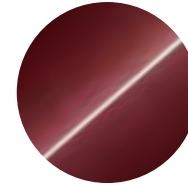

Classic red, pearl effect

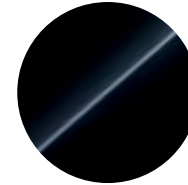

Mamba black, metallic

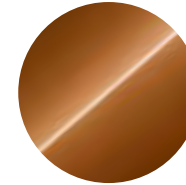

Ipanema brown, metallic

### Customised

If you have a particular colour in mind, we'll mix the exact metallic or pearl-effect shade you want.\*\*



Any colour in the Audi range or 100 exclusive colours to choose from\*

**Audi exclusive\***  
**Total RRP inc VAT<sup>†</sup>**  
 £2,155.00



Customised paint\*\*

**Customised\*\***  
**Total RRP inc VAT<sup>†</sup>**  
 £2,615.00

Options are subject to availability and may extend time taken for delivery.

All the colour swatches on this page are matched as accurately as possible to the actual paint colours used. However, due to print processes, Audi UK cannot guarantee that colours shown are 100% accurate.

Visit your local Audi Centre for a more accurate colour swatch.

\*Audi exclusive paint is subject to factory approval. Visit your local Audi Centre for colour samples.

\*\*Customised paint is subject to factory approval, and is available for metallic and pearl-effect water-based paints only. Three-colour process colours and two-tone schemes are not available.

<sup>†</sup>Total RRP inc VAT - Recommended Retail Price including VAT which is calculated at 20%. This may alter to reflect any change in the applicable VAT rate.

## Upholstery

It's important to feel comfortable on the road. Just choose from our range of luxury upholstery materials and textures, including additional support and colour options, for complete relaxation while you drive.







# Upholstery

## Standard seats

Choose your upholstery from the swatches shown opposite to give your car's interior the look and feel you want.

Milano leather



Black - FZ

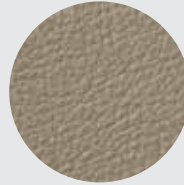

Pistachio beige - VI

Fine Nappa leather\*



Black - FZ

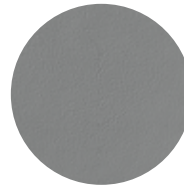

Titanium grey - IK



Chestnut brown - VR



Pistachio beige - VI

	SE	S line	S line Plus	SQ5	SQ5 plus	Total RRP inc VAT <sup>†</sup>
Milano leather	S	-	-	-	-	£0.00
Fine Nappa leather*	•	-	-	-	-	£410.00

Options are subject to availability and may extend time taken for delivery.

- = Not available
- = Available
- S = Standard

All the colour swatches on this page are matched as accurately as possible to the actual upholstery colours used. However, due to print processes, Audi UK cannot guarantee that colours shown are 100% accurate.







\*Includes leather door armrests (7HB).

<sup>†</sup>Total RRP inc VAT - Recommended Retail Price including VAT which is calculated at 20%. This may alter to reflect any change in the applicable VAT rate.

# Upholstery

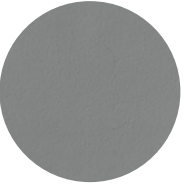
## Sport seats

With electric lumbar support.

	SE	S line	S line Plus	SQ5	SQ5 plus	Total RRP inc VAT*
<b>Milano leather</b>  Black - FZ  Pistachio beige - VI	•	-	-	-	-	£410.00
<b>Fine Nappa leather*</b>  Black - FZ  Titanium grey - IK  Chestnut brown - VR  Pistachio beige - VI	•	-	-	-	-	£775.00
<b>Leather/Alcantara</b>  Black - FZ	•	-	-	-	-	£0.00

Options are subject to availability and may extend time taken for delivery.

- = Not available
- = Available
- S = Standard

All the colour swatches on this page are matched as accurately as possible to the actual upholstery colours used. However, due to print processes, Audi UK cannot guarantee that colours shown are 100% accurate.

\*Includes leather door armrests (7HB).

\*Total RRP inc VAT – Recommended Retail Price including VAT which is calculated at 20%. This may alter to reflect any change in the applicable VAT rate.



Fine Nappa leather Sport seat in Chestnut brown

# Upholstery

## Climate Comfort seats

Front Climate Comfort seats with perforated leather on the actively ventilated and heated areas of the front seats, and on the non-ventilated areas of the rear seats.

Also includes:

- electrical adjustment for height, forwards and backwards position, backrest angle and lumbar support
- memory function for driver's seat
- folding and auto-dimming door mirrors with memory function and automatic kerb view function, which tilts the passenger mirror downwards towards the kerb when reverse gear is engaged.

Options are subject to availability and may extend time taken for delivery.

- = Not available
- = Available
- S = Standard

All the colour swatches on this page are matched as accurately as possible to the actual upholstery colours used. However, due to print processes, Audi UK cannot guarantee that colours shown are 100% accurate.

\*Total RRP inc VAT – Recommended Retail Price including VAT which is calculated at 20%. This may alter to reflect any change in the applicable VAT rate.

Milano leather



Black – FZ

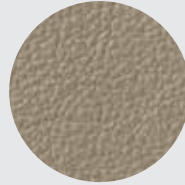

Pistachio beige – VI



Chestnut brown – VR

SE	S line	S line Plus	SQ5	SQ5 plus	Total RRP inc VAT*
•	-	-	-	-	£2,155.00



Climate controlled Comfort seat in Milano leather, Pistachio beige

# Upholstery

## S line Sport seats

Front Sport seats with S line embossing and prominent side bolsters for lateral support when cornering. Also features electric 4-way lumbar support and manual seat cushion angle adjustment with extendable thigh support.

Fine Nappa leather



Black - QE

Perforated leather/Alcantara



Black with Silver stitching - QF

	SE	S line	S line Plus	SQ5	SQ5 plus	Total RRP inc VAT*
Fine Nappa leather	-	S	S	-	-	£0.00
Perforated leather/Alcantara	-	•	•	-	-	£0.00

Options are subject to availability and may extend time taken for delivery.

- = Not available
- = Available
- S = Standard

All the colour swatches on this page are matched as accurately as possible to the actual upholstery colours used. However, due to print processes, Audi UK cannot guarantee that colours shown are 100% accurate.

\*Total RRP inc VAT - Recommended Retail Price including VAT which is calculated at 20%. This may alter to reflect any change in the applicable VAT rate.

# Upholstery

## SQ5 Sport seats

Electrically-adjustable front seats with SQ5 embossing. Includes adjustment for height, forwards and backwards position, backrest angle and lumbar support.

Fine Nappa leather  
Fine Nappa leather with diamond stitching\*

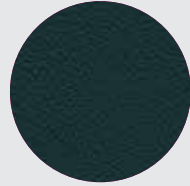

Black/Black  
- XG/IM

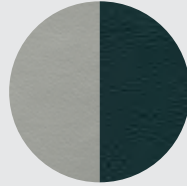

Lunar silver/Black  
- XO/XN



Magma red/Black  
- FA/SZ



Chestnut brown/Black  
- SV/WY



Black/Black  
- XG/IM



SQ5 Sport seat with electrically adjustable front seats

SE	S line	S line Plus	SQ5	SQ5 plus	Total RRP inc VAT*
-	-	-	S	-	£0.00
-	-	-	•	S	£795.00

Options are subject to availability and may extend time taken for delivery.

- = Not available
- = Available
- S = Standard

All the colour swatches on this page are matched as accurately as possible to the actual upholstery colours used. However, due to print processes, Audi UK cannot guarantee that colours shown are 100% accurate.

\*Only available in combination with Rear bench seat plus (SKA).

\*Total RRP inc VAT - Recommended Retail Price including VAT which is calculated at 20%. This may alter to reflect any change in the applicable VAT rate.

# Seats

Choose from a variety of different seat options, so you can maintain a comfortable driving posture at all times.

Order Code		SE	S line	S line Plus	SQ5	SQ5 plus	Total RRP inc VAT*
4A3	<b>Heated front seats.</b> Individually controlled variable temperature adjustment	●	●	●	●	●	£300.00
4A4	<b>Heated front and rear seats.</b> Individually controlled variable temperature adjustment	●	●	●	●	●	£460.00
PV1	<b>Electrically-adjustable front seats.</b> Includes adjustment for height, forwards and backwards position, backrest angle and lumbar support  In combination with Sport seats	●	—	—	—	—	£765.00
		●	●	●	S	S	£560.00
PV3 6XL	<b>Electrically-adjustable front seats with memory function and lumbar support.</b> Comprising electric front seats with memory function on driver's side and lumbar support. Also includes folding and auto-dimming door mirrors with memory function and automatic kerb view function, which tilts the passenger mirror downwards towards the kerb when reverse gear is engaged  In combination with Sport seats	●	—	—	—	—	£1,085.00
		●	●	●	—	—	£850.00
		—	—	—	●	●	£450.00
7P1	<b>Electric lumbar support.</b> For front seats with horizontal and vertical adjustment	●	S	S	S	S	£235.00
Q2N	<b>Folding front passenger seat.</b> Not available with lumbar support, S line or electric seats	●	—	—	—	—	£130.00
5KA	<b>Rear bench seat plus.</b> Allows both the 1/3 and 2/3 sections of the rear bench seat to be independently adjusted by 100mm forwards and backwards. Also includes a through-load facility with an integral centre armrest containing two cup holders	●	●	●	●	S	£175.00

Options are subject to availability and may extend time taken for delivery.

- = Not available
- = Available
- S = Standard

\*Total RRP inc VAT – Recommended Retail Price including VAT which is calculated at 20%. This may alter to reflect any change in the applicable VAT rate.



Electrically-adjustable front seats



Rear bench seat plus

# Colour and trim guide

## Interior trim colours

### Standard seats

To help you choose the right interior for your new Audi Q5, please use this guide, showing the carpet, dashboard and headlining colours that have been matched to your chosen upholstery. For pricing information please refer to pages 42–46.

### Sport seats

### Climate Comfort seats (PS8)

Order Code	Upholstery	Carpet	Dashboard (upper/lower)	Headlining	Milano leather (PEB)	Fine Nappa leather (PEC and 7HB/7HC)
FZ	Black	Black	Black	Moon silver	●	●
VI	Pistachio beige	Truffle beige	Truffle beige	Silk beige	●	●
IK	Titanium grey	Black	Black	Moon silver	—	●
VR	Chestnut brown	Black	Black	Moon silver	—	●

Order Code	Upholstery	Carpet	Dashboard (upper/lower)	Headlining	Leather/Alcantara (PED)	Milano leather (PEL)	Fine Nappa leather (PEE and 7HB/7HC)
FZ	Black	Black	Black	Moon silver	●	●	●
VI	Pistachio beige	Truffle beige	Truffle beige	Silk beige	—	●	●
IK	Titanium grey	Black	Black	Moon silver	—	—	●
VR	Chestnut brown	Black	Black	Moon silver	—	—	●

Order Code	Upholstery	Carpet	Dashboard (upper/lower)	Headlining	Milano leather (PEB)
FZ	Black	Black/Black	Black	Lunar silver	●
VI	Pistachio beige	Black/Black	Truffle beige	Truffle beige	●
VR	Chestnut brown	Black/Black	Black	Lunar silver	●

Options are subject to availability and may extend time taken for delivery.



# Colour and trim guide

## Interior trim colours

### S line seats

Order Code	Upholstery	Carpet	Dashboard (upper/lower)	Headlining	Perforated leather/Alcantara (N7K)	Fine Nappa leather (N2R)
<b>QE</b>	Black	Black/Black	Black	Black	—	●
<b>QF</b>	Black/Black silver	Black/Black	Black	Black	●	—

### SQ5 Sport seats

Order Code	Upholstery	Carpet	Dashboard (upper/lower)	Headlining	Fine Nappa leather (N3M)	Fine Nappa leather with diamond stitching (N1H)
<b>XG or IM*</b>	Black/Black	Black	Black	Black or silver	●	●
<b>XO or XN*</b>	Lunar silver/Black	Black	Black	Black or silver	●	—
<b>FA or SZ**</b>	Magma red/Black	Black	Black	Black or silver	●	—
<b>SV or WY***</b>	Chestnut brown/Black	Black	Black	Black or silver	●	—

Options are subject to availability and may extend time taken for delivery.

— = Not available  
 ● = Available  
 S = Standard

\*Stitching in Dark silver.

\*\*Stitching in Magma red.

\*\*\*Stitching in Chestnut brown.

# Upholstery

## Audi exclusive

With Audi exclusive, you can specify your seats in Fine Nappa leather, Valcona leather or Valcona leather/Alcantara in an array of different colours shown to the right.

Select just one all-over shade for each seat, or customise each panel in two or more complementary colours from the distinctive Audi exclusive palette. You can even choose the colour of the decorative stitching – to match or contrast with your chosen upholstery – from this varied collection. Whatever combination you decide upon, we think you'll be extremely satisfied with the result.

Options are subject to availability and may extend time taken for delivery.

All the colour swatches on this page are matched as accurately as possible to the actual upholstery colours used. However, due to print processes, Audi UK cannot guarantee that colours shown are 100% accurate.



Chestnut brown



Jet grey



Alabaster white

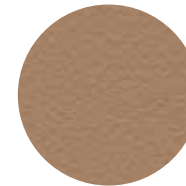

Sand beige



Magnolia white



Havanna brown

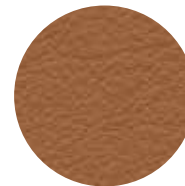

Cognac brown

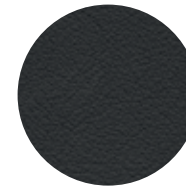

Night blue

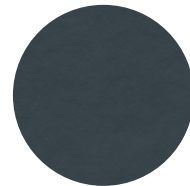

Smoky blue

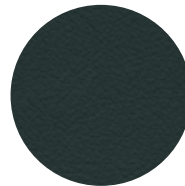

Iceland green



Powder beige



Classic red



Saddle brown



Cloudy grey

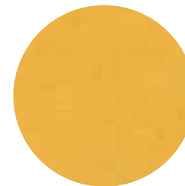

Calendula yellow

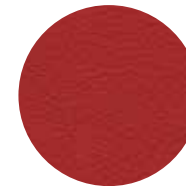

Crimson red

## Also available:

**Alcantara colours:** available in all the Audi exclusive colours shown, except for Crimson red, Jet grey and Sand beige. Alcantara equivalents are Chilli red, Amethyst grey, and Sesame beige respectively.

Please consult your Audi Centre for examples of Alcantara and carpet colours.

# Upholstery

## Audi exclusive

Order Code		SE	S line	S line Plus	SQ5	SQ5 plus	Total RRP inc VAT <sup>†</sup>
<b>PYA S3G</b>	<b>Audi exclusive leather package 1 in Fine Nappa leather.</b> Includes leather-covered seat upholstery, door armrests, door trims and front centre armrest. Backrest covers and seat add-on parts come in the interior trim colour*	●	–	–	–	–	£2,135.00
<b>PYB S3G</b>	<b>Audi exclusive leather package 1 in Valcona leather with Climate Comfort seats.</b> Includes leather-covered seat upholstery, door armrests, door trims and front centre armrest. Backrest covers and seat add-on parts come in the interior trim colour*	●	–	–	–	–	£5,655.00
<b>PYC S3G</b>	<b>Audi exclusive leather package 1 in Valcona leather/Alcantara.</b> Includes leather-covered seat-side trims, head restraints, door armrests, front centre armrest and Alcantara seat-centre sections and door trim inserts. Backrest covers and seat add-on parts come in the interior trim colour*	●	–	–	–	–	£2,545.00
		–	●	●	●	●	£2,135.00
<b>PYD S3G</b>	<b>Audi exclusive leather package 2 in Fine Nappa leather.</b> Includes all the contents of leather package 1 (PYA/S3G) plus leather-covered seat backrest covers and colour-coordinated seat-side trims and add-on parts	●	–	–	–	–	£3,625.00
<b>PYE S3G</b>	<b>Audi exclusive leather package 2 in Valcona leather with Climate Comfort seats.</b> Includes all the contents of leather package 1 (PYB/S3G) plus leather-covered seat backrest covers. Seat-side trims and add-on parts are colour-coordinated	●	–	–	–	–	£7,150.00
<b>PYG S3G</b>	<b>Audi exclusive leather package 1 in Fine Nappa leather with Sport seats.</b> Includes all the contents of leather package 1 (PYA/S3G) plus leather-covered front Sport seats	●	–	–	–	–	£2,545.00
		–	●	●	●	●	£2,135.00
<b>PYJ S3G</b>	<b>Audi exclusive leather package 2 in Fine Nappa leather with Sport seats.</b> Includes all the contents of leather package 1 (PYA/S3G) plus leather-covered Sport seats, seat backrest covers. Seat-side trims and add-on parts are colour-coordinated	●	–	–	–	–	£4,040.00
		–	●	●	●	●	£3,630.00

Options are subject to availability and may extend time taken for delivery.

– = Not available  
● = Available  
S = Standard

\*Leather and stitching (where applicable) colours can be specified in a variety of colours from the Audi exclusive range.

<sup>†</sup>Total RRP inc VAT – Recommended Retail Price including VAT which is calculated at 20%. This may alter to reflect any change in the applicable VAT rate.

# Upholstery

## Audi exclusive line

Audi exclusive is ultimately about choice – but if you'd rather leave some of the decisions in the capable hands of our designers, the expert team at quattro GmbH have compiled Audi exclusive line, combining some of the most popular elements of the exclusive range in one, beautifully coordinated package.

Options are subject to availability and may extend time taken for delivery.

- = Not available  
• = Available  
S = Standard

All the colour swatches on this page are matched as accurately as possible to the actual upholstery colours used. However, due to print processes, Audi UK cannot guarantee that colours shown are 100% accurate.

\*When ordered in combination with S line, Audi exclusive removes all S line interior badging.

\*\*When ordered in combination with S line, the S line embossing on the seats is removed.

\*Total RRP inc VAT – Recommended Retail Price including VAT which is calculated at 20%. This may alter to reflect any change in the applicable VAT rate.

Order Code		SE	S line	S line Plus	SQ5	SQ5 plus	Total RRP inc VAT <sup>+</sup>
<b>WQK</b>	<b>Audi exclusive line</b>	•	–	–	–	–	£2,470.00
<b>PQL</b>	<b>Audi exclusive line*</b>	–	•	•	–	–	£850.00

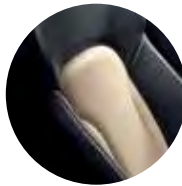

Alabaster white – UA

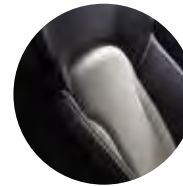

Cloudy grey – UH



Cognac brown – QX

### This package includes

- ▶ Two-colour seat upholstery in Fine Nappa leather (black seat-side sections, seat-centre section in Alabaster white, Cloudy grey or Cognac brown)\*\*
- ▶ Seat-side sections and head restraints with coloured piping (to match seat-centre section)
- ▶ Sport seats including electric lumbar support
- ▶ Black interior including black add-on seat parts
- ▶ Headlining in black cloth
- ▶ Audi exclusive door sill trims, additional stainless steel loading lip cover
- ▶ Leather-covered cockpit on driver's side in black with coloured stitching
- ▶ Inlays in Walnut, balsamic brown (SE only), Matt-brushed aluminium or Piano finish, black
- ▶ Leather-covered Sport steering wheel in 3-spoke design with coloured stitching (to match seat-centre section)
- ▶ Gear-lever gaiter with coloured stitching (to match seat-centre section)
- ▶ Door trim colour matched to seat-centre section
- ▶ Armrest and door trims in leather with coloured stitching (to match seat-centre section)
- ▶ Floor mats with coloured piping (to match seat-centre section)

Can only be ordered in conjunction with Rear bench seat plus (SKA)



## Inlays

Attention to detail can make a big impact. From contemporary Piano finish, black to a walnut, balsamic brown, our selection of inlays make the perfect finishing touch to your car's interior.





# Inlays

Inlays are the all-important finishing touch that add flair and interest to your car's interior.

Order Code		SE	S line	S line Plus	SQ5	SQ5 plus	Total RRP inc VAT*
5MF	Aluminium satellite	S	-	-	-	-	£0.00
5TG	Matt-brushed aluminium	-	S	S	S	S	£0.00
5MT	Beaufort oak, light brown	●	-	-	-	-	£205.00
5MG	Walnut, balsamic brown	●	-	-	-	-	£205.00
7TL	Fine grain ash, natural	●	-	-	-	-	£205.00
5MK	Carbon atlas	-	-	-	●	●	£255.00
5TL	Piano finish, black	-	●	●	●	●	£305.00
5TB	Aluminium, beaufort	-	●	●	●	●	£950.00

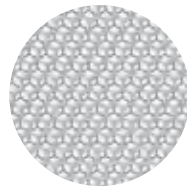

Aluminium satellite – 5MF



Matt-brushed aluminium – 5TG



Beaufort oak, light brown – 5MT



Walnut, balsamic brown – 5MG



Fine grain ash, natural – 7TL

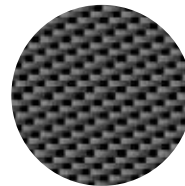

Carbon atlas – 5MK

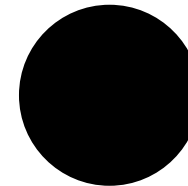

Piano finish, black – 5TL



Aluminium, beaufort – 5TB

Options are subject to availability and may extend time taken for delivery.

- = Not available  
● = Available  
S = Standard

All the inlay swatches on this page are matched as accurately as possible to the actual inlays colours used. However, due to print processes, Audi UK cannot guarantee that colours shown are 100% accurate.

\*Total RRP inc VAT – Recommended Retail Price including VAT which is calculated at 20%. This may alter to reflect any change in the applicable VAT rate.



# Inlays

## Audi exclusive

Audi exclusive offers an alternative range of materials which you can select for your inlays, from Oak, sepia to Fine grain myrtle, nutmeg.

Order Code		SE	S line	S line Plus	SQ5	SQ5 plus	Total RRP inc VAT*
<b>YTA S3G</b>	<b>Audi exclusive inlays</b> (cannot be combined with the inlays shown on page 56)	●	●	●	●	●	£910.00
<b>YTE S3G</b>	<b>Audi exclusive Carbon</b>	—	●	●	●	●	£1,125.00



Fine grain ash, nougat



Fine grain myrtle, nutmeg

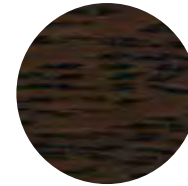

Oak, sepia

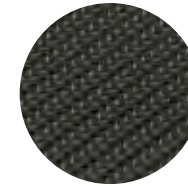

Carbon

Options are subject to availability and may extend time taken for delivery.

- = Not available
- = Available
- S = Standard

All the inlay swatches on this page are matched as accurately as possible to the actual inlays colours used. However, due to print processes, Audi UK cannot guarantee that colours shown are 100% accurate.

\*Total RRP inc VAT – Recommended Retail Price including VAT which is calculated at 20%. This may alter to reflect any change in the applicable VAT rate.

## Options

Every driver has different needs, which is why we have created some useful options to further enhance your car. For extra comfort, support, style or function, you can choose from a variety of additional features, tailoring everything from your infotainment and audio equipment to your wheels and lighting.





## Wheels, tyres and suspension

Choose a set of specially-selected alloy wheels to subtly enhance the way your car looks. And you can also specify Audi Drive Select, which allows you to change suspension and steering settings according to your driving style.



19" x 8J '5-arm Star' design alloy wheels – PRV



19" x 8J '5-arm' design alloy wheels, partly-polished – PRL



19" x 8J '5-arm off-road' design alloy wheels – PQ2



19" x 8J '10-spoke' design alloy wheels – PQ5



20" x 8.5J '5-segment-spoke' design alloy wheels – PQ6



20" x 8.5J '5-twin-spoke off-road' design alloy wheels – PQ7\*



20" x 8.5J '5-segment' design alloy wheels in Titanium Optic finish – PQK



20" x 8.5J '10-Y-spoke' design alloy wheels – PQ1\*



20" x 8.5J '5-arm' design alloy wheels, partly-polished – PR1



21" x 8.5J '5-twin-spoke Star' design alloy wheels in titanium look with a high-gloss finish – PQ8\*



21" x 8.5J '5-twin-spoke Star' design alloy wheels in gloss black with a high-gloss finish – PQI\*

Options are subject to availability and may extend time taken for delivery.

Please note that choosing an optional wheel may affect the fuel consumption figures and the CO<sub>2</sub> emissions on your Audi Q5. This may result in a change in the subsequent Vehicle Excise Duty payable. Please see pages 87, 88 and 93 for more details.

All alloy wheel images are matched as accurately as possible to the actual colour. However, due to print processes, Audi UK cannot guarantee that the colours shown are 100% accurate.

# Wheels, tyres and suspension

Options are subject to availability and may extend time taken for delivery.

- = Not available  
• = Available  
S = Standard

Please note that choosing an optional wheel may affect the fuel consumption figures and the CO<sub>2</sub> emissions on your Audi Q5. This may result in a change in the subsequent Vehicle Excise Duty payable. Please see pages 87, 88 and 93 for more details.

\*Please note: this option includes a small extension to the wheel arches.

On S line trims the wheel arch is matt black, while on SE models, it matches the colour of the contrasting bumpers.

\*Total RRP inc VAT – Recommended Retail Price including VAT which is calculated at 20%. This may alter to reflect any change in the applicable VAT rate.

Order Code	SE	S line	S line Plus	SQ5	SQ5 plus	Total RRP inc VAT*
<b>PRV</b> 19" x 8J '5-arm Star' design alloy wheels with 235/55 R19 tyres	•	-	-	-	-	£510.00
<b>PRL</b> 19" x 8J '5-arm' design alloy wheels, partly-polished with 235/55 R19 tyres	•	-	-	-	-	£510.00
<b>PQ2</b> 19" x 8J '5-arm off-road' design alloy wheels with 235/55 R19 tyres. Only available in combination with off-road styling package – PKQ	•	-	-	-	-	£650.00
<b>PQ5</b> 19" x 8J '10-spoke' design alloy wheels with 235/55 R19 tyres	• -	- •	- -	- -	- -	£920.00 £265.00
<b>PQ6</b> 20" x 8.5J '5-segment-spoke' design alloy wheels with 255/45 R20 tyres	• -	- •	- S	- -	- -	£1,250.00 £510.00
<b>PQ7</b> 20" x 8.5J '5-twin-spoke off-road' design alloy wheels with 255/45 R20 tyres.* Only available in combination with off-road styling package – PKQ, except on S line Plus and SQ5	• -	- -	- •	• -	- -	£590.00 £0.00
<b>PQK</b> 20" x 8.5J '5-segment' design alloy wheels in Titanium Optic finish with 255/45 R20 tyres	- -	• -	- •	- -	- -	£650.00 £510.00
<b>PQ1</b> 20" x 8.5J '10-Y-spoke' design alloy wheels with 255/45 R20 tyres*	• - -	- • -	- - •	- - -	- - -	£1,250.00 £510.00 £0.00
<b>PR1</b> 20" x 8.5J '5-arm' design alloy wheels, partly-polished with 235/45 R20 tyres	•	-	-	-	-	£1,250.00
<b>PQ8</b> 21" x 8.5J '5-twin-spoke Star' design alloy wheels in titanium look with a high-gloss finish with 255/40 R21 tyres*	-	-	-	•	S	£1,250.00
<b>PQI</b> 21" x 8.5J '5-twin-spoke Star' design alloy wheels in gloss black with a high-gloss finish with 255/40 R21 tyres*	-	-	-	-	•	£0.00

# Wheels, tyres and suspension

Order Code		SE	S line	S line Plus	SQ5	SQ5 plus	Total RRP inc VAT*
<b>2H1</b>	<b>Audi Drive Select</b> – changes your car’s handling and responses at the touch of a button to suit the way you want to drive. There are five modes: Comfort, Dynamic, Auto, Efficiency and Individual. Please note that you can only choose the ‘Individual’ mode and customise your settings if you also have Technology package (WB7) installed	●	●	●	●	●	£220.00
<b>1N8</b>	<b>Dynamic steering.</b> With this technology, driving is significantly more agile under everyday conditions, while directional stability is increased at high speeds and in demanding driving situations (must be combined with Audi Drive Select – 2H1)	●	●	●	●	●	£375.00
<b>1BL</b>	<b>Damper control</b> – formed on the basis of lowered Sport suspension, the optional damper control system fine-tunes suspension settings according to road conditions and driver needs (must be combined with Audi Drive Select – 2H1)	●	●	●	–	–	£680.00
<b>1BV</b>	<b>S line Sport suspension (not lowered)</b>	–	●	●	–	–	£0.00
<b>PC2</b>	<b>Red brake calipers</b>	–	–	–	●	●	£430.00

Options are subject to availability and may extend time taken for delivery.

– = Not available  
● = Available  
S = Standard

\*Total RRP inc VAT – Recommended Retail Price including VAT which is calculated at 20%. This may alter to reflect any change in the applicable VAT rate.



# Packages

Some items work well together, which is why we've created these special packages.

Vehicle driver assistance and safety systems are not a substitute for attentive driving. Drivers retain full responsibility for providing the necessary inputs for safe control of the vehicle. System descriptions within this brochure are provided for information purposes only. System limitations and operational requirements apply. See manual for details.

Options are subject to availability and may extend time taken for delivery.

- = Not available
- = Available
- S = Standard

\*Total RRP inc VAT – Recommended Retail Price including VAT which is calculated at 20%. This may alter to reflect any change in the applicable VAT rate.

Order Code	SE	S line	S line Plus	SQ5	SQ5 plus	Total RRP inc VAT*
<b>WB7</b> <b>Technology package</b> Featuring MMI Navigation system – HDD-based with Audi Music Interface and Audi Parking System Plus <b>MMI Navigation system plus.</b> Hard disk navigation with topographical map display, places of interest and town models in 3D, with high-resolution 7" colour TFT display. The system offers three alternative routes, with the ability to scroll along the selected route and manoeuvre within the map. Uses 7-digit postcode recognition. Includes split-screen mode for route information, dynamic route guidance (TMC), intersection zoom function, motorway exits and lane recommendations in Driver's Information System (DIS). Includes two SD card readers, single CD/DVD player, 40GB hard drive and Jukebox (20GB) for storing and managing music files in WMA and MP3 format. Includes European navigation data (where digitised) <b>Audi Music Interface.</b> Connection for use with stereo audio sources, USB and MP3 devices including Apple iPod generation 4 onwards and Apple iPhone <b>Audi Parking System Plus.</b> Acoustic and visual parking system for the front and rear	•	•	S	•	S	£1,695.00

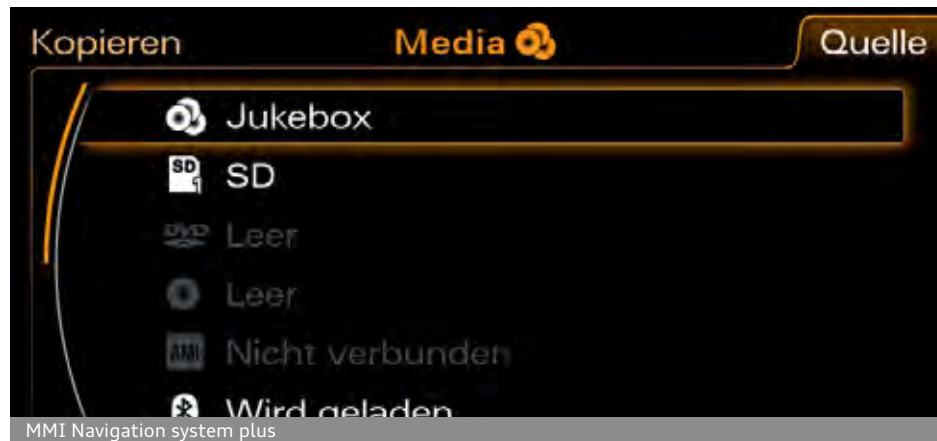



# Packages

Vehicle driver assistance and safety systems are not a substitute for attentive driving. Drivers retain full responsibility for providing the necessary inputs for safe control of the vehicle. System descriptions within this brochure are provided for information purposes only. System limitations and operational requirements apply. See manual for details.

Options are subject to availability and may extend time taken for delivery.

- = Not available
- = Available
- S = Standard

\*Where the law permits.

\*Total RRP inc VAT – Recommended Retail Price including VAT which is calculated at 20%. This may alter to reflect any change in the applicable VAT rate.

Order Code	SE	S line	S line Plus	SQ5	SQ5 plus	Total RRP inc VAT*
<b>PCF WB7</b> <b>Technology package – Advanced.</b> Includes all the features of Technology package (WB7) as well as <b>Adaptive Cruise Control with braking guard.</b> Intelligent automatic speed and distance control system. Works at speeds from 20-100mph,* using radar sensors to measure and maintain required distance to vehicle ahead by braking and accelerating. Four programmes (distance 1 to distance 4) set via steering column controls of the cruise control system. Includes Audi braking guard – a system which triggers a visual and acoustic alarm when it detects the risk of a rear end collision with the vehicle in front. At speeds below 20mph, the system can initiate partial braking or full deceleration if a potential impact is detected or if it is not possible to completely prevent a collision, the system will focus on reducing the speed at which the vehicles collide <b>Audi Side Assist.</b> Aids the driver when changing lane. Audi Side Assist monitors the area behind your car using radar sensors located discreetly in the rear bumper. It then informs the driver with a visual warning signal in the door mirror if there is a vehicle in their blind spot or approaching quickly from behind	•	•	-	•	-	£2,320.00
<b>PKQ 7M4</b> <b>Off-road package.</b> Includes front and rear bumpers, side ventilation grilles, door capping strips and wheel arch extensions in a striking off-road design. Designer stainless steel underbody guards on the front and rear bumpers. Audi exclusive doorsill trims and loading-sill protector in stainless steel. Only available in combination with PQ2, PQ6, PQ7, PQF or PQS. This option removes the chrome tailgate strip	-	-	•	-	•	£625.00
	•	-	-	-	-	£1,795.00

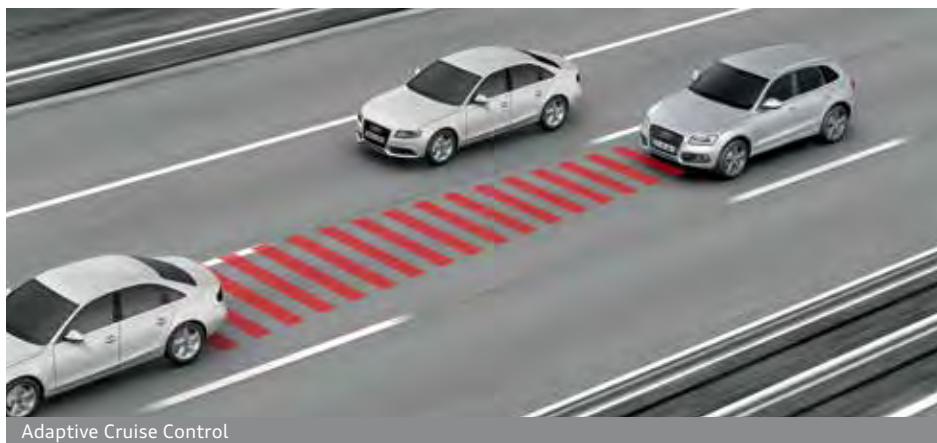

Adaptive Cruise Control



Off-road package with 20" x 8.5J '5-twin-spoke off-road' design alloy wheels (PQ7)

# Packages

Some items work well together, which is why we've created these special packages.

Order Code	SE	S line	S line Plus	SQ5	SQ5 plus	Total RRP inc VAT*
<b>PB2</b> <b>Extended Black Styling Package.</b> Consists of black roof rails, black window surrounds, radiator grille frame in gloss black, radiator grille in matt black, number plate and fog light surround in High-gloss black. Piano finish, black inlays, Exterior door mirror housing in High-gloss black and 21" x 8.5J '5-twin-spoke Star' design alloy wheels in gloss black with high-gloss finish. Package only available in combination with following colours: Ibis white (T9), Daytona grey, pearl effect (6Y), Floret silver, metallic (L5), Suzuka grey, metallic (M1), and Sepang blue, pearl effect (E9). The SQ5 colour, Sepang blue, pearl effect, is available on S line Plus models when ordering this option	—	—	●	—	—	£850.00

Options are subject to availability and may extend time taken for delivery.

- = Not available
- = Available
- S = Standard

\*Total RRP inc VAT – Recommended Retail Price including VAT which is calculated at 20%. This may alter to reflect any change in the applicable VAT rate.



Extended Black Styling Package (PB2)



21" x 8.5J '5-twin-spoke Star' design alloy wheels in gloss black with high-gloss finish (PQI)



# Audio and communication

Stay in touch using our range of communication functions, and give each journey its own soundtrack with our advanced audio equipment.

Order Code		SE	S line	S line Plus	SQ5	SQ5 plus	Total RRP inc VAT <sup>†</sup>
<b>8UM</b>	<b>Audi Symphony radio.</b> AM/FM twin tuner with TP memo function. Front-loading 6-CD changer with MP3 compatibility and active front and rear speakers. Includes colour centre console screen, SD memory-card reader and AUX-IN socket. Cannot be combined with Technology packages	●	●	—	●	—	£230.00
<b>QU6</b>	<b>TV reception – digital.</b> TV tuner for reception of ‘free-to-air’ TV channels. Picture display only possible on MMI screen when vehicle is stationary, audio available at all times. Reception dependent upon local digital network availability. Only in combination with Technology package (WB7)	●	●	●	●	●	£825.00
<b>9VK</b>	<b>Bang &amp; Olufsen sound system.</b> Designed specifically for the Audi Q5, featuring 14 high-performance speakers and two amplifiers which create 505 watts of stunning sound, balanced to suit the specific acoustic properties of the car’s interior. The system constantly and automatically adapts the sound characteristics to the vehicle’s speed and background noise providing the highest level of quality. The reproduction of 5.1 surround sound is possible in combination with Technology package (WB7)	●	●	●	●	●	£535.00

Options are subject to availability and may extend time taken for delivery.

- = Not available
- = Available
- S = Standard

<sup>†</sup>Total RRP inc VAT – Recommended Retail Price including VAT which is calculated at 20%. This may alter to reflect any change in the applicable VAT rate.



Audi Music Interface



Control panel for HDD Satellite Navigation and MMI



MMI media options menu



Bang & Olufsen sound system

# Audio and communication

Order Code		SE	S line	S line Plus	SQ5	SQ5 plus	Total RRP inc VAT*
PT5	<b>Mobile telephone preparation – Low with Bluetooth and voice control.</b> Provides hands-free connection via Bluetooth using mobile phone aerial. Alternatively, it can use a cradle with charging facility for optimal reception via external aerial located in front centre armrest (included). Cradle available at extra cost. For mobile phone and software version compatibility, please visit your Audi Centre or <a href="http://audi.co.uk/phonecompatibility">audi.co.uk/phonecompatibility</a>	●	●	●	●	●	£175.00
9ZW	<b>Mobile telephone preparation – High with Audi Connect.</b> Audi Connect provides access to a number of innovative online services via an internal UMTS (3G) module. Audi Connect online services include: navigation using Google Earth™ images and Google Street View™, destination entry via Google Maps™ or myAudi, online point-of-interest search and information services such as weather forecasts and the latest world news. Audi Connect also includes Audi traffic information online, which gives accurate real-time forecasts of the traffic situation along the chosen route. The traffic situation can be displayed on the navigation map or Google Earth™ image. Audi Connect can also create a Wi-Fi hotspot in the car for convenient internet access using a mobile device (e.g. laptop or tablet). Many Audi Connect features can be simply operated via MMI Navigation Plus, the multi-function steering wheel or the voice control system. Only in combination with Technology package (WB7). Important connectivity information: An external data source is required to enable the Audi Connect online services. Please refer to the detailed information on Audi Connect compatibility and data source requirements which can be found on page 93	●	●	●	●	●	£350.00
UF7	<b>Audi Music Interface (AMI).</b> Universal connection for use with stereo audio sources, USB and MP3 devices including Apple iPod generation 4 onwards (iPod, iPod classic, iPod mini, iPod nano, iPod photo, iPod video, iPod touch). Provides intuitive control through the audio system and multi-function steering wheel (where fitted). It also replicates the iPod display on the audio screen and DIS, including track titles. Please note that this option will replace the standard AUX-IN socket	●	●	S	●	S	£255.00
7D1	<b>CD changer and DVD player.</b> 6-CD changer located in the glovebox and single CD/DVD slot in centre console. Only available with Technology package (WB7)	●	●	●	●	●	£365.00
9WM	<b>Rear Seat Entertainment.</b> Includes two detachable DVD players/monitors fitted to the back of the front seats (supplied by Audi Genuine Accessories). The backs of the front seats are fitted with mountings and power connections. The system can be used outside the car with a rechargeable battery or mains power connection, which is included in the package. Includes individual remote controls and two sets of headphones	●	●	●	●	●	£1,050.00

Options are subject to availability and may extend time taken for delivery.

- = Not available
- = Available
- S = Standard

\*Total RRP inc VAT – Recommended Retail Price including VAT which is calculated at 20%. This may alter to reflect any change in the applicable VAT rate.

# Interior equipment

Specify every detail of your car's interior with this range of options.

Vehicle driver assistance and safety systems are not a substitute for attentive driving. Drivers retain full responsibility for providing the necessary inputs for safe control of the vehicle. System descriptions within this brochure are provided for information purposes only. System limitations and operational requirements apply. See manual for details.

Options are subject to availability and may extend time taken for delivery.

- = Not available
- = Available
- S = Standard

\*Where the law permits.

\*\*HomeLink® is a registered trademark of Johnson Controls. For more information on compatibility visit [homelink.com](http://homelink.com)

\*Total RRP inc VAT – Recommended Retail Price including VAT which is calculated at 20%. This may alter to reflect any change in the applicable VAT rate.

Order Code		SE	S line	S line Plus	SQ5	SQ5 plus	Total RRP inc VAT*
PG3	<b>Advanced key.</b> Access and authorisation system which automatically exchanges data between key and vehicle, allowing the driver to keep the key in their pocket or bag at all times. To unlock and open, simply lift the exterior door handle. To lock, press the button on the handle. Pressing the start/stop button integrated in the centre console starts and stops the engine	•	•	•	•	•	£470.00
8T4	<b>Adaptive Cruise Control (ACC) with braking guard.</b> Intelligent automatic speed and distance control system. Works at speeds from 20-100mph,* using radar sensors to measure and maintain required distance to vehicle ahead by braking and accelerating. Four distance levels and four driving modes are individually selectable (Dynamic, Standard, Comfort and Efficiency). Includes Audi braking guard – a system which triggers a visual and acoustic alarm when it detects the risk of a rear end collision with the vehicle in front. At speeds below 20mph, the system can initiate partial braking or full deceleration if a potential impact is detected or if it is not possible to prevent a collision, the system will focus on reducing the speed at which the vehicles collide	•	•	•	•	•	£900.00
VC1	<b>Garage door opener (HomeLink®**).</b> Programmable radio-operated remote control for compatible doors/gates. Control buttons integrated in the front roof module	•	•	•	•	•	£180.00
QQ1	<b>Interior light package.</b> Includes front footwell lighting, active door reflectors, illuminated vanity mirrors, rear reading lights, entrance lights and illuminated glove compartment, vents and internal door controls	•	•	•	S	S	£150.00
3FU	<b>Open sky panoramic sunroof.</b> Comprising glass roof with electric slide-and-tilt control and sunshade at front and rear	•	•	•	•	•	£1,125.00



Advanced key start/stop button



Adaptive Cruise Control

# Interior equipment

Order Code		SE	S line	S line Plus	SQ5	SQ5 plus	Total RRP inc VAT*
QES	<b>Storage package</b> – includes nets on the back of the front seats, storage compartment under the front seats (only under passenger seat if memory function is fitted), luggage spider-net for boot floor and lockable glove compartment	●	●	●	●	●	£125.00
WTG	<b>Luggage package</b> – includes folding front passenger seat (Q2N) when ordered with Standard seats, rear bench seat plus (5KA), net partition (3CX), rail system with load-securing net (3GN) and reversible luggage compartment mat (6S). Not available with lumbar support, S line and electric seats	●	–	–	–	–	£485.00
3GN	<b>Load-area fixing kit.</b> Includes telescopic bar and securing belt for dividing up luggage compartment	●	●	●	●	●	£180.00
3CX	<b>Removable net partition.</b> Located between rear seats and rear luggage compartment. Can be used with rear seat-back in upright position, one side folded down, or completely folded down	●	●	●	●	●	£90.00
3X2	<b>Ski/snowboard bag</b> – only in combination with Rear bench seat plus (5KA)	●	●	●	●	●	£70.00
6SN	<b>Underfloor storage tray in luggage compartment.</b> Size will differ depending on trim/options	●	●	●	●	●	£60.00
6SJ	<b>Reversible load floor mat.</b> Luggage compartment floor mat can be reversed to provide a rubber mat which extends to protect rear bumper. Includes bumper cover	●	●	●	●	●	£85.00
6SU	<b>Underfloor storage tray in boot.</b> Includes reversible load mat with bumper cover. Size will differ depending on trim/options	●	●	●	●	●	£145.00

Options are subject to availability and may extend time taken for delivery.

- = Not available
- = Available
- S = Standard

\*Total RRP inc VAT – Recommended Retail Price including VAT which is calculated at 20%. This may alter to reflect any change in the applicable VAT rate.



Open sky panoramic sunroof



Open sky panoramic sunroof

# Interior equipment

Order Code		SE	S line	S line Plus	SQ5	SQ5 plus	Total RRP inc VAT*
6NQ	<b>Cloth headlining – black.</b> Not available in combination with interior codes VI or IE	●	S	S	S	S	£225.00
6NN	<b>Alcantara headlining – light grey.</b> Only in combination with interior light package (QQ1). Not available in combination with interior code VI or with Audi exclusive line (WQK). On SQ5, only available with interiors IM, XN, SZ, or WY	●	–	–	●	●	£1,020.00
6NS	<b>Alcantara headlining – black.</b> Only in combination with interior light package (QQ1). Not available in combination with interior code VI or with Audi exclusive line (WQK/PQL). On SQ5, only available with interiors XG, XO, FA, or SV	●	●	●	●	●	£1,020.00
7HB	<b>Leather package – door armrests.</b> Only in combination with leather or leather/Alcantara upholstery. When combined with S line the stitching is only in black. In combination with upholsteries UH, QX, UA the stitching is in a contrasting colour	●	S	S	S	S	£205.00
	In combination with Fine Nappa leather upholstery (PEC/PEE)	●	–	–	–	–	£0.00
7HC	<b>Leather package plus – door armrests and instrument cowling.</b> When combined with S line, the stitching is only in black. In combination with upholsteries UH, QX, UA, the stitching is in a contrasting colour	●	–	–	–	–	£460.00
		–	●	●	●	●	£255.00
KT1	<b>Climate cup holder.</b> Allows cup holder to be cooled to 3°C or heated to 58°C. Operated via two control switches (one for hot and one for cold) positioned behind the cup holder. Located between driver and front passenger	●	●	●	●	●	£100.00

Options are subject to availability and may extend time taken for delivery.

– = Not available  
 ● = Available  
 S = Standard

\*Total RRP inc VAT – Recommended Retail Price including VAT which is calculated at 20%. This may alter to reflect any change in the applicable VAT rate.



Leather package plus – door armrest



Climate cup holder



# Interior equipment

Options are subject to availability and may extend time taken for delivery.

- = Not available
- = Available
- S = Standard

\*The colours of the stitching and piping (where applicable) can be selected from any of the Audi exclusive colours shown on page 50. The carpet colour can also be selected from any of the Audi exclusive colours shown on page 50.

\*\*Available in Chestnut brown, Saddle brown, Havana brown, Jet grey, Smoky blue, Night blue, Iceland green, Classic red or Crimson red.

\*Total RRP inc VAT – Recommended Retail Price including VAT which is calculated at 20%. This may alter to reflect any change in the applicable VAT rate.

Order Code		SE	S line	S line Plus	SQ5	SQ5 plus	Total RRP inc VAT*
<b>5XF</b>	<b>Retractable and extendable sun visor.</b> Extendable sun visors for both driver and front passenger, folds out and swivels to the side to help protect the driver's eyes against sunlight from the side of the vehicle. Only in combination with Interior light package (QQ1). Cannot be combined with Alcantara headlinings 6NS and 6NN	•	•	•	•	•	£45.00
<b>3Y4</b>	<b>Side window blinds – manual</b>	•	•	•	•	•	£100.00
<b>YSQ S3G</b>	<b>Audi exclusive carpets.*</b> Includes four Audi exclusive floor mats with leather piping. Cannot be combined with option YSR/S3G – Audi exclusive floor mats	•	•	•	•	•	£960.00
<b>YSR S3G</b>	<b>Audi exclusive floor mats with leather piping.*</b> Includes four floor mats for front and rear. Cannot be combined with option YSQ/S3G – Audi exclusive carpets	•	•	•	•	•	£375.00
<b>YSK S3G 6NS</b>	<b>Audi exclusive headlining in black Alcantara with contrast stitching.*</b> Only in combination with interior light package (QQ1)	•	•	•	•	•	£1,595.00
<b>YSO S3G</b>	<b>Audi exclusive leather-covered instrument cowl with contrasting stitching**</b>	•	•	•	•	•	£875.00



Audi exclusive upholstered headrests



Audi exclusive floor mats with leather piping

# Exterior equipment

Make sure your car looks exactly as you want it to by selecting some of the striking options from our detailed list.

Options are subject to availability and may extend time taken for delivery.

- = Not available  
 ● = Available  
 S = Standard

\*Additional wiring is required for auxiliary equipment.

\*Total RRP inc VAT - Recommended Retail Price including VAT which is calculated at 20%. This may alter to reflect any change in the applicable VAT rate.

Order Code		SE	S line	S line Plus	SQ5	SQ5 plus	Total RRP inc VAT*
YNB S3C	<b>Running boards.</b> Cannot be ordered in combination with both Tow bar – swivelling (1D4) and Open sky panoramic sunroof (3FU)	●	●	●	●	●	£735.00
8N7	<b>High-beam assist.</b> Automatically adjusts headlights from high-beam to dipped-beam when another vehicle is approaching	●	●	●	●	●	£110.00
8Q5	<b>Adaptive lights.</b> Swivelling headlights for improved illumination of winding roads	-	●	●	●	●	£330.00
PX1 8Q5	<b>Adaptive Xenon headlights.</b> Swivelling headlights for improved illumination of a winding road. Includes Xenon Plus headlights with LED daytime-running lights, headlight washers and LED rear lamps	●	-	-	-	-	£1,130.00
4ZD 3S2	<b>Black styling package.</b> Consists of black roof rails, black window surrounds, radiator grille frame in gloss black, radiator grille in matt black, number plate and fog light surround in high-gloss black. This option removes the chrome door handles and chrome tailgate strip	-	●	●	●	S	£330.00
3S2	<b>Black roof rails</b>	●	●	●	●	S	£0.00
2Z7	<b>Deletion of engine technology designation at rear</b>	●	●	●	-	-	£0.00
2Z0	<b>Deletion of model and engine technology designation at rear</b>	●	●	●	●	●	£0.00
6XE	<b>Door mirrors – electrically adjustable, folding and heated.</b> Includes kerb view function which tilts the passenger side mirror for increased visibility whilst reversing	●	●	●	●	●	£190.00
4E9	<b>Power-operated tailgate.</b> Opens by pressing button on the car key, button in the driver’s door trim or soft-touch button in the handle recess on the luggage compartment lid. Including lid-closing assistance unit and programmable angle for the luggage compartment lid	●	●	S	●	S	£385.00
4KF	<b>Privacy glass.</b> Dark tinted glass from B-pillar backwards. Only available on 4-cylinder engines	●	●	S	-	-	£380.00
VW6	<b>Privacy glass.</b> Dark tinted glass from B-pillar backwards. Only available on 6-cylinder engines	●	●	S	●	S	£380.00
1D4	<b>Tow bar – swivelling.</b> Includes single European 13-pin electric socket and may require a 13- to 7-pin adaptor. Pin 10 (required for power supply to fridge or additional consumers) is not connected. Please consult your Audi Centre for details*	●	●	●	●	●	£665.00

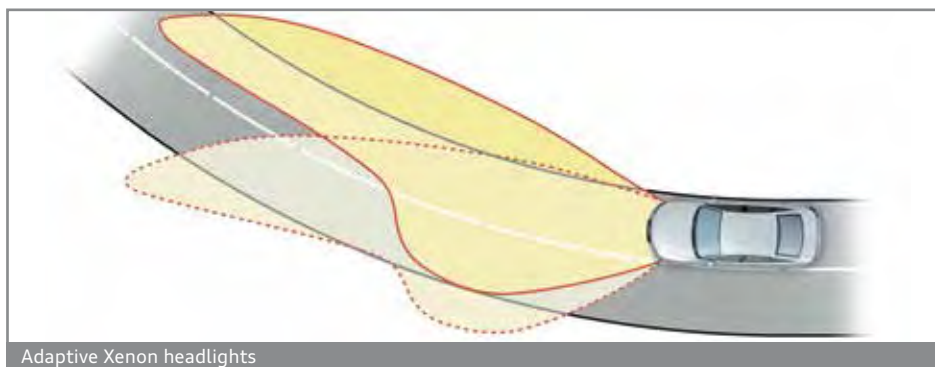

Adaptive Xenon headlights



Xenon Plus headlights (included with adaptive headlights)



# Safety and security

Technology designed to give you better all-round awareness and safety on the road.

Vehicle driver assistance and safety systems are not a substitute for attentive driving. Drivers retain full responsibility for providing the necessary inputs for safe control of the vehicle. System descriptions within this brochure are provided for information purposes only. System limitations and operational requirements apply. See manual for details.

Options are subject to availability and may extend time taken for delivery.

- Not available
- = Available
- S = Standard

\*Total RRP inc VAT – Recommended Retail Price including VAT which is calculated at 20%. This may alter to reflect any change in the applicable VAT rate.

Order Code		SE	S line	S line Plus	SQ5	SQ5 plus	Total RRP inc VAT*
UH2	<b>Audi hill-hold assist.</b> Uses either the ESP system or electromechanical parking brake to hold the vehicle stationary	•	•	•	•	•	£65.00
7Y1	<b>Audi Side Assist.</b> Aids the driver when changing lane. Audi Side Assist monitors the area behind your car using radar sensors located discreetly in the rear bumper. It then informs the driver with a visual warning signal in the door mirror if there is a vehicle in their blind spot or approaching quickly from behind. The system is activated using a button in the driver's door	•	•	•	•	•	£440.00
7X4	<b>Audi Parking System Plus.</b> Aids parking by acoustically and visually indicating distances to obstacles in front of and behind your Audi Q5	•	•	S	•	S	£325.00
7X8	<b>Audi Parking System Advanced.</b> Aids parking by acoustically and visually indicating distances to obstacles with guiding lines. Measured by sensors and reversing camera. Only in combination with Technology package (WB7)	•	•	•	•	•	£340.00
8X1	<b>Headlight washers</b>	•	S	S	S	S	£230.00
4X4	<b>Rear side airbags.</b> Situated in side of rear seats	•	•	•	•	•	£255.00



Audi Parking System Advanced

# Steering wheels

You can choose from a selection of leather multi-function steering wheels, allowing you to control your audio system at the touch of a button.

Options are subject to availability and may extend time taken for delivery.

- = Not available
- = Available
- S = Standard

\*The colours of the leather and stitching (where applicable) can be selected from any of the Audi exclusive colours shown on page 50.

\*Total RRP inc VAT – Recommended Retail Price including VAT which is calculated at 20%. This may alter to reflect any change in the applicable VAT rate.

Order Code		SE	S line	S line Plus	SQ5	SQ5 plus	Total RRP inc VAT*
<b>1XW</b>	<b>3-spoke multi-function steering wheel without gear-shift paddles.</b> Manual models only	•	S	S	-	-	£105.00
<b>1XX</b>	<b>3-spoke multi-function steering wheel with gear-shift paddles.</b> Automatic models only	•	S	S	S	S	£255.00
<b>2PF</b>	<b>3-spoke multi-function flat-bottomed steering wheel.</b> Manual models only	-	•	•	-	-	£100.00
<b>2PK</b>	<b>3-spoke multi-function flat-bottomed steering wheel with gear-shift paddles.</b> Automatic models only	-	•	•	•	•	£100.00
<b>6Q6</b>	<b>Audi aluminium gear knob (manual models only).</b> Not available in combination with IE or VI	•	•	•	-	-	£125.00
<b>YRB S3G</b>	<b>Audi exclusive controls package.*</b> Includes leather-covered steering wheel and gear-shift gaiter	•	•	•	•	•	£695.00



## Looking after your Audi

When you've chosen your ideal model, it's reassuring to know that it will remain in safe hands. That's why we've created products to protect your Audi, from extended warranties to Audi Complete – our comprehensive service and maintenance package. And there's also a range of Audi accessories and merchandise to choose from, enabling you to further enhance and safeguard your car.





# Audi Complete

If you drive under 10,000 miles per annum your vehicle will be placed on a Fixed Inspection Service schedule. If your mileage tends to exceed 10,000 miles per annum it will be placed on the Flexible Service schedule.

## Warranty

All new Audi models come with a three-year warranty as standard, and you can choose to extend this to a four or five-year warranty\* for a one-off cost. What's more, if you decide to sell your Audi before the warranty expires, it will be fully transferred to the new owner.

- = Not available  
• = Available  
S = Standard

\*Three-year warranty consists of a two-year unlimited mileage warranty and a third year warranty with a 60,000-mile limitation. Four-year warranty consists of a two-year unlimited mileage warranty and two further years' coverage with a 75,000-mile limitation. Five-year warranty consists of a two-year unlimited mileage warranty and three further years' coverage with a 90,000-mile limitation.

\*\*Only available before registration of your Audi Q5. Please speak to your Audi Centre for full details.

\*Total RRP inc VAT – Recommended Retail Price including VAT which is calculated at 20%. This may alter to reflect any change in the applicable VAT rate.

Audi Complete is our fixed-cost maintenance plan, which helps you keep your Audi in top condition and stay in control of your finances. For a simple monthly payment, you could cover your car's servicing, maintenance and, if you want, its tyres too.

So not only will you ensure your car runs smoothly, regular servicing can also protect its future resale value. And because everything's covered by one competitive price, there's no need to go anywhere else.

Pricing is completely tailored to your vehicle and takes into consideration the options you have on your vehicle and your likely annual mileage and resultant service schedule. Please speak to your Audi Centre for a personalised quote for Audi Complete.

Order Code		Q5	SQ5	Total RRP inc VAT†
-	<b>Audi Warranty</b> , covering you for unlimited mileage in the first 2 years of ownership, and up to 60,000 miles in the third year. Transferable between owners**	S	S	£0.00
EA6	<b>Audi Warranty</b> , covering you for up to 4 years or 75,000 miles, whichever comes soonest. Cover includes a 2-year unlimited mileage warranty, and up to 75,000 miles in the third and fourth years. Transferable between owners**	•	•	£535.00
EA9	<b>Audi Warranty</b> , covering you for up to 5 years or 90,000 miles, whichever comes soonest. Cover includes a 2-year unlimited mileage warranty, and up to 90,000 miles in the third, fourth and fifth years. Transferable between owners**	•	•	£1,255.00





## Accessories

Choosing an Audi isn't just a matter of deciding on the model you want; it's about creating a car that suits your needs perfectly. And that's why we've developed a whole range of optional accessories to enhance your Audi Q5, enabling you to customise it down to the last detail. Like your Audi, all these accessories are developed to the highest possible standards. They're all available exclusively from Audi. To find out more, just visit [audi.co.uk/accessories](http://audi.co.uk/accessories) or contact your local Audi Centre.

### Warranty

All of the accessories available on the Audi Q5 are covered by a three-year warranty\* if they are ordered and included in the purchase price of the car at date of delivery. Any accessories ordered and installed after delivery include a two-year warranty.\*

\*Excluding Road Angel products. Audi Accessories warranty terms and conditions can be found at [audi.co.uk/warrantyterms](http://audi.co.uk/warrantyterms)



## Merchandise

From the enthusiasts' motorsport collection to the sophisticated Audi collection, there's a wide variety of adults' and children's clothing, lifestyle accessories and collectables, all of which bear the Audi name.

Please speak to a member of our team at your local Audi Centre to see the full Audi collection and to place an order. A selection of Audi merchandise is also available to buy from [audi.co.uk/merchandise](http://audi.co.uk/merchandise)



Image shown is the Audi kids' car legends, item number 320.13.004.00

# The Audi Difference

## The experts in Vorsprung durch Technik

Our Audi Approved Master Technicians have undergone an impressive 100,000 hours of training over a 10-year programme to ensure they have the latest technical expertise for maintaining and servicing your Audi. All our Service Advisors undergo a specialist induction and training to ensure they are Audi professionals and able to talk to you about any issues you may have with your Audi vehicle.

## Servicing tailored to your needs

Regular servicing is key to safeguarding your Audi's performance and a full service history could help you enhance the future re-sale value. To make servicing easy, the Audi Service Schedules have been designed to work with your individual driving style and vehicle.

We offer two different schedules: the Fixed Inspection Service and the Flexible Service schedule. The conventional Fixed Inspection Service schedule has fixed intervals for the Oil-change Service and Inspection Service, which are determined by time and distance.

With the Flexible Service schedule, the Inspection Service intervals are also fixed but the Oil-change Service intervals are variable. Sensors take account of driving style and conditions to determine when the Oil-change Service is required and the driver is informed via the on-board service interval display.

The choice of Service Schedule will depend on journey type and mileage as well as individual driving style and conditions. The table to the right can be used for guidance but your Audi Centre will help you to determine the most suitable Service schedule for you based on your individual circumstances and preferences.

### Fixed Inspection Service Schedule

	Vehicle usage:
Mileage	Less than 10,000 miles per annum. Mainly city/town centre driving. Short journeys.
	Service Intervals:
Oil-change Service	Fixed to every 9,000+ miles/1 year
Inspection Service	Fixed to every 19,000+ miles/2 years

### Flexible Service Schedule

	Vehicle usage:
Mileage	More than 10,000 miles per annum. Motorway and main road driving. Mainly longer distance journeys. Constant speeds.
	Service Intervals:
Oil-change Service	Variable to a maximum of every 19,000+ miles/2 years
Inspection Service	Fixed to every 19,000+ miles/2 years

When a vehicle is frequently used in the following conditions, we recommend a Fixed Inspection Service Schedule, regardless of mileage:

Uneconomical driving styles, e.g. heavy acceleration and braking, constant use of high revs

High engine-loading conditions, e.g. frequent towing and hill climbs

\*As indicated by the service interval display. Mileages are approximate as the Service Indicator system uses kilometres as its distance measurement.

## Your convenience comes first

At Audi you can choose from a range of convenient services that suit your needs. Why not book a 'service while you wait' appointment\* and enjoy our complimentary refreshments while your car is with us? Or, if you need to be mobile, take advantage of one of our courtesy cars which we can even deliver to you.\* We guarantee we can service your Audi within 5 days without a courtesy car or within 10 days if you need transport. We will also ensure your car is returned to you with a full valet.

## Audi Genuine Parts

You can rest assured that only Audi Genuine Parts will be used on your vehicle. What's more, Audi parts and labour come with a 2-year guarantee.\*\*

## No hidden costs

We believe strongly in transparency when it comes to our prices. For added peace of mind, we will give you a quotation over the phone for the work you have requested and email you the price confirmation. We'll consult you if any additional work on your car is needed when it is with us. We won't carry out any extra work without asking your permission first.

## All part of the service

Whenever we see an Audi for a service, we connect it directly to our headquarters in Ingolstadt which enables us to check your car's software and make sure it's as up-to-date as possible. If the factory has released a software upgrade for your model, it can be applied immediately – improving anything from your car's efficiency to the precision of its parking system.

## Audi Roadside Assistance

Your new car comes complete with 3 years' complimentary roadside assistance and recovery across the UK, provided by Automobile Association Insurance Services Limited. Also included is roadside assistance throughout Europe, managed by Automobile Association Insurance Services Limited.

For further information and terms and conditions please visit [audi.co.uk](http://audi.co.uk)

\*Subject to availability.

\*\*Excludes wear and tear.



# Off-road capabilities of the Audi Q5

The Audi Q5 excels both on the road and off it, thanks to its impressive all-terrain abilities. And these attributes are reinforced by special technologies, such as hill descent assist, ABS with automatic off-road detection and an Electronic Stability Programme that includes an off-road mode.

## Hill descent assist

Available as standard in the Audi Q5, hill descent assist automatically maintains the speed set by the driver on steep descents and on any surface (up to 19mph). This makes negotiating descents far more straightforward and substantially enhances stability. Hill descent assist is activated and deactivated using a separate button.

## ESP off-road mode

The Electronic Stability Programme in the Audi Q5 features a special off-road mode which can be controlled by a switch. This reprograms the ESP system, traction control and anti-lock braking system to adapt them to the driving conditions encountered in off-road terrain, such as sand, gravel or mud. This leads to good traction in all conditions, a more exciting drive and great handling even on unpredictable surfaces.

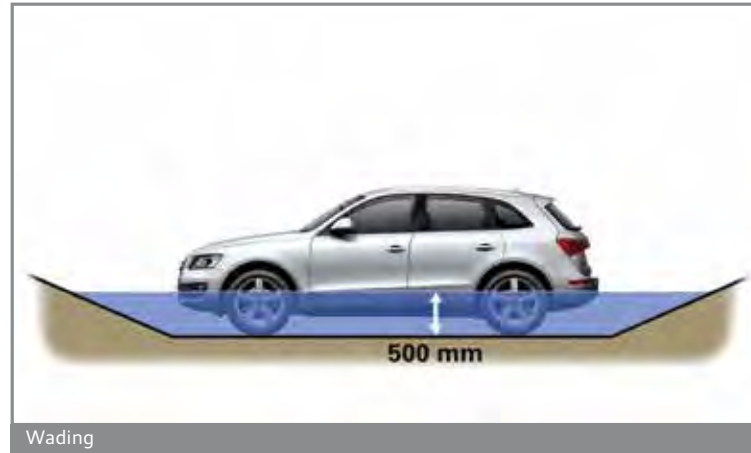

# Off-road capabilities of the Audi SQ5



# Audi Q5 technical data

Engine	Petrol			Diesel		
	2.0 TFSI quattro	2.0 TFSI quattro	2.0 TDI quattro	2.0 TDI quattro	2.0 TDI quattro	3.0 TDI quattro
Transmission	6-speed manual	8-speed tiptronic	6-speed manual	6-speed manual	7-speed S tronic	7-speed S tronic
Cylinder	4-cylinder	4-cylinder	4-cylinder	4-cylinder	4-cylinder	6-cylinder
Displacement, cubic cm (valves per cylinder)	1984	1984	1968	1968	1968	2967
Max. power, <sup>1</sup> PS at rpm	230/4700-6200	230/4700-6200	150/3250-4200	190/3800-4200	190/3800-4200	258/4000-4500
Max. torque, Nm at rpm	350/1500-4600	350/1500-4600	320/1500-3250	400/1750-3000	400/1750-3000	580/1750-2500
Top speed, mph	142	142	118	130	130	143
0-62mph acceleration, seconds	7.2	6.9	10.8	8.4	8.4	6.2
ABI insurance group 1-50*	29E	30E	22E	29E	29E	39E
Unladen weight, <sup>2</sup> kg	1730	1770	1820	1820	1860	1880
Gross weight limit, kg	2340	2380	2430	2430	2470	2490
Roof load limit/nose weight, kg	75/100	75/100	75/100	75/100	75/100	75/100
Max trailer load <sup>3</sup> unbraked, kg	750	750	750	750	750	750
Max trailer load <sup>3</sup> with 12% gradient, kg	2000	2000	1800	2000	2000	2400
Max trailer load <sup>3</sup> with 8% gradient, kg	2400	2400	2000	2400	2400	2400
Luggage compartment capacity, rear seats upright, litres	540	540	540	540	540	540
Luggage compartment capacity, rear seats folded, litres	1560	1560	1560	1560	1560	1560
Fuel tank capacity approx, litres	75	75	75	75	75	75
AdBlue <sup>®</sup> tank approx capacity, litres <sup>^</sup>	n/a	n/a	23	23	23	23
Emission standard	EU6	EU6	EU6	EU6	EU6	EU6

\*Highest insurance group rating shown. Group may be lower dependent on trim level. Please visit [thatcham.org/abigroupratings](http://thatcham.org/abigroupratings) for details.

<sup>^</sup>The addition of AdBlue<sup>®</sup> technology ensures compliance with EU6 emission standards. The use of AdBlue<sup>®</sup> will vary based on a number of conditions and the tank requires refilling when indicated on the instrument cluster.

<sup>1</sup>The given value was obtained in accordance with the specified measurement procedure (the respective current version of the Directive 80/1269/EEC).

<sup>2</sup>Vehicle's unladen weight without driver (calculated in accordance with the current version of Directive 80/1268/EEC). The fitting of additional equipment may increase the vehicle's unladen weight and drag coefficient, whereupon the potential carrying capacity and top speed will be correspondingly reduced.

<sup>3</sup>The engine's power output always goes down with increasing altitude. At 1,000m above sea level, and for every additional 1,000m, deduct 10% from the weight of the outfit (trailer load limit + gross weight of the towing vehicle).

# Audi Q5 technical data

Depending upon your chosen Q5 wheel size, different efficiency figures for CO<sub>2</sub> emissions and fuel consumption will apply (based on EU directive no. 715/2007 effective from 01/09/14). This table is a quick reference guide to assist you in finding the correct values based on wheel sizes and chosen engine.

Engine		Petrol			Diesel		
		2.0 TFSI quattro	2.0 TFSI quattro	2.0 TDI quattro	2.0 TDI quattro	2.0 TDI quattro	3.0 TDI quattro
Transmission		6-speed manual	8-speed tiptronic	6-speed manual	6-speed manual	7-speed S tronic	7-speed S tronic
Max. power, <sup>1</sup> PS at rpm		230/4700-6200	230/4700-6200	150/3250-4200	190/3800-4200	190/3800-4200	258/4000-4500
CO <sub>2</sub> emissions, <sup>2</sup> g/km	18" wheels	173	169	147	148	152	158
	19" wheels	179	172	150	151	154	161
	20-21" wheels	181	174	152	153	157	163
Benefit in kind (BIK)%	18" wheels	29%	28%	27%	27%	28%	29%
	19" wheels	30%	29%	28%	28%	28%	30%
	20-21" wheels	31%	29%	28%	28%	29%	30%
Fuel consumption, <sup>2</sup> mpg (l/100km) Urban	18" wheels	30.1 (9.4)	32.8 (8.6)	43.5 (6.5)	42.8 (6.6)	42.8 (6.6)	42.8 (6.6)
	19" wheels	29.1 (9.7)	32.8 (8.6)	42.8 (6.6)	42.2 (6.7)	42.2 (6.7)	41.5 (6.8)
	20-21" wheels	28.8 (9.8)	32.5 (8.7)	42.2 (6.7)	41.5 (6.8)	42.2 (6.7)	40.9 (6.9)
Fuel consumption, <sup>2</sup> mpg (l/100km) Extra Urban	18" wheels	43.5 (6.5)	42.8 (6.6)	55.4 (5.1)	54.3 (5.2)	52.3 (5.4)	50.4 (5.6)
	19" wheels	41.5 (6.8)	42.2 (6.7)	54.3 (5.2)	53.3 (5.3)	51.4 (5.5)	49.6 (5.7)
	20-21" wheels	40.9 (6.9)	41.5 (6.8)	53.3 (5.3)	52.3 (5.4)	50.4 (5.6)	47.9 (5.9)
Fuel consumption, <sup>2</sup> mpg (l/100km) Combined	18" wheels	37.2 (7.6)	38.7 (7.3)	50.4 (5.6)	49.6 (5.7)	48.7 (5.8)	47.1 (6.0)
	19" wheels	36.2 (7.8)	38.2 (7.4)	49.6 (5.7)	48.7 (5.8)	47.9 (5.9)	46.3 (6.1)
	20-21" wheels	35.8 (7.9)	37.7 (7.5)	48.7 (5.8)	47.9 (5.9)	47.1 (6.0)	45.6 (6.2)

<sup>1</sup>The given value was obtained in accordance with the specified measurement procedure (the respective current version of the Directive 80/1269/EEC).

<sup>2</sup>Fuel consumption and CO<sub>2</sub> emissions figures are obtained under standardised test conditions (Directive 93/116/EEC) using a representative model. This allows direct comparison between different models from different manufacturers, but may not represent the actual fuel consumption achieved in 'real world' driving conditions. More information is available at [dft.gov.uk/vca](http://dft.gov.uk/vca)

Standard EU test figures for comparative purposes and may not reflect real driving results.

Optional wheels may also affect emissions and fuel consumption figures.

# Audi SQ5 and SQ5 plus technical data

Depending upon your chosen Audi SQ5 wheel size, different efficiency figures for CO<sub>2</sub> emissions and fuel consumption will apply (based on EU directive no. 715/2007 effective from 01/09/14). This table is a quick reference guide to assist you in finding the correct values based on wheel sizes and chosen engine.

<sup>^</sup>The addition of AdBlue® technology ensures compliance with EU6 emission standards. The use of AdBlue® will vary based on a number of conditions and the tank requires refilling when indicated on the instrument cluster.

\*Electronically Limited

\*\*Highest insurance group rating shown. Group may be lower dependent on trim level. Please visit [thatcham.org/abigroupratings](http://thatcham.org/abigroupratings) for details.

<sup>1</sup>The given value was obtained in accordance with the specified measurement procedure (the respective current version of the Directive 80/1269/EEC).

<sup>2</sup>Fuel consumption and CO<sub>2</sub> emissions figures are obtained under standardised test conditions (Directive 93/116/EEC) using a representative model. This allows direct comparison between different models from different manufacturers, but may not represent the actual fuel consumption achieved in 'real world' driving conditions. More information is available at [dft.gov.uk/vca](http://dft.gov.uk/vca)

<sup>3</sup>Vehicle's unladen weight without driver (calculated in accordance with the current version of Directive 80/1268/EEC). The fitting of additional equipment may increase the vehicle's unladen weight and drag coefficient, whereupon the potential carrying capacity and top speed will be correspondingly reduced.

<sup>4</sup>The engine's power output always goes down with increasing altitude. At 1,000m above sea level, and for every additional 1,000m, deduct 10% from the weight of the outfit (trailer load limit + gross weight of the towing vehicle).

Standard EU test figures for comparative purposes and may not reflect real driving results.

Optional wheels may also affect emissions and fuel consumption figures.

	SQ5	SQ5 plus
Engine	3.0 BiTDI quattro	3.0 BiTDI quattro
Transmission	8-speed tiptronic	8-speed tiptronic
Cylinder	6-cylinder	6-cylinder
Displacement, cubic cm (valves per cylinder)	2967	2967
Max. power, <sup>1</sup> PS at rpm	326/4000-4500	340/4100-4300
Max. torque, Nm at rpm	650/1400-2800	700/1500-2250
Top speed, mph	155*	155*
0-62mph acceleration, seconds	5.1	5.1
ABI insurance group 1-50**	42E	44E
Unladen weight, <sup>3</sup> kg	2000	2000
Gross weight limit, kg	2585	2585
Roof load limit/nose weight, kg	75/100	75/100
Max trailer load <sup>4</sup> unbraked, kg	750	750
Max trailer load <sup>4</sup> with 12% gradient, kg	2400	2400
Max trailer load <sup>4</sup> with 8% gradient, kg	2400	2400
Luggage compartment capacity, rear seats upright, litres	540	540
Luggage compartment capacity, rear seats folded, litres	1560	1560
Fuel tank capacity approx, litres	75	75
AdBlue® tank approx capacity, litres <sup>^</sup>	23	23
Emission standard	EU6 <sup>^</sup>	EU6 <sup>^</sup>

		SQ5	SQ5 plus
Engine		3.0 BiTDI quattro	3.0 BiTDI quattro
Transmission		8-speed tiptronic	8-speed tiptronic
Max. power, <sup>1</sup> PS at rpm		326/4000-4500	340/4100-4300
CO <sub>2</sub> emissions, <sup>3</sup> g/km	20" wheels	174	n/a
	21" wheels	174	174
Benefit in kind (BIK)%	20" wheels	32%	n/a
	21" wheels	32%	32%
Fuel consumption, <sup>3</sup> mpg (l/100km) Urban	20" wheels	35.3 (8.0)	n/a
	21" wheels	35.3 (8.0)	36.2 (7.8)
Fuel consumption, <sup>3</sup> mpg (l/100km) Extra Urban	20" wheels	47.9 (5.9)	n/a
	21" wheels	47.9 (5.9)	47.9 (5.9)
Fuel consumption, <sup>3</sup> mpg (l/100km) Combined	20" wheels	42.8 (6.6)	n/a
	21" wheels	42.8 (6.6)	42.8 (6.6)





# Audi Q5 dimensions

The technical drawings opposite show the exact dimensions of the Audi Q5, so you can check everything – from whether the car will fit in your garage to whether your luggage will fit in the boot.

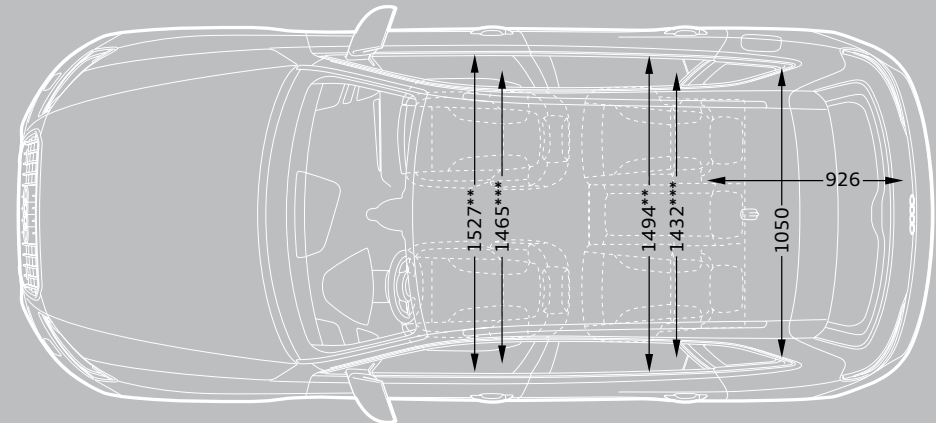
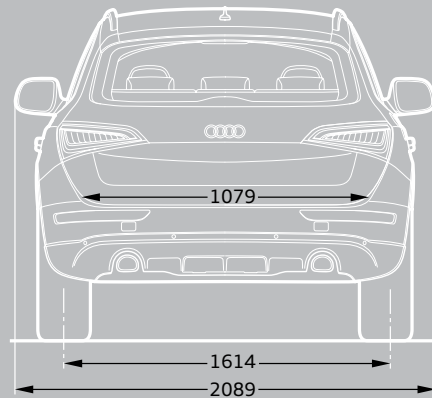
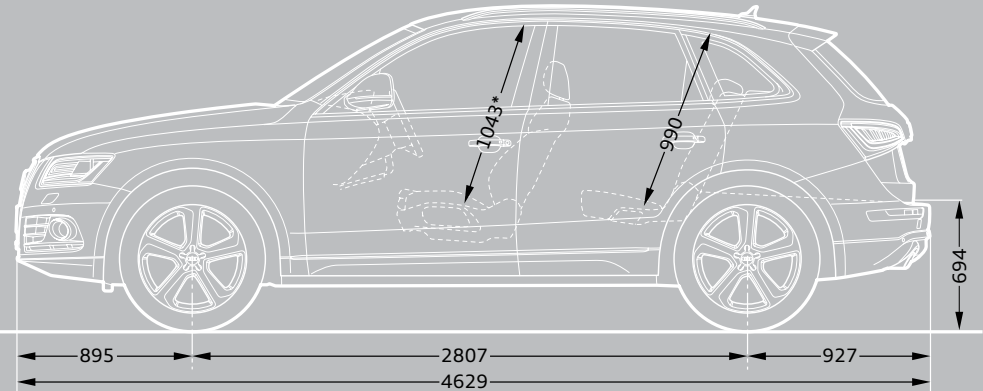
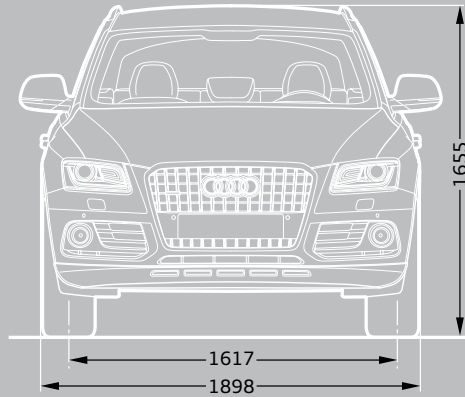

Dimensions measured with vehicle at unladen weight. Optional equipment may affect dimensions.

Turning circle approx 11.7m.

Dimensions in millimetres.

\*Maximum headroom.

\*\*Elbow width room.

\*\*\*Shoulder width room.

# Audi SQ5 dimensions

The technical drawings opposite show the exact dimensions of the Audi SQ5, so you can check everything – from whether the car will fit in your garage to whether your luggage will fit in the boot.

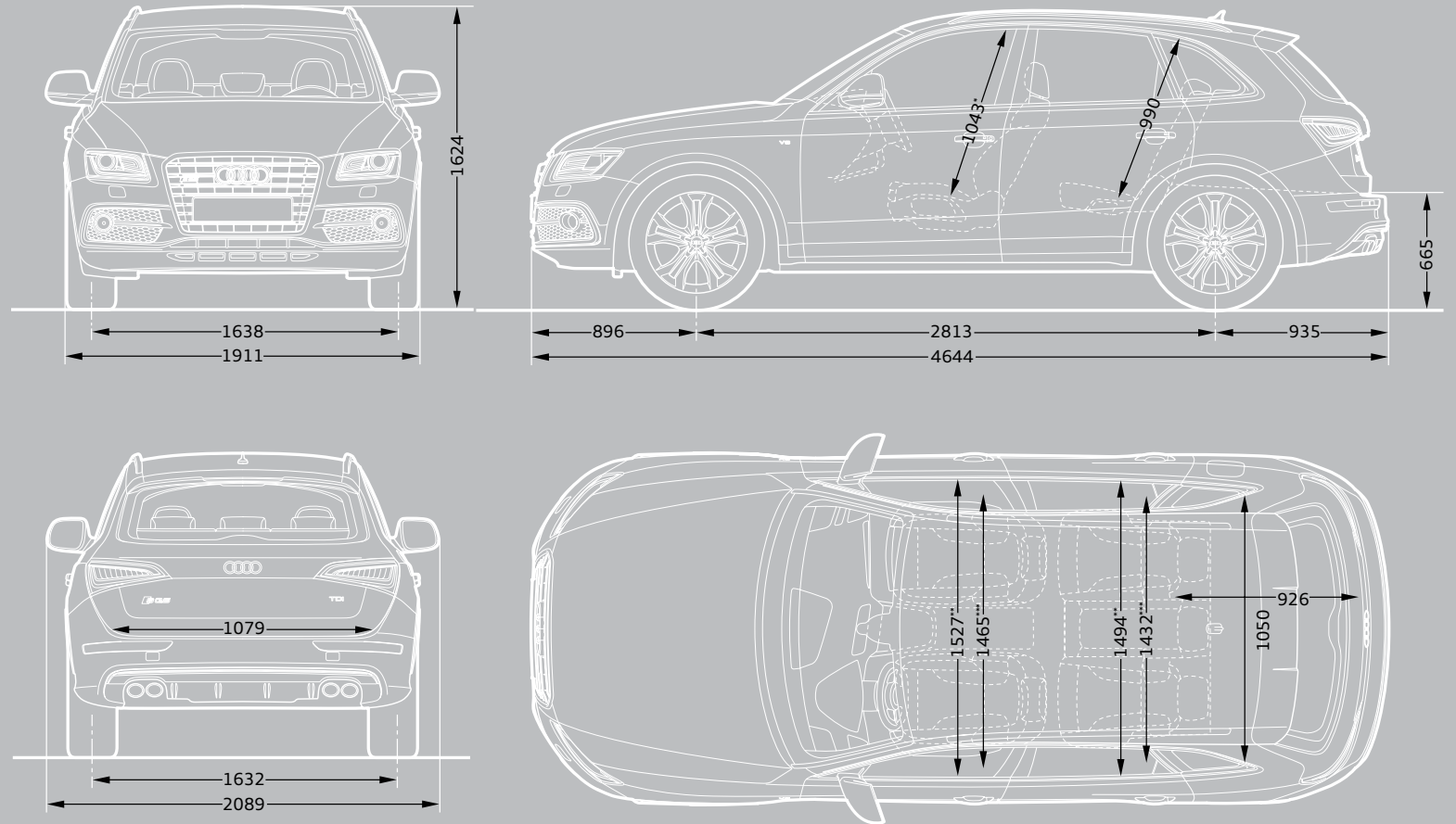

Dimensions measured with vehicle at unladen weight. Optional equipment may affect dimensions.

Turning circle approx 11.7m.

Dimensions in millimetres.

\*Maximum headroom.

\*\*Elbow width room.

\*\*\*Shoulder width room.

# Pricing and Additional information

## Welcome to Audi

By placing an order for your Audi, you're choosing to drive a car created in the spirit of Vorsprung durch Technik.

And because we believe the service we offer should reflect the quality of our cars, we want to let you know exactly what you can expect from us, now and in the future.

## Audi Promise

### Audi Centres

We guarantee that all our Centres will be open as follows:

Sales: Monday to Friday 9am–6pm  
Saturday 9am–5pm

Service: Monday to Friday 8am–6pm  
Saturday 8.30am–1pm

Sunday opening is at local discretion.

### New car delivery

Once we've confirmed a delivery date for your car, we'll keep you informed of progress. Subject to reasonable notice, we'll then deliver it to a place of your choice, whether that's your home or work. In the unlikely event of a delay, we'll provide a courtesy car to minimise inconvenience and keep you mobile.

### Information in this guide

We've done all we can to make the prices, specifications, technical details and all other information you see in this guide accurate at the time of publication. However, as our products are constantly being updated, we recommend checking the details with your Audi Centre. We reserve the right to change prices or specifications at any time.

All prices are subject to VAT, currently charged at 20%, but this may alter to reflect any change in the applicable VAT rate.

Delivery charges and number plates are not included in the Total RRP inc VAT vehicle price.

Delivery charge	£504.99
Number plate	£20.00
VAT	£105.01
Total	£630.00

Recommended On-The-Road (OTR) prices include the delivery and number plate charges above, Road Fund Licence (which may vary depending on model/transmission – see table for details) and first registration fee at £55.00.

The images featured in this guide are for illustrative purposes only. They may feature left-hand drive vehicles and include equipment that is not UK specification.

### Audi Customer Care

Every new Audi benefits from the comprehensive Audi Customer Care Package, which comprises:

- ▶ A 3-year Audi warranty, which covers you for unlimited mileage in the first 2 years of ownership, with a full mechanical and electrical warranty which covers you for up to 60,000 miles in the 3rd year
- ▶ A 3-year paint warranty
- ▶ A 12-year anti-corrosion warranty
- ▶ 3 years' UK roadside assistance and recovery

You also have the option when ordering your new car of choosing a 4-year or 5-year Audi warranty. Speak to a member of the sales team for more information.

Warranty terms and conditions apply. Please see [audi.co.uk/warrantyterms](http://audi.co.uk/warrantyterms) for further details.

### Audi tax-free sales

If you are entitled to purchase a vehicle free of VAT, normally through military or diplomatic privilege, please contact your local Audi Centre for full details.

Should you have any difficulty obtaining the information you require, please call 0870 241 5663.

## Audi Financial Services

Audi Financial Services specialises in providing funding solutions for Audi drivers. Whether your Audi is for private or business use, there is a range of funding options to choose from.

Below is the full range of finance products, which comprises:

- ▶ Solutions – a Personal Contract Plan
- ▶ Hire purchase
- ▶ Lease purchase
- ▶ Finance lease
- ▶ Contract hire

With all products, you can choose a fixed-cost maintenance plan designed to help you budget accurately.

No matter which Audi model you choose, your local Audi Centre can provide you with a personalised quote designed to fit your budget and motoring needs.

Audi Financial Services is a trading name of Volkswagen Financial Services (UK) Limited. An offer of finance depends on certain conditions. Available to people over 18 in the UK only.

### Audi Insurance

To ensure you can start enjoying your new car from day one, the first five days' insurance is included as standard with all new Audi models. To activate simply call 0330 303 6900, provide us with a few details, and we'll send a cover note to your Audi Centre.

They will then tax your car and you can drive it away. Telephone lines are open Monday to Friday 8am–8pm and Saturday 9am–4pm. For details of our full range of Insurance products visit [insurewithaudi.co.uk](http://insurewithaudi.co.uk)

# Additional information

## CO<sub>2</sub> data and information

### CO<sub>2</sub> emissions-based Vehicle Excise Duty

Vehicle Excise Duty (Road Fund Licence) is based upon the amount of Carbon Dioxide (CO<sub>2</sub>) a vehicle emits, measured in grams per kilometre (g/km). First year VED rates apply to the first year of ownership. Annual VED rates apply thereafter. The DVLA has created thirteen categories:

Petrol and Diesel engines	First year	Annual rate (second year onwards)
A – up to 100g/km	£0.00	£0.00
B – 101 to 110g/km	£0.00	£20.00
C – 111 to 120g/km	£0.00	£30.00
D – 121 to 130g/km	£0.00	£110.00
E – 131 to 140g/km	£130.00	£130.00
F – 141 to 150g/km	£145.00	£145.00
G – 151 to 165g/km	£180.00	£180.00
H – 166 to 175g/km	£295.00	£205.00
I – 176 to 185g/km	£350.00	£225.00
J – 186 to 200g/km	£490.00	£265.00
K – 201 to 225g/km	£640.00	£290.00
L – 226 to 255g/km	£870.00	£490.00
M – over 255g/km	£1,100.00	£505.00

Vehicle Excise Duty (VED) rates correct at time of going to print, but these may alter to reflect any change in the applicable VED rate.

### Audi Connect

An external data source is required to enable Audi Connect online services. One of two can be used:

1. A Bluetooth compatible mobile telephone with remote SIM Access Profile (rSAP). For mobile phone and software compatibility please visit [audi.co.uk/phonecompatibility](http://audi.co.uk/phonecompatibility) or your Audi Centre.
2. A separate SIM card which can be inserted in the included SIM card reader. When a separate SIM card is used, hands-free phone calls are possible using the SIM card or by connecting a different mobile telephone via Bluetooth Hands-Free Profile. For mobile phone and software compatibility please visit [audi.co.uk/phonecompatibility](http://audi.co.uk/phonecompatibility) or your Audi Centre.

Online services will only be available within the coverage of the mobile phone network; there may be additional costs for the use of these services (charges and billing correspond to the personal mobile phone contract or SIM card contract). Due to high data volumes, a mobile phone contract including an unlimited or high usage data plan is strongly recommended. The content and scope of the online-based services offered may vary.

When ordered as an option, a 36-month Audi Connect subscription is provided with your vehicle. The subscription runs from the point of vehicle delivery. Should you wish to continue to use Audi Connect after 36 months, please consult your Audi Centre for details (including the latest subscription fees).

Audi Connect services listed are correct at time of publication. We may add, change, replace or remove individual Audi Connect services or features at any time during your subscription.

Audi Connect enables access to the services of Google and Twitter. Permanent availability cannot be guaranteed as this is the responsibility of Google and Twitter. Google and the Google logo are registered trademarks of Google Inc.

The availability of services supported by Audi Connect varies from country to country and is dependent on the capability of your mobile phone. For mobile phone and software compatibility please visit [audi.co.uk/phonecompatibility](http://audi.co.uk/phonecompatibility) or your Audi Centre.







**Audi UK**

Customer Services  
Selectapost 29  
Sheffield  
S97 3FG  
0800 699888  
audi.co.uk

Information in this guide is subject  
to change without notice.

© Audi UK

Printed in the UK  
Edition 9.0 01/16  
2016 model year

Images are for illustrative purposes only.

