

AM/FM STEREO RECEIVER

SX-1980

OPERATING INSTRUCTIONS

S
S/G



SX-1980 is designed to operate from 110V, 120V, 220V or 240V main. Before turning on the power, please confirm the line voltage setting indicated on the rear of your unit corresponds to the supply voltage in your area; if not, change the setting as described in LINE VOLTAGE SELECTOR SWITCH on page 23.

CONTENTS

Features	2
Installation Cautions	3
Connection Diagram	4
Connections	6
Antenna and Ground Connections	8
Front Panel Facilities	10
Prior to Switching Power On	13
FM Reception	13
AM Reception	13
Playing Records	14
Using the Microphone	15
Using the AUX jacks	15
Effective Operations	18
Using the Tape Decks	18
Adaptor Jacks for Increased Versatility	19
Using PREAMP OUT and POWER AMP IN Jacks ..	20
Conditions Frequently Mistaken for Malfunction ..	21
Specifications	22
Line Voltage Selector Switch	23

 PIONEER®

FEATURES

Power Amplifier for a Continuous Power Output of 270 Watts Per Channel and for Ultra-stable Sound Reproduction

- The adoption of a single-stage differential amplifier with low-noise dual transistors, a current mirror load and a 3-stage Darlington triple SEPP circuit provides a bumper power output of 270 watts + 270 watts (continuous power output of 270 watts per channel, min., at 8 ohms from 20 Hertz to 20,000 Hertz with no more than 0.03% total harmonic distortion) which is extremely stable. These features also guarantee a stable operation at all times from low outputs to high outputs.
- The power amplifier is configured as a DC power amplifier with the capacitors removed from the NFB circuit for a flat gain response all the way from the lowest of the low frequencies up to the audio frequencies. At the same time, the design is engineered for low distortion with the incorporation of newly developed power transistors.
- The pre-drive stage is a highly dependable amplifier section featuring a power limiter circuit and an overdrive limiter which control the power output so that the power transistors are protected from damage when excessive loads are applied under high power output conditions.

Power Supplies with Large-sized Toroidal Transformers That Really Pack a Punch

- The large-sized toroidal transformers with their superb regulation employ 22,000 μ F large-capacity electrolytic capacitors (two for each channel). There are independent dual power supply circuits with separate power transformer windings to provide power for the left and right channels. Together, these two features make for a reproduction of sound that ensures excellent channel separation and the ultimate clarity even under high power conditions.
- There is an inrush current suppressor which serves to suppress high-value currents that will charge the power capacitors and also inrush currents from the power transformers. This circuit works to prevent excessive power from being applied to the internal circuitry of the receiver.

IC-based FM Tuner with High Selectivity, High S/N and Low Distortion

- The FM front end incorporates a two-stage RF circuit that employs a 5-gang tuning capacitor and three dual gate MOS FETs for high gain and low noise. This configuration excels in ridding the sound of undesirable

interference for impressive statistics: 1.5 μ V (IHF) sensitivity, more than 120dB spurious response ratio and more than 120dB image response ratio.

- The FM IF amplifier combines five dual-element ceramic filters with excellent group delay response with four IC's which contain quadrature detectors for a high selectivity (80dB) and a low distortion (MONO: 0.07% at 1kHz).
- The stereo demodulator employs an NFB-type PLL MPX IC with a self-contained automatic pilot canceller which automatically cancels out the pilot signals without reducing the high-end frequency. This means that the leak carrier level is amply suppressed for a tip-top separation and flat frequency response in the reproduction frequency band.
- The local oscillator includes Pioneer's very own quartz sampling locked APC (Automatic Phase Control). The output of this extremely precise quartz oscillator is divided into frequencies of 100kHz and so reception frequencies which are a multiple of 100kHz are locked at every 100kHz. This means that the tuning condition is always maintained at its peak even if there are fluctuations in the temperature or humidity.
- After tuning in the station (a broadcasting station whose broadcasting frequency is a multiple of 100kHz), the quartz sampling locked APC will be actuated when you remove your hand from the tuning knob, and it will lock the optimum tuning point. This is what Pioneer calls its 'touch tuning system.'

Reduced Distortion AM Circuit

Careful engineering is also evident in the AM tuner circuit. Automatic gain control in the RF and IF stages, together with a 3-gang variable capacitor and IC circuitry deliver improved image ratio, selectivity and frequency response, plus reduced distortion.

Equalizer Amplifier with High Allowable PHONO Inputs for Low Distortion and High S/N Ratio

- The first stage employs a differential amplifier that features a newly developed super-low-noise dual FET (Field Effect Transistor), while the final stage employs a pure complementary SEPP circuit. These two features yield a signal-to-noise ratio of 87dB (IHF-A) and a maximum allowable PHONO input of 300mV (1kHz) with respect to rating of 2.5mV. Pioneer has also improved the transient response and combined with the wide dynamic range this helps to ensure enjoyment of record play at very low distortion levels even when using high-output phono cartridges or when the music source has high output peaks.
- The equalizer elements which are designed to produce the RIAA characteristics use high-precision parts to keep the equalizer deviation between 20Hz - 20kHz down to ± 0.2 dB for faithful sound reproduction from records.

Other Features

Twin bass and treble tone controls: Pioneer has applied its originally developed twin tone controls to this receiver. Along with conventional bass and treble controls, knobs are provided for adjusting the ultra-deep bass and the ultra-high treble independently. By combining the operation of the main and sub tone controls, it is possible to undertake a wide range of tone adjustments. Furthermore, there is an ON/OFF tone control switch which can be used to make the frequency response flat at a moment's notice and to monitor the acoustics of the listening room, as well as the sound produced by the speakers and phono cartridge.

PHONO 1 CARTRIDGE LOAD switch: The PHONO 1 input circuit is provided with a cartridge load knob which can be used to obtain the optimum input resistance (ohms) and capacitance (pF) in accordance with the characteristics of the MM (moving magnet), MI (moving iron) and IM (induced magnet) types of cartridges. Moreover, by selecting load resistances and capacitances which are beyond the range of those designated, it is possible to enjoy subtle variations in the sound quality of the phono cartridges.

Highly reliable protection circuitry: In order to protect the speakers and the power transistors, this receiver features a newly developed protection IC as well as a special muting circuit that cuts out the noise produced by the on/off operation of the power switch. Needless to say, these are very dependable and stable protection circuits.

ADAPTOR switch and FM 25 μ s switch: The receiver's front panel is equipped with a de-emphasis selector switch

which is useful when the receiver is tuned into an FM Dolby* station. Also provided are ADAPTOR jacks and an ADAPTOR switch in addition to the two sets of TAPE jacks. This facilitates operation when the receiver is set up for the reception of an FM Dolby broadcast.

TAPE DUPLICATE switch: This switch allows you to use two tape decks to edit or duplicate material recorded on one tape to another. Duplication from an open-reel deck to a cassette deck, for example, can be performed in a one-touch operation.

Peak power meters: Each channel has its own peak power meter (0.01W - 540W display range) with a logarithmic compression scale. These meters feature a fast response speed, and they enable you to read out the power values at an 8-ohm impedance across a power band stretching from 0.01W up to the maximum output of the receiver.

FM multipath switch: Set this switch to ON and use it to locate the height and direction of the FM antenna which do not produce any multipath interference when you are deciding on a location for the antenna.

8kHz (high) and 15Hz (low) filter switches: Featured are an active filter for 12dB/octave attenuation at frequencies below 15Hz in order to eliminate ultra-low-range noise generated by warps in the records, and also an 8kHz (12dB/oct attenuation) filter that eliminates high-range noise such as that produced by scratches on the records and hiss.

* The word "Dolby" is a trademark of Dolby Laboratories Inc.

INSTALLATION CAUTIONS

To ensure the best sound quality and trouble-free operation, avoid setting up the SX-1980 in any of the locations described below.

Location liable to downgrade performance and result in breakdowns	Resulting trouble
1. Locations exposed to direct sunlight, or near heaters.	1. External heat causes the performance of the circuit parts to deteriorate, and operation becomes unstable.
2. Locations with poor ventilation, or with high humidity or moisture contents, or dusty locations.	2. Cause of faulty contact in input/output terminals, and rust. High humidity and a high moisture content cause deterioration in insulation. There is also the danger of current leakage and heat generation in the circuit parts. Dust or grease in the rotating parts causes the parts to deteriorate.
3. Locations susceptible to vibration.	3. These locations affect the precision parts adversely.
4. Locations where an AM radio or TV set is being used simultaneously.	4. Mutual interference can occur from the oscillator circuits used in these products.

Don't put anything on the top of the receiver because high power receiver will produce a lot of heat. Also leave sufficient around the receiver for adequate ventilation.

CONNECTION DIAGRAM

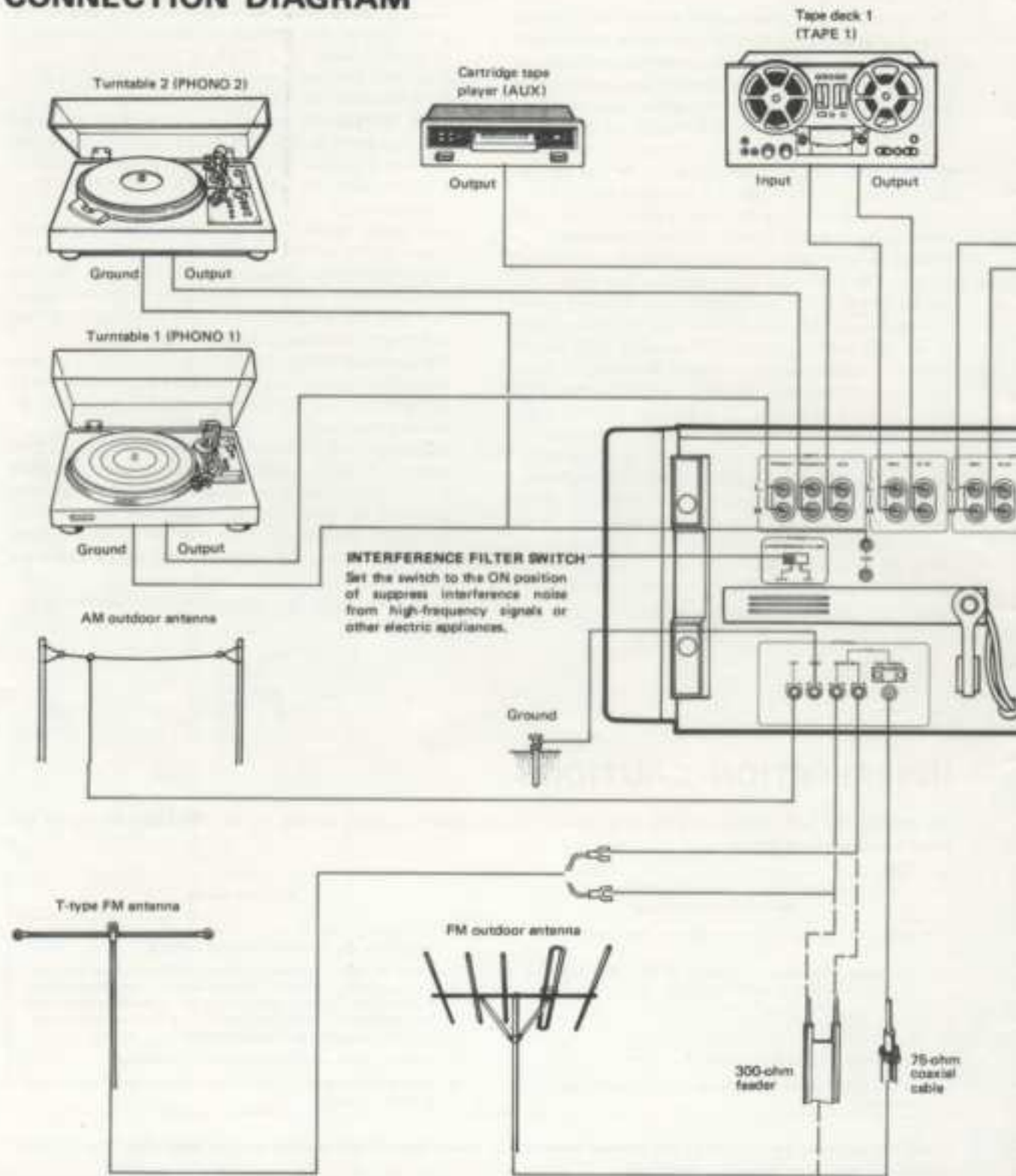

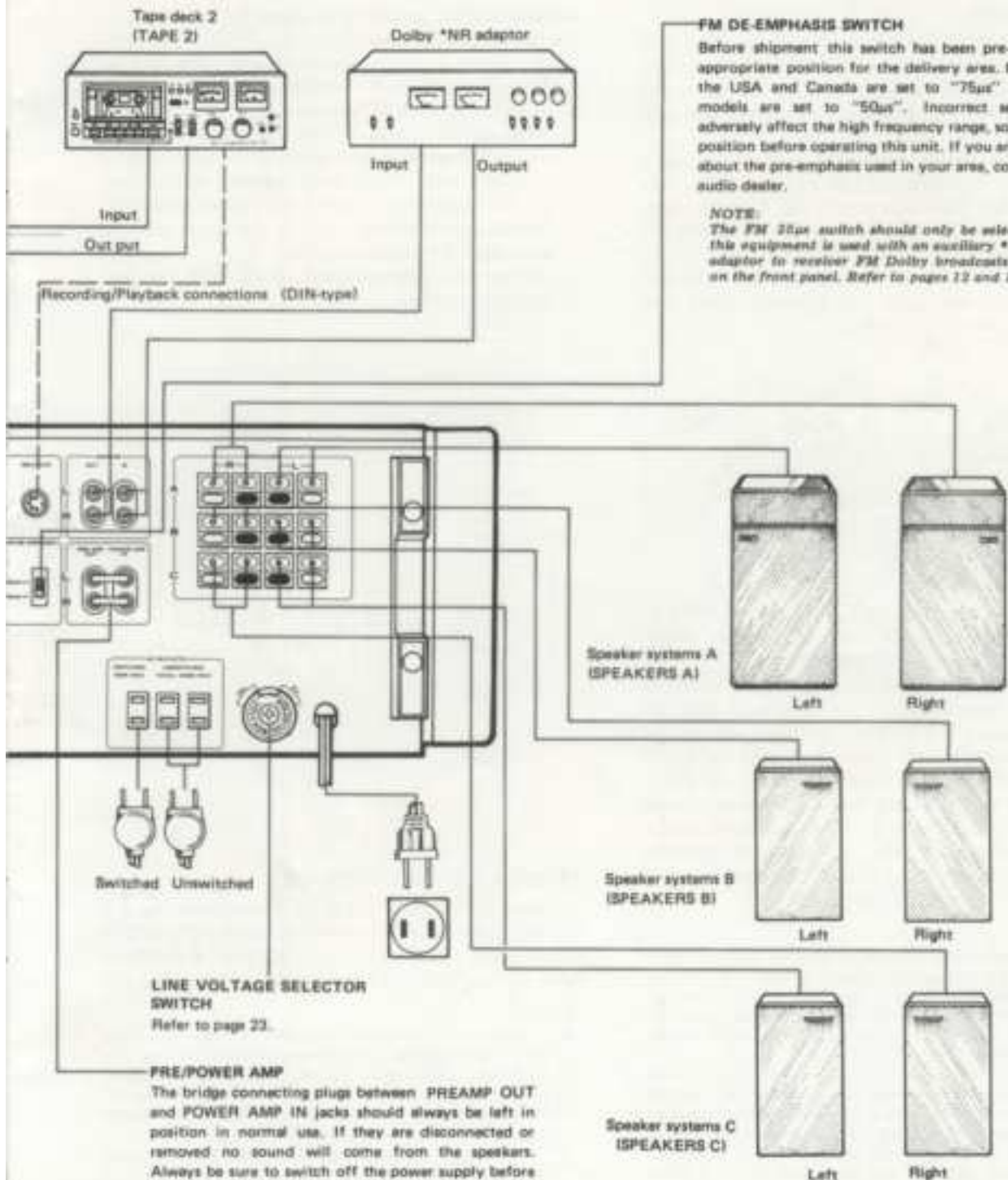

FM DE-EMPHASIS SWITCH

Before shipment this switch has been pre-set to the appropriate position for the delivery area. Models for the USA and Canada are set to "75µs" and other models are set to "50µs". Incorrect setting will adversely affect the high frequency range, so check the position before operating this unit. If you are in doubt about the pre-emphasis used in your area, consult your audio dealer.

NOTE:

The FM 75µs switch should only be selected when this equipment is used with an auxiliary *Dolby NR adaptor in receiver FM Dolby broadcasts is located on the front panel. Refer to pages 12 and 19.

LINE VOLTAGE SELECTOR SWITCH
Refer to page 23.

PRE/POWER AMP
The bridge connecting plugs between PREAMP OUT and POWER AMP IN jacks should always be left in position in normal use. If they are disconnected or removed no sound will come from the speakers. Always be sure to switch off the power supply before attempting to remove them. Refer to the section "USING THE PRE AMP OUT AND POWER AMP IN JACKS" on page 20.

* The word "Dolby" is a trademark of Dolby Laboratories Inc.

CONNECTIONS

PRECAUTIONS

- Set the POWER switch to ON only when you have completed all the connections of the stereo system. Always set this switch to its lower position (OFF) if you want to change the connections.
- All the receiver's jacks are aligned for easy connection in two rows: the top row for L (left channel) and the bottom row for R (right channel). Always connect L to L and R to R with the audio component outputs and input jacks.
- Make sure that the connections are secure. Improper connections can generate noise and cause the sound to be cut off.

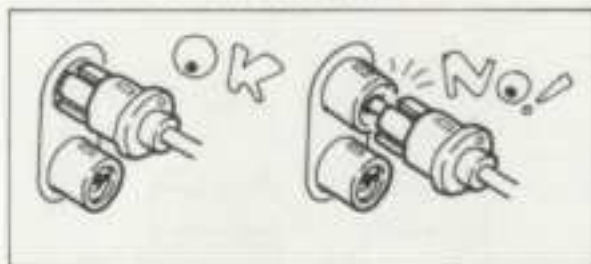

SPEAKER SYSTEMS

The receiver is provided with three sets of SPEAKERS output terminals. Use the A set when connecting only one set of speakers.

Viewed from the front, the R (right channel) SPEAKERS terminals are on the right and the L (left channel) SPEAKERS terminals are on the left. Connect the left channel speaker to the L terminals and the right channel speaker to the R terminals. The red L and R SPEAKERS terminals have a plus polarity and the black terminals have a minus polarity just like the speaker systems themselves. When connecting, always connect minus to minus and plus to plus (Fig. 1).

NOTES:

1. If you want to use two sets of speaker systems, make sure that the impedance of each system is 8 ohms or more. If the impedance is less than 8 ohms, the protective circuitry will be actuated when the volume is turned up and you will not be able to enjoy proper stereo performance.
2. The high output power of this receiver requires that the speaker lead wires have an ample current carrying capacity. Use wires with a high capacity and connect them securely. If you use low capacity wires and do not connect them properly, the reproduced sound will be adversely affected and heat generation or short circuits may be caused.
3. This receiver delivers a high output power and so make sure that you use speakers with a high allowable input.

Connecting the speaker lead wires to the SPEAKERS terminals

1. Do not plug the receiver's power cord into an AC outlet before the speakers are fully connected to the SPEAKERS terminals.
2. Strip about 10mm of the insulation from the end of the speaker lead wires. If the conductor is stranded, twist the strands together so that they do not come into contact with other terminals.
3. Depress the terminal buttons and insert the lead wires into the terminal holes.
4. Release the buttons and check that the lead wires are secure.

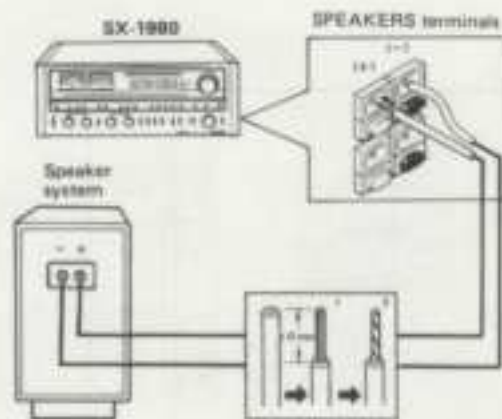

Fig. 1

TURNTABLE CONNECTIONS

Connect the output cords of a turntable using a moving magnet (MM) cartridge to the PHONO 1 input jacks. Connect the ground lead of the turntable to the GND terminal on the receiver (Fig. 2).

NOTES:

- In addition to turntables using MM cartridges, there are others that employ induced magnet (IM), moving iron (MI) and high-output moving coil (MC) cartridges. If you intend to use a turntable with a low-output MC cartridge, always provide a special MC cartridge boosting transformer or head amplifier.
- Connect your second turntable to the PHONO 2 input jacks.
- If your turntable is fitted with two tonearms, the output cords for each of the tonearms should be connected to the PHONO 1 and PHONO 2 input jacks.

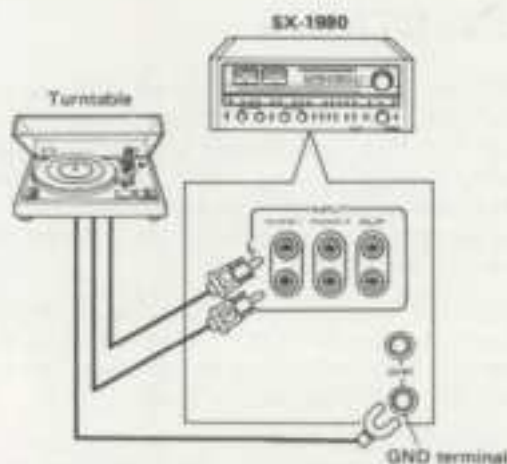

Fig. 2

TAPE DECK CONNECTIONS

The receiver is provided with two sets of recording (TAPE REC) output jacks and two sets of playback (TAPE PLAY) input jacks. Connect each of the jacks in the following way using the connecting cords which come with the tape deck. The upper row of jacks is for the left channel (L) and the lower row for the right channel (R) (Fig. 3).

Connections for recording

Connect the recording input jacks (LINE INPUT) on the tape deck to the TAPE 1 REC jacks on the receiver.

Connections for playback

Connect the playback output jacks (LINE OUTPUT) on the tape deck to the TAPE 1 PLAY jacks on the receiver.

NOTE:

Connect your second tape deck to the TAPE 2 jacks (REC, PLAY).

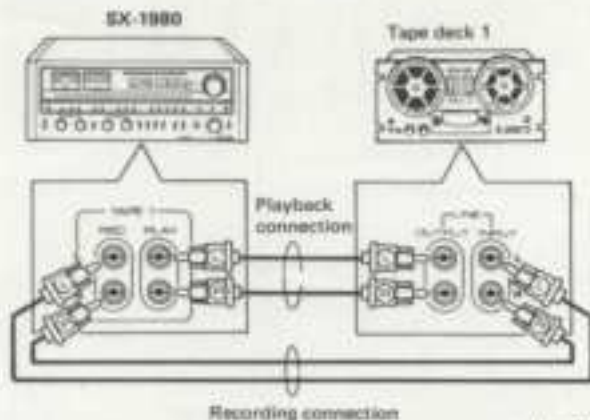

Fig. 3

Connections using the recording/playback connector (DIN cord)

If your tape deck is equipped with a recording/playback connector (DIN-type), use the optional recording/playback cord to connect this connector with the TAPE 2 REC/PLAY jack on the receiver. This means that the deck and receiver are now set up for both recording and playback. In such cases, do not connect pin cords (ordinary pin plug cords) to the TAPE 2 REC and PLAY jacks.

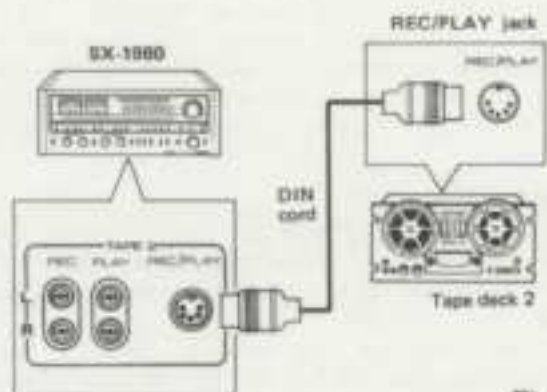

Fig. 4

AC OUTLETS AND POWER PLUGS

Plug the power plug of your audio components into the SWITCHED and UNSWITCHED convenience outlets.

SWITCHED. . . . The power supplied through this outlet is coupled to the operation of the receiver's POWER switch; so when the POWER switch is turned to ON, power is supplied through this outlet and when turned to OFF, power is cut off. For instance, if you connect a turntable to the outlet and keep its power switch at ON, you can turn it on and off by turning the receiver's POWER switch on and off. The maximum power capacity which may be connected to the SWITCHED outlet is 50W.

UNSWITCHED. . . . Power is always supplied through these two outlets regardless of the position of the POWER switch. The maximum power capacity which may be connected to these two outlets is 100W.

- Never connect an iron or a toaster to these outlets.
- Do not get the power outlets and the power plugs wet or touch them with wet hands, since you may get an electric shock.

ANTENNA AND GROUND CONNECTIONS

FM ANTENNA CONNECTIONS

The signals transmitted by an FM broadcasting station inevitably become weak when received behind mountains, between buildings and inside reinforced concrete structures. In weak-signal areas, signals which are reflected off mountains and other obstacles in their path may be picked up by the antenna which causes a multipath effect. This affects the sound received adversely. This is why it is necessary to choose an antenna and an installation location which are best suited to cope with the ambient conditions and the strength of the signals. For further details on multipath refer to page 9.

Special FM antennas

It is recommended that you use a special FM antenna in order to obtain input signals which will allow your receiver to display its capabilities to the full.

- When installing your antenna, refer to the instructions in FM RECEPTION on page 13 and determine in which direction the antenna should point for the best reception, all the while listening to a broadcast to check the reception. Mount the antenna securely.
- In accordance with the application of the antenna, use a 75-ohm coaxial cable or a 300-ohm feeder to connect the antenna to the receiver.

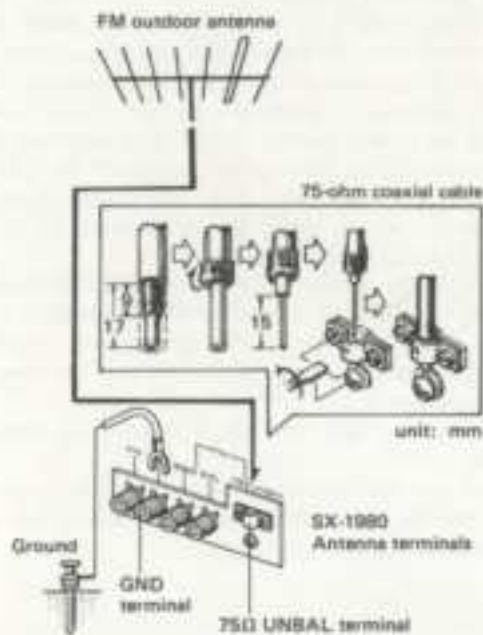

Fig. 5

75-ohm coaxial cable: As shown in Fig. 5, connect the cable to the 75Ω UNBAL terminal of the receiver. This cable is used in locations near roads with a great deal of traffic, and near overhead high-tension power lines which generate a lot of noise. It is also used when the antenna and the receiver are far apart.

300-ohm feeder: As shown in Fig. 6, connect the feeder to the 300Ω BAL terminals. Use it when there is little external noise and when the antenna and the receiver are not far apart.

NOTE:

Consult your nearest audio dealer concerning the special FM antenna and the 75-ohm coaxial cable.

T-type antenna

When the broadcasting station is located nearby and when the FM signals are strong in wooden frame buildings and others, you can use the accessory T-type antenna.

As shown in Fig. 6, connect the end of the T-type antenna to the 300Ω terminals. Spread the two arms of the antenna horizontally and while listening to an FM station, rotate the antenna through 180 degrees and position it for the best reception. Tape the antenna to a wall or ceiling.

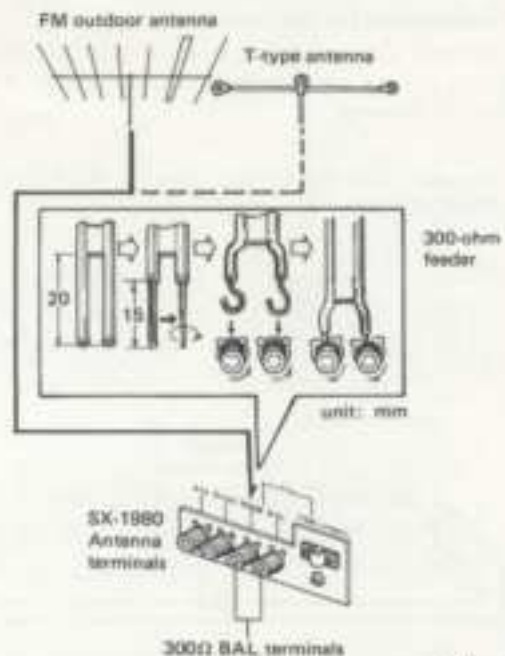

Fig. 6

AM ANTENNA CONNECTION

Move the AM bar antenna on the rear panel of the receiver and find the best reception position, all the while following the instructions outlined on page 13 under 'AM RECEPTION.'

- If you still cannot obtain good reception even by moving the AM bar antenna, erect an indoor AM antenna with a vinyl insulated wire (about 5-6 meters long). As shown in Fig. 8, connect the lead wire to the AM antenna terminal, and tape it to the wall or ceiling.
- If you live in an area where the reception is poor even if you erect an indoor AM antenna, use a tree to erect an outdoor AM antenna with a vinyl insulated wire (Fig. 8).

GROUNDING

As shown in Fig. 5, connect a ground wire the GND terminal on the receiver for maximum safety and noise reduction. Never make this connection near gas pipes and other potentially dangerous locations.



Fig. 7

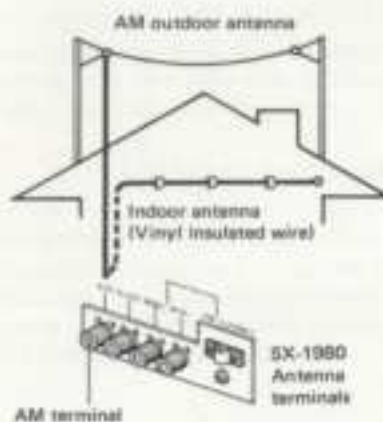

Fig. 8

FM MULTIPATH REFLECTION

This phenomenon is mainly caused, as illustrated in Fig. 9, when the direct signals from an FM station are reflected by objects such as mountains and buildings. Both the direct and the reflected signals then enter the receiving antenna from different directions, and the slight timing difference due to the different paths results in mutual interference between the signals. The received sound is then affected by phase distortion, and both the signal-to-noise ratio and the channel separation are downgraded. In particular, weak-signal areas and locations are most susceptible to these effects.

Orientation

1. Tune into the FM broadcasting station, following the procedure on page 13.
2. Depress the FM MULTIPATH button. This will produce multipath sound from the speaker systems or headphones.
3. Adjust the height and direction of the antenna so that the multipath sound is canceled out or reduced to the minimum and so that the signal meter pointer deflects as far to the right as possible.
4. Release the FM MULTIPATH button.
5. Check that the FM station is being optimally received.

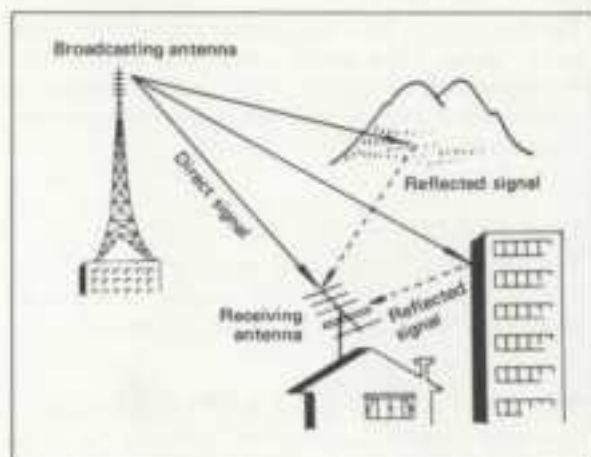

Fig. 9

FRONT PANEL FACILITIES

FILTER BUTTONS

15Hz .. When this button is pressed, a 12dB/oct attenuation can be provided for frequencies below 15Hz. This means that you can cancel out noise in the ultra-low frequencies which is generated by low-pitched rumble from a turntable and other forms of distortion. Although this noise cannot be heard, it can generate intermodulation distortion and damage the speakers.

8kHz .. Press this button to provide a 12dB/oct attenuation at frequencies above 8kHz. Set it to this position when you find high-frequency noise, such as that from scratched records, unpleasant.

SPEAKERS BUTTONS

Press the button corresponding to the speakers connected to the **SPEAKERS** terminals (A, B, C) on the rear panel. You can press two of these buttons to listen to sound from two pairs of speaker systems at the same time.

NOTE:

No sound will be heard through the speakers if all three buttons are pressed at the same time.

PHONES JACK

Plug the headphones into this jack when you want to listen through your stereo headphones.

Release all the **SPEAKERS** buttons if you want to listen to the sound through your headphones only. (This means that all three buttons will be released).

POWER SWITCH

Flip this switch to the **ON** position to supply power to the stereo receiver. There will be a short delay when it is set to **ON**, because the muting circuit has been actuated to suppress the unpleasant noise that is sometimes generated when the power is switched on and off.

TONE SWITCH

Set this switch to **ON** when adjusting the **BASS** and **TREBLE** controls. In the **OFF** position, it causes the amplifier to operate with a flat frequency response.

TWIN BASS AND TREBLE CONTROLS

Use these controls to adjust the bass and the treble. For further details, refer to 'Twin **BASS** and **TREBLE** tone controls' on page 16.

FUNCTION BUTTONS

Press the function button which corresponds to the program source. Turn the **VOLUME** control down first before selecting a different function button while the sound from one program source is being reproduced.

FM .. Press this button for FM broadcasts.

The **FM STEREO** indicators light up when the receiver is tuned into an FM stereo broadcast. The sound is automatically received monophonically during FM monophonic broadcasts.

AM .. Press this button for AM broadcasts.

MEMORY MARKERS

These are very convenient for frequent tuning in to the same broadcasting station.

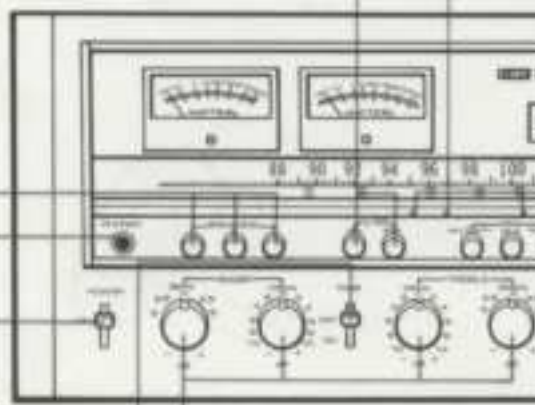

TAPE DUPLICATE SWITCH

Set this switch to **ON** when you want to duplicate or edit a pre-recorded tape using two tape decks. For further details, refer to 'Using the tape decks' on page 18.

TAPE MONITOR SWITCHES (1, 2)

Set switch 1 to **ON** with a tape deck which is connected to the **TAPE 1** jacks (**REC** and **PLAY**) when you want to monitor the playback or recording of a tape. The tape on a deck which is connected to the **TAPE 2** jacks (**REC** and **PLAY**) can be similarly monitored by setting switch 2 to **ON**. For further details, refer to 'Using the tape decks' on page 18.

NOTE:

Set these switches to the upper (off) position when listening to records or a broadcast.

Continued next page

AUX Press this button when listening to an audio component connected to the AUX input jacks.

PHONO 2/MIC . . . Press this button when playing a record on the turntable connected to the PHONO 2 jacks, or when using a microphone which you have plugged into the MIC jack.

PHONO 1 Press this button when playing a record on the turntable connected to the PHONO 1 jacks.

NOTES:

1. Unplug the microphone from the MIC jack when you do not intend to use the microphone otherwise you will not be able to use the PHONO 2 jacks.
2. Only one function button should be pressed at a time.

PHONO 1 CARTRIDGE LOAD SWITCH

Use this knob to select the input impedance (ohms) and the input capacitance (pF) in accordance with the specified load impedance and load capacitance of the moving magnet (MM) cartridge connected to the PHONO 1 jacks. For further details, refer to page 14.

MIC JACK

Plug your microphone into this jack. The microphone signals are reproduced in mono through the left and right speakers.

NOTE:

A high impedance (approx. 50 kilohms) dynamic type microphone with a standard plug can be connected to this jack.

VOLUME CONTROL

Use this control to adjust the output level to the speakers and headphones. Turn it clockwise to increase the output level. No sound will be heard if you set it to ∞. The scale is graduated in dB which indicate the attenuation when the maximum output level is 0dB.

MUTING SWITCH

Set this switch to the -20dB position to attenuate the audio output indicated by the VOLUME control by 20dB. There is no need to adjust the VOLUME control if you use this switch when turning down the audio output temporarily and when changing over records or tapes. For further details, refer to page 17.

BALANCE CONTROL

Use this control to balance the volume of the left and right channels. First, however, set the MODE switch to MONO, and adjust so that the sound appears to come from somewhere exactly between the two speakers. If the sound appears to be louder on the right, it means that the volume of the right channel is higher. Turn the BALANCE control to the left and adjust. Conversely, if the sound appears to be louder on the left, it means that the volume of the left channel is higher. Therefore, turn the BALANCE control to the right and adjust. After adjusting, return the MODE switch to STEREO.

LOUDNESS SWITCH

Set this switch to ON when listening at a low volume. The frequency response of the human ear varies according to the listening volume, and setting this switch to the ON position compensates for hearing response by emphasizing the bass and treble.

MODE SWITCH

Use this switch for selecting mono or stereo performances.

STEREO: Set to this position for normal stereo operation.

MONO: When set to this position, the left and right channel signals will be mixed and reproduced monophonically from both speaker systems.

ADAPTOR SWITCH

Set this switch to ON when reproducing sound from an optional component which has been connected to the ADAPTOR jacks. Always set it to its upper position if you are not using a component with these terminals. For further details, refer to 'Adaptor Jacks for Increased Versatility' on page 19.

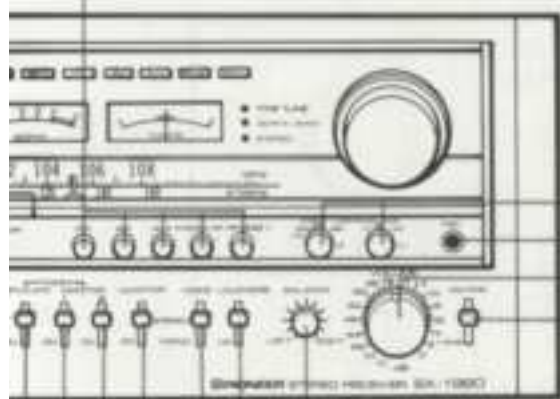

POWER METERS

These power meters allow you to read out the rated power level when speakers with a nominal impedance of 8 ohms are connected to the receiver's speaker terminals.

NOTE:

These values are related to the impedance of the speakers and they vary according to the frequency. In order to find out the exact output level, connect an 8-ohm dummy load instead of the speakers.

SIGNAL METER

When tuning in to an AM or FM station, the optimum reception position is indicated by the maximum deflection of the meter pointer to the right.

SPEAKER INDICATOR

QUARTZ-LOCKED INDICATOR

When you let go of the tuning knob which has been used to tune an FM station for optimum reception, the FINE TUNE indicator will go off and this indicator will come on.

The automatic phase control circuit is actuated and it tunes the receiver correctly into the frequency of the broadcasting station and locks on to this frequency. (This indicator will not light up with stations whose broadcasting frequency is not a multiple of 100kHz.)

FINE TUNE INDICATOR

This indicator lights up to show the optimum tuning position on the tuning dial of an FM station when the pointer of the TUNING meter deflects to near the center. (This indicator will not light up with stations whose broadcasting frequency is not a multiple of 100kHz.)

FUNCTION INDICATOR

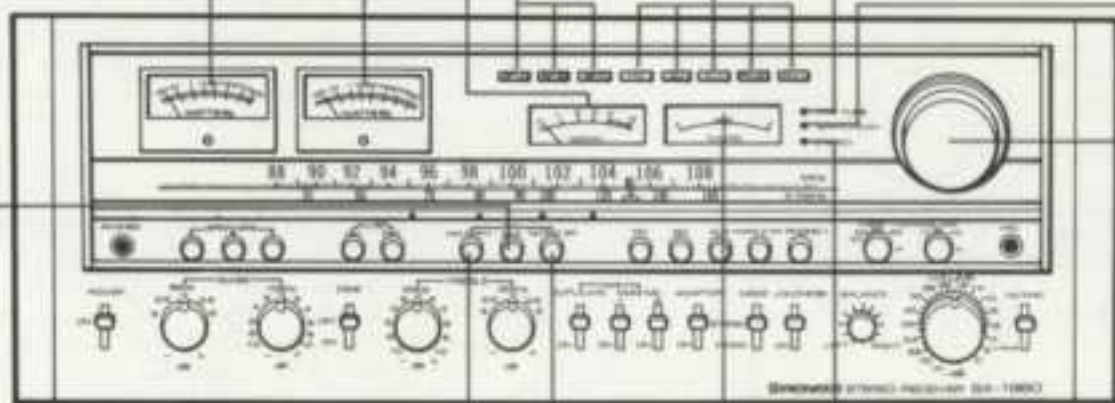

FM MULTIPATH BUTTON

Use this button to detect multipath sound when installing the FM antenna in a position which yields the minimum multipath interference. For further details, refer to "Orientation" on page 9.

FM 25µS BUTTON

Press this button when listening to a Dolby FM broadcast; otherwise keep this button at the released position. For further details, refer to page 19.

FM MUTING BUTTON

ON (released position) . . . Release this button to suppress unpleasant inter-station noise when tuning in to FM stations.

OFF (depressed position) . . . Depress this button to pick up weak stations.

STEREO INDICATOR

This indicator lights up when the receiver is tuned to receive an FM stereo broadcast.

TUNING METER

When tuning in an FM station, the optimum reception position is indicated when the meter pointer deflects to dead center. Check that the SIGNAL meter pointer has deflected as far to the right as possible.

TUNING KNOB

Use this to tune in to broadcasting stations. Select the station and tune for optimum reception by observing the SIGNAL meter for AM stations and both the SIGNAL and TUNING meters for FM stations.

PRIOR TO SWITCHING POWER ON

Before switching the power on, set the various controls as follows:

- Set the two FILTER buttons to the released positions.
- Press the SPEAKERS button that corresponds to the speaker system which is connected to the SPEAKERS terminals on the rear panel.
- Set the FM 25 μ S button to the released position.
- Set the FM MULTIPATH button to released position.
- Set the FM MUTING button to the released position (ON).
- Set the VOLUME control to the ∞ position.
- Set the BALANCE control to the center position.
- Set the MODE switch to STEREO.
- Set the TAPE MONITOR and the ADAPTOR switches to the upper positions (OFF).
- Set the DUPLICATE switch to the upper position (OFF).
- Set the TONE switch to OFF.

FM RECEPTION

1. Press the FM function button.
2. Slightly turn the VOLUME control clockwise direction to obtain the sound.
3. Select the broadcasting station with the tuning knob. See Fig. 10.

When the frequency of the broadcasting station is a multiple of 100kHz, this frequency will be locked by the APC circuit if the tuning knob is turned according to the procedure outlined below.

- Choose a point where the SIGNAL meter pointer deflects to the far right.
 - After the TUNING meter pointer has deflected to the far left or far right, adjust so that it indicates the center.
 - When the TUNING meter pointer comes within the center marker and is positioned almost dead center, adjust the TUNING knob finely so that the FINE TUNE indicator comes on.
- When this indicator lights up, this denotes the optimum tuning point.
- When the program is in stereo, the STEREO indicator will light up.
- When the FINE TUNE indicator comes on, let go of the tuning knob and the QUARTZ LOCKED indicator will come on to indicate that the tuning knob is locked to the frequency of the broadcasting station.

When the FINE TUNE indicator does not come on even if the SIGNAL meter pointer deflects, press the MUTING switch (to OFF) and re-tune the station. In this case, APC circuit does not work.

When tuning stations whose frequency is not a multiple of 100kHz.

- As shown in Fig. 10 adjust so that the SIGNAL meter pointer deflects to the far right, and then adjust so that the TUNING meter pointer is

positioned in the center.

If the signals are weak and it is difficult to receive the station, press the FM MUTING switch and then re-tune the station.

If the program is being broadcast in stereo, the STEREO indicator will come on.

NOTE:

When you use the tuning knob to tune in a station, do not put your other hand on the front panel of the receiver since this will cause interference.

4. Adjust the volume with the VOLUME control.
5. To adjust the tone, first set the TONE switch to ON, and then adjust the BASS and TREBLE controls for the preferred bass and treble levels.

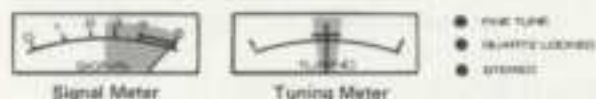

Fig. 10

AM RECEPTION

1. Depress the AM function button.
2. Slightly turn the VOLUME control clockwise direction to obtain the sound.
3. Turn the tuning knob to select a station. The best reception is obtained when the signal meter pointer deflects to the extreme right (see Fig. 10).
4. Adjust the volume with the VOLUME control.
5. To adjust the tone, first set the TONE switch to ON, and then adjust the BASS and TREBLE controls for the preferred bass and treble levels.

NOTE:

If, when listening to either an FM or AM broadcast, your listening pleasure is seriously affected by poor sensitivity or strong interference, refer to the section 'ANTENNA AND GROUND CONNECTIONS' on page 8, and make any necessary changes.

PLAYING RECORDS

1. If your turntable is connected to the PHONO 1 input jacks, depress the PHONO 1 function button. If it is connected to the PHONO 2 input jacks, depress the PHONO 2 function button.
- When the cartridge connected to the PHONO 1 jacks is a moving magnet type, set the PHONO 1 CARTRIDGE LOAD switches to the appropriate position in accordance with the "Load Resistance and Load Capacitance."
2. Operate the turntable to play the record.
3. Adjust the volume with the VOLUME control.
4. To adjust the tone, first set the TONE switch to ON, and then adjust the BASS and TREBLE controls for the preferred bass and treble levels.

Precautions when playing records

- Lower the stylus gently onto the surface of the record. It is a good idea to set the MUTING switch to -20dB or to turn the volume down when lowering the stylus onto the record.
- Depress the 15Hz button if there is a great deal of noise or if the speaker cone paper is seen to be moving despite the fact that you cannot hear the sound during a performance.
- To reduce other electric appliance noise during record play turn the PHONO INTERFERENCE FILTER switch on the rear panel ON.
- Do not cause the turntable to vibrate while a record is being played since this will cause the stylus to jump and scratch the record. Do not turn off the power if the stylus is still tracing grooves on the record.

LOAD RESISTANCE AND LOAD CAPACITANCE

Typical moving magnet (MM) cartridges have resonance peaks at high frequencies, as is shown in Fig. 12. However, the height of the peaks can be varied by changing the load resistance ($k\Omega$). The peaks increase as the resistance is increased. In addition, the resonance frequency (center of the peak frequency) can be varied by changing the load capacitance (pF), as is shown in Fig. 13. If the capacitance is increased, then the resonance frequency is lowered and the peaks are increased.



Fig. 11

To provide the best characteristics of your cartridge, set the 'pF' and " $k\Omega$ " PHONO 1 CARTRIDGE LOAD switches, following the instructions outlined below. By combining these two knobs, you will be able to obtain a variety of different high-frequency responses.

When the phono cartridge load resistance and capacitance are specified

- Set the specified load resistance with the ' $k\Omega$ ' knob.
- Subtract the turntable capacitance (stray capacitance of the output cord, tonearm, etc.) from the cartridge's specified capacitance and select this value with the 'pF' knob.

NOTES:

- Refer to the operating instructions of the cartridge for the specified load resistance and capacitance values.
- Since the turntable capacitance varies with the output cord, wiring and other factors, a precise value cannot be definitely determined. In general, however, it can be considered to be in the range of 100pF to 200pF. Adjust the load capacitance while listening to a record.

When not specified

The example in Fig. 13 shows typical high-end frequency curves. In a case like this, adjust both knobs for the desired response while listening to a record. With ordinary MM cartridges, the values are 50kiloohms and 100pF-200pF.

Examples of frequency response variations due to CARTRIDGE LOAD $k\Omega$ knob settings



Fig. 12

Examples of frequency response variations due to pF knob settings



Fig. 13

Makes of cartridges and recommended loads

Manufacturer	Cartridge (power generating type)	Load resistance (ohms)	Load capacitance (pF)
Pioneer	PC-550E/S (MM)	47k	170
ADC	XLM MKII (IM)	47k	275
AKG	PSE (MI)	47k	400
Empire	2000Z (MI)	47k	300
Ortofon	VMS20E (MI)	47k	400
Shure	V15 TYPE III (MM)	47k	400-500
Stanton	680 EE (MI)	47k	275

The capacitance of Pioneer's turntables ranges from 75pF to 150pF. Subtract the capacitance from the load capacitance shown in the table, and then set the switch to the value which is closest to the resulting figure.

For example, say you are using the PC-550E/II by Pioneer. Subtract 100pF from 170pF which gives 70pF. Set the PHONO 1 CARTRIDGE LOAD switch to the closest figure, which is "100" (pF).

USING THE MICROPHONE

1. Connect the microphone to the MIC jack.
2. Depress the PHONO 2/MIC function button.
3. Adjust the sound level by turning the VOLUME control gradually to the right.

NOTES:

1. You should unplug the microphone jack when not using the microphone, otherwise you cannot use the turntable connected to PHONO 2 jacks.
2. You should use high impedance (above 50 kilohms) microphones of the dynamic type, with standard 6mm diameter phones plug.
3. Under certain conditions, microphone is liable to give rise to howl or feedback noise. Take care not to raise the volume too much when the microphone is close to the speaker systems or in a room with a great deal of resonance. It is a good idea to set the BASS and TREBLE controls to their center positions or switch the TONE switch to the OFF position.
4. You cannot use the microphone to perform mixing operations with other program sources.

USING THE AUX JACKS

You can connect an 8-track cartridge tape player, TV tuner, second tuner or tape deck playback output to these jacks. (See Fig. 15).

PROCEED AS FOLLOWS:

1. Depress the AUX function button.
2. Operate the audio component which you have connected to the AUX jacks.
3. Adjust the volume with the VOLUME control.
4. To adjust the tone, first set the TONE switch to ON, and then adjust the BASS and TREBLE controls for the preferred bass and treble levels.

PROTECTION CIRCUIT

For some 6 to 10 seconds after the receiver is switched ON, no sound will be heard. This is due to the operation of protection circuits which are designed to safeguard transistors and speakers from possible damage, due chiefly to switching transients, etc. Should the receiver remain silent for considerably longer than this, switch off and check the speaker system connections. Should the receiver suddenly go silent while you are listening to it, and a continuous series of "clicks" can be heard due to relay contacts opening and closing within the receiver, this can be an indication of a short circuit in the speaker system connections. Switch off, and re-check the speaker system impedances, etc. The protection circuit re-sets itself automatically, so that normal operation is resumed as soon as the fault is cured.

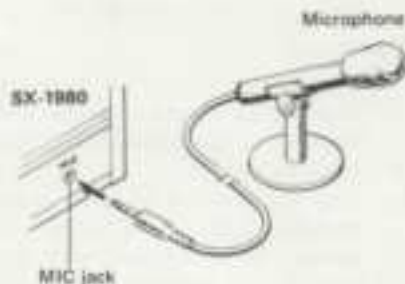

Fig. 14

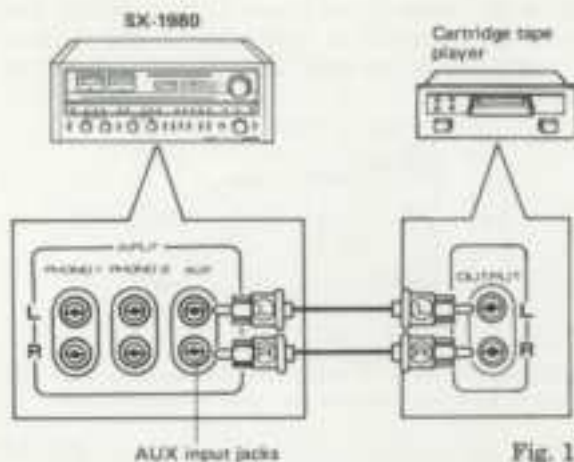

Fig. 15

EFFECTIVE OPERATIONS

TWIN BASS AND TREBLE TONE CONTROLS

Main and sub-controls make up the twin control system, as is illustrated in Fig. 16. Adjust each of the controls for the following sound effects.



Fig. 16

BASS controls

100Hz... (main) This control can be used to adjust frequencies lower than 400Hz to enhance or attenuate the frequency by 10dB at 100Hz.

50Hz... (sub) This control can be used to adjust frequencies lower than 200Hz, which have already been adjusted with the 100Hz control, to enhance or attenuate the frequency by 5dB at 50Hz.

TREBLE controls

10kHz... (main) This control can be used to adjust frequencies higher than 2.5kHz to enhance or attenuate the frequency by 10dB at 10kHz.

20kHz... (sub) This control can be used to adjust frequencies higher than 5kHz, which have already been adjusted with the 10kHz control, to enhance or attenuate the frequency by 5dB at 20kHz.

Using only the main controls provides the same function as conventional audio tone controls. Employing the sub-controls, however, has the same effect as changing the turnover frequencies. The combined operation of both controls will produce a broad range of tone variations as shown in Fig. 17 & 18.

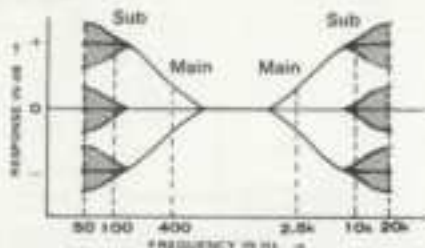

Adjusting first the main, then the sub controls can provide the range of adjustment shown by the shaded areas in the figure.

Fig. 17

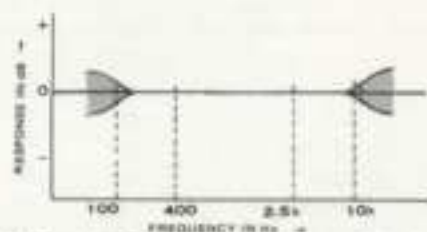

With BASS and TREBLE main controls set at 0dB, adjustment range of the sub-controls will be as shown by the shaded areas in the figure.

Fig. 18

Examples of effective operation

- If the BASS controls are adjusted as in Fig. 19, low frequencies in the 100Hz–150Hz region, which delicately influence the bass impression, can be enhanced. While retaining an overall flat impression, slightly more weight can be obtained in the low frequency band (A). Since the opposite adjustment can also be performed, it is possible to improve such effects as standing waves and extended reverberations, which can occur in reinforced steel framework buildings and create an unnatural effect (B).

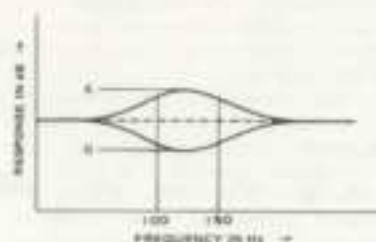

Adding slight body to low frequencies

Fig. 19

- High frequencies can be adjusted with the twin TREBLE controls to compensate for the quavering that often occurs with moving magnet (MM) cartridges and to obtain a reproduced sound with a completely flat response. To cite another example, when conventional tone controls are used to enhance high frequencies from records, ultra high frequency peaking can occur from the cartridge. This drawback is eliminated by the twin control system which can enhance 8kHz–10kHz frequencies while maintaining an overall flat response.

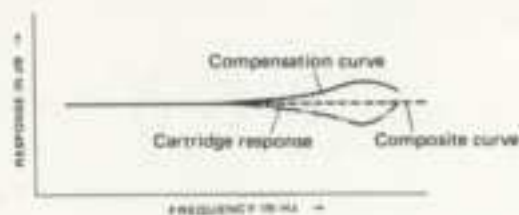

Compensation for cartridge high frequency "hollowness"

Fig. 20

NOTE:

You can use the CARTRIDGE LOAD switches to compensate for the frequency response at the high-end of MM cartridges. For further details, refer to 'Load Resistance and Load Capacitance' on page 14.

- Fig. 21 shows an example of where the adjustment of the BASS and TREBLE controls together can have the relative effect of enhancing the mid-range. This is effective in producing an audio 'close-up' of a singer's voice.



Relatively enhancing the mid-range

Fig. 21

TONE SWITCH

Regardless of the twin tone control settings, a completely flat response can be obtained at any time by setting the TONE switch to OFF. The delicate effects of the tone controls and their optimum adjustment according to different program sources can then be evaluated.

VOLUME CONTROL AND MUTING SWITCH

The VOLUME control scale is directly calibrated in dB. By adjusting it in combination with the MUTING switch, it is possible to adjust the attenuation more finely across a very wide range. The attenuation (volume) is equal to the VOLUME control indication plus 20dB.

- One convenient application of the MUTING switch is for temporarily reducing the volume while changing records, tapes or for other applications. This eliminates the need for continual re-adjustment of the VOLUME control.
- With late-night listening or at other times when low volumes are used, precise adjustment becomes difficult when the VOLUME control is near the = position. In these cases, it is convenient to first set the MUTING switch to -20dB and then adjust the VOLUME control.

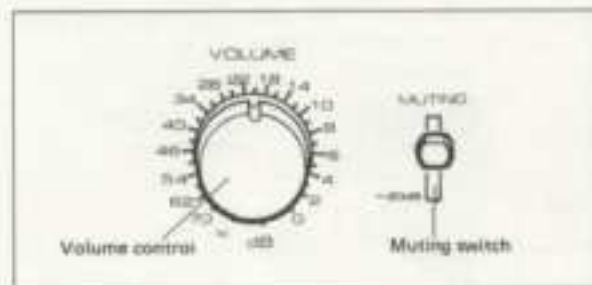

Fig. 22

USING THE TAPE DECKS

PLAYBACK

Proceed as follows when playing back pre-recorded music tapes available on the open market, and tapes on which you have recorded programs:

1. As shown in Fig. 23, set the TAPE MONITOR switch 1 to ON if the tape deck is connected to the TAPE 1 jacks. Set the TAPE MONITOR switch 2 to ON if it is connected to the TAPE 2 jacks.
2. Operate the tape deck controls for playback.
3. Adjust the volume with the VOLUME control.
4. To adjust the tone, first set the TONE switch to ON, and then adjust the BASS and TREBLE controls for the preferred bass and treble levels.

NOTES:

1. Always return the TAPE MONITOR and the ADAPTOR switches to the upper position (OFF) when you are not playing back a tape and using a component.
2. As long as the TAPE MONITOR switch 1 or 2 is at ON, you will be able to play back a tape regardless of the setting of the function buttons.

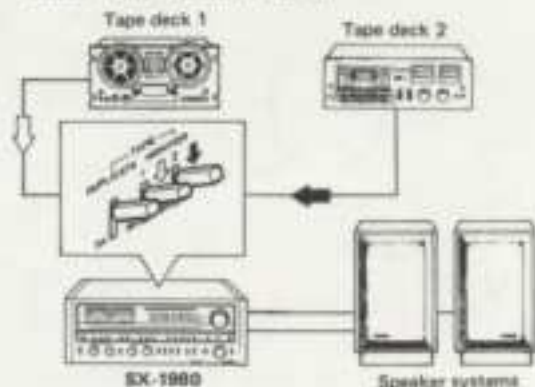

Fig. 23

RECORDING

1. Press the function button that corresponds to the program source which you intend to record (for example, a record off a turntable or an FM broadcast).
2. Set the DUPLICATE switch to OFF (upper position).
3. Play the selected program source.
4. Operate the tape deck controls and start recording.

NOTES:

1. When recording, keep the MODE switch at STEREO.
2. Adjust the recording level with the tape deck's recording level controls.
3. The receiver's VOLUME, BASS and TREBLE controls have no effect on the recorded sound when a recording is being made.



Fig. 24

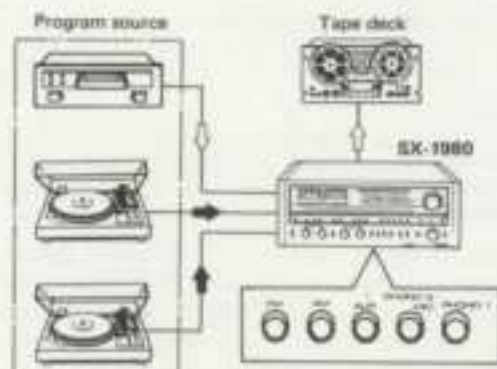

Fig. 25

Tape monitoring

If a recording is being made on a 3-head tape deck, the recorded sound can be monitored through the speaker systems if the TAPE MONITOR switch 1 or 2 is set to ON. In this case, both recording and playback connections must be made.

NOTE:

If you have a 2-head open-reel deck or cassette deck, you will not be able to monitor the recorded sound even if you set the TAPE MONITOR switch to ON. However, you will be able to hear the sound at the playback end (program source).

Duplicating and editing recorded tapes

If you have two tape decks, a recording of, say, a complete FM broadcast can be made and then those items that you want for your permanent 'tape library' can be selected and re-recorded onto another tape. It is also possible to duplicate tapes from an open-reel tape deck onto a cassette tape deck.

1. As shown in Fig. 29, connect the tape decks to the receiver's TAPE 1 and TAPE 2 jacks.
 2. Set the DUPLICATE switch to ON.
 3. Play back the recorded tape on tape deck 1 and record it on tape deck 2. It is also possible to play the tape back on tape deck 2 and record it on tape deck 1.
 4. Set the TAPE MONITOR switch 1 or 2 to ON when you want to monitor the recorded sound.
- Do not set both tape decks to the recording mode at the same time.

ADAPTOR JACKS FOR INCREASED VERSATILITY

RECEPTION OF FM DOLBY BROADCASTS

In you live in an area where you can receive FM Dolby broadcasts, you can listen in if you connect an optional Dolby adaptor to the ADAPTOR jacks.

1. Connect the Dolby adaptor to the ADAPTOR jacks (OUT, IN), as shown in Fig. 26.
2. Depress the FM 25 μ s button.
3. Set the ADAPTOR switch to ON.
4. Operate the Dolby adaptor.
5. Depress the FM function button and tune in to the Dolby broadcast with the tuning knob. For reception, refer to 'FM RECEPTION' since the procedure is the same.

NOTES:

- For detailed instructions on connections and the handling of the Dolby adaptor, refer to its operating instructions.
- When you are not listening to an FM Dolby broadcast, return the FM 25 μ s button and the ADAPTOR switch to their original positions.

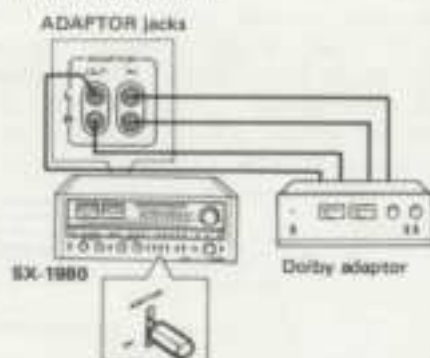

Fig. 26

DOLBY RECORDING AND PLAYBACK

If you use the optional Dolby adaptor, you can make Dolby system recordings and play them back. As shown in Fig. 27, connect the Dolby adaptor to the ADAPTOR OUT and ADAPTOR IN jacks on the receiver, and connect the Dolby adaptor to the tape deck.

Dolby recording

1. Select the function button corresponding to the program source that you intend to record.
2. Operate the Dolby adaptor.
3. Proceed to record in Dolby in accordance with the recording procedure of the tape deck.

Dolby playback

1. Set the ADAPTOR switch to ON.
2. Operate the tape deck and play back the Dolby system recording.

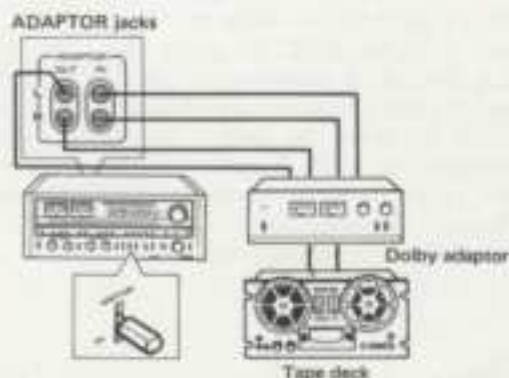

Fig. 27

OTHER AVAILABLE ADAPTORS

These convenient adaptor jacks are available in addition to the normal tape REC/PLAY jacks to enable other sophisticated adaptor units (graphic equalizer, RG dynamic processor) to be connected without disturbing the full tape monitoring and duplicating facility. When using an adaptor, the program source can be taken from the function selector or the tape deck output jacks. Fig. 28 illustrates an RG dynamic processor connected to the ADAPTOR jacks.

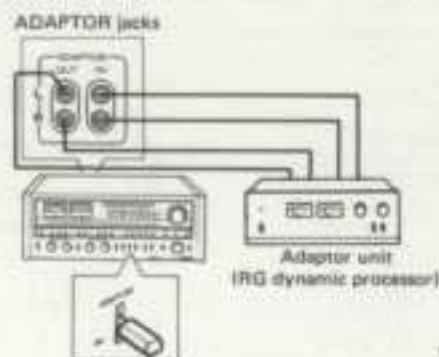

Fig. 28

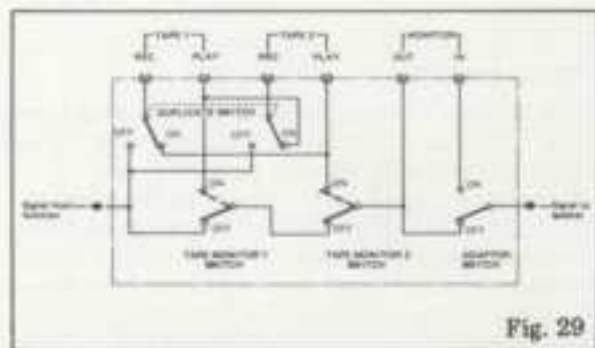

Fig. 29

USING PREAMP OUT AND POWER AMP IN JACKS

If the connections between the PRE AMP OUT and POWER AMP IN jacks are removed (see Fig. 30), it is possible to use the preamplifier section and the power amplifier section independently. However, for normal use always keep these connections in place since once you remove them, no sound will be heard through the speakers. Always set the POWER switch to OFF when removing or replacing these connections.



Fig. 30

INDEPENDENT PREAMPLIFIER SECTION

As shown in Fig. 31, you can connect a high output power stereo power amplifier or a home-built power amplifier to the PRE AMP OUT jacks and compare the sound with the power amplifier section of the stereo receiver.

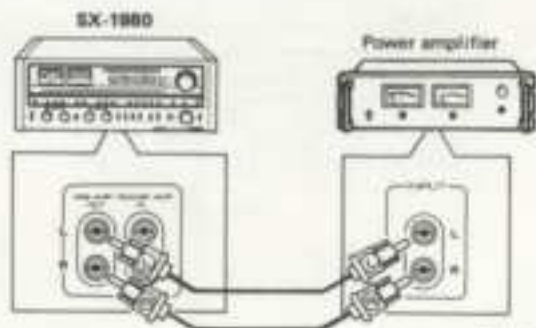

Fig. 31

INDEPENDENT POWER AMPLIFIER SECTION

As shown in Fig. 32, you can connect a stereo amplifier which you may have to the POWER AMP IN jacks and compose your own stereo system.

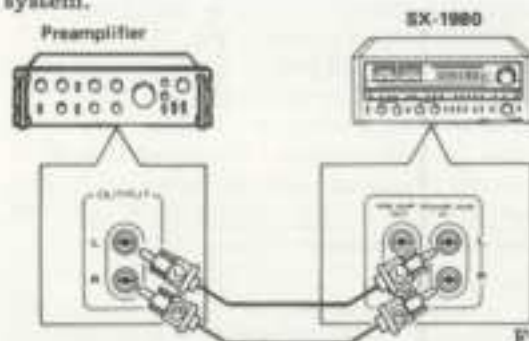

Fig. 32

COMPOSING A MULTI-AMPLIFIER SYSTEM

As shown in Fig. 33, you can compose your own multi-amplifier system if you connect an optional stereo power amplifier and crossover network. A multi-amplifier system splits up the audible frequency range into different frequency bands. Each of these bands is then amplified by the amplifiers and so this has the advantage of reducing intermodulation distortion.

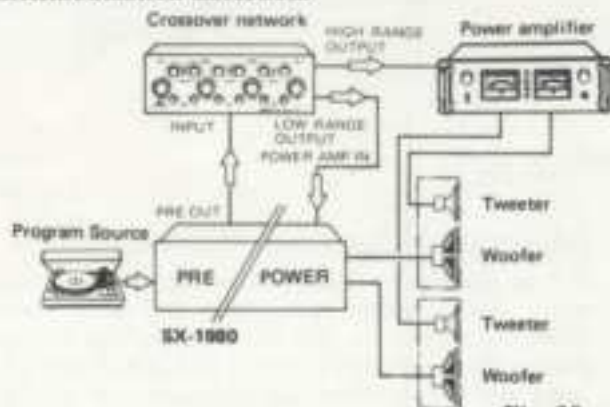

Fig. 33

HEX. WRENCH

The accessory hexagonal wrench is provided for removing the TUNING knob and VOLUME knob or tightening their set screws should they become loose.

If required, loosen the set screw by inserting the wrench into the hole on the side of the knob and turning the wrench counter-clockwise. Be particularly careful not to scratch the front panel when employing the wrench.



CONDITIONS FREQUENTLY MISTAKEN FOR MALFUNCTION

If your stereo appears to malfunction, first check such things as the controls (power switch, function selector, tape monitor, etc.) and connecting cords (components connected correctly).

Noise: There are a variety of noises relating to the operation of a hi-fi unit. These are generally divided into two types; (1) the unit is faulty (a transistor or part has deteriorated) and (2) an external source is adding to the unit.

When a hi-fi unit produces an unpleasant noise, it is

often assumed that the unit is faulty, but statistical records indicate that the majority of noises produced in hi-fi acoustic units result from external sources of noise: Due to the inherent high sensitivity and the high fidelity in reproduction, the unit amplifies and reproduces extraneous noises, however small, into audible output noise. If your receiver produces a noise, check according to the following table and trace out the source of noise for the appropriate corrective action.

	Symptom	Suspected source of noise	Diagnosis and remedy
When listening to broadcasts	Continuous or intermittent buzzing noise.	<ul style="list-style-type: none"> • Static (lightning) • Fluorescent lamp, motor, or thermostat may be in use in house or in the vicinity of the house. 	In many cases, it is very difficult to remove the source of noise. In order to make the radio input larger than the noise level, set up a good outdoor antenna and make a complete grounding.
	When a station is tuned in, hum is mixed in the program.	<ul style="list-style-type: none"> • Poor fluorescent lamp, motor, or electric heater may be in use in house or near the house. 	Reversing the line plug may occasionally alleviate this noise problem. Usually it is very difficult to eliminate the noise.
	Hissing sound noise in AM (medium wave) reception.	<ul style="list-style-type: none"> • The frequency of an adjacent station is interfering with that of the station being tuned in (10kHz beat interference). • TV set is on in the same house with the receiver. 	Impossible to remove such interference. If the cause of such noise is the TV set, increase the distance between the TV set and receiver.
	Static noise (in particular, when automobiles run close to the house).	<ul style="list-style-type: none"> • White noise generated from automobile engines. • High frequency sewing machine or welding machine being used near your house. 	In an area surrounded by hills or high buildings, the FM input signals are very weak. Thus the noise limiter in the circuit loses its function. Set up an FM outdoor antenna having many director elements.
	Reception of FM stereo program contains more noise than FM mono program.	<ul style="list-style-type: none"> • Noise that the service area covered by an FM stereo broadcast is about 50% of that of a regular mono broadcast. 	Increasing the FM input signal may alleviate this problem. Use an exclusive FM outdoor antenna instead of the indoor T-type antenna.
When playing records	Hum or buzz. When switched to radio reception, the noise disappears.	<ul style="list-style-type: none"> • Poor connection of shielded wire. (a) • Jack connection is loose. (b) • Line cord of fluorescent lamp passes near the shielded wire. (c) • Poor grounding. (d) • Ham transmitting station or TV transmitting station is near your house. (e) 	Correct the conditions stated in (a), (b), (c) or (d). In case of (e), report it to an official authority.
	Output tone quality is poor and mixed with noise. Treble is not clear.	<ul style="list-style-type: none"> • Stylus is worn. (a) • Record is worn. (b) • Dust adhering to stylus. (c) • Stylus is improperly mounted. (d) • Stylus pressure is not correct. (e) • The TREBLE level is too high. 	Check (a) through (e) and correct the condition. Lower the TREBLE level.
	In playing a record, increasing the volume causes howling.	<ul style="list-style-type: none"> • Distance between the turntable and the speakers is too short. • The turntable or speakers supports are unstable. 	Increase the distance or rearrange the installation of the unit and speakers. (Installing the turntable on a firm, solid stand may alleviate this problem.) Do not enhance the BASS sound level excessively.
When using microphone	Howling occurs	<ul style="list-style-type: none"> • Feedback between microphone and speakers. 	<ul style="list-style-type: none"> • Keep microphone away from speakers. • Do not set the VOLUME control too high. • Set BASS and TREBLE controls to center positions.

SPECIFICATIONS

Semiconductors

FETs	12
ICs	11
Transistors	130
Diodes	84

Power Amplifier Section

Continuous power output of 270 watts* per channel min., at 8 ohms from 20 Hertz to 20,000 Hertz with no more than 0.03% total harmonic distortion.

Total Harmonic Distortion (20 Hertz to 20,000 Hertz)

Continuous Rated Power Output . . . No more than 0.03%	
135 watts per channel power	
output, 8 ohms	No more than 0.02%
1 watt per channel power	
output, 8 ohms	No more than 0.02%

Intermodulation Distortion (50 Hertz to 7,000 Hertz=4:1)

Continuous Rated Power Output . . . No more than 0.03%	
135 watts per channel power	
output, 8 ohms	No more than 0.01%
1 watt per channel power	
output, 8 ohms	No more than 0.006%

Frequency Response 5 Hertz to 100,000 Hertz $\pm 1\frac{1}{2}$ dB

Input Sensitivity / Impedance (POWER AMP IN)
 2V/50 kilohms

Output

Speaker A, B, C, A+B, B+C, A+C

Damping Factor

(20 Hertz to 20,000 Hertz, 8 ohms) 40

Hum and Noise (IHF, short-circuited, A Network) . . 120dB

Preamplifier Section

Input Sensitivity / Impedance

PHONO 1	2.5mV/10, 50, 100 kilohms
Cartridge load (capacitance) . . .	100, 200, 300, 400pF
PHONO 2	2.5mV/50 kilohms
MIC	7.5mV/50 kilohms
AUX	150mV/50 kilohms
TAPE PLAY 1, 2	150mV/50 kilohms
TAPE PLAY 2 (DIN connector) . . .	150mV/50 kilohms

PHONO Overload Level (1kHz; T.H.D. 0.03%)

PHONO 1, 2
 300mV |

Output Level / Impedance

TAPE REC 1, 2	150mV
TAPE 2 (DIN connector)	30mV/80 kilohms
PRE OUT	2V/1 kilohms

Total Harmonic Distortion

(20Hz to 20,000Hz, 2V output) . . . No more than 0.01%

Frequency Response

PHONO(RIAA Equalization) . 20Hz to 20,000Hz ± 0.2 dB

AUX, TAPE PLAY 5Hz to 80,000Hz $\pm 1\frac{1}{2}$ dB

Tone Control

BASS Main control	± 10 dB (100Hz)
Sub control	± 5 dB (50Hz)
TREBLE Main control	± 10 dB (10kHz)
Sub control	± 5 dB (20kHz)

Filter

LOW	15Hz (12dB/oct.)
HIGH	8kHz (12dB/oct.)

Loudness Contour (Volume control set at -40dB position)

..... +6dB (100Hz), +3dB (10kHz)

Hum and Noise (IHF, short-circuited, A network)

PHONO (PHONO INTERFERENCE FILTER
 switch OFF)
 87dB |

AUX, TAPE PLAY
 100dB |

Muting
 -20dB |

FM Section

Usable Sensitivity

MONO
 8.7dBf (1.5 μ V) |

50dB Quieting Sensitivity

MONO
 11.5dBf (2.2 μ V) |

STEREO
 36.0dBf (34 μ V) |

Signal-to-Noise Ratio

(at 75dBf) . . . STEREO
 75dB |

(at 65dBf) . . . MONO
 83dB |

STEREO
 74dB |

Distortion (at 65dBf)

100Hz MONO/STEREO
 0.05%/0.1% |

1kHz MONO/STEREO
 0.07%/0.1% |

6kHz MONO/STEREO
 0.2%/0.2% |

Frequency Response 30Hz to 15,000Hz $\pm 1\frac{1}{2}$ dB

Capture Ratio
 1.0dB |

Alternate Channel Selectivity
 80dB |

Spurious Response Ratio
 120dB |

Image Response Ratio
 120dB |

IF Response Ratio
 120dB |

AM Suppression Ratio
 60dB |

Muting Threshold
 19.2dBf (5 μ V) |

Stereo Separation . . . 50dB (1kHz), 40dB (30Hz~15kHz)

Subcarrier Product Ratio
 65dB |

SCA Rejection Ratio
 65dB |

Antenna Input
 300 ohms balanced |

75 ohms unbalanced

AM Section

Sensitivity (IHF, Ferrite antenna)	300 μ V/m
(IHF, Ext. antenna)	15 μ V
Selectivity	26dB
Signal-to-Noise Ratio	55dB
Image Response Ratio	70dB
IF Response Ratio	70dB
Antenna	Built-in Ferrite Loopstick Antenna

Miscellaneous

Power Requirements	AC 110V, 120V, 220V, 240V (switchable) 50Hz/60Hz
Power Consumption	1400W (max.)
Dimensions	560(W) x 211(H) x 497(D)mm 22-1/16(W) x 8-5/16(H) x 19-9/16(D)in
Weight Without Package	35.4kg (78lb)
With Package	40.3kg (88lb 14oz)

Furnished Parts

FM T-type Antenna	1
Operating Instructions	1
Hex. Wrench	1
Fuse 15A	1
Fuse 8A	1

*Measured pursuant to Federal Trade Commission's Trade Regulation rule on Power Output Claims for Amplifiers.

NOTE:

Specifications and the design subject to possible modification without notice due to improvements.

LINE VOLTAGE SELECTOR SWITCH

The SX-1980 is equipped with a line voltage selector switch which allows this receiver to be used in locations where the power voltage is 110V, 120V, 220V or 240V.

Before your receiver is shipped from the factory, the switch is set to the power requirements of the destination, although you should check that it is set properly before plugging the power cord into the outlet. If the voltage is not properly set or if you move to an area where the voltage requirements differ, adjust the selector switch as follows:

1. Disconnect the power cord.
2. Use the Phillips screwdriver to unscrew the fuse cap, then take out the fuse and VOLTAGE SELECTOR plug.
3. Re-install the plug with its cutaway section exposing the correct voltage indication.
4. Refer to the table and install a replacement fuse (provided as an accessory).
5. Insert the fuse in the fuse cap, then fit the cap to the plug and tighten.

TABLE

VOLTAGE	FUSE
110V, 120V	15A
220V, 240V	8A

