

Io Volcano Observer (IVO)

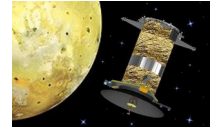

Alfred McEwen
University of Arizona
March 2009

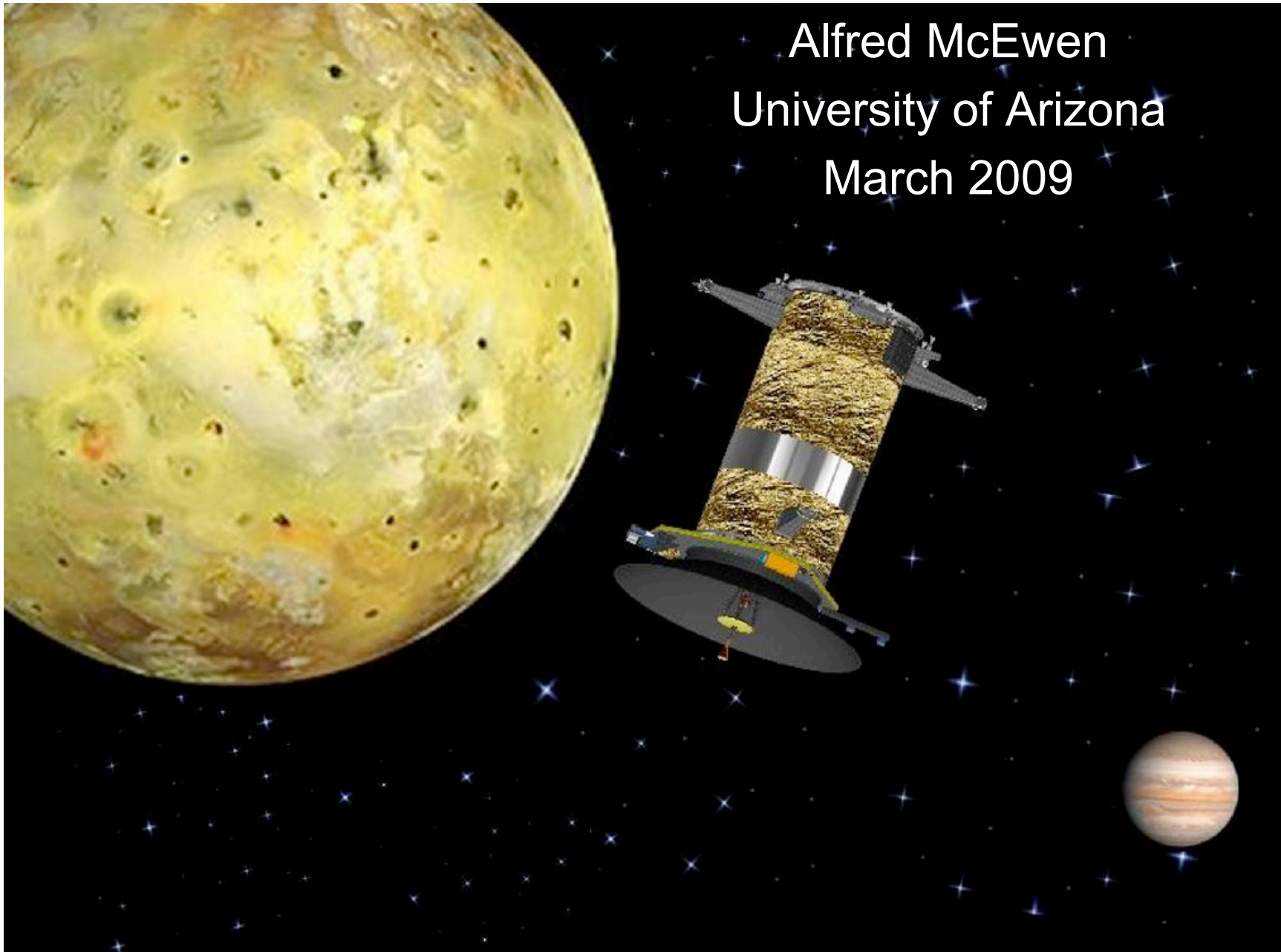

NASA wants to flight-test the Advanced Stirling Radioisotope Generator (ASRG) on a Discovery-class mission

- Pu²³⁸ is in very short supply!
 - ASRG requires 6x less Pu²³⁸ per W of electric power than conventional RTGs
- ASRG Characteristics:
 - ≥14 year lifetime *requirement*
 - Nominal power : 140 W electric, ~100 W thermal (useable)
 - Mass ~ 20 kg
 - System efficiency: ~ 30 %
 - 2 GPHS (“Pu²³⁸ Bricks”) modules
 - Uses 0.8 kg Pu²³⁸
- Reliability to be demonstrated by the end of 2009; Flight units ready by mid-2014 (or later)
- 9 DSMCE studies funded.

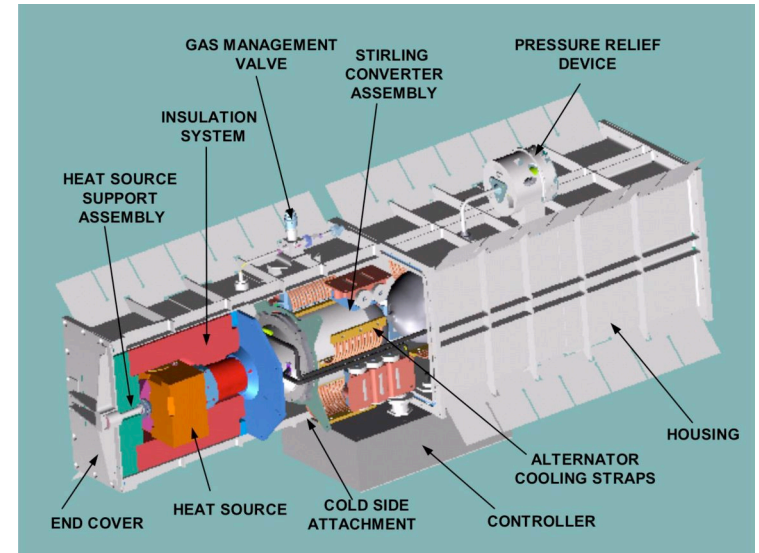

Lockheed Martin/Sunpower

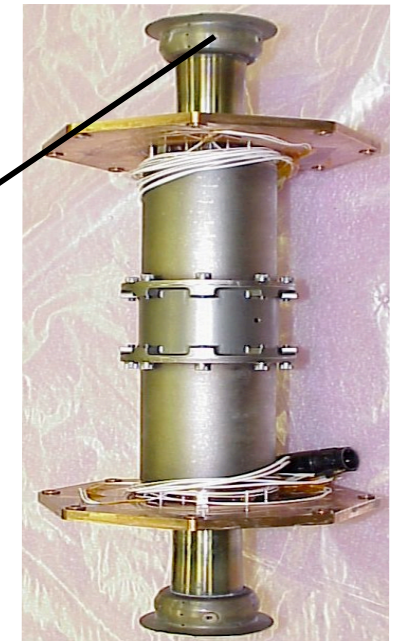
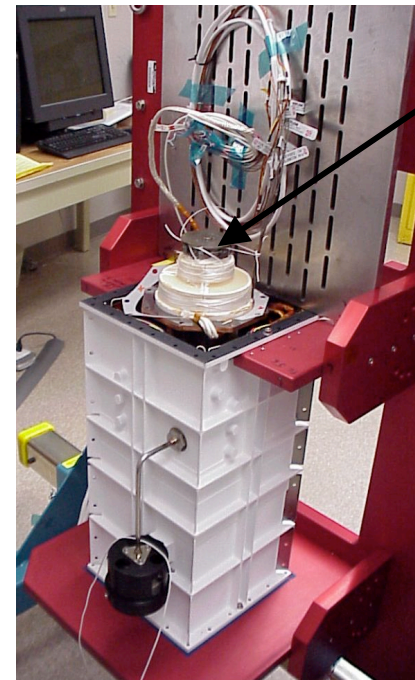

Paired converters with interconnect sleeve assembly

Outboard Housing and Paired ASC-Es

IVO DSMCE Study Team

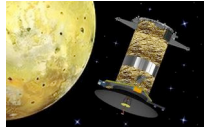

- **PI/Science team**
 - Alfred McEwen, UofA, PI
 - Laszlo Keszthelyi (USGS), John Spencer (SwRI), Nick Thomas (U Bern), Torrence Johnson (JPL), Phil Christensen (ASU), Karl-Heinz Glassmeier (IGEP), Elizabeth Turtle (APL), Krishan Khurana (UCLA), Julie Moses (LPI)
- **Instrument teams**
 - US-built:
 - RCam: UA lead McEwen, Chris Shinohara, others
 - ThM: ASU lead P. Christensen
 - Contributed:
 - INMS: U. Bern lead N. Thomas, Peter Wurz
 - FGM: IGEP lead Karl-Heinz Glassmeier
- **Spacecraft team**
 - Tim Girard (Sierra Nevada Corp.), Chris Shinohara (UA), Roberto Furfaro (UA), Thomas Gardner (RMS), Dan Cheeseman (RMS)
- **JPL team**
 - Richard Beatty, Jan Ludwinski, Theresa Kowalkowski, Chen-wan Yen, Robin Evans, Insoo Jun, many others from Team X



An Io Mission is High Priority for Solar System Exploration

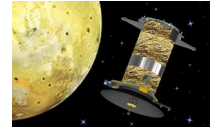

- 2002 Solar System Decadal Survey identified 4 broad themes:
 - The first billion years of Solar System history
 - Ancient voluminous and high-temperature volcanic and interior processes on the Earth, Moon, Mercury, and Mars are active on Io today.
 - Volatiles and organics: The stuff of life
 - Discerning how Io became devoid of water (and carbon?) but retained sulfur is fundamental to understanding the evolution of volatiles.
 - The origin and evolution of habitable worlds
 - Tidal heating determines the habitable zone in the Jovian system and analogous processes may apply to extrasolar planetary systems.
 - Processes: How planetary systems work
 - Hyperactive Io is an ideal target for studying how planets work.
 - Io is the Hawai'i of the Solar System.
 - *Io Observer* is mentioned in Decadal Survey for a New Frontiers Class mission in the next decade (2013-2023), the NRC study on choices for the next New Frontiers AO, and is included in NF-3 AO.
 - *IVO* can make significant contributions to all seven of the NF *Io Observer* Science goals

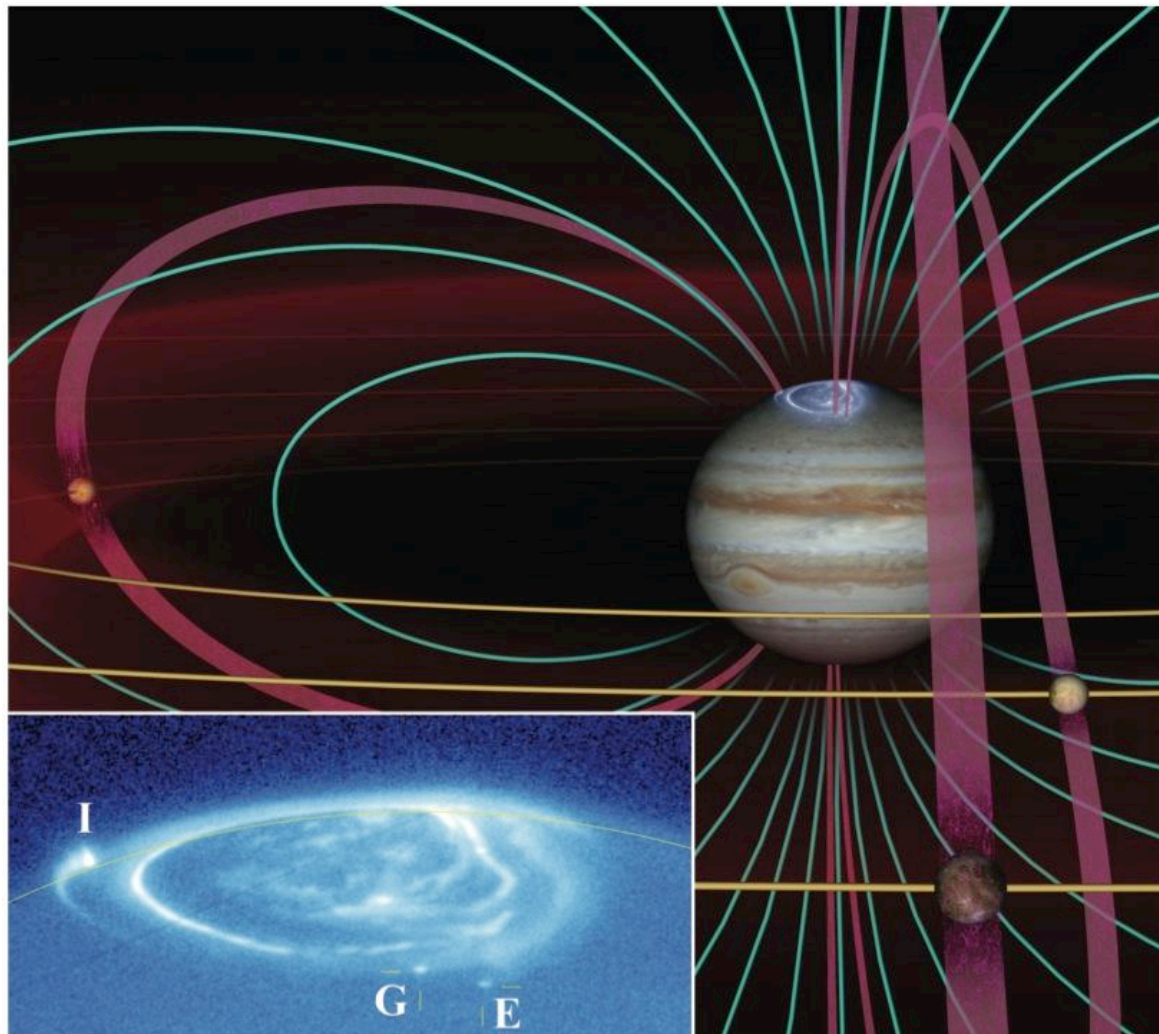
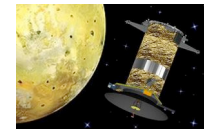
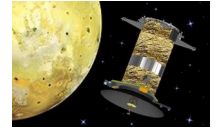

FIGURE 2.4 Electrical currents aligned with Jupiter's strong magnetic field couple the moons Io, Ganymede, and Europa with Jupiter's high-latitude ionosphere. Bright auroral emissions observed at the footpoints of the magnetic flux tubes linking the moons to the ionosphere (inset) are the signature of this coupling, the physics of which is only partially understood. (The letters superposed on the auroral image in the inset identify the emission features associated with the footpoints of Io, Ganymede, and Europa.) A probe to study the still unexplored polar regions of Jupiter's magnetosphere will answer basic questions about the nature of electrodynamic coupling between the Jovian atmosphere and magnetosphere and about auroral acceleration in a magnetospheric environment much different from Earth's. Hubble Space Telescope image courtesy of J.T. Clarke (Boston University) and NASA/Space Telescope Science Institute. Artist's rendering of the Jovian inner magnetosphere courtesy of J.R. Spencer (Lowell Observatory). Reprinted by permission from *Nature* 415:997-999 and cover, copyright 2002, Macmillan Publishers Ltd.

***Jupiter Polar* mission is a high priority in the Solar and Space Physics Decadal study**

- Rank 3 of moderate cost missions
- *Juno* partially satisfies these objectives, but *IVO* would explore a different region of space and has a higher data rate for remote sensing of polar phenomena on Jupiter.
- *IVO* would observe auroral phenomena on Io as well as Jupiter and directly measure the species escaping from Io
- “Io is the heartbeat of the Jovian magnetosphere”
- Lou Frank

I/O Mission Overview



- \$450 M cost cap including launch vehicle (but not ASRGs or NEPA).
- Launch in 2015 on Atlas V 401.
- VEEGA trajectory and Jupiter Orbit Insertion (JOI) in 2021.
- Io flyby before JOI, then 6-month capture orbit about Jupiter inclined $\sim 49^\circ$.
- 6 additional Io flybys over 10 months.
- Closest approach to Io from 1000 to 100 km, closer in extended mission.
 - Fly through active plumes late in late nominal and in extended mission.
- Collect 20 Gb science data near Io (100x total data from *Galileo* on each flyby).
- Playback of Io encounter data + Jupiter system science near apoapsis.
- Extended mission options
- **End mission with Io impact**

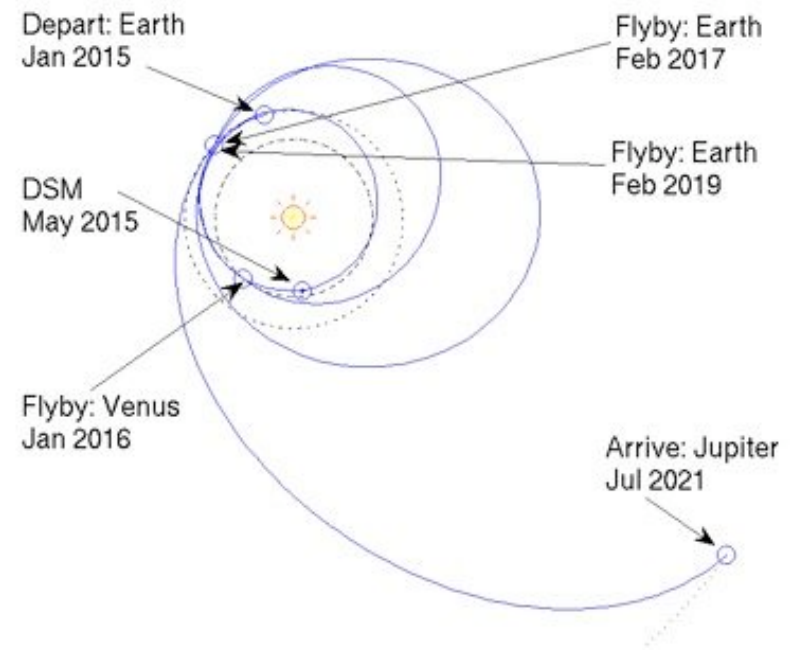
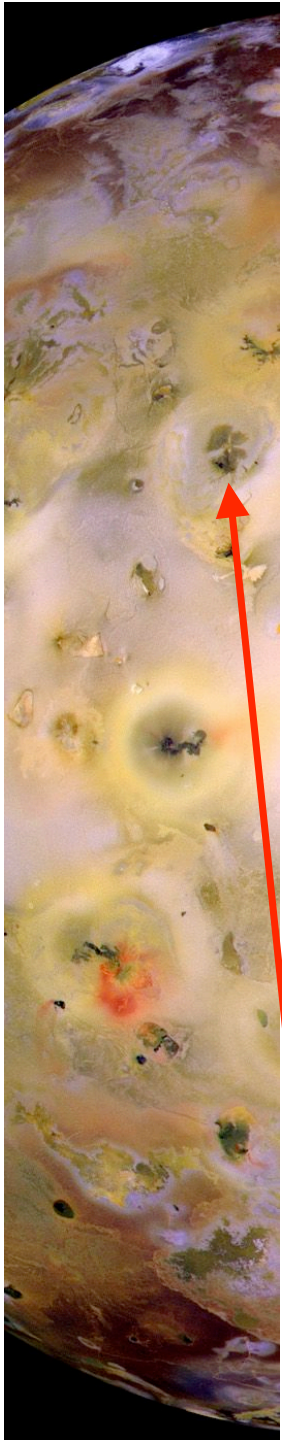
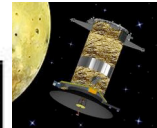

Table 5.1-3. Example Jupiter tour with 10 Io flybys.



| Io Flyby # | Days from JOI | Days after last Io | Io-relative Quantities | | | | | | | | Jupiter-relative Quantities | | | Sun-Jup-lo (deg) | Jup-lo-s/c (deg) |
|------------|---------------|--------------------|------------------------|-----------|-----------|-------------|---------------|-------------|--------------|-----------|-----------------------------|---------------|-------|------------------|------------------|
| | | | Altitude (km) | Lat (deg) | Lon (deg) | Phase | | Incl. (deg) | Apojove (Rj) | Desc (Rj) | | | | | |
| | | | | | | Angle (deg) | Speed (km/s)* | Vinf (km/s) | | | Node (Rj) | Perijove (Rj) | | | |
| 1 | 199.6 | n/a | 546 | 4.58 | 268.37 | 147.3 | 18.54 | 18.38 | 102.22 | 181.0 | 99.8 | 5.748 | 57.94 | 90.8 | |
| 2 | 311.1 | 111.5 | 325 | 5.63 | 268.37 | 137.4 | 18.54 | 18.38 | 102.04 | 105.6 | 70.6 | 5.718 | 48.45 | 91.2 | |
| 3 | 362.4 | 51.3 | 256 | 6.50 | 268.35 | 132.6 | 18.54 | 18.36 | 101.91 | 78.3 | 56.7 | 5.716 | 44.04 | 91.5 | |
| 4 | 396.0 | 33.6 | 672 | -6.50 | 88.43 | 50.4 | 18.47 | 18.36 | 78.16 | 103.0 | 69.4 | 5.728 | 41.13 | 88.4 | |
| 5 | 445.5 | 49.5 | 355 | 2.54 | 251.10 | 108.1 | 18.52 | 18.35 | 103.09 | 81.2 | 59.1 | 5.745 | 36.82 | 109.0 | |
| 6 | 480.9 | 35.4 | 998 | -6.38 | 88.51 | 57.8 | 18.43 | 18.34 | 78.51 | 105.6 | 71.9 | 5.761 | 33.67 | 88.5 | |
| 7 | 532.2 | 51.3 | 861 | -12.53 | 160.80 | 16.4 | 18.47 | 18.34 | 91.98 | 120.4 | 82.3 | 5.791 | 29.16 | 157.4 | |
| 8 | 594.1 | 61.9 | 291 | 3.92 | 257.07 | 101.5 | 18.52 | 18.35 | 101.96 | 86.8 | 65.1 | 5.791 | 23.68 | 102.3 | |
| 9 | 633.1 | 38.9 | 433 | -11.52 | 125.07 | 35.6 | 18.50 | 18.36 | 85.33 | 108.1 | 79.1 | 5.800 | 20.23 | 125.0 | |
| 10 | 686.1 | 53.1 | 412 | -0.48 | 233.59 | 70.2 | 18.53 | 18.37 | 102.11 | 81.1 | 64.6 | 5.793 | 15.50 | 125.5 | |
| 11 | 721.5 | 35.4 | Impact | | | | | | | | | | | | |



- Higher inclination (non-equatorial) is desired for polar coverage
- Repeat ~same sub-solar longitude for change detection
- Observe many eclipses (occur every Io day-- 42.5 hours)
- Goal is to go as low as 100 km, through active plumes, near end of mission

Table 5.1-4. Io eclipse opportunities inbound and outbound for each Io flyby in the example tour.



| Enc # | In/Out | Enter eclipse | Exit eclipse | Eclipse Duration | Entry range (km) | Entry range (Rj) | Exit Range (km) | Exit Range (Rj) |
|-------|--------|---------------------|---------------------|------------------|------------------|------------------|-----------------|-----------------|
| 1 | In | 7/13/2020 09:40:18 | 7/13/2020 11:56:33 | 2:16:15 | 1573574 | 22.01 | 1387711 | 19.41 |
| 1 | Out | 7/15/2020 04:08:49 | 7/15/2020 06:25:05 | 2:16:16 | 773088 | 10.81 | 908804 | 12.71 |
| 2 | In | 11/1/2020 21:41:32 | 11/1/2020 23:59:28 | 2:17:56 | 1455497 | 20.36 | 1269776 | 17.76 |
| 2 | Out | 11/3/2020 16:10:10 | 11/3/2020 18:28:07 | 2:17:57 | 824828 | 11.54 | 959899 | 13.43 |
| 3 | In | 12/23/2020 05:33:35 | 12/23/2020 07:52:03 | 2:18:28 | 1364752 | 19.09 | 1182472 | 16.54 |
| 3 | Out | 12/25/2020 00:02:20 | 12/25/2020 02:20:50 | 2:18:30 | 845559 | 11.83 | 977975 | 13.68 |
| 4 | In | 1/25/2021 20:39:17 | 1/25/2021 22:57:58 | 2:18:41 | 1297443 | 18.15 | 1118816 | 15.65 |
| 4 | Out | 1/27/2021 15:08:02 | 1/27/2021 17:26:40 | 2:18:38 | 877276 | 12.27 | 1015164 | 14.20 |
| 5 | In | 3/16/2020 10:03:30 | 3/16/2021 12:22:03 | 2:18:33 | 1291441 | 18.06 | 1111935 | 15.55 |
| 5 | Out | 3/18/2021 04:32:10 | 3/18/2021 06:50:43 | 2:18:33 | 899032 | 12.58 | 1034776 | 14.47 |
| 6 | In | 4/20/2021 19:37:20 | 4/20/2021 21:55:40 | 2:18:20 | 1232162 | 17.23 | 1057035 | 14.79 |
| 6 | Out | 4/22/2021 14:05:59 | 4/22/2021 16:24:18 | 2:18:19 | 932422 | 13.04 | 1073269 | 15.01 |

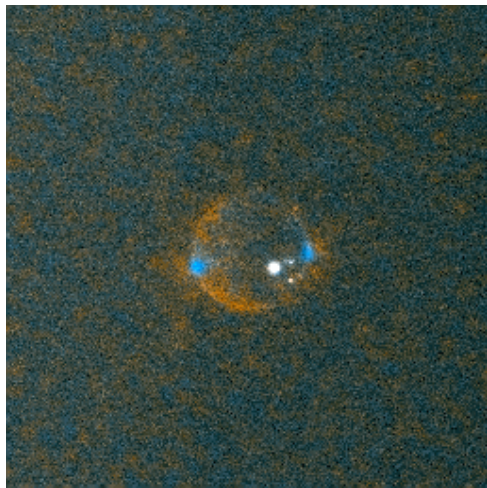

Eclipse movie from *Cassini*

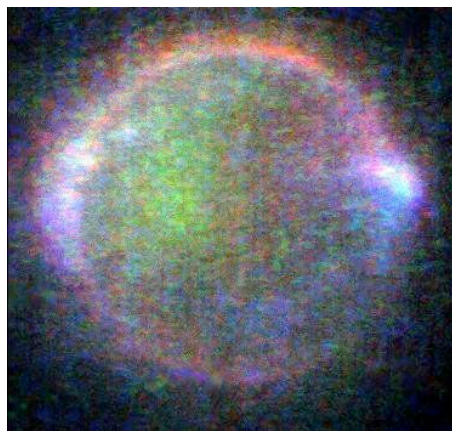

Visible colors in eclipse (*Galileo*)

I/O: ~10 km/pixel images and 125 km/pixel thermal mapping

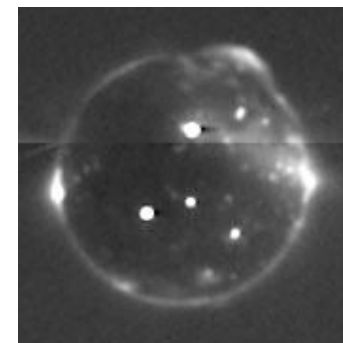

New Horizons image

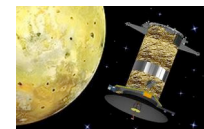

IVO Total Dose Environment

- Primary science achieved in 7 fast (~18.5 km/s) fly-bys
- Significant shielding typically available from S/C elements
 - 100 krad parts should suffice even without extra shielding
- IVO will have radiation “vaults” and spot shielding (200 kg allocated)

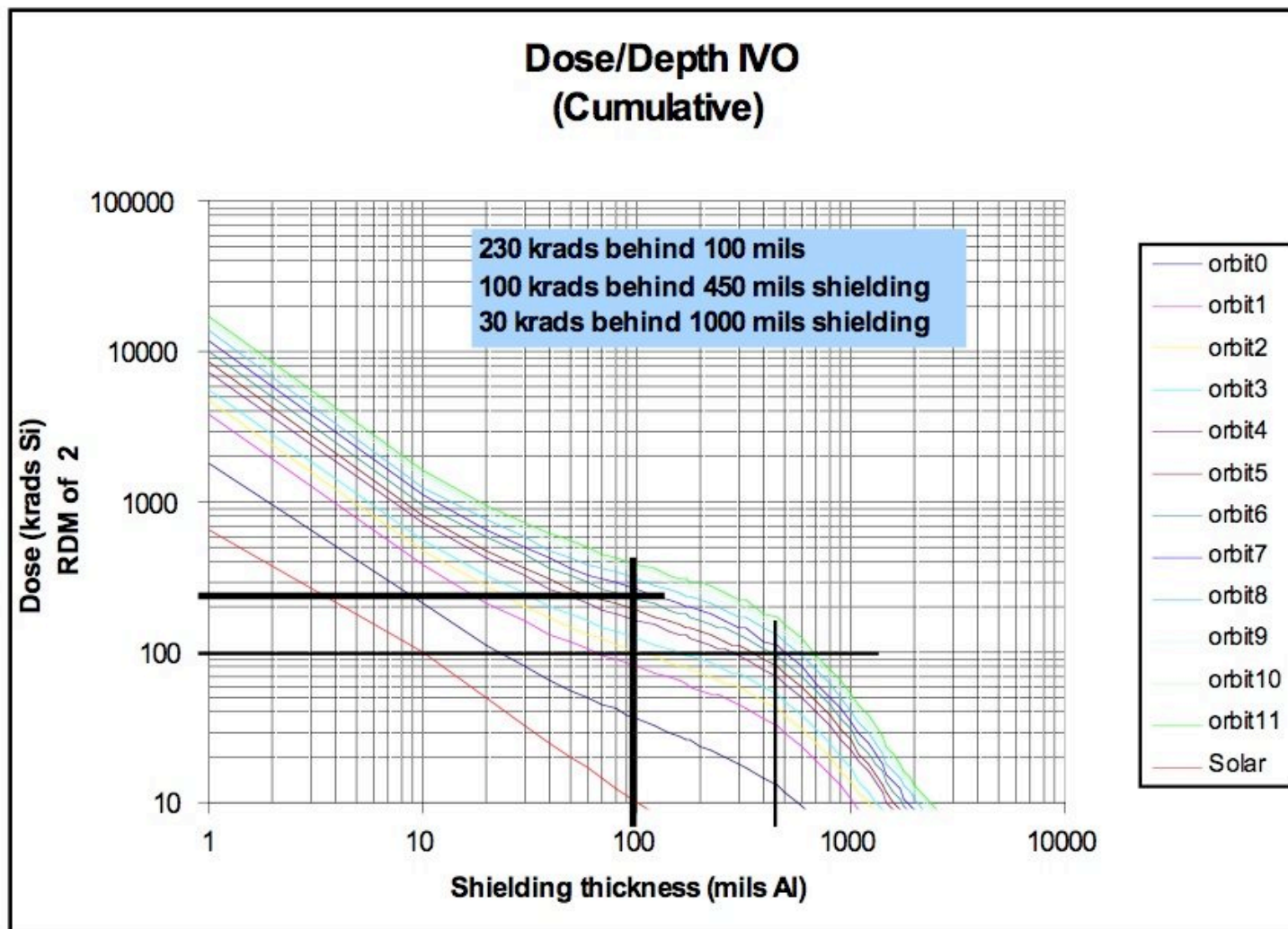

Science Payload

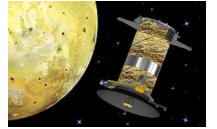

- Radiation-hard camera (RCam)
 - NAC (10 μ rad/pixel), digital processing unit (DPU), 15 color bandpasses from 200-1100 nm
 - Monitor eruptions, Io Plasma Torus (IPT), measure peak lava temperatures, stereo images for topography, movies of plumes and lava lakes, eclipse imaging, optical navigation
- Thermal mapper (ThM)
 - 125 μ rad/pixel, 10 bandpasses from 3-20 microns
 - Map and monitor temperatures, heat flow pattern related to tidal heating mechanisms, silicate emissions for composition
- Ion and Neutral Mass Spectrometer (INMS)
 - Determine composition of ions and neutrals in plumes, atmosphere, IPT
- Two fluxgate magnetometers (FGM)
 - Intrinsic and induced magnetic signatures of Io; explore new regions of Jovian magnetosphere
- Payload enhancement options
 - Wide-angle camera for stereo, 2nd INMS, contributed NIR spectrometer (like JIRAM on *Juno*), deployable boom for FGM, energetic particle detector, student-built dust detector

Narrow-Angle Radiation-hard Camera (RCam)

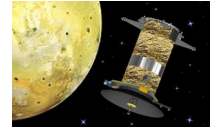

- Moderate resolution monitoring during approach to and departure from Io; high resolution and stereo near closest approach
 - NAC: 10 μ rad/pixel gives 1 km/pixel from 100,000 km, 10 m/pixel from 1,000 km
 - New CMOS focal-plane system, pushbroom and framing modes
 - Excellent performance (< 2 e- read noise) after 1-2 Mrad total dose (Janesick et al. 2008)
 - Data readout extremely fast (240 Mb/s per ADC) to minimize radiation noise in images
 - New Digital Processing Unit
- Near-simultaneous multispectral measurements for peak lava temperatures
 - 0.1 sec time differential ruins the measurement because hot lava is so dynamic
 - Working on CMOS FPS with narrow (4 line) filters for nearly simultaneous color
- ASRG-induced jitter not a significant concern, unless 1 ASC is lost

Highest-resolution *Galileo* image: 6 m/pixel

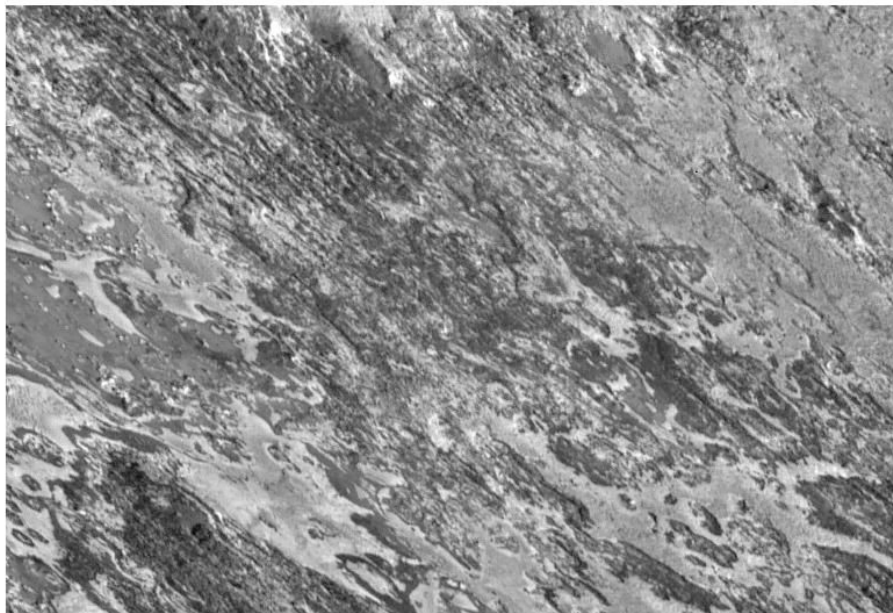

1 km (0.6 mile)

Lava glowing in the dark

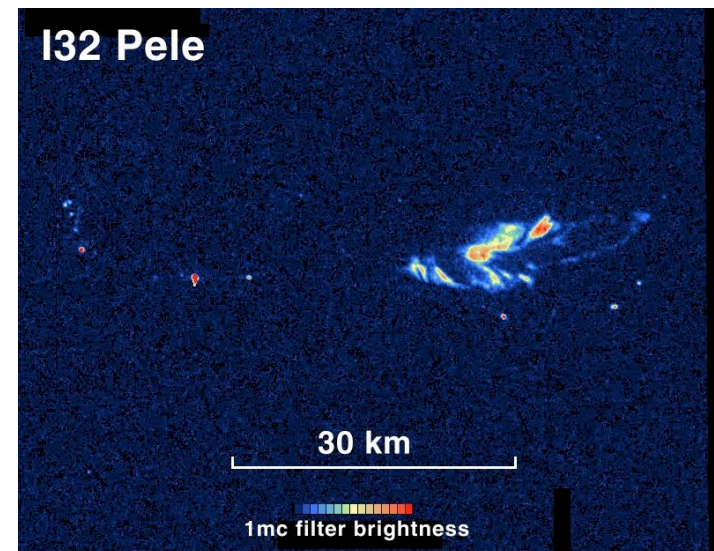

RCam Color Filters

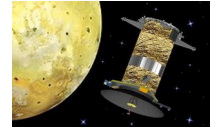

- Spectral range of backside-thinned CMOS detector is ~200-1000 nm (QE > 0.1)
- Threshold Mission:
 - Blue-green (450-650 nm), red (650-800 nm), near-IR (>800 nm), and >950 nm for lava temperatures and color images
 - 16 sets of 4-line filters for nearly simultaneous measurements of lava temperatures via dTDI
 - UV (200-400 nm) for plumes
 - Na-D band to monitor Na cloud
- Baseline Mission:
 - Spectrally narrow filters for O, S+
 - Can usefully monitor Na, O escaping from Europa as well as I₂; unique viewing geometry
 - Additional bands for silicate mineralogy and sulfur species
 - Methane bands for Jupiter
 - Room for 15 bandpasses with 64 dTDI lines on 2,000 x 2,000 array
 - Save at least 1000 x 2000 for clear framing mode

Figure 1. Planck function for emissivity of 1.

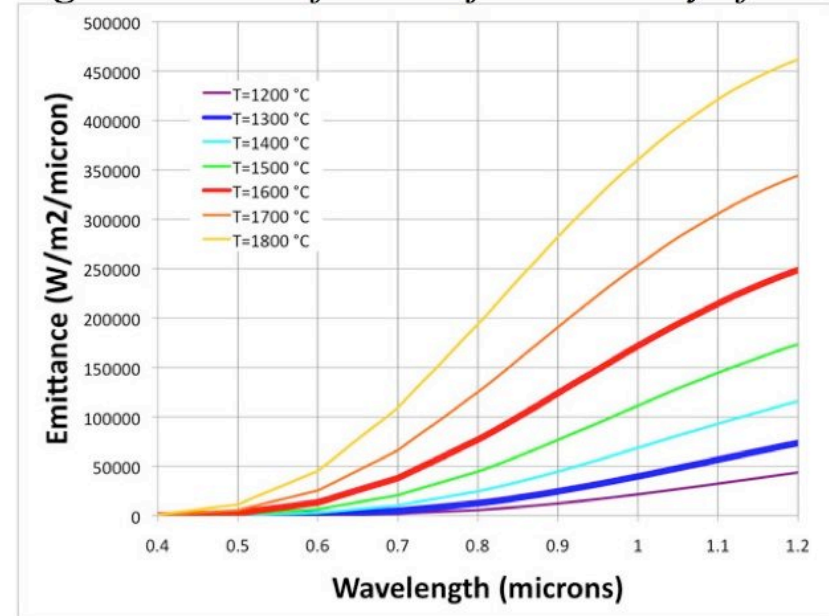

Thermal Mapper

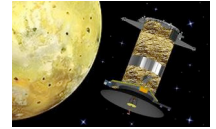

- **Threshold Mission: ~2, 5, 8, 20 microns to monitor volcanism and measure heat flow**
 - Io surface Ts range from 70 to 1800 K!
 - Mercury T range is ~90 to 700 K
- **Thermal Emission Imaging System (THEMIS)**
 - 4.6 deg FOV, 250 urad/pixel, 1 km/pixel from 4,000 km, 10 bandpasses
 - New 640 x 480 detectors: 1 km/pixel from 8,000 km
- **Baseline Mission:**
 - Optimize bandpasses for thermal mapping
 - Thermal emission compositional studies of silicate mineralogy
 - Lava expected to be glassy--problem for NIR but not thermal IR

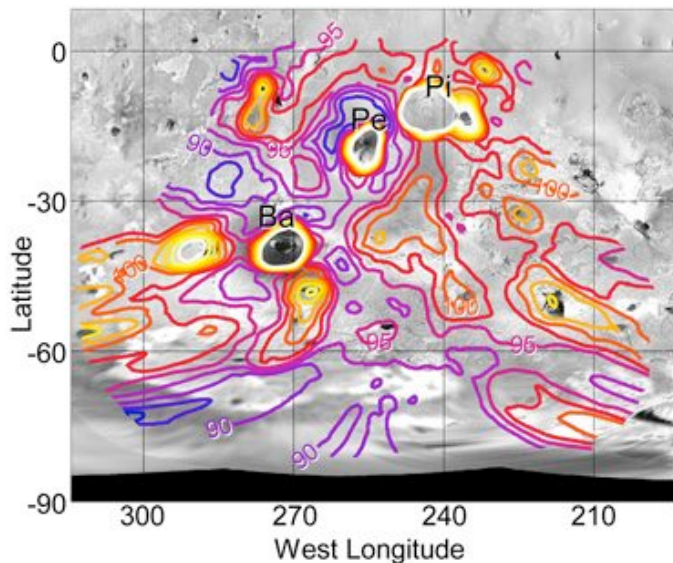

Nighttime T
map from
Galileo PPR

THEMIS

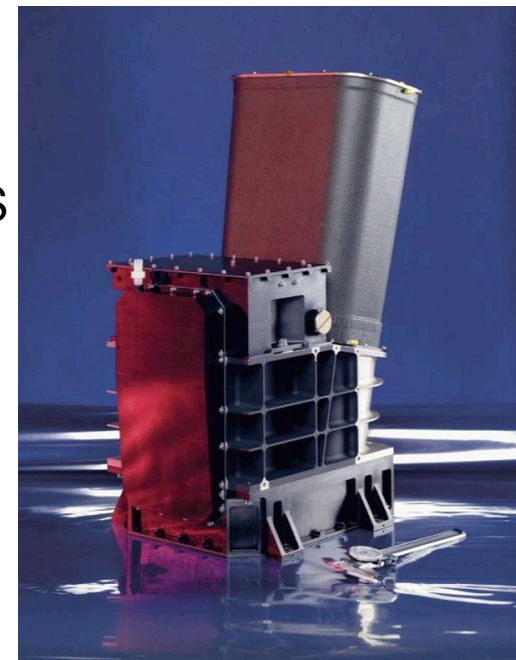

Ion and Neutral Mass Spectrometer (INMS)

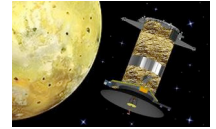

To be contributed by U. Bern--Nick Thomas,
Peter Wurz and Swedish Institute of Space
Physics--Martin Wieser and Stas Barabash

Mass range 1-300 amu; $M/\Delta M = 300 - 1000$,
increases with mass

Mass spectra are recorded once every 5 seconds
(flyby mode) that gives a direct science data rate
of 19,200 bits/s.

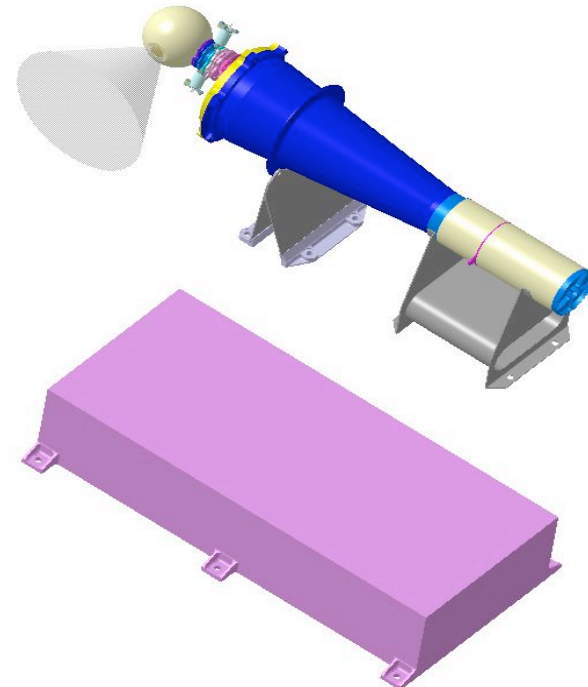

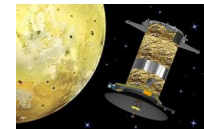

P-BACE quick-look data

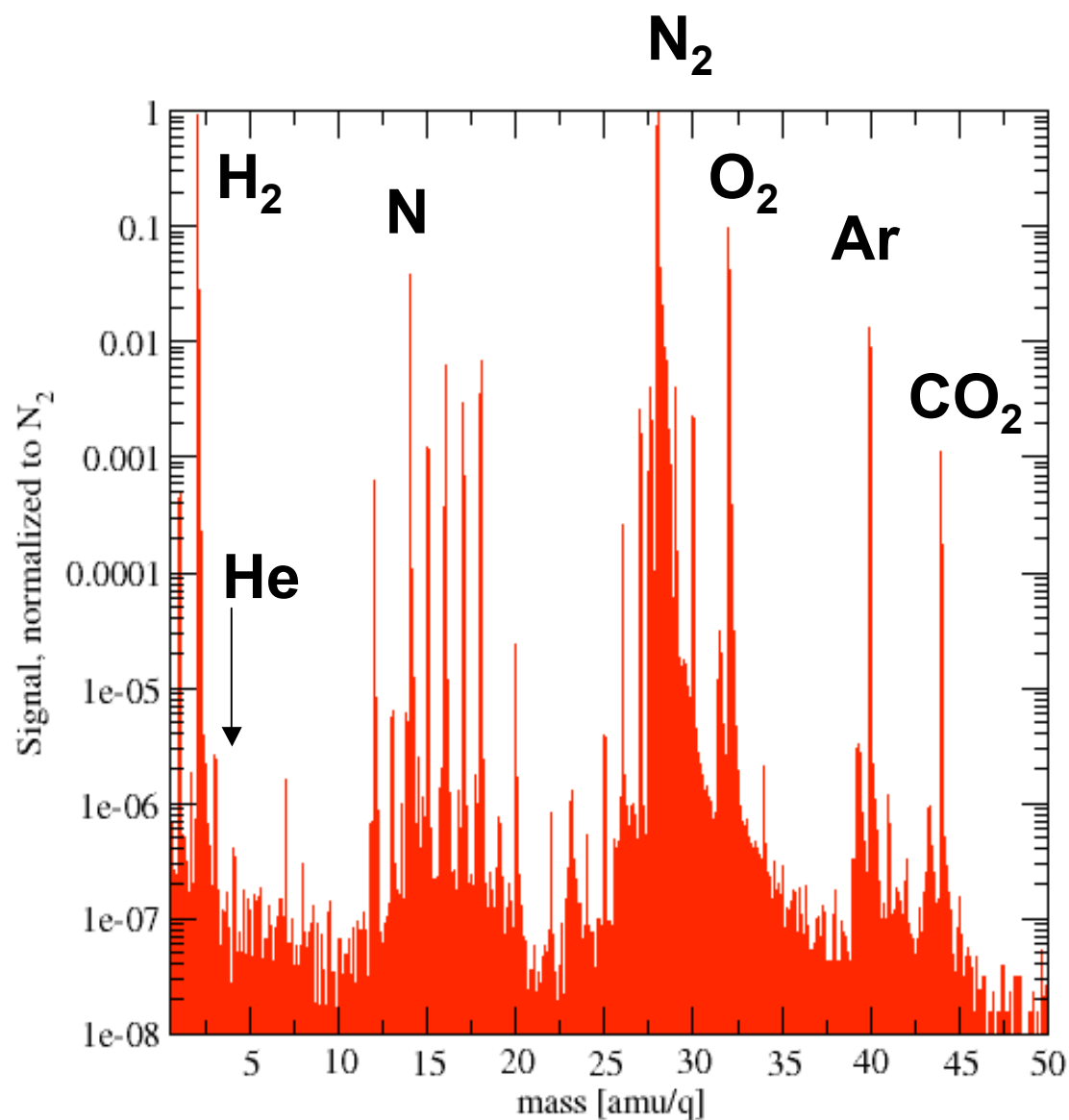

- Raw data--no background subtracted
- Dynamic range: 6–7 orders of magnitude
- Mass range: 1–1000 amu/q

Fluxgate Magnetometer

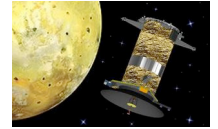

Vector compensated fluxgate ringcore sensor

Contributed by Karl-Heinz Glassmeier, IGEP

Heritage: Rosetta, Venus Express, Themis, BepiColombo

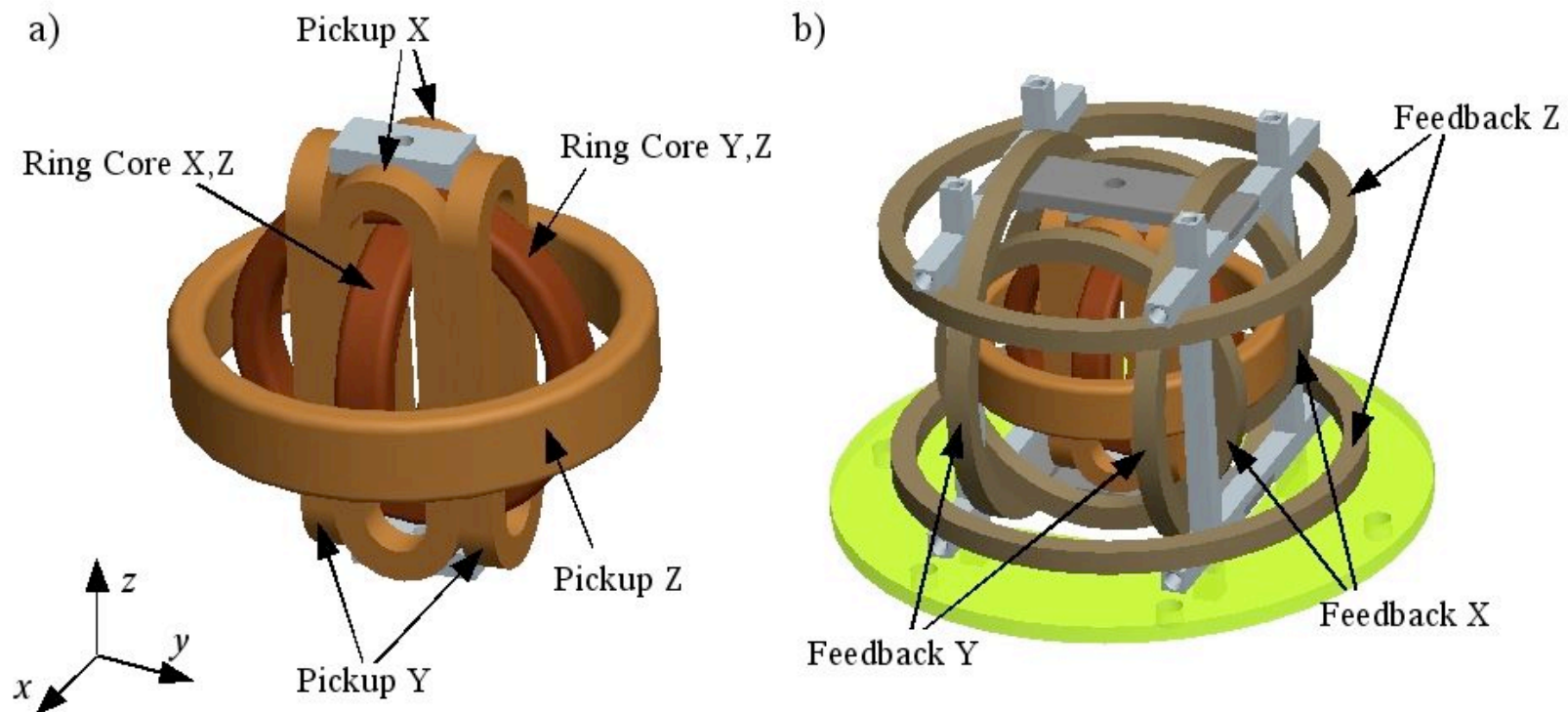

IVO Science Objectives

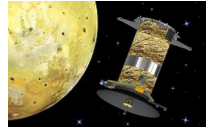

There are 7 science goals for NF-3 *Io Observer*. *IVO*'s baseline mission addresses all of these and 1 more, prioritized into Groups A and B.

- A1. Understand the eruption mechanisms for Io's lavas and plumes and their implications for **volcanic processes** on Earth and the other terrestrial planets.
- A2. Determine Io's interior structure, especially the **melt fraction of the mantle**.
- A3. Determine the properties and mechanisms of Io's **tidal heating** and implications for the coupled orbital-thermal evolution of Io and Europa.
- B1. Investigate the processes that form Io's mountains and the implications for **tectonics** under high-heat-flow conditions that may have existed early in the history of other planets.
- B2. Understand Io's atmosphere and ionosphere, the dominant mechanisms of **mass loss**, and the connection to Io's volcanism.
- B3. Determine whether Io has a **magnetic field** and implications for the state of Io's large core.
- B4. Understand Io's **surface chemistry**, including volatiles and silicates, and implications for crustal differentiation and mass loss.
- B5. Improve our understanding of **Jupiter system science**, including meteorology, vertical structure, and auroral phenomena on Jupiter; composition and temporal variability of Europa's exosphere; Jovian magnetospheric processes; and small inner moons and rings of Jupiter.

Science Objective A1

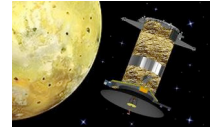

- Understand the eruption mechanisms for Io's lavas and plumes and their implications for volcanic processes on Earth and the other terrestrial planets.
 - *High-resolution repeat imaging at UV to thermal-IR wavelengths (RCam, ThM) and monitoring of escaping species (INMS).*
 - *Movies of dynamic phenomena such as plumes, vents, and lava lakes (RCam)*
 - *Requires high data rate*



Lava fountain on Etna.

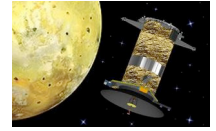

Is Io Impossible?

- Peak temperature measurements suggest Io's mantle has a high degree of melt, but that would lead to insufficient tidal heating and is unstable [Keszthelyi et al. 2007].
- Temperature measurements may be wrong or Io's heat flow and volcanic activity may be out of equilibrium with periodic tidal heating.

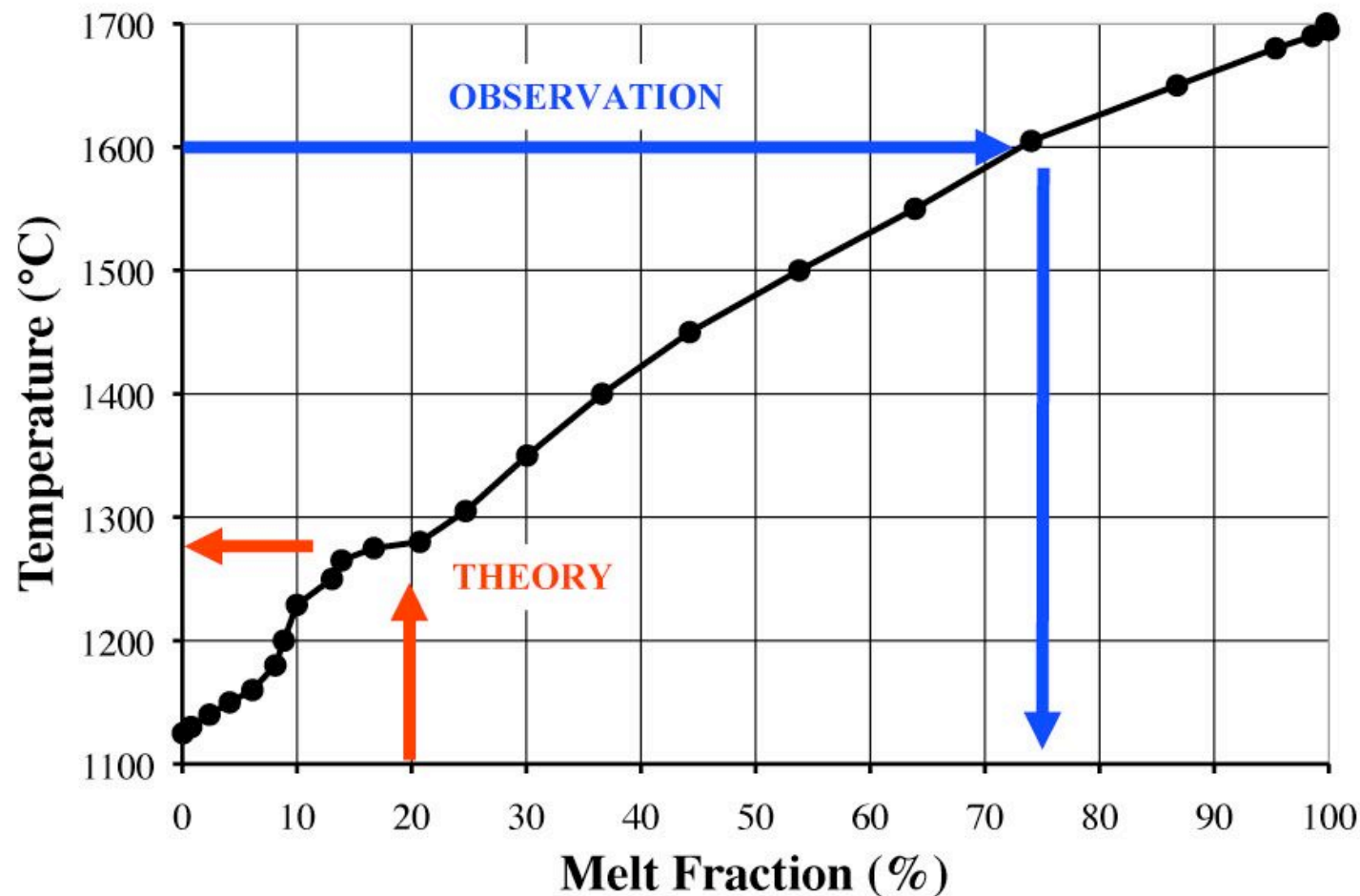

Science Objective A2

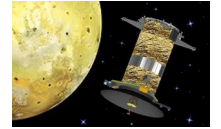

- Determine Io's interior structure, especially the melt fraction of the mantle.
 - *Measure peak lava temperatures to estimate the temperature of the mantle (RCam)*
 - *Need near-simultaneous color, high SNR, and unsaturated data*
 - *Measure electromagnetic induction signal to test for a magma ocean (FGM).*
 - *Electrical conductivity of basaltic liquid is >10x that of solid*
 - *Plan 2 identical passes but at max and min magnetic latitude for induction responses of opposite sign.*
 - *Improved measurements of the shape of Io and search for nonsynchronous rotation (RCam).*

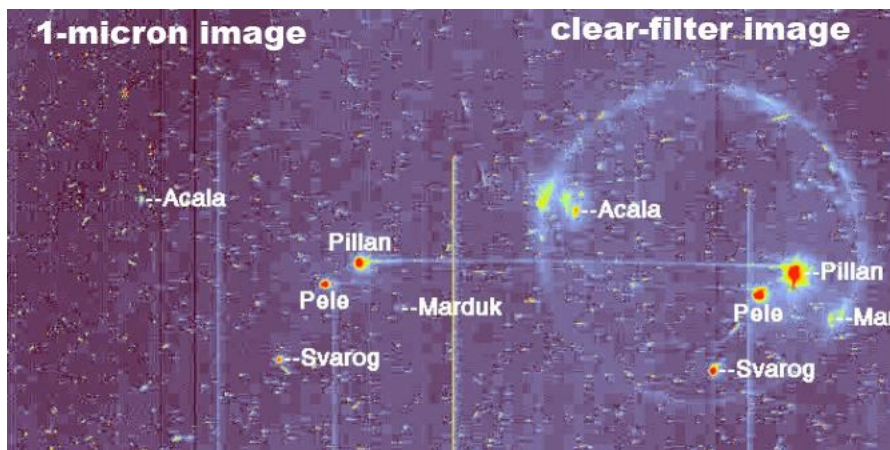

Galileo eclipse image during the initial outburst (lava fountaining) from Pillan Patera, used to estimate lava temperatures on Io. IVO can provide such observations with much improved quality and more tightly constrained peak temperatures.

Science Objective A3

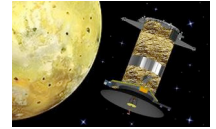

- Determine the properties and mechanisms of Io's tidal heating and implications for the coupled orbital-thermal evolution of Io and Europa.
 - *Map and monitor global heat flow, especially during eclipses to minimize re-radiated solar heat, and especially polar regions (ThM).*
 - *Requires polar views of eclipses*

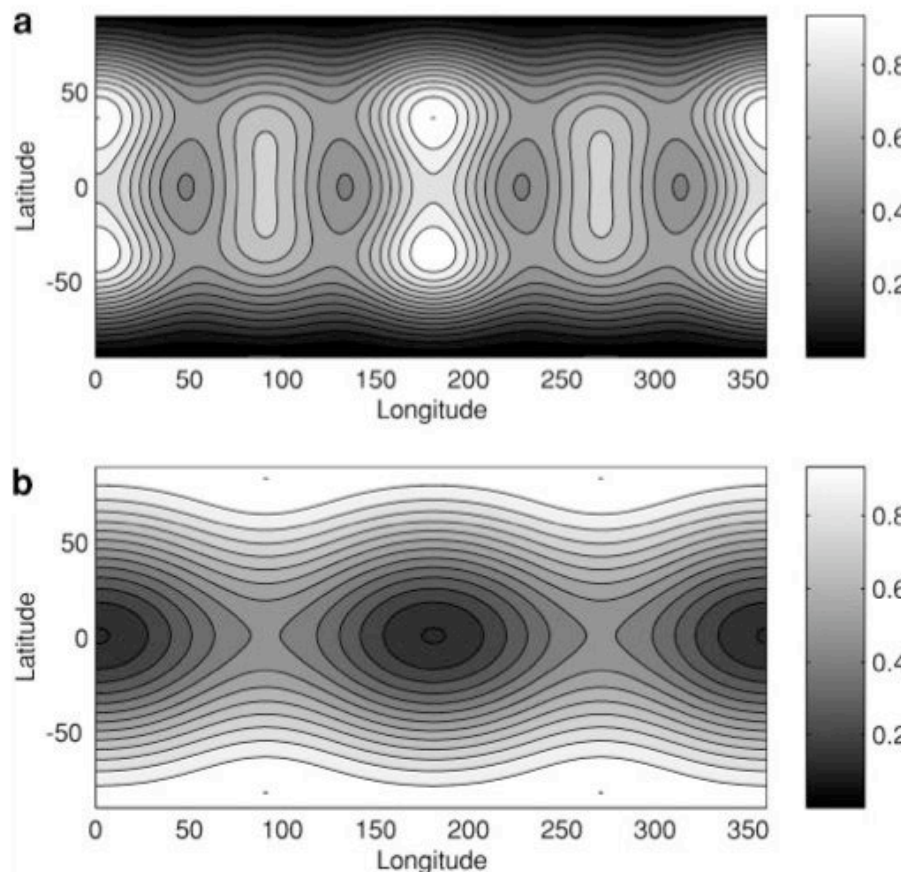

Models for heat flow patterns:
asthenospheric (top) and
deep mantle (bottom)

(Segatz et al., 1988; Ross et al., 1990; Tackley et al., 2001)

Objective A2 (melt fraction of the mantle) is also key to this objective.

Science Objective B1

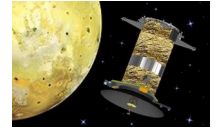

- Investigate the processes that form Io's mountains and the implications for tectonics under high-heat-flow conditions that may have existed early in the history of other planets.
 - *Image and measure topography of key tectonic structures (RCam).*
 - *WAC would provide pole-pole strip of stereo coverage from each flyby, 25 m/pixel from 200 km range.*
 - *NAC can provide ~2 stereo image pairs per flyby as well as limb images.*
 - *Color imaging of volatiles associated with tectonic structures.*

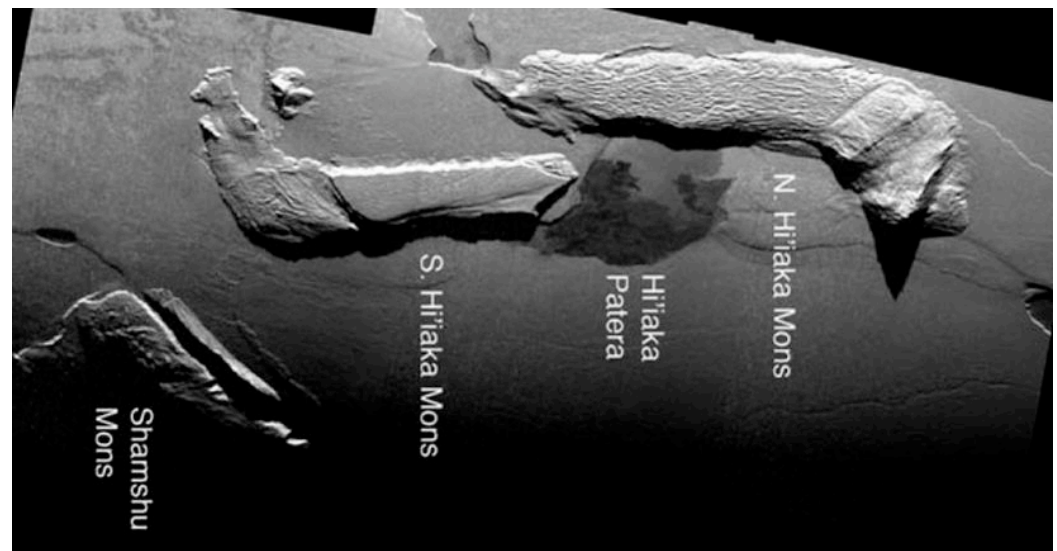
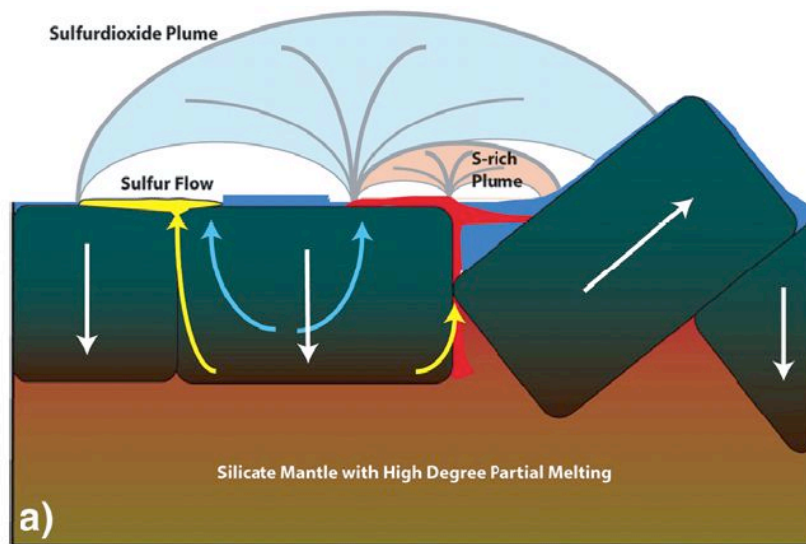

Science Objective B2

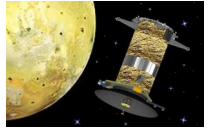

- Understand Io's atmosphere and ionosphere, the dominant mechanisms of mass loss, and the connection to Io's volcanism.
 - *Determine composition and temporal and spatial variability of escaping species (INMS, RCam, FGM).*
 - *Directly sample gravitationally bound portions of volcanic plumes and atmosphere, late in the mission (INMS).*
 - *Consider two INMS instruments:*
 - *One mounted orthogonal to remote sensing, to acquire data at closest approach while imaging Io*
 - *One pointed 180 deg away from optical boresights, for flying through plumes.*
 - *Protect instruments, then observe plume source region at high resolution after flying through the plume.*

150-km high Loki plume
imaged by Voyager 1

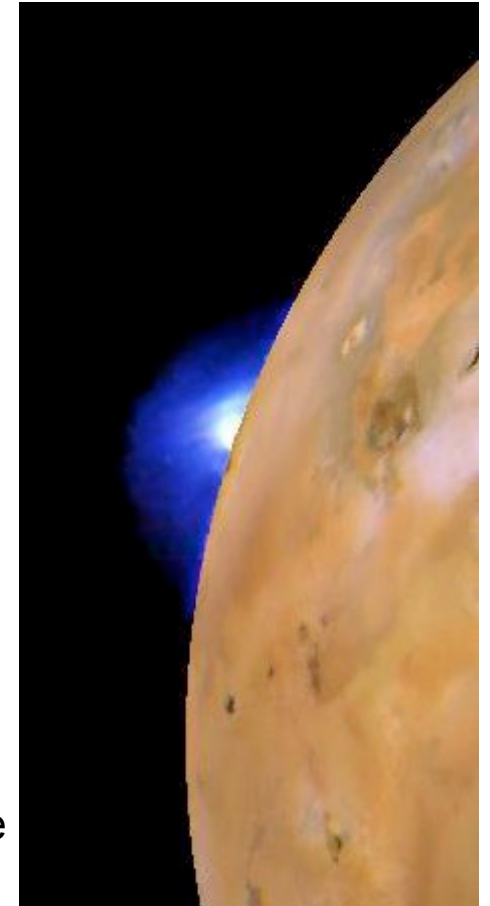

Science Objective B3

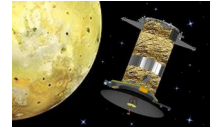

- Determine whether Io has a magnetic field and implications for the state of Io's large core.
 - *Measure magnetic signatures with FGM*
 - *Jupiter's field is ~ 2000 nT*
 - *Galileo found no internal dipole field at Io stronger than a few hundred nT, but core convection may be complex, leading to higher-order (quadrupolar or octupolar) fields*
 - *Target flybys to high magnetic latitudes and a variety of Io longitudes.*
 - *Combine with Galileo data (and future JEO data) to model higher-order magnetic fields.*
 - *Io's core may lack significant convection if the mantle is hot.*

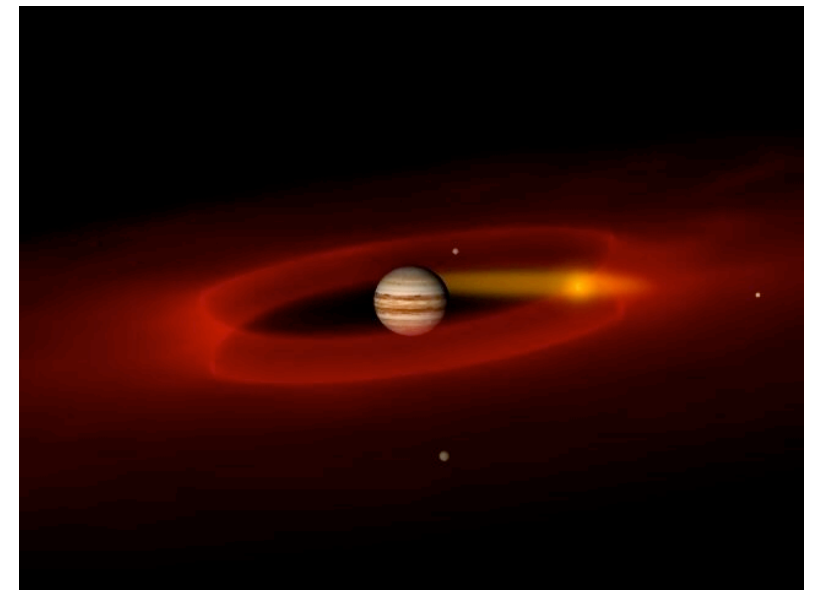
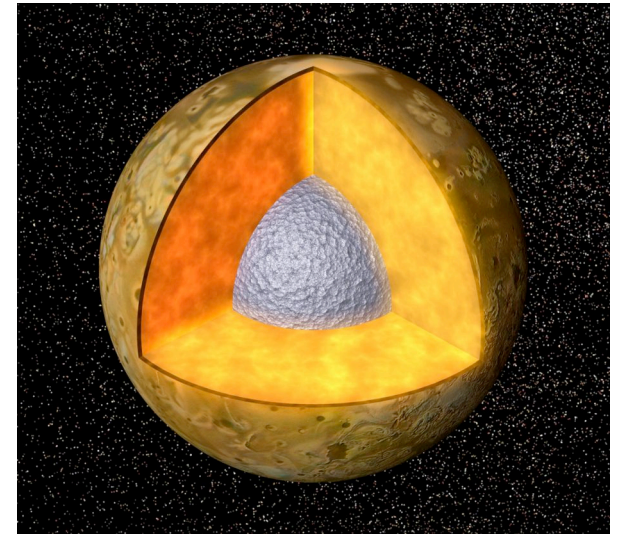

Science Objective B4

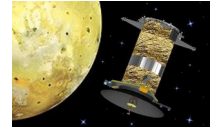

- Understand Io's surface chemistry, including volatiles and silicates, and implications for crustal differentiation and mass loss.
 - *Image at UV to near-IR wavelengths (RCam), measure spectral thermal emission (ThM), and determine composition of escaping species (INMS).*
 - *Addition of contributed 2-5 micron Imaging Spectrometer (JIRAM) would be important to this objective.*

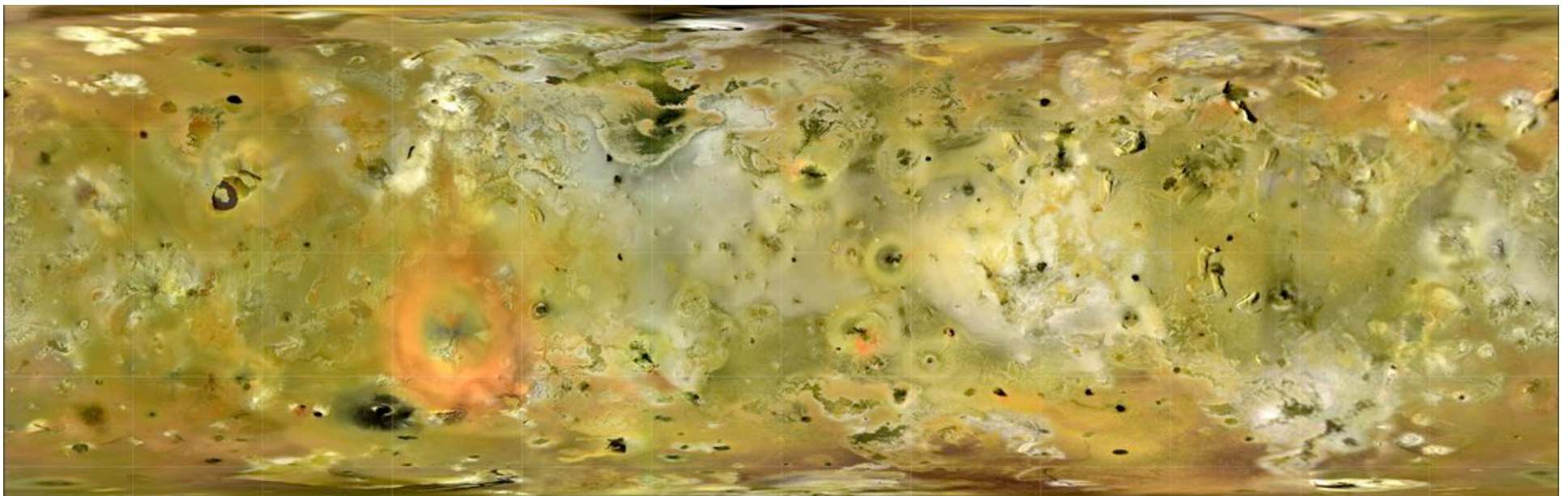
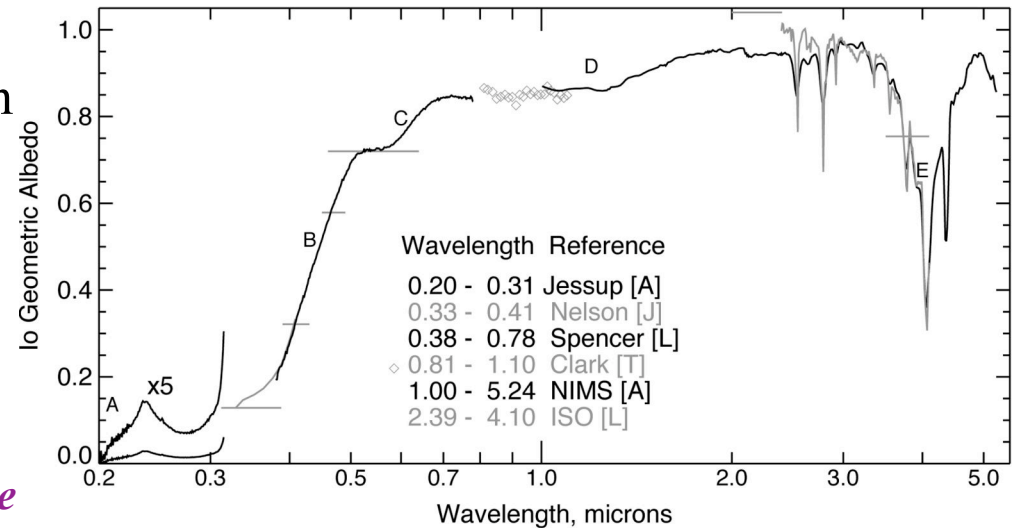

Science Objective B5

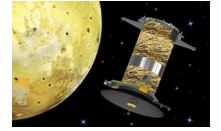

- Improve our understanding of Jupiter system science, including meteorology, atmospheric structure, and auroral phenomena on Jupiter; composition and temporal variability of Europa's exosphere; Jovian magnetospheric processes; and small inner moons and rings of Jupiter.
 - *Observations by full payload when outside Io encounter periods.*

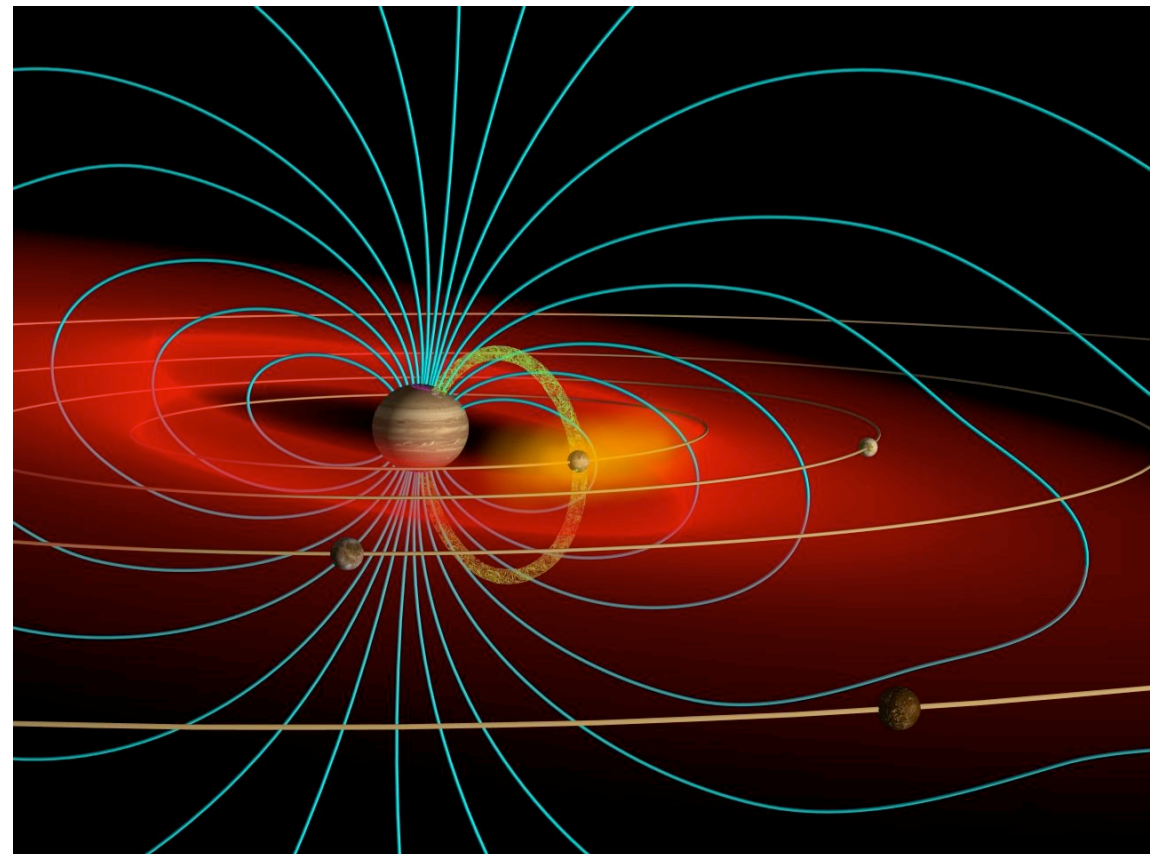
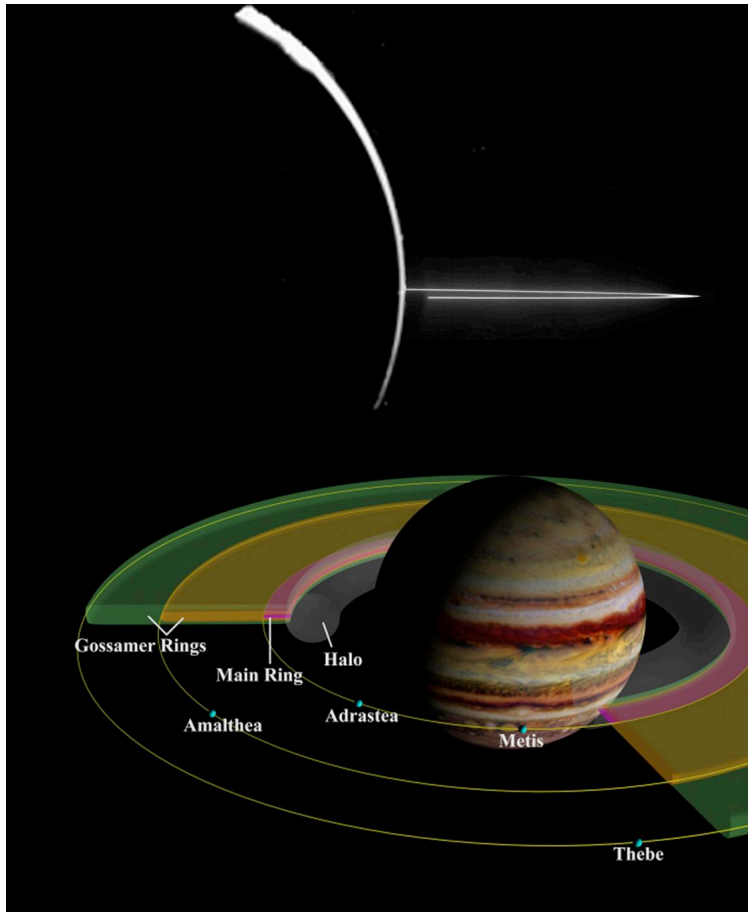

Technology Objectives

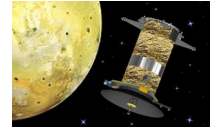

- **Long-term in-flight test of ASRG**
 - Test microphonics via NAC imaging
 - Make sure mission can continue if 1 of 4 ASCs fail
 - Rcam NAC imaging jitter, less data volume
- **NASA Announced *Jupiter/Europa Orbiter (JEO)* for next Outer Planets Flagship Mission**
 - May increase attractiveness of *IVO* to NASA, due to risk reduction for *JEO*
 - *JEO* may use ASRGs, because Pu^{238} is very scarce
 - *IVO* would provide ASRG-based spacecraft design experience for Jupiter environment
 - An *IVO* mission launched in ~2015 would provide several years of in-flight experience with ASRGs prior to *JEO* launch.
 - *IVO* would provide ASRG experience in the Jupiter trapped radiation belts starting (nominally) after launch of *JEO* but well in advance of its arrival, providing experience with operations and mitigation of potential problems.
 - New information about Jupiter radiation environment
 - Dosimeters to measure TID
 - Science instruments and star trackers provide further information

IVO Extended Mission

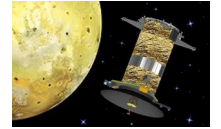

- **Lifetime is the major concern for ASRGs, so a long-term life test is important to future exploration in the outer Solar System**
 - An inflight life test of full 14-yr ASRG requirement would be best
 - IVO nominal mission is 8 years
 - Extended mission with continued Io flybys every 1-2 months would be limited to less than a few years by radiation damage.
 - ***OPAG should urge NASA to give the ASRGs get a long-term, in-flight life test***
- **Extended mission option: pump out orbit to ~1 year period to ensure completion of 14-yr ASRG life test**
 - Could provide another ~8 Io flybys
 - Io's sub-solar longitude at C/A will move ~37° per year
 - May be possible to target an outer irregular Moon, which probably has same origin as Trojans (possible captured KBOs)
 - Better measure of non-synchronous rotation and orbital evolution of Io
- **End mission by impact into Io or Jupiter**
 - Planetary protection requirements

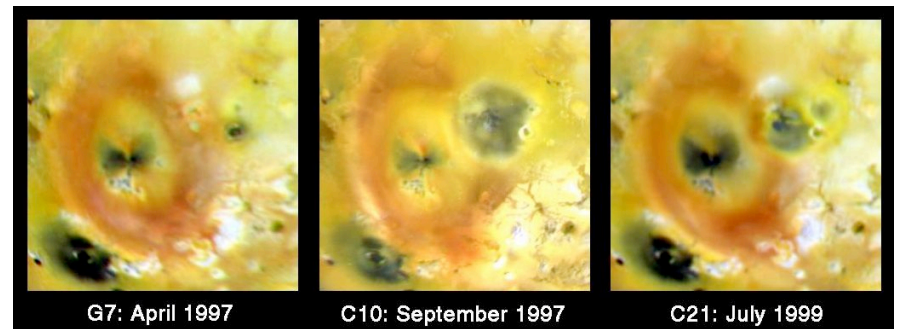

Io Science with *JEO* and *IVO*

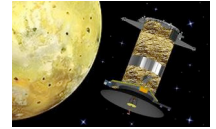

- ***JEO* SDT report describes 4 Io flybys, 3 with science observations**
 - Io is a secondary objective to *JEO* and could be descoped
- ***IVO* will be designed to address key Io issues that *JEO* would or could be unable to accomplish**
 - Polar heat flow is key to distinguishing between deep and shallow tidal heating models
 - *Galileo*, *JEO*, *NH*, Earth-based telescopes: all equatorial views
 - Measuring peak lava temperature is a requirement for *IVO*
 - INMS will be designed for 19 km/s flybys at close range (~100 km) of Io.
 - *Is JEO* really going to fly through a plume and risk damage early in the mission?
 - *IVO* orbit designed for repeat imaging at similar illumination angles
 - Random imaging leads to ambiguity over photometric or diurnal v. volcanic changes
 - *IVO* will tweak orbits for optimal magnetic measurements
 - *IVO* provides unique high-inclination remote sensing of Io plumes, atmosphere, and magnetospheric interactions
 - In-situ measurements (INMS, magnetometer) in unexplored region via *IVO* orbit
 - Spectral bandpasses of *IVO* remote sensing (15 for imaging, 10 for thermal mapper) will be chosen primarily for Io
- ***JEO* will accomplish unique science even if *IVO* flies**
 - Unique instrumentation: UV spectrometer, etc.
 - The more the better--Io is constantly changing.
 - *Galileo* saw new class of large polar eruptions only in its last year.

Typical Dataset from 1 Orbit

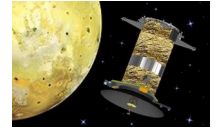

- Monitoring of Jupiter system.
- Imaging of entire illuminated hemisphere of Io at <1 km/pixel in 8 colors, key features at 10-100 m/pixel in 4 colors and <10 m/pixel clear filter.
- Imaging of high-temperature activity on night side in 4 colors at <100 m/pixel to measure liquid lava temperatures.
- Regional thermal mapping at 0.1-100 km/pixel.
- Two NAC stereo image pairs and two movies of active volcanism.
- Imaging of Io eclipses for ThM global heat flow mapping at <200 km/pixel and RCam emissions from 200-1000 nm at <16 km/pixel.
- Continuous FGM measurements.
- INMS data (hundreds of spectra) at Io closest approach, and other segments of time away from Io.
- Equivalent of $\sim 5,000$ Cassini ISS images (1,000 x 1,000 pixels)

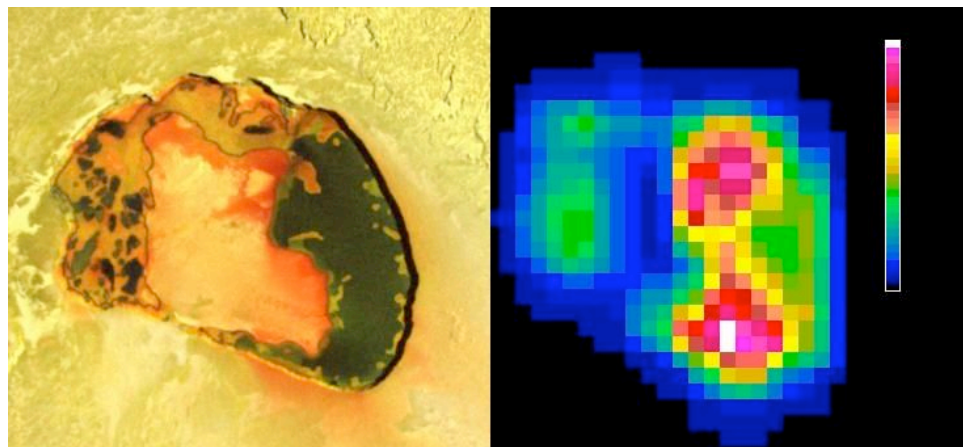

Tupan Patera from *Galileo* imaging at 135 m/pixel and NIMS temperature map

IVO is exactly what NASA needs

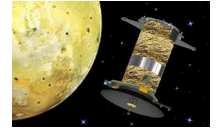

- Exciting new target for Discovery
 - New Frontiers class science from Discovery program
- Test ASRG long-term and in Jupiter's trapped radiation
 - Given the great scarcity of Pu²³⁸ NASA is counting on ASRGs for many future missions
 - IVO provides a low-risk flight test during a 6-yr cruise to Jupiter, then an important test in a high radiation environment, then a long-term test to verify ASRGs can last 14 yrs.
 - *A long-term ASRG test is important to future exploration at Saturn and beyond*

