

UNCLASSIFIED

AD 263 548

*Reproduced
by the*

**ARMED SERVICES TECHNICAL INFORMATION AGENCY
ARLINGTON HALL STATION
ARLINGTON 12, VIRGINIA**



UNCLASSIFIED

NOTICE: When government or other drawings, specifications or other data are used for any purpose other than in connection with a definitely related government procurement operation, the U. S. Government thereby incurs no responsibility, nor any obligation whatsoever; and the fact that the Government may have formulated, furnished, or in any way supplied the said drawings, specifications, or other data is not to be regarded by implication or otherwise as in any manner licensing the holder or any other person or corporation, or conveying any rights or permission to manufacture, use or sell any patented invention that may in any way be related thereto.

703354
120354

REPORT OF ENVIRONMENTAL OPERATION



LEAD DOG
1960

61-4-5-
XEROX

UNITED STATES ARMY TRANSPORTATION BOARD
Fort Eustis, Virginia

FINAL REPORT

PROJECT LEAD DOG 60

TCB-60-023-E0

A TRAVERSE OF NORTH GREENLAND AND AN
AERIAL AND SURFACE EXPLORATION OF
PEARY LAND AND CROWN PRINCE CHRISTIAN
LAND CONDUCTED BY THE US ARMY TRANS-
PORTATION CORPS MAY-JULY 1960

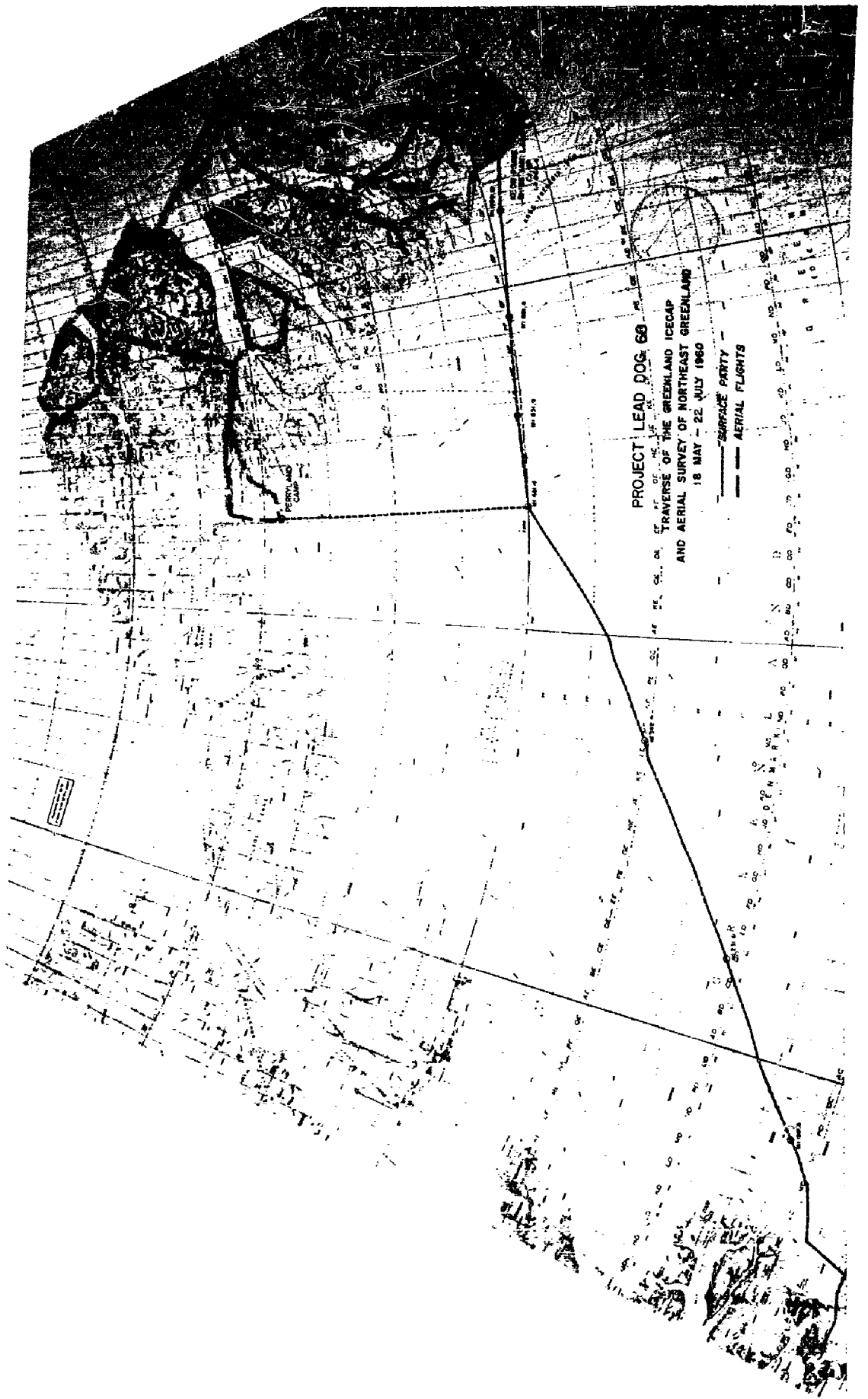

TABLE OF CONTENTS

		Page
CHAPTER I	Introduction, /Summary, /Conclusions, /Recommendations	1
CHAPTER II	Narrative of the Tractor Swing Operation	5
CHAPTER III	Aviation Operations	22
CHAPTER IV	Scientific Studies	35
CHAPTER V	Navigation and Trail Operations	55
CHAPTER VI	Equipment Operations and Maintenance	70
CHAPTER VII	Quartermaster Test Items	90
CHAPTER VIII	Land Route From the Inland Ice to Centrum Lake	95
CHAPTER IX	Accessibility and Traversability of Southern Peary Land	102
CHAPTER X	Personnel, Administration and Logistics	134
CHAPTER XI	Communications and Electronic Equipment	151
ANNEX A	Activity Report of Sikorsky Technical Representative	158
ANNEX B	Airlift of Two H-34C Type Helicopters in One C-124 Cargo Transport	162
ANNEX C	Air Shipment of H-34C Helicopters in C-133A Cargo Aircraft	168
ANNEX D	References	170
DISTRIBUTION		172



Figure 2. M29C Weasel with crevasse detector leads the LEAD DOG 60 expedition through a suspected crevasse field.

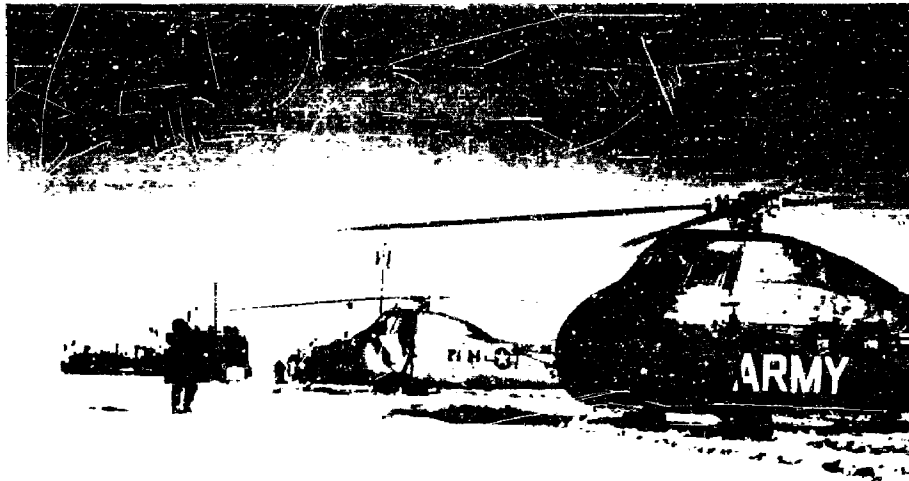

Figure 3. Two H34C helicopters land at the LEAD DOG 60 Crown Prince Christian Land base camp after successfully crossing the Greenland icecap.

CHAPTER I

INTRODUCTION, SUMMARY, CONCLUSIONS, RECOMMENDATIONS

I. INTRODUCTION

Each year since 1952 the Transportation Corps has conducted operations and studies designed to extend the military and scientific knowledge of the Greenland icecap and surrounding ice-free land areas. The operating and navigation techniques which have been developed by the Transportation Corps have become standard for icecap operations in both the Arctic and Antarctic regions. Project LEAD DOG 60, a continuation of these studies, was carried out in conjunction with nine other Department of Defense and US Government agencies.

The US Army Transportation Environmental Operations Group was directed by the Chief of Transportation to organize and conduct a heavy swing operation over the Greenland Icecap from Camp Tuto to Crown Prince Christian Land and to Peary Land; to establish a marked trail from 80° North Latitude, 39° 38' West Longitude (Mile 481.4) to the vicinity of Cape George Cohn; to establish a descent and overland route from the icecap to Centrum Lake and to Brønlunds Fjord; to conduct, in conjunction with other agencies, a scientific investigation of the icecap and the ice-free land areas of northern Greenland.

Planning for this extensive operation was begun in 1958, and since that time has involved nearly 400 individuals from over 20 military and civilian agencies of the US Government. Every aspect of the operation had to be closely coordinated and every contingency had to be planned for in detail. A total of 242 tons of POL and supplies was necessary to maintain the swing and the aircraft for the period that the project was on the icecap. In addition, 12 caches were established by Air Force para-drop, ranging in size to 20 tons; for the aircraft exploration of northeast Greenland. The logistical requirements of the project required detailed planning and coordination to insure a successful operation.

Outstanding support was provided to the project by the Polar Research and Development Center at Camp Tuto, Greenland. In addition to the support rendered prior to the swing's departure from Camp Tuto, a PR&DC swing cached a total of 619 drums of POL at Mile 120 and Mile 231. The caching of this cargo allowed the LEAD DOG 60 swing to move from Camp Tuto to Mile 231 lightly loaded, thereby permitting the swing to get off to a fast start. While the swing was on the icecap PR&DC continued to support the project with spare parts, radio communications, and two support flights by their organic aircraft.

2. SUMMARY OF OPERATIONS

On 18 May 1960, the tractor swing departed from Camp Tuto, thereby beginning its traverse of the icecap to Crown Prince Christian Land. Twenty-six days were required to travel the 664.4 miles to the first of the two programmed base camps. Scientific studies were made enroute, and the trail, marked by LEAD DOG 59 to Mile 481.4, was continued to Mile 664.4. Immediately following the swing's arrival at the eastern edge of the icecap, the surface party was joined by the project's two H-34C helicopters which had followed the swing's trail from Camp Tuto and refueled from caches established at prearranged points. Immediately after setting up camp, the helicopters flew to the USAF Cambridge Research Center Camp at Centrum Lake, 35 miles from the swing's position.

During the 13 days that the swing was in Crown Prince Christian Land, numerous flights were made transporting scientists and technicians to various areas of scientific interest, and a five-man, two-vehicle trail party located a descent route from the icecap and an overland route to the Centrum Lake camp. On 16 June, an Air Force ski-equipped C-130 aircraft landed at the swing's position with scientists, spare parts, and helicopter maintenance personnel.

The swing and the helicopters separated on 25 June. The helicopters began their aerial survey of the ice-free land areas of northeastern Greenland and the swing made a rapid move to Mile 124.2P, the point which had been selected as the second base camp. Little of note occurred to the swing during the march to Peary Land. The two tractors, which had been cached on the outbound trip because of mechanical failures, were repaired and recovered. Additional studies were made and the altimetry line from Mile 481.4 to Mile 661.4 was closed. Enroute, the swing was visited by two U1A Otters which delivered a scientist, mail, and fresh foods. However, the benefits accrued from this flight were negated by a 68 hour delay to the swing because of low visibility which grounded the aircraft. The swing reached the Peary Land camp on 6 July, 12 days after their departure from Crown Prince Christian Land.

While the swing was underway, the ten-man, two helicopter party was conducting extensive geologic, geographic and archeologic studies in Peary Land and Crown Prince Christian Land. This party set numerous firsts as its helicopters were the first to completely cross Greenland, the first to operate in northeast Greenland or to land at Station Nord, and the first aircraft to land at Cape Morris Jessup, the world's most northern point of land. The aircraft rejoined the swing early on 8 July, after a 12 1/4 day separation.

While in Peary Land, the Project continued its scientific studies and, by helicopter reconnaissance, located a route from the icecap to Brønlunds

Fjord. An initial attempt to descend by Weasel over this route was aborted as the party failed to correct for map error and became headed 12° off course into a severe crevasse field. A second attempt was not made as the helicopters lacked sufficient remaining hours of operation and the swing was nearing the point of "no-return" with its reserve of diesel fuel. Accordingly, on 12 July, the helicopters and the tractor swing began the 605.6 mile trip back to Camp Tuto. Although the helicopters were forced down by weather for 52 hours, they arrived at Thule Air Base on 14 July. The swing made the return trip without mishap, taking ten days to travel the 605.2 miles, arriving on 22 July.

During the 68-day operating period, the surface and aerial parties successfully accomplished their assigned mission, and in the process, collected much valuable scientific data. The geologic, geographic, meteorological, and other studies conducted by the project have greatly extended the current knowledge of the Arctic.

3. CONCLUSIONS

- a. The assigned mission was accomplished.
- b. Descent routes from the icecap to Centrum Lake and Brønlunds Fjord exist and are negotiable by tracked, low-ground-pressure vehicles.
- c. The ability of a tractor-train to travel long distances over the icecap and then to support other military activities at the terminus was demonstrated for the first time. The addition of wheeled transporters made possible the support of aviation operations in northeast Greenland with 19,850 gallons of Avgas and 9,000 pounds of spare parts. Through an increased use of Rolling Liquid Transporters and 10-ton Off-Road Trailers, this figure could have been increased materially.
- d. The slow speed of the D-8 LGP Tractor (2-4 mph) greatly restricts military operations in the Arctic.
- e. Icecap navigation and trail operations procedures have been refined to a point of extreme reliability.
- f. The use of helicopters greatly facilitates detailed investigations of areas inaccessible to other means of transportation.
- g. The current "W" System Crevasse Detector is not sufficiently reliable for icecap operations. A more reliable detector is necessary for surface operations in marginal zones.

h. On a project of this type, the breaking of the workday into two 12 hours shifts provides sufficient periods of rest and relaxation for all personnel.

4. RECOMMENDATIONS

a. Future tractor-train icecap operations should make a greater use of wheeled trailers and transporters.

b. Future exploratory operations of this nature should make maximum utilization of mutually supporting surface-aviation parties.

c. A more reliable crevasse detector should be developed.

d. A high speed prime mover should be developed to make maximum utilization of the wheeled equipment. At present, there are no vehicles in the supply system which can be effectively mated with the 10 Ton Off-Road Trailers. The LGP D-8 Tractor, which must be specially modified at high cost, can move trailers more efficiently than it can haul sleds, but it is too slow to make maximum utilization of these trailers.

CHAPTER II

NARRATIVE OF THE TRACTOR SWING OPERATIONS

On 1 April 1960 personnel scheduled to participate in Project LEAD DOG 60 began arriving in Greenland to prepare for the coming project. The Project's tractor train was scheduled to depart for its trip to the east coast of Greenland on 15 May. However, before the train could depart, it was necessary to make extensive preparations and to look after numerous details and contingencies.

Between 1 April and 15 May, processing and final procurement of all mission equipment and stores for the coming operation took place. It was necessary to dig out equipment stored outside during the previous summer, to load the mammoth fuel requirements, to process all incoming equipment, and to make modifications to the equipment based on experience gained in the course of the 1959 Greenland operations.

As the personnel arrived in Greenland they were originally quartered at Camp Tuto. As the tractor train was prepared for the trail, however, personnel moved to the expedition's wanigans parked in the staging area at the base of the ramp road. On 6 May the swing moved 2.9 miles to the top of the ramp road and prepared for its scheduled departure. However, as the two modified 10-ton Off-Road Trailers had been delayed in shipment from CONUS to Thule Air Base, the project officer was directed by the Commanding Officer, USATREOG, to delay the swing's departure pending the arrival of these vehicles. The trailers arrived on 16 May and after a one day delay in delivery to Camp Tuto, the swing personnel immediately began their assembly, and to transfer to the trailers drummed fuel previously loaded on sleds in anticipation of the trailers' non-arrival.

Project LEAD DOG 1960 departed the end of the ramp road at 1100 hours on 18 May after appropriate ceremonies. The following is a selective log of the 69 day expedition.

Mile 3 - Mile 60.8 (181100 - 191800 May)

Almost 58 miles progress in 31 hours. Extremely good time considering that 13 1/4 hours of this time were spent moving through ice fog which at times reduced visibility to less than 200 feet. As the swing was moving through the marginal area of the icecap, the fog posed a greater threat than normal because of the danger of one of the tractors losing the trail and blundering into a crevasse.

During a six hour period of extremely low visibility, the radar set in the command Weasel was utilized quite effectively to follow the trail and to guide tractors around the numerous turns in the marginal area. However, it was often difficult to distinguish between the echos received from the tractors and those received from the small drifts along the trail. This problem is not as acute outside the marginal area as the trail is not as rough and the Weasel is able to maintain a more stable movement. Through the use of FM radios installed in the command vehicle and each of the tractors, control was effectively maintained.

During this period no major mechanical difficulties were experienced. The trail was rough, but, considering the amount of traffic which had been passing over it enroute to Camp Century and Camp Fistclench, it was in very good condition. All crevasses were closed and well bridged. Snow conditions were excellent since the trail was hard packed from previous traffic.

During this stage of the expedition, all of the tractors were pulling relatively light loads as the swing planned to pick up eight sleds of diesel fuel and aviation gas from the cache at Mile 231. Accordingly, the swing made very good time, traveling most of this distance in third gear. During this period, the swing was actually underway 22 hours and 8 minutes, maintaining an average speed of 2.65 miles per hour. The remainder of the time was spent performing maintenance and conducting studies.

One difficulty was experienced during this period relative to the gravity survey which was to be conducted. All the markers marking the 1959 altimetry stations had been blown away or had fallen over during the previous melt season. Accordingly, the first gravity station which could be found was at Mile 60.8 and plans were made to keep an accurate measurement of the distance traveled by the command vehicle odometer.

Mile 60.8 - Mile 231.0 (191800 - 241020 May 1960)

The terrain from this point on consists of a featureless plateau which rises gently to the center of the icecap. The area past this point is known as the interior of the icecap while the first 60 miles are considered to be the marginal zone.

After a maintenance halt of 1 hour and 17 minutes, the swing departed Mile 60.8, but again experienced difficulty in finding the 1959 altimetry stations. At the next gravity station, Mile 75.0, readings were taken at the approximate location, and at Mile 85.3, the markings flags were found in place and for the remainder of the operation this ceased to be a problem.

At Mile 85.3 the first major mechanical failure occurred when the right outside axle bearing on an RLT failed and the cell locked on the axle. After

several attempts to repair the RLT, it was decided to top load it on one of the sleds and replace the bearing at a later time. The swing was underway after a nine hour and 15 minute halt. However, at Mile 89.7 the right bearing on another RLT began squeaking and, after inspection, it was found that the bearing had been crushed by the tightening action of the bearing carrier. (See Chapter VI for description of these failures and the corrective action taken). After a stop of 13 hours and 55 minutes, during which time the RLT was repaired, the swing was once again underway.

After refueling from a previously established cache at Mile 120.6, the swing departed from the relatively well-traveled trail to Camp Century and followed, to Mile 481.4, the trail established by the 1955 Eastwind Expedition and remarked by the 1958 and 1959 LEAD DOG expeditions. The trail was clearly visible and marked by bamboo poles and flags every one-quarter mile. Some poles from 1955 were barely visible, protruding above the snow one or two inches. However, all the flags had been blown away by the severe winds characteristic of this region. The swing departed from Mile 120.6 at 0500 hours on 22 May after an 8 1/2 hour halt.

At Mile 85.3, the swing was visited by two TREOG H-34C helicopters which brought Lt Col James Sandridge, CO, USATREOG, and Major William Gardner, Office of the Chief of Transportation, for a brief visit to the swing. At Mile 120.6 a Weasel was dispatched to carry these two officers to Camp Century to await transportation to Camp Tuto. This delayed the swing's departure by three hours.

The first defective RLT was cached at Mile 137.3 since it had been emptied previously and no protracted stops were planned to effect repairs.

At Mile 151.3, two USAPR&DC helicopters brought fresh foods, spare parts, glaciological equipment and one aviation mechanic who was to accompany the swing to provide support for the helicopters when they joined the swing permanently.

At 240005 May, the first radio contact was made with the Air Force party at Centrum Lake. Both parties exchanged status reports and wished each other luck.

The third RLT failure occurred at Mile 224.0. Again the right outside bearing had been crushed by the tightening action of the bearing carrier. At the time of the previous failures, an attempt had been made to back off on the carrier, but it had become too tight. The key washer had been locked to the carrier and lock nut, but the tabs had been sheared off. The RLT was top loaded to be repaired at a later time and the swing continued on to Mile 231.

The trail from Mile 60.8 to Mile 231 was relatively smooth with tractor penetration varying from two to six inches. During this period, the tractors were underway a total of 65 3/4 hours averaging 2.57 miles per hour. This reduction in average speed from that during the first 60 miles was due primarily to the softness of the trail after Mile 120.6, and the increased penetration by all vehicles. During this period the swing halted for a total of 46 hours and 36 minutes for maintenance, refueling, and studies.

Mile 231.0 to Mile 481.4 (241020 - May - 030700 June)

At Mile 231.0 all the trains were rearranged and the eight 10-ton sleds of aviation gas and diesel fuel which had been cached by the USAPR&DC caching swing earlier in the year were added. The six tractors were heavily loaded at this time pulling a total of thirteen 10-ton sleds, one 20-ton sled, two 10-ton trailers, six RLTs, one rolli-trailer, one 1-ton sled, and six wanigans. The trains were broken down as follows:

Tractor Number 1:	Generator Wanigan Signal Wanigan Mess Wanigan Command Wanigan
Tractor Number 2:	3 ea 10-Ton Sleds 1 ea 10-Ton Trailer 2 ea 1000 gal RLTs
Tractor Number 3:	5 ea 10-Ton Sleds 1 ea Rolli-Trailer
Tractor Number 4:	3 ea 10-Ton Sleds 1 ea 10-Ton Trailer 2 ea 1000 gal RLTs
Tractor Number 5:	1 ea 20-Ton Sled 1 ea 10-Ton Sled 2 ea 1000 gal RLTs 1 ea 1-Ton Sled
Tractor Number 15:	1 ea 15-Ton Ration Sled 2 ea Crew Wanigans

All the tractors and wanigans were refueled from the cache and drummed fuel was added to the loads to replace the fuel used reaching this point. Detailed preventive maintenance was performed on all tractors by the maintenance personnel and operators to include the replacement of all oil and fuel

filters. A 10 foot snow cairn was built and marked with drums. After an 18 hour and 40 minute halt the swing was underway at 250500 May.

As all the tractors except T-1 were able to travel in third gear, the swing halted at Mile 237.5 where the Command Wanigan was switched to tractor T-15. After this, all tractors were able to pull their loads easily in third gear.

At Mile 238.1 freezing of wanigan fuel lines was encountered for the first time when the lines on both crew wanigans froze. This problem became quite bothersome at times, but would have been non-existent had the fuel lines been placed on the inside of the wanigans.

On 271840 May the swing arrived at Mile 341.4 and began digging the cache out, refueling the swing, and caching two sleds with miscellaneous POL and supplies (38 drums of diesel fuel, 24 drums of Avgas, 2 drums Mogas, 1 drum 0E1100 and 2 cases of rations). The POL consisted of the fuel necessary to return the swing the 111.5 miles to the previous cache and to refuel the Army Aircraft which visited the swing. The sled loaded with Mogas was removed from the cache to provide the necessary Mogas for the swing's reconnaissance vehicles.

The swing left Mile 342.5 at 0500 after a 10 hour and 20 minute stop. However, at Mile 347.5, the swing was again forced to stop due to the inability of tractor T-1 to maintain sufficient fuel pressure. After 27 hours, the cause of the trouble was found to be a worn seal between the injector pump housing and the governor housing. At 291700 May a request was sent to Camp Tuto to fly in a replacement part as none were available on the swing. Due to local weather conditions at Camp Tuto, the aircraft were unable to reach the swing until the following day at 1632 hours. At this time, two USAPR&DC U1A Otters arrived at the swing with the spare parts and mail. Repairs were completed and the swing moved out at 0145 hours on 1 June, after a delay of 75 hours and 13 minutes.

At mile 456.4, on 020415 June, tractor T-1 developed a loud knock in its engine. As the cause of the knock was diagnosed as a cracked crank shaft it became necessary to tow the tractor to Mile 481.4 and cache it for future repairs. The swing was completely refueled and the two navigation Weasels unloaded from their sled. The empty three 10-ton sleds were then cached along with one full sled of diesel fuel for the return trip. The swing was then rearranged to permit the tractors to pull the swing's entire load along with the disabled tractor. Tractor T-2 pulled one sled, one trailer, and two RLTs in addition to the disabled vehicle. After a 12-hour halt the swing moved out in third gear.

After traveling 21.1 miles, tractor T-3 was unable to pull its load in third gear and, consequently, the swing was forced to proceed in second gear. The snow at this time was as soft as any encountered, other than in the marginal melt zones, with the tractors penetrating an average of seven inches, and the sleds plowing snow with their front bunks. Tractor T-3 was pulling the 15-ton ration sled, three 10-ton sleds (one of which carried a full, in-operative RLT top loaded in addition to 40 drums of fuel and 1000 lbs of explosives), a 10-ton off-road trailer, and the 3-ton Rolli-Trailer.

The swing arrived at Mile 481.4 on 030700 June. During this portion of the traverse the swing had averaged 2.57 miles per hour while traveling a total of 97 hours and 33 minutes. In all the swing was halted for a total of 228 hours and 47 minutes for maintenance, refueling and scientific studies. (This included an 89-hour halt at Mile 347.5 awaiting spare parts for the repair of tractor T-4).

Mile 481.4 to Mile 664.4 (020700 - 121900 June)

Plans called for the caching of two tractors and all equipment and fuel not needed for the movement to Cape George Cohn. Accordingly, tractors T-5 and T-1 were cached along with five ten ton sleds loaded with miscellaneous POL and explosives. The train, made up at this point, consisted of four tractors, six wanigans, one 20-ton sled, four 10-ton sleds, two 10-ton trailers, one rolly-trailer, five RLTs, three Weasels, and one 1-ton sled. In addition, the Hyster Hoist was transferred to tractor T-15 from the disabled tractor T-1, extensive maintenance was performed on all equipment, and the first 5-meter snow pit was dug. During this period, tractor T-1 was torn down and it was definitely determined that the vehicle had a cracked crankshaft. After a 37 hour stop the swing was underway on 042017 June.

Shortly after moving out the swing was forced to halt as the two navigation Weasels were unable to maintain contact. After a four hour halt to net and adjust the radios, the swing once again moved out. A partial radio blackout compounded the difficulty.

The swing reached Mile 496.4 at 051150 and stopped for lunch. Upon preparing to depart, at 1230 hours, it was ascertained that the battery of tractor T-2 was discharging due to a faulty voltage regulator. After the voltage regulator was replaced, the vehicle completely lost its oil pressure and had to be shut down. A preliminary check failed to disclose the difficulty. At 1435 hours a three man party departed for Mile 481.4 to recover tractor T-5 which had been cached earlier. A closer inspection of tractor T-2 revealed that the oil pressure had been lost due to an air lock. When the party returned with T-5 that tractor was again cached and the swing continued with T-2.

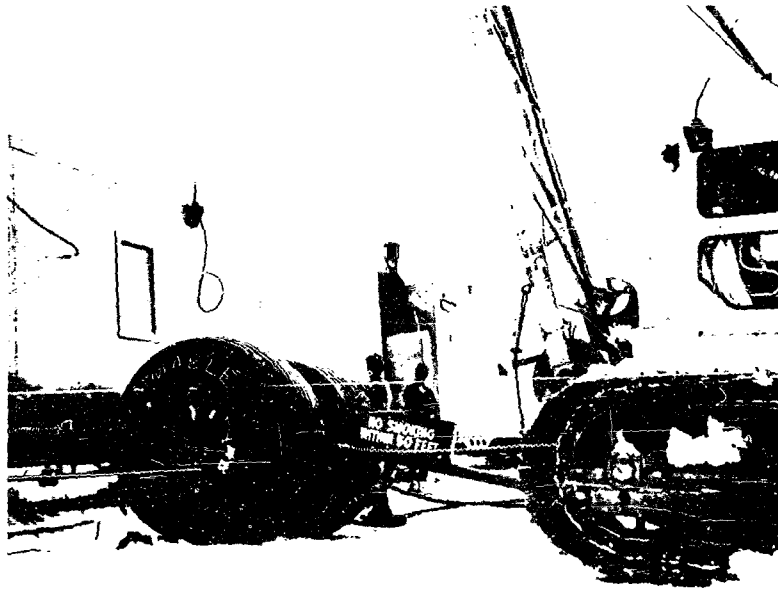

Figure 4. Expedition personnel refuel a sleeping wanigan from a T-3 RLT during halt at Mile 481.4.

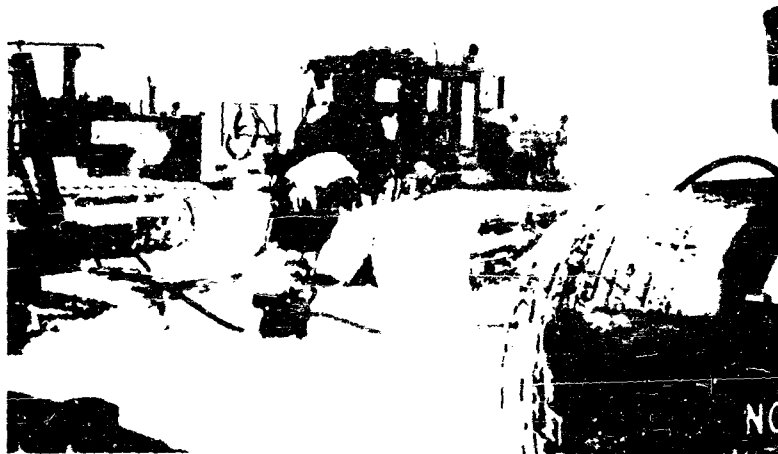

Figure 5. Refueling a D-8 tractor from drummed fuel during a maintenance halt at Mile 531.

The swing proceeded to Mile 531.4 where a pit was dug for the glaciological studies. Upon starting the tractors, after completion of the studies, the operator on tractor T-2 reported a serious knock in the engine. Once again a Weasel party was sent back to pick up vehicle T-5 while work was begun tearing tractor T-2 down. It was found that all the main bearings and the number two insert bearing were badly scored and required replacement. The cause of the failure was a piece of gasket which clogged the oil pump, thereby starving the engine of oil. One RLT was cached along with the disabled tractor and the swing was underway at 071728 June.

The swing reached its next "pit stop" at 0800 on 8 June. While the glaciologist was conducting his studies, the navigation section assembled and checked the "W" system crevasse detector. As work was progressing, a whiteout closed in reducing visibility to 1/4 mile. However, the weather cleared prior to the swing's departure at 0845 on 9 June.

As the swing proceeded, it became increasingly clear that it was approaching the eastern edge of the icecap. Temperatures began warming, the terrain became an observable downhill grade, and at 1430 on 9 June, the first land was sighted. The crevasse detector recorded numerous readings. However, no crevasses were found even though thoroughly probed. At 101735 June, the first and only crevasse in this area was located and blown. It proved to be a melt stream three to four feet wide and 20 feet deep.

At 110600 June, the swing stopped at Mile 636.4 due to the malfunctioning of tractor T-15 which was missing and backfiring. While maintenance personnel were replacing three injector pumps and adjusting the timing, two helicopters (#4908 and #4931) arrived at the swing's position. Two hours later the aircraft took off to make a reconnaissance of the route ahead. No crevasses were observed and the aircraft returned after a 30 minute flight. The swing then moved out leaving the helicopters and crews encamped.

As the swing approached land, the temperatures became warmer, rising above the freezing point. At Mile 656, the snow actually became rotten, and the tractors often penetrated over a foot. It was necessary on numerous occasions to double-head a tractor to get it started once it had stopped. Each of the four tractors became stuck at one time or another during the last eight miles. At 121815 June, the swing reached Mile 664.4 and, because of the increasing grade and deteriorating snow conditions, the swing commander decided to halt and set up camp at this point. The two helicopters arrived at the same time thereby completing their traverse of the icecap.

During the last leg of the crossing, the swing averaged 2.21 miles per hour during the 83 hours 22 minutes it was underway.

Base Camp Mile 664.4 (121815 to 250015 June)

Immediately after arriving, the swing attempted to contact the Cambridge Research Center camp at Centrum Lake by radio, but to no avail. Accordingly, after allowing the helicopter crews to rest, following their grueling flight, the aircraft, with five passengers, flew the 35 miles to Centrum Lake. The aircraft later returned with eight members of the Air Force party who were afforded the opportunity to shower and purchase personal goods from the swing exchange.

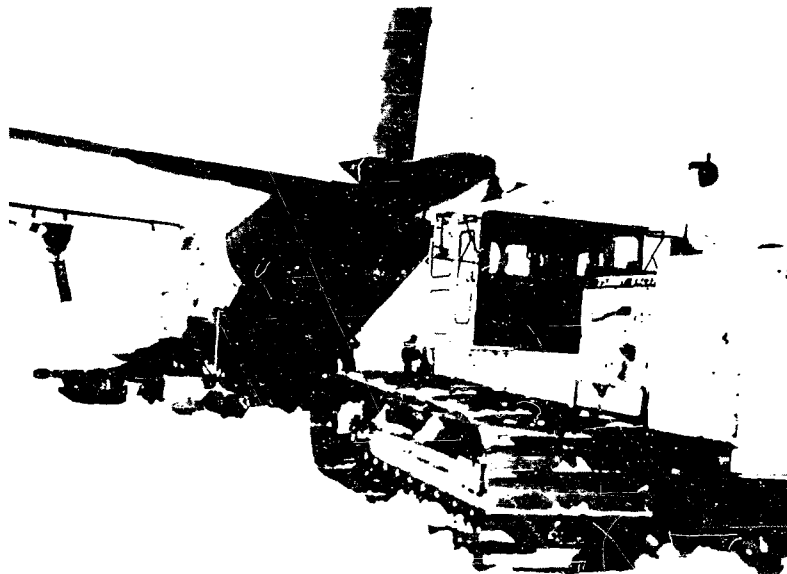

Figure 6. D-8 tractor winches replacement tractor engine from Air Force C-130 aircraft at Mile 664.4. The engine was for the disabled tractor cached at Mile 481.4.

The helicopters made two more flights on 13 June. The first was to locate a descent route off the icecap to South Valley, and the second was to return the visitors to Centrum Lake. Two scientists from Centrum Lake, Daniel Krinsley and Stanley Needleman, remained with the swing to coordinate the joint Army-Geological Survey exploration of northeastern Greenland.

At 0800 hours on 14 June 1961, a five man party departed with two M29C Weasels and one 1-ton sled to locate a descent route off the icecap and an overland route to Centrum Lake. (See Chapter VIII)



Figure 7. Trail party leader receives last minute briefing from swing commander prior to the trail party's departure for Centrum Lake.



Figure 8. Chaplain (Lt) Grover G. DeVault conducts Protestant services on the icecap at Mile 664.4. Chaplain DeVault flew out to the expedition aboard the C-130 aircraft.

One of the highlights of the expeditions occurred on 16 June when an Air Force ski-equipped C-130 aircraft landed at the swing at 0415 hours. In addition to the much appreciated mail and fresh foods and necessary repair parts (especially the new engine for T-1), the aircraft brought Catholic and Protestant Chaplains who performed their respective religious services next to the plane. One Air Force scientist, one Danish Archeologist, the Commanding Officer of USATREOG, and the Aviation Officer of USATREOG, arrived on the aircraft while the LEAD DOG Project Officer, the Chemical Corps R&D Officer, and one EM on emergency leave departed with the plane.

Immediately after the C-130 departed, the weather closed in around the swing and for the period of 16 to 22 June the helicopters were grounded. The Weasel party returned from Centrum Lake at 1330 on 21 June 1960 with, in addition to their two vehicles, the TREOG Weasel, previously loaned to the Cambridge Research Center and flown into Centrum Lake earlier in the year. They left their one ton sled at Centrum Lake to be evacuated later by the C-130 aircraft.

By 2315 hours on the 22nd, the weather had cleared sufficiently to permit the helicopters to fly to Centrum Lake. During the six day period of bad weather, 11.6 inches of new snow fell. Although a hindrance to the air operations, the new snow proved quite beneficial to the tractor operations as it provided an ideal surface. The rotten snow under the new snow froze and the new snow formed a smooth cushion for the trains.

From the 22nd to the 25th, the weather remained generally good with the aircraft and scientists carrying out their studies of the ice free land area of Crown Prince Christian Land. At 2000 hours on the 25th, the helicopter party of ten personnel detached from the swing and departed for Centrum Lake to conduct their studies and proceed to Peary Land. Twenty-three drums of Avgas and 2 1/2 drums of OE1100 were cached at Mile 664.4.

Mile 664.4 to 481.4 (250015 to 300540 June)

The swing departed Mile 664.4 for Peary Land at 0015 hours on 26 June. At 1758 hours, the swing arrived at Mile 631.4 and stopped to perform a pit study. There was only 1.5m of snow at this point. The swing was underway at 2355 hours.

The return trip from Mile 664.4 to Mile 481.4 was uneventful. The two cached RLTs were recovered along with the deadlined tractor (11 hours was required to replace five insert bearings, five main bearings, and an oil pump). The swing experienced some difficulty due to freezing of fuel lines on the wangan generators, but this was not critical. Because of the extremely bad weather the swing was forced to stop for 2 hours and 40 minutes to await on two occasions a slackening in the wind. This was necessary to permit the

navigators to make an accurate reading from the altimeters and to follow the trail. The glaciologist conducted a ramsonde study every five miles from Mile 664.4 to Mile 481.4.

The swing actually traveled a total of 64 hours and 10 minutes averaging 2.85 miles per hour. This increased speed was due mainly to the fact that the tractors, with their light loads, were able to travel in fourth gear for much of the time. The swing was halted for 37 hours and 10 minutes for maintenance, scientific studies and refueling.

Mile 481.4 to Mile 124.2P Peary Land (300540 June to 062200 July)

The swing maintenance personnel began, immediately after the swing's arrival at the junction, to effect the replacement of the engine in tractor T-1. While the mechanics were working on the engine, the remainder of the swing personnel refueled the tractors and RLTs; remade the swing; replaced the rear RLT unit on the Rolli-Trailer (the unit was showing numerous cracks on the inside bead of both cells); performed necessary maintenance on all vehicles; and cached seven sleds, two tractors, three RLTs, one Weasel, and all fuel and supplies not needed for the movement to Mile 124.2P.

After a 32 hour halt, the swing headed north for Peary Land over the trail marked by the LEAD DOG 59 expedition. After traveling only 10.8 miles, the swing stopped to make some minor adjustments to the engine on tractor T-1. While stopped, the swing received word that the two TREGO U1A Otters were enroute to the swing's position. The two fixed wing aircraft arrived at 2305 hours on 1 July, bringing fresh foods, mail, spare parts, and a civilian geographer. At 0120 hours, the aircraft attempted to take off, but they were unable to reach sufficient take off speed because of the softness of the snow. While the aircraft were attempting to take off, the weather deteriorated below a safe minimum and the aircraft were shut down.

While waiting for the weather to clear, two tractors were dispatched to pack a runway a mile in length. At 0340, the weather cleared sufficiently to allow the aircraft to take off from the strip. However, the aircraft returned at 0445 due to adverse weather in the vicinity of Mile 450.

At 0815 the swing received word that the helicopters had departed Centrum Lake for Station Nord. Nine and a half hours later the swing received word that the helicopters had been forced down by weather 15 miles southeast of Station Nord.

At 2000 hours the weather at the swing cleared and preparations were made to get the aircraft airborne. The following is extracted from the LEAD DOG 60 Journal:

2205 hours: Fixed wing aircraft departed swing for Thule AB. For better than two hours the swing worked to get the aircraft airborne. Even after being freed from the snow surface (broken loose), which was done by pulling (the aircraft) with a D8 tractor, the aircraft were still unable to move under their own power. A short strip was packed by two tractors (about 250 yards long) and A/C 1703 towed over (to it). However, the aircraft was still unable to move itself. A/C 1703 was then towed down to the strip at Mile 9.2. While 1703 was being towed down A/C 1704 was towed over to the short strip where it was able to pick up sufficient speed to taxi down to the longer strip. A/C 1703 followed (took off).

The aircraft returned one hour later. The swing had been unable to move because the rear bob had been pulled out from under sled S-18.

IFR weather¹ continued through 4 July when it was decided to leave the aircraft and crews and proceed. Accordingly, the swing moved out at 1900 hours leaving five personnel behind with 20 days rations. At 2115 the swing was stopped due to a broken tongue on one of the 10-ton Off-Road Trailers. Two hours and 55 minutes later the swing was once again underway after welding the broken member.

At 2000 hours on 5 July the swing received a message from aircraft 1703 that the two aircraft were moving up to the swing's position. At 2025 hours the swing stopped and five minutes later the aircraft landed. After a quick meal, the aircraft departed for Thule Air Base with four passengers. The swing pulled out ten minutes later.

Other than normal maintenance and scientific stops nothing of note occurred until the swing reached Mile 124.2P and established camp at 2200 hours on 6 July. This spot, five miles south of last year's camp, was selected to avoid the numerous crevasses encountered north of this position.

The swing was underway for a total of 43 hours and 15 minutes while moving the 124.2 miles for an average speed of 2.87 miles per hour. During this period, the swing was delayed for 68 hours and 15 minutes because of the grounded aircraft. The swing was actually stopped for a period of 56 hours and 50 minutes for maintenance, scientific studies and refueling. (This period included the 31 hours and 50 minute halt at Mile 481.4).

Mile 124.2P Base Camp (062200 to 120825 July)

While enroute to Mile 124.2P the swing maintained contact with the helicopters operating in northeast Greenland. At the time of the swing's arrival

¹Weather requiring the pilot to use instruments. Generally considered to occur when the ceiling is below 1000 feet and the visibility below three miles. Especially dangerous for flights over the icecap.

the helicopter party was at F. J. Hyde Fjord in Peary Land. They were contacted and informed of the swing's arrival. The following day, 7 July, the aircraft radioed that they were enroute to our position at 2000 hours. At 2050 hours the aircraft radioed they were low on fuel, and heading for Brønlunds Fjord. At this point radio contact was lost. Emergency procedure called for a 12 hour wait after losing contact before initiating a search, so the swing personnel stood by anxiously. Fortunately, at 0230 the aircraft landed at the swing after having been detached for 12 1/4 days.

After allowing the crew 12 hours rest the aircraft took off at 1445 hours for a reconnaissance of the edge of the icecap in Walcotts Land. This area, an aerial photography study indicated, would be the most promising. The aircraft returned at 1715 hours, and at 1950 hours, departed for Brønlunds Fjord to continue their studies of the ice free land.

Preparations were immediately made to send a two Weasel party forward to attempt a descent from the icecap. However, the party encountered an extensive belt of crevasses and was forced to return to camp due to the unreliability of the crevasse detector.

During the first eight miles, numerous crevasse readings were recorded on the crevasse detector. However, when probed, these turned out to be only small cracks or undulations in the ice under the thin snow cover (hummocks). After traveling eight miles the right track on the second of the two vehicles broke through the bridge of a crevasse running at a 30° angle to the trail. This crevasse was probed and found to be at least 14 feet wide. As the entire vehicle was resting on the snow bridge, the party was extremely lucky that the vehicle had not fallen through completely. The vehicle was then pulled out, and the party retreated 100 yards back the trail to confer and eat.

While eating it was found that the trail vehicle was again parked on a crevasse. The vehicles were moved back up the trail and this crevasse was blown open. This crevasse proved to be 12 feet wide and at least 45 feet deep. The detector had not recorded either of the crevasses encountered, although it picked up the numerous cracks and hummocks encountered on the return trip.

Due to the low reserve of diesel fuel and the lack of hours remaining before the next aircraft inspection, it was decided that the swing and aircraft would depart at 0800 hours on 12 July for the return trip to Camp Tuto without attempting another descent from the icecap. Accordingly, plans were initiated to prepare the swing for its departure. POL products not needed for the swing's return were cached (See Table 13, Cache Record) and the tractors prepared for the departure.



Figure 9. Crevasse field on the icecap south of Peary Land.

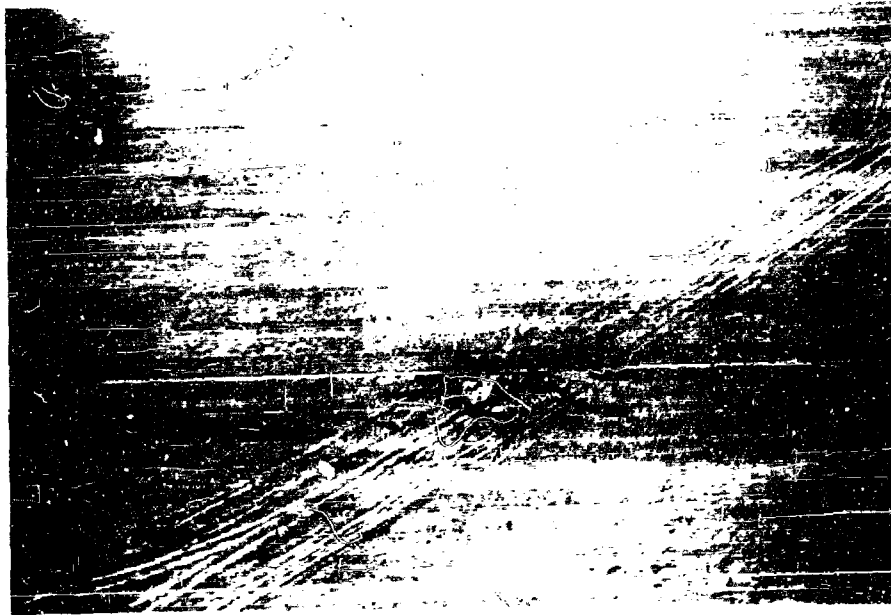

Figure 10. Crevasse blown by party attempting to descend from the icecap in Peary Land. Two passes were made over the crevasse by the Weasel mounting the crevasse detector which gave no indication of the crevasse's presence. This fissure was 12 feet wide and at least 75 feet deep.

Mile 124.2P to Mile 481.4 (120825 to 140330 July)

The helicopters departed at 0812 hours with seven passengers including all the civilian scientists. The swing departed 13 minutes later for a planned speedy return to Camp Tuto.

At 0930 hours, the swing received word that the aircraft were forced to set down at Mile 81.8P due to weather. The swing reached the downed aircraft at 2310 hours, and, after picking up the passengers and leaving 150 gallons of Avgas, moved on towards Mile 481.4. The swing reached the junction at 0330 hours on 14 July.

At Mile 481.4, the swing unloaded and cached all supplies and POL not needed for the return trip in order to lighten the swing as much as possible, thereby conserving fuel. All cached equipment, i. e., the two tractors, the seven sleds, the three RLTs and the Weasel were recovered. Plans called for the swing to remain at Mile 481.4 until the helicopters passed. Fortunately, the delay was brief and the aircraft arrived at 1250 hours. After refueling and picking up their passengers, the aircraft departed for Thule at 1420 hours. Thirty minutes later the swing moved out.

The swing averaged 3.35 miles per hour for the 37 hour and 5 minute period they were actually underway. Only 5 hours and 50 minutes were spent refueling and conducting scientific studies. No mechanical difficulties occurred and shift changes were made while moving, thereby speeding up the swing's progress. A total of 11 hours and 20 minutes were spent at Mile 481.4 junction remarking the swing and awaiting the helicopters.

Mile 481.4 to Camp Tuto (141450 to 221930 July)

The return trip was made in half the time of the outbound trip. This was due to the fact the swing experienced no major mechanical difficulties and was lightly loaded. All equipment dropped along the trail was recovered including the sleds which had been cached by the LEAD DOG 59 swing.

The fourth RLT failure occurred at Mile 292 when the right outside bearing failed due to the tightening action of the bearing carrier. This RLT was loaded on a sled and repaired after the swing's return to Camp Tuto.

The goose neck on the Rolli-Trailer failed at Mile 231 and the trailer bed and its RLTs were loaded on a sled.

At Mile 60.3, the bed of sled S-54 dropped off its bobs. As stated in the swing log:

20 July, 2045 hours "The front bobs pulled out from under sled S-54 behind tractor T-2, leaving load (and bed) behind. The rolling action of the 10-ton trailers twisted the bed off of the rear bobs. There was no apparent damage to the Weasel (T-21) riding on the sled. The right tire on the trailer was bruised in two places - once where the Weasel's tow tongue hit the tire and once where the tire hit the bed. There were no cuts. The swing traveled 2.5 miles before the tractor operator could stop the swing as the radio on tractor T-2 was not functioning. The tongue on the trailer was bent to the right."

21 July 0140 hours "Completed repairs on sled S-54. Replaced both bobs, inserted new rear king pin, inserted new rear bolster, and replaced two new cross chains. Completed refueling and maintenance. Miserable weather for working with light-wet snow falling and 25-30 knot wind blowing. Underway."

The swing stopped at 1025 hours on 22 July because of the extremely rough trail and poor visibility (under 100 yards). In starting up again four hours later, the left runners on the command wanigan dropped in a hole rolling the wanigan off its bobs and onto its left side. The one occupant received only minor bruises and the swing was underway 1 1/2 hours later after replacing the front bolster and one king pin.

At 2030 hours the crew wanigan was tipped off both bobs at a 50° angle. The wanigan was respotted and the swing was underway 45 minutes later. Again at Mile 25 the command wanigan rolled off the bobs.

The swing reached the new ramp road at Camp Tuto at 221930 July after 66 days on the icecap. During the 8 day return trip the swing averaged 3.23 miles per hour being underway 14 hours and 33 minutes and halted for maintenance and refueling for 51 hours and 7 minutes.

During the period the tractor swing was on the icecap it averaged 2.85 miles per hour while traveling 1580 miles. This average speed was just for the periods when the swing was actually underway and did not include the numerous and often long halts which the swing made. The farthest distance traveled on any one day was 83 miles.

CHAPTER III

AVIATION

1. MISSION

The general mission of LEAD DOG 60 aviation element was to provide an aerial capability for reconnaissance, transportation, resupply, and emergency evacuation while the swing operated in NE Greenland. In addition, the air section evaluated its aviation equipment and flight and maintenance techniques as related to the arctic environment. Due to the remote location of the Cape George Cohn base camp in Crown Prince Christians Land, and the formidable obstacle of the Greenland Icecap, the air-ground link up was also a primary mission requiring extensive planning and coordination.

2. HISTORY

Since 1952, helicopters temporarily assigned to the Transportation Corps' Arctic Group, had been used in Greenland. In 1955, the Aviation Section became an organic part of the group, and, in 1956, the Section became a Detachment functioning as an integral part of the Arctic Group on a year-round basis. This status was continued in the reorganization of the group from TRARG to TREG in 1958. In 1960, the Aviation Section consisted of four H-34C helicopters and two U-1A fixed wing aircraft. Two H-34C helicopters were used in conjunction with LEAD DOG 60. In addition, two U1A Otters made two contact and resupply flights to the swing.

Shipment of all aircraft from CONUS to Thule Air Base, Greenland was accomplished by MATS airlift. Details regarding loading plans and other pertinent factors for both C-124 and C-133 aircraft are contained in Annexes B and C. The first elements of the Aviation Section arrived at Thule Air Base on 20 March 1960 to begin reassembly of the aircraft. A heated hangar was made available for this purpose. As the outside temperature at times reached -30°F, such facilities are considered necessary for maintenance operations during this season. With the arrival of the main party on 1 May 1960, TREG projects "TOP DOG 60" and "POLE HOP" were begun. Details of these operations are contained in separate project reports.

3. ORGANIZATION AND EQUIPMENT

The aviation element consisted of four pilots, seven enlisted maintenance personnel, and one civilian aircraft technical representative. The senior aviator was designated as aviation project officer: other additional duties delegated to the pilots were:



Figure 11. Helicopters await clearing weather at the Crown Prince Christian Land Camp.

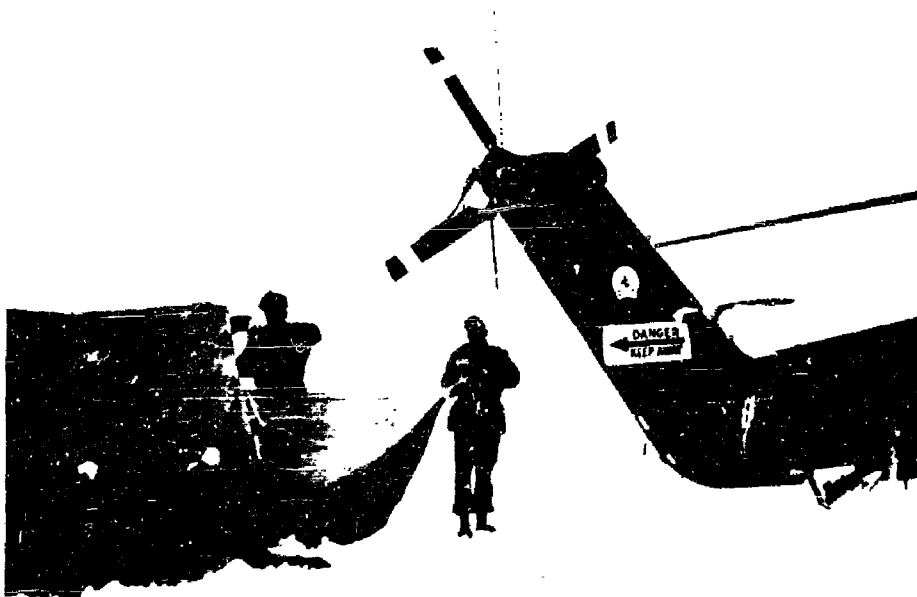

Figure 12. Helicopter crews erect an emergency tent after being forced down by weather enroute to the expedition.

- a. Maintenance Officer - Responsible for all aircraft maintenance, supervision of enlisted maintenance personnel, determination and procurement of required spare parts and tools.
- b. Survival Officer - Determined and procured survival equipment, (clothing, food, tents, pyrotechnics, weapons, etc.) instructed personnel in the use of all equipment and the theories of arctic survival. A list of survival equipment is contained in Table 3.
- c. Camp Commander - Responsible for control, sanitation and house-keeping in camp areas established while away from swing base camp.
- d. Other job titles were:
- | | |
|-----------------------------------|-----------|
| Technical inspector | - 1 |
| H-34 crew chiefs | - 2 |
| Helicopter mechanics | - 2 |
| Aircraft electrician | - 1 |
| Sheet metal repairman | - 1 |
| Sikorsky technical representative | - 1 (civ) |

Aircraft Equipment - All TREG aircraft were equipped with a Collins Hi-frequency radio for voice or continuous wave transmission (ARC 59). Previous experience with conventional VHF-UHF & FM receiver transmitters had shown these radios to be inadequate for the long distances encountered in arctic areas between radio stations. The CW feature of this radio is often the only means of contact during the frequent atmospheric disturbances caused by sun spot storms. One pilot in each aircraft was proficient in receiving and transmitting moderate speed CW traffic.

Neither helicopter was winterized and both had the standard 250,000 BTU heater. This configuration is feasible for the short summer period such as these helicopters operated in, but should not be attempted if operations are to be conducted during the colder months.

Each aircraft carried a complete tie-down kit, a set of foul weather covers, and while one helicopter carried a Herman Nelson 400,000 BTU heater, the other carried an auxiliary power unit.

4. DESCRIPTION OF OPERATIONS

On 10 June 1960, the aircraft departed Thule Air Force Base for Cape George Cohn. Navigating by means of the marked trail established by the swing, the helicopters proceeded to Mile 550 where deteriorating weather caused a halt. Prior to this, routine refueling stops had been made from

established caches at Miles 120, 231, 342.4, and 481.4. After waiting fifteen hours for the weather to clear, the flight was continued and the swing reached at 1755 hours, 11 June.

For the next two weeks the helicopters were located at the swing base camp and flew missions from Nioghalvfjerdingsfjorden Glacier in the south to Danmarks Fjord in the north. On 25 June the swing departed for Peary Land and the aircraft began a twelve day, self sustained operation.

During this period the twelve man party conducted investigations in Gluckstad Land and Peary Land. During the course of studies in Peary Land the group landed at Cape Morris Jessup, the most northerly point of land in the world. On 8 July the aircraft joined the swing at its Peary Land Base Camp and for the next five days provided transportation in this area.

With all projects complete, the helicopters departed for Thule Air Base at 0815 hours on 12 July. Due to poor weather conditions enroute, considerable time was spent on the ground and the aircraft did not arrive at Thule until 2215 hours on 14 July.

PROBLEMS ENCOUNTERED AND RECOMMENDATIONS

1. ENVIRONMENTAL WEATHER PROBLEMS

Helicopters should be winterized prior to attempting any long range project in this area. By carrying the Herman-Nelson Heater and operating only during the short summer months this project was successful without winterization. However, the heater's weight (500 lbs) did reduce useful payload, and its configuration is unwieldy for this type of operation.

Extreme cold, blowing snow, and wind storms create difficult, sometimes impossible, working conditions for maintenance personnel. This problem is magnified when one considers that it is imperative to take advantage of any good weather to perform the flight missions, and it is desirable that maintenance be performed during the period when the aircraft are grounded due to severe weather. The Arctic Test Board is currently evaluating a portable tent-like hangar which may provide a solution to this maintenance problem.

The phenomenon of white-out or gray-out occurs in several ways and in varying degrees. This subject has been the object of considerable study and its description is readily available, hence we will not analyze but rather describe it only. White-out occurs when blowing snow, ice crystals, or visible moisture obscure the horizon and severely limit visibility. Gray-out occurs when a heavy cloud cover erases all shadows. This results in the sky

and icecap surface blending, thereby eliminating the horizon and making it impossible for the pilot to visually determine the altitude of the aircraft above the snow surface. To attempt flights during periods of restricted visibility on the icecap is to seek disaster. Depending upon its severity and the size of the affected area, this situation does not pose as great a hazard over land areas where the helicopter, flying at reduced speeds, can follow a coast line or navigate from point to point with these references as a guide to altitude and an indication of the horizons relationship. Due to the land's contrast, this condition can be seen at a distance and, in many cases, circumnavigated. In several instances the aircraft were able to carry out operations on the land mass, but could not return to the swing on the icecap even though it was a scant six miles away and clearly visible from the cap's edge.

In crossing the cap it was anticipated that weather might prove a problem. Between Thule and Nord lay 800 miles where no weather reports are available and much severe weather occurs. Once the flight passed Mile 120 it had been decided that in the event of poor weather the crew would land and sit out the storm rather than return to Thule. This occurred on both crossings. It is believed that in order to operate in this manner, personnel are needed who are schooled and experienced in the art of arctic survival.

During the 35 days that the helicopters were away from Thule, weather interfered with flying operations on 17 days. On eight of these days no flying was attempted at all.

2. REMOTE AREA DIFFICULTIES

Auxiliary power units were not installed on the aircraft requiring one of the ships to carry a separate auxiliary power unit. This unit weighed 550 lbs and not only reduced the aircraft's payload, but was very clumsy since it had to be off loaded each time it was used. Small, light auxiliary power units could undoubtedly be obtained and installed in the H-34 helicopter, and this is recommended prior to any remote self-sustained operation.

The air dropped caches presented two problems. (See table 2)

a. Difficult to locate. Several solutions to this problem are apparent. When possible, the person who is to locate and use a cache should accompany the drop aircraft and note where the drop lands. Colored chutes should be used in place of the present camouflage type. Where a certain cache is of primary importance, an inexpensive, remotely triggered, low power homing beacon could be packed with the drop.

b. Damaged, scattered, or irretrievable drops. Parachute harnesses should have an automatic release on one set of straps so that the wind will not disperse the load once it is on the ground.

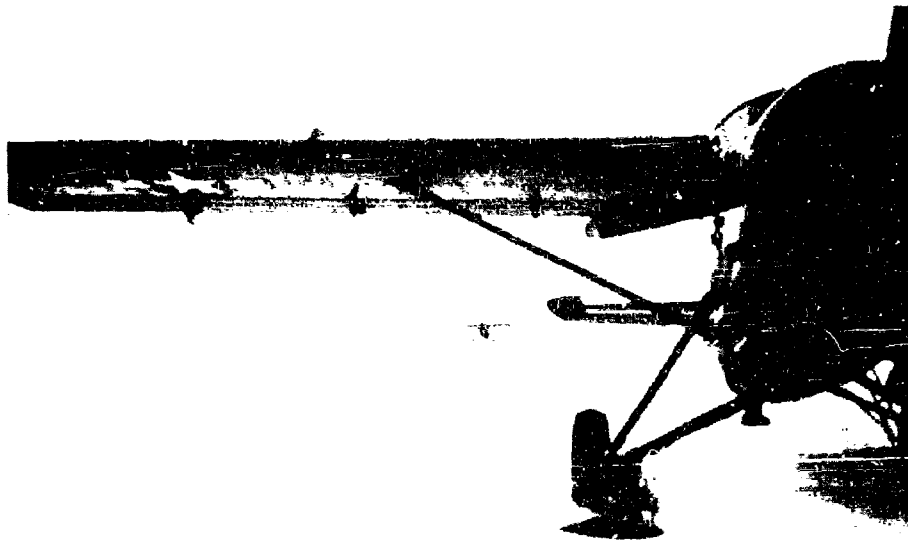

Figure 13. Two ULA Otters land at Mile 489 bringing fresh food, mail, and scientific personnel to the expedition.

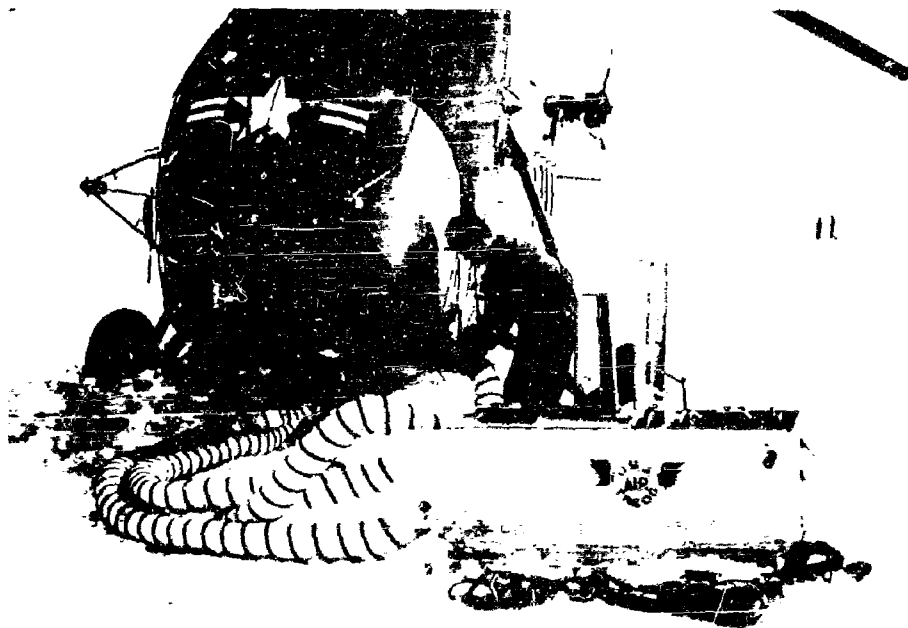

Figure 14. Mechanic uses 400,000 BTU Herman-Nelson heater to pre-heat a helicopter at the Peary Land Camp prior to the return flight to Thule Air Base.

Careful selection of the drop sites is very important in Arctic areas. If the drop is placed on low ground, the melt season may find a large river where this flat snow field was but a month earlier. If placed on the north slope of a hill, the snow may not melt here and the drop may become buried by shifting snow and lost (Bliss Bay drop). If it is placed on too steep a slope, the danger of it tumbling down the hill and damaging the equipment is apparent (Constable Bay). Since terrain and circumstances will vary, no specific drop zone can be described, however, the above considerations should be kept in mind.

In any remote operation, the possibility exists that a small, unforeseen aircraft part may fail, disabling the helicopter. This would be inconvenient and perhaps compromise a mission in any area. However, in remote areas it could well result in the abandonment of the aircraft. A large number of spare parts was carried by the swing. As it is not possible to anticipate every eventuality or stock one of each aircraft part, a judicious selection of spare parts must be carried and a capability to resupply the remote project must be maintained in event of unforeseen emergencies.

Navigation presents a considerable obstacle in an area of several thousand miles where only one low frequency homing beacon exists (Station Nord). During Project LEAD DOG 60, this lack of navigational aids precluded any attempt at instrument flight. It is possible that the doppler type navigation aid currently being tested by the US Army Transportation Board will provide this capability in the near future.

World Aeronautical Charts used by the air section were quite inaccurate and, although they provided a usable guide with reference to coast lines, mountain ranges and other prominent terrain features, location errors of up to 20 nautical miles limited their value.

ICE-FREE LAND AREA CACHE POINTS

CAPE MORRIS JESSUP

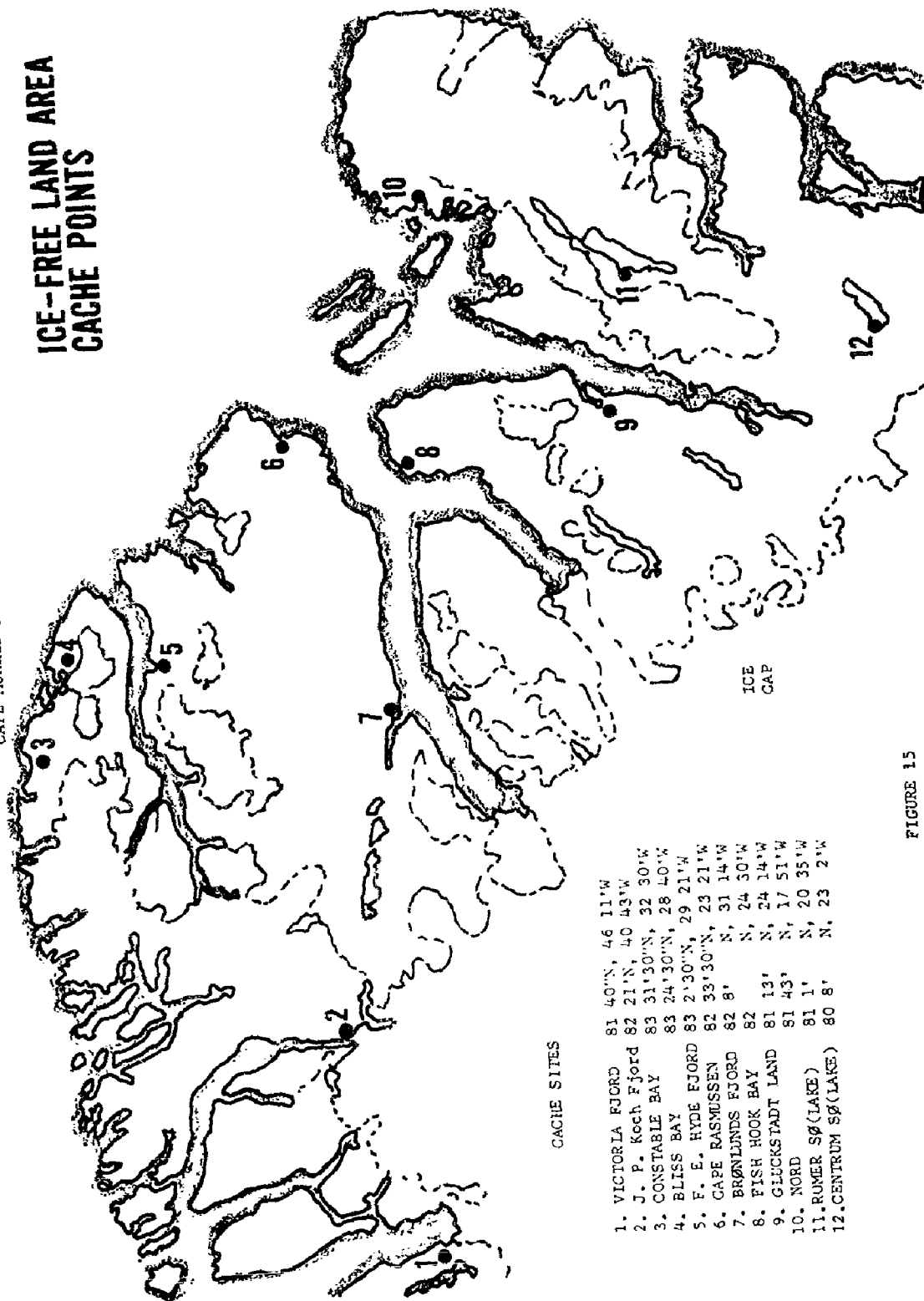

CACHE SITES

1. VICTORIA FJORD 81 40'N, 46 11'W
2. J. P. Koch Fjord 82 21'N, 40 43'W
3. CONSTABLE BAY 83 31'30"N, 32 30'W
4. BLISS BAY 83 24'30"N, 28 40'W
5. F. E. HYDE FJORD 83 2'30"N, 29 21'W
6. CAPE RASMUSSEN 82 33'30"N, 23 21'W
7. BRØNLUNDS FJORD 82 8' N, 31 14'W
8. FISH HOOK BAY 81 13' N, 24 14'W
9. GLUCKSTADT LAND 81 43' N, 17 51'W
10. NORD 81 1' N, 20 35'W
11. RØMER SØ(LAKE) 81 1' N, 23 2'W
12. CENTRUM SØ(LAKE) 80 8' N, 23 2'W

FIGURE 15
SCALE 1:2,000,000

TABLE 1

CHRONOLOGICAL RECORD OF FLIGHTS

<u>HOURS FLOWN</u>	<u>NO. PASS</u>	<u>PASS MILES</u>	<u>LBS CARGO</u>	<u>TON MILES</u>	<u>DATE</u>
12.8	1	580	5000	1450	10 Jun 60
1.9	7	296	5000	135	11 Jun 60
2.0	1	60	5000	15	12 Jun 60
8.4	35	2760	1000	30	13 Jun 60
4.5	6	635	----	---	14 Jun 60
4.0	9	1120	1000	40	15 Jun 60
6.4	11	970	1900	40	23 Jun 60
4.0	8	1230			24 Jun 60
4.1	3	100	10000	150	25 Jun 60
5.2	5	1000	200	40	26 Jun 60
6.6	18	2070	2100	183	27 Jun 60
6.0	4	519	250	2	28 Jun 60
4.9	9	1580	100	1	29 Jun 60
1.3	6	600	3000	150	30 Jun 60
9.3	6	2240	4000	680	2 Jul 60
0.4	6	240	3000	90	3 Jul 60
8.8	6	2100	3000	510	4 Jul 60
3.8	4	1200	1000	160	5 Jul 60
5.7	3	1440	----	---	6 Jul 60
10.7	6	2320	4000	960	7 Jul 60
6.3	7	3940	1000	280	8 Jul 60
6.3	3	1480	----	---	9 Jul 60
8.6	8	5120	2000	640	10 Jul 60
4.4	6	1820	----	---	11 Jul 60
0.6	8	320	4000	80	12 Jul 60
0.6	-	---	4000	60	13 Jul 60
11.2	8	4660	4000	1040	14 Jul 60
148.8	194	40400	64550	6736	35 days elapsed time

TABLE 2

ICE-FREE LAND AREA CACHES

ROMER LAKE (81° 01' N - 20° 35' W) (PRINCE CHRISTIANS LAND)

5 bbls avgas
1 bbl oil
2 cs C rations
2 cs B rations

GLUCKSTADT LAND (81° 13' N - 24° 14' W)

21 bbls avgas
1 bbl oil
2 cs B rations
2 cs C rations

VICTORIA FJORD (81° 40' N - 46° 11' W) (WULFF LAND)

4 bbls avgas
1 bbl oil
3 cs C rations

HYDE FJORD (83° 02' N - 29° 21' W)

4 bbls avgas
1 cs C rations

J. P. KOCK FJORD (82° 21' N - 20° 43' W)

4 bbls avgas
1 cs C rations

FISH HOOK BAY (82° N - 24° 30' W) (GLUCKSTADT LAND)

4 bbls avgas
1 cs C rations

AIRLIFTED into NORD (81° 43' N - 17° 51' W)

16 bbls avgas
1 bbl oil
1 bbl white gas

Items Airdropped into BRØNLUNDS FJORD (82° 00N) (31° 14' W)

10 cs B rations
15 cs C rations
2 bbls white gas
3 bbls oil
67 bbls avgas (8 lost)
Plus miscellaneous supplies and equipment

Items Airdropped into CAPE RASMUSSEN (82° 33' N - 23° 21' W)

8 cs C rations
5 cs B rations
1 bbl white gas
1 bbl oil
18 bbls avgas
Plus miscellaneous supplies and equipment

Items Airdropped into BLISS BAY (83° 24' N - 28° 40' W)

6 cs C rations
6 cs B rations
1 bbl white gas
1 bbl oil
16 bbls avgas
Plus miscellaneous supplies and equipment

Items Airdropped into COMSTOCK BAY (83° 31' 30" N - 32° 30' W)

8 cs C rations
5 cs B rations
1 bbl oil
2 bbls white gas
20 bbls avgas
1 life raft (2 man)
Plus miscellaneous supplies and equipment

Items Airdropped into CENTRUM LAKE (80° 08' N - 23° 02' W)

24 bbls avgas
1 bbl oil
4 bbls white gas
17 cs C rations
20 cs B rations
Plus miscellaneous supplies and equipment

TABLE 3

AIRCRAFT SURVIVAL EQUIPMENT (CARRIER IN EACH AIRCRAFT)

- 1 100-lb ahkio sled with survival equipment
- 2 four-six man arctic survival tents
- 5 S-A-6 survival rations
- 24 dehydrated rations
- 1 sterno stove
- 14 cans sterno
- 2 cans heat tablets
- 8 candles, wax
- 1 can sand - (to be used with Avgas as a heater)
- 2 mountain stoves
- 1 cook set
- 1 waterproof bag
- 1 ice saw with handle
- 1 snow shovel with handle
- 1 ice axe
- 50 ft rope 1/2", nylon
- 1 knife TL-29
- 1 matchbox with flint and matches
- 1 first aid booklet FM 21-11
- 1 survival book
- 1 transportation of sick and wounded booklet
- 1 aircraft first aid kit
- 1 first aid kit supplement consisting of:
 - 50 3/4" x 3" bandaids
 - 1 tube burn ointment
 - 8 ace bandage 2" x 4"
 - 2 small sterile dressings
 - 1 splint
 - 2 boxes APC
 - 6 pr sunglasses and/or goggles
 - 5 chapsticks
 - 2 gauze roller bandages
 - 6 petrolatum gauze pads
 - 1 tube eye ointment
 - 40 yards adhesive tape assorted widths 3", 2", 1", 1/2"
- 1 emergency radio with 2 batteries (AN/URC-14)
- 12 flares, red star
- 1 flare pistol
- 4 smoke grenades
- 1 parachute flare red
- 1 signal mirror

1 cleaning kit rifle
1 cargo parachute canopy (For use as fair weather shelter)
1 rifle, M-1, 30 cal.
80 rounds 30 cal. ammunition
2 water cans
Sleeping bag, Arctic, w/cover - 1 per individual
Socks, wool, ski - 2 pair per individual
Undershirt, wool - 1 pair per individual
Drawers, wool - 1 pair per individual
Mattress, pneumatic, air - 1 per individual

CHAPTER IV
SCIENTIFIC STUDIES

1. GENERAL

This chapter presents a brief description of the scientific activities carried out by civilian and military technicians attached to the project from other agencies. For a discussion of the altimetry survey conducted by TREG from Mile 481.4 to Mile 664.4, see Chapter V, Navigation and Trail Operations. For a discussion of the access routes from the icecap to Peary Land and Crown Prince Christian Land, see Chapters VIII and IX. The information gathered by these personnel will be included in the reports published separately by their respective agencies.

a. Activities by the Quartermaster Corps observer (Mr. Donald W. Hogue).

An observer from the Quartermaster Corps accompanied LEAD DOG 60 from 18 May to 5 July 1960 and returned to Camp Tuto by air. Several flights by helicopter were made over the northeast margin of the icecap and the ice-free littoral in the vicinity of Centrum Lake from the Base Camp (Mile 664.4) to obtain a more comprehensive view of the terrain.

Objectives of the Quartermaster observer were: (1) familiarization with environmental conditions on the icecap and the ice-free littoral, especially as they may affect requirements for Quartermaster equipment; (2) testing of experimental paper overgarments under adverse field conditions.

The paper overgarments were issued to maintenance personnel by the supply sergeant as needed. A questionnaire was filled out by the person who used each garment before a new one was issued. In this way an individual opinion of each garment was obtained before some important points were forgotten. Probable stress areas were itemized in the questionnaire. Other questions pertained to general suitability, strength and pliability of the fabric and the design and acceptability of the garments.

During the test period, observations were made in regard to their use. Some of the maintenance men were questioned about the usefulness of the garments. Supervisory personnel concerned mainly with POL soiling of clothes, which reduced their insulating qualities, were also consulted during and at the end of the test period.

A complete summary of the observations and comments obtained from the crew, sergeants, and officers was presented to the Quartermaster

scientists primarily responsible for development of the paper overgarments. (See Chapter VII).

A detailed report on "Environment of the Icecap", based in part on observations made during the LEAD DOG 60 swing, is in the final stages of revision prior to publication. This report stresses the surface configuration and climate of the icecap, based on accounts by earlier expeditions as well as more recent observations. Liaison with the Signal Corps observers was maintained during the swing to obtain information on current weather.

Except for minor surface irregularities (small drifts), usually much less than a foot in height, the Icecap was remarkably smooth along most of the 908 miles the observer accompanied the swing over the 7-week period. Variation in surface configuration was slight but sometimes varied appreciably after traveling 10 to over 50 miles, or occasionally from day to day following a moderate snowfall. The consistently roughest portion of the surveyed route was the crevasse belt from about Mile 10 to Mile 60. Well-developed snowdrifts oriented diagonally across the trail in this belt accentuated greatly the uneven support characteristics of the snow surface. By contrast, the vast interior was relatively smooth. The drifts were often 1 to 3 inches high on the wind-eroded surface.

Moist snow was encountered between elevations of 3,000 and 2,600 feet in the northeast marginal zone of the icecap. During the afternoon of 12 June, after the sled trains had stopped and while the air temperature had risen to 37°F, the D-8 tractors were unable to pull adequately three to four heavy sleds downslope. The sleds sank into the soft snow from 8 to over 12 inches, or about twice the depth of the much heavier tracked D-8.

No significant crevasses were detected from Mile 481.4 along the previously unsurveyed route that closely follows the 80th parallel until reaching Mile 664.4 where a 6-inch crack was uncovered by a bulldozer. A moderately good ice ramp was found near the head of the broad, U-shaped Grasrig River valley that extends northeastward toward Centrum Lake (see Chapter VIII). To the north and south of this ramp, the icecap terminates as an ice cliff, estimated to be from 50 to well over 100 feet high.

The ice-free area around Centrum Lake consists in large part of barren, rather bold limestone formations overlooking a flat valley bottom. The moderately dark rock outcrops and clusters of glacial boulders add to the bleak appearance of the region. Some of the higher mountain peaks in the area are permanently snow-capped. The mountains to the east of Centrum Lake appear to have an increasingly rugged character and were snow-capped.

On the return flight from Mile 64.6P, the LEAD DOG trail was used as a navigational aid to Camp Tuto. The sled train tracks remained clearly



Figure 16. Glaciologist conducts snow accumulation studies at Mile 531.



Figure 17. Geologist examines bedrock in Peary Land.

visible from altitudes up to 500 feet, even in those areas where considerable blowing snow was sweeping over the surface. The melt zone of the icecap adjacent to the Tuto area (7 July) was marked by broad and highly irregular areas of color contrast, varying from white to the lighter shades of blue and brown. The outer margin of the icecap was dissected by relatively shallow melt streams at frequent intervals, most of them flowing over an extremely steep slope. A multitude of crevasses, mostly bridged with snow, were also readily apparent from the low altitude flight.

Photographs were made for illustrating the technical report now in preparation, and for indoctrination of other Quartermaster personnel regarding environmental conditions on the icecap.

b. Activities of the Glaciologist (Mr. Roger D. Summer).

Snow studies were carried out on LEAD DOG 60 by a scientist from the U. S. Army Snow, Ice and Permafrost Research Establishment (recently redesignated the U. S. Army Cold Regions Research and Engineering Laboratory) of Wilmette, Illinois. Support and assistance required by him for this work were provided by Transportation Corps members of the traverse party. These studies were part of a long range program being conducted by the Corps of Engineers to learn the physical properties of Greenland snows as they affect military construction and operations on the icecap. During the last several years, traverse parties have studied snow structure and accumulation in most of the climatological area units which comprise the icecap, with the exception of the east central and northeast segments.

The north central area was studied by C. C. Langway in conjunction with Operation LEAD DOG 59 and, in 1960, R. D. Summer continued Mr. Langway's line eastward from Mile 480 to Mile 664.4 at the eastern edge of the ice sheet. An additional pit study was made on a small icecap in Crown Prince Christian Land during a helicopter flight from the base camp. The same procedure was used in making each of the deep pit studies. A bulldozer first cut a trench four to five meters (13 to 16 feet) deep and one trench wall was then planed smooth with a shovel. Dial thermometers were used to determine snow temperatures while depth and density samples were taken at close intervals down the wall to provide data for a complete depth-temperature-density analysis. The trench wall was then brushed to expose variations in hardness and texture of snow layers and a stratigraphic study was made to determine thickness of the layers, variations in grain size, melt zones, hoar frost, and other features which indicate variations in seasonal and annual accumulation. From the bottom of the trench, the snow was cored with a hand auger to extend the density and stratigraphic profile to a total depth of ten meters. Snow temperature at a depth of ten meters (33') was also determined from the drill hole to provide a close approximation to the local mean annual air temperature

Deep pits were made at Mile 481.4, 531.4, 581.4 and 664.4. In addition, a two meter (6') pit was made at Mile 496.4 during a halt for repairs and a smaller pit at Mile 664.4 which exposed glacier ice at a depth of only one and a half meters (5'). Four different pit studies were made near the base camp at Mile 664.4.

On the return swing to Mile 481.4, ram hardness tests were made at 5 mile intervals. At each test site, the snow hardness profile was determined to a depth of four meters (13') as an aid in correlating stratigraphy between the deep pit sites.

The following are preliminary results obtained:

<u>Test Site</u>	<u>Mean Annual Accumulation (water equivalent)</u>	<u>Mean Annual Temp.</u>
(1) Mile 481.4, 3 June 60 El: 2071 m (6793') 4.15 m pit (13.6')	11.5 cm (4.5")	-29°C (-20.5°F)
(2) Mile 496.4, 5 June 60 El: 2027 m (6649') 2.0 m pit (6.6')	12.0 cm (4.7")	
(3) Mile 531.4, 7 June 60 El: 1921 m (6301') 5.3 m pit (17.4')	13.9 cm (5.5")	-18°C (-18.4°F)
(4) Mile 581.4, 9 June 60 El: 1685 m (5527') 4.25 m pit (14')	20.1 cm (7.9")	-25.5°C (-13.9°F)
(5) Mile 664.4, 16 June 60 El: 763 m (2503')	-	-17°C (1.4°F)

The data from these studies are being analyzed and the results will form an important contribution to the overall knowledge of snow conditions on the Greenland icecap. This information will form a sound basis on which to plan military construction and operations in Greenland and on polar snow environments in general.

The one remaining section of the Greenland icecap about which very little is known is the central and north central portion of the eastern slope. Studies in this area would fill the gap in knowledge of snow structure, density,

annual and seasonal accumulation, and surface conditions for the entire ice-cap, as well as provide specific information about snow conditions in another climatic environment.

Another, and most valuable, study should be made of Flade Isblink at the northeastern tip of Crown Prince Christian Land, northeast Greenland. This small icecap is rather unique in terms of size and strategic location. Such a study should determine whether it is subject to net accumulation or ablation and whether it is a disconnected remnant of the main icecap or has formed more recently.

c. Activities by the Chemical Corps Representatives (Capt Don W. Bronson and Sp5 Gayle T. Payne).

The objective of Chemical Corps participation in LEAD DOG 60 was to test various chemical, biological and radiological aspects of the approach march in the polar environment. Specifically it was desired to determine the operability and actual usefulness of selected items of chemical equipment under the conditions peculiar to the polar regions; in addition, background radiation monitoring readings and snow, soil, and vegetation samples were obtained during the traverse. Test procedures utilized and the significant results observed are indicated below:

Sixteen each of the red, green, yellow, and violet M18 colored smoke grenades were functioned at various points during the trek. No appreciable number of malfunctions occurred and no defects developed during the testing. Contrary to what might be expected, the green colored smoke proved to be the easiest to distinguish on the interior of the icecap. The red smoke was the easiest color to identify in the marginal regions of the icecap and on the land areas.

Six of the newly standardized M17 protective masks were tested under actual polar operating conditions by members of Operation LEAD DOG 60. Participating in the evaluation were tractor drivers, pathfinders, and radio and radar operators as well as the two Chemical Corps representatives on the trek. The masks were worn in temperatures ranging from 42°F to -14°F and during periods of blowing snow. Except for discomfort caused by snow glare, the masks performed satisfactorily during all phases of the operation. In addition, they also provided adequate protection against the blowing snow and cold at the temperature ranges encountered.

Field tests of two ABC M6 300 CFM gas-particulate filter units (formerly called collective protectors) were conducted during the traverse. One unit was installed inside one of the 24 man crew wanigans and the other was mounted on the outside of the same wanigan. Both units operated satisfactorily for a total operating period of 35 hours; blowing snow and cold soaking

at -17°F did not affect the operation of the unit. However, the noise from the inside mounted unit was disturbing to some individuals.

Radiological background monitoring readings were taken with an MX-5 survey meter at various locations across the icecap and the northeastern land areas of Greenland. Instrument readings ranged from 0.01 to 0.055 milliroentgen per hour (mr/hr). Readings taken from pits dug in the snow showed results from 0.03 to 0.04 mr/hr at the 1955-57 snow level. This would indicate that increased radioactive fallout occurred during this period. Snow, earth, and vegetation samples were collected when the monitoring data showed appreciable radiation. At the conclusion of the operation these samples were forwarded to the U. S. Army Chemical Corps Nuclear Defense Laboratories, Army Chemical Center, Maryland, for radio-activity determination.

From the Chemical Corps' participation in Operation LEAD DOG 60, it was concluded that the items evaluated in Greenland are capable of performing satisfactorily under the polar environment encountered during the trek. Analysis of the environmental radiation monitoring data indicated that on the average, more radiation fallout has occurred on the east coast of the island than in the western portion (north of latitude 76° 25' N).

d. Activities by the U. S. Geological Survey Representatives (Mr. William Davies and Mr. Daniel Krinsley).

The U. S. Geological Survey participated in the Project LEAD DOG 60 on a helicopter traverse of northern Greenland. Investigations were concerned primarily with engineering aspects of the ice-free terrain and geological studies which included bedrock and surface mapping, glacial geology, permafrost and limology. Survey geologists have conducted field investigations in North Greenland in 1953, and from 1956 through 1960. This work was in cooperation with the Air Force Cambridge Research Laboratories.

During May 1960, ten scientists and technicians including a Geological Survey geologist were landed on Centrum Lake, Crown Prince Christian Land. Their program included the examination and preparation of a large river terrace as a landing site for heavy wheeled aircraft, an extensive limological study of Centrum Lake, and meteorological measurements.

On June 13, 1960, two H-34 helicopters attached to Project LEAD DOG 60 arrived at Centrum Lake and, on the following day, transported the geologist to Blass S, adjacent to 79° Glacier where an extensive outwash plain was examined for utilization as an aircraft landing site. The helicopters were grounded from 15 through 22 June because of bad weather.

The period 23 through 30 June included helicopter flights to Cape George Cohn, Cape Viborg, Ingolfs Fjord, Hekla Sund and to numerous points in the

vicinity of Centrum Lake. This fast and efficient method of transportation enabled the geologist to map large areas which had never before been visited during the snow-free period. Bedrock samples, glacial boulders, shells and driftwood for Carbon 14 analysis, and soil samples were collected for later laboratory analysis. Limestone caves (the first such caves discovered in Greenland) were observed from the helicopters on 26 June and visited on 29 June.

On 2 July, the helicopters departed the Centrum Lake area and began a 10-day geological reconnaissance of Northeast Greenland. Utilization of food and fuel caches which had been paradropped prior to the arrival of the helicopters extended their range and permitted the first extensive summer investigation of Peary Land. Immediate geological results have been the demarcation of the southern boundary of Caledonian thrusting, at its eastern boundary north of G. B. Schley Fjord; and substantiation of Lauge Koch's (Danish geologist) postulation of local glaciation of the Peary Land coast rather than its glaciation beneath an overwhelming continental icecap.

Important data were collected concerning the extent of past glaciations and the amount of isostatic rebound (recovery after ice unloading) in areas recently free of ice. Absolute dating of the glacial events will be possible by carbon 14 analysis of shells collected from recently elevated beaches, stratigraphically related to the glacial deposits.

This joint Army-Survey expedition enabled the participating geologists to accomplish years of difficult work in a short time and with great efficiency.

e. Activities by the Archeologist (Count Eigil Knuth)

The Archeologist accompanied the helicopter party during their traverse of northeastern Greenland. Paleo Eskimo camping sites were examined in Crown Prince Christian Land and Peary Land. Numerous artifacts were found at these sites, and organic refuse was collected for Carbon 14 analysis.

f. Meteorological Data Collected (Sgt George E. Anderson, PFC Gerald R. Kramer)

The operation plan for Project LEAD DOG 60 stipulated that surface weather observations would be taken at three-hour intervals. The two-man meteorological team divided each day into two 12-hour shifts and took observations every hour to provide more specific weather information along the LEAD DOG route across the icecap.

The standard WBAN Forms 10a & 10b were used to record all surface meteorological parameters observed. A summary of the weather observations taken during the period is contained in Tables 3 and 4.

The instrumentation used to obtain the various surface parameters was with one exception, comprised of standard Army, Navy, Air Force, and Weather Bureau types. The one exception, a frigorimeter, was operated from 18 May to 27 June 1960. Data recorded by this instrument was furnished directly to Dr. Helmut Weickmann, US Army Signal Corps Research and Development Laboratory, Fort Monmouth, N. J., for evaluation. Standard instrumentation included psychrometers, aneroid barometer, microbarograph, snow surface thermometers, wind equipment (GMQ-11), theodolite, maximum and minimum thermometers, and applicable technical manuals, calculators and meteorological tables. A "snow catcher" designed and fabricated by PFC Kramer provided excellent results in obtaining snow surface temperatures while the swing was on the move.

Winds aloft observations were taken twice daily, at 0600Z and 1800Z hours, with 20-second readings for the first three minutes of each run and readings each minute thereafter until termination. These PIBALS were taken as scheduled from the date of departure (18 May 1960) until arrival at the Mile 664.4 Base Camp. From this point on, and at the request of the TREOG Commander, the runs were limited to 30 minutes. After 481 miles enroute to Peary Land, the train encountered a fuel shortage. In order to conserve fuel the Commander did not stop movement except for the noon and midnight meals. Consequently, PIBAL releases were changed to 1200Z and 0000Z hours to coincide with the limited stops. Additional releases were made at 0600Z and 1800Z if the expedition stopped for any reason.

g. Activities of the Topographic Survey Team (SP5 Donald E. Beck, SP5 Loren M. Maxfield, SP5 Howard J. Wagner)

Three enlisted men from the 30th Engineer Battalion (Base Topographic), Fort Belvoir, Virginia were attached to LEAD DOG 60 for the purpose of conducting a gravity survey of the icecap, to assist TREOG personnel in conducting the altimetry survey from Mile 480 to Mile 664.4, and to make astronomical fixes for the purpose of vertical map control.

For the accomplishment of their primary mission, the gravity survey of the route followed by the tractor swing, the team used a North American Gravimeter. On the outbound journey, readings were made every 15 miles at the altimetry stations established by LEAD DOG 59 and this year's operation. On the inbound trip, readings were made at selected points to reduce the survey.

SP5 Wagner accompanied the helicopter party during the survey of the northeast Greenland ice-free land areas. During this time he made a series of astronomical position determinations of selected points in Crown Prince Christian Land and Peary Land for the purpose of vertical map control of this extensive area which previously had not been accurately plotted.



Figure 18. Meteorologist prepares for PIBAL observations at Mile 341.4.

All data collected by this team was forwarded to the Army Map Service, Washington, D. C. for computation and plotting.



Figure 19. Members of the topographic survey team read gravity meter during halt at Mile 341.4.

TABLE 3

STATION METEOROLOGICAL SUMMARY
(18 May-22 July 1960)MAYPsychrometry:Dry Bulb:

Monthly Average 1.3°F
 Highest 28.0°F on 18 May 60
 Lowest -16.7°F on 24 May 60

Dew Point:

Monthly Average -1.3°F
 Highest 23°F on 18 May 60
 Lowest -24°F on 26 May 60

Relative Humidity:

Monthly Average 77%
 Highest 100% on 18, 19 May 60
 Lowest 62% on 19 May 60

Wind Speed:

Monthly Average 11 knots
 Fastest 22 knots on 29 May 60
 Direction SW

Weather:Number of days:

Clear (0 - 3 tenths) 5
 Partly Cloudy (4 - 7 tenths) 5
 Cloudy (8 - 10 tenths) 4

Number of days with:

0.01" or more Precip 0
 0.10" or more Precip 0
 0.50" or more Precip 0
 1.00" or more Precip 0

Precipitation:

Total for the month 0 Inches
 Greatest in 24 hours - Inches -

JUNE

Psychrometry:

Dry Bulb:

Monthly Average 24.1°F
Highest 39.8°F on 14 Jun 60
Lowest -9.4°F on 2 Jun 60

Dew Point:

Monthly Average 20°F
Highest 33°F on 11, 13, 17 Jun 60
Lowest -14°F on 2 Jun 60

Relative Humidity:

Monthly Average 86%
Highest 100% on 1, 3, 4, 9, 10, 11, 16, 17, 20, 23, 24, 26,
29, 30 June 60
Lowest 58% on 1 Jun 60

Wind Speed:

Monthly Average 9 knots
Fastest 35 knots on 29 Jun 60
Direction WNW

Weather:

Number of days:

Clear (0 - 3 tenths) 7
Partly Cloudy (4 - 7 tenths) 10
Cloudy (8 - 10 tenths) 13

Number of days with:

0.01" or more Precip 2
0.10" or more Precip 3
0.50" or more Precip 2
1.00" or more Precip 0

Precipitation:

Total for the month 2.31 inches
Greatest in 24 hours .94 inches on 21 Jun 60

JULY

Psychrometry:

Dry Bulb:

Monthly Average 24.7°F
Highest 35.8°F on 22 Jul 60
Lowest 1.6°F on 16 Jul 60

Dew Point:

Monthly Average 22°F
Highest 34°F on 21-22 Jul 60
Lowest -2°F on 16 Jul 60

Relative Humidity:

Monthly Average 89%
Highest 100% on 2, 3, 8, 13, 16, 20, 21, 22 Jul 60
Lowest 71% on 1 Jul 60

Wind Speed:

Monthly Average 17 knots
Fastest 30 knots on 21 Jul 60
Direction E

Weather:

Number of days:

Clear (0 - 3 tenths) 3
Partly Cloudy (4 - 7 tenths) 8
Cloudy (8 - 10 tenths) 11

Number days with:

0.01" or more Precip 1
0.10" or more Precip 1
0.50" or more Precip 0
1.00" or more Precip 0

Precipitation:

Total for the month .27 inches
Greatest in 24 hours .24 inches on 3 July 60

TABLE 4
DAILY MAXIMUM/MINIMUM RECORDINGS

Date	Precip (Inches)	Temp °F		Dew Point °F		% RH		Sfc Wind		Cid Cv (tenths)	Mile @1200GCT				
		Max	Min	Max	Min	Max	Min	Dir*	Avg						
18	T	28.0	21.0	24.5	23	15	19	100	67	84	ENE	18	7	6	6.0
19	T	23.9	8.6	16.3	20	3	12	100	62	81	ESE	11	7	6	47.1
20	0	16.2	1.5	9.9	10	-4	3	83	63	73	ESE	16	12	5	85.4
21	T	17.9	0.6	9.4	14	-5	5	84	71	78	SE	14	9	10	102.5
22	T	9.1	-9.7	-0.3	4	-17	-6	81	68	75	E	14	10	2	137.3
23	T	M	-13.4	M	M	-19	M	81	M	M	E	12	6	3	179.2
24	T	2.8	-16.7	-7.0	-2	-23	-13	83	66	75	W	16	11	8	231.0
25	T	0.9	-12.3	-6.8	-4	-18	-11	80	71	76	SSE	18	10	10	242.6
26	0	2.3	-18.0	-7.8	-3	-24	-14	80	68	74	SSE	21	16	1	282.4
27	0	5.6	-11.0	-2.7	0	-17	-9	82	71	77	SSE	18	15	0	328.1
28	0	12.8	-13.3	-0.2	9	-20	-6	85	69	77	SSE	16	15	2	347.5
29	T	11.7	-9.9	0.9	7	-15	-4	86	67	77	SW	22	16	8	237.5
30	T	17.3	2.7	12.7	11	-3	4	84	72	78	SSW	18	15	7	347.5
31	T	13.1	1.2	7.1	7	-3	2	84	67	76	SSW	10	8	5	373.6

Date	Precip (Inches)	Temp °F		Dew Point °F		% RH		Sfc Wind		Avg	Cld Cv (tenths)	Mile @1200GCT			
		Max	Min	Max	Min	Max	Min	Dir*	Max						
1	T	11.8	-6.2	2.8	2	-11	-4	100	58	79	WSW	11	5	3	423.5
2	0	13.5	-9.4	2.1	5	-14	-6	84	66	75	W	12	7	1	456.4
3	T	16.9	4.7	10.8	13	-5	4	100	65	83	WNW	17	13	5	481.4
4	T	18.3	5.0	11.7	14	1	8	100	69	85	W	13	10	2	481.4
5	T	22.0	3.1	12.6	19	-5	7	87	66	77	W	12	8	6	496.4
6	0	26.8	9.7	18.3	22	5	14	90	77	84	W	15	8	7	519.9
7	0	32.3	18.1	25.3	30	14	22	93	76	85	W	10	6	2	531.4
8	0	30.8	19.7	25.3	29	14	22	95	74	85	WNW	17	12	2	566.5
9	T	27.1	16.4	21.8	27	12	20	100	67	84	N	17	12	4	588.6
10	T	31.6	20.7	26.2	30	13	22	100	72	86	N	20	14	6	623.4
11	T	34.2	26.0	30.1	33	22	28	100	83	92	NNW	8	4	5	636.3
12	0	37.2	22.6	29.9	31	17	24	88	67	78	W	9	4	1	656.4
13	0	38.9	28.1	33.5	33	25	29	95	68	82	W	11	6	7	664.4
14	0	39.8	25.3	32.6	32	20	26	88	64	76	NW	10	6	6	664.4
15	0	39.5	30.6	35.1	30	21	26	85	63	74	NW	12	8	10	664.4
16	.40	36.3	31.0	33.7	32	28	30	100	77	89	NNW	12	7	10	664.4
17	.60	33.7	28.1	30.9	33	26	30	100	88	94	N	11	6	10	664.4
18	.07	30.0	27.7	28.9	26	23	25	94	77	86	S	8	2	10	664.4
19	T	34.0	26.7	30.4	31	25	28	95	83	89	N	12	6	10	664.4
20	.10	31.0	25.6	27.8	30	23	27	100	89	95	N	19	12	10	664.4

June

UO

Date	Precip (inches)	Temp °F			Dew Point °F			% RH		Sfc Wind			Cld Cv (tenths)	Mils @1200ZCT	
		Max	Min	Avg	Max	Min	Avg	Max	Min	Avg	Dir*	Max			Avg
June															
21	.94	32.0	26.1	29.1	30	25	28	98	86	92	N	19	13	10	664.4
22	T	31.8	19.2	25.5	30	18	24	97	88	93	NNW	7	4	10	664.4
23	T	33.0	21.0	27.0	31	20	26	100	86	93	NNW	11	5	8	664.4
24	.18	30.6	23.4	28.0	31	21	26	100	90	95	N	9	5	10	664.4
25	.02	31.9	23.7	27.8	30	17	24	96	76	86	N	7	2	9	664.4
26	T	28.2	9.4	16.8	25	5	15	100	77	89	N	13	8	7	664.0
27	T	30.8	9.5	20.2	29	6	18	94	79	87	NW	20	16	7	594.5
28	0	26.2	12.0	19.1	21	6	14	86	71	79	WNW	19	16	3	551.5
29	T	28.3	20.2	24.3	28	16	22	100	82	91	WNW	35	23	10	513.4
30	T	36.8	27.0	31.9	32	24	28	100	72	86	WNW	23	14	10	481.4
July															
1	.03	28.8	22.7	25.8	25	16	21	91	71	81	W	13	8	8	481.4
2	T	29.7	19.7	24.7	26	16	21	100	83	92	W	8	8	9	491.6
3	.24	23.1	15.2	19.2	21	13	17	100	84	92	W	16	12	10	491.6
4	T	26.6	17.1	21.9	24	14	19	92	79	86	WSW	20	16	9	491.6
5	T	28.2	18.3	23.3	27	16	22	97	85	91	W	25	17	7	526.4
6	0	32.0	23.7	27.9	30	21	26	97	88	93	W	29	21	4	581.4
7	0	35.1	28.3	31.7	33	25	29	96	84	90	WSW	28	23	5	605.6
8	T	34.2	28.1	31.2	32	22	27	100	73	87	SW	20	15	3	605.6
9	T	35.0	29.2	32.1	32	28	30	99	83	91	WSW	16	12	8	605.6

Date	Precip (Inches)	Temp °F		Dew Point °F		% RH		Sfc Wind		Cld Cv (tenths)	Mile @1200GCT			
		Max	Min	Max	Min	Max	Min	Avg	Dir*			Max	Avg	
July 10	0	33.1	25.2	29.1	21	25	90	83	87	WSW	18	13	1	605.6
11	0	33.0	23.0	28.0	19	25	91	82	87	WSW	18	13	1	605.6
12	T	32.0	22.2	27.1	18	25	96	78	87	SW	12	7	5	596.2
13	T	24.9	18.7	21.8	16	19	100	81	91	SW	15	6	9	519.2
14	T	24.8	15.0	19.9	11	16	92	77	85	W	11	6	7	481.4
15	0	22.2	8.0	15.1	4	12	92	80	86	WSW	11	9	7	422.1
16	0	21.4	1.6	11.5	16	7	100	78	89	SSW	12	8	5	355.4
17	T	29.7	18.5	24.1	25	21	96	79	88	W	14	11	10	288.9
18	T	27.0	20.0	23.5	24	21	96	85	91	WSW	15	10	10	230.0
19	T	25.4	11.4	18.4	22	7	90	79	85	SSE	17	14	7	154.8
20	T	26.8	17.2	22.0	27	21	100	85	93	SE	28	22	10	91.1
21	T	34.9	26.2	30.6	34	30	100	95	98	E	30	25	10	41.0
22	T	35.8	32.8	34.3	34	33	100	89	95	SE	24	17	8	13.0



Figure 20. D8 tractor fills open crevasse at Mile 12.

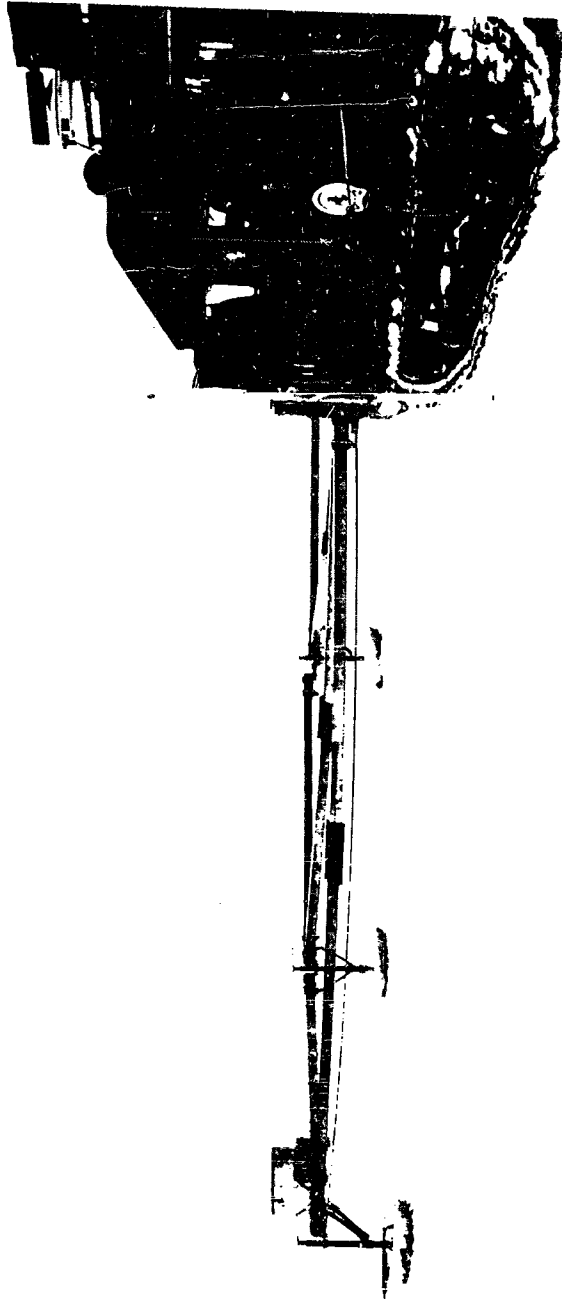

Figure 21. Crevasse detector mounted on M29C Weasel seeks crevasses at Mile 595. Bamboo poles with attached flags, used to mark the trail, can be seen in the foreground and the background.

CHAPTER V

NAVIGATION AND TRAIL OPERATIONS

1. GENERAL

The trail operating procedures employed by the LEAD DOG 60 swing did not vary considerably from those procedures employed by the two previous LEAD DOG operations. As this year's project included more scientific studies than the past projects, the operation assumed the nature of a service mission rather than a mission with its own ends. Icecap tractor-train operations and navigation have become more or less standardized. Naturally all personnel, both commanders and operators, must be capable of a great deal of flexibility during the operation in order to adapt to the changing situations, but the day to day operating techniques are fairly standardized. This chapter will be divided into two sections. The first will give the procedures utilized by the swing to move the tractor-trains across the trackless wastes, the second section will describe the techniques used by the swing's navigators to locate the trail from Mile 481.4 to Crown Prince Christian Land and to conduct the altimetry survey.

2. TRAIL OPERATIONS PROCEDURE

During the period the swing was on the trail, personnel were divided into two shifts, each of which worked 12 hours a day. Shift changes were made at 0600 and 1800 hours (G. C. T.). During these halts, daily operator maintenance was performed on all vehicles. The two tractors with the dozer blades, rather than the bow tanks, and the M29C Weasels were refueled at this time. At 1200 and 2400 hours, the swing was stopped to permit the vehicular operators on duty to eat their midday meal. The mess wanigan served meals at regular six hour intervals. The food consisted of those class "A" rations which could be frozen and carried on the swing's ration sled. After the first few days of the operation, fresh foods were available only following the occasional visits from the outside by the aircraft. During all halts, the snow melters were filled, the chemical toilets were emptied, and all refuse was buried.

The swing was periodically stopped to permit the project scientists to carry out their studies. Every 15 miles, the topographic team conducted a gravity station. Deep pit glacial studies were conducted at Miles 481.4, 531.4, 581.4, 631.4 and 664.4. At each maintenance halt, a PIBAL observation was made by the meteorological team. (For a summary of the scientific activities, see Chapter IV).

Prior to each scheduled maintenance, caching, or scientific halt, the swing commander and the NCOIC planned in detail all work which had to be performed. The shift NCO (senior tractor operator) was then briefed thoroughly. Prior to the swing departing, following a halt, the shift NCO reported to the CO or the NCOIC on the status of the equipment, any caches made, and fuel utilized. These steps aided greatly in insuring that all necessary work was carried out, and in providing an easy method for the command personnel to keep abreast of the fuel and maintenance needs of the swing.

Due to the heavy load of aviation gasoline and repair parts which the tractor swing carried, it was necessary to plan very closely the quantity of diesel fuel required, and fuel management became increasingly important as the project progressed. In order to reduce the swing's load as much as possible, a swing from the Polar Research and Development Center established two large caches for the project at Miles 120 and 231. At Mile 231, 477 drums of diesel fuel and Avgas were cached while 142 drums were cached at Mile 120. As the swing moved farther out onto the icecap, fuel was cached to provide sufficient quantities for the return trip. In addition to this, Avgas was cached to provide refueling points for the flights by TREOG aircraft to the swing.

Since, past Mile 231, the swing was carrying a larger load than the previous year (generally one sled more per train) a rack setting of .225 inch was used for the tractor engines as compared to a setting of .170 inch used the previous year. This provided a great deal more power to the tractors, but also resulted in a much higher rate of fuel consumption than in 1959. A total of 28,843 gallons of diesel fuel was used by the six tractors in 5,556 hours of operation. This is an average of 4,967 gallons per hour.¹

If, when having stopped for one reason or another, it is anticipated the swing would be underway within 45 minutes the tractors were not shut down. However, when longer halts were contemplated, all tractors were shut down to protect the tractor turbo-chargers from overheating at the rarified altitude, to prevent excessive carboning of the engines, and to conserve fuel. Under no circumstances were the tractors allowed to low idle (450-500 RPM). When it was necessary to idle the tractors, they were operated at approximately 1,000 RPM. This precaution was necessary to keep oil from bleeding out from the labyrinth seals in the center section of the turbo, and getting on the turbo wheels. It is advisable to set the adjusting screw on the governor at 600 RPM. This not only protects the turbo charger, but is of benefit to the electrical charging system.

¹For an operation of this type, it is more practical to base fuel consumption by the hour rather than by the mile because of the large number of halts which are made for maintenance, meals, and research.

FIGURE 22
DAILY RATE OF TRAVEL

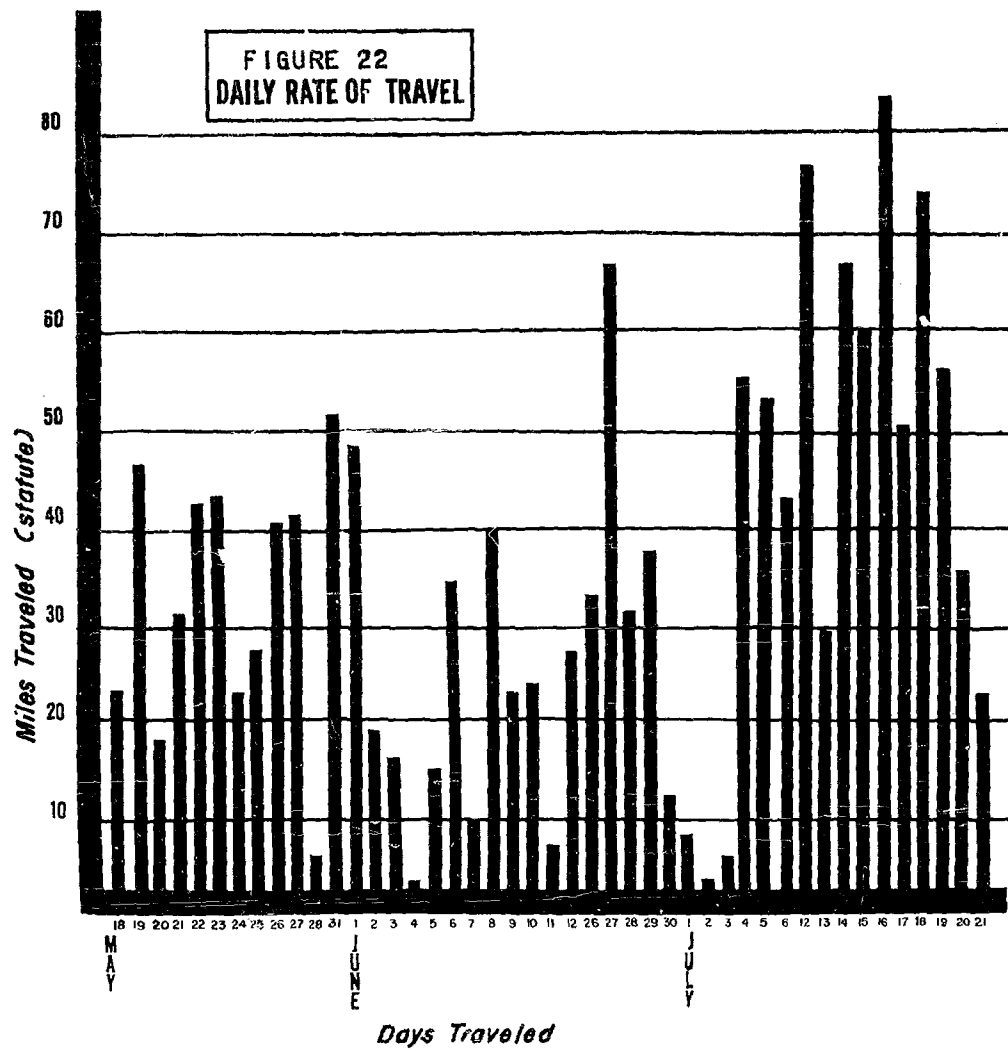

On any Diesel engine, and especially one equipped with a turbo-charger, it is imperative that proper starting and shutting down procedures be followed. Accordingly, when cranking the engine, all personnel were instructed to wait a full three minutes after the oil pressure gauge indicated oil pressure before starting the Diesel engine. When shutting the engine down, they were allowed to idle at 800 RPM for five minutes and at 600 RPM for three minutes. This action reduces the residual heat in the cylinder heads, exhaust system, and turbo lubrication system. If the engine is shut down immediately from a full throttle, it will force the turbo assembly to rotate for about five minutes without forced lubrication. Whenever starting an engine, the tractor operator was supervised by one of the three maintenance personnel to insure proper procedures were followed.

All personnel were quartered in one of three wanigans (two 24-men crew and one 6-man command wanigan). These prove to be quite comfortable as living quarters, each having a thermostatically controlled hot water heating system, a hot and cold water shower, and a 5 KW generator which provided electricity for the lighting, water pump, oil burner, and circulating fans. Maintenance of an adequate water supply required frequent shoveling of snow into the snow melters.

As there were shifts sleeping at all hours, and there are 24 hours of daylight, each bunk was equipped with heavy curtains to keep out the light and provide a degree of privacy. In addition, each bunk was equipped with a reading light and an inner-spring mattress to provide an extra measure of comfort for each individual.

At all time, safety procedures were emphasized to the utmost. Because of the swing's distance from adequate medical facilities and the difficulty in evacuation of personnel, any serious injury would necessitate extensive rescue operations. Through the use of experienced personnel, close supervision, proper training, and a good deal of luck, no accidents occurred. A medical corpsman accompanied the swing and carried a large store of medical supplies and medicines.

As a fire in the Arctic is always a disaster of varying proportions, every precaution was taken to prevent such an occurrence. Each wanigan was equipped with three fire extinguishers placed at strategic locations. Two men had the duty of inspecting the wanigans periodically throughout the day and night to insure that the heaters, boilers, and wiring were in a safe state. All personnel refrained from such obviously dangerous procedures as smoking in bed, tampering with the electrical wiring, or overloading the circuits.

In order to maintain a high state of personal and group hygiene, the strictest sanitary procedures were followed. The wanigans were aired daily, and thoroughly cleaned periodically. All personnel were required to keep

their private possessions and clothing within the area allotted and to bathe frequently. All personnel and wanigans were informally inspected daily to insure that they met the high standards which were set. In addition to the more obvious advantages, this policy had the added benefit of contributing to the high state of morale of all personnel assigned to the project.

The standard method of marking icecap trails is through the use of 9 to 15 foot bamboo poles, mounted with either international orange or black flags. The only trail marked this year was from Mile 481.4 to Mile 664.4. Along this leg of the trip, flagged poles were placed every quarter mile. Every five miles, these poles were marked to indicate the altimetry stations by wrapping a flag around the pole with the mileage and station number marked with an indelible pen.

In order to insure a straight trail, it was necessary to align the poles. At each astronomical position determination, four poles were aligned to the proper azimuth through the use of the theodolite. Then each pole was aligned with the preceding poles by sighting on the two previous poles. This can best be done by using binoculars. The pole which is being placed is held vertically between the two scopes of the binoculars, and the pole can be aligned with great accuracy.

Caches were marked by placing poles at each of the corners. When supplies were cached on a sled, a flagged pole was attached to each corner of the sled. When caches were left on the snow, empty drums were placed in the first layer with full drums and other items pyramided on top. Flagged poles were then placed within the cached drums.

Proper crevasse detection is based on a thorough knowledge of the terrain, aerial reconnaissance of crevassed areas, and careful surface inspection utilizing all available means for detecting the crevasses. At present, the detection of crevasses is accomplished by observation of the terrain ahead, probing, and the use of an electrical or electronic crevasse detector.

On occasion, crevasses are indicated by slight depressions which result from sagging snow bridges or other irregularities in the snow surface. On Project LEAD DOG 60, a "W" type crevasse detector was used to supplement visual observation. This crevasse detector is an instrument incorporating audio frequency radio waves to detect variations (crevasses) in electrical conductivity in substances (snow and ice) through which these waves pass. When a regulated signal is emitted over a crevasse, the signal is distorted by the differential resistance between the snow and air and then recorded. A trained operator is able to tell if these waves are being distorted by a crevasse or small cracks in the ice surface.

Upon receiving a reading on the detector, the detector equipped Weasel is backed up and personnel are sent forward to probe for the hidden trap. These man should be roped together. A light weight one-half inch diameter metal rod 15 feet long has been used and found to be ideal for probing. When the probing rod goes through suddenly, or when it continues to go down with little resistance, the prober is over the crevasse.

All crevasses located should be opened and refilled prior to crossing by heavy tractor traffic. Generally a bridge three times as thick as the width of the crevasse will support tractor train operations. The method utilized for opening a crevasse was to place a charge of composition C-3 or C-4 approximately three feet below the snow surface and arm this charge with an electric blasting cap. The charges were then detonated by touching the main line to the battery terminals on the Weasel. WD-1 wire makes an excellent main line between the cap wires and the battery. Depending on the depth of the snow bridge and the width of the crevasse more than one charge can be placed. If a snow bridge is under five feet thick, two 2-pound charges placed five feet apart will insure the complete removal of the bridge.

This year, with the exception of a melt stream in Crown Prince Christian Land, the only unmarked crevasses encountered were those found by the Weasel party in Peary Land. As a result, none of these crevasses were filled as this party did not have a tractor with them. However, once a crevasse has been opened, it can be easily filled through the use of a vehicle equipped with a bull-dozer blade. Actually, filling a crevasse, is a poor term as the crevasse is not filled but rather bridged across the top 12 to 14 feet.

The swing always traveled single file through the marginal zones. All personnel were cautioned not to walk around the swing but to remain in the wanigans and to dismount only for meals.

Travel during periods of reduced visibility caused by blowing snow, fog, or ice fog was generally slowed considerably. During periods when the visibility was 1/8 to 1/4 mile, a Weasel preceded the swing picking up the flags as they came in sight. The tractor trains were then able to guide on the Weasel. During periods when the visibility was less than 1/8 mile, two methods were employed. The first was relatively simple. The tractors lined up along the trail in single file. By aligning on the tractors to the rear, the front tractor was able to proceed in a straight line. The second method was through the use of radar. Operating by this method, the radar Weasel moved in front of the swing about 1/4 mile. Then the vehicle was able to follow the trail poles by the radar and talk the swing along the right course over the radio. This method proved quite slow and laborious, however, and where possible, visual methods for following the trail were used. Naturally,

where the trail had been traveled within two weeks, the tracks of these vehicles could be followed.

All trail parties sent out by the swing were carefully equipped with survival rations and equipment. Tables 5 and 6 show the basic load of equipment and clothing recommended for a small trail party. All clothing and equipment should be divided proportionally among the vehicles to prevent disaster through the loss of one vehicle.

TABLE 5

RECOMMENDED BASIC LOAD OF SURVIVAL EQUIPMENT
FOR AN ICECAP PARTY

1.	Individual field clothing (See Table 2)	1 set per man
2.	AM Radio Transmitter/Receiver	1 per vehicle
3.	Ice ax	1 per man
4.	Crampons	1 pair per man
5.	Nylon Rope 5/8, 3400 lbs test	120 ft per man
6.	Survival Tent, Barren Ground	1 per 3 men
7.	Two-burner mountain cook stove	1 per vehicle
8.	One-burner mountain cook stove	1 per vehicle
9.	Mountain Cook Set	1 per vehicle
10.	Binoculars	1 pr per vehicle
11.	Rifle, M-1, Cal 30 w/24 rds of ammo	1 per vehicle
12.	Pistol, flare w/6 red star flares	1 per vehicle
13.	First Aid Kit	1 per vehicle
14.	O.V.M. Tools and Equipment	1 set per vehicle
15.	General Mechanic Tool Set	1 set per vehicle
16.	Explosives (C-3 or C-4) 1 pound blocks	24 pounds
17.	Caps, electrical	24 ea
18.	Wire, WD-1, field, quarter mile roll	1 roll
19.	Rations	Min of 15 days
20.	POL - gas, oil, antifreeze, grease	As needed
21.	Spare parts carried as space is available	As needed
22.	Spare air mattress and sleeping bag	1 set per party

TABLE 6

RECOMMENDED BASIC ISSUE OF INDIVIDUAL FIELD CLOTHING
FOR ICECAP OPERATIONS

<u>Item</u>	<u>Quantity</u>
Bag, Duffle	1 each
Boots, Combat, man's, felt (w/2 pairs of insoles, blocked type)	1 pair
Boots, Combat, man's, rubber, black	1 pair
Cap, field, wool pile-lined	1 each
Drawers, wool	4 each
Drawers, cotton	6 each
Glasses, sun, polarizing	1 each
Gloves, man's, leather, w/inserts, wool	2 pair
Gloves, man's nylon, anti-contact	1 pair
Hood, parka, w/fur ruff	1 each
Jacket, man's, cotton, OD 107	1 each
Liner, Parka, nylon pile	1 each
Liner, jacket, nylon pile	1 each
Liner, Trousers, nylon pile	1 each
Mask, cold weather, OD or Blue	1 each
Mattress, pneumatic, rubber	1 each
Mitten set, Arctic	1 pair
Parka, man's, cotton, coated OD No. 7	1 each
Scarf, neck wear, man's, OD	1 each
Shirt, man's, wool, OG 108	3 each
Sleeping Bag, Arctic, outer and inner bag, w/case and waterproof bag	1 each
Socks, man's, wool, white, ski	3 pair
Socks, man's, wool, cushionsole	6 pair
Suspenders, trousers, OD 107	1 each
Trousers, man's, cotton, field, shells	2 each
Trousers, man's, sateen, shells	1 each
Undershirt, man's, wool	4 each
Undershirt, man's, cotton	6 each

3. NAVIGATION PROCEDURES

ALTIMETRY SURVEY

Four 4500-meter altimeters were utilized to conduct the survey. Two M29C Weasels were used, each of which had two altimeters mounted in wooden boxes and cushioned against shock. The four altimeters were designated A, B, C, and D. A and B were mounted on one vehicle, C and D on

another. Whenever read, the altimeters were allowed to settle for 10 minutes, then they were read three times at three minute intervals. Instruments A and C were always read first followed by B and D.

Since a survey had been run to Mile 481.4 by LEAD DOG 59, this point was used as the base station for the survey to Mile 664.4. The altimeters were read simultaneously at this base station after being allowed to settle for 10 minutes, then the first vehicle moved forward to the first station. After reaching this point, the vehicle operator radioed back giving a time, 10 minutes after the vehicle had stopped, to take a reading. Then the trail vehicle moved forward to the station and, after a 10-minute settling wait, the altimeters were read simultaneously. The first vehicle then moved forward again and the process was repeated.

The data taken included altimeter readings to the nearest 1/2 meter, instrument temperature, air temperature, wind velocity and direction, and general observations on weather conditions. Distance between stations was measured by the vehicle odometer. Each station was marked by a trail marker with flag attached at the top, and an orange flag, with the station number and mileage marked on it, wrapped tightly around the pole and secured with wire four feet above the ground.

Elevation differences were computed throughout the entire line by comparing two independent sets of altimeters and meaning the results of their differences. A correction for air temperature was then applied to these differences. Elevations for each station were then computed with a closing error of +8.2 meters, or 26.8 feet. This error was then prorated among the stations. (See Table 7 for final computed elevations. All field notes are available for inspection at the Transportation Board Headquarters).

TRAIL PLOTTING

Project LEAD DOG 60 was presented with the problem of moving from Mile 481.4 (Lat. $79^{\circ} - 59' - 42''$ N, Long. $39^{\circ} - 38'$ W) to a predetermined entry into Crown Prince Christian Land (Lat. $79^{\circ} - 50'$ N Long. $24^{\circ} - 30'$ W).

A great circle course and distance was computed between points of departure and destination -

Results:

Initial course $86^{\circ} - 57'$ (True)

Distance 180 statute miles

The following formulae were used for the computations:

$\text{hav } D = \text{hav } D \text{Lo ccs } L, \cos L_2 + \text{hav } L$

D = Distance

TABLE 7
 COORDINATES & ELEVATIONS TRANS-GREENLAND TRAIL
 481.4 TO CROWN PRINCE CHRISTIAN LAND

STATION	MILE	N LATITUDE	W LONGITUDE	METERS ELEVATIONS	FEET ELEVATION
0	481.4*	79-59-42	39-38	2070.8	6794
1	1.5	79-59-48	39-31	2067.4	6783
2	4.0	80-00	39-19	2059.1	6755
3	10.0	80-00	38-50	2042.6	6701
4	15.0	80-01	38-25	2028.2	6654
5	20.0	80-01	38-00	2009.9	6594
6	25	80-01	37-35	1994.5	6544
7	30	80-01	37-10	1980.1	6496
8	35	80-02	36-45	1964.1	6441
9	40	80-02	36-20	1950.8	6400
10	45	80-02	35-57	1935.8	6351
11	50*	80-02	35-34	1923.5	6311
12	55	80-02	35-08	1909.1	6263
13	60	80-02	34-42	1890.6	6203
14	65	80-02	34-18	1873.7	6147
15	70	80-01	33-52	1852.1	6076
16	75	80-01	33-25	1829.3	6002
17	80	80-00	32-56	1797.2	5896
18	85	80-00	32-30	1774.1	5820
19	90	80-00	32-05	1750.1	5742
20	95	80-00	31-40	1720.3	5644

COORDINATES & ELEVATIONS (Continued)

STATION	MILE	N LATITUDE	W LONGITUDE	METERS ELEVATIONS	FEET ELEVATION
21	100*	80-00	31-15	1690.2	5545
22	105	80-00	30-50	1653.9	5426
23	110	79-59	30-25	1610.4	5283
24	115	79-59	30-00	1564.0	5131
25	120	79-58	29-35	1536.0	5039
26	125	79-58	29-10	1492.3	4896
27	130	79-57	28-45	1439.8	4724
28	135	79-56	28-20	1412.6	4634
29	140	79-56	27-55	1359.0	4459
30	145	79-55	27-30	1293.2	4243
31	147.5*	79-54	27-15	1282.7	4208
32	150	79-53	27-05	1213.3	3981
33	155	79-52	26-40	1106.0	3269
34	160	79-52	26-15	1011.6	3319
35	165	79-51	25-50	971.8	3188
36	170	79-51	25-25	928.8	3047
37	175	79-50	25-00	8824	2895
38	180	79-50	24-35	827.7	2716
39	183*	79-49	24-23	762.8	2503 Base Camp
Astro Point Lake Centrum	*	80°-09'- 20"N	22°-29'- 05"W	14.7	48
Astro Point Access Ramp	*	79°-54'- 40"N	23°-58'- 30"W	354.3	1162
Mid Point				46.9	154

*NOTE: These positions are determined by observations on the sun and plotting lines of position. Other positions are determined by dead reckoning.



Figure 23. Personnel probe for suspected crevasse after receiving warning from the crevasse detector.



Figure 24. Navigator takes sighting with a T-2 theodolite.

DLo = Difference in longitude

L_1 = Latitude of departure

L_2 = Latitude of destination

hav C = Sec L, csc D (hav CoL_2 - hav D = CoL_1)

C = Course

$CoL = 90^\circ - L_1 = 90^\circ - L_2$

D = CoL_1 is always the numerical difference between D and CoL_1 .

When the same problem is determined graphically from the world aeronautical chart, scale 1: 1000000 the results are:

Initial course $87^\circ - 00'$ True

Distance 180 miles

From the above information, lengthy and tedious computations of great circle courses for short distances are unnecessary for icecap navigation. Mercator plotting sheets for 50 mile courses would be adequate.

Because of uncertainties in maintaining direction and the fact that high latitude dead reckoning is complicated because the elements of dead reckoning, distance and direction, are usually known with less certainty than in lower latitudes, astronomic positions were established every 50 miles (approx).

The initial azimuth ($87^\circ T$) was determined by use of a Wild T-2 direction instrument, observing the horizontal angle between a mark and the sun, then computing azimuth of sun from observed altitude, meridian angle and declination.

Formula: $\sin A = \frac{\cos \theta \sin "t"}{\cosh}$

A = Azimuth

θ = declination

"t" = meridian angle

h = Altitude

By subtracting horizontal angle from mark to sun, the azimuth of mark is established. With azimuth from instrument to mark known, any other azimuth can be readily turned off

An azimuth of 87° true was set with the instrument and the first mile of trail markers was aligned with the instrument. This insured correct starting azimuth of trail markers.

Fixes (astronomic positions) were established at Mile 50, 100, 147.5 and 183. These positions agreed within $1/2$ mile of the dead reckoning position determined by use of trail markers and M29C (Weasel) odometer.

Fixes were determined by observations on the sun for altitude and hour angle, then plotting sun lines of position on a Lambert Conformal Projection Chart.

Accuracy of positions are dependent upon the number of observations observed and position of the sun. However, time and weather sometimes restricted observation to a minimum.

Rapid convergence of meridians dictated the plotting and following of new courses from each fix. Therefore, at each fix, a new course was laid out by using the T-2 theodolite to lay in the first four trail markers.

CHAPTER VI

EQUIPMENT OPERATIONS AND MAINTENANCE

1. GENERAL.

In addition to the support and scientific missions which LEAD DOG was assigned, the swing personnel had the additional duty of appraising the performance of all vehicles used by the swing, and to conduct an evaluation of three items of test equipment used extensively on the icecap for the first time. Systematic observations of equipment performance and reliability were made and maintenance requirements analyzed. Most of the data for this evaluation (No instrumentation was made, as a detailed study had been made in 1959 and the 1960 testing was designed to supplement rather than duplicate these studies¹) has been extracted from the official LEAD DOG 60 Daily Journal which is available in the Transportation Board Library.

2. MOBILITY.

The snow encountered along the trail was generally quite strong. However, as the swing progressed past Mile 120, the snow became progressively softer as the crest of the cap was neared, and then progressively stronger as the Eastern edge of the cap was approached. This trend was reversed during the periods that the swing operated in the melt zones, with increased melt leading to increased vehicle penetration. With the exception of the melt zones, the variation in snow density had little effect on the penetration of the D-8 tractors, which varied from 1 to 12 inches, but was more noticeable in its effects on the sleds and wanigans which often sank in up to their benches. This sinkage on the part of the sleds required the tractors to move in a lower gear and increased their track slippage thereby reducing the swing's overall speed twofold. The reason for the decreased strength of the snow towards the crest of the cap is the fact that, as ambient temperatures become lower, the snow becomes dryer, and consequently the bonding and compaction of the snow decreases.

The barrier towards mobility posed by the melt zones during the melt season is more serious than the soft snow of the interior. The melt season begins around 1 June and thereafter the snow within the melt zone² of the

¹See U S Army Transportation Corps Arctic Projects - Greenland 1959

²The melt zone varies in width around the edge of the icecap. Generally it extends to the 4000 foot level in northern Greenland, but this varies from year to year. Mile 60 (trail miles) on the Tuto Trail is generally considered the edge of the marginal zone. The elevation at Mile 60 is 4354 feet.

icecap deteriorates progressively until it no longer resembles snow, but turns to slush and large ice granules commonly called "corn snow". Along the Tuto Trail, when the melt season is at its peak (during July) large melt pools and streams accumulate forming obstacles, but not barriers, to transportation. However, in many areas of the icecap, melting water accumulates in glacial lakes and flows towards the edge of the cap in glacial streams which often reach torrential proportions. These streams often reach 30 to 40 feet in depth, and pose as great a problem as crevasses in some areas.

The terminus of the Trans-Greenland Trail (the marking of which was completed this year), is one of the more serious thaw zones in Northern Greenland. Aerial photographs of this area indicate large lakes and numerous deeply cut glacial streams during late summer. Upon entering this areas the swing encountered extremely wet rotten snow within a twelve mile



Figure 25. Snow piled up by the sleds bench greatly increased drag when moving through areas of soft snow.

belt along the edge of the cap. While moving eight miles through this belt, to its camp, the swing experienced considerable difficulty with the tractors becoming stuck quite often and double-heading being necessary on several occasions.

3. TEST ITEMS.

Three separate types of wheeled trailers were evaluated for icecap operations during LEAD DOG 60. The value of wheeled trailers for icecap operations as opposed to sleds is obvious once their capabilities are compared.

- a. The drag resistance of fully loaded rolling stock is at most 1/3 that of a fully loaded sled per cargo pound:
- b. The wheeled trailers have an all terrain capability while the sleds are restricted to operating over snow covered ground:
- c. Wheeled trailers are less likely to freeze down, and when they do, there is much less pull required to break them loose: and
- d. With less pull required, there is less strain on the trailers than the sleds, therefore, fewer breakdowns.

The following facts, proven during LEAD DOG 59, indicate the relative merit of wheeled trailers over sleds. With 2000 gallons of Diesel fuel, a. the drag resistance of a 10-ton sled is 2100 pounds; b. the drag resistance of a 1000-gallon RLT is 350 pounds; and c. the drag resistance of a 10-ton Off-Road trailer (with 2400 gallons of Diesel Fuel) is 450 pounds. As drag resistance is the primary criteria limiting the load capability of a prime mover, it can be seen that, on this one basis alone, wheeled trailers offer a tremendous advantage over sleds. Three types of wheeled trailers were evaluated during LEAD DOG 60 as to their suitability for icecap operations. They were: the 10-ton Off Road trailer, the 1000-gallon Rolling Liquid Transporter, and the Rolli-Trailer. All three types of vehicles proved to be highly efficient, and made significant contributions to the success of the project.

Transporter, Liquid, Rolling Wheel Type: 1000-gallon, T-3

A total of seven of these trailers were utilized during the project to haul diesel fuel for a total of 7,871.2 vehicle miles. The RLT's proved an efficient and convenient method of hauling bulk diesel fuel. Fuel was loaded into the cells through the use of a gasoline driven pump with a 30-gallon per minute capacity. For the transfer of fuel from the RLT cells to the tractor storage tanks, a 6 CFM compressor was utilized to place the fuel under pressure in the cell.

The primary failure which occurred to these trailers was a crushing of the right outside wheel bearing by the bearing carrier. A total of four of these failures occurred: (a) because of the failure of the manufacturer

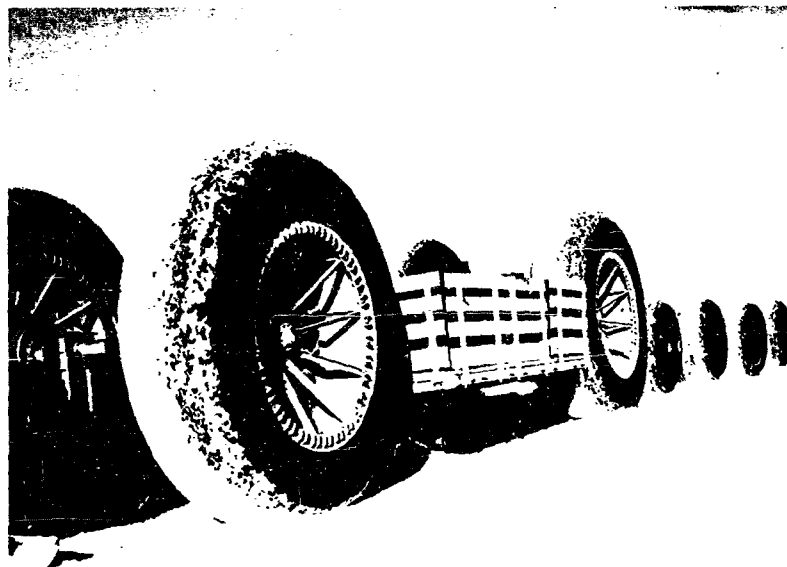

Figure 26. Four Rolling Liquid Transporters and a 10 ton off-road trailer are being towed behind two 10 ton sleds by a D-8 tractor.



Figure 27. Wheeled trailers tested by this year's expedition being towed by a D-8 tractor. One tractor could easily tow twice this number vehicles carrying 82 tons of cargo. The most that could be carried using the obsolete sleds would be 50 tons.

to properly lock the bearing carrier with the lock washer, two failures - and (b) because of the light construction of the lock washer which sheared off allowing the carrier to tighten and crush the bearing, two failures. In addition, the initial fueling of the RLT's was delayed when one of the spring loaded valves failed to seat because of the formation of ice and, following the return of the project, one cell was found to be badly blistered.

Following is a chronological listing of the incidents with the cause and corrective action taken:

INCIDENT #1: On 7 May, during the initial fueling of the cells prior to the departure of the swing, the spring loaded valve inside the intake disconnect coupling on the right cell of RLT number 0137 failed to seat because of the formation of ice inside the valve. The ice formed around the inside of the valve seat, thus resulting in excessive fuel leakage upon the removal of the valve adapter. The air temperature at the time was -3°F , the fuel temperature was $+14^{\circ}\text{F}$, the wind speed was 15 MPH.

The ice was melted by the application of heat directly to the valve through the use of a 400,000 BTU Herman-Nelson heater. This incident did not occur when the ambient temperature rose above 0°F .

The installation of non-metallic valve seats with corresponding lower thermal conductivity would relieve future occurrences of this nature.

INCIDENT #2: After a stop on the trail at Mile 84.3 (200800 May) and while preparing to move out, it was noticed that the right cell on RLT 0138 was locked. The seal carrier and allied components were removed and the outer bearing was examined. The bearing cone was badly crushed and the rollers broken, thereby locking the wheel, even though adequate grease was present. Several attempts were made to remove the bearing carrier and the bearing cone from the axle, but these only resulted in the breaking of several spanner wrenches as the two components are evidently "frozen" together. As the cause of the failure was not known, the fuel was removed from this unit and it was loaded on a 10-ton trailer. The average temperature at this time was $+10^{\circ}\text{F}$. The average speed was in the neighborhood of 2.5 miles per hour.

INCIDENT #3: At Mile 89.7, after traveling 5.4 miles since the previous failure, the right cell on RLT 0142 was heard squealing as though the bearing were dry. The seal carrier was removed and the bearing was inspected. Again the bearing had failed even though adequate grease was present for positive lubrication. This failure, as well as the previous one, was caused by the bearing carrier revolving to the right, thus tightening on the axle against the bearing cone until the roller bearings were crushed

TRANSPORTER, LIQUID, ROLLING WHEEL TYPE,
1000 GALLON, T-3

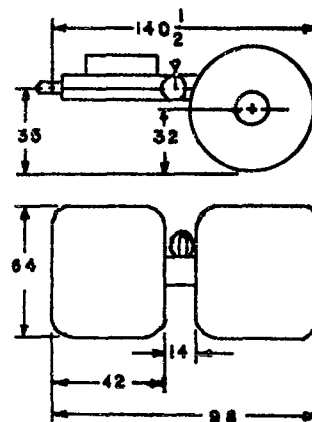

Note: All dimensions shown are in inches.

PURPOSE: To transport bulk POL over all types of terrain.

GENERAL DATA

Weight: (lb) Net 2240
 Gross w/gasoline. 8540
 Payload (gal) 1000

Fuel Cell Wheels: Ply. 4
 Size (in) 64x42x18
 Pressure (psi) 3-15

Shipping Dimensions: (in)
 Towbar removed. 98x64x64

Transporter Dimensions: (in)
 Ground Clearance. 28
 Length. 140½
 Width 98
 Height. 64
 Towbar Height 35

Brakes: Type . . . Air/hydraulic

ADDITIONAL DATA

Side Slope: (max. percent) 30
 Transporter is capable of operating in temperatures from -40°F to +125°F. (adaptable for operation from -65°F to +165°F w/special Fuel Cell Wheels.)

Discharge Rate: (gpm)
 Ea. Fuel Cell Wheel (max.) 50

Ground Pressure: (psi) 3-15
 Towing Speed: (max. mph) 25

Towing Vehicles:
 on highway - 2½ ton truck or larger w/pintle
 shuttle operation - ½ ton truck or larger w/pintle

A maximum of five transporters may be towed in tandem.
 Transporter is air transportable.
 Hand Pump Capacity: (gpm) 15

Figure 28. Technical Data Sheet for T-3 RLT.

against the bearing cup, thereby locking the wheel. Examination revealed that the bearing carrier had rotated away from the key washer and lock nut. None of the tabs of the key washer had been depressed into the slots of the bearing carrier, therefore, once the tension was broken between the lock nut, key washer, and bearing carrier, the carrier was free to rotate into a tightening position against the bearings. At this time, an inspection was ordered of all lock nuts and key washers on all RLT's. It was found that no key washer tabs were depressed into bearing slots. Due to the concave design of the key washer, some doubt existed as to whether the tabs were designed to be depressed into the slots of both the lock nut and the bearing carrier. In order to mechanically favor the tabs depressed into the bearing carrier, the key washers on all RLT cells were faced inward and three tabs locked into the carrier and one or two tabs bent backward into the lock nut.

The right cell on RLT 0142 was removed from the axle with considerable difficulty and resulting damage to the axle. The axle assembly, bearing cone, and bearing carrier were replaced and the RLT reassembled.

INCIDENT #4: At Mile 224.0, the third RLT bearing failure occurred. The bearings on this RLT had been inspected at Mile 89.7 and the right hand bearing carrier was found to be too tight to be relieved by the spanner wrench. As the wheel was rotating freely, the bearing was packed and the tabs of the key washer were seated into the bearing carrier (two tabs) and the lock nut (one tab). Upon examination, after the failure, it was noted that one tab in the carrier had been sheared off and the other badly bent due to the rotating force of the bearing carrier. The inoperative RLT was loaded aboard a 10-ton sled and repaired while the swing was stopped in Peary Land.

INCIDENT #5: The fourth bearing failure occurred at Mile 292, on the return trip, when the right wheel locked on RLT 0142. Upon inspection of the bearing locking group, it was found that the three tabs locking the bearing had either sheared off or been badly twisted, thereby permitting the carrier to tighten on the axle and crush the bearing cone. The RLT was loaded on a sled and repaired upon the swing's return to Camp Tuto.

INCIDENT #s 6 and 7: While repairing the RLT's, it was found that the OVM spanner wrench and wheel puller assembly were grossly inadequate. The four teeth or lugs on the spanner wrench break when moderate pressure is applied to them, while the holes drilled in the wheel puller assembly were too small to accept the cap crews for which they were designed. Field expedient repairs were made on both items. High carbon steel lugs were welded to the wrench in place of the original teeth and the holes in the wheel puller assembly were cut larger.

INCIDENT #8: During a technical inspection of all RLT's following the Project, one cell was found to have developed three large blisters inside the cell. A representative of the manufacturer was consulted and he stated that these blisters were caused by a failure on the manufacturer's part to completely bond the inner liner with the inside nylon ply. Fuel had seeped into this space and resulted in the formation of blisters. The cell was returned to the factory and repaired on a 'no cost' to the government basis.

After examining the four bearing failures, the following facts are considered pertinent: (1) all failures occurred to the right hand cell; (2) all failures occurred to the lead RLT in the train; (3) all failures were caused by the key washer either not being properly locked or by the tabs shearing off or bending out of place, and (4) adequate lubrication was present at all times. It is felt that temperature, speed and cargo had little or no bearing on the failures.

In examining the reason for failures always occurring on the lead RLT in the train make-up, the matter of compatibility of tracking is believed to be a factor. (See figures 29 and 30 attached). The surface snow of the Greenland icecap compresses to varying degrees under traffic. This past year, an LGP D-8 tractor sank about 6 inches, the sleds following the tractor made runner tracks which are about 10 inches deep. RLT's following, having been designed to be towed by tactical vehicles, have a rather narrow total wheel width. As shown in figure 1, the lead RLT always has a ramp of snow to overcome which bears well on the inner half of each fuel cell. The RLT's following the lead RLT do not have this total ramp of snow to overcome and can, to a large degree, ride rather effortlessly in the path of the lead RLT.

It is interesting to note that for the first 60 miles of travel, the tractor trains were forced to follow a narrow well traveled and compacted trail through the crevassed marginal area of the icecap. This fact explains the lack of failures initially. After reaching Mile 60, the tractor trains seek smoother going by pulling off the rough portion of the traveled trail to virgin snow where possible. The virgin snow maximized the snow ramp to be overcome by the lead RLT.

Apparently the axle was flexed slightly or, by some other means, the outer bearing and carrier was bound enough to impart rotation to the bearing carrier. This force or torque must have been considerable since it broke the carrier away from the compression holding it as well as shearing the tabs off of the key washer.

Since none of the key washer tabs were originally depressed into the slots of the bearing carrier, and this matter is not discussed in the TM, considerable doubt existed as to whether the key washer was intended to

be tabbed both into the lock nut and bearing carrier. If this was the intention, the gage and concave design of the key washer would appear inadequate. Tabs were depressed into both components as a matter of field expediency since other than locking by compression, there is no other means of locking the bearing carrier.

Admittedly the tracking problem encountered behind present equipment on the Greenland icecap is a rather uncommon situation, but it is felt this problem might arise to some degree in travel over rutted roads which prevail in all theaters of combat.

To correct all deficiencies noted and prevent any recurrence, the following should be accomplished:

1. The right and left axles should be threaded in opposite directions, therefore, any action by the bearing on the carrier or the carrier on the bearing would be of a loosening rather than a tightening nature.
2. The axle should be bolted to the frame in such a manner that it can be removed without going through the cell with the axle locked to it. As it is now, the entire RLT must be handled when working on one axle.
3. The bearing carrier and the lock nut should have hexagonal heads to facilitate removal when bound.
4. The key washer should be installed and designed so as to lock both the bearing carrier and the lock nut.
5. The diagram and written material in the TM should be more detailed as to the proper assembly of the axle group.

Trailer, RLT mounted, 3-ton, 2000 gallon capacity

Only one of these vehicles was utilized during the Project. This trailer traveled 1346.2 miles, 1095.8 under full load, before a goose neck failure put it out of service. In addition to this failure, which was the only major failure of the trailer, the RLT's supporting the bed showed increased wear which could or could not be accounted for by the weight of the bed and trailer. When fully loaded, the trailer carried 2,000 gallons of bulk fuel in the RLT cells and 13 drums of drummed fuel on the cargo bed for a total weight of 12,600 pounds. The following is a chronological listing of deficiencies:

INCIDENT #1: After traveling 137.1 miles (221250 May), the pin securing the tongue worked part way out thereby rubbing the inside of the right cell. The pin was driven in and secured with a stronger cotter key.

FIG. 29
 TRACKING OF LGP TRACTOR, D-8,
 10 TON SLED AND RLT ON THE
 GREENLAND ICECAP. Scale: $\frac{1}{2}$ "=1'-0"

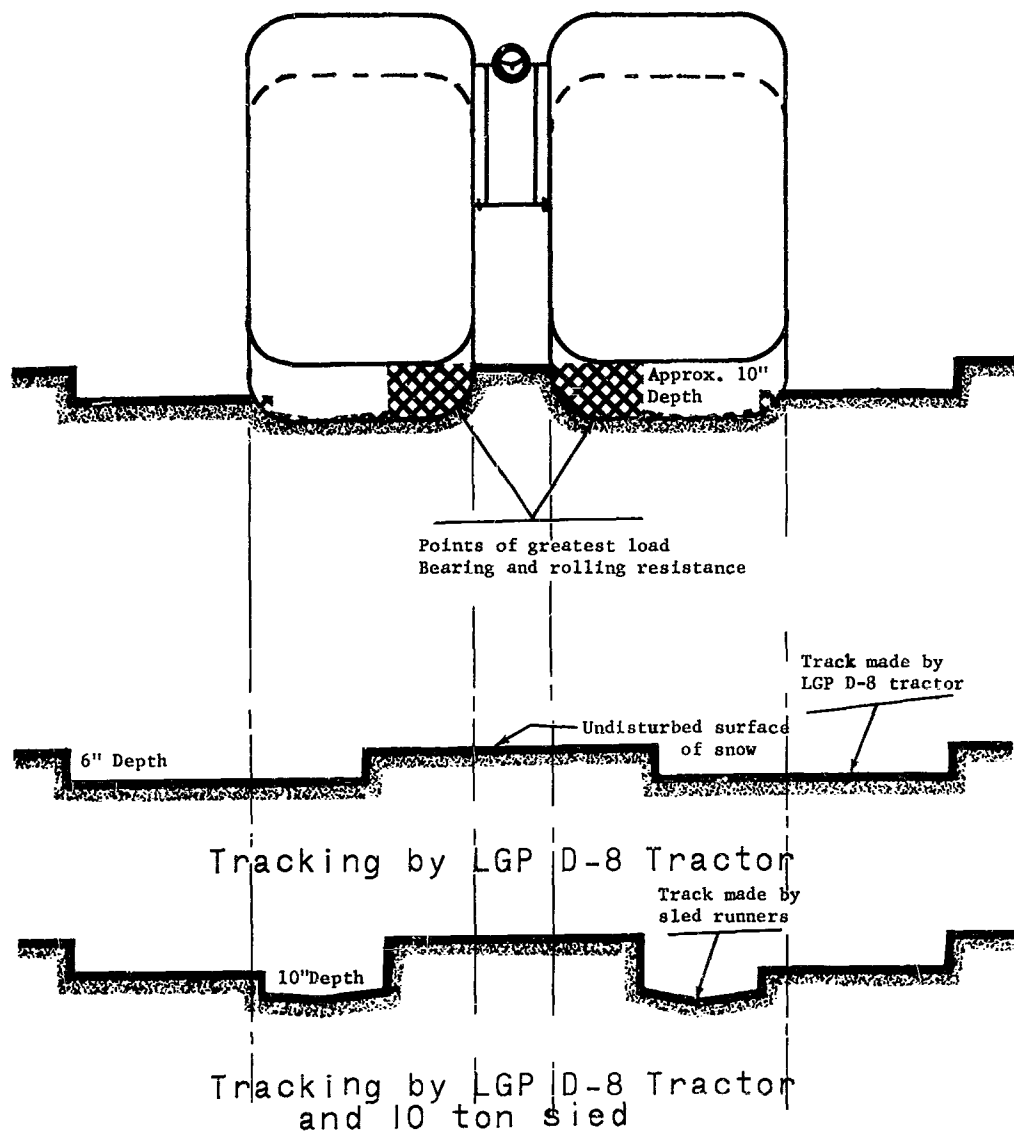

D-8 LOW GROUND PRESSURE TRACTOR

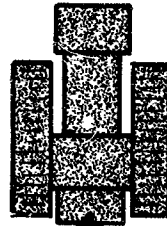

10 TON CARGO SLED

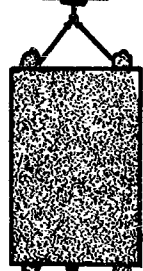

10 TON CARGO SLED

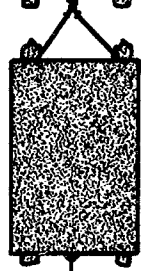

ROLLING LIQUID TRANSPORTER



ROLLING LIQUID TRANSPORTER



ROLLING LIQUID TRANSPORTER



FIG.30
Location of
Rolling Liquid
Transporters in
in Tractor Train
at Time of
Failuers

not to scale

All failures occurred at
this point- The right hand
wheel of the lead transporter.

INCIDENT #2: All during the project, it was found that the side gates tend to come loose when traveling across rough terrain. Some method of securing the side gates in the stake pocket would be desirable.

INCIDENT #3: At Mile 664.4, it was found that the goose neck pin was broken in the center and one end of the pin was working out. A plate was inserted in the goose neck to take up the strain from the trailer bed, and the outside ends of the pin blocked by small plates welded in place. Evidently the pin had snapped from the trailer bed's weight, however, the two halves of the pin were able to adequately support the weight.

INCIDENT #4: Between Mile 50P and 380, the rear unit on the trailer tended to plow snow in front of it for up to 100 yards. At this time snow conditions were as soft as any encountered with the exception of the melt zones. The cause of this plowing action may be the fact that more weight from the cargo bed rides on the rear unit than the front. Contributing to this is the fact that the front RLT unit was empty and not compacting the snow sufficiently for the rear unit which contained approximately 400 gallons of diesel fuel. At all prior times, the front unit had been loaded when the cargo bed was loaded. The result of this plowing action was greatly increased drag on the prime mover, the greater strain on the entire trailer, and possibly the failure described in Incident #5.

INCIDENT #5: At Mile 231.0 on the return trip (180530 July), the goose neck hinge broke immediately above the pin. As replacement parts were not available, the trailer was loaded on a 10-ton sled and carried back to Tuto for repairs.

The "Rolli-Trailer" proved to be an extremely versatile and efficient vehicle for icecap operations. The one vital deficiency is the inherent weakness of the goose neck. This component will have to be designed to provide greater reliability and a more even distribution of weight on the two RLT units.

Trailer, 10-Ton, Wheeled, Off-Road

Two of these trailers were utilized to carry drummed POL products during Project LEAD DOG 60. The vehicles traveled a total of 3,154.4 vehicle miles without suffering any mechanical breakdowns due to structural failures or engineering faults. At all times the trailers were operated with a load, ranging in size up to 50 drums of POL products (20,150 lbs). Because of the much lower rolling resistance of the trailers, as opposed to a loaded sled, the trailers were always the last to be unloaded and the first to be reloaded at caches.

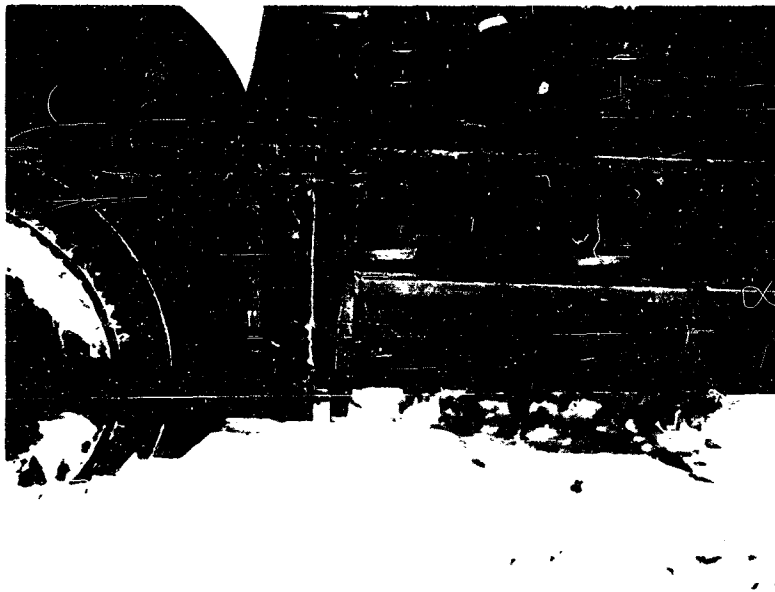
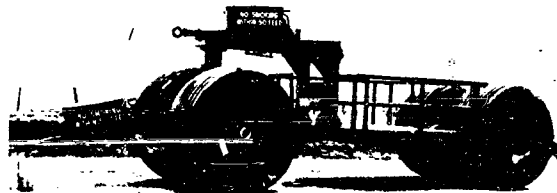
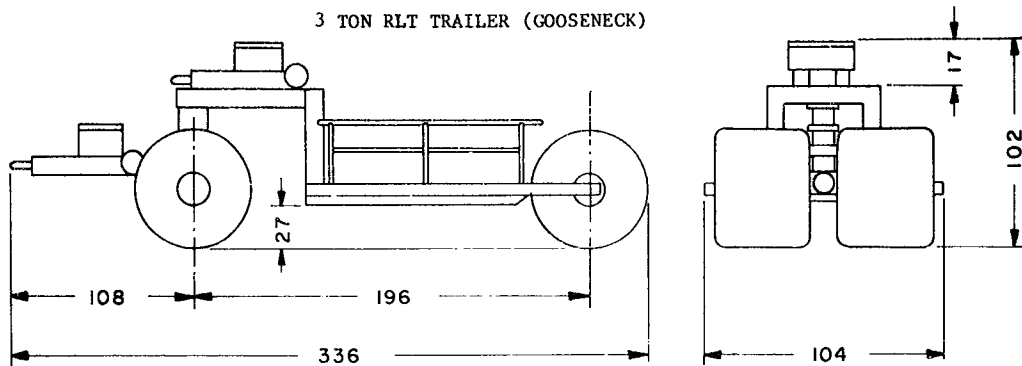

Figure 31. Snow plowing action by the rear RLT on the Rolli-Trailer resulted in greatly increased drag and increased strain on the trailer.



Figure 32. Failure to Rolli-Trailer goose neck occurred at Mile 231 on the return trip.

3 TON RLT TRAILER (GOOSENECK)



NOTE: All dimensions shown are in inches.

PURPOSE: To transport bulk POL and general cargo over all types of terrain.

GENERAL DATA

Weight: (lb) Net 6750
 Gross w/gasoline 19350
 Gross w/gasoline and
 3 tons of cargo 25350

Payload:
 POL (gal) 2000
 Dry cargo (lb) 6000

Fuel Cell Wheels: Ply 4
 Size (in)64x42x18
 Pressure (psi) 3 - 15

Shipping Dimensions: (in)
 Assembled:336x104x102
 With towbars stowed
 inside of trailer
 body:260x104x85

Trailer Dimensions: (in)
 Ground clearance 27
 Length 336
 Width 104
 Height (Reducible to 85) . . 102
 Towbar height 35

Brakes: Type air/hydraulic

ADDITIONAL DATA

Side Slope: (max percent) 30
 Transporter is capable of operating
 in temperatures from -40°F to 125°F.
 (adaptable for operation from -65°F
 to 165°F w/special Fuel Cell Wheels)

Discharge Rate: (gpm)
 Ea. Fuel Cell Wheel (max) 50
 Towing Speed: (max. mph) 25

Towing Vehicles:
 on highway - 2½ ton truck or
 larger w/pintle
 shuttle operation - 3/4 ton
 truck or larger w/pintle

A maximum of three trailers may
 be towed in tandem.

Hand Pump Capacity: (gpm) 15

The wagonwheel steering principle is
 inherent in the gooseneck design.

Figure 33. Technical Data Sheet for the 3-Ton RLT Trailer.

10-TON WHEELED SNO-TRAILER

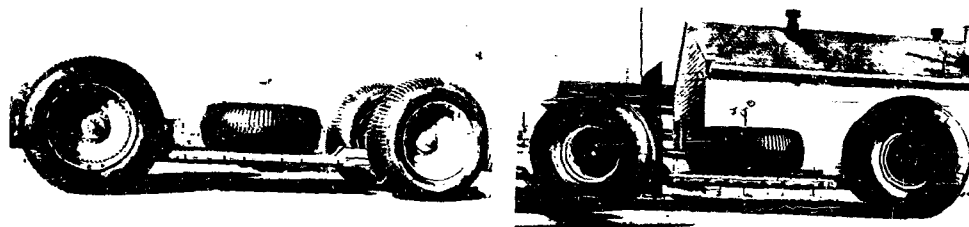
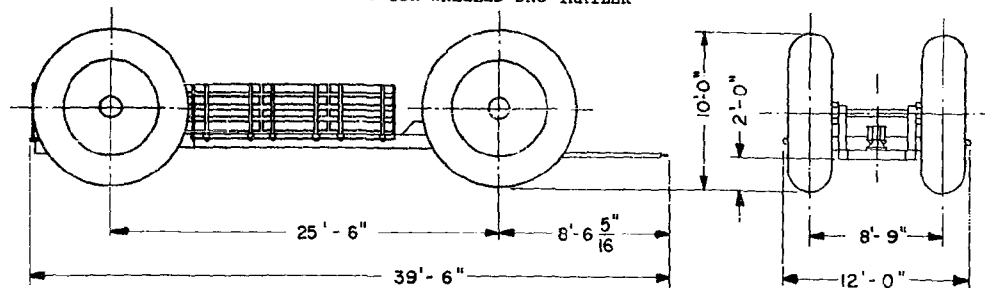

Sno-Trailer With Firestone Tires

Sno-Trailer With Goodyear Tires

PURPOSE: To transport cargo in snow covered areas and to replace tractor drawn sleds.

GENERAL DATA

Overall Length:		
With drawbar		39'-6"
Without drawbar		35'-6"
Wheel base		25'-6"
Overall Width	Reducible to 8' with wheels and stub axles removed.	
Height of Bed		3'-5"
Stake Height		6'-7"
Cargo Area		197 sq ft
Weight, Curb		19,980#
Payload		10 Tons
Turning Radius		50'
Tire Sizes:		
Firestone	120 OD X 48 wide X 68	
Goodyear	118 OD X 44½ Wide X 45	
Inflation Pressure		15-25 psi

Figure 34. Technical Data Sheet 10-Ton Off Road Trailer.

For the repair of any flat tires or wheel failures, similar to those experienced during LEAD DOG 59, an inflated spare tire mounted on a wheel was carried by the swing for each trailer. These proved to be more of a burden than their possible use would have warranted. These tires were bulky and had to be switched around quite often to permit loading or unloading of a sled or trailer. It would have been much more suitable to have carried two deflated spare tires which could have been crated and stowed in 1/10 the cube. The modification of the wheel flanges; ie. reinforcement by 30 three-quarter inch hard steel bolts per rim, proved quite efficient. The hinging of the outside 3 feet of each side of the cargo bed to permit air transportability in no way reduced the vehicle's suitability for icecap operations.

A chronological listing of mechanical and operational incidents follows:

INCIDENT #1: At Mile 185.4 (231415 May), the prime mover for trailer No. 1 was stopped as one hub bolt on the right rear wheel was sheared off. All the hub bolts on this wheel were loose, requiring tightening. None of the other hub bolts on the remaining wheels or the other trailers were or became loose, though periodic inspections were made. As no more hub bolts sheared off, the cause of the one failure must have been incomplete tightening of this one wheel at the time of assembly.

INCIDENT #2: With the swing's departure from the gravity station at Mile 491.4 (050706 June), the tongue on trailer number 1 was broken at the attachment point (truncheon eye) to the trailer. The cotter key in the left side truncheon pin had worked out permitting the pin to work loose. The initial shock upon starting had placed too much strain on the small portion of the pin holding the tongue and it had pulled loose. This resulted in a wrenching action on the right side truncheon eye placing too much stress at this point and snapping the tongue. The primary cause of this failure was the loss of the cotter key. However, as the swing's SOP called for a detailed inspection of all tongues, pins, hitch blocks, and chains at all stops, had the SOP been followed by the tractor operator, this failure would not have occurred.

INCIDENT #3: At Mile 60.3 (202045 July), on the return trip, the rolling action of the trailer over rough terrain pushed the rear bob of the towing 10-ton sled forward and to the side thereby disengaging the king pin and allowing the bed to drop to the snow. Actually this rolling action of uneven terrain proved to be the only operational shortcoming of the vehicle demonstrated. This action accounted for several broken chains and greatly increased wear to the rear bobs of all towing sleds. This was especially true in the rough marginal areas.

The trailers proved to be an extremely versatile and efficient vehicle for icecap operations. However, the trailers should be operated, whenever possible, in a train by themselves, or with other rolling stock, not with sleds. The prime mover for this train must be equipped with a trailer air brake system for braking, and to prevent "jackknifing" when operating on slopes.

4. STANDARD ITEMS.

In addition to the test items already discussed, the Project utilized standard LGP D-8 tractors, 10-ton OTACO sleds, 20-ton OTACO sleds, Wanigans, M29C Weasels, and 1-ton sleds. All of this equipment operated within the capabilities indicated in previous reports of USATREOG and the Transportation Arctic Group.

D-8 LGP Tractors

A total of six tractors were utilized for this project. As in the past, the tractors proved to be the work horse of the swing. The major drawback to this vehicle as a prime mover for military operations is its slow speed. During the period the swing was underway the train averaged 2.85 miles per hour over the 1580 miles. No mechanical deficiencies, other than those which can be normally expected, occurred.

The major mechanical failures which did occur were the cracked crankshaft on one vehicle, and the scoring of the main and insert bearing on another. The failure of the crankshaft, it is believed, can be traced back to the time that the tractor was dropped during unloading operation at Fort Eustis in 1958. Although this tractor was rebuilt following this drop, the crankshaft was not replaced or magnifluxed. The scoring of the bearings probably resulted from oil starvation due to a piece of gasket becoming stuck in the oil pump. How and when the gasket fell into the oil pan is purely conjectural.

In reference to the use of 30 weight oil, rather than 10 weight or sub-zero, contrary to normal military specifications, it has been found that fewer engines burn out when the heavier oil is used. Until 1958, TREOG used the lighter oils and experienced numerous lost engines. Of course, the engines started easier using the lighter weight oils, but these did not possess sufficient body for sustained operations. During operations in 1958 and 1959, not one engine was lost due to using the heavier oils. Accordingly the standard practice now is to use SAE 30 oil, and to preheat the vehicles thoroughly through the use of a 400,000 BTU Herman-Nelson heater. This insures positive lubrication at all times even when operating at high RPM for long periods while towing extremely heavy loads.

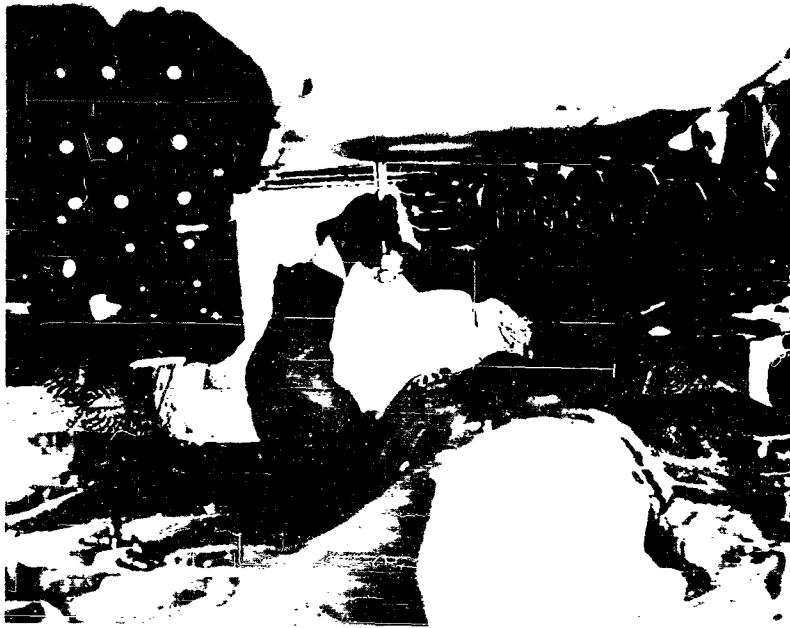

Figure 35. Mechanic repairs suspension system of M29C Weasel.



Figure 36. Hyster Hoist mounted on the rear of D-8 tractor greatly facilitated the loading and unloading of drummed fuel.



Figure 37. Mechanics replace engine in disabled tractor at Mile 481.4.

All equipment programmed for icecap operations must be in prime condition and all operators must follow extremely detailed maintenance procedures.

Sleds and Wanigans

Nineteen 10-ton OTACO sleds, six bob sled Wanigans, and one 20-ton sled were utilized during Project LEAD DOG 60. Structural failures to these vehicles occurred principally to the chains and bobs. At this time, it is felt that these sleds have been developed to their utmost. The high stresses resulting from friction and the twisting of parts make it impossible to construct a sled with reasonable weight characteristics which will withstand the stresses of hundreds of miles of icecap hauling without failure.

The placing of small wedges between the bunks and benches of the Wanigans would reduce the number of overturned Wanigans when operating over a rough trail. This is especially a problem for the top heavy command Wanigan which has a very high center of gravity in proportion to the other Wanigans.

M29C Weasels

Both winterized and non-winterized Weasels were utilized as pathfinder vehicles. The winterized Weasels had the extended body as modified in 1958. While for convenience this vehicle proved the superior for icecap operations, the lighter canvas topped Amphibian proved to be the more practical in operations through the marginal melt zones and in the ice free land areas. Because of its greater versatility, the canvas topped vehicle was capable of crossing streams and melt pools, had a greater gradeability, and was generally more powerful because of the lighter weight. Even with the canvas top, the vehicle heater and engine generated sufficient heat for the comfort of the crew.

The failures which occurred in the Weasels were those which are inherent weaknesses in these vehicles. These include track breakage and numerous minor engine malfunctions.

These vehicles proved quite adequate for use with tractor train operations, but would be too slow for use with higher speed operations. Their speed is generally not restricted by power but rather their rough riding over rough terrain.

One ton Sled

Two of these sleds were utilized for this project. One was towed along with the swing for maintenance purposes and one accompanied the trail party overland to Centrum Lake. Both sleds operated within their established capabilities.

CHAPTER VII

QUARTERMASTER TEST ITEMS

1. GENERAL

Two separate experimental Quartermaster Test items were evaluated during Project LEAD DOG 60 to determine their suitability for icecap exploratory operations. The Quick Serve Meals, developed by the QM Food and Container Institute, and the POL resistant paper overgarments developed by the QM Research and Engineering Command, were utilized extensively in the field and proved to be readily adaptable to the icecap environment. The Quick Serve Meals were popular with all utilizing personnel, who preferred the dehydrated rations to the standard, canned, small unit 5-in-1 and Combat "C" rations. The POL resistant overgarments did not prove to be as popular with the personnel but indicated a great deal of promise for operations where normal laundering is not available.

2. QUICK SERVE RATIONS

The 6-in-1 and 25-in-1 module Quick Serve Meals, as well as several containers of miscellaneous dehydrated foods, were issued to TREOG for use during Project LEAD DOG 60. The "quick serve" meals were utilized by the field parties which the project sent out while the miscellaneous dehydrated foods were prepared by the main party's cooks to supplement the frozen and canned foods carried by the expedition. Three separate field parties utilized the "quick serve" meals for periods ranging up to 12 days.

The first field party was sent out to locate a route from the icecap to the USAF Cambridge Research Center camp at Centrum Lake. During the seven days that the field party was separated from the swing, its personnel prepared a total of ten meals (the remaining meals were eaten with the Air Force scientific party at Centrum Lake). Of these ten meals, nine were prepared from the "quick serve" rations and one was prepared from Combat "C" Rations. All five personnel in the party preferred the dehydrated rations to the conventional canned rations.

The second party utilizing the dehydrated rations was a 11 man helicopter party which conducted an aerial and surface survey of northeast Greenland. This party was separated from the swing for a 12 day period. During this period the "quick serve" meals were served at least once a day. These rations were supplemented by "C" rations and canned foods which had been cached by air with the party's gasoline. All personnel preferred the dehydrated rations to the conventional field rations.



Figure 38. Members of the helicopter field party dine on dehydrated rations while camped at Brønlunds Fjord.

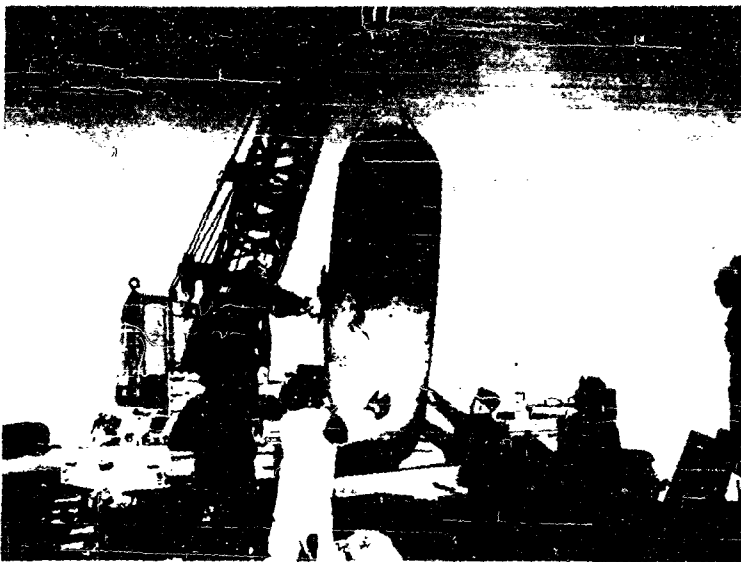

Figure 39. Tractor operator wearing POL resistant paper overgarment helps assemble 10-ton Off-Road Trailer prior to the swing's departure from Camp Tuto. The torn shoulder seam was the second commonest reason for discarding the disposable uniforms.

The third field party was only separated for 24 hours. During this period two "quick serve" meals were served and appreciated by the four men.

In addition, a total of seven meals were eaten by aviation parties which were forced down on the icecap because of weather. Further, all six TREG aircraft were equipped with 30 days rations for emergency situations. Of this total, 15 days rations consisted of the "quick serve" meals and 15 days rations consisted of the conventional field ration. The dehydrated rations are especially suited as emergency rations for Army aircraft because of their light weight.

The rations were prepared according to the instructions packed with each meal. The only deviation was the adding of the proper amount of water gradually while the rations were cooking rather than all at one time. The equipment used to prepare the meals consisted of a coleman two-burner mountain stove (FSN 7310-263-8736) and the field cook set (FSN 7360-272-2485). It was found that where soap and sufficient water were present, the paper plates and plastic utensils could be cleaned and reused.

Water was procured from melting snow, and when possible, off the icecap, from melt streams. The melting of large quantities of snow proved to be the only major drawback to the use of dehydrated rations in Arctic regions. However, when time is available, all personnel agreed that this added inconvenience is more than offset by the superior quality of the rations.

The following statements were made by one or more persons concerning the "quick serve" rations:

- a. The potato-hamburger hash should be replaced. It is rather unpalatable.
- b. The candy bars are not too tasty.
- c. Jello and dried fruits should be included.
- d. The cigarette sampling should be more varied to include mentholated brands.
- e. There was little demand for soluble tea.
- f. Powdered milk should be included.
- g. A cold beverage should be included with each meal.
- h. A larger quantity of margarine, sugar and powdered cream should be included.

i. The spaghetti w/meat sauce and the puddings were especially palatable.

j. The rations cannot be eaten "on the run". It is necessary to stop the whole party to cook a meal.

k. The potato sticks proved very popular as snacks.

The miscellaneous dehydrated foods were prepared by the swing's cooks in a fully equipped kitchen wanigan. These foods included instant rice, macaroni, dehydrated juices, applesauce, and beef. All these foods proved perfectly acceptable although generally the frozen meats and the canned juices were preferred. The dehydrated ground beef proved to be quite popular when prepared as creamed beef on toast.

At no time during the feeding of the dehydrated rations were any gastric changes reported, although all personnel were periodically questioned. The rations are completely digestible, and much less monotonous than the standard field rations.

3. PETROLEUM RESISTANT PAPER OVERGARMENTS

A total of 200 paper overgarments were provided Project LEAD DOG 60 prior to the swing's departure from Camp Tuto. During the course of the project, a total of 104 sets (shirt and trousers) were issued to personnel participating in the project. The garments averaged 30 hours of wear before having to be discarded because of fraying and tearing.

The longest period any one set of garments was worn was 84 hours. The wearer of these garments was the swing's plumber who had the duty of maintaining the wanigan boilers, generators, pumps and plumbing. The shortest period any one set of garments was worn was 3 hours. The wearer of these garments was a M29C Weasel operator who was forced to discard his garments because of numerous tears.

Generally the vehicle operators experienced less wear from a set of overgarments than other personnel because of their climbing in and out of the vehicles. This resulted in numerous tears and rips to the garments due to bulky clothing catching on the machinery. This is especially true for the Weasel operator due to the cramped operator seat on the M29C. The plumber and the electrician, who carried out similar duties during the alternating shifts, averaged four work-days wear from each set (48 hours), however, only one work-days wear (12 hours) could be expected from a vehicle operator's garments.

The majority of the failures resulted from the paper tearing along the arms or legs, with the largest number of tears occurring at the slit in the lower leg. The excess paper at this point was constantly bulking out and allowing the slit to catch on any projection. Second to tears, the next major failure was in the seams, especially the seam attaching the arm to the shoulder. If the overgarments were able to escape tearing they would invariably pull loose at the shoulder after approximately 72 hours of wear. The next reason for discarding the uniforms was because of their becoming POL soaked. Although the overgarments provided the uniforms a great deal of protection from diesel fuel, they themselves rather quickly became saturated.

Actually this year's LEAD DOG swing had less of a requirement for these uniforms than past operations of a similar nature. This is the first time that washing and drying machines had been carried along on a swing, thereby providing a means of thoroughly cleaning the swing personnel's clothing. However, on operations where no means are available for cleaning soiled clothing, the paper overgarments of this type would prove invaluable.

The following statements were made by personnel wearing the overgarments in reference to their suitability:

- a. The garments are not water resistant and become wet fairly rapidly when personnel are kneeling, sitting, or lying on snow while performing maintenance. Once wet, the paper tears easily.
- b. The garments should be sized. Their bulkyness makes them dangerous when operating around exposed machinery.
- c. Most personnel expressed preference for a garment of one piece construction rather than the current shirt and trousers.
- d. The trousers should have at least one hip pocket.
- e. The trousers should have elastic at the ankle similar to that at the wrist.
- f. The shirt shoulder seam should be double stitched.
- g. The POL resistant qualities are generally acceptable.

CHAPTER VIII

LAND ROUTE FROM THE INLAND ICE TO CENTRUM LAKE

In addition to marking a trail over icecap from Mile 480 to Crown Prince Christian Land, the expedition had the additional duty of locating a descent route from the icecap and an overland route to Centrum Lake. The reason for choosing this lake as the terminus of the trail across the icecap was the fact that the Air Force Cambridge Research Center (USAFCRC) had established a small camp at this point and had laid out an airstrip of sufficient size for the landing of large multi-engine aircraft.

Accordingly, after the swing's arrival at the eastern edge of the icecap, plans were immediately carried forth to equip a party for the descent. While two Weasels were outfitted with rations, POL and survival gear, a helicopter made a reconnaissance to locate a favorable descent point and to select a tentative overland route to Centrum Lake. On the basis of this flight, it was decided to attempt to leave the icecap at the head of South River Valley and then to follow the valley to the Centrum Lake camp.

The five man, two Weasel party departed at 0800 on 14 June 1960. One of the Weasels was equipped with a crevasse detector while the other towed a one ton sled carrying gasoline, rations and survival gear. The party's electronic devices, in addition to the crevasse detector, included a gyro-compass, a marine radar, two AN/GRC-9 radios for contacting the swing and one AN/PRC-9 for radio contact with the TREG aircraft. The party was equipped to be completely self sufficient for a thirty day period.

The icecap trail from Mile 480 to Crown Prince Christian Land bypasses Cape George Kohn on the south side and continues towards the ice margin at $79^{\circ} 49'$ north latitude ($79^{\circ} 53'$ NL on the Aeronautical Approach Chart) $24^{\circ} 23'$ W Longitude. The ice margin there forms a broad lobate protrusion, approximately 3 miles wide at the base, with two blunt, yet distinct tips from which streams issue northeastward into South River Valley. The descent trail leads from the swing's camp to the southeastern flank of this double tipped lobe. The Weasel party traveled 10 miles through the marginal zone of the icecap before reaching the descent point. This trail was necessarily extremely devious, as the party had to pick their way through an area badly hummocked and devoid of snow cover. The hummocks in this area ranged in relief up to 12 feet with the frequency of waves on a choppy sea. Numerous small melt streams crossed the area. The roughness of this terrain resulted in the breaking of one of the Weasel tracks. All of the snow encountered in this area was rotten and would have greatly hindered movement by any vehicles larger than the Weasel.

Following their descent from the icecap (Figure 40), the Weasel party followed the southern shore of a small meltwater lake which was located in the immediate proximity of the icecap. The trail then crossed the lake outlet and the stream channels issuing from the other tip of the ice lobe and encountered a series of low rugged hills. The party crossed a rugged hogback, 600 feet in height, which proved to be quite rough and barely negotiable for the vehicles. Reaching the top of this first hill, the route was clear across a small meltwater lake and up another hill with a more gradual slope. After reaching the top of the second hill, a reconnaissance disclosed a descent route that brought the party to the valley floor. Thus the worst of the obstacles had been encountered and only the deep water of the river remained to be crossed. (Figures 41 and 42)

The trail continued along the side of the valley over low alluvial terrace surfaces for approximately eight miles, then crossed over to the southeastern side of the valley (Figure 43), (the river at this point approaches the bluffs on the northwestern side of the valley). The broad terrace surfaces on the southeastern side of the valley (Figures 44 and 45) are followed by the trail all the way to the inner end of the South River delta, near the western end of Centrum Lake. The river braids very strongly at this delta, its many channels are spread out and shallow and provide a convenient ford to the northern bank where the USAFCRC camp is located on a low terrace (Figure 46).

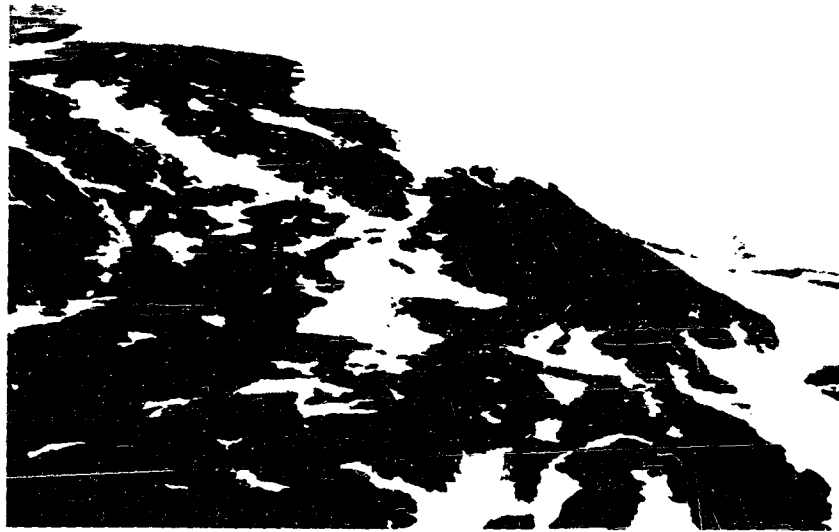

Figure 40. Ramp from the inland ice to the head of South River.

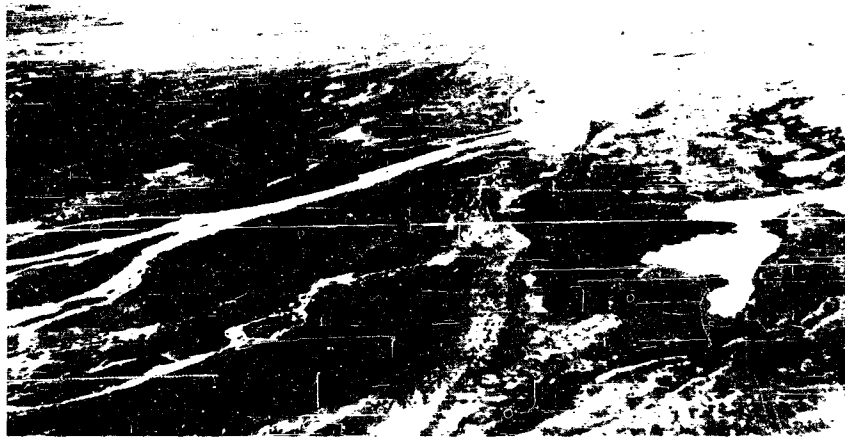

Figure 41. Trail in upper South River Valley crossing the N. W. side of the valley floor.



Figure 42. Trail crossing stream channels at the head of South River.



Figure 43. Trail on the alluvial terraces. Notice the frost crack patterns.



Figure 44. Trail along the southeastern side of the valley approximately half way down the valley. (Looking up stream)

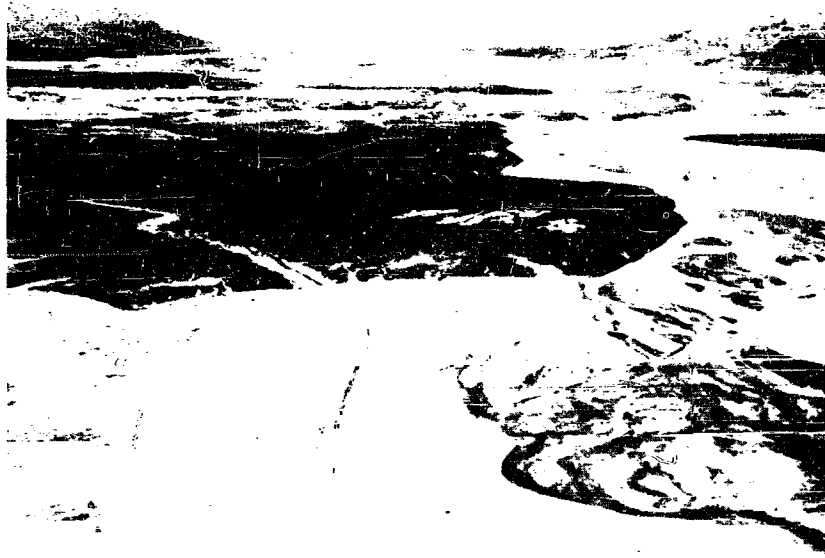

Figure 45. Trail along the lower South River. Note the increased braiding of the river at right. (Looking up stream)



Figure 46. The end of the trail at the USAF CRC camp and airstrip at Centrum Lake. The trail crossed the river at the widest, most braided point.

The vehicle party traveled the 38.8 miles to Centrum Lake in an elapsed time of 45 hours and 30 minutes. However, the party was actually underway only for a total of 28 hours having been stopped for 17 hours 30 minutes for eating, sleeping and radio contacts. The one-ton sled measurably impeded the party's progress as there was a complete lack of snow cover after the icecap was passed. The crevasse detector was cached at the eastern edge of the icecap to be picked up at a later time.

While at Centrum Lake, the Weasel party attempted to find a route around the lake to Hekla Sound but, because of the steep bluffs on both sides of the lake, such a route appeared to be non-existent. Had the party reached this point a month earlier, (May) they could have crossed the lake on the ice and easily reached the Atlantic Ocean, but, at this advanced date, such a traverse was impossible.

The party departed for the return trip to the swing at 1115 on 20 June. Twenty-five hours and forty-five minutes later, including an 11 hour and 35 minute halt because of weather, the party arrived at the swing's camp. Visibility during much of the return trip seldom exceeded 1/2 mile. The party returned with the TREG M29C Weasel which had been loaned to USAFCRC and flown into Centrum Lake earlier in the year. The one-ton sled, which the party had towed into Centrum Lake was left to be returned to Thule Air Base by C-130 aircraft later in the year.

The construction of a trace completely negotiable to any tracked vehicle would require very little engineer effort. A D2 tractor, equipped with a blade, could easily cut a route through the low rugged hills at the head of the canyon. Past this point, the only work which would be required would be the knocking down of the banks at the numerous fords along the route. None of the fords which the vehicles crossed exceeded 40 inches in depth.

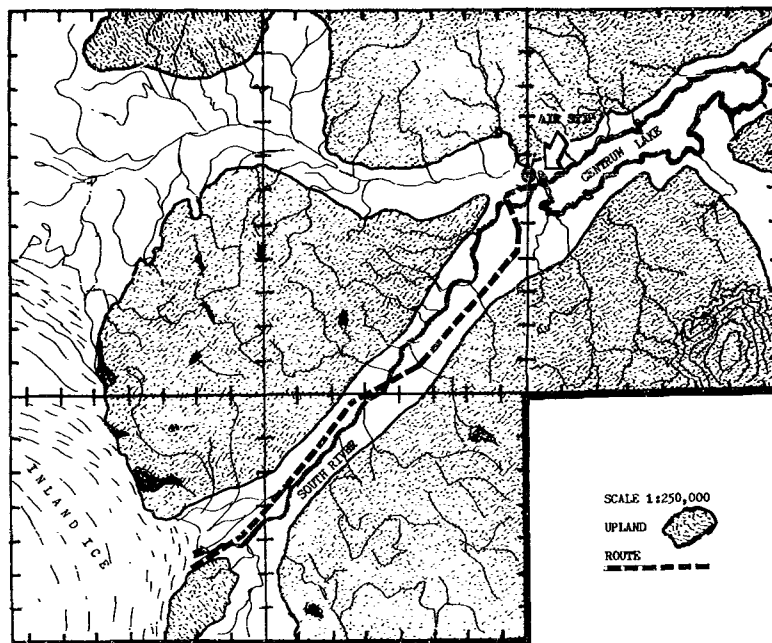

Figure 47. Sketch map of route to Centrum Lake.

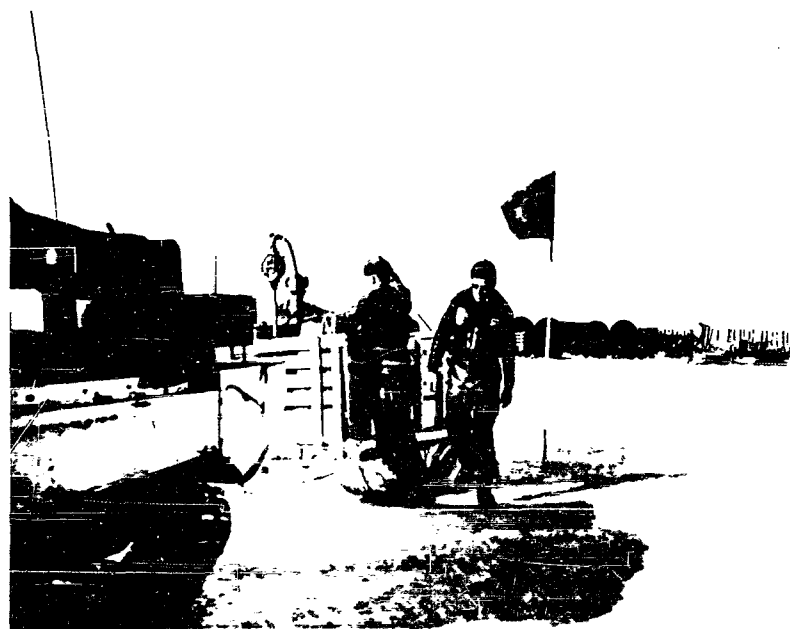

Figure 48. The trail party loads its supplies in preparation for the overland trip to Centrum Lake.

CHAPTER IX

THE ACCESSIBILITY AND TRAVERSABILITY OF SOUTHERN PEARY LAND, NORTH GREENLAND

1. GENERAL

Dr. Frank Ahnert¹ accompanied Project LEAD DOG 60 to southern Peary Land with the assignment to assess that area's terrain, and to assist in determining the feasibility of vehicular transportation into and through that area. This chapter, resulting from this investigation, has, therefore, a threefold purpose:

a. To briefly describe the landscape of southern Peary Land in terms of its rocks, landforms, climate, glaciers and wildlife and thus to provide background information necessary for judging the area as a field of possible future activities.

b. To discuss ways and means of access to southern Peary Land, and possible routes along which a vehicular traverse could be made, in terms as detailed and factual as they can be spelled out with the incomplete information at hand.

c. To formulate recommendations concerning future actions designed to fill in the gaps in our knowledge about the accessibility and traversability of southern Peary Land, and also recommendations concerning the establishment of camps there.

2. SOURCES OF INFORMATION

The available literature on the area can be subdivided into two main groups: (1) popular accounts usually too generalized for the detailed information desirable here, and (2) scientific papers focussing on special problems within an academic discipline. There are several papers on geological aspects of the area, but no detailed comprehensive treatments of its landforms. Most useful, however, was the log of meteorological observations made at Jorgen Brønlunds Fjord by the Danish Peary Land Expedition, which

¹Dr. Frank Ahnert of the University of Maryland was contracted by USATREOG to accompany the LEAD DOG 60 expedition into Peary Land. This chapter encompasses his report on the traversability of southern Peary Land.

was published by B. Fristrup (1952) and covers a period of two full years (August 2, 1948 - August 12, 1950). It supplied the raw material for the treatment of the climate in this report.

Published maps include the World Aeronautical Charts (1: 1 Million), useful for little more than a general overview of north Greenland, the Aeronautical Approach Charts at 1: 250,000, and an Army Map Service series at the same scale. The AMS maps are of a somewhat better quality, with 200m (660 ft.) contours instead of the 1000-foot contour interval on the Aeronautical Approach Chart. These maps show rather well the relative location of major features - valleys, plateaus, glaciers, and lakes - and permit the determination of distances within the area at least with approximate accuracy; but they allow hardly any conclusions about the shape of slopes, the configuration of valley bottoms, etc. Any surface feature with a relative height less than the large contour interval cannot be shown, and even those of greater relative height appear obscured. Besides their too large contour interval and the overly great generalization, the most serious drawback is the inaccuracy of their geographical coordinates. Particularly the longitude seems to be off by more than one degree.

Fortunately, the available air photos (USAF) provide a great amount of terrain information not contained on the maps or in the literature. However, the aerial photography was made with trimetrogon cameras along widely spaced flight lines, so that much of the area is only shown on high oblique photos far away from the flight line, at very small scales and with a corresponding loss of detail. Photos taken with hand cameras from helicopters and on the ground on Project LEAD DOG 60 supplement the Air Force photos.

Last, but not least, there is the information gathered by this reporter through personal observation both from the air and on the ground. The few days spent in and over southern Peary Land were far too short a period to make a comprehensive series of systematic observations, yet they were sufficient to give this reporter a "feel" of the area which greatly improved his ability to evaluate and assess the other sources of information available to him.

3. THE PHYSICAL-GEOGRAPHIC CHARACTERISTICS OF SOUTHERN PEARY LAND

Named after Admiral Robert E. Peary, Peary Land is the northernmost land on earth. It lies at the northern tip of Greenland between the great expanse of the inland ice in the south and the basin of the Arctic Sea in the north - or, expressed in geographical coordinate, between latitudes $81^{\circ} 30'$ N. (at the head of Academy Glacier) and $83^{\circ} 38'$ N. (Cape Morris Jessup), and between longitudes $22^{\circ} 50'$ W. (Cape Eiler Rasmussen) and $47^{\circ} 45'$ W.

(Sverdrup Island), approximately. These coordinates are subject to revision, as during Project LEAD DOG 60 considerable inaccuracies - especially of longitude - were apparent.

On the basis of geological and geomorphological criteria, Peary Land can be conveniently subdivided into a northern, a central, and a southern part. Northern Peary Land possesses folded mountains of Alpine character, the Roosevelt range, with elevations up to 6300 feet. South of a line connecting Frederick E. Hyde Fjord in the east with the outer part of J. P. Kochs Fjord in the west lie on nearly horizontal rock beds the large plateaus of central Peary Land, which gradually decrease in elevation from west (Hans Tausen Icecap, 5100 ft.) to east (Herluf Trolle Land, mostly below 2000 ft.). The boundary between central and southern Peary Land is best placed along the northern rim of a latitudinal valley zone (South Pass - Wandels Valley) that extends for approximately 90 miles between Adams Glacier near the head of J. P. Kochs Fjord in the west and the mouth of Jørgen Brønlunds Fjord in the east. In contrast to the plateaus of central Peary Land, long interconnecting valleys are the most characteristic landforms of southern Peary Land. Its plateaus are small, and are frequently surrounded by valleys and their submerged extensions - fjords - on all sides. They range in elevation between 4300 feet (Storm Icecap) and a little over 2000 ft. (Buen, on north shore of Jorgen Brønlunds Fjord); generally, the height of the plateaus decreases from more than 3000 feet in the west and south to less than 3000 feet eastward along the Wandels Valley zone. The floors of the major valleys, on the other hand, descended from about 1000 feet in the west to sea level at Jørgen Brønlunds Fjord, so that the local relief, the elevation difference between the plateaus and the adjacent valleys, throughout most of southern Peary Land is approximately 2000 feet. As in the other parts of Peary Land, several smaller areas bear names of their own: "Walcotts Land" denotes the part lying between the inland ice, Hans Tausen Icecap and Storm Icecap, "Heilprin Land" the plateau between Independence Fjord and Jørgen Brønlunds Fjord.

The principal places of access to - and the routes of overland traverse through - southern Peary Land are concentrated within a narrow belt between Walcotts Land-Jørgen Brønlunds Fjord. During Project LEAD DOG 60, air and ground reconnaissance exploring the trafficability of southern Peary Land was confined to this belt; the air photos made available to this reporter also hardly reach beyond it with their coverage. Consequently, the description of the physical geography, too, shall be limited to this area.

The bedrocks of southern Peary Land are almost entirely sedimentary, namely, sandstones, shales, limestones and dolomites. They range in age from pre-Cambrian to Ordovician, and are unfolded, nearly horizontal, with a regional dip of 2 - 3° to the northeast. Consequently, in the southern

and the western portion the oldest rocks are exposed, while eastward and northward higher, younger strata occupy an increasing part of the land surface. The pre-Cambrian "Thule group" consists predominantly of sandstones and shales, with some dolomitic layers; it also contains the only non-sedimentary rock of the area, an intrusive sill of diabase which crops out in several places along the Wandels Valley zone from South Pass to the head of Jørgen Brønlunds Fjord. In Walcotts Land, all bedrock belongs to the Thule group which must be several thousand feet thick; farther eastward, it only occurs on the lower part of the valley slopes and is overlain by the Cambrian Brønlund Fjord dolomite (approximately 500 feet thick), a brown rock which weathers to a yellowish-light gray color. On top of that follows the Ordovician Wandels Valley limestone, about 1100 feet in thickness, light-colored with dolomitic layers, and, farther east, the dark Børglum River limestone (Ordovician) with an estimated thickness of about 300 feet. These Ordovician rocks disappear northeastward, in central Peary Land, beneath Silurian strata.

Rock structure and rock type are to a large degree reflected in the major landforms of southern Peary Land. The nearly horizontal attitude of the strata finds its morphological expression in the plateaus which are supported by resistant beds of sandstone in the west, limestone or dolomite in the east. Where large valleys border the plateaus, these same resistant layers crop out in high cliffs along the valley wall, forming a striking contrast to the sloping, usually waste-covered surfaces on the less resistant shale. In Walcotts Land, where shale covers wide areas, the valley slopes are generally less steep than in the limestone areas to the east. On the plateaus, the small streams have been able to carve only shallow valleys. Upon reaching the edge of one of the major valleys, these streams plunge down over the cliffs in impressive waterfalls. Larger plateau streams, with a greater erosive capability, have cut deep, steep-walled gorges in their effort to adjust the elevation of their own beds to that of the rivers into which they flow. On the floors of the large major valleys the rivers possess intricately braided channel patterns due to their being overloaded with gravel, sand and silt. Much of this material is deposited in extensive alluvial flats. Where it is coarse-grained gravel, the pebbles and cobbles have been sorted by frost action into stone polygons, while the finer-grained materials bear a polygonal pattern of frostcracks like the mesh of a net. On silt flats not flooded by the river, the dry climate leads to an upward movement of water in the capillaries and thereby to the efflorescence of salts which form white crusts. Moraine deposits also are concentrated in the valley bottoms, either as low hummocky ground moraine or - in places where the end of a glacier has remained for a longer time - in the form of a terminal moraine. Since the glacier ice transports large and small particles indiscriminately, the moraines contain all grain sizes from boulders to clay. Only after their deposition has frost action produced a superficial sorting into stone polygons.

The moraines also are partly responsible for the existence of the lakes in the area, which are dammed up by the moraine hills. However, some of the lakes - especially the larger ones - seem to occupy bedrock basins gouged out of the valley floor by glacial erosion.

After the recession of the glaciers at the end of the Pleistocene, and the resulting decrease in the load of ice resting on the land, the land has risen isostatically. Numerous marine terraces have been found at elevations up to 700 feet, attesting for this postglacial rise. They are particularly well developed in the area around Jørgen Brønlunds Fjord, where Troelsen (1949) ascertained the presence of at least 10 different terrace levels between present sea level and 370 ft. The stones lying on these terraces near Jørgen Brønlunds Fjord display very strongly the effect of wind abrasion, exclusively on their western side, thus giving an unmistakable indication of a predominant westerly direction of strong surface winds. The wind-driven sand has smoothly polished the windward side of cobbles and boulders made up of hard materials, while on less resistant stones it has carved an intricate micro-relief of grooves and holes.

The principal elements of the climate of southern Peary Land - temperature, precipitation and winds - are demonstrated quantitatively in figure 49 (temperature graph), figure 50 (precipitation), figure 51 (wind directions and speeds), and figure 52 (wind roses). These figures are based on the meteorological observations carried out during the Danish Peary Land Expedition (Leader: Count Eigil Knuth) 1948-50 at the base camp of that expedition, Brønlund House, which stands on the south shore of Jørgen Brønlunds Fjord at about 25 feet above sea level. These observations form the only meteorological record that is long enough to permit at least some conclusions concerning the climatic characteristics of the area. Of course, it fully represents only the weather of the station itself and in its immediate vicinity; nevertheless, it can also be considered fairly representative for the broad valleys of southern Peary Land along which lie the travel routes suggested in this report. The climates on the high plateau surfaces most likely differ from that at Jørgen Brønlunds Fjord in that they have lower temperature, different winds, and a somewhat higher precipitation. The temperatures at Brønlunds Fjord follow the typical pattern of high polar climates: a very large annual range of temperature (absolute maximum temperature 64°F , absolute minimum temperature -47°F , i. e. a maximum annual range of 111°F ; mean temperature of warmest month 43°F , mean temperature of coldest month -24°F , i. e. a mean annual range of 67°F) combined with a small daily range of temperature (usually varying between 5°F and about 12°F). From October to April the temperature never rises above freezing, and in September and May it only rarely does so during the warmest part of the day; on the other hand, in July it never falls below the freezing point. The more or less frost-free period lasts from about mid-June to about mid-August. In

order to estimate the temperatures occurring in nearby localities of higher elevation, one has to subtract 3.3°F , for every 1000 feet of elevation increase.

The precipitation in southern Peary Land is extremely light. Although, in this cold climate, evaporation cannot be very effective, either, the climate is essentially arid. Most of the fresh water available here is derived from the melting of the inland ice, some water from the melting of the local plateau glaciers, and little water from the melting of the seasonal snow cover. The streams that are fed by the solid reservoirs of the inland ice and the plateau glaciers flow throughout the summer, those fed only by the snow cover of the land flow during June and usually dry up in July when most of the snow cover is gone. The early part of the summer in which the more steadily flowing glacial meltstreams receive the additional meltwater from the snow cover, is therefore the period of maximum stream discharge.

The most local characteristic of the climate at Jørgen Brønlunds Fjord is the seasonal distribution of wind directions and wind speeds. The main part of the fjord extends east-west and exerts a strong topographic control upon the wind directions by channeling the air movements along its axis, as either east or west winds. Westerly winds predominate heavily from September through April, easterly winds from May to July. In August, both directions have a substantial share. The easterly winds are practically always light, while the westerly winds reach velocities of more than 20 knots in almost every month, and often exceed even 40 knots. These are the winds responsible for the polishing of the western face of boulders and cobbles in the area. Periods of calm are -paradoxically- most frequent during those months in which the prevailing winds are the strong west winds, namely, in the cold season. The development of temperature inversions during this time may be a main reason for that. In the warmest period of prevailing easterlies the calms are negligibly few.

Since most of the major valley zones in southern Peary Land also extend east-west, the same seasonal pattern of prevailing surface wind directions can be expected to exist there. Matters become different near the ice cap, where the fall winds that frequently drain off the ice follow the slope of the surface towards the larger valleys, and on the plateau surfaces, where the wind directions are more determined by the general pressure distribution than by topographic controls. In the absence of weather stations on the plateaus, it appears impossible to make valid assumptions concerning the frequency of various wind directions and speeds there.

Highly dependent on the climate is the existence of glacier ice. Besides the inland ice, there are the plateau glaciers of the Hans Tausen Ice Cap, which extends north of Evening Star Lake for more than 100 miles and is

about 40 miles wide, the storm ice cap (about 18 miles long, 10 miles wide) and the Christian Erichsen Glacier in Heilprin Land, just south of Jørgen Brønlunds Fjord, with a length of about 25 miles and a width of about 15 miles. The inland ice as well as these plateau glaciers reach down below the 3000 foot contour along most of their margin, while on the other hand the snow line (i. e. the line above which the snow remains on the ground during the warm season) lies at between 3300 and 3600 feet. This means that large marginal belts of the ice are snow-free in summer, and that there the ice itself is subject to melting. On the Christian Erichsen Glacier, with a maximum elevation of 3800 ft., only a very small portion of its surface lies above the snow line, consequently, only little snow remains to add substance to the glacier ice and to compensate for the loss by melting. A comparison of this small area of alimentation above the snow line with the large area of ablation below the snow line suggests that more ice melts each year from this plateau glacier than is added, that the glacier is shrinking. Glaciological measurements carried out by the Danish Peary Land Expedition have verified this fact. The plateau glacier, therefore, must have formed and expanded during a past climate in which the ratio between snow supply and wastage by melting was more favorable than it is now. The expedition also found that the ice of the Christian Erichsen Glacier is stagnant with the exception of the two lobes descending to Etukussuk Valley which show signs of movement. Storm Ice Cap and Hans Tausen Ice Cap, however, have large areas above the snow line, possess therefore a more favorable "ice budget" and very likely are more actively moving. The greatest glacial activity, of course, is shown by the inland ice whose large high surface collects enough snow to supply ice for the strongly moving lobes that issue from its margin and plow forward over the land, down to the valleys, and into lakes and fjords which they supply with large fleets of icebergs. Near the head of these lobes, the inland ice is strongly crevasses.

Vegetation in Peary Land is limited to low-lying, well-sheltered and well-watered spots where the soil contains a sufficiently large proportion of fine-grained particles. Thus it is found mostly along the bottoms of the large valleys, and in small coves traversed by streams. The Danish Peary Land Expedition of 1947-50 collected about 90 species of vascular plants, 120 species of mosses and many lichen and other lower plants. All the plants are characterized by low, ground-hugging growth and by the ability to reproduce within the extremely short-growing season. Besides mosses, the plants most commonly encountered are the Arctic dwarf willow, the yellow Arctic poppy, Arctic cotton grass, and the purple saxifrage. Feeding on this scant vegetation are a large number of musk-ox, usually moving in small scattered herds, and Arctic hares. Lemmings also are common. Foxes prey on the rodents, while the polar bear seems to be rather rare in the inner parts of the fjords and on the land. Caribou and wolf have been reported by the early expeditions of Knud Rasmussen and Lauge Koch, but have

not been seen in more recent years. Seals inhabit the fjords, and the bird life includes most of the north Greenland species, such as snow bunting, ptarmigan, king eider duck, arctic tern and jaeger. Near moist spots, mosquitos swarm about by the hundreds and can become very annoying.

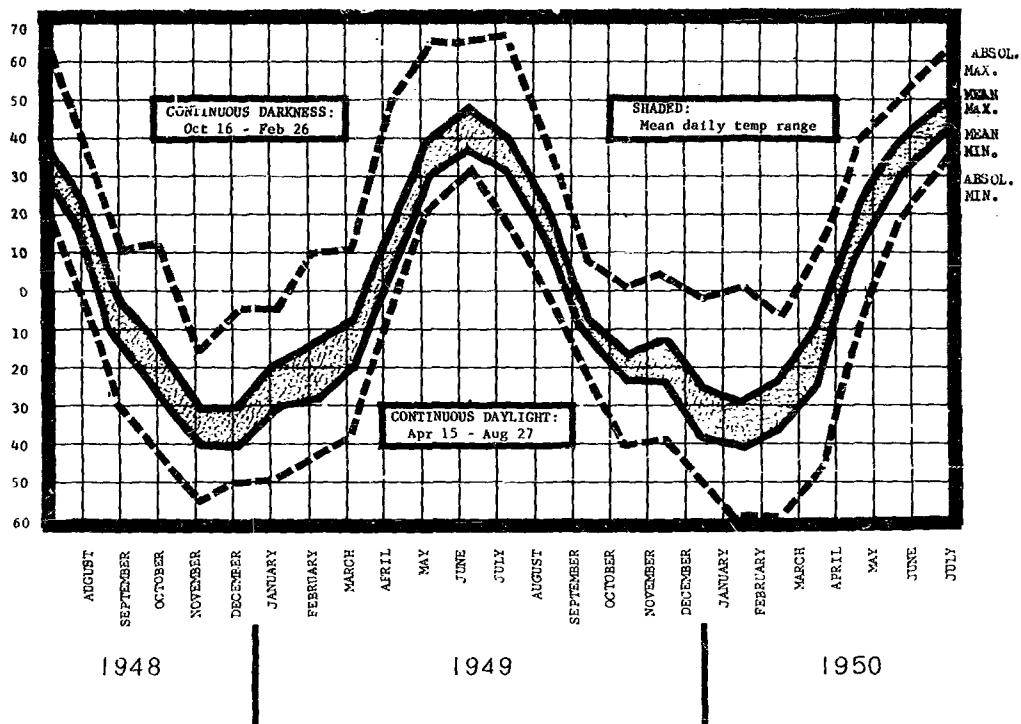

Figure 49. Absolute and mean monthly temperature extremes at Jorgen Fjord, August 1948-July 1950.

Precipitation at Jørgen Brønlunds Fjord

August 1948 - July 1950

(Compiled from B. Fristrup, 1952)

in mm (1" = 25.4 mm)

	<u>1948-49</u>	<u>1949-50</u>
August	12.0	X
September	27.8	0.1
October	22.1	6.3
November	7.6	Trace
December	3.0	0.2
January	0.3	0.5
February	X	0.2
March	0.3	X
April	X	1.0
May	0.2	0.2
June	6.8	4.4
July	<u>2.3</u>	<u>6.7</u>
	(82.4)mm	(19.6)mm

X = Measurement was impossible.

Figure 50

Wind directions and wind speeds
at Jørgen Brønlands Fjord, Aug. 1948-July 1950
(Observations every 3 hours, compiled from B. Fristrup, 1952)

February 1949

No. of observations during which
wind speed (in knots) was

September 1949

No. of observations during which
wind speed (in knots) was

					Total						Total
1-10	11-20	21-30	31-40	40		1-10	11-20	21-30	31-40	40	
knots	knots	knots	knots	knots		knots	knots	knots	knots	knots	
N	-	-	-	-	-	-	-	-	-	-	- N
NE	-	1	-	-	1	-	-	-	-	-	- NE
E	15	3	-	-	18	27	2	-	-	-	29 E
SE	-	-	-	-	-	1	1	-	-	-	2 SE
S	-	-	-	-	-	1	-	-	-	-	1 S
SW	2	-	-	-	2	3	-	-	-	-	3 SW
W	51	48	18	20	157	77	26	6	12	1	122 W
NW	1	-	-	-	1	-	-	-	-	-	- NW
Calm	-	-	-	-	45	-	-	-	-	-	-
Total Obs.	-	-	-	-	224	-	-	-	-	-	83
											240

October 1948

N	-	-	-	-	-
NE	1	-	-	-	1
E	2	-	-	-	2
SE	2	-	-	-	2
S	-	-	-	-	-
SW	7	-	-	-	7
W	54	30	-	-	84
NW	2	-	-	-	2
Calm	-	-	-	-	150
Total Obs.	-	-	-	-	248

November 1948

N	-	-	-	-	-
NE	3	-	-	-	3
E	4	-	-	-	4
SE	4	-	-	-	4
S	2	-	-	-	2
SW	4	-	-	-	4
W	66	42	9	4	121
NW	-	-	-	-	-
Calm	-	-	-	-	102
Total Obs.	-	-	-	-	248

December 1948

N	-	-	-	-	-
NE	-	-	-	-	-
E	10	-	-	-	10
SE	3	-	-	-	3
S	-	-	-	-	-
SW	1	-	-	-	1
W	68	47	30	7	111
NW	-	-	-	-	-
Calm	-	-	-	-	70
Total Obs.	-	-	-	-	248

January 1949

N	-	-	-	-	-
NE	2	1	-	-	3
E	5	-	-	-	5
SE	2	1	-	-	3
S	3	-	-	-	3
SW	8	-	-	-	8
W	49	38	22	12	121
NW	-	1	-	-	1
Calm	-	-	-	-	99
Total Obs.	-	-	-	-	248

February 1949

N	-	-	-	-	-
NE	-	1	-	-	1
E	15	3	-	-	18
SE	-	-	-	-	-
S	-	-	-	-	-
SW	2	-	-	-	2
W	51	48	18	20	157
NW	1	-	-	-	1
Calm	-	-	-	-	45
Total Obs.	-	-	-	-	224

March 1949

N	-	-	-	-	-
NE	2	3	-	-	5
E	6	4	-	1	11
SE	3	2	-	2	7
S	2	-	-	-	2
SW	3	1	-	-	4
W	25	28	45	35	145
NW	1	-	-	-	1
Calm	-	-	-	-	73
Total Obs.	-	-	-	-	248

Figure 51

April 1949

No. of observations during which
wind speed (in knots) was

May 1949

No. of observations during which
wind speed (in knots) was

					Total						Total
1-10	11-20	21-30	31-40	40		1-10	11-20	21-30	31-40	40	
knots	knots	knots	knots	knots		knots	knots	knots	knots	knots	
N	-	-	-	-	-	-	-	-	-	-	- N
NE	4	-	-	-	4	18	11	-	-	-	29 NE
E	20	2	-	-	22	58	51	-	-	-	109 E
SE	3	3	-	-	6	26	24	-	-	-	50 SE
S	4	-	-	-	4	-	-	-	-	-	- S
SW	1	-	-	-	1	-	-	-	-	-	- SW
W	25	29	54	22	130	12	20	6	6	-	44 W
NW	1	-	-	-	1	-	-	-	-	-	- NW
Calm	-	-	-	-	1	-	-	-	-	-	- Calm
Total Obs.					<u>72</u>						<u>16</u> Calm
					240						248

June 1949

July 1949

N	1	-	-	-	1	-	-	-	-	-	- N
NE	5	4	-	-	9	7	7	-	-	-	14 NE
E	61	120	1	-	182	66	69	7	-	-	142 E
SE	-	3	-	-	3	7	7	1	-	-	15 SE
S	-	-	-	-	-	-	-	-	-	-	- SE
SW	-	-	-	-	-	-	-	-	-	-	- S
W	5	16	11	-	32	4	30	28	9	3	74 W
NW	-	-	-	-	-	-	-	-	-	-	- NW
Calm	-	-	-	-	-	-	-	-	-	-	- Calm
Total Obs.					<u>13</u>						<u>3</u> Calm
					240						248

August 1949

September 1949

N	-	-	-	-	-	-	-	-	-	-	- N
NE	15	5	-	-	20	-	-	-	-	-	- NE
E	53	27	-	-	80	23	6	-	-	-	29 E
SE	27	14	-	-	41	14	-	-	-	-	14 SE
S	-	-	-	-	-	7	-	-	-	-	7 S
SW	5	7	-	-	12	16	6	-	-	-	22 SW
W	8	56	-	-	64	27	50	27	1	-	105 W
NW	1	4	-	-	5	-	1	-	-	-	1 NW
Calm	-	-	-	-	-	-	-	-	-	-	- Calm
Total Obs.					<u>26</u>						<u>62</u> Calm
					248						240

October 1949

November 1949

N	-	-	-	-	-	-	-	-	-	-	- N
NE	-	-	-	-	-	-	-	-	-	-	- NE
E	6	1	-	-	7	21	2	-	-	-	23 E
SE	7	-	-	-	7	2	-	-	-	-	2 SE
S	3	-	-	-	3	1	-	-	-	-	1 S
SW	27	11	-	-	38	9	1	-	-	-	10 SW
W	56	42	11	8	118	55	43	22	-	-	120 W
NW	-	-	-	-	-	-	-	-	-	-	- NW
Calm	-	-	-	-	-	-	-	-	-	-	- Calm
Total Obs.					<u>75</u>						<u>84</u> Calm
					248						240

December 1949No. of observations during which
wind speed (in knots) wasJanuary 1950No. of observations during which
wind speed (in knots) was

					Total						Total
1-10	11-20	21-30	31-40	40		1-10	11-20	21-30	31-40	40	
knots	knots	knots	knots	knots		knots	knots	knots	knots	knots	
N	-	-	-	-	-	-	-	-	-	-	- N
NE	-	-	-	-	-	-	-	-	-	-	- NE
E	3	4	-	-	7	12	7	-	-	-	19 E
SE	3	-	-	-	3	2	-	-	-	-	2 SE
S	-	-	-	-	-	1	1	-	-	-	2 S
SW	3	-	-	-	3	1	-	-	-	-	1 SW
W	59	48	54	2	163	65	49	18	-	-	132 W
NW	-	-	-	-	-	1	-	-	-	-	1 NW
Calm					72						91 Calm
Total Obs.					248						248

February 1950March 1950

N	-	-	-	-	-	-	-	-	-	-	- N
NE	-	-	-	-	-	1	-	-	-	-	1 NE
E	2	1	-	-	3	7	-	-	-	-	7 E
SE	1	-	-	-	1	1	-	-	-	-	1 SE
S	2	-	-	-	2	2	-	-	-	-	2 S
SW	3	2	1	-	6	9	1	-	-	-	10 SW
W	39	57	22	5	123	60	22	38	17	1	139 W
NW	-	-	-	-	-	2	-	-	-	-	2 NW
Calm					89						86 Calm
Total Obs.					224						248

April 1950May 1950

N	-	-	-	-	-	-	-	-	-	-	- N
NE	-	-	-	-	-	1	-	-	-	-	1 NE
E	30	6	-	-	36	89	39	-	-	-	128 E
SE	6	2	-	-	8	1	-	-	-	-	1 SE
S	-	-	-	-	-	-	-	-	-	-	- S
SW	4	1	-	-	5	-	1	1	1	1	1 SW
W	34	34	26	11	106	6	54	22	3	-	85 W
NW	-	-	-	-	-	1	-	-	-	-	1 NW
Calm					85						31 Calm
Total Obs.					240						248

June 1950July 1950

N	-	-	-	-	-	-	-	-	-	-	- N
NE	15	3	-	-	18	4	7	-	-	-	11 NE
E	71	81	1	-	153	57	114	-	-	-	171 E
SE	5	19	1	-	25	9	5	-	-	-	14 SE
S	-	-	-	-	-	-	-	-	-	-	- S
SW	-	-	-	-	-	-	-	-	-	-	- SW
W	7	27	6	-	40	3	29	3	-	-	35 W
NW	-	-	-	1	1	1	2	1	-	-	4 NW
Calm					3						13 Calm
Total Obs.					240						248

4. SUITABLE TRAVEL ROUTES

Access from the Sea

In view of the continuous presence of pack ice on the northeast coast of Greenland, southern Peary Land is virtually inaccessible by ship. However, during the cold season tracked vehicles should succeed in reaching the area - for example, from Station Nord - by travelling on the sea ice across Danmarks Fjord, along the coast of Valdemar Gluckstadt Land, across the mouth of Hagens Fjord and up Independence Fjord. Protected by the land, these fjords are less susceptible to the pressure that produces ridges on the pack ice of the open sea; they possess, consequently, smooth and level ice surfaces. Icebergs are spaced well apart and can easily be circumvented.

Such vehicular travel on the sea ice appears most practicable in spring, from March to early May. Untried heretofore in this area, this mode of approach to Peary Land certainly merits testing. The experiences gathered by TREGOG's Project TOP DOG 59 and 60 could be useful in the preparation of such a test.

Access by Air

Southern Peary Land provides landing surfaces for aircraft throughout the year; however, in different seasons different types of landing gear would have to be used, and planes would have to land in different places. Thus, it will be most convenient to discuss the possible landing surfaces grouped according to types of aircraft landing gear.

Surfaces for landings and take-offs with conventional wheel gear are extremely limited in southern Peary Land. The upland areas have to be dismissed as unsuitable because of their relief, and most of the low-lying valley floors and terraces are strewn with cobbles and boulders, or traversed by frost cracks, which could severely damage the aircraft. One notable exception is an emergency landing strip that lies on a plain of marine clays - a former fjord bottom - approximately 1-1/2 miles N NE of Cape Harold Moltke, near the east side of the entrance of Jørgen Brønlunds Fjord. It extends from ESE to WNW, the latter being the prevailing direction of strong winds here. In July 1960, the strip contained only few wet and superficially soft spots; it was otherwise dry and firm. Tire marks of a C-124 could be noticed, but revealed very little penetration. The likely presence of snow drifts in winter restricts this strip probably to summer use (June - September). In winter, wheel landings may succeed on the ice of Jørgen Brønlunds Fjord and of the lakes, but these surfaces appear more suitable for ski landings.

Aircraft equipped with either oversized tires or tandem wheel gear should be able to land not only on the emergency landing strip at Jørgen Brønlunds Fjord, but also on relatively flat valley floors whose rougher surface precludes the use of conventional wheels. In southern Peary Land, this applies particularly to the valley named "South Pass" (Sydpasset) between Evening Star Lake (Aftenstjerne Sø) and Midsommer Lake. It is oriented east-west. Its floor consists mainly of alluvial deposits up to boulder size. Along this valley, there are several unobstructed flat stretches of one mile or more in length suitable for landings and take-offs of aircraft with special wheel landing gear.

Ski landings can be performed the year round on the inland ice and on the four plateau glaciers of southern Peary Land, namely, the Hans Tausen Icecap north of Walcotts Land, the unnamed 14,500 ft. ice field to the east of it, the Storm Icecap in southern Walcotts Land, and the Christian Erichsen Glacier in Heilprin Land. Of these, the inland ice area immediately south of Walcotts Land deserves special attention as here is located the northern end of the swing trail of Project LEAD DOG. Surface and air operations can, therefore, be conveniently combined in this area. The four plateau glaciers mentioned above doubtlessly provide good ski landing surfaces; however, routes for the descent from these smaller icecaps to the land remain to be determined.

During the cold season, excellent ski landing surfaces are supplied by several large lakes and by Jørgen Brønlunds Fjord. Since no glaciers enter the fjord, it is free of icebergs, only at its mouth there are occasionally bergs that have drifted in from Independence Fjord. Independence Fjord itself is too cluttered with icebergs to provide sufficiently large areas of level sea ice for landings. The lakes suitable for ski landings are Lower and Upper Midsommer Lake, the Twin Lakes, and the eastern part of Evening Star Lake (for their location, see figure 52). According to information by Count Eigil Knuth, Jørgen Brønlunds Fjord opens in mid-July. On air photos taken on August 22 (1947), it is still open. In mid-September it has already frozen over firmly enough to support dogsleds, and during the winter its ice reaches a thickness of over 8 feet (B. Fristrup). The fjord ice, therefore, should serve as a good landing surface for light aircraft between November and early June, with the possibility of landing heavy aircraft in early spring (March - April). Before attempting to land heavy aircraft, however, it is advisable to test strength and thickness of the ice. A team to perform these tests could be flown in by light plane from Nord. The same precaution applies to the lakes.

The western (inner) part of Jorgen Bronlunds Fjord provides an unobstructed runway over 9 miles long, oriented east-west, with prevailing winds blowing from the west.

The eastern (outer) part of the fjord extends S.E. - N.W., with about 5 miles of unobstructed surface. In this part, presence of a few icebergs must be expected (two icebergs were there in the summer of 1960).

Lower Midsommer Lake is divided by a constriction of its shorelines into two unobstructed parts, each of them about 4.5 miles in length. Both are oriented east-west. Upper Midsommer Lake has in its central section an unobstructed surface extending east-west for over 9 miles, and its westernmost part (Baggarden) a slightly curving stretch of over 4 miles.

The Twin Lakes, in a valley flanking Storm Ice Cap on the north, also extend approximately east-west, with the eastern Twin Lake having an unobstructed length of 4.5 miles, the western Twin Lake of 3 miles.

Evening Star Lake, also runs east - west, and was, in the summer of 1960, iceberg-free east of the terminal of Evening Star Glacier for about 7 miles. A low-level approach to Jørgen Brønlunds Fjord, to the Midsommer Lakes, and to Evening Star Lake can be made from east or west without obstruction along the Wandels Valley - South Pass valley zone which they occupy. The Twin Lake valley is bordered in the east by low hills (an estimated 500 ft. above lake level, about 1 mile away from the end of Eastern Twin Lake), while there is no comparable obstruction in the west. Along the north and south sides of the fjord and the lakes, however, the land rises, partly in cliffs, up to 2000 ft. above the lake level. The horizontal distance between the lake shore and the upper rim of these cliffs is almost everywhere greater than 1 mile.

Since the fresh-water ice of the lakes forms earlier and melts later than the sea ice of Jørgen Brønlunds Fjord, and since the lakes lie at higher elevations than the fjord (e.g., Upper Midsommer Lake at 240 ft., the Twin Lakes at over 1000 ft.), the annual period for safe ski landings on the lakes is somewhat longer than that for such landings on the fjord.

In the summer, float planes and flying boats can touch down on Jørgen Brønlunds Fjord and on the lakes discussed for ski landings. An example is the remarkable achievement of the Danish Peary Land Expedition in 1948, which landed its entire equipment by PBY (Catalina) flying boat at Jørgen Brønlunds Fjord. The period for such landings, however, is short. On the fjord, it lasts from the middle of July to about the end of August; on the lakes, it shortens with increasing elevation of the lake surface.

Rotary-wing aircraft can land almost anywhere in southern Peary Land. The principal factor restricting their use is their relatively short range. However, they could operate from Nord, which lies only 130 miles away from Jørgen Brønlunds Fjord, or base their operations on previously

air-dropped fuel supplies. The latter method was successfully used by the TREGO H-34C helicopters during the summer of 1960.

Access from the inland ice

The vital importance of being able to reach southern Peary Land from the inland ice is self-evident. The means of surface transportation - tractor-drawn trains of sleds, 10-ton off-road trailers, and rolling liquid transporters - with their capability of hauling heavy loads and of operating in almost any weather could support activities in the area dependably. Yet to date the access from the inland ice has been the most difficult to achieve.

A usable ramp must possess a combination of three environmental properties: 1. The ice margin must be reasonably free of crevasses. 2. The ice must slope to the land at a gradient passable for the vehicles; in particular, it must not form a cliff. 3. The terrain beyond the ice margin must be passable for the vehicles and permit establishment of a route beyond the immediate vicinity of the inland ice. These three properties are unrelated causally, which means that their combined presence in a given area is purely a matter of chance. This explains the scarcity of suitable ramps. The most intensive crevasse fields occur where ice of rather limited thickness moves rapidly over an irregular subsurface. Along the Peary Land ice margin, these conditions exist particularly in its eastern and northwestern parts. In the east, the large Academy Glacier and Marie Sophie Glacier plunge from the inland ice down to the head of Independence Fjord, and Hobbs Glacier descends similarly to Inuiterk Lake. In the northwest, an almost labyrinthic network of ice streams leads from the icecap down to J. P. Kochs Fjord and Nordenskjold Fjord. Only in the north-central portion of the ice margin, in Walcotts Land, are the lobate protrusions of the inland ice less pronounced. This state of affairs caused P. E. Victor, who flew across this area, to pronounce the ice margin of Walcotts Land to be stagnant and crevasse-free. The trail reconnaissance party of Project LEAD DOG 59, working with a crevasse-detector weasel from the swing's position at Mile 481.4 and 129 towards Walcotts Land, disproved Victor's statement, since extensive fields of large crevasses halted each of their several attempts to reach land.

Project LEAD DOG 60, by way of helicopter reconnaissance, again verified the presence of crevasse fields, but succeeded in finding an apparently crevasse-free lane leading to a practically slopeless ice-land contact halfway between Evening Star Glacier and the next small glacier (W1) to the east of it (see Figure 52). Crevasses were observed on the west side of the head of Evening Star glacier, as well as east of the proposed ramp; but between these crevasse fields there seems to be a crevasse-free lane about 2 - 3 miles wide. The ease with which the crevasses were spotted strongly supports the assumption that the area in which no crevasses could be recognized actually

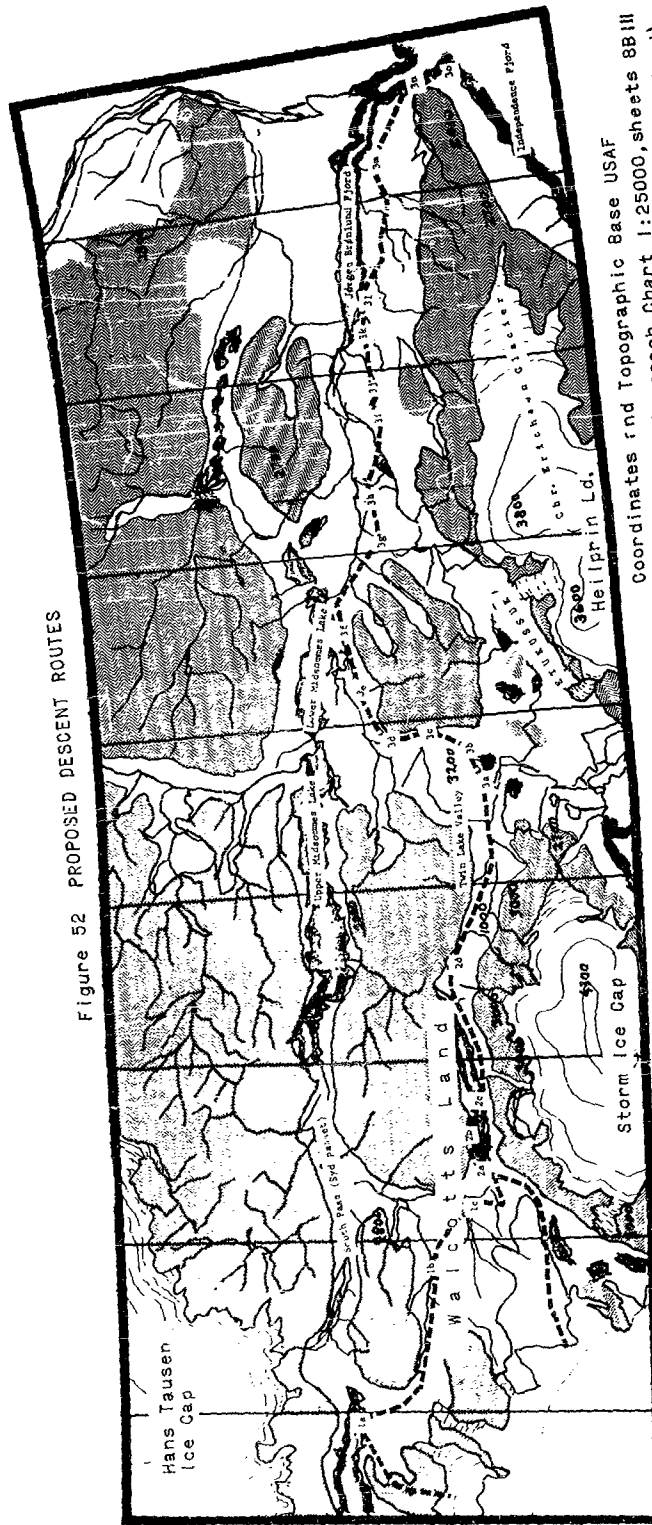

Figure 52 PROPOSED DESCENT ROUTES

Coordinates and Topographic Base USAF
 Aeronautical Approach Chart 1:25000, sheets 8B III
 (Odins Fjord) and 3A IV (Jorgens Brøn'lunds Fjord)

DISLECTED ISLANDS
 GLACIERS
 LAKES
 STREAMS
 ROUTES
 30 statute miles
 Reference points mentioned in text

is crevasse-free. A follow-up reconnaissance by crevasse-detector Weasel missed this lane due to the fact that the coordinate net of the Aeronautical Approach chart, which was used as a map, was wrong by more than one degree of longitude, so that the Weasel ran into crevasses near the head of Adam Glacier, a full 12 miles west of the intended course, and turned back. Unfortunately, lack of adequate time prevented further surface reconnaissance of this crevasse-free lane. Nevertheless there is hardly any doubt about its reality among those who located it and checked it on two helicopter flights. From the ice edge, a gentle slope can be followed northward to the shore of Evening Star Lake. The route leads along the interfluvial crests in order to avoid several sharply incised small valleys. The surface consists of solifluction material ranging in grain size from silt to cobbles. The silt is quite wet in summer, but as it is mixed with many stones, ground penetration remains slight even in extremely wet places.

The suggested trail from the inland ice to Evening Star Lake is shown on the map. On a flight from Midsommer Lake to the LEAD DOG 60 swing, this reporter noticed that on the western flank and near the head of Three-Lake Valley the ice leads without a slope over into the land, and proposed that this area was to be reconnoitered by helicopter. The resulting flight yielded the discovery of the Three-Lake Valley ramp as an alternate possible route of descent from the ice. The ice-land contact point of this route lies at the southwest end of the long interfluvial with the spot elevation 3500 (AAC, sheet 8BIII) on the west side of Three-Lake Valley, between the northernmost ice lobe that is still tributary to Three-Lake Valley and next - sharply triangle-shaped - lobe to the west whose meltstream flows towards South Pass and Midsommer Lake. As seen from the helicopter, the access to this contact point appeared crevasse-free. The ice-land contact is almost level. From there, the route follows the crest line of the 3500 ft. ridge to the NE, descends to the shore of the northernmost lake in Three-Lake Valley, and then follows the valley to the western Twin Lake. The cliffs marked on the Aeronautical Approach Chart along the 3000 ft. contour where it crosses the proposed route do not exist. The surface materials were not inspected on the ground; but judging from experience gained elsewhere, they will be predominantly stony along the crest of the ridge, and silt - and -stones (similar to the Evening Star ramp) in the valley. This route was considered suitable by all participants in the reconnaissance party (1st Lt. Walton, M/Sgt. Fields, and this writer.)

In view of the inaccuracy of the Aeronautical Chart's geographical coordinates, one cannot expect to reach the two ramps discussed here by plotting and measuring the azimuth from the astronomically determined swing position to the ramp on these maps. This routine method of course determination will become feasible only after the map coordinates have been corrected by fixing the astro positions of at least two easily and precisely identifiable stations on the land, with preferably a third station for control purposes. Such a correction has yet to be undertaken.



Figure 53. Dissected plateau in Walcotts Land.

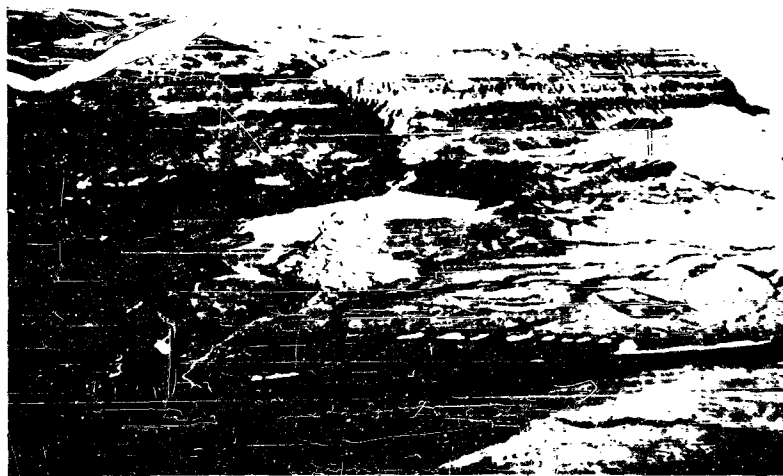

Figure 54. Wandels Valley. Note narrow ravine cut by the stream coming from the plateau and the alluvial fans deposited by the same stream on the floor of Wandels Valley.

Fortunately, the maps are fairly accurate with regard to the relative positions of features and outlines (streams, lake shores, ice-land boundaries) that they contain; this is at least true within areas of limited extent such as Walcotts Land. Consequently, a surface reconnaissance team trying to find the ramps will have to move towards the land far enough to be able to visually identify conspicuous landmarks that can be pinpointed on the maps. Particularly well suited for this purpose are the tips of the numerous short glacial lobes that protrude from the southern margin of Hans Tausen Icecap, as their white surface contrasts sharply against the dark color of the adjacent land and as their high elevation (about 3000 ft.) makes them visible from afar. With their help, the team can determine its relative position on the map (regardless of coordinates) by simple triangulation and then set its course to the ramps.

Land routes from Walcotts Land to Jørgen Brønlunds Fjord

A land route from the two ramp areas in Walcotts Land to Jørgen Brønlunds Fjord, as the nearest conveniently located embayment of the sea, forms a logical continuation of the icecap trail established by Project LEAD DOG to the Walcotts Land ice margin. Unlike the icecap trail, this land route has yet to be tested. It has been arrived at predominantly through interpretation of aerial photographs, supported by rather brief, yet nevertheless useful, observations from helicopters. The analysis carried out on this basis did not reveal any evidence against the usability of the route; yet, on the other hand, it is unable to absolutely confirm that the route is suitable for vehicular traffic along its entire length. This uncertainty is due to the rather weak photographic coverage. For large portions of the route there are only oblique photographs available, with a resulting lack of photographic detail, so that, for example, questions regarding the composition of surface materials or the feasibility of stream crossings must frequently be answered by inference based on analogy rather than by direct observation, and in some cases cannot be answered at all.

There are two possible ways of future actions to eliminate the uncertainties inherent in such inferences and thereby to definitely ascertain the quality of this route:

1. Large-scale vertical aerial photography, with 60% overlap, along the entire route (taken preferably in summer). This could easily be accomplished by one aircraft, on one mission.
2. A check of the route by a reconnaissance party on the ground. The vertical aerial photography would have the advantage of not only permitting more detailed observations than the presently available obliques, it would also make it easy to quickly locate possible detours around local obstacles. The check on the ground, on the

other hand, would be the most definite test, as it could determine directly the passability of the route and obtain pertinent information on strength and texture of surface materials, gradient of slope, and other terrain properties. As seen on a map, the Wandels Valley zone from Evening Star (Aftenstjerne) Lake in the west via South Pass (Sydpasset) and the Midsommer Lakes to Jørgen Brønlunds Fjord in the east appears as the most natural route. However, this route cannot be used in the warm season, as the shores of the Upper Midsommer Lake are too steep to permit passage of vehicles. Consequently another route had to be chosen. It leads from Evening Star Lake via the Twin Lakes (where it receives the trail from the Three-Lakes Valley ramp), Etukussuk Valley and Lower Midsommer Lake to Brønlunds Fjord. In the discussion below, this route has been subdivided into three convenient sections in order to facilitate the identification of individual points.

Section 1: Evening Star Lake (Aftenstjerne So) to west end of Twin Lake Valley.

The route starts near the eastern end of the lake (See figure 52, point 1a), just west of the mouth of the easternmost stream entering the lake from the south. It leads southward up a gentle slope presumably made up of stony silt, and free of obstacles. After about two miles the route turns southeastward, paralleling the foot of the broad hill that lies to the east.² Upon reaching the meltwater stream issuing from the ice lobe W2 (W for Walcotts Land), the route crosses this stream at a convenient point and continues eastward on the south side of the stream towards its junction with the stream draining lobes W3 and W4 (Figure 52, point 1b). This junction is marked by an isolated low hill that stands immediately west of it and serves as a good landmark for orientation. The hill may be bypassed closely either on its north or its south side. After passing the hill, the route crossed the stream coming from W3 and W4 and parallels its easterly course for about two miles along the southern bank. Shortly before the stream turns northeastward into a valley with higher slopes (which continues into a narrow gorge), the route takes a southeasterly course over a low and gently sloping interfluvium which forms a low pass (Figure 52, point 1c). It descends from the pass to a stream on the other side, continues southeast across this stream and across several small tributaries and then leads over the next low and gentle interfluvium to the western end of Twin-Lake Valley. Here it is joined by the route from the Three-Lake Valley ramp.³

The surface along the entire section consists of fragmented materials of various kinds. On the slopes and interfluviums, solifluction materials made up of a stone-and-silt mixture prevail; along the streams, gravel terraces are likely. One may expect to find the stones superficially sorted by frost

²USAF Aerial Photo Mission M17 311RW ERG, Photograph. 74LT, 13 May 1947.

action, forming stone rings on flat surfaces, stone stripes on slopes; the stripes are oriented in the direction of maximum gradient.

Section 2: Along Twin-Lake Valley to Hub Mountain in Etukussuk Valley.

The route crosses the stream (Figure 52, point 2a) entering the western Twin Lake from the northwest at its mouth and follows a terrace along the lake eastward.⁴ The terrace is in places covered by moraine with an irregular relief but with enough openings to find a trail around the individual moraine hummocks (Figure 52, point 2b). A delta near the middle part of the shore line should be easily crossed as its stream branches into several shallow distributary channels. At the eastern end of the western lake, the trail cuts across the isthmus (Figure 52, point 2c) between the lakes, a flat surface made up mostly of stream gravels, and continues eastward on the south side of the eastern lake.^{5,6} Because of the rough, apparently morainic, relief along the immediate shore, the route keeps as far away from the shore as possible and runs close to the foot of the steeply sloping valley side. After passing the east end of the lake, the route returns to the middle of the valley and gradually crosses over to the north side of the valley in order to bypass a rough moraine field (Figure 52, point 2d) which blocks the greater part of the valley floor approximately 2.5 miles east of the lake end.⁷ For nearly three miles beyond the beginning of the moraine field the northern side of the valley floor retains a rather smooth surface, but from the point where the longest stream from Storm Icecap joins the main stream (and where the 1000 ft. contour on the Aeronautical Approach Chart crosses the main stream) (Figure 52, point 2e) all the way to Etukussuk Valley the valley floor is covered by a round-hilly ground moraine relief.⁸ Along the meandering course of the main stream lie flat and apparently discontinuous gravel surfaces. The ground moraine generally slopes gently, but is in numerous places dissected by small, yet sharp, cuts; when traveling over the ground moraine it will be advantageous to move along the crests of moraine hills as far as possible and select the spots where the cuts can be either circumvented or crossed.⁹ This procedure necessitates a zig-zag course. Along the last 4.5 miles before Twin Lake Valley opens to the wide plain of Etukussuk Valley, its main stream braids more extensively, and the gravel flats become continuous and a most useful roadway which should be followed along the left bank of the stream. In the middle of the Etukussuk valley plain, and in plain view as one travels down the last few miles of Twin-Lake Valley, lies an

³Ibid, 78 LT.

⁴Ibid, 83 LT.

⁵Ibid, 84 VT.

⁶Ibid, 86 VT.

⁷Ibid, 88 VT.

⁸Ibid, 89 RT.

⁹Ibid, 91 RT.



Figure 55. Plateau stream descending in steps, which form waterfalls, to Upper Midsommer Lake, where it has formed a delta.



Figure 56. View northward across Jørgen Brønlunds Fjord. July 9, 1960

isolated table mountain from which valley zones extend like the spokes of a wheel to the west-north-west (Twin-Lake Valley) to the east-north-east (Etukussuk Valley) and to the north (towards the Midsommer Lakes). Because of this location, the isolated table mountain is herewith tentatively called "Hub Mountain". Two of the valleys radiating from Hib Mountain are potential access-ways to Jørgen Brønlunds Fjord: Etukussuk Valley and the unnamed valley that stretches northward. Study of the air photos reveals, however, that Etukussuk Valley is unsuitable for a vehicle route. Parts of its valley floor have a very rough moraine relief. A glacier tongue descending from Heilprin Land extends half way across the valley floor and thereby bars any further advance, as the remainder of the valley floor opposite this glacier is impassable. Furthermore, for several miles northeast (down stream) from this point, the main stream (Etukussuk Elv) has cut a gorge into the valley floor, which prohibits any advance along the stream bed. Thus, from Hub Mountain onward, the other, northerly route towards Lower Midsommer Lake and then eastward towards Jørgen Brønlunds Fjord holds the only promise of success.

Section 3: From Hub Mountain via Lower Midsommer Lake to Jørgen Brønlunds Fjord.

At the mouth of Twin-Lake Valley (Figure 52, point 3a) the trail turns northward into the unnamed valley that leads from Hib Mountain to Lower Midsommer Lake.¹⁰ The route crosses the valley in a northeasterly direction, passing first over ground moraine (silt-and-stones), then over a wide alluvial fan (Figure 52, point 3b) that occupies the center of the valley, and over ground moraine again on the east side of the fan. Upon reaching the east side of the valley floor (Figure 52, point 3c), the route continues northward roughly parallel to, and about one-half mile away from, the foot of the valley slope. By following this route, an incised stream that runs close to the slope foot in the northern part of the valley is avoided. This stream can be crossed only at the northern exit of the valley (Figure 52, point 3d), where its erosion has given way to deposition and where, consequently, its braided channels flow across a flat gravel surface.¹¹ This crossing marks the eastward turn of the route, which, from here on, follows the south side of Lower Midsommer Lake. Between the lake shore and the steep and cliffy bedrock slopes to the south of it there is interspersed a belt of ground moraine which consists of several long, low, gently sloping ridges running from west to east. The trail utilizes the longest and most continuous of these ridges, leading along its crest, until this ridge reaches the edge of the small bay (Figure 52, point 3e) lying at about the middle of the southern lake shore.¹² From this bay to Midsommer Elv, the outlet of the lake (a river leaving the

¹⁰Ibid. 230 RT.

¹¹Ibid. 97 RT.

¹²Ibid. 100 RT.

lake southeastward) the trail remains close to the shore line, on gently sloping ground moraine. It then turns southeast (Figure 52, point 3f) along Midsommer Elv, staying for the first 2.5 miles close to its bank so that tributary streams can be crossed at their depositional fans rather than their erosional cuts, then veering away from the river because of an increased roughness of the terrain. Near the junction of Etukussuk Elv with Midsommer Elv, the route enters a wide alluvial plain (Figure 52, point 3g) of silt, sand, and gravel flats traversed by numerous braided stream channels - the elongated delta of Midsommer Elv.¹³ The air photo coverage of this plain is too poor to determine the best crossing with certainty. Therefore, the course plotted is based on the assumption that the attempt to cross will be most successful where the greatest number of braided channels occur and where, therefore, the total amount of water is subdivided into small and presumably shallow streams. The trail leads across the alluvial plain in a southeasterly direction in order to quickly gain the higher ground (Figure 52, point 3h) on the south side of the valley. On this higher ground, three major streams traversing the ground moraine area can be crossed from west to east: the first one (Figure 52, point 3i) in the middle part of its course, the second one (Figure 52, point 3j) near its head, and the third one (Figure 52, point 3k) near its mouth, close to the fjord.¹⁴ After that last crossing, vehicular movement probably can proceed without trail improvement for only about one more mile eastward to the next major stream, which has built a terraced delta (Figure 52, point 3l) out into the fjord.¹⁵ The stream has cut a deep channel into the higher terrace levels of the delta. Neither that incision nor the narrow valley extending from here upstream into the mountains to the south can be crossed without bridge construction.¹⁶ By grading somewhat the steep slope between the delta terrace and the youngest delta (at sea level), however, it should be possible to move down to that lowest delta level, to cross the stream there and to come up to higher ground again. The eastward continuation of the route stays away from the steeply sloping fjord shore and crosses two more major streams at convenient points before it reaches the vicinity of Brønlund House (Figure 52, point 3m), the building erected by the Danish Peary Land Expedition.¹⁷ Brønlund House stands on a low marine terrace level on the south side of the fjord.¹⁸ The route itself stays on a higher terrace, and remains near the landward margin of this terrace, as its seaward margin is dissected by many small streams.^{19, 20} Opposite Cape Harold Moltke a major stream flowing west to east from the plateau of

¹³Ibid, 104 RT.

¹⁴Ibid, 217 VT.

¹⁵Ibid, 215 VT.

¹⁶Ibid, 213 VT.

¹⁷Ibid, 211 VT.

¹⁸USAF Aerial Photo Mission M61 311 RV ERG,
Photograph 216VV, 30 July 1947

¹⁹Ibid, 218VV

²⁰Ibid, 241 VV



Figure 57. View northeastward across the head of Jørgen Brønlunds Fjord, July 9, 1960.



Figure 58. South shore of Jørgen Brønlunds Fjord. In the center Brønlund House can be seen. It was the base for the Danish Peary Land Expedition (1948-1950).

Heilprin Land marks the end of this terrace stretch. That stream has built a delta into the fjord (Figure 52, point 3n). The route descends from the terrace onto the delta, crosses it, and follows the shore line at the foot of the high, cliffed slope of the Heilprin upland, which here comes closest to the shore, southward. At the point where the cliff turns westward, a fairly steep but passable grade leads up to the slope that slants southward towards Independence Fjord (Figure 52, point 3o), and to Cape Knud Rasmussen, at the mouth of Jørgen Brønlunds Fjord. Here the trail ends. Its total length from Evening Star Lake to Cape Knud Rasmussen is approximately 100 miles.

An Alternate Cold Season Route to Jørgen Brønlunds Fjord

The all season land route from Walcotts Land to Jørgen Brønlunds Fjord described above should be trafficable throughout the year. However, in winter a more direct route can be followed; it saves time and fuel, and has fewer obstacles. Between October and May, the solidly frozen surfaces of Jørgen Brønlunds Fjord and of the lakes in southern Peary Land provide convenient travel surfaces free of obstructions. Although an exact determination of the strength of their ice cover remains to be made, the ice certainly will support light vehicles (Weasels), and during early spring (March, April) in all probability even heavier ones.

The more direct cold season route which thus can be used leads from the Evening Star ramp eastward through Southpass (Sydpasset) via the Midsommer Lakes to Jørgen Brønlunds Fjord, and on the ice of the Fjord to any desirable point on its shores.

Alternate routes to the mouth of Brønlunds Fjord plus some thoughts on establishment of a camp near Cape Harold Moltke

The intended alternate summer route -- from the east end of Lower Midsommer Lake through the valley paralleling Brønlunds Fjord in the north and further on through the lower part of Borglum Elv Valley southward to Cape Harold Moltke -- is for all practical purposes impassable for vehicles. Shortly before reaching Borglum Elv Valley, the trail would pass through a valley stretch with a sharp V-shaped cross-section, i. e., an unbraided and presumably deep river channel at the valley bottom, and slopes with gradients of 40% or more rising on both sides immediately from the water's edge. Even before reaching this stretch, there are several points past which successful passage in summer is not very likely.

The feasibility of a route which crosses Midsommer Elv at its exit from Lower Midsommer Lake, then follows that river along its northern bank to Brønlunds Fjord, ascends the slope on the north side of the fjord and runs along one of two seemingly continuous beaches, approximately 200 yards wide and remarkably level, located in the slope below the cliff should be

investigated. In order to ascertain the continuity of these beaches eastward to the mouth of Borglum Elv, however, air photographic coverage would be necessary.

If this route should also prove impassable, the following suggestions concerning establishment of a base camp near Cape Harold Moltke would be worth consideration and discussion within the report.

During cold seasons, preferably early spring, transport of cargo and personnel over the fjord ice to the area near Cape Moltke, establishment of a camp there during the summer, evacuation of personnel either by air (C-124 to Thule or H-34 to Nord) or, in late fall (from October onward) over the re-frozen fjord by vehicle to the inland ice.

In any season except midwinter, transport of cargo over a land route to a convenient point on the south shore of the fjord, building up of a cargo cache there and in summer (mid-July) delivery of one or two motor-powered small barges, of personnel and essential survival gear by air (C-124) to Cape Harold Moltke. After launching barges and ferrying cargo over the open water of fjord from cache to Cape Harold Moltke, the building of camp could be consummated. The most expensive proposition would be to fly in all the equipment, supplies and personnel.

Prior to carrying out the plans suggested above, the proposed land route should, of course, be checked by a surface reconnaissance party.

5. RECOMMENDATION

The preceding discussion of the possibilities of access to, and of traverse through, southern Peary Land makes it feasible to spell out, in principle, several plans of action that can be adopted in the future by either scientific expeditions or military operations concerned with this area. The following recommendations are based on the assumption that establishment of a camp near the mouth of Jørgen Brønlunds Fjord is desired. Such a location of this hypothetical camp has the advantage of being (a) at the very end of any overland trail from the icecap that has been determined up to now; (b) in the vicinity of the emergency air strip which could be useful in supplying the camp; and (c) at a place from which exploration could be carried out through the Borglum Elv Valley northward, along the Wandels Valley westward, and along Independence Fjord eastward and southwestward.

If the camp site is to be located on the west side of the mouth of Jørgen Brønlunds Fjord at Cape Knud Rasmussen, it can in all probability be reached directly by the all-season overland route described earlier in this chapter. If, however, it is to be located on the east side near Cape Harold Moltke, degree and means of accessibility would vary with the seasons.



Figure 59. View from Jørgen Brønlunds Fjord towards Independence Fjord (with numerous icebergs in the background). Cape Harald Moltke protrudes from the left, while Cape Knud Rasmussen can be seen on the right.

Nevertheless, this latter location is to be preferred because of the availability of a larger area of level ground (wide, hard clay flats) and because here the locational advantages stated above are more strongly present than at Cape Knud Rasmussen.

Recommendation 1: Concerning a preparatory ground check of the all-season overland route.

As was pointed out above, the ramps for the descent from the inland ice as well as the overland route to Jørgen Brønlunds Fjord have not yet been tested by vehicles on the ground. If practical future use of this route by full-scale transportation operations is contemplated, such a test would deserve first priority. The ground check should not be combined with a heavy swing operation, as the swing's slow speed and other logistical problems (high fuel consumption) severely limits the time that would be available for the actual exploration off the ice cap. Operations LEAD DOG 59 and LEAD DOG 60 provide several examples to illustrate this point. Instead, the ground check should be carried out as an independent operation based on light, fast vehicles only, with amphibious weasels being the

principal "workhorses". One D-2 tractor, equipped with a dozer blade, would be useful for minor grading work along the trail. A total of four vehicles (3 weasels, 1 tractor) appears entirely sufficient. Light trailers (jeep trailers) with oversized wheels would carry the equipment that cannot be stored in the weasels themselves (e. g., spare tracks); two or three inflatable rafts should also be taken along. The size of the team is not to exceed 11 men (team commander, 1 or 2 scientists - one of them versed in astronavigation -, 1 radio-operator, 1 medical corpsman who also serves as cook, 6 driver-mechanics, at least one of them able to substitute as radio-operator). All should be experienced volunteers. As shelter, the light Barren Ground survival tents are entirely sufficient. The trail reconnaissance should be carried out in summer, and a time of not less than one month, preferably more, should be allotted to it. As this light reconnaissance team will hardly be able to take along all its fuel, air drops of fuel and of any other additional items of equipment should be made in advance along the route, in places dictated by the expected fuel needs as well as by the configuration of the terrain. The team also could use the gasoline cache left by Project LEAD DOG 60 at the Peary Land Base Camp (for amounts, see cache record, Chapter X, Table 6). For delivering the reconnaissance team to the inland ice margin at Walcotts Land, the starting point of its operations, an airlift by C 130 aircraft from Thule appears to be the most economical means. The C-130 can make a ski landing on the rather firm snow on the ice near the Peary Land Base Camp of Project LEAD DOG 1960. Not more than two such flights would be needed to transport the entire team. Additional air support by helicopters during the course of the reconnaissance would be very helpful, but not absolutely necessary.

Recommendation 2: Concerning a preparatory check of the ice strength and thickness on the Midsommer Lakes and on Jørgen Brønlands Fjord during the cold season.

To determine the usability of the winter route, it appears desirable to find out how high a ground pressure the lake and fjord ice can stand without breaking, so that for a cold season operation along this route the vehicles can be selected, and the cargo weight distributed, in such a manner as to be most economical without a hazard to safety. A small airborne team flying either two ski equipped U1A "Otters" or two H-34 helicopters could best perform this task. Besides the aviation personnel, two glaciologists who specialize in problems of lake and fjord ice should be on the team. The aircraft could use station Nord as a base of operations, with one or two additional air-dropped fuel caches within the area of study. The test is best carried out twice, once in mid-April when the ice probably still has its full thickness and strength, and once near the end of May or the beginning of June in order to determine any possible deterioration that might have occurred by then. Each of these two operations will require only a few days. If U1A "Otters" are used, they can land on and take off from the ice itself, while the helicopters may land on shore points as well.

Recommendation 3: Concerning the establishment of a small, temporary camp near Cape Harold Moltke.

If it is intended to establish a small camp limited to one or several summers' use by a small number of personnel, an airlift of men and equipment by C-124 or C-130 to the Jørgen Brønlunds Fjord landing strip would be the simplest and probably the cheapest method. An example of a similar operation is presented by the camp (two Jamesway huts) of Operation Groundhog 1960 on the shore of Centrum Lake in Kron Prins Christians Land, northeast Greenland.

Recommendation 4: Concerning the establishment of a semipermanent or permanent camp near Cape Harold Moltke.

Depending on the season, there are several different routes and methods by which men and materials could be brought to the camp site. It is assumed that the camp would be so large that transporting all the equipment by air would be more expensive than overland transportation. Similarly, air transport to station Nord and vehicular transport from there to Cape Harold Moltke over the fjord ice would be most likely more expensive than an operation based entirely on surface transportation. It is further assumed that the land routes described above have been tested as recommended above (see recommendations 1 and 2) and have been found usable.

a. During the cold season, the camp site can be reached by way of the winter route along the South Pass - Wandel Valley axis.

b. During the warm season, all equipment can be transported by way of the all-season route to a convenient point on the shore of Jørgen Brønlunds Fjord and cached there. The terraced delta (point 31 of the all-season trail) on the southern shore may be most convenient for this. In the following spring, the equipment can be brought by vehicles on the fjord ice to the Cape Harold Moltke area.

c. As an alternative to b, the transport of the equipment from the cache at point 31 of the all-season trail to Cape Harold Moltke area could be accomplished by small barges (pontoons) with outboard motors during the time (mid-July to end of August) in which the fjord is open. The pontoons, and personnel to operate them, would have to be flown to the emergency air strip near Cape Harold Moltke by C-130 or C-124 aircraft. Needed also for this operation would be a vehicle and trailer to transport the barges over the short distance from the airstrip to the water's edge. The advantage of ferrying the equipment over the open fjord is that all the transporting could be done during the relatively warm summer months of one year - the establishment of a cache in June and early July, and the ferrying thereafter.

Recommendation 5: Concerning the establishment of a camp near Cape
Knud Rasmussen.

The all-season trail from Walcotts Land ends at this cape; it can also be reached on the cold season route via the ice of Jørgen Brønlunds Fjord, and from the airstrip near Cape Harold Moltke by vehicle across the fjord ice in the cold season, by boat or pontoon in late July and August. Cape Knud Rasmussen is somewhat less satisfactory as a camp site than is Cape Harold Moltke because of the more limited accessibility of the areas north of Jørgen Brønlunds Fjord from here, and because of the relative remoteness from the emergency airstrip.

CHAPTER X

PERSONNEL, ADMINISTRATION, AND LOGISTICS

1. PERSONNEL ASSIGNMENTS

The number of military and civilian personnel assigned to the project varied in number from 33 to 63. Of this number one officer and 26 enlisted men had the primary responsibility of manning the sled train and keeping it underway. The remaining personnel consisted of civilian scientists and military technicians whose duties involved carrying out very specific studies for their respective Department of Defense agencies.

The personnel duty assignments were as follows: (See Table 8)

a. Project Officer (Captain, who had reassignment orders and left the swing on 16 May by Air Force C130 aircraft). The Project Officer coordinated the movement of the swing with the requirements of the accompanying scientists and technicians. His duties were taken over by the Swing Commander after his departure.

b. Swing operations personnel consisting of one officer and 26 enlisted men and were as follows: one swing commander (1st Lt), one NCO-in-charge (Master Sergeant), one navigator (Sgt E-5), one assistant navigator, 12 D-8 tractor operators, one supply man, two radio operators, one radio-radar repairman, two cooks, one electrician, one plumber, two vehicle maintenance mechanics, and one photographer.

c. The aviation element consisted of four warrant officers, seven enlisted men and one civilian. These personnel spent varying lengths of time with the swing accompanying the aircraft into the field as the situation required. The element was divided as follows: four rotary-winged pilots (warrant officers) one rotary wing aircraft technical inspector, two rotary wing mechanics, two rotary wing crew chiefs, one sheet metal worker, one electrician and one civilian technical representative.

d. A Chemical Corps Test Team consisting of one officer (Captain) and one enlisted man conducted Chemical Corps studies.

e. A Signal Corps Meteorological Team consisting of two enlisted observers and recorders accumulated meteorological data.

f. Two U. S. Geographic Survey Scientists joined the Aviation Element at Mile 664.4 for the purpose of conducting a geological survey of the ice-free land areas.

g. One civilian geographer from the University of Maryland, under contract to USATREOG, joined the expedition at Peary Land to conduct a detailed study of the mobility potential of the terrain in this area.

h. For the outbound portion of the expedition, one civilian geographer from the Quartermaster Research and Engineering Command accompanied the surface party to study the effects of the environment on military operations.

i. One civilian scientist from the U. S. Army Cold Region Research and Engineering Laboratories accompanied the expedition and conducted deep pit and ramsonde studies in continuance of similar studies conducted in 1959.

j. Three technicians from the Army Map Service accompanied the expedition for the purpose of conducting a gravity survey of the route followed, to make astronomical position determinations for the purpose of exactly locating points of land reached on the earth's surface, and to aid the TREOG personnel in conducting an altimetry survey.

k. Two Signal Corps photographers accompanied the expedition for the purpose of making still and motion picture photographs for documentation, reporting and training purposes.

l. One Marine Corps Gunnery Sergeant received extensive on-the-job training in all phases of the expedition's operations.

m. One Navy Lieutenant (pilot) worked with the Aviation Element in Thule and studied Army Aviation icecap flying techniques during resupply flights to the surface party.

n. Three TREOG officers and two enlisted men composed the crews of 2 U1A Otters based at Thule Air Base and used as back up support for Project LEAD DOG. These aircraft were available for emergency evacuation and rescue, and were utilized for resupplying the swing with small repair parts, mail, and fresh foods on two occasions.

o. Lt Col James W. Sandridge, Commanding Officer, USATREOG, actively participated in the project. Col Sandridge spent 18 days with the surface party and 16 days with the Aviation Element in the field.

p. One Medical Corps aid man accompanied the surface party.

q. The USATREOG communications officer accompanied the swing to Mile 81 to work out any communications problems.

2. ADMINISTRATION

All personnel assigned to TREG projects conducted in Greenland during the summer of 1960, were assigned to the US Army Polar Research and Development Center for administrative support as provided by AR 70-15. Over all command authority for these projects was exercised by the USATREG Task Element Commander.

As was the case in 1959, every effort was made to reduce the administrative requirements of the Task Element in Greenland to the lowest possible level. Whenever possible, the Group Headquarters at Fort Eustis, Virginia, processed all paperwork leaving only the most essential details to be handled in the field.

Prior to the departure of the project personnel for Greenland, all personnel were given extensive physical and dental examinations. All defects noted during these examinations were corrected prior to shipment, or replacement personnel were assigned when the defects were of a serious nature. This care paid dividends during the course of the project as no major illnesses presented themselves. One man, however, was evacuated to Camp Tuto from the swing because of broken dentures, but this was in no way an emergency evacuation and the man could have remained on duty had it been necessary. One man was found to be suffering from a broken wrist bone after his arrival in Greenland, however, a cast was placed on his arm for the duration of the project and proved to be no hindrance to the carrying out of his assigned duties.

The only personnel records which were forwarded with the personnel were DD Forms 93 (Emergency Addressee), DA Form 14-118 (Travel Card), and the medical and dental records. Through prior agreement with USAPR & DC other individual records were retained at Fort Eustis, thereby, considerably reducing the administrative burden of the task element. In order to insure the prompt payment of all personnel and the availability of funds for their dependents, arrangements were made to have all project personnel paid by check rather than by cash.

One emergency leave arose during the project. The man involved was evacuated from the swing to Thule Air Base by a ski equipped Air Force C-130 and was returned to CONUS on the first available MATS aircraft.

3. MORALE AND WELFARE

Every effort was made to insure a high state of morale among project personnel during their tour in Greenland. In this area, USAPR & DC and the Group Headquarters at Fort Eustis made significant contributions. Exchange facilities, Special Service activities, and the Chaplain's services provided

for the troops while quartered at Camp Tuto, were commendable. The Group Headquarters at Fort Eustis bolstered the morale of the troop in Greenland by taking a direct and genuine interest in the families of the Project LEAD DOG 60 personnel. Every assistance was given to these families by the adjutant and administration section to resolve all problems which arose. News from the project was forwarded to all families and aid was given in cases where the family was forced to move to new quarters or medical assistance was needed. This active interest by the organization reduced anxiety of project personnel over the comfort of their dependents.

During the period the swing was on the icecap, morale remained at an extremely high level. Since inactivity causes many psychological problems in any isolated area, it was important that every effort be made to keep everyone active and to prevent boredom from overcoming the men. All personnel were required to work a 12 hour shift each day, seven days a week.



Figure 60. Distributing mail to LEAD DOG 60 personnel. The frequent delivery of mail greatly enhanced morale.

In order to provide maximum relaxation during the personnel's free time, many books were carried and movies were shown periodically in the Signal Wanigan.

Every opportunity was made to deliver mail to the surface party. Each aircraft flight to the swing carried mail and fresh milk. In addition, the C-130 flight at Crown Prince Christian Land brought Protestant and Catholic Chaplains who performed their respective services next to the aircraft.

Class "A" rations were served in the swing's mess wanigan four times a day. The high quality of the meals from both a nutritional and taste standpoint contributed greatly to the comfort of all personnel.

An important factor in the high state of morale was the high living standard required of all personnel and the care taken to prepare the living wanigans for the projects. Prior to the swing's departure from Camp Tuto, every effort was made to insure that all electrical, heating, and plumbing facilities were in perfect condition in order to provide maximum comfort for all personnel throughout the project. Innerspring mattresses were installed in all bunks and sheets were provided to the personnel. Washing and drying machines were installed in the wanigans and all personnel were required to maintain a high standard of personal appearance to include daily shaves and closely cut hair. In addition, due to the cramped quarters, it was necessary that the crew wanigans be cleaned and aired frequently. An extremely high degree of personal hygiene and self-discipline was maintained by all personnel and personality conflicts were virtually nonexistent.

A small non-profit exchange, stocked with over \$2,688.16 worth of goods, was maintained on the swing and sold personal supplies valued at \$1,874.00. Shaving and toilet articles, as well as numerous niceties and snacks were provided all personnel.

B. LOGISTICS.

An operation of this nature requires extremely efficient and careful logistical support. Because of the area of operations it is necessary that every contingency be conceived and planned for in detail. A total of 564 line items of spare parts totaling over 2,000 separate items were carried to insure against disastrous breakdowns. Even so it was necessary to airlift 50 parts to the swing on contact flights. Another 1108 line items of supplies were carried as tools, survival gear, expendable items and other supplies to support the project during the period it was in the field. (See Table 9 & 10)

The necessary supplies was provided by USATREOG and USAPR&DC. Those items which were not available from stocks maintained by USAPR&DC and USATREOG in Greenland were shipped to Thule from Fort Eustis, Virginia. These items were airlifted to Thule Air Base by MATS and included the TREGO aircraft, the new rolling stock to be evaluated on the ice-cap, and several CONEX Containers packed with the numerous items which

TABLE 8
PERSONNEL PARTICIPATING IN PROJECT LEAD DOG 66

NAME	RANK	DUTY	ORGANIZATION	PERIOD WITH PROJECT	REMARKS
Sandridge, James W.	Lt. Col.	Commanding Officer	USATREOG	16 June - 19 July	Accompanied helicopters into field. (25 June to 12 July)
Munsel, Harold M.	Capt.	Project Officer	USATREOG	15 May - 16 June	Departed on AF C130
Davis, Clarence A.	Capt.	Aviation Officer	USATREOG	16 June - 5 July	Observed rwing operations
Roberts, Arthur R.	Capt.	Aviation Maint. Officer	USATREOG		Commander rear element - pro- cured spare parts and coordinated flights to the swing
Bronson, Don W.	Capt.	Chemical Test	Chemical Corps Test Team	15 May - 16 June	Departed on AF C130
Duffy, Henry A.	1/Lt.	Fixed Wing Pilot	USATREOG	19 July	Made one flight to the swing. At- tempted two flights to the swing
Walton, Joseph A.	1/Lt.	Swing Commander	USATREOG	15 May - 24 July	
Tracy, George	1/Lt.	Fixed Wing Pilot	USATREOG	1 July - 5 July 19 July	Made two flights to the swing, weathered in on one flight
Schwenka, Medric C.	CWO	Communications Officer	USATREOG	15 May - 20 May	
Madden, Michael J.	CWO	Rotary Wing Pilot	USATREOG	10 June - 14 July	Helicopters in field 25 June to 12 July
Lindsey, David H.	CWO	Rotary Wing Pilot	USATREOG	do	do
Mayville, Michael	CWO	Rotary Wing Pilot	USATREOG	do	do
Morton, Ulysees	CWO	Rotary Wing Pilot	USATREOG	do	do
Davies, William	Civ.	Geologist	U. S. G. S.	16 June - 14 July	Arrived on AF C130 aircraft, ac- companied helicopters into field
Krinsley, Daniel	Civ.	Geologist	U. S. G. S.	13 June - 14 July	Accompanied helicopters into the field

NAME	RANK	DUTY	ORGANIZATION	PERIOD WITH PROJECT	REMARKS
Knuth, Count Eigil	Civ.	Archeologist	Danish Gov.	16 June - 14 July	Arrived on AF C130 aircraft accompanied helicopters into the field
Hogue, Donald W.	Civ.	Geographer	QMREC	15 May - 5 July	Returned to Camp Tuto on Otter Flight
Sumner, Roger D.	Civ.	Glaciologist	USACRREL	do	do
Abnert, Dr. Frank	Civ.	Geographer	USATRECOM	5 July - 14 July	Arrived on Otter flight Departed with helicopters
Mommett, Wallace L.	Civ.	H-34 Tech. Rep.	SIKORSKY	16 June - 14 July	Arrived on AF C130 aircraft Departed with helicopters
Fields, James S	M/Sgt.	NGOIC	USATREOG	15 May - 24 July	
Gould, Roger C.	SFC	A/C Crew Chief	USATREOG	10 June - 14 July	Accompanied helicopters
Martinez, Augustin	SFC	Shift/Ldr Operator	USATREOG	15 May - 24 July	
Pitts, Elery F.	SFC	Shift/Ldr Operator	USATREOG	15 May - 4 July	Departed swing on Otter flight
Santana, Frank S.	SFC	Operator - Welder	USATREOG	15 May - 24 June	
Agnew, Johnson E.	SP6	A/C Technical Inspector	USATREOG	do	
Gallagher, John W.	SP6	Aircraft Mechanic	USATREOG	10 June - 14 July	Accompanied helicopters
Noxon, Winford C.	Gun/Sgt	Trainee/Observer (USMC)	YX 6	15 May - 24 July	
Myer, John R.	Sgt	Aircraft Mechanic	USATREOG	10 June - 14 July	
Smith, William L.	Sgt	Supplyman	USATREOG	15 May - 24 July	
Winn, Busby M.	Sgt	Navigator	USATREOG	do	
Anderson, George E.	Sgt	Weather Observer	SIG R&D	do	

NAME	RANK	DUTY	ORGANIZATION	PERIOD WITH PROJECT	REMARKS
Beck, Donald E.	SP5	Gravity Team	Army Map Svc	do	
Casey, Minor J.	SP5	Radio Operator	USATREOG	do	
Cohingham, Charles F.	SP5	First Cook	USATREOG	do	
Ezell, Jack J.	SP5	Tractor Operator	USATREOG	do	
Gregory, James S.	SP5	Tractor Operator	USATREOG	do	
Grisolano, Fred L.	SP5	First Cook	USATREOG	do	
Hutchens, James C.	SP5	Tractor Operator	USATREOG	do	
Lowther, Gaylord, G	SP5	Electrician	USATREOG	15 May - 19 July	
Maxfield, Loren M.	SP5	Topographic Team	Army Map Svc	15 May - 24 July	
Mayo, Joseph B.	SP5	Maintenance NCO	USATREOG	do	
Nornburg, Paul I.	SP5	Motion Picture Photographer	Army Pic. Svc.	do	
Payne, Gayle T.	SP5	Chemical Test	Chnl Corps Test Team	do	
Rowe, Eugene A.	SP5	Tractor Operator	USATREOG	do	
Wagner, Howard J.	SP5	Topographic Team	Army Map Svc	do	
Williamns, Herbert	SP5	Plumber	USATREOG	do	
Anderson, Wayne R.	SP4	Radio-/Radar Repairman	USATREOG	do	
Forci, Joseph J.	SP4	Photographer	USATREOG	do	
Henry, Kenneth D.	SP4	Tractor Operator	USATREOG	do	
Hogan, Robert E.	SP4	Asst Navigator	USATREOG	15 May - 19 July	Returned to Camp Tuto By Helicopter
Larsen, Wilmer E.	SP4	A/C Crew Chief	USATREOG	10 June - 14 July	Accompanied Helicopters

NAME	RANK	DUTY	ORGANIZATION	PERIOD WITH PROJECT	REMARKS
Morton, James D.	SP4	Tractor Operator / Mechanic	USATREOG	15 May - 24 July	
McCullum, Robert L.	SP4	Tractor Operator	USATREOG	do	
Rainsberg, Ralph	SP4	Tractor Operator / Mechanic	USATREOG	do	
Roy, Jess L.	SP4	Sheet Metal Worker	USATREOG	22 May - 14 July	Arrived by PR & DC Helicopter
Schultz, John Jr.	SP4	Tractor Operator	USATREOG	15 May - 24 July	
Thompson, Donald I.	SP4	Mechanic	USATREOG	do	
Walters, Dixon L.	SP4	Radioman	USATREOG	do	
Wyatt, Eugene	SP4	Corpsman	USAPR & DC	do	
Castro, Ronald B.	PFC	Still Photography	Army Pic. Svc.	do	
Correia, Charles H.	PFC	A/C Electrician	USATREOG	15 May - 24 July	Returned with Helicopters
Kramer, Gerald R.	PFC	Weather Observer	Sig R & D	15 May - 24 July	

are required for an operation of this nature. As the Transportation Corps had no future plans for operations in Greenland, all those items which were not required for operations in other environments, or which were not worth the cost of retrograde shipment were turned over to USAPR&DC. These items included Wanigans, sleds, Weasels, Electronic equipment, and a multitude of spare parts and miscellaneous equipment.

Accountability for all property was maintained through hand receipt accounts maintained by the Swing Commander and Aviation Officer from the TREG and PR&DC property book officers. One supply man accompanied the swing and supervised the issuance of parts and supplies. Rations for the project were drawn from the USAF at Thule Air Base. In addition to emergency rations, the tractor swing carried 12 tons of those Class "A" rations available in Thule which could be frozen and kept during the period the swing was in the field. (See Table 11)

Fuel management was very important during the course of the project. Due to the large load of Avgas and Aviation spare parts that the swing was required to carry, fuel requirements had to be computed to the last gallon. Including the fuel available to the swing from its cargo and the caches, there was a 35,900 gallon store from which the swing could draw. Of this total the swing's equipment actually burned 33,725 gallons of Diesel Fuel. This close figuring required a detailed accounting at all times of the fuel available in order to insure that sufficient reserves were available for the swing's return to Camp Tuto.

As the swing returned, all unnecessary consumable items were cached at various points along the trail. (See Table 13) The supplies in these caches were placed on the snow surface and marked at the corners with trail markers. These supplies should be visible for two years and the markers for at least one more. The supplies cached at Mile 664.4 and 124.2 should be visible for several more years as the summer melt is extreme in these areas.

TABLE 9

CARGO CARRIED

POL

Diesel Fuel - Arctic	35,900 gallons
Automotive Gasoline - 86 Octane	4,950 gallons
Aviation Gasoline - 115/145 Octane	19,850 gallons
Miscellaneous Lubricants	2,950 gallons
Total POL	63,400 gallons

TABLE 9 (Cont'd)

CARGO CARRIED

DRY CARGO

Rations	28,000 pounds
Spare Parts (Aircraft and Surface Vehicles)	36,000 pounds
Explosives	5,000 pounds
Miscellaneous Equipment	9,000 pounds
Total Dry Cargo	78,000 pounds
Total Cargo	484,700 pounds

TABLE 10

PROJECT SUPPLIES

Accountable Property		476 line items
Provided by USATREOG	414 line items	
Provided by USAPR&DC	62 line items	
Spare Parts		564 line items
Provided by USATREOG	287 line items	
Provided by USAPR&DC	277 line items	
Consumable Supplies		632 line items
TOTAL SUPPLIES		1672 line items

TABLE 11

RATIONS CARRIED

Beef Grill Steak	297 Lbs
Beef Oven Roast	256 Lbs
Beef Pot Roast	252 Lbs
Beef Swiss Steak	298 Lbs
Beef Ground	690 Lbs
Beef Liver	52 Lbs
Fish Cod	100 Lbs
Fish Perch	100 Lbs
Ham Canned	824 Lbs

TABLE 11 (Cont'd)

RATIONS CARRIED

Chicken RTC	530 Lbs
Turkey RTC	583 Lbs
Veal Roast	205 Lbs
Veal Steak	209 Lbs
Veal Ground	217 Lbs
Pork Loin P/D	410 Lbs
Pork Ham Fresh Frozen	179 Lbs
Shrimp Breaded	150 Lbs
Butter Surplus	120 Lbs
Butter Patties	600 Lbs
Cheese American	60 Lbs
Cheese Cheddar	83 Lbs
Eggs Shell Fresh	690 Doz
Cabbage White	150 Lbs
Carrots Fresh	50 Lbs
Celery Fresh	165 Lbs
Lettuce Fresh	350 Lbs
Onions Dry	150 Lbs
Onions Green	60 Lbs
Peppers Green	56 Lbs
Radishes	45 Lbs
Tomatoes Fresh	364 Lbs
Beans Lima Frozen	80 Lbs
Beans Green Snap Frozen	160 Lbs
Beans Wax Frozen	160 Lbs
Broccoli Frozen	30 Lbs
Brussel Sprouts Frozen	60 Lbs
Cauliflower Frozen	30 Lbs
Peas Frozen	80 Lbs
Vegetables Mixed Frozen	40 Lbs
Apples Fresh	200 Lbs
Grapefruit Fresh	128 Lbs
Lemons Fresh	36 Lbs
Oranges Fresh	280 Lbs
Peaches Frozen	234 Lbs
Strawberries Frozen	156 Lbs
Juice Grape Frozen 32 oz cans	48 cans
Juice Grapefruit Frozen 32 oz cans	36 cans
Juice Orange Frozen 32 oz cans	96 cans
Bacon Canned 24 oz cans	240 cans
Pork Sausages Links 23 oz cans	24 cans

TABLE 11 (Cont'd)

RATIONS CARRIED

Eggs Whole Dried #10 cans	30 cans
Milk Evap 14.5 oz can	960 cans
Asparagus can #300	48 cans
Beans Lima #10 can	24 cans
Bean Green #10 can	12 cans
Beets #10 can	12 cans
Corn Cream Style #303 can	72 cans
Corn Whole Grain #10 can	42 cans
Peas #10 can	42 cans
Potatoes Sweet #3 squat	24 cans
Potatoes White Whole #10 can	270 cans
Potatoes Grandulated #10 can	42 cans
Tomatoes #10 can	60 cans
Beans Red Kidney	50 Lbs
Beans Dry White	60 Lbs
Beans W/Pork in Ts #2.5 can	120 cans
Applesauce #10 can	12 cans
Apples #10 can	24 cans
Cherries Red Sour #10 can	18 cans
Cranberry Sauce #300 can	120 cans
Grapefruit Segm. #2 can	24 cans
Peaches #10 can	60 cans
Pears #10 can	60 cans
Pineapple Crushed #10 can	6 cans
Pineapple Sliced #10 can	18 cans
Pineapple Tidbits #10 can	6 cans
Juice Orange #3 cyl can	60 cans
Orange and Grapefruit #3 cyl can	36 cans
Juice Pineapple #3 cyl can	48 cans
Juice Tomato #3 can	96 cans
Coffee	810 Lbs
Dessert Pud Butterscotch #2.5 can	24 cans
Dessert pud Chocolate #2.5 can	24 cans
Dessert pud Vanilla #2.5 can	24 cans
Dessert pud Lime #2.5 can	24 cans
Dessert pud Cherry #2.5 can	24 cans
Ice Cream Mix #10 can	60 cans
Spaghetti	80 Lbs
Macaroni	72 Lbs
Noodles	20 Lbs
Rice	120 Lbs

TABLE 11 (Cont'd)

RATIONS CARRIED

Apples #10 Dehy.	6 cans
Baking Powder 1 lb can	24 cans
Catsup #10 can	36 cans
Cereal Bran Flakes Ind Pkg	450 pkg
Cereal Corn Flakes ind pkg	600 pkg
Cereal Sugar Pops ind pkg	500 pkg
Cereal Wheat Farina #10 can	6 cans
Cereal Rolled Oats 20 oz can	24 cans
Cherries Maraschino 28 oz btl	24 btl
Chilli sauce 12 oz btl	24 btl
Cocoa 1 lb can	24 cans
Cornmeal #10 can	6 cans
Cornstarch 1 lb pkg	48 pkg
Coconut 1 lb can	12 cans
Crackers soda	96 lb
Extract lemon 8 oz btl	12 btl
Extract vanilla 8 oz btl	24 btl
Flour Wheat Hard	1,100 lb
Honey 1 lb	24 jars
Jam Cherry #2.5 can	48 cans
Jam Raspberry #2.5 can	48 cans
Jam Strawberry #2.5 can	48 cans
Jelly Apple #2.5 can	36 cans
Jelly Blackberry #2.5 can	36 cans
Jelly Grape #2.5 can	36 cans
Salad oil 1 gal can	24 cans
Mushrooms sliced 8 oz can	48 cans
Mustard prep. #10 can	6 cans
Nuts Walnuts 1 lb can	24 cans
Olives Green 1 qt	24 jars
Olives stuffed 1 qt	36 jars
Onions Dehy #10 can	36 cans
Tomato Paste #2.5 can	24 cans
Peanut Butter #2.5 can	72 cans
Pepper Black 1 lb co	12 cos
Pickles Whole Dill #10 can	6 cans
Pickles Whole Sweet #10 can	6 cans
Pimentoes 7 oz can	48 cans
Raisins #10 can	6 cans
Salad Dressing #10 can	18 cans
Salt Celery 4 oz	48 cos
Salt Table	180 lb

TABLE 11 (Cont'd)

RATIONS CARRIED

Sauce Meat 8 oz btl	24 btl
Sauce Worchestershire	48 btl
Sauce Hot	144 btl
Syrup Maple imit #2.5 can	24 cans
Sugar Granulated	720 lb
Sugar Ref Pwd 1 lb pkg	96 pkg
Sugar Brown 1 lb pkg	48 pkg
Soup & gravy base #2.5 can	24 cans
Tea Bags 425, s	6 cans
Toothpicks 720's	48 boxes
Soup Chicken Noodle #10 can	24 cans
Potato Chips	24 lb
Soup Pea #10 can	12 cans
Pretzels	24 lb
Pigs feet 14 oz jar	24 jars
Sausages Polished 1/2 gal jar	6 jars
Shortening 5 gal can	10 cans
Milk Dry n/f #50	200 lbs
Bread White loaf	1,200 loaves
Ration Combat "C"	35 cases
Ration Small Detachment "5 in 1"	120 cases
Ration Dehydrated Quick-Serve	106 boxes

TABLE 12

MAJOR ITEMS OF EQUIPMENT

LGP D8 Tractor w/dozer blade	1 ea
LGP D8 Tractor w/dozer blade and Hyster Hoist	1 ea
LGP D8 Tractor w/650 gallon bow tank	4 ea
M29C Weasel w/modified body	3 ea*

*NOTE: One M29C Weasel and one 1 ton Sled were airlifted in to the Cambridge Research Center Camp at Centrum Lake by C130 aircraft prior to the departure of the swing from Camp Tuto. The M20C was returned by the swing while the sled was evacuated later in the year by C130. The remainder of the items were used in direct support of the project.

TABLE 12 (Cont'd)

MAJOR ITEMS OF EQUIPMENT

M29C Weasel	1 ea
10 Ton OTACO bobsled	20 ea
20 Ton bobsled	1 ea
Crew Wanigan - 24 man	2 ea
Command Wanigan - 6 man	1 ea
Signal Wanigan	1 ea
Mess Wanigan	1 ea
Generator/Maintenance Wanigan	1 ea
1 Ton sled	3 ea*
Rolling Liquid Transporter, T-3	7 ea
2,000 Gal/3 ton RLT Trailer	1 ea
10 Ton Off-Road Trailer	2 ea
19 K.W. Generator, A.C.	2 ea
5 K.W. Generator, A.C.	4 ea
5 CFM Compressor	1 ea
Hobart Welder	1 ea
AN/GRC-19 Radio Receiver-Transmitter	2 ea
AN/GRC-9 Radio Receiver-Transmitter	5 ea
T-368-C/U Radio Transmitter	1 ea
Radar Set, Bendix, MR3B	1 ea
Radar Set, Sperry Mark 22	1 ea
AN/PRC-9 Radio Receiver-Transmitter	8 ea
Herman-Nelson Heating, 500,000 BTU	3 ea
Crevasse Detector	1 ea
Wilcox Beacon Set 444 B	1 ea
R 388/URR Radio Receiver	2 ea
R 390/URR Radio Receiver	1 ea
H34C Helicopter	2 ea
U1A Aircraft (Based at Thule Air Base)	2 ea

*NOTE: One M29C Weasel and one 1 ton Sled were airlifted in to the Cambridge Research Center Camp at Centrum Lake by C130 aircraft prior to the departure of the swing from Camp Tuto. The M29C was returned by the swing while the sled was evacuated later in the year by C130. The remainder of the items were used in direct support of the project.

TABLE 13

CACHE CONSIST

Mile 231	
AvGas	59 drums
OE 10	20 gallons
Rations	1 case
MoGas	2 drums
Mile 342.4 (79° 02' N 49° 10'W)	
AvGas	15 drums
MoGas	2 drums
Mile 410	
AvGas	6 drums
OE 1100	1 drum
Rations	4 cases
Mile 481.4 (79° 59' 42" N 39° 38' 12"W)	
CO 90	240 gallons
AvGas	91 drums
OE 1100	1 drum
MoGas	19 drums
Antifreeze	2 drums
Rations	27 cases
Flags	3 cases
Blasting caps (electric)	1 case
Reflectors	1 case
Explosives (C4 & C3)	91 cases
Bamboo poles	200 ea
Mile 581.4 (79° 59' N 30° 25'W)	
AvGas	6 drums
Mile 124.2P (81° 48' N 39° 55'W)	
Rations	21 cases
OE 1100	1 drum
AvGas	72 drums
MoGas	11 drums
Mile 664.4 (79° 49' N 24° 23'W)	
OE 1100	1 drum
AvGas	15 drums

NOTE: This is the contents of the caches remaining after the completion of the project.

CHAPTER XI

COMMUNICATIONS AND ELECTRONIC EQUIPMENT

1. GENERAL

This chapter covers the activities of the Signal personnel and the operation of electronic equipment utilized by Project LEAD DOG 60. The chapter is divided into two sections. The first section covers radio communications procedures, while the second discusses the effectiveness of the electronic devices utilized by the project.

2. RADIO COMMUNICATIONS PROCEDURES

During the entire period the swing was on the icecap voice radio communications were maintained with at least one of the numerous radio stations operating in Northern Greenland and Ellesmere Island. Although the primary net on which the project operated was that maintained by the US Army Polar Research and Development Center at Camp Tuto, regular radio contact was maintained with Thule Air Base, Station Nord, Station Alert, and the Cambridge Research Center Camp at Centrum Lake. In reference to this last station, the LEAD DOG radio station often acted as a relay station between Thule and Centrum Lake. Although radio contact was lost with Camp Tuto on occasion, due to atmospheric conditions, voice contact with Nord Radio and Thule was always possible. In addition, periodic messages were relayed to Ward Hunt Island, Sondrestrom and Resolute Bay.

The primary transmitter utilized was a T-368 c/u AM transmitter. This transmitter was used to send the majority of the swings radio traffic, that traffic sent to Camp Tuto and Thule. One AN/GRC-19 radio was netted with Centrum Lake, and the TREOG aircraft, and the trail parties. Another AN/GRC-19 radio was used as a spare and set on a third frequency when necessary. The T368 c/u transmitter proved far superior to AN/GRC-19 radios because of its greater power. The T368 c/u sends a signal of 450 watts of RF output while the AN/GRC-19 transmits at a maximum of 80 watts. The T368 c/u has the added advantage of being capable of transmitting at full wattage regardless of frequency while the AN/GRC-19's output varies according to the frequency. However, adequate communications could have been maintained on the AN/GRC-19, although the majority of the traffic would have had to be continuous wave transmission.

On two separate occasions, while the swing was at Mile 664.4, freak atmospheric conditions permitted loud and clear FM voice transmission between the swing and Camp Tuto. The swing transmitted and received on an AN/PRC-9 while Camp Tuto operated on an AN/VRC-9.

Adequate AM radio reception was provided through the use of two R-388/URR and one R-390/URR receivers. These receivers were set on the two primary and one alternate net over which the swing operated. The R-390/URR proved to be far superior to R-388/URR because of its greater sensitivity. These receivers operated directly on the 120 AC volt power system.

An FM net was established between all the swing's vehicles and the signal wanigan. The AN/PRC-9 (FM transmitter/receiver) was chosen for this job because of its simplicity, limited range, and ruggedness. It has sufficient range to cover the entire swing when completely spread out, but would not interfere with distant radio nets. This net greatly facilitated the movement of the swing. The maintenance NCO, or his assistant who continually patrolled the swing in the maintenance Weasel, were readily available to the tractor operators in case of a mechanical malfunction. At all times, and especially during periods of bad weather, these radios provided an easy and efficient method of controlling the swing's movement.

With the exception of the vehicle radios, all of the swing's radio equipment was installed in the 24 man wanigan which had been modified for use as a radio station, and an office for the scientists and technicians. The power source for the radios was a 19,000 watt generator which was mounted in the generator wanigan. The power was converted for use by the AN/GRC-19 and AN/PRC-9 radios by a PP-1104 converter. The T-369 c/u transmitter was capable of operating directly from the 120 volt power generated by the generator. Two Whip antennas, each 15 feet long, were mounted externally on the command wanigan. The whips were mounted in the center of the wanigan in such a manner that the metal top was used as a counterpoise.

A new type gig antenna was rigged and installed on the top of the mess wanigan which was always towed behind the signal wanigan. The frame on this antenna was made of two inch pipe. A total of 280 feet of 14 gauge copper wire was stretched between the two uprights of the antenna. This antenna was installed in such a manner as to be 360° directional. It was used for receiving on all the AM frequencies, and was found to be more than adequate, and superior to the whip and the long wire antenna for periods when the swing was underway.

However, for periods when the swing was stopped and the long wire could be oriented perpendicularly to the waves of the desired station, the long wire proved to have a greater sensitivity.

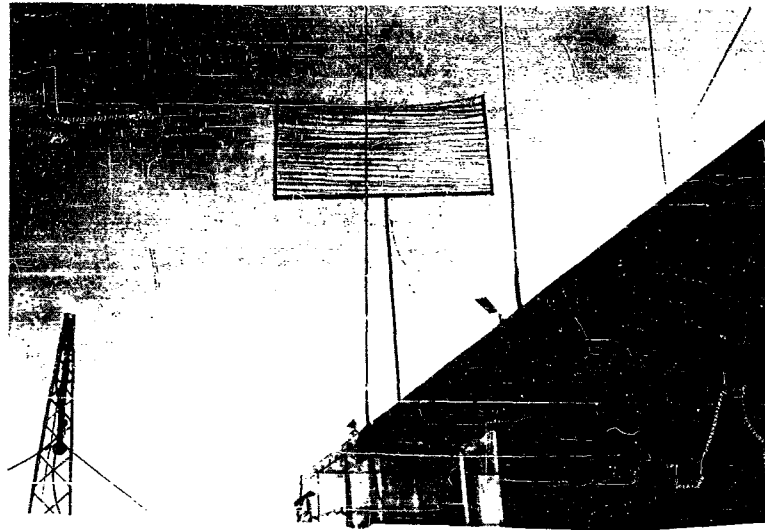

Figure 61: "Gig" receiving antenna and whip antennas used for transmitting shown mounted on the signal wagon.

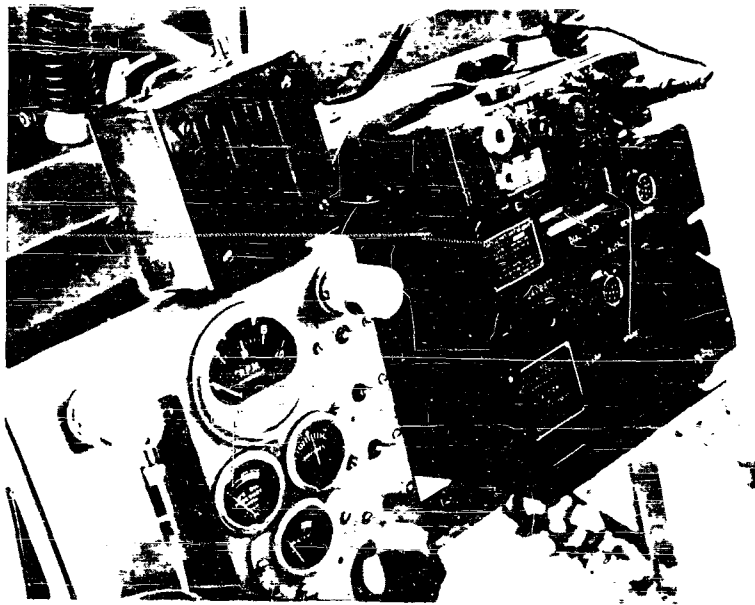

Figure 62: AN/PRC-9 transmitter/receiver and power supply mounted in D-8 tractor.

3. ELECTRONIC NAVIGATION AIDS

AIRCRAFT HOMING BEACON

A Wilcox 444-B low frequency beacon was utilized to determine its suitability for homing aircraft to the swing. Although repeated attempts were made to provide a homing beacon, it was never capable of providing a sufficiently strong signal on which the aircraft could home. During the C130 flight to the swing, the aircraft was able to read the signal 35 miles away, but, even though the full load of 50 watts was transmitted, the signal did not have sufficient strength on which to guide. The primary reason for this is that the proper type antenna can not be installed by an icecap swing. With this type beacon, an 1100 foot long wire antenna must be suspended at least 40 feet above the ground. This could not be done, and the wire was stretched out on the ground.

VEHICLE MOUNTED RADAR

The maintenance Weasel and one of the two navigation Weasels were equipped with radar. A Bendix MR3B Marine radar set was installed in the maintenance Weasel, while a Sperry No. 5 radar set was installed in the trail marking Weasel.

The Bendix set has a range of from 40 yards to 20 miles. It was generally used for short ranges up to a maximum distance of four miles. It proved quite useful for guiding the swing over a marked trail during periods of low visibility. A very clear representation of the trail was obtained, showing trail markers, barrels, vehicular tracks, and other vehicles. When used in conjunction with radio, the radar would allow a swing to move over a marked trail during periods of zero visibility. When used with a gyro compass and radio, the radar would allow a swing to mark a trail during periods of zero visibility. Power for the set was provided through the use of a power supply which inverted 24 volts generated by an auxiliary generator installed on the Weasel, to 115 volts for the radar. This is the primary restriction with this set as an auxiliary power supply is necessary to operate the radar.

Difficulty was experienced with the Sperry Marine Radar System No. 5. The contrast proved difficult to adjust and once adjusted required constant tuning to maintain the proper contrast. The maximum effective range of the radar was only 1/4 mile. After 406 miles, the tripod mount cracked in two places. The mount is not strong enough to withstand the stress of the Weasel's rough riding characteristics when operating on the icecap. The vehicles had to be completely level in order to maintain the image, and, as a result, the set proved effective only when the vehicle was stationary. The set is relatively simple to install and operate, and the fact that it will operate on 12 or

32 volts makes it adaptable to mounting on a Weasel, although its use on a 24 volt combat vehicle would be prohibited.

GYROCOMPASS

Two different makes of gyrocompass were obtained for evaluation during Project LEAD DOG 60. An Arma Subminiature Gyrocompass was installed in each of the trail marking and maintenance Weasels, and utilized extensively while operating over the icecap. Two Sperry Mark 22 Gyrocompasses were also procured but could not be utilized as the compass fating weights, which compensate for compass drift, had not been properly adjusted at the factory, and proper instruments were not available in Greenland to make this adjustment.

The Arma Gyrocompass proved to be an invaluable aid to navigation. Fortunately visibility during the trail marking period was generally excellent and it was not necessary to rely on compasses to any extent. The compass was used to maintain the proper course between trail markers. Nevertheless, if it had been necessary to follow the compass from Mile 481.4 to Mile 664.4 it is believed that the swing could have relied upon the gyrocompass to bring it to its destination within a maximum error of five miles. Assuming of course, that convergence of meridians was accurately computed and that extreme care was exercised in following the compass bearings. During several periods of low visibility ranging from 15 to 50 minutes, when it was impossible to back sight, poles were placed by using the compass and the vehicle odometer. There proved to be a maximum of only three feet variation in course among the poles placed in this manner.

CREVASSE DETECTOR

One of the "W" System crevasse detectors was installed on the trail marking vehicle for periods when moving through unmarked marginal areas. This detector did not prove to be sufficiently accurate for icecap operations. It often gave false readings, or strong indications when crossing small cracks, air pockets, and melt pockets, but would give no indication when crossing large crevasses. The present detector is not considered to be sufficiently reliable for icecap operations.

VEHICLE DIRECTION AND POSITION COMPUTER

Two Ford Vehicle Direction and Position Computers (VDPC) were provided by the Engineer Research and Development Laboratory for evaluation by TREG in the various environments of the world. The VDPC system consists of the following components: the Ford computer, a motor generator

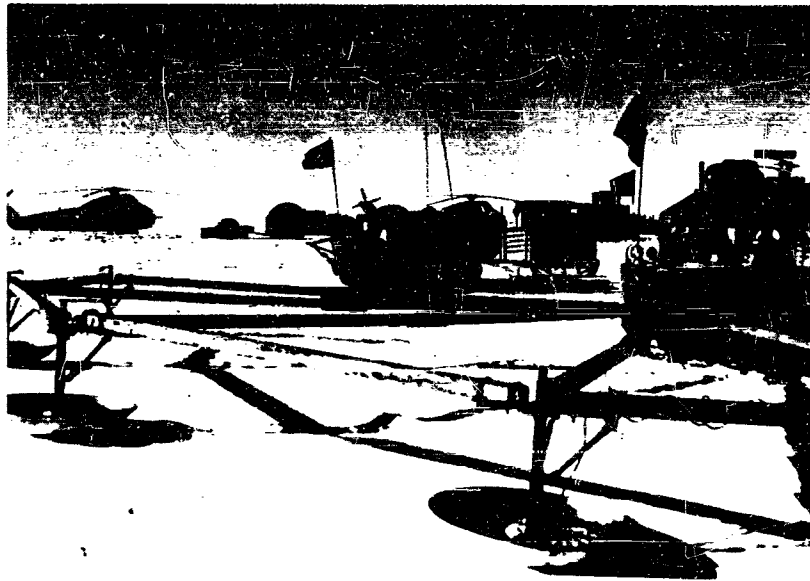

Figure 63: "W" System crevasse detector and Sperry Marine Radar mounted on pathfinder weasel.

with attached control box, a frequency regulator, the Arma Subminiature Gyrocompass, and a distance data transmitter.

As this computer requires all positions to be programmed by grid rather than geographic position, it tends to be very impractical in extremely northern (or southern) latitudes. As there was no military grid mapping of the area of this project's operations, extremely complicated computations would have been necessary to convert from geographic to grid positions. When computing distance and azimuth traveled from a known point, the information is given in meters thereby requiring conversion to latitude and longitude. Because of the decreasing value of a degree of longitude towards the pole, extensive computations are necessary to arrive at a proper positioning. (See TM 5-237, Surveying Computer's Manual, DA Technical Manual, dated May 1957, page 152-154, for the formula for converting from grid to geographic position). Further complicating the use of this system is the fact that extending to the poles from 80° North or 80° South, the Polar Stereographic Grid System is used which does not give position, but only azimuth. As ice-cap trails, except in marginal zones, generally follow great circle routes with only occasional changes in course to compensate for meridian convergence, a computer of this type appears to be of limited value.

The computers were not utilized due to the lack of personnel capable of programming the grid position and operating the system. Furthermore, geographic positions determined from sun observations are, at best, semi-accurate positions. For proper evaluation of the computer, the point of departure and the destination must be accurately known. Sufficient time was not available to make the lengthy and complicated position determinations necessary to accurately evaluate the computer.

ANNEX A

ACTIVITY REPORT ON W. L. MONNETT, JR.,
SIKORSKY TECHNICAL REPRESENTATIVE

June 1960

1. This report is submitted as the required Contractor's Representative report for the subject period. This representative is assigned to the U. S. Army TREG Element, Camp Tuto, Greenland, under Army Contract Number DA23-204-TC-782, call number 14.

2. The duties of this representative have been to render all possible assistance in the maintenance and operation of Sikorsky H-34C model helicopters which are assigned to the above organization.

3. Two H-34C's, DA#54-908 and DA#54-931, departed Thule AB on 10 June 1960 to fly across the Greenland Icecap as part of Operation LEAD DOG 60. At about Mile 570 from Camp Tuto, it was necessary to land because of bad weather ahead. In DA#54-908, a capacitor had burned out in the transmitter of the ARC/59 radio. The ARC/59 in DA#54-931 was functioning all right but atmospheric conditions prevented radio contact with Camp Tuto. After camping out overnight, the helicopters joined the sled swing near the base site for LEAD DOG 60 at the northeastern edge of the Greenland Icecap. A replacement part was brought to the LEAD DOG 60 base site on 15 June via a C-130 cargo transport aircraft, along with other spare parts, rations, and passengers, including this representative, who were to join the sled swing. The writer remained with the sled swing, which maintained radio communication with the helicopters when the latter were away from the swing.

4. An incident occurred which reflected very favorably on the protective capability of the lightweight main rotor blade container, Specification MIL-P-5806A(ASG). Three of these containers, with H-34C main rotor blades, had been removed from the above mentioned C-130 and stacked in a pile about 40 feet behind the aircraft. Normally this would be a safe distance. When ready to depart, the C-130's four engines had to be "revved up" to break the skis loose from the snow and start the aircraft moving. The blade containers were right in the prop blast, and the top one was picked up and tossed approximately 50 feet, being lifted to a height of about 15 feet above the snow level in its flight. The writer went over to look at the container and a cursory inspection revealed no obvious damage. Later on the container was opened and the blade carefully inspected, but no damage to the blade or container was detected. Of course, the container had a cushion of snow to land in, but it was still quite a shock to withstand.

5. A Tokheim hand operated fuel transfer pump, manufacturer's P/N 406431, was carried by the H-34C helicopters for use in refueling from drums previously deposited at various points. It was found that fabricating a seal for the standpipe assembly, which screws into the fuel drum, made it possible to pressurize the drum by connecting a small air compressor to the drum vent hole. When the pump itself was replaced in the fuel line by a piece of pipe, a small air pressure applied to the drum would suffice to get a forced flow of fuel. This was used successfully in crossing the Icecap from Thule AB to LEAD DOG 60 base site. However, on subsequent missions the fuel was hand pumped from the drums because it would be necessary to unload too much other cargo to get to the air compressor and auxiliary power unit.

6. The helicopters did succeed in locating a route by which Weasels could leave the Icecap and travel to Centrum Lake, base camp of the Cambridge Research Center.

7. After being grounded by weather for several days, the H-34C's were able to transport 24 drums of aviation fuel from the LEAD DOG 60 base site on the Icecap to Centrum Lake. On 25 June the helicopters departed the LEAD DOG 60 base site carrying scientist personnel for their respective missions in Kron Prins Christians Land. The sled swing departed the LEAD DOG 60 base camp shortly thereafter on the same date to proceed back along the marked trail to Mile 480 (from Camp Tuto) and then turn north toward a new base camp at the northern edge of the Icecap near Peary Land.

8. At the end of the subject period, the sled swing had reached Mile 480 and stopped to repair a tractor which had been left there on the way out. Up to that time the helicopters, when not grounded by weather, were very capably performing their mission of transporting scientist personnel from place to place in Kron Prins Christians Land. A minor problem reported was a crack discovered in the S1630-80903-24 Clamp Assembly (TM1-1H-34A-10, Figure 6, index 9) at the base of one of the attachment lugs. The clamp assembly was welded at Nord weather station and the helicopter was back on flight status the same day.

9. No other maintenance problems were reported during the subject period.

July 1960

1. This is submitted as the required Contractor's Representative report for the subject period. It is also his final report covering assignment with U. S. Army TREG Element, Camp Tuto, Greenland, under Army Contract Number DA23-204-TC-782, call number 14.

2. The duties of this representative have been to render all possible assistance in the maintenance and operation of Sikorsky H-34C model helicopters which are assigned to the above organization. The writer accompanied the sled swing which supported the H-34C helicopters on the Greenland Icecap as part of Operation LEAD DOG 60. He joined the swing on 15 June 1960, four days after the helicopters, and returned to Thule AB with the helicopters on 14 July 1960.

3. The two H-34C's, DA#54-908 and DA#54-931, which flew across the Greenland Icecap to join the sled swing at the eastern edge of the Cap near Kron Prins Christians Land, performed their missions to the complete satisfaction of all concerned. They were both 100% available from the time of their first joining the sled swing on 11 June 1960 until their arrival back at Thule AB on 14 July 1960. There was one minor trouble of a cracked exhaust collector ring clamp but when the aircraft was flown to Nord weather station to have the clamp welded, it was still able to perform a mission of delivering a scientist to a desired spot on the way and picking him up again on the way back from Nord. During the Icecap operation, DA#54-931 was flown 76:55 hours. DA#54-908 was flown 79:25 hours, and then an additional mission of 3:30 hours from Thule AB to Camp Century and return. During the whole 1960 tour in Greenland, from early April until late July, the total number of hours flown by each H-34C was as follows:

DA#54-908	94:35 hours
DA#54-931	85:30 hours
DA#54-3016	64:30 hours
DA#54-3018	29:40 hours

Total for four aircraft: 274:15 hours

4. For return to CONUS, C-133A cargo transport aircraft were used for the first time to airlift H-34C's mounted in the tapered skids, P/N S1670-10190. It was found that two H-34C's could be carried in one C-133A with a loading time of an hour and a half (the helicopters had already been disassembled and mounted in the skids in about six hours for each aircraft). It was thought previously that at least one of the H-34C's (when two were to be carried in one C-133A) could be loaded without removing the main rotor head and main transmission. However, without benefit of exact measurements, it appeared to the writer and other observers when a H-34C was being loaded (with the main rotor head and main transmission removed) that the clearance between the top of the helicopter canopy and the raised door of the C-133A lacked at least a foot of being great enough to allow an H-34C to be loaded with the main rotor head and main transmission installed.

5. Airlift Recommendations:

a. Floor loading space could be saved by carrying the tail rotor pylon in a saddle strapped to the tail cone and the fuselage skid. Another advantage of this type of pylon loading would be when utilizing a C-124 aircraft for transporting two H-34C's at one time. It would be greatly preferable to carrying the pylon installed in folded position on the hinges, both from loading and from safety standpoints.

b. It might be possible to carry two main rotor blades in the S1670-10190 skid below the fuselage. The other two could be carried in supports bolted on the flange at the top of the skid, one on each side of the fuselage. This would pose problems of blade handling prior to and following shipment, but the possibility would merit investigation.

c. The FM Homer Antenna should be removed from the nose doors prior to shipment. They protrude beyond the skid and are subject to damage. Antenna damage did occur on one H-34C being returned via C-133A from Thule AB.

6. This representative departed Thule AB, Greenland, at 2230 hours on 26 July 1960 and arrived at McGuire AFB, New Jersey, at 1000 hours on 27 July 1960. 28 July 1960 was a travel day for return to Sikorsky Aircraft, Stratford, Connecticut, to complete this assignment.

ANNEX B

AIRLIFT OF TWO H-34C TYPE HELICOPTERS IN ONE C-124 CARGO TRANSPORT¹

1. The writer was present as an observer at Dover AFB, Delaware, in April 1960 when two H-34C helicopters were mounted in the S1670-10190 tapered skids and then loaded on a C-124 cargo transport for airlift to Greenland. The total time required for loading aboard the C-124 was approximately 12 hours. This was the first time that two H-34C's had been carried in one C-124 and the loading time would undoubtedly be reduced somewhat with experience or a standard procedure. It required the MATS crew 5 hours and 55 minutes to unload the helicopters at Thule AB, Greenland. The helicopters and components were carried aboard the C-124 arranged as shown in Figure 1 below.

FIGURE 1

Floor Plan of C-124 Loaded with Two H-34C's

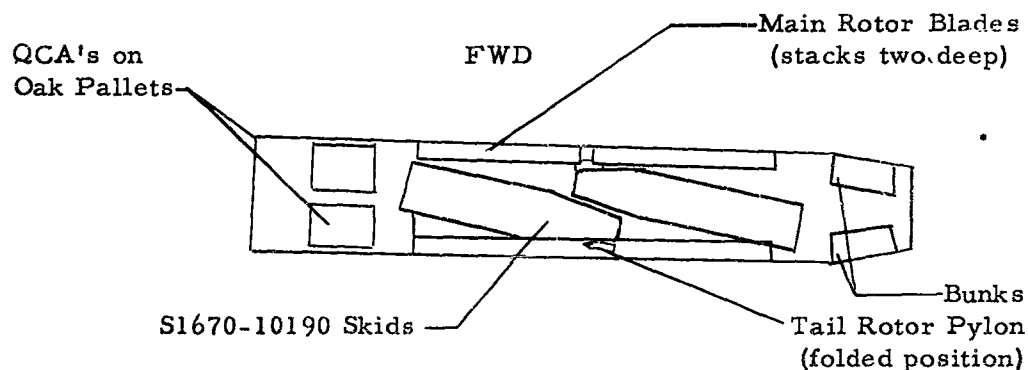

2. Components were handled as follows:

a. Main Rotor Blades

The main rotor blades were transported in the individual light-weight containers, Specification MIL-P-5806A(ASG). These were carried in the C-124 as a stack of two blade containers on each side of each helicopter.

b. Tail Rotor Pylon

Because of interference at the C-124 nose door, it is necessary to remove the tail rotor pylon before loading the fuselage. Once the first

¹Report submitted to Sikorsky Aircraft by W. L. Monnett, Jr, 12 Sep 60.

helicopter is in the C-124 (nose first), it is necessary to re-install the pylon on the hinges in the folded position. (The tail rotor blades are removed by removing the four S1610-31002 Pins, and the blades stowed in the helicopter cabin). The helicopter skid must then be shifted laterally (with pylon out-board) until the top of the pylon is within about 2 inches of the hydraulic lines, hoist track, etc., in the top of the C-124 cargo compartment. This is necessary to make room for the second skid - the tapered ends of the two skids must overlap several feet. The second pylon must then be carried aboard and supported until the second helicopter skid is loaded tail cone (tapered end) first. The pylon then must be mounted on the hinges in folded position and the second helicopter skid maneuvered into a position where the two skids overlap several feet at their tapered ends. This is necessary to have the second skid protrude a minimum over the ramp, which is built at an angle to the floor. NOTE: The C-124 at Dover AFB had bunks set up at the aft end of the cargo compartment. With no bunks, the space would not have been so critical, and possibly could have accommodated the pylons mounted in their own separate skids.

c. Main Rotor Head and Main Transmission Quick Change Assembly

These were mounted individually on heavy oak pallets, being bolted to the pallets at the four transmission support tie-down points. These items were loaded last and were carried lashed to the ramp, riding at an angle of perhaps 15-20 degrees.

3. Advantages of and objections to the above method:

a. Main Rotor Blades

Advantage - Maximum protection of main rotor blades.

Objections - (1) Difficulty in handling - they have to be hand carried and placed in narrow spaces barely wide enough to accommodate the containers, with no room for maneuvering.

(2) Empty containers must be transported separately to the site of loading, and handled and stored or transported at the site of unloading.

b. Tail Rotor Pylon

Advantage - Carrying pylon on the hinges saves floor space in cargo compartment of the C-124.

Objections - (1) Perhaps the greatest single objection to carrying two H-34C's in one C-124 was the handling of the pylon. It was extremely unhandy to manipulate the pylons as outlined above in the confined space and limited hoist or winch positions. The pylons had to be largely supported by hand and the mounting on the hinges accomplished extremely slowly and carefully because of the ever-present danger of a slight slip resulting in a cracked hinge fitting - a major repair.

(2) The height of the installed pylons caused interference problems which limited maneuverability of the helicopter skids. It also made the shifting of skids highly critical because it was necessary to move the heavy skids to within about 2 inches of the C-124 structure as mentioned above, and a slight "overshoot" would result in damage to the pylon, the C-124, or both.

(3) With the pylon carried on the two hinges only, "bouncing" in rough or turbulent air, should it be encountered, could conceivably crack or break a pylon hinge fitting.

c. Main Rotor Head and Main Transmission Quick Change Assembly

Advantage - Mounting the QCA directly on an oak pallet provided a place to rest the QCA on removal from the helicopter, and it could be dragged as a skid or carried on a fork lift for loading aboard the C-124.

Objection - When the two QCA's are mounted on individual pallets, the ramp extensions of the C-124 are a little too narrow to drag the pallet safely up one extension, and a little too far apart to use both safely. One pallet can be lifted to the ramp with a fork lift, but the first one must be moved to one side of the ramp to leave room for the second. This movement, on the slanting ramp, required the constant changing of safety chains, etc. The ramp extensions, though movable, could not be manipulated so as to allow a fork lift to place the two pallets on the ramp directly in the locations where they would be carried. Because of this it required approximately one hour just to load the two pallets onto the C-124 ramp.

4. Recommendations:

a. Main Rotor Blades

Blades could be placed temporarily in simple wood and felt floor racks when first removed from the helicopter. After the helicopter skids are loaded on the C-124, the blades could be easily hand carried aboard and placed in steel supports which are bolted to the top flange of the

S-1670-10190 skids, two blades on each side of each helicopter, as shown in Figure 2 below. The small wood floor racks would be stowed in the helicopter cabin for use at the time of unloading and reassembly of the helicopters for flight.

FIGURE 2

Suggested Method of Carrying Main Rotor Blades

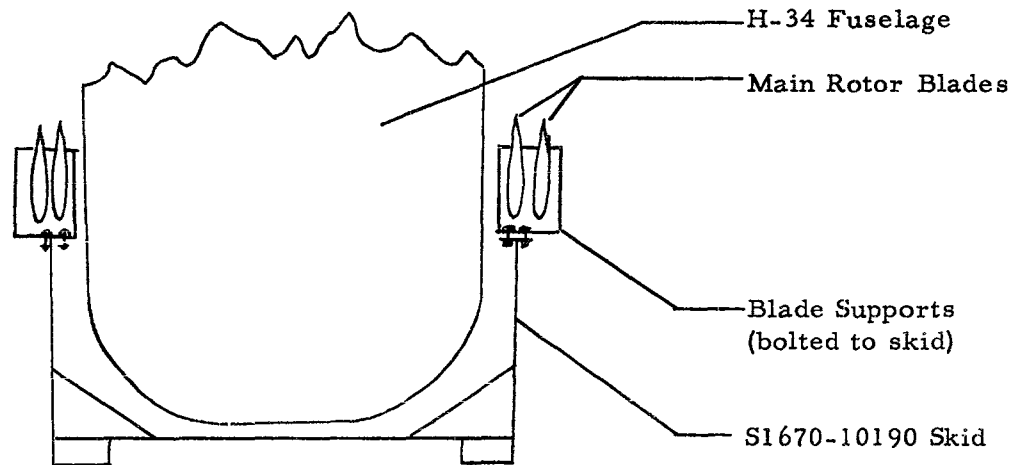

This method would keep the blades high enough above the floor level that there should be no damage to the trailing edges from personnel stepping on them (which has been done in the past when blades were in open racks).

b. Tail Rotor Pylon

The writer recommends that saddle supports be designed to accommodate the pylon, two supports on each helicopter. See Figures 3 and 4 below. These should be flat on the bottom for use in supporting the pylon temporarily on the ground before loading. When ready to load the pylon, it could be raised from the supports and the supports quickly and easily mounted on the helicopter tail cone at designated frames. The pylon could then be placed in the saddle supports and the securing of the pylon completed. Web straps over the tail cone and bolted to the skid on the other side would serve to support the pylon. Or perhaps it would be easier and faster to secure the pylon in the supports while still on the ground and then mount the supports and pylon together on the tail cone. In either case this whole process should be accomplished quickly and easily, since an inch or two either way on the position of the pylon in the supports or the supports on the tail cone would not be significant. This method would also minimize the

possibility of damage to pylon or tail cone in the event of a "rough ride". Height would not be a factor and the helicopter skids could be shifted inside the C-124, with or without the pylon in the saddle supports, and again with a minimum possibility of damage. The saddle supports would be inexpensive to build or replace, and would require a minimum of storage space when not in use.

FIGURE 3

Left Side View of Suggested Pylon and
Main Rotor Blade Arrangement

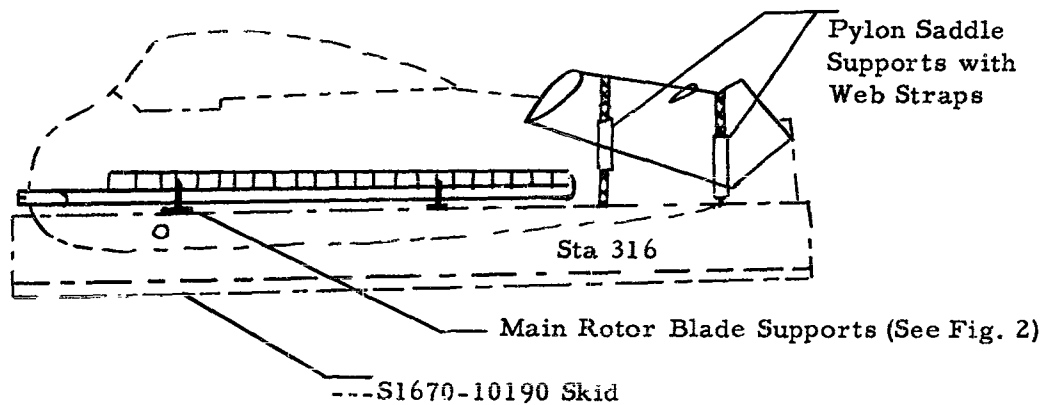
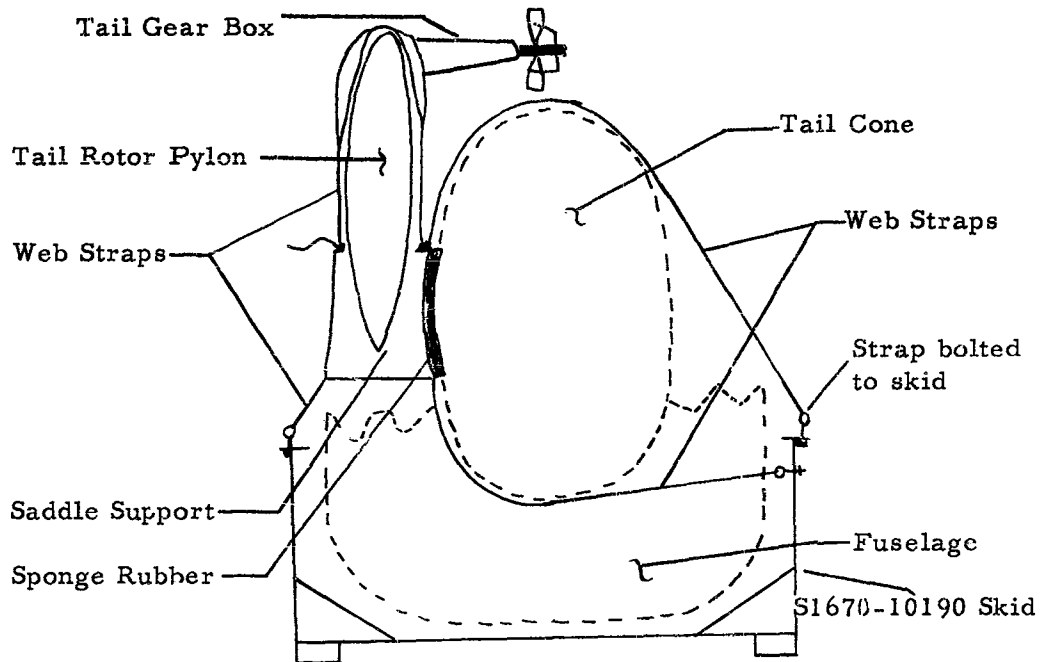

FIGURE 4

Suggested Pylon Arrangement as Viewed Looking FWD



c. Main Rotor Head and Main Transmission Quick Change Assembly

The writer recommends that a heavy wood pallet be designed to accommodate both QCA's, side by side. This could be dragged as a skid up the ramp extensions and onto the ramp, ready for immediate landing. No more than five minutes should be required to load or unload such a pallet. If desired, the pallet could be bolted together, and thus could be disassembled and parts rearranged to minimize size for storage or transport.

d. Additional Space

The method of loading the main rotor blades and tail rotor pylon suggested in a. and b. above should allow enough space along one side of the C-124 compartment for installation of troop seats. Since the additional weight, properly placed, would not be critical on a C-124, it might easily be possible to transport 15-20 passengers and tool boxes right along with the helicopters. The advantage of having the crews immediately available for reassembly and flight of the helicopters at their destination is obvious.

ANNEX C

AIR SHIPMENT OF H-34C HELICOPTER IN C-133A CARGO AIRCRAFT

1. In airlifting four H-34C helicopters from Thule AB, Greenland, to CONUS, C-133A cargo transport aircraft were used for the first time. All H-34Cs had been mounted previously in the tapered skid, P/N S1670-10190, with the main rotor blades in individual containers, and the tail rotor pylons in separate skids. The main transmission and main rotor head from each helicopter had been removed as a quick change assembly and mounted on a wooden pallet, the transmission supports being bolted to the pallet at the four tie down points.

2. On the first shipment, only one H-34C with accompanying parts was loaded on the C-133A. The Air Force loading personnel had piled their regular cargo loading equipment in the front end of the cargo compartment. After the first helicopter was loaded, it was found there would not be room for a second one and still be possible to remove the winch from the C-133A. The writer observed that had the regular cargo loading equipment been placed differently, the first helicopter could have been placed approximately fifteen feet further forward. However, because of the "turn-around" time allowed for the C-133A, it was not possible to make the necessary changes.

3. On the second shipment, two H-34Cs were loaded on a C-133A without difficulty. The main transmission quick change assemblies were loaded at the forward end of the cargo compartment. The first helicopter was loaded tail cone forward and the second with the tail cone aft. This brought the greater concentration of weight near the center of lift of the C-133A. The main rotor blades were stacked along both sides of each helicopter and the tail rotor pylons in their separate skids were lashed to the loading ramp. Total loading time as recorded by the Air Force loading personnel was one hour and a half.

4. The fourth H-34C assigned to the U S Army TREG Element in Greenland this year was returned, together with U-1A Otter aircraft, on a subsequent C-133A shipment.

5. Conclusions and Recommendations:

a. It had been hoped that H-34Cs in skids could be loaded aboard C-133As without removing the main transmission and main rotor head. The advantage in disassembly and reassembly time would be very substantial, inasmuch as all other required disassembly and mounting in skids could be accomplished by a crew of 4-6 men and a crane operator in one hour to an hour and a half. The same would be true for reassembly following shipment.

However, without benefit of exact measurements, it appeared to the writer and other observers when the H-34C fuselage was being loaded (with the main rotor head and main transmission removed) that the clearance between the top of the helicopter canopy and the raised door of the C-133A lacked at least a foot of being great enough to allow an H-34C to be loaded with the main rotor head and main transmission installed.

b. Floor loading space could be saved by carrying the tail rotor pylon in a saddle strapped to the tail cone and skid. (Another advantage of this type of pylon loading would be when utilizing a C-124 aircraft for transporting two H-34Cs at one time. It would be greatly preferable to carrying the pylon installed in folded position on the tail cone hinges, both from loading and from safety standpoints).

c. It might be possible to carry two main rotor blades in the S1670-10190 skid below the fuselage. The other two main rotor blades could be carried in supports bolted on the flange at the top of the skid, one on each side of the fuselage. This would pose problems of blade handling prior to and following shipment, but the possibility would merit investigation.

d. • The FM Homer Antenna should be removed from the nose doors prior to air shipment. They protrude beyond the skid and are subject to damage. Antenna damage did occur on one of the H-34Cs being returned to CONUS from Thule AB.

ANNEX D

REFERENCES

- Ellitsgaard-Rasmussen, K.: "Preliminary Report on the Geological Field Work Carried Out by the Danish Peary Land Expedition in the Year 1949-1950". Dansk Geologisk Forening, Meddelelser, Bd. 11, pp. 589-595, 1950.
- Ellitsgaard-Rasmussen, K.: "Features of the Geology of the Folding Range of Peary Land, North Greenland". Meddelelser om Gronland, Bd. 127, Nr. 7, 1953.
- Fristrup, B.: "Peary Land". Naturens Verden, 1951, pp. 19-33 (Danish-English translation available from Defence Scientific Information Service, DRB Canada, Ottawa).
- Fristrup, B.: "Climate and Glaciology of Peary Land". International Geodetic and Geophysical Union. Association of Scientific Hydrology. General Assembly, Brussels, 1951, Tome 1, pp. 185-193.
- Fristrup, B.: "Physical Geography of Peary Land. 1. Meteorological Observations for Jørgen Brønlunds Fjord". Meddelelser om Gronland, Bd. 127, Nr. 4, 1952.
- Fristrup, B.: "Wind Erosion Within The Arctic Deserts". Geografisk Tidsskrift, Vol. 52, pp. 51-65, 1952-53.
- Fristrup, B.: "High Arctic Deserts". Deserts Actuels et Anciens, sect. 7, fasc. 7, pp. 91-99, 1953.
- Holmen, K.: "The Vascular Plants of Peary Land, N. Greenland". Meddelelser om Gronland, Bd. 124, Nr. 9, 1957.
- Johnsen, P.: "Birds and Mammals of Peary Land in North Greenland". Meddelelser om Gronland, Bd. 128, Nr. 6, 1953.
- Knuth, E.: "The Nothernmost Country in the World". Geographical Magazine, Vol. 24, pp. 218-229, 1951.
- Knuth, E.: "The Danish Expedition to Peary Land". Geographical Journal, Vol. 118, pp. 1-11, 1952.
- Knuth, E.: "Exploring Unknown Greenland". The Danish Peary Land Expedition, 1945-1950". Danish Foreign Office Journal, 1952, No. 4 pp. 1-10.

- Koch, L.: "Preliminary Report Upon the Geology of Peary Land, Arctic Greenland". American Journal of Science, Series 5, Vol. 5, pp. 189-198, 1923.
- Koch, L.: "The Physiography of Northern Greenland". Greenland, Vol. 1, pp. 491-518, Copenhagen, 1928.
- Koch, L.: "Contributions to the Glaciology of North Greenland". Meddelelser om Gronland, Bd. 65, pp. 181-464, 1928.
- Koch, L.: "Survey of North Greenland". Meddelelser om Gronland, Bd. 130, Nr. 1, 1940.
- Laursen, D.: "Emerged Pleistocene Marine Deposits of Peary Land". Meddelelser om Gronland, Bd. 127, Nr. 5, 1954.
- Troelsen, J. C.: "Contributions to the geology of the area round Jørgen Brønlunds Fjord, Peary Land, North Greenland". Meddelelser om Gronland, Bd. 149, Nr. 2, 1949.
- Troelsen, J. C.: "Notes on the pleistocene geology of Peary Land, North Greenland". Dansk Geologisk Forening, Meddelelser, Bd. 12, pp. 211-220, 1952.
- Troelsen, J. C.: "The Cambrian of North Greenland and Ellesmere Island". Notes of 20th International Geological Congress, Mexico City, Vol. 1, pp. 71-90, 1956.
- Victor, P. E.: "Geography of northeast Greenland". U.S.A. Corps of Engineers SIPRE Special Report 15, 1955.

For further references, see:

Arctic Bibliography, prepared for and in cooperation with the Department of Defense, under the direction of The Arctic Institute of North America. Vol. I (1953) - Vol. VIII (1959), with a total of 49,086 entries. Further volumes will appear.

USAF Aerial Photo Missions flown over the area:

<u>Mission No.</u>	<u>Date</u>	<u>Type</u>
M 17 311 RW ERG	13 May 1947	Trimetrogon (VT, RT, LT)
M 18 311 RW ERG	13 May 1947	Trimetrogon (VT, RT, LT)
M 61 311 RW ERG	30 July 1947	Verticals only

All vertical photos have a scale of approximately 1:32000.

DISTRIBUTION LIST

UNITED STATES CONTINENTAL ARMY COMMAND

Commanding General
United States Continental Army Command
Fort Monroe, Virginia
ATTN: Transportation Officer 1
ATTN: Chief, Combat Development Group 1
ATTN: ASA Liaison Officer 1
ATTN: Chief, Materiel Development (6-Air) 1

Commanding General
First United States Army
ATTN: Transportation Officer
Governors Island
New York 4, New York 1

Commanding General
Second United States Army
ATTN: Transportation Officer
Fort George G Meade, Maryland 1

Commanding General
Third United States Army
ATTN: Transportation Officer
Fort McPherson, Georgia 1

Commanding General
Fourth United States Army
ATTN: Transportation Officer
Fort Sam Houston, Texas 1

Commanding General
Fifth United States Army
ATTN: Transportation Officer
1660 East Hyde Park Boulevard
Chicago 15, Illinois 1

Commanding General
Sixth United States Army
ATTN: AMTRO
Presidio of San Francisco, California 1

Commanding General United States Army Infantry Center ATTN: Transportation Officer Fort Benning, Georgia	1
Commandant Armed Forces Staff College ATTN: Librarian Naval Operating Base Norfolk 11, Virginia	1
Commandant National War College Fort Leslie J McNair Washington, D. C.	1
Commandant Command and General Staff College Fort Leavenworth, Kansas ATTN: Chief, Advanced Operations Research Department ATTN: Chief, Archives	1 1
Commandant Army Cold Weather and Mountain School APO 733 Seattle, Washington	1
Commandant The Armor School Fort Knox, Kentucky	1
President U S Army Arctic Test Board APO 733 Seattle, Washington	1
President United States Army Armor Board Fort Knox, Kentucky	1
Commanding General United States Army Aviation Center ATTN: Transportation Officer Fort Rucker, Alabama	1

Commanding General
1st Logistical Command
ATTN: Transportation Officer
Fort Bragg, North Carolina 1

OVERSEA AGENCIES

Commanding General
United States Army Alaska
ATTN: Transportation Officer
APO 949
Seattle, Washington 1

Commanding General
United States Army Caribbean
ATTN: Transportation Officer
Fort Amador, Canal Zone 2

Commanding General
United States Army Pacific
ATTN: Transportation Officer
APO 958
San Francisco, California 1

Commander-in-Chief
United States Army, Europe
ATTN: Transportation Officer
APO 403
New York, New York 1

Commanding General
Seventh United States Army
ATTN: Transportation Officer
APO 46
New York, New York 1

Senior Standardization Representative
United States Army
Canadian Army Headquarters
Ottawa, Canada 3

Commander
United States Army Military Assistance Advisory Group (Norway)
APO 85
New York, New York 3

Commanding General United States Army Communications Zone, Europe ATTN: Transportation Officer APO 58 New York, New York	1
Commanding Officer United States Army Port of Embarkation, Bremerhaven ATTN: Director of Port Operations APO 69 New York, New York	1
Chief Joint United States Military Aid to Greece ATTN: Transportation Officer APO 223 New York, New York	1
Chief Joint United States Military Mission for Aid to Turkey ATTN: Chief, Transportation Section APO 254 New York, New York	1
Commanding General United States Army, Ryukyu Islands/IX Corps ATTN: Transportation Officer APO 331 San Francisco, California	1
Commanding General Eighth United States Army ATTN: Transportation Officer APO 301 San Francisco, California	1
Commanding General United States Army, Japan ATTN: Transportation Officer APO 343 San Francisco, California	1
Commanding General United States Army, Hawaii/25th Infantry Division ATTN: Transportation Officer APO 957 San Francisco, California	1

Commanding General
United States Army, Caribbean
ATTN: Transportation Officer
Fort Amador, Canal Zone

1

TECHNICAL SERVICES

CHEMICAL CORPS

Chief Chemical Officer
Department of the Army
Washington 25, D. C.

1

CORPS OF ENGINEERS

Chief of Engineers
Department of the Army
Washington 25, D. C.
ATTN: Chief, Special Engineering Branch,
Engineer R&D Division
ATTN: ENCOT

1

1

Commanding General
U S Army Engineer Research and Development Laboratories
Fort Belvoir, Virginia

Director
U S Army Cold Regions Research and Engineering Laboratory
821 Emerson Street
Evanston, Illinois

1

Commanding Officer
Polar Research and Development Center
Fort Belvoir, Virginia

2

Director
Waterways Experimental Station
U S Army Corps of Engineers
Vicksburg, Mississippi

1

Commanding General
U S Army Chemical Engineering Research and Development Laboratories
Fort Monmouth, New Jersey
ATTN: Chief, Meteorology Department
ATTN: Chief, Communication Facility Branch
ATTN: Chief, Avionics Branch, Evans Laboratories

1

1

1

ORDNANCE CORPS

Chief of Ordnance
ATTN: ORDTX-AR
Department of the Army
Washington 25, D. C. 1

Director
Land Locomotion Laboratory
Detroit Arsenal
Center Line, Michigan 1

Commanding Officer
Diamond Ordnance Fuze Laboratories
ATTN: Chief, Technical Reference Branch (ORDTL 012)
Washington 25, D. C. 1

Commanding General
U S Army Ordnance Tank Automotive Command
ATTN: ORDMC-REO
Detroit Arsenal
Center Line, Michigan 1

Commanding General
U S Army Ordnance Missile Command
ATTN: ORDXM-T
Redstone Arsenal, Alabama 1

President
The Ordnance Board
ATTN: Librarian
Aberdeen Proving Ground, Maryland 1

QUARTERMASTER CORPS

The Quartermaster General
Department of the Army
Washington 25, D. C. 1

Commanding General
U S Army Quartermaster Research and Engineering Command
Natick, Massachusetts
ATTN: Chief, Technical Library Research Service Office 1
ATTN: QMREL-ER 1
ATTN: Polar Project Projects Officer (only for polar/
subpolar reports) 2

Commandant
The Quartermaster School
ATTN: Chief, QM Library
Fort Lee, Virginia 1

President
U S Army Quartermaster Board
Fort Lee, Virginia 1

Commanding Officer
U S Army Quartermaster Field Evaluation Agency
U S Army Quartermaster Research and Engineering Command
Fort Lee, Virginia 1

SIGNAL CORPS

Chief Signal Officer
Department of the Army
Washington 25, D. C. 1

Commanding General
U S Army Electronic Proving Ground
ATTN: Chief, Meteorology Department
Fort Huachuca, Arizona 1

President
U S Army Signal Board
Fort Monmouth, New Jersey 1

SURGEON GENERAL

The Surgeon General
Department of the Army
Washington 25, D. C. 1

TRANSPORTATION CORPS

Chief of Transportation
Department of the Army
Washington 25, D. C.
ATTN: ACOT(R&D) 1
ATTN: TCCAD 4
ATTN: Security Officer for Onward Transmission to
Danish Military Attache (Greenland reports only) 6
ATTN: Chief, Historical Research Office 1
ATTN: Security Officer for U S State Department 1

Commanding General
U S Army Transportation Materiel Command
ATTN: Director of Engineering
P O Box 209, Main Office
St Louis 66, Missouri 2

Commanding General
U S Army Transportation Materiel Command
ATTN; TCMAC-AP
P O Box 209, Main Office
St Louis 66, Missouri 1

Transportation Corps Liaison Officer
U S Army Engineer Research and Development Laboratories
Building 314, Room A-214
Fort Belvoir, Virginia 6

U S ARMY TRANSPORTATION TRAINING COMMAND

Commanding General
U S Army Transportation Training Command
Fort Eustis, Virginia
ATTN: ACOFS, G1 1
ATTN: ACOFS, G3 1
ATTN: ACOFS, G4 1

Commandant
U S Army Transportation School
Fort Eustis, Virginia
ATTN: Canadian Liaison Officer 3
ATTN: Librarian 4

Commanding Officer
U S Army Transportation Combat Development Group
Fort Eustis, Virginia 1

TERMINAL COMMANDS

Commanding General
United States Army Transportation Terminal Command, Atlantic
ATTN: Staff Director of Operations
1st Avenue and 58th Street
Brooklyn 50, New York 2

Commanding General
United States Army Transportation Terminal Command, Gulf
New Orleans 40, Louisiana 1

Commanding General
United States Army Transportation Terminal Command, Pacific
Fort Mason, California 1

Commanding Officer
United States Army Transportation Terminal Agency, Seattle
Naval Supply Depot
Seattle 99, Washington 1

U S ARMY TRANSPORTATION RESEARCH COMMAND

Commanding Officer
U S Army Transportation Research Command
Fort Eustis, Virginia
ATTN: Chief, Land Mobility Division 1
ATTN: Chief, Central Files 1
ATTN: Chief, Technical Library 1
ATTN: Chief, Transportation Engineering Directorate 1
ATTN: Chief, Military Liaison and Advisory Office 1
ATTN: British Exchange Officer 1

USATRECOM Liaison Officer
U S Army Engineer Research and Development Laboratories
Fort Belvoir, Virginia 1

USATRECOM Liaison Officer
U S Army Ordnance Tank-Automotive Command
Detroit Arsenal
Center Line, Michigan 1

USATRECOM Liaison Officer
Atomic Energy Commission
Germantown, Maryland 1

USATRECOM Liaison Officer
Wright-Patterson Air Force Base
Dayton, Ohio 1

Officer-in-Charge
USATRECOM Test Activity
Aberdeen Proving Grounds
Aberdeen, Maryland 1

Commanding Officer
U S Army Research and Development Liaison Group
ATTN: USATRECOM Liaison Officer
APO 757
New York, New York 1

Commanding Officer
Transportation Intelligence Agency
Arlington Hall Station
Arlington 12, Virginia 2

AIR FORCE

Director of Transportation
Headquarters, United States Air Force
ATTN: AFMTP-MC-C-a
Main Navy Building
Washington 25, D. C. 2

Commanding Officer
USAF Cambridge and Research Center
Air Research and Development Command
Bedford, Massachusetts 3

Chief
Air University Library
ATTN: Chief, Document Acquisition Branch
(3R-AUL-60-16)
Maxwell Air Force Base, Alabama 1

Commanding General
Air Research and Development Command
ATTN: RDTAED
Andrews Air Force Base
Washington 25, D. C. 1

Deputy Commander for Development and Test
Air Proving Ground Center
ATTN: PGTRIL
Eglin Air Force Base, Florida 1

Commander
Wright Air Development Center
ATTN: WCLERBV
Wright-Patterson Air Force Base, Ohio 1

Assistant Director for Technical Information
National Aeronautics and Space Administration
1520 H Street, NW
Washington 25, D. C.

1

Commander
Langley Research Center
National Aeronautics and Space Administration
Langley Air Force Base, Virginia

1

Librarian
National Aeronautics and Space Administration
Lewis Research Center
21000 Brookpark Road
Cleveland 35, Ohio

1

UNITED STATES NAVY

Chief of Naval Operations
(Op-343)
Department of the Navy
Washington 25, D. C.

1

Chief of Naval Operations
(Op-91D)
Department of the Navy
Washington 25, D. C.

1

Chief of Naval Research
ATTN: ALO
Code 461
Washington 25, D. C.

1

Chief
Bureau of Ships
ATTN: Chief, Research and Development Program
Planning Branch
Code 320
Department of the Navy
Washington 25, D. C.

1

Chief
Bureau of Ordnance
(Rex-3)
Department of the Navy
Washington 25, D. C.

1

Assistant Chief for Research and Development (OW)
Bureau of Supplies and Accounts
Department of the Navy
Washington 25, D. C. 1

Chief
Bureau of Yards and Docks
Code D-420
Department of the Navy
Washington 25, D. C. 1

Commanding Officer and Director
U S Naval Civil Engineering Laboratory
Port Hueneme, California 1

Officer-in-Charge
U S Naval Supply Research and Development Facility
ATTN: Librarian
Naval Supply Depot
Bayonne, New Jersey 1

Chief
Technical Reports Section
U S Naval Postgraduate School
Monterey, California 1

Commander
Naval Air Test Center
Patuxent River, Maryland
ATTN: U S Army Liaison Officer 1
ATTN: Chief, Technical Library 1

Chief
Bureau of Naval Weapons (R-38)
Department of the Navy
Washington 25, D. C. 1

COAST GUARD

Commandant
U S Coast Guard
ATTN: Chief, Testing and Development Division
1300 "E" Street, N. W.
Washington 25, D. C.

NAVY - ANTARCTICA

Commander
U S Navy Support Force, Antarctica
Building "D", Sixth and Independence Avenue, S. W.
Washington 25, D. C. 2

UNITED STATES MARINE CORPS

Commandant of the Marine Corps
United States Marine Corps
Code AO4E
Washington 25, D. C. 1

President
Marine Corps Equipment Board
Marine Corps Schools
Quantico, Virginia 1

Director
Marine Corps Educational Center
Marine Corps Schools
Quantico, Virginia 1

Director
Marine Corps Landing Force Development Center
Marine Corps Schools
Quantico, Virginia 1

Commandant
U S Army Transportation
ATTN: Marine Corps Liaison Officer
Fort Eustis, Virginia 1

MISCELLANEOUS

Director
U S Army Research Office
Arlington Hall Station
Arlington 12, Virginia 2

Assistant Secretary of Defense (R&D)
Room 3E-1065
The Pentagon
Washington 25, D. C. 1

Deputy Chief of Staff for Personnel Department of the Army Washington 25, D. C.	1
Deputy Chief of Staff for Military Operations Department of the Army Washington 25, D. C.	1
Deputy Chief of Staff for Logistics Department of the Army Washington 25, D. C.	1
Secretary of the Interior U S Geological Survey Washington 25, D. C.	1
Chief of Research and Development Department of the Army Washington 25, D. C.	2
Director The Armed Services Technical Information Agency Arlington Hall Station Arlington 12, Virginia	10
Librarian U S Government Printing Office Division of Public Documents Washington 25, D. C.	1
Commanding Officer Eastern Ocean District Engineers New York, New York	1
Area Engineer Eastern Ocean District Engineers APO 121 New York, New York	1
Chief Exchange and Gift Division Library of Congress Washington 25, D. C.	4

Senior Standardization Representative U S Army Standardization Group, U. K. Box 65, U S Navy 100 Fleet Post Office New York, New York	1
Director Operations Research Office ATTN: Librarian The Johns Hopkins University 6935 Arlington Road Bethesda, Maryland	1
President U S Army Airborne and Electronics Board Fort Bragg, North Carolina	1
President U S Army Air Defense Board Fort Bliss, Texas	1
President U S Army Aviation Board Fort Rucker, Alabama	1
President U S Army Security Agency Board Arlington Hall Station Arlington 12, Virginia	1
President U S Army Artillery Board Fort Sill, Oklahoma	1
President U S Army Chemical Corps Board Army Chemical Center, Maryland	1
Commanding General U S Army Combat Development Experimentation Center Fort Ord, California	1
President U.S Army Infantry Board Fort Benning, Georgia	1

President U S Army Maintenance Board Fort Knox, Kentucky	1
President U S Army Military Police Board Fort Gordon, Georgia	1
Officer in Charge U S Army Transportation Aviation Field Office ATTN: Army Liaison Officer Room 1716 Bureau of Naval Weapons Department of the Navy Washington 25, D. C.	1
Commandant U S Army Aviation School ATTN: Chief, Combat Developments Office Fort Rucker, Alabama	1
Commander Allied Land Forces Southern Europe ATTN: Chief, Transportation Branch, G4 Division APO 224 New York, New York	1
Commanding Officer 7th Artillery Group APO 23 New York, New York	1
Commanding Officer U S Army Aviation Test Office ATTN: FTZAT Edwards Air Force Base, California	1
Commander Aeronautical Research Laboratories ATTN: RRLA (Library) Wright-Patterson Air Force Base, Ohio	1
Commandant Army War College ATTN: Librarian Carlisle Barracks, Pennsylvania	1

Commanding Officer and Director David Taylor Model Basin Aerodynamics Laboratory Library Washington 7, D. C.	1
Chief Officer of Technical Services Acquisition Section Department of Commerce Washington 25, D. C.	1
Librarian Ames Research Center National Aeronautics and Space Agency Moffett Field, California	1
Librarian Institute of Aeronautical Sciences 2 E 64th Street New York 21, New York	1
Chief National Aviation Facilities Experimental Center Atlantic City, New Jersey	1
Chief Division of Reactor Development United States Atomic Energy Commission Washington 25, D. C.	1

UNCLASSIFIED

UNCLASSIFIED