

# Producer Gas Plants

A profile of Producer Gas Plants, their design, development, application and type of contaminants present.

Prepared by Dr Russell Thomas, Technical Director Parsons Brinckerhoff, Redland, Bristol, UK, 0117-933-9262, [thomasru@pbworld.com](mailto:thomasru@pbworld.com) or [gasworkshistory@gmail.com](mailto:gasworkshistory@gmail.com). The author is grateful to fellow members of the Institution of Gas Engineers and Managers Panel for the History of the Industry and the staff of the National Grid Gas Archive for their kind assistance.

## Introduction

When William Murdock used coal gas to light his house and office in Redruth in 1792, it was the first practical demonstration of how coal gas could be used commercially. Different combustible gases have been used ever since for commercial, industrial and domestic applications. Gas was first manufactured from coal and later from oil until its replacement in Britain by natural gas in the mid 1970s. The conventional production of gas from coal is well documented; however, there was also another simpler method of gas production which is less well known, called "producer gas". Although producer gas was manufactured at gasworks, it was not generally used to provide a public supply. Its main application was supplying a cheap low calorific value gas for industrial heating purposes.

Producer gas plants started to become popular in the early 1880s and were in extensive use by 1910. As producer gas plants developed from the first plant built by Bischof (Figure 1) until their demise in Britain from competing technologies in the mid-20<sup>th</sup> century, many varied types evolved.

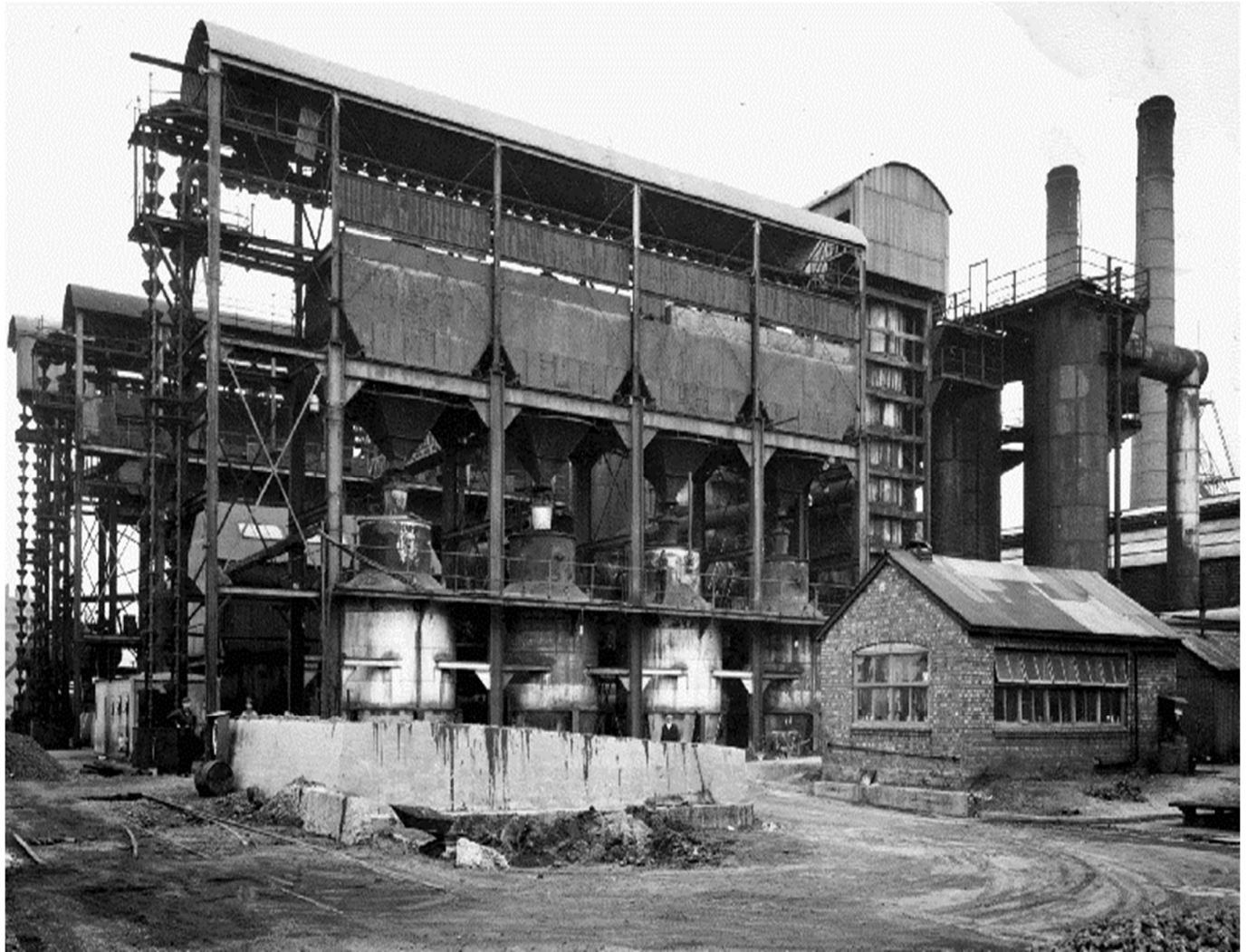

**Photograph 1. The Mond gas plant at the former South Staffordshire Mond Gas Company plant, Tipton. Image courtesy of the National Grid Gas Archive.**

The German Bischof undertook the early pioneering work on the development of the gas producer. Bischof, from Magdeburg in the Saxony-Anhalt region of Eastern Germany, constructed the first gas producer in 1839. This was built simply from bricks as shown in Figure 1. It worked under suction

conditions with air drawn through the producer from the top of the fuel bed. Bischof was closely followed by Ebelman in France in 1840. Ebelman's design was based on a blast furnace and operated quite differently to Bischof's. Ebelman's producer was of a slagging type, using a mixture of coke and charcoal

as fuel which was admixed with lime or furnace slag to produce a fusible ash. The producer was operated at a high temperature to ensure the slag was removed in a molten form.

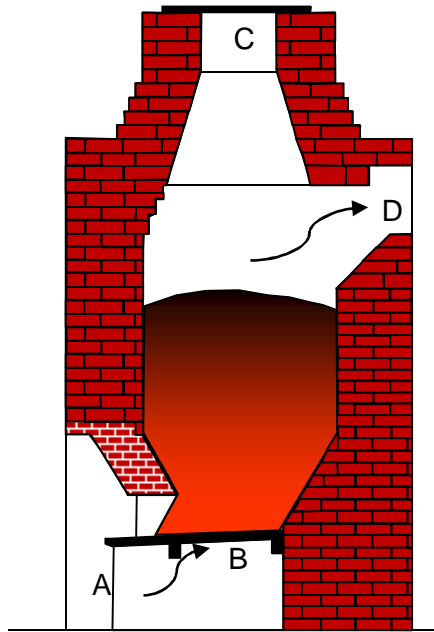

**Figure 1. Bischof Gas Producer.** Air was drawn into the producer (A) through the fire bars (B) and fuel, exiting via the vent (D). Fuel was loaded via door C. Image courtesy of Russell Thomas.

The next major development was that of Fredrick Siemens who developed a combined gas producer and regenerative furnace in 1857. This system was gradually improved and introduced to the UK through William Siemens. Producer gas plants provided a considerable benefit to those industries requiring high and uniform temperatures. This greatly aided those industrial processes which were unable or found it very difficult to use directly fired solid fuel furnaces. It also saved fuel as the gas could be burnt at the exact point required.

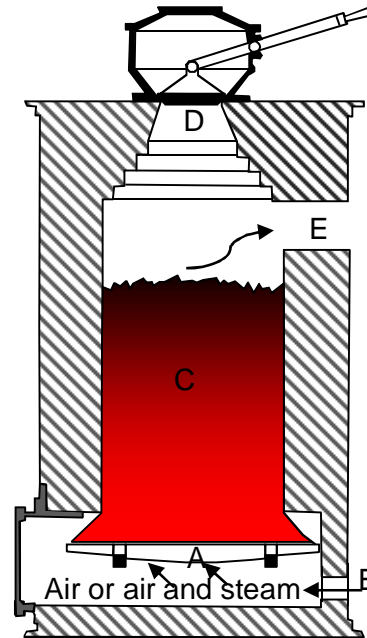

**Figure 2. Gas producer working with air or air and steam.** Image courtesy of Russell Thomas.

A simple drawing of a gas producer using just air or air and steam is shown in Figure 2. A represents the fire bars or grate, B is the air inlet, C is the column of fuel, D is a hopper with a close-fitting valve through which the fuel is introduced, and E is the gas outlet.

The next major advance in the application of gas producers came in 1878, when Dowson developed the Dowson complete gas plant. This plant could be used both industrially and domestically. Dowson went on to demonstrate the effectiveness of gas engines (developed by Otto *circa* 1876) when in 1881 he combined one of his producer gas plants with a 3 horsepower (HP) Otto gas engine. These early gas engines had a maximum of 20 HP, equivalent to 14.9 kilowatts. But by 1910, gas engines had reached 2,000 HP, equivalent to 1,491 kilowatts.

*Circa* 1900, suction gas plants and engines were introduced; these plants were able to make more effective use of the lower quality producer gas and became a popular system in their own right.

### Principles of Producer Gas

Producer gas manufacture differed from traditional gas production in the way and conditions in which the gas was made. A traditional gasworks would manufacture gas by indirectly heating coal contained within a retort through a separate furnace located beneath the retort. The retort was an oxygen-free environment, meaning that as the coal was heated, it would not combust but instead would thermally decompose, releasing gas and other by-products such as tar. This gas has a complex composition.

By comparison, and in simplistic terms, a producer gas plant would manufacture gas by partially combusting coke in an oxygen-limited atmosphere. The gas produced primarily consisted of carbon monoxide, carbon dioxide and nitrogen.

In slightly more detail, the producer gas plant made gas by forcing or drawing air, with or without the addition of steam, through an incandescent deep bed of fuel in a closed producer vessel. The fuel was gradually consumed during the process and the gas was simply piped to where it was required.

An important characteristic of the producer gas process was that no external heat was applied to the producer: it was heated by the combustion of the fuel within the producer itself. The skill in effectively operating a gas producer was to ensure that the fuel bed was of sufficient depth and the air supply was not too great, limiting the amount of combustion.

Once the fuel inside the producer had started to burn, the air supply was carefully controlled to allow continuous combustion in the lower regions of the fuel bed. This provided the high temperature required to produce the necessary reactions higher up the fuel bed and, if steam was added, to decompose the steam.

The producer gas process focussed on the incomplete combustion of carbon to maximise the carbon monoxide produced and minimise the amount of carbon dioxide (which has no calorific value). This was achieved through the reactions shown below.

Within a conventional fire, the carbon in coal would react with oxygen forming carbon dioxide, an exothermic reaction where each kilogram (kg) of carbon would produce 33 megajoules (MJ) of energy.

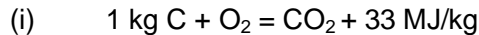

This reaction also occurred within the fuel pile at the base of the producer. Due to the limited oxygen supply, carbon monoxide was also formed in the fuel bed, in the reaction below. This was also exothermic, producing 10 megajoules for each kg of carbon.

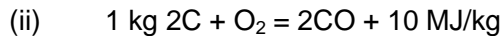

As the carbon dioxide formed passed up through the bed of coke, it was reduced by further hot carbon higher up the fuel bed. This formed carbon monoxide through an endothermic reaction where 13 megajoules of energy would be consumed for each kg of carbon:

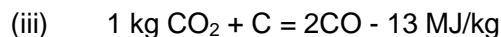

This reaction was reversible and the amount of carbon dioxide converted to carbon monoxide was highly dependent on temperature. At 850°C, the reaction forming carbon dioxide was found to proceed 166 times more rapidly than the reverse reaction.

Where moisture was present in the fuel, or where steam was injected into the producer, additional reactions between the carbon and carbon compounds and water would occur. When steam interacts with carbon at a high temperature, it decomposes and the oxygen is transferred to the carbon, producing hydrogen. The oxygen released from the reaction of the steam could, depending on the conditions, combine with carbon to form carbon monoxide or carbon dioxide. These reactions are the basis of water gas production, which is the subject of a separate profile called **Water Gas Plant**. It is also discussed later in the section on Mond gas.

When coal gas was produced in a retort, complex organic compounds within coal would thermally decompose, forming gaseous and vapour phase organic compounds within the gas. If soft or bituminous coal was used in the producer, similar by-products would form in the gas (Table 1). In Great Britain, coke and anthracite were primarily used as the fuel in a gas producer. These fuels were primarily composed of carbon and produced few organic by-products within the gas (Table 1).

Theoretically, producer gas would consist of 34.2% carbon monoxide and 65.2% nitrogen, but these conditions would never actually occur. A composition of 25% carbon monoxide would have been the target.

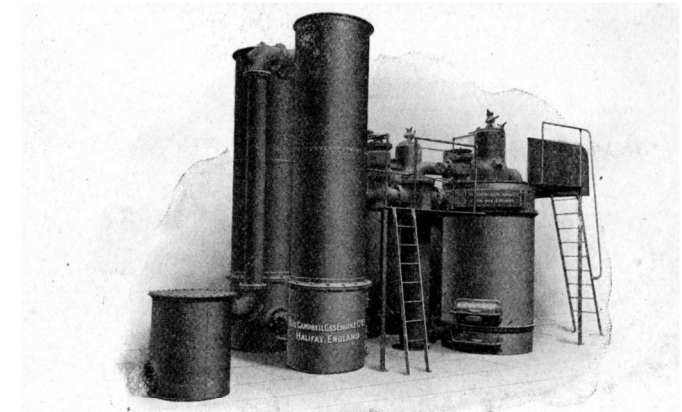

150 B.H.-P. SUCTION GAS PLANT FOR ANTHRACITE.  
Provided with Duplicate Producer.

## “CAMPBELL” Suction Gas Plants

FOR ANTHRACITE, COKE, CHARCOAL, Etc.

**THE CAMPBELL GAS ENGINE CO., Ltd.,**  
HALIFAX, ENGLAND.

LONDON: 114, Tooley Street, S.E.    GLASGOW: 104, Bath Street.

**Figure 3. An advert for a suction gas producer plant. Image courtesy of Russell Thomas.**

Considering the composition in more detail, producer gas was a mixture of carbon monoxide, hydrogen, carbon dioxide and nitrogen, in varying proportions, and a very small quantity of gaseous hydrocarbons (predominantly methane).

The carbon monoxide, hydrogen, gaseous hydrocarbons were combustible (30-45% of the gas composition), and the calorific value of the gas was dependent on the relative proportions in which they were present. The carbon dioxide and nitrogen were diluents which lowered the calorific value and subsequent flame temperature of the combustible gases when burnt.

The nitrogen concentration in producer gas was much higher than in coal gas. This was because the producer was aerated by a restricted supply of air (nitrogen forms 78% of air) and coal gas was an enclosed process and not aerated.

Component of the gas	Coke (% composition)	Soft coal (% composition)
Carbon monoxide	25	27
Carbon dioxide	5	4
Hydrogen	6	10
Methane	1	3
Nitrogen	63	55
Oxygen	-	0.5

**Table 1. Composition of producer gas from coke and American soft coal.**

Gas from producers can be split into two different types: “hot unpurified gas” and “cooled and purified gas”. For most industrial heating purposes, the gas was used in a hot and unpurified state, allowing the entrained heat in the gas to be used in addition to the heat generated from burning the gas and any tar which may be present in the gas.

This avoided the cost of cooling the gas and minimised the use of regenerators to heat incoming air. There were problems using producer gas in this way; in particular, any precipitated tar and dust could block pipes, allowing only short pipe runs to be used. Using coke would minimise tar deposition and bituminous coal would greatly exacerbate the problem.

If the item being heated was sensitive, such as kilns fired for glass or ceramic ware, then the dust and tar could damage the finished product. In these situations, and when used for heating retort/coke ovens or powering gas engines, the gas would be purified, removing any dust, ammonia and tarry

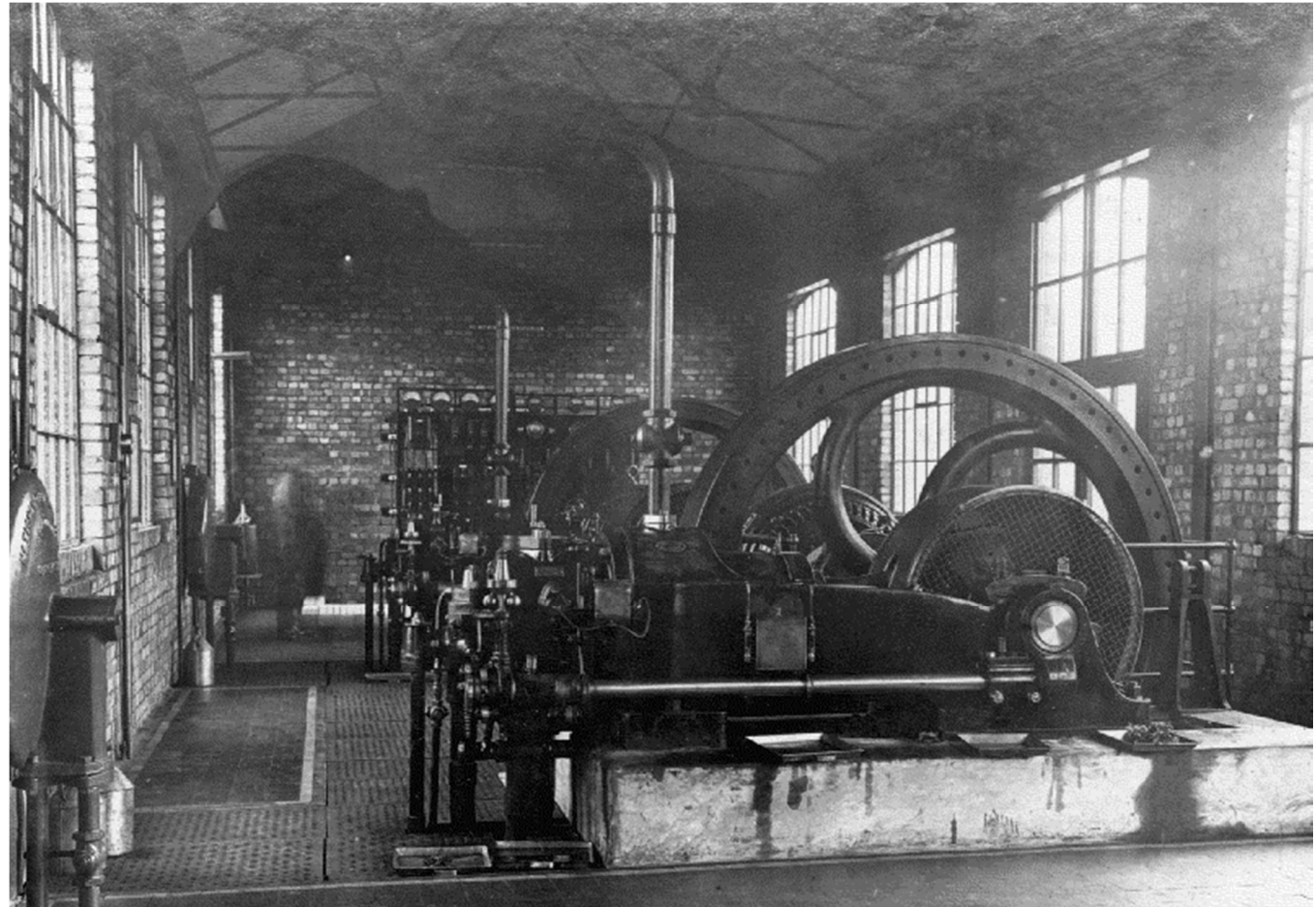

**Photograph 2. Two gas engines installed at the former Wandsworth power house. Image courtesy of the National Grid Gas Archive.**

residues. The gas was cleaned with a scrubber, which is described on page 5.

Producer gas could be obtained from almost any carbonaceous fuel. The type of fuel used depended not only on the purpose for which the gas was to be used, but on its cost and the ease with which each fuel could be purchased locally.

Producer gas was predominantly made from anthracite or coke, especially where the gas use was sensitive. Where the end use of the gas was not sensitive, bituminous or semi-bituminous coal could be used (Photograph 8), and in some circumstances it was also possible to use brown coal, lignite, peat or charcoal. The composition of the gas and by-product was largely influenced by the nature of the fuel used as a feedstock.

## Suction Gas

Early gas producers operated using the suction of gas through the fuel; this was later disregarded in preference to pressurised gas injection. Developments in the 1860s gradually led to the construction of efficient suction gas plants based on Dowson's design (Figure 4).

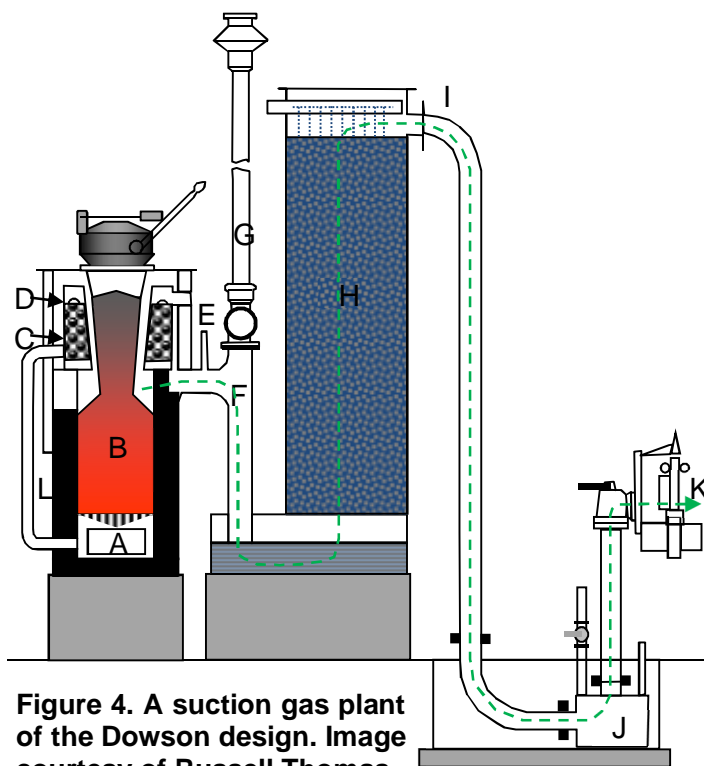

**Figure 4. A suction gas plant of the Dowson design. Image courtesy of Russell Thomas.**

Suction gas plants were very effectively employed in combination with gas engines optimised for suction gas producers. The operation of the system can be explained by referring to Figure 4, where A was the grate on which the fuel was placed; B was the container holding the store of fuel, which entered through the hopper and valve at the top; C was a circular chamber filled with broken firebrick; D was a circular pipe which sprayed water into the system; E

was the air inlet and F the gas outlet; G was the chimney; H was the scrubber with a water seal at the bottom; and I was the gas outlet leading to the expansion box (J) and gas engine (K).

To ignite the fuel in the producer some oily waste and wood were placed on the grate and the producer was filled with small pieces of anthracite or coke. The feeding hopper was closed and the fire then lit. The fan (not shown in Fig. 5) was set in motion, and the exiting gases from the producer were initially allowed to escape through the chimney. Once combustion was effective, the water supply would be turned on; as soon the gas produced was burning effectively it was connected to the gas engine. The engine would be started and the fan stopped. From this time, the engine itself would suck the air required into the producer. Before entering the engine, the gases passed upwards through the coke-filled scrubber, ascending through a column of coke continually sprayed by water. The role of the scrubber was to purify the gas, removing fine dust, ammonia and tarry residues in particular. The gases then passed along the pipe main and into an expansion box, which was in direct communication with the engine cylinder.

## Mond Gas

Mond gas was a variant of producer gas and was in essence a form of complete gasification whereby coal would be fully converted to ash, rather than to coke as would happen in a retort. The Mond gas process was designed to enable the simultaneous conversion of bituminous small coal (slack) into flammable gas, largely composed of hydrogen, and at the same time recover ammonium sulphate.

Sir George Bielby and William Young (of oil shale fame) did much of the early work on both the complete gasification process and the steaming of the char subsequently produced. Despite this,

recognition for the Mond gas process goes to its namesake, Dr Ludwig Mond, who commercially developed the process. Mond realised that by greatly restricting the air supply and saturating that air with steam, the fuel bed could be kept dark red in colour, providing a low working temperature. There were two key reasons for the low temperature. Firstly, it was below the temperature of dissociation for ammonia, which prevented its destruction and maximised the amount of ammonia which could be obtained from the nitrogen entrained in the bituminous coal. Secondly, the low temperature prevented the formation of clinker which would hamper the operation of the process, the ash being easily removed from the water seal around the base of the cone of the producer.

The first Mond gas plant was put into operation at the Brunner, Mond & Co's Works at Northwich, Cheshire. These plants required a massive capital outlay in order for them to be profitable, as only very large plants were economically viable. They had to use over 182 tonnes of coal per week for the ammonia recovery to be profitable. The efficiency of the Mond plant was as high as 80 per cent. In order to achieve this, however, a large excess of steam was required so that the small proportion of steam which was decomposed (about one third) was sufficient to absorb the heat evolved in the formation of carbon dioxide and carbon monoxide from air and carbon. For each tonne of coal, two tonnes of steam would be required for the process. This amount was reduced to one tonne of steam if ammonia was not being recovered by the plant.

Coal would be fed by coal elevators, as can be seen on the left side of the building in Photograph 1, up to hoppers which would feed the small pieces of bituminous coal down into the Mond producers. The Mond producer operated at about 600°C and was fed with hot moist air (250°C) from the superheater.

Following the mechanical washer, the gas was subjected to treatment in the acid tower (labelled as 4 on Figure 5), which was designed to remove ammonia. The gas passed upwards through the tower against a counter-current flow of weak sulphuric acid sprayed down the brick- and tile-filled tower, forming ammonium sulphate. The weak sulphuric acid solution would be recirculated until a concentration of between 36 and 38% ammonium sulphate was reached. At this point, the solution would be removed and replaced by fresh weak sulphuric acid. The ammonium sulphate solution would be removed and evaporated, yielding the ammonium sulphate. The acid tower was lead lined (steel would have been corroded by the acid), as lead was resistant to corrosion and had been commonly used in processes involving acids (e.g. lead chamber process). The acid tower was therefore a source of potential lead contamination on these former Mond gas plants.

With the ammonia removed, the gas was then passed through the gas cooling tower (labelled as 7 on Figure 5), where the upflow of gas was met with a downward spray of cold water, cooling the gas. Following this treatment, the gas could be used for its intended purpose. The water from the gas cooling tower emerged hot, and any suspended tar within water was removed in the settling tank (labelled as 8 on Figure 5). This hot water was then pumped up to the top of the air saturation tower where it was used to heat (to 85°C) the hot moist incoming blast air being blown into the Mond producer.

The Mond gas process would produce between 19 kg and 40 kg of ammonium sulphate and between 3,960m<sup>3</sup> and 4,530m<sup>3</sup> of gas per tonne of coal. The amount of ammonia produced was dependent on the nitrogen content of the coal, the latter having a preferred nitrogen content higher than 1.5%. The predominant reaction in the Mond gas process is between carbon and water forming

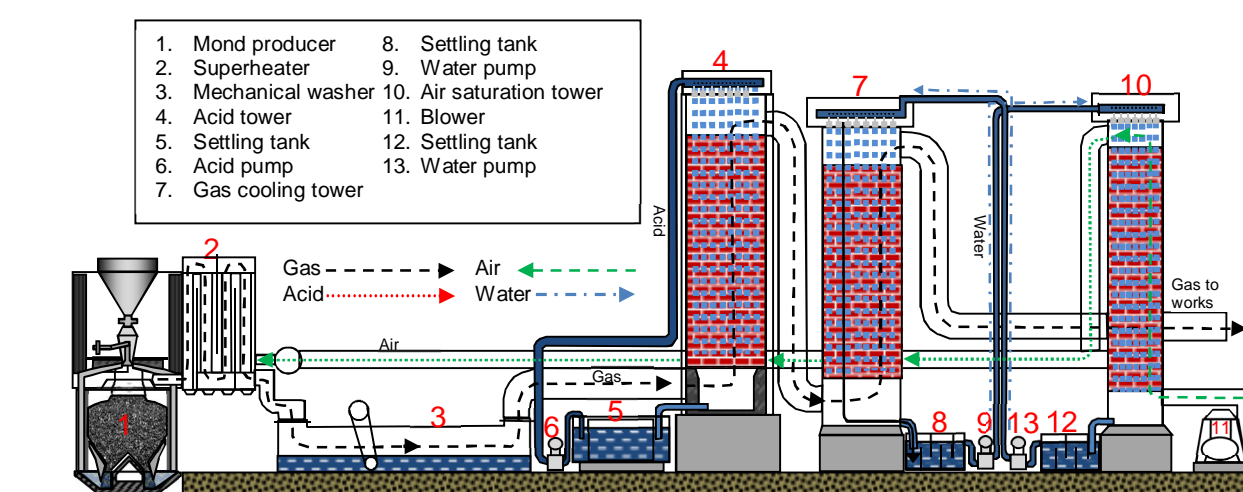

**Figure 5. The Mond system of gas production and ammonia recovery. Based on historical process drawings, image courtesy of Russell Thomas.**

carbon dioxide and hydrogen. The water gas process which predominates at higher temperatures forms carbon monoxide and hydrogen. Both reactions are shown below.

Predominant reaction in Mond gas process:

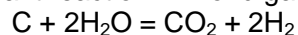

Predominant reaction in water gas process:

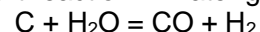

The gas manufactured was hydrogen rich and carbon monoxide poor (water gas has a much higher carbon monoxide content). It was of limited use for heating or lighting, but it could be used for some industrial purposes and power generation. The tar produced would have been brown in colour and typical of a low temperature coal tar, being high in paraffinoid components and tar acids. It would have been removed and processed elsewhere.

The Mond gas process was further developed by the Power Gas Corporation as the Lymn system.

This process was found on some larger gasworks and was more popular than the earlier Mond gas system. It was similar to the Mond gas system but used much weaker sulphuric acid and a different configuration of washers. Lymn washers can often be found recorded on plans of large former gasworks. The gas leaves the Mond producer via a piece of plant referred to as either a superheater or a regenerator (labelled as 2 on Figure 5). The purpose of this plant was twofold.

The heat of the gas and steam leaving the producer is transferred to the incoming blast of air and steam from the air saturation tower (heated to 250°C). The reverse of this is that the gas and steam leaving the producer is cooled by this process equally. From the superheater, the gas enters a mechanical washer (labelled as 3 on Figure 5), a rectangular iron chamber where the gas was thoroughly washed with a fine spray of water generated by rotating dashers. This further cooled the gas (to 100°C), whilst removing dust or heavy tarry residues.

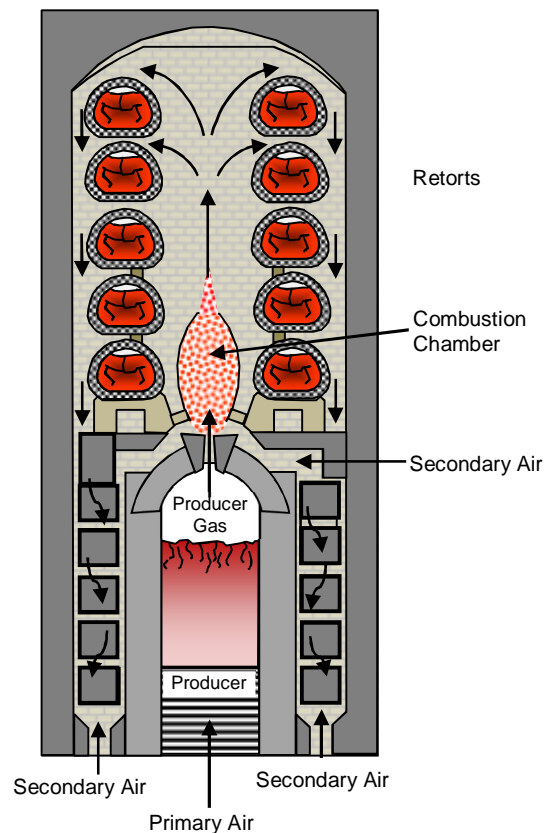
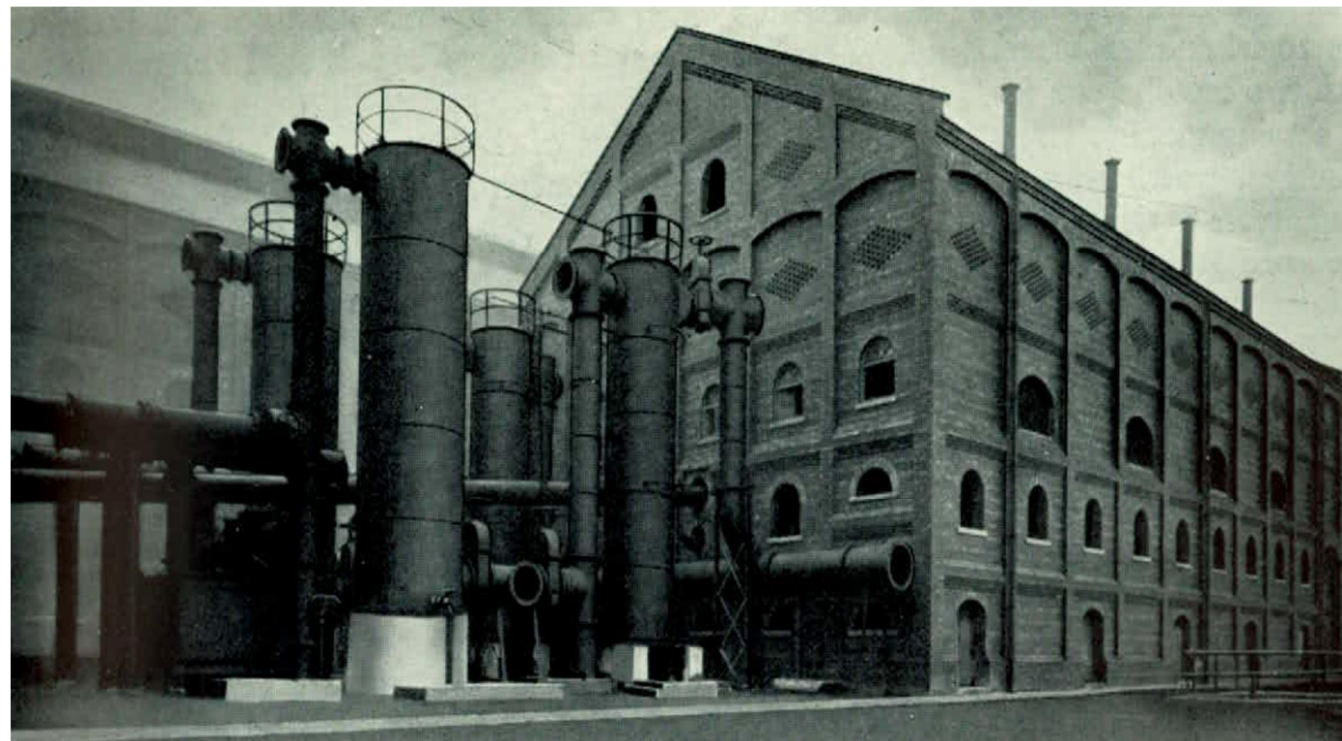

**Figure 6. Cross section of a horizontal retort, showing the gas producer. Based on historical drawings, image courtesy of Russell Thomas.**

### Gas Producers, Gasworks and Coking Works

Gas and coking works were major users of gas producers, not for producing gas to distribute (although it was sometimes used to dilute town gas) but to produce a cheap low-grade carbon monoxide gas for the heating of the retorts.

Early gasworks used horizontal retorts which were heated directly by a shallow fuel bed of coke lit



**Photograph 3. The Trefois producer house, built by Drakes at the Partington Gasworks, Manchester, which supplied producer gas to the retorts. The ancillary washers and scrubbers can be seen outside the building. Image courtesy of the National Grid Gas Archive.**

beneath the bench of retorts. The direct radiant heat from the fuel bed in the furnace and the hot waste gases heated the retort. This approach was not very efficient and was only able to heat the retort to temperatures of approximately 600°C. As a result, the amount of gas produced was relatively low in comparison with later methods and the decomposition of the organic compounds in the gas and resulting tar was limited.

The heating of the retorts developed from these early directly fired settings, through semi-gaseous fired settings (allowing some secondary combustion of gases), to gaseous producer fired settings, as shown in Figure 6.

The gaseous-fired setting used a gas producer to provide gas to heat the retorts. This system was used on all the different retort designs from horizontal to vertical. The gas producer did not need to be adjacent to the retorts (as shown in Figure 6), although if it was the heat loss was minimised. The producer could be located remotely on the gasworks supplying multiple benches of retorts. The fuel bed in a producer would be approximately 1.5m to 1.8m deep and the primary air supply was very carefully controlled to enable the correct composition of the producer gas. The producer gas was channelled to a combustion chamber directly adjacent to the retorts, where it was mixed with a secondary supply of air and burned. The subsequent hot exhaust gas

was routed through flues around the retort, heating the coal in the retort.

The gas producer was the most efficient method of heating retorts. Fuel consumption was improved further in gaseous-fired settings if advantage was taken of the waste heat in the gas after heating the retorts. If the hot waste gas was used to heat incoming air via a heat exchanger then this was called a recuperative or regenerative gaseous-fired setting. If the hot waste gas just passed out of the chimney directly or via a waste heat boiler then it was termed a non-recuperative gaseous-fired setting. These developments helped make the gas-making process more cost effective and much more efficient.

For large gasworks such as those at Partington and Garston, the producers were housed in external buildings (Photograph 3) and the gas was purified through washers and scrubbers before being piped to the retorts. Like most other producers, this plant was generally located above ground; therefore little evidence is found on former gasworks sites where the plant had previously existed.

Later gasworks, for example the one at East Greenwich in South London, used larger more advanced gas producers such as the Marishka type gas producer shown in Figure 7. This type of gas producer was separate from the gas-making plant which at the East Greenwich works included both retorts and coking works. The producer gas was used for heating coke ovens as well as retorts. It was common practice at coke works to use producer gas to heat the ovens. As the value of coke oven gas has dropped (it cannot easily be sold for domestic or industrial use) and the value of the coke increased, most coking works use coke oven gas to heat the coke ovens, rather than producer gas.

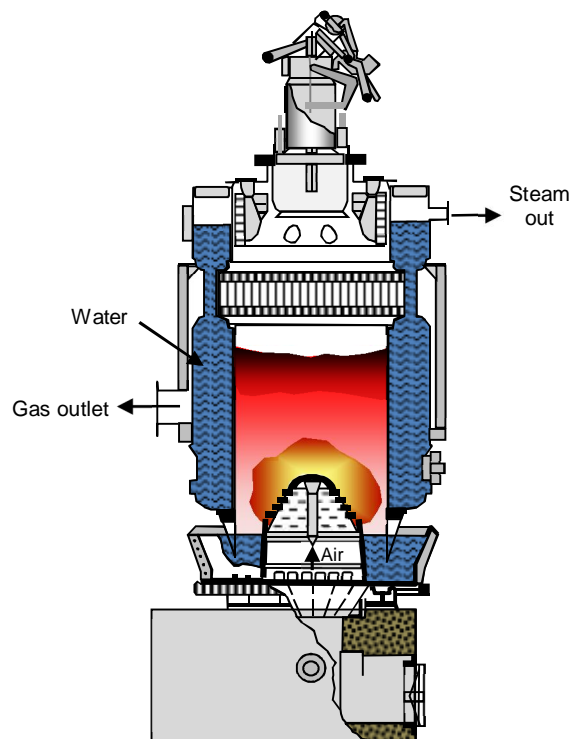

**Figure 7. Cross section of a Marishka type gas producer. Based on a historical drawing, image courtesy of Russell Thomas.**

The more advanced gas producers, such as the Marishka producer, used steam injection into the air blast. The purpose of the steam was to control the endothermic water gas reaction, the temperature of the zone of combustion, the degree of fusion of the ash, and the temperature of both the grate and exiting producer gas. The formation of water gas raised the calorific value of the gas above that of producer gas.

Producer gas production was a highly efficient process. It had low capital costs and became one of the most widely used industrial gas production methods in Britain, as it did not require cooling or gas treatment. As natural gas, liquid petroleum gas

and oil-based town gases became available and coke became costly and scarce, the popularity of gas producers diminished; they are now largely obsolete.

### **Contaminants Associated with Producer Gas Plants**

In general terms, producer gas plants were not as contaminating as traditional coal gas production methods which used retorts to produce gas. This was primarily because the feedstock fuel used within a producer was predominantly either coke or anthracite (a high-rank coal with a low concentration of volatile hydrocarbons). In some circumstances, however, other feedstocks such as coal were used; these would produce much greater concentrations of oily and tarry components when heated. The Mond gas producer and other later developments, such as the Power Gas Corporation's Lymn System, did produce tar, typically of a low temperature (500-600°C). The Mond gas process used an acid-washing process to produce ammonium sulphate which required a lead-lined acid tower.

- **Ash/Coal Dust**

Ash was the waste material remaining after the burning of the coal or coke in the producer; it contained heavy metals (e.g. As, Pb, Cu, Cd, Ni, Zn) though generally only at low concentrations. Ashes were often used for raising ground levels or for use on cinder paths.

- **Ammoniacal Liquor and Ammonium Sulphate**

Ammonia-rich liquors were formed in the scrubber of a conventional producer by spraying the gas with water. In the Mond gas process, ammonia-rich liquors were formed by spraying



the gas with a weak sulphuric acid solution within the acid tower. The action of the water or weak acid dissolved the soluble ammonia and if phenolic compounds were present they would also be dissolved. In conventional producer gas plants, the ammoniacal liquor would consist of up to 1% ammonium and a much lower concentration of phenol. Ferrocyanide and thiocyanate may also be present. Within the Mond gas process (and similar subsequent processes) the concentration of ammonium could reach 38% and then solid ammonium sulphate would be produced from the concentrated liquor by evaporation.

High concentrations of ammonium may be found in the ground around scrubbers, washers and settling tanks and the connecting pipes.

- **Coal Tars**

Significant concentrations of coal tars were generally not produced by producer gas plants, however those plants designed to be operated using bituminous coal (e.g. Mond gas) did produce coal tars. The exact composition of the coal tar produced depended on many factors, the most important being the type of gas producer operated (e.g. conventional or Mond type) and the type of coal or other fuel used.

In terms of elemental composition, coal tar is approximately 86% carbon, 6.2% hydrogen, 1.8% nitrogen and 1% sulphur, with the remaining 5% composed of oxygen and ash. In terms of the types of organic compounds present, a composition of a typical crude coal tar carbonised in retort is given below.

- Saturates 15%

- Aromatics 37%
- Resins 42%
- Asphaltenes 6%

The exact proportions are likely to be different in producer gas tars. Producer gas tar was recorded by Young in 1922 as being very viscous and containing large amounts of water which would prove difficult to separate. If distilled, producer gas tar would contain no light oils, paraffins or high boiling tar acids, but would contain a large percentage of pitch. This suggests it was a highly degraded tar, similar to coke oven tar.

Mond gas tar, which was produced by a relatively low temperature process, would produce a low-temperature tar which would be brown, oily and contain unsaturated hydrocarbons (olefins), naphthenes, paraffins, phenols and pyridines; benzene and its homologues and aromatic compounds naphthalene and anthracene would be absent.

The main contaminants of concern within coal tar would be:

- Polycyclic aromatic hydrocarbons (PAH), in particular carcinogenic PAH such as Benzo(a)pyrene.
- Phenolic compounds (e.g. phenol, cresols, xylenols).
- Benzene, toluene, ethylbenzene and xylenes (BTEX).
- Aromatic and aliphatic petroleum hydrocarbons.
- Ammonia, styrene, carbazole and dibenzofuran.

- **Lead**

Lead was used to line the acid towers of the Mond gas plant. Lead may therefore be found associated with the site of the former acid towers on Mond gas plants.

- **Sulphuric Acid**

Weak sulphuric acid was used within the acid towers in the Mond gas process to remove ammonia from the gas as ammonium sulphate.

### **Scenarios Where Producer Gas Plants Were Used**

Gas producers were employed in Britain in many and varied industrial, commercial and domestic settings from 1880s to the mid-20<sup>th</sup> Century. They are still used in some other countries.

Gas producers were used in the following settings:

- Gasworks, to heat the retorts and occasionally to produce gas at times of high demand.
- Coking works, to heat the coke ovens.
- Steel works.
- Ore roasting plants.
- Power stations.
- Factories and mills.
- Railway works.
- Glass works.
- Potteries and kilns.
- Muffle furnaces.

- Chemical works (e.g. those using the Mond process).
- Country estates to power gas engines for electricity generation and to directly drive plant such as saw mills.
- Large schools, hospitals or other public institutions to power gas engines for electricity generation and to directly drive plant.

Unlike conventional coal gasworks which are often visible on Ordnance survey maps, producer gas plants are not always clearly marked. They did not always use large gasholders which would be marked on maps (labelled gasometer). Often, if the plant was small, it would be housed within a building and therefore not visible to the map surveyors. They may, however, be marked on site plans.

### Case Studies

#### *Small-Scale Gas Producer Plants - Canwell Estate*

Canwell was typical of many country estates; it consisted of a substantial house, containing 43 rooms. The estate also included stables, garages and farms with associated tenanted cottages. As with many such estates, lighting would be very desirable, as would a readily available source of power.

The estate was powered by a conventional coal gasworks until 1905, providing light and power to the whole estate. Power came from two gas engines powered by the gasworks and was used for both pumping and powering the farm machinery. Where the tenants used gas, they were charged at the cost of production.

In 1905, an electric plant was installed to replace the gasworks. The plant consisted of two 30 HP gas

engines (equivalent to 22.3 kW), each with suction-gas producers and two generators. The generators powered an accumulator (battery) capable of maintaining all the lights that were required for nine hours (overnight). The plant powered a maximum of 720 lights plus two additional 15 HP motors



**Photograph 4. Suction Gas Producers at Canwell. From Country House and Its Equipment, L. Weaver, Country Life 1912.**

(equivalent to 11.1 kW) running various pieces of plant such as a saw mill and laundry. The conversion to the producer gas system was approximately 10 to 15% cheaper than the previous energy provided by the gasworks. This conversion to gas producers and electric power generation was common place *circa* 1900, when many country estates ceased coal gas production.

#### *Medium-Scale Gas Producer Plants – Electrical Generating Stations and Gasworks*

During the gradual switch to electrical power generation, some power plant used gas producers to power gas engines which in turn powered generators producing electricity.

Towns such as Chelmsford and Walthamstow switched to producer gas powered electricity generation. The electricity generating station of the Urban District Council of Walthamstow provided electric power for the electric lighting of the town and also for powering the electric tramway service. In this particular plant, the gas engines were built by Westinghouse and the producer gas plant used was a Dowson steam-jet type.

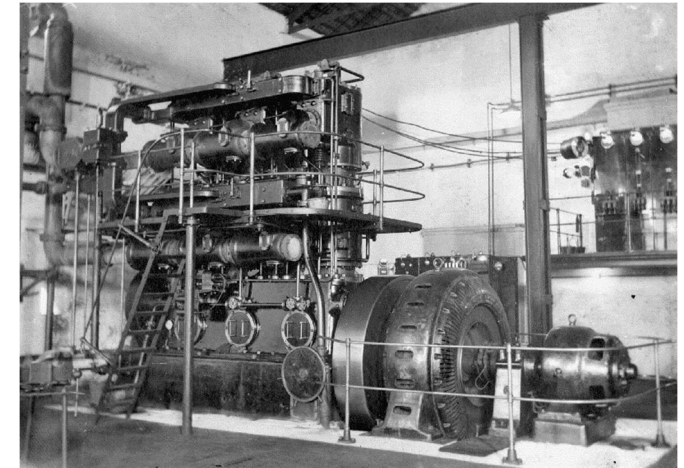

**Photograph 5. Gas engine powering an electrical generator at a colliery powerhouse, 1914. Image courtesy of the National Grid Gas Archive.**

These works had an aggregate power of 3,000 HP (equivalent to 2.2 megawatts) in 1905.

As mentioned previously, gasworks were major uses of producer gas plants. They provided a cheap source of low calorific value gas which could be used to heat retorts and utilise the ready supply of surplus coke generated by the coal gasification process. Photograph 6 shows a gas producer at the the Garston gasworks located near Liverpool.

This plant operated producers for heating retorts, however it is also known that the producers were used to dilute the town gas supply at times of peak demand. Given that producer gas contained high quantities of nitrogen and carbon monoxide, then care would have had to be used not to dilute the gas too significantly.

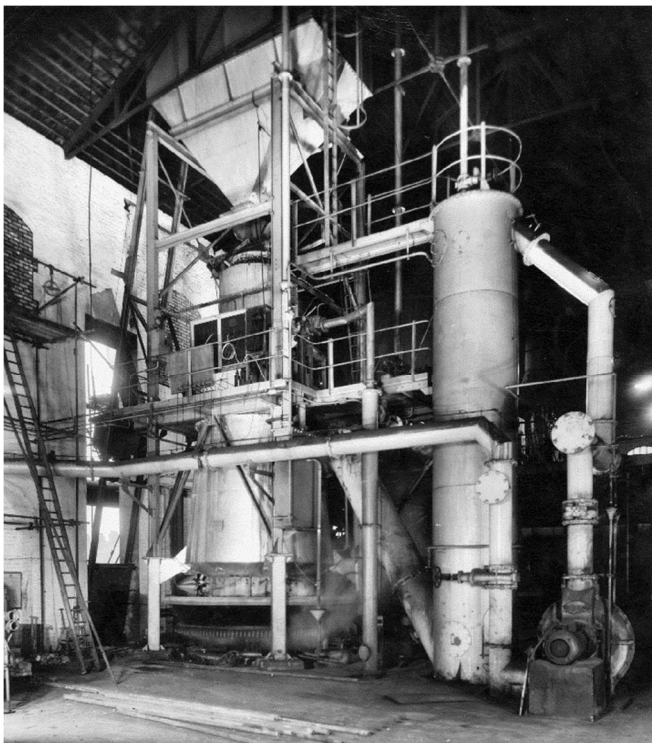

**Photograph 6. Gas producer (left) and Scrubber (right) at the former Garston gasworks, 1947. Image courtesy of the National Grid Gas Archive.**

The gas from the producers was cleaned using gas scrubbers, shown on the right of Photograph 6. These towers would be filled with material with a high surface area such as coke, ceramic or wood and would be continually sprayed with water to remove dust, any residual tar and ammonium.

### *Large-Scale Gas Producer Plants – South Staffordshire Mond Gas Company*

The largest example of a producer gas plant in the UK was that built at Dudley Port, Tipton. This Mond gas plant was built by South Staffordshire Mond Gas Company *circa* 1902 after it had obtained the parliamentary powers to distribute producer gas in South Staffordshire via a gas distribution network. The plant was designed to house 32 producers, capable of gasifying over 600 tonnes of coal per day. To ensure a supply of gas could be maintained, the plant was designed in duplicate, including the producers, ammonia recovery, gas washing and cooling apparatus.



**Photograph 7. The former South Staffordshire Mond Gas Company works. Image courtesy of the National Grid Gas Archive.**

The gas was distributed from the plant through the use of compressors at a pressure of 10 PSI equivalent to 68.9 kilopascals. The mains were manufactured as specialised asphalt-covered steel mains. The works provided gas to industrial customers via a specialised high-pressure gas network which covered a large area of South Staffordshire, competing against other gas companies. This was the first example of such a high-pressure gas network in the UK.

When the Mond gas plant switched to coke as a feedstock, the resulting gas was of a lower calorific value, as volatile and semi-volatile hydrocarbon and organic compounds were not present in coke. Gas from the plant therefore had to be mixed with conventional coal gas from a nearby gasworks to enrich its calorific value to make it suitable for use.

### **Known Producer Gas Plants**

The sites listed below are examples of known sites or companies in the UK where producer gas plants were previously installed. This is not an exhaustive list and many other sites were also known to have existed, especially small producer gas plants such as that described at Canwell. It should also be noted that most medium- and large-scale gas manufacturing plants and many coke ovens also used gas producers to heat the retorts and coke ovens. These gas producers could be integrated or separate from the retort house or coke ovens.

- Medium to large sized gasworks
- By-product coking works
- The Castner-Kellner Alkali Co Ltd, Runcorn
- Albright & Wilson Ltd, Oldbury
- Ashmore, Benson, Pease & Co Ltd, Stockton-on-Tees
- Gloucester Asylum, Coney Hill
- The Railway and General Engineering Co Ltd, Nottingham
- Birmingham Small Arms Factory, Smallheath
- The Salt Union Ltd, Liverpool
- The South Staffordshire Mond Gas Co
- Brunner, Mond & Co Ltd, Northwich
- Cadbury Bros Ltd, Birmingham
- D&W Henderson & Co Ltd, Glasgow
- The Premier Gas Engine Co Ltd, Nottingham
- J&E Wright of Millwall
- The Trafford Power and Light Co Ltd, Manchester

- Walthamstow District Isolation Hospital
- The Farnley Iron Co Ltd, Leeds

### Selected Bibliography

Below is a selected bibliography of books which may be of interest to the reader:

Clegg Jnr S., A Treatise on Gas Works and the Practice of Manufacturing and Distributing Coal Gas, 1841 (other later editions), John Weale, London.

Newbigging, T., and Fewtrell, Wm., three volumes published between 1878-1913 King's Treatise on the Science & Practice of the Manufacture & Distribution of Gas, Walter King, London.

Wyer, S.S. A treatise on producer-gas and gas-producers, 1906, New York, McGraw-Hill.

Hunt, C., A History of the Introduction of Gas Lighting, 1907, Walter King, London.

Dowson, J.E, Larter, A.T., Producer Gas, Longmans, Green and Co. 1907.

Smith, C.A.M, Suction gas plants, 1909, London, C. Griffin.

Latta, M.N. American Producer Gas Practice and Industrial Gas Engineering, 1910, New York, D. Van Nostrand company.

Meade, A., Modern Gas Works Practice, 1916, 1921, 1934, Benn Brothers, London.

Lowry, H.H. - Chemistry of Coal utilisation, Vol. 2, Chapter 37, Water Gas, 1945, John Wiley And Sons Inc.

King C. Ed - Kings Manual of Gas Manufacture, 1948, Walter King, London.

Terrace, J., Terrace's Notebook for Gas Engineers & Students, 1948, Ernest Benn, Ltd., London.

**Photograph 8. A producer gas plant with cooling and purifying plant for gasification of bituminous coal. Image courtesy of the National Grid Gas Archive.**

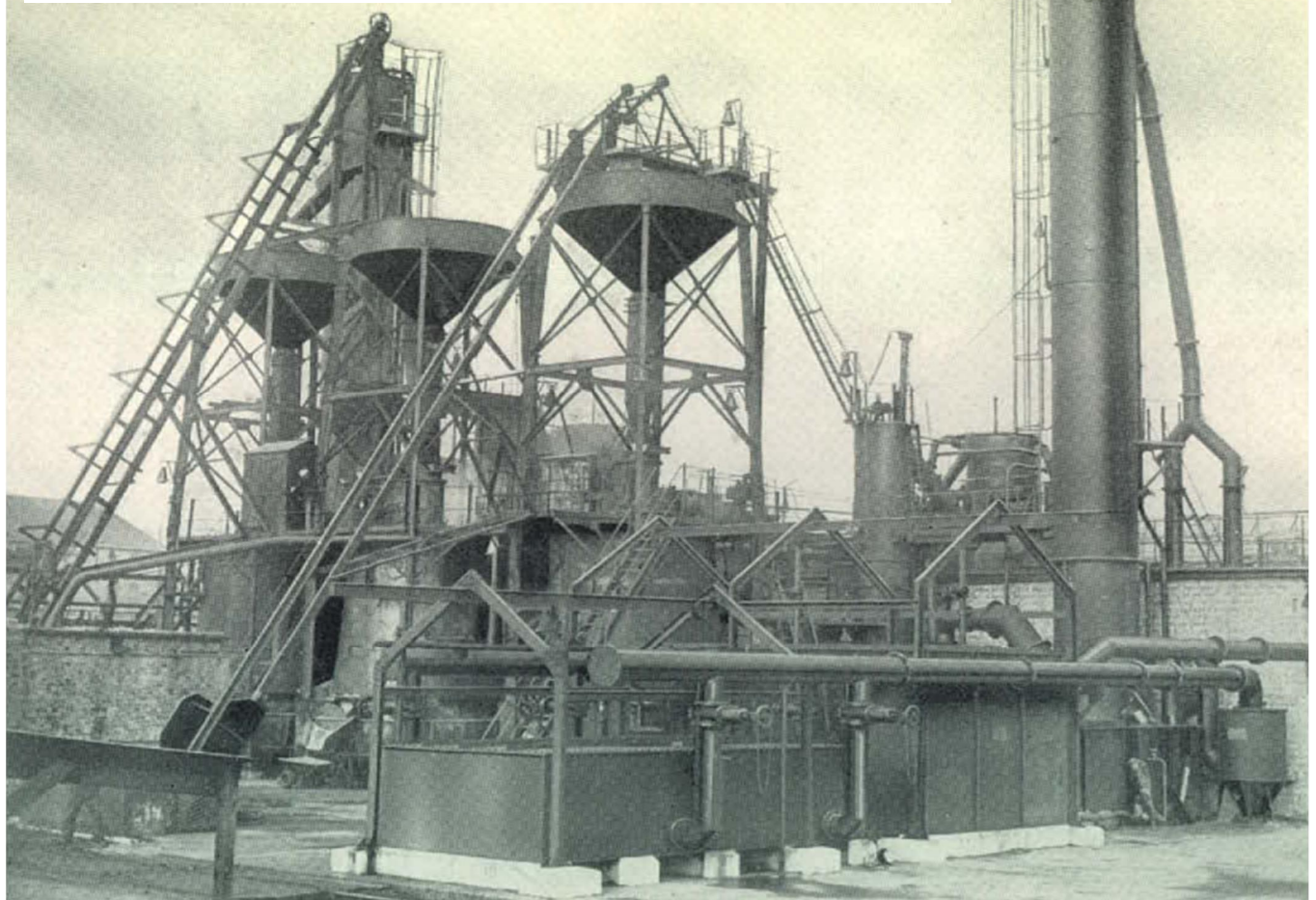

Chandler, D. and Lacey, A.D. The rise of the gas industry in Britain, 1949, British Gas Council.

British Petroleum - Gasmaking, 1959 and 1965, The British Petroleum Company Ltd, London.

**Disclaimer.** The purpose of this document is to act as a pointer to the activities carried out on former producer gas plants. The author will not be responsible for any loss, however arising, from the use of, or reliance on, this information. This document ('this publication') is provided 'as is', without warranty of any kind, either expressed or implied. You should not assume that this publication is error-free or that it will be suitable for the particular purpose which you have in mind. We assume no responsibility or liability for errors or omissions in this publication. Readers are advised to use the information contained herein purely as a guide and to take appropriate professional advice where necessary.