

Chicago Code Exit and Emergency Lighting

Specification-grade exit and emergency lighting
for commercial and industrial applications

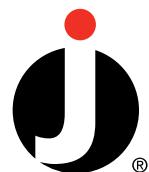



Table of Contents

Chicago Code Exit Signs

Steel LED Exit Signs - NCXL and NCSL series	4
Surface Mount Edgelit Exit Signs - NCEXL and NCESL series	5
Recessed Mount Edgelit Exit Signs - NCREXL and NCRESL series	6

Chicago Code Emergency Lighting

Steel Emergency Light - NC627 Series	7
T-Bar Recessed Emergency Light – NCR Series	8
High Wattage Steel Emergency Lights – NC6 and NC12 series	9
Photometry/Technical Data	10
Wiring and Warranty Information	11

Chicago Code Exit and Emergency Lighting

Durable – Reliable – Economical – Installer-Friendly

Juno Lighting Group – the perfect single source for all your exit and emergency lighting needs – features premium NaviLite Chicago Code Exit and Emergency Lights. Ideal for retail, commercial and industrial applications, NaviLite's extensive offering now includes a complete line of Chicago Code exit signs and emergency lighting units to suit practically any application.

Rugged design – easy installation:

NaviLite Chicago Code Steel Exit Signs and Emergency Units are constructed using high quality, heavy gauge steel. Finishes are rugged and scratch resistant. A universal pattern knock-out template comes standard with all steel exit signs to reduce installation time.

Commercial grade aesthetics and performance:

For a more elegant appearance, NaviLite Chicago Code Edgelit Exit Signs deliver long lasting performance in a compact and unobtrusive design. Constructed of high quality acrylic, the white background and the red letters blend seamlessly to any decor.

Energy and maintenance savings:

All NaviLite Chicago Code Exit Signs use high output white LED light sources, cutting energy consumption to the bone. The LED chips deliver lasting performance for years to come without the need to replace lamps.

Unparalleled reliability:

NaviLite Emergency Lights utilize integrated solid state electronics that maximize battery performance through a multi-rate controlled automatic charger. The electronics are also sensitive to the charge level in the battery and they prevent deep discharge, increasing the useful life of the battery.

Regulatory compliance:

NaviLite Chicago Code Exit and Emergency Lighting products are designed to comply with the latest codes and performance standards including: UL924, NFPA 101 Life Safety Code, NEC, OSHA and Chicago Building Code.

Chicago Code Steel LED Exit Signs

AC Only and Battery Backup

NaviLite NCXL and NCSL Series Steel LED Signs provide durability, reliability, and unsurpassed quality while offering installation flexibility with features such as simple screw on canopy and knockouts for top, side or back mounting.

Features

- Rugged, heavy duty steel construction
- Includes canopy and hardware for easy top or end mount installation
- Universal mounting pattern knockouts in back plate for back mounting
- Open-face glass panel
- Silk screen 6" letters with 3/4" stroke width
- Full size arrow directional indicators
- Red letters on white translucent background reading "EXIT" (NCXL) or "STAIRS" (NCSL)
- Corrosion resistant powder-coat white finish
- Long life LED light source
- Maintenance-free NiCad battery (battery backup version only)



Code Compliance

- UL Listed
- NFPA 101 Life Safety Code compliant
- NEC and OSHA compliant
- Chicago Code

Ordering Information

Example: NCXLU1WHNA					
Series		Voltage	# of Faces	Finish	Arrow Configuration
NCXL	Steel EXIT Sign	U 120-277VAC	1 Single Face	WH White	NA No Arrow
	- AC only		2 Double Face		AR Arrow Right →
NCSL	Steel STAIRS Sign				AL Arrow Left ←
	- AC only				DA Double Arrow ↔
NCXLB	Steel EXIT Sign				
	- Battery Backup				
NCSLB	Steel STAIRS Sign				
	- Battery Backup				

Accessories

Catalog Number	Description
T91-12-WH	Pendant Kit 12" for Rigid Ceiling
T90-12-WH	Pendant Kit 12" for T-bar

Accessories are ordered separately. To order, specify catalog number.

Dimensions

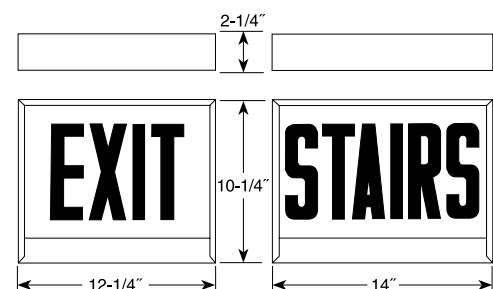



Chicago Code Surface Mount Edgelit Exit Signs

AC Only and Battery Backup

Navilite NCEXL and NCESL Series Signs provide durability, reliability, and unsurpassed quality while offering energy savings and reduced maintenance with a long life LED light source.

Features

- Rugged, aluminum housing construction
- Includes canopy and hardware for easy top or end mount installation
- Clear acrylic face plate
- 6" letters with 3/4" stroke width
- Full size arrow directional indicators
- Red letters on white translucent background reading "EXIT" (NCEXL) or "STAIRS" (NCESL)
- Corrosion resistant powder-coat white finish
- Long life LED light source
- Maintenance-free sealed NiCad battery (battery backup version only)



Code Compliance

- UL Listed
- NFPA 101 Life Safety Code compliant
- NEC and OSHA compliant
- Chicago Code

Ordering Information

Example: NCEXLU1WHNA

Series		Voltage	# of Faces	Finish	Arrow Configuration
NCEXL	Chicago Surface Mount	U 120-277VAC	1 Single Face	WH White	NA No Arrow
	Edgelit EXIT - AC Only		2 Double Face		AR Arrow Right →
NCESL	Chicago Surface Mount	U 120-277VAC	1 Single Face	WH White	AL Arrow Left ←
	Edgelit STAIRS - AC Only		2 Double Face		DA Double Arrow ↔
NCEXLB	Chicago Surface Mount	U 120-277VAC	1 Single Face	WH White	NA No Arrow
NCESLB	Chicago Surface Mount	U 120-277VAC	1 Single Face	WH White	NA No Arrow

Accessories

Catalog Number	Description
T91-12-WH	Pendant Kit 12" for Rigid Ceiling
T90-12-WH	Pendant Kit 12" for T-bar

Accessories are ordered separately. To order, specify catalog number.

Dimensions

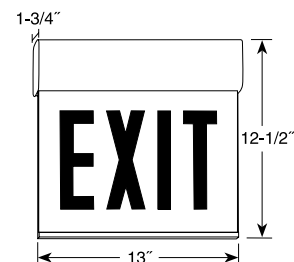

Chicago Code Recessed Edgelit Exit Signs

AC Only and Battery Backup

NaviLite NCREXL and NCRESL Series Recessed Edgelit Signs provide durability, reliability, and unsurpassed quality while offering energy savings and reduced maintenance with a long life LED light source.



Features

- Rugged, heavy duty recessed housing
- Clear acrylic face plate
- 6" letters with 3/4" stroke width
- Full size arrow directional indicators
- Red letters on white translucent background reading "EXIT" (NCREXL) or "STAIRS" (NCRESL)
- Corrosion resistant powder-coat white finish
- Energy saving LED light source
- Maintenance-free NiCad battery (battery backup version only)
- Chicago plenum construction

Code Compliance

- UL Listed
- NFPA 101 Life Safety Code compliant
- NEC and OSHA compliant
- Chicago Code
- CCEA (Chicago Plenum)

Ordering Information

Example: NCREXLU1WHNA					
Series		Voltage	# of Faces	Finish	Arrow Configuration
NCREXL	Chicago Recessed Mount	U 120-277VAC	1 Single Face	WH White	NA No Arrow
	Edgelit EXIT- AC only		2 Double Face		AR Arrow Right →
NCRESL	Chicago Recessed Mount				AL Arrow Left ←
	Edgelit STAIRS- AC only				DA Double Arrow ↔
NCREXLB	Chicago Recessed Mount				
	Edgelit EXIT- Battery Backup				
NCRESLB	Chicago Recessed Mount				
	Edgelit STAIRS- Battery Backup				

Dimensions

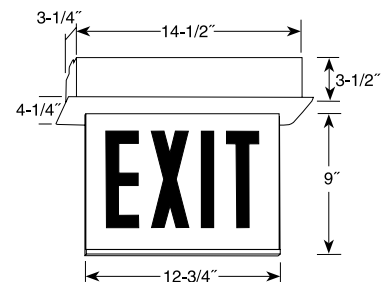



Chicago Code T-Bar Recessed Emergency Lights

Adjustable Round Steel Heads

NaviLite NCR Series T-Bar Recessed Emergency Lights mount flush with the ceiling for a concealed, unobtrusive look. The NCR Series is an ideal choice for commercial applications that require adjustability when wall mounting is undesired or not practical.



Features

- Rugged, heavy duty steel construction
- Designed for recessed mounting in 2-foot grid (T-Bar) drop ceilings
- Corrosion resistant powder-coat finish
- Chicago plenum construction
- Dual voltage transformer 120/277VAC
- Multi-rate, controlled, automatic charger keeps battery at peak operating levels
- Low-voltage battery cut-off protects battery from deep discharge
- AC power indicator and test switch
- Supplied with two 6V, 12W halogen lamps
- Maintenance-free sealed lead acid battery

Code Compliance

- UL Listed
- NFPA 101 Life Safety Code compliant
- NEC and OSHA compliant
- Chicago Code
- CCEA (Chicago Plenum)

Ordering Information

Example: NCR627WH

Catalog Number	Finish	Output Voltage	Lamp Wattage	Rated Output Watts		
				1 1/2 hrs.	2 hrs.	3 hrs.
NCR627WH	White	6V	2 x 12W	27	-	-
NCR650WH	White	6V	2 x 12W	50	36	24
NCR1250WH	White	12V	2 x 12W	50	36	24

Dimensions

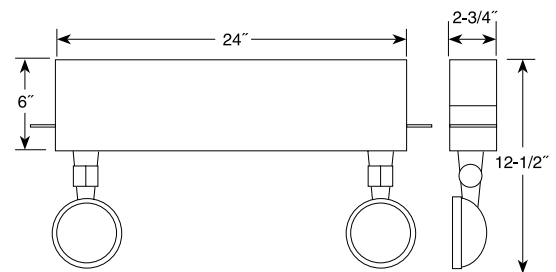

Chicago Code Steel Emergency Light

Adjustable Round Steel Heads

NaviLite NC627 Steel Adjustable Emergency Light offers contemporary aesthetics, quick installation and premium features like steel lamp heads and halogen lamps.

Features

- Rugged, heavy duty steel construction
- Universal mounting pattern knockouts in back plate for back mounting
- Corrosion resistant powder-coat finish
- Dual voltage transformer 120/277VAC
- Multi-rate, controlled, automatic charger keeps battery at peak operating levels
- Low-voltage battery cut-off protects battery from deep discharge
- AC power indicator and test switch
- Supplied with two 6V 12W halogen lamps
- Maintenance-free sealed lead acid battery
- Standard battery will operate a maximum load of 27W for a minimum of 90 minutes



Code Compliance

- UL Listed
- NFPA 101 Life Safety Code compliant
- NEC and OSHA compliant
- Chicago Code

Ordering Information

Example: NC627WH

Catalog Number	Finish	Output Voltage	Lamp Wattage	Rated Output Watts 1 1/2 hrs.
NC627WH	White	6V	2 x 12W	27

Dimensions

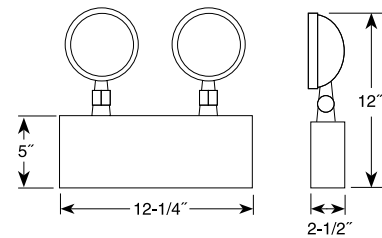



Chicago Code High Wattage Steel Emergency Lights

6 Volt or 12 Volt Emergency Operation

Navilite NC6 and NC12 Series High Wattage Steel Emergency Lights are high end units designed with larger batteries to deliver remote capacity or longer emergency operation. They are ideal choices for commercial and industrial applications.

Features

- Rugged, heavy duty steel construction
- Corrosion resistant white powder-coat finish
- Steel lamp heads
- Dual voltage transformer 120/277VAC
- Multi-rate, controlled, automatic charger keeps battery at peak operating levels
- Low-voltage battery cut-off protects battery from deep discharge
- AC power indicator and test switch
- Supplied with two 12V (NC12) or 6V (NC6), 12W halogen lamps
- Maintenance-free sealed lead acid battery
- 6 Volt or 12 Volt operation

Code Compliance

- UL Listed
- NFPA 101 Life Safety Code compliant
- NEC and OSHA compliant
- Chicago Code

Ordering Information

Example: NC650WH								
Catalog Number	Finish	Output Voltage	Lamp Wattage	Rated Output Watts				
				1 1/2 hrs.	2 hrs.	3 hrs.	4 hrs.	6 hrs.
NC650WH	White	6V	2 x 12W	50	36	24	-	-
NC6100WH	White	6V	2 x 12W	100	75	48	36	24
NC1250WH	White	12V	2 x 12W	50	36	24	-	-
NC12100WH	White	12V	2 x 12W	100	75	48	36	24



Dimensions

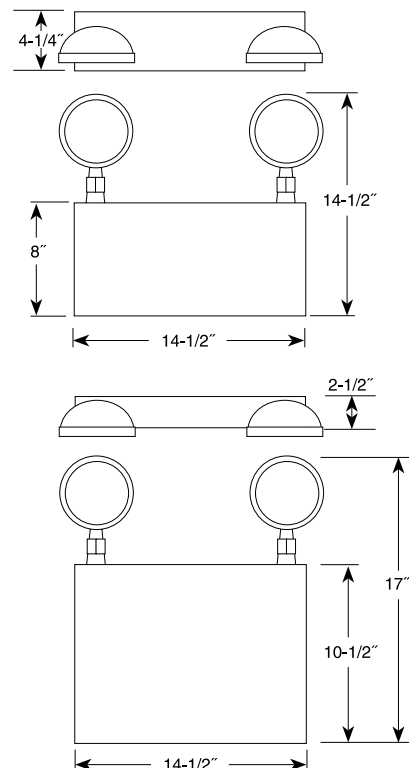

Photometry

The following ISO-footcandle diagrams are provided as estimates of the anticipated light levels at various points relative to the light source. The actual light levels may differ due to cavity reflectance and manufacturing variables; the diagrams should only be used to estimate the type and quantity of fixtures needed to meet illumination requirements. Actual light levels should be verified following installation to determine code compliance.

**NC650WH, NC6100WH, NC627WH,
NCR627WH, NCR650WH**

**NC650WH, NC6100WH, NC627WH,
NCR627WH, NCR650WH**

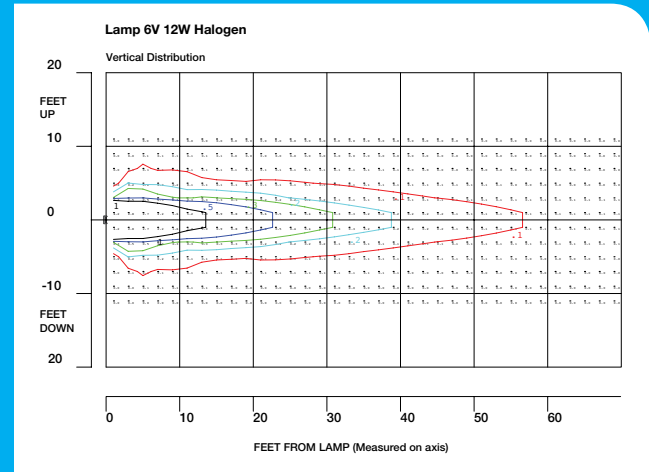
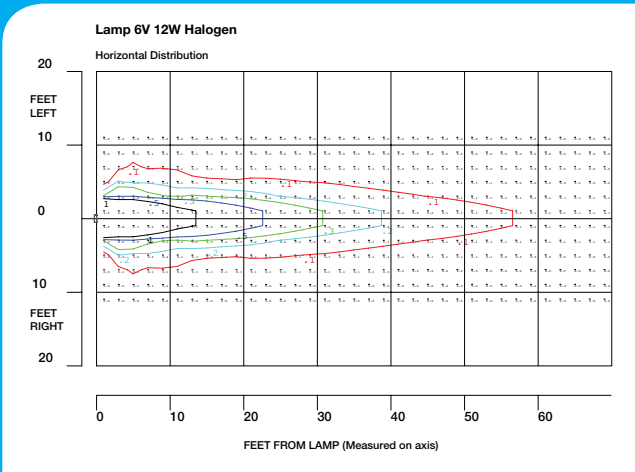

NC1250WH, NC12100WH, NCR1250WH

NC1250WH, NC12100WH, NCR1250WH

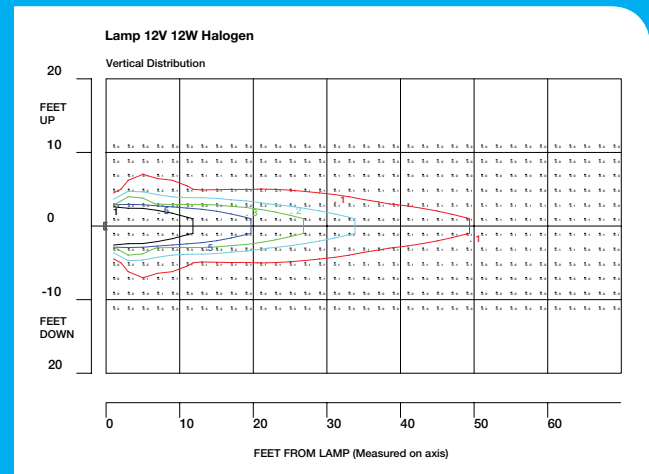
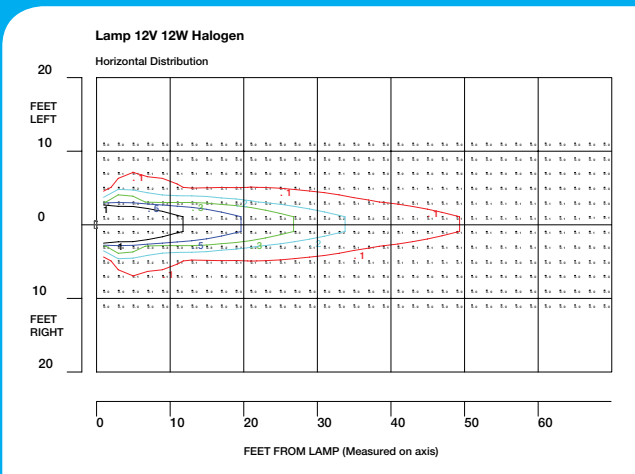

Wiring and Warranty Information

Determining Wire Size

When remote lighting fixtures are connected to emergency lighting units, circuit runs must be of sufficient size to maintain a proper operating voltage to all lamps. The National Electrical Code limits voltage drop to a maximum of 5% of normal. The accompanying table gives the maximum length of wire run based on system voltage, wire gauge and total wattage on the run. To determine the maximum length of a wire run not listed, divide the value of the load in watts into the constant listed at the bottom of each row. For examples, the maximum wire run length for #10 wire on a 12 volt system, with a 63 watt is $3397 \div 63$, or 53 feet. Conversely, to determine the maximum load on a run of known length, divide the run length into the constant. For example, a 100 foot run of #10 wire on a 12 volt system can be loaded to, $3397 \div 100$, or 33 –watts; on #8 wire, $5403 \div 100$, or 54 watts.

Total Watts on Wire Run	Wiring Distance in Feet (for maximum voltage drop of 5%)									
	6 Volt System Wire Size				12 Volt System Wire Size					
	#12	#10	#8	#6	#12	#10	#8	#6	#4	
6	89	141	225	357	356	566	900	1431	2276	
8	66	106	168	268	327	424	675	1073	1707	
9	59	94	150	238	237	377	600	954	1517	
10	53	84	135	214	213	339	540	859	1366	
12	44	70	112	178	178	283	450	715	1138	
16	33	53	84	134	133	212	337	536	853	
18	29	47	75	119	118	188	300	477	758	
24	22	35	56	89	89	141	225	357	569	
25	21	33	54	85	85	135	216	343	546	
27	19	31	50	79	79	125	200	318	505	
30	17	28	45	71	71	113	180	286	455	
36	14	23	37	59	59	94	150	238	379	
42	12	20	32	51	50	80	128	204	325	
45	11	18	30	47	47	75	120	190	303	
48	11	17	28	44	44	70	112	178	284	
50	10	16	27	42	42	67	108	171	273	
75	7	11	18	28	28	45	72	114	182	
100	5	8	13	21	21	33	54	85	136	
Constant	534	849	1350	2148	2137	3397	5403	8590	13660	

Longer Wire Runs

The wiring distances give the maximum length of a low voltage circuit, assuming that the entire load is concentrated at the end of the circuit. If loads are uniformly spaced along the circuit path (equal watts, equal spacing distances), the lengths in the table may be increased, based on number of fixtures on a given circuit, by means of the chart and formula at the top of the right column

For example, a 60 foot long, 12 volt circuit has five 9 watt heads spaced 12 feet apart. According to the wire run table, #10 wire must be used (at 75 feet for a 5% voltage drop). However, by multiplying the 47 feet for #12 wire by 1.67 (5 fixtures equally spaced multiplier), a 78 foot wire run is acceptable, so #12 wire may be used and still meet the 5% voltage drop limitation.

Number of Fixtures	2	3	4	5	6	n
Multiply Feet by	1.33	1.5	1.6	1.67	1.7	$2n/(n+1)$

Product Warranty Information

All NaviLite Chicago products are warranted against defects in material or workmanship for a full 5 years from date of invoice. This guarantee covers all components except batteries (which are warranted on a pro-rata basis as described below) provided the defect develops while the product is used under normal and manufacturer specified conditions. NaviLite's sole obligation in the event of such defect is limited to repair or replacement of the defective component — no labor charges will be honored.

Battery Warranty Information

All NaviLite batteries are warranted on a pro-rata basis. The battery warranty period is defined as follows:

Battery Type	Warranty Period		
	No Charge Period	Pro-Rata Charge Period	Total Warranty
Lead Acid	1 Year	4 Years	5 Years
Nickel Cadmium	5 Years	5 Years	10 Years

The "No Charge" Warranty Period begins on the date of installation or 90 days from the date of invoice, whichever is earlier. The "Pro-Rata Charge" Warranty Period begins the day that the No Charge Warranty Period ends.

A battery that is determined to be defective during the Pro-Rata Charge Warranty Period will be replaced at the cost of the net price in effect at the time, less the relative percentage of years remaining on the Total Warranty. For example, a Lead calcium battery determined to be defective in year 2 of the Total Warranty would be replaced for the cost of the net price less 60% (3 of 5 years remaining).





Juno[®]

Recessed and Trac Lighting

indy[™]

Architectural Recessed Lighting

AccuLite[®]

Commercial and Industrial Lighting

AcuLux[™]

Precision Recessed Lighting

Navilite[®]

Exit and Emergency Lighting

DanaLite

Architectural Linear Lighting

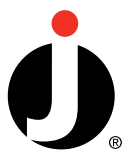

Juno Lighting Group

1300 South Wolf Road
Des Plaines, IL 60018

Ph: 847.827.9880

www.junolightinggroup.com

Regional Offices & Warehouses

California

Illinois

Indiana

Pennsylvania

Texas

Ontario, CN



©2016 Acuity Brands Lighting, Inc. The marks appearing in this catalog are trademarks of Acuity Brands Lighting, Inc. Products shown in this brochure may be covered by U.S. and international patents and patents pending. Specifications subject to change without notice.