



UDC 62.52

SECU-3i PROGRAMMABLE ENGINE MANAGEMENT SYSTEM

*Alexey Shabelnikov**Шабельников Олексій Олексійович інженер-програміст*

Summary: the article deals with research and development of the hardware of programmable and fully customizable engine management system for spark-ignition internal combustion engine. The task is solved by designing of the microcontroller based device consisting of two boards. By means of data from sensors and using of actuators, system controls fuel injection, ignition, fuel pump, canister purge valve, electric cooling fan and other devices on the engine. Schematic diagrams, photos of printed circuit boards, photo of the assembled unit and example of the wiring diagram are described. Developed hardware is flexible and versatile and in conjunction with open source software has opportunity to be installed on different type of engines and to build unique system configurations.

Keywords: injection, ignition, knock, sensor, actuator, microcontroller, control, engine, SECU-3

Introduction. Number of vehicles in the world is growing and most of them are still use internal combustion engines. Modern electronic engine management systems (EMS) allow achieving very high indexes in fuel economy, power, efficiency and ecology. At the same time, there are still a lot of old or relatively old vehicles with legacy EMS (often out of production) or even with carburetor and contact ignition (for instance, rare cars).

EMS, which are produced for serial vehicles are designed for certain engines, configured for specific sensors and actuators and can't be reprogrammed (or it is not easy), algorithms can't be changed etc. This is a big drawback for installing them on old vehicles or simply engines which EMS was not designed for.

Some companies develop and offer fully programmable and customizable EMS units, but they are very expensive and are not an open source. Like many years ago, many specifications and algorithms of software remain close. The author knows only one fully open source and finished project – FreeEMS [1].

The aim of this work is research and development of the fully customizable, programmable, cheap and open source EMS unit “SECU-3i” (which is the part of the complex project [2]) for spark-ignition internal combustion engine, with real time tuning capabilities and possibility to support several types of fuel.

Results. SECU-3i unit has two printed circuit boards (PCB), installed into the metallic enclosure. One PCB mounted at the bottom of enclosure and the second one is at the top. Schematic diagram of the bottom board is shown on Fig. 1. PCBs are connected together internally with 18-pin header (e.g. ZL2038).

The core of the system is microcontroller integrated circuit (IC) U6; it executes firmware and controls over all system's functions. It is AVR microcontroller (MCU), which is run on 20 MHz and uses external crystal oscillator. Second major IC is knock signal processor U4, which is connected to microcontroller using serial peripheral interface (SPI) bus.

The HIP9011 is used to provide a method of detecting premature detonation often referred to as “Knock or Ping” in internal combustion engines [3]. U4 has its own crystal oscillator. Output of this IC is connected to PA3 pin of the MCU; it is an analog-to-digital converter (ADC) input.

J9 connector is for in-system programming (actually it is need only one time – for writing out a boot loader). USB interface is built on U1 with isolation by means of dual-channel digital isolator U3 and connected to the MCU via diodes (for logic OR of signals from USB chip and Bluetooth module installed on the top board). Isolation of USB interface will improve noise immunity and protect USB port of the personal computer (PC) from voltage spikes (automotive environment).

All discrete and analog inputs are protected by simple resistor-capacitor circuits (RC circuit) and Schottky diodes. Mentioned circuits on analog inputs (PA0–PA7 pins of U6) also act as simple anti-aliasing filters for ADC [4]. ADC uses reference voltage of 5 V. All inputs have optional pull-up resistors, using of some of them can be configured on PCB.

Dual comparator IC U7 forms two input signal conditioners for connecting of variable reluctance (VR) sensors (crankshaft and/or camshaft position sensors) [5]. One of them (U7 : B) has special circuit on transistor VT11 for adaptive sense. Input of the U7 : A has optional pull-up resistor, which is useful when connecting sensor with open collector (drain) output (e. g. Hall-effect of optical sensor).

A board has two grounds – power and signal. First one is return path for high currents from the outputs. The second one is return path for small currents, such as from MCU, knock signal processor, input

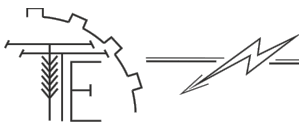

signal conditioners and so on. The circuit on the C27, R51 is for reducing return currents path for low power and high frequency signals.

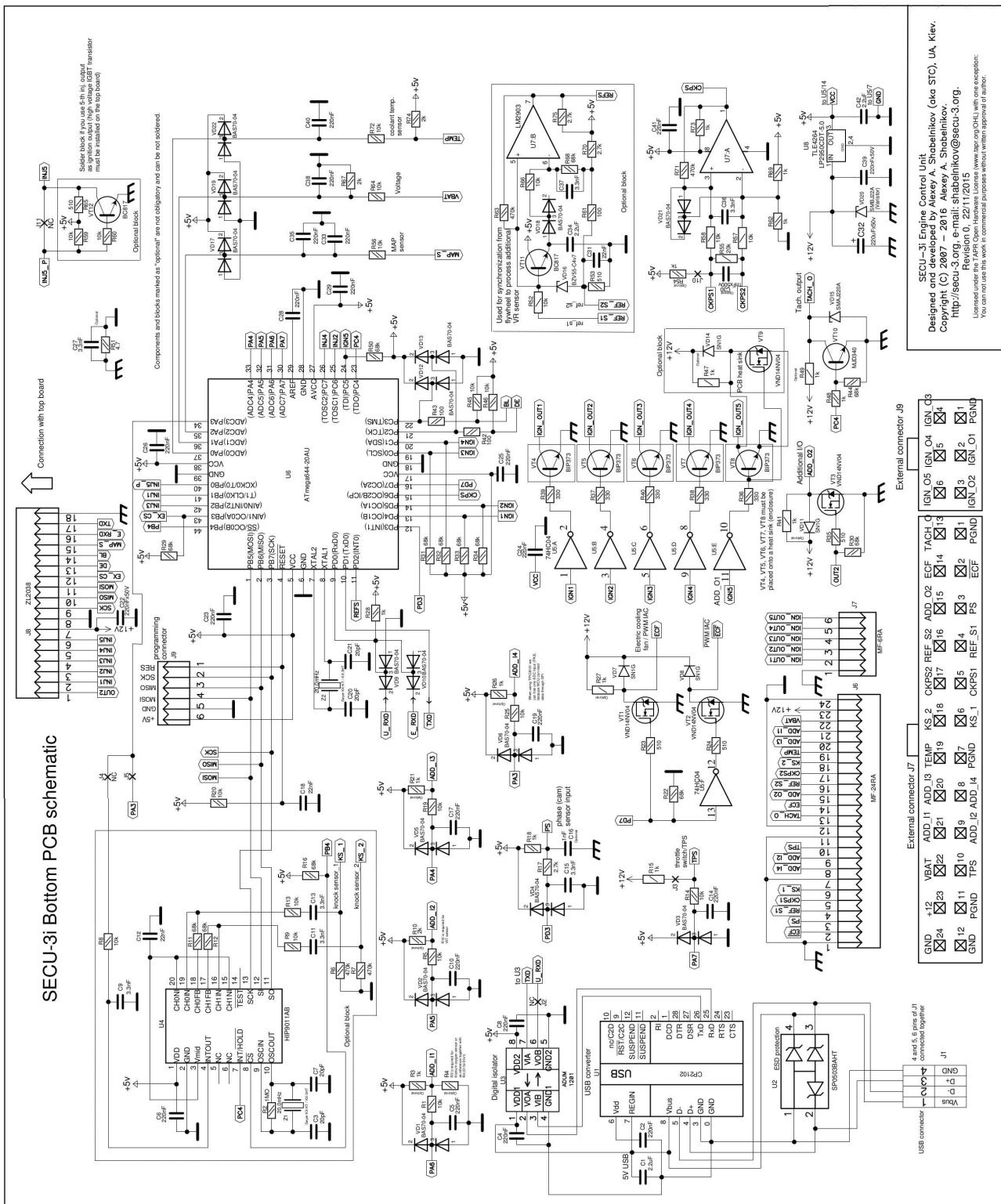

SECU-3i Engine Control Unit
Designed and developed by Alexey A. Shabelnikov (aka STC), UA, Kiev.
Copyright (C) 2007 – 2016 Alexey A. Shabelnikov.
http://secu-3.org, e-mail: shabelnikov@secu-3.org.
Revision 0.1, 22/11/2015
Licensed under the Creative Commons Attribution 4.0 International License.
You can not use this work in commercial purposes without written approval of author.

Fig. 1. Schematic diagram of the SECU-3i bottom board

There are five ignition outputs (VT4–VT8), two outputs for pulse-width modulation (PWM) controlled idle air control (IAC) valve (VT1, VT2) [3], an output for high or low voltage tachometer (VT10) and one spare output on transistor VT3. The 5-th ignition output can be configured for using as the 6-th fuel injection output (VT9 should be soldered instead of VT8). Some outputs have optional diodes (useful for PWM) and pull-up resistors (useful when the output is connected to the input which has no input pull-up resistor). All outputs are fully protected (overvoltage, overcurrent and overtemperature).

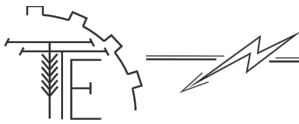

To save budget (but losing the protection), IRGB14C40L can be used instead of fully protected BIP373. Schematic diagram of the top PCB is shown on the Fig. 2. Board has inputs, outputs, intake manifold pressure (MAP) sensor, driver for stepper motor [6], IC for interfacing with bottom board and Bluetooth module for wireless connection with PC or smartphone. U13 IC is connected to the bottom board via SPI bus and controls inputs and outputs on the top board. All inputs are protected by Zener diodes and have optional pull-down resistors. Two inputs also have optional pull-up resistors.

Like on bottom board, all outputs are fully protected (overvoltage, overcurrent and overtemperature). There are five outputs to control fuel injectors.

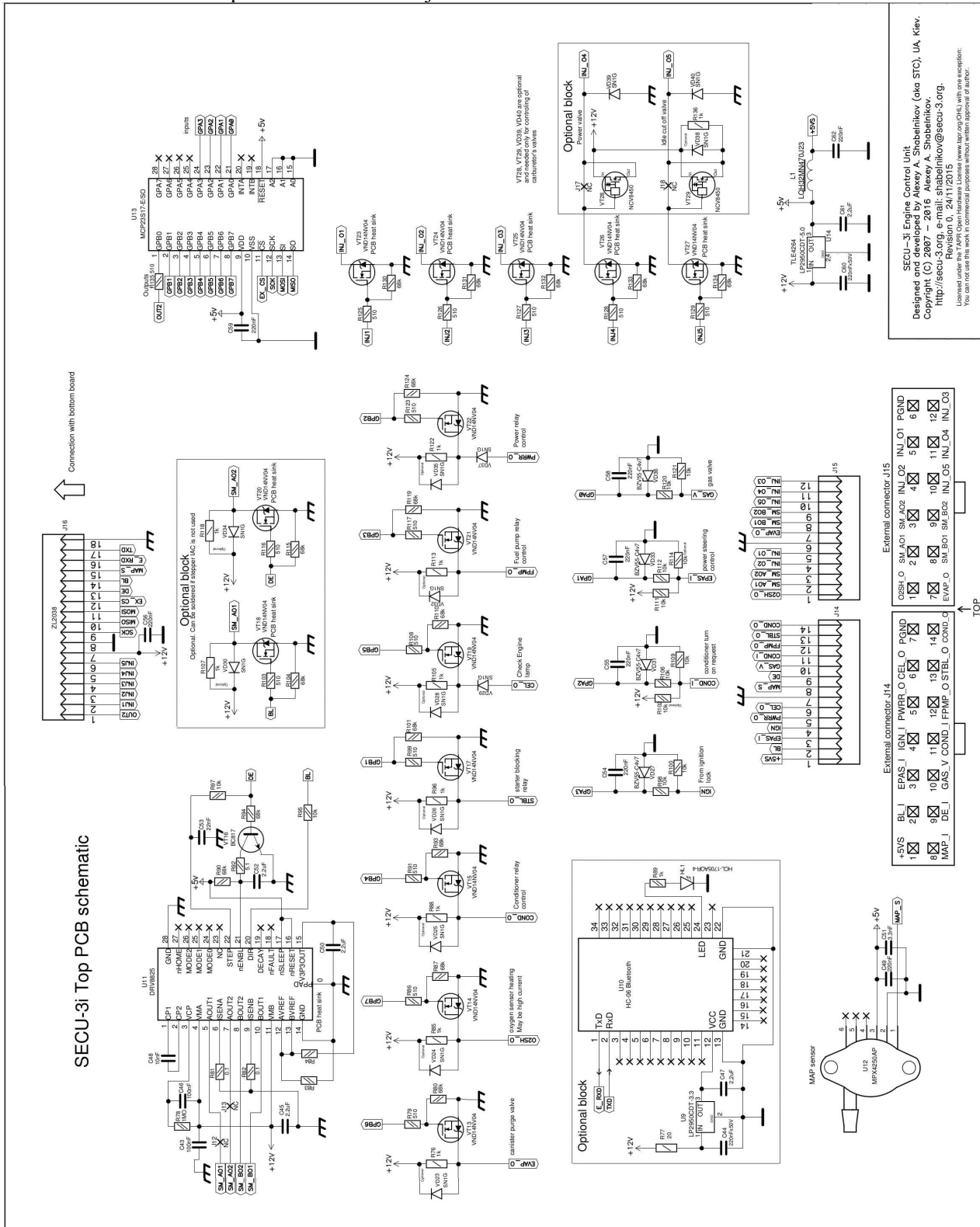

SECU-3i Engine Control Unit
 Designed and developed by Alexey A. Shabalinov (aka STC), UA, Kiev.
 Copyright (C) 2007 - 2016 Alexey A. Shabalinov.
<http://secu-3.org>, e-mail: shabalinov@secu-3.org.
 Licensed under the Apache License (see www.apache.org/licenses/), with one exception:
 You cannot use this work in commercial purposes without written approval of author.

Fig. 2. Schematic diagram of the SECU-3i top board



The 4-th and 5-th channels can be configured as high side outputs (additional components should be soldered). The 5-th output has optional pull-up resistor (R136) and diode (VD38). Additionally, the 5-th output can be used as the 6-th ignition channel. In this case high voltage transistor (e. g. NGD8201N) should be installed instead of VT27 and 4 additional components should be soldered on the bottom PCB (R59, R60, R65 and VT12). All other outputs have optional diodes and pull-up resistors.

Optional diodes allow using cheap field-effect transistors (FET) instead of VND14NV04 (which has embedded clamping). No protection in this case, but may be useful when budget must be as small as possible. Embedded MAP sensor is optional and used mainly for airflow calculations, based on the speed-density method. U11 IC is a single chip driver for stepper motor, which is usually need in two cases. First one is to control IAC stepper motor actuator. The second case is to control a gas doser actuator. When control of stepper motor is not necessary, two channels which control U11 can be used as regular outputs, for instance, as additional injector outputs. In this case two additional transistors (VT18, VT20) and corresponding components should be soldered.

Bluetooth module has its own power supply voltage regulator (U9) and status light emitting diode (LED) HL1. In small budget versions or in applications where wireless connection is not necessary, installation of Bluetooth module and corresponding components can be discarded. The photo of the assembled bottom board is shown on Fig. 3 and the photo of the assembled top board is shown on Fig 4.

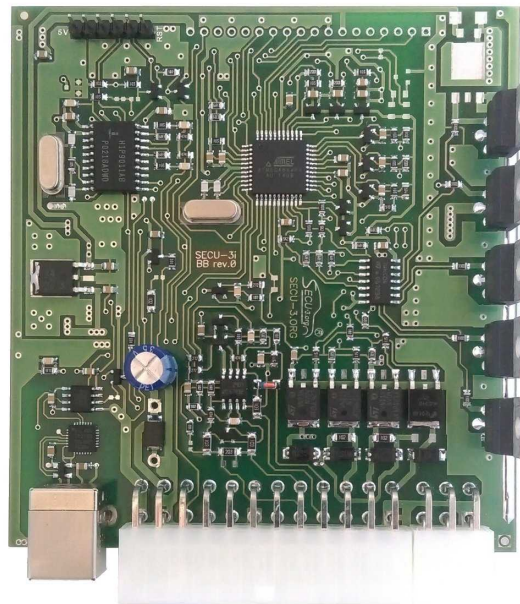
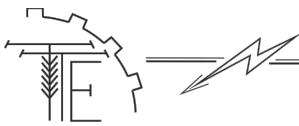

Fig. 3. The photo of the assembled SECU-3i bottom PCB



Fig. 4. The photo of the assembled SECU-3i top PCB



At the top right corner of the board on Fig. 4 we can see a Bluetooth module and status LED. MAP sensor is placed at the bottom right corner and fastened by two bolts. Both PCBs (top and bottom) are double sided. Almost all of the electronic components are surface-mount devices (SMD), so cost-effective automated assembly can be used.

Photo of the fully assembled unit is shown on Fig. 5. PCBs mounted into the UNI-M-BOX-100 aluminium profile enclosure. At the front panel we can see a black MAP sensor's nipple, USB connector and four connectors for sensors and actuators. Five screws at the right wall of the enclosure are fastening of the ignition transistors. So, enclosure used as heat sink. Transistors are mounted using silicon insulators and insulating tablets for TO-220.

Usage of a profile enclosure gives advantage in possibility of adding some custom PCBs into the body of unit, because such enclosures have variety of length options. This is convenient for extending of unit's functionality and simplifying future research.



Fig. 5. The photo of the assembled SECU-3i EMS unit

An example of wiring diagram of the SECU-3i unit is shown of Fig. 6. It is drawn for 4-cylinder automotive engine. Most sensitive to noise sensors are connected using shielded cable. Fuel pump, cooling fan and starter solenoid are controlled via relays. Ignition coils, fuel injectors, Check Engine light, stepper motor IAC and canister purge valve are controlled directly from SECU-3i unit. Not all possible connections are shown on this wiring diagram. For instance, if IAC actuator requires PWM control, it can be connected to 2 and 14 pins of J7 connector. In this case stepper motor outputs (2, 3, 8, 9 pins of J15) become free and can be used to control other devices. Vehicle speed sensor can be connected to J7/4 pin.

Conclusions. So, in the article the main ideas and development of the “SECU-3i” EMS unit are described. Division of the device into two boards brings some flexibility and simplifies future developments of different device versions (e. g. version for low impedance injectors). Versatile hardware design together with flexible software will allow building unique, not standard configurations. The author plans to finish development of the software for this unit soon, which will be continuously extending by adding of new algorithms. We think that the work will be used also in research and educational purposes.

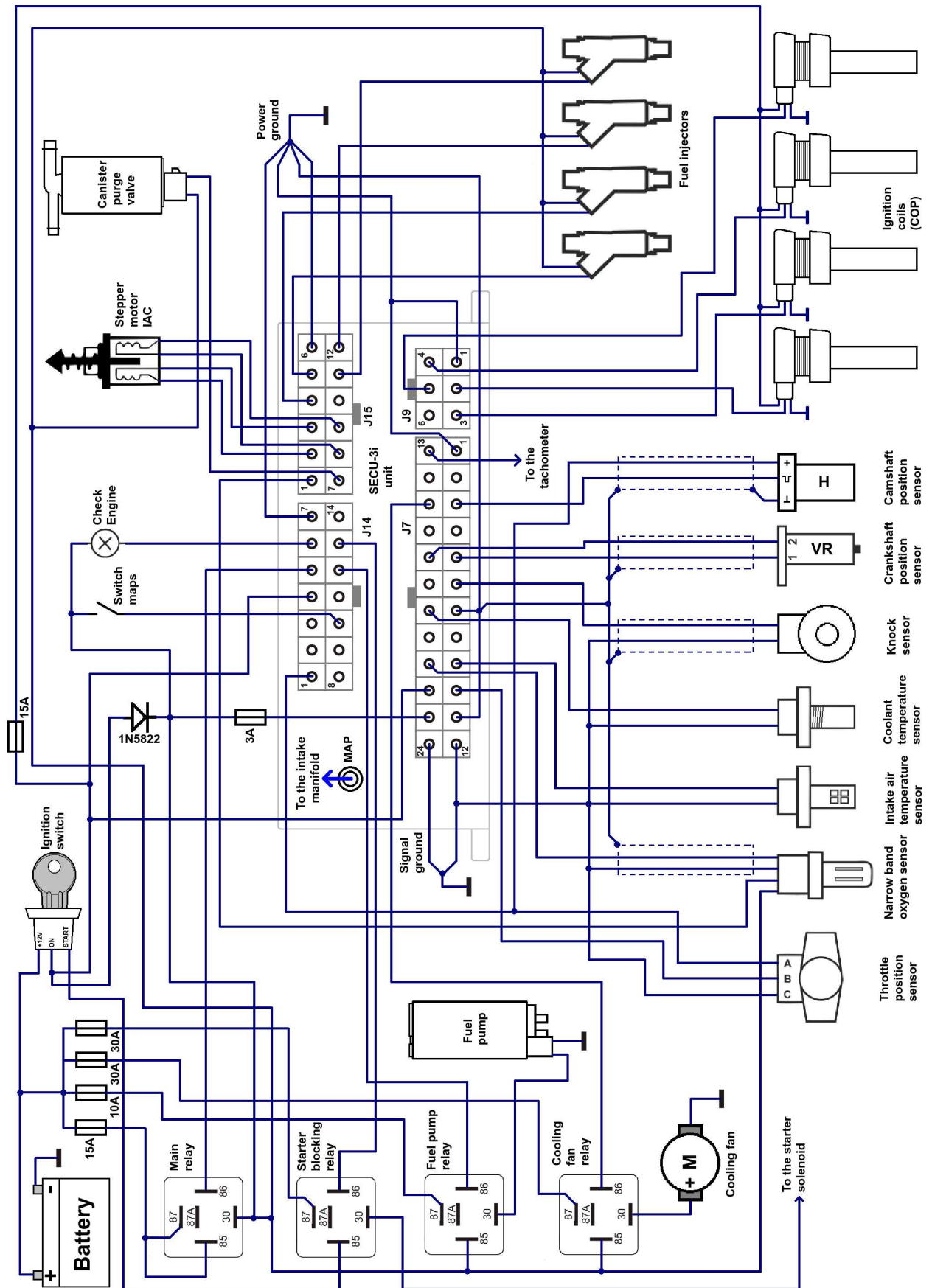
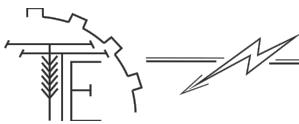

Fig. 6. Example of wiring diagram of the SECU-3i



References

1. FreeEMS. [Virtual Resource]:[Site]. – Available at: <http://freeems.org/>.
2. MPSZ SECU-3 / Ignition and fuel injection ECU [Virtual Resource]:[Site]. – Available at: <http://secu-3.org/>.
3. Banish, G. (2007). Engine Management: Advanced Tuning / Greg Banish / North Branch: CarTech, 2007. 128.
4. Smith, S. W. The Scientist and Engineer's Guide to Digital Signal Processing / Steven W. Smith // 2nd ed. – San-Diego: California Technical Publishing, 1999. 650.
5. Horowitz, P. The Art of Electronics /P. Horowitz, W. Hill // 3-d ed. - Cambridge University Press, 2015, 1219.
6. Kenjo, T. Stepping motors and their microprocessor control / Takashi Kenjo // Oxford University Press, Oxford, 1984. 244.

SECU-3і ПРОГРАМОВАНА СИСТЕМА УПРАВЛІННЯ ДВИГУНОМ

Анотація: розроблено апаратне забезпечення програмованої системи управління двигуном внутрішнього згоряння з іскровим запалюванням. Проблема вирішується за допомогою розробки пристрою на базі мікроконтролера, який складається з двох плат. Отримуючи дані з датчиків і використовуючи виконавчі пристрої, система керує вприскуванням палива, запалюванням, бензонасосом, клапаном продувки адсорбера, електровентилятором охолодження двигуна та іншими пристроями у моторному відсіку. У статті описуються принципові електричні схеми, надано фотографії друкованих плат та готового пристрою, а також приклад схеми підключення блоку в автомобілі. Розроблений пристрій є гнучким і універсальним та в поєднанні з відкритим програмним забезпеченням надає широкі можливості для установки на різні типи двигунів і реалізації унікальних та нестандартних конфігурацій системи.

Ключові слова: мікроконтролер, система управління, двигун внутрішнього згоряння, датчик, котушка запалювання, форсунка, SECU-3

SECU-3і ПРОГРАММИРУЕМАЯ СИСТЕМА УПРАВЛЕНИЯ ДВИГАТЕЛЕМ

Аннотация: разработано аппаратное обеспечение программируемой и полностью конфигурируемой системы управления двигателем внутреннего сгорания с искровым зажиганием. Проблема решается посредством разработки устройства на базе микроконтроллера, состоящего из двух плат. Получая данные от датчиков и используя исполнительные устройства, система управляет впрыском топлива, зажиганием, бензонасосом, клапаном продувки адсорбера, электровентилятором охлаждения двигателя и другими устройствами в моторном отсеке. В статье описываются принципиальные электрические схемы, показаны фотографии печатных плат и готового устройства, а также пример схемы включения блока в автомобиле. Разработанное устройство является гибким и универсальным и в сочетании с открытым программным обеспечением дает широкие возможности для установки на различные типы двигателей и реализации уникальных и нестандартных конфигураций системы.

Ключевые слова: микроконтроллер, система управления, двигатель внутреннего сгорания, датчик, катушка зажигания, форсунка, SECU-3