

White Paper

Electrical Energy Storage

Executive summary

Electrical Energy Storage, EES, is one of the key technologies in the areas covered by the IEC. EES techniques have shown unique capabilities in coping with some critical characteristics of electricity, for example hourly variations in demand and price. In the near future EES will become indispensable in emerging IEC-relevant markets in the use of more renewable energy, to achieve CO₂ reduction and for Smart Grids.

Historically, EES has played three main roles. First, EES reduces electricity costs by storing electricity obtained at off-peak times when its price is lower, for use at peak times instead of electricity bought then at higher prices. Secondly, in order to improve the reliability of the power supply, EES systems support users when power network failures occur due to natural disasters, for example. Their third role is to maintain and improve power quality, frequency and voltage.

Regarding emerging market needs, in on-grid areas, EES is expected to solve problems – such as excessive power fluctuation and undependable power supply – which are associated with the use of large amounts of renewable energy. In the off-grid domain, electric vehicles with batteries are the most promising technology to replace fossil fuels by electricity from mostly renewable sources.

The Smart Grid has no universally accepted definition, but in general it refers to modernizing the electricity grid. It comprises everything related to the electrical system between any point of electricity production and any point of consumption. Through the addition of Smart Grid technologies the grid becomes more flexible and interactive and can provide real-time feedback. For instance, in a Smart Grid, information regarding the price of electricity and the situation of the power

system can be exchanged between electricity production and consumption to realize a more efficient and reliable power supply. EES is one of the key elements in developing a Smart Grid.

In October 2010, the IEC MSB (Market Strategy Board) decided to establish a project team to plan future IEC activities in EES. This White Paper summarizes present and future market needs for EES technologies, reviews their technological features, and finally presents recommendations for all EES stakeholders.

.....

Acknowledgments

This paper has been prepared by the Electrical Energy Storage project team, a part of the Special Working Group on technology and market watch, in the IEC Market Strategy Board, with a major contribution from the Fraunhofer Institut für Solare Energiesysteme.

.....

Table of contents

List of abbreviations	7
Section 1 The roles of electrical energy storage technologies in electricity use	9
1.1 Characteristics of electricity	9
1.2 Electricity and the roles of EES	9
1.2.1 High generation cost during peak-demand periods	9
1.2.2 Need for continuous and flexible supply	10
1.2.3 Long distance between generation and consumption	10
1.2.4 Congestion in power grids	11
1.2.5 Transmission by cable	11
1.3 Emerging needs for EES	11
1.3.1 More renewable energy, less fossil fuel	11
1.3.2 Smart Grid uses	13
1.4 The roles of electrical energy storage technologies	13
1.4.1 The roles from the viewpoint of a utility	13
1.4.2 The roles from the viewpoint of consumers	15
1.4.3 The roles from the viewpoint of generators of renewable energy	15
Section 2 Types and features of energy storage systems	17
2.1 Classification of EES systems	17
2.2 Mechanical storage systems	18
2.2.1 Pumped hydro storage (PHS)	18
2.2.2 Compressed air energy storage (CAES)	18
2.2.3 Flywheel energy storage (FES)	19
2.3 Electrochemical storage systems	20
2.3.1 Secondary batteries	20
2.3.2 Flow batteries	24
2.4 Chemical energy storage	25
2.4.1 Hydrogen (H ₂)	26
2.4.2 Synthetic natural gas (SNG)	26

2.5	Electrical storage systems	27
2.5.1	Double-layer capacitors (DLC)	27
2.5.2	Superconducting magnetic energy storage (SMES)	28
2.6	Thermal storage systems	29
2.7	Standards for EES	30
2.8	Technical comparison of EES technologies	30
Section 3 Markets for EES		35
3.1	Present status of applications	35
3.1.1	Utility use (conventional power generation, grid operation & service)	35
3.1.2	Consumer use (uninterruptable power supply for large consumers)	37
3.1.3	EES installed capacity worldwide	38
3.2	New trends in applications	39
3.2.1	Renewable energy generation	39
3.2.2	Smart Grid	43
3.2.3	Smart Microgrid	44
3.2.4	Smart House	45
3.2.5	Electric vehicles	46
3.3	Management and control hierarchy of storage systems	48
3.3.1	Internal configuration of battery storage systems	49
3.3.2	External connection of EES systems	49
3.3.3	Aggregating EES systems and distributed generation (Virtual Power Plant)	50
3.3.4	“Battery SCADA” – aggregation of many dispersed batteries	50
Section 4 Forecast of EES market potential by 2030		53
4.1	EES market potential for overall applications	53
4.1.1	EES market estimation by Sandia National Laboratory (SNL)	53
4.1.2	EES market estimation by the Boston Consulting Group (BCG)	53
4.1.3	EES market estimation for Li-ion batteries by the Panasonic Group	55
4.2	EES market potential estimation for broad introduction of renewable energies	55
4.2.1	EES market potential estimation for Germany by Fraunhofer	56
4.2.2	Storage of large amounts of energy in gas grids	56
4.2.3	EES market potential estimation for Europe by Siemens	58
4.2.4	EES market potential estimation by the IEA	59

4.3	Vehicle to grid concept	60
4.4	EES market potential in the future	61
Section 5 Conclusions and recommendations		65
5.1	Drivers, markets, technologies	65
5.2	Conclusions regarding renewables and future grids	66
5.3	Conclusions regarding markets	67
5.4	Conclusions regarding technologies and deployment	67
5.5	Recommendations addressed to policy-makers and regulators	68
5.6	Recommendations addressed to research institutions and companies carrying out R&D	69
5.7	Recommendations addressed to the IEC and its committees	70
Annex A Technical overview of electrical energy storage technologies		72
Annex B EES in Smart Microgrids		74
References		76

List of abbreviations

Technical and scientific terms

Br	Bromine
BMS	Battery management system
CAES	Compressed air energy storage
Cd	Cadmium
Ce	Cerium
CHP	Combined heat and power
CO₂	Carbon dioxide
Cr	Chromium
CSP	Concentrated solar power
DLC	Double layer capacitor
EES	Electrical energy storage
EMS	Energy management system
EV	Electric vehicle
FB	Flow battery
FES	Flywheel energy storage
H₂	Hydrogen
HEV	Hybrid electric vehicle
HFB	Hybrid flow battery
HP	High pressure
LA	Lead acid
Li-ion	Lithium ion (battery)
LP	Low pressure
Me-air	Metal-air
NaS	Sodium sulphur
NiCd	Nickel cadmium
NiMH	Nickel metal hydride
PCM	Phase change material
PHS	Pumped hydro storage

List of abbreviations

PV	Photovoltaic
R&D	Research and development
RE	Renewable energy/ies
RES	Renewable energy systems
RFB	Redox flow battery
SCADA	Supervisory control and data acquisition
SMES	Superconducting magnetic energy storage
SNG	Synthetic natural gas
UPS	Uninterruptable power supply
V2G	Vehicle to grid
V2H	Vehicle to home (appliances)
VRFB	Vanadium redox flow battery
Zi-air	Zinc air
Zn	Zinc

.....

Organizations, institutions and companies

IEA	International Energy Agency
IEC	International Electrotechnical Commission
Fraunhofer	
ISE	Fraunhofer Institute for Solar Energy Systems
MSB	(IEC) Market Strategy Board
SEI	Sumitomo Electric Industries
SMB	(IEC) Standardization Management Board
TEPCO	Tokyo Electric Power Company

Section 1

The roles of electrical energy storage technologies in electricity use

1.1 Characteristics of electricity

Two characteristics of electricity lead to issues in its use, and by the same token generate the market needs for EES. First, electricity is consumed at the same time as it is generated. The proper amount of electricity must always be provided to meet the varying demand. An imbalance between supply and demand will damage the stability and quality (voltage and frequency) of the power supply even when it does not lead to totally unsatisfied demand.

The second characteristic is that the places where electricity is generated are usually located far from the locations where it is consumed¹. Generators and consumers are connected through power grids and form a power system. In function of the locations and the quantities of power supply and demand, much power flow may happen to be concentrated into a specific transmission line and this may cause congestion. Since power lines are always needed, if a failure on a line occurs (because of congestion or any other reason) the supply of electricity will be interrupted; also because lines are always needed, supplying electricity to mobile applications is difficult. The following sections outline the issues caused by these characteristics and the consequent roles of EES.

¹ However, in the future there will be an increase in distributed generation (as mentioned for example in sections 3.1 and 3.2), where consumption and generation are typically close together.

1.2 Electricity and the roles of EES

1.2.1 High generation cost during peak-demand periods

Power demand varies from time to time (see Figure 1-1), and the price of electricity changes accordingly. The price for electricity at peak-demand periods is higher and at off-peak periods lower. This is caused by differences in the cost of generation in each period.

During peak periods when electricity consumption is higher than average, power suppliers must complement the base-load power plants (such as coal-fired and nuclear) with less cost-effective but more flexible forms of generation, such as oil and gas-fired generators. During the off-peak period when less electricity is consumed, costly types of generation can be stopped. This is a chance for owners of EES systems to benefit financially. From the utilities' viewpoint there is a huge potential to reduce total generation costs by eliminating the costlier methods, through storage of electricity generated by low-cost power plants during the night being reinserted into the power grid during peak periods.

With high PV and wind penetration in some regions, cost-free surplus energy is sometimes available. This surplus can be stored in EES and used to reduce generation costs. Conversely, from the consumers' point of view, EES can lower electricity costs since it can store electricity bought at low off-peak prices and they can use it during peak periods in the place of expensive power. Consumers who charge batteries during off-peak hours may also sell the electricity to utilities or to other consumers during peak hours.

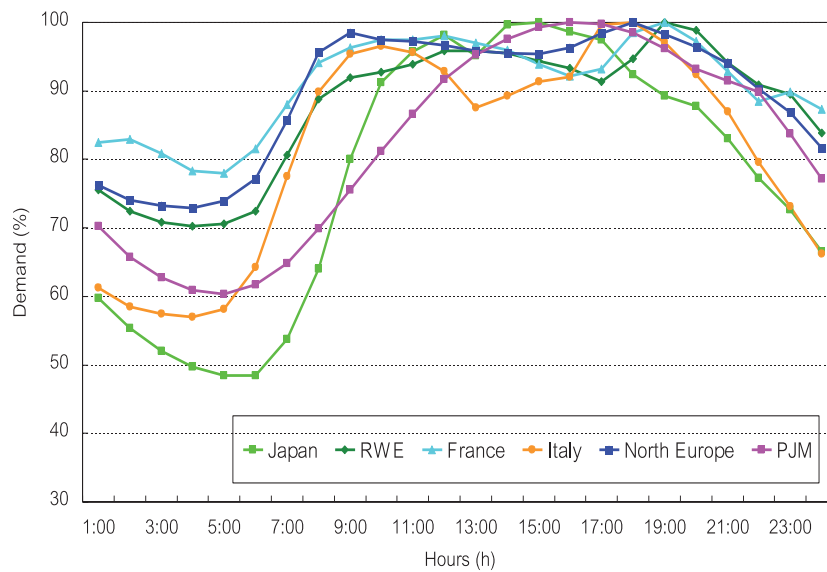

Figure 1-1 | Comparison of daily load curves (IEEJ – The Institute of Energy Economics, Japan, 2005)

1.2.2 Need for continuous and flexible supply

A fundamental characteristic of electricity leads to the utilities’ second issue, maintaining a continuous and flexible power supply for consumers. If the proper amount of electricity cannot be provided at the time when consumers need it, the power quality will deteriorate and at worst this may lead to a service interruption. To meet changing power consumption appropriate amounts of electricity should be generated continuously, relying on an accurate forecast of the variations in demand.

Power generators therefore need two essential functions in addition to the basic generating function. First, generating plants are required to be equipped with a “kilowatt function”, to generate sufficient power (kW) when necessary. Secondly, some generating facilities must possess a frequency control function, fine-tuning the output so as to follow minute-by-minute and second-by-second fluctuations in demand, using the extra power from the “kilowatt function” if necessary. Renewable energy facilities such as solar and

wind do not possess both a kW function and a frequency control function unless they are suitably modified. Such a modification may be a negative power margin (i.e. decreasing power) or a phase shift inverter².

EES is expected to be able to compensate for such difficulties with a kW function and a frequency control function. Pumped hydro has been widely used to provide a large amount of power when generated electricity is in short supply. Stationary batteries have also been utilized to support renewable energy output with their quick response capability.

1.2.3 Long distance between generation and consumption

Consumers’ locations are often far from power generating facilities, and this sometimes leads to higher chances of an interruption in the power supply. Network failures due to natural disasters (e.g. lightning, hurricanes) and artificial causes (e.g.

² In Germany such a modification, called “system services”, must be implemented in large wind power generators.

overload, operational accidents) stop electricity supply and potentially influence wide areas.

EES will help users when power network failures occur by continuing to supply power to consumers. One of the representative industries utilizing EES is semiconductor and LCD manufacturing, where a voltage sag lasting for even a few milliseconds impacts the quality of the products. A UPS system, built on EES and located at a customer's site, can keep supplying electricity to critical loads even when voltage sag occurs due to, for example, a direct lightning strike on distribution lines. A portable battery may also serve as an emergency resource to provide power to electrical appliances.

1.2.4 Congestion in power grids

This issue is a consequence of the previous problem, a long distance between generation and consumption. The power flow in transmission grids is determined by the supply and demand of electricity. In the process of balancing supply and demand power congestion can occur. Utility companies try to predict future congestion and avoid overloads, for example by dispatching generators' outputs or ultimately by building new transmission routes. EES established at appropriate sites such as substations at the ends of heavily-loaded lines can mitigate congestion, by storing electricity while transmission lines maintain enough capacity and by using it when lines are not available due to congestion. This approach also helps utilities to postpone or suspend the reinforcement of power networks.

1.2.5 Transmission by cable

Electricity always needs cables for transmission, and supplying electricity to mobile applications and to isolated areas presents difficulties. EES systems such as batteries can solve this problem with their mobile and charge/discharge capabilities. In remote places without a power grid connection recharging an electric vehicle may present a challenge, but EES

can help realize an environmentally friendly transport system without using conventional combustion engines.

1.3 Emerging needs for EES

There are two major emerging market needs for EES as a key technology: to utilize more renewable energy and less fossil fuel, and the future Smart Grid.

1.3.1 More renewable energy, less fossil fuel

On-grid areas

In on-grid areas, the increased ratio of renewable generation may cause several issues in the power grid (see Figure 1-2). First, in power grid operation, the fluctuation in the output of renewable generation makes system frequency control difficult, and if the frequency deviation becomes too wide system operation can deteriorate. Conventionally, frequency control is mostly managed by the output change capability of thermal generators. When used for this purpose thermal generators are not operated at full capacity, but with some positive and negative output margin (i.e. increases and decreases in output) which is used to adjust frequency, and this implies inefficient operation. With greater penetration of renewable generation this output margin needs to be increased, which decreases the efficiency of thermal generation even more. Renewable generation units themselves in most cases only supply a negative margin³. If EES can mitigate the output fluctuation, the margins of thermal generators can be reduced and they can be operated at a higher efficiency.

Secondly, renewable energy output is undependable since it is affected by weather conditions. Some measures are available to cope with this.

³ With extra investment in advanced control schemes and regulation they can also be made to provide a positive margin.

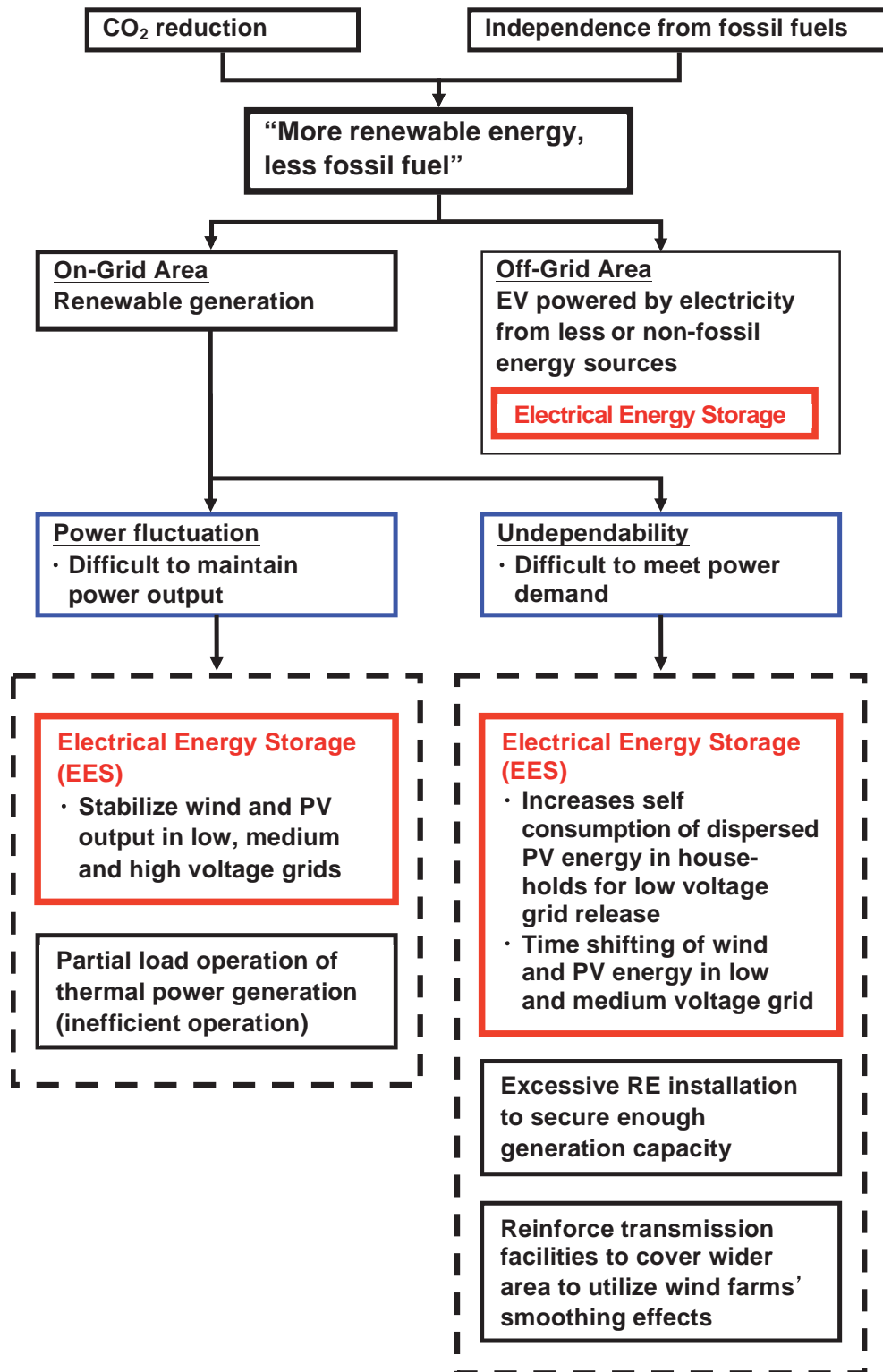

Figure 1-2 | Problems in renewable energy installation and possible solutions (TEPCO)

One is to increase the amount of renewable generation installed, i.e. provide overcapacity, so that even with undependability enough power can be secured. Another is to spread the installations of renewable generators over a wide area, to take advantage of weather conditions changing from place to place and of smoothing effects expected from the complementarity of wind and solar generators. These measures are possible only with large numbers of installations and extension of transmission networks. Considering the cost of extra renewable generation and the difficulty of constructing new transmission facilities, EES is a promising alternative measure.

Off-grid areas

In off-grid areas where a considerable amount of energy is consumed, particularly in the transport sector, fossil energy should be replaced with less or non-fossil energy in such products as plug-in hybrid electric vehicles (PHEVs) or electric vehicles (EVs) (see Figure 1-2). More precisely, fossil fuels should be replaced by low-carbon electricity produced mainly by renewable generation. The most promising solution is to replace petrol or diesel-driven cars by electric ones with batteries. In spite of remaining issues (short driving distance and long charging time) EES is the key technology for electric vehicles.

1.3.2 Smart Grid uses

EES is expected to play an essential role in the future Smart Grid. Some relevant applications of EES are described below.

First, EES installed in customer-side substations can control power flow and mitigate congestion, or maintain voltage in the appropriate range.

Secondly, EES can support the electrification of existing equipment so as to integrate it into the Smart Grid. Electric vehicles (EVs) are a good example since they have been deployed in several regions, and some argue for the potential of EVs

as a mobile, distributed energy resource to provide a load-shifting function in a smart grid. EVs are expected to be not only a new load for electricity but also a possible storage medium that could supply power to utilities when the electricity price is high.

A third role expected for EES is as the energy storage medium for Energy Management Systems (EMS) in homes and buildings. With a Home Energy Management System, for example, residential customers will become actively involved in modifying their energy spending patterns by monitoring their actual consumption in real time. EMSs in general will need EES, for example to store electricity from local generation when it is not needed and discharge it when necessary, thus allowing the EMS to function optimally with less power needed from the grid.

1.4 The roles of electrical energy storage technologies

Generally the roles for on-grid EES systems can be described by the number of uses (cycles) and the duration of the operation, as shown in Figure 1-3. For the maintenance of voltage quality (e.g. compensation of reactive power), EES with high cycle stability and short duration at high power output is required; for time shifting on the other hand longer storage duration and fewer cycles are needed. The following sections describe the roles in detail.

1.4.1 The roles from the viewpoint of a utility

1) Time shifting

Utilities constantly need to prepare supply capacity and transmission/distribution lines to cope with annually increasing peak demand, and consequently develop generation stations that produce electricity from primary energy. For some utilities generation cost can be reduced by storing electricity at off-peak times, for example at

night, and discharging it at peak times. If the gap in demand between peak and off-peak is large, the benefit of storing electricity becomes even larger. Using storage to decrease the gap between daytime and night-time may allow generation output to become flatter, which leads to an improvement in operating efficiency and cost reduction in fuel. For these reasons many utilities have constructed pumped hydro, and have recently begun installing large-scale batteries at substations.

2) Power quality

A basic service that must be provided by power utilities is to keep supply power voltage and frequency within tolerance, which they can do by adjusting supply to changing demand. Frequency is controlled by adjusting the output of power generators; EES can provide frequency control functions. Voltage is generally controlled by taps of transformers, and reactive power with phase modifiers. EES located at the end of a heavily loaded line may improve voltage drops by discharging electricity and reduce voltage rises by charging electricity.

3) Making more efficient use of the network

In a power network, congestion may occur when transmission/distribution lines cannot be reinforced in time to meet increasing power demand. In this case, large-scale batteries installed at appropriate substations may mitigate the congestion and thus help utilities to postpone or suspend the reinforcement of the network.

4) Isolated grids

Where a utility company supplies electricity within a small, isolated power network, for example on an island, the power output from small-capacity generators such as diesel and renewable energy must match the power demand. By installing EES the utility can supply stable power to consumers.

5) Emergency power supply for protection and control equipment

A reliable power supply for protection and control is very important in power utilities. Many batteries are used as an emergency power supply in case of outage.

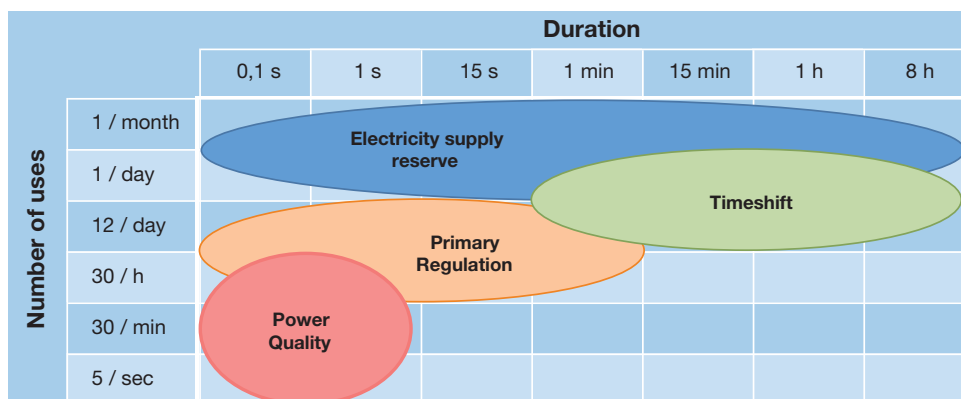

Figure 1-3 | Different uses of electrical energy storage in grids, depending on the frequency and duration of use [eus06]

1.4.2 The roles from the viewpoint of consumers

1) Time shifting/cost savings

Power utilities may set time-varying electricity prices, a lower price at night and a higher one during the day, to give consumers an incentive to flatten electricity load. Consumers may then reduce their electricity costs by using EES to reduce peak power needed from the grid during the day and to buy the needed electricity at off-peak times.

2) Emergency power supply

Consumers may possess appliances needing continuity of supply, such as fire sprinklers and security equipment. EES is sometimes installed as a substitute for emergency generators to operate during an outage. Semiconductor and liquid-crystal manufacturers are greatly affected by even a momentary outage (e.g. due to lightning) in maintaining the quality of their products. In these cases, EES technology such as large-scale batteries, double-layer capacitors and SMES can be installed to avoid the effects of a momentary outage by instantly switching the load off the network to the EES supply. A portable battery may also serve in an emergency to provide power to electrical appliances.

3) Electric vehicles and mobile appliances

Electric vehicles (EVs) are being promoted for CO₂ reduction. High-performance batteries such as nickel cadmium, nickel metal hydride and lithium ion batteries are mounted on EVs and used as power sources. EV batteries are also expected to be used to power in-house appliances in combination with solar power and fuel cells; at the same time, studies are being carried out to see whether they can usefully be connected to power networks. These possibilities are often abbreviated as “V2H” (vehicle to home) and “V2G” (vehicle to grid).

1.4.3 The roles from the viewpoint of generators of renewable energy

1) Time shifting

Renewable energy such as solar and wind power is subject to weather, and any surplus power may be thrown away when not needed on the demand side. Therefore valuable energy can be effectively used by storing surplus electricity in EES and using it when necessary; it can also be sold when the price is high.

2) Effective connection to grid

The output of solar and wind power generation varies greatly depending on the weather and wind speeds, which can make connecting them to the grid difficult. EES used for time shift can absorb this fluctuation more cost-effectively than other, single-purpose mitigation measures (e.g. a phase shifter).

Section 2

Types and features of energy storage systems

In this section the types of EES system and their features are listed. A brief classification is followed by a description of the various EES types with their advantages and disadvantages. Finally the main technical features are summarized.

2.1 Classification of EES systems

A widely-used approach for classifying EES systems is the determination according to the form of energy used. In Figure 2-1 EES systems are classified into mechanical, electrochemical, chemical, electrical and thermal energy storage systems. Hydrogen and synthetic natural gas (SNG) are secondary energy carriers and can be used to store electrical energy via electrolysis of water to produce hydrogen and, in an additional step, methane if required. In fuel

cells electricity is generated by oxidizing hydrogen or methane. This combined electrolysis-fuel cell process is an electrochemical EES. However, both gases are multi-purpose energy carriers. For example, electricity can be generated in a gas or steam turbine. Consequently, they are classified as chemical energy storage systems. In Figure 2-1 thermal energy storage systems are included as well, although in most cases electricity is not the direct input to such storage systems. But with the help of thermal energy storage the energy from renewable energy sources can be buffered and thus electricity can be produced on demand. Examples are hot molten salts in concentrated solar power plants and the storage of heat in compressed air plants using an adiabatic process to gain efficiency.

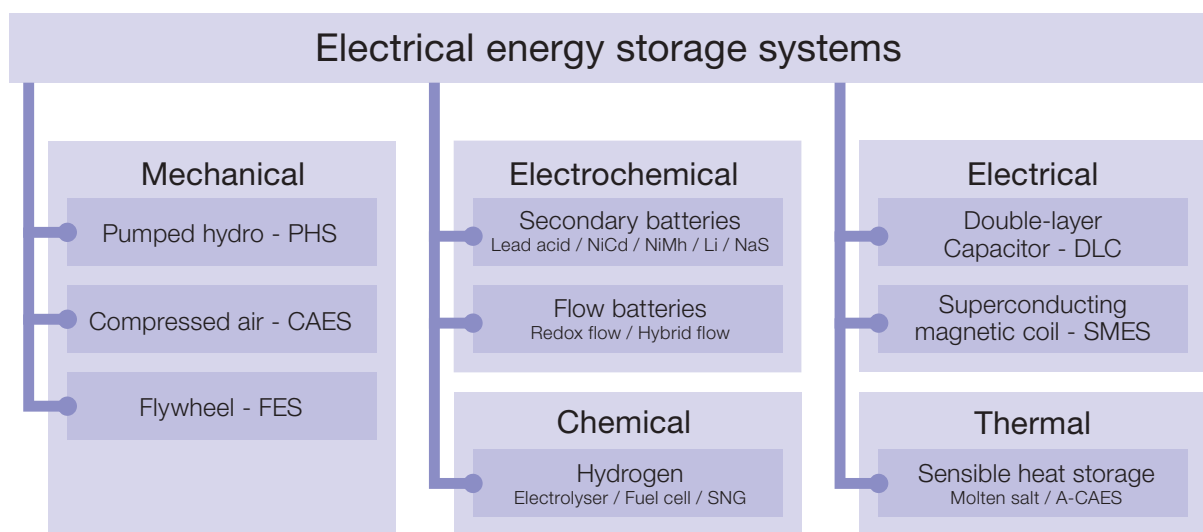

Figure 2-1 | Classification of electrical energy storage systems according to energy form
(Fraunhofer ISE)

2.2 Mechanical storage systems

The most common mechanical storage systems are pumped hydroelectric power plants (pumped hydro storage, PHS), compressed air energy storage (CAES) and flywheel energy storage (FES).

2.2.1 Pumped hydro storage (PHS)

With over 120 GW, pumped hydro storage power plants (Figure 2-2) represent nearly 99 % of world-wide installed electrical storage capacity [doe07], which is about 3 % of global generation capacity⁴. Conventional pumped hydro storage systems use two water reservoirs at different elevations to pump water during off-peak hours from the lower to the upper reservoir (charging). When required, the water flows back from the upper to the lower reservoir, powering a turbine with a generator to produce electricity (discharging). There are different options for the upper and lower reservoirs, e.g. high dams can be used as pumped hydro storage plants. For the lower reservoir flooded mine shafts, other underground cavities and the open sea are also technically

possible. A seawater pumped hydro plant was first built in Japan in 1999 (Yanbaru, 30 MW) [fuj98].

PHS has existed for a long time – the first pumped hydro storage plants were used in Italy and Switzerland in the 1890s. By 1933 reversible pump-turbines with motor-generators were available⁵. Typical discharge times range from several hours to a few days. The efficiency of PHS plants is in the range of 70 % to 85 %. Advantages are the very long lifetime and practically unlimited cycle stability of the installation. Main drawbacks are the dependence on topographical conditions and large land use. The main applications are for energy management via time shift, namely non-spinning reserve and supply reserve.

2.2.2 Compressed air energy storage (CAES)

Compressed air (compressed gas) energy storage (Figure 2-3) is a technology known and used since the 19th century for different industrial applications including mobile ones. Air is used as storage



Figure 2-2 | Pumped Hydro Storage (*Vattenfall, IEC MSB/EES Workshop, 2011*)

⁴ The largest PHS plant in the world, with 2 100 MW peak power, is the Bath County hydroelectric pumped storage plant located in Virginia, USA [bat85].

⁵ Adjustable-speed machines are now being used to improve efficiency.

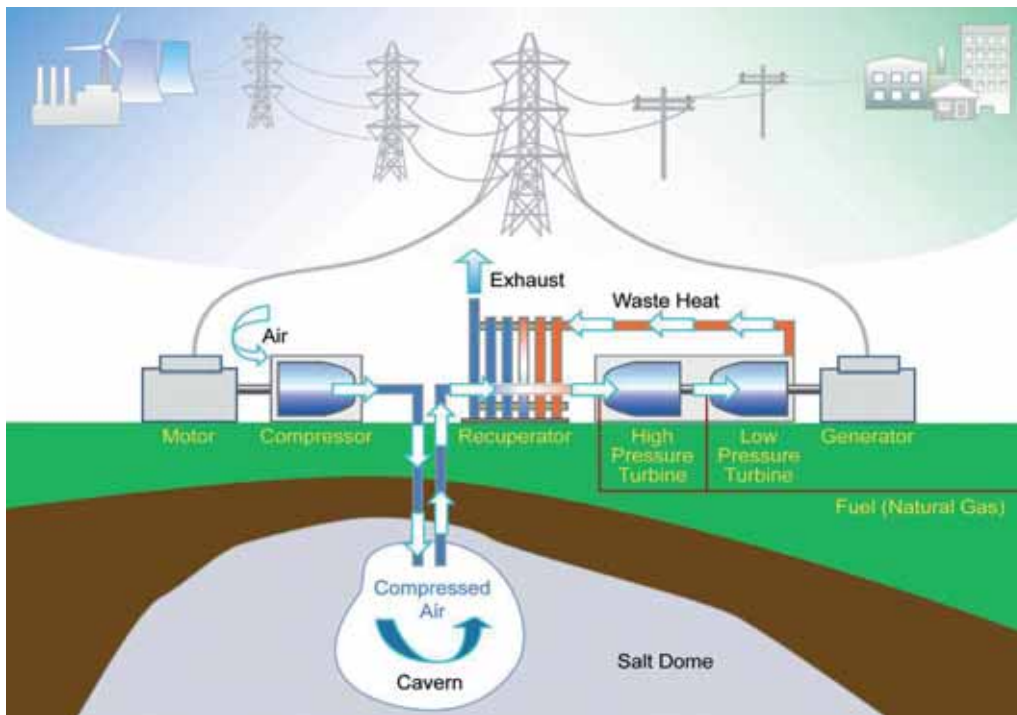

Figure 2-3 | Underground CAES [rid11]

medium due to its availability. Electricity is used to compress air and store it in either an underground structure or an above-ground system of vessels or pipes. When needed the compressed air is mixed with natural gas, burned and expanded in a modified gas turbine. Typical underground storage options are caverns, aquifers or abandoned mines. If the heat released during compression is dissipated by cooling and not stored, the air must be reheated prior to expansion in the turbine. This process is called diabatic CAES and results in low round-trip efficiencies of less than 50 %. Diabatic technology is well-proven; the plants have a high reliability and are capable of starting without extraneous power⁶. The advantage of CAES is its large capacity; disadvantages are low round-trip efficiency and geographic limitation of locations [nak07].

⁶ In an adiabatic CAES process, currently under development, the released heat is retained in thermal storage (e.g. porous stones) and used again during expansion in a turbine.

2.2.3 Flywheel energy storage (FES)

In flywheel energy storage (Figure 2-4) rotational energy is stored in an accelerated rotor, a massive rotating cylinder. The main components of a flywheel are the rotating body/cylinder (comprised of a rim attached to a shaft) in a compartment, the bearings and the transmission device (motor/generator mounted onto the stator⁷). The energy is maintained in the flywheel by keeping the rotating body at a constant speed. An increase in the speed results in a higher amount of energy stored. To accelerate the flywheel electricity is supplied by a transmission device. If the flywheel's rotational speed is reduced electricity may be extracted from the system by the same transmission device. Flywheels of the first generation, which have been available since about 1970, use a large steel rotating body on mechanical bearings. Advanced FES systems have rotors made of high-strength carbon

⁷ The stator is the static part of the assembly at the top of the tower.

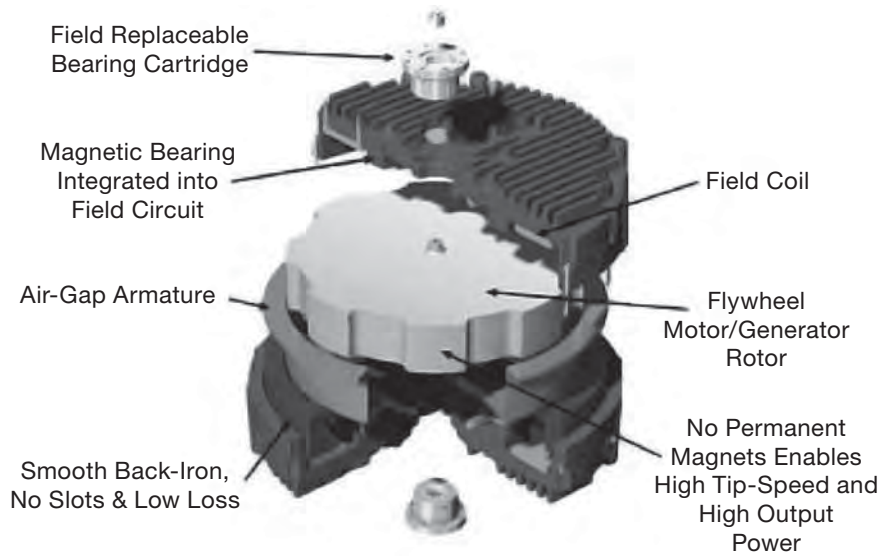

Figure 2-4 | Flywheel energy storage [act11]

filaments, suspended by magnetic bearings, and spinning at speeds from 20000 to over 50000 rpm in a vacuum enclosure. The main features of flywheels are the excellent cycle stability and a long life, little maintenance, high power density and the use of environmentally inert material. However, flywheels have a high level of self-discharge due to air resistance and bearing losses and suffer from low current efficiency.

Today flywheels are commercially deployed for power quality in industrial and UPS applications, mainly in a hybrid configuration. Efforts are being made to optimize flywheels for long-duration operation (up to several hours) as power storage devices for use in vehicles and power plants.

2.3 Electrochemical storage systems

In this section various types of batteries are described. Most of them are technologically mature for practical use. First, six secondary battery types are listed: lead acid, NiCd/NiMH, Li-ion, metal air, sodium sulphur and sodium nickel chloride; then follow two sorts of flow battery.

2.3.1 Secondary batteries

Lead acid battery (LA)

Lead acid batteries are the world's most widely used battery type and have been commercially deployed since about 1890. Lead acid battery systems are used in both mobile and stationary applications. Their typical applications are emergency power supply systems, stand-alone systems with PV, battery systems for mitigation of output fluctuations from wind power and as starter batteries in vehicles. In the past, early in the "electrification age" (1910 to 1945), many lead acid batteries were used for storage in grids. Stationary lead acid batteries have to meet far higher product quality standards than starter batteries. Typical service life is 6 to 15 years with a cycle life of 1500 cycles at 80 % depth of discharge, and they achieve cycle efficiency levels of around 80 % to 90 %. Lead acid batteries offer a mature and well-researched technology at low cost. There are many types of lead acid batteries available, e.g. vented and sealed housing versions (called valve-regulated lead acid batteries, VRLA). Costs for stationary batteries are currently far higher than for starter batteries. Mass production of lead acid

batteries for stationary systems may lead to a price reduction.

One disadvantage of lead acid batteries is usable capacity decrease when high power is discharged. For example, if a battery is discharged in one hour, only about 50 % to 70 % of the rated capacity is available. Other drawbacks are lower energy density and the use of lead, a hazardous material prohibited or restricted in various jurisdictions. Advantages are a favourable cost/performance ratio, easy recyclability and a simple charging technology. Current R&D on lead acid batteries is trying to improve their behaviour for micro-hybrid electric vehicles (cf. section 3.2.5) [etg08] [lai03].

Nickel cadmium and nickel metal hydride battery (NiCd, NiMH)

Before the commercial introduction of nickel metal hydride (NiMH) batteries around 1995, nickel cadmium (NiCd) batteries had been in commercial use since about 1915. Compared to lead acid batteries, nickel-based batteries have a higher power density, a slightly greater energy density and the number of cycles is higher; many sealed construction types are available.

From a technical point of view, NiCd batteries are a very successful battery product; in particular, these are the only batteries capable of performing well even at low temperatures in the range from -20 °C to -40 °C. Large battery systems using vented NiCd batteries operate on a scale similar to lead acid batteries. However, because of the toxicity of cadmium, these batteries are presently used only for stationary applications in Europe. Since 2006 they have been prohibited for consumer use.

NiMH batteries were developed initially to replace NiCd batteries. Indeed, NiMH batteries have all the positive properties of NiCd batteries, with the exception of the maximal nominal capacity which is still ten times less when compared to NiCd and lead acid. Furthermore, NiMH batteries have much higher energy densities (weight for weight). In portable and mobile applications sealed NiMH

batteries have been extensively replaced by lithium ion batteries. On the other hand, hybrid vehicles available on today's market operate almost exclusively with sealed NiMH batteries, as these are robust and far safer than lithium ion batteries. NiMH batteries currently cost about the same as lithium ion batteries [etg08] [smo09] [dah03].

Lithium ion battery (Li-ion)

Lithium ion batteries (Figure 2-5) have become the most important storage technology in the areas of portable and mobile applications (e.g. laptop, cell phone, electric bicycle, electric car) since around 2000. High cell voltage levels of up to 3.7 nominal Volts mean that the number of cells in series with the associated connections and electronics can be reduced to obtain the target voltage. For example, one lithium ion cell can replace three NiCd or NiMH cells which have a cell voltage of only 1.2 Volts. Another advantage of Li-ion batteries is their high gravimetric energy density, and the prospect of large cost reductions through mass production. Although Li-ion batteries have a share of over 50 % in the small portable devices market, there are still some challenges for developing larger-scale Li-ion batteries. The main obstacle is the high cost of more than USD 600/kWh due to special packaging and internal overcharge protection circuits.

Lithium ion batteries generally have a very high efficiency, typically in the range of 95 % - 98 %. Nearly any discharge time from seconds to weeks can be realized, which makes them a very flexible and universal storage technology. Standard cells with 5000 full cycles can be obtained on the market at short notice, but even higher cycle rates are possible after further development, mainly depending on the materials used for the electrodes. Since lithium ion batteries are currently still expensive, they can only compete with lead acid batteries in those applications which require short discharge times (e.g. as primary control backup).

Safety is a serious issue in lithium ion battery technology. Most of the metal oxide electrodes

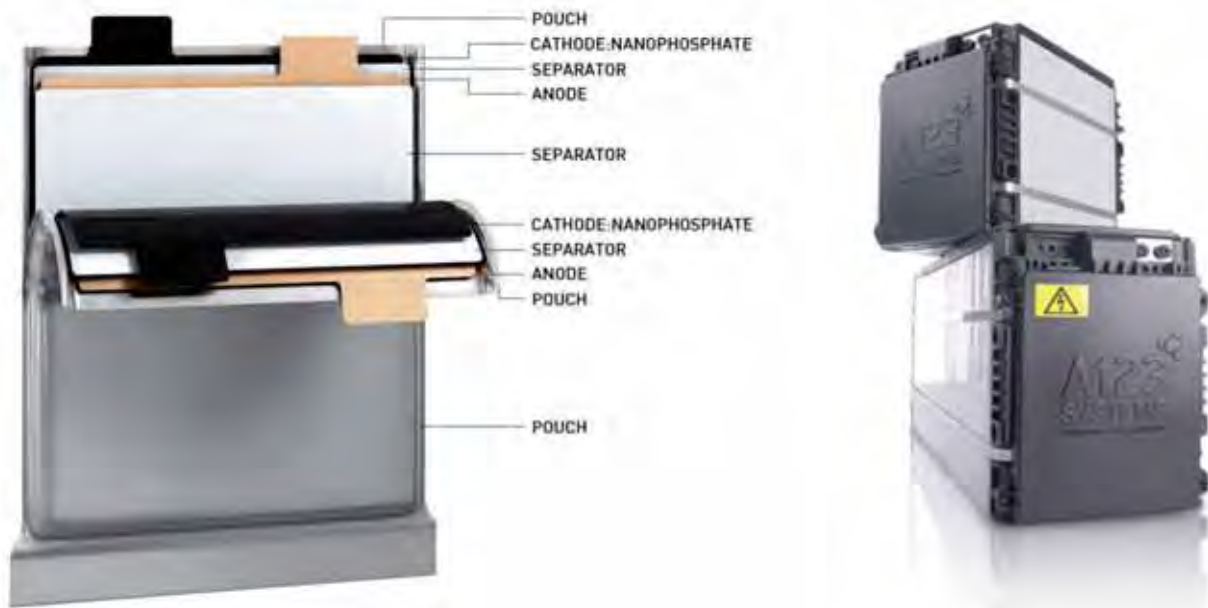

Figure 2-5 | Typical Li-ion prismatic cell design and battery modules (A123, IEC MSB/EES Workshop, 2011)

are thermally unstable and can decompose at elevated temperatures, releasing oxygen which can lead to a thermal runaway. To minimize this risk, lithium ion batteries are equipped with a monitoring unit to avoid over-charging and over-discharging. Usually a voltage balance circuit is also installed to monitor the voltage level of each individual cell and prevent voltage deviations among them. Lithium ion battery technology is still developing, and there is considerable potential for further progress. Research is focused on the development of cathode materials [etg08] [esp11].

Metal air battery (Me-air)

A metal air electrochemical cell consists of the anode made from pure metal and the cathode connected to an inexhaustible supply of air. For the electrochemical reaction only the oxygen in the air is used. Among the various metal air battery chemical couples, the lithium air battery is most attractive since its theoretical specific energy excluding oxygen (oxygen is not stored in the battery) is 11.14 kWh/kg, corresponding to about

100 times more than other battery types and even greater than petrol (10.15 kWh/kg). However, the high reactivity of lithium with air and humidity can cause fire, which is a high safety risk.

Currently only a zinc air battery with a theoretical specific energy excluding oxygen of 1.35 kWh/kg is technically feasible. Zinc air batteries have some properties of fuel cells and conventional batteries: the zinc is the fuel, the reaction rate can be controlled by varying air flow, and oxidized zinc/electrolyte paste can be replaced with fresh paste. In the 1970s, the development of thin electrodes based on fuel-cell research made small button prismatic primary cells possible for hearing aids, pagers and medical devices, especially cardiac telemetry. Rechargeable zinc air cells have a difficulty in design since zinc precipitation from the water-based electrolyte must be closely controlled. A satisfactory, electrically rechargeable metal air system potentially offers low materials cost and high specific energy, but none has reached marketability yet [wor02] [atw11].

Sodium sulphur battery (NaS)

Sodium sulphur batteries (Figure 2-6) consist of liquid (molten) sulphur at the positive electrode and liquid (molten) sodium at the negative electrode; the active materials are separated by a solid beta alumina ceramic electrolyte. The battery temperature is kept between 300 °C and 350 °C to keep the electrodes molten. NaS batteries reach typical life cycles of around 4500 cycles and have a discharge time of 6.0 hours to 7.2 hours. They are efficient (AC-based round-trip efficiency is about 75 %) and have fast response.

These attributes enable NaS batteries to be economically used in combined power quality and time shift applications with high energy density. The NaS battery technology has been demonstrated at around 200 sites in Japan, mainly for peak shaving, and Germany, France, USA and UAE also have NaS batteries in operation. The main drawback is that to maintain operating temperatures a heat source is required, which uses the battery's own stored energy, partially reducing the battery performance. In daily use the temperature of the battery can almost be maintained by just its own reaction heat, with

appropriately dimensioned insulation. Since around 1990 NaS batteries have been manufactured by one company in Japan, with a minimum module size of 50 kW and with typically 300 kWh to 360 kWh. It is not practical for the present to use only one isolated module. Because 20 modules are combined into one battery the minimal commercial power and energy range is on the order of 1 MW, and 6.0 MWh to 7.2 MWh. These batteries are suitable for applications with daily cycling. As the response time is in the range of milliseconds and NaS batteries meet the requirements for grid stabilization, this technology could be very interesting for utilities and large consumers [esp11] [kaw11].

Sodium nickel chloride battery (NaNiCl)

The sodium nickel chloride (NaNiCl) battery, better known as the ZEBRA (Zero Emission Battery Research) battery, is – like the NaS battery – a high-temperature (HT) battery, and has been commercially available since about 1995. Its operating temperature is around 270 °C, and it uses nickel chloride instead of sulphur for the positive electrode. NaNiCl batteries can withstand limited overcharge and discharge and have potentially better safety characteristics and a

Battery Cell

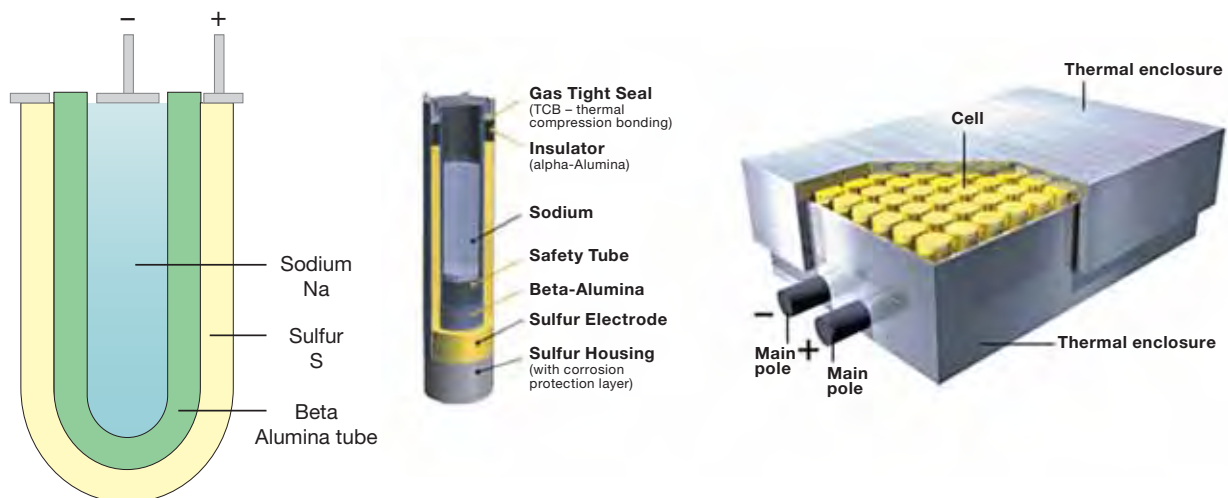

Figure 2-6 | NaS Battery: Cell design and 50 kW module (NGK, IEC MSB/EES Workshop 2011)

higher cell voltage than NaS batteries. They tend to develop low resistance when faults occur and this is why cell faults in serial connections only result in the loss of the voltage from one cell, instead of premature failure of the complete system. These batteries have been successfully implemented in several electric vehicle designs (Think City, Smart EV) and are an interesting opportunity for fleet applications. Present research is in developing advanced versions of the ZEBRA battery with higher power densities for hybrid electric vehicles, and also high-energy versions for storing renewable energy for load-levelling and industrial applications [esp11].

2.3.2 Flow batteries

In conventional secondary batteries, the energy is charged and discharged in the active masses of the electrodes. A flow battery is also a rechargeable battery, but the energy is stored in one or more electroactive species which are dissolved in liquid electrolytes. The electrolytes are stored externally in tanks and pumped through the electrochemical cell that converts chemical energy directly to electricity and vice versa. The power is defined by the size and design of the electrochemical cell whereas the energy depends on the size of the tanks. With this characteristic flow batteries can be fitted to a wide range of stationary applications. Originally developed by NASA in the early 70s as EES for long-term space flights, flow batteries are now receiving attention for storing energy for durations of hours or days with a power of up to several MW. Flow batteries are classified into redox flow batteries and hybrid flow batteries.

Redox flow battery (RFB)

In redox flow batteries (RFB) two liquid electrolyte dissolutions containing dissolved metal ions as active masses are pumped to the opposite sides of the electrochemical cell. The electrolytes at the negative and positive electrodes are called anolyte and catholyte respectively. During charging and

discharging the metal ions stay dissolved in the fluid electrolyte as liquid; no phase change of these active masses takes place. Anolyte and catholyte flow through porous electrodes, separated by a membrane which allows protons to pass through it for the electron transfer process. During the exchange of charge a current flows over the electrodes, which can be used by a battery-powered device. During discharge the electrodes are continually supplied with the dissolved active masses from the tanks; once they are converted the resulting product is removed to the tank.

Theoretically a RFB can be “recharged” within a few minutes by pumping out the discharged electrolyte and replacing it with recharged electrolyte. That is why redox flow batteries are under discussion for mobile applications. However, up to now the energy density of the electrolytes has been too low for electric vehicles.

Today various redox couples have been investigated and tested in RFBs, such as a Fe-Ti system, a Fe-Cr system and a polyS-Br system (Regenesys installation in UK with 15 MW and 120 MWh, but never commissioned) [jos09]. The vanadium redox flow battery (VRFB, Figure 2-7) has been developed the furthest; it has been piloted since around 2000 by companies such as Prudent Energy (CN) and Cellstrom (AU). The VRFB uses a V^{2+}/V^{3+} redox couple as oxidizing agent and a V^{5+}/V^{4+} redox couple in mild sulphuric acid solution as reducing agent. The main advantage of this battery is the use of ions of the same metal on both sides. Although crossing of metal ions over the membrane cannot be prevented completely (as is the case for every redox flow battery), in VRFBs the only result is a loss in energy. In other RFBs, which use ions of different metals, the crossover causes an irreversible degradation of the electrolytes and a loss in capacity. The VRFB was pioneered at the University of New South Wales, Australia, in the early 1980s. A VRFB storage system of up to 500 kW and 10 hrs has been installed in Japan

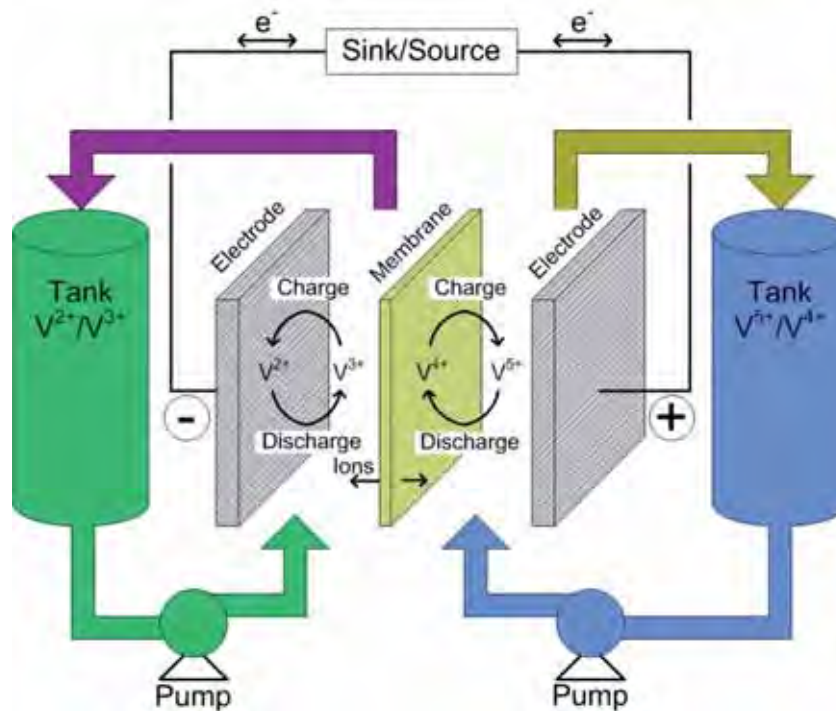

Figure 2-7 | Schematic of a Vanadium Redox Flow Battery (Fraunhofer ISE)

by SEI. SEI has also used a VRFB in power quality applications (e.g. 3 MW, 1.5 sec.).

Hybrid flow battery (HFB)

In a hybrid flow battery (HFB) one of the active masses is internally stored within the electrochemical cell, whereas the other remains in the liquid electrolyte and is stored externally in a tank. Therefore hybrid flow cells combine features of conventional secondary batteries and redox flow batteries: the capacity of the battery depends on the size of the electrochemical cell. Typical examples of a HFB are the Zn-Ce and the Zn-Br systems. In both cases the anolyte consists of an acid solution of Zn^{2+} ions. During charging Zn is deposited at the electrode and at discharging Zn^{2+} goes back into solution. As membrane a microporous polyolefin material is used; most of the electrodes are carbon-plastic composites. Various companies are working on the commercialization of the Zn-Br hybrid flow battery, which was developed by Exxon

in the early 1970s. In the United States, ZBB Energy and Premium Power sell trailer-transportable Zn-Br systems with unit capacities of up to 1 MW/3 MWh for utility-scale applications [iee10]. 5 kW/20 kWh systems for community energy storage are in development as well.

2.4 Chemical energy storage

In this report chemical energy storage focuses on hydrogen and synthetic natural gas (SNG) as secondary energy carriers, since these could have a significant impact on the storage of electrical energy in large quantities (see section 4.2.2). The main purpose of such a chemical energy storage system is to use “excess” electricity to produce hydrogen via water electrolysis. Once hydrogen is produced different ways are available for using it as an energy carrier, either as pure hydrogen or as SNG. Although the overall efficiency of hydrogen and SNG is low compared to storage technologies such as PHS and Li-ion,

chemical energy storage is the only concept which allows storage of large amounts of energy, up to the TWh range, and for greater periods of time – even as seasonal storage. Another advantage of hydrogen and SNG is that these universal energy carriers can be used in different sectors, such as transport, mobility, heating and the chemical industry.

2.4.1 Hydrogen (H₂)

A typical hydrogen storage system consists of an electrolyzer, a hydrogen storage tank and a fuel cell. An electrolyzer is an electrochemical converter which splits water with the help of electricity into hydrogen and oxygen. It is an endothermic process, i.e. heat is required during the reaction. Hydrogen is stored under pressure in gas bottles or tanks, and this can be done practically for an unlimited time. To generate electricity, both gases flow into the fuel cell where an electrochemical reaction which is the reverse of water splitting takes place: hydrogen and oxygen react and produce water, heat is released and electricity is generated. For economic and practical reasons oxygen is not stored but vented to the atmosphere on electrolysis, and oxygen from the air is taken for the power generation.

In addition to fuel cells, gas motors, gas turbines and combined cycles of gas and steam turbines are in discussion for power generation. Hydrogen systems with fuel cells (less than 1 MW) and gas motors (under 10 MW) can be adopted for combined heat and power generation in decentralized installations. Gas and steam turbines with up to several hundred MW could be used as peaking power plants. The overall AC-AC efficiency is around 40 %.

Different approaches exist to storing the hydrogen, either as a gas under high pressure, a liquid at very low temperature, adsorbed on metal hydrides or chemically bonded in complex hydrides. However, for stationary applications gaseous storage under

high pressure is the most popular choice. Smaller amounts of hydrogen can be stored in above-ground tanks or bottles under pressures up to 900 bar. For larger amounts of hydrogen, underground piping systems or even salt caverns with several 100 000 m³ volumes under pressures up to 200 bar can be used.

Up to now there have not been any commercial hydrogen storage systems used for renewable energies. Various R&D projects carried out over the last 25 years have successfully demonstrated the feasibility of hydrogen technology, such as a project on the self-sufficient island of Utsira in Norway. Another example is a hybrid power plant from Enertrag in Germany which is currently under construction [ene11]. Wind energy is used to produce hydrogen via electrolysis if the power cannot be directly fed into the grid. On demand, the stored hydrogen is added to the biogas used to run a gas motor. Moreover the hydrogen produced will be used for a hydrogen refilling station at the international airport in Berlin.

Water electrolysis plants on a large scale (up to 160 MW) are state-of-the-art for industrial applications; several were built in different locations (Norway, Egypt, Peru etc.) in the late 1990s.

2.4.2 Synthetic natural gas (SNG)

Synthesis of methane (also called synthetic natural gas, SNG) is the second option to store electricity as chemical energy. Here a second step is required beyond the water splitting process in an electrolyzer, a step in which hydrogen and carbon dioxide react to methane in a methanation reactor. As is the case for hydrogen, the SNG produced can be stored in pressure tanks, underground, or fed directly into the gas grid. Several CO₂ sources are conceivable for the methanation process, such as fossil-fuelled power stations, industrial installations or biogas plants. To minimize losses in energy, transport of the gases CO₂ (from the CO₂ source) and H₂ (from the electrolysis plant)

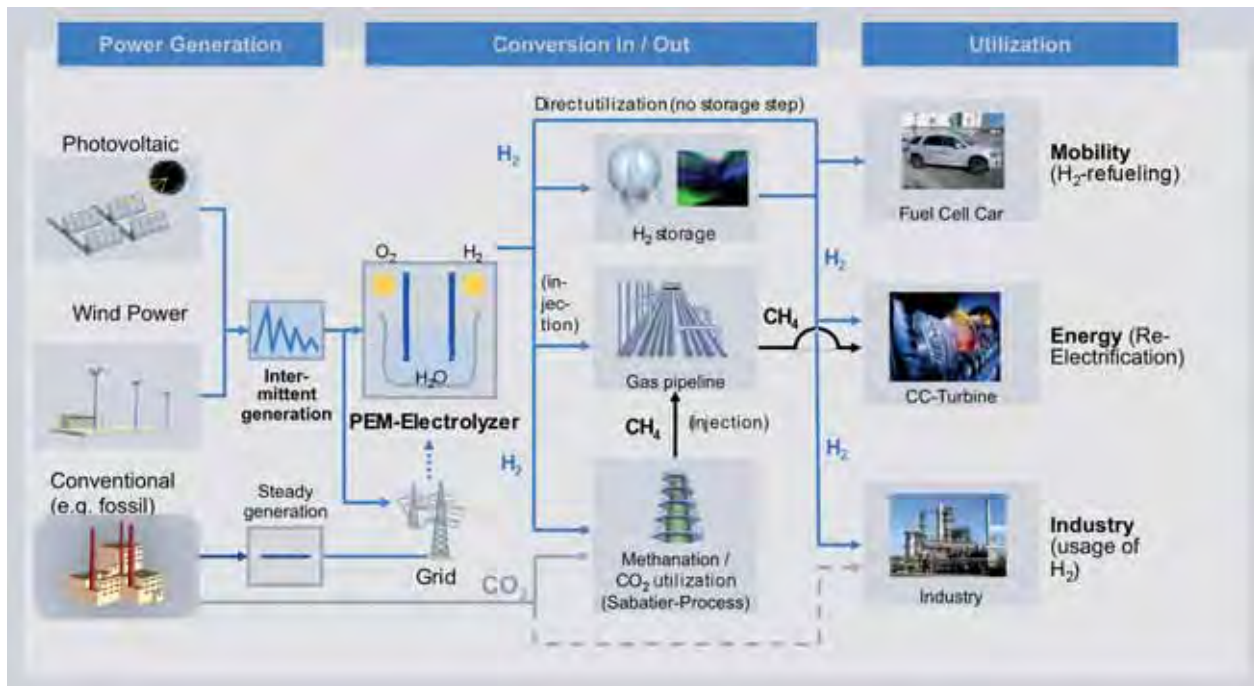

Figure 2-8 | Overall concept for the use of hydrogen and SNG as energy carriers [wai11]

to the methanation plant should be avoided. The production of SNG is preferable at locations where CO_2 and excess electricity are both available. In particular, the use of CO_2 from biogas production processes is promising as it is a widely-used technology. Nevertheless, intermediate on-site storage of the gases is required, as the methanation is a constantly running process. Recently this concept “power to methane” has been the subject of different R&D projects (e.g. in Germany, where a pilot-scale production plant is under construction [kuh11]).

The main advantage of this approach is the use of an already existing gas grid infrastructure (e.g. in Europe). Pure hydrogen can be fed into the gas grid only up to a certain concentration, in order to keep the gas mixture within specifications (e.g. heating value). Moreover, methane has a higher energy density, and transport in pipelines requires less energy (higher density of the gas). The main disadvantage of SNG is the relatively low efficiency

due to the conversion losses in electrolysis, methanation, storage, transport and the subsequent power generation. The overall AC-AC efficiency, $< 35\%$, is even lower than with hydrogen [ste09]. A comprehensive overview of the combined use of hydrogen and SNG as chemical energy storage is shown in Figure 2-8 [wai11].

2.5 Electrical storage systems

2.5.1 Double-layer capacitors (DLC)

Electrochemical double-layer capacitors (DLC), also known as supercapacitors, are a technology which has been known for 60 years. They fill the gap between classical capacitors used in electronics and general batteries, because of their nearly unlimited cycle stability as well as extremely high power capability and their many orders of magnitude higher energy storage capability when compared to traditional capacitors. This technology still exhibits a large

development potential that could lead to much greater capacitance and energy density than conventional capacitors, thus enabling compact designs.

The two main features are the extremely high capacitance values, of the order of many thousand farads, and the possibility of very fast charges and discharges due to extraordinarily low inner resistance which are features not available with conventional batteries.

Still other advantages are durability, high reliability, no maintenance, long lifetime and operation over a wide temperature range and in diverse environments (hot, cold and moist). The lifetime reaches one million cycles (or ten years of operation) without any degradation, except for the solvent used in the capacitors whose disadvantage is that it deteriorates in 5 or 6 years irrespective of the number of cycles. They are environmentally friendly and easily recycled or neutralized. The efficiency is typically around 90 % and discharge times are in the range of seconds to hours.

They can reach a specific power density which is about ten times higher than that of conventional batteries (only very-high-power lithium batteries can reach nearly the same specific power density), but their specific energy density is about ten times lower.

Because of their properties, DLCs are suited especially to applications with a large number of short charge/discharge cycles, where their high performance characteristics can be used. DLCs are not suitable for the storage of energy over longer periods of time, because of their high self-discharge rate, their low energy density and high investment costs.

Since about 1980 they have been widely applied in consumer electronics and power electronics. A DLC is also ideally suited as a UPS to bridge short voltage failures. A new application could be the electric vehicle, where they could be used as

a buffer system for the acceleration process and regenerative braking [esp11].

2.5.2 Superconducting magnetic energy storage (SMES)

Superconducting magnetic energy storage (SMES) systems work according to an electrodynamic principle. The energy is stored in the magnetic field created by the flow of direct current in a superconducting coil, which is kept below its superconducting critical temperature. 100 years ago at the discovery of superconductivity a temperature of about 4 °K was needed. Much research and some luck has now produced superconducting materials with higher critical temperatures. Today materials are available which can function at around 100 °K. The main component of this storage system is a coil made of superconducting material. Additional components include power conditioning equipment and a cryogenically cooled refrigeration system.

The main advantage of SMES is the very quick response time: the requested power is available almost instantaneously. Moreover the system is characterized by its high overall round-trip efficiency (85 % - 90 %) and the very high power output which can be provided for a short period of time. There are no moving parts in the main portion of SMES, but the overall reliability depends crucially on the refrigeration system. In principle the energy can be stored indefinitely as long as the cooling system is operational, but longer storage times are limited by the energy demand of the refrigeration system.

Large SMES systems with more than 10 MW power are mainly used in particle detectors for high-energy physics experiments and nuclear fusion. To date a few, rather small SMES products are commercially available; these are mainly used for power quality control in manufacturing plants such as microchip fabrication facilities [jea09].

2.6 Thermal storage systems

Thermal (energy) storage systems store available heat by different means in an insulated repository for later use in different industrial and residential applications, such as space heating or cooling, hot water production or electricity generation. Thermal storage systems are deployed to overcome the mismatch between demand and supply of thermal energy and thus they are important for the integration of renewable energy sources.

Thermal storage can be subdivided into different technologies: storage of sensible heat, storage of latent heat, and thermo-chemical ad- and absorption storage [sch08]. The storage of sensible heat is one of the best-known and most widespread technologies, with the domestic hot water tank as an example. The storage medium may be a liquid such as water or thermo-oil, or a solid such as concrete or the ground. Thermal energy is stored solely through a change of temperature of the storage medium. The capacity of a storage system is defined by the specific heat capacity and the mass of the medium used.

Latent heat storage is accomplished by using phase change materials (PCMs) as storage media. There are organic (paraffins) and inorganic PCMs (salt hydrates) available for such storage systems. Latent heat is the energy exchanged during a phase change such as the melting of ice. It is also called “hidden” heat, because there is no change of temperature during energy transfer. The best-known latent heat – or cold – storage method is the ice cooler, which uses ice in an insulated box or room to keep food cool during hot days. Currently most PCMs use the solid-liquid phase change, such as molten salts as a thermal storage medium for concentrated solar power (CSP) plants [jee08]. The advantage of latent heat storage is its capacity to store large amounts of energy in a small volume and with a minimal temperature change, which allows efficient heat transfer.

Sorption (adsorption, absorption) storage systems work as thermo-chemical heat pumps under vacuum conditions and have a more complex design. Heat from a high-temperature source heats up an adsorbent (e.g. silica gel or zeolite), and vapour (working fluid, e.g. water) is desorbed from this adsorbent and condensed in a condenser at low temperatures. The heat of condensation is withdrawn from the system. The dried adsorbent and the separated working fluid can be stored as long as desired. During the discharging process the working fluid takes up low-temperature heat in an evaporator. Subsequently, the vapour of the working fluid adsorbs on the adsorbent and heat of adsorption is released at high temperatures [jäh06]. Depending on the adsorbent/working fluid pair the temperature level of the released heat can be up to 200 °C [sch08] and the energy density is up to three times higher than that of sensible heat storage with water. However, sorption storage systems are more expensive due to their complexity.

In the context of EES, it is mainly sensible/latent heat storage systems which are important. CSP plants primarily produce heat, and this can be stored easily before conversion to electricity and thus provide dispatchable electrical energy. State-of-the-art technology is a two-tank system for solar tower plants, with one single molten salt as heat transfer fluid and storage medium [tam06]. The molten salt is heated by solar radiation and then transported to the hot salt storage tank. To produce electricity the hot salt passes through a steam generator which powers a steam turbine. Subsequently, the cold salt (still molten) is stored in a second tank before it is pumped to the solar tower again. The main disadvantages are the risk of liquid salt freezing at low temperatures and the risk of salt decomposition at higher temperatures. In solar trough plants a dual-medium storage system with an intermediate oil/salt heat exchanger is preferred [tam06]. Typical salt mixtures such as Na-K-NO₃ have freezing temperatures > 200 °C, and storage materials and containment require a higher

volume than storage systems for solar tower plants. The two-tank indirect system is being deployed in “Andasol 1-3”, three 50 MW parabolic trough plants in southern Spain, and is planned for Abengoa Solar’s 280 MW Solana plant in Arizona. Apart from sensible heat storage systems for CSP, latent heat storage is under development by a German-Spanish consortium – including DLR and Endesa – at Endesa’s Litoral Power Plant in Carboneras, Spain. The storage system at the pilot facility is based on sodium nitrate, has a capacity of 700 kWh and works at a temperature of 305 °C [csp11].

In adiabatic CAES the heat released during compression of the air may be stored in large solid or liquid sensible heat storage systems. Various R&D projects are exploring this technology [rwe11] [bul04], but so far there are no adiabatic CAES plants in operation. As solid materials concrete, cast iron or even a rock bed can be employed. For liquid systems different concepts with a combination of nitrate salts and oil are in discussion. The round-trip efficiency is expected to be over 70 % [rad08].

Of particular relevance is whether a pressurized tank is needed for the thermal storage, or if a non-pressurized compartment can be used. In liquid systems, a heat exchanger can be used to avoid the need for a large pressurized tank for the liquid, but the heat exchanger means additional costs and increases the complexity. A dual-media approach (salt and oil) must be used to cover the temperature range from 50 °C to 650 °C [bul04]. Direct contact between the pressurized air and the storage medium in a solid thermal storage system has the advantage of a high surface area for heat transfer. The storage material is generally cheap, but the pressurized container costs are greater.

2.7 Standards for EES

For mature EES systems such as PHS, LA, NiCd, NiMH and Li-ion various IEC standards exist. The standards cover technical features, testing and system integration. For the other technologies

there are only a few standards, covering special topics. Up to now no general, technology-independent standard for EES integration into a utility or a stand-alone grid has been developed. A standard is planned for rechargeable batteries of any chemistry.

Standardization topics for EES include:

- terminology
- basic characteristics of EES components and systems, especially definitions and measuring methods for comparison and technical evaluation
 - capacity, power, discharge time, lifetime, standard EES unit sizes
- communication between components
 - protocols, security
- interconnection requirements
 - power quality, voltage tolerances, frequency, synchronization, metering
- safety: electrical, mechanical, etc.
- testing
- guides for implementation.

2.8 Technical comparison of EES technologies

The previous sections have shown that a wide range of different technologies exists to store electrical energy. Different applications with different requirements demand different features from EES. Hence a comprehensive comparison and assessment of all storage technologies is rather ambitious, but in Figure 2-9 a general overview of EES is given. In this double-logarithmic chart the rated power (W) is plotted against the energy content (Wh) of EES systems. The nominal discharge time at rated power can also be seen, covering a range from seconds to months. Figure 2-9 comprises not only the application areas of today’s EES systems but also the predicted range in future applications.

Not all EES systems are commercially available in the ranges shown at present, but all are expected to become important. Most of the technologies could be implemented with even larger power output and energy capacity, as all systems have a modular design, or could at least be doubled (apart from PHS and some restrictions for underground storage of H₂, SNG and CAES). If a larger power range or higher energy capacity is not realized, it will be mainly for economic reasons (cost per kW and cost per kWh, respectively).

On the basis of Figure 2-9 EES technologies can be categorized as being suitable for applications with:

- **Short discharge time** (seconds to minutes): double-layer capacitors (DLC), superconducting magnetic energy storage (SMES) and flywheels (FES). The energy-to-power ratio is less than 1 (e.g. a capacity of less than 1 kWh for a system with a power of 1 kW).

- **Medium discharge time** (minutes to hours): flywheel energy storage (FES) and – for larger capacities – electrochemical EES, which is the dominant technology: lead-acid (LA), Lithium ion (Li-ion) and sodium sulphur (NaS) batteries. The technical features of the different electrochemical techniques are relatively similar. They have advantages in the kW - MW and kWh - MWh range when compared to other technologies. Typical discharge times are up to several hours, with an energy-to-power ratio of between 1 and 10 (e.g. between 1 kWh and 10 kWh for a 1 kW system). Batteries can be tailored to the needs of an application: tradeoffs may be made for high energy or high power density, fast charging behaviour or long life, etc.
- **Long discharge time** (days to months): hydrogen (H₂) and synthetic natural gas (SNG). For these EES systems the energy-to-power ratio is considerably greater than 10.

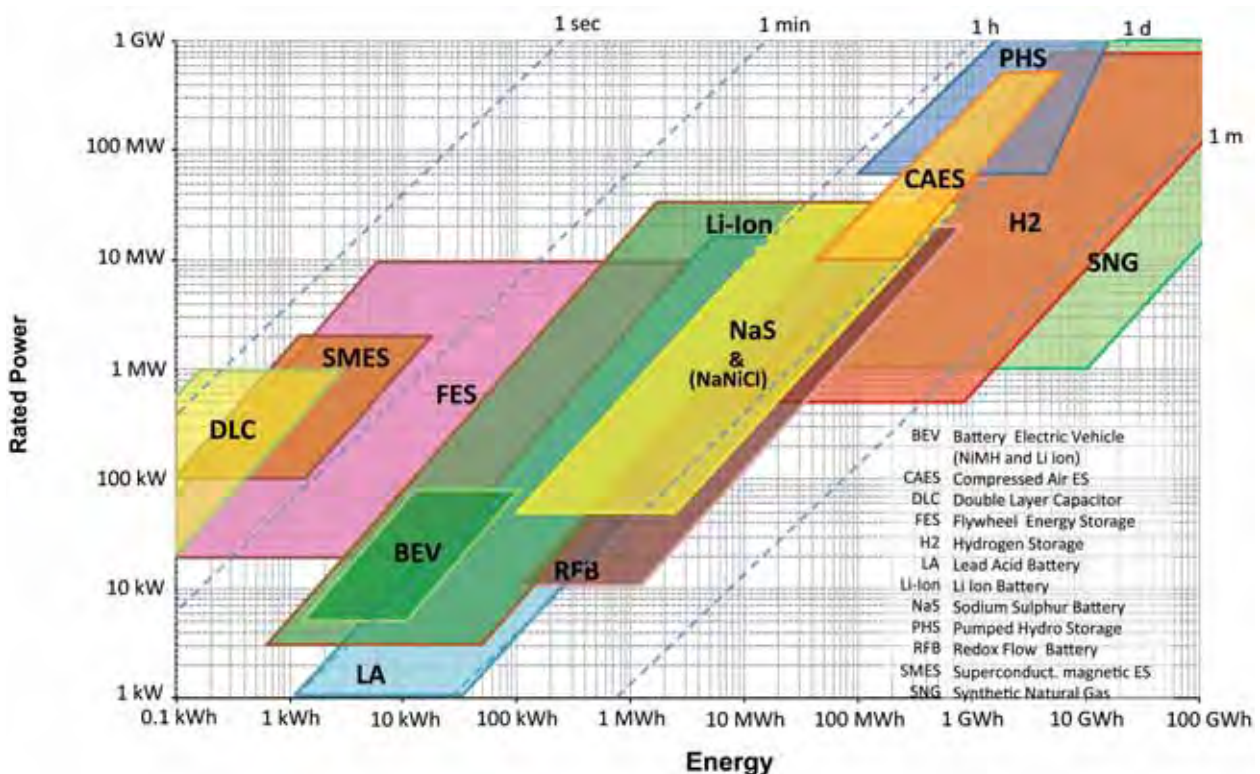

Figure 2-9 | Comparison of rated power, energy content and discharge time of different EES technologies (Fraunhofer ISE)

Pumped hydro storage (PHS), compressed air energy storage (CAES) and redox flow batteries are situated between storage systems for medium and long discharge times. Like H₂ and SNG systems, these EES technologies have external storage tanks. But the energy densities are rather low, which limits the energy-to-power ratio to values between approximately 5 and 30.

In Figure 2-10 the power density (per unit volume, not weight) of different EES technologies is plotted versus the energy density. The higher the power and energy density, the lower the required volume for the storage system. Highly compact EES technologies suitable for mobile applications can be found at the top right. Large area and volume-consuming storage systems are located at the bottom left. Here it is again clear that PHS, CAES

and flow batteries have a low energy density compared to other storage technologies. SMES, DLC and FES have high power densities but low energy densities. Li-ion has both a high energy density and high power density, which explains the broad range of applications where Li-ion is currently deployed.

NaS and NaNiCl have higher energy densities in comparison to the mature battery types such as LA and NiCd, but their power density is lower in comparison to NiMH and Li-ion. Metal air cells have the highest potential in terms of energy density. Flow batteries have a high potential for larger battery systems (MW/MWh) but have only moderate energy densities. The main advantage of H₂ and SNG is the high energy density, superior to all other storage systems.

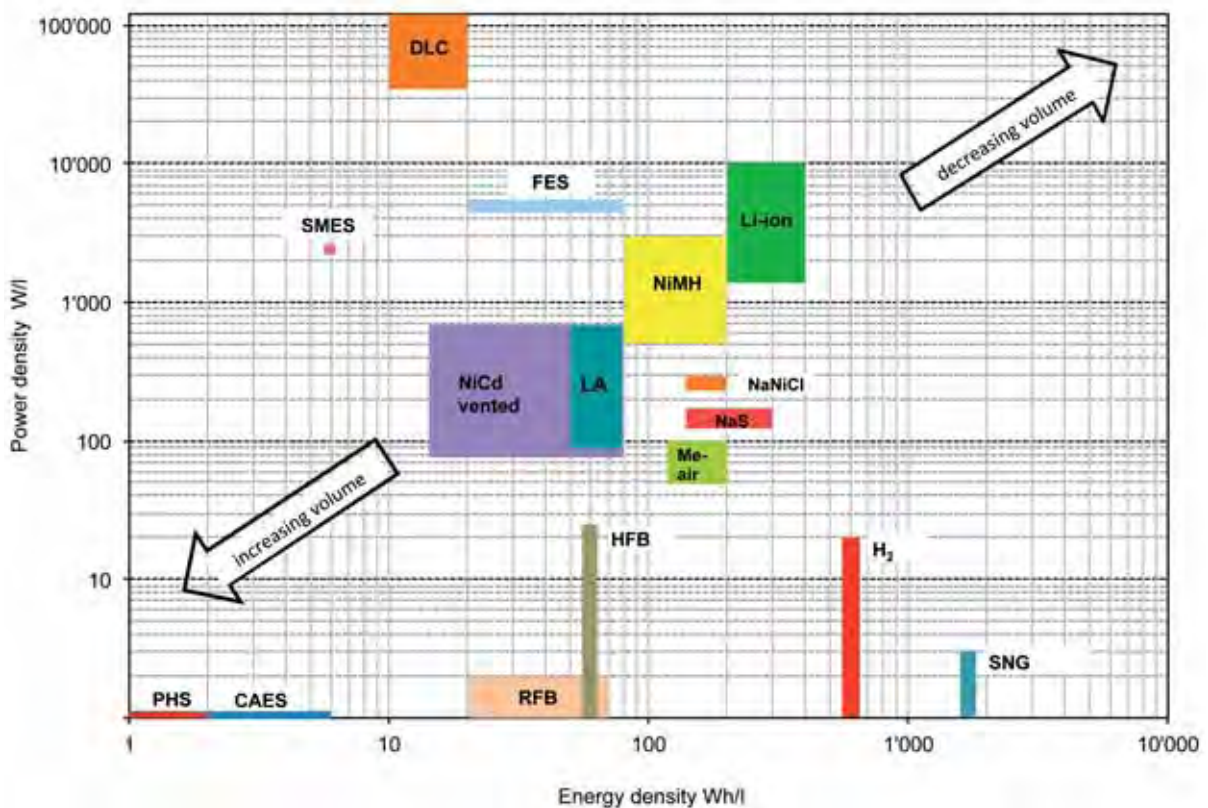

Figure 2-10 | Comparison of power density and energy density (in relation to volume) of EES technologies (Fraunhofer ISE)

Figure 2-11 summarizes the maturity of the storage technologies discussed. The state of the art for each EES technology is plotted versus the power range. Thus the suitability for different applications of the available technologies covered can be compared.

Clearly PHS, CAES, H₂ and SNG are the only storage technologies available for high power ranges and energy capacities, although energy density is rather low for PHS and CAES. Large power ranges are feasible as these EES systems use the turbines and compressors familiar from other power generation plants. However, only PHS is mature and available. Restrictions in locations (topography) and land consumption are a more severe limit for this technology than the characteristic of low energy density (although the two may be linked in some cases). Figure 2-11 shows a lack of immediately deployable storage systems in the range from 10 MW to some hundreds of MW. Diabatic CAES is well-developed but adiabatic CAES is yet to be demonstrated. Single components of H₂ and SNG

storage systems are available and in some cases have been used in industrial applications for decades. However, such storage systems become viable and economically reasonable only if the grids have to carry and distribute large amounts of volatile electricity from REs. The first demonstration and pilot plants are currently under construction (e.g. in Europe).

From the technical comparison it can be concluded that a single universal storage technology superior to all other storage systems does not exist. Today and in the future different types of EES will be necessary to suit all the applications described in section 1. Bearing in mind the findings from Figures 2-9 and 2-10, Figure 2-11 suggests the following conclusions.

- 1) EES systems for short and medium discharge times cover wide ranges of rated power and energy density. Several mature EES technologies, in particular FES, DLC and battery systems, can be used in these ranges.

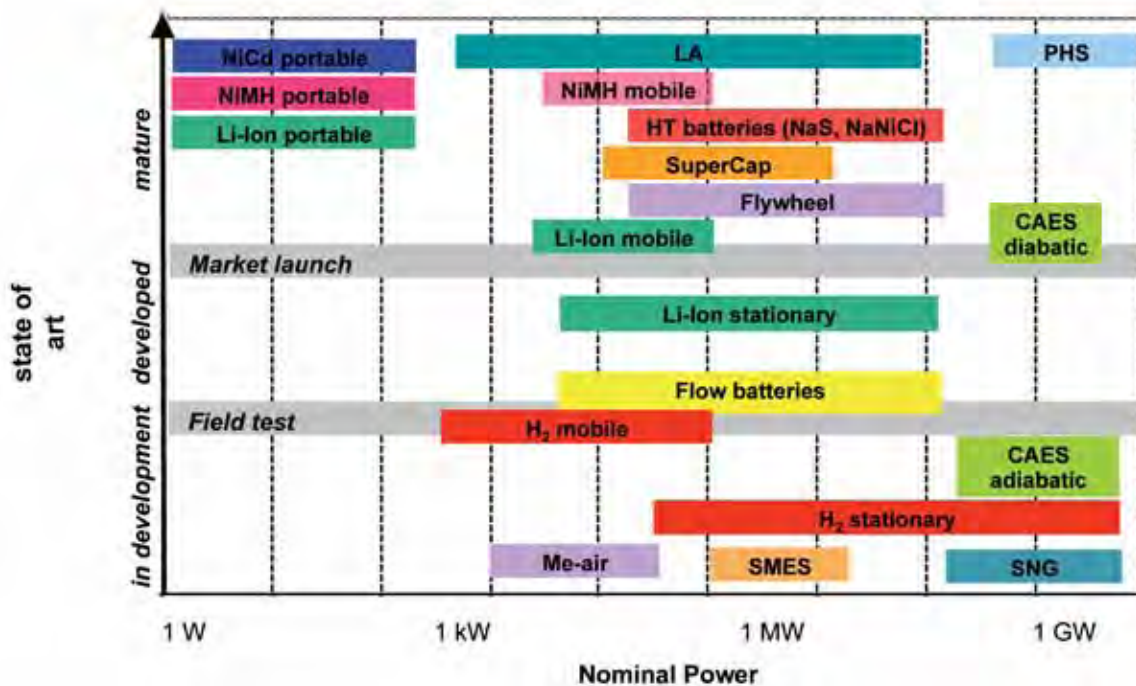

Figure 2-11 | Maturity and state of the art of storage systems for electrical energy (Fraunhofer ISE)

- 2) PHS is the only currently feasible large-capacity EES for medium discharge times; further development in CAES is expected. Suitable locations for large PHS and CAES systems are topographically limited. An increase in the capacity of other EES systems, and control and integration of dispersed EES systems (see section 3.3), will be required for medium-duration use.
- 3) For long discharge times, days to months, and huge capacities (GWh - TWh), no EES technologies have so far been put into practical operation. New EES technologies such as H₂ and SNG have to be developed.

Section 3

Markets for EES

In this section an overview of the markets for EES is given by describing existing EES application cases. Applications for conventional electric utilities and consumers are presented as well as near-future use cases, concentrating on storage applications in combination with renewable energy generation.

3.1 Present status of applications

In this section, those cases are described which have already been implemented by electric utilities and consumers. These are respectively time shift and investment deferral for the former, and emergency supply and power quality for the latter.

3.1.1 Utility use (conventional power generation, grid operation & service)

1) Reduce total generation costs by using pumped hydroelectricity for time shifting, which stores electricity during off-peak times and provides electricity during peak hours.

- 2) Maintain power quality, voltage and frequency, by supplying/absorbing power from/into EES when necessary.
- 3) Postpone investment needed by mitigating network congestion through peak shift.
- 4) Provide stable power for off-grid systems (isolated networks).
- 5) Provide emergency power supply.

Utility use of pumped hydro storage for time shift and power quality

Pumped hydro storage (PHS) has historically been used by electric utilities to reduce total generation cost by time-shifting and to control grid frequency. There are many PHS facilities in different countries, and they have the largest proportion of total storage capacity worldwide. A conventional installation cannot function as a frequency controller while pumping, but an advanced variable-speed-control PHS (Figure 3-1) can do so by varying the rotational speed of the motor.



Figure 3-1 | Variable-speed PHS operated by TEPCO (TEPCO)



Figure 3-2 | CAES plant in Huntorf (Vattenfall, IEC MSB/EES Workshop 2011)

Utility use of compressed air energy storage for time shift and power quality

Today only two diabatic compressed air energy storage (CAES) power plants are in operation worldwide. In 1978 the first CAES power plant was built in Huntorf, Germany (Figure 3-2). It works as a diabatic CAES plant with a round-trip efficiency of roughly 41 % [rad08]. It consists of a low-pressure and high-pressure compressor with intercooler, two salt caverns (2 x 155000 m³ usable volume, 46 - 72 bar pressure range), a motor-generator (60 MW charging, 321 MW discharging) and a high-pressure (inlet conditions: 41 bar, 490 °C) and low-pressure turbine (13 bar, 945 °C). The second CAES plant is in McIntosh (Alabama, USA) and was commissioned in 1991. It has a net electrical output of 110 MW and is also based on a diabatic CAES process, but additionally a recuperator is used to recover heat from the exhaust at the outlet of the gas turbine. Therefore a higher round trip efficiency of

54 % can be achieved. Both systems use off-peak electricity for air compression and are operated for peak levelling on a daily basis.

Worldwide several CAES plants are under development and construction. In Germany for example a small adiabatic CAES plant is scheduled for demonstration in 2016 (project ADELE), which will achieve a higher efficiency in comparison to a diabatic CAES [rwe11].

Utility's more efficient use of the power network

As one of the examples of EES for utilities, a Li-ion battery can provide the benefit of more efficient use of the power network.

In 2009 the US companies AES Energy Storage and A123 Systems installed a 12 MW, 3 MWh Li-ion battery at AES Gener's Los Andes substation in the Atacama Desert, Chile (Figure 3-3). The battery helps the system operator manage fluctuations in



Figure 3-3 | Li-ion battery supplying up to 12 MW of power at Los Andes substation in Chile
(A123, 2009)

demand, delivering frequency regulation in a less expensive and more responsive manner than transmission line upgrades. In addition, because the project replaces unpaid reserve from the power plant, AES Gener will receive payment for its full output capacity by selling directly to the electric grid.

Utility’s emergency power supply

Important facilities, such as power stations, substations and telecommunication stations, need power sources for their control installations with high power quality and reliability, since these are the very facilities which are most needed for power in the case of an interruption. EES systems for this application are mostly DC sources and supported by batteries. Historically lead acid batteries have been used for this purpose.

Utility’s off-grid systems (isolated grids)

In the case where a utility company supplies electricity in a small power grid, for example on an island, the power output from small-capacity generators such as diesel and renewable energy must also match with the power demand. On Hachijo-jima (island), where about 8 000 people

live, TEPCO uses NaS batteries with diesel generators and a wind power station to meet the varying demand. For off-grid photovoltaic systems in the power range (50 W -) 1 kW - 500 kW lead acid batteries for EES are commonly used.

3.1.2 Consumer use (uninterruptable power supply for large consumers)

- 1) Suppress peak demand and use cheaper electricity during peak periods, i.e. save cost by buying off-peak electricity and storing it in EES. The result is load leveling by time-shifting.
- 2) Secure a reliable and higher-quality power supply for important factories and commercial facilities.

Example: consumers’ use of NaS batteries

Figure 3-4 shows the applications of NaS batteries installed in the world with their respective power capacities. The systems used exclusively for load levelling (LL) account for almost half the total, and installations for load levelling with the additional functions of emergency power supply or stand-by power supply represent another 20 % each. However, the need for storage linked to renewable energy, as explained in section 3.2, is growing.

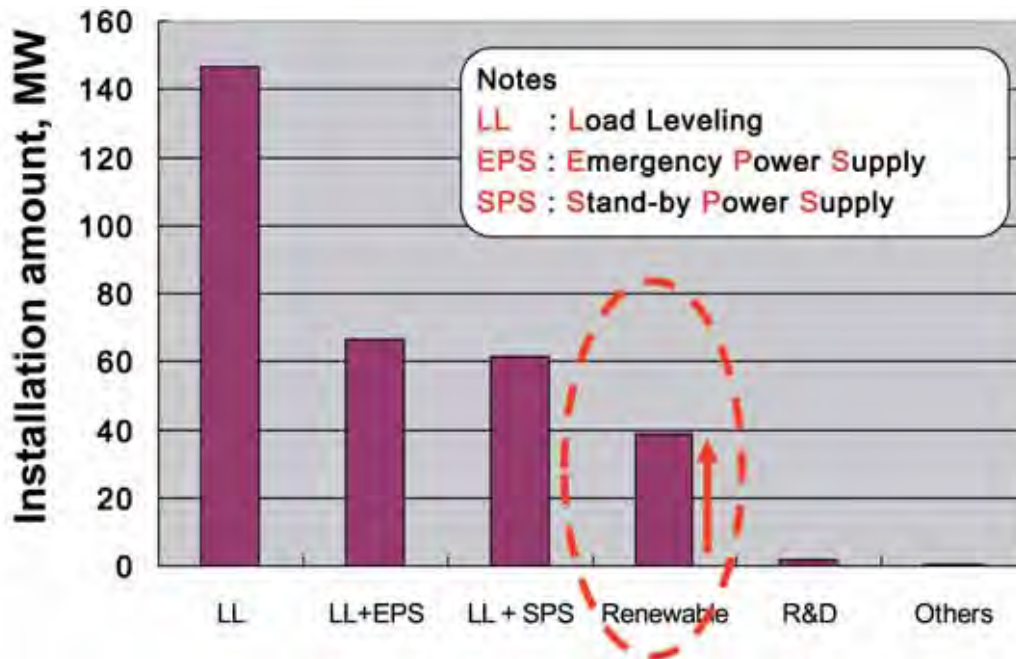

Figure 3-4 | NaS battery applications and installed capacities (NGK, IEC MSB/EES Workshop, 2011)

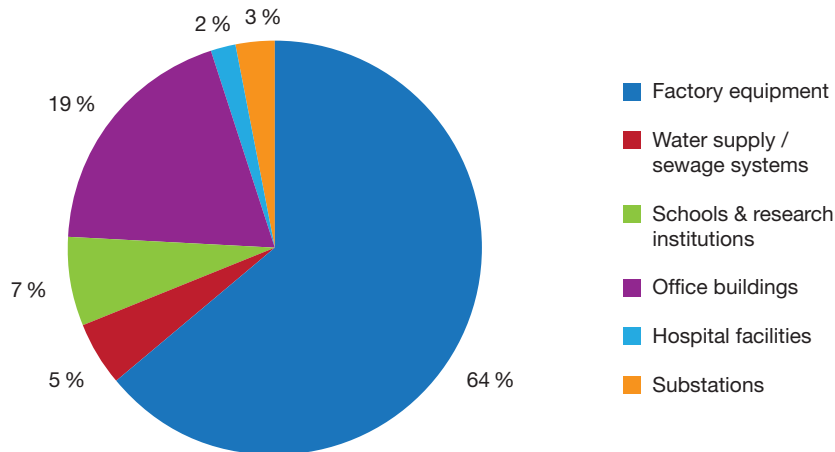

Figure 3-5 | Locations of NaS systems in the TEPCO service area (TEPCO)

Figure 3-5 shows the locations of NaS batteries installed in the TEPCO service area; the average capacity per location is about 2 MW. The majority of batteries are installed in large factories (64%), but there are some in large commercial buildings (19%) as well as in water supply/sewerage systems and schools/research institutes (12% together).

3.1.3 EES installed capacity worldwide

Figure 3-6 shows the installed capacity of EES systems used in electricity grids. Pumped hydro storage (PHS) power plants, with over 127 GW, represent 99%, and this is about 3% of global generation capacity. The second-largest EES in

Pumped Hydro

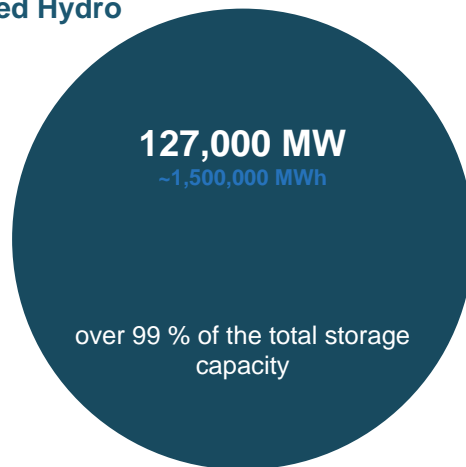

- Compressed Air Energy Storage
440 MW 3,730 MWh
- Sodium Sulphur Battery
316 MW 1,900 MWh
- Lithium Ion Battery
~70 MW ~17 MWh
- Lead Acid Battery
~35 MW ~70 MWh
- Nickel Cadmium Battery
27 MW 6,75 MWh
- Flywheels
<25 MW <0,4 MWh
- Redox Flow Battery
<3 MW <12 MWh

Figure 3-6 | Worldwide installed storage capacity for electrical energy [epr10] [doe07]

installed capacity is CAES, but there are only two systems in operation. The third most widely-used EES is the NaS battery. As of the end of September 2010, NaS systems were installed and operational in 223 locations in, for example, Japan, Germany, France, USA and UAE (total: 316 MW). However, a large quantity of other EES is expected to be installed given the emerging market needs for different applications, as shown in the next section.

3.2 New trends in applications

Five new trends in EES applications are described: renewable energy, smart grids, smart microgrids, smart houses and electric vehicles. Current use cases of these applications include experimental equipment and plans.

3.2.1 Renewable energy generation

In order to solve global environmental problems, renewable energies such as solar and wind will be widely used. This means that the future energy supply will be influenced by fluctuating renewable energy sources – electricity production will follow weather conditions and the surplus and deficit

in energy need to be balanced. One of the main functions of energy storage, to match the supply and demand of energy (called time shifting), is essential for large and small-scale applications. In the following, we show two cases classified by their size: kWh class and MWh class. The third class, the GWh class, will be covered in section 4.2.2.

Besides time shifting with energy storage, there are also other ways of matching supply and demand. With a reinforced power grid, regional overproduction can be compensated for by energy transmission to temporarily less productive areas. The amount of energy storage can also be reduced by overinstallation of renewable energy generators. With this approach even weakly producing periods are adequate for the load expected.

A further option is so-called demand-side management (described under Smart Grid in section 3.2.2), where users are encouraged to shift their consumption of electricity towards periods when surplus energy from renewables is available.

These balancing methods not requiring EES need to be considered for a proper forecast of the market potential for EES.

Decentralized storage systems for increased self-consumption of PV energy (kWh class)

With the increasing number of installed PV systems, the low-voltage grid is reaching its performance limit. In Germany, the EEG (Renewable Energies

Law) guarantees, for a period of 20 years, a feed-in tariff for every kWh produced and a fixed tariff for every kWh produced and self-consumed. To encourage operators of decentralized systems, the price for self-consumed PV energy is higher.

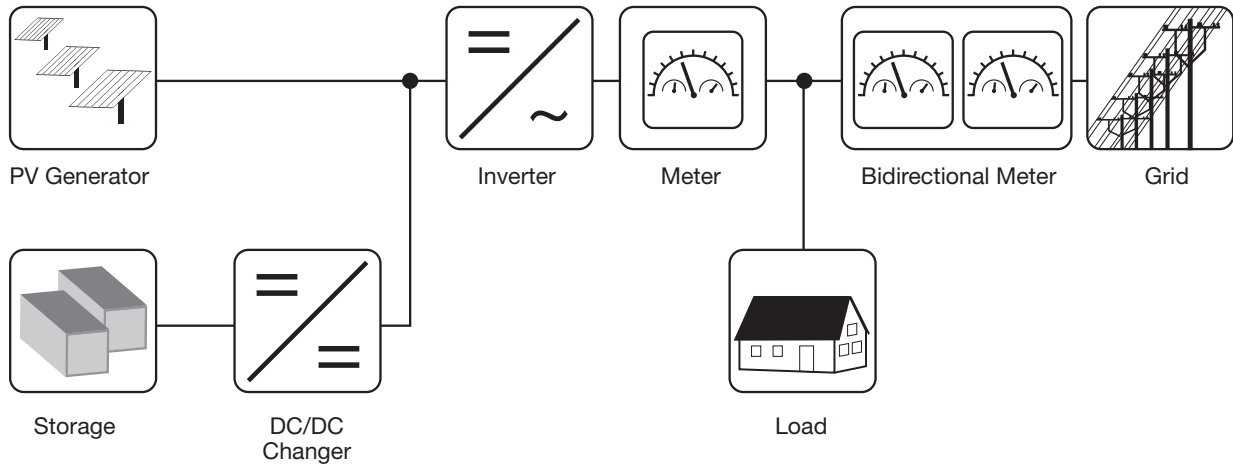

Figure 3-7 | PV system designed for energy self-consumption (Fraunhofer ISE)

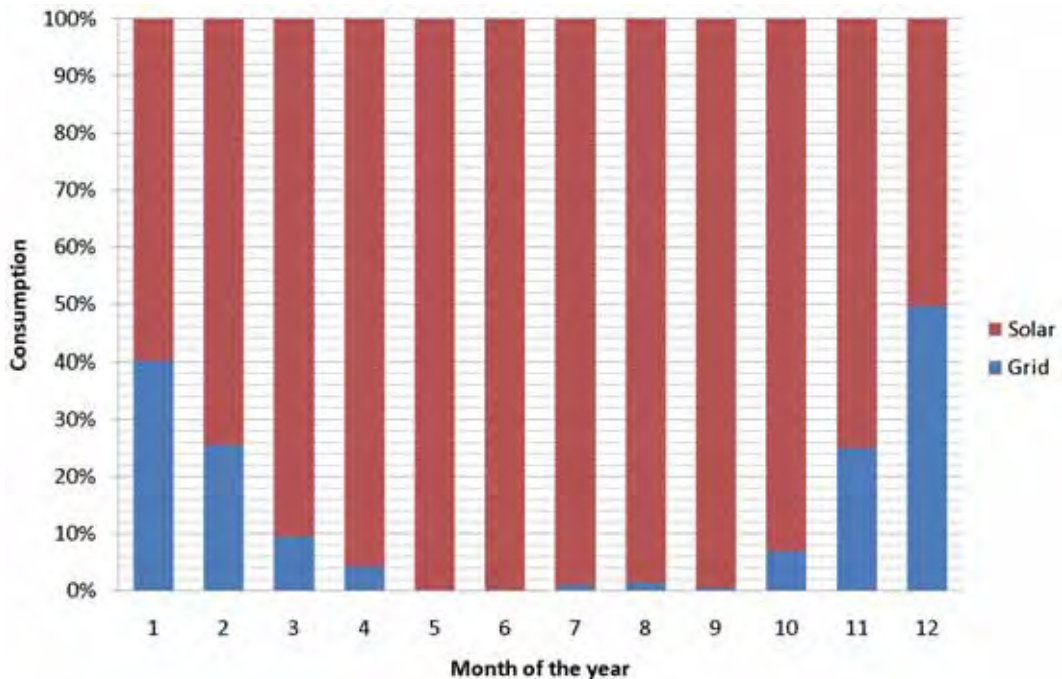

Figure 3-8 | Consumption of a typical household with a storage system: energy consumed from the grid and from the PV system (Fraunhofer ISE)

Therefore self-consumption of power will become an important option for private households with PV facilities, especially as the price of electricity increases.

Figure 3-7 shows an example of system design. To measure the amount of energy consumed or fed into the grid two meters are needed. One meter measures the energy generated by the PV system. The other meter works bidirectionally and measures the energy obtained from or supplied to the grid. The generated energy that is not immediately consumed is stored in the battery.

In order to examine how much electricity can be self-supplied from PV, the results from a simulation for a typical household in Madrid may be of interest [sch11]. The total consumption of the household over one year is about 3400 kWh. The aim is to use as much energy internally as possible, with a 10.7 kW PV generator and a 6 kWh lithium ion storage system. Figure 3-8 shows the electricity consumption of the household over a year. Regardless of the time of energy production, the storage provides the energy generated by the PV generator to electrical appliances. Supply and demand can be adjusted to each other. The

integrated storage system is designed to cover 100 % of the demand with the energy generated by the PV system during the summer. During the rest of the year a little additional energy has to be purchased from the grid.

To provide a consumer-friendly system at low cost, maintenance cost in particular needs to be low and the most important factor for stationary batteries is still the price per kWh. Currently for this application lead acid batteries are the most common technology because of the low investment costs. Lithium ion batteries are generally better in efficiency and in the number of cycles, but they have much higher investment costs. NaNiCl batteries are also an option for this application, but they need daily cycling to avoid additional heating.

Smoothing out for wind (and PV) energy (MWh class)

The Japan Wind Development Co. Ltd. has constructed a wind power generation facility equipped with a battery in Aomori, Japan (Futamata wind power plant, shown in Figures 3-9 and 3-10). This facility consists of 51 MW of wind turbines (1 500 kW x 34 units) and 34 MW of NaS batteries (2 000 kW x 17 units). By using the NaS battery,

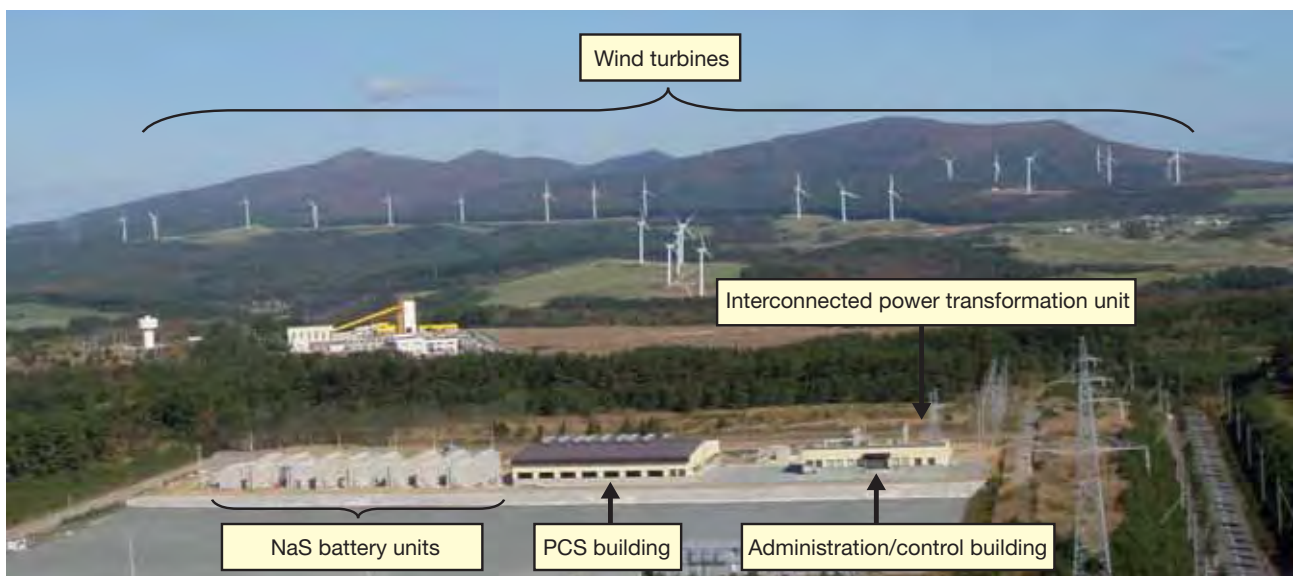

Figure 3-9 | General view of the Futamata wind power plant (*Japan Wind Development Co.*)

the total power output of this facility is smoothed and peak output is controlled to be no greater than 40 MW. Operation started in June 2008.

Figure 3-11 shows an example of output from this facility. The electric power sales plan is

predetermined one day before. In order to achieve this plan, the NaS battery system controls charging or discharging in accordance with the output of wind power generation. This facility meets the technical requirements of the local utility company to connect to the grid.



Figure 3-10 | NaS battery units – 34 MW (Japan Wind Development Co.)

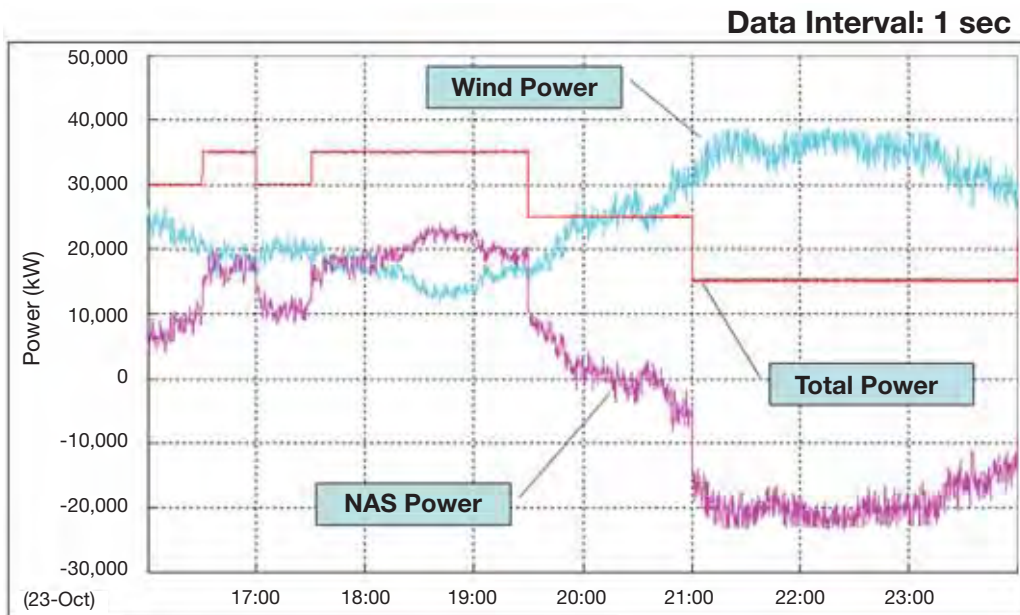

Figure 3-11 | Example operational results of constant output control over 8 hours (NGK)

3.2.2 Smart Grid

Today's grids are generally based on large central power plants connected to high-voltage transmission systems that supply power to medium and low-voltage distribution systems. The power flow is in one direction only: from the power stations, via the transmission and distribution grid, to the final consumers. Dispatching of power and network control is typically conducted by centralized facilities and there is little or no consumer participation.

For the future distribution system, grids will become more active and will have to accommodate bi-directional power flows and an increasing transmission of information. Some of the electricity generated by large conventional plants will be displaced by the integration of renewable energy sources. An increasing number of PV, biomass and on-shore wind generators will feed into the medium and low-voltage grid. Conventional electricity

systems must be transformed in the framework of a market model in which generation is dispatched according to market forces and the grid control centre undertakes an overall supervisory role (active power balancing and ancillary services such as voltage control).

The Smart Grid concept (Figure 3-12) is proposed as one of the measures to solve problems in such a system. The Smart Grid is expected to control the demand side as well as the generation side, so that the overall power system can be more efficiently and rationally operated. The Smart Grid includes many technologies such as IT and communications, control technologies and EES. Examples of EES-relevant applications in the Smart Grid are given below.

- 1) Penetration of renewable energy requires more frequency control capability in the power system. EES can be used to enhance the capability through the control of charging and discharging

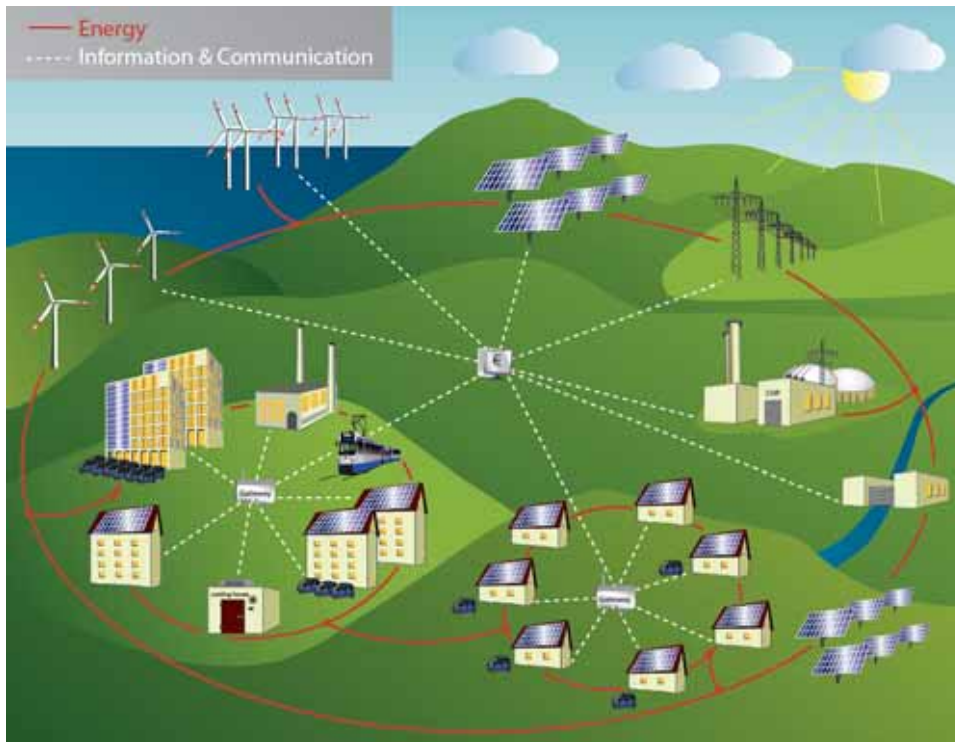

Figure 3-12 | The Smart Grid (Fraunhofer ISE)

from network operators, so that the imbalance between power consumption and generation is lessened.

- 2) In some cases, EES can reduce investment in power system infrastructure such as transformers, transmission lines and distribution lines through load levelling in certain areas at times of peak demand. EES for this purpose may also be used to enhance frequency control capability.
- 3) A further option is so-called demand-side management, involving smart grids and residential users. With intelligent consumption management and economic incentives consumers can be encouraged to shift their energy buying towards periods when surplus power is available. Users may accomplish this shift by changing when they need electricity, by buying and storing electricity for later use when they do not need it, or both.

Electrochemical storage types used in smart grids are basically lead acid and NaS batteries, and in some cases also Li-ion batteries. For this application redox flow batteries also have potential because of their independent ratio of power and energy, leading to cost-efficient storage solutions.

3.2.3 Smart Microgrid

A smart factory, smart building, smart hospital, smart store or another intermediate-level grid with EES may be treated as a “Smart Microgrid”⁸. For flexibility in resisting outages caused by disasters it is very important to deploy Smart Microgrids, that is, distributed smart power sources, as an element in constructing smart grids.

EES is an essential component of a Smart Microgrid, which should be scalable, autonomous and

⁸ Note that the term “microgrid” has been the subject of various specific definitions, none of which is assumed here.

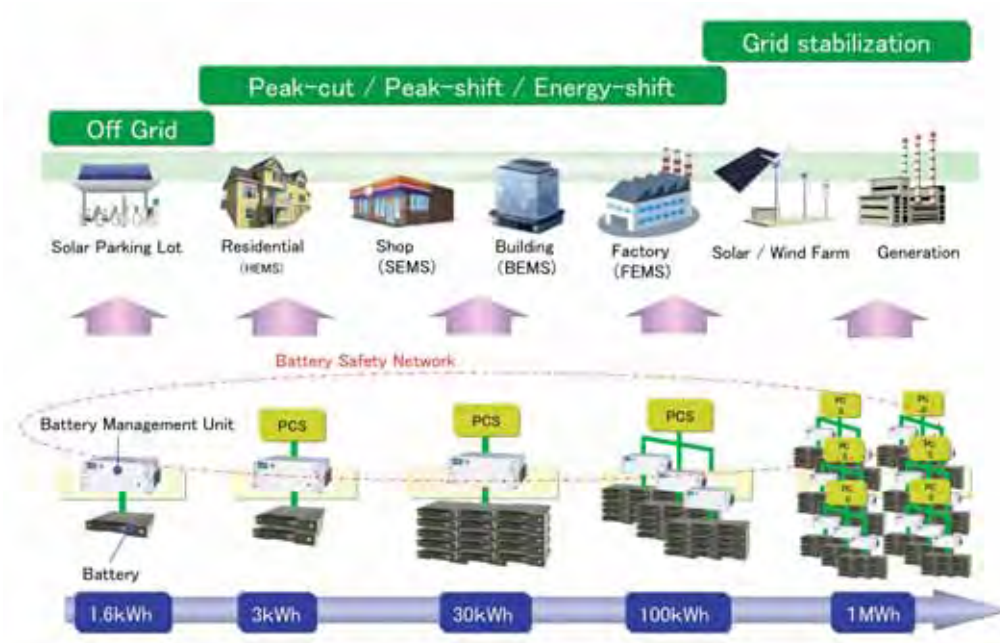

Figure 3-13 | Scalable architecture for EES applications in a Smart Microgrid
(Sanyo, IEC MSB/EES Workshop, 2011)

ready to cooperate with other grids. The architecture for the Smart Microgrid should have a single controller and should be scalable with respect to EES, i.e. it should adjust smoothly to the expansion and shrinkage of EES (battery) capacities according to the application in for example a factory, a building, a hospital or a store. The microgrid and EES should in general be connected to the network; even if a particular Smart Microgrid is not connected to a grid, for example in the case of an isolated island, it should still have similar possibilities of intelligent adjustment, because an isolated Smart Microgrid can also expand or shrink. Figure 3-13 shows a schematic of a scalable architecture.

In Annex B two examples are given, a factory and a store, which have fairly different sizes of batteries, but with controllers in common. Microgrids controlled in this way have the features of connecting and adjusting to the main grid intelligently, showing and using the input and

output status of batteries, and controlling power smoothly in an emergency (including isolating the microgrid from the main grid if needed). These are the characteristics needed in Smart Microgrids, regardless of EES scale or applications.

3.2.4 Smart House

The concept of the Smart House is proposed in order to use energy more efficiently, economically and reliably in residential areas. EES technologies are expected to play an important role.

- 1) The consumer cost of electricity consists of a demand charge (kW) and an energy charge (kWh). Load levelling by EES can suppress the peak demand; however, charge/discharge loss will simultaneously increase the amount of electricity consumed. Consumers may be able to reduce electricity costs by optimizing EES operation.

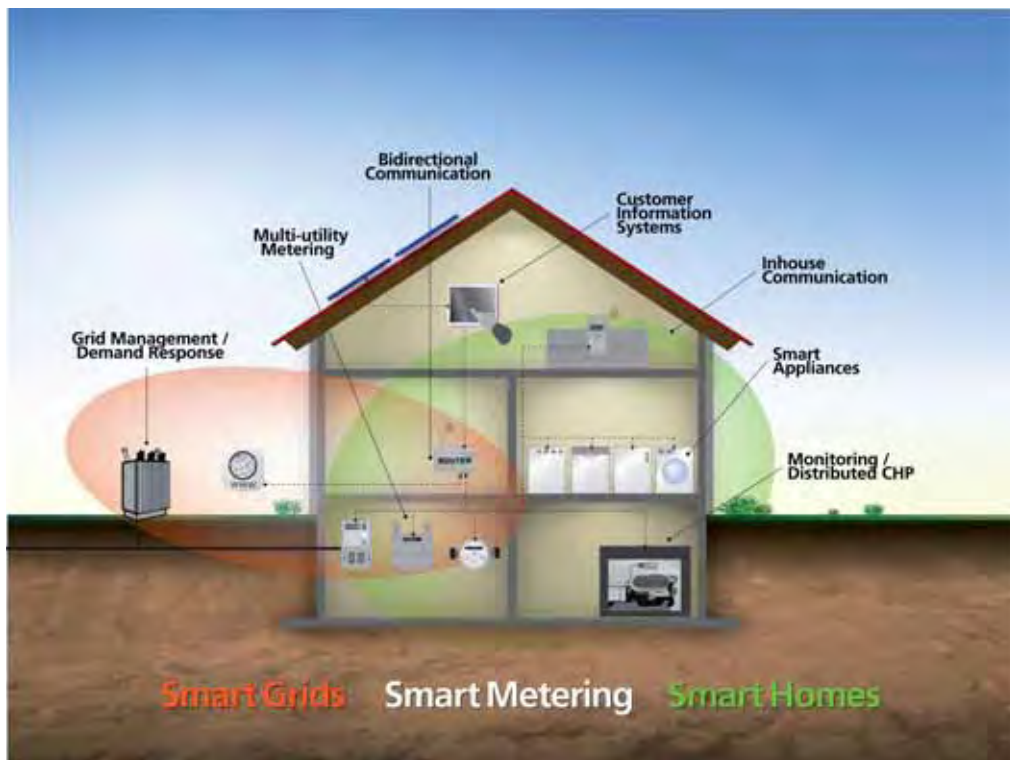

Figure 3-14 | The Smart House (Fraunhofer ISE)

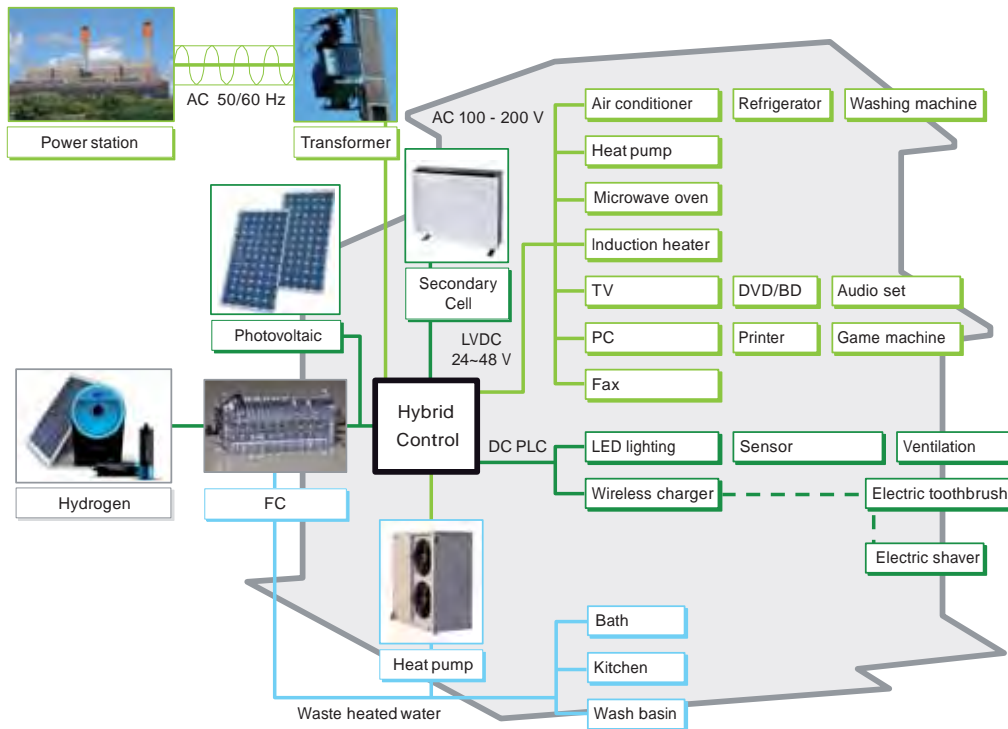

Figure 3-15 | Future home energy network in a smart house (IEC White Paper 2010)

- 2) Some consumers prefer to use their own renewable energy sources. EES can reduce the mismatch between their power demand and their own power generation.
- 3) In specific situations such as interruption of power supply, most on-site renewable generators have problems in isolated operation because of the uncontrollable generation output. EES may be a solution.

Figure 3-14 schematically represents the smart house, and Figure 3-15 maps a possible energy architecture for it. In smart houses mainly lead acid systems are used currently, but in the future Li-ion or NaNiCl batteries in particular may be installed because of their high cycle lifetime and their ability to deliver high peak power.

3.2.5 Electric vehicles

Electric vehicles (EVs) were first developed in the 19th century but, since vehicles with conventional combustion engines are much cheaper and have other advantages such as an adequate driving range of around 500 km, electric vehicles have not been introduced in large quantities to the market. The main obstacle for building electricity-driven vehicles has been the storage of energy in batteries. Due to their low capacity it has not been possible to achieve driving ranges that would be accepted by the consumer. The emerging development of battery technology in recent years presents new possibilities, with batteries displaying increased energy densities.

In the transitional period of the next few years, mainly hybrid cars will come onto the market. They combine an internal combustion engine with an electric motor, so that one system is able to compensate for the disadvantages of the other. An example is the low efficiency in partial-load states of an internal combustion engine, which can be compensated for by the electric motor. Electric drive-trains are particularly well suited to road vehicles due to their precise response behaviour, their high efficiency and the relatively simple handling of the energy storage. In spite of the advantages of electric motors, the combination of an electric drive-train with an internal combustion engine is reasonable. That is because electricity storage for driving ranges of up to 500 km, which are achieved by conventional drive-trains (and petrol tanks), are not feasible today.

Hybrid classes and vehicle batteries

Generally the different hybrid vehicles are classified by their integrated functions, as shown in Figure 3-16. The power demand on the battery

increases with additional integrated functions. The more functions are integrated in the vehicle, the higher the potential of fuel savings and therefore the reduction of carbon dioxide emissions. While vehicles up to the full hybrid level have already entered the market, plug-in hybrids and pure electric vehicles are not yet established in larger quantities.

Regarding energy storage for vehicles, today lead acid batteries are commonly used in micro-hybrids. In combination with a double-layer capacitor there might also be options for their use in mild or full hybrids, but since technically better solutions are available and economically feasible they will not play any role in the future.

NiMH batteries are mainly used in hybrid vehicles because their system is well-engineered and, compared to Li-ion batteries, they are actually more favourable especially due to safety issues. Good cycle stability in low states of charge which often appear in hybrid cars is characteristic for these batteries. All Toyota hybrid vehicles use a

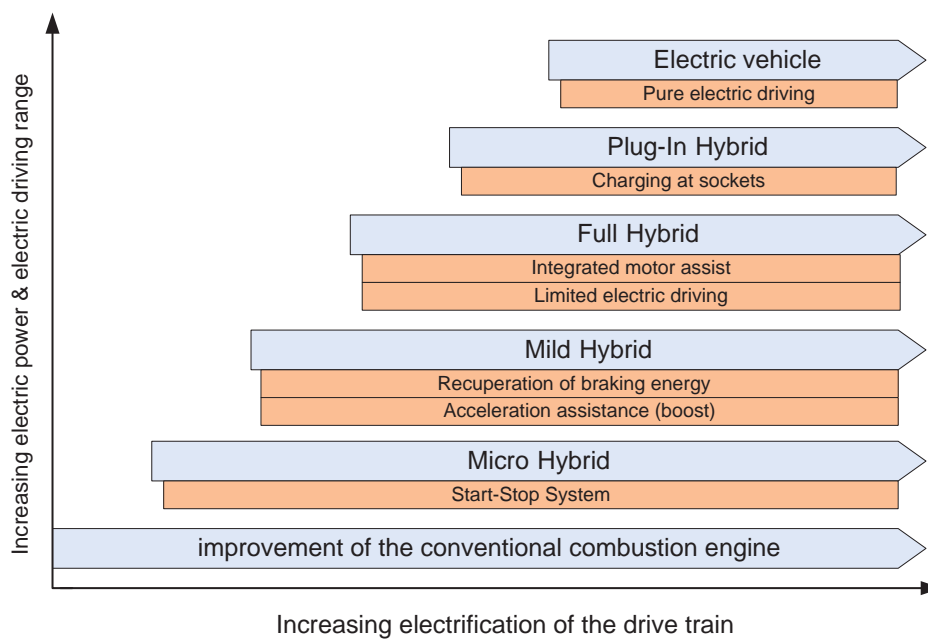

Figure 3-16 | Hybrid classes sorted by electrical power and functional range, against stage of development (Fraunhofer ISE)

Table 3-1 | Differences between hybrid and electric vehicles' power trains [smo09]

Specifications	Micro Hybrid	Mild Hybrid	Full Hybrid	Plug-In Hybrid	Electric vehicle
Power electric motor	2 – 8 kW	10 – 20 kW	20 – 100 kW	20 – 100 kW	< 100 kW
Capacity Batteries	< 1 kWh	< 2 kWh	< 5 kWh	5 – 15 kWh	15 – 40 kWh
DC voltage	12 V	36 – 150 V	150 – 200 V	150 – 200 V	150 – 400 V
Potential in saving fuel	- 8 %	- 15 %	- 20 %	- 20 %	--
Range for electrical driving	--	< 3 km	20 – 60 km	< 100 km	100 – 250 km
EES type	Lead Acid, NiMH, Li-Ion	NiMH, Li-Ion	NiMH, Li-Ion	Li-Ion	Li-Ion, NaNiCl

NiMH battery with 1.3 kWh and 40 kW. Toyota has sold in total about 3 million hybrid vehicles with this battery; this means the total storage volume sold is about 4 GWh and 120 GW.

A major problem of this technology is the limited potential for further technical or economic improvements. With lithium ion batteries becoming technically more favorable and having significant potential for cost reduction there does not seem to be a medium-term future for NiMH batteries.

Lithium batteries are ideally suited for automotive use, for both electric vehicles and hybrid electric vehicles. For the hybrid vehicles a good choice might be the lithium-titanate battery because of its high cycle stability and power density. With rising battery capacities for more advanced hybrid types, the relatively low energy density of the lithium-titanate batteries has a bigger effect on the total car weight that results in a higher energy demand. Therefore lithium-iron-phosphate and especially lithium-NMC batteries with high energy densities are preferred for plug-in-hybrids and pure electric cars – for the latter the driving range is the most important criterion.

An alternative battery technology for pure electric cars is the high-temperature sodium-nickel-chloride battery (also called ZEBRA battery). It has a huge self-discharge rate of about 10 % per day in stand-by status from having to keep the battery

at a high temperature. Therefore these NaNiCl batteries are preferred for fleet vehicles such as buses, where they are in permanent operation and no additional battery heating is usually necessary.

3.3 Management and control hierarchy of storage systems

In this section the concepts of the management and control of storage systems are introduced. While it is essential to have local management for the safe and reliable operation of the storage facilities, it is equally important to have a coordinated control with other components in the grid when grid-wide applications are desired. The purpose of this section is to help readers visualize the components and their interactions for some of the applications described in this paper.

Many storage systems are connected to the grid via power electronics components, including the converter which modulates the waveforms of current and voltage to a level that can be fed into or taken from the grid directly. Sometimes the converter is connected to a transformer before the grid connection in order to provide the required voltage. The converter is managed by a controller which defines the set-points of the storage system. These set-points can be expressed as the magnitude of active and reactive power, P and Q. Such a controller

may also be called control electronics – a controller in this context is simply a representation of the place where intelligence for decision-making is applied.

3.3.1 Internal configuration of battery storage systems

Complex storage systems consisting of batteries are equipped with a Battery Management System (BMS) which monitors and controls the charge and discharge processes of the cells or modules of the batteries. This is necessary in order to safeguard the lifetime and ensure safe operation of the batteries. The diagram in Figure 3-17 shows a possible realization of the internal control architecture for a battery storage system. It should be noted that for bulk energy storage it is very likely that there is a more refined hierarchy for the BMS, which involves a master control module coordinating the charging and discharging of the slave control modules. It is possible that the batteries and converters are from two different manufacturers, and therefore compatibility and interoperability of the two systems regarding both communication and electrical connections is imperative.

3.3.2 External connection of EES systems

The P and Q set-points for an EES for a certain application can be set locally or remotely,

depending on the control scheme implemented. The control scheme should in turn be determined by the application. More precisely, the application determines the algorithmic and input/output requirements for the EES system. For instance, an application which requires simple logic using only local measurements can have the set-points determined locally through the storage controller. An example of such an application is load levelling, which only needs to know the loading conditions of the local equipment (e.g. lines, transformers) next to which the EES is installed. The same applies for applications which have pre-determined set-points that do not change during operation. However, set-points for applications which require dynamic adaptation to the network operational environment and much remote data or measurements might be better determined by a remote controller which can gather these remote inputs more efficiently. One example of such an application is wind power smoothing, which uses wind output forecasts as well as measurements from the wind farm as inputs. Another example is energy time-shifting, making use of dynamic market prices. A generalized setup with remotely determined set-points is shown in Figure 3-18. Batteries and the BMS are replaced by the “Energy Storage Medium”, to represent any storage technologies including the necessary energy conversion subsystem.

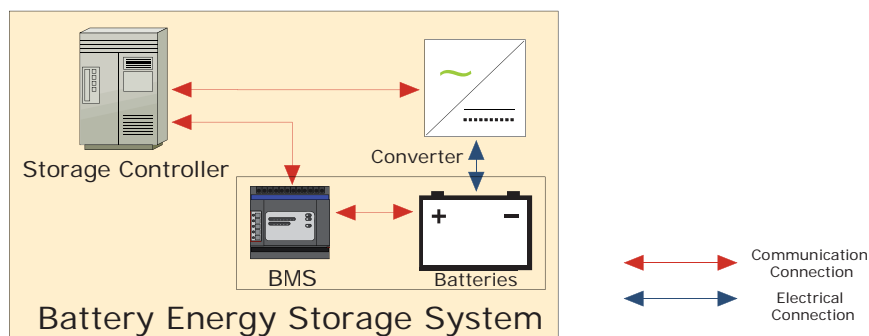

Figure 3-17 | A possible realization of internal control architecture for a battery storage system (ABB)

3.3.3 Aggregating EES systems and distributed generation (Virtual Power Plant)

The control hierarchy can be further generalized to include other storage systems or devices connected to the grid, illustrated in Figure 3-19. This diagram represents an aggregation of EES systems and DGs (Distributed Generators) which can behave like one entity, a so-called “VPP with EES” in this example. VPP stands for Virtual Power Plant which, according to one definition, is *the technology to aggregate power production from a cluster of grid-connected distributed generation sources via smart grid technology, by a centralized controller which can be hosted in a network control centre or a major substation*. The integration of distributed energy storage systems at different locations of the grid will further enhance the capabilities of the VPP. It should be noted that in the figure the communication and electrical infrastructures are highly simplified in order to show the general concept but not the details.

A concrete example of an implementation based on aggregated energy storage systems using batteries is given in the following section on “battery SCADA”.

3.3.4 “Battery SCADA” – aggregation of many dispersed batteries

As progress is realized in battery capabilities and costs, many batteries will be installed both by consumers and in the grid, with large cumulative capacity and correspondingly large effects. Most will be small battery storage systems, dispersed in location and used locally. However, if they are gathered into a virtual assembly and controlled centrally, they may also be used for many utility applications, such as load frequency control, load levelling and control of transmission power flow. To implement such uses, a group of battery manufacturers and electric utilities in Japan is developing technologies for central control of dispersed batteries, named “Battery SCADA”.

Using Battery SCADA distributed batteries can be assembled and managed like a virtual large-capacity battery, and batteries with different specifications made by different manufacturers can be controlled and used by grid operators in an integrated way. Battery SCADA is shown schematically in Figure 3-20. Information from batteries on both the grid side and the customer side is collected by Battery SCADA, processed, and transmitted to the control centre. Based

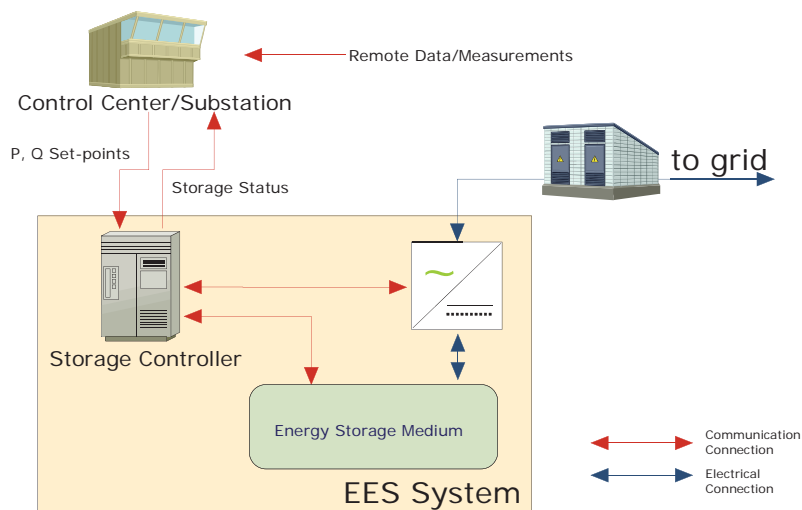

Figure 3-18 | A Control hierarchy involving remote data/measurements (ABB)

on this information and the situation of the network, the control centre sends commands to Battery SCADA, which distributes corresponding commands to each battery system.

Demonstration of this technology will start in 2012 in Yokohama City, Japan, with various types of Li-ion batteries installed on the grid side and in consumer premises, to be controlled by the Battery SCADA.

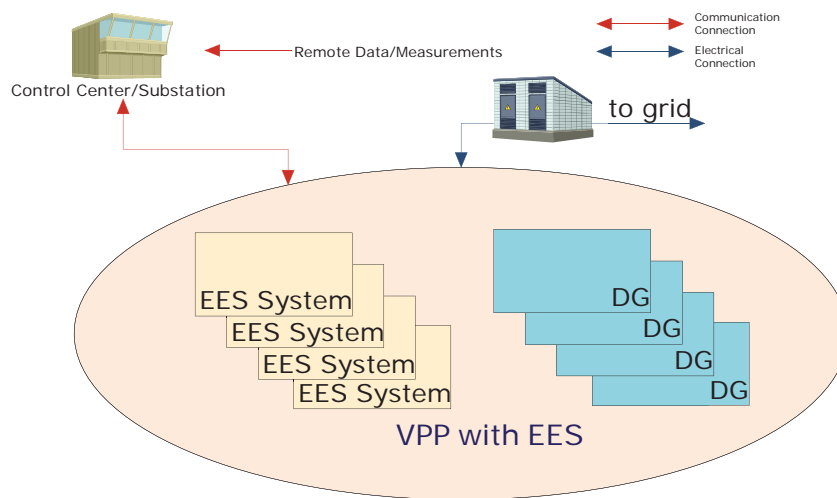

Figure 3-19 | A generalized control concept for aggregated EES systems and DGs (ABB)

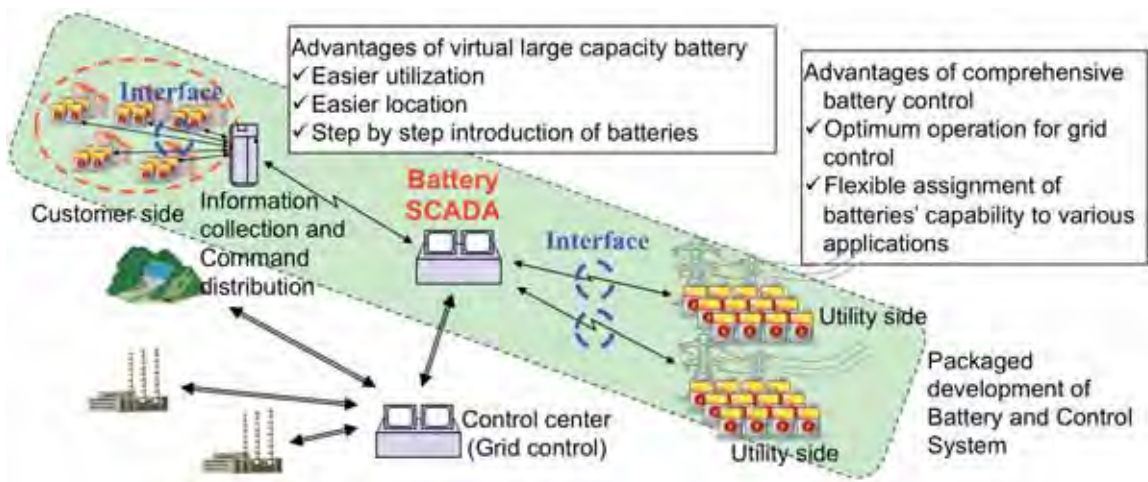

Figure 3-20 | Schematic diagram of Battery SCADA (TEPCO)

Section 4

Forecast of EES market potential by 2030

As mentioned in section 3, there are many applications for EES. For some applications EES has already been commercially deployed and it will continue to be used for these applications in the future. Furthermore, some new applications for EES are emerging, such as support for the expansion of renewable energy generation and the smart grid. The importance of EES in the society of the future is widely recognized, and some studies on the future market potential for EES have already been carried out. While these studies vary in target time range, target area, applications considered and so on, they can be classified into two categories: estimates of the future market covering almost all the applications of EES, and estimates of the future market focusing on specific new EES applications. In this section some studies' results are shown for these two categories.

4.1 EES market potential for overall applications

In this section two examples of studies and one specialized simulation are presented: a study from Sandia National Laboratory (USA) which evaluates EES benefits and maximum market potential for almost all applications in the USA; a study prepared by the Boston Consulting Group which forecasts the cost reductions in EES technologies and estimates the profitability of investments in EES by application, so as to judge the world market potential; and a simulation of the future Li-ion market by Panasonic.

4.1.1 EES market estimation by Sandia National Laboratory (SNL)

Figure 4-1 shows EES market potential by application type in the USA, as estimated by Sandia National Laboratory. Market size and benefits corresponding to the break-even cost of EES per kW are estimated for each application separately. While this study only treats present market potential and only for one (large) market, it provides useful suggestions for considering the future EES market. The results indicate that no market exists for any application at present which is both high-value and large. For example, the application "Substation On-site", which means an emergency power source installed at a substation, presents a relatively high value, but its market is small. On the other hand, for the application "Time-of-use Energy", meaning time shifting at a customer site, a large market size is expected but its value is not high.

The study indicates that value and market size for each application can vary with circumstances in the future, and that one EES installation may be used for multiple applications simultaneously, which increases the benefits. One factor affecting the future market is the scale of new installation of renewable energies.

4.1.2 EES market estimation by the Boston Consulting Group (BCG)

In this study, a price reduction in EES technologies is forecast for 2030 and the investment profitability by EES application is evaluated. Eight groups of

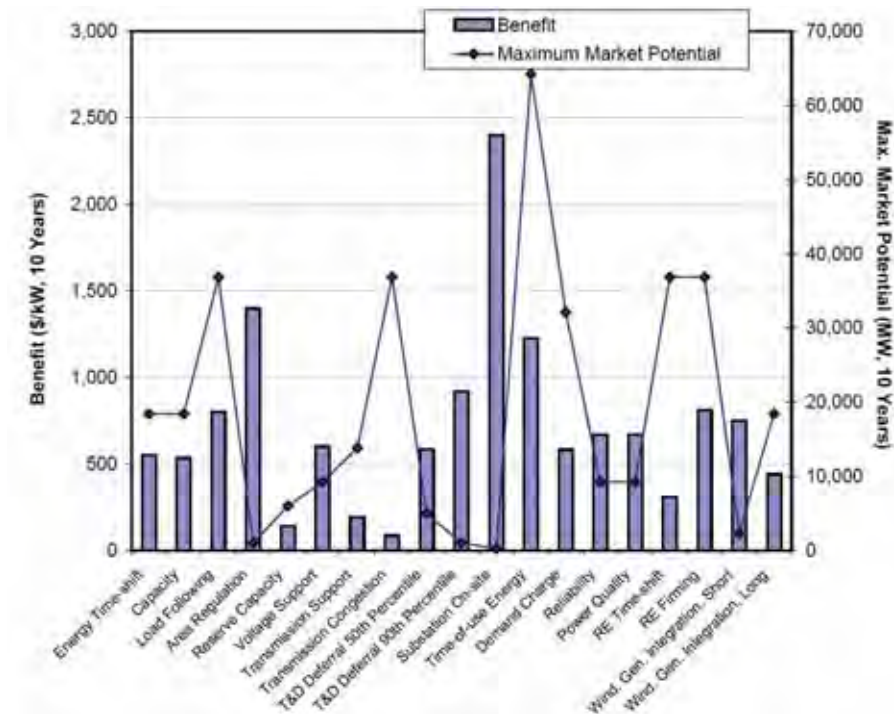

Figure 4-1 | EES benefit (break-even cost) and market size by application in the US [eye11]

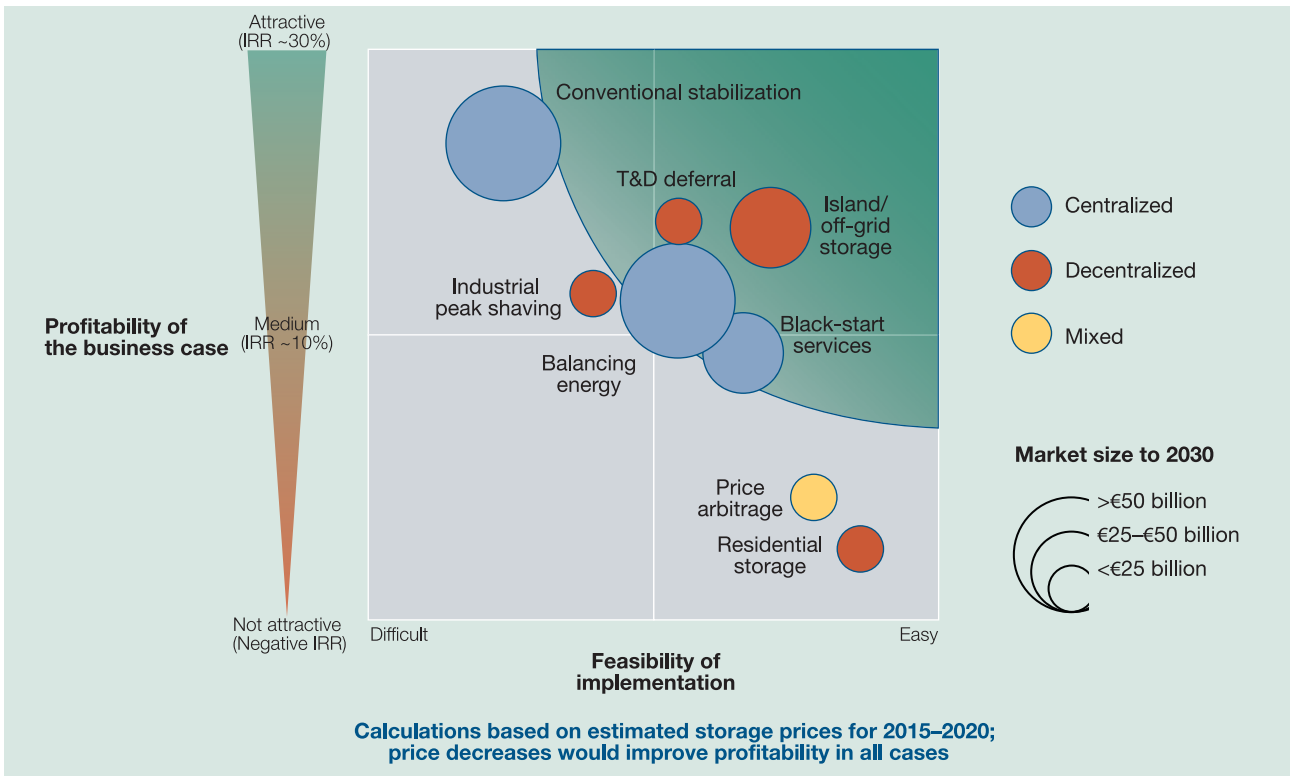

Figure 4-2 | EES market forecast by application for 2030 [bcg11]

applications are defined. To help determine the future EES market potential by application this study also evaluates the feasibility of implementation, which is made up of the existence of conventional technologies, technological difficulty of the EES technology development concerned, compatibility with the related existing business and the social circumstances. The results are shown in Figure 4-2.

The most promising market, where a large market and high profitability can be expected, is “Conventional Stabilization”, where pumped hydro storage and CAES are applicable. Conventional stabilization includes time shift, smoothing of output fluctuations and efficiency improvement of conventional generators. The reason why this application is promising is that the need for time shift and smoothing output fluctuations will grow dramatically in accordance with the expected broad introduction of renewable energies.

Another attractive market is “Balancing Energy”, which corresponds to adjusting power supply to meet demand that fluctuates within short periods. Large storage technologies such as PHS and CAES are already economically feasible in this application, and other EES technologies will have great opportunities in the future. The need for balancing energy is likely to rise as renewable energy generation causes fluctuations on the supply side to increase, and more and more power markets will introduce sophisticated market mechanisms for the procurement of balancing energy. The study concludes that total market potential for the eight groups of applications is 330 GW.

4.1.3 EES market estimation for Li-ion batteries by the Panasonic Group

Panasonic Group (Sanyo) has estimated the EES market potential of the Li-ion battery. This

estimation was made by a simulation, with the following assumptions:

- 1) assuming that the trend of battery purchase prices will continue as determined by a market survey, and comparing with the future price of the Li-ion battery;
- 2) for utility use, assuming community energy storage and partial substitution of investment for transmission and distribution;
- 3) for UPS, assuming the probability of replacement of a lead acid battery by Li-ion to save space, for easy maintenance and considering the price gap;
- 4) assuming that growth in EV stations will be comparable to that in EVs themselves;
- 5) assuming no lithium shortage.

The result of the simulation, shown in Figure 4-3, indicates that the Li-ion battery market will grow steadily, and the residential market in particular will increase rapidly starting in 2017. There are, and will be, a wide variety of Li-ion battery applications, from small to large in battery size.

4.2 EES market potential estimation for broad introduction of renewable energies

The integration of renewable energies into the electric power grid can cause problems of output fluctuation and unpredictability. When the total volume of renewable energies connected to the grid exceeds a certain level such problems will appear and countermeasures will be needed. Ambitious plans with significant incentives for the introduction of renewable energies exist in certain markets (notably in the EU), and it is expected that EES will be a key factor in achieving the targets. For this reason some studies have been done to determine the amount of EES needed to match the planned introduction of renewable energy.

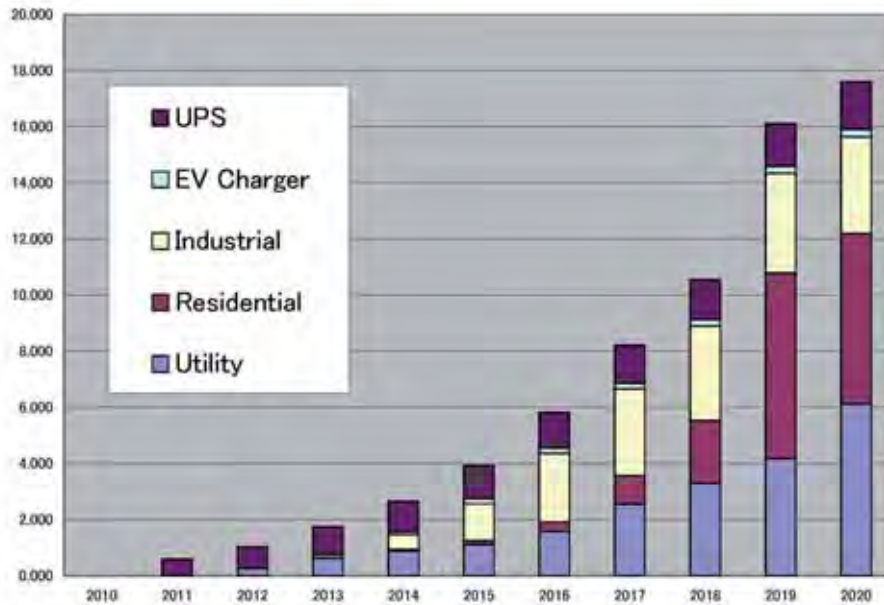

Figure 4-3 | Global market for Li-ion batteries (Sanyo, 2011)

4.2.1 EES market potential estimation for Germany by Fraunhofer

Germany is well known as a leading country for the introduction of renewable energies, so a large market for EES is expected. As shown in Figure 4-4, Germany has set a target to increase the share of renewable energy from less than 20 % to around 60 % to 80 % by 2030.

To achieve the German target more EES capacity is necessary: Figure 4-5 shows a scenario for wind production in the Vattenfall grid in 2030 which is estimated to be four times higher than today. The blue curve, representing wind power, shows a massive fluctuation resulting in huge amounts of energy which will need to be charged and discharged, while the red curve displays the actual load. The light blue field indicates the storage capacity in Germany in pumped hydro (40 GWh, 7 GW), which represents 95 % of total energy storage today [den10], and is totally inadequate for the quantity of energy which will need to be stored (area under the purple curve).

Figure 4-6 shows the estimation of required EES capacity by time range to handle the integration of

renewable energies in the past and future [ste11]. For both short-term and long-term needs a very large amount of EES will be needed to deliver peak power. In 2030 the following capacities are necessary (peak power multiplied by time):

- Hourly: 16 GWh
- Daily: 170 GWh
- Weekly: 3.2 TWh
- Monthly: 5 TWh
- Total: ~8.4 TWh

The present installed storage capacity of 40 GWh PHS can cover only the hourly demand and a part of the daily demand. To cover the additional hourly and daily demand electrochemical EES such as batteries can be used. For the weekly and monthly demand, CAES, H₂ and SNG storage technologies are expected.

4.2.2 Storage of large amounts of energy in gas grids

For the storage of large amounts of energy electrochemical EES would be too expensive

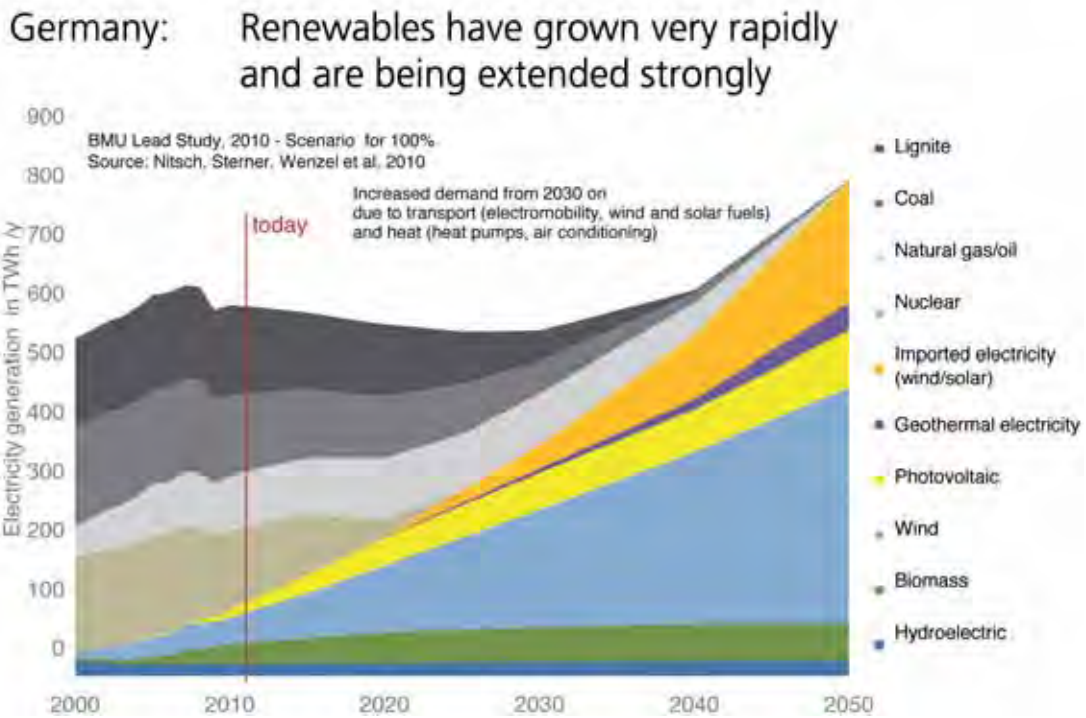

Figure 4-4 | Expected penetration of renewable energy in Germany [ste11]

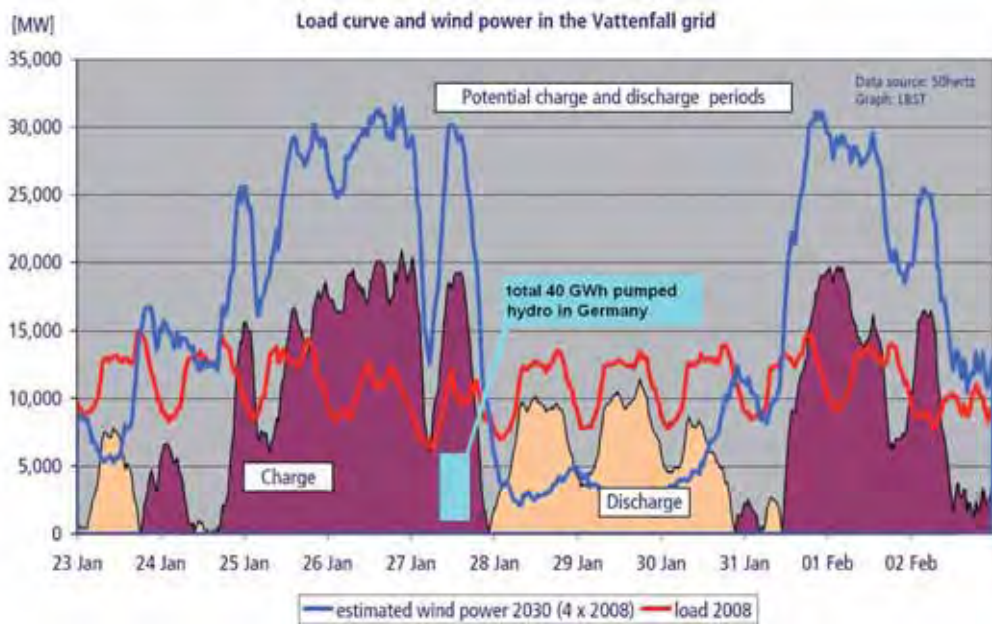

Figure 4-5 | Load curve (red) and wind power (blue) in the Vattenfall grid (north-east Germany): charge and discharge volume in 2030 in comparison with pumped hydro storage capacity [alb10]

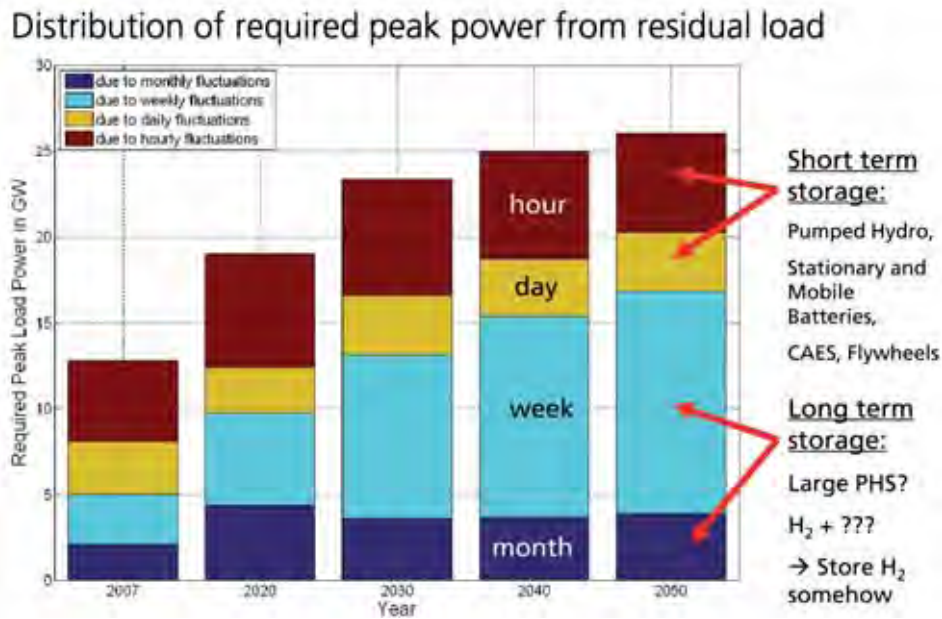

Figure 4-6 | Distribution of required peak power for integration of renewables by time [ste11]

and require too much space. An alternative is the transformation of electricity into hydrogen or synthetic methane gas for storage and distribution within the existing natural gas grid (see sections 2.4.1 and 2.4.2). The efficiency of full-cycle conversion of electric power to hydrogen is about 55 % - 75 %, and to SNG about 50 % - 70 %. In Germany the storage capacity of the existing natural gas grid is very large, at about 200 TWh (about 400 TWh including the distribution grid). From a technical point of view it is possible to inject up to 10 % hydrogen into natural gas without any negative effects on the gas quality. Because hydrogen has one-third the energy of natural gas it is possible to inject hydrogen containing 7 TWh of energy into the natural gas grid. At any point of the gas grid it is possible to convert the gas back into electricity with a high-efficiency gas power plant (~60 %). In Germany in 2030 the weekly and monthly EES demand will be about 8.2 TWh (see section 4.2.1), which can nearly be covered by such an injection of hydrogen into the gas grid. This solution is only possible in countries where a gas grid exists; otherwise, the hydrogen or synthetic methane must be stored in additional

high-pressure vessels (which normally presents no difficulties) or caverns.

4.2.3 EES market potential estimation for Europe by Siemens

Another study on the EES market potential to manage the issues caused by large amounts of renewable energies has been carried out by Siemens [wol11] [hof10]. This study covers the whole of Europe and adopts an extreme assumption, that *all* of the electricity is supplied by renewables (65 % wind, 35 % solar).

Since renewable energies are by nature uncontrollable, a mismatch between demand and supply can happen both in the geographic domain and the time domain. When there is a mismatch between supply and demand, shortage of supply is conventionally backed up by a reliable power supply such as fossil fuel generators. To avoid this, geographic mismatch in an area can be decreased by reinforcement of interconnections with neighbouring areas, and time mismatch can be solved

by the EES time shift function. A simulation was carried out in order to determine how much EES would be needed if it alone, without any reinforcement of interconnections, were used to eliminate backup capacity (see Figure 4-7). Europe was divided into 83 areas, each with a different mix of renewable energy – in the figure, “EMix 1 % PV” for example means 1 % PV and 99 % wind. For the whole of Europe 65 % is generated by wind and 35 % by PV. The results show that 30 % - 50 % of the load needs to be backed up by fossil fuel generators if there is no EES (“0h” in Figure 4-7). The backup needed decreases to 10 % - 20 % of demand if EES equivalent to one week’s load is available (“7d” in Figure 4-7), which corresponds to EES of 60 TWh or about 2 % of the annual demand (3200 TWh).

In practice, for 100 % renewables, both reinforcement of interconnection lines and EES capacity of between 2 % and 8 % of the annual total demand is necessary. The value depends on how much re-

inforcement of grid connections and over-dimensioning of renewables takes place. For hourly and daily storage the study suggests using PHS and electrochemical EES (NaS, Li-ion, LA or RFB). For the weekly and monthly demand CAES and H₂ are recommended. As an alternative for the weekly and monthly demand, large, new PHS in the TWh range in the Scandinavian countries (Sweden, Norway) is discussed. However, connecting these would need transmission lines over long distances. The financing and acquisition of such transmission lines seem to be difficult from today’s viewpoint.

4.2.4 EES market potential estimation by the IEA

Another study on the potential EES market to cope with massive renewable energy introduction in the world has been done by the IEA (International Energy Agency) [iea09]. In this study the necessary amount of EES is calculated in relation

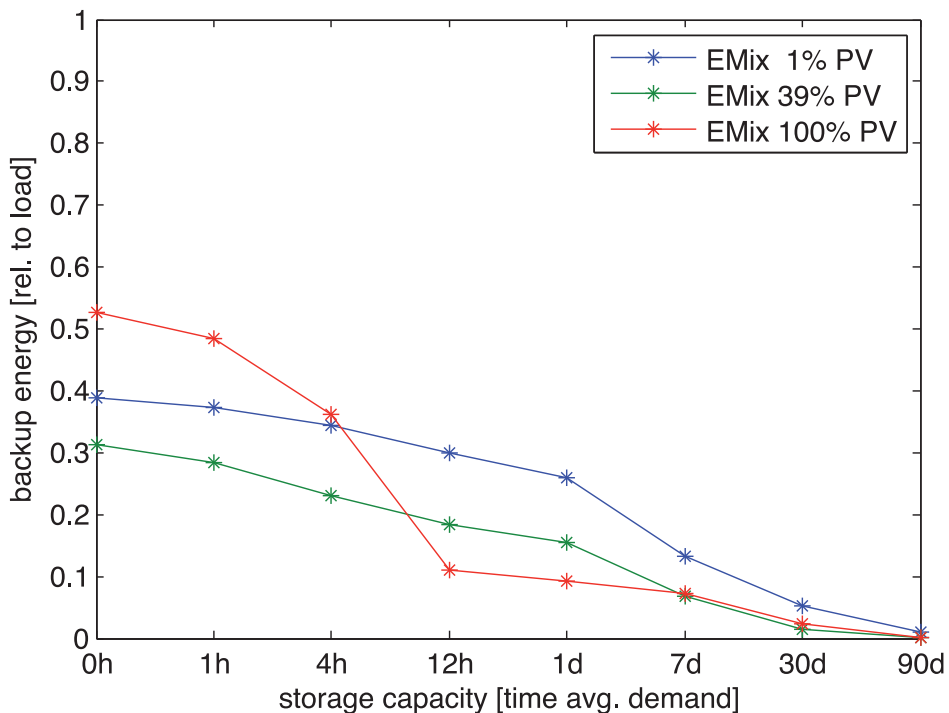

Figure 4-7 | Necessary backup energy related to EES capacity [wol11]

to variation of output from renewable energies. As shown in Figure 4-8, the required amount of EES increases with renewable energy penetration and the assumed output variation from renewable energies. For example, if the net variation in wind power is assumed to be 30 % of its rated output, the amount of EES needed in Western Europe will increase from 3 GW in 2010 to 90 GW in 2050 to keep pace with the forecast increase in wind power generation. The necessary amount of EES in 2050 can vary from 50 GW to 90 GW according to the assumed rate of net output variation in wind power between 15 % and 30 %.

In Figure 4-9, the necessary amount of EES by region is estimated based on the forecast of renewable energy introduction. Since high renewable energy penetration is expected in Western Europe and China, EES potential markets in both regions are relatively large. The necessary amount of EES in the world in 2050 is estimated at 189 GW or 305 GW, corresponding to an output

variation rate of renewable energies of 15 % or 30 % respectively.

Total current EES capacity (mainly PHS) being 100 GW, a doubling or tripling of available EES will be needed (assuming perfect geographical distribution – otherwise even more).

4.3 Vehicle to grid concept

Depending on the probable development and spread of electric vehicles, there will be a great potential for power to be fed back from car batteries into the grid. The federal government of Germany has forecast up to one million EVs by 2020 [bmw10]. Including hybrid and pure EVs the average capacity is about 20 kWh per vehicle. In a scenario in which about 30 % of these capacities are used, we would have about 6 GWh available for energy storage. Compared to pumped hydro storage in Germany with capacities of about 40 GWh in 2011 this would represent about 15 % extra.

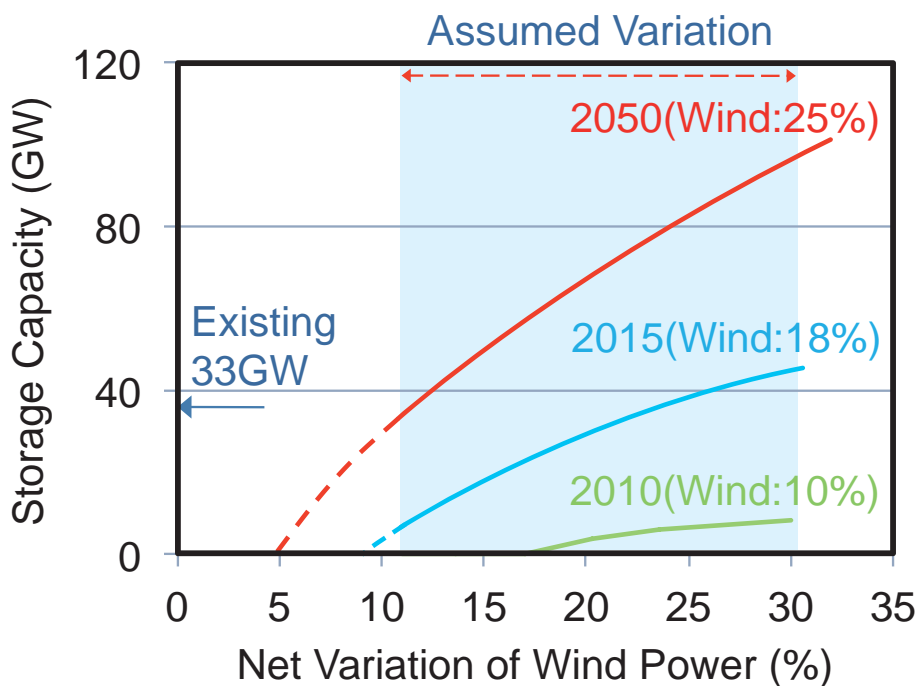

Figure 4-8 | Necessary storage capacity in Western Europe againsts wind variability [shi11]

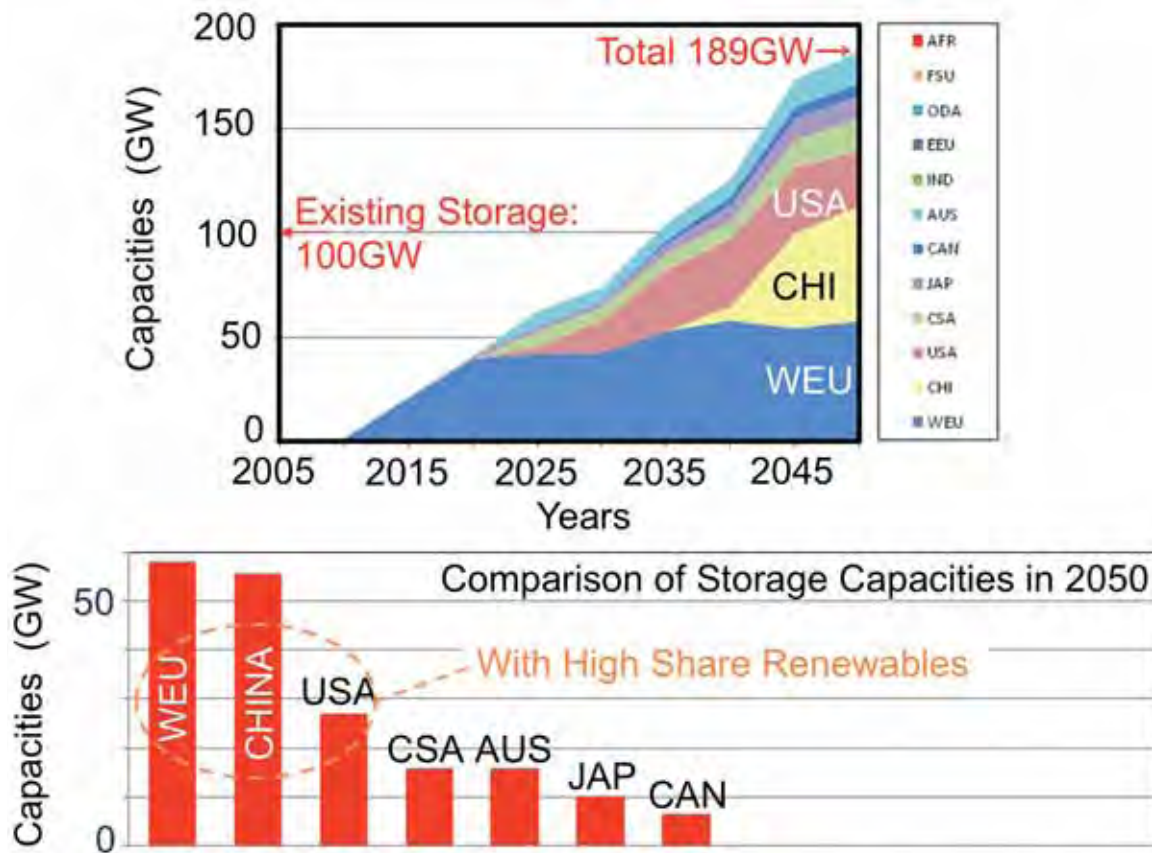

Figure 4-9 | Necessary storage capacity estimation by region (wind variation rate: 15 %) [shi11]

The IEA has also carried out a worldwide study on using EV batteries for mitigation of renewable energy output variations. If EV batteries are used for time shift and smoothing of short-term fluctuations by using vehicle-to-grid (V2G) technology, the EES needed can be decreased from 189 GW to 122 GW or from 305 GW to 280 GW in the two scenarios (see section 4.2.4). If these capacities are used in the future, grid operators will have more scope for short-term time shift and a higher level of security of supply can be guaranteed.

A field where development is needed is the reinforcement of the low-voltage power grid, whose infrastructure is not yet ready for the power feed-in of a large number of electric vehicles – the grid’s limited transmission capacity would be overstretched. For the communication between

vehicles and grid operators an intelligent system will also be needed, one acceptable to the consumer. Consumer acceptance will play a major role in the success of the V2G concept. Different business models are under discussion, e.g. one where the car owner is not the owner of the battery but rents or leases it, or pays for the electricity at a rate which covers the battery cost.

4.4 EES market potential in the future

Several studies on market potential have been mentioned in this section; they have suggested the following conclusions.

- 1) The potential market for EES in the future is much larger than the existing market, mainly

driven by the extended use of renewable energy sources and the transformation of the energy sector, including new applications such as electric mobility. The market volume is related to the (future) renewable energy ratio and varies among regions.

- 2) If further cost reductions and technology improvement can be achieved, EES systems will be widely deployed, for example, to shift the demand, smooth renewable energy output and improve the efficiency of existing power generation.
- 3) European studies indicate huge expectations for EES technologies to compensate for the fluctuation of renewable energy power output. Large installations of wind turbines and PVs may require numerous EES systems, capable of discharging electricity for periods from two hours up to one day. Hence the market for conventional large-scale EES, such as PHS and adiabatic CAES, is attractive. But in many countries such as Germany and Japan the future potential of PHS and CAES is very limited due to the lack of suitable locations or underground formations.
- 4) The extensive introduction of electrochemical EES such as NaS, Li-ion and RFB in the MW - MWh range is expected, for discharge times of hours to days.
- 5) Long-term energy storage is essential to achieving very high renewable energy ratios. The IEA report shows that further installation of renewable energy will lead to an insufficiency of thermal power generators for power control, and cause short-time output fluctuations. This scenario may be expected in Western Europe and China which have both set high renewable-energy-penetration targets.
- 6) To cover longer discharge times of days to months hydrogen and SNG technology have to be developed. The well-established natural gas grid and underground storage in regions such

as Europe can be (partly) used for H₂ and SNG storage.

- 7) Smart Grid technology using many small, dispersed batteries, such as EV batteries, is attractive for many applications. But even if all EV batteries are used for this purpose they will be insufficient to cover future demand for EES.

Given these studies, Table 4-1 shows which EES technology is or will become feasible for what applications, and where further research and development are necessary.

In addition to the conclusions above, Table 4-1 shows that Li-ion has great potential for many applications, but needs further careful development and introduction of mass production to achieve cost effectiveness. CAES, RFB and H₂ applicable to utility use for time shifting also need further development and mass production to achieve cost effectiveness. HFB and SNG, also potentially applicable to this application, need further fundamental research and development to achieve reliable and cost-effective products.

Table 4-1 | EES present feasibility, future potential, need for further research and development
 (Fraunhofer ISE)

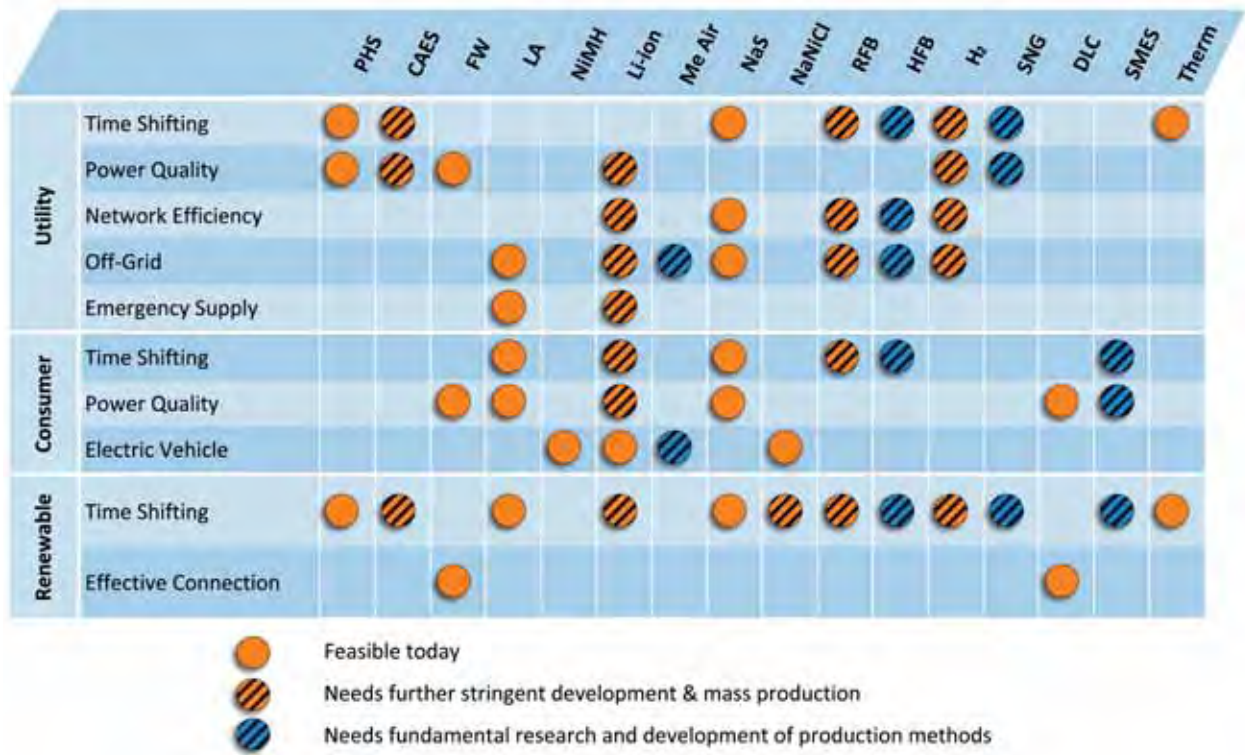

Section 5

Conclusions and recommendations

5.1 Drivers, markets, technologies

From the first four sections of the present paper – the substantive, factual, objective part – the present section seeks to derive conclusions in the form of a coherent picture. From these in turn recommendations may be formulated in the

areas of policy (including regulation), research & development, and standardization. This is summarized in Figure 5-1.

In the electricity market, global and continuing goals are CO₂ reduction and more efficient and reliable electricity supply and use.

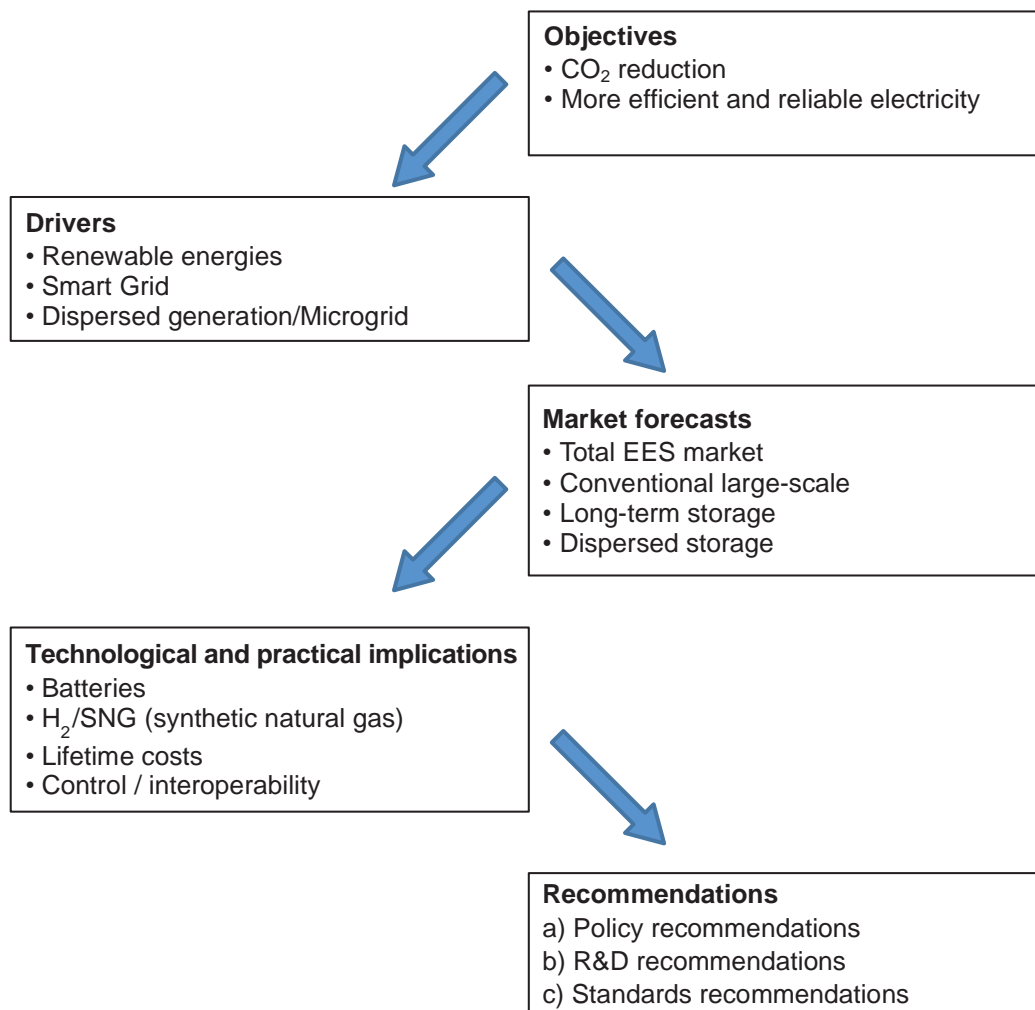

Figure 5-1 | Conclusions in the form of a logical progression

.....
: The IEC is convinced that electrical energy :
: storage will be indispensable to reaching these :
: public policy goals. It is therefore essential that :
: deployment of storage should receive long- :
: term and robust support from policy-makers :
: and regulators. :
:.....

Corresponding to these goals, three major drivers determining the future of EES have been identified (see section 3): the foreseeable increase in renewable energy generation, the design and rollout of Smart Grids, and the future spread of dispersed generation and dispersed management of electrical energy – referred to here for simplicity as “microgrids”. These drivers are only partly independent of each other: renewables clearly encourage, and simultaneously need, microgrids, and the increase in both renewables and dispersed sources demands a smarter grid. However, this paper has shown that the three drivers usefully illuminate different aspects of what will condition the future of electrical energy storage systems.

The results of these drivers on future demand for EES may be conveniently divided into four market segments, the total EES market, conventional large-scale systems (e.g. pumped hydro storage, PHS), long-term storage (e.g. H₂), and dispersed storage. How these markets are expected to develop has direct implications for which technologies will be most needed, which technology will need what type of further development, what considerations will influence rollout and penetration, and what implementation problems may be expected. A serious analysis of these complex factors, going beyond what has already been attempted in previous sections, is not the purpose here; the four aspects listed, two technology families (batteries and H₂/SNG) and two constraints (lifetime costs and control/interoperability), seem merely to be the most important areas for future actions.

This, finally, leads to the actions themselves, i.e. to recommendations. It will be seen below that recommendations fall into groups addressed to three different audiences: policy-makers including regulators, companies and laboratories deciding what research and product development to pursue, and the IEC itself for what standards will be needed by all EES market players.

5.2 Conclusions regarding renewables and future grids

Many studies have shown that EES is indispensable for the introduction of large amounts of renewable energy. Therefore the necessary volume and timing of EES is strongly dependent on the pace of renewable energy development.

The Smart Grid integrates facilities on both the utility (grid) side and the customer side by using advanced information technologies; the benefits from this can only be achieved if storage is available. EES is therefore considered to be a key component of the Smart Grid, among other things as a basic requirement for coping with electrical outages caused by disasters. In addition the Smart Grid is likely to use, and possibly to require, dispersed storage (e.g. batteries installed for local purposes). This in turn implies overall control of many dispersed small storage installations together in the grid⁹. The implication is that autonomous operation, easy extension and coordination with grids are important characteristics of future EES.

Microgrids will be a key to the “smart” energy use of communities, factories, buildings etc. Small-scale EES is absolutely imperative for microgrids to achieve fair and economic consumption of electrical energy. In order to optimize cost efficiency, microgrids also require that their EES should be connected to the grid (as does the grid – see above) and be able to adjust smoothly to increases and decreases in the amount of electrical energy

⁹ A single virtual energy storage installation.

consumed. Dispersed facilities, whether generation or storage (for example the EES in a smart house or an electric vehicle), are normally owned by end users, who have in principle the right to decide how to use the facilities. This implies a differentiated policy and regulatory regime, with conditions applying to centralized facilities distinguished from those applying to dispersed ones.

5.3 Conclusions regarding markets

The total EES market is expected to be large, but will remain very sensitive to cost (see section 5.4 below). This has very specific implications on what R&D and policy goals are recommended. It also means that whether the relevant standards (e.g. to reduce costs by creating or enlarging homogeneous markets) are available at the right moment will have a great influence.

Some of the total market will be for conventional large-scale EES such as PHS to enable the introduction of renewable energies. The need for extremely large (GWh and TWh-scale) facilities will increase; in some applications they will need to be operated like conventional generators (in spite of being limited in total energy).

When a very high renewable energy ratio is achieved, long-term energy storage will be needed which, since the storage period is up to several months, implies very large storage amounts. A possible solution is the new EES technologies hydrogen and synthetic natural gas (see sections 2.4 and 4.2.2). Development of these involves chemical research and engineering, which are beyond the traditional scope of work of the IEC; this gives rise to certain recommendations.

With rollout of the Smart Grid and microgrids, implying storage installed at customer sites, the market for small and dispersed EES is also expected to be quite large. EES will be used not only for single applications but simultaneously for several, made possible by integrating multiple dispersed storage sites.

5.4 Conclusions regarding technologies and deployment

As the renewable energy (RE) market grows, the market for EES systems, especially for small and dispersed ones, will also expand and require technical specifications and regulation frameworks for grid interconnection of EES. The aspects of interconnecting dispersed generation including RE have been investigated. However, issues such as power quality and safety in connecting large numbers of EES installations, mostly together with RE, have not yet been thoroughly researched. Thus, in order to assure the smooth connection of EES to grids, additional technical requirements and the necessary regulatory frameworks need to be investigated.

Given the cost sensitivity, cost reduction is vital to implementation. For this, lifetime cost should be considered, not simply installation cost but also cost of operation and disposal. Low raw material cost, a part of total installation cost, may become a specific selection criterion for EES technology. In addition, as explained in sections 3.2 and 3.3, interoperability among the various very different parts of the whole grid must be ensured, and sophisticated control intelligence is also essential for availability and overall efficiency¹⁰. Successful deployment in any one country may further depend on the size and health of an indigenous “EES supply industry” which can help to control costs and ensure availability.

Three storage technologies seem to emerge from the study as the most significant. In order of decreasing technological maturity, they are pumped hydroelectricity (PHS), electrochemical batteries, and hydrogen/synthetic natural gas. In Figure 5-1 only the last two are mentioned because they both – in different ways – need more development than PHS. Batteries require development primarily to decrease cost, and for

¹⁰ These aspects of implementation will be particularly dependent on the existence of the relevant international standards.

some technologies to increase energy density as well; hydrogen/SNG must be further researched and developed across a broad front, including physical facilities, interactions with existing uses of gas, optimal chemical processes, safety, reliability and efficiency.

5.5 Recommendations addressed to policy-makers and regulators

Recommendation 5.5.1 – Public support for development of conventional storage

Given their intentions to increase greatly the proportion of renewable energies, the IEC recommends policy-makers to consider seriously the further development of conventional storage, such as pumped hydroelectricity, notwithstanding the difficulties of siting and construction.

Recommendation 5.5.2 – Long-term storage, on the order of months

The IEC's study has shown that many governments' current plans for how electricity will be generated and managed in the future cannot be implemented without long-term storage with capacities in the multi-TWh range. It therefore recommends policy-makers, whose actions are essential to the creation of long-term, very-large-capacity storage, to work actively on the public aspects, and to create the incentives to encourage private actors to play their part.

Recommendation 5.5.3 – Cooperation between energy sectors; coherent regulations

Hydrogen and synthetic natural gas added to natural gas are likely to be essential elements of future electric grids because of their energy storage duration and capacity. The IEC therefore recommends regulators to achieve the conditions for all necessary cooperation between the energy

markets in electricity and gas, including use of infrastructure.

Recommendation 5.5.4 – Incentives for development and operation of storage

The IEC recommends policy-makers to make the encouragement of storage deployment a public policy goal. The long-term storage of surplus energy from renewables is sometimes more expensive than additional generation from existing fossil-fuel plants. However, the storage necessary for future grids will only become available if private actors see an advantage in acquiring and operating it, and for this regulations including financial incentives will frequently be needed. The regulatory regime may also need to differentiate between private consumer-owned storage and storage directly connected to the regulated grid.

Recommendation 5.5.5 – Public policy for and investment in storage research

Several areas are described in the IEC's study where concentrated research and development are needed. The IEC recommends governments and public authorities with a role in research to adjust their research policies and investments to the desired targets for storage development.

Recommendation 5.5.6 – Potential barriers to the introduction of microgrids

Some existing regulatory regimes hinder the introduction or operation of microgrids or their storage components. The IEC recommends these to be revised, since microgrids will be essential to future electricity distribution and should be encouraged.

Recommendation 5.5.7 – Regulations for the safety of new storage technologies

The IEC expects to keep pace, as in other areas in the past, with the need for international consensus standards for the safety of new

storage technologies. It recommends regulators to anticipate the requirement to guarantee this safety, and to contribute to shaping suitable International Standards upon which harmonized regulations may be based.

Recommendation 5.5.8 – Environmental regulations for new storage technologies

New storage technologies may present new challenges in protecting the natural and human environment, challenges involving the materials, conditions and land use required to implement them. The IEC recommends regulators to help ensure that standards are in place to allow an internationally agreed technical basis for any new regulations, so that unnecessary differences among countries and regions may be avoided.

5.6 Recommendations addressed to research institutions and companies carrying out R&D

Recommendation 5.6.1 – R&D targeted to low-cost materials and manufacturing

The IEC recommends targeting research and development to EES technologies with a potential for low raw-material cost and low-cost mass production techniques.

Recommendation 5.6.2 – Research on renewables’ interactions with storage

Since the specifications and volume of the storage needed are largely influenced by renewable energies, the IEC recommends further study of the influence of renewable energies on the power system and the functions that storage should fulfil in consequence.

Recommendation 5.6.3 – R&D on hydrogen and synthetic natural gas used for EES

Storage and use of hydrogen, and generation and use of synthetic natural gas for storing electricity,

are relatively new technologies; improvements particularly in reliability and cost are needed. In addition, in order to use existing gas supply and distribution networks, technical and procurement issues will arise in infrastructure, system operation and safety. The IEC recommends the electric power sector, the gas sector and research laboratories to pursue collaborative research and development in these areas.

Recommendation 5.6.4 – Development of versatile storage management systems

The IEC recommends industry to develop storage management systems which will allow use of a single storage system for not just one but many of the applications described in the IEC study. Controllers and management systems are required which function independently of the types of the batteries being controlled¹¹. Also, the control technology should function even when the applications belong to different actors (grid operator, end-use supplier, consumer).

Recommendation 5.6.5 – Development of local storage for grid use

The IEC recommends industry and utilities to develop the technology to use storage rationally and efficiently for both local purposes and grid purposes¹², allowing many dispersed storage installations to be used as a single, large facility.

Recommendation 5.6.6 – Development of vehicle-to-grid and vehicle-to-home

Since electric vehicle batteries are a potential source of storage for grid regulation and electricity use outside the vehicle, the IEC recommends research and development of vehicle-to-grid and vehicle-to-home technologies.

¹¹ See also Rec. 5.7.4 which mentions standardization of control for batteries with different technologies.

¹² E.g. “Battery SCADA” – see section 3.3.4.

Recommendation 5.6.7 – Architecture

A precondition to many of the standards recommended in the IEC study is a robust architecture and management/control scheme for storage, which today is not available. The IEC recommends laboratories and industry to collaborate with the IEC to develop rapidly an architecture and management scheme, to serve as the basis for standards.

5.7 Recommendations addressed to the IEC and its committees

Recommendation 5.7.1 – Cooperation needed for hydrogen and SNG standards

The MSB recommends the IEC to work out future standardization solutions in the domain of hydrogen and synthetic natural gas (SNG) storage in close collaboration with ISO and with industries, such as hydrogen, natural gas and petroleum, with which it has historically had few contacts.

Recommendation 5.7.2 – Architecture and structure of EES systems

The IEC study shows that a thorough, shared comprehension of the roles and functions of storage in all grid-related circumstances is currently not available. The MSB therefore recommends the IEC to develop an EES architecture and a fundamental standard on the structure of EES systems, upon which all the other standards needed may be based.

Recommendation 5.7.3 – Users' guide on planning and installing storage

One of the determining factors in successful rollout of storage solutions will be the players' level of understanding of the cost and functionality of the different technologies. The MSB recommends the IEC to develop a users' guide containing suggested criteria to apply when planning and

using each specific technology (type of product) for a specific application. In addition to data on storage technology behaviour and characteristics (speed, power, energy), it will probably also need to contain information on full lifecycle cost, disposal cost, regulatory considerations, and environmental advantages and disadvantages.

Recommendation 5.7.4 – Interface, control and data element standards

Several elements of the IEC study show a pressing need for the control and interconnection of EES installations: small-scale storage in microgrids and its connection to the grid, integration of storage systems with different technologies into a single virtual store, systems used jointly by different organizations (generation plant owner, grid operator, electricity seller) and for different applications, etc. Insofar as the relevant standards do not yet exist, the MSB therefore recommends the IEC to standardize rapidly the interfaces between storage and other grid elements, protocols for data exchange and control rules, and the data elements for the input, output and control information supplied by or to storage systems.

Recommendation 5.7.5 – Standards for systems to relieve transmission congestion

The introduction of large quantities of renewable energies will cause transmission system congestion, to which storage can be a solution. Some of the resulting integrated systems, for example a hybrid system consisting of storage combined with a wind farm, will require standards in order to function correctly. The MSB recommends the SMB to initiate the standards needed.

Recommendation 5.7.6 – Standards for unit size and other factors affecting costs

Reducing lifetime costs of storage requires, among many other things, a range of standards, such as standardized EES unit sizes and technical features

to allow mass production of associated equipment. The MSB therefore recommends the SMB to launch such projects.

Recommendation 5.7.7 – Safety of new storage technologies

The rapid growth and the new technologies involved in electrical energy storage in the near future, as well as their installation by consumers, will impose particular requirements for safety. At the same time, society and governments will need assurance of safety before the much-needed systems can be deployed. The MSB therefore recommends the SMB to set in motion rapidly the development of storage safety standards.

Recommendation 5.7.8 – Compatibility of EES with the environment

The scale, the impact and the materials of EES all represent potential challenges to the environment, especially when new technologies are involved. Without International Standards in place the regulatory requirements may be different in different regions, which would be an unnecessary burden on manufacturers and owners. The MSB consequently recommends that standards for EES compatible with the environment be developed as soon as possible.

Annex A

Technical overview of electrical energy storage technologies

Table A-1 | Overview technical data for EES (Fraunhofer)

Battery Technology	Nominal Voltage [V]	Capacity per cell [Ah]	Response Time	Energy Density [Wh/kg]	Energy Density [Wh/l]	Power Density W/l
PHS	-	-	min	0.2 – 2	0.2 – 2	0.1 – 0.2
CAES	-	-	min	-	2 – 6	0.2 – 0.6
Flywheel	-	0.7 – 1.7 MW	< sec	5 – 30	20 – 80	5 000
Lead acid	2.0	1 – 4 000	< sec	30 – 45	50 – 80	90 – 700
NiCd Vented sealed	1.2	2 – 1 300 0.05 – 25	< sec	15 – 40 30 – 45	15 – 80 80 – 110	75 – 700 (vented)
NiMH sealed	1.2	0.05 – 110	< sec	40 – 80	80 – 200	500 – 3 000
Li-ion	3.7	0.05 – 100	< sec	60 – 200	200 – 400	1 300 – 10 000
Zinc air	1.0	1 – 100	< sec	130 – 200	130 – 200	50 – 100
NaS	2.1	4 – 30	< sec	100 – 250	150 – 300	120 – 160
NaNiCl	2.6	38	< sec	100 – 200	150 – 200	250 – 270
VRFB	1.6	-	sec	15 – 50	20 – 70	0.5 – 2
HFB	1.8	-	sec	75 – 85	65	1 – 25
Hydrogen central decentral	-	-	sec – min	33 330	600 (200 bar)	0.2 – 2 2.0 – 20
SNG	-	-	min	10 000	1 800 (200 bar)	0.2 – 2
DLC	2.5	0.1 – 1 500 F	< sec	1 – 15	10 – 20	40 000 – 120 000
SMES	-	-	< sec	-	6	2 600

*) insufficient experience in applications

Typical Discharge time	Energy-Efficiency η_{Wh} [%]	Lifetime [a]	Typ. Cycle Lifetime [cycles]	Typical applications
hours	70 – 80	> 50	> 15 000	Time shifting, Power quality, Emergency supply
hours	41 – 75	> 25	> 10 000	Time shifting
seconds	80 – 90	15 – 20	$2 \cdot 10^4 - 10^7$	Power quality
hours	75 – 90	3 – 15	250 – 1 500	Off-Grid, Emergency supply, Time shifting, Power quality
hours	60 – 80	5 – 20	1 500 – 3 000	Off-Grid, Emergency supply, Time shifting, Power quality
	60 – 70	5 – 10	500 – 800	
hours	65 – 75	5 – 10	600 – 1 200	Electric vehicle
hours	85 – 98	5 – 15	$500 - 10^4$	Power Quality, Network efficiency, Off-Grid, Time shifting, Electric vehicle
hours	50 – 70	> 1	> 1 000	Off-Grid, Electric Vehicle
hours	70 – 85	10 – 15	2 500 – 4 500	Time shifting, Network efficiency, Off-Grid
hours	80 – 90	10 – 15	~ 1 000	Time shifting, Electric vehicles
hours	60 – 75	5 – 20	> 10 000	Time shifting, Network efficiency, Off-Grid
hours	65 – 75	5 – 10	1 000 – 3 650	Time shifting, Network efficiency, Off-Grid
hours – weeks	34 – 44	10 – 30	$10^3 - 10^4$	Time Shifting
hours – weeks	30 – 38	10 – 30	$10^3 - 10^4$	Time Shifting
seconds	85 – 98	4 – 12	$10^4 - 10^5$	Power Quality, Effective Connection
seconds	75 – 80	*)	*)	Time Shifting, Power Quality

Annex B

EES in Smart Microgrids

Two examples of Smart Microgrid scalable architectures for EES applications are given. The first is for a factory (Figure B-1). Panasonic Group (Sanyo) has developed a Smart Microgrid with a large-scale storage battery system using lithium ion batteries at the Kasai factory in Japan. The system was installed in October 2010. The system charges the batteries with late-night electricity and surplus solar electricity and uses it during the day. The EES system has more than 1 000 battery boxes, each box consisting of 31 218 650 cell batteries. Therefore, the system consists of more than 300 000 18 650 cells. With the battery management system, the whole EES can be used as if it were just one battery. The capacity of the EES is approximately 1 500 kWh; the PV system can distribute 174 060 kW DC power. The system can cut off power over 15 % at peak time, through total energy management by controllers.

The other example is a Smart Microgrid system (EES application) for a convenience store, a next-generation store in Japan (Figure B-2). Even at a time of electrical outage caused by a disaster, the system can support the point-of-sale (POS) system, LED lighting and other functions which are critical for the business, with renewable energy 24 hours a day, every day. The system is located in Kyoto, and started operation in December 2010. It uses lithium ion batteries and 10 kW PV.

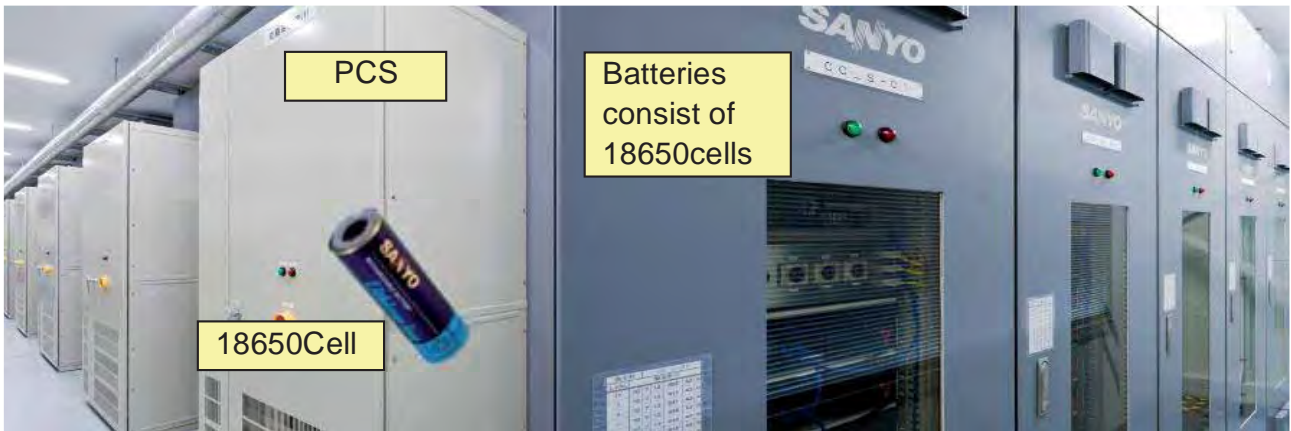
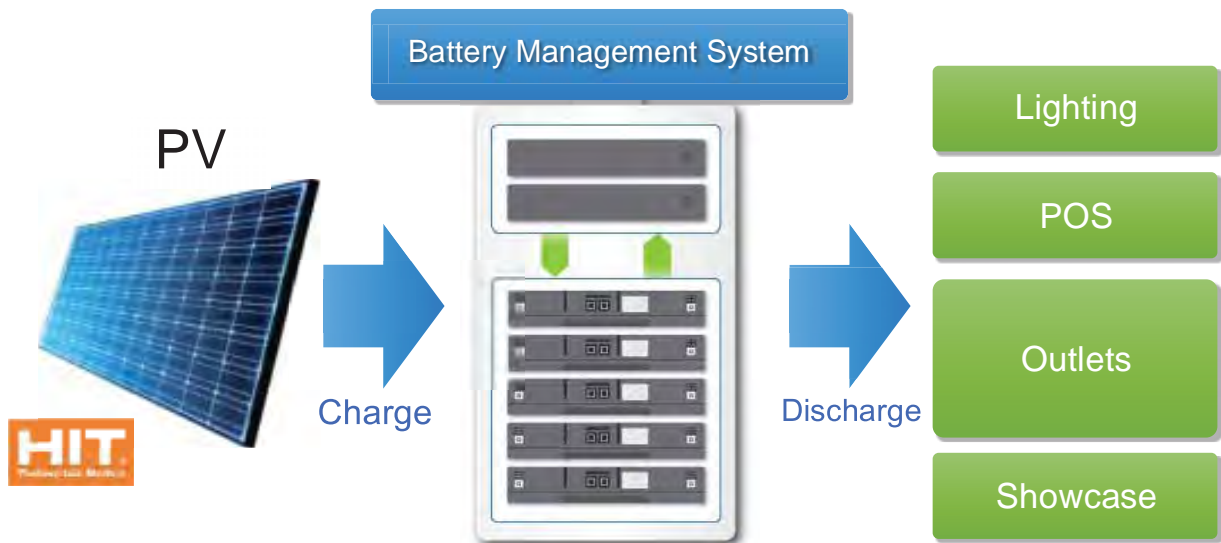

Figure B-1 | The battery management system of a factory (Sanyo, IEC MSB/EES Workshop, 2011)



* HIT is a registers trademark of SANYO Electric Co., Ltd.

Figure B-2 | Next generation convenience store (Sanyo, IEC MSB/EES Workshop, 2011)

References

- [act11] Webpage Active Power, Inc.: <http://www.activepower.com>, Accessed: 8 Aug 2011.
- [alb10] Uwe Albrecht: *Hydrogen as storage option in the energy system of the future*, Presentation, Ludwig-Bölkow-Systemtechnik GmbH, 10th annual meeting of the network for fuel cells and hydrogen (NRW), 9 Dec 2010.
- [atw11] T. B. Atwater and Arthur Doble, *Metal/Air batteries*, Lindens Handbook of Batteries, 2011, ISBN 978-0-07-162421-X.
- [bat85] N.N.: *Bath County Pumped Storage. Civil Engineering*, ASCE, 55 (7), pp. 55, 1985.
- [bcg11] The Boston Consulting Group: *Revisiting Energy Storage*, Report, Feb 2011.
- [bmw10] Bundesministerien BMWI und BMU Energiekonzept für eine umweltschonende, zuverlässige und bezahlbare Energieversorgung Bericht, Bundesministerium für Wirtschaft und Technologie (BMWi) und Bundesministerium für Umwelt (BMU), September 2010.
- [bul04] C. Bullough: *Advanced Adiabatic Compressed Air Energy Storage for the Integration of Wind Energy European*, Wind Energy Conference and Exhibition, London, 22-25 Nov 2004.
- [csp11] Webpage CSP Today: <http://social.csptoday.com/industry-insight/direct-steam-generation-parabolic-troughs-what-does-endesa-dlr-have-store>, Accessed 4 Aug 2011.
- [dah03] M. Dahlen, et al: *Nickel Batteries*, INVESTIRE 2003, [per04].
- [den10] Dena - power grid study II: *Integration erneuerbarer Energien in die deutsche Stromversorgung im Zeitraum 2015-2020 mit Ausblick 2025*, Report, German Energy Agency (DENA), 2010.
- [doe07] C. Dötsch: *Electrical energy storage from 100 kW – State of the art technologies, fields of use. 2nd*, 2nd Int. Renewable Energy Storage Conference, Bonn/Germany, 22 Nov 2007.
- [ene11] Webpage Enertrag: <https://www.enertrag.com/en/project-development/hybrid-power-plant.html>, Accessed: 8 Aug 2011.
- [epr10] Electric Power Research Institute: *Electric Energy Storage Technology Options White Paper*, 2010.
- [esp11] B. Espinar, D. Mayer: *The role of energy storage for mini-grid stabilization*, Report, IEA-PVPS T11-0X:2011, 2011.
- [etg08] VDE - ETG Energy Storage Task Force: *Energy storage in power supply systems with a high share of renewable energy sources Significance - state of the art - need for action*, Report, Dec 2008.
- [eus06] Concept of the graphic from EUS GmbH; 2006.
- [eye11] Jim Eyer, Garth Corey: *Energy Storage for the Electricity Grid: Benefits and Market Potential Assessment Guide*, Report, Sandia National Laboratories, Feb 2010.

References

- [fuj98] T. Fujihara, et al.: *Development of pump turbine for seawater pumped-storage power plant*, Hitachi Review 47 (5), pp. 199-202, 1998.
- [hof10] C. Hoffmann: *Design of transport- and storage capacities in energy supply systems with high shares of renewable energies*; IRES, Berlin, 2010.
- [iea09] International Energy Agency: *Prospects for Large Scale Energy Storage in Decarbonised Grids*, Report, 2009.
- [iee08] P. Fairley: <http://spectrum.ieee.org/energy/environment/largest-solar-thermal-storage-plant-to-start-up>, Article 2008, Accessed 27 July 2011.
- [iee10] P. Patel: <http://spectrum.ieee.org/energy/the-smarter-grid/batteries-that-go-with-the-flow>, Article, May 2010, Accessed 10 April 2011.
- [jäh06] D. Jähnig, et al.: *Thermo-chemical storage for solar space heating in a single-family house*, 10th International Conference on Thermal Energy Storage: Ecostock 2006, 31 May - 2 June 2006, New Jersey, USA.
- [jos09] A. Jossen: *Redox-Flow Batterien – Ein System zur Langzeitspeicherung*, Forum Elektrische Energiespeicher - Netzoptimierung bei regenerativer Stromerzeugung, Nürnberg/Germany, 6 Dec 2007.
- [kaw11] M. Kawashima: *Overview of Electric Power Storage*, Internal paper of Tepco, 2011.
- [kuh11] E. Kuhnenn, J. Ecke: *Power-to-gas Stromspeicher, Gasproduktion, Biomethan oder flexible Last*, DVGW Energie / Wasserpraxis 7/8, 2011.
- [lai03] P. Lailier, et al.: *Lead Acid Systems*, INVESTIRE 2003, [per04].
- [nak07] M. Nakhamkin: *Novel Compressed Air Energy Storage Concepts Developed by ESPC*, EESAT, May 2007.
- [per04] M. Perrin, et al.: *Investigation on Storage Technologies for Intermittent Renewable Energies: Evaluation and recommended R&D strategy*, INVESTIRE, Final Technical Report of European Community project ENK5-CT-2000-20336, 2004.
- [rad08] P. Radgen: *30 Years Compressed Air Energy Storage Plant Huntorf - Experiences and Outlook*, 3rd International Renewable Energy Storage Conference, Berlin/Germany, 24-25 November 2008.
- [rid11] Ridge Energy Storage & Grid Services L.P.: <http://www.ridgeenergystorage.com>, Accessed 8 Aug 2011.
- [rwe11] Webpage RWE ADELE: www.rwe.com/web/cms/en/365478/rwe/innovations/power-generation/energy-storage/compressed-air-energy-storage/project-adele, Accessed 8 April 2011.
- [sch11] Simon Schwunk: *Battery systems for storing renewable energy*, Report, Fraunhofer-Institut für Solare Energie, April 2011.
- [sch08] P. Schossig: *Thermal Energy Storage*, 3rd International Renewable Energy Storage Conference, Berlin/Germany, 24-25 November 2008.

References

- [shi11] Shin-ichi INAGE: *Prospective on the Decarbonised Power Grid*, IEC/MSB/EES Workshop, Germany, 31 May - 1 June 2011.
- [smo09] T. Smolinka, et al.: *Stand und Entwicklungspotenzial der Speichertechniken für Elektroenergie – Ableitung von Anforderungen an und Auswirkungen auf die Investitionsgüterindustrie*, BMWi-Auftragsstudie 08/28, 2009.
- [ste09] Michael Sterner: *Bioenergy and renewable power methane in integrated 100% renewable energy systems - Limiting global warming by transforming energy systems*, Dissertation, University Kassel, July 2009.
- [ste11] Michael Sterner: *Power-to-Gas: Storing renewables by linking power and gas grids*, Presentation, IEC Workshop EES, Freiburg, 31 May 2011.
- [tam06] R. Tamme: *Development of Storage Systems for SP Plants*, DG TREN - DG RTD Consultative Seminar "Concentrating Solar Power", Brussels/Belgium, 27 June 2006.
- [wai11] M. Waidhas: *Elektrolysetechnologie aus Sicht eines Großunternehmens*, NOW Workshop Stand und Entwicklungspotenzial der Wasserelektrolyse, Berlin/Germany, 9 May 2011.
- [wol11] P. Wolfrum, F. Steinke, C. Hoffmann: *EES Requirements for a renewable Europe*, Presentation, IEC Workshop EES, Freiburg, 31 May 2011.
- [wor02] B. Worth: *Metal/Air*, INVESTIRE 2002, [per04].



International
Electrotechnical
Commission

3 rue de Varembe
PO Box 131
CH-1211 Geneva 20
Switzerland

T +41 22 919 02 11
info@iec.ch
www.iec.ch

ISBN 978-2-88912-889-1



CHF 50.-