



U.S. DEPARTMENT OF  
**ENERGY**

Energy Efficiency &  
Renewable Energy

## Better Buildings, Better Data Centers: Applying Best Practices

August 10, 2015

**Dale Sartor**

P.E., Lawrence Berkeley National  
Laboratory

**FEMP**  
Federal Energy Management Program

# Download Presentation

This Presentation is Available for download at:  
<http://datacenterworkshop.lbl.gov/>



# Agenda

- Introduction
- Performance metrics and benchmarking
- IT equipment and software efficiency
- Federal acquisition
- Data center environmental conditions
- Break
- Air management
- Cooling systems (part 1)
- Break
- Cooling systems (part 2)
- Electrical systems
- Break
- Use IT to manage IT (Monitoring and integrated controls)
- Resources and workshop summary

# Learning Objectives

- Understand why data center energy use is a concern
- Identify and define key data center energy performance metrics (e.g., power usage effectiveness [PUE])
- Understand standards for monitoring, analytics, and reporting
- Understand best practices for data center energy efficiency
- Identify key federal requirements related to energy efficiency in data centers
- Understand the need to integrate acquisition, IT, and facilities to optimize energy performance

# Challenging Conventional Wisdom: Game Changers

## Conventional Approach

- All data centers are “mission critical”
- Data centers need to be cool and controlled to tight humidity ranges
- Data centers need raised floors for cold air distribution
- Data centers require highly redundant building infrastructure



## Need Holistic Approach

- IT and Facilities partnership



# Introduction

# Data centers are energy-intensive facilities

- 10 to 100 times more energy intensive than an office building
- Some server racks now designed for more than 30 kW
- Surging demand for data storage
- 2% of U.S. electricity consumption
- Projected to double in next 5 years
- Power and cooling constraints in existing facilities



# Global Data Center Electricity Use

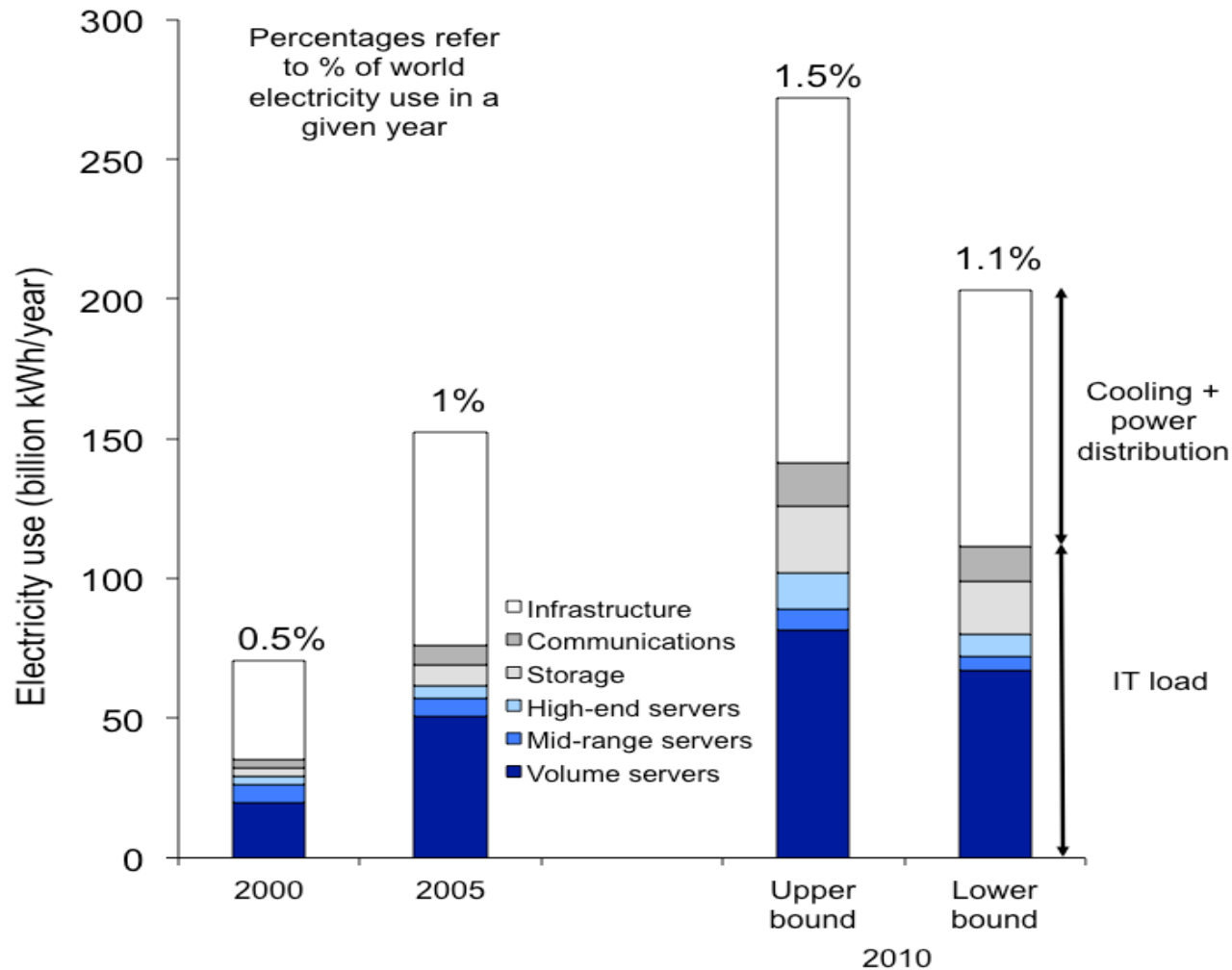

Source: Koomey 2011



# How Much is 152B kWh?

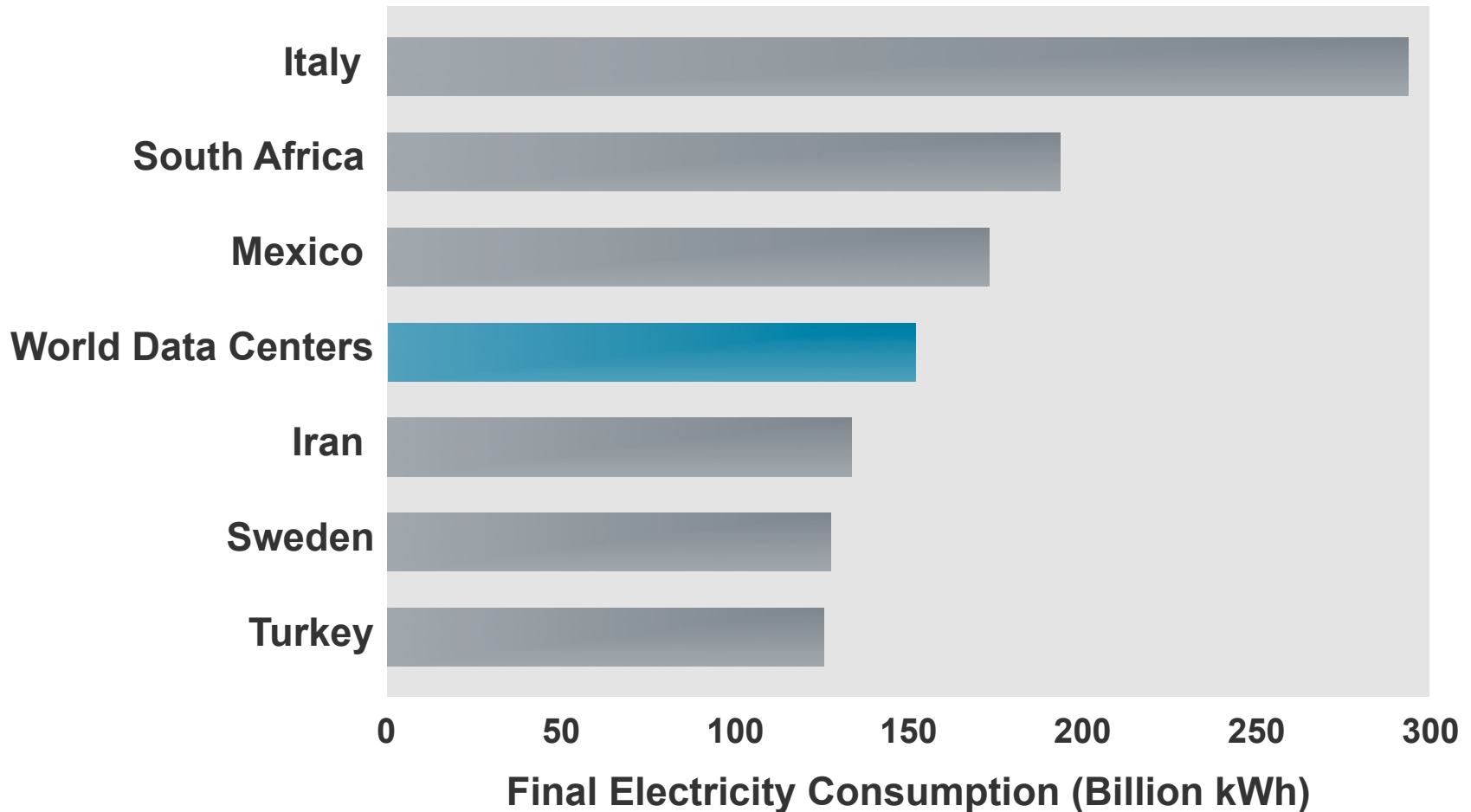

Source for country data in 2005: International Energy Agency, *World Energy Balances* (2007 edition)

# Projected Data Center Energy Use

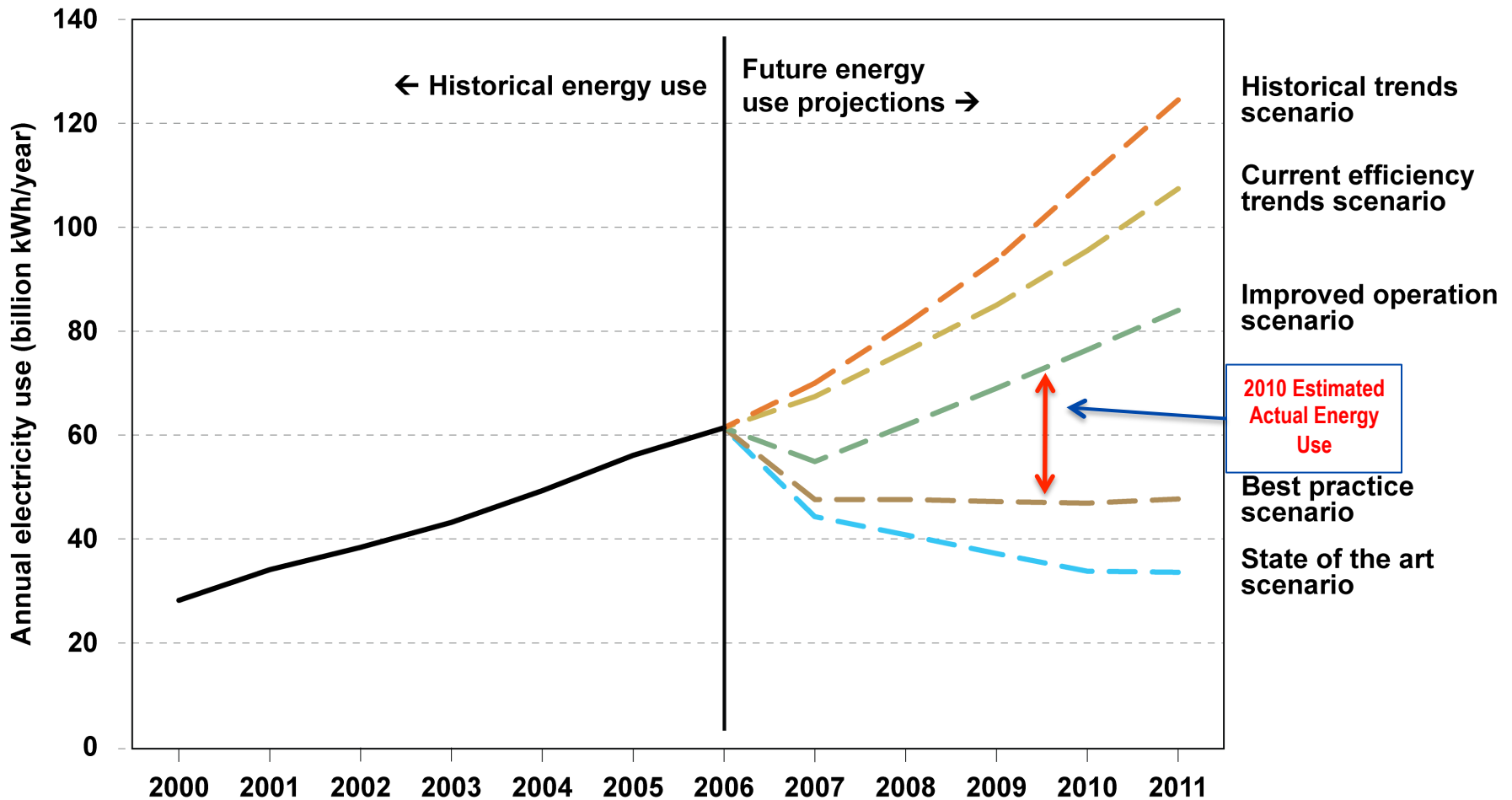

2013 ~ 103 BkWh/year

EPA Report to Congress 2008  
Koomey 2011

# The Increase in Data Center Energy

- Demand for computing power is growing faster than energy efficiency gains
- Cost of electricity for IT equipment and supporting infrastructure surpasses the capital cost of IT equipment
- Perverse incentives: IT and facility costs are paid by separate departments/accounts

# Lawrence Berkeley National Laboratory (LBNL)

- Operates large systems along with legacy equipment

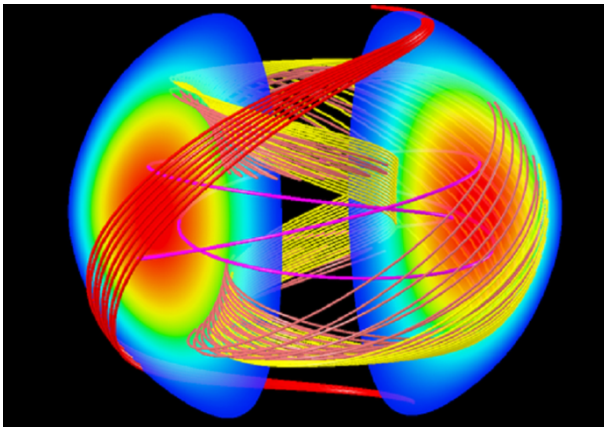

- We also research energy-efficiency opportunities and work on various deployment programs

# LBNL Feels the Pain!



# LBNL Super Computer Systems Power

**NERSC Computer Systems Power**  
(Does not include cooling power)  
(OSF: 4MW max)

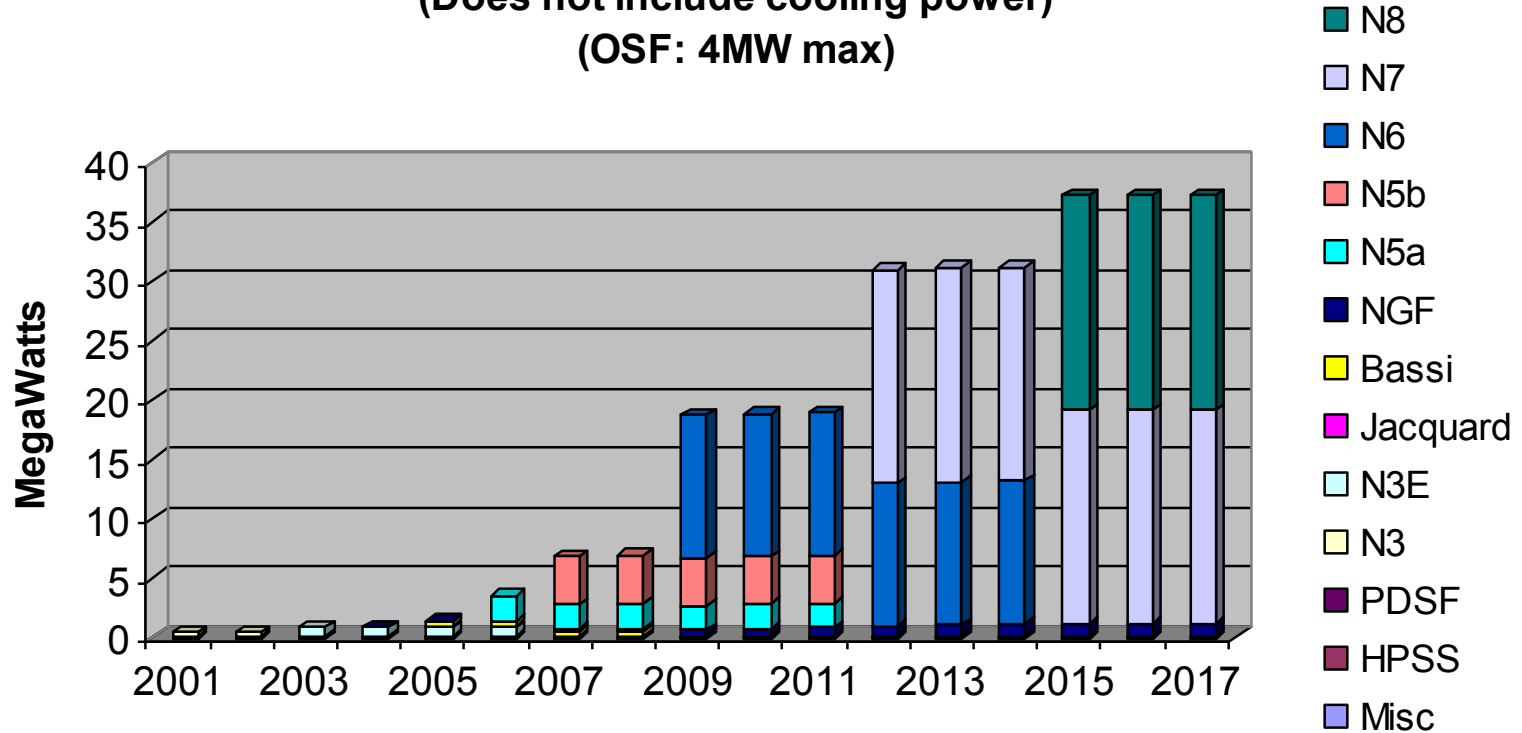

# Typical Data Center Energy Efficiency ~ 15%



100 Units  
Source  
Energy

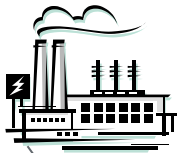

35 Units  
Power  
Generation

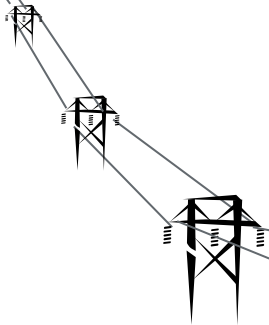

33 Units  
Delivered

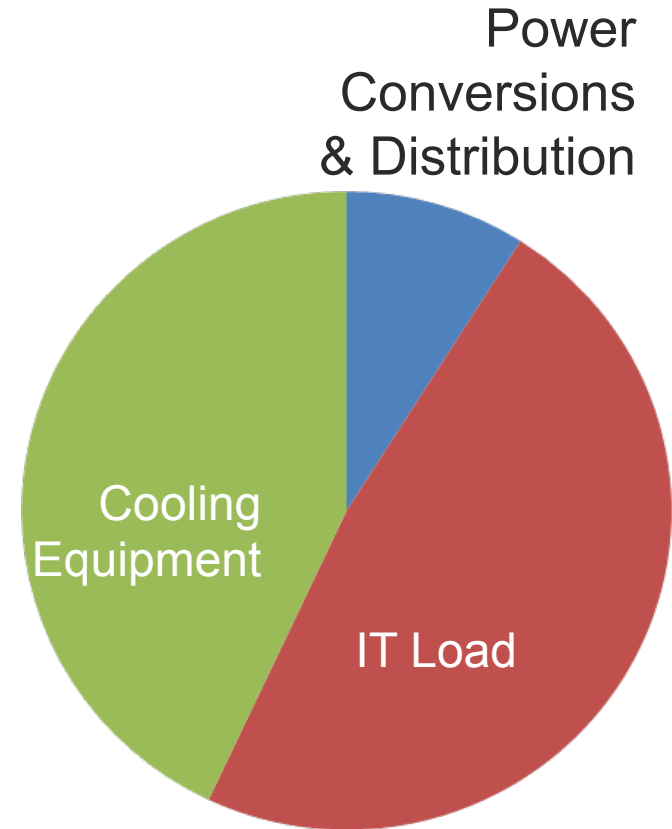

# Energy Efficiency Opportunities

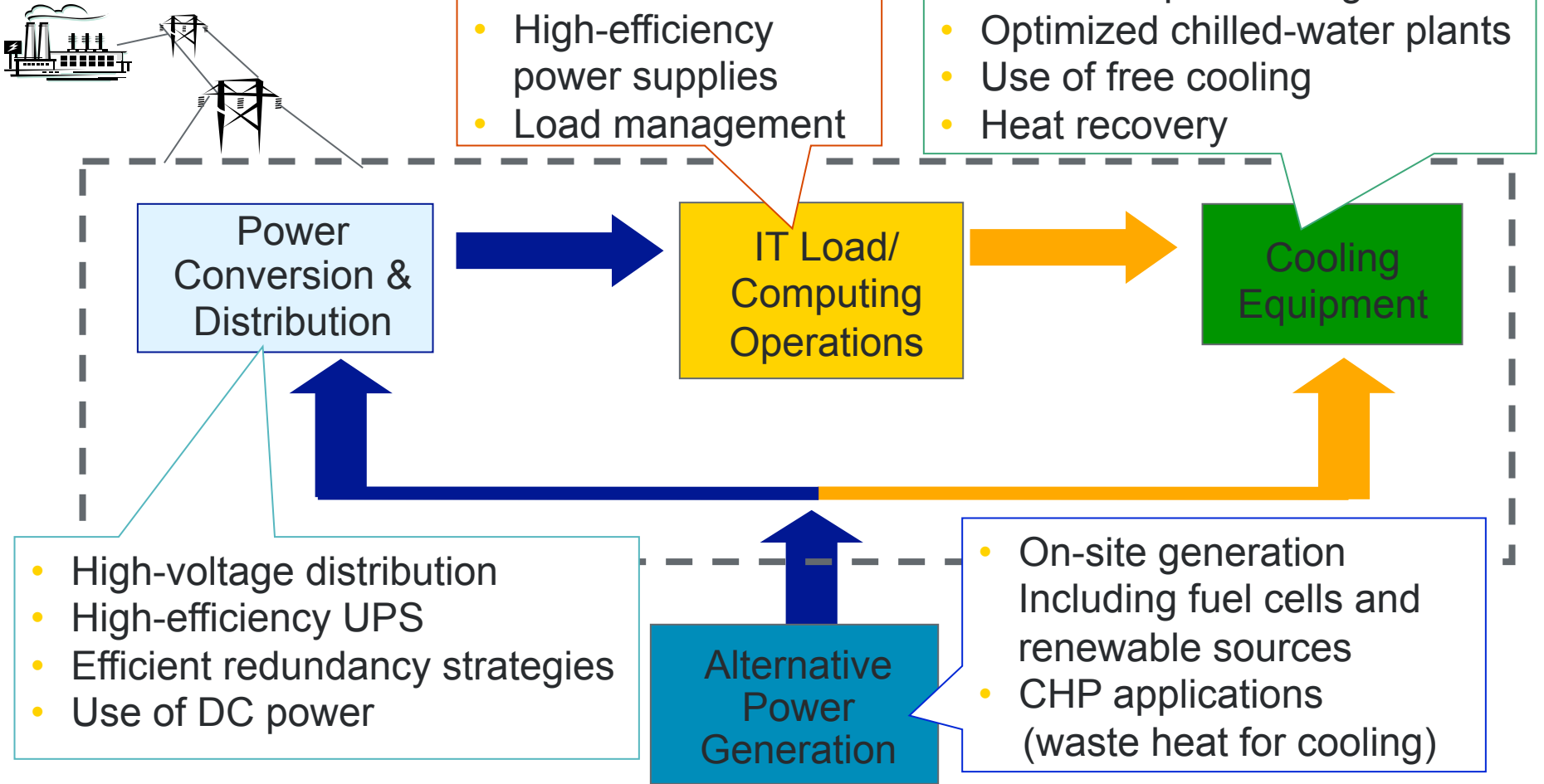



# Electricity End Use in Data Centers

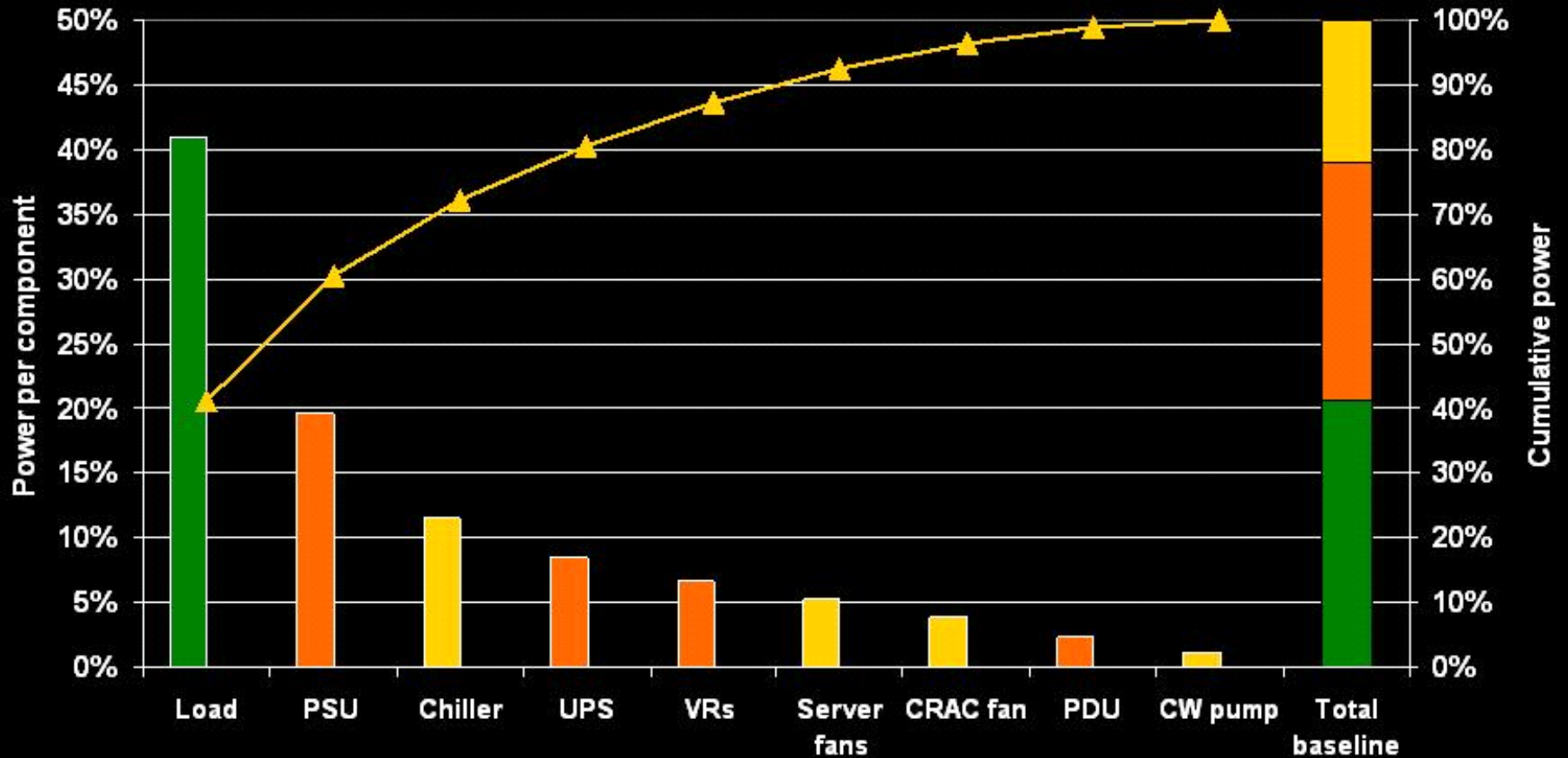

Courtesy of Michael Patterson, Intel Corporation

# Benefits of Higher Data Center Efficiencies

- Typical savings: 20%–40%
- Aggressive Savings: 50%+
- Extend life of infrastructure
- Cooling capacity re-gain
- But is my data center efficient?

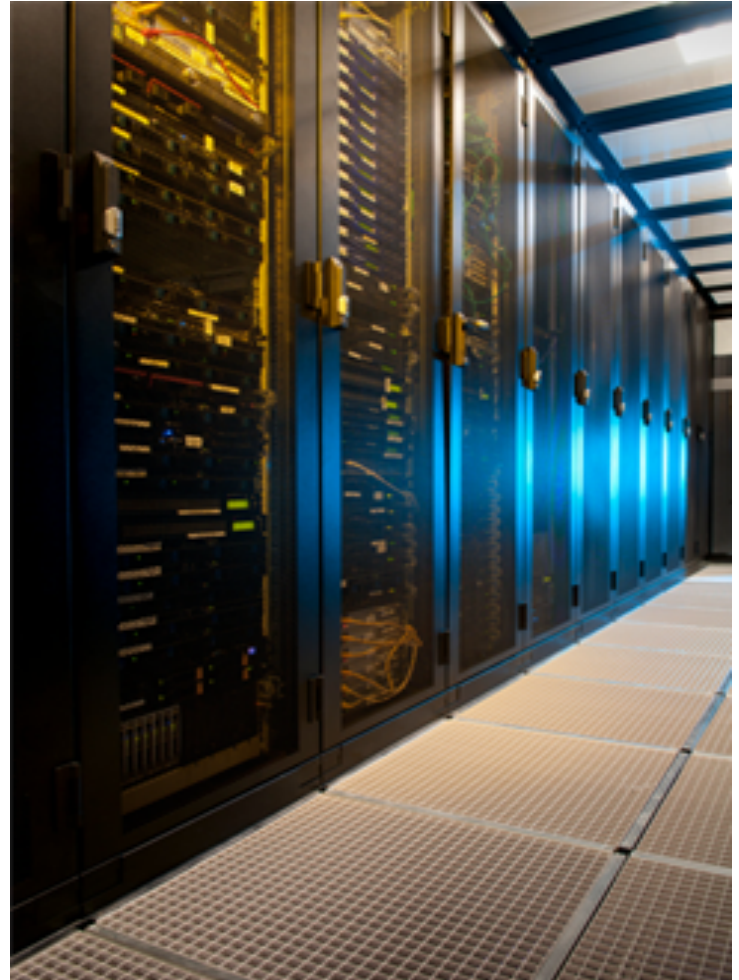

# Executive Order 13693: The New Driver

## Specific goals for data centers:

- Promote energy optimization, efficiency, and performance
- Installing and monitoring advanced energy meters in all data centers by fiscal year 2018
- Establishing a Power Usage Effectiveness (PUE) target of 1.2 to 1.4 for new data centers and less than 1.5 for existing data centers.

## Other related goals:

- Reduce building energy 2.5% per year per sq.ft.
- Increase clean and renewable energy (to 25 & 30%)
- Reduce water consumption 2% per year per sq.ft.
- Energy Star or FEMP designated acquisitions.

# Questions





# Performance Metrics and Benchmarking

# Benchmark Energy Performance

- Compare to peers
  - Wide variation
- Identify opportunities
- Identify best practices
- Track performance
  - Can't manage what isn't measured.



# Your Mileage Will Vary

The relative percentages of energy actually doing computing varies considerably between data centers.

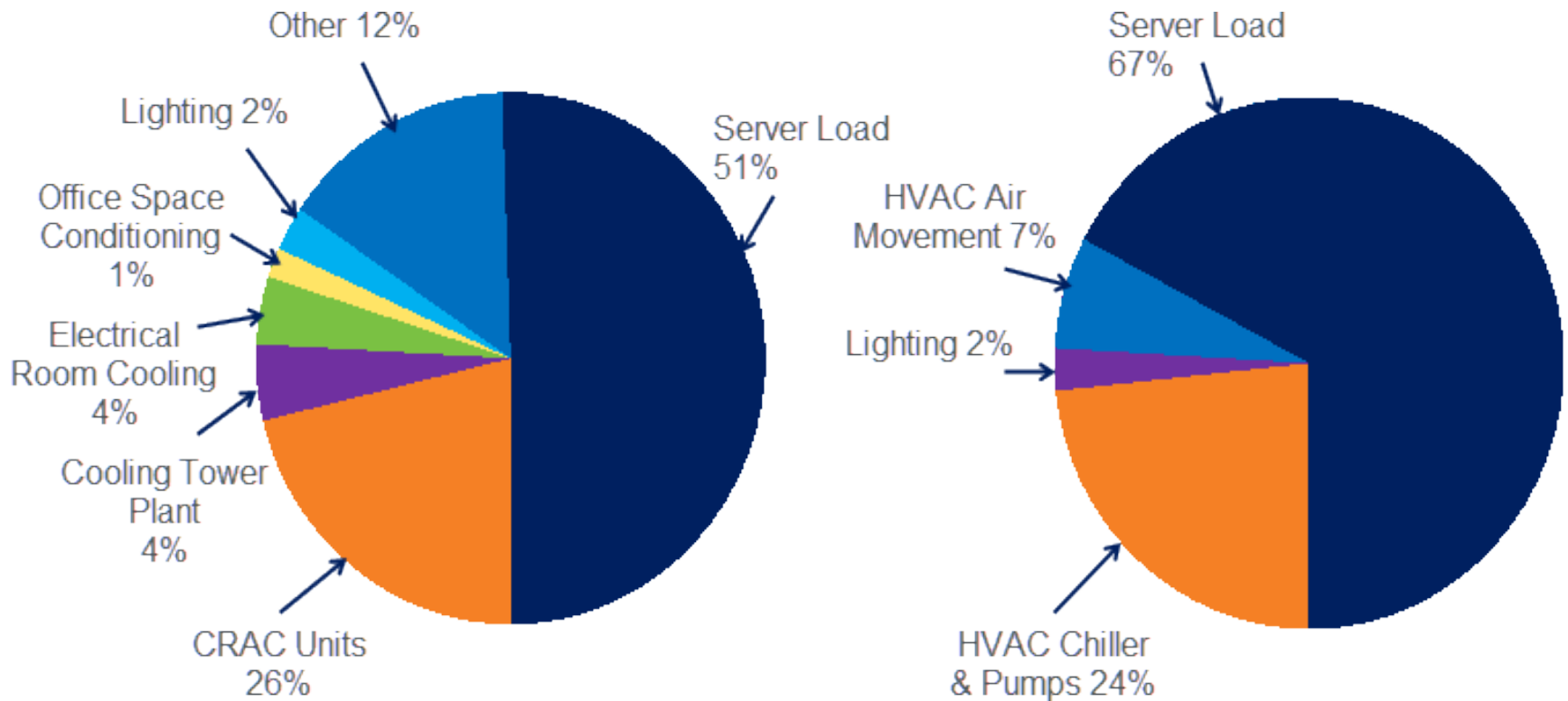

# Benchmarks Obtained by LBNL

High-Level Metric: Power Usage Effectiveness (PUE) = Total Power/IT Power

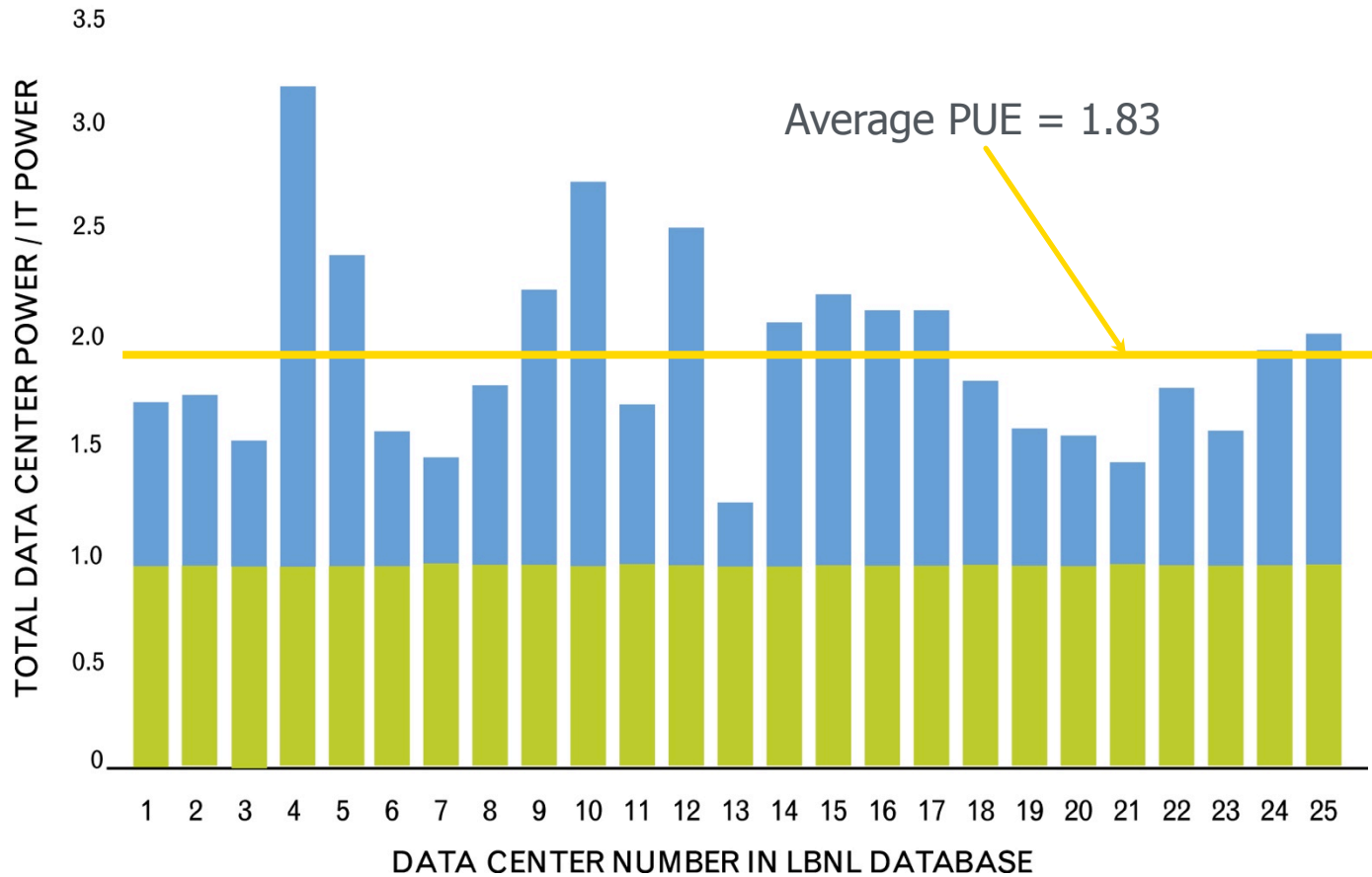



PUEs: Reported & Calculated	PUE
EPA ENERGY STAR Average	1.91
Intel Jones Farm, Hillsboro	1.41
T-Systems & Intel DC2020 Test Lab, Munich	1.24
Google	1.16
Leibniz Supercomputing Centre (LRZ)	1.15
National Center for Atmospheric Research (NCAR)	1.10
Yahoo, Lockport	1.08
Facebook, Prineville	1.07
National Renewable Energy Laboratory (NREL) *	<b>1.06</b>

Slide Courtesy Mike Patterson, Intel

# PUE Measurement Categories Recommended by The GreenGrid (TGG) Task Force

Table 1: PUE measurement categories recommended by this task force.

	PUE Category 0*	PUE Category 1	PUE Category 2	PUE Category 3
IT energy measurement location	UPS output	UPS output	PDU output	IT equipment input
Definition of IT energy	Peak IT electric demand	IT annual energy	IT annual energy	IT annual energy
Definition of Total energy	Peak Total electric demand	Total annual energy	Total annual energy	Total annual energy

\*For PUE Category 0 the measurements are electric demand (kW).

Courtesy of TGG



# Energy Metrics and Benchmarking

- Key Metrics:
  - PUE and partial PUEs (e.g., HVAC, Electrical distribution)
  - Energy Reuse (ERF)
  - Utilization.
- The future: Computational Metrics (e.g., peak flops per Watt; transactions/Watt)

# Other Data Center Metrics

- Watts per square foot, watts per rack
- Power distribution: UPS efficiency, IT power supply efficiency
- HVAC
  - Fan watts/cubic feet per minute (cfm)
  - Pump watts/gallons per minute (gpm)
  - Chiller plant (or chiller or overall HVAC) kW/ton
- Air Management
  - Rack Cooling Index (RCI = measure of temperature compliance)
  - Return Temperature Index (RTI =  $(RAT-SAT)/\Delta T_{IT}$ )
- Lighting watts/square foot

# Metrics and Benchmarking

## Power Usage Effectiveness

$$PUE = \frac{\text{Total Facility Energy}}{\text{IT Equipment Energy}}$$

Standard	Good	Better
2.0	1.4	1.1

## Airflow Efficiency

$$\frac{\text{Total Fan Power (W)}}{\text{Total Fan Airflow (cfm)}}$$

Standard	Good	Better
1.25W/cfm	0.75 W/cfm	0.5 kW/cfm

## Cooling System Efficiency

$$\frac{\text{Average Cooling System Power (kW)}}{\text{Average Cooling Load (ton)}}$$

Standard	Good	Better
1.1 kW/ton	0.8 kW/ton	0.6 kW/ton

Source: LBNL Programing Guide

# Best Practices Based on Benchmark Results

- IT equipment and software efficiency
- Optimize environmental conditions
- Manage airflow
- Efficient cooling options
  - Free cooling
  - Humidity control
  - Liquid cooling
- Improve power chain
- Use IT to save energy in IT

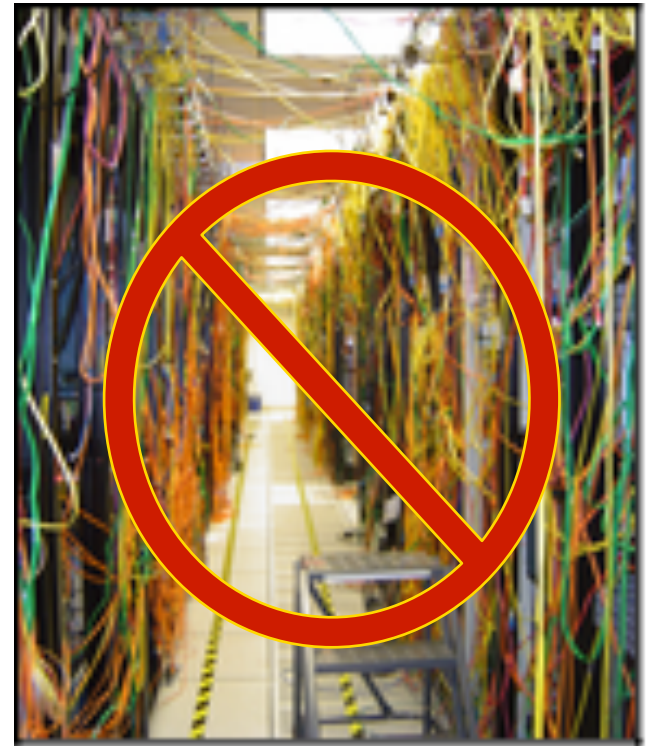

# Questions





# IT Equipment and Software Efficiency



# IT Equipment Load Can Be Controlled

Computations per Watt is improving, but computation demand is increasing even faster, so overall energy use is increasing.

- Consolidation
- Server efficiency (Use ENERGY STAR servers)
  - Flops per Watt
  - Efficient power supplies and less redundancy.
- Software efficiency
  - Virtualize for higher utilization
  - Data storage management.
- Enable power management (e.g., sleep mode)
- Reducing IT load has a multiplier effect
  - Savings in infrastructure energy depends on PUE

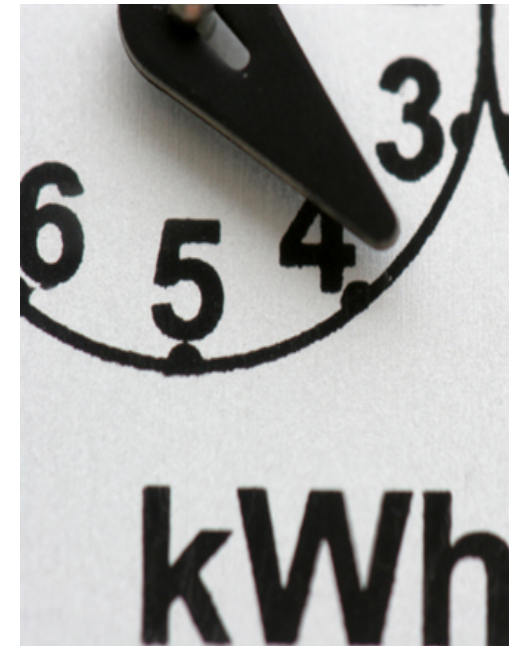

# Actual Saving of One Watt Saved at the IT Equipment

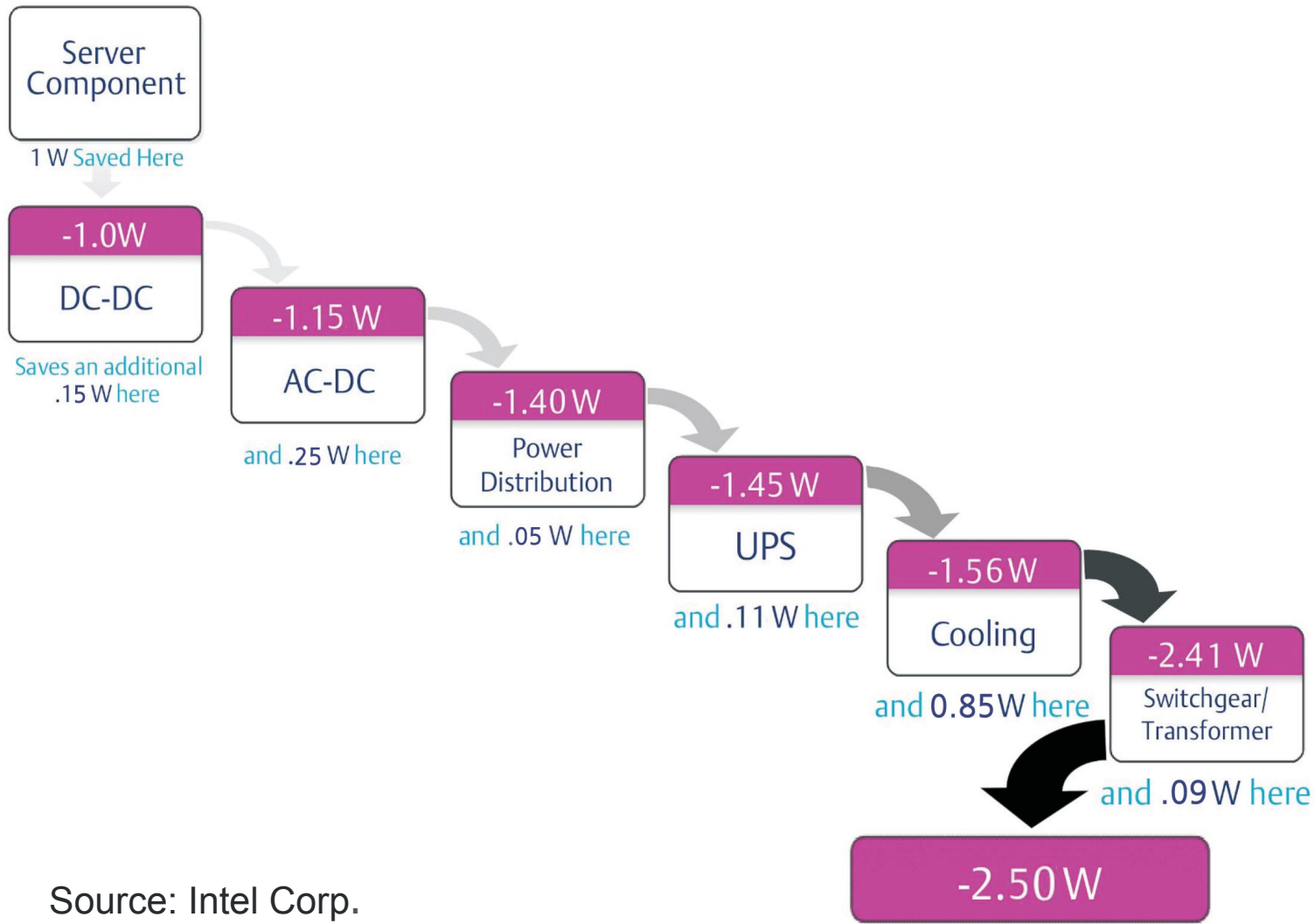

Source: Intel Corp.

# Moore's Law

Power Reduction Over Time\*

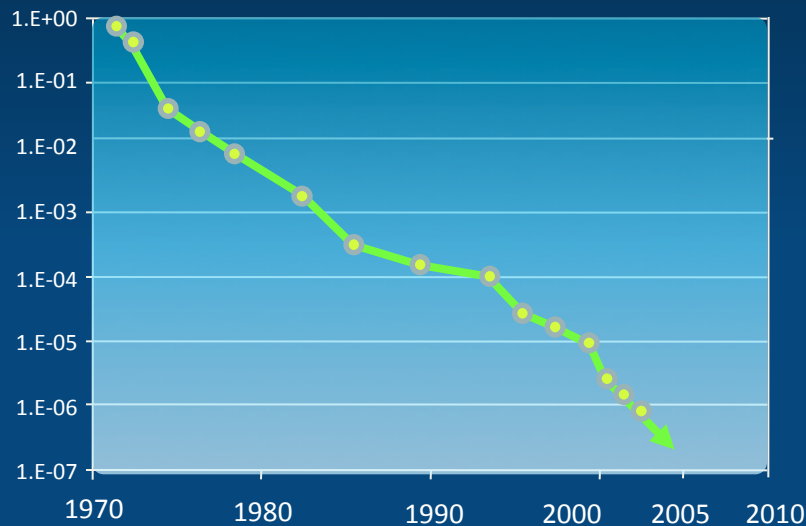

Core Integer Performance Over Time\*

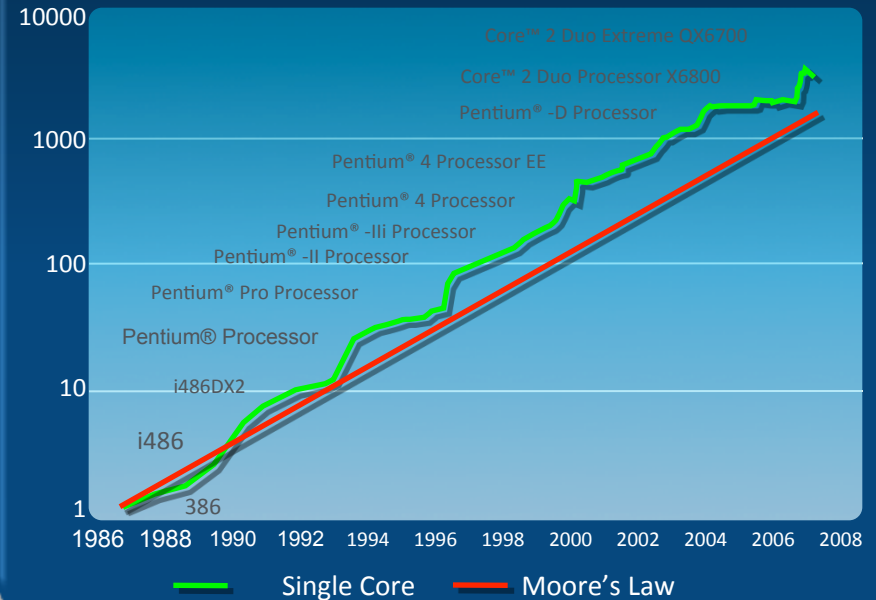

- Every year brings smaller, more energy-efficient transistors
- Miniaturization reduced transistor size 1 million times over 30 years
- Benefits: Smaller, faster transistors => faster AND more energy-efficient chips

Source: Intel Corporate Technology Group

# Computing Efficiency Increases 100x Every Decade

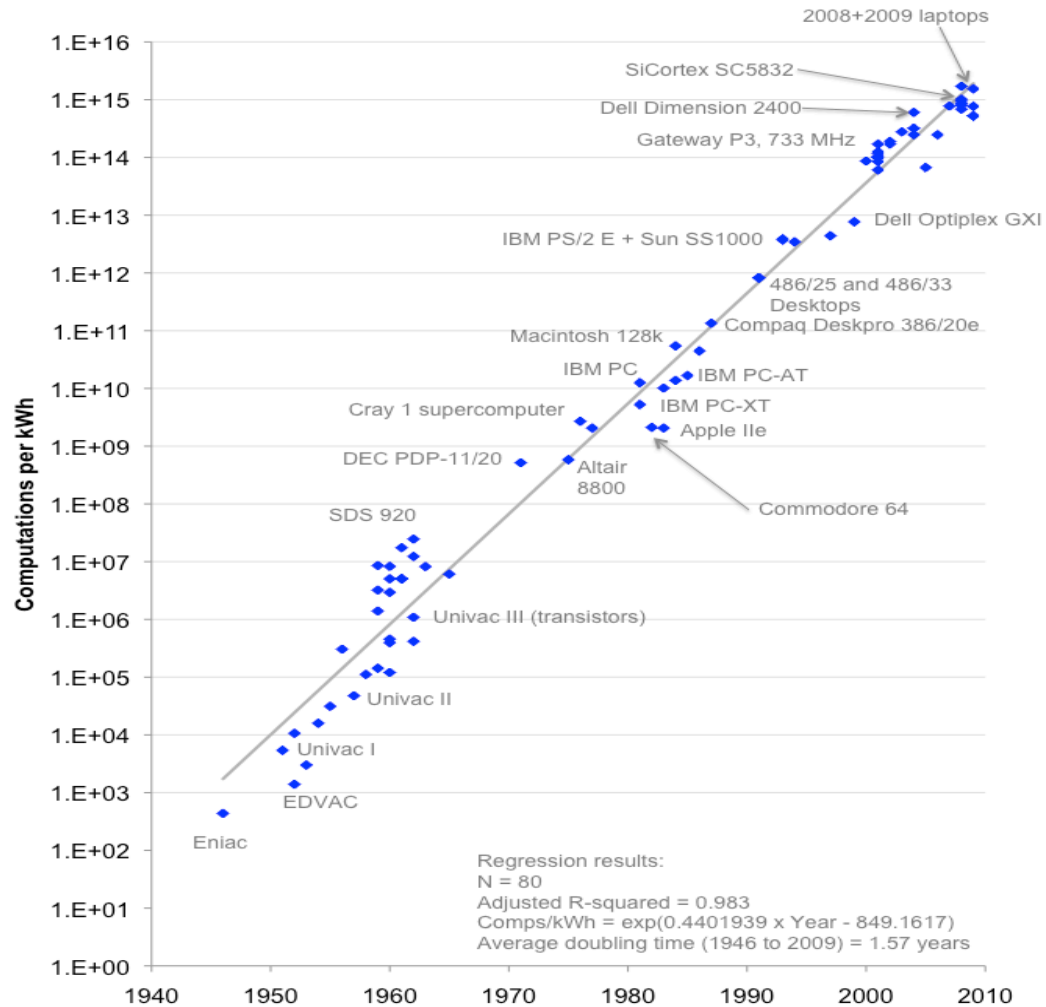

Source: Koomey et al. 2011

## Old servers consume 60% of energy, but deliver only 4% of performance capability

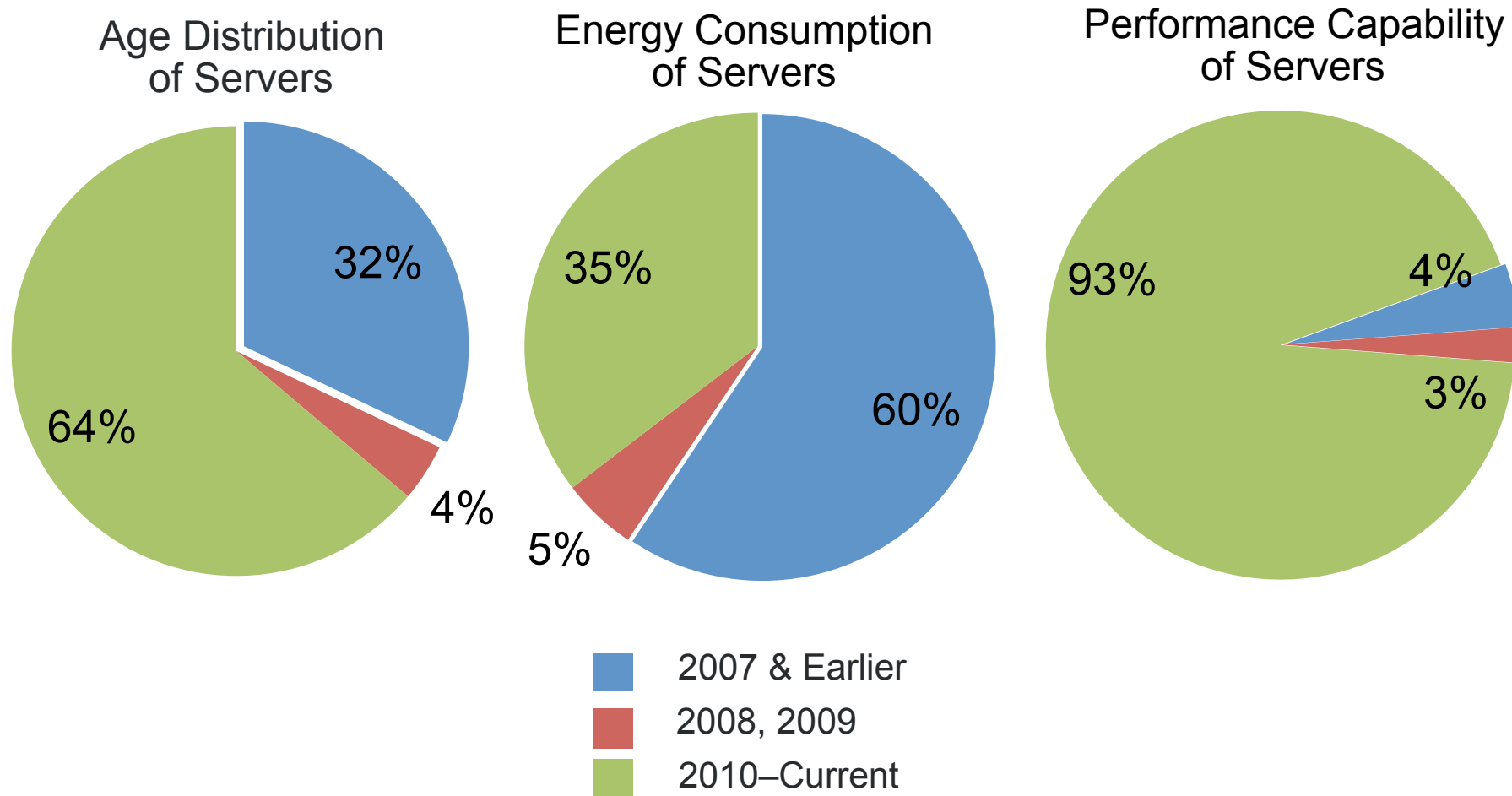

Data collected recently at a Fortune 100 company; courtesy of John Kuzma and William Carter, Intel

# Decommission Unused Servers

- Physically Retire an Inefficient or Unused System
- The Uptime Institute reported 15%–30% of servers are on but not being used
- Decommissioning process includes:
  - Regularly inventory and monitoring
  - Consolidate/retire poorly utilized hardware

# IT Energy Use Patterns: Servers

Idle servers consume as much as 50%–60% of power at full load.

## Benchmark Results Summary

Performance			Power	Performance to Power Ratio
Target Load	Actual Load	ssj_ops	Average Active Power (W)	
100%	99.2%	308,022	269	1,144
90%	90.2%	280,134	264	1,063
80%	80.0%	248,304	256	971
70%	69.9%	217,096	247	877
60%	60.1%	186,594	238	785
50%	49.6%	154,075	227	680
40%	39.9%	123,805	215	575
30%	29.9%	92,944	203	459
20%	20.1%	62,364	189	330
10%	10.0%	31,049	174	178
Active Idle		0	160	0
$\Sigma$ ssj_ops / $\Sigma$ power =				698

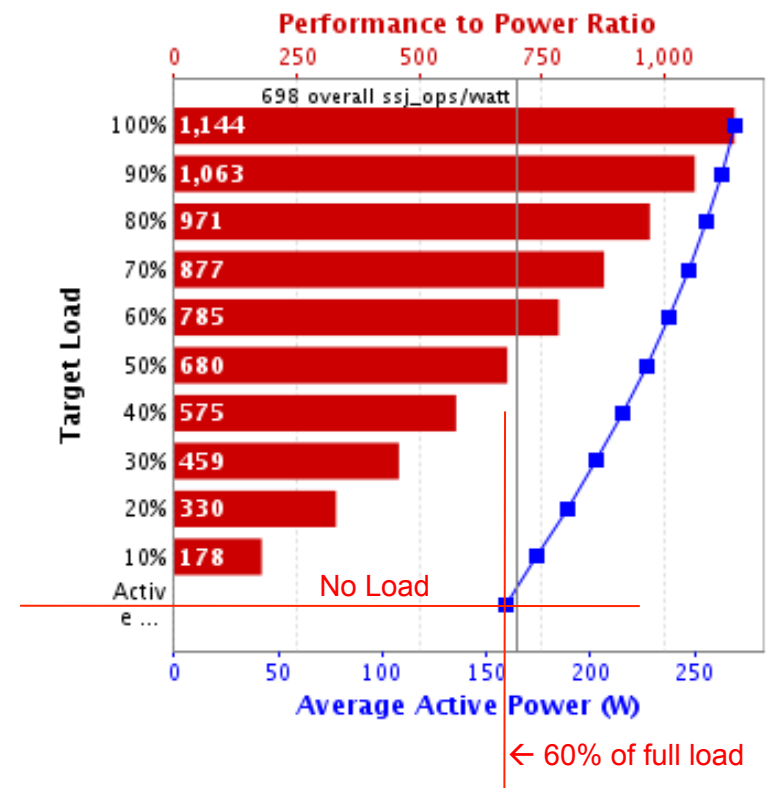

Source: SpecPower Benchmarks

# Virtualize and Consolidate Servers & Storage

- Run many “virtual” machines on a single “physical” machine
- Consolidate underutilized physical machines, increasing utilization
- Energy is saved by shutting down underutilized machines.

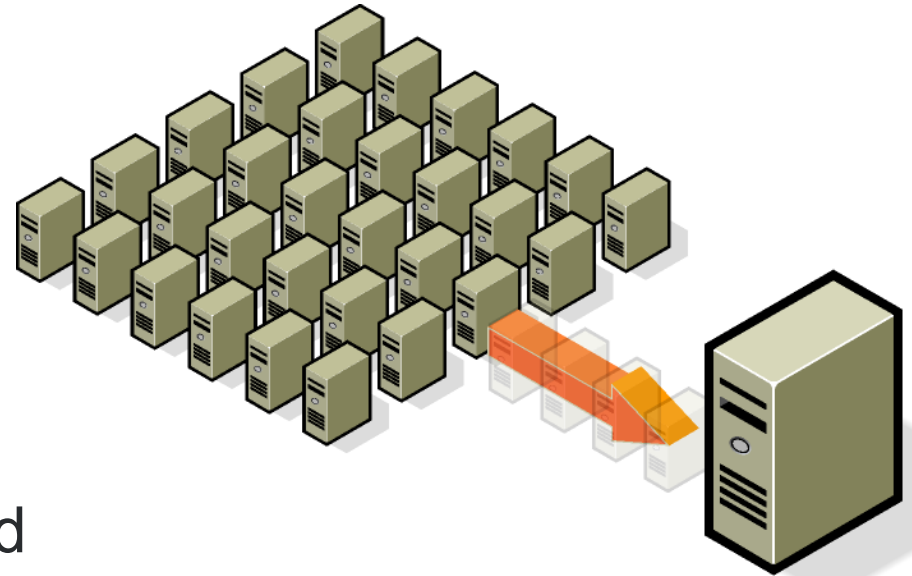



# Virtualization: Workload Provisioning

## Server Consolidation

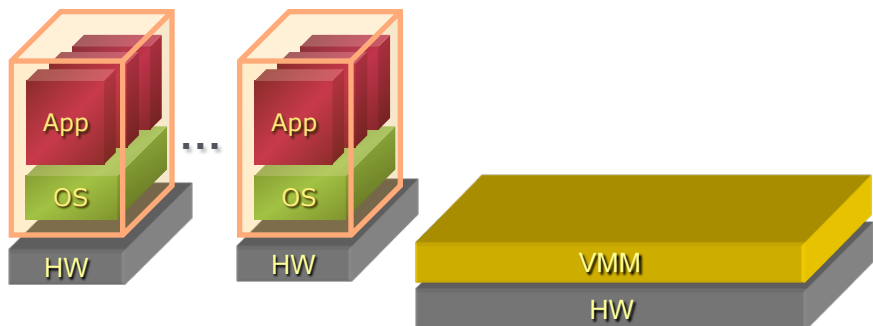

10:1 in many cases

## R&D

## Production

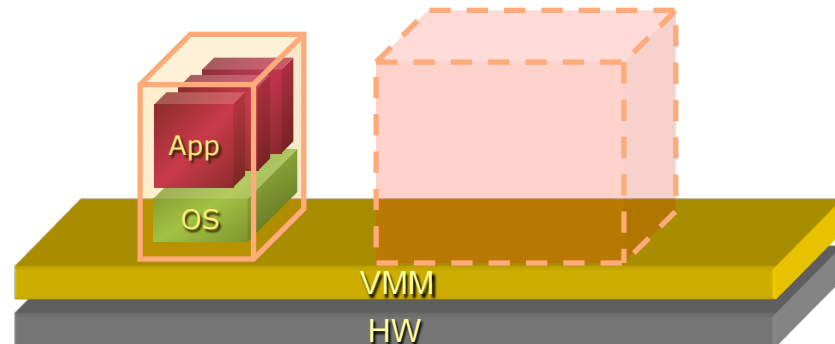

Enables rapid deployment, reducing number of idle, staged servers

## Disaster Recovery

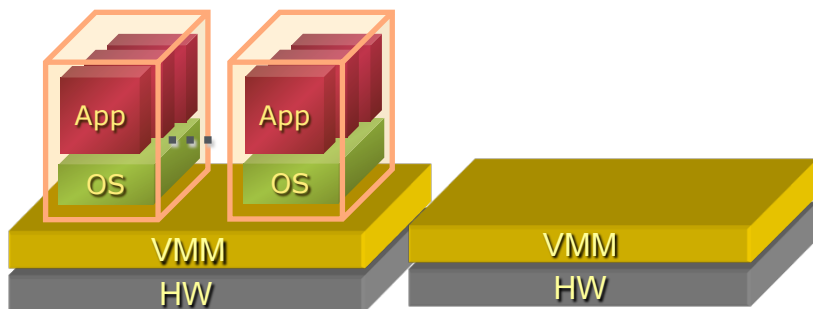

- Upholding high-levels of business continuity
- One Standby for many production servers

## Dynamic Load Balancing

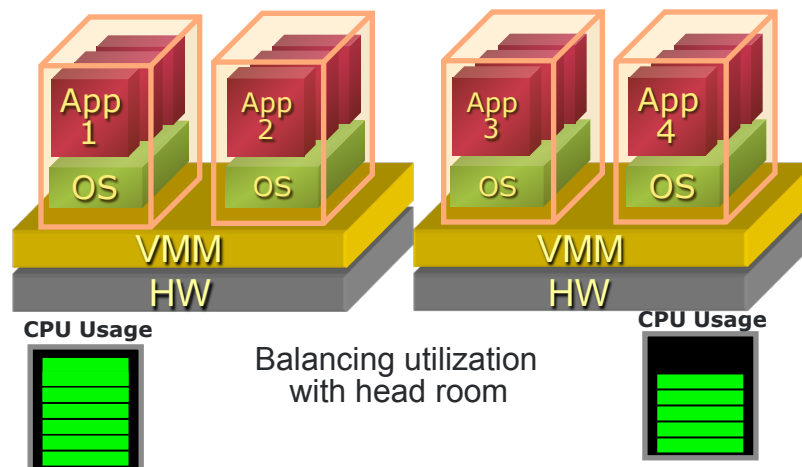

# Cloud Computing

## Virtualized cloud computing can:

- Provide dynamically scalable resources over the Internet
- Be internal or external
- Balance different application peak loads
- Typically achieve high utilization rates

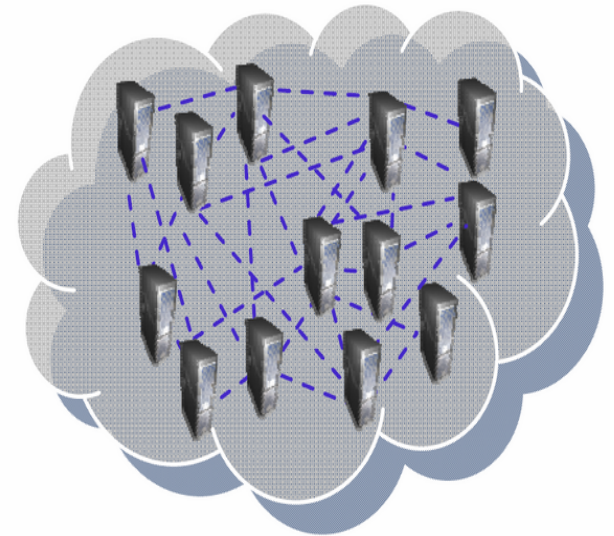

# Data Storage Systems and Energy

- Power roughly linear to storage modules
- Storage redundancy significantly increases energy
- Consider lower-energy hierarchal storage
- Storage de-duplication - eliminate unnecessary copies

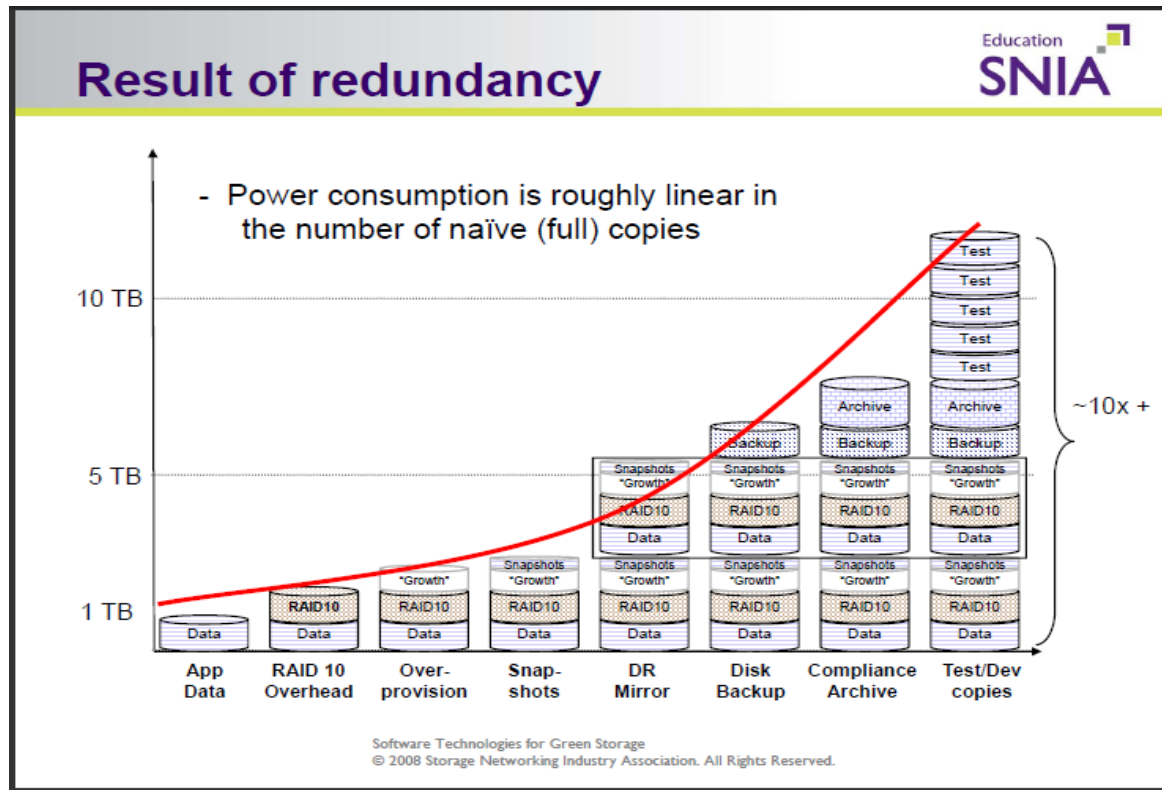

# IT System Efficiency Review

## Servers



- Enable power management capabilities!
- Use ENERGY STAR® Servers

## Power Supplies



- Reconsider Redundancy
- Use 80 PLUS or Climate Savers products

## Storage Devices



- Take superfluous data offline
  - Use thin provisioning technology
- De-duplicate

## Consolidation

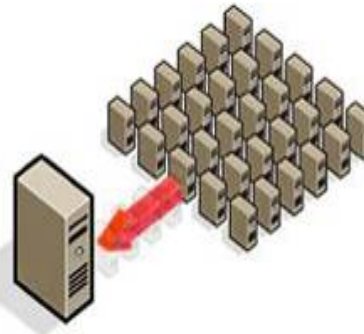

- Use virtualization
- Consider cloud services

# Questions





# Federal Acquisition

# Federal Mandates

Include ENERGY STAR-qualified products, products that exceed FEMP-designated efficiency requirements AND low standby power products:

- Federal Acquisition Regulations (FAR 23.203 and 52.223)
- Energy Independence and Security Act of 2007
- Energy Policy Act of 2005
- Executive Order 13693  
*Planning for Federal Sustainability in the Next Decade*
- Executive Order 13221  
*Energy-efficient Standby Power Devices*
- <http://energy.gov/eere/femp/energy-and-water-efficient-products>

# Efficient Acquisition

- FEMP provides performance requirements for each product type
- Buyers can compare the FEMP requirements to the specifications for commercially available models

TABLE 1. EFFICIENCY REQUIREMENTS FOR FEDERAL PURCHASES	
Category	Luminaire Efficacy Rating (LER)
Fuel pump canopy luminaires	70
Parking garage luminaires	
Outdoor pole/arm-mounted area and roadway luminaires	65
Outdoor pole/arm-mounted decorative luminaires	
Outdoor wall-mounted luminaires	60
Bollards	35

<http://energy.gov/eere/femp/covered-product-category-exterior-lighting>



# Efficient Acquisition

## What Are the Barriers?

- Deep-rooted institutional processes
- Tendency to focus on first cost
- Lack of feedback to buyers/specifiers

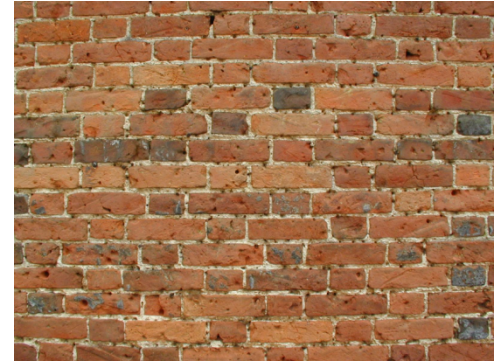

## How Are They Overcome?

- Address the problem at the process (not policy) level
- Make efficient purchasing easy (the default case)
- Publicize agency-level bright spots more broadly



# Questions





# Environmental Conditions

# Environmental Conditions

## What are the main HVAC Energy Drivers?

- IT Load
- Climate
- HVAC System
- Room temperature and humidity
  - Most data centers are overcooled and have too strict of a humidity control
  - Human comfort should not be a driver

# Safe Temperature Limits

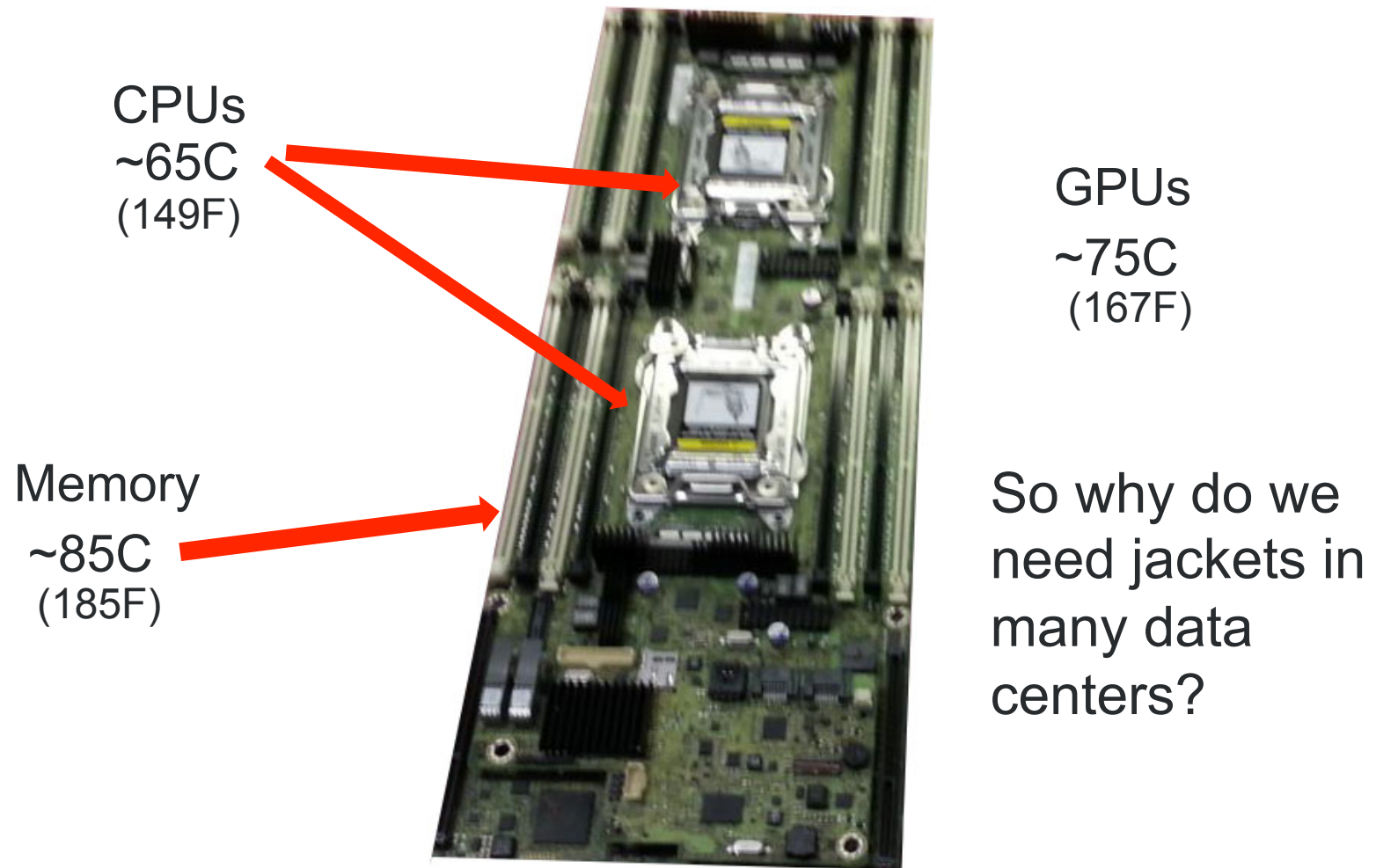

CPU, GPU & Memory, represent ~75-90% of heat load

# Equipment Environmental Specification

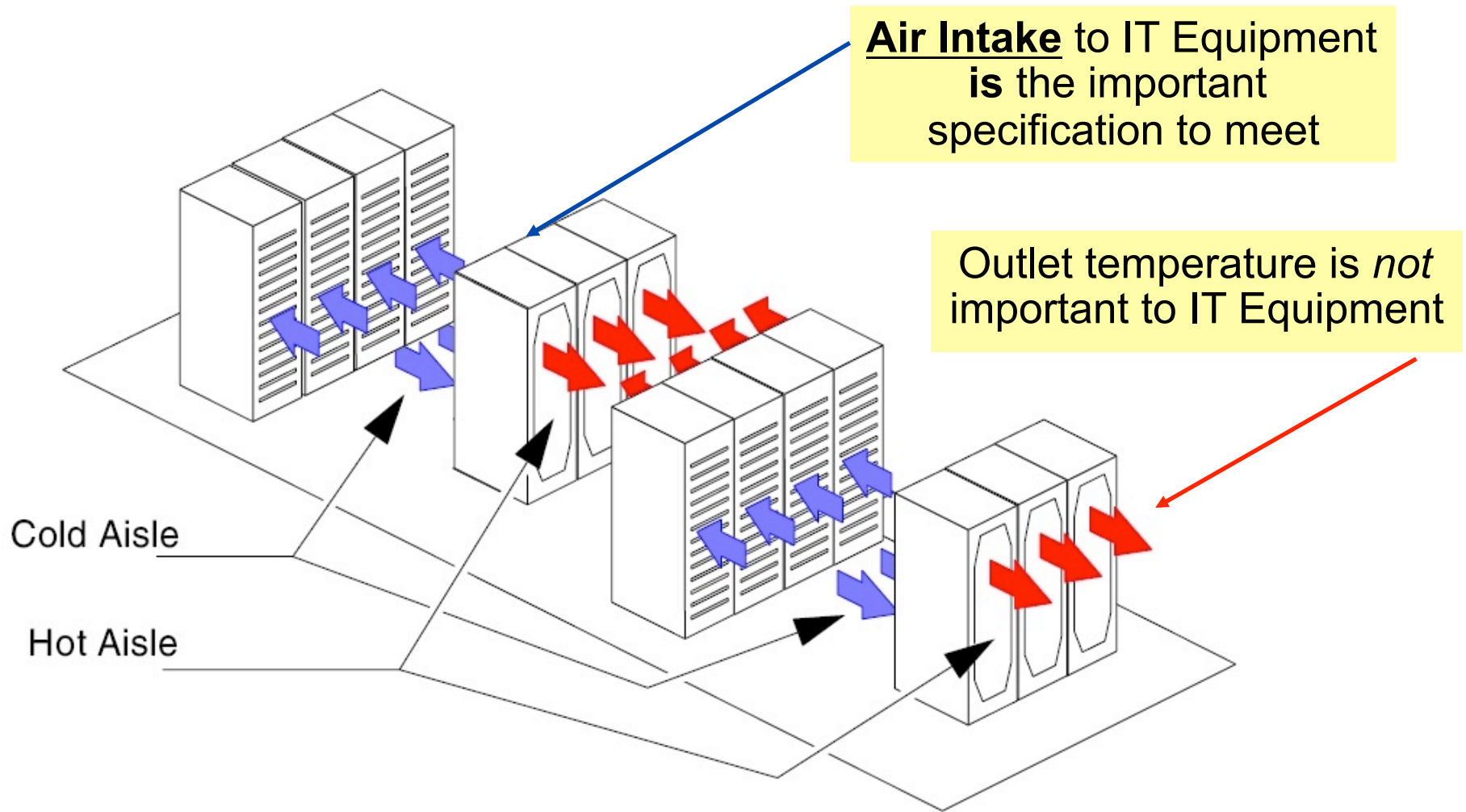

# Key Nomenclature

- The recommended range is a statement of reliability. For extended periods of time, the IT manufacturers recommend that data centers maintain their environment within these boundaries.
- The allowable range is a statement of functionality. These are the boundaries where IT manufacturers test their equipment to verify that the equipment will function.

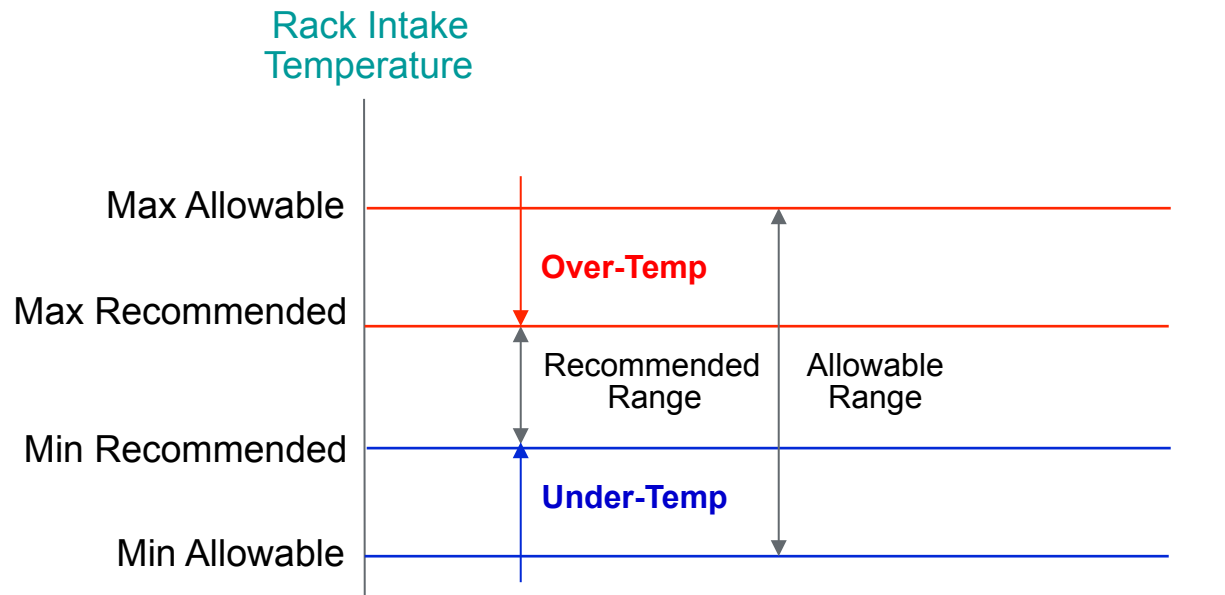

# ASHRAE Thermal Guidelines

- Default recommended range = 64.4 - 80.6F
- Provides guidance for operating above the default upper limit
- Default allowable range = 59.0 – 89.6F (Class A1)
- Six classes with allowable ranges up to 113.0F

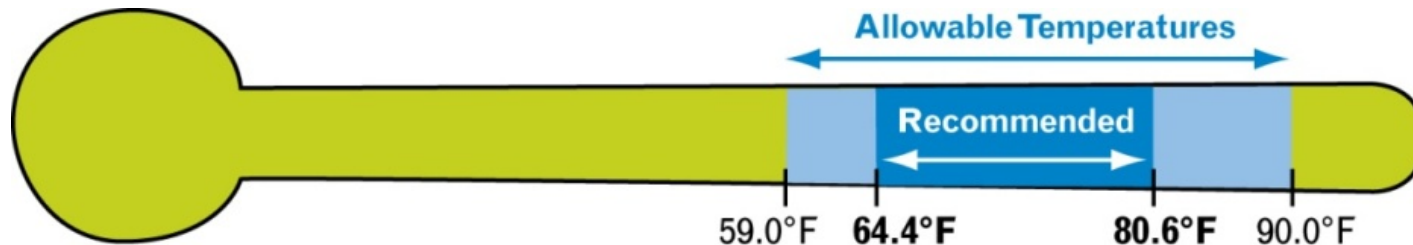



# Recommended Data Center Environmental Conditions

ASHRAE 2011:

**ITE Environment – 2011 Environment Specifications Table (Partial)**



Class		Dry Bulb (°F)	Humidity Range	Max Dew Point (°F)	Max Elevation (ft)	Max Rate of Change (°F / hr)
Previous	Current					
<b>Recommended</b>						
<b>1 &amp; 2</b>	<b>A1 to A4</b>	<b>64.4 to 80.6</b>	<b>41.9°F DP to 60% RH &amp; 59°F DP</b>	<b>N/A</b>		
<b>Allowable</b>						
1	A1	59 to 89.6	20% to 80% RH	62.6	10,000	9* / 36
2	A2	50 to 95	20% to 80% RH	69.8	10,000	9* / 36
N/A	A3	41 to 104	10.4°F DP & 8% RH to 85% RH	75.2	10,000	9* / 36
N/A	A4	41 to 113	10.4°F DP & 8% RH to 90% RH	75.2	10,000	9* / 36

\* More stringent rate of change for tape drives

© ASHRAE Table reformatted by DLB Associates

# 2011 ASHRAE Allowable Ranges

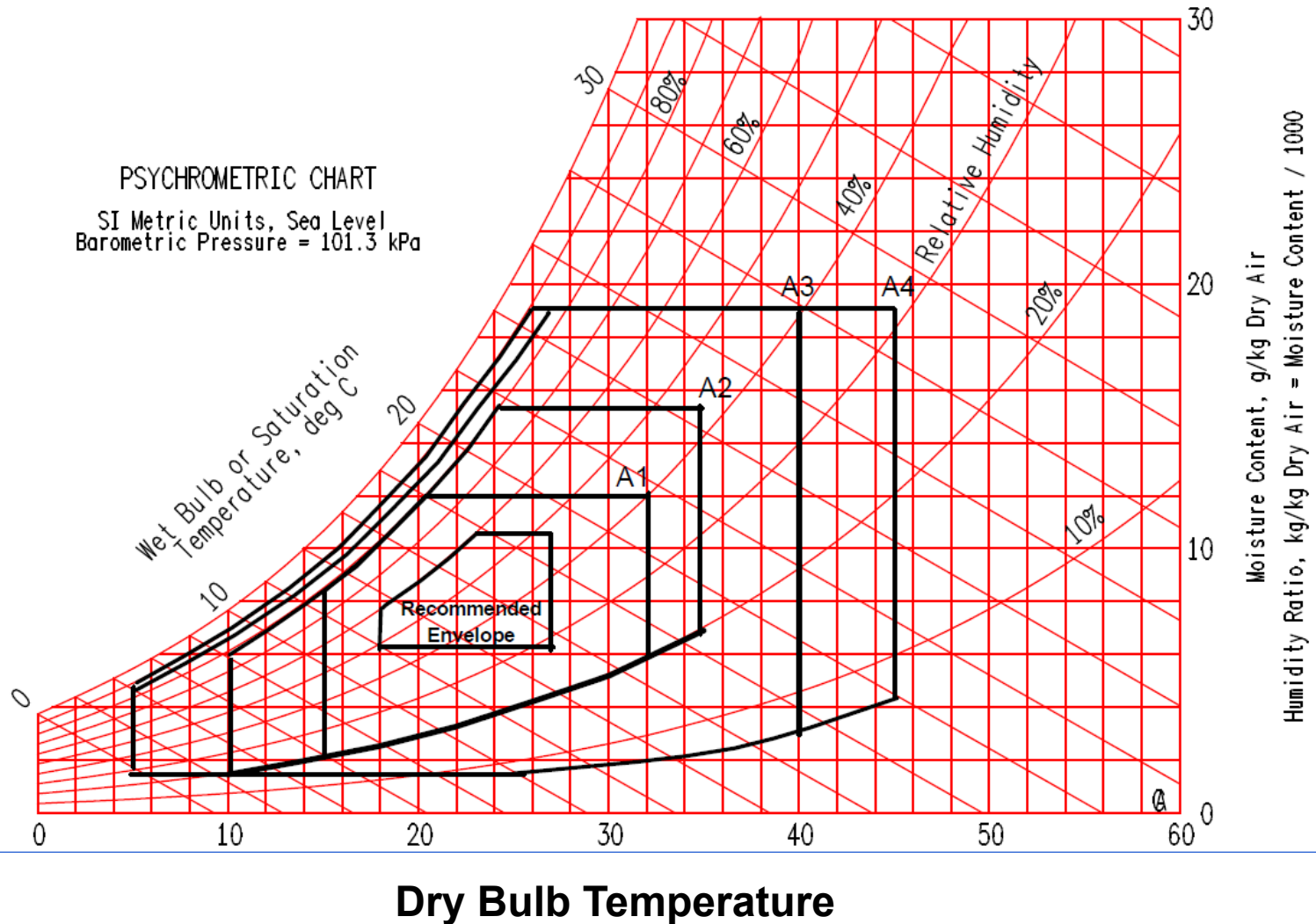

# Thermal Conditions Are Less Relevant

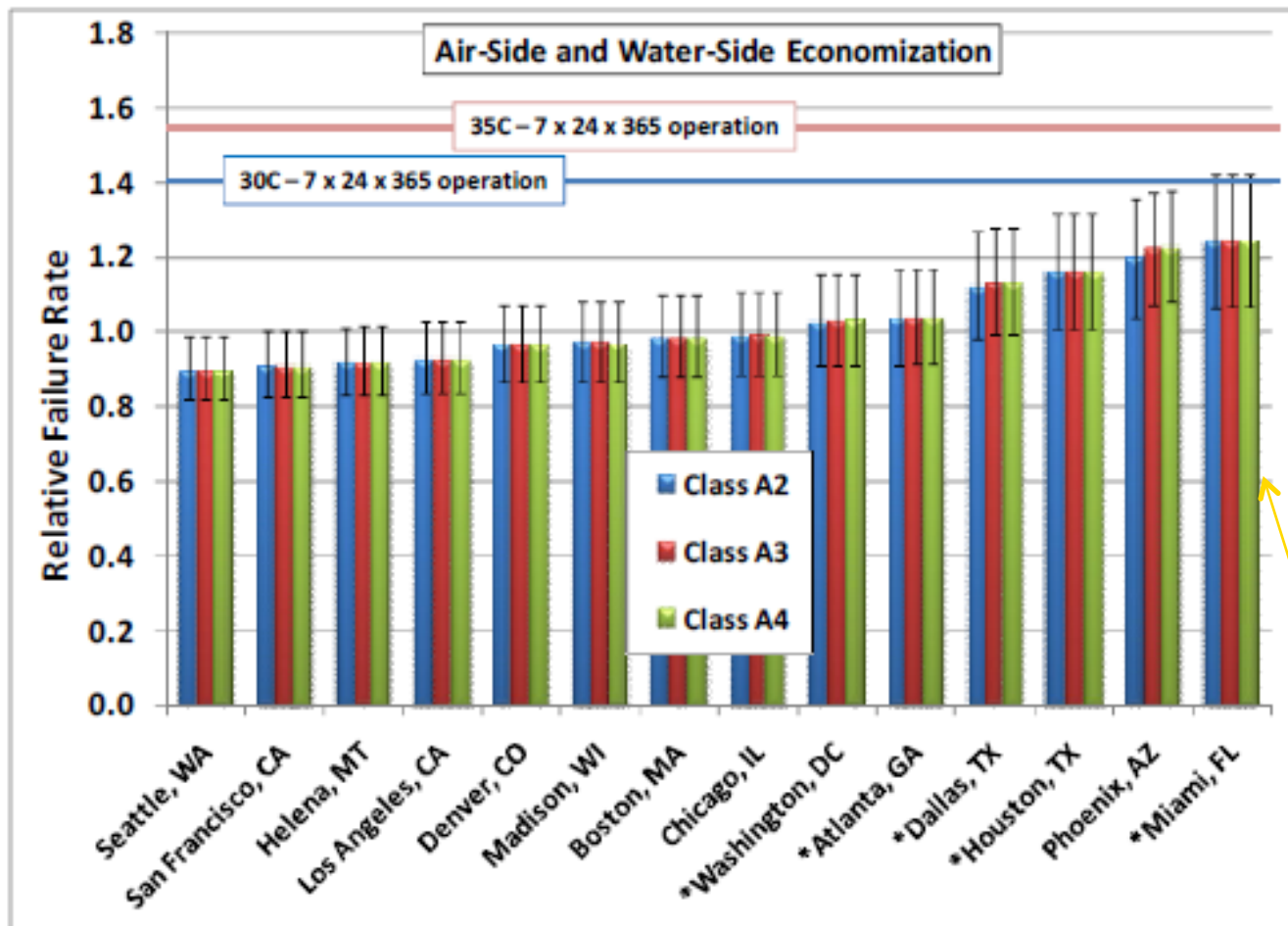

Source: ASHRAE

If 4 failures per 1,000 servers incorporates warmer temperatures, and the relative failure rate is 1.2, then the expected failure rate would be 5 failures per 1,000 servers.

# 2011 ASHRAE Thermal Guidelines

ASHRAE's key conclusion when considering potential for increased failures at higher (allowable) temperatures:

“For a majority of U.S. and European cities, the air-side and water-side economizer projections show failure rates that are very comparable to a traditional data center run at a steady-state temperature of 20°C (68°F).”



# ASHRAE Liquid Cooling Guidelines

- ASHRAE and a DOE High Performance Computer (HPC) user group developed guidance
- Three temperature standards defined based on three mechanical system configurations:
  - Chilled water provided by a chiller (with or without a “tower side economizer”)
  - Cooling water provided by a cooling tower with possible chiller backup
  - Cooling water provided by a dry cooler with possible backup using evaporation

# ASHRAE Liquid Cooling Guidelines

Liquid Cooling Class	Main Cooling Equipment	Supplemental Cooling Equipment	Building Supplied Liquid Cooling Maximum Temperature
L1	Cooling Tower and Chiller	Not Needed	17°C (63°F)
L2	Cooling Tower	Chiller	32°C (89°F)
L3	Dry Cooler	Spray Dry Cooler, or Chiller	43°C (110°F)



# Environmental Conditions Review

- Most computer room air conditioners (CRACs) are controlled based on the return air temperature; *this needs to change*
- A cold data center = efficiency opportunity
- Perceptions, based on old technology, lead to cold data centers with tight humidity ranges; *this needs to change*
- Many IT manufacturers design for harsher conditions than ASHRAE's "default" Class A1
- Design Data Centers for IT equipment performance, *not people comfort*
- **Address air management issues first**

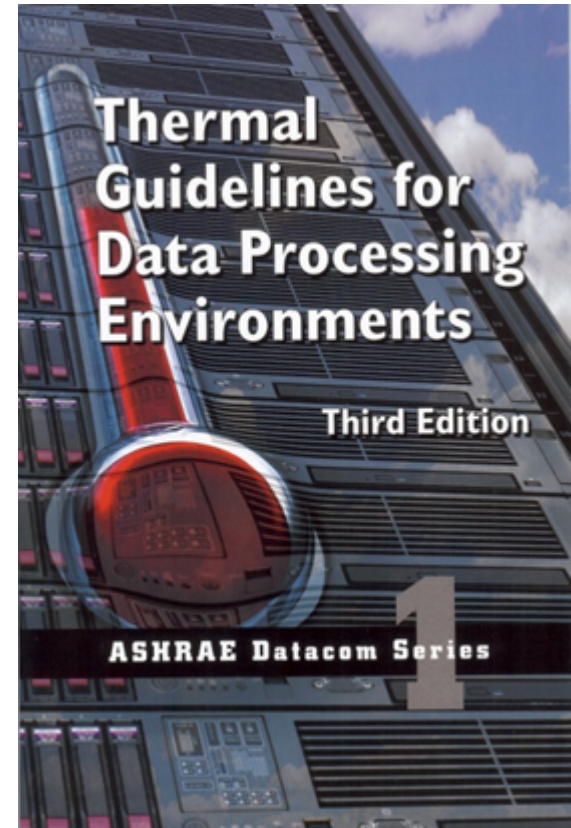

# Questions







# Air Management

# The Early Days at LBNL

It was cold, but hot spots were everywhere:



Fans were used to redirect air



High-flow tiles reduced air pressure

# Air Management

- Problem 1: By-pass air, often to control hotspots
- Problem 2: Re-circulation air causes hotspots
- Solution: Air Management
- Use hot and cold aisles
- Improve isolation of hot and cold aisles
  - Reduce fan energy
  - Improve air-conditioning efficiency
  - Increase cooling capacity

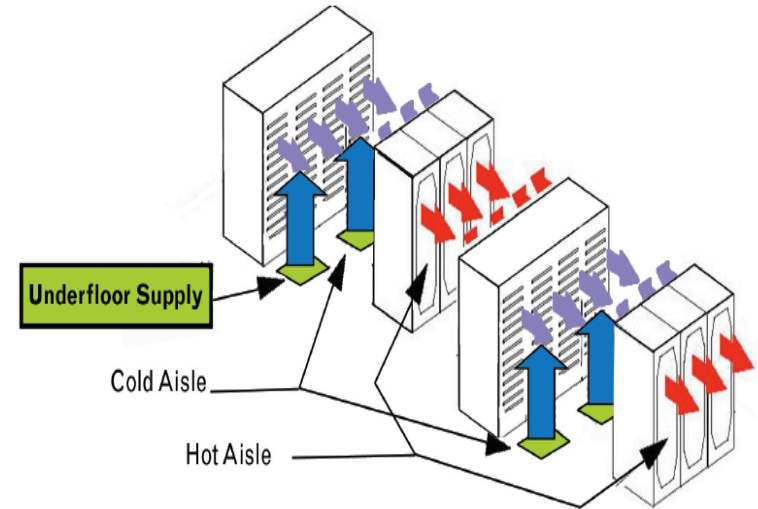

Hot aisle/cold aisle configuration decreases mixing of intake and exhaust air, promoting efficiency.

# Benefits of Hot- and Cold-aisles

- Improves equipment intake air conditions by separating cold from hot airflow
- Preparation
  - Arrange racks with alternating hot and cold aisles
  - Supply cold air to front of facing servers. Hot exhaust air exits into rear aisles.

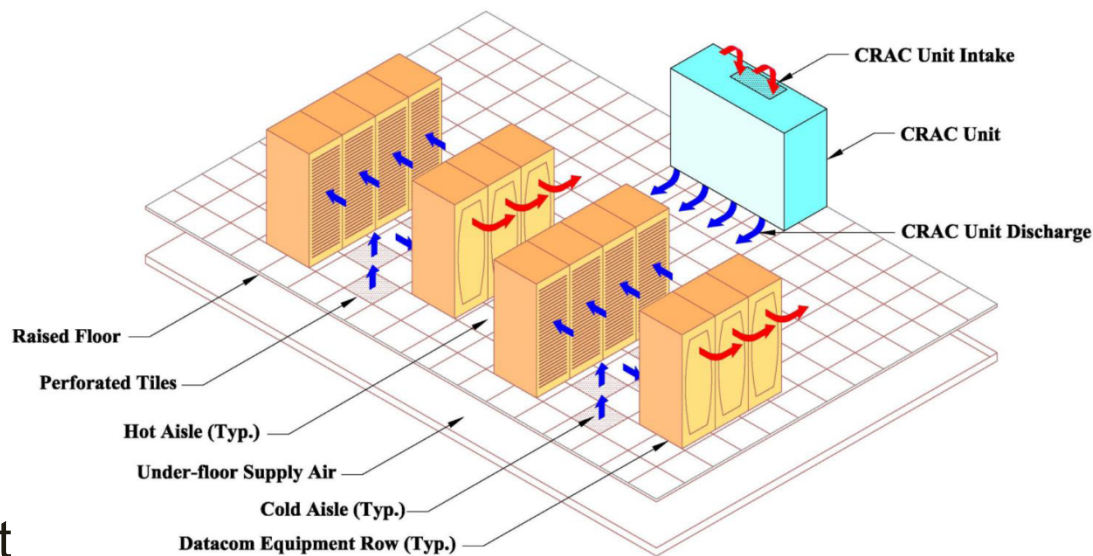

# Separating Cold from Hot Airflow

- Supply cold air as close to the rack inlet as possible
- Reduce mixing with ambient air and hot rack exhaust
- Rack moves air from the cold front aisle to the rear hot aisle

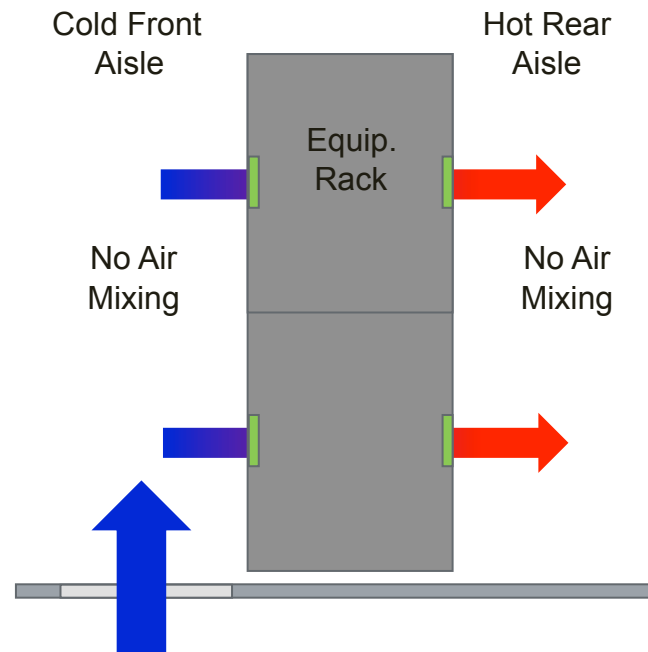

# Reduce By-Pass and Recirculation Air

## Bypass Air / Short-Circuiting

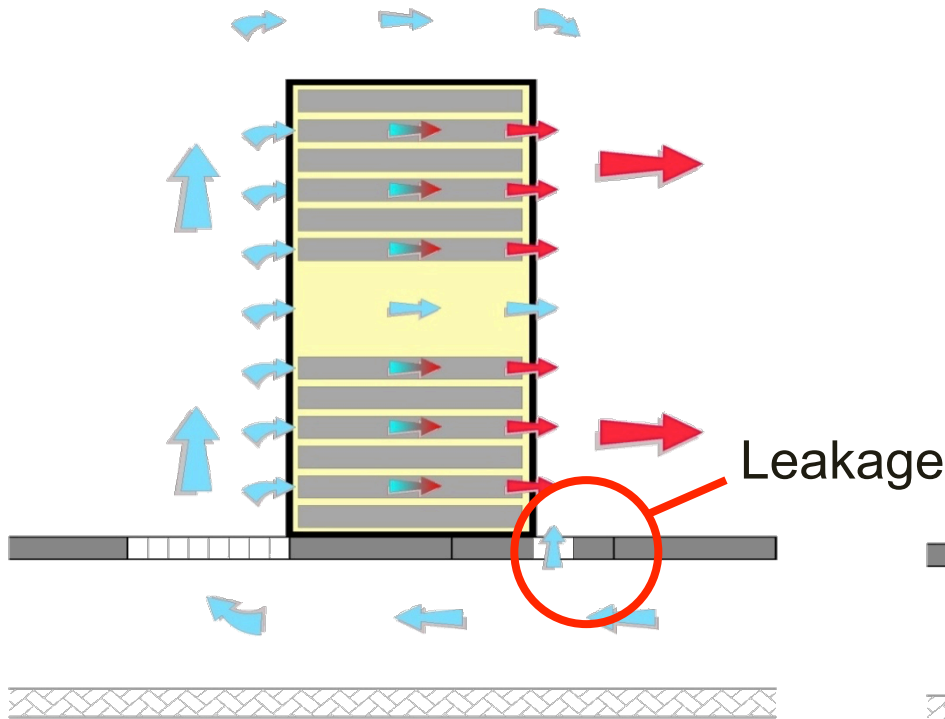

Wastes fan energy as well as cooling energy and capacity

## Recirculation

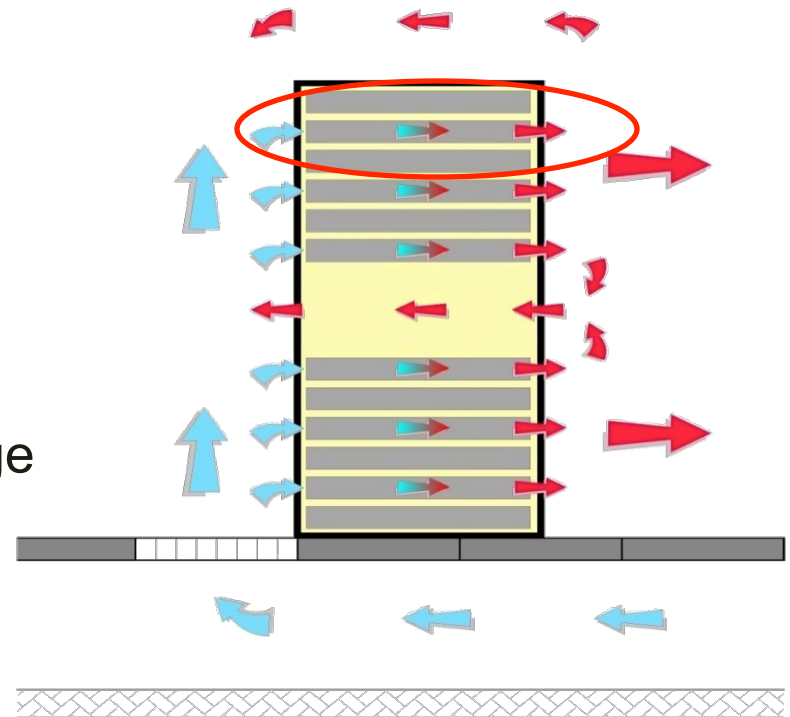

Increases inlet temperature to servers

# Bypass Air - Common Causes

- Too much supply airflow
- Misplaced perforated tiles
- Leaky cable penetrations
- Too high tile exit velocity

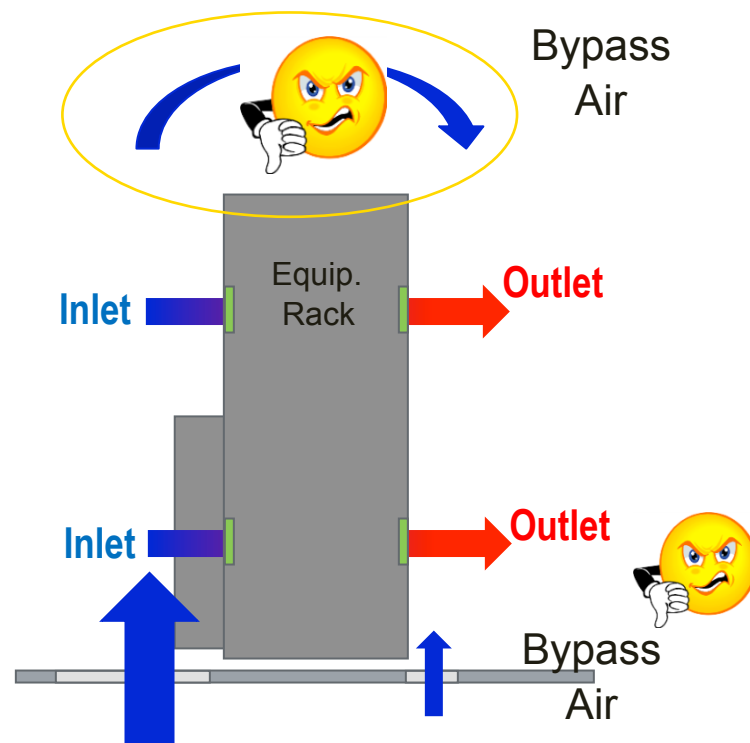

# Recirculation Air - Common Causes

- Too little supply airflow
- Lack of blanking panels
- Gaps between racks
- Short equipment rows

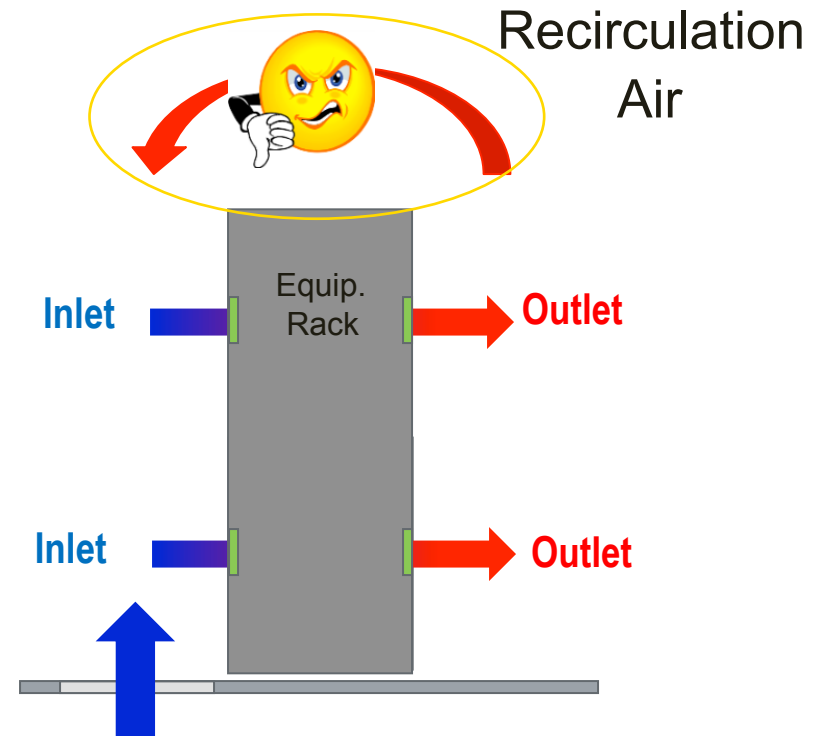



# Maintaining Raised-Floor Seals

Maintain seals of all potential leaks in the raised floor plenum.



Unsealed cable penetration (inside rack)



Sealed cable penetration

# Managing Blanking Panels

- Any opening will degrade the separation of hot and cold air
- One 12" blanking panel reduced temperature ~20°

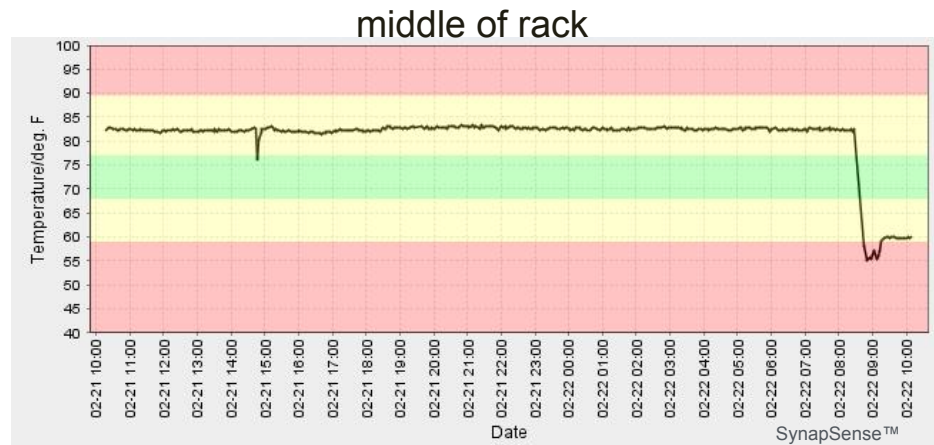
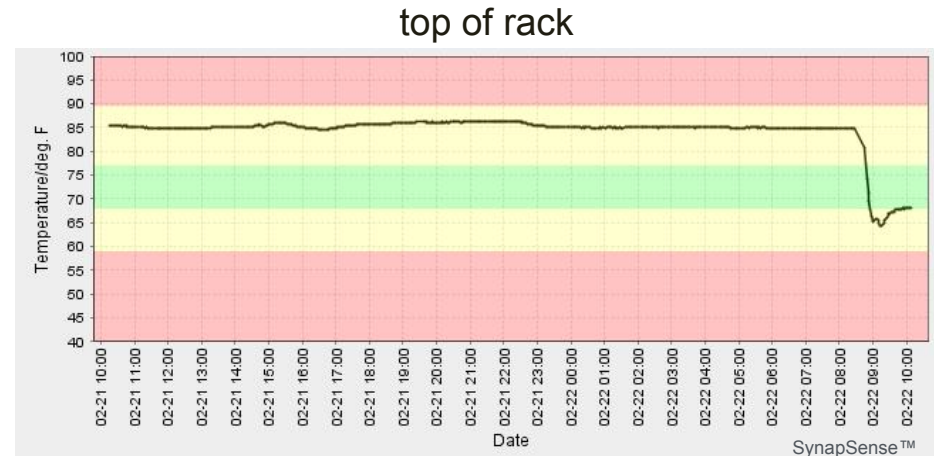
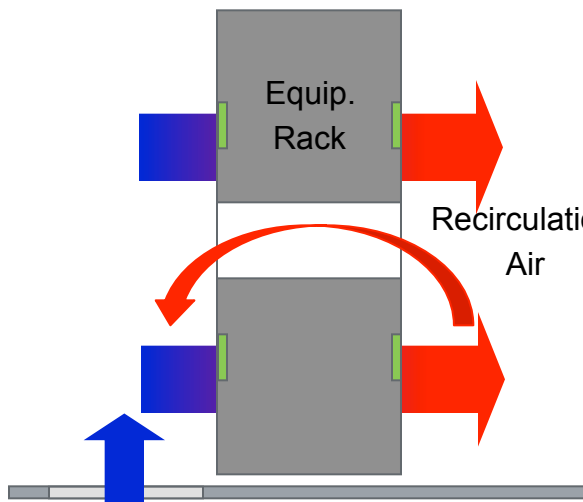

# Reduce Airflow Restrictions & Congestion

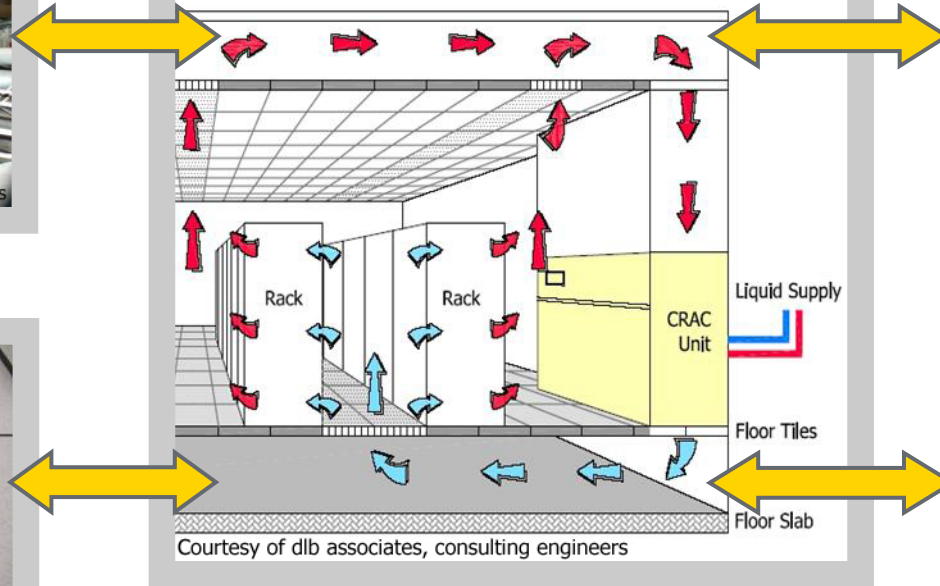
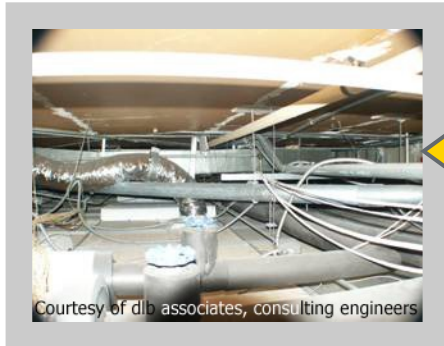

Congested Floor & Ceiling Cavities

Consider the Impact that Congestion Has on the Airflow Patterns



Empty Floor & Ceiling Cavities

# Reduce Cable Congestion

- Cable congestion sharply reduces airflow and degrades airflow distribution
- No cable trays should be placed below perforated tiles
- Generally, it is obvious when there is too much “*stuff*”

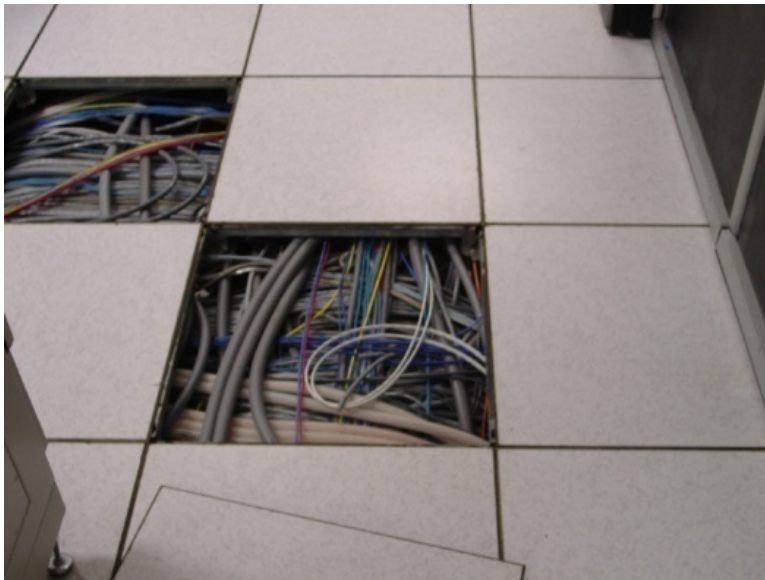

# Resolve Airflow Balancing

- Balancing is required to optimize airflow
- Rebalance with new IT or HVAC equipment
- Place perforated floor tiles *only* in cold aisles

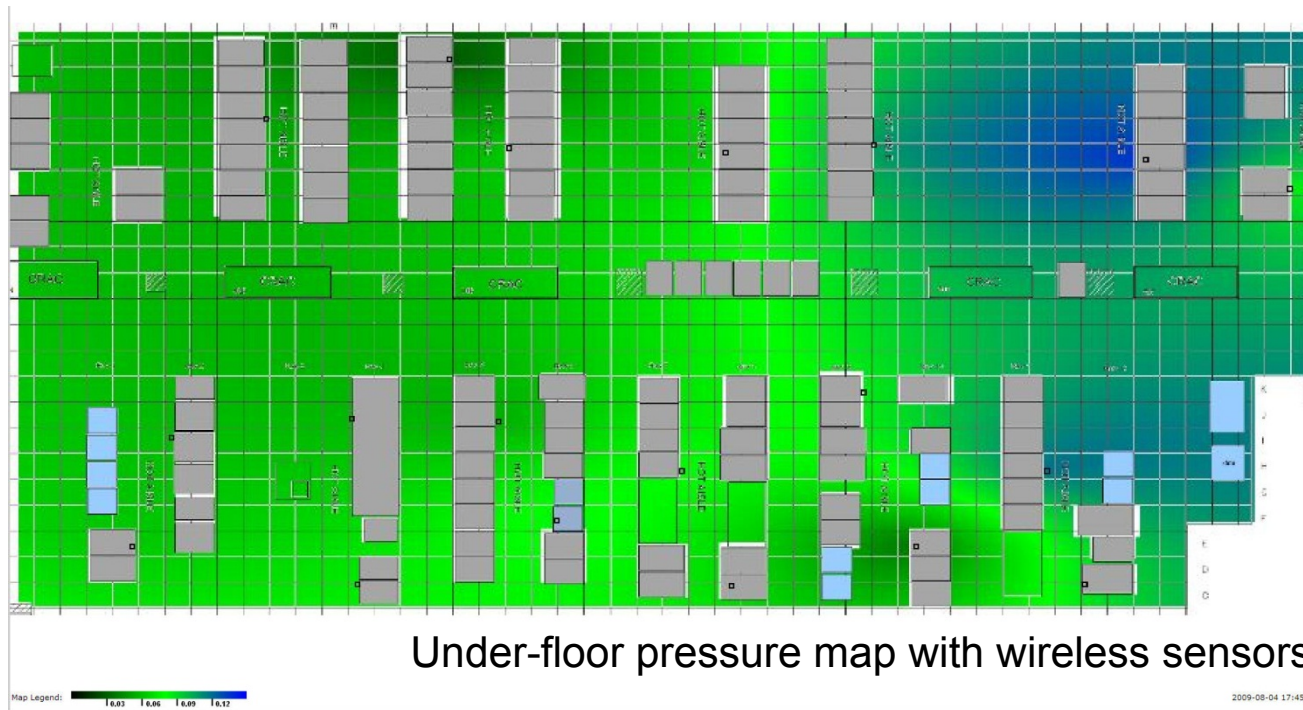

# Results: Tune Floor Tiles

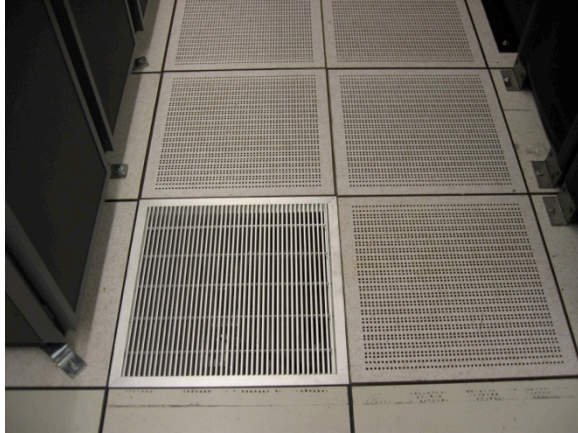

- Too many permeable floor tiles
- If airflow is optimized
  - under-floor pressure  $\uparrow$
  - rack-top temperatures  $\downarrow$
  - data center capacity increases
- Measurement and visualization assisted the tuning process

under-floor pressures

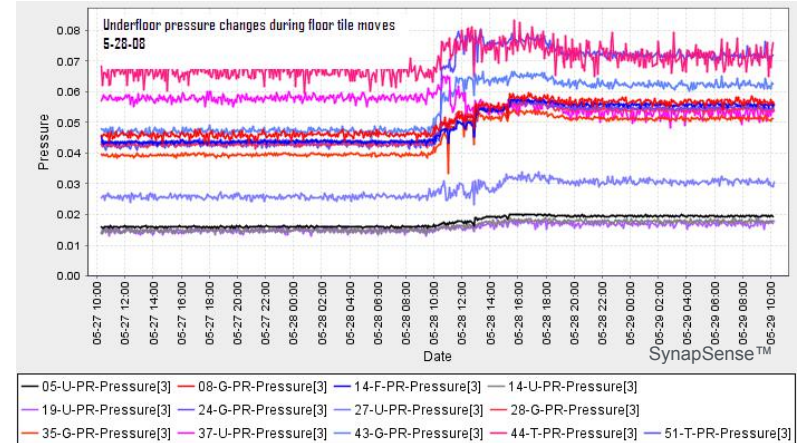

rack-top temperatures

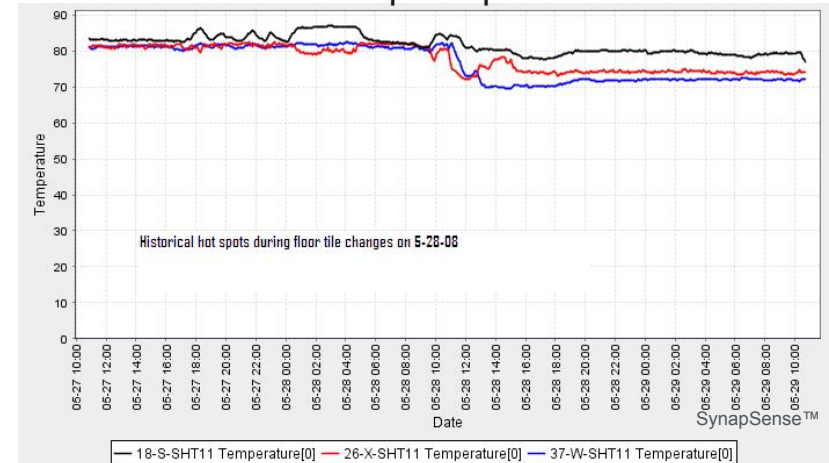

# Optimally Locate CRAC/CRAHs

At ends of hot aisles:

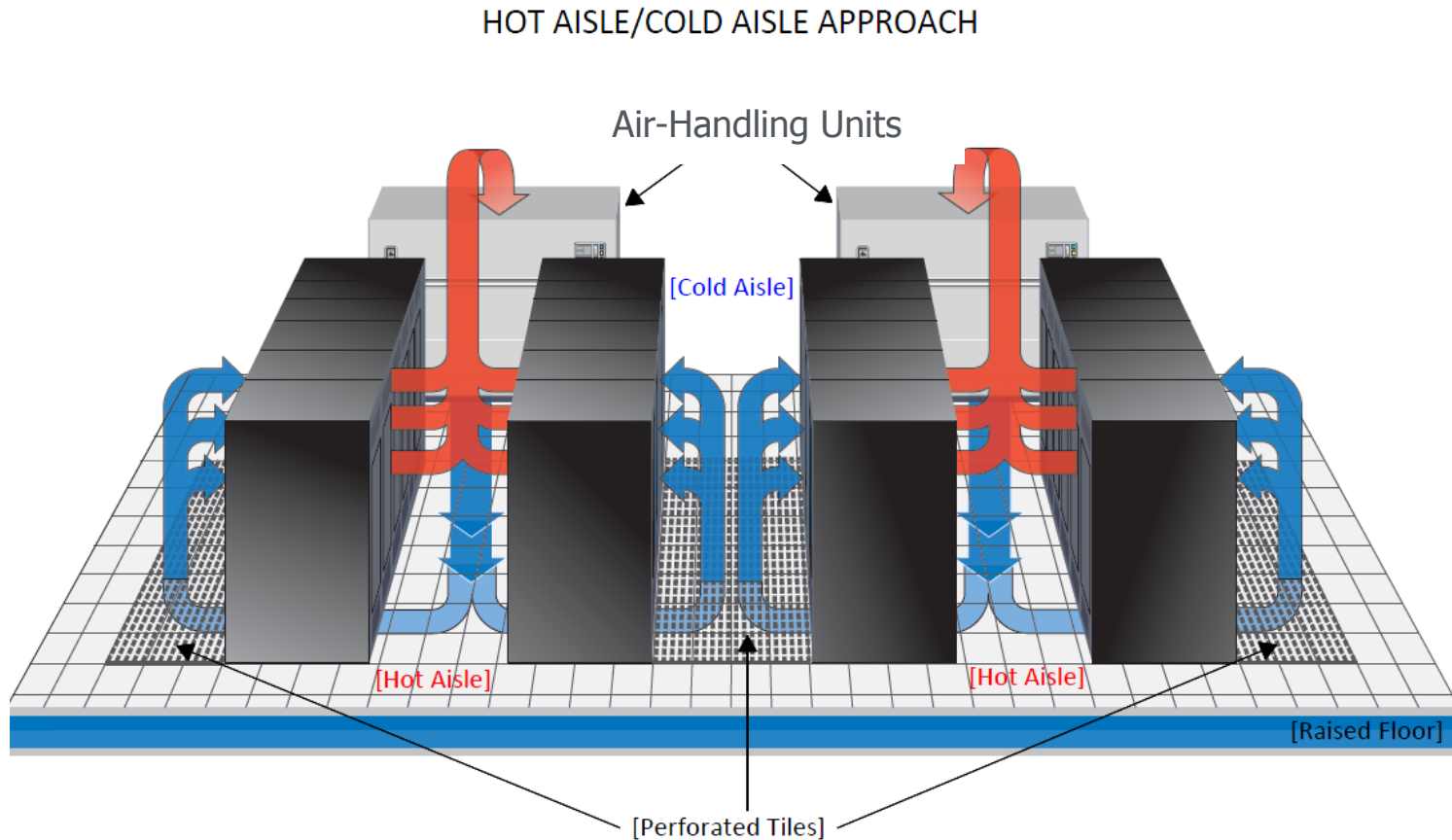

# Typical Temperature Profile with Under-floor Supply

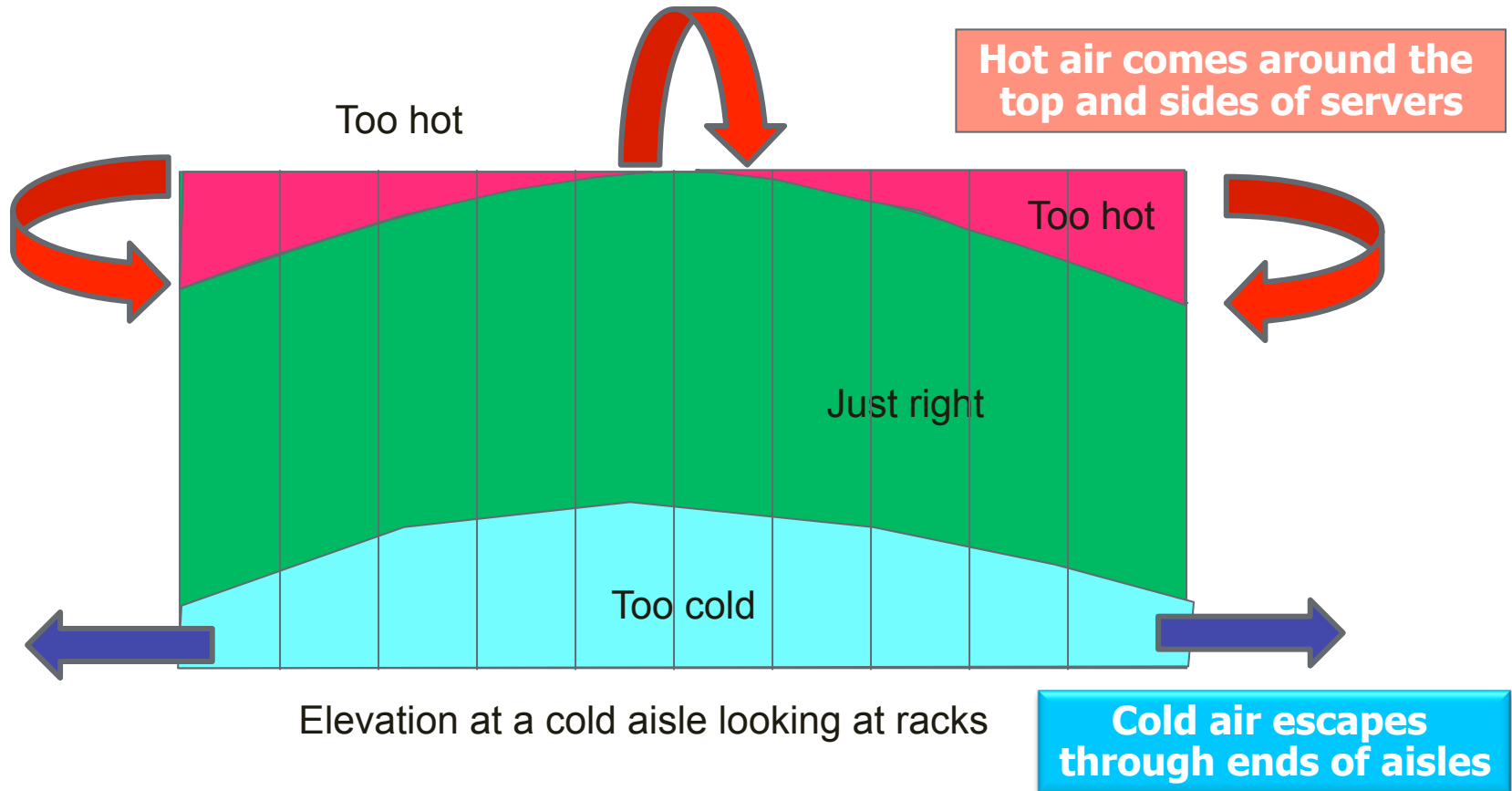

There are numerous references in ASHRAE.  
See for example V. Sorell et al; "Comparison of Overhead and Underfloor Air Delivery Systems in a Data Center Environment Using CFD Modeling"; ASHRAE Symposium Paper DE-05-11-5; 2005.



# Next step: Air Distribution Return-Air Plenum

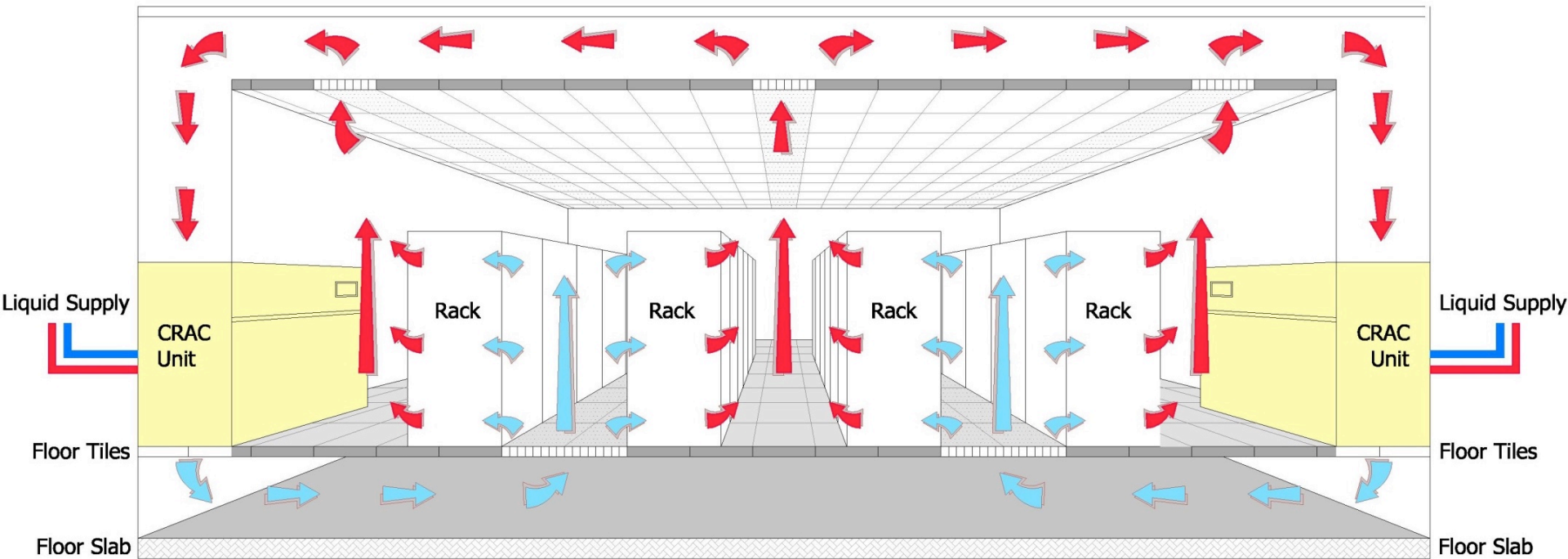

# LBNL Improved Air Management

- Overhead plenum converted to hot-air return (A)
- CRAC intakes extended to overhead plenum (B)
- Return registers placed over hot aisle (C)



Before



After

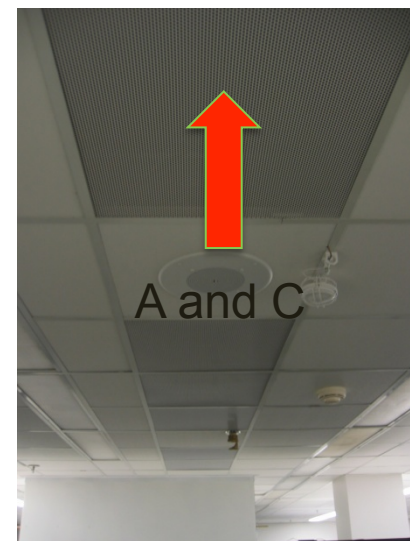

# Return-Air Plenum Connections

Isolate return air at CRAC/CRAH:



# Enhanced Isolation Options

- Physical barriers enhance separate hot and cold airflow
- Barrier placement must comply with fire codes
- Curtains, doors, or lids have been used successfully

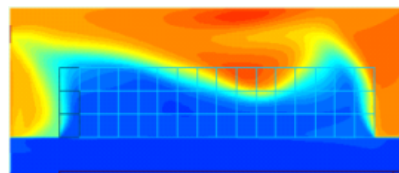
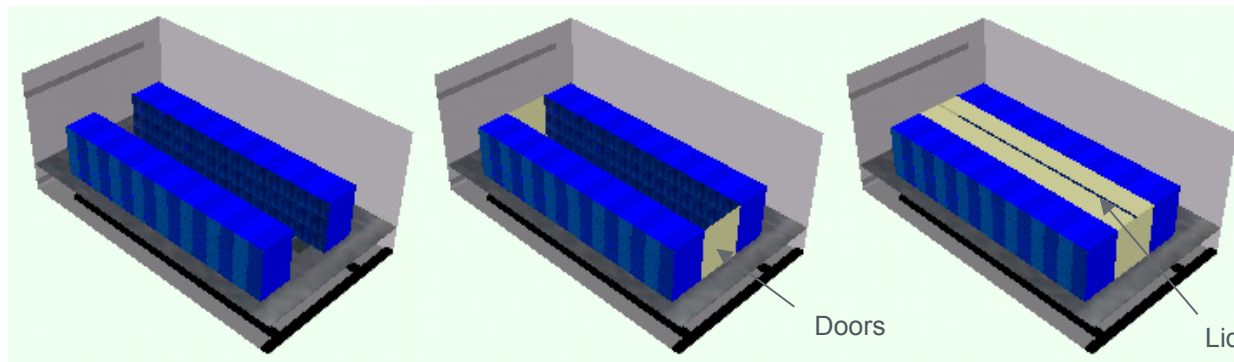

Open

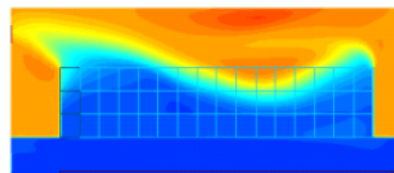

Semi-enclosed  
cold aisle

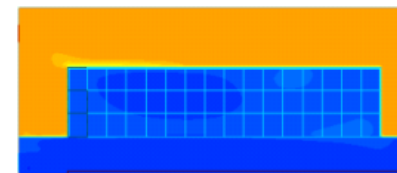

Enclosed  
cold aisle

# Adding Air Curtains for Hot/Cold Isolation



# Air Management: Separate Cold and Hot Air

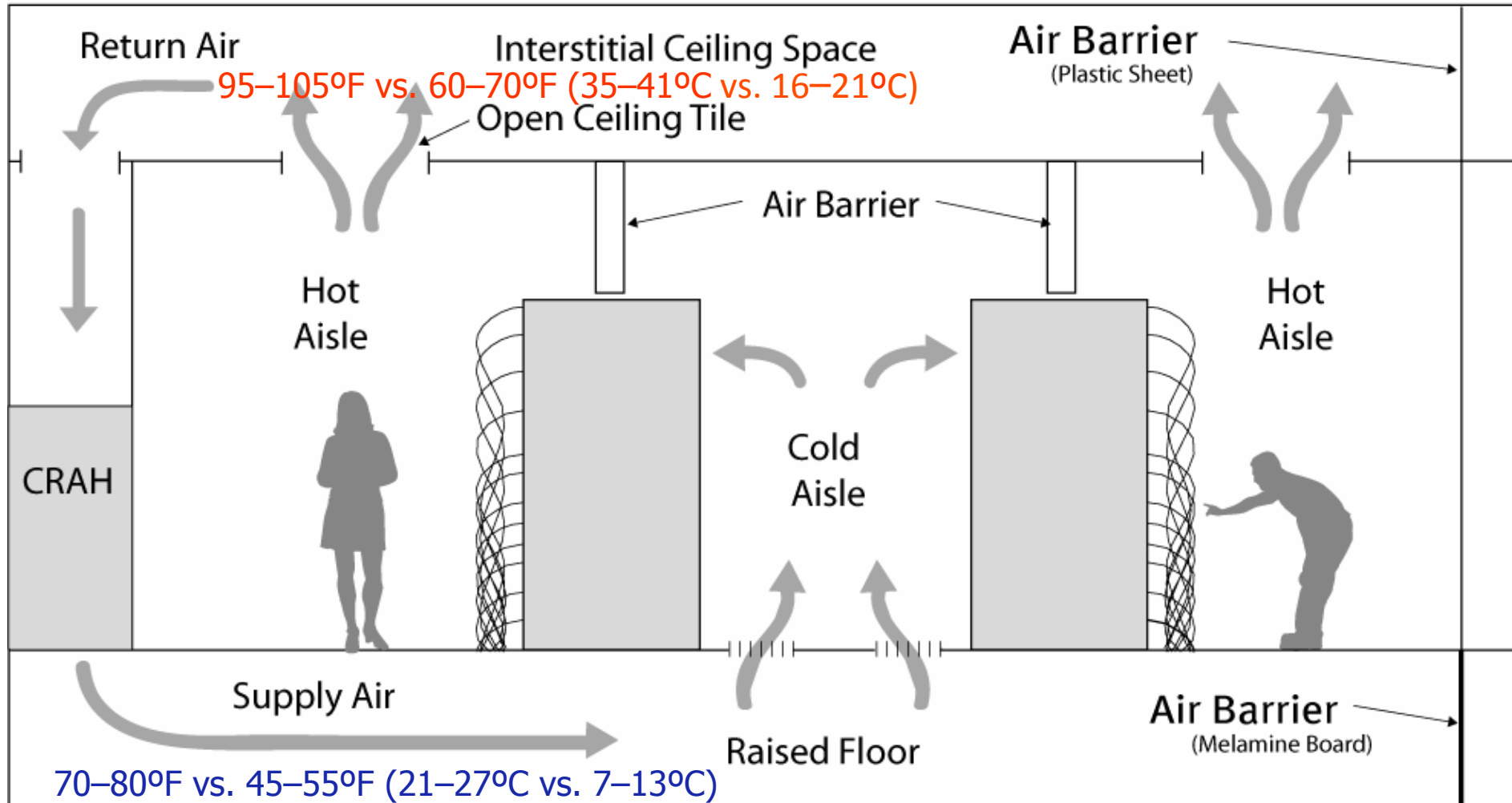

# Cold Aisle Airflow Containment Example

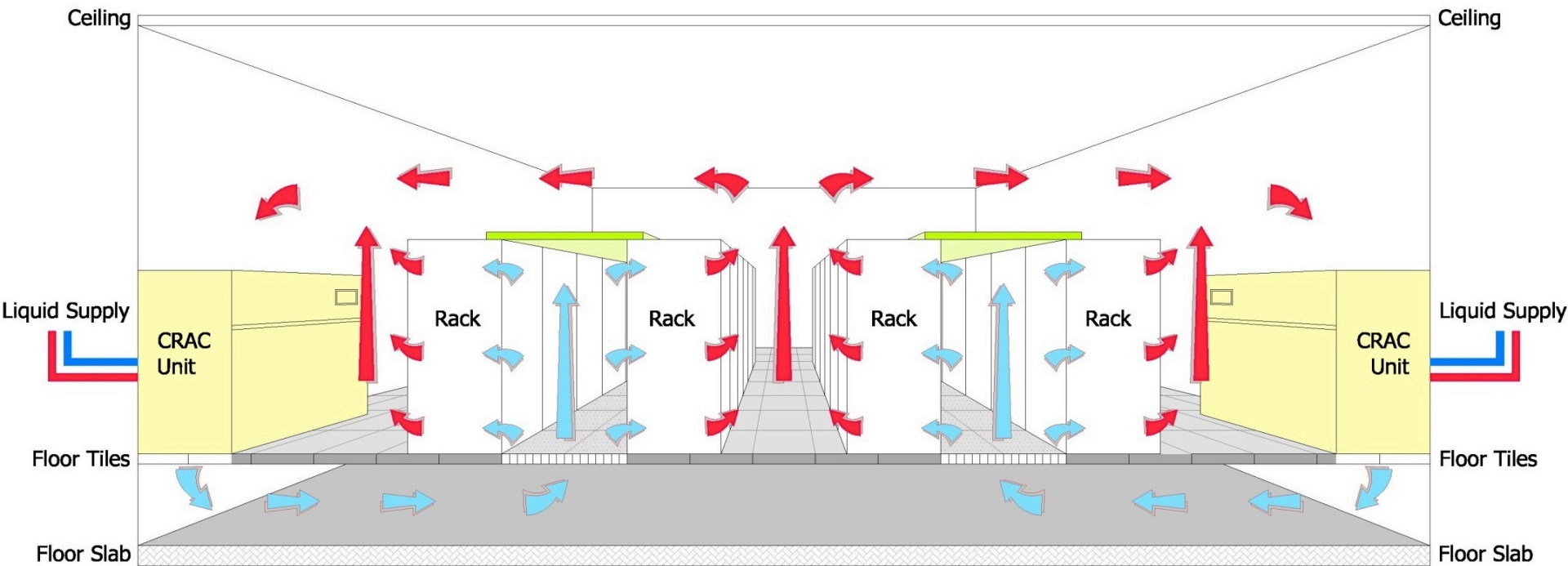

LBNL's Cold Aisle Containment study achieved fan energy savings of ~75%

# Fan Energy Savings

- Isolation significantly reduces bypass air, which in turn allows reduction of supply airflow
- Fan speed can be reduced, and fan power is proportional to nearly the cube of the flow
- Fan energy savings of 70%–80% is possible with variable air volume (VAV) fans

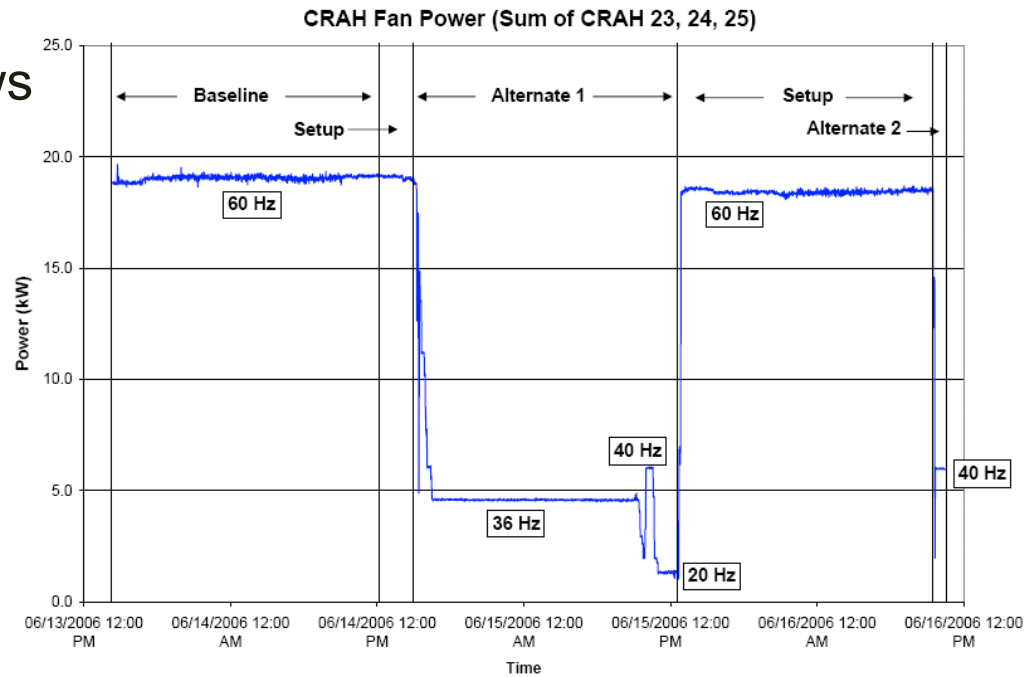

Without Enclosure

With Enclosure

Without Enclosure



# LBNL Air Management Demonstration

Better airflow management permits warmer supply temperatures!

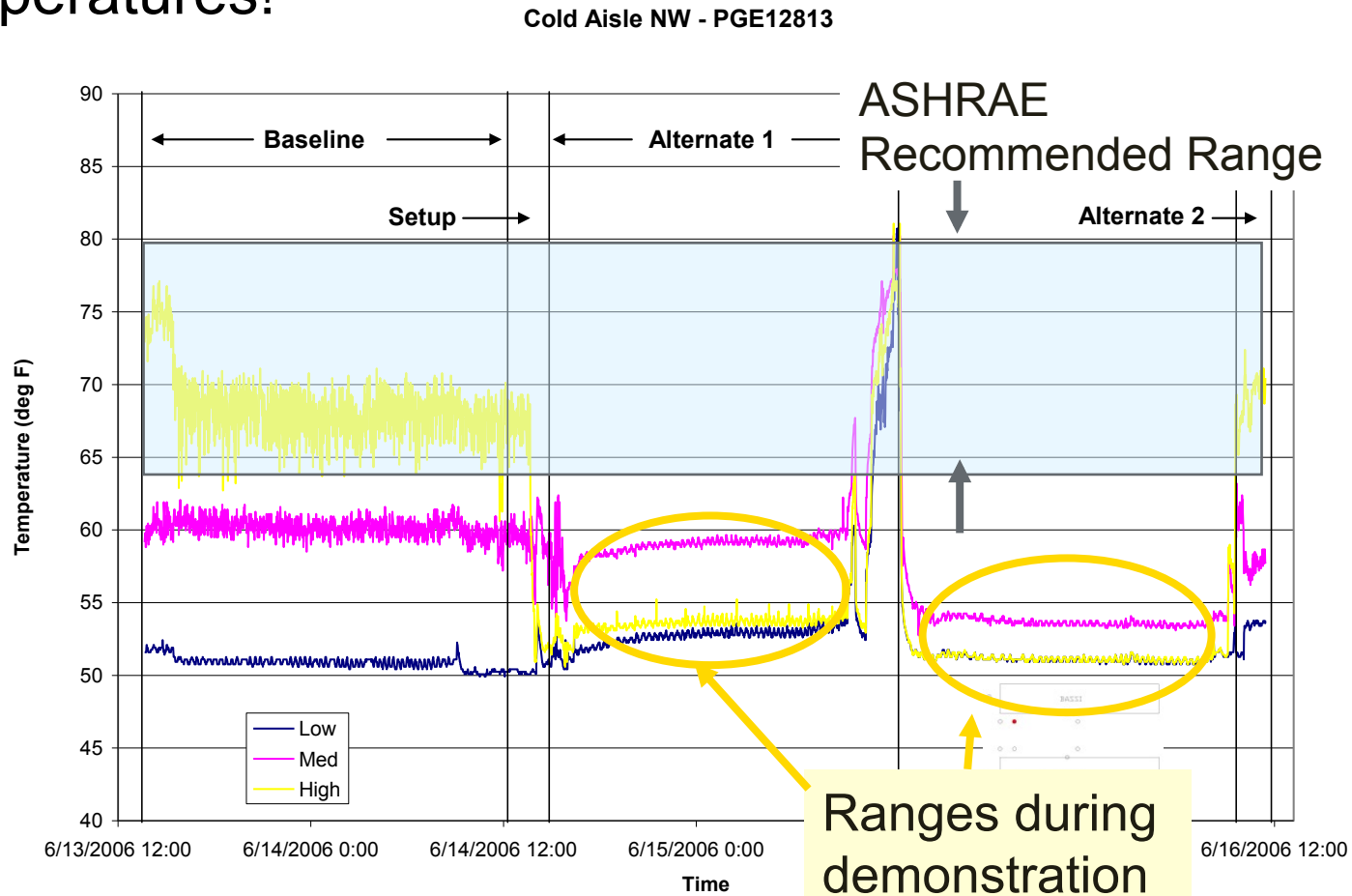

# Hot and Cold Aisle Containment

## Subzero Cold Aisle Containment

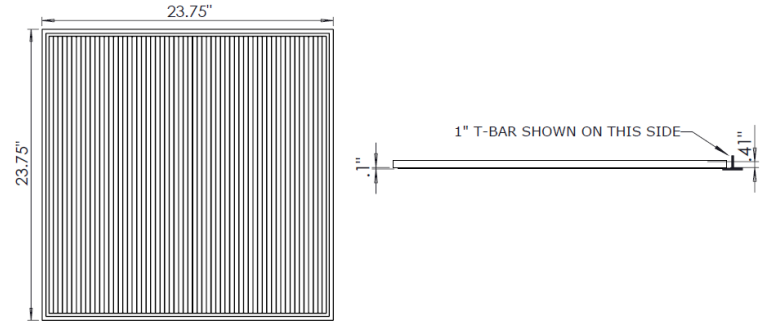

APC Hot Aisle Containment  
(with in-row cooling)

## Ceilume Heat Shrink Tiles



# LBNL Air Management Improvement Effort

- Perform CFD modeling
- Deploy a wireless monitoring system
- Identify opportunities for improvement
  - Enforce hot aisle/cold aisle arrangement
  - Use blanking panels
  - Improve airflow and under-floor pressure by tuning floor tiles
  - Reduce mixing and short circuits
  - Convert overhead plenum to return
  - Extend CRAC intakes into overhead plenum
  - Add air curtains to improve isolation.

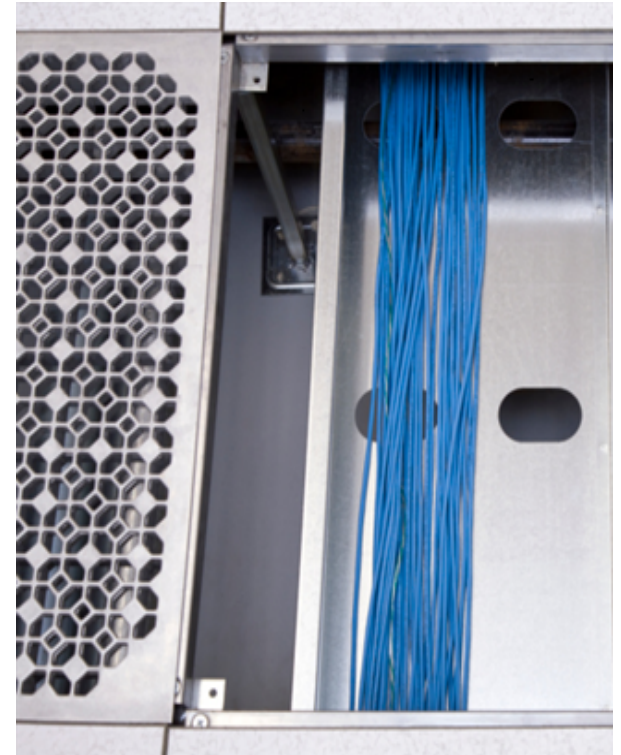

# Isolated Hot Return



Duct on top of each server rack connects to the overhead return air plenum



# Cabinet/Row Containment

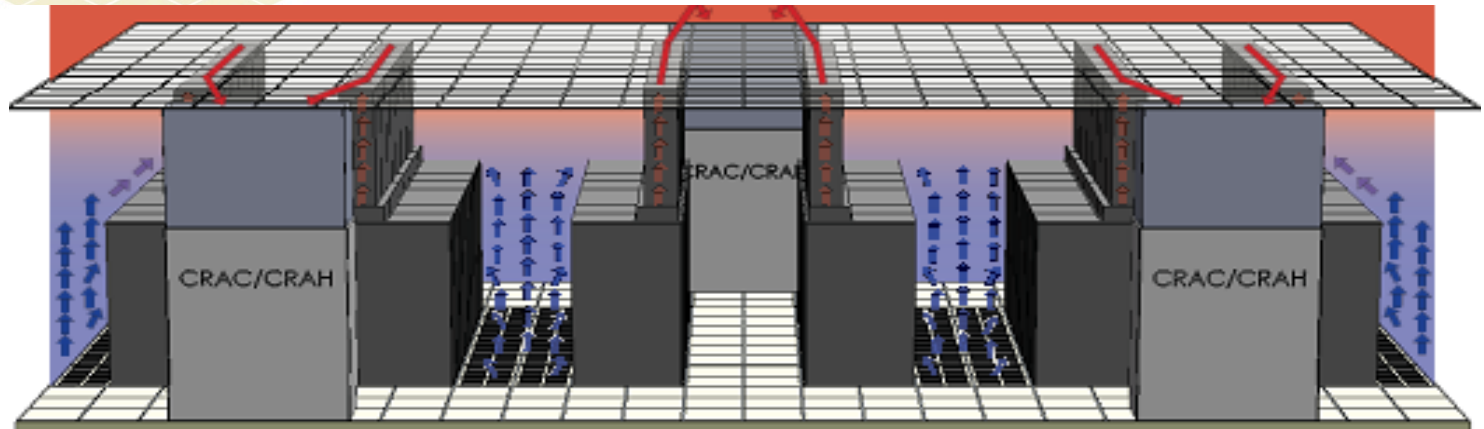
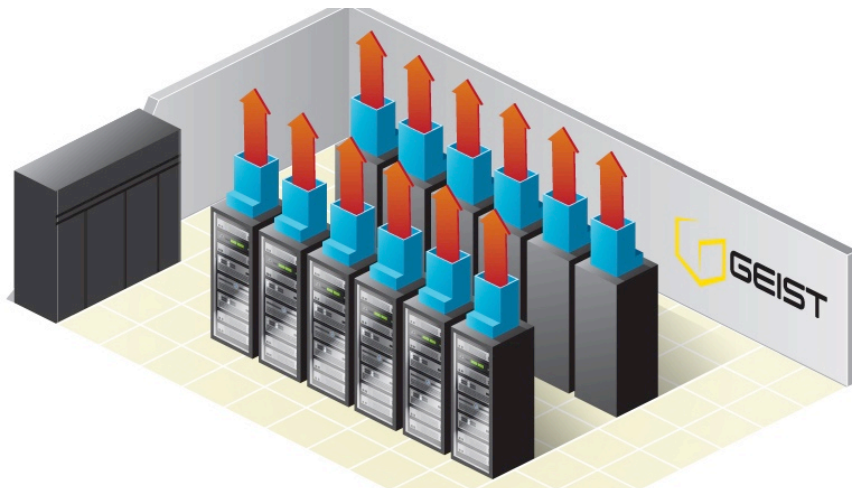

## geist's ACTIVE CABINET or ROW BASED containment method

- + No hot air mixing, no wrap around heating, NO HOT SPOTS
- + Actively balances return airflow to server usage
- + Complete hot air separation enabling highest CRAC/CRAH return air temperatures
- + Eliminates raised floor pressure balancing issues making it suitable for slab environments
- + Data center floor becomes a cold aisle providing comfortable working conditions
- + 1:1 airflow balance makes cooling over-provision unnecessary

# Isolating Hot and Cold Aisles Summary

- Energy intensive IT equipment needs good isolation of “cold” intake and “hot” exhaust
- Supply airflow can be reduced if no bypass occurs (assuming VFD fans)
- Supply temperature can be raised if air is delivered without mixing
- Chillers and economizers are more efficient with warmer return air temperatures
- Cooling and raised-floor capacity increase with air management

# Efficient Alternatives to Under-Floor Air Distribution

- Overhead air distribution is common in telecom centers (raised floor not required)
- Localized air cooling systems with hot and cold isolation can supplement or replace under-floor systems
- Examples
  - Row-based cooling units
  - Rack-mounted heat exchangers
- Both options “pre-engineer” hot and cold isolation

# Example - Local In-Row Based Cooling

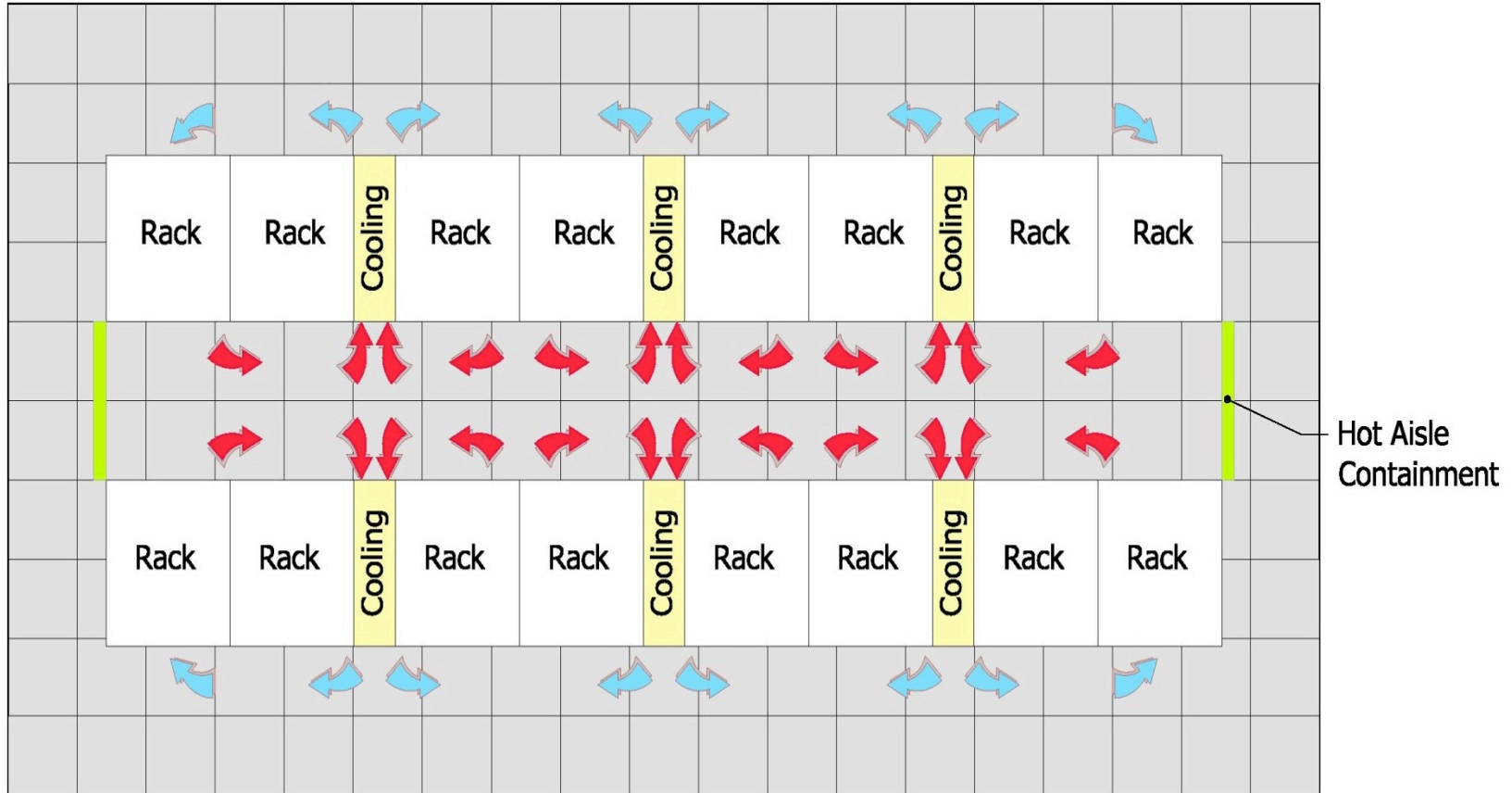



# In-Row Cooling System

With hot aisle containment, the general data center space is neutral (75°F–80°F).

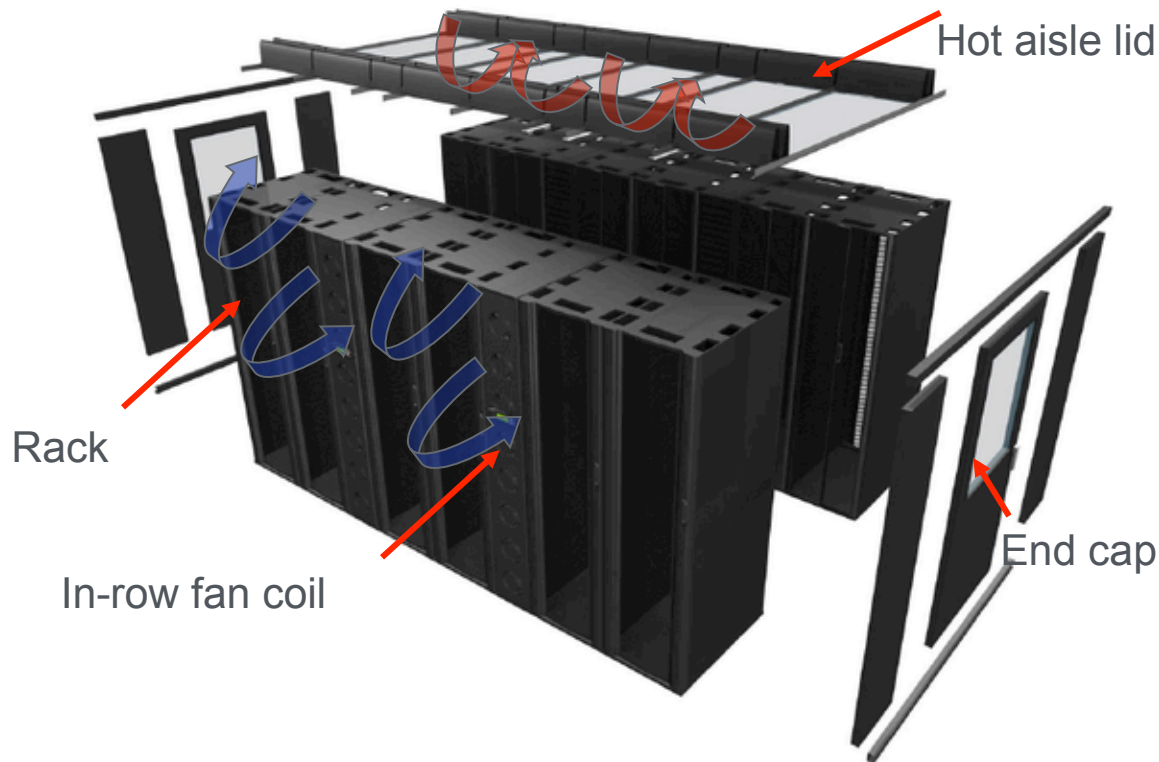

© APC, reprinted with permission

# Rack-Mounted Heat Exchangers (“Rear Doors”)

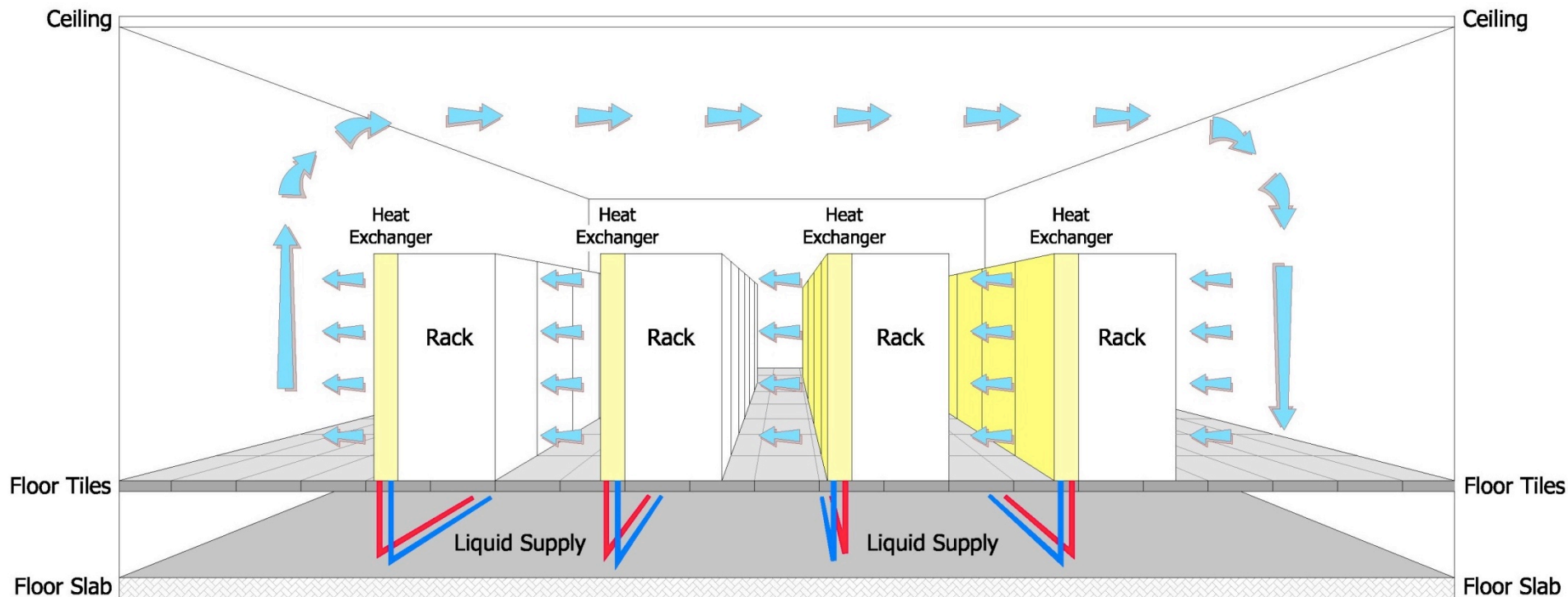

# Airflow Management Review

## Air management techniques:

- Seal air leaks in floor (e.g., cable penetrations)
- Prevent recirculation with blanking panels in racks
- Manage floor tiles (e.g., no perforated tiles in hot aisle)
- Improve isolation of hot and cold air (e.g., return air plenum, curtains, or complete isolation)

## Impact of good isolation:

- Supply airflow reduced
  - Fan savings up to 75%+
- Supply air temperature can be raised
  - Chiller efficiency improves
  - Greater opportunity for economizer operation (“free” cooling)
- Cooling and raised-floor capacity increases.

# Questions





# Cooling Systems

# HVAC Systems Overview

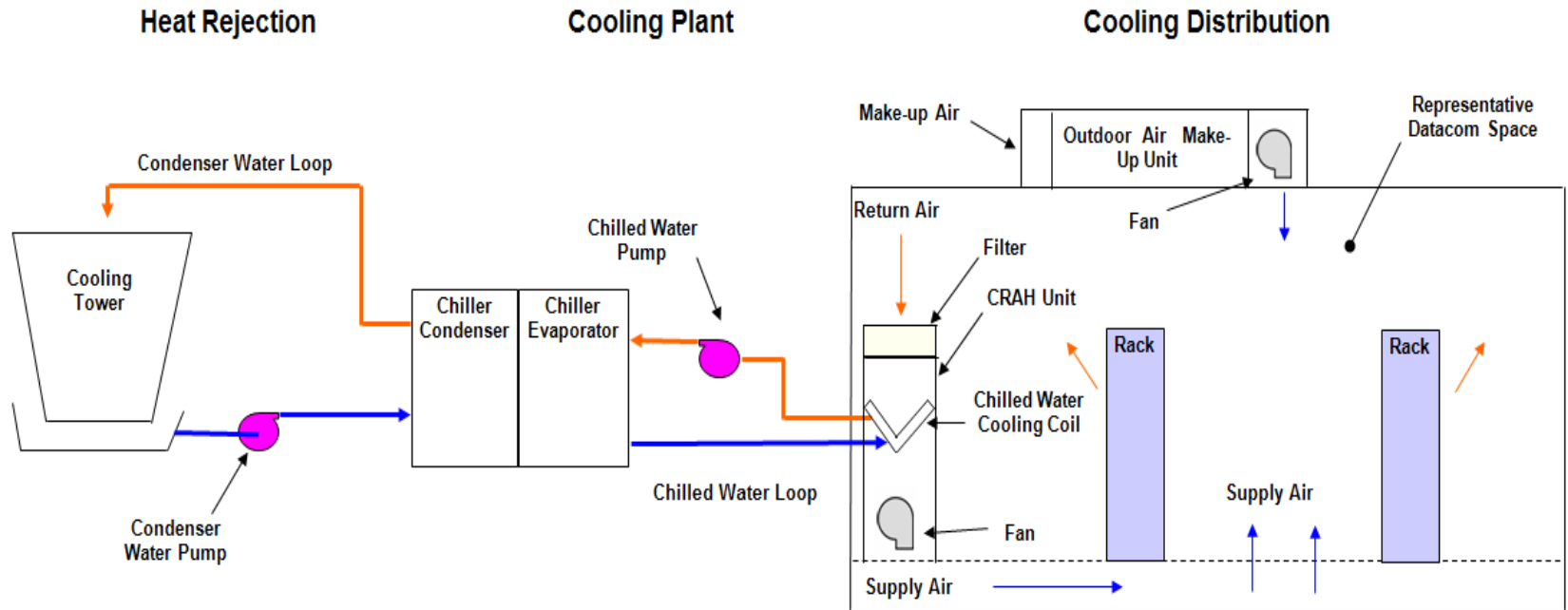

## Heat Rejection Alternatives:

- High Eff
- ↑  $\eta$
- Water Cooled Direct (shown)
  - Water Cooled Indirect (with HX)
  - Evaporatively Cooled
  - Air Cooled
  - Dry Cooler (Air Cooled with Glycol)
- Low Eff

## Cooling Plant Alternatives:

- Water-Side Economizer (HX)
- Chiller (shown)
- Direct Expansion (DX)

## Terminal Unit Alternatives

- Liquid Cooling
- Central AHU
- CRAH Unit (shown)
- CRAC Unit (DX)

## Distribution Alternatives

- On Board
- In Rack
- In Row
- Overhead Air
- Underfloor Air (Shown)

- High Eff
- ↑  $\eta$
- Low Eff

# Computer Room Air Conditioners (CRACs) and Computer Room Air Handlers (CRAHs)

## CRAC units

- Fan, direct expansion (DX) coil
- Refrigerant compressor

## CRAH units

- Fan and chilled water coil
- Typically in larger facilities with a chiller plant

## Both

- Often equipped with humidifiers and reheat for dehumidification
- Often independently controlled
  - Tight ranges and poor calibration may lead to in-fighting among units



# DX (or AC) units reject heat outside

Dry-Cooler DX



Air-Cooled DX



Evaporatively-Cooled DX

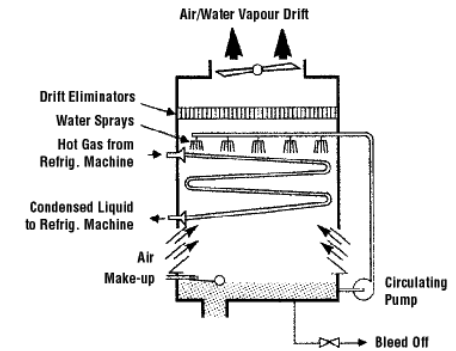

Water-Cooled DX

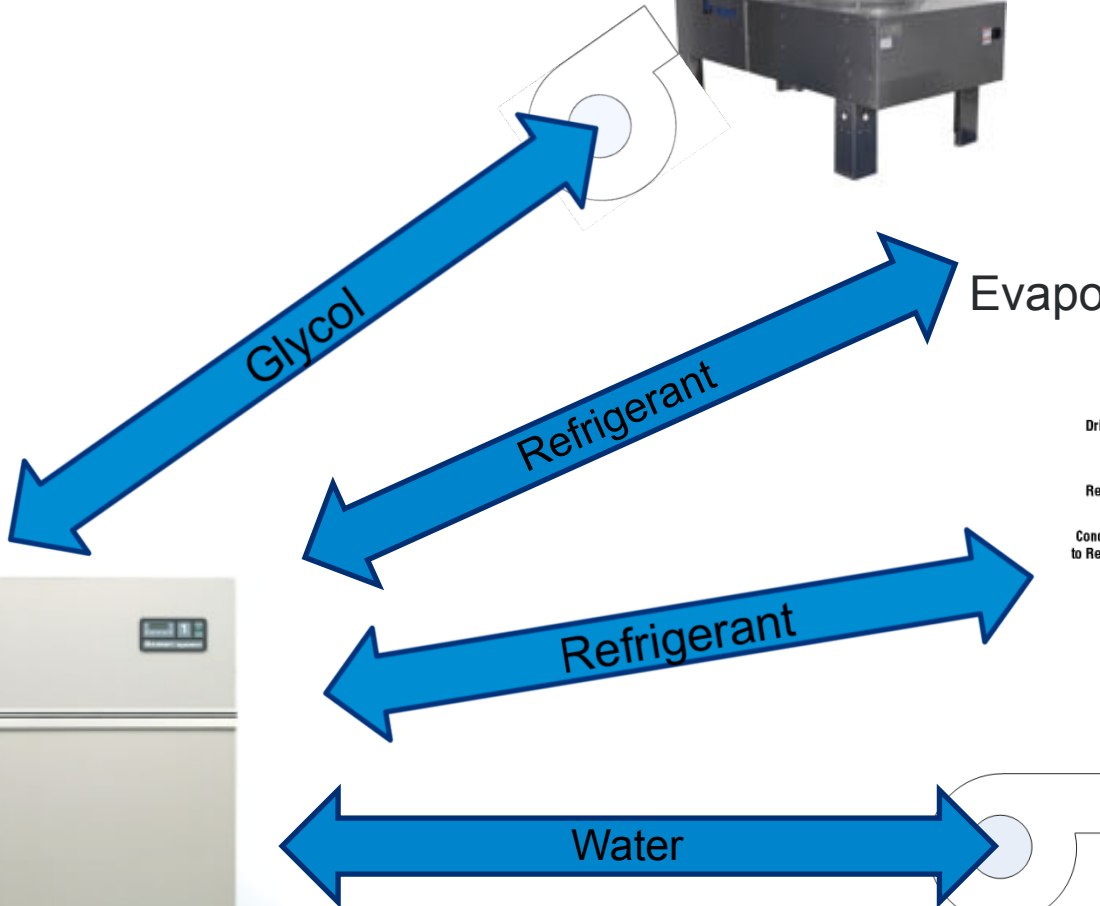
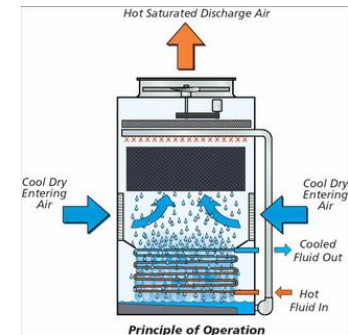



# Computer Room Air Handling (CRAH) units using Chilled-Water

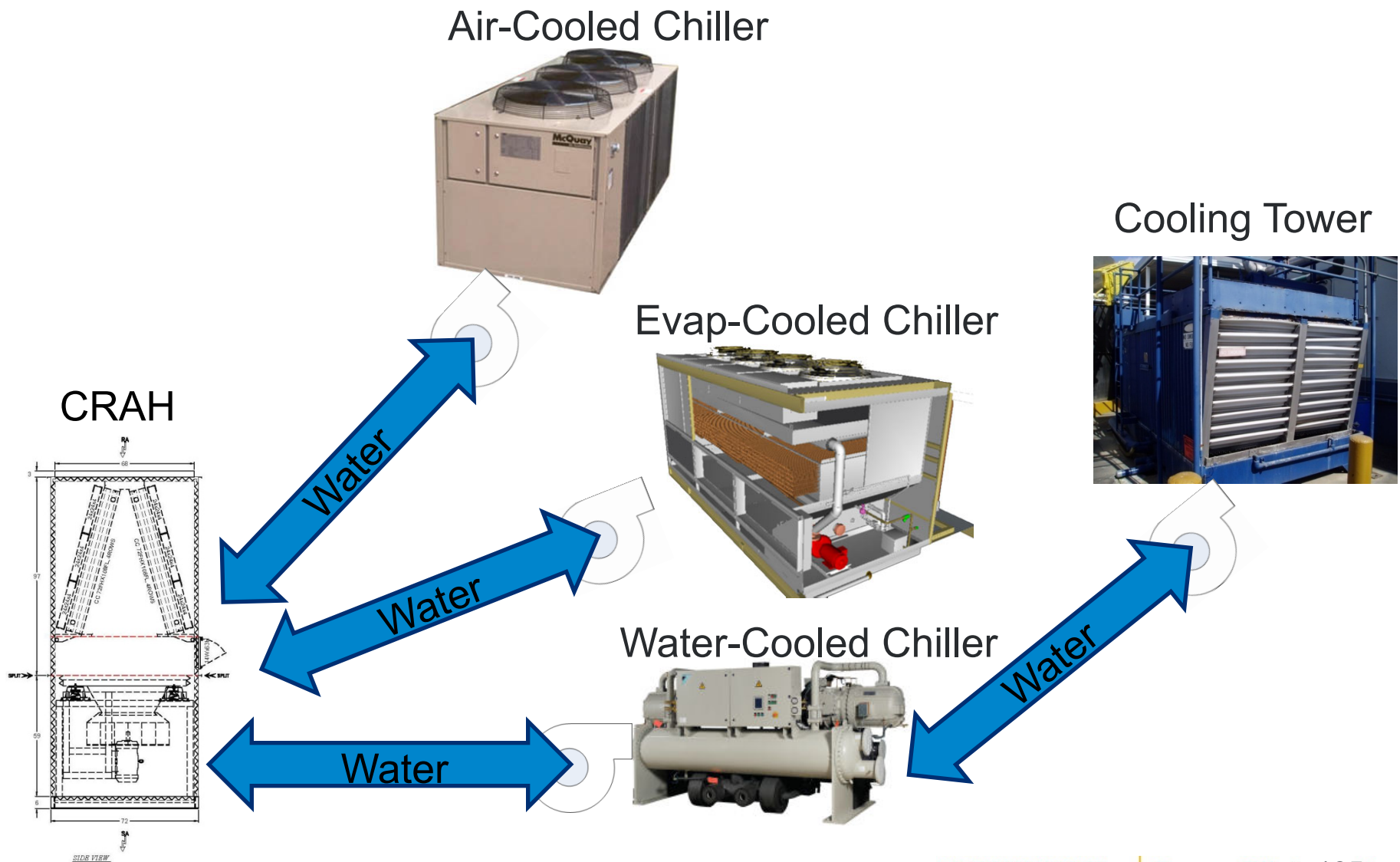

# Optimize the Chiller Plant

- Have a plant (vs. distributed cooling)
- Use “warm” water cooling (multi-loop)
- Size cooling towers for “free” cooling
- Integrate controls and monitor efficiency of all primary components
- Thermal storage
- Utilize variable speed drives “everywhere”:
  - Fans
  - Pumps
  - Towers
  - Chillers

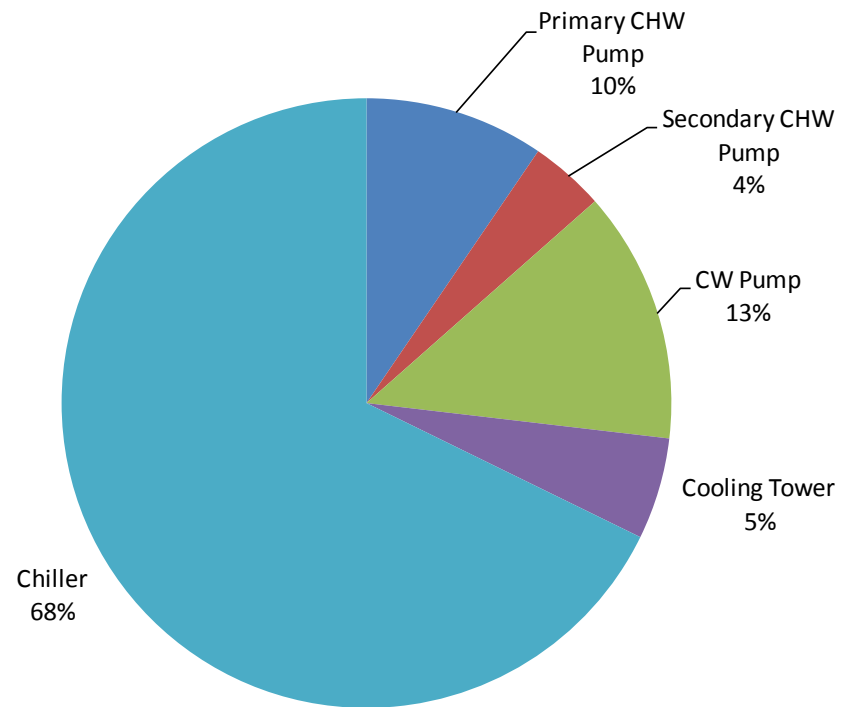

# Select Efficient Chillers

Chiller	Compressor kW / ton			
	25%	50%	75%	100%
<b>400-Ton Air Cooled</b>	<b>0.69</b>	<b>0.77</b>	<b>0.96</b>	<b>1.25</b>
<b>1,200-Ton Water Cooled w/o VFD</b>	<b>0.51</b>	<b>0.41</b>	<b>0.45</b>	<b>0.55</b>
<b>1,200-Ton Water Cooled with a VFD</b>	<b>0.34</b>	<b>0.30</b>	<b>0.43</b>	<b>0.57</b>

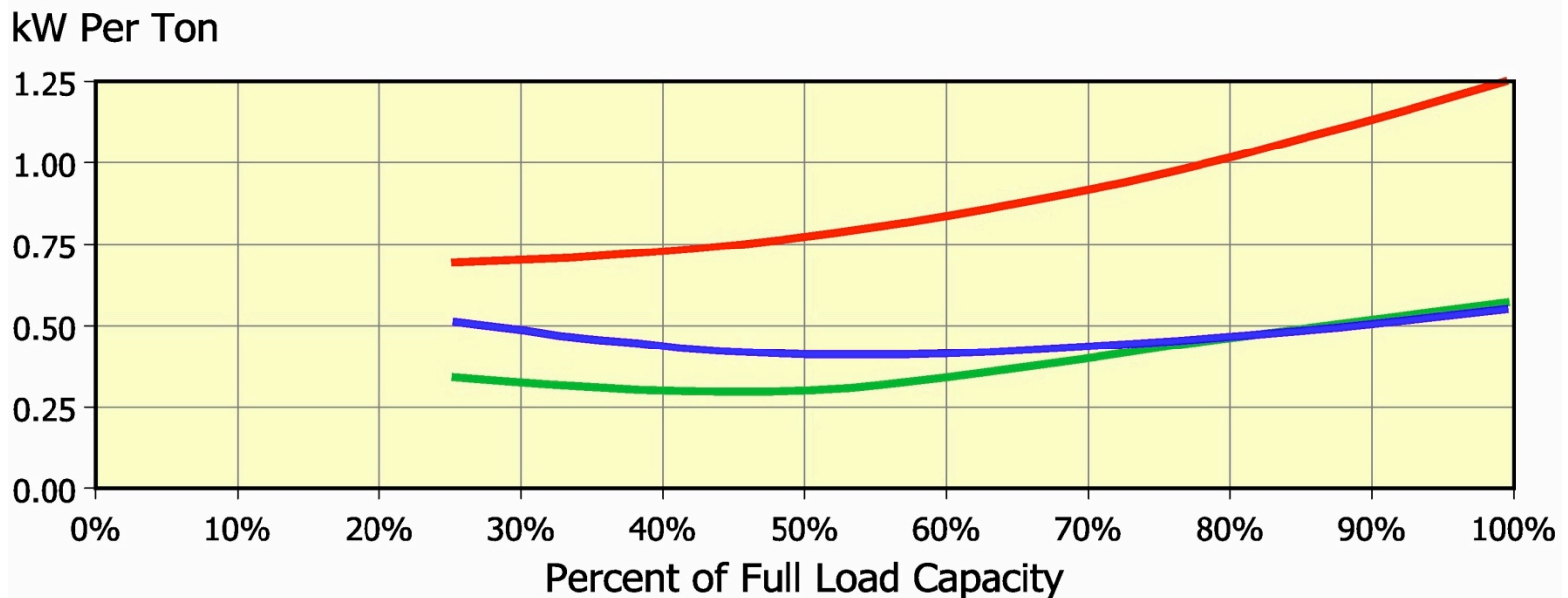

# Increase Temperature of Chilled Water

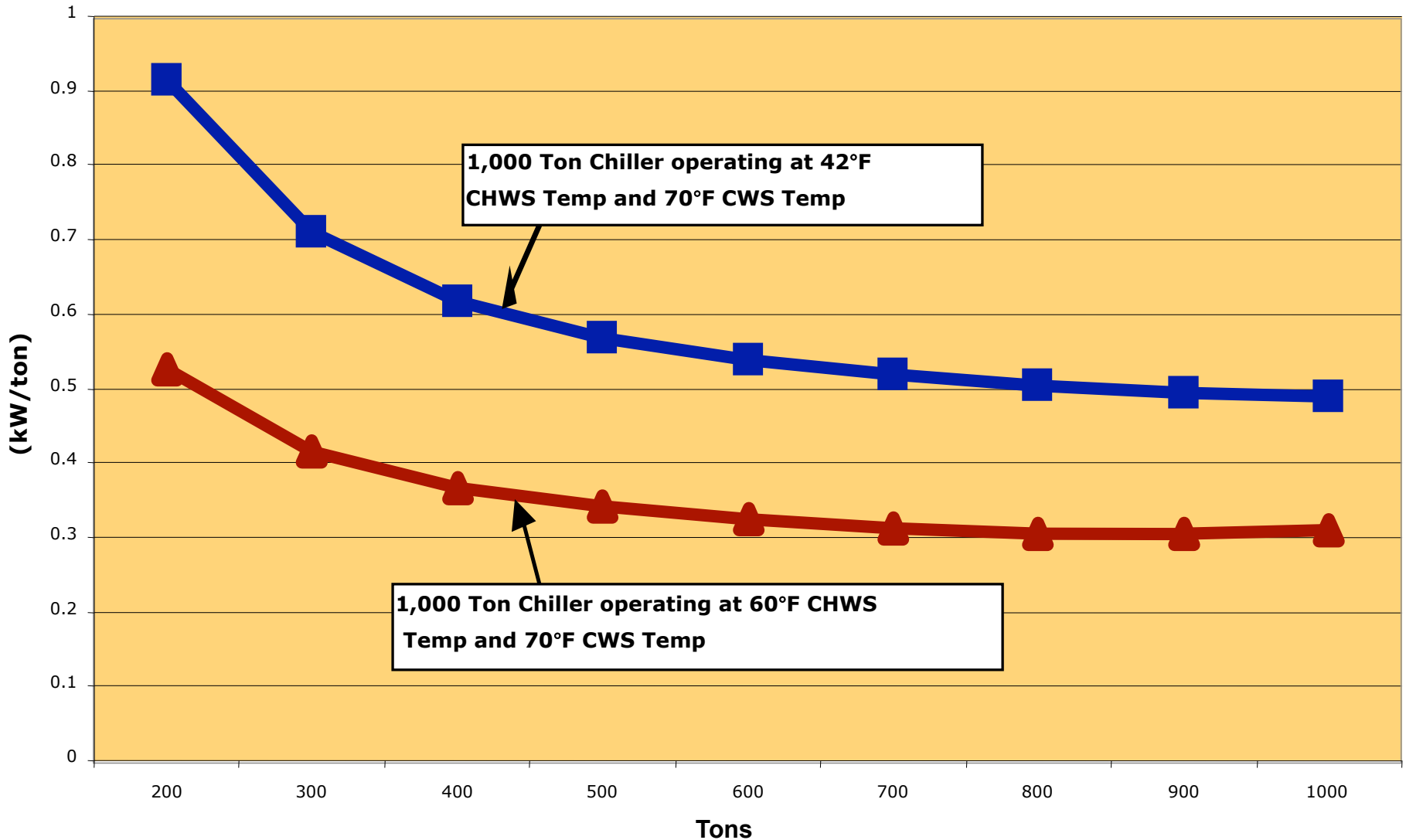

Data provided by York International Corporation

# Moving (Back) to Liquid Cooling

- As heat densities rise, liquid solutions become more attractive
- Volumetric heat capacity comparison

(5,380 m<sup>3</sup>)



Water

=



Air

# Why Liquid Cooling?

- Heat removal efficiency increases as the liquid gets closer to the heat source
- Liquids can provide cooling with a higher temperature coolant
  - Improved cooling efficiency
  - Increased economizer hours
  - Greater potential use of waste heat
- Reduced transport energy:

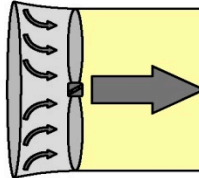
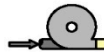
Heat Transfer		Resultant Energy Requirements			
Rate	$\Delta T$	Heat Transfer Medium	Fluid Flow Rate	Conduit Size	Theoretical Horsepower
10 Tons	12°F	Forced Air 	9217 cfm	34" Ø	3.63 Hp
		Water 	20 gpm	2" Ø	.25 Hp

# In-Row Liquid Cooling

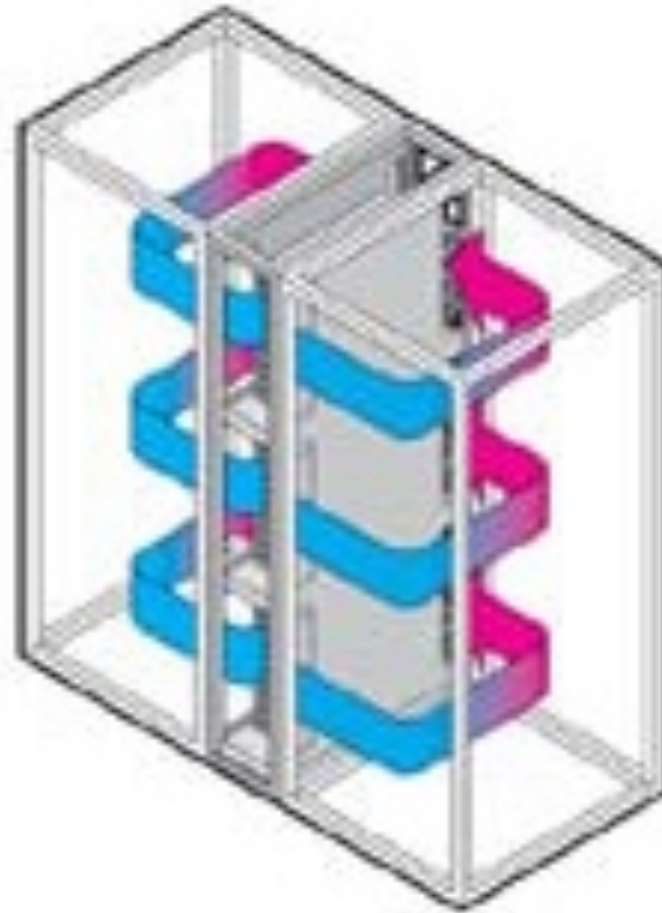

Graphics courtesy of Rittal

# In-Rack Liquid Cooling

Racks with integral coils and full containment:

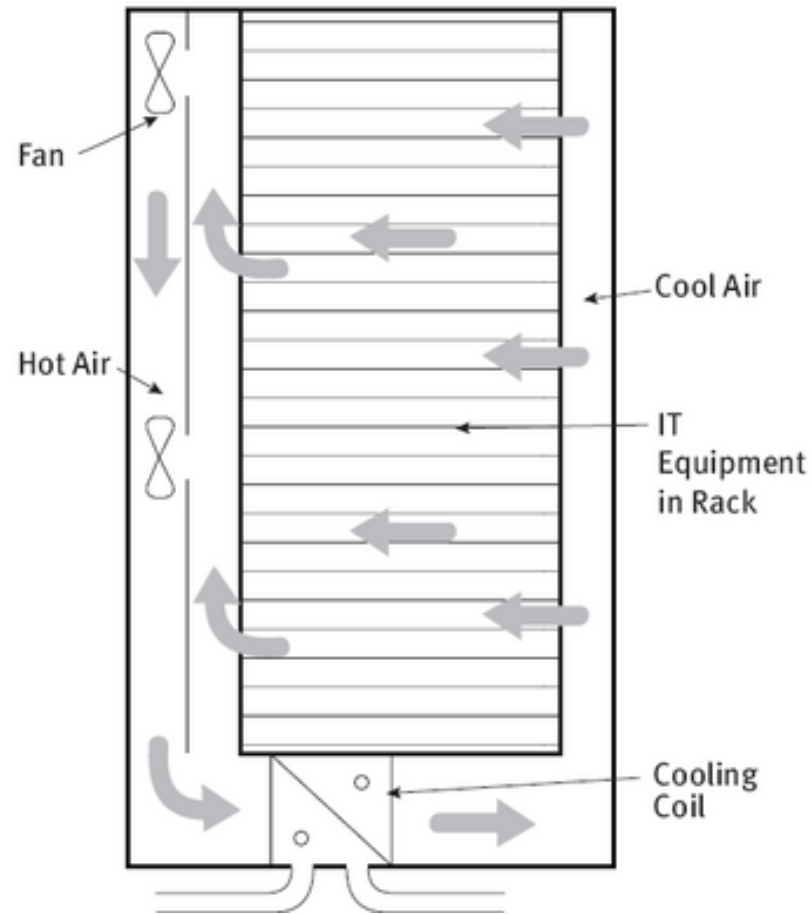
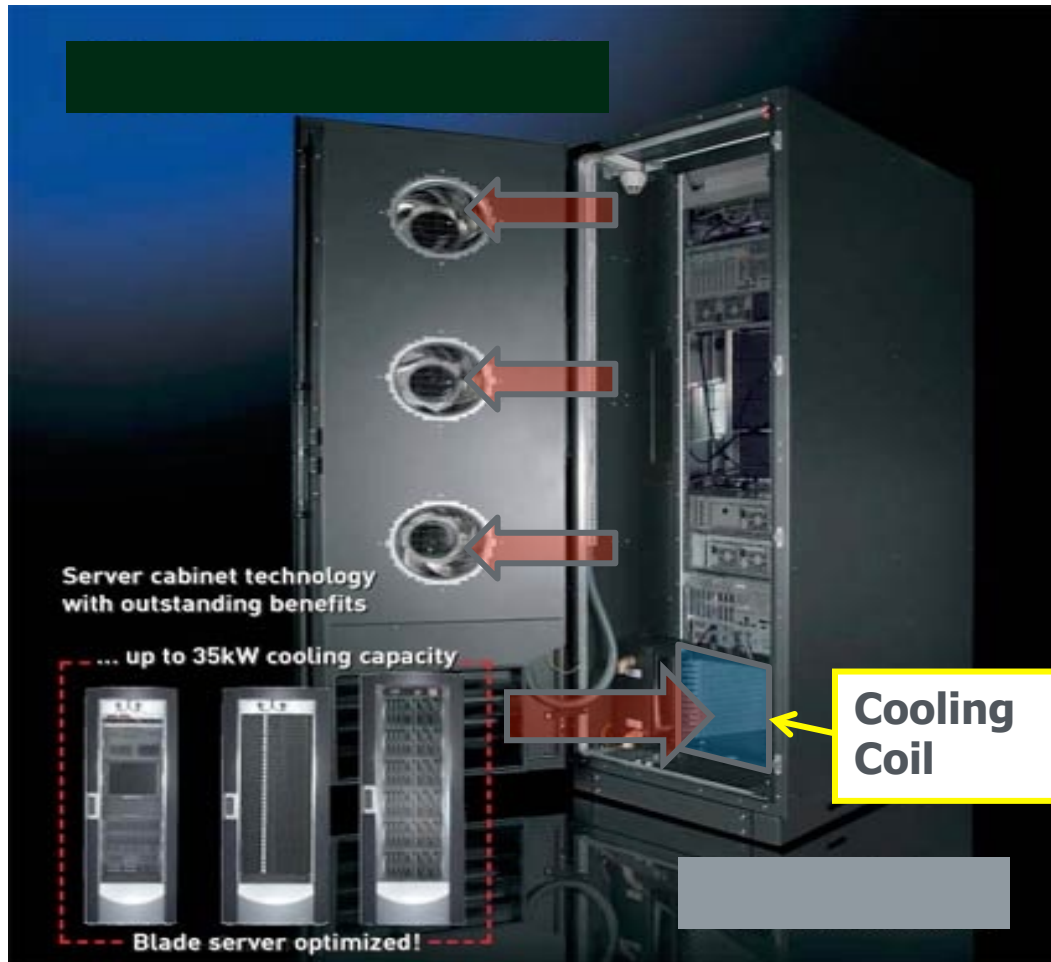



# Rear-Door Heat Exchanger

- Passive technology: relies on server fans for airflow
- Can use chilled or higher temperature water for cooling



Photo courtesy of Vette

# Rear-Door Liquid Cooling

Rear Doors (closed)



Inside rack RDHx, open 90°

Liquid Cooling Connections



# Liquid On-Board Cooling

- Clustered Systems design
- Conducting heat to a cold plate containing refrigerant

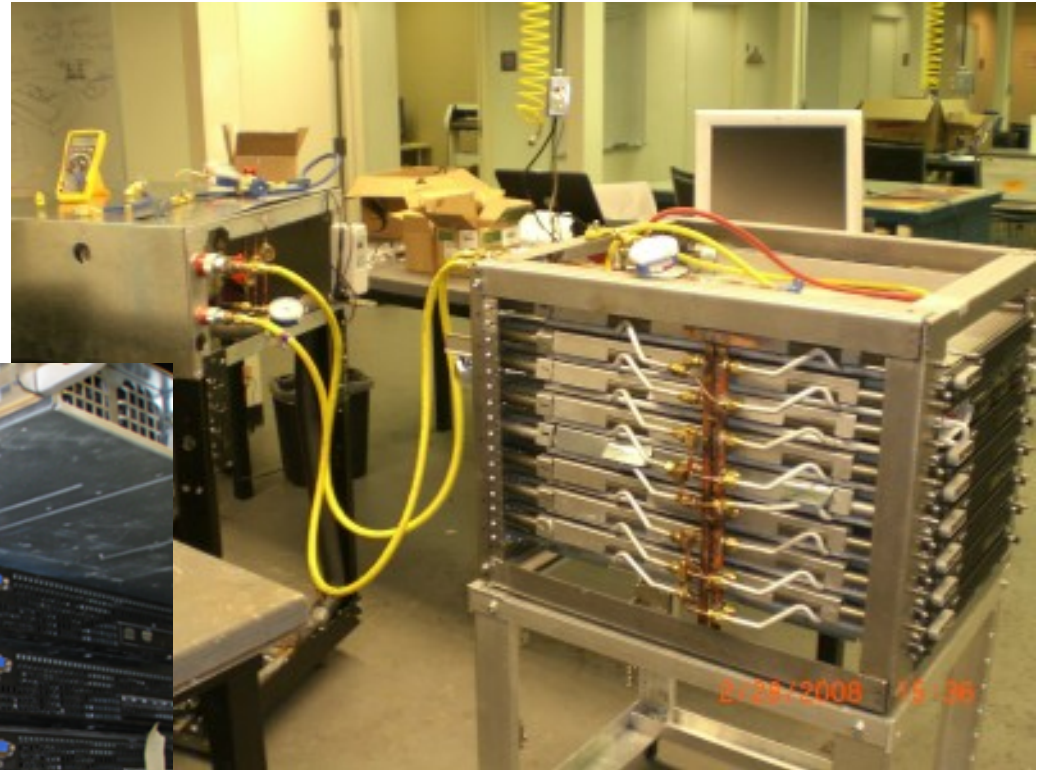

# Liquid On-Board Cooling

- Server fans are removed
- Heat risers connect to the top plate, which has a micro channel heat exchanger

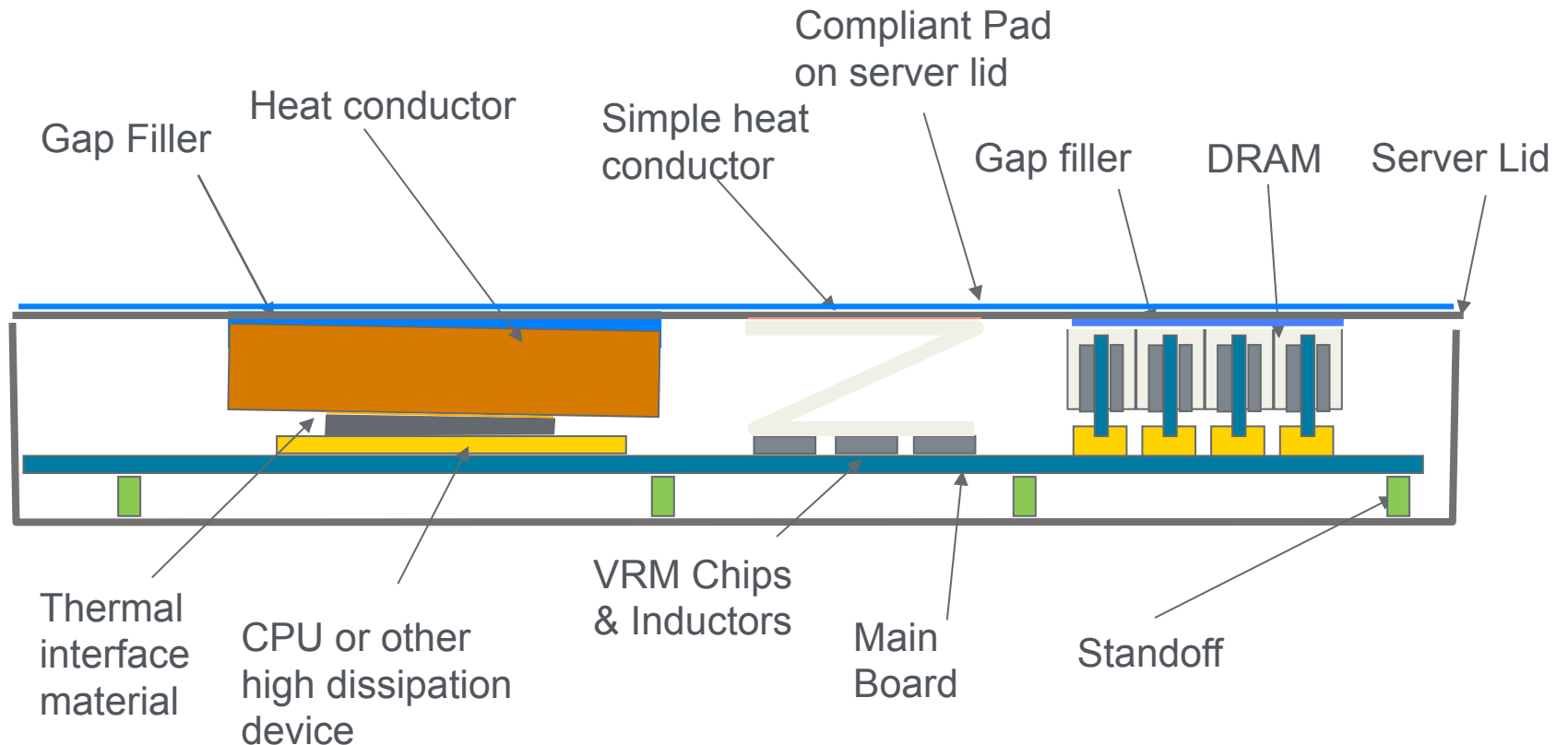

# Liquid On-Board Cooling

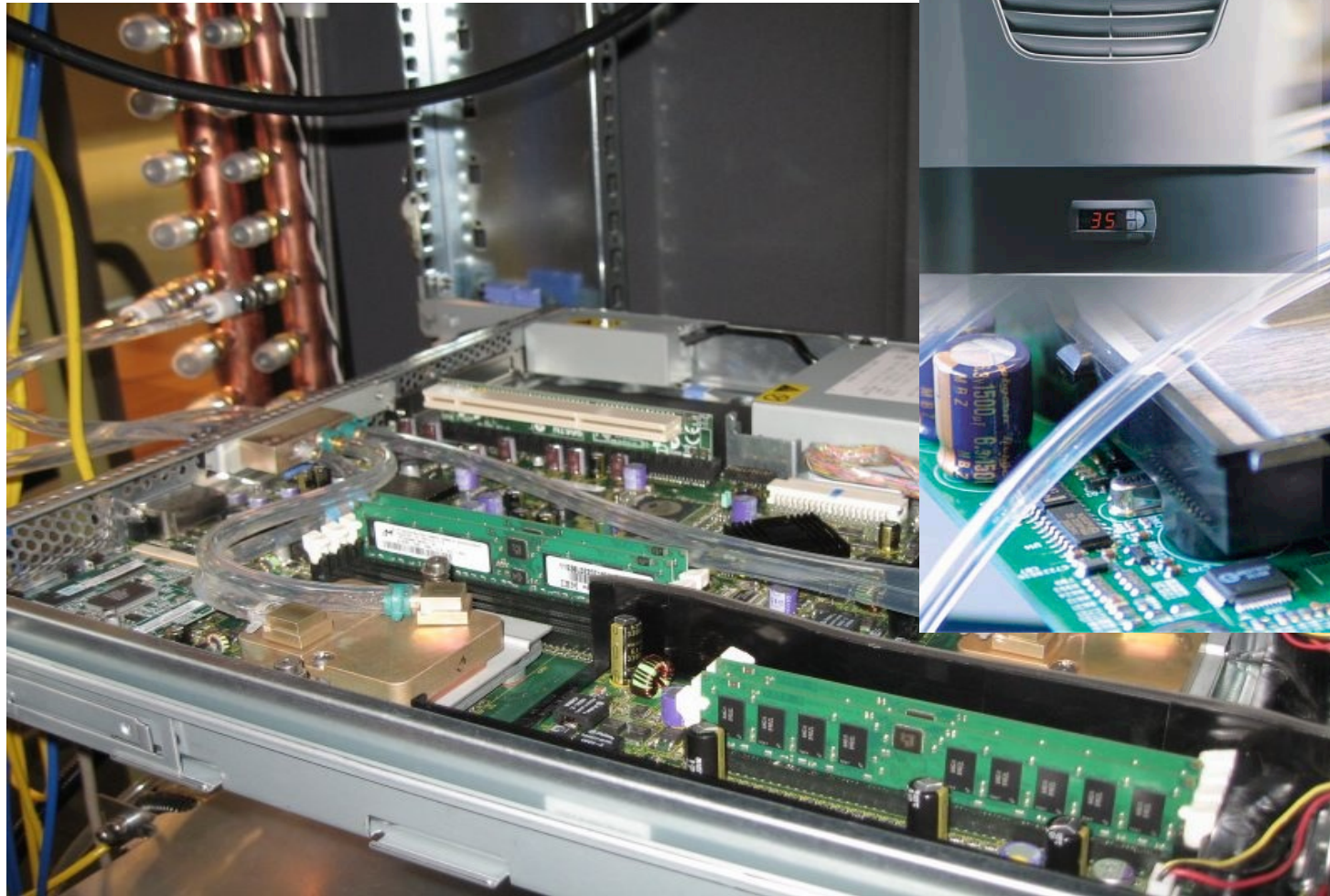

# Maui HPC Center Warm Water Cooling

IBM System x iDataPlex



90% water cooled, 10% air cooled

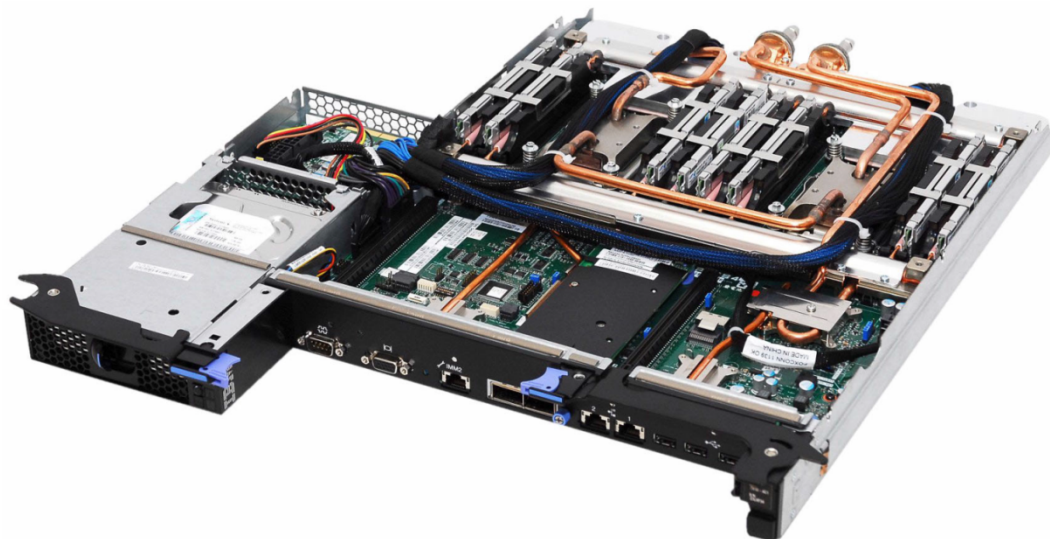

Water inside

# MHPCC Water Cooling, continued

Water piping behind the servers



Cooling water temperature as high as 44°C

Dry Coolers, 10 kW each  
compared to 100 kW Chillers



# Liquid Immersion Cooling Demonstration

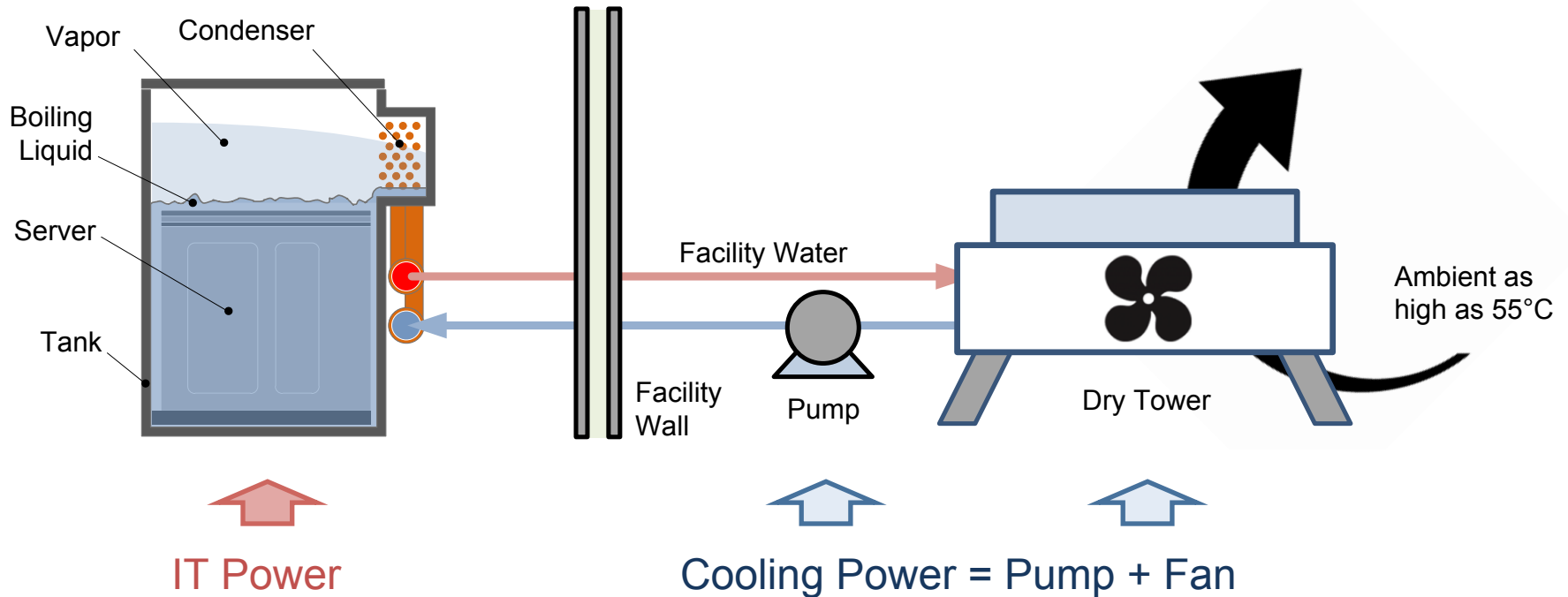

## No longer requirements:

- chillers
- cooling towers
- water use
- raised floors
- computer room air conditioners
- earplugs!



# Phase Change of Dielectric Fluid Removes Heat Efficiently

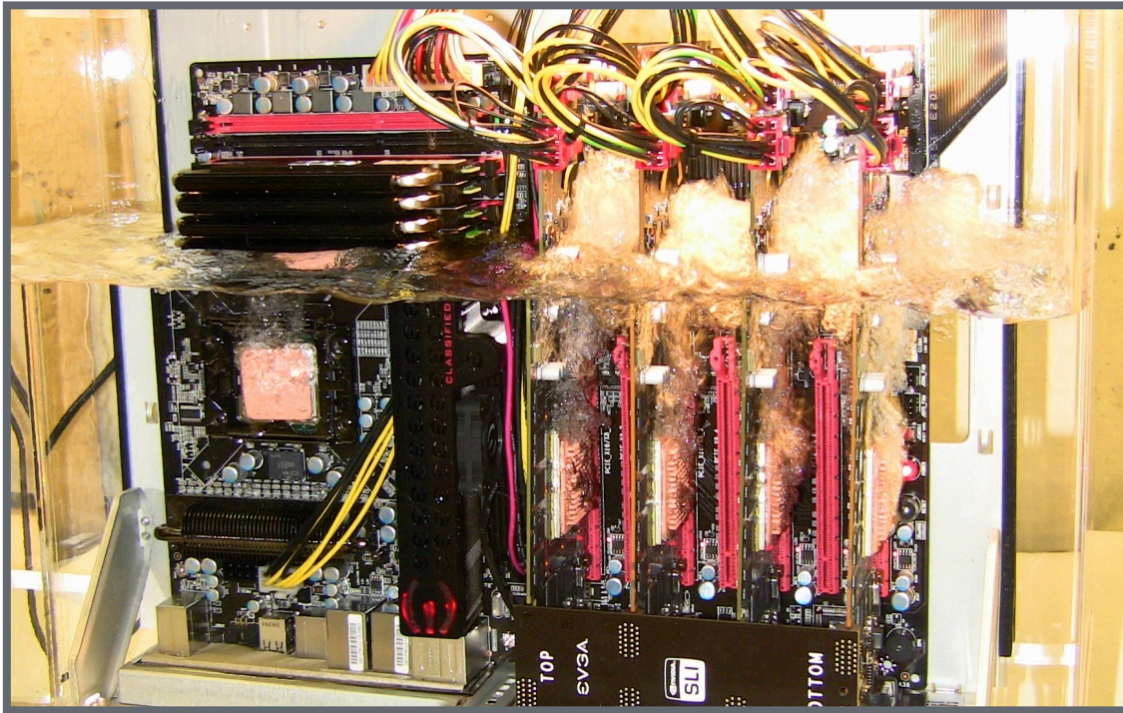

Computer in glass tank



3M Corp.  
4 server system

# “Chill-Off 2” Evaluation of Liquid Cooling Solutions

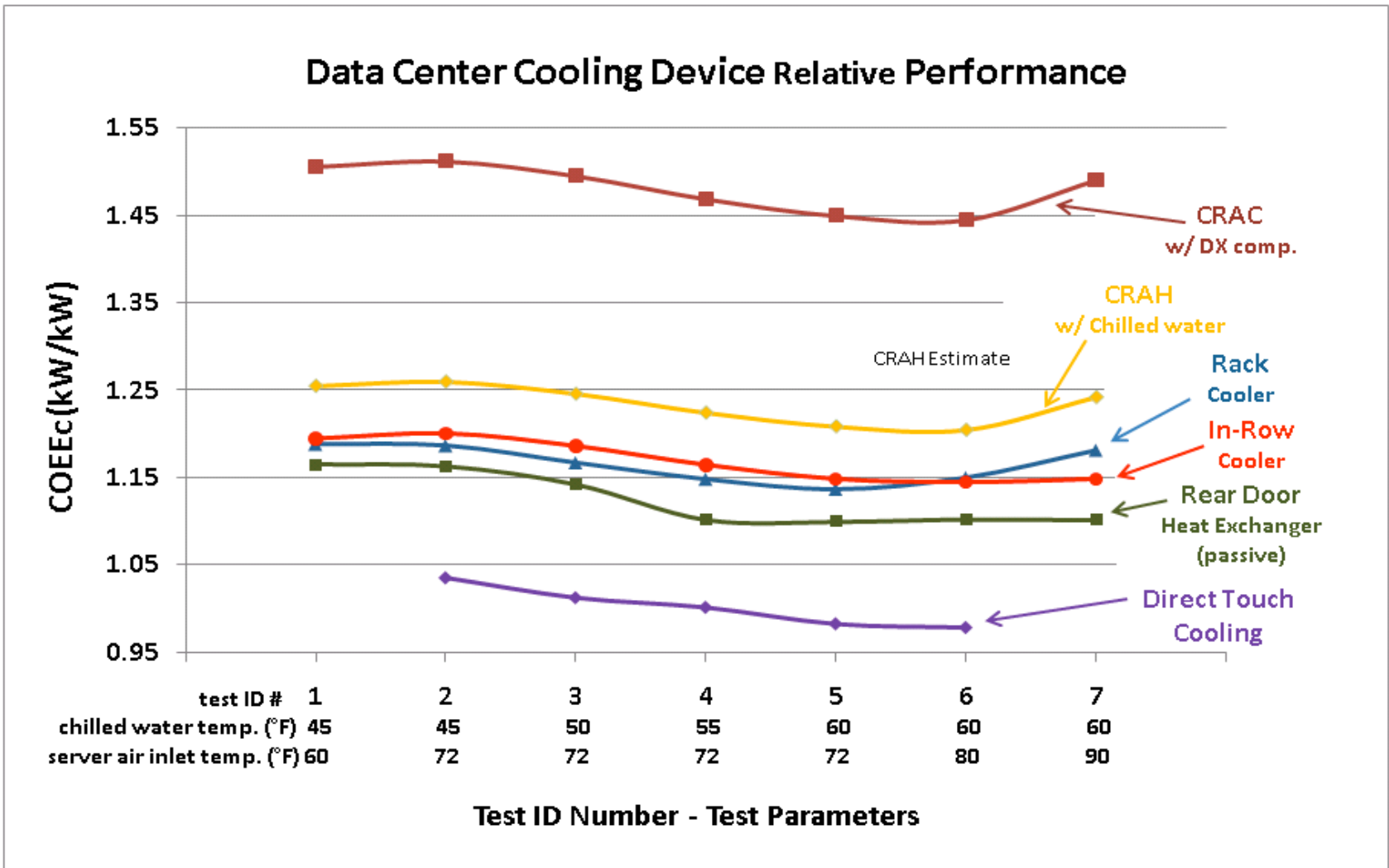

# Use “Free” Cooling

## Cooling without Compressors:

- Air-Side Economizers
- Water-Side Economizers



# Air-Side Economizers

## Advantages

- Lower energy use
- Added reliability (backup for cooling)

## Potential Issues

- Space (retrofit projects difficult)
- Outside dust
  - Not a concern with MERV 13 filters
- Outside gaseous contaminants
  - Not widespread
  - Impacts normally cooled data centers as well
- Shutdown or bypass if smoke or other contaminant is outside data center

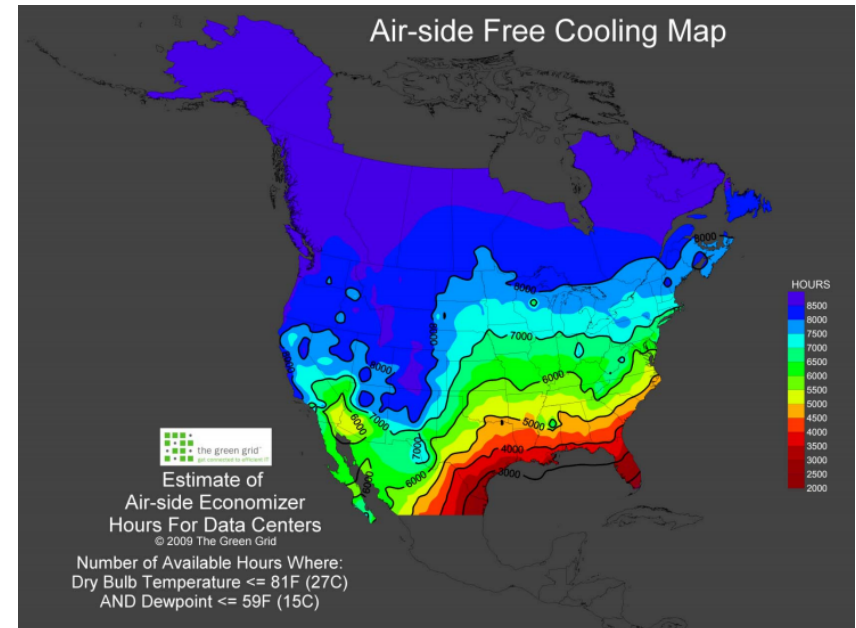

[http://cooling.thegreengrid.org/namerica/WEB\\_APP/calc\\_index.html](http://cooling.thegreengrid.org/namerica/WEB_APP/calc_index.html)

# The Green Grid Tool



## Free-Cooling Estimated Savings

US/CANADA LOCATION (ZIP CODE):

DEGREES IN:  FAHRENHEIT  
 CELSIUS

ALLOW MIXING OF SUPPLY AND RETURN AIR

ALLOW HUMIDIFICATION

	MAX LIMIT	MIN LIMIT
DRYBULB TEMP THRESHOLD (DEG): ?	<input type="text" value="27.0"/>	<input type="text" value="NONE"/>
DEWPOINT TEMP THRESHOLD (DEG): ?	<input type="text" value="15.0"/>	<input type="text" value="NONE"/>
REL. HUMIDITY THRESHOLD (%): ?	<input type="text" value="NONE"/>	
DESIRED CHILLED WATER TEMP (DEG): ?	<input type="text" value="13.0"/>	
COOLING SYSTEM APPROACH TEMP (DEG): ?	<input type="text" value="3.0"/>	
DATA CENTER IT POWER (kW): ?	<input type="text" value="1000"/>	
POWER USAGE EFFECTIVENESS (PUE): ?	<input type="text" value="1.6"/>	
TOTAL FACILITY POWER (kW): ?	<input type="text" value="1600"/>	
OVERHEAD POWER (kW): ?	<input type="text" value="600"/>	
PERCENT OF OVERHEAD POWER FOR COOLING SYSTEM (%): ?	<input type="text" value="80"/>	% <input type="text" value="480"/> kW
PERCENT OF COOLING SYSTEM POWER FOR CHILLER (%): ?	<input type="text" value="40"/>	% <input type="text" value="192"/> kW
PERCENT OF COOLING SYSTEM POWER FOR TOWER (%): ?	<input type="text" value="40"/>	% <input type="text" value="192"/> kW

HOURS MEETING CRITERIA FOR FREE-AIR COOLING:

ESTIMATED SAVINGS USING FREE-AIR COOLING:

HOURS MEETING CRITERIA FOR WATER SIDE ECONOMIZER:

# LBL's Computational Research and Theory (CRT) Facility



# Free Cooling: Outside Air-Based

1. Blue = recommended supply.
2. Green can become blue mixing return and outdoor air.
3. Most of the conditions below and right of blue can be satisfied with evaporative cooling.
4. Hot and humid hours will enter the “allowable” range or require compressor air conditioning.

**Annual Psychrometric Chart of Oakland, CA**  
(relative humidity lines are stepped by 10%,  
wetbulb lines by 10 degrees F)

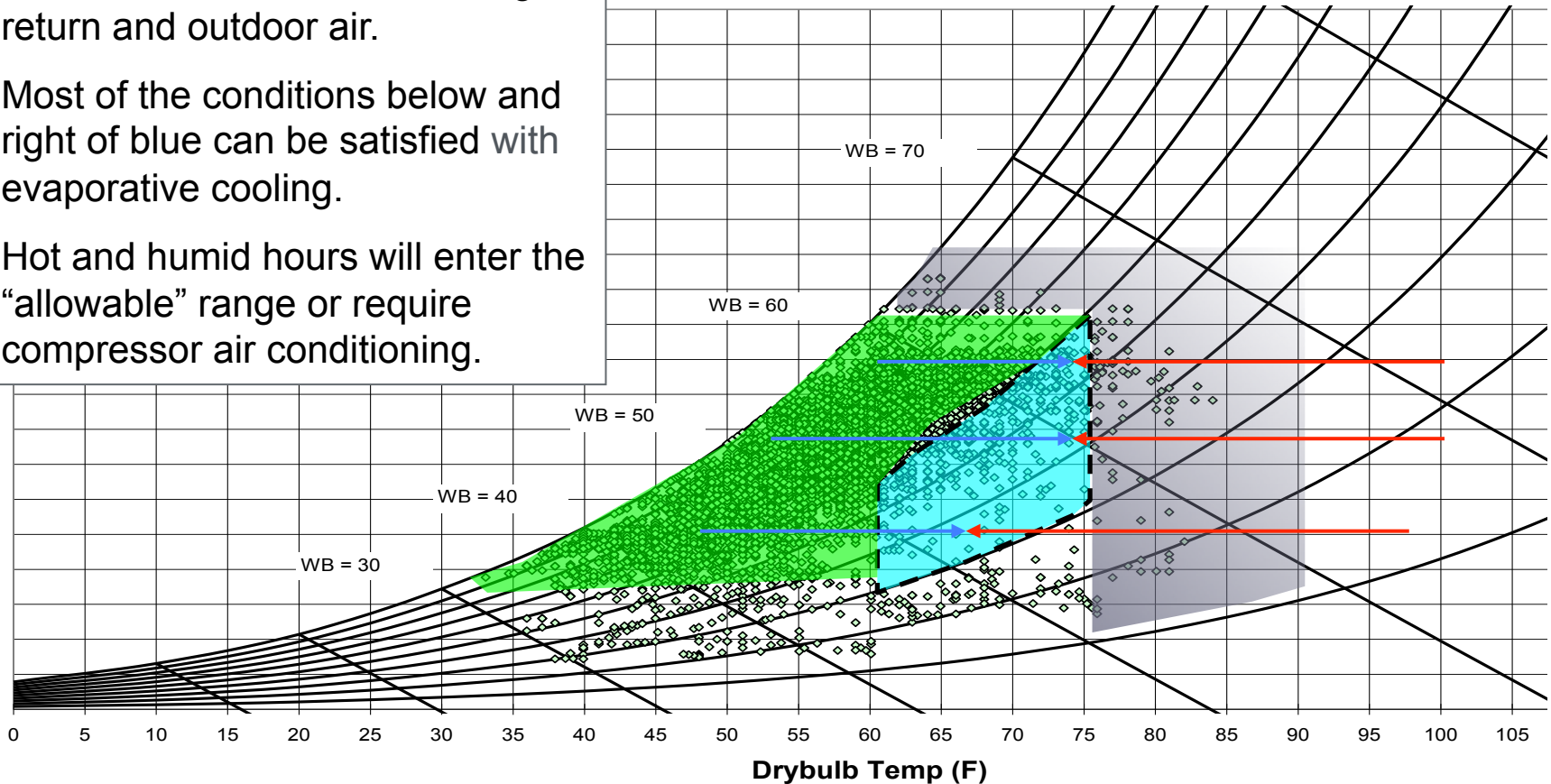

# LBNL Computational Research and Theory (CRT) System Design Approach

- Air-Side Economizer
  - 93% of hours
- Direct Evaporative Cooling for Humidification/Pre-cooling
- Low Pressure-Drop Design
  - 1.5" total static

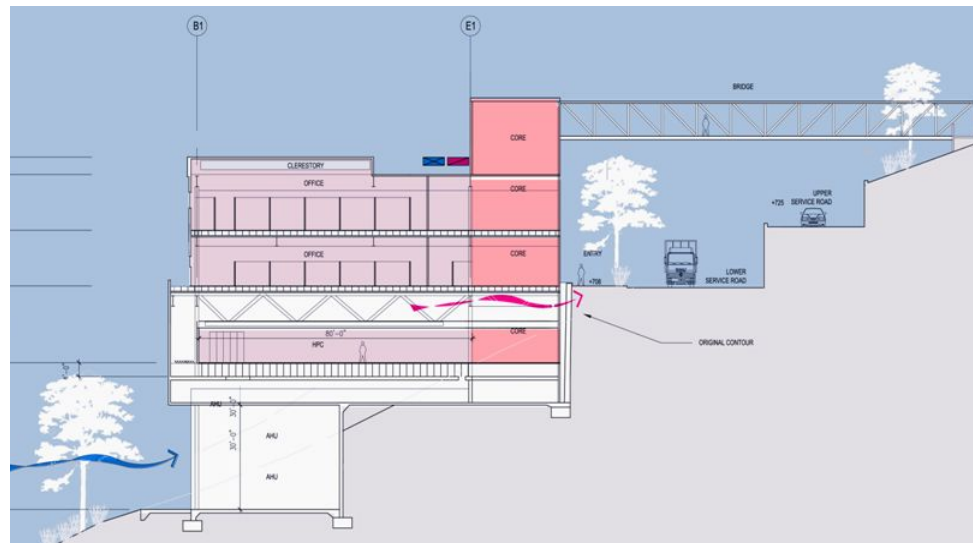



# Water-Side Economizers

- Easier retrofit
- Added reliability (backup in case of chiller failure)
- No contamination issues
- Put in series with chiller
- Uses tower or dry cooler

No or minimum compressor cooling



Cooling tower and HX = Water-side Economizer

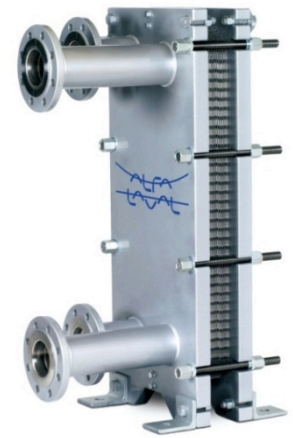

# Integrated Water-Side Economizer

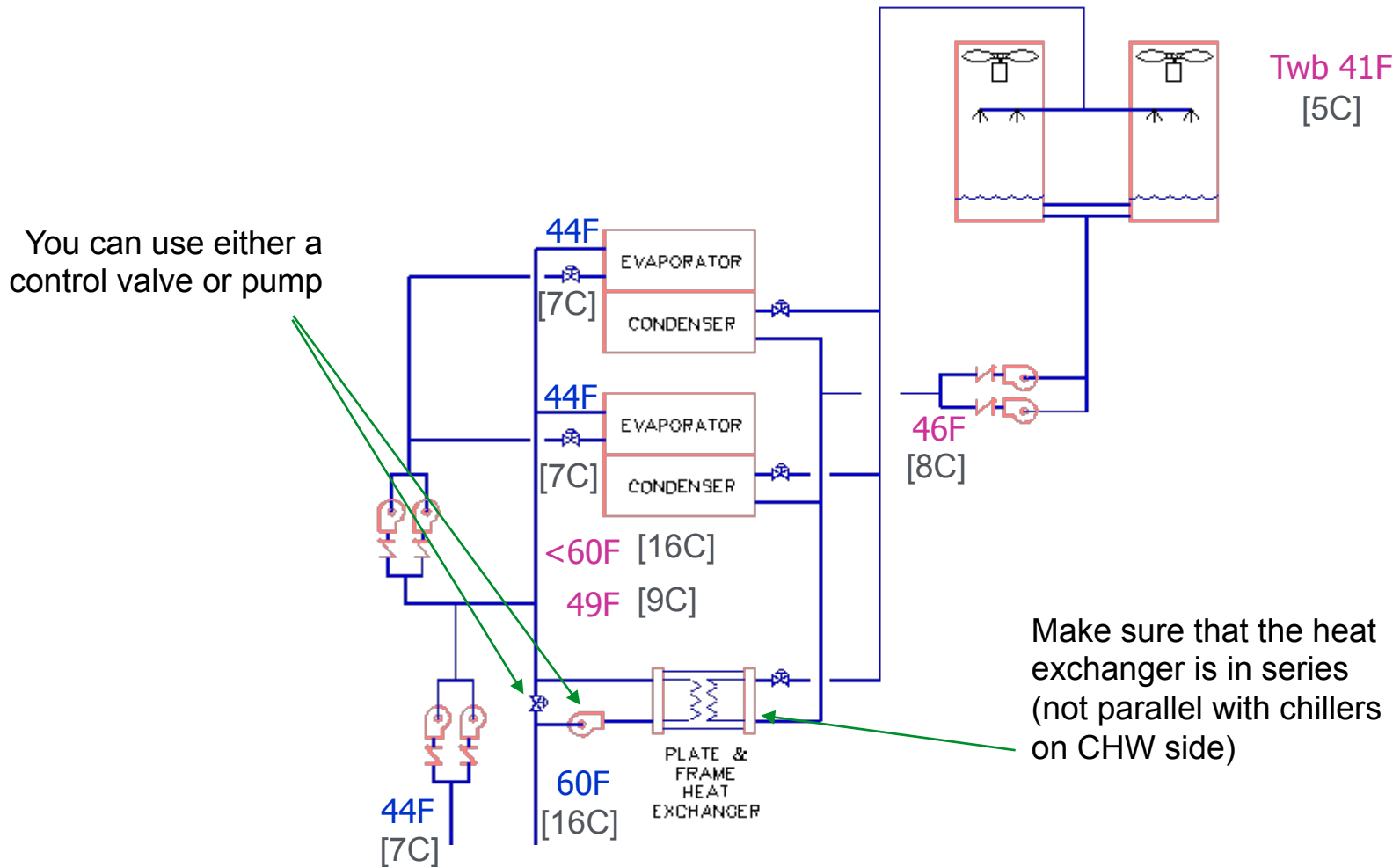

# Potential for Tower Cooling

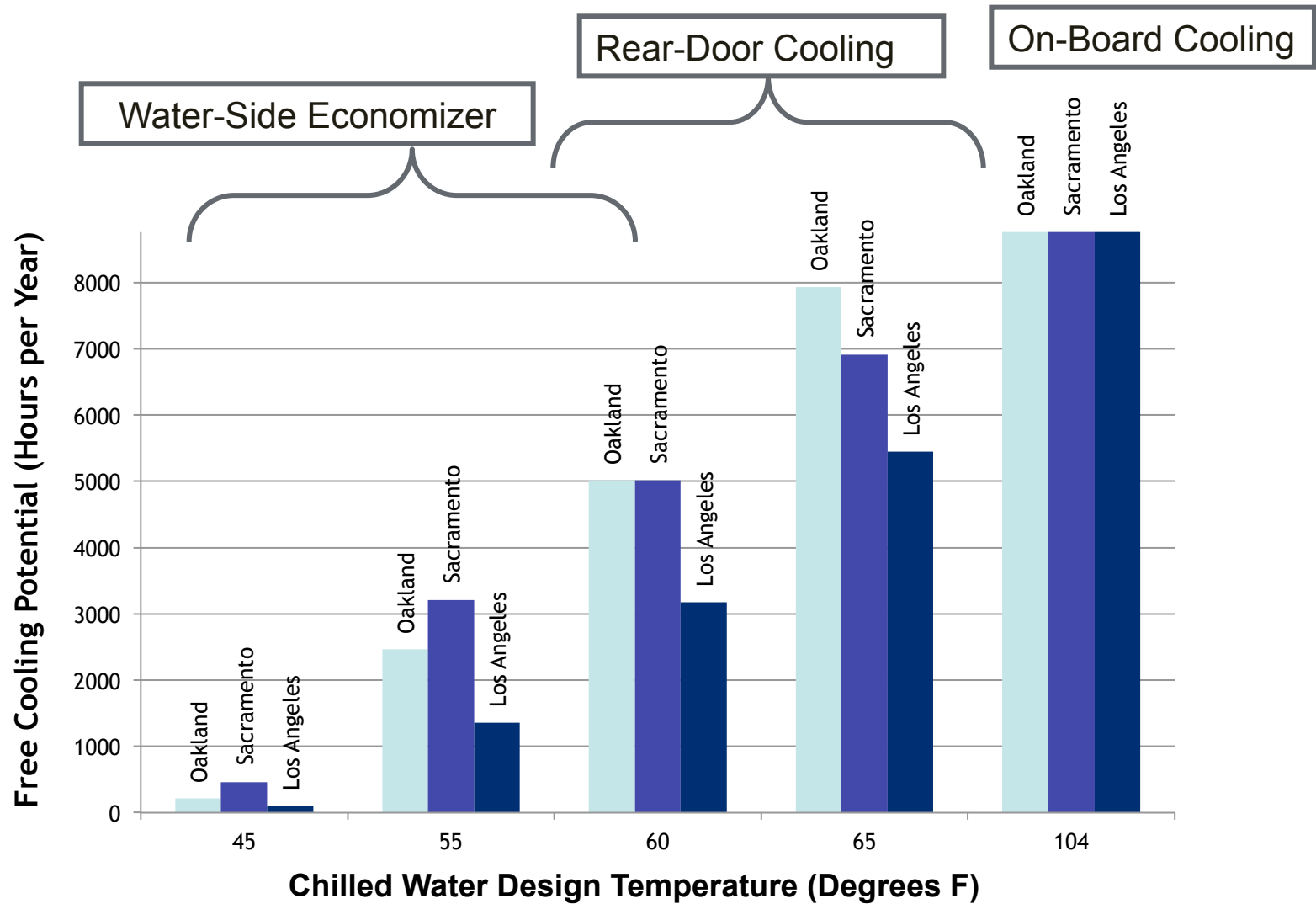

# LBNL Example: Rear-Door Cooling

- Used instead of adding CRAC units
- Rear-door water cooling with tower-only (or central chiller plant in series)
  - Both options significantly more efficient than existing direct expansion (DX) CRAC units



# Re-Use of Waste Heat

- Heat from a data center can be used for:
  - Heating adjacent offices directly
  - Preheating make-up air (e.g., “run around coil” for adjacent laboratories)
- Use a heat pump to elevate temperature
  - Waste heat from LBNL ALS servers captured with rear door coolers feed a heat pump that provides hot water for reheat coils
- Warm-water cooled computers are used to heat:
  - Greenhouses, swimming pools, and district heating systems in Europe

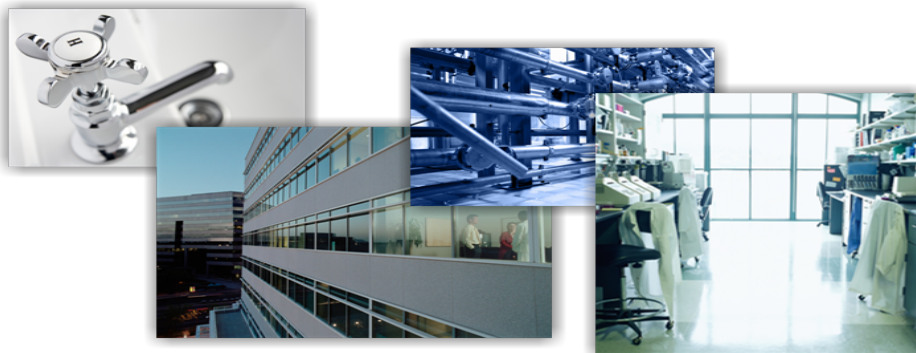

# Improve Humidity Control

- Eliminate inadvertent dehumidification
  - Computer heat load is sensible only
- Use ASHRAE allowable RH and temperature ranges
  - Many manufacturers allow even wider RH and temperature ranges
- Defeat equipment “fighting”
  - Coordinate controls (central)
  - Disconnect and only control humidity of makeup air, or one CRAC/CRAH unit
- Entirely disconnect (many have, including telecom)



# High-Humidity Limit Issues

- Contaminants (e.g., hygroscopic salts)
- Gaseous contamination
  - More study is needed in this area; however, few locations have such condition
- Particulates
  - Normal building filtration is effective in removing “enough” particulates

# Low-Humidity Limit Issues

## Electrostatic Discharge (ESD)

- Industry practices
  - Telecom has no lower limit (personnel grounding expected)
  - Electrostatic Discharge Association removed humidity control as a primary ESD control measure in ESD/ANSI S20.20
  - IT equipment is qualified to withstand ESD, and it is grounded
  - Many centers eliminate humidification with no adverse effects.
- Recommended procedures
  - Personnel grounding
  - Cable and floor grounding.



# Not to Worry

Server Performance Specifications Generally Exceed ASHRAE Ranges

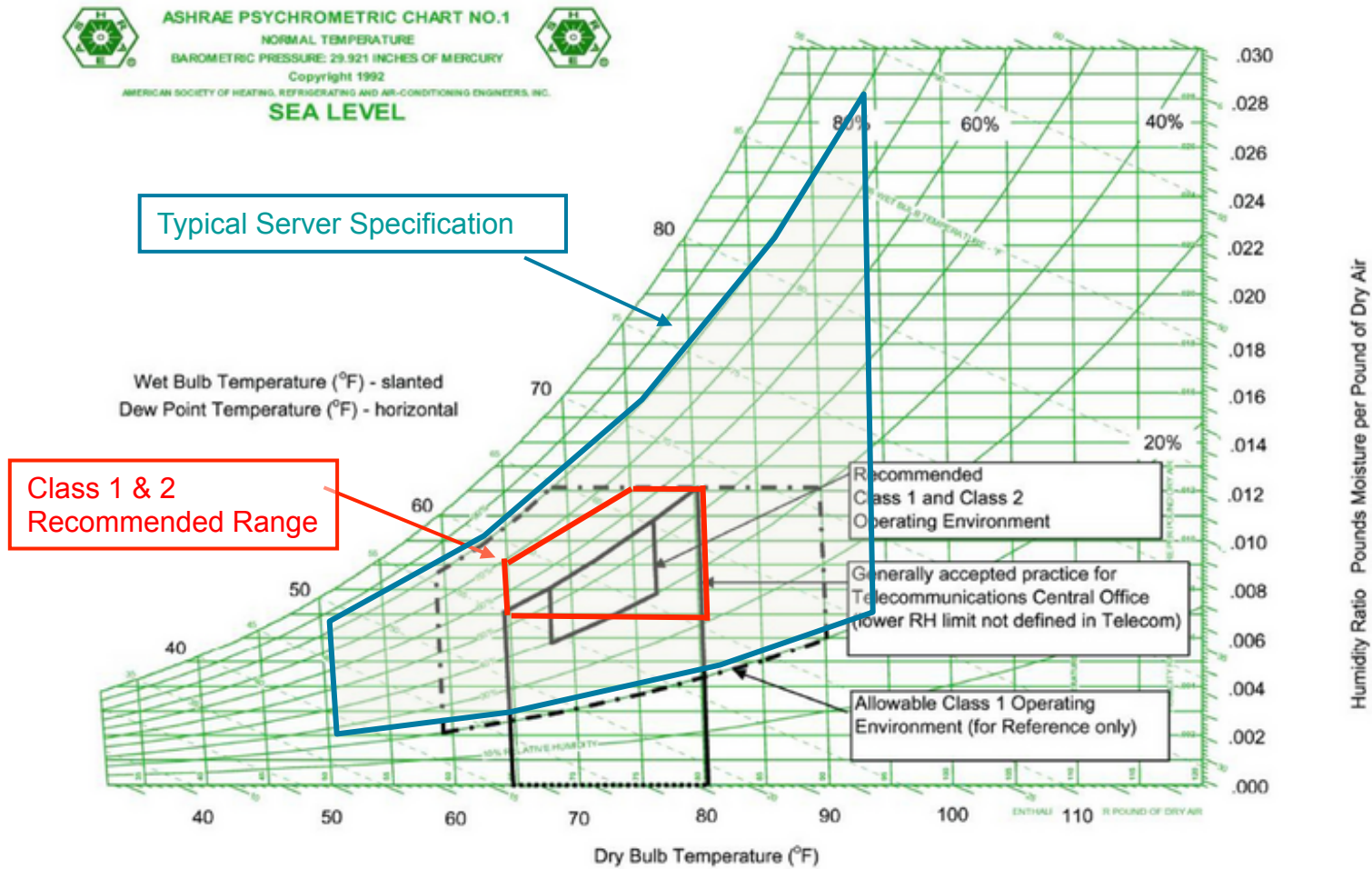

Chart courtesy of ASHRAE

# The Cost of Unnecessary Humidification

	Visalia Probe			CRAC Unit Panel			
	Temp	RH	Tdp	Temp	RH	Tdp	Mode
AC005	84.0	27.5	47.0	76	32.0	44.1	Cooling
AC006	81.8	28.5	46.1	55	51.0	37.2	Cooling & Dehumidification
AC007	72.8	38.5	46.1	70	47.0	48.9	Cooling
AC008	80.0	31.5	47.2	74	43.0	50.2	Cooling & Humidification
AC010	77.5	32.8	46.1	68	45.0	45.9	Cooling
AC011	78.9	31.4	46.1	70	43.0	46.6	Cooling & Humidification
Min	72.8	27.5	46.1	55.0	32.0	37.2	
Max	84.0	38.5	47.2	76.0	51.0	50.2	
Avg	79.2	31.7	46.4	68.8	43.5	45.5	



Humidity down 2%

CRAC power down 28%

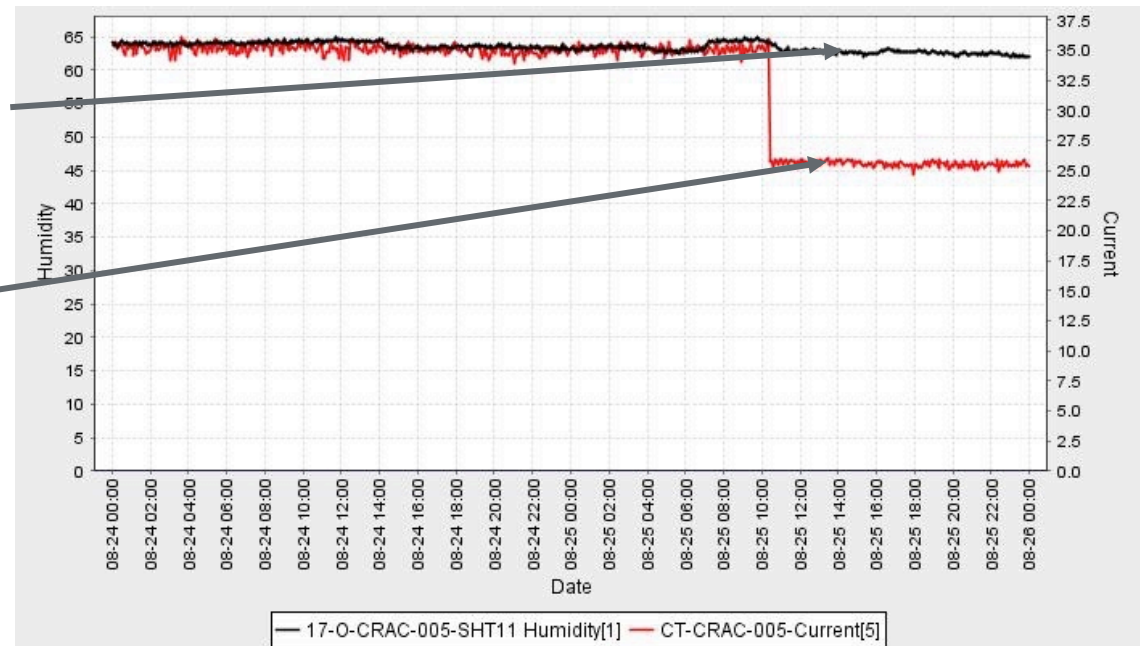

# Cooling Review

- Use efficient equipment and a central plant (e.g., chiller/ CRAHs) vs. CRAC units
- Use centralized controls on CRAC/CRAH units
  - Prevent simultaneous humidifying and dehumidifying
  - Optimize sequencing and staging.
- Move to liquid cooling (room, row, rack, chip)
- Consider VSDs on fans, pumps, chillers, and towers
- Use air- or water-side economizers where possible
- Expand humidity range and improve humidity control (or disconnect)

# Questions



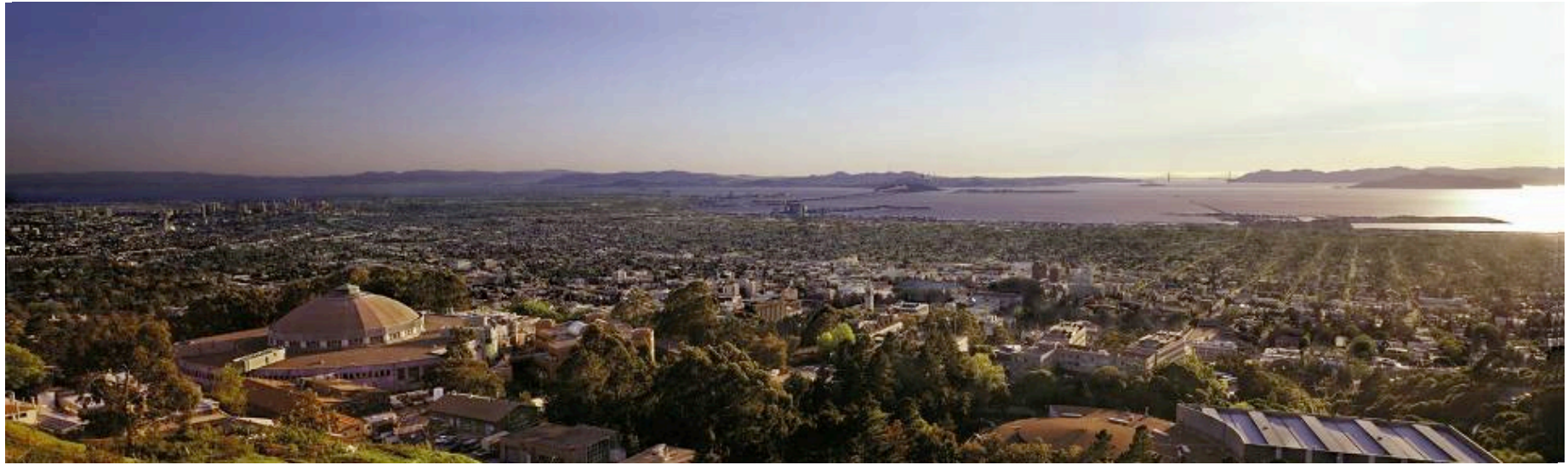

# Electrical Systems

# Electrical System End Use – Orange Bars

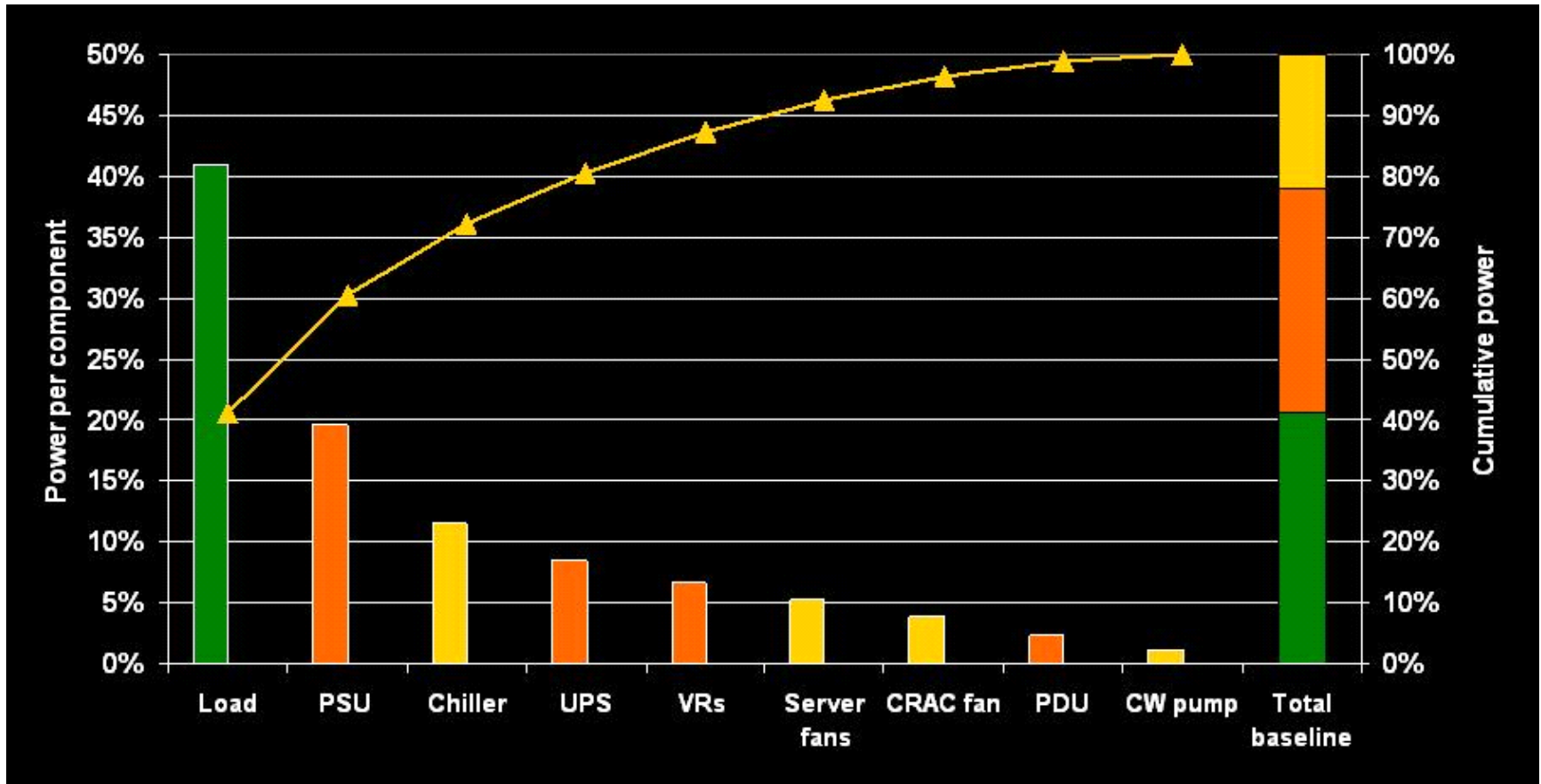

Courtesy of Michael Patterson, Intel Corporation

# Power Chain Conversions Losses

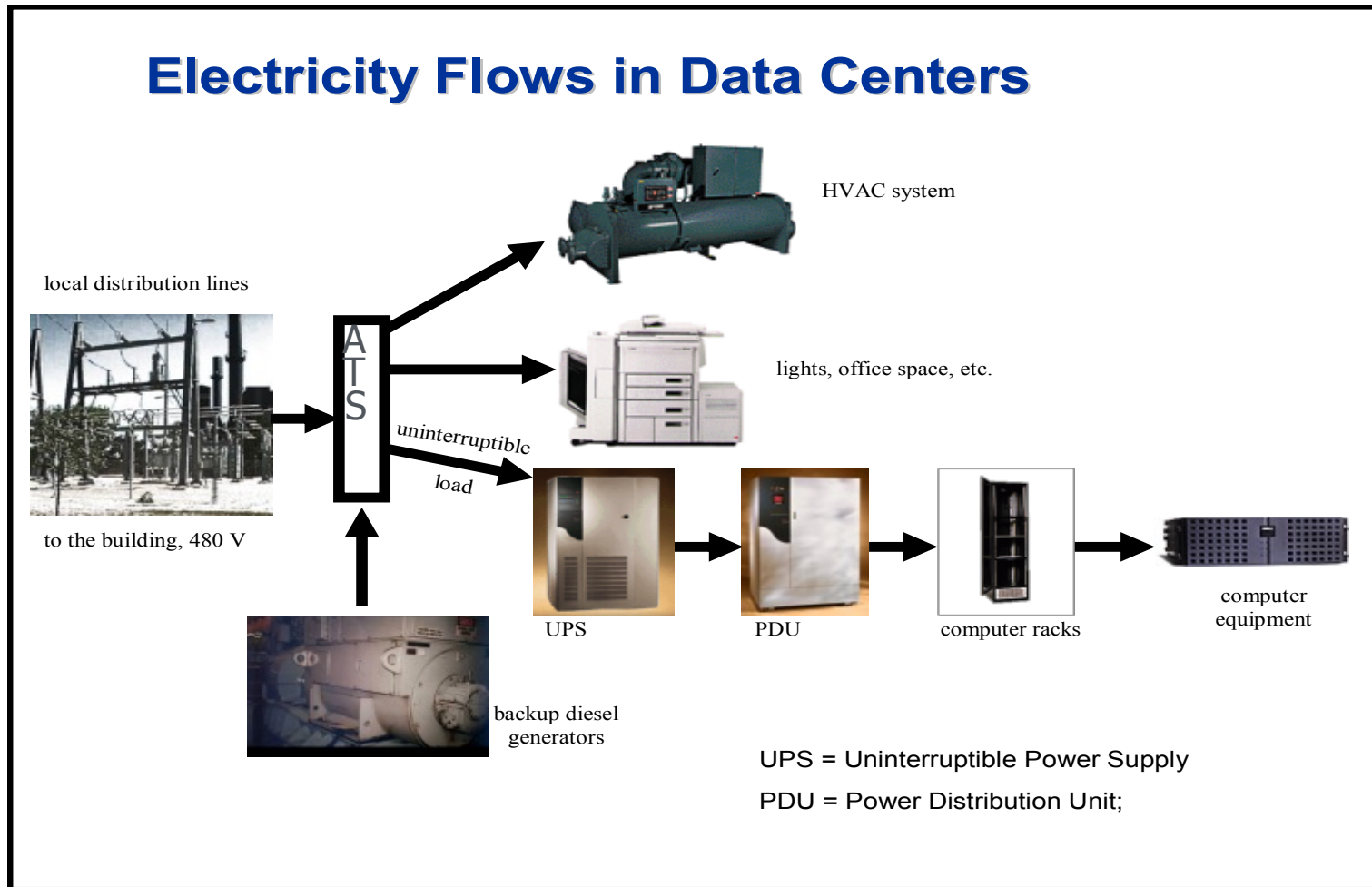

# Electrical Distribution

- Every power conversion (AC-DC, DC-AC, AC-AC) loses some energy and creates heat
- Efficiency decreases when systems are lightly loaded
- Distributing higher voltage is more efficient and can save capital cost (conductor size is smaller)
- Power supply, uninterruptible power supply (UPS), transformer, and PDU efficiency varies – carefully select
- Lowering distribution losses also lowers cooling loads



# Electrical System Points of Losses

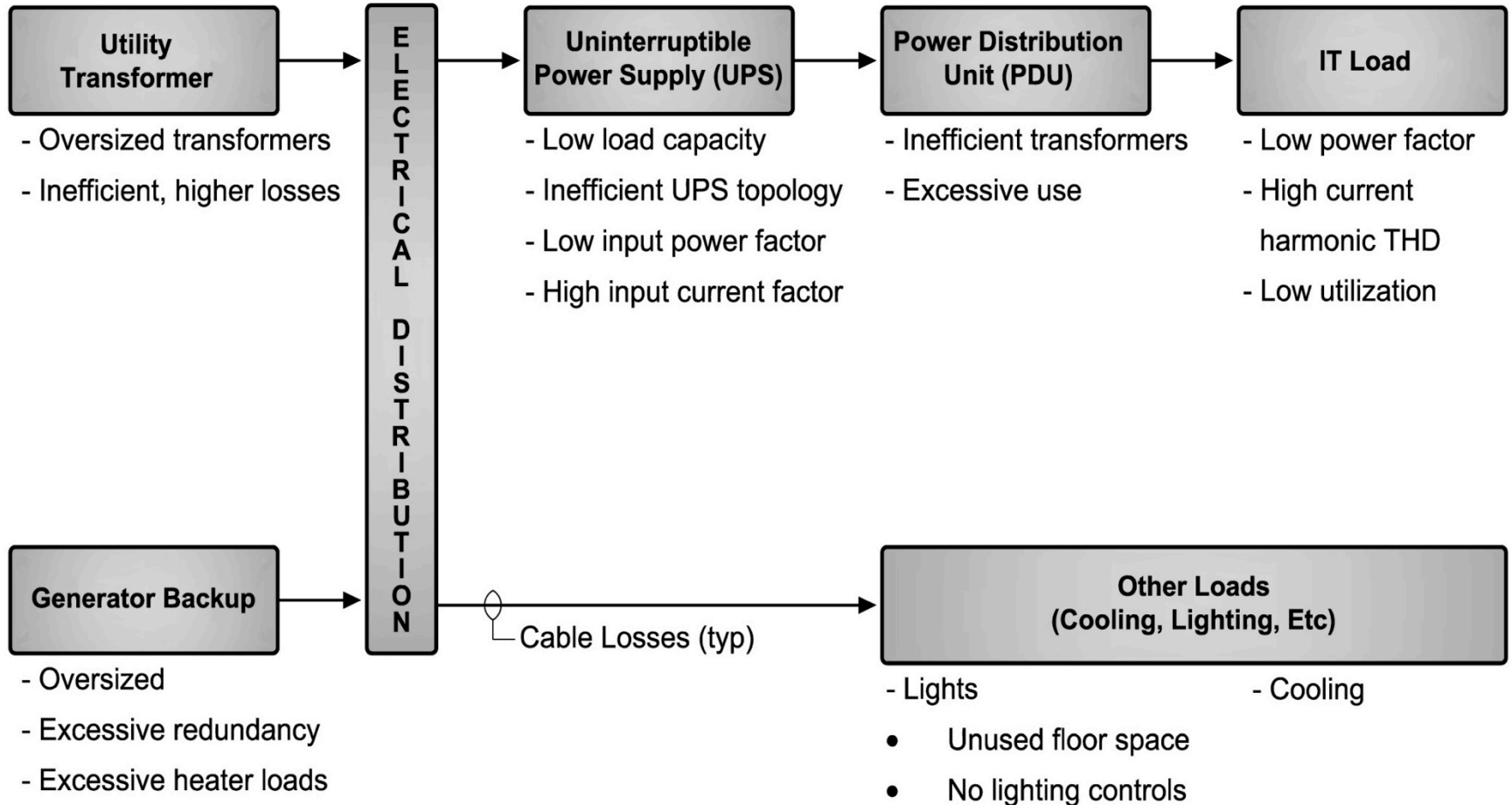

# Select/Configure Power Supplies for Greater Efficiency

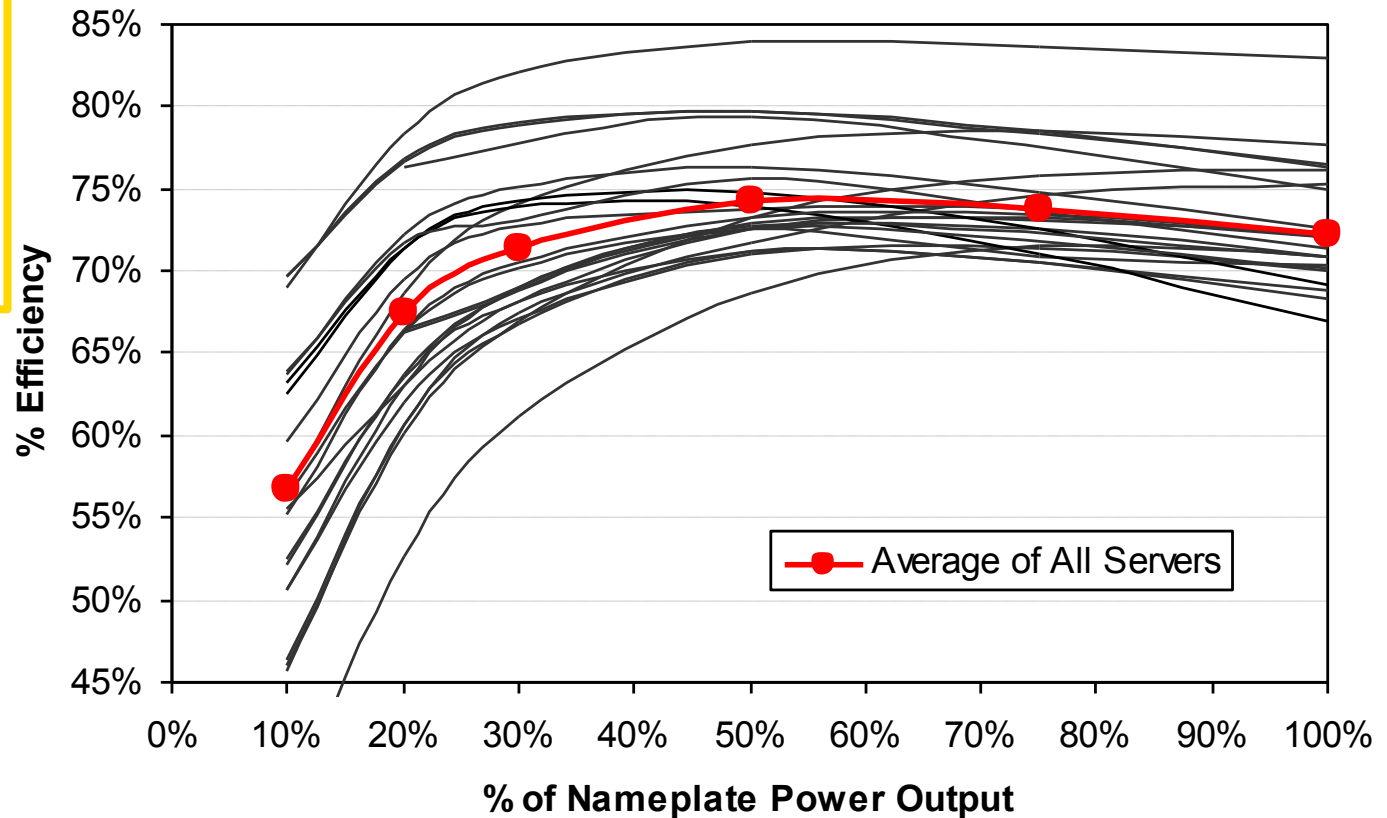

Source: LBNL and EPRI study

# Use Efficient Power Supplies

- Most efficient in the mid-range of performance curves
- Right-size for load
- Power supply redundancy puts operation lower on the curve
- Use ENERGY STAR or Climate Savers power supplies

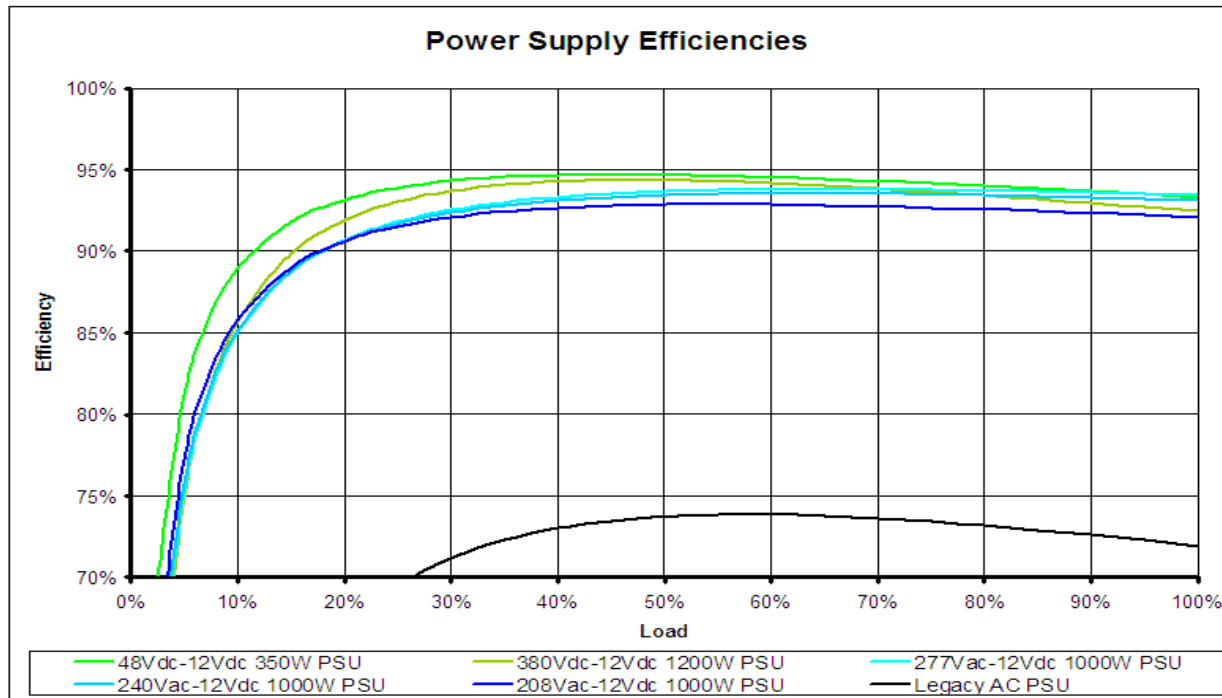

Source: The Green Grid

# Use Efficient Power Supplies

## 80 PLUS Certification Levels

Level of Certification	Efficiency at Rated Load					
	115V Internal Non-Redundant			230V Internal Redundant		
	20%	50%	100%	20%	50%	100%
<b>80 PLUS</b>	80%	80%	80%	n/a	n/a	n/a
<b>80 PLUS Bronze</b>	82%	85%	82%	81%	85%	81%
<b>80 PLUS Silver</b>	85%	88%	85%	85%	89%	85%
<b>80 PLUS Gold</b>	87%	90%	87%	88%	92%	88%
<b>80 PLUS Platinum</b>	n/a	n/a	n/a	90%	94%	91%

# Use Efficient Power Supplies

## Power supply savings add up

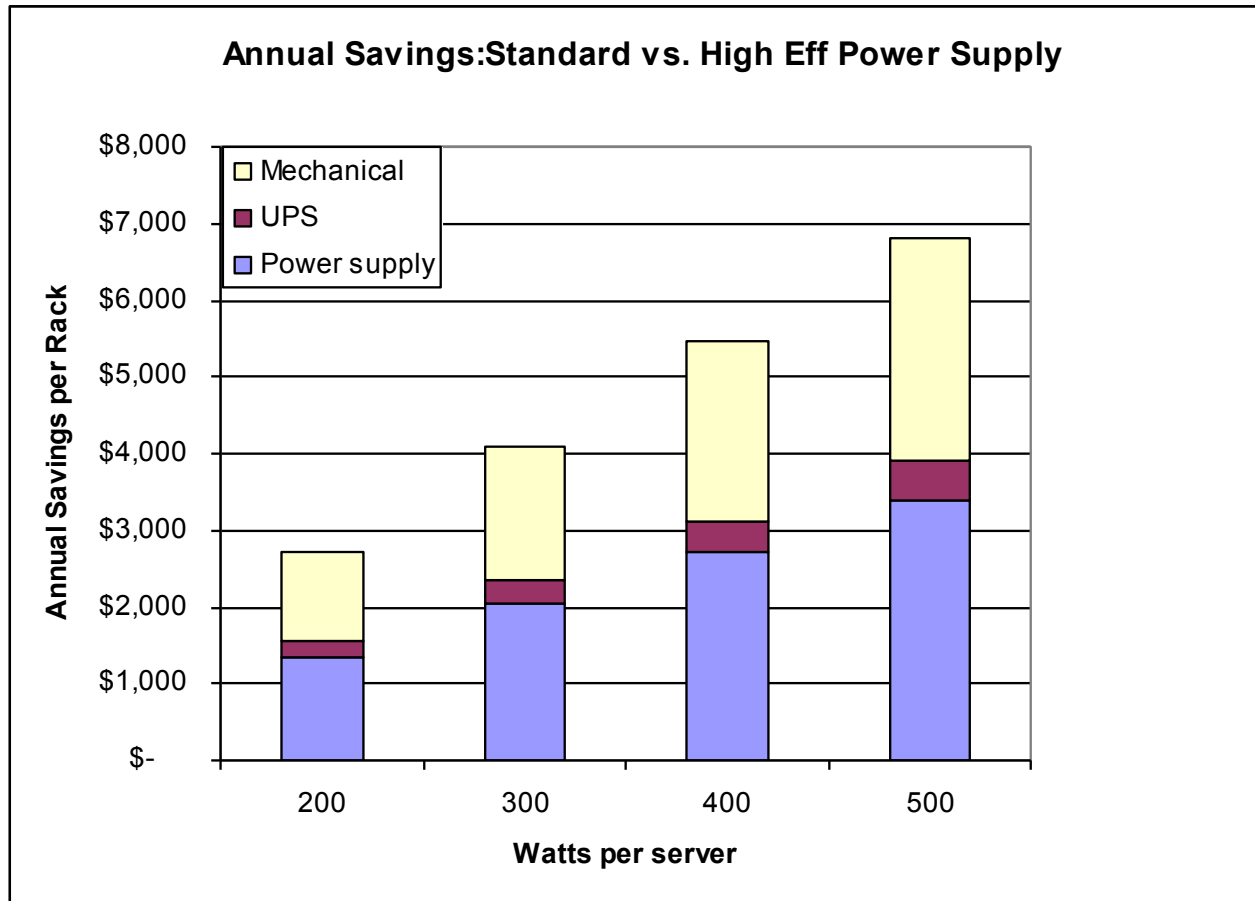

Source: Integral Group

# The 80 Plus Program Drives Efficiency Improvements

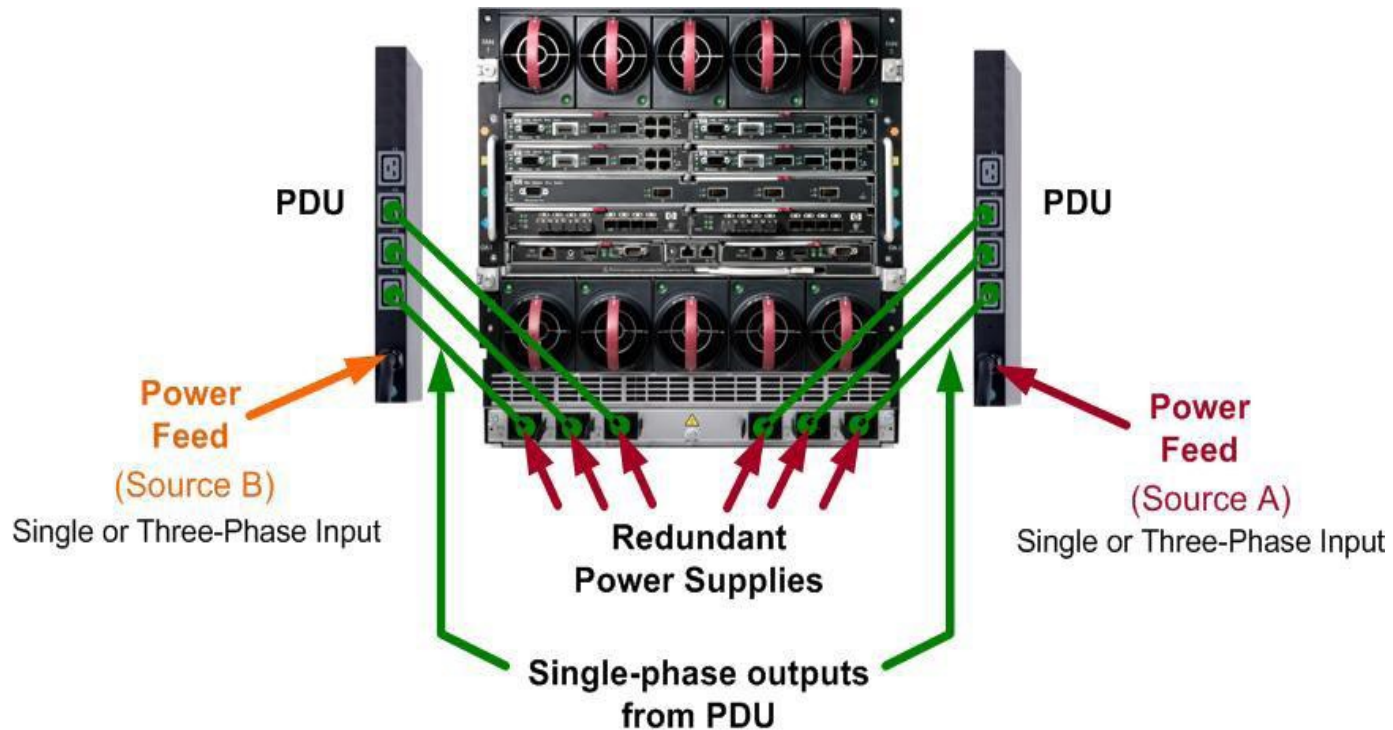

- An Electric Power Research Institute (EPRI) case study illustrated the savings

# Upgraded Power Supplies and Controls

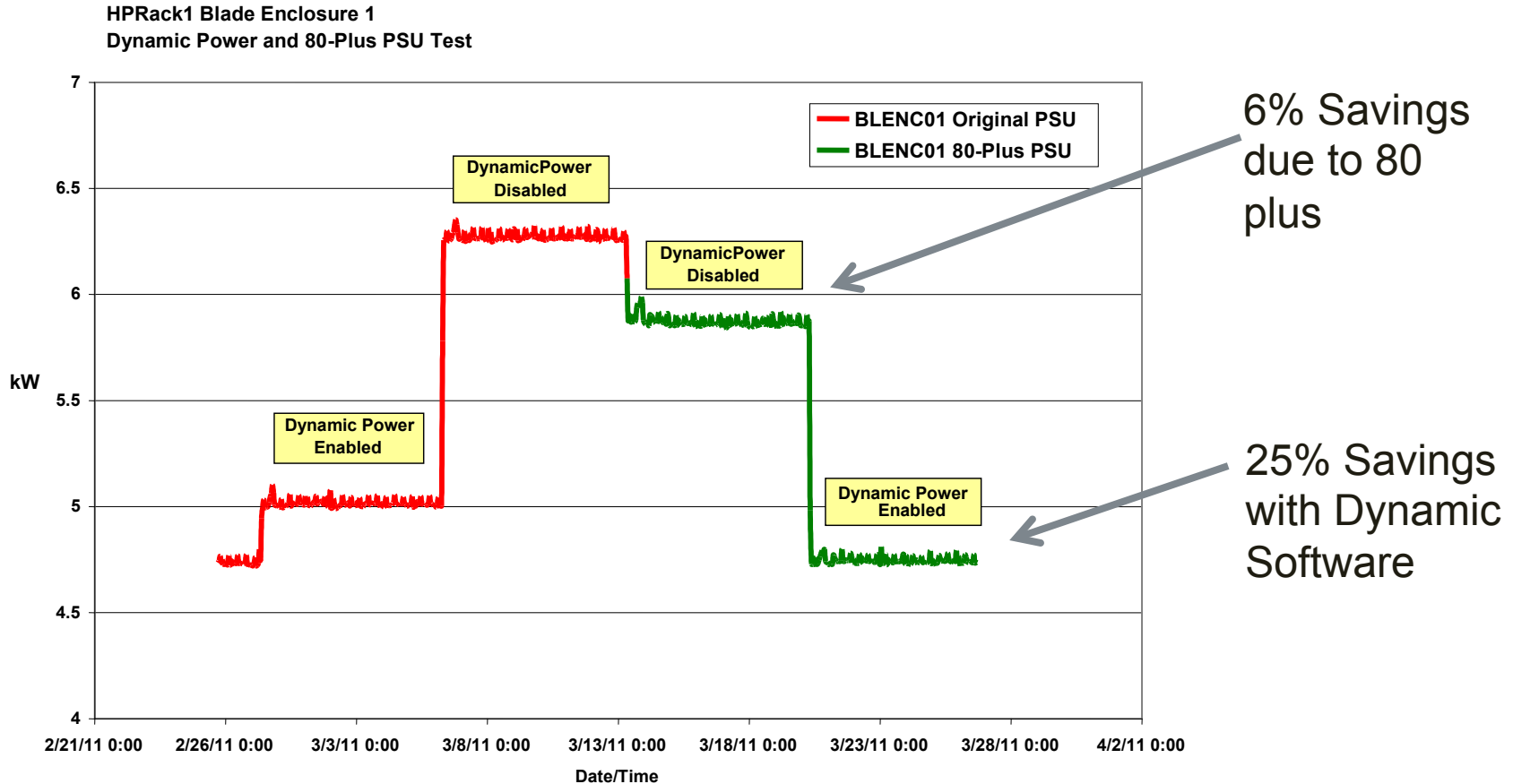

- Dynamic power software turns off redundant power supplies when not needed

# UPS, Transformer, and PDU Efficiency

- Efficiencies vary with system design, equipment, and load
- Redundancies impact efficiency

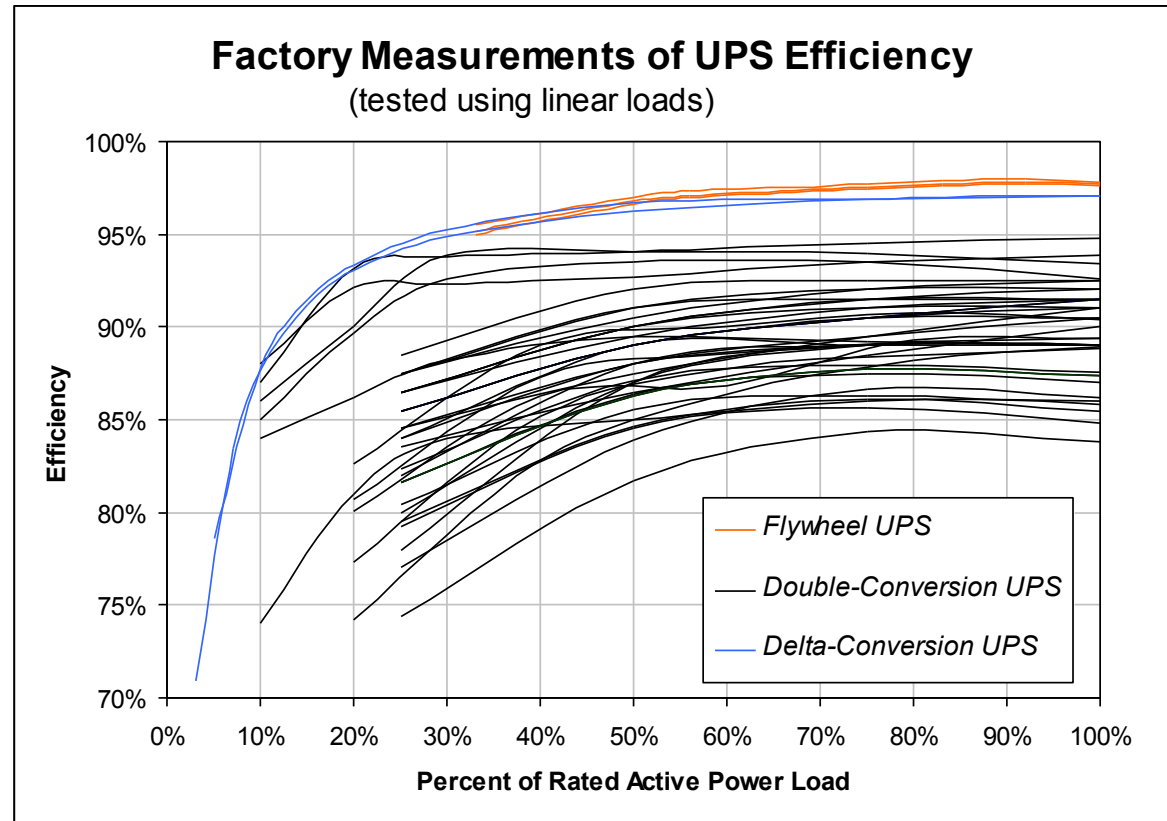

Source: LBNL and EPRI study



# Measured UPS Efficiency

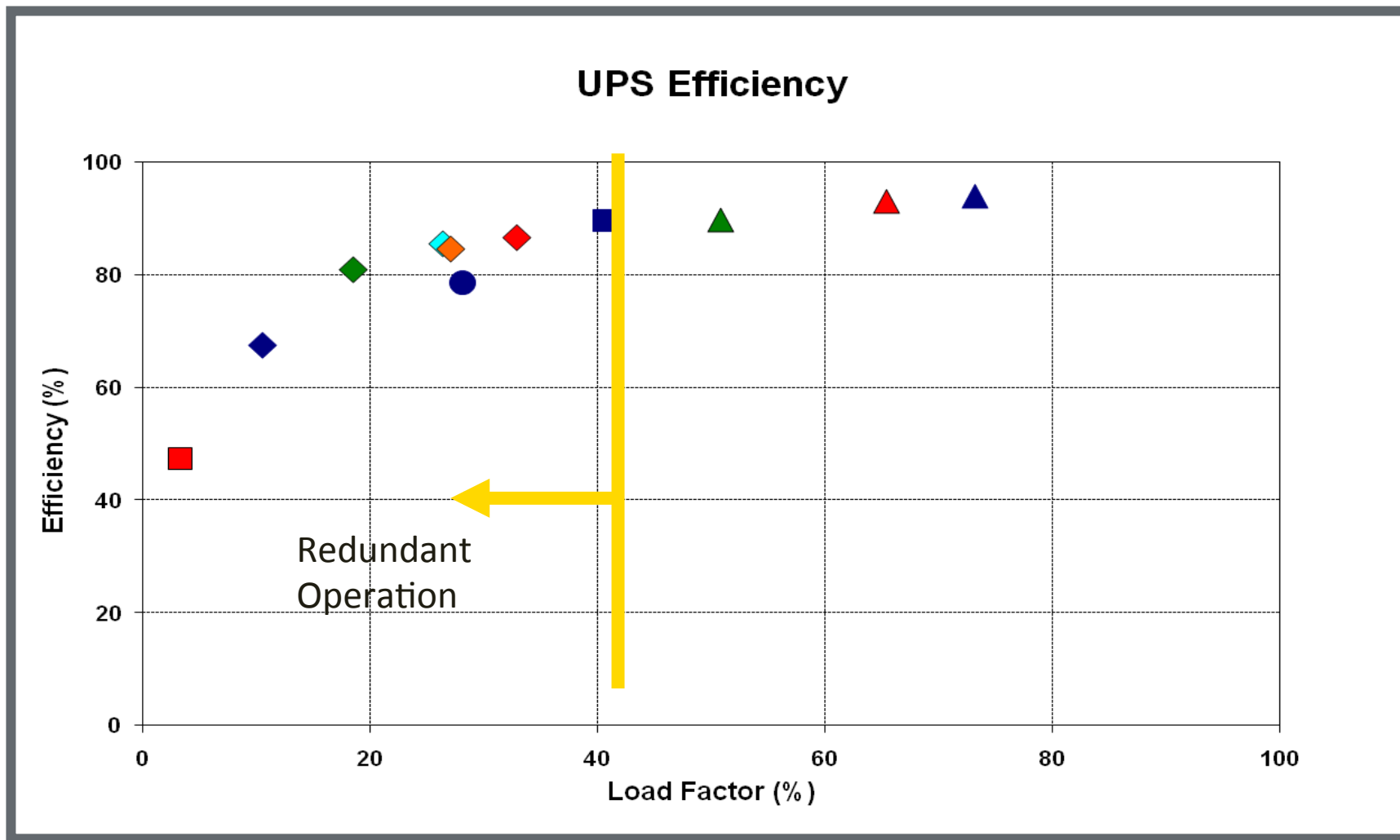

Source: LBNL Benchmarking study

# Understand What Redundancy Costs

- Different strategies have different energy penalties (e.g.,  $2N$  vs.  $N+1$ )
- Redundancy in electrical distribution puts you down the efficiency curve
- Does everything need the same level?
- Establish redundancy in the network rather than in the data center

# From Utility Power to the Chip

## Multiple Electrical Power Conversions:

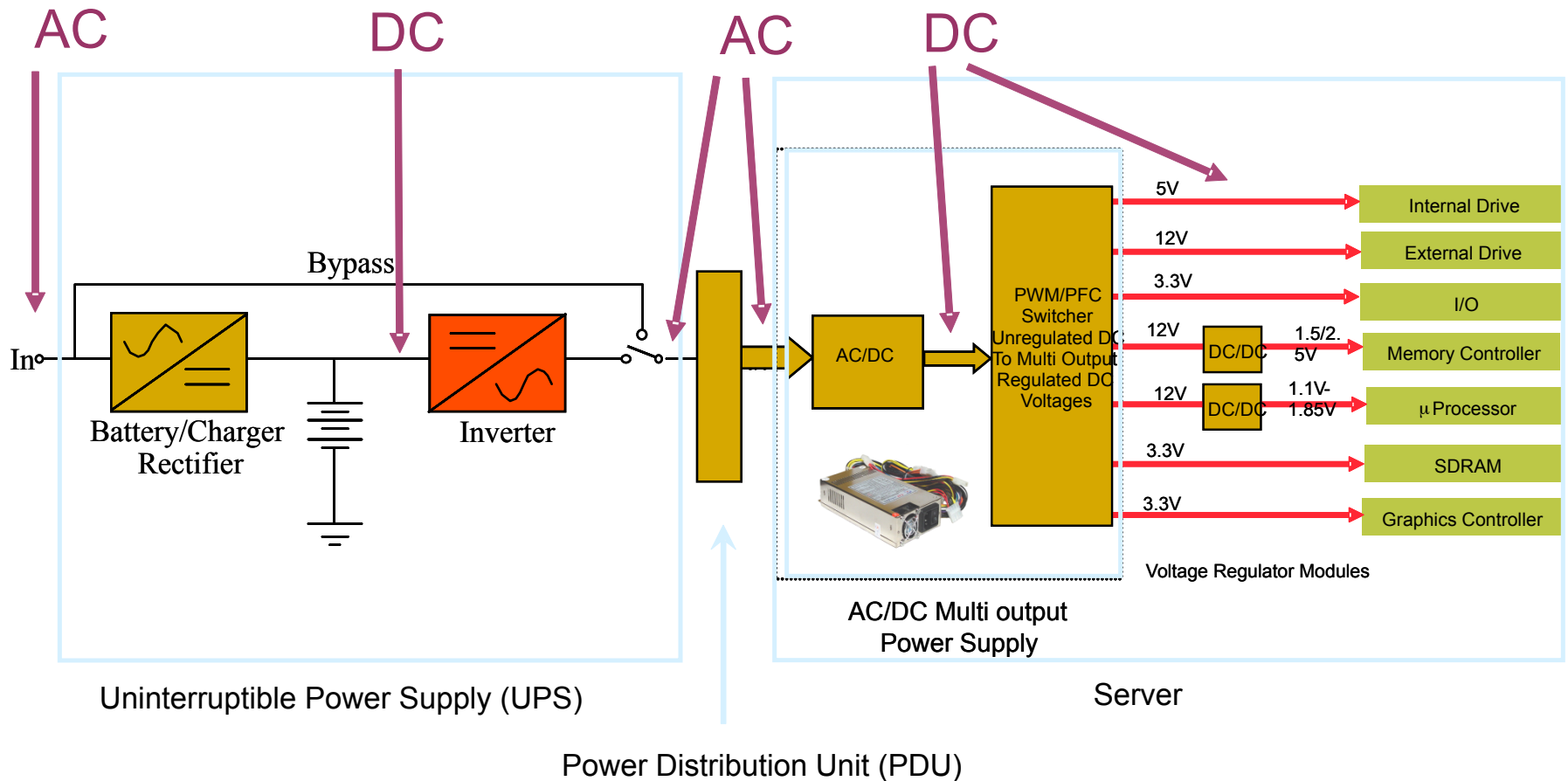

# Emerging Technology: DC Distribution

- Eliminates several conversions
- Also use for lighting and variable speed drives
- Use with on-site generation including renewable energy sources

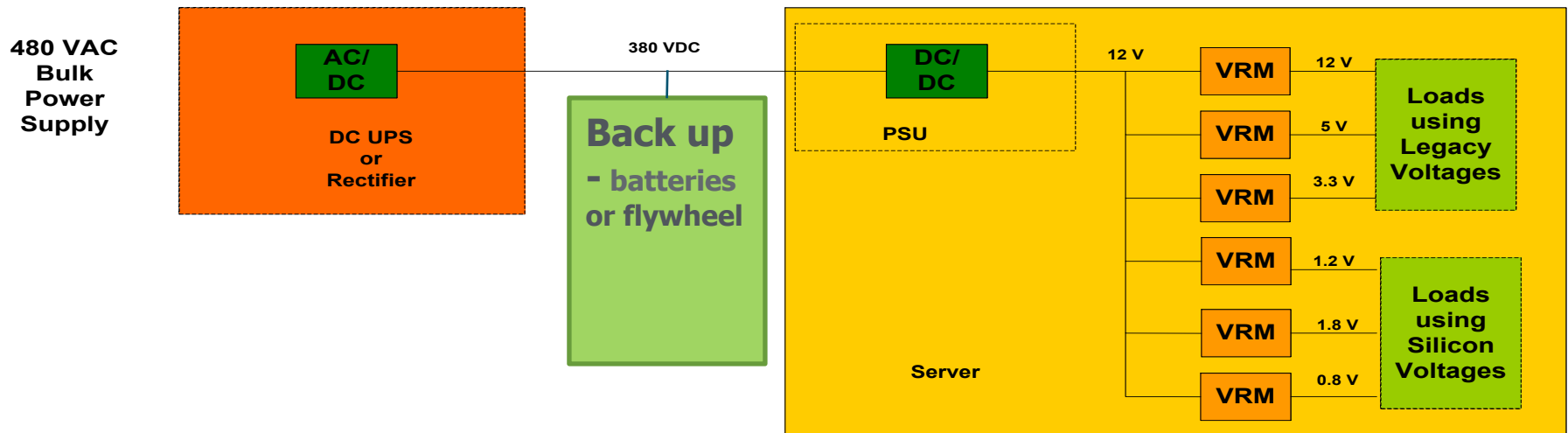

# Standby Generation Loss

- Standby generators typically use more energy than they will ever generate
- Several Load Sources
  - Heaters
  - Battery chargers
  - Transfer switches
  - Fuel management systems
- Reduce or eliminate heating, batteries, and chargers. Check with the manufacturer for temperature and control requirements.
- Other Options
  - Right-sizing of stand-by generator
  - Consider redundancy options



# Standby Generator Heater

Generator Standby Power Loss

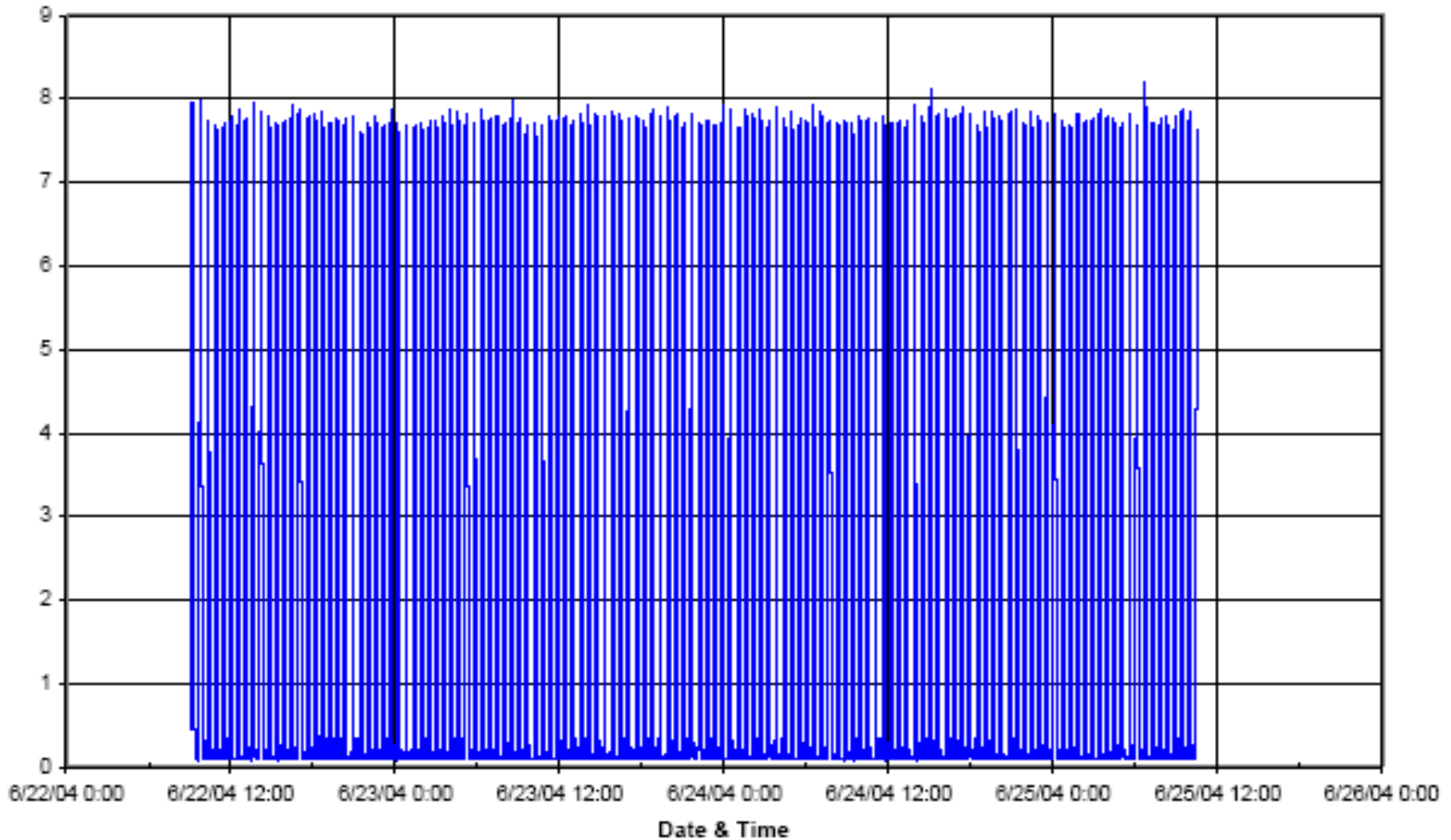

Source: LBNL

# Data Center Lighting

- Lights are on and nobody's home
  - Switch off lights in unused/unoccupied areas or rooms (UPS, Battery, SwitchGear, etc.)
  - Lighting controls such as occupancy sensors are well proven
- Small relative benefit but easy to accomplish
  - Also saves HVAC energy
- Use energy-efficient lighting
- Lights should be located over the aisles



# Motors and Drives

---

- Since most cooling system equipment operates continuously, premium efficiency motors should be specified everywhere
- Variable speed drives should be used for:
  - Chillers
  - Pumps
  - Air handler fans
  - Cooling tower fans



# Improving the LBNL Power Chain

- Increase distribution voltage
  - NERSC going to 480 volts to the racks
- Improve equipment power supplies
  - Avoid redundancy unless needed
- Improve UPS
  - LBNL uses minimal UPS
  - Selected to minimize losses

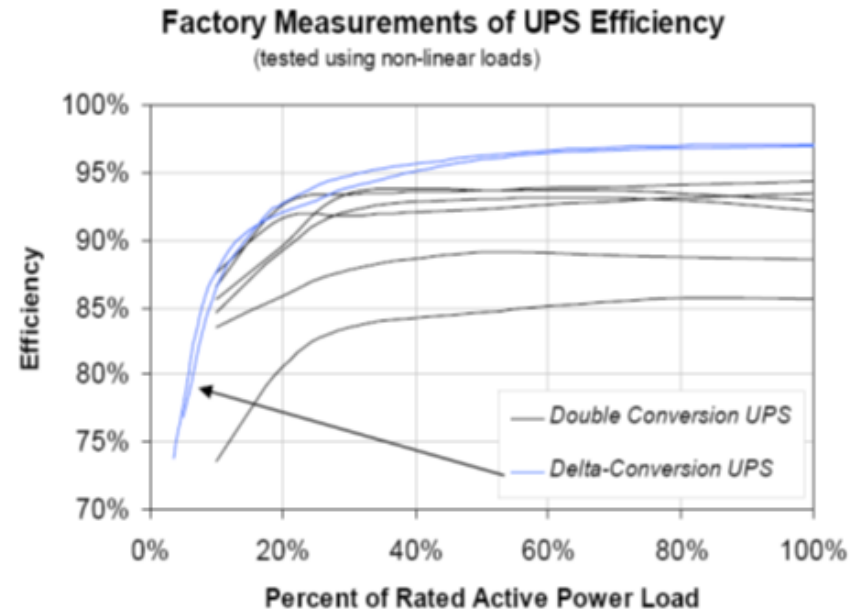

Source: LBNL and EPRI study

# Electrical Systems Review

- Choose highly efficient components and configurations
- Reduce power conversion (AC-DC, DC-AC, AC-AC, and DC-DC)
- Consider the minimum redundancy required, as efficiency decreases when systems are lightly loaded

# Questions





# Using IT to Manage IT

## Application of IT in Data Centers for Energy Efficiency

# The Importance of Converting Data to Information

- IT Systems & network administrators have tools for visualization
- Useful for debugging, benchmarking, capacity planning, forensics
- Data center facility managers have had comparatively poor visualization tools
- Operators can't manage what they don't measure.

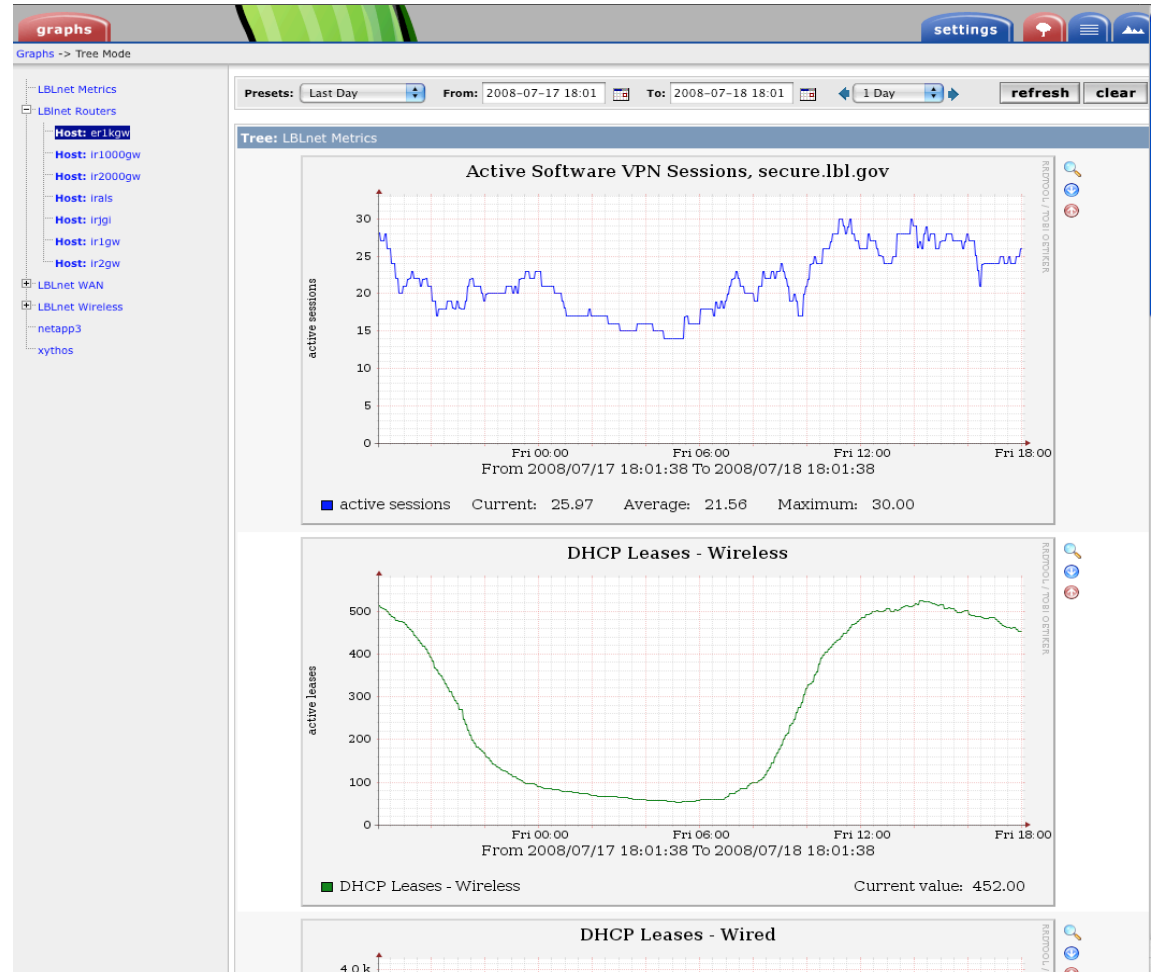

# Using IT to Save Energy in IT

- Goals for an Energy Information System:
  - Provide the same level of monitoring and visualization of the physical space that exists for monitoring the IT environment
  - Measure and track performance
  - Spot problems before they result in high energy cost or down time
- May be part of a broader Data Center Infrastructure Management (DCIM) system



# LBNL Wireless Sensor Installation

- LBNL installed 800+ point sensor network
- Measures:
  - Temperature
  - Humidity
  - Pressure (under floor)
  - Electrical power
- Presents real-time feedback and historic tracking
- Optimize based on empirical data, not intuition

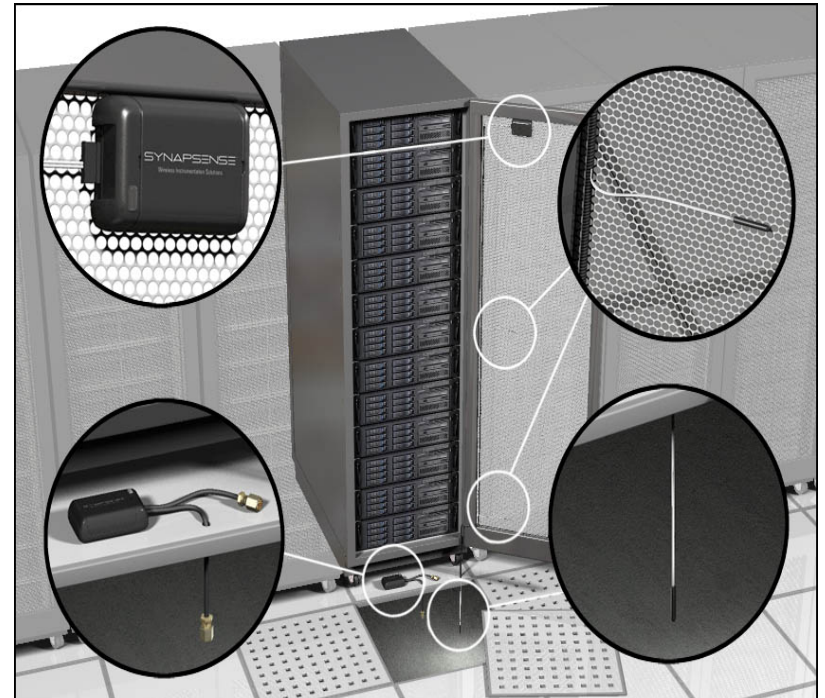

# Communicating/Presenting Data

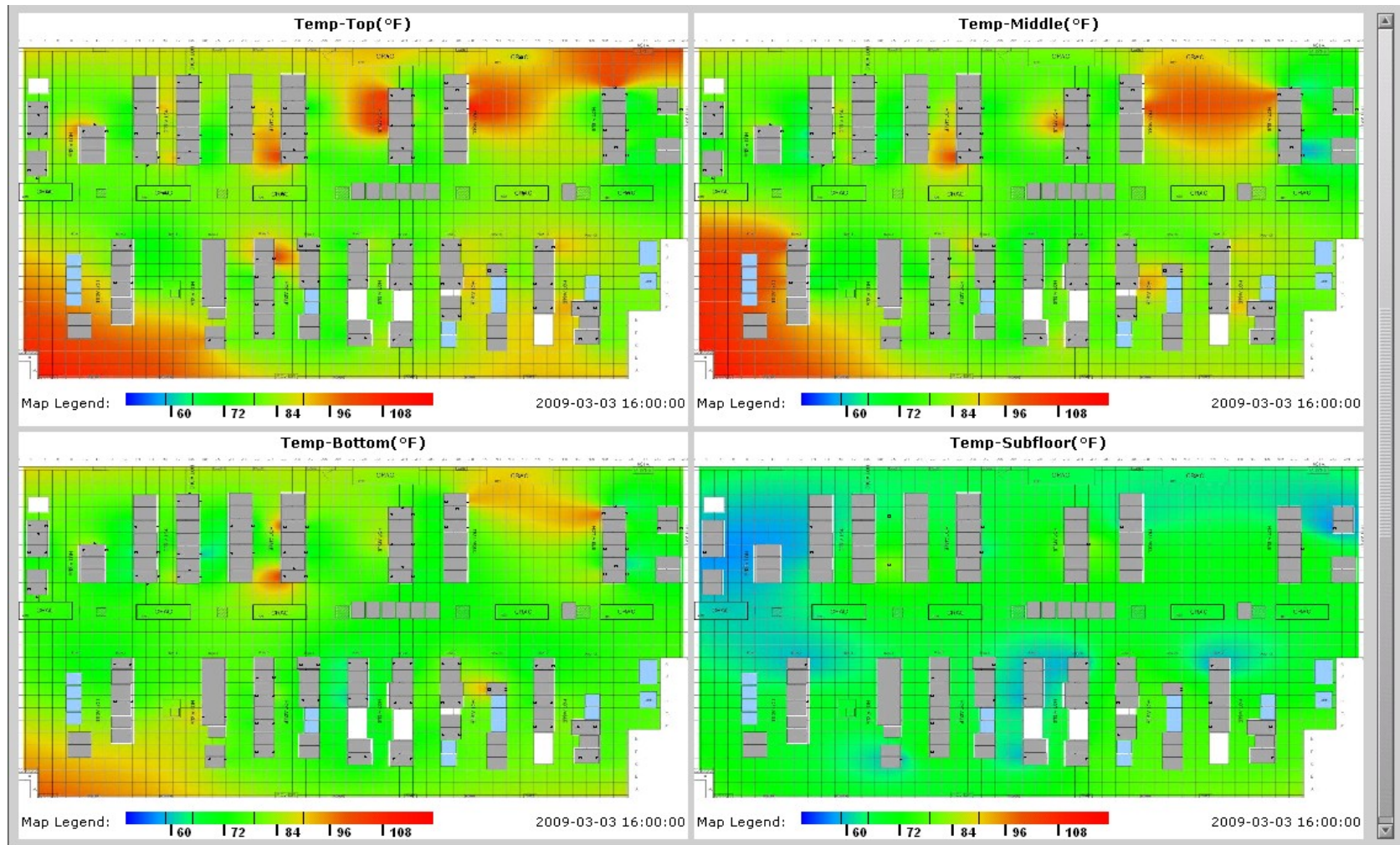



# Displayed Under-floor Pressure Map

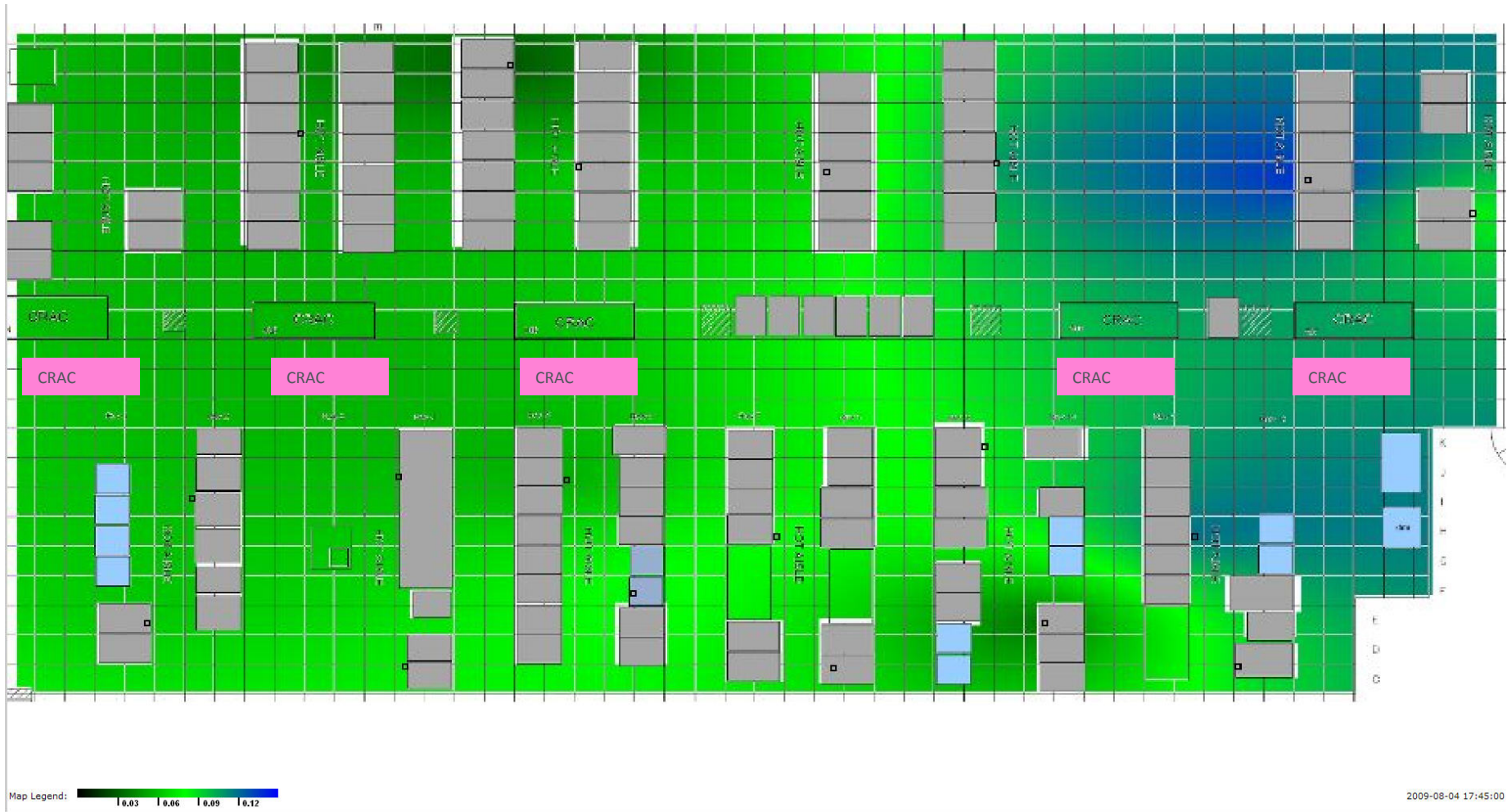

# Provides Real-Time Feedback

- Removing guesswork by monitoring and using visualization tool
  - Floor tile tuning

## Under-Floor Pressure

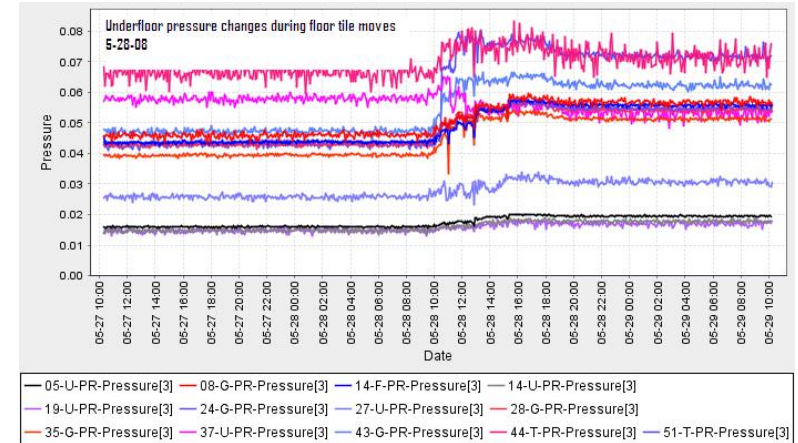

## Rack-Top Temperatures

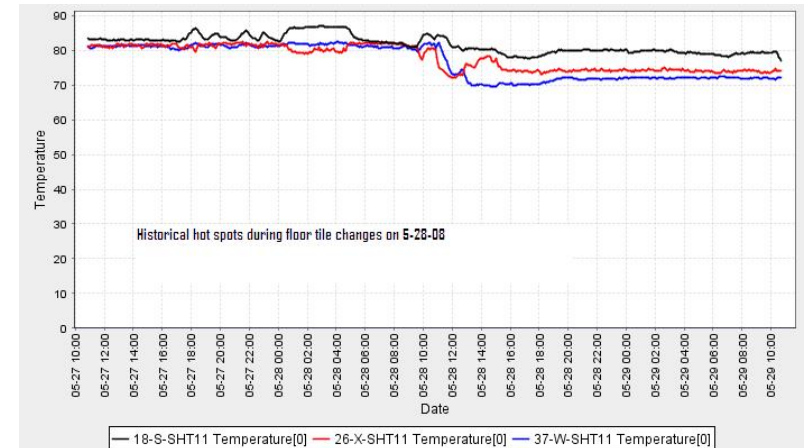

# Provides Real-Time Feedback

- Determined relative CRAC cooling energy impact
- Enhanced knowledge of data center redundancy
- Turned off unnecessary CRAC units to save energy

## Under-Floor Pressure

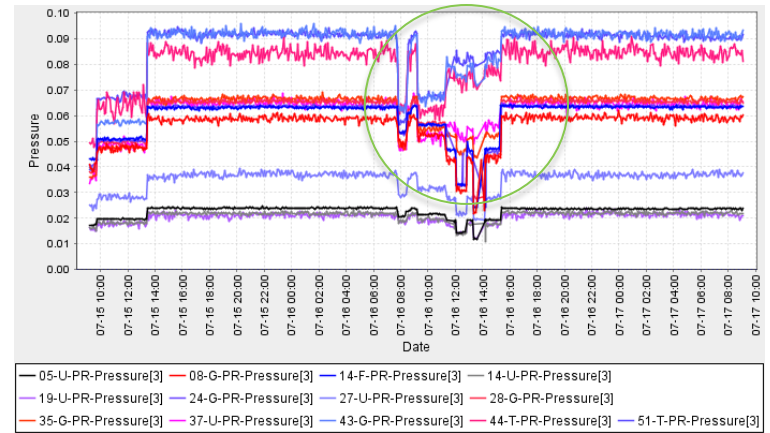

## Rack-Top Temperatures

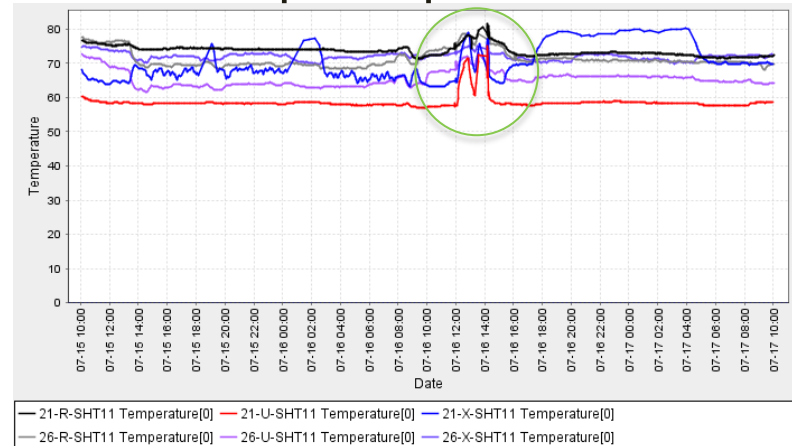

# Feedback Continues to Help

- Note impact of IT cart!
- Real-time feedback identified cold aisle air flow obstruction

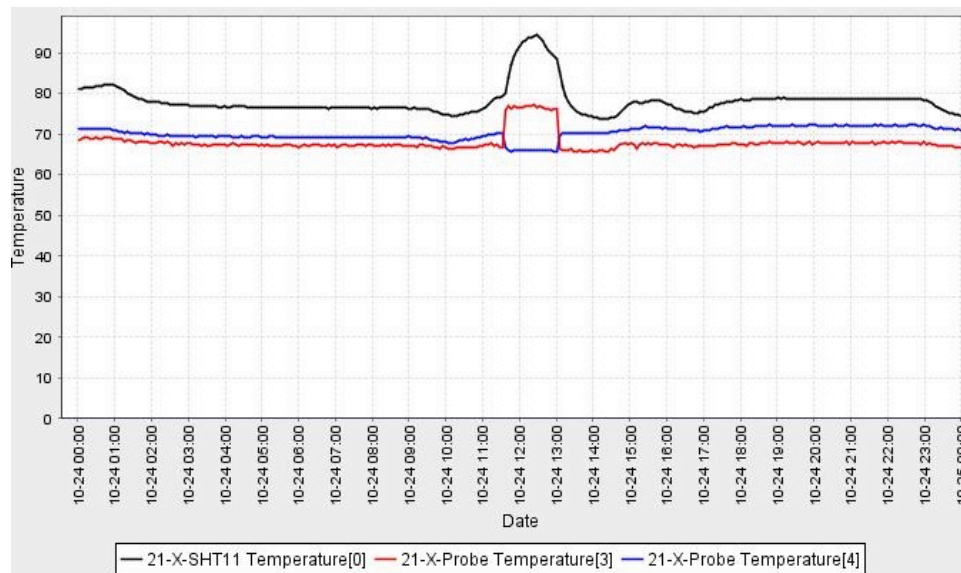

# Real-time PUE Display

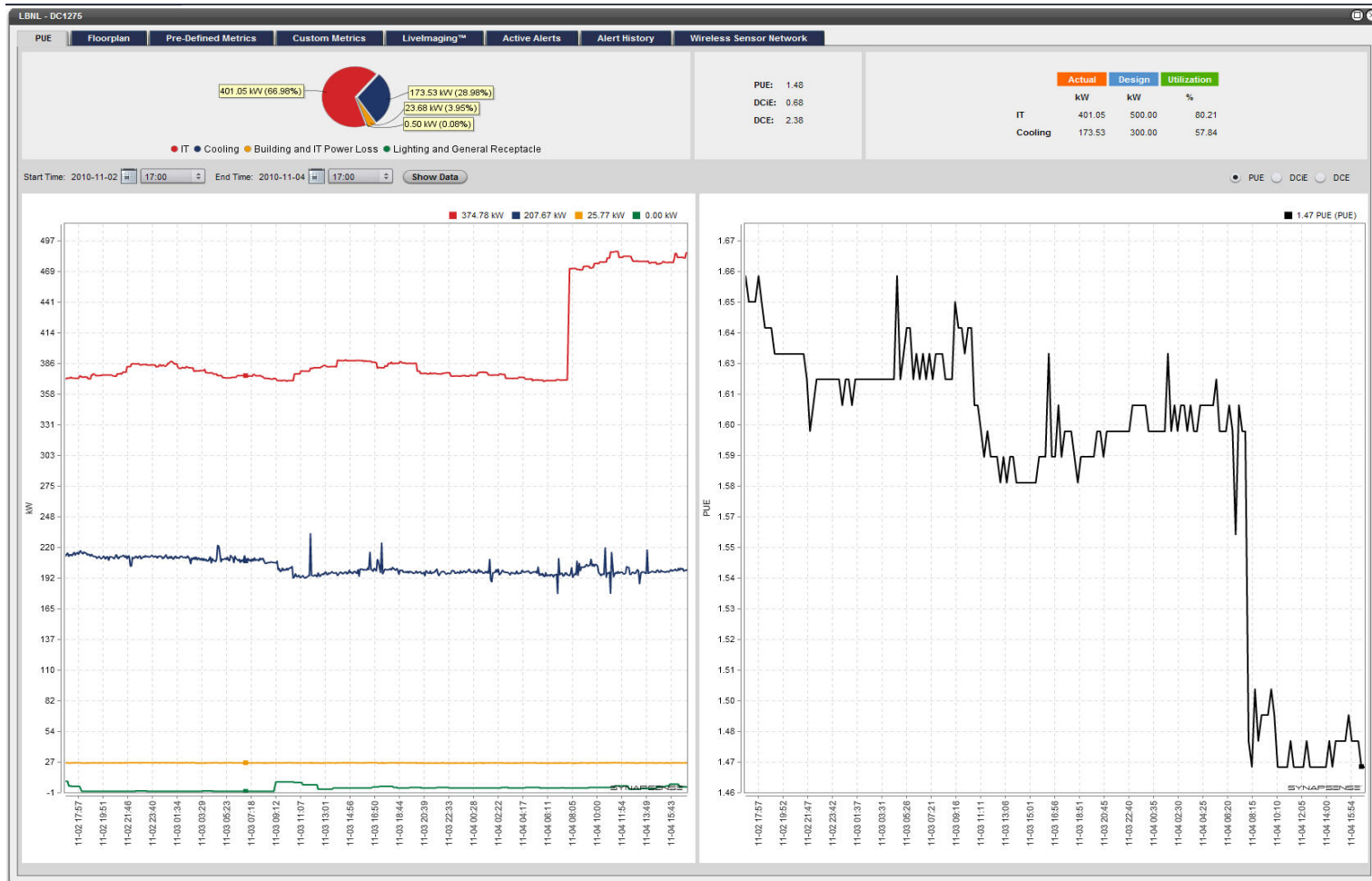

# Franchise Tax Board (FTB) Case Study

## Description

- 10,000 Sq.Ft.
- 12 CRAH cooling units
- 135 kW load.

## Challenges

- Over-provisioned
- History of in-fighting
- Manual shutoff not successful.



## Solution

- Intelligent supervisory control software with rack intake temperature sensing

# FTB Wireless Sensor Network (WSN)

- WSN included 50 wireless temperature sensors (Dust Networks radios)
- Intelligent control software

## FACS Dashboard:

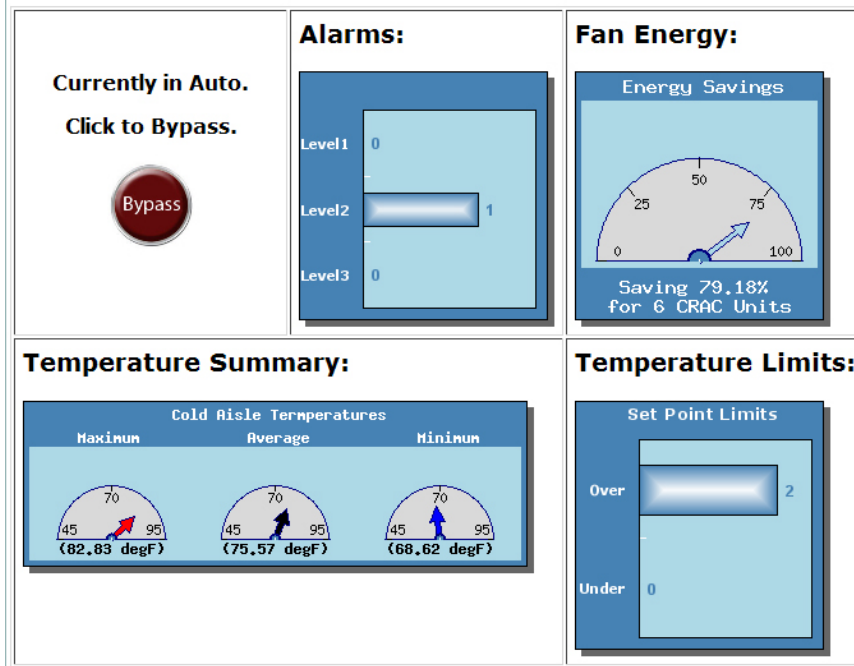

# WSN Smart Software: Learns About Curtains

CRAH 3 influence at start

CRAH 3 influence after curtains

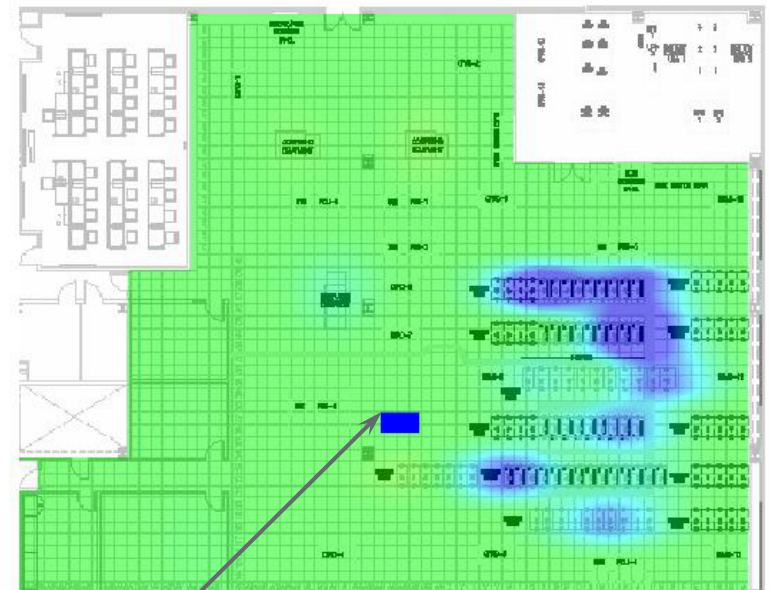
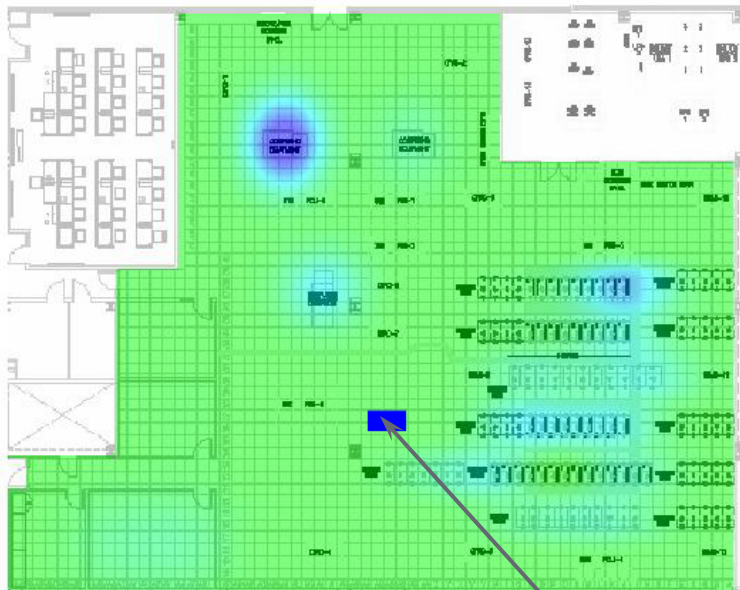

CRAH-03



# WSN Tracked Cold-aisle Temperatures

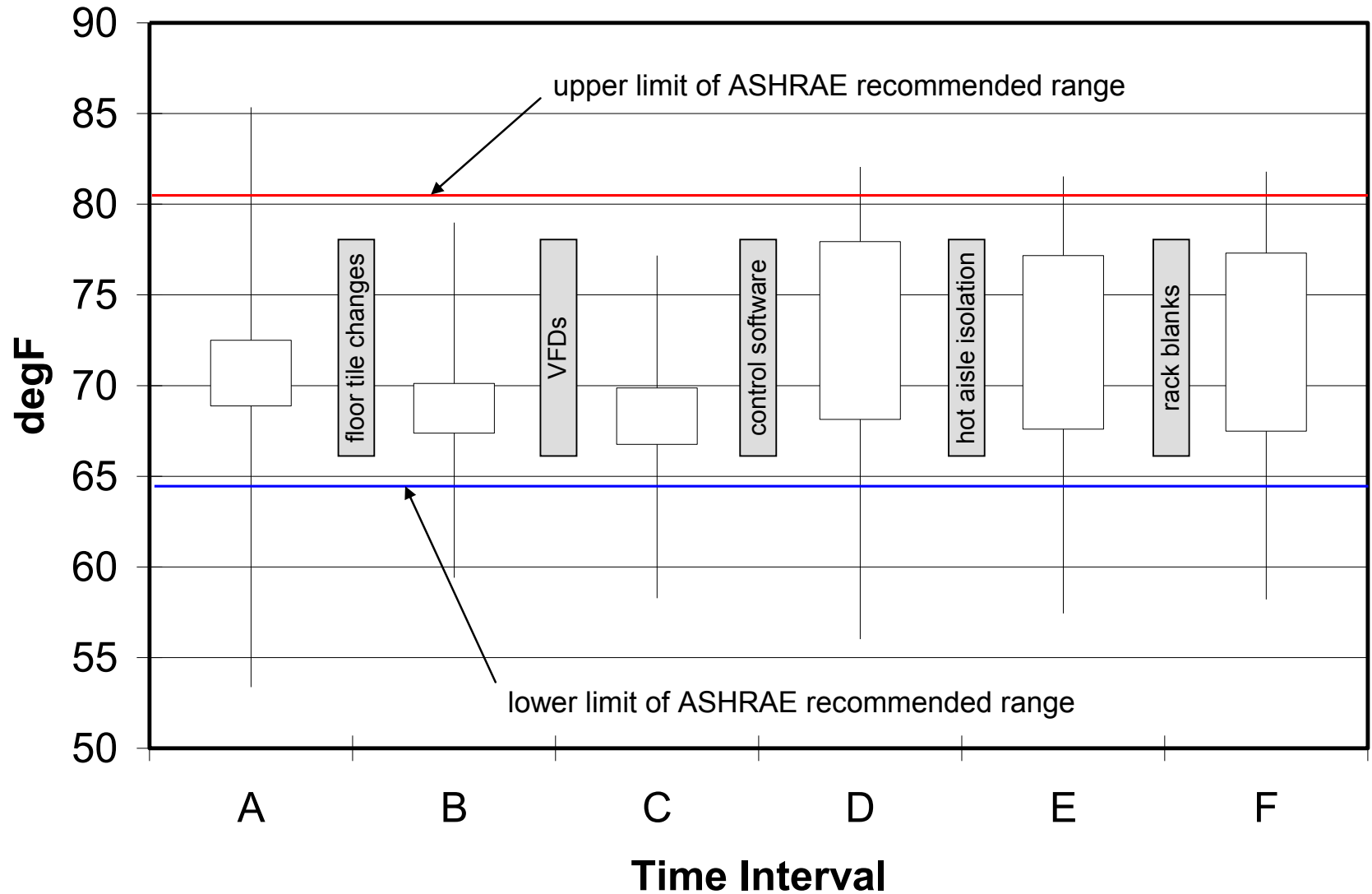

# WSN Software = Dramatic Energy Reduction

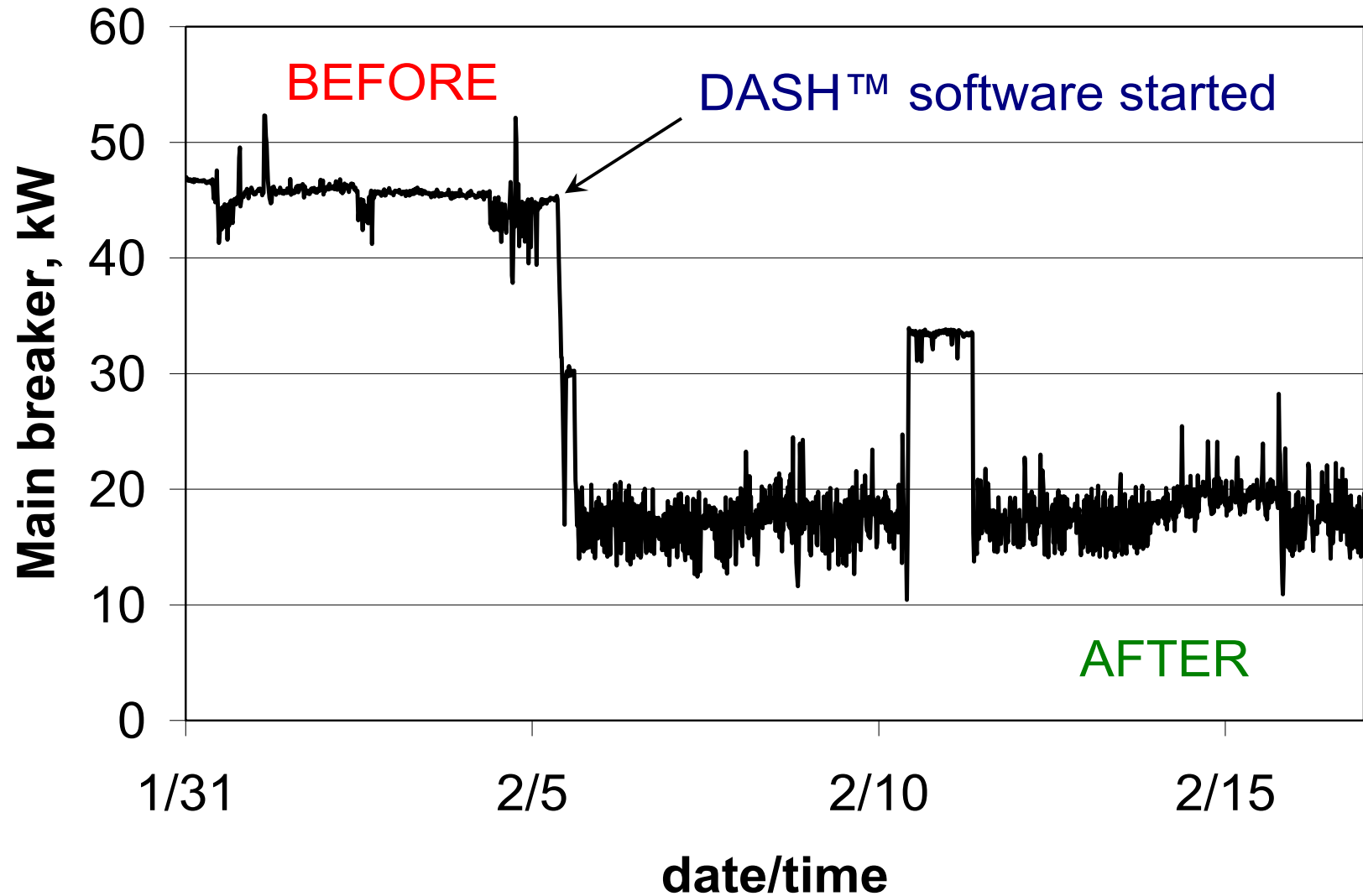

# Cost-Benefit Analysis

## DASH cost-benefit (sensors and software)

- Cost: \$56,824
- Savings: \$30,564
- Payback: 1.9 years

## Total project cost-benefit

- Cost: \$134,057
- Savings: \$42,772
- Payback: 3.1 years

# An Emerging Technology

- Control data center air conditioning using the *built-in* IT equipment temperature sensors
- Typically, data center cooling uses *return air temperature* for control
  - Optimum control difficult
  - ASHRAE and IT manufacturers recommend use of inlet air temp
- IT equipment has multiple temperature sensors
- Information from these sensors is available on the IT network.



# Intel Demonstration

- Servers can provide temperature data to a facility control system
- Given server inlet temperature, facility controls improved temperature control and efficiency
- Effective communications and control were accomplished without significant interruption or reconfiguration of systems

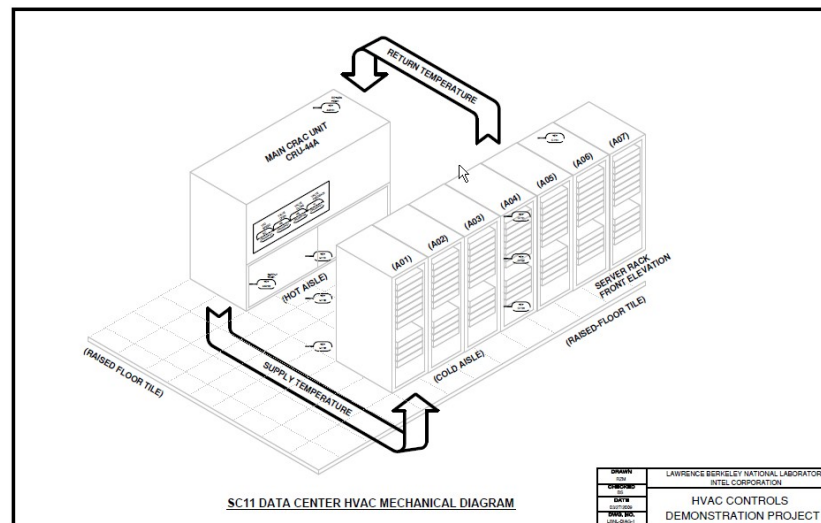

# Energy Information System Dashboards

Dashboards can display multiple systems' information for monitoring and maintaining data center performance.

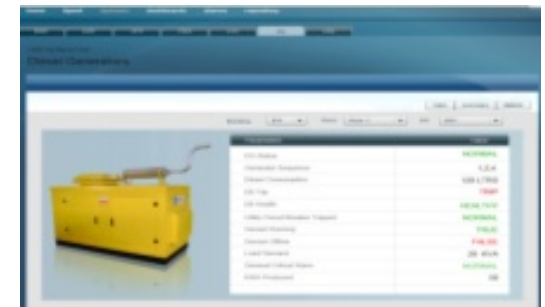
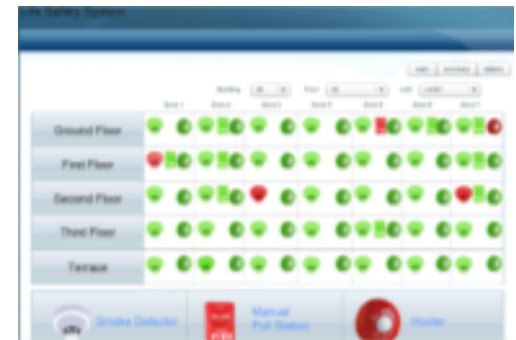

# Why Dashboards?

- Provide IT and HVAC system performance at a glance
- Convert data to actionable information
- Identify operational problems
- Baseline energy use and benchmark performance
- View effects of changes
- Share information and inform integrated decisions.

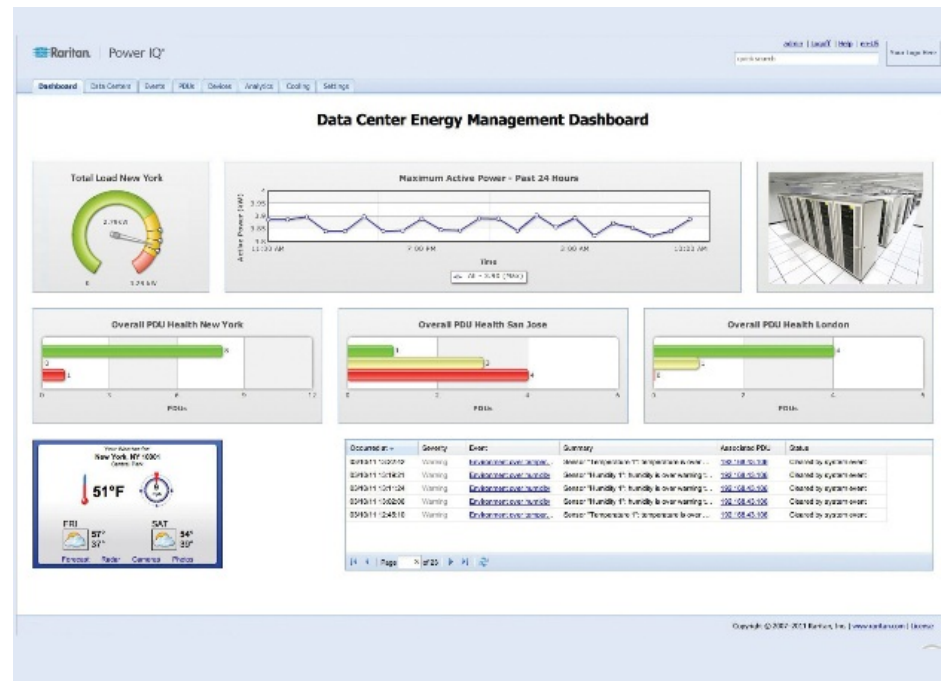

# Highest Staff-Chosen Metrics for Dashboards

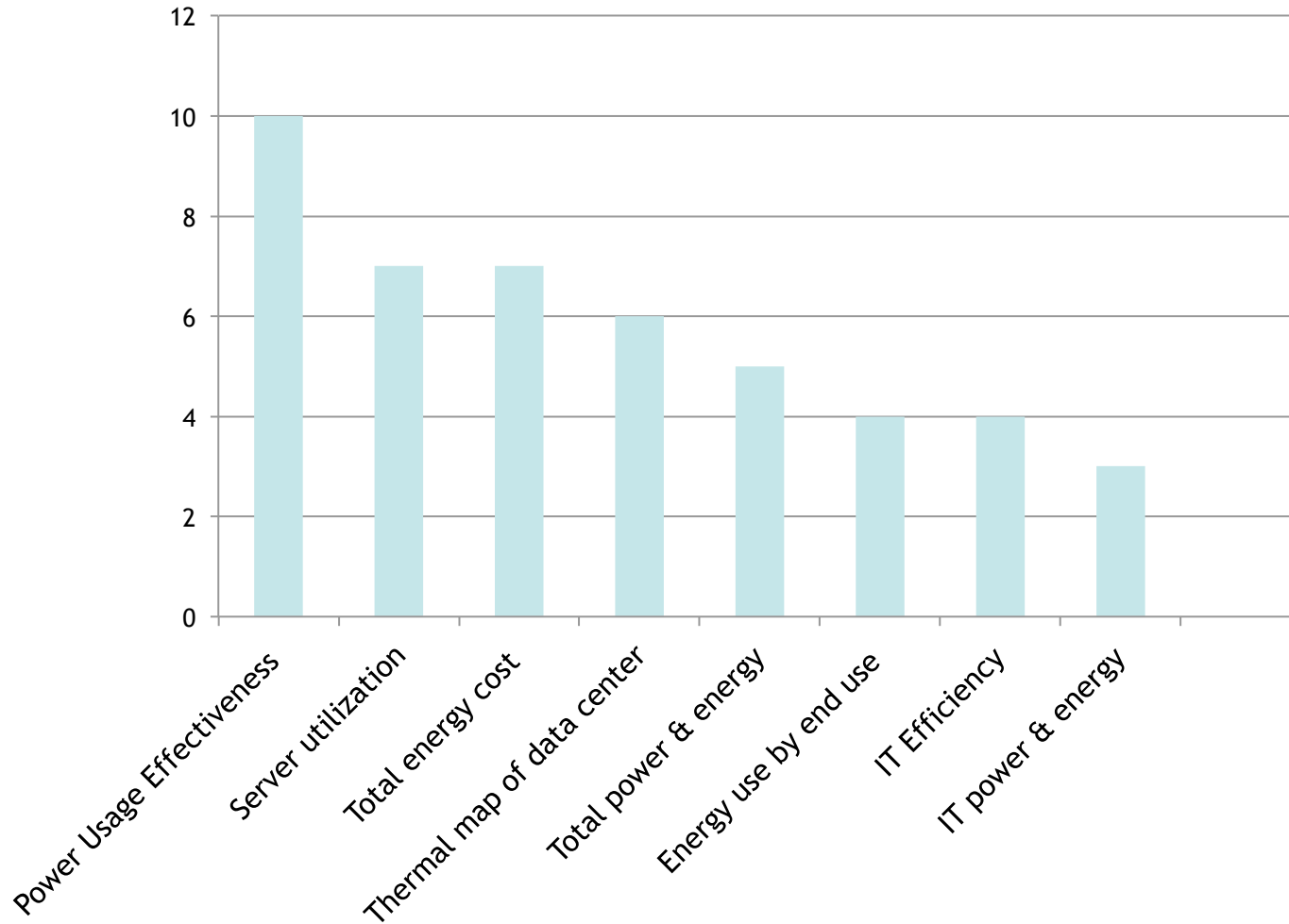



# Key Performance Metrics

- Power Usage Effectiveness (PUE)
- Energy Cost
- Energy Use by end-use
- Electrical distribution efficiency
- Cooling efficiency
- Environmental map
- IT utilization

# Dashboard and Reporting, NGA Reporting Example

## Power Utilization Efficiency

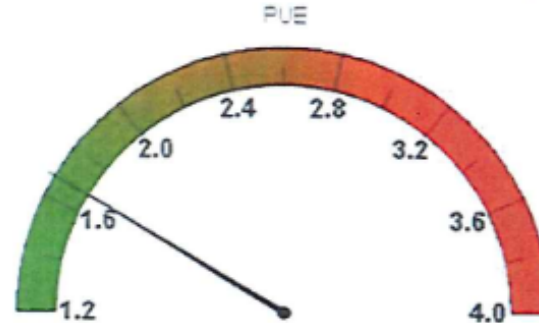

## Power Summary



## Temperature Summary

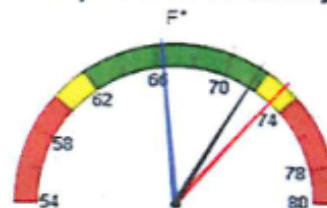

## Humidity Summary

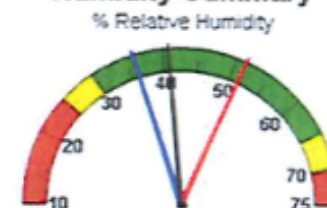

## Rack Units Used

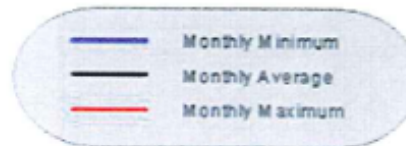
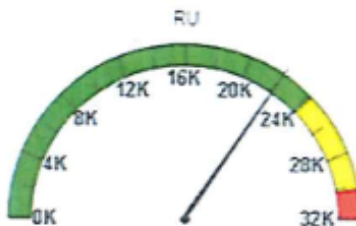

## Rack Area Used

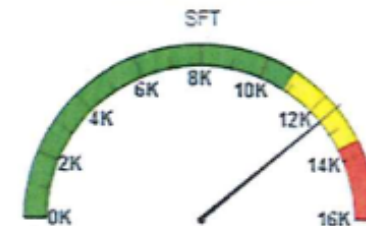

# Dashboard and Reporting, modius

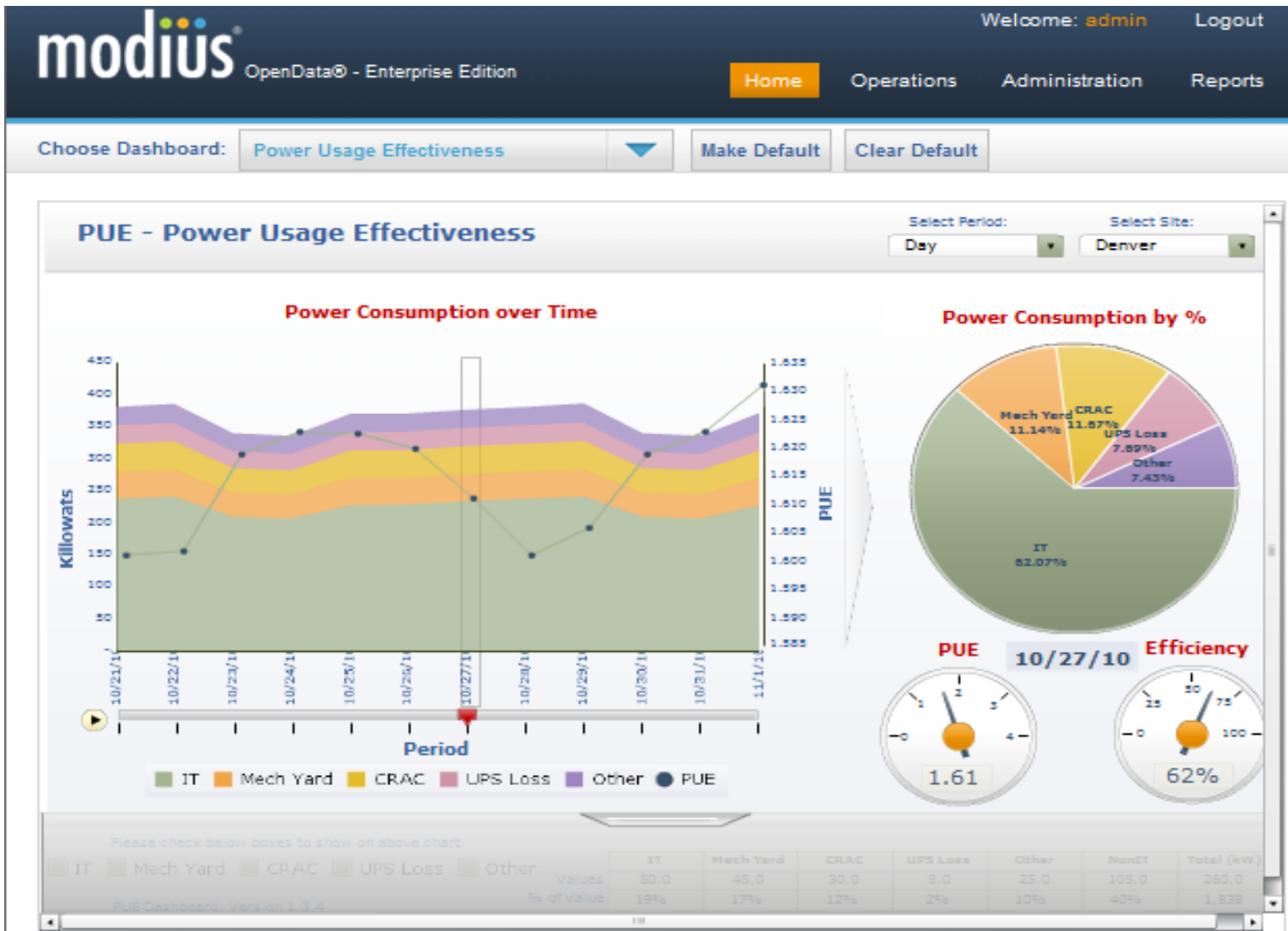

# High-Level Energy Performance Dashboard

Hourly Energy Cost

Last 7days   
 Last 30days   
 Last 12months

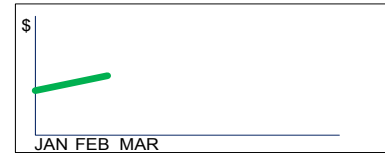

ENERGY COST

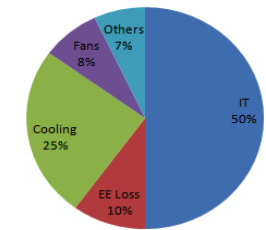

Percent POWER USE Real Time

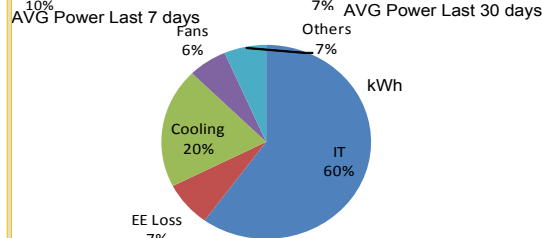
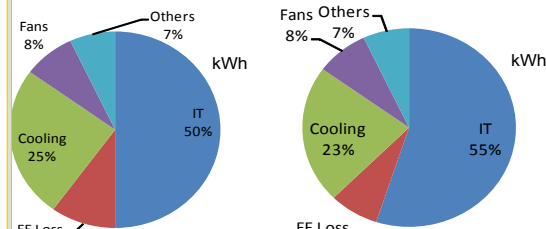

AVG Power Last 12 months

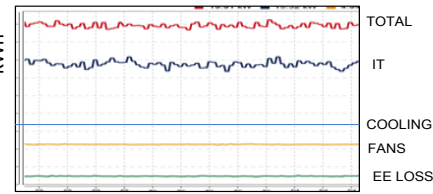

ENERGY USE trend

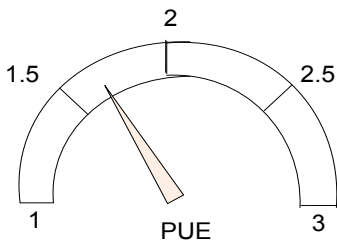

PUE



Avg PUE

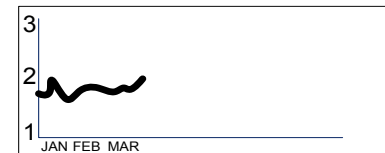

PUE trend

# Facility Manager's Dashboard (added)

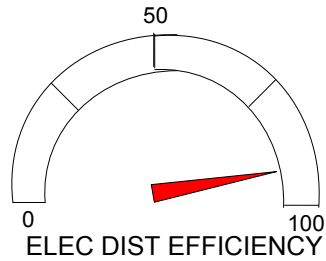

WEEK TO DATE  %

MONTH TO DATE  %

YEAR TO DATE  %

AVG ELEC DIST EFFICIENCY

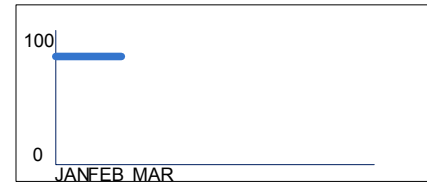

ELEC DIST EFFICIENCY

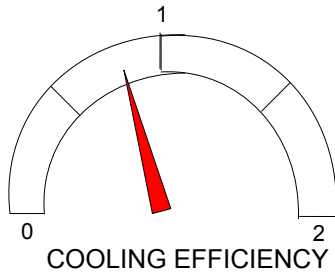

WEEK TO DATE  kW/ton

MONTH TO DATE  kW/ton

YEAR TO DATE  kW/ton

AVG COOLING EFFICIENCY

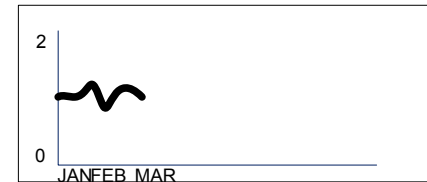

COOLING EFFICIENCY

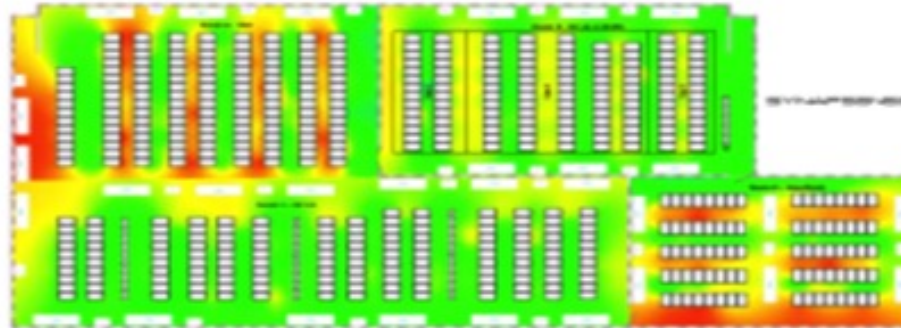

Thermal Map

# IT Manager's Dashboard

In addition to the previous dashboards, a third dashboard is recommended for the IT manager:

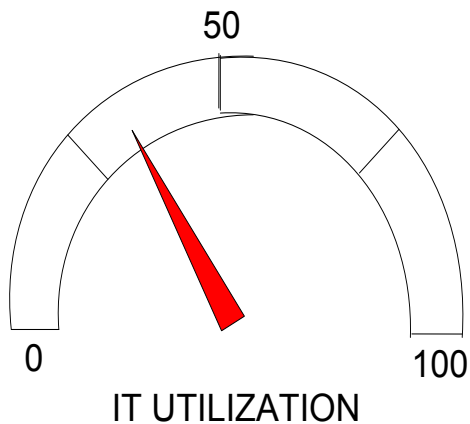

Last 7days	35	%
Last 30days	35	%
Last 12months	35	%

AVG IT UTILIZATION

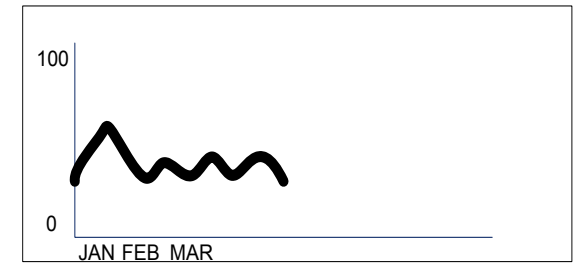

IT utilization trend

# End-to-End Management with DCIM

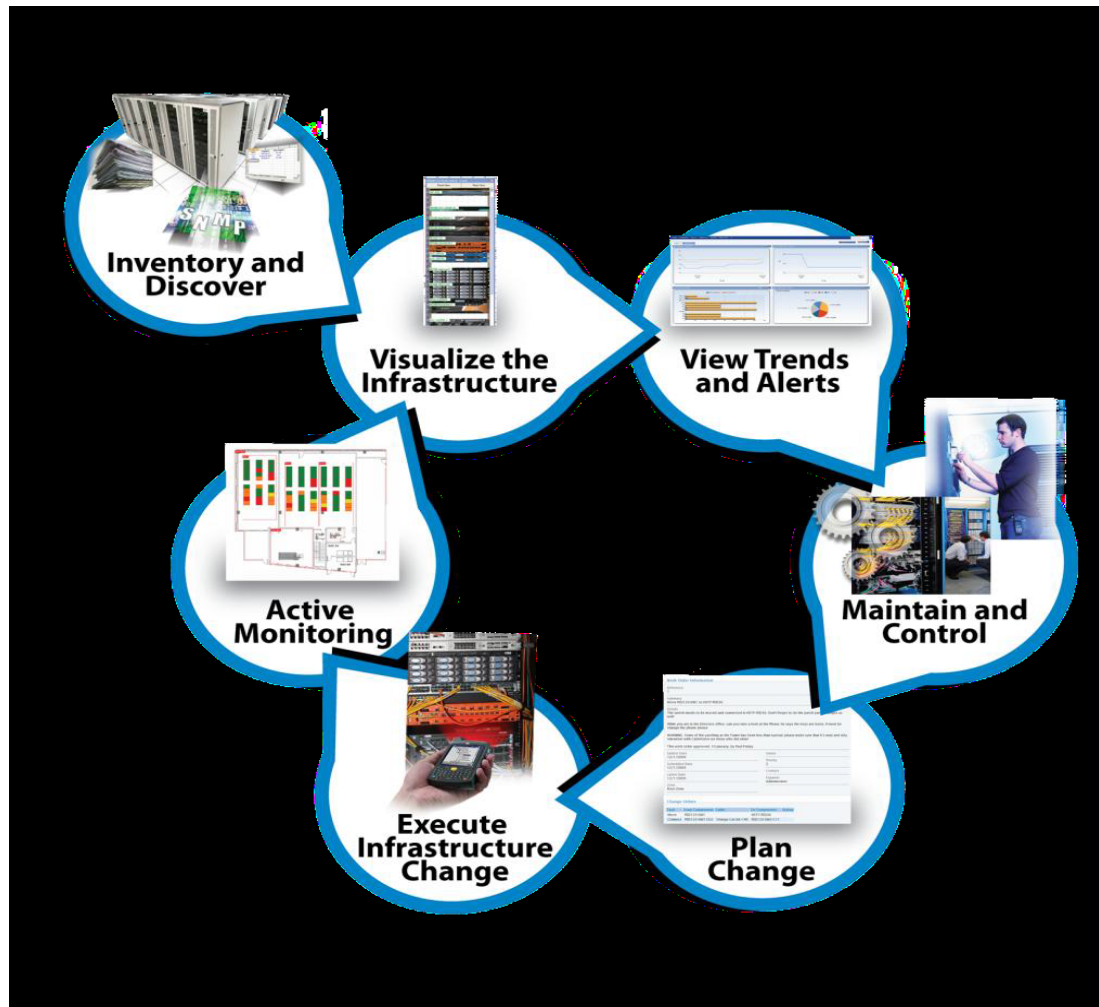

Courtesy of Cormant Inc.

# Use IT to Manage IT: Summary

---

- Evaluate monitoring systems to enhance operations and controls
- Install dashboards to manage and sustain energy efficiency



# Questions



# Questions





# Resources

# Resources



## DOE Better Buildings

- Tool suite & metrics for base-lining
- Training
- Showcase case studies
- Recognition of high energy savers



## Federal Energy Management Program

- Workshops
- Federal case studies
- Federal policy guidance
- Information exchange & outreach
- Qualified specialists
- Technical assistance

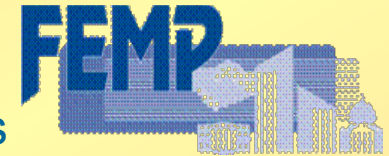

## EPA

- Metrics
- Server, UPS, network equipment performance rating & ENERGY STAR label
- Data center benchmarking



## Industry

- Tools
- Metrics
- Training
- Best practice information
- Best-in-Class guidelines
- IT work productivity standard



# Center of Expertise (COE)



**CENTER OF EXPERTISE**  
FOR ENERGY EFFICIENCY IN DATA CENTERS

SEARCH



[HOME](#) [ABOUT](#) [TECHNOLOGIES](#) [ACTIVITIES](#) [RESOURCES](#) [CONTACT US](#) [ADMIN](#)

**"While information technology (IT) is improving the efficiency of government, energy use in data centers is growing at a significantly faster rate than any other building segment..."**



The Department of Energy-led CENTER of EXPERTISE demonstrates national leadership in decreasing the energy use of data centers. The Center partners with key influential public and private stakeholders. It also supplies know-how, tools, best practices, analyses, and the introduction of technologies to assist Federal agencies with implementing policies and developing data center energy efficiency projects.

### Better Buildings Data Center Partners

Program requires participating Federal agencies and other data center owners to establish an efficiency goal for their data centers, and to report and improve upon their performance through metrics such as Power Usage Effectiveness (PUE).

### Measure and Manage

LBL and FEMP perform ongoing work with industry groups to assemble cost-effective, customer-friendly approaches to enable data center stakeholders to measure and manage the energy performance of their data center over time.

# Data Center Resources

- Best Practices Guide
- Benchmarking Guide
- Data Center Programming Guide
- Technology Case Study Bulletins
- Procurement Specifications
- Report Templates
- Process Manuals
- Quick-Start Guide

**Data Center Rack Cooling with Rear-door Heat Exchanger**  
Technology Case-Study Bulletin

As data center energy densities in power-use per square foot increase, energy savings for cooling can be realized by incorporating liquid-cooling devices instead of increasing airflow volume. This is especially important in

Server racks can also be cooled with competing technologies such as modular, overhead coolers, in-row coolers, and above-rack coolers with dedicated containment enclosures.

During operation, hot server-rack airflow is forced through the RDEHX device by the server fans. Heat is exchanged from the hot air to circulating water from a chiller or cooling tower. Thus, server-rack outlet air temperature is reduced before it is

**Best Practices Guide for Energy-Efficient Data Center Design**  
January 2010

Benefits  
Devices can save energy, ensure reliability in data of straightforward installation, and low maintenance, combined with indirect evaporative cooling, cable technology in both data center designs. It eliminates the complexity of floor air distribution.

Benefits  
e RDEHX devices have no fan require less maintenance to computer room (CRAC) units. RDEHX give occasional cleaning from the air-side of the efficiency also depends maintenance.

minimize Challenge  
present an opportunity by either reducing or

Prepared by the National Renewable Energy Laboratory (NREL), a national laboratory of the U.S. Department of Energy, Office of Energy Efficiency and Renewable Energy. NREL is operated by the Alliance for Sustainable Energy, LLC.

**Data Center Airflow Management Retrofit**

**1 Introduction**  
As data center energy densities in power-use per square foot increase, energy savings for cooling can be realized by optimizing airflow pathways within the data center. This is especially important in existing data centers with typical underfloor air distribution primarily due to constraints from underfloor dimensions, obstructions, and leakage. Fortunately, airflow-velocity can be improved significantly in most data centers, as described below in this airflow management overview. Next, this case study bulletin presents air management improvements that were identified in an edge Tier-3 data center at Lawrence Berkeley National Laboratory (LBNL). Particular airflow improvements, performance results, and benefits are reviewed that enhanced cooling efficiency at LBNL. In addition, a more generalized list of measures to improve data center airflow is provided. Finally, a series of lessons-learned gained during the retrofit project at LBNL is presented.

**2 Airflow Management Overview**  
Airflow retrofits can increase data center energy efficiency by fixing up standard airflow and cooling

Figure 2: Data center CFD model of return airflow short circuit. (Courtesy: ANCC)

Technical Case Study Bulletin | 6 July 2010

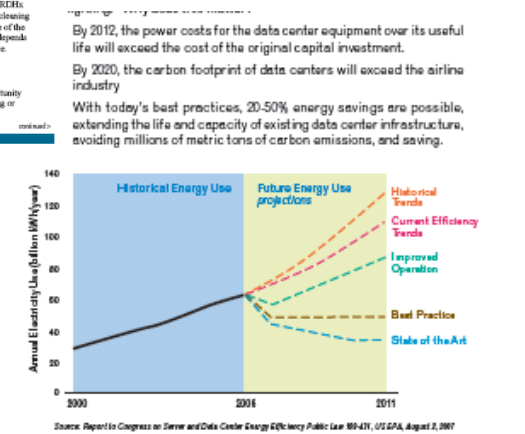

# Federal Energy Management Program (FEMP)

DOE's FEMP data center program provides tools and resources to help owners and operators:

- DC Pro Software and Assessment Tool Suite
  - Tools to define baseline energy use and identify energy-saving opportunities
- Information products
  - Manuals, case studies, and other resources
- End-user awareness training
- Data Center Energy Practitioner (DCEP) certificate program
  - Qualification of professionals to evaluate energy efficiency opportunities in data centers <http://datacenters.lbl.gov/dcep>

# Data Center Software Tool Suite

## High-Level Online Profiling Tool (DC Pro v.3)

- Overall efficiency (Power Usage Effectiveness [PUE])
- End-use breakout
- Potential areas for energy-efficiency improvement
- Overall energy use reduction potential

### Air Management

- Hot/cold separation
- Environmental conditions
- RCI and RTI

### Electrical Systems

- UPS
- PDU
- Transformers
- Lighting
- Standby genset

### Future Tools

- HVAC
- IT



# Data Center Energy Practitioner (DCEP) Program

U.S. DOE certificate process for energy practitioners qualified to assess energy consumption and energy efficiency opportunities in data centers.

## **Key objective:**

- Raise the standard of energy assessors
- Greater repeatability/credibility of recommendations

## **Target groups** include:

- Data center personnel (in-house experts)
- Consulting professionals (for-fee consultants)

# Data Center Energy Practitioner (DCEP) Program

## Training & Certificate Disciplines, Levels, and Tracks

**Level 1 “Generalist” (1-day):**  
Pre-qualifications, Training/  
Exam on All Disciplines  
+ Assessment Process  
+ DC Pro Profiling Tool

**Level 2 “Specialist” (2-day):**  
Pre-qualifications, Training/  
Exam on Select Disciplines  
+ Assessment Process  
+ System Assessment Tool

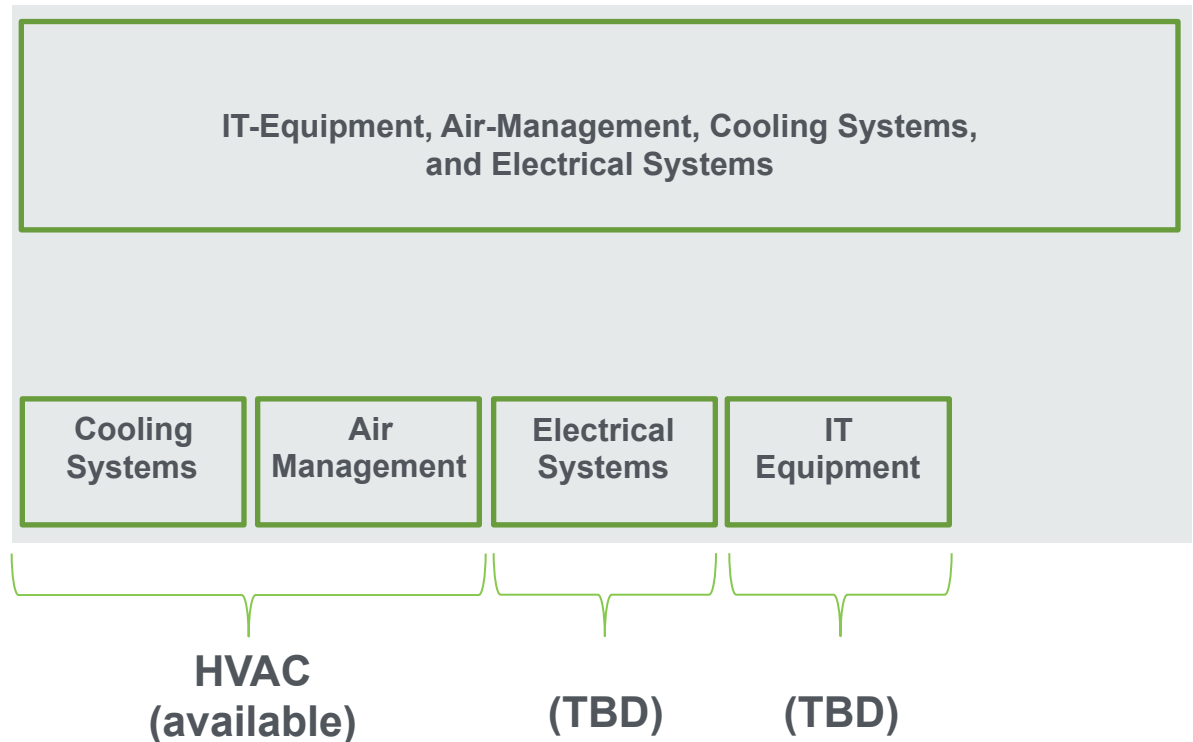

There is also a “Training Track”: Training only (no pre-qualifications and no exam)

# DCEP Training Organizations

- DCEP training is delivered by two training organizations that were selected through a competitive process.



- The training organizations:
  - license training and exam content from U.S. DOE
  - provide training/exams
  - issue certificates
- Access up-to-date program information and complete training schedule at U.S. DOE Center of Expertise for Energy Efficiency in Data Centers:  
<http://datacenters.lbl.gov/dcep>

# Energy Star

- A voluntary public-private partnership program
  - Buildings
  - Products (and servers)



# Energy Star Data Center Activities

- ENERGY STAR Datacenter Rating Tool
  - Build on existing ENERGY STAR platform with similar methodology (1-100 scale)
  - Usable for both stand-alone and data centers housed within another buildings
  - Assess performance at building level to explain how a building performs, not why it performs a certain way
  - ENERGY STAR label to data centers with a rating of 75+
  - Rating based on data center infrastructure efficiency
    - Ideal metric would be measure of useful work/energy use
    - Industry still discussing how to define useful work.
- Energy STAR specification for servers, UPSs, storage, and networking equipment



# DOE's Better Buildings Challenge

Launched December 2011

## Goals:

- Make commercial, industrial buildings & multifamily housing 20% + more efficient in 10 years
- Save more than \$80B for US organizations
- Create American jobs; improve energy security
- Mitigate impacts of climate change

## How:

- Leadership
- Results
- Transparency
- Best Practice Models
- Recognition
- Catalyzing Action



## Now 200+ Partners

*Commercial, Industrial, Public, Private*

## Represent:

3.5+ Billion Square Feet

\$2 Billion Private Financing

600+ Manufacturing plants

\$2 B Federal Commitment

150 MW Data Centers

# Data Center Partnerships

DOE has expanded the Better Buildings Challenge to include data centers; also added a new Data Center Accelerator:

- Federal Government, Public, and Private Sector leadership
- 25 partners, over 150 MW committed to date
- Unique opportunity– included in many other buildings
- Small, medium and large data centers
- Focus on infrastructure savings; ~50% of energy
- Highlight innovative and replicable solutions, leaders

<http://www4.eere.energy.gov/challenge/partners/data-centers>

# Data Centers Added To The BB Program

Organizations that own and/or operate data centers can now partner with DOE to lead by example in one of two ways:

## 1. Better Buildings Challenge

Partners commit to reduce the energy intensity of their portfolio (including data centers) by at least 20% within 10 years and share their results.

## 2. Better Buildings Data Center Accelerator

Partners commit to reducing the infrastructure energy use of at least one data center (IT load  $\geq$  100 kW) by at least 25% within 5 years and share their results.

### DOE agrees to:

- Provide technical expertise, communications support, and dedicated account manager
- Create networking opportunities to help Partners share best practices and innovative solutions
- Collaborate with Partners regularly
- Recognize Partners' progress and successes; highlight leadership



# Partner Participation Process

- Management commits to goal and forms team
- Baseline established (can be up to 3 years in past)
- Benchmark performance and develop plan
- Identify and implement efficiency measures
- Measure and track PUE performance
- Continuous improvement.

# How Will Data Be Tracked?

- DOE will collect data center PUE data annually through portfolio manager
- DOE will calculate portfolio PUE-1 (infrastructure energy intensity) from the collected PUE data
- Year-by-year and current vs. base year will be tracked for % change in PUE-1
- Base year can go back as far as three years from joining.

# What If Current Metering Is Insufficient?

- If metering is not fully implemented when joining, partners may work with DOE to estimate a PUE baseline, with the goal of moving towards full metering for subsequent data submissions
- Partners must install metering as part of their participation, then track PUE using metered data.



# Resources



[http://www1.eere.energy.gov/femp/program/data\\_center.html](http://www1.eere.energy.gov/femp/program/data_center.html)



<http://datacenters.lbl.gov/>



[http://www.energystar.gov/index.cfm?  
c=prod\\_development.server\\_efficiency](http://www.energystar.gov/index.cfm?c=prod_development.server_efficiency)



<https://www4.eere.energy.gov/challenge/partners/data-centers>

# Questions



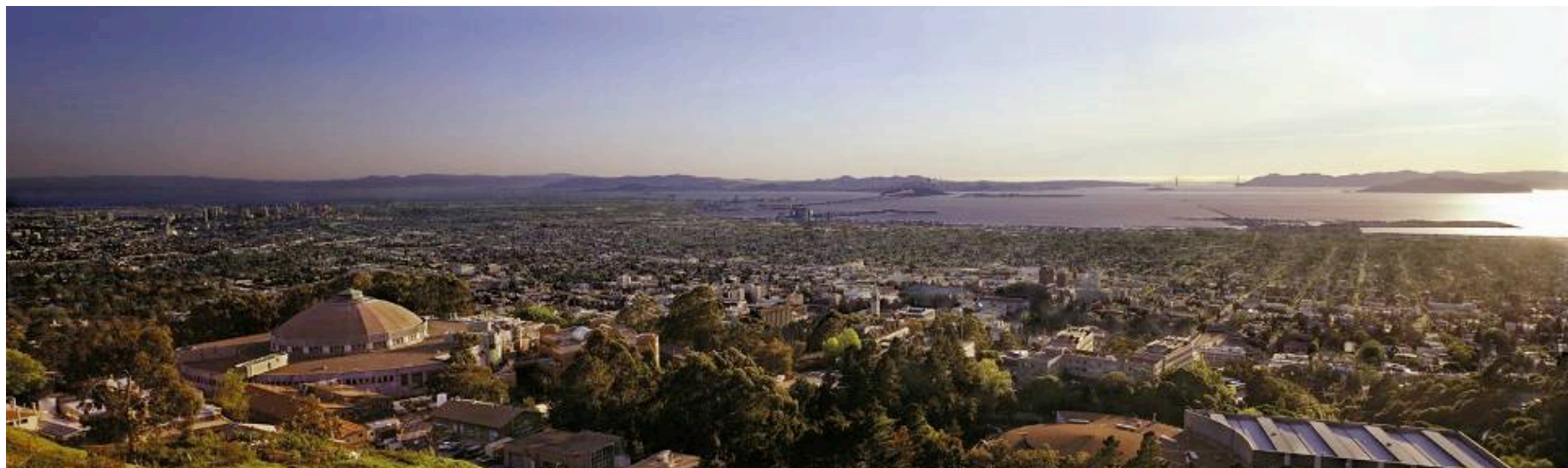

# Workshop Summary

## Best Practices

# Summary

- A data center uses 10-80 times more energy than an office building per sq.ft.
- There are federal mandates and requirements related to energy efficiency in data centers
- Integration of acquisition, IT, and facilities optimizes energy performance
- Key data center energy performance metrics assist in benchmarking data centers
- Monitoring, analytics, and reporting should be standardized.

# Data Center Best Practices Summary

1. Measure and Benchmark Energy Use
2. Identify IT Opportunities, and modify procurement processes to align with the procurement policy
3. Optimize Environmental Conditions
4. Manage Airflow (Air Management)
5. Evaluate Cooling Options
6. Improve Electrical Efficiency
7. Use IT to Control IT



# 1. Measure and Benchmark Energy Use

---

- Use metrics to measure efficiency
- Benchmark performance
- Establish continual improvement goals

## 2. Identify IT Opportunities

- Specify efficient servers (incl. power supplies)
- Virtualize
- Refresh IT equipment
- Turn off unused equipment
- Implement acquisition systems to assure efficient products are purchased

# 3. Optimize Environmental Conditions

- Follow ASHRAE guidelines or manufacturer specifications
- Operate near maximum ASHRAE recommended range
- Anticipate servers will occasionally operate in allowable range
- Minimize or eliminate humidity control

# 4. Manage Airflow

---

- Implement hot and cold aisles
- Seal leaks
- Manage floor tiles
- Isolate hot and cold air streams

# 5. Evaluate Cooling Options

---

- Use centralized cooling system
- Maximize central cooling plant efficiency
- Provide liquid-based heat removal
- Compressorless cooling (“free” cooling)

# 6. Improve Electrical Efficiency

---

- Select efficient UPS systems and topography
- Examine redundancy levels
- Increase voltage distribution and reduce conversions.

# 7. Use IT to Control IT Energy

---

- Evaluate monitoring systems to enhance real-time management and efficiency
- Use visualization tools (e.g., thermal maps)
- Install dashboards to manage and sustain energy efficiency

# Most importantly

---

Get IT and Facilities people talking and working together as a team!



# Questions



# After the Training

- Below is the link to access the final quiz and course evaluation for the Data Centers pre-conference workshop on August 10th:

<http://www.wbdg.org/education/femplt08102015b.php>

- This link can be used by your learners can access the final quiz and evaluation after the workshop to obtain CEU credit and provide course feedback. It can be included in course materials and presentations.
- The following video slide explains how to login to the WBDG. If they have not already, learners will need to sign up for a WBDG account using their basic contact information to access the quiz and evaluation.



## **FEMP AND WBDG: HOW TO REGISTER**

# Contact Information

Dale Sartor, P.E.

[DASartor@LBL.gov](mailto:DA_Sartor@LBL.gov)

(510) 486-5988



Steve Greenberg, P.E.

[SEGreenberg@lbl.gov](mailto:SEGreenberg@lbl.gov)

(510) 486-6971

**Lawrence Berkeley National Laboratory**

MS 90-3111

University of California

Berkeley, CA 94720

<https://datacenters.lbl.gov/>