

JDEM-ISWG Report to NASA and DOE Headquarters

May 4, 2010

Executive Summary

In December 2009, NASA HQ and DOE HQ asked the Joint Dark Energy Mission-Interim Science Working Group (ISWG) to provide science requirements, key mission parameters and any other scientific studies needed to support the process to design an optimized Probe-class space mission concept(s) for the study of dark energy subject to a cost cap (\$650M in FY2009 dollars, not including the launch). To achieve this goal the ISWG met monthly through April of 2010 to deliberate and confer with the GSFC and LBL Project Offices, with significant additional effort by Working Groups on individual subjects.

As a minimum requirement for a worthwhile mission, the ISWG adopted a Figure of Merit (FoM) of approximately 500 with the Planck Mission plus Stage III¹ experiments (i.e. near-term, medium-cost, currently proposed projects) as priors, consistent with the findings of the Dark Energy Task Force (DETF). Additional considerations were: the redshift ranges should complement those achievable from the ground and at least two techniques should be enabled by a mission concept.

Working closely with the two project offices, the ISWG was successful in identifying two designs of interest, which are described in the following paragraphs. This was possible because of two advances. The first was the use of an unobstructed telescope aperture, which in addition to increased throughput, significantly improves the point-spread function, allowing performance of a 1.1 m unobstructed telescope to rival that of a 1.3-1.5 conventional telescope. The second advance was a set of new scientific strategies for the surveys. Of particular importance was the strategy for supernovae (SNe). A slitted low-resolution spectrometer or IFU would be used to obtain the precision light curves, with the imaging detector used only for SNe discovery, permitting compatibility with the large pixels optimized for a baryon acoustic oscillation (BAO) survey. Together these advances made possible cost constrained designs with a 1.1 meter telescope.

The ISWG working with the Project Offices identified a compelling mission concept, Design A, that is estimated by the GSFC Project office to fit within the cost cap of a Probe-class mission. Requiring 17 IR detectors totaling 68 million

pixels, the design enables a BAO + SNe dark energy survey. Using 50% of the three-year mission time, the BAO survey would cover 16,000 square degrees to a sensitivity depth of 2×10^{-16} ergs-cm⁻²-sec⁻¹ over the redshift range $1.3 < z < 2.0$. Likewise the SNe survey would study 1500 SNe with redshifts from 0.2 to 1.5 with 50% of the mission time. The design does not include a Weak Lensing survey. It does include the potential for obtaining new information about gravity by using the BAO data set for red shift space distortion studies. The ISWG finds that the potential for this mission is exciting and additional studies would be valuable.

The ISWG identified a second concept, Design B, which had enhanced capability for discovering modifications to general relativity. Design B can conduct a parallel BAO + weak lensing survey with a SN capability added and will have a higher scientific reach than Design A. (See the figure below.) The GSFC cost estimate does not fit within the Probe-class mission budget limit, but the scientific and technical understanding of the design at this time is limited because of the time constraints of the study. The ISWG brought this information to the attention of the Agencies, because a follow-on study of Design B represents an opportunity to better understand the technical and scientific drivers of a mission that includes weak lensing within a cost constrained budgetary environment.

Figure of Merit Summary. The two axes are the DETF FoM vs. γ FoM. γ FoM characterizes the growth of structure e.g. tests of General Relativity. The symbol III with an oval around it represents the FoM estimated for Stage III¹ ground-based studies. A and B refer to the two designs, G to ground-based studies. B assumes weak lensing and BAO only, B' includes SNe also. Blue is for a ground program that is slightly better than Stage III¹. Red is for a maximal Stage IV¹ ground program including Big Boss (24,000 sq deg) and LSST. The enhancements to the FoM and the γ FoM by measurements of redshift space distortions are not included.

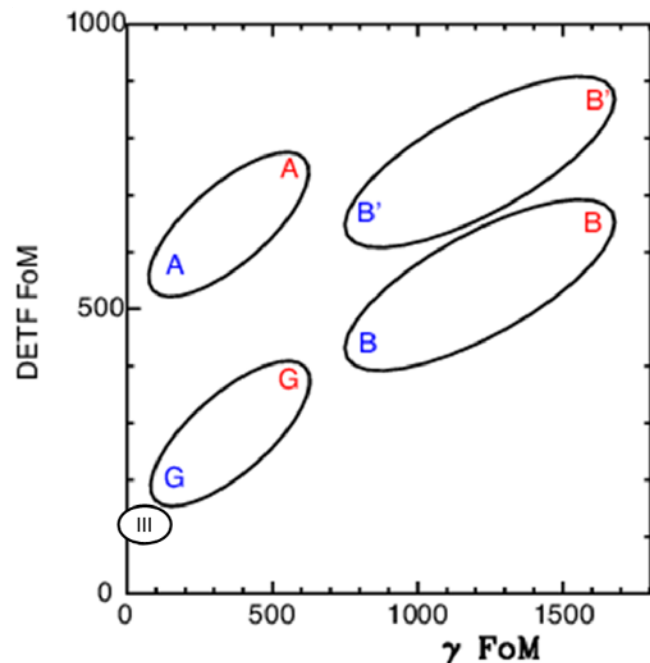

1. The DETF Report describes dark-energy research in *Stages*: Stage III comprises near-term, medium-cost, currently proposed projects; Stage IV comprises a Large Survey Telescope (LST), and/or the Square Kilometer Array (SKA), and/or a Joint Dark Energy (Space) Mission (JDEM).

Final Version

JDEM-ISWG Report
To NASA HQ & DOE HQ

May 4, 2010

**Charter for the DOE and NASA Joint Dark Energy Mission (JDEM)
Interim Science Working Group (ISWG)
December 3, 2009**

Purpose

The JDEM ISWG is being constituted by NASA HQ and DOE HQ (hereafter the Agencies) to provide scientific assistance during JDEM pre-phase A activities and will inform the Agencies on their findings. A near-term study is requested by the Agencies. Further studies may be requested in the future.

Study Request

The Agencies' near-term request to the ISWG is to provide science requirements, key mission parameters and any other scientific studies needed to support a process to design an optimized Probe-class space mission concept(s) for the study of dark energy, subject to budget constraints (\$650M in FY2009 dollars, not including the launch vehicle). To aid their studies, the ISWG may review past mission concepts developed, including the concepts presented to the National Research Council's Astro2010 panel, and the families of low-cost Probe-class concepts currently under development by the Project Office (PO), as well as other studies and reports. Justification for going to space should be included.

Concept Development

The JDEM Project Office (PO) is at Goddard Space Flight Center (GSFC). The DOE Lawrence Berkeley National Laboratory (LBNL) Project Office works in coordination with GSFC.

The PO will be responsible for actual mission concept development, based on input and/or comment from the ISWG, and costing studies, eventually followed by independent cost estimates. One, or at most two, concepts shall be defined by April 15 2010 in sufficient detail for Independent Cost Estimates. Cost estimates shall be completed by June 15 2010.

Organization

The ISWG and the PO are independent of each other, but need to work in close coordination. They will iterate on science requirements and the mission concepts that flow from these and will share results with each other in a two-way exchange.

The ISWG may ask the PO to study particular mission concept(s), trades or other studies, including variations of concepts already studied or new concepts.

The ISWG may seek advice from external scientists. Though permission is not required, the ISWG will inform the Agencies and PO of these interactions.

The PO may ask the ISWG for science advice or studies. Any external science advice and discussions needed by the PO should be with the ISWG only.

Comments on the ISWG Process

Purpose: Provide scientific assistance during pre-Phase A activities. Proceed in two phases

- **First phase** — through Spring 2010
 - Develop one or two best designs for JDEM with the fiscal constraint of 650 2009 M\$ + Launch (as costed by the GSFC Project Office) i.e. a Probe Class Mission

Comments on ISWG Process (continued)

- Expect new information over the next few months
 - Costing by Independent Cost Estimate (ICE)
 - Report from the Decadal Survey
 - Status of plans for new ground based programs
 - Input from the broader scientific community
- **Second phase** to follow later
 - Reexamine JDEM mission design with possibly new constraints based on new information
 - Continue the present joint scientific and engineering efforts

The JDEM ISWG

Warren Moos (Co-chair)
Charlie Baltay (Co-chair)

Dominic Benford
Gary Bernstein
Wendy Freedman
Chris Hirata
Alex Kim
Rocky Kolb
Sangeeta Malhotra
Nikhil Padmanabhan
Jason Rhodes
Gregory Tarle

Neil Gehrels (Ex Officio)
Michael Levi (Ex Officio)

Monthly Meetings December to April

- December 7, 8 2009 Johns Hopkins
- January 28, 29 2010 Johns Hopkins
- February 25, 26 2010 Berkeley LBNL
- March 25, 26 2010 Fermilab
- April 15, 16 2010 GSFC

Working Groups

- BAO Working Group
 - Padmanabhan, Moos, Hirata, Malhotra
- SNe Working Group
 - Kim, Baltay, Tarle, Benford, Freedman
- Weak Lensing Working Group
 - Bernstein, Rhodes, Hirata, Gehrels, Levi
- Calibration Working Group
 - Tarle, Benford, Gehrels, Levi
- Redshift Space Distortions
 - Padmanabhan, Moos, Bernstein, Hirata, Gehrels

The Project Offices and the Working Groups worked very well together. A significant amount of work was done between each of the ISWG meetings.

Minimum Performance Requirements

December Meeting

- What are the minimum Performance requirements that make a JDEM mission worthwhile?
 - The Dark Energy Task Force (DETF) minimum requirement of a Figure of Merit 10 times Stage II and 3 times Stage III is still valid
 - DETF estimated Stage II as FoM = 50 and FoMSWG estimated Stage III as FoM = 116
 - The panel therefore felt that we should aim for a minimum FoM = 500 with Planck + Stage III priors

Minimum Performance Requirements

December Meeting

The DETF FoM is not the only relevant measure.

- JDEM should aim for a redshift reach complementary to what is possible from the ground.
- JDEM should enable at least **two methods** to investigate Dark Energy
 - Note that this is consistent with the DETF recommendation that the Dark Energy **program** have multiple techniques at every stage, at least one of which is a probe sensitive to the growth of structure in the form of galaxies and clusters of galaxies.

It is important not to look at JDEM in isolation but as a component of a coordinated space and ground based Dark Energy program, to ensure that techniques not enabled by one mission are covered by some other component of the program, and that the different parts of the program help and complement each other.

**The JDEM ISWG relied heavily on the families
of Probe Class missions developed by the
Project Offices at GSFC and LBL**

JDEM Probe Study Status

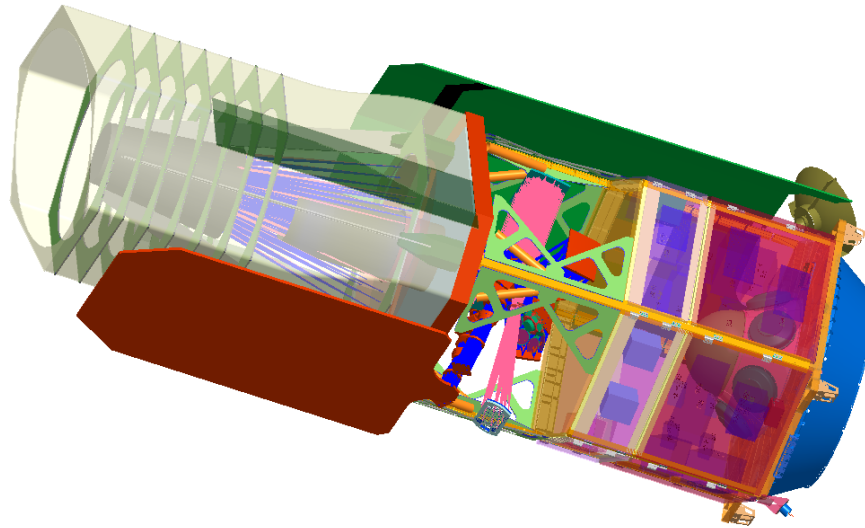

January 28, 2010

ISWG#2: Options Refined to 3 Single-FPA and 3 Dual-FPA Families

JDEM Probe Concepts_v15_ALL, Jan 26, 2010

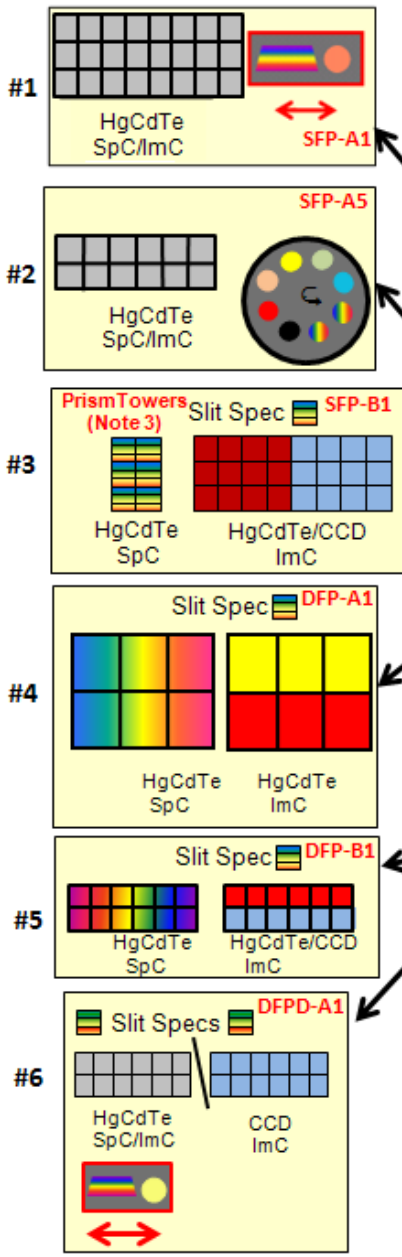

CONCEPTS (w/ID# and Mech notes;	CONFIGURATION							Methods (note 8)	BAO 1.5 ≤ z ≤ 2 deg ² /yr	WL M _{gal} resolved per yr	SNe-Ia (Slit) per yr
	Aperture	# NIR SCAs	# CCDs	Wavelength (note 7)	Pixel Scale (arcsec/pix)	SNe Spec	BAO Prism				
Single Focal Plane (SFP)											
SFP-A:	SpC/ImC			NIR					no img		
SFP-A1:	1.1m	24	0	0.9-1.7um	0.225	No	Yes	B+W	7499	514	0
SFP-A2:	1.3m	18	0	0.9-1.7um	0.225	No	Yes	B+W	4113	197	0
SFP-A3:	1.1m	18	0	0.9-2.0um	0.225	No	Yes	B+W	5624	386	0
SFP-A4:	1.3m	12	0	0.5-1.7um	0.30	Slit	Yes	B+S	5404	0	194
SFP-A5:	1.1m	12	0	0.5-1.7um	0.30	R75	Yes	B+S	7306	0	n/a
SFP-B:	SpC+ImC			NIR/CCD					w/nir img		
SFP-B1:	1.1m	6+12	0+12	0.5-1.7um	0.30/ 0.175	Slit	Towers	B/W+S	3653	502	185
SFP-B2:	1.3m	0+12	0+12	0.5-1.7um	0.30/ 0.175	Slit	No	W+S	0	194	194
Dual Focal Planes (DFP)											
DFP-A:	SpC+ImC			NIR/NIR					w/nir img		
DFP-A1:	1.1m	6+6	0	0.5-2.0um	0.45/0.45	Slit	Yes	B+S	8529	0	385
DFP-A2:	1.3m	6+6	0	0.5-1.7um	0.45/0.45	Slit+	Yes	B+S	6364	0	143
DFP-A3:	1.1m	12+12	0	0.5-2.0um	0.30/0.30	Slit	Yes	B+S	7306	0	508
DFP-A4:	1.3m	12+12	0	0.5-1.7um	0.30/0.30	Slit	Yes	B+S	5404	0	194
DFP-A5:	1.1m	6+12	0	0.9-1.7um	0.45/0.225	No	Yes	B/W	8529	257	0
DFP-B:	SpC+ImC			NIR/CCD					w/nir img		
DFP-B1:	1.3m	12+6	0+6	0.5-1.7um	0.30/ 0.175	Slit	Yes	B/W+S	5404	97	194
DFP w/Dichroic (DFPD)											
DFPD-A1:	SpC/ImC		ImC	NIR/CCD					w/vis img		
DFPD-A1:	1.1m	12	12	0.5-1.7um	0.30/ 0.175	Slit	Yes	B+W+S	7306	502	185
DFPD-A2:	1.1m	12	12	0.5-1.7um	0.30/ 0.175	Slit	No	W+S	0	502	185
DFPD-A3:	1.1m	12	12	0.5-1.7um	0.30/ 0.175	No	Yes	B+W	7306	502	0
DFPD-A4:	1.1m	12	12	0.5-2.0um	0.30/ 0.175	Slit	Yes	B+W+S	7306	502	508
DFPD-A5:	1.3m	12	12	0.5-1.7um	0.30/ 0.175	Slit	Yes	B+W+S	5404	194	194
DFPD-A6:	1.3m	12	12	0.5-1.7um	0.30/ 0.175	Slit	No	W+S	0	194	194
DFPD-A7:	1.3m	12	12	0.5-1.7um	0.30/ 0.175	No	Yes	B+W	5404	194	0

ISWG#2: Options Refined to 3 Single-FPA and 3 Dual-FPA Families

JDEM Probe Concepts_v15_ALL, Jan 26, 2010

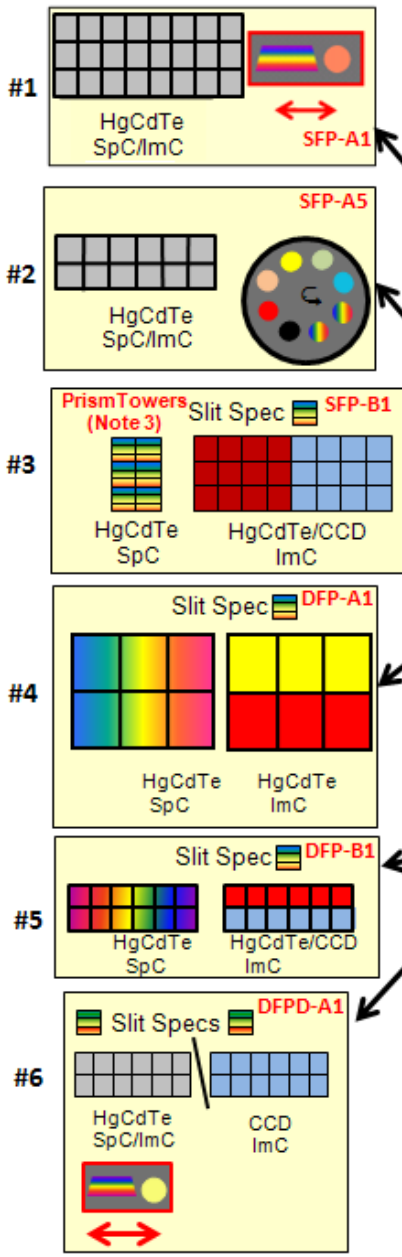

CONCEPTS (w/ID# and Mech notes;	CONFIGURATION							Methods (note 8)	BAO 1.5 ≤ z ≤ 2 deg ² /yr	WL M _{gal} resolved per yr	SNe-Ia (Slit) per yr
	Aperture	# NIR SCAs	# CCDs	Wavelength (note 7)	Pixel Scale (arcsec/pix)	SNe Spec	BAO Prism				
Single Focal Plane (SFP)											
SFP-A:	SpC/ImC			NIR					no img		
SFP-A1:	1.1m	24	0	0.9-1.7um	0.225	No	Yes	B+W	7499	514	0
SFP-A2:	1.3m	18	0	0.9-1.7um	0.225	No	Yes	B+W	4113	197	0
SFP-A3:	1.1m	18	0	0.9-2.0um	0.225	No	Yes	B+W	5624	386	0
SFP-A4:	1.3m	12	0	0.5-1.7um	0.30	Slit	Yes	B+S	5404	0	194
SFP-A5:	1.1m	12	0	0.5-1.7um	0.30	R75	Yes	B+S	7306	0	n/a
SFP-B:	SpC+ImC			NIR/CCD					w/nir img		
SFP-B1:	1.1m	6+12	0+12	0.5-1.7um	0.30/ 0.175	Slit	Towers	B/W+S	3653	502	185
SFP-B2:	1.3m	0+12	0+12	0.5-1.7um	0.30/ 0.175	Slit	No	W+S	0	194	194
Dual Focal Planes (DFP)											
DFP-A:	SpC+ImC			NIR/NIR					w/nir img		
DFP-A1:	1.1m	6+6	0	0.5-2.0um	0.45/0.45	Slit	Yes	B+S	8529	0	385
DFP-A2:	1.3m	6+6	0	0.5-1.7um	0.45/0.45	Slit+	Yes	B+S	6364	0	143
DFP-A3:	1.1m	12+12	0	0.5-2.0um	0.30/0.30	Slit	Yes	B+S	7306	0	508
DFP-A4:	1.3m	12+12	0	0.5-1.7um	0.30/0.30	Slit	Yes	B+S	5404	0	194
DFP-A5:	1.1m	6+12	0	0.9-1.7um	0.45/0.225	No	Yes	B/W	8529	257	0
DFP-B:	SpC+ImC			NIR/CCD					w/nir img		
DFP-B1:	1.3m	12+6	0+6	0.5-1.7um	0.30/ 0.175	Slit	Yes	B/W+S	5404	97	194
DFP w/Dichroic (DFPD)											
DFPD-A1:	SpC/ImC		ImC	NIR/CCD					w/vis img		
DFPD-A1:	1.1m	12	12	0.5-1.7um	0.30/ 0.175	Slit	Yes	B+W+S	7306	502	185
DFPD-A2:	1.1m	12	12	0.5-1.7um	0.30/ 0.175	Slit	No	W+S	0	502	185
DFPD-A3:	1.1m	12	12	0.5-1.7um	0.30/ 0.175	No	Yes	B+W	7306	502	0
DFPD-A4:	1.1m	12	12	0.5-2.0um	0.30/ 0.175	Slit	Yes	B+W+S	7306	502	508
DFPD-A5:	1.3m	12	12	0.5-1.7um	0.30/ 0.175	Slit	Yes	B+W+S	5404	194	194
DFPD-A6:	1.3m	12	12	0.5-1.7um	0.30/ 0.175	Slit	No	W+S	0	194	194
DFPD-A7:	1.3m	12	12	0.5-1.7um	0.30/ 0.175	No	Yes	B+W	5404	194	0

Important New Design Considerations

- Several significant new design considerations emerged from these studies that allowed a breakthrough in cost effective designs
 - **Technical:** Unobstructed view telescope. A 1.1 meter unobstructed view telescope has a performance similar to a 1.3 to 1.5 m conventional telescope (the enhanced psf improves S/N significantly).
 - **New survey strategies:** Supernova survey for example
 - In previous designs, SNAP for example, supernova light curves were built from photometric measurements with a **large area, fine plate scale** imager with 9 filters. Spectrometer was used to take a single spectrum for each supernova for typing.
 - New survey strategy uses a small area wide field imager for discovery and a high quality spectrometer to generate photometric lightcurves. The imager is not used for precision photometry and can have a coarse plate scale and only two broadband filters. The spectrometer provides the requisite spatial and wavelength resolution for the lightcurves.

Obscured vs Unobscured TMAs

Obscured

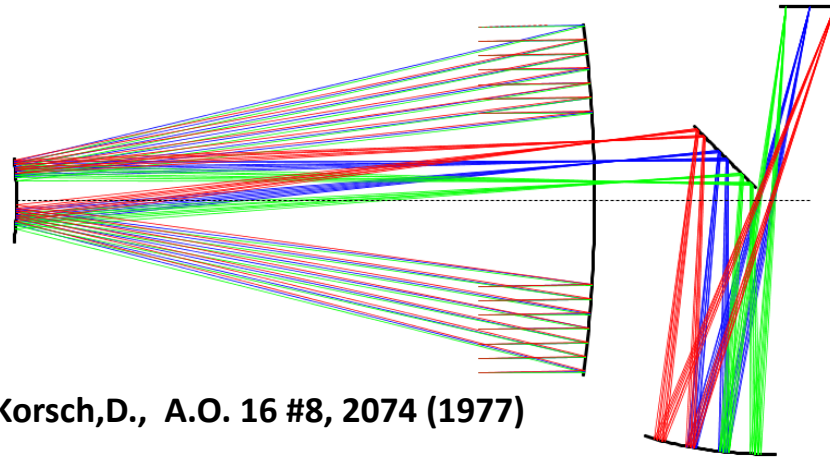

Korsch,D., A.O. 16 #8, 2074 (1977)

Unobscured

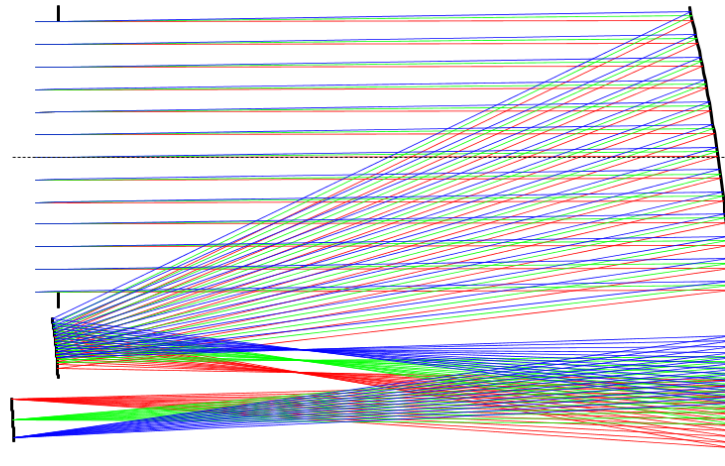

Cook,L.G., Proc.SPIE v.183 (1979)

50% Encircled Energy Radius

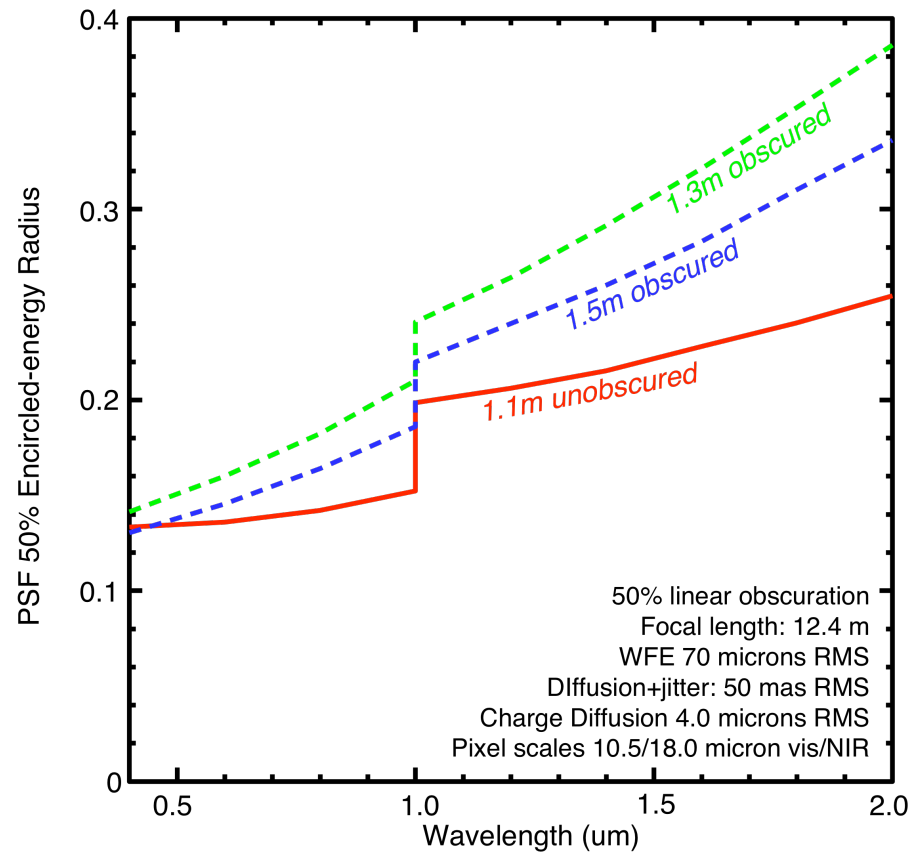

Advantages of the new SNe Strategy

- **Lightcurves from a Rolling Search.**
 - SNAP and Destiny were planning to follow many supernovae in one field in a rolling search. With the large mirror apertures and fields of view this was very efficient.
 - All exposures had to be long enough to give precision lightcurve points for the highest redshift supernova at its faintest (early or late) epoch
- **Lightcurves from spectroscopy**
 - Need one exposure for each lightcurve point of each supernova
 - Single exposures gets full wavelength range (instead of 9 filters in SNAP) i.e. we switch from spatial multiplexing to wavelength multiplexing. With the smaller apertures and fields of view we are considering here, this turns out to be much more efficient.
 - Exposure time can be tailored for the brightness of any given SNe
 - Better systematics—no need for K corrections, no filter transmission curves to calibrate, simpler flux calibration.
 - Needs more frequent interactions with the spacecraft after SNe discovery.

Significance of the New Considerations

- Unobstructed View Telescope enables BAO, WL, and Supernova Surveys with a 1.1 meter telescope
- New Supernova Survey Strategy
 - Instead of a large number of detectors with fine plate scale and many filters, can use either of the wide-field imagers required by the BAO or Weak Lensing surveys with fewer detectors and larger plate scales
 - This makes a supernova survey compatible with BAO or WL
 - The supernova survey is now an easy add-on to any Weak Lensing or BAO mission, requiring only an IFU or slit spectrometer which is relatively inexpensive

Two 3-Year Mission Concepts

- **Design A enables BAO + SN**
 - PO Cost Estimate: Fits Probe Class
 - Imager with 8 NIR Detectors, 0.45"/pixel
 - BAO Spectrometer with 8 NIR Detectors, 0.45"/pixel
 - IFU or slit SNe Spectrometer, single arm, single detector 0.26"/pixel
 - 17 identical NIR detectors, 68 Megapixels, no moving parts!
- **Design B enables Weak Lensing, BAO, and Supernova Surveys**
 - PO Cost Estimate: Does not fit into a Probe Class Mission but has greater science reach (less mature at this time than Design A)
 - For example: Imager with 18 CCD's, 0.175"/pixel, 18 NIR's, 0.30"/pixel
 - Photo z Calibration Spectrometer
 - BAO Spectrometer
 - Supernova spectrometer
 - Optimized for Weak Lensing, but allows a flexible mission strategy
 - For example, a 3 year mission can do two of the three techniques, a 4 year mission can do all three.

Design A Performance

- **BAO** 1.1 meter mirror, 3 year mission
 - 16,000 square degrees in 1.5 yrs
 - Redshift range $1.3 < z < 2.0$
 - Depth limit 2×10^{-16} ergs/sqcm/sec, redshifts for 60 million galaxies
 - Redshift uncertainty $0.001(1 + z)$
- **Supernovae**
 - 1500 supernova to redshift of 0.2 to 1.5 in 1.5 yrs
 - Supernova discovery with JDEM imager
 - Assumes large sample of ground based nearby ($z < 0.1$) supernovae

Good performance for a 3 year mission, even better performance with a potential extended lifetime

Design A Figure of Merit

Assuming only Stage III priors

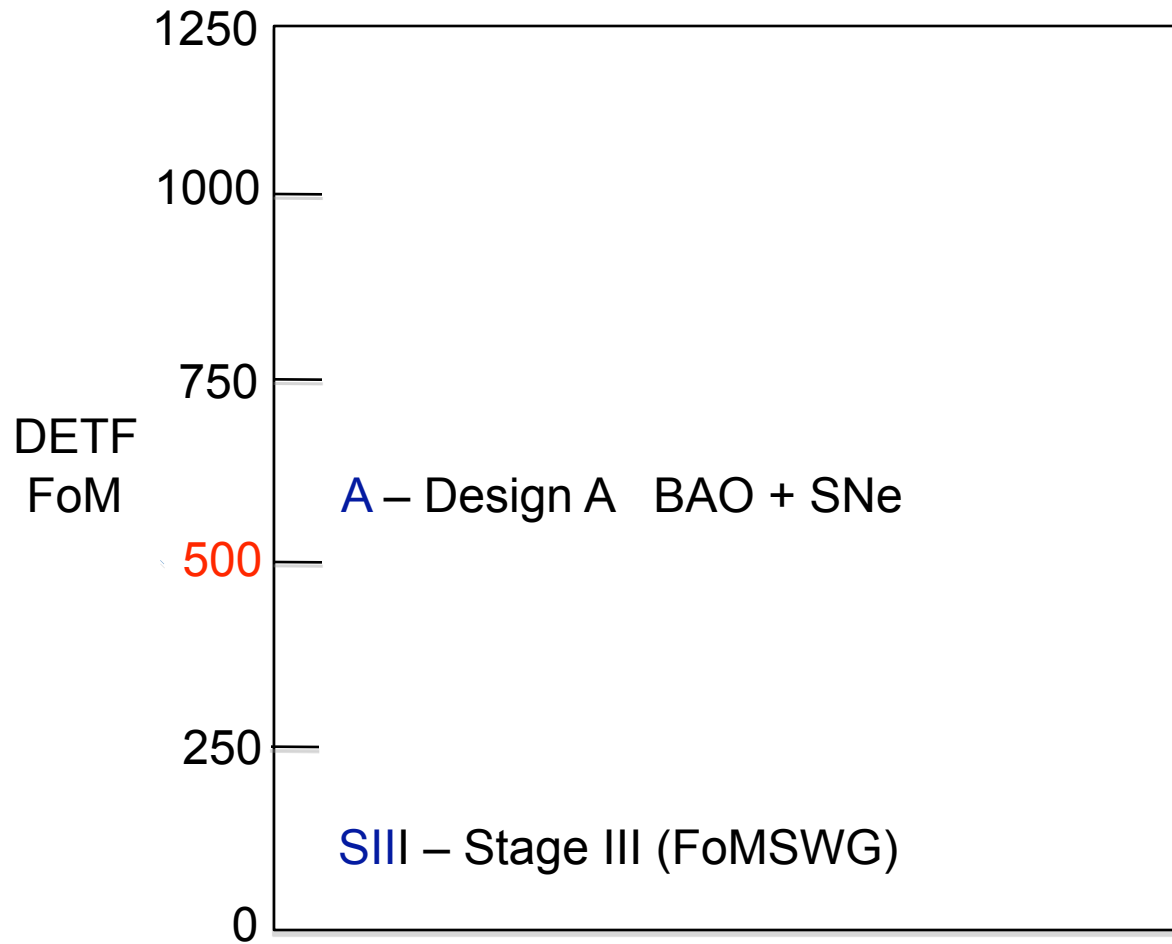

Design A Figure of Merit

Assuming Maximal Stage IV Ground (24,000 deg² BigBOSS + LSST)

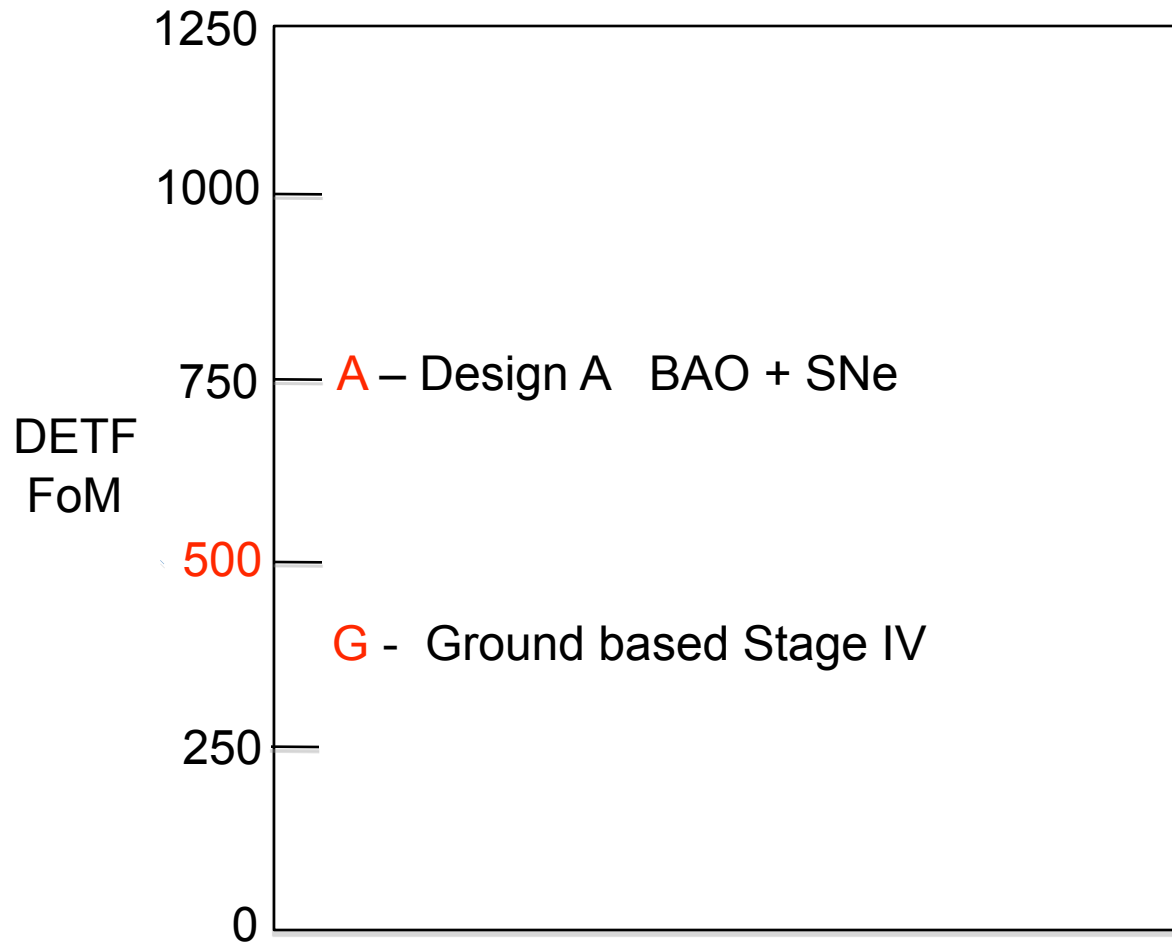

Design B Performance

- **Weak Lensing**
 - 10,000 square degrees
 - 30 Galaxies/ square arcminute
 - 100,000 spectra for photo z calibration
 - Assumes ground based visible 10,000 square degree survey to complete Photo-z measurements
- **BAO and Supernovae**
 - Similar performance to Design A per unit time

Comments on the FoM Summary Plot

- The DETF FoM characterizes the expansion history of the universe i.e. the growth of geometry, while the γ FoM characterizes the growth of structure.
 - The two are related by General Relativity and thus a measurement of both provides a check on GR.
 - The strength of Weak Lensing is the sensitivity to the growth of structure. The BAO survey has some sensitivity to the growth of structure through the measurement of Redshift Space Distortions (RSD) but is not as sensitive as Weak Lensing.

Figure of Merit Summary

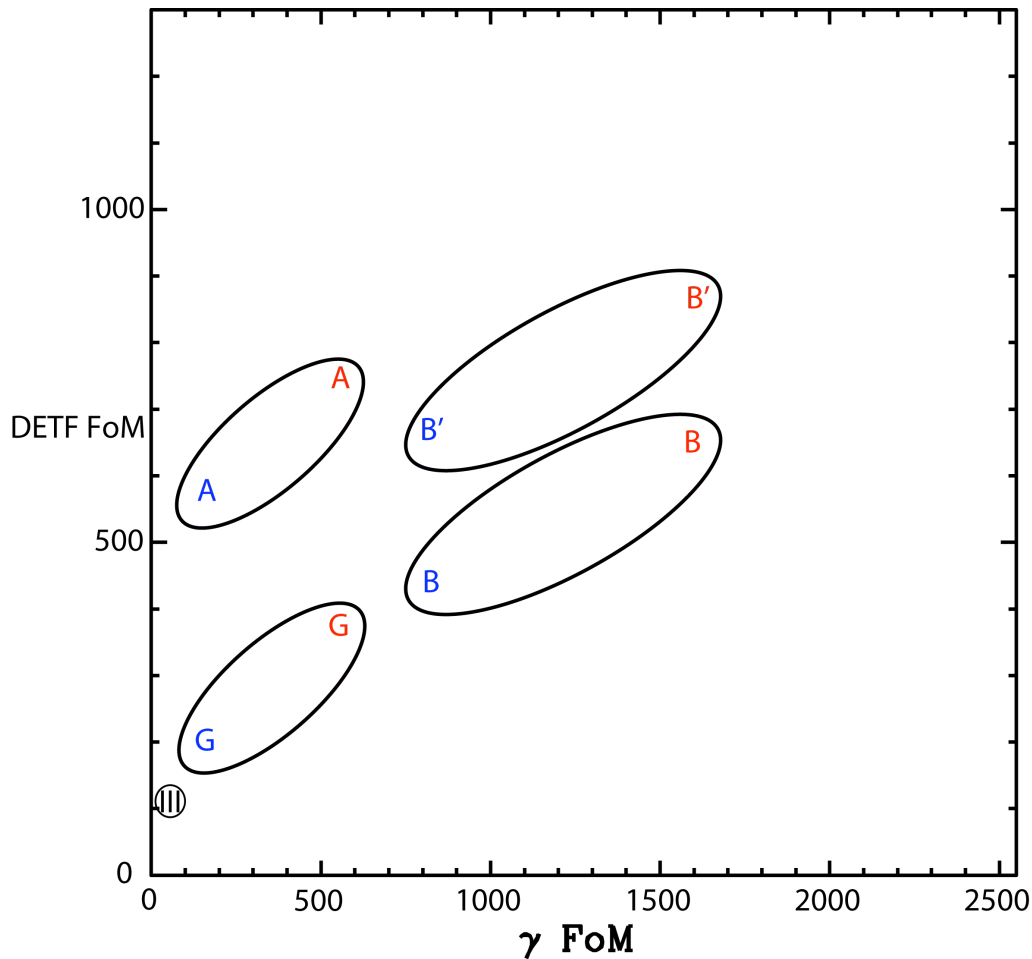

III is FoMSWG Stage III FoM

A and B stand for Designs A and B
G is for Ground Based

B is WL and BAO only
B' includes Supernovae

Blue for minimal ground program
Stage III + Double DES + u band

Red is for a maximal Stage IV
Ground program including
BigBOSS(24,000 sq deg) and
LSST

Redshift Space Distortions

- Redshift Space Distortions measure the velocities of galaxies with respect to the Hubble flow
 - Allows probes of growth of structure independent of WL by redshift surveys
- Significant improvements in DETF/ γ FoM when included
 - All scenarios (JDEM & ground) see ~50-100% increases in γ FoM and ~50% increases in DETF FoM when simplified RSD estimates are included.
- Combining RSD with WL enables new tests of GR not captured by existing FoM's
- Open issues :
 - Systematics not as well characterized
 - Further work needed on requirements, optimization

An adequately funded archival program will return the full scientific value of the investment.

- JDEM can furnish valuable data sets which can be used for non-Dark Energy science, for example:
 - 60 million emission-line galaxy redshifts,
 - infrared images with an associated catalog containing $\sim 10^9$ objects
 - 1500 SN spectral photometric time series
 - Ten square degrees imaged down to a magnitude of 28.5 in two filters
 - a complete redshift survey of 100,000 galaxies to 25th magnitude
- The data products may need to be enhanced in order to be useful for a broad range of science other than DE. These new analyses likely will in turn improve the quality of the Dark Energy measurements.
- This may require enhancements to the data pipeline, a good archive, support manuals and a help desk
- Continued studies of low cost modifications to the mission which would improve ancillary science performance and, as appropriate, dialogs with the broad community will be useful.

Findings

- The ISWG and the Project Offices have developed two JDEM mission designs to investigate the nature of Dark Energy. Two new design innovations, unobstructed view telescope optics and alternative survey strategies, enable cost effective designs with a 1.1 meter telescope.

Findings

- **Design A** : The ISWG and the Project Offices arrived at a mission concept that satisfies the criteria for a compelling space mission and is estimated by the GSFC Project Office to fit within the cost cap of a Probe class mission.
 - This design enables BAO and Supernova Dark Energy surveys in a 3 year mission
 - The design does not enable a Weak Lensing survey.

Findings

Design B The ISWG and the Project Offices are considering mission concepts with an enhanced science capability for testing GR modifications as the source of the acceleration of the universe. These designs were estimated by the GSFC Project Office to be more expensive than a Probe class mission.

- This design enables Weak Lensing, BAO, and Supernova techniques
- Optimized for Weak Lensing, but allows a flexible mission strategy
- For example, a 3 year mission can do two of the three techniques, a 4 year mission can do all three.

Findings

The ISWG finds that the following would be valuable:

- Continued joint study by the ISWG for science performance and by the Project Offices for engineering design and cost optimization of the two designs. One goal of this study is to better understand the science performance and cost differential of the two designs.
- A more detailed analysis of Redshift Space Distortions by the ISWG
- Additional studies based on the new information coming in the next few months

JDEM Project Probe Study Summary

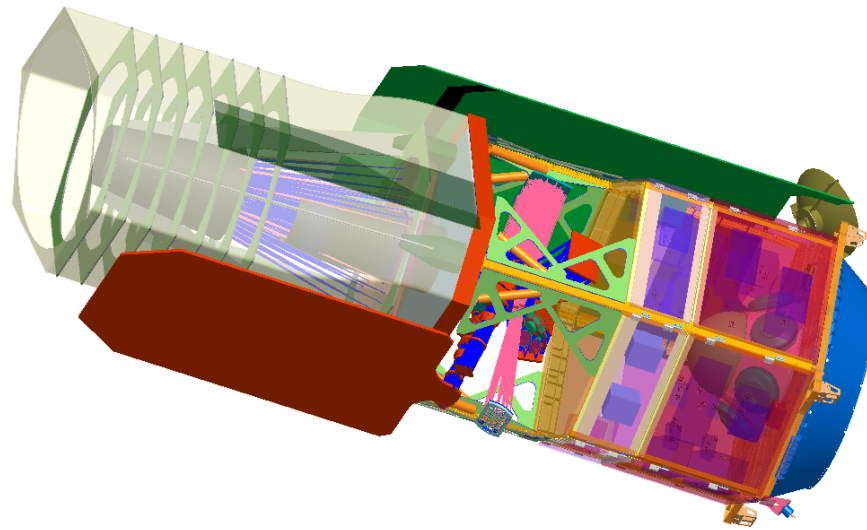

May 4, 2010

JDEM Project Office Briefing to NASA and DOE HQs



AGENDA

- Introduction/Findings
- Concept and Configuration Development
- Optical Studies

Tasking Statement

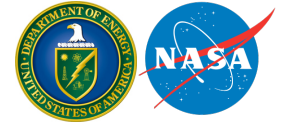

- Develop at least one space-based JDEM-Probe mission concept option within cost envelope of \$650M (FY09) plus launch vehicle
- NASA-DOE Memorandum of Understanding (MOU) forms framework of agency roles and mission development responsibilities as well as general management principles.
 - MOU frame work to be used as a guide in the concept definition
- Maximize dark energy science research potential using IR-optical techniques
 - Optimization should be focused on dark energy research, but ancillary science benefits should also be assessed.
- Concept(s) will be ready for the independent cost estimate and independent science review by mid-2010.
- Roles and responsibilities of each Agency on any concept defined are mutually acceptable

Probe Study Development Flow

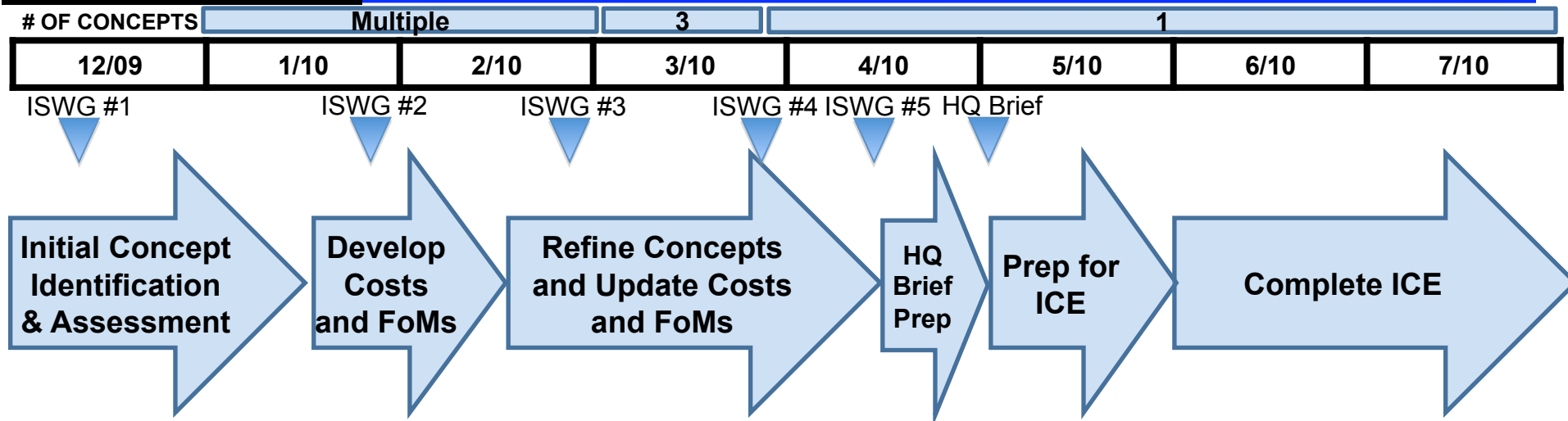
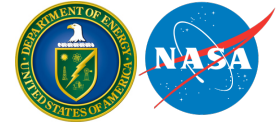

- Explored broad trade space to capture **wide variety of DE (~60) concepts** that deliver on 1 or more techniques
- Project scientist briefed ISWG #1 on prior JDEM work, Astro2010 submittals and initial (pre-ISWG) work on the Probe concepts

- At ISWG #2, **presented ~20 payload concepts** with estimated science returns and costs
- **Established Probe development schedule and significance of the schedule** assumptions to meeting the cost cap
- ISWG selected 3 of the concepts for further evaluation

- At ISWG #3, presented science returns and cost estimates for the ISWG requested concepts.
- **Baselined an unobscured telescope for all concepts.**
- **Baselined 2.0µm as the red cutoff for BAO and SNe spectroscopy.**
- **Identified either an IFU or a dedicated slit spectroscopy channel as viable options for SNe.**
- ISWG selected 3 two-technique concepts for further evaluation

- At ISWG #4/5, updated science returns and costs for the remaining concepts.
- Presented proof of concept designs for a focal BAO prism.
- **Focal/afocal, dichroic & reflective/refractive implementations available**, further work needed to understand the relative risks/benefits of implementing each option.

- Brief HQs on study
- HQs determines option for ICE
- Submit selected option for ICE
- Perform reconciliation on ICE
- Brief HQs on ICE reconciliation

ISWG – Interim Science Working Group

- A shortened schedule (relative to IDECS/Omega) is critical to meeting the cost cap.
 - Shorter schedule is only possible with mature, validated science requirements with well-defined margins
 - An instrument of low complexity enables shortened preliminary and detailed design phases; no time for technology development in this schedule
 - Payload and Observatory I&T phases are similarly focused; no time assumed for evolving new integration or verification techniques or strategies
- Funding profile commensurate with the schedule
- The majority of the observatory is single string in order to meet the cost cap.
 - Further discussions on the appropriate mission risk for a Dark Energy mission are necessary
- No flight calibration hardware is included at this time, but is suggested for follow-on study assessment.

**SCHEDULE DRIVES COST AND LOW COMPLEXITY
ENABLES THE PROBE SCHEDULE**

A Broad Range of Probe Options Were Considered/Refined

Intent was to capture a broad range of concepts

ISWG Preparations: Over 60 concepts with 1-3 techniques were studied during Fall '09

Down-select drivers were cost and sky coverage;

ISWG#2: Concepts condensed to 20; grouped in 6 distinct Focal Plane Families (2-3 techniques each)

- Mission Calc Link updates BAO integration times;
- Ancillary Science not a primary driver;
- Concepts cover BAO/SNe, SNe/WL, and WL/BAO.

ISWG#3: Ten 2-technique concepts; ISWG Working Groups provide key inputs

- SNe light curves via Slit-Spec vs. large FPA
- 1.1m unobstructed tele;
- 2 μ m BAO Spec red cutoff;

- WL rqts. guidance from ISWG;
- Dichroic cut at 1.5 μ m OK for BAO/SNe; enables large 1-FOV 1-TM concept.

ISWGs #4/#5:
Refined to 7
Concepts

- 2.0 μ m SNe Spec red cutoff;
- 1.5 μ m BAO Spec blue cutoff;
- Separate SNe Slit-Spec Instr.
- Focal prism proof of concept.

- Many optical trades for Phase-A: reflective /refractive, focal/afocal, dichroic/no-dichroic;
- Dichroic concept is of great interest due to large spectrometer FOV.

BAO/SNe Option A-1

- 2x4 NIR imager and 2x4 NIR spec;
- SNe Slit Spectrometer;
- Afocal, no dichroic

ICE(s) Planned after HQ decision

Developed Over 60 Concepts Enabling 1-3 Techniques

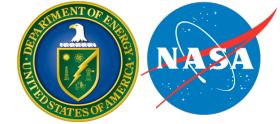

1. Benchmark Probe (8 of 18 cases shown)

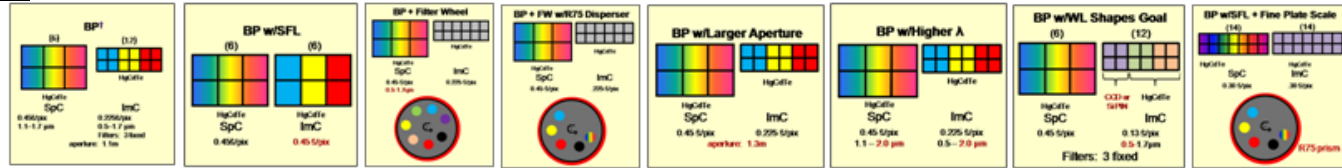

2. Focal Single Channel Imagers (6 of 11 cases shown)

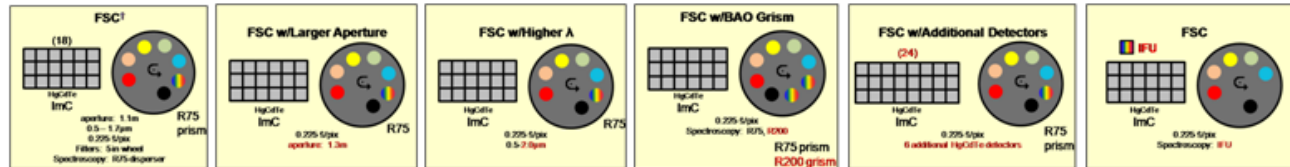

3. Focal/ Dichroic Imagers (6 of 10 cases shown)

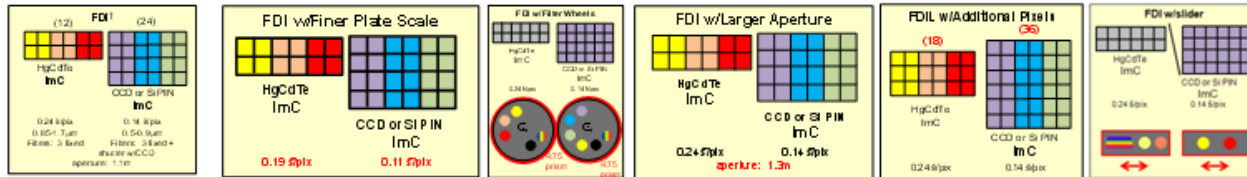

4. Dichroic Spec/Imager (8 of 10 cases shown)

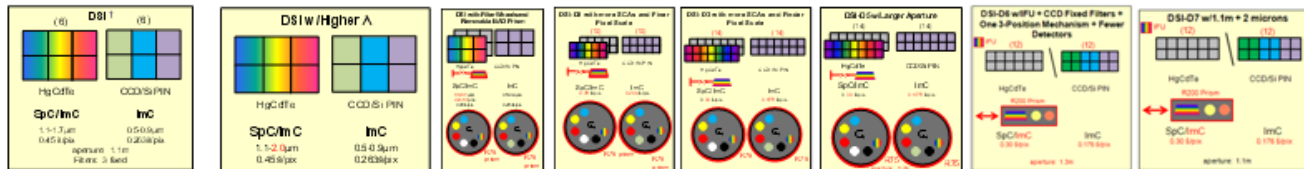

5. Single Focal Plane Transformer (7 of 7 cases shown)

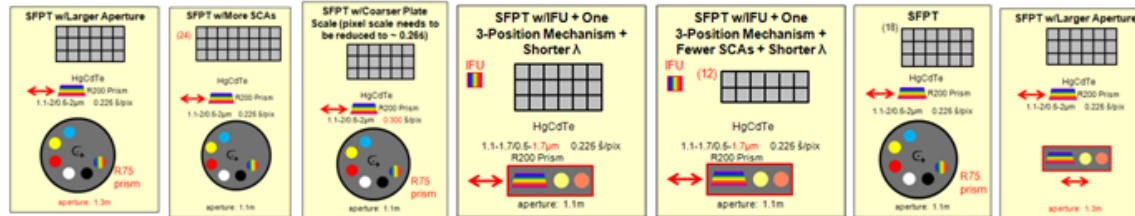

6. Heterogeneous Focal Single Focal Plane (5 of 5 cases shown)

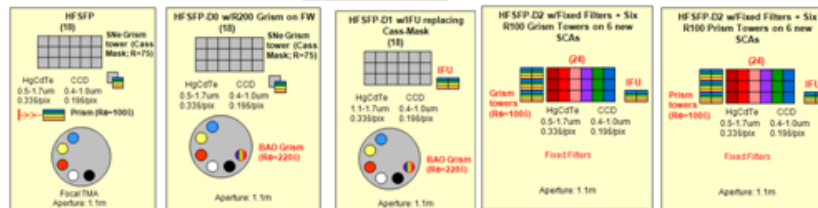

- The Projects and ISWG worked to develop two-technique concepts for all combinations of BAO, SNe and WL that fit within the cost cap
- Only concepts in the BAO/SNe category were near the cost box
- What can be done for WL?
 - The ISWG identified what a minimally acceptable WL only mission would require. We agreed on a hardware complement, but it too was well outside of the cost box.
- As the Probe study concluded, there was an additional configuration under consideration by the ISWG to improve the science reach.
 - This consisted of 3-technique (linked WL/BAO and SNe) concepts. The ISWG defined the minimally acceptable WL performance (e.g. 10K deg², 30 galaxies/square arcmin, PZCS) which implies configurations that are more complex (e.g. number of detectors, multiple mechanisms).

BAO/SNe Probe Concept

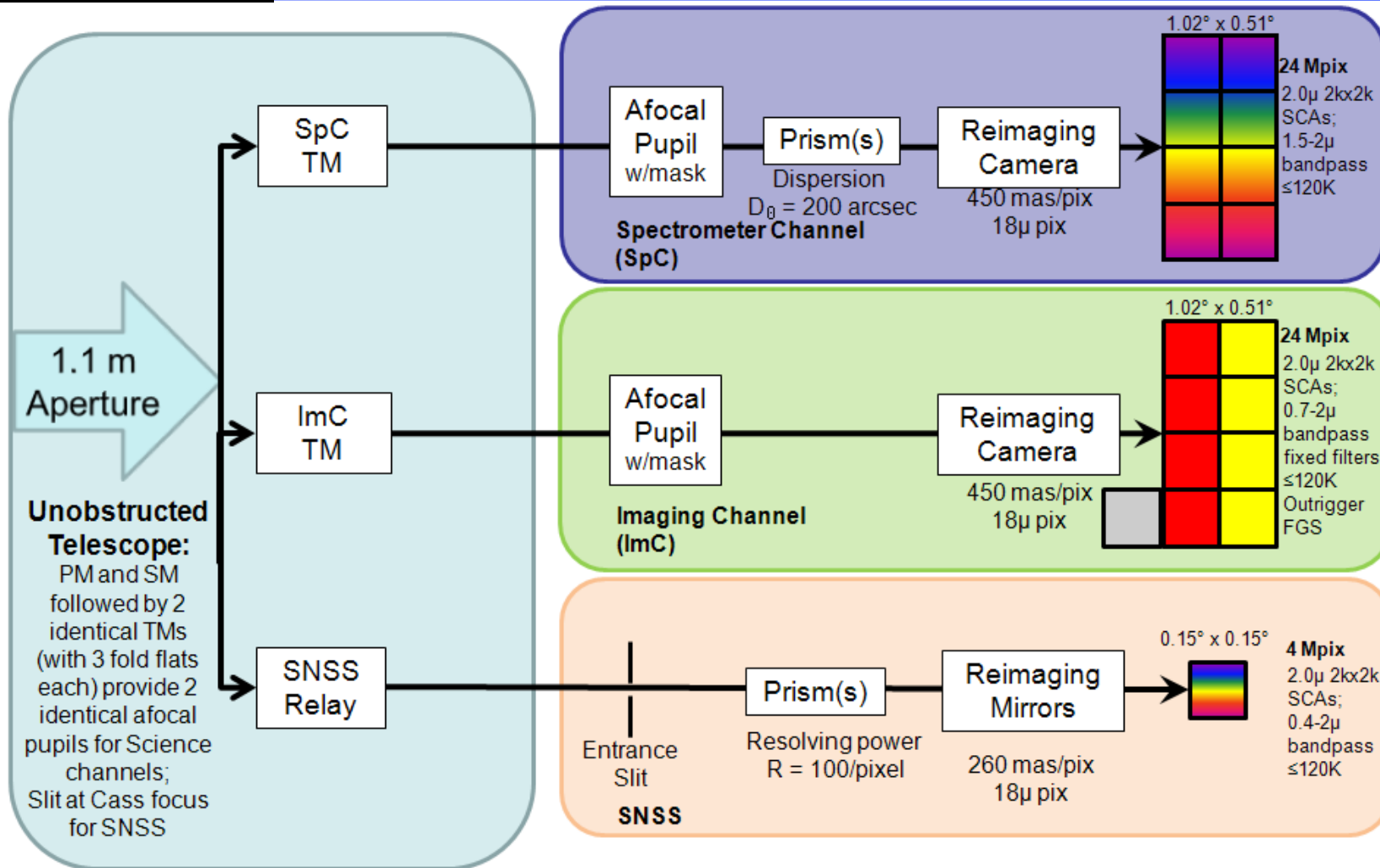
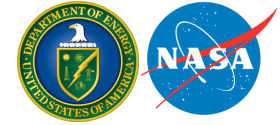

FGS = Fine Guidance Sensor
SNSS = Supernova Slit Spectrometer

Key Findings



- An unobscured telescope provides higher performance for lower cost.
 - Engineering packaging in process; will be followed by higher fidelity costing.
- A small, dedicated, single detector SNe slit spectrometer with targeted observations is a lower cost option that builds SNe light curves from spectra.
- 2.0 μm red cut-off established as a requirement for BAO spectroscopy and desirable for SNe spectroscopy.
- BAO spectrometer blue cut-off set at 1.5 μm ($z=1.3$) to maximize the BAO survey rate by minimizing z overlap with possible ground BAO surveys.
- Multiple optical options (focal/afocal, reflective/refractive, dichroic) will require detailed engineering optimization to further evaluate the risk, cost and benefit of each implementation.
- For follow-on study: a single tertiary mirror with a dichroic significantly increases the BAO field of view (survey speed) if imaging red cut-off at 1.5 μm is acceptable.

Optical Implementation Options for Large FOV Channels

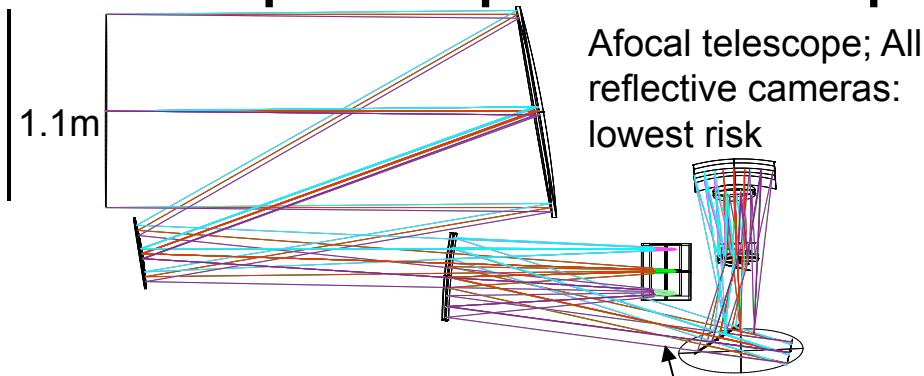

Same afocal telescope w/ compact, refractive cameras



Non dichroic, i.e. ImC, SpC are separate fields of view

name	FOV	Telescope	ImC/SpC
Afocal/reflective	2(3x2)	afocal	R/R + P
Afocal/refractive	2(3x2)	afocal	T/T + P
Focal prism w/o dichroic	2(4x2)	focal	-/- + P

Dichroic (@1.5 μ m), shared field of view

name	FOV	Telescope	ImC/SpC
Afocal/dichroic refractive	2(4x3)	afocal	T/T + P
Focal prism w/ dichroic	2(6x2)	focal	-/- + P

R=reflective camera, T=transmissive (refractive) camera, P=prism
Aperture Stop

Afocal telescope, refractive cameras w/ dichroic

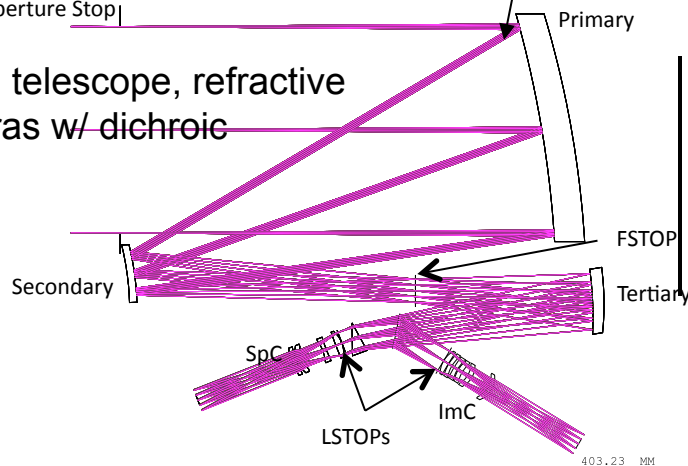

Focal telescope, focal ~TRL 5 prism, separate FOVs

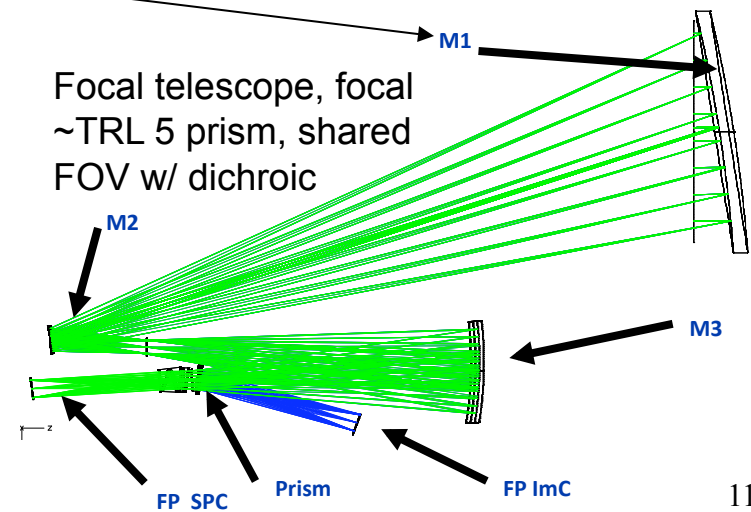

- Using SnSS allows:
 - single SCA for light curves and coarse pixels in ImC
 - Significant savings
- SnSS “existence proof” layout shown here
 - Reflective form for 0.4-2.0 μ m bandpass
 - Off axis elliptical relay mirror provides good slit image (if necessary)
- High TRL, small, simple elements

Spectrometer with Cassegrain Focus Corrector Mirror

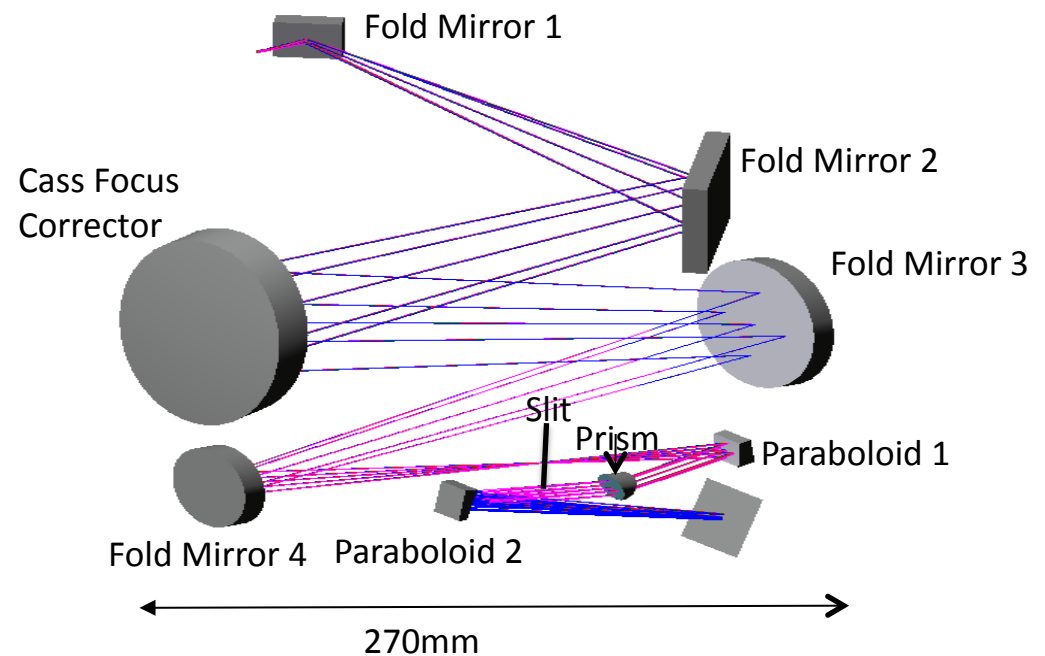

SnSS, including slit corrector, fits within 27x27x20cm volume

Configuration A Variations

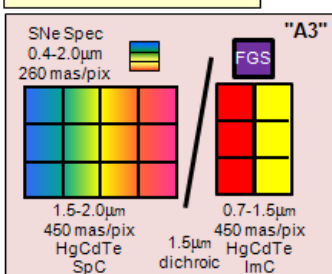
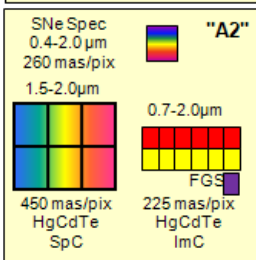
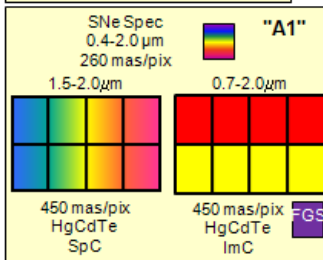
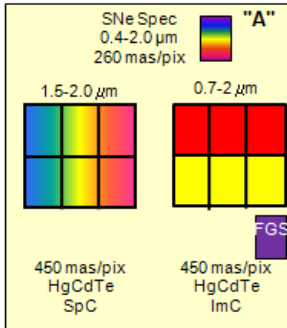
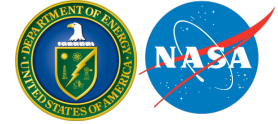

SpC = Spectrometer Camera; ImC = Imager Camera

JDEM Probe Concepts _v37_ALL, April 13, 2010

CONCEPTS	CONFIGURATION							SCIENCE RETURN (dedicated clock yrs)					
	Afocal /Focal Tele.	Dichr. Feas. ?	# NIR SCAs	# CCDs	Max λ (μm)	SpC/ImC $\$/\text{pix}$	SNe Spec $\$/\text{pix}$	BAO / PZCS Disp. Types	Sci Types	BAO $z=1.3-2$ deg^2/yr $nP=1$ @ $z=1.65$	WL deg^2/yr	WL M_{gal}/yr	SNe-Ia /yr (Slit Spec) $z=0.2-1.5$
NIR/NIR DFPs			SpC+ImC			NIR/NIR							
No Dichroic													
Option A	A (F)	Y	6+6	0	2.0	0.45/0.45	0.26	P/x	B+S	8000	n/a	n/a	1000
Option A1	A (F)	Y	8+8	0	2.0	0.45/0.45	0.26	P/x	B+S	10667	n/a	n/a	1000
Option A2	A (F?)	Y	6+12	0	2.0	0.45/0.225	0.26	P/x	B+S	8000	n/a	n/a	1000
Dichroic													
Option A3	A (F)	n/a	12+6	0	2.0	0.45/0.45	0.26	P/x	B+S	16000	n/a	n/a	1000

Summary of “A” configuration concepts:

- **A1 provides a compelling 2-technique (BAO/SNe) 3 yr Dark Energy survey;**
 - **A1: ~16K/1500 BAO/SNe + Ph-z’s**
- **A2 enhances ancillary science via a finer pixel scale, but increases costs and slows the BAO survey rate;**
 - **A2: ~12K/1500 BAO/SNe + Ph-z’s (shallower)**
- **A3 provides a greatly increased BAO survey rate at a comparable cost to A1 for a mission duration of ~2 ½ yrs, if a spec/imager shared bandpass is acceptable;**
 - **A3: ~24K/1500 BAO/SNe + Ph-z’s (less red)**
- **Option A is a potential descope that meets minimum science.**

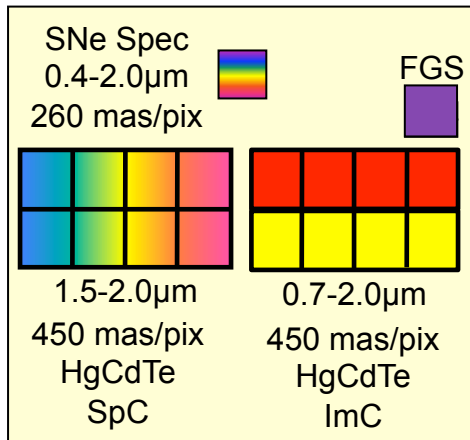

✓ Configuration A-1 is the recommended configuration for the Probe independent cost estimate:

- 1.1m unobscured afocal telescope
- 2x4 detector NIR FPAs with separate Spectrometer and Imager Channels
- SNe Slit Spectrometer
- BAO return of $\sim 10,700 \text{ deg}^2$ per dedicated year ($z = 1.3-2$, $n_P = 1 @ z = 1.65$)
- SNe return of ~ 1000 per dedicated year ($z = 0.2-1.5$)
- Photo- z 's provided for ground based WL programs
- 3-year total: 16K deg^2 BAO; 1500 SNe; DETF FoM: 600, assuming Stage 3 priors

WL Requirements Studies

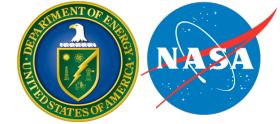

SpC = Spectrometer Camera; ImC = Imager Camera

JDEM Probe Concepts_v37_ALL, April 13, 2010

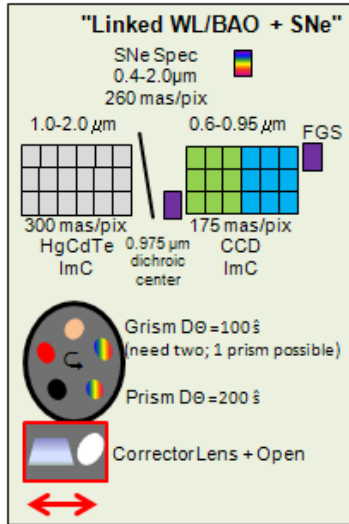

CONCEPTS	CONFIGURATION								SCIENCE RETURN (dedicated clock yrs)				
	Afocal /Focal Tele.	Dichr. Feas. ?	# NIR SCAs	# CCDs	Max λ (μm)	SpC/ImC \$/pix	SNe Spec \$/pix	BAO / PZCS Disp. Types	Sci Types	BAO z=1.3-2 deg ² /yr nP=1 @ z=1.85	WL deg ² /yr	WL M_gal /yr	SNe-Ia /yr (Slit Spec) z=0.2-1.5
NIR/CCD DFPs			Grism+ImC			NIR/CCD							
Dichroic													
Linked WL/BAO+SNe	F (A)	n/a	0+18	0+18	2.0	0.30/0.175	0.26	P/G	W:B+S	3340	3340	361	1000

WL Configuration Summary:

- The ISWG has pointed out that a linked (BAO/WL) 3-technique mission would have a higher science reach than Configuration A. While a specific configuration for this mission was not developed, one possibility is shown above.

- The instrument hardware would include: 2 large focal planes, ~300Mpixels, 2 mechanisms and a SNe Slit Spectrometer.
- The survey requirements for this mission could be on the order of 10-15k deg² for BAO, 10k deg² for WL and ~1000-1500 SNe. This configuration would require ~4-5 years on-orbit to reach these numbers.
- The cost of this configuration is well above the Probe cost cap.
- *The JDEM Project is committed to continuing to study Probe-class missions. However, for many reasons, we believe WL should continue to be studied in pre-phase A. It is important for the Program to better understand WL requirements and feasibility. Both the Project and the ISWG find that end-to-end analyses (i.e. sky inputs to datasets/errors to shear maps/errors to FoM constraints) should be performed to refine/develop WL's engineering & science requirements (e.g. pointing control/knowledge, shape measurement error tolerance, absolute spatial resolution, psf stability, beam reconstruction, etc). Could current requirements be relaxed to enable useful WL shape measurements in a Probe context?*

Proposed Design A1 Follow-On Work

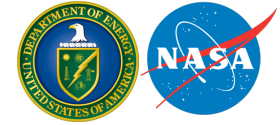

- Parallel Follow-on Studies to Mature/Optimize the A1 Design
 - **Develop/Detail A1:** Create a preliminary afocal A1 Mission Design that addresses packaging layouts, filled/un-filled FPAs, ops concepts (e.g. slew/settle times, mapping overlaps, BAO/SNe interleaved scheduling, calibration, momentum unloading, etc.), discipline analyses, and end-to-end data simulation/science extraction to assess design feasibility/margins and refine requirements;
 - **Confirm that a 1.5 μm imager red cutoff is scientifically acceptable for BAO and SNe [Science Input Needed;** benefit is x1.5 BAO survey rate; lower telescope cost, but +2 SCAs +dichroic]
 - Verify focal prism feasibility via sensitivity, conceptual design, and I&T studies
 - Trade finer plate scale in imager (ancillary science and possibly WL shape measurement benefits) vs. reduced imaging depth, filled survey impacts, and slower BAO survey [Science Input Needed]
 - Trade cost/performance of on-board calibration hardware vs. other payload capabilities [Science Input Needed]

