

2008

FLOODPLAIN MANAGEMENT IN SOUTH CAROLINA

Quick Guide



DNR

South Carolina Department of Natural Resources
Flood Mitigation Programs

<http://www.dnr.sc.gov>

Table of Contents

1.....	About This Guide	30.....	Completing the Elevation Certificate
2.....	Introduction	31.....	Paperwork is Important – for You and Your Community
3.....	South Carolina Floodplain Facts	32.....	Floodplain Fill Can Make Things Worse
4.....	Flood Insurance: Property Owner’s Best Protection	33.....	Required Floodway “No Impact” Certification
5.....	Turn Around Don’t Drown™	34.....	How to Elevate Your Floodplain Building
6.....	Why Do Communities Regulate the Floodplain?	35.....	Compaction of Floodplain Fill
7.....	Community Responsibilities	36.....	Manufactured Homes Require Special Attention
8.....	Looking for Floodplain Information?	37.....	Enclosures Below the BFE
9.....	FIRMette: Flood Maps On-Line	38.....	Crawlspace Details
10.....	Understanding the Riverine Floodplain	39.....	Typical Elevation Methods for Coastal Buildings
11.....	Understanding the Floodway	40.....	Coastal Houses Must Resist Wind and Water Forces
12.....	New Format Flood Insurance Rate Map (Riverine)	41.....	The V Zone Certificate (Sample)
13.....	Old Format Flood Insurance Rate Map (Riverine)	42.....	Enclosures Below V Zone Buildings
14.....	The Flood Boundary and Floodway Map	43.....	Utility Service Outside Buildings
15.....	Use the Riverine Flood Profile to Determine BFEs	44.....	Utility Service Inside Enclosures
16.....	Approximate Flood Zones and Unnumbered A Zones	45.....	Accessory (Appurtenant) Structures
17.....	Understanding the Coastal Floodplain	46.....	Recreational Vehicles
18.....	The Flood Insurance Rate Map (Coastal)	47.....	Planning to Improve Your Floodplain Building?
19.....	Flood Map Revisions Issued by FEMA	48.....	Non-Substantial Improvements
20.....	Activities Requiring Permits Include:	49.....	Substantial Improvement: Renovation Only
21.....	Safe Uses of the Floodplain	50.....	Substantial Improvement: Lateral Addition Only
22.....	Is Your Building Site Higher than the BFE?	51.....	Substantial Improvement: Addition Plus Other Work
23.....	What is Meant by Pre-FIRM and Post-FIRM?	52.....	What About After Damages?
24.....	Nature Doesn’t Read Maps	53.....	Paying for Post-Flood Compliance
25.....	Think Carefully Before You Seek A Variance	54.....	Elevating a Pre-FIRM Building
26.....	Some Key Permit Review Steps	55.....	Some Flood Protection for Older Homes is Easy and Low Cost
27.....	Carefully Complete the Permit Application	56.....	Some Flood Mitigation Projects are More Costly
28.....	Freeboard: Go the Extra Foot!	57.....	Useful Resources and Common Acronyms
29.....	What is the Elevation Certificate and How is it Used?	58.....	Want to Learn More?

About This Guide

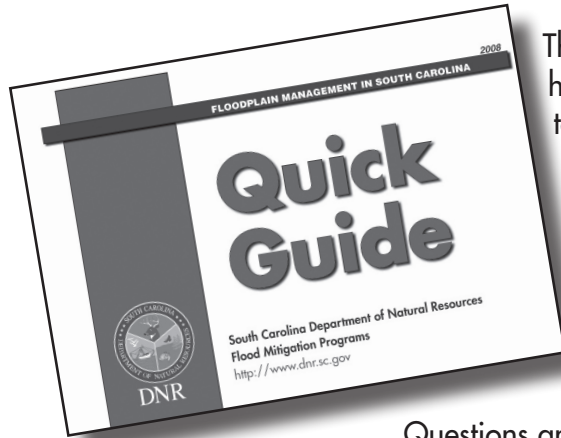

This **Quick Guide** will help you understand more about why and how communities in the State of South Carolina manage floodplains to protect people and property.

Flood-prone communities adopt ordinances that detail the rules and requirements. In case of conflict, that ordinance and not this publication, must be followed. If you have questions, be sure to talk with your local planning, permit, engineering or floodplain management office.

Questions and comments on the **Quick Guide** can be directed to the South Carolina Department of Natural Resources, Flood Mitigation Programs at

<http://www.dnr.sc.gov>

Prepared by

RCQUINN
CONSULTING, INC.
www.rcquinconsulting.com

Support provided by

S.C. ASSOCIATION FOR
Hazard Mitigation

This publication is supported with funding from the Federal Emergency Management Agency. It does not necessarily reflect the views of that agency.

Introduction

South Carolina Department of Natural Resources, Flood Mitigation Programs, is pleased to provide this **Quick Guide** to help our citizens understand what floodplain management is and why we regulate floodplain development.

Counties and local communities regulate the floodplain to:

- **Protect** people and property
- **Ensure** that Federal flood insurance and disaster assistance are available
- **Save** tax dollars
- **Reduce** future flood losses

Floods have been, and continue to be, a destructive natural hazard in terms of economic loss to the citizens of South Carolina. About 13% of the State's land area is subject to flooding. Since 1978, flood insurance policy holders have received over \$416 million in claim payments. Even though that represents many insurance payments, most of the State's flood-prone property owners do not have flood insurance.

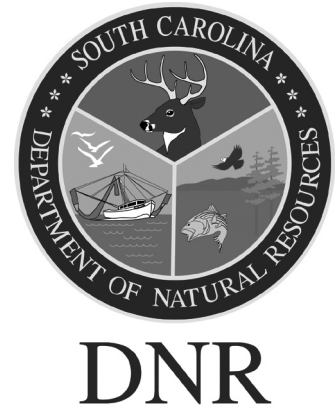

South Carolina Floodplain Facts

State of South Carolina

Presidential Disaster Declarations

Number of Declarations

By County (1965-2003)

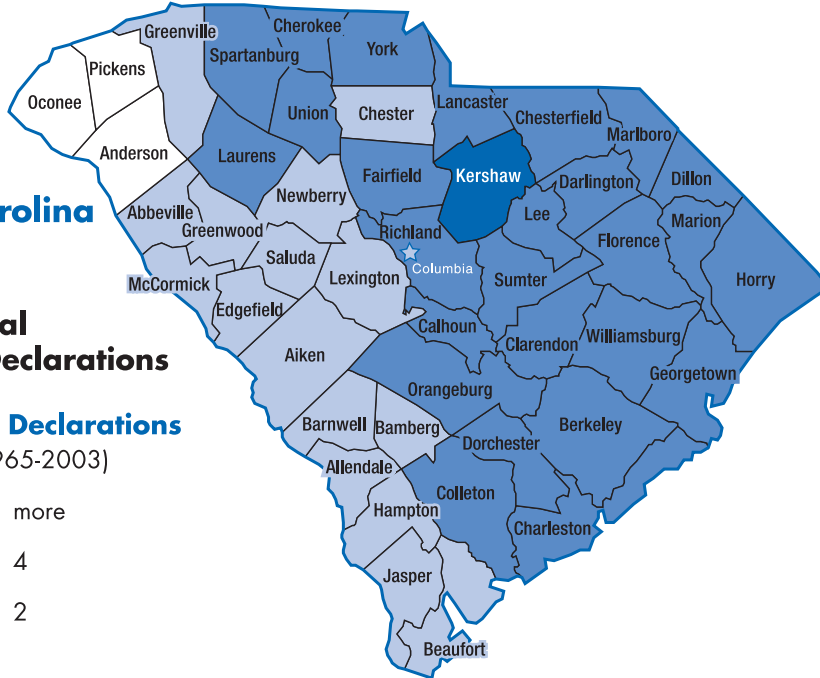
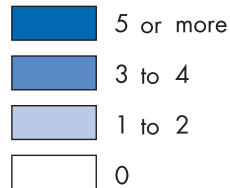

- Flood-prone areas have been identified in every county, city and town in South Carolina.
- Approximately 172,156 buildings and structures are located in mapped flood-prone areas.
- Flash floods and hurricane surge flooding are dangerous. Since 1903, 165 people have died in flood-related disasters.
- About 13% of the state's land area is mapped floodplain. Many waterways have not been mapped in detail.

Not all flood events are declared major disasters.
Many floods are local, affecting only small areas or a few watersheds.

Flood Insurance: Property Owner's Best Protection

Who needs flood insurance? Every homeowner, business owner, and renter in South Carolina communities that participate in the National Flood Insurance Program (NFIP) may purchase a flood insurance policy — regardless of the location of the building. Federal disaster grants do not cover most losses and repayment of a disaster loan can cost many times more than the price of a flood insurance policy.

COMPARE TYPICAL YEARLY COSTS

\$500/year Flood Insurance



Call Your Insurance Agent to Learn More

Unfortunately, it's often after a flood that many people discover that their homeowner or business property insurance policies do not cover flood damages. Approximately 25% of all flood damages occur in low risk zones, commonly described as being "outside the mapped flood zone."

The South Carolina Department of Natural Resources urges **YOU** to protect your financial future by getting a flood insurance policy. To purchase a policy, call your insurance agent. To get the name of an agent in your community, call the NFIP's toll free number, 1-888-356-6329.

Turn Around Don't Drown™

Follow these safety rules:

- When flooding is expected, stay away from creeks, streams, and rivers.
- NEVER drive through flooded roads – they may be washed out.
- Passenger cars may float in only 18-24 inches of water.
- Be especially cautious at night when it is harder to recognize dangers.
- Just six inches of fast-moving water can knock you off your feet.



Why Do Communities Regulate the Floodplain?

- **To protect people and property.** Floodplain management is about building smart. It makes good sense. If we know part of our land will flood from time to time, we should make reasonable decisions to help protect our families, homes, and businesses.
- **To make sure that federal flood insurance and disaster assistance are available.** If your home or business is in the floodplain, and federal flood insurance isn't available, then you can't get some types of federal financial assistance. Home mortgages will be hard to find, and you won't be able to get some types of state and federal loans and grants.
- **To save tax dollars.** Every flood disaster affects your community's budget. If we build smarter, we'll have fewer problems the next time the water rises. Remember, federal disaster assistance isn't available for all floods. And even when the President declares a disaster, your community still has to pay a portion of the costs of evacuation, temporary housing, repair, and clean-up.
- **To avoid liability and law suits.** If we know an area is mapped as floodplain and likely to flood, if we know people could be in danger, and if we know that buildings could be damaged, it makes sense to take reasonable protective steps when we develop and build.
- **To reduce future flood losses in South Carolina.** Development that complies with the minimum floodplain management regulations is significantly protected against major flood-related damage.

Community Responsibilities

To participate in the National Flood Insurance Program, your community agrees to:

- **Adopt and enforce** a flood damage prevention ordinance
- **Require** permits for all types of development in the floodplain (see page 20)
- **Assure** that building sites are reasonably safe from flooding
- **Estimate** flood elevations that were not determined by FEMA
- **Require** new or improved homes and manufactured homes to be elevated above the Base Flood Elevation (BFE)
- **Require** other buildings to be elevated or floodproofed
- **Conduct** field inspections and cite violations
- **Require** Elevation Certificates to document compliance (see pages 29, 30, and 31)
- **Carefully consider** requests for variances
- **Resolve** non-compliance and violations
- **Advise** FEMA when updates to flood maps are needed



**NATIONAL
FLOOD
INSURANCE
PROGRAM**

Looking for Floodplain Information?

Enter the FEMA Flood Map Store at <http://www.msc.fema.gov>. Digital scans of flood maps can be downloaded or hardcopy maps can be ordered. Reach the Map Store by calling (800) 358-9616.

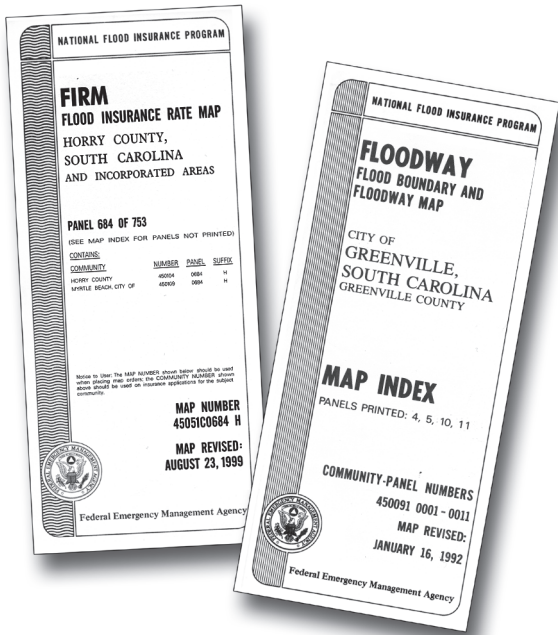

- FEMA prepares Flood Insurance Studies and Flood Insurance Rate Maps (FIRMs) for communities in South Carolina.
- Most FIRMs show Special Flood Hazard Areas and floodways. Some FIRMs show floodplains delineated using approximation analyses (see page 16).
- Not all waterways have designated floodplains – but all waterways will flood, even though a floodplain study may not have been prepared.
- In coastal communities, FIRMs show Special Flood Hazard Areas, including areas subject to wave action (see page 18).

Need a fast answer? Visit your community's planning, engineering, or permit office where flood maps are available for viewing by the public.

FIRMette: Flood Maps On-Line

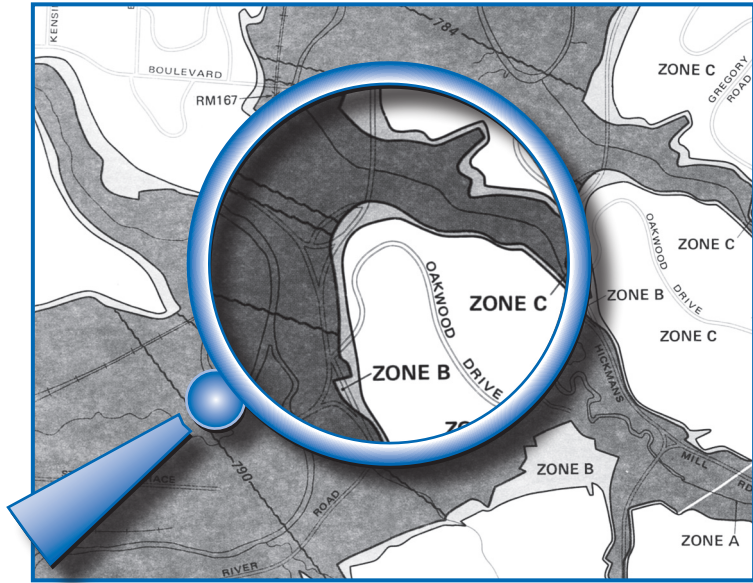

You can order paper maps or digital maps on CD-ROM.

- You can find and print a FIRM by using FEMA's on-line tools.
- Go to <http://msc.fema.gov>
- Click "Map Search" link (top of page) and select "Public Flood Map" from the product pull-down menu.
- Enter the address and click the "Go" button.
- On the Map Search Result Page, click the green "View" button (far right).
- When the map appears, drag the red translucent box to the area you want to print.
- Select paper size and select the scale, north arrow, and title block.
- Your FIRMette will be displayed and you can print or save the file as an Adobe Acrobat (pdf) or graphic image file (gif).

Understanding the Riverine Floodplain

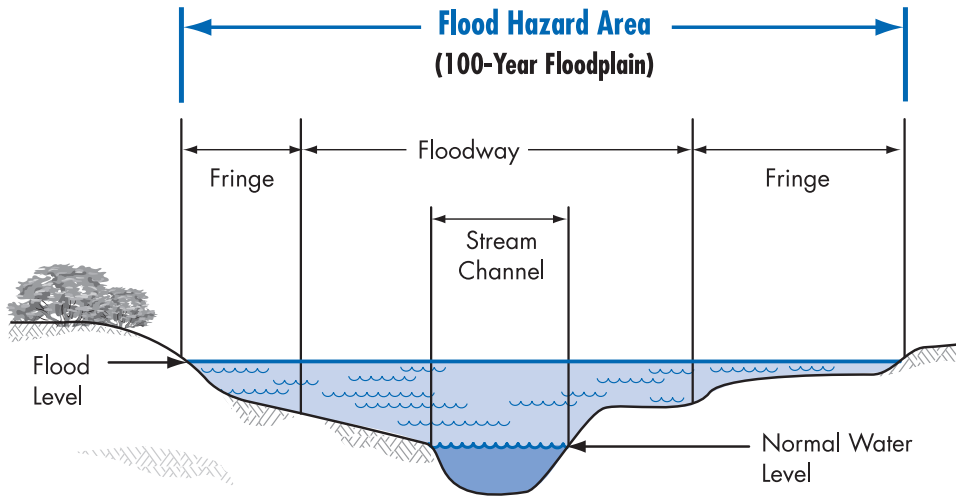

Terms and Definitions

The **Special Flood Hazard Area (SFHA)** is that portion of the floodplain subject to inundation by the base flood and/or flood-related erosion hazards. SFHAs are shown on FHBMs or FIRMs as Zones A, AE, A1-A30, AH, AO, AR, V, VE, and V1-V30.

See page 11 to learn about the floodway, the area of the floodplain where floodwaters usually flow faster and deeper.

For floodplains with Base Flood Elevations, check the Flood Insurance Study to find the Flood Profile which shows water surface elevations for different frequency floods (see page 15).

Understanding the Floodway

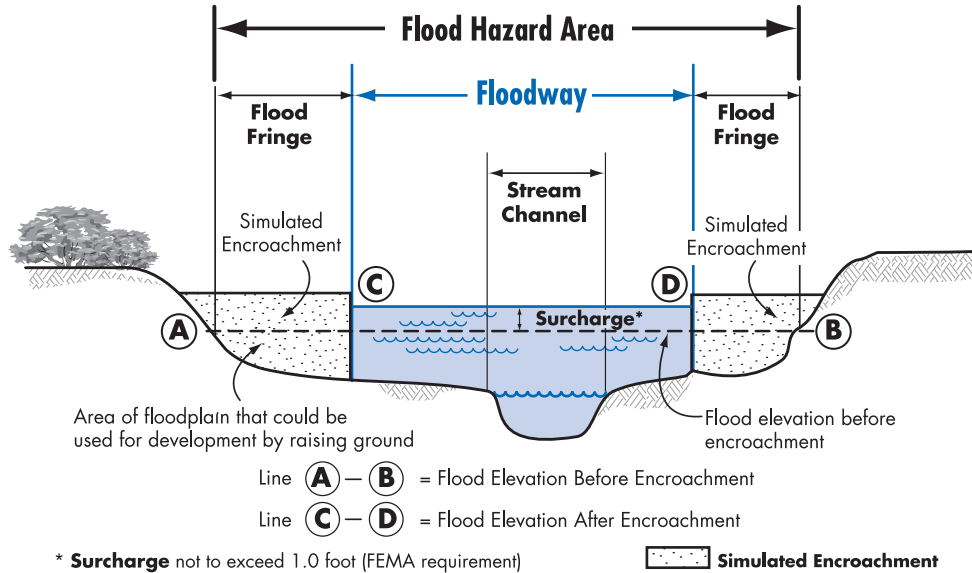

Terms and Definitions

The **Floodway** is the channel of a river or other watercourse and the adjacent land areas that must be reserved in order to pass the base flood discharge without increasing flood depths.

Computer models of the floodplain are used to simulate “encroachment” or fill in the flood fringe in order to predict where and how much the base flood elevation would increase if the floodplain is allowed to be filled.

For any proposed floodway development, before a local floodplain permit can be issued, the applicant must provide evidence that “no impact” will occur (see page 33). You will need a qualified engineer to make sure your proposed project won’t increase flooding on other properties.

New Format Flood Insurance Rate Map (Riverine)

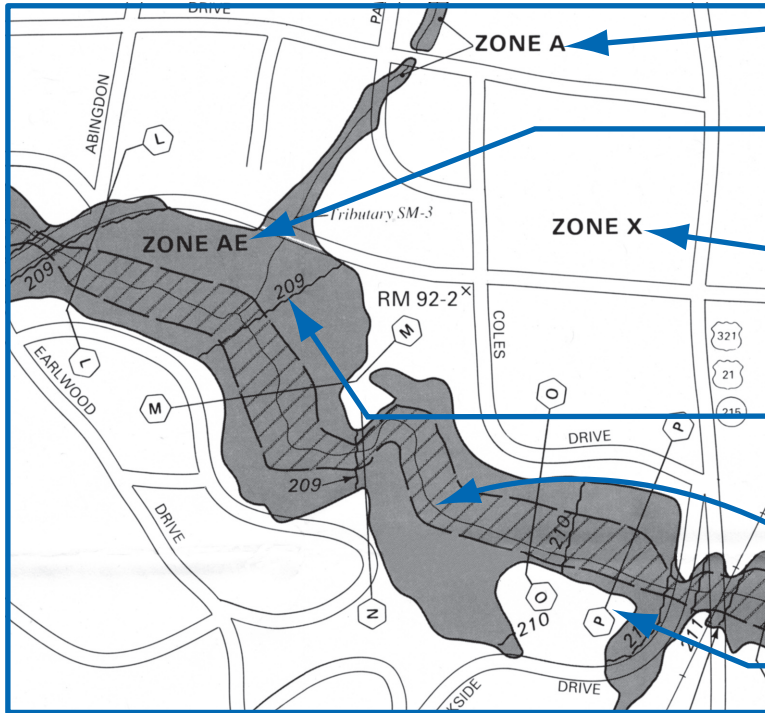

- 1 Zone A** (unnumbered) is the flood hazard area without BFEs.
- 2 Zone AE** is the 100-year (1% annual chance) floodplain with BFEs (also called Zone A1- A30).
- 3 Zone X** (shaded or unshaded) is all other areas considered low-risk (formerly Zone B or C).
- 4 Base Flood Elevation (BFE)** is the water surface elevation of the base flood at specific locations.
- 5 The Floodway** is the “cross-hatched” area.
- 6 Cross Section** location
(See page 15 for an example of how a Cross Section is shown on a profile).

Old Format Flood Insurance Rate Map (Riverine)

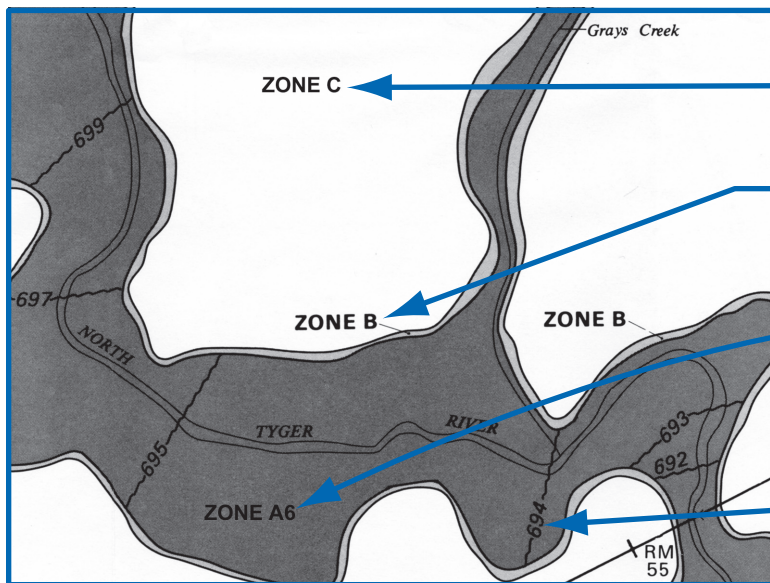

FLOOD HAZARD ZONES

- 1 Zone C** (or Zone X) is all other areas, considered to be low-risk.
- 2 Zone B** (or shaded Zone X) is subject to flooding by the 500-year flood (0.2% annual chance), and is a moderate risk area.
- 3 Zone A, Zones A1-A30 and Zone AE** are subject to flooding by the base or 100-year flood (1% annual chance), and are considered high-risk areas.
- 4 Base Flood Elevation (BFE).** Water surface elevation of the base flood at specific locations.

FEMA prepares Flood Insurance Rate Maps (FIRMs) to show areas that are at high risk of flooding after intense or major storms. Most FIRMs show the flood elevation (how high the water may rise), called the Base Flood Elevation.

The Flood Boundary and Floodway Map

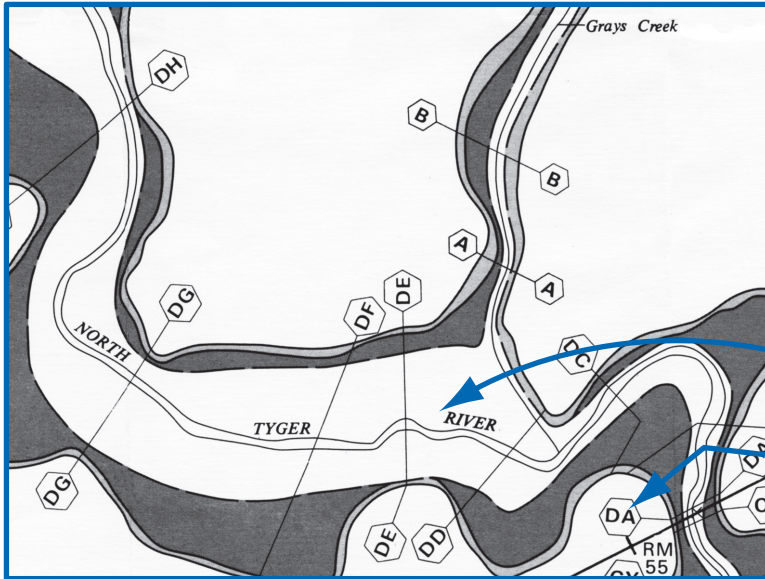

Important

Information

Floodway maps do not show flood zones or BFEs. Check the companion FIRM for that information. Page 13 shows the FIRM that matches the map clip to the left.

1

The Floodway is the "white" area around the waterway centerline.

2

Cross Section location, where ground surveys determined the shape of the land and how constrictions such as bridges and culverts affect the flow of floodwater.

FEMA prepares Floodway maps as companions to many FIRMs. You should check to see if your project will be in the Floodway because additional engineering may be required (see page 33).

Use the Riverine Flood Profile to Determine BFEs

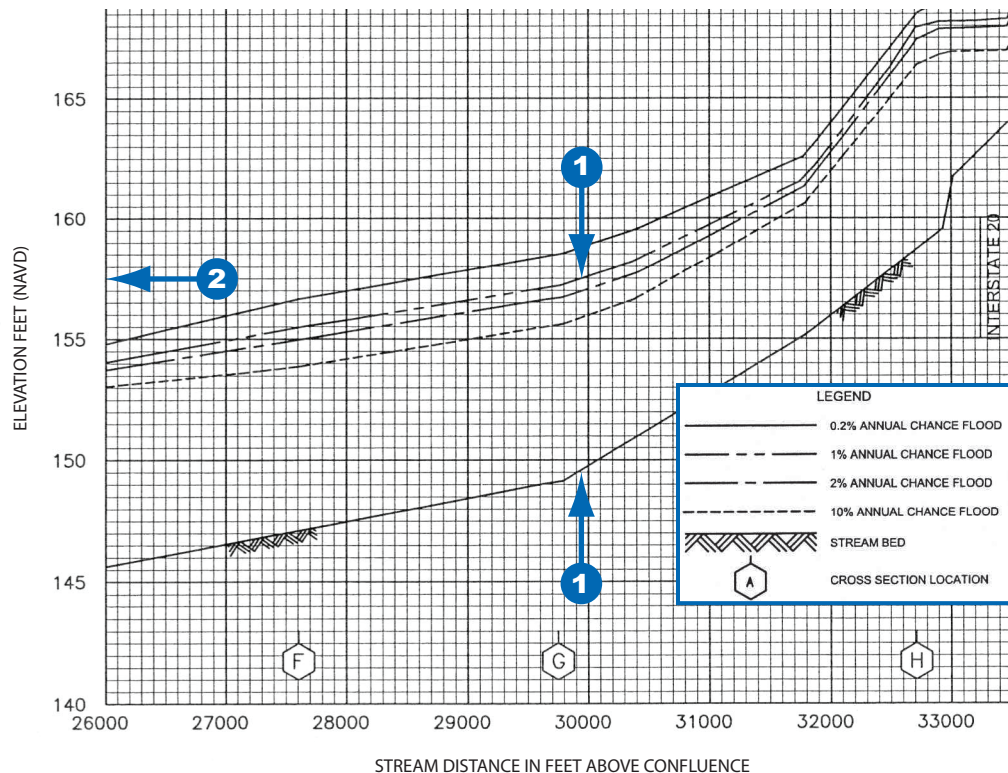

Flood profiles can be used to determine the BFE at a specific site. Profiles also show estimated water surface elevations for floods other than the 100-year flood (1% chance flood).

- 1 On the effective flood map, locate your site by measuring the distance, along the center line of the stream channel, from a road or cross section, for example, **G** or **H**.
- 2 Scale that distance on the Flood Profile and read up to the profile of interest, then across to determine the elevation.

Approximate Flood Zones and Unnumbered A Zones

Topographic maps can be used to estimate the Base Flood Elevation if the FIRM shows approximate or unnumbered A Zones.

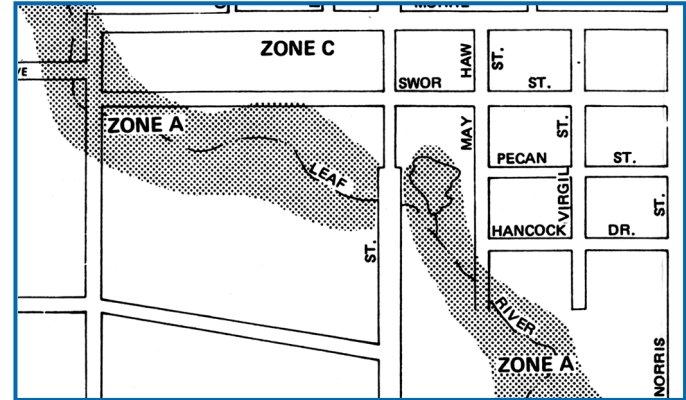
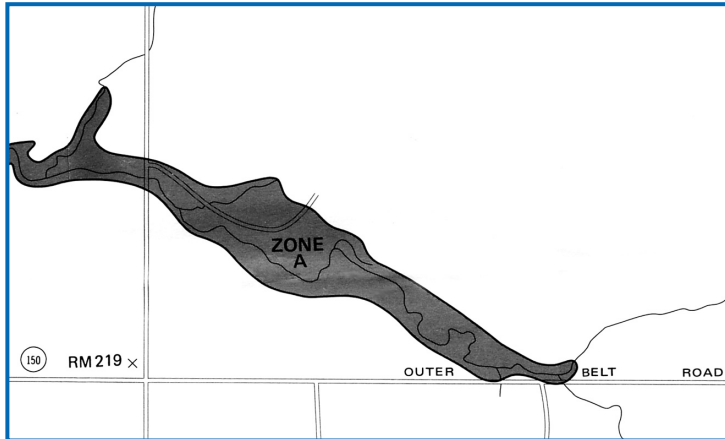

If you need help determining the BFE, check with your community's planning, engineering, or permit office.

FEMA publication *Managing Floodplain Development in Approximate Zone A Areas* (FEMA 265) is useful for engineers.

Understanding the Coastal Floodplain

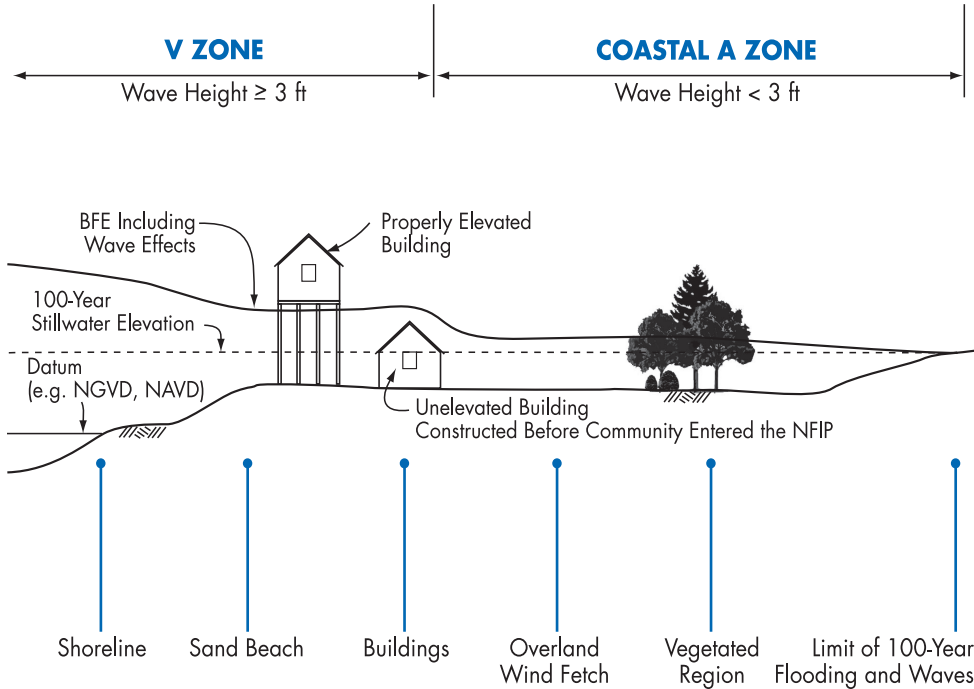

Coastal graphics from Coastal Construction Manual (FEMA 55CD).

de Terms and Definitions

The **Coastal High Hazard Area (V Zone)** is the area of special flood hazard that extends from offshore to the inland limit of a primary frontal dune along an open coast and any other area subject to high velocity wave action. The area is designated on the FIRM as Zone V1-V30, VE, or V.

The term **Coastal A Zone** means the portion of the SFHA landward of the V Zone or landward of a shoreline that does not have a mapped V Zone. The principle sources of flooding are associated with astronomical tides, storm surges, seiches or tsunamis. Coastal A Zones may be subject to wave effects, velocity flows, erosion, scour, or combinations of these forces and may be treated as V Zones.

The Flood Insurance Rate Map (Coastal)

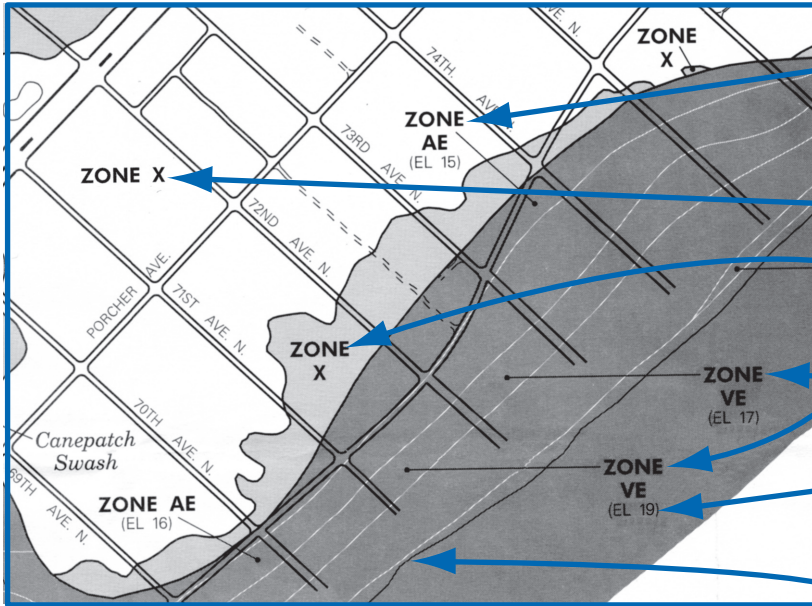

COASTAL FLOOD HAZARD ZONES

- 1 **Zone A, Zones A1-A30, and Zone AE** are subject to flooding by the base or 100-year flood (1% annual chance), and waves less than 3 feet.
- 2 **Zone X** is all other areas.
- 3 **Shaded Zone X** (or Zone B) is subject to flooding by the 500-year flood (0.2% annual chance).
- 4 **Zone V, Zones V1-V30, and Zone VE** are where waves are expected to be 3 feet or more.
- 5 **Base Flood Elevation (BFE)** is the predicted water surface elevation (in feet above datum).
- 6 **Shoreline**

UNDEVELOPED COASTAL BARRIERS



In undeveloped Coastal Barrier Resource Areas (COBRA), NFIP insurance is not available for new or substantially improved structures built after November 16, 1990.

Flood Map Revisions Issued by FEMA

- 1. Letter of Map Amendment (LOMA)** is an official amendment to an effective FIRM that may be issued when a property owner provides additional technical information from a surveyor, such as ground elevation relative to the BFE, SFHA, and the building. Lenders may waive the flood insurance requirement if the LOMA documents indicate that a building is on ground above the mapped floodplain.
- 2. Letter of Map Revision (LOMR)** is an official revision to an effective FIRM that may be issued to change flood insurance risk zones, floodplain and floodway boundary delineations, BFEs and/or other map features. Lenders may waive the insurance requirement if the approved map revision shows buildings to be outside of the SFHA.
- 3. Letter of Map Revision Based on Fill (LOMR-F)** is an official revision to an effective FIRM that is issued to document FEMA's determination that a structure or parcel of land has been elevated by fill above the BFE, and therefore is no longer in the SFHA. Lenders may waive the insurance requirement if the LOMR-F shows that a building on fill is above the BFE.
- 4. Physical Map Revision (LOMR PMR)** may be issued for major floodplain changes that require engineering analyses, such as bridges, culverts, channel changes, flood control measures, and large fills that change the BFE or Floodway. Physical map revisions are also issued when a new study updates or improves the FIRM.



Important

Information

Check FEMA's Flood Hazard Mapping Web Site for more information about map revisions concerning Homeowners



Civil Engineers/
Surveyors.



www.fema.gov/fhm

Requests for map revisions must be coordinated through your community.

Activities Requiring Permits Include:

- Constructing new buildings
- Additions to existing buildings
- Substantially improving existing buildings
- Interior renovations of existing buildings
- Placing manufactured (mobile) homes
- Subdivision of land
- Temporary buildings and accessory structures.
- Agricultural buildings
- Parking or storage of recreational vehicles
- Storing materials, including gas/liquid tanks
- Roads, bridges, and culverts
- Fill, grading, excavation, mining, and dredging
- Altering stream channels



YOU NEED PERMITS FOR **ALL** OF THESE ACTIVITIES.

Safe Uses of the Floodplain

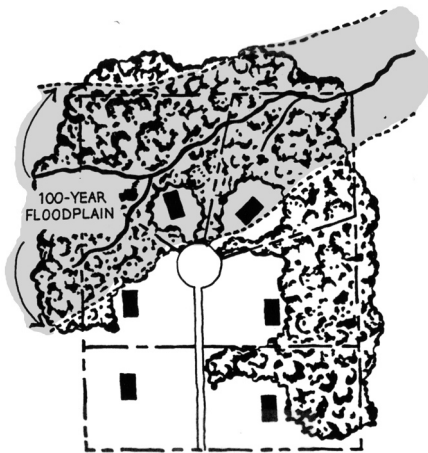

All land subdivided into lots, some homesites and lots partially or entirely in the floodplain.

NOT RECOMMENDED

All land subdivided into lots, some lots partially in the floodplain, setbacks modified to keep homesites on high ground.

RECOMMENDED

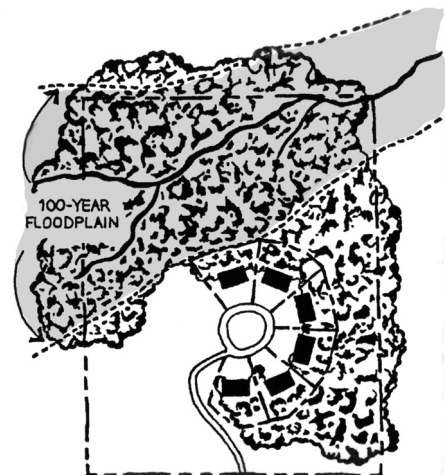
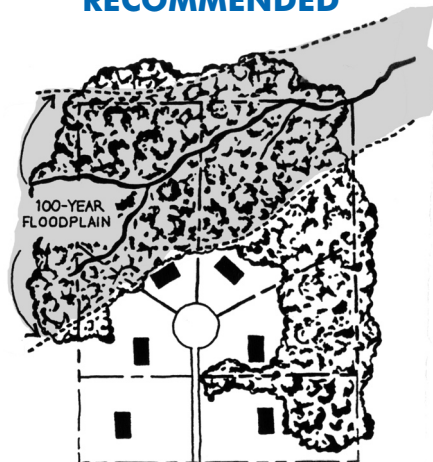

Floodplain land put into public/common open space, net density remains, lot sizes reduced and setbacks modified to keep homesites on high ground.

RECOMMENDED

Let the floodplain do its job – if possible, keep it natural open space. Other low damage uses: recreational areas, playgrounds, reforestation, parking, gardens, pasture, accessory structures, created wetlands.

Is Your Building Site Higher than the BFE?

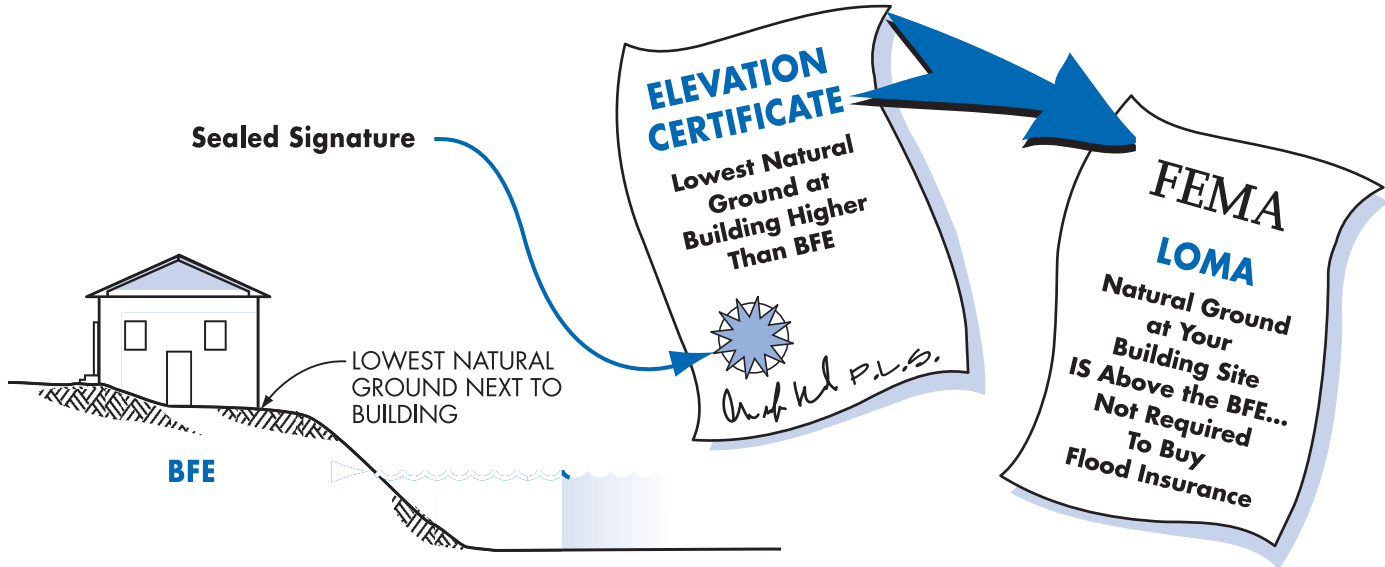

If your land is shown on the map as "in" the floodplain, but your building site is higher than the Base Flood Elevation (BFE)... get a surveyor or engineer to complete a FEMA Elevation Certificate (EC). Submit the EC with an application to FEMA and a Letter of Map Amendment may be issued (page 19). This is the **ONLY** way to remove the mandatory requirement to buy flood insurance. Keep the certificate with your deed, it will help future buyers.

What is Meant by Pre-FIRM and Post-FIRM?

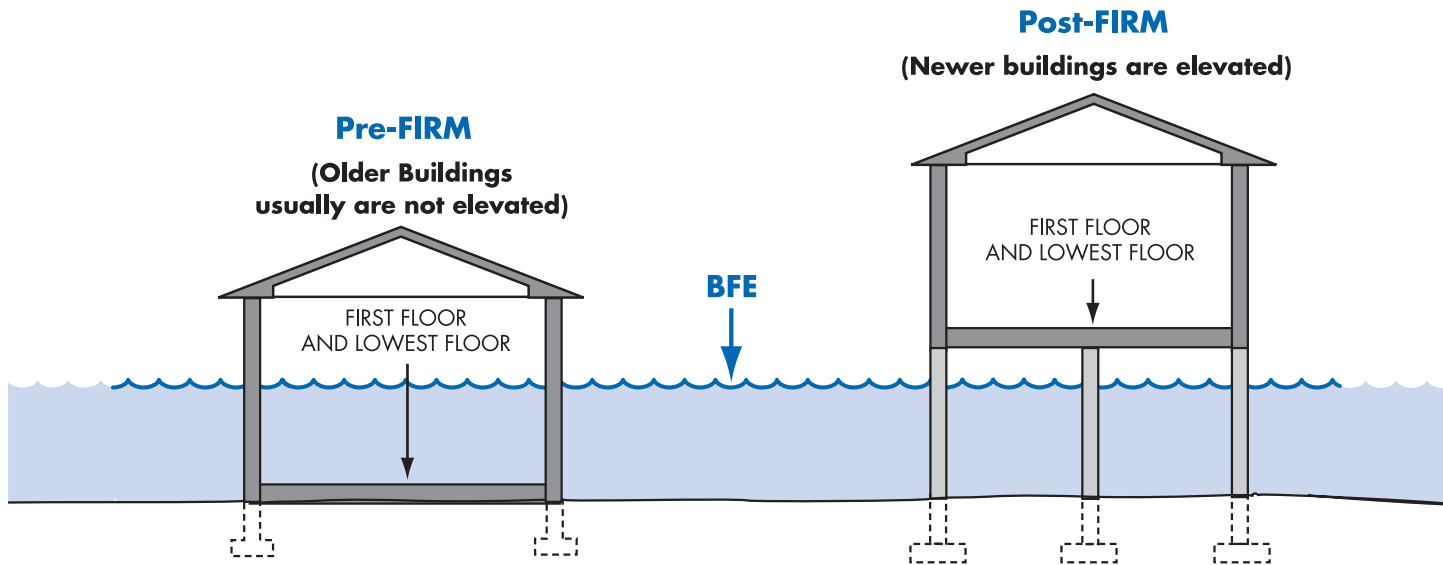

A building is **Pre-FIRM** if it was built **before** the date of your community's first FIRM.
If built **after** that date, a building is **Post-FIRM**.

Improvements or repairs to Pre-FIRM buildings may require permits (see pages 47 through 52).

Nature Doesn't Read Maps

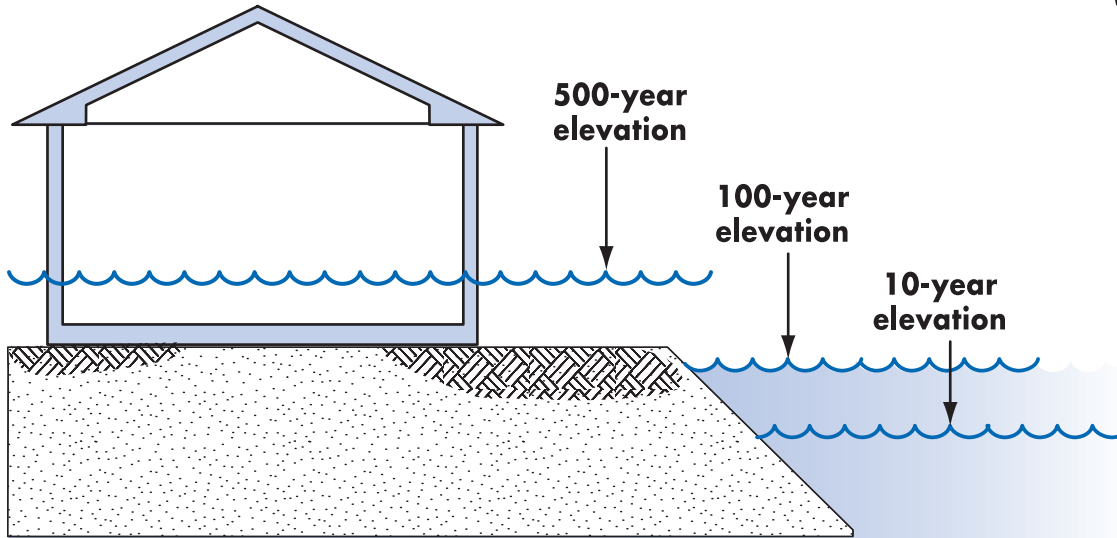

Important

Information

Many people don't understand just how risky the floodplain can be. There is a 26% chance that a non-elevated home in the floodplain will be damaged during a 30-year mortgage period. The chance that a major fire will occur during the same period is only 9%!

CAUTION! Nature doesn't read the flood map! Major storms and flash floods can cause flooding that rises higher than the 100-year elevation (BFE). Consider safety – protect your home or business by building higher. See page 28 to see how this will save you money on insurance.

Think Carefully Before You Seek A Variance

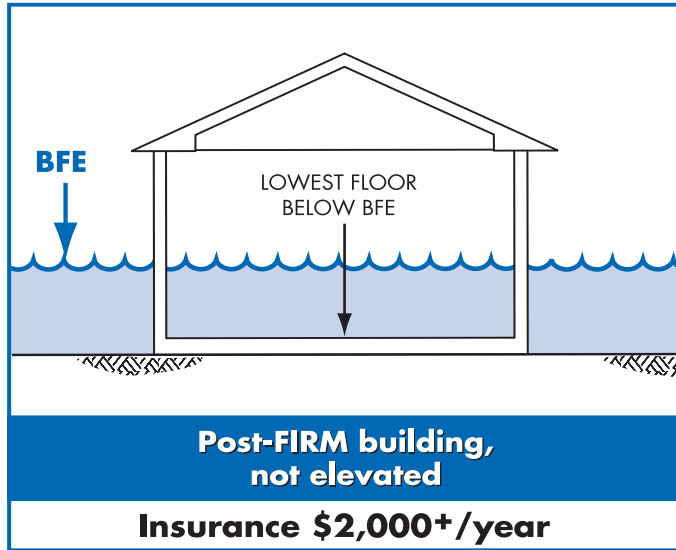

Very specific conditions related to the property (not the owner) must be satisfied to justify a variance:

- Good and sufficient cause
- Unique site conditions
- Non-economic hardship
- If in the floodway, no increase in flood level

A variance that allows construction below the BFE does not waive your lender's flood insurance requirement. Flood insurance will be very expensive – perhaps more than \$2,000 per year (see page 28)!

Think carefully before seeking a variance to build below the Base Flood Elevation. Not only will your property be more likely to get damaged, but insurance will be very costly. If your community has a pattern of issuing variances, sanctions could be imposed – costing you even more!

Some Key Permit Review Steps

The Permit Reviewer has to Check Many Things. Some of the Key Questions are:

- Is the site in the mapped floodplain?
- Is the site in the mapped floodway?
- Have other state and federal permits been obtained?
- Is the site reasonably safe from flooding?
- Does the site plan show the Base Flood Elevation?
- Is substantial improvement of an older building proposed?
- Is an addition proposed?
- Will new buildings and utilities be elevated properly?
- Will manufactured homes be properly elevated and anchored?
- Do the plans show an appropriate and safe foundation?
- Has the owner submitted an Elevation Certificate?



Carefully Complete the Permit Application

Owner's Name: DAVID & SALLY JONES

Site Address, Tax #, Parcel #: 781 REED STREET, 400-33A-002

A. Description of Work

1. Proposed Development Description:

New Construction Dredging

Alteration or Repair Manufactured/Modular

Filling Logging

Grading Other

2. Size and Location of Development

SINGLE FAMILY (2,000 CY FILL);

FLOOD FRINGE OF DRY RIVER

3. Type of Construction

New Residential Improvement

New Non-Residential Renovation

Addition Accessory structure

Temporary

Applicant's Signature: David M. Jones

Application for a Permit to Develop in a Flood Hazard Area (partial)

For Internal Use Only:

- Community No: 450299
- Panel No: 125C
- Zone AE
- Base Flood Elevation 59.2
- Required Lowest Floor Elevation (including basement) 60.2
- If floodproofed, required floodproofing elevation N/A
- Elevation to which all attendant utilities, including all heating, duct work, and electrical equipment will be installed or floodproofed: 60.2



Important

Information

You must get a permit **before** you do work in a floodplain.

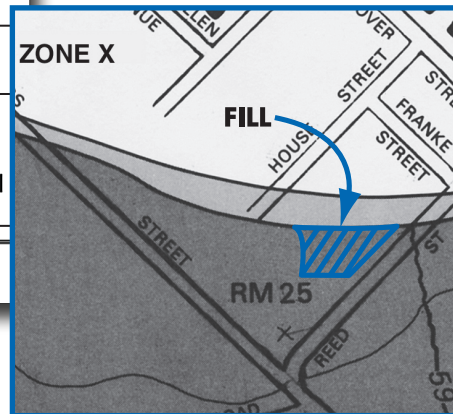

Good information will lead to better construction and less exposure to future flood damage.

Freeboard: Go the Extra Foot!

Want to save some money and have peace of mind at the same time? Then add Freeboard to build higher than the minimum elevation requirement! Freeboard is a factor of safety, usually one or two feet above the BFE.

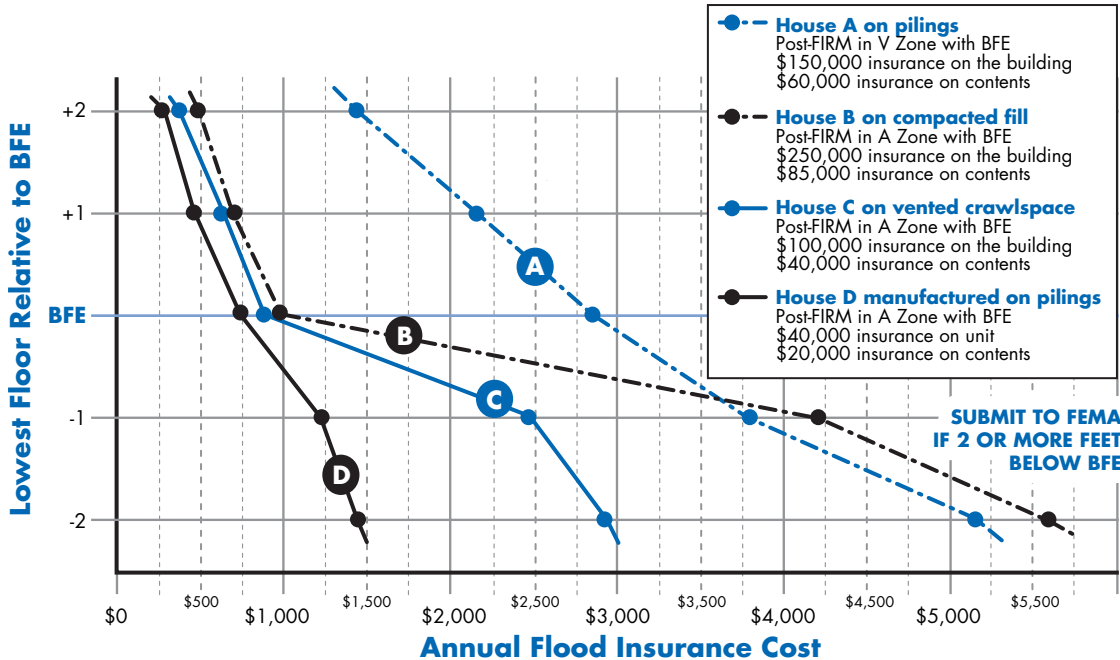

Important Information

NOTE: Flood insurance rates and various fees change from time to time. Rather than specific costs for insurance, this figure gives a feel for how much difference just a foot or two can make.

Building owners will save insurance money if they elevate above the BFE. But more impressive is how the cost of insurance can more than double if the building is only one foot below the BFE.

Remember! The community may be able to grant a variance, but the owner will probably still be required to buy insurance. Imagine trying to sell a house if the bank requires insurance that costs over \$2,000 a year!

What is the Elevation Certificate and How is it Used?

- The Elevation Certificate (EC) is a FEMA form. Go to <http://www.fema.gov/> and search on “Elevation Certificate.”
- The EC must be completed and sealed by a registered surveyor or engineer when the floodplain has BFEs.
- A community official may complete the EC for sites in approximate flood zones.
- It can be used to show that sites are natural ground above the Base Flood Elevation (see page 22).
- It is used to verify that buildings are elevated properly (see page 31).
- Insurance agents use the EC to write and rate flood insurance policies.

By itself, the EC cannot be used to waive the requirement to get flood insurance. See page 19 to learn about Letters of Map Amendment.

**FEDERAL EMERGENCY MANAGEMENT AGENCY
NATIONAL FLOOD INSURANCE PROGRAM
ELEVATION CERTIFICATE**

U.S. DEPARTMENT OF HOMELAND SECURITY
Federal Emergency Management Agency
National Flood Insurance Program

ELEVATION CERTIFICATE Form No. 81-31-2009
Revised February 20, 2009

Important: Read the instructions on pages 1-8.

SECTION A - PROPERTY INFORMATION

A1. Building Owner's Name: _____
 A2. Building Street Address including Apt., Unit, Suite, and/or Bldg. No. (or P.O. Route and Box No.): _____
 City: _____ State: _____ ZIP Code: _____

A3. Property Description (Lot and Block Numbers, Tax Parcel Number, Legal Description, etc.): _____

A4. Building Use (e.g., Residential, Non-Residential, Address, Assembly, etc.): _____
 A5. Labeled Complete, Lot: _____
 A6. Has a floor level (elevation) of the building (see Certificate) being used to obtain flood insurance: National Datum NAD 1987 NAD 1983

A7. Building Elevation Number: _____
 A8. For a building with a crawl space or embankment, provide: No Yes
 A9. If a building with an attached garage, provide: No Yes
 B1. No. of permanent floor openings in the attached garage: _____
 B2. No. of permanent floor openings in the detached garage: _____
 B3. No. of permanent floor openings in the attached garage: _____
 B4. No. of permanent floor openings in the detached garage: _____
 C1. Total net area of floor coverings in A8-B: _____ sq. ft.

SECTION B - FLOOD INSURANCE RATE MAP (FIRM) INFORMATION

B1. FIRM Community Name & Community Number: _____ B2. County Name: _____ B3. FIRM Title: _____

B4. Map Panel Number: _____ B5. Scale: _____ B6. FIRM Panel: _____ B7. Flood Zone(s): _____ B8. Base Flood Elevation(s) (Zone): _____
 (All use base flood only)

B9. Indicate the source of the Base Flood Elevation (BFE) data on which you are based: Profile Flood Community Determined Other (describe): _____
 B10. Is the building located in a Coastal Storm Risk Area (CSRA)? Yes No
 B11. Is the building located in a Coastal Storm Risk Area (CSRA)? Yes No
 Designation Code: _____

SECTION C - BUILDING ELEVATION INFORMATION (SURVEY REQUIRED)

C1. Building elevations are based on: Construction Drawing Building Under Construction Finished Construction
 C2. Elevation: Zone(s) A, B, C, D, E, F, G, H, I, J, K, L, M, N, O, P, Q, R, S, T, U, V, W, X, Y, Z, AA, AB, AC, AD, AE, AF, AG, AH, AI, AJ, AK, AL, AM, AN, AO, AP, AQ, AR, AS, AT, AU, AV, AW, AX, AY, AZ, BA, BB, BC, BD, BE, BF, BG, BH, BI, BJ, BK, BL, BM, BN, BO, BP, BQ, BR, BS, BT, BU, BV, BW, BX, BY, BZ, CA, CB, CC, CD, CE, CF, CG, CH, CI, CJ, CK, CL, CM, CN, CO, CP, CQ, CR, CS, CT, CU, CV, CW, CX, CY, CZ, DA, DB, DC, DD, DE, DF, DG, DH, DI, DJ, DK, DL, DM, DN, DO, DP, DQ, DR, DS, DT, DU, DV, DW, DX, DY, DZ, EA, EB, EC, ED, EE, EF, EG, EH, EI, EJ, EK, EL, EM, EN, EO, EP, EQ, ER, ES, ET, EU, EV, EW, EX, EY, EZ, FA, FB, FC, FD, FE, FF, FG, FH, FI, FJ, FK, FL, FM, FN, FO, FP, FQ, FR, FS, FT, FU, FV, FW, FX, FY, FZ, GA, GB, GC, GD, GE, GF, GG, GH, GI, GJ, GK, GL, GM, GN, GO, GP, GQ, GR, GS, GT, GU, GV, GW, GX, GY, GZ, HA, HB, HC, HD, HE, HF, HG, HH, HI, HJ, HK, HL, HM, HN, HO, HP, HQ, HR, HS, HT, HU, HV, HW, HX, HY, HZ, IA, IB, IC, ID, IE, IF, IG, IH, II, IJ, IK, IL, IM, IN, IO, IP, IQ, IR, IS, IT, IU, IV, IW, IX, IY, IZ, JA, JB, JC, JD, JE, JF, JG, JH, JI, JJ, JK, JL, JM, JN, JO, JP, JQ, JR, JS, JT, JU, JV, JW, JX, JY, JZ, KA, KB, KC, KD, KE, KF, KG, KH, KI, KJ, KK, KL, KM, KN, KO, KP, KQ, KR, KS, KT, KU, KV, KW, KX, KY, KZ, LA, LB, LC, LD, LE, LF, LG, LH, LI, LJ, LK, LL, LM, LN, LO, LP, LQ, LR, LS, LT, LU, LV, LW, LX, LY, LZ, MA, MB, MC, MD, ME, MF, MG, MH, MI, MJ, MK, ML, MM, MN, MO, MP, MQ, MR, MS, MT, MU, MV, MW, MX, MY, MZ, NA, NB, NC, ND, NE, NF, NG, NH, NI, NJ, NK, NL, NM, NN, NO, NP, NQ, NR, NS, NT, NU, NV, NW, NX, NY, NZ, OA, OB, OC, OD, OE, OF, OG, OH, OI, OJ, OK, OL, OM, ON, OO, OP, OQ, OR, OS, OT, OU, OV, OW, OX, OY, OZ, PA, PB, PC, PD, PE, PF, PG, PH, PI, PJ, PK, PL, PM, PN, PO, PP, PQ, PR, PS, PT, PU, PV, PW, PX, PY, PZ, QA, QB, QC, QD, QE, QF, QG, QH, QI, QJ, QK, QL, QM, QN, QO, QP, QQ, QR, QS, QT, QU, QV, QW, QX, QY, QZ, RA, RB, RC, RD, RE, RF, RG, RH, RI, RJ, RK, RL, RM, RN, RO, RP, RQ, RR, RS, RT, RU, RV, RW, RX, RY, RZ, SA, SB, SC, SD, SE, SF, SG, SH, SI, SJ, SK, SL, SM, SN, SO, SP, SQ, SR, SS, ST, SU, SV, SW, SX, SY, SZ, TA, TB, TC, TD, TE, TF, TG, TH, TI, TJ, TK, TL, TM, TN, TO, TP, TQ, TR, TS, TT, TU, TV, TW, TX, TY, TZ, UA, UB, UC, UD, UE, UF, UG, UH, UI, UJ, UK, UL, UM, UN, UO, UP, UQ, UR, US, UT, UY, UZ, VA, VB, VC, VD, VE, VF, VG, VH, VI, VJ, VK, VL, VM, VN, VO, VP, VQ, VR, VS, VT, VU, VW, VX, VY, VZ, WA, WB, WC, WD, WE, WF, WG, WH, WI, WJ, WK, WL, WM, WN, WO, WP, WQ, WR, WS, WT, WU, WV, WW, WX, WY, WZ, XA, XB, XC, XD, XE, XF, XG, XH, XI, XJ, XK, XL, XM, XN, XO, XP, XQ, XR, XS, XT, XU, XV, XW, XX, XY, XZ, YA, YB, YC, YD, YE, YF, YG, YH, YI, YJ, YK, YL, YM, YN, YO, YP, YQ, YR, YS, YT, YU, YV, YW, YX, YY, YZ, ZA, ZB, ZC, ZD, ZE, ZF, ZG, ZH, ZI, ZJ, ZK, ZL, ZM, ZN, ZO, ZP, ZQ, ZR, ZS, ZT, ZU, ZV, ZW, ZX, ZY, ZZ

SECTION D - SURVEYOR, ENGINEER, OR ARCHITECT CERTIFICATION

The information on this form is prepared and certified by the undersigned, representing the property owner, and is true and correct. I certify that the information on this form is true and correct. I understand that any false statement may be punishable by fine or imprisonment under 18 U.S.C. Section 1001.

Check here if comments are provided on back of form.

 Title: _____
 Signature: _____
 Date: _____
 Company Name: _____
 Address: _____
 City: _____ State: _____ ZIP Code: _____
 Telephone: _____

PLACE
SEAL
HERE

FEMA Form 81-31, February 2009 See reverse side for continuation. Replaces all previous editions.

Completing the Elevation Certificate

Elevation Certificate (partial)

SECTION C - BUILDING ELEVATION INFORMATION (SURVEY REQUIRED)

C1. Building elevations are based on: Construction Drawings* Building Under Construction* Finished Construction
*A new Elevation Certificate will be required when construction of the building is complete.

C2. Elevations – Zones A1-A30, AE, AH, A (with BFE), VE, V1-V30, V (with BFE), AR, AR/A, AR/AE, AR/A1-A30, AR/AH, AR/AO. Complete Items C2.a-g below according to the building diagram specified in Item A7.

Benchmark Utilized 140025 Vertical Datum NAD 1988

Conversion/Comments _____

a) Top of bottom floor (including basement, crawl space, or enclosure floor),	<u>627 0</u>	<input checked="" type="checkbox"/> feet
b) Top of the next higher floor	<u>N/A</u>	<input type="checkbox"/> feet
c) Bottom of the lowest horizontal structural member (V Zones only)	<u>N/A</u>	<input type="checkbox"/> feet
d) Attached garage (top of slab)	<u>622 5</u>	<input checked="" type="checkbox"/> feet
e) Lowest elevation of machinery or equipment servicing the building (Describe type of equipment in Comments)	<u>627 0</u>	<input checked="" type="checkbox"/> feet
f) Lowest adjacent (finished) grade (LAG)	<u>622 5</u>	<input checked="" type="checkbox"/> feet
g) Highest adjacent (finished) grade (HAG)	<u>626 0</u>	<input checked="" type="checkbox"/> feet

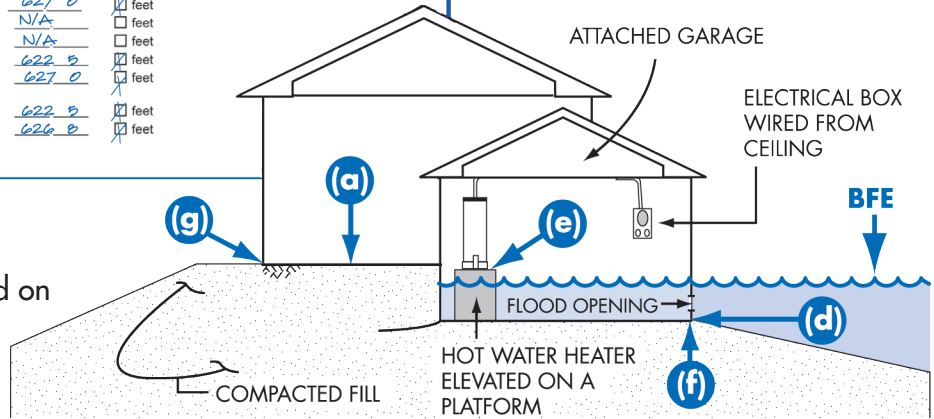

In this example, the BFE is 626 feet.

The slab-on-grade house was elevated on fill 1' above the BFE, and the vented garage is 3.5' below the BFE.

You will get a blank Elevation Certificate form when you get your permit. You **must** have a surveyor or engineer fill it out and seal it. The Elevation Certificate includes diagrams for eight building types. Several points must be surveyed.

Paperwork is Important – for You and Your Community



Terms and Definitions

Lowest Floor means the lowest floor of the lowest enclosed area (including basement). An unfinished or flood resistant enclosure (that is not a basement) is not the lowest floor if the enclosure is built as required in the local ordinance (see pages 37 and 42), which includes limited uses.

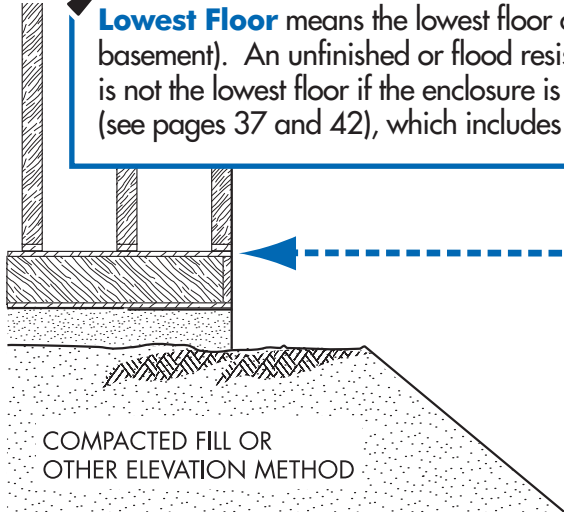

ELEVATION CERTIFICATE

Lowest Floor
At or Above
BFE



W. H. P. L. S.

If you get a permit to build in the floodplain, you will be given an Elevation Certificate form. As soon as your lowest floor is set, get the form filled out and sealed by a surveyor or engineer.

This form is important!

It proves that you built correctly, and it can be used to get the lowest cost flood insurance.

Floodplain Fill Can Make Things Worse

Floodplains are supposed to store floodwater. If storage space is filled with dirt and other fill, future flooding may be worsened. Your community may require an engineering analysis (“no impact” certificate) to show how floodplain fill will alter flooding. Floodplain fill can alter valuable floodplain functions, including wildlife habitat and wetlands.

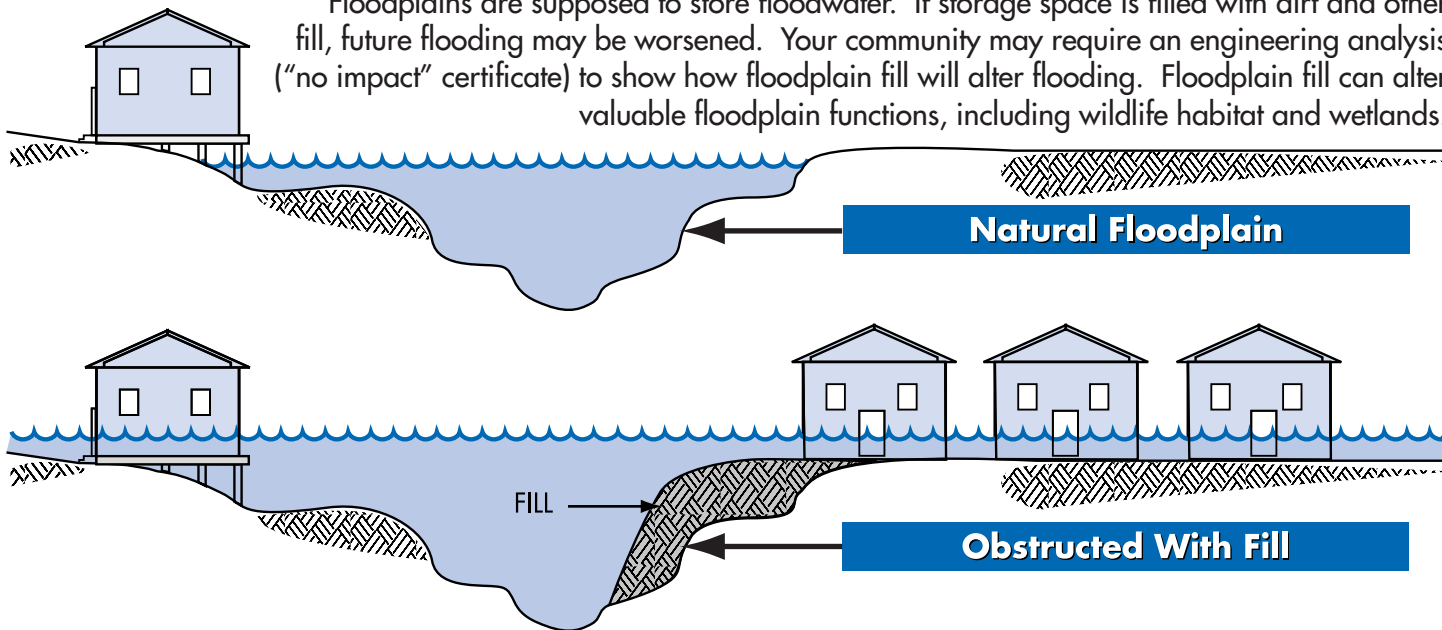

Make sure your floodplain fill project won't harm your neighbors. Floodway fill is allowed **only** if an engineering evaluation demonstrates that “no impact” in flood level will occur (see page 33).

Required Floodway “No Impact” Certification

- Floodways can be dangerous because water may flow very fast
- Development is not allowed unless “no impact” in flood elevations, floodway elevations, and floodway widths is certified
- An engineer must evaluate the hydraulic impact of proposed development
- A “no impact” certification is required and must be signed, sealed, and dated by a registered professional engineer
- Check with your community for guidance **before** you decide to work in a floodway

ENGINEERING “NO IMPACT” CERTIFICATION *(example)*



This is to certify that I am a duly qualified engineer licensed to practice in the State of South Carolina. It is to further certify that the attached technical data supports the fact that the proposed **(Name of Development)** will not impact the Base Flood Elevations (100-year flood), floodway elevations and the floodway widths on **(Name of Stream)**.

Signature _____ Seal _____

The engineering analysis must be based on technical data obtained from FEMA.
Save time and money – don’t build in the floodway!

How to Elevate Your Floodplain Building

Elevate on Foundation Walls

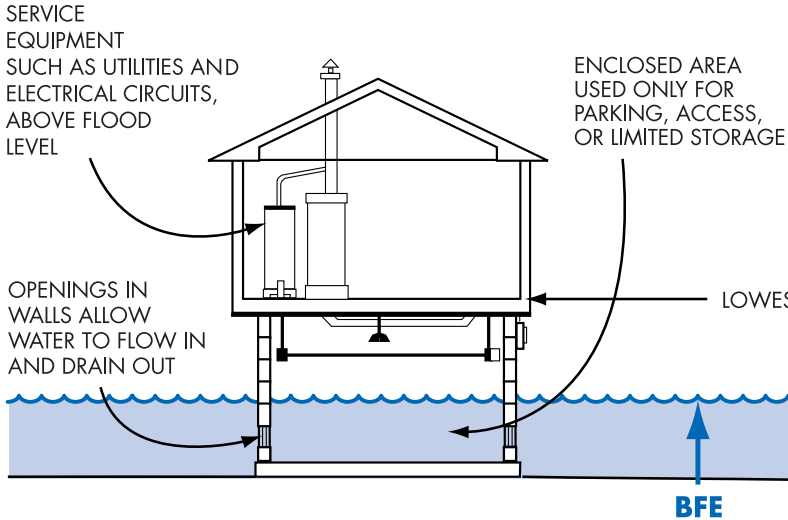

Elevate on Fill

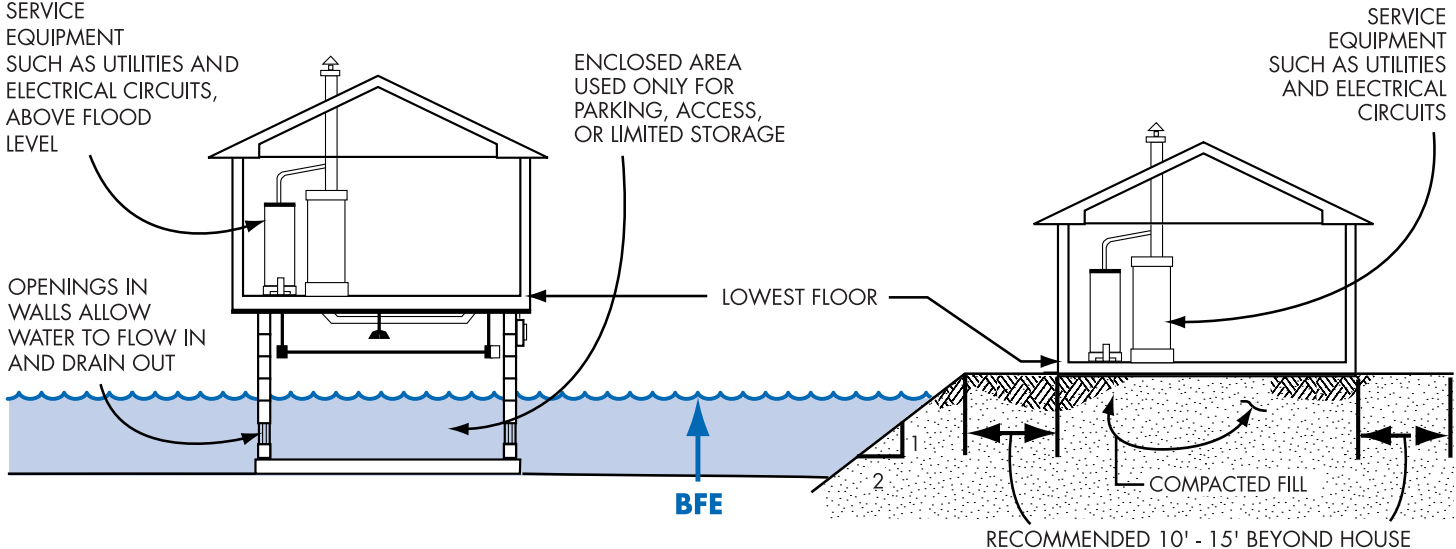

CAUTION! Enclosures (including crawlspaces) have some special requirements, see pages 37, 38 and 42.

Note: When the walking surface of the lowest floor is at the minimum elevation, under-floor utilities are not allowed. Fill used to elevate buildings must be placed properly (see page 35).

Compaction of Floodplain Fill

Earthen fill used to raise the ground above the flood elevation must be placed properly so that it does not erode or slump when water rises. For safety and to meet floodplain requirements, floodplain fill should:

- Be good clean soil, free of large rocks, construction debris, and woody material (stumps, roots).
- Be machine compacted to 95 percent of the maximum density (determined by design professional).
- Have graded side slopes that are not steeper than 1:1.5 (one foot vertical rise for every 1.5 feet horizontal extent); flatter slopes are recommended.
- Have slopes protected against erosion (vegetation for “low” velocities, durable materials for “high” velocities – determined by design professional).

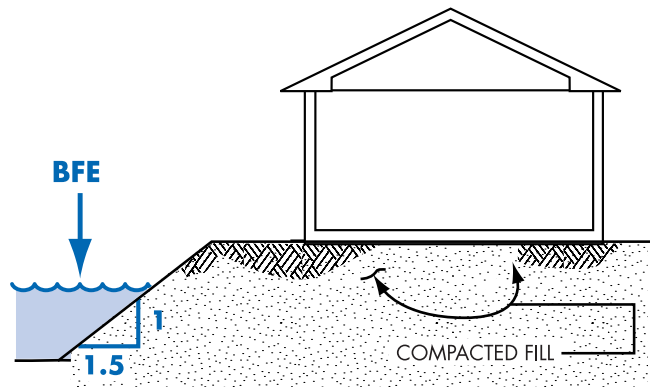

Your community may ask for certification of the elevation, compaction, slope, and slope protection materials. Your engineer or design professional can find more information in FEMA's technical guidance (MT-1).

Manufactured Homes Require Special Attention

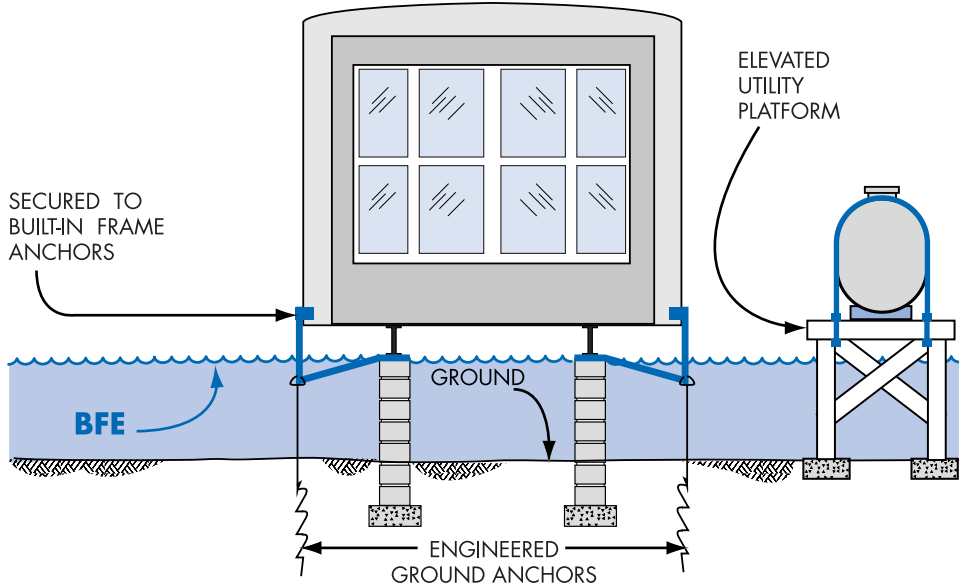

Manufactured homes must be anchored to resist flotation, collapse, or lateral movement by being tied down in accordance with your community's ordinance or the manufacturers' installation specifications.

Experience shows that manufactured homes are easily damaged. As little as one foot of water can cause substantial damage.

Dry stacked blocks are not acceptable — they will **NOT** withstand a flood.

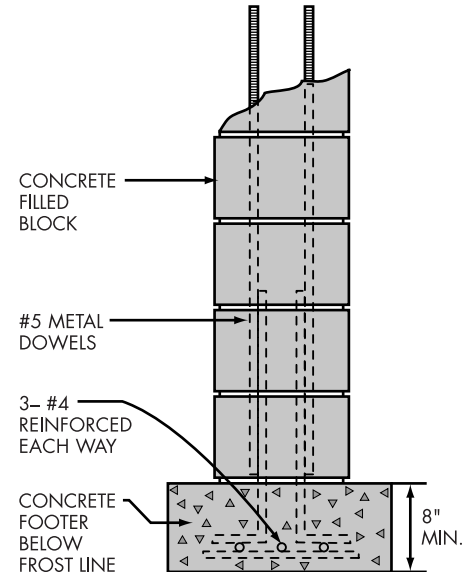

Enclosures Below the BFE

NOTE:

- Total net area of all total openings is 1 sq. in. per sq. ft. of enclosed area
- A 25' x 45' building needs 1125 sq. inches of openings
- Standard ventilation units used in block foundation walls must be disabled in the open position to allow water to flow in and out
- A standard ventilation unit, with screen, provides 42 to 65 sq. inches of opening

ALTERNATIVE: Engineered openings are acceptable if certified to allow adequate automatic inflow and outflow of floodwaters.

AT LEAST TWO
FLOOD OPENINGS
ON DIFFERENT SIDES

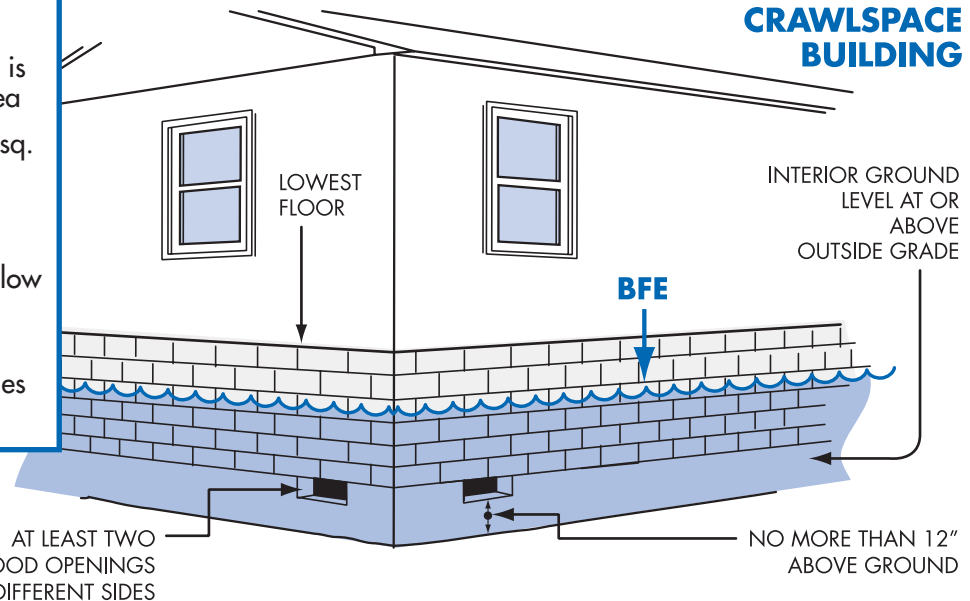

Solid perimeter wall foundations can enclose flood-prone space. A crawlspace is a good way to elevate just a couple of feet. In all cases, the following are required: openings/vents, elevated utilities, flood resistant materials, and limitations on use.

Crawlspace Details

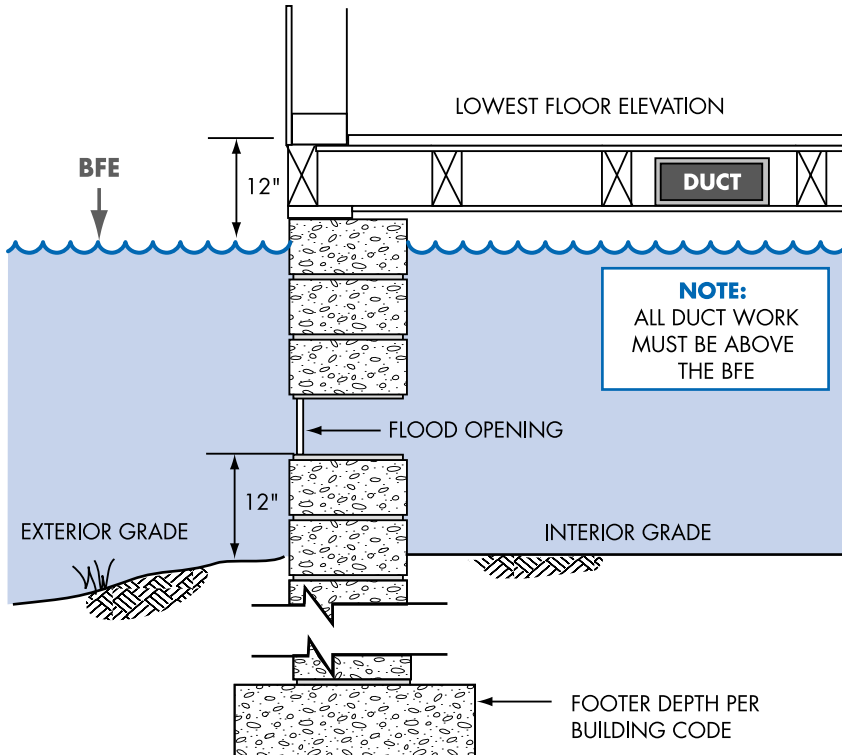

- The Lowest Floor Elevation must be at or above the BFE.
- The bottom of flood openings must be no more than 1 foot above grade.
- Standard ventilation units must be disabled in the “open” position to allow water to flow in and out.
- Interior grade must be equal to or higher than exterior grade on at least one side.

Calculate Net Flood Opening:

A building that measures 25' x 45' has 1,125 square feet of enclosed crawlspace. Flood openings must provide 1,125 sq. in. of net open area (or have certified engineered openings). If a standard air vent unit provides 60 sq. in. of net open area, then to satisfy the flood opening requirement 19 vent units are required (1,125 divided by 60).

Typical Elevation Methods for Coastal Buildings

Elevate on Pilings

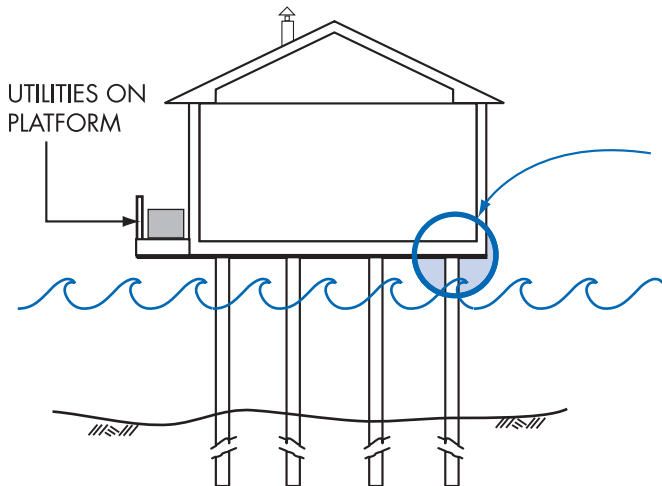

Wood or Metal Piles Installed to Proper Depth

See details on
page 40

Elevate on Columns

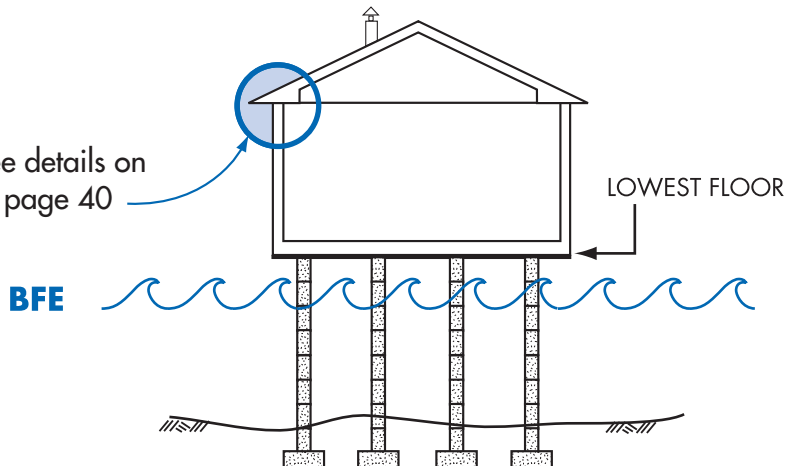

BFE

Reinforced Masonry or
Concrete Columns on Spread Footers

In V Zones the design specifics will be determined by your architect or engineer based on your site, including how your building will be elevated and how deep in the ground the foundation elements will extend. Your community will require certified or sealed building designs and plans (see page 41).

Coastal Houses Must Resist Wind and Water Forces

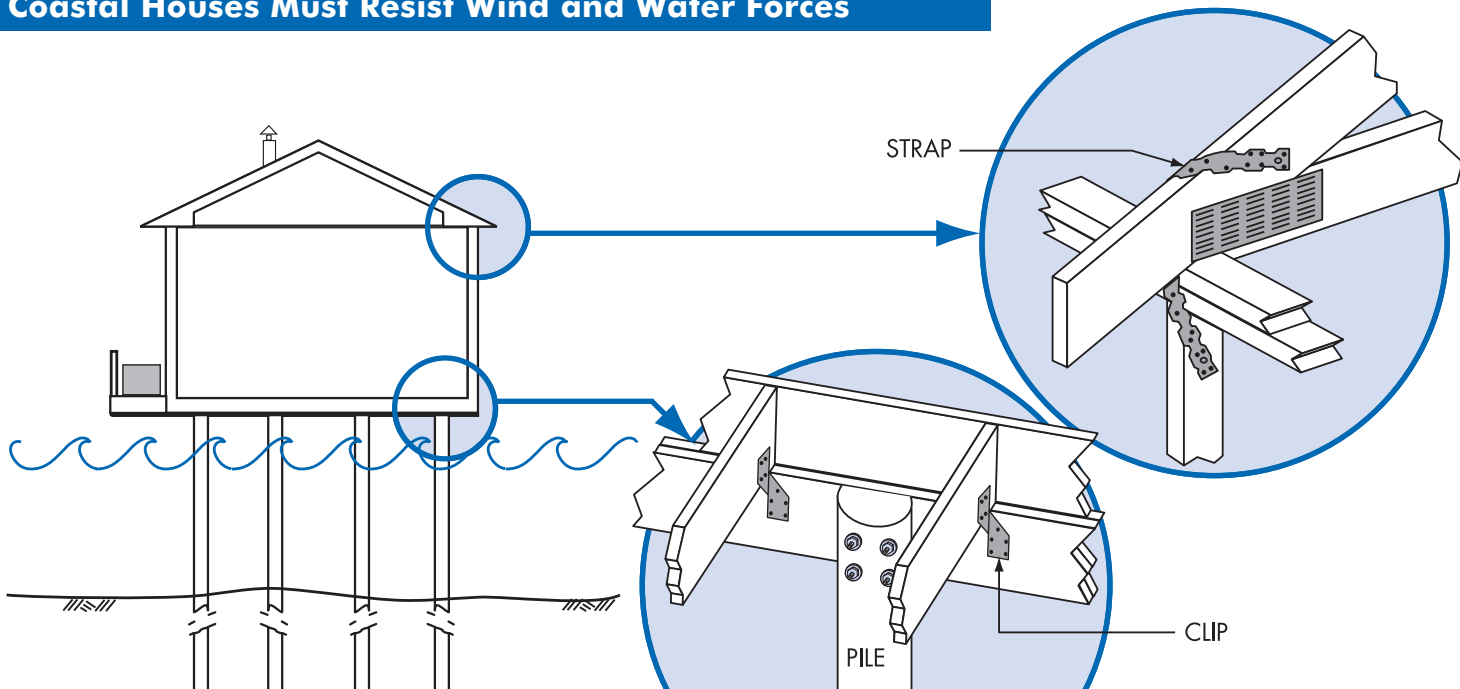

Coastal buildings may be exposed to both hurricane winds and floodwater, so they must be built to hold together during storms. These details are only examples. Your architect or engineer will decide the type of clips and straps to keep the roof and building connected to the foundation.

The V Zone Certificate (Sample)

V Zone Building Design and Performance Certificate (partial)

Section 2: Elevation Information

1. Elevation of the Bottom of the Lowest Horizontal Structural Member..... 17 feet
2. Base Flood Elevation (BFE)..... 16 feet
3. Elevation of Lowest Adjacent Grade (LAG)..... 6 feet
4. Foundation type: Piling / Post / Pier / Column / Fill / Shear Wall / Enclosed Wall
Foundation Description: DRIVEN WOOD PILES, NO
OBSTRUCTIONS EXCEPT OPEN STAIRS
5. Approximate depth of scour/erosion used for foundation design..... 3 feet
6. Embedment depth of pilings or foundation below LAG..... 16 feet

A Registered Professional Engineer or Architect must review or prepare your building design and provide a signed and sealed statement that the design meets minimum design and construction requirements.

Note: You will also have to submit an "as-built" certification when construction is finished.

Resource: Coastal Construction Manual (FEMA 55CD). Revised in 2000, this interactive CD is a useful tool for engineers and architects who design buildings in V zones.

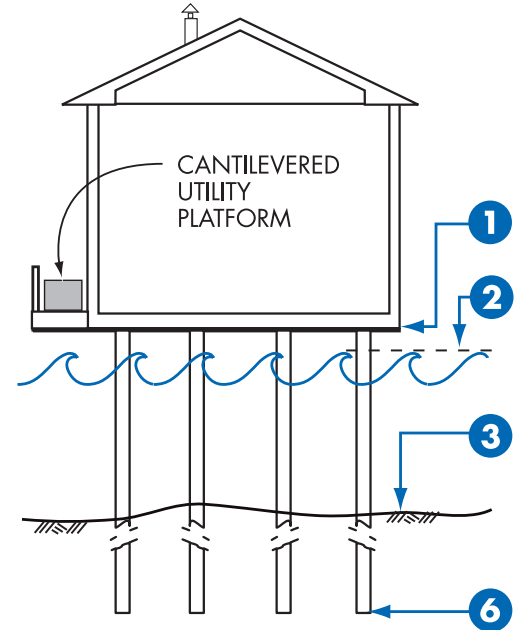

Enclosures Below V Zone Buildings

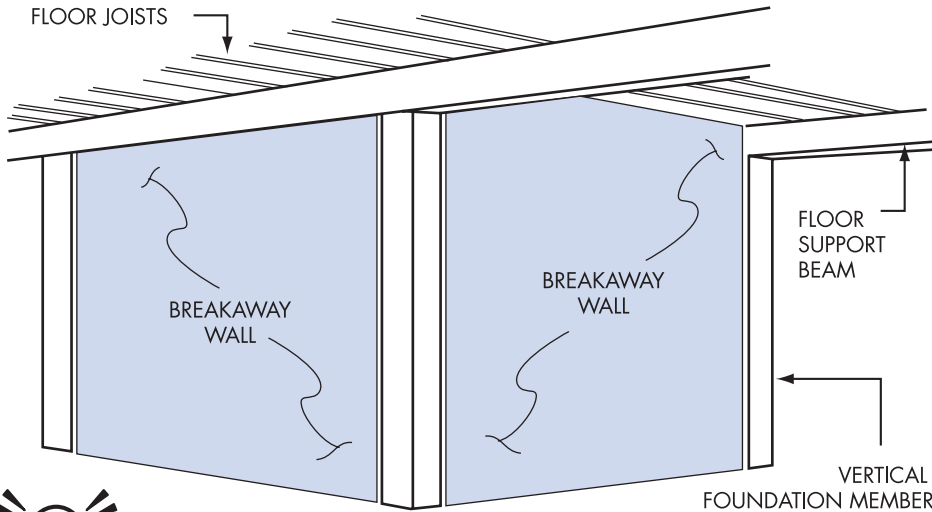

Important

Information

Do not modify an enclosure below an elevated V Zone building (or any zone for that matter)! It is a violation of your community's regulations, and you may have increased damage when it floods. Plus, your flood insurance policy will cost a lot more!

Avoid building an enclosure under your V Zone building. If you must enclose a small area, your community will require:

- Walls must be designed to collapse or “breakaway” under storm and flood conditions
- Must be unfinished or use flood resistant materials
- Utility wires and pipes should not go through or be attached to the breakaway walls
- Enclosed area is to be used only for parking, building access, or storage
- No bathrooms, utility rooms, or electric service below BFE
- Size limited to less than 300 square feet (or insurance premiums are higher)

Utility Service Outside Buildings

**Heat Pump or A/C
on Platform**

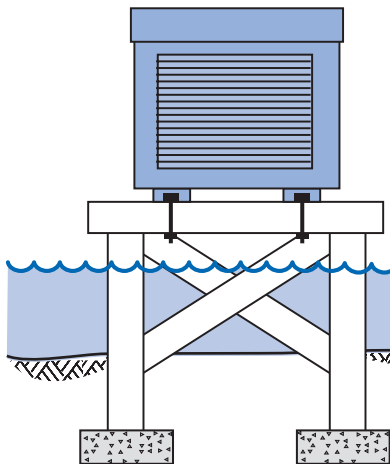

BFE

**Fuel or Propane Tank
Anchored on Platform**

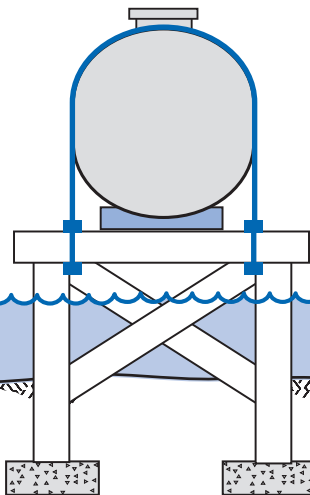

Important

Information

Fuel and propane tanks may cause explosion and pollution risks during flood conditions! Even shallow water can create large buoyant forces on tanks, so extra care must be taken to ensure that all tanks are anchored.

**Fuel or Propane Tank
Anchored to Prevent Flotation**

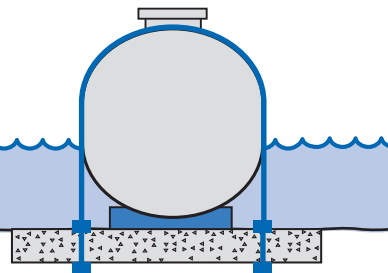

Whether inside an attached garage or outside the building, all utilities, appliances and equipment must be elevated above the BFE or protected against flood damage. Utilities include plumbing, electrical, gas lines, fuel tanks, and heating and air conditioning equipment.

Utility Service Inside Enclosures

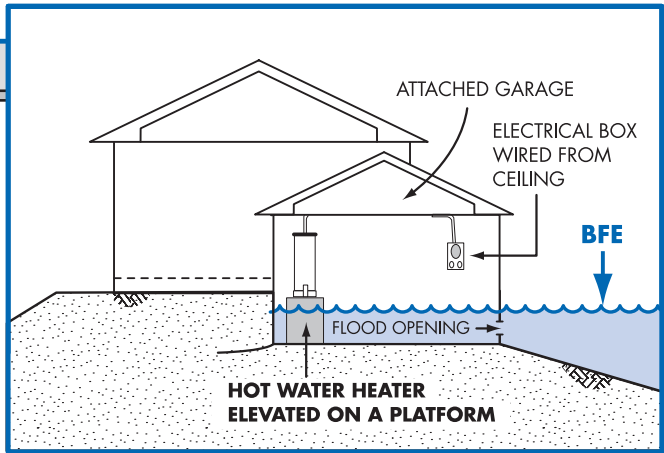
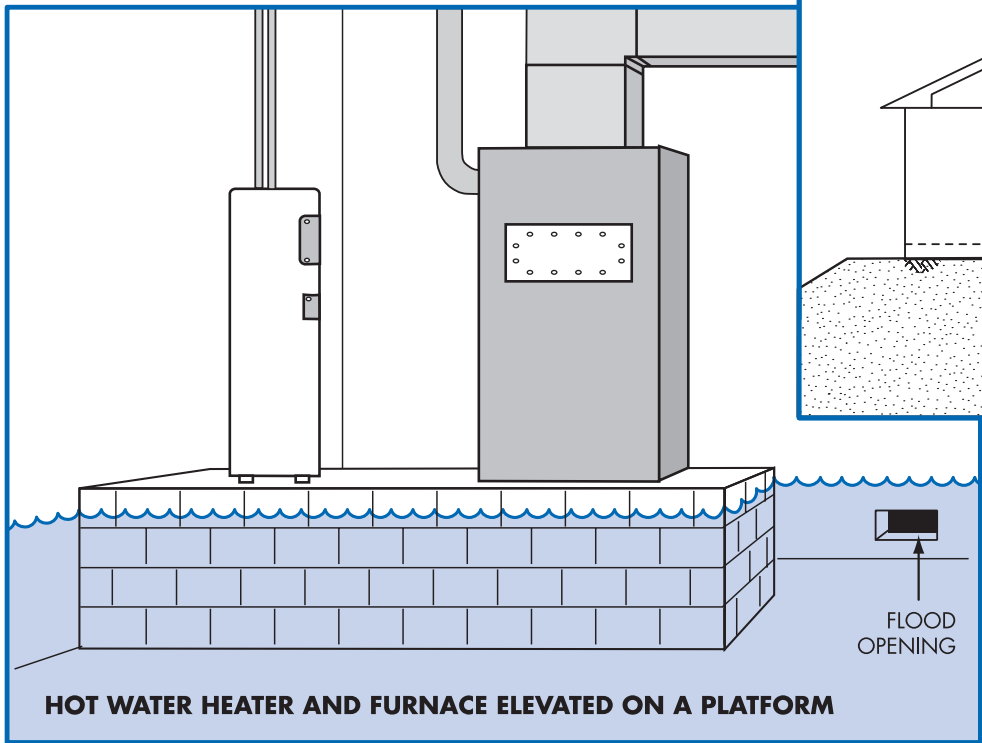

All utilities, appliances, and equipment must be elevated above the BFE or protected. Utilities include plumbing, electrical, gas lines, heating, and air conditioning.

Accessory (Appurtenant) Structures

- Not habitable
- Anchored to resist floating
- Flood openings/vents
- Built of flood resistant materials
- Elevated utilities
- Used only for storage or parking
- Cannot be modified for different use in the future
- Document floor elevation

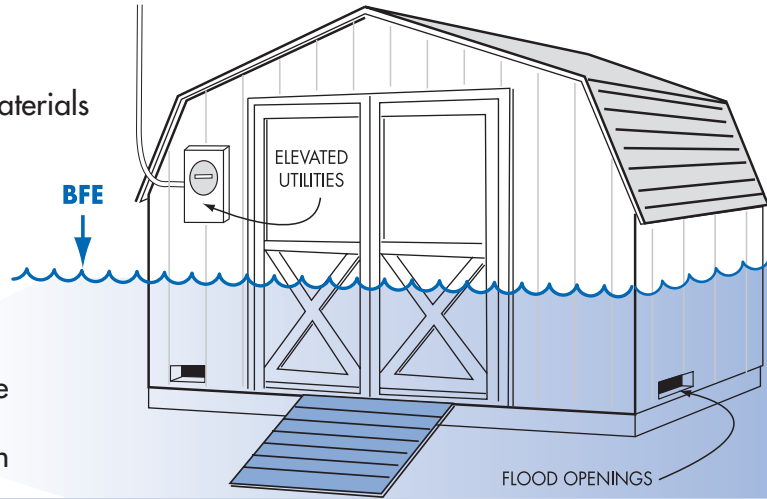

Even small buildings are “development” and permits or variances with noted conditions are required. They must be elevated or anchored and built to withstand flood damage.

Caution! Remember, everything inside is likely to get wet when flooding occurs.



Terms and Definitions

Accessory (Appurtenant) Structure means a structure that is located on the same parcel of land as a principle structure and whose use is incidental to the use of the principle structure. Accessory structures should be no more than a minimal initial investment, may not be used for human habitation, and must be designed to minimize flood damage. Examples: detached garages, carports, storage sheds, pole barns, and hay sheds.

Recreational Vehicles

In a flood hazard area, an RV must:

- Be licensed and titled as an RV or park model (not as a permanent residence)
- Be built on a single chassis
- Have inflated wheels and be self-propelled or towable by light truck
- Have no attached deck, porch, or shed
- Be used for temporary recreational, camping, travel, or seasonal use (no more than 180 days)
- Have quick-disconnect sewage, water, and electrical connectors

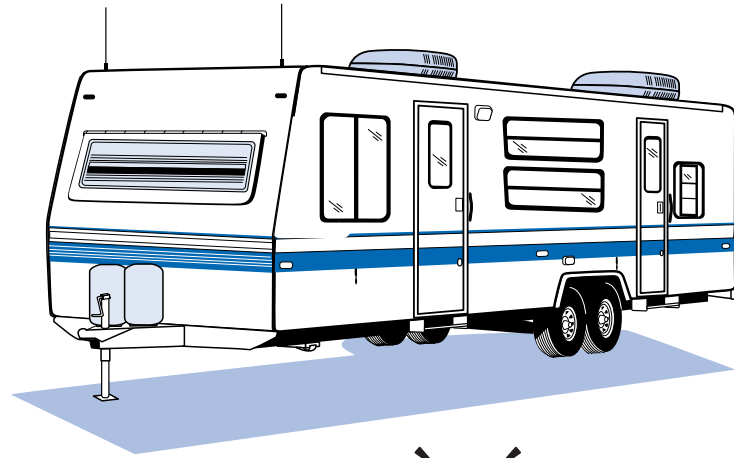

Important Information

Camping near the water?

Ask the campground or RV park operator about flood warnings and plans for safe evacuations.

RVs that do not meet these conditions must be installed and elevated like Manufactured Homes, including permanent foundations and tie-downs (see page 36).

Planning to Improve Your Floodplain Building?

To obtain a permit to improve an existing building:

- You must provide a copy of your construction contract or a cost estimate (including estimated market value of your own or donated labor and materials);
- Your community will compare the cost of the proposed work to the market value of your building;
- You may submit an independent assessment of the market value of the building, if performed by a qualified professional; and
- If the cost of the improvement equals or exceeds 50% of the market value of the building (or a lesser percent if specified in the local ordinance), you must comply with the Substantial Improvement requirements.
- If the costs are less than 50% (or your community's lesser percent), you should consider ways to reduce future damage (see page 48)

Terms and Definitions

Substantial improvement means any reconstruction, rehabilitation, addition, or other improvement of a structure, the cost of which equals or exceeds 50% of the market value of the structure before the start of construction of the improvement. This term includes structures which have incurred substantial damage, regardless of the actual repair work performed (see page 52).



Important

Information

Improvements include:

- Renovation/rehabilitation of the interior of the existing building (see page 49)
- Lateral addition, without renovation or structural alteration of the existing building (see page 50)
- Lateral addition, with renovation or structural alteration of the existing building (see page 51)
- Vertical addition (add new story).

Non-Substantial Improvements

Your proposed improvements are “non-substantial” if the costs are less than 50% of the market value of the building (or less than the percent specified in your community’s ordinance). Although you are not required to bring the existing building into compliance, there are many things you can do to reduce future flood damage. Find out the BFE at your location and consider the following:

- Use flood resistant materials, for example tile, closed-cell wall insulation, polyvinyl wall coverings.
- Raise air conditioning equipment, heat pump, furnace, hot water heater and other appliances on platforms.
- Install electric outlets higher above the floor.
- Move ductwork out of crawlspaces.
- Retrofit crawlspaces with flood openings.
- Fill in below-grade crawlspaces/utility space.

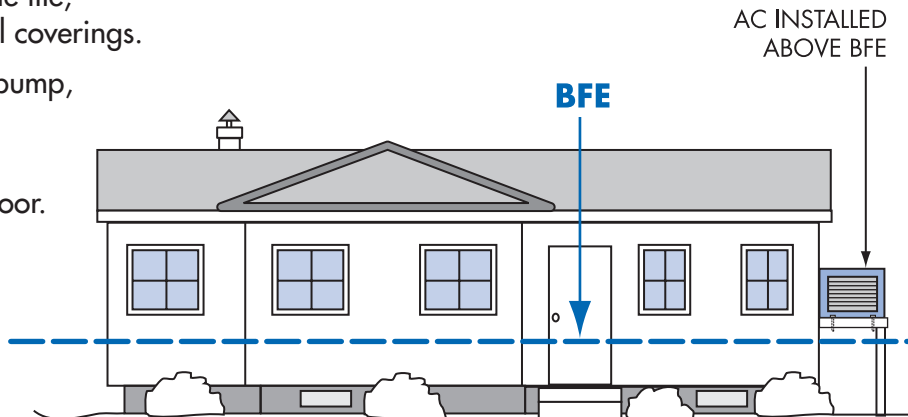

Note! Be sure to include ALL proposed work in your initial permit application. If you add more work after the permit is issued, your community will make another evaluation for Substantial Improvement.

Substantial Improvement: Renovation Only

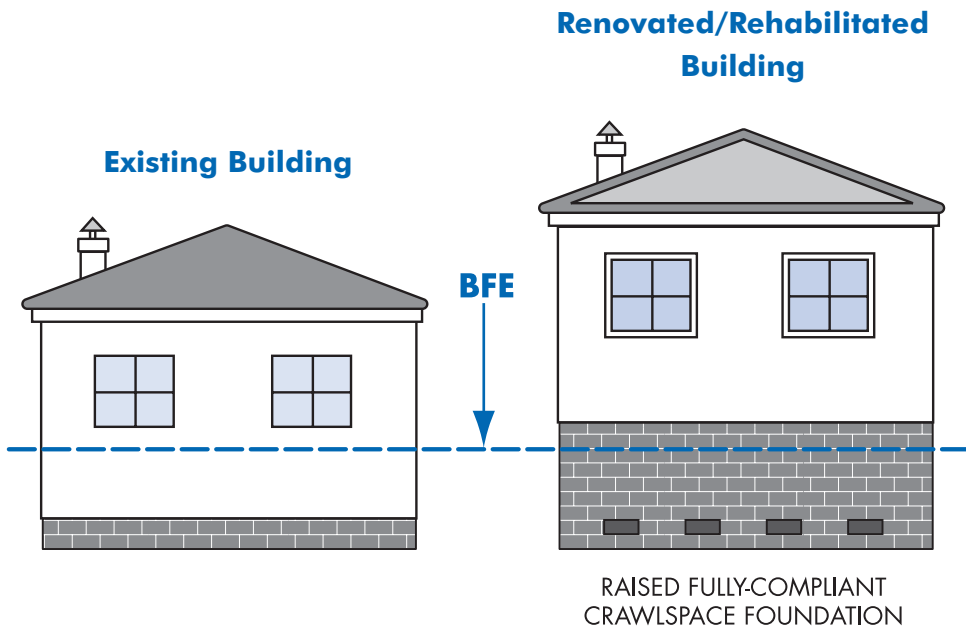

In V Zones, a piling or column foundation is required and must be designed by a registered design professional (see page 39).



Important

Information

Floodplain buildings can be improved, renovated, rehabilitated or altered, but special rules apply.

Check with your local permit office before you begin planning. It will be easier to do it right the first time.

The cost to correct previously cited violations of state or local health, sanitary, or safety codes to provide safe living conditions can be excluded from the cost of renovations.

Alteration of a registered historic structure is allowed, as long as it will continue to meet the criteria for listing as a historic structure.

Substantial Improvement: Lateral Addition Only

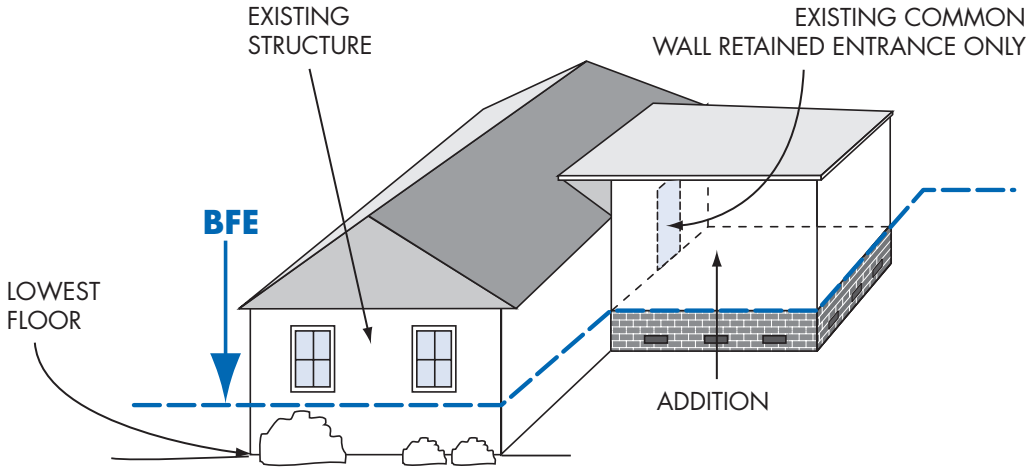

Important

Information

See page 51 if your project to add a lateral addition also includes modifying the interior of the existing building or making structural modifications to the existing common wall.

You must get a permit from your community to build an addition to your floodplain building. If the existing building is not already properly elevated, then only the addition must be built with the lowest floor at or above the Base Flood Elevation provided:

- You make no interior modifications to the existing building; and
- You make no structural modifications to the existing common wall other than adding a connecting doorway.

Substantial Improvement: Addition Plus Other Work

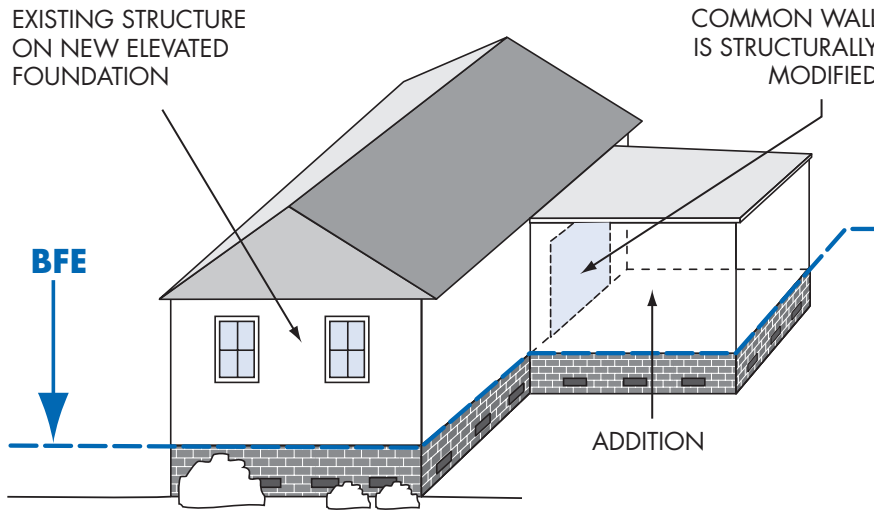

Your community must prepare an evaluation to determine if all of your proposed work will trigger the Substantial Improvement requirement. Substantial Improvement is triggered if:

- The work involves adding a new top floor, modifying the interior of the existing building, or structural modifications to the existing common wall (for lateral addition); and
- The cost of all proposed work equals or exceeds 50% of the market value of the existing building.

Your community's permit office can help you determine which requirements apply. It is always a good idea to request a preliminary review before you get too far along with your plans.

What About After Damages?

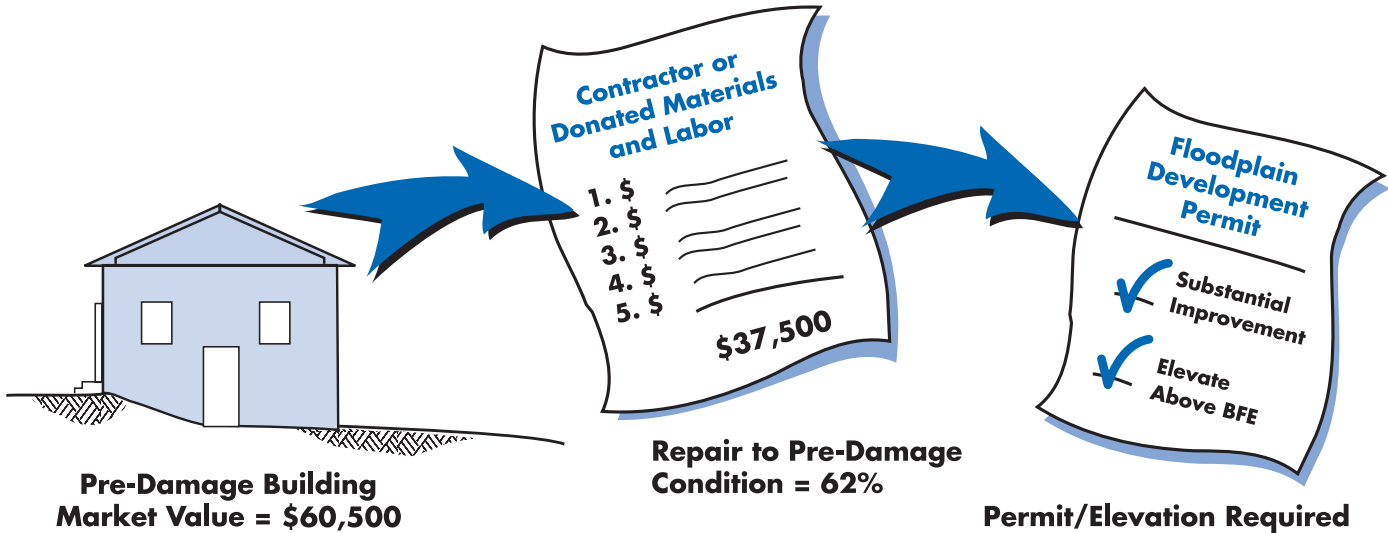

A permit is required to repair substantial damage from any cause — fire, flood, wind, or even a truck running into a building. Check with your community permit office to be sure.

You will be asked to provide a detailed cost estimate for repairs.

See page 54 for more information about elevating an existing building above a crawlspace.

Paying for Post-Flood Compliance

You may be eligible for up to \$30,000 to help pay to protect your building from future flood damage – to bring it into compliance with your community’s floodplain requirements – if:

USE THE ICC CLAIM TO:



Elevate on your lot



Demolish and rebuild the house



Move the house to high ground

- You have NFIP flood insurance – it includes Increased Cost of Compliance (ICC), coverage.
- Your building is in the mapped Special Flood Hazard Area.
- Your community has made an official determination that the building was substantially damaged by flooding.
- You act quickly to process all the required paperwork.

Owners whose buildings are substantially damaged are required to “bring the building into compliance.” Substantial damage is a special case of substantial improvement (see pages 47 and 52).

Elevating a Pre-FIRM Building

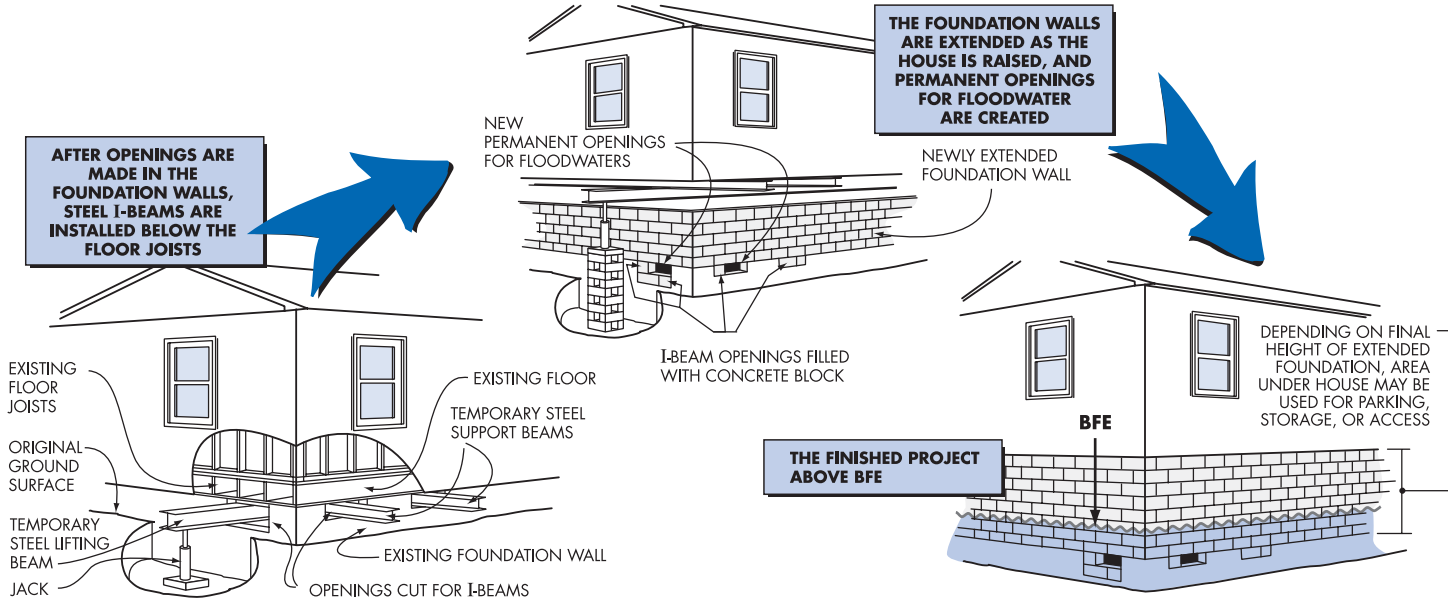

This is one way to elevate an existing building to comply with floodplain regulations. If your insured building is damaged by flood, you may be eligible for an **Increased Cost of Compliance** payment (see page 53). The state and FEMA can help with more information and options.

Some Flood Protection for Older Homes is Easy and Low Cost

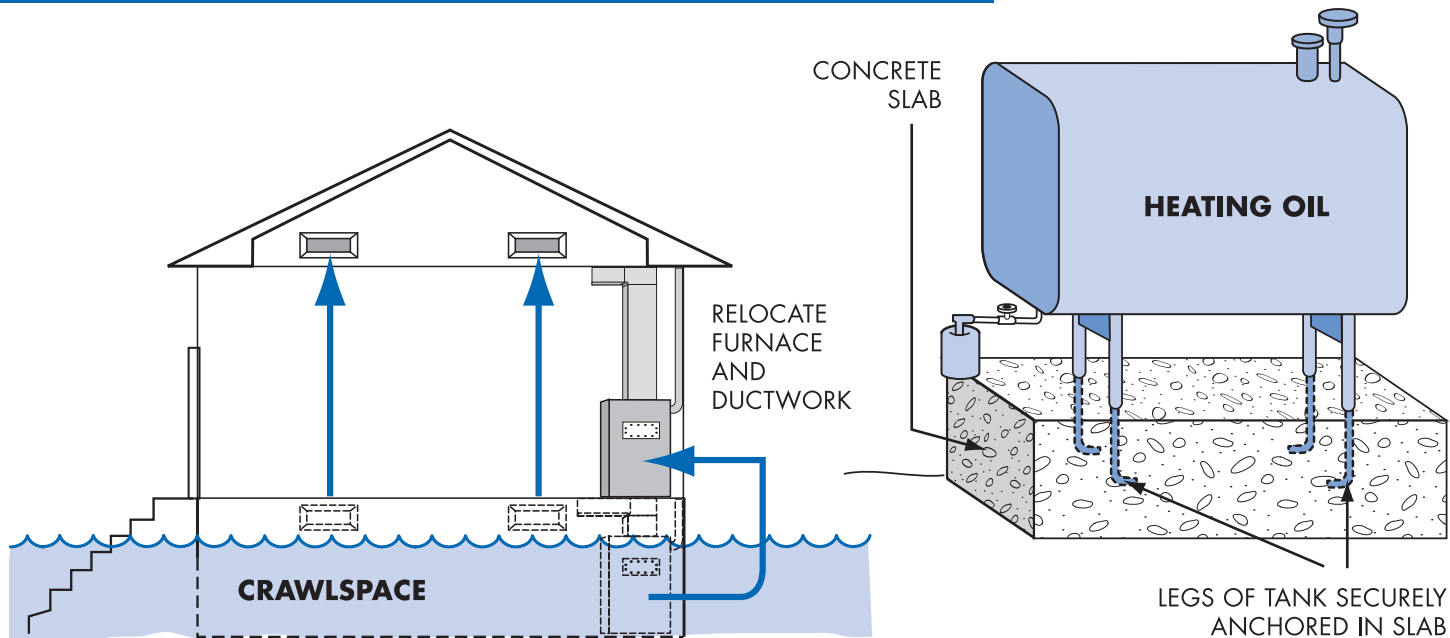

Move hot water heaters, furnaces, and ductwork out of crawlspaces. Anchor heating oil and propane gas tanks to prevent flotation. **Do not** store valuables in a flood-prone crawlspace or basement. Use water-resistant materials when you repair.

Some Flood Mitigation Projects are More Costly

But Give You More Protection

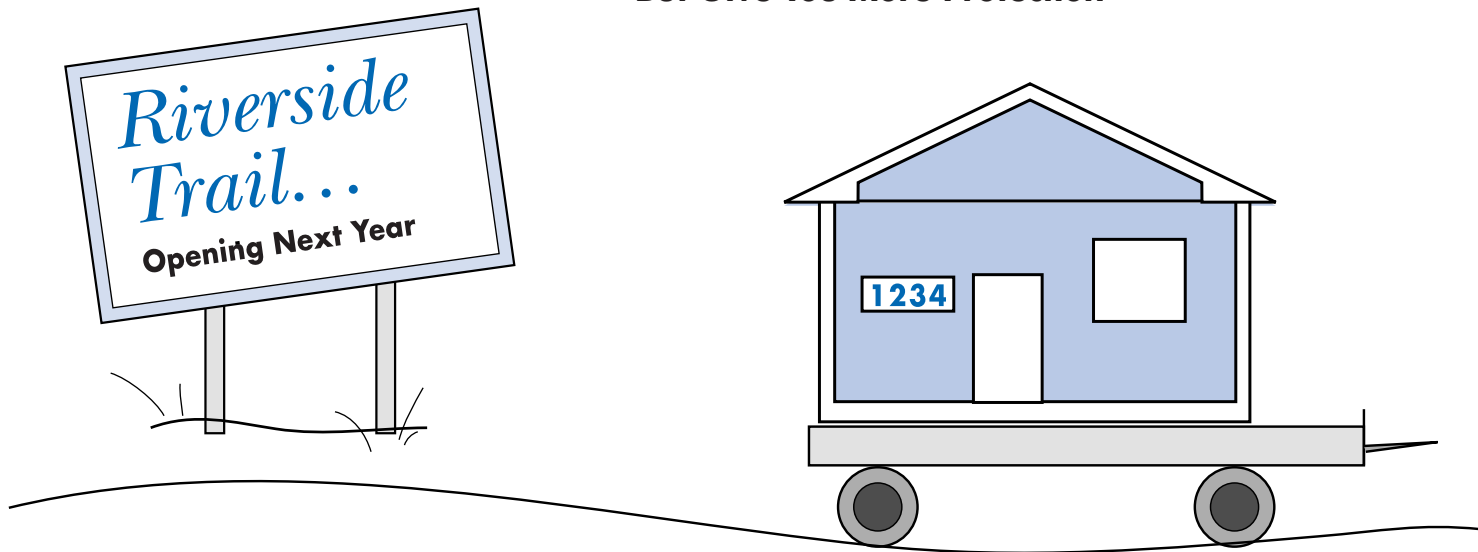

After floods, some communities buy out and demolish homes that were severely damaged. The acquired land is dedicated to open space and can be used for recreation or to help restore wildlife habitat and wetlands. Homes have been raised up on higher foundations, and others have been moved to safer high ground.

Useful Resources and Common Acronyms

Useful Resources

- For information on disaster safety, being prepared, and repairing homes, click on Disaster Services when you visit the American Red Cross webpage at <http://www.redcross.org>.
- FEMA has developed materials to help families and businesses learn more about preparing for floods and recovering from disasters at <http://www.fema.gov/library>.
- **SC DNR Flood Mitigation Programs:**
<http://www.dnr.sc.gov/water/flood>
- **SC Emergency Management Division:**
<http://www.scemd.org>
- **SC Department of Health & Environmental Control:**
<http://www.scdhec.net>
- **SC Department of Insurance:** <http://www.doi.sc.gov>
- **SC DNR Land, Water & Conservation Division:**
<http://www.dnr.sc.gov/conservation.html>

Common Acronyms

- BFE = Base Flood Elevation
- DNR = Department of Natural Resources
- EC = Elevation Certificate
- FEMA = Federal Emergency Management Agency
- FIRM = Flood Insurance Rate Map
- ICC = Increased Cost of Compliance
- NFIP = National Flood Insurance Program
- SFHA = Special Flood Hazard Area

Want to Learn More?

- For advice on flood information and permits, call your community's building permit office or planning department.
- To order flood maps, call FEMA's Map Service Center – 1(800) 358-9616 or enter the FEMA Map Store to order on-line at <http://msc.fema.gov>.
- To learn more about flood maps and to check the Status of Map Change Requests, click on "Flood Hazard Mapping" at <http://www.fema.gov>.
- FEMA's on-line publications can be found in the FEMA Virtual Library. Many are posted in the Portable Document Format (PDF). Go to <http://www.fema.gov> for more information. You can order printed copies of FEMA publications from the FEMA Distribution Center, at **1(800) 480-2520**.
- To learn about flood insurance, call your insurance agent. Most insurance companies can write an NFIP policy for you. If you need more help, call the National Flood Insurance Program's toll free number to get the name of an agent in your area who does write flood insurance. The number is **1(888) 356-6329**.
- To get the best rates for flood insurance, call a local surveyor to complete an Elevation Certificate.
- Find out about on-line Elevation Certificate training for surveyors by going to <http://www.fema.gov> and searching on "Elevation Certificate."