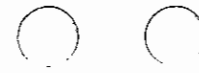
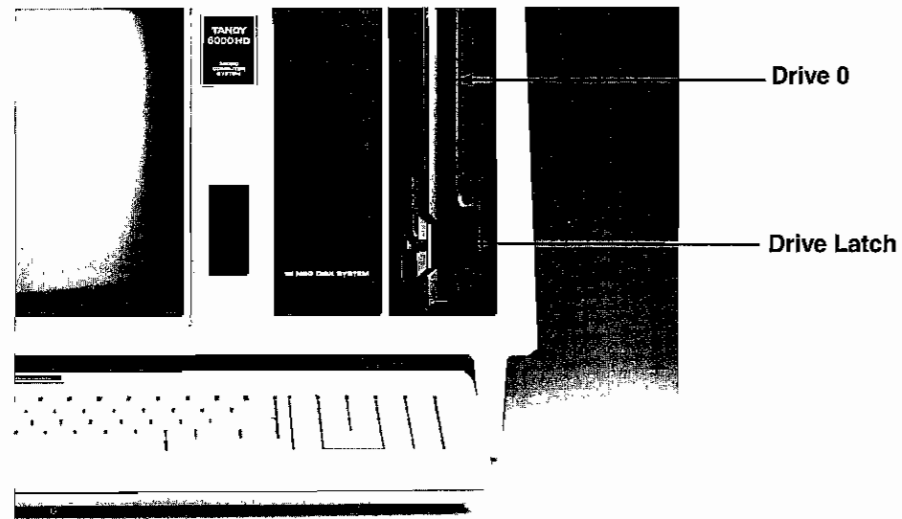

**To insert a floppy diskette:**

1. Power up your Tandy 6000 computer, and press **RPT** **BREAK**. Be sure the drive latch is in the vertical position.

**To remove a floppy diskette:**

1. Be sure the drive light is off. **Never remove a diskette when the drive light is on.**
2. Turn the drive latch counterclockwise until it is in the vertical position. The diskette pops partially out of the drive.
3. Carefully remove the diskette from the drive, making sure its shiny surface does not touch anything. Return the diskette to its storage envelope.

**powering down the system**

1. Be sure that all floppy drives (internal and external) are empty.
2. Turn off all peripheral equipment. External primary and secondary drives are turned off with the computer.
3. Turn off the Tandy 6000 computer system by pressing the power button.

2. When the screen shows the INSERT DISKETTE message, carefully insert a diskette into floppy Drive 0 with the label facing the display screen. (On the Tandy 6000, the floppy drive on the left is Drive 0.) Push the diskette into the slot until it locks into place.

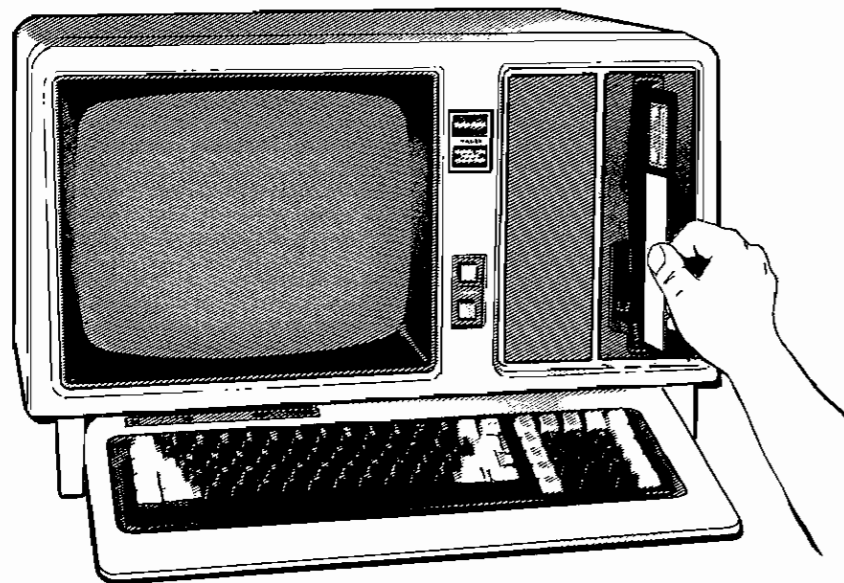

3. Turn the latch clockwise until it locks into a horizontal position.  
**Warning:** Never turn the computer on or off when a diskette is in a drive. Doing so can destroy the data on the diskette.



# maintenance

## Care of floppy diskettes

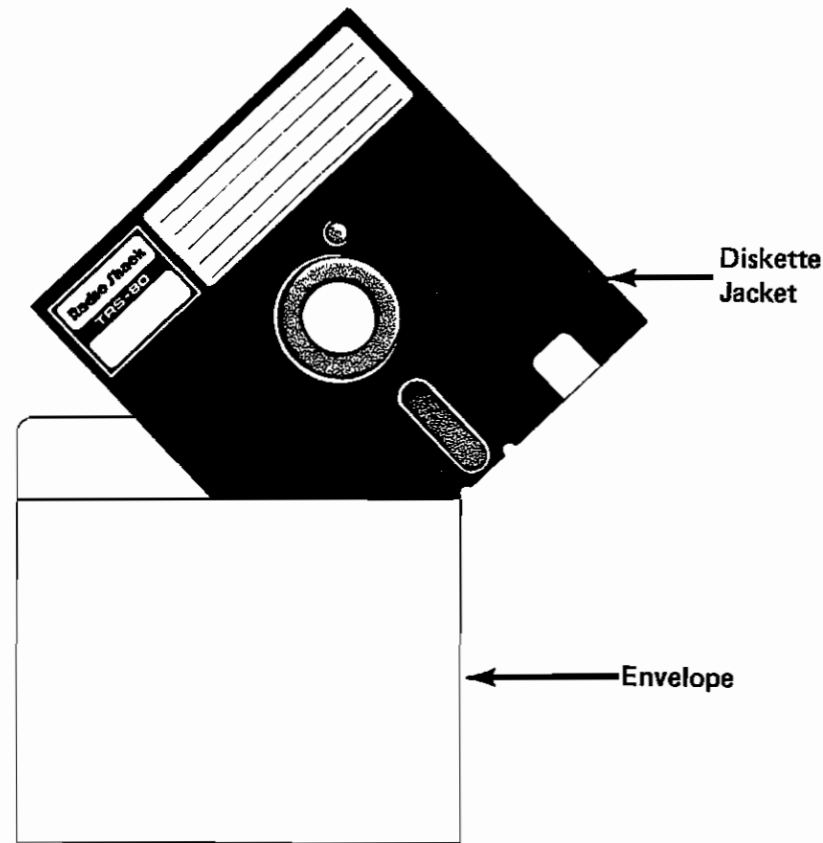

Handle floppy diskettes carefully. A scratch or small indentation or even a speck of dust could destroy some or all of the data on a diskette.

To protect your diskettes (and the information they contain) from accidental damage, follow these guidelines:

- Never turn on your computer system while a diskette is in a drive.
- Store diskettes in their envelopes, making certain that there is no pressure on their sides.
- Keep diskettes away from magnetic fields (such as transformers, AC motors, magnets, TVs, radios, and the computer system's display console).
- Don't bend diskettes.
- Never touch a diskette's shiny exposed surface. Never try to wipe or clean the shiny disk surface—it scratches easily.
- Keep diskettes out of direct sunlight and away from heat.

# power up/power down

Always turn your Tandy 6000 computer on and off exactly as described in this chapter. Changes in the sequence might damage the system and data.

You can use your Tandy 6000 in two ways: under hard disk control or under floppy diskette control.

Until you install an operating system on your hard disk however, you must operate under floppy diskette control.

## powering up the system

1. Be sure that all disk drives are empty and all equipment is off.
2. Turn on the system by pressing the power switch on the lower left side of the display console. This automatically turns on all built-in hard and floppy drives. If you have the Tandy 6000 HD, allow the hard disk to warm up for at least 30 minutes before you use it the first time. (If you have a Tandy 6000 with an external hard disk, the hard disk turns on automatically only if the power switch key on the front of the hard disk unit is turned on.)  
**Note:** We recommend that you leave your system up and running 24 hours a day. The continuing successful operation of your hardware is more assured if the system is not turned off with any frequency. The cost of power to keep it running is offset by fewer hardware repair bills and less down time.
3. Turn on any other peripheral equipment.

## hard disk control

After you format your hard disk and install the XENIX operating system on it, your Tandy 6000 computer automatically boots XENIX from the hard disk when you power up the system. (See *The System Administrator's Guide to XENIX* for formatting and installation procedures.)

## floppy diskette control

To operate under floppy diskette control after you install XENIX, press **RPT** and **BREAK** simultaneously during the "white-out" of the video display. The screen displays the following message:

INSERT DISKETTE

If this message does not appear, try the following:

- Press the reset button, and then press **RPT** **BREAK** to begin floppy diskette control.
- Adjust the brightness and contrast controls.
- Turn off all peripherals, and then turn off the computer. Check all connections to and from the peripherals.

After the screen displays the INSERT DISKETTE prompt, turn on your system's peripheral equipment.

## internally connected peripheral equipment

The floppy disk and hard disk expansion connectors are behind the Input/Output access panel on the back of the Tandy 6000 computer.

**FLOPPY DISK EXPANSION CONNECTOR**—Used to add floppy diskette storage devices such as the Thinline Disk Bay. (Instructions for connecting the cable follow the illustration below.)

**TANDY 6000 HD SECONDARY HARD DISK CONNECTOR**—Used to add an optional secondary hard disk to your system's built-in hard disk. (Instructions for connecting the cable follow the illustration below.)

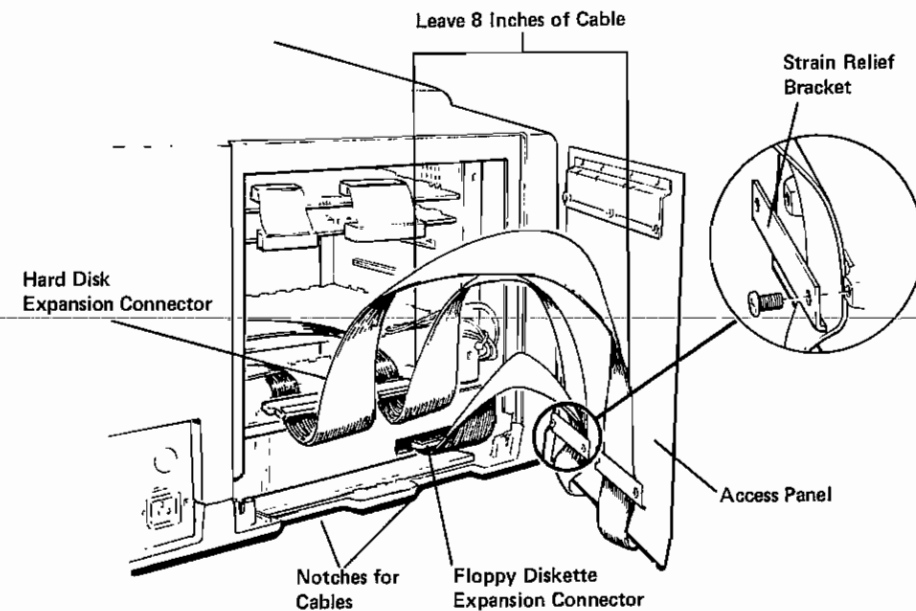

1. Remove the access panel by loosening the thumbscrews.
2. Attach the cables that are included with your expansion unit. If you are connecting a secondary hard disk, connect the 34-pin secondary hard disk expansion cable connector to the 34-pin snap-in connector on the edge of the printed circuit board. Then, connect the 20-pin data cable connector to the 20-pin snap-in connector of the printed circuit board. Position the built-in hard disk connectors so that the cables exit from the bottom.

If you are connecting a floppy disk expansion unit to the Tandy 6000, attach the connector on one end of the cable to the 50-pin connector on the chassis. Connect the other end of the cable to the expansion unit.

3. Remove the strain relief brackets from the access panel. Run each cable downward through the nearest strain relief, leaving about 8 inches of cable between the strain relief and the computer.
4. Replace the strain relief brackets, and run the cable through the slot in the base of the display console.
5. Replace the access panel and tighten the thumbscrews.

**Note:** Your system's hard disk drives must always contain a line terminator. Check with your Tandy Computer Center for details.

- Keep diskettes away from cigarette ashes, dust, and other particles. In dusty areas, use filters to clean the air in the computer room.
- Don't write on the diskette label with a hard point pen or lead pencil. Use only a soft felt-tip pen.

## floppy disk drive maintenance

Your computer's floppy disk drives need periodic care to prevent damage to your diskettes. Be sure to have your floppy disk drives checked every 6 months.

Ask a Radio Shack Computer Center sales representative about disk drive head cleaning kits.

## hard disk drive maintenance

Hard disk drives don't require the same maintenance as floppy disk drives, but they do require special care. For example, never move or jar external hard disk drives while they are powered up. (Never move the Tandy 6000 HD display console while the unit is on.)

Be sure that the air around your hard disk is as free of dust and other particles as possible, and that the intake and output cooling vents are unobstructed.

If you have external hard disk drives, be sure to periodically clean the filter on the back of the unit. Carefully remove the outer grill. **DO NOT REMOVE THE SCREWS.** Remove the filter and rinse with tap water. When the filter is completely dry, put it back in the drive.

# SPECIFICATIONS

## Processors

### INPUT/OUTPUT PROCESSOR SYSTEM

- Z80-A based with 64K bytes of random access memory
- Independent bus can support all the standard system boards
- Floppy disk mode lets you run programs previously developed for the Model II and Model 12 without changing them first

### COMPUTATIONAL PROCESSOR SYSTEM

- 68000 based with either 512K or 1 megabyte of RAM
- Independent bus can support multiple bus masters

The 2 processors share the computing load from the applications programs (the Z80-A based processor performs input/output tasks while the 68000 based processor performs computational tasks).

## Video Display

### LSI CONTROLLER CHIP

Frees the input/output (Z80-A based) processor for much of the overhead required to update and maintain the video display.

### FOUR MODES

- Green/white on black (normal)
- Black on green/white (reversed)
- 80 characters by 24 lines
- 40 characters by 24 lines

### DISPLAYABLE CHARACTERS

- Full ASCII set
- 32 graphics characters

## Keyboard

- LSI Controller frees the input/output (Z80-A based) processor from keyboard scan and related tasks
- Located in a separate case for convenience
- The Tandy 6000/6000 HD computer connects to the display console via a built-in, coiled cord that exits beneath the keyboard

# installing peripheral equipment

You can use other Tandy computer equipment with your Tandy 6000. These peripherals include printers, floppy disk expansion units, and a primary hard disk for the Tandy 6000 or a secondary hard disk for the Tandy 6000 HD. To install such equipment, refer to the following instructions as well as to the installation instructions supplied with the equipment.

## externally connected peripheral equipment

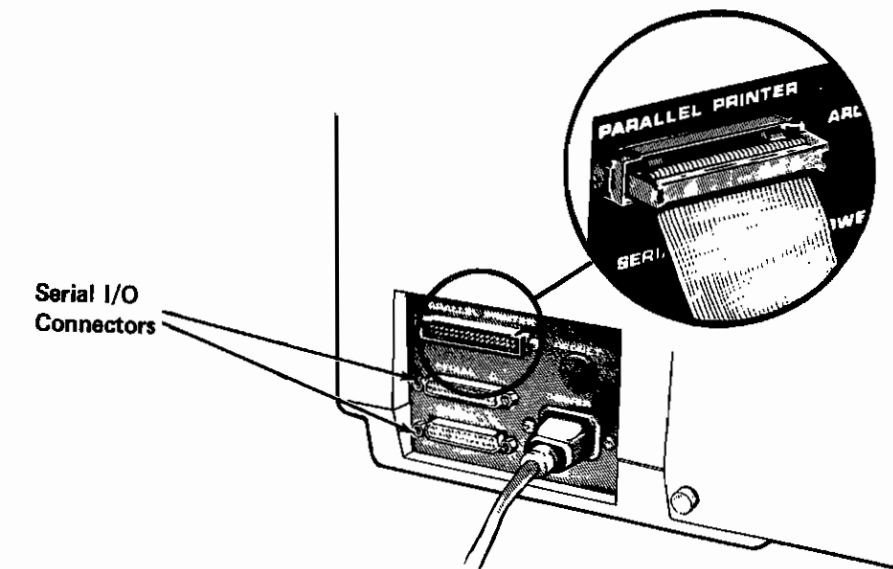

**External Peripheral Equipment Connections.**

**PARALLEL PRINTER CONNECTOR**—Used to connect Tandy parallel printers. Be sure that the printer cable exits the bottom of the connector.

**SERIAL I/O CONNECTOR**—Used to install serial equipment such as serial line printers, modems, and data terminals. If you have a Tandy 6000 HD, you must connect a DB-25 cable to the Serial I/O Connector on the back of the unit.

# setting up your system

Improperly connecting or grounding your computer exposes you to the danger of electrical shock. It also endangers your system and data. Follow these installation instructions carefully:

1. Place your Tandy 6000 display console near a grounded, 120 VAC, 3-prong outlet that does not power heavy machinery, copiers, or office machines that may have defective switches. (If you must use an extension, use a grounded power strip, such as Radio Shack's Plug-In Power Strip.)
2. Be sure all your computer equipment is turned off.
3. Connect the keyboard's built-in cable to the jack at the front of the computer console below the video screen.



4. Plug the power cord into the back of the display console.
5. Plug the power cord into the outlet or grounded power strip specified in Step 1.



- Standard typewriter keys, repeat key, and 8 general-purpose function keys
- Four modes with the following priority (highest to lowest):
  1. Unshift
  2. Shift
  3. Caps
  4. Control

## Floppy Disk Drives

### MINIMUM

Tandy 6000 HD

- One built-in 8-inch, double-sided floppy disk drive

Tandy 6000

- Two built-in, 8-inch, double-sided floppy disk drives

### MAXIMUM

Tandy 6000 HD

- One built-in and a maximum of 2 external, 8-inch, double-sided floppy disk drives (floppy disk expansion unit needed for 2 external drives)

Tandy 6000

- Two built-in and a maximum of 2 external, 8-inch, double-sided floppy disk drives (floppy disk expansion unit needed for 2 external drives)

### PREVENTIVE MAINTENANCE INTERVAL

- Typical usage (3,000 power-on hours per year): Every 8000 power-on hours
- Heavy usage (8,000 power-on hours per year): Every 5000 power-on hours

### REQUIRED MEDIA

- Tandy double-sided, 8-inch floppy diskettes
- Data Transfer Rate is 500,000 bits per second (except Track 0, which has 250,000 bps).
- Diskette life is 3.5 million passes per track. To prevent limiting life by improper handling, follow diskette-care recommendations.

## Power Supply

### POWER REQUIREMENTS

- 105 - 130 VAC, 60 Hz
- 240 VAC, 50 Hz (Australian)
- 220 VAC, 50 Hz (European)
- Grounded outlet

**MAXIMUM CURRENT DRAIN**

- 2.1 amps

**TYPICAL CURRENT DRAIN**

- 1.6 amps

**WARM-UP PERIOD**

- 30 minutes (first time)
- 15 seconds thereafter

**Operating Temperature**

- 55 to 85 degrees Fahrenheit
- 13 to 29 degrees Celsius

**Peripheral Interfaces**

**STANDARD**

- Serial port A (RS-232C)
- Serial port B (RS-232C)
- Parallel input/output channel, for connection to Tandy standard parallel interface line printers
- Floppy diskette input/output channel for connection of a floppy diskette expansion unit
- Hard disk drive interface (Tandy 6000 HD only)

**OPTIONAL**

- ARCNET interface
- Graphics Board

**SERIAL INTERFACE**

Two Ports

- Channel A allows asynchronous or synchronous transmission
- Channel B allows asynchronous transmission only
- Both conform to the RS-232C standard
- Both use the DB-25 connectors on the back of the display console

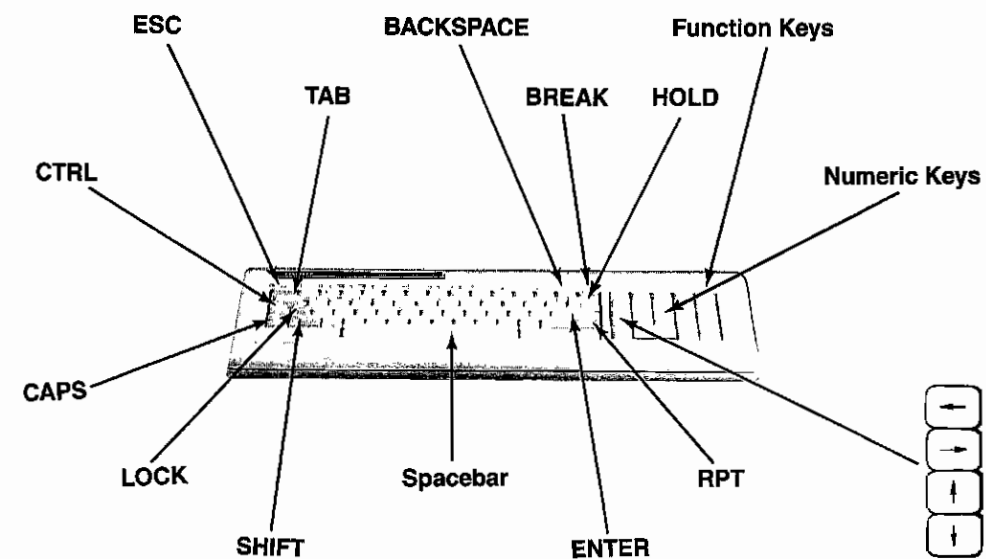

**CAPS** — When the CAPS light is on, the keyboard produces only capital letters for the alphabet keys. **CAPS** does not affect other keys. Press **CAPS** once to activate caps-only mode; press again to return to normal mode.

**SHIFT**, **LOCK** — Lets you type capital letters and shifted punctuation symbols. Hold down **SHIFT** while pressing the desired key, or press **LOCK** once (the red light comes on). When **LOCK** is activated, your computer recognizes only shifted characters. To release **LOCK**, press **SHIFT**.

**RPT** — Repeats a character continuously when held down at the same time as another key.

**Note:** The numeric keypad keys are not affected by **CAPS**, **SHIFT**, or **LOCK** keys.

**Note:** Disk media flaws on the Tandy 6000 HD hard disk unit are identified before the hard disk is installed in the unit. Attached to the inside of the access panel on the back of your display console is a MEDIA ERROR MAP that specifies the flawed locations on your particular unit. **Do not throw this error map away!** You need to refer to it when formatting the hard disk, and Tandy Computer service technicians may need to refer to it if your drive ever needs servicing.

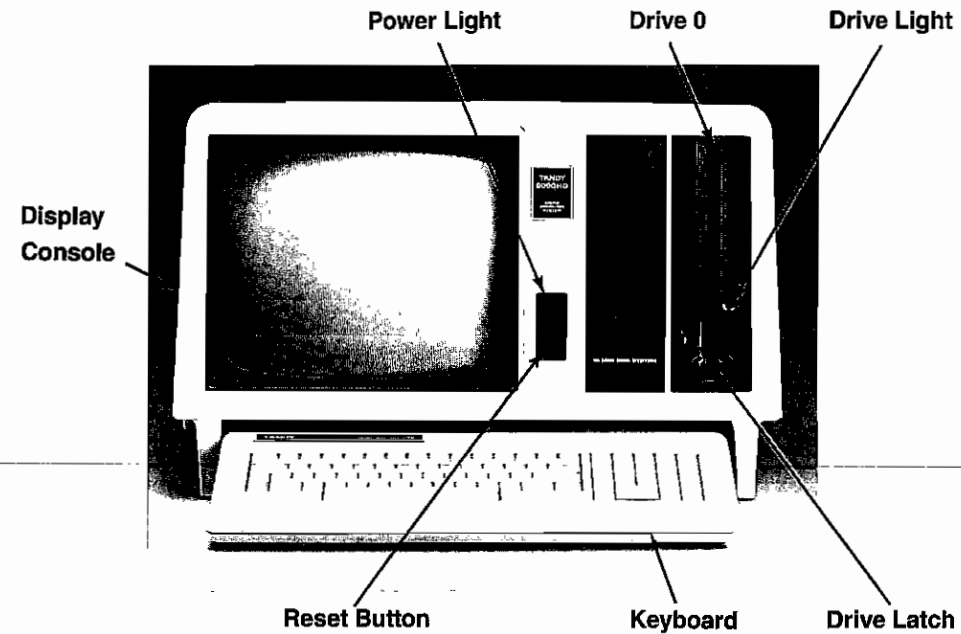

RESET BUTTON—Repeats the power-up sequence.

POWER LIGHT—Lights when the system's power is on. Never move the unit when this light is on.

DRIVE LIGHT—Lights when the drive is active. **Never remove a diskette when a disk drive light is on.**

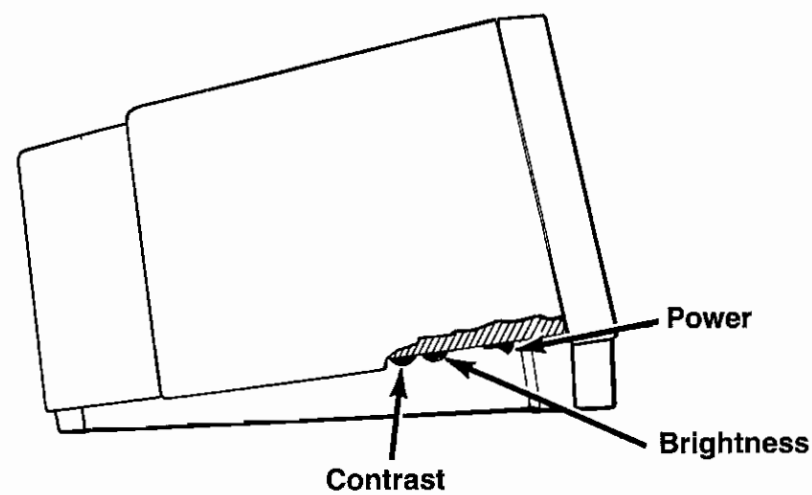

The DB-25 connector pin-outs and signals available are listed below.

Channel A Standard RS-232C Signal	Pin #	Channel B Standard RS-232C Signal	Pin #
I/O Transmit S.E.T.	15	Ground	1,7
Ground	1 7	Receive Data	3
Receive Data	3	Receiver Xmitter Clock	17
Receiver Clock	17	Data Set Ready	6
Transmit Clock	24	Clear-to-Send	5
Data Set Ready	6	Carrier Detect	8
Clear-to-Send	5	Transmit Data	2
Carrier Detect	8	Request-to-Send	4
Transmit Data	2	Data Terminal Ready	20
Request-to-Send	4		
Data Terminal Ready	20		

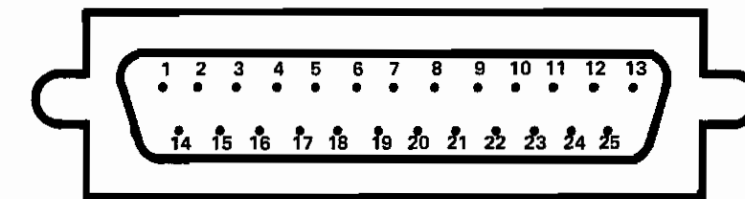

**PARALLEL INTERFACE**

- Connection to a line printer via the 34-pin connector on the back panel of the display console
- Eight data bits are output in parallel
- Four data bits are input
- All levels are TTL compatible

The connector pin-outs and signals available are listed below.

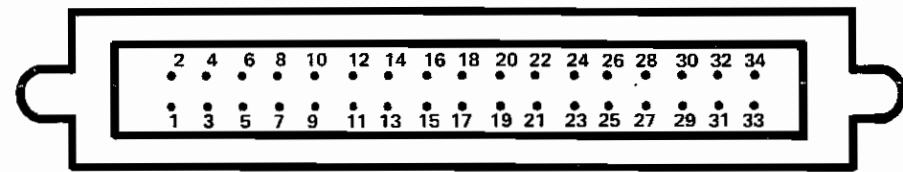

Signal	Function	Pin #
ACK	Input to the computer from the printer; low indicates data byte is received	19
BUSY	Input to the computer from the printer; high indicates busy	21
PAPER EMPTY	Input to the computer from the printer; high indicates no paper—if the printer doesn't provide this, the signal is forced low	23
BUSY*	Input to the computer from the printer; low indicates device is selected	25
PRIME*	Output to the printer to clear the buffer; reset the printer logic	26
FAULT*	Input to the computer from the printer; low indicates fault (paper empty, light detect, deselect, and so on)	28
GROUND	Common signal ground	2, 4, 6, 8, 10, 12, 14, 16, 18, 20, 22, 24, 27, 31, 33
NC	Not connected	29, 30, 32, 34

\*These signals are active-low.

### EXTERNAL SECONDARY 15-MEGABYTE HARD DISK POWER REQUIREMENTS (TANDY 6000 HD)

#### AC Power Requirements

- 50/60 Hz  $\pm$  0.5 Hz
- 100/115 VAC installations (90 to 127V at 1.1A typical)
- 200/230 VAC installations (100 to 253V at 0.6A typical)

## your equipment

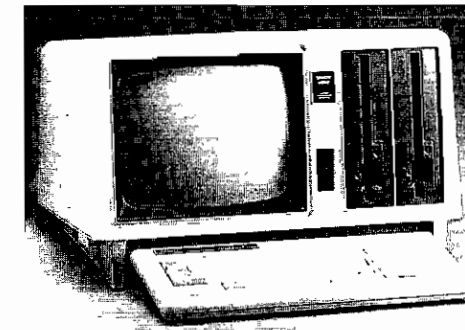

Tandy 6000

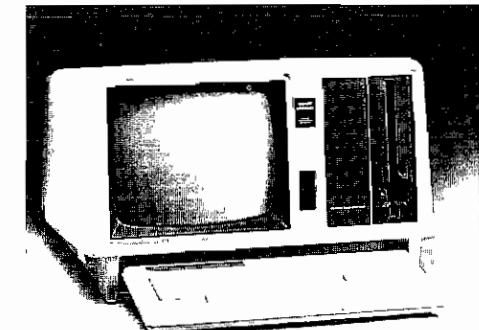

Tandy 6000 HD

Carefully unpack the Tandy 6000 computer, and be sure you have the following items:

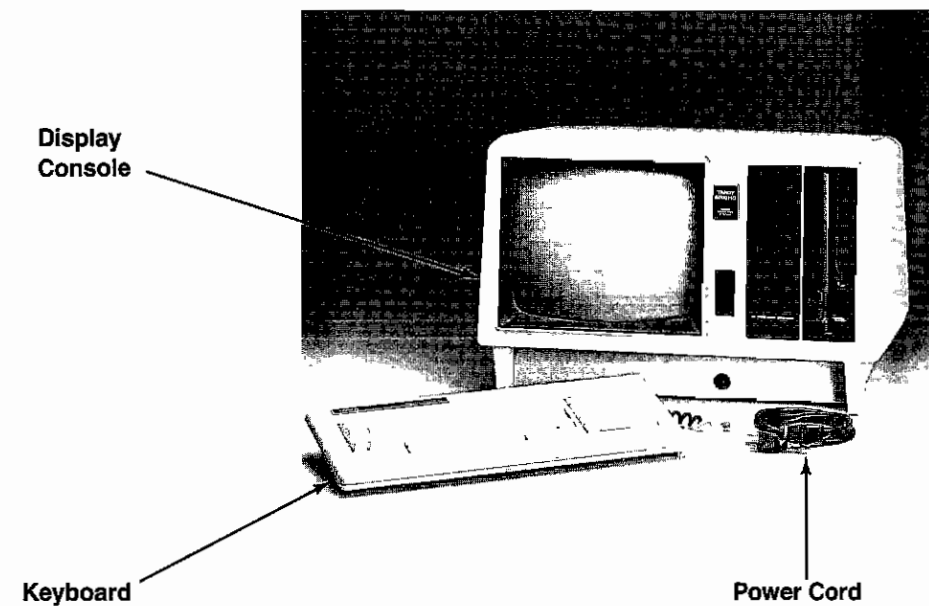

Your Tandy 6000 package also includes the XENIX™ operating System. This system must be installed on a hard disk.

If you have a Tandy 6000, you must add a hard disk to install and use XENIX. Instructions for connecting a hard disk to the Tandy 6000 follow in this manual.

If you have a Tandy 6000 HD, your computer has a built-in 15-megabyte hard disk on which you may install XENIX. After reading this manual, follow the instructions in *The System Administrator's Guide to XENIX* to install the operating system.



**15-MEG DISK CHARACTERISTICS**

No. of cylinders	306
No. of heads	6
Track access time	3msec
Data Transfer Rate	5.0MB/ sec

**15-MEG DIMENSIONS (CASE)**

Height	5.5" (140 MM)
Width	14" (356 mm)
Depth	15" (381 mm)
Weight	15.5 lbs. (7.02 kg)

**ENVIRONMENT**

Ambient temperatures	
Operating	55 to 85 degrees F. (13 to 29 degrees C.)
Nonoperating	-40 to 140 degrees F. (-40 to 60 degrees C.)
Relative humidity	8% to 80%
Relative humidity gradient	
Operating	10% per hour
Nonoperating	Below that causing condensation
Maximum wet bulb Temp.	78.8 F. (26 C.) degrees non-condensing
Head dissipation	150 watts (511 BTU/hr) Max.
Altitude	Operating Density-Altitude 1500 to 9750 ft. (457 to 1982 m.) Storage 0 to 12000 ft. (0 to 3650 m.)

**BUILT-IN 15-MEG HARD DISK DRIVE (TANDY 6000 HD)**

Disk organization	
Cylinders per disk	306
Tracks per unit	1836
Tracks per platter	612
Sectors per track	34
Bytes per sector	256
Average latency	8.3 msec
Rotational speed	3600.0 rpm
Recording density	9625.0 bpi
Flux density	9625.0 fci
Track density	345.0 tpi
Storage capacity (hard disk)	
Unformatted	
per drive	19.0 Mbytes
Formatted	
per drive	15.5 Mbytes (primary) 15.9 Mbytes (secondary)

### TANDY 6000 SYSTEM-TO-SYSTEM DIRECT COMMUNICATIONS

To directly connect 2 Tandy 6000s that have either built-in or external hard disk drives, use the wiring arrangement illustrated below.

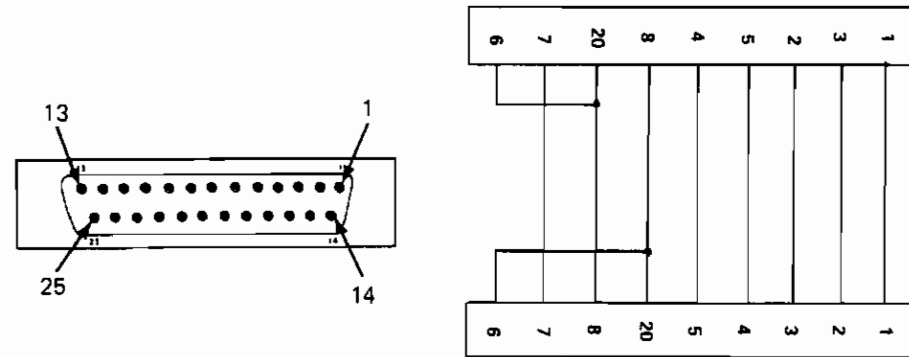

Connection diagram, Tandy 6000 (Channel A or B) to Tandy 6000 (Channel A or B). Use stranded wire, 24-gauge, to connect 2 DB-25 connectors as illustrated. If the wire length exceeds 50 feet, twist lines 7 (GND), 2 (TD), and 3 (RD).

## contents

<b>your equipment</b>	5
<b>setting up your system</b>	8
<b>installing peripheral equipment</b>	9
externally connected peripheral equipment	9
internally connected peripheral equipment	10
<b>power up/power down</b>	11
powering up the system	11
hard disk control	11
floppy diskette control	11
powering down the system	13
<b>maintenance</b>	14
care of floppy diskettes	14
floppy disk drive maintenance	15
hard disk drive maintenance	15
<b>specifications</b>	16
<b>index</b>	23

## index

BREAK 11  
CAPS 7  
drive light 6  
floppy disk drive maintenance 15  
floppy diskette 14–15  
    care and handling 14  
    inserting into disk drive 12  
    removing from disk drive 13  
floppy diskette control 11  
hard disk control 11  
hard disk drive maintenance 15  
inserting a floppy disk 12  
LOCK 7  
media error map 6  
peripheral equipment 9–10  
    parallel printer connector 9  
    serial I/O connector 9  
    floppy disk drive expansion connector 10  
    secondary hard disk drive connector 10  
power light 6  
powering down the system 11  
powering up the system 11  
removing a floppy disk 13  
RESET 6  
RPT 7, 11  
setting up the system 8  
SHIFT 7  
specifications 16–22  
    built-in 15-megabyte hard disk drive 21  
    external secondary hard disk drive 20–21  
    floppy disk drives 17  
    keyboard 16  
    operating temperature 18  
    peripheral interfaces 18–20  
    power supply 17  
    processors 16  
    system to system direct communications 22  
    video display 16

**Introducing Your Tandy 6000**  
©1984 Tandy Corporation  
All rights reserved.

Reproduction or use, without express written permission from Tandy Corporation and/or its licensor, of any portion of this manual is prohibited. While reasonable efforts have been taken in the preparation of this manual to assure its accuracy, Tandy Corporation assumes no liability resulting from any errors or omissions in this manual, or from the use of the information contained herein.

XENIX™ is a trademark of Microsoft Corporation.

The Input/Output circuitry of the Tandy 6000 is covered by U.S. Patent No. 4,468,753.

10 9 8 7 6 5 4 3 2

( )

.

.

( )

.

.

( )

**introducing your  
Tandy 6000**

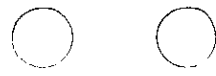

.

.



.

.



TERMS AND CONDITIONS OF SALE AND LICENSE OF TANDY COMPUTER EQUIPMENT AND SOFTWARE PURCHASED FROM RADIO SHACK COMPANY-OWNED COMPUTER CENTERS, RETAIL STORES AND RADIO SHACK FRANCHISEES OR DEALERS AT THEIR AUTHORIZED LOCATIONS

**LIMITED WARRANTY**

**I. CUSTOMER OBLIGATIONS**

- A. CUSTOMER assumes full responsibility that this computer hardware purchased (the "Equipment"), and any copies of software included with the Equipment or licensed separately (the "Software") meets the specifications, capacity, capabilities, versatility, and other requirements of CUSTOMER.
- B. CUSTOMER assumes full responsibility for the condition and effectiveness of the operating environment in which the Equipment and Software are to function, and for its installation.

**II. LIMITED WARRANTIES AND CONDITIONS OF SALE**

- A. For a period of ninety (90) calendar days from the date of the Radio Shack sales document received upon purchase of the Equipment, RADIO SHACK warrants to the original CUSTOMER that the Equipment and the medium upon which the Software is stored is free from manufacturing defects. **This warranty is only applicable to purchases of Tandy Equipment by the original customer from Radio Shack company-owned computer centers, retail stores, and Radio Shack franchisees and dealers at their authorized locations.** The warranty is void if the Equipment's case or cabinet has been opened, or if the Equipment or Software has been subjected to improper or abnormal use. If a manufacturing defect is discovered during the stated warranty period, the defective Equipment must be returned to a Radio Shack Computer Center, a Radio Shack retail store, a participating Radio Shack franchisee or a participating Radio Shack dealer for repair, along with a copy of the sales document or lease agreement. The original CUSTOMER'S sole and exclusive remedy in the event of a defect is limited to the correction of the defect by repair, replacement, or refund of the purchase price, at RADIO SHACK'S election and sole expense. RADIO SHACK has no obligation to replace or repair expendable items.
- B. RADIO SHACK makes no warranty as to the design, capability, capacity, or suitability for use of the Software, except as provided in this paragraph. Software is licensed on an "AS IS" basis, without warranty. The original CUSTOMER'S exclusive remedy, in the event of a Software manufacturing defect, is its repair or replacement within thirty (30) calendar days of the date of the Radio Shack sales document received upon license of the Software. The defective Software shall be returned to a Radio Shack Computer Center, a Radio Shack retail store, a participating Radio Shack franchisee or Radio Shack dealer along with the sales document.
- C. Except as provided herein no employee, agent, franchisee, dealer or other person is authorized to give any warranties of any nature on behalf of RADIO SHACK.
- D. **EXCEPT AS PROVIDED HEREIN, RADIO SHACK MAKES NO EXPRESS WARRANTIES, AND ANY IMPLIED WARRANTY OF MERCHANTABILITY OR FITNESS FOR A PARTICULAR PURPOSE IS LIMITED IN ITS DURATION TO THE DURATION OF THE WRITTEN LIMITED WARRANTIES SET FORTH HEREIN.**
- E. Some states do not allow limitations on how long an implied warranty lasts, so the above limitation(s) may not apply to CUSTOMER.

**III. LIMITATION OF LIABILITY**

- A. **EXCEPT AS PROVIDED HEREIN, RADIO SHACK SHALL HAVE NO LIABILITY OR RESPONSIBILITY TO CUSTOMER OR ANY OTHER PERSON OR ENTITY WITH RESPECT TO ANY LIABILITY, LOSS OR DAMAGE CAUSED OR ALLEGED TO BE CAUSED DIRECTLY OR INDIRECTLY BY "EQUIPMENT" OR "SOFTWARE" SOLD, LEASED, LICENSED OR FURNISHED BY RADIO SHACK, INCLUDING, BUT NOT LIMITED TO, ANY INTERRUPTION OF SERVICE, LOSS OF BUSINESS OR ANTICIPATORY PROFITS OR CONSEQUENTIAL DAMAGES RESULTING FROM THE USE OR OPERATION OF THE "EQUIPMENT" OR "SOFTWARE." IN NO EVENT SHALL RADIO SHACK BE LIABLE FOR LOSS OF PROFITS, OR ANY INDIRECT, SPECIAL, OR CONSEQUENTIAL DAMAGES ARISING OUT OF ANY BREACH OF THIS WARRANTY OR IN ANY MANNER ARISING OUT OF OR CONNECTED WITH THE SALE, LEASE, LICENSE, USE OR ANTICIPATED USE OF THE "EQUIPMENT" OR "SOFTWARE." NOTWITHSTANDING THE ABOVE LIMITATIONS AND WARRANTIES, RADIO SHACK'S LIABILITY HEREUNDER FOR DAMAGES INCURRED BY CUSTOMER OR OTHERS SHALL NOT EXCEED THE AMOUNT PAID BY CUSTOMER FOR THE PARTICULAR "EQUIPMENT" OR "SOFTWARE" INVOLVED.**
- B. RADIO SHACK shall not be liable for any damages caused by delay in delivering or furnishing Equipment and/or Software.
- C. No action arising out of any claimed breach of this Warranty or transactions under this Warranty may be brought more than two (2) years after the cause of action has accrued or more than four (4) years after the date of the Radio Shack sales document for the Equipment or Software, whichever first occurs.
- D. Some states do not allow the limitation or exclusion of incidental or consequential damages, so the above limitation(s) or exclusion(s) may not apply to CUSTOMER.

**IV. SOFTWARE LICENSE**

- RADIO SHACK grants to CUSTOMER a non-exclusive, paid-up license to use the TANDY Software on one computer, subject to the following provisions:
- A. Except as otherwise provided in this Software License, applicable copyright laws shall apply to the Software.
  - B. Title to the medium on which the Software is recorded (cassette and/or diskette) or stored (ROM) is transferred to CUSTOMER, but not title to the Software.
  - C. CUSTOMER may use Software on one host computer and access that Software through one or more terminals if the Software permits this function.
  - D. CUSTOMER shall not use, make, manufacture, or reproduce copies of Software except for use on one computer and as is specifically provided in this Software License. Customer is expressly prohibited from disassembling the Software.
  - E. CUSTOMER is permitted to make additional copies of the Software **only** for backup or archival purposes or if additional copies are required in the operation of one computer with the Software, but only to the extent the Software allows a backup copy to be made. However, for TRSDOS Software, CUSTOMER is permitted to make a limited number of additional copies for CUSTOMER'S own use.
  - F. CUSTOMER may resell or distribute unmodified copies of the Software provided CUSTOMER has purchased one copy of the Software for each one sold or distributed. The provisions of this Software License shall also be applicable to third parties receiving copies of the Software from CUSTOMER.
  - G. All copyright notices shall be retained on all copies of the Software.

**V. APPLICABILITY OF WARRANTY**

- A. The terms and conditions of this Warranty are applicable as between RADIO SHACK and CUSTOMER to either a sale of the Equipment and/or Software License to CUSTOMER or to a transaction whereby Radio Shack sells or conveys such Equipment to a third party for lease to CUSTOMER.
- B. The limitations of liability and Warranty provisions herein shall inure to the benefit of RADIO SHACK, the author, owner and or licensor of the Software and any manufacturer of the Equipment sold by Radio Shack.

**VI. STATE LAW RIGHTS**

The warranties granted herein give the original CUSTOMER specific legal rights, and the original CUSTOMER may have other rights which vary from state to state.