

MEDITERRANEAN WRESTLING CHAMP.



BUDVA (MNE)

2011-06-10 - 2011-06-12 2011

Résultats - Results

Lutte Greco-Romaine - Greco-Roman



**Liste des arbitres / Referee list****MEDITERRANEAN WRESTLING CHAMP.**

N°	Licence	Pays Country	Nom - Last Name	Prénom - First Name
		ALB	MUHO	SPARTAK
		ALG	SIGUERDJEDJENE	OMARA
		CRO	BELUSIC	ALEN
		CRO	MARJANOVIC	MIJO
		CYP	CHRISTODOLUOU	CHRISTOFOROS
		CYP	PANAGIOTIS	CHARPAS
		FRA	DAMIENS	SERGE
		GRE	STAVROU	HRISTOS
		ITA	LUCA	VALENTINI
		SRB	ACIC	RADOMIR
		TUR	DAGLAR	ABDURRAHMAN
		TUR	MEHMET	SARI
		TUR	METIN	KARPUR
		TUR	SELAHATTIN	KARAMAN

Nombre d'arbitres - Number of Referee

14



Liste des nations / Countries List

MEDITERRANEAN WRESTLING CHAMP.

STYLE GR



Pays - Country

	ALBANIA	ALB
	BOSNIA AND HERZEGOVINA	BIH
	CROATIA	CRO
	FRANCE	FRA
	GREECE	GRE
	ITALY	ITA
	MONACO	MON
	MONTENEGRO	MNE
	SERBIA	SRB
	SLOVENIA	SLO
	TURKEY	TUR

Nombre de nations - Number of Countries 11

**Nombre d'engagés par nation / Number of Entries By Country****MEDITERRANEAN WRESTLING CHAMP.****STYLE GR**

Pays - Country	55 KG	60 KG	66 KG	74 KG	84 KG	96 KG	120 KG	TOTAL
ALB			1	1		1		3
BIH	1							1
CRO	1	1	1	1	1	1	1	7
FRA			1	1	1	1		4
GRE				1			1	2
ITA		1		1	1	1	1	5
MNE					1	2		3
MON		1		1	1	1		4
SLO		1			1			2
SRB	2	2	2	2	1	1	2	12
TUR	1	1	1	1	1	1	1	7
TOTAL	5	7	6	9	8	9	6	50

Nombre de nations - Number of Countries **11**



Liste des Engagés par pays / Entry-List By Country

MEDITERRANEAN WRESTLING CHAMP.



STYLE GR

ALBANIA (ALB)

Entraîneur / Coach : ILIA, KELI

Lutteur(s) / Wrestler(s) :

66 kg	THEREPELI, DRITAN
74 kg	BENDO, ENO
96 kg	SERIAN, KADIU

BOSNIA AND HERZEGOVINA (BIH)

Entraîneur / Coach : BRAJLOVIC, ABDUL AZIZ

Arbitre(s) / Referee(s) : MUHO, SPARTAK

Lutteur(s) / Wrestler(s) :

55 kg	BRKIC, AJDIN
-------	--------------

CROATIA (CRO)

Chef de délégation / Team Leader : OCIC, ZVONKO

Entraîneur / Coach : JAKUBEK, DAVOR

Arbitre(s) / Referee(s) : SIGUERDJEDJENE, OMARA

Lutteur(s) / Wrestler(s) :

55 kg	LIZATOVIC, IVAN
60 kg	SOKOL, TONIMIR
66 kg	JANECIC, DANIJEL
74 kg	STARCEVIC, BOZO
84 kg	ZUGAJ, NENAD
96 kg	HOGAC, SINISA
120 kg	KOSCEVIC, MARKO

FRANCE (FRA)

Lutteur(s) / Wrestler(s) :

66 kg	HASSLI, FRANCK
74 kg	VITTMANN, STEVE
84 kg	HASSLI, ALAIN
96 kg	FETHY, EDDOUH

GREECE (GRE)

Entraîneur / Coach : SOTIRIS, Petrakis

Lutteur(s) / Wrestler(s) :



Liste des Engagés par pays / Entry-List By Country

MEDITERRANEAN WRESTLING CHAMP.



STYLE GR

74 kg PAPADOPULUS, Konstatinos
120 kg KOUTSIOUPAS, Ksenofon

ITALY (ITA)

Chef de délégation / Team Leader : CAUDULLO, ANTONINO

Entraîneur / Coach : CAMPANELA, Salvatore

Lutteur(s) / Wrestler(s) :

60 kg FUCILE, Paolo
74 kg SCARRAMUZZI, Saverio
84 kg SCIBILIA, Vincenzo
96 kg SCIBILIA, Beniamino
120 kg FICARA, DANIELE

MONACO (MON)

Entraîneur / Coach : LACALVEZ, I

Lutteur(s) / Wrestler(s) :

60 kg LEMAIRE-THIAM, JONATHAN
74 kg PATTE, MARC
84 kg PATTE, PAUL
96 kg MOCANU, ANDRIAN

MONTENEGRO (MNE)

Lutteur(s) / Wrestler(s) :

84 kg STANJEVIC, PREDRAG
96 kg MISUROVIC, MLADEN
RADOSAVLJEVIC, VLADIMIR

SERBIA (SRB)

Chef de délégation / Team Leader : ZATEZALO, SAVO

Entraîneur / Coach : DAMJANOVIC, SRETEN

VARAGIC, VOJISLAV

Lutteur(s) / Wrestler(s) :

55 kg GAZDAG, KRISTIJAN
MARKOVIC, NIKOLA
60 kg DESIC, DRAGAN
NADJ, TAMAS
66 kg BOSKOV, BOBAN
STEFANEK, DAVOR



Liste des Engagés par pays / Entry-List By Country

MEDITERRANEAN WRESTLING CHAMP.



STYLE GR

74 kg	BAJLOVIC, MIHAJLO TODOROVIC, MILAN
84 kg	BALO, PETAR
96 kg	FRANJKOVIC, DEJAN
120 kg	SPASIC, MILOS VARGA, ZOLTAN

SLOVENIA (SLO)

Chef de délégation / Team Leader : SERNEK, STANISLAV

Entraîneur / Coach : BACIC, RADE

Lutteur(s) / Wrestler(s) :

60 kg	HAJRIZI, DRITANO
84 kg	KUHAR, JURE

TURKEY (TUR)

Entraîneur / Coach : YASAR, TEMEL
KARAALI, ERDOGAN

Lutteur(s) / Wrestler(s) :

55 kg	BAYRAM, GARIP
60 kg	TAHSIN OZDUL, HASAN
66 kg	COSKUN, ABDULLAH
74 kg	KUCUKOSMEN, M. ALI
84 kg	ILDEM, KANSU
96 kg	JYLMAZ, DOGAN
120 kg	OZTURK, EMIN



Feuille de compétition / Competition Sheet

MEDITERRANEAN WRESTLING CHAMP.

STYLE : GR 55 kg



TOUR : 1

1	$\frac{3}{7}$	BAYRAM GARIP (TUR)	P1	P2	P3	1	BAYRAM GARIP (TUR)
			2	5	0		
2	$\frac{0}{0}$	MARKOVIC NIKOLA (SRB)	P1	P2	P3		
			0	0	0		
3	$\frac{3}{7}$	LIZATOVIC IVAN (CRO)	P1	P2	P3	3	LIZATOVIC IVAN (CRO)
			4	3	0		
4	$\frac{0}{0}$	GAZDAG KRISTIJAN (SRB)	P1	P2	P3		
			0	0	0		

TOUR : 2

5	$\frac{0}{0}$	BRKIC AJDIN (BIH)	P1	P2	P3	1	BAYRAM GARIP (TUR)
			0	0	0		
1	$\frac{3}{8}$	BAYRAM GARIP (TUR)	P1	P2	P3		
			1	7	0		
2	$\frac{0}{0}$	MARKOVIC NIKOLA (SRB)	P1	P2	P3	3	LIZATOVIC IVAN (CRO)
			0	0	0		
3	$\frac{4}{13}$	LIZATOVIC IVAN (CRO)	P1	P2	P3		
			7	6	0		

TOUR : 3

4	$\frac{1}{3}$	GAZDAG KRISTIJAN (SRB)	P1	P2	P3	1	BAYRAM GARIP (TUR)
			3	0	0		
1	$\frac{3}{8}$	BAYRAM GARIP (TUR)	P1	P2	P3		
			0	4	4		
5	$\frac{0}{0}$	BRKIC AJDIN (BIH)	P1	P2	P3	2	MARKOVIC NIKOLA (SRB)
			0	0	0		
2	$\frac{4}{0}$	MARKOVIC NIKOLA (SRB)	P1	P2	P3		
			0	0	0		

TOUR : 4

3	$\frac{3}{10}$	LIZATOVIC IVAN (CRO)	P1	P2	P3	3	LIZATOVIC IVAN (CRO)
			6	4	0		
1	$\frac{1}{3}$	BAYRAM GARIP (TUR)	P1	P2	P3		
			0	3	0		
4	$\frac{4}{5}$	GAZDAG KRISTIJAN (SRB)	P1	P2	P3	4	GAZDAG KRISTIJAN (SRB)
			5	0	0		
5	$\frac{0}{0}$	BRKIC AJDIN (BIH)	P1	P2	P3		
			0	0	0		

TOUR : 5

2	$\frac{0}{0}$	MARKOVIC NIKOLA (SRB)	P1	P2	P3	4	GAZDAG KRISTIJAN (SRB)
			0	0	0		
4	$\frac{3}{5}$	GAZDAG KRISTIJAN (SRB)	P1	P2	P3		
			1	4	0		
3	$\frac{4}{0}$	LIZATOVIC IVAN (CRO)	P1	P2	P3	3	LIZATOVIC IVAN (CRO)
			0	0	0		
5	$\frac{0}{0}$	BRKIC AJDIN (BIH)	P1	P2	P3		
			0	0	0		

Classement

Cl	Pays	Nom	Points
1	CRO	LIZATOVIC IVAN	14
2	TUR	BAYRAM GARIP	10
3	SRB	GAZDAG KRISTIJAN	8
4	SRB	MARKOVIC NIKOLA	4
5	BIH	BRKIC AJDIN	0



Classement

MEDITERRANEAN WRESTLING CHAMP.



STYLE : GR 55 kg

1 - Or / Gold



LIZATOVIC IVAN

2 - Argent / Silver



BAYRAM GARIP

3 - Bronze



GAZDAG KRISTIJAN

Classement	Nom - Name	Pays - Country	Points
1	LIZATOVIC IVAN	CRO	14
2	BAYRAM GARIP	TUR	10
3	GAZDAG KRISTIJAN	SRB	8
4	MARKOVIC NIKOLA	SRB	4
5	BRKIC AJDIN	BIH	0



Feuille de compétition / Competition Sheet

MEDITERRANEAN WRESTLING CHAMP.



STYLE : GR 60 kg

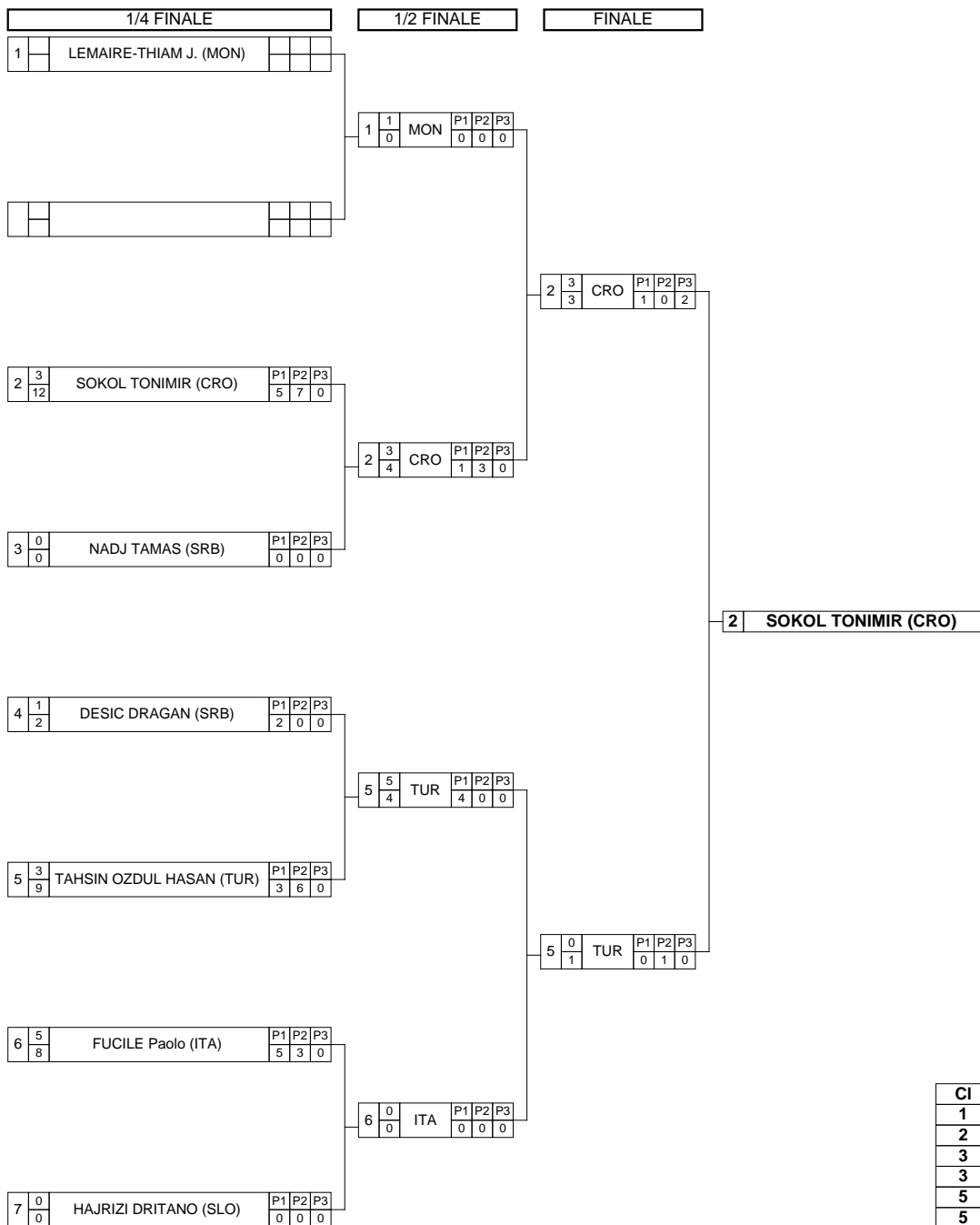

Classement

Cl	Pays	Nom
1	CRO	SOKOL TONIMIR
2	TUR	TAHSIN OZDUL HASAN
3	MON	LEMAIRE-THIAM JONATHAN
3	SRB	DESIC DRAGAN
5	SRB	NADJ TAMAS
5	ITA	FUCILE Paolo
7	SLO	HAJRIZI DRITANO

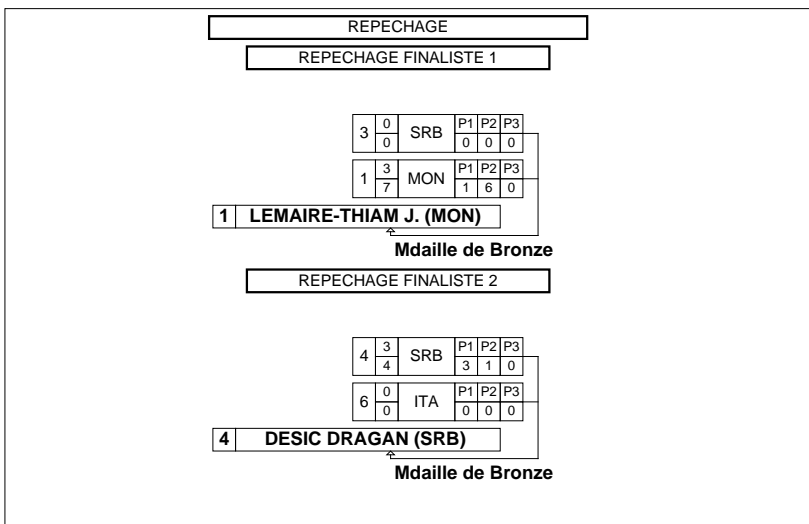

Classement**MEDITERRANEAN WRESTLING CHAMP.**

STYLE : GR 60 kg

**1 - Or / Gold****SOKOL TONIMIR****2 - Argent / Silver****TAHSIN OZDUL HASAN****3 - Bronze****LEMAIRE-THIAM JONATHAN****DESIC DRAGAN**

Classement	Nom - Name	Pays - Country
1	SOKOL TONIMIR	CRO
2	TAHSIN OZDUL HASAN	TUR
3	LEMAIRE-THIAM J.	MON
3	DESIC DRAGAN	SRB
5	NADJ TAMAS	SRB
5	FUCILE Paolo	ITA
7	HAJRIZI DRITANO	SLO



Feuille de compétition / Competition Sheet

MEDITERRANEAN WRESTLING CHAMP.



STYLE : GR 66 kg

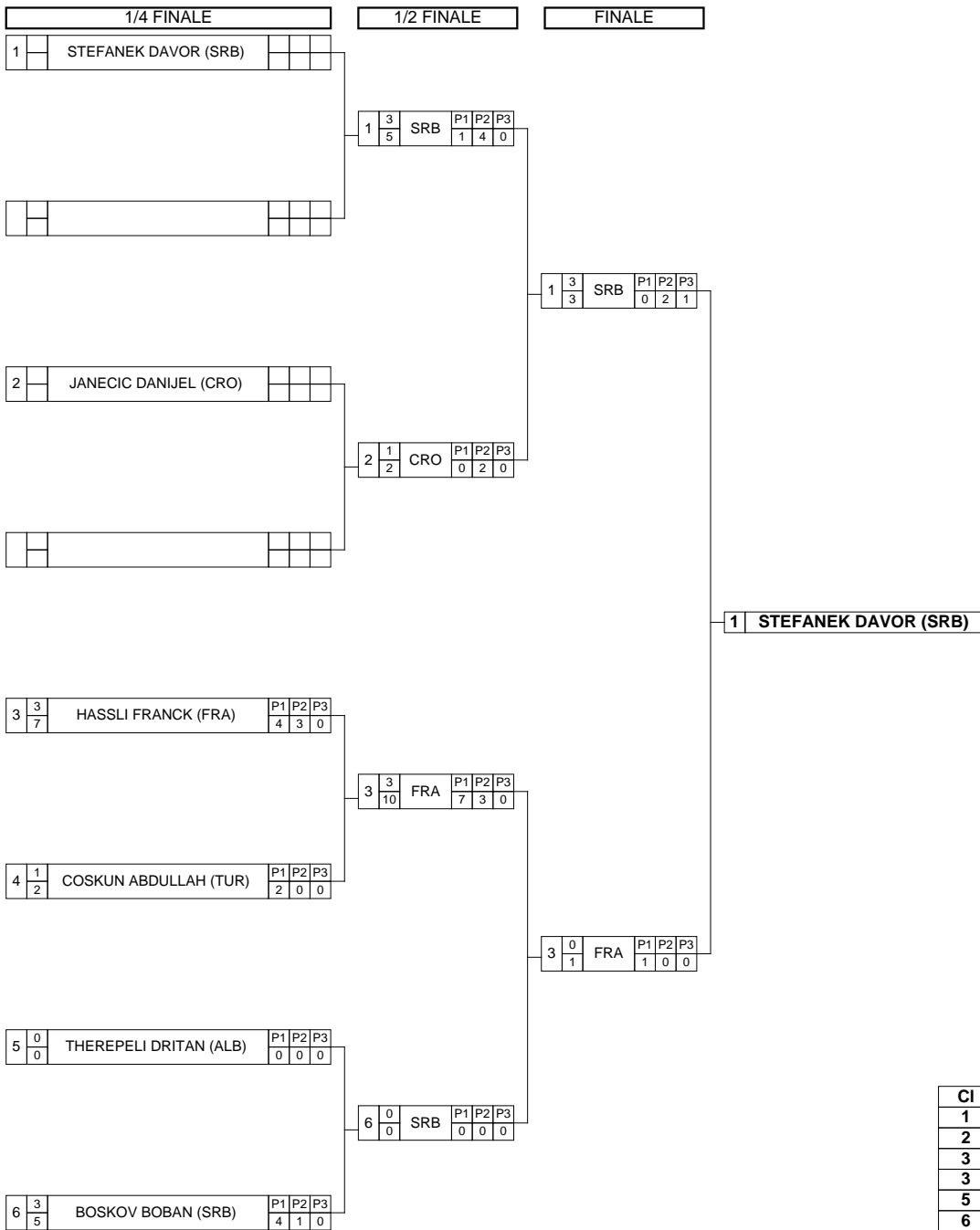

Classement

Cl	Pays	Nom
1	SRB	STEFANEK DAVOR
2	FRA	HASSLI FRANCK
3	CRO	JANECIC DANIJEL
3	TUR	COSKUN ABDULLAH
5	SRB	BOSKOV BOBAN
6	ALB	THEREPELI DRITAN

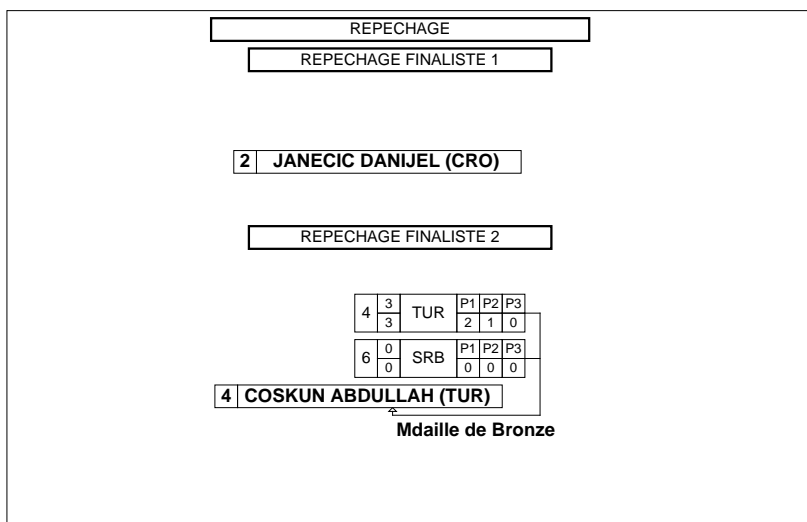



Classement

MEDITERRANEAN WRESTLING CHAMP.



STYLE : GR 66 kg

1 - Or / Gold

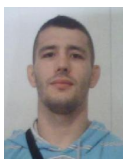

STEFANEK DAVOR

2 - Argent / Silver



HASSLI FRANCK

3 - Bronze



JANECIC DANIJEL



COSKUN ABDULLAH

<i>Classement</i>	<i>Nom - Name</i>	<i>Pays - Country</i>
1	STEFANEK DAVOR	SRB
2	HASSLI FRANCK	FRA
3	JANECIC DANIJEL	CRO
3	COSKUN ABDULLAH	TUR
5	BOSKOV BOBAN	SRB
6	THEREPELI DRITAN	ALB



Feuille de compétition / Competition Sheet

MEDITERRANEAN WRESTLING CHAMP.



STYLE : GR 74 kg

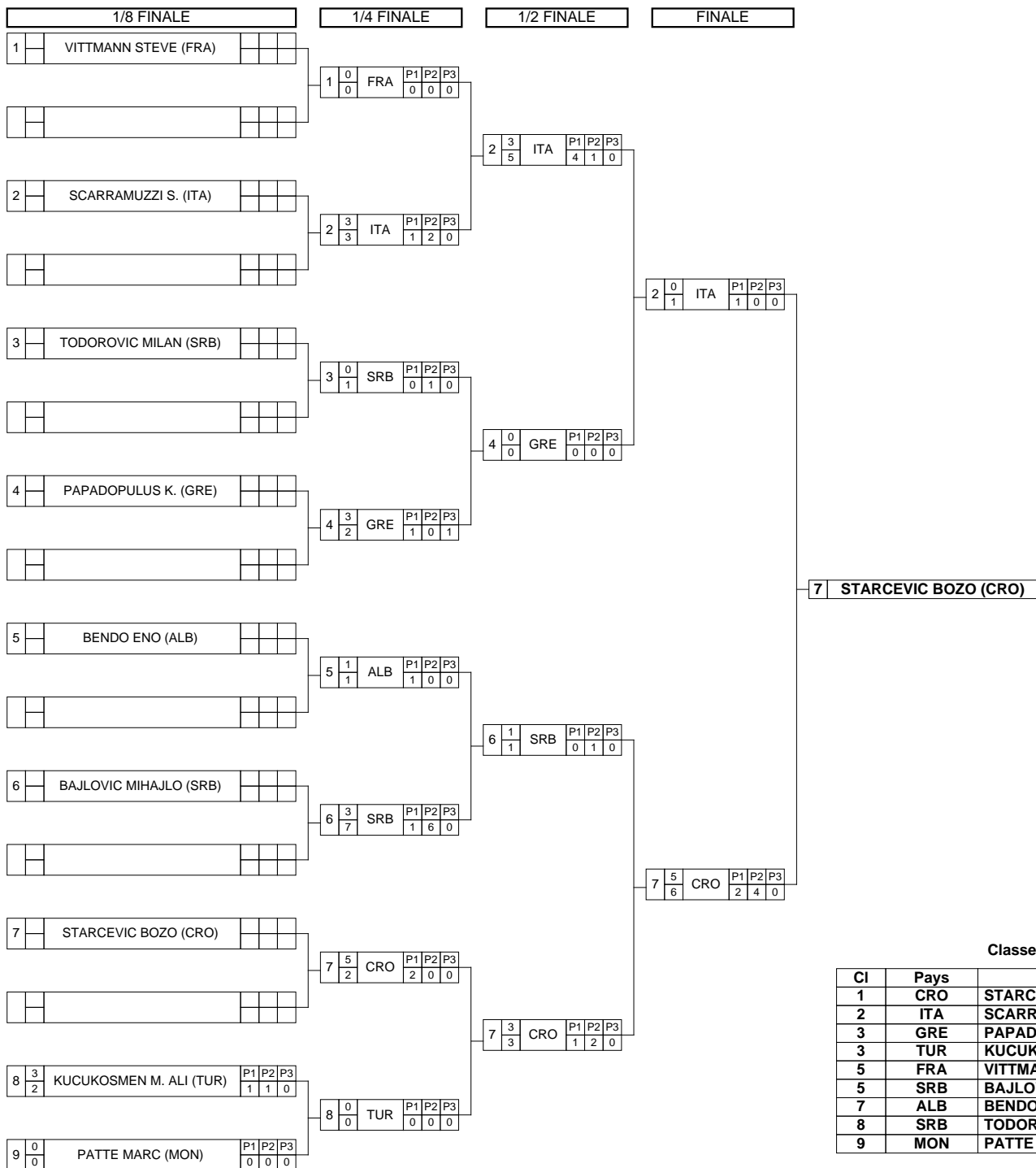

Classement

Cl	Pays	Nom
1	CRO	STARCEVIC BOZO
2	ITA	SCARRAMUZZI Saverio
3	GRE	PAPADOPULUS Konstatinos
3	TUR	KUCUKOSMEN M. ALI
5	FRA	VITTMANN STEVE
5	SRB	BAJLOVIC MIHAJLO
7	ALB	BENDO ENO
8	SRB	TODOROVIC MILAN
9	MON	PATTE MARC

REPECHAGE

REPECHAGE FINALISTE 1

1	1	FRA	P1	P2	P3
	1		0	1	0
4	3	GRE	P1	P2	P3
	9		2	0	7

4 PAPADOPULUS K. (GRE)

Mdaille de Bronze

REPECHAGE FINALISTE 2

8	3	TUR	P1	P2	P3
	8		4	4	0
6	0	SRB	P1	P2	P3
	0		0	0	0

8 KUCUKOSMEN M. ALI (TUR)

Mdaille de Bronze



Classement

MEDITERRANEAN WRESTLING CHAMP.



STYLE : GR 74 kg

1 - Or / Gold



STARCEVIC BOZO

2 - Argent / Silver



SCARRAMUZZI Saverio

3 - Bronze



PAPADOPULUS Konstatinos



KUCUKOSMEN M. ALI

Classement	Nom - Name	Pays - Country
1	STARCEVIC BOZO	CRO
2	SCARRAMUZZI Saverio	ITA
3	PAPADOPULUS K.	GRE
3	KUCUKOSMEN M. ALI	TUR
5	VITTMANN STEVE	FRA
5	BAJLOVIC MIHAJLO	SRB
7	BENDO ENO	ALB
8	TODOROVIC MILAN	SRB
9	PATTE MARC	MON



Feuille de compétition / Competition Sheet

MEDITERRANEAN WRESTLING CHAMP.



STYLE : GR 84 kg

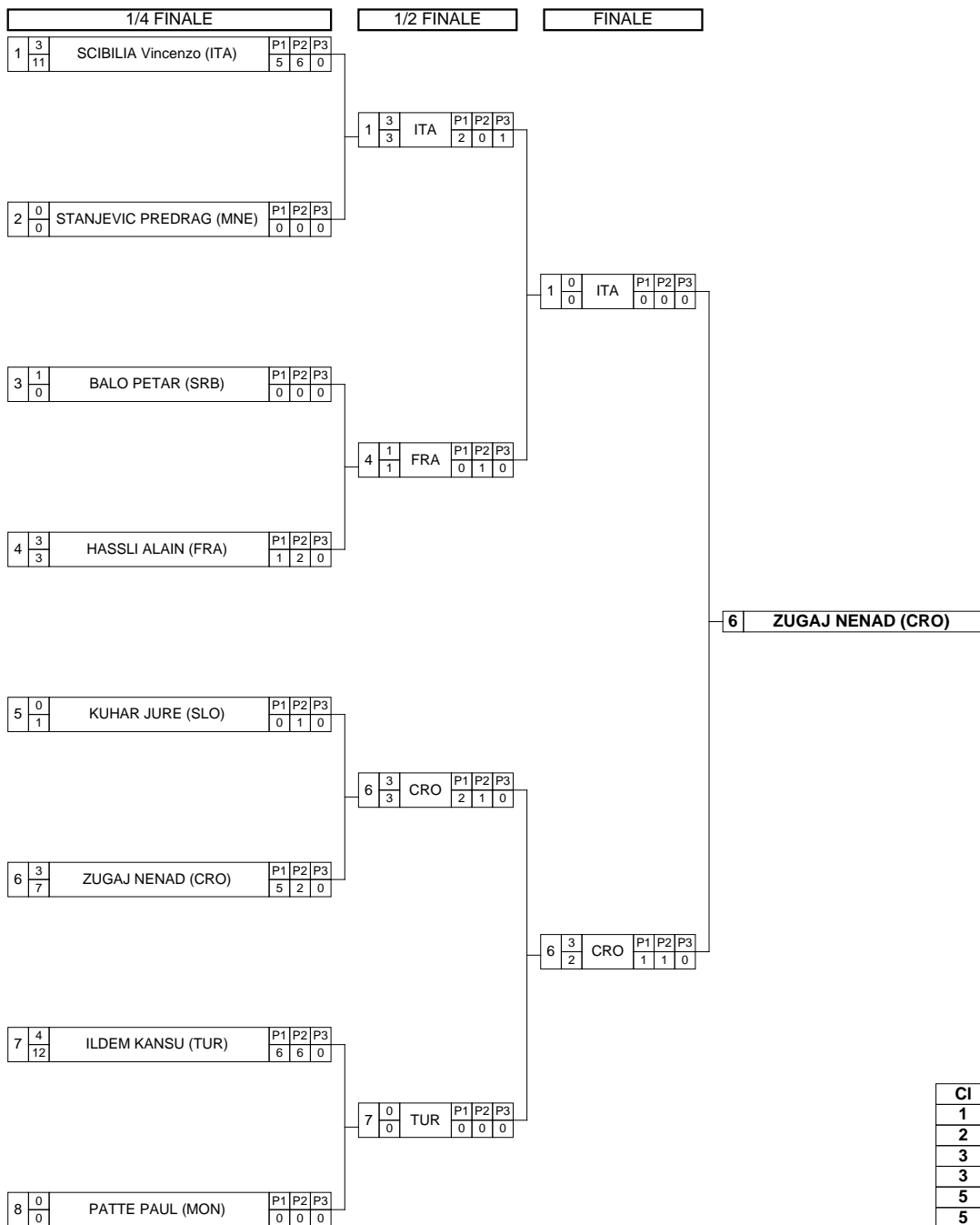

Classement

Cl	Pays	Nom
1	CRO	ZUGAJ NENAD
2	ITA	SCIBILIA Vincenzo
3	FRA	HASSLI ALAIN
3	TUR	ILDEM KANSU
5	MNE	STANJEVIC PREDRAG
5	SLO	KUHAR JURE
7	SRB	BALO PETAR
8	MON	PATTE PAUL

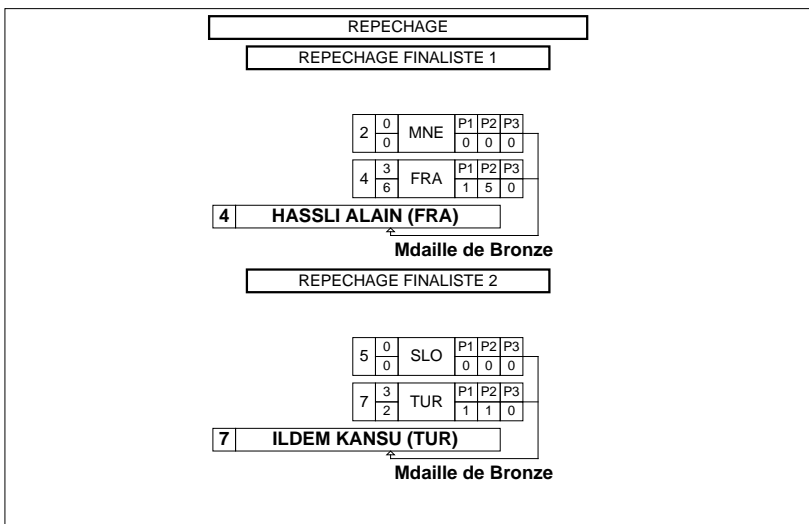



Classement

MEDITERRANEAN WRESTLING CHAMP.



STYLE : GR 84 kg

1 - Or / Gold



ZUGAJ NENAD

2 - Argent / Silver



SCIBILIA Vincenzo

3 - Bronze



HASSLI ALAIN



ILDEM KANSU

Classement	Nom - Name	Pays - Country
1	ZUGAJ NENAD	CRO
2	SCIBILIA Vincenzo	ITA
3	HASSLI ALAIN	FRA
3	ILDEM KANSU	TUR
5	STANJEVIC PREDRAG	MNE
5	KUHAR JURE	SLO
7	BALO PETAR	SRB
8	PATTE PAUL	MON



Feuille de compétition / Competition Sheet

MEDITERRANEAN WRESTLING CHAMP.



STYLE : GR 96 kg

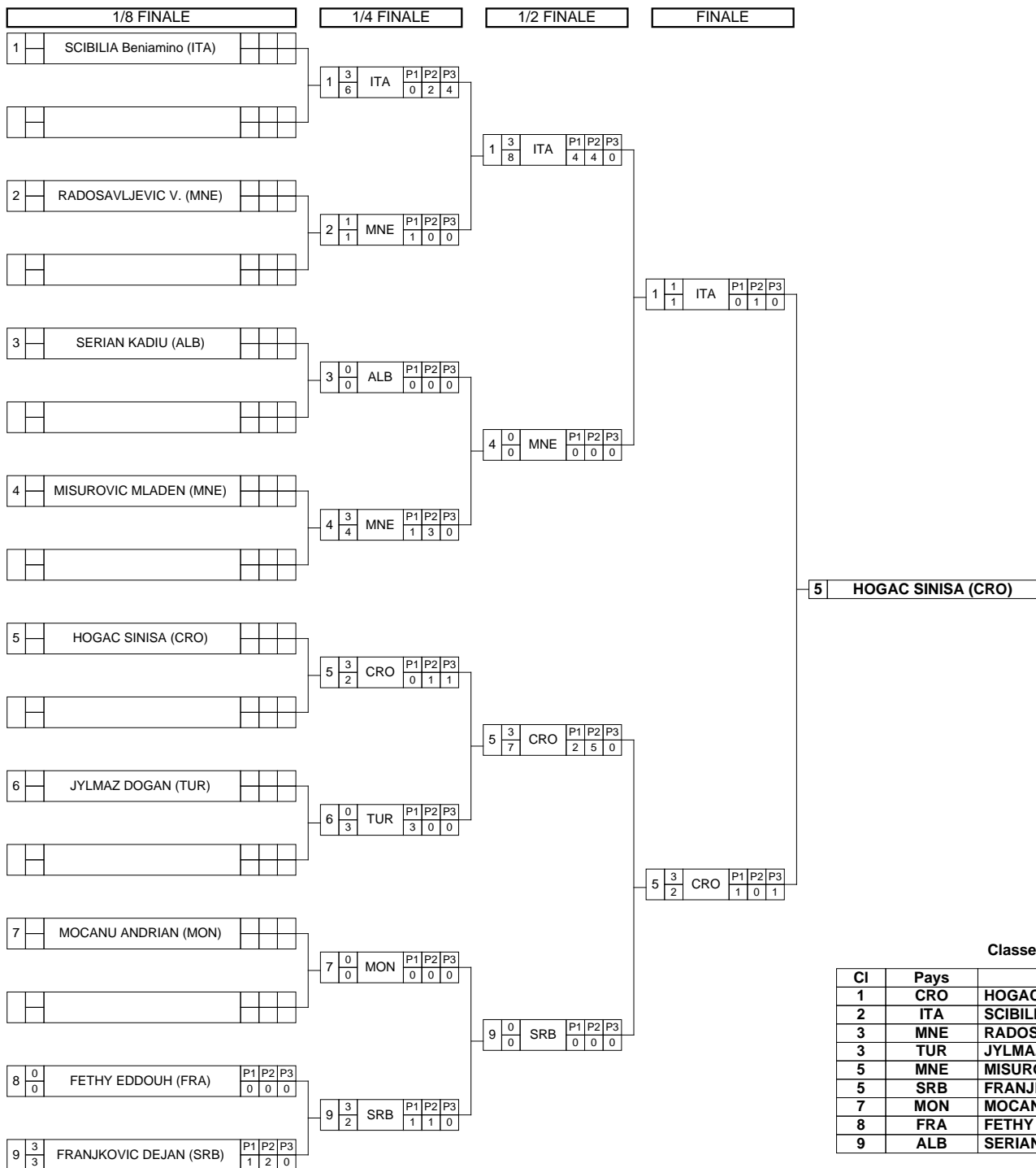

Classement

Cl	Pays	Nom
1	CRO	HOGAC SINISA
2	ITA	SCIBILIA Beniamino
3	MNE	RADOSAVLJEVIC VLADIMIR
3	TUR	JYLMAZ DOGAN
5	MNE	MISUROVIC MLADEN
5	SRB	FRANJKOVIC DEJAN
7	MON	MOCANU ANDRIAN
8	FRA	FETHY EDDOUH
9	ALB	SERIAN KADIU

REPECHAGE

REPECHAGE FINALISTE 1

2	3 2 MNE	P1 P2 P3 1 1 0
4	0 0 MNE	P1 P2 P3 0 0 0

2 | RADOSAVLJEVIC V. (MNE)

Mdaille de Bronze

REPECHAGE FINALISTE 2

6	3 3 TUR	P1 P2 P3 2 0 1
9	1 1 SRB	P1 P2 P3 0 1 0

6 | JYLMAZ DOGAN (TUR)

Mdaille de Bronze



Classement

MEDITERRANEAN WRESTLING CHAMP.



STYLE : GR 96 kg

1 - Or / Gold



HOGAC SINISA

2 - Argent / Silver



SCIBILIA Beniamino

3 - Bronze

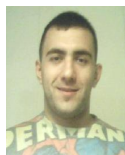

RADOSAVLJEVIC VLADIMIR



JYLMAZ DOGAN

Classement	Nom - Name	Pays - Country
1	HOGAC SINISA	CRO
2	SCIBILIA Beniamino	ITA
3	RADOSAVLJEVIC V.	MNE
3	JYLMAZ DOGAN	TUR
5	MISUROVIC MLADEN	MNE
5	FRANJKOVIC DEJAN	SRB
7	MOCANU ANDRIAN	MON
8	FETHY EDDOUH	FRA
9	SERIAN KADIU	ALB



Feuille de compétition / Competition Sheet

MEDITERRANEAN WRESTLING CHAMP.



STYLE : GR 120 kg

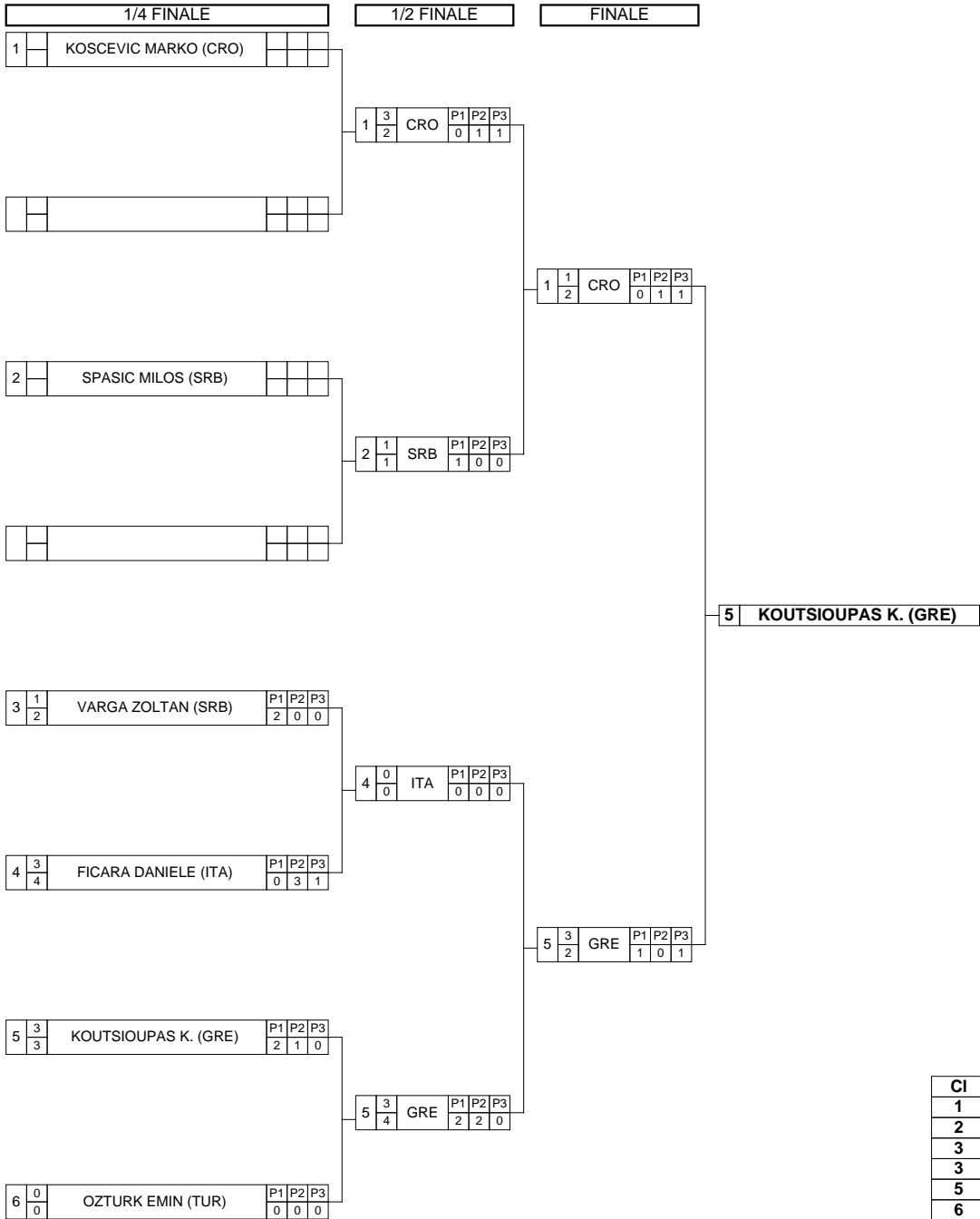

Classement

Cl	Pays	Nom
1	GRE	KOUTSIOPAS Ksenofon
2	CRO	KOSCEVIC MARKO
3	SRB	SPASIC MILOS
3	ITA	FICARA DANIELE
5	TUR	OZTURK EMIN
6	SRB	VARGA ZOLTAN

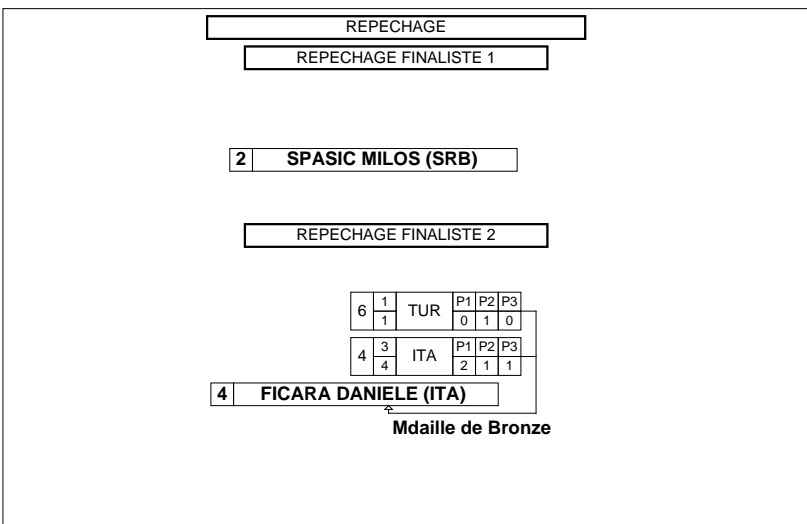



Classement

MEDITERRANEAN WRESTLING CHAMP.



STYLE : GR 120 kg

1 - Or / Gold



KOUTSIOUPAS Ksenofon

2 - Argent / Silver



KOSCEVIC MARKO

3 - Bronze



SPASIC MILOS



FICARA DANIELE

Classement	Nom - Name	Pays - Country
1	KOUTSIOUPAS K.	GRE
2	KOSCEVIC MARKO	CRO
3	SPASIC MILOS	SRB
3	FICARA DANIELE	ITA
5	OZTURK EMIN	TUR
6	VARGA ZOLTAN	SRB

**Classement par équipe / Teams ranking****MEDITERRANEAN WRESTLING CHAMP.****STYLE GR**

Rang	Equipe	55 KG	60 KG	66 KG	74 KG	84 KG	96 KG	120 KG	TOTAL
1	SRB	15	14	16	9	4	6	13	77
2	CRO	10	10	8	10	10	10	9	67
3	TUR	9	9	8	8	8	8	6	56
4	ITA		6		9	9	9	8	41
5	FRA			9	6	8	3		26
6	MNE					6	14		20
7	GRE				8			10	18
8	MON		8		2	3	4		17
9	ALB			5	4		2		11
10	SLO		4			6			10
11	BIH	6							6