



Pioneering Space – the Evolvable Mars Campaign

Greg Williams, Jason Crusan

HEOMD

April 2015



JOURNEY TO MARS

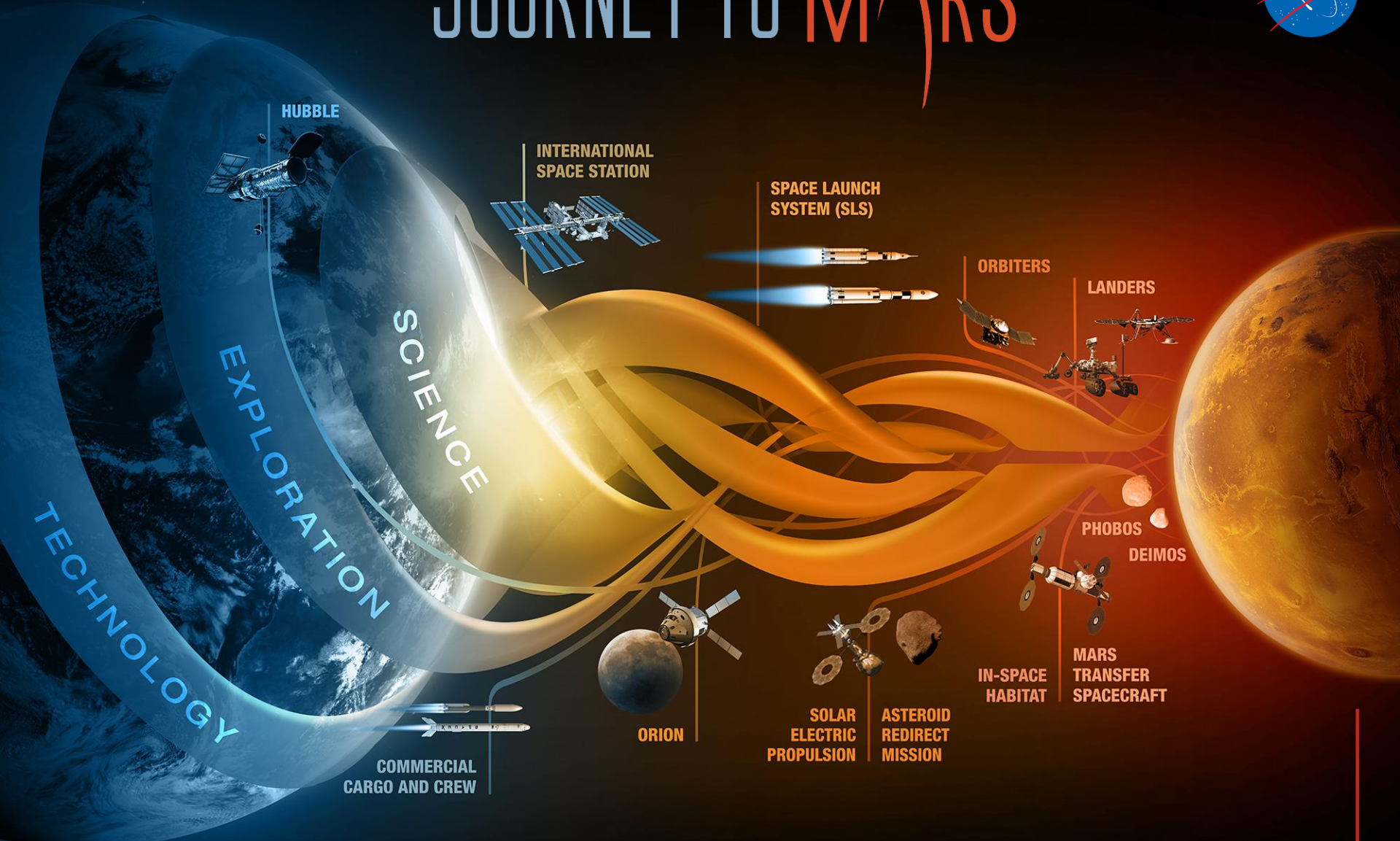

MISSIONS: 6-12 MONTHS
RETURN: HOURS

EARTH RELIANT

MISSIONS: 1 TO 12 MONTHS
RETURN: DAYS

PROVING GROUND

MISSIONS: 2 TO 3 YEARS
RETURN: MONTHS

EARTH INDEPENDENT

Engagement Product Development: *Pioneering Space (update to Voyages)*



- **Integrated agency-level document that articulates NASA's top-level exploration strategy, encompassing robotics, human operations, and technology developments over the near- and far-term. Purpose is to:**

- Illustrate how the activities being implemented across the agency contribute to an integrated exploration strategy
- Succinctly communicate our overall strategy of sustainable expansion of human presence across the solar system. Leave details with tailored documents and established processes within HEOMD and the Agency
- Show that there are technically implementable ways to achieve human exploration beyond low Earth orbit. Each activity informs the next more ambitious objective in a real and tangible way.



- **Target Audience is:**

- Internal NASA exploration team members – agency-wide – should be able to use this document to explain to an external audience how their work fits in the larger context of PS.
- Informed, nontechnical policy makers and decision makers – White House, Congressional staffers, domestic aerospace industry executives
- International space agencies
- Advisory and special groups

- **Pioneering Space document will be used to create other communication tools and techniques for the general public, formal programs and projects and other media**

Pioneering Space - Outline



- Overall Flow

- Letter From Administrator
- Our Goal
- Our Approach – Pioneering Principles
- Our Approach – Pioneering Strategy
- Proving Ground
- Pioneering Challenges
 - Transportation
 - Working in Space
 - Staying Healthy
 - Strategic Knowledge Gaps
- Our Progress and Plans
 - Earth-Reliant – ISS, Commercial Crew/Cargo
 - Proving Ground – SLS, Orion, SEP, protoflight habitat systems
 - Earth-Independent – Robotic missions, evolving architectures
- On the Horizon – Mars
- Summary

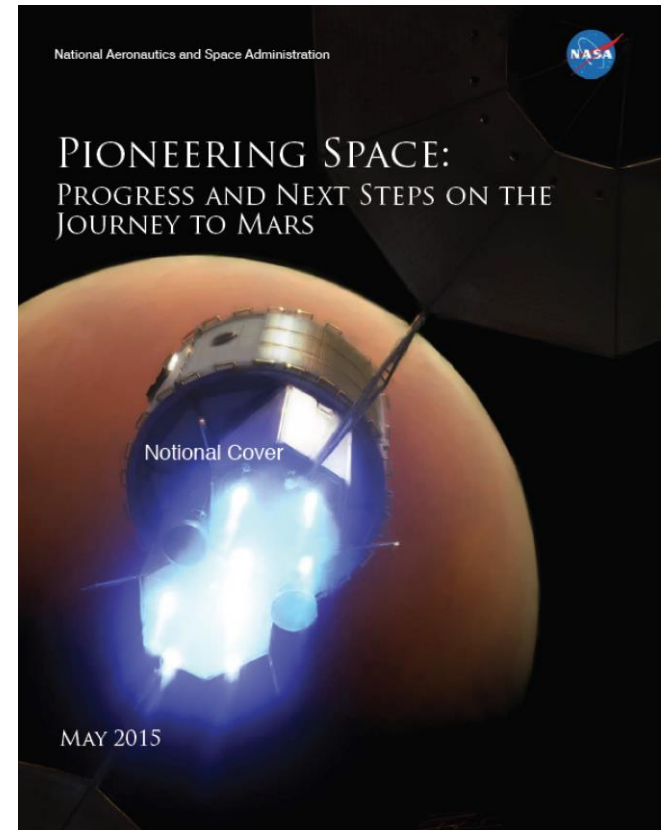







Pioneering Space - Goals

“Fifty years after the creation of NASA, our goal is no longer just a destination to reach. Our goal is the capacity for people to work and learn and operate and live safely beyond the Earth for extended periods of time, ultimately in ways that are more sustainable and even indefinite. And in fulfilling this task, we will not only extend humanity’s reach in space -- we will strengthen America’s leadership here on Earth.”

- President Obama - April, 2010

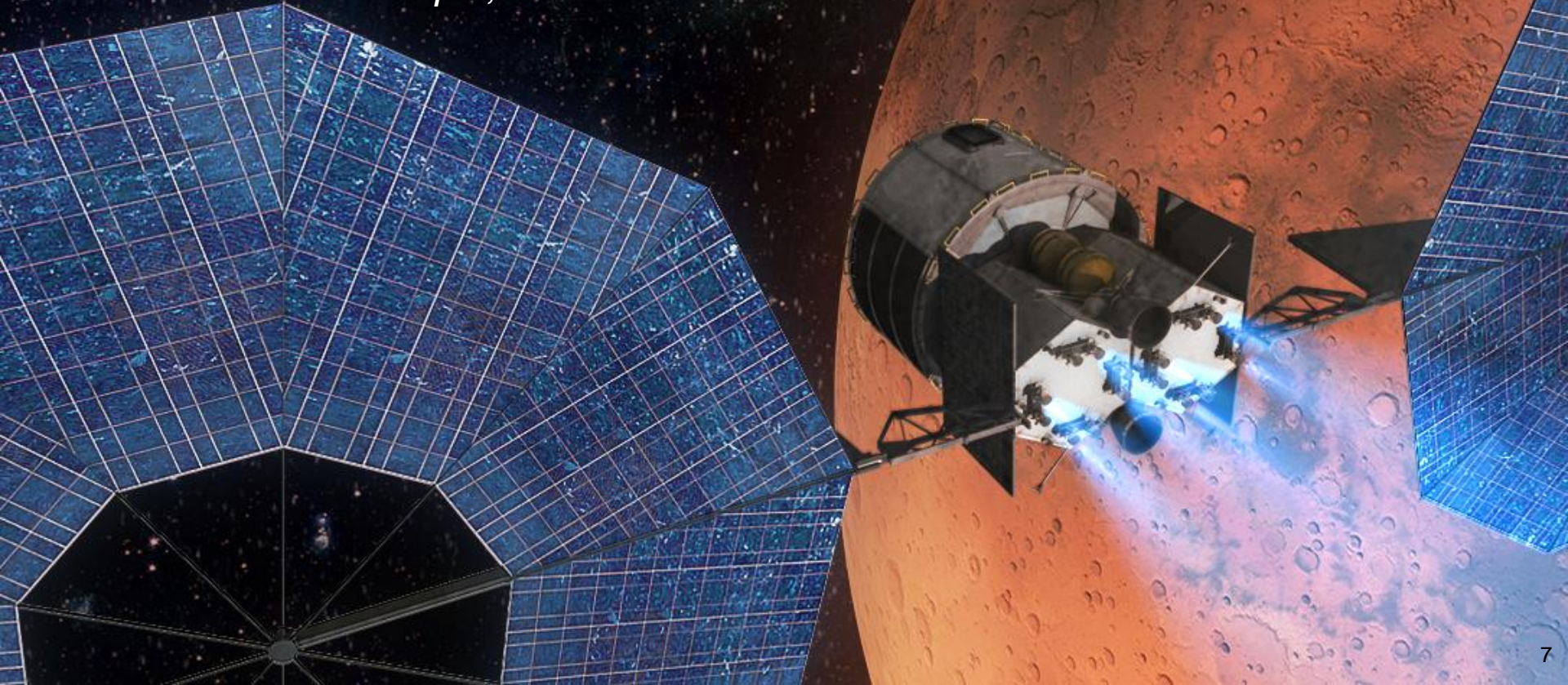



NASA Strategic Plan Objective 1.1

Expand human presence into the solar system and to the surface of Mars to advance exploration, science, innovation, benefits to humanity, and international collaboration.

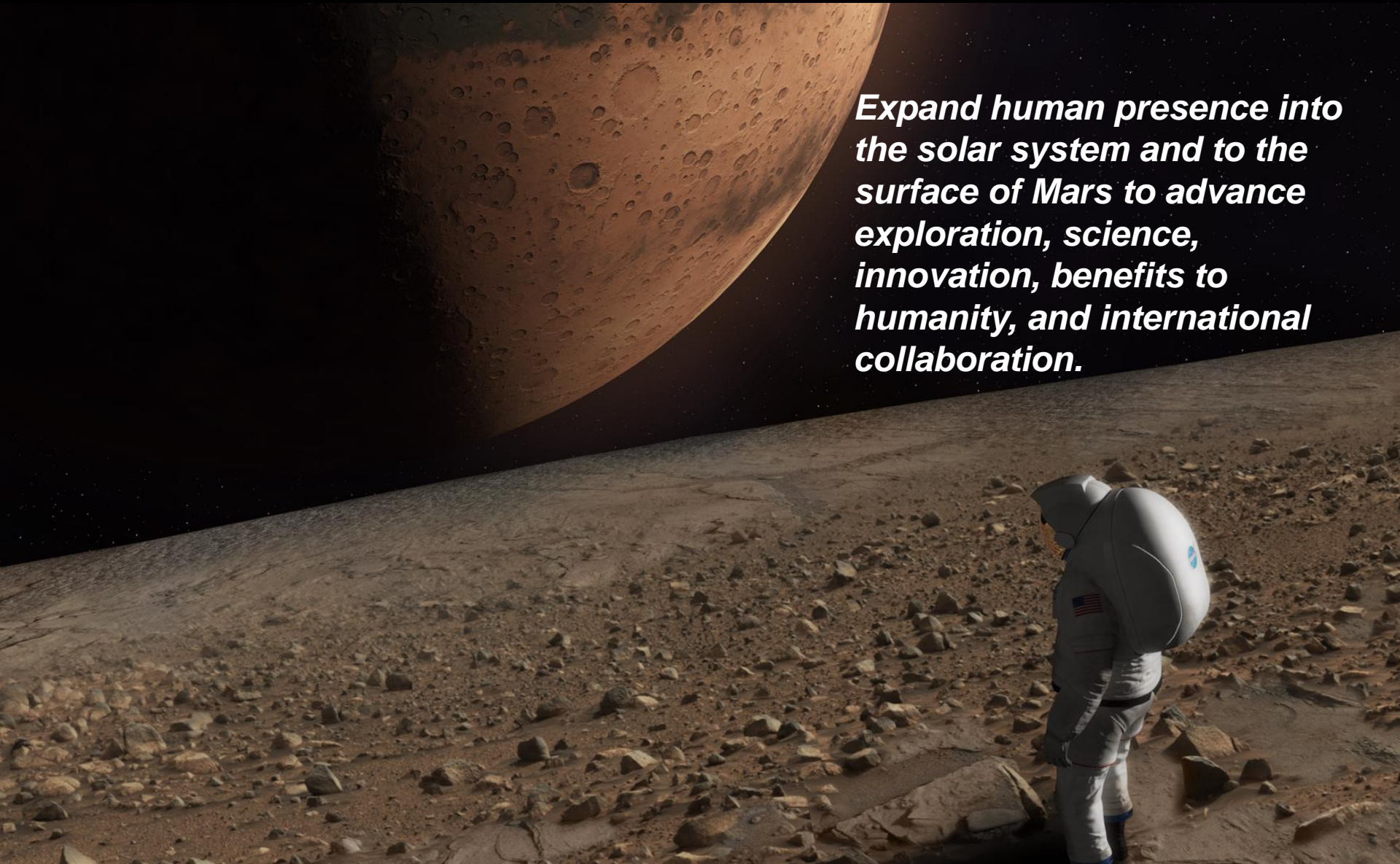

NASA Strategic Plan Objective 1.5



Ascertain the content, origin, and evolution of the solar system and the potential for life elsewhere.

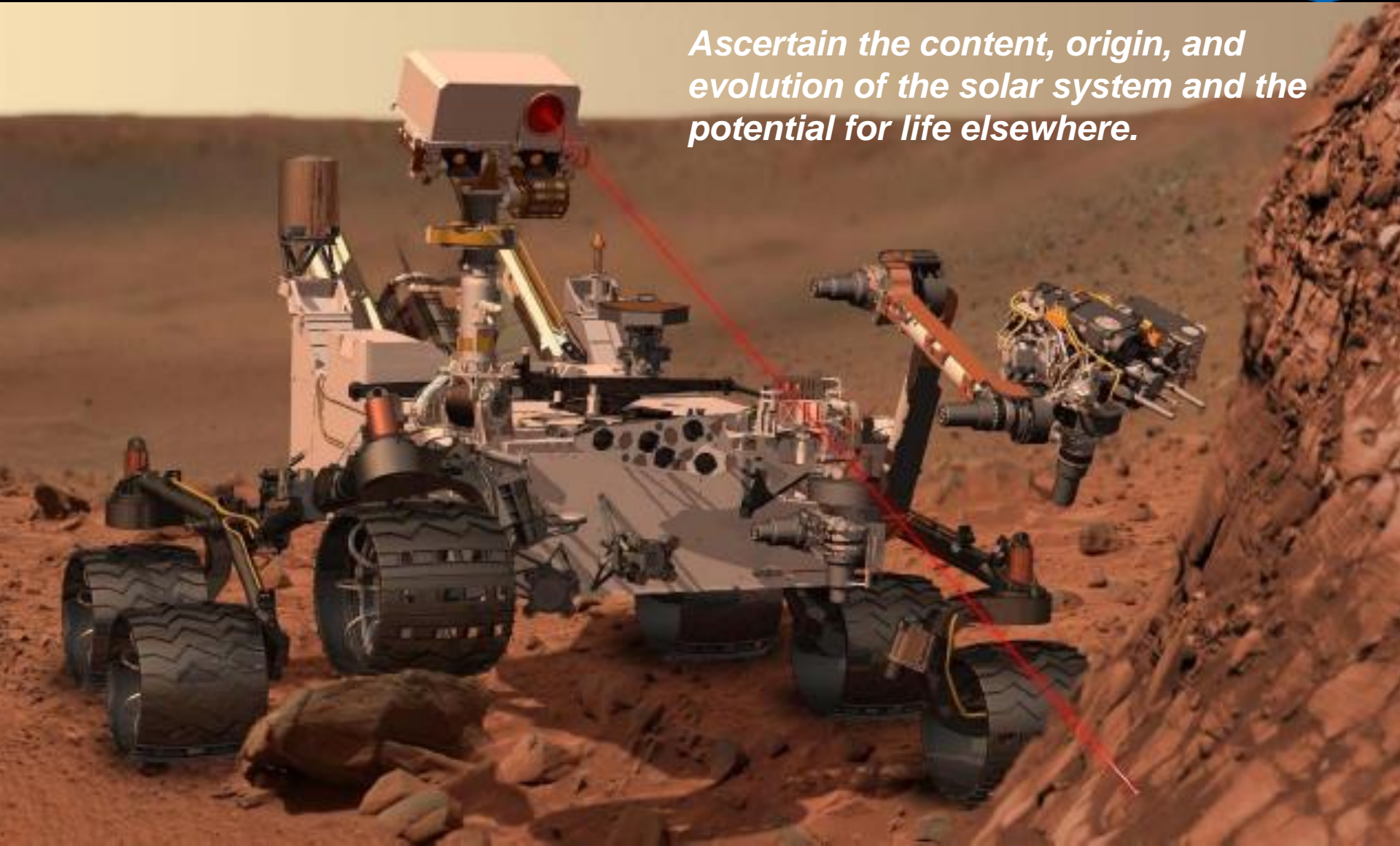



Strategic Principles for Sustainable Exploration

- Implementable in the ***near-term with the buying power of current budgets*** and in the longer term with budgets commensurate with economic growth;
- ***Exploration enables science and science enables exploration, leveraging robotic expertise for human exploration of the solar system***
- Application of ***high Technology Readiness Level*** (TRL) technologies for near term missions, while focusing sustained investments on ***technologies and capabilities*** to address challenges of future missions;
- ***Near-term mission opportunities*** with a defined cadence of compelling and integrated human and robotic missions providing for an incremental buildup of capabilities for more complex missions over time;
- Opportunities for ***U.S. commercial business*** to further enhance the experience and business base;
- ***Multi-use, evolvable*** space infrastructure, minimizing unique major developments, with each mission leaving something behind to support subsequent missions; and
- Substantial ***international and commercial participation***, leveraging current International Space Station and other partnerships.

EVOLVABLE MARS CAMPAIGN

A Pioneering Approach to Exploration



EARTH RELIANT

PROVING GROUND

EARTH INDEPENDENT

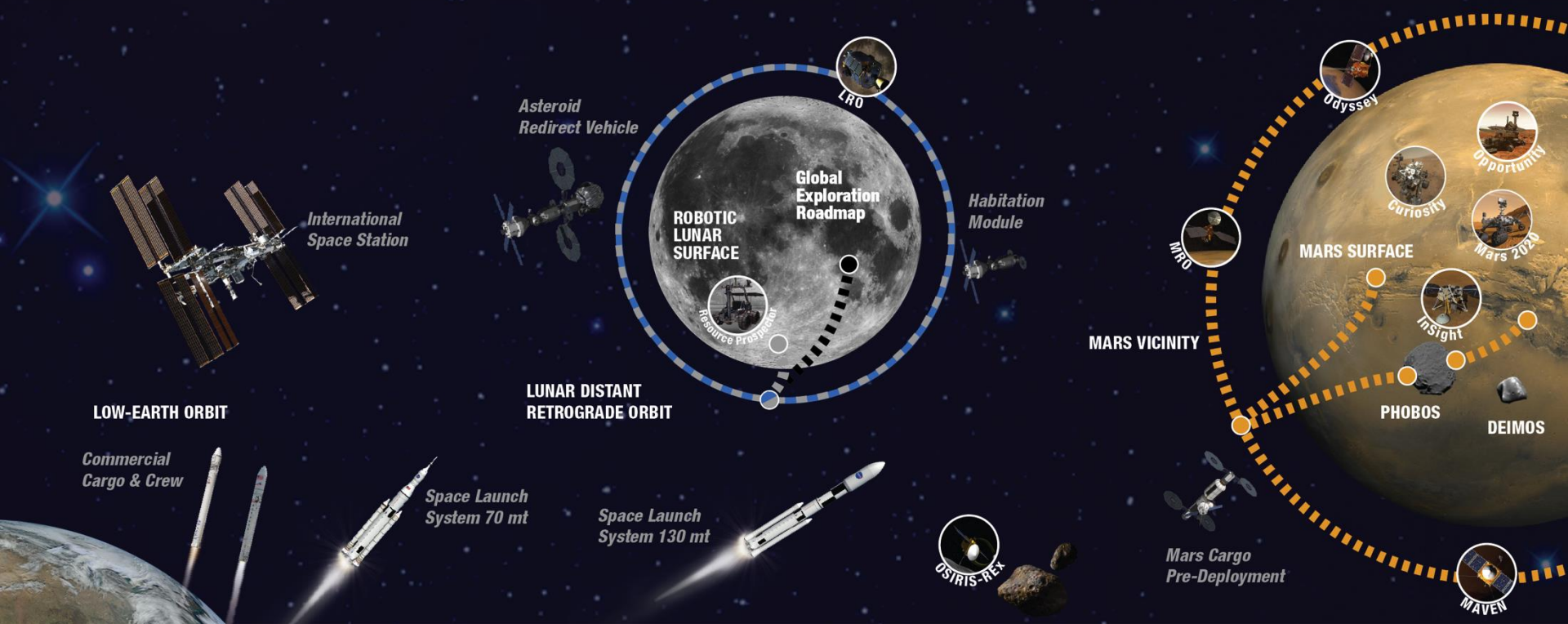

THE TRADE SPACE

Across the Board | Solar Electric Propulsion • In-Situ Resource Utilization (ISRU) • Robotic Precursors • Human/Robotic Interactions • Partnership Coordination • Exploration and Science Activities

Cis-lunar Trades | • Deep-space testing and autonomous operations
• Extensibility to Mars
• Mars system staging/refurbishment point and trajectory analyses

Mars Vicinity Trades | • Split versus monolithic habitat
• Cargo pre-deployment
• Mars Phobos/Deimos activities
• Entry descent and landing concepts
• Transportation technologies/trajectory analyses

Evolvable Mars Campaign

EMC Goal: Define a pioneering strategy and operational capabilities that can extend and sustain human presence in the solar system including a human journey to explore the Mars system starting in the mid-2030s.

- Identify a plan that:
 - Expands human presence into the solar system to advance exploration, science, innovation, benefits to humanity, and international collaboration.
 - Provides different future scenario options for a range of capability needs to be used as guidelines for near term activities and investments
 - In accordance with key strategic principles
 - Takes advantage of capability advancements
 - Leverages new scientific findings
 - Flexible to policy changes
 - Identifies linkages to and leverage current investments in ISS, SLS, Orion, ARM, habitation module, technology development investments, science activities
 - Emphasizes repositioning and reuse/repurposing of systems when it makes sense
 - Use location(s) in cis-lunar space for aggregation and refurbishment of systems

Internal analysis team members:

- ARC, GRC, GSFC, HQ, JPL, JSC, KSC, LaRC and MSFC
- HEOMD, SMD, STMD, OCS and OCT

External inputs from:

- International partners, industry, academia, SKG analysis groups

PROVING GROUND OBJECTIVES



Enabling Human Missions to Mars

VALIDATE through analysis and flights

- ✓ Advanced Solar Electric Propulsion (SEP) systems to move large masses in interplanetary space
- ✓ Lunar Distant Retrograde Orbit as a staging point for large cargo masses en route to Mars
- ✓ SLS and Orion in deep space
- ✓ Long duration, deep space habitation systems
- ✓ Crew health and performance in a deep space environment
- ✓ In-Situ Resource Utilization in micro-g
- ✓ Operations with reduced logistics capability
- ✓ Structures and mechanisms

CONDUCT

- ✓ EVAs in deep space with sample handling in micro-g
- ✓ Integrated human and robotic mission operations
- ✓ Capability Pathfinder and SKG missions

EMC

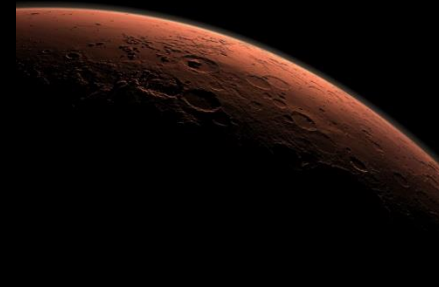

- ✓ Leverages current investments in ISS, SLS, Orion, ARM, and habitation, technology development, science activities
- ✓ Emphasizes prepositioning and reuse/repurposing of systems

Major Results to Date



- **Regardless of Mars vicinity destination, common capability developments are required**
 - Mars vicinity missions selection not required before 2020
- **ISS provides critical Mars mission capability development platform**
- **Lunar DRO is efficient for aggregation and potential refurbishment due to stable environment**
 - Use of gravity assist trajectories enable use of DRO
- **Orion Block 1 is sufficient for Mars architectures with reusable habitats**
- **SLS co-manifested cargo capability increases value of crewed missions and improves cadence**
- **Deep-space habitation serves as initial starting point regardless of implementation or destination**
- **ARV derived SEP vehicle can serve as an effective tool for human Mars missions**
 - Reusability can enable follow-on use in cis-lunar space
 - Refuelability under study to enable Mars system follow-on use
 - Current SEP evolvability enables Mars system human missions
- **Mars Phobos /Deimos as initial Mars vicinity mission spread out development costs and meets policy objectives of Mars vicinity in 2030's**
 - Common crew transportation between Mars Phobos / Deimos and Mars Surface staging
 - Phobos provides 35% reduction of radiation exposure compared to other Mars orbit missions
 - Provides ability to address both exploration and science objectives
 - ARM returned asteroid at Lunar DRO serves as good location for testing Mars moon's operations

Mars Vicinity Missions Provide the “Pull”

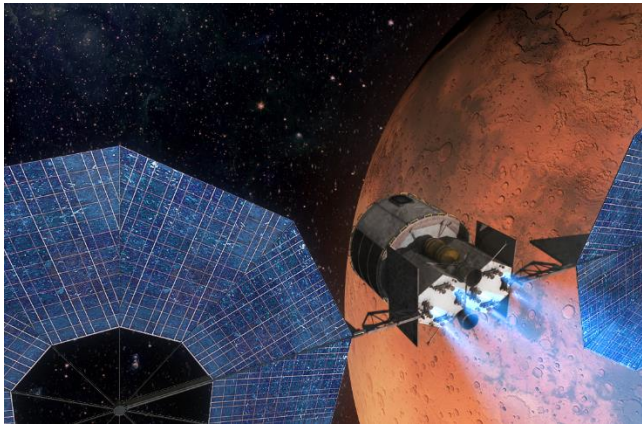

Mars Orbit

- Opportunities for integrated human-robotic missions:
 - Real time tele-operation on Martian surface
 - Mars sample return
- Demonstrate sustainable human exploration split-mission Mars concept
- Validate transportation and long-duration human systems
- Validate human stay capability in zero/micro-g

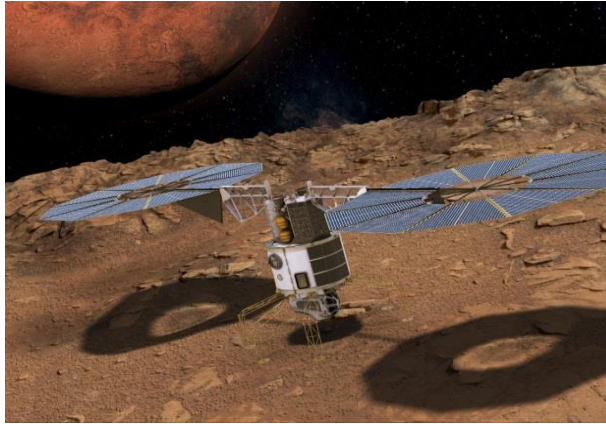

Mars Moons

- Opportunities for integrated human-robotic missions:
 - Real time tele-operation on Martian surface
 - Mars & moons sample return
- Demonstrate sustainable human exploration split-mission Mars concept
- Moons provides additional radiation protection
- In-situ resource utilization
- Validate human stay capability in low-g



Mars Surface

- Opportunities for integrated human-robotic missions:
 - Search for signs of life
 - Comparative planetology
 - Understanding Mars climate changes
 - Geology/geophysics
- Planet provides radiation protection
- Entry, descent, landing
- EVA surface suits
- In-situ resource utilization
- Validate human stay capability in partial-g

Cis-Lunar Space: How the Earth and the Moon Interact

The contours on the plot depict energy states in the Earth-Moon System and the relative difficulty of moving from one place to another.

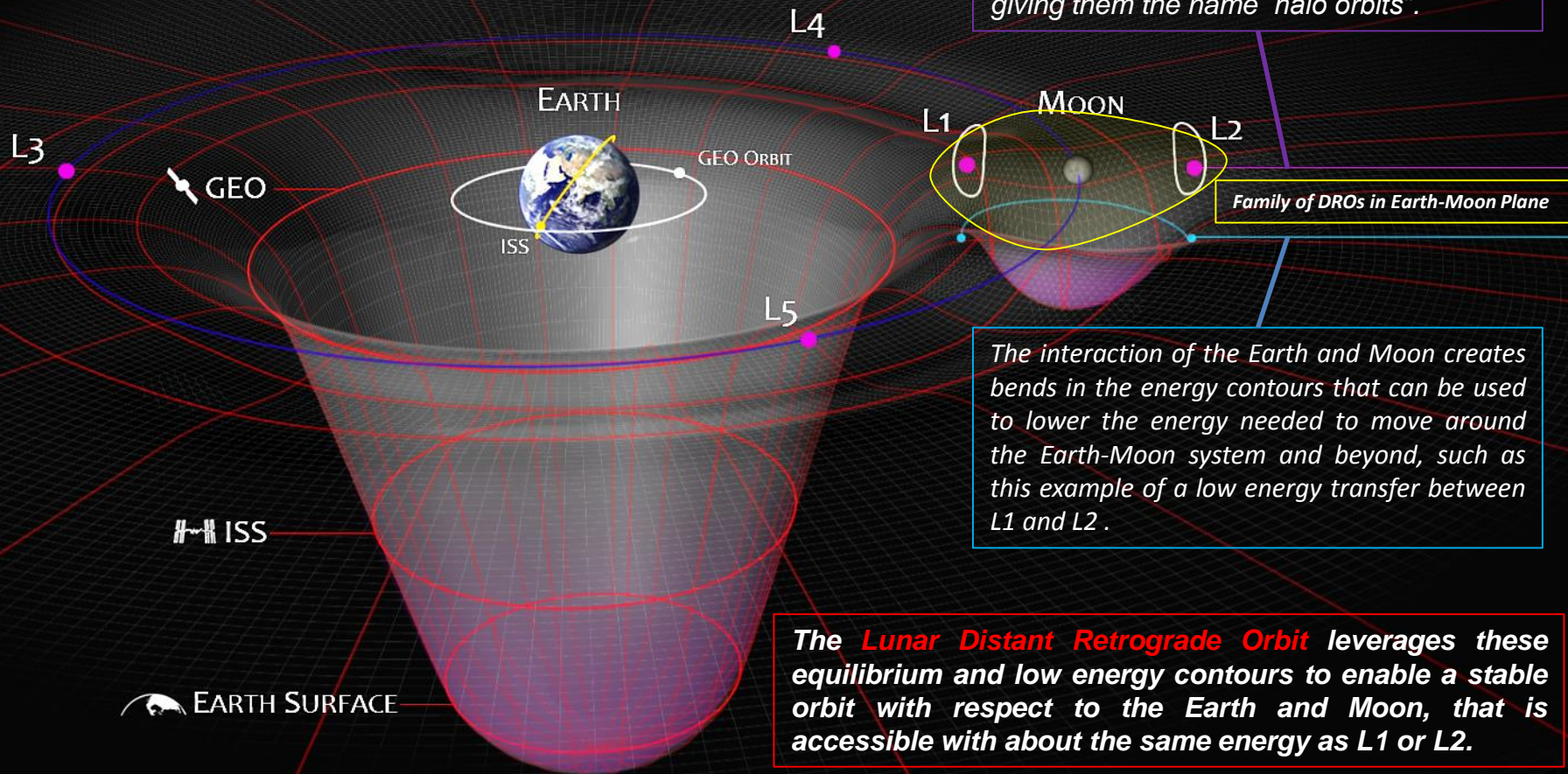

A spacecraft at L2 is actually orbiting Earth at a distance just past the Moon, however if you look at it from the Moon, the orbit will look like an ellipse around a point in space giving them the name “halo orbits”.

Family of DROs in Earth-Moon Plane

The interaction of the Earth and Moon creates bends in the energy contours that can be used to lower the energy needed to move around the Earth-Moon system and beyond, such as this example of a low energy transfer between L1 and L2 .

The **Lunar Distant Retrograde Orbit** leverages these equilibrium and low energy contours to enable a stable orbit with respect to the Earth and Moon, that is accessible with about the same energy as L1 or L2.

SLS Block 1B & Mission Element Concepts Under Study

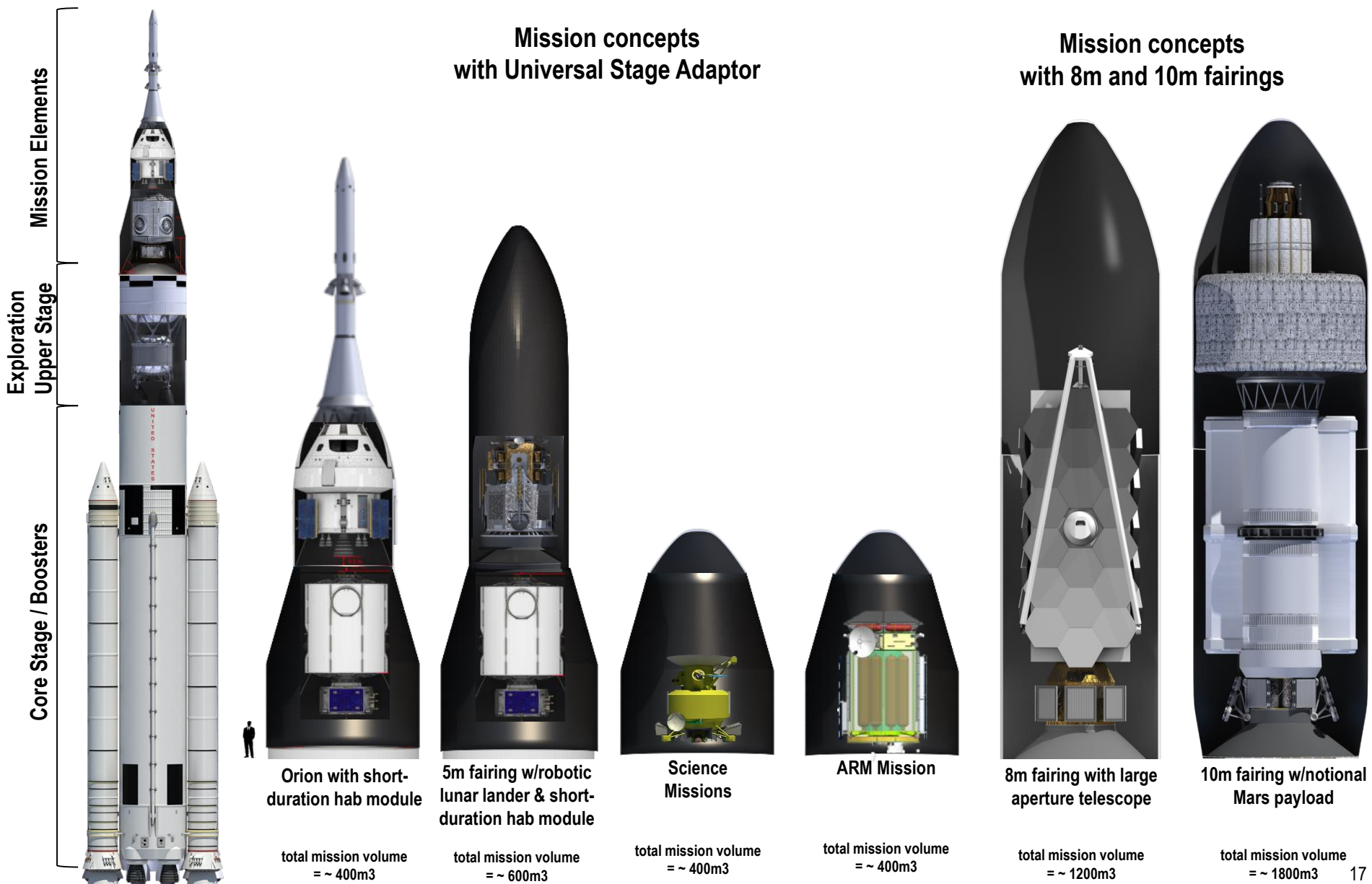

ARM is a Stepping Stone to Higher Power SEP Needed to Support Human Missions to Mars

ARM

Cis-Lunar Mission

Mars Moons

Mars Surface

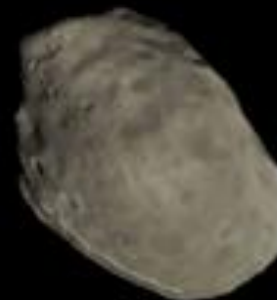
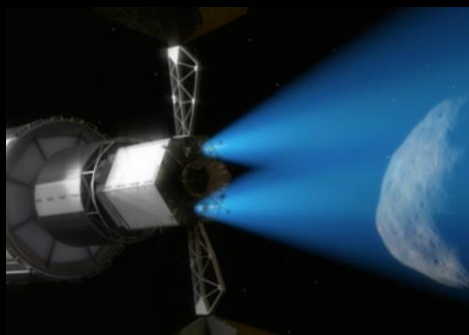

Deep Space 1

Dawn

ARM

SEP
Mars Cargo

Chem/SEP
Mars Crew

1

10

100

1000

Solar Array Power (kW)

Energy Comparison with SSME



SSME



x 3

$I_{sp} = 453 \text{ s}$

$Thrust = 2090 \text{ kN}$

$P = 13,900,000 \text{ kW}$ (all 3 engines)

Burn Time: 8 minutes

$Energy = 1,860,000 \text{ kW-hrs}$ (all 3 engines together)

Propellant Mass: $835,000 \text{ kg}$

300-kW SEP

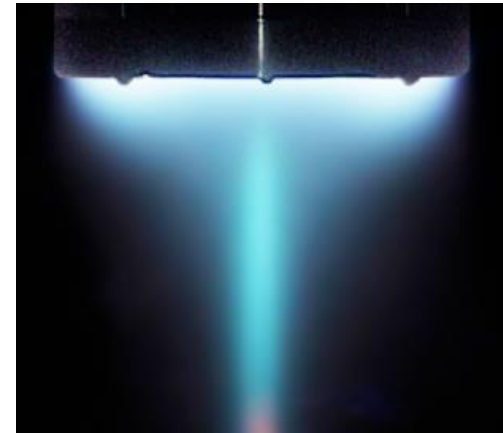

x 6

$I_{sp} = 2000 \text{ s}$

$Thrust = 18 \text{ N}$ (all 6 engines)

$P = 195.3 \text{ kW}$ (all 6 engines)

Burn Time: 10,000 hours

$Energy = 1,950,000 \text{ kW-hrs}$ (all 6 engines together)

Propellant Mass: $32,500 \text{ kg}$

EMC Ground Rules & Constraints



- Humans to the Mars System by mid-2030's
 - Could imply Orbital, Phobos/Deimos and/or Surface
 - Mars Mission opportunities throughout the 2030s will be evaluated to avoid overly restrictive mission availability
- Propulsion technology will utilize solar-electric systems extensible from the Asteroid Redirect Vehicle (ARV) spacecraft bus
- SLS Block 2B launch vehicle will be available (4xRS25 Core + EUS + Advanced Boosters + 10-m shroud)
- Orion spacecraft will be available
- SLS/Orion launch rate of 1 per year is sustainable
- Vehicle checkout/aggregation in cis-lunar space may be advantageous
- Crew of four to Mars system assumed
- Crewed vehicle reusability is highly desirable for sustainability and potential cost advantages

FY2015 EMC Questions/Work Groups (A-F)



A. How do we pioneer an extended human presence on Mars that is Earth independent?

- In-situ Resource Utilization to reduce logistics chain and increase sustainability

B. What are the objectives, engineering, and operational considerations that drive Mars surface landing sites?

- Mars exploration and science objectives
- Landing Site Requirements and Constraints

C. What sequence(s) of missions do we think can meet our goals and constraints?

- Will concepts satisfy the strategic principles?

D. Is a reusable Mars transportation system viable?

- Can an evolved ARV provide required function of in-space transportation to transport to Mars vicinity?
- Reuse of habitat - Can a 1000 day habitat be refurbished and reused for multiple missions?
 - Can the in-space habitat be used on Phobos?

E. Can ARV derived SEP support Mars cargo delivery requirements?

- Human class Mars lander
 - Can surface exploration be accomplished with an 18t lander? 27t?
 - Can an EDL system be developed for 18t lander? 27t?

F. How can we maximize commonality across Mars ascent, Mars vicinity taxi, exploration vehicle and initial deep-space habitation component?



G. What are the required capability investments for the EMC over the next five years?

- What are the capabilities that need to be developed prior to sending crew to Mars vicinity?
 - What are the capabilities that need to be tested on ISS?
 - What are the capabilities that need to be tested in cis-lunar space?

H. What is the appropriate habitation system?

- What functions do habitation systems need to be able to perform?
- Architecture sensitivities of transit habitat mass and volume
- Identify evolvability of habitation systems into Mars architecture to include identification of functional requirements.

I. Is Phobos a viable human target?

- Concepts for Mars moon exploration by crew
 - Phobos exploration and *notional* science objectives
 - Potential exploration sites
- What are the strategic knowledge gaps at Mars moons and potential pathfinder concepts?

J. What are potential Mars surface pathfinder concepts?

K. What capabilities are needed to enable elements to survive long dormancy periods in space?

L. What communications capabilities are needed?

M. Can humans survive 1000 days in deep space?



- **ISRU implementation is phased to minimize risk to human exploration plans**
 - **Prospect and Demonstrate** – *Mission Feasibility*
 - Evaluate potential exploration sites: terrain, geology/resources, lighting, etc.
 - Demonstrate critical technologies, functions, and operations
 - Evaluate environmental impacts and long-term operation on hardware: dusty/abrasive/electrostatic regolith, radiation/solar wind, day/night cycles, polar shadowing, etc.
 - **Pilot Scale Operation** – *Mission Enhancement*
 - Perform critical demonstrations at scale and duration to minimize risk of utilization
 - Obtain design and flight experience before finalizing human mission element design
 - Pre-deploy and produce product before crewed missions arrive to enhance mission capability
 - **Utilization Operations** – *Mission Enabling*
 - Produce at scale to enable ISRU-fueled reusable landers and support extended duration human surface operations
 - Commercial involvement or products bought commercially based previous mission results
- **Identify technologies and systems for multiple applications (ISRU, life support, power) and multiple mission (Moon, Mars, NEOs)**
- **Multinational involvement based on expertise and long-term objectives**

Mars Site Selection: Early Stages of SMD/HEOMD Development



- **SMD and HEOMD initiated a collaborative site selection study in Dec. 2014.**
 - Co-chaired by Rick Davis (SMD) and Ben Bussey (HEOMD)
- **Forward work in FY2015:**
 - Identify existing work to identify a set of sites that would meet both human exploration and science requirements.
 - Identify those that have not yet been imaged by MRO and prioritize future observations
 - Refine HEOMD preliminary human landing site requirements
 - Jointly present Human Exploration Landing Site study at the MEPAG Mars 2020 site selection workshop in Aug. 2015

2015 Human Landing Sites Study

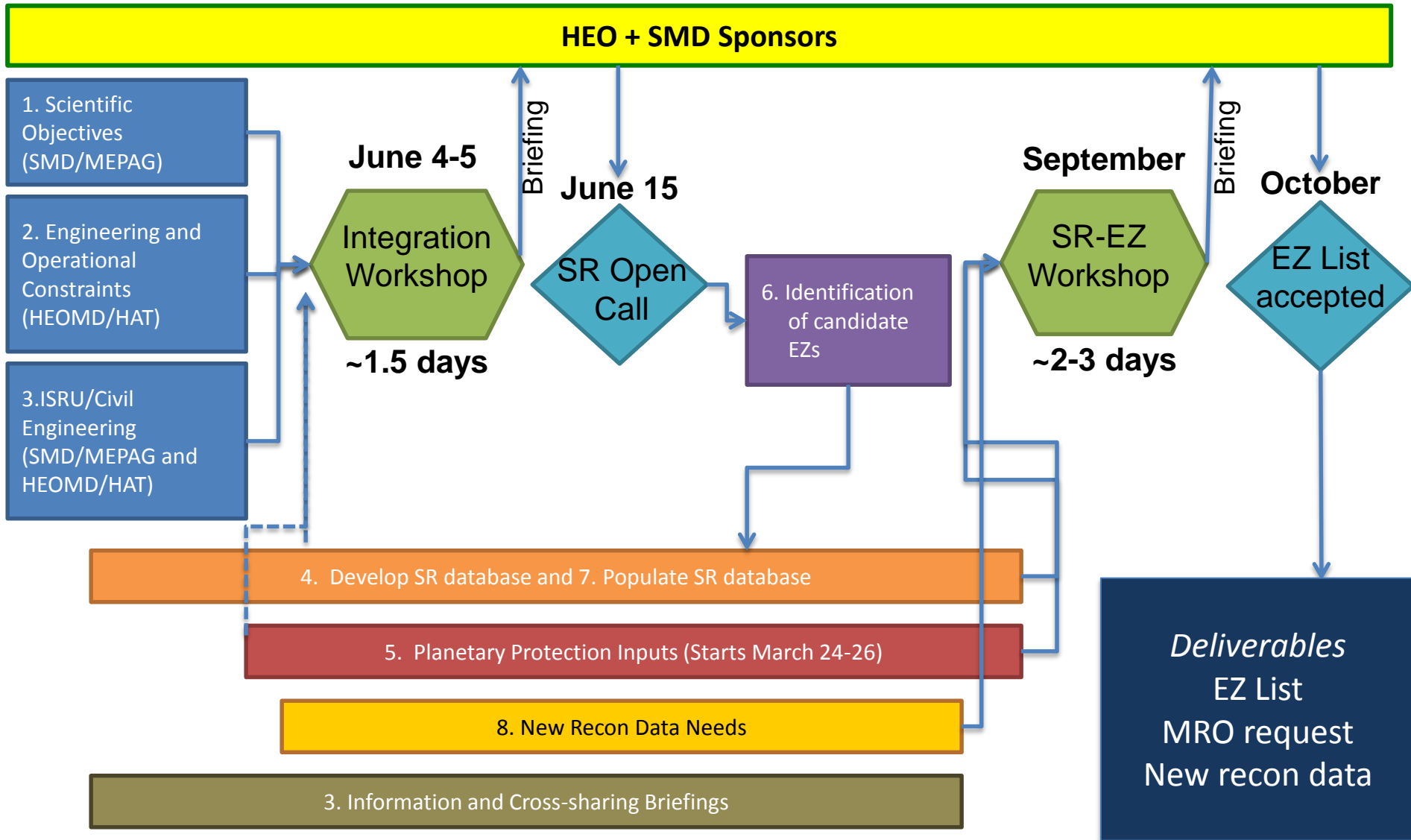

SR = Science Region-Exploration Zone Region

EZ = Exploration Zones

SEP Module Extensibility for Mars

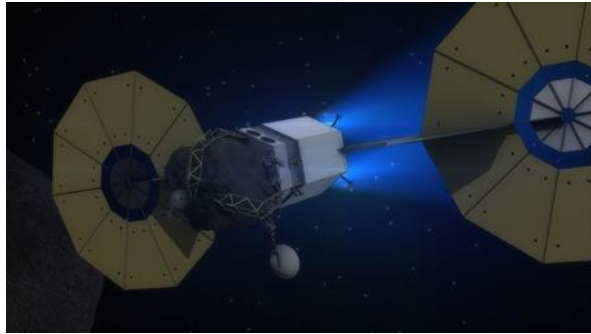

Block 1

- 50-kW Solar Array
- 40-kW EP System
- 10-t Xenon Capacity

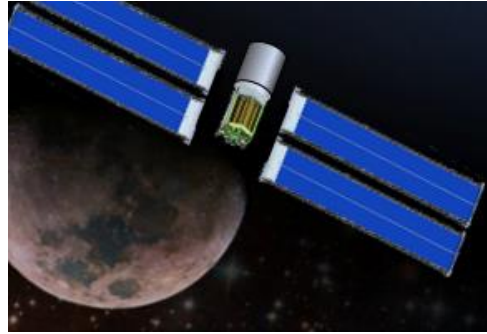

**Block 1a
(SEP/Chem)**

- 190-kW Solar Array
- 150-kW EP System
- 16-t Xenon Capacity

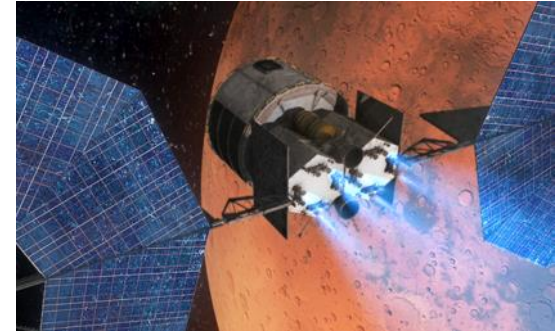

Hybrid

- 250 to 400-kW Solar Array
- 150 to 200-kW EP System
- 16-t Xenon Capacity With Xe Refueling Capability

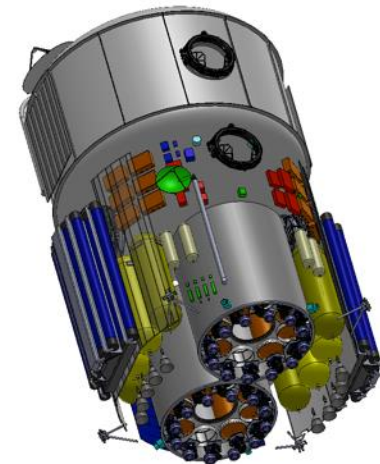
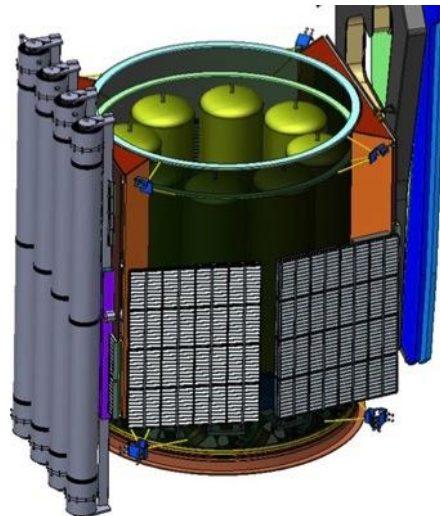
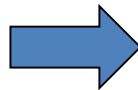
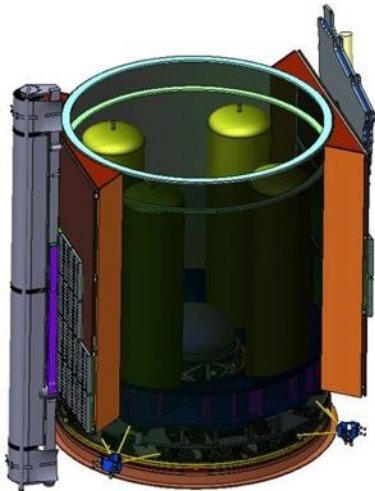

Largest Indivisible Payload Element and Options for Size of the Lander

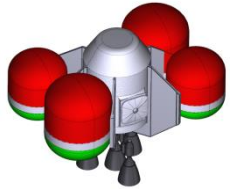

Inerts	10.5t
CH4	5.8t
LOX	19.2t
Total	35.5t

Payload Elements

Crew

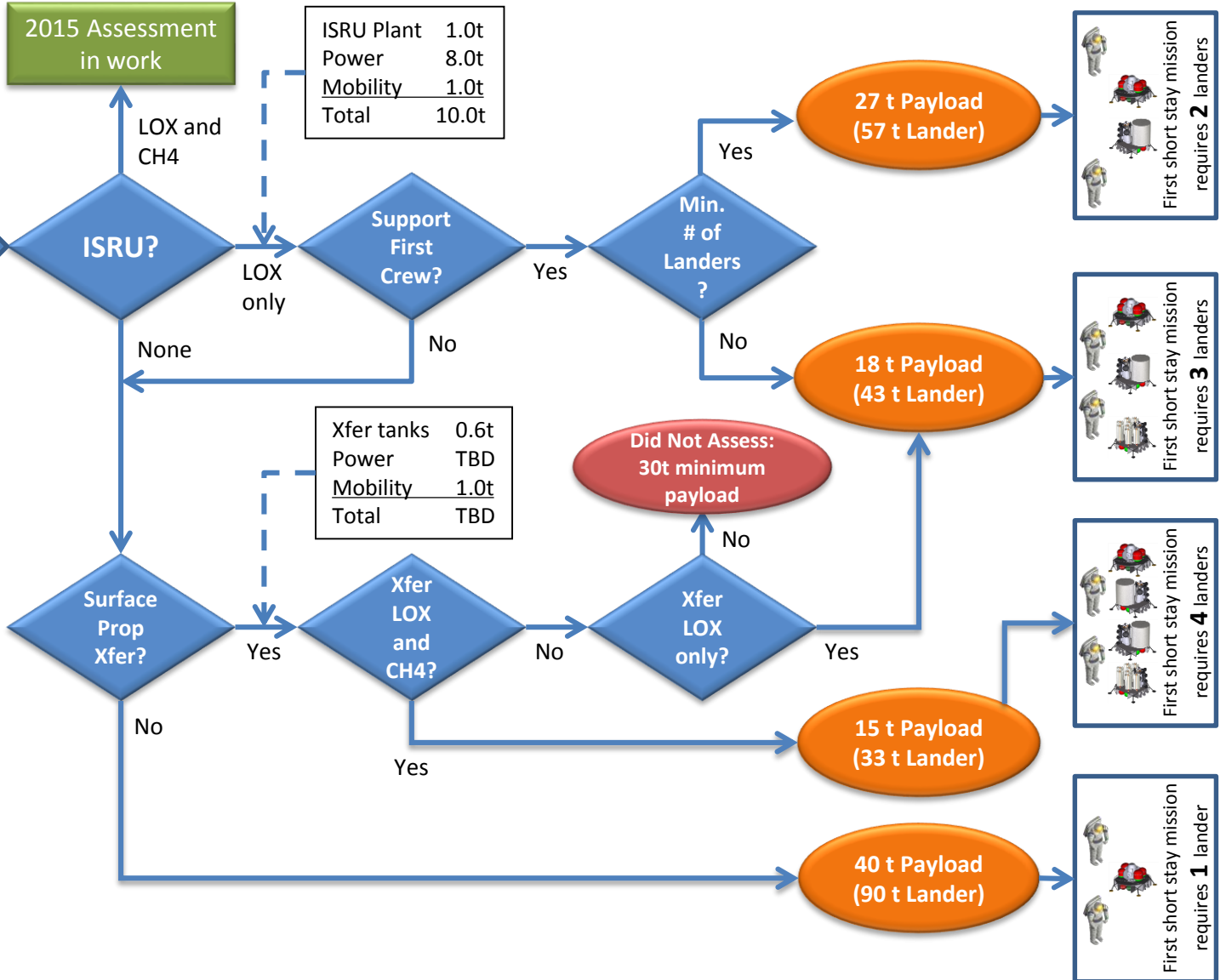

ISRU Plant	1.0t
Power	8.0t
Mobility	1.0t
Total	10.0t

Xfer tanks	0.6t
Power	TBD
Mobility	1.0t
Total	TBD

Minimum lander size driven by **Crew Ascent Stage**. Various techniques (and risks) for loading or producing propellant on Mars can reduce lander payload requirement from 40 t to 15 t (but increase number of landers required).

Lander Payload Options

Extensibility of Habitation Systems - Commonality



- Habitation systems are under study in the EMC and considered the next habitation system following Orion. The new system would serve as the foundation for deep space testing and proto-flight vehicle for smaller/short-duration Mars exploration systems
- Commonality can be leveraged across two major classes of vehicles:
 - Short duration/destination – initial deep-space habitation, Phobos Taxi, logistics carriers, Mars Surface/Phobos Mobility, Mars/Lunar Ascent, and possibly airlocks
 - Long duration – Transit Habitat, Phobos Habitat, Mars Surface Habitat



Hab and logistics carriers constrained by early cargo capability (SLS cargo with crew and EELVs - ~4.6m x 10m)

30 – 60 Days

Short Duration



Logistics Carriers



Phobos Taxi



Mars Surface/Phobos Mobility



Mars/Lunar Ascent Vehicle Cabin

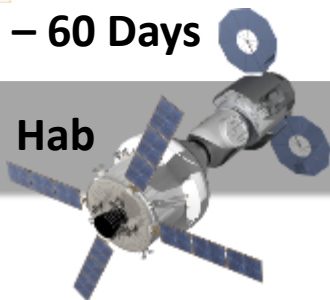

Hab

Transit/Phobos Hab
(docked to hab)

Phobos Hab

Mars Surface Habitat

Long Duration

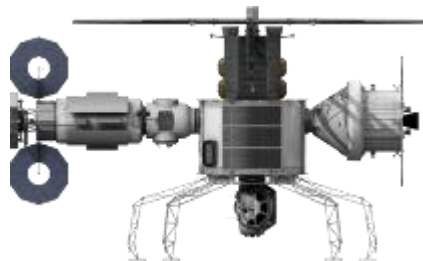

500 Days

Extensibility of Habitation Systems - Modularity



- **Two paths for long duration habitation modularity**

- **Right to Left:** Derive common long duration habitat systems and pressure shell commonality options from Mars lander and Phobos habitat transportation system (SEP) constraints.

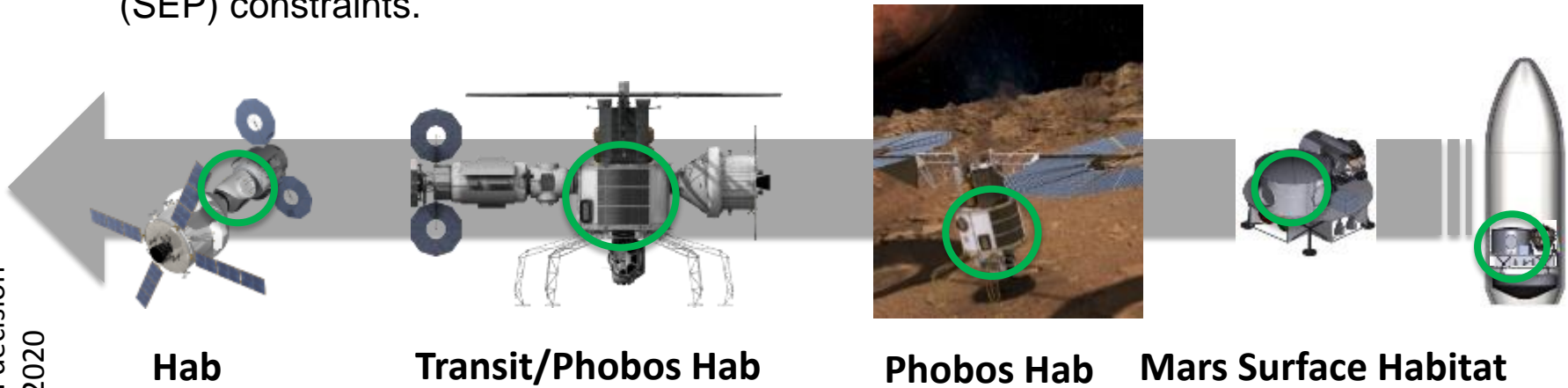

Habitat is common to either approach. Approach decision not needed before 2020

- **Left to Right:** Build up long duration, in-space habitats from initial cis-lunar habitats, logistics carriers, and inflatables launched in sections that fit in SLS crew cargo area and aggregated in LDRO

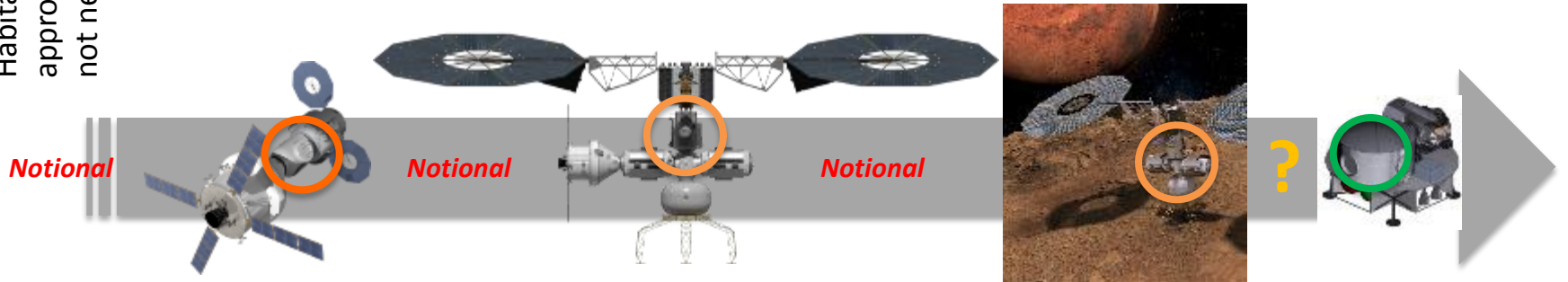

Commercial Opportunities in Space with NASA

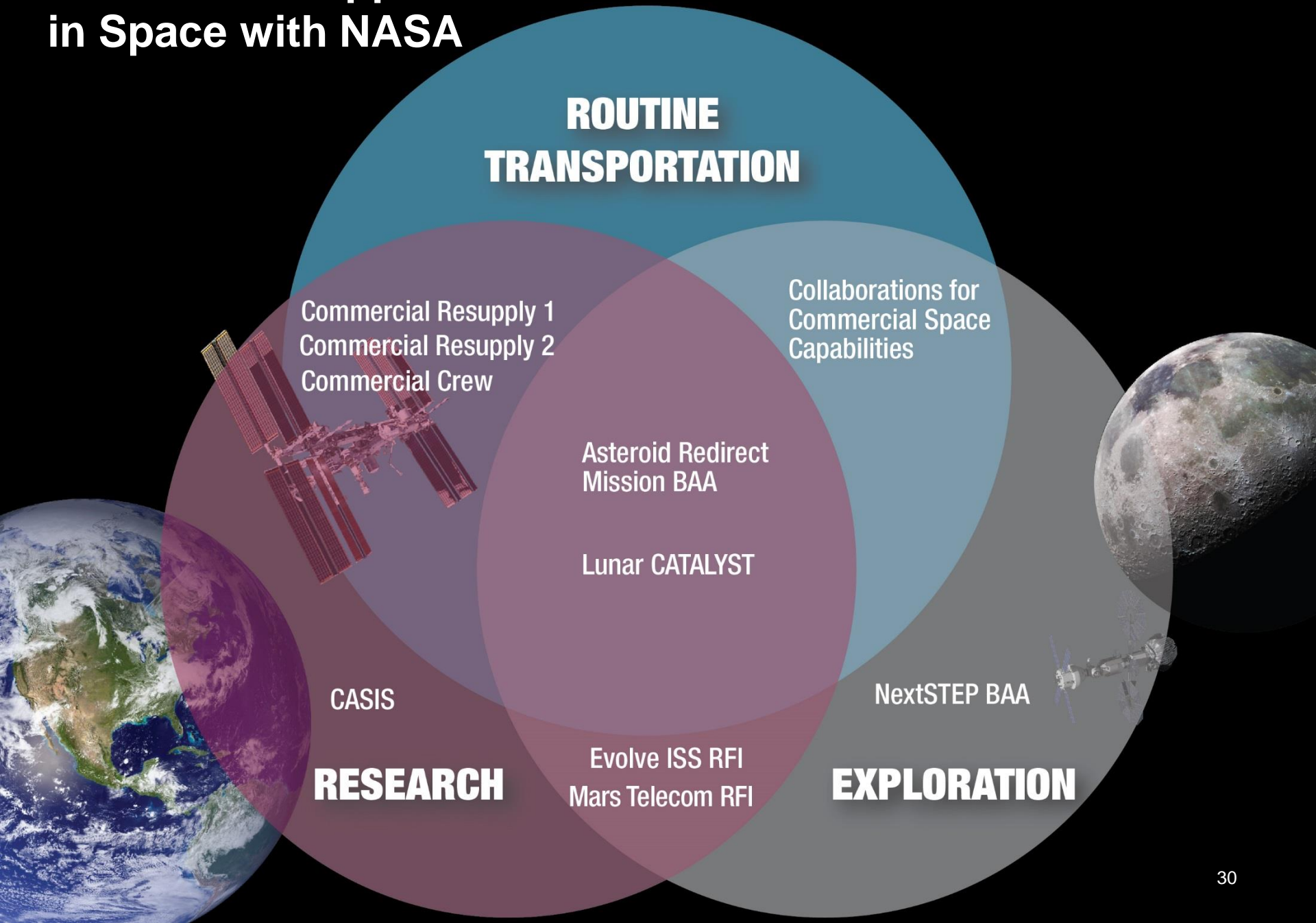

ROUTINE TRANSPORTATION

Commercial Resupply 1
Commercial Resupply 2
Commercial Crew

Collaborations for
Commercial Space
Capabilities

Asteroid Redirect
Mission BAA

Lunar CATALYST

CASIS

RESEARCH

Evolve ISS RFI
Mars Telecom RFI

NextSTEP BAA

EXPLORATION

NextSTEP BAA Overview



- **Solicited three critical areas for technology maturation:**
 - Advanced Propulsion Systems
 - Habitation Systems (Including Life Support)
 - Small Satellite Missions (EM-1 secondary payloads)
- **Facilitates development of deep space human exploration capabilities in the cis-lunar proving ground and beyond**
- **Continues successful public-private partnership model and spurs commercial endeavors in space**
- **Selected 12 proposals and will proceed to enter into *Fixed Price Contracts* with technical/payment milestones with private-sector partners**
 - Emphasis for eligibility and execution placed on contribution of private corporate resources to the private-public partnership to achieve goals and objectives
 - Selected partners with the technical capability to mature key technologies and demonstrate commitment toward potential commercial application



NextSTEP: Two BAA Small Satellite Awards



Two CubeSat projects will address Strategic Knowledge Gaps

Morehead State University
Morehead, KY

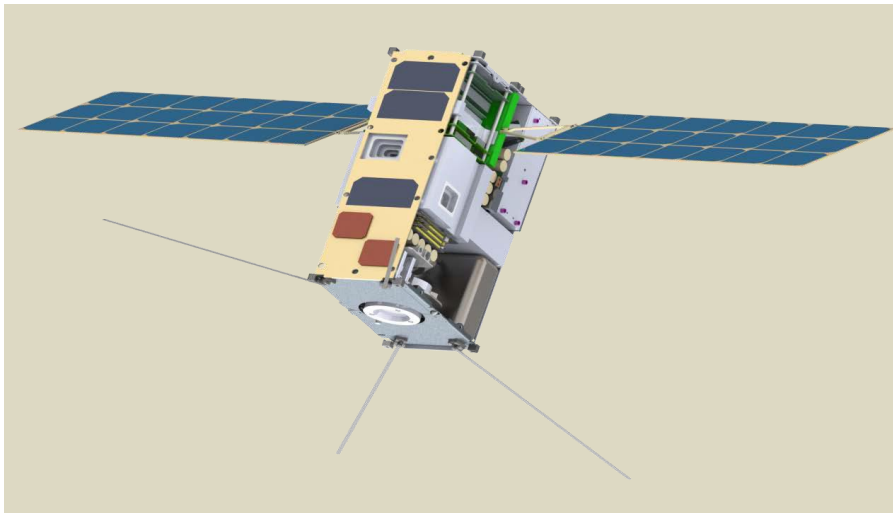

6U Lunar IceCube

Prospect for water in ice, liquid, and vapor forms and other lunar volatiles from a low-perigee, highly inclined lunar orbit using a compact IR spectrometer

Lockheed Martin
Denver, CO

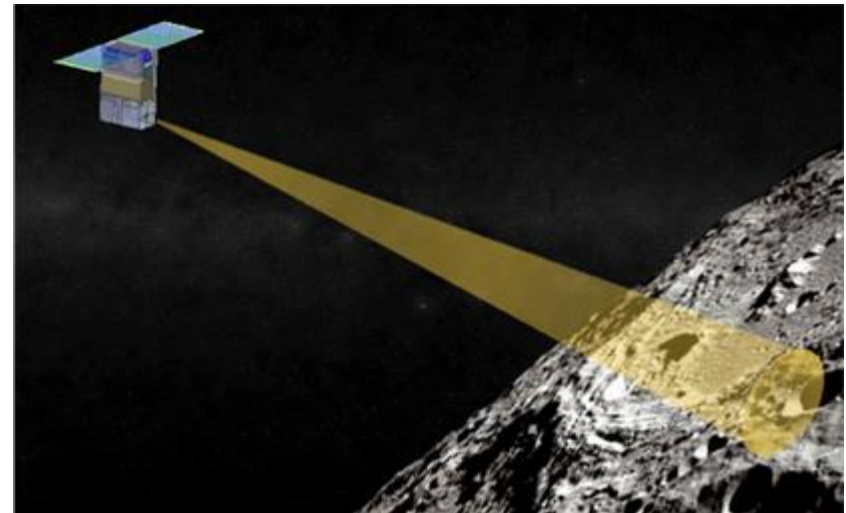

Skyfire 6U CubeSat

GEO Technology Demo
Will perform lunar flyby, collecting spectroscopy and thermography address both Moon and Mars SKGs for surface characterization, remote sensing, and site selection.

NextSTEP BAA: Three Propulsion Awards



Developing propulsion technology systems in the 50- to 300-kW range to meet the needs of a variety of deep-space mission concepts

Ad Astra Rocket Company
Webster, Texas

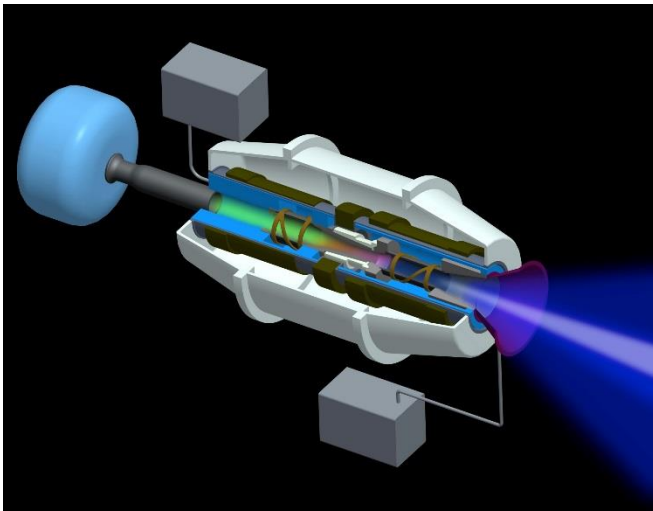

Thermal Steady State Testing of a VASIMR Rocket Core with Scalability to Human Spaceflight

Aerojet Rocketdyne Inc.
Redmond, Washington

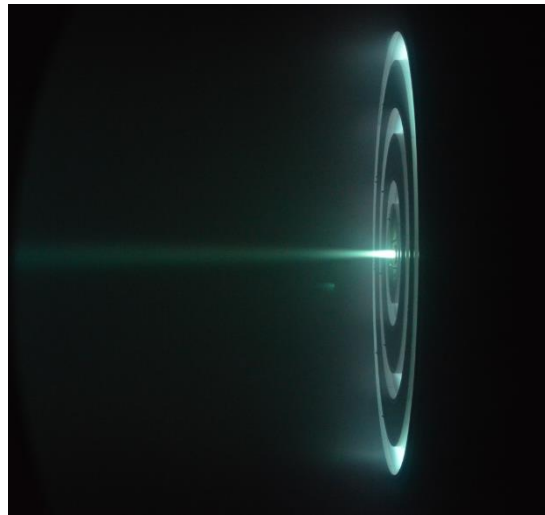

Operational Demonstration of a 100 kW Electric Propulsion System with 250 kW Nested Hall Thruster

MSNW LLC,
Redmond, Washington

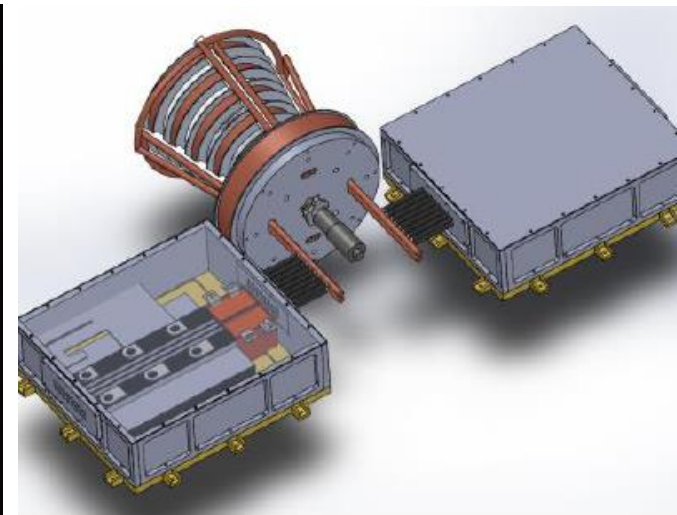

Flexible High Power Electric Propulsion for Exploration Class Missions

NextSTEP BAA: Seven Habitation Awards (1 of 3)



NASA awarded seven habitation projects. Four will address habitat concept development, and three will address Environmental Control and Life Support Systems (ECLSS)

Lockheed Martin
Denver, CO

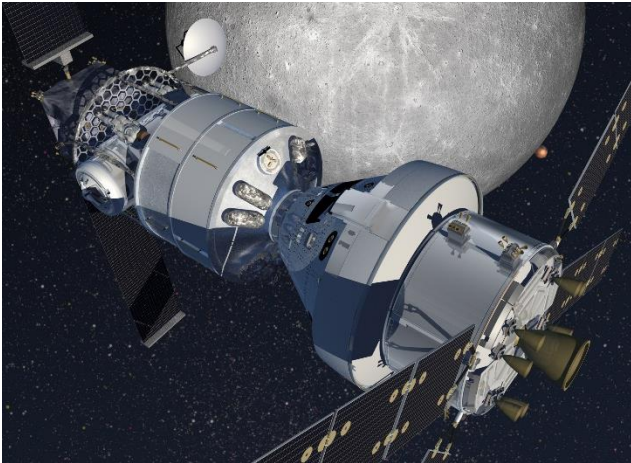

Habitat to augment Orion's capabilities. Design will draw strongly on LM and partner Thales Alenia's heritage designs in habitation and propulsion.

Bigelow Aerospace LLC
Las Vegas, NV



The B330 for deep-space habitation will support operations/missions in LEO, DRO, and beyond cis-lunar space

NextSTEP BAA Habitation Awards (2 of 3)



NASA awarded seven habitation projects. Four will address habitat concept development, and three will address Environmental Control and Life Support Systems (ECLSS)

Orbital ATK
Dulles, VA

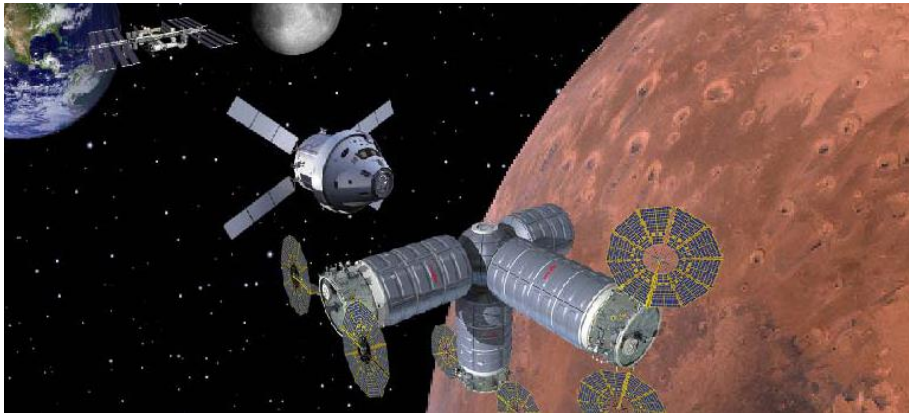

Habitat that employs a modular, building block approach that leverages the Cygnus spacecraft to expand cis-lunar and long duration deep space transit habitation capabilities and technologies

Boeing
Houston, TX

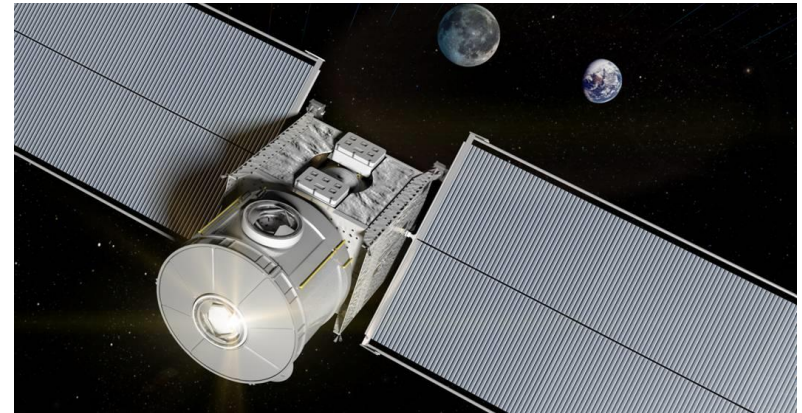

Developing a simple, low cost habitat that is affordable early on, allowing various technologies to be tested over time, and that is capable of evolving into a long-duration crew support system for cis-lunar and Mars exploration

NextSTEP BAA Habitation Awards (3 of 3)



NASA awarded seven habitation projects. Four will address habitat concept development, and three will address Environmental Control and Life Support Systems (ECLSS)

Dynetics, Inc Huntsville, AL

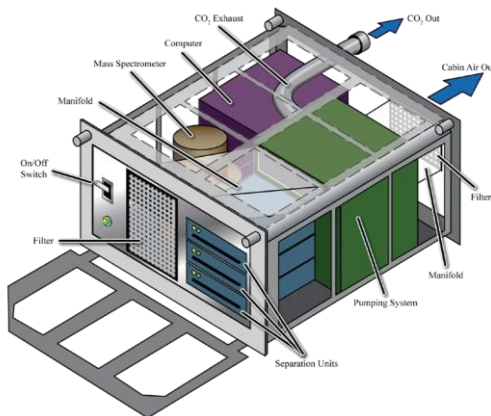

Miniature atmospheric scrubbing system for long-duration exploration and habitation applications. Separates CO₂ and other undesirable gases from spacecraft cabin air

Hamilton Sundstrand Space Systems International Windsor Locks, CT

Larger, more modular ECLSS subsystems, requiring less integration and maximize component commonality

Orbitec Madison, WI

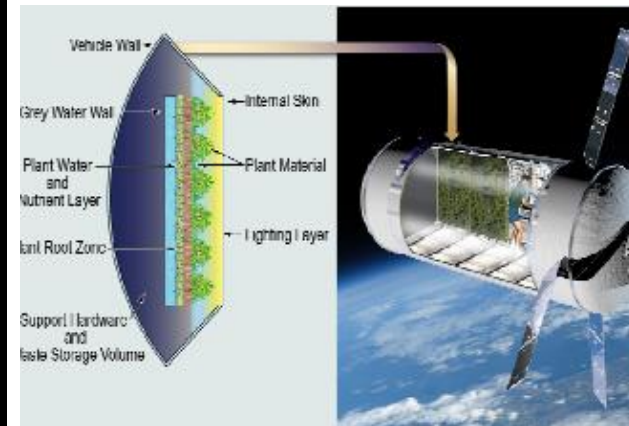

Hybrid Life Support Systems integrating established Physical/Chemical life support with bioproduction systems



- **The SMTs are a standing team of subject matter experts that have been asked to identify capability performance requirements for each Capability Driven Framework (CDF) mission class.**
 - Also used to review project proposals, recommendations for integrated ISS and ground testing and budget inputs for their perspective areas.
- **SMTs generated data sets identifying state-of-the-art technology performance parameters deemed necessary for exploration systems**
 - Used existing Design Reference Missions
 - Using data as input for OCT Agency technology road-mapping activity
 - Using data to engage international partners

NASA Technology Roadmaps & Investment Plan

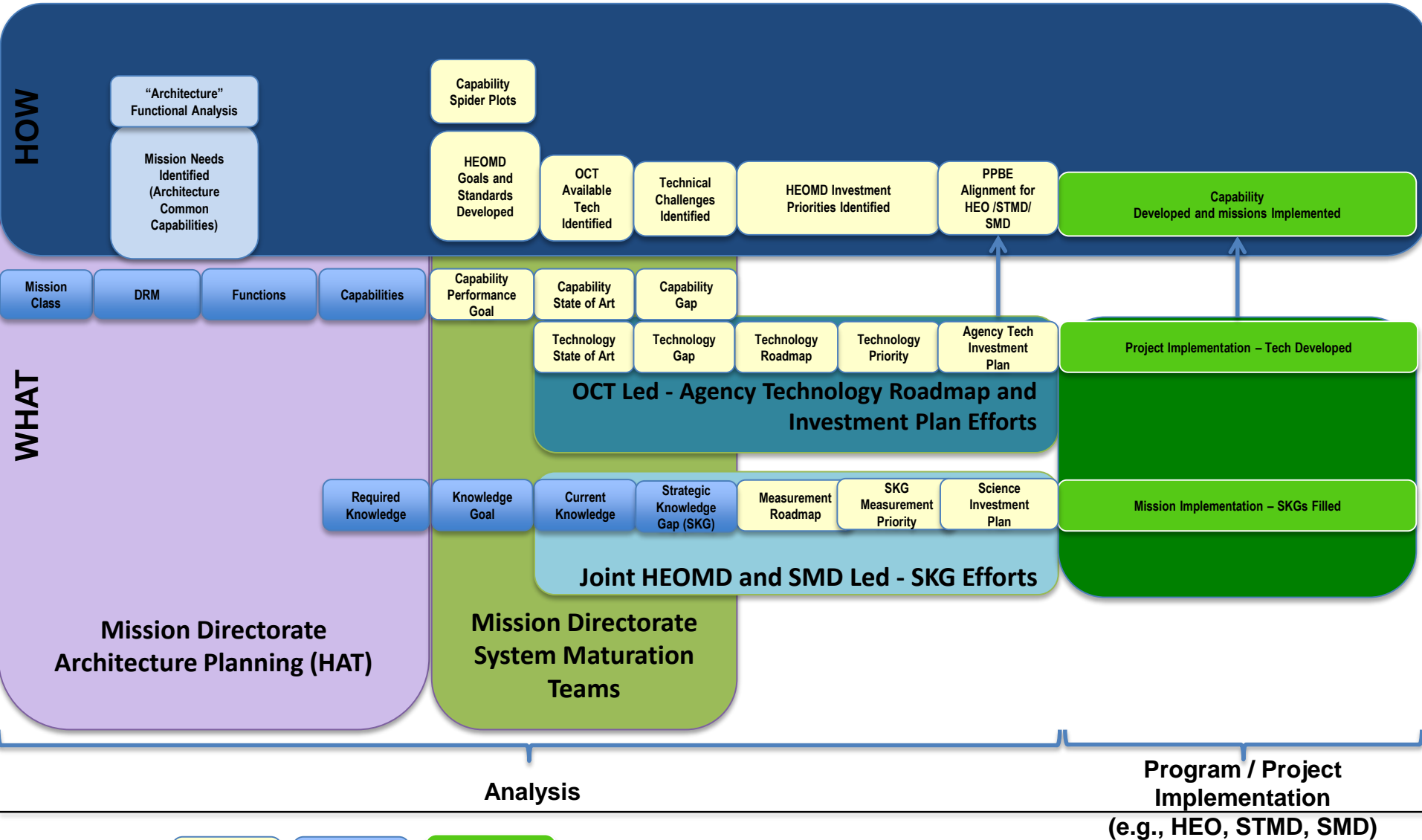

LEGEND



Achieving Alignment for Pioneering Space

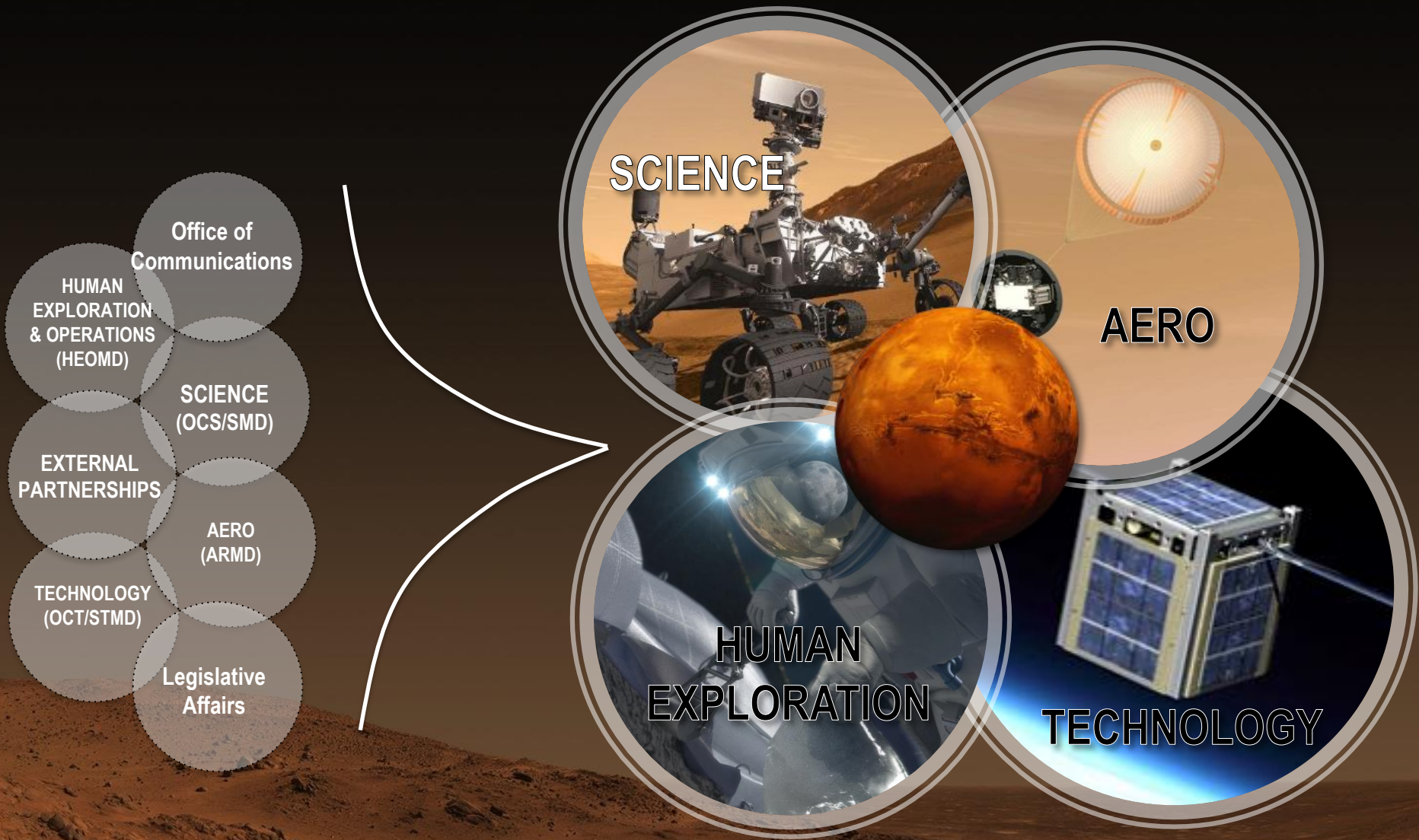

Commercial & International Partners • Other Government Agencies • Citizen Innovators

