

# DRM Introduction and Implementation Guide

 [www.drm.org](http://www.drm.org)

Revision 2  
September 2013

UPDATED

## IMPRESSUM

### The DRM Digital Broadcasting System Introduction and Implementation Guide

**Copyright:**

DRM Consortium, Postal Box 360, CH – 1218 Grand-Saconnex, Geneva, Switzerland

All rights reserved. No part of this publication may be reproduced or transmitted, in any form or by any means, without permission.

**Published and produced**

by the DRM Consortium

**Editor:**

Nigel Laffin

**Date of Publication:**

Revision 2, 13th September 2013

**Designed by:**

Matthew Ward

**For inquiries and orders contact:**

projectoffice@drm.org

[www.drm.org](http://www.drm.org)

---

**Registered address:**

DRM Consortium, PO BOX 360, CH – 1218, Grand-Saconnex,  
Geneva, Switzerland

**DRM Project Office,**

C/o BBC Global News

3rd Floor, Brock House, 19 Langham Street, London, W1A 1AA

Phone: +44 (0)20-36142310

e-mail: [pressoffice@drm.org](mailto:pressoffice@drm.org)



@drmdigitalradio



[www.facebook.com/digitalradiomondiale.drm](http://www.facebook.com/digitalradiomondiale.drm)

# The DRM Digital Broadcasting System

## Introduction and Implementation Guide

### PREFACE

This guide is aimed at the management of broadcasting organisations in areas of policy making as well as in programme making and technical planning. It explains in some detail the advantages gained by radio broadcasters introducing the DRM® Digital Radio Mondiale™ technology and some of the technical and commercial considerations they need to take into account in formulating a strategy for its introduction.

The guide is a development of the previous 'Broadcast User Guide' and includes information on latest system and regulatory aspects for the introduction of the various DRM system variants. It also includes links to reports and articles on an extensive range of highly successful real-life trials.

Digital Radio Mondiale (DRM) is the universal, openly standardised digital broadcasting system for all broadcasting frequencies up to 240 MHz, including the AM bands (LW, MW, SW) and VHF bands I, II (FM band) and III.

DRM is greener, clearer, wider, bigger, better quality & audio content and cost efficient than analogue radio; it provides digital sound quality and the ease-of-use that comes from digital radio, combined with a wealth of enhanced features such as, Surround Sound, Journaline text information, Slideshow, EPG, and data services.

DRM on short, medium and long wave for broadcasting bands up to 30 MHz (called 'DRM30') provides large coverage areas and low power consumption. The DRM standard for broadcast frequencies above 30MHz (called 'DRM+') uses the same audio coding, data services, multiplexing and signalling schemes as DRM30, but introduces an additional transmission mode optimised for those bands. This provides a digital radio solution for those broadcasters seeking a single service solution (i.e. not part of a multiservice multiplex). The DRM system specification is published as ETSI standard ES 201 980 [1]. A full list of DRM standards and specifications is available on-line at [www.drm.org](http://www.drm.org). A summary list is also included in Annex 1.

Readers looking for greater technical detail can refer to a range of published information that covers various specialised aspects of the DRM system and which provides detailed explanations of its operation. The most important ones are noted in Section 12, or are listed on the DRM website: [www.drm.org](http://www.drm.org).



The DRM Consortium (Digital Radio Mondiale) is **an international not-for-profit organisation** composed of broadcasters, network providers, transmitter and receiver manufacturers, universities, broadcasting unions and research institutes. Its aim is to support and spread a digital broadcasting system suitable for use in all the frequency bands up to VHF Band III. In 2013 there are around 100 members and 90 Supporters from 40 countries active within the Consortium.

# CONTENTS

<b>IMPRESSUM</b>	2
<b>PREFACE</b>	3
<b>2 EXECUTIVE SUMMARY</b>	<b>8</b>
2.1 What is DRM?	8
2.2 Why go Digital?	9
2.3 Key system features	9
<b>3 INTRODUCTION</b>	<b>11</b>
3.1 The objectives of this guide	11
3.2 What's included in this guide?	11
<b>4 LAUNCHING DIGITAL RADIO SERVICES</b>	<b>13</b>
4.1 Introduction	13
4.2 Critical success factors for Digital Radio	13
4.2.1 Working together promotes success	13
4.2.2 Consumers need a reason to buy	14
4.2.3 Technology solutions need to be readily available	14
4.2.4 Marketing needs to be right	14
4.3 Digital Migration	14
4.4 Migration policy and choice of technology	14
4.5 Migration Strategies	15
4.5.1 'Market Seeding'	15
4.5.2 'Trojan Horse' migration	15
<b>5 THE DRM SYSTEM</b>	<b>16</b>
5.1 Principal Features	16
5.2 The Broadcast chain	17
5.2.1 DRM content encoding and Multiplexing	17
5.2.2 DRM distribution	18
5.2.3 DRM Coding and Modulation	18
5.2.4 Broadcast signal framing	19
5.3 Configuring the DRM system	20
5.3.1 Modulation & Coding parameters	20
5.3.2 Service multiplexing and pay-load capacity	21

5.3.3 Single and Multi Frequency Networks	23
5.3.4 Simulcast	24
5.3.5 Alternative Frequency Signalling (Checking and Switching)	25
5.3.6 Programme acquisition	26
5.4 The AM Signalling System (AMSS)	26

## **6 DRM CONTENT** 28

6.1 Broadcast meta-data	28
6.1.1 Service ID {M}	28
6.1.2 Service Labelling {M}	28
6.1.3 Programme Type	29
6.1.4 Service Language	29
6.1.5 Country of origin	29
6.2 Audio content	29
6.2.1 Audio Coding	29
6.2.2 Optimising sound quality	30
6.3 Value-added services	30
6.3.1 Overview	30
6.3.2 DRM Text Messages	31
6.3.3 Journaline text information service	31
6.3.4 Electronic Program Guide (EPG)	33
6.3.5 Slideshow	34
6.3.6 TMC (Traffic Message Channel)	34
6.4 DRM Emergency Warning Feature	35
6.4.1 Overview	35
6.4.2 Task	35
6.4.3 How DRM EWF Works	36
6.4.4 DRM EWF Implementation	

## **7 DRM RECEIVERS** 38

7.1 DRM Receiver Specifications	38
7.2 Receiver development	38
7.3 Software radios	39
7.4 Man-machine interface (MMI)	39

## **8 REGULATION & STANDARDISATION** 41

8.1 Regulation	41
8.2 DRM Standards	43

## 9 BROADCAST NETWORK INFRASTRUCTURE 46

9.1 Programme distribution	46
9.1.1 Multiplex Distribution	46
9.1.2 Network Synchronization	47
9.2 Transmitting in DRM30 modes	48
9.2.1 Overview	48
9.2.2 DRM Amplification	48
9.2.3 Using Non-Linear Amplifiers for DRM	48
9.2.4 The DRM Signal	49
9.2.5 AM transmitter conversion	49
9.2.6 Performance of DRM30 transmitters	50
9.2.7 Out of band Power (OOB)	52
9.2.8 Use of older Transmitters for DRM Trials	53
9.3 Transmitting in DRM+ configuration	53
9.3.1 Network system architectures for DRM+	54
9.3.2 Basic DRM+ setup	54
9.3.3 DRM+ ‘Simulcast Mode’	55
9.3.4 DRM+ combined Mode Setup (signal level combining)	57
9.4 Spectrum masks and protection levels for DRM+	58
9.4.1 VHF Bands I and II	58
9.4.2 VHF Band III	59
9.5 Transmitter Monitoring	59
9.5.1 Characterising Transmitter Performance: the MER	60
9.6 Test Equipment	61
9.7 Antenna Systems	61
9.7.1 MF Antennas	61
9.7.2 LF Antennas	62
9.7.3 Matching and Combining Networks	63
9.7.4 Implementing a DRM Service on an Existing Antenna System	63

## 10 SERVICE PLANNING 66

10.1 Scope	66
10.2 Network topologies	66
10.2.1 Single Frequency Networks (SFNs)	67
10.2.2 Multi-frequency networks	67
10.3 Available Frequency Bands	68
10.3.1 LF/MF/HF	68
10.3.2 26 MHz band	68
10.3.3 Band I (47 – 68 MHz)	69
10.3.4 Band II (87.5 – 108 MHz)	69

10.3.5 Band III (174 – 230 MHz)	69
10.3.6 Other VHF Frequency Bands	69
10.4 Planning tools	69
10.5 Planning data for DRM30	70
10.5.1 DRM30 Theoretical S/N ratios	70
10.5.2 DRM minimum field-strengths (MFS)	71
10.5.3 Relative protection and power reduction	74
10.6 Planning data for DRM+	74
10.6.1 Reception modes	74
10.6.2 Correction factors for field-strength predictions	74
10.6.3 System parameters for field-strength predictions – Mode E	75
10.6.4 Single frequency operation capability	76
10.6.5 Minimum wanted field strength values	76
10.6.6 Position of DRM frequencies	78
10.6.7 Protection ratios for DRM	78
10.6.8 Protection ratios for other broadcasting systems interfered with by DRM	82
10.6.9 Sharing Criteria with Other Services	83
10.7 Reception Monitoring	83

## **11 DRM INTELLECTUAL PROPERTY** 84

11.1 Summary	84
11.2 IPR and the DRM Consortium	84
11.3 Licenses for DRM IPR	85
11.3.1 Manufacturers of DRM equipment	85
11.3.2 Marketing of DRM products	85
11.3.3 Use of DRM logo on products	85

## **12 REFERENCES** 87

## **13 GLOSSARY OF ABBREVIATIONS** 89

## **14 ANNEXES** 90

ANNEX 1 – List of main DRM Standards	90
ANNEX 2 – COFDM basics	91
ANNEX 3 – DRM Radio Receiver Profiles	92
ANNEX 4 – Information on DRM field trials	94

## 2

# Executive Summary

### 2.1 What is DRM?

The DRM Broadcasting system has been designed by broadcasters, for broadcasters, but with the active assistance and participation of both transmitter and receiver manufacturers and other interested parties (such as regulatory bodies). It has been designed specifically as a high quality digital replacement for current analogue radio broadcasting in the AM and FM/VHF bands; as such it can be operated with the same channelling and spectrum allocations as currently employed. An overview of the frequency-bands where DRM operates is shown in Figure 2.1.

The DRM standard describes a number of different **operating modes**, which may be broadly split into two groups as follows:

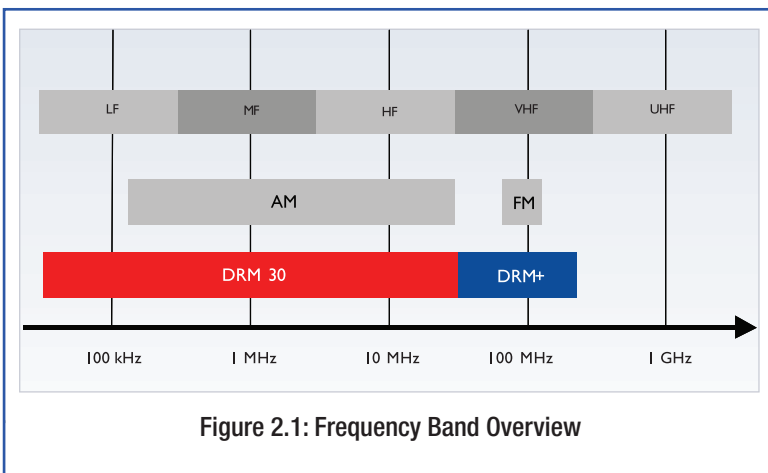

**'DRM30'** modes, which are specifically designed to utilise the AM broadcast bands below 30 MHz, and  
**'DRM+'** modes, which utilise the spectrum from 30 MHz to VHF Band III, centred on the FM broadcast Band II.

DRM has received the necessary recommendations from the ITU, hence providing the international regulatory support for transmissions to take place. The main DRM standard [1] has been published by ETSI. In addition, ETSI publishes and is the repository of the entire range of current DRM technical standards.

Apart from the ability to fit in with existing spectrum requirements, the DRM system also benefits from being an **open system**<sup>1</sup>. All manufacturers and interested parties have free access to the complete technical standards, and are able to design and manufacture equipment on an equitable basis. This has proved to be an important mechanism for ensuring the timely introduction of new systems to the market and for accelerating the rate at which equipment prices reduce. This is a significant consideration for broadcasters investing in DRM infrastructure, manufacturers investing in receiver development and production, and even more for the listeners who will need to invest in the new DRM-capable receivers.

<sup>1</sup> An **open system** or standard is one in which a complete system description is openly published with sufficient technical detail to allow a manufacturer to implement the whole or part of the broadcast chain.



## 2.2 Why go Digital?

There is a global trend towards the adoption of digital technology in radio and communications, especially for distribution and transmission. Digitalisation offers many substantial advantages to national and international broadcasters and ‘infocasters’.

We are now seeing the introduction of high quality digital delivery system in homes. Although FM sound broadcasting is gradually moving to a DAB standard in Band III, the possibilities for extending coverage in the FM Band (88-108 MHz) remains limited. For many national and international broadcasters, the advantages of a complementary digital broadcast system below 30 MHz are becoming clear. However, the limited fidelity of existing AM services is causing listeners to search for other alternatives.

Implementation of digital radio in today's AM bands (i.e. long, medium and shortwave) will enable operators to provide services which will be successful with both existing and future high-quality services operating on other parts of the dial. Digital broadcasting on short-, medium-, or long wave (AM) has many advantages when compared to the conventional analogue system we use now.

DRM+ has a narrow bandwidth that provides an ideal ‘digital’ solution for those regional and local broadcasters for whom a broadband-shared multiplex is not suitable. The coverage can be tailored to the individual broadcasting station requirements and there are no complex and potentially expensive multiplex agreements to negotiate. Furthermore, the high commonality with the existing DRM standard allows easy and fast equipment implementation. It is therefore a flexible solution allowing single or small numbers of audio services to be broadcast together.

The introduction of DRM services allows a broadcaster to provide listeners with significant improvements in service reliability, audio quality and, most importantly, usability. By usability we mean those features that enhance the listener experience, as outlined below.

The DRM standard provides many features and facilities that are impossible to replicate in analogue broadcasting. It is essential that prospective broadcasters understand the potential and flexibility of the system in order to allow them to optimise and configure their DRM networks in accordance with their particular market conditions.

From a **technical perspective**, a key and revolutionary feature of DRM is the ability to select from a range of transmission modes. This allows the broadcasters to balance or exchange bit-rate capacity, signal robustness, transmission power and coverage. What's more, it is possible to do this dynamically, in response to any local changes in the environment, without disturbing the audience. A classic problem that can be mitigated by this feature is dealing with night-time sky-wave interference in the AM bands.

Furthermore, DRM is the only digital radio system that embraces all the currently used radio frequency bands; it provides an ideal replacement for existing analogue services as well as complementing existing digital services such as DAB.

From a **commercial perspective**, there is no demand from audiences to ‘consume’ digital services for their own sake. It is essential therefore that the audience is presented both with receivers at prices it is prepared to pay and, more importantly, an attractive package of benefits:

- The availability of a wider range of services,
- Easier tuning and selection of programming – e.g. automatic switching between different transmitters or electronic programme guides.
- Improved formats such as stereo in the ‘AM bands’ and surround-sound in cars,
- Improved and more consistent sound quality
- Programme-associated data, textual content description or even independent services such as traffic information

The importance of quality content, while outside the scope of this guide, cannot be stressed too highly.

Subsequent sections of this guide provide more detailed information on these enhancements.

## 2.3 Key system features

The system is specifically designed to allow the new **digital transmissions to co-exist with the current analogue broadcasts**, and a significant amount of work has been undertaken to quantify the operating parameters that assure mutual analogue and digital compatibility. Hence the changeover from analogue to digital broadcasting can be phased over a period of time, which in turn allows existing broadcasters to spread the required investment to meet any budgetary constraints. Furthermore, unlike some other digital systems, the DRM system has been designed to allow suitable analogue transmitters to be modified to switch easily between digital and analogue broadcasts. This can significantly reduce the initial investment cost for a broadcaster. An additional budgetary benefit is the reduction of transmission energy costs.

DRM exploits the unique propagation properties of the **AM bands**. The introduction of DRM30 services allows a broadcaster to provide listeners with **significantly improved audio quality** and service reliability. As a result, international broadcasters can provide services on SW and MW that are comparable to local FM services, whilst **enhancing the listener experience** with easier tuning and added data services. National and local LF and MF broadcasters will derive similar benefits.

This is not all; a summary of the key benefits of DRM for the listeners, manufacturers, broadcasters and regulators is given in Figure 2.3.

In the **VHF bands**, DRM+ can be configured to use **less spectrum** than current stereo FM broadcasts, whilst additionally deriving the potential benefits of **increased robustness, reduced transmission power, increased coverage or additional services**.

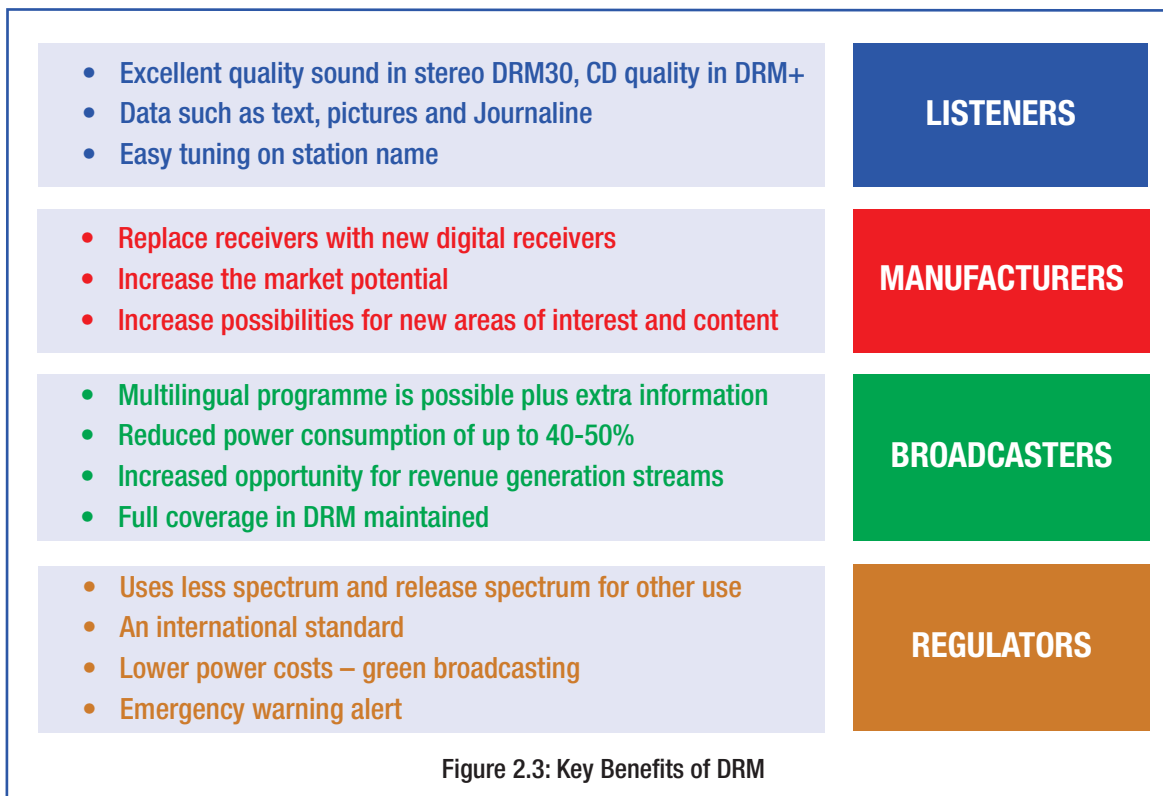

DRM is unique in providing an extensive and extremely powerful ‘toolkit’ array of operating modes and techniques, which allow a broadcaster to tailor the system to best meet the needs of his or her particular market. For instance, DRM allows the independent selection of modulation parameters (code-rates, constellation, guard-intervals etc.) to enable an optimum **trade-off between capacity and signal robustness**. DRM also supports both multi- and single-frequency network operation, (MFN/SFN), and **hand-over to other frequencies and even other networks** (AFS – Automatic Frequency Checking & Switching). This latter feature allows a broadcaster operating on several different platforms to hand a listener from DRM to AM, FM or DAB and back again. The appropriate signalling is intrinsically supported by DRM and DAB, and by data carriers on AM and FM (AMSS and RDS respectively).

Of particular note amongst the various data services is the **DRM Electronic Programme Guide (EPG)**, which allows listeners with appropriate receivers to access the broadcast schedule and set recording times accordingly, and **Journaline** – accompanying audio programmes with interactive textual information, like news, or graphics.

DRM can alert the widest possible audiences in case of pending disasters through its built-in **Emergency Warning Feature (EWF)**, allowing to serve as a last resort when all local infrastructure is down by covering the affected area with radio signals from outside. In case of an emergency, DRM receivers are ordered to switch to and present the emergency programme, and may even be able to turn on automatically. The emergency programme combines on-screen signalling, audio content, DRM text messages, and may include Journaline text with detailed look-up information in multiple languages in parallel.

DRM is being operated at power levels ranging from a few watts on 26 MHz through to several hundred kilowatts on long-wave. It is possible to utilise the one technical standard to provide coverage ranging from international, national (c.1000 km), all the way down to local community radio (c.1 km radius).

### 3.1 The objectives of this guide

This document is written primarily as a guide to radio broadcasters contemplating a transition from analogue to digital broadcasting in the AM and VHF broadcasting bands. It will also be of value to manufacturers, service-planners, administrations and regulatory bodies involved with broadcasting systems and/or policy. The document is intended to:

- Explain how and why a broadcaster might go digital, from both technical and commercial perspectives.
- Describe the basic operation of the DRM system and its many features.
- Provide a definitive source of references to key technical standards, including regulatory, co-ordination and planning information for DRM broadcasting.
- Supplement various existing documents, as appropriate.
- Provide information on where to find additional material on the practical experiences and know-how that DRM members, broadcasters and supporters have gained from several system trials.

### 3.2 What's included in this guide?

This guide provides more detailed information on both the techniques described above and other useful features, such as bespoke commercial applications designed to run on the DRM platform. The techniques are generally applicable equally to international, national and local services.

This document addresses the following aspects of the DRM system in particular, and Digital Radio in general:

- **Launching Digital Radio:** Includes a summary of the critical success factors and lessons learnt by broadcasters who have migrated and launched digital radio services.
- **DRM Technology:** Description of the broadcast chain and main features of the DRM System, followed by a look at the options for tailoring a DRM system to broadcasters' requirements. The DRM System section also introduces multi- and single-frequency networks, alternative-frequency signalling and DRM simulcast options.
- **DRM Content:** This section covers all aspects of DRM content, from essential meta-data relating to receiver tuning through audio coding and quality issues, to finally, an overview of value-added services.
- **Broadcast Network Infrastructure:** contains a description the broadcast network from studio output through to the radiated signal. This section includes a wealth of practical knowledge related to DRM transmitter specifications, antenna systems, programme distribution, network synchronisation and information relating to transmitter measurements and monitoring equipment.
- **DRM receivers:** It provides an overview of recent DRM receiver technology and relevant specifications.
- **Regulatory aspects and Service Planning:** Information on how DRM services may be introduced into the bands with respect to the HFCC planning process in the SW bands, and the existing Regional Plans covering the LW and MW or higher frequency bands. Specialised applications such as NVIS (Near Vertical Incidence Sky-wave) and SFN (Single Frequency Networks) are also explained here. Information is also included here on how transmissions may be monitored in order to verify coverage. In addition, this guide includes information on the regulatory and planning aspects for the introduction of DRM+ in the VHF frequency bands.
- **IPR:** A description of DRM branding and logos, together with a description of the DRM technology licensing process.

**Annexes:** Further technical descriptions of the DRM system and related technology, together with reference to published articles and system trials.

AMPEGON

ampegon.com



# Expertise of a Century

Innovation, advanced technology and premium quality systems

## Ampegon AG

Spinnereistrasse 5 | CH-5300 Turgi, Switzerland  
Tel. +41 58 710 44 00 | Fax +41 58 710 44 01  
info@ampegon.com | ampegon.com

## Ampegon Antenna Systems GmbH

Carl-Benz-Strasse 6-8 | D-67105 Schifferstadt, Germany  
Tel. +49 6235 9250 300 | Fax +49 6235 9250 330  
antennas@ampegon.com | ampegon.com



Transmission  
Systems



Antenna  
Systems



Scientific  
Applications



Green  
Technologies



# 4

# Launching Digital Radio Services

## 4.1 Introduction

Building a digital radio network is relatively easy. Migrating listeners and/or building an audience from scratch is a significant challenge. Over the last decade this has been amply demonstrated in a diversity of markets and driven by both public and commercial radio consortia. It is instructive to examine the underlying reasons for this situation, and indeed for those markets where digital radio has achieved some success, much analysis has already been undertaken to understand both the mistakes made and the critical success factors involved. These are summarised below.

## 4.2 Critical success factors for Digital Radio

Several factors have all been identified as key determinants to success in building an audience on digital radio. The principle challenge lies in getting digital receivers into the market in volume. Inevitably, for a new technology, we're starting from an installed-receiver base of zero. Consumers need to be initially made aware that exciting new services are on-air, and then be told how they can receive them. These are marketing issues.

The approach taken by an individual broadcaster will clearly be dependent on a number of factors, not least the budget available, access to broadcast spectrum, the nature, competitiveness and maturity of the local radio market, and the demographics of the target audience.

### 4.2.1 Working together promotes success

All the stake-holders need to be co-ordinated and committed to the launch of digital radio services to reduce overall risk. Factors that are crucial to ensuring success include:

- Regulatory incentives and support from the local administration.
- Ideally, all broadcasters operating in the same region (both commercial and public service) participating in the launch, or at least a grouping with sufficient resources to launch a critical mass of new services.
- Similarly, the full engagement of transmission providers, and crucially, retailers and receiver manufacturers.

Getting the whole process started involves a series of logical conditions to be met. These feed back 'positively' in a loop, which fundamentally requires the broadcaster to take the initiative:

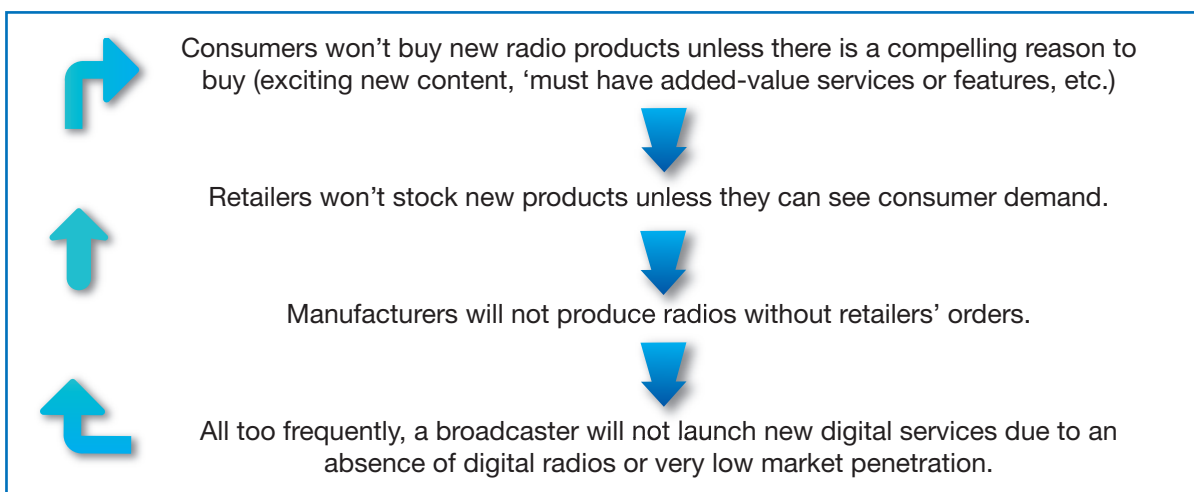

In some countries this process is aided and the loop 'booted' through the formation of one or more. National Platforms, where plans are developed and co-ordinated and funding agreed.

#### 4.2.2 Consumers need a reason to buy

The most powerful driver found to date is access to new content. There are other drivers, for instance ease of use and launching services with an absence of advertising into a market where such advertising is perceived as intrusive by a large section of the audience. Additionally;

- Benefits need to match price of entry.
- Improved quality has only marginal attraction: there may be some examples where this does assist take-up, but it is very much a secondary factor.

#### 4.2.3 Technology solutions need to be readily available

- It goes without saying that the receiver industry must play its part in ensuring that products are available at the right moment and at the right price-point. Creating a strong initial demand through appropriate marketing assists in raising volumes and reducing costs.

#### 4.2.4 Marketing needs to be right

- It is essential that the marketing of the new services is sustained and high profile. Existing broadcasters can use their own media to cross-promote: television, radio and on-line. Competitions can be held with prizes of digital radios. Using creative scheduling, it is possible to entice people to use digital services by, for example, pre-releasing prime content on digital ahead of analogue, or vice-versa, using the digital service to repeat programmes which were missed the first time round.

It is important that all stakeholders play their part for the greater good. Each party may perceive high risks (though not at the same time); a collaborative model reduces these risks as far as possible and should lead more quickly to success.

### 4.3 Digital Migration

The DRM system was specifically designed to align with and make use of current analogue spectrum allocations to co-exist with current analogue broadcasts<sup>2</sup>. This allows broadcasters to make the required investment on a timescale that meets their budgetary needs. It will ensure that expensively acquired and perfectly satisfactory transmission equipment and infrastructure is not suddenly made obsolete. Suitable analogue transmitters can be modified to switch between digital and analogue broadcasts, further reducing the initial investment required for a broadcaster wishing to migrate to DRM. This in turn allows broadcasters to focus their capital resources on new content and services. Additionally, the reduction of the transmitting energy costs allows additional revenue savings, which can be ploughed back into programming.

Apart from the ability to fit in with existing spectrum requirements, the DRM system also benefits from being an 'open' system, allowing any manufacturer to design and manufacture equipment on an equitable basis. This has proved, in the recent past, to be an important mechanism for ensuring the timely introduction to market of new systems and for accelerating the rate at which equipment prices reduce. This is a significant consideration for broadcasters but even more so for the millions of listeners who will need to invest in new, DRM-capable receivers.

### 4.4 Migration policy and choice of technology

It is clearly important for any administration regulating broadcasting to choose the systems used for digital broadcasting, both radio and TV, in order to avoid consumer confusion and a proliferation of standards. It also avoids the premature writing-off of investments made by broadcasters in the 'wrong' technology.

**Factors that might become of greater importance in the 21st century include:**

- **Energy constraints:** choice of system to minimise power consumption in both transmitters and consumer receivers. Efficient network planning and robust transmission parameters play a key part, optimising coverage and avoiding excessive transmitter power levels.
- **Economic and Social benefits** which might flow from, for instance, the provision of universal real-time traffic information, or local design and manufacture of digital receivers.
- **Control of long-term costs** through a full knowledge of royalty charges and the ability to design and manufacture locally, free of operating licenses, trade secrets and similar barriers to a fully-competitive open market.

<sup>2</sup> DRM30 modes have received the necessary mandate for use the AM bands worldwide and DRM+ modes in FM Band II by way of ITU recommendations, and these provide the international regulatory basis upon which transmissions may take place.

- **Market Regulation** which works toward the common-good, and avoids the disenfranchisement of some listeners and/or broadcasters. For instance, this might include the requirement to co-site transmitters to avoid local 'holes' being punched in the service area of other radio stations, and a mandate that radio receivers should incorporate all relevant standards used for radio within the territory.

## 4.5 Migration Strategies

Many creative solutions have been proposed which address the issue of how to initially launch a new digital service when there are no receivers in the market.

### 4.5.1 'Market Seeding'

The most radical example of this technique requires an up-front investment in receivers: the broadcaster places an order for a large quantity of digital receivers, which are then either given to consumers or sold with a significant discount. One broadcaster proposed purchasing 500,000 receivers, and free-issuing to taxi-cabs, retail outlets and domestic consumers. This strategy yields a low initial receiver cost, combined with the ability to guarantee potential advertisers a sizeable audience from day one.

### 4.5.2 'Trojan Horse' migration

The 'Trojan Horse' approach to digital migration has the potential to seed the market with digital radios ahead of a formal digital radio service. This serves as a catalyst to the launch process and boots the positive feedback loop described earlier. The technique is simply to introduce and market new 'analogue' receivers which include some new or distinctive features which are either intrinsic to the radio itself (e.g. recording-to-memory, radical styling), and, or can be readily supported by existing broadcasts (some RDS or AMSS data service etc.).

These new radios also support DRM, **but initially this is not the key feature used for marketing**; the DRM function is 'hidden', and hence the term 'Trojan Horse'. In this scenario, it is clearly vital to have a medium-term strategy agreed and co-ordinated with the receiver manufacturers. Once sales have reached some target, digital services can be launched to an audience that is ready-equipped with receivers.

# MORE CONTROL

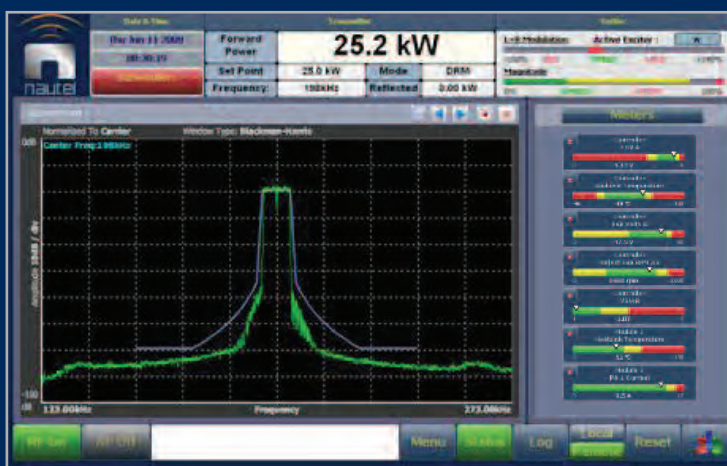

Nautel's Advanced User Interface (AUI) gives you more **DRM** transmitter control and instrumentation at the transmitter site, office or even your living room. Learn more at [www.nautel.com/drm](http://www.nautel.com/drm)



Making Digital Radio Work.

+1.902.823.5131  
[www.nautel.com/drm](http://www.nautel.com/drm)

# 5

# The DRM System

This section includes a brief description of some of the more important features and supported services of the DRM system, followed by an overview of the main components found in the broadcast chain.

## 5.1 Principal Features

DRM30 uses the existing AM broadcast frequency bands and is designed to fit in with the existing AM broadcast band plans, based on signals of 9 kHz or 10 kHz bandwidth. It also has modes requiring only 4.5 kHz or 5 kHz bandwidth (AM), and modes that can take advantage of wider bandwidths – 18 kHz or 20 kHz.

DRM+ has a narrow bandwidth and is designed to fit in the FM broadcast band plan with a frequency grid of 100 kHz. Its small spectrum needs supports its use in crowded bands. DRM+ provides bit rates from 37 kbps to 186 kbps and, like DRM, permits up to four services. It is therefore a flexible solution allowing single or small numbers of audio services to be broadcast together.

The above features allow DRM to operate alongside existing analogue transmissions in every world market.

The DRM system uses COFDM (Coded Orthogonal Frequency Division Multiplex). This means that all the data, produced from the digitally encoded audio and associated data signals, is shared out for transmission across a large number of closely spaced carriers. All of these carriers are contained within the allotted transmission channel. Time interleaving is applied in order to mitigate against fading. Various parameters of the OFDM and coding can be varied to allow DRM to operate successfully in many different propagation environments - the selection of the parameters allows transmissions to be planned that find the best combination of transmit power, robustness and data capacity.

The DRM system uses MPEG xHE-AAC and AAC with SBR and PS for mixed programming providing high quality at low data rates.

From a broadcaster's perspective, DRM offers a wealth of features and a powerful array of options. For instance, DRM provides support for

- Broadcasting in all frequency bands (LF/MF/HF and Bands I, II, III) currently used for AM and FM analogue radio.
- Migration from, and co-existence with, analogue broadcasting: complies with existing spectrum masks and analogue frequency grids.
- Up to four services per frequency, each of which can be any mixture of audio and data.
- Single-frequency and multi-frequency networks, plus associated signalling and automated receiver tuning.
- a state of the art audio coder.
- text-messaging, advanced text information for weather, sports and news, slide-shows, EPG and a wide range of similar value-added services.

DRM additionally offers assistance to broadcasters and manufacturers by virtue of publishing an extensive range of open standards<sup>3</sup>, which support the main system standard [1]

Above all else DRM is designed to improve the listener experience through a combination of improved usability, improved audio quality and data-enhancements to the audio content.

<sup>3</sup> See Annex 1



## 5.2 The Broadcast chain

Figure 5.2 shows a very simple ‘single-service, single transmitter’ broadcast chain and depicts the general flow of different classes of information (audio, data, etc.) from their origination in a studio or control centre on the left of the figure to a DRM receiver on the right.

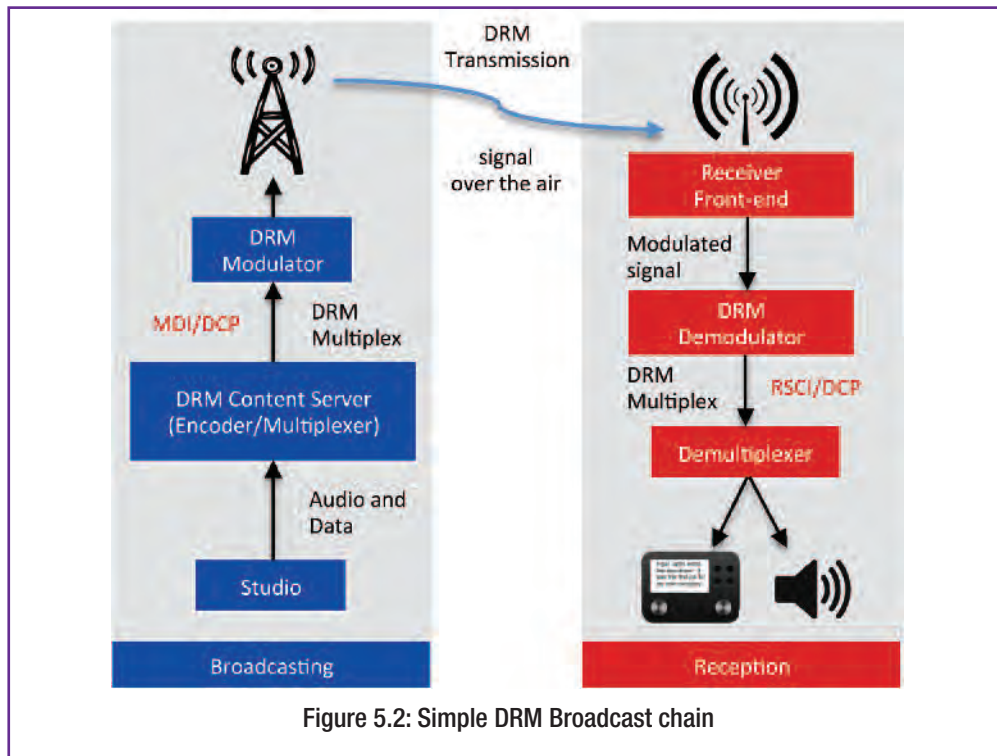

In the following sections we will examine the operation of the two main functional blocks shown above: the Content Server and the Modulator. In most (but not all) installations, these functional blocks correspond to commercially available products. They communicate via a Multiplex Distribution interface (MDI) over a Distribution and Communications protocol (DCP), both of which have been standardised [2], [3].

### 5.2.1 DRM content encoding and Multiplexing

These functions may be integrated into a product that is known as a Content Server (Figure 5.2.1).

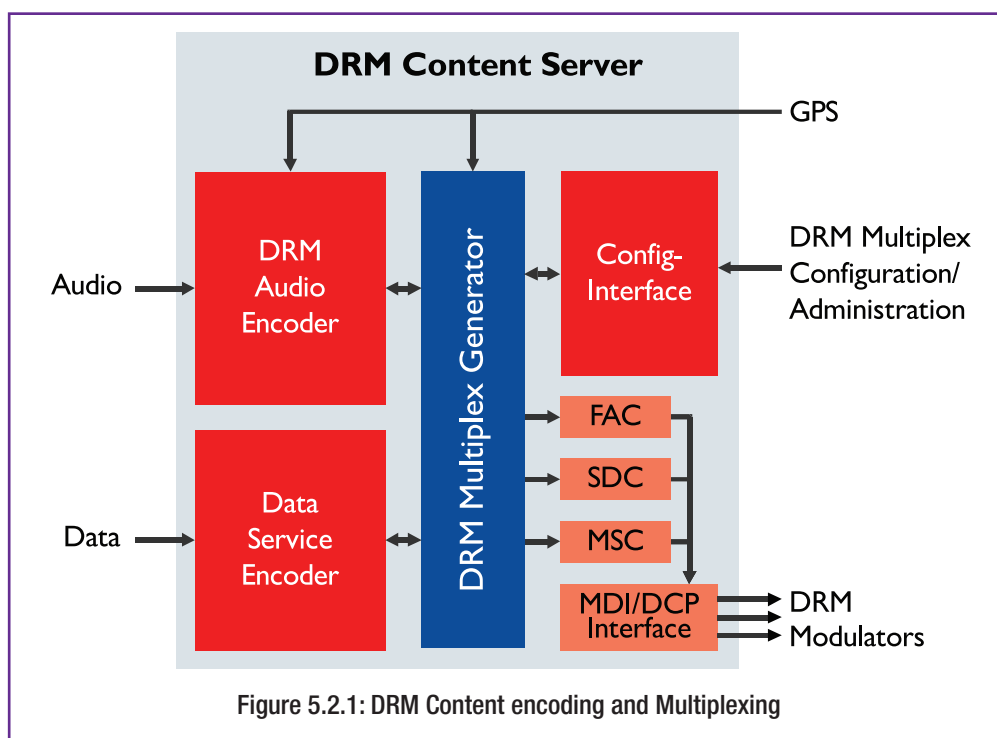

Setting aside local control and command interfaces, there are two basic classes of input information:

- i. The encoded audio and broadcast data services which form the **Main Service Channel (MSC)**;
  - ii. Information which travels via the **Fast Access Channel (FAC)** and **Service Description Channel (SDC)**.  
These channels communicate service identification and parameter selection for a transmission and ensure that the appropriate decoding parameters are selected within a receiver.
- The FAC contains a set of core parameters required to quickly check for available services within a multiplex and to allow de-modulation of the DRM signal.
  - The SDC carries advanced information like audio and data coding parameters, service labels, current time and date, AFS tables (Alternative Frequency Signalling), etc.

The **audio encoder** and the **data encoders** ensure the adaptation of the input streams into an appropriate digital format. The output of these encoders may optionally comprise a higher and a lower protected part, each of which will be given one of two different protection levels within the subsequent channel encoder.

The **multiplexer** combines the protection levels of all data and audio services, in a defined format, within the frame structure of the bit stream.

If the audio coding and multiplexing is performed remotely from the transmission site (as is the norm), the signal is distributed using the **Multiplex Distribution Interface (MDI)** protocol, described below.

### 5.2.2 DRM distribution

To enable both the audio and data services, (together with the associated transmission parameter data) to be combined into one transmission feed, DRM has specified a standardised and efficient method for combining all this data into a single multiplex; known as

- the **MDI** (Multiplex Distribution Interface [2]), which in turn employs a standardised protocol;
- the **DCP** (Distribution and Communications Protocol [3]).

Although the broadcaster is strongly advised to locate the audio encoder and/or DRM Content Server at the studio centre, (for the reasons set out under 6.2.2 Optimising Sound Quality), there remains the option of distributing the audio to a DRM multiplexer at the transmitter site, in which case the existing programme distribution system would likely be used. There will be additional information required for the operation of the multiplexer, which would not typically be required for, say, an analogue AM service. This information relates to the choice of audio coding, audio data rate, AFS list, transmission Mode (A, B, C, D & E), modulation (e.g. 4, 16, or 64QAM) and transmission bandwidth etc. This must be supplied to the multiplexer and encoder to ensure that the correct parameters are used for a particular transmission. This will be particularly relevant to SW transmissions, but less so for 'fixed' services on VHF frequencies.

### 5.2.3 DRM Coding and Modulation

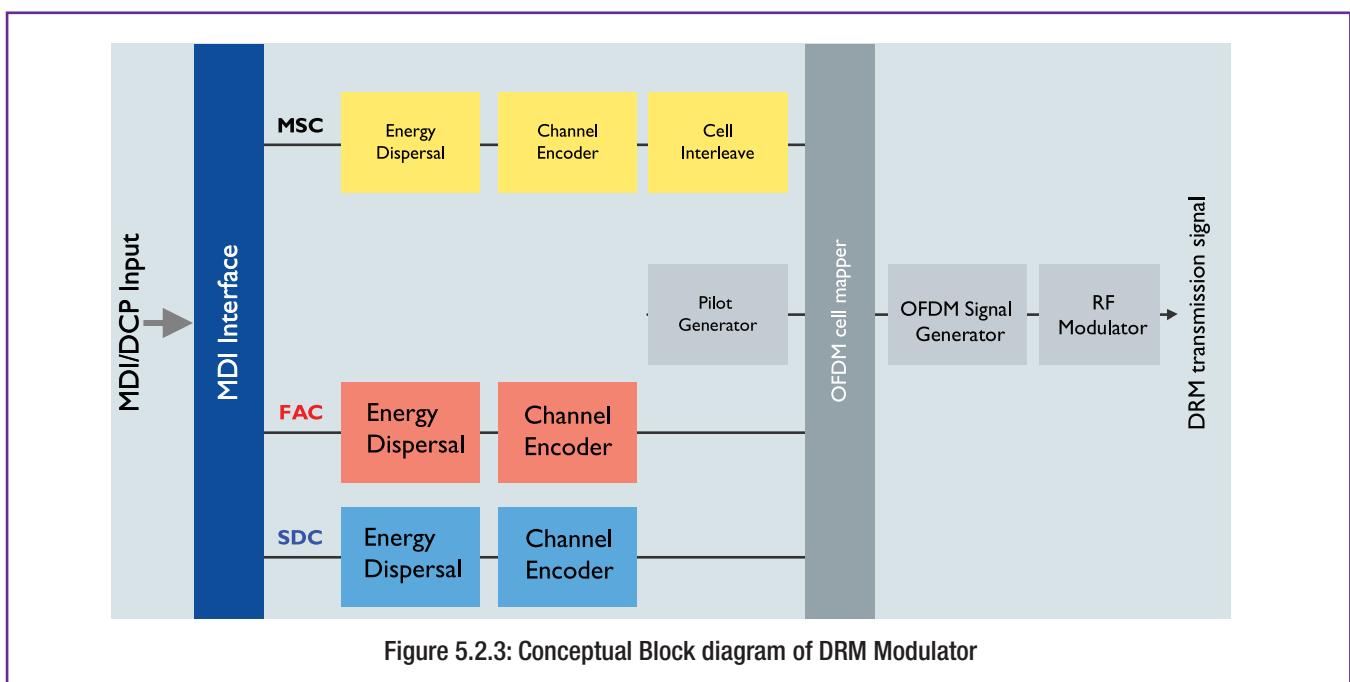

Figure 5.2.3: Conceptual Block diagram of DRM Modulator

- The energy dispersal provides a 'randomising' of the bits that reduces the possibility of unwanted regularity in the transmitted signal.
- The channel encoder adds redundant bits to the data in a defined way, in order to provide a means for error protection and correction, and defines the mapping of the digitally encoded information into QAM cells. These are the basic carriers of the information supplied to the transmitter for modulation.
- Cell interleaving rearranges the time sequence of the signal bits in a systematic way as a means of "scrambling" the signal, so that the final reconstruction of the signal at a receiver will be less affected by fast fading than would be the case if speech or music data were transmitted in its original continuous order.
- The pilot generator injects non-data carriers of prescribed amplitude and phase which permits a receiver to derive channel-equalisation information, thereby allowing coherent demodulation of the signal.
- The OFDM cell-mapper collects the different classes of cells and places them on a time-frequency grid, in effect distributing the information across the sub-carriers.

The output from the Modulation process can take one of several forms:

- A complex waveform representing the broadcast signal, already modulated onto an IF or RF frequency
- Analogue or digital representations of In-phase and Quadrature base-band signals ("I-Q"): the I-Q signals can then be used to modulate an IF or RF carrier
- Analogue or digital representations of Phase and Amplitude signals, (which can be derived from a transform of the I-Q signals) : this signal format is known as "A-RFP"

The A-RFP signal is of particular importance for DRM amplification using the traditional transmitter topography employed by high-efficiency AM transmitters. This is described in greater detail in Section 9.

#### 5.2.4 Broadcast signal framing

Figure 5.2.4 shows the framing and temporal relationship between the three basic classes of transmitted data. The scheme employed is governed principally by the requirements of receivers for tuning, re-tuning and content operations

The data carried in the FAC is not time-interleaved, and is confined to a specific group of carriers in the frequency-domain. This enables the receiver to rapidly achieve synchronisation and determine the modulation parameters used for the MSC.

The SDC is broadcast across all carriers for a period of two symbols at the start of each super-frame. This data is normally static and hence repetitious; this allows a fully-synchronised receiver to use this period for alternative frequency switching (see section 5.3.5).

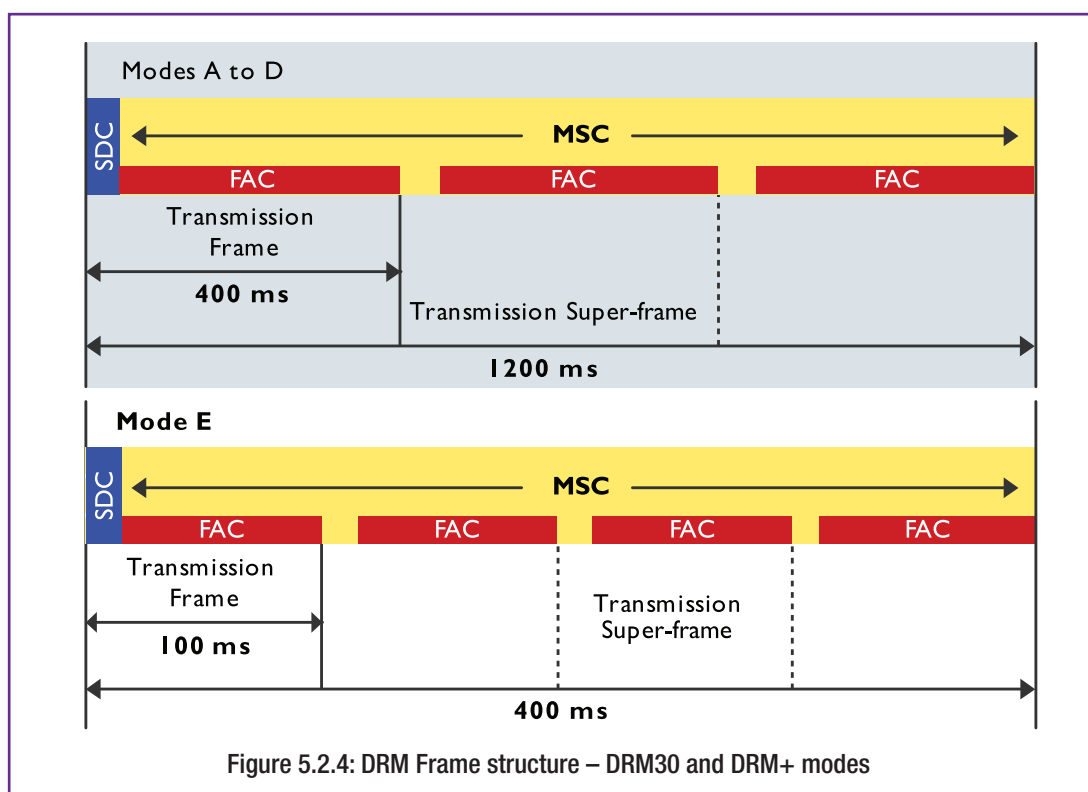

Figure 5.2.4: DRM Frame structure – DRM30 and DRM+ modes

### 5.2.4.1 Fast Access Channel structure

The FAC's structure is built around a 400 or 100ms frame (Figure 5.2.4). The FAC is used to provide information on the channel parameters required for the de-modulation of the multiplex as well as basic service selection information for fast scanning.

The channel parameters (for example the spectrum occupancy and interleaving depth) allow a receiver to quickly decode the multiplex. It also contains information about the services in the multiplex which allow the receiver to decide to either decode this multiplex or, if the desired service is not present, to change frequency and search again.

Each transmission frame contains an FAC block. An FAC block contains parameters that describe the channel and parameters to describe either one or two services along with a CRC (Cyclic Redundancy Check).

For robustness modes A, B, C and D, the FAC block contains parameters that describe both the channel together with one set of service parameters, along with a CRC.

For robustness mode E, the FAC block is similarly configured but includes two sets of service parameters. When more services are carried in the multiplex than can be described within one FAC block, a number of FAC blocks are required to describe all the services.

Full details and a description of the FAC structure and contents can be found in Section 6.3 of the DRM specification [1].

### 5.2.4.2 Service Description Channel structure

The SDC contains information on how to decode the MSC, how to find alternative sources of the same data, and gives attributes to the services within the multiplex.

The SDC's frame-periodicity corresponds to the super-frame length (1200 or 400 ms), as defined by the DRM mode. The data capacity of the SDC varies with the spectrum occupancy of the multiplex and other parameters. Making use of the AFS index can also increase the SDC capacity.

Alternative frequency checking may be achieved, without loss of service, by keeping the data carried in the SDC quasi-static. Therefore, the data in the SDC frames should be carefully managed.

The SDC conveys key data and information, including:

- Multiplex description
- Alternative frequency signalling
- Announcement support and switching
- Time and date information
- Audio information
- FAC channel parameters
- Language and country data
- Signalling of reconfigurations

A comprehensive description of the SDC's structure and many components can be found in Section 6.4 of the DRM specification [1].

## 5.3 Configuring the DRM system

The following sections describe how the various component parts of the DRM system work together in order to provide a system that can be optimised to meet the broadcaster's specific requirements for quality and number of audio services, data services and service robustness.

### 5.3.1 Modulation & Coding parameters

This section provides an indication of how some of the DRM signal parameter options might be used for typical applications. The following paragraph provides more detail on how these parameter options might best fit the broadcaster's particular coverage requirements.

#### i. Robustness Modes

In order to optimise the performance of the system, the transmission OFDM parameters (carrier-spacing, guard interval, pilot density etc.) need to be matched to the characteristics of the RF channel. The DRM system is designed to operate in both ionised and non-ionised media, and over an extremely wide frequency-range

spanning some 3 decades. Propagation in the AM bands can range from ground-wave, where electrical noise is the predominant interference mechanism, to sky-wave with varying degrees of channel complexity and where both differential delay and Doppler effects are additional adverse factors. In some circumstances signals may reach some locations in the coverage area by means of both types of propagation. In all of these cases the received signal is likely to suffer from the addition of distortions or noise, which have been caused by the imperfect transmission path.

Hence the system defines five pre-set “Modes”, labelled A to E respectively, which are outlined in Table 5.1 below.

Table 5.3.1: DRM Transmission modes

Mode	MSC QAM options	Bandwidth options (kHz)	Typical uses	
A	16, 64	4.5, 5, 9, 10, 18, 20	LF & MF ground-wave, 26MHz band line-of-sight	DRM30 modes
B	16, 64	4.5, 5, 9, 10, 18, 20	HF & MF transmission on sky-wave	
C	16, 64	10, 20	Difficult sky-wave channels on HF	
D	16, 64	10, 20	NVIS sky-wave (highest Doppler & delay spread)	
E	4, 16	100	VHF transmissions in the bands above 30 MHz	DRM+

- Mode A is designed to deliver the highest bit rate possible within the context of ground-wave or line-of-site coverage.
- Mode B will generally be the first choice for sky-wave services.
- Where propagation conditions are more severe, such as for long paths with multiple hops, or near vertical incidence, where several very strong reflections may occur, Mode C or Mode D may need to be employed.
- Finally, Mode E is used for the VHF frequency bands from 30 MHz up to Band III (DRM+).

## ii. Modulation parameters

In addition to the basic transmission Modes, there is also a choice of modulation (QAM constellation) and coding (Viterbi) rates for the main service channel. Normally, provided the broadcaster has selected the transmission mode correctly, the service area achieved should be defined predominantly by the received signal-to-noise ratio. This allows the use of simple analogue planning tools (see Section 10)

In all DRM30 Modes the option exists to choose either 64QAM or 16QAM for the Main Service Channel, and this choice will be largely influenced by the signal-to-noise + interference ratio (SNR) that can be achieved in the target area. The more robust 16QAM option is normally chosen where the SNR is expected to be too low to support 64QAM. For DRM+ (Mode E), it is possible to employ either 16QAM or 4QAM for the Main Service Channel.

### 5.3.2 Service multiplexing and pay-load capacity

Within the constraints of the modulation parameters required to deliver the required quality of service within the targeted coverage area, the broadcaster has some flexibility in the way the available capacity of the MSC is used. The broadcaster may wish to allocate some of the capacity to provide data services alongside the audio, and to split the capacity to provide more than one audio service. Examples might be a high-quality service, containing music and speech, together with a low bit-rate speech service, carrying news headlines or a similar voice-only information service such as traffic updates.

Table 5.3.2 ‘DRM system Bit Rate Table’ sets out the range of bit rates that are available for different levels of signal robustness and channel bandwidth. The smallest bit-rate increment is 20bps in DRM30 modes, and 80bps (DRM+).

Table 5.3.2: The DRM system Bit Rates

			Nominal Signal Bandwidth (kHz)						
Mode	MSC Modulation (nQAM)	Robustness level	4.5	5	9	10	18	20	100
			Approx. available bit rate kb/s (equal error protection, standard mapping)						
A	64	Min.	14.7	16.7	30.9	34.8	64.3	72.0	
		Max.	9.4	10.6	19.7	22.1	40.9	45.8	
	16	Min.	7.8	8.8	16.4	18.4	34.1	38.2	
		Max.	6.3	7.1	13.1	14.8	27.3	30.5	
B	64	Min.	11.3	13.0	24.1	27.4	49.9	56.1	
		Max.	7.2	8.3	15.3	17.5	31.8	35.8	
	16	Min.	6.0	6.9	12.8	14.6	26.5	29.8	
		Max.	4.8	5.5	10.2	11.6	21.2	23.8	
C	64	Min.				21.6		45.5	
		Max.				13.8		28.9	
	16	Min.				11.5		24.1	
		Max.				9.2		19.3	
D	64	Min.				14.4		30.6	
		Max.				9.1		19.5	
	16	Min.				7.6		16.2	
		Max.				6.1		13.0	
E	16	Min.							186.3
		Max.							99.4
	4	Min.							74.5
		Max.							37.2

In DRM, a 'Service' may be either audio or data:

- Audio services consist of one audio component, plus up to four associated data components (referred to as "PAD" – programme associated data).
- Data services consist of one data component.

A DRM transmission provides between one and four services. Listeners select a service by using the label provided in the SDC and the receiver uses the configuration information in the SDC to select the correct data streams from the MSC (Main Service Channel). The MSC can hold up to four MSC streams. An MSC **stream** may contain one audio component (including optional DRM text messages), or one data component in synchronous stream mode, or up to 4 data components in packet mode. The available MSC capacity (depending on the chosen modulation parameters) can be flexibly assigned to the required number of MSC streams and changes may be made using the dynamic reconfiguration process.

Audio or data components carried in MSC streams can be referenced and linked to from multiple DRM Services simultaneously, but every component must be linked with at least one DRM Service. This allows for example to share a PAD component between multiple DRM audio services, thereby preventing the need to transmit identical data multiple times. Figure 5.3.2 shows a possible linking scenario from DRM services to MSC streams. More options and possibilities demonstrating the flexibility are contained in the DRM system specification [1], Annex M.



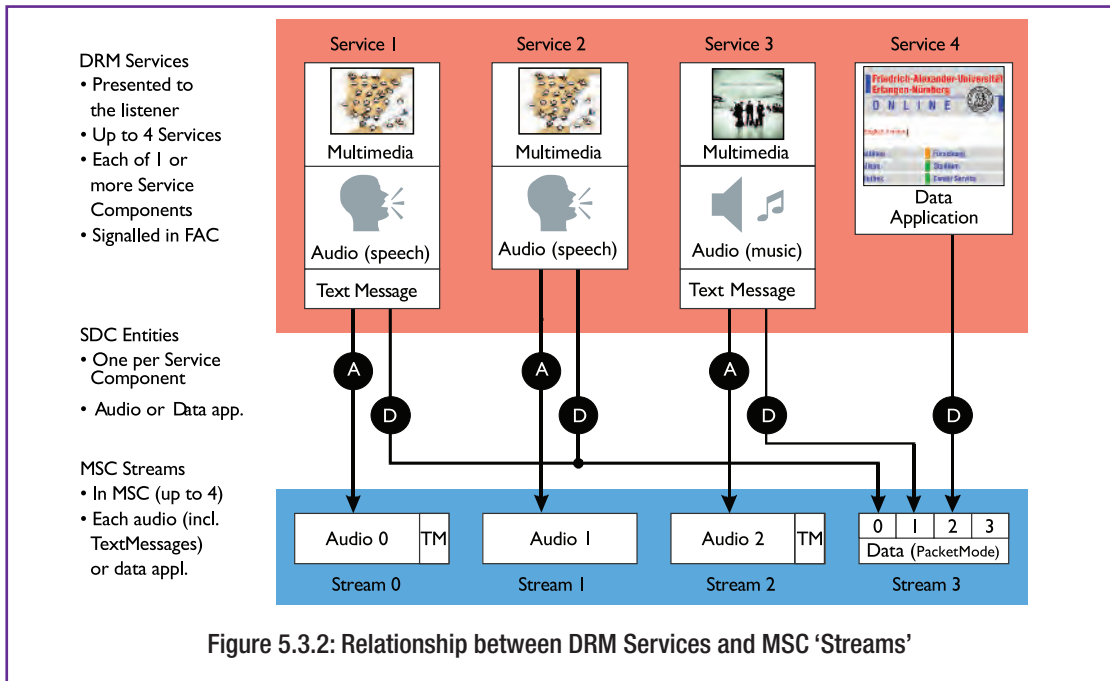

Figure 5.3.2: Relationship between DRM Services and MSC 'Streams'

The system is flexible in other ways as well, in that the broadcaster has the facility to vary the occupied bandwidth of the signal to exploit the spectrum available in different frequency bands and in different regions of the world. Alternatively, where planning conditions allow, double bandwidth signals (18 or 20 kHz bandwidth) can be transmitted in the AM bands to provide an increased level of audio quality.

### 5.3.3 Single and Multi Frequency Networks

The DRM system is capable of supporting **Single Frequency Network (SFN)** operation. This is the case where a number of transmitters transmit, on the same frequency, identical DRM signals. Generally these transmitters are arranged to have overlapping coverage areas, within which a radio will receive signals from more than one transmitter. Provided these signals arrive at the receiver within a time difference of less than the guard interval, they will provide positive signal reinforcement. Therefore the service coverage will be improved at that location, compared to that obtained if there was only a single transmitter providing service at that location.

By careful design, and using a number of transmitters in a SFN, a region or country may be completely covered using a single frequency, rather than a number of different frequencies, thus dramatically improving spectrum efficiency.

Figure 5.3.3 illustrates how an existing UK national network, currently using five analogue MF frequencies, could be migrated to a DRM SFN, thus releasing four channels for other services.

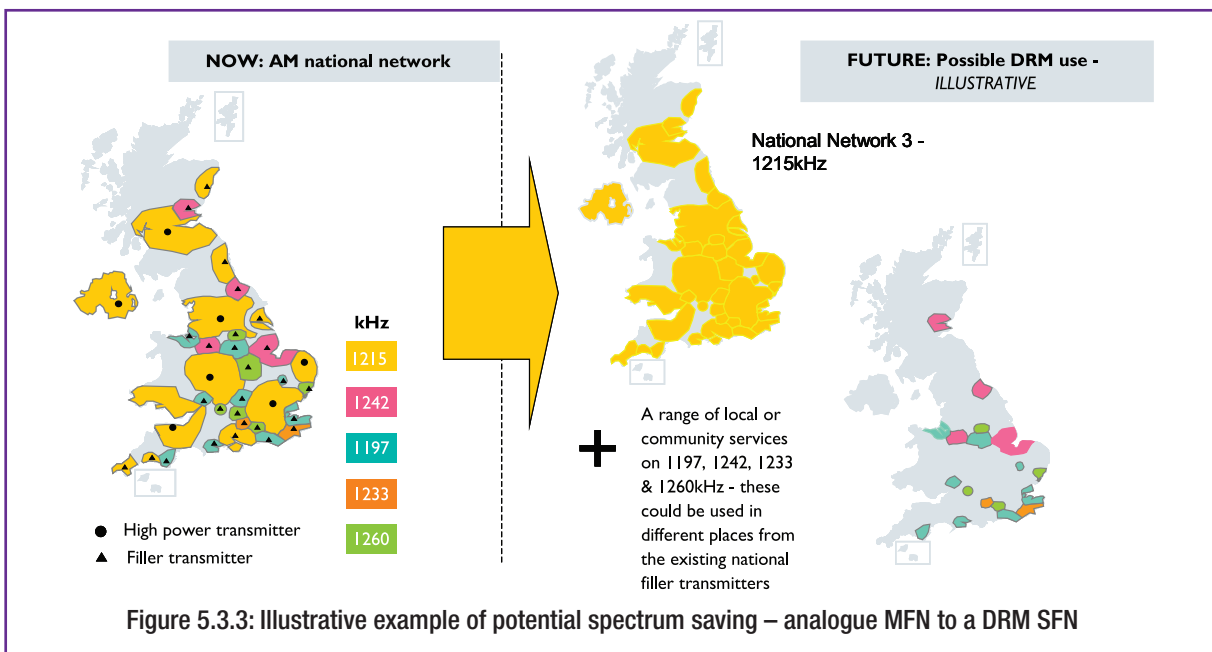

Figure 5.3.3: Illustrative example of potential spectrum saving – analogue MFN to a DRM SFN

Where use of an SFN may be impractical for some reason, a **Multi-Frequency Network (MFN)** may be employed. In this case the transmitted DRM signals are identical but the frequency used for each transmitter is different. The DRM signal provides a short period during which no MSC data is transmitted. This is not audible to the listener as the data is re-timed in the receiver to ensure continuous data arrives at the audio decoder. However this period provides a short time interval, during which the receiver may tune to an alternative frequency carrying the same programme, in order to determine its signal quality.

If the quality on the alternative frequency is better, the receiver can stay on that frequency, if not it can return to the original frequency. However this operation will only work seamlessly if the signals on the alternative frequencies are accurately synchronised at the receiver. MFN operation relies on the use of AFS signalling, as described below in Section 5.3.5. Where a receiver is equipped with dual signal-decoding chains, it is possible to compare two or more signals on a continuous basis or even combine the signals to provide a significant improvement in reception reliability through frequency and propagation-path diversity.

#### 5.3.4 Simulcast

Simulcast is an option of particular interest to broadcasters who have to continue to satisfy existing analogue listeners for several years to come, but who wish to introduce DRM services as soon as possible. In many cases these broadcasters are restricted in the ways in which the digital service can be introduced. For example they may have a single MW assignment and no prospect of receiving an additional frequency assignment to start a digital only version of their service. They may also be keen to avoid having to make a short-term investment in an additional transmitter and/or antenna and site to start a digital service on a new frequency. These broadcasters would like to be able to transmit both the existing analogue service and a new DRM service, with the same content, whilst using the existing transmitter and antenna. This option is probably most applicable to broadcasters with LW or MW assignments, where there is generally less freedom to use new frequencies, although there may be similar SW applications where NVIS is used for domestic radio coverage. Nevertheless, it is now the case that Broadcasters in Europe are either closing or considering closing down LF and MF services and this would offer an ideal opportunity for the introduction of new digital radio services.

Transmitting the same programmes in both analogue and digital formats but at different times of the day is one option to provide the benefits of digital whilst maintaining services to listeners with only analogue receivers. The times of day and duration of the different offers are best determined by the broadcaster since he has a good knowledge of his audience, and of course as more listeners convert to digital the proportions of digital and analogue services can be changed.

Strictly the term simulcast can be taken to describe the simultaneous transmission of more than one signal carrying the same programme content. In this context it may describe the simultaneous transmission of analogue and digital versions of the same programme from the same transmitter and therefore from a common location. In some cases it could be more economical to add a new lower powered transmitter for the DRM service, feeding the same antenna, rather than making extensive modifications to an older less suitable transmitter currently carrying the analogue service.

Attractive simulcast modes require the use of either 18/20 kHz channels or additional spectrum outside an assigned 9 kHz or 10 kHz channel in a Multi-Channel or Multi-frequency Simulcast (MCS) configuration. The DRM signal can be located in the next adjacent upper or lower channel (see Figure 5.3.4.1). Significant testing, both in the laboratory and in the field, has been carried out to determine the optimum level of DRM signal needed to provide a good quality DRM service, whilst avoiding significant impact on the analogue service.



### 5.3.4.1 DRM30 Modes

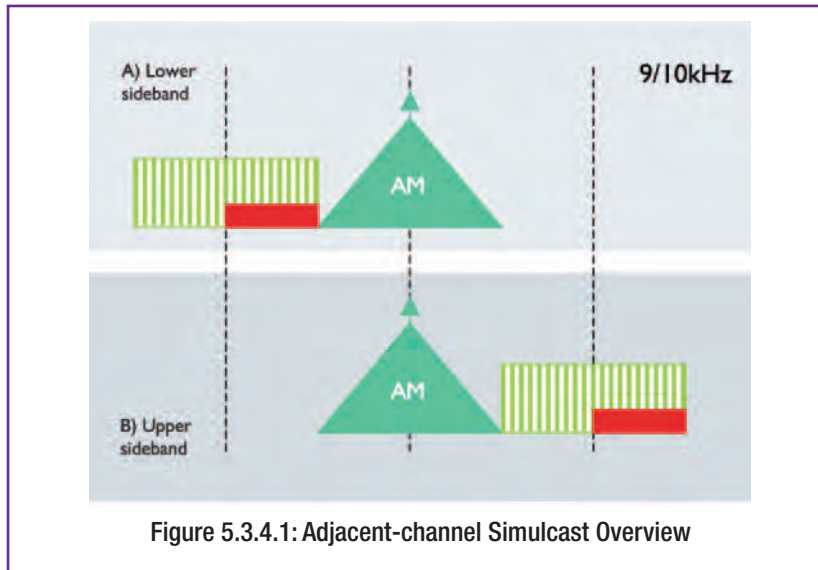

The conclusion is that a satisfactory compromise can be obtained when the level is around 14-16 dB below the adjacent analogue carrier level.

### 5.3.4.2 DRM+ Mode E

FM and DRM+ simulcast working is described in Section 9.3.2.

### 5.3.5 Alternative Frequency Signalling (Checking and Switching)

Alternative Frequency Switching forms an integral part of the mechanism allowing the use of MFN's. The AF (alternative frequency) list is transmitted in the SDC part of the DRM multiplex and provides the receiver with a list of frequencies carrying the same programme or associated programmes. The AF list can also provide information on non-DRM services, such as analogue AM, FM and DAB multiplexes that carry the same or associated programme. Depending on the coverage of the receiver, it may therefore be able to switch backwards and forwards between these other types of transmissions and the DRM service(s).

There are two distinct modes of Alternative Frequency switching, as follows:

- **Seamless** AFS, whereby the receiver re-tunes with virtually no break in the audio. This is illustrated in Figure 5.3.5. Note that this mode requires network synchronisation similar to a single-frequency network, and seamless switching is only supported between DRM transmissions.
- **Generic** AFS, which allows the receiver to be directed to another transmission carrying the same service, and which is not constrained to be either a DRM broadcast nor time-synchronised.

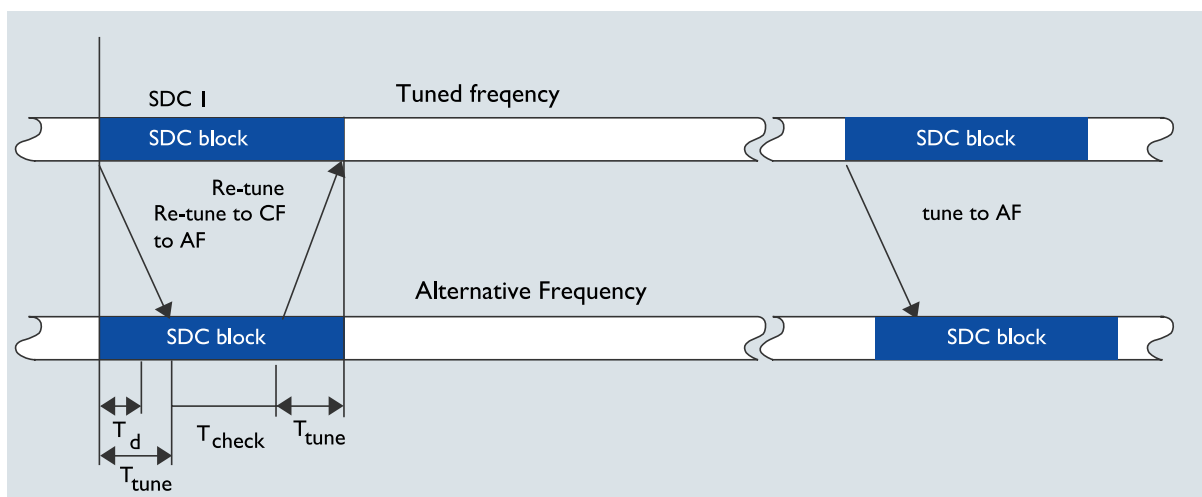

Figure 5.3.5: Seamless Alternative Frequency Switching

An example of 'generic' AFS might be a metropolitan FM service, carrying RDS, which points to a DRM frequency. Outside the metropolitan area the coverage might be extended by using one or more DRM transmitters so that a car receiver could switch from the FM service to the DRM service. The reverse process would apply on returning to the metropolitan area. Another similar application might be an international SW service transmitted from outside a country, but where a local relay was provided in the capital city of that country, using a Band II FM frequency.

In the case of the DRM AFS function, it is possible not only to transmit information about current frequencies carrying the same programme but also other frequencies, which will carry the same service at other times of day or in other regions of the world. This can be particularly useful for SW services, where different frequencies are required to provide service to a region at different times of day, due to diurnal propagation variations, or to different regions, because of differing propagation paths. In these cases the receiver can be equipped with data storage to ensure that the listener can select a programme service by name and allow the receiver to select the optimum frequency for that region and time of day.

Annex G of the DRM system specification [1] contains some detailed information and guidance on AFS handling in receivers.

### 5.3.6 Programme acquisition

Where DRM services are to be broadcast at bit-rates below 30kb/s, it is important to ensure that the processes of content acquisition, editing, and storage and play-out retain the maximum audio fidelity prior to audio DRM coding, and avoid as far as possible multiple encode-decode concatenation. For further information see section 6.2.

## 5.4 The AM Signalling System (AMSS)

DRM has developed a system for digital signalling over AM transmissions. This system has been designed so that AMSS-equipped analogue transmissions can be identified, selected and tuned on hybrid analogue/DRM (or even analogue-only) radios, just as if they were digital services – see Figure 5.4. This greatly simplifies radio tuning and service selection for the listener and provides an extremely powerful and cost-effective facility during the migration of an audience from analogue to digital. In addition, the system supports alternative frequency signalling, such that a station equipped with AMSS can hand the listener's receiver automatically to a digital, AM or FM simulcast transmission, as appropriate.

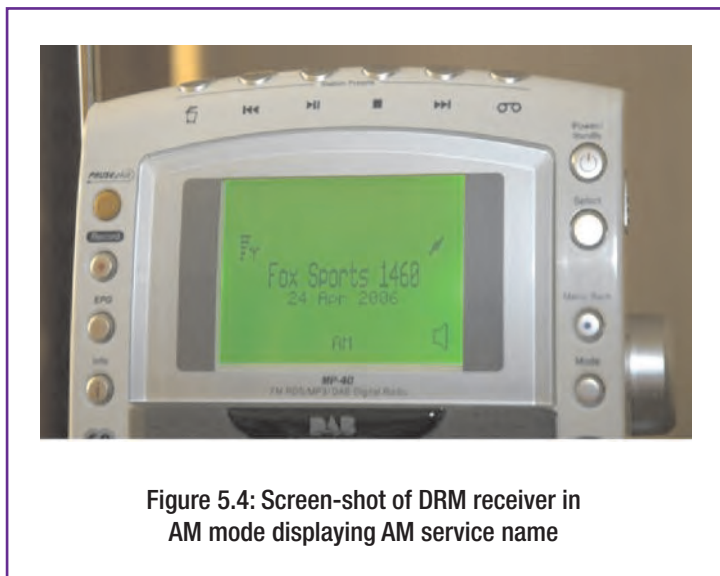

The system was engineered to be extremely robust whilst preserving excellent compatibility with existing AM receivers. The gross bit-rate is circ. 47b/s, and the system has been successfully launched and tested on both MF and HF transmissions.

AMSS has now been published as ETSI standard TS 102 386 [4] and has been implemented in at least one first-generation DRM radio module. A description of the system, its features and implementation has been published by the EBU [5].

# MORE



NX Series MW or LW 25 kW – 2 MW

**90%\***  
EFFICIENCY

Nautel offers the most advanced DRM transmitters available today. Choose from power outputs of 1 kW to 2000 kW MW and 300 W to 88 kW FM. Available with integrated instrumentation, industry leading efficiency, comprehensive web management and of course Nautel's renowned reliability and support. Expect more from Nautel. Learn more at [www.nautel.com/drm](http://www.nautel.com/drm)



+1.902.823.5131  
[www.nautel.com/drm](http://www.nautel.com/drm)

Making Digital Radio Work.

\*NX100 and above

# DiGiDiA

[www.digidia.fr](http://www.digidia.fr)

the **specialist**  
of Digital Radio Transmission  
**systems**

## ALTO

DRM30/DRM+ AUDIO/CONTENT SERVER

- . Up to four services
- . AAC+, CELP & HVXC audio encoding
- . Text Messages insertion
- . Data insertion as option (MOT SLS & BWS, IP Tunneling etc.)
- . Management software through WEB
- . SNMP agent (MIB v2)
- . SFN Ready
- . 1+1 redundancy



## TENOR

DRM30 MODULATOR/EXCITER  
with integrated audio encoder

- . Audio in RF out feature

DRM30 has never  
been so easy !



## SOPRANO

DRM30/DRM+ MODULATOR/EXCITER

- . All modes (A, B, C, D & E) and bandwidths
- . IQ, Amplitude & Carrier, direct RF output types possibilities
- . Simulcast ready with spectral shaping (DRM30)
- . SFN Ready
- . Front Panel LCD for local settings
- . Management software through WEB
- . SNMP agent (MIB v2)
- . Adaptive precorrection and delay adjustment



contact : [sales@digidia.fr](mailto:sales@digidia.fr) phone : +33 2 99 14 63 32 fax : +33 2 99 14 58 83

# 6

# DRM Content

This section describes the various elements of the broadcast signal. It may broadly be described as 'content'. This includes the following main elements:

1. mandatory meta-data which is an essential component of the DRM system. Examples include much of the data carried in the Fast Access and Service Description channels (FAC/SDC)
2. non-mandatory information which a broadcaster may chose to include and which is automatically supported by receivers (e.g. text messages)
3. the audio content (radio services): both encoding and audio quality considerations
4. any value-added and/or data services which broadcasters may chose to implement

It should be noted that whilst '1', '2' and '3' above will automatically be supported by any receiver which meets the relevant DRM specifications (Annex 3 and [6]), broadcasters should work closely with the receiver industry to ensure that support for any additional features ('4.' above) is properly integrated into consumer radios. See Section 7 – DRM Receivers for more information.

## 6.1 Broadcast meta-data

In this section, data that is mandatory is indicated by appending '{M}' to the sub-heading.

### 6.1.1 Service ID {M}

The DRM Service ID is a worldwide unique identifier assigned to every DRM programme. It enables the AFS mechanism (Alternative Frequency Signalling) and allows a receiver to find and identify the selected programme even if its frequency has changed. It is not used by the listener for service or programme selection, nor is it shown on consumer receiver displays.

It is the broadcaster's responsibility to assign a unique ID to each of its DRM services. The DRM Service ID values are typically assigned by national authorities. More information on the format of the Service ID can be found on the DRM web site

### 6.1.2 Service Labelling {M}

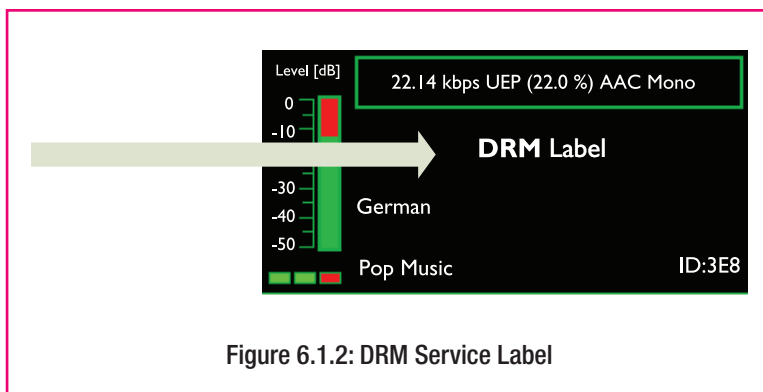

The listener is informed about the tuned service by the name of the programme (DRM service label). The DRM service label is the primary programme identification and selection mechanism for the listener, while information about the current broadcast frequency or even the broadcast standard may not be disclosed at all by modern Digital Radio receivers.

The DRM service label can be any free text, up to 16 characters long. All worldwide scripts are supported for broadcast (up to 64 bytes of UTF-8 encoded text), but the

characters displayed by receivers will depend on those implemented by the manufacturer. If a station is known to its listeners currently by its AM or FM main frequency, this information could be sent as part of the DRM service label.

### 6.1.3 Programme Type

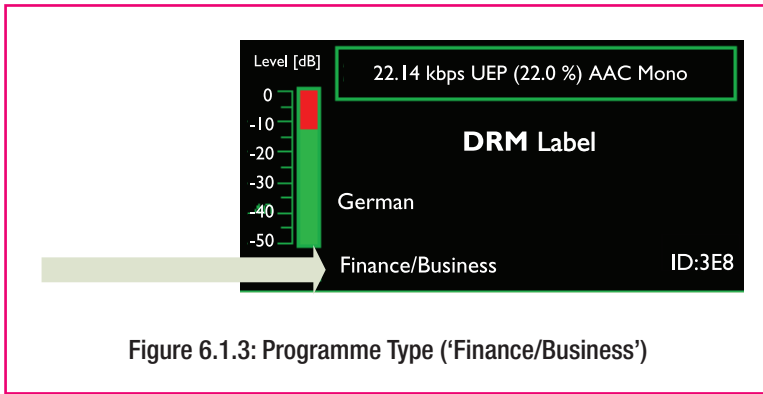

Figure 6.1.3: Programme Type ('Finance/Business')

The selection of a service can be made by the genre of the programme, for example news, rock music or drama. The figure above shows Pop Music and below Finance/Business information, which could be information from the currency markets or stock exchange. DRM supports the optional signalling of 29 common programme types for audio services.

### 6.1.4 Service Language

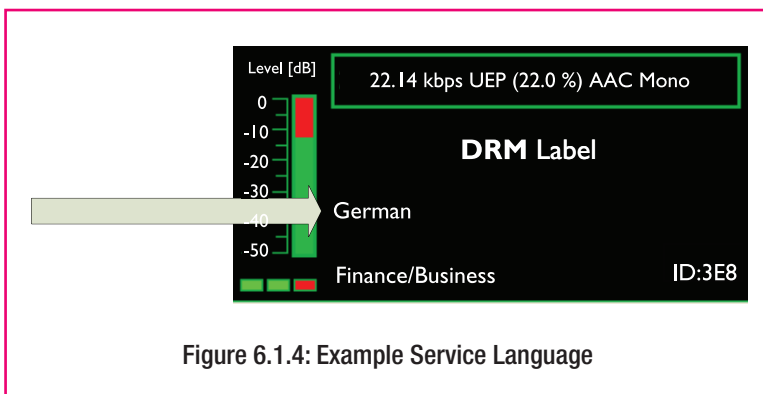

Figure 6.1.4: Example Service Language

The listener may be able select the language of the programmes he wants to receive on the radio. In regions with many languages, this might be helpful to avoid tuning into services that cannot be understood. DRM supports the optional signalling of all languages worldwide by using their respective ISO language codes.

### 6.1.5 Country of origin

The broadcast can optionally signal the country of origin for a particular DRM service. This information refers to the site of the studio, not a transmitter site. Thereby a receiver can enable the listener to scan for programmes originating from a particular country, for example to easily identify the national news programme whilst on vacation. All countries worldwide can be signalled by using their respective ISO country codes.

## 6.2 Audio content

### 6.2.1 Audio Coding

The DRM system has adopted the latest audio coding technology from MPEG, xHE-AAC (Extended High Efficiency Advanced Audio Coding). xHE AAC can operate from only 6 kbps, and handles both speech and general-purpose audio content equally well. In addition, DRM still provides AAC audio coding to continue support for on-air services. Existing DRM broadcasts using AAC can migrate to xHE-AAC by upgrading the audio coding library of content servers.

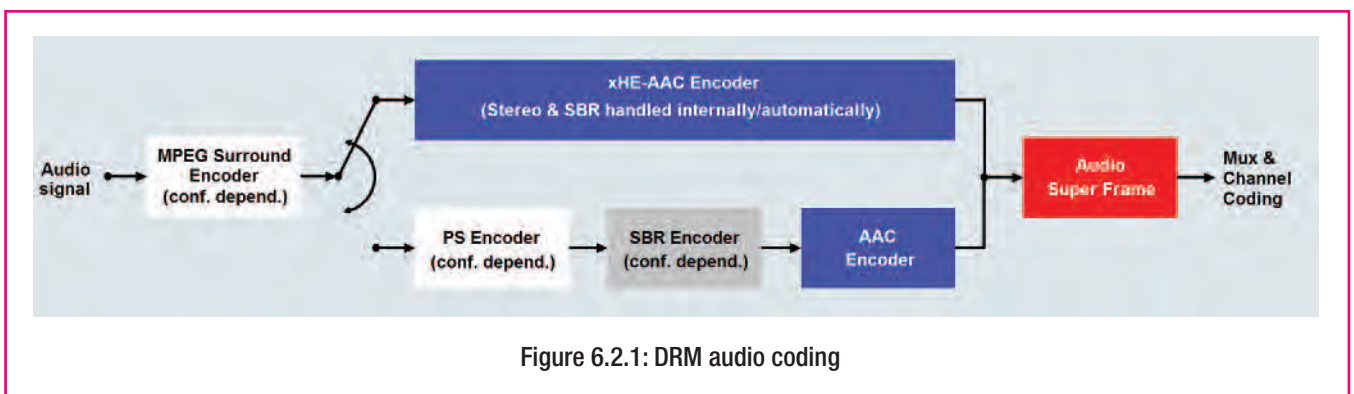

Figure 6.2.1: DRM audio coding



Both encoders can operate over a range of bit rates, and consequently support a range of programme content. In the 18/20 kHz DRM30 modes and DRM+ mode, the available data rate allows the possible use of MPEG 4 stereo-compatible 5.1 surround sound broadcasts.

### 6.2.2 Optimising sound quality

Digital audio coding has been in use within broadcast organisations for a number of years. Most broadcasters have experiences of multiple tandem coding and the problems that this incurs in reducing the overall quality of the audio, after it has been through this process. In most cases the digital audio compression systems work by endeavouring to remove information inaudible to the human hearing mechanism. This 'lost' information is masked from audibility by higher-level sounds that are normally adjacent or close in frequency. However, this is an inherently lossy process. Each time the audio is encoded and decoded there is a danger that audio artefacts, introduced by a previous codec in a chain, are seen as 'wanted' components for a later codec in the chain. This can lead to the artefacts being coded in preference to or as well as the 'real' audio information. This progressively leads to worsening quality as the audio proceeds through the broadcast chain.

The ideal solution to this 'concatenation' problem is to avoid cascaded coding altogether. Where this is not feasible, it is good practice to maintain the highest-possible bit-rates in the content acquisition and editing processes, and to then code for distribution and transmission once only, at the correct bit-rate for broadcasting.

In many instances, broadcasters use audio coding for programme acquisition (via ISDN, Internet etc.), followed by audio coding in their digital editing systems and finally they recode again to save data bandwidth for distribution to one or more transmitters. It is quite possible that each of these coding processes will use different data rates and, often, different audio coding algorithms. Presently this signal would generally then be transmitted to listeners in analogue form via AM or FM transmitters. However, when a DRM transmission is introduced at the end of this chain there will be an additional audio coding process.

As a direct response to the concatenation issues described above, the MDI specification is designed to encourage broadcasters to encode DRM transmissions at the earliest point in this chain, where the quality will be highest; for example at the studio centre, rather than at the transmitter site. This ensures that there are no further coding processes before the audio arrives at the receiver. The MDI specification provides additional advantages in terms of efficiently packaging together with the audio, all the data that is needed for a DRM transmission.

The advantage of this is that the DRM audio can be encoded using the highest quality source available, avoiding any intermediate coding such as, for example, a studio to transmitter link using MPEG2 Layer II compression. For the case of a 9 or 10 kHz bandwidth DRM transmission (i.e. MSC data rate ~30kb/s or less) all of the MSC, SDC and FAC, together with the transmission control parameters, can be contained within less than 64kb/s of data capacity. The transmission control data allows the DRM exciter parameters at the transmitter to be remotely controlled, so that the transmission Mode, modulation etc. can be set at the studio centre, without intervention at the transmitter site.

## 6.3 Value-added services

### 6.3.1 Overview

The DRM system provides for a number of data applications. These can range from a simple low bit-rate text service, alongside the audio, to the use of the entire MSC capacity for multimedia-type data services. In general the simple text applications can be used to transmit programme-associated data services, such as news, sports or weather information services, alongside the main audio service.

The more complex multimedia types of service can include both text and pictures, although for DRM30 Modes the relatively low bit-rate will constrain the quantity of data and the refresh-rate. In practice, for these Modes it is most likely that such a service would employ around 2 to 4kb/s of the MSC capacity, as the majority of the MSC capacity is likely to continue to be used for audio services for some time to come.

Providing data and multimedia services in addition to plain audio presentation gives Digital Radio the chance to evolve and to establish a stronger link between listeners and broadcasters.

User-targeted multimedia services will typically be presented on a receiver display. While most of the services require a simple text-only screen, some depend on a graphical display. Therefore manufacturers should be encouraged to provide the largest screen possible in order to support these advanced offerings.

Some of the data services focus especially on car radios and provide road traffic updates for integrated

navigation systems. Providing this kind of service is most useful for local, regional or national broadcasters. TMC (described below) and TPEG are important travel services.

In addition to the multimedia services presented in this chapter, other features can also show the advantage of Digital Radio to the listener. For example the option to enable a receiver to pause and rewind a program is of high interest for consumers. With the single touch of a button the reception of the favourite station can be paused. Later on, the user can continue listening from the point at which he or she left the programme. Depending on the internal memory capacity and the data rate of the service, several hours of content can be recorded. When using an additional flash card memory the recorded programme can also be replayed on other radios supporting this feature.

### 6.3.2 DRM Text Messages

DRM includes the facility for broadcasters to send a sequence of short text messages<sup>4</sup> each message composed of up to 128 characters in length. DRM Text Messages are always part of an audio programme; their content is therefore typically related to this audio service (current song title and artist, show name, station news, etc.). The update timing on the receiver's display is controlled by the broadcaster; therefore a minimum delay of 10 to 20 seconds between successive messages should be respected, to reduce the distraction of listeners, particularly in in-car scenarios. Where the receiver is unable to display the entire message on-screen, it is common to scroll the text smoothly from right to left – see Figure 6.3.2.



Figure 6.3.2: Scrolling text (bottom of screen) describing the programme currently on-air

DRM Text Messages support all worldwide scripts through UTF-8 encoding, using 1 to 4 bytes to encode one character (out of 128 bytes

available per message). Therefore a single message may have more than a hundred characters in a Latin-based language, but only about 40 characters in Chinese script.

### 6.3.3 Journaline text information service



Figure 6.3.3a: Journaline – textual information pages accompanying the radio programme

Journaline is a text-focussed information service [see Annex 1 #12]. It can be signalled as belonging to an audio programme (PAD – Programme Associated Data), or as a stand-alone service.

The user is provided with a selection of information topics and sub-topics, from which he can interactively select those pieces he is currently interested in.

The broadcaster defines the service structure and information elements presented to the user. Information is provided in the form of plain-text pages, list/table pages, or ticker messages. Plain-text pages consist of a title followed by the detailed body text; they typically carry news items, programme background information, station contact information, etc. List/table pages are typically used for sports scores, financial tables and stock market updates, or airport arrival/departure times. Ticker messages (like news headlines, financial tickers, radio captioning subtitles, etc.) carry a single message at a time, which should fully be presented on screen and these will automatically be updated.

<sup>4</sup> see Clause 6.5 of ETSI TS 201 980[1]

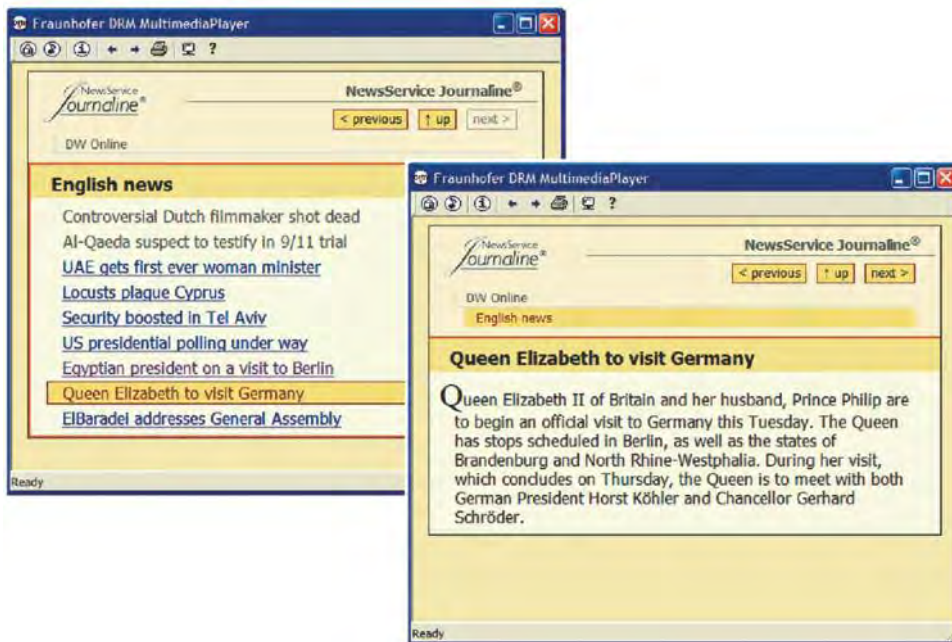

Figure 6.3.3b: Navigating through the topics of a Journaline service

In total, a Journaline service can be composed of more than 65000 individual pages, each carrying up to 4 kBytes of textual content. All textual information is UTF-8 encoded, thereby allowing any worldwide script to be used. Information in multiple languages can be provided in parallel as part of a single Journaline service, for example to cover mixed-lingual audiences whose language(s) are not currently carried by the main audio programme.

'Hot Button' functionality allows the broadcaster to optionally trigger back-channel interactivity from the user, if supported by a particular receiver; those links can point to online web URLs or phone numbers, send SMS messages or e-mails, jump to other Journaline pages, etc. Broadcasters also have the option to enhance Journaline pages with geo-references. This allows a receiver to present the user with a selection of locally relevant information, or to forward the location of e.g. a restaurant being advertised to the navigation system.

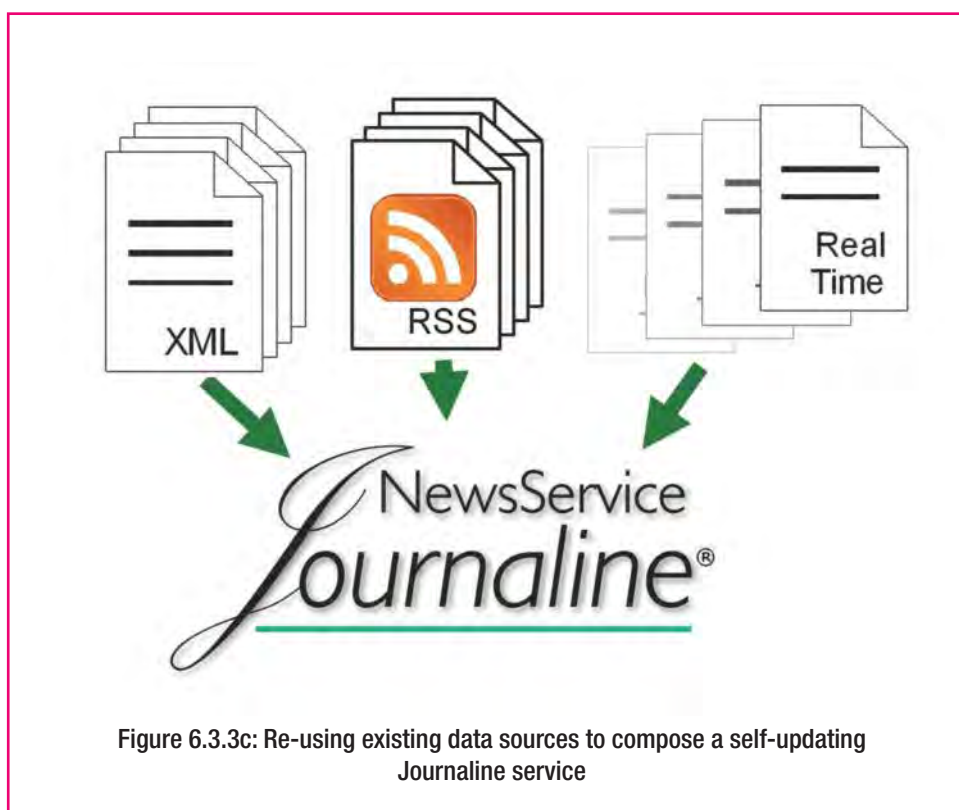

Figure 6.3.3c: Re-using existing data sources to compose a self-updating Journaline service



On the broadcaster side, existing data source like RSS feeds, XML interfaces, or UECF real-time messages can be re-used, to compose a useful service for the listener without the need to manually update its content after its initial setup. Over the air, Journaline can work with very limited bit-rates; it has successfully been broadcast with a transmission capacity as little as 200 bps. Therefore a Journaline service can be added even to shortwave broadcasts without affecting the audio quality. On the receiver side, Journaline requires very limited decoding, cache memory, and user interface capability, and can therefore be implemented on all receiver types with at least a textual screen.

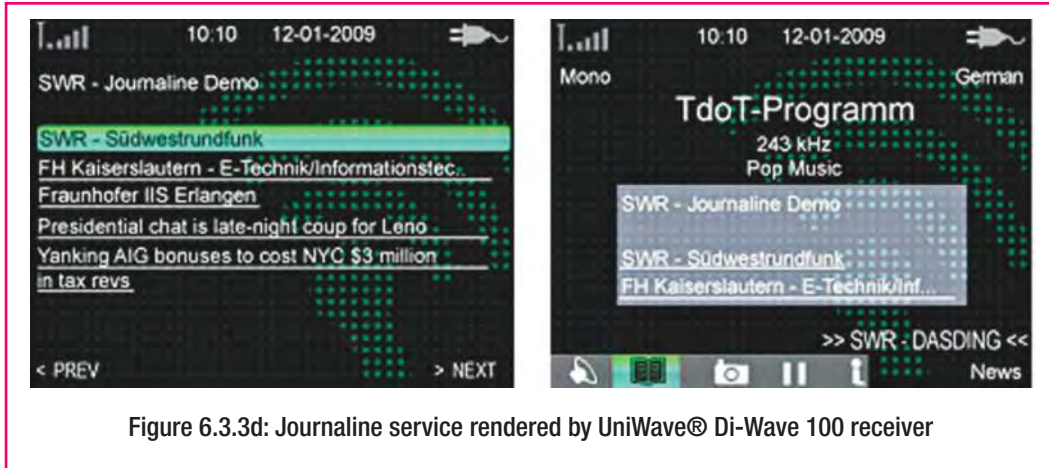

Figure 6.3.3d: Journaline service rendered by UniWave® Di-Wave 100 receiver

### 6.3.4 Electronic Program Guide (EPG)

An electronic programme guide (EPG)<sup>5</sup> is a digital guide to scheduled radio programmes. The content is typically displayed on-screen with functions allowing a viewer to navigate, select, and discover content by time, title, channel, genre, etc. by use of their remote control, a keyboard, or other input devices on the receiver. Both the EPG structure and transport protocol have been standardised by ETSI [see Annex 1, #10 & #11].

The EPG could also allow the easy selection of broadcast content to be scheduled for future recording by the DRM radio or a digital recorder.

The DRM EPG can carry the full programme schedule for the next days, providing detailed information on shows and even sub-show elements (like individual news report items), station and programme logos, and much more. In addition, a simplified and reduced now-and-next information set can be provided, which can easily be decoded even on receivers with limited memory capacity, and presented on text-only screens.

In DRM, one EPG instance will typically carry the combined information for all programmes (DRM services) contained on the same frequency, and optionally for all other programmes provided by the same broadcast network. Therefore at least in the case that more than one audio programme is carried in a DRM broadcast, the EPG will be signalled as an independent DRM service instead of a PAD service (Programme Associated Data).

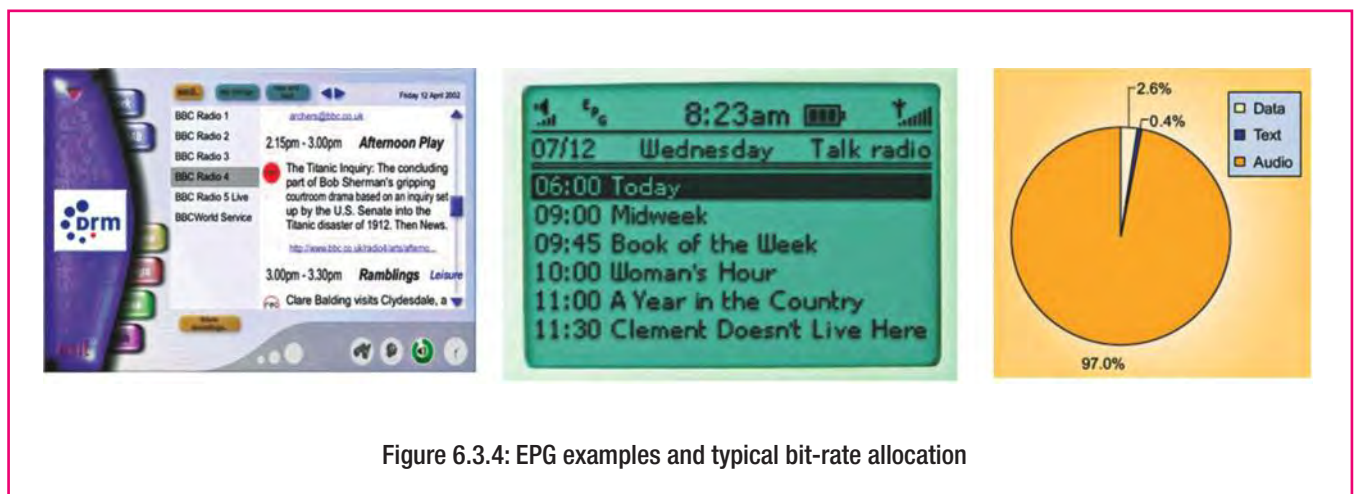

Figure 6.3.4: EPG examples and typical bit-rate allocation

<sup>5</sup> or interactive programme guide (IPG); or electronic service guide (ESG)

### 6.3.5 Slideshow

A slideshow is a sequence of images [ETSI standard, see Annex 1, #15]. The DRM terminal displays them in response to a trigger set by the broadcaster, which typically means immediately after their successful reception. The content of a slideshow should be composed such that the user is presented with useful information whenever he or she glances at the screen; it will typically be programme related (current album cover, show or program logo, presenter portrait, view into the studio, maps and celebrity portraits during the news, etc.), but may also carry programme independent elements (like graphical weather forecast or advertisements).

The broadcaster decides when a new slide replaces an older one on the receiver's display. So it is also up to the broadcaster to ensure that slides change at an acceptable rate. As with DRM Text Messages, the broadcaster should allow at least a presentation time of 10 to 20 seconds for each slide, for example to reduce the driver distraction in case of in-car radio consumption. Typically the bitrate required to transmit images should not be below 4 kbps; therefore DRM30 double channel or DRM+ broadcasts offer the best opportunity to add the slideshow service to a radio programme.

The image files carried in a slideshow service are either in PNG or JPG format. While PNG is particularly suitable for logos and graphics, JPG is the primary choice for photos. A receiver supporting the slideshow application should be able to decode and present images with a minimum resolution of 320 x 240 pixels. Besides static images, the slideshow specification also supports simple animation sequences based on the PNG format (APNG – Animated PNG); those image files are encoded in a backward compatible way, so that every legacy PNG-decoder will present at least the first slide of the animation sequence.

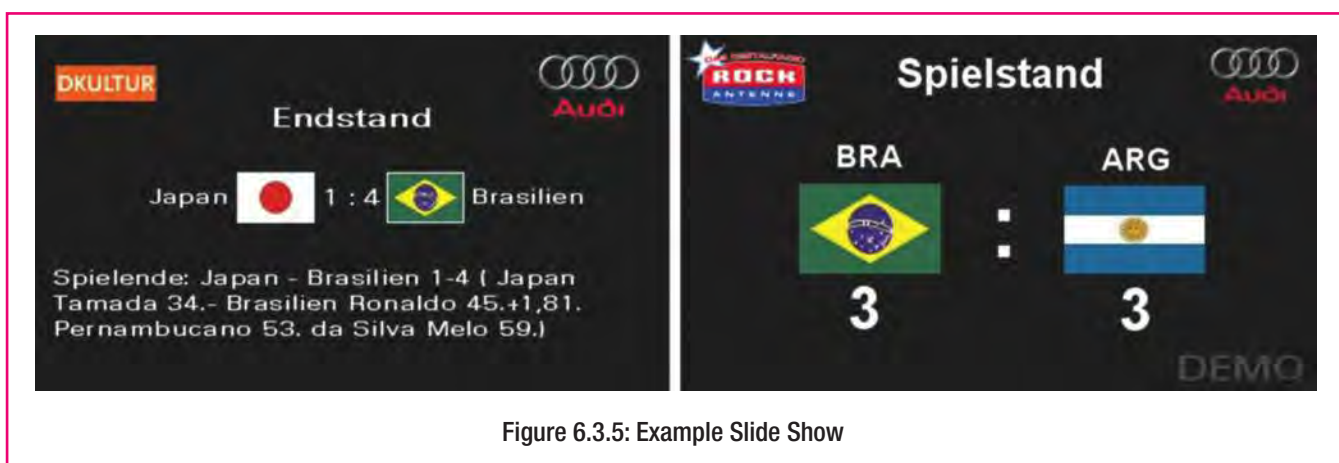

Figure 6.3.5: Example Slide Show

### 6.3.6 TMC (Traffic Message Channel)

The Traffic Message Channel (TMC) was originally designed for the Radio Data System (FM-RDS). It is primarily used for broadcasting real-time traffic information. Data messages are received silently and decoded by a TMC-equipped car radio or navigation system. These messages can be delivered to the driver in a variety of ways; the most common of these is a TMC-enabled navigation system that can offer dynamic route guidance – alerting the driver to a problem on the planned route and calculating an alternative route to avoid the incident.

#### Benefits for users are:

- Updated traffic information, delivered in real time
- Instant knowledge of accidents, road-works and traffic jams
- Filtered information only for the immediate route
- Information in user's own language
- High-quality digital transmission
- Global compatibility of receivers
- Free or low-cost services right across neighbouring countries
- Instant information en route

TMC traffic information offers several advantages. First, it is received via a "silent" data channel, which means that users can listen to music or news broadcasts simultaneously with – and without interference from – TMC data transmissions. Second, messages arrive and are displayed immediately, so you don't need

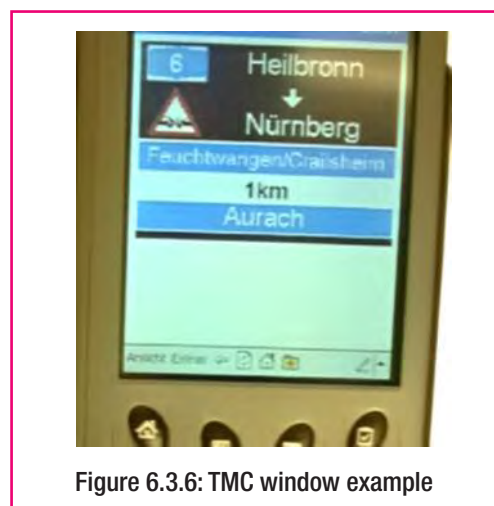

Figure 6.3.6: TMC window example

to wait for the scheduled traffic news bulletin, or to listen to a specific programme. Also, TMC services are continuously updated and their information is constantly available to the driver, unlike occasional roadside information services such as variable message signs.

Thanks to TMC receiver technology, users can receive traffic information in their own language. The TMC unit, typically an in-car navigation system, decodes the received traffic information and presents it to the user. Whichever country the user is driving in, he or she can understand the local traffic situation immediately.

DRM has defined a dedicated TMC message encapsulation protocol, to allow for a bitrate-efficient transport of TMC messages within the DRM multiplex (see Annex 1, #11).

## 6.4 DRM Emergency Warning Feature (EWF)



### 6.4.1 Overview

DRM supports and provides a fully integrated disaster and early warning service called Emergency Warning Feature (EWF).

The DRM technology provides an ideal platform for delivering emergency warning services. DRM EWF support is mandatory as described in the DRM minimum receiver requirements and second level receiver profile, with no need for special chipsets or extra adaptation for EWF. Everything needed for EWF is already in the receivers built according to the above specifications issued by the DRM Consortium.

The DRM technology should therefore be the major building block of a national emergency warning policy, providing full and continuous services as a last resort, potentially even from a remotely located transmitter site.

### 6.4.2 Task

The task of any early warning system is to inform the general public (and relevant authorities) about the impending disaster, with maximum reach and as quickly as possible, giving all relevant information to a maximum audience (including foreign-language visitors and people with impairments).

### 6.4.3 How DRM EWF Works

The DRM system employs Alternative Frequency Signalling (AFS), which points the receiver to the emergency broadcast (even if the receiver is tuned to a different service or on a different frequency). It also employs emergency announcement signalling, where the receiver has general support for the emergency announcement feature and the current activation status of the tuned programme (can be sent in DRM signalling channel along with any audio or data transmission).

Receivers may check regularly for announcement activity even if turned off, as announcement information is carried in the signalling channel (no need to decode full DRM signal for checking; for battery-operated receivers proper engineering solutions are needed to make this feature available). If emergency announcement is active, DRM receivers switch automatically to the emergency broadcast. Emergency content is provided automatically in the form of audio and text information (see below for details).

Listeners receive emergency broadcasts comprising:

- Audio programme (provided in one language at a time);
- DRM text messages (short text lines appearing on screen, updated automatically every few seconds);
- Journaline advanced text service (providing detailed instructions in multiple languages simultaneously).

When the alarm signal is triggered by the authorities, all running DRM receivers pick up the alarm signal from the currently tuned DRM service and switch to the emergency broadcast. All DRM receivers present the audio content of the emergency broadcast. DRM receivers with a text screen, in addition present text headlines (DRM text messages) plus detailed, multilingual information and instructions (Journaline) for instant and interactive look-up by the user. Receivers which are turned off may switch on automatically. This is a requirement to be defined by regulators for DRM receivers sold domestically.

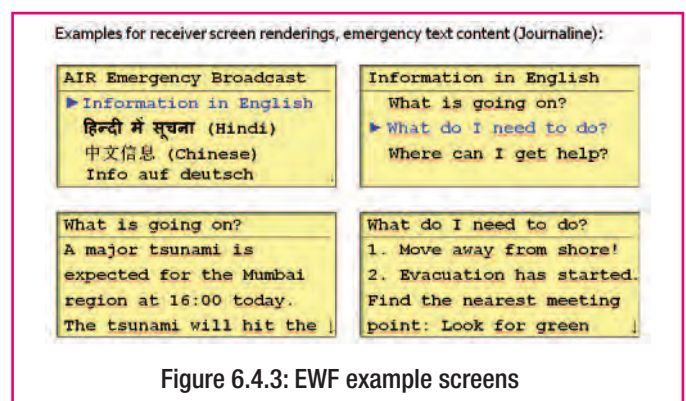



### 6.4.4 DRM EWF Implementation

A DRM broadcast chain consists of:

Studio (content) → DRM Content Server(s) → DRM Modulator(s)/Transmitter(s)

If authorities trigger the emergency signal, it must automatically be provided to the studios, which in turn activate it at the DRM Content Server(s) (or grant authorities direct access to an appropriate interface). The emergency warning signal must be activated for all DRM on-air services (even if they do not carry the emergency programme themselves, but simply point receivers to it, for example a public broadcast).

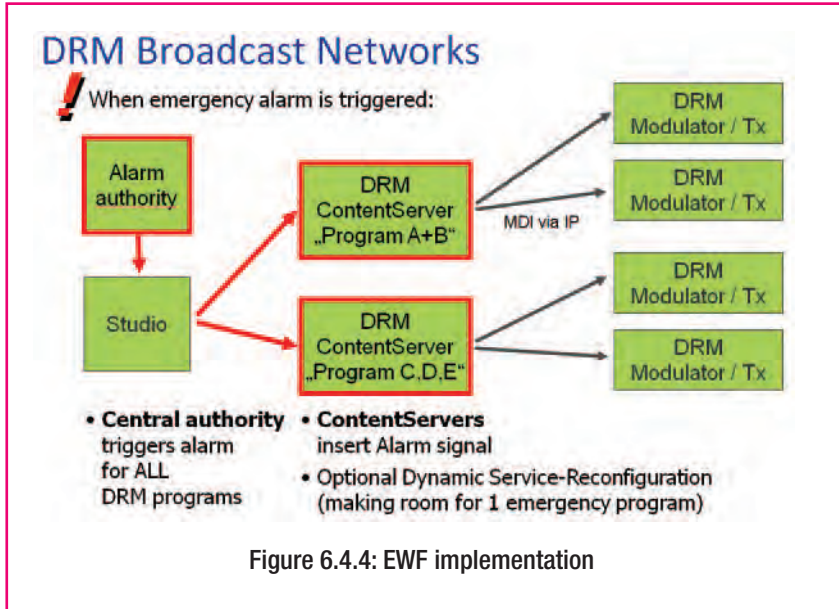

## One Platform

for DRM(+), DAB/DAB+/T-DMB and HD Radio®

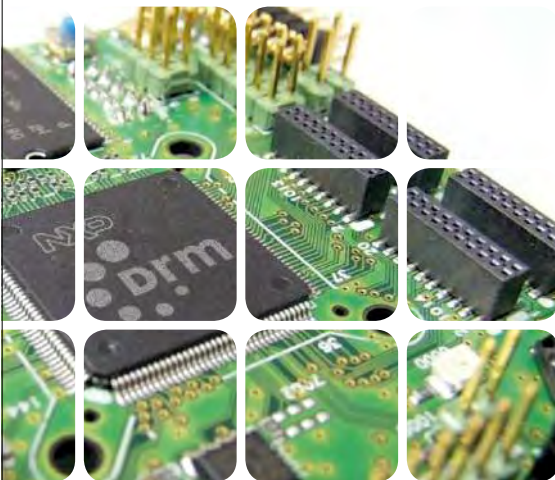

World Leader in Automotive Entertainment ICs

SAF356x: Multi-Standard Digital Radio Processor

Best-in-class Performance

Leading Solutions in High Performance Mixed Signal and Standard Products

[www.nxp.com](http://www.nxp.com) | [nxp.digitalradio@nxp.com](mailto:nxp.digitalradio@nxp.com)





# OEM SOLUTIONS FOR DIGITAL RADIO MONDIALE

Serving the Broadcast Equipment and Receiver Industry

---

- Fraunhofer DRM ContentServer™
- Fraunhofer DRM30 / DRM+ Developer Solution
- DCPServer Professional
- Fraunhofer Software Radio
- DRM MultimediaPlayer
- NewsService Journaline®
- DRM Test Equipments DT230 and DT4030
- DRM Monitoring Receiver DT700 / DT4700 and DT41200
- DRM Chip Set and Receiver IP
- Encoder and Decoder software modules for audio, data services, protocols, signalling and others

Fraunhofer Institute for Integrated Circuits IIS  
Digital Broadcasting  
Phone +49 9131 776-6301  
[bc-info@iis.fraunhofer.de](mailto:bc-info@iis.fraunhofer.de)  
[www.iis.fraunhofer.de/drm](http://www.iis.fraunhofer.de/drm)



The DRM consortium supports the vision of a vibrant international digital radio market. The DRM system was developed with the goal of promoting the development of low-cost, mass-market receivers, which is a precondition for the long-term market success. Over the next few years DRM should become integrated into multi-standard receivers alongside other digital and analogue broadcast systems. The benefit for consumers is the ability to receive all radio services on one device. To support this process, many DRM receiver functions were chosen to be compatible to other digital systems, which decreases receiver costs. In addition, several data services are compatible with DAB+, RDS and AMSS to further reduce receiver development effort and improve usability.

## 7.1 DRM Receiver Specifications

DRM has issued two important documents which can be downloaded from the DRM web-site:

- Digital Radio Receiver Profiles (included in this document in Annex 3), and
- Minimum Receiver Requirements for DRM [6]

Both of these documents provide guidance to broadcasters, manufacturers and consumers in the evolving market,

- Broadcasters receive the performance information required to plan their networks and gain confidence that their transmissions will be receivable.
- Manufacturers obtain guidelines about the necessary performance and features so that their technology investments will be supported by services.
- The consumer gains from knowing that the product they have chosen contains the necessary features to provide them with a consistent quality of experience and assured levels of interoperability across their region and beyond.

The Digital Radio Profiles are composed of mandatory features that must be implemented, together with recommended features that offer enhancements with wide appeal. A standard radio receiver and a “rich media” radio receiver are defined. Manufacturers may offer additional features in order to differentiate their product from others.

The Minimum Receiver Requirements for DRM document describes receiver characteristics in more detail. It contains basic implementation and functional performance requirements. The most important features for the audio decoder, the channel decoder etc. are described as mandatory to allow reception of worldwide transmissions. In addition, minimum performance levels with the related measurement methods are described. Technical performance parameters including sensitivity, selectivity and linearity are included.

## 7.2 Receiver development

A typical radio receiver comprises several basic blocks:

- i. Antenna
- ii. RF Front End
- iii. Demodulator / De-multiplexer
- iv. Audio / Data Service Decoder
- v. Amplifier / Loudspeaker
- vi. Micro-processor controller / Display Driver

The antenna, amplifier and loudspeaker are common to analogue and digital reception, and can clearly be used for both. Some companies have specialised in designing integrated modules which combine all the highlighted

elements ii, iii, iv and vi above into one 'component', which allows manufacturers to integrate digital radio into existing or new products very rapidly. 'Modular' solutions capable of supporting both analogue and digital reception are also available. These can employ either Digital Signal Processors (DSP's) or on dedicated Integrated Circuits (ICs). The decision is a trade off between flexibility, power consumption and costs.

Several DRM implementations running on DSP's are available on the market: see the DRM web site for updates.

The DRM standard shares some commonality with the WorldDMB digital radio system, especially in the areas of audio coding and ancillary data, which simplifies the design of multi-standard receivers.

Nowadays several stand-alone receivers are available on the market. The product range includes devices with colour screens supporting new radio features available with the DRM system, through to home entertainment systems with DRM included. The car radio manufacturers have also developed devices and modules for DRM. A new digital car radio platform that supports DRM next to other major global digital radio standards – all on one platform – was unveiled in 2012.

The market is constantly evolving and readers should refer to the DRM website for up-to-date information.

## 7.3 Software radios

DRM receivers, developed using an analogue receiver plus demodulation software running on a PC platform, were designed to satisfy the test and measurement requirements of DRM system developers. Modern consumer PCs have more than sufficient processing power to provide all of the functions of a DRM receiver. DRM originally developed a simplified version of a professional DRM receiver using this technique. This would allow enthusiasts to make the necessary modifications to their own analogue receiver and interconnect it with an existing home PC. This was followed by an open-source initiative, entitled Dream<sup>6</sup> [7]. Fig 7.3 shows a screen shot of a "Dream" receiver in operation (left) and the "Fraunhofer DRM MultimediaPlayer" (right). This latter receiver implements all the DRM functionalities and runs on all operating systems, including mobile platforms.

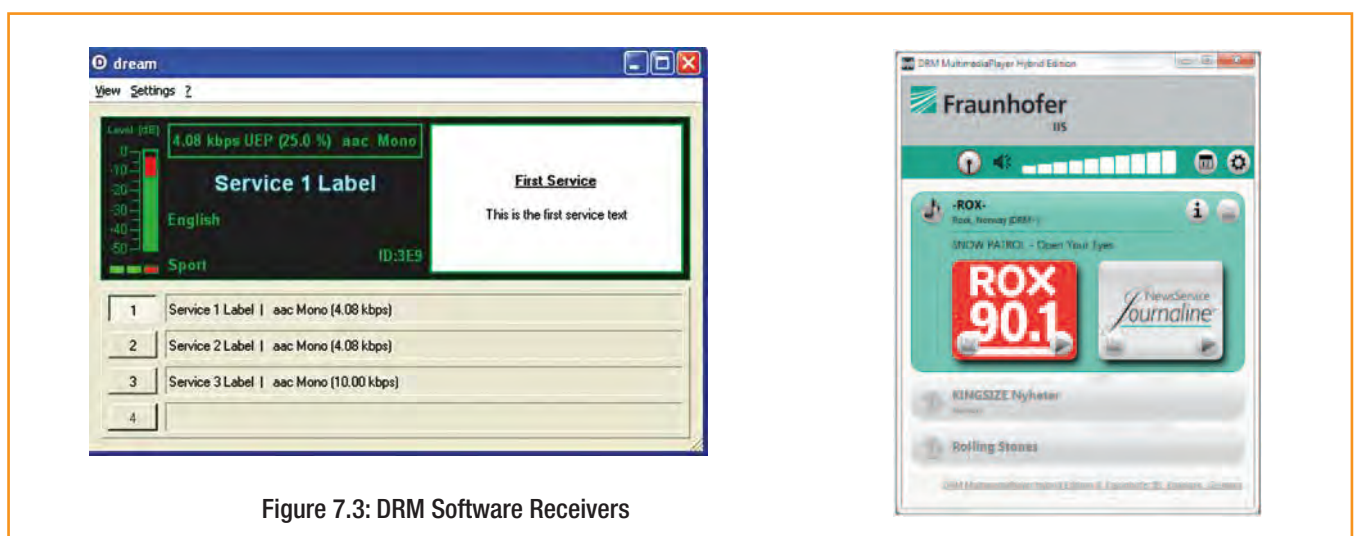

Figure 7.3: DRM Software Receivers

## 7.4 Man-machine interface (MMI)

**User-friendliness** in operation is an important item for market success. DRM offers the tools to achieve this goal.

Service selection by station name instead of frequency from a list built up automatically by the receiver has proved to be a popular way to "tune" a digital radio. Manufacturers are free to choose how to compile the station list according to market need, for example by evaluating AFS and EPG information, offering frequency scanning, or evaluating service lists provided by other broadcast systems, etc.

So ideally the user of a Digital Radio set should not be asked for, nor presented with a station selection by broadcast standard and/or frequency (at least not as the primary option). As soon as the user has chosen a service by its service label from a system-spanning list of currently available services, it should be the receiver's task to identify the best suitable reception method for the indicated service, and to automatically follow the service in case of temporary frequency changes or when crossing coverage area boundaries.

<sup>6</sup> Dream is a software implementation of a Digital Radio Mondiale (DRM) receiver. With Dream, DRM broadcasts can be received with a modified analogue receiver (SW, MW, LW) and a PC with a sound card.



# MORE CONTROL

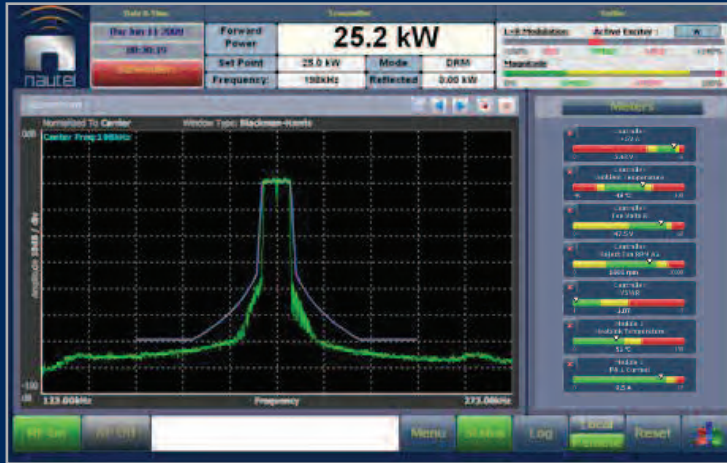

Nautel's Advanced User Interface (AUI) gives you more DRM transmitter control and instrumentation at the transmitter site, office or even your living room. Learn more at [www.nautel.com/drm](http://www.nautel.com/drm)



+1.902.823.5131  
[www.nautel.com/drm](http://www.nautel.com/drm)

Making Digital Radio Work.



# RFmondial

*Products and Services  
 for Digital Broadcasting*

- » Multiplexer, audio encoder (ContentServer)
- » Exciters and modulators incl. SFN and redundancy
- » AM/DRM monitoring receivers
- » Flexible distributed monitoring and archiving systems
- » Livewire audio nodes
- » Field trials, consulting, design services

Products are available as stand-alone or for licensing. Please check our website, send an e-mail or give us a call.

**ON AIR**

[www.rfmondial.com](http://www.rfmondial.com)

mail [info@rfmondial.com](mailto:info@rfmondial.com)  
 phone +49 (511) 762 19704



# 8

# Regulation and Standardisation

## 8.1 Regulation

At the international level spectrum for Broadcasting is regulated by the International Telecommunications Union (ITU). Any change in the use of this spectrum, such as is caused by the introduction of a new digital broadcasting system into the broadcasting bands, requires approval from Member Administrations.

The International Telecommunication Union's Radio communication Sector (ITU-R) has given this approval for the broadcast of DRM signals on a regular basis in all the broadcasting bands below 30 MHz in its Recommendation **ITU-R Rec. BS.1514** [8], 'System for digital sound broadcasting in the broadcasting bands below 30 MHz'.

**ITU-R Rec. BS.1615** [9] provides the planning parameters for the deployment of DRM30 throughout the world by utilising the existing planning agreements for analogue AM services, for example the Geneva 1975 Assignment Plan for the LF and MF bands for Regions 1 and 3 (Europe, Africa, Asia) and the Rio de Janeiro 1988 plan for Region 2 (Americas). Figure 8.1 shows the world distribution of the three ITU Regions – the shaded part is referred to as the Tropical Zone.

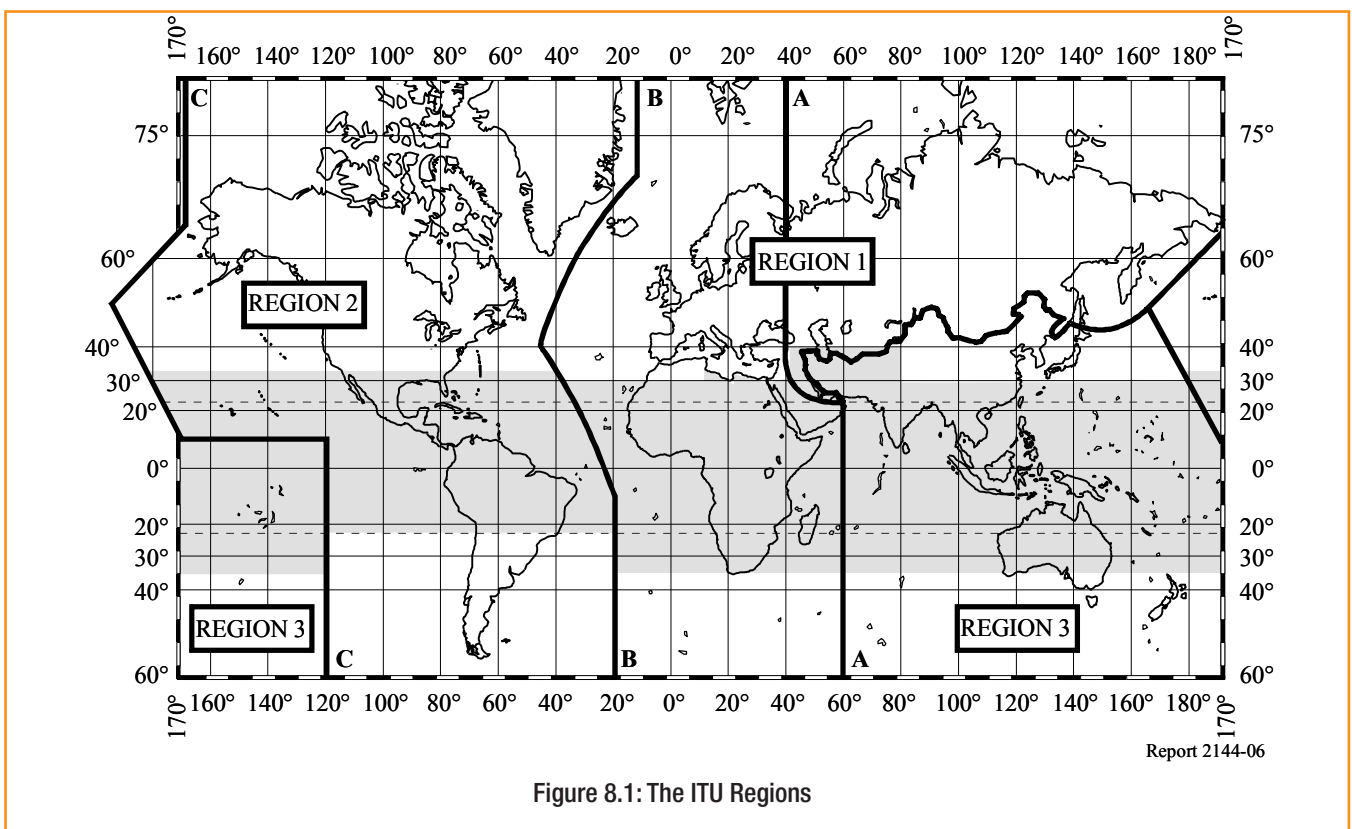

For the HF bands above 5900 kHz, all DRM broadcasts are co-ordinated in accordance with **Article 12** of the **ITU—R Radio Regulations** [10] – the 6 month scheduling procedure – in the same way as for analogue broadcasts. In the "tropical HF bands" – those below 5900 kHz intended for national coverage in low latitude countries – the coordination procedure is one of bi-lateral arrangements, rather than a global procedure. Countries in the "tropical zone" that wish to use DRM should be able to do so using 'near vertical incidence' propagation just as they do now, with proper account taken of the average power factor

For the broadcasting bands above 30 MHz the ITU has published three recommendations on DRM+, known in the documents as Digital System G:

**ITU-R Rec. BS.1114** [11] ‘Systems for terrestrial digital sound broadcasting to vehicular, portable and fixed receivers in the frequency range 30-3 000 MHz’.

**ITU-R Rec. BS.1660** [12] ‘Technical basis for planning of terrestrial digital sound broadcasting in the VHF band’.

**ITU-R Rec. BS.1894** [13] ‘Digital radio broadcast service, captioned radio’.

Furthermore, there are a number of regional ITU Agreements together with CEPT Special Arrangements that cover the broadcasting bands as summarised in the Table 8.1 below.

Table 8.1: ITU Regulation Applicable to Terrestrial Radio Services<sup>7</sup>

Frequency Bands	LF/MF/HF bands (148.5 - 283.5 kHz)/ (526.5 - 1606.5 kHz)/ (3 - 30 MHz)	Band I (47 - 68 MHz)	Band II (87 -108 MHz)	Band III (174 - 230 MHz)
Covered by:	GE75 [14]: (LF/MF only) ITU Region 1 & 3  RJ81 & RJ88 (MF only): ITU Region 2 [15, 16]  ITU-R RR §12 for HF [10]: Worldwide	RRC-06-Rev.ST61 [17]: Parts of Regions 1 & 3	GE84*[18]: Region 1, Afghanistan and Iran	GE06 [19]: Parts of Regions 1 & 3  WI95revCO07 [20]: Europe

\* Under the Geneva 1984 (GE84) Plan FM frequency allocations in Band II may be used for digital broadcasting services providing:

- the transmission characteristics remain within the envelope of an existing GE84 Plan [18] entry or aggregate entries under the provisions of GE84
- the affected administrations agree that any such use will be afforded protection to the levels defined by the interfering field strengths as arising from their frequency allocations, taking into account any relevant bilateral agreements.

This means any such alternative usage of Band II frequencies must not produce more interference nor claim more protection than the corresponding frequency allocation of GE84. This approach could also be applicable to other parts of the world.

Details of planning assumptions and references to protection ratios for DRM are set out in Section 10 Service Planning.

The regulatory and technical aspects for the introduction of digital radio services in Europe are set out in a series of CEPT-ECC reports<sup>8</sup>. Although these focus on the European situation much of the information may be found relevant to other parts of the world. The reports cover:

**ECC Report 117: Managing the transition to Digital Sound Broadcasting in the frequency bands below 80 MHz** [21] – This report looks at the use of the LF, MF, 26 MHz (HF) bands and VHF Band I for digital broadcasting to national, local and community audiences. DRM is anticipated to be used alongside AM initially and then supersede it over time. All the necessary regulatory provisions, in particular the Rules of Procedure associated with the GE75 Agreement, are already in place to allow the deployment of DRM within the existing GE75 Plan and to allow a progressive analogue to digital transition for sound

<sup>7</sup> Details of the ITU Regional plans can be found at <http://www.itu.int/ITU-R/terrestrial/broadcast/plans/index.html>

<sup>8</sup> ECC reports are available at <http://www.cept.org/ecc> under ‘Deliverables’

broadcasting in the LF and MF bands. In addition to a comprehensive source of information on the regulatory aspects for the introduction of DRM in the above mentioned bands, this report also provides information from European administrations on their current and future use of frequency bands (2010)

All concerned broadcasters and administrations within CEPT are encouraged to consider the transition from analogue to DRM digital transmissions in order to benefit from the improved quality of service, which is already available.

**ECC Report 141: Future possibilities for the digitalisation of band II (87.5-108 MHz) [22] and an associated Technical Supplement [23]** – Band II is regarded as essential spectrum for FM broadcasting of audio programs. Given the increasing demands on Band II spectrum for broadcasting there is a need to consider measures that could allow Band II services to meet future requirements. This may best be achieved by taking advantage of emerging digital sound broadcasting systems. In the technical supplement planning and sharing criteria are presented comprising of technical characteristics, protection ratios and criteria for the protection of other services.

**ECC Report 177: Possibilities for Future Terrestrial Delivery of Audio Broadcasting Services [24]** – considers the possibilities for continuing radio broadcasting into the future. The report concentrates on terrestrial distribution platforms and especially the relevant digital technologies that exist and are being developed. Looking to the future the available spectrum is clearly going to be limited. Classical analogue based systems, while capable of providing a good quality signal to the listener, provide no easy means for the expansion of facilities.

Amongst other things particular note is made of the following points:

- Terrestrial audio broadcasting is highly effective in reaching very large audiences.
- The strength of terrestrial audio broadcasting is that audio programmes are generally offered free-to-air. This constitutes the main pillar on which the success of radio is built.
- Audio broadcasting may be the only sustainable source of information in emergency situations.
- Migrating from analogue to digital distribution technology offers the opportunity for more services and higher quality services. Thus, digital broadcasting paves the way for more efficient use of spectrum than analogue technologies do.
- In Band III (Europe) the necessary regulatory framework for the introduction of digital audio broadcasting is already fully in place. However, there may be a need for Rules of Procedure at ITU level to enable the introduction of digital services in Band II.
- Introduction of digital terrestrial audio broadcasting in the bands currently allocated to it may take advantage of existing broadcasting network infrastructure.

Finally, notwithstanding the above international regulation, permission to use DRM has to take into account any policy put in place by a broadcaster's national administration.

## 8.2 DRM Standards

The main DRM standard has been published by the global standards body based in Europe, the European Telecommunications Standards Institute (ETSI) as ES 201 980 [1] and is available for free download from the ETSI website<sup>9</sup>. All the supporting standards, for distribution interfaces, data applications and so on, are also published by ETSI and available the same way, searchable from the keyword 'DRM'. A comprehensive list of these standards is set out in **Annex 1**.

The relevance of each frequency band to DRM together with associated ETSI and ITU standards is given in Table 8.2.

<sup>9</sup> The ETSI web site address is <http://pda.etsi.org/pda>

Table 8.2: Application of DRM standards to frequency bands

System	Multiplex Bandwidth	Suitable Band(s)	Channel Raster ITU Region 1) <sup>1</sup>	Standardisation / Regulation
<b>DRM30 (DRM Mode A-D)</b>	4.5 – 20 kHz	LF, MF, HF	9 kHz or 10 kHz <sup>2</sup> 5 kHz	ETSI ES 201 980 [1] ITU-R Rec. BS.1514 [8]
<b>DRM+ (DRM Mode E)</b>	96 kHz	VHF I, VHF II VHF III	See <sup>3</sup> 100 kHz See <sup>3</sup>	ETSI ES 201 980 [1] ITU-R Rec. BS.1114 [11] ITU-R Rec. BS.1660 [12]

#### TABLE NOTES

1. Basis of the given channel rasters are the Final Acts of the ITU-R Conferences for the respective broadcasting bands (e.g. for Region 1: Final Acts of Geneva 1975 for LF/MF, Final Acts of Geneva 1984 for VHF Band II, Final Acts of Geneva 2006 for VHF Band III). The channel raster is the basic ‘grid’ on which the frequency allocations for different services are laid out. In VHF Band II in Europe, for example, transmission frequencies (currently for Analogue FM) are usually allocated at 100 kHz intervals. Given that the band occupancy of an analogue FM channel is  $\pm 100$  kHz (200 kHz overall) two services in the same area with a 100 kHz spacing would clearly interfere with one another. Care has to be taken to ensure that through geographical separation and the use of directional transmitting antennas interference is kept within acceptable limits. Particular care has to be taken when introducing different modulation formats where the band occupancy or the energy distribution within the band might be different.
2. For ITU Regions 1 and 3 the channel raster is 9 kHz; for ITU Region 2 the channel raster is 10 kHz.
3. The DRM+ system can operate in any of the VHF Bands I, II and III, each of which has its own channel raster. Currently the channel raster for Band II is 100 kHz and for Band III, 1.75 MHz. No channel raster currently exists for digital radio in Band I. For DRM+ in VHF band III a channel raster of 100 kHz is proposed in the ITU-R Report BS.2214.

In respect of the future development of digital radio in Europe the Radio Spectrum Policy Group (RSPG)<sup>10</sup> of the European Union (EU) in a report on ‘The Future of Radio Broadcasting in Europe – identified needs, opportunities and possible ways forward’ [24, 25], acknowledges DAB and DRM but remains neutral on the impact on local and community radio of the adoption of a single standard for digital radio. They stress that currently there is no common policy on radio broadcasting.

However, the EU sees a consensus that the future of radio distribution will be multi-platform and that terrestrial distribution is still the sole platform for truly mobile reception, in particular in cars. The EU accepts that there are terrestrial radio standards in use for distributing national and regional services, i.e. the DAB family of standards as well as the DRM family conceived as a separate, but complementary development. "We note that building multiple standards into radio receiver chips is becoming a reality and that software implementation of radio receiver standards is evolving into a mass-market phenomenon. Public policy has to remain both neutral in terms of technological solutions and sufficiently flexible to adapt to future evolutions."

<sup>10</sup> The Radio Spectrum Policy Group (RSPG) is a high-level advisory group that assists the European Commission in the development of radio spectrum policy.

# WHERE GREAT RADIO BEGINS

*Harris is the global leader for end-to-end radio solutions. After all, we've been helping you create and distribute high-quality audio content since 1922.*

*Our complete portfolio for analogue and digital radio supporting DAB/DAB+, DRM & HD Radio™ includes some of the most trusted brands in the industry — from PR&E® VistaMax™ networked audio systems to the Intraplex® line for studio-transmitter and interfacility link needs to our Platinum™ VAX/VLX Band III, DX®/3DX® AM and Flexiva™ FM transmitters, which incorporate Harris® PowerSmart® technology.*

*Unmatched efficiency. Increased power density. Lower operating costs. Leading broadcasters turn to Harris for our proven range of analogue and digital platforms that deliver outstanding performance in radio networks around the globe.*

Learn more at [broadcast.harris.com/radio](http://broadcast.harris.com/radio).

DAB DAB+ DRM HD Radio®



[harris.com](http://harris.com)

**HARRIS®**  
assuredcommunications®



## 9

# Broadcast Network Infrastructure

This chapter begins by detailing the way in which the DRM signal is distributed to the transmitter(s). It continues by outlining methods for adapting existing analogue AM transmitters and FM transmission facilities to provide DRM transmissions, and considers the performance requirements for the attached antennas and matching networks. Finally, there is an overview of monitoring and measurements of DRM signals to ensure that they achieve the desired quality of service.

Propagation and service planning aspects of the signal after it leaves the transmitter antenna and up to its arrival at the receiver antenna are dealt with in the next section (10).

## 9.1 Programme distribution

This section provides more detail on the way in which the various protocols and interfaces described previously link together. This enables the audio and control signals, required by the DRM receiver, to be packaged together in an efficient way, at the studio or control centre, and sent to the DRM transmitter(s).

### 9.1.1 Multiplex Distribution

The MDI stream comprises the following information:

- DRM Multiplex, consisting of MSC, FAC, SDC
- All information necessary to run the DRM modulator with the correct settings (robustness Mode, time stamps for SFN etc.)
- Optional proprietary information

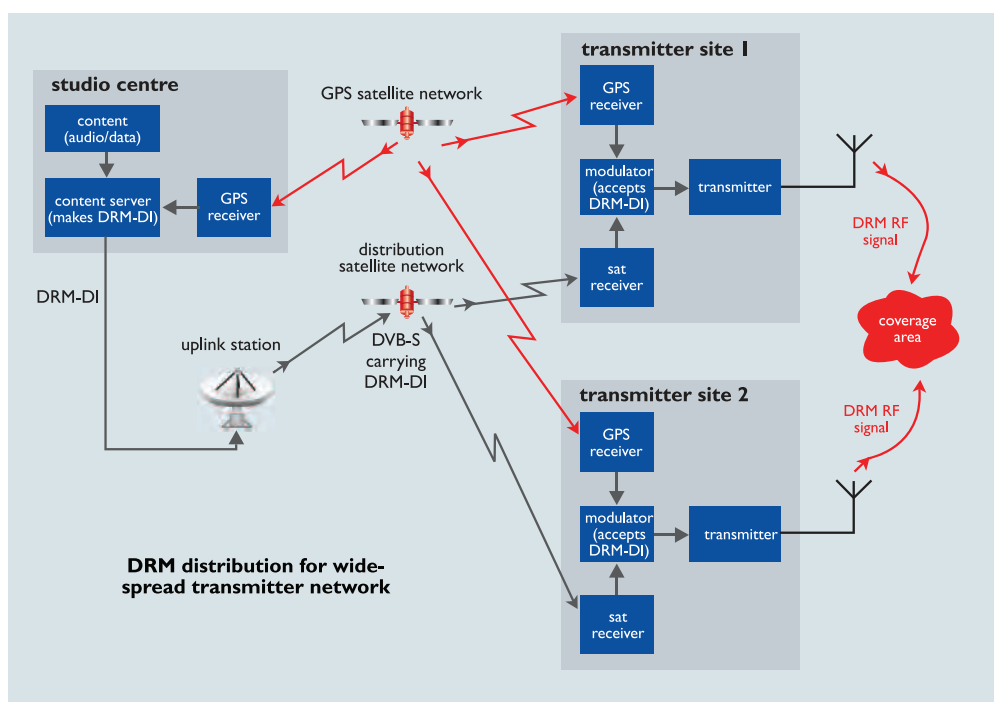

Figure 9.1.1a: Example of DRM distribution suitable for international broadcasting



The data is sent asynchronously in packets. Therefore a large variety of basic transport mechanisms may be used, such as UDP/IP, serial lines, Satellite, WAN, LAN, and ISDN. As the multiplex is based upon either a 100ms or 400ms DRM frame, and the transmission of data is effected asynchronously, both the DRM multiplexer and modulator must possess their own source of time synchronization (GPS or Network Time Protocol, **NTP**), to ensure the long-term stability of this framing.

The MDI stream is a very efficient means of transferring encoded audio in terms of bandwidth usage, whilst retaining the original quality of the programme. By placement of the encoders and multiplexer at the studio the audio can be encoded directly, using the efficient MPEG coding system, eliminating degradation through trans-coding. With additional protection and control information the MDI bit rate is only about 20-25% higher than the encoded audio bit rate, with the result that a typical MDI stream is about 27kb/s for a standard HF channel and about 35kb/s for a typical MF service. A single 64kb/s distribution channel would therefore be adequate for most of the DRM30 system combinations, thereby saving on costly distribution bandwidth. However, where a number of separate DRM services are sent to one or more common sites, using a multiplexed system, it may be advisable to use distribution channels, which can be incremented in smaller steps than 64kb/s, in order to attain the highest capacity efficiency.

A further benefit of this method of distribution is that **it is possible to send the same MDI stream to any number of modulators**. The benefit is that only one DRM Content Server needs to be purchased; however the constraint is that each modulator has to transmit the same audio programme using the same Mode.

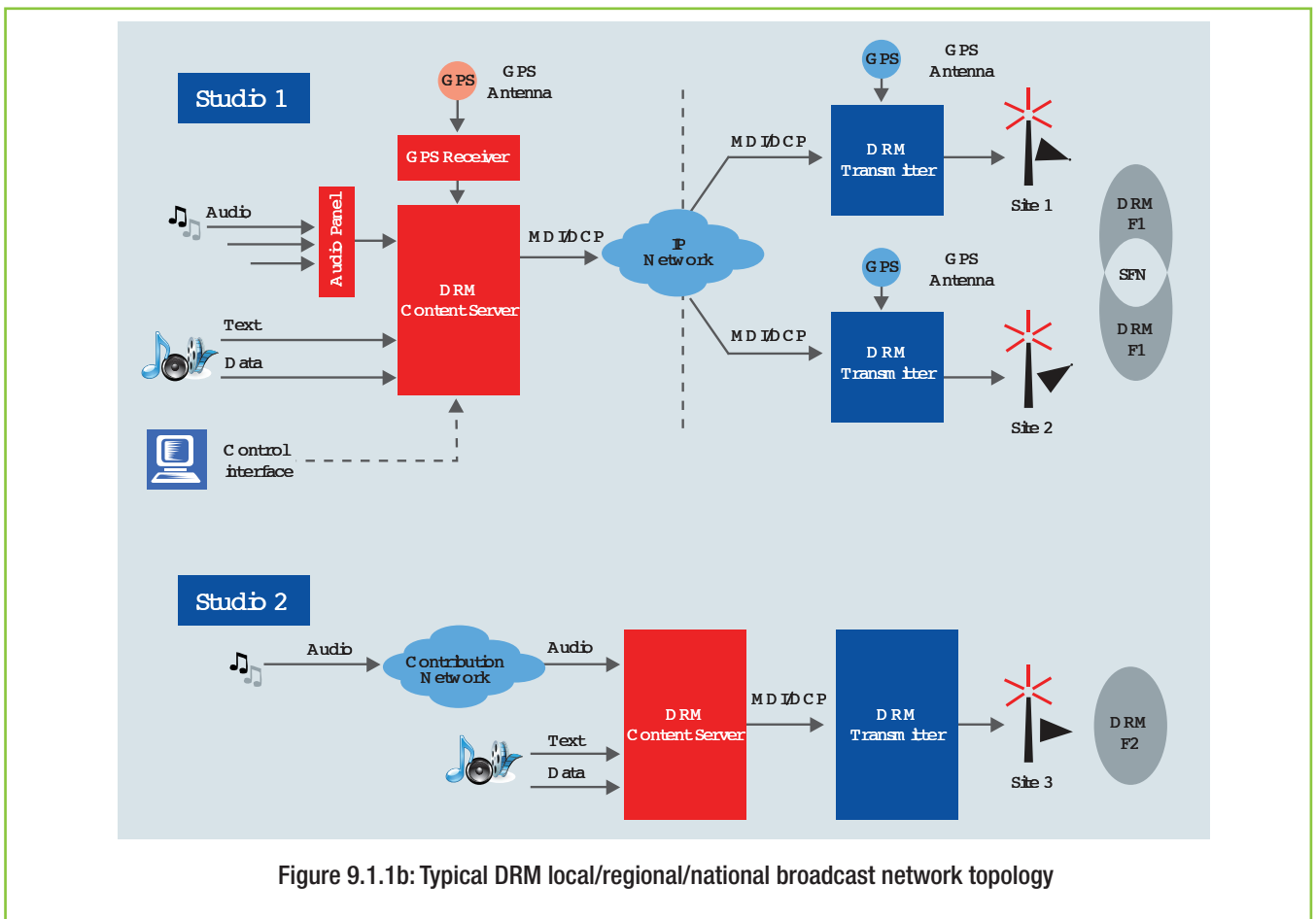

Figure 9.1.1b: Typical DRM local/regional/national broadcast network topology

For broadcasters wishing to retain their present audio programme distribution network, placement of the Content Server at the transmitter site is acceptable. However, to retain the superior audio quality of the DRM system requires that the programme be distributed at the highest possible bit rate in order to minimize tandem-coding artefacts.

### 9.1.2 Network Synchronization

A major benefit of the DRM system is its support for Single and Multi-Frequency Networks (SFN's/MFN's), which can provide reliable contiguous coverage, with seamless reception within the planned service area. The benefits of such networks to broadcasters are explained in Sections 5.3.3 and 10.2.1.

Creation of an SFN can be achieved using a single DRM Content Server at a broadcaster's studio; distribution of the MDI stream to the network of transmitters can utilize either satellite or land lines. Each transmitter requires a DRM modulator that can be assigned an individual identifier for adjusting time delay. The network is configured so that the DRM output from transmitter is received at precisely the same time at a specific location in the target zone. This is achieved through **timestamps** embedded in the MDI protocol, with each modulator capable of buffering at least 10 seconds of MDI data stream.

The DRM Content Server and each DRM modulator require GPS timestamp information, or an equivalent time reference. Without this synchronisation, the received signals would be insufficiently time-coincident. This could cause the delay spread to exceed the guard interval, causing inter-symbol interference, and audio dropouts would result. Additionally, inputs of 1 Pulse/second (1 PPS) and 10 MHz are required at the DRM modulator to provide long term RF stability.

## 9.2 Transmitting in DRM30 modes

### 9.2.1 Overview

The fundamental requirement for all DRM modes is that the transmitter functions as a linear amplifier, and this section show how linear amplification can be achieved with existing AM broadcast transmitter designs.

### 9.2.2 DRM Amplification

While it is possible to construct a linear amplifier to provide the power level required for broadcast transmission, the energy conversion efficiency is very poor, typically somewhere between 20 - 30%. Thus significant cooling will be required and operating costs will be high. However, it is worth noting that some HF transmitter designs implement SSB working by changing the operating conditions of the final stage so that it functions as a linear amplifier. If this is the case it may be used for DRM transmissions. However, as the cooling system is generally sized for high-efficiency non-linear operation, available power output is reduced in "linear" mode. As an example, the peak power capability of one example of a 500kW PDM transmitter, when operating as a linear amplifier, is reduced to about 300kW. Thus the maximum average DRM signal power available is about 30kW. The relevant figure must always be checked with the transmitter manufacturer.

A number of current DRM services use transmitters working as linear amplifiers. Essentially the transmitter RF input is driven by the I/Q signal from the DRM Modulator or the fully modulated DRM RF signal at the required centre frequency. Some linearity correction has been found to be necessary and existing correctors provided for SSB working have been used successfully.

Although some earlier low power transmitters were configured as linear amplifiers, high power AM transmitters invariably use a non-linear RF amplifier to achieve high conversion efficiency. In a valve (electronic tube) transmitter, the final RF amplifier valve will have a resonant circuit connected to the anode (plate). The grid bias voltage is chosen such that the valve conducts over a limited range of the RF cycle and effectively delivers energy to the anode circuit as a series of pulses (Class B or Class C operation). This sets up oscillatory currents in the anode resonant circuit and RF power is coupled from this circuit to the antenna.

With the use of modern high power valve technology and efficient cooling systems, very high output power can be achieved for relatively low drive power with high conversion efficiency. Solid-state modular MF/LF transmitters use a switching technique to achieve high conversion efficiency, typically between 70 and 80%. The output stage of each power amplifier module uses MOSFET transistors as switches arranged in an 'H Bridge' arrangement. RF power is taken from a transformer connected between the mid-points of each arm. In operation, diagonally opposite transistors are sequentially switched at carrier frequency rate to produce alternate current reversals in the output transformer primary. In this way significant RF power levels can be generated at high conversion efficiency.

### 9.2.3 Using Non-Linear Amplifiers for DRM

Non-linear amplifiers cannot be used directly for DRM amplification, for the precisely same reason that they are unsuitable for AM amplification: AM and DRM signals both comprise multiple RF carriers, which when passed through a non-linear process will generate intermodulation and cross-modulation products. However a technique exists where a modulated non-linear amplifier can be driven with suitable RF and base-band signals derived from the original low level complex I/Q signal, such that the component signals combine in the modulated final amplifier to form a high level replica of the original signal. The overall effect is that the modulated amplifier

functions as a linear amplifier even though the amplifier itself continues to work in a non-linear manner. This technique is described in the following Section 9.2.4. Although, a modular solid-state MF/LF transmitter does not have a separate modulated amplifier as such, the functionality is identical.

### 9.2.4 The DRM Signal

As described earlier, the DRM signal from the COFDM modulator may take the form of an I/Q signal, i.e. the complex signal is described by two signals representing the In-phase and Quadrature components respectively. In raising the level of this signal to the power required for broadcast transmission it is imperative that the correct phase and amplitude relationship of the “I” and “Q” components is maintained.<sup>11</sup> If the signal is distorted, the MER<sup>12</sup> may well fall to unacceptable levels (together with out-of-band intermodulation products), and ultimately the DRM signal will be rendered unusable.

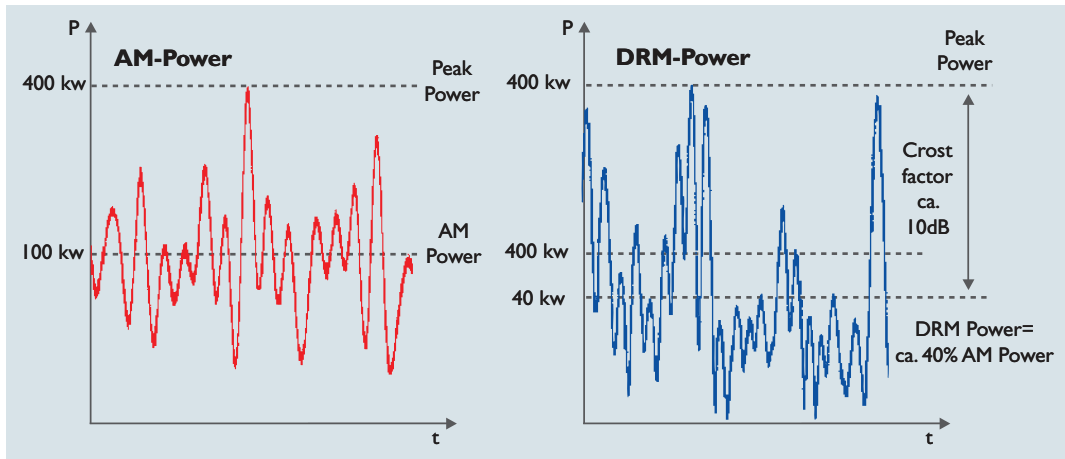

Figure 9.2.4: AM and DRM RF envelopes

The DRM signal, as broadcast, closely resembles band-limited noise. This is an advantage when considering the protection ratio of analogue systems interfered with by DRM, but not when it comes to amplification. The statistical variation of envelope voltage theoretically follows a Rayleigh distribution, but in practice the peak-to-mean ratio lies between 10 and 11dB<sup>13</sup>. Fortunately, for DRM30 modes, current AM transmitter topologies can be adapted to amplify the DRM signal in an efficient manner.

### 9.2.5 AM transmitter conversion

With a traditional AM high-powered transmitter (see Figure 9.2.5), the DRM signal is first converted into amplitude (A) and phase (RFP) format for injection into the modulator audio input and carrier-frequency drive circuits respectively. The relative timing of the A and RFP signals is adjusted to ensure synchronism at the modulator, and they are effectively recombined through this hybrid modulation scheme.

<sup>11</sup> Similarly, for a modulator with A/RFP outputs

<sup>12</sup> See also section 9.5.1

<sup>13</sup> This figure represents the normally-observed-peak-to-mean ratio, and applies to a DRM signal, which has not been deliberately clipped. (9.5.1)

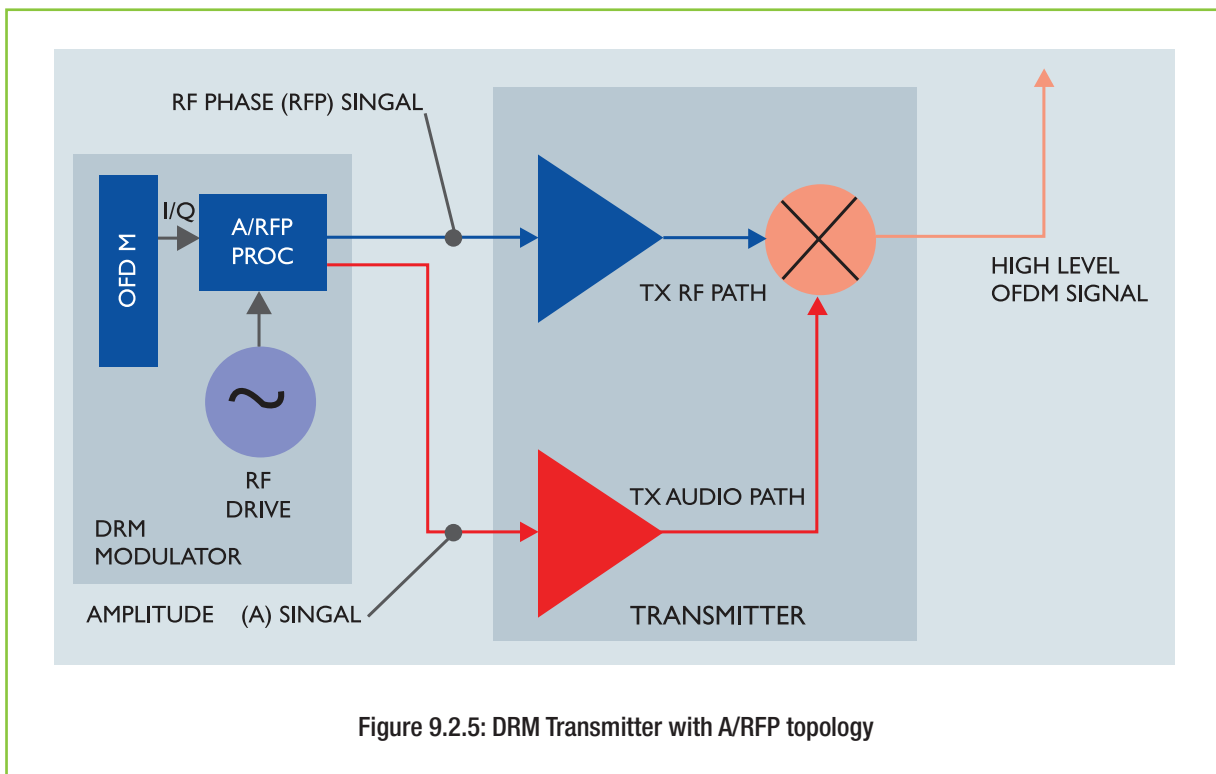

Figure 9.2.5: DRM Transmitter with A/RFP topology

For this technique to work correctly there are a number of requirements that must be satisfied by the transmitter.

1. There must be a direct (DC) connection between the modulator and the final amplifier. Unfortunately this means that the A/RFP technique cannot be used with transmitters having Class B transformer coupled modulators. The DC Offset must be matched accurately to the transmitter to avoid unwanted emissions.
2. The relative timing of the RFP and A signals need to be adjusted to ensure optimum modulation performance.
3. The bandwidth of the audio path in the transmitter needs to be significantly greater than that required for normal AM working. Typically, the audio path bandwidth should be at least 3.5 times the bandwidth of the wanted DRM signal. The sampling frequency of solid-state Pulse Step or Pulse Duration Modulators (PDM/PSM) must be more than twice this frequency limit to meet Nyquist criteria. Any bandwidth limiting filters in the audio path must be removed and the modulator output filter will need to be modified to achieve the required bandwidth. In modifying the filter response it is important to ensure that a substantially flat group delay characteristic is maintained over the pass-band.

Transmitter manufacturers now offer DRM and AM transmitters that can switch rapidly between AM and DRM modes based on considerable accumulated knowledge. They can also advise on the conversion of existing AM transmitters (both LF, MF and HF), many of which have been field-converted over the last few years.

### 9.2.6 Performance of DRM30 transmitters

DRM transmitters based on AM amplifiers and employing A/RFP modulation are capable of providing excellent performance, provided the technical criteria outlined previously are addressed. Typical efficiencies of modern DRM transmitters lie in the range 70 to 85% (mains in to RF out) over the corresponding power range 10 to 250 kW.

The following plots illustrate the relative impact of differential signal timing, DC offset and the bandwidth of the Amplitude (envelope) channel on the transmitter output spectrum (N.B. the red curve is the DRM spectrum mask).

- a. **DC offset error** must be less than 1% (relative to the mean DRM envelope level).

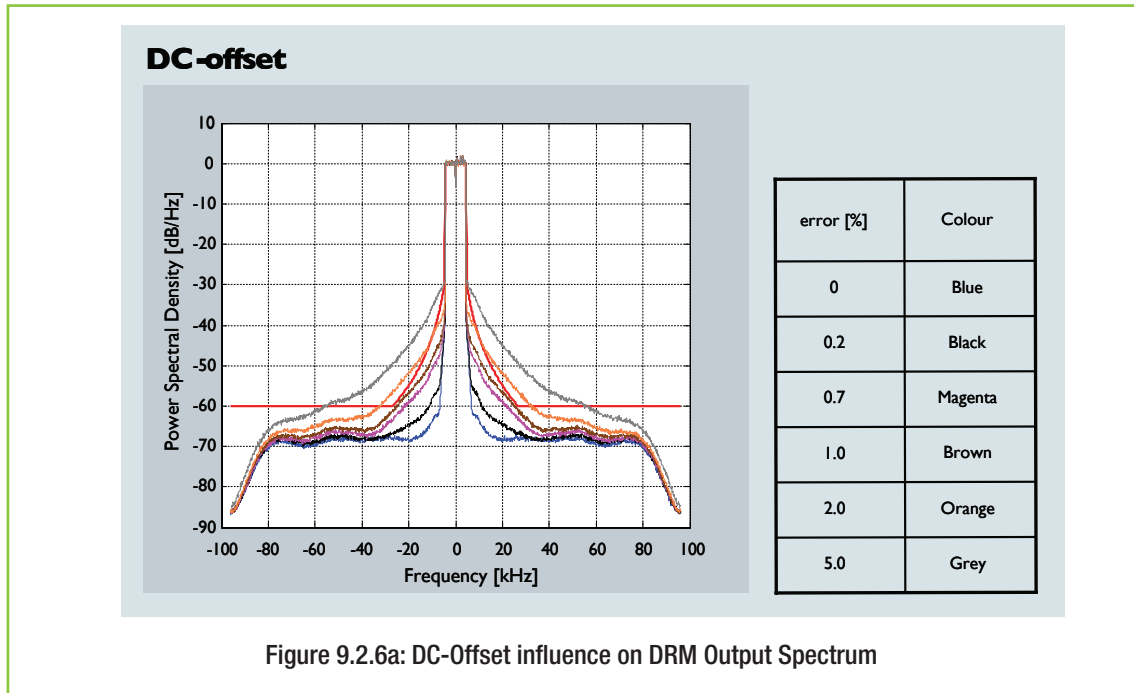

- b. **A/RFP signal delay.** The time delay between envelope and phase signal must be matched to better than 1  $\mu$ s. in order to fulfil the DRM spectrum mask.

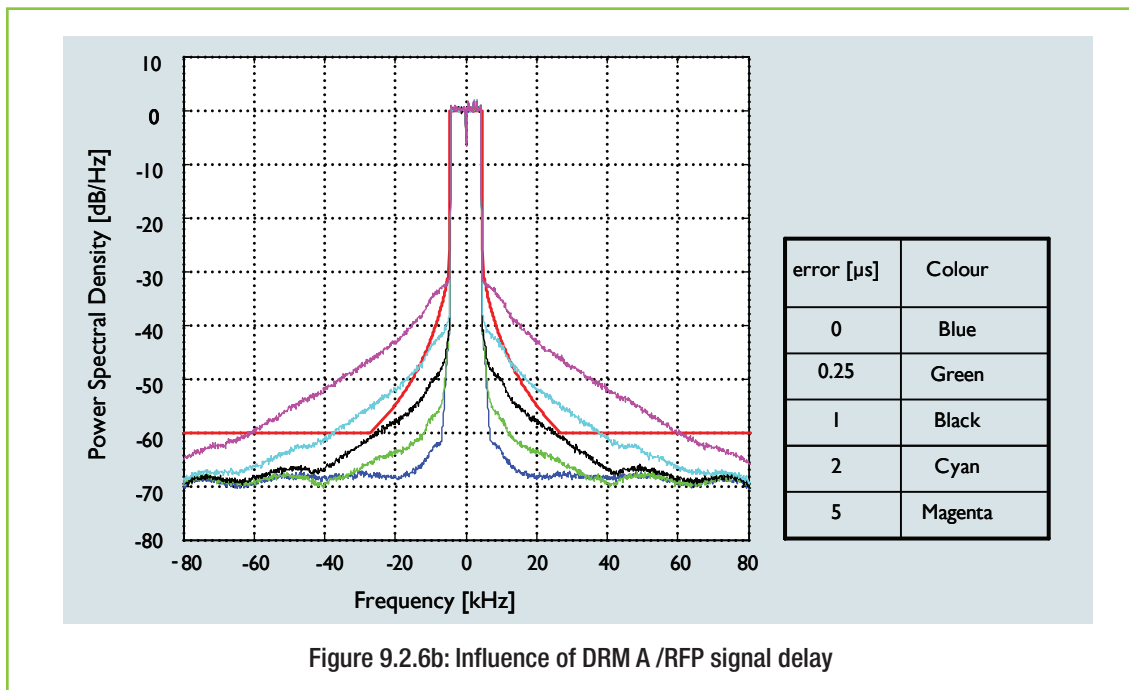

- c. **Bandwidth of A /RFP paths.** Figure 9.2.6c illustrates the influence of a band limitation in the envelope signal path on the DRM spectrum. All other parameters, which influence the DRM spectrum, are matched perfectly in this figure.

The envelope (A) bandwidth should be at least 3.5 times the bandwidth of the DRM signal in order to fulfil the DRM spectrum mask. If the bandwidth is less than optimum, but the roll-off is not too steep, it may still be possible to meet the mask using pre-correction in the modulator.

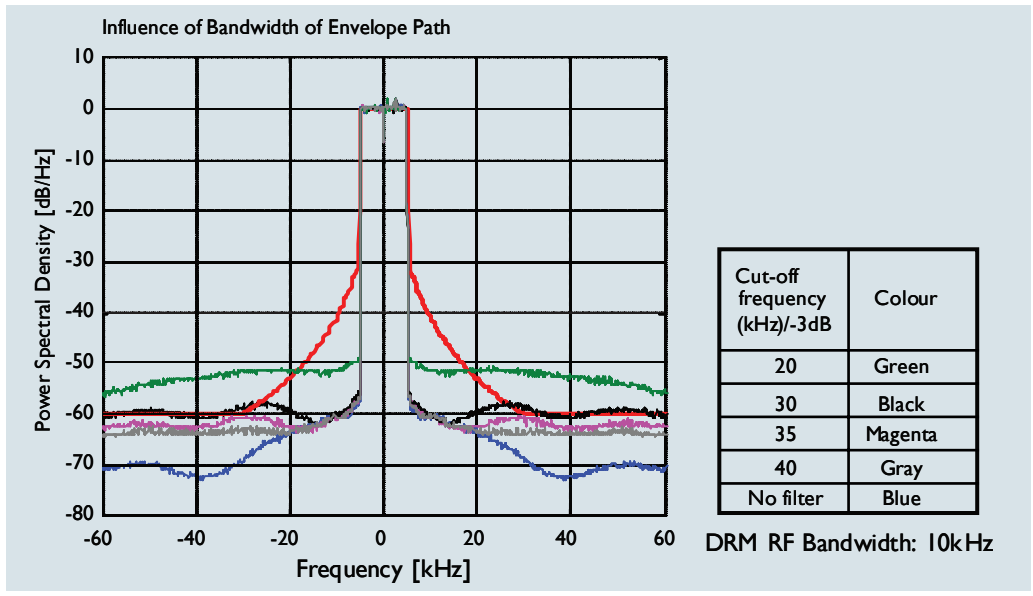

Figure 9.2.6c: Impact of envelope bandwidth on DRM output spectrum

### 9.2.7 Out of band Power (OOB)

All transmitters, whether AM or DRM, will generate some power outside of the bandwidth needed for transmission of the required signal. In order to avoid undue interference to adjacent channels, the ITU has laid down recommendations (ITU-R SM. 328) in the form of a spectrum mask within which the out of band power spectrum of AM transmitters must be confined. A similar shaped spectrum mask will be applied to DRM transmissions.

The plot in Figure 9.2.7 shows the spectrum obtained from an example of the A/ RFP topology used in a LF transmitter with a 9 kHz DRM signal.

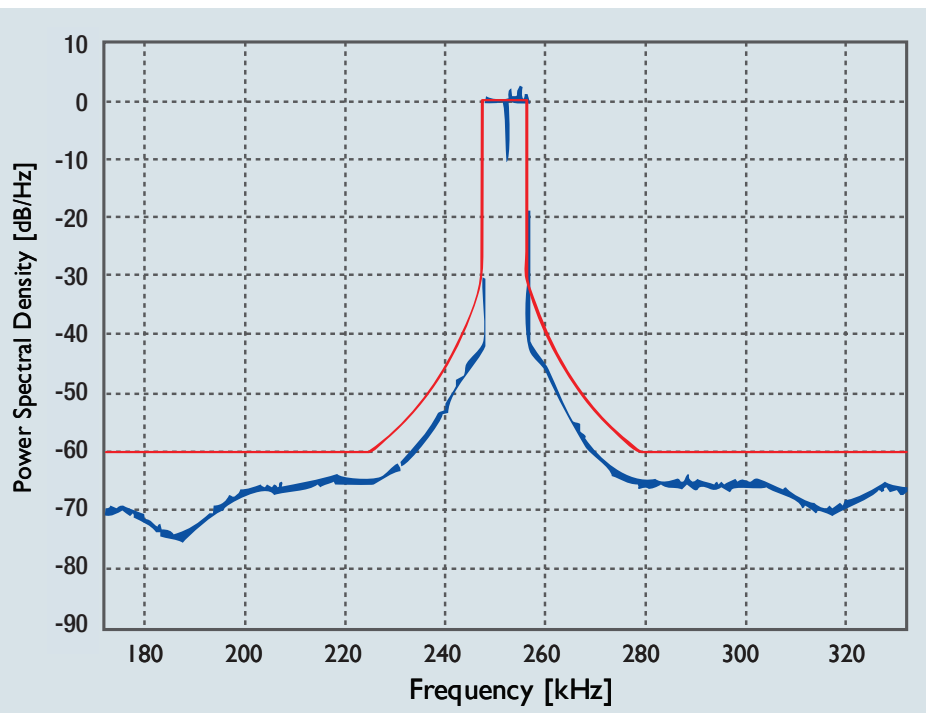

Figure 9.2.7: DRM LF TX Spectrum



### 9.2.8 Use of older Transmitters for DRM Trials

In some older transmitters<sup>14</sup>, it is often found that one or more of the parameters set out above cannot be met. This normally results in higher OOB that exceed the spectrum mask. As an interim measure, for instance to allow demonstrations or trials to take place, it may be possible to re-introduce the normally-suppressed centre-frequency carrier, some DRM Modulators provide this facility. Reintroducing this CW signal has the effect of changing the composite signal amplitude-distribution in such a way that the signal bandwidth of the “A” channel is reduced. This results in improved linearity and ensures that out-of-band radiation is minimised (Figure 9.2.8 DRM spectrum with additional carrier).

The level of the re-introduced carrier is adjusted experimentally for best results while observing the RF output spectrum with the transmitter connected to the antenna system. This technique, while effective, is not ideal due to the energy wasted in the carrier signal and the impact of the carrier on the performance of DRM receivers. For these reasons it is not recommended to use this technique for a permanent DRM service.

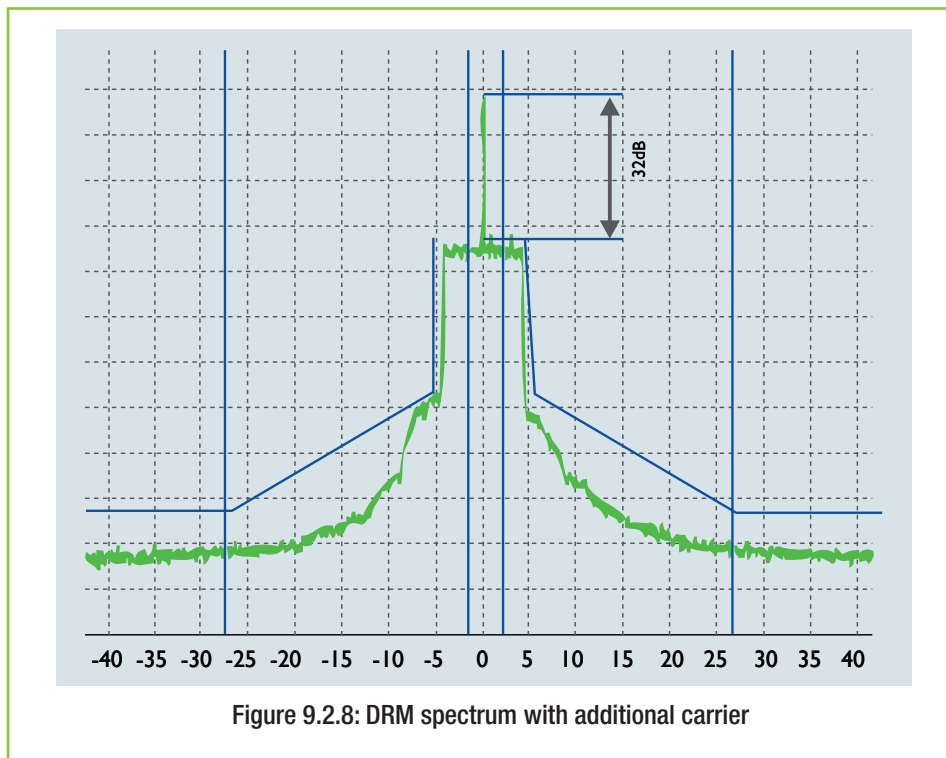

## 9.3 Transmitting in DRM+ configuration

For the DRM+ setup it is also possible as in DRM30 to use a variety of configurations for existing or new installations to bring the DRM+ service on air.

Table 9.3: DRM+ Mode E Parameters

DRM+ Mode E Parameters		Bit-rate (kbits/s) @		
		Code-rate	4- QAM	16-QAM
Occupied Bandwidth	95 kHz	0.25	37.3	
Number of carriers	213	0.333	49.7	99.4
Carrier spacing	444.44 Hz	0.4	59.6	
Symbol length $T_u$	2.25 mS	0.411		122.4
Guard interval $T_g$	0.25 mS	0.5	74.5	149.1
Overall symbol length $T_u + T_g$	2.5 mS	0.625		186.4

14 Older transmitters using phase and amplitude (A/RFP) topology.

### 9.3.1 Network system architectures for DRM+

In all digital transmission systems with a non-constant amplitude, the amplifiers need to be as linear as possible to get the best performance out of the system. One possible arrangement is to use a linear Class A, or in preference a push-pull Class A-B amplifier. Future developments may lead to VHF amplifiers employing topologies similar to the A/RFP arrangement that is now ubiquitous in AM transmitters.

### 9.3.2 Basic DRM+ setup

For a DRM+ only transmitter, the typical architecture is very simple and could look like Figure 9.3.2a. The audio programme and the additional digital information are combined in the content server and feed to the Modulator over the MDI data stream. The DRM+ modulator provides a final-frequency modulated RF output signal that is directly connected to the power amplifier device.

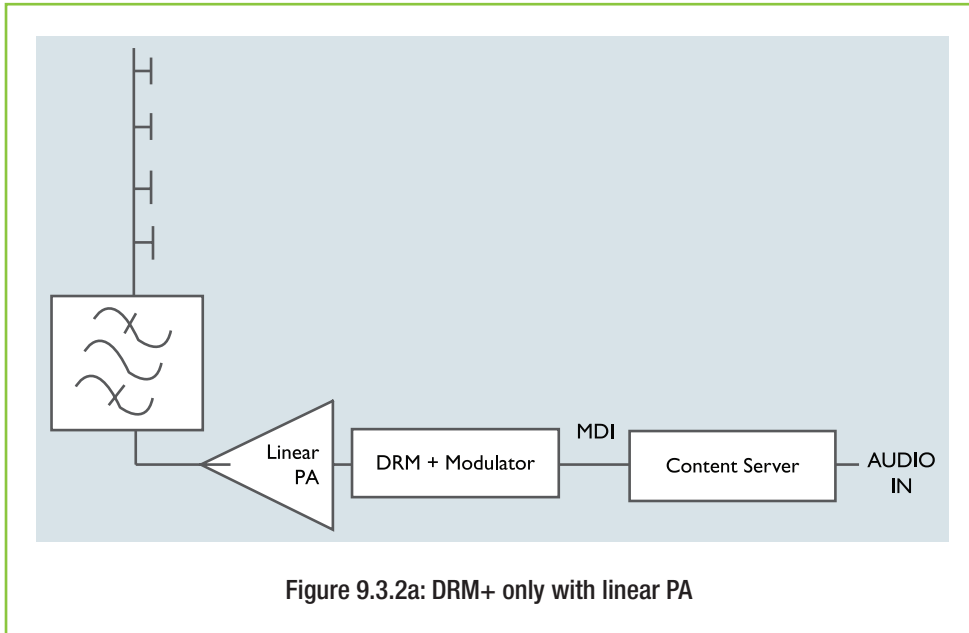

The output spectrum, shown together with the DRM+ spectrum mask superimposed, will look similar to Figure 9.3.2b.

For further information on the DRM Spectrum mask see Section 9.4.

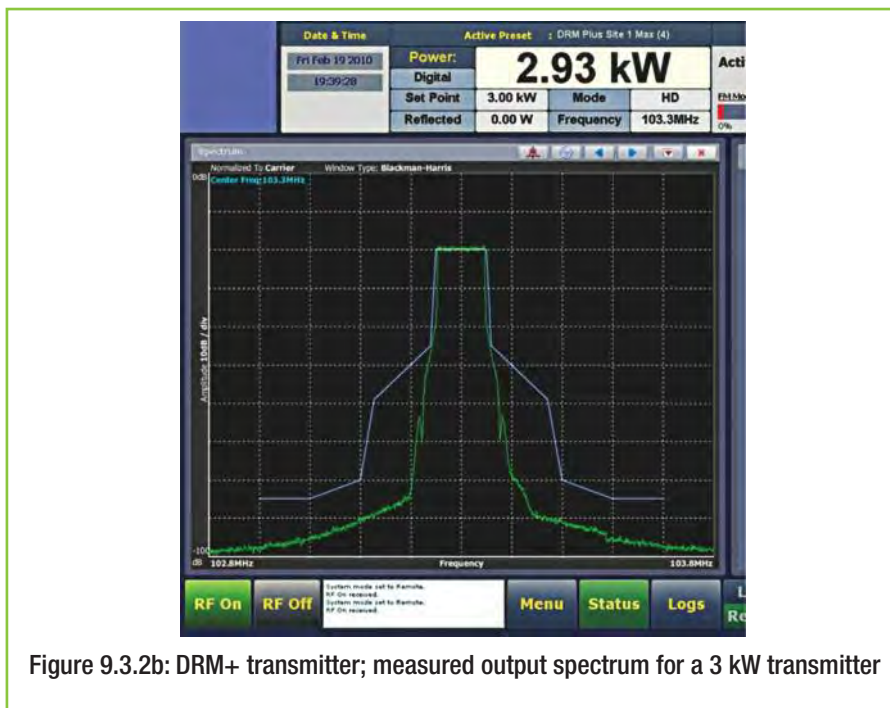

### 9.3.3 DRM+ ‘Simulcast Mode’

In some circumstances it is also possible to have a mixed setup of the DRM+ signal with an existing FM broadcast installation. In the case of combined mode, where a DRM+ is added to an existing analogue transmitter, the spectrum arrangement and the two principle variables (frequency offset and relative amplitude) are illustrated in Figure 9.3.3.

The most common architecture to have such a signal configuration on-air will be the combining the respective power amplifier outputs (FM and DRM+) with a high level combining system. This may take several forms, as outlined in the following sections.

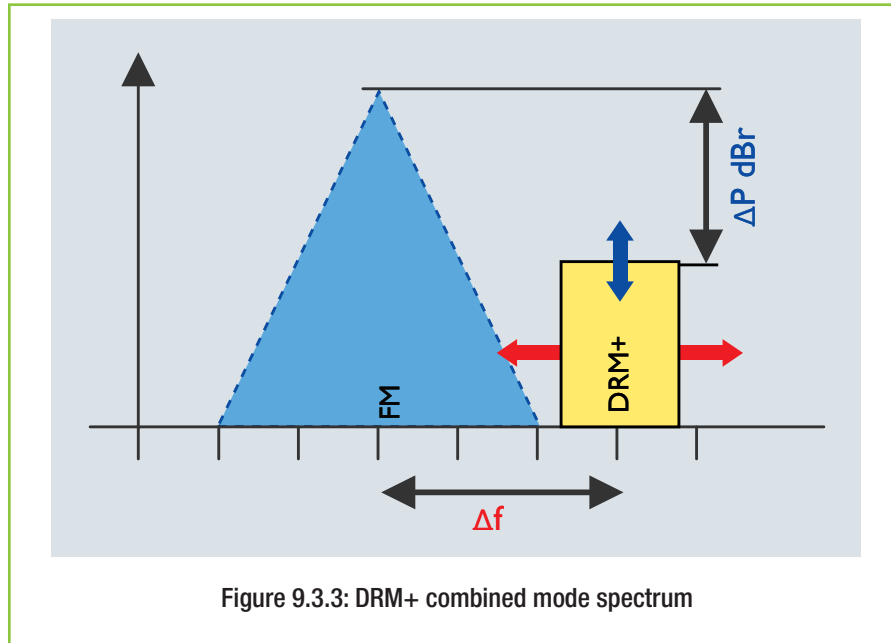

#### 9.3.3.1 Directional Coupler Combining

The DRM+ and FM signals are combined using a hybrid coupler after the two power amplifiers – Figure 9.3.3.1. The coupling factor is chosen to strike the optimum compromise between power loss in the FM channel, and the size (power rating) of the DRM+ amplifier. The coupling chosen is normally in the range 6 to 10dB (see Table 9.3.3.1).

Table 9.3.3.1: DRM+ combiner options

Mode	FM RF out (kW)	DRM+Transmitter rating (for -10dB relative to FM) (kW)	FM Power reduction	Overall efficiency (Mains to RF, indicative)
1. FM Only (reference)	10	-	0%	64
2.a) 6dB Coupler-combiner	7.5	3.0	25%	44
2. b) 10dB coupler-combiner	9.0	9.0	10%	36
3. “In-air” combiner (antenna)	10	1.0	0%	56

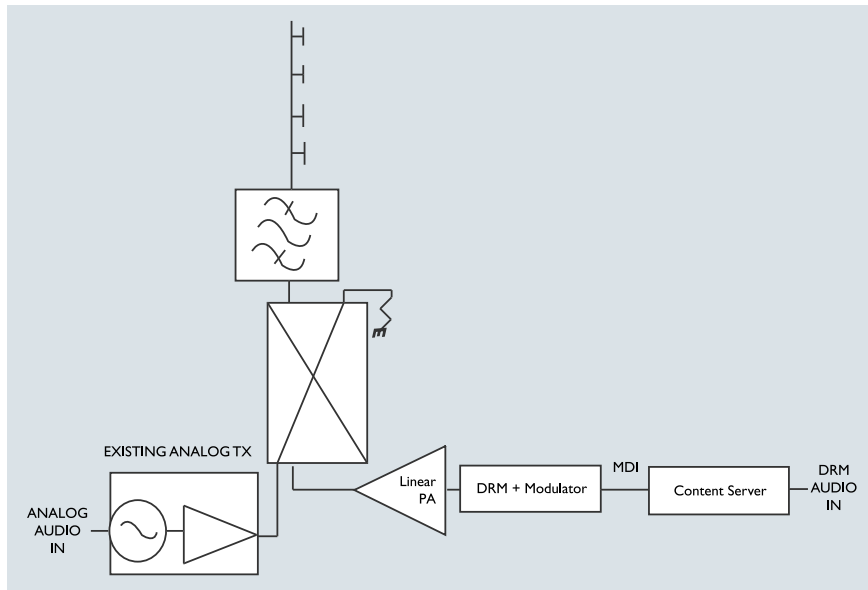

Figure 9.3.3.1: DRM+ combined mode with RF power combining

Transmission power is lost in the dummy load connected to the necessary hybrid coupler, but the advantage is that the analogue and digital chains are fully independent in operation.

### 9.3.3.2 'In Air' Combined mode with separate antennas

It is also possible to use two antennas for the different signals; one for the DRM+ signal and one for the FM signal. The two antennas should ideally be on the same mast and have similar radiation patterns in order to preserve the amplitude relationship between analogue and digital signals. From the energy point of view, this is the most efficient way to operate a combined mode arrangement (see Table 9.3.3.1).

This mode doesn't guarantee that the power level between analogue and digital transmission stays absolutely constant in multipath reception conditions.

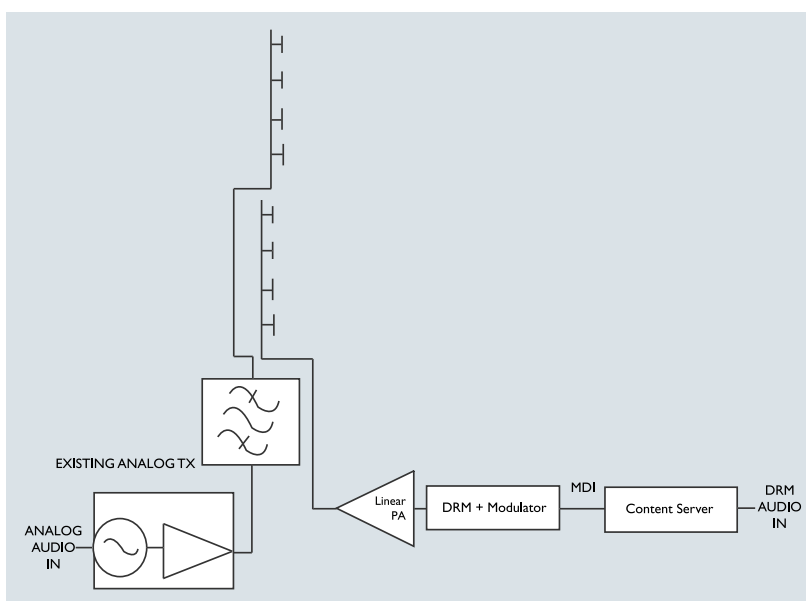
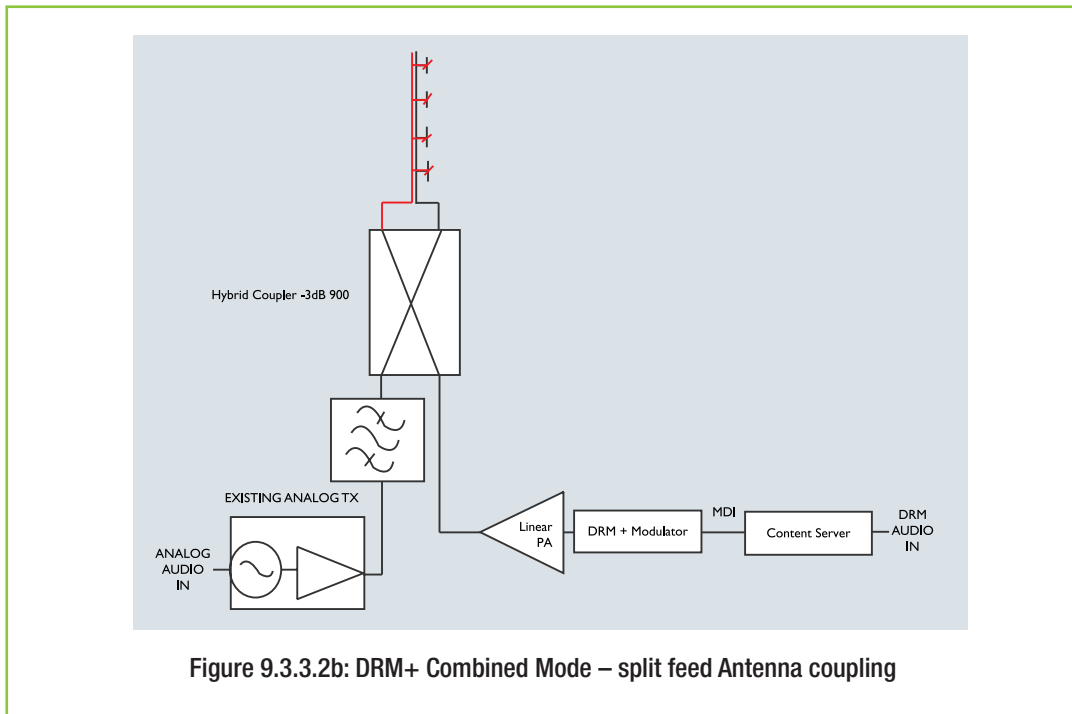

Figure 9.3.3.2a: DRM+ combined mode antenna coupling

A very elegant option solution is to use a mixed, slant or circular polarisation antenna with independent input feeds of the H and V polarisation elements – a split feed antenna as shown in Figure 9.3.2.b.



Note that in multipath conditions, neither option above will guarantee that the power level between analogue and digital transmission will stay absolutely constant.

### 9.3.4 DRM+ combined Mode Setup (signal level combining)

It is also possible to combine the FM and DRM+ signals prior to the main power amplifier. For this mode, the PA is required to be modified or designed specifically to accommodate the two signals without generating excessive intermodulation products.

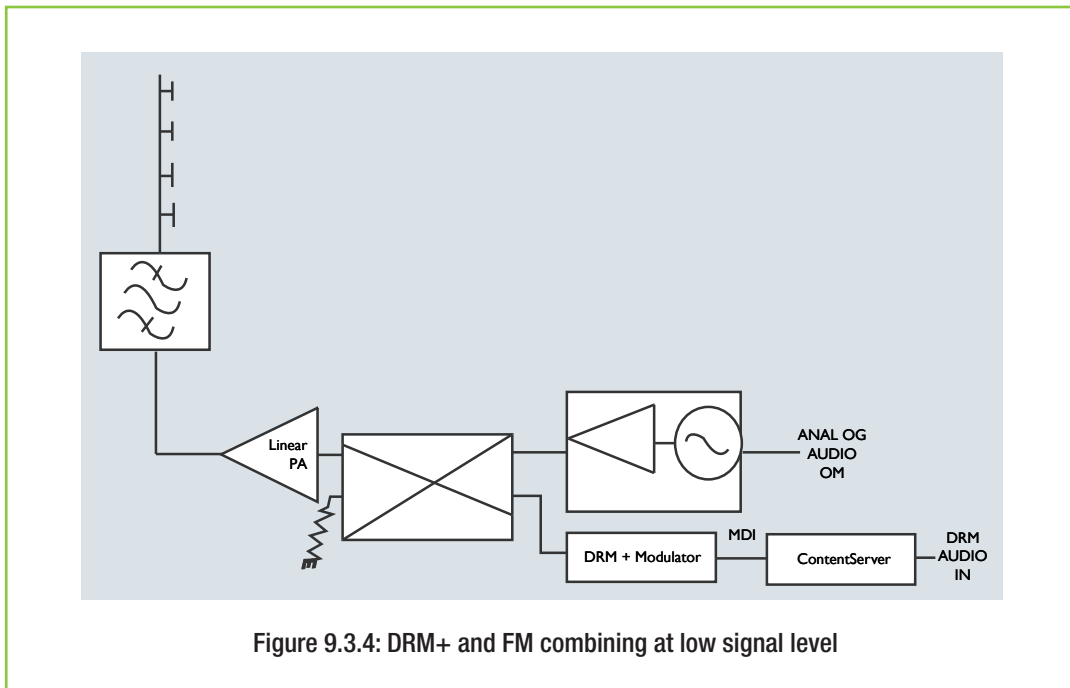

In this configuration the DRM+ signal and the FM signal are combined in front of the power amplifier. The coupling is done at low signal level and the energy losses on the dummy load resistor connected to the hybrid coupler is insignificant.



## 9.4 Spectrum masks and protection levels for DRM+

### 9.4.1 VHF Bands I and II

To broadcast with DRM+ in the existing bands alongside other transmissions, the protection levels and a transmitter spectrum mask have been defined as given in Figures 9.4.1a and 9.4.1b. The goal for a Broadcaster is to tune all the parameters perfectly to stay within the masks, avoiding interference with other transmissions and maximise the coverage of their own transmission.

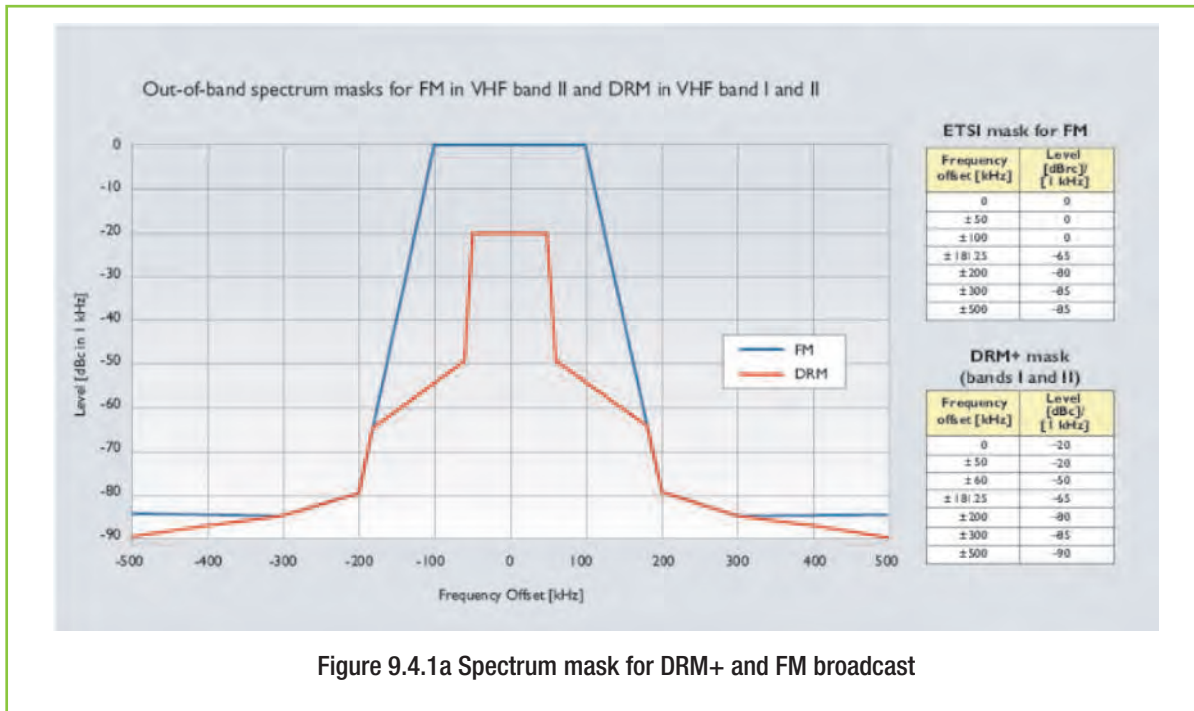
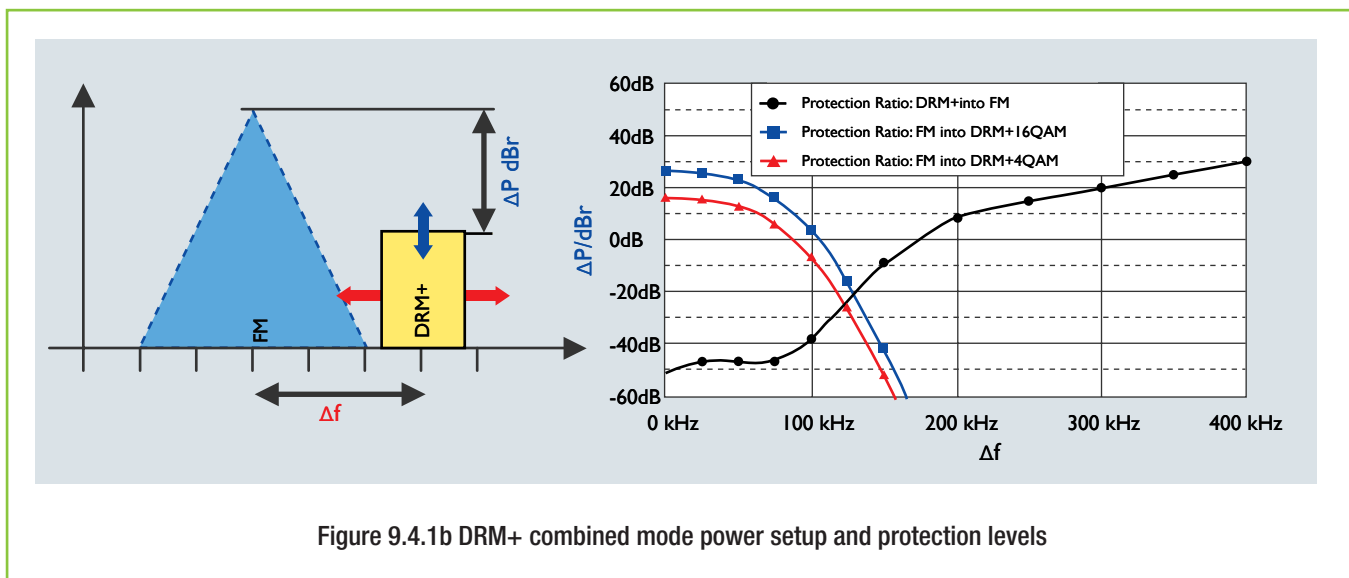

Figure 9.4.1a Spectrum mask for DRM+ and FM broadcast



- The **black** curve shows the maximum DRM + power ratio that will not affect the analogue signal beyond the recommended protection criteria.
- The **blue** curve shows the minimum power ratio for 16 QAM DRM+ in the presence of an analogue FM interferer.
- The **red** curve shows the minimum power ratio for 4 QAM DRM+ in the presence of an analogue FM interferer.

### 9.4.2 VHF Band III

An out-of-band spectrum mask for DRM in VHF Band III is given in Figure 9.4.2 and Table 9.4.2, together with the vertices of the symmetric out-of-band spectrum masks for DAB transmitters<sup>15</sup> as minimum transmitter requirement, defined for a resolution bandwidth (RBW) of 4 kHz. Thus the value of -14 dBr results for DRM.

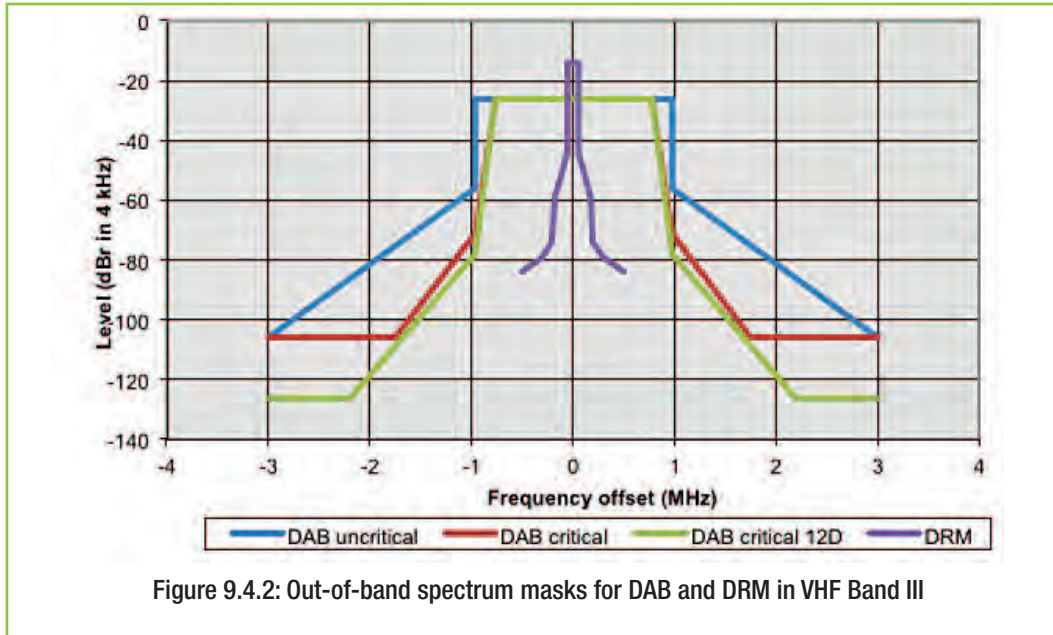

Figure 9.4.2: Out-of-band spectrum masks for DAB and DRM in VHF Band III

Table 9.4.2: Out-of-band spectrum masks for DAB and DRM in VHF Band III

Spectrum mask (1.54 MHz channel) / relative level for DAB (in 4 kHz)				Spectrum mask (100 kHz channel) relative level for DRM (in 4 kHz)	
Frequency offset (MHz)	Level (dBc) (non-critical cases)	Level (dBc) (critical cases)	Level (dBc) (critical cases/12D)	Frequency offset (kHz)	Level (dBc)
±0.77	---	-26	-26	0	-14
< ±0.97	-26	---	---	±50	-14
±0.97	-56	-71	-78	±60	-44
±1.75	---	-106	---	±181.25	-59
±2.2	---	---	-126	±200	-74
±3.0	-106	-106	-126	±300	-79
				±500	-84

## 9.5 Transmitter Monitoring

DRM requires a different approach to monitoring, than that normally used for analogue broadcasting. Observation of the DRM RF envelope on an oscilloscope reveals little useful information and the RF spectrum of a DRM pseudo random binary test sequence (PRBS) is essentially identical to the spectrum of a DRM programme or data signal. A simple AM or FM demodulator can of course no longer be used to monitor the transmitter.

An immediate and simple monitoring solution is to employ a software receiver, which uses an analogue receiver as a front-end together with a PC decoder. At least one manufacturer offers the front-end receiver with the necessary 12 kHz IF output.

<sup>15</sup> Given in Recommendation ITU-R BS.1660-3; Technical basis for planning of terrestrial digital sound broadcasting in the VHF band.

The decoder can be easily implemented on a laptop PC, which is set up alongside the DRM transmitter with the audio output routed into the station monitoring system – or the system can be included as part of the maintenance engineer's toolkit when visiting unattended transmitter sites. This simple system will allow basic monitoring and programme checking to be carried out on the transmitter.

Some DRM excitors on the market use built in test receivers to supervise the output signal.

### 9.5.1 Characterising Transmitter Performance: the MER

As well as compliance with the OOB power spectrum mask, a useful way of characterising the performance of a DRM transmitter is to measure the Modulation Error Ratio (MER). Every DRM capable transmitter must match the DRM spectrum mask and the MER limit at the same time. As has been explained in an earlier section, the DRM signal consists of a group of discrete equally spaced carriers.

Each carrier is modulated in terms of amplitude and phase and so can be represented as a vector. Errors in the modulation process, phase noise in the RF drive synthesiser and less than ideal response in the transmitter amplitude and phase paths can be considered to add an error vector which, when added to the distortions introduced by the RF channel and receiver may cause overall errors in the decoding process in the receiver. The MER indicates the ratio between the undistorted 'wanted' vector and the error vector introduced by the system, averaged over many carriers, and is normally expressed in dB. Thus a high MER figure shows that the error vector is small compared with the wanted vector and in consequence there should be little difficulty in correctly decoding the data represented by the carrier phase and amplitude. For a compliant DRM transmitter, an MER of 30 dB or greater should be expected.

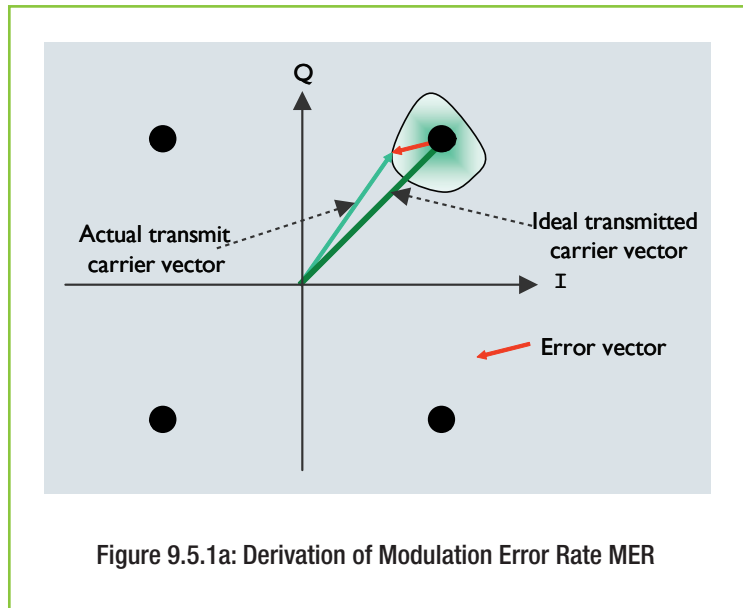

Figure 9.5.1a: Derivation of Modulation Error Rate MER

As mentioned earlier, DRM power available from an AM transmitter is normally lower than the rated AM power. This is because the peak-to-mean ratio of the DRM signal is around 4dB higher than that for 100% AM modulation. Thus from a broadcaster standpoint, it might be desirable to enhance the DRM power by effectively clipping the peak envelope and hence reducing the transmitted crest factor of the DRM signal. The price paid for this power enhancement is a decrease in MER. Figure 9.5.1b illustrates the relation between TX power, MER and the crest factor of the DRM signal.

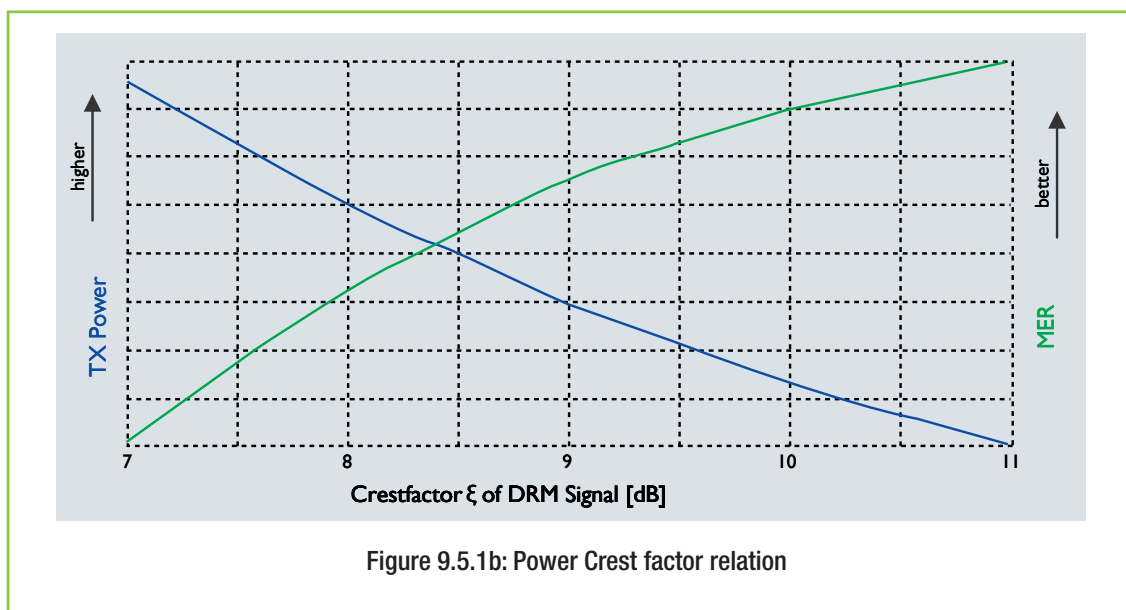

Figure 9.5.1b: Power Crest factor relation

## 9.6 Test Equipment

As a minimum, a Spectrum Analyser having sufficient dynamic range to confirm out of band spectrum mask compliance and a DRM Reference Receiver for determining MER, bit error rates and audio quality checks on the transmitted signal, will be needed to commission and maintain a DRM system. See the DRM web-site for links to manufacturers and suppliers.

## 9.7 Antenna Systems

As a very broad generalisation, the antenna systems used for analogue broadcasting in the HF and FM Bands can be used for a DRM service operating in the same band.

For LF and MF services, the primary concern is that of obtaining adequate bandwidth, as determined by the return-loss seen by the transmitter. This is particularly important where 18 or 20 kHz DRM signals are to be radiated or where analogue 9/10 kHz DSB and 9/10 kHz DRM signals are to be radiated on adjacent channels in simulcast modes. In the later case it may not be practical to use the existing antenna, if it cannot be economically modified to provide sufficient bandwidth.

An immediate effect of a restricted antenna system bandwidth is to attenuate the amplitude and alter the phase relationship of the outer carriers. This is not actually a problem for DRM, as the receiver is able to correct such distortions. There is also a possibility that a restricted bandwidth may react on the associated transmitter and increase the OOB power. Equally well a restricted antenna response may serve to attenuate some OOB power. In extreme cases, excessive reflected power can cause transmitter to cut back output power, or even trip.

Where the antenna bandwidth is commensurate with the DRM signal bandwidth, it can be expected that the RF spectrum observed with the transmitter loaded with the antenna will be different to that observed with a resistive test load. In setting pre-correction, it may well be necessary to take account of antenna characteristics.

### 9.7.1 MF Antennas

MF antennas are normally tuned to the service frequency, although in some installations two or more services may be radiated from a common antenna. Many types of MF antenna exist. The particular configuration used is determined by coverage area and whether ground wave only, or a combination of both ground- and sky-wave propagation, is to be used.

MF Antennas are usually adjusted to present a resistive load at the service frequency. Either side of this frequency, the load impedance presented to the transmitter becomes complex with an increasing imaginary component. For DRM, the recommendation is that the antenna impedance characteristic is symmetrical, that is, the sign of the imaginary component changes either side of centre frequency and the rate of rise (or fall) of the antenna impedance either side is equal. Thus, if the imaginary component is  $-j$  below centre frequency it must be  $+j$  above centre frequency or vice versa. Antenna bandwidth can also be expressed in terms of the VSWR characteristic. Investigations undertaken by several companies indicate that for DRM, the VSWR at  $\pm 10$  kHz from centre should be not greater than 1.1:1 and not greater than 1.05:1 at  $\pm 5$  kHz from centre. Performance parameters better than this may be required for the satisfactory radiation of DRM 18/20 kHz wideband signals.

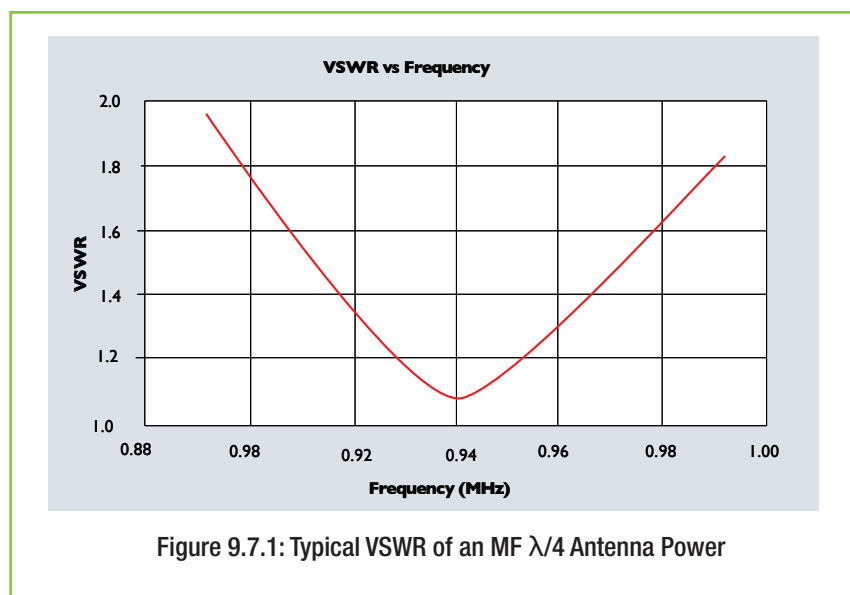

To illustrate this, the basic Voltage Standing Wave Ratio (VSWR) characteristic for typical single  $\lambda/4$  resonant mast radiator is shown in Figure 9.7.1. This characteristic refers to a base fed 75 metre mast, having a diameter of 0.5 metre, and was obtained by NEC modelling. The resonant frequency is approximately 939 kHz.

Shunt fed and folded monopole resonant configurations have a similar response and the VSWR characteristic meets the requirement for DRM. In electrical terms the antenna 'Q' factor, and hence bandwidth, is very dependent on the physical size and form of the radiator. Thus a "cigar" shaped mast would have a low Q, flat VSWR characteristic and wide bandwidth, whereas a "thin" antenna would have a high Q, steep VSWR characteristic and narrow bandwidth.

Generally, practical single mast radiators, operated at their resonant frequency, are unlikely to present bandwidth problems for DRM. In very extreme cases, however, modifications may be needed to the physical structure of the mast in order to achieve the required bandwidth.

In multi-mast antenna configurations, such as Yagi arrays and 'Four Posters', the coupling between radiators and reflectors will have an influence on the bandwidth of the driven masts and generally tends to increase the Q and decrease the bandwidth. For these examples, some further work may be required to ensure satisfactory operation.

As has been shown, the bandwidth and hence VSWR characteristic of the basic practical MF resonant antenna is unlikely to present any serious problems for DRM. Consideration must however be given to the likely effects on bandwidth of matching networks, reject filters, combining networks and feeder systems that are interposed between the antenna and transmitter.

### 9.7.2 LF Antennas

The plot in Figure 9.7.2a shows the input impedance characteristic of a 220-metre base fed mast.

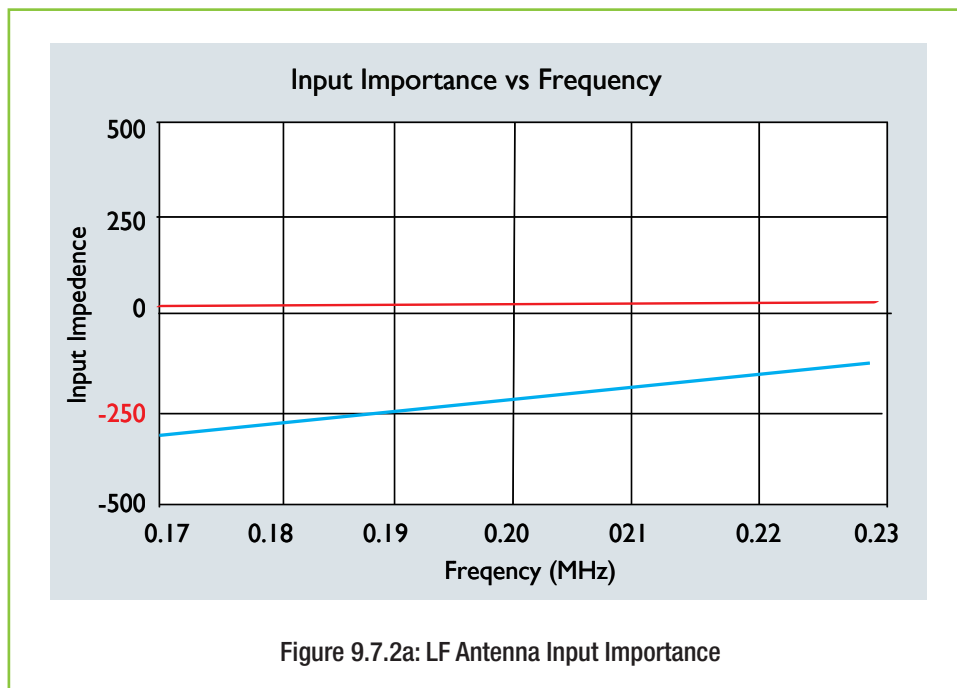

The **red** curve represents the resistive component and the **blue**, the reactive component. As can be seen the antenna is predominantly capacitive with a very small resistive component, typically this is of the order of 5 – 10 Ohms.

The use of non-resonant antennas may reduce the bandwidth; however the implications are not considered here.

Figure 9.7.2b shows the characteristic Smith Chart plot of a folded monopole LF antenna operated at 198kHz over  $\pm 10$ kHz before and after an optimised broadband matching ATU network.



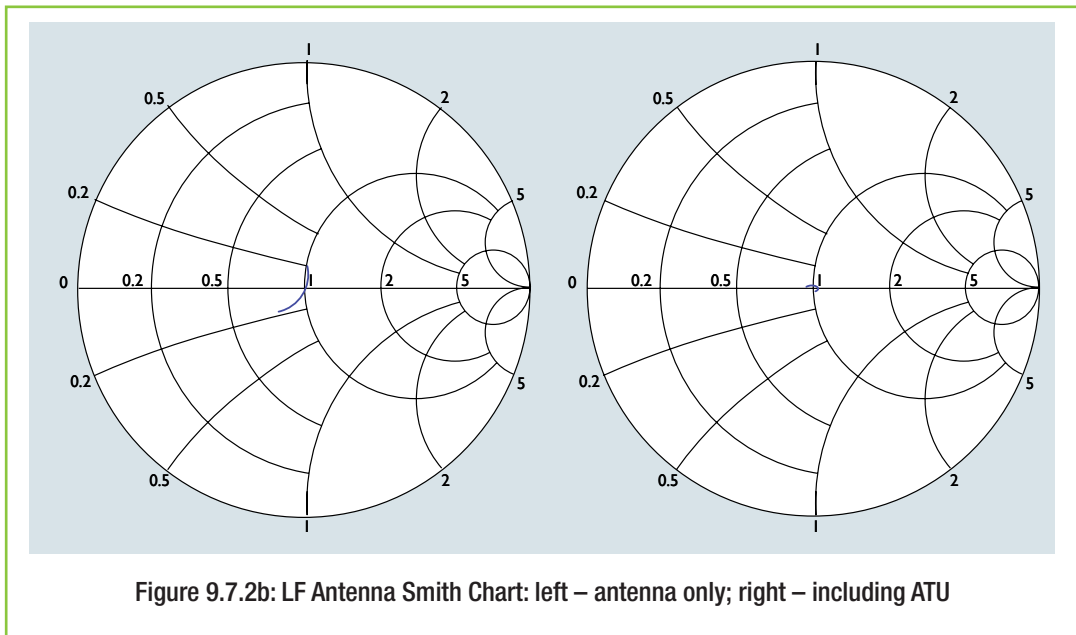

### 9.7.3 Matching and Combining Networks

In order to ensure that the transmitter is presented with a symmetrical impedance characteristic, it is necessary that the matching network and feeder system interposed between the antenna and transmitter corresponds to an integer-multiple of quarter wavelengths at the channel centre-frequency. Where this criterion is not met, symmetry can be restored with the addition of phase shift or phase rotation networks. This will also often improve the bandwidth. Matching networks for non-resonant antennas, or those including rejection filters and combiners at multi-service sites may have a restricted bandwidth. Methods of overcoming restricted bandwidths are discussed in the next section.

### 9.7.4 Implementing a DRM Service on an Existing Antenna System

As mentioned earlier, the intrinsic bandwidth of HF and FM antennas is more than adequate for the DRM signal, and such antenna systems can normally be used without alteration.

The situation is however different at LF & MF. As a first step, the antenna impedance characteristic must be established. This is most easily obtained using a Network Analyser and if presented in the form of a Smith Chart, the amount of phase rotation needed to correct an asymmetrical characteristic can be determined directly from the plot. The required phase rotation can either be implemented with an additional phase shift network or the existing matching circuit modified.

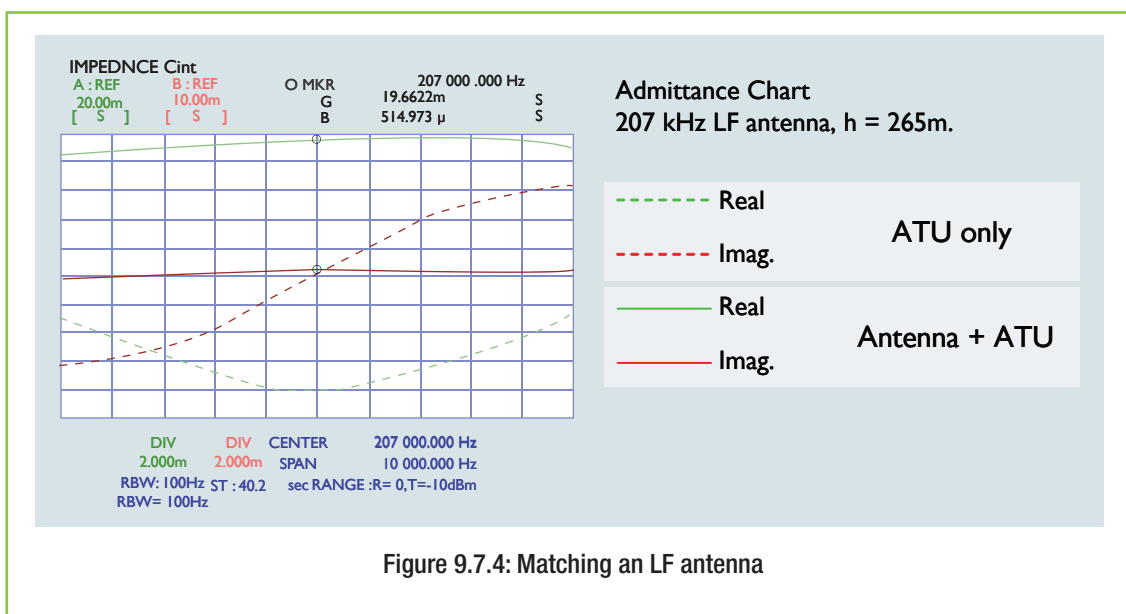

Where system bandwidth (in terms of the VSWR characteristic — which can also usually be obtained from the Network Analyser), is less than optimum, the first line of approach is to consider the transmitter and antenna system response as a whole. The overall response is then measured and used to determine the pre-correction required at the DRM Modulator and so compensate for the restricted antenna bandwidth

The better solution is to review the antenna system design in consultation with the suppliers as they may be able to offer alternate matching and combiner network configurations having a wider bandwidth.

# MORE



NV Series FM 3.5 kW – 88 kW

Nautel offers the most advanced DRM transmitters available today. Choose from power outputs of **300 W to 88 kW FM** and **1 kW to 2000 kW MW**. Available with integrated instrumentation, industry leading efficiency, comprehensive web management and of course Nautel's renowned reliability and support. Expect more from Nautel. Learn more at [www.nautel.com/drm](http://www.nautel.com/drm)

Making Digital Radio Work.



+1.902.823.5131  
[www.nautel.com/drm](http://www.nautel.com/drm)



[www.drm.org](http://www.drm.org)

# DIGITAL RADIO MONDIALE

## The Future of Global Radio



### DRM brings you efficient digital radio

DRM's digital broadcasting system takes the radio listening experience to the next level. It provides disruption free audio quality and service reliability. It is highly cost and energy efficient and gives increased coverage.

With DRM's digital broadcasting system you can broadcast bands covering LW, SW, MW and FM Bands I, II and III.

### DRM benefits:

- Greater reach
- Cost-efficient broadcast
- Wider content/channels
- Multi-platform
- Zero disruption
- User friendly
- Saves energy

### DIGITAL RADIO IS IDEAL FOR:

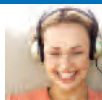

#### LISTENERS

Get excellent sound quality and undisturbed reception on the go  
Get a wider choice of content, channels and programmes

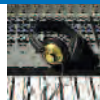

#### BROADCASTERS

Reach more listeners with new, additional digital services and generate new revenue streams



#### MANUFACTURERS

Generate a new market for digital radio sets and related hardware like chipsets, transmitters and other equipment

## 10.1 Scope

This section provides some illustrative background information (and a number of important references) to documents which detail the work undertaken to derive the protection and planning criteria required for DRM transmissions. Service planning is a complex subject, and it is neither appropriate nor feasible to reproduce all the relevant information in this manual, especially as it is already openly published elsewhere by the ITU and others [9, 27, 28]. However, an overview of some of the more important techniques and know-how gleaned from several years of operating and monitoring DRM and similar digital services are included in this section.

Finally, there is a short summary on reception monitoring.

## 10.2 Network topologies

Normally, the service planner is set the task of designing a transmission system to achieve a prescribed quality-of-service over a given target area (local, regional, national etc.) In most instances, the editorial or geographic boundary of the target service area will not coincide with the service area dictated by propagation physics. In other words, it normally requires careful planning and optimisation of transmitter powers, site locations, and antenna configuration to achieve something close to the desired coverage. The whole process is further constrained by (in particular) budgets, site access, frequency allocations and co-ordination issues.

The DRM system provides the planner with a powerful tool-kit of techniques that can significantly ease these problems when designing a digital network.

### i. Choice of frequency-band

As DRM supports broadcasting in all the LF, MF and HF bands, together with VHF bands I, II and III, finding suitable frequency allocations should be made much easier.

### ii. Out-of-band operation and cross-network signalling

Frequently, broadcasters who are currently confined to one band (e.g. MF or FM) often make the assumption that they should seek to migrate to digital transmissions operating in the same band. With the ability to signal (AFS) and cross-link between AM, FM, and all DRM modes, it is possible to commence digital services in any band. The listener will tune a radio using a list of station names derived from band-scans, and will be unaware of (and unconcerned by) the actual frequencies used for transmission.

### iii. Multi-band digital networks

Whilst SFN's and MFN's can provide a flexible range of coverage options, it is also feasible to exploit the unique advantages of the various DRM modes when planning services. For instance, an MF frequency can be used for wide-area rural coverage, supplemented by 26MHz or Mode E transmissions in cities, where man-made noise-levels and steel-framed buildings cause reception difficulties.

### iv. Dynamic mode-changing

The ability to change the broadcast signal parameters in response to propagation conditions is an extremely powerful tool that is only available in digital modes.

One illustration of the use of such a technique is dealing with the effects of night-time (sky-wave) interference to services in the medium waveband. In addition to any possible change to transmitter power, by moving from 64 to 16QAM and applying stronger coding, an additional 6 to 10dB of protection can be obtained, helping to balance day and night-time coverage.



### 10.2.1 Single Frequency Networks (SFNs)

Although analogue synchronous networks are sometimes used at MF and LF to provide extended coverage, there will always be problems with mutual interference in the overlap regions, sometimes known as ‘Mush Areas’. This usually requires the use of additional frequencies to supplement coverage in these areas. Analogue FM transmissions are particularly susceptible to multipath, especially in stereo, and single-frequency networks are therefore only rarely used, and then under very prescribed conditions<sup>16</sup>.

With careful design, these problems can be all but eliminated using a DRM SFN. Provided the received signals all arrive within the guard interval they will reinforce each other and reception should be improved compared to a single-transmitter case. There are two separate mechanisms at play that lead to improved reception:

- i. Increased strength-strength as a result of the ‘power-sum’ of the individual transmission components (see Figure 10.2.1)
- ii. At VHF frequencies, a phenomena known as ‘network gain’ whereby the standard deviation of the median field-strength is reduced as a result of contributions from two or more transmissions received over uncorrelated paths.

The impact of network gain at VHF frequencies can be significant<sup>17</sup>; in essence, it is a quantitative figure reflecting the benefit of diversity in reducing the probability of a flat fade in a Raleigh channel.

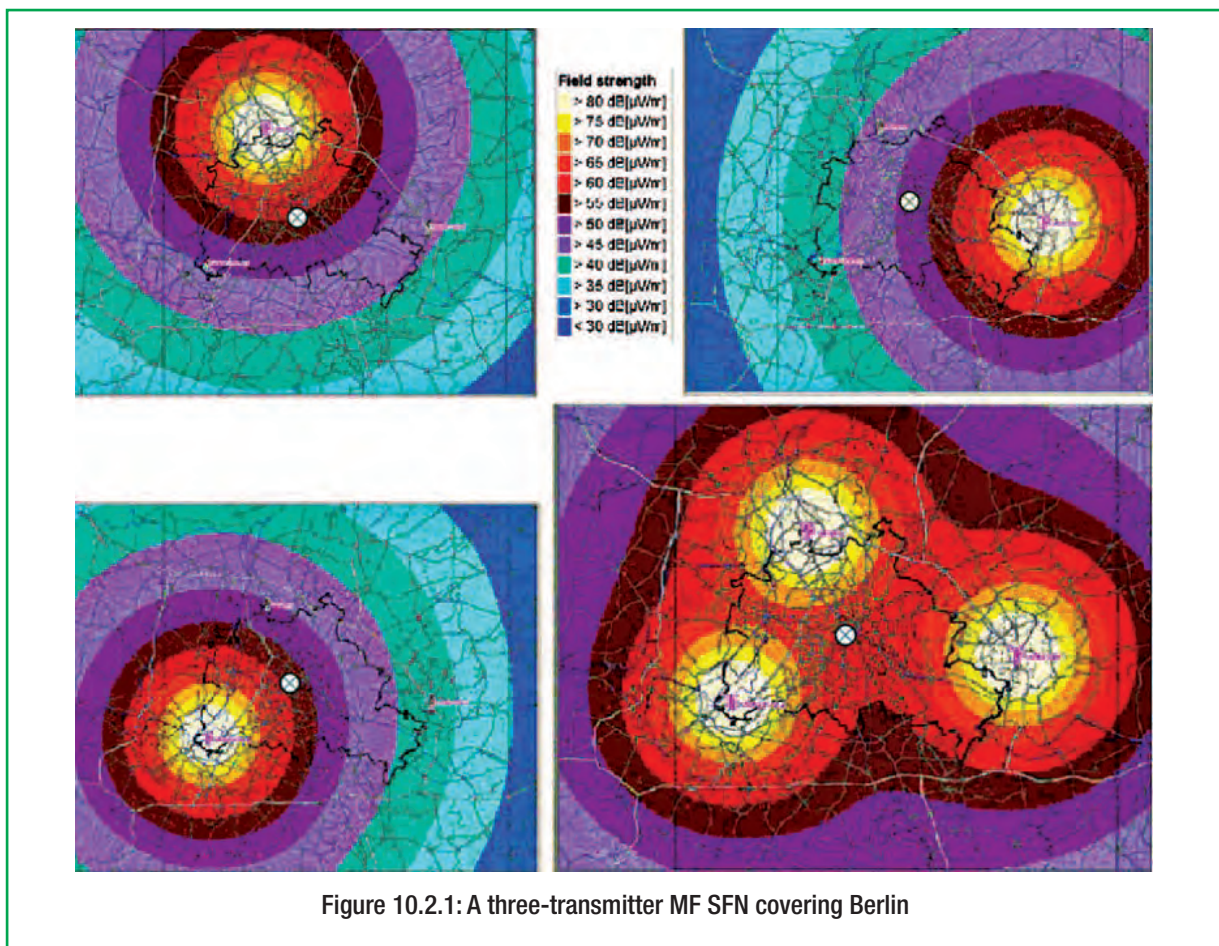

### 10.2.2 Multi-frequency networks

MFN's offer an attractive solution to providing wide-area coverage in situations where any one frequency cannot be co-ordinated or licensed across the desired territory. As described earlier in Section 5.3.5, providing the same DRM mode is used for all transmissions then it is possible for a DRM receiver to switch between frequencies without breaks in the audio, (in a similar manner to the AFS feature of FM RDS). Network synchronisation requirements are virtually identical to those required for an SFN.

<sup>16</sup> For instance, providing coverage along a highway using a “linear” network of transmitters each feeding a directional antenna

<sup>17</sup> Research results for DAB SFN's in Band III yielded a figure of around 4dB for Network Gain



For the more general case where the listener may be handed from DRM-to-DRM, but in different bands (and hence probably different modes) or to an analogue sustaining service, audio interruptions can be minimised by using dual-front-end receivers together with either:

- A receiver memory buffer, or
- The use of delay-matched transmission networks.

The typical delays inherent in interleaving etc. in various broadcast modes are set out in Annex R of the DRM standard [1].

## 10.3 Available Frequency Bands

Several frequency bands are used for radio broadcasting. These frequency bands have different characteristics that make them suitable for different types of radio service. As a general rule, wide area coverage is easier to achieve in the lower frequency bands but the capacity of these bands is restricted. Higher frequency bands have greater capacity but it is more difficult and costly to provide coverage over a wide area.

Propagation characteristics vary with frequency and different radio systems have been devised to make best use of them. As a general rule, lower frequencies are better able to cover large areas (countries and even continents) with a single transmitter whilst the higher frequency bands are most suitable for regional and local services.

### 10.3.1 LF/MF/HF

The LF, MF and HF frequency bands between 148.5 kHz and 30 MHz<sup>18</sup> are traditionally used for analogue AM broadcasting. However, as already explained in this guide, DRM is designed to operate in these bands as a quality digital replacement for the analogue services. The LF and MF bands are primarily used for domestic broadcasting and the HF bands for international broadcasting. Due to changing propagation conditions during the day the coverage in these bands is variable. This can be tolerated by listeners of analogue services but requires extra care in planning digital services to ensure that listeners do not lose their reception.

There are ITU rules of procedure in place to allow DRM transmissions LF/MF/HF bands – see Section 8.1.

### 10.3.2 26 MHz band

DRM is the only digital broadcasting system designed to operate in the shortwave bands (broadcast allocations within 3 – 30 MHz). The “26 MHz band” (25.67 to 26.1 MHz) is a 430 kHz wide broadcasting service allocation at the upper end of the HF range, providing forty-two 10 kHz (or 21 x 20 kHz) channels. International broadcasters tend to favour the lower frequency broadcast bands (below 21 MHz), partly because low cost HF receivers do not pick up the 26 MHz band and partly because there are few times in the 11 year solar sunspot cycle when the band supports long-range propagation. Therefore part of the band may be available for local broadcasting.

The result of using low power ‘line of sight’ transmission systems in the 26 MHz band is a coverage area very similar to a Band I transmission. An additional benefit of the band is that man made noise levels are usually much lower than, for instance, the MW band.

For local coverage the system offers the following features:

- Coverage of an entire metropolitan area, or a small portion serving a specific community.
- Use of a 10 kHz channel provides equivalent ‘FM-mono’ or ‘parametric stereo’ audio quality. Use of a 20 kHz channel yields more capacity and hence greater flexibility in terms of transmission modes and audio configurations.
- Use of an SFN or MFN to cover a wider area with lower power transmitters than if a single transmitter were to be used.
- Employ Alternative Frequency Switching (AFS) if the same programme is broadcast on more than one frequency, with the receiver dynamically selecting the best signal.
- Significantly lower power levels than those needed for an MF transmission providing similar coverage.

<sup>18</sup> LF band: 148.5 - 283.5 kHz; MF band: 526.5 – 1606.5 kHz; HF band: 3 – 30 MHz.

### 10.3.3 Band I (47 – 68 MHz)

The frequency range between 47 – 68 MHz has mainly been used by analogue television, and it is not planned for digital television<sup>19</sup>. Consequently, DRM+ could in principle be introduced in Band I. At the present time, no regulatory framework exists for the introduction of DRM+ and it should be noted that in some countries there are other services in operation.

Services in this Band are particularly subject to long distance interference (Sporadic E) at certain times of the year and therefore Band I is more suitable for the provision of local services where the wanted signal can be relatively high.

### 10.3.4 Band II (87.5 – 108 MHz)

The frequency range between 87.5 and 108 MHz is used for FM broadcasting. DRM+ is an ideal candidate digital radio system for use in Band II<sup>20</sup>.

Nevertheless, the introduction of DRM in Band II would have to be considered on a case-by-case basis due to the intensive use of this band throughout the world for FM radio services. The digital assignments should initially be inserted between existing analogue FM assignments and eventually on free FM assignments where possible. There may be a need for some 'Rules of Procedure' in relation to existing international agreements (e.g. The Geneva 84 Agreement [18]) in order to take into account digital system parameters.

### 10.3.5 Band III (174 – 230 MHz)

Band III, the frequency range between 174 and 230 MHz has been used extensively for analogue television but is now planned and used for digital television and digital radio services. In Europe and some other countries (e.g. Australia, China, South Korea) it is the primary spectrum range for the introduction of radio broadcasting on the basis of the DAB-family, i.e. DAB, DAB+ and DMB. These dedicated radio broadcasting systems deliver radio content in terms of several programme services bundled to generate a single multiplex which is transmitted within the intended bandwidth of 1.75 MHz. Clearly, broadcasters who are not in a position to fill an entire multiplex will need to share a multiplex with others. DRM provides an ideal alternative solution where single service coverage planning is desirable.

If different digital radio systems are introduced into Band III appropriate channel rasters must be defined together with the necessary sharing criteria.

### 10.3.6 Other VHF Frequency Bands

Other frequency allocations in VHF bands assigned to broadcasting services are not exhaustively covered yet, e.g. areas in ITU Region 1 where allocations of the Wiesbaden T-DAB Agreement 1995 are still used (230 - 240 MHz) or in some Southern African countries, where the VHF Band III is allocated to the broadcasting services up to 254 MHz, or the broadcasting bands in ITU Regions 2 and 3, perhaps the OIRT FM band (65.8 - 74 MHz) or the Japanese FM band (76-90 MHz), respectively, that can later be adapted. Planning parameters for these unconsidered cases can be derived or taken from the given values, considering 254 MHz as the international top boundary of the VHF broadcasting spectrum.

## 10.4 Planning tools

At the time of writing there are no planning tools available which have been specifically designed to calculate coverage and availability for DRM transmissions.

However, provided that the broadcaster uses a **transmission mode** appropriate to the channel being used, the more esoteric aspects of digital transmission and reception (delay spread, channel impulse response etc.) are automatically catered for within the various DRM-mode parameters. This then leaves only the received field-strength (and predicted interference levels from other broadcasts) to be determined by the planning tool in precisely the same manner as when planning an analogue service. In other words, given the additional knowledge of the receiver performance and the relevant local noise-floor, the overall received c/n ratio can be calculated in the normal way.

<sup>19</sup> In a few European countries this Band was also used for FM services (so called OIRT FM Band 66 - 73 MHz). However, most of these countries have ceased using Band I for FM broadcasting services.

<sup>20</sup> ECC Report 141 [22] and the associated Technical Annex provide a comprehensive overview of the possibilities for introducing digital radio into this Band in Europe.

Hence, current ‘analogue’ planning tools capable of predicting mean and standard deviation of field-strength can be used to plan DRM services, provided the appropriate target s/n figure for the relevant DRM mode is used.

For the specific case of propagation in the 26 MHz Band studies have been carried out for evaluating different prediction algorithms on the basis of empirical measurements. The algorithms under test were; ITU-R P.1546, Longley-Rice, Diffraction effects (Deygout and ITU-R P.526) and empirical algorithms for mobile reception such as Okumura-Hata. The results revealed that for close-to transmitter coverage-calculation, ground wave propagation should be considered. As for the overall coverage area, no model outperforms the others in all situations. Nevertheless, the algorithm in ITU-R P.1546 provided the highest accuracy and it can be improved by considering clearance angle, elevation and diffraction issues.

## 10.5 Planning data for DRM30

The planning data for DRM networks has been derived from a mixture of theoretical and simulation modelling, complemented by laboratory and field trial measurements. The starting point for this work is a set of theoretical minimum carrier-to-noise ratios for the DRM system: these figures assume perfect receivers and no man-made noise etc. It is then possible to derive real-world performance data using ITU planning assumptions and methodology, as described in ITU-R BS.2144 [27]. An outline is given below.

### 10.5.1 DRM30 Theoretical S/N ratios

These values were derived by passing the various modes of DRM signals through one of six pre-defined channel models. These channel models in turn were based on real-world channel-sounding experiments that were used to characterise Doppler and delay spread, and multipath (number of paths, relative amplitudes etc.). These six channel models are labelled 1 to 6: Table 10.5.1a gives an overview of their basic scope and intended use. They are defined in detail in ITU-R BS.1615 [9].

Table 10.5.1a: Summary of DRM30 RF channel models

Channel model No.		Representative of:		
		Good	Typical/Moderate	Bad
1	Additive white Gaussian noise	LF MF HF	LF with variable S/N	
2	Ground-wave + sky-wave		MF, HF	
3	4-path spread 2.2mS		HF	MF
4	2 equal paths spread 2mS			HF
5	2 equal paths spread 4mS			HF
6	Near vertical incidence in tropical zones			HF (NVIS)

Table 10.5.1b shows the required signal-to-noise ratios (S/N) for four DRM30 modes when operating in channel 1. A bit-error ratio of  $1 \times 10^{-4}$  corresponds to the point at which subjective audio quality starts to degrade to the point that is defined as ‘limit of service’. Similar tables for all six channels are listed in both EBU Tech 3330 [28] and ITU-R Recommendation BS.1514 [8].

Table 10.5.1b: S/N (dB) to achieve BER of  $1 \times 10^{-4}$  for all DRM30 robustness modes – Channel model No. 1

Modulation scheme	Protection level No	Average code rate	Robustness mode/spectrum occupancy type			
			A/2	B/3	C/3	D/3
			(9 kHz)	(10 kHz)	(10 kHz)	(10 kHz)
16-QAM	0	0.5	8.6	9.3	9.6	10.2
	1	0.62	10.7	11.3	11.6	12.1
64-QAM	0	0.5	14.1	14.7	15.1	15.9
	1	0.6	15.3	15.9	16.3	17.2
	2	0.71	17.1	17.7	18.1	19.1
	3	0.78	18.7	19.3	19.7	21.4

## 10.5.2 DRM minimum field-strengths (MFS)

Extensive work has been carried out to determine the protection ratios and minimum field-strength for the various DRM modes.

For DRM30, the definitive data is published in ITU-R Rec. BS.1615 [9]. Additionally, and freely available as a pdf download, the EBU have published an excellent summary (in EBU Tech 3330 [28]), of the DRM planning and co-ordination process which includes much of the key data contained the ITU document. Planners requiring detailed information on DRM planning are urged to read this document.

### 10.5.2.1 MFS Derivation process for DRM30 modes

As DRM is intended to work alongside AM services for some considerable time, the planning process used is based on the same underlying principles and assumptions as those uses for AM services. For AM planning purposes, the minimum field-strength is based on

- An audio S/N ratio of 26dB referred to 30% modulation, and
- A notional figure for overall noise as seen by the receiver, and expressed as an equivalent field-strength. This noise-field is frequency-band dependant.

Table 10.5.2.1a below sets out the ITU procedure used to derive the received noise field-strengths, from which the resultant minimum field strengths for DRM are calculated by adding the required DRM S/N data from, for example, Table 10.5.1b.

Table 10.5.2.1a: Procedure for estimation of the minimum usable field strength

Parameter		DSB (AM)		Digital	
1) Required receiving quality		Audio frequency signal-to-noise ratio: 26 dB with 30% (-10.5 dB)		BER: 1.0E-04	
2) Required C/N for the above quality		mod. (Rec. ITU R BS.703) (26 + 10.5 =) 36.5 dB		x dB (see e.g Table 10.5.1b) (10 kHz)	
3) Receiver (IF) bandwidth		(8 kHz)		(1 dB higher receiver intrinsic noise than DSB)	
4) Receiver sensitivity for the above C/N; dB( V/m)	LF	66	Required in Rec. ITU-R BS.703	30.5 + x	x dB above the receiver intrinsic noise
	MF	60		24.5 + x	
	HF	40		4.5 + x	
5) Receiver intrinsic noise related to field strength, for the above sensitivity; dB(µV/m)	LF	29.5	36.5 dB(C/N) below the sensitivity	30.5	1 dB higher than DSB
	MF	23.5		24.5	
	HF	3.5*		4.5	

(\*) This value, 3.5dB(µV/m), is also indicated in Annex 4 to Rec. ITU-R BS.560 [29].

NOTE 1 In the case of the digital receiver, the expression S/N should be used instead of C/N, which is used for the analogue DSB receiver.

NOTE 2 Intrinsic noise of the reference DSB receiver can be calculated as 36.5dB below the sensitivity.

NOTE 3 Intrinsic noise of the reference digital receiver is estimated about 1dB higher than DSB due to IF bandwidth difference. And the sensitivity of the reference digital receiver for xdB S/N is calculated as xdB above that.

NOTE 4 The increase of antenna loss for any receiver that uses a small-sized built-in antenna directly increases the receiver intrinsic noise related to the field strength. This should be taken into account.

### 10.5.2.2 Minimum usable field strength values

For the LF and MF bands, the results for the DRM robustness mode A are given below in Tables 10.5.2.2a to 10.5.2.2c. It should be noted that these results correspond to minimum noise-conditions, typically found only in quiet rural locations. If one of the other robustness modes is to be used in these bands, the corresponding field strength values can be computed with the help of appropriate S/N values for these modes as given in ITU R BS.1615 [9].

Table 10.5.2.2a

Minimum usable field strength (dB( $\mu$ V/m)) to achieve BER of  $1 \times 10^{-4}$  for DRM robustness mode A with different spectrum occupancy types dependent on protection level and modulation scheme for the LF frequency band (ground-wave propagation)

Modulation scheme	Protection level No	Average code rate	Robustness mode/Channel bandwidth	
			A/0 (4.5 kHz)	A/2 (9 kHz)
16-QAM	0	0.5	39.3	39.1
	1	0.62	41.4	41.2
64-QAM	0	0.5	44.8	44.6
	1	0.6	46.3	45.8
	2	0.71	48.0	47.6
	3	0.78	49.7	49.2

Table 10.5.2.2b

Minimum usable field strength (dB( $\mu$ V/m)) to achieve BER of  $1 \times 10^{-4}$  for DRM robustness mode A with different spectrum occupancy types dependent on protection level and modulation scheme for the MF frequency band (ground-wave propagation)

Modulation scheme	Protection level No	Average code rate	Robustness mode/Channel bandwidth	
			A/0 (4.5 kHz) A/1 (5 kHz)	A/2 (9 kHz) A/3 *(10 kHz)
16-QAM	0	0.5	33.3	33.1
	1	0.62	35.4	35.2
64-QAM	0	0.5	38.8	38.6
	1	0.6	40.3	39.8
	2	0.71	42.0	41.6
	3	0.78	43.7	43.2

\* A3 (10 kHz) is not applicable to GE75



Table 10.5.2.2c

Minimum usable field strength (dB( $\mu$ V/m)) to achieve BER of  $1 \times 10^{-4}$  for DRM robustness mode A with different spectrum occupancy types dependent on protection level and modulation scheme for the MF frequency band (ground-wave plus sky-wave propagation)

Modulation scheme	Protection level No	Average code rate	Robustness mode/Channel bandwidth	
			A/0 (4.5 kHz) A/1 (5 kHz)	A/2 (9 kHz) A/3* (10 kHz)
16-QAM	0	0.5	34.3	33.9
	1	0.62	37.2	37.0
64-QAM	0	0.5	39.7	39.4
	1	0.6	41.1	40.8
	2	0.71	44.2	43.7
	3	0.78	47.4	46.5

\* A3 (10 kHz) is not applicable to GE75

Table 10.5.2.2d shows the range for minimum usable field strength needed to achieve the BER target on HF channels using robustness mode B. This range arises from varying propagation channel conditions. Mode A is not applicable to HF transmission because of the lack of robustness in the OFDM parameters (length of the guard interval and frequency spacing of the subcarriers).

The results for protection level Nos. 2 and 3 in combination with 64-QAM are not included in Table 10.5.2.2d for the HF bands, due to the occurrence of bit error floors even at higher S/N, which are caused by the weak error protection. These protection levels are not recommended for HF transmission on channels with strong time or frequency-selective behaviour.

Table 10.5.2.2d

Range of minimum usable field strengths (dB( $\mu$ V/m)) to achieve BER of  $1 \times 10^{-4}$  for DRM robustness mode B with spectrum occupancy types 1 or 3 (5 or 10 kHz) dependent on protection level and modulation scheme for the HF frequency band

Modulation scheme	Protection level No	Average code rate	Robustness mode/Channel bandwidth	
			B/1 (5 kHz)	B/3 (10 kHz)
16-QAM	0	0.5	19.2 - 22.8	19.1 - 22.5
	1	0.62	22.5 - 25.6	22.2 - 25.3
64-QAM	0	0.5	25.1 - 28.3	24.6 - 27.8
	1	0.6	27.7 - 30.4	27.2 - 29.9

### 10.5.2.3 Other Factors

Several measurement campaigns have been carried out (see Annex 4) in order to evaluate the performance of the DRM system in the MF band and to verify the planning parameters specified in the relevant ITU Recommendations Summary. The measurements indicate that the reception environment (Urban, Suburban or Rural) has a considerable influence on the requirements in terms of field strength.

For urban environments, the main factor affecting the reception in the MF band is man-made noise the levels of which may vary considerably from location to another. Depending on the density of urbanisation and the level of industrial activity measurements show the median values in the range 10 to 40dB higher than the ITU-R reference for the MF band.

Local surveys should therefore be carried out to establish the extent and level of these environmental factors prior to any detailed planning for LF and MF bands.

Furthermore it should be noted that the receiver performance could be a determining factor in defining the minimum field strength required for planning and the resulting reception quality. This performance depends on the following receiver characteristics:

- Sensitivity (including receiving antenna performance)
- Selectivity
- Behavior in overloading conditions.

### 10.5.3 Relative protection and power reduction

The values of protection ratios can be found in ITU-R BS 1615 [9]. They are also freely available in EBU Tech 3330 [28]. In addition, for the introduction of a digitally modulated signal in an existing environment, it has to be ensured that this new signal will not cause more interference to other AM stations than the AM signal which is replaced by the digitally modulated signal. Values for the required power reduction to fulfill this requirement can be found when the RF protection ratios for AM interfered with by AM, and AM interfered with by digital, are known.

The RF protection ratio is the required power difference between the wanted and the unwanted signal that ensures a stated quality (either analogue audio or digital S/N). When the wanted audio quality for AM interfered with by AM is comparable to AM interfered with by digital, the difference in RF protection ratio is the required power reduction.

Recommendation ITU-R BS.560 [29] contains relative RF protection ratios for AM interfered with by AM.

For the purpose of HF coordination, Resolution 543 (WRC03) [30] provides Provisional RF protection ratio values for analogue and digitally modulated emissions in the HF broadcasting service.

## 10.6 Planning data for DRM+

Full details of the system parameters and network concepts for planning broadcasting networks with DRM+ are provided in Annex 3 of ITU-R Rec. BS.1660 (Technical basis for planning of terrestrial digital sound broadcasting System G (DRM) in the VHF band) [12]. The following sub-sections of §10.6 provide an overview of the key planning elements.

### 10.6.1 Reception modes

Six reception modes are considered:

- **Fixed reception (FX)** – reception where a receiving antenna mounted at roof level is used (10 m above ground level is assumed for planning)
- **Portable Outdoor reception (PO)** – reception where a portable receiver with battery supply and an attached or built-in antenna is used outdoors at no less than 1.5 m above ground level.
- **Portable Indoor reception (PI)** – reception where a portable receiver is used indoors with stationary power supply and a built-in (folded) antenna, or with a plug for an external antenna, at no less than 1.5 m above floor level in rooms with a window in an external wall.
- **Portable outdoor handheld reception (PO-H)** - the reception situation in an urban area with bad reception conditions and a receiver with an external antenna (for example, telescopic antennas or the cable of wired headsets)
- **Portable indoor handheld reception (PI-H)** – as for the above PO-H with the addition of a building penetration loss.
- **Mobile reception (MO)** – reception in a rural area with hilly terrain by a receiver in motion also at high speed with a matched antenna situated at no less than 1.5 m above ground level or floor level

### 10.6.2 Correction factors for field-strength predictions

In order to take into account the given different receiving modes and circumstances in network planning, correction factors have to be included to carry the minimum field-strength level over to the median minimum field-strength level for predictions (e.g. with Recommendation ITU-R P.1546).

These include:

- Antenna Gain
- Feeder Loss
- Height Loss Correction factor
- Building penetration loss
- Allowance for man made noise
- Implementation loss factor
- Correction factors for location variability
- Distribution factor
- Polarization discrimination

These correction factors are calculated for the reference frequencies given in Table 10.6.2.

Table 10.6.2: Reference frequencies for calculations

VHF band (frequency range)	I (47-68 MHz)	II (87.5-108 MHz)	III (174-230 MHz)
Reference frequency (MHz)	65	100	200

### 10.6.3 System parameters for field-strength predictions – Mode E

Several of the derived planning parameters depend on the characteristic of the transmitted DRM signal. Two typical parameters for the mode and code rate were chosen as basic sets – see Table 15:

- **DRM with 4 QAM** as a high protected signal with a lower data rate which is suited for a robust audio signal with a low data rate data service.
- **DRM with 16 QAM** as a low protected signal with a high data rate, which is suited for several audio signals or for an audio signal with a high data rate data service.

Table 10.6.3a: MSC code rates for calculations

MSC mode	11 – 4 QAM	00 – 16 QAM
MSC protection level	1	2
MSC code rate $R$	1/3	1/2
SDC mode	1	1
SDC code rate $R$	0.25	0.25
Bit rate approx.	49.7 kbit/s	149.1 kbit/s

The propagation-related OFDM parameters of DRM are given in Table 10.6.3b.

Table 10.6.3b: OFDM Parameters

Elementary time period $T$	83 1/3 $\mu$ s
Duration of useful (orthogonal) part $T_u = 27 \cdot T$	2.25 ms
Duration of guard interval $T_g = 3 \cdot T$	0.25 ms
Duration of symbol $T_s = T_u + T_g$	2.5 ms
$T_g/T_u$	1/9
Duration of transmission frame $T_f$	100 ms
Number of symbols per frame $N_s$	40
Channel bandwidth $B$	96 kHz
Carrier spacing $1/T_u$	444 4/9 Hz
Carrier number space	$K_{\min} = -106$ ; $K_{\max} = 106$
Unused carriers	none

#### 10.6.4 Single frequency operation capability

A DRM+ transmitter can be operating in single-frequency networks (SFN). The maximum transmitter distance that that must not be exceeded in order to prevent self-interference depends on the length of the OFDM guard interval. Since the length  $T_g$  of the DRM guard interval is 0.25 ms, the maximum echo delay, and therefore the maximum transmitter distance, is 75 km.

#### 10.6.5 Minimum wanted field strength values

The minimum wanted field strength values used for planning are given in the following tables for bands I, II and III. In each table minimum median field strength,  $E_{\text{med}}$  (dB( $\mu$ V/m)) is derived for the various reception conditions; it is the appropriate value of minimum usable field strength for planning purposes to be used for coverage by a single transmitter, being a value for 50% of locations and for 50% of the time at 10 m above ground level. Further details on the derivation of the values can be found in ITU-R Rec. BS.1615 [9].

Table: 10.6.5a: Minimum median field-strength level  $E_{\text{med}}$  for 4 QAM,  $R = 1/3$  in VHF Band I

DRM modulation		4 QAM. $R = 1/3$					
Receiving situation		FX	PI	PI-H	PO	PO-H	MO
Minimum receiver input power level	$P_{s,\text{min}}$ (dBW)	-142.68	-136.68	-136.68	-136.68	-136.68	-138.48
Antenna gain	$G_D$ (dBd)	0.00	-2.20	-22.76	-2.20	-22.76	-2.20
Effective antenna aperture	$A_a$ (dBm <sup>2</sup> )	4.44	2.24	-18.32	2.24	-18.32	2.24
Feeder-loss	$L_c$ (dB)	1.10	0.00	0.00	0.00	0.00	0.22
Minimum power flux-density at receiving place	$\varphi_{\text{min}}$ (dBW/m <sup>2</sup> )	-146.02	-138.92	-118.36	-138.92	-118.36	-140.50
Minimum field-strength level at receiving antenna	$E_{\text{min}}$ (dB $\mu$ V/m)	-0.25	6.85	27.41	6.85	27.41	5.27
Allowance for man-made noise	$P_{\text{mmn}}$ (dB)	15.38	15.38	0.00	15.38	0.00	15.38
Antenna height loss	$L_h$ (dB)	0.00	8.00	15.00	8.00	15.00	8.00
Building penetration loss	$L_b$ (dB)	0.00	8.00	8.00	0.00	0.00	0.00
Location probability		70%	95%	95%	95%	95%	99%
Distribution factor	$\mu$	0.52	1.64	1.64	1.64	1.64	2.33
Standard deviation of DRM field strength	$\sigma_m$ (dB)	3.56	3.56	3.56	3.56	3.56	2.86
Standard deviation of MMN	$\sigma_{\text{mmn}}$ (dB)	4.53	4.53	0.00	4.53	0.00	4.53
Standard deviation of building penetration loss	$\sigma_b$ (dB)	0.00	3.00	3.00	0.00	0.00	0.00
Location correction factor	$C_i$ (dB)	3.02	10.68	7.65	9.47	5.85	12.46
<b>Minimum median field-strength level</b>	<b><math>E_{\text{med}}</math> (dB<math>\mu</math>V/m)</b>	<b>18.15</b>	<b>48.91</b>	<b>58.06</b>	<b>39.71</b>	<b>48.26</b>	<b>41.11</b>

Table: 10.6.5b: Minimum median field-strength level  $E_{med}$  for 16 QAM, R = 1/2 in VHF Band I

DRM modulation		16 QAM. R = 1/2					
Receiving situation		FX	PI	PI-H	PO	PO-H	MO
Minimum receiver input power level	$P_{s,min}$ (dBW)	-136.08	-128.58	-128.58	-128.58	-128.58	-131.18
Other corrections as for Table 10.6.5a		-	-	-	-	-	-
<b>Minimum median field-strength level</b>	<b><math>E_{med}</math> (dB<math>\mu</math>V/m)</b>	<b>24.75</b>	<b>57.01</b>	<b>66.16</b>	<b>47.81</b>	<b>56.36</b>	<b>48.41</b>

Table: 10.6.5c: Minimum median field-strength level  $E_{med}$  for 4 QAM, R = 1/3 in VHF Band II

DRM modulation		4 QAM. R = 1/3					
Receiving situation		FX	PI	PI-H	PO	PO-H	MO
Minimum receiver input power level	$P_{s,min}$ (dBW)	-142.68	-136.68	-136.68	-136.68	-136.68	-138.48
Antenna gain	$G_D$ (dBd)	0.00	-2.20	-19.02	-2.20	-19.02	-2.20
Effective antenna aperture	$A_a$ (dBm <sup>2</sup> )	0.70	-1.50	-18.32	-1.50	-18.32	-1.50
Feeder-loss	$L_c$ (dB)	1.40	0.00	0.00	0.00	0.00	0.28
Minimum power flux-density at receiving place	$\varphi_{min}$ (dBW/m <sup>2</sup> )	-141.97	-135.17	-118.35	-135.17	-118.35	-136.69
Minimum field-strength level at receiving antenna	$E_{min}$ (dB $\mu$ V/m)	3.79	10.59	27.41	10.59	27.41	9.07
Allowance for man-made noise	$P_{mnn}$ (dB)	10.43	10.43	0.00	10.43	0.00	10.43
Antenna height loss	$L_h$ (dB)	0.00	10.00	17.00	10.00	17.00	10.00
Building penetration loss	$L_b$ (dB)	0.00	9.00	9.00	0.00	0.00	0.00
Location probability		70%	95%	95%	95%	95%	99%
Distribution factor	$\mu$	0.52	1.64	1.64	1.64	1.64	2.33
Standard deviation of DRM field strength	$\sigma_m$ (dB)	3.80	3.80	3.80	3.80	3.80	3.10
Standard deviation of MMN	$\sigma_{mnn}$ (dB)	4.53	4.53	0.00	4.53	0.00	4.53
Standard deviation of building penetration loss	$\sigma_b$ (dB)	0.00	3.00	3.00	0.00	0.00	0.00
Location correction factor	$C_l$ (dB)	3.10	10.91	7.96	9.73	6.25	12.77
<b>Minimum median field-strength level</b>	<b><math>E_{med}</math> (dB<math>\mu</math>V/m)</b>	<b>17.32</b>	<b>50.92</b>	<b>61.37</b>	<b>40.74</b>	<b>50.66</b>	<b>42.27</b>

Table: 10.6.5d: Minimum median field-strength level  $E_{med}$  for 16 QAM, R = 1/2 in VHF Band II

DRM modulation		16 QAM. R = 1/2					
Receiving situation		FX	PI	PI-H	PO	PO-H	MO
Minimum receiver input power level	$P_{s,min}$ (dBW)	-136.08	-128.58	-128.58	-128.58	-128.58	-131.18
Other corrections as for Table 10.6.5c		-	-	-	-	-	-
<b>Minimum median field-strength level</b>	<b><math>E_{med}</math> (dB<math>\mu</math>V/m)</b>	<b>23.92</b>	<b>59.02</b>	<b>69.47</b>	<b>48.84</b>	<b>58.76</b>	<b>49.57</b>



Table: 10.6.5e: Minimum median field-strength level  $E_{med}$  for 4 QAM, R = 1/3 in VHF Band III

DRM modulation		4 QAM. R = 1/3					
Receiving situation		FX	PI	PI-H	PO	PO-H	MO
Minimum receiver input power level	$P_{s,min}$ (dBW)	-142.68	-136.68	-136.68	-136.68	-136.68	-138.48
Antenna gain	$G_D$ (dBd)	0.00	-2.20	-13.00	-2.20	-13.00	-2.20
Effective antenna aperture	$A_a$ (dBm <sup>2</sup> )	-5.32	-7.52	-18.32	-7.52	-18.32	-7.52
Feeder-loss	$L_c$ (dB)	2.00	0.00	0.00	0.00	0.00	0.40
Minimum power flux-density at receiving place	$\varphi_{min}$ (dBW/m <sup>2</sup> )	-135.35	-129.15	-118.35	-129.15	-118.35	-130.55
Minimum field-strength level at receiving antenna	$E_{min}$ (dB $\mu$ V/m)	10.41	16.61	27.41	16.61	27.41	15.21
Allowance for man-made noise	$P_{mnn}$ (dB)	3.62	3.62	0.00	3.62	0.00	3.62
Antenna height loss	$L_h$ (dB)	0.00	12.00	19.00	12.00	19.00	12.00
Building penetration loss	$L_b$ (dB)	0.00	9.00	9.00	0.00	0.00	0.00
Location probability		70%	95%	95%	95%	95%	99%
Distribution factor	$\mu$	0.52	1.64	1.64	1.64	1.64	2.33
Standard deviation of DRM field strength	$\sigma_m$ (dB)	4.19	4.19	4.19	4.19	4.19	3.49
Standard deviation of MMN	$\sigma_{mnn}$ (dB)	4.53	4.53	0.00	4.53	0.00	4.53
Standard deviation of building penetration loss	$\sigma_b$ (dB)	0.00	3.00	3.00	0.00	0.00	0.00
Location correction factor	$C_i$ (dB)	3.24	11.29	8.48	10.15	6.89	13.31
<b>Minimum median field-strength level</b>	<b><math>E_{med}</math> (dB<math>\mu</math>V/m)</b>	<b>17.26</b>	<b>52.52</b>	<b>63.89</b>	<b>42.38</b>	<b>53.30</b>	<b>44.13</b>

Table: 10.6.5f: Minimum median field-strength level  $E_{med}$  for 16 QAM, R = 1/2 in VHF Band III

DRM modulation		16 QAM. R = 1/2					
Receiving situation		FX	PI	PI-H	PO	PO-H	MO
Minimum receiver input power level	$P_{s,min}$ (dBW)	-136.08	-128.58	-128.58	-128.58	-128.58	-131.18
Other corrections as for Table 10.6.5e		-	-	-	-	-	-
<b>Minimum median field-strength level</b>	<b><math>E_{med}</math> (dB<math>\mu</math>V/m)</b>	<b>23.86</b>	<b>60.62</b>	<b>71.99</b>	<b>50.48</b>	<b>61.40</b>	<b>51.43</b>

### 10.6.6 Position of DRM frequencies

The DRM system is designed for use at any frequency with variable channelisation constraints and propagation conditions. For VHF Band I, and VHF Band II, the DRM centre frequencies are positioned in 100 kHz distance according to the FM frequency grid in VHF Band II. The DRM system is designed for use with this raster. For VHF Band III, the DRM centre frequencies are positioned in 100 kHz distance beginning by 174.05 MHz and integral multiples of 100 kHz up to the end of VHF Band III.

### 10.6.7 Protection ratios for DRM

The basic protection ratio  $PR_{basic}$  for DRM is valid for all VHF bands – see Table 10.6.7a. However, because the standard deviation of DRM differs in the respective VHF bands the corresponding protection ratios<sup>21</sup>  $PR(p)$ , are different in the respective VHF bands.

<sup>21</sup> **Corresponding protection ratio  $PR(p)$ :** for a wanted digital signal interfered with by an unwanted signal at location probability greater than 50%, taking into account the respective location probability of the corresponding reception modes that have higher protection requirements due to the higher location probability to be protected.

Table 10.6.7a: Basic protection ratios  $PR_{basic}$  for DRM interfered with by DRM

Frequency offset	(kHz)	0	$\pm 100$	$\pm 200$
DRM (4 QAM, R = 1/3)	$PR_{basic}$ (dB)	4	-16	-40
DRM (16 QAM, R = 1/2)	$PR_{basic}$ (dB)	10	-10	-34

### 10.6.7.1 DRM interfered with by DRM

Table 10.6.7.1a: Corresponding protection ratios  $PR(p)$  to reception modes for DRM (4 QAM, R = 1/3) interfered with by DRM

Reference frequency band		65 MHz VHF Band I		
Frequency offset	(kHz)	0	$\pm 100$	$\pm 200$
Fixed reception (FX)	$PR(p)$ (dB)	6.64	-13.36	-37.36
Portable reception (PO, PI, PO-H, PI-H)	$PR(p)$ (dB)	12.27	-7.73	-31.73
Mobile reception (MO)	$PR(p)$ (dB)	13.40	-6.60	-30.60

Reference frequency band		100 MHz VHF Band II		
Frequency offset	(kHz)	0	$\pm 100$	$\pm 200$
Fixed reception (FX)	$PR(p)$ (dB)	6.82	-13.18	-37.18
Portable reception (PO, PI, PO-H, PI-H)	$PR(p)$ (dB)	12.84	-7.16	-31.16
Mobile reception (MO)	$PR(p)$ (dB)	14.20	-5.80	-29.80

Reference frequency band		200 MHz VHF Band III		
Frequency offset	(kHz)	0	$\pm 100$	$\pm 200$
Fixed reception (FX)	$PR(p)$ (dB)	7.11	-12.89	-36.89
Portable reception (PO, PI, PO-H, PI-H)	$PR(p)$ (dB)	13.75	-6.25	-30.25
Mobile reception (MO)	$PR(p)$ (dB)	15.49	-4.51	-28.51

Table 10.6.7.1b: Corresponding protection ratios  $PR(p)$  to reception modes for DRM (16 QAM. R = 1/2) interfered with by DRM

Reference frequency band		65 MHz VHF Band I		
Frequency offset	(kHz)	0	±100	±200
Fixed reception (FX)	$PR(p)$ (dB)	12.64	-7.36	-31.36
Portable reception (PO, PI, PO-H, PI-H)	$PR(p)$ (dB)	18.27	-1.73	-25.73
Mobile reception (MO)	$PR(p)$ (dB)	19.40	-0.60	-24.60

Reference frequency band		100 MHz VHF Band II		
Frequency offset	(kHz)	0	±100	±200
Fixed reception (FX)	$PR(p)$ (dB)	12.82	-7.18	-31.18
Portable reception (PO, PI, PO-H, PI-H)	$PR(p)$ (dB)	18.84	-1.16	-25.16
Mobile reception (MO)	$PR(p)$ (dB)	20.20	0.20	-23.80

Reference frequency band		200 MHz VHF Band III		
Frequency offset	(kHz)	0	±100	±200
Fixed reception (FX)	$PR(p)$ (dB)	13.11	-6.89	-30.89
Portable reception (PO, PI, PO-H, PI-H)	$PR(p)$ (dB)	19.75	-0.25	-24.25
Mobile reception (MO)	$PR(p)$ (dB)	21.49	1.49	-22.51

### 10.6.7.2 DRM interfered with by FM in VHF Band II

The basic protection ratio  $PR_{\text{basic}}$  for DRM interfered with by FM in VHF Band II is given in Table 10.6.7.2a. The values for the corresponding protection ratios  $PR(p)$ , are given in Table 10.6.7.2b and Table 10.6.7.2c.

Table 10.6.7.2a: Basic protection ratios  $PR_{\text{basic}}$  for DRM interfered with by FM

Frequency offset	(kHz)	0	±100	±200
DRM (4 QAM. R = 1/3) interfered with by FM (stereo)	$PR_{\text{basic}}$ (dB)	11	-13	-54
DRM (16 QAM. R = 1/2) interfered with by FM (stereo)	$PR_{\text{basic}}$ (dB)	18	-9	-49

Table 10.6.7.2b: Corresponding protection ratios  $PR(p)$  to reception modes for DRM (4 QAM. R = 1/3) interfered with by FM stereo

Frequency offset	(kHz)	0	±100	±200
Fixed reception (FX)	$PR(p)$ (dB)	15.79	-8.21	-49.21
Portable reception (PO, PI, PO-H, PI-H)	$PR(p)$ (dB)	26.02	2.02	-38.98
Mobile reception (MO)	$PR(p)$ (dB)	31.61	7.61	-33.39

Table 10.6.7.2c: Corresponding protection ratios  $PR(p)$  to reception modes for DRM (16 QAM. R = 1/2) interfered with by FM stereo

Frequency offset	(kHz)	0	±100	±200
Fixed reception (FX)	$PR(p)$ (dB)	22.79	-4.21	-44.21
Portable reception (PO, PI, PO-H, PI-H)	$PR(p)$ (dB)	33.02	6.02	-33.98
Mobile reception (MO)	$PR(p)$ (dB)	38.61	11.61	-28.39

### 10.6.7.3 DRM interfered with by DAB in VHF Band III

The basic protection ratio  $PR_{basic}$  for DRM interfered with by DAB in VHF Band II DAB in Band III is given in Table 10.6.7.3a. The values for the corresponding protection ratios  $PR(p)$ , are given in Table 10.6.7.3b and Table 10.6.7.3c.

Table 10.6.7.3a: Basic protection ratios  $PR_{basic}$  for DRM interfered with by DAB

Frequency offset	(kHz)	0	±100	±200
Basic protection ratio for DRM (4 QAM. R = 1/3)	$PR_{basic}$ (dB)	-7	-36	-40
Basic protection ratio for DRM (16 QAM. R = 1/2)	$PR_{basic}$ (dB)	-2	-18	-40

Table 10.6.7.3b: Corresponding protection ratios  $PR(p)$  to reception modes for DRM (4 QAM. R = 1/3) interfered with by DAB

Frequency offset	(kHz)	0	±100	±200
Fixed reception (FX)	$PR(p)$ (dB)	-3.37	-32.37	-50.37
Portable reception (PO, PI, PO-H, PI-H)	$PR(p)$ (dB)	4.37	-24.63	-42.63
Mobile reception (MO)	$PR(p)$ (dB)	8.16	-20.84	-38.84

Table 10.6.7.3c: Corresponding protection ratios  $PR(p)$  to reception modes for DRM (16 QAM. R = 1/2) interfered with by DAB

Frequency offset	(kHz)	0	±100	±200
Fixed reception (FX)	$PR(p)$ (dB)	1.63	-14.37	-45.37
Portable reception (PO, PI, PO-H, PI-H)	$PR(p)$ (dB)	9.37	-6.63	-37.63
Mobile reception (MO)	$PR(p)$ (dB)	13.16	-2.84	-33.84

### 10.6.7.4 DRM interfered with by DVB-T in VHF Band III

Since the impact mechanism of DAB into DRM is the same as that of DVB-T the same protection ratios for DRM interfered with by DVB T in VHF Band III can be assumed as for DRM interfered with by DAB in VHF Band III.

## 10.6.8 Protection ratios for other broadcasting systems interfered with by DRM

### 10.6.8.1 Protection ratios for FM in VHF Band II

The FM signal parameters are given in Recommendation ITU-R BS.412 [32]. In Annex 5 of Recommendation ITU-R BS.412, it is indicated that interferences can be caused by intermodulation of strong FM signals in a frequency offset greater than 400 kHz. This cross-modulation effect from a high interfering signal level in a range up to 1 MHz distance has also to be taken into account when planning OFDM systems into VHF Band II. Therefore  $PR_{\text{basic}}$  in the range of 0 kHz to  $\pm 1000$  kHz are given in Table 10.6.8.1a.

Table 10.6.8.1a: Basic protection ratios  $PR_{\text{basic}}$   
FM interfered with by DRM

Frequency offset	(kHz)	0	$\pm 100$	$\pm 200$	$\pm 300$	$\pm 400$	$\pm 500$	$\pm 1000$
Basic protection ratio for FM (stereo)	$PR_{\text{basic}}$ (dB)	49	30	3	-8	-11	-13	-21

Further considerations on the effects of interference in Band II can be found in the Technical Supplement to ECC Report 141 [23]. This includes a note that care should be taken to avoid aeronautical interference.

### 10.6.8.2 Protection ratios for DAB in VHF band III

The DAB signal parameters are given in Recommendation ITU-R BS.1660 [12]. T-DAB planning should be able to deal with mobile reception with a location probability of 99%, and with portable indoor reception with a location probability of 95%, respectively<sup>22</sup>. In addition, the values for fixed reception with a location probability of 70% are given.

The basic protection ratio  $PR_{\text{basic}}$  for DAB interfered with by DRM in VHF Band III is given in Table 10.6.8.2a. The values for the corresponding protection ratios  $PR(p)$ , are given in Table 10.6.8.2b.

Table 10.6.8.2a: Basic protection ratios  $PR_{\text{basic}}$  for  
DAB interfered with by DRM

Frequency offset	(kHz)	0	$\pm 100$	$\pm 200$
Basic protection ratio for T-DAB	$PR_{\text{basic}}$ (dB)	10	-40	-40

Table 10.6.8.2b: Corresponding protection ratios  $PR(p)$  to reception modes for  
DAB interfered with by DRM

Frequency offset	(kHz)	0	$\pm 100$	$\pm 200$
DAB fixed reception	$PR(p)$ (dB)	13.63	-36.37	-36.37
DAB portable reception	$PR(p)$ (dB)	21.37	-28.63	-28.63
DAB mobile reception	$PR(p)$ (dB)	25.16	-24.84	-24.84

<sup>22</sup> Final Acts of the Regional Radiocommunication Conference for planning of the digital terrestrial broadcasting service in parts of Regions 1 and 3, in the frequency bands 174-230 MHz and 470-862 MHz (RRC-06).



### 10.6.9 Sharing Criteria with Other Services

Analogue broadcasting compatibility with aeronautical services is fully specified in Recommendation ITU-R SM.1009 [31]. Digital broadcasting will have to comply with the same requirements. All broadcasting signals by definition must have the main power content contained completely within the broadcasting band.

ITU studies are on going to provide the necessary recommendations for the new digital transmission formats and their compatibility with aeronautical systems. However, initial investigations do not indicate any significant difference to the results previously obtained with analogue FM signals.

## 10.7 Reception Monitoring

An important part of assuring the quality of any radio transmission comes from monitoring the transmitted signals within the target coverage area. In the case of analogue services, this has generally been accomplished by using a high quality receiver for signal reception. The signal strength is then read from a calibrated meter, whilst making a subjective assessment of the audio quality. Someone in the target area tuning a receiver to the required service and then listening to it in real time has historically made such an assessment.

More recently, this manual method has been supplemented by using unmanned remotely-controlled or scheduled receivers to receive the signals and record the various signal parameters, (such as MER<sup>23</sup>), and sometimes a sample of the audio. This information can include not only the signal strength and audio quality, which can be assessed from the audio bit error rate, but also continuous parameters describing the quality and nature of the transmission channel. Over time the accumulation of this information should lead to an improved understanding of the propagation channel.

Data acquired by the monitoring receiver can be stored locally and downloaded from the reception site on a regular basis, to provide evidence of the performance of a particular transmission, or accessed in near real time. This enables the monitoring of reception to be completely automated.

To help facilitate this DRM has developed a specification and protocol for the control interface (RSCI) (ETSI TS102 349). If manufacturers of professional receivers use this specification it will ensure that an operator can use monitoring receivers of more than one manufacturer to build a monitoring network, but use the same software to control and download data from all these receivers. Furthermore, this opens the possibility for several operators or broadcasters to share the same receivers, if they so wish.

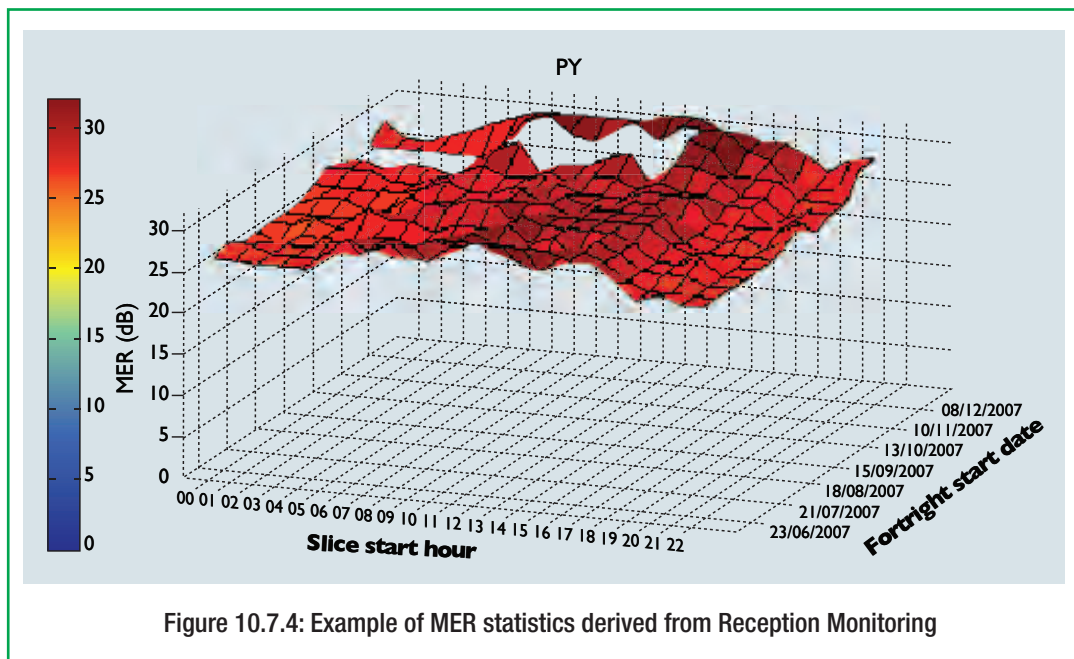

Several DRM broadcasters have developed monitoring infrastructure: see for example the BBC MF monitoring system [33].

<sup>23</sup> As described earlier in section 9.5 the MER is based on the ratio of size of the error vector from the currently received point to the closest point on an ideal constellation. A range of MER types of is defined by the DRM Receiver Status and Control Interface (RSCI).

## 11.1 Summary

DRM is an open standard: all information relating to the technology is published in a series of standards administered by ETSI (see Annex 1)

- The DRM Consortium does not own any DRM patents, and is completely divorced from the entire technology-licensing process.
- DRM Technology licensing is handled by Via Licensing, on behalf of a group of licensor companies.
- There is no running-royalty or other charge to broadcasters or listeners for use of the system.
- Royalties relating to DRM equipment (transmitters, receivers etc.) are paid by manufacturers to Via Licensing and thence to the relevant patentees.
- The DRM Consortium **does** own the DRM trade-mark, which is administered by DRM as set out in 11.3 below.

## 11.2 IPR and the DRM Consortium

From a practical standpoint, there are two important classes of IPR that have a long-term impact on DRM:

- Essential patents relating to the DRM standard, i.e. patents which are necessarily infringed when implementing the system (hardware or software which is processing DRM signals: transmitters, receivers etc.)
- The DRM trademark (Fig 11.2), which is registered in Switzerland and a number of other key territories, including the European Community, the USA, Taiwan, Canada, South Korea, the Russian Federation, China and Singapore.



Figure 11.2: The DRM logo / trademark

## 11.3 Licenses for DRM IPR

### 11.3.1 Manufacturers of DRM equipment

A DRM Patent Pool was formed in 2003 in order to facilitate a simple “One-stop” licensing regime for manufacturers. There is no link, either financial or managerial, between the DRM Consortium and this pool of licensors. The licensing of DRM IPR is undertaken by Via Licensing, a Licensing Administrator acting on behalf of the licensor patent pool – see [www.vialicensing.com](http://www.vialicensing.com)

The VIA web-site gives details of royalty fees for all classes of DRM equipment. There is no royalty charge for actual use of the system (broadcasting or reception).

The DRM Association owns the DRM trademark (logo) on behalf of its members. It is protected through the process of trademark registration in target territories. Separately, it is also protected by copyright law and, in some territories, by laws prohibiting unfair competition.

There are a number of logo variants, comprising the basic logo plus a single word: examples are:

- **Member** - used by a DRM Member to denote membership, and to distinguish between this use and the use of the "basic" logo on official DRM business (or on behalf of the consortium).
- **Supporter** - used by DRM supporters to denote their participation in the DRM supporter's programme.

DRM Trademark use requires a formal licensing agreement to be signed and this is available, on request, from the DRM Project Office.

### 11.3.2 Marketing of DRM products

The DRM Association, as owner of the DRM trademark, is responsible for setting the Terms and Conditions for use of the logo on DRM products.

It is highly probable that in many markets, DRM will be just one of several technologies bundled together, in an item of consumer equipment, to form an attractive ‘whole’. Examples might include radios which support AM, FM, RDS, DAB+ and DRM, which will be marked as "Digital Radio": any reference to DRM will be reserved either to denote functionality (as with "Intel Inside"), or compliance with the minimum performance requirement set by DRM. Thus the logo, whilst potentially performing an important short-hand or quality assurance role, will normally be displayed alongside other branding on the packaging and/or product itself.

### 11.3.3 Use of DRM logo on products

Manufacturers of DRM equipment may request a license to use the DRM logo on their products. The criteria for use are set out on the DRM web-site, but may be summarised as follows:

- For consumer receivers, the manufacturer is required to self-certify the performance and functionality of the design against the standards laid down in the DRM Minimum Receiver Requirements specification [6]
- For professional equipment, the manufacturer is required to self-certify his product for compliance with the appropriate DRM standard(s).

NEW COMPANY IMAGE AND  
NEW PRODUCTS COME  
TOGETHER



Fully complies with the latest ETSI ES 201 980 DRM system specification

**Modes of Operation:**

- Analog: AM, AMC, CCM,  
optionally DSB-SC, SSB
- Digital: DRM
- Simulcast: MCS, SCS

**Pre-corrections:**

- AM/AM, AM/PM
- Phase/envelope equalizers
- Automatic phase/envelope delay adjustment



**New DRM Modulator/ Exciter** comes as a standard with new generation of SW DRM transmitters, up to 500kW.

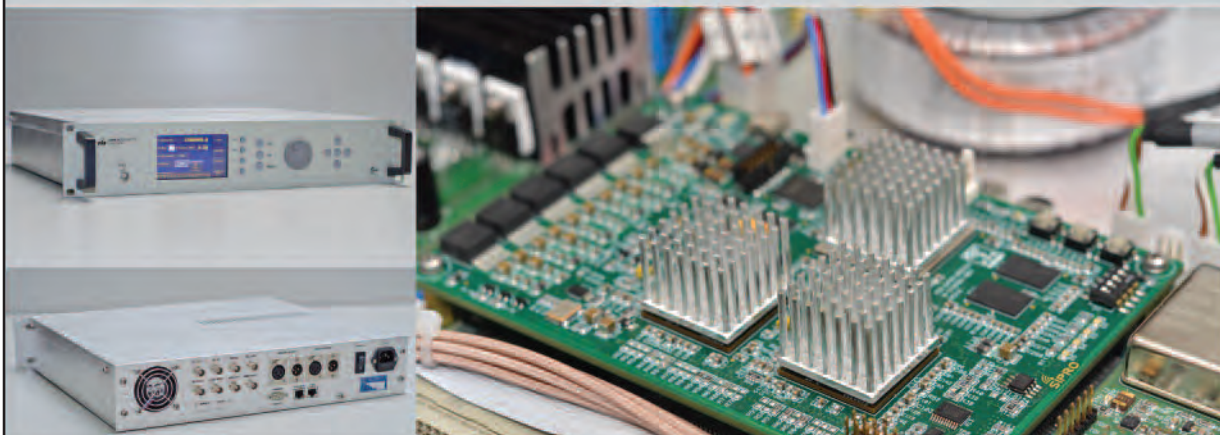



- [1] ETSI ES 201 980: Digital Radio Mondiale (DRM); System Specification ([www.etsi.org](http://www.etsi.org))
- [2] ETSI TS 102 820: Multiplex Distribution Interface (MDI)
- [3] ETSI TS 102 821: Distribution and Communications Protocol (DCP)
- [4] ETSI TS 102 386: Digital Radio Mondiale (DRM); AM Signalling System (AMSS)
- [5] Ranulph POOLE & Andrew Murphy, 'The AM Signalling Systems, AMSS – does your radio know what it is listening to?' EBU Technical Review No 5. January 2006
- [6] 'DRM Minimum Receiver Requirements' see [www.drm.org](http://www.drm.org)
- [7] DReaM receiver download page on Sourceforge: <http://sourceforge.net/projects/drm/>
- [8] ITU-R Rec. BS 1514: System for digital sound broadcasting in the broadcasting bands below 30 MHz
- [9] ITU-R Rec. BS 1615: Planning parameters for digital sound broadcasting at frequencies below 30 MHz
- [10] Article 12 of the ITU Radio Regulations: Seasonal planning of the HF bands allocated to the broadcasting service between 5900 kHz and 26100 kHz
- [11] ITU-R Rec. BS.1114: Systems for terrestrial digital sound broadcasting to vehicular, portable and fixed receivers in the frequency range 30-3 000 MHz
- [12] ITU-R Rec. BS.1660: Technical basis for planning of terrestrial digital sound broadcasting in the VHF band
- [13] ITU-R Rec. BS.1894: Digital radio broadcast service, captioned radio
- [14] GE75: Final Acts of the Regional Administrative LF/MF Broadcasting Conference (Regions 1 and 3) Geneva, 1975 ([www.itu.int](http://www.itu.int))
- [15] RJ81: Final Acts of the Regional Administrative MF Broadcasting Conference (Region 2), Rio de Janeiro, 1981 ([www.itu.int](http://www.itu.int))
- [16] RJ88: Final Acts of the Regional Administrative Radio Conference to Establish a Plan for the Broadcasting Service in the Band 1 605 - 1 705 kHz in Region 2, Rio de Janeiro, 1988 ([www.itu.int](http://www.itu.int))
- [17] RRC-06-Rev.ST61: Final Acts of the Regional Radiocommunication Conference for the revision of the Stockholm 1961 Agreement, Geneva 2006 ([www.itu.int](http://www.itu.int)).
- [18] GE84: Final Acts of the Regional Administrative Conference for the Planning of VHF Sound Broadcasting (Region 1 and Part of Region 3); Geneva 1984 ([www.itu.int](http://www.itu.int))
- [19] GE06: Final Acts of the Regional Radiocommunication Conference for planning of the digital terrestrial broadcasting service in parts of Regions 1 and 3, in the frequency bands 174-230 MHz and 470-862 MHz (RRC-06) ([www.itu.int](http://www.itu.int))
- [20] WI95revCO07: The Wiesbaden, 1995, Special Arrangement, as revised in Constanța, 2007 for the VHF the frequency bands 47-68 MHz, 87.5 - 108 MHz and 230-240 MHz ([www.cept.org](http://www.cept.org))
- [21] ECC Report 117: Digital Sound Broadcasting in the bands below 80 MHz ([www.cept.org](http://www.cept.org))
- [22] ECC Report 141: Future possibilities for the digitalisation of band II (87.5-108 MHz) ([www.cept.org](http://www.cept.org))
- [23] Technical Supplement To ECC Report 141 Future Possibilities For The Digitalisation of Band II (87.5 – 108 MHz) ([www.cept.org](http://www.cept.org)).
- [24] ECC Report 177: Possibilities for Future Terrestrial Delivery of Audio Broadcasting Services. ([www.cept.org](http://www.cept.org))
- [25] RSPG10-349: The Future of Radio Broadcasting in Europe - identified needs, opportunities and possible ways forward ([http://rspg.groups.eu.int/consultations/consultation\\_futradio/rspg10\\_349\\_report\\_future\\_radio\\_broadcasting.pdf](http://rspg.groups.eu.int/consultations/consultation_futradio/rspg10_349_report_future_radio_broadcasting.pdf))

(Note: see Annex 1 for complete list of ETSI standards)



- [26] RSPG10-349 bis: The Future of Radio Broadcasting in Europe - replies to questionnaires ([http://rspg.groups.eu.int/consultations/consultation\\_futradio/rspg10\\_349\\_annex.pdf](http://rspg.groups.eu.int/consultations/consultation_futradio/rspg10_349_annex.pdf))
- [27] ITU-R Report BS.2144: Planning parameters and coverage for Digital Radio Mondiale (DRM) broadcasting at frequencies below 30 MHz
- [28] EBU Report Tech 3330: Technical Bases for DRM Services Coverage Planning (<http://tech.ebu.ch/docs/tech/tech3330.pdf>)
- [29] ITU-R Rec. BS.560: Radio-frequency protection ratios in LF, MF and HF broadcasting
- [30] Resolution 543 (WRC-03): Provisional RF protection ratio values for analogue and digitally modulated emissions in the HF broadcasting service.
- [31] ITU-R Rec. SM.1009: Compatibility between the sound-broadcasting service in the band of about 87-108 MHz and the aeronautical services in the band 108-137 MHz
- [32] ITU-R Rec. BS.412: Planning standards for terrestrial FM sound broadcasting at VHF
- [33] Andrew Murphy 'The Plymouth Digital Radio Mondiale (DRM) Trial: Long-term Reception Results' BBC Research White Paper WHP 174 [<http://www.bbc.co.uk/rd/pubs/whp/whp174.shtml>]
- [34] Jonathan Stott: The How and Why of COFDM, EBU Technical Review No. 278, Winter 1998. [http://www.ebu.ch/trev\\_278-stott.pdf](http://www.ebu.ch/trev_278-stott.pdf)
- [35] James Briggs: DRM, a summary of the field tests, EBU Technical Review No. 296, October 2003. [http://www.ebu.ch/trev\\_296-briggs.pdf](http://www.ebu.ch/trev_296-briggs.pdf)

#### **Other useful references**

- I. DRM main web site: <http://www.drm.org>
- II. DRM software receiver project web site: <http://www.drmrx.org>
- III. ETSI web site: <http://www.etsi.org>
- IV. Frank Hofmann, Christian Hansen and Wolfgang Schäfer: IEEE Transactions on Broadcasting, Vol. 49, No. 3, September 2003, P. 319, Digital Radio Mondiale (DRM), Digital Sound Broadcasting in the AM Bands.
- V. IPR: World Intellectual Property Organisation (WIPO): 'About intellectual Property' (<http://www.wipo.int/about-ip/en/>)
- VI. Jonathan Stott: DRM, Key Technical Features, EBU Technical Review No. 286, March 2001. [http://www.ebu.ch/trev\\_286-stott.pdf](http://www.ebu.ch/trev_286-stott.pdf)
- VII. Jonathan Stott: DRM: Key Technical Features, IEE Electronics and Communication Engineering Journal, Vol. 14 No.1, Feb. 2002, Pp 4-14
- VIII. M.J. Bradley: Wideband receivers for DRM, IEE Electronics and Communication Engineering Journal, Vol. 14 No.1, Feb. 2002, Pp 15-20
- IX. Martin Dietz and Stefan Meltzer: CT-aacPlus, A state-of-the-art audio coding scheme, EBU Technical Review No. 291, July 2002. [http://www.ebu.ch/trev\\_291-dietz.pdf](http://www.ebu.ch/trev_291-dietz.pdf)
- X. UserManual\_DRM-CS\_R4\_THOMSON.pdf August 2009

<b>AFS</b>	Alternative Frequency Switching	<b>LW</b>	Long Wave
<b>AM</b>	Amplitude Modulation	<b>MCI</b>	Modulator Control Interface
<b>AMSS</b>	AM Signalling System	<b>MCS</b>	Multiple Channel Simulcast
<b>BER</b>	Bit Error Rate	<b>MDI</b>	Multiplex Distribution Interface
<b>CEPT</b>	European Conference of Postal and Telecommunications Administrations	<b>MER</b>	Modulation Error Ratio
<b>COFDM</b>	Coded Orthogonal Frequency Division Multiplex	<b>MF</b>	Medium Frequency
<b>CRC</b>	Cyclic Redundancy Check	<b>MFN</b>	Multi Frequency Network
<b>DAB</b>	Digital Audio Broadcasting	<b>MLC</b>	Multi Level Coding
<b>DC</b>	Direct Current	<b>MMI</b>	Man Machine Interface
<b>DCP</b>	Distribution and Communications Protocol	<b>MPEG</b>	Moving Picture Experts Group
<b>DRM</b>	Digital Radio Mondiale	<b>MSC</b>	Main Service Channel
<b>DRM+</b>	Digital Radio Mondiale, system used in Frequency range above 30 MHz	<b>MW</b>	Medium Wave
<b>DRM30</b>	Digital Radio Mondiale, system used in Frequency range below 30 MHz	<b>NTP</b>	Network Time Protocol
<b>DSB</b>	Double Side-Band	<b>NVIS</b>	Near Vertical Incidence Sky-wave
<b>DSP's</b>	Digital Signal Processors	<b>OOB</b>	Out Of Band
<b>DVB</b>	Digital Video Broadcasting	<b>PFT</b>	Protection, Fragmentation and Transport
<b>EBU</b>	European Broadcasting Union	<b>QAM</b>	Quadrature Amplitude Modulation
<b>ECC</b>	CEPT's Electronic Communications Committee	<b>RDS</b>	Radio Data System
<b>ETSI</b>	European Telecommunications Standards Institute	<b>RF</b>	Radio Frequency
<b>FAC</b>	Fast Access Channel	<b>RFP</b>	Radio Frequency Phase
<b>FM</b>	Frequency Modulation	<b>RRB</b>	ITU Radio Regulatory Board
<b>GPS</b>	Global Positioning System	<b>RSCI</b>	Receiver Status and Control Interface
<b>HF</b>	High Frequency	<b>SBR</b>	Spectral Band Replication
<b>IBOC</b>	In Band On Channel	<b>SCE</b>	Service Component Encoder
<b>ICs</b>	Integrated Circuits	<b>SDC</b>	Service Description Channel
<b>IEC</b>	International Electrotechnical Committee	<b>SDI</b>	Service Distribution Interface
<b>IP</b>	Internet Protocol	<b>SFN</b>	Single Frequency Network
<b>IPR</b>	Intellectual Property Rights	<b>SNR</b>	Signal to Noise Ratio
<b>ISDN</b>	Integrated Services Digital Network	<b>SW</b>	Short Wave
<b>ITU-R</b>	International Telecommunications Union - Radio Communications Sector	<b>TAG</b>	Tag
<b>LAN</b>	Local Area Network	<b>UDP</b>	User Datagram Protocol
<b>LF</b>	Low Frequency	<b>VSAT</b>	Very Small Aperture Terminal
		<b>VSWR</b>	Voltage Standing Wave Ratio
		<b>WAN</b>	Wide Area Network
		<b>WRC</b>	World Radio Conference

**ANNEX 1****List of main DRM Standards**

All documents are available as free PDF downloads from ETSI ([www.etsi.org](http://www.etsi.org)).

**DRM System Description:**

- |    |                              |                 |
|----|------------------------------|-----------------|
| 1) | DRM System Specification:    | ETSI ES 201 980 |
| 2) | Data Application Directory:  | ETSI TS 101 968 |
| 4) | AMSS – AM Signalling System: | ETSI TS 102 386 |

**Multiplex Distribution / Receiver Data Access:**

- |    |   |                 |
|----|---|-----------------|
| 5) | DCP – Distribution & Communication Protocol:            | ETSI TS 102 821 |
| 6) | DCP/DRM – DRM specific restrictions for the use of DCP: | ETSI TS 102 358 |
| 7) | MDI – Multiplex Distribution Interface:                 | ETSI TS 102 820 |
| 8) | RSCI – Receiver Status & Control Interface:             | ETSI TS 102 349 |
| 9) | ASDI AMSS Distribution Interface:                       | ETSI TS 102 759 |

**DRM Data Applications:**

- |     |  |             |                 |
|-----|--|-------------|-----------------|
| 10) | EPG – Electronic Programme Guide:            | (structure) | ETSI TS 102 818 |
|     |  | (transport) | ETSI TS 102 371 |
| 11) | TMC (Traffic Message Channel),               |             | ETSI TS 102 668 |
| 12) | Journaline – Text based information service: |             | ETSI TS 102 979 |

In addition, the following applications standardised for DAB (Digital Audio Broadcasting), can be signalled and broadcast. Such applications and protocols used in DRM include:

- |     |  |                 |
|-----|--|-----------------|
| 13) | MOT – Multimedia Object Transfer Protocol: | ETSI EN 301 234 |
| 14) | IP Tunnelling:                             | ETSI ES 201 735 |
| 15) | Slideshow:                                 | ETSI TS 101 499 |
| 16) | Broadcast Website:                         | ETSI TS 101 498 |

## ANNEX 2

### COFDM basics<sup>24</sup>

DRM is based on the use of COFDM (Coded Orthogonal Frequency-Division Multiplex). The 'C', the channel encoding employed to support error correction in the receiver, is described in 5.3.

The resulting coded information is then conveyed using OFDM (Orthogonal Frequency-Division Multiplex), by which the coded data is distributed over many sub-carriers for transmission. Each sub-carrier is modulated with a particular amplitude and phase combination – a QAM constellation point – for the duration of a transmitted symbol. As each sub-carrier only carries a small part of the total data, these transmitted symbols can be relatively long (= time duration), which together with the concept of guard intervals makes DRM tolerant of multipath propagation – especially necessary to cope with ionospheric propagation or to permit single-frequency-network operation.

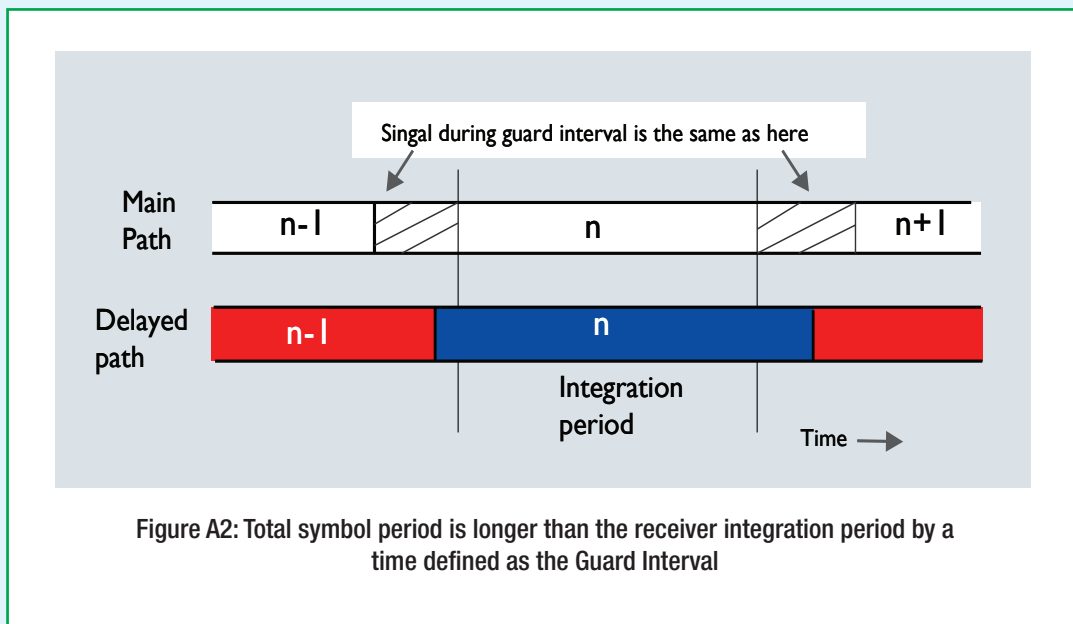

Orthogonality (absence of mutual crosstalk) between sub-carriers (the 'O') is ensured by choosing the sub-carrier spacing to be the reciprocal of the so-called 'useful symbol period'. This is the duration of the time window within which the receiver observes each received symbol. However, each symbol is transmitted for a slightly longer period, the 'guard-interval' duration. This approach provides tolerance against multipath propagation, provided the delay difference between the various propagation paths does not exceed this Guard Interval.

Distributing the coded information across many sub-carriers helps when there is selective fading. Typically only a few sub-carriers will be badly affected (and the receiver can determine which they are) so that error correction in the receiver can recover the transmitted information by exploiting the redundancy introduced by the coding.

The number of sub-carriers, and their spacing, depends on the DRM robustness mode, each mode being designed to suit particular operating conditions. For DRM30 there are 4 robustness modes (with 88 to 226 sub-carriers for a channel bandwidth of 10 kHz); for DRM+ there are some 213 carriers occupying a 96 kHz bandwidth.

<sup>24</sup> see [34] for a more comprehensive overview of COFDM

## ANNEX 3

# DRM Radio Receiver Profiles

### Summary

The DRM Digital Radio Receiver Profiles are designed to help create a vibrant digital radio market across the world by defining minimum functionality for different classes of digital radio receivers that use the DRM system. This provides broadcasters with confidence that the services they plan will be receivable, and manufacturers that their technology investments will be supported by services. The consumer gains from knowing that the product they have chosen contains the necessary features to provide them with a consistent quality of experience and assured levels of interoperability across their region and beyond.

Products designed to meet the DRM Receiver Profiles will decode all audio services, along with other features depending on the complexity of the receiver. The profiles were developed by DRM with the aid of member experts representing silicon manufacturers, consumer device manufacturers, radio broadcasters and other experts from across the industry. The composition of the profiles takes into account consumer experience, manufacturing issues, broadcaster requirements and other market aspects.

### Scope

The DRM Digital Radio Receiver Profiles define the minimum functionality requirements of products within each profile.

The Receiver Profiles are composed of mandatory features which must be implemented and recommended features which offer enhancements with wide appeal.

Manufacturers may offer additional features in order to differentiate their product from others.

Products conforming to the DRM Receiver profiles will provide a step change in usability over analogue radios, with service selection by station name from a list built up automatically by the receiver. Manufacturers are free to choose how to compile the station list according to market need, for example by evaluating AFS and EPG information, offering frequency scanning, evaluating service lists provided by other broadcast systems (if applicable), etc. DRM service tuning by frequency should be available to the user, but never be the primary option for selecting services.

The DRM Receiver Profiles describe minimum functionality; the implementation of each feature in conformance with the relevant ETSI standards is best determined by each manufacturer and is not proscribed. In-car products are subject to the normal safety related conditions, for example limitations for scrolling, access to services while driving, image per second limitations, etc., according to regulators or OEM requests.

Products which do not meet the minimum requirements of the profiles may be manufactured on a market-specific basis.

Regulators may use the Receiver Profiles to develop strategies and policies for digital radio broadcasting within national boundaries or with reference to trans-national and harmonised markets.

The DRM Receiver Profiles reflect receiver design issues and broadcaster capabilities appropriate for the current period and for the foreseeable future. Future changes and additions to the ETSI standards defining the DRM system<sup>1</sup>, technology advances and market developments will be reviewed and may lead to revision of these Receiver Profiles.

The DRM Digital Radio Receiver Profiles focus on features of the Digital Radio Mondiale system. However the profile definitions are designed to support the easy co-integration with other digital and analogue broadcast systems in multi-standard receivers; in particular we recommend that all receivers should include analogue AM-AMSS and FM-RDS reception.

The DRM Consortium will globally publicise the DRM Digital Radio Receiver Profiles and actively encourage its members to adopt them.



## Receiver Profile 1 – Standard Radio Receiver

### This is an audio receiver with at least a basic alphanumeric display.

Spectrum	DRM reception in the MF (530 kHz to 1720 kHz), HF (2.3 MHz to 27 MHz) and international FM (87.5 to 108 MHz) bands is mandatory in all territories. DRM reception in other broadcasting bands is mandatory on a regional basis according to the licensed service plan <sup>25</sup> . DRM reception in all broadcasting bands below 174 MHz is recommended.
Channel decoding	Decoding of all defined channel band-widths is mandatory.
Audio	Stereo decoding (including Parametric Stereo) is mandatory if a stereo capable output is provided.
Emergency warning Text	Implementation of the emergency warning/alert feature is mandatory.
Text	Service label (station name) display is mandatory. Text message display is mandatory on products with a 2-line display or better (except for in-car products). Journaline <sup>26</sup> presentation is recommended. Support for regional character sets is recommended according to the region the product will be manufactured for or sold into.
EPG	Electronic Programme Guide <sup>27</sup> presentation is recommended
Traffic & Travel	For in-car products, TPEG <sup>28</sup> and TMC <sup>29</sup> decoding is recommended.
Service following	DRM to DRM service following (automatic frequency switching) is mandatory. For products that include analogue service decoding (e.g. AM-AMSS <sup>30</sup> , FM-RDS <sup>31</sup> ), DRM to analogue service following is mandatory. For products that include other digital radio systems, DRM to digital service following is recommended.

## Receiver Profile 2 – Rich Media Radio Receiver

### This is an audio receiver with a colour screen display of at least 320 x 240 pixels.

All Receiver 'Profile 1' functionality, plus:

Audio	Surround Sound decoding <sup>32</sup> is recommended.
Text	Journaline <sup>33</sup> presentation is mandatory.
EPG	Electronic Programme Guide <sup>34</sup> presentation is mandatory. Decoding of the advanced EPG profile is recommended.
SlideShow	SlideShow <sup>35</sup> presentation is mandatory.

25 In ITU region 1 this includes LF (153 to 279 kHz)

26 As defined in ETSI TS 102 979; decoded from packet mode including FEC

27 As defined in ETSI TS 102 818 and TS 102 371; decoded from packet mode including FEC 5 As defined in ISO TS 18234

28 As defined in ISO TS 18234

29 As defined in ETSI TS 102 668

30 As defined in ETSI TS 102 368

31 As defined in ISO EN 62106

32 Discrete multi-channel output and/or binaural rendering on stereo headphone output.

33 As defined in ETSI TS 102 979; decoded from packet mode including FEC

34 As defined in ETSI TS 102 818 and TS 102 371; decoded from packet mode including FEC

35 As defined in ETSI TS 101 499; decoded from packet mode including FEC

## ANNEX 4

### Information on DRM field trials

Extensive tests and field trials have been conducted throughout the World using the DRM system. The results confirm that the DRM system (both the DRM30 and DRM+ variants) performs according to the specification and that it can be implemented to meet a wide range of requirements in all types of environment. The results are too extensive to adequately cover in this document; instead references are provided to reports, many of which were submitted to the prevailing ITU-R Working Party, to assist in the preparation system and planning standards. The list is not exhaustive, however further references are contained within the listed sources.

Table A4: List of DRM field trials

Year	Field Trials	Source	Frequency Band
2004	DRM test in the MF band in Madrid*	DRM Web Site: ITU-R Contribution WP6E/175	MF
2005	DRM Local Coverage using the 26 MHz Broadcasting Band in Mexico City*	DRM Web Site: ITU-R Contribution WP6E/274	26 MHz
2006	DRM test in the MF band in Mexico City*	DRM Web Site: ITU-R Contribution WP6E/403	MF
2006	DRM/AM simulcast tests at MW in Mexico*	DRM Web Site: ITU-R Contribution WP6E/403	MF
2006	DRM test in the MF band in Italy*	DRM Web Site: ITU-R Contribution SG6/353	MF
2007	DRM trials in India: simulcast MW, Tropical Band NVIS and 26 MHz local broadcasting*	DRM Web Site: ITU-R Contribution WP6A/10	MF, HF, 26MHz
2007	Digital Radio Mondiale field trials in Brasilia for local radio coverage using the 26 MHz band	Peña et al., "Digital Radio Mondiale field trials in Brasilia for local radio coverage using the 26 MHz band". IEEE Broadband Multimedia Systems and Broadcasting 2007. Las Vegas (USA)	26 MHz
2007	DRM trial Spain: Multichannel Simulcast, urban and indoor reception in MW Band *	DRM Web Site: ITU-R Contribution WP6A/73	MF
2008	Local Radio using Digital Radio Mondiale(DRM) in the 26 MHz Band, Germany	Lauterbach et al., "LocalRadio using Digital Radio Mondiale(DRM) in the 26 MHz Band –A Résumé at the end of the Nuremberg/Dillbergfield trial" September 18 –19, 2008, FraunhoferInstitute for Integrated Circuits IIS Erlangen, Germany.	26 MHz
2008/9	DRM + field trials in the VHF Band II in Kaiserslautern	DRM Web Site: ITU-R Contribution WP6A/347 Annex 1 & 2	Band II

Year	Field Trials	Source	Frequency Band
		DRM Web Site: ITU-R Contribution WP6A/537 Attachment 1 & 2	
2009	Project Mayflower: The DRM Trial, UK	<a href="http://downloads.bbc.co.uk/devon/pdfs/project-mayflower-summary-report.pdf">http://downloads.bbc.co.uk/devon/pdfs/project-mayflower-summary-report.pdf</a>	MF
2009	Field trial with DRM in Paris	DRM Web Site: ITU-R Contribution WP6A/347 Annex 3 DRM Web Site: ITU-R Contribution WP6A/537 Attachment 4	Band I
2010	DRM + field trials in the VHF Band III in Kaiserslautern	DRM Web Site: ITU-R Contribution WP6A/537 Attachment 3	Band III
2010	Results of the DRM FM band field trial in Sri Lanka	DRM Web Site: ITU-R Contribution WP6A/503	Band II
2011	DRM Single Frequency Network Field Test Results, Hanover	DRM Web Site: ITU-R Contribution WP6A/504	Band II
2011	Results of the DRM field trial in Band I in Turin, Italy	DRM Web Site: ITU-R Contribution WP6A/512	Band I
2011	Results of the DRM High Power Field Trial in the United Kingdom	DRM Web Site: ITU-R Contribution WP6A/532 BBC Research White Paper WHP 199 <a href="http://www.bbc.co.uk/rd/publications/wHITEPAPER199.shtml">http://www.bbc.co.uk/rd/publications/wHITEPAPER199.shtml</a>	Band II
	Unable to find source information on the following trials: DRM NVIS trials in Germany Multi-channel Simulcast, Urban and Indoor reception in MW Band DRM tests in the 26 MHz band for local coverage in Italy		MF MF 26 MHz

\* A summary of these trials can be found in Annex 3 of Report ITU-R BS.2144 [27]. See also [35]



[www.drm.org](http://www.drm.org)

# DIGITAL RADIO MONDIALE

## The Future of Global Radio



### DRM brings you efficient digital radio

DRM's digital broadcasting system takes the radio listening experience to the next level. It provides disruption free audio quality and service reliability. It is highly cost and energy efficient and gives increased coverage.

With DRM's digital broadcasting system you can broadcast bands covering LW, SW, MW and FM Bands I, II and III.

### DRM benefits:

- Greater reach
- Cost-efficient broadcast
- Wider content/channels
- Multi-platform
- Zero disruption
- User friendly
- Saves energy

### DIGITAL RADIO IS IDEAL FOR:



#### LISTENERS

Get excellent sound quality and undisturbed reception on the go  
Get a wider choice of content, channels and programmes

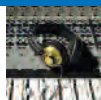

#### BROADCASTERS

Reach more listeners with new, additional digital services and generate new revenue streams



#### MANUFACTURERS

Generate a new market for digital radio sets and related hardware like chipsets, transmitters and other equipment



**DrM** is one of the driving forces  
**behind**  
**GLOBAL DIGITAL RADIO.**

And  is Proud to be in the  
**Middle of it ALL.**

Building upon the success of its solid-state modulator product line, Continental Electronics brings high efficiency DRM transmissions to the world with its 418/419/420 product line of shortwave broadcast transmitters. Whether the broadcaster is looking for a DRM upgrade, a brand new, fully compliant DRM transmitter, or even a fully configured DRM content server, Continental has your solution. Utilizing the RF Phase and Amplitude signals within the transmitter, Continental transmitters provide a high efficiency DRM signal that is spectrally compliant while still producing the full PEP capability of the AM transmitter.



418DRM

**Continental Electronics®**

4212 South Buckner Blvd. Dallas, Texas 75227  
 phone: 214.381.7161 • fax: 214.381.3250  
[www.contelec.com](http://www.contelec.com)



# GET COVERAGE WITH **DRM**



**TRANSRADIO** offers:

- Complete DRM-Systems
- LW + MW Transmitters up to 2,000 kW
- VHF/FM Transmitters and Transposers from 5W to 40kW
- Outstanding Antenna Solutions for DRM Systems
- Standby and Reserve Systems
- Turn Key Projects

**TRANSRADIO**

SenderSysteme Berlin AG  
Mertensstrasse 63  
13587 Berlin  
Germany

Phone: +49-30-3 39 78-0  
Fax: +49-30-3 39 78-599  
E-mail: info@tsb-ag.com

