



# **DEBRIS EXAMINATION REPORT**

## **SAFETY INVESTIGATION FOR MH370**

**Malaysia Airlines MH370 Boeing B777-200ER (9M-MRO)  
08 March 2014**

**Identification of Debris (Item 6 in the “Summary of Possible MH370 Debris Recovered”) recovered south of Chidenguele, Mozambique on 24 April 2016**

Issued on 28<sup>th</sup> February 2017

Ref: DB/01/17



The Malaysian ICAO Annex 13  
Safety Investigation Team for MH370

Email : [MH370SafetyInvestigation@mot.gov.my](mailto:MH370SafetyInvestigation@mot.gov.my)

## Malaysia Airlines Boeing B777-200ER (9M-MRO), 08 March 2014

### Identification of Debris (Item 6 in the “Summary of Possible MH370 Debris Recovered”) recovered south of Chidenguele, Mozambique on 24 April 2016

#### 1.0 Introduction

This item was recovered south of Chidenguele in Mozambique on 24 April 2016. It is identified as Item No. 6 from the items recovered; refer to the “*Summary of Possible MH370 Debris Recovered*”.



The item was brought back to Malaysia for identification and further examination by the “*Malaysian ICAO Annex 13 Safety Investigation Team for MH370*”.

## 2.0 Part Characteristics

The part was measured to be approximately 18 in. in length and weighed 8.44 Kg.

The structure was of composite honeycomb sandwich with non-metallic core. It had a number of fracture lines and one of the sides which was the 'end of part', was intact. The external skin was dark grey in colour and the inner skin was white.

A part of a metal bracket was still attached on the debris and it was observed that another one had broken off. This was the attachment for the "Hold-Open Stay Rod"

## 3.0 Identification

The part was taken to a B777-200ER, formally operated by Malaysia Airlines (MAS), undergoing a maintenance check at Subang, Malaysia, for identification purposes. The possible location of the part on the aircraft was determined.

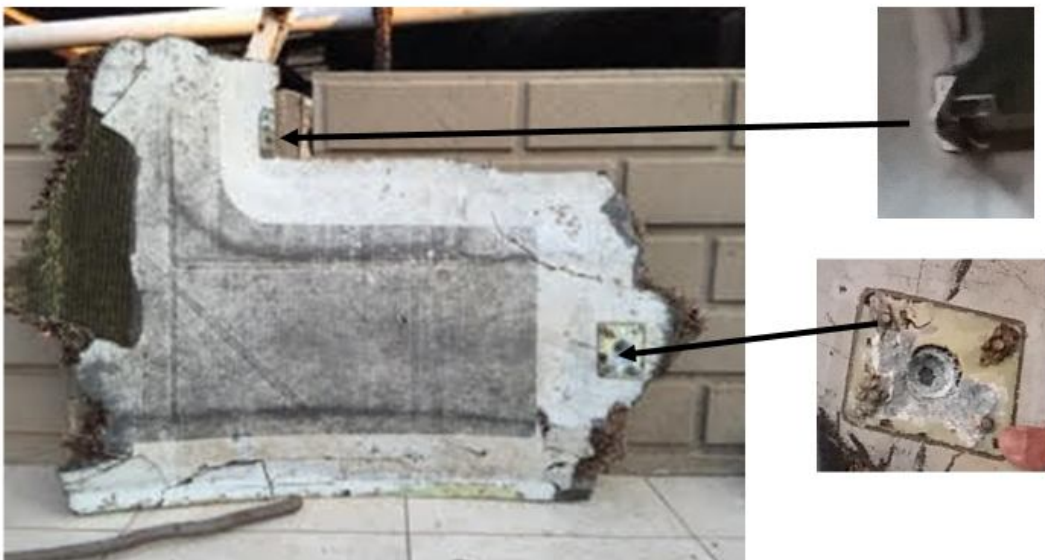

The hinge bracket, number of fasteners and fasteners' pitch on the part were consistent with those on the right engine fan cowl on the aircraft. The mount found on the part was also consistent with the mount of the fan cowl "Hold-Open Stay Rod" in regards to its location, shape and size of the mounting bracket.



The words "HOIST POINT" were still visible and in the correct location. The fonts used for the words on the part matched those on the fan cowl of the aircraft.



The dimension from the forward edge of the part to the start of the core ramp, which was 18 in., was also consistent with that of the fan cowl on the aircraft, as shown in the above figure.



The part was brought near to the right fan cowl and was found to physically resemble it in terms of shape, size, colour and features.

Based on the above, the part is confirmed to be part of the **Right Fan Cowl** of a B777 aircraft.

#### 4.0 Structure Examination

The fracture on the laminate appears to be more likely a tension failure. The honeycomb core was intact and there was no significant crush on the honeycomb core. All the metal parts were detached and the fastener holes for the hinge door brackets were clearly visible. The attachment for the "Hold-Open Stay Rod" was detached and corrosion was visible on the remaining metal part.

#### 5.0 Conclusion

It has been concluded that the debris is part of the **Right Fan Cowl** of a B777. As the right fan cowls on both the engines are similar, there is no conclusive evidence to determine whether it belongs to the left (No. 1) or right (No. 2) engine. Based on the other features on the recovered part it has also been determined that the part is almost certain from MH370 (aircraft registered as 9M-MRO).



# **DEBRIS EXAMINATION REPORT**

## **SAFETY INVESTIGATION FOR MH370**

**Malaysia Airlines MH370 Boeing B777-200ER (9M-MRO)  
08 March 2014**

**Identification of Debris (Item 7 in the “Summary of Possible MH370 Debris Recovered”) recovered at Anvil Bay, Chemucane, Mozambique on 30 April 2016**

Issued on 28<sup>th</sup> February 2017

Ref: DB/02/17



The Malaysian ICAO Annex 13  
Safety Investigation Team for MH370

Email : [MH370SafetyInvestigation@mot.gov.my](mailto:MH370SafetyInvestigation@mot.gov.my)

## Malaysia Airlines Boeing B777-200ER (9M-MRO), 08 March 2014

### Identification of Debris (Item 7 in the “Summary of Possible MH370 Debris Recovered”) recovered at Anvil Bay, Chemucane, Mozambique on 30 April 2016

#### 1.0 Introduction

This item was recovered at Anvil Bay, Chemucane, Mozambique on 30 April 2016. It is identified as Item No. 7 of the items recovered; refer to the “*Summary of Possible MH370 Debris Recovered*”.



The item was brought back to Malaysia for identification and further examination by the “Malaysian ICAO Annex 13 Safety Investigation Team for MH370”.

#### 2.0 Part Characteristics

The part was a typical Carbon Fiber Reinforced Plastic (CFRP) with non-metallic honeycomb core. The part was triangular in shape and approximately 22 in. at its longest edge. It weighed 0.31 Kg. The white paint on both sides of the debris had faded. It had an ‘end of part’ which had a distinctive corner radius but the length of the possible flange could not be determined since it had fractured immediately after the radius. There were no identification numbers on the part. The overall plan form of the part is not flat, it had a curvature.

### 3.0 Identification

The part was taken to a B777-200ER, formally operated by Malaysia Airlines (MAS), undergoing a maintenance check at Subang, Malaysia, for identification purposes.

The exact location of the part on the aircraft could not be identified since it did not have any markings or numbers and there were no peculiar features which could match it on the aircraft except for one edge of the part which had a distinct radius, which suggested that the joining part would be at an angle. While the construction was similar to a B777 part, there was no conclusive evidence to determine the origin of this part with respect to the aircraft.

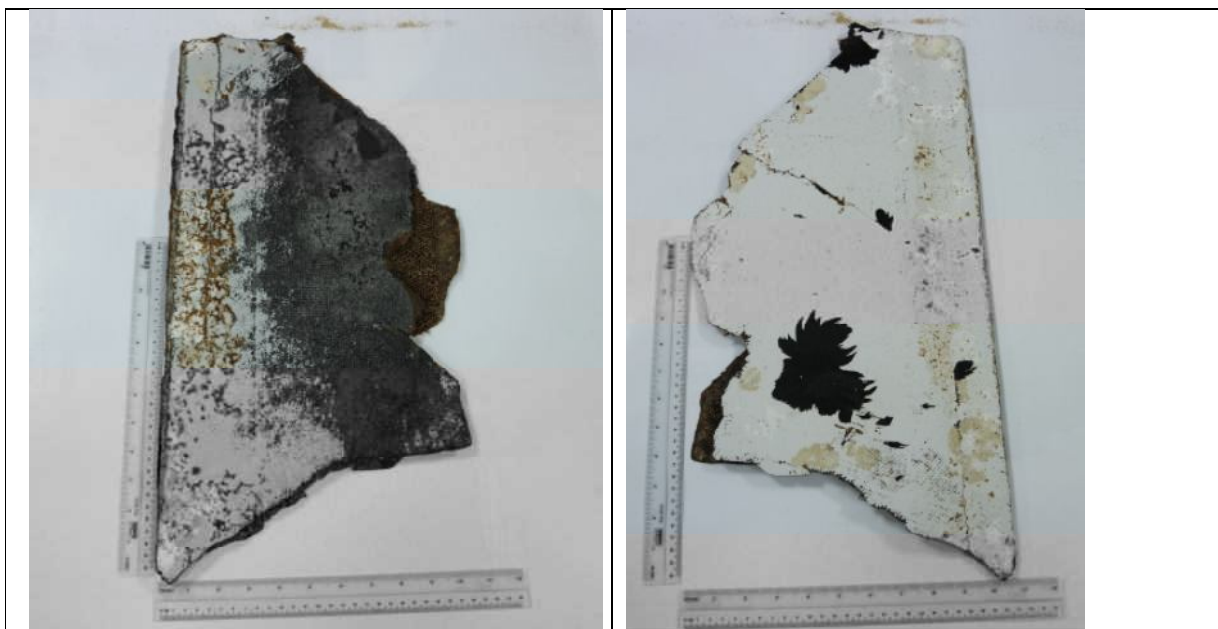

After review of the B777 Illustrated Parts Catalogue (IPC), the most possible location of the part was determined to be the wing to fuselage body fairing. The location of where the part was



found, considering that MH370 (aircraft registered as 9M-MRO) ended its flight in the South Indian Ocean, is consistent with the drift path modeling produced by the Commonwealth Scientific and Industrial Research Organisation (CSIRO). This suggests that the part is likely from MH370 given that the likelihood of it originating from another source is quite remote. The Australian Transport Safety Bureau (ATSB) reports on the drift modeling can be found at [http://www.atsb.gov.au/media/5772107/ae2014054\\_final-first-principles-report.pdf](http://www.atsb.gov.au/media/5772107/ae2014054_final-first-principles-report.pdf) and [http://www.atsb.gov.au/media/5771939/ae-2014-054\\_mh370-search-and-debris-update\\_2nov-2016\\_v2.pdf](http://www.atsb.gov.au/media/5771939/ae-2014-054_mh370-search-and-debris-update_2nov-2016_v2.pdf).

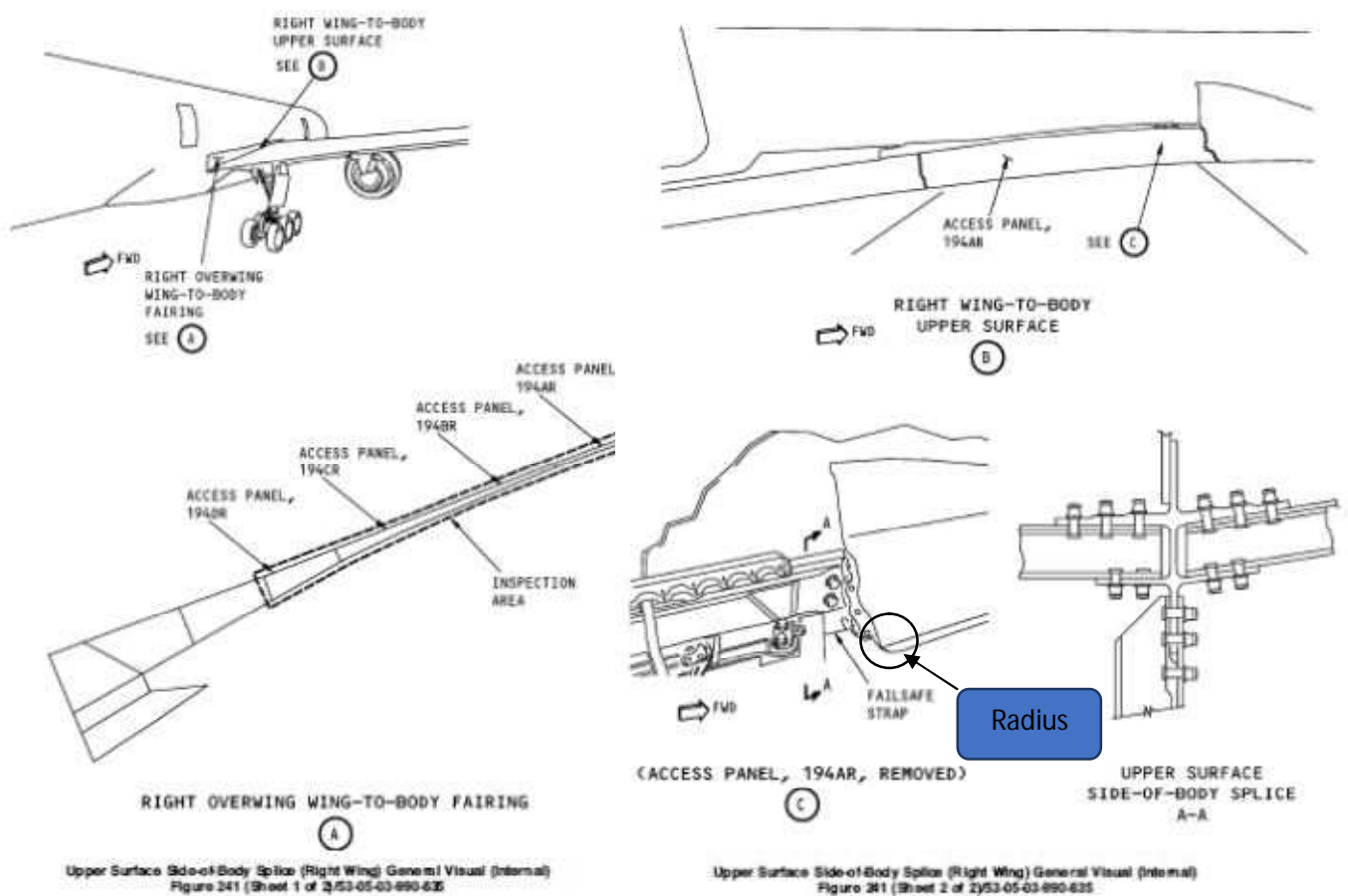

#### 4.0 Structure Examination

The part had fractured at all sides. One side had fractured immediately after the corner radius. The fibres appeared to have been pulled away and there were no visible kink on the fibres. The core was not crushed; it had fractured along the skin fracture line.



## 5.0 Conclusion

There is no conclusive evidence to determine the origin of this part with respect to the aircraft however it is likely to be a part of a panel of the wing to body fairing on a B777 and it is likely to be from MH370 (aircraft registered as 9M-MRO).



# **DEBRIS EXAMINATION REPORT**

## **SAFETY INVESTIGATION FOR MH370**

**Malaysia Airlines MH370 Boeing B777-200ER (9M-MRO)  
08 March 2014**

**Identification of Debris (Item 8 in the “Summary of Possible MH370 Debris Recovered”) recovered at Gris Gris Beach, Mauritius on 24 May 2016**

Issued on 28<sup>th</sup> February 2017

Ref: DB/03/17



The Malaysian ICAO Annex 13  
Safety Investigation Team for MH370

Email : [MH370SafetyInvestigation@mot.gov.my](mailto:MH370SafetyInvestigation@mot.gov.my)

## Malaysia Airlines Boeing B777-200ER (9M-MRO), 08 March 2014

### Identification of Debris (Item 8 in the “Summary of Possible MH370 Debris Recovered”) recovered at Gris Gris Beach, Mauritius on 24 May 2016

#### 1.0 Introduction

This item was recovered at Gris Gris Beach, Mauritius on 24 May 2016. It has been identified as Item No. 8 of the items found; refer to the “*Summary of Possible MH370 Debris Recovered*”.



The item was brought back to Malaysia for identification and further examination by the “Malaysian ICAO Annex 13 Safety Investigation Team for MH370”.

#### 2.0 Part Characteristics

The part was a typical Carbon Fiber Reinforced Plastic (CFRP) with Honeycomb Core. The part weighed 1.21 Kg. A metal strap was still attached on the inner skin, complete with its fasteners.

### 3.0 Identification

Initial assessment indicated that this could be a flap track fairing tail cone of a B777. The part was identified from the legible numbers that were observed on the inner surface. The following part number 113W9154-401 and serial number 407 were visible on one side. The profile of the part resembled the wing flap tail cone fairing.

The part number was cross referenced to the Boeing component maintenance manual and drawings. This identified it as a component of the wing flap fairing assembly and the fit closely matched that of the No. 1 flap track fairing. Further research and identification of the serial number 407 did not directly link the part to the MAS aircraft registration 9M-MRO.



The Debris – external surface

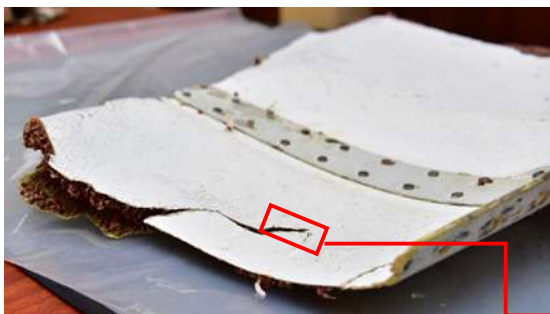

Inner side of the debris

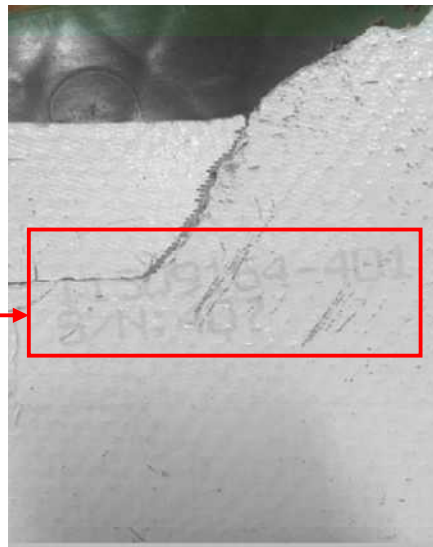

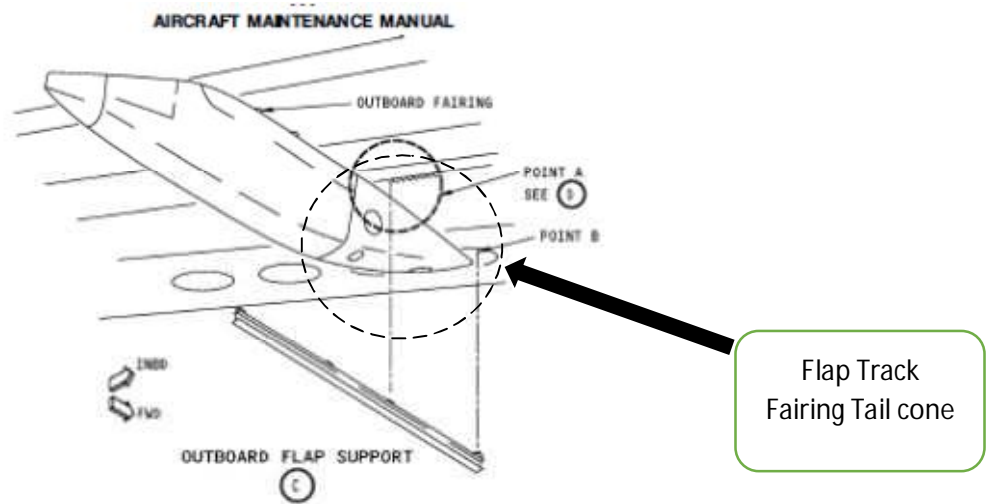

The location of where the part was found, considering that MH370 (aircraft registered as 9M-MRO) ended its flight in the South Indian Ocean, is consistent with the drift path modeling produced by the Commonwealth Scientific and Industrial Research Organisation (CSIRO). This suggests that the part is highly likely from MH370 given that the likelihood of it originating from another source is very remote. The Australian Transport Safety Bureau (ATSB) reports on the drift modeling can be found at [http://www.atsb.gov.au/media/5772107/ae2014054\\_final-first-principles-report.pdf](http://www.atsb.gov.au/media/5772107/ae2014054_final-first-principles-report.pdf) and [http://www.atsb.gov.au/media/5771939/ae-2014-054\\_mh370-search-and-debris-update\\_2nov-2016\\_v2.pdf](http://www.atsb.gov.au/media/5771939/ae-2014-054_mh370-search-and-debris-update_2nov-2016_v2.pdf).

#### 4.0 Structure Examination

The fracture line on the part showed the fibers to be 'pulled out' showing tension failure. Most of the core was intact and there was no sign of excessive crush.

#### 5.0 Conclusion

Based on the legible numbers and the fit, it is confirmed that the part is the tail cone of the No. 1 flap track fairing of B777 and highly likely to be from MH370 (aircraft registered as 9M-MRO).



# DEBRIS EXAMINATION REPORT

## SAFETY INVESTIGATION FOR MH370

**Malaysia Airlines MH370 Boeing B777-200ER (9M-MRO)  
08 March 2014**

**Identification of Debris (Items 9 and 15 in the “Summary of Possible MH370 Debris Recovered”) recovered at Macenta Peninsular, Mozambique on 22 May 2016 and Riake Beach, Nosy Boraha Island, Madagascar on 06 June 2016, respectively**

Issued on 28<sup>th</sup> February 2017

Ref: DB/04/17



The Malaysian ICAO Annex 13  
Safety Investigation Team for MH370

Email : [MH370SafetyInvestigation@mot.gov.my](mailto:MH370SafetyInvestigation@mot.gov.my)

## Malaysia Airlines Boeing B777-200ER (9M-MRO), 08 March 2014

Identification of Debris (Items 9 and 15 in the “Summary of Possible MH370 Debris Recovered”) recovered at Macenta Peninsular, Mozambique on 22 May 2016 and Riake Beach, Nosy Boraha Island, Madagascar on 06 June 2016, respectively

### 1.0 Introduction

Item 9 was recovered at Macenta Peninsular, Mozambique on 22 May 2016 while Item 15 was recovered at Riake beach, Nosy Boraha Island, Madagascar on 06 June 2016. The parts were identified as Item No. 9 and 15 of the items found; refer to the “*Summary of Possible MH370 Debris Recovered*”.



Item 9

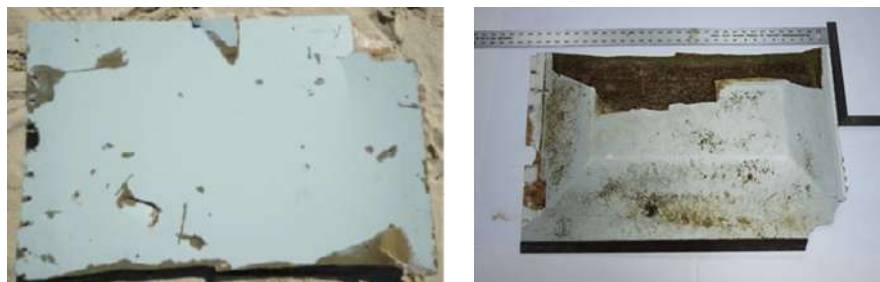

Item 15



The items were brought back to Malaysia for identification and further examination by the "Malaysian ICAO Annex 13 Safety Investigation Team for MH370".

## 2.0 Parts' Characteristics

Both debris (Items 9 and 15) were of composite structure with non-metallic honeycomb core and of Graphite Fibre Reinforced Plastic (GFRP) construction. The upper surfaces of the parts were painted with grey paint. The core ramps were visible at two places for Item 9 and three places for Item 15. Rub strips were still intact on one edge of the parts. Item 9 was weighed and found to be 2.18 Kg, while Item 15 was 3.34 Kg.

## 3.0 Identification

The parts were taken to a B777-200ER, formally operated by Malaysia Airlines (MAS), undergoing a maintenance check at Subang, Malaysia, for identification purposes.

Item 9 matched the left part (outboard section) of the Upper Fixed Panel forward of the flaperon on the **left** wing.

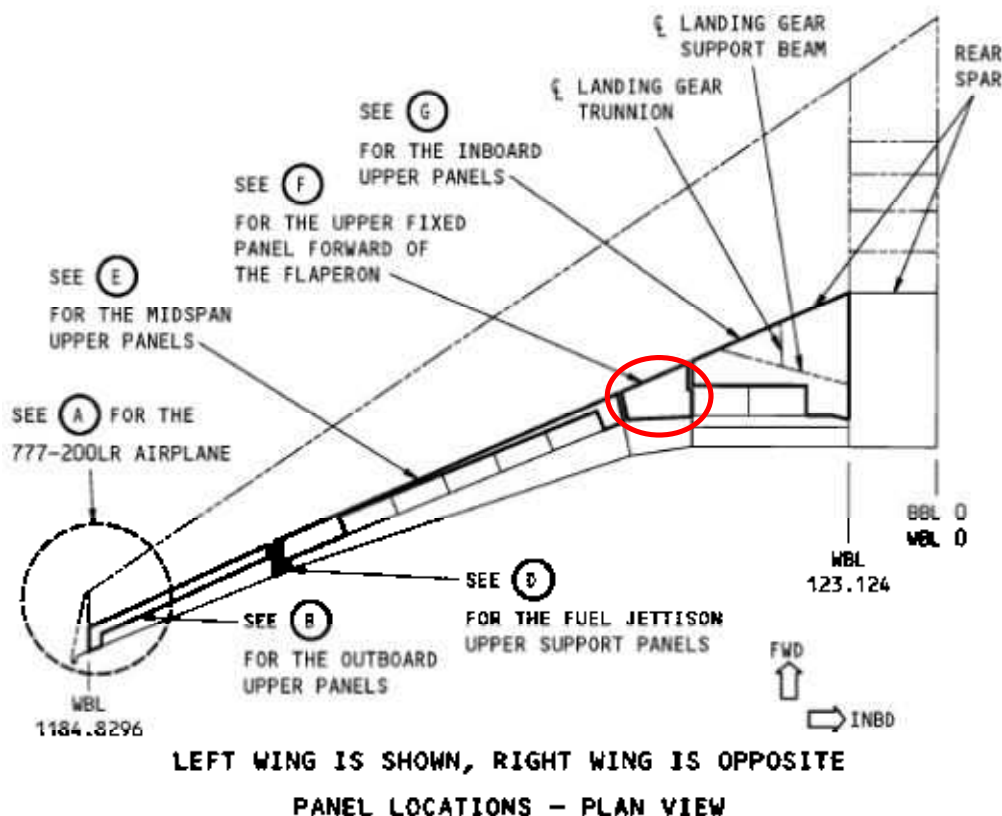

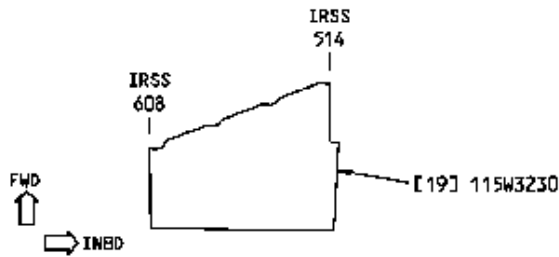

UPPER FIXED PANEL FORWARD OF THE FLAPERON

(F)



777-200  
STRUCTURAL REPAIR MANUAL

RUBSTRIP.  
0.10 INCH THICK PHENOLIC STRIP AS GIVEN IN  
MIL-I-24768/16, TYPE FBM, OR /14, TYPE FBG.  
BOND WITH BMS 5-95 ADHESIVE.

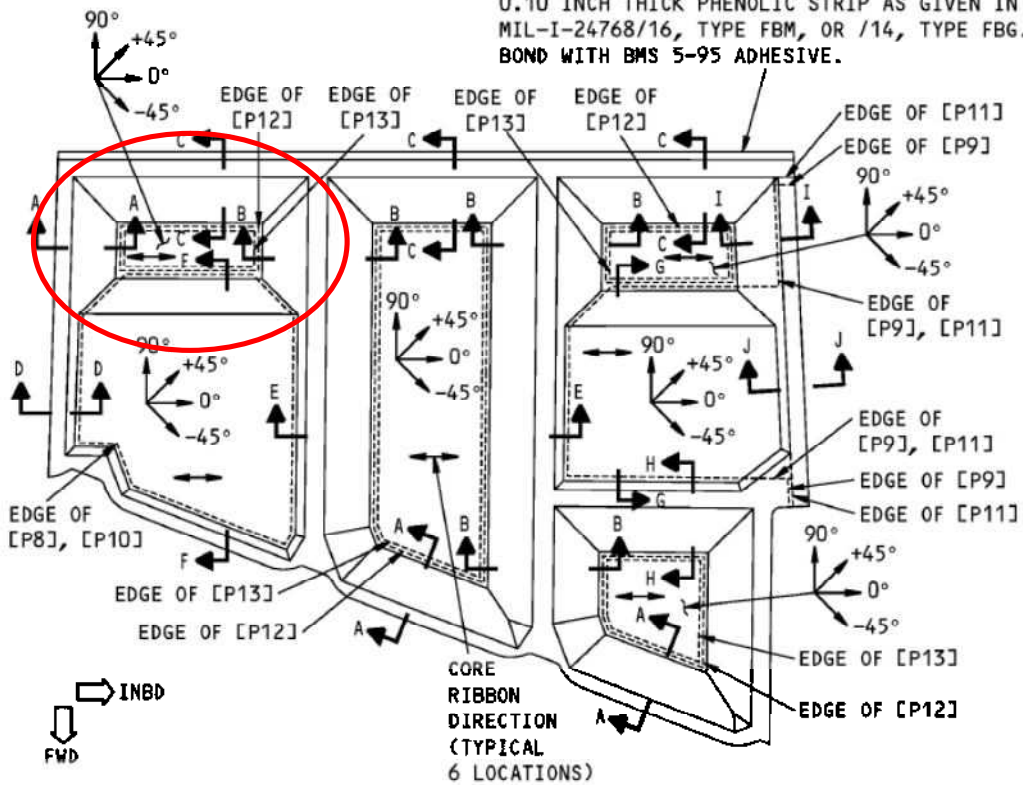

PLY LAYUP AND CORE RIBBON DIRECTION

777-200/200ER AIRPLANES

Further verification was carried out with reference to the B777 Aircraft Structure Repair Manual (SRM) which indicated that the panel was indeed the Upper Fixed Panel forward of the left flaperon.

The above figure shows Item 9 as a section of the "Upper Fixed Panel Forward of the Flaperon" on the left wing. It was observed that the outboard side was fractured and on the inboard side the fastener holes were still visible with a pitch of 1 inch. This fastener pitch matched that on the inboard side of the panel of the aircraft. The fasteners' pitch on the outboard side is 2 in. The raised portion of the core of the section of the panel (see figure below) of length 18 in. also matched with that on the aircraft panel.

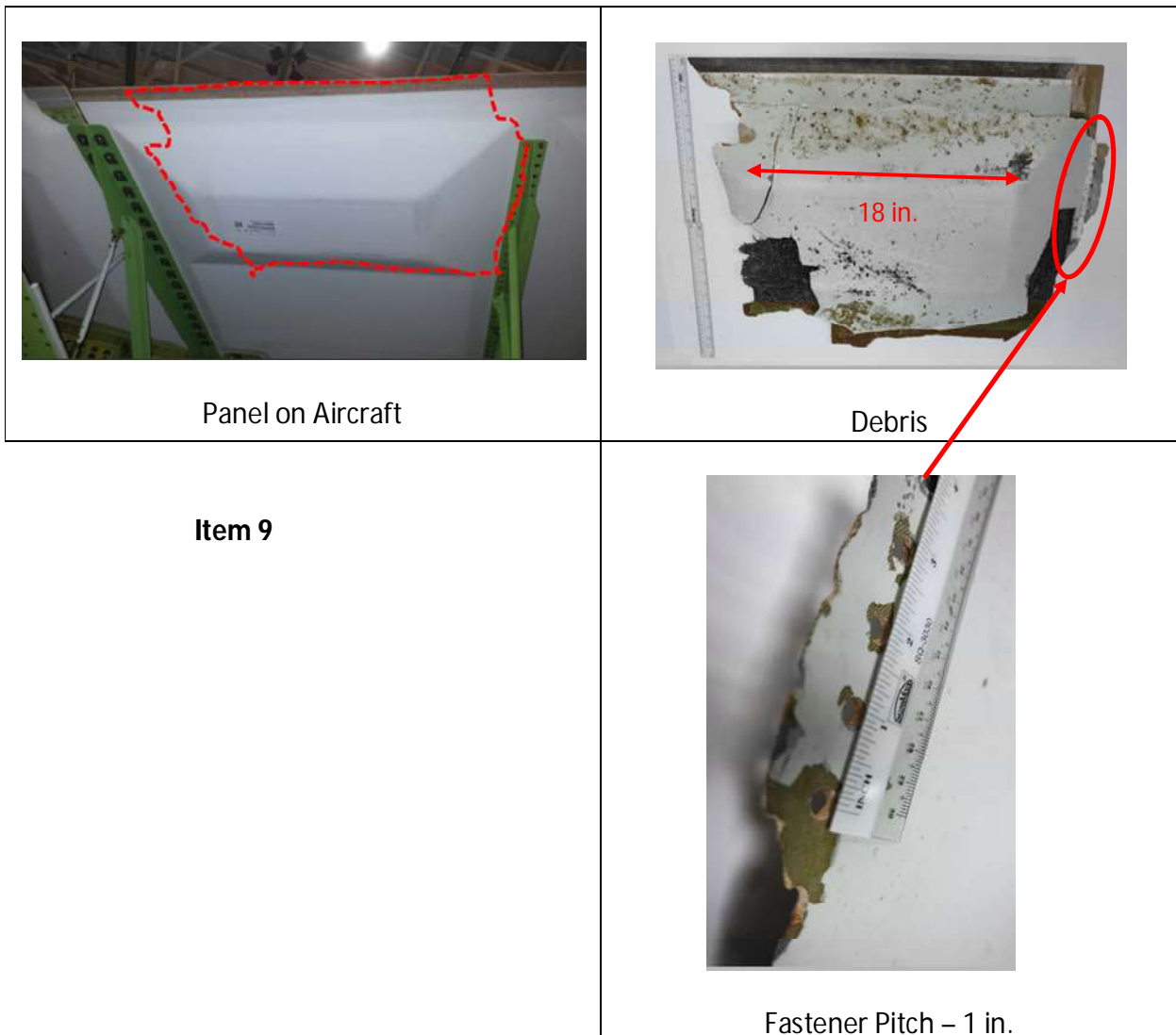

Similar matching process was carried out on Item 15; it was identified to be the outboard section of the "Upper Fixed Panel forward of the flaperon" on the **right** wing (refer to figure below). The pitch of the fasteners' holes on the right side (outboard) of the panel was measured to be 2 in. and that matched that on the debris.

The Boeing 777 Illustrated Parts Catalog (IPC) indicates that the part numbers of the Upper Fixed Panels forward of the left flaperon to be 115W3210-1 and that forward of the right flaperon to be 115W3210-2, respectively.



Item 15 against Upper Fixed Panel forward of Right Flaperon

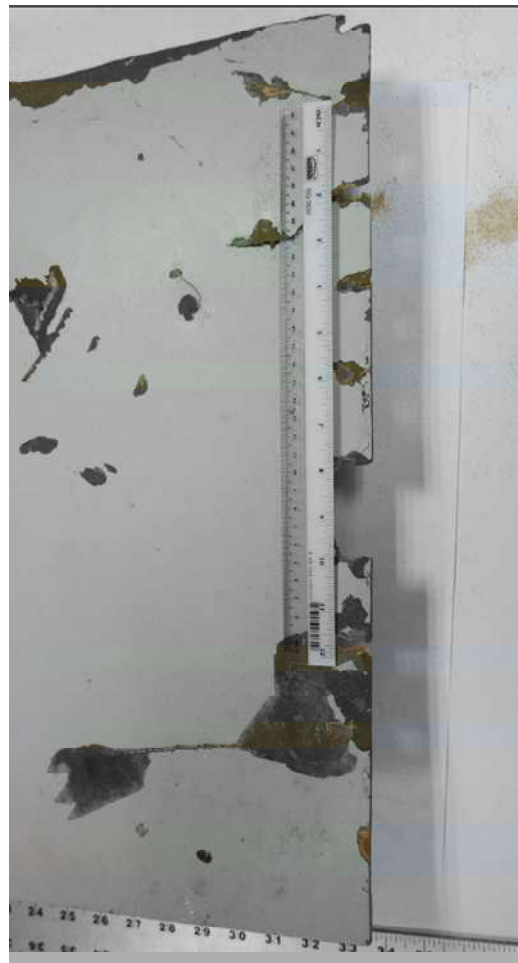

Fastener pitch – 2 in.

The locations of where the parts were found, considering that MH370 (aircraft registered as 9M-MRO) ended its flight in the South Indian Ocean, are consistent with the drift path modeling produced by the Commonwealth Scientific and Industrial Research Organisation (CSIRO). This suggests that the parts are highly likely from MH370 given that the likelihood of them originating from another source is quite remote. The reports from the Australian Transport Safety Bureau (ATSB) on the drift modeling can be found at [http://www.atsb.gov.au/media/5772107/ae2014054\\_final-first-principles-report.pdf](http://www.atsb.gov.au/media/5772107/ae2014054_final-first-principles-report.pdf) and [http://www.atsb.gov.au/media/5771939/ae-2014-054\\_mh370-search-and-debris-update\\_2nov-2016\\_v2.pdf](http://www.atsb.gov.au/media/5771939/ae-2014-054_mh370-search-and-debris-update_2nov-2016_v2.pdf).

#### **4.0 Structure Examination**

Item 9 was fractured at three places and one edge was still intact. The intact edge was that with the rub strip and indicated that it was the rear section of the panel. The fracture lines showed that the fibres were pulled but there were no signs they were kinked. The core was intact and had not crushed; it had fractured along the skin.

Item 15 had fractured at two places; the rear section was intact with the rub strip. The outboard section had the fasteners torn out with some of the fastener holes still recognizable. The inboard section was observed to have signs of 'net tension' failure as it had fractured along the fastener holes.

#### **5.0 Conclusion**

Item 9 is confirmed to be the outboard section of the "Upper Fixed Panel forward of the flaperon" on the **left** wing whilst item 15 is confirmed to be the outboard section of the "Upper Fixed Panel forward of the flaperon" on the **right** wing. The debris are highly likely to be from MH370 (aircraft registered as 9M-MRO).



# DEBRIS EXAMINATION REPORT

## SAFETY INVESTIGATION FOR MH370

**Malaysia Airlines MH370 Boeing B777-200ER (9M-MRO)  
08 March 2014**

**Identification of Debris (Item 11 in the “Summary of Possible MH370 Debris Recovered”) recovered at Riake beach, Nosy Boraha Island, Madagascar On 06 June 2016**

Issued on 28<sup>th</sup> February 2017

Ref: DB/05/17



The Malaysian ICAO Annex 13  
Safety Investigation Team for MH370

Email : [MH370SafetyInvestigation@mot.gov.my](mailto:MH370SafetyInvestigation@mot.gov.my)

## Malaysia Airlines Boeing B777-200ER (9M-MRO), 08 March 2014

### Identification of Debris (Item 11 in the “Summary of Possible MH370 Debris Recovered”) recovered at Riake beach, Nosy Boraha Island, Madagascar On 06 June 2016

---

#### 1.0 Introduction

This item was recovered at the Riake beach, Nosy Boraha Island, Madagascar on 06 June 2016. The part is identified as Item No. 11 of the 25 items found; refer to the “*Summary of Possible MH370 Debris Recovered (15 August 2016)*”.



The item was brought back to Malaysia for the identification and further examination by the “Malaysian ICAO Annex 13 Safety Investigation Team for MH370”.

#### 2.0 Part Characteristics

The part was intact with slight distortion. There was no sign of black soot or any other sign that the part had been exposed to fire.

#### 3.0 Identification

The part was taken to a B777-200ER, formally operated by Malaysia Airlines (MAS), undergoing a maintenance check at Subang, Malaysia, for identification purposes.

The part was identified as the seat back trim panel which encases the In-Flight Entertainment (IFE) monitor, as shown in the photograph below. There was a small fragment of fabric around the coat hanger on the debris, which was greenish in colour. This colour matched the seat

fabric used on the Malaysia Airlines (MAS) B777 on the center seats. The location of the coat hanger on the left conforms to the Right Hand, Triple Seat Assembly column in the Economy (EY) class.



The location of where the part was found, considering that MH370 (aircraft registered as 9M-MRO) ended its flight in the South Indian Ocean, is consistent with the drift path modeling produced by the Commonwealth Scientific and Industrial Research Organisation (CSIRO). This suggests that the part is highly likely from MH370 given that the likelihood of it originating from another source is very remote. The Australian Transport Safety Bureau (ATSB) reports on the drift modeling can be found at [http://www.atsb.gov.au/media/5772107/ae2014054\\_final-first-principles-report.pdf](http://www.atsb.gov.au/media/5772107/ae2014054_final-first-principles-report.pdf) and [http://www.atsb.gov.au/media/5771939/ae-2014-054\\_mh370-search-and-debris-update\\_2nov-2016\\_v2.pdf](http://www.atsb.gov.au/media/5771939/ae-2014-054_mh370-search-and-debris-update_2nov-2016_v2.pdf).

#### **4.0 Structure Examination**

As this was an aircraft interior part no detailed structural examination was conducted.

#### **5.0 Conclusion**

This part is confirmed to be the seat back trim panel for encasing the IFE monitor and is highly likely to be from MH370 (aircraft registered as 9M-MRO).





# **DEBRIS EXAMINATION REPORT**

## **SAFETY INVESTIGATION FOR MH370**

**Malaysia Airlines MH370 Boeing B777-200ER (9M-MRO)  
08 March 2014**

**Identification of Debris (Item 12 in the “Summary of Possible MH370 Debris Recovered”) recovered at Riake Beach, Nosy Boraha Island, Madagascar on 06 June 2016**

Issued on 28<sup>th</sup> February 2017

Ref: DB/06/17



The Malaysian ICAO Annex 13  
Safety Investigation Team for MH370

Email : [MH370SafetyInvestigation@mot.gov.my](mailto:MH370SafetyInvestigation@mot.gov.my)

## Malaysia Airlines Boeing B777-200ER (9M-MRO), 08 March 2014

Identification of Debris (Item 12 in the "Summary of Possible MH370 Debris Recovered") recovered at Riake Beach, Nosy Boraha Island, Madagascar on 06 June 2016

### 1.0 Introduction

This item was recovered at Riake beach, Nosy Boraha Island, Madagascar on 06 June 2016. It is identified as item 12 of the items recovered; refer to the "*Summary of Possible MH370 Debris Recovered*".



The item was brought back to Malaysia for identification and further examination by the "Malaysian ICAO Annex 13 Safety Investigation Team for MH370".

## 2.0 Part Characteristics

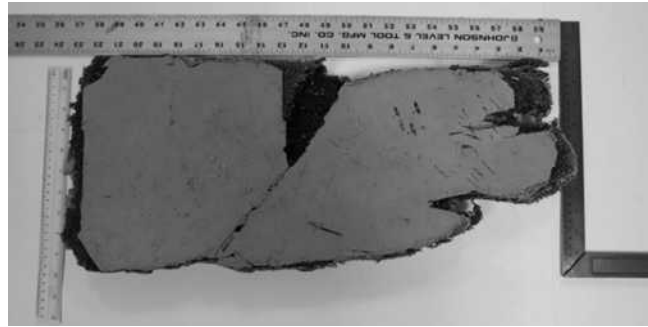

It was made of Carbon Fibre Reinforced Plastic (CFRP) with honeycomb core. The honeycomb core was measured to be more than 1 inch thick. The core taper was observed to be prominent. It was approximately 23 in. by 10 in. in size.

## 3.0 Identification

The letters "FB" were clearly visible on the part which indicates that it is a bottom panel on the wing or horizontal stabilizer.

An attempt was made to match the part to all the wing and horizontal stabilizer panels with the identification marks ending with "FB". The thickness and profile of the part did not match any of those panels on the aircraft. However it could be confirmed that it is very likely to be a part from a Boeing aircraft.

The location of where the part was found, considering that MH370 (aircraft registered as 9M-MRO) ended its flight in the South Indian Ocean, is consistent with the drift path modeling produced by the Commonwealth Scientific and Industrial Research Organisation (CSIRO). This suggests that the part is likely from MH370 given that the likelihood of it originating from another source is quite remote. The Australian Transport Safety Bureau (ATSB) reports on the drift modeling can be found at [http://www.atsb.gov.au/media/5772107/ae2014054\\_final-first-principles-report.pdf](http://www.atsb.gov.au/media/5772107/ae2014054_final-first-principles-report.pdf) and [http://www.atsb.gov.au/media/5771939/ae-2014-054\\_mh370-search-and-debris-update\\_2nov-2016\\_v2.pdf](http://www.atsb.gov.au/media/5771939/ae-2014-054_mh370-search-and-debris-update_2nov-2016_v2.pdf).

## 4.0 Structure Examination

The carbon fibre laminate had fractured and appeared to have pulled out but there was no crush on the core.

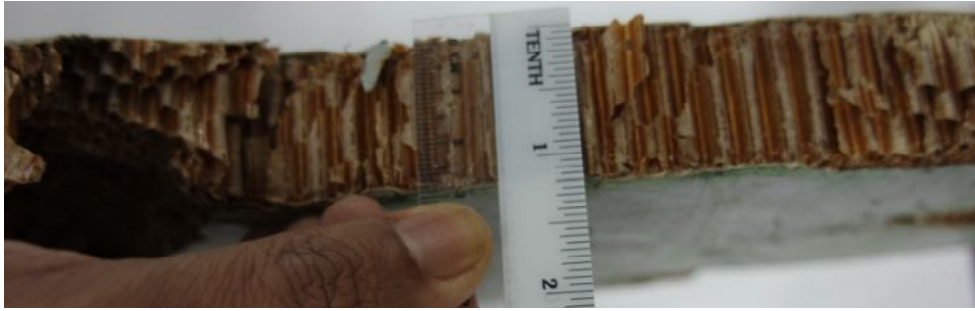

## 5.0 Conclusion

The part is very likely from a Boeing aircraft and is likely to be from MH370 (aircraft registered as 9M-MRO).



# DEBRIS EXAMINATION REPORT

## SAFETY INVESTIGATION FOR MH370

**Malaysia Airlines MH370 Boeing B777-200ER (9M-MRO)  
08 March 2014**

**Identification of Debris (Item 13 in the “Summary of Possible MH370 Debris Recovered”) recovered from Riake Beach, Nosy Boraha Island, Madagascar on 12 June 2016**

Issued on 28<sup>th</sup> February 2017

Ref: DB/07/17



The Malaysian ICAO Annex 13  
Safety Investigation Team for MH370

Email : [MH370SafetyInvestigation@mot.gov.my](mailto:MH370SafetyInvestigation@mot.gov.my)

## Malaysia Airlines Boeing B777-200ER (9M-MRO), 08 March 2014

### Identification of Debris (Item 13 in the “Summary of Possible MH370 Debris Recovered”) recovered from Riake Beach, Nosy Boraha Island, Madagascar on 12 June 2016

---

#### 1.0 Introduction

This item was recovered from Riake Beach, Nosy Boraha Island, Madagascar on 12 June 2016. The part was identified as Item No. 13 of the items recovered; refer to the “*Summary of Possible MH370 Debris Recovered*”.



The item was brought back to Malaysia for the further examination and identification by the “Malaysian ICAO Annex 13 Safety Investigation Team for MH370”.

## 2.0 Part Characteristics

The item was measured to be approximately 19 in. in length and 10 in. in width and weighed 0.375 Kg.



## 3.0 Identification

The part was taken to a B777-200ER, formally operated by Malaysia Airlines (MAS), undergoing a maintenance check at Subang, Malaysia, for identification purposes. The part could not be matched exactly to any part on the aircraft. There were also no identification numbers on the part.

## 4.0 Structure Examination

The item was a typical Carbon Fiber Reinforced Plastic (CFRP) construction with honeycomb core. One of the layers in the laminate top surface was clearly visible to be made of Unidirectional Carbon fibers. The fasteners were attached to an angle made of CFRP which was broken at one of the flanges. However, the angle radius was still visible.



## 5.0 Conclusion

There is insufficient evidence to indicate that it could be from a B777 or from MH370.





# DEBRIS EXAMINATION REPORT

## SAFETY INVESTIGATION FOR MH370

**Malaysia Airlines MH370 Boeing B777-200ER (9M-MRO)  
08 March 2014**

**Identification of Debris (Item 14 in the “Summary of Possible MH370 Debris Recovered”) recovered from Riake Beach, Nosy Boraha Island, Madagascar on 12 June 2016**

Issued on 28<sup>th</sup> February 2017

Ref: DB/08/17



The Malaysian ICAO Annex 13  
Safety Investigation Team for MH370

Email : [MH370SafetyInvestigation@mot.gov.my](mailto:MH370SafetyInvestigation@mot.gov.my)

## Malaysia Airlines Boeing B777-200ER (9M-MRO), 08 March 2014

Identification of Debris (Item 14 in the “Summary of Possible MH370 Debris Recovered”) recovered from Riake Beach, Nosy Boraha Island, Madagascar on 12 June 2016

### 1.0 Introduction

This item was recovered from Riake Beach, Nosy Boraha Island, Madagascar on 12 June 2016. It was identified as Item No. 14 of the items found; refer to the “*Summary of Possible MH370 Debris Recovered*” .



The item was brought back to Malaysia for the identification and further examination by the “Malaysian ICAO Annex 13 Safety Investigation Team for MH370”.

### 2.0 Part Characteristics

The part was observed to be of non-metallic honeycomb sandwich construction with decorative finish. The part was approximately 20 in. in length and weighed 0.145 Kg.

### 3.0 Identification

The part was taken to a B777-200ER, formally operated by Malaysia Airlines (MAS), undergoing a maintenance check at Subang, Malaysia, for identification purposes. The part did not have any distinguishing features to match any on the aircraft. The part resembled a cabin interior piece based on the decorative finish. It did not have any identification numbers.



### 4.0 Structure Examination

The part was fractured on all sides. The fibres appeared to be pulled rather than being compressed.

### 5.0 Conclusion

There is insufficient evidence to positively identify the part to be from an aircraft.



# DEBRIS EXAMINATION REPORT

## SAFETY INVESTIGATION FOR MH370

**Malaysia Airlines MH370 Boeing B777-200ER (9M-MRO)  
08 March 2014**

**Identification of Debris (Items 16 and 17 in the “Summary of Possible MH370 Debris Recovered”) recovered from Antsiraka Beach, Madagascar on 12 June 2016**

Issued on 4<sup>th</sup> October 2016

Ref: DB/01/16



The Malaysian ICAO Annex 13  
Safety Investigation Team for MH370

Email : [MH370SafetyInvestigation@mot.gov.my](mailto:MH370SafetyInvestigation@mot.gov.my)

## **Malaysia Airlines Boeing B777-200ER (9M-MRO), 08 March 2014**

### **Identification of Debris (Items 16 and 17 in the “Summary of Possible MH370 Debris Recovered”) recovered from Antsiraka Beach, Madagascar on 12 June 2016**

#### **Introduction**

Items 16 and 17 were found on 12 June 2016 in Antsiraka Beach, Madagascar. These items were taken to Air Accident Investigation Board (AAIB) Malaysia office in Putrajaya, Federal Territory, Malaysia and stored in the quarantine room before they were removed and brought to Science & Technology Research Institute for Defence (STRIDE) for detailed examination.

The MH370 Safety Investigation Team was assisted by the MAB (Malaysia Airlines Berhad) Sdn Bhd, Technical Services Engineer in the part identification process.



**Item No. 16**



**Item No. 17**

#### **Identification**

The initial stage was to carry out the identification of the parts, which included a general examination of the items. The size and weight of the items were taken and then they were inspected for any signs of abnormal marks or discoloration which could indicate a specific pattern of failure or destruction.



**Item No. 16**



**Item No. 17**

The next phase was to determine the possible clues, which may lead to any evidence of the MH370 end of flight scenario. However, if there was not enough evidence to indicate these parts were from MH370, no further action was deemed required.

The observations and findings on these parts are in the following table.

	<b>Item 16</b>	<b>Item 17</b>
Size	Small piece of bigger part	Small piece of bigger part
Weight	235.58 grams	215.08 grams
Color	White with vinyl cover on both sides of the panel, one side just plain white vinyl, the other side with white vinyl with rice plant pattern. This design is unique to Malaysia Airlines B777 and B747 interior as per interior specifications made available by MAB Engineering Technical Services.	Not painted, either has been removed or just bare composite panel
Part Number	Nil	Nil
Serial Number	Nil	Nil
Special features	The honeycomb core was identified as Nomex with a thickness of 1.025 inches.  Observed three holes for insert on one side of the panel.  White Vinyl with pattern unique to Malaysia Airlines B777 and B747 cabin interior.	There was a hole for pin or fasteners. The size of the hole was 0.514 inches; it appeared to be the hole for a Dzus fastener.  However, there was no sign of an insert, which is required for structural panel.
Abnormal marks	Nil	2 Localised burn spots.

### Further work

There is no further work required on these two items.

### Conclusion

1. Item No. 16 is a cabin interior panel based on the Nomex honeycomb core and panel construction. The vinyl decorative sheet on one side of the panel is the same as the specification used on MAS 777 cabin interior. This item is almost certain from MH 370 (aircraft registered as 9M-MRO).
2. Item No. 17 is not identifiable.



# DEBRIS EXAMINATION REPORT

## SAFETY INVESTIGATION FOR MH370

**Malaysia Airlines MH370 Boeing B777-200ER (9M-MRO)  
08 March 2014**

**Identification of Debris (Item 18 in the “Summary of Possible MH370 Debris Recovered”) recovered from Antsiraka beach, Madagascar on 12 June 2016**

Issued on 28<sup>th</sup> February 2017

Ref: DB/09/17



The Malaysian ICAO Annex 13  
Safety Investigation Team for MH370

Email : [MH370SafetyInvestigation@mot.gov.my](mailto:MH370SafetyInvestigation@mot.gov.my)



## **Malaysia Airlines Boeing B777-200ER (9M-MRO), 08 March 2014**

### **Identification of Debris (Item 18 in the “Summary of Possible MH370 Debris Recovered”) recovered from Antsiraka beach, Madagascar on 12 June 2016**

#### **1.0 Introduction**

This item was recovered from Antsiraka beach, Madagascar on 12 June 2016. The part is identified as Item No 18 of the items found; refer to the “*Summary of Possible MH370 Debris Recovered*”.



The item was brought back to Malaysia for the identification and further examination by the “Malaysian ICAO Annex 13 Safety Investigation Team for MH370”.

#### **2.0 Part Characteristics**

The part was observed to be Carbon Fiber Reinforced Plastics (CFRP) honeycomb sandwich. The core was nonmetallic honeycomb. Both the outer and inner skins were made of carbon fibre and were white in colour. The part size was approximately 36 in. by 12 in. and the weight was 3.34 Kg.

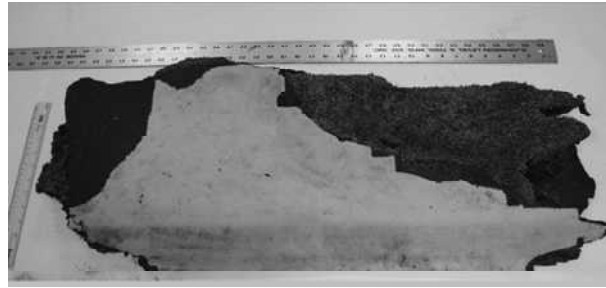
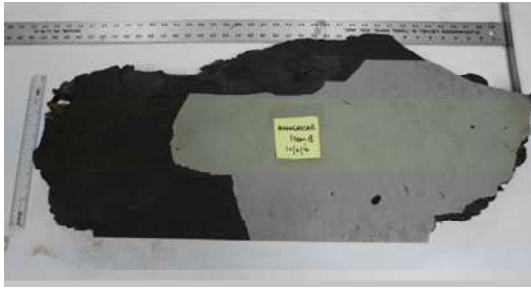

### 3.0 Identification

The part was taken to a B777-200ER, formally operated by Malaysia Airlines (MAS), undergoing a maintenance check at Subang, Malaysia, for identification purposes. The part did not have any identification numbers on it. However the features on the part resembled the Right Nose Gear Forward Door. The oval depressions on the inner skin and the orientation of a diagonal, raised bar matched that on the Right Nose Gear Forward Door on the aircraft.



The above photo shows the item matched the Right-Hand Nose Gear Forward Door. The photo below shows the oval depressions and the raised diagonal bar.

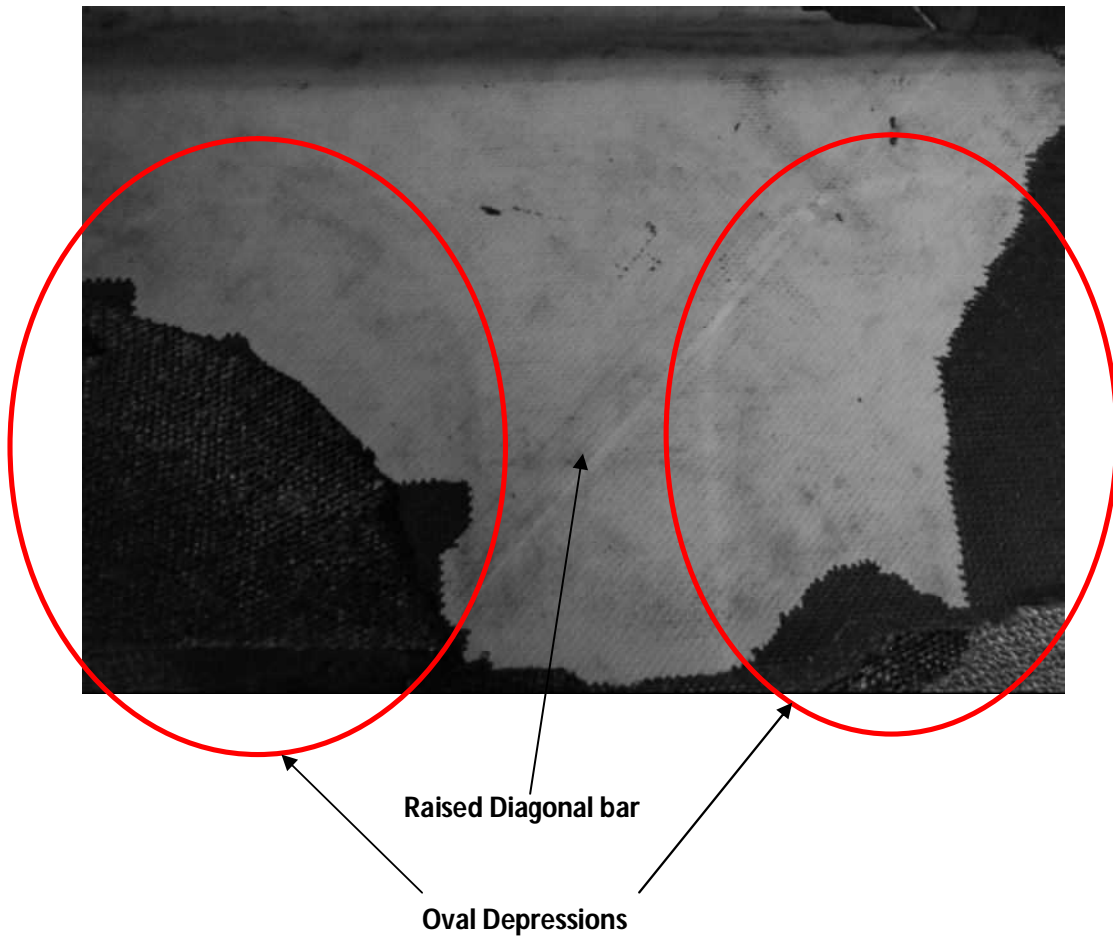

The location of where the part was found, considering that MH370 (aircraft registered as 9M-MRO) ended its flight in the South Indian Ocean, is consistent with the drift path modeling produced by the Commonwealth Scientific and Industrial Research Organisation (CSIRO). This suggests that the part is highly likely from MH370 given that the likelihood of it originating from another source is very remote. The Australian Transport Safety Bureau (ATSB) reports on the drift modeling can be found at [http://www.atsb.gov.au/media/5772107/ae2014054\\_final-first-principles-report.pdf](http://www.atsb.gov.au/media/5772107/ae2014054_final-first-principles-report.pdf) and [http://www.atsb.gov.au/media/5771939/ae-2014-054\\_mh370-search-and-debris-update\\_2nov-2016\\_v2.pdf](http://www.atsb.gov.au/media/5771939/ae-2014-054_mh370-search-and-debris-update_2nov-2016_v2.pdf).

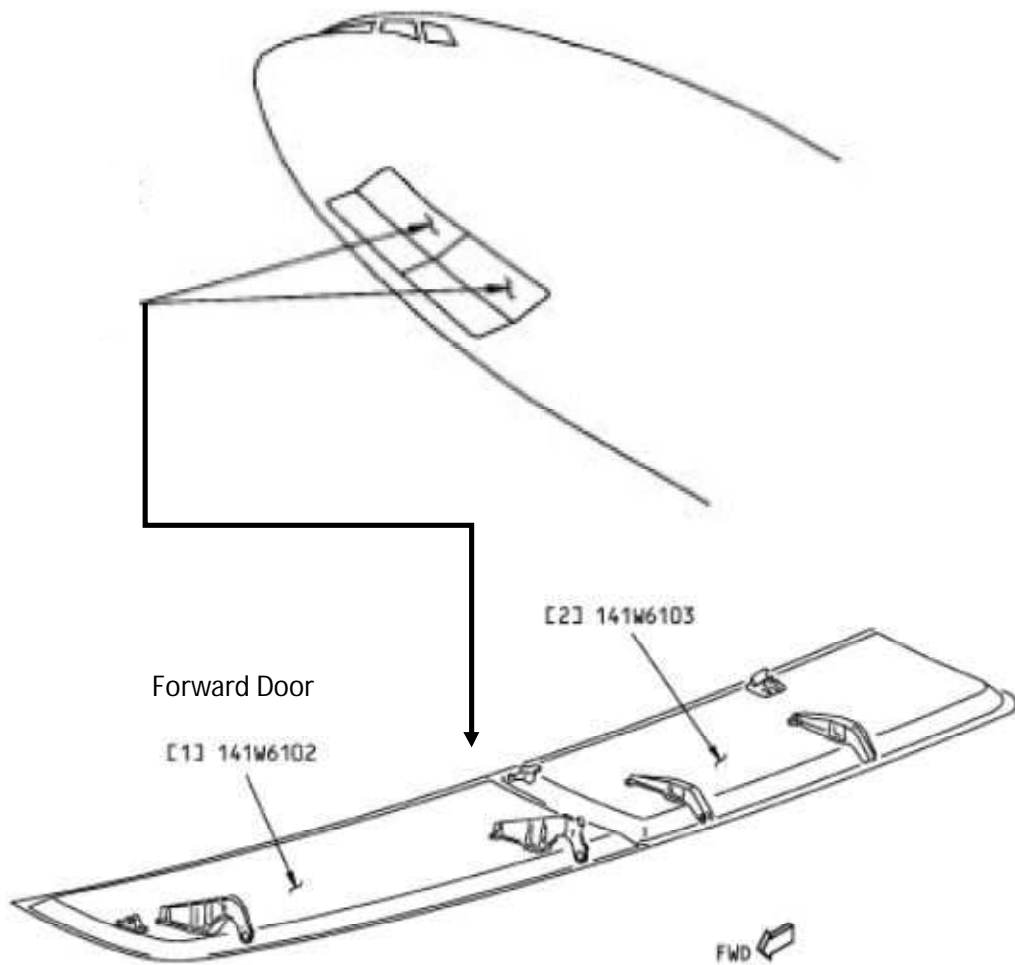

LEFT SIDE IS SHOWN, RIGHT SIDE IS OPPOSITE

#### 4.0 Structure Examination

The part was fractured on three edges except at one end, the edge where the hinges were installed. Close visual examination of the fracture lines showed the fibers were pulled and there was no sign of kink.

#### 5.0 Conclusion

The part is positively identified as the Right Hand Nose Gear Forward Door of a B777. It is highly likely to be from MH370 (aircraft registered as 9M-MRO).



# **DEBRIS EXAMINATION REPORT**

## **SAFETY INVESTIGATION FOR MH370**

**Malaysia Airlines MH370 Boeing B777-200ER (9M-MRO)  
08 March 2014**

**Identification of Debris (Item 20 in the “Summary of Possible MH370 Debris Recovered”) recovered from Kosi Bay mouth, Northern Kwa Zulu Natal, South Africa on 21 June 2016**

Issued on 28<sup>th</sup> February 2017

Ref: DB/10/17



The Malaysian ICAO Annex 13  
Safety Investigation Team for MH370

Email : [MH370SafetyInvestigation@mot.gov.my](mailto:MH370SafetyInvestigation@mot.gov.my)

## Malaysia Airlines Boeing B777-200ER (9M-MRO), 08 March 2014

Identification of Debris (Item 20 in the “Summary of Possible MH370 Debris Recovered”) recovered from Kosi Bay mouth, Northern Kwa Zulu Natal, South Africa on 21 June 2016

### 1.0 Introduction

This item was recovered from Kosi Bay mouth, Northern Kwa Zulu Natal, South Africa on 21 June 2016. It was identified as Item No. 20 of the items recovered; refer to the “*Summary of Possible MH370 Debris Recovered*”.



The item was brought back to Malaysia for identification and further examination by the “Malaysian ICAO Annex 13 Safety Investigation Team for MH370”.

## 2.0 Part Characteristics

The part was Carbon Fibre Reinforced Plastic (CFRP), honeycomb sandwich design. It had non-metallic honeycomb core. The part was measured to be approximately 12 in. by 20 in. size and weighed 0.315 Kg.

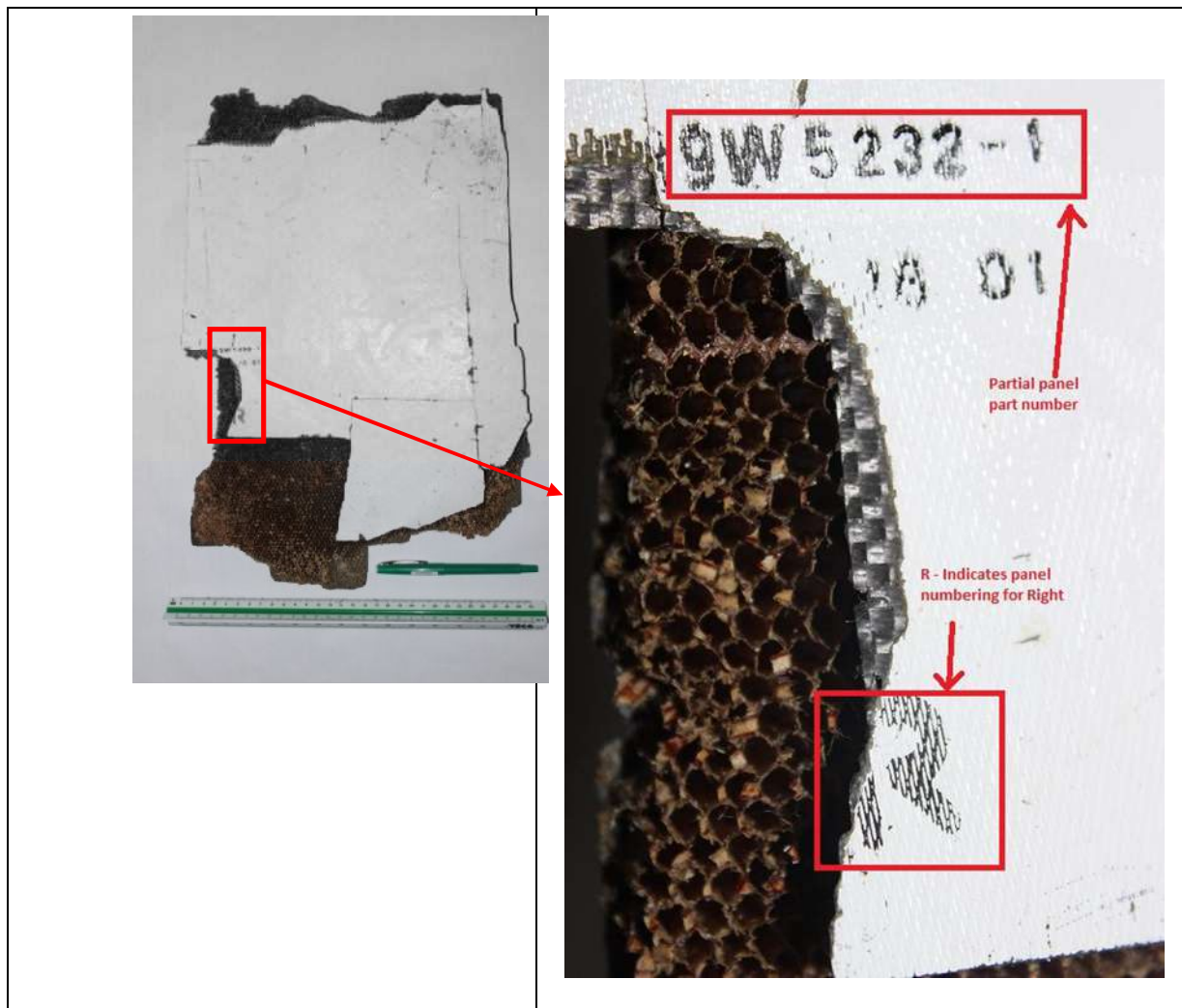

## 3.0 Identification

Part of the identification number was visible on the debris indicating that it is part of the right aft wing to body fairing panel, 196 MR. Part of the part number, 149W5232-1, was visible with the letter 'R' below it, indicating it is a panel on the right side of the aircraft.

The location of where the part was found, considering that MH370 (aircraft registered as 9M-MRO) ended its flight in the South Indian Ocean, is consistent with the drift path modeling

produced by the Commonwealth Scientific and Industrial Research Organisation (CSIRO). This suggests that the part is highly likely from MH370 given that the likelihood of it originating from another source is very remote. The Australian Transport Safety Bureau (ATSB) reports on the drift modeling can be found at [http://www.atsb.gov.au/media/5772107/ae2014054\\_final-first-principles-report.pdf](http://www.atsb.gov.au/media/5772107/ae2014054_final-first-principles-report.pdf) and [http://www.atsb.gov.au/media/5771939/ae-2014-054\\_mh370-search-and-debris-update\\_2nov-2016\\_v2.pdf](http://www.atsb.gov.au/media/5771939/ae-2014-054_mh370-search-and-debris-update_2nov-2016_v2.pdf).

#### **4.0 Structure Examination**

This part was fractured on all sides. Visual examination of the fracture lines indicated that the fibers appeared to have pulled away with no sign of kink on the fibers.

#### **5.0 Conclusion**

This item is confirmed to be part of the right aft wing to body fairing panel from a B777 aircraft. It is highly likely to be from MH370 (aircraft registered as 9M-MRO).





# DEBRIS EXAMINATION REPORT

## SAFETY INVESTIGATION FOR MH370

**Malaysia Airlines MH370 Boeing B777-200ER (9M-MRO)  
08 March 2014**

**Identification of Debris (Item 21 in the “Summary of Possible MH370 Debris Recovered”) recovered from Northern Kwa Zulu Natal, South Africa on 18 July 2016**

Issued on 28<sup>th</sup> February 2017

Ref: DB/11/17



The Malaysian ICAO Annex 13  
Safety Investigation Team for MH370

Email : [MH370SafetyInvestigation@mot.gov.my](mailto:MH370SafetyInvestigation@mot.gov.my)

## Malaysia Airlines Boeing B777-200ER (9M-MRO), 08 March 2014

### Identification of Debris (Item 21 in the "Summary of Possible MH370 Debris Recovered") recovered from Northern Kwa Zulu Natal, South Africa on 18 July 2016

#### 1.0 Introduction

This item was recovered from Northern Kwa Zulu Natal, South Africa on 18 July 2016. It was identified as No. 21 of the items found; refer to the "*Summary of Possible MH370 Debris Recovered*".



The item was brought back to Malaysia for identification and further examination by the "Malaysian ICAO Annex 13 Safety Investigation Team for MH370".

## 2.0 Part Characteristics

The debris was observed to be of Carbon Fiber Reinforced Plastic (CFRP) honeycomb sandwich construction. The honeycomb core was non-metallic. The grey paint top coat was still intact. It was triangular in shape with an approximate length of 21 in. and weighed 0.87 Kg.



## 3.0 Identification

Based on the structure construction, this part could be a small section of a panel from an aircraft. There were no identification numbers on the part and it could not be positively determined from which aircraft and which section it could have come from.

## 4.0 Structure Examination

The part was fractured on all sides except on one edge. Some fasteners were still intact in position. The fibers appeared to be pulled and not kinked.

## 5.0 Conclusion

It could not be positively determined whether the debris could be from a B777 aircraft.



# DEBRIS EXAMINATION REPORT

## SAFETY INVESTIGATION FOR MH370

**Malaysia Airlines MH370 Boeing B777-200ER (9M-MRO)  
08 March 2014**

**Identification of Debris (Item 22 in the “Summary of Possible MH370 Debris Recovered”) recovered at Linga Linga beach, Mozambique on 26 August 2016**

Issued on 28<sup>th</sup> February 2017

Ref: DB/12/17



The Malaysian ICAO Annex 13  
Safety Investigation Team for MH370

Email : [MH370SafetyInvestigation@mot.gov.my](mailto:MH370SafetyInvestigation@mot.gov.my)

## Malaysia Airlines Boeing B777-200ER (9M-MRO), 08 March 2014

### Identification of Debris (Item 22 in the “Summary of Possible MH370 Debris Recovered”) recovered at Linga Linga beach, Mozambique on 26 August 2016

#### 1.0 Introduction

This debris was recovered at Linga Linga beach, Mozambique on 26 August 2016. The part is identified as Item No 22 of the items found; refer to the “*Summary of Possible MH370 Debris Recovered*”.



The item was brought back to Malaysia for the identification and further examination by the “Malaysian ICAO Annex 13 Safety Investigation Team for MH370”.

#### 2.0 Part Characteristics

It was of Graphite Fibre Reinforced Plastic (GFRP) honeycomb sandwich with Aluminum honeycomb. The part was measured and observed to have an overall dimension of 48 in. in length and weighed 4.77 Kg.

### 3.0 Identification

On the interior side of the part, there was still a decal with part identification numbers. Refer to the picture below. The Assembly (Assy) Number 177W3103-8 was visible. When referred to the Boeing 777 Illustrated Parts Catalog (IPC) this part was confirmed to be the right vertical stabilizer panel between the auxiliary and front spar. The red/white paint on the panel and the paint configuration appeared to match that of the Malaysia Airlines 'kite' logo on the right side of the vertical stabilizer. Refer to the photos below.





**BOEING**  
777  
**PARTS CATALOG (MAINTENANCE)**

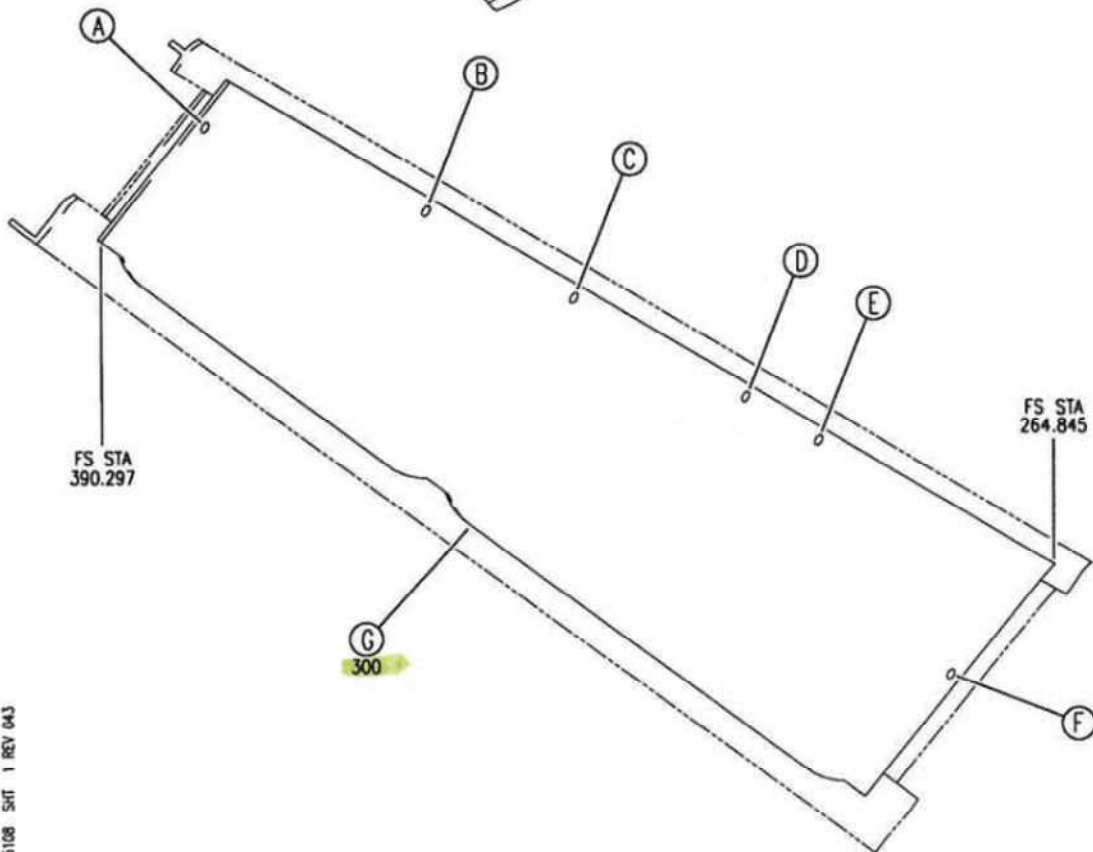
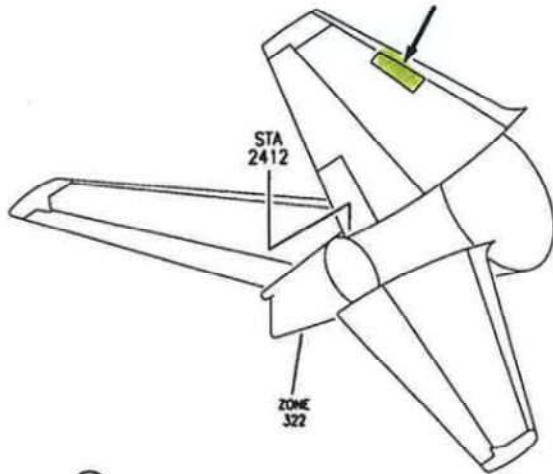

3345108 SHIT 1 REV 043



#### 4.0 Structure Examination

The outer skin had slightly buckled and dented but the inner skin was fractured in several places.

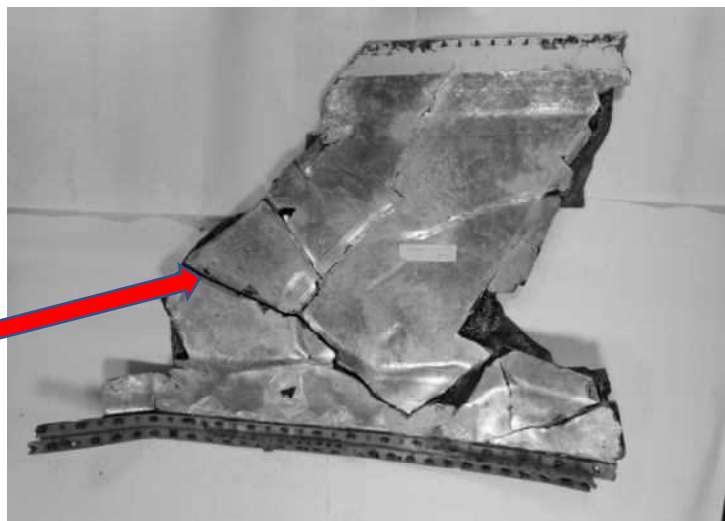

The internal laminate seems to be squashed

#### 5.0 Conclusion

The debris is confirmed to be part of the right vertical stabilizer panel of a B777. Based on the red/white livery on the panel it is determined to be almost certain from MH370 (aircraft registered as 9M-MRO).



# **DEBRIS EXAMINATION REPORT**

## **SAFETY INVESTIGATION FOR MH370**

**Malaysia Airlines MH370 Boeing B777-200ER (9M-MRO)  
08 March 2014**

**Identification of Debris (Item 23 in the “Summary of Possible MH370 Debris Recovered”) recovered from Riake Beach, Nosy Bohara Island, Madagascar in October 2016**

Issued on 28<sup>th</sup> February 2017

Ref: DB/13/17



The Malaysian ICAO Annex 13  
Safety Investigation Team for MH370

Email : [MH370SafetyInvestigation@mot.gov.my](mailto:MH370SafetyInvestigation@mot.gov.my)

## Malaysia Airlines Boeing B777-200ER (9M-MRO), 08 March 2014

### Identification of Debris (Item 23 in the "Summary of Possible MH370 Debris Recovered") recovered from Riake Beach, Nosy Bohara Island, Madagascar in October 2016

#### 1.0 Introduction

This item was recovered from Riake Beach, Nosy Bohara Island, Madagascar in October 2016. The item is identified as Item No 23 of the items recovered; refer to the "***Summary of Possible MH370 Debris Recovered***".



The item was brought back to Malaysia for the identification and further examination by the "***Malaysian ICAO Annex 13 Safety Investigation Team for MH370***".

#### 2.0 Part Characteristics

It was a basic composite part with non-metallic honeycomb core. The laminate was obviously not made of carbon fiber since it was brown in colour. The part was measured to be approximately 20 in. in length and weighed 0.545 Kg.



### 3.0 Identification

The part was taken to a B777-200ER, formally operated by Malaysia Airlines (MAS), undergoing a maintenance check at Subang, Malaysia, for identification purposes. The part structure construction characteristics showed that it was not part of the aircraft structure. It appeared more likely to be from the aircraft interior based on the vinyl and edge sealant which was on the part. The vinyl and sealant colour on the part matched that of the parts generally used in aircraft galleys.

#### **4.0 Structure Examination**

The fractured fibres on the item indicated the fibres were pulled out which could indicate tension failure on its structure.

#### **5.0 Conclusion**

Although it appeared to be part of an aircraft interior there is no conclusive evidence to indicate whether the part could have actually originated from an aircraft.



# DEBRIS EXAMINATION REPORT

## SAFETY INVESTIGATION FOR MH370

**Malaysia Airlines MH370 Boeing B777-200ER (9M-MRO)  
08 March 2014**

**Identification of Debris (Item 25 in the “Summary of Possible MH370 Debris Recovered”) recovered from Riake beach, Nosy Boraha Island, Madagascar in July 2016**

Issued on 28<sup>th</sup> February 2017

Ref: DB/14/17



The Malaysian ICAO Annex 13  
Safety Investigation Team for MH370

Email : [MH370SafetyInvestigation@mot.gov.my](mailto:MH370SafetyInvestigation@mot.gov.my)

## Malaysia Airlines Boeing B777-200ER (9M-MRO), 08 March 2014

### Identification of Debris (Item 25 in the “Summary of Possible MH370 Debris Recovered”) recovered from Riake beach, Nosy Boraha Island, Madagascar in July 2016

#### 1.0 Introduction

This item was recovered from Riake beach, Nosy Boraha Island, Madagascar in July 2016. It was identified as item 25 of the items recovered; refer to the *“Summary of Possible MH370 Debris Recovered”*.



The item was brought back to Malaysia for examination and identification by the *“Malaysian ICAO Annex 13 Safety Investigation Team for MH370”*.

#### 2.0 Part Characteristics

It was of Carbon Fibre Reinforced Plastic (CFRP) honeycomb sandwich construction. The outer and inner skins were carbon fibres and the core was non-metallic. The outer skin was grey in colour.



### **3.0 Identification**

The part was taken to a B777-200ER, formally operated by Malaysia Airlines (MAS), undergoing a maintenance check at Subang, Malaysia, for identification purposes. There were no identification numbers on the part and with the available features it could not be matched to any part on the aircraft.

### **4.0 Structure Examination**

The part was fractured on all sides and some portion of the inner skin had peeled off from the core. Some section of the skin and core were crushed. Visual examination of fibers showed that they were rough and there was no visual evidence of the fibers being kinked.

### **5.0 Conclusion**

The debris was not identifiable to be from a B777 aircraft.