



United Nations
Educational, Scientific and
Cultural Organization

International Centre for the Study of
the Preservation and Restoration of
Cultural Property



Endangered Heritage

Emergency Evacuation of Heritage Collections



United Nations
Educational, Scientific and
Cultural Organization

International Centre for the Study of
the Preservation and Restoration of
Cultural Property



Endangered Heritage Emergency Evacuation of Heritage Collections

Published by the United Nations Educational, Scientific and Cultural Organization (UNESCO), 7, place de Fontenoy, 75352 Paris 07 SP, France, & by the International Centre for the Study of the Preservation and Restoration of Cultural Property (ICCROM), Via di San Michele 13, 00153 Rome, Italy.

© UNESCO and ICCROM, 2016

UNESCO ISBN 978-92-3-100162-8

ICCROM ISBN 978-92-9077-247-7



This publication is available in Open Access under the Attribution ShareAlike 3.0 IGO (CC-BY-SA 3.0 IGO) license (<http://creativecommons.org/licenses/by-sa/3.0/igo/>). By using the content of this publication, the users accept to be bound by the terms of use of the UNESCO Open Access Repository (<http://www.unesco.org/open-access/terms-useccbysa-en>) as well as by the terms of the future ICCROM Open Access Repository.

The designations employed and the presentation of material throughout this publication do not imply the expression of any opinion whatsoever on the part of UNESCO concerning the legal status of any country, territory, city or area or of its authorities, or concerning the delimitation of its frontiers or boundaries.

The ideas and opinions expressed in this publication are those of the authors; they are not necessarily those of UNESCO and of ICCROM and do not commit the Organizations.

Co-Creation:

Concept and text in English	Aparna Tandon, ICCROM
Images	Abdel Hamid Salah, EHRF – Egyptian Heritage Rescue Foundation
Information design and visualisation	Visuality - www.visuality.be
Printing	ICCROM-ATHAR
Research	Eugénie Crété & Alessia Strozzi, for ICCROM Amira Sadik, HebatAllah AbdelHamid, Dalia Hassan & Sara Nor, EHRF
Coordination	Catherine Antomarchi, Aparna Tandon & Isabelle Verger, ICCROM Nao Hayashi, UNESCO

Preface by UNESCO

In 1945, after the devastation and destruction of World War II, UNESCO was created on the conviction that lasting peace can only be built in the minds of women and men, on the basis of dignity, equality and mutual respect. Museums are ideally placed to share this vision. No longer mere temples of erudite scholarship and keepers of artefacts, they play a vital role in education, social cohesion and sustainable development by stimulating intellectual exchange and creativity and as symbols of identity. The international community has acknowledged that museums continue to fulfil a wide variety of useful functions for society at large. The great potential of museums in fulfilling our common mission has been all the more apparent in recent years as witnessed by the adoption by all Member States of UNESCO, in November 2015, of the Recommendation concerning the Protection and Promotion of Museums and Collections, their Diversity and their Role in Society, 55 years after the adoption of the previous global recommendation on the subject in 1960. Over the past decades, museums and heritage institutions have increasingly become the target of violent extremists. When museums are threatened for their role in protecting and valorizing precious witnesses of the past and human creativity, it is their intrinsic value for intercultural dialogue and mutual understanding that we must protect and support. Museums and their staff have gone through challenging times also due to natural disasters and climate change. Together with ICCROM, our long-term partner, UNESCO stands united with the international heritage community to increase museums' capacity in responding to diverse emergency situations. We also wish to highlight that how to ensure women's participation in decision-making and actions related to heritage is a key challenge for UNESCO, Member States and the international heritage community. It is a necessity for achieving sustainable development. Equally in emergency situations, ensuring women's involvement whenever possible through a multi-stakeholder and contextual approach is desirable for yielding beneficial results for gender-responsive action in national policy-making. It is our sincere hope that these guidelines will serve the best interests of all stakeholders concerned.

Why this handbook?

Protecting cultural heritage during an armed conflict is challenging, and, at times, proves to be life threatening. Yet communities trapped in war zones valiantly try to save their cultural heritage, as it provides a sense of continuity amid turmoil and uncertainty. A striking example of a community-led rescue of cultural heritage is the successful evacuation of the privately held manuscript collections from Timbuktu during the conflict that broke out in northern Mali in 2013.

This handbook is the result of insights gained from similar on-the-ground experiences collected through ICCROM's capacity building initiative on First Aid to Cultural Heritage in Times of Crisis. It provides step-by-step guidance for evacuating cultural collections under extreme conditions. It is meant to assist those communities and institutions, which are trying to prevent the destruction and looting of cultural objects during a crisis situation. It can be used to train others and to improve emergency preparedness at cultural sites.

Considering that no two emergency situations are alike, the handbook describes a simple work flow that can be customized to meet the needs of a specific emergency context. The publishers thank the Egyptian Heritage Rescue Foundation (EHRF), a Cairo based non-governmental organisation for field-testing this work flow. EHRF is a team of 97 women and men trained to provide first aid to cultural heritage in crisis situations. In 2014, the team was called upon to salvage the collection of the Museum of Islamic Art of Cairo which was damaged due to a bomb attack at a nearby police station.

Every effort has been made to ensure that the information provided in this publication is relevant. Nonetheless, the publishers would like to present it as a work in progress and invite the feedback of the users.

When to evacuate?

The decision to evacuate a threatened collection of objects from a museum or an archaeological site is an important one. If not thought out carefully, a hastily executed move can expose valuable cultural objects to newer and unforeseen threats. That is why this decision should be taken only if all the following conditions are met:

- the threat to your institution is real;
- the current measures in place would not be able to prevent damage to your collection;
- safer place for storage of the collection is available;
- formal authorization to evacuate and relocate objects has been secured;
- you have sufficient man-power and resources to relocate the endangered collection;
- there is no threat to the personal safety and security of the people involved in the operation.

How to evacuate?

In the next chapters we will describe the [workflow](#) of an evacuation.

- 1** Assess
- 2** Prepare
- 3** Document, pack and move
- 4** Relocate and store



The Workflow

you are here →

ASSESS

PREPARE

DOCUMENT,
PACK AND MOVE

RELOCATE
AND STORE

ASSESS



PREPARE



DOCUMENT,
PACK AND
MOVE



RELOCATE
AND STORE



Assess

- 1 ASSESS THE THREAT
- 2 BLOCK THE THREAT
- 3 PRIORITISE OBJECTS

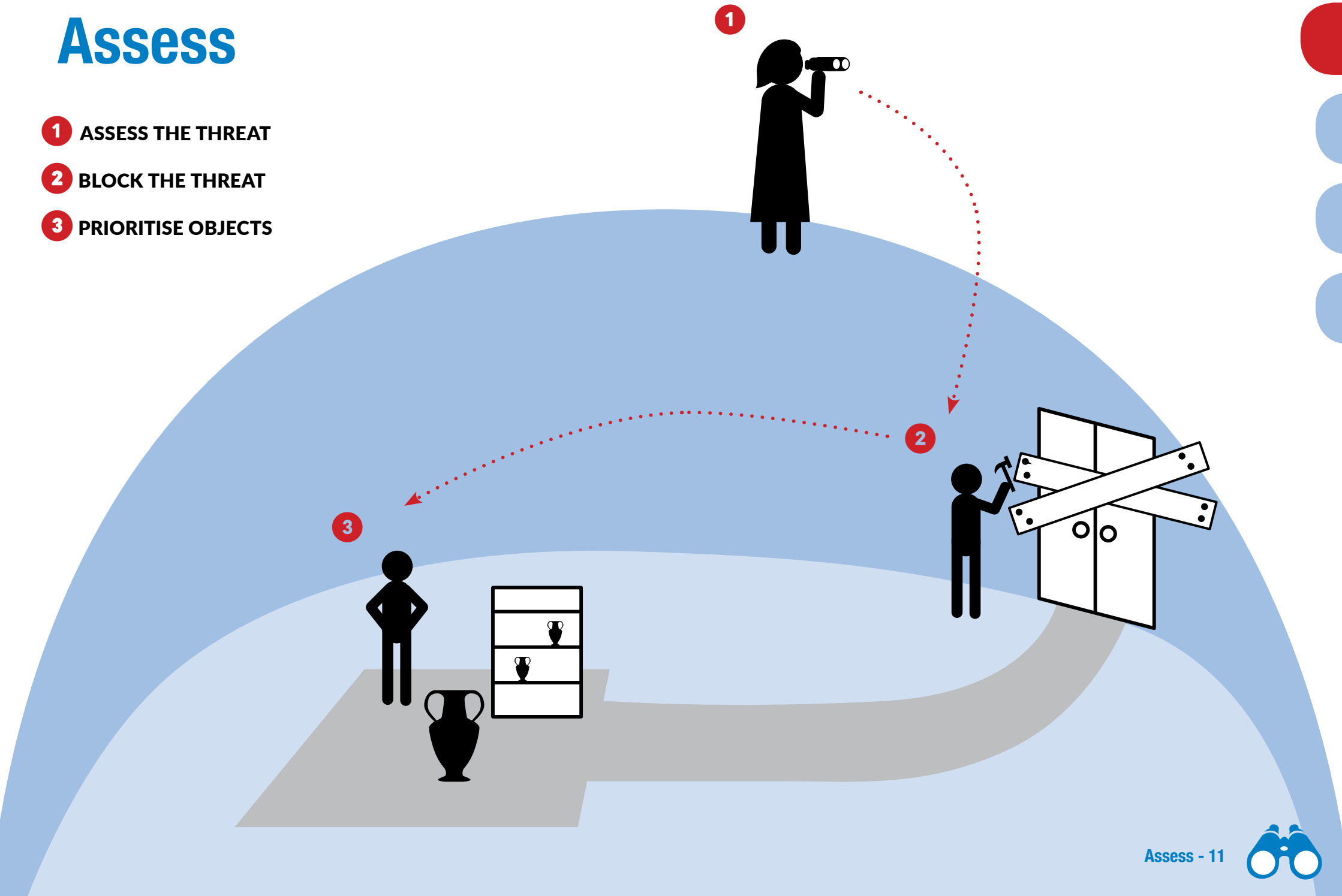

1 ASSESS THE THREAT

Assess if the threat is real.

To begin with, analyse the likelihood of a particular threat e.g. a flood or a riot affecting your institution. Often the location of an institution makes it more vulnerable to a specific threat. For example, a violent riot in the vicinity of a museum poses a threat to its safety. In such a scenario, the concerned staff should treat the threat of vandalism and/or looting as real and take proper counter measures.

Similarly an archaeological site would be considered unsafe if it is located near a water body that is overflowing.



2 BLOCK THE THREAT

Block the threat or prevent it from entering.

Once you have ascertained that the threat is real, try to ensure that there are counter measures in place that would effectively block a certain threat from entering your site. These measures have to be threat specific.

This is best demonstrated through an example. Consider a scenario where a museum has to be protected from armed looters. Threat specific counter measures in this case may include:

- Deployment of additional security personnel to guard the museum building;
- Putting up of concrete barriers around the museum building and/or boarding up of the doors and windows to block forceful entry.

If for some reason, the museum under threat is unable to adopt such measures, in that case, the concerned authorities should prepare to evacuate both the staff and the collections.

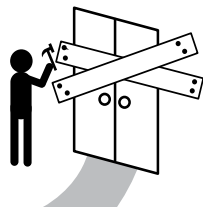

3 PRIORITISE OBJECTS

Prepare a list of objects that have to be evacuated first.

Prepare a list of priority items.

Consult with the officer-in-charge or the custodian, and check the previous documentation to identify the most valuable objects that have to be evacuated first. For easy identification, mark such objects by placing small pieces of paper next to them.

In case the information about the significance of the individual objects is not available, prepare the list of priority items by identifying objects that are more exposed to a specific threat.

A simple way of doing so is to trace the likely routes through which a threat could enter your institution, and then list those objects that would fall within the easy reach of the threat from these routes. As explained above, use small pieces of paper to identify these objects and their respective locations.

Example: If armed looters can enter a museum through its front entrance, then the objects housed in the surrounding area could be easily damaged or looted.

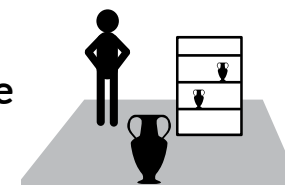

⚠ Caution: In some situations, it is difficult to ascertain the route of the threat. A typical example is that of an archaeological site in the middle of a conflict zone, which could be fired upon from any direction.

How to prioritise when the value of the objects and the likely routes of a threat are not known?



In case the significance of the endangered objects or the possible route of the threat is not known, the following criteria could be used to prepare a list of priority items:

a) Material of the object

Generally speaking, organic materials such as paper, wood, textile and bone can be easily harmed by fire, water and biological or chemical contaminants. Physical forces can cause structural damage to inorganic materials such as glass, ceramic and clay. Thus, objects made from organic materials and those fabricated from fragile inorganic materials like glass should be secured first.

b) Size and weight of the object

You may not have sufficient time or resources to evacuate oversized objects or the ones that are extremely heavy e.g. lifted mosaics or wall size framed oil paintings. Such objects should be secured in-situ.



Prepare

- 1 SAFE LOCATION & ROUTE
- 2 PERMISSION
- 3 CREATE TEAM
- 4 ASSIGN A UNIQUE NUMBER AND A LOCATION CODE
- 5 PREPARE EMERGENCY EVACUATION INVENTORY
- 6 GATHER SUPPLIES
- 7 IDENTIFY WORKSPACE
- 8 SAFE TRANSPORTATION

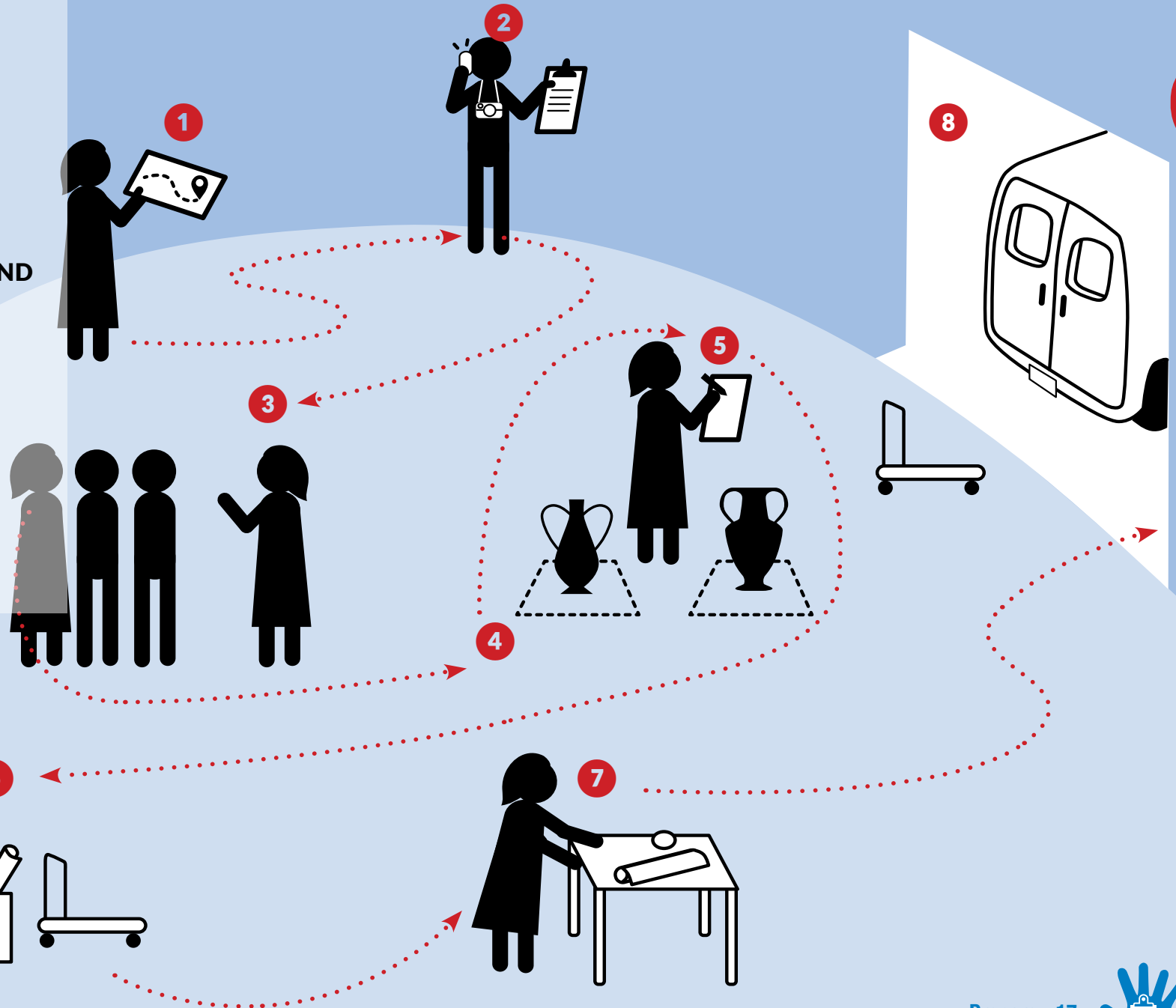

1 SAFE LOCATION & ROUTE

Identify a safe location and a safe route.

Once you have identified the number and the type of objects that have to be evacuated, find a safe location that can serve as a place for their temporary storage. While choosing such a space make sure that:



- 1 it is large enough to accommodate the number of objects that have to be relocated;
- 2 it is sanitized and does not have any pest or mould infestations;
- 3 it is airy and not damp or humid;
- 4 it is secure against theft or vandalism;
- 5 it is accessible through a route that would allow the safe transportation of the objects, and if needed, objects could be left in it for an indeterminate period.

⚠ Caution: Experience has shown that once moved, objects can remain in temporary storage for several years. Keep this in mind while selecting the storage space.

2 PERMISSION

After the identification of a safe location, seek official permission from the concerned authorities to evacuate and temporarily relocate the objects.



3 CREATE TEAM

Constitute a team for the operation.

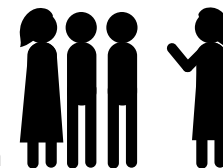

It should include all the officials who are directly in charge of the threatened collection. The team must have a leader, who can in turn explain the scope and the aims of the operation as well as assign specific tasks to team members. These tasks include:

- documentation;
- handling and packing;
- transportation;
- organization of the temporary storage.

⚠ Caution: Communication and coordination between team members who are performing different tasks is crucial for the success of the operation. Therefore, identify effective but safe means of communication between team members that do not threaten the security of the operation.

How to enhance coordination between team members?



- 1 Divide the team into smaller units and assign specific tasks to each unit;
- 2 Ensure that someone is responsible for each unit and act as focal point;
- 3 Ask the focal points to provide regular updates on the work done by their respective units;
- 4 Develop a common system of documentation in order to enhance coordination.



4 ASSIGN A UNIQUE NUMBER AND A LOCATION CODE



Assign a unique number and identify the location of each object.

- Before moving an object, give it a unique identification number so that you can track its movement during the operation. Ensure that the numbering system developed for the purpose of the evacuation is simple, uniform and understood by all involved. It could be just a number in ascending order, or a combination of a letter and a number e.g. C32, where C refers to the name of the institution.

⚠ Caution: In most cases, objects are likely to have numbers previously given by the owner institution. Sometimes you may even find more than one number. All previous numbers must be recorded in the Emergency Evacuation Inventory (see page 22).

- Assign a location code. A location code is usually made up of letters and numbers and is used to find an object within a given space. Ideally, previous documentation should include a location code system. If it is not the case, create a simple location code system which is easy to understand.

Tip: How to make a location code for an object?



The location code should include:

- the institution site code (letters)
- floor number (applicable only when the objects are located at different floors)
- room number
- cabinet or shelf number

Example: the location code of an object number 128 owned by Craft Gallery and located in cabinet A, room number 1 on the ground floor will be: CG. 0.1.A.128

- Attach a label to the object indicating its assigned unique number and location code.

⚠ Caution: Avoid the use of pressure sensitive tape or staples to attach label to the object.

- Take photos of the room and those of the cabinets and shelves containing the objects to be evacuated. Make sure that the labels of the objects are visible in the photos. Alternatively, make a floor plan of the room using pillars and openings as points of reference and then write location codes indicating the physical location of the objects to be moved. If objects are displayed on the walls, make a sketch of the walls, and then write the location codes of the objects on it.

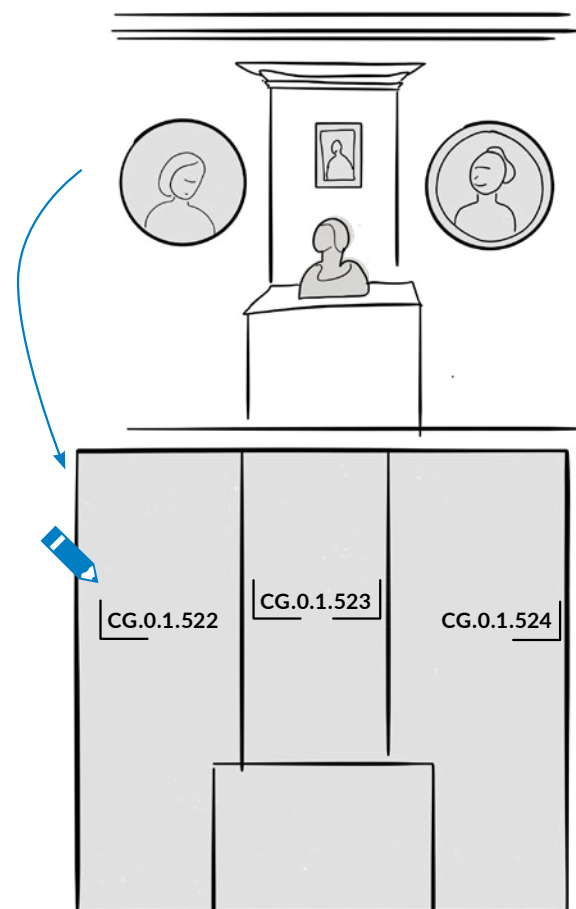

5 PREPARE EMERGENCY EVACUATION INVENTORY

Prepare an inventory for the purpose of evacuation.

Previous documentation, if available, can help to carry out this task. An emergency evacuation inventory may include the following fields of information:



Entry number	Previous number	Assigned identification number	Type of object	Materials	Dimensions: length, width, height	Weight	Original location code	Photo or floor plan reference number	New location	Photo or floor plan reference number
--------------	-----------------	--------------------------------	----------------	-----------	-----------------------------------	--------	------------------------	--------------------------------------	--------------	--------------------------------------

In ascending numerical order, from 1 to the last object moved, it indicates the number of objects evacuated.

This field is to record the unique identification number assigned to the object for the purpose of evacuation.

Object type: use it to briefly describe the object e.g. illustrated manuscript, sculpture, vessel, etc.

What the object is made of: e.g. glass, ceramic, metal, textile, etc.

Fill in the weight of the object. If, a weighing scale is not available, use symbols such as + to indicate the weight. For example, if an object can be easily handled and moved by one person use +; similarly, if two persons are required to lift it, use ++ and +++, if special equipment is required for lifting and transporting it.

List the original location code of the object as explained in step 4.

This field should be filled in once the evacuation is completed and objects are moved into their new safer location.

All pictures and floor plans should have a reference number.



6 GATHER SUPPLIES

Gather the necessary supplies for documenting, handling, packing, transporting and storing objects. Make sure that the evacuation team has access to suitable personal safety equipment such as masks, gloves and crash helmets. While collecting the safety equipment, keep in mind the nature of the threat and the type of objects to be handled.



See Annex (page 51) for a list of possible materials that can be used for documenting, handling, packing, transporting and storing cultural objects.



7 IDENTIFY WORKSPACE

Identify an area or an empty room at the site of evacuation that can be used as a workspace for documenting and packing objects. It should be large enough to accommodate at least two big tables, and have room for keeping packing materials and other relevant supplies.

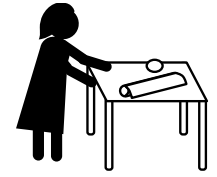

8 SAFE TRANSPORTATION

Identify the safest way to transport objects from the endangered site to the new location. Make sure that the time needed for safe transportation is included in the workflow.



Document, Pack and Move

- 1 ORGANIZE**
- 2 FILL EMERGENCY EVACUATION INVENTORY**
- 3 PREPARE WORKSPACE**
- 4 PACK OBJECTS**
- 5 LABEL TRACK AND MOVE**
- 6 CHECKLIST**

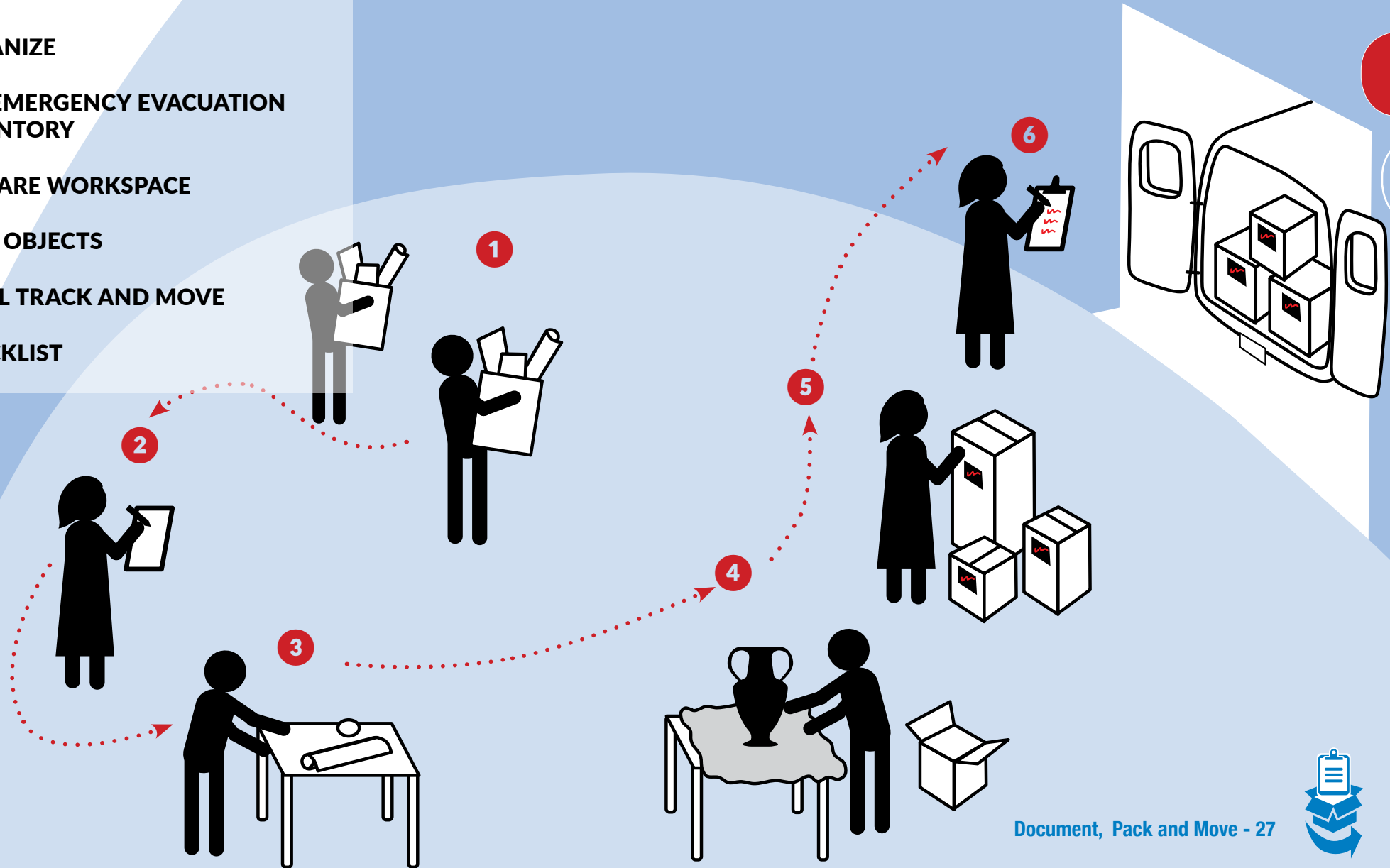

1 ORGANIZE

After all the preparations have been made, the team should collect the necessary supplies and begin the operation.



2 FILL EMERGENCY EVACUATION INVENTORY

After labelling and recording the physical location of the objects to be evacuated (see page 20), the sub-team in charge of the documentation may fill in the inventory prepared for the purpose of evacuation (see page 22).



3 PREPARE WORKSPACE

At the same time the handling and packing team could prepare the work space while the documentation team is filling in the inventory (see page 19).



4 PACK OBJECTS



Once all the objects to be evacuated have been recorded in the inventory, carry them to the prepared workspace, and start the work of packing them. Ensure that a copy of the completed inventory accompanies the objects.

Tips for Handling Cultural Objects



Before touching an object, ensure that your hands are clean and dry, and remain so throughout the process.

- 1 In order to handle objects that are dusty or contaminated, use nitrile or vinyl gloves.
- 2 To avoid fingerprints on photographs, drawings, and objects with painted or highly polished surfaces, always wear gloves.
- 3 If objects are stored in a dusty environment, wear a mask to protect yourself.
- 4 When you are using gloves, make sure that they are the right size and fit your hands; otherwise you may damage or drop the object inadvertently.
- 5 In order to avoid transferring dirt from one object to another, change the gloves when they get dirty.
- 6 While handling, ensure that your clothes or accessories such as jewellery do not scratch or become entangled with the object.
- 7 Before transporting objects from one place to another, identify a clear path that has no obstructions such as furniture in the middle.
- 8 Always ask for help to handle oversize or heavy objects, and while transporting them appoint someone to open doors.
- 9 In order to avoid accidents or breakage, do not carry too many objects at a time.



- 10** Use containers, boxes, or trays to move objects.
- 11** For carrying objects at a distance use trolleys, if possible.
- 12** Do not handle objects from their handles or spouts.
- 13** Always use both hands to hold the object. To ensure that the weight of the object is balanced, place one hand underneath the object and cradle it with the other hand.
- 14** For handling works of art on paper, documents and fragile plant based materials such as papyrus use rigid supports e.g. cardboard to transport them. To avoid displacement during transportation, cover with another rigid support.
- 15** Always transport fragile objects in boxes of suitable sizes and add cushioning materials to avoid accidental jerks.
- 16** Be careful while handling objects with sharp corner or edges, and if possible, cover them with cloth or paper or bubble wrap in order to avoid injuries or damage to other objects.
- 17** Before transporting an object, secure and support any loose or detachable parts of an object. This way you can minimise the risk of damage or theft.





Tips for Packing Cultural Objects

- 1** Incorrect packing can cause lasting physical damage to cultural objects, as they are normally fragile due to their age or past usage. That is why while packing such objects for an emergency evacuation, it is important to consider the following:
 - The packing materials used should protect the surface of the object and at the same time they should protect the object from shock, vibrations, dust and other pollutants, and sharp fluctuations in the outside environment.
 - In order to avoid strain or deformation, materials used for packing should conform the shape and size of the object.
 - It should be easy to identify the object within its package. This will help to minimise its handling.
- 2** For choosing the right packing materials, it is important to identify the materials used to fabricate the objects that have to be packed. For example, to pack paper based objects or textiles, it is important to ensure that they are not placed in a container that might release acidic vapours (e.g. anything made with freshwood, plywood, etc.)
- 3** From the materials available, choose the best quality to use in direct contact with the object. Generally, unstarched cotton or muslin that has not been dyed can be safely used for wrapping most organic and inorganic materials.
- 4** While gathering materials for packing, try to choose materials that you can use for different purposes. This will help to cut costs and ensure the efficient use of resources.
- 5** For packing objects, select those boxes that have lids and are sturdy enough to be stacked under other boxes.
- 6** If you are using a second hand box or container, ensure that it has no contaminants such as remnants of vegetables, pests or chemicals.



- 7** Pack the objects made from similar materials together. However, use partition or cushioning materials to prevent contact between objects.
- 8** Do not put lightweight and heavy objects in the same carrying box/crate as during transportation, heavy objects can fall over the light ones and cause stress.
- 9** Once you have placed the object (s) in a crate or a box, fill the voids with cushioning materials to prevent displacement of the object and to absorb shocks.
- 10** For packing valuable documents or works of art on paper or papyrus, use flat boxes. Alternatively, wrap the object in a good quality paper such as the paper made from cotton rags, and then place it between two rigid supports.
- 11** For packing more than one paper based item, use good quality blank paper sheets to separate individual items. This will help to reduce the risk of ink or colour transfer from one object onto the other.
- 12** In order to retain the shape and structure of a book, wrap it in a good quality paper and then place it spine-down in a box.
- 13** For packing a large and unframed work of art on paper or textile, use an archival quality picture tube and roll the work of art face-out onto the tube. Finally cover the roll with muslin or good quality hand made paper. In case the archival quality tube is not available, use a thick-walled cardboard tube and wrap muslin or good quality paper on it before rolling out the object on it. Make sure that the diameter of the tube is large, as it will help to reduce the risk of damage due to creasing.
- 14** Pack fragile objects fabricated from materials such as terracotta, glass or ceramic in separate plastic bags before placing them in one big container. Use cushioning and/or partition materials to prevent contact with other objects and avoid damage due to abrasion.

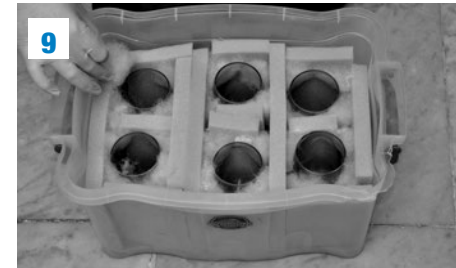

- 15** For ensuring correct packing under emergency conditions, work in an assembly line fashion i.e. assign one person to wrap, another to prepare the box/crate, and another person to label the object with its unique number and place it in the prepared container.
- 16** Ensure that all boxes have labels that indicate the number and type of objects contained in them.
- 17** In order to avoid the wrong handling of the boxes containing objects, mark them with commonly used signs (as illustrated below) to indicate fragility, top/bottom, handle with care, and do not turn upside down.

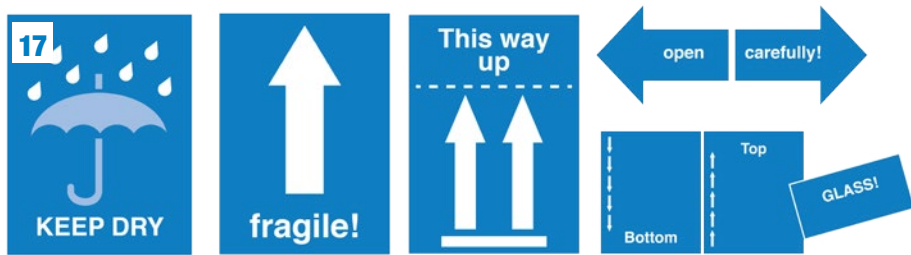

5 LABEL TRACK AND MOVE

While packing the objects, ensure that the labels bearing the identification numbers of objects remain in place. The packing supports should also carry these labels.

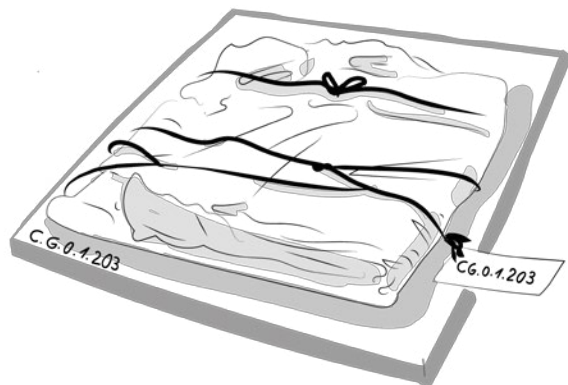
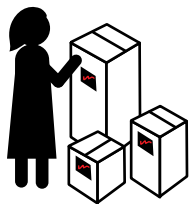

Ensure that at least one member of the documentation unit is tracking the placement of objects in various boxes by filling in a simple form with the following suggested fields. Prepare multiple copies of the movement tracking form.

Movement tracking form

Entry number	Box number	Total number of items in a box	Instructions for handling/ transportation	Dispatched by	Date left	Courier/vehicle number	Date received	Box number	Total number of items in a box	Received by
1	12	20	Glass: handle with care	Abdel Hamid, curator	25 Jan	xxx256	25 Jan	12	20	xxx store keeper
...

Note: The last four columns of the movement tracking are to be filled by the person in charge at the site of the temporary storage.

6 CHECKLIST

Once all objects are packed, they are ready to be transported to the new safer location. The package should include copies of the inventory and dispatch form, as explained in the previous step.

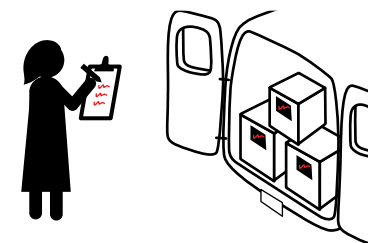

Relocate and Store

- 1 PREPARE SPACE
- 2 SORT OBJECTS
- 3 RECORD NEW LOCATION
- 4 SECURE
- 5 REPORT
- 6 MONITOR

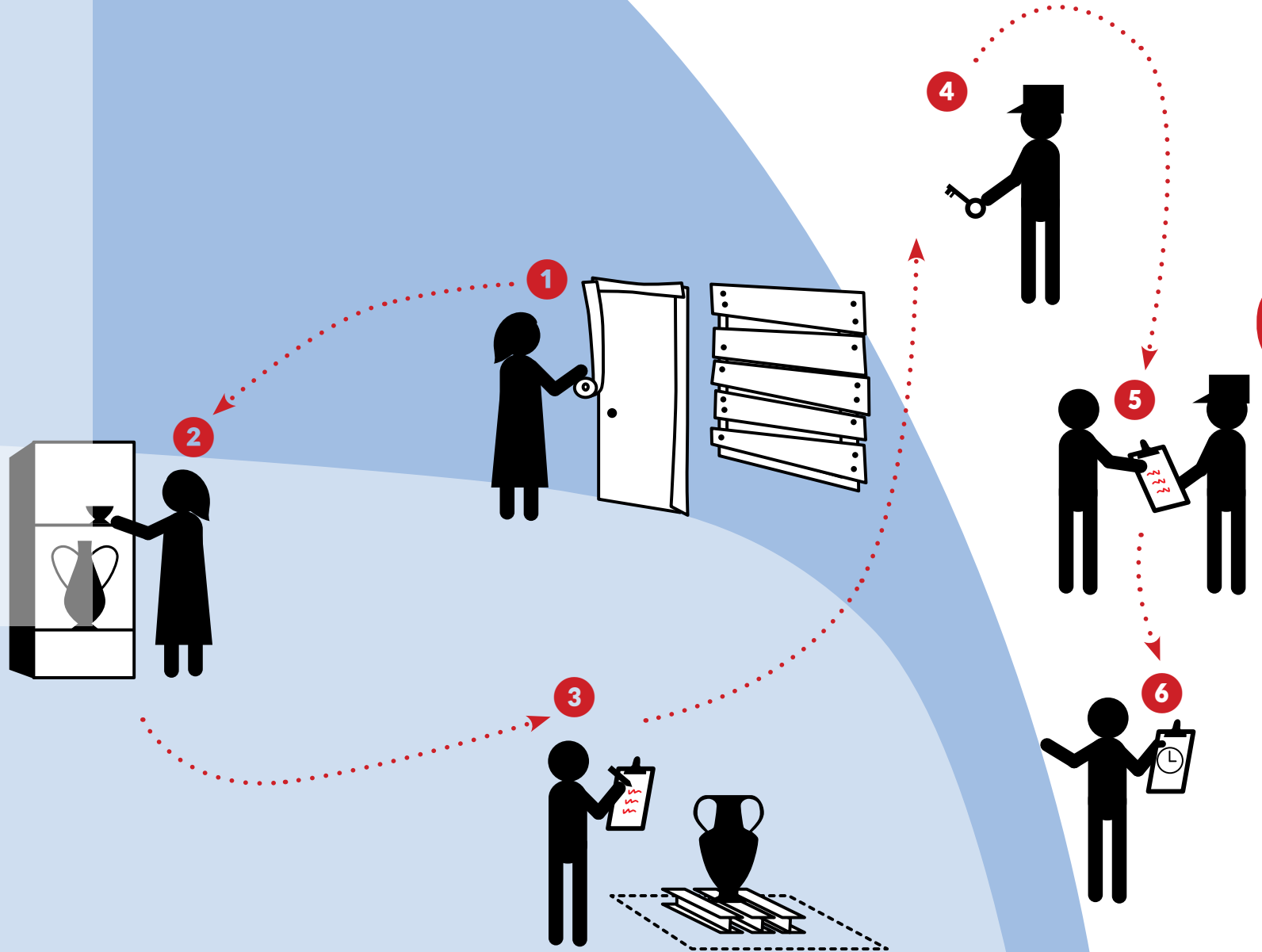

1 PREPARE SPACE

While a part of the team is engaged in documenting and packing the objects, the other part should focus on preparing the storage space at the new site. This includes ensuring that the new location is sanitized and secure (see page 18) and that a location code system is in place.

It is also the time to start thinking together how best to arrange objects in the new space.

Place available furniture accordingly and assign location codes to cabinets and shelves for marking the new location of the objects. Make sure this is done before the arrival of the objects.

It may not be possible to acquire suitable furniture such as shelving units during an emergency evacuation, in which case, objects are to be kept on the floor in their packaging. Use pallets or tarpaulin (water resistant canvas) to avoid direct contact between the boxes containing objects and the floor. If you are using wooden pallets, make sure they are not infested with pests.

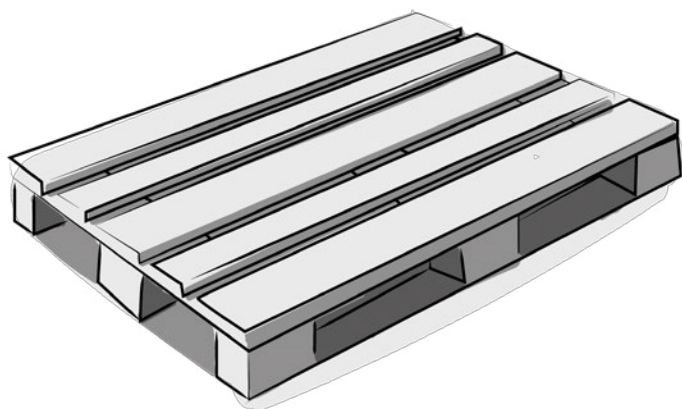

Tip: How to prepare a location code system in a temporary storage space?



A simple way to prepare a consistent location code system is to draw a grid on the floor with paint, adhesive tape or ropes.

To begin with, divide the floor space in squares of a suitable unit length e.g., 1 m x 1 m. Use letters and figures to differentiate between rows and columns. Use labels on the wall to record them.

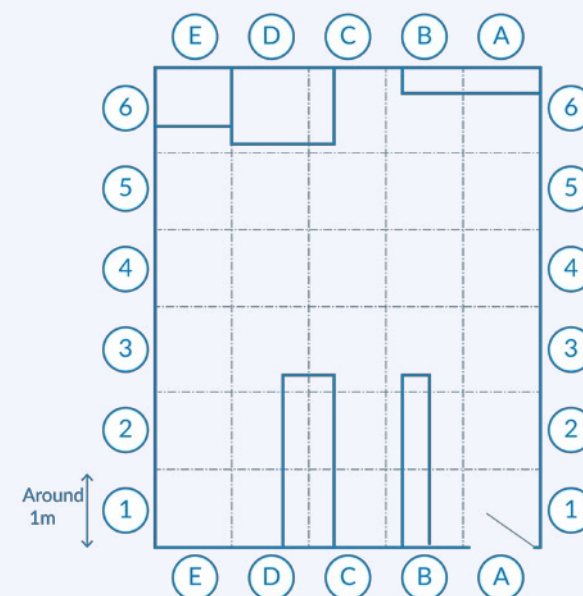

Once the objects are sorted and placed in their respective storage unit, record the complete location code, e.g. NS (New Storage). 0 (ground floor).1 (room number).3A (object location). 128 (assigned unique number), see page 20.



2 SORT OBJECTS

After formally receiving the objects at the new site (see page 40), check the accompanying emergency evacuation inventory and separate the objects as per material type and size. Place the objects (in their packaging) on shelves or sanitized pallets and other such available furniture. Try to keep the fragile objects off the ground and place them at the far end of the room beyond easy reach. Similarly, large or heavy objects should be placed at one end of the room in order to clear space for moving and organizing smaller objects.

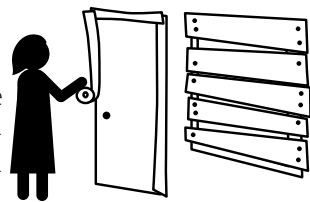

3 RECORD NEW LOCATION

In order to document the physical position of each object in the new temporary storage, note its box number and shelf number under the 'new location' field of the inventory.

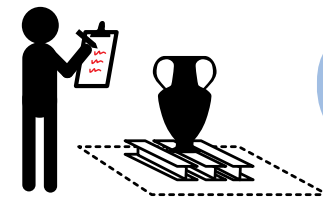

4 SECURE

Take appropriate security measures at the new temporary storage site to prevent theft and vandalism. If needed, post guards.

! Caution: In areas of active conflict, it is important to constantly monitor the security situation so that if needed, there is sufficient time to move the objects to yet another location.

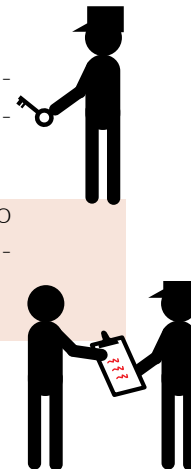

5 REPORT

Provide the updated inventory complete with the new location of objects to the concerned authorities.

6 MONITOR

Develop a routine for cleaning and monitoring the new temporary storage in order to avoid pests, fire, water and other such agents that could cause damage to the objects.



References

Handling and packing

Bendix, C. 2013. *Moving Collections*. London, Preservation Advisory Centre, British Library. Available at: http://www.bl.uk/aboutus/stratpolprog/collectioncare/publications/booklets/moving_library_and_archive_collections.pdf [Accessed 9 December 2015].

Permanent link: <https://perma.cc/35Z6-HCPL>

Heritage Collections Council. 1998. *reCollections: caring for collections across Australia. Handling, Transportation, Storage and Display*. Canberra, Heritage Collections Council. Available at: https://aiccm.org.au/sites/default/files/docs/reCollections/6_htsd.pdf [Accessed 9 December 2015].

Permanent link: <https://perma.cc/6HNW-HAKW>

Museum of London. 2013. *Assessing the Object: What is the object made from?* Available at: <http://www.museumoflondon.org.uk/Resources/e-learning/packing-museum-objects-for-storage/s03p01.html> [Accessed 30 December 2015].

Shelley, M. 1987. *The Care and Handling of Art Objects: Practices in the Metropolitan Museum of Art*. New York, The Metropolitan Museum of Art. Available at: http://www.metmuseum.org/research/metpublications/The_Care_and_Handling_of_Art_Objects_Practices_in_The_Metropolitan_Museum_of_Art [Accessed 16 December 2015].

Permanent link: <https://perma.cc/2DZP-L7QW>

Stolow, N. 1981. *Procedures and conservation standards for museum collections in transit and on exhibition*. Protection of the Cultural Heritage: Technical Handbooks for Museums and Monuments 3. Paris, UNESCO. Available at: <http://unesdoc.unesco.org/images/0004/000468/046862eo.pdf> [Accessed 9 December 2015].

Permanent link: <https://perma.cc/MWK8-HZRE>

UNESCO. 2006a. *Care and Handling of Manuscripts*. Cultural Heritage Protection Handbook No. 2. Paris, UNESCO. Available at: <http://unesdoc.unesco.org/images/0014/001484/148463E.pdf> [Accessed 9 December 2015].

Permanent link: <https://perma.cc/QPQ5-XPW5>

UNESCO. 2006b. *Handling of Collections in Storage*. Cultural Heritage Protection Handbook No. 5. Paris, UNESCO. Available at: <http://unesdoc.unesco.org/images/0018/001879/187931E.pdf> [Accessed 9 December 2015].

Permanent link: <https://perma.cc/AD26-63WK>

Transportation of Collections

Heritage Collections Council. 1998. *reCollections: caring for collections across Australia. Handling, Transportation, Storage and Display*. Canberra, Heritage Collections Council. Available at: https://aiccm.org.au/sites/default/files/docs/reCollections/6_htsd.pdf [Accessed 9 December 2015].

Permanent link: <https://perma.cc/6HNW-HAKW>

Stolow, N. 1981. *Procedures and conservation standards for museum collections in transit and on exhibition*. Protection of the

Cultural Heritage: Technical Handbooks for Museums and Monuments 3. Paris, UNESCO. Available at: <http://unesdoc.unesco.org/images/0004/000468/046862eo.pdf> [Accessed 9 December 2015].

Permanent link: <https://perma.cc/MWK8-HZRE>

Storage Organization

Canadian Conservation Institute. 2002. General Precautions for Storage Areas. *CCI Notes* 1/1. Ottawa. Available at: http://cci-icc.gc.ca/resources-ressources/ccinotesicc/1-1_e.pdf [Accessed 9 December 2015].

Permanent link: <https://perma.cc/2JJ3-897G>

Johnson, E.V. & Horgan, J.C. 1979. *Museum collection storage*. Protection of the Cultural Heritage: Technical Handbooks for Museums and Monuments 2. Paris, UNESCO. Available at: <http://unesdoc.unesco.org/images/0004/000423/042316eo.pdf> [Accessed 9 December 2015].

Permanent link: <https://perma.cc/R33E-CA8N>

Annex

Materials and equipment that could be used for an emergency evacuation of collections

SAFETY GEAR

- **Face masks:** In order to prevent the inhalation of dust and other airborne particles, use a face mask. Use masks with filters if handling objects coated with chemicals.
- **Gloves:** Cotton, nitrile or latex can be used for handling objects. Latex gloves, however, can cause allergic reactions.
- **Safety goggles:** Use safety goggles to protect eyes if you are working in a dusty or otherwise contaminated environment.
- **Safety helmets:** Also known as a hard hat, a safety helmet can be used to protect head from falling objects.
- **Aprons/lab coats:** Use aprons or white lab coats made of linen, cotton or cotton polyester to protect your clothing from contaminants while handling or packing objects.
- **High visibility jackets:** If you are working in dark areas or would like your team to be distinguished easily, use jackets with reflective bands or colours that can be seen from a distance such as those used by emergency responders.
- **First Aid Kit:** Put a first aid kit together for the team. Do include drinkable water, a flash light and spare batteries in the kit.

NOTE: In areas of active conflict, other protective gear such as bulletproof vests, gas masks etc. may be required.

FOR DOCUMENTATION

- 1 **Camera** (with spare batteries) for photo documentation
- 2 **Sketch pads and note pads**
- 3 **Pens and pencils**
- 4 **Twill tape** or cotton tape to tie labels and packages.
- 5 **Self-adhesive labels** to be used on packing supports to write down the identification numbers of the objects. Such labels should not be attached to the surface of the object.

FOR PACKING

We have listed materials that are easily available. However, under extreme conditions it may not be possible to acquire certain materials in large quantities. In such circumstances, use the best materials in direct contact with the object. For Example, use cotton or muslin to wrap the object and then place it in a cardboard box.

- **Muslin [1]:** unstarched and white muslin or fine cotton can be safely used as cushioning material or to wrap most objects. It is also widely available.
- **Pure rag paper [2]:** a good substitute for acid-free tissue and easily available, paper made of cotton and/or linen rags can be used to wrap works of art on paper and textile.
- **Polyester film:** a transparent and colourless plastic sheet used to store photos or other paper documents. It is normally sold as Mylar or Melinex.
- **Tyvek:** a synthetic material made of high-density polyethylene fibers, tyvek can be used to make water resistant covers. It is commonly used to protect buildings during construction.
- **Tarpaulin**
- **Polyethylene Foam [3]:** usually sold as Ethafoam, polyethylene foam can be used as a cushioning material as it can be easily cut out to embed the



- object in its packing in order to absorb shocks.
- **Bubble wrap [4]:** a short-term solution, bubble wraps can be used as shock absorbing materials. However, the bubbled surface should not be in direct contact with the object.
 - **Cushions/pillows:** ordinary cushions and pillows can be used to pack fragile objects.
 - **Towels:** white cotton towels can be used as cushioning material.
 - **Polyethylene bags:** food grade polyethylene bags can be used to pack fragile or small objects.
 - **Cardboard boxes [5]:** ordinary card board boxes can be used as containers for objects. However, as they age, they can give off acidic vapours, which can be harmful for objects. In order to safeguard the objects, it is recommended to line the inside of a box with unstarched and non-dyed cotton or pure rag paper.
 - **Wooden fruit crates:** usually made of poor quality wood; such crates can be used to transport inorganic materials such as stone or clay. However, they must be lined with paper or cotton. Use of such crates is essentially a short-term solution.
 - **Plastic boxes [6]:** transparent containers made of plastic and ordinarily used to store food can serve as containers for fragile or small objects.
 - **Plastic crates:** often used to carry milk cartons or fruits and vegetables, plastic crates are another short-term solution for storing and transporting objects.
 - **Plastic trays:** normally used in museums and archives, shallow plastic trays made of polyethylene can be safely used to store and transport objects.
 - **Rolling tubes:** wide diameter, wall-rolling tubes can be used to pack canvases and works of art on paper and textile.



- **Pallets [7]:** plastic or wooden pallets can be used to store boxes containing objects and keep them off the ground. However, while using wooden pallets, make sure that they are insect free and are covered with polyester film or tyvek in order to prevent direct contact with the boxes containing objects.



Other useful supplies include:

- Scissors
- Rope
- Rulers
- Measuring tapes
- Buckets
- Ladders
- Trolleys (e.g. shopping trolley)
- Dollies
- Wheelbarrows





United Nations
Educational, Scientific and
Cultural Organization

7, place de Fontenoy
75352 Paris 07 SP France
Telephone: +33 (0)1 4568 1000
www.unesco.org

UNESCO ISBN 978-92-3-100162-8
ICCROM ISBN 978-92-9077-247-7



Via di San Michele 13
I-00153 Rome, Italy
Telephone: +39-06585531
Fax: +39-0658553349
iccrom@iccrom.org
www.iccrom.org



9 789231 001628