



Robot Cleaner

ME770 Style User Manual

ME770 Style (MR6803VM)

Thank you for purchasing the ME770 Style robot cleaner.
Before using the product, please read this User Manual carefully, and keep it for future reference.
Depending on your model, some contents of this User Manual may differ from the actual product.
The contents of this User Manual are subject to change without notice.

MONEUAL®

Robot Cleaner

User Manual

ME770 Style
(MR6803VM)

MONEUAL®

Features

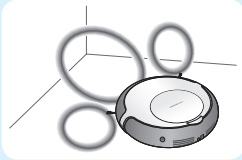

Smart Vision Mapping

The Smart Vision Mapping Technology is capable of mapping out the surrounding area and accurately tracking its previous location to further cover the unclean areas.

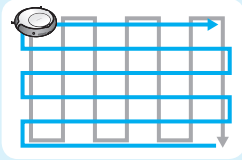

Deep Cleaning Pattern

Performs Vertical pattern overlapped by the horizontal pattern. It enables to get 2 times of cleaning result at the same area. The factory default is set to Deep Cleaning Pattern in Hybrid/ Vacuum/ Mop/ Shadow Cleaning modes.

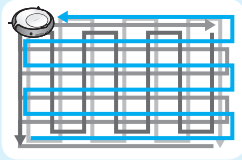

Double Deep Cleaning Option

Performs 2 cleaning sessions of Deep Cleaning mode. It enables to get 4 times of cleaning result at the same area. Double Deep Cleaning Option is available for Hybrid Cleaning, Mop Cleaning, Vacuum Cleaning and Shadow Cleaning modes.

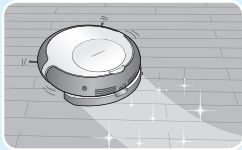

Mop Cleaning

Utilizing the attachable full sized mop, the mop cleaning mode is optimized for cleaning even the finest dusts that are harmful to health.



Big Mop with Water Supply System

By Water Supply system, the Big mop is continuously moistened to clean your hard floors during the cleaning cycle.

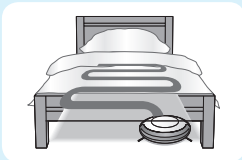

Shadow Cleaning

This is a function that enables you to clean area where the light does not reach. In Shadow Cleaning mode, you can intensively clean areas under the bed, sofa, etc. that are difficult to clean with a conventional vacuum cleaner.

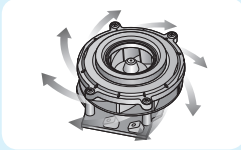

High Performance BLDC Motor

The cleaning performance is excellent due to the powerful BLDC (suction) motor. The BLDC motor is 30% more powerful than a DC motor, and the lifetime is approximately 10 times as long (estimated: 5,000 hours).

Various Cleaning Modes

The various cleaning modes provide different cleaning functions and levels of performance, which are optimized for the user environment and purpose.

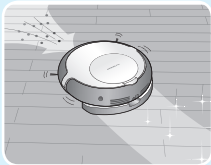

Hybrid Cleaning

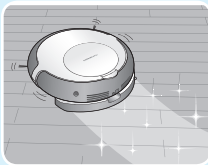

Mop Cleaning

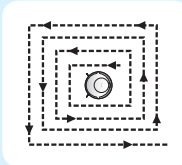

Intensive Cleaning



Manual Cleaning

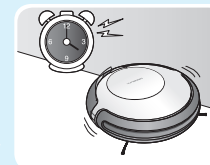

Scheduled Cleaning

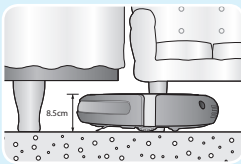

8.5 cm Slim Design

With a slim design, the MONEUAL ME770 Style is just 8.5 cm high, enabling it to clean under the bed and the sofa, where it is difficult to clean with a vacuum cleaner or by hand.



Eco-friendly Lithium Iron Phosphate Battery

The MONEUAL ME770 Style uses an eco-friendly battery that does not contain any heavy metals or acids that are harmful to the human body. The Lithium Iron Phosphate Battery has a lifetime that is approximately three times longer (1,000 cycles) than standard lithium-based or nickel-based batteries. It provides higher levels of operational safety due to high resistance to heat and explosion.

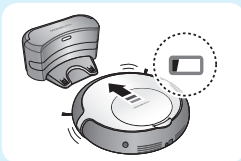

Auto Charging

After it is finished cleaning or when it detects that the battery is low, the robot cleaner automatically returns to the charger and starts charging.

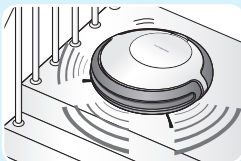

Obstacle Avoidance and Fall Protection

The obstacle detection sensors in the bumper help the MONEUAL ME770 Style avoid obstacles and walls, and the cliff detection sensors in the bottom detect height differences and prevent it from falling down stairs.

Contents

Before Use	Features	02	Maintenance	Language Setting	36
	Safety Information	05		Cleaning the Dust Bin	37
	What's in the Box	10		Cleaning the Dust Filter	38
	Overview	11		Cleaning Sensors and Wheels	39
Installing	Installing the Charger	14		Cleaning the Dust Inlet	40
	Installing the Side Brushes	15		Using and Managing the Battery	41
	Remote Control	16		Voice Guidance	44
	Charging	17		Error Message Description	45
	Installing the Water Supply Big Mop Kit	18	Customer Support	Troubleshooting	48
Product Operation	Before You Start	21		Specifications	49
	Starting & Stopping Cleaning	22		Product Warranty	50
	How to Recharge the Battery	24			
	Hybrid Cleaning	25			
	Vacuum Cleaning	26			
	Mop Cleaning	27			
	Other Cleaning Modes and Options	28			

Safety Information

Please read and follow the instructions in this manual to ensure your safety and the safe use of your robot cleaner.

Safety symbols

In this manual, various Warnings, Cautions and Notes are provided to help you to avoid potential hazards that can hurt you and/or damage your robot vacuum cleaner.



You may be killed or seriously injured if you do not follow this instruction.

Warning



You may be injured or your appliance may be damaged if you do not follow this instruction.

Caution



You should refer to this note when using your robot cleaner.

Note

Before you use



Do not install or use the robot cleaner in a place where it will be exposed to direct sunlight.

- If the power adapter becomes overheated during charging it may cause a fire, short circuit, or electrical shock.
- The robot cleaner may become discolored and deformed.



Do not install the charger on an inclined floor, and do not apply impact to the charger.

- The charger may become damaged or broken.



Do not use the product in a room with an unattended child or an elderly person.

- There is a risk that the child or elderly person may become frightened or injured.



This robot cleaner is not intended for use by children, or by persons with reduced physical, sensory or mental capabilities, unless they have given supervision or instruction concerning the use of the robot cleaner by a person responsible for their safety.

- This may cause injury or damage the robot cleaner.



Before you use the robot cleaner, remove any small objects, clothes, and fragile objects from the floor to be cleaned.

- This may cause damage to the robot cleaner and obstruct the movement of the robot cleaner.
- Make sure to remove fragile objects (glass, china, flowerpot, etc.).
- Small cloths, power cords, belts, towels, pads, and telephone cords can become entangled in the wheels or brushes.



Remove obstacles on the floor before cleaning.

- The robot cleaner will not be able to move beyond obstacles of a certain height.
-



Install the charger in a location that can be easily accessed by the robot cleaner.

- If you install the charger in a corner or if there are many obstacles around the charger, it may prevent the robot cleaner from automatically charging.



Make sure that the charger is always plugged into a power source.

- If no power is supplied to the charger, you will not be able to use the automatic charge function.

When you use



Do not use the power adaptor with another appliance.

- This may cause damage to the appliance and fire by overheating.



Ensure that clothes or any part of the body (hair, finger, foot, etc.) do not get entangled in the brushes or wheels.

- This may cause injury.



Do not use or store the robot cleaner near flammable materials (alcohol, gasoline, kerosene, thinner, etc.) or heating sources (cigarettes, candles, stove, etc.).

- This may cause fire and damage to the robot cleaner.



If you notice smoke or a burning smell coming from the robot cleaner, immediately turn the power switch off and contact your service center.



Do not stand or sit on the robot cleaner.

- Movement of the robot cleaner may cause injury or the robot cleaner may be damaged.



Do not use the robot cleaner on a narrow high place such as a desk, table, etc.

- The robot cleaner may fall off which could cause injury or damage to the product.



Do not let the robot cleaner pass over or sweep up liquids, oil, pet droppings, etc.

- This may cause malfunction of the robot cleaner and damage.
- Liquid on the wheels may cause stains in other places.



If the robot cleaner sucks a plastic bag in while operating, immediately remove it.

- If you run the robot cleaner for a long time with the dust inlet covered with a plastic bag, the motor will be overheated and the robot cleaner will be damaged.



Do not press strongly or impact the bumper.

- This may cause damage to bumper sensors and malfunction.



Do not use the robot cleaner in a place where the temperature is too low or too high (lower than -5°C and higher than 35°C).

- This may cause damage to the product.



Do not use the robot cleaner when the dust bin is completely filled up.

- This may reduce the suction power.



Never use the robot cleaner without the filters.

- Doing so may cause a malfunction of the robot cleaner.



Remove objects (such as loose clothing, towels, cloths, belts, or hairs) scattered on the floor before cleaning. Keep objects away from brushes and wheels to prevent entanglement.

- This may cause noise, reduce the suction power, and damage the robot cleaner.



Do not use the robot cleaner in a place where the floor or wall is made of glass or mirrors.

- The robot cleaner detect obstacles by using an IR sensor, so it may not detect glass and mirrors as obstacle.



Do not use the robot cleaner in a utility room, on a wet floor, on stairs, on a table or shelf, in an underground room, in a warehouse, in a commercial building, or outdoors.



If you have dropped or given an impact to the robot cleaner, contact your service center.

Electrical instructions



Please use the power source and socket with the correct voltage and current.

- If you use a power source or socket that does not fit the power specifications, there is the risk of fire, electrical shock, and damage to the robot cleaner.



Make sure the power cord is not bent or crushed by heavy objects.

- A damaged power cord may cause fire or electrical shock.
- To repair or replace a damaged power cord, contact a qualified service agent to ensure your safety.



When plugging in or removing the power plug, always plug it in or remove it by holding the plug, not the cable.

- Stress on the cable will damage the power cord, which may cause fire or electrical shock.



Do not use a damaged power cord! To repair or replace a damaged power cord, contact a qualified service agent to ensure safety.

- If a non-qualified person repairs the power cord, there is a risk of fire or electrical shock.



Do not touch the plug or wall socket with wet hands.

- Doing so may cause electric shock.



If you spill water into the robot cleaner, unplug the power cord and allow the unit to dry completely before use.

- Water can bring the risk of fire and electrical shock.
- Immediately remove the power cord from the outlet and contact your service center.



Do not use chargers other than the charger that came with your robot cleaner.

- Overvoltage brings the risk of fire and electrical shock.



Do not install the charger in a location that is damp or wet, dusty, or near water.

- This may cause a fire or an electrical shock and damage to the unit.



Do not touch the terminal of the charger with any metallic object (such as a clip, pin, etc.).

- This creates the risk of fire and electrical shock.



If you do not plan to use the robot cleaner for an extended period of time, turn off the power switch at the bottom of the back.

- The battery may be discharged if you leave it switched on.
-

Management



To ensure safety, only a qualified service agent should repair or disassemble the product.

- Repair by unqualified personnel may damage the robot cleaner, and brings the risk of fire and electrical shock.



Dispose of the battery properly.

- If you throw the battery into fire or expose it to direct sunlight, there is the risk of fire and explosion.
- Dispose of your old batteries according to the local laws and regulations of your region.



Clean the obstacle and bottom sensors periodically.

- If the sensor becomes covered by lint and dust, the robot cleaner may malfunction.



Please use the specified filter.

- Use of a different filter will void your warranty.
-



Please clean the robot cleaner after turning it off.

- If you clean it when the power is on or it is operating, it may cause injury.



Clean the main brush, dust bin, dust filter, and dust inlet periodically.

- If you use the robot cleaner for a long time without cleaning it, there is the risk of malfunction and damage.
-

Copyright and instructions

- Copyright © 2015 MONEUAL Europe GmbH All rights reserved.
- Published in April 2015
- This publication is protected by copyright and all rights are reserved. No part of it may be reproduced or transmitted by any means or in any form, without the prior written consent of MONEUAL.
- Depending on the model and type of your appliance, some of the contents in this manual may differ from your actual product.
- MONEUAL Europe GmbH assumes no responsibility for technical or editorial errors or omissions contained herein, nor for any incidental or consequential damages and failures of the appliance caused by not following the precautions and instructions.
- MONEUAL Europe GmbH assumes no responsibility for damages resulting from the use of the product that is not approved by the company.

What's in the Box



Robot cleaner
(1400 mAh built-in battery)



Charger

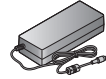

Power adaptor



Power cord



Remote Control
(including two AAA
batteries)



Side brushes (1 set)



Cleaning brush



User manual



Quick start guide

Mop kits

Water Supply Big Mop Kit

1. Water Supply mop plate
for a big mop

2. Big mop

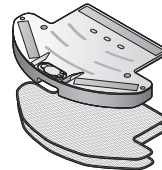

► The appearance and specifications may be changed without notice in order to improve functions or performance.

Overview

Robot Cleaner

| Top |

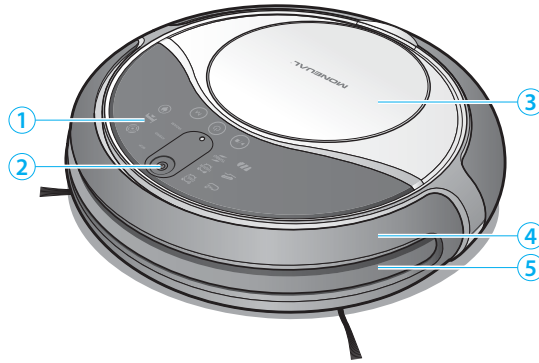

| Rear |

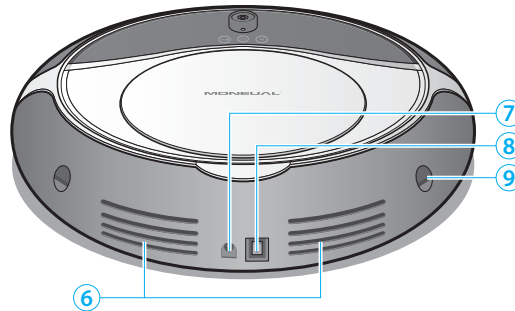

| Bottom |

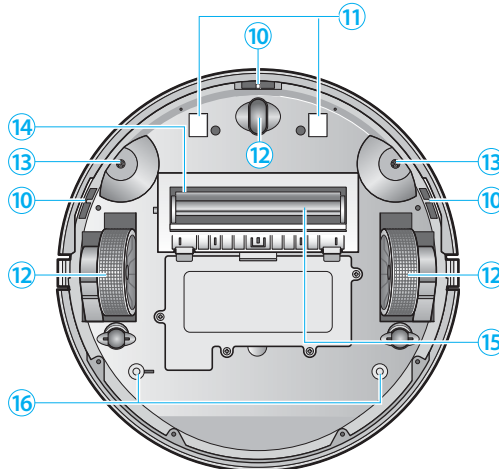

- ① Control buttons and indicators
- ② Camera
- ③ Dust Bin Cover
- ④ Bumper
- ⑤ Obstacle and signal detection sensors
- ⑥ Air outlet
- ⑦ Adaptor jack
- ⑧ Power switch
- ⑨ Signal receiving sensor
- ⑩ Cliff detection sensors
- ⑪ Charging terminals
- ⑫ Wheels
- ⑬ Side brush installation pins
- ⑭ Dust inlet
- ⑮ Main brush
- ⑯ Mop plate installation holes

Control Buttons and Indicators

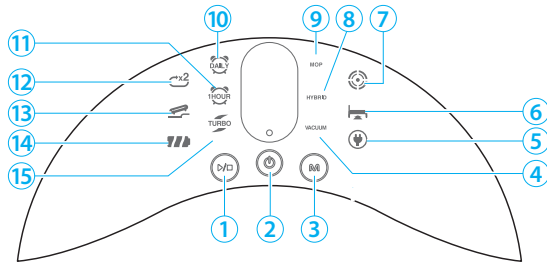

- ① Start/stop button
- ② Power button
- ③ Cleaning mode selection button
- ④ Vacuum Cleaning mode indicator
- ⑤ Charging mode indicator
- ⑥ Shadow Cleaning mode indicator
- ⑦ Intensive Cleaning mode indicator
- ⑧ Hybrid Cleaning mode indicator
- ⑨ Mop Cleaning mode indicator
- ⑩ Timer (every day) indicator
- ⑪ Timer (1 hour) indicator
- ⑫ Double Cleaning Option indicator
- ⑬ Threshold Option indicator
- ⑭ Battery level indicator
- ⑮ Turbo mode indicator

Charger

| Front |

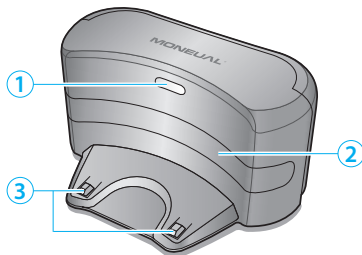

| Back |

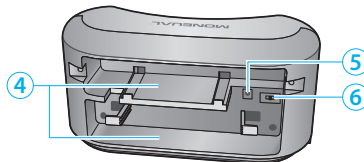

- ① Power/charging lamp
- ② Guide signal transmission sensor
- ③ Charging terminals
- ④ Adaptor holder
- ⑤ Adaptor jack
- ⑥ Sensor's signal distance selection switch

Remote Control

You can conveniently access the various functions of the robot cleaner with your remote control.

- Functions that can be controlled through the control panel on the robot cleaner: vacuum cleaning, hybrid cleaning, mop cleaning, shadow cleaning, intense cleaning and charging.
- Functions that can be controlled through the remote control: vacuum cleaning, hybrid cleaning, mop cleaning, shadow cleaning, intense cleaning, manual cleaning, charging, control suction power, scheduled cleaning.

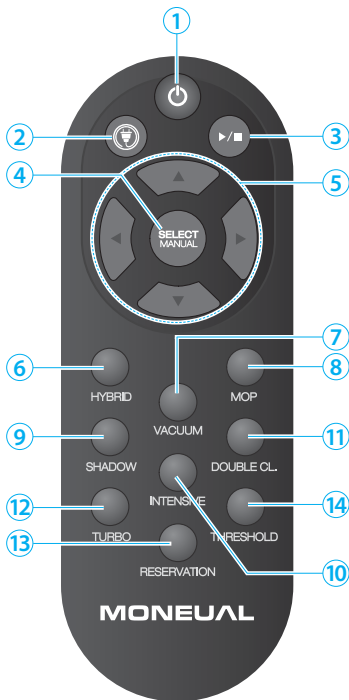

① Power Button

- Press to turn the power on/off.
- Press to return the ME770 Style to operation mode when it has stopped due to failure.

② Charging Button

- Press to move robot cleaner to charger

③ Start/Stop Button

- Press to start the selected operation
- Press to start/stop cleaning and driving

④ SELECT/MANUAL Button

- Press to confirm your selection.
- Press to start Manual Cleaning (see page 31).

⑤ Direction buttons

- Press to drive the robot cleaner in manual mode (forward, backward, left, and right).

⑥ Hybrid Cleaning Button

- Press to start Hybrid Cleaning (see page 25). (Mop + Vacuum)

⑦ Vacuum Cleaning Button

- Press to start Vacuum Cleaning (see page 26). (Vacuum only)

⑧ Mop Cleaning Button

- Press to start Mop Cleaning (see page 27). (Mop only)

⑨ Shadow Cleaning Button

- Press to start under furniture cleaning (see page 30).

⑩ Intensive Cleaning Button

- Press to start Intensive Cleaning (see page 29).

⑪ Double CL. Button

- Press to select Double Deep Cleaning Option (see page 34).

⑫ Turbo Option Button

- Press to select Turbo Option (see page 33).

⑬ Reservation Cleaning Button

- Press to set the timer (see page 32).

⑭ Threshold Option Button

- Press to select Threshold Option (see page 33).

Installing the Charger

- 1 • Connect the power adaptor.
 - Set the robot cleaner detection distance (5 m or 8 m).
 - Place the power adaptor in the holder of the charger.

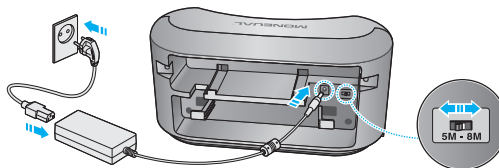

- 2 • Check the power connection (blue lamp).

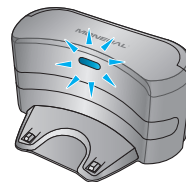

- 3 • Check the location of the charger.
 - Clear all obstacles in the area within 1 m in front, left, and right of the charger.

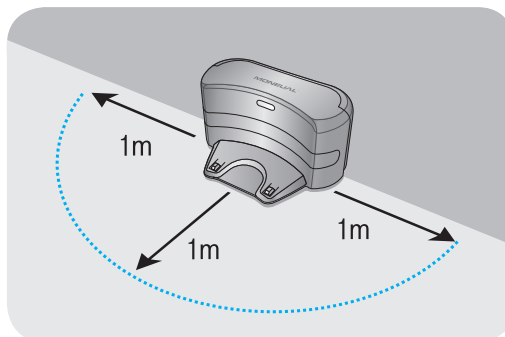
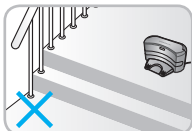
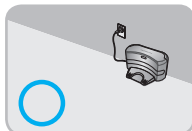

- ▶ If you install the robot cleaner in a place where it will be exposed to direct sunlight, the heat of the sun may interfere with the auto charging, and the robot cleaner may become discolored over time.
- ▶ If your robot cleaner can't return to the charger, reset the detection distance.
 - In a narrow area, set it to 5 m, and in a wide area, set it to 8 m.
 - If you set the detection distance to 8 m in a narrow area, the auto charging may be interfered with.

Installing the Side Brushes

- Check for the L mark under the side brush.

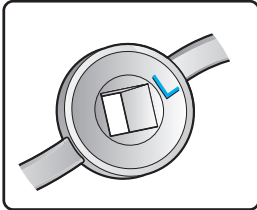

- Check for the R mark under the side brush.

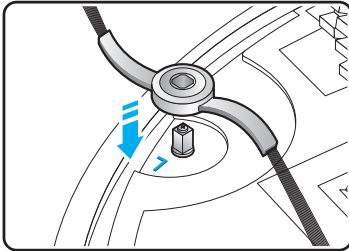
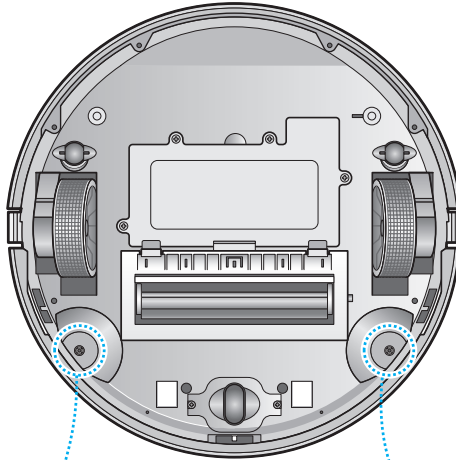
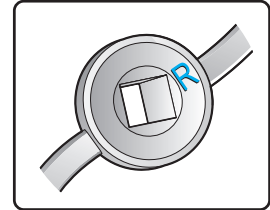

- Align with the L mark under the robot cleaner and install the L brush.

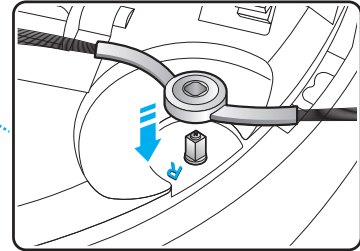

- Align with the R mark under the robot cleaner and install the R brush.

Remote Control



- ▶ **Make sure to properly orient the + and – poles of the batteries when inserting the battery.**
- ▶ **If you insert batteries incorrectly, there is a risk of fire or damage to the remote control.**
 - Only use standard AAA 1.5V batteries. Do not use any non standard batteries.
 - If your batteries have had a leakage, immediately replace them.
 - Dispose of batteries according to the local laws and regulations of your region.

Inserting batteries

- 1 • Remove the battery cover.

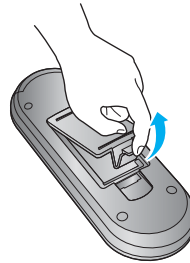

- 2 • Insert the two AAA batteries that came with your ME770 Style.

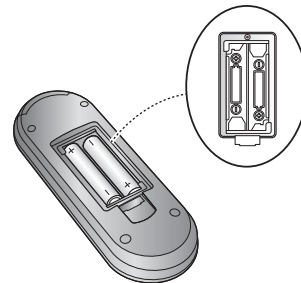

- 3 • Input the battery cover.



Charging

If you have prepared the charger, main body, and remote control, you must then charge the battery of the robot cleaner to use it. To charge the robot cleaner, follow these steps:

- 1 • Turn the power switch on.

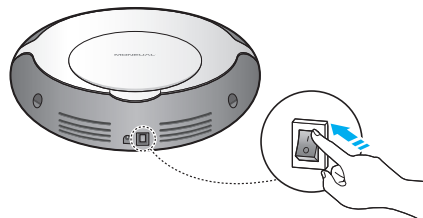

- 2 • Hold the robot cleaner with both hands and put it on the charger.
 - Match the terminals of the robot cleaner with the terminals of the charger.
 - Put the robot cleaner in the front center of the charger and push the robot cleaner toward the charger slowly until the status indicator turns red.

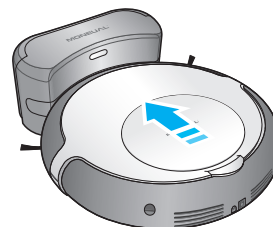

- 3 • Use the robot cleaner after charging.
 - It takes about 1 hour to charge the battery fully. (For 2800mAh battery models, it takes about 2 hours.)
 - After charging for 1 hour, you can use the robot cleaner in normal suction mode for about 1 hour. (Depending on conditions, the battery usage time may vary.)

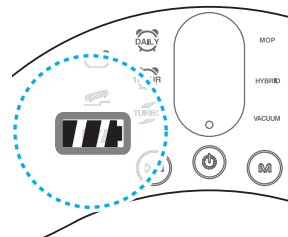

Battery status indicator 	Charging	Blinking every second
	Charging completed	On
	Low battery	Blinking 4 times every second



- You can charge the robot cleaner using connecting the power adaptor directly to the power jack on the lower-rear side of the robot cleaner.

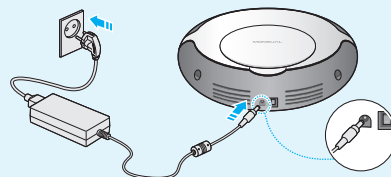

Installing the Water Supply Big Mop Kit

- 1 • Supply water into the mop plate and attach the mop to it.

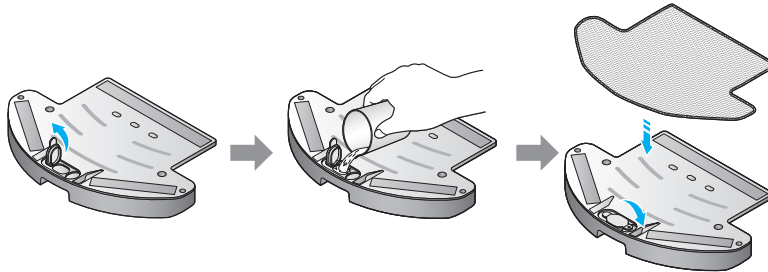

- 2 • Turn the power switch off (on the lower rear side of the robot cleaner).

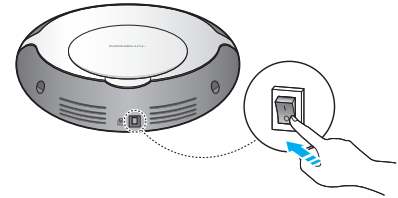

- 3 • Attach the mop plate. Fit the joint parts well to the holes of the robot cleaner.



▶ If you apply excessive force to the mop plate when you install it on the robot cleaner, the joint parts of the mop plate may be damaged.

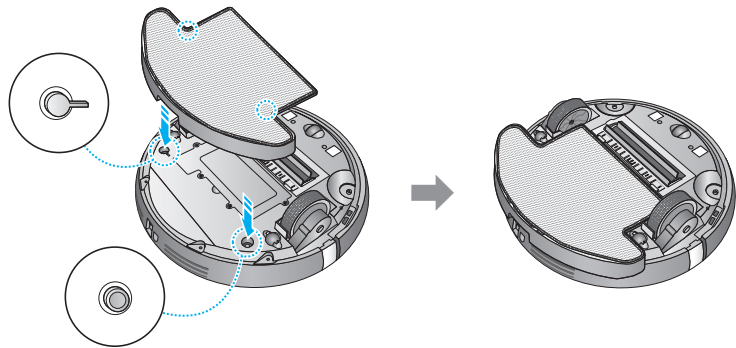

- 4 • Flip it over and turn the system power switch on.

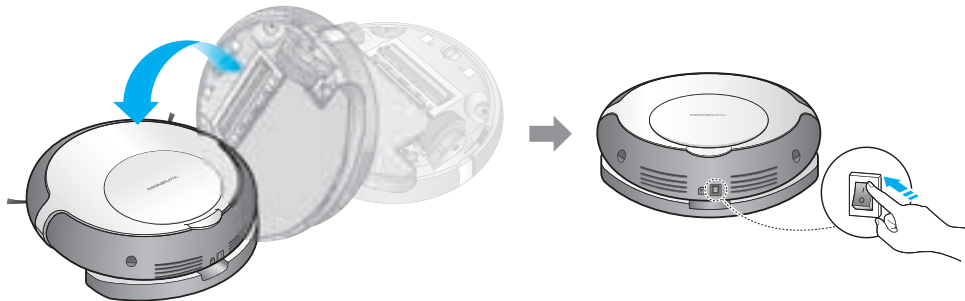



- ▶ After cleaning, remove the mop plate from the robot cleaner and the mop from the mop plate.
- ▶ Remove water in the mop plate and let the cover open to dry the mop plate.
- ▶ Wash and dry the mop for the next use.
- ▶ You may use the included cleaning brush for cleaning the mop more thoroughly.

Big Mop Recommendation

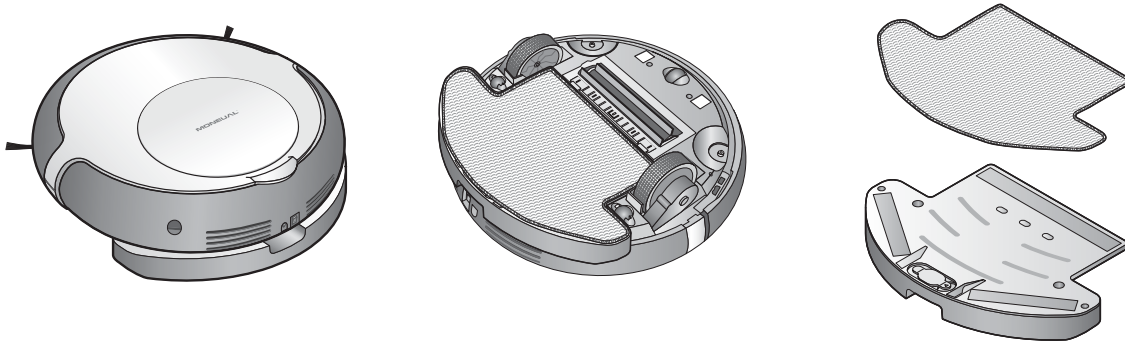

- ME770 Style's specially designed Big Mop can be rewashed and reused.
- Dampen the Big Mop before attaching it to the water Tank.
- Make sure the Big Mop is not excessively wet to avoid the wheels from slipping.
- You may add cleaning solution to the Big Mop, but it may create wheel slippage.
- The ME770 Style with Big Mop is designed to clean hard surface floors including wood, tile, vinyl, linoleum and laminate. The ME770 Style cleans best on smooth hard surfaces and may not perform well on uneven tiles, heavily waxed floors or rough surfaces like slate or brick which can snag the cleaning cloth.



- ▶ **Do not use Hybrid and Vacuum Cleaning in a puddle of liquid. Please use only on dried spills or liquid residue. You can use Mop Cleaning for puddles of liquid.**
- ▶ **After cleaning, remove the Big Mop and the water from the water Tank and leave the cover open to dry the inside of the water Tank.**
- ▶ **A wet Big Mop may not be suitable for cleaning unsealed floors. Ask your flooring manufacturer or installer if you are unsure whether damp mopping is safe for your floor.**
- ▶ **ME770 Style is not intended to pick up large debris. Before cleaning with the ME770 Style, pick up large debris and check for gravel or sharp objects that could scratch the floor if captured under the cleaning pad.**

Before You Start

Check the following before you start the robot cleaner.

- 1 Be careful not to break the robot cleaner when you pull the robot cleaner out of the box.**
For information of installing the robot cleaner, see page 14.
- 2 Check the location (L/R) of the brushes and install them.**
For information on installing the brushes, see page 15.
- 3 Pull the robot cleaner out and manually charge it first.**
When you start the robot cleaner for the first time, it may not work, as the battery has probably been discharged. For information on manual charging, see page 17.
- 4 Remove any obstacles on the floor.**
Remove small objects, clothes, and fragile objects from the floor before cleaning. Fold up lengthy carpet/rug tassels or keep the robot cleaner away from them.
- 5 If the dust bin is full, the cleaning performance will be reduced. Emptying the dust bin frequently is highly recommended.**
For information on cleaning the dust bin, see page 37.
- 6 If there is anything on cliff detection sensors or wheels, remove it.**
This may cause failure or malfunction of the robot cleaner. For information on cleaning cliff detection sensors and wheels, see page 39.
- 7 Children and seniors may be surprised at the sight of the robot cleaner in operation.**
Please let children and seniors know about the operation of the robot cleaner.
- 8 Be careful not to drop the robot cleaner from a high place.**
Do not use the robot cleaner on a narrow and a high place such as a desk, table, etc. If shoes are placed side by side at the entrance to the living room, the robot cleaner may recognize them as the floor, which may cause falling.
- 9 The robot cleaner cannot climb over a threshold higher than 1cm.**
- 10 After charging is complete, keep the robot cleaner docked in the charger, or turn the power switch off which is located on the lower rear side of the robot cleaner.**

Starting & Stopping Cleaning

Starting Cleaning

1 • Turn the power switch on.

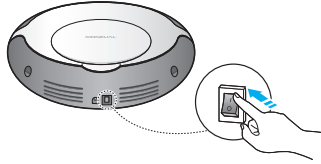

2



or



3

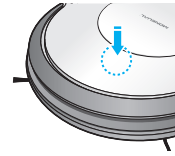

or



4 • If you are cleaning an area that is difficult to clean using auto cleaning mode, change to the proper cleaning mode.

Stopping Cleaning

After cleaning, the robot cleaner returns to the charger or stops on the spot according to the cleaning mode.

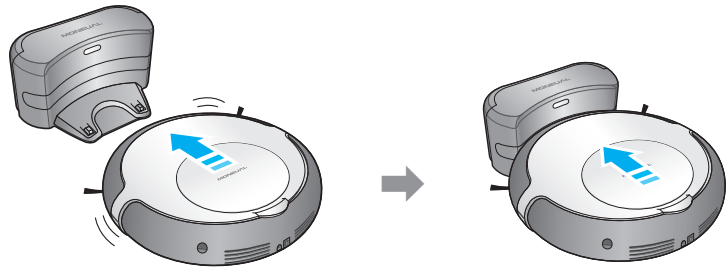

If you press the **Start/stop** (▶/■) button when the robot cleaner is operating, the cleaning will be stopped.

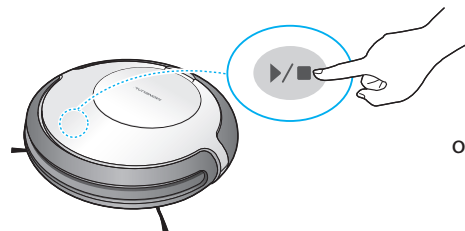

or



Changing the Cleaning Mode

User can set the cleaning mode to match the cleaning environment.

- Cleaning modes that you can select using the **Mode (M)** button on the robot cleaner:

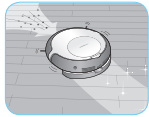

Hybrid
Cleaning

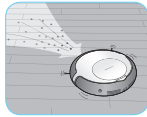

Vacuum
Cleaning

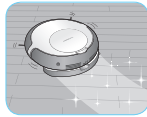

Mop
Cleaning

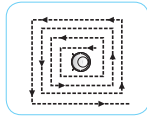

Intensive
Cleaning



Shadow
Cleaning

- Cleaning modes that you can select using the remote control:

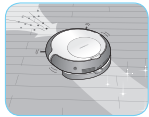

Hybrid
Cleaning

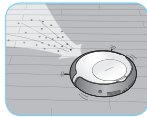

Vacuum
Cleaning

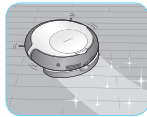

Mop
Cleaning

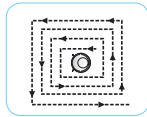

Intensive
Cleaning

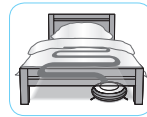

Shadow
Cleaning



Manual
Cleaning

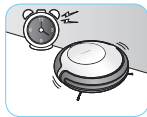

Scheduled
Cleaning



- ▶ You can't change the cleaning mode during operation. Select the cleaning mode before starting the robot cleaner, or select it after stopping the robot cleaner by pressing the **Start/stop** (▶/■) button on the robot cleaner or the remote control, then selecting the cleaning mode.

How to Recharge the Battery

Auto Charging

- When the robot cleaner has finished cleaning, it returns to the charger.
- If the battery is low and the battery indicator is blinking rapidly, the robot cleaner will stop cleaning and return to the charger to charge.

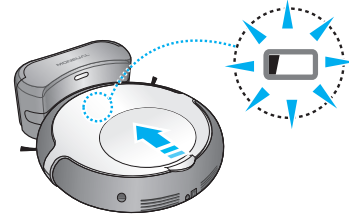

Manual Charging

- Hold the robot cleaner with both hands and put it on the charger.
- Match the terminals of the robot cleaner with the terminals of the charger.
- Put the robot cleaner in the front center of the charger and push the robot cleaner toward the charger slowly until the status indicator turns to red.

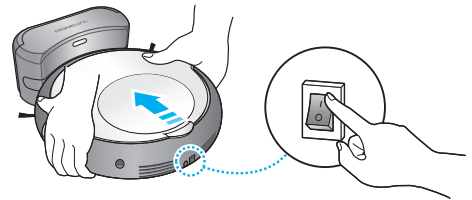



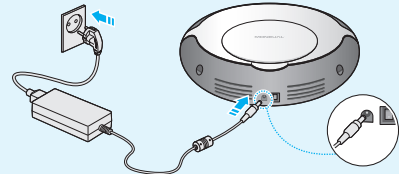

► You can charge the robot cleaner using connecting the power adaptor directly to the power jack on the lower-rear side of the robot cleaner.



Battery Status Indicator

- You can check the battery status by the battery status indicator.

Battery status indicator	Battery status
 Blinking 4 times every second	Need to charge
	Low
	Middle
	High or fully charged
 Blinking 1 time every second	Charging

- It takes about 1 hour to charge the battery fully. (For 2800mAh battery models, it takes about 2 hours.)
- After charging for 1 hour, you can use the robot cleaner in normal suction mode for about 1 hour. (Depending on conditions, the battery usage time may vary.)

HYBRID Hybrid Cleaning

In Hybrid Cleaning, the robot cleaner performs the Vacuum Cleaning and Mop Cleaning at the same time. Hybrid Cleaning offers a comprehensive floor care solution because of the use of the twin side brushes, the main brush, the BLDC suction, and the reusable microfiber Big Mop with the Water Supply Tank all together. The Hybrid Cleaning is recommended for comprehensive cleaning on your hard floors.



- ▶ Please do not use Hybrid Cleaning mode on the carpet or rug because the carpet or rug can be damaged by the Hybrid Cleaning mode. Use Hybrid Cleaning mode only on the hard floor.

- 1 • Follow the directions on page 18 to attach the Big Mop with the Water Supply Tank.

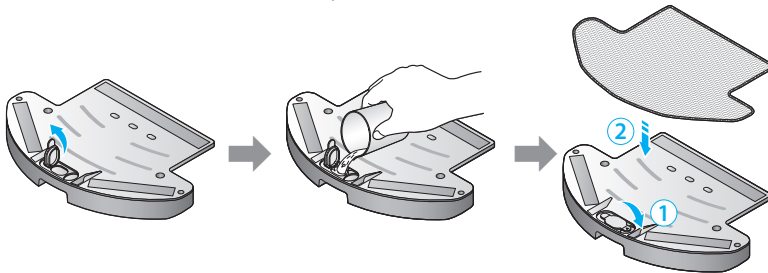

- 2 • Turn the main power button on.

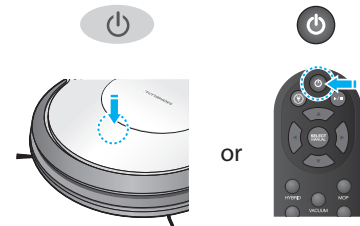

3

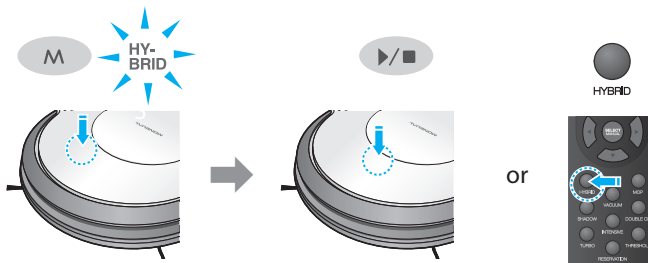

4

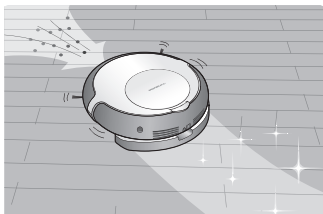

- ▶ While in Hybrid Cleaning mode, you can also select Double Cleaning Option and Threshold (climb over) Option.
- ▶ To select these options, please refer to the pages that reference each.

VACUUM Vacuum Cleaning

Vacuum cleaning is used where the needs are vacuum suction only without mop cleaning. It can be used on hard floor or carpet.

- 1 • Turn the system power switch on.

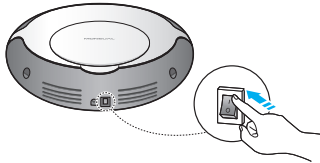

- 2 • Turn the main power button on.

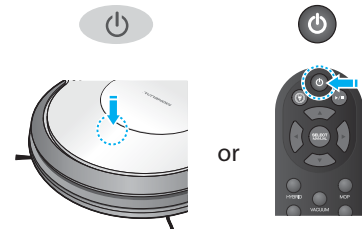

- 3 • Select the Vacuum Cleaning with the **Mode** button on the Control Panel and press the **Start/Stop** button or just press the **Vacuum Cleaning** button on the remote control.

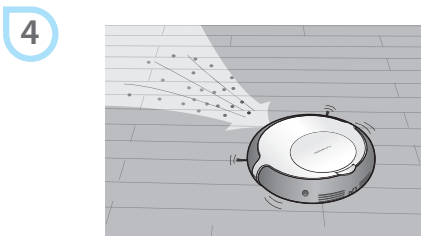
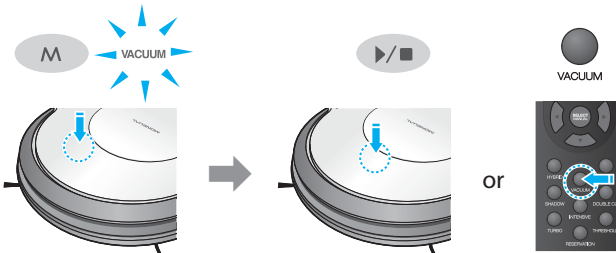

► While in Vacuum Cleaning mode, you can also select Turbo option, Double Cleaning option and Threshold (climb over) option. To select these options, please refer to the pages that reference each.

MOP Mop Cleaning

Mop Cleaning mode is used for when you need mopping only without vacuuming.



- ▶ If Mop Cleaning mode is used on carpet or rug, the carpet or rug can be damaged. Therefore, please use the Mop Cleaning mode only on hard floor.
- ▶ For Big Mop with Water Supply Tank, we recommend moistening the Big Mop before attaching it for longer wet cleaning performance.

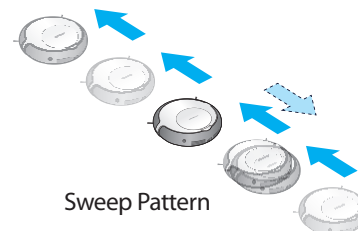

- 1** • Follow the directions on page 18 to attach the Big Mop with the Water Supply Tank.

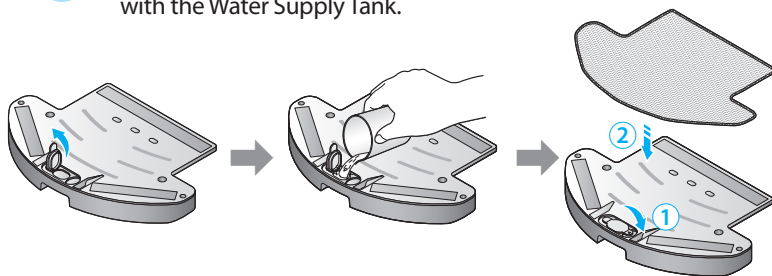

- 2** • Turn the main power button on.



3

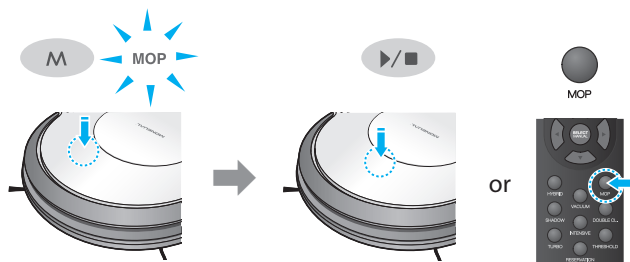

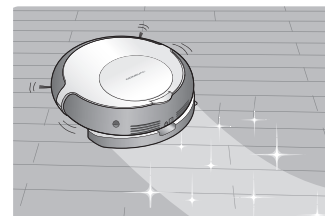

4

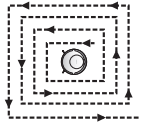

- ▶ While in Mop Cleaning mode, you can also select Turbo option, Double Cleaning option and Threshold (climb over) option. To select these please refer to the pages that reference each.

Other Cleaning Modes and Options

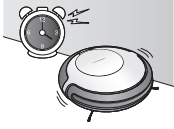
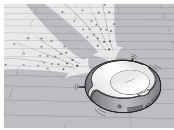
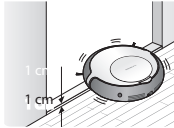
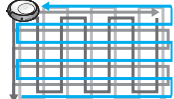
Cleaning Mode	Function	For Where	How to Select	
Intensive	Clean in 1m x 1m area where the robot cleaner located.	Heavy Dust Particles or Heavy Traffic Area	Select Intensive with the Mode button on the Control Panel or press the Intensive button on the remote control	
Shadow	Clean in the hard to reach areas	Under a bed or furniture	Select Shadow with the Mode button on the Control Panel or press the Shadow button on the remote control	
Manual	Control the robot vacuum cleaner directly using the remote control	Anywhere you want to go	Press the Manual button on the remote control and press the Arrow button where you want to go	
Scheduled	Start cleaning after 1 hour or at the same time every day	Anywhere you want to go	Press the Reservation button and press the Select button on the remote control	
Option	Function	Applicable Cleaning Mode	How to Select	
Turbo	Start cleaning with turbo suction power	Except Hybrid Cleaning and Mop Cleaning modes, other cleaning modes.	Press the Turbo button on the remote control	
Threshold	Set to be able to climb over a threshold lower than 1 cm	Except Manual Cleaning mode, other Cleaning modes.	Press the Threshold button on the remote control	
Double Deep Cleaning	Performs 2 cleaning sessions of the vertical pattern overlapped by the horizontal pattern.	Except Manual Cleaning, Scheduled Cleaning and Intensive Cleaning modes.	Press the Double CL button on the remote control	

Intensive Cleaning

The robot cleaner intensively cleans the surrounding area relative to its current location.

1 • Turn the power switch on.

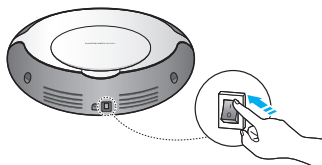

2

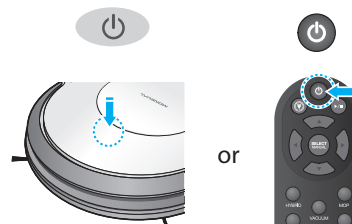

3

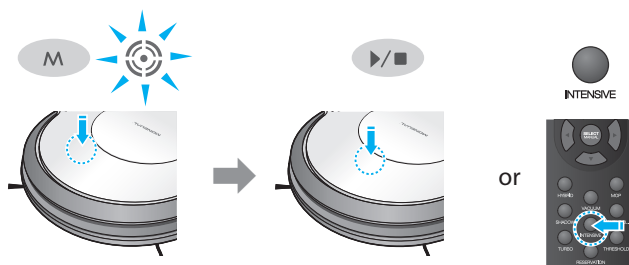

4

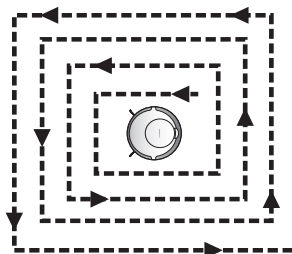

- ▶ In Auto Cleaning mode, the robot cleaner stops on the spot after it has finished the cleaning.
- ▶ In the area in which there are many obstacles, the robot cleaner may not operate in normal cleaning modes.

Shadow Cleaning

You can clean under your bed or furniture.



- ▶ To use shadow cleaning mode, turn the room light on. In a dark room, the robot cleaner can't detect the space under the bed or furniture.
- ▶ The robot cleaner moves to a place under the bed or furniture to start shadow cleaning. To reduce the time spent moving through the room, put the robot cleaner in front of the bed or furniture under which you want to perform shadow cleaning.

- 1 • Turn the power switch on.

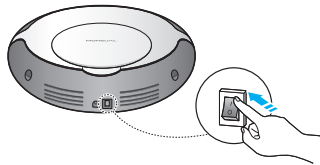

- 2 • Put the robot cleaner in front of a bed or furniture.

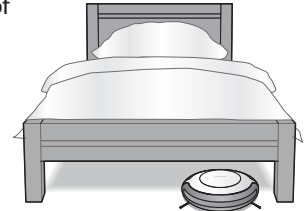

- 3 • Turn the power switch on.

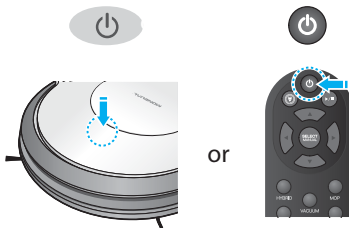

- 4 • Put the robot cleaner in front of a bed or furniture.

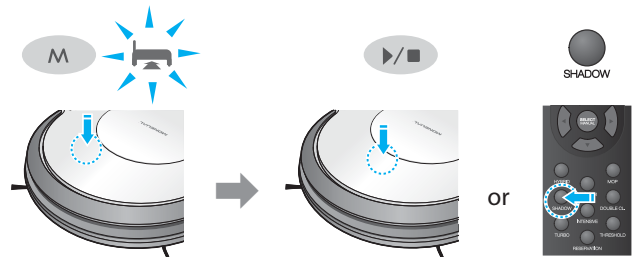

- 5 • Turn the power switch on.

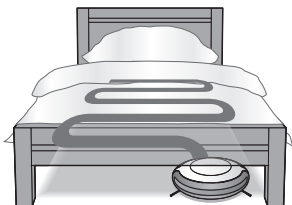

- ▶ When Shadow Cleaning is completed, the robot cleaner comes out under a furniture and stops.

Manual Cleaning

You can control the robot cleaner directly using the remote control.

- 1 • Stop the robot cleaner that is operating by pressing the **Start/stop** (▶/■) button.

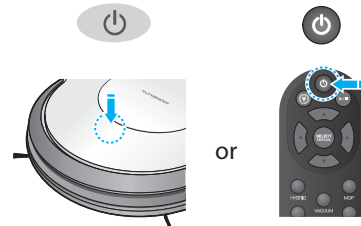

- 2 • Press the **Manual** button on the remote control.
 - Air suction will start in its current place.
 - If you press the **Manual** button again, air suction will be stopped.



- 3 • By pressing direction keys on the remote control, you can move the robot cleaner where you want it to go.



- ▶ **During charging, you can't move the robot cleaner manually.**
- ▶ **You can use this mode when you want to move the robot cleaner without air suction.**

Scheduled Cleaning (Reservation Cleaning)

For daily efficient hands free cleaning, the robot cleaner provides 2 Reservation Cleaning modes. One starts cleaning after 1 hour from the time you set it and the other starts at the same time everyday.



- ▶ Reservation Cleaning only works from the charging station after you set the Reservation Cleaning. You must put the robot cleaner on the charging station to begin at the scheduled time.
- ▶ You can only set the Reservation Cleaning mode using your remote control.
- ▶ If the robot cleaner is charging at the scheduled time, it will start the cleaning after finishing the charging.
- ▶ If the cleaning time is scheduled to '1 hour', your setting will be cleared after completing the '1 hour' scheduled cleaning.

- 1** • Turn the system power switch on.

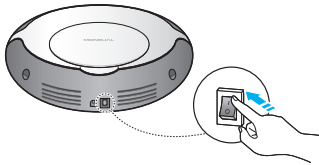

- 2** • Turn the main power button on.

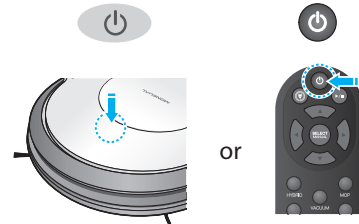

- 3** • Press the Reservation mode either 1 hour or Daily by pressing the **Reservation** button on the remote control.



- 4** • Press the **Select** button to confirm the Reservation setting.



- 5** • The robot cleaner will be cleaning at the time of your Reservation setting.

TURBO Turbo Option

While you are using the Hybrid / Vacuum / Intensive / Shadow / Manual Cleaning, by pressing the **Turbo** button on the remote controller you can control suction power.



▶ Turbo option is not available in Hybrid Cleaning mode and Mop Cleaning mode.

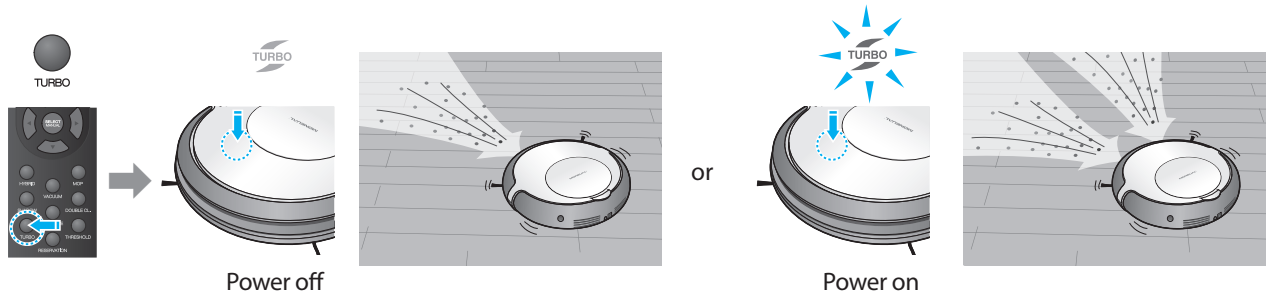

Threshold Option

For less than a 1cm threshold height of threshold or carpet, rug and etc, the user is able to choose threshold climbing over ON/OFF option by the remote control.



- ▶ We recommend not to climb over while in Mop Cleaning mode and Hybrid Cleaning mode due to the Big Mop with the Water Supply System.
- ▶ We also recommend that you select the Threshold option (climb over) ON while in Vacuum Cleaning mode.
- ▶ Factory default is set to not climb over for Hybrid, Vacuum and Mop Cleaning mode.

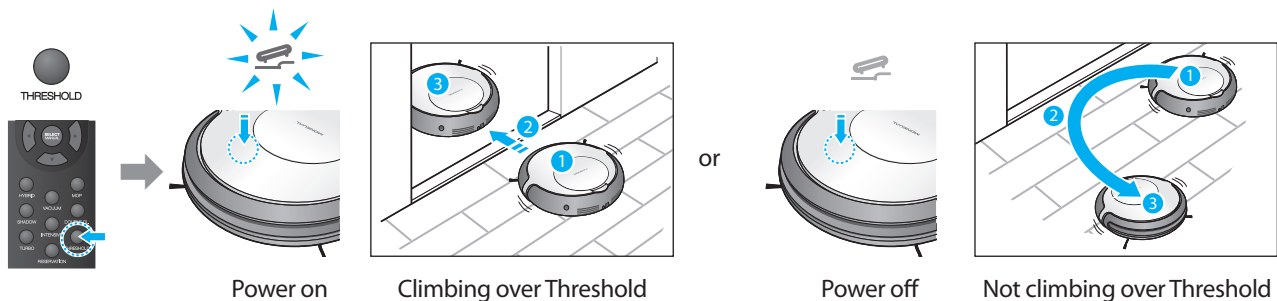

Double Deep Cleaning Option

The Double Deep Cleaning Option performs 2 cleaning sessions of the vertical pattern overlapped by the horizontal pattern.

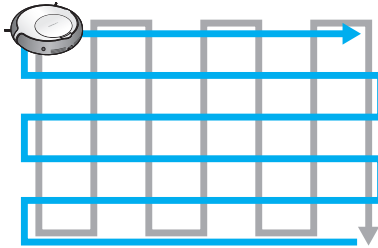

Deep Cleaning Pattern
Vertical pattern overlapped by
the horizontal pattern

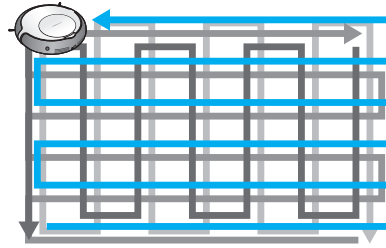

Double Deep Cleaning Option
Performs 2 cleaning sessions of the vertical
pattern overlapped by the horizontal pattern.



► The factory default is set to Deep Cleaning Pattern in Hybrid / Vacuum / Mop / Shadow Cleaning modes.

1 • Turn the system power switch on.

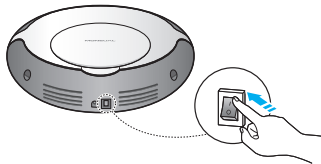

2 • Turn the main power button on.

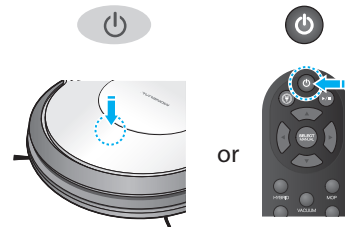

- 3 • Select any one of Hybrid / Vacuum / Mop / Shadow Cleaning. To learn how to select these options, you may refer to the relevant sections on the User Manual.

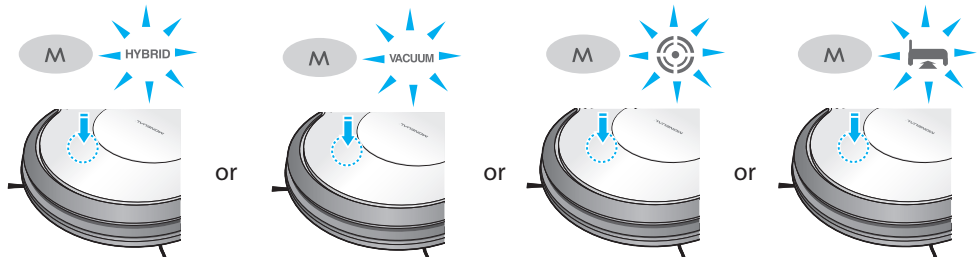

- 4 • Press the **Double CL** button on the remote control. The Double Deep Cleaning Option indicator is now turned on.

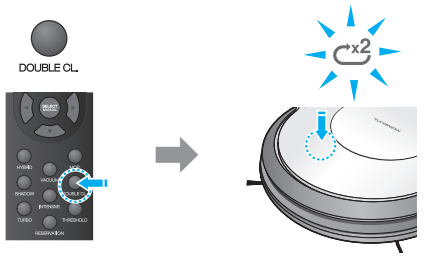

- 5 • The robot cleaner will perform 2 cleaning sessions of the vertical pattern overlapped by the horizontal pattern.

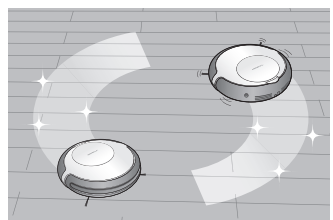

► Double Deep Cleaning option is available for Hybrid Cleaning, Mop Cleaning, Vacuum Cleaning and Shadow Cleaning modes. Double Deep Cleaning option is not available in Scheduled Cleaning, Intensive Cleaning, and Manual Cleaning modes.

Language Setting



You can select a language for voice guidance from the ones available in the system.

1

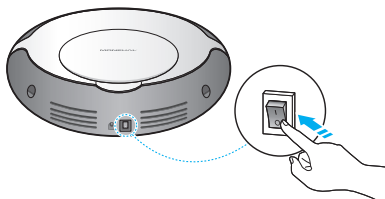

Turn the power switch off.

2

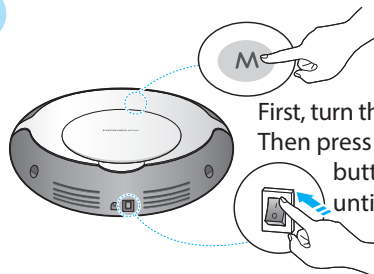

First, turn the power switch on. Then press and hold the Mode button for 2~3 seconds until the display appears with a beep sound.

3

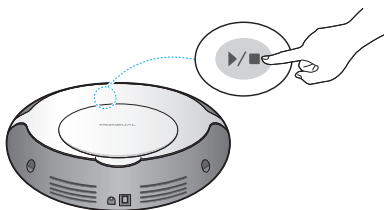

Keep pressing the **Start/stop** button until you have reached the language you desire.



Whenever you press the **Start/stop** button, you will hear the following sentence in a different language.

- "Starting automatic cleaning."
- "Cleaning is canceled."

4

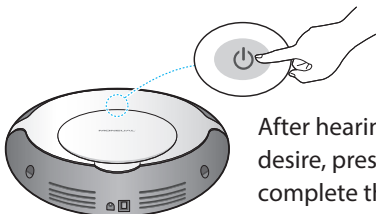

After hearing the language you desire, press the **power** button to complete the language setting.



Depending on the model, supported languages may vary.

Language	English	German	French	Italian	Spanish
No.	1	2	3	4	5

Cleaning the Dust Bin

1

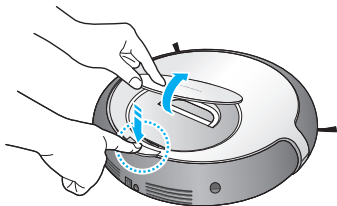

Remove the dust bin cover.

2

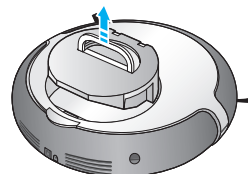

Remove the dust bin.

3

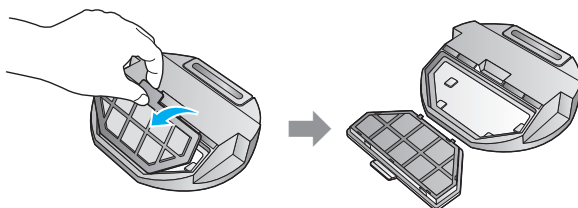

Remove the dust filter.

4

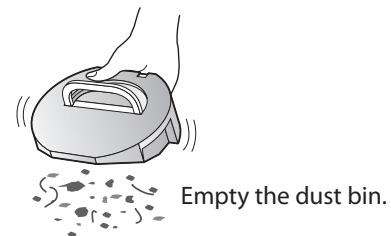

Empty the dust bin.

5

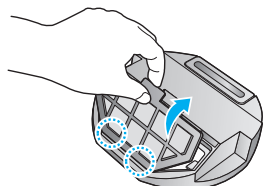

Replace the dust filter.

6

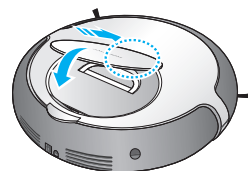

Replace the dust bin in the robot cleaner.

► Make sure to follow the directions carefully when installing the dust bin.

7



Replace the dust bin cover.



► To clean the dust filter and determine its lifetime, see page 38.

Cleaning the Dust Filter



- ▶ **The dust filter can be easily cleaned by gently scraping off the surface or compressed air.**
 - The dust filter is reusable.
 - It is recommended not to clean with water.
- ▶ **We recommend that you clean the dust filter whenever the bin is more than 2/3 full.**
 - If you do not clean the dust filter, the suction power of the robot cleaner can be reduced.
- ▶ **Replace the dust filter if you notice a tear or a hole.**
 - The lifetime of a dust filter is about 3 months for normal use, but may vary depending on the frequency and operating environment.

1

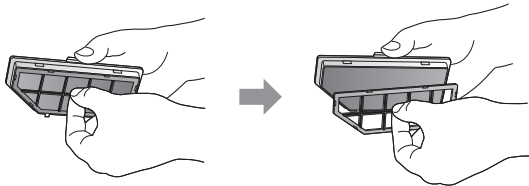

Remove the dust filter.

2

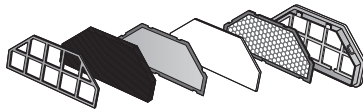

Clean the dust filter.
(Remove dust from each of the four filters by blowing.)

3

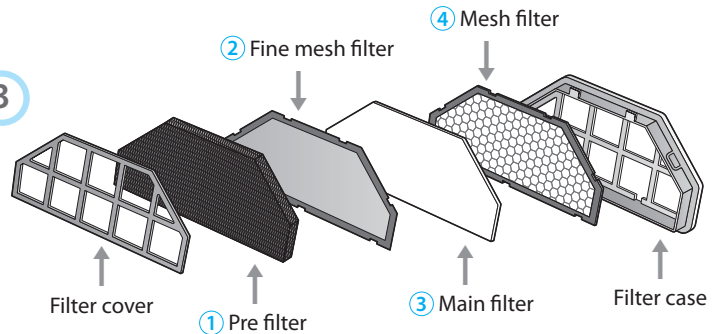

Assemble the dust filter .
(Assemble four filters as described above)



- ▶ **Applying excessive force will damage the dust filter cover while disassembling the dust filter.**
- ▶ **If you assemble the filter incorrectly, the performance may be degraded or the suction power may be reduced.**

Cleaning Sensors and Wheels

Cleaning Sensors

- Clean (blow or wipe) the three sensors with the included cleaning brush or a cotton swab.
 - If sensors are severely contaminated, wipe with a moistened cotton swab.
 - Do not wipe directly with water, and do not use benzene or alcohol to clean sensors.

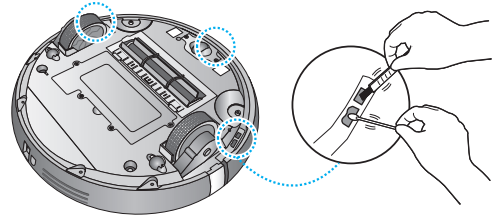

Cleaning Wheels

- Clean wheels using the brush.
 - To clean the front wheel, remove the screws and remove the wheel, and clean it with the brush.
 - To clean the two main wheels, clean them with the brush while rotating slightly by hand.
 - Remove foreign objects such as hair that obstruct the wheel's operation.

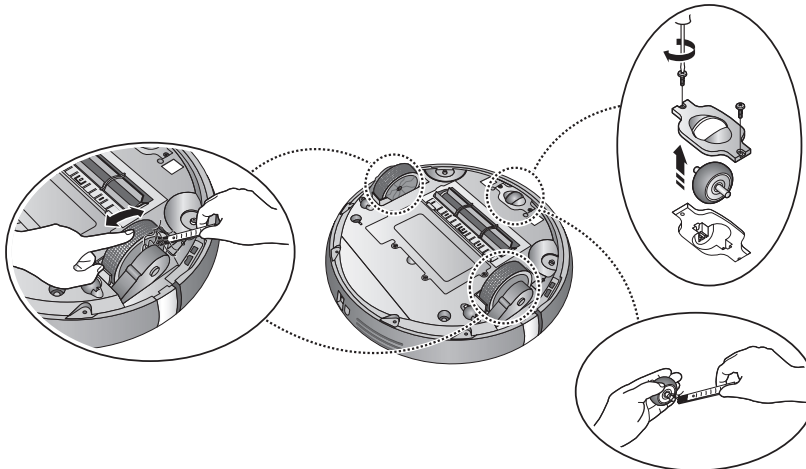

Cleaning the Dust Inlet

1

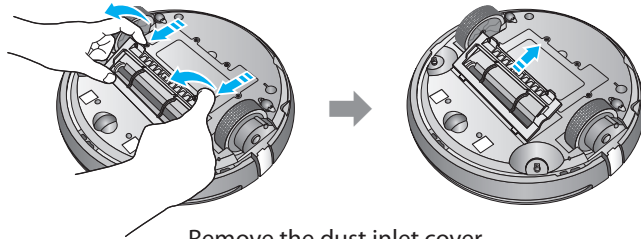

Remove the dust inlet cover.

2

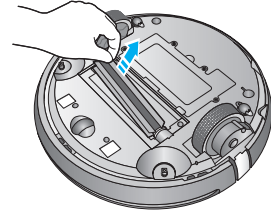

Remove the main brush.

3

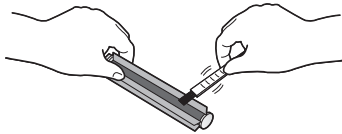

Clean the removed main brush with the cleaning brush.

4

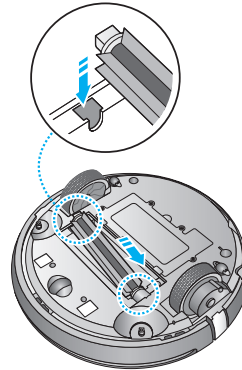

Check the groove's shape and insert the main brush into the fixing hole, and then secure the wing of the fixing pin to the fixing pin.

5

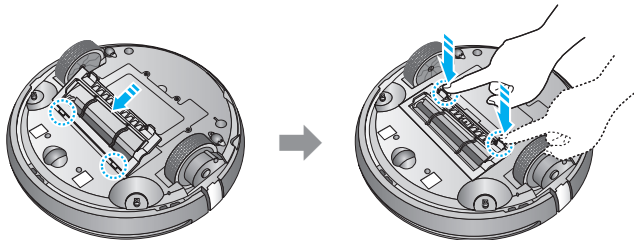

To reinstall the dust inlet cover, insert the 2 tips to the matching holes on the robot cleaner.

Using and Managing the Battery

The battery is a consumable item. The more you use the battery, the shorter the battery's lifetime.

Battery Lifetime

- We guarantee 6 months of use in a normal environment.
- Always charge the battery for the best use experience.
- The battery lifetime may vary depending on the use environment.

Charging Battery

- If you are using the robot cleaner for the first time, please fully charge the battery first.
- It takes about 1 hour to charge the battery fully. (For 2800mAh battery models, it takes about 2 hours.)

To Extend Battery Life

- If you don't intend to use the robot cleaner for an extended period of time, turn off the power switch after charging the battery fully.
- Clean the dust inlet, dust bin, main brush, and side brushes frequently. If you use the robot cleaner with the dust bin full, the rotation of the internal motor will be increased, which may shorten the battery lifetime.
- Always use the robot cleaner after charging.
- Do not use the robot cleaner in a place where it will be exposed to direct sunlight or near the heating source.

Battery Replacement

- If you notice that the operating time has been significantly reduced, you may need to replace the battery.
- You must use a battery that is manufactured by Moneual.
- Remove the battery from the robot cleaner when the system power is off.
- Dispose of your old batteries according to the local laws and regulations of your region.
To purchase an extra battery, please contact our customer service.
- If it is difficult to replace the battery by yourself, please contact our customer service.

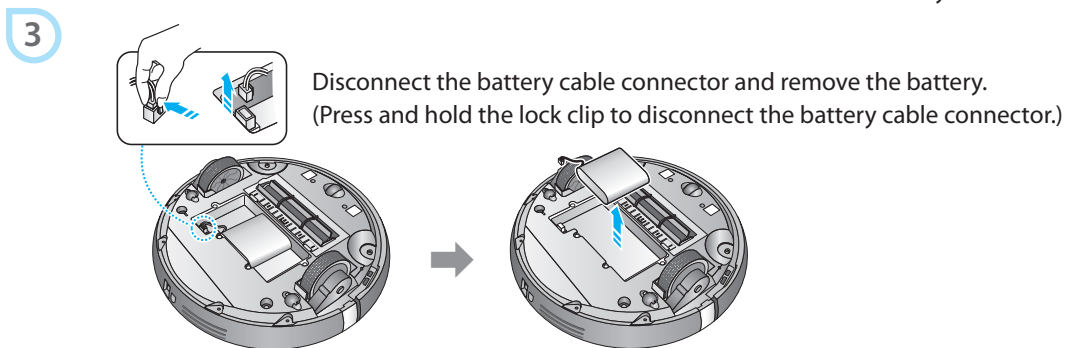
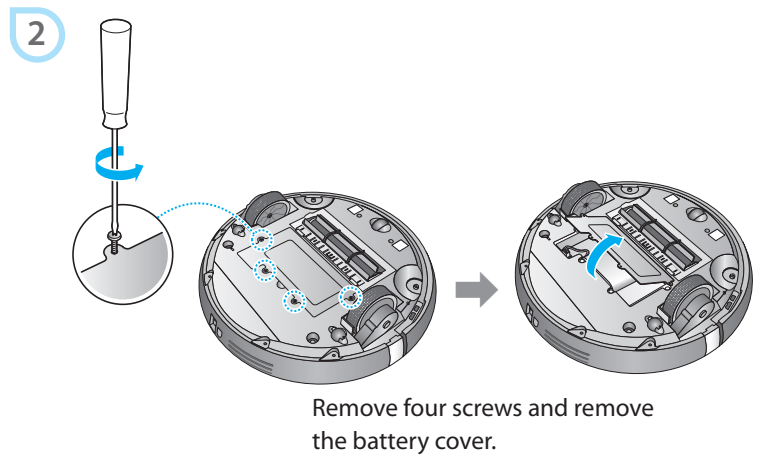
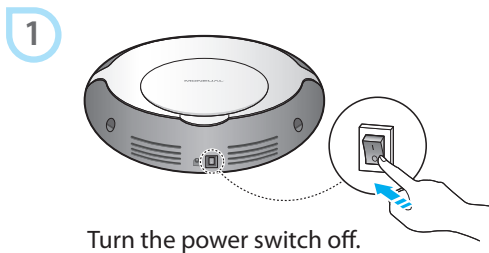

4

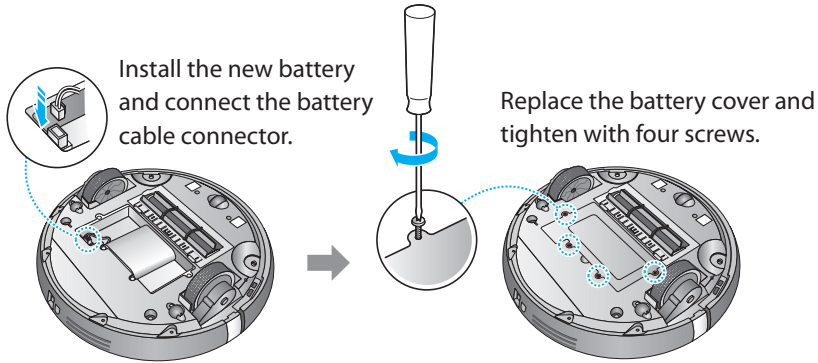

Battery Handling and Safety Information

- If you leave the fully discharged battery for a long time, the battery may become damaged and you may not be able to use it.
- If you use a battery other than Moneual's for use with the robot cleaner or the battery may be damaged.
- Remove the battery before disposing of the robot cleaner.

Voice Guidance

Following voices are the basic voice list. Depending on your model, some contents of these voices may differ from the actual voices.

Voice Guidance	
Starting Intensive Cleaning.	The robot cleaner will start Intensive Cleaning.
Starting Pre-set Cleaning.	The robot cleaner will start the Scheduled Cleaning.
Starting Shadow Cleaning.	The robot cleaner will start Shadow Cleaning.
Cleaning is completed.	The cleaning is completed.
Cleaning is cancelled.	When you press the Start/stop (▶/■) button during operating.
Moving toward the Charger.	When you press the Charge button or the robot cleaner is moving to the charger for auto charging.
Starting to charge.	The charger will start the charging process.
Starting Scheduled Cleaning after 1 Hour.	The time setting is completed for 1 hour later cleaning.
Setting Daily Cleaning.	The time setting is completed for every day cleaning.
Moving to shadowed area.	When starting a Shadow Cleaning, the robot cleaning moves to the shadowed area.
Starting Double Cleaning.	When you select the Double Cleaning option and start secondary cleaning, voice guidance.
Please, detach the mop pad.	When starting Vacuum Cleaning mode and attaching the mop plate to the robot cleaner, voice guidance to detach the plate.
Starting Vacuum Cleaning.	When starting Vacuum Cleaning mode.
Starting Hybrid Cleaning.	When starting Hybrid mode.
Starting Mop Cleaning.	When starting Mop Cleaning mode.







Maintenance Messages	
Out of battery.	The battery has been discharged.
Dust bin is missing.	The dust bin has been removed.
Please place the robot cleaner on the floor.	The robot cleaner has been lifted from the floor.
Please check the wheels.	The wheels are jammed.
Please check the main brush.	The main brush is jammed with hairs or other obstacles.
Please check the side brush.	The side brushes are jammed with hairs or obstacles.
Please, attach the mop.	You have selected mop cleaning mode, but the mop plate is not attached to the robot cleaner.
There is an error.	An error has occurred (refer to the error code).

Error Message Description



- ▶ The cleaner will display combination of numbers and icons to inform users of what the issue is. Using the information below, it is important to resolve the issue first as pressing any button will clear the error message.
- ▶ If the problem has not been solved with one of the solutions below, please contact your customer service.
- ▶ The error voice guidance comes only one time when the error has occurred. You can re-check the error status by pressing the SELECT button on the remote control when the power is off.

	Cause	The battery is fully discharged, so the robot cleaner does not work.
	Voice	Out of battery.
	Solution	Charge the robot cleaner manually.
	Cause	The wheel motor has been overloaded. Some obstacles (hairs, wires, etc.) are jammed on one or both wheels.
	Voice	Please check the wheels.
	Solution	Move the robot cleaner to another place. Remove obstacles on the wheel(s).
	Cause	The dust inlet fan is overloaded.
	Voice	There is an error.
	Solution	Remove obstacles in the dust inlet and empty the dust bin.
	Cause	The main brush is overloaded.
	Voice	Please check the main brush.
	Solution	Remove obstacles (hairs, wires, etc.) in the main brush.
	Cause	You tried to charge the robot cleaner without the battery.
	Voice	No battery.
	Solution	Check if the battery is installed in the robot cleaner properly.
	Cause	The battery failure.
	Voice	There is an error.
	Solution	Contact your customer service.

	Cause	You operated the robot cleaner without the dust bin.
	Voice	Dust bin is missing.
	Solution	Replace the dust bin.
	Cause	Both main wheels have been lifted.
	Voice	Please place the cleaner on the floor.
	Solution	Put the robot cleaner on the floor or move it to another place.
	Cause	Escape rough road mode continually occurred in excess of the limit while moving.
	Voice	Please check the front wheel.
	Solution	Remove obstacles from the front caster and empty the dust bin.
	Cause	Bumper crash continually occurred in excess of the limit while moving.
	Voice	Please check the bumper.
	Solution	Remove obstacles from the bumper and check if the bumper has been dented.
	Cause	The robot cleaner has continually detected the risk of falling more than limitation.
	Voice	Please check the bottom sensor.
	Solution	If the color of the floor is black, move the robot cleaner to another place. Clean or wipe obstacles from the cliff sensors (see page 39).
	Cause	Other error.
	Voice	There is an error.
	Solution	Contact your customer service.

Troubleshooting

Problem	Solution
The robot cleaner does not work.	<ol style="list-style-type: none"> ① Turn off the power switch on the lower-rear side. ② Check the battery. → Charge the battery in the charger.
The robot cleaner does not charge.	<ol style="list-style-type: none"> ① Remove any obstacles around the charger. ② Check if the power cord is connected to the charger. ③ Turn on the power switch at the rear of the charger. → If you charge the robot cleaner forcedly, it may not be charged.
The remote control does not work.	Replace the batteries.
Suction power is weak.	<ol style="list-style-type: none"> ① Clear the dust bin. ② Clear the filter of the dust bin. ③ Check if there is any obstacle in the dust inlet.
The power is not turned on.	<ol style="list-style-type: none"> ① Turn off the power switch on the lower-rear side. ② Check the battery.
The brush does not rotate.	<ol style="list-style-type: none"> ① Check if there is any obstacle in the brush. ② Check if the brush has been installed properly.
The operational noise is louder than normal.	<ol style="list-style-type: none"> ① Check if the dust filter is installed properly. ② Check if there is any obstacle in the brush.
The robot cleaner action is not working normally during cleaning.	<ol style="list-style-type: none"> ① Check if the mop plate is installed properly. ② Clean the sensor with a soft cloth.
The Scheduled Cleaning does not work.	Press the Select button to confirm the time setting.
The robot cleaner does not respond if you press the button.	When you are charging the robot cleaner by connecting the power adaptor directly, the buttons will not be recognized. This is normal.
The operating time is short.	<ol style="list-style-type: none"> ① If you do not properly connect the robot cleaner to the charger or the adaptor for a long time, the battery may be discharged. In this case, the battery usage time may be short. ② Do not disconnect the charger, even if the charge is completed. ③ If you do not intend to use the robot cleaner for an extended period of time, turn off the power switch on the lower-rear side.
I can't control the suction power.	<ol style="list-style-type: none"> ① If the mop plate is attached to the robot cleaner, you can't control the suction power. ② Clean the mop plate installation holes.

Specifications

Robot Cleaner

Model	ME770 Style	
Dimensions	348 mm (Diameter) x 85 mm (Height)	
Weight	2.674 kg	
Speed	Cleaning mode: 32 cm/sec., Driving mode: 30 cm/sec.	
Operating Noise	- Max. 68 dB (1400 mAh battery)	
Power Consumption	- Max. 20 W (1400mAh battery)	
Battery	Lithium iron phosphate (LiFePO4) 12.8V DC	
Dust Bin Capacity	600ml	
Charging Time	- Max. 60 minutes (1400 mAh battery)	
Operating Time	- Vacuum Cleaning: 60 minutes - Turbo Cleaning: 40 minutes - Hybrid Cleaning: 60 minutes	Mop Cleaning: 120 minutes (Cleaning time can differ depending on floor condition)

Charger

Model	MRD6500
Dimensions	264 mm (W) x 179 mm (H) x 134 mm (D)
Weight	606 g
Input Power	18V DC
Output Power	18V DC
Signal Transmission Distance (IR)	5 m / 8 m

Remote Control

Model	RC750
Dimensions	133 mm (W) x 23 mm (H) x 47 mm (D)
Weight	60 g
Battery	AAA size x2
Signal Transmission Distance (RF)	10 m

Product Warranty

The warranty service we provide to our consumers is based on the customer compensation regulation. If you request warranty service, MONEUAL will provide the service. The company will notify the customer of whether he or she will be compensated and the details of the compensation within seven (7) business days after the day of the customer's request, and offer the compensation within fourteen (14) business days after the day of notification. We do not offer any paid/free service for parallel imports.

Product Name			
Purchased Date	Month	Date	Year
Dealer			

The warranty period for the product is two (2) years, and the warranty for the battery is six (6) months.

Model Name	
Serial No.	
Price	

Free Service

❖ If products for general users are used for commercial purposes, free service may not be offered.

Type of damages to customers		Compensation details		
		Within the warranty period	After the warranty period	
Malfunctions in performance and functions during normal use within the holding period of parts.	Essential repair is required within ten (10) days after the purchase.	Replace the product with a new one or refund the product at the purchased price.	Not applicable	
	Essential repair is required within one (1) month after the purchase.	Replace the product with a new one or offer free service.		
	A replaced product is faulty, requiring essential repair within one (1) month after replacement.	Refund the product at the purchased price.		
	No replacement is available.			
	Repair is available.	Malfunctions occur three (3) times due to the same defects.	Replace the product with a new one or refund the product at the purchased price.	Paid repair
		Malfunctions occur five (5) times due to different defects.		Paid repair
	The repair company has lost the product for which a repair was requested by the customer.	Refund the product at the fixed depreciated price after adding 10% of the fixed depreciated amount.		
Repair is NOT available as no parts for repair are in stock within the period in which related parts should be stored.				
Repair is NOT available although parts for repairing are stored.	Refund the product after the fixed depreciation.			
Malfunctions due to intention or negligence of customers.	Repair is NOT available.	Replace the product after the amount corresponding to the expenses for paid repair has been paid.	Replace the product by applying fixed depreciation, after the expenses for paid repair has been paid.	
	Repairs are available.	Paid repair	Paid repair	

Paid Service

❖ If you ask for after-sales service and the product is not found to be faulty, you will be responsible for the service fee. Please read through the User Manual before contacting the service center.

Malfunctions due to customer negligence

- Malfunctions caused by incorrect power capacity.
- Malfunctions caused from external shock or fall.
- Malfunctions due to the use of consumables or optional devices not specified by our company.
- Malfunctions caused by repair person who is not from the partner companies specified by our company.
- Malfunctions caused by ignorance of the "Safety Information" described in the User Manual.

Cases when the product is not faulty

- Users asking for warranty service before fully understanding the User Manual.
- Problems in external environment, including propagation of radio waves and wired signals.
- Errors in initial installation for the supplied product.
- Treatment of filtering and removal of foreign substances from accessories.
- Malfunctions caused by other companies' products (including software).

Other cases

- Malfunctions caused by natural disasters (lightning, fire, salt damage and water damage).
- The life of consumables has expired.

Customer Service

info@moneual.eu

Before you call for service, please be ready to provide the following information:

- Model name
- A description of your problem
- Phone no. & address

MONEUAL®

www.moneual.eu