

kogan

KAPHN4G6PA
Kogan Agora 6Plus

USER MANUAL

Table of Contents

Safety Notes.....	2
Welcome.....	3
Introduction.....	3
Phone Display.....	3
Getting Started.....	4
Inserting the SIM card and SD card.....	4
Switch ON/OFF.....	4
Unlocking the SIM Card.....	4
Connecting to your Network.....	4
Charging the Battery.....	5
Connecting your Phone to your PC.....	5
Basic Functions.....	5
Make Calls.....	5
Make Domestic Calls.....	5
Call Extension Phone.....	5
Make International Calls.....	6
Make Listed Calls.....	6
Emergency Calls.....	6
Answering Calls.....	6
Connection Options.....	6
Menu Functions.....	7
Browser.....	7
Calculator.....	7
Calendar.....	7
Camera.....	7
Clock.....	7
Contacts.....	8
Downloads.....	8
Email.....	8
File Manager.....	8
Flashlight.....	8
FM Radio.....	8
Gallery.....	8
Gmail™.....	8
Google.....	8
Maps.....	8
Messages.....	9
Music.....	9
Phone.....	9
Play Store.....	9
All Settings.....	9
SIM Toolkit.....	11
Sound Recorder.....	11
Videos.....	11
YouTube™.....	11
Input.....	11
Troubleshooting.....	12
Safety Information and Notices.....	13
Using the mobile phone and charger.....	13
Using the mobile phone.....	13
Using the battery.....	13
Using the charger.....	14
Cleaning and Maintenance.....	14











© 2016. All rights are reserved. No part of this document may be reproduced without permission.

While all efforts have been made to ensure the accuracy of all the contents in this manual, we assume no liability for errors or omissions or statements of any kind in this manual, whether such errors or omissions or statements resulting from negligence, accidents, or any other cause. The contents of this manual are subject to change without notice.

Protect our environment! We strive to produce products in compliance with global environmental standards. Please consult your local authorities for proper disposal.

Note: User Manual is just to guide the user about the functionality of the phone. It is not a certificate of technology. Some functions may vary due to modifications and upgrade of software, or due to print mistake.

Safety Notes

	Do not switch your phone on when the use of wireless devices is prohibited or when the wireless device may cause interference or danger.
	Do not use your phone while driving.
	Follow relevant rules or regulations in hospitals and health care facilities. Switch your phone off near medical devices.
	Switch your phone off in an aircraft. The radio signal from it may cause interference in signals of the aircraft.
	Switch your phone off near high-precision electronic devices. It may affect the performance of these devices.
	Do not attempt to disassemble your phone or its accessories. Only qualified personnel may service or repair the phone.
	Do not place your phone and its accessories in containers with strong electromagnetic field.
	Do not place magnetic storage media near your phone. Radiation from the phone may erase the information stored on them.
	Do not put your phone in a high-temperature place or use it in a place with flammable gas such as a petrol pumps.
	Keep your phone and its accessories away from children. Do not allow children to use your phone without guidance.
	Respect others' privacy and legal rights when using your phone.

Welcome

Congratulations on your purchase of the KAPHN4G6PA mobile phone. Your phone provides many functions which are practical for daily use, such as a hands-free loudspeaker, camera, MP3 player, internet browser and much more.

You can read this manual to understand how to use the Mobile phone and experience the functions and simple operation method. Please use original accessories in order to achieve the best results.

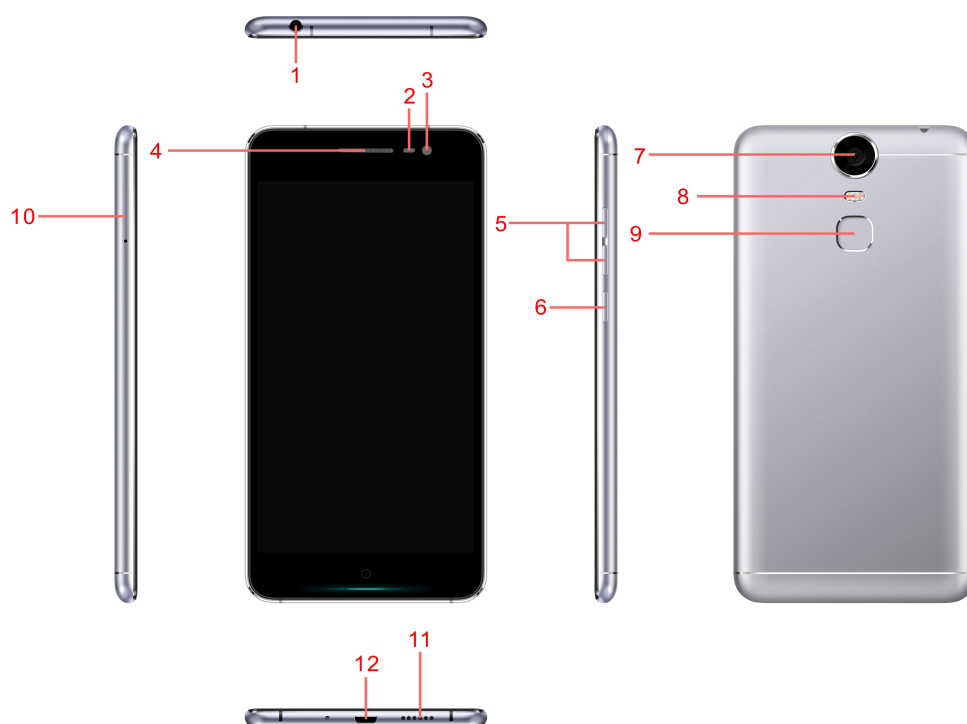

Introduction

Phone Display



No	Description	No	Description
1	Earphone Jack	2	Light Sensor
3	Front Camera	4	Receiver
5	Volume +/- Key	6	Power ON/OFF Key
7	Back Camera	8	Flash
9	Finger Print	10	SIM Card Slot
11	Loud Speaker	12	USB Jack

Back Key: Press  to open the previous screen you were working on.

Home Key: Press  at a non-standby screen to go back to the home screen. Hold  to enter Google Now™/Google™ Search.

Menu Key: Press  to open a list of thumbnail images of apps you've worked with recently.
Volume +/- Key: Press to change the volume.

Getting Started

Please read the safety instructions prior to first use.

Inserting the SIM card and SD card

Make sure the phone is switched off. Make sure that the clipped corner of the nano SIM card is facing the correct direction and the metallic contacts are facing upwards. Slide the SIM card into the card slot until it stops.

Please note: you can either insert a microSD card and a nano SIM card, or two nano SIM cards.

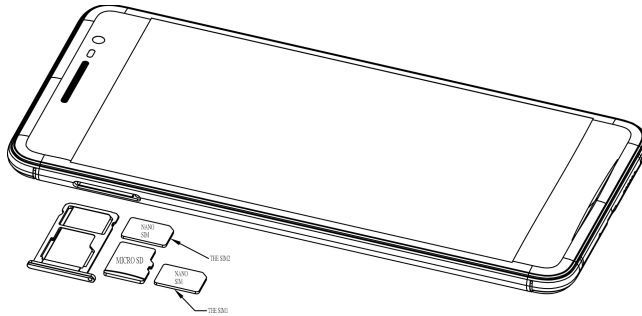

Switch ON/OFF

Hold down the ON/OFF key to switch the phone on and off.

If inserting a new SIM card, the screen will show the notes in the following order when the phone is switched on:

- Type in PIN — if you have already set the SIM code.
- Search — The handset will be searching for proper network connection.

Unlocking the SIM Card

To avoid illegal use, the SIM card is locked with a PIN (personal identification number) as a protection. When this function is ON and you have already set a PIN code, you need to type in the PIN code every time the handset is switched on in order to unlock SIM card.

You can turn off the SIM PIN code, however the SIM card won't be locked from illegal use.

Input PIN code, (press the arrowhead icon to erase any typing errors) and press OK.

For example, if the PIN code is set as 1234, then type "1234" then press OK.

The SIM card will be locked if you type in wrong code for three times continuously. The handset will then inform you to type in PUK code.

Attention: Your network provider will set a standard PIN code (four to eight numbers) for your SIM card. It is recommended that you change the code to a personal code as soon as possible.

Connecting to your Network

When the SIM card is successfully unlocked, the handset will automatically search for available networks (the lock screen shows searching). The handset will show information of the network provider, and the status bar will show the signal strength and the network condition once the handset is successfully connected to a network.



Note: if the lock screen shows "Emergency", this means you are out of network coverage, or your SIM card is not valid. You will still be able to make emergency calls to 000 based on signal strength.

Charging the Battery

To charge the battery, plug in the charger connector at the top of your phone (USB interface) and then plug the other end into an AC power socket.

The battery icon indicates the charging state. While charging, the charge indicate lightning icon will display.



Note: if the battery is completely empty, it may take a few minutes of charging before any icons or information will be displayed on-screen.

Connecting your Phone to your PC

Once phone is connected to a PC by USB cable, the below screen will show:

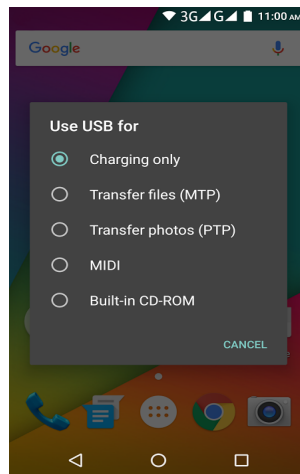

You can now exchange/manage data between your phone and PC.

Once finished, for USB storage mode, click (“Turn off USB storage”) to unmount storage from computer and use it with phone again. For other modes, just unplug the USB cable.

Basic Functions

Make Calls

When the network provider icon appears on the standby screen, you can call out or answer calls. The indicator on the upper right part shall show the signal strength.

Quality of connection will be greatly influenced by obstructions. So movement in a small range may effectively improve the quality of connection.

Make Domestic Calls

Use virtual keyboard to enter phone numbers and then press Dial icon to call. If you need to change the phone number, please press the delete key on the touch screen to delete. When the call is answered, the screen shall show the connection status.

Call Extension Phone

Some extension phones can't be directly connected to. Using the virtual keyboard, enter the switchboard number, open the option menu and choose " Add 2-sec pause", and then dial the extension phone number.

Type in as follows to call extension phone:

Zone description > switchboard number > Add 2-sec pause > extension phone number > call

Make International Calls

If you need to make an international call, hold down the 0 key on the virtual keyboard until the "+" sign appears for international call prefix, which helps you call from any country, even if you don't know the international call prefix of that country.

You can make an international call according to the following typing order: + › country code › complete phone number › dialling icon (type in the prefix code, and then continue to enter the country code and complete phone number). Country code usually follows conventional practice: Germany is 49, UK 44, Sweden 46 and so on.

When making international phone calls, the "0" in the city code should be omitted.

Make Listed Calls

Every dialled and received phone number is recorded in the call log list. Recently dialled, answered and missed phone numbers are chronologically (newest to oldest) listed in the "ALL" log.

You can also choose and check missed, answered and dialled list according to your needs.

Listed phone numbers can be called out by pressing the respective log.

In the call history interface, users can do a long press to save or delete the number.

In the details interface, the phone number save function is preset.

Emergency Calls

You can call for emergency services as long as you are in any network coverage (check the signal strength indication bar on the upper right side of the handset screen). If your network provider doesn't provide roaming service in this area but another network does, there will be "Emergency Calls" on the lock screen. If you are within any network coverage, you can even make emergency calls without a SIM card.

Answering Calls

Drag the middle icon to right to answer an incoming call. If your headphones are connected to the handset, you can use the headphone key on the headphones to answer calls.

Attention: A short press of the headphone key will answer the call while holding the key down will reject the call.

Connection Options

These options can only be seen during a call. The waiting call, hold call, multi-party call functions require the support of the network. Please contact your network provider for information.

In the connection option, you can do the following operations:

Dialpad: Enter the dialling screen of the current call.

Speaker: Switching hands-free and handheld modes.

Mute: Turn on/off Mute. When the mute is ON, the other person can't hear audio.

Hold: Temporarily hold the current one-line call.

Start recording: Record the current call.

Add Call: Enter the dialling screen for a new call.

End: End the current call.

Conference*: In Conference call mode, you can answer the incoming call and add it to the conference in accordance with the instructions; Hold multiparty conference; Have a private conversation with one party and hold other parties' call; Connect one party to the other and end the conference call; Put one party on hold; End current call and all hold on calls.



Note: conference call mode is only available under certain conditions. Users will need to ensure that conference call functions are available from their service provider.

Menu Functions

Browser

Your phone comes with a browser. You can use Browser to access and browse the Internet. Open the browser options menu and to perform one of the operations, press Menu key then tap it.

Calculator

The handset is provided with a calculator with basic functions. Use the calculator to solve simple arithmetic problems or use its advanced operators to solve more complex equations.

1. Touch Calculator to open the application.
2. Flick the screen to the left or make the screen horizontal to switch to the Advanced panel on the Calculator screen.

Attention: the accuracy is limited with extremely long numbers and round-off errors may occur.

Calendar

Use the Calendar to create and manage events, meetings, and appointments. Depending on your synchronization settings, the calendar on your phone can stay in synchronization with your calendar on the web.

Press the touch screen to browse date and the calendar information on the screen shall be correspondingly updated.

Camera

Under viewing condition, press the bottom icons to do the corresponding operations. Press the Capture icon to capture a picture. Press the Record icon to record video. The Thumbnail icon shows the currently captured picture or video.

In the camera preview interface, you can press the volume keys for zoom In/Out.

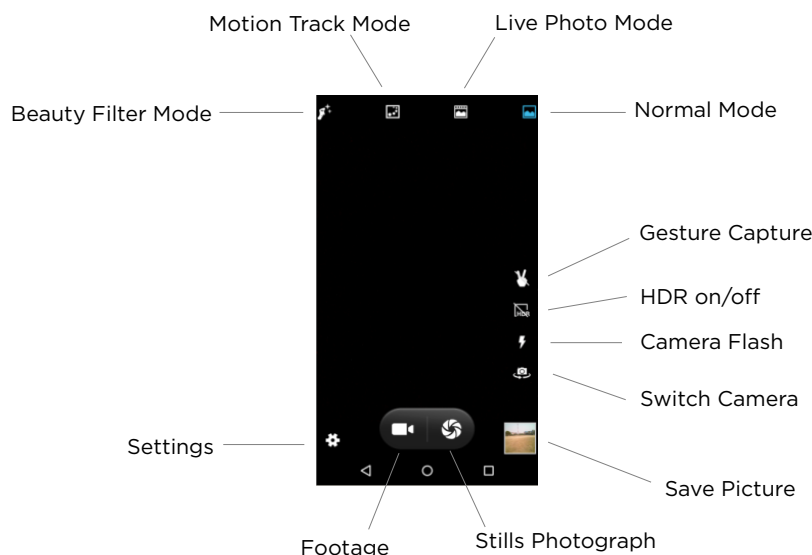

Clock

Enter the clock menu and touch the alarm icon to enter the alarm list interface. You can add a new alarm. The Countdown and Stopwatch function can also be used inside the Clock.

Contacts

Entering the Contacts, you can check all the contacts, search for contacts or add new contact. New contact means a newly added phone number that is recorded in the SIM card or the handset. You can also check contact group.

Downloads

You can check the downloaded or being-downloaded contents.

Email

When using the Email application for the first time, you must configure your email account. The Email setup wizard helps you set up your account for many popular email systems. Using Email, you can send or receive emails from other email accounts.

File Manager

You can manage files, including music, videos, documents and other formats files. Enter the file manager, you can select external or internal SD card, and touch the icons of the lower screen to do some operations.

Flashlight

Tap this icon to turn the flashlight on/off.

FM Radio

FM Radio lets you listen to FM radio stations on your mobile phone. Since FM Radio uses the provided wired stereo headset as the antenna, connect the headset first to the audio jack of your phone before you open the application.

Gallery

In the gallery interface, there are different folders. Select a folder and press to enter it. Press image or video to view pictures or videos.

When viewing the picture, if you touch the screen, you will see the share icon. Touch "share icon" to send the file through Bluetooth or via a messages. Touch the option menu to delete or edit the picture.

Gmail™

Gmail (also known as Google Mail) is a free email service with innovative features such as "conversation view" email threads, search-orientation, tagging etc.

Google

Google is a web search engine owned by Google Inc. you can search the online information, including webpages, images, videos and more.

Maps

The phone provide maps service for your travel.

Messages

Compose new message

Press edit new message to get a new text message:

Click the edit frame, type in after a virtual keyboard pops out.

Press the number frame and enter number, or press add contact icon  and select stored contact number from Contacts.

Input contents into the typing frame on the touch screen.

Touch the add attachment icon  of left screen to add files.

Press upper right corner option icon  to insert quick text, Insert contact, Add subject and Discard.

After editing, press send icon  to send the text.

Message Settings

Include SMS Enabled Text Message (SMS), Multimedia Message (MMS), notifications and General.

Music

Use the Music player to play music files. The songs saved in your SD Card can be played using the Music Player of the device.

The songs are categorized by Artists, Albums and Songs. You can make your favourite playlist by holding your finger on a song and selecting Add to playlist. While listening to the music, you can choose among various sound effects.

Phone

Press the keyboard, enter the phone number then press the Dial icon.

Google Play™ Store

Google Play Store is dedicated to establishing the latest, fastest and most comprehensive third-party application store, making the Android™ system simpler. You can pick software and games to your taste from thousands of applications anywhere and at anytime.

All Settings

- **Wi-Fi**
To use Wi-Fi on your mobile phone, you need to have an access to wireless access points (hotspots). Obstacles that block the Wi-Fi signal will reduce its strength.
- **Turbo Download**
Download large files (over 20MB) faster using Wi-Fi and 4G/3G networks at the same time. The Turbo Download icon will be shown on the status bar when it is running. To use Turbo Download, both Wi-Fi and Mobile data must be turned on. When it is enabled, any application data that you have selected to download via Wi-Fi only will be downloaded via WLAN and 4G/3G networks anyway.
- **Bluetooth**
If you are using Bluetooth, remember to stay within 10 meters (33 feet) of other Bluetooth devices. Be aware that obstacles like walls or other electronic equipment may interfere with your Bluetooth connection.
Touching your Bluetooth device name lets others can find your Device
Touching Refresh to scan and search devices
Touching other device name to Pair.
Pressing menu key to do other operations. Such as Refresh, Rename this device and Show received files.

- **SIM cards**
The contents in this menu will differ according to different network providers. For detailed information, please look at the phone.
- **Data usage**
To view the data usage conditions including SIM card and wifi.
- **More**
In this menu, it is including Airplane mode ,Tethering & portable hotspot,VPN, Cellular networks.
- **Display**
Change settings of MiraVision ,Wallpaper, Brightness level,Adaptive brightness and so on.
- **Sound & notification**
Include General, Silent, Meeting and Outdoor.You can also add custom profiles and setting Notification & Others.
- **Storage & USB**
Include the SD card storage, available storage, insert SD card (If a SD card has already been inserted, then this option will become "Unmount SD card "), Erase SD card and all available storage in the internal storage space.
- **Battery**
To view the battery usage.
- **Memory**
To view the memory use (RAM).
- **Apps**
Include the management of applications, to view and manage the applications of downloaded, SD card, running and all.
- **Location**
Locate your position through tools like wireless network and GPS satellite.
- **Security**
Change the settings of Screen security, Encryption, SIM card lock, Password and so on.
Screen lock:
Voice Unlock: Unlock the screen use your voice.
Pattern: unlock the screen through designed pattern. Draw a private pattern to unlock the screen so as to avoid unauthorized use of the handset.
PIN: type in PIN numbers to unlock the screen.
Password: type in code to unlock the screen.
- **Accounts**
The type of account include Exchange, Facebook, Google and so on.
- **Language & input**
Include language settings, keyboard & input method and so on.
- **Backup & reset**
If you reset your phone to the settings that were configured at the factory, all of your personal data from internal phone storage, including information about your Google Account, any other accounts, your system and application settings, and any downloaded applications will be erased. Resetting the phone does not erase any system software updates you've downloaded or any files on your SD card, such as music or photos.

- **Date & time**
Include Automatic date & time, Automatic time zone, Set date, Set time, Select time zone, Use 24-hour format.
- **Scheduled power on & off**
You can set the time for ON/OFF, which include setting time and repeated date.
- **Accessibility**
Power button ends call: press power button to end calls.
- **Printing**
You can print pictures in the phone by connecting the cloud client printer.
- **About phone**
Include Software update, Status, Legal information, Model number, Android version, Baseband version, Kernel version and Build number.

SIM Toolkit

The contents in this menu will differ according to different network providers. For detailed information, please look at the phone.

Sound Recorder

Press Recording icon to start recording. In the middle of the screen is a timer. Press Stop Key to stop recording and select "Save" in the popped out "Discard/Save" option to save the record. You can press play key to listen to the record before selecting "Discard/Save".

Videos

Play video. Enter the video list, scroll the screen to browse and choose the file you want to play.

YouTube™

YouTube is a video-sharing website. It is the world leader in online video, and the premier destination to watch and share original videos worldwide through the Web.

Input

Click the editing frame and a input option menu will pop out which include upper-case letters, lower-case letters and number mode.

Press  to switch freely between English and Number typing.

Press , you can switch the input method between ABC and abc.

Troubleshooting

Problem	Suggested Solution
Unable to turn on phone	Press the power on key for over 1 second. Check if battery is appropriately charged
Unable to connect to a network	Weak signal. Please Try and move to a location with strong signal and try connecting to the network again; Please ensure that you are not beyond the network coverage of service providers; Please ensure you have a valid SIM card. Please contact your network provider for further information;
Display information while turning on	Check if the SIM card (insert the SIM card) is installed correctly Handset lock password. If the handset lock is activated, you have to input handset password before using. Input PIN. Inputting PIN while turning on each time is activated, you have to input the PIN code. Input PUK code: Having input wrong PIN code for 3 times straight will lock the SIM card. You need to input the PUK code provided by your network provider.
Poor quality of calling	Please check if the sound volume is tuned improperly In an area with poor receiving condition, example: basement, the signal might be weak. Try reaching a location with stronger signal reception and call again. While using the mobile phone in the peak period of communication, like commute time, you may be unable to call because of line congestion.
Standby duration shortened	The standby duration is relative to the system setting of network. While the mobile phone is in an area with poor signal strength and can not receive the signal, the handset will continuously search for a base station. This will significantly reduce battery charge. It is recommended that you turn off your mobile in area with no signal reception to save battery. Need replacing the battery. Please change a new battery.
SIM Card Error	Dirt on the metal surface of an SIM card. Use clean cloth to wipe the metal touch point on an SIM card. The SIM card is not installed. The SIM card is damaged. Please contact your network service provider.
Unable to dial out	Please confirm if you press ED the dial key after dialing. Please confirm if calling is forbidden because of default settings. Please confirm if the SIM is valid. Please confirm if the call barring is set. Please confirm if the fixed dial function is set.
Callers unable to contact you	Please confirm if the mobile phone is on and connected with the network. Please confirm if calling is forbidden because of defaulting. Please confirm if the SIM card is valid. Please confirm if the call barring is set.
Unable to charge handset	Poor contact. Please check if the plug is connected well. Please confirm if the environment temperature is within the range of 0°C - 40°C while charging. The battery or charger is damaged. You need to replace it.
Unable to set some functions	Wrong operation. The network provider does not support the function, or you have not applied for it.

If the suggestions above cannot assist you in solving your problems, please contact the Kogan.com customer support team.

Safety Information and Notices

Using the mobile phone and charger

Only use the authorised battery and charger. Using other brands may cause battery leakage, overheating, explosions or even fire.

Caution:

Keep the phone away from dust, water and damp areas. Dust, water or other liquids may cause overheating, electrical leakage, and/or phone failure.

The phone, battery, charger and AC adapter are not waterproof. Keep them away from rain and liquids.

Warning:

Do not bump, shake or tamper with the phone or charger. This may cause battery leakage, overheating, explosions or even fire.

Do not place the battery, phone or charger near a microwave or high-voltage device. This may cause battery leakage, overheating, explosions or even fire; also prevent the phone and AC adapter from overheating, smoking or short circuiting.

Do not use the phone around volatile oil. This may cause fire, breakdown or damage.

To avoid any damage or breakdown, do not disassemble the phone, battery, charger or internal components by yourself.

Using the mobile phone

Warning:

Do not use the phone while you are driving. Pull over and stop your automobile to dial or listen to a phone call.

Usage of mobile phones in aircrafts or hospitals is prohibited. Switch the phone off to prevent interference with electronic medical devices. Follow any rules or regulations in such places.

Do not use the phone at a gas station, near fuel or near chemicals.

Do not use the phone near electronic medical devices such as hearing aids, pacemakers and auto-control devices such as fire detectors and automatic doors.

If you have to use your mobile phone near an electronic medical device such as a pacemaker, please contact your manufacturer of the medical device for information about preventing interference.

Caution:

Electronic systems in automobiles such as anti-lock brakes, speed control, or fuel spraying systems, are usually not influenced by wireless devices. Manufacturers of these systems will tell you whether they are provided with good screening functions. If you suspect that an automobile failure is caused by wireless activity, please contact your automobile dealer.

Avoid using your phone in crowded places.

Do not store your mobile phone near or with a credit card, disk or other magnetic materials. This may effect information stored on your phone.

Keep your phone away from pins. Pins can be absorbed by the phone's receiver magnet, which may cause harm.

Using the battery

Do not dispose of the battery into a fire. Doing so may cause battery explosion or even fire.

If you have difficulties installing the battery, do not force the installation. This may cause battery leakage, overheating, explosions or even fire.

Keep metal objects away so they do not come in contact with the battery or its connectors as it may cause the battery to short circuit, overheat or explode.

Do not weld the polarities of the battery directly together. This may cause battery leakage, overheating, explosions or even fire.

Battery liquid is severely harmful for your eyes. If battery liquid gets in your eyes, do not rub them. Instead, wash your eyes with water first and then go directly to a doctor for help. Do not use or store your phone in high temperature areas. This may cause battery leakage, overheating, explosion or even fire.

Warning:

Replace the battery when the normal usage time begins to decrease or if you notice the battery is overheated or has changed shape or colour.

If battery liquid leaks onto your skin or clothes, immediately wash the affected parts with water. If the battery begins to leak or emits a strange odour, properly dispose of the battery according to local regulations. Do not throw it into a fire.

Caution:

Do not leave the product or its battery inside a vehicle or in places where the temperature may exceed 60°C, such as on a car dashboard, window sill, or behind a glass that is exposed to direct sunlight or strong ultraviolet light for extended periods of time. This may damage the product, overheat the battery, or pose a risk to the vehicle.

Using the charger

Only use the charger that came with the phone. Using a different charger may cause the phone to breakdown or explode.

If the charger short circuits, a fire may occur.

Do not use a damaged, worn or broken charger. This may cause a fire.

Clean dust away from the power socket to avoid the possibility of a fire.

Do not store the charger near any liquids. If liquids spill onto the charger it may cause it to overheat or breakdown.

If liquid does spill onto the charger, immediately unplug the power cable to prevent overheating, fire or another type of breakdown.

Do not use the charger in places with high humidity like a bathroom. This may cause a fire or other breakdown.

Do not touch the charger, power cable or socket with wet hands. This may cause an electric shock.

Caution:

Keep the environment temperatures within the range of 0°C ~40°C while charging. Temperature below 0°C or higher than 40°C will cause insufficient charging, terminate charging or even cause the battery to explode.

Unplug the charger from its power source before cleaning it.

Do not place heavy objects on the power cord. This may cause electric shock or fire.

Hold the plug while unplugging the power cord. This will avoid any potential damage or even fire.

Cleaning and Maintenance

The phone, the battery and the charger are not waterproof. Do not use them in places with high humidity like bathrooms, and also avoid spilling any liquids on them.

Use a soft cloth to clean the phone, the battery and the charger.

Do not use alcohol, diluted liquid or benzene to clean the phone.

If dust gets in the sockets the phone can be damaged, short-circuit or even the lose the ability to be re-charged. Be sure to clean the socket regularly.