

NPP

NPOESS Preparatory Project

1/22 Scale Detailed Model

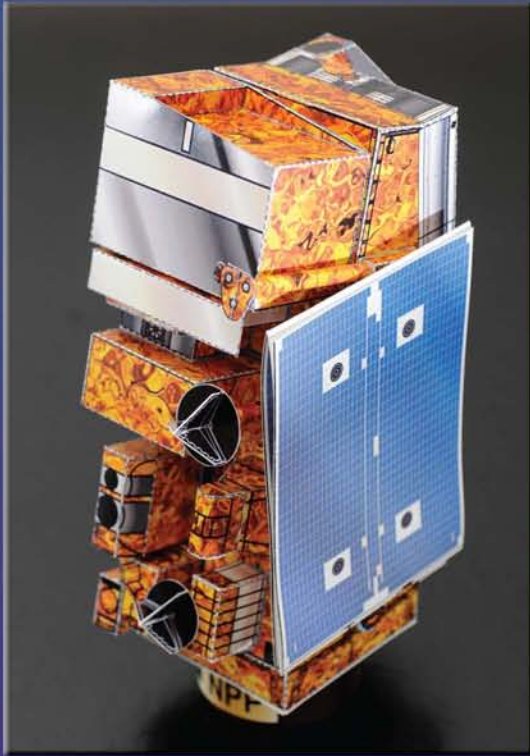

Hurricanes, tornadoes, heat waves, severe snowfalls! Extreme weather events pummeled the United States this year. We rely on satellites orbiting Earth to predict these events and to monitor climate change.

NPP is NASA's next weather and climate spacecraft, and its five instruments will gather critical data. Ball Aerospace built OMPS, the instrument that measures atmospheric ozone. Ball also built NPP's bus, the main structure that carries the instruments.

NPP will be launched from Vandenberg Air Force Base in California, in October 2011.

Build your own NPP with this realistic model kit. It requires some patience, but is actually fairly easy to build.

To learn more about NPP, visit
<http://jointmission.gsfc.nasa.gov>
www.ballaerospace.com



**Ball Aerospace
& Technologies Corp.**



GENERAL INSTRUCTIONS

NUMBERING CODE

- Parts are numbered in sequence of assembly.
- **Black** denotes the part.
- **Blue** indicates where to glue one part to another.

LINE CODE

Part outlines (cut lines)

Score and **Mountain Fold** (bend down) - 

Score and **Valley Fold** (bend up) - 

Location of an attaching part

Cut here

Roll or curve part

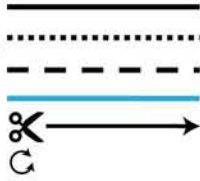

TOOLS YOU'LL NEED

- Small scissors (for cutting all curved lines)
- An X-Acto knife with a new blade (but scissors are OK)
- A scriber, ball-point pen, small knitting needle or large smooth sewing needle (for scoring folds)
- A metal-edged ruler
- Dowel or round pencil; table edge is OK (for forming curved parts)
- A cutting board, if using an X-Acto knife (tagboard or cardboard is OK)
- Rubber or foam pad (for forming curved parts)
- Tweezers (for holding and bending small parts)
- White glue, such as Elmer's
- Toothpicks (for glue applications)

PROCEDURE

1. **SCORE** each part before cutting out.
2. **CUT OUT** and assemble in numerical sequence.
Caution: X-Acto knives are extremely sharp!
3. **FOLD** parts as instructed by line code.
4. **CHECKFIT** each part before gluing, matching alignment as indicated.
5. **ASSEMBLE** using minimal glue; wipe off excess.

FORMING THE PARTS

SCORING

Always score a part before you cut it out! Scoring slightly weakens the paper so you can make perfect folds. To score, line up a metal-edged ruler with a score line. Then use a scriber or other round-tipped tool, and firmly draw along the ruler.

CYLINDERS

Glue tabs or strips should remain attached during forming. To form a cylinder, slide a dowel or round pencil over the part, using a rubber or foam pad underneath. Face part up or down as required. Part will curve up at the ends, becoming cylindrical. Repeat forming process until desired shape is attained. *Drinking straws cut to size will also work.*

GLUING

It is best to use glue very sparingly; too much results in warping and excessive drying times. Use a toothpick with a small puddle of glue on scrap paper. Do not try to glue too much at a time on any part. Glue only 4 or 5 tabs at a time, and let them dry before going on.

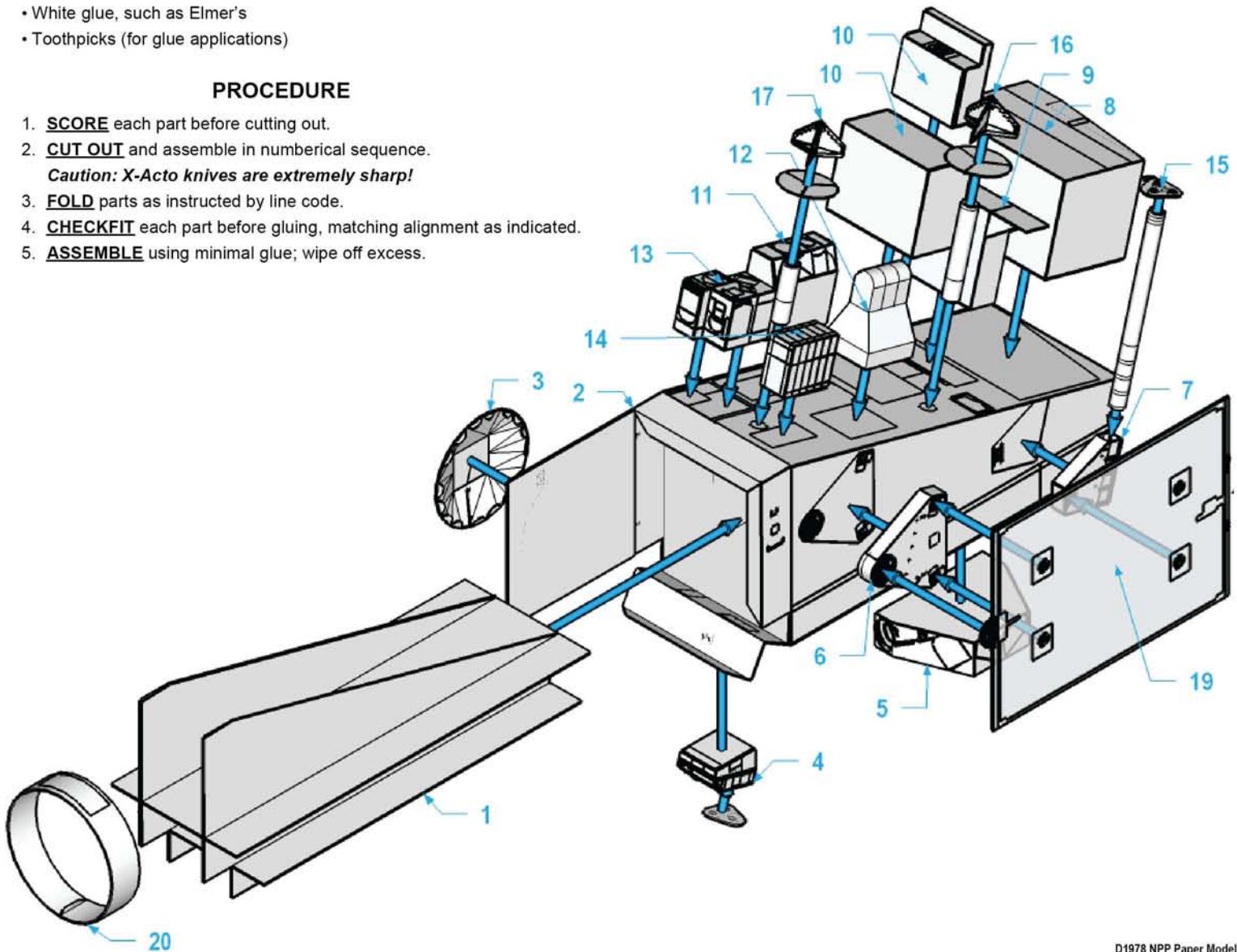

1 Internal Support Structure

After cutting out these four panels, match the symbols and slide the panels together.

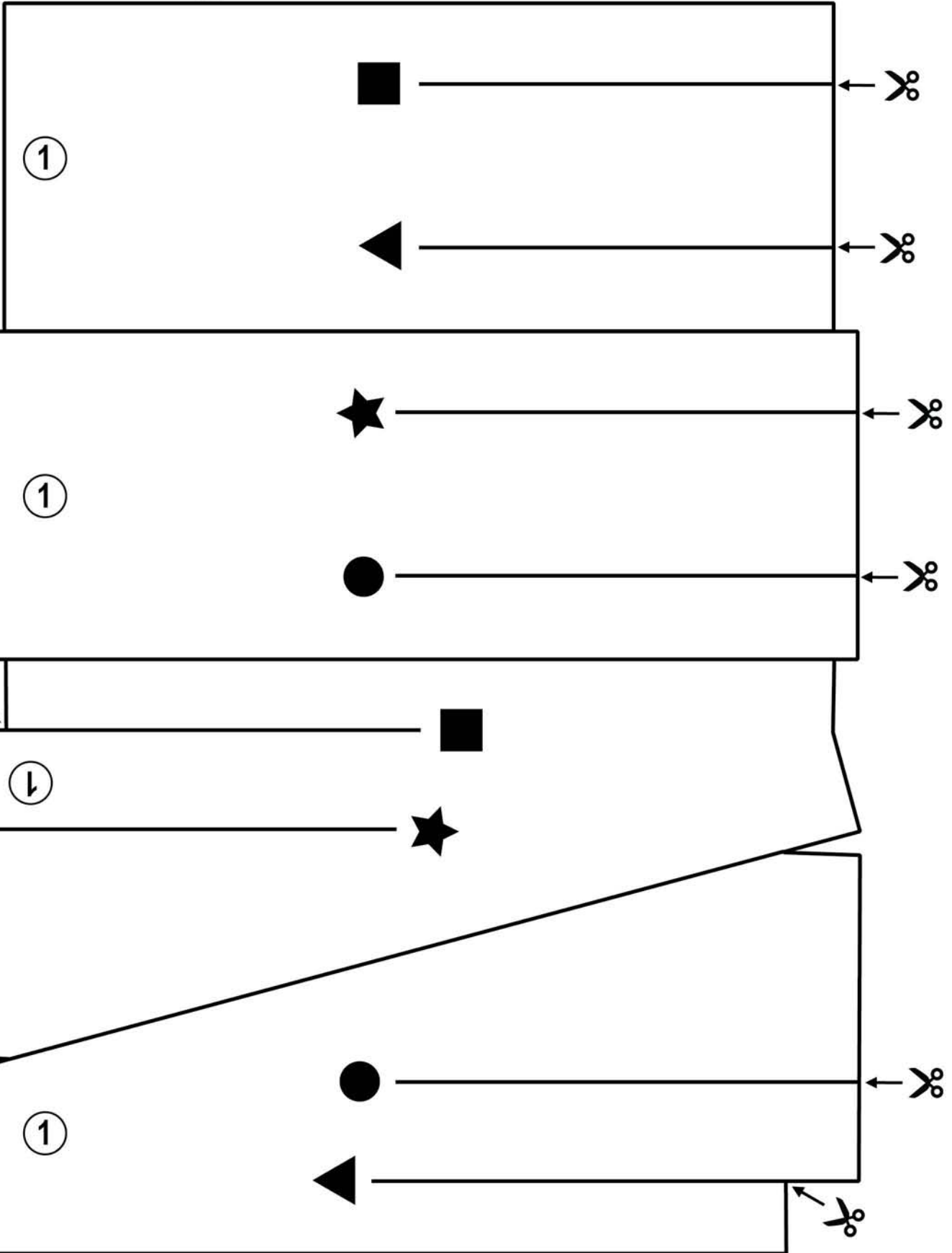

Model Stand

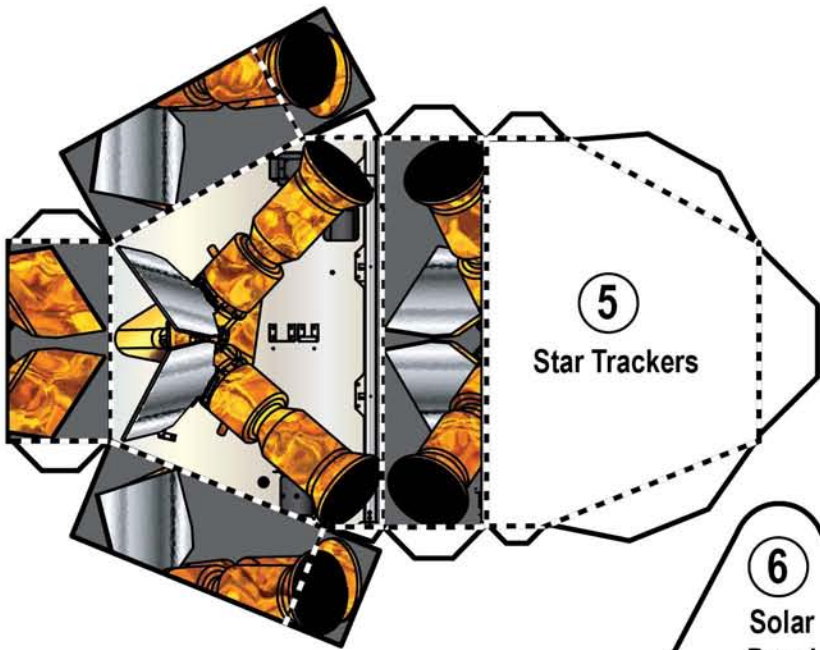

5
Star Trackers

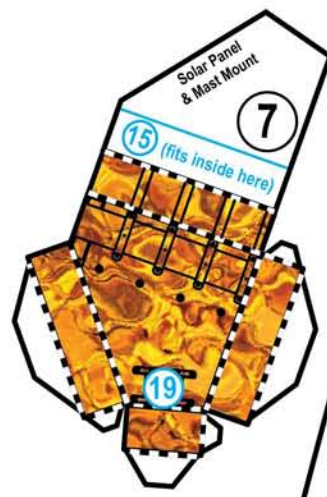

Solar Panel & Mast Mount
7
15 (fits inside here)
19

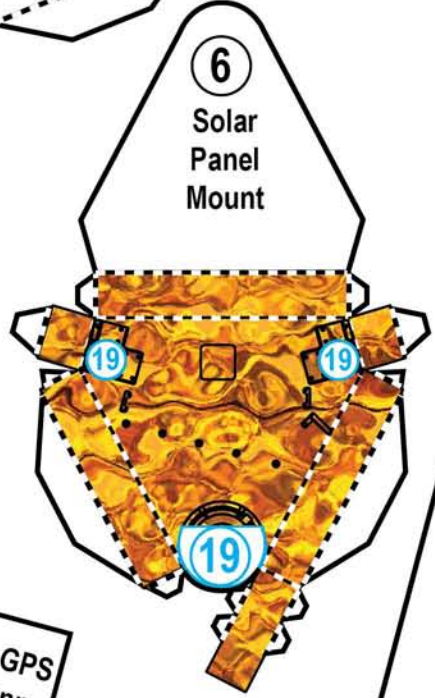

6
Solar Panel Mount
19

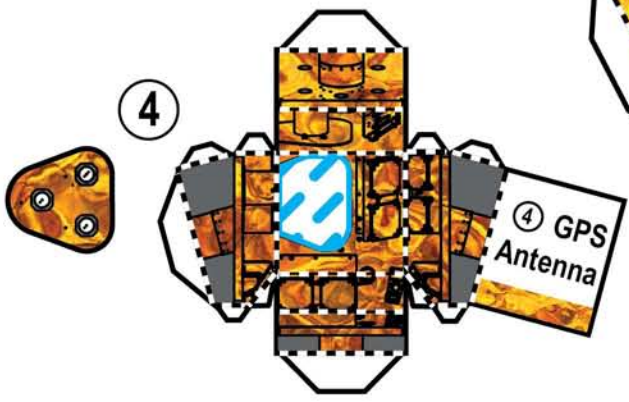

4
GPS Antenna

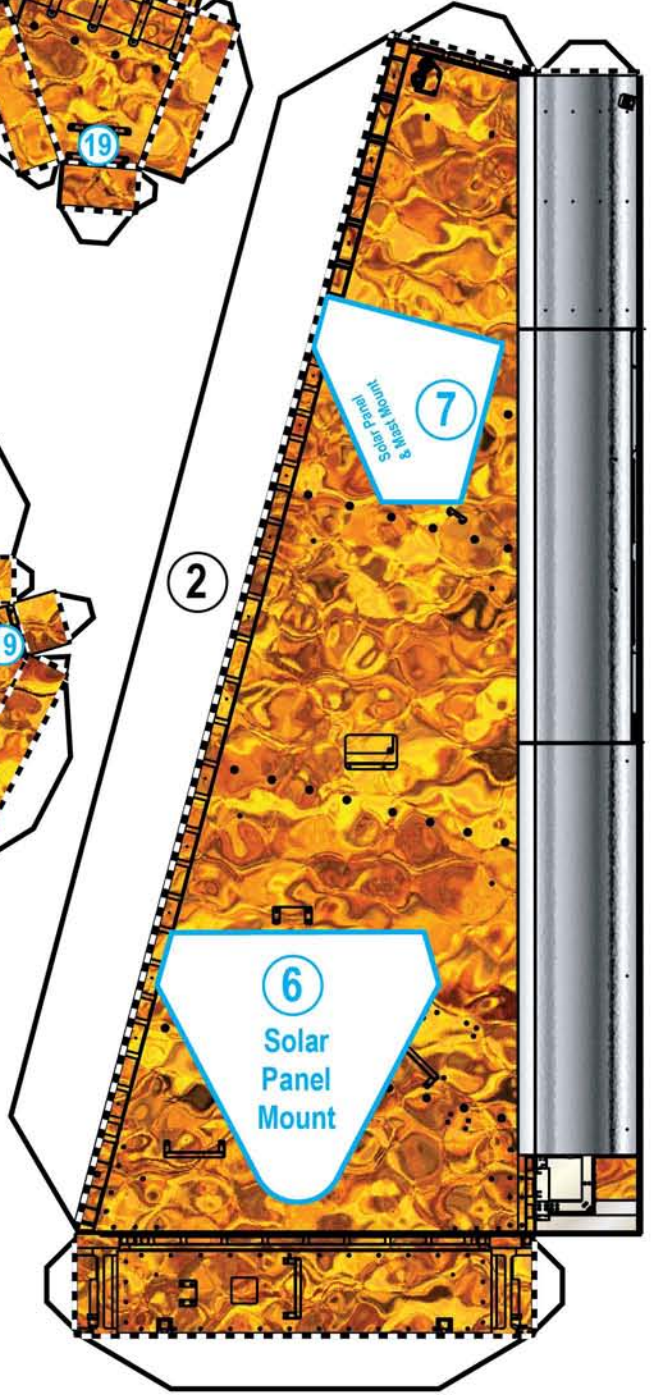

2
6
7
6
Solar Panel Mount

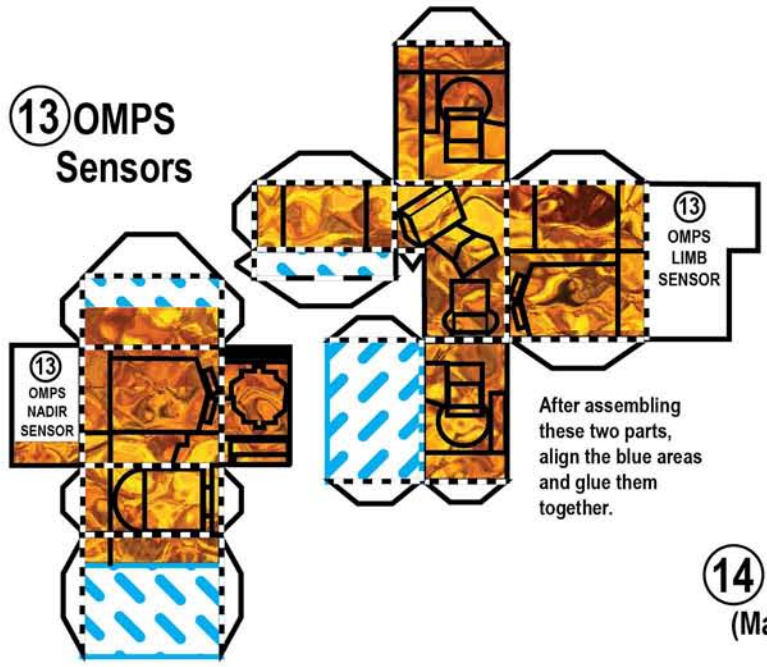

13 OMPS Sensors

13 OMPS LIMB SENSOR

After assembling these two parts, align the blue areas and glue them together.

14 OMPS MEB (Main Electronics Box)

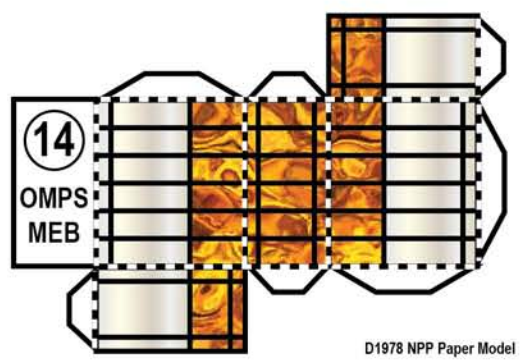

14 OMPS MEB

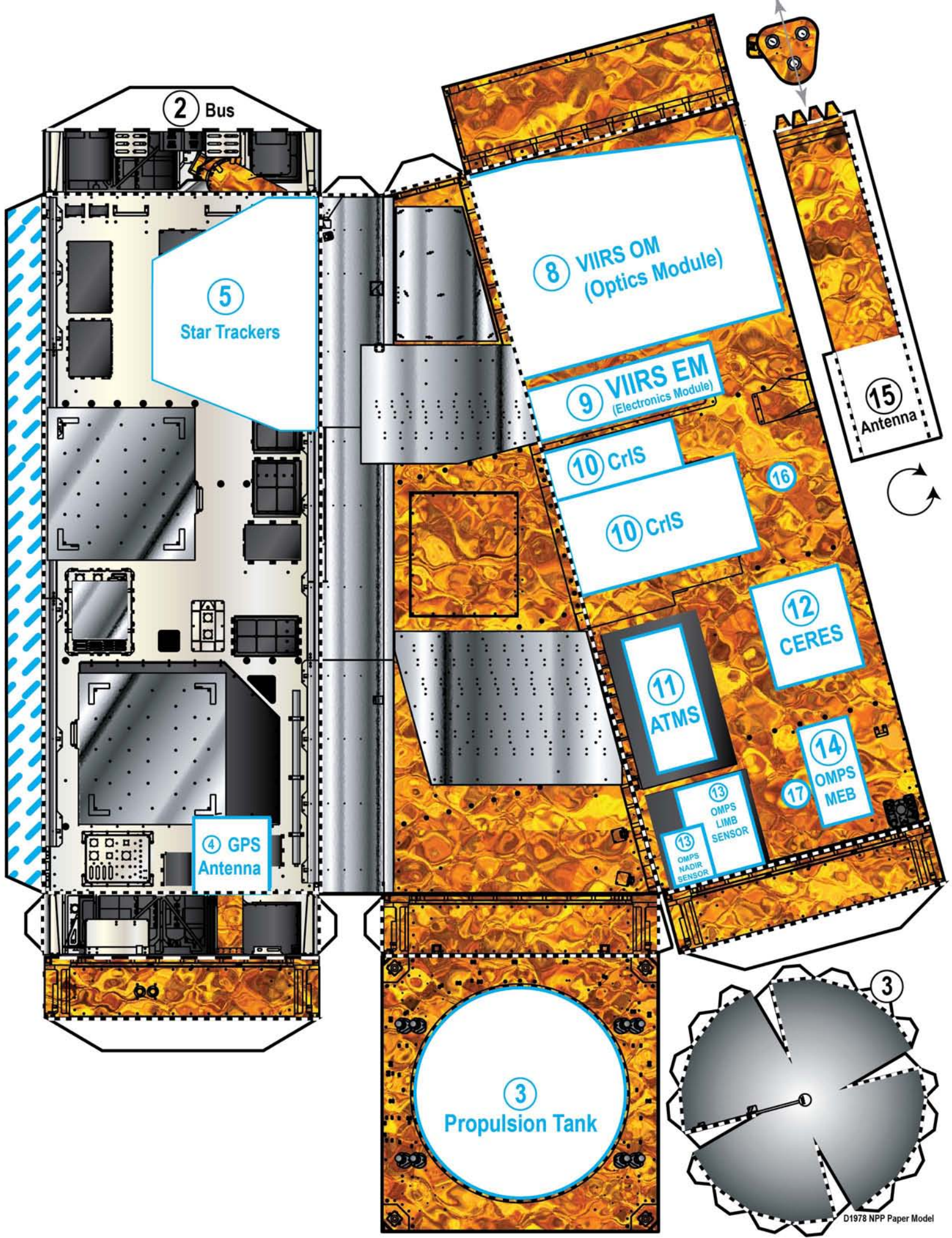

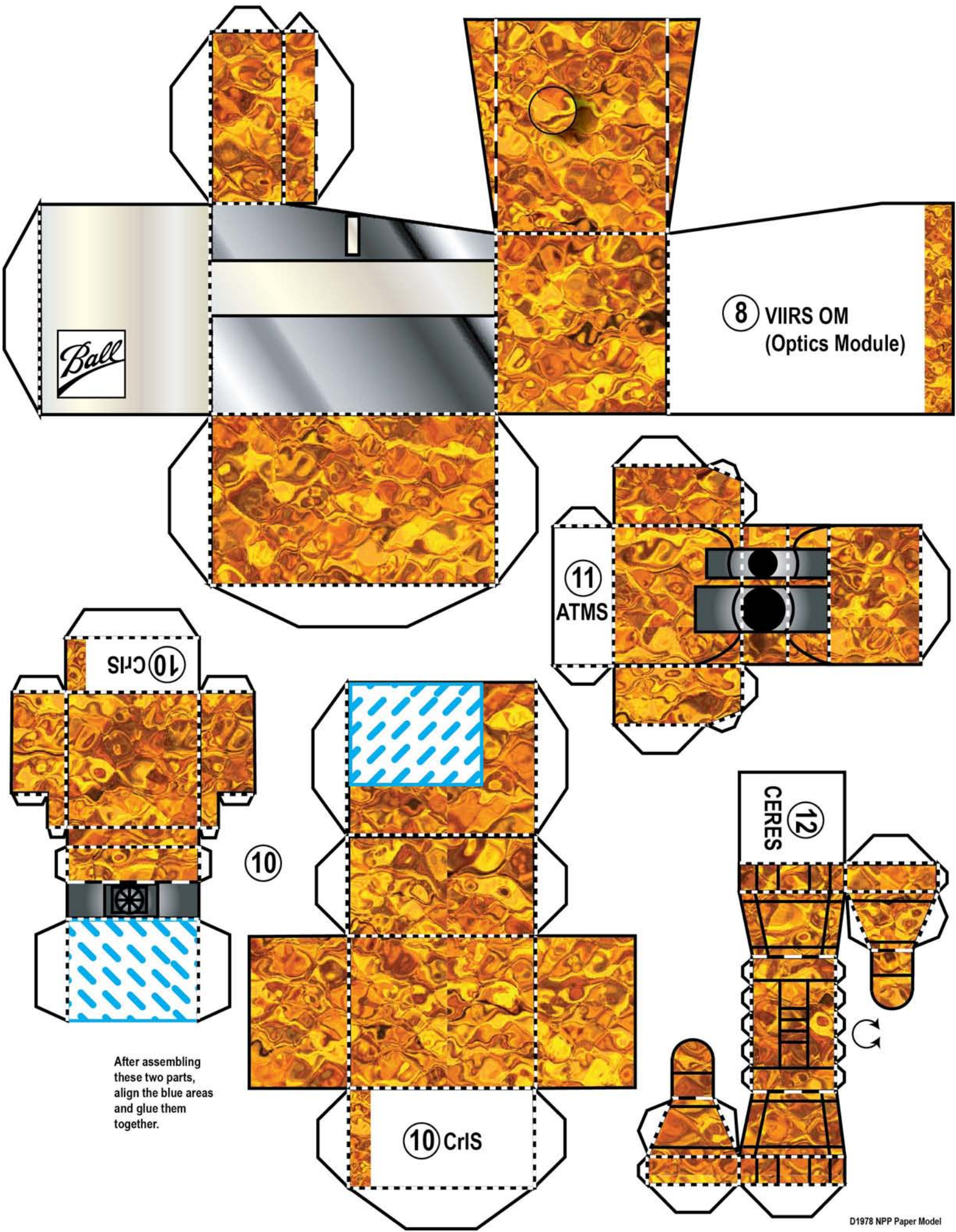

8 VIIRS OM
(Optics Module)

11
ATMS

10 CrIS

10

10 CrIS

12
CERES

After assembling these two parts, align the blue areas and glue them together.



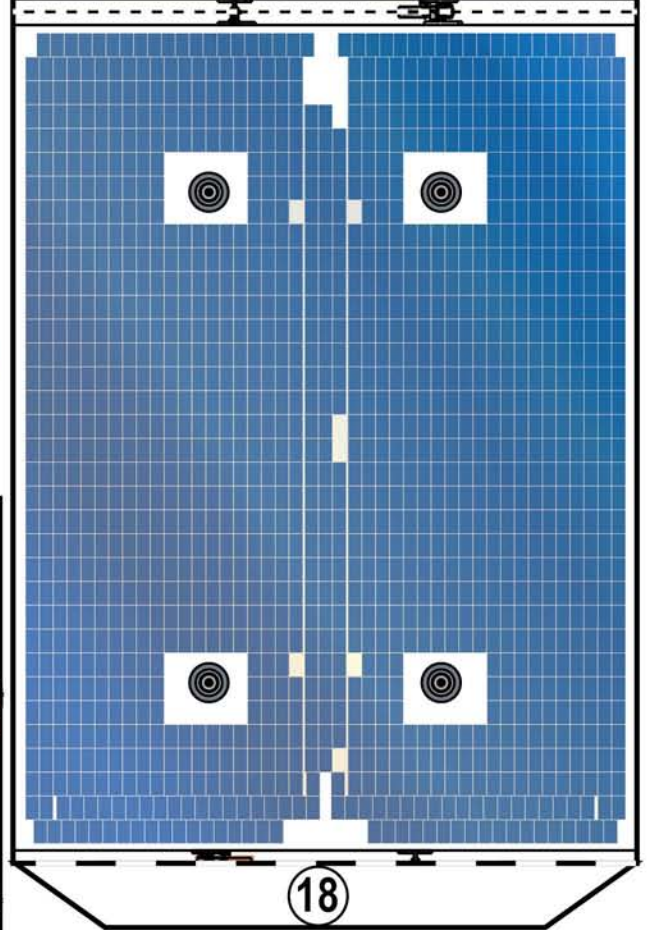
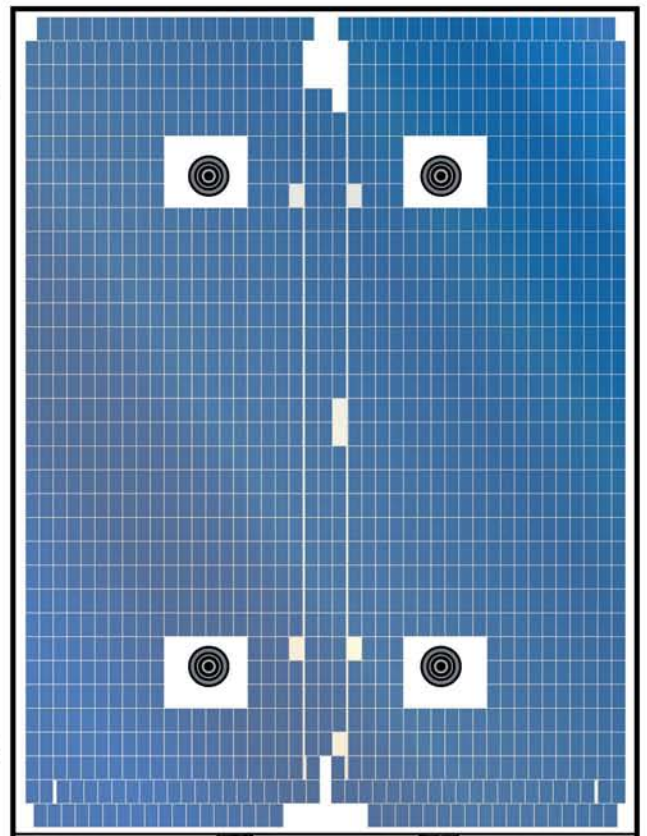
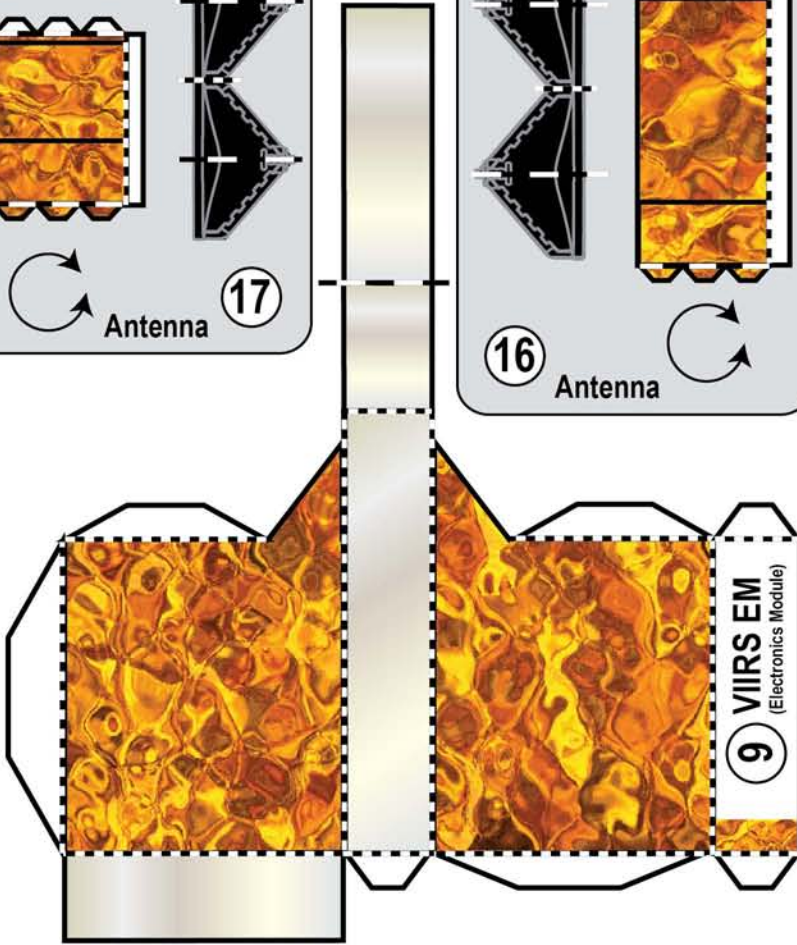
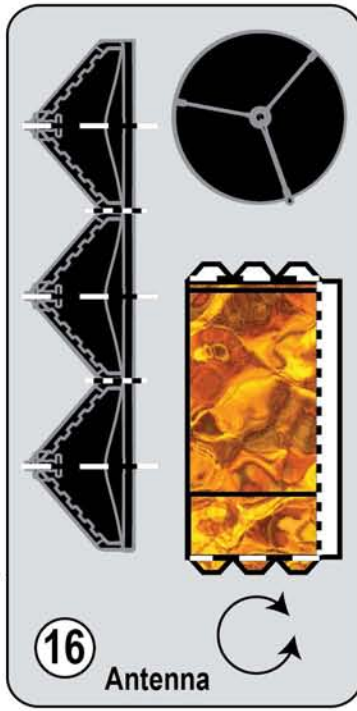
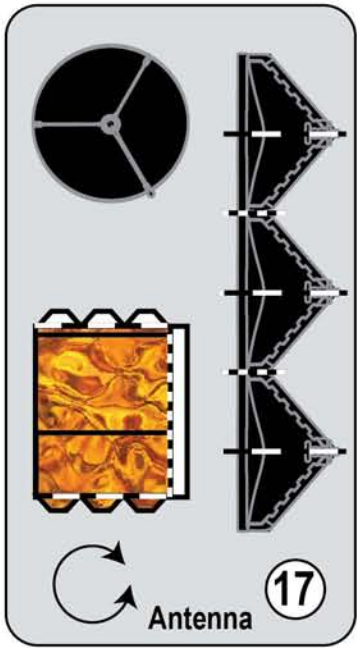

Optional Solar Array Extension

(if using this part, glue to part 19 *before* attaching the complete array to the model.)

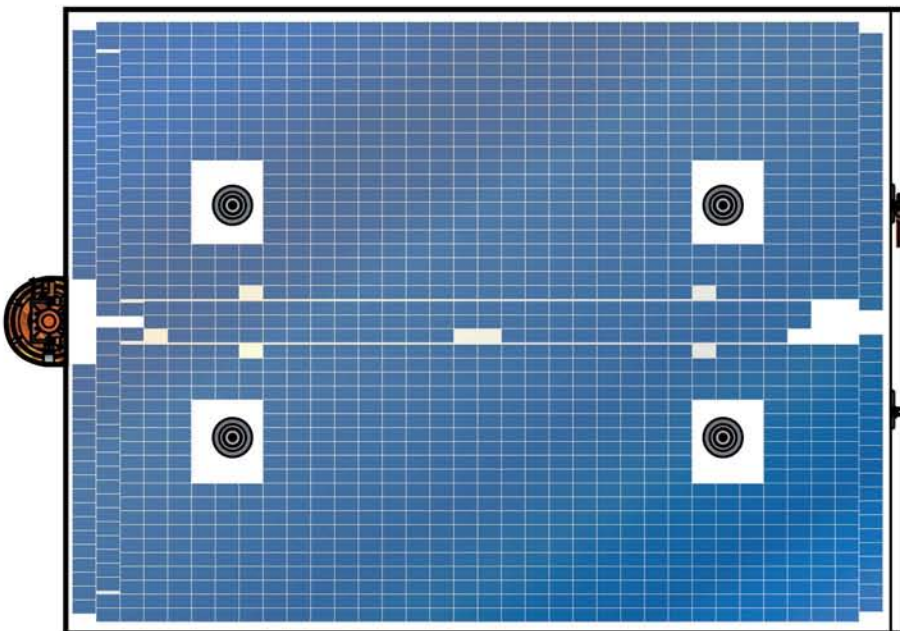

19 Solar Array

Finished NPP Model Parts

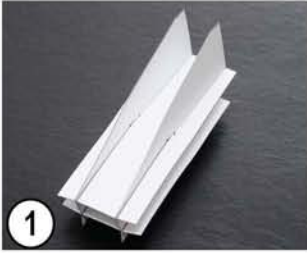

1
Internal Support
Structure



2
Bus

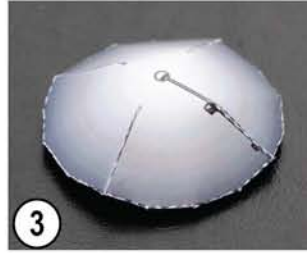

3
Propulsion Tank



4
GPS Antenna



5
Star Trackers



6
Solar Panel Mount



7 15
Solar Panel Mount and
Antenna



8
VIIRS Optics Module



9
VIIRS Electronics Module



10
CrIS



11
ATMS



12
CERES



13
OMPS Sensors



14
OMPS Main
Electronics Box



16 17
Antennas



18 19
Solar Array



20
Model Stand



Radiator Side View

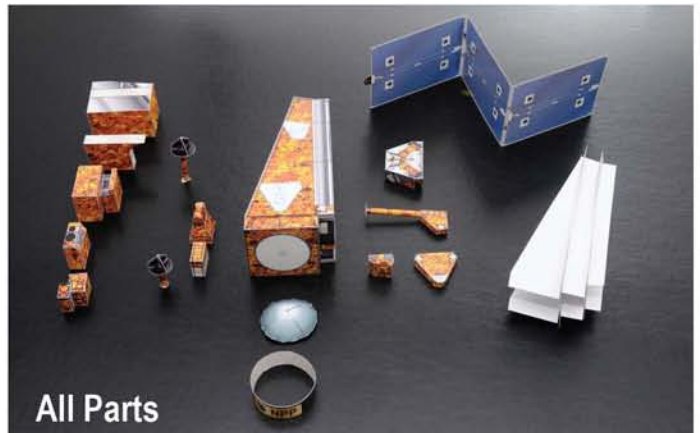

All Parts