

IAEA-TECDOC-1340

***Manual for
reactor produced radioisotopes***



INTERNATIONAL ATOMIC ENERGY AGENCY

IAEA

January 2003

The originating Section of this publication in the IAEA was:

Industrial Applications and Chemistry Section
International Atomic Energy Agency
Wagramer Strasse 5
P.O. Box 100
A-1400 Vienna, Austria

MANUAL FOR REACTOR PRODUCED RADIOISOTOPES

IAEA, VIENNA, 2003

IAEA-TECDOC-1340

ISBN 92-0-101103-2

ISSN 1011-4289

© IAEA, 2003

Printed by the IAEA in Austria
January 2003

FOREWORD

Radioisotopes find extensive applications in several fields including medicine, industry, agriculture and research. Radioisotope production to service different sectors of economic significance constitutes an important ongoing activity of many national nuclear programmes. Radioisotopes, formed by nuclear reactions on targets in a reactor or cyclotron, require further processing in almost all cases to obtain them in a form suitable for use. Specifications for final products and testing procedures for ensuring quality are also an essential part of a radioisotope production programme.

The International Atomic Energy Agency (IAEA) has compiled and published such information before for the benefit of laboratories of Member States. The first compilation, entitled Manual of Radioisotope Production, was published in 1966 (Technical Reports Series No. 63). A more elaborate and comprehensive compilation, entitled Radioisotope Production and Quality Control, was published in 1971 (Technical Reports Series No. 128). Both served as useful reference sources for scientists working in radioisotope production worldwide. The 1971 publication has been out of print for quite some time.

The IAEA convened a consultants meeting to consider the need for compiling an updated manual. The consultants recommended the publication of an updated manual taking the following into consideration:

- significant changes have taken place since 1971 in many aspects of radioisotope production;
- many radioisotopes have been newly introduced while many others have become gradually obsolete;
- considerable experience and knowledge have been gained in production of important radioisotopes over the years, which can be preserved through compilation of the manual;
- there is still a need for a comprehensive manual on radioisotope production methods for new entrants to the field, and as a reference.

It was also felt that updating all the subjects covered in the 1971 manual at a time may not be practical considering the numerous new developments that have taken place since then. Hence in this manual it was decided to focus only on reactor produced radioisotopes. This manual contains procedures for 48 important reactor-produced isotopes. These were contributed by major radioisotope producers from different parts of the world and are based on their practical experience. In case of widely used radioisotopes such as ^{131}I , ^{32}P and ^{99}Mo , information from more than one centre is included so that the users can compare the procedures.

As in the earlier two versions, a general introductory write-up is included covering basic information on related aspects such as target irradiation, handling facilities, radiation protection and transportation, but in less detail. Relevant IAEA publications on such matters, particularly related to radiation protection and transportation, should be referred to for guidelines. Similarly, the nuclear data contained in the manual are only indicative and the relevant databases should be referred to for more authentic values.

It is hoped that the manual will be a useful source of information for those working in radioisotope production laboratories as well as those intending to initiate such activities.

The IAEA wishes to thank the consultants and all the contributors for their co-operation in compiling the manual. The IAEA officers responsible for this publication were D.V.S. Narasimhan and H. Vera Ruiz of the Division of Physical and Chemical Sciences.

EDITORIAL NOTE

This publication has been prepared from the original material as submitted by the authors. The views expressed do not necessarily reflect those of the IAEA, the governments of the nominating Member States or the nominating organizations.

The use of particular designations of countries or territories does not imply any judgement by the publisher, the IAEA, as to the legal status of such countries or territories, of their authorities and institutions or of the delimitation of their boundaries.

The mention of names of specific companies or products (whether or not indicated as registered) does not imply any intention to infringe proprietary rights, nor should it be construed as an endorsement or recommendation on the part of the IAEA.

The authors are responsible for having obtained the necessary permission for the IAEA to reproduce, translate or use material from sources already protected by copyrights.

CONTENTS

1. PRINCIPLES OF PRODUCTION, PROCESSING AND HANDLING OF RADIOISOTOPES	1
1.1. Introduction	1
1.2. Research reactors for isotope production	2
1.3. Nuclear reactions	2
1.3.1. Energy of neutrons in pile	4
1.3.2. Cross-section	4
1.3.3. Types of nuclear reactions	4
1.4. Calculation of radioisotope yield	6
1.4.1. Corrections to the activation equation	7
1.4.2. Self-shielding effect	7
1.4.3. Power variation in the reactors	8
1.4.4. Corrections for burnup of the target and destruction of target atoms	8
1.4.5. Irradiation efficiency	9
1.5. Irradiation techniques	10
1.5.1. Choice of target material	10
1.5.2. Target encapsulation	11
1.5.3. Safety evaluation of in-pile irradiation and experimental assemblies	11
1.6. Laboratory facilities for radioisotope production	11
1.6.1. Layout and basic infrastructure	12
1.6.2. Radiological protection	13
1.6.3. Radioisotope handling facilities	13
1.6.4. Ventilation	16
1.6.5. Management of radioactive waste	16
1.6.6. Surveillance and monitoring	17
1.7. Packing and transportation of radioisotopes	18
1.7.1. Transport regulations	18
1.7.2. Types of packages	18
1.7.3. Categories of packages	20
1.8. Conclusion	20
Bibliography to Section 1	21
2. PRODUCTION AND PROCESSING METHODS FOR INDIVIDUAL RADIOISOTOPES	
Bromine-82 ($^{82}\text{Br}_{35}$)	25
Calcium-45 ($^{45}\text{Ca}_{20}$)	29
Carbon-14 ($^{14}\text{C}_6$)	31
Chromium-51 ($^{51}\text{Cr}_{24}$)	35
Cobalt-58 ($^{58}\text{Co}_{27}$)	41
Cobalt-60 ($^{60}\text{Co}_{27}$)	44
Copper-64/Copper-67 ($^{64}\text{Cu}_{29}$, $^{67}\text{Cu}_{29}$)	51
Dysprosium-165 ($^{165}\text{Dy}_{66}$)	58
Dysprosium-166 ($^{166}\text{Dy}_{66}$)	60
Gadolinium-153 ($^{153}\text{Gd}_{64}$)	62
Gold-198 ($^{198}\text{Au}_{79}$)	63

Gold-199 ($^{199}\text{Au}_{79}$)	66
Gold-199 ($^{199}\text{Au}_{79}$) (Alternate procedure)	69
Holmium-166 ($^{166}\text{Ho}_{67}$)	71
Iodine-125 ($^{125}\text{I}_{53}$)	75
Iodine-131 ($^{131}\text{I}_{53}$) (Wet distillation method)	82
Iodine-131 ($^{131}\text{I}_{53}$) (Dry distillation method)	86
Iodine-131 ($^{131}\text{I}_{53}$) (Dry distillation method (Alternate procedure))	90
Iodine-131 ($^{131}\text{I}_{53}$) (Dry distillation method (Alternate procedure))	95
Iodine-131 ($^{131}\text{I}_{53}$) (Dry distillation method (Alternate procedure))	102
Iodine-131 ($^{131}\text{I}_{53}$) (Fission product)	111
Iridium-192 ($^{192}\text{Ir}_{77}$)	116
Iron-59 ($^{59}\text{Fe}_{26}$)	118
Lutetium-177 ($^{177}\text{Lu}_{71}$)	121
Lutetium-177 ($^{177}\text{Lu}_{71}$) (Alternate procedure)	124
Mercury-197 ($^{197}\text{Hg}_{80}$)	129
Mercury-203 ($^{203}\text{Hg}_{80}$)	132
Molybdenum-99 ($^{99}\text{Mo}_{42}$) (Fission product)	135
Molybdenum-99 ($^{99}\text{Mo}_{42}$) (By neutron irradiation)	141
Nickel-63 ($^{63}\text{Ni}_{28}$)	143
Osmium-191 ($^{191}\text{Os}_{76}$)	145
Osmium-194 ($^{194}\text{Os}_{76}$)	150
Palladium-103 ($^{103}\text{Pd}_{46}$)	154
Palladium-109 ($^{109}\text{Pd}_{46}$)	156
Phosphorous-32 ($^{32}\text{P}_{15}$)	158
Phosphorus-32 ($^{32}\text{P}_{15}$) (Alternate procedure)	161
Phosphorus-33 ($^{33}\text{P}_{15}$)	167
Platinum-195m ($^{195\text{m}}\text{Pt}_{78}$)	171
Rhenium-186 ($^{186}\text{Re}_{75}$)	179
Rhenium-186 ($^{186}\text{Re}_{75}$) (Alternate procedure)	183
Rhenium-188 ($^{188}\text{Re}_{75}$)	186
Samarium-153 ($^{153}\text{Sm}_{62}$)	189
Scandium-46 ($^{46}\text{Sc}_{21}$)	193
Scandium-47 ($^{47}\text{Sc}_{21}$)	194
Silver-111 ($^{111}\text{Ag}_{47}$)	198
Sodium-24 ($^{24}\text{Na}_{11}$)	203
Strontium-89 ($^{89}\text{Sr}_{38}$)	206
Strontium-89 ($^{89}\text{Sr}_{38}$) (Alternate procedure)	212
Sulphur-35 ($^{35}\text{S}_{16}$)	217
Tellurium-123m ($^{123\text{m}}\text{Te}_{52}$)	220
Thallium-204 ($^{204}\text{Tl}_{81}$)	222
Thulium-170 ($^{170}\text{Tm}_{69}$)	224
Tin-113 ($^{113}\text{Sn}_{50}$)	226
Tin-117m ($^{117\text{m}}\text{Sn}_{50}$)	230
Tungsten-188 ($^{188}\text{W}_{74}$)	233
Ytterbium-169 ($^{169}\text{Yb}_{70}$)	238
Yttrium-90 ($^{90}\text{Y}_{39}$)	244
Xenon-133 ($^{133}\text{Xe}_{54}$)	248
CONTRIBUTORS TO DRAFTING AND REVIEW	253

1. PRINCIPLES OF PRODUCTION, PROCESSING AND HANDLING OF RADIOISOTOPES

1.1. Introduction

Radioisotopes find wide-ranging applications in various fields, including industry, research, agriculture and medicine. Production of radioisotopes, radiolabel led compounds, radiation sources and other products based on radioisotopes constitute important activities of several national nuclear programmes. These often support several areas of national economic significance such as health care services and industrial quality control. Two major sources of artificial radioisotopes are accelerators and reactors. Radioisotopes produced in reactors represent a large percentage of the total use of radioisotopes due to a number of factors. The reactor offers large volume for irradiation, simultaneous irradiation of several samples, economy of production and possibility to produce a wide variety of radioisotopes. The accelerator-produced isotopes relatively constitute a smaller percentage of total use. The accelerators are generally used to produce those isotopes which can not be produced by reactor or which have unique properties.

The isotope production programme involves several interrelated activities such as target fabrication, irradiation in reactor or accelerator, transportation of irradiated target to radioactive laboratory, radiochemical processing or encapsulation in sealed source, quality control and transportation to end users. Each step needs experts from respective disciplines, laboratory facilities equipped for radioactivity handling and other supporting infrastructure. Radioisotope production started on a significant scale in several countries with the commissioning of research reactors starting from the late 1950s. In 1966 the IAEA published a compilation of procedures for production of 15 radioisotopes. It also contained an introductory chapter covering the handling and processing facilities, radiation protection aspects and applications among others. The years 1955 to 1970 witnessed rapid growth in construction of new research reactors and corresponding increase in radioisotope production and utilization. In response to this the IAEA published an updated manual in 1971 which covered 25 reactor-produced isotopes and 8 accelerator produced isotopes. In addition it also included preparation of radioisotope generators and radiolabel led compounds. As in the earlier volume, this also contained an introductory chapter covering related aspects such as irradiation techniques and handling. Both publications served as useful references for laboratories engaged in and initiating radioisotope production and supply programmes the world over. The 1971 publication has been out of print for quite sometime. Publication of an updated manual was considered in a consultants meeting organized in 1998. The meeting considered publications on the topic available from other sources, need for a reference manual, developments in isotope production that have taken place since 1971, changes in the pattern of use and the need to preserve the expertise developed over the years in several centres. It recommended that the IAEA should bring out an updated manual. The meeting also made recommendations on the proposed contents of the manual. The earlier publications contained detailed procedures followed in different centres for the same isotope. For example, for ^{131}I production, the first and second contained 13 and 17 procedures, respectively. It was recommended that typical procedures followed from representative laboratories be compiled. Based on the information available from responses to a questionnaire from the IAEA to different isotope producers and on the consultants' personal information, they also suggested the contributors for each isotope. Unlike the 1971 publication, the meeting felt that the compilation of information be done in stages, the first one to be focused on reactor-produced isotopes. A format in which the contributions are to be sought was also suggested. The

identified laboratories were requested to submit their contributions in this format. By and large all contributors followed the given format. But still some variations in the presentation of technical information and additional data were observed and nevertheless accepted. The contributions received are included with minimum editing. The consultants were also in favour of including a brief introductory write-up covering the essentials of related aspects, such as irradiation and handling techniques. The availability of several IAEA publications related to transportation of radioisotopes, radiological safety and radioactive waste handling was given consideration and these aspects are only briefly referred to.

1.2. Research reactors for isotope production

The first operating nuclear reactor that used natural uranium as fuel and graphite blocks as moderator (graphite reactor) was constructed in Oak Ridge, Tennessee, USA and operated from 1943 to 1963.

The IAEA maintains a worldwide directory of research reactors. The period from 1950 to 1970 saw construction of a large number of research reactors with multiple facilities. After 1980, because of the decommissioning of many old ones, the number of operating reactors has been steadily decreasing. At present there are 278 research reactors in operation of which nearly 73 are useful for regular isotope production.

The research reactors used for radioisotope production could be broadly classified into:

- enriched uranium, light water moderated, swimming pool type reactors (FIG. 1-1)
- natural uranium, heavy water moderated and cooled tank type reactors (FIG. 1-2).

Radioisotopes are produced by exposing suitable target materials to the neutron flux in a nuclear reactor for an appropriate time. In swimming pool type reactors, the core is compact and visible, and is accessible from the top of the pool. Target materials to be irradiated are sealed in primary capsules, loaded in specially designed irradiation jigs and then lowered in predetermined locations in the core for irradiation. In swimming pool reactors, the core being easily accessible, loading and unloading of targets are easy, and can be carried out from top of the pool using simple devices. The irradiated targets are then loaded in appropriate shielding containers and transported to the radioisotope processing laboratories.

In the tank type reactors, the irradiation assemblies contain a large number of target capsules and are lowered using specially designed jigs. The irradiation assembly is lowered into a hot cell fitted with master slave manipulators for carrying out loading and unloading of target capsules subsequent to irradiation.

Production of quality radioisotopes with high specific activity will depend on the target as well as irradiation conditions.

1.3. Nuclear reactions

Factors that determine the type of nuclear reaction taking place and the rate of production of the product are:

- energy of the neutrons and the neutron flux
- characteristics of the target material
- activation cross-section for the desired reaction.

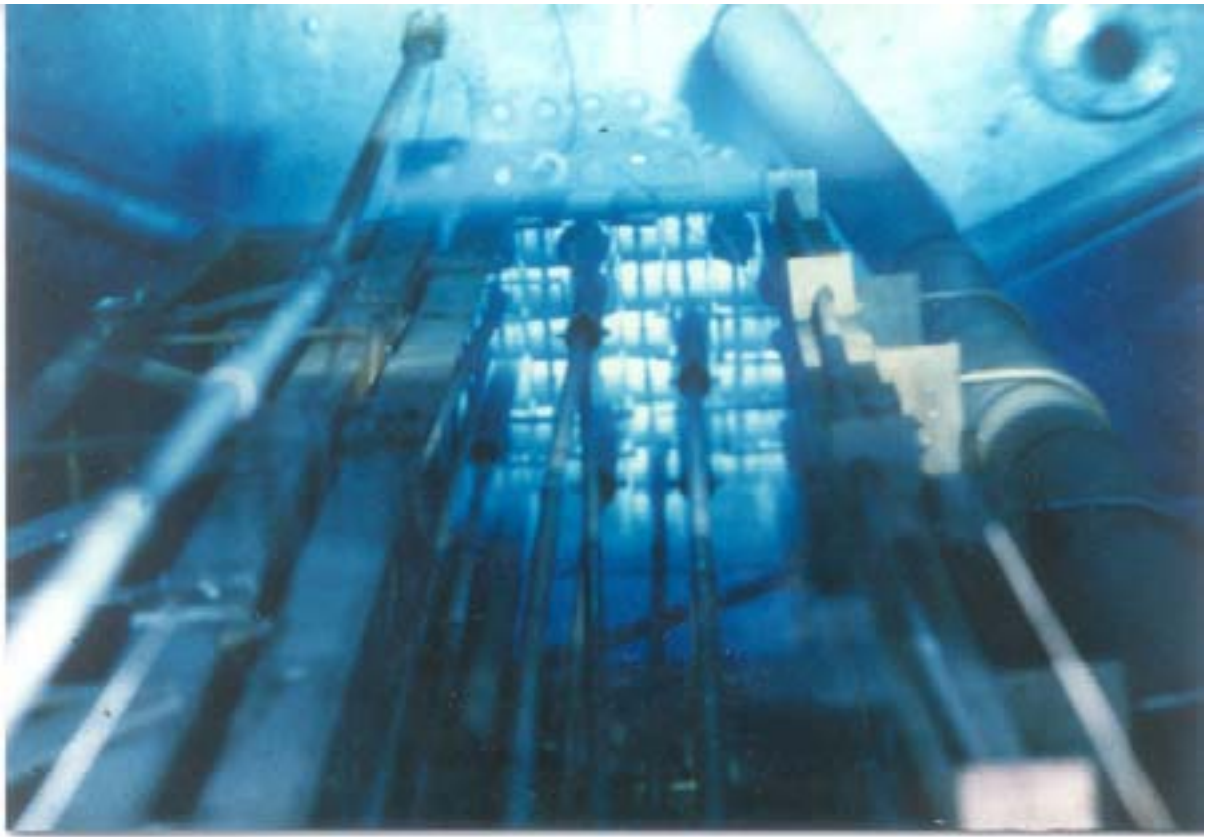

FIG. 1-1. Cerenkov radiation in the core of swimming pool reactor.



FIG. 1-2. The reactor block of a tank type reactor with irradiation facilities.

1.3.1. Energy of neutrons in pile

The pile neutrons are classified according to their energy as follows:

1.3.1.1. Thermal neutrons

Thermal neutrons are those which are in thermal equilibrium with molecules/atoms of the surrounding medium. The energy distribution of this group of neutrons can be represented by Maxwellian distribution. The thermal neutrons have energy of about 0.025 eV at a temperature of 20°C.

1.3.1.2. Epithermal neutrons

These are neutrons of intermediate energy, normally in the keV region. The 1/E law can represent their distribution.

1.3.1.3. Fast neutrons

Fast neutrons are neutrons with high energy (above 1 MeV). They have an energy distribution similar to that of fission neutrons.

The distribution of neutrons in the three groups is different at different locations in the reactor. For example in the reactor core, the fast neutron percentage will be higher, whereas as one approaches the periphery of the reactor, the fast neutrons flux will decrease.

1.3.2. Cross-section

The neutron interaction with the nucleus of the target material can be expressed quantitatively in terms of the nuclear cross-section, which is a measure of the probability that the given reaction takes place. This can be expressed in terms of an imaginary cross sectional area presented by the nucleus around the nucleus to the beam of neutrons, perpendicular to the beam, such that if and only if the neutrons pass through this area, the nuclear reaction takes place. The unit of cross-section is barn (one barn = 10^{-24} cm²). The value of cross-section varies with energy of the neutrons and from nucleus to nucleus.

In general, slower the neutron, greater is the probability for the reaction. Hence thermal neutrons have the maximum value for the cross-section. In this region, cross-section varies as '1/v', where v is velocity of neutrons. Normally the cross-section values are quoted at room temperature (20°C).

If the moderator temperature is high, the cross-section value will have to be corrected for the temperature.

As the energy of neutrons increases to epithermal region, the cross-section shows sharp variation with energy, with discrete sharp peaks or resonances.

At very high neutron energies, the cross-section value decreases sharply.

1.3.3. Types of nuclear reactions

Some of the major nuclear reactions that are used for radioisotope production are given below:

1.3.3.1. (n, γ) reaction

Most of the reactor-produced radioisotopes, are products of the (n, γ) reaction. This reaction is also referred to as radiative capture and is primarily a thermal neutron reaction. Some of the common radioisotopes produced by (n, γ) reactions are:

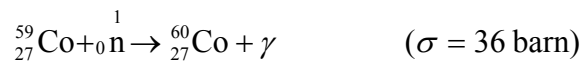

Here, the product is an isotope of the target element itself and hence cannot be chemically separated. Therefore the specific activity is limited by the neutron flux available in the reactor.

1.3.3.2. (n, γ) $\rightarrow \beta^-$ reaction

In some cases the (n, γ) reaction produces a very short-lived radioisotope, which decays by beta emission to a different radioisotope.

Example:

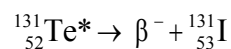
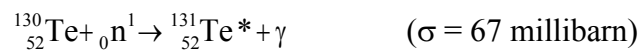

The product can be chemically separated from the target. This will enable us to obtain high specific activity or carrier free radioisotope.

1.3.3.3. (n, p) reaction

In some cases the absorption of neutron leads to emission of a proton as outgoing particle. Such a reaction is termed as (n, p) reaction, caused by fast neutrons having energy more than a particular value known as threshold energy. Hence, such a reaction is known as threshold reaction.

Examples:

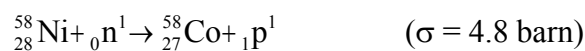

Also in this case, the product nucleus can often be chemically separated from the target, thereby obtaining very high specific activity product.

1.3.3.4. (n, α) reaction

This reaction is also a threshold reaction as neutrons having energy above a specific value (threshold energy) is absorbed by the nucleus causing an alpha particle to be ejected. In some very special cases, the reaction is caused by thermal neutrons as well.

Example:



High specific activity/carrier free products could also be obtained in this.

1.3.3.5. Multistage reactions

There are certain radioisotopes that are produced by multistage processes or successive neutron capture:

Example:

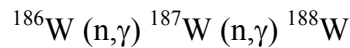

1.3.3.6. Fission

Thermal neutron induced fission of uranium-235 provides a host of useful radioisotopes. Each fission provides two fission fragments. The fission products fall into two definite groups, one light group with a mass number of around 95 and a heavy group with a mass number of around 140. The fission yield of a nuclide is a fraction or the percentage of the total number of fissions, which leads directly or indirectly to that nuclide. The total fission yield is 200%. In addition, some fission products undergo successive decays, leading to production of decay products forming a fission decay chain. Some of the most important fission products that find useful applications are:

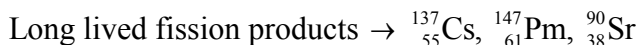

1.4. Calculation of radioisotope yield

When a target is under irradiation in a reactor, the activation per second can be represented by:

$$\frac{dN'}{dt} = nv \sigma_{\text{act}} N_T \quad (1)$$

where

N_T is the total number of atoms present in target,

nv is neutron flux = ϕ ,

σ_{act} is activation cross-section,

N' the number of activated atoms,

A atomic weight of the target.

Equation 1 considers the neutron flux to be isotropic. In case the neutrons are not mono-energetic and if a velocity distribution exists, then the average value of the flux is to be considered.

Since the product radioisotope starts decaying with its own half-life, once production starts Equation 1 representing net growth rate of active atoms can be written as:

$$\frac{dN'}{dt} = \phi \sigma_{act} N_T - \lambda N' \quad (2)$$

where

$\lambda N'$ indicates the decay rate of product nucleus.

Equation 2 can be solved to determine the value of radioactive atoms at time 't', as follows:

$$S = \frac{0.6\sigma\phi}{A}(1 - e^{-\lambda t}) \quad \text{Bq / g} \quad (3)$$

where

- σ is the neutron activation cross-section leading to the production of radioisotope of interest in barn,
- ϕ is the flux in n/cm²/s,
- t is the time of irradiation,
- λ is the decay constant = 0.693/T_{1/2}.
- A is atomic weight of target element

When $t \gg T_{1/2}$, we get saturation activity

$$S = \frac{0.6\sigma\phi}{A} \quad \text{Bq / g} \quad (4)$$

Equation 3 clearly shows that growth of activity in a target under irradiation is exponential in nature and reaches a saturation value limited by the neutron flux in the reactor.

1.4.1. Corrections to the activation equation

In practice, the activity induced in the target under irradiation will be less than the activity calculated using the above equation, due to several factors, such as:

- self shielding effect in the target
- power variation in the reactor
- flux depression due to adjacent samples in the reactor especially when such samples are high neutron absorbers
- burn up of the target material with time
- destruction of the product nucleus due to subsequent neutron capture.

1.4.2. Self-shielding effect

This becomes predominant in case of targets with high activation cross-section where the neutron flux in the volume of the target gets reduced, thereby decreasing the activity build up. The correction factor f depends upon the geometry of target and can be evaluated theoretically using the equation given below:

The neutron self-shielding factor is:

$$f = \frac{1}{2\tau} (1 - e^{-2\tau}) \quad (5)$$

$$\tau = 2 \sum a' \frac{\text{Volume}}{\text{Surface area}}$$

in which

where

$\Sigma a'$ is the microscopic absorption cross-section.

FIG. 1-3 shows the self-shielding factor for the slab and sphere of various thicknesses. It is rather difficult to arrive at a suitable correction factor for odd geometry. It is preferable to establish such factors by actual trial irradiation in the reactor.

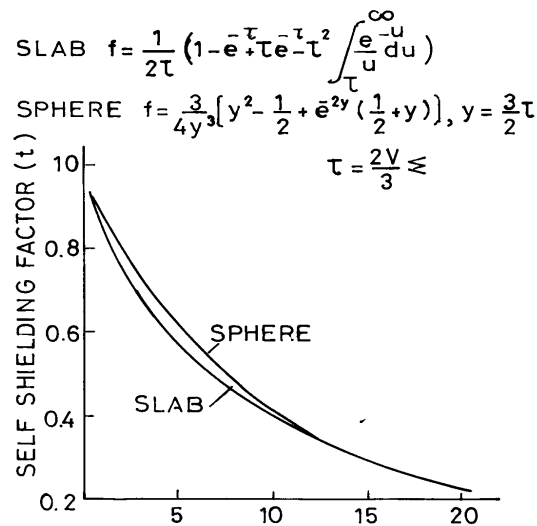

FIG. 1-3. Self-shielding factor for slab and sphere.

1.4.3. Power variation in the reactors

It is difficult to theoretically evaluate the effect of power variation on the activity buildup in the target except by following the operating history of the reactor and applying decay corrections as applicable.

1.4.4. Corrections for burnup of the target and destruction of target atoms

The above effects become predominant in the long term irradiation of targets with high activation cross-sections, such as production of cobalt-60.

In such cases the net rate of growth of the product nucleus could be written as:

$$\frac{dN'}{dt} = N a_{\text{act}} \phi - \lambda N' - N' \sigma'_{\text{ab}} \phi \quad (6)$$

where

- N is equal to $N_0 e^{-\sigma_{\text{ab}} \phi t}$,
- σ_{act} is the activation cross-section for product nucleus,
- λ is the decay constant of product nucleus,
- N' is the number of product atoms at time t,
- ϕ is the neutron flux,
- σ_{ab} is absorption cross-section of the target causing target burn up,
- σ'_{ab} is absorption cross-section of the product nucleus.

Equation 6 can be solved to obtain specific activity S, as follows:

$$S = \frac{0.6 \sigma_{\text{act}} \phi \lambda}{A(C - K)} (e^{-Kt} - e^{-Ct}) \quad \text{Bq/g} \quad (7)$$

where

- S is specific activity,
- K is equal to $\sigma_{\text{ab}} \phi$,
- C is equal to $\lambda + \sigma'_{\text{ab}} \phi$.
- A is atomic weight of target.

From Equation 7, irradiation time for obtaining maximum specific activity t_m is found as

$$t_m = \frac{\log(C/K)}{(C - K)} \quad (8)$$

For example, in the case of cobalt-60 production by irradiation of cobalt metal pellets, it could be seen that at a flux of 4×10^{13} n/cm²/s, maximum attainable specific activity is 225 Ci/g in approximately 11 years (FIG. 1-4). Whereas at a flux of, approximately 10^{14} n/cm²/s, the specific activity reaches a maximum value at the end of seven years of irradiation to 370 Ci/g and, thereafter, decreases with time. At a flux of 2×10^{14} n/cm²/s, a maximum activity of 325 Ci/g can be reached after an irradiation for three and a half years. Irradiation beyond the time indicated above will tend to reduce the specific activity.

1.4.5. Irradiation efficiency

The ratio of the activity actually produced in the target to the activity calculated using the basic growth equation is referred to as the irradiation efficiency. It depends on the cumulative effects of all factors referred to above. This factor should be experimentally determined by trial irradiation. This factor could vary from 90% to as low as a value as 10%.

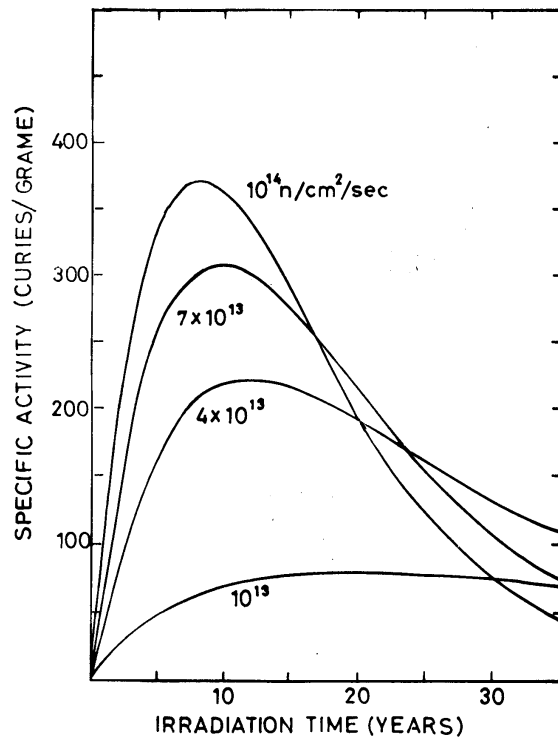

FIG. 1-4. Production of cobalt-60 in various neutron fluxes with cobalt metal target.

1.5. Irradiation techniques

1.5.1. Choice of target material

The following points should be kept in mind while selecting a target material for irradiation in a reactor.

- Substances which are explosive, pyrophoric, or volatile, are not to be irradiated in the reactor.
- As a policy, in many reactors, mercury in elemental form is not permitted to be irradiated since most of reactor components are made of aluminium and an amalgam could be formed when aluminium comes into contact with mercury.
- Targets should be stable under irradiation conditions. It should not decompose under irradiation to form any gaseous products. Generally unstable products like hydrocarbons, are not permitted to be irradiated except under extremely controlled conditions.
- High purity targets should be irradiated to avoid production of unwanted radionuclides.
- Enriched target materials will enable production of radioisotopes with higher specific activity.
- Physical form of the target or the target geometry should be such that self absorption is minimum.
- Target should be in a suitable chemical form to enable easy post irradiation processing. Usually targets in metallic forms or oxides are preferred.
- Whenever long lived radioisotopes like cobalt-60, iridium-192 are involved, the size and shape of the targets and encapsulation should be so chosen that the irradiated assembly could preferably be used as such for the intended purpose.

- If the target is hygroscopic in nature, it is preferable to pre-heat and completely dry the target prior to encapsulation.
- Since targets in metallic form like cobalt do contain certain amount of adsorbed gases like hydrogen, nitrogen, etc. such targets should be de-gassed in an inert atmosphere before encapsulation. Targets like cobalt are normally plated with nickel, to avoid oxide formation leading to contamination during post irradiation handling.

1.5.2. Target encapsulation

Target materials should be properly encapsulated in suitable containers before introducing in the reactor. Choice of the encapsulation material and method of encapsulation will depend upon various factors, such as:

- physical form of target (solid, liquid or gas)
- characteristics of target
- duration of irradiation
- design of the irradiation assembly in the reactor
- type of coolant used in the reactor
- post irradiation handling proposed
- end-use of radioisotope.

The most commonly used encapsulation materials are aluminium, zircaloy and stainless steel. However, majority of targets is encapsulated in aluminium capsules. Aluminium is chosen as the material for fabrication of irradiation capsules because of the following reasons:

- Absorption cross-section is low (aluminium is considered as nearly transparent to neutrons).
- Radioisotopes produced in the aluminium capsule material are very short lived, hence post irradiation handling and disposal are easy.
- Good thermal conductivity, hence heat produced in the target is easily transferred to the coolant.
- It is possible to make air/water tight container by cold welding a lid to the container with the target material inside. This has the advantage of not subjecting the targets to high temperature thus avoiding oxidation/decomposition of the target.

Cold welded capsules are generally tested for leak tightness before irradiation, either by hot water bath bubbling test, or by using ethylene glycol. A helium leak test is also possible to conduct if helium is admitted in the capsule while sealing.

1.5.3. Safety evaluation of in-pile irradiation and experimental assemblies

It is required to thoroughly evaluate a target material or an assembly to be introduced in a reactor to ensure their safety and that of the reactor. Evaluation should mainly consist of calculation of reactivity effects, calculation of nuclear heating effects, radioactivity produced in the target and radiation shielding for safe handling and transport of the irradiated materials.

1.6. Laboratory facilities for radioisotope production

During irradiation of target a number of radionuclides of different half-lives and energies can be produced along with the radioisotope of interest. The irradiated target will often require chemical processing to separate the radioisotope of interest. The radioisotope

may also often have to be further processed and purified to obtain a product which could be used effectively and safely for the intended purpose.

It will be ideal to locate such a radioisotope processing facility in the vicinity of a research reactor, preferably with facilities for direct transfer of irradiated targets into processing plants. A typical radioisotope production facility could consist of the following specialized facilities and capabilities:

- facilities for processing low level radioisotopes involving simple procedures like dilution, dispensing, etc.
- facilities for processing medium level radioisotopes involving complex procedures like purification
- facilities for processing high level radioisotopes, e.g. cobalt-60, fission products, molybdenum-99, etc. which will need heavily shielded hot cells and allied facilities
- quality control laboratories
- health physics monitoring set-up
- analytical laboratories
- research and development laboratories
- counting room consisting of β , γ counting instruments, multichannel analyser, etc.
- animal house, in case the programme involves production of radiopharmaceuticals
- decontamination room for personnel and equipment
- radioactive solid waste storage room with lead shielded cell
- radioactive consignment packing room
- stores
- workshop
- offices.

The extent of the facilities to be included and areas to be allocated will depend on the volume of activities.

1.6.1. Layout and basic infrastructure

Since a radioisotope production facility will be handling radioisotopes with different levels of activities, suitable airlock or double door systems should ideally separate the facilities. These areas will need different ventilation supplies.

The laboratory areas can be broadly categorized as high active and low active areas, depending upon the levels of activities handled. While designing a laboratory, it would be appropriate to locate the high active area in the central portion of the facility, whereas peripheral rooms or areas could be used for low levels laboratories, inactive laboratories as well as offices. Entry into the high active areas should be through barriers. This arrangement will enable segregation of the low active and high active areas, keeping intact their functional relationship.

Utility services at the laboratory can include:

- hot and cold water
- compressed air
- vacuum lines
- electrical connections
- specific gas supplies, as required.

In addition, appropriate waste collection and disposal system needs to be incorporated. There is also a need to provide a low level effluent collection tank with sufficient capacity (say, for effluents generated over a week).

The flooring of such radiochemical laboratories is preferably covered with replaceable plastic tiles and the walls painted such that it can be easily washed and decontaminated.

1.6.2. Radiological protection

The design of a radioisotope production facility should take into account appropriate radiation protection rules, which aim to limit radiation exposures of occupational workers to acceptable limits, both from the point of view of acute radiation effects and delayed effects of radiation. Adopting safety standards set on the basis of relevant IAEA publications can attain these objectives. Safety measures in any installation are to be included in the planning stage by giving adequate consideration for control of external radiation and contamination hazards. Planning should also provide for appropriate emergency preparedness. The nature of radioactivity as well as the processing and handling operations involved is to be considered while providing for external radiation control. Adequate shielding should be provided to keep the radiation levels to acceptable levels.

In a permanent facility, acceptable levels of radiation are achieved by providing fixed shielding (iron, lead or concrete) around handling facilities. The exact shield design depends on nature and energy of radiation. Remote handling devices such as tongs, master slave manipulators, etc. can be used for performing various operations through the shield.

Contamination can occur and easily spread in working environment unless adequate steps for confinement of radioactivity are taken at all stages of operations. The presence of radioactive materials on the surfaces in concentration greater than derived working levels (DWL) may result in significant uptake by ingestion and inhalation routes. The training of workers in radiological safety and implementation of proper operating procedures plays an important role in the maintenance of radiologically safe conditions.

Inhalation is a possible way of intake by workers of airborne radioactive materials. Providing containment commensurate with the degree of hazard associated with operations minimizes inhalation hazard. However, some air contamination may arise due to breach of containment. A well-designed ventilation system should pick up this contamination and prevent its spread to other working areas under normal operating conditions. Negative pressure and suitable air changes should be maintained in the laboratory.

The incidents or accidents that could occur in radioisotope laboratories range from small radioactive spillage which can be controlled quickly without much radiological significance to a severe accidents involving large amounts of radioactive materials which could result in high external and internal exposure. Fire incidents involving large quantity of radioactive material are equally serious. Adequate emergency plans should be in place to tackle such occurrences.

1.6.3. Radioisotope handling facilities

Radioisotope processing laboratories are provided with handling facilities, such as fume hoods, glove boxes, shielded tong boxes, and hot cells.

(1) Fume hoods

Fume hoods are generally used when contamination and external hazards are not significant. It is a partial enclosure and the opening of the panel provides an access to the material being handled (FIG. 1-5). The face velocity of air (0.5–0.75 m/s) at the fume hood opening should be comparable to or greater than capture velocity for the particular contaminant likely to be released into fume hood atmosphere. Utility services such as lighting, electrical power, instrument air and water are provided inside the fume hood. The quantities of radioactivity handled in fumehood are limited by their toxicity grading.

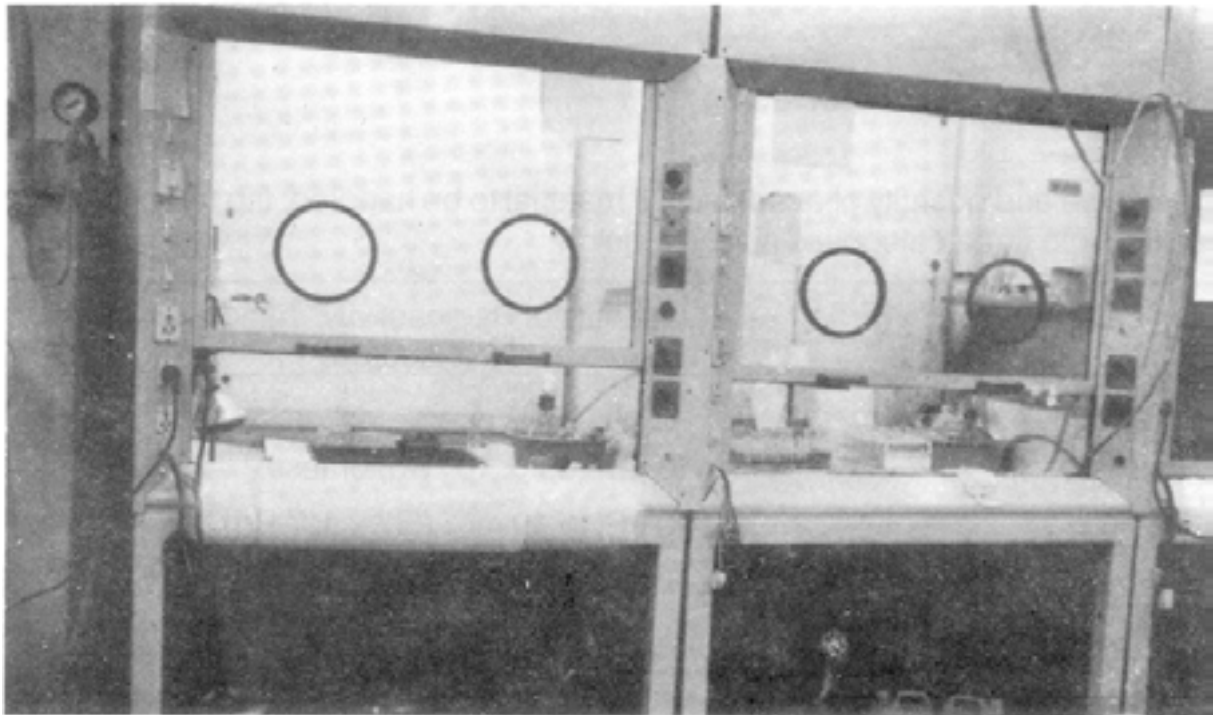

FIG. 1-5. Fume hood for handling radioisotopes.

(2) Glove boxes

When quantity of radioactive material being handled exceeds the limit prescribed for a fume hood, the operation should be carried out in a glove box. A glove box is a total containment system, which completely isolates the hazardous materials from the operator's environment (FIG. 1-6). It is made up of mild steel, stainless steel or aluminium coated with epoxy paints. They are provided with laminated safety glass panels for viewing. The gloves are made of neoprene with thickness varying from 0.2 mm to 1.4 mm.

The degree of leak tightness may vary from a few percentage of box volume per hour for simple chemical operations to less than 0.05% box volume per hour for dry and dusty operations.

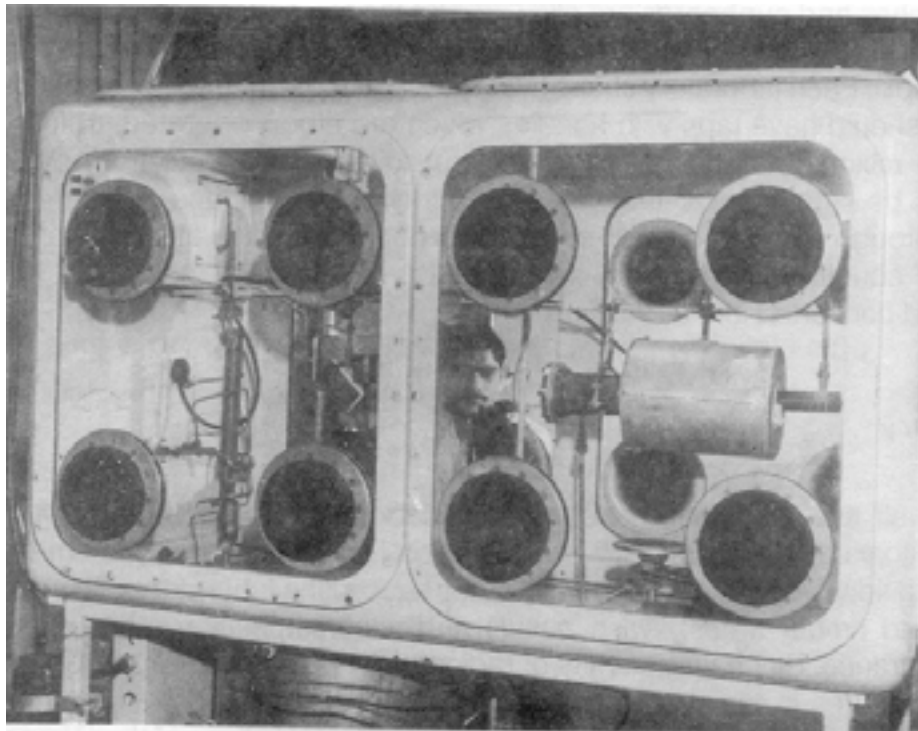

FIG. 1-6. A view of typical glove box.

(3) Shielded tong boxes

Lead shielded tong boxes are very often used in radioisotope laboratory (FIG. 1-7). The lead shield thickness varies from 50 mm to 200 mm.

They are fabricated out of mild steel frame and aluminium panels with perspex viewing windows. Up to several curies of gamma emitting isotopes are routinely handled in such facilities. They are fitted with tongs or mini manipulators for handling. Lead glass viewing windows with glass thickness equivalent to lead shield are also provided.



FIG. 1-7. Shielded tong boxes for processing of radioisotopes.

(4) Hot cells

A hot cell is a large volume shielded enclosure in which operations are carried with master slave manipulators, FIG. 1-8. The cell walls are usually made of concrete. These are used for handling kilocurie quantities of gamma emitters.



FIG. 1-8. Hot cells with master slave manipulators.

1.6.4. Ventilation

Ventilation is the most important and expensive part of the radioactive laboratory where large quantity of radioactive materials are handled (class A laboratory). The general laboratory ventilation system consists of a balanced supply and exhaust of air. The air supply in isotope production laboratory is a once-through system. The air is conditioned for human comfort and for stable operation of electronic equipment and counting systems. The airflow always follows the pattern from inactive to low active to high active areas to prevent spread of air borne contamination. The major part of the laboratory air is exhausted through a bank of HEPA filters and is released through a stack.

The glove box and other handling facilities have no separate air supply but draw air from the surroundings through leakage and, in certain cases, through designed air inlet points.

1.6.5. Management of radioactive waste

During the operation of a radioisotope laboratory several types of non-radioactive and radioactive wastes are generated. The radioactive waste should be segregated and managed

following guidelines given in relevant IAEA publications. They consist of solid, liquid and gaseous wastes.

(1) Solid wastes

Radioactive solid waste consists of tissue papers/absorbent sheets, glass wares, protective wears such as hand gloves, shoe covers, worn out metallic parts, equipment, mops and spent radiation sources. They should be categorized by their level of radioactivity, heat content, potential hazards and/or method of treatment. For general purposes, wastes are labelled as low level, medium level, high level and alpha bearing wastes. Radioactive solid wastes with relatively high radioactivity content should be collected in appropriate shielded containers. Low level wastes should be segregated as combustible, non-combustible and compressible wastes. These are then sent to the waste management facility for further treatment/disposal.

(2) Liquid wastes

Low and medium active liquid wastes from laboratories should be collected first in a hold up tank and pumped/transported to the treatment facility after checking for activity content. High active liquid wastes generated during processing of radioisotopes should be stored for sufficient period to allow activity to decay before transporting to the treatment plant.

(3) Gaseous wastes

These wastes are mainly in the form of ventilation air and, in few cases, consist of volatile products generated during processing of radioisotopes such as fission products and I^{131} .

Management of gaseous wastes should be an integral part of the plant ventilation system. Exhaust air should be filtered through HEPA filters. Activated charcoal filters should also be used as primary filters for effective removal of volatile isotopes such as I^{131} . Gaseous wastes should then be discharged through a tall stack.

1.6.6. Surveillance and monitoring

The radioisotope laboratory should have a system of radiological surveillance and monitoring following guidelines in IAEA publications. The main objectives of monitoring system are to prevent deterioration of radiological conditions in the plant and to avoid unnecessary exposure of personnel.

(1) Personnel monitoring

It includes monitoring of external exposure by personnel monitoring devices such as film badges or thermoluminescent dosimeters (TLD), and of internal contamination by bioassay (either urine or fecal sampling) or whole body counting methods.

Dose limits are recommended by the International Commission on Radiological Protection (ICRP) to prevent deterministic effects and limit the probability of stochastic effects to acceptable levels.

(2) Area monitoring

Area monitoring system indicates the radiation status in the area and gives an early indication of any unusual radiation fields to which the attention of the supervisors and health physicists should be drawn. Areas handling significant amount of radioactive materials should be provided with fixed gamma radiation monitors. In addition portable radiation survey meters should be used for routine surveillance.

(3) Air monitoring

Monitoring of airborne activity in the laboratory and exhaust stream of ventilation system should be carried out routinely by two methods: (a) spot sampling and (b) continuous air monitoring.

(4) Contamination monitoring

The presence of radioactive material on the surfaces in concentration greater than the derived working level (DWL) may ultimately result in significant uptake by operating staff. Monitoring of surface contamination of the workplace is carried out by direct monitoring using probes and by measuring radioactivity in swipes of the surfaces. Whenever contamination level exceeds the limit set for specific purpose, decontamination procedure is recommended and followed.

1.7. Packing and transportation of radioisotopes

Transportation of radioactive materials and related products is required on a regular basis for use in medicine, industry, agriculture and research. Packages containing radioactive materials are transported throughout the world routinely by different modes of transport, such as rail, road, sea or air. Radioactive materials are considered as hazardous cargo (dangerous goods) for transportation purposes. They are classified as Class 7 dangerous goods. They have to be properly packed and labelled. Their movements are also to be documented.

1.7.1. Transport regulations

The IAEA has formulated regulations governing design requirements for different types of packages for radioactive materials, categories of packages, procedures for testing of packages, their storage, quality assurance requirements, documentation and emergency response planning to deal with accident situations during transport. These regulations have been adopted by most of the countries and also by various international organizations such as the International Air Transport Association (IATA), International Maritime Organization (IMO) and International Civil Aviation Organization (ICAO).

1.7.2. Types of packages

The packages generally used for transporting radioactive materials are classified into various types: (1) excepted, (2) industrial, (3) Type A, (4) Type B, and (5) Type C packages depending on the material's nature and quantity.

Type A package is the most commonly used one for transport of relatively smaller quantities of radioactive materials, FIG. 1-9. Its design is such that it is capable of withstanding the rigors of normal conditions of transport.



FIG. 1-9. Typical components of a type A package.



FIG. 1-10. Type B containers for transport of radioisotopes.

If the radioactivity of the material to be transported exceeds the Type A limits, Type B package which is designed to withstand the rigors of normal transport as well as severe accidental conditions should be used, FIG. 1-10.

1.7.3. Categories of packages

Another important aspect of safe transport of radioactive material is categorizing and labelling of the packages as per guidelines in IAEA publications. Based on the maximum radiation level observed on the surface of the package and at 1 meter from the surface of the package, three types of category labels are used.

These labels are also known as radioactive material transport labels, and are affixed on two opposite sides of the package. The category label provides: radiation symbol, hazards class number 7 for the radioactive material, transport index of the package (i.e. number indicating maximum radiation level measured at 1 meter distance from the surface of the package in mSv/h multiplied by 100), name and activity of the radioactive material. In addition, it is required to indicate the complete address of the consignor.

In view of the hazardous nature of the radioactive material cargo, every package, other than postal and excepted packages, should be accompanied by a shipping document providing details as per IAEA guidelines.

The labels and documents are very useful for easy identification of the nature and contents of the package, procedures to be followed for handling the package during transport and storage, and precautions to be taken in the event of an emergency involving the package.

1.8. Conclusion

Undertaking a radioisotope production and supply programme involves infrastructural and expertise support of many specialist agencies. These are often available within the national nuclear establishments. The above summary has just given the outline of such support needed. A detailed and authentic information is available in many IAEA publications included in the bibliography. The focus of this publication is compilation of chemical processing methods for radioisotopes produced in the reactor elaborated in the next section.

BIBLIOGRAPHY TO SECTION 1

IAEA Publications

- Manual of Radioisotope Production, Technical Reports Series No. 63 (1966).
- Radioisotope Production and Quality Control, Technical Reports Series No. 128 (1971).
- Basic Principles for Occupational Radiation Monitoring, Safety Series No. 84 (1987).
- Operational Radiation Protection: A Guide to Optimization, Safety Series No. 101 (1990).
- Compliance Assurance for the Safe Transport of Radioactive Material, Safety Series No. 112 (1994).
- Quality Assurance for the Safe Transport of Radioactive Material, Safety Series No. 113 (1994).
- The Principles of Radioactive Waste Management: A Safety Fundamental, Safety Series No. 111-F (1995).
- Workplace Monitoring for Radiation and Contamination, Practical Radiation Technical Manual No. 1 (1995).
- Personal Monitoring, Practical Radiation Technical Manual No. 2 (1995).
- International Basic Safety Standards for Protection Against Ionizing, Radiation and for the Safety of Radiation Sources, Safety Series No. 115 (1996).
- Radiation Protection and the Safety of Radiation Sources, Safety Series No. 120 (1996).
- Characterization of Radioactive Waste Forms and Packages, Technical Reports Series No. 383 (1997).
- Management of Radioactive Waste from ⁹⁹Mo Production, IAEA-TECDOC-1051 (1998).
- Occupational Radiation Protection Safety Guide, Safety Standards Series No. RS-G-1 (1999).
- Regulations for the Safe Transport of Radioactive Material — 1996 Edition (Revised): Safety Requirements, Safety Standards Series No. TS-R-1 (ST-1, Rev.) (2000).
- Nuclear Research Reactors in the World; September 2000, Reference Data Series No. 3, Edition 13 (2000).
- The Applications of Research Reactors, IAEA-TECDOC-1234 (2001).

International Commission on Radiological Protection (ICRP) Publications

- Annual Limits on Intake of Radionuclides by Workers on the 1990 Recommendations, ICRP Publication 60 (1991).
- 1990 Regulations of the International Commission on Radiological Protection, ICRP Publication 61 (1991).
- Safety Series No. 120: Recommendations of the International Commission on Radiological Protection, ICRP Publication 26 (1996).

United Nations Publication

- Recommendations on the Transport of Dangerous Goods”, Ninth Revised Edition (ST/SG/AC. Rev. 9) UN, New York and Geneva (1995).

2. PRODUCTION AND PROCESSING METHODS FOR INDIVIDUAL RADIOISOTOPES

Bromine-82 ($^{82}\text{Br}_{35}$)

Half-life	:	35.30 h
Production scheme	:	$^{81}\text{Br} (n, \gamma) ^{82}\text{Br}$
Target material	:	Anhydrous Potassium Bromide
Decay product	:	Krypton-82 (stable).

Target specification and preparation

Target purity	:	Meets British Pharmacopoeia 1998 requirements.
Enrichment factor	:	nil
Impurity details	:	Contains 98.0–100.5% KBr with reference to the dried substance
Isotopic composition	:	Non-enriched material is used
Supplier	:	BDH or Merck
Grade	:	Analytical reagent grade

Irradiation parameters, specific activity and total yield at EOI

Reactor used	:	HIFAR, Lucas Heights, Australia
Assembly	:	Hydraulic tube with conveyor unload
Capsule details	:	Potassium bromide starting material is housed in a standard silica ampoule, sealed by glass blower. The silica ampoule is then placed in a screw top aluminium or titanium inner can, which in turn is placed in a weld sealed aluminium or titanium outer can
Target mass	:	93 mg KBr/capsule
Target preparation	:	Dry at 150°C for 4 h
Reactor neutron flux	:	$\sim 5 \times 10^{13}$ n/cm ² /s (thermal)
Irradiation time	:	30 hours
Cooling period	:	24 hours
Expected activity	:	16.65 GBq (450 mCi) $^{82}\text{Br}/\sim 6$ GBq/g Bromine element

Processing facility

This material is processed inside a hot cell.

Analysis of raw materials, reagents and chemicals required for processing

Water for injections BP

This material is purchased as such and meets British Pharmacopoeia 1998 requirements.

The above procedure was provided by:
Australian Nuclear Science and Technology Organisation,
Radiopharmaceutical Division,
Operations-Lucas Heights, Australia.

Cation exchange resin

Dowex 50-W-X8 size 50 to 100 mesh or approved equivalent.

Sodium chloride intravenous infusion BP

This material is purchased as such and meets British Pharmacopoeia 1998 requirements.

1.0 M Sodium hydroxide solution

This material is prepared by making a ~4% w/v solution of sodium hydroxide in Water for Injections BP. The solution is filtered through a 0.22 µm membrane filter into sterile clinbritic vials. The solution is standardized by titrating against standardized 1.0 M hydrochloric acid, using phenolphthalein as an indicator. The solution is approved for use with a concentration of 0.9–1.1 M NaOH. Material approved for use is stored under refrigeration, and has an expiry period of 3 months.

1.0 M Hydrochloric acid solution

This material is prepared by diluting concentrated Hydrochloric Acid AR grade with Water for Injections BP. The solution is filtered through a 0.22 µm membrane filter into sterile clinbritic vials. The vials are then autoclaved for 6 minutes at 132°C. The solution is standardized by titrating against standardized 1.0 M sodium hydroxide solution, using phenolphthalein as an indicator. The solution is approved for use with a concentration of 0.9–1.1 M HCl. Material approved for use is stored under refrigeration, and has an expiry period of 6 months.

Exchange resin column

The preferred column is a 10 or 20 mL disposable plastic syringe body with a silica wool wad pushed into the body. Alternatively, a glass column can also be used. The column is prepared by weighing 5–10 g of cationic exchange resin into a beaker and covering with Water for Injections BP, and allowing to hydrate for 5 minutes. The water is decanted then the process repeated another 2 times. The cationic exchange slurry is then poured into the column over the silica wool to a level of ~10 mL. The column is then rinsed with a minimum of 50 mL of Water for Injections BP.

Chemical processing procedure

1. All equipment is transferred to the manufacturing cell before commencing.
2. Remove the irradiated potassium bromide from the silica target ampoule, and dissolve in 3 mL of water for injections BP.
3. Pour the dissolved bromine target through the prepared exchange resin column. Collect the solution in a receiving vessel containing 0.8 mL of 1.0 M sodium hydroxide. Rinse the preparation vessel with several small volumes of water, adding each washing to the column until an elution volume of 15 mL is reached.
4. Mix well and measure pH by placing a drop of the solution onto pH paper via pipette without making contact with paper to pipette. Adjust pH to 6–8 with 1.0 M NaOH or 1.0 M HCl if required. Make up to 20 mL with Sodium Chloride Intravenous Infusion BP.
5. Measure the activity at calibration of 1 mL of solution, and calculate the volume of Sodium Chloride Intravenous Infusion BP needed to make the required quantity of dilute stock (40 MBq/mL at calibration).

6. Add the required calculated volume and mix well. Then filter diluted stock through a 0.22 μm membrane filter into a sterile vial.
7. Using a clean pipette dispense the required volumes into sterile vials. Seal then autoclave the vials at 132°C for 6 minutes.
8. When autoclaving is complete, place the vials into 25 mm lead pots.

Dispensing, assay and quality control

Radioactive concentration

The radioactive concentration must be 36–44 MBq/mL ^{82}Br at the calibration time and date. Measure a sample in an ionization chamber that has been calibrated to measure bromine-82.

$$A_c = A_m e^{-0.019t}$$

where

A_c is the activity at the calibration date and time,
 A_m is the activity at the measurement date and time,
 0.019 is the decay factor based on half-life of 35.4 h,
 t is the difference in hours between measurement time and calibration time.

Radionuclidic purity

The radionuclidic purity is acceptable if a gamma spectrum analysis identifies ^{82}Br , and all other gamma emitters are <0.05%.

A sample of bromine-82 solution is put in a sealed container, and placed centrally on the detector of a gamma spectrometer. The data must be collected over the 2000 keV range for at least 1000 s.

The product is identified from the following major γ -energy peaks:

554, 619, 698, 777, 828, 1044, 1317, and 1475 keV.

Potassium-42 which has a γ -energy peak at 1525 keV must not be detected.

The sample is kept for 24 h after irradiation, and before dispensing, to ensure that the bromine-80m content is less than 2%. ($^{80\text{m}}\text{Br}$ major γ -energy peaks: 511, 617 and 666 keV)

pH

The pH must be between 4.0–10.0. Measure the sample on a pH meter or using a suitable narrow pH range paper.

Isotonicity

The isotonicity is measured on a standardized osmometer. The value obtained must be between 240 and 360 milliosmoles/kg. The measurement is made on a decayed sample.

Final product specification

Dosage form	:	The dosage form is a sterile, isotonic and non-pyrogenic solution for intravenous injection containing radioactive bromine-82 as sodium bromide/chloride.
Formulation	:	Each vial contains 80 MBq of bromine-82 at calibration in 2 mL of sodium chloride/bromide.
Physical form	:	2 mL of a colourless aqueous solution contained in a 10 mL serum vial.
pH	:	4–10.
Specific activity	:	~6 GBq/g bromine element at calibration.
Radionuclidic purity	:	All other gamma emitters are <0.05% at calibration.
Radiochemical purity	:	~100% bromine present as bromide ions.
Radioactive concentration	:	36–44 MBq/mL at calibration.
Radioactive content	:	72–88 MBq bromine-82 at calibration.
Chemical purity	:	Heavy metals <10ppm.
Isotonicity	:	The solution has an osmotic pressure of 240–360 milliosmoles/kg.
Sterility	:	The product is sterile.
Pyrogens	:	The product is pyrogen free.
Expiry	:	96 h after calibration time and date.
Storage	:	Store at ambient temperature.
Cell cleanup	:	All waste is removed from the cell and placed into the appropriate shielded waste receptacles. Solid waste is stored separate to liquid waste. If required, equipment in the cell is allowed to decay prior to cleaning the cell. The cell surfaces are then cleaned by swabbing with lint free cloths liberally doused with isopropanol or ethanol.

Calcium-45 ($^{45}\text{Ca}_{20}$)

Half-life : 162.61 ± 0.09 d

Production scheme : $^{44}\text{Ca} (n,\gamma) ^{45}\text{Ca}$

Target material : CaCO_3 (G.R./A.R.) (E.M.)

Decay product : Scandium-45

Nuclear reactions and yield

Reaction	Isotopic abundance of nuclide%	Cross-section barn	Activity of element at $10^{12} \text{ n/cm}^2/\text{s}$			Secondary reactions and properties of nuclide formed
			One week	Four weeks	Saturation	
$^{44}\text{Ca} (n,\gamma) ^{45}\text{Ca}$	2.086	0.88±	7 MBq	27 MBq	237 MBq	$^{46}\text{Ca} (n,\gamma) ^{47}\text{Ca}$ Half-life: 4.536 days Isotopic Abundance: 0.004% $\sigma = 0.74 \pm 0.07 \text{ b}$
		0.05	(0.189 mCi)/g Ca	(0.726 mCi)/g Ca	(6.4 mCi)/g Ca	
$^{45}\text{Sc} (n,p) ^{45}\text{Ca}$	100	<10 ⁻⁹ b				$^{45}\text{Sc} (n,\gamma) ^{46}\text{Sc}$ Half-life: 83.79 days $\sigma = 27.2 \pm 0.2 \text{ b}$

Type of decay and energy : β^- (MeV) 0.257 (E_{max}) (100%)

Target specification and preparation

Target	2 × 5 g of CaCO_3 (EM) (GR/AR).
Container	Standard 1S aluminium can 22 mm dia and 44 mm ht. (cold welded).
Reactor used	Heavy water moderated 100 MW DHRUVA or 40 MW Cirus reactor provides the necessary irradiation facility.
Duration	6 months.
Flux	$4 \times 10^{13} \text{ n/cm}^2/\text{s}$.
Production yield	400–1200 MBq (10–30 mCi/g of CaCO_3 . Sp. Activity >1200 MBq (30 mCi)/g of Ca.

Reagents

All the reagents used are of GR/AR grade.

The above procedure was provided by:

M. Ananthkrishnan,
Board of Radiation and Isotope Technology,
Department of Atomic Energy, Mumbai, India.

Type of facility for processing

Standard fumehood 4 feet × 3 feet × 6 feet with local 2 inch lead shielding.

Chemical process

The irradiated CaCO₃ can is cooled for one month to allow the decay of short lived ⁴⁷Ca activity. The can is opened and then irradiated target is transferred to a beaker. Approx. 30 mL concentrated HCl is added slowly to dissolve the CaCO₃. The solution is boiled to expel CO₂. About 1 g iron carrier as FeCl₃ in solution is added to the beaker. Sufficient quantities of ammonium chloride and ammonium hydroxide are added to it and iron hydroxide is precipitated which carries the scandium-46 impurity activity. The precipitate of iron hydroxide (Fe (OH)₃) is separated by filtration. Filtrate is heated to reduce the volume and carrier iron precipitation is repeated thrice to eliminate impurities. The filtrate is boiled. Volume of the solution is reduced and a solution of saturated ammonium carbonate is added to precipitate calcium as calcium carbonate. The precipitate is filtered, washed with dilute solution of ammonium carbonate and double distilled water and finally dissolved in dilute HCl. The solution is boiled to expel CO₂ and filtered to a clear solution.

Assay and quality control

Activity is assayed by liquid scintillation counting.

Radionuclide purity is determined by beta ray absorption analysis and by confirming absence of gamma emitting impurities in gamma ray spectrum.

Calcium content is determined by volumetric method.

Characteristics of final solution

Radiochemical form	Calcium chloride in HCl solution.
Radioactive concentration	37–185 MBq/mL (1–5 mCi/mL).
Radiochemical purity	>99% as sulphate.
Radionuclide purity	>99%.
Specific activity	>1 GBq/g Ca.
Code	Ca-2.
Appearance	A clear colourless solution.

Carbon-14 ($^{14}\text{C}_6$)

Half-life	:	5730 ± 40 a	
Production and decay scheme	:	$^{14}\text{N}_7 + ^1_0\text{n} \rightarrow ^{14}\text{C}_6 + ^1_1\text{p}_1$	$\sigma = 1.81$ b
Type of decay and energy	:	β^- (keV)	156.478 ± 0.009
Target material	:	AlN	

Flow chart of the operation and procedures

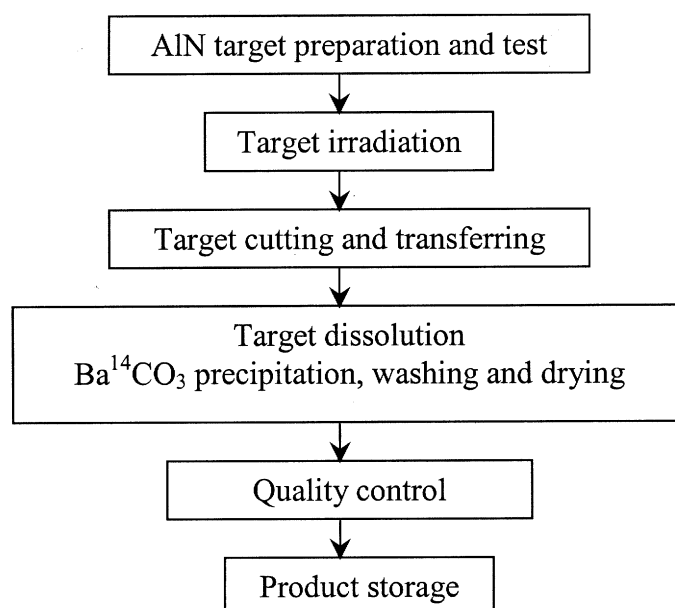

Target specification and preparation

The purity of AlN target powder is not less than 95%. The AlN powder has a particle size between 0.007 to 0.1mm, and contains ^{12}C of less than 0.01%.

AlN synthesis

The synthesis apparatus is illustrated in Fig. 1. 100g Al powder ($\geq 99.999\%$) and 5g KHF_2 (A.R.) is mixed in a Ni boat(2), and the Ni boat is put into a quartz tube(3) in an electric resistance furnace(4) which is flowed through with N_2 gas at a flow rate of 2 L/min. The furnace is heated up to 820°C . Airflow at a flow rate of 300mL/min is used to control the reaction. After reaction for 3 hours, the AlN product is cooled down to room temperature.

The above procedure was provided by:

Jiang B., Cheng Z., Li M.,
Nuclear Power Institute of China,
P.O.Box 436, Chengdu 610041, China.

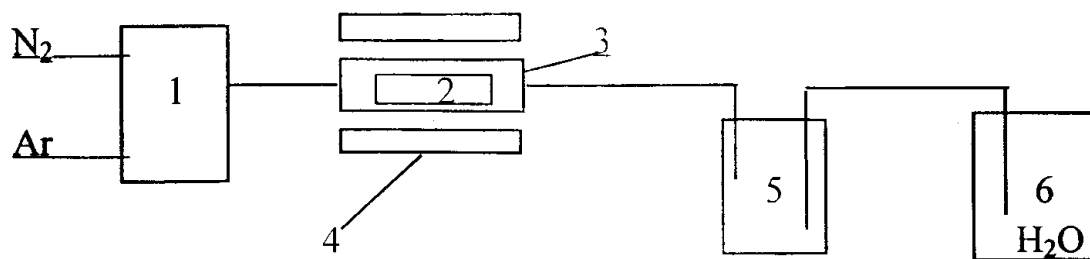

FIG. 1. Illustration of the AlN synthesis apparatus: 1—gas mixing chamber; 2—Ni boat; 3—quartz tube; 4—electric resistance furnace; 5—buffer bottle; 6—glass beaker

Target capsule preparation

Target capsule: 14g AlN powder is added into a 305 Al alloy can of 10mm in inner diameter and 100mm in length. Two Al plates are put on the top of AlN powder. Air in the can is replaced with N₂ gas and the can is argon arc welded.

Target assembly: Eight target capsules are put into a 305 Al alloys tube and the tube is argon arc welded.

Irradiation parameters, specific activity and total yield at EOI

The target is irradiated in the beryllium channel ($\Phi=20\text{mm}$) of the High Flux Engineering Test Reactor at the Nuclear Power Institute of China for 180 days. The neutron flux is 12×10^{14} n/cm²/s. Specific activity is over 185 MBq/gAlN and the typical total yield of one target assembly at EOI is 21GBq.

Type of facility for processing

The hot cell used for target assembly cutting is 2200 × 1800 × 2400(length × width × high), shielded with concrete of 500mm in thickness, and equipped with a pair of MJ-2 model master-slave manipulators.

The glove box used for target capsule cutting is shielded with cast iron of 75mm in thickness. The glove box used for chemical processing is shielded with stainless steel of 3 mm in thickness.

Analysis of raw materials, reagents and chemicals required for processing

Analysis of AlN powder

Size: assayed by standard sieve.

AlN content: 100 mg AlN is dissolved in a Sn(II)-H₃PO₄ solution(2g SnCl₂ is dissolved in 30 mL concentrated H₃PO₄) and mixed with excess 40% NaOH, and then heated. The NH₃ formed is absorbed in 50 mL saturated boric acid, and 0.1 mol/l HCl is used for titration of the solution. The AlN content was calculated, as follows:

$$C=2.93 \times (V_1-V_2) \times T/W \times 100\%$$

Where

- C is AlN content(%),
V₁ is the volume of HCl used (mL),
V₂ is the volume of HCl used in blank titration (mL),
W is the sample weight(g) and T is the titer of HCl to N.

C content in AlN: AlN is dissolved in a 40% NaOH solution and CH₄ formed is oxidized to CO₂ by heat CuO. Then CO₂ is determined with GC. The LOD of the method is 20ppm, and the relative standard deviation is 10%.

H₂SO₄, H₃PO₄ used are of MOS grade, while CrO₃, KIO₃, NaOH, Ba(OH)₂ and C₂H₅OH were of G.R. grade.

Chemical processing procedure

100 mL oxidant (5g KIO₃ and 25g CrO₃ dissolved in 333 mL H₂SO₄ and 167 mL H₃PO₄ solution at 150°C) is added into the reaction flask(1). The reaction flask is heated to 130°C and the system is flowed with N₂ gas for 30min. Then the reaction flask was heated to 150°C, while the temperature of CuO oven is kept at 750°C. After reaction for 4 hours, 9 mL saturated Ba(OH)₂ solution is added into 2.5 mol/l NaOH adsorption solution (11). Ba¹⁴CO₃ precipitated is filtered by the funnel (12) and washed with CO₂-free water and CO₂-free ethyl alcohol and finally dried by infrared lamp in an N₂ atmosphere. The processing system is shown in Fig. 2.

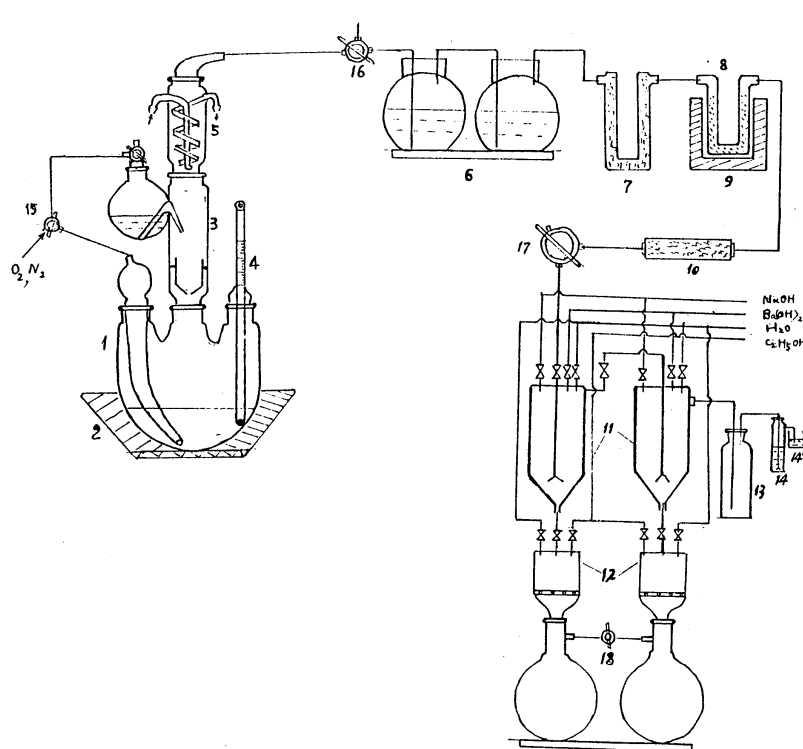

FIG. 2. System of chemical processing of ¹⁴C production: 1-reaction flask; 2-heater; 3-sampling funnel; 4-thermometer; 5-reflux condenser; 6-cleaner; 7-glass wool; 8-quartz tube (CuO); 9-electric resistance furnace; 10-glass wool; 11-¹⁴CO₂ adsorption vessel; 12-G-5 filter; 13-buffer bottle; 14,14'-water; 15-18-vacuum valve.

Dispensing, assay and quality control

Specific activity assay

1.0 mg Ba¹⁴CO₃ is put into a 10 mL beaker and 0.5 mL EDTA solution (30g/l, PH=13) is added. After Ba¹⁴CO₃ is dissolved, the solution was diluted to 50 mL with 1 mol/l NaOH solution. About 10mg of the solution is taken and weighed, and the radioactivity is measured by scintillation spectrometry. The specific activity is calculated by the following equation:

$$A_{sp} = N \cdot K / (E \cdot M)$$

where

A_{sp} is the specific activity(Bq/mg),
N is count(cps); M is the weight of the solution taken from BaCO₃ sample solution(g),
K is the ratio of the weight of BaCO₃ sample solution to M,
E is the detection efficiency.

Radionuclidic purity: is determined by a HPGe γ spectrometry.

Final product specification for use

Physical observations: the product is a white powder.

Radionuclide identification: by comparison of the standard spectrum of ¹⁴C with that of the product. The ratio of radioactivity of β impurities to that of ¹⁴C should be less than 0.1%.

Practical experience gained

1. The ¹²C content in AlN powder must be controlled under 0.01%.
2. The processing system and the reagents should be purified.

BIBLIOGRAPHY

ANAL. CHEM. **44** (1972) 887.

ATOMPROXIS. **14** (1968) 491–494.

FUCCILLO, D.A.JR., ORNL-3633, Oak Ridge National Laboratory, Tennessee (1964) 41.

ISOTOPENPROXIS. **8** (1972).

Chromium-51 ($^{51}\text{Cr}_{24}$)

Half-life	:	27.70 d.
Production scheme	:	$^{50}\text{Cr} (n, \gamma) ^{51}\text{Cr}$ $\sigma = 15.9 \pm 0.2 \text{ b}$
Target material	:	Chromium metal
Type of decay and energy	:	100% EC \rightarrow 51
Decay product	:	Vanadium-51 (stable)

Target specification and preparation

Target purity	:	99.9% chromium
Enrichment factor	:	Nil
Impurity details	:	Total radioisotopic impurities in activated sample should be <0.1%.
Isotopic composition	:	A sample is activated and processed as per instructions below, then analysed via gamma spectroscopy. After production, only peaks for ^{51}Cr should be detected. After a 54 d decay period, the following impurities should be identified and quantified relevant to initial ^{51}Cr : ^{60}Co <0.001% ^{59}Fe <0.005% ^{182}Ta <0.005%
Solubility	:	Must readily dissolve in 8 M hydrochloric acid. Insoluble in nitric acid and aqua regia. Note: The dissolution of "Specpure" grade chromium is unacceptably slow
Supplier	:	Various metal industries
Grade	:	High purity grade

Irradiation parameters, specific activity and total yield at EOI

Reactor used	:	HIFAR, Lucas Heights, Australia
Assembly	:	Hydraulic tube with conveyor unload
Capsule details	:	Chromium metal is placed in a screw top aluminium or titanium inner can, which in turn is placed in a screw top aluminium or titanium outer can
Target mass	:	1 g chromium metal
Target preparation	:	Metal is finely ground before irradiation, degreased with acetone
Reactor neutron flux	:	$\sim 5 \times 10^{13} \text{ n/cm}^2/\text{s}$ (thermal).
Irradiation time	:	24 d
Cooling period	:	N/A
Expected activity	:	>30 GBq ^{51}Cr /g chromium element

The above procedure was provided by:
Australian Nuclear Science and Technology Organisation,
Radiopharmaceutical Division,
Operations-Lucas Heights, Australia.

Processing facility

This target material is processed inside a Hot Cell to make the stock Chromium (^{51}Cr) Chloride solution. The Chromium (^{51}Cr) Edetate Injection BP is manufactured in a class 350 clean room (AS 1386), which contains a class 3.5 (100) laminar flow cabinet (AS 1386.5–1994) for dispensing.

Analysis of raw materials, reagents and chemicals required for processing

Water for injections BP

This material is purchased as such and meets British Pharmacopoeia 1998 requirements.

Sodium chloride intravenous infusion BP

This material is purchased as such and meets British Pharmacopoeia 1998 requirements.

1.0 M Sodium hydroxide solution

This material is prepared by making a ~4% w/v solution of sodium hydroxide in Water for Injections BP. The solution is filtered through a 0.22 μm membrane filter into sterile clinbritic vials. The solution is standardized by titrating against standardized 1.0 M hydrochloric acid, using phenolphthalein as an indicator. The solution is approved for use with a concentration of 0.9–1.1 M NaOH. Material approved for use is stored under refrigeration, and has an expiry period of three months.

EDTA (diSodium Edetate)

This material is purchased as such and meets British Pharmacopoeia 1998 requirements.

Inactive chromium chloride solution (20 mg/mL Cr)

The solution is made by dissolving chromium metal (same as irradiation target) in hydrochloric acid (~10 mL of concentrated hydrochloric acid and 1 mL of water for every gram of metal). The solution is evaporated to NEAR dryness and then redissolved in Water for Injections BP to give a concentration of 20 mg Chromium/mL. The solution is filtered through a 0.22 μm membrane filter into sterile vials. Material approved for use is stored under refrigeration, and has an expiry period of six months.

Hydrochloric acid

This material is purchased as such and meets British Pharmacopoeia 1998 requirements.

Chemical processing procedure

Preparation of stock chromium (^{51}Cr) chloride solution

1. All equipment is transferred to the manufacturing cell before commencing.
2. Add the irradiated target material to a 50 mL beaker, and slowly add 10 mL of hydrochloric acid. Heat on a hotplate until dissolved then evaporate to dryness. Try to avoid spluttering.
3. Dissolve residue in 10 mL of Water for Injections BP and evaporate to dryness.
4. Redissolve residue in 20 mL of Water for Injections BP and mix well.

5. Filter through a 0.45 µm membrane filter into a sterile 30 mL vial.
6. Cap, seal and autoclave the vial at 132°C for 6 minutes. This stock solution can then be stored in a shielded storage area until required for manufacture of Chromium (⁵¹Cr) Edetate Injection BP.

Preparation of chromium (⁵¹Cr) edetate injection BP

1. All equipment is transferred to the manufacturing clean room before commencing.
2. Calculate the required reagent quantities as follows:
 EDTA (g) = 1.09 V/100
 where V = nominal batch size (mL)
 Water for Injections BP (mL) = 0.45 V
 Volume of stock Chromium (⁵¹Cr) Chloride solution (mL) = 8.8 V/A
 where A = stock solution activity at calibration (MBq/mL)
 Volume of Inactive Chromium Chloride Solution (mL) = B/C
 where $B = 0.29 V - D$
 C = inactive chromium chloride solution concentration (mg/mL)
 D = 8.8 V/E
 E = stock solution specific activity at calibration (MBq/mg).
3. Dissolve required amount of EDTA in required amount of Water for Injections BP in a 250 mL round bottom flask.
4. Add the required amounts of stock chromium (⁵¹Cr) chloride solution and inactive chromium chloride solution to the flask.
5. Reflux the flask contents under gentle boiling for at least 30 min; observe that the vapour does not rise above the water level in the condenser. After refluxing, allow to cool to ambient temperature.
6. Adjust the pH to ~5.5 using 1 M sodium hydroxide solution and a dedicated pH meter.
7. Dilute the solution with Sodium Chloride Intravenous Infusion BP, so that the final solution has an activity concentration of 7.2–8.8 MBq/mL at calibration. Confirm by measuring 1 mL of diluted stock in an ion chamber.
8. Transfer the diluted solution to a laminar flow cabinet for dispensing.
9. Using a clean pipette, fitted with a 0.45 µm membrane filter and a 0.22 µm membrane filter in tandem, dispense the required volumes into sterile vials. Seal then autoclave the vials at 132°C for 6 minutes.

When autoclaving is complete, place the vials into lead pots containing absorbent material.

Dispensing, assay and quality control

Radioactive concentration

The radioactive concentration must be 7.2–8.8 MBq/mL ⁵¹Cr at the calibration time and date. Measure a sample in an ionization chamber that has been calibrated to measure chromium-51.

$$A_c = A_m e^{-0.025t}$$

where

- A_c is the activity at the calibration date and time,
 A_m is the activity at the measurement date and time,
 0.025 is the decay factor based on half-life of 27.7 d,
 t is the difference in hours between measurement time and calibration time.

Radionuclidic purity

The radionuclidic purity is acceptable if a gamma spectrum analysis identifies ^{51}Cr , and no other gamma emitter is detected.

A sample of chromium-51 solution is put in a sealed container, and placed centrally on the detector of a gamma spectrometer. The data must be collected over the 2000 keV range for at least 1000 s. The product is identified from the major γ -energy peak at 320 keV.

Radiochemical purity

The solution is analysed by paper electrophoresis, using 0.005 M hydrochloric acid as the mobile phase. The strips are marked with an origin 3 cm from the anode, and one strip is spotted with the dilute solution, and a second strip is spotted with a chromium-51 sample. These strips are electrolysed for 35 min at 1000 V. The strips are dried, then cut into 1 cm segments, which are counted in a γ well counter.

The chromium (^{51}Cr) edetate species is found approximately 0–5 cm on the cathode side from the point of application, and must be greater than 95% of the total radioactivity. The Cr^{3+} species is found approximately 10–13 cm on the cathode side from the point of application, and must be less than 0.5% of the total radioactivity.

pH

The pH must be between 3.5–6.5. Measure the sample on a pH meter.

Isotonicity

The isotonicity is measured on a standardized osometer. The value obtained must be between 240 and 360 milliosmoles/kg. The measurement is made on a decayed sample.

Limit test for EDTA

Prepare the following reagents :

EDTA standard 10.9 mg/mL	:	10.9 g of disodium EDTA in 100 mL of water.
EDTA standard 15 mg/mL	:	15 g of disodium EDTA in 100 mL of water.
0.5% potassium chromate solution	:	A 0.5% w/v solution of potassium chromate AR grade made in water.
Reducing agent	:	Dissolve 2.473 g of arsenious oxide and 1.75 g of sodium hydroxide in 75 mL of water. Carefully neutralize with acetic acid and dilute to 150 mL with water. To this solution, slowly add 100 mL glacial acetic acid with constant mixing.
Into 3 small test tubes add	:	(a) 0.1 mL of prepared Chromium (^{51}Cr) Edetate Injection BP. (b) 0.1 mL of EDTA standard 10.9 mg/mL. (c) 0.1 mL of EDTA standard 15 mg/mL.

To each tube, add 1 mL of 0.5% potassium chromate solution and mix. Carefully add 1 mL of the reducing agent, then heat the tubes in boiling water for 5 minutes. Compare the tubes against a white background. The colour in the Chromium (^{51}Cr) Edetate Injection BP sample

tube should be equivalent to the EDTA standard 10.9 mg/mL, and should not be darker than the EDTA standard 15 mg/mL.

Limit test for chromium

Prepare a standard chromium edetate solution (1% w/v Cr) as follows:

Dissolve 0.96 g of chromium (III) potassium sulphate AR grade and 2.87 g of sodium edetate in 50 mL of water. Boil for 10 minutes, cool, adjust to pH 3.5–6.5 with 2 M sodium hydroxide and dilute to 100 mL with water.

The absorbance measured at 560 nm for the Chromium (⁵¹Cr) Edetate Injection BP sample is not more than the standard chromium edetate solution.

Final product specification

Dosage form	:	The dosage form is a sterile, isotonic and non-pyrogenic solution for intravenous injection containing radioactive chromium-51 as chromium edetate. The solution conforms to the British Pharmacopoeia 1998 requirements for Chromium (⁵¹ Cr) Edetate Injection BP.
Formulation	:	Each vial contains 8 MBq of chromium-51 at calibration, ~0.3 mg of chromium element and ~10 mg of EDTA in 1 mL of solution.
Physical form	:	1 mL of solution contained in a 3 mL serum vial.
PH	:	3.5–6.5.
Specific activity	:	>30 GBq ⁵¹ Cr/g chromium element at calibration.
Radionuclidic purity	:	No other gamma emitters are detectable at calibration.
Radiochemical purity	:	<0.5% radioactivity present as chromic ions; >95% radioactivity present as chromium edetate species.
Radioactive concentration	:	8 MBq/mL at calibration.
Radioactive content	:	8 MBq chromium-51 at calibration.
Isotonicity	:	The solution has an osmotic pressure of 240–360 milliosmoles/kg.
Limit test for EDTA	:	≥ 10.9 mg/mL and <15 mg/mL.
Limit test for chromium	:	<0.1% w/v Cr.
Sterility	:	The product is sterile.
Pyrogens	:	The product is pyrogen free.
Expiry	:	31 d after calibration time and date.
Storage	:	Store at ambient temperature.

Cell cleanup : All waste is removed from the cell and placed into the appropriate shielded waste receptacles. Solid waste is stored separate to liquid waste. If required, equipment in the cell is allowed to decay prior to cleaning the cell. The cell surfaces are then cleaned by swabbing with lint free cloths liberally doused with isopropanol or ethanol.

Practical experience gained

It has been found beneficial during the reflux step to use a specially designed condenser that is filled with cold water and ice.

BIBLIOGRAPHY

COMMISSION OF THE EUROPEAN COMMUNITIES, Cr-51 EDTA (injection), 111/3140/93-EN (1993).

Cobalt-58 ($^{58}\text{Co}_{27}$)

Half-life	:	70.86 ± 0.07 d
Production scheme	:	$^{58}\text{Ni} (n,p) ^{58}\text{Co}$
Target material	:	Nickel metal
Type of decay and energy	:	0.4746 MeV (14.9%) positron 0.81 MeV gamma (99.45%)
Decay product	:	Nickel-58

Irradiation parameters, specific activity and total yield at EOI

High purity nickel metal targets (i.e. 68.27% natural abundance) are used. The projected production yields of cobalt-58 from irradiation of nickel as a function of irradiation time at various thermal neutron flux values are shown in Fig. 1.

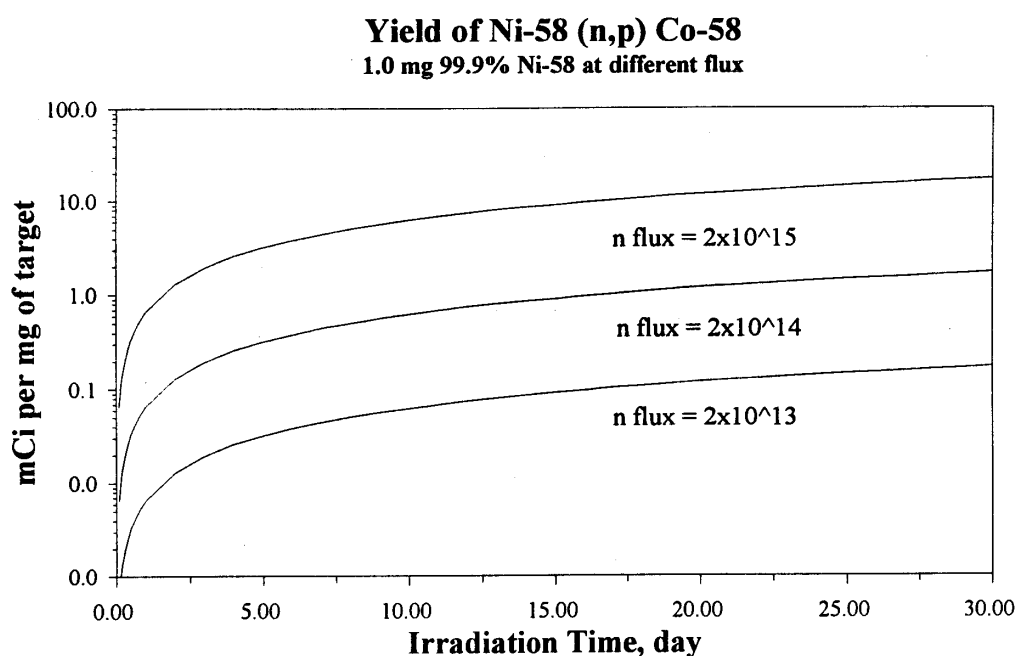

FIG. 1. Calculated production yields of cobalt-58 by neutron irradiation of nickel targets as a function of irradiation time at various thermal neutron flux values.

Type of facility for processing

An adequately shielded hot cell or other shielded facility, dependent upon the levels of activity handled, is required for processing the irradiated targets.

The above procedure was provided by:

M. Du and F.F. Knapp, Jr.,
Nuclear Medicine Program, Oak Ridge National Laboratory,
Oak Ridge, Tennessee 37830-6229, United States of America.

Chemical processing procedure

Processing of cobalt-58 from nickel targets (from ORNL Radioisotopes Procedure Manual, ORNL-3633, 1964)

1. The following equipment should be prepared: Hot off-gas scrubber unit, quartz evaporation dish, five 150 mL Pyrex beakers, 40 mL ion exchange column and 100 mL product bottle.
2. Open irradiation can and remove target from ampule.
3. Wash crushed quartz capsule and NiO into evaporation dish with 12 M HCl.
4. Heat to dissolve NiO using hot off-gas scrubber assembly. Add additional HCl if necessary to dissolve sample.
5. Dissolve NiCl₂·6 H₂O crystals in 12 M HCl. Use approximately 100 mL of 12 M HCl per gram of nickel and heat if necessary to produce clear solution.
6. Evaporate NiCl₂ solution to dryness and fume with 12 M HCl. Care should be taken to avoid conversion of the chloride to oxide.
7. Prepare a 100-mesh Dowex 1 resin column for ⁵⁸Co separation conditioned with 12 M HCl. Resin volume should be ~70 mL per gram of nickel in solution.
8. Pass NiCl₂ solution through the resin column and rinse column with 12 M HCl until green color is eluted. Cobalt-58 remains on the column.
9. Elute ion exchange column with distilled H₂O and check effluent for ⁵⁸Co activity to determine efficiency of removal from column.
10. Collect effluent in beaker and evaporate to near dryness under hot off-gas scrubber assembly.
11. Fume residue with 16 M HNO₃.
12. Fume with 12 M HCl to destroy any organic compounds which may be present and to remove the Nitric acid.
13. Dissolve in 50 mL of 1 M HCl and transfer to product bottle.
14. Sample and analyse for:
 - Molarity of HCl
 - ⁵⁸Co concentration
 - Radiochemical purity
 - Total solids.

Dispensing, assay and quality control

The final product is analysed by gamma spectroscopy.

Final product specification for use

The final product should be analysed by gamma spectroscopy and is provided as the chloride in HCl solution.

Practical experience gained

Because of the low 0.092 barn production cross-section, only low yields of cobalt-58 are produced by this route. At ORNL, yields of 400 mCi were produced after one year irradiation of a one gram target at a flux of 2×10^{14} n/cm²/s.

BIBLIOGRAPHY

OAK RIDGE NATIONAL LABORATORY, Radioisotopes Procedures Manual, ORNL-3633, UC-23-Isotopes — Industrial Technology, TID-4500 (30th ed.), Tennessee (1964).

Cobalt-60 ($^{60}\text{Co}_{27}$)

Half-life	:	5.2714 ± 0.0005 a
Nuclear reaction	:	$^{59}\text{Co} (n, \gamma) ^{60}\text{Co}$ $\sigma = 37.18 \pm 0.06 (m + g)$
Target material	:	Metallic cobalt
Decay product	:	Nickel-60

Type of decay and energy (MeV)

Beta (β^-)	1.49 (0.011%)	Gamma (γ)	1332.5 keV (99.9856%)
(E_{max})	0.31 (99.925%)		1173.2 keV (99.9736%)

$^{60\text{m}}\text{Co}$:	10.467 min
		99.76% IT
		0.24% β^-

Production flow chart

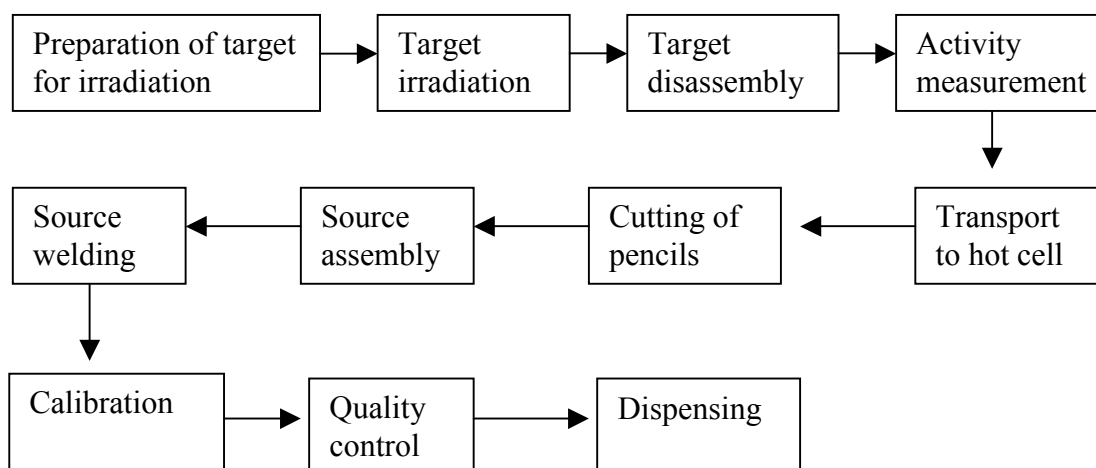

Target specification and preparation

Target material: metallic cobalt, covered with nickel.

Specific purity: > 99.7% of Co-59

The cobalt is in form of metallic cylinders (slugs with 6.4 mm of diameter and 12.7 mm or 25.4 mm of length) or in form of pellets (1 mm of diameter and 1 mm of length).

The slugs and pellets encapsulated inside Zircalloy 4 tubes (called pencils) with welded seal caps at both ends.

The above procedure was provided by:
Ezeiza Atomic Centre,
Comisión Nacional de Energía Atómica,
Buenos Aires, Argentina.

Irradiation parameters, specific activity and total yield at EOI

1. Reactor used and which assembly:

CANDU 6 Reactor (pressure tubes, heavy water moderated)
Gross power: 648 Mew
Assembly: Adjuster/absorber Rods (Co-59), mechanical assembly
Working temperature (moderator temperature): 50/60°C
Working pressure: almost atmospheric pressure.

2. Capsule details (Fig. 1):

Stringing a number of cobalt bundles onto a tie rod makes up the cobalt adjuster element of the CANDU reactor. The bundles consist of cobalt pencils arranged circumferentially around a central rod, and held between two end plates; these are counter bored to receive the cobalt pencils. The rod and the plates are made of Zircalloy. Twenty-one cobalt adjuster elements are placed in the reactor.

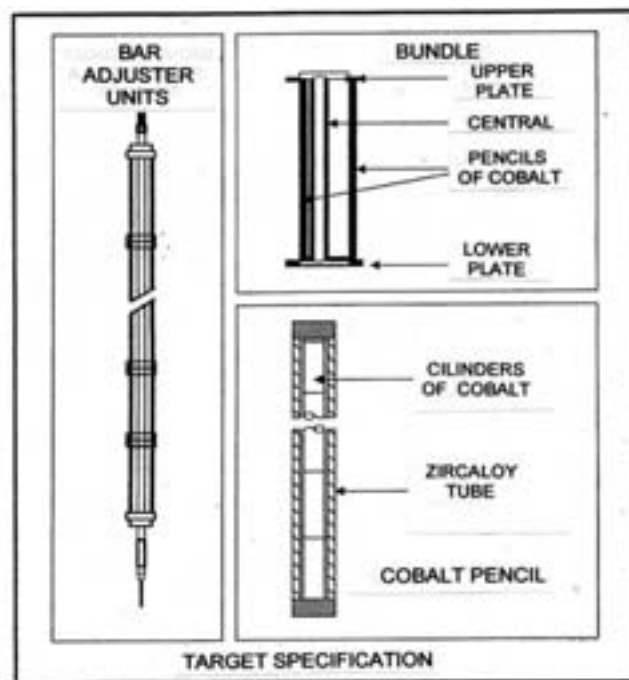

FIG. 1. Cobalt target assembly.

3. Mass of target:

The mass of each pencil varies from 52 g to 80 g depending of the length of the pencils and the form of the cobalt (slugs or pellets).

4. Reactor irradiation parameters:

Irradiation Flux (average value): 2×10^{14} n/cm²/s (thermal neutrons).

Irradiation Period: 18, 24 or 36 months. This period range depends of Planned Outage schedule and marketing conditions of specific activity requested by CNEA.

5. Specific activity achieved:

The specific activity varies between a range of 4.5–9.5 TBq (120–250 Ci)/g depending of Planned Outage schedule and marketing conditions.

Type of facility for processing

POOL in Embalse Nuclear Power Plant for target disassembly and the calibration underwater of the bundles of pencils with Co-60.

PRODUCTION HOT CELL in Ezeiza Atomic Center for the fabrication of the sealed sources.

Thickness: 1,3 m of heavy concrete.

Internal dimensions: 3 m × 3 m × 4 m of height.

Internal equipment: bridge-crane, containers for transitory storage, TIG electronic welding machine.

3. QUALITY CONTROL HOT CELL for the quality control of all the sealed sources and the calibration of the sources used in teletherapy.

Thickness: 1 m of heavy concrete

Internal dimensions: 2 m × 2 m × 3,3 m of height.



FIG. 2. Hot cell for Co-60 handling.

4. POOL OF TRANSFER for the calibration of the industrial sealed sources and the loading of the sources in transport containers.

Dispensing, assay and quality control

Test method by radioactive means

Immersion test (hot liquid) in agreement with ISO 9978 (5.1.1)/ ISO: TR 4826 (2.1.3).

Dry wipe test in agreement with ISO 9978 (5.3.2)/ ISO: TR 4826 (2.1.2).

Approval criteria: If the activity detected does not exceed 0,2 kBq (5 nCi) in agreement with ISO 9978 (5.1.5 and 5.3.3).

Test methods by non-radioactive means

Helium test in agreement with ISO 9978 (6.1.1)/ISO: TR 4826 (2.2.4) .

For calibrating sealed sources the following procedures are applied

Bundles: Radiation measurement procedure for underwater measurement of cobalt-60 bundles.

Sealed Source for teletherapy: ICRU-Report 18

Sealed Source for Industrial Use: in air or in water, ICRU-Report 18.

For welding sealed sources

The sources has two stainless steel AISI 316-L encapsulations sealed by TIG Electronic Welding, in agreement with:

ASTM-A-240

ASTM-A-312

ASTM-A-380

ASME-SECC IX-DIV 1

ASME-SECC V-DIV 1.

The transport of high activities of Cobalt 60 is made with transport packaging in agreement with the: "Regulations for the safe transport of radioactive materials", 1985 Edition (As Amended 1990), Safety Series N° 6 of the International Atomic Energy Agency (IAEA).

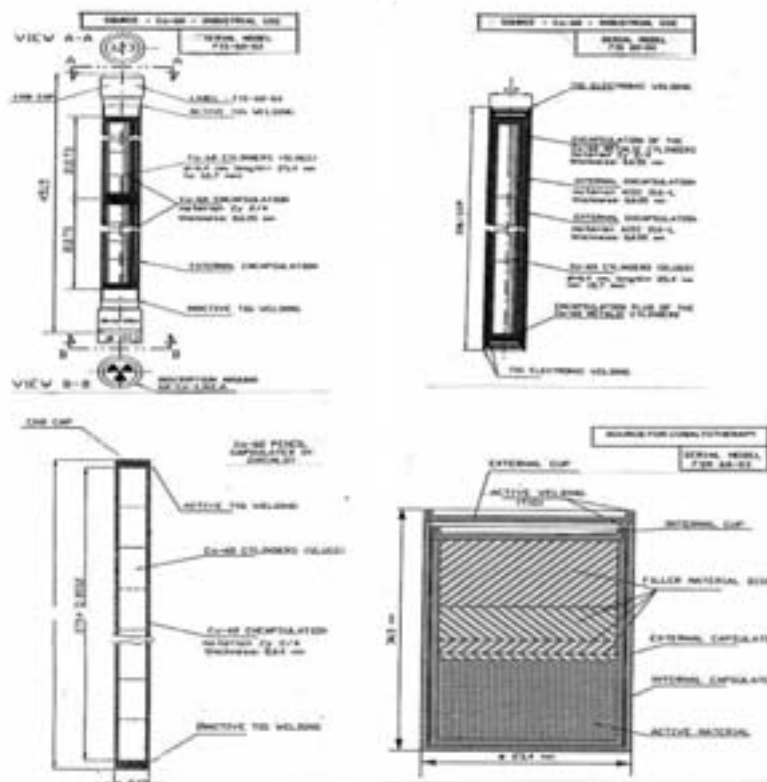

FIG. 3. Dimensions of different Co-60 sources.

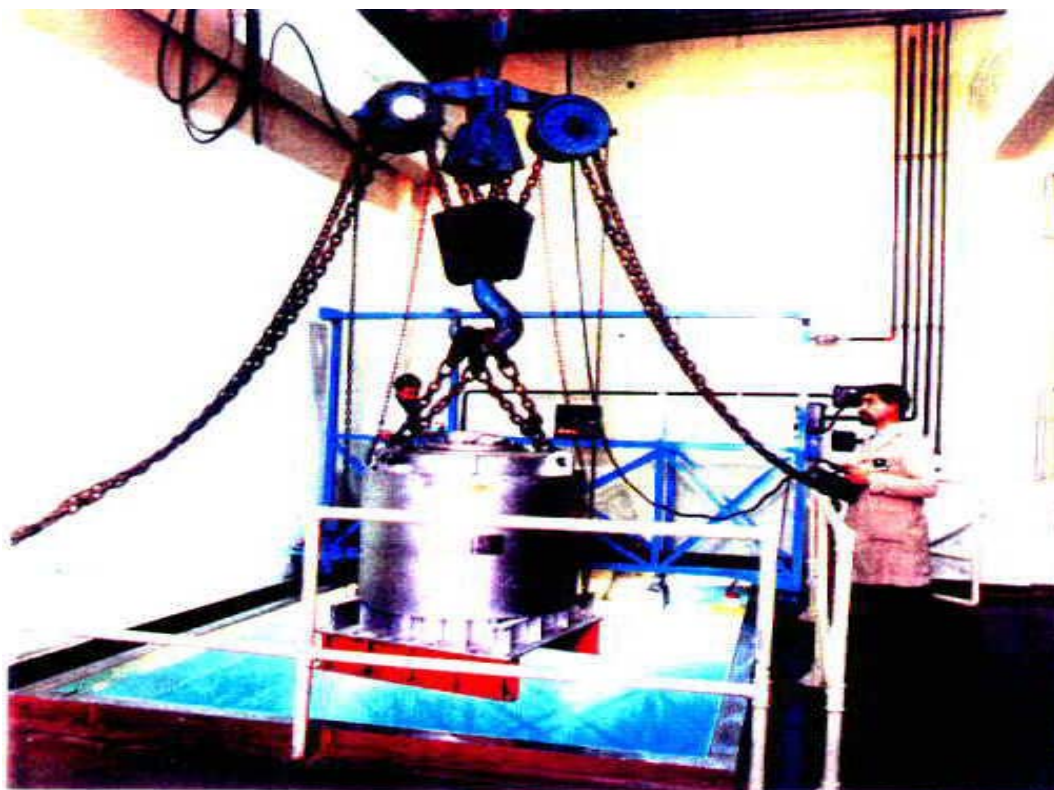

FIG. 4. Containers for Co-60 and their handling in Argentina.

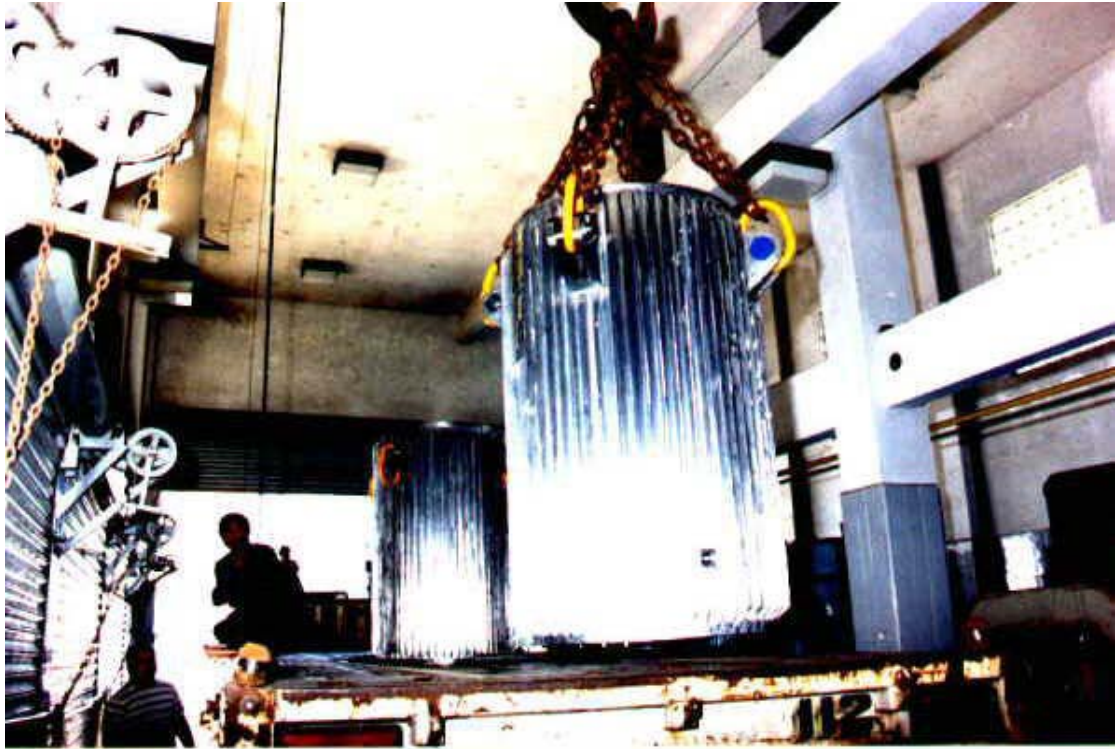

FIG. 5. Containers for Co-60 and their handling in Argentina (cont.).

Final product specification for use

1. Description of the special form radioactive material (Fig. 3).
 - 1.1 Co-60 Pencil has one zircaloy encapsulation sealed by TIG. Dimensions: total length 212,73 mm or 285,2 mm; external diameter 8,05 mm.
 - 1.2 FIS 60–04 (Industrial Source) has an internal Cobalt-60 pencil and two external stainless steel AISI 316-L encapsulations sealed by TIG. Dimensions: total length 296 mm or 229 mm; external diameter 11,3 mm.
 - 1.3 FIS 60–03 (Industrial Source) has two internal Cobalt-60 pencils (length 212,73 mm) and an external stainless steel AISI 316-L encapsulation sealed by TIG. Dimensions: total length 451,5 mm; external diameter 11,1 mm. Classification ISO 2919 E 66646.
 - 1.4 FSM 60–03 (Teletherapy Source) Cobalt-60 is in the form of slugs or pellets has two stainless steel AISI 316-L encapsulations sealed by TIG. Dimensions are total length 36,5 mm; external diameter 23,5 mm. Classification ISO 2919 E 53524.

Practical experience gained

The National Commission of Atomic Energy of Argentina (CNEA) produces Co-60 sealed sources from 1981, for teletherapy, industry and research.

Since then, the sources have been exported to different countries all over the world.

With the production Co-60 and important experience has been obtained, especially in the handling of high activities.

Copper-64/Copper-67 ($^{64}\text{Cu}_{29}$, $^{67}\text{Cu}_{29}$)

Half-life	:	$^{64}\text{Cu} - 12.7 \pm 0.02 \text{ h}$ $^{67}\text{Cu} - 61.83 \pm 0.12 \text{ h}$	
Production scheme	:	$^{63}\text{Cu} (n,\gamma) ^{64}\text{Cu}$ $^{67}\text{Zn} (n,p\gamma) ^{67}\text{Cu}$	$\sigma = 4.5 \text{ b}$
Target material	:	High purity copper and/or zinc targets	
Decay energy	:	Copper 64	
		β^- (MeV)	β^+ (MeV)
		0.5787 (39%)	0.653 (17.4%)
			EC (MeV)
			43%
		Copper 67	
		β^- (MeV)	Gamma (MeV)
		0.391 (57%)	0.1845 (48.7%)
		0.483 (22%)	0.0933 (16.1%)
		0.576 (20%)	0.0912 (7%)
		0.182 (1%)	

Target specification and preparation

Copper-64 is one of the few neutron rich positron emitting radioisotopes which can be reactor-produced by a simple radiative (n, γ) reaction with relatively high specific activity. As an alternative, carrier-free copper-64 can also be reactor-produced (n,p) by neutron irradiation of enriched zinc-64 targets. Although the preferred route for production of copper-67 is *via* spallation using an accelerator (Mirzadeh, *et al.*, 1986), low levels of carrier-free copper-67 can be produced in a nuclear reactor by the (n,p) reaction *via* irradiation of the very expensive enriched zinc-67 targets. Three typical procedures are provided describing the processing of copper targets by direct dissolution of copper-63 targets, solvent extraction of solutions prepared from neutron-irradiated enriched zinc targets and more recent electrochemical techniques for processing of zinc targets to obtain carrier-free copper-64 and copper-67.

Irradiation parameters, specific activity and total yield at end of irradiation

For direct production of copper-64, high purity enriched copper-63 targets (i.e. 63.9% natural abundance) are used. The projected production yields of copper-64 from irradiation of copper-63 as a function of irradiation time at various thermal neutron flux values are shown in Fig. 1. For production of copper-67, highly enriched zinc-67 targets (i.e. >94%) are required.

The above procedure was provided by:
 S. Mirzadeh and F. F. Knapp, Jr.,
 Nuclear Medicine Programme,
 Oak Ridge National Laboratory,
 Oak Ridge, Tennessee 37830-6229, United States of America.

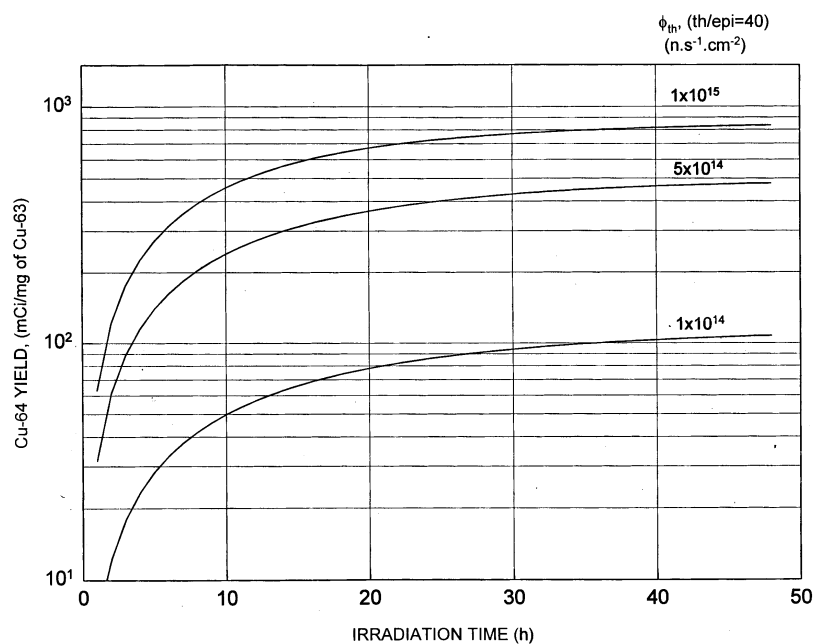

FIG. 1. Calculated production yields of copper-64 by neutron irradiation of enriched copper-63 targets as a function of irradiation time at various thermal neutron flux values.

Type of facility for processing

An adequately shielded hot cell or other shielded facility, dependent upon the levels of activity handled, is required for processing the irradiated targets.

Chemical processing procedure

Processing of copper-64 from enriched copper-63 targets (from ORNL nuclear medicine procedure # 24)

1. The quartz ampule is removed from the aluminum capsule using tubing cutter and vise and examine ampule to determine if it has been broken. If unbroken, place the ampule on cloth wipe and rinse with 1 M HCl and then blot dry. If broken, proceed to Step 5.
2. Transfer the quartz ampule to a plastic break tube, stopper, and crush using vise. Transfer the content of the break tube to a 125 mL flask and add sufficient volume of 4 M HCl and transfer to flask.
3. Begin evaporation of the liquid on a hot plate adjusted to keep the temperature just below the boiling point. Shake the flask occasionally to insure that the quartz pieces have been wetted. Continue the evaporation to incipient dryness and then allow the flask to cool.
4. Transfer the ⁶⁴CuCl₂ residue in the flask to a 15 mL product bottle using incremental portions of 0.1 M HCl. Be sure the quartz fragments are rinsed after each addition of acid.
5. Rinse outside of product bottle using small amount of H₂O and transfer out of the hot cell into a lead shield for radiochemical assay. **Caution:** ⁶⁴Cu yields a 511 keV gamma due to positron emission.

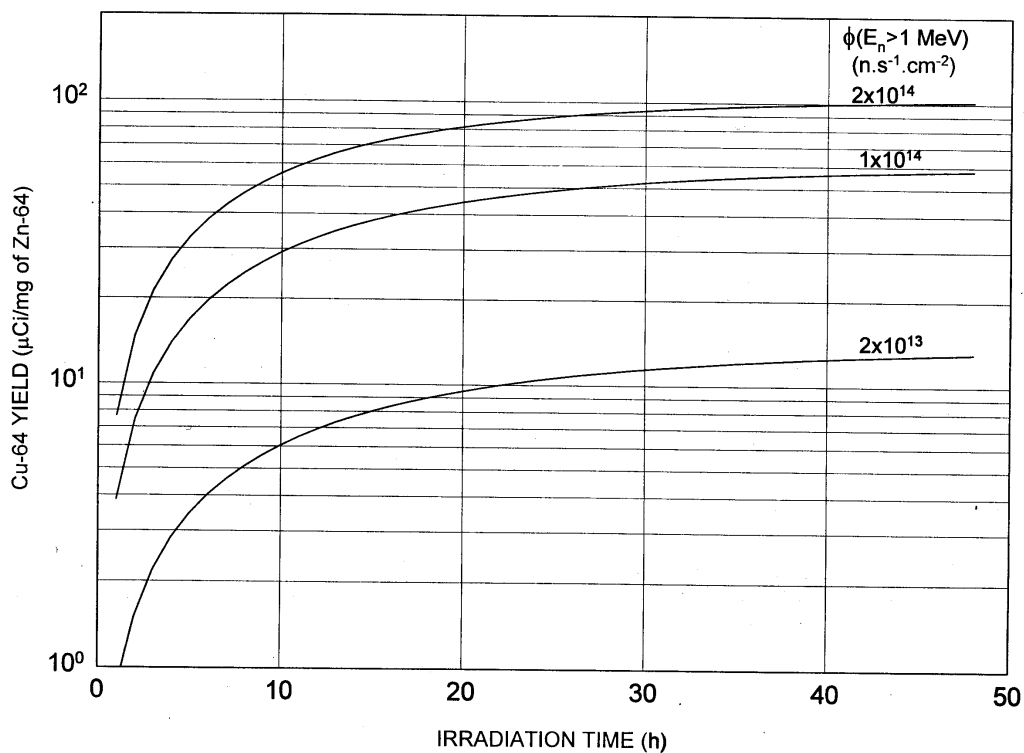

FIG. 2. Calculated production yields of copper-64 by neutron irradiation of enriched zinc-64 targets as a function of irradiation time at various thermal neutron flux values.

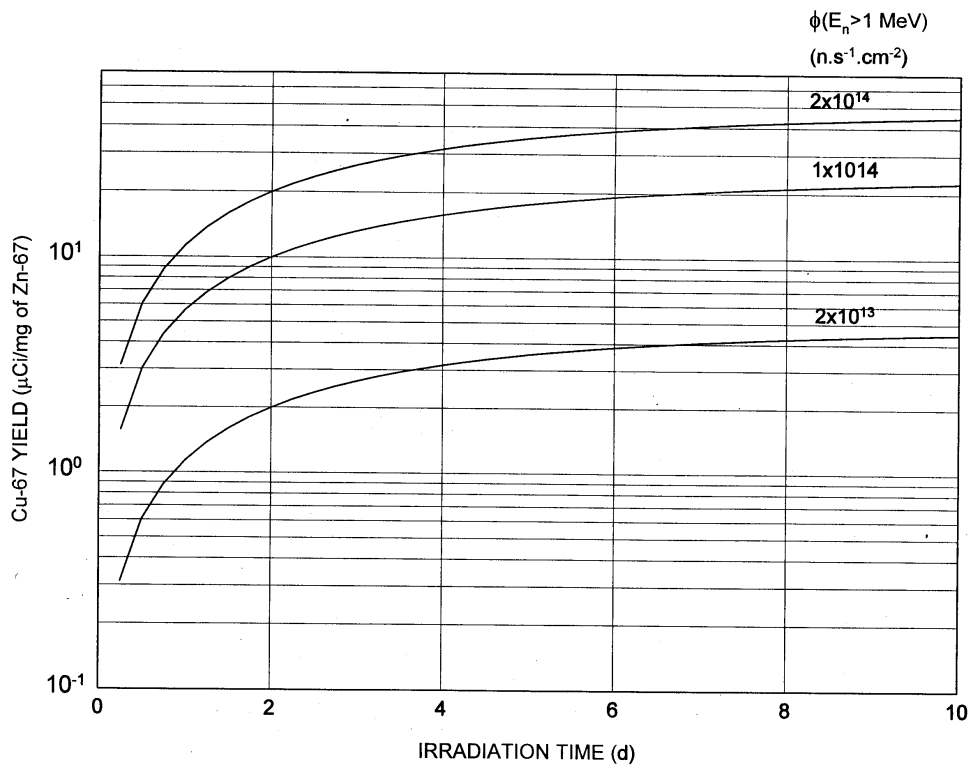

FIG. 3. Calculated production yields of copper-67 by neutron irradiation of enriched zinc-67 targets as a function of irradiation time at various thermal neutron flux values.

6. Transfer the lead shield to a radiochemical hood and prepare for radiochemical assay. Make a dilution of 0.1 mL of product solution to 0.9 mL 0.1 M HCl. Prepare a counting mount of 20 μ l for assay on a γ -Spectrometer. Assay is made using the 38.6% abundant annihilation gamma (511 keV).

Solvent extraction processing of copper-67 produced after irradiation of enriched zinc-67 targets (from ORNL nuclear medicine procedure # 45):

1. Dissolve 2.22 gm of thienyltrifluoroacetone, TTA (M.W. = 222.18) in 50 mL of reagent grade benzene (thiophene-free). The solution should be prepared fresh just prior to use.
2. For pre-equilibration, measure required volumes of organic and aqueous reagents into a clean, dry separatory funnel. Contact phases for 5 minutes and allow phases to separate for a minimum of 10 minutes. Drain aqueous phase into a clean, dry labeled stock bottle and transfer organic phase **through top of funnel** into a separate clean, dry labeled stock bottle.
3. Transfer Cu-67 target to "hot-cell" and remove from aluminum can. Crush ampule using break-tube and vise. Pour contents into 150 mL beaker and rinse break-tube 2 times using small aliquots of 1 N HCl (containing 5–10 drops of 30% H₂O₂). Transfer rinses to 150 mL beaker. Add 1 N HCl until volume equals 10.0 mL. Transfer beaker to hot-plate and heat gently if necessary to dissolve ZnO.
4. After dissolution, transfer solution to a clean 150 mL beaker. Rinse beaker containing quartz using small volumes of H₂O, and transfer rinses to beaker containing Cu-67 solution. Evaporate solution to dryness, allow to cool, and add a small volume of H₂O. Evaporate **slowly** to dryness. **Complete** dryness on all surfaces is necessary at this stage to ensure correct acid normality.
5. Allow residue to cool for 5 minutes, then dissolve solids in 15.0 mL 0.01 N HCl. Mix well, and assay for Cu-67 (184.6 keV).
6. Transfer solution to a clean separatory funnel (labeled #1). Add 15.0 mL of pre-equilibrated 0.2 M TTA and contact for 2 minutes. Allow phases to separate for 5 minutes.
7. Drain aqueous (lower) phase into a clean separatory funnel (labeled #2), and repeat above step.
8. Drain aqueous (lower) phase into a clean bottle (labeled "holding bottle #1"). Set aside bottle for ZnO recovery.
9. Combine organic phases into separatory funnel #2 and wash 4 times using 15.0 mL volumes of 0.01 N HCl (pre-equilibrated using 0.2 M TTA/benzene). Drain the aqueous phases from first and second washes into "holding bottle #1". Drain the third and fourth washes into separate holding bottles (labeled accordingly). Monitor fourth wash if possible, since detectable radioactivity should be very low.
10. Transfer organic phases through top of separatory funnel #2 into a clean separatory funnel (labeled #3). **DO NOT TRANSFER THROUGH STOPCOCK !!**

11. Back extract Cu-67 from organic phases 2 times using 15.0 mL volumes of pre-equilibrated 0.5 N HCl. Drain aqueous (lower) phases into a clean separatory funnel (labeled #4). Drain organic phases into a separate holding bottle.
12. Wash aqueous phase in separatory funnel #4 using 15.0 mL volume of pre-equilibrated benzene. Drain aqueous phase into clean 250 mL beaker and evaporate slowly under air or argon stream. Air or argon stream decreases evaporation time. As evaporation volume decreases, solution may appear yellow. This is a normal observation.
13. After evaporation is complete, fume several times using concentrated HNO₃ to destroy any remaining organic residue.*

*NOTE: If no solids are present, continue to Step #15.
14. Fume solids from step #11 using concentrated HCl to convert solids from nitrate to chloride form. Add concentrated HCl 3 times and evaporate slowly under argon or air stream.
15. Dissolve chloride solids in 10.0 mL of 0.05 N HCl, mix well, and assay for Cu-67 (184.6 keV). After assay, store product in appropriate facility for future experimental use.

Zinc target recovery

1. Collect and combine “holding bottles” from Cu-67 processing that contain Zn-65, by assay, into clean 150 mL beaker. Transfer beaker to hot-plate and begin evaporation under argon stream. **EXTREME** care must be taken to avoid “burping” and splatter. Loss of solution will decrease recovery yield.
2. During evaporation, assemble glass column using glass wool and Bio-Rad resin. Load resin to a height of approximately 5" (12.7 cm). Pre-equilibrate column using 2.0 N HCl.
3. After evaporation is completed (all solutions containing Zn-65 are combined and evaporated), allow ZnO solids to cool.
4. Dissolve solids in 20.0 ml of 2 N HCl and transfer solution onto pre-equilibrated Bio-Rad column, and rinse beaker using small volumes of 2 N HCl. Transfer rinses to column.
5. Wash column using 100 mL of 2 N HCl and collect eluent in labeled glass bottle for assay if necessary.
6. Wash column using 200 mL of 6 N HNO₃, and collect solution in tared beaker #1.

NOTE: Monitor column and determine Zn-65 activity. If appreciable activity is present, continue washing with 6 N HNO₃, and collect eluent tared beaker #2. Save for additional ZnO recovery.

7. Begin evaporation of Zn-65 solution under argon stream. During this evaporation, set up furnace and test temperature using temperature controller. Furnace must be capable of maintaining prescribed temperature setting.

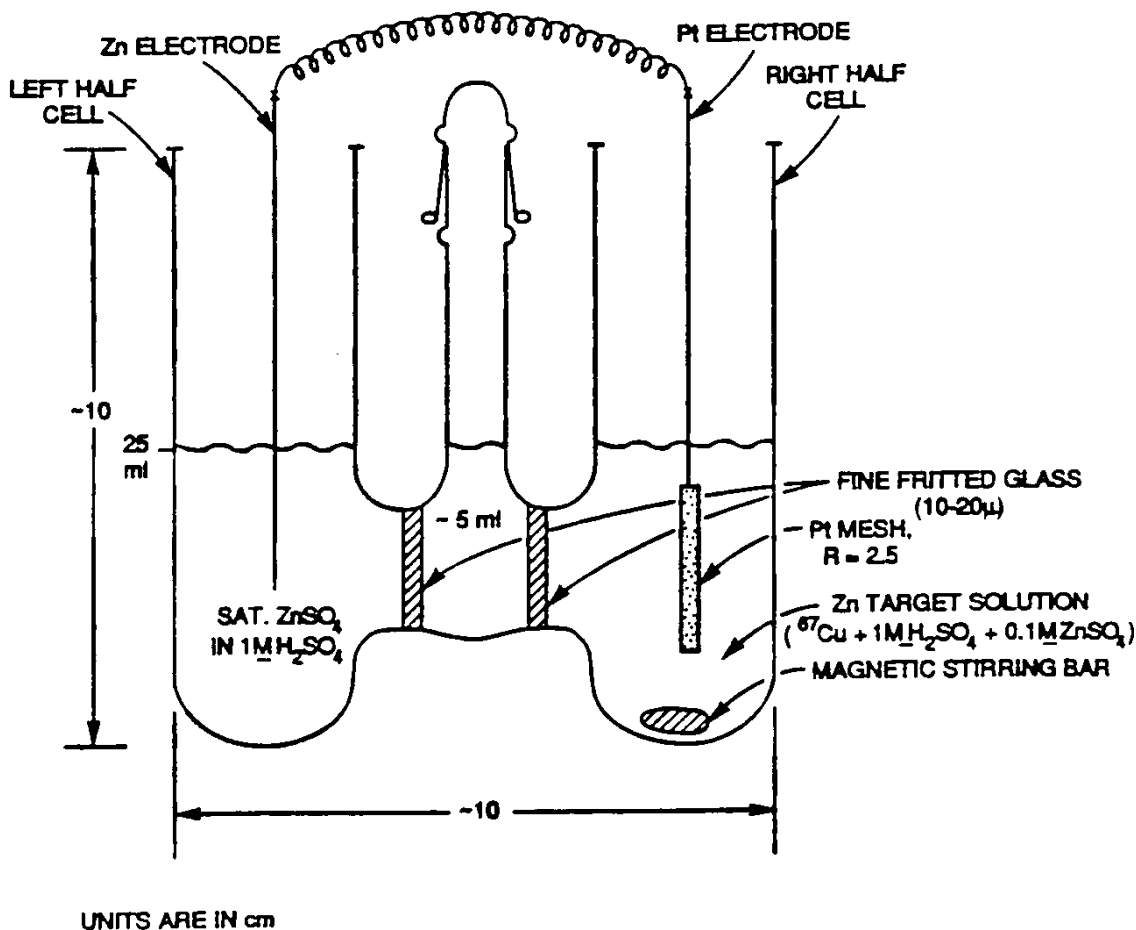

FIG. 4. Apparatus use for the spontaneous electrodeposition of carrier-free copper-67 (from, Mirzadeh, et al., 1992).

8. Continue evaporation until beaker is **completely dry**, and no condensate is present on sides of beaker. When beaker is dry, transfer beaker containing ZnO solids to furnace and start increasing temperature slowly. Observe temperature and maintain at 350°C for 2 h.
9. Remove beaker from furnace and cool to facility temperature. After beaker has cooled, weigh tared beaker and calculate ZnO recovery yield.
10. Store recovered ZnO in appropriately labeled and shielded container.

Spontaneous electrochemical separation of carrier-free copper-65 and copper-67 from zinc targets (from Mirzadeh, et al., 1992):

1. After irradiation, the Zn target (~50 mg) is dissolved in 2 mL of 6 M HCl containing 0.25 mL of conc. HNO₃. The mixture is then evaporated to near dryness, and after cooling, the residue is dissolved in 1 M H₂SO₄ yielding a solution ~10 mg/mL of Zn²⁺.
2. The electrolysis apparatus (Fig. 3) consists of a U-shape cell (three chamber right and left half cells), a Zn electrode (1.5 mm O.D. rod) immersed in a saturated solution of ZnSO₄ in 1 M H₂SO₄ (left half cell) and a Pt electrode (1.5 mm O.D.). The ^{nat}Zn(wire) target material is of Puratronic grade and all metal electrodes should be of high chemical purity (99.999%).

3. To eliminate traces of copper, the new Pt electrodes or electrolysis cells should always be soaked in conc. HNO₃ for several hours prior to use. A typical source of stable copper is from the spotwelder contacts which are generally made from copper and leave traces of it on the Pt.
4. The two electrolytes are separated by a porous barrier (10–20 micron fritted glass disc, 2 mm thick, ~2 cm² surface area), which allows electrical contact but prevents excessive mixing of the solutions by interdiffusion. The external connection of the two half cells is simply achieved by connecting the Pt and Zn electrodes with a suitable conductor. During the electrolysis, the right electrolyte is mixed magnetically, and the volume of each electrolyte is 25 mL.
5. At the end of electrolysis, the Pt electrode is removed from the electrolysis apparatus, and the deposited ⁶⁷Cu dissolved by immersing the Pt electrode in concentrated HNO₃ for 1–2 minutes. The electrolysis is performed at room temperature, and the duration of electrolysis is 30 minutes.

Dispensing, assay and quality control

The final product should be analysed by gamma spectroscopy.

Practical experience gained

For the electrodeposition method, in a typical production run, the neutron-irradiated ⁶⁷Zn target (50–100 mg as ZnO) is dissolved directly in 25 mL of 1 M H₂SO₄ and transferred to the electrolysis cell. After 30 minutes, when an assay of the right electrolyte indicates the quantitative removal of ⁶⁷Cu, the target solution is replaced with fresh 1 M H₂SO₄, and deposition continued for an additional 30 minutes. This step is repeated once more and then the deposited carrier-free ⁶⁷Cu is dissolved by immersing the Pt electrode in concentrated HNO₃ for 1–2 minutes.

Although the routine production of copper-67 *via* the (n,p) reaction in a nuclear reactor is probably not practical because of the relatively low yields and highly expensive enriched zinc-67 target material, this route can be used as a back-up when accelerator-produced copper-67 is unavailable.

BIBLIOGRAPHY

BROWN, L.C., CALLAHAN, A.P., “Copper-67 Processing and ZnO Recovery Procedure by Solvent Extraction”, Nuclear Medicine Procedure # NMG-45, Life Sciences Division, Oak Ridge National Laboratory, (L. C. Brown) 1972).

MIRZADEH, S., KNAPP, F.F., JR., “Spontaneous Electrochemical Separation of Carrier-free Copper-64 and Copper-67 from Zinc Targets”, *Radiochim. Acta*, **57** (1992) 193–199.

MIRZADEH, S., MAUSNER, L., SRIVASTAVA, S.C., “Production of No-Carrier Adder ⁶⁷Cu”, *Appl. Radiat. Isot.* **37**, (1986) 29–36.

RICE, D.E., Oak Ridge National Laboratory ‘Copper-64 Processing Procedure of Enriched Copper-64 Target’, Nuclear Medicine Procedure # NMG-24, Life Sciences Division (1986).

HARLING, O.K., et al., Boron Neutron Capture Therapy and Radiation Synovectomy Research at the Massachusetts Institute of Technology Research Reactor, Nuclear Science and Engineering, **110** (1992) 330–348.

SLEDGE, C.B., et al., Treatment of Rheumatoid Synovitis of the Knee with Intraarticular Injection of Dysprosium 165-Ferric Hydroxide Macroaggregates, Arthritis and Rheumatism, Vol. **29** No. 2 (1986).

SLEDGE, C.B., et al., Synovectomy of the Rheumatoid Knee Using Intra-Articular Injection of Dysprosium 165-Ferric Hydroxide Macroaggregates, Journal of Bone and Joint Surgery, Vol. **69-A**, No. 7 (1987).

Dysprosium-166 ($^{166}\text{Dy}_{66}$)

Half-life	:	81.6 ± 0.01 h	
Production scheme	:	$^{164}\text{Dy} (n,\gamma) ^{165}\text{Dy} (n,\gamma) ^{166}\text{Dy}$	$\sigma = 2650 \text{ b}$
Target material	:	Enriched dysprosium-164	
Decay energy	:	β^- (MeV) 0.404 (92%); 0.4327 (5%); 0.4869 (5%) γ (MeV) 0.08247 (13.8%)	
Decay product	:	^{166}Ho	

Dysprosium-166 is a lanthanide which can be reactor-produced by double neutron capture on enriched dysprosium-164 (28.2% natural abundance) with relatively high specific activity (Fig. 1) and decays to holmium-166, a beta-emitting radioisotope of interest for nuclear medicine applications.

Target specification and preparation

Enriched dysprosium-164 targets (>95%) as dysprosium oxide are irradiated.

Irradiation parameters, specific activity and total yield at end of irradiation

As shown in Fig. 1, even at low to moderate thermal neutron flux, multicurie levels of dysprosium-166 can be produced by the radiative (n,γ)(n,γ) reaction.

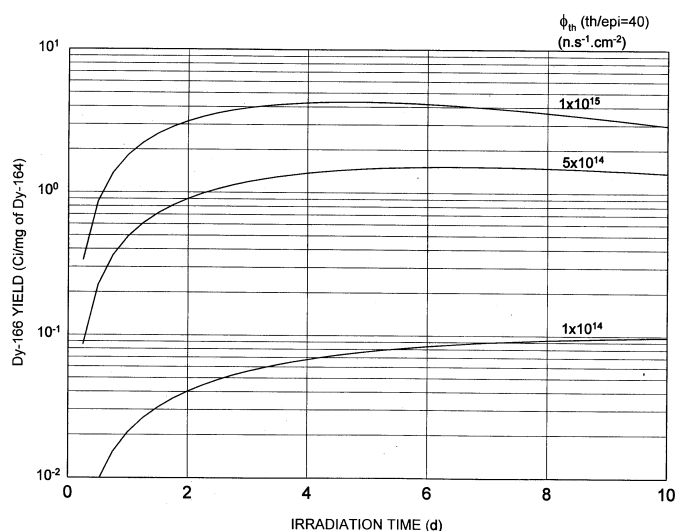

FIG. 1. Projected reactor production of dysprosium-166 as a function of irradiation time for various thermal neutron flux values.

The above procedure was provided by:
 S. Mirzadeh and F.F. Knapp, Jr.,
 Nuclear Medicine Programme, Oak Ridge National Laboratory,
 Oak Ridge, Tennessee 37830-6229, United States of America.

Type of facility for processing

An adequately shielded hot cell is required for processing the irradiated target.

Chemical processing procedure

Processing of irradiated dysprosium-164-enriched Dy₂O₃ targets involves cooling the target for the required time period, at ORNL 2–3 days, and then dissolution in 5–10 mL of 9 M HCl. After evaporation to dryness, the residue is dissolved in 0.01 N HNO₃ (Dadachova, et al., 1994).

Dispensing, assay and quality control

Solutions of the dysprosium nitrate can be dispensed as required. A modified dysprosium-166/holmium-166 generator system (Dadachova, et al., 1994) has also been developed (200–400 mesh AG 50WX × 12 resin) which provides carrier-free holmium-166 by elution with α-hydroxyisobutyric acid (α-HIBA). Because of the very similar chromatographic properties of dysprosium and holmium, however, following elution of holmium-166, the dysprosium-166 is eluted also, requiring re-processing re-adsorption of the dysprosium-166 for each subsequent run.

Final product specification for use

The radiochemical purity of the dysprosium-166 can be evaluated with a germanium crystal detector system.

Practical experience gained

Processing of reactor-irradiated enriched dysprosium-166 targets is straight forward and separation of carrier-free holmium-166 is feasible even on a high activity level.

BIBLIOGRAPHY

DADACHOVA, E., MIRZADEH, S., LAMBRECHT, R.M., HETHERINGTON, E.L., KNAPP, F.F., JR., "Separation of Carrier-free Holmium-166 from Neutron-Irradiated Dysprosium Targets", *Anal. Chem.*, **66** (1994) 4272–4277.

Gadolinium-153 ($^{153}\text{Gd}_{64}$)

Half-life	:	241.6.d		
Production scheme	:	$^{152}\text{Gd}(n,\gamma)^{153}\text{Gd}$	$\sigma = 735 \pm 20 \text{ b}$	
Type of decay and energy		EC (100%)	γ	IC
		0.06987 (2.42%)	11%	
		0.09743 (29.5%)	8%	
		0.1032 (21.1%)	30%	
Target material	:	Spec pure Gd_2O_3 (JM Grade)		

Target preparation

50 mg of the target is sealed in the standard aluminum can of dimension 22 mm dia \times 46 mm ht, which is cold-welded.

Irradiation period	:	2 months
Neutron flux	:	$6 \times 10^{13} \text{ n/cm}^2/\text{s}$
Yield	:	1.85 GBq (50 mCi)

Facility for processing

Standard glove box of dimensions 2 m \times 1 m \times 2 m fitted with 5 cm thick lead wall.

Chemical processing

The irradiated target is allowed to cool for about two weeks before taking up for chemical processing to allow the decay of shorter half-life component, ^{159}Gd (half-life-18.5 hours). The irradiated can is cut open and the target is dissolved in 5 mL of 3N HCl. The solution is then heated to enable complete dissolution of the powder and then diluted with 10 mL of 0.1N HCl.

Assay and quality control

The radioactive concentration of the solution is determined by measuring the ion-current produced by a known volume of the solution in a standardized ion chamber. The specific activity is calculated knowing the quantity of the target irradiated and the final yield of the product.

Characteristics of the solution

Chemical form	GdCl_3 in dilute HCl.
Radioactive concentration	37–185 MBq/g of Gd.
Specific activity	>700 MBq/g of Gd.

The above procedure was provided by:

M. Ananthkrishnan,
Board of Radiation and Isotope Technology,
Department of Atomic Energy, Mumbai 400 085, India.

Gold-198 ($^{198}\text{Au}_{79}$)

Half-life	:	2.69517 ± 0.00021 d
Production scheme	:	$^{197}\text{Au} (n,\gamma) ^{198}\text{Au}$ $\sigma = 98.65 \pm 0.09 \text{ b}$
Target material	:	Metallic gold with a purity of 99.9999%

Type of decay and energy

β^- (MeV)	0.2847 (0.985%)	γ (MeV)	0.4118 (95.58%)
E_{max}	0.960 (98.99%)		0.676 (0.804%)
	1372.4 (0.025%)		1.088 (0.159%)

Decay product : ^{198}Hg .

Production flow chart

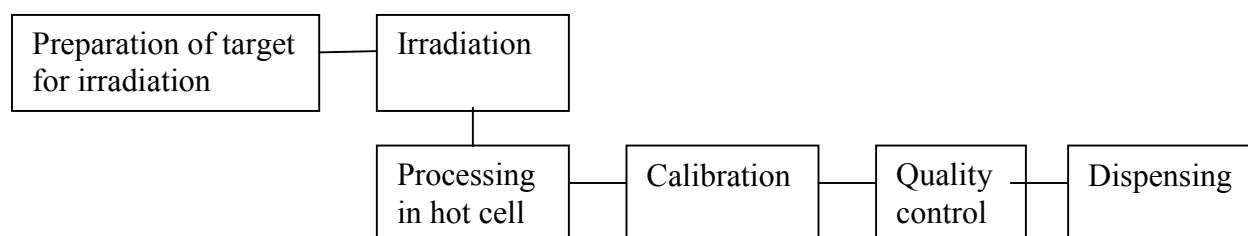

Target specification and preparation

Target material: metallic gold in the form of wire, diameter 0.8 mm.

Irradiation parameters, specific activity and total yield at EOI

Reactor used: RA-3, 5 MW pool type research reactor. Thermal fluxes from 2×10^{13} to 1×10^{14} n/cm²/s, 4 irradiation boxes with 14 places each one, and 120 hours of continuous operation per week.

Capsule details: a quartz ampoule is used; dimensions are 40–50 mm long, 6–8 mm diameter. The quartz ampoule sealed using an oxygen/gas blowpipe is placed with quartz wool into an aluminium can (70 mm long, 20 mm diameter) which is cold welded.

Mass of target per capsule: 100 mg of metallic gold.

Reactor irradiation parameters: flux 4×10^{13} n/cm²/s; irradiation time: 24 h

Specific activity achieved: 2.6 GBq (70 mCi)/mg.

Total activity under this conditions: 7 Ci EOI.

Impurity: ^{199}Au <0.5%, other <0.5%.

The above procedure was provided by:
Ezeiza Atomic Centre,
Comision Nacional de Energia Atomica,
Buenos Aires, Argentina.

Type of facility for processing

The hot cell is a sealed box under reduced pressure (15–20 mm of water-reduced pressure), with remote handling tong, and with a wall 5 cm of lead thickness as biological shielding. Viewing windows are made of lead glass (10 cm thick). The windows are mounted in frames fitting the interlocking lead brick system, and the space between the glass and the lead frame is packed with lead yarn. The tong used has a detachable head to enable to change the types of jaws without removing the tong from the box. A flexible plastic sleeve is attached to the tong shaft to prevent contamination being carried into the laboratory when the tong is drawn outwards. In addition there are a few special tools for opening cans and cutting quartz ampoules, a rigid support for the glass material, a sealing machine for glass vials, a fume hood and the glass vial containing the radioisotope solution (storage bottle).

For dispensing a remote operated pipette connected by means of a plastic tube to a hypodermic syringe is used.

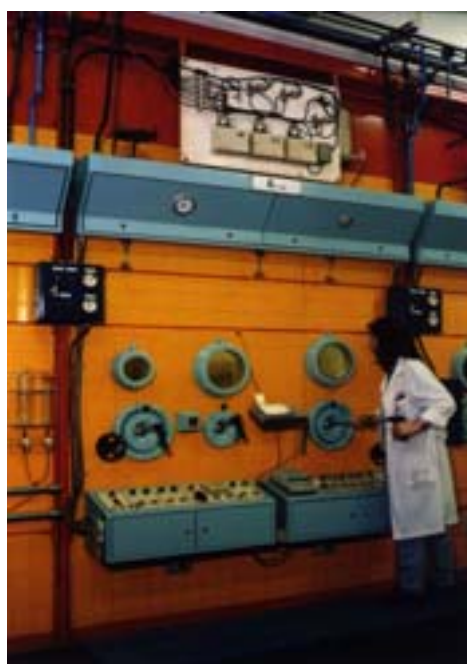

FIG. 1. Hot cell for the production of ^{198}Au .

Reagents and chemicals required for processing

HCl (Hydrochloric acid, 0.1 N solution)
3 HCl-1 HNO₃ (aqua regia)
H₂O (bidistilled water).

Chemical processing procedure

After irradiation the aluminium can and the ampoule are opened in hot cell.

The irradiated gold wire is converted to gold chloride by reaction with aqua regia at 100°C and the excess of aqua regia is evaporated to dryness, in the case of seeds they are not processed. The residual gold chloride is dissolved in 0.1 N HCl, assayed for radioactivity and dispensed.

Dispensing, assay and quality control

The final solution of $^{198}\text{AuCl}_3$ (act.conc. 1.8–3.7 GBq (50- 100 mCi)/mL) is filtered through Millipore filter 0.22 μm for dispensing or used for the production of gold colloides. For quality control a 3 mL fraction is separated.

Radionuclidic purity: determined by γ - spectrometry with a GeHp semiconducting detector associated to a multichannel analyser.

Radiochemical purity: determined by paper chromatography.

Final product specification for use

Limpid, yellowish acid solution.

Radionuclide identification: ^{198}Au .

Radionuclide purity: >99%.

pH of final solution: 1–2.

Radiochemical purity: >95%.

Concentration requirements: concentration activity at date of calibration: 1.8–3.7 GBq (50–100 mCi)/mL.

Storage conditions: at room temperature.

Gold-199 ($^{199}\text{Au}_{79}$)

Half-life	:	3.139 ± 0.007 d
Production reaction	:	$^{198}\text{Pt}(n,\gamma)^{199}\text{Pt}(\beta^-)\Psi^{199}\text{Au}$
Decay product	:	^{199}Hg (stable)

Target specification and preparation

Target purity: Enriched ^{198}Pt (95.31% ^{198}Pt , <0.05% $^{190,192}\text{Pt}$, 1.06% ^{194}Pt , 1.60% ^{195}Pt , 2.03% ^{196}Pt and <0.05% ^{197}Au) purchased from Oak Ridge National Laboratory (ORNL). Stable gold in the target material shall be kept low to maximize specific activity.

Irradiation parameters, specific activity and total yield at EOI

Reactor	:	The V-14 thimble position at High Flux Beam Reactor (HFBR) at Brookhaven National Laboratory (BNL) ($\phi_n = 4.2 \times 10^{14}$ n/cm ² /s) and the High Flux Irradiation Reactor (HFIR) at ORNL ($\phi_n = 1.58 \times 10^{15}$ n/cm ² /s).
Capsule details	:	0.5 cm ID × 5 cm Suprasil (purchased from Heraeus) quartz ampules.
Target mass	:	5–20 mg of powdered metal.
Irradiation length	:	3–5 days.
Specific activity, production yield:		BNL specific activity: ~ 7.5 GBq (205 mCi)/μg ORNL Specific activity: ~ 7.5 GBq (205 mCi)/μg Production Yield: >90% of theoretical ORNL: ($t_b = 5$ day) 12.2 GBq (330 mCi)/mg ^{198}Pt BNL: ($t_b = 4.02$ day) 2.37 GBq (64 mCi)/mg ^{198}Pt .

Type of facility for processing

Processing shall be performed in a shielded hot cell with HEPA filtration in the hot cell exhaust line.

Analysis of raw materials, reagents and chemicals required for processing

All reagents used in processing were of analytical grade without further analysis.

The above procedure was provided by:
L.F. Mausner,
Office of Isotope Production, Bldg. 801,
Medical Department, Brookhaven National Laboratory,
Upton, New York 11973, United States of America.

Chemical processing procedure

Reagents

Silica gel, SiO₂ (100–200 mesh, Davisil™) deactivated by treatment with dimethyl-dichlorosilane (DMCS) as discussed in the reference given below; Tri-n-butyl phosphate (TBP) was 99+% pure when purchased from Aldrich. All glassware was acid washed with HNO₃ before use. Nitric and hydrochloric acids were purchased from Aldrich. Nitric acid solutions used on the columns was always presaturated with TBP prior to use.

Preparation

Columns were prepared by thoroughly mixing the hydrophobic silica gel with TBP until no air bubbles remained on the support material. Columns were filled with the slurry and excess TBP was eluted under pressure with presaturated 14 N HNO₃. Under these conditions, the absorption capacity was measured to be 0.18 g TBP per g of dried silica gel. The column was then preconditioned with presaturated 1 N HNO₃. Typical columns were 2.54–4 cm × 0.5 cm ID.

Target dissolution

Enriched ¹⁹⁸Pt targets were dissolved slowly (t ~ 1–2 h) in warm aqua regia.

Separation procedure

After dissolution, the solution was evaporated to near dryness and redissolved in 1–3 mL 1 N HNO₃. This solution was loaded on the column. Platinum was eluted with 30 mL of 1 N HNO₃ followed by 10 mL of 3.5 N HNO₃ (typical flowrates were 1 mL/min). Gold-199 was eluted with 10–15 mL of 14 N HNO₃. This solution was gently evaporated to dryness using a rotoevaporator. The residue was redissolved in aqua regia and converted to the chloride by several evaporations to near dryness with HCl. The gold chloride was then redissolved in methanol (2 mg/μL) for cluster synthesis.

Dispensing, assay and quality control

Final products are assayed with regard to yield and radionuclidic purity.

Radioactivity measurements

Radioactive samples were assayed by direct γ counting on an intrinsic germanium detector (50 cm³, FWHM 2.0 keV at 1332 keV) connected to a 8192 multichannel analyser. The detector was calibrated against a known mixed gamma solution standard traceable to NIST. Counting samples were prepared in a plastic vial by dilution of the sample aliquot to 1 mL. All samples were counted at distances ≥ 8 cm from the detector face where coincident summing corrections are negligible.

Stable elemental analysis is made with spectrophotometric assay. From this data, the specific activity may be estimated.

Final product specification for use

The final product was intended for use in radiopharmaceutical development by synthesizing gold clusters and attaching them to antibodies.

Physical observations	:	The final product should be clear and colorless.
Radionuclide identification	:	by the 159 keV photon (37% abundant)
Radionuclide purity	:	Radionuclide impurity (due to ¹⁹⁸ Au) should total <2% of ¹⁹⁹ Au activity
Solution pH	:	pH <1
Radiochemical purity	:	The radiochemical purity of is determined using HPLC and spectrophotometric assay (for stable Pt).
Concentration requirements	:	Varies depending on application.
Shelf life and recommended storage	:	conditions: Shelf life depends on specific activity requirements of final preparation of antibody conjugate. If not used immediately, the radionuclide should be stored at pH <1.
Waste disposal	:	Waste disposal is similar for waste disposal of any waste containing β/γ radionuclides.
Preparation and cleanup considerations:		Extraction columns are poured fresh for each production run. Acid solutions are presaturated with TBP immediately prior to each production run.

Practical experience gained

Silica gel must be hydrophobized before use to ensure consistently high ¹⁹⁹Au recovery from the target material.

BIBLIOGRAPHY

HAINFELD, J.F., FOLEY, C.J., SRIVASTAVA, S.C., MAUSNER, L.F., FENG, N.I., MEINKEN, G.E., STEPLEWSKI, Z., Radioactive Gold Cluster Immunoconjugates: Potential Agents for Cancer Therapy, Nucl. Med. Biol. **17** (1990) 287.

KOLSKY, K. L., MAUSNER, L.F., Production of No-carrier-added ¹⁹⁹Au for Gold Cluster-labelled Antibodies, Appl. Radiat. Isot. **44** (1993) 553.

Gold-199 (¹⁹⁹Au₇₉)
(Alternate procedure)

Half-life : 3.139 ± 0.007 days

Production scheme : $^{198}_{78}\text{Pt} (n,\gamma) \rightarrow ^{199}_{78}\text{Pt}$
 $\downarrow \beta^-_{30 \text{ min}}$
 $^{199}_{79}\text{Au}$

Decay product : ^{199}Hg

Nuclear reactions and yield

Reaction	Isotopic abundance of nuclide%	Cross-section barn	Activity of element at $10^{12} \text{ n/cm}^2/\text{s}$	
			One week	Saturation
$^{198}_{78}\text{Pt} (n,\gamma) \rightarrow ^{199}_{78}\text{Pt}$ $\downarrow \beta^-$ $^{199}_{79}\text{Au}$	7.2	3.66 ± 0.19	650 MBq (17.61 mCi)/g	1.19 MBq (22.26 mCi)/g

Type of decay and energy (MeV)

β^-	0.244 (21.5%)	Gamma	0.1584 (40%)	IC	36.4%
	0.294 (72.0%)		0.2082 (8.72%)		9%
	0.4526 (6.5%)				

Target specification and preparation

Target	Spec.pure Pt sponge 100 mg. (J.M.).
Container	Standard 1S aluminium can 22 mm dia and 44 mm ht. cold weld sealed.
Irradiation	1.week
Flux	$5 \times 10^{13} \text{ n/cm}^2/\text{s}$.
Activity produced	3.7 GBq (100 mCi).
Type of facility for processing	Standard glove box with 2 inch lead shielding.

The above procedure was provided by:
M. Ananthkrishnan,
Board of Radiation and Isotope Technology,
Department of Atomic Energy, Mumbai, India.

Chemicals and reagents required for processing

HCl (AR Grade)
HNO₃ (AR Grade)
Ethylacetate (AR Grade)

Processing

100 mg of irradiated platinum is dissolved in 10 mL aqua regia in a dissolution flask and refluxed for 10 minutes. The solution is concentrated to approx. 0.5 mL and excess nitric acid is removed by repeated treatment with 5 mL concentrated HCl each time. (This is done thrice) Final solution is concentrated to approx. 0.5 mL and 25 mL 3 N HCl is added to it. The solution is transferred to a 125 mL separating funnel. 25 mL ethyl acetate pre-equilibrated with 3NHCl is added to the solution and gold 199 is extracted in ethyl acetate. (This procedure is repeated thrice) Ethyl acetate fraction separated is washed with 3NHCl and transferred to a distillation flask. Ethyl acetate is removed by distillation and the residue is treated with 5 mL concentrated HNO₃ to destroy any organic matter. Excess nitric acid is destroyed by treatment with concentrated HCl. The solution is evaporated to near dryness and activity leached out in 10 mL 0.1 N HCl.

Assay and quality control

Activity yield	100%.
Specific activity	carrier free.
Activity determination	γ -measurement with ionization chamber. The radioactivity is measured in a well type ionization chamber (ORNL).

Radionuclide purity is checked by γ spectrometer using HP Ge detector.

Characteristics of final solution

Appearance	A clear solution.
Chemical form	HA _U Cl ₄ in 0.1 NHCl.
Specific activity	Carrier free.
Radioactive concentration	370–740 MBq (10–20 mCi)/mL.
Radiochemical purity	>99%.

Holmium-166 ($^{166}\text{Ho}_{67}$)

Half-life	:	26.763 ± 0.004 h
Production scheme	:	$^{165}\text{Ho} (n,\gamma) ^{166}\text{Ho}$ $\sigma_{n\gamma}(\text{g}) = 61.2 \pm 1.1 \text{ b}$
Decay product	:	$^{166}\text{Er}_{68}$.

Type of decay and energy

β energy: Max. 1853.9 keV (50%)
 1773.3 keV (48.7%)
 + 4 others, low yield
 Mean 0.67 MeV

γ energy: 0.081 MeV (6.71%)
 1.379 MeV (0.93%)
 + several others to 1.83 MeV.

Flow chart of the operation and procedures

Preparation of target → Irradiation → Cooling → Chemical Processing → Dispensing.

Target material : $^{165}\text{Ho}(\text{NO}_3)_3 \cdot 5\text{H}_2\text{O}$ or $^{165}\text{Ho}_2\text{O}_3$

Target specification and preparation

Target purity

>99.9% Holmium(III) nitrate pentahydrate.

Enrichment factor, if applicable

^{165}Ho (natural abundance is 100%).

Impurity details (in irradiated sample)

Check radionuclidic impurities in an activated sample (typical results given below)

Instrument : GMS-25190 detector (EG & G, ORTEC)

Cooling time : 14 d

The above procedure was provided by:

Kyung Bae Park,
Radioisotopes and Radiation Team, HANARO Centre,
KAERI, Taejon, Republic of Korea

Nuclide	Half-life	Activity (Bq)	Initial Activity	Remarks
Ho-166	26.8 h	573,200	3,3 E09 (92 mCi)	
Ho-166m	1200 a	1,858	1,860	0.564 ppm
Lu-177m	160.9 d	1,550	1,646	0.5 ppm
Lu-177	6.71 d	8,390	35,621	10.79 ppm
Ce-141	32.5 d	457	616	0.19 ppm
Yb-169	32.02 d	2,488	3,369	1.02 ppm
Yb-175	324.19 d	17,640	178,695	54.15 ppm
La-140	40.22 h	90	29,412	8.91 ppm

Isotopic composition and supplier of target material and grade

Holmium(III) nitrate pentahydrate, >99.9% (Aldrich chemical company, Inc) or Holmium Oxide.

Irradiation parameters, specific activity and total yield at EOI

1. Reactor used and which assembly (hydraulic tube, etc.) HANARO, HTS (Hydraulic Transfer System) in D₂O reflect region of HANARO
2. Capsule details (material, dimensions, encapsulation method, etc.) any special precautions for target encapsulation (degassing, low pressure, etc.)
 - Sample container material: Titanium, Dia. 15 mm, length: 50 mm
 - Inner capsule material: Aluminum 1050, Dia. 22 mm, length: 107 mm, Sealing method: cold welding, 10–6 torr
 - Outer capsule material: Aluminum 1050, Dia. 28 mm, length: 150 mm Sealing method: tig welding in Helium chamber, 10–8 torr
3. Mass of target per capsule: 200 mg
4. Preparation of target for encapsulation, reactor irradiation parameters (flux, irradiation time, etc.)
 - Thermal neutron flux in HANARO (at 20 MW, power): 4.2×10^{13} n/cm²/s
 - Irradiation time: 60 h
 - Cooling time: 30 h
5. Specific activity achieved and typical production yield per capsule
 - Specific Activity: 2.28 GBq (75 mCi)/mg
 - Production Yield per Capsule: approximately 90%
6. Any other pertinent information

Type of facility for processing

1. Negative pressure: hot cell in: 9,000 zone, out: 8,000 zone, operation area: 7,000 zone
2. HEPA filter and activated charcoal filter

Analysis of raw materials, reagent and chemical required for processing

Holmium nitrate pentahydrate

Ho(NO₃)₃ 5H₂O, M.Wt, 441.02

It contains not less than 99.0 percent of Ho(NO₃)₃ 5H₂O

1. Characteristics: A light yellow or orange, crystalline powder; odorless.
2. Identification

Weight out approximately 0.05 g and 0.1 g respectively and dissolve to 100 mL with 1% nitric acid and complies with atomic spectrometry of Korea pharmacopoeia.

- Absorbency: 410.4 and 425.4 nm.
- Light source: Holmium lamp.
- Combustibles: mixed gas of nitrous oxide and acetylene (9:5).

3. pH: Between 4.0 to 6.0, in solution (1 in 100).
4. Moisture content: Between 20.4 to 22.2 percent.

5. Purity

5.1 Characteristics

Colourless or light orange in a solution (1 in 100).

5.2 Heavy metals

Dissolves 100 mg in 10 mL of 1% nitrate and complies with atomic spectrometry.

–Calcium: not more than 200 ppm.

–Erbium: not more than 30 ppm.

5.3 Arsenic

Weigh out 1 g and complies with limit tests for arsenic of Korea Pharmacopoeia

6. Assay

Approximately 100 mg is dissolved in 100 mL water.

Add 2–3 aliquot of xylene orange and titrate with 0.05 M EDTA until red colour changed to yellow. Carry out the blank test.

0.05 M EDTA 1 mL = 22.051 mg $\text{Ho}(\text{NO}_3)_3 \cdot 5\text{H}_2\text{O}$

$$\text{Ho}(\text{NO}_3)_3 \cdot 5\text{H}_2\text{O} (\%) = \frac{22.051 \times B \times f}{W_t} \times \frac{100}{100 - (m - 20.4)}$$

Wt.: weight of sample (mg)

B: the amount of consumption of 0.05 M EDTA (mL)

f: Normality of 0.05 M EDTA

m: Moisture content (%).

Chemical processing procedure

1. Cask transfer from reactor to hot cell.
2. Operation with manipulator in hot cell: outer capsule → inner capsule cutting → titanium capsule opening → target dissolved with HCl soln. (pH 3.0) → 0.2 μm Membrane filter to 0 mL vial → dispensing in clean bench.

Dispensing, assay, quality control

Same for finished products.

Final product specification for use

Physical observation

A clear, light brown colour solution.

Radionuclide identification

The most prominent gamma rays of holmium-166 have energies of 80.6, 1379.4 keV.

Radionuclidic purity

Record the gamma ray and X ray spectrum using a multi channel analyser The spectrum does not differ significantly from that of a standardized solution of holmium-166.

PH of final solution

Between 2.0 to 4.0

Radiochemical purity

Examine by thin-layer chromatography using silicic acid as the coating substance on a instant thin layer sheet. Apply to the plat 5 µl of the solution to be examined. Develop immedicately over a path of 10 cm using a solution (methanol: water: glacial acetae = 100: 100: 1) Allow the plate to dry in a current of cold air. Determine the distribution of radioactivity using a TLC scanner. Holmium-166 nitrate migrates with an Rf value of 1.0. Not less than 95% of total radioactivity of the chromatogram corresponds to holmium-166 nitrate.

Concentration requirement for specific application specific volume

The specific radioactivity is not less than 2.28 GBq (75 mCi) of holmium-166 per milligram of holmium.

Half-life and recommended storage conditions

Half-life is 26.7 hour. Holmium nitrate [¹⁶⁶Ho] sterile solution should be used not later than 3 days from the date stated on the label.

Special comments on disposal of waste generated

None.

Preparation and cleanup of the facility and preparation for processing of next batch

Complies with GMP.

Iodine-125 ($^{125}\text{I}_{53}$)

Half-life : 59.408 d

Production scheme

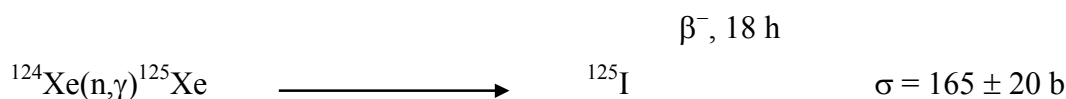

Decay product : ^{125}Te

Type of decay and energy

Iodine-125 decays directly to the excited state at 0.03549 MeV by electron capture. Only 6.68% of this excited state decays to the ground state, to ^{125}Te stable nuclide. The remainder 93.32% decays by internal conversion. As a consequence of electron vacancies in inner shell results in characteristic X ray, the main energy is 0.028 MeV.

EC: 100% Gamma: 0.03549 MeV, (6.68%)
X ray: 0.028 MeV

Cross-section data for $^{124}\text{Xe}(n,\gamma)^{125}\text{I}$ reaction are, as follows:

$$\sigma^m = 28 \text{ b}, \sigma^g = 137 \text{ b}$$

As natural xenon target contains ^{124}Xe nuclide in 0.096% only, there are two options to produce high yields of ^{125}I : (i) long irradiation of natural xenon, (ii) use of enriched xenon target. In the former case it is necessary to calculate with the following nuclear reaction:

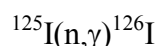

since the forming ^{125}I radionuclides can also capture neutrons with a cross-section of 900 barn which leads to the presence of ^{126}I radionuclidic impurity. If long irradiation of the natural xenon target is performed the amount of the ^{126}I impurity can be decreased by cooling since the physical half-life of ^{126}I is shorter (13 days). If the construction of a loop in the nuclear reactor is possible, the circulation of the natural xenon target can ensure extremely low level of ^{126}I since the forming ^{125}I radionuclides are immediately taken away from the circulation.

In case of using enriched xenon-124 target, the short irradiation period keeps the ^{126}I content on low level. On the other hand the recovery of the expensive enriched xenon target is required.

The above procedure was provided by:

J. Környei,
Institute of Isotopes Co., Ltd.,
H-1535 Budapest, P.O. Box 851, Hungary.

The flow chart of the technology is given below:

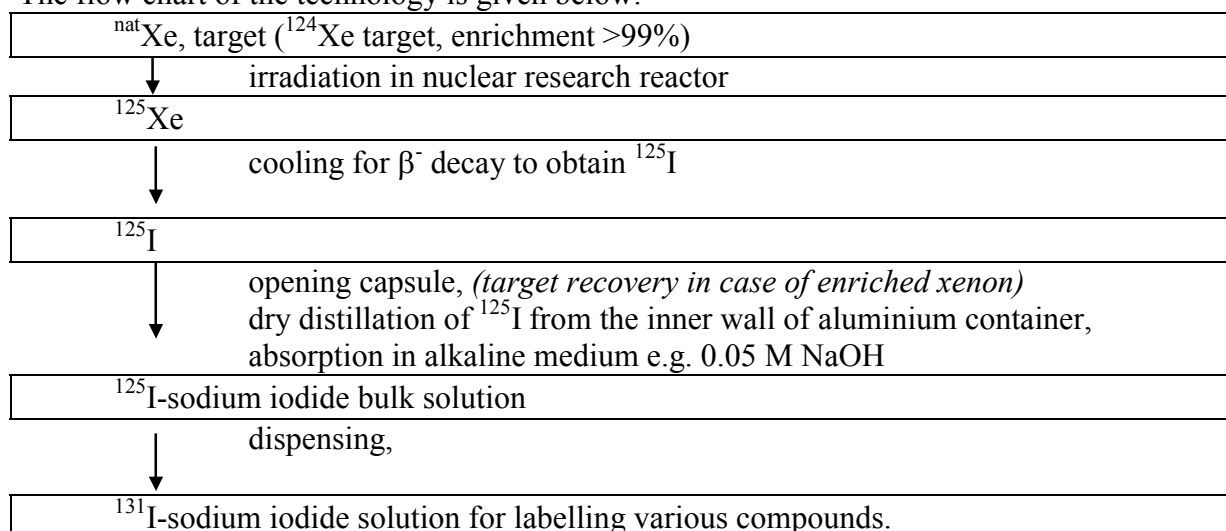

Target specification

Target purity

Xenon gas, 99.99%.

Enrichment factor

Natural isotopic composition, ^{124}Xe content: 0.096%.
(*Enriched xenon-124, enrichment factor >99%*).

Impurity details

No detectable impurities.

Isotopic composition and supplier of target material and grade

natural xenon		<i>enriched xenon-124</i>
^{124}Xe :	0.096%	>99%
^{126}Xe :	0.09%	0.05%
^{128}Xe :	1.92%	0.01%
^{130}Xe :	4.80%	0.01%
^{132}Xe :	26.9%	0.01%
^{134}Xe :	10.4%	-
^{136}Xe :	8.87%	-

Supplier of target: Campro Scientific BV., 3900 AH Veenendaal, The Netherlands.

Irradiation parameters, specific activity and total yield at the EOI

Reactor

Nuclear research reactors with a neutron flux of $1 \times 10^{13} - 1 \times 10^{14}$ n/cm²/s can be used. Higher fluxes should be avoided as the pressure in the target capsule containing natural xenon can increase up to 50 kg/cm² during irradiation. Water cooling of the target within the irradiation channel, during the whole irradiation, is necessary.

Capsule details

Irradiation capsule is made of aluminium containing magnesium in 0.3–1.5%, silicium in 0.2–1.5%, manganese up to 1.5%, iron in 0.5%. This composition ensures the firmness of the capsule against the pressure of the target gas. Dimensions of the irradiation capsule are: diameter 27mm, height 200 mm.

Mass of target per capsule

The capsule contains 15 g of natural xenon or 0.4 g enriched xenon-124.

Preparation of target for encapsulation and irradiation parameters

15 g of natural Xe gas is filled into the aluminium capsule in the filling equipment showed in the Fig. 1. The aluminium capsule is fixed to the tube and liquid nitrogen containing Dewar bottle is placed under the Al-capsule. The capsule is immersed into the liquid nitrogen. The valve is opened and pressure is adjusted to 6 bar. Vacuum pump is connected to the tube end and it is switched on and operated for approx. 3 minutes. The aluminium capsule is vacuumed followed by filling it with xenon gas up to a pressure of 5 bar three times as 5 bar pressure corresponds to 5 g natural xenon gas. Finally the aluminium capsule is removed (asbest gloves!) and plugged with hand pressing machine. The aluminium capsule is left to warm up to room temperature and the leak-tightness is tested in glicerine at a temperature of 120–240°C.

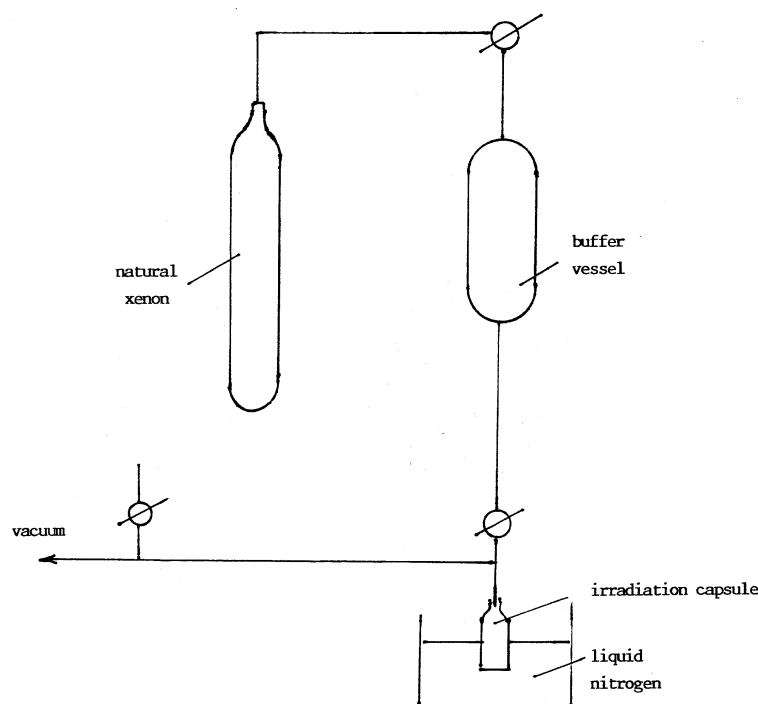

FIG. 1. Scheme of xenon filling.

In case of enriched xenon-124 capsule filling is performed by similar way with the exception of the pressure adjusted since only 0.4 g of target should be encapsulated.

Fluxes up to 1×10^{14} n/cm²/s can be used, a typical flux used is 5×10^{13} n/cm²/s. At least 200 hours irradiation is required which can be extended up to 300 hours from point of view

of higher yields. After irradiation a cooling period of at least 120 hours is required to complete β^- decay for obtaining iodine-125. In addition to this further cooling for 30–40 days is necessary so that the ^{126}I content should decrease to an acceptable level.

In case of the use of enriched xenon-124 irradiation for 10–24 hours is sufficient followed by a 10–20 days cooling period.

SPECIFIC ACTIVITY ACHIEVED AND TYPICAL PRODUCTION YIELDS/CAPSULE

Flux, n/cm ² /s	5×10^{13}			
Target	natural Xe		<i>enriched ¹²⁴Xe</i>	
Mass of target, g	15		0.4	
Irradiation time, hours	200	300	10	24
Cooling period, days	40	45	20	20
Yield of ¹²⁵ I, GBq	29.15	40.32	50.71	121.2
¹²⁶ I content, after cooling, %	0.77	0.89	0.02	0.11
Specific activity, GBq/mg	Theoretical specific activity of the carrier-free iodine-125 = 646.02 Obtained: >600			

Type of facility for processing

For iodine-125 production two hot cells under negative pressure with 2–2 manipulators, as well as air ventilation system with iodine (aerosol) filter is required. Hot cells are made of iron with a lead shielding of 15 cm. The window of the hot cell is made of lead glass with a thickness of 20 cm. One hot cell is prepared for the target opening and for the distillation equipment, the other is used for dilution, dispensing and sterilization of the ¹²⁵I-sodium iodide solutions. Any other conditions (e.g. radiation protection system, etc.) should correspond to the regulations being valid for isotope laboratories of level "A".

In case of the use of enriched ¹²⁴Xe as target, the recovery of the irradiated xenon in a hot cell is necessary.

Analysis of raw materials, reagents and chemicals required for processing

1. Natural xenon gas or enriched ¹²⁴Xe gas target, see the specifications above. No other analysis than trial irradiation and the determination of the radionuclidic purity as well as radiochemical and chemical purity of the ¹²⁵I obtained are suggested.
2. Sodium hydroxide
Sodium hydroxide white pellets, grade extra pure is used (DAB, Ph.Eur, BP). Identification is performed by flame photometry. Drops coming from the aqueous solution of NaOH give a bright yellow colour. Content determination is carried out by acidi-alkalimetric titration.

Chemical processing procedure

The aluminium capsule is opened in the first hot cell. When the needle punches the aluminium the Xe gas is released into the chimney and the ¹²⁵I radioisotope is adsorbed on the inside wall of the aluminium capsule.

Before placing the capsule into the dry distillation equipment two holes with diameter of approximately 5 mm is advisable to drill through the wall of the aluminium capsule at the lower one third part to increase efficiency of the distillation. The dry distillation equipment can be shown on Fig. 2. It consists of a furnace (1), a quartz bridge (2), an acidic washing vessel (3) and alkaline collectors (4a,b). The distillation is followed through 120 minutes at a temperature of 550°C.

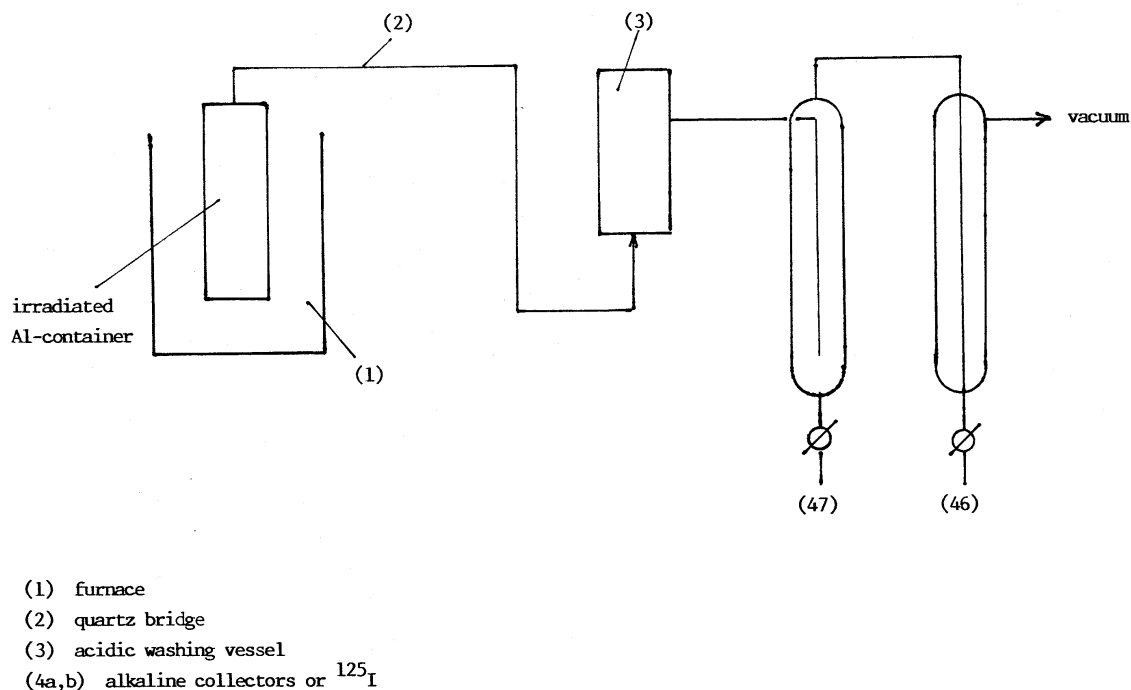

FIG. 2. Dry distillation equipment.

Dispensing and quality control

Dispensing

The ^{125}I -NaI solution is transferred to the second hot cell. Radioactive concentration of the fractions is determined. Based on the measured radioactive concentration the required value should be adjusted dilution with 0.04 M NaOH. Solutions of the required radioactive concentration are dispensed to portions into vials. If sterile product is required ampoules should be autoclaved for 30 minutes at a temperature of 120°C.

Determination of radionuclidic purity

A vial containing 5–10 MBq I-125 sample is measured. Main gamma-peak of ^{125}I are: 28 keV (X ray) and 35.49 keV (γ -ray). Impurity limit: not more than 0,9% of ^{126}I (gamma of 380 keV and 650 keV, beta: 390 keV, 870 keV and 1250 keV, positron: 460 keV and 1110 keV). A gamma spectrum of iodine-125 can be seen in Fig. 3.

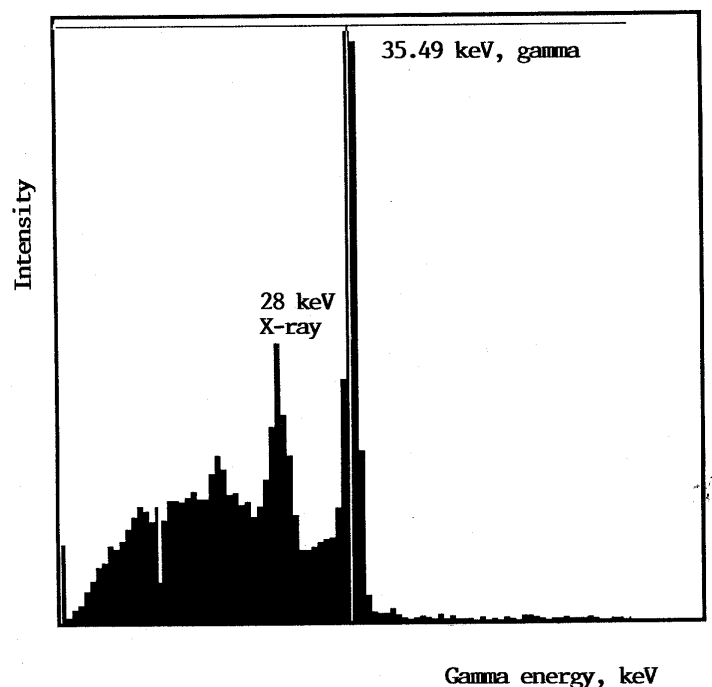

FIG.3. Gamma spectrum of ^{125}I .

Determination of radiochemical purity

Paper electrophoresis is used. Paper stripes, type Whatman No.3 MM for electrophoresis, possess dimension of 65×3 cm. Dropping of 10–20 μl samples takes place in a distance of 10–13 cm from the end of the stripes. Borate buffer is used, concentration 9 g/l, $\text{pH}=9 \pm 0.1$. Electrophoresis is carried out on a potential of 900 V. Time: 50 min.

Rf values: product, i.e. iodide	Rf =	0.7–0.9
impurities: iodate:	Rf =	0.4
periodate:	Rf =	0–0.1
elemental iod:	Rf =	0.

Product can be accepted if the I-125-iodide anion content is higher than 95% even on the expiration date.

Final product specification

1. Physical observation: Clear, colourless solution.
2. Radionuclide identification:
Iodine-125 radionuclide is identified by gamma spectrum (see above characterization).
3. Radionuclidic purity: should be higher than, or equal to 99.1%, i.e. ^{126}I content should be less than 0.9%.
4. pH of final solution: 8–10.
5. Radiochemical purity:
Measured by the above detailed electrophoresis, it should be higher than 95%.
6. Concentration requirements:
 - a) Product of high radioactive concentration
>7400 MBq/mL, chemical content: 0.04 M NaOH, reductant-free
 - b) Product of medium radioactive concentration
1850–7400 MBq/mL, chemical content: 0.04 M NaOH, reductant-free
 - c) Product of low radioactive concentration.
<1850 MBq/mL, chemical content: 0.04 M NaOH, reductant-free.

7. Shelf life and recommended storage conditions.
Expiry: production + 60 days, storage at room temperature.
8. Special comments of waste generated:
Wastes should be collected and left for decay. No special prescriptions are given, the normal radioactive waste treatment procedures described for isotope laboratories should be applied. Do not let iodine-125 to be contacted with acidic medium!
9. Preparation and clean up of the facility for next production.
The distillation equipment is surely contaminated and should be dismantled by manipulators in the hot cell. Acidic and alkaline solutions should be taken off into separate vessels. The quartz bridge should be washed in 1 M NaOH and finally rinsed with water.

Practical experience gained

Iodine-125 production from natural xenon gas target is a safe method if irradiation capsules made of aluminium are well prepared and well-controlled against both negative and positive pressure in order to avoid the xenon loss as well as the explosion of the capsule during irradiation. This method has been used in Hungary for more than 20 years without any breakdown. The air coming from the hot cells of ^{125}I production should be filtered by using a multilayer filter which is capable of capturing radioactive aerosols as well.

In case of the use of enriched xenon the proper closing of the aluminium capsule is the crucial factor for avoiding the eventual loss of the very expensive target. A careful servicing of the equipment can help.

BIBLIOGRAPHY

DEWANJEE, M.K., RAO, S.A., "Principles of radioiodination and iodine labelled tracers", Radiotracers for Medical Application, CRC Press, Vol. II, Boca Raton (1983).

FIRESTONE, R.B., Table of Isotopes, CD ROM Edition, (SHIRLEY V.S., CHU S.Y., Eds.) Version 1.0, Office of High Energy and Nuclear Physics, US Department of Energy (1996).

MYERS, G.W., Radioisotopes of iodine, (Proc. Symp. Oak Ridge, 1965), USAEC Techn. Information Extension, Oak Ridge (1966) 217.

MYERS, W.G., VANDERLEEDEN, J.C., Radioiodine-125., J. Nucl. Med. **1** (1960), 149; **16** (1971) 565.

Iodine-131 (¹³¹I₅₃)
(Wet distillation method)

Half-life : 8.04 days

Production scheme:

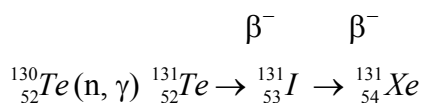

Target material : Tellurium metal powder

Decay product : ¹³¹Xe

Nuclear reactions and yield

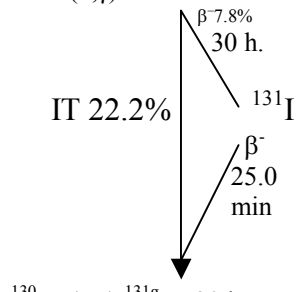
Reaction	Abundance of target nuclide %	Cross-section barns	Activity of element at 10 ¹³ n/cm ² /s			Side reactions and half-life of nuclide formed.
			24 h.	7 days	Saturation	
¹³⁰ Te(n,γ) ^{131m} Te 	33.8	0.04	14.8 MBq (1.4 mCi) /g	292 MBq (7.9 mCi) /g	650 MBq (17.5 mCi) /g	¹²⁰ Te(n,γ) ^{121g} Te Half-life: 17 days Isotopic abundance: 0.089% σ = 2.0 barn
	33.8	0.2	250 MBq (6.8 mCi) /g	1.4 GBq (38.0 mCi) /g	3 GBq (83.0 mCi) /g	¹²⁰ Te(n, γ) ^{121m} Te Half-life: 154 days σ = 0.34 barn ¹²² Te(n,γ) ^{123m} Te Half-life: 119.7 days Isotope abundance: 2.46% σ = 1.1 barn ¹²⁴ Te(n,γ) ^{125m} Te Half-life: 47.4 d Isotopic Abundance: 4.61% σ = 0.04 barn ¹²⁶ Te(n,γ) ^{127g} Te Half-life: 9.4 hours Isotopic Abundance: 18.71% σ = 0.9 barn ¹²⁶ Te(n,γ) ^{127m} Te Half-life: 109 days σ = 0.135 barn ¹²⁸ Te(n,γ) ¹²⁹ Te Half-life: 69.6 minutes Isotopic Abundance: 31.7% σ = 0.14 barn ¹²⁸ Te(n,γ) ^{129m} Te Half-life: 33.6 days σ = 0.015 barn

The above procedure was provided by:
M. Ananthkrishnan,
Board of Radiation and Isotope Technology,
Department of Atomic Energy, Mumbai, India.

Type of decay and energy (MeV)

β^-	0.25	2.1% approx.	Gamma	0.08	2.6%
	0.33	7.27%		0.177	0.26%
	0.304	0.651%		0.284	6.14%
	0.608	89.9%		0.325	0.274%
	0.81	0.48%		0.364	81.7%
				0.503	0.36%
				0.636	7.2%
				0.722	1.8%
				0.164	0.6%
		Via 11.8 d $^{131}\text{Xe}^m$			

Target specifications : Heavy metals like Ag, Au, Pb <0.005%
Anions like Cl, SO₄ <0.01%

Irradiation parameters

Reactor used	Dhruva reactor in BARC complex, Mumbai, India.
Capsule details	1S Aluminium can 22 mm dia × 44 mm ht.
Target material	Natural Tellurium 20 g.in one can-cold weld sealed (3 × 20 g. in one batch).
Irradiation time and flux	3 weeks at a flux of 10 ¹⁴ n/cm ² /s.
Typical production yield	9.25–11.1 GBq (250–300 mCi)/g of Te at EOI.

Facility for processing

The radiochemical processing of I-131 is carried out in sealed boxes (Al or SS) kept under negative pressure (2–3 cm WG) and provided with 4 inch lead shielding. The boxes are connected to iodine filters (charcoal) fixed at the top.

Raw materials, reagents and chemicals required for processing

All the reagents used is chromic acid, sulphuric acid, oxalic acid, sodium sulphate, sodium hydride are AR/GR.

Chemical processing procedure

The irradiated can containing 60g tellurium powder is opened and the contents are transferred into a 4-necked 5 lit distillation flask. The oxidation mixture consisting of 360 mL of 15 N chromic acid solution and 960 mL of 50% H₂SO₄ is loaded into the dissolution flask. The mixture is then refluxed for two and half hours using infra red lamps to heat the flask. After dissolution, the mixture is cooled for 3 hours by passing water through a cooling coil fitted to the centre neck of the flask. 240 g of oxalic acid dihydrate are added to reduce the excess of

chromic acid. After about half-an-hour of completion of reduction reaction, the flask is heated using the infra red lamp. The receiver flask is cleaned with double distilled water and ten millilitres of 0.01 N Na_2SO_3 is transferred to it. The distillation of iodine-131 is carried out for half an hour or till no more iodine-131 distils into the receiver flask as indicated by the reading in the ion chambers kept close to the dissolution flask. The flask is allowed to cool for 15 minutes. The pH of distillate is adjusted to approx. 8 by adding necessary quantity of 1 N NaOH solution. The contents of the receiver flask is concentrated to a small volume to obtain the necessary radioactive concentration of 250–400 mCi/mL. Finally the radioactive iodine-131 solution is transferred into a storage bottle (Fig.1).

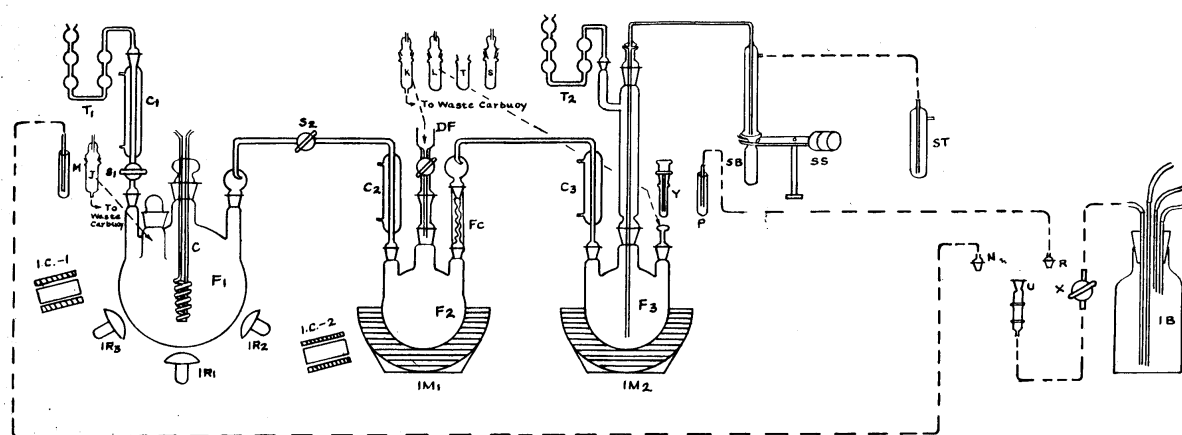

REFERENCE TABLE

F ₁ ——— Dissolution flask	IC ₁ , IC ₂ ——— Ion-chambers	Y ——— Capillary tube (used for adjusting pH)
F ₂ ——— Purification flask	S ₁ , S ₂ ——— Stopcocks	MN, PR ——— Waste lines
F ₃ ——— Concentration flask	T ₁ , T ₂ ——— Traps	IB ——— Intermediate Waste bottle
C ₁ , C ₂ , C ₃ ——— Condensers	ST ——— Safety Trap	SB ——— Storage bottle
C ——— Cooling coil	J, K, L ——— Receptacles for ends of reagents lines	U ——— Socket for N and R
IR ₁ - IR ₂ ——— Infra-red lamps	DF ——— Dropping Funnel	X ——— Stopcock connecting U to IB
IM ₁ - IM ₂ ——— Isomenties	FC ——— Fractionating column	SS ——— See Saw

FIG. 1. Iodine-131 production facility.

Assay and quality control

The activity is assayed by taking the ion current measurement of known volume of stock solution in a calibrated ion chamber.

Radionuclide identification is performed by checking the 0.36 MeV (81.2%) gamma peak. The gamma ray spectrum is examined for any other gamma emitting impurities.

Radiochemical purity

This is determined by a paper chromatogram, using iodide and iodate carrier and a solvent mixture of 75% methanol and 25% water adjusted to pH 7–8 with potassium carbonate.

Rf value of	I^-	= 0.75
Rf value of	IO_3^-	= 0.50
Rf value of	IO_4^-	= 0.00

The iodide content must be more than 95% in a typical batch. The total solid content is determined by evaporating a known volume of the stock solution and weighing the residue. Any heavy metal impurity is estimated colorimetrically.

Total reducing agents: A known amount of stock solution is treated with a known excess of potassium permanganate solution and the excess of permanganate is back titrated against standard oxalic acid solution. The reducing agent content is expressed in millilitres of 0.1N KMnO₄ per mL of Na ¹³¹I solution.

Characteristics of the final solution

Code	I-2 (Non-injectable) Iodine-131 as Na ¹³¹ I in dilute alkaline sulphate solution.
Radioactive concentration	7.4–14.8 GBq (200–400 mCi)/mL

Na ¹³¹I product specification

1	Description	A clear colourless solution. On standing, glass and solution may darken.
2	Radionuclide identification	By photopeak corresponding to the principal of gamma peak 0.36 MeV.
3	Radionuclide purity	No other extraneous gamma emitting radionuclide is detectable in the gamma ray spectrum.
4	PH	8–10.
5	Radiochemical purity	The activity in the Na ¹³¹ I zone shall not be less than 95% of the total activity.
6	Sodium sulphite content	↔ 10 mg/ 3.7 GBq (100 mCi) of ¹³¹ I.
7	Assay for activity	In mCi/mL
8	Tellurium content	<5 µg/mL.
9	Storage	In glass vials.

Chemical reaction

The following reactions take place during the oxidation of tellurium and subsequent reduction with oxalic acid prior to the distillation of iodine:

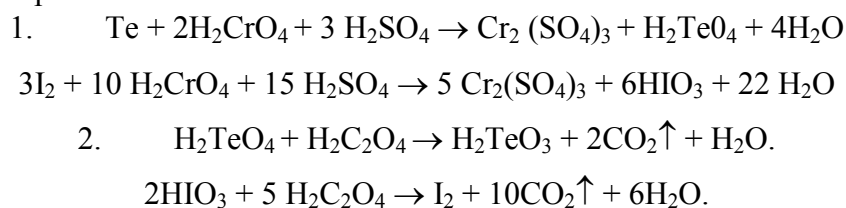

The distilled iodine reacts with the sodium sulphite and sodium hydroxide solution in the receiver flask.

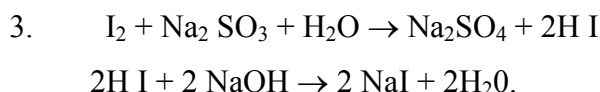

The following observations merit attention:

- Distillation of iodine from the acid solution of Te containing gold in excess of 200 ppm is observed to be incomplete.
- If tellurium metal of fine particle size (>100 mesh) is used for irradiation, it leads to irident reacton, at times leading to exlosion, during the dissolution stage.

Iodine-131 ($^{131}\text{I}_{53}$) (Dry distillation method)

Production scheme

Iodine-131 is produced by the neutron irradiation of tellurium according to the nuclear reaction $^{130}\text{Te}(n, \gamma) ^{131}\text{Te} \xrightarrow{\beta^-} ^{131}\text{I}$. The iodine is separated from the target material by dry distillation above 750°C and absorbed in dilute sodium hydroxide solution.

Production process

The ^{131}I production process: ^{131}I is produced by the irradiation of TeO_2 in the heavy water research reactor. After irradiation, the ^{131}I is dry-distilled off and absorbed in an alkaline solution containing sulfite, dispensed according to the pharmacopoeia. The overall yield of ^{131}I is $95\% \sim 2\%$. The whole process is described in Fig.1.

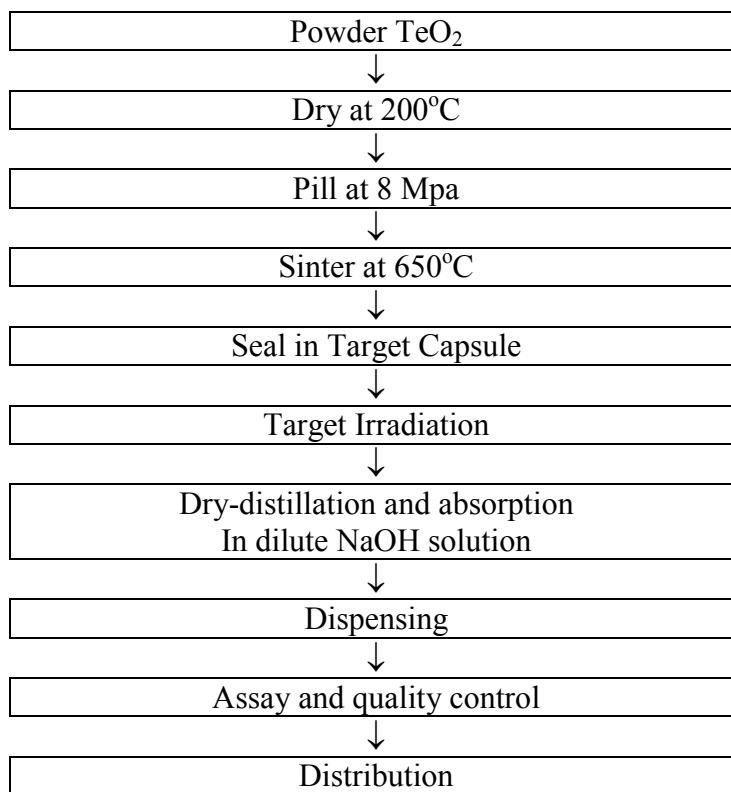

FIG.1. ^{131}I production process.

Target specification and preparation

1. Target purity: $\text{TeO}_2 > 99.9\%$ (A.R)
2. Impurity details:

The above procedure was provided by:
Jin Xiao Lai,
Department of Isotope, CIAE,
Beijing, China.

I	No ¹²⁷ I	Tl:	<0.001%
Al	<0.001%	Mg:	<0.0003%
Na	<0.03%	Ca:	<0.001%
Sr	<0.003	Sn:	<0.0003%
P	<0.00001%	Cu:	<0.0003%
Fe	<0.01%	Mn:	<0.0003%
As	<0.000001%	Ba:	<0.01%
Cd	<0.001%	Si:	<0.1ppm

3. Isotopic composition and supplier of target material and grade isotopic composition:

Te	120	122	124	125	126	128	130
%	0.096	2.60	4.816	7.14	18.95	31.69	33.80

Supplier of target material: Beijing Chemical Factory (A.R.)

Irradiation parameters, specific activity and total yield at EOI

1. Reactor: heavy water research reactor.
2. Target capsule: Double-layer Aluminum cans sealed by cold-welding. Internal dimension: 39mm-diamH 68mm high.
3. Mass of target per capsule: 80g TeO₂.
4. Reactor irradiation parameters
Flux: 1.1×10^{14} n/cm²/s
Irradiation time: 6 days.
5. Specific activity achieved: above 740GBq(20 Ci)/mg iodine
Yield per capsule: 481GBq (13 Ci).

Type of facility for processing

The facilities for dry-distillation of ¹³¹I showed in Fig. 2 are placed in a hot cell with an exhaust line.

Hot cell wall-thickness: 20cm cast steel and 10cm lead.

Hot cell dimension: 1550LH1200WH2600mmH.

Negative pressure: Maintain at the negative pressure of 20mm H₂O.

The exhaust line: The radioactive waste gas should pass through the 2.0mol/L NaOH, 0.5mol/L Na₂SO₃ solution, the activated charcoal filter and then get into the radioactive management factory.

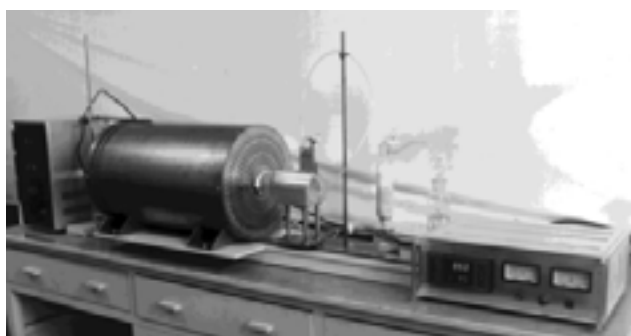

FIG.2. ¹³¹I separation apparatus.

Analysis of raw materials, reagents and chemicals required for processing

No chemical purity determination is made, except a periodic check of TeO₂ by emission spectroscopy. Other reagents: analytical grade reagent.

Chemical processing procedure

1. The powder TeO₂ heated at 200°C for two hours.
 2. Make the powder TeO₂ sintered into a pill under the pressure of 8MPa by press.
 3. Put the TeO₂ pill into an oven and heat it at 700°C for half-hour.
 4. Put the TeO₂ pills into double-layer can and seal it by cold-welding, leak check up to standard.
 5. Put the target can into the reactor.
 6. Irradiate the target at the flux of 1.1×10^{14} n/cm²/s for 6 days.
 7. Cut off the aluminum can by a cutting apparatus in the hot cell.
 8. Heat the irradiated TeO₂ at above 700°C for 1.5 hours, and dry distillation the ¹³¹I. A slow flow of carrier gas (2–3 bubbles/s) is passed into the dry distillation apparatus. The ¹³¹I is absorbed in the 0.01 mol/L NaOH solution.
- Sample ¹³¹I solution in an ampoule vial and samples are assayed for ¹³¹I concentration, pH value, radionuclidic purity and radiochemical purity.

Dispensing, assay and quality control

Dispensing

The ¹³¹I is separated from the target TeO₂ by dry distillation and absorbed in 17 mL of a mixed solution of 0.02M NaOH-0.004M Na₂SO₃. Then the solution is adjusted to pH7–9 with distilled water i.e. final product.

Assay and quality control

Radioactive concentration

Radioactive concentration is determined by a CAPINTEC CRC-30 BC ionization chamber with ²²⁶Ra standardized source. The ²²⁶Ra source has been previously compared with the ¹³¹I source calibrated by absolute measurement.

Radionuclidic purity

Gamma-emitting impurities in the solution are determined by gamma spectrum, using a high purity Ge(Li)-detector and a multi-channel pulse height analyser.

Radiochemical purity

By ascending paper chromatography using the methanol: water (4:1) solvent developing system.

Chemical purity

Tellurium content is determined by double-channel Hydride-Generation atomic fluorescence spectrometer.

Final product specification for use

1. Physical observations: colorless clear solution. No suspended particles presented.
2. Radionuclide identification: Its gamma ray spectrum is identical to that of specimen of iodine 131 of know purity that exhibits a major photopeak having energy of 0.364 MeV. The gamma spectrum of ¹³¹I product is shown in Fig. 3.
3. Radionuclidic impurity: 0.01%~0.0001%.

4. pH: 7~9.
5. Radiochemical purity: >95%.
The method of determination is paper chromatographs of the usual way.
6. Radioactive concentration and application
1.85–3.7 GBq/mL for diagnosis and/or therapy thyroid disease.
73.7GB1/mL for radioisotope labeling.
7. Shelf-life and recommended storage condition
Expiry: The expiration of 8 days after reference date is indicated on the quality certificate and on the labels.
Storage: In lead container at room temperature.
8. Preparation and cleanup of the facility and preparation for processing of next production batch.
 - (a) Put the dry-distilled target material into a special steel can for storage.
 - (b) Wash the hot cell floor to clean up all the powder TeO_2 and liquid waste that may be thrown off during the processing.
Keep all the transportation system, the heating system and the adsorbing system in a good state for production of next batch.

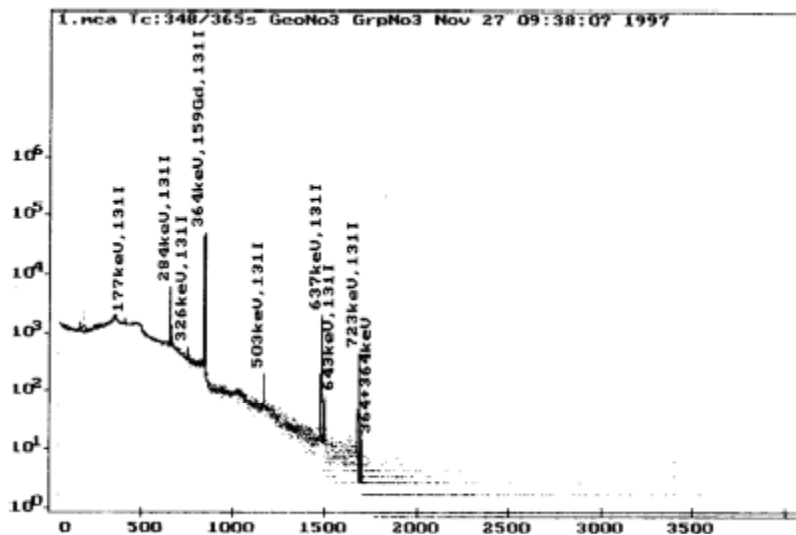

FIG. 3. The gamma spectrum of ^{131}I product.

Mass of target per capsule is 100 g of tellurium dioxide. Target preparation is carried out as follows. The target material is transferred to porcelain crucible and placed in a muffle furnace at temperature 500°C for 2 hours. The tellurium dioxide is allowed to cool to room temperature and placed in a ball mill and broken up until it has a fine texture. The precise quantity of target material is carefully transferred to the clean dried inner capsule and an aluminum plug is placed in the open end and welded closed. The leak of the capsule is checked by immersing the capsule in water and bubble checking in a vacuum of at least 30% of Hg and stored until it is transferred into the outer capsule scheduled for irradiation in the reactor core. If the target capsule is not used for a period of time the leak test is repeated prior insertion into the reactor core.

The activity of I-131 at the end of irradiation (EOI) by irradiating 100 g TeO₂ at a thermal neutron flux of 1.0×10^{14} n/cm²/s in reactor for 120 hours is 740 GBq (20 Ci), so the total yield at EOI is ~ 83.3%.

Type of facility for processing

The facilities for processing include glove box, hot cell, and supporting areas, which equipped with the ventilation system, such as carbon filter, pre-filter, HEPA filter, etc., for nuclear grade installation. A glove box is used for dispensing low activity final product.

The hot cell include master slave manipulators, shield window, a conveyor for interconnecting with other hot cells, an overhead shield plug (to allow for the removal of hot cell containment box and equipment), and a shield door on the back side. The cell was lined or coated with material that facilitates decontamination, and containment box is provided to minimize the spread of contamination.

Concrete shielding walls of the cell consists of higher-density hematite concrete (minimum density 3.0 g/cm³). Glove box and fume hood filter housings were shielded with 1.3 cm of lead as required. Other local shielding are used as necessary to reduce dose rates.

Ventilation exhaust from radioactively contaminated areas and areas in which radioactive materials are handled (except materials packaged for shipping) will flow through HEPA filters to protect against inadvertent release of radioactive materials. Ventilation exhaust from the hot cell will also flow through charcoal filter for absorption of any gaseous iodine prior to release. If there is a loss a normal power, emergency electrical power will be provided to maintain at least 50% of the ventilation exhaust flow rate from general areas that are potentially contaminated. In addition, hot cell ventilation exhaust will be operated at a sufficient flow rate to maintain negative pressure in the cell with all doors and inlet dumpers closed. The ventilation exhaust systems were designed to achieve internal negative pressure up to 76 mm of water for hot cell and up to 51 mm of water for glove box, respectively.

Analysis of raw materials, reagents and chemicals required for processing

Analysis of raw materials, reagent and chemicals required for processing is performed to confirm that all materials comply to the specified criteria for processing. Analysis includes the determination of chemical purity and concentration by emission spectrograph and titrimetric. The acceptable impurities of tellurium dioxide raw materials through analysis by emission spectrograph should show selenium content less than 0.05% and heavy metal content less than 0.1%.

Chemical processing procedure

The target capsule is transported from the reactor using the transfer cask to the hot cell for processing after the irradiation process is complete. The processing reagents and supporting components required to process the target material are transported to the hot cell using the inter-cell cart system.

The flow chart of iodine-131 processing is shown in Fig. 1 and the processing is carried out as follows:

3. Check the engraved serial number on the target capsule and confirm to the correct target capsule for processing, and then the capsule is stood on end.
4. Completely vibrate the target capsule using a vibrating tool to knock down any target material which might be on the side walls of the target capsule. Then, the top of the target capsule is cut off using a tubing cutter.
5. Pour the irradiated tellurium powder from the opened target capsule into the Vycor tube, taking care to minimize spillage of the powder. The tellurium powder should dry and pour freely from the target capsule.
6. Make a visual inspection of the capsule to be sure that all of the tellurium powder has been transferred to the Vycor tube. Repeat the vibration process if there is any remaining target material on the inner capsule walls.
7. Cap off the Vycor tube and place the Vycor tube on the furnace, then connect it to the gooseneck and vacuum lines.
8. Position the stopcocks for distillation so that the vacuum pump is pumping in a direct path to the Vycor tube. Turn on the vacuum pump, and establish a vacuum of at least – 28” of Hg on the gauge.
9. Physically and visually check all connection and valves in the distillation system to be sure that they are secure and functioning properly.
10. Turn on the furnace, and observe the temperature controller to be sure that it is working properly.
11. Set the temperature controller at 750°C.
12. Observe the furnace and the controller until the 750°C temperature is reached. At this point, check operation of the distillation system by moving the controller set point up and down slightly to ensure that the furnace turns on and off at the proper temperature. Also recheck the vacuum connection at this point.
13. Periodically check the charcoal column trap with the radiation monitor in the hot cell to ensure that I-131 activity is loading properly on the charcoal column trap.
14. When the run has been completed, turn off the furnace, maintain vacuum on the system until the furnace has cooled down to no more than 200°C, and turn all valves in the distillation system to the elution position.
15. Mount the loaded charcoal column trap in the ring stand, and read it with the radiation monitor.
16. Wash the column with ~10 mL of sterile water for injection, collecting this water in a water bottle. Check the water bottle with the radiation monitor to be sure that I-131 product activity is not being eluted.
17. Elute the column with sodium hydroxide 0.05N, collecting the I-131 produced in a cleaned labeled glass bottle. Elute with 5 mL portions of sodium hydroxide 0.05N until all significant activity has been removed from the charcoal column trap.

18. The tellurium breakthrough is checked by placing 3–4 grains of thioacetamide in a clean 25 mL beaker and send the beaker into the I-131 processing hot cell. To the beaker containing thioacetamide is added 3 drops of I-131 product and the solution is swirled. If the solution color change to grey/black, the resulting solution indicates the presence of tellurium in the product, and the product must be rejected and disposed of in a capped waste bottle containing absorbent material.

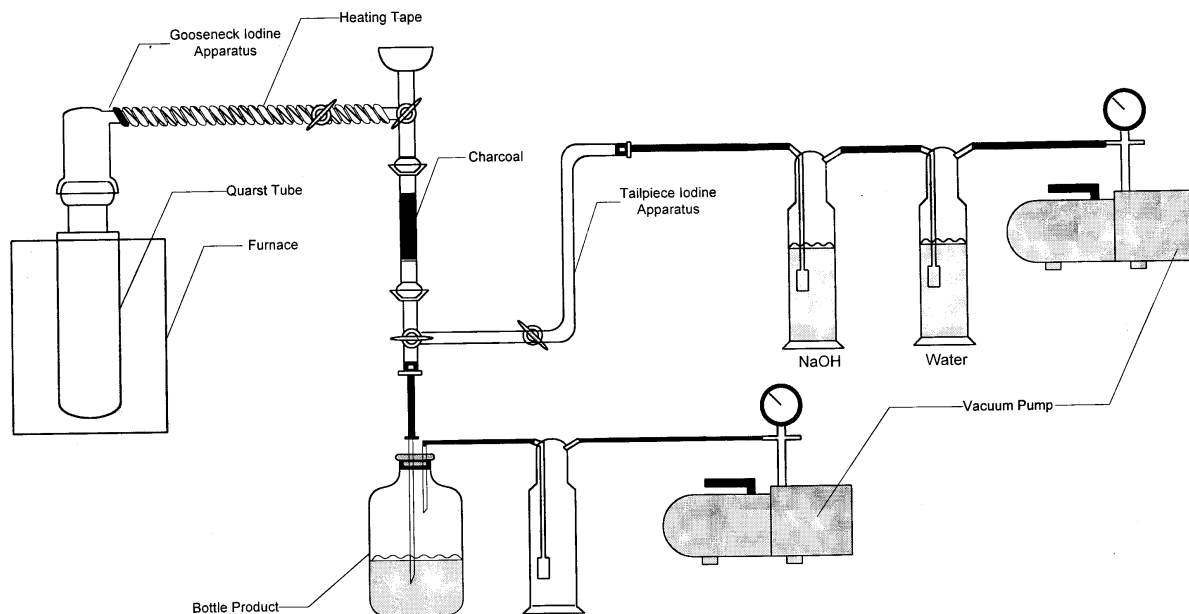

FIG. 1. ^{131}I distillation system.

Dispensing, assay and quality control

The dispensing of final product for assay and quality control is carried out by removing a 0.1–0.2 mL of I-131 sample and placing it into 2 mL sample bottle, to be transported to the hood or glove box inside a lead assay pig. From this sample two 20 lambda aliquots are removed to prepare sample dilution to perform the bulk of the final product tests and the remaining sample volume is used to performed a pH analysis using a strip of pH paper, with a range of 10.5 to 12.5. The pH results should be greater than 11.

Samples of the 20 lambda/50 mL dilution containing 4 drops of carrier solution, 10 mg I/mL, are assayed for determination of I-131 concentration, I-133 concentration, radionuclidic purity, and radiochemical purity.

Two dram vial for the determination of I-131 concentration are prepared by removing a known amount aliquot of the 20 lambda/50 mL dilution, transferring each aliquot to a separate 2 dram sample vial, and checking I-131 activity of both 2 dram vial with the Gamma Ionization Chamber (GIC). The reading difference should not greater than 5%.

I-131 concentration assay is performed by (a) removing two 10 lambda aliquots from each 2 dram vial, (b) placing each aliquot onto a stainless steel counting planchet located in the drying hood, (c) adding three drops of silver nitrate 0.1N solution to precipitate the iodine, (d) drying the liquid on the planchets under heat lamp, and (e) counting all four sample planchets placed into a plastic bag at the calibrated geometry on the GeLi multichannel analyser system. The I-133 concentration determination is performed using one of the four planchet sources

prepared for the I-131 concentration determination on the GeLi detector system. The radionuclidic purity determination is carried out by counting a 2 mL sample of the 20 lambda/50 mL dilution at the GeLi multichannel analyser system and analysing the spectra for positive gamma emitters. The radiochemical purity is controlled by paper chromatography utilizing one of the two dram sample vials, using 75% methanol as solvent.

Final product specification for use

The final product as sodium iodide, ^{131}I , solution in NaOH, without reducing agents will be used as ^{131}I bulk solution for radiopharmaceuticals production. The specification of the final product:

Physical appearance	colorless solution.
Radioactive concentration	>11.1 GBq (300 mCi) I-131/mL.
I-133 concentration	≤ 0.80% of the I-131 concentration at assay time.
pH	>11
Radionuclidic purity	I-131 content >99.9%.
Radiochemical purity	Iodide ≥ 95%.

Practical experience gained

The ability to maintain vacuum on the system during the distillation process in separating iodine from the irradiated tellurium is very critical and important. If the vacuum system doesn't work as expected, not only the distillation process will be uncontrollable, but also the expensive Vycor will be broken.

BIBLIOGRAPHY

MEDI-PHYSICS INC., Manufacturing Manual of Radiochemical Iodine I-131, prepared for the Radioisotope Production Centre, Indonesian National Atomic Energy Agency.

MEDI-PHYSICS INC., Quality Control Manual of Radiochemical Iodine I-131, prepared for the Radioisotope Production Centre, Indonesian National Atomic Energy Agency.

Iodine-131(¹³¹I₅₃)
(Dry distillation method)
(Alternate procedure)

Production scheme

Production of Iodine-131 radioisotope is usually performed in (n,γ) nuclear reactions as follows:

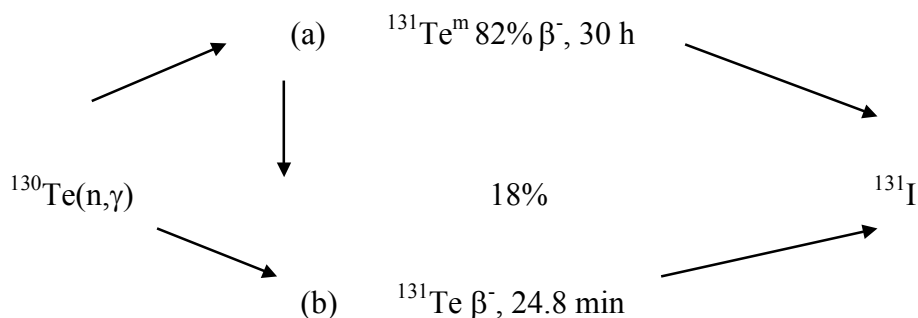

Cross-sections for (a) and (b) routes are 0.04 barn and 0.2 barn, respectively. As natural tellurium contains ¹³⁰Te nuclide in 34.48% there is no special need for using enriched tellurium target. On the other hand, natural tellurium contains ¹²⁶Te in 18.71%, which can take part in the following nuclear reaction:

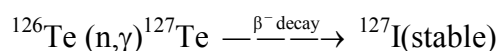

As a consequence of this, the ¹³¹I produced from natural tellurium cannot be considered as carrier-free radioisotope and specific activity may play role in radiolabelling of organic molecules. In order to attain sufficiently high yields of ¹³¹I as well as to simplify the processing technology of the target, irradiation of tellurium can be recommended from point of view of expedience. A wet method was earlier used for distillation of iodine, nowadays dry distillation became wide-spread due to the higher yields and lower amount of radioactive wastes.

As an alternative way extraction of Iodine-131 from uranium fission products may also be considered. Since the uranium fission technology requires a rather complicated and expensive facility, the tellurium irradiation would be the proper method for isotope production laboratories established beside nuclear research reactors. Thus flow chart of the technology based on tellurium dioxide irradiation is given as follows:

The above procedure was provided by:

J. Környei,
 Department of Radiochemistry, Institute of Isotopes Co., Ltd.,
 H1121, Budapest, Konkoly Thege WT-29.33, Hungary.

$^{nat}\text{TeO}_2$, target
↓ irradiation in nuclear research reactor
$^{131}\text{Te}^m$, ^{131}Te
↓ cooling for β^- decay to obtain ^{131}I
^{131}I
↓ opening capsule, dry distillation of ^{131}I from tellurium, absorption in alkaline medium e.g. 0.05 M NaOH
^{131}I -sodium iodide solution
↓ dispensing, sterilizing, adding reducing agent in case of direct human use
^{131}I -sodium iodide solution as radiopharmaceutical, for direct use or for labelling

Target specification and preparation

Target purity

Tellurium dioxide-mol.w. 159.60, content: >95%.
Faintly yellow powder. Identification of tellurium: by roentgenfluorescency.

Enrichment factor

Natural isotopic composition, ^{130}Te content: 34.48%.

Impurity details

Lead: <0.002%,	Copper: <0.0005%,	Iron: <0.003%
Nickel: <0.0005%	Silver: <0.0005%,	Selenium: <0.0005%

Isotopic composition and supplier of target material and grade

^{120}Te : 0.0089%,	^{122}Te : 2.46%,	^{123}Te : 0.87%,	^{124}Te : 4.61%,
^{125}Te : 6.99%,	^{126}Te : 18.71%,	^{128}Te : 31.79%	^{130}Te : 34.48%

Supplier of target and grade: Fluka Chemie AG., Buchs, Switzerland, purum 02TE, product number 86370, analytical data confirmed by certificate of analysis enclosed to the shipments.

Irradiation parameters, specific activity and total yield at the EOI

Reactor

Nuclear research reactors with a neutron flux of $5 \times 10^{12} - 1 \times 10^{14}$ n/cm²/s can be used. Higher fluxes should be avoided as the explosion of the target may occur due to the generating heat and aerosols. Water cooling of the target within the irradiation channel, during the whole irradiation, is necessary.

Capsule details

150 g tellurium dioxide powder is measured into a quartz tube and put into an electric furnace. In a temperature range of 800–850°C the tellurium dioxide is melted and carefully poured into an aluminium vessel (capsule) of dimensions diameter 22 mm and height: 90 mm.

The aluminium capsule is cooled by immersing in water while. Proper eye-guard and safety gloves should be worn by the staff. After cooling to room temperature.

Mass of target per capsule

The capsule contains 140 g of melted tellurium dioxide.

Preparation of target for encapsulation and irradiation parameters

The aluminium capsule containing the tellurium dioxide is placed into an aluminium container possessing diameter of 30 mm and height of 110 mm. The container is closed by welding. A lifting head, for handling the container in the irradiation channel, supplied with a screw is fixed in the top of the container.

Fluxes up to 1×10^{14} n/cm²/s can be used, the higher flux results in higher yield of iodine-131. At least 120 hours irradiation is required. It is worthwhile to extend the irradiation time up to 200 hours from point of view of higher yields however specific activities obtained decrease slightly.

After irradiation a cooling period of 48 hours is required to complete β^- decay for obtaining iodine-131.

Specific activities achieved and typical production yields/capsule

fluxes, n/cm ² /s	5×10^{12}		3×10^{13}		1×10^{14}	
Irradiation time, h	120	200	120	200	120	200
mass of target, g	140					
Calculated yields, after cooling, GBq	53.79	81.68	322.79	490.13	1075.9	1633.7
calculated specific activity, GBq/mg iodine	1113	1050	1120	1049	1120	1048

Type of facility for processing

For iodine-131 production two hot cells under negative pressure, with manipulators, as well as air ventilation system with iodine (aerosol) filter is required. Hot cells are made of iron with a lead shielding of 15–20 cm. The window of the hot cell is made of lead glass with a thickness of 40 cm. One hot cell is used for the distillation and absorption equipment, the other is used for dilution, dispensing and sterilization of the ¹³¹I-sodium iodide solutions. The cells and systems (e.g. radiation protection system, etc.) should correspond to the regulations being valid for isotope laboratories of level "A".

Analysis of raw materials, reagents and chemicals required for processing

Tellurium dioxide target

See above.

Sodium hydroxide

Sodium hydroxide white pellets, grade extra pure is used (DAB, Ph.Eur, BP). Identification is performed by flame photometry. Drops coming from the aqueous solution of NaOH give a bright yellow colour. Content determination is carried out by acidi-alkalimetric titration.

Sodium sulphate

Odour-free, colourless, transparent crystals or powder. Sodium gives bright yellow colour by flame photometric analysis. Sulphate is identified when sodium sulphate is dissolved in 2 M hydrochloric acid and barium chloride is added into it. White precipitation is formed. Limits for impurities: Pb and Fe <10 µg/g, As <2 µg/g, K <1 mg/g, chloride <200 µg/g. By heating at 130°C for 3 hours, rest should be 44.0–48.0%.

Sodium thiosulphate

Colourless transparent crystals. Sodium is identified by flame photometry. Thiosulphate is identified by adding 2 M HCl. Sulphur should be precipitated. When adding 0.5 M silver nitrate to the thiosulphate solution, white precipitation should be formed which will be turned to yellow, brown and black. Limits for impurities: heavy metals <20 µg/g, As <5 µg/g, chloride <50 µg/g. Content determination: titrating with iodine measuring solution: 1.00 mL 0.1 N measuring solution is equal to 24.817 mg sodium thiosulphate.

Chemical processing procedure

The irradiated container, delivered to the first hot cell, is opened by mechanical cutting. The tellurium dioxide is crushed and filled into the vessel (1) of the distillation equipment, see Fig. 1. The equipment, in addition, consists of a quartz bridge (2), acidic washing vessel (3) and alkaline collectors (4a,b,c) are necessary to the distillation. Before starting glass beads are filled into vessels (3) and (4c). In vessel (3) 40 mL 90% sulphuric acid is filled, while vessels (4a,b,c) are filled with 0.05 M NaOH.

After assembling the distillation equipment, heating and vacuum is started. The melting point of tellurium dioxide is attained within 30–60 minutes. Iodine-131 is collected in a collector and is registered by the detectors. The distillation can be regarded as completed if the detector and the recording unit do not indicate any further increase in radioactivity in the collector. pH value of the collected solution should be higher than 8.

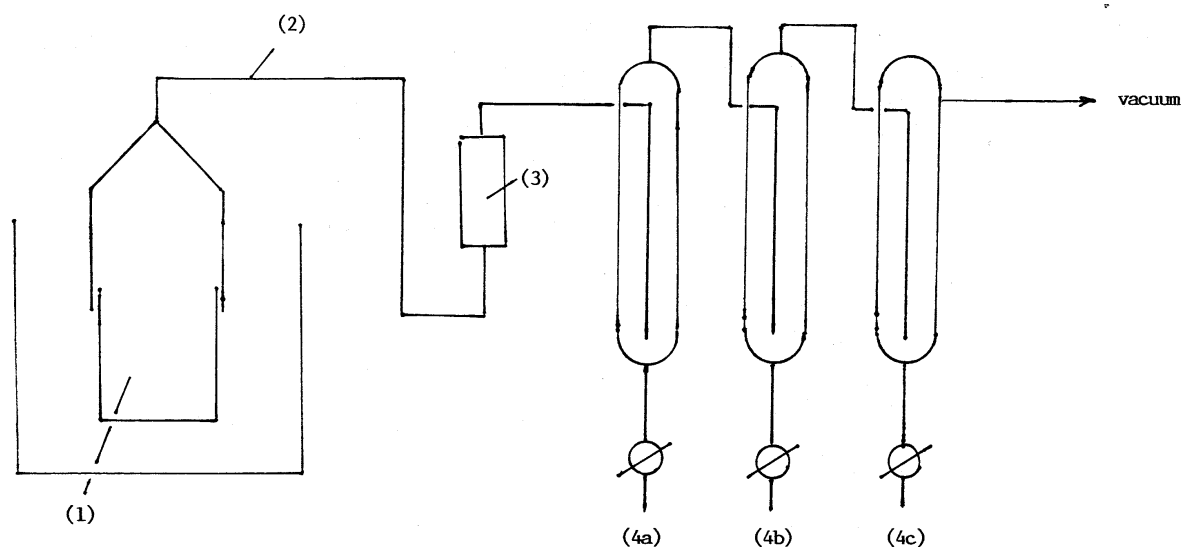

- (1) ceramic vessel in the furnace
- (2) quartz bridge
- (3) acidic washing vessel
- (4a,b,c) alkaline collectors of ^{131}I

FIG. 1. Distillation equipment for ^{131}I production.

Dispensing and quality control

Dispensing

The ^{131}I -NaI solution is transferred to the second hot cell. The required radioactive concentration is adjusted by adding 0.05 M NaOH and 0.01 M sodium sulphate solutions. If the Iodine-131 solution is for direct human use (for thyroid diagnosis or for therapy), maximum 2 mg/mL sodium thiosulphate solution is added into it. The activity is dispensed into vials as required and sterilized by heat in an autoclave in the hot cell at 120°C for 30 minutes.

Determination of radionuclidic purity

A vial containing 5-10 MBq I-131 sample is shielded by 0.5 mm lead foil. The detector is positioned 30 cm far from the sample and the sample measured for 1000 seconds. Main gamma-peak of I-131: 364.5 keV. Impurity limit: not more than 0,1% of other gamma emitting impurities. A gamma-spectrum of Iodine-131 can be seen in Fig. 2.

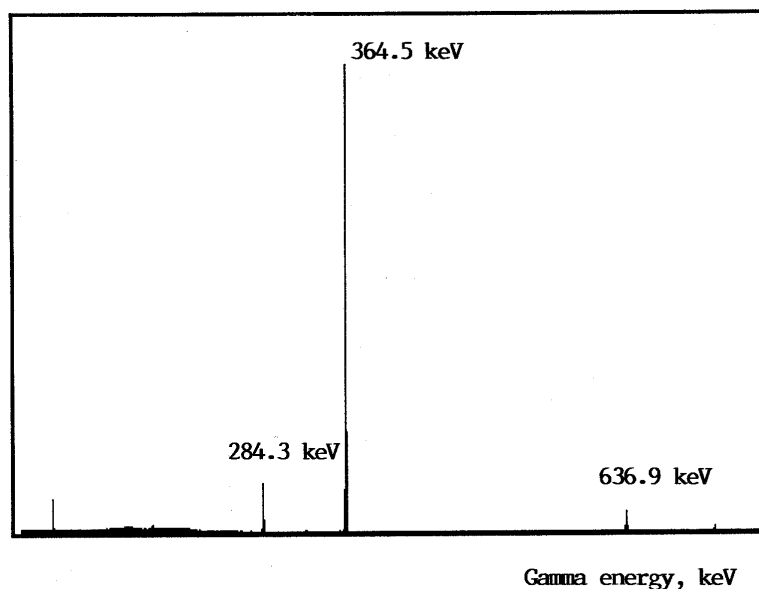

FIG. 2. Gamma spectrum of ¹³¹I.

Determination of radiochemical purity

Paper-electrophoresis is used. Paper stripes, type Whatman No.3 MM for electrophoresis having dimensions of 65 × 3 cm. Dropping of 10–20 μl samples takes place in a distance of 10–13 cm from the end of the stripes. Borate buffer is used, concentration 9 g/l, pH=9 ±0.1. Electrophoresis is carried out on a potential of 900 V. Time: 50 min.

Rf values: product, i.e. iodide Rf = 0.7–0.9
 impurities: iodate: Rf = 0.4
 periodate: Rf = 0–0.1
 elemental iod: Rf = 0

Product can be accepted if the ¹³¹I-iodide anion content is higher than 95% even on the expiration date.

Final product specification

1. Physical observation: Clear, colourless solution.
2. Radionuclide identification: Iodine-131 radionuclide is identified by gamma spectrum (see above characterization).
3. Radionuclidic purity: should be higher than, or equal to 99.9%.
4. pH of final solution: 8–10.
5. Radiochemical purity: Measured by the above detailed electrophoresis, it should be higher than 95%.
6. Concentration requirements:
 The adjusted concentration depends on the application purpose.
 - a) Preparatum for labelling: >7400 MBq/mL
 chemical content: 0.05 M NaOH and 0.01 M Na₂SO₄, reductant-free.
 - b) For thyroid diagnosis: 18.5 MBq/mL
 chemical content: 0.05 M NaOH, 0.01 M Na₂SO₄ and 2 mg/mL Na₂S₂O₃.
 - c) For thyroid therapy: >740 MBq/mL
 chemical content: 0.05 M NaOH, 0.01 M Na₂SO₄ and 2 mg/mL Na₂S₂O₃.

7. Shelf life and recommended storage conditions:
Expiry: production + 21 days, storage at room temperature.
8. Special comments of waste generated:
As Iodine-131 radionuclide is of relatively short half-life, wastes should be left to decay. No special prescriptions are given, the normal radioactive waste treatment procedures described for isotope laboratories should be applied. Do not let iodine-131 to be contacted with acidic medium!
9. Preparation and clean up of the facility for next production.
The distillation equipment is surely contaminated and should be dismantled by manipulators in the hot cell. Acidic and alkaline solutions should be taken off into separate vessels. The molten tellurium dioxide should be poured into a steel receiver. The quartz bridge should be washed in 1 M NaOH and finally rinsed with water.

Practical experience gained

Dry distillation has been developed around 1980 and ^{131}I has been manufactured by this method since that time. Purity of products was always found over the given limits ($>99.9\%$). One of them, ^{129}I may be present only in insignificant quantities (less than $1 \times 10^{-5}\%$). The ventilated air coming from the hot cells of ^{131}I production should be filtered by using a multilayer filter that is capable of capturing radioactive aerosols as well.

BIBLIOGRAPHY

DEWANJEE, M.K. RAO, S.A., Principles of radioiodination and iodine labelled tracers, Radiotracers for medical application, Vol. **II**, CRC Press, Boca Raton (1983).

FIRESTONE, R.B., Table of Isotopes, CD ROM Edition, (Shirley V.S., Chu S.Y., Eds.) Version 1.0, Office of High Energy and Nuclear Physics, US Department of Energy (1996).

MONTESA, E., Production of iodine-131 by the wet distillation of tellurium dioxide, Philipp. Nucl. J. **3** (1) (1975) 262.

MILLER, J., FÁBIÁN, GY., MÁNDLI, J., DORKÓ, GY., SASHEGYI, L., BIRÓ, GY., Dry distillation method for iodine-131 production, Hungarian Patent No. 34.710 (1984).

SHIKATA, E., AMANO, H., Dry distillation of iodine-131 from several tellurium compounds, J. Nucl. Sci. Tech., **10** (2) (1973) 80.

Iodine-131 (¹³¹I₅₃)
(Dry distillation method)
(Alternate procedure)

Production scheme	:	$^{130}\text{Te} (n,\gamma) ^{131}\text{Te} \xrightarrow{\beta^-} ^{131}\text{I}.$
Target material	:	TeO ₂ 99.99% pure, 100 mesh, CERAC incorporated (treated by washing with distilled water and melting at 700°C and then reground.).
Amount	:	4 × 65 g.
Time of irradiation	:	5–6 weeks (reactor working 40 MW-h/week at 1.2 MW).
Average neutron flux	:	About 1.78 × 10 ¹³ n/cm ² /s.
Target container	:	Aluminium container (Japan Industrial standard JIS grade A-1050 purity 99.5%) sealed by cold welding (700 kg/cm ²).
Production yield	:	192 GBq (5.2 Ci).

Production route

1. TeO₂ target purification, preparation and testing.
2. Target canning.
 - cleaning aluminium container.
 - compacted 65 g TeO₂ target in aluminium container
 - cold welding of aluminium container.
 - leak testing by bubble test.
3. Irradiation for 5–6 weeks.
4. Unloading target from reactor core and transfer to production cell.
5. Production process by dry distillation at 700°C.
6. Bulk product collected in 10 mL vial.
7. Transfer bulk product from production cell to dispensing cell and measurement of total activity.
8. Sampling product for processing of quality control.
9. Processing of dilution and dispensing.
10. Activity measurement from each dispensing.
11. Capping vial with aluminium cap, washing with water and let it dry.
12. Transfer vial of product from dispensing cell into lead pot.
13. Packaging.
14. Final survey of contamination and dose rate exposure.
15. Deliver to customer.

The above procedure was provided by:

G. Aungurarat,
 Isotope Production Division, Office of Atomic Energy for Peace,
 Bangkok, Thailand.

A flow chart of the operations and ^{131}I production apparatus.

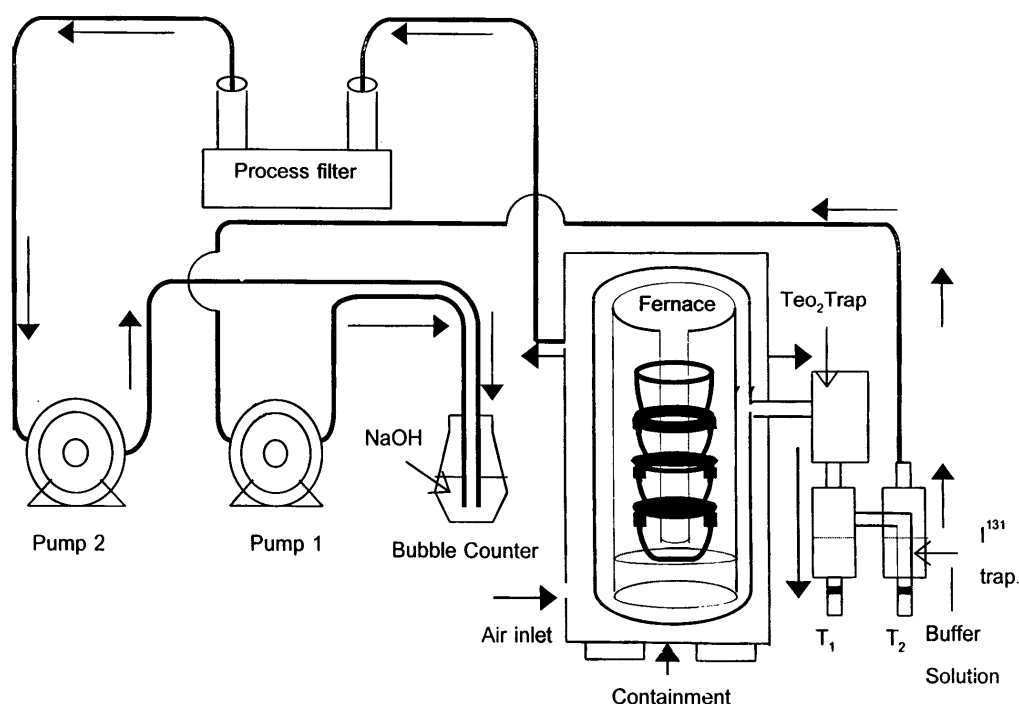

Procedure of ^{131}I production

1. Charge TeO_2 irradiated target in furnace.
2. Fill I-131 trap, T_1 , T_2 , with buffer solution.
3. Operate pump 1 for carrying Iodine vapor to T_1 , T_2 trap, releasing air from pump 1, trapped in bubble counter contained NaOH.
4. Increase temperature of furnace to 700°C .
5. TeO_2 trap, trapped some TeO_2 powder from furnace.
6. After 1 h. at 700°C lower temperature of furnace to 200°C and operate pump 2 for carrying Iodine vapor that leak from furnace into containment absorbed in process filter and releasing air from pump 2, trapped in bubble counter.
7. Turn off pump 2, open a containment transfer the spent target out of furnace and make a new charge of target.
8. Final product in T_1 , T_2 collected in 10 mL vial.

Target specification and preparation

Specify target purity

Specific analysis

- TeO_2 - 99.99% pure (79.62% Te)
- 100 mesh

X ray diffraction analysis

- TeO_2 - paratellurite, tetragonal

Enrichment factor if applicable
Impurity details

Element	Results
Na	<1 ppm
Al	<0.001%
Ca	<0.001%
Cu	<0.001%
Fe	<0.001%
Mg	<0.001%
Sb	<0.002%
Se	<0.002 5
Si	<0.001%
Ti	<0.001%

Isotopic composition and supplier of target material and grade

Supplier : Cerac incorporated
P.O. Box 1178, Milwaukee, WI 53201-1178
Tel: (414) 289-9800
Fax: (414) 289-9805

Purification of tellurium dioxide

Attention: Tellurium dioxide is a toxic substance!

The quality of the tellurium dioxide from diverse origins varies significantly. A purification as indispensable due to impurities such as nitric acid and others.

1. Take up to 2 kg. customary TeO₂ into a glass-filter funnel and wash it by at least two liters distilled water until the wash-water shows a pH neutral reaction.
2. Dry the TeO₂ in the covered glass-filter funnel over night.
3. Transfer the moderate wet TeO₂ into porcelain crucibles, dry it carefully at 100 to 150°C and then melt it for about 1 hour in order to evaporate any volatile impurity as e.g. Cool down and repeat the wash procedure if brown nitrous gases are vigorously released during the melting procedure.
4. After cooling break the TeO₂, which often shows green or yellow-brown colour.
5. Remove the crucible fragments.
6. Grind the TeO₂ lumps in a ball mill and separate the powder by a sieve (0.100 mm).
7. Test a powder sample for constant weight after heating at 150°C.
8. Test another powder sample by a could test-run in the furnace cell: the absorption solution in the first winding absorber of the iodine traps must stay at neutral pH.

If the test was satisfactory the TeO₂ powder can be used as target material.

Irradiation parameters, specific activity and total yield at EOI

1. Reactor used and which assembly (hydraulic tube, etc.)
Facilities for Primary Radioisotope Production
Research Reactor : TRIGA Mark III
Reactor power : 2 MW (Operate at 1.2 MW)
Operating period : 40 MW-h /week. (Wed = 12 h, Thur = 12 h, Fri = 10 h).

Irradiation position	Thermal neutron flux n/cm ² /s
CT	3.1×10^{13}
C8	2.5×10^{13}
C12	2.5×10^{13}
G5	1.2×10^{13}
G6	1.0×10^{13}
G32	0.98×10^{13}
G33	1.2×10^{13}

2. Capsule details (material, dimension, encapsulation method, etc.) any special precautions for target encapsulation (degassing, low pressure, etc.)
 - Material : Aluminium Japan Industrial Standard (JIS) grade A-1050 purity 99.5%
 - Dimension : OD 22 mm, ID 19 mm, L 12.5 cm
 - Encapsulation method : Cold welding at pressure 700 kg/cm².
 - Leak testing : Bubble test with acetone.

Note: Special precaution for target encapsulation is the cleaning of Al-container.

Step of cleaning procedure

- Aluminium can.
 - Soaking in acetone solvent for removing organic substance (24 h), let it dry.
 - cleaning with 10% NaOH (15 min).
 - Rinsing with clean water.
 - Dipping into 30% HNO₃ (1–2 min).
 - Rinsing with clean water.
 - Rinsing with distilled water.
 - Drying at 105°C (1 h).
3. Mass of target per capsule.
65 g. of TeO₂/capsule.
 4. Preparation of target for encapsulation, reactor irradiation parameters (flux, irradiation time, etc.).
 - Preparation of target for encapsulation. TeO₂ in Powder form (100 mesh) is compacted in Al. Container and sealed by cold welding method (700 kg/cm²).
 - Reactor irradiation parameters.;
 - Reactor Power : Operate at 1.2 MW
 - Operating period : 40 MW-h/week (wed = 12 h., Thur = 12 h, Fti = 10 h)
 - Neutron flux : average 1.78×10^{13} n/cm²/s
 - Irradiation time : average 5 weeks by rotating position of irradiation from G → C → CT.
 5. Specific activity achieved and typical production yield per capsule.
11 GBq (1.3 Ci)/capsule (65 g. TeO₂).
 6. Any other pertinent information.

Type of facility for processing

- Two cells boxes of stainless steel sheets (x 8 CrNiTi 18.10) of 0.2 mm. thickness, dimension l 1850 mm. w 855 mm. h 1510 mm. Use for Production cell and dispensing cell.
- A channel l 200 mm., w 220 mm., h 340 mm. Connects the two cell boxes.

- Shielding
 - Front 100 mm. Pb.
 - Side 100 mm. Pb.
 - Back 50 mm. Pb.
 - Roof 30 mm. Pb.
- Four lead-glass windows 300 × 300 mm. 220 mm. thickness, density 3.6 g/cm³
- 8 Ball tongs.
- Conditional Processing:
 - negative pressure — 150 Pa.
 - exhaust fan 48 m³/h (1.7 m/s).
- Special filters in the exhaust line is siliga gel treated with silver nitrate and maintain at 60–90°C.
- Dose rate monitor.
 - Adjustable alarm threshold 0 to 50 µGy/h.
- Under pressure gauge and under pressure monitor.

The under pressure monitor gives optic and acoustic signals if the actual under pressure in the cell box drop to less than — 50 Pa.

Analysis of raw materials, reagents and chemicals required for processing

Analysis of raw material (TeO₂)

Method	:	Polarography
Voltage	:	- 980 mV
Supporting electrolyte	:	0.5 (NH ₄) ₂ SO ₄ + 0.004 M Na ₂ EDTA.

Analysis of Te in ¹³¹I

Method	:	Spot Test (see the description on page no. 114)
Limit	:	Te ≤ 10 ppm.

Chemical processing procedure

The irradiated tellurium dioxide is transferred into 50 mL porcelain crucible (65 g of TeO₂/crucible). Put the crucibles into the furnace. Start the furnace and increase the temperature and maintain at 700°C for 60 minutes. Simultaneously apply a stream of air by vacuum pump with a flow rate 20–80 l/h pass through the furnace and iodine traps. The iodine vapor will be absorbed in NaHCO₃/Na₂CO₃* buffer solution which contained in the iodine traps. The product is drained from the traps into the vial and ready for activity measurement and dispensing.

Note: * = Buffer solution preparation:

A tenfold concentrated buffer solution can be prepared in a 500 mL batch and stored in a closed flask for a certain period. The required volume of buffer solution must be freshly prepared immediately before use by dilution of the tenfold concentrated buffer solution and succeeding filtration.

1. Take 8.0 g NaHCO₃ (AR) and 4.35 g Na₂CO₃ (AR) into a 500 mL volumetric flask, add water and shake thoroughly for dissolving.
2. Fill up after complete dissolving to 500 mL with tridistilled water.

3. Filter through a glass-filter funnel (fritte G 3 average pore diameter 15 to 40 micrometers) into a clean storage flask. Thus the tenfold concentrated solution is obtained and can be stored in the closed flask for a certain period.
4. Immediately before use dilute the required volume of the concentrated buffer solution by tridistilled water in a ratio 1: 9 and filter again through a glass-filter funnel G 3 into a clean 20 mL vial. Close the vial by a rubber stopper and transfer it into the production cell.

Dispensing, assay and quality control

Radiopharmaceutical finished product analytical procedures

<i>Product</i>	:	Sodium Iodide (I-131).
PH	:	The pH must be 8.0 to 10.0.
<i>Procedure</i>	:	The pH of the sample is measured using an appropriate indicator paper.
Appearance	:	A clear colorless solution.

Radioactive concentration

The radioactive concentration is measured at 1.00 p.m. hours on the date specified on the label. Sodium iodide (I-131) contains not less than 90.0% and not more than 110.0% at the date and hour stated on the label. The activities of the product available are not less than 25.0 mCi per mL.

Procedure

The sample in a sealed and capped vial is measured in an ionization chamber detector, the activity is calibrated using an appropriate factor. Decay factor and volume correction.

Radionuclidic purity

Iodine-131 decays by beta and gamma emissions with physical half-life of 8.04 days. The main photopeaks are 80.02 (2.2%) 284.3 (6.3%) 364.5 (79.0%) 639.9 (9.3%) and 722.9 (2.8%) keV.

Procedure

Using the NBS mixed standard No. 4275C-90 contained with ^{154}Eu , ^{155}Eu , ^{125}Sb and the OMNIGAM package for calibration of HPGe detector equipped Multichannel Analyser. The radionuclidic purity is determined by measuring the small amount of sodium iodide (I-131) in the same geometry of the calibrated standard. The quantity is expressed in kBq and the five photopeaks are presented.

Radiochemical purity

The radiochemical purity is not less than 95.0% of iodide ion.

Reagent

Sodium carbonate solution 0.05 M. Sodium carbonate (AR) 5.29 g is dissolved in 1,000 mL of distilled water.

Palladium chloride solution 0.1%. Palladium chloride (AR) 0.1 g is dissolved in 100 mL of methanol.

Instrument.

EC Power Supply Model EC-500 and Gelman Electrophoresis Chamber Raytest Scanner Model Gita-92 Thin-layer Chromatography Analyser.

Paper

Whatman No. 1 (40 × 300 mm.)

Procedure

1. Whatman paper is dipped in the Sodium carbonate solution.
2. Place a measured volume of solution containing 100 mg of potassium iodide, 200 mg of potassium iodate and 1 g of sodium bicarbonate in each 100 mL, 50 mm. from one end of the strip.
3. Add a similar volume of appropriate sodium iodide I-131 solution which count rate about 20,000 counts per sec.
4. Develop the chromatographic strip in electrophoresis chamber using high voltage 240 volts (8 volts/cm.). 60 min. The cathode is at the origin.
5. Dry the chromatogram in air, and determine the radioactive distribution by scanning with Na (TI) detector equipped with Raytest Scanner. The radioactivity of the iodide ^{131}I band is not less than 95.0% of the total radioactivity and its Rf values about 0.7 while the Rf value of $^{131}\text{IO}_3$ is about 0.4.
6. Confirm the identity of the iodide band by spraying with PdCl_2 solution. The development of a brown color indicates the presence of iodide ions.

Chemical purity

The tellurium content is not more than 10 ppm.

Reagent

Standard tellurium solution 10.0 ppm. Stock solution of tellurium 1,000 ppm. is prepared by dissolving 125.0862 mg of tellurium dioxide in 100 mL of distilled water. The stock solution is diluted with distilled water to prepare the standard solution with concentration of 10.0 ppm. Stannous chloride solution 5.0% (fresh preparation). Stannous chloride dihydrate ($\text{SnCl}_2 \cdot 2\text{H}_2\text{O}$) 0.25 g is dissolved in 0.25 mL of concentrated hydrochloric acid, heated to the clear solution and diluted to 5 mL with distilled water.

Sodium hydroxide solution 25.0%. Sodium hydroxide 25 g is dissolved in 100 mL of distilled water.

Saturated sodium carbonate solution

Procedure

1. Place one drop of standard tellurium solution, water (blank) and sodium iodide (sample) solution into each hole of spot plate.
2. Add one drop of stannous chloride, saturated sodium carbonate and 25.0% of sodium hydroxide solution respectively.
3. Compare the black precipitation of Te metal from the sample with standard Te and blank. (Te^{4+} is reduced by Sn^{2+} to give the tellurium metal). If there is preservative such as sodium thiosulfate ($\text{Na}_2\text{S}_2\text{O}_3$) in the sample solution, it will give the dark brown precipitation together with Te metal.

Final product specification for use

The intended use of the final product is for oral and some labeled compound preparation.

Sodium iodide (I-131)

Product specification

Chemical form: Sodium iodide (I-131) in carbonate buffer pH 8.0–10.0.

Appearance: A clear colorless solution.

Radionuclide: Iodine-131 contains not less than 95.0% of the labeled amount of ^{131}I as iodide expressed in megabecquerels (microcuries or millicuries) per milliliter at the time indicated in the labeling.

Chemical purity: For dry distillation process, sodium iodide (I-131) in carbonate buffer solution contains not more than 10.0 ppm. of tellurium.

Radionuclidic Purity: ^{131}I decays by beta and gamma emission with a physical half-life of 8.06 days. The principle beta mean energy is 192 keV (90.0%), and the major photopeak of gamma emission is 364 keV (79.0%).

pH: Between 8.0 and 10.0.

Radiochemical purity: More than 95.0% of the ^{131}I presented as iodide ion.

Radioactive concentration: Not less than 925 MBq (25 mCi) of ^{131}I per mL at hours and date specified on the label.

Expiry: Two weeks after manufacturing date.

Packaging: Ten mL vial sealed with a rubber stopper and aluminium seal. Package in a 25 mm. thick lead shielding.

Special comments on disposal of waste generated.

The advantage of dry distillation method is less liquid waste from the process. The liquid waste is only came from water for cleaning cell box, vial, iodine traps and dispensing unit which can be drained directly to a tank under the cell and leave for decay.

Solid waste of Al container, paper etc. is collected in the cell box for decay and disposed to the waste management facility.

Spent TeO_2 target is collected in 5 litre can, stored for decay. After decay for 3–5 year, it can be reprocessed and reused.

Preparation and cleanup of the facility and preparation for processing of next production batch:

- cleaning iodine traps and dispensing unit with distill water.
- clean the floor of cell box which should be free from TeO_2 powder.
- check every production system and equipment which should be in the proper function ready to work.

Practical experience gained

- The booting of ball tong used in I-131 production cell should be able to resist penetration of iodocompounds. As some iodo-compounds can penetrate rubber booting and leak into the operating room.
- The iodine up to three production runs can be absorbed into the same absorption solution in order to produce a higher concentration of radio-iodine solution.

BIBLIOGRAPHY

BEYER, J.J., ET AL., Isotope Production Technology I-131 Iodine Production Line Part I, Rossendorf. Dresdren, Germany.

EG & ORTEC, Gamma VisionTM. Gamma ray Spectrum Analysis and MCA Emulation for Microsoft Windows 3x and Microsoft Windows for Workgroups A66-BI, Software User Manual, Software Version 2.4, Ortec Part No. 762880, Manual Revision F, USA.

EUROPEAN PHARMACOPEIA COMMISSION, Public Health Committee European Pharmacopeia Commission, Group of Experts No. 14 (Radioactive Compounds). Council of Europe, 5th revision (1985).

FEIGL, F., Spot Tests in Inorganic Analysis, 5th edition, Elsevier Publishing Company, Rio de Janeiro (1958) 600.

INTERNATIONAL ATOMIC ENERGY AGENCY, Radioisotope Production and Quality Control, Technical Report Series No. 128, Vienna (1971) 968.

PHAN, T., WANICH, R., Practical Nuclear Pharmacy, 2nd edition, Banyan Enterprises Ltd., Lit Fresenius, Z. Te determination by polarography and CSV., Anal. Chem. **295** (1981) 1–6.

UNITED STATE PHARMACOPEIA CONVENTION, INC., 21st Revision, Mack Printing Company, Easton, USA (1985).

Iodine-131 ($^{131}\text{I}_{53}$)
(Fission product)

Production scheme : $^{235}\text{U} (n,f) ^{131}\text{I}$

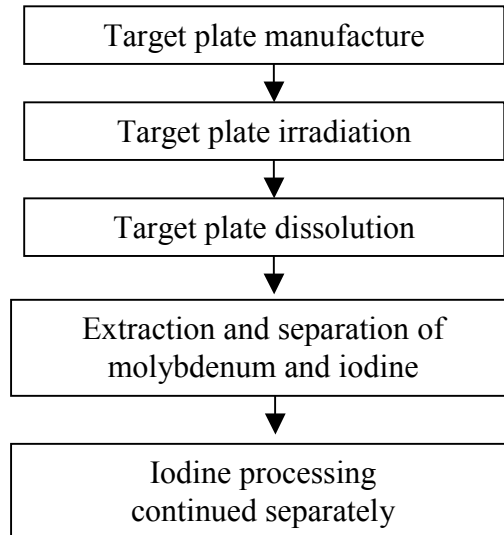

FIG. 1. I-131 Process flow sheet.

Target specification and preparation

The targets for fission I-131 production are the same as for ^{99}Mo , viz. an uranium/aluminium alloy (containing U enriched to 45% ^{235}U) clad in aluminium. It contains 4.2 g ^{235}U in a 200 mm \times 45 mm target plate manufactured by the NECSA of SA. Only very low levels of impurities which could act as neutron poisons are allowed.

Irradiation parameters

Irradiation is done in in-core irradiation in the 20 MW SAFARI-1 research reactor at Pelindaba near Pretoria. SAFARI-1 is a tank-in-pool type light water reactor of Oak Ridge design. Six dedicated positions are equipped with thimble tubes which allow for the insertion and retrieval of target plates with the reactor on power. A maximum of seven target plates in an aluminium plate holder can be irradiated per position for a period of up to 200 hours, depending on customer demand. The average thermal neutron flux is 1.5×10^{14} n/cm²/s at 20 MW. After irradiation the target plates are stored in the reactor pool for up to 24 hours to allow for the decay in gamma heating and short lived fission products. After ^{99}Mo extraction the iodine nuclides are stored on a resin column for at least 10 days before being extracted and purified. The maximum ^{131}I activity available per plate (after storage) for maximum irradiation conditions is 3.3×10^6 MBq (90 Ci).

The above procedure was provided by:
W. Van Zyl de Villiers,
The South African Nuclear Energy Corporation, Ltd.,
Bldg. 1900, PO Box 582, Pretoria 0001,
South Africa.

Processing facility

A typical production line of four shielded hot cells consists of the following:

- an elution cell in which the first ion exchange column from the ^{99}Mo process is eluted as well as waste tank under the cell floor for the accumulation of liquid waste. The dissolver cell of the ^{99}Mo process can also be used to elute the ^{131}I from the stored resin column;
- a purification cell containing the distillation apparatus;
- a dispensing cell containing an ionization chamber for the quantification of the product and the dispensing thereof according to client needs; and
- a packaging cell where the product bottles are placed into transport containers, labelled and removed for shipment to the client.

The ^{131}I production hot cells are served by a dedicated ventilation system, keeping the cells under slight negative pressure relative to the surrounding areas. It is an once-through system to prevent any build-up of process gases. There is 100% back-up with respect to the extraction as well as the primary filtration system, and the system is coupled to emergency diesel generator and uninterrupted power supply standby systems.

Dedicated filtration is provided for aerosols (HEPA filters), iodine (specially impregnated activated carbon filter beds) and noble gases which are realized during dissolution of the target plates (activated carbon filter banks). The dissolution rate of target plates, during which hydrogen is formed, is controlled in such a way that the hydrogen concentration in the ventilation system is within safety limits. In addition the I-131 purification and dispensing cells contain in-cell impregnated activated carbon filters to trap volatile iodine at low flow speeds.

Monitoring systems for noble gases, iodine, alpha and beta/gamma emitters as well as hydrogen are distributed throughout the ventilation system for process control measures as well as the quantification of releases to the environment as part of application of the ALARA principle.

Analysis of raw materials, reagents and chemicals required for processing

The materials and reagents used in the extraction and purification of ^{131}I are prepared in a dedicated laboratory consisting of a quarantine holding area, a section for storage of approved materials and reagents, and a processing area where chemicals and reagents are prepared.

Raw materials received from suppliers are placed in quarantine, and released for further use only after being tested for compliance with specified requirements. Bulk reagents prepared from approved raw chemicals are tested (where applicable) for functionality and concentration. These reagents are also placed in quarantine directly after preparation, and released only when verified to comply with specification. Process reagents are made up and transferred to the ^{131}I processing facility in quantities just enough for each production run.

A typical specification for the concentration of process reagents is $\pm 10\%$. Analytical methods such as atomic absorption spectrometry, titrimetry and ion chromatography, with precision and accuracy typically 1–4%, are used in the analysis of process reagents.

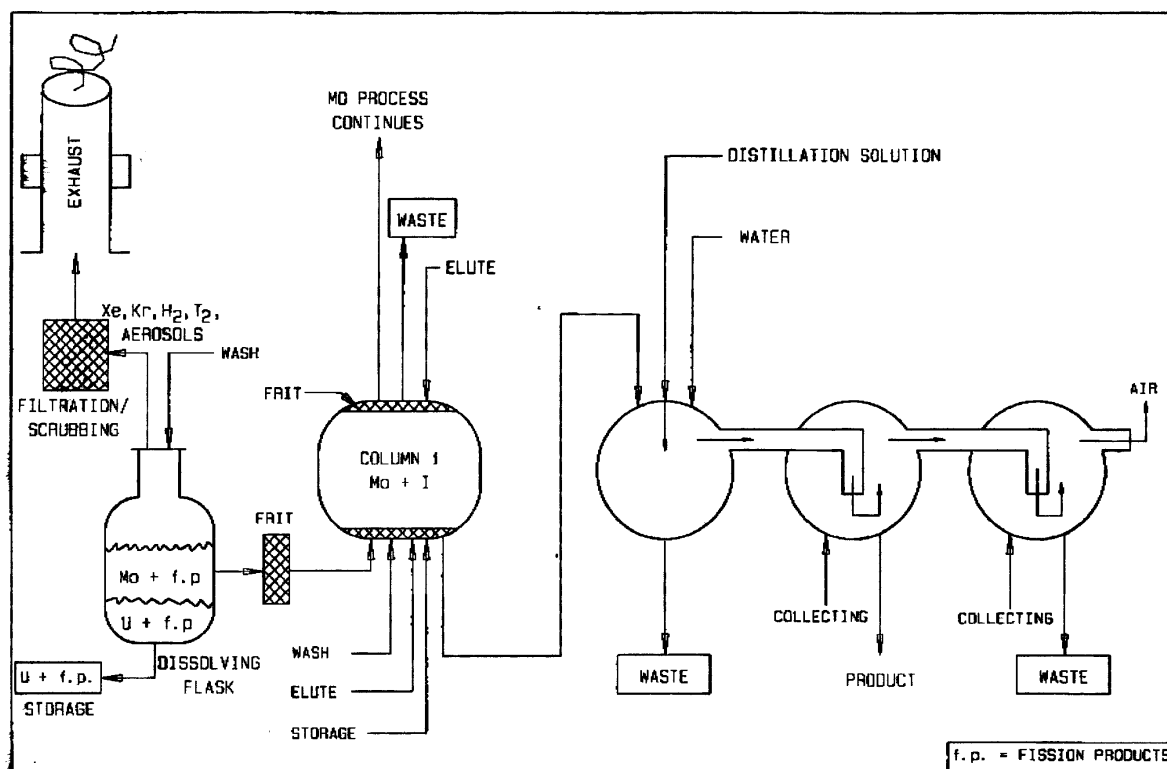

FIG. 2. Process scheme for I-131 extraction and purification.

Chemical processing

Irradiated target plates are dissolved in concentrated NaOH. A suitable oxidizing agent is added to ensure that all molybdenum is dissolved, while at the same time leaving the non-fissioned uranium as a solid residue for recovery at a later stage. Nuclides of only a few elements are dissolved with molybdenum, and the purification steps following dissolution have been designed to specifically ensure proper decontamination of Mo and I (in separate production streams) with respect to these elements, while also giving good product recovery.

Purification of iodine is carried out by means of an anion exchange resin and a distillation step. The first purification step consists of sorption of I, treating the resin column with a storage solution and storing it for a suitable decay period, followed by elution of I from the column. In the second step the eluate is distilled and collected in a solution as specified by the client, or in a related NaOH solution which is adjusted to the client's specifications afterwards.

Apart from the above mentioned control measures regarding process reagents, the distillation rate as well as the flow rate through ion exchange columns is controlled and monitored. Progress is monitored through observation of colour changes and by means of analysis of pre-distillation samples. All actions are carried out according to prescribed work instructions for the operators.

Dispensing, assay and quality control

The ^{131}I product is dispensed according to clients' requirements based on the bulk activity measured in the third hot cell and the particular precalibration period. Assaying is done by means of a frequently calibrated ionization chamber. Radioactive concentration ($\text{MBq}\cdot\text{cm}^{-3}$) is calculated from the product activity and the final volume of product solution. The final mass is also reported to the client.

Quality control testing of the final ^{131}I product is geared to provide a certificate of compliance within 48 hours of the dispensing of each production run. This demonstrates that the product is within specifications and is reported in a “less than” format.

Radionuclidic purity of ^{131}I is determined through the following measurements in a separate dedicated laboratory:

- γ spectrometric determination of ^{131}I activity by using a calibrated high purity Ge detector;
- γ spectrometric determination of gamma emitting impurities that are present. From the pulse height spectrum activities for selected nuclides (based on decay and chemical criteria) are determined. For nuclides not found in the spectrum minimum detectable activities are calculated;
- α and pure β emitting nuclides (e.g. ^{89}Sr , $^{90}\text{Sr}/\text{Y}$ and ^{99}Tc) are not analysed for an a routine basis. Information is available on a once-off test of a 110 day decay sample (to diminish the effect of the β particle from ^{131}I) to verify that the product is free of α and β -emitting nuclides as well as Sr nuclides.

Radiochemical purity of ^{131}I is determined by means of adsorption chromatography on a silica gel column. The iodine species are separated due to their different affinities for eluting agents. The column is washed with carbon tetrachloride, acetone and water and the activity in each elute is measured by γ -spectrometry.

Final product specification

Fission ^{131}I , which is produced as described above, is used for the production of Na^{131}I capsules and solution. The final ^{131}I product complies with the specifications derived from European, British and United States Pharmacopoeia specifications for Sodium Iodine- ^{131}I :

Radionuclidic purity

Not less than 99.9% of the total radioactivity is due to ^{131}I and not more than 0.1% of the total radioactivity is due to ^{133}I , ^{135}I and other impurities.

Other nuclides

$^{95}\text{Nb}:$ ^{131}I	$<1 \times 10^{-3}$
$^{95}\text{Zr}:$ ^{131}I	$<1 \times 10^{-3}$
$^{132}\text{I}:$ ^{131}I	$<1 \times 10^{-3}$
$^{133}\text{I}:$ ^{131}I	$<1 \times 10^{-3}$
Nuclides not specified	Not detected

Radiochemical purity

>95% as iodine (Γ).

Radioactive concentration

$\geq 1 \text{ Ci}(3.7 \times 10^{10} \text{ Bq})/\text{cm}^3$ at calibration time.

Product solvent

0.05 M NaOH, with a client specified reducing agent and buffer solution.

Calibration date

3 to 8 days after production.

Shelf-life

30 days after production.

Waste management

All process consumables such as pipes, ion exchange columns and reagent containers are used for only one production run. After each run, these are collected and stored to allow for decay of the short-lived nuclides with which it is contaminated. This is followed by compaction and disposal as low level waste.

Alkaline liquid waste is accumulated in shielded stainless steel tanks for later immobilization in a cement-vermiculite or left to decay for treatment with other on-site low-level liquid waste.

Hot cell off gas is treated by adsorption and filtration as described above.

Practical experience gained

Being a raw material for medical end use, it is absolutely imperative that all aspects of fission ^{131}I production are covered by a quality assurance programme. The latter should conform to an internationally accepted code of practice for quality systems, e.g. ISO 9002, as well as other requirements such as Good Manufacturing Practice according to 21 CFR Parts 210 and 211. Particularly important aspects are quality control of process consumables, strict control of the chemical purification process and purity certification of the final product.

Radiological and environmental monitoring as well as thorough waste management practices are critically important to ensure adherence to the ALARA principle and to minimize the environmental impact of production activities.

Drug Master Files have to be submitted to the pharmaceutical regulatory authorities in the countries where the product will be used in Na^{131}I capsules, solution and other products.

Iridium-192 ($^{192}\text{Ir}_{77}$)

Half-life : 73.83 d
 Metastable 1 (m_1): 1.45 min (~100% IT)
 Metastable 2 (m_2): 241 a

Production scheme : $^{191}_{77}\text{Ir} (n, \gamma) ^{192}_{77}\text{Ir}$

Target material : Na_2IrCl_6 (Koch Light /Fluka) (GR/AR)

Nuclear reactions and yield

Reaction	Isotopic Abundance of nuclide%	Cross Section barn	Activity of element at $10^{12} \text{ n/cm}^2/\text{s}$.			Secondary reactions And properties of Nuclide formed
			One week	Four Weeks	Saturation	
$^{191}_{77}\text{Ir} (n, \gamma) ^{192}_{77}\text{Ir}$	37.3	954 ± 10 ($\sigma_g = 309$ $\sigma_{m1} = 695$ $\sigma_{m2} = 0.16$)	68 GBq (1.85 Ci)/g Ir	250 GBq (6.73 Ci)/g Ir	1 TBq (28.9 Ci)/g Ir	$^{23}\text{Na} (n, \gamma) ^{24}\text{Na}$ Half-life: 14.95 h Isotope Abundance 100% $\sigma = 0.53 \text{ b}$ $^{35}\text{Cl} (n, \gamma) ^{36}\text{Cl}$ Half-life: $3.01 \times 10^5 \text{ Y}$ Isotope Abundance 75.77% $\sigma = 43.6 \text{ barns}$ $^{35}\text{Cl} (n, p) ^{35}\text{S}$ Half-life: 87.5 d Isotope Abundance 75.77% $\sigma = 0.48 \text{ barn}$ $^{37}\text{Cl} (n, \gamma) ^{38}\text{Cl}$ Half-life: 37.24 minutes Isotope Abundance 24.23% $\sigma = 0.43 \text{ barn}$

Type of decay and energy (MeV)

β^-	0.259	5.6%	Gamma	0.2058	3.34%	IC	
	0.539	41%		0.296	28.7%		2.5%
	0.675	48%		0.3084	29.7%		2.5%
EC		4.6%		0.3165	82.71%		5.7%
				0.4681	47.8%		1.5%
				0.4846	3.19%		
				0.5886	4.52%		
				0.6044	8.18%		

The above procedure was provided by:

M. Ananthkrishnan,
 Board of Radiation and Isotope Technology,
 Department of Atomic Energy, Mumbai, India.

Target specification and preparation

Target material	Koch Light/Fluka Na ₂ IrCl ₆ 10 mg (AR/GR).
Container	Standard 1S aluminium can 22 mm dia and 44 mm ht. cold weld sealed.
Irradiation	One week .
Type of facility for processing	Standard glove box 6 feet × 4 feet × 6 feet with 4 inch lead shielding- under negative pressure.
Flux	1-1.5 × 10 ¹³ n/cm ² /s.

Chemical process

The can is opened and the irradiated target transferred to a 100 mL beaker. 10 mL 0.1 N HCl is added to it and the solution stirred to complete the dissolution of target.

Assay and quality control

Radioactive concentration: An aliquot of the product solution is measured for radioactive concentration in a well type ionization chamber standardized with ²²⁶Ra.

Radio nuclide purity is determined by gamma ray spectrometer (MCA) Specific activity is determined by the known weight of target taken for Irradiation.

Characteristics of solution

Chemical form	Na ₂ Ir Cl ₆ in dilute HCl solution.
Radionuclide purity	>99%.
Radiochemical concentration	74–370 MBq/mL.
Specific activity	>185 GBq/g Ir.
Acidity	Approx. 0.1 N with respect to. HCl.

Iron-59 ($^{59}\text{Fe}_{26}$)

Half-life	:	44.5 d	
Production scheme	:	$^{58}\text{Fe} (n,\gamma) ^{59}\text{Fe}$	$\sigma = 1.155 \text{ b}$
Decay energy	:	β (MeV)	γ (MeV)
		0.273 (45.3%)	0.1923 (3.08%)
		0.463 (53.1%)	1.099 (56.5%)
		1.566 (0.18%)	1.291 (43.2%)
		0.130 (1.31%)	

Target specification and preparation

Iron-59 is reactor-produced by the radiative (n, γ) reaction on enriched (>60%) iron-58 ferric oxide targets.

Irradiation parameters, specific activity and total yield at EOI

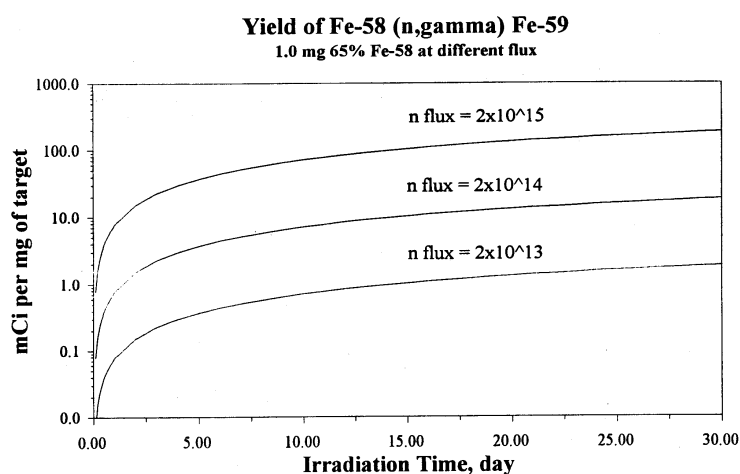

FIG. 1. Calculated production yields of iron-59 by neutron irradiation of nickel targets as a function of irradiation time at various thermal neutron flux values.

Enriched iron oxide targets (i.e. only 0.28% natural abundance) are used. The projected production yields of iron-59 from irradiation of enriched iron-58 as a function of irradiation time at various thermal neutron flux values are shown in Fig. 1.

Type of facility for processing

An adequately shielded hot cell or other shielded facility, dependent upon the levels of activity handled, is required for processing the irradiated targets.

The above procedure was provided by:
M. Du and F.F. Knapp, Jr.,
Nuclear Medicine Programme,
Oak Ridge National Laboratory,
Oak Ridge, Tennessee 37830-6229, USA.

Chemical processing procedure

Processing of iron-59 produced from enriched iron-58 ferric oxide targets (from ORNL radioisotopes procedure manual, ORNL-3633, 1964)

1. The following equipment should be prepared: 100 mL product bottle, 50 mL Vycor beaker, 1 liter separatory funnel, 150 mL Pyrex beaker, 250 mL separatory funnel and the hot off-gas scrubber unit.
2. Open irradiation can and transfer contents to 150 mL Pyrex beaker.
3. Add 10 to 20 mL of 12 M HCl and heat solution on hot plate under hot off-gas scrubber assembly. Adjust solution to ~100 mL of 9 M HCl solution to prepare for extraction of ^{54}Mn (i.e. from any ^{54}Fe activation).
4. Equilibrate 500 mL of dichlorodiethyl ether with 9 M HCl by shaking in a 1 liter separatory funnel for 10 min. Separate the HCl wash and hold the ether for extraction of ^{59}Fe solution.
5. Transfer the 9 M HCl solution containing the ^{59}Fe into 250 mL separatory funnel and add an equal volume of HCl-washed dichlorodiethyl ether. Agitate for 10 min and separate the two phases. Iron-59 is extracted into the organic phase.
6. Repeat the extraction procedure twice.
7. Collect ether fractions and extract with 50 mL of distilled H_2O . This step removes all ^{59}Fe from aqueous solution. Iron-59 is extracted into aqueous phase.
8. Repeat water wash with 10-min agitation periods until all ^{59}Fe is removed from organic phase. Three extractions are usually sufficient.
9. Collect water wash in a 50 mL Vycor beaker and evaporate to dryness under hot off-gas assembly.
10. Fuming the product with 16 M HNO_3 removes any organic compounds which may be present.
11. Fume twice with 12 M HCl to completely decompose the HNO_3 .
12. Dissolve residue in 50 mL of 1 M HCl and transfer to product bottle. Product should be clear and yellow-colored solution.
13. Sample and analyse for:
 - Molarity of HCl
 - Total solids
 - Radiochemical purity
 - ^{55}Fe concentration
 - ^{59}Fe concentration
 - ^{60}Co concentration.

Dispensing, assay and quality control

The final product should be analysed by gamma spectroscopy and is provided as the chloride in HCl solution.

Final product specification for use

The product is provided as the chloride in HCl solution — ^{59}Fe >99% (exclusive of ^{55}Fe) and ^{55}Fe <5%.

Practical experience gained

Iron-59 had been produced at ORNL with a specific activity of about 16 mCi/mg. A typical production run consisted of irradiation of a 10 mg for 30 minutes at a flux of 2×10^{14} . The processing yields are >95%.

BIBLIOGRAPHY

OAK RIDGE NATIONAL LABORATORY, Radioisotopes Procedures Manual, ORNL-3633, UC-23-Isotopes — Industrial Technology, TID-4500 (30th ed.), Tennessee (1964).

Lutetium-177 ($^{177}\text{Lu}_{71}$)

Half-life : 6.734 d

Production scheme : $^{176}\text{Lu} (n,\gamma) ^{177}\text{Lu}$

Lutetium-177 (maximal beta energy of 0.497 MeV) is an useful lanthanide +3 metal for various therapeutic application. Because of a rather large cross-section, lutetium-177 can be directly reactor-produced (Fig. 1) with relatively high specific activity by neutron capture of enriched lutetium-176. Because of the relatively low 2.6% natural abundance, enriched lutetium-176 (i.e. >70%) target material is required for this production route. As an alternative production route, carrier-free lutetium-177 can be obtained carrier-free from beta decay (indirect production) of ytterbium-177 produced by neutron capture of enriched ytterbium-176.

Target specification and preparation

For direct production, enriched lutetium-176 oxide targets are used.

Irradiation parameters, specific activity and total yield at end of irradiation

The production of lutetium-177 by direct (n, γ) activation of enriched lutetium-176 as a function of irradiation time for various thermal neutron flux values is illustrated in Fig. 1.

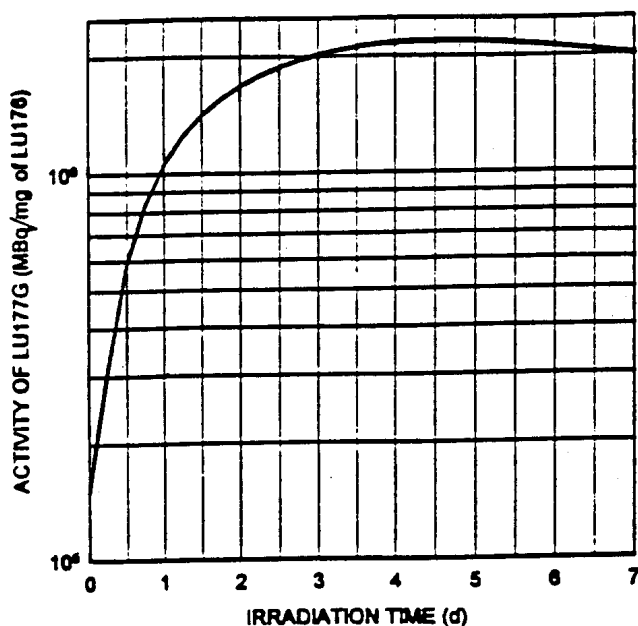

FIG. 1. The projected direct production of lutetium-177 from neutron irradiation of enriched lutetium-176 as a function of irradiation time for various thermal neutron flux values.

The above procedure was provided by:

S. Mirzadeh and F.F. Knapp, Jr.,
Nuclear Medicine Programme
Oak Ridge National Laboratory,
Oak Ridge, Tennessee 37830-6229, USA

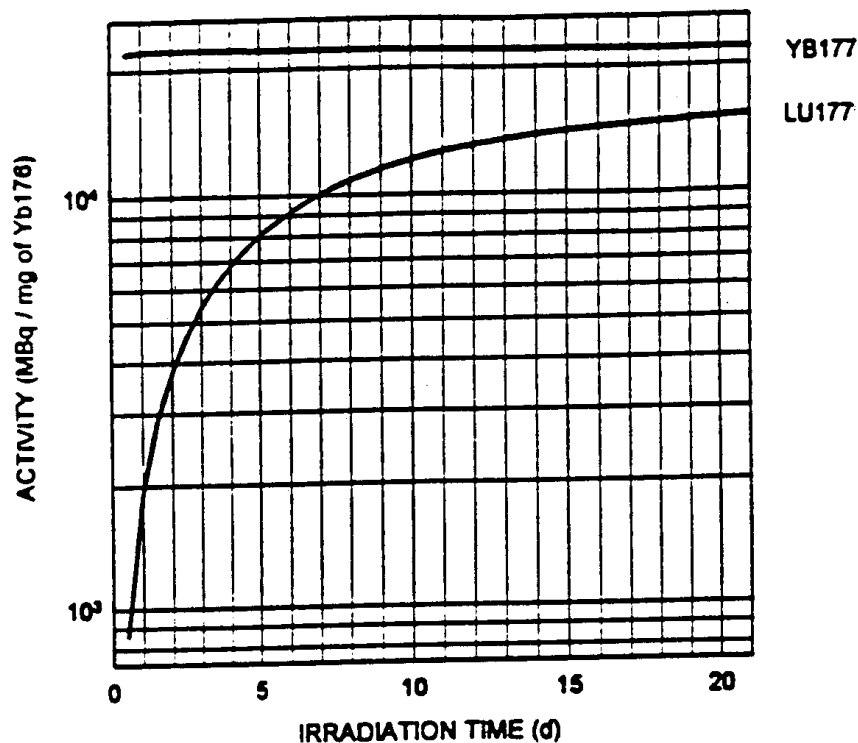

FIG. 2. Indirect production of ¹⁷⁷Lu illustrating the theoretical yields of ¹⁷⁷Yb and ¹⁷⁷Lu as a function of irradiation time in hydraulic position of # 5 of the ORNL High Flux Isotope Reactor; ($\phi_{th} = 2.05 \times 10^{15} \text{ n/cm}^2/\text{s}$).

Type of facility for processing

An adequately shielded hot cell is required for processing the irradiated target.

Chemical processing procedure

These initial irradiation studies conducted at ORNL did not involve chemical processing and irradiated samples were counted directly. Efficient techniques for the separation of carrier-free lutetium-177 from the irradiated ytterbium-166 targets would have to be developed.

Dispensing, assay and quality control

The product should be analysed by gamma spectroscopy.

Final product specification for use

The specific activity of lutetium-177 directly produced from enriched lutetium-176 may be limited by the irradiation periods required to minimize the production of the long-lived ^{177m}Lu produced by the competing lutetium-176(n,γ)lutetium-177m reaction. For these reasons the indirect route provides the highest radiochemically pure lutetium-177.

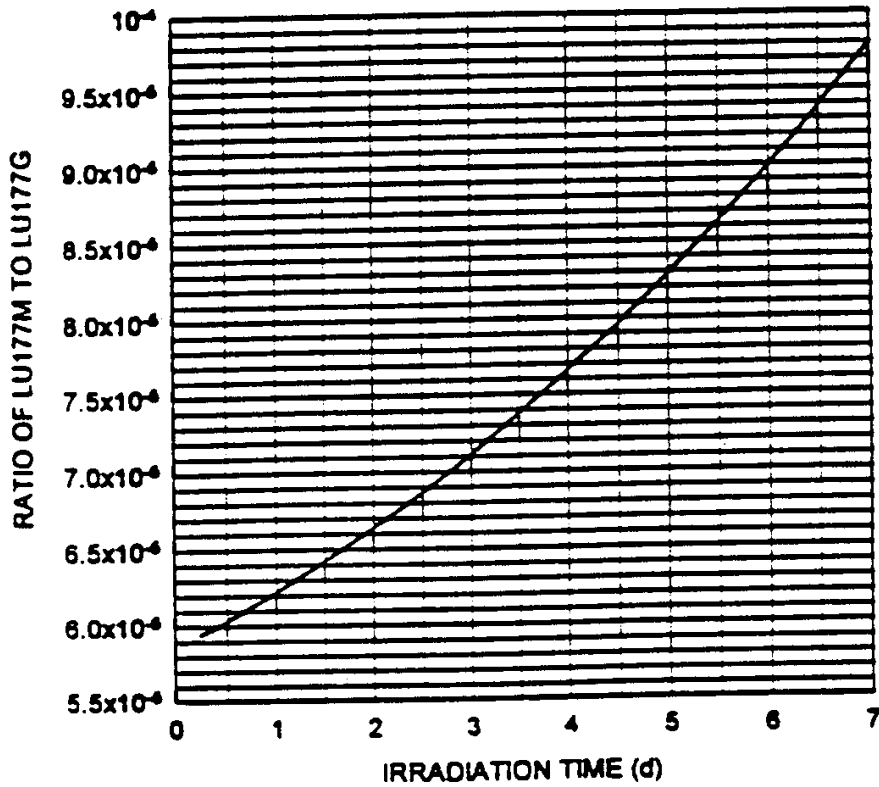

FIG. 3. The ratio of $^{177m}\text{Lu}/^{177}\text{Lu}$ as a function of irradiation time in hydraulic position # 4 or 6 of the ORNL High Flux Isotope Reactor ($\phi_{th} = 1.76 \times 10^{15} \text{ n/cm}^2/\text{s}$).

BIBLIOGRAPHY

OAK RIDGE NATIONAL LABORATORY, Nuclear Medicine Program Progress Report # ORNL/TM-13107 (1995).

**Lutetium-177 ($^{177}\text{Lu}_{71}$)
(Alternate procedure)**

Half-life : 6.734 d (^{177g}Lu)

Production scheme : $^{176}\text{Lu} (n,\gamma) ^{177}\text{Lu}$ $\sigma^g = 1770 \text{ b}$, $\sigma^m = 317 \text{ b}$

^{177m}Lu : 160.4 d
(78.3% β^- , 21.7% IT)

Type of decay, and energy (keV)

Beta	176.5 (12.2%)	Gamma	71.65 (0.15%)
(β^- max. energy)	248.5 (0.053%)		112.95 (6.4%)
	384.8 (9.1%)		136.7 (0.05%)
	497.8 (78.6%)		208.37 (11.06%)
			249.67 (0.21%)
			321.32 (0.22%)

Decay product : ^{177}Hf

Production process

Radioactive ^{177}Lu is produced by the $^{176}\text{Lu} (n,\gamma) ^{177}\text{Lu}$ reaction in a Lu_2O_3 target and is prepared as $^{177}\text{LuCl}_3$ in HCl solution. After irradiation, the target is decayed for 3 days for reduction of activity of ^{176m}Lu (half-life 3.664 h) produced by the side reaction.

Procedures

Capsuling, Neutron irradiation, Cooling, Decanning, Gross-activity measurement, Chemical treatment, Inspection, Stock.

Target specification and preparation

Target purity

Lu_2O_3 99.99%

Enrichment factor if applicable

(None)

Impurity details

$\text{Y}_2\text{O}_3 < 5 \text{ ppm}$, $\text{CeO}_3 < 5 \text{ ppm}$, $\text{Pr}_2\text{O}_3 < 5 \text{ ppm}$, $\text{Nd}_2\text{O}_3 < 5 \text{ ppm}$, Sm_2O_3 15 ppm,
 $\text{Eu}_2\text{O}_3 < 5 \text{ ppm}$, Gd_2O_3 14 ppm, $\text{Tb}_2\text{O}_3 < 5 \text{ ppm}$, $\text{Dy}_2\text{O}_3 < 5 \text{ ppm}$, $\text{Ho}_2\text{O}_3 < 5 \text{ ppm}$,
 $\text{Er}_2\text{O}_3 < 5 \text{ ppm}$, $\text{Tm}_2\text{O}_3 < 7 \text{ ppm}$, Yb_2O_3 22 ppm, $\text{La}_2\text{O}_3 < 5 \text{ ppm}$, CaO 30 ppm,
 $\text{Fe}_2\text{O}_3 < 5 \text{ ppm}$, SiO_2 30 ppm.

The above procedure was provided by:

H. Takahashi,
Isotope Division, Japan Atomic Energy Research Institute,
Tokai, Ibaraki, Japan.

Isotopic composition and supplier of target material and grade

Natural abundance
Rare Metallic Co., Ltd., Japan
White powder of Lu₂O₃ 99.99%.

Irradiation parameters, specific activity and total yield at EOI

Reactor used and which assembly

JRR-3M, Hydraulic tube.

Capsule details

The target is sealed in a quartz ampoule (outer diameter: 10 mm, inner diameter: 8 mm, length: 50 mm) which is in a cold-pressure-weld type cylindrical aluminium can (Outer diameter: 30 mm, inner diameter: 25 mm, length: 150 mm) with aluminium foil as shock absorber.

Mass of target per capsule

Weight of the target is measured precisely by a microbalance
Lu₂O₃ : ~10 mg

Preparation of target for encapsulation, reactor irradiation parameters

Neutron flux : $\sim 1 \times 10^{14}$ n/cm²/s
Irradiation time : 1 d

Specific activity achieved and typical production yield per capsule

Specific activity : ~ 2 T Bqg⁻¹Lu
Production yields : $\sim 90\%$ (~ 18 G Bq)

Type of facility for processing

A 5 cm thick lead hot cell equipped with tongs, lead glass windows and apparatus inside is used to treat the irradiated target. The apparatus consists of cutter, dissolving vessel, hotplate-stirrer unit, reagent feeding pipe, trap for exhausted fumes, remote pipette, etc. Absolute filters are in the exhaust line of cell.

Analysis of raw materials, reagents and chemicals required for processing

All reagents are high pure grade and guaranteed.

Hydrogen peroxide

Concentration 35%, Residue on evaporation 0.05%, Heavy metals 0.0001%.

Hydrochloric acid

Concentration 35.0 ~ 37.0%, Residue on evaporation 0.001%, Heavy metals 0.000005%.

Pure water

Purified by Milli-QSP ultra pure water production system, Electric resistance >18 MΩ.

Chemical processing procedure

After irradiation, quartz ampoule is broken off carefully. Target is drawn out from it to dissolving vessel with 2 mL 6M-HCl, then added 2 mL H₂O₂. The vessel is put on a hotplate-stirrer unit and connected to trap.

The target is dissolved at room temperature (~25°C) by stirring with a magnetic rod. After dissolution, the solution is heated and evaporated to dry.

The dried LuCl₃ is dissolved in 30 mL of 1 M-HCl as product.

Dispensing, assay and quality control

Target material used must be guaranteed more than 99% for radionuclidic purity of the product by activation analysis. Radioactivity of target in ampoul is measured with a calibrated well-type ionization chamber. A small quantity of the product is spent for assay. Radionuclidic purity is checked by gamma-spectrometry using a germanium detector system. Chemical assay performed is the determination of acidity and heavy metal impurities.

Final product specification for use

Physical observation

Final product is colourless and clear aqueous solution. The colour of the solution and presence of suspended particles are confirmed by an appearance test used a microscope.

Radionuclide identification

¹⁷⁷Lu product is checked by γ ray spectrometry using HPGe detection system. Gamma spectrum is shown in Fig. 1.

Radionuclidic purity

>99%.

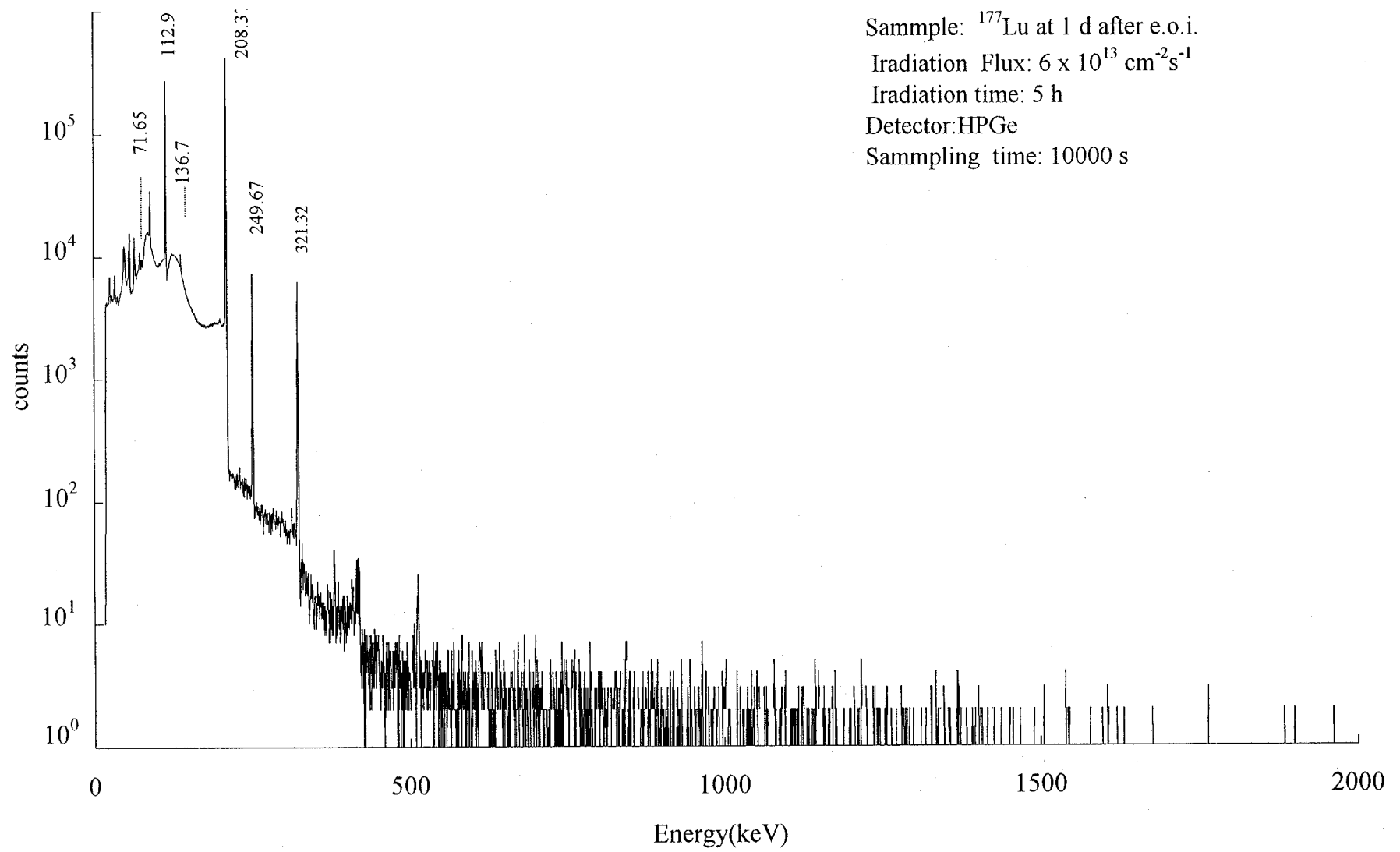

Acidity

Acidity is determined by titration of an aliquot of product solution with 0.1 M sodium hydroxide solution using 0.2% methyl-red solution as an indicator.

Radiochemical purity

(None).

Radioactive concentration

~300 M Bq mL⁻¹

Storage conditions

The product is dispensed into glass storage bottle and stored till next production.

Disposal of waste generated

The radioactive ^{177m}Lu waste, after ¹⁷⁷Lu has decayed, is stored.

BIBLIOGRAPHY

FIRESTONE, R.B., SHERLEY, V.S., Table of Isotopes, 8th Edition, Vol. II (1996).

Mercury-197 ($^{197}\text{Hg}_{80}$)

Half-life	:	64.13 h
Production scheme	:	$^{196}\text{Hg} (n,\gamma) ^{197}\text{Hg}$
Target material	:	HgO powder
Decay product	:	^{197}Au

Nuclear reactions and yield:

Reaction	Isotopic Abundance of nuclide%	Cross Section (barns)	Activity of element at $10^{12} \text{ n/cm}^2/\text{s}$		Secondary reactions and properties of Nuclide formed
			1 week	Saturation	
$^{196}\text{Hg} (n,\gamma) ^{197\text{m}}\text{Hg}$ IT 23.8 93.5% h. ↓	0.15	$\sigma^{\text{m}} =$ 109±6	385 MBq (14.3 mCi)/g Hg	386 MBq (14.4 mCi)/g Hg	$^{198}\text{Hg} (n,\gamma) ^{199\text{m}}\text{Hg}$ Half-life: 42.6 min. Abundance: 9.97% $\sigma = 0.018 \pm 0.04 \text{ b}$
$^{196}\text{Hg} (n, \gamma) ^{197\text{g}}\text{Hg}$	0.15	$\sigma^{\text{g+m}} =$ 3080± 180 $\sigma^{\text{g}} =$ 2970 b	12.3 MBq (334.5 mCi)/g Hg	14.5 MBq (396.5 mCi)/g Hg	$^{202}\text{Hg} (n,\gamma) ^{203}\text{Hg}$ Half-life: 46.61 days Abundance: 29.86% $\sigma = 4.9 \text{ barns.}$

Type of decay and energy (MeV)

EC	100%	Gamma	0.07735	18.7%	IC 80.7%
$^{197\text{m}}\text{Hg}$	Half-life: 23.8 Hours				
IT	93.5%	Gamma	0.1339	33.5%	IC 85.5%
EC	6.5%		0.2790	6.1%	0.9%

Target specification and preparation

Target HgO (GR/AR) 500 mg sealed in quartz ampoule.
Target purity >99.9% pure. (E. Merck/Fluka).

Container Standard 1S aluminium can 22 mm dia and 44 mm ht. cold weld sealed.

The above procedure was provided by:
M. Ananthkrishnan,
Board of Radiation and Isotope Technology,
Department of Atomic Energy, Mumbai, India.

<i>Irradiation</i>	72 hours.
<i>Flux</i>	10^{13} n/cm ² /s.
<i>Type of facility for processing</i>	Standard glove box 1.5 m × 1.2 m × 1.5 m. with 5 cm lead shielding with HEPA filters.
<i>Reagents used:</i>	All the reagents used are of AR/GR grade.

Chemical processing

The irradiated can is opened and quartz ampoule broken inside a teflon tube and HgO transferred to a 100 mL beaker. A few mL of con. HNO₃ is added to it and HgO completely dissolved. The solution is diluted with double distilled water to required volume and transferred to a storage bottle.

Assay and quality control

Activity is assayed in a well type ionization chamber standardized with ²²⁶Ra. Radionuclide purity is determined by gamma spectrometry using MCA.

Characteristics of final solution

Radiochemical form	Hg (NO ₃) ₂ in HNO ₃ solution.
Radioactive concentration	Approx. 185–370 MBq (5–10 mCi)/mL.
Radionuclide purity	²⁰³ Hg < 5%.
Specific activity	>400 MBq/g Hg.

Preparation of ¹⁹⁷Hg in elemental form for industrial applications

The irradiated can is opened and the quartz ampoule is crushed inside a tygon tube. Mercuric oxide is transferred to a 100 mL beaker and dissolved in 30 mL concentrated HCl. The solution is decanted into a 250 mL beaker. The dissolution vessel is washed with 20 mL double distilled water and washings transferred to the 250 mL beaker and solution warmed on hot plate. 10 mL solution of 10% hypophosphorous acid is added to the hot solution of HgCl₂ and stirred. Reduction of HgCl₂ to elemental mercury is completed in a few minutes and Hg separates out. The supernatant liquid is separated and mercury washed with hot double distilled water thrice. Traces of moisture from mercury are removed and beaker warmed to dry the mercury and then transferred to a vial.

Assay and quality control

Radioactive concentration

A measured quantity, 50–100 mg, of metallic mercury is taken in a vial and mercury dissolved in minimum quantity of hot concentrated HNO₃ which is then diluted with double

distilled water to 5 mL. Radioactive concentration of this solution is measured in a precalibrated well type ion chamber.

Radionuclide purity is determined by gamma ray spectrometry.

Specific activity is determined by the knowledge of quantity of metallic mercury taken in the sample for ion current measurement.

Characteristics of final product

Radioactive form	Metallic mercury.
Radioactive concentration	3.7 MBq/g Hg.
Radionuclide purity	$^{197m}\text{Hg} + ^{197}\text{Hg} > 95\%$ $^{203}\text{Hg} < 5\%$.
Specific activity	3.7 MBq/Hg.

Mercury-203 ($^{203}\text{Hg}_{80}$)

Half- life	:	46.61 d
Production scheme	:	$^{202}_{80}\text{Hg} (n,\gamma) ^{203}_{80}\text{Hg}$
Target material	:	HgO powder
Decay product	:	^{203}Tl

Nuclear reactions and yield

Reaction	Isotopic Abundance of nuclide%	Cross Section barn	Activity of element at $10^{12} \text{ n/cm}^2/\text{s}$			Secondary reactions And properties of Nuclide formed
			One week	Four Weeks	Satu- Ration	
$^{202}_{80}\text{Hg} (n,\gamma) ^{203}_{80}\text{Hg}$	29.86	4.9	410 MBq (11.6 mCi)/g Hg	1.5 GBq (39.97 mCi)/g Hg	4.1 GBq (116.54 mCi)/g Hg	$^{196}\text{Hg} (n,\gamma) ^{197\text{m}}\text{Hg}$ Half-life: 23.8 h. Isotope abundance 0.15% $\sigma = 109$ barns $^{196}\text{Hg} (n, \gamma) ^{197\text{g}}\text{Hg}$ Half-life: 64.1 h. Isotope abundance 0.15% $\sigma^{\text{g+m}} = 3080$ barns $^{198}\text{Hg} (n,\text{p}) ^{198}\text{Au}$ Half-life: 2.69 days Isotope abundance 10% $^{199}\text{Hg} (n,\text{p}) ^{199}\text{Au}$ Half-life: 3.14 days Isotope abundance 16.84%

Type of decay and energy (MeV)

β^-	0.2126	100%	Gamma	0.2792	81.5%	IC 18.5%
-----------	--------	------	-------	--------	-------	----------

Target specification and preparation

Target	HgO (E. Merck/JM (AR/GR) – 2 g.
Container	Quartz ampoule in Standard aluminium can 22 mm dia and 44 mm ht. cold weld sealed.
Irradiation	3 months.

The above procedure was provided by:
 M. Ananthkrishnan,
 Board of Radiation and Isotope Technology,
 Department of Atomic Energy, Mumbai, India.

Flux	Approx. $5 \text{ to } 6 \times 10^{13} \text{ n/cm}^2/\text{s}$.
Usual yield	4 curies after a period of one month cooling.
Type of facility for processing	Standard glove box $1.5 \text{ m} \times 1.2 \text{ m} \times 1.5 \text{ m}$ Under negative pressure (2–3 cm WG).

Chemical process

The target is stored for one month to allow the decay of ^{197}Hg . Can is opened and quartz ampoule crushed in a tygon tube. HgO is transferred to a dissolution flask and 10 mL concentrated HNO_3 is added to it. The dissolution is completed by warming. The solution is concentrated to minimum volume and diluted with required volume of 1N HNO_3 , filtered and transferred to a storage bottle.

Assay and quality control

Radioactive concentration is measured in a well type ion chamber standardized with ^{226}Ra . Radionuclide purity is determined by gamma spectrometry. Specific activity is calculated from the known weight of the target taken for irradiation.

Characteristics of final solution

Chemical form	Mercuric nitrate in nitric acid solution.
Radioactive concentration	74–740 MBq/mL
Radionuclide purity	$^{197}\text{Hg} < 1\%$.
Radiochemical purity	>99%.
Specific activity	>10 GBq/g Hg.
Acidity	Approx. 1 N with respect to HNO_3 .

Preparation of ^{203}Hg in elemental form for industrial applications

After irradiation, the can is opened and quartz ampoule crushed in a tygon tube. HgO is transferred to a 100 mL beaker and dissolved in 30 mL concentrated HCl . The solution is warmed to complete the dissolution and decanted into a 250 mL beaker. The dissolution vessel is washed with 30 mL concentrated HCl and washings added to the HgCl_2 solution. The solution is warmed. 20 mL 10% solution of hypophosphorous acid is diluted to 50 mL with double distilled water and is added to hot solution of HgCl_2 in HCl and stirred for a few minutes. Mercury globules separate out. The supernatant solution is removed by decantation and mercury washed thrice with hot double distilled water. Washings removed and trace of moisture in the beaker containing Hg is removed. Beaker warmed to completely dry the mercury and the active mercury transferred to a storage vial. Recovery is 98 to 100%.

Assay and quality control

Radioactive concentration: A known quantity 100–200 mg metallic mercury from the stock is taken in a vial and dissolved in minimum quantity of a hot solution of concentrated HNO₃. The solution is diluted to 5 mL with double distilled water and radioactivity measured in a well type ion chamber standardized with ²²⁶Ra.

Radionuclide purity is determined by gamma spectrometer.

Specific activity is calculated from the quantity of metallic mercury taken for assay.

Characteristics of final product

Chemical form	Metallic mercury.
Radioactive concentration	<200 MBq/g Hg.
Radionuclide purity	¹⁹⁷ Hg <1%.

Molybdenum-99 ($^{99}\text{Mo}_{42}$)
(Fission product)

Half-life : 65.94 h

Production scheme : $^{235}\text{U} (n,f) ^{99}\text{Mo}$

Decay products : $^{99m}\text{Tc} (t_{1/2} 6.01 \text{ h})$ and $^{99}\text{Tc} (t_{1/2} 2.11 \times 10^5 \text{ a})$

Type of decay and energy

β	1.2145	(82.4%)	γ	0.7395	(12.13%)
	0.4366	(16.4%)		0.181	(6.0%)
				0.1405	(4.52%)
				0.7779	(4.26%)

Production : thermal neutron induced fission of ^{235}U ;
fission products contains 6.1 mass-% ^{99}Mo

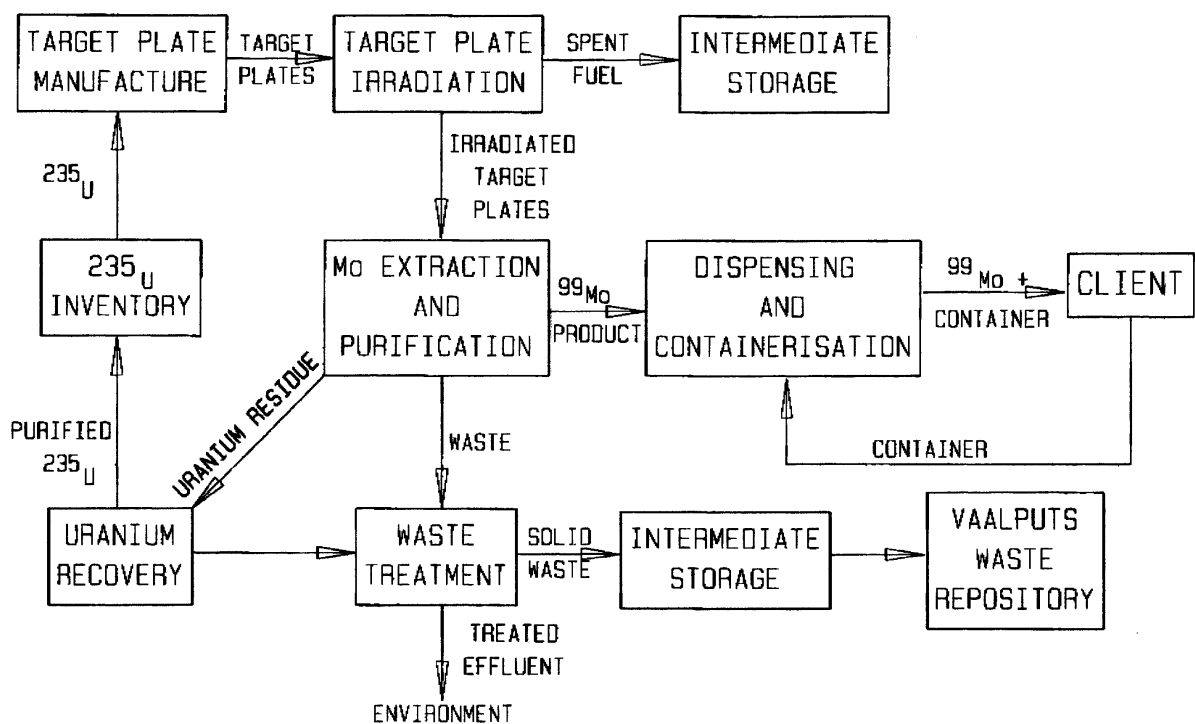

FIG. 1. Mo-99 process flow sheet.

The above procedure was provided by:
W. Van Zyl de Villiers,
The South African Nuclear Energy Corporation, Ltd,
Bldg. 1900, PO Box 582,
Pretoria 0001, South Africa.

Target specification and preparation

The targets for fission Mo-99 production consist of a uranium/aluminium alloy (containing U enriched to 45% ^{235}U) clad in aluminium. It contains 4.2 g ^{235}U in one 200 mm \times 45 mm target plate manufactured by NECSA. Only very low levels of impurities that could act as neutron poisons are allowed.

Irradiation

Irradiation is done in in-core irradiation positions in the 20 MW SAFARI-1 research reactor at Pelindaba near Pretoria. SAFARI-1 is a tank-in-pool type light water reactor of Oak Ridge design. Six dedicated positions are equipped with thimble tubes which allow for the insertion and retrieval of target plates with the reactor on power. A maximum of seven target plates in an aluminium plate holder can be irradiated per position for a period of up to 200 h, depending on customer demand. The average thermal neutron flux is 1.5×10^{14} n/cm²/s at 20 MW. After irradiation the target plates are stored in the reactor pool for up to 24 hours to allow for the decay in gamma heating and short-lived fission products. The ^{99}Mo activity per plate at the end of a 50 h–200 h irradiation varies from 200 to 500 Curies ($8 \times 10^6 - 18 \times 10^6$ MBq).

Processing facility

A typical production line of five shielded hot cells (shielding capacity of 200–250 mm lead equivalent) consists of the following:

- As dissolver cell containing the dissolution vessel for irradiated target plates, the first ion exchange column, as well as waste tanks under the cell floor for the accumulation of liquid waste for further processing after sufficient decay;
- A purification cell containing the second and third purification columns;
- A filtration cell containing the evaporator and sundry equipment for the filtration, redissolution, sampling and bottling of the ^{99}Mo containing solution;
- A dispensing cell containing an ionization chamber for the quantification of the product and the dispensing thereof according to client needs; and
- A packaging cell where the product bottles are placed into transport containers, labelled and removed for shipment to the client.

The ^{99}Mo production hot cells are served by a dedicated ventilation system, keeping the cells under slight negative pressure relative to the surrounding areas. It is a once-through system to prevent any build-up of process gases. There is 100% back-up with respect to the extraction as well as the primary filtration system, and the system is coupled to emergency diesel generator and uninterrupted power supply standby systems.

Dedicated filtration is provided for aerosols (HEPA filters), iodine (specially impregnated activated carbon filter beds) and noble gases. During target plate dissolution the latter gases are trapped on activated carbon in large stainless steel columns, which are then closed off and left for a period long enough to allow for sufficient decay of the relevant isotopes. The dissolution rate of target plates, during which hydrogen is formed, is controlled in such a way that the hydrogen concentration in the ventilation system is within safety limits.

Monitoring systems for noble gases, iodine, alpha and beta/gamma emitters as well as hydrogen are distributed throughout the ventilation system for process control measures as

well as the quantification of releases to the environment as part of application of the ALARA principle.

Analysis of raw materials, reagents and chemicals required for processing

The materials and reagents used in the extraction and purification of ^{99}Mo are prepared in a dedicated laboratory consisting of a quarantine holding area, a section for storage of approved materials and reagents, and a processing area where chemicals and reagents are prepared.

Raw materials received from suppliers are placed in quarantine, and released for further use only after being tested for compliance with specified requirements. This includes analysing raw materials for a selected constituent. Bulk reagents prepared from approved raw chemicals are tested (where applicable) for identity and concentration. These reagents are also placed in quarantine directly after preparation, and released only when verified to comply with specification. Process reagents are made up and transferred to the ^{99}Mo processing facility in quantities just enough for each production run.

A typical specification for the concentration of process reagents is $\pm 10\%$. Analytical methods such as atomic absorption spectrometry, titrimetry and ion chromatography, with precision and accuracy typically 1–5%, are used in the analysis of process reagents.

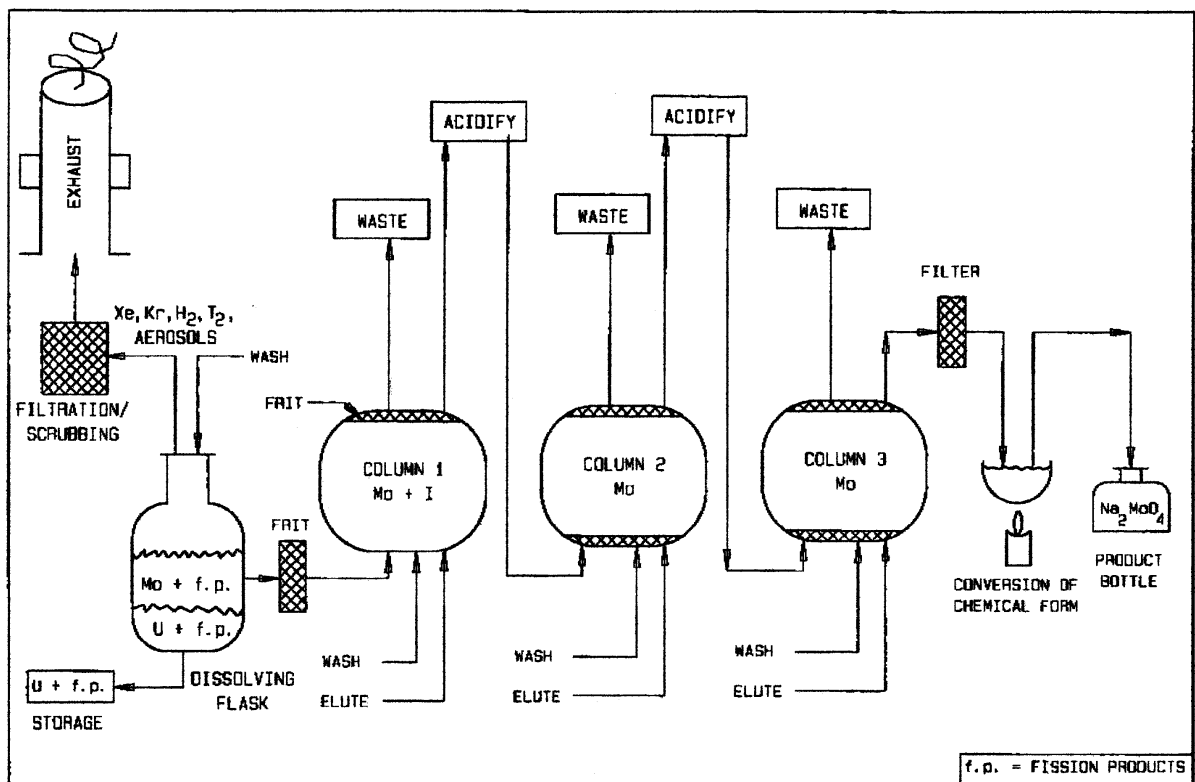

FIG. 2. Process scheme for Mo-99 extraction and purification.

Chemical processing

Irradiated target plates are dissolved in concentrated NaOH. A suitable oxidizing agent is added to ensure that all molybdenum is dissolved, while at the same time leaving the non-fissioned uranium as a solid residue for recovery at a later stage. Nuclides of only a few elements are dissolved with molybdenum, and the purification steps following dissolution

have been designed to specifically ensure proper decontamination of Mo with respect to these elements, while also giving good product recovery.

Purification is carried out by means of two anion exchange resins and one chelating resin, all commercially available. Each purification step consists of sorption of Mo, washing to remove any residual source solution, and elution of Mo under conditions suitable for separation from any impurities which might still be present at the particular stage. The eluate from the third column is filtered, evaporated to dryness, and redissolved in 0.2 M NaOH to convert the product into sodium molybdate. Sodium hypochlorite is normally added at this stage to ensure that Mo is maintained in the molybdate form.

Apart from the above mentioned control measures regarding process reagents, the process or solution temperature as well as the flow rate through ion exchange columns are controlled with predefined parameters. All actions are carried out according to prescribed checklists for the operators.

Dispensing, assay and quality control

The ^{99}Mo product is dispensed according to clients' requirements based on the bulk activity measured in the fourth hot cell and the particular precalibration period. Assaying is done by means of a frequently calibrated ionization chamber. Radioactive concentration ($\text{MBq}\cdot\text{cm}^{-3}$) is calculated from the product activity and the final volume of product solution.

Quality control testing of the final ^{99}Mo product is geared to provide a preliminary certificate of compliance within 24 hours of the completion of each production run. This demonstrates that the product is within specifications and is reported in a "less than" format. Samples from each production run are also analysed 10 weeks after production for final certification. This demonstrates the extent to which the product is within specifications.

Radionuclidic purity of ^{99}Mo is determined through the following measurements in a separate dedicated laboratory:

- γ spectrometric determination of ^{99}Mo activity by using a calibrated high purity Ge detector;
- γ spectrometric determination of ^{131}I after separation by distillation with the aid of a carrier and tracer;
- γ spectrometric determination of ^{103}Ru after separation by ion-exchange with the aid of a carrier and tracer;
- β counting of ^{89}Sr and ^{90}Sr on a calibrated gas-flow proportional counter after separation by ion-exchange and precipitation with the aid of a carrier;
- α spectrometric determination of the total α activity with a calibrated low background α spectrometer after separation by ion-exchange and precipitation; and
- γ spectrometric measurement of a sub-sample to identify and quantify any possible γ emitting impurities at low levels.

Radiochemical purity of ^{99}Mo is determined by means of paper chromatography with a mixture of hydrochloric acid, water, ether and methanol as mobile phase. The distribution of activity on the paper is determined with a scanner, and the specific nuclide content of the relevant areas is measured by γ spectrometry.

Final product specification

Fission ^{99}Mo , which is produced as described above, is used for the production of $^{99\text{m}}\text{Tc}$ generators. The final ^{99}Mo product complies with the following specifications, which have been derived from European, British and United States Pharmacopoeia specifications for Sodium Pertechnetate- $^{99\text{m}}\text{Tc}$:

Radionuclidic purity

$^{131}\text{I}:$ ^{99}Mo	$< 5 \times 10^{-5}$
$^{103}\text{Ru}:$ ^{99}Mo	$< 5 \times 10^{-5}$
$^{89}\text{Sr}:$ ^{99}Mo	$< 6 \times 10^{-7}$
$^{90}\text{Sr}:$ ^{99}Mo	$< 6 \times 10^{-8}$
$\Sigma\alpha:$ ^{99}Mo	$< 1 \times 10^{-9}$
Other $\Sigma\beta/\gamma:$ ^{99}Mo	$< 1 \times 10^{-4}$

Radiochemical purity

>95% as molybdate (MoO_4^{-2}).

Radioactive concentration

>1 Ci(3.7×10^{10} Bq)/ cm^3 at calibration time.

Product solvent

0.2 M NaOH, normally containing NaOCl to stabilize Mo in the molybdate form.

Calibration date

3 to 7 days after shipment to the customer.

Shelf-life

7 days after the calibration date.

Waste management

All process consumables such as pipes, ion exchange columns and reagent containers are used for only one production run. After each run, these are collected and stored to allow for decay of the short-lived nuclides with which it is contaminated. This is followed by compaction and disposal as low-level waste.

Alkaline liquid waste is accumulated in shielded stainless steel tanks for later immobilization in a cement-vermiculite mixture. Other liquid waste, which is slightly acidic, is left to decay and is then treated with other on-site low-level liquid waste.

Hot cell off-gas is treated by adsorption and filtration as described above.

Practical experience gained

Being a raw material for medical end-use, it is absolutely imperative that all aspects of fission ^{99}Mo production are covered by a quality assurance programme. The latter should conform to an internationally accepted code of practice for quality systems, e.g. ISO 9002, as well as other requirements such as Good Manufacturing Practice according to 21 CFR Parts 210 and 211. Particularly important aspects are quality control of process consumables, strict control of the chemical purification process and purity certification of the final product.

Radiological and environmental monitoring as well as thorough waste management practices are critically important to ensure adherence to the ALARA principle and to minimize the environmental impact of production activities.

Drug Master Files have to be submitted to the pharmaceutical regulatory authorities in the countries where the product will be used in $^{99\text{m}}\text{Tc}$ generators and radiopharmaceuticals.

**Molybdenum-99 (⁹⁹Mo₄₂)
(By neutron irradiation)**

Half-life	:	65.94 h	
Production scheme	:	⁹⁸ Mo (n,γ) ⁹⁹ Mo	σ =0.13b
Target material	:	MoO ₃ (Fluka grade)	

Target specification and preparation

Target	MoO ₃ (90–120g per batch)
Container	Standard 1S aluminum cans, 22mm dia & 44mm ht cold weldable.
Target purity	>99.5%.
Enrichment	nil.
Impurities	Chloride, nitrate, phosphate, arsenate, silicate, sulphate to be less than 0.0115%. Calcium, cadmium, cobalt, chromium, copper, iron, potassium, magnesium, manganese, sodium, to be less than 0.0195%.
Suppliers	Fluka, E Merck.

Irradiation details

Reactor	100MW DHRUVA reactor.
Neutron flux	1.6×10^{14} n/cm ² /s.
Duration of Irradiation	1 week.
Cooling if applicable	nil.
Yield of ⁹⁹ Mo at EOI	1.48 GBq (40Ci) per batch.

Processing procedure

Facility: The radiochemical processing of molybdenum-99 is carried in sealed tong boxes kept under negative pressure (2–3 cm water gauge) and provided with 100 mm lead shielding. The boxes are connected to high efficiency particulate air filters (HEPA) fixed at the top of the boxes.

Procedure: Irradiated MoO₃ cans are opened using specially designed can cutters and the target is transferred to a dissolution flask containing 4N NaOH solution. The solution is heated to 60 degrees centigrade to facilitate complete dissolution. The solution is also simultaneously stirred by passing compressed air. The solution is then allowed to cool and passed through a filter to remove any undissolved impurity.

Final product specification

Radiochemical purity	Sodium molybdate in sodium hydroxide solution.
Radionuclide identification	By photo peaks corresponding to ⁹⁹ Mo.

The above procedure was provided by:
M. Ananthkrishnan,
Board of Radiation and Isotope Technology,
Department of Atomic Energy, Mumbai, India.

Radioactive concentration	2.2–2.6 GBq (60–70 mCi)/mL
Radionuclide purity	No other extraneous gamma emitters should be detectable in the gamma spectrum.
Specific activity	11–15 GBq (300–400 mCi)/g.
Appearance	A clear colorless solution.

Dispensing

⁹⁹Mo as sodium molybdate on sodium hydroxide solution is dispensed in 10–15 mL vials for supply to users directly or in 100 mL vials for shipment to Radiopharmaceutical labs for use as raw material for conversion into medical grade product for supply to hospitals for extraction of ^{99m}Tc^m.

Assay and quality control

The radioactivity is measured in a well type ionization chamber calibrated against a standard source. The radionuclide purity is checked by taking a gamma spectrum.

Nickel-63 ($^{63}\text{Ni}_{28}$)

Half-life	:	100 a
Production scheme	:	$^{62}_{28}\text{Ni} (n,\gamma) ^{63}_{28}\text{Ni}$
Target material	:	Ni powder (J.M. – Sp.pure)
Type of decay and energy	:	β^- (MeV) 0.066 (100%)
Decay product	:	^{63}Cu

Nuclear reactions and yield

Reaction	Isotope Abundance of nuclide%	Cross Section barns	Activity of element at $10^{12} \text{ n/cm}^2/\text{s}$			Secondary reactions And properties of Nuclide formed
			1 W	1 M	1 Year	
$^{62}_{28}\text{Ni} (n,\gamma) ^{63}_{28}\text{Ni}$	3.63	14.5	670 KBq (18.3 μCi)/g Ni	2.7 MBq (73.17 μCi)/g Ni	35 MBq (0.95 mCi)/g Ni	$^{58}\text{Ni}(n,\gamma) ^{59}\text{Ni}$ Half-life: 7.6×10^4 years Abundance: 68.08% $\sigma = 4.6$ barn $^{58}\text{Ni}(n,\alpha) ^{55}\text{Fe}$ Half-life: 2.73 years $\sigma = < 1$ mb $^{62}\text{Ni}(n,\alpha) ^{59}\text{Fe}$ Half-life: 44.5 days $\sigma = 0.002$ mb $^{64}\text{Ni}(n,\gamma) ^{65}\text{Ni}$ Abundance: 0.926% Half-life: 2.517 h $\sigma = 1.52$ b

Target specification and preparation

Target	10 g J.M.Spec Pure Ni powder.
Container	1S aluminium can 22 mm dia and 44 mm ht. cold weld sealed.
Irradiation	8 to 12 weeks.
Flux	$4 \times 10^{13} \text{ n/cm}^2/\text{s}$.
Type of facility For processing	Standard glove box with 5 cm local shielding. Box is maintained under negative pressure (2- 3 cm WG).

The above procedure was provided by:

M. Ananthkrishnan,
 Board of Radiation and Isotope Technology,
 Department of Atomic Energy, Mumbai, India.

Reagents

All the reagents used are of GR/AR quality and all dilutions are carried out using double distilled water.

Chemical process

The irradiated can is opened and nickel powder transferred to a dissolution flask. 60 mL concentrated HCl is added to it and the solution refluxed under heating for one hour to complete the dissolution. Acidity of the solution is adjusted to 9.5 N with reference to HCl by addition of concentrated HCl. The solution is then passed through an anion exchange column. Dowex 1 × 8 (50 to 100 mesh) (1 cm × 15 cm) conditioned with 200 mL 9.5 N HCl. The flow rate is maintained at 0.3 mL/minute. (The column is separately treated to recover ^{58}Co). The effluent is collected and concentrated to approx. 50 mL and once again the ion exchange procedure is repeated to eliminate trace quantities of gamma emitting impurities like ^{58}Co , ^{60}Co , ^{59}Fe etc.

The effluent from the column is concentrated to minimum volume and the solution is diluted with 0.1N HCl.

Assay and quality control

The activity assay is done by liquid scintillation counting. Radionuclide purity is controlled by beta absorption analysis and gamma spectrometry.

Characteristics of final solution

Chemical form	Ni Cl ₃ in dil. HCl solution.
Radioactive concentration	4 to 40 MBq/mL
Radionuclide purity	>99%.
Specific activity	>200 MBq/g Ni.

Osmium-191 ($^{191}\text{Os}_{76}$)

Half-life : 15.4 d
Production scheme : $^{190}\text{Os} (n,\gamma) ^{191}\text{Os}$

Osmium-191 is used as the parent for the osmium-191/iridium-191m generator system (Brihaye, *et al.*, 1986a; Brihaye, *et al.*, 1986b). The ultra short-lived iridium-191m ($t_{1/2}$ 4.96s) has been used for firstpass ventriculography (Franken, P.R., *et al.*, 1989).

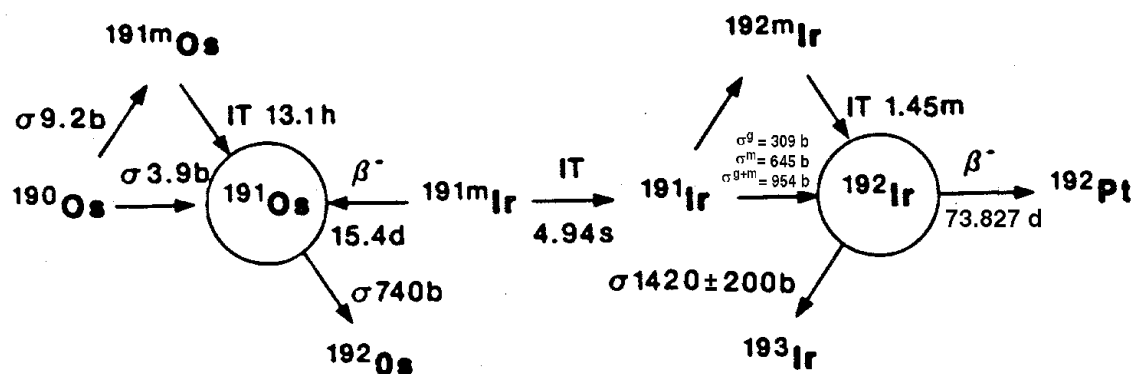

FIG. 1. Production and decay scheme for osmium-191.

Type of decay and energy

β	0.1424	(100%)
γ	1.29.43	(29%)

Target specification and preparation

1. Highly enriched and highly purified osmium-190 is generally used as the metallic powder for production of osmium-191 to minimize any radionuclide impurities in the final product. Depending on the desired activity yield, 10–30 mg of enriched osmium-190 are sealed in evacuated quartz tubes.
2. Enrichments greater than 96% will provide the highest purity osmium-191.
3. Although highly enriched osmium-190 target material is used, decay of the metastable iridium-191m in the reactor during the irradiation process forms iridium-191 which captures a neutron with formation of low levels of iridium-192 ($t_{1/2}$ 73.8 days) as an induced radionuclide impurity (Brihaye, *et al.*, 1989; Butler, *et al.*, 1985).
4. Highly enriched osmium-190 (>95%) is available from Isotope Distribution Office (IDO) the Oak Ridge National Laboratory (ORNL).

The above procedure was provided by:

F.F. Knapp, Jr.,
 Oak Ridge National Laboratory,
 Oak Ridge, Tennessee 37830-6229, USA

C. Brihaye,
 Cyclotron Research Centre,
 Sart Tilman, B-4000, Liege, Belgium

Irradiation parameters, specific activity and total yield at EOI

The calculated specific activity values for production of osmium-191 at various thermal neutron flux values are illustrated in Fig. 2.

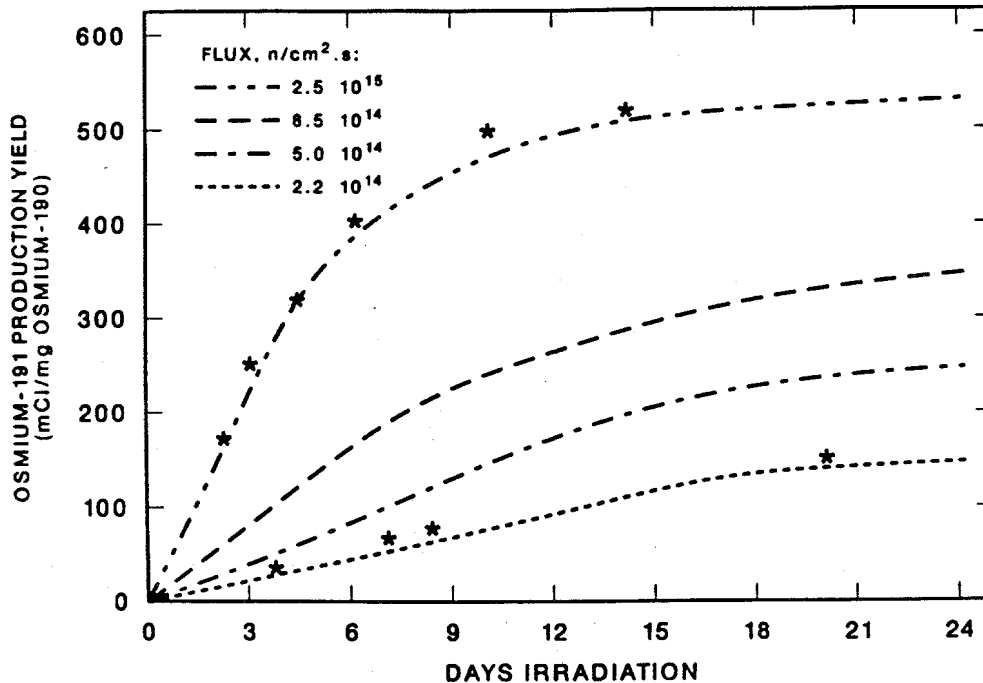

FIG. 2. Predicted specific activity values for reactor production of osmium-191 at various thermal neutron flux values (from Brihaye, et al., 1989).

Type of facility for processing

A highly shielded hot cell is required for processing any significant levels of osmium-191. An apparatus similar to the one shown in Fig. 3 is required for removal of the iridium-192 impurity.

Analysis of raw materials, reagents and chemicals required for processing

A zirconium crucible is required for the oxidative dissolution of the irradiated osmium-190 target (Brihaye, et al., 1989; Butler, et al., 1985). All other reagents and chemicals should be analytical grade.

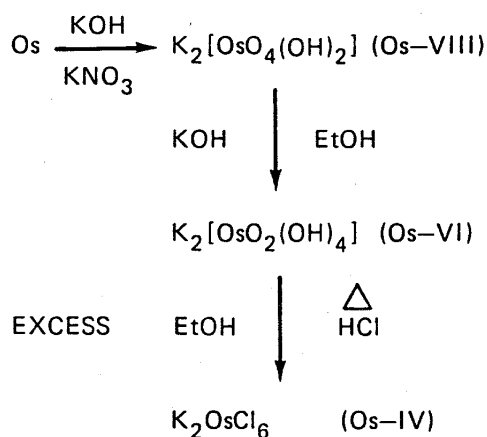

FIG. 3. Processing of reactor-irradiated osmium-191 target.

Chemical processing procedure

The procedure for the chemical processing of reactor-produced osmium-191 has been described in detail earlier (Brihaye, *et al.*, 1989; Brihaye, *et al.*, 1986a) and is based on the sequential oxidative dissolution of the irradiated target as summarized in Fig. 3.

The iridium-192 radionuclide impurity is always present in reactor-produced osmium-191. It is formed by neutron capture of the iridium-191 formed *via* isomeric decay of the metastable iridium-191m formed by decay of osmium-191 (Fig. 1). The iridium-192 can be readily removed by acidification of the processed solution and distillation of osmium-191 as osmium tetroxide. The non-volatile iridium-192 remains behind in the vessel as described in detail earlier (Brihaye, *et al.*, 1989), and can be a source of carrier iridium-192 (Fig. 4a).

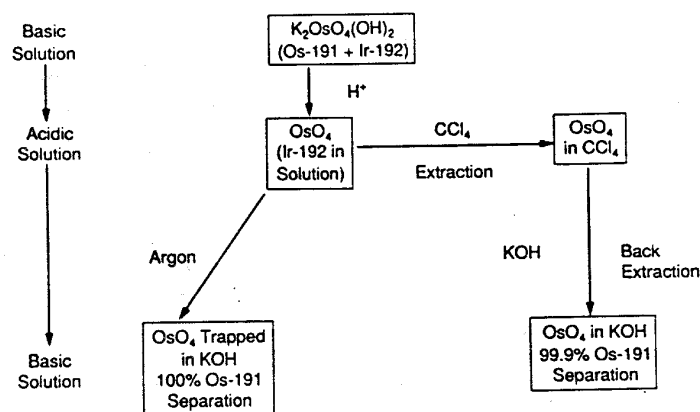

FIG. 4a. Chemical transformations used for purification of osmium-191 and removal of iridium-192 impurity (from Brihaye, *et al.*, 1989).

Dispensing, assay and quality control

Following dissolution and distillation, the sodium perosmate solution probably has a definite shelf-life and should be used for generator fabrication within a few days after formation, although the effects of long-term storage on stability and decomposition have not been evaluated and reported.

Final product specification for use

The required specifications for the final osmium-191 product depend upon the intended application. For medical use for fabrication of the osmium-191/iridium-191 m generators, it is important that the iridium-192 impurity be removed. The levels of iridium-192 formed will of course depend upon the particular reactor used for the irradiation. A gamma spectrum should be provided to document the radionuclidic purity.

Practical experience gained

In our experience, the shelf-life of the processed osmium-191 solution may be limited.

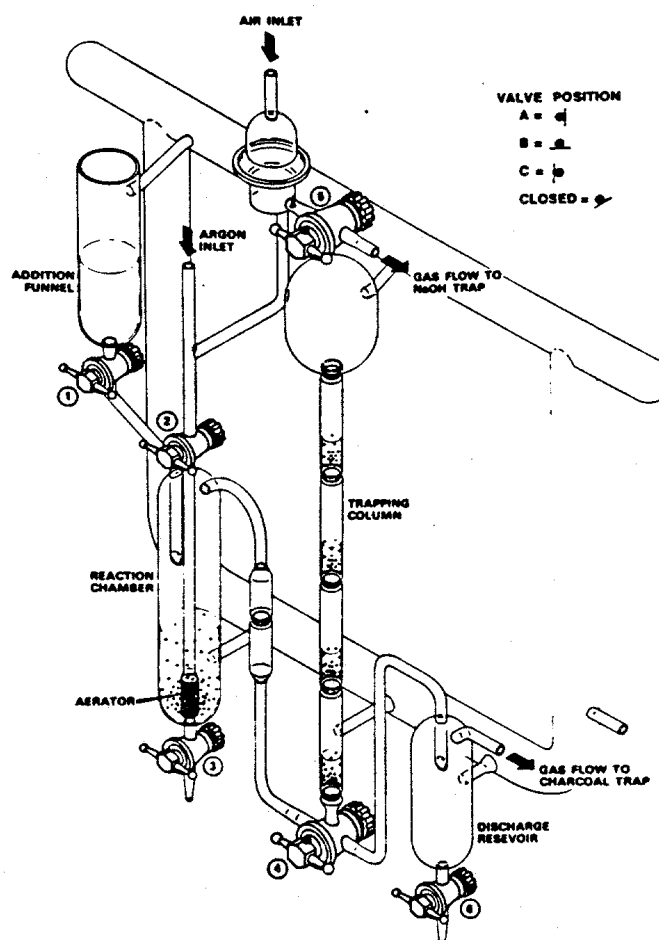

FIG. 4b. Apparatus used for purification of osmium-191 and removal of iridium-192 impurity (from, Brihaye, et al., 1989).

BIBLIOGRAPHY

BRIHAYE, C., BUTLER, T.A., KNAPP, F.F., JR. "The $^{191}\text{Os}/^{191m}\text{Ir}$ Generator for Clinical Use. I. Evaluation of Potential Adsorbants", *J. Radioanalyt. Nucl. Chem.*, **102** (1986) 399–411.

BRIHAYE, C., BUTLER, T.A., KNAPP, F.F., JR., GUILLAUME, M., WATSON, E.E., STABIN, M.G., "New Osmium-191/Iridium-191 m Radionuclide Generator System Using Activated Carbon", *J. Nucl. Med.*, **27** (1986) 380–387.

BRIHAYE, C., DEWEZ, S., GUILLAUME, M., CALLAHAN, A.P., RICE, D.E., KNAPP, F. F., JR., "Reactor Production and Purification of Osmium-191 for Use in a New $^{191}\text{Os}/^{191\text{m}}\text{Ir}$ Radionuclide Generator System", *Appl. Radiat. Isot.*, **40** (1989) 183-191.

BUTLER, T.A., BUYER, C.E., KNAPP, F.F., JR., "Production of Osmium-191 in the Oak Ridge High Flux Isotope Reactor" (Proc. International Symposium on Single-Photon Ultra-Short Lived Radionuclides, PARAS, P., THIESSEN, J.W., Eds.), U. S. Department of Energy, DOE Symposium Series, No. 57, Office of Scientific and Technical Information, Oak Ridge, TN, USA (1985) 195-201.

FRANKEN, P.R., DOBBELEIR, A.A., HAM, H.R., BRIHAYE, C., GUILLAUME, M., KNAPP, F.F., JR., VANDEVIVIERE, J. "Clinical Usefulness of Ultrashort-Lived Iridium-191m from a Carbon-Based Generator System for Evaluation of the Left Ventricular Function", *J. Nucl. Med.*, **30** (1989) 1025-1031.

Osmium-194 ($^{194}\text{Os}_{76}$)

Half-life	: 6.0 ± 0.2 a	
Production scheme	: $^{192}\text{Os} (n,\gamma) ^{193}\text{Os} (n,\gamma) ^{194}\text{Os} \rightarrow ^{194}\text{Ir}^{\beta^-}$	$\sigma_1 = 2.0 \pm 0.1$ b $\sigma_2 = 38 \pm 10$ b
Type of decay and energy	: β^-	2.246 MeV (85.4%) 1.918 MeV (9.3%) 1.625 MeV (1.28%)

Target specification and preparation

The target material is enriched metallic osmium-192.

Irradiation parameters, specific activity and total yield at EOI

Because of the relatively low thermal neutron cross-sections of the osmium-192(n, γ)osmium-193 (2 barn) and for the second osmium-193(n, γ)osmium-194 neutron capture (250 mb; estimated, see Mirzadeh, et al., 1992), and the long 6-year half-life of osmium-194, production yields are low (Fig. 1), even at high thermal neutron flux values. As an example, even at a thermal neutron flux of about 2.5×10^{15} n/cm²/s, a 60-day irradiation in the ORNL HFIR provides osmium-194 is only about 18.5 MBq (0.5 mCi)/mg enriched osmium-192 (Fig. 1).

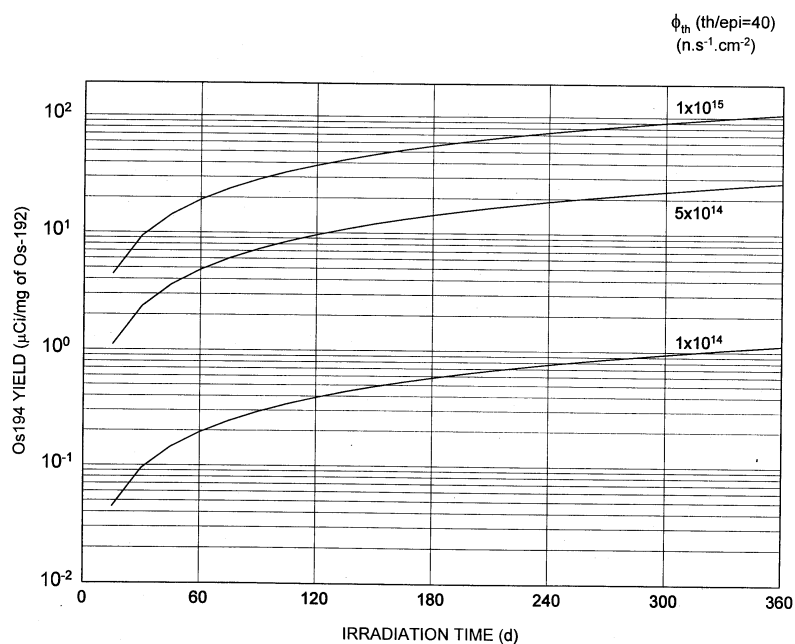

FIG. 1. Projected reactor production yields of osmium-194.

The above procedure was provided by:
S. Mirzadeh and F. F. Knapp, Jr.,
Nuclear Medicine Programme,
Oak Ridge National Laboratory,
Oak Ridge, Tennessee 37830-6229, USA.

Type of facility for processing

An adequately shielded hot cell is required for processing the irradiated target.

Chemical processing procedure

An efficient method involving the thermographic conversion of the metallic osmium-192 target material to osmium tetroxide (Fig. 2) which is removed in a stream of air and subsequently trapped as potassium osmate (Mirzadeh, et al., 1992).

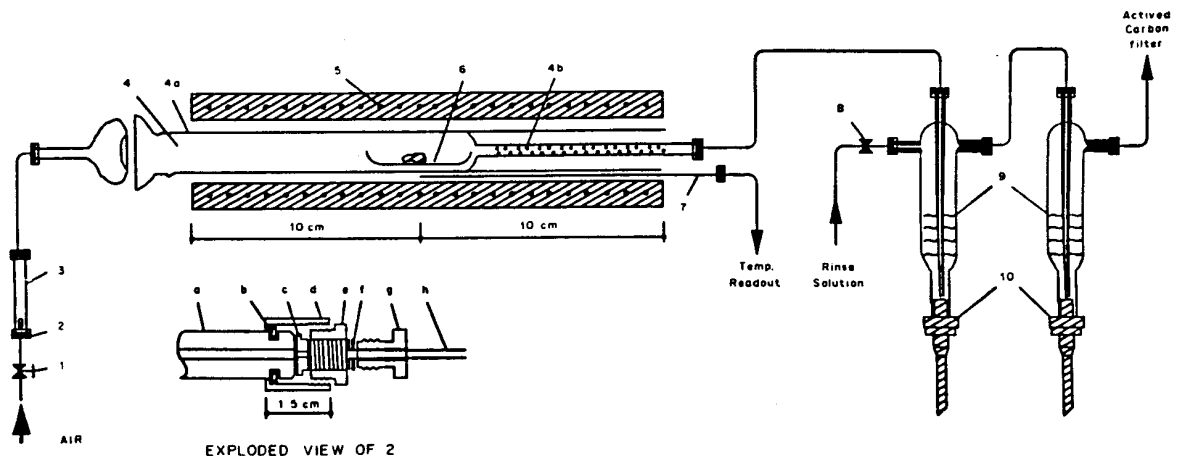

FIG. 2. Apparatus for the gas-thermochromatographic system for purification of reactor-produced osmium-194 (From Mirzadeh, et al., 1992) — 1. Metering Valve; 2. CHIMINERT⁷ glass/Teflon connector (See exploded view); 3. Air volume flow meter; 4. Chromatographic tube assembly; 4a. Quartz tube (2.8 cm o.d., 2.4 cm i.d., 20 cm long); 4b. Chromatographic tube (quartz, 6 mm o.d., 12 cm long) containing 60 mesh quartz powder held in tube by quartz wool; 5. Split tube furnace; 6. Quartz boat containing osmium target; 7. Thermocouple; 8. Sliding ring (PVC); (c) bed support (Teflon), (d) nut (PVC), (e) bushing (PVC), (f) washer (SS), (g) tube end fitting (PVC), (h) Teflon tubing (0.6 mm i.d.) With flanged end.

Thermochromatography separation of osmium

1. The thermochromatography apparatus is of a conventional design (Fig. 2). A quartz tube (2 cm i.d. and 10 cm long) from one end is attached to a ball joint and the other end (the exit end) is reduced in orifice and attached to a 4 mm i.d. chromatographic column. This column (12 cm long) is packed with 60 mesh acid-washed quartz powder. The cold end of the chromatographic column is attached in series to two KOH traps and one activated carbon trap.
2. The chromatography tube assembly is placed into a split tube furnace. The boat containing the irradiated osmium-102 sample is introduced into the tube from the ball joint end and centered at the position of the maximum temperature at the center of the furnace.

3. The furnace temperature is monitored with a thermocouple placed close to the center of the oven and a Variac is used to control the furnace temperature. The volume flow rate of the carrier gas (air) is monitored by a flow meter. An evolved version of the above apparatus that is currently used for routine hot-cell operations is shown in Fig. 2.
4. For ease of remote handling connections between the chromatographic assembly and air supply line, the traps are made with Teflon tubing (0.6 mm i.d.). The glass/Teflon-tubing connections can conveniently be made by the use of Cheminert connectors (Valco Instruments Co., Houston, TX). The exploded view of this connector is also shown in Fig. 2.
5. The irradiated ^{192}Os (50 mg or less) target is transferred to a quartz boat which is then placed in the chromatography tube assembly. While maintaining an air flow rate of 10–20 mL/min the furnace is turned on.
6. As OsO_4 forms, it is carried by the air and trapped in 2 mL of 0.1 M KOH placed downstream (Fig. 2). The first evidence of conversion of metallic Os to OsO_4 usually occurs at ~300EC within the first 30 min of start of distillation, as indicated by the slight yellowish color in the first trap.
7. Distillation is continued for the next 2 h where the furnace temperature is increased to ~500EC. At this point, conversion is usually complete, and the furnace is turned off. The air flow is continued for an additional 3 h to insure quantitative transport and recovery of the OsO_4 .

Dispensing, assay and quality control

The gamma spectrum of the product is used to determine the purity of the distilled/trapped osmium-194 by analysis of the 328 keV (13% abundance) gamma photon of the iridium-194 daughter after equilibrium is attained.

Final product specification for use

The final product can be stored as a solution of potassium perosmate and used for subsequent reduction to the Os(IV) species for preparation of the activated carbon-based osmium-194/iridium-194 generator system as described in detail for preparation of the osmium-191/iridium-191m generator system (Brihaye, et al., 1986).

Practical experience gained

The quantitative conversion of 50 mg of Os to OsO_4 within 2.5 h and under the above conditions is demonstrated by analysis of the mass of the boat before and after distillation in several cold runs employing natural Os metal. Consistently, a light-weight black residue (~1% of the Os mass) remains in the boat after distillation. By spectrographic analysis, the residue is found to be primarily graphite.

BIBLIOGRAPHY

BRIHAYE, C., BUTLER, T. A., KNAPP, F.F., JR. GUILLAUME, M., WATSON, E.E., STABIN, M.G., "New Osmium-191/Iridium-191m Radionuclide Generator System Using Activated Carbon", *J. Nucl. Med.*, **27** (1986) 380–387.

MIRZADEH, S., KNAPP, F.F., JR., CALLAHAN, A.P., Production of Tungsten-188 and Osmium-194 in a Nuclear reactor for New Clinical Generators, *Nuclear Data for Science and Technology* (QAIM, S., Ed.), Springer Verlag Pub. (1992) 619–620.

MIRZADEH, S., RICE, D.E., KNAPP, F.F., JR. "Carrier-free ^{194}Ir from an $^{194}\text{Os}/^{194}\text{Ir}$ Generator — A New Candidate for Radioimmunotherapy," *Appl. Radiat. Isot.*, **43** (1992) 689–692.

Palladium-103 ($^{103}\text{Pd}_{46}$)

Half-life : 16.99 d
Production scheme : $^{102}\text{Pd} (n,\gamma) ^{103}\text{Pd}$ $\sigma = 3 \text{ b}$

Type of decay and energy

EC 100%
 γ (MeV) 0.04 (2%)
0.02 Rh X rays
IC 10%

Secondary reactions : $^{108}\text{Pd}(n,\gamma)^{109}\text{Pd}$ (Half-life-13.46 h).
 $^{110}\text{Pd}(n,\gamma)^{111}\text{Pd} \rightarrow ^{111}\text{Ag}$ (Half-life-7.5days).

Target material : Palladium sponge.

Specifications and preparation target

Palladium sponge spec pure, J.M (100 mg).

Irradiation container

Standard aluminum container of dimensions: 22 mm dia \times 46 mm ht and cold-welded.

Irradiation period : 4 weeks.

Neutron flux : $4 \times 10^{13} \text{ n/cm}^2/\text{s}$.

Yield : 370 MBq (10 mCi) (approx.).

Type of facility for processing

Standard glove box of dimensions 2 \times 1 \times 2 m provided with lead shielding wall of 5 cm.

Chemical processing

The irradiated target palladium is allowed to cool for about a week before chemical processing for decay of short-lived contaminants. The target is dissolved in 5 mL of aqua regia. Excess HNO_3 is destroyed by repeated treatment with small quantities of concentrated hydrochloric acid. The solution is evaporated to small volume and 10 mL 9.5 N HCl is added to it. Then the solution is passed through an ion-exchange column (1 cm dia \times 15 cm long) Dowe \times 1 \times 8, 50–100mesh conditioned with 9.5N HCl at a flow rate of 0.25 mL/minute. The column is washed with approximately 100 mL of 9.5 N HCl. The effluent is collected for recovery of an important by-product ^{111}Ag .

The above procedure was provided by:

M. Ananthkrishnan,
Board of Radiation and Isotope Technology,
Department of Atomic Energy, Mumbai, India.

The column is washed free from HCl by passing double distilled water. Palladium is eluted with 25 mL of concentrated ammonia solution followed by 100 mL of 1N ammonium hydroxide. The eluate is collected and evaporated to a small volume and treated with 5 mL concentrated HNO₃. A small quantity of concentrated HCl is also added to the solution and boiled to remove excess HNO₃. The solution is diluted with 10 mL of 1N HCl.

Assay and quality control

Radioactive concentration and activity yield are calculated based on activation data such as, period of irradiation, neutron flux and mass of the target.

Radionuclidic purity

This is determined by gamma ray spectrometer.

Specific activity

The quantity of palladium in the solution is estimated spectrophotometrically and the activity is calculated from irradiation data.

Characteristics of the solution

Chemical form: PdCl₃ in dilute hydrochloric acid.

Radioactive concentration: ~37 MBq (1 mCi)/mL

Palladium-109 ($^{109}\text{Pd}_{46}$)

Half-life	:	13.7012 ± 0.0024 h	
Production scheme	:	$^{108}\text{Pd} (n,\gamma) ^{109}\text{Pd}$	$\sigma = 8.5 \pm 0.5$ b
Type of decay and energy	:	β^- (MeV) 1.028 (99.9%)	γ (MeV) 0.088 (3.6%)

Target specification and preparation

Palladium-109 is reactor-produced by the radiative (n, γ) reaction on palladium metal targets.

Irradiation parameters, specific activity and total yield at end of irradiation

Enriched high purity palladium metal targets are used. The projected production yields of palladium-109 from irradiation of palladium-108 as a function of irradiation time at various thermal neutron flux values are shown in Fig. 1.

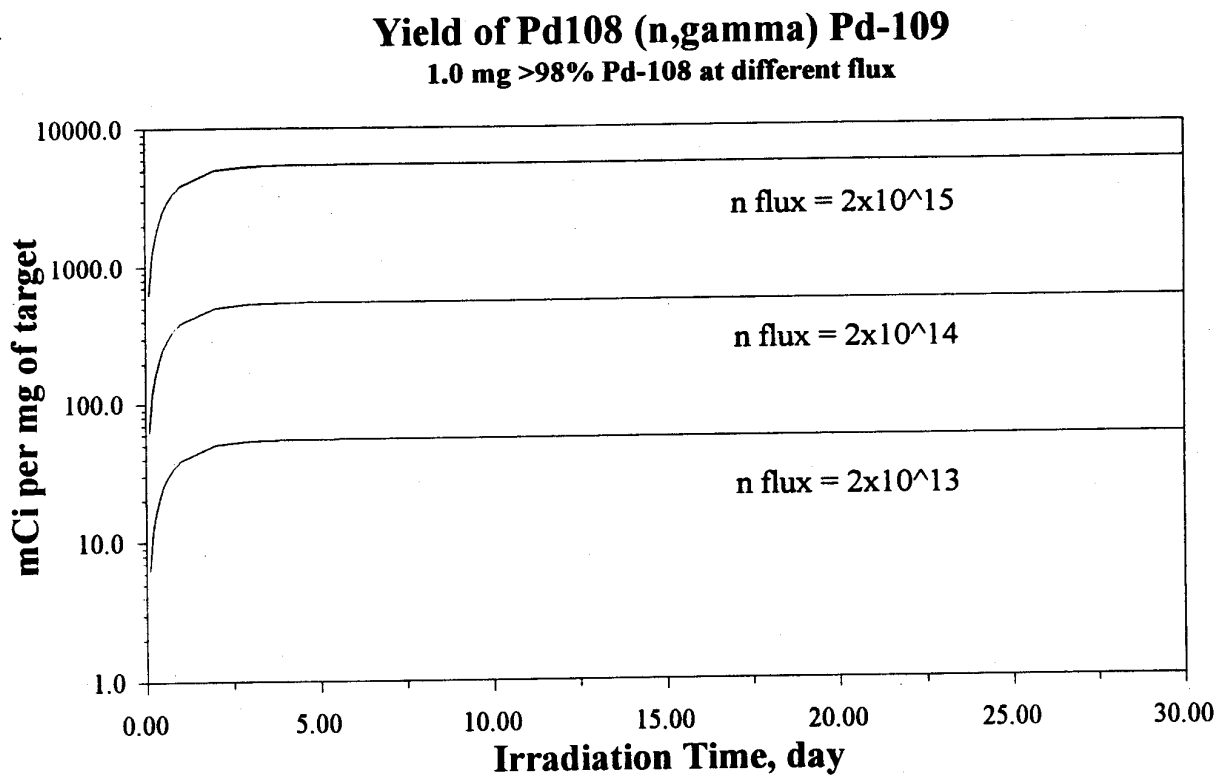

FIG. 1. Calculated production yields of palladium-109 by neutron irradiation of palladium targets as a function of irradiation time at various thermal neutron flux values.

The above procedure was provided by:
M. Du and F.F. Knapp, Jr.,
Nuclear Medicine Programme,
Oak Ridge National Laboratory,
Oak Ridge, Tennessee 37830-6229, USA.

Type of facility for processing

An adequately shielded hot cell or other shielded facility (>3 inches of lead), for processing the irradiated targets equipped of an off gas system is required.

Chemical processing procedure

Processing of palladium-109 from palladium metal targets (from ORNL radioisotopes procedure manual, ORNL-3633, 1964)

1. Prepare equipment which includes the hot off-gas scrubber unit, 150 mL Pyrex beaker and 100 mL product bottle.
2. Open irradiation can and transfer target into beaker under a hot off-gas scrubber assembly.
3. Cover target material with *aqua regia* and heat to near boiling. Add fresh *aqua regia* as required until the target material is completely dissolved.
4. Evaporate target solution to 3 to 4 mL during which time the excess acid is expelled.
5. Dilute to 50 mL with distilled H₂O and transfer to product bottle. Product solution should be clear and reddish brown in color.
6. Sample and analyse for:

Molarity of HCl
Total solids
¹⁰⁹Pd concentration
Radiochemical purity.

Dispensing, assay and quality control

The final product should be analysed by gamma spectroscopy.

Final product specification for use

The product is supplied as the chloride in HCl solution. The radiochemical purity should be >95%, exclusive of the silver-109m daughter activity.

Practical experience gained

The final yields of palladium-109 are usually >80%. At ORNL at a thermal neutron flux of about 1×10^{13} n/cm²/s, the optimal irradiation time was about 60 hours, with an average target mass of 50 mg, and a yield of 12.95 GBq (350 mCi).

BIBLIOGRAPHY

OAK RIDGE NATIONAL LABORATORY, Radioisotopes Procedures Manual, ORNL-3633, UC-23-Isotopes — Industrial Technology, TID-4500 (30th ed.), Tennessee (1964).

Phosphorous-32 ($^{32}\text{P}_{15}$)

Half-life : 14.26 d

Production scheme : $^{32}_{16}\text{S}(\text{n,p})^{32}_{15}\text{P}$

Nuclear reactions and yield

Reaction	Isotope Abundance of nuclide%	Cross Section barns	Activity of element at 10^{12} n/cm ² /s.			Secondary reactions and properties of Nuclide formed
			One week	Four Weeks	Saturation	
$^{31}\text{P}(\text{n},\gamma)^{32}\text{P}$	100	0.17	950 MBq (25.6 mCi)/g	2.5 GBq (66 mCi)/g	3.26 GBq (88.2 mCi)/g	$^{31}\text{P}(\text{n,p})^{31}\text{Si}$ Half-life: 2.62 h. (threshold 732 keV)
$^{32}\text{S}(\text{n,p})^{32}\text{P}$	95.02	0.065	330 MBq (9 mCi)/g	860 MBq (23.2 mCi)/g	1.15 GBq (31 mCi)/g	$^{34}\text{S}(\text{n},\gamma)^{35}\text{S}$ Half-life: 87.51 days Abundance=4.21 $\sigma = 0.227$ b $^{33}\text{S}(\text{n,p})^{33}\text{P}$ Half-life: 25.34 days Abundance: 0.75%

Type of decay and energy

β^- 1.71 MeV (E_{max}) 0.6949 MeV (E_{av}).

Decay product : ^{32}S

Target material : Elemental sulphur (S)- redistilled.

Target specification and preparation

Target Elementary sulphur (EM) GR highly purified by many cycles of distillation purity greater than 99%, used as target for irradiation.

Container Standard 1S aluminium can (22 mm dia and 44 mm ht.) each is filled with 18 g of sulphur. The capsules are sealed by cold welding process and tested leak proof in boiling water. 14 capsules are normally processed per run.

The above procedure was provided by:

M. Ananthkrishnan,
Board of Radiation and Isotope Technology,
Department of Atomic Energy, Mumbai, India.

Irradiation	A typical irradiation of 250 g of purified sulphur at a flux of 1×10^{14} n/cm ² /s. For 8 weeks produces ~100 GBq (2.5 to 3 Ci) of ³² P with sp. activity in the HE range of 185 TBq (5000 Ci)/m.mole.
Flux	10^{14} n/cm ² /s.

Extreme care is taken in cleaning the buffed surface of irradiation container to prevent any impurity coming in contact with the target.

Reagents

All the reagents used are of GR/AR grade.

Type of facility for processing

³²P is classified as a class 3 (moderate toxicity) isotope and has an effective half-life of 14.26 days. The maximum beta energy value being 1.71 MeV. The bremsstrahlung spectrum has maximum at 100–300 keV. The practical system of shielding ³²P consists of a sheet of perspex followed by lead. The processing plant set up in A type of radioactive laboratory consists of a tight aluminium glove box 1.5 m × 1.2 m × 1.5 m feet size with 5 cm lead wall on all four sides. The front and back sides of the box are fitted with 150 mm dia glove port rings to mount gloves, gaiters, can openers, panthograph etc. A cut out 60 cm × 30 cm on front and back side of the box is fitted with 10 mm perspex. A pair of 100 mm × 150 mm inch × 100 mm inch lead glass on both sides provides the necessary view inside the box. Sufficient number of glands fitted with nozzles on top as well as bottom side of box are connected to service lines such as reagents, compressed air, suction, electric supply, cooling water etc. A fume hood 1.2 m × 1 m × 1.5 m feet is attached to the glove box through a tunnel door of the glove box which opens into the fume hood. An aluminium rail with a trolley runs through the entire length of the box and ends at the tunnel box to facilitate movement of the material inside the box. An exhaust pump connected through a HEPA filter to the plant provides the necessary negative pressure inside the plant which is maintained at about 2 to 3 cm WG less than atmosphere.

The process equipment consists of a distillation flask, receiver, ion exchange (cation) column, evaporating flask and storage bottle all made of corning glass with standard joints.

Chemical process

The irradiated cans are decapped and transferred to a funnel on the distillation flask and heated to 130 degrees C when all the sulphur melts and collects in the distillation flask. The distillation assembly is connected to a vacuum pump and pressure reduced to 1 to 5 mm Hg. Distillation of sulphur takes place between 180 to 200° C and is completed in 1–2 h. The vacuum is released and flask allowed to cool. ³²P activity is leached out in 100 mL 0.1 N pure HCl heated to approx. 60–70° as H₃³²PO₄ and purified free from impurities by passing through a cation exchange column. Dowex 50 (1 × 8). Excess HCl is removed by evaporation under infrared lamp and then pH of product brought to 1 to 2 with respect to HCL.

The distilled sulphur collected in a receiver is found suitable for reuse as target after a period of six months.

Assay and quality control

The stock solution is assayed for radioactivity in ion chamber by measuring the ion current produced by bremsstrahlung radiation (or by β^- counting in a GM counter). Specific activity is determined by spectrophotometric method measuring the absorption maxima at 660 nm of the malachite green molybdophosphate complex containing ^{32}P .

The radionuclide purity is determined by finding the range of beta by beta absorption using GM Counter and absence of any gamma emitting impurities in gamma spectrum (MCA).

Radiochemical purity is determined by paper chromatography using a solvent mixture consisting of isopropanol, ammonia and trichloroacetic acid.

Rf of orthophosphate	0.76
Rf of metaphosphate	0.00
Rf of pyrophosphate	0.40.

Characteristics of final solution

Radiochemical form	H_3PO_4 in dilute HCl.
Radioactive concentration	1.11 to 2.96 GBq (30–80 mCi)/mL.
Radiochemical purity	Orthophosphate content >95 per cent.
Radionuclide purity	>99%, no extraneous gamma emitting impurities noticeable.
Specific activity	>110 TBq (3000 Ci)/mM of P (>111 TBq).
Appearance	A clear colourless solution turns the colour of container glass vial brown.
Intended use	$\text{H}_3\text{}^{32}\text{PO}_4$ is used in the preparation of ^{32}P labelled nucleotides. It is also used for bone pain palliation in metastasis. Phosphatic fertilizers with labelled ^{32}P are prepared using $\text{H}_3\text{}^{32}\text{PO}_4$.

Phosphorus-32 ($^{32}\text{P}_{15}$) (Alternate procedure)

Production scheme : $^{32}\text{S} (\text{n,p}) ^{32}\text{P}$

Target specification and preparation

Sublimated sulphur in the form of fine powder is used as a target material. It is obtained by evaporation and sublimation condensation of sulphur in the inert gas atmosphere.

Trade name: Sulphur sublimated for analysis Chemical specification:

assay of sulphur	>99.96%
sulphated ash	<0.02%
arsenic	absence
water	<0.10%
acids (as H_2SO_4)	<0.005%
organic matter	<0.015%
solubility in NaOH	complete

Supplier: Research and Development Centre of Sulphur Industry (“SIARKOPOL”), 39–405 Tarnobrzeg, Poland.

Sulphur is melted and poured to the aluminium capsules which are immersed in the cooling water bath. After cooling down the capsules are sealed and transferred to the irradiation site.

Irradiation parameters, specific activity and total yield

Irradiation site:	MARIA reactor IEA, Swierk, Poland Russia	SM-3 reactor NIAR Dymitrovgrad,
Assembly:	vertical irradiation channel in aluminium block	
Capsules:	aluminium, ϕ 15, length 88 mm mm	aluminium, ϕ 8, length 80
Sealing:	cold rolling	welding
Mass of target:	about 19 g	about 3 g
Reactor flux:	10^{14} n/cm ² /s	1.37×10^{14} n/cm ² /s
Irradiation time:	5–6 cycles of 100 hours	20 days

The average activity obtained (calculated at the activation end) is about 8.15 GBq (220 mCi) ^{32}P /g of sulphur.

Type of facility for processing

The hot cell of 100 mm lead wall equipped with manipulators and connected to the separate ventilation system. Filters on the air outlet: paper-charcoal. Standard under pressure inside the hot-cell is 20 mm H_2O .

The above procedure was provided by:

K. Chrustowski
Radioisotope Centre, OTWOCK
Swierk, POLATOM, Poland.

Analysis of raw materials, reagents and chemicals required for processing

Sulphuric acid 96%	:	Ultrapur, supplier Merck.
Ethyl alcohol 96%	:	pure for analysis, supplier: Polish Chemicals.
Hydrochloric acid 36%	:	reagent Ph.Eur., supplier Merck.
Purified water	:	deionized water, Elix 10 system, Millipore.

Chemical processing procedure

The irradiated target material is melted and poured into water. Dispersed material is dried out and grind to the fine powder. The leaching process is carried out in diluted sulphuric acid solution with addition of ethyl alcohol and continuous agitation. Phosphorus-32 is separated from the residual sulphur by filtration. The obtained solution is evaporated to about 5 mL volume, transferred to the glass vial and autoclaved for about 1h at 131°C. The obtained product solution is purified by chromatography. First on the column filled with Dowex 50W × 4 (cation exchanger) eluted with water and then on the column with cellulose DE-11 (anion exchanger) eluted with 0.01 M HCl. The obtained solution of H₃³²PO₄ is diluted with 0.01 M HCl to the desired activity. Schematic diagram of the production process is presented on the next page.

Dispensing, assay and quality control

Parameters of the obtained solution are controlled: pH, radiochemical purity, specific activity, radioactive concentration and radionuclidic purity.

Natural sulphur consists mostly of ³²S but it contains also other isotopes of sulphur like ³³S, ³⁴S and ³⁶S. Due to possible reactions: ³³S (n, p) ³³P and ³⁴S (n, γ) ³⁵S phosphorus-33 and sulfur-35 can be present in the product.

³³P has a half-life of 25,3 days and decays by β⁻ with the energy of 250 keV.

³⁵S has a half-life of 87,5 days and decays by β⁻ with the energy of 167 keV.

Test for radionuclidic purity

Gamma radiation impurities

The measurement is performed by gamma-spectrometry (HPGe detector with the volume of 70 cm³ and resolution of 0.8 keV at 122 keV from ⁵⁷Co and 1.8 keV at 1332 keV from ⁶⁰Co). The spectrum is recorded by multichannel analyser ND-76 (The Nuclear Data, Inc.) 1 mL of the solution in a standard glass vial is measured. γ-radionuclidic impurities are detected at the lowest limit of 5 × 10⁻⁵%. In most of the produced batches γ impurities were not exceeding 0.001%.

Beta radiation impurities

The measurement is performed on anthracene crystal detector (φ 15 × 8 mm) and spectrum is recorded by multichannel analyser ND-76 (The Nuclear Data Inc.). The sample is prepared in the form of point source on mylar foil. In most of the produced batches the results of ³⁵S determination in the product were far below 0.1%

Intensities of the emitted lines in the recorded spectrum are evaluated. The limits for impurities in ^{32}P - solution are as follows:

Element	Concentration [$\mu\text{g/mL}$]	Element	Concentration [$\mu\text{g/mL}$]	Element	Concentration [$\mu\text{g/mL}$]
Fe	0.2	As	0.5	Cd.	0.3
Cu	0.1	Al.	0.5	Si	0.2
Ca	0.1	Ba	0.1	Mg	0.2
Pb	0.2	B	0.2	Mn	0.1
Te	0.5	Zn	0.5	Ni	0.1

Test for pH

Potentiometric pH determination of the radioactive $\text{H}_3^{32}\text{PO}_4$ with a glass electrode immersed in the solution is not possible. Therefore pH of the solution is determined by colorimetric relative method (paper strips). The strips are covering the pH range specified for the $\text{H}_3^{32}\text{PO}_4$. Sensitivity of the strips is controlled periodically.

Final product specification for use

TESTS	SPECIFICATIONS
Identification: beta -spectrum	absorption curve of maximum energy 1.71MeV
Characters	Clear, colourless liquid
pH	1.0–2.2
Radionuclidic purity	>99.5%
Radiochemical purity	>99.0%
Radioactive concentration	$\geq 14.8 \text{ GBq/mL}$
Specific activity	$\geq 9 \text{ TBq/mg P.}$
Chemical purity	$\geq 99.9\%$

^{32}P in the form of ortho-phosphoric acid is used for production of nucleotides labeled with ^{32}P etc. and for production of radiopharmaceutical: Sodium ortho-phosphate - ^{32}P for injection, destined for therapy of polycythemia vera and polythrombocythemia.

Shelf-life: four weeks from the calibration date.

Disposal of generated waste: The residual sulphur which still contains some not leached phosphorus-32 is melted and poured to the metal containers and then disposed as a solid waste.

Preparation and cleanup of the facility and preparation for processing of next production batch: The processing is performed in single steps which are performed in the destined cells of a hot cell. Therefore there aren't any special requirements for cleanup of the facility. Glass vials for final product dispensing are washed and heated in 250°C prior to use and closures are washed and autoclaved.

Practical experience gained

The glass beakers and other vials used during processing of carrier-free ^{32}P must be made of good quality glass (high hydrolytic resistance). This prevents washing out of cations which may contaminate the product and reduces adsorbance of carrier-free phosphorus-32 on glass walls which may influence the yield of the process.

Preparation of target material in the form of melt and then melting of residual sulphur for waste disposal make the handling of sulphur easier, its volume is reduced and contamination of laboratory space and inside a hot-cell is avoided.

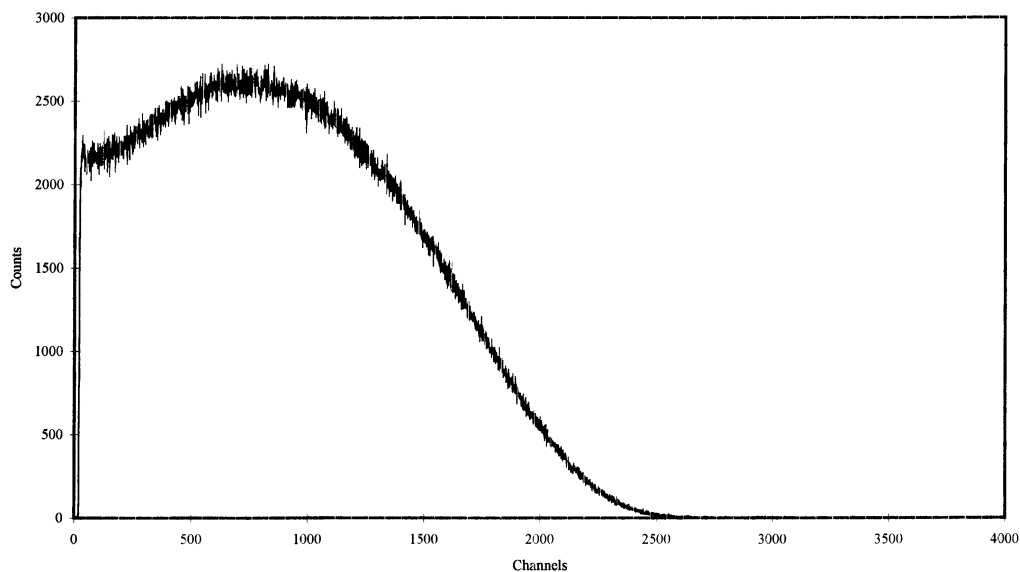

FIG. 1 Beta spectrum of P-32 on the antracene detector.

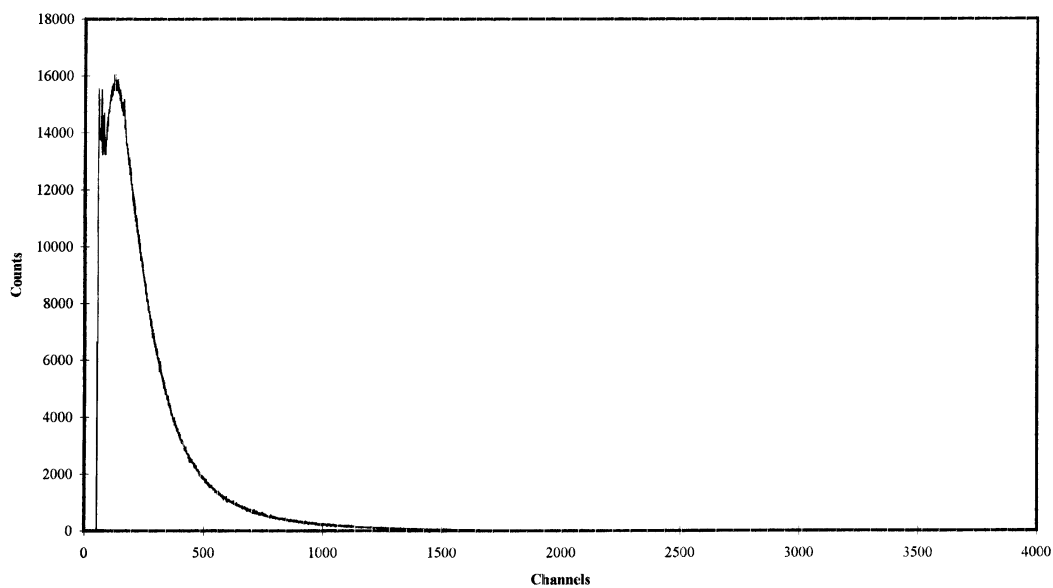

FIG. 2. Gamma spectrum of P-32 on HPGe detector.

BIBLIOGRAPHY

NOWAK, K., PANASIEWICZ, J., DOMARADZKI, M., Production of orthophosphoric acid $\text{H}_3^{32}\text{PO}_4$ of chromatographic purity, Patent No. 289923 (1993).

Phosphorus-33 ($^{33}\text{P}_{15}$)

Half-life	:	25.3 ± 0.12 d	
Production scheme	:	$^{36}\text{Cl} (n,\alpha) ^{33}\text{P}$ $^{33}\text{S} (n,p) ^{33}\text{P}$	$\sigma = 0.59 \text{ mb}$ $\sigma = 1.6 \text{ mb}$
Type of decay and energy	:	β^-	0.2485 MeV (max)

Phosphorus-33 is a useful radioisotope for medical research and has a longer half-life and less energetic beta emission than phosphorus-32. Phosphorus-33 had been routinely produced at the Oak Ridge National Laboratory (ORNL) by the (n, α) reaction by neutron irradiation of chlorine-36-enriched potassium chloride targets (Brown, et al.; Nuclear Medicine Group Procedure #2). Phosphorus-33 can also be produced by the enriched sulfur-33(n,p)phosphorus-33 reaction, since the natural abundance is only about 0.75%. (Lewis, et al., 1965; Lewis, et al., 1967).

Target specification and preparation

The target material for the (n, α) route is chlorine-36-enriched potassium chloride and enriched sulfur-33 for the (n,p) route.

Irradiation parameters, specific activity and total yield at end of irradiation

As an example of production yields, 66 day irradiation of 3 grams of K^{36}Cl (60% ^{36}Cl) in the ORNL High Flux Isotope Reactor (HFIR) provided 2 Curies of phosphorus-33 after processing. Using the (n,p) route, irradiation of 275 mg of enriched ^{33}S (68%) in the CP-5 Reactor at the Argonne National Laboratory (ANL) at $\phi_{\text{th}} = 2.66 \times 10^{13} \text{ n/cm}^2/\text{s}$ for 23 days, gave a phosphorus-33 yield of 90 MBq (2.44 mCi) at reactor discharge (7.7 ΦCi of ^{32}P impurity). At the Missouri University Research Reactor (MURR) irradiation of recycled enriched sulfur-33 (From Russian source) for 69 days at $\phi_{\text{th}} = 3 \times 10^{14} \text{ n/cm}^2/\text{s}$ gave a yield of 74 GBq (2 Ci)/2 g.

Type of facility for processing

An adequately shielded hot cell is required for opening the irradiated reactor target but the phosphorus-33 can be processed in a glove box or fume hood with adequate shielding.

Chemical processing procedure

The following procedure has been tested and proven satisfactory for the preparation of carrier-free products of ^{33}P in the form $\text{H}_3^{33}\text{PO}_4$. Phosphorus-33 is produced by neutron irradiation of K^{36}Cl (~60% ^{36}Cl) sealed in quartz ampuls which are in turn sealed in aluminum RB tubes for insertion in the High Flux Isotope Reactor (HFIR). The nuclear

The above procedure was provided by:
M. Du and F.F. Knapp, Jr.,
Nuclear Medicine Programme,
Oak Ridge National Laboratory,
Oak Ridge, Tennessee 37830-6229, USA.

reaction is $^{36}\text{Cl}(n,\alpha)^{33}\text{P}$. A typical target containing 3.0 grams of K^{36}Cl will yield ~ 74 GBq (2000 mCi) of ^{33}P product after a 66-day irradiation period.

The processing of the irradiated enriched chlorine-36 targets and recovery of the chlorine-36-enriched target material are described below

1. In the hot cell, open the target unit over a plastic tray and remove the quartz ampoules. Insert the quartz ampoules in the plastic break-tube, stopper the end, and crush the ampoules.
2. Transfer the contents of the break-tube to a 150 mL beaker, rinse the break-tube with pure water and transfer rinses to the 150 mL beaker. Stir the solution to dissolve the KCl and then decant the solution to the 500 mL product bottle.
3. Continue additions of pure water to the 150 mL beaker containing the broken quartz followed by stirring and decantations to the 500 mL product bottle until ~ 300 mL of solution has been accumulated.
4. Cap the 500 mL product and transfer to the glove box. Proceed with glove-box operations within 3 hours or less.

The following procedure can be conducted in a glove box

1. Filter the hot-cell product solution through a medium-frit glass filter using vacuum and wash the filter with pure water and discard the filter
2. Transfer the K^{36}Cl solution to a 500 mL beaker. Rinse the suction flask with pure water and add rinses to the beaker.
3. Add the 150 mg of $\text{Fe}_2(\text{SO}_4)_3$ solution to the beaker and adjust the solution pH to ~ 10 with NH_4OH .
4. Heat the solution to $\sim 80^\circ\text{C}$ to form a flocculent brick-red precipitate which carries the ^{33}P activity. Cool to ambient temperature.
5. Filter the slurry through a medium-frit glass filter using a suction flask. Rinse beaker with pure water containing a few drops of 1 M NH_4OH and add to the filter. Let filter pull dry and read at 6–8 inches with a Cutie Pie inserted in the glove port. Reading should be ~ 10 R/h directly above the filter cake.
6. Transfer the filtrate and washings, which contain the valuable K^{36}Cl target material to a clean bottle, cap, and save for subsequent recovery operations.
7. Break vacuum on suction flask. Add ~ 20 mL of 1 M HCl to the filter funnel and allow to stand until the $\text{Fe}(\text{OH})_3$ dissolves. Add vacuum and pull the solution into the suction flask. Check to make sure all of the precipitate dissolved, if not repeat the
8. HCl addition. Otherwise, wash the filter thoroughly with pure water.
9. Transfer the filtrate to a beaker, wash suction flask with pure water and add washings to the beaker.

10. Adjust the pH to ~10 with 1 M NH₄OH, heat to ~80°C and cool to ambient temperature to reform the Fe(OH)₃ precipitate and carry the ³³P recovery has been obtained.
11. Repeat steps 7, 8, and 9 three more times using clean glassware each time. The filtrates from the Fe(OH)₃ precipitations are accumulated and held until it has been determined that a satisfactory ³³P recovery has been obtained.
12. Dissolve the final Fe(OH)₃ precipitate in 6 M HCl, rinse filter with 6 M HCl. Hold total volume of 6 M HCl to 25 mL or less. **Note:** Further processing can be deferred until the next day if desired.

Extraction of Fe³⁺ from ³³P solution

1. Transfer 6 M HCl solution from II, 11 to a 100 mL separatory funnel along with 6 M HCl rinses of the vessel.
2. Add an equal volume of methylisobutyl ketone (*MIBK*) and shake for 2 minutes. Let phases separate completely.
3. Drain the acid phase (lower) into the second 100 mL separator funnel and ~0.5 mL of the organic phase (upper). Add an equal volume of *MIBK*, shake 2 minutes, and let phases separate completely.
4. Drain almost all of the acid phase (lower) into a 150 mL beaker. Leave ~0.5 mL of the acid phase in the separator funnel. Dilute out the small acid heel by addition of three 1 mL portions of 6 M HCl with draining of ~1 mL after each addition. Do not shake the separator funnel and do not let any organic phase enter the beaker.
5. Evaporate the 6 M HCl solution to a damp-dry solid using a hood and NaOH scrubber solution to trap the HCl vapor.
6. Dissolve the solids in ~5 mL of 0.01 M HCl and pass through a clean AG-50W-X8 column and catch effluent in a 150 mL beaker. Wash original beaker with pure water and pass through the ion-exchange column. Wash column with ~15 mL of pure water.
7. Evaporate the solution to damp-dryness and dissolve the solids in 25 mL of 1 M HCl.
8. Pass the solution through a *Millipore-Millex* (0.22 μ) filter into a labeled, 100 mL product bottle.
9. Remove ~2 mL of the solution for local assay of ³³P and ³²P concentration and submit a sample for complete assay.

The isolation of carrier-free phosphorus-33 from neutron irradiated enriched sulfur-33 targets is, as follows:

Solvent extraction method

1. Following irradiation the sulfur target is dissolved in dichloroethylene and the phosphorus extracted with an equal volume of 1.0M HCl. By gently heating the solution

to reflux temperature, the rate of extraction is accelerated and more complete during which the $^{33}\text{P}_2\text{O}_5$ is converted to $\text{H}_3^{33}\text{PO}_4$.

2. The enriched sulfur-33 target material is recovered by simple evaporation of the dichloroethylene solution following extraction of the phosphorus.

Distillation method

1. The irradiation enriched sulfur-33 target is heated at 450–475°C and the distilled sulfur recovered.
2. The residue containing the phosphorus-33 as P_2O_5 is leached with 1 M HCl at 80°C.
3. The solution is heated at for 4 hours for conversion to $\text{H}_3^{33}\text{PO}_4$.

Dispensing, assay and quality control

The relative phosphorus-33/phosphorus-32 content is determined by beta liquid scintillation counting. From an aliquot of the acidic phosphorus solution, phosphomolybdic acid is extracted with n-butanol and the sulfur-35 content of the aqueous solution is analysed by liquid scintillation counting. The sulfur-35 levels are usually <0.5% and not other radiocontaminates are usually detected.

Practical experience gained

Both methods work well for the reactor production of phosphorus-33 but the enriched sulfur-33 target material for the (n,p) reaction is more widely available.

BIBLIOGRAPHY

BROWN, L., CALLAHAN, A.P., Taken from ORNL Nuclear Medicine Program Procedure #2, Phosphorus-33 Processing Procedure, ORNL, Tennessee (1979).

LEWIS, R.E., REYNOLDS, S.A., Preparation of Phosphorus-33 by Irradiation of Enriched Sulfur-33 in Highly Thermalized Flux, Isotopes Development Center, Oak Ridge National Laboratory (1967).

LEWIS, R.E., BUTLER, T.A., Reactor Neutron Cross-Sections for Production of Phosphorus-33 from Chlorine-36 and Enriched Sulfur-33 in the Oak Ridge Research reactor, Isotope Development Center, Oak Ridge National Laboratory (1967).

Platinum-195m ($^{195m}\text{Pt}_{78}$)

Half-life	:	4.02 ± 0.01 d
Production scheme	:	$^{194}\text{Pt} (n,\gamma) ^{195m}\text{Pt}$
Type of decay and energy	:	γ (MeV) 0.12979 (2.83%) 0.1295 (0.084%) 0.0989 (11.4%) 0.03089 (2.28%)
Target material	:	95% enriched ^{194}Pt (metal) from ORNL or ISOTEC Inc., and 95.54% enriched ^{194}Pt (metal) from ICON, USA

Flow chart of procedure

See Fig. 1.

Irradiation parameters, specific activity and total yield at EOI

1. Reactor used and which assembly: KUR (Kyoto University Reactor) and Hydraulic Tube (Fig. 2).
2. Capsule details as per Fig. 3, weight 69.5 g made of Al. Silica tube: 1.8 g.
3. Mass of target per capsule: 10–100 mg.
4. Preparation of target for encapsulation, reactor irradiation parameters: ^{194}Pt -metal powder is packed into a silica tube and sealed at 1×10^{-5} mm Hg pressure. The sample is irradiated at a flux of 8.15×10^{13} n/cm²/s for a period of 75 hours.
5. Specific activity achieved and typical production yield per capsule: Sp. Act. 11.1 MBq/mg-Pt and Prod. Yield: 111–1110 MBq/capsule.
6. Properties of various ^{195m}Pt -compounds are given in Table 1.

TABLE 1. CHEMICAL AND PHYSICAL PROPERTIES OF VARIOUS Pt-COMPOUNDS SYNTHESIZED

	CDDP	TDDP	DWA2114R	CBDCA
Chemical yield (%)	61.0	62.3	65.5	59.1
Chemical purity (%)	99.7	98.5	99.2	99.3
Radionuclidic purity (%) c.a.	100	100	100	100
Specific activity (MBq/mg)	7.4	7.4	5.0	6.7

The above procedure was provided by:
Mitsuhiko Akaboshi,
Research Reactor Institute, Kyoto University, Japan.

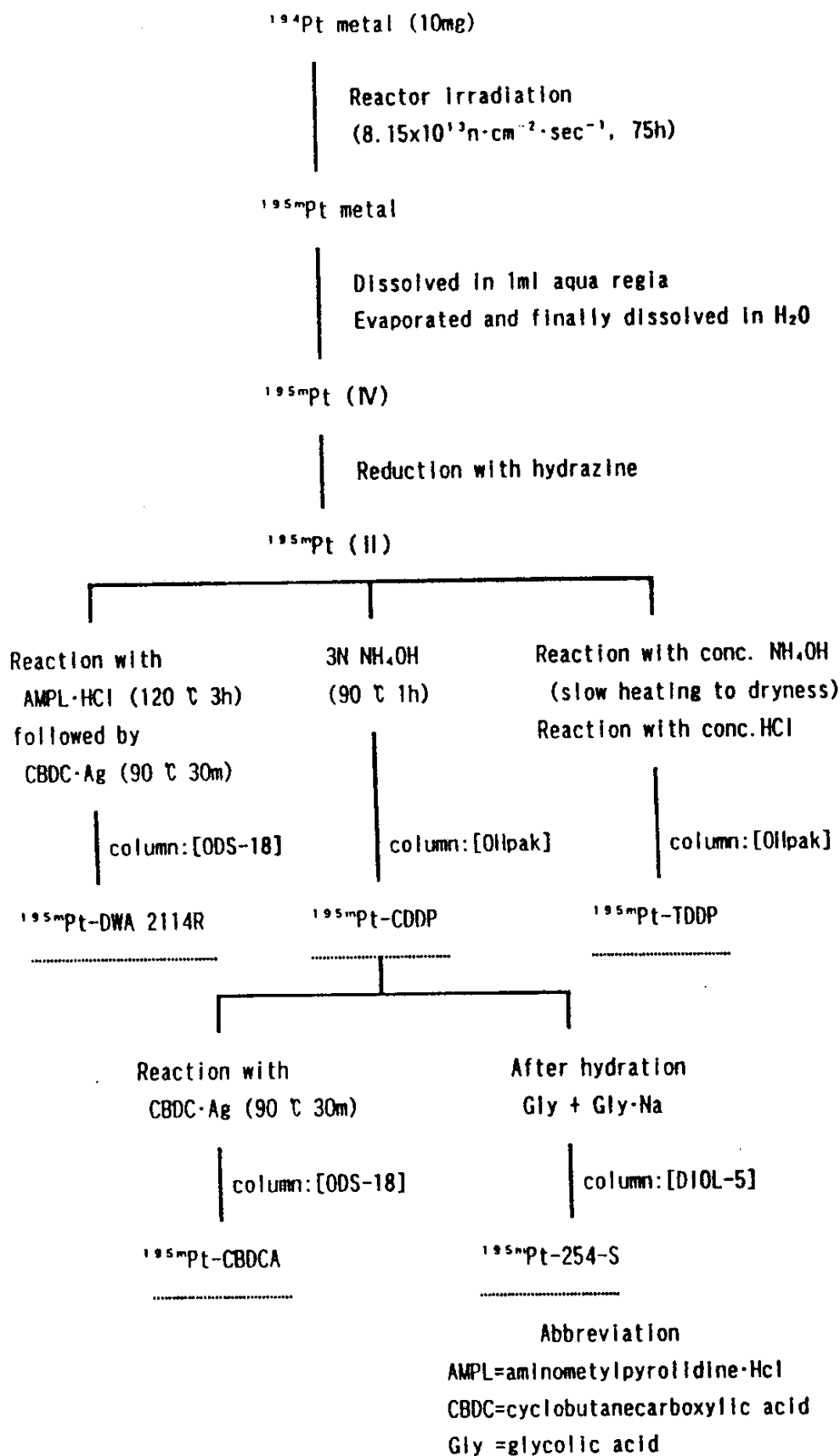

FIG. 1. Synthesis route map of various ^{195m}Pt-labelled compounds.

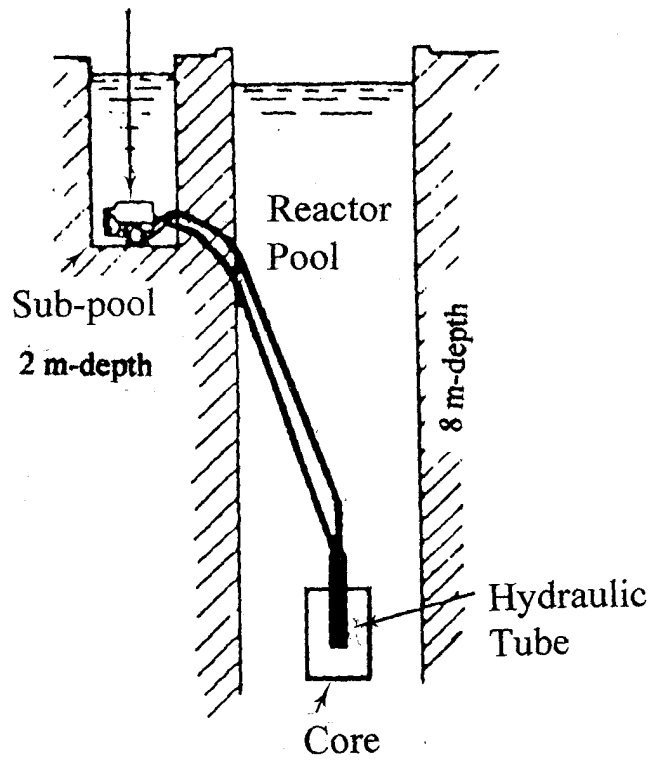

FIG. 2. Capsule handling station.

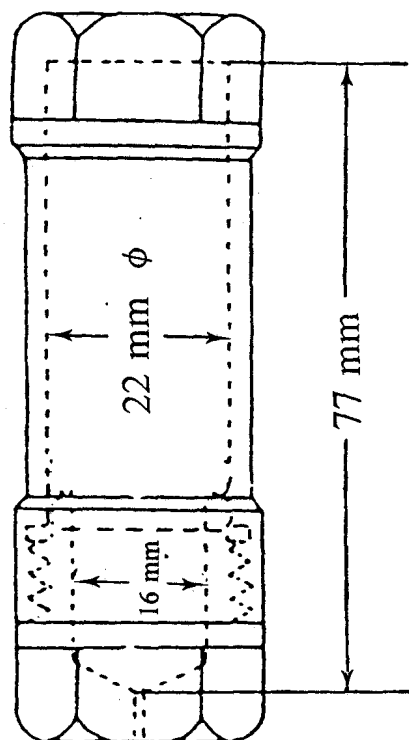

FIG. 3. Irradiation capsule.

Final product specification for use

See Fig. 4 indicating intermediate and final product.



FIG. 4. Platinum-195m compounds.

- From right
1. Irradiated sample (Pt) dissolved in aqua regia.
 2. after evaporation the sample (Pt(IV)) was dissolved in H₂O.
 3. The sample (Pt(II)) after reduction with hydrazine.
 4. Product (^{195m}Pt-CDDP) after reaction with NH₄OH and evaporated.
 5. ^{195m}Pt-CDDP dissolved in physiological saline.

Practical experience gained

As the final concentration, in the case of CDDP, is higher than 1 mg/mL in physiological saline, a long time (overnight) storage in a refrigerator makes the CDDP precipitate.

Type of facility for processing

An HPLC Unit along with an Automatic synthesizer is used in synthesizing of various ^{195m}Pt compounds and the same is shown in Fig. 5.

Dispensing, assay and quality control

The gamma spectrum of the irradiated ¹⁹⁴Pt target and synthesized finished product ^{195m}Pt-CDDP is taken to ensure the purity of the product. Figs. 6 and 7 show the gamma spectra obtained. Figs. 8 and 9 indicate the results of HPLC analysis carried out on labeled CDDP and chromatogram on the CDDP fraction.



FIG. 5. Automatic synthesizer and HPLC-apparatus inside a hot-cell.

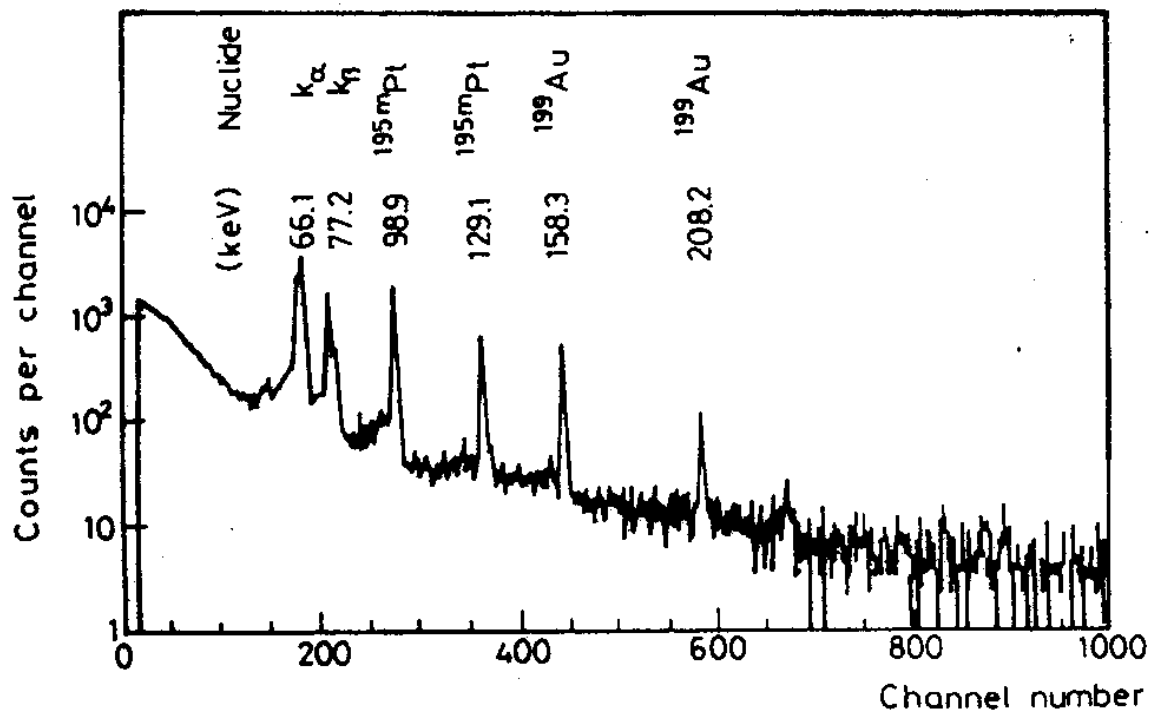

FIG. 6. γ ray spectrum of irradiated 95% enriched ^{194}Pt .

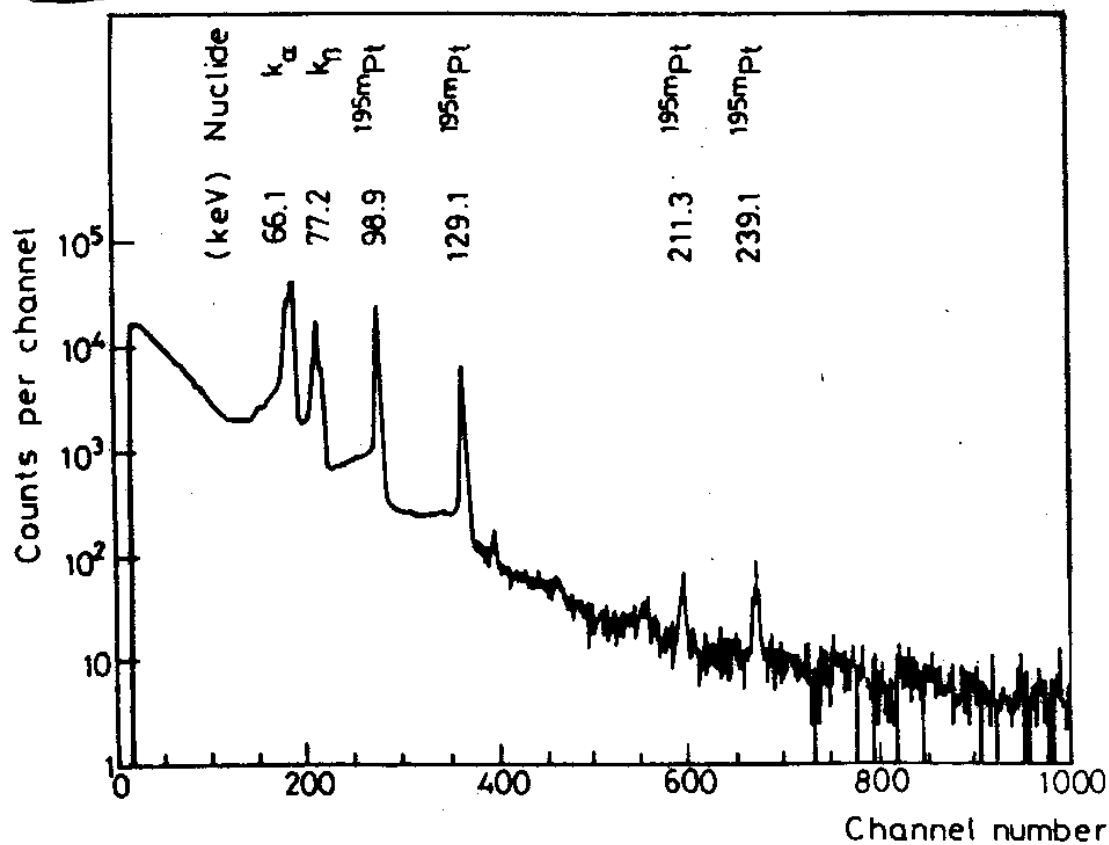

FIG. 7. γ ray spectrum of ^{195m}Pt labeled CDDP.

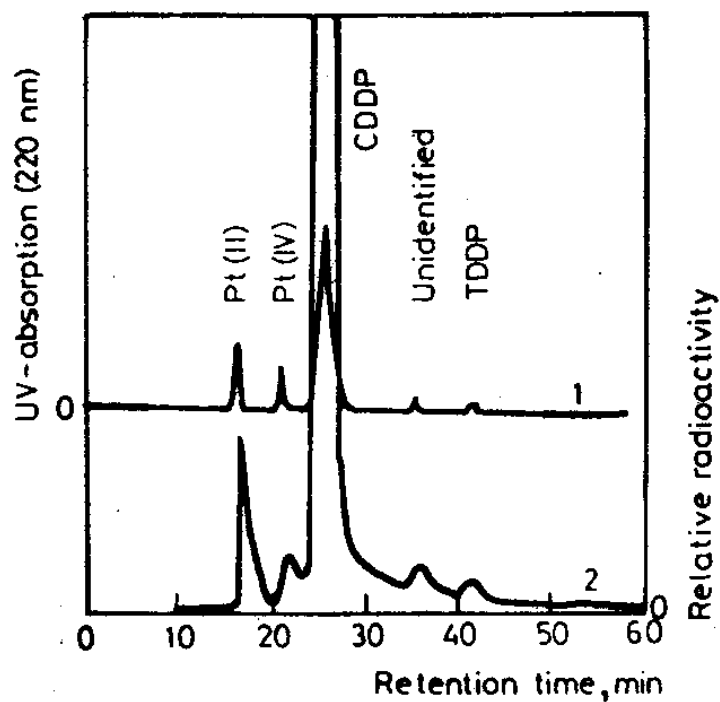

FIG. 8. HPLC analysis of ^{195m}Pt labeled CDDP (Sample: 20 μl specimen taken out at the final step of the synthesis; Elution: H_2O , at 4.0 mL/min).

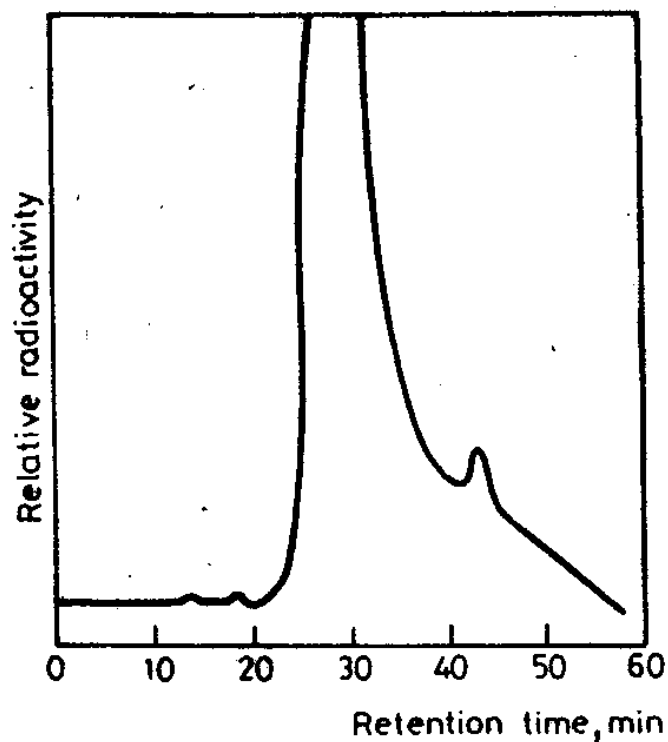

FIG. 9. Re-chromatogram of the CDDP fraction (from Fig. 8).

BIBLIOGRAPHY

AKABOSHI, M. et. al., Annu. Rep. Res. Reactor Inst. Kyoto Univ., **23** (1990) 64–69.

- Int. J. Radiat. Biol., **66** (1994) 215–220.
- J. Radioanal. Nucl. Chem, **217** (1997) 179–183.
- J. Radioanal. Nucl. Chem., **236** (1998) 145–148.
- Jpn. J. Cancer Res., **83** (1992) 522–526.
- Jpn. J. Cancer Res., **87** (1996) 178–183.
- Jpn. J. Cancer Res., **88** (1997) 506–511.
- Nucl. Med. Biol., **20** (1993) 389–393.
- Nucl. Med. Biol., **21** (1994) 953–958.
- Toxicol. Environ. Chem., **38** (1993) 51–60.
- Jpn. J. Cancer Res., **85** (1994) 106–111.

AKABOSHI, M., et. al., Annu. Rep. Res. Reactor Inst. Kyoto Univ., **20** (1987) 150–154.

EHDICH, W., et. al., Annu. Rep. Res. Reactor Inst. Kyoto Univ., **22** (1989) 97–101.

KATAOKA, M., et. al., Radiat. Med, **11** (1993) 247–250.

– Radiat. Med., **11** (1993) 173–176.

KAWAI, K. et al., J. Radioanal. Nucl. Chem Letters, **136** (1989) 67–74.

– Annu. Rep. Res. Reactor Inst. Kyoto Univ., **19** (1986) 42–47.

– Annu. Rep. Res. Reactor Inst. Kyoto Univ., **25** (1992) 78–82.

– J. Labelled Compd. Pharmaceut., **36** (1994) 65–71.

– J. Radioanal. Nucl. Chem. Letters, **164** (1992) 123–130.

– J. Radioanal. Nucl. Chem. Letters, **199** (1995) 207–215.

MIYAHARA, T., et. al., Japan J. Cancer Res., **84** (1993) 336–340.

Rhenium-186 ($^{186}\text{Re}_{75}$)

Half-life : 3.7183 d

Production scheme : $^{185}\text{Re} (n,\gamma)^{186}\text{Re}$ $\sigma = 112 \text{ b}$

Type of decay and energy : $\text{EC} \rightarrow ^{186}\text{W}; \beta^- \rightarrow ^{186}\text{Os}$

Decay Scheme

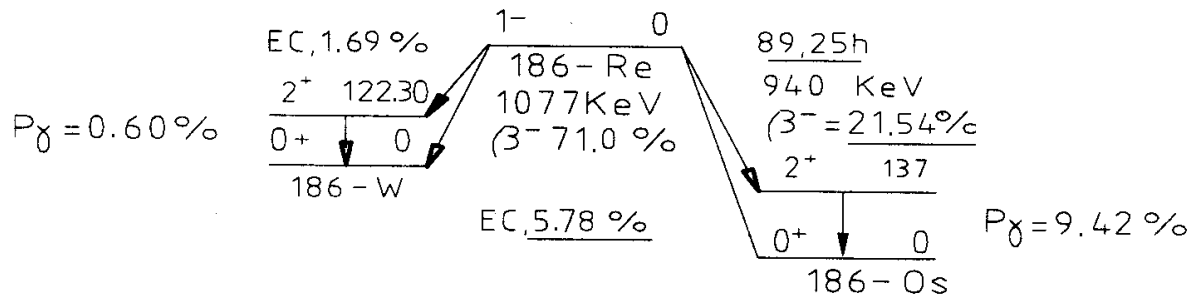

The 137 keV γ -ray energy (9.42%) provides an excellent tool for calibration and activity measurement.

Operations and procedures flow chart

1. *Target preparation*
1–12 mg metal; $^{185}\text{Re} > 94\%$
2. *Irradiation-HFR*
5–10 days
3. *Target dissolution*
200 μl 30% H_2O_2 ; 40°C; 25 min.
4. *H_2O_2 evaporation-low press.*
150–250 Pa; 40°C; 70 min.
5. *Residue dissolution*
isoton. saline-6 mL
6. *0.22 μm filtration/collection*
 ^{186}Re - NaReO_4 -concentrate-6 mL
7. *Total volume/activity-calibration*
weighing/ionization chamber
8. *Dilution/filtration*
0.9% NaCl/0.22 μm filter
9. *Final calibration*
Radioactive concentration
10. *Dispensing/assay ^{186}Re*
11. *Quality control*
certificate
12. *Packaging/shipment*
ART 64 h. AEI

Target specification and preparation

Material: Re-powder, metal
Isotopic enrichment: min. 94% ^{185}Re
Total metallic impurities: $\leq 0.1\%$

Isotopic composition: ^{185}Re ^{187}Re
Supplier: US-DOE or: Campro-Scientific
Manufacturer: ORNL-Tennessee

The above procedure was provided by:
H. Panek Finda,
Mallinckrodt Medical B.V.,
Weserduinweg-3,
NL-1755 LF Petten, Netherlands.

Irradiation parameters, specific activity, total yield at EOI

Reactor: HFR-Petten (NL) operated by JRC Eur. Comm. in operation since 1962.

Type – pressurized tank-in – pool, light water-cooled and moderated, operated at 45 MW.

Facility – TIRO: Thermal Flux Irradiation Device for Radioisotope Production in-core reloadable during reactor cycle

Capsule: Desiccator-dried target material 1–12 mg is encapsulated under N₂ in clean and depyrogenated synthetic quartz-“Spectrosil”-ampoule I.D. 9.3mm, max L=55 mm.

Irradiation: Time: 240 h.; Flux: $2.2\text{--}3 \times 10^{14}$ n/cm²/s

EOI yield: 65–88 GBq (1750–2390 mCi)/mg for 97.4% ¹⁸⁵Re enrichment

Typical spec. activity EOI: 68 GBq (1840 mCi)/mg

Processing facility

Standard hot cell provided with 1 activated charcoal and 1 absolute filter in the exhaust-line. Required: negative pressure 150–250 Pa; max. dose/rate 1 μSv/h at 1m distance from the cell.

Analysis of raw material, reagents and chemicals required for processing

Target material ¹⁸⁵ Re-metal	:	isotopic composition and ¹⁸⁵ Re enrichment-ICP/MS min. 94% metallic impurities-ICP/MS max. 0.1%.
30% H ₂ O ₂ anal. Grade	:	Pharmacopoeia Eur.
0.9% NaCl for injections	:	Pharmacopoeia Eur.

Chemical processing procedure

The irradiated ampoule is removed from the aluminium can, behind the shield of a hot cell. The ampoule is then properly cleaned by sonication in Re-processing cell. The tip of the ampoule is removed by means of electrical ampoule opener (2) and the ampoule is transferred into a glass ampoule holder (1). After addition of magnetic mini-bar into the ampoule, the holder is crimp-sealed and positioned on second production panel where a required micro-volume of 30% H₂O₂ (e.g. 200 μl/ 4 mg target) is added. After 5 minutes on still-standing, the ampoule holder is locked in the miniature low pressure distillation apparatus (3) provided with off-gas trap (4) and hot-water jacket (5). Re is then completely dissolved under constant stirring at elevated temperature (+ 40°C; 20 min.). The excess of H₂O₂ is removed from residing HReO₄ by means of low pressure distillation (–40 kPa; +40°C; 70 min.).

Any escape of vapours to the pump is prevented by incorporation of a system of 2 Re-traps and 2 moisture traps in the vacuum exhaustion line. The dry Re-residue (6) is dissolved in portions of isotonic saline (7) and quantitatively transferred via 0.2 μm filter into a sterile crimp-sealed collection vial (8) on the 3rd production panel. All operation steps in this validated process are computer controlled and all additions of solutions are conducted by means of the electronic pipette system. The vial, containing 6 mL of (¹⁸⁶Re)-NaReO₄-Concentrate is transferred into a dedicated hot cell system in the Radiopharmacy, where after the volume/activity calibration in well-type ionization chamber and weighing on electronic balance, the concentrate is diluted to required radioactive concentration (0.9% NaCl) by means of positive N₂-pressure. The finally calibrated solution is dispensed into the transport vials where each of the vials is again assayed for total vial activity prior to packaging and shipment.

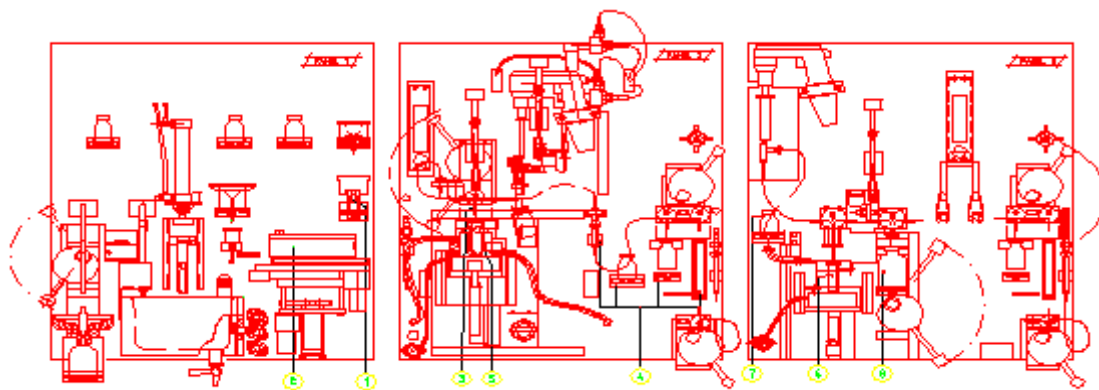

FIG.1. In cell equipment for Re186 processing

Dispensing, assay and quality control

The final product is dispensed according to the internationally recognized method, where the nominal value of the dispensed activity lies between 90–110%. All vials are assayed in well-type, standard-calibrated ionization chamber where the ionization current is corrected for present ^{188}Re -impurity and the vial geometry at the time of measurement. Radionuclidic purity is determined by means of Ge-detector combined with multichannel analyser and computer system where all γ -energies originated from other radionuclides than ^{186}Re are subtracted and computed as radionuclidic impurities. ^{188}Re impurity is individually determined and evaluated in relationship to ^{186}Re activity.

Final product specification

Description: clear, aqueous, slightly yellow-orange solution, free of visible impurities, contained in labelled 10-mL moulded vial

Chem. composition per mL of Final Solution: approx. 0.4 mg NaReO_4 ; 9.0 mg NaCl

pH: 2.5–5.0

Radiochem. Purity: $\geq 98\%$ as ReO_4^- [PC (Whatman 3MM; 20–25°C; 15 cm; 25 g $\text{Na}_2\text{HEDP}/100\text{ mL}$ 0.9% NaCl ; R_F 0–0.25 hydrolysed, reduced Re)]

Radioact. concentration: $\approx 8,5\text{ GBq/mL}$ at ART ($\approx 230\text{ mCi/mL}$)

H_2O_2 : $\leq 5\text{ }\mu\text{g/mL}$ [Merckoquant 10011]

Specific activity: $\approx 29.6\text{ GBq/mg Re}$ at ART ($\approx 800\text{ mCi/mg}$) – [ICP/AES and ionization chamber]

Radionuclid. purity: 99.9% [Ge-detector]

^{188}Re assay: max. 6.2 kBq/MBq ^{186}Re [Ge-detector]

Comments

1. Activity reference time (ART) is on Wednesday 8.00 CET (max. 56 h after EOI).
2. (^{186}Re) NaReO_4 Radiochemical is not a sterile solution – therefore it is supplied as: not for direct human application.
3. The product can be used for preparation of sterilized pharmaceuticals and for research.
4. The radioactive waste generated during processing and Q.C., can be handled as a short half-life radioactive waste.
5. All glassware and small accessories that come in contact with the product, such as: needles and tubing used for transfer of fluids are disposed after every production run.

Practical experience gained

- Target material is hygroscopic – should be protected from moisture.
- To prevent violent reaction during dissolution, the 1st five minutes of contact with 30% H₂O₂ should be motionless.
- All free H₂O₂ in dissolved target solution must be evaporated. Presence of H₂O₂ in perrhenate can be detrimental to all labelling reactions – based on reduction of ReO₄⁻ to lower oxidation state.
- High specific activity and chemical purity are essential for labelling of monoclonal antibodies and peptides [3].
- High radionuclidic purity is essential for human applications.
- Relative proportion of ¹⁸⁸Re-impurity to ¹⁸⁶Re is dependent on irradiation time. Longer irradiated (e.g. 5 days or more) results in lower ¹⁸⁸Re-impurity.

BIBLIOGRAPHY

COURSEY, B.M., et al., The Standardization and Decay Scheme of Rhenium-¹⁸⁶Re, Appl. Radiat. Isot. Vol. **42**, No. 9 (1991) 865–869.

GOLDENBERG, D.M., GRIFFITHS, G.L., Radioimmunotherapy: arming the missiles. J. Nucl. Med. Vol. **33**, (1992) 1110–1112.

KARLSRUHER NUKLIDKARTE 6, Auflage (1995).

Rhenium-186 ($^{186}\text{Re}_{75}$)
(Alternate procedure)

Production scheme : $^{185}\text{Re} (n,\gamma) ^{186}\text{Re}$

Rhenium-186 is of broad interest for the preparation of a variety of rhenium-186-labeled therapeutic agents for applications in nuclear medicine and oncology (Knapp, et al., 1999), and is produced in a nuclear reactor by the neutron irradiation of enriched rhenium-185 targets (Figure 1). An alternate accelerator route is by proton or deuteron irradiation of enriched tungsten-186 targets via the $^{186}\text{W}(p,n)^{186}\text{Re}$ (Shigetha, et al., 1996) and $^{186}\text{W}(d,2n)^{186}\text{Re}$ reactions, respectively (Szelecsenyi, et al., 1999).

Although the reactor route can produce relatively high specific activity rhenium-186 even at low to moderate thermal neutron flux values, for many applications, such as for the radiolabeling of peptides and antibodies where receptors are present at very low concentrations and can be easily saturated, requires the availability of a very high thermal neutron flux or production of carrier-free rhenium-186 in an accelerator.

Target specification and preparation

Highly enriched rhenium-185 (>99%) targets are required for reactor production.

Irradiation parameters, specific activity and total yield at EOI

The projected specific activity of rhenium-186 as a function of irradiation time for various thermal neutron flux values is shown in Fig. 1.

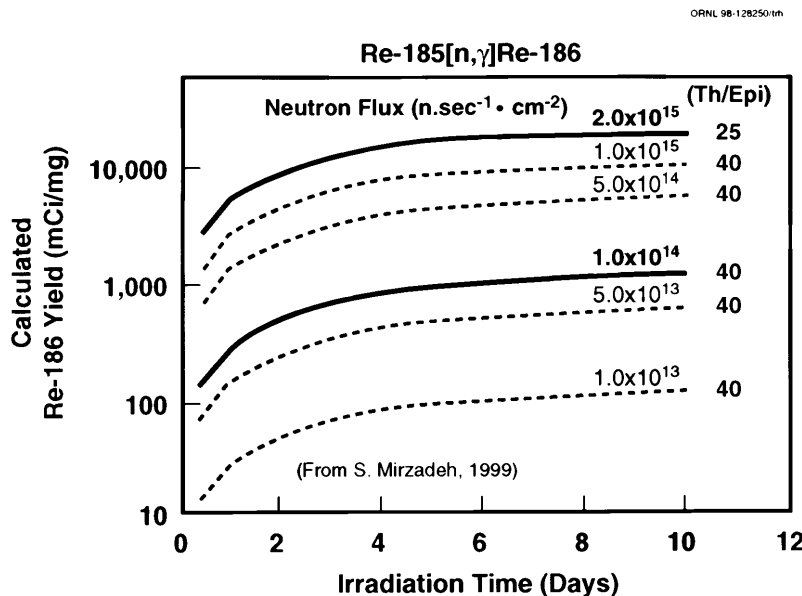

FIG. 1. Projected production yields of rhenium-186 at various thermal neutron flux values.

The above procedure was provided by:
A.L. Beets and F.F. Knapp, Jr.,
Nuclear Medicine Programme,
Oak Ridge National Laboratory,
Oak Ridge, Tennessee 37830-6229, USA.

Type of facility for processing

An adequately shielded hot cell is required for processing the irradiated target.

Chemical processing procedure

The chemical processing of reactor-irradiated enriched rhenium-185 targets is the same as described for the production of rhenium-188 by neutron irradiation of enriched rhenium-187 targets:

1. The target (i.e. aluminum and/or quartz tube) is opened and if a quartz tube is used, the tube containing the irradiated rhenium-187 target material is carefully opened with a break tube or cut open, etc. The target material and crushed quartz glass are transferred into a conical 3–5 mL Pierce processing vessel placed in a heating block. About 2 mL of 30% hydrogen peroxide solution is then added.
2. The processing vessel is sealed with a Teflon-lined cap. For processing at ORNL, a sidearm attachment (evaporation head) is also used and vented through a coarse charcoal trap to cell vacuum line. The rhenium metal is allowed to react at room temperature for 30 min to insure complete dissolution.
3. The vial is then heated at $<80^{\circ}\text{C}$ until dry (2–4 hours) to insure decomposition of excess peroxide and removal of all moisture until sample has evaporated to dryness.
4. To prepare stock solution of processed sample, add 2 mL of sterile saline solution (0.9% NaCl) to the processing vessel for an expected final concentration (i.e. based on target size and irradiation period and HT position) of > 10 Curies per 0.5 mL.
5. The solution is filtered through a 0.22 micron Gelman hydrophobic/hydrophilic filter. Filtered solution must be colorless and clear, and free of any visible impurities. Record any comments.
6. Peroxide levels in the stock solution are determined with the peroxide colorimetric test strip. Peroxide solution must be less than 2 $\Phi\text{gm/mL}$. Record peroxide ppm on Check Sheet (Note — Because of thickness of leaded glass cell window, it will be difficult to accurately assess light colors).
7. The pH of processed stock solution should also be determined with pH paper or a pH meter.
8. For radioassay, take 100 microliters (for example) of sample from stock solution and dilute with 50 mL of distilled water (Dilution # 1). After making a second dilution of 100 microliters of Dilution 1 with 50 mL of water, take aliquot from Dilution # 2 (100 microliters) out of hot cell for assay of rhenium-186 and rhenium-188 and any radionuclide contaminants by gamma spectroscopy.
9. Dispense required level of the product into product bottle for shipment.

Dispensing, assay and quality control

The saline rhenium-186 perrhenate solution is stable indefinitely.

Final product specification for use

The specific activity and specific volume requirements are specified by the customer.

BIBLIOGRAPHY

KNAPP, F. F., JR., BEETS, A.L., PINKERT, J., KROPP, J., LIN, W.-Y., WANG, S.-Y., "Rhenium radioisotopes for radiopharmaceutical development", (Proc., International Seminar on Therapeutic Applications of Radiopharmaceuticals, Hyderabad, 1999), IAEA-SR-209, Vienna.

OAK RIDGE NATIONAL LABORATORY (ORNL), Nuclear Medicine Procedure # 60, Rhenium-186 Hydrogen Peroxide Processing Procedure, Tennessee.

SHIGETA, N., MATSUOKA, H., OSA, A., KOIZUMI, M., IZUMO, M., KOBAYASHI, K., HASHIMOTO, K., SEKINE, T., LAMBRECHT, R.M., J. Radioanalyt. Nucl. Chem. Articles, **205** (1996) 85.

SZELECSENYI, S., TAKACS, S., TARKANYI, F., SONCK, M., HERMANNE, A., Study of Production Possibility of ^{186}Re via the $^{186}\text{W}(d,2n)^{186}\text{Re}$ Nuclear Reaction for Use in Radiotherapy, J. Lab. Cmpds, Radiopharm., **42**, Suppl. 1 (1999) S912-S914.

Rhenium-188 ($^{188}\text{Re}_{75}$)

Half-life	:	17.005 ± 0.004 h
Production scheme	:	$^{187}\text{Re} (n,\gamma) ^{188}\text{Re}$ $\sigma = 76.4 \text{ b}$
Type of decay and energy	:	β^- (MeV) 2.120 (71.1%) 1.965 (25.6%)

Rhenium-188 is a very attractive radioisotope for a variety of therapeutic applications in nuclear medicine, oncology and interventional cardiology (Knapp, et al., 1997,1998,1999). Although carrier-free rhenium-188 is conveniently and inexpensively available from the tungsten-188/rhenium-188 generator system, production of tungsten-188 from irradiation of enriched tungsten-186 requires a very high thermal neutron flux, which for practical purposes to provide tungsten-188 with a specific activity >18.5 MBq (0.5 mCi)/mg must exceed about $5 \times 10^{14} \text{ n/cm}^2/\text{s}$ (Knapp, et al., 1994; Mirzadeh, et al., 1992). However, neutron activation of enriched rhenium-187 can also provide rhenium-188 with relatively high specific activity. Thus, even research reactors with relatively modest thermal neutron flux can be used to directly produce this important therapeutic radioisotope.

Target specification and preparation

Highly enriched rhenium-187 (97%) metallic targets are usually used for production of rhenium-188 since they are easily directly oxidized to Re(VII) perrhenic acid. The concomitant production of rhenium-186 (i.e. from the rhenium-185 impurity) is minimized by use of highly enriched rhenium-187.

Irradiation parameters, specific activity and total yield at EOI

The projected production of rhenium-188 from the radiative (n, γ) reaction on enriched rhenium-187 at various thermal neutron flux values is shown in Fig. 1.

Type of facility for processing

An adequately shielded hot cell is required for processing the irradiated target.

Chemical processing procedure

The chemical processing of reactor-irradiated enriched rhenium-187 targets is the same as described for the production of rhenium-186 by neutron irradiation of enriched rhenium-185 targets,

1. The target (i.e. aluminum and/or quartz tube) is opened and if a quartz tube is used, the tube containing the irradiated rhenium-187 target material is carefully opened with a break tube or cut open, etc. The target material and crushed quartz glass are transferred into a conical 3–5 mL Pierce processing vessel placed in a heating block. About 2 mL of 30% hydrogen peroxide solution is then added.

The above procedure was provided by:

A.L. Beets and F.F. Knapp, Jr.,
Nuclear Medicine Programme, Oak Ridge National Laboratory,
Oak Ridge, Tennessee 37830-6229, USA.

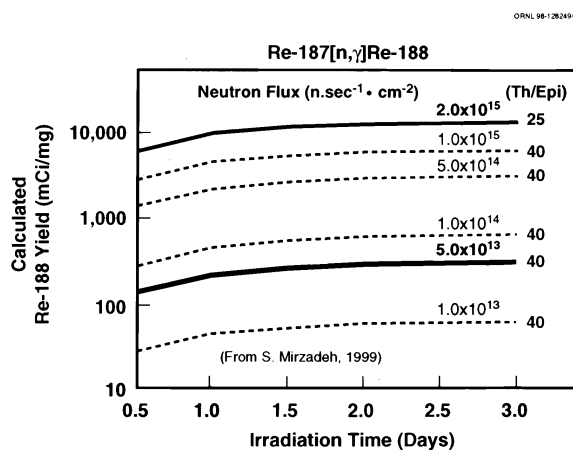

FIG. 1. Projected reactor production of rhenium-188 from enriched rhenium-187 as a function of irradiation time at various thermal neutron flux values.

2. The processing vessel is sealed with a Teflon-lined cap. For processing at ORNL, a sidearm attachment (evaporation head) is also used and vented through a coarse charcoal trap to cell vacuum line. The rhenium metal is allowed to react at room temperature for 30 min to insure complete dissolution.
3. The vial is then heated at <math><80^{\circ}\text{C}</math> until dry (2–4 hours) to insure decomposition of excess peroxide and removal of all moisture until sample has evaporated to dryness.
4. To prepare stock solution of processed sample, add 2 mL of sterile saline solution (0.9% NaCl) to the processing vessel for an expected final concentration (i.e. based on target size and irradiation period and HT position) of > 370 GBq (10 Ci) per 0.5 mL.
5. The solution is filtered through a 0.22 micron Gelman hydrophobic/hydrophilic filter. Filtered solution must be colorless and clear, and free of any visible impurities. Record any comments.
6. Peroxide levels in the stock solution are determined with the peroxide colorimetric test strip. Peroxide solution must be less than 2 Φ gm/mL. Record peroxide ppm on Check Sheet (Note — Because of thickness of leaded glass cell window, it will be difficult to accurately assess light colors).
7. The pH of processed stock solution should also be determined with pH paper or a pH meter.
8. For radioassay, take 100 microliters (for example) of sample from stock solution and dilute with 50 mL of distilled water (Dilution # 1). After making a second dilution of 100 microliters of Dilution 1 with 50 mL of water, take aliquot from Dilution # 2 (100 microliters) out of hot cell for assay of rhenium-186 and rhenium-188 and any radionuclide contaminants by gamma spectroscopy.
9. Dispense required level of the product into product bottle for shipment.

Dispensing, assay and quality control

The saline rhenium-188 perrhenate solution is stable indefinitely. The product should be analysed by gamma spectroscopy.

Final product specification for use

The specific activity and specific volume requirements are specified by the customer.

Practical experience gained

Although the availability of carrier-free rhenium-188 from the tungsten-188/rhenium-188 generator is the most cost-effective and readily available source, the direct production of rhenium-188 from irradiation of enriched rhenium-187 targets has the advantage that the approach can be used with even moderate thermal neutron flux research reactors.

BIBLIOGRAPHY

KNAPP, F.F., JR. Use of Rhenium-188 for Cancer Treatment, *Cancer Biotherapy and Radiopharm.*, **13** (5) (1998) 337–349.

KNAPP, F.F., JR., BEETS, A.L., GUHLKE, S., ZAMORA, P.O., BENDER, H., PALMEDO, H., BIRSACK, H.-J., Development of the Alumina-Based Tungsten-188/Rhenium-188 Generator and Use of Rhenium-188-Labeled Radiopharmaceuticals for Cancer Treatment, *Anticancer Research*, **17** (1997) 1783–1796.

KNAPP, F.F., JR., BEETS, A.L., PINKERT, J., KROPP, J., LIN, W.-Y., WANG, S.-Y., Rhenium Radioisotopes for Radiopharmaceutical Development, (Proc. International Seminar on Therapeutic Applications of Radiopharmaceuticals, IAEA-SR-209, Hyderabad, 1999), IAEA, Vienna.

KNAPP, F.F., JR., CALLAHAN, A.P., BEETS, A.L., MIRZADEH, S., HSIEH, B.-T., Processing of Reactor-Produced ^{188}W for fabrication of Clinical Scale Alumina based $^{188}\text{W}/^{188}\text{Re}$ Generators, *Appl. Radiat. Isot.*, **45** (1994) 1123–1128.

MIRZADEH, S., KNAPP, F.F., JR., CALLAHAN, A.P., Production of Tungsten-188 and Osmium-194 in a Nuclear reactor for New Clinical Generators, *Nuclear Data for Science and Technology* (QAIM, S., Ed.) Springer Verlag Pub., (1992) 619–620.

Samarium-153 ($^{153}\text{Sm}_{62}$)

Half-life	:	46.27 h	
Production scheme	:	$^{152}\text{Sm} (n,\gamma) ^{153}\text{Sm}$	$\sigma = 206 \text{ b}$
Target material	:	Sm_2O_3 ($^{152}\text{Sm} > 98\%$)	

Type of decay and energy (MeV):

beta (β^-)	0.808 (17.5%)	gamma (γ)	0.103 (29.8%)
	0.705 (49.6%)		0.069 (4.85%)
			0.635 (32.2%)

Production flow chart

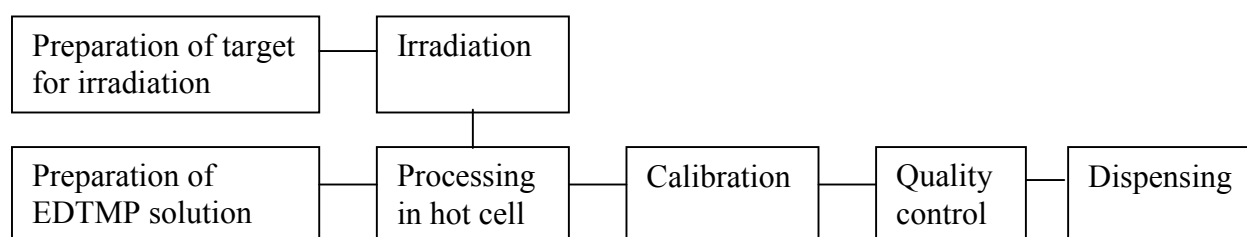

Target specification and preparation

Specific target purity: samarium oxide (Sm_2O_3) 99.999%.

Target purity: samarium oxide (Sm_2O_3), enriched in Sm-152: 98% or greater.

Target material supplier: ISOTEC INC cat. no. 77-68901.

Target solution: prepared with 10 mg of samarium oxide (Sm_2O_3) in 2 mL of nitric acid 1% (HNO_3 1%).

Irradiation parameters, specific activity and total yield at EOI

1. Reactor used: RA-3, 5 MW pool type research reactor. Thermal fluxes from 2×10^{13} to 1×10^{14} n/cm²s, 4 irradiation boxes with 14 places each one, and 120 hours of continuous operation per week.
2. Capsule details: the samarium oxide is irradiated in a quartz ampoule; dimensions are 40–50 mm long, 6–8 mm diameter; oxygen/gas blowpipe is used to seal the ampoule.
3. Mass of target per capsule: 1 mg of samarium oxide.
4. Preparation of target for encapsulation: 0.2 mL of target solution is placed in the quartz ampoule, taken to dryness in nitrogen atmosphere by heating up to 100–120°C on a heating plate. The quartz ampoule, sealed with a blowpipe, is then placed with quartz wool into an aluminium can (70 mm long, 20 mm diameter), which is cold welded. Reactor irradiation parameters: neutron flux 4×10^{13} n/cm²/s; irradiation time: 48–54 h.
5. Specific activity achieved at EOI: 14.8–16.8 GBq (400–450 mCi)/mg oxide. Total activity achieved at EOI: 14.8–16.8 GBq (400–450) mCi.

The above procedure was provided by:

Alberto Manzini,

Ezeiza Atomic Centre, Comisión Nacional de Energía Atómica,

Camino Borlenghi S.N, Agencia Mimpost 1842, Buenos Aires, Argentina.

Flux (n/cm ² /s)	Irradiation time (days)				
	1	2	3	4	5
1,00E+13	56	95	123	142	156
2,00E+13	112	191	246	285	312
3,00E+13	168	287	370	428	468
4,00E+13	225	382	493	570	625
5,00E+13	281	478	616	713	781
6,00E+13	337	574	740	856	937
7,00E+13	393	670	863	998	1093
8,00E+13	450	765	986	1141	1250
Total activity at EOI (mCi/mg oxide)					

Type of facility for processing

The hot cell is a sealed box under reduced pressure (15–20 mm of water-reduced pressure), with remote handling tong, and 10 cm of lead thickness as biological shielding. Viewing windows are made of lead glass (20 cm thick). The windows are mounted in frames fitting the interlocking lead brick system, and the space between the glass and the lead frame is packed with lead yarn. The tong used has a detachable head to enable to change the types of jaws without removing the tong from the box. A flexible plastic sleeve is attached to the tong shaft to prevent contamination being carried into the laboratory when the tong is drawn outwards. In addition there are a few special tools: for opening cans, cutting quartz ampoules, rigid support for the glass material and a sealing machine for glass vials.

For dispensing a sealed glove box working at reduced pressure is used. The equipment placed inside consist in a remote operated pipette (5 mL syringe) connected by means of a plastic tube to a hypodermic syringe, a glass vial containing the radioisotope solution (storage bottle) placed in a lead pot, a crimper for opening the vial, millipore filters and needles fitting the pipette for sterilization of the solution when dispensing.

Reagents and chemicals required for processing

EDTMP (ethylene diamine tetramethylene phosphonic acid) .

NaOH (sodium hydroxide, 1 N solution).

H₂O (bidistilled water).

Chemical processing procedure

EDTMP solution: 150 mg of EDTMP, dissolved in bidistilled H₂O (1.5 mL) with NaOH 1N (2.5 mL) up to pH=8–9. Final volume is 4 mL.

After irradiation the aluminium can and the ampoule are opened in the hot cell.

The active target is dissolved in the EDTMP solution. After 15–20 minutes bidistilled H₂O (2 mL) is added. Final volume is 6 mL. The solution is heated for 45–60 minutes at 75–80°C.

Total activity calibration is carried out, and bidistilled H₂O is added to achieve an activity concentration of 1.1–1.3 GBq (30–35 mCi)/mL.

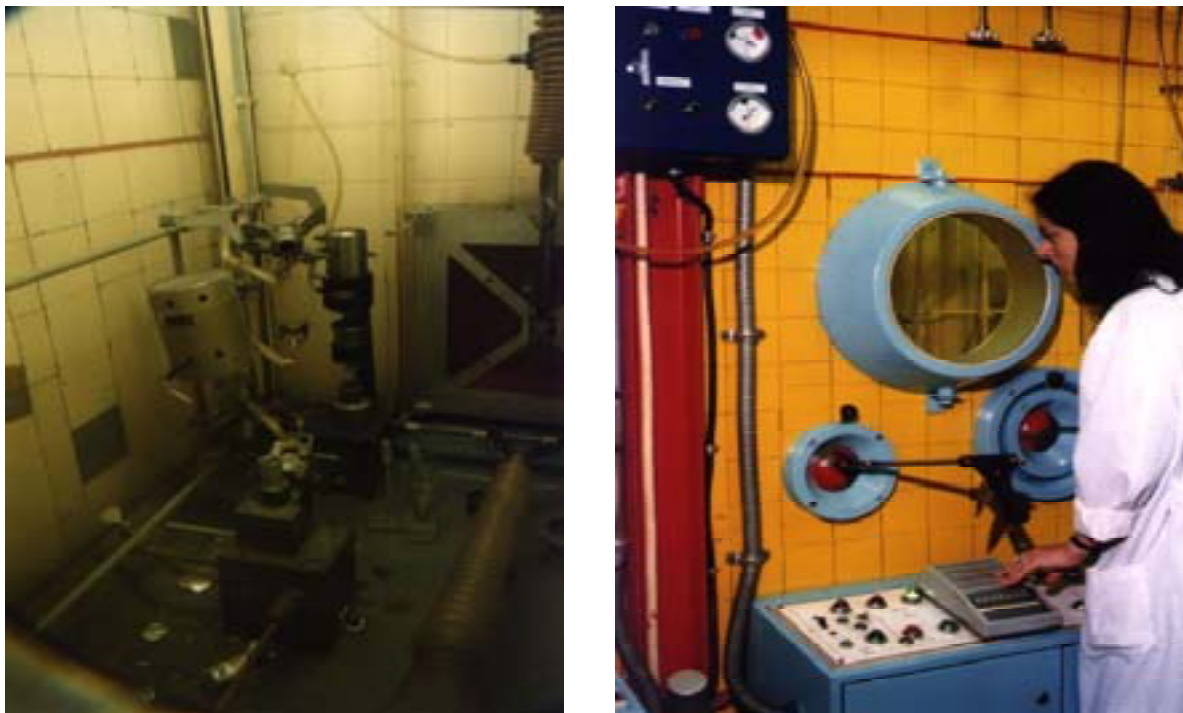

FIG. 1. Hot cell for the production of $^{153}\text{Sm-EDTMP}$.

Dispensing, assay and quality control

The final solution of Sm-153-EDTMP (act.conc. 1.1–1.3 GBq (30–35 mCi)/mL) is filtered through Millipore filter 0.22 μm for dispensing. For quality control a 3 mL fraction is separated.

Radionuclidic purity: determined by γ -spectrometry with a GeHp semiconducting detector associated to a multichannel analyser.

Alcalinity: determined by pHmeter.

Radiochemical purity: determined by thin layer chromatography, using ITLC-SG/ H_2O . Rf (Sm^{3+}) = 0. Rf (Sm-EDTMP) = 0.8–1.0.

Sterility: by millipore filter 0,22 μm .

Pirogenity: test on animals. Three rabbits are injected in the ear vein.

Toxicity: test on animals. A lot of five NIH mice are injected with 0.1 mL of the final solution. The animals remain under observation during 5 hours.

Biodistribution: test on animals. Wistar rats, weight 200–250 g, i.v. injected (0.2 mL).

Isotonicity: determined by conductimetry.

Radioactive concentration: determined by comparative method in a well-type ionization chamber.

According to the required activity, a determined volume of Sm-153-EDTMP solution from the storage bottle is dispensed into a steril evacuated penicillin-type glass vial, sealed with a rubber stop and an aluminium cap crimped on.

Final product specification for use

1. Limpid, colorless, water solution.
2. Radionuclide identification: ^{153}Sm .
3. Radionuclidic purity: > 99%.
4. pH of final solution: 7–8.
5. Radiochemical purity: >95%.

6. Concentration activity at date of calibration: 740–925 MBq (20–25 mCi)/mL.
7. Specific activity: 14.8–16.8 GBq (400–450 mCi)/mg oxide.
8. Storage conditions: at room temperature.
9. Disposal of waste generated: all the solid material used during the process in the hot cell is discarded to a polyethylene container placed under the box of the hot cell. A small quantity of liquid waste is generated in the process. Remaining liquid after dispensing in the glove box is stored for decay. All the solid material used is discarded to a shielded recipient, and stored for decay.

Intended use of the final product: pain palliation of bone metastases.

Practical experience gained

Labelling is better carried out when solid target is irradiated and dissolved with the EDTMP solution. Colloid is formed when liquid solution of target (nitric solution) is irradiated and diluted with EDTMP solution.

A remarkable difference is noticed when EDTMP concentration is modified in the final solution. When this concentration is increased, hepatic uptake of the complex diminishes. For EDTMP concentration a minimum of 10 mg/mL was established.

BIBLIOGRAPHY

- COLLINS, C., EARY, J.F., et al., *J. Nucl. Med.*, **34** (1993) 1839–1844.
- EARY, J.F., COLLINS, C., et al., *J. Nucl. Med.*, **34** (1993) 1031–1036.
- FARHANGHI, M., HOLMES, R.A., et al., *J. Nucl. Med.*, **33** (1992) 1451–1458.
- FARMACOPEA NACIONAL ARGENTINA, 6° Edición.
- GOECKELER, W.F., EDWARDS, B., VOLKERT, W.A., et al., *J. Nucl. Med.*, **28** (1987) 495–504.
- KETRING, A.R., *Nucl. Med. Biol.*, **14** (1987) 223–232.
- LEDERER, C.M., SHIRLEY, V.S., *Table of Isotopes*, 7th Ed., *Manual of Radioisotope Production*, Tech. Rep. Series N° 63, IAEA, Vienna (1966).
- VERA RUIZ, H., *Boletin OIEA*, **1**, IAEA, Vienna (1993) 24–27.

Scandium-46 ($^{46}\text{Sc}_{21}$)

Half-life	:	83.77 ± 0.04 d
Production scheme	:	$^{45}\text{Sc}(n,\gamma)^{46}\text{Sc}$ $\sigma = 27$ b
Type of decay and energy	:	β^- (MeV) 0.3566 (99.996%) γ (MeV) 0.889 (99.98%) 1.120 (99.98%)
Target material	:	Scandium oxide

Target specifications and preparation

Spec pure Sc_2O_3 (10 mg) (JM Grade) .

Irradiation container

Standard high purity aluminium can of dimensions 22 mm dia × 46 mm ht., cold welded.

Neutron flux : 3×10^{13} n/cm²/s approx.

Irradiation time : 1 month

Yield at EOI : 9.25 GBq (250 mCi)

Facility for processing

Standard glove box of dimensions 2 M × 1M × 2 M fitted with 100 mm of lead shielding wall.

Chemical processing

The irradiated Sc_2O_3 is transferred to a dissolution flask and 10 mL of 3N HCl is added to it. The solution is heated to boiling and dissolution of the target is completed. 20 mL of 0.1N HCl is then added to it and the solution transferred to a storage bottle.

Assay and quality control

The radioactive concentration is determined by measuring the ion current produced by a known volume of the solution in a calibrated ion chamber. The specific activity of the product is calculated from the known quantity of the target irradiated and the activity yield.

Characteristics of the final product

Chemical form	ScCl_3 in dilute hydrochloric acid.
Radioactive concentration	37–370 MBq/mL.
Radionuclidic purity	>99%.
Specific activity	>20 GBq/g of Sc .

The above procedure was provided by:

M. Ananthkrishnan,
Board of Radiation and Isotope Technology,
Department of Atomic Energy, Mumbai, India.

Scandium-47 ($^{47}\text{Sc}_{21}$)

Half-life	:	3.35 d
Production scheme	:	^{47}Ti (n,p) ^{47}Sc
Type of decay and energy	:	β^- (MeV) 0.4407 (68.4%) 0.6001 (31.6%) γ (MeV) 0.15938 (68.3%)
Decay product	:	^{47}Ti (stable)

Target specification and preparation

Target Purity: Enriched ^{47}Ti (94.53% ^{47}Ti , 4.74% ^{48}Ti , 0.35% ^{46}Ti , 0.2% ^{49}Ti , and 0.18% ^{50}Ti) purchased from Oak Ridge National Laboratory (ORNL). Stable scandium in the target material shall be kept low to maximize specific activity.

Irradiation parameters, specific activity and total yield at EOB

Reactor	:	The V-15 or V-16 thimble positions at High Flux Beam Reactor (HFBR) at Brookhaven National Laboratory (BNL) ($\phi_n = 1.5 \times 10^{14}$ n/cm ² /s, $E_n > 1$ MeV) and the HT-5 hydraulic tube position at High Flux Irradiation Reactor (HFIR) at ORNL ($\phi_n = 4.6 \times 10^{14}$ n/cm ² /s, $E_n > 1$ MeV).
Capsule details	:	0.5 cm ID \times 5 cm Suprasil (purchased from Heraeus) quartz ampules.
Target mass	:	50–250 mg of oxide.
Irradiation length	:	3–5 days.
Specific activity, production yield:		
	BNL	Specific activity: >285 MBq (7.7 mCi)/ μg in the “in-core” positions (V-15 or V-16 thimble positions, located 13 cm from bottom). Production yield: ^{47}Sc saturation yield = 25.23 MBq/mg ^{47}Ti .
	ORNL	Specific activity: >1.23 GBq (33.3 mCi)/ μg in the HT #5 position. Production yield: ^{47}Sc saturation yield = 109.41 MBq/mg ^{47}Ti .

The above procedure was provided by:

L.F. Mausner,
Office of Isotope Production,
Medical Department, Brookhaven National Laboratory,
Upton, New York 11973, USA.

Type of facility for processing

Processing shall be performed in a shielded hot cell with HEPA filtration in the hot cell exhaust line.

Analysis of raw materials, reagents and chemicals required for processing

All reagents used in processing were of analytical grade without further testing or purification.

Chemical processing procedure

Reagents

Dowex AG 50W-X4 cation-exchange resin was purchased in 100–200 mesh size from BIO-RAD. All glassware was acid washed with HNO₃ before use.

Preparation

Dowex AG 50W-X4 resin was purified as follows. Batches of resin were purified by washing seven times with H₂O, each time decanting the fines, twice with 95% ethanol, twice with H₂O, four times with KOH, followed by a H₂O rinse to neutrality, and four times with 2 N HCl followed by a H₂O rinse to neutrality. Ion-exchange columns were poured using a H₂O slurry containing the resin. After allowing time for the resin to settle, a quartz wool plug was placed on the top of the resin bed and the columns were eluted with 5 column volumes of H₂O. Columns were then preconditioned with the same solution containing the sample.

Target dissolution

Enriched ⁴⁷TiO₂ targets were dissolved slowly (t ~ 1–2 h) in very hot H₂SO₄ (heated to copious fuming) containing a 10:1 mass ratio of (NH₄)₂SO₄ to Ti. Volumes were reduced with heating to 10–15 mL and diluted with H₂O and H₂O₂ to obtain a solution (V_f ~ 750 mL) approximately # 0.15 M in ammonium sulphate, # 3 N in H₂SO₄ and 0.3% in H₂O₂. Addition of peroxide is necessary to oxidize all Ti species in solution to Ti(IV).

Separation procedure

Tests were made with irradiated targets ranging from 50–200 mg of irradiated ⁴⁷TiO₂ or 1.2 g of Ti metal. The separation procedure is shown schematically in Figure 1. The target solution was passed over a large column (2 cm ID × 11 cm) containing 35 mL of the cation exchanger that was previously conditioned 0.2 N HCl. Both Ti and Sc were retained, the Ti appearing as a large orange band whose width was dependent on the solution acidity. The column was then washed with 4 column volumes of 0.2 N HCl to further elute traces of the ammonium sulfate/sulfuric acid solution, followed by 5 column volumes of 1.5 N HCl to elute the majority of the Ti. More Ti was then eluted with 3 column volumes of 2.5 N HCl along with trace impurities of Cu, Zn, Co, Pb, or Fe⁺³. Sc-47 was eluted in nearly quantitative yield with 5 column volumes of 4 N HCl/0.1 N HF. ⁴⁷Sc was eluted in nearly quantitative yield with 5 column volumes. The 4 N HCl/0.1 N HF fraction containing ⁴⁷Sc from the first column was evaporated to near dryness and taken up with 2–3 mL aqua regia to destroy organic residue which may have eluted with ⁴⁷Sc from the first column. This solution was evaporated to near dryness and redissolved in 2–3 mL of 12 N HCl to convert ⁴⁷Sc to the chloride, followed by another evaporation to dryness. The residue was taken up in 2–3 mL 0.2 N HCl and this

solution was passed over a smaller column (1.1 cm ID × 6 cm, 5.7 mL, Dowex AG 50W-X4 cation-exchange resin). Sc and Ti were again retained, the column was washed with 5 column volumes of 0.2 N HCl, and Ti was eluted with 5 column volumes of 2.5 N HCl. Scandium-47 was then eluted with 5 column volumes of 4 N HCl/0.1 N HF. This solution was evaporated to near dryness and the residue was first taken up with ~ 0.3 mL 30% H₂O₂ and evaporated with heat to ~ 0.1 mL, and then treated as described above with aqua regia and HCl. After the final evaporation with HCl, the solution was transferred with 2–3 mL of 0.5 N HCl from the beaker to a small rotovap tube. An aliquot was removed for determination of recovery yield and stable metal analysis (Fe, Zn, Co, Cu, Pb, Sc), and the remaining solution was evaporated to dryness under vacuum using a rotavapor and redissolved in 0.01 N HCl.

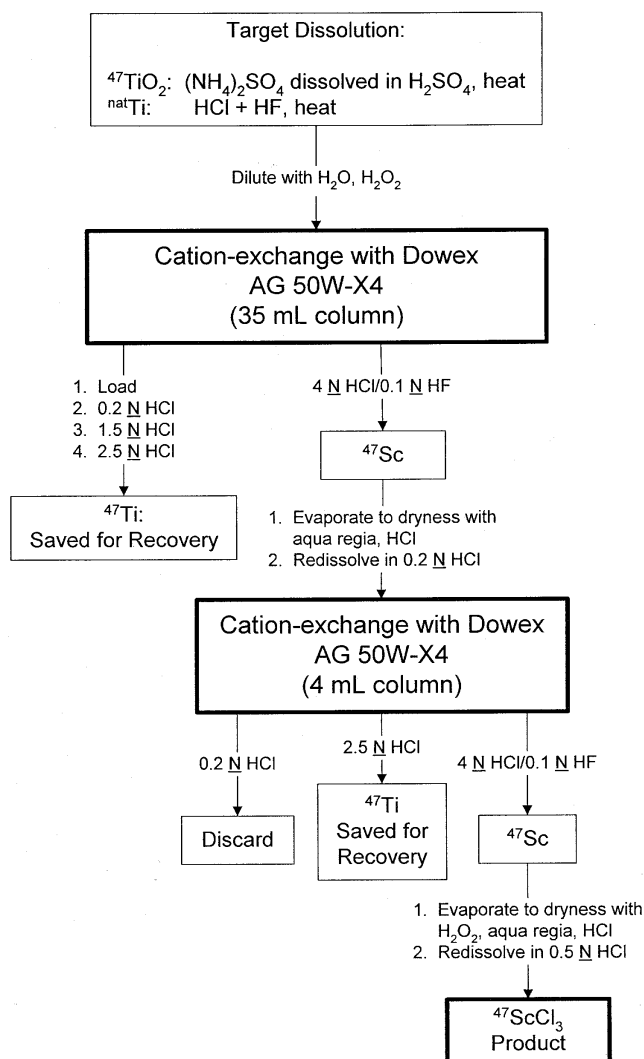

FIG. 1. ⁴⁷Sc Separation from Ti Targets: Cation exchange with Dowex AG 50W-X4 resin.

Dispensing, assay and quality control

Final products are assayed with regard to yield and radionuclidic purity.

Radioactivity measurements

Radioactive samples were assayed by direct γ counting on an intrinsic germanium detector (50 cm³, FWHM 2.0 keV at 1332 keV) connected to a 8192 multichannel analyser. The

detector was calibrated against a known mixed gamma solution standard traceable to NIST. Counting samples were prepared in a plastic vial by dilution of the sample aliquot to 1 mL. All samples were counted at distances ≥ 8 cm from the detector face where coincident summing corrections are negligible.

Stable elemental Analysis is made with and ICP-AE. From this data, the specific activity may be determined. Chemical purity limits: <30 μg each of Pb, Mn, Zn, Cu, or Ti (though actual impurity levels should be kept as low as possible).

Final product specification for use

The final product is intended for use in radiopharmaceutical development by attachment of ^{47}Sc to the 4-ICE-anti-CEA F(ab')₂ MAb conjugate (4-ICE:MAB = 1.7–3.4) where 4-ICE is 4-isothiocyanatocyclohexyl EDTA.

Physical observations	:	The final product should be clear and colorless.
Radionuclide identification	:	by the 159 keV photon (68% abundant).
Radionuclide purity	:	Radionuclide impurity limits should total $<2\%$ of ^{47}Sc activity.
Solution pH	:	pH =5 for ^{47}Sc to be conjugated.
Radiochemical purity	:	The radiochemical purity of ^{47}Sc is determined using HPLC.
Concentration requirements	:	Requires 3-fold molar excess of 4-ICE-Mab conjugate relative to total metals content, requires >185 MBq (5 mCi)/ μg ^{47}Sc .
Shelf life and recommended storage conditions:		Shelf life depends on specific activity requirements of final preparation of antibody conjugate. If not used immediately, the radionuclide should be stored at pH < 2 .
Waste disposal	:	Waste disposal is similar as waste disposal for other radionuclides. Presence of small amounts of ^{46}Sc extends time period when waste is radioactive.
Preparation and cleanup considerations:		Ion-exchange columns are poured fresh for each production run. Peroxide is stored in a refrigerator and disposed after its expiration date (generally 6 mo. after bottle is opened).

Practical experience gained

To achieve dissolution of target material requires very high heat (vigorous fuming of H_2SO_4) and at least a 10-fold excess of ammonium sulphate. Ion-exchange column fractions containing ^{47}Sc must be rigorously digested with peroxide and aqua-regia to remove organic residues that co-elute with ^{47}Sc from the columns. Failure to follow these steps can lead to disappointing labeling results. Further details are given in the references cited below.

BIBLIOGRAPHY

MAUSNER, L.F., et al, Radionuclide Development at BNL for Nuclear Medicine Therapy, Appl. Radiat. Isot. **49** (1998) 285.

Silver-111 ($^{111}\text{Ag}_{47}$)

Half-life	:	7.45 d
Production scheme	:	$^{110}\text{Pd} (n,\gamma) ^{111}\text{Pd} \xrightarrow{\beta^-} ^{111}\text{Ag}$
Decay product	:	^{111}Cd

Production process

Ag-111 is a radionuclide with potential application in the field of radioimmunotherapy. It can easily be prepared by neutron irradiation of palladium according to the nuclear reactions depicted in scheme 1. Natural palladium consists of a mixture of 6 stable isotopes but only the upper three neutron capture processes are relevant. For the production of Ag-111 from natural palladium, the neutron capture of Pd-108 to Pd-109 with subsequent decay to stable Ag-109 is the most important parallel reaction, since this isotope limits the final specific activity after the separation of silver (Ag-109 and Ag-111) from target palladium. Therefore, preparation of Ag-111 from natural palladium results always in carrier added Ag-111 according to the datas given in Table I.

To yield n.c.a. Ag-111, enriched Pd-110 has to be used instead of natural Pd. 98% isotopically pure Pd-110 is commercially available, however it is rather expensive. For the processes described below it has to be recycled, which might cause problems due to long lived contamination in the original sample (i.e. Ir-192, Hg-203 etc.) which are always present as impurities in the targets. The specific activities achieved with natural Pd are usually sufficiently high for the labelling of therapeutically useful biomolecules, the studies have been performed with nat. Pd only.

Scheme 1. Neutron irradiation of nat. Pd, Pd-102 (1.02%); Pd-104 (11.14%); Pd-105 (22.33%); Pd-106 (27.33%); Pd-108 (26.46%); Pd-110; 11.72%

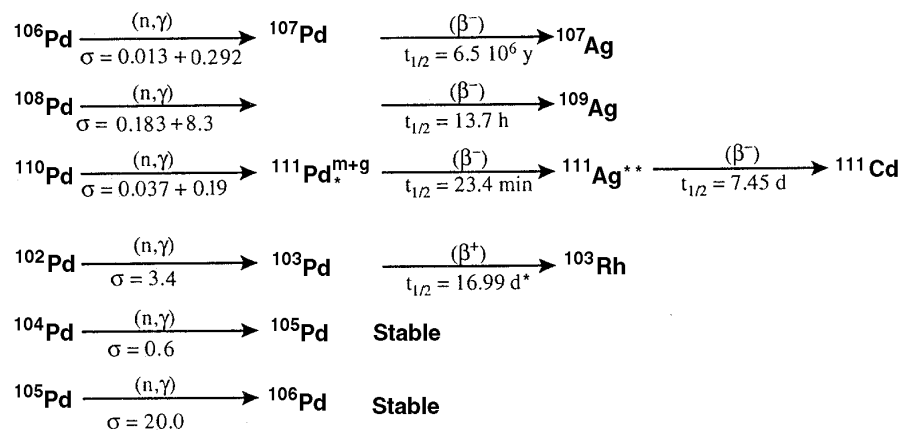

* ^{111m}Pd	:	5.5 h, 73% IT, 27% β^-
^{111g}Pd	:	23.4 min, β^-
** ^{111m}Ag	:	64.8 s, 99.3% IT, 0.7% β^-
^{111g}Ag	:	7.45 d, β^-

The above procedure was provided by:

R. Alberto and P. August Schubiger,
 Centre for Radiopharmaceutical Sciences, Paul Scherrer Institute,
 CH-5232 Villigen PSI, Switzerland.

TABLE I. ACTIVITIES AND AMOUNTS OF AG-109 AND AG-111 PRODUCED UPON IRRADIATION OF 0.1 G NAT. PD AT A NEUTRON FLUX OF 5×10^{13} n/cm²/s

Irradiation [h]	Act _{EOB} Pd-109 [mCi/GBq]	Act _{EOB} Ag-111 [mCi/MBq]	Amount Ag-109 [μg]	Amount Ag-111 [μg]	A _{spec.} [mCi/mg]/ [GBq/mg]
24	1706/62.9	3.4/125	1.4	0.02	2430/90
48	2217/82	6.5/240	2.84	0.04	2290/85
72	2360/85	9.4/344	4.3	0.06	2190/80
96	2400/89	12.0/440	5.75	0.075	2051/76
144	2400/89	16.5/510	8.6	0.1	1896/70
192	2400/89	20.3/750	11.4	0.13	1760/65
240	2400/89	23.4/860	14.3	0.15	1620/60
480	2400/89	32.7/1200	28.5	0.21	1140/42
960	2400/89	37.7/1380	57.0	0.24	658/24

Principle of the separation process

Since the purification process is special it will be explained in detail. Liquid/liquid extractions are usually applied for the separation of a component from bulk material, which forms with high selectivity and stability only compounds with the desired radionuclide. If the process is repeatedly performed, high purity material can be yielded.

Such specific ligands or phase transfer carriers do not exist for palladium and silver, since their chemistry is very similar in terms of preferred ligand atoms or ligands. Comparing the few thermodynamic stability constants reveals, that log K are larger for Pd²⁺ by about 1–2 orders of magnitude. Consequently, Pd²⁺ could be extracted into an organic layer with a versatile ligand, however, very high accumulation of Ag-111 can obviously not be achieved by this method. A very slight excess of ligand would transfer Ag⁺ as well.

Pd²⁺ and Ag⁺ differ significantly in their kinetic behaviour Pd²⁺ is very slowly reacting while Ag⁺ is a very fast. The basis of the separation is, thus, different kinetic behaviour rather than thermodynamics.

The phase transfer ligand is triphenyl-phosphine (TPP) which forms stable complexes with Ag⁺ and Pd²⁺.

Pd²⁺ is extracted slower to a concentration which corresponds to about 1 eq. Pd²⁺ per

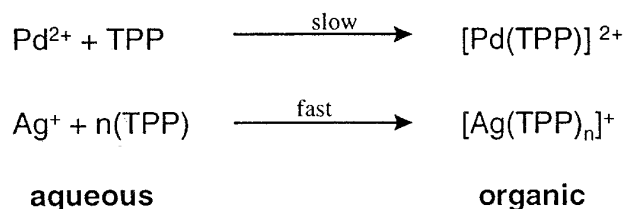

TPP. This process can easily be monitored by external radioactivity measurement, since Pd-109 decomposes to short-lived Ag-109m. After all TPP are coordinated to Pd²⁺, the TPP ligands coordinated to Ag⁺ are slowly released by competition of [Pd(TPP)]²⁺. The remaining Ag⁺ is then again phase transferred back into water.

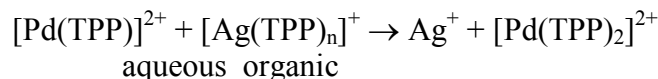

The original acidic layer is exchanged by a slightly acidic fresh solution Ag^+ can be collected after reextraction in quantitative yield and very high purity. The Pd-TPP complexes are almost insoluble in aqueous solution. After a certain period of time, Ag-111 is reextracted into the fresh aqueous solution.

Detailed experimental procedure

In a typical standard experiment, 0.4 g of Pd metal was irradiated at the Seibersdorf research reactor over 72 h. After a decay period of about 2–3 days, the material contained about 1.48 GBq (40 mCi) of Ag-111 and still 7.4 GBq (200 mCi) of Pd-109.

Dissolution of Pd to Pd(NO₃)₂

The irradiated capsule was broken and the aluminium packages transferred to a round bottom flask. The metallic Pd powder was dissolved in conc. HNO₃ (20 cm³) over 12 h at 130°C, resulting in a dark brown but clear solution. The Pd must completely be dissolved, otherwise catalytic decomposition of TPP might occur. The solution was then diluted to a final volume of a 50 cm³ with bidistilled water.

Extraction of Ag⁺/Pd²⁺ into Toluene

The aqueous nitric acid solution was transferred into a round bottom flask equipped with stir bar and overlaid with 150 cm³ of toluene. The stirring rate was adjusted to a value, where the two layers did not mix and no toluene drops in water (and vice versa) formed. For reproducibility of the procedure, this rate should be kept constant. 5 cm³ of a 0.1 M solution of TPP in toluene were added by means of a syringe. The activity in the organic layer was monitored either by a γ -counting tube focused on the organic layer or by a bypass attached to the flask continuously flushed by a means of peristaltic pump. The activity in the organic layer steadily increased. Maximum was reached after about 20 min depending on the stirring rate. The organic layer turned yellow. At the maximum, about 95% of Ag-111 was in the organic layer.

Reextraction of Ag-111/Ag-109 into 10⁻⁴ M HNO₃

After the maximum was achieved, stirring was stopped and the organic layer transferred into a separation funnel, containing about 10 cm³ of 10⁻⁴ M HNO₃. For the purity of the product careful separation was crucial. Remaining toluene fractions and the 10⁻⁴ M HNO₃ were mixed by dropping the aqueous layer continuously through the organic layer for about 2h. After this time period, about 80% of Ag-111 were reextracted into the aqueous solution, which was separated through the lower end of the funnel. The solution was completely colourless and even UV/VIS spectroscopy did not show the presence of any Pd²⁺. Pd²⁺ contamination was checked by means of ICP-MS, which gave usually less than 1% of Pd relative to Ag⁺.

Apparatus and flowchart

A schematized drawing of an apparatus for routine use is given in Scheme 2. In general, teflon tubes have been chosen for the transfer from one bottle to another. The flask can be

normal glass ware with the exception of the last separation funnel, which has to be either from teflon or better quartz glass. Ag^+ has the tendency to adsorb very well on normal glass probably by ion exchange with Na^+ or K^+ . As long as the aqueous solution was acidic, no problem with adsorption were encountered since competition of H^+ was strong enough. However, when changing to more physiological buffer solution or to slightly acidic medium, a steadily growing amount of Ag-111 was found to bind irreversible to glass. In any case, rubber should be omitted, since any sulfur containing material will adsorb Ag^+ very efficiently.

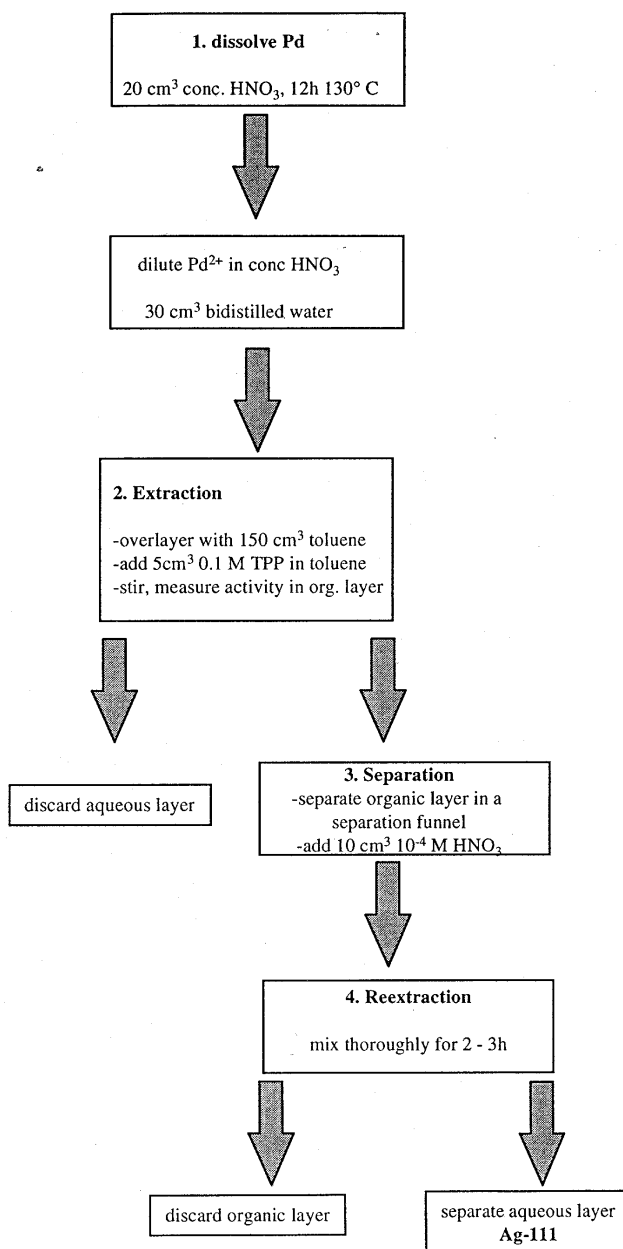

Target specification

0.1 g of Pd powder was packed in a aluminium foil. Two of these packages were placed in a quartz glass ampule and sealed under vacuum. Pd was purchased in puriss quality from Fluka AG Buchs/Switzerland.

Irradiation parameters and facility of processing

In general, the Seibersdorf Astra research reactor was used for irradiation, in a few exceptions also the Dutch research reactor at Petten. The amount of target and its quality are described above. The targets were usually irradiated during a 72 h time period at a neutron flux between 7.7 and 8.3×10^{13} n/cm²/s. The specific activities achieved after the separation process corresponded in general the data given in Table I. For the processing of the target, hot cells with negative pressure and charcoal filters were used.

BIBLIOGRAPHY

ALBERTO, R., BLAEUENSTEIN, P. SMITH, A., SCHUBIGER, P.A., An Improved Method for the Separation of Ag-111 from Irradiated Natural Palladium. *Int. J. Appl. Radiat. Isot.*, **43** (7) (1992) 869–872.

Sodium-24 ($^{24}\text{Na}_{11}$)

Half-life	:	14.959 h
Production scheme	:	$^{23}\text{Na} (n, \gamma) ^{24}\text{Na}$ $\sigma = 0.53 \text{ b}$
Type of decay and energy	:	β^- (MeV) 1.3907 (99.94%) γ (MeV) 1.369 (100%) 2.754 (99.94%)
Target material	:	Anhydrous sodium carbonate
Decay product	:	Magnesium-24

Target specification and preparation

Target Purity	:	Meets British Pharmacopoeia 1998 requirements.
Enrichment factor	:	Nil.
Impurity details	:	Contains 98.5–101.5% Na_2CO_3 with reference to the dried substance.
Isotopic composition	:	Non-enriched material is used.
Supplier	:	BDH or Merck.
Grade	:	Suprapur grade.

Irradiation parameters, specific activity and total yield at EOI

Reactor used	:	HIFAR, Lucas Heights, Australia.
Assembly	:	Hydraulic tube with conveyor unload.
Capsule details	:	Anhydrous Sodium Carbonate starting material is placed in a screw top aluminium or titanium inner can, which in turn is placed in a screw top aluminium or titanium outer can.
Target mass	:	100 mg Na_2CO_3 /capsule.
Target preparation	:	Dry at 200°C for 4 h.
Reactor neutron flux	:	$\sim 6 \times 10^{13} \text{ n.cm}^{-2}.\text{s}^{-1}$ (thermal).
Irradiation time	:	8 h
Cooling period	:	N/A.
Expected activity	:	9.25 GBq (250 mCi) ^{24}Na , > 5 GBq/g Sodium element.

Processing facility

This material is processed inside a hot cell.

The above procedure was provided by:
Australian Nuclear Science and Technology Organisation,
Radiopharmaceutical Division,
Operations-Lucas Heights, Australia.

Analysis of raw materials, reagents and chemicals required for processing

Water for injections BP

This material is purchased as such and meets British Pharmacopoeia 1998 requirements.

0.2 M Sodium hydroxide solution

This material is prepared by dissolving sodium hydroxide in Water for Injections BP. The solution is filtered through a 0.22 μm membrane filter into sterile clinbritic vials. The solution is standardized by titrating against standardized 0.1 M hydrochloric acid, using phenolphthalein as an indicator. The solution is approved for use with a concentration of 0.18–0.22 M NaOH. Material approved for use is stored under refrigeration, and has an expiry period of 3 months.

0.2 M Hydrochloric acid solution

This material is prepared by diluting concentrated Hydrochloric Acid AR grade with Water for Injections BP. The solution is filtered through a 0.22 μm membrane filter into sterile clinbritic vials. The vials are then autoclaved for 6 minutes at 132°C. The solution is standardized by titrating against standardized 0.1 M sodium hydroxide solution, using phenolphthalein as an indicator. The solution is approved for use with a concentration of 0.18–0.22 M HCl. Material approved for use is stored under refrigeration, and has an expiry period of 6 months.

Chemical processing procedure

1. All equipment is transferred to the manufacturing cell before commencing.
 2. To a 30 mL beaker, add 3 mL of 0.2 M hydrochloric acid, 15 mL of Water for Injections BP and a teflon coated magnetic stirrer bar.
 3. Place beaker on a hot plate-stirrer and with stirring, slowly add the irradiated sodium carbonate powder. Tap to ensure all powder is removed.
 4. Heat until all CO₂ evolution has ceased and remove from hot plate and allow to cool for 5 min.
 5. Adjust pH to 6–8 with either 0.2 M hydrochloric acid or 0.2 M sodium hydroxide, added dropwise with constant stirring. Check pH by placing a drop onto pH paper without touching the pipette to the paper. Repeat until pH is correct.
 6. Make up to 20 mL with water for injections BP.
 7. Dispense 1 mL into a serum vial, and measure the activity at calibration time and date, in an ion chamber.
 8. Dilute the stock solution to the required activity concentration and mix well.
 9. Dispense solution into sterile vials, then cap and seal vials.
- Place vials into lead pots of thickness appropriate to activity concentration.

Dispensing, assay and quality control

Radioactive concentration

The radioactive concentration must be within 90–110% of the required concentration at the calibration time and date. Measure a sample in an ionization chamber that has been calibrated to measure sodium-24.

Radionuclidic purity

The radionuclidic purity is acceptable if a gamma spectrum analysis identifies ^{24}Na as >99% of the total gamma emitters

pH

The pH must be between 6.0–8.0. Measure the sample on a pH meter or using a suitable narrow pH range paper.

Final product specification

Physical form	:	A clear, colourless aqueous solution contained in a serum vial.
Chemical form	:	An aqueous solution of sodium(^{24}Na) chloride.
PH	:	6–8.
Specific activity	:	>5 GBq/g sodium element at calibration.
Radionuclidic purity	:	>99% ^{24}Na at calibration.
Radioactive concentration	:	A specified by customer, typically 40 MBq/mL at calibration.
Storage	:	Store at ambient temperature.
Cell cleanup	:	All waste is removed from the cell and placed into the appropriate shielded waste receptacles. Solid waste is stored separate to liquid waste. If required, equipment in the cell is allowed to decay prior to cleaning the cell. The cell surfaces are then cleaned by swabbing with lint free cloths liberally doused with isopropanol or ethanol.

Strontium-89 ($^{89}\text{Sr}_{38}$)

Half-life : 50.53 d

Production scheme : $^{88}\text{Sr} (n,\gamma) ^{89}\text{Sr}$ $\sigma = 0.058$ b

Decay product : ^{89}Y

Type of decay and energy : β^- (keV) 586.1
1495.1

Target specification and preparation

Strontium-88 carbonate, isotopic enrichment 99.0%.

Supplier: Cambridge Isotope Laboratories, USA.

Cat. Number: SRLM-3825.

Irradiation parameters, specific activity and total yield

Irradiation site:	MARIA reactor IEA, Swierk, Poland	SM-3 reactor NIIAR Dymitrovgrad, the Russian Federation
Assembly:	vertical channel in beryllium block	no data
Capsules:	quartz ampoule in aluminium capsule, ϕ 25 mm, length 88 mm	quartz ampoule in aluminium capsule, ϕ 9 mm, length 60 mm
Sealing:	cold welding	welding
Mass of target:	about 1 g	about 6g
Reactor flux:	2.5×10^{14} n/cm ² /s	1.37×10^{14} n/cm ² /s fast neutrons + 10^{15} n/cm ² /s thermal neutrons
Irradiation time:	5–6 cycles of 100 hours	20 days

The average activity obtained at Maria reactor (calculated at the activation end) was about 110 mCi (4.0 GBq)/g of Sr. Currently the irradiation is not possible; installation of thermal neutrons converter is planned.

The average activity obtained at SM-3 reactor (calculated at the activation end) is about 900mCi (33 GBq) per target i.e. 0.15–0.2 Ci (5.5–7.4 GBq)/g of strontium.

Type of facility for processing

The hot cell of 100 mm lead wall equipped with manipulators and connected to the separate ventilation system. Filters on the air outlet: paper-charcoal. Standard under pressure inside the hot-cell is 20 mm H₂O.

The above procedure was provided by

R. Mikloczak

Radioisotope Centre, OTWOCK Swierk, POLATOM, Poland.

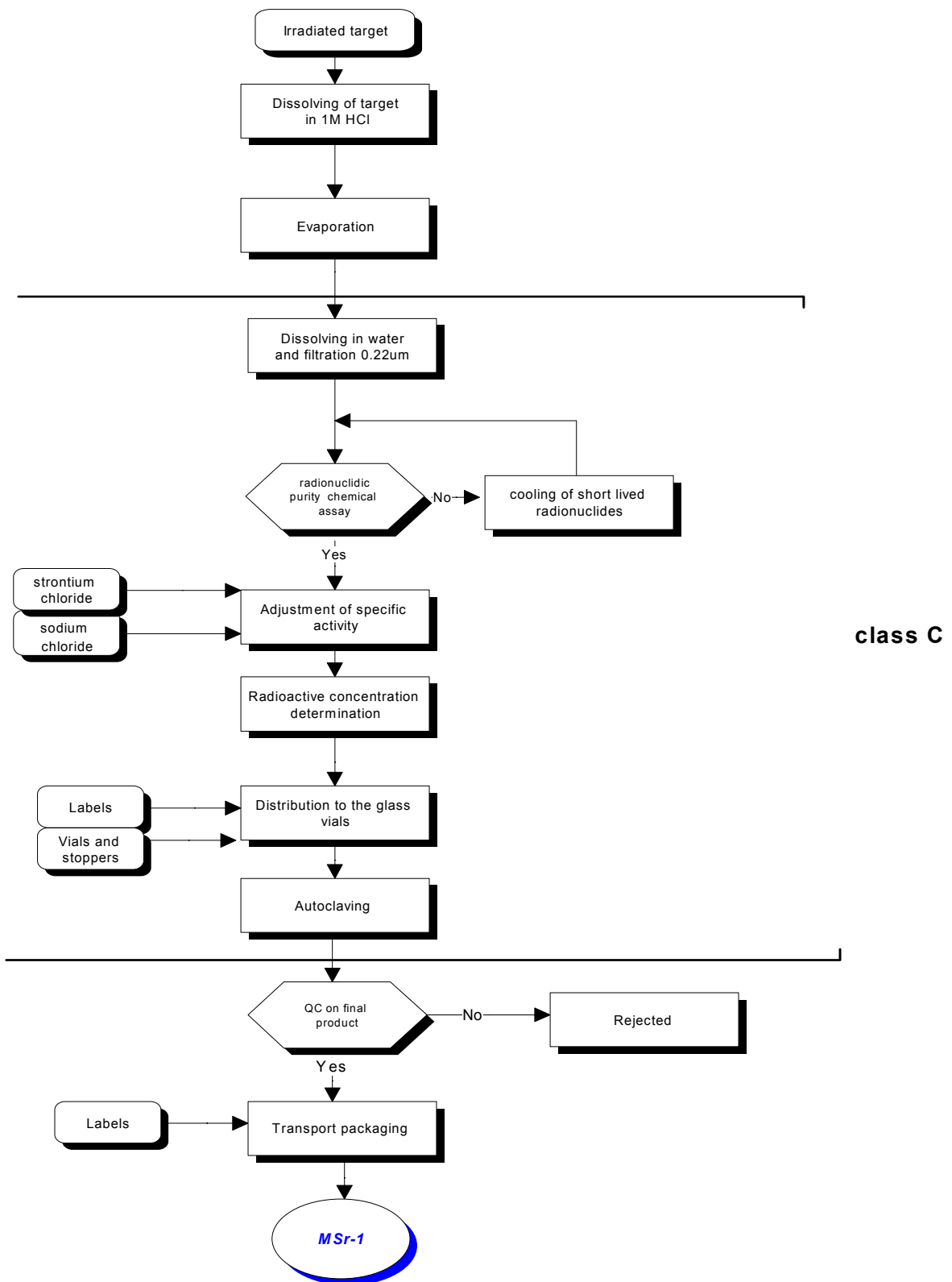

FIG. 1. Schematic flow chart of the production process.

Analysis of raw materials, reagents and chemicals required for processing

Hydrochloric acid 36% : reagent, European Pharmacopoeia, supplier Merck
Sodium chloride : reagent, European Pharmacopoeia, supplier Merck
Water for injection : European Pharmacopoeia, supplier POLATOM

Chemical processing procedure

The irradiated target material is dissolved in 1 M HCl, evaporated to dryness and dissolved in water (bulk solution). After in-process control the isotonicity of the solution is adjusted by addition of NaCl. The solution is filtered on 0.22µm filter and dispensed into glass vials, sealed and autoclaved.

Dispensing, assay and quality control

Parameters of the obtained solution are controlled: pH, assay of strontium and sodium chlorides, specific activity, radioactive concentration and radionuclidic purity.

Test for radionuclidic purity

Gamma radiation impurities

The measurement is performed by gamma-spectrometry (GC 1520 detector with the volume of 70 cm³ and resolution of 0.8 keV at 122 keV from ⁵⁷Co and 1.8 keV at 1332 keV from ⁶⁰Co). The spectrum is recorded by multichannel analyser AccuSpecA (Canberra) and Genie2000 software. The volume of 1 ml of the solution in a standard glass vial is measured, γ-radionuclidic impurities are detected at the lowest limit of $5 \times 10^{-5}\%$. In most of the produced batches γ impurities were not exceeding 0.001%.

Beta radiation impurities

Beta radiation impurities are measured by LSC (liquid scintillation count) method in WALLAC 1411 (LKB) spectrometer with application of liquid scintillator Ultima Gold (Hewlett Packard). Measured spectrum is identified against theoretical spectrum of ⁸⁹Sr available in the spectrometer's software.

The measurement of the strontium-90 impurity is based on separation of yttrium-90 (in equilibrium with Sr-90) from the tested sample by solid phase extraction chromatography.

Test for radioactive concentration

Activity of strontium-89 in the known volume of the solution was measured by Liquid Scintillation Method. Liquid scintillator Ultima Gold from Packard was used. The results were calculated by TDK method (the overall uncertainty of the measurement ±3%).

Test for assay of chlorides

Determination of chlorides assay is performed by potentiometric titration with 0.01 N silver nitrate.

Test for specific activity

Determination of strontium assay in the strontium chloride, $^{89}\text{SrCl}_2$ is performed by complexometric method. In acetone solution Sr^{2+} and arsenazo III form a complex which maximum absorbance can be measured in the visible region at $\lambda = 640 \text{ nm}$.

Specific activity, r_s of the SrCl_2 solution is determined on the basis of its radioactive concentration according to the formula:

$$r_s = \frac{C_R}{C_{\text{Sr}}}$$

where

C_R is radioactive concentration of the solution [GBq/mL]

C_{Sr} is concentration of strontium in the solution [ngSr/mL]

Test for chemical purity

Chemical impurities in the $^{89}\text{SrCl}_2$ solution are determined by ICP-OES spectrometry. In the inductively coupled plasma optical emission spectrometry (ICP-OES) the liquid sample is transformed into aerosol in the nebulizer. The very small drops of liquid are injected into the plasma by a stream of carrier gas. In the plasma the atoms are excited and form ions of the analytes. Characteristic radiation is emitted and analysed on a polichromator. Each line intensity is measured on a semiconductor detector SCD. Intensities of the emitted lines in the recorded spectrum are evaluated. Quantitative measurement needs calibration of the spectrometer using standard solutions of the analytes. According to European Pharmacopoeia (monograph 01/2002:1475) the limits for chemical impurities in the $^{89}\text{SrCl}_2$ solution are:

Al < 2 ppm

Fe < 5 ppm

Pb < 5 ppm

The detection limits (LDL) for impurities in $^{89}\text{SrCl}_2$ solution are, as follows:

Element	LDL [$\mu\text{g/ml}$]	Element	LDL [$\mu\text{g/ml}$]	Element	LDL [$\mu\text{g/ml}$]
Fe	0.30	As	3.90	Cd.	0.23
Cu	0.51	Al	0.36	Si	0.58
Ca	0.25	Ba	0.09	Mg	1.91
Pb	0.73	B	0.28	Mn	0.08
Te	3.18	Zn	0.67	Ni	1.36

Test for pH

Potentiometric pH determination of the radioactive $^{89}\text{SrCl}_2$ with a glass electrode combined electrode or colorimetric relative method (paper strips). The strips are covering the pH range specified for the $^{89}\text{SrCl}_2$. Sensitivity of the strips is controlled periodically.

Final product specification for use

Tests	Specifications
<i>Identification:</i> beta-spectrum gamma-spectrum	absorption curve of maximum energy 1.49 MeV $E_{\max} = 909 \text{ keV}$
<i>Characters:</i>	Clear, colorless liquid
<i>PH:</i>	4.0–7.0
<i>Radionuclidic purity:</i>	>99.6% total beta impurities <0.2%
<i>Assay of strontium chloride:</i>	10.8–19.4 mg/ml
<i>Assay of sodium chloride:</i>	0–3.0 mg/ml
<i>Radioactive concentration:</i>	37.5 MBq/ml
<i>Specific activity:</i>	3.5–6.3 MBq/mg Sr
<i>Chemical purity:</i>	overall $\geq 99.9\%$ Al < 2 ppm Fe < 5 ppm Pb < 5 ppm
<i>Sterility:</i>	sterile

Radiopharmaceutical is delivered in portions (a single patient dose) containing about 4 ml of solution with total activity of 150 MBq of strontium chloride, $^{89}\text{SrCl}_2$ (certified on 12⁰⁰ CET of the day of calibration). The preparation is delivered in glass vials of 10 ml volume sealed with rubber stopper and aluminum cap. The shielding container is made of lead.

^{89}Sr -strontium chloride is a radiopharmaceutical used for palliative therapy of multiple malignant metastases to the skeleton, mainly from prostate and breast cancer.

Shelf-life: 4 weeks from the calibration date.

Preparation and cleanup of the facility and preparation for processing of next production batch: the processing is performed in single step, which is performed in the destined cells of a hot cell. Therefore there aren't any special requirements for cleanup of the facility. Glass vials for final product dispensing are washed and heated in 250°C prior to use, vials and closures are autoclaved. The product is administered intravenously after final sterilization. The requirements of GMP apply to the manufacturing process.

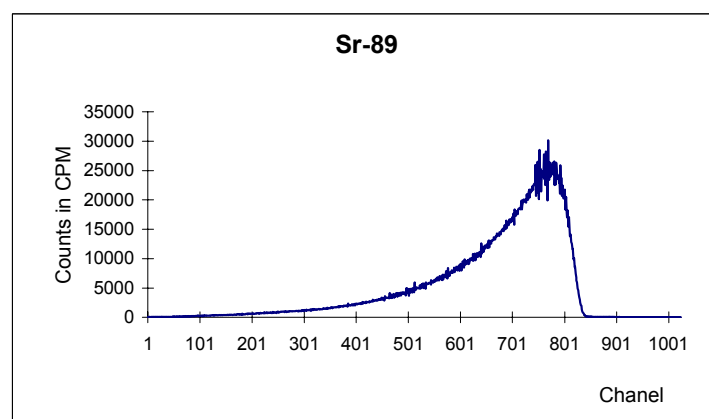

FIG. 2. Beta spectrum of Sr-89 recorded in the Wallac 1411 spectrometer.

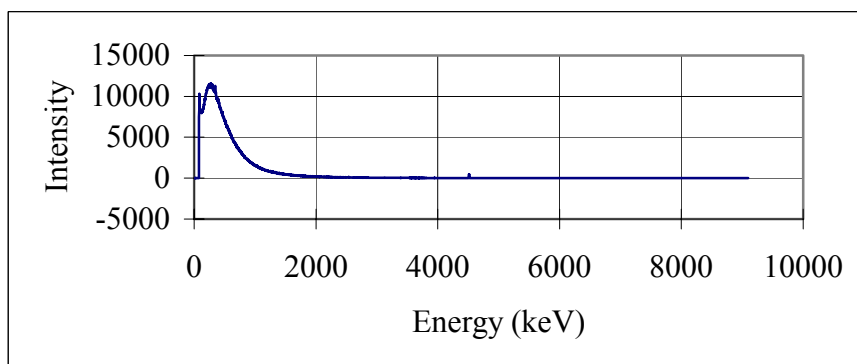

FIG. 3. Gamma spectrum of Sr-89 on GC 1520 detector.

BIBLIOGRAPHY

DEPTULA, C.Z., CHMIELOWSKI, K., KEMPISTY, T., et al., Method of preparation and application of strontium chloride- $^{89}\text{SrCl}_2$ for palliative treatment of painful bone metastases, Part I. Production method of strontium - ^{89}Sr chloride, *Problemy Medycyny Nuklearnej* **10** (19) (1996) 161–168.

DEPTULA, C.Z., KEMPISTY, T., MARKIEWICZ, A., et al., Quality control methods of strontium chloride $^{89}\text{SrCl}_2$, radiopharmaceutical for palliative treatment of bone metastases (Proceedings of the 2nd International Conference of Isotopes, Sydney) (1997) 196–199.

Strontium-89 ($^{89}\text{Sr}_{38}$) (Alternate procedure)

Production technological flowchart

Sr-89 is produced by the natural yttrium oxide irradiation (Y-89–100%) in the fast neutron reactor as result of (n,p) reaction.

The technological flow-chart of Sr-89 radionuclide production:

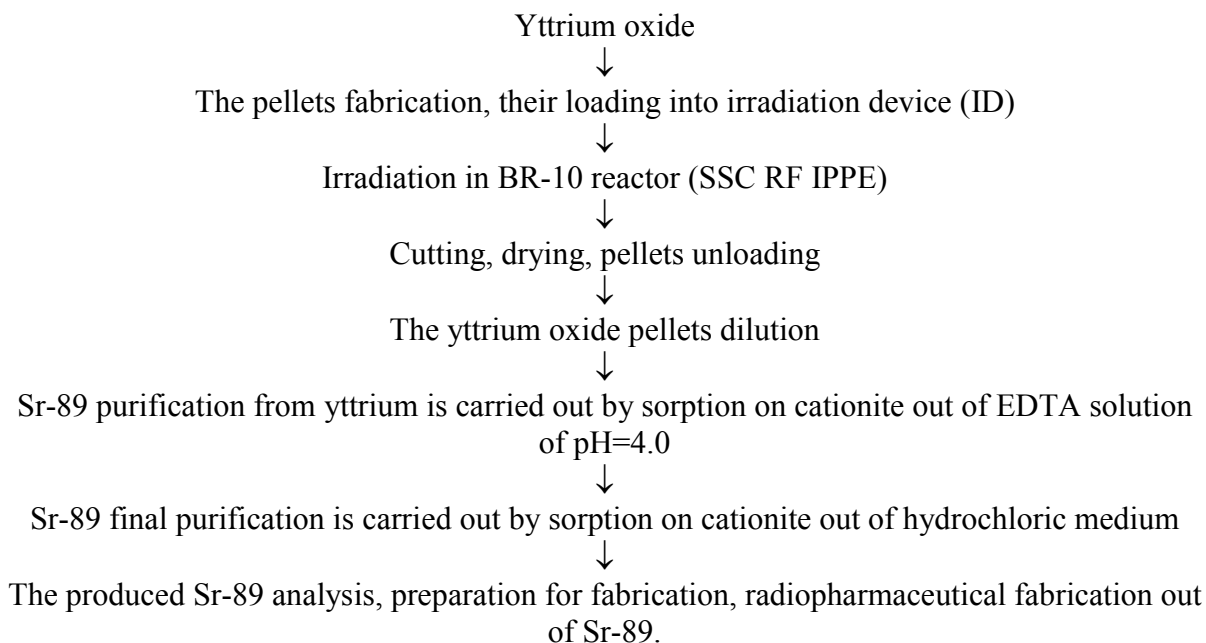

Target specification and preparation

The raw material for Sr-89 production is the natural yttrium oxide, the chemical impurity content of which is not more than 10^{-3} – 10^{-4} % of mass, and the fissile uranium content is not more than 10^{-5} % of mass. The uranium concentration in the initial product is controlled by the method of glass track detectors during its brief irradiation in reactor. The method of Sr-89 production does not require the enrichment of the target initial material.

Due to the fact that (n,p) nuclear reaction cross-section is not large it is necessary to load a significant amount of yttrium oxide into ID with maximally possible density in order to accumulate the economically acceptable amount of Sr-89.

The process of the pellets pressing and caking in vacuum at $t \sim 1600^\circ\text{C}$ has been developed.

The yttrium oxide pellets are put into irradiation device (ID). The pellets are of 18.6mm diameter, 4.6 – 10.7mm height, 4.16 – 4.44g/cm³ density. The yttrium oxide amount in ID is 330–340g. (Up to 1kg for BOR-60 reactor in Dimitrovgrad).

The above procedure was provided by:
Institute of Physics and Power Engineering,
Department of Research Reactors, Isotopes and Radiopharmaceuticals,
Obninsk, Kaluga Region, Russian Federation.

In order to prevent the irradiated yttrium oxide contamination with fission products (FP) during the ID unloading and transportation the pellets are put into the quartz ampoules which are brought into ID after their sealing (3 ampoules into ID). The ID outer diameter is 26.0 mm, length is 832.0mm. ID is made of stainless steel of 06X18H10T. Its tightness is provided and controlled. That ID is put into the fast neutron reactor core. Sr-89 yield per ampoule is 150 mCi.

Irradiation parameters, specific activity and total yield at EOI

The yttrium oxide irradiation takes place in BR-10 reactor during 45–50 days in the fast neutron flux of $(5 \div 8) \cdot 10^{14}$ n/sec. \cdot cm², the neutron fluence is $(2 \div 4) \cdot 10^{21}$ n/cm².

In the chain of nuclear transformations during the Y-89 irradiation by fast neutrons the probability of Sr-89 accumulation is negligible, Sr-90 accumulation is less than 10⁻⁵%, rubidium-89 accumulation is about 1% of Sr-89 activity, the strontium stable accumulation (mainly of Sr-88 >88%) reduces the Sr-89 specific activity from theoretic value— $2.9 \cdot 10^4$ C/g up to $(1.6–1.7) \cdot 10^4$ Ci/g (according to the calculation).

Type of facility for processing

All the operations of the irradiation device unloading out of reactor, its transportation, cutting and chemical processing have to be remote-controlled ones. The cutting and chemical processing take place in the hot cells with double air refinement system and the refined air exhaust through the 100m height pipe. The cell biological shielding has to provide the standard operation conditions for the personnel. The pressure difference between the operation room and the hot cell has to be kept not less than 20mm of the mercury column. The final operations of purification and control and packing are to be carried out in the shielded sealed box (with 50 mm of lead) with the same pressure difference between the inner box space and the operation room (20 mm of the mercury column).

That operation section infrastructure has to provide the personnel clothes entire changing, the possible collection and disposal (storage) of the solid and liquid radioactive waste.

Analysis of the raw material, reagents and chemicals needed for processing

The following materials have to be subjected to the inlet analysis:

- yttrium dioxide — for the chemical admixture content, uranium especially;
- quartz and stainless steel (pipe) — for their certificates compliance;
- chemical agents: nitric acid, EDTA, ammonia solution, hydrochloride acid have to be of “X4” model and their compliance have to be controlled;
- tributylphosphate of “technical” model is used after washing by soda solution and saturation with nitric acid.

Chemical processing procedure

The technological flow chart of Sr-89 production consists of the following operations:

- the external surface of the quartz ampoules with yttrium oxide is decontaminated by boiling in 12 M nitric acid with 0.1M hydrofluoric acid, rinsed by distillate; the ampoules are broken; the pellets with the fragments of quartz glass are put into the basket of the device-dissolver;
- the pellets are dissolved in 3–4M nitric acid at ~110°C during 22–24 hours; as the acid is consumed in the process of dissolving 12M nitric acid is added at ~25–30 mL/h flow rate; the dissolving results in 2.5–2.81 of yttrium nitric acid solution of 120–130 g/L

- concentration containing 450–500 mCi of Sr-89 and 120–150 mCi of Y-88 (by the end of irradiation);
- separation of the main part of yttrium (>99%) from Sr-89 is carried out by the yttrium extraction by 100% tributylphosphate previously saturated with nitric acid. Extraction takes place from the nitric acid solution of not less than 12–13M acidity. Sr-89 is kept in liquid phase in these conditions; yttrium is re-extracted from 100%TBP by distillate and kept in a vessel in the form of nitric acid solution (~2M) during 2.5–3.0 years up to full Y-88 decay ($T_{1/2} = 100$ days); after that yttrium can be used again; Sr-89 purification from Y-88 factor is not less than $5 \cdot 10^3$; the further operations of Sr-89 purification are carried out in the glove boxes of work premises with the use of local shielding;
 - Sr-89 further purification from macro (Y) and micro (Rb-86, Fe, Cr, NiO) admixtures is carried out by the sorption method with the use of cation exchange resins (KU-2, KU-23, Dawex-50) in NH_4^+ form, from solution out of 0.1M, EDTA at pH=+4,0; the solution for Sr-89 sorption on the cationite is prepared by the nitric acid sublimation by the solution evaporation up to moist salts, dilution in 0.1M nitric acid, the yttrium hydroxide fallen sediments dilution in EDTA solution at slight warming and the solution bringing up to pH=4.0 by ammonia at pH-meter device;
 - Sr-89 sorption final purification takes place on cationite in NH_4^+ form with the solution flow rate $\sim 1 \text{ mL/min} \cdot \text{cm}^2$;
 - Sorption column is washed first by 0.1M EDTA solution of pH=4.0 which amount equals to 5–6 column free volumes and then it is washed out of EDTA by the distillate which flow rate is 3–5mm/min;
 - the column washing by 0.25–0.3M hydrochloride acid takes place in order to put the sorbent into H^+ from which amount equals to 6-8 free volumes (V_{free});
 - Sr-89 is desorped into small volume (70–100 mL) by 7M hydrochloride acid of 0.2–0.3 mL/min $\cdot\text{cm}^2$ rate;
 - Sr-89 desorbent obtained is gathered into the quartz vessel and analysed regarding Sr-89 content by beta-accounting and regarding radionuclide admixtures at gamma-spectrometer. As for radionuclide admixtures at that purification phase as a rule only Rb-86 tracks can be detected in Sr-89 solution;
 - Sr-89 final purification is also carried out on the cationites with preliminary sublimation of 7M hydrochloride acid, the solution acidity correction up to 0.15–0.2M, Sr-89 sorption on cationite out of that acidity, column washing by 0.2M hydrochloride acid first with amount equal to 5 free column volumes and then column washing by 0.4–0.45M hydrochloride acid in order to refine from Rb-86. Rb-86 content is controlled by gamma-spectrometric method during the washing; Sr-89 desorption is carried out by 4–5M hydrochloric acid at $\sim 0.1 \text{ mm/min} \cdot \text{cm}^2$ rate into 30–4-mL volume; all the operations of that phase of Sr-89 purification are carried out in the quartz dishware with the use of quartz distillate and hydrochloric acid obtained by isothermal method;
 - Sr-89 desorbent obtained is carefully boiled down up to the moist salts, diluted by the hydrochloric acid solution of pH~4,5 and put into injection vials; the product obtained is the final product, i.e. strontium-89 radionuclide solution.

Dispensing, assay and quality control

The sampling and the volume measurements are carried out with the help of calibration pipette with not more than 2% error.

The product appearance is visually controlled.

The product total activity and concentration activity are defined as follows:

The sources are fabricated out of the purified strontium-89 chloride solution by sampling the definite amount of the liquid, putting it on to the substrate and drying. Sr-89 activity is defined according to beta-emission at the beta-radiometer. The measurement are carried out by relative method by comparison with beta-emission of the reference source made of reference solutions of the first grade.

The result processing is carried out according to the special method. The relative value of the measurement result total error is not more than $\pm 5\%$.

The activity of gamma-emitting admixtures is defined with the help of semi-conduction gamma-spectrometer.

The beta-emitting admixtures (Sr-90, Y-90) content is defined by measuring the activity of Y-90 recovered out of the solution which acid concentration is 0.4mol/L by the method of ascending chromatography on the paper impregnated by di-2-ethyl-gexyl-phosphoric acid. That operation is carried out after ~ 7 days storage for the yttrium accumulation. Activity is defined with the help of scintillation beta-spectrometer. Beta spectrometer energy and efficiency calibration is carried out with the help of the reference Cs-137 sources.

The product Sr-90 activity will correspond to Y-90 activity calculated by the moment of its recovering according to the formula: $A^0 = At/e^{-\lambda T}$

Chemical admixture determination: The chemical admixture content in Sr-89 product is defined by atomic-emission method. The reference solutions 50mkl each containing 18 elements-admixtures (Al, As, Ba, Be, Cd, Cr, Cu, Fe, Hg, Mn, Ni, Mg, Pb, Sb, Sn, Tc, Zr) and the samples 50mkl each are put on the electrodes impregnated by polystyrene with the help of pipettes. The arc of direct current from the ИBC-22 spectrum exciting source is used as the source for the spectrum excitement. ИСП-30 spectrograph is used for that operation The spectral lines blackening (ΔS) is measured with the help of ИФО-463 micro-photometer.

Final product specification for use

“Strontium-89 Chloride Carrier-free”

1. Appearance — transparent colorless solution.
2. Concentration activity is not less than 0.5–2.5 mCi/cm³ on delivery day.
3. Radionuclide admixture content on delivery day in% per Sr-89 content:
 - beta particles energy from P-32 up to S-35 < 0.2
 - Sr-90 < $2.3 * 10^{-4}$
 - gamma-emitting radionuclides < 0.4
4. Chemical admixture content, mkg/cm³:
 - Al < 2.0
 - Fe < 5.0
 - Pb < 5.0
5. Molar concentration of hydrochloric acid, m/L: 0.05–0.5
6. Useful life, days: 50.

Practical experience gained

After a set of scientific research and calculation and experimental work the target processing technology has been developed, the Sr-89 produced amounts have been defined in the fast neutron reactors and the product quality has been defined in several batches. This product has

been tested at the US NIST and certified. A number of other foreign companies have tested it too.

Sr-89 carrier-free production according to the given technology has a number of advantages:

- there is no need to use the enriched Sr-89 target;
- high specific activity of Sr-89 and the low Sr-90 content allow longer radiopharmaceutical shelf-life;
- the synthesis of the radiopharmaceuticals with the optimal specific activity is possible;
- there are more preferable economical parameters of the process.

Sulphur-35 ($^{35}\text{S}_{16}$)

Half-life	:	87.51 d
Production scheme	:	$^{35}\text{Cl} (n, p) ^{35}\text{S}$
Type of decay and energy	:	β^- (MeV) 0.167 (100%) E_{max} 0.049 (E_{ave})
Decay product	:	^{35}Cl

Nuclear reactions and yield

Reaction	Isotope abundance of nuclide%	Cross section barn	Activity of element at $10^{12} \text{ n/cm}^2/\text{s}$			Secondary reactions And properties of Nuclide formed
			1 week	4 weeks	Saturation	
$^{34}\text{S} (n, \gamma) ^{35}\text{S}$	4.21	0.227	11.5 MBq (0.31 mCi)/g S	42 MBq (1.16 mCi)/g S	212 MBq (5.77 mCi)/g S	$^{32}\text{S}(n,p) ^{32}\text{P}$ Half-life: 14.26 days Abundance: 95%
$^{35}\text{Cl} (n,p) ^{35}\text{S}$	75.77	0.49	338 MBq (9.11 mCi)/g Cl	1.23 GBq (33.6 mCi)/g Cl	6 GBq (167.2 mCi)/g Cl	$^{33}\text{S} (n,p) ^{33}\text{P}$ Half-life: 25.34 days Abundance = 0.75% $^{35}\text{Cl} (n, \gamma) ^{36}\text{Cl}$ Half-life: 3.01×10^5 a $^{35}\text{Cl} (n, \alpha) ^{32}\text{P}$ Half-life: 14.26 days

Target material : KCl

Target specification and preparation

Target	EM (GR/AR grade KCl with SO_4^{2-} content less than 0.001%.
Container	Standard 1S aluminium can 22 mm dia and 44 mm ht. cold welded.
Irradiation	Heavy water moderated 100 MW DHRUVA or 40 MW Cirus reactor provides the necessary irradiation facility.
Flux	2×5 g KCl irradiated for 3 months at $4 \times 10^{13} \text{ n/cm}^2/\text{s}$ yields 370 GBq (10 Ci) ^{35}S activity, with Sp.Act. > 9.25 TBq (250 Ci)/mmole of S.

The above procedure was provided by:
M. Ananthkrishnan,
Board of Radiation and Isotope Technology,
Department of Atomic Energy, Mumbai, India.

REAGENTS	SO_4^{--} content	
HCl	<0.001%	All the reagents used are of GR/AR Grade
HNO ₃	<0.001%	
NH ₄ OH	<0.001%	
KCl	Mg, Ca, Fe < 0.001%	
	PO ₄ ³⁻ < 0.001%	
	SO ₄ ²⁻ < 0.001%	

Type of facility for processing

The processing is carried out in a glove box 6 feet × 4 feet × 6 feet with Perspex sheets as wall on two sides and fitted with gloves. Exhaust line connected through a pair of HEPA filters to the fox provides the required negative pressure in the box which is maintained slightly below atmosphere.

The process equipment consists of distillation unit, ion exchange alumina column, filter assembly with G-2 filter and concentration flask.

The process

The irradiated potassium chloride is allowed to cool for a week to allow the decay of ⁴²K formed. The can is decapped and irradiated KCl powder transferred to a 250 mL beaker, 100 mL 0.1 N HCl (purified by repeated distillation) is added to it and KCl is completely dissolved. Ion exchange column (1 cm dia and 12 cm height) prepared with chromatography grade alumina is washed with double distilled water and conditioned with 200 mL 0.1 N HCl. KCl solution is passed through the column at a flow rate of 0.15 mL per minute and effluent is collected in a receiver to recover ³⁶Cl isotope. The column is washed with 100 mL 0.1 N HCl and then with 100 mL double distilled water. ³⁵S activity is eluted with 25 mL 1N NH₄OH followed by 50 mL 0.1 N NH₄OH. The eluate is collected and concentrated to approx. 10 mL and neutralized with 1N HCl. It is passed through a filter assembly (G-2) and filtrate is collected in a concentration flask. Filtrate is concentrated to near dryness and treated with 10 mL concentrated HNO₃ to remove ammonia. The residual activity is treated with concentrated HCl (5 mL) twice to remove traces of HNO₃ followed by 10 mL double distilled water. 25 mL double distilled water is added to the flask, solution warmed and allowed to cool and then ³⁵S activity is transferred to storage bottle.

Assay and quality control

Activity assayed in liquid scintillation counter with respect to a known reference sample of ³⁵S. Specific activity is determined by spectro photometric analysis.

Radionuclitide purity is determined by the aluminium absorption curve for the test sample compared with that of standard and by absence of any gamma emitting radionuclide.

Acidity is determined by titration against standard alkali.

Radiochemical purity is determined by paper chromatography.

Characteristics of final solution

Radiochemical form	H ₂ ³⁵ SO ₄ in 0.1 N HCL.
Radioactive concentration	3.7–7.4 GBq (100–200 mCi)/mL.
Radiochemical purity	>95% as sulphate.
Radionuclide purity	>99%.
Specific activity	>9.25 TBq (250 Ci/mMole).
Appearance	A clear colourless solution.

Tellurium-123m ($^{123\text{m}}\text{Te}_{52}$)

Half-life	:	119.7 ± 0.1 d	
Production scheme	:	$^{122}\text{Te} (n,\gamma) ^{123\text{m}}\text{Te}$	$\sigma = 1.1 \pm 0.5 \text{ b}$
Type of decay and energy	:	γ (MeV)	0.159 (84%)

Target specification and preparation

Natural tellurium contains only about 2.59 per cent of tellurium-122 so highly enriched targets are required for production of tellurium-123m. Enriched tellurium-122 powder is used as the target material.

Irradiation parameters, specific activity and total yield at EOI

Tellurium-123m is reactor-produced by neutron irradiation of enriched tellurium-122. Although low specific activity of about 37 MBq (1 mCi/mg) is obtained for even long irradiations (23–24 days; 1 Cycle in the ORNL High Flux Isotope Reactor, HFIR) at high neutron flux ($2\text{--}3 \times 10^{15} \text{ n/cm}^2/\text{s}$), the high abundance of the 159 keV (84%) gamma photon emitted makes tellurium-123m an attractive candidate as a SPECT transmission line source (Wang, et al., 1995) and a variety of organometallic tellurium-123m-labeled radiopharmaceuticals have been developed and evaluated (Knapp, et al., 1980; Knapp, et al., 1981).

Detailed production yields of tellurium-123m in comparison to the estimated production yields at various time periods as a function of the thermal neutron flux are not available since detailed irradiation studies have not been reported and the cross-section data for ^{122}Te are not well known.

Type of facility for processing

An adequately shielded hot cell or shielded glove box, dependent upon the levels of $^{123\text{m}}\text{Te}$ handled, is required for processing the irradiated target.

Chemical processing procedure

Reactor irradiation of the metallic tellurium-122 target material can often result in the formation of a molten target mass that solidifies hard when cooled. The typical chemical processing of reactor-irradiated enriched tellurium-122 target involves oxidation to telluric acid. For many chemical reactions involving initial chemical dissolution, the tellurium is usually required as a fine powder followed. Tellurium-123m powder is thus obtained from the telluric acid solution by reduction of the tellurium with sulfur dioxide to the tellurium precipitate which is recovered by centrifugation or filtration as described below.

The above procedure was provided by:
M. Du, C., A.P. Callahan and F.F. Knapp, Jr.,
Nuclear Medicine Programme,
Oak Ridge National Laboratory,
Oak Ridge, Tennessee 37830-6229, USA.

1. The irradiated tellurium-122 target is dissolved in concentrated HNO₃ by heating in a sand bath at a temperature of 90-100°C. Aliquots are taken for counting to accurately determine the production yield.
2. The solution is then taken to incipient dryness, and the product dissolved in 5 mL of HCl and the solution taken to dryness again.
3. At incipient dryness, 5 mL of concentrated HBr is added.
4. The deposit is dissolved by adding two 5 mL aliquots of 3M HCl.
5. Small aliquots of hydrazine hydrate (N₂H₄·H₂O, MW 50.07) are added and the metallic tellurium precipitates as a fine powder which is recovered by low speed centrifugation.
6. As an alternative procedure (Knapp, *et al.*, 1980), after dilution of the HCl solution of telluric acid in 200 mL of distilled water, 5 gm of NaBr is added and the solution boiled for 30 min, cooled, and sulfur dioxide gas is slowly passed through the solution (about 2 bubbles/sec) for 2 hours. The metallic tellurium precipitates as very fine powder which is recovered by low speed centrifugation.
7. The powder is re-suspended in with water and centrifuged three times, and then dried in an oven at 140 °C or under a heating lamp. This material is then ready for tellurium-123m source fabrication.

Dispensing, assay and quality control

The tellurium-123m should be assayed by gamma spectroscopy and solution of tellurium-123m are generally stable indefinitely and can be dispensed as required.

Practical experience gained

The recovery of tellurium-123m by this procedure is generally greater than 90%.

BIBLIOGRAPHY

- KNAPP, F.F., JR., Selenium and Tellurium as Carbon Substitutes, Radiopharmaceuticals-Structure-Activity Relationships (SPENCER, R.P., Ed.) Grune and Straaton, Inc. (1981) 345–391.
- KNAPP, F.F., JR., AMBROSE, K.R., CALLAHAN, A.P., Tellurium-123m-Labeled-23-(Isopropyl Telluro)-24-nor-5α-Cholan-3β-ol: A New Potential Adrenal Imaging Agent, *J. Nucl. Med.*, **21** (1980) 251–257.
- WANG, H., JASZCZAK, R.J., MCCORMICK, J.W., et al., Experimental Evaluation of a Tellurium-123m Transmission Source to Determine Attenuation Maps for SPECT, *IEEE Trans. Nucl. Sci.*, **42** (1995) 1214–1218.

Thallium-204 ($^{204}\text{Tl}_{81}$)

Half-life : 3.78 years

Production scheme : $^{203}_{81}\text{Tl}(n,\gamma)^{204}_{81}\text{Tl}$

Nuclear reactions and yield

Reaction	Isotope abundance of nuclide%	Cross-section barn	Activity of element at 10^{12} n/cm ² /s		
			One week	Four weeks	1 year
$^{203}_{81}\text{Tl}(n,\gamma)^{204}_{81}\text{Tl}$	29.52	11.4	0.94 mCi/g	3.75 mCi/g	45mCi/g

Type of decay and energy (MeV)

β^-	0.7637 MeV	97.1%
E.C.		2.9%

Target material : Thallium metal (J.M.)

Target specification and preparation

Target	1 g Thallium metal (Johnson Matthey).
Container	Standard 1S aluminium can 22 mm dia and 44 mm ht. cold weld sealed.
Irradiation	1.year
Flux	Approx. 5 to 6×10^{13} n/cm ² /s .
Typical production yield	1.0–2.0 curies.
Type of facility for processing	Standard glove box 6 feet \times 4 feet \times 6 feet. Under negative pressure (2–3cm WG).

Chemical process

The can is opened and the irradiated sample transferred to a 250 mL dissolution flask. 30 mL IN H_2SO_4 and 5 mL 30 percent v/v H_2O_2 is added to it and solution refluxed for one hour to complete the dissolution. Excess H_2O_2 is boiled off and active solution transferred to storage bottle.

The above procedure was provided by:

M. Ananthkrishnan,
Board of Radiation and Isotope Technology,
Department of Atomic Energy, Mumbai, India.

Extra care is taken to maintain the negative pressure in the glove box during the entire period of processing and extra hand glove used to carry out any operation in the box to avoid contamination.

Assay and quality control

The radioactivity is assayed by beta counting in a Geiger Muller Counter. Chemical form: As Thallous sulphate in approx. 1N H₂SO₄.

Radionuclide purity is determined by beta absorption (in aluminium) analysis and gamma ray spectrum.

Specific activity is determined from the known quantity of target taken for irradiation.

Characteristics of final solution

Radiochemical form	Thallous sulphate in approx. 1 N. H ₂ SO ₄ solution.
Radiocactive concentration	2–10 mCi/mL (74–370 MBq/mL).
Radionuclide purity	>99%.
Specific activity	>10 GBq/g Tl.

Thulium-170 ($^{170}\text{Tm}_{69}$)

Half-life : 128.6 d

Production scheme : $^{169}\text{Tm} (n,\gamma)^{170}\text{Tm}$

Nuclear reactions and yield

Reaction	Isotopic Abundance of nuclide%	Cross Section barns	Activity of element at 10^{12} n/cm ² /s		
			One week	Four Weeks	Saturation
$^{169}\text{Tl} (n,\gamma)^{170}\text{Tl}$	100	105	1.37 GBq (373 mCi)/g Tm	15 GBq (1.41 Ci)/g Tm	370 GBq (9.99 Ci)/g Tm

Type of decay and energy : β -(MeV) 0.884 (18.3%)
0.968 (81.5%)
 γ (MeV) 0.084 (2.48%)
EC (0.15%)
IC (20.79%)

Decay product : ^{170}Yb and ^{170}Er .

Target material : Spec. pure Tm_2O_3 (Johnson Matthey).

Target specification and preparation

Target	Sp.pure Tm_2O_3 (Johnson Matthey) 50–100 mg.
Container	Standard 1S aluminium can 22 mm dia and 44 mm ht. cold weld sealed.
Irradiation	1–2 weeks.
Flux	Approx. $2\text{--}4 \times 10^{13}$ n/cm ² /s.
Type of facility for processing	Standard glove box 1.5 m \times 1.2 m \times 1.5 m. Under negative pressure (2–3 cm WG).

Reagents used: All the reagents used are of AR/GR grade.

The above procedure was provided by:
M. Ananthkrishnan,
Board of Radiation and Isotope Technology,
Department of Atomic Energy, Mumbai, India.

Chemical processing

After irradiation the can is opened and Tm_2O_3 powder is transferred to a 100 mL beaker. 10 mL 3N HCl solution is added to it and boiled to complete the dissolution of target. Solution is concentrated to minimum volume and 20 mL of 1.0 N HCl added to it and activity transferred to a storage bottle.

Assay and quality control

Radioactive assay is done by beta counting in a G.M.Counter. Radionuclide purity is determined by beta absorption analysis. Specific activity is calculated from the known weight of target used for irradiation.

Characteristics of final solution

Radiochemical form	$TmCl_3$ in HCl solution.
Radioactive concentration	74–370 MBq/mL.
Radionuclide purity	>99%.
Specific activity	>50 GBq/g Tm.
Acidity	Approx. 1N with reference to HCl.

Tin-113 ($^{113}\text{Sn}_{50}$)

Half-life	:	115 d (^{113g}Sn)	
Production scheme	:	$^{112}\text{Sn} (n,\gamma) ^{113}\text{Sn}$	$\sigma = 1.0 \text{ b}$ $\sigma^m = 0.3 \text{ b}$ and $\sigma^g = 0.71 \text{ b}$

Type of decay and energy

^{113m}Sn (21.4 min)		91.1% IT
		8.9% EC
	γ	0.077 (0.5%)
^{113g}Sn (115.09 d)		EC
	γ	0.3917 (65%)
		0.2551 (2.11%)

Target specification and preparation

The radionuclide ^{113}Sn decays by electron capture to ^{113m}In with a physical half-life of 115 days. Tin-113 is obtained by irradiation of isotope enriched metallic tin-112 in nuclear reactor in the thermal neutron flux.

Tin-112 isotope enriched 81.7% in metallic form is used as a target material.

Trade name: Sn-112 metal.

Isotopic composition [%].

Sn-112	Sn-114	Sn-115	Sn-116	Sn-117	Sn-118	Sn-119	Sn-120	Sn-121	Sn-122
81.7	0.44	0.06	3.47	1.52	4.83	1.35	5.43	0.55	0.65

Chemical impurities [%]

Fe	Al	Si	Cr	Ni	Cu	Pb	Sb	Bi	Zn	As
0.007	0.003	0.004	<0.003	0.004	0.006	0.003	<0.003	<0.002	0.070	<0.002

Supplier: Chemotrade, Chemiehandelsgesellschaft mbH.

Irradiation parameters, specific activity and total yield

Irradiation site:	SM-3 reactor, NIAR Dymitrovgrad, the Russian Federation.
Assembly:	vertical irradiation channel in aluminium block
Capsules:	quartz, ϕ 6, length 40 mm.
Sealing:	welding.
Mass of target:	100–200 mg.
Reactor flux:	$\sim 10^{15} \text{ n/cm}^2/\text{s}$.
Irradiation time:	40 days.

The average activity obtained (calculated at the activation end) is about 30 mCi/mg Sn.

The above procedure was provided by:

K. Novak
Radioisotope Centre
Polatom, Otwock, Swierk, Poland.

Type of facility for processing

The hot cell of 100 mm lead wall equipped with the manipulators and connected to the separate ventilation system. Filters on the air outlet: paper — charcoal. Standard under pressure inside the hot-cell is 20 mm H₂O.

Analysis of raw materials, reagents and chemicals required for processing

Zirconium (IV) oxide chloride octahydrate: GR for Analysis, Merck

Ethyl alcohol 96%: pure for analysis, supplier: Polish Chemicals

Hydrochloric acid 36%: reagent Ph.Eur., supplier Merck

Purified water: deionized water, Elix 10 system, Millipore

Ammonia solution 25%: GR for analysis, Merck

Potassium permanganate: GR for analysis, Merck

Chemical processing procedure

¹¹³Sn is used for production of isotope generators ¹¹³Sn/^{113m}In. Eluate of the generators contains indium-113m in the chemical form of chloride, ^{113m}InCl₃. Indium-113m is a radionuclide which decays by γ -radiation with a $T_{1/2}$ = 1.66 h and E_{\max} = 0.392 MeV.

The solution of tin-113 is loaded on the generator column containing zirconium oxide. Then the column is washed with 0.05N HCl. After the equilibrium between tin-113 and indium-113m is reached the generator is eluted with 0.05 N HCl. Indium-113m is present in the eluate as In(III). Production steps are described below.

Preparation of zirconium oxide

Zirconium oxide chloride octahydrate is dissolved in water and heated to 50°C, 0.1N NH₄OH is added to precipitate zirconium hydroxide. The precipitate is washed out of chlorides and dried in 120°C for 24 hours. After drying the glassy precipitate of zirconium oxide is ground and sieved. The fraction between 0.250 mm and 0.125 mm is used for production of the generator columns.

Target dissolving

After opening the container and cutting off the quartz capsule the irradiated target is dissolved in concentrated hydrochloric acid. Tin dissolves completely within 24 hours, the process can be faster when the solution is heated.

Preparation of hydrated chloride Cl₂×8H₂O for oxidation of tin

React potassium permanganate with hydrochloric acid in the glass reactor. Collect produced chloride into the water trap and cool the solution below 8°C to get saturated chloride solution. Yellow crystals of Cl₂×8H₂O are formed. Filter the solution and separate the crystals.

Oxidation of tin

Absorption of tin-113 on the zirconium oxide is the most efficient when it is oxidized to tin (IV), SnCl₄. To the solution with dissolved target the Cl₂×8H₂O dissolved in 50 mL of water is added. The volume of the solution is adjusted with water to obtain final concentration 0.4 N HCl.

A portion of 0.1 mL is taken for radionuclidic purity control and of 1 mL for radioactive concentration test. Portions containing required activity of ^{113}Sn are dispensed onto the generator columns. Then generator column is washed with 100 mL of 0.05 N HCl. Final mounting of the generator elements is made.

Dispensing, assay and quality control

For the elution of the generator the vacuum vials and eluent (0.05N HCl) vials are needed. Six elutions (each made with 3 times 6 mL of eluent) are made for control of the generator. Sample volume of each fraction — 6 mL. Usually it is not recommended to use the third fraction because of low activity of $^{113\text{m}}\text{In}$. Every single generator is controlled.

Elution yield of $^{113\text{m}}\text{In}$ should not be less than 75% of the nominal activity (with respect to ^{113}Sn parent — daughter decay scheme). Nominal activity of the generator is 4–8 GBq. Over 90% of indium-113m activity is collected in the first 10 mL of eluent.

Radionuclidic purity

Other nuclides present next to tin-113 in the irradiated target: $^{117\text{m}}\text{Sn}$ ($T_{1/2} = 13.6\text{d}$), $^{119\text{m}}\text{Sn}$ ($T_{1/2} = 293.1\text{d}$), ^{121}Sn ($T_{1/2} = 27.06\text{h}$), $^{123\text{m}}\text{Sn}$ ($T_{1/2} = 40\text{m}$), $^{125\text{g}}\text{Sn}$ ($T_{1/2} = 9.64\text{d}$).

The radionuclidic purity of the eluate of $^{113\text{m}}\text{InCl}_3$ from isotope generator $^{113}\text{Sn}/^{113\text{m}}\text{In}$ is controlled by gamma-spectrometry with use of Ge(Li) detector (20cm^3 FWHM = 4.0 keV for 1332 keV of ^{60}Co). The activities of characteristic lines corresponding to each isotope are measured:

190 keV for $^{114\text{m}}\text{In}$
391 keV for ^{113}Sn
427.87 keV for ^{125}Sb

and related to the total activity of $^{113\text{m}}\text{In}$ in the sample. The limit for the total activity of radionuclidic impurities measured in the eluate is 0.1%, related to indium-113m.

Chemical purity

Eluates are controlled for chemical contamination by DC spectrography. The limits for the impurities are:

Zr,As,Pb,Cr,Ni,Fe <5 $\mu\text{g/mL}$
Ag <10 $\mu\text{g/mL}$

Zinc can be present in the eluate.

Radiochemical purity

In the environment of 0.05N HCl used as an eluent for the generator, indium chloride InCl_3 is completely dissociated and no other electrovalence states of indium than In^{3+} are present in the solution.

Stability of the generator

The generator can be used over the period of 6 months and it is stable from the chemical point of view. No changes in the performance of the generator have been observed over that period.

Applications

Indium-113m was popular in eighties and seventies as a diagnostic agent, used for labelling of kits such as DTPA, Phytate, colloid etc. It's production is much cheaper than indium-111 and therefore ^{113m}In still can be used as a model radionuclide in research studies. Because of its short half-life and gamma-radiation, indium-113m is presently used as a tracer in various technical experimental studies.

Product characteristics

Tests	Specifications
Identification: spectra identification	gamma ray spectra confirms prominent photon of 392 keV
Chemical purity Zr, As, Pb, Cr, Ni, Fe Ag	<5 $\mu\text{g/mL}$ <10 $\mu\text{g/mL}$
Radionuclidic purity	not less than 99.9%
Elution yield	not less than: 75% of nominal activity

Shelf-life of the generator: 6 months.

Disposal of generated waste

Low radioactive concentration liquid waste is produced when generator column is being washed after tin-113 deposition.

Preparation and cleanup of the facility and preparation for processing of next production batch

- Preparation of zirconium oxide and tin oxidation agent is performed in a laboratory fume-hood.
- Dissolving of target, oxidation to tin(IV) and dispensing of the dissolved tin-113 on the generator columns is performed in the destined cells of a hot cell. Therefore there aren't any special requirements for cleanup of the facility. Glass vials for final product dispensing are washed and heated in 250°C prior to use and closures are washed and autoclaved.

Practical experience gained

Efficient oxidation of tin-113 is essential for its good absorption on the zirconium oxide.

Tin-117m ($^{117m}\text{Sn}_{50}$)

Half-life	: 13.6 ± 0.04 d	
Production scheme	: $^{116}\text{Sn} (n, \gamma) ^{117m}\text{Sn}$ $^{117}\text{Sn} (n, n') ^{117m}\text{Sn}$	$\sigma = 6 \pm 2$ mb
Type of decay and energy	: β^- (MeV)	γ (MeV)
	0.1268 (64.9%)	0.15856 (86.4%)
	0.15156 (26.2%)	0.15602 (2.11%)
	0.12936 (11.7%)	

Target specification and preparation

Tin-117m is an attractive radioisotope for use in radiopharmaceuticals, particularly for therapeutic applications, such as bone pain palliation (Oster, et al., 1985; Srivastava, et al., 1985), because of the emission of low energy conversion electrons with energies of 0.126 MeV (64%) and 0.152 MeV (26.1%), and also the emission of a gamma photon with energy of 158.5 keV. In a research reactor, tin-117m can be produced by two reactions, involving either the radiative neutron capture of enriched tin-116 or the neutron inelastic reaction on enriched tin-117. The later reaction (Fig. 1; Mirzadeh, et al., 1997) is the most attractive at least in higher flux reactors since specific activity values of about two times higher than the radiative capture reaction can be achieved.

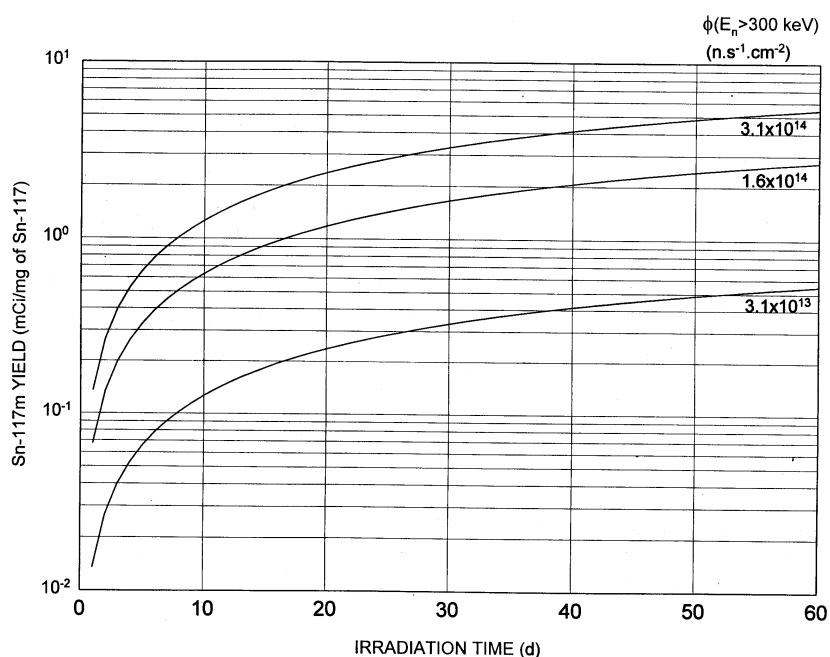

FIG. 1. Production yields of tin-117m by the inelastic pathway.

The above procedure was provided by:
 S. Mirzadeh and F.F. Knapp, Jr.,
 Nuclear Medicine Programme,
 Oak Ridge National Laboratory,
 Oak Ridge, Tennessee 37830-6229, USA.

Irradiation parameters, specific activity and total yield at EOI

Type of facility for processing

An adequately shielded hot cell is required for processing the irradiated target.

Chemical processing procedure

Dependent upon the subsequent chemical requirements, tin-117m can be processed in a number of ways. For preparation of tin-(IV)-117m-DTPA agent for bone pain palliation, the target is dissolved under rigorous oxygen-free conditions by dissolution in HCl. For preparation of organometallic compounds of tin-117m for radiopharmaceutical applications, the metallic tin-117m is converted to tin tetrachloride by reaction with chlorine gas (Woo, et al., 1979; Knapp, et al., 1981). The tin-117m-tetrachloride is a useful starting material for conversion to a variety of alkyl tin chlorides (Woo, et al., 1979; Knapp, et al., 1981) which can also be readily converted to the lithium salts, such as lithium trimethyl tin-117m, via lithiation with metallic lithium metal (Knapp, et al., 1981).

Dispensing, assay and quality control

The radiochemical purity is assessed by gamma spectroscopy.

Final product specification for use

Specifications of the product will depend upon the particular application. Generally, the tin-117m powder is subsequently processed as described above for a particular chemical transformation.

Practical experience gained

Although tin-117m has not been widely used in radiopharmaceuticals, the use of tin(IV)-117m-DTPA for bone pain palliation is an attractive application which is being evaluated in patient trials. The major impediment for wider use of this radioisotope is the low specific activity of tin-117m produced in research reactors.

BIBLIOGRAPHY

KNAPP, F.F., JR., Tin-117m Radiopharmaceuticals: Effects of Structural Modifications on the Adrenal Uptake of Steroids Labeled in the Sidechain with ^{117m}Sn (Proc. International Symposium on Medical Radionuclide Imaging, Heidelberg, 1980), **I**, International Atomic Energy Agency (IAEA-SM-247/89), Vienna (1981).

MIRZADEH, S., KNAPP, F.F., JR., ALEXANDER, C.W., MAUSNER, L., Evaluation of Neutron Inelastic Scattering for Radioisotope Production, *Appl. Radit. Isot.*, **48** (1997) 441–446.

OSTER, Z.H., SOM, P., SRIVASTAVA, S.C., FAIRCHILD, et al., The Development and *In Vivo* Behaviour of Tin Containing Radiopharmaceuticals, II. Autoradiographic and Scintigraphic Studies in Normal Animals and in Animal Models of Bone Disease, *Int. J. Nucl. Med. Biol.*, **12** (1985) 175–184.

SRIVASTAVA, S.C., MEINKEN, G.E., RICHARDS, P., et al., The Development and *In Vivo* Behaviour of Tin Containing Radiopharmaceuticals, I. Chemistry, Preparation, and Biodistribution in Small Animals, *Int. J. Nucl. Med. Biol.*, **12** (1985) 167–174.

WOO, D.V., KNAPP, F.F., JR., BUTLER, T.A., CALLAHAN, A.P., An Efficient Micro-scale preparation of Tin-117m Tin Tetrachloride — A pivotal Intermediate for the Synthesis of Tin-117m-Labeled Radiopharmaceuticals (Proc., 2nd International Symposium on Radiopharmaceuticals, Seattle, Washington, 1979) Society of Nuclear medicine, New York, (1979) 147–154.

Tungsten-188 ($^{188}\text{W}_{74}$)

Half-life : 69.4 d

Production scheme : $^{186}\text{W} (n,\gamma) ^{187}\text{W} (n,\gamma) ^{188}\text{W}$

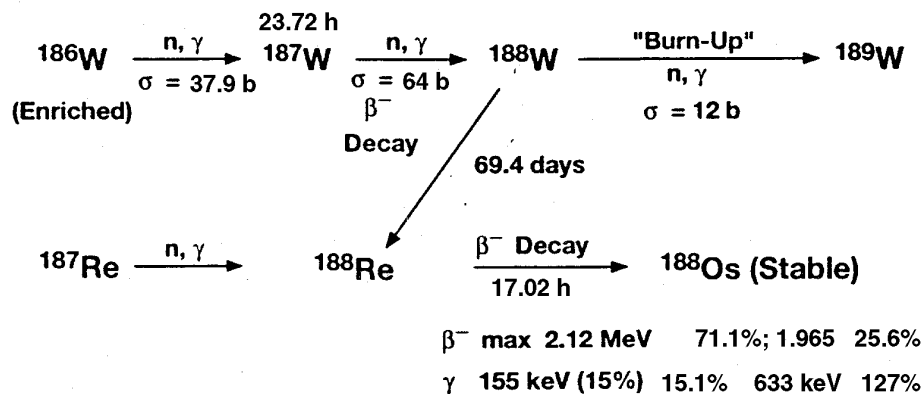

FIG. 1. Production and decay scheme for tungsten-188.

Tungsten-188 is reactor-produced by double neutron capture on tungsten-186 as summarized in Figure 1, and is primarily used as the parent for the tungsten-188/rhenium-188 radionuclide generator system (Knapp 1998; Knapp, et al., 1997; Mirzadeh, et al., 1997; Knapp, et al., 1994; Kamioki, et al., 1994; Callahan, et al., 1989; Mirzadeh, et al., 1992).

Decay product : ^{188}Re

Target specification and preparation

Highly enriched and highly purified tungsten-186 is required for production of tungsten-188 to eliminate or minimize radionuclide impurities formed during the irradiation process. Either enriched granular tungsten-186 metal powder targets or granular tungsten oxide targets have been used, but the present preferred route uses the metal targets (Knapp, et al., 1994). More recently, the use of high density, pressed, enriched tungsten-186 targets has been described as an alternative method to increase the target mass per irradiation volume (Mirzadeh, et al., 1998).

The use of tungsten-186 with enrichment greater than 96% will provide the highest purity tungsten-188 via the double neutron process.

Iridium-192 and osmium-191 are two radionuclide impurities which are formed during reactor irradiation of tungsten-186 (Figure 1) and are thus always present in reactor-produced tungsten-188. Both of these impurities can be subsequently removed, however, when the rhenium-188 daughter is obtained by generator elution and subsequent sequential post elution

The above procedure was provided by:
 S. Mirzadeh and F.F. Knapp, Jr.,
 Nuclear Medicine Programme,
 Oak Ridge National Laboratory,
 Oak Ridge, Tennessee 37830-6229, USA.

passage through an alumina SepPak, to remove any possible tungsten-188 breakthrough (Callahan, et al., 1989), and then the cation/anion tandem concentration system (Knapp, et al., 1998; Guhlke, et al., 1997).

As an example, 97.5% enriched W-186 is available from the Oak Ridge National Laboratory (ORNL) Isotope Production and Distribution Program (IPDP).

Irradiation parameters, specific activity and total yield at end of irradiation

Because the production of tungsten-188 from enriched tungsten-186 is a double neutron capture process, the production yield is a function of the square of the neutron flux. For this reason, a very high neutron flux is required for the production of tungsten-188 (Knapp, et al., 1997), probably greater than $8-10 \times 10^{14}$ n/cm²/s (Knapp, et al., 1998). The projected production yields as a function of flux are shown in Figure 2. Because of the high 12 b “burn-up” cross-section estimated for tungsten-188 (Mirzadeh, et al., 1997), the actual production are lower than predicted.

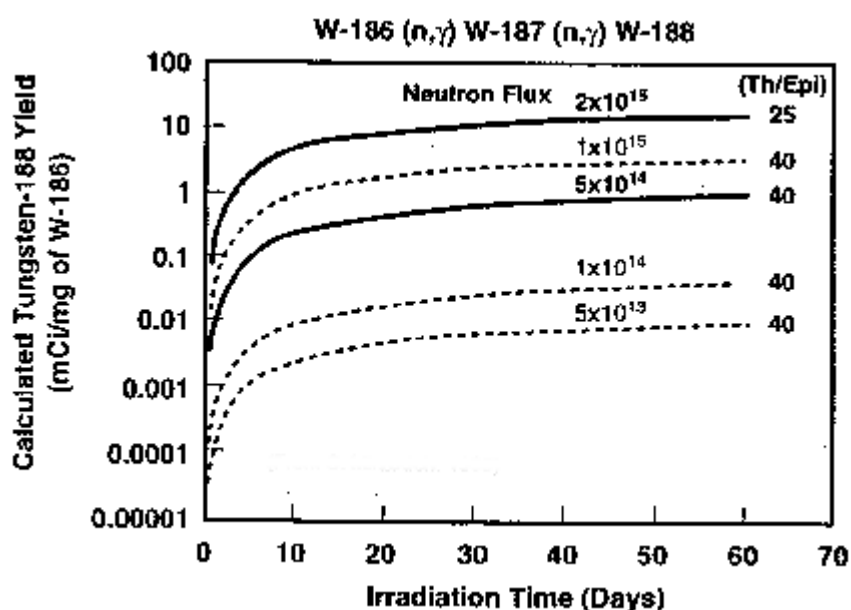

FIG. 2. Predicted specific activity values for tungsten-188 produced at various thermal neutron flux values.

Type of facility for processing

A shielded radiochemical hot cell is required for processing any significant levels of tungsten-188. In addition, because of the high energy gamma emissions (479 keV, 23.4%; 685 keV, 29.2%) from the short-lived intermediary tungsten-187 ($t_{1/2}$ 23.8 hours), Curie-level batches of tungsten-188 require a 7–10 day decay period, for example, to allow decay of tungsten-187 to levels which allow shipment as a Type A shipment.

Analysis of raw materials, reagents and chemicals required for processing

The processing of tungsten-188 is generally conducted in a quartz glass vessel. All reagents and chemicals should be analytical grade.

Chemical processing procedure

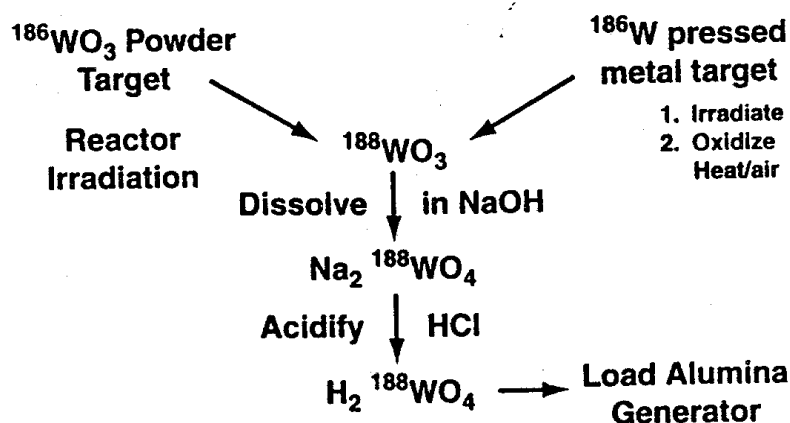

FIG. 3. Processing of reactor produced tungsten-188.

The chemical processing procedures are summarized in Figure 3. Processing of the granular tungsten metal and tungsten oxide targets involves dissolution in sodium hydroxide solution containing hydrogen peroxide solution to form sodium tungstate.

Dispensing, assay and quality control

Following dissolution of the irradiated target, the solution is then filtered and aliquots analysed using a germanium crystal detector, if available, to determine the specific volume levels of tungsten-188, osmium-191 and iridium-192, and any other radionuclidic impurities which may be present. The basic sodium tungstate solution can be stored indefinitely.

Final product specification for use

Processed tungsten-188 is generally stored as sodium tungstate in sodium hydroxide solution, which is acidified just prior to loading, for example, of the alumina-based tungsten-188/rhenium-188 generator system (Knapp, et al., 1998; Knapp, et al., 1997; Knapp, et al., 1994; Callahan, et al., 1989). The specific volume requirements depend upon the size generators which are prepared. For large, clinical-scale generators (500–1000 mCi tungsten-188), it is convenient to have specific volume solutions >20 mCi/mL. The specific activity values also depend upon the size generators which are required, since the binding capacity of the alumina column is finite (Kamioki, et al., 1994), although this parameter has not yet been accurately determined using high levels of activity. At ORNL, the maximum levels of tungsten which are used for generator fabrication are <80 – 90 milligrams of tungsten per gram of the aluminum oxide column adsorbant.

Practical experience gained

Enriched tungsten-186 with very high chemical purity should be used for reactor production of tungsten-188. We have noted that low levels of cobalt-60, and antimony-124 and antimony-125 can be formed during irradiation if even very low levels of cobalt-59 and antimony-123/124, respectively, are present in the target material because of the high thermal neutron cross section values for neutron capture.

If any aluminum from the irradiation vessel or from shims used in the target holder is dissolved during the target processing, low levels of cobalt-60 can also be introduced into the tungsten-188 product by this route. It is recommended that silicon wool or some other inert material be used if shims are required for loading the quartz tube containing the target material into the aluminum capsule. Any aluminum which may have been introduced can be removed by acidification to <pH 8 followed by filtration or centrifugation.

At high neutron flux such as in the ORNL HFIR, an unidentified black solid is also usually formed which is difficult to solubilize in base, and even under oxidizing conditions with hydrogen peroxide and potassium hypochlorite (Knapp, et al., 1994). Processing of metal powder targets involves the oxidation and dissolution in base. In contrast, the pressed targets are efficiently processed by oxidation in an air stream at high temperature (>750 °C). The green-colored tungsten oxide which is formed is then dissolved in sodium hydroxide to form sodium tungstate (Mirzadeh, et al., 1998).

The recovery of enriched tungsten-186 from used tungsten-188/rhenium-188 generators has also been described (Mustaq, 1996).

BIBLIOGRAPHY

CALLAHAN, A.P., RICE, D.E., KNAPP, F.F., JR. "Rhenium-188 for Therapeutic Applications from an Alumina-Based W-188/Re-188 Radionuclide Generator System", *NucCompact*, **20** (1989) 3–6.

KAMIOKI, H., MIRZADEH, S., LAMBRECHT, R.M., KNAPP, F.F. JR., DADACHOVA, E. "Tungsten-188/Rhenium-188 Generator for Biomedical Applications," *Radiochim. Acta*, **65**, 39–46 (1994).

KNAPP, JR., F.F., CALLAHAN, A.P., BEETS, A.L., MIRZADEH, S., HSIEH, B.-T. "Processing of Reactor-Produced Tungsten-188 for Fabrication of Clinical Scale Alumina-Based Tungsten-188/Rhenium-188 Generators," *Appl. Rad. and Isot.*, **45** (1994) 1123–1128.

KNAPP, F.F., JR., MIRZADEH, S., BEETS, A.L., Reactor Production and Processing of Therapeutic Radioisotopes for Applications in Nuclear Medicine," *J. Radioanalyt. Nucl. Chem. Lett.*, **205** (1996) 93–100.

KNAPP, F.F., JR., BEETS, A.L., GUHLKE, S., ZAMORA, P.O., BENDER, H., PALMEDO, H., BIRSACK, H.-J., "Development of the Alumina-Based Tungsten-188/Rhenium-188 Generator and Use of Rhenium-188-Labeled Radiopharmaceuticals for Cancer Treatment," *Anticancer Research*, **17** (1997) 1783–1796.

KNAPP, F.F., JR., BEETS, A.L., MIRZADEH, S., GUHLKE, S., "Use of a New Tandem Cation/Anion Exchange System with Clinical-Scale Generators Provides High Specific Volume Solutions of Technetium-99m and Rhenium-188," (Proc. International Trends in Radiopharmaceuticals for Diagnosis and Therapy) IAEA TECDOC-1029, (1998) 419–425.

KNAPP, F.F., JR., "Radionuclide Generators in Nuclear Medicine: Present Status and Future Perspectives," *Proceedings, International Trends in Radiopharmaceuticals for Diagnosis and Therapy*, IAEA TECDOC-1029 (1998) 485–495.

KNAPP, F.F., JR., BEETS, A.L., MIRZADEH, S., ALEXANDER, C.W., HOBBS, R.L., "Production of Medical Radioisotopes in the ORNL High Flux Isotope Reactor (HFIR) for Cancer Treatment and Arterial Restenosis Therapy after PTCA" (Proc. 13th Radiochemical Conference, Marianske Lazne, Czech Republic, 1998).

- KNAPP, F.F., JR., "Use of Rhenium-188 for Cancer Treatment," *Cancer Biotherapy and Radiopharm.*, **13** (1998) 337–342.
- KNAPP, F.F., JR., BEETS, A.L., PINKERT, J., KROPP, J., LIN, W.-Y., WANG, S.-Y., "Therapeutic Applications of Rhenium-188 — A readily Available Generator-Derived Radioisotope" (Proc. International Seminar on Therapeutic Applications of Radiopharmaceuticals, IAEA-SR-209, Hyderabad, 1999).
- MIRZADEH, S., KNAPP, F.F., JR., CALLAHAN, A.P., "Production of Tungsten-188 and Osmium-194 in a Nuclear Reactor for New Clinical Applications" (Proc. International Conference on Nuclear Data for Basic and Applied Sciences, Julich, 1991), *Nuclear Data for Science and Technology*, (Qaim, S., Ed.); Springer Verlag, (1992) 619–620.
- MIRZADEH, S., BEETS, A.L., KNAPP, F.F., JR., "HFIR-Produced Radioisotopes of Current Medical Interest" (Proc. Sixth Workshop on Targetry and Chemistry, Vancouver, B.C., Canada, 1995, Link, J. M., Ruth, T.J., Eds.) (1996) 129-131.
- MIRZADEH, S., KNAPP, F.F. JR, LAMBRECHT, R.M., "Burn-up Cross-section of Tungsten-188," *Radiochemica Acta*, **77** (1997) 99–102.
- MIRZADEH, S., DU, M., BEETS, A. L. AND KNAPP, F.F., JR., "Thermochromatographic Separation of Medical Radioisotopes," *Industrial and Engineering Research* (Proc. ACS Symposium on Nuclear Separation for the Radiopharmacy, National Meeting, Boston, 1998).
- MUSTAQA, A. "Recovery of Enriched ^{186}W from Spent $^{188}\text{W}/^{188}\text{Re}$ generators," *Appl. Radiat. Isot.*, **47** (1996) 727–729.

Ytterbium-169 ($^{169}\text{Yb}_{70}$)

Half-life	:	32.026 d
Production scheme	:	$^{168}\text{Yb} (n,\gamma) ^{169}\text{Yb}$
Type of decay and energy	:	γ (MeV) 0.0631 (44.2%) 0.0936 (2.61%) 0.1097 (17.47%) 0.1181 (1.87%) 0.1305 (11.31%) 0.1772 (22.16%) 0.1979 (35.8%) 0.2610 (1.71%) 0.3077 (10.05%)
Decay product	:	^{169}Tm

Target specification

1. Target purity : Ytterbium-oxide, analytical grade
2. Enrichment factor : ^{168}Yb enriched up to 17.1%

3. Impurity details:

Possible chemical impurities:

Gd: 0.19%, Lu: 0.05%, Er: 0.07%, Sm: 0.05%, Ho: 0.04%,
others such as K, Na, Ca, Mg, Si, Fe, Al, Cr, Ni, Cu, Mn, Pb, Sn altogether <0.1%.

4. Isotopic composition and supplier of target material:

^{168}Yb : 17.1%, ^{170}Yb : 11.3%, ^{171}Yb : 22.6%, ^{172}Yb : 19.0%,
 ^{173}Yb : 10.0%, ^{174}Yb : 15.5%, ^{176}Yb : 4.5%

Ytterbium oxide of analytical grade, supplier Technabexport, Russian Federation

Cross-section value of 2300 barn is known in case of thermal neutrons. As natural ytterbium target contains ^{168}Yb nuclide in 0.13% only, the use of enriched ytterbium target is necessary in order to attain proper specific activity. On the other hand, even the enriched target may contain ^{174}Yb and ^{176}Yb stable isotopes in considerable extent. Since cross-section data for these nuclides are 69 barn and 2.85 barn, the corresponding (n, γ) reactions lead to the presence of ^{175}Yb and ^{177}Yb impurities, respectively. The half-life of these radionuclides formed are 101 hours and 1.9 hours, so they can be let to decay to an acceptable level by cooling.

The above procedure was provided by:

J. Környei,
Department of Radiochemistry, Institute of Isotopes Co., Ltd.,
H11121, Budapest, Konkoly Thege Wt-29.33, Hungary.

The ^{169}Yb radionuclides can capture further neutrons with a cross-section of 3600 barn,

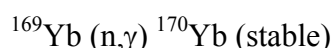

which decreases the ^{169}Yb yield by forming stable ytterbium isotope in nuclear reaction. This consecutive reactions should be taken into consideration when specific activities are calculated.

Production flow chart

The flow chart of the ytterbium-169 production technology can be given as follows:

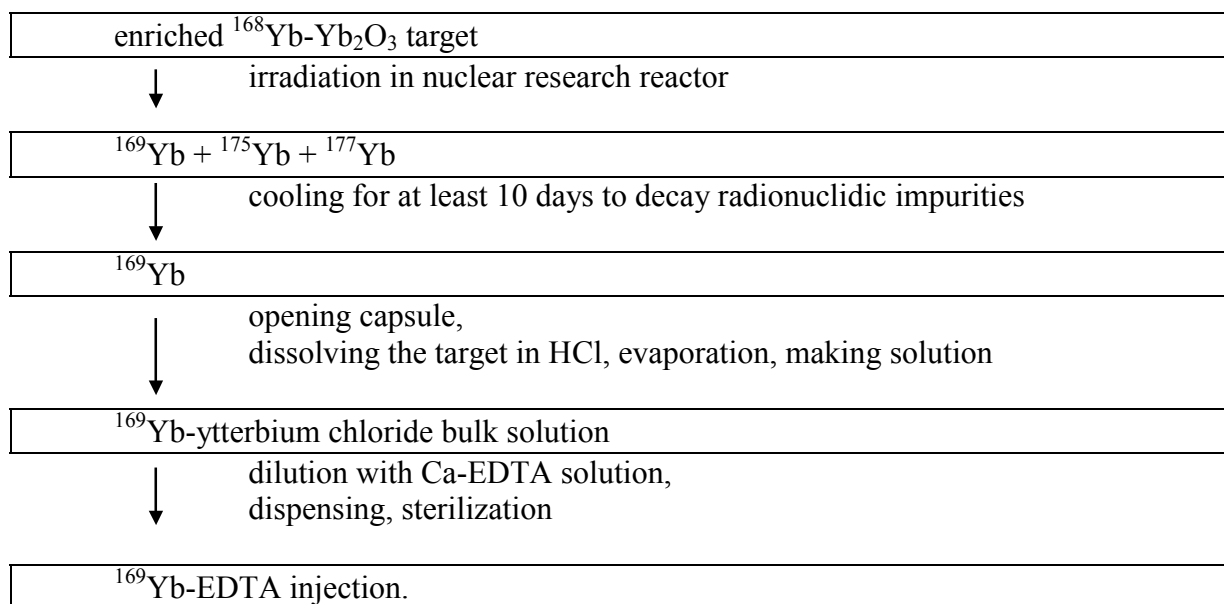

Irradiation parameters, specific activity and total yield at the EOI

Reactor

Nuclear research reactors with a neutron flux of $3 \times 10^{13} - 2 \times 10^{14}$ n/cm²/s can be used. Even higher fluxes can be used if available. Water cooling of the target within the irradiation channel, during the whole irradiation, can be advised.

Capsule details

A quartz vial with ground quartz stopper is used. Dimensions: diameter 14 mm, height:40mm. The proper amount of the enriched ytterbium-oxide is dissolved in 2 M nitric acid at elevated temperature. The solution is carefully evaporated to dryness. The rest is dissolved in distilled water and an ytterbium concentration of 4 mg/mL is adjusted. 0.25 mL of this solution is poured into the quartz irradiation vial and evaporated to dryness in vacuum. The quartz vial is closed with its ground quartz stopper. The stopper is firmed to the vial with aluminium wire.

Mass of target per capsule

The quartz vial contains 1.0 mg of ytterbium i.e. 1.14 mg Yb_2O_3

Preparation of target for encapsulation and irradiation parameters

The stoppered quartz vial is encapsulated into an aluminium container possessing diameter of 30 mm, height of 110 mm. The container is closed by welding. A lifting head, for handling the container in the irradiation channel supplied with a screw is fixed on the top of the container. Fluxes up to 2×10^{14} n/cm²/s or even higher can be used.

100–288 hours irradiation can be performed. Irradiation on higher fluxes makes possible the decrease of the irradiation time.

After irradiation, a cooling period of at least 30 days is required so that the ¹⁷⁷Yb content should completely decay and the ¹⁷⁵Yb content should decay to an acceptable level.

Specific activity achieved and typical production yield/capsule

fluxes, n/cm ² /s	3×10^{13}		1×10^{14}		2×10^{14}	
irradiation time, h	100	288	100	288	100	288
mass of target, mg	1.14					
ytterbium, mg	1.00					
calculated ¹⁶⁹ Yb yields *), GBq	1.6	4.23	5.31	14,1	10.63	28.21
¹⁷⁵ Yb impurity, GBq	0.0045	0.008	0.015	0.026	0.030	0.052
¹⁷⁵ Yb impurity, %	0.28	0.18	0.28	0.18	0.28	0.18

*) Since yields are calculated for 1.00 mg ytterbium, the data in GBq give directly the specific activity in GBq/mg, as well.]

Type of facility for processing

For ytterbium-169 production one hot cell under negative pressure with 2 manipulators, as well as air ventilation system with filter is required. Hot cells are made of iron with a lead shielding of 15–20 cm. The window of the hot cell is made of lead glass with a thickness of 25 cm. Any other conditions (e.g. radiation protection system, etc.) should correspond to the regulations being valid for isotope laboratories of level "A".

Analysis of raw materials, reagents and chemicals required for processing

1. Enriched ytterbium oxide target: see the specifications above.
No other analysis than trial irradiation and the determination of the radionuclidic as well as radiochemical and chemical purity of the ¹⁶⁹Yb obtained are suggested.
2. Nitric acid. Assay: 64–66% which corresponds to cca. 14.4 M solution. Other impurities: chloride $<5 \times 10^{-3}\%$, sulphate $<1 \times 10^{-3}\%$, Cd, Co, Cu, Fe, Ni, Pb, Zn $<5 \times 10^{-4}\%$. (Fluka).
3. Hydrochloric acid. Assay: $>36.5\%$.

Impurities: sulphate $<5 \times 10^{-4}\%$, Fe, Zn $<5 \times 10^{-5}\%$,
As, Cd, Co, Cr, Cu, Mn, Ni, Pb $<5 \times 10^{-6}\%$ (Fluka).

4. Ca-EDTA (Ethylenediamine-tetraacetic acid calcium disodium salt). Assay: $>97\%$. (Riedl de Haen). Water content measured by Karl Fisher reagent $<13\%$. pH = 6.5–8.5
Free EDTA $<1\%$, As $<3 \times 10^{-4}\%$, lead and heavy metals $<2 \times 10^{-3}\%$.
5. Sodium chloride. Assay $>99\%$, sodium and chloride content measured by flame photometry and precipitating with barium chloride, respectively. No insoluble or coloured materials are present. Heavy metals $<10 \mu\text{g/g}$, arsene $<1 \mu\text{g/g}$.

Chemical processing procedure

The irradiated container is delivered to the hot cell in lead container providing adequate protection against radiation. The container is opened by mechanical cutting. The quartz vial containing the irradiated ytterbium oxide is opened and 1 mL 1 M HCl is added to it. The solution will be ready when is heated until boiling. The solution is poured into a glass of 50 mL and the quartz vial is rinsed with double distilled water. The solution is carefully evaporated to a volume of cca. 0.1 mL and taken up in 10 mL double distilled water. pH should be in the range of 2–4. Activity of 1.0 mL of the bulk ytterbium chloride solution is measured for the calculation of specific activity and radioactive concentration.

Preparation of ^{169}Yb -EDTA is performed by diluting the bulk solution with the mixture of 5% Ca-EDTA and 95% NaCl solutions to the proper radioactive concentration. The final solution is filtered on G4 filter.

Dispensing and quality control

Dispensing

The final ^{169}Yb -EDTA solution is dispensed into vials by pipetting, the vials are closed with rubber stoppers and aluminium caps. Vials are autoclaved for 30 minutes at a temperature of 120°C for sterilization.

Determination of radionuclidic purity

A vial containing 5–10 MBq I-125 sample is measured. Main gamma-peak of ^{169}Yb are: 63.1 keV, 109.7 keV, 130.5 keV, 177.2 keV, 197.9 keV and 307.7 keV.

Impurity limits: not more than 0,4% of ^{175}Yb (gamma of 283 keV and 396 keV, beta: 70 keV, 470 keV).

A gamma-spectrum of Ytterbium-169 can be seen in Fig. 1.

Determination of radiochemical purity

The examined sample (volume 5–15 μL) is dropped onto a chromatographic paper stripe, type Whatman No.3, dimensions of $40 \times 3 \text{ cm}$. The chromatogram is developed in the following eluent mixture:

100 mL 0.025 M ammonium-sulphate + 50 mL acetone + 0.03 mL 25% ammonium-hydroxide.

Developing time. 5 hours. Front distance: 20–22 cm.

Rf values: product, $^{169}\text{Yb-EDTA}$: Rf = 0.7–0.9
impurity: $^{169}\text{Yb-chloride}$: Rf = 0.0

As reference ytterbium-169-chloride solution should be used.

Product can be accepted if the ^{169}Yb -content is higher than 98% even on the expiry date.

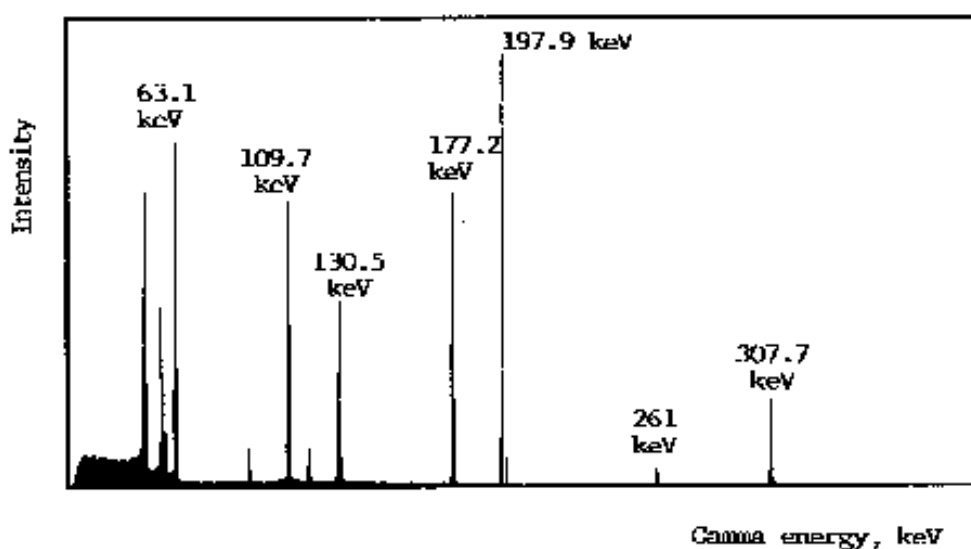

FIG. 1. Gamma Spectrum of ^{169}Yb .

Final product specification

1. Physical observation: Clear, colourless, isotonic solution.
2. Radionuclide identification:
Ytterbium-169 radionuclide is identified by gamma spectrum (see above).
3. Radionuclidic purity: should be higher than, or equal to 99.3% i.e. ^{175}Yb content should be less than 0.4%, other impurities should be less than 0.3%.
4. pH of final solution: 5–8.
5. Radiochemical purity:
Measured by the above detailed paper chromatographic method, it should be higher than 98%.
6. Concentration requirements
Specific activity: >1.11 GBq/mg
Radioactive concentration: 3.7–11.1 MBq/mL
Chemical content: 0.13–10 μg ytterbium/mL in EDTA complex form, 0.2–18 mg $\text{Na}_2\text{Ca-EDTA}$ /mL.
7. Shelf life and recommended storage conditions
Expiry: production + 40 days, storage at room temperature.

8. Special comments of waste generated
Wastes should be collected and left for decay. No special prescriptions are given, the normal radioactive waste treatment procedures described for isotope laboratories should be applied.
9. Preparation and clean up of the facility for next production.
In case of careful operation low level contamination is expected. The glasses can be washed and rinsed in distilled water. Radioactive wastes should be collected and let to stay on a properly protected place to decay. New glasses should be used for each production.

Practical experience gained

The technology can easily be performed. One crucial point should be emphasized: the target should be enriched at least to the given factor (17.1%) in order to decrease the radionuclidic impurities. If a target with higher ^{168}Yb content is available, the use of it is advisable. As high flux as possible should be used in order to increase specific activity.

BIBLIOGRAPHY

ALAZRAKI, N.P., HALPERN, S.E., ASHBURN, W.L., J. Nucl. Med. **14** (1973) 226.

DOGE, H., JOHANSEN, B.A., J. Nucl. Med. **18** (1977) 1202.

FIRESTONE, R.B., Table of Isotopes, CD ROM Edition (SHIRLEY, V.S., CHU S.Y., Eds.), Office of High Energy and Nuclear Physics, US Department of Energy, Version 1.0 (1996).

GRYCHOWSKY, P.I., MIKULSKI, J., PETRINA, T., Obtaining and separation of ^{169}Yb for nuclear medicine, Radiochem. Radioanal. Letters **40**(6) (1979) 373.

HETHERINGTON, E.L.R., WOOD, N.R., Production of ^{169}Yb radiography sources in a high flux reactor, AAEC/E, Australia **306** (1974) 22.

Yttrium-90 ($^{90}\text{Y}_{39}$)

Half-life	:	64.0 ± 0.21 h	
Production scheme	:	$^{89}\text{Y} (n,\gamma) ^{90}\text{Y}$	$\sigma = 1.28$ b
		$^{235}\text{U} (n,f) ^{90}\text{Sr} \xrightarrow{\beta} ^{90}\text{Y}$	
Type of decay and energy	:	β^- (MeV)	2.28 (100%) E_{max}

Production process

Yttrium-90 is an important pure beta-emitting radioisotope of interest for therapeutic applications in medicine as a result of the emission of a beta particle with a high maximal energy of 2.3 MeV. Yttrium-90 is formed by decay of fission-produced strontium-90 and is normally batch extracted from an inventory of the long-lived strontium-90 parent. In addition, several strontium-90/yttrium-90 generators have been described, such as the chromatographic system using Dowex 50 cation exchange system eluted with 0.003M ethylenediamine-tetraacetic acid (EDTA) for routine in-house use (Chinol, et al., 1987). The procedure described in this report is the process which was developed at ORNL, involving batch extraction of yttrium-90 from fission-produced strontium-90 using di-(2-ethylhexyl) phosphoric acid (HDEHP) extraction method.

Although batch-extracted yttrium-90 is available from several sources, the principal source in recent years has been the U.S. Department of Energy facilities in the U.S., initially at the Oak Ridge National Laboratory (ORNL) in Oak Ridge, Tennessee (Wike, et al., 1990), and more recently from about 1991 to 1998, from the Pacific Northwest National Laboratory (PNNL), in Hanford, Washington. Since 1998, the technology from PNNL was privatized by an agreement with NEN Life Sciences, in North Billerica, Massachusetts, and yttrium-90 is now commercially available from this source.

Target specification and preparation

The radioactive strontium-90 parent material is available from purification from uranium fission products. Yttrium-90 can also be produced by radiative (n, γ) neutron capture by stable ^{89}Y targets (100% abundance).

Irradiation parameters, specific activity and total yield at end of irradiation

Strontium-90 is one of the major products obtained from uranium fission in a nuclear reactor.

Type of facility for processing

Dependent upon the levels handled, a shielded hot cell is not normally required for processing yttrium-90 from strontium-90, and an adequately shielded glove box can be used. Since the presence of metallic (M^{+3}) impurities is more of a concern than radiation exposure, very high purity water, reagents and equipment free of metal impurities must be used.

The above procedure was provided by:
S. Mirzadeh and F.F. Knapp, Jr.,
Nuclear Medicine Programme,
Oak Ridge National Laboratory,
Oak Ridge, Tennessee 37830-6229, USA.

Chemical processing procedure

The processing procedure (Figure 1) described here is summarized from the procedure which had been used at ORNL for many years which was described by Wike, et al. (1990).

Separation and purification of ^{90}Y

1. The HDEHP-dodecane stock reagent is prepared for use by first stripping three times with equal volumes of 6 M HCl to reduce trace elements and then washing with 0.1 M HCl to reduce the acid content. Filtration through Whatman No. 1 filter paper is necessary to remove suspended water droplets from the HDEHP-dodecane phase.
2. Strontium-90 cows up to 20 Ci* of $^{90}\text{SrCl}_2$ are diluted to 50 mL with 0.1 M HCl. New glassware, which has been acid washed, is required for each step in the separation procedure.
3. The ^{90}Sr cow is transferred to a 125-mL separatory funnel that contains 25 mL of 1.0 M HDEHP in dodecane. The phases are mixed by agitation for 5 minutes and allowed to separate.
4. The aqueous phase cow is drained into a 140-mL beaker and the ^{90}Y -rich organic phase is washed four times with 25 mL of 0.1 M HCl to strip the residual ^{90}Sr . The first 25-mL wash is added to the cow to recover ^{90}Sr . Approximately 95% of the ^{90}Y is back-extracted from the organic phase by shaking it with two 25-mL vol of 6 M HCl for 5 minutes each.
5. The 6 M HCl is evaporated to moist dryness, cooled, and transferred to a second 125-mL funnel with 25 mL of 1.0 M HDEHP-dodecane followed by a 50-mL rinse with 0.1 M HCl.
6. A second 5-minute extraction is made, followed by four 0.1 M HCl washes that are discharged to waste.
7. The ^{90}Y is stripped with two 5-minute contacts with 30 mL each of 9 M HCl. The strip solutions are combined and mixed in preparation for trace-element removal by ion-exchange chromatography.
8. AG-1X8 (50-100 mesh) anion-exchange resin in the hydrogen form is placed in a 0.7-cm-dia glass column to a depth of 12 cm. The column is alternately washed with 50 mL of 9 M HCl and 0.1 M HCl.
9. The ^{90}Y -rich 9 M HCl strip solution is then passed through the anion-exchange resin at the rate of 2 mL/minute. Finally, the column is washed with 5 mL of 9 M HCl to clean out any residual ^{90}Y solution.
10. The column effluent, which contains the ^{90}Y , is again evaporated to moist dryness to prepare for cation-exchange chromatography to remove phosphates and traces of organic residue remaining after the previous treatment in the anion-exchange column.
11. The cation-exchange column is prepared by placing AG-50X8 (50–100 mesh) cation-exchange resin in a 0.7-cm-dia glass column to a depth of 5 cm. The resin is conditioned successively with 50 mL of 6 M HCl and 50 mL of 0.1 M HCl. The ^{90}Y product from the anion-exchange step is dissolved and transferred to the column with 50 mL of 0.1 M HCl.

The column flow rate is set at 2 mL/min. The ^{90}Y adsorbed near the top of the resin is removed from the column with 60 mL HCl, and the resulting solution is evaporated to near dryness.

12. The yttrium product is then diluted to the desired volume and normality. The ^{90}Sr cow must be prepared for the subsequent separation by oxidizing soluble organic phosphates with 5 mL of aqua regia. The residue is redissolved in 50 mL of 0.1 M HCl and stored for the next separation.
13. Quality control and analytical procedures must be conducted rapidly and efficiently because of the short half-life of ^{90}Y . In addition, the ^{90}Sr level must be accurately determined because of the possible therapeutic application in humans. The intense β radiation from the ^{90}Y product solution must be reduced (by coprecipitation of the ^{90}Y on iron hydroxide) so that radiochemical analyses for the ^{90}Sr in the ^{90}Y product can be performed in a laboratory hood. Most of the ^{90}Y is precipitated with the iron when made basic with NH_4OH . Samples are prepared for ^{90}Sr analyses by pipeting 1 mL of a 1000-fold dilution into a beaker containing 10 mL of distilled water, 10 mg of Fe^{3+} , and 25 mg of standardized natural strontium carrier. Then the filtrate is analysed for ^{90}Sr by routine radiochemical methods (Krieger, 1980) following the removal of the ^{90}Y .

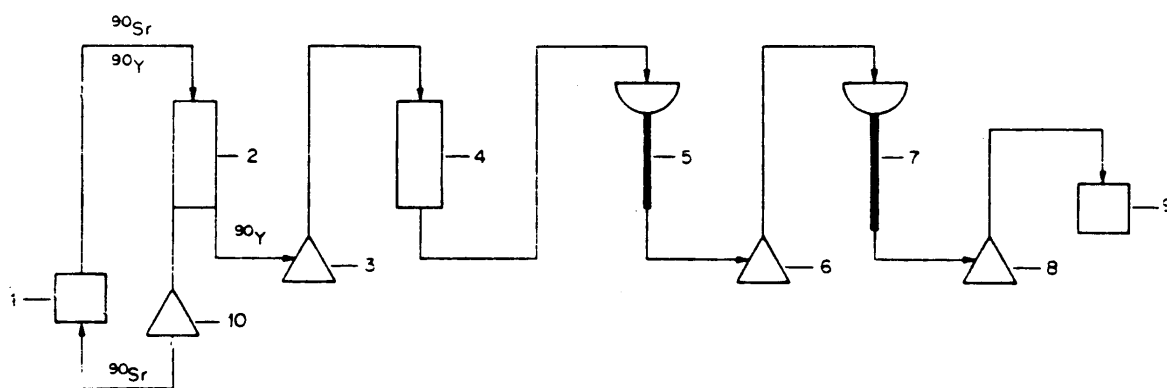

- 1 $^{90}\text{Y}/^{90}\text{Sr}$ "COW"
- 2 First HDEHP extraction
- 3 Evaporation / acid adjustment
- 4 Second HDEHP extraction
- 5 ^{90}Y extract through anion-exchange column
- 6 Evaporation / acid adjustment
- 7 ^{90}Y through cation-exchange column
- 8 Evaporation / acid adjustment
- 9 ^{90}Y product makeup
- 10 Evaporation / acid adjustment of ^{90}Sr "COW"

FIG. 1. Processing scheme for obtaining carrier-free yttrium-90 from the strontium-90 stock solution by solvent extraction.

Dispensing, assay and quality control

As indicated earlier, high purity water, reagents and equipment must be used which are free of metallic impurities, especially iron. The yttrium-90 is carrier-free, and is usually dispensed as the chloride in dilute (0.05–0.1) HCl solution.

Final product specification for use

The product is assayed by beta counting and for the absence of metal impurities.

Practical experience gained

The radiochemical purity of yttrium-90 free of the strontium-90 parent is usually not a problem and can be assessed by beta counting. The chemical purity of yttrium-90 free of any contaminating metal impurities is very important, however, since the chelation of yttrium-90 to many organ-specific therapeutic agents such as antibodies and peptides requires very high specific activity with no competing metallic impurities which may compete with the limited chelation sites. Very high purity water, reagent solutions and equipment which is free of metallic impurities, especially iron, must therefore be used at all steps in the purification process.

BIBLIOGRAPHY

CHINOL, M., HNATOWICH, D.J., “Generator-produced Yttrium-90 for Radioimmuno-therapy”, *J. Nucl. Med.*, **28** (1987) 1465–1470.

WIKE, J.S., GUYER, C.E., RAMEY, D.W., PHILLIPS, B.P., “Chemistry for Commercial Scale Production of Yttrium-90 for Medical Research”, *Appl. Radiat. Isot.*, **41** (1990) 861–865.

Xenon-133 ($^{133}\text{Xe}_{54}$)

Half-life	:	5.243 ± 0.001 d
Production scheme	:	$^{235}\text{U} (n,\gamma) ^{133}\text{Xe}$
Type of decay and energy	:	β^- (MeV) 0.3464 (95%)

Production process

Xenon-133 is formed according to $^{235}\text{U} (n,f)$ reaction among the other fission products when uranium-235 contained targets are irradiated by thermal neutrons. Xenon-133 is a gas. Then it is purified from iodine radioactive isotopes and other volatile elements. Fission fragments yield is 6.7%. The isotope activity per 1 g uranium-235 is ~370–445 GBq (10–12 Ci) (after six days in irradiation and one day storage).

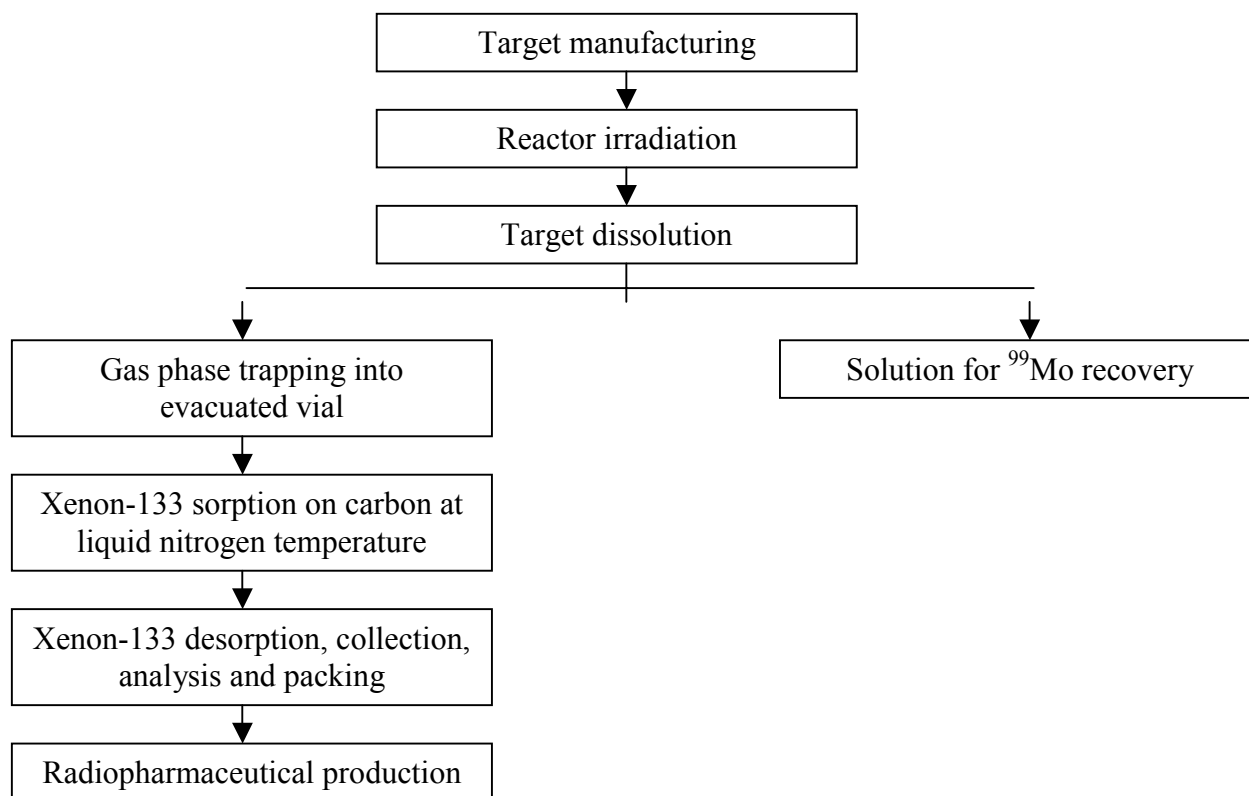

The processing flowsheet includes the following operations:

Target specification and preparation

Uranium-235 (90% enrichment) as uranium oxide pressed with magnesium oxide into a bushing is a raw material for the xenon-133 production. The bushing is put into the annular gap of the jackets made of stainless steel, filled with magnesium and welded. The uranium

The above procedure was provided by:

V.V. Kanygin, E. Ya. Smetanin,
Department of Research Reactors, Isotopes and Radiopharmaceuticals,
Institute of Physics and Power Engineering, Obninsk, Russian Federation.

quantity per 1 target is 4.2 g. Uranium-235 of 90% enrichment produced in the Russian Federation is used.

Irradiation parameters, specific activity and full yield at the EOI

The target is irradiated in the research reactor “AM” during 6 days in thermal neutron flux 3×10^{13} n/cm²/s. Then the ampoule is stored during 4–6 hours for radioactive short-lived isotopes decay.

The main requirement to the target is the uranium uniform distribution in the target composition, tightness, and heat removal possibility during the irradiation.

The irradiation is performed in a water cooling channel. Isotope Xe-133 carrier free is formed during the irradiation process. (specific activity is 1.4 PBq (3.8×10^4 Ci)/g. Xenon- 133 yield per 1 target is 1.6–1.8 TBq (45–50 Ci).

TABLE I. IMPURITIES PERCENTAGE IN THE RAW MATERIAL

Impurities	Percentage in uranium
Mo	2.5×10^{-3}
Fe	2.5×10^{-3}
Mn	3.0×10^{-4}
Bu	$<2.0 \times 10^{-3}$
Cu	1.1×10^{-4}
Al	3.0×10^{-3}
Cd	$<3.0 \times 10^{-5}$
Ti	$<1.0 \times 10^{-4}$
Cr	$<2.5 \times 10^{-3}$
Pb	10^{-3}

Type of facility for processing

The main process operation is the ampoule dissolution. It is performed in the “hot” cell having the sufficient biological shield and the infrastructure appropriate for the isotope production (special ventilation, special sewerage, zonal layout of premises).

The processing is continued in the protective scaled box, the product is transferred through the process lines.

The pressure drop between the operator's and working premises must not be less than 20 mm of water column in case of the “hot” cell and protective box.

Taking into account the physical state (gas) all the process equipment and process lines have to ensure the tightness.

Analysis of raw material, reagents and chemicals required for processing

As it is described in the section II (the target preparation) 90% enriched uranium is used as the raw material. The input control of uranium dioxide batches and the ampoule composition materials (MgO, Mg) is carried out.

The reagents — activate carbon, ethyl alcohol, distilled water, acetone — are of the best marks (X4, RGA), and the input control confirms their correspondence to the given specification.

Chemical processing procedure

After the irradiation the ampoule is transported from the reactor facility to the “hot” laboratory building. The ampoule is cut to pieces of 400 mm in the “hot” cell, and these pieces are dissolved in nitric acid (8M).

During the cutting and dissolution the exhaust goes through aerosol and radioactive iodine trapping system (two scrubbers with 4M alkali + silica gel columns) and is collected in a tank of 50 liters volume. Then it is sorbed on carbon column by cryogen method.

The sorption column is transported to a heavy box where it is connected to the gas collector with the help of the reentrant line. A heater is put inside the sorption column, and the column heating is turned on.

The heating is controlled with the help of a thermocouple put into the sorption column, and also — by water coming into a receiving tank of the gas collector according to the measuring line.

When the gas collector is filled 90%, the heating is turned off. The gas sample is taken to an evacuated vial through the pre-packing device transferring line.

Xenon-133 content is measured approximately in a gas sample. If the gas concentration activity is not a satisfactory one, the gas from the gas collector is transferred to a tank through the reentrant line for xenon utilization. And the column annealing is repeated.

If the gas concentration activity is a satisfactory one, the gas from the gas collector is transferred by accurately measured portions to the pre-packing box through the transfer line. The pre-packing device electromagnetic valves control the solution volume being transferred.

In the xenon pre-packing device the gas is transferred to an evacuated vial through the valve system and the needle.

The vial is put into KT-1-5 transport container and sent for the activity measurement.

Dispensing, assay and quality control

A batch of the preparation which is extracted and collected into the gas collector (see the processing flowsheet) is the final product. A sample is taken from this batch to an injection vial for measurements of total activity, activity concentration and radionuclide impurity contents. The activity and radionuclide impurity content values are determined by means of the gamma-spectrometric method.

The measurement equipment is a semi-conducting gamma-spectrometer which includes the following units:

- detector of DGDK-63 type placed into evacuated cryostat and being cooled up to the temperature of -160°C ;
- pre-amplifier of BUS-2-96 type or PUG-P-01 type;
- multi-channel pulse analyser of AI-1024-95M type;
- information processing and management unit on the base of PC “ES-1841”;
- gamma-spectrum processing code “Balbi-S”.

Auxiliary equipment:

- set of standard spectrometric gamma-sources;
- reference volumetric radiation source containing radionuclide Ba-133 which is calibrated with an error of $\pm 5\%$;
- the detector lead shield of 50mm thickness;
- KT-5 lead container with a collimator on the bottom.

The same equipment is used to measure the radionuclide impurities simultaneously with the sample activity measurement. The radionuclide impurity detection sensitivity is not less than 0.05% of the basic isotope activity.

The product quality control also includes:

- visual inspection (transparent, colourless gas);
- capsule or vial scaling control.

This operation is carried out by the method of xenon-133 activity measurement repeated in 12 hours. The vial is considered sealed if a result of the xenon activity repeated measurement differs from the first measurement result within the confident boundaries of the measurement result total error taking into account a correction for radionuclide xenon-133 decay.

The ampoule or vial surface contamination level is determined by taking a smear and by measuring its activity.

Final product specification for use

Chemical form, appearance: transparent, colourless gas.

Specific activity, Ci/g: >1000 .

Concentration activity, Ci/mL

Content of radionuclide impurities, % of xenon- 133 activity:

$$\begin{aligned} &^{131m}\text{Xe} - 1.5 \\ &^{135m}\text{Xe} - 1.0 \\ &^{85}\text{Kr} - 0.5 \end{aligned}$$

Shelf life is up to 10 days.

Practical experience gained

The xenon-133 production technology is a part of Mo-99 recovery technology from irradiated uranium target. ^{131}I (fission), ^{95}Zr , and ^{140}Ba are also recovered from the same target.

The ^{133}Xe production technology provides its regular (weekly) production and stable quality parameters. This preparation is supplied to radiopharmaceutical companies for radiopharmaceuticals production.

In particular, the stable routine production of two radiopharmaceuticals is organized on the basis of ^{133}Xe production cycle:

- xenon-133 in isotonic solution;
- air-xenon mixture.

CONTRIBUTORS TO DRAFTING AND REVIEW

Akaboshi, M.	Research Reactor Institute, Kyoto University, Japan
Alberto, R.	Paul Scherrer Institute, Switzerland
Ananthakrishnan, M.	Board of Radiation and Isotope Technology, India
Aungurarat, G.	Office of Atomic Energy for Peace, Thailand
Beets, A.L.	Oak Ridge National Laboratory, United States of America
Bhagwat, A.M.	Bhabha Atomic Research Center, India
Brihaye, C.	Cyclotron Research Centre, Belgium
Callahan, A.P.	Oak Ridge National Laboratory, United States of America
Cheng Zuoyong	Nuclear Power Institute of China, China
De Villiers, W. van Z.	South African Nuclear Energy Corporation Ltd., South Africa
Du, M.	Oak Ridge National Laboratory, United States of America
Hanafiah Ws., A.	National Atomic Energy Agency, Indonesia
Iyer, S.R.K.	Board of Radiation and Isotope Technology, India
Jauhri, G.S.	Bhabha Atomic Research Center, India
Jiang Bingsheng	Nuclear Power Institute of China, China
Jin Xiao Lai	Department of Isotope, CIAE, China
Kanygin, V.V.	Institute of Physics and Power Engineering, Obninsk, Russian Federation
Knapp, F.F., Jr.	Oak Ridge National Laboratory, United States of America
Környei, J.	Institute of Isotopes Co. Ltd, Hungary
Kyung Bae Park	Hanaro Centre, KAERI, Republic of Korea
Lambrecht, R.M.	University of Tübingen, Germany
Li Maoliang	Nuclear Power Institute of China, China
Li Wen	Massachusetts Institute of Technology, Cambridge, United States of America
Manzini, A.	Ezeiza Atomic Centre, CNEA, Argentina
Mausner, L.F.	Brookhaven National Laboratory, United States of America

Mirzadeh, S.	Oak Ridge National Laboratory, United States of America
Narasimhan, D.V.S.	International Atomic Energy Agency
Novak, K.	POLATOM, Poland
Panek Finda, H.	Mallinckrodt Medical B.V., Netherlands
Ponsard, B.	CEN.SCK, Belgium
Sangurdekar, P.R.	Bhabha Atomic Research Center, India
Sankaranarayanan, S.	Bhabha Atomic Research Center, India
Schubiger, P.A.	Paul Scherrer Institute, Switzerland
Schwerer, O.	International Atomic Energy Agency
Smetanin, E.Y.	Institute of Physics and Power Engineering, Obninsk, Russian Federation
Srivenkatesan, R.	Bhabha Atomic Research Center, India
Subramanian, V.G.R.	Board of Radiation and Isotope Technology, India
Takahashi, H.	Japan Atomic Energy Research Institute, Japan
Vera Ruiz, H.	International Atomic Energy Agency