

# Aluminum Electrical Conductor Handbook

THIRD EDITION

1989



**the Aluminum Association**  
Incorporated

900 19th Street, N.W., Washington, D.C. 20006



## table of contents

---

### Section I Aluminum — the Metal

<u>Chapter one</u>	<u>Early and Present-Day Processing</u>	
	<b>Aluminum metal-working processes</b> . . . . .	1-1
	sequence of fabricating operations	
	<b>Aluminum and aluminum alloys for electrical conductors</b> . . . . .	1-4
	treatment for improvement of physical properties	
	temper designations	
	<b>Anodizing</b> . . . . .	1-7
	<b>Other processes</b> . . . . .	1-7
<u>Chapter two</u>	<u>Aluminum Conductor Properties and Advantages</u>	
	<b>The effect of alloying</b> . . . . .	2-1
	<b>Conductivity</b> . . . . .	2-1
	<b>Light weight</b> . . . . .	2-2
	<b>Strength</b> . . . . .	2-2
	<b>Workability</b> . . . . .	2-2
	<b>Corrosion resistance</b> . . . . .	2-3
	<b>Creep</b> . . . . .	2-3
	<b>Compatibility with insulation</b> . . . . .	2-3
	<b>Thermal properties</b> . . . . .	2-3

### Section II Bare Aluminum Wire and Cable

<u>Chapter three</u>	<u>Engineering Design</u>	
	<b>Mechanical design of conductors</b> . . . . .	3-1
	aluminum wire gage	
	stranded conductors	
	concentric-lay stranding	
	difference between stranded and solid conductors	
	special conductor construction	
	<b>Composite conductors</b> . . . . .	3-3
	aluminum conductor steel reinforced (ACSR) and modifications	
	aluminum conductor alloy reinforced (ACAR)	
	international annealed copper standard	
	<b>Calculation of dc resistance</b> . . . . .	3-7
	change of dc resistance with temperature	
	temperature-resistance coefficients for various temperatures	
	<b>Calculation of ac resistance</b> . . . . .	3-8
	skin effect in steel-reinforced stranded conductors (ACSR, etc.)	
	proximity effect	
	hysteresis and eddy current effects	
	radiation loss	
	corona	
	<b>Inductive and capacitive reactance</b> . . . . .	3-12
	inductive reactance $X_L$	
	geometric mean radius (GMR)	
	inductive reactance of bundled conductors	
	zero-sequence resistance and inductive reactance	
	shunt capacitive reactance $X_C$	
	zero-sequence capacitive reactance	
	capacitive reactance of bundled conductors	
	<b>Ampacity of bare conductors</b> . . . . .	3-19

## table of contents (continued)

	heat balance	
	ampacity of 1350-H19 all-aluminum conductor and standard-strength ACSR conductors	
	ampacity of single-layer high-strength ACSR conductors	
	ampacity 6201-T81, and ACAR conductors	
<b>Chapter four</b>	<b>Product Identification and Data</b>	
	<b>Product classification of bare aluminum conductors</b> . . . . .	4-1
	<b>Product identification</b> . . . . .	4-1
	for 1350 aluminum and temper AAC	
	for ACSR, AAAC and ACAR	
	size relationships	
	technical data and catalog information	
	<b>List of tables in chapter 4</b> . . . . .	4-3
<b>Chapter five</b>	<b>Installation Practices</b>	
	<b>Line design factors</b> . . . . .	5-1
	initial and final sag-tension charts for variable-length spans	
	<b>Initial stringing chart</b> . . . . .	5-4
	<b>The ruling span</b> . . . . .	5-4
	completion of stringing graph by use of parabola formula	
	sag correction for long spans	
	<b>Use of stringing charts</b> . . . . .	5-7
	<b>The sag-span parabola and template</b> . . . . .	5-7
	sag when supports are at different elevations	
	<b>The uplift condition (negative span)</b> . . . . .	5-8
	unbalanced forces at support points	
	<b>Preparation of sag-tension charts</b> . . . . .	5-10
	<b>The catenary curve and preliminary sag-tension graph</b> . . . . .	5-10
	<b>Method of drawing the parabola</b> . . . . .	5-11
	<b>The stress-strain graph</b> . . . . .	5-12
	initial and final sag and tension of a designated conductor, span and NESC loading at various temperatures	
	<b>Sag-tension graphs for composite conductors</b> . . . . .	5-18
	<b>Overhead conductor accessories and fittings</b> . . . . .	5-21
	joints and connectors	
	bolted clamp connectors	
	welded connections	
	dead-ends and dead-ends clamps	
	suspension clamps	
	tie wires	
	armor rods	
	<b>Aluminum-to-copper connections</b> . . . . .	5-25
<b>Chapter six</b>	<b>Operating Performance and Problems</b>	
	<b>Short-circuit performance</b> . . . . .	6-1
	adjustments for 6201-T81 and ACAR conductors	
	adjustment for upper temperature limit	
	<b>Arcing</b> . . . . .	6-2
	<b>Arcing effects</b> . . . . .	6-2
	<b>Loss of strength</b> . . . . .	6-2
	<b>Fault-current electro-magnetic forces between parallel bare wires and cables</b> . . . . .	6-9

## table of contents (continued)

---

<b>Emergency loading</b> . . . . .	6-10
<b>Vibration and fatigue of overhead conductors</b> . . . . .	6-11
aeolian vibration of conductors	
fatigue of conductor strands	
vibration dampers	
spacers and dampers for bundled conductors	

### Section III Covered and Insulated Aluminum Wire and Cable

#### Chapter seven      Review of Types and Applications

<b>Conductors for use with covered or insulated wires or cables</b> . . . . .	7-1
<b>The distinction between covered and insulated conductors</b> . . . . .	7-1
<b>Covered aluminum line wires and cables</b> . . . . .	7-2
covered line wires	
tree wire	
spacer cable	
<b>Insulated conductors and cables (0-600 volts)</b> . . . . .	7-2
aluminum power and lighting insulated 600-volt cables	
<b>Single conductors (0 to 600 volts)</b> . . . . .	7-2
<b>Aerial cable assemblies (0 to 600 volts)</b> . . . . .	7-2
parallel aerial cables (PAC)	
reverse twist secondary cables (RTS)	
service drop cables	
<b>Multiple conductor power cables (0 to 600 volts)</b> . . . . .	7-3
aluminum interlocked or seamless armored cables	
aluminum service-entrance cables (600-volt)	
aluminum sheathed cables (600-volt)	
<b>Aluminum cables for underground installation (600-volt)</b> . . . . .	7-4
<b>Insulated conductors (above 600 volts)</b> . . . . .	7-4
power cables (above 600 volts)	
primary URD cables for underground residential distribution (5 kV to 35 kV)	
medium-voltage shielded single-conductor power cables (5 kV to 35 kV)	
interlocked-armor cables	
preassembled aerial cables (to 35 kV)	
<b>Aluminum insulated conductors for special conditions</b> . . . . .	7-5
aluminum pole-and-bracket cables for series street lighting	
aluminum mine power cables	
aluminum portable cables	
aluminum submarine cables	
special applications cables	

#### Chapter eight      Insulation and Related Cable Components

<b>Typical 3-conductor cable assemblies</b> . . . . .	8-1
<b>Conductors for insulated cables</b> . . . . .	8-2
<b>Coverings for uninsulated conductors</b> . . . . .	8-2
<b>Insulating materials and performance</b> . . . . .	8-2
<b>Thermosetting insulating materials</b> . . . . .	8-4
styrene-butadiene synthetic rubber (SBR)	
butyl synthetic rubber	
cross-linked polyethylene insulation (XLPE,XHHW)	

## table of contents (continued)

	ethylene-propylene rubber (EPR)	
	fluorinated ethylene propylene rubber (FEP)	
	neoprene synthetic rubber	
	asbestos insulations (SA, AVA, AVL)	
	<b>Thermoplastic insulating materials</b> . . . . .	8-9
	thermoplastic polyvinyl chloride (PVC)	
	thermoplastic polyethylene (PE)	
	<b>Jacket materials</b> . . . . .	8-9
	polyvinyl chloride jackets	
	polyethylene jackets	
	neoprene jackets	
	nylon jackets	
	nitrile-butadiene/polyvinyl-chloride jackets	
	'unipass' jackets	
	no jacket requirements	
	<b>Tapes and shielding materials</b> . . . . .	8-10
	insulating tapes	
	shielding materials and shielding methods	
	the effect of corona on insulation and shielding	
	sheaths, fillers and binders	
	<b>ICEA performance specifications</b> . . . . .	8-12
	insulation resistance	
	water absorption	
	temperature	
	<b>NEC designations</b> . . . . .	8-12
<b>Appendix 8A</b>	<b>Elements of Dielectric Theory</b> . . . . .	8-13
	charging current and leakage conduction current	
	charging and leakage-conduction currents under direct and alternating potential	
	total dielectric current and power factor under a-c conditions	
	dielectric constant ( $\epsilon_r$ ) under a-c conditions	
	capacitance of insulated conductors with grounded sheath or directly buried	
	example of dielectric computation	
<b>Chapter nine</b>	<b>Engineering Design as Related to Cable Applications</b>	
	<b>Cable diameter</b> . . . . .	9-1
	<b>Duct, conduit and raceway installations</b> . . . . .	9-1
	spacing between cables	
	<b>Cable-conductor resistance</b> . . . . .	9-3
	ac/dc ratios for aluminum cables	
	general conditions applying to table 9-4	
	<b>Cables in aluminum conduit</b> . . . . .	9-6
	<b>Series inductive reactance</b> . . . . .	9-8
	series-inductive-reactance calculation	
	supplementary table for series inductive reactance	
	reactance of conductors on rigid cable supports	
	<b>Shunt capacitive reactance</b> . . . . .	9-9
	<b>Voltage-drop</b> . . . . .	9-12
	<b>Ampacity of insulated conductors</b> . . . . .	9-13
	ampacity ratings	
	emergency overload ratings	
	short-circuits	

## table of contents (continued)

---

<u>Chapter 9A</u>	<u>Explanation of ICEA-IEEE tables of ampacity of insulated aluminum cables for various conditions of installation</u>	
	<b>Cable types</b> . . . . .	9-21
	<b>Installation methods</b> . . . . .	9-21
	description of typical section of ICEA-IEEE ampacity table	
	tables for installation in air or in conduit exposed to air	
	construction of cables used as basis for ampacity table	
	supplementary constants	
	ICEA ampacity grouping factors	
	cable spacing maintained	
	cable spacing not maintained	
<u>Chapter ten</u>	<u>Product Classification and Technical Data</u>	
	<b>Service and secondary cables</b> . . . . .	10-1
	class 10-1 to 10-11	
	<b>Cables for primary distribution voltages</b> . . . . .	10-10
	tabular voltages for determining insulation thickness	
	jacket thickness	
	primary unshielded cables (3 kV and 5 kV)	
	primary cables with insulation shielding (to 35 kV)	
	primary interlocked-armor cables	
	primary cables for underground residential distribution—URD	
	high voltage primary cables	
	ampacity of high voltage aluminum cables	
<u>Chapter eleven</u>	<u>Installation Practices</u>	
	<b>Aluminum conductor connections</b> . . . . .	11-1
	<b>Building wire connectors</b> . . . . .	11-2
	<b>Building wire terminations</b> . . . . .	11-3
	<b>Basic installation techniques</b> . . . . .	11-7
	1. stripping insulation	
	2. making connections	
	3. pulling conductors in conduit	
	4. installation of cables in trays	
	5. minimum training radii	
	6. conductors in vertical raceways	
	<b>Installing cable in conduit or duct</b> . . . . .	11-10
	allowable pulling tension	
	<b>Installing directly buried power cables</b> . . . . .	11-12
	<b>Splicing and terminating in u/g systems</b> . . . . .	11-14
	600 volt secondary circuits	
	primary voltage circuits	
	<b>Installing aerial insulated cables</b> . . . . .	11-23
	primary aerial cables	
	neutral-supported secondary and service drop cables	
	Initial sag-tension values for aerial cable	
	Initial stringing tensions for overhead triplex	
<u>Chapter twelve</u>	<u>Operation and Operating Problems</u>	
	<b>Emergency overloads</b> . . . . .	12-1

## table of contents (continued)

---

<b>Short circuit loading</b> . . . . .	12-1
short circuits in shields and sheaths	
<b>Causes of insulation failure</b> . . . . .	12-4
external causes of cable failure	
<b>Installation and maintenance proof-testing</b> . . . . .	12-5
<b>Fault location</b> . . . . .	12-6
<b>Identify and isolate faulted section</b> . . . . .	12-6
<b>Location of fault</b> . . . . .	12-6
radar	
bridge	
capacitance	
impulse generator (thumper)	
earth gradient detection	
acoustic detection	
electromagnetic detection	
audio tone	
burndown	
<b>Recommendations</b> . . . . .	12-7

### Section IV    Bus Conductors

#### Chapter thirteen    Bus Conductor Design and Applications

<b>Alloys and tempers</b> . . . . .	13-1
mechanical properties	
effects of heating	
stress-strain and creep factors	
<b>Bending and forming</b> . . . . .	13-7
bend properties of bus bar	
bending tubular conductors	
lubrication	
<b>Resistance to corrosion</b> . . . . .	13-8
<b>Bus conductor shapes and shape selection</b> . . . . .	13-8
rectangular bar	
tubular conductors	
square tubular bus	
integral web channel conductor (IWCB)	
channels — structural shape and uniform thickness	
angles	
round rod	
special shapes	
<b>Factors affecting bus design</b> . . . . .	13-11
<b>Temperature rise</b> . . . . .	13-11
effect of conductivity	
effects of dimensions	
temperature rise — ampacity tables	
<b>Energy loss</b> . . . . .	13-12
<b>Alternating current (ac) applications</b> . . . . .	13-12
skin effect	
proximity effect	
interfaced and paired phase arrangements	
transposition	
mutual heating	
heating due to magnetic materials near the buses	
induced circulating currents	

## table of contents (continued)

---

calculation of a-c resistance	
temperature rise — ampacity tables	
reactance	
consolidation of multiple bars — reactance	
<b>Corona and radio-influence voltage (RIV)</b> .....	13-19
<b>Ampacity of aluminum bus conductors</b> .....	13-19
heat-balance equation of electric conductors (general)	
ampacity (vertical bars)	
multiple bar arrangements	
ampacity (IWCB)	
ampacity (round tubular bar)	
ampacity for outdoor bus conductors	
emissivity and absorptivity	
effect of painting	
ampacity tables	
current vs. temperature rise	
enclosed bus conductors	
isolated phase bus	
<b>Short-circuit conditions</b> .....	13-24
direct current	
alternating current	
application of formulas	
direct current buses	
low-voltage alternating current buses	
high-voltage substations	
longitudinal forces	
torsional forces	
stresses caused by short-circuit currents	
heating caused by short-circuit currents	
<b>Mechanical design</b> .....	13-28
<b>Vibration</b> .....	13-28
electro-magnetic (resonance)	
aeolian vibration	
expansion joints for bus conductors	
rectangular bars	
structural shape	
tubular	
positioning expansion joints — continuous spans	
expansion joint types	
bus supports	
clearances and phase spacings	
<b>Jointing and connecting</b> .....	13-36
nature of contact interface	
constriction resistance	
film resistance	
design factors of bolted and clamped joints	
contact surface area (overlap)	
contact resistance — clamping force	
contact surface preparation	
characteristics of dissimilar metal interfaces	
<b>Bolted joints and jointing hardware</b> .....	13-41
bolts — size and number	
bolts — torque vs. clamping pressure	
aluminum alloy bolts	



**table of contents (continued)**

steel bolts and belleville spring washers	
steel bolts and pressure plates	
steel bolts and standard flat washers	
quality steel bolts	
special clamps	
<b>Aluminum-to-copper connections</b> .....	13-45
<b>Welded aluminum-to-aluminum connections</b> .....	13-46
welding processes	
strength of aluminum in weld-heat zone	
<b>Bus installations</b> .....	13-47
generator and station bus	
switchyard bus	
gas insulated bus	
busways	
switchgear	
<b>Buses for the chlor-alkali industry</b> .....	13-52
<b>Buses for the aluminum industry</b> .....	13-52
<b>Buses for the magnesium industry</b> .....	13-52
<b>Buses for electric furnaces</b> .....	13-52
<b>Appendix 13A, notes to tables 13-25 through -32</b> .....	13-63
<b>Appendix 13B, Chapter 13 bibliography</b> .....	13-68

**Section V Electromagnetic and Other Electrical Applications of Aluminum**

Chapter fourteen Aluminum Magnet Conductor

<b>Aluminum magnet wire (round, square, rectangular)</b> .....	14-1
light weight	
windability	
<b>Thermal thickness</b> .....	14-2
economic factors	
<b>Coil design</b> .....	14-2
<b>Coil connections</b> .....	14-4
<b>Aluminum strip magnet conductor</b> .....	14-4
strip magnet conductor insulation	
<b>Coil design with aluminum strip magnet conductor</b> .....	14-6
winding design techniques	
<b>Determination of foil size and coil characteristics</b> .....	14-7
dielectric and thermal advantages	
joining	
strip magnet conductor types	
<b>Some basic considerations relating to aluminum magnet wire</b>	14-13

Chapter fifteen Capacitor Foil

<b>Capacitor design considerations</b> .....	15-1
equivalent network of a capacitor	
effective resistance of foil electrodes	
<b>Electrolytic capacitors</b> .....	15-4
<b>Capacitor foil availability</b> .....	15-4

Chapter sixteen Cast Aluminum Rotors and Switchgear

<b>The cast rotor</b> .....	16-1
<b>Comparative performance of cast aluminum rotors</b> .....	16-1

**table of contents (continued)**

---

alloy selection  
**Manufacture of cast aluminum rotors** . . . . . 16-2  
melting and metal preparation equipment  
casting methods employed for aluminum rotors  
casting problems  
**Aluminum in power switchgear** . . . . . 16-5

**Section VI Related Structural Applications of Aluminum**

Chapter seventeen Rigid Aluminum Conduit

**Elements of conduit design** . . . . . 17-1  
**Rigid aluminum conduit** . . . . . 17-2  
advantages of aluminum conduit  
**Electrical characteristics** . . . . . 17-3  
**Corrosion characteristics** . . . . . 17-4  
**Installation of aluminum conduit** . . . . . 17-6

Chapter eighteen Street-Lighting Poles, Transmission Towers and Station Structures

**Aluminum light standards** . . . . . 18-1  
**Aluminum transmission towers** . . . . . 18-3  
aluminum transmission tower designs  
**Aluminum station structures** . . . . . 18-8

Chapter I

## Early and Present-Day Processing

Aluminum is the most abundant of all metals and, next to oxygen and silicon, is the most abundant of some 90 elements found in the earth's crust. Aluminum is a ductile metal, silver-white in color, which can be readily worked by rolling, drawing, spinning, extruding, and forging. Its specific gravity is 2.70. Pure aluminum melts at 660°C (1220°F).

Aluminum has relatively high thermal and electrical conductivities. The metal, in the presence of oxygen, is always covered with a thin, invisible film of oxide which is impermeable and protective in character. Aluminum, therefore, shows stability and long life under ordinary atmospheric exposure.

Because of its chemical activity and affinity for oxygen, aluminum does not occur in nature in its metallic state; it is always in combination with other elements. Many gems are crystalline forms of aluminum compounds. Rubies and sapphires, for example, are combinations of aluminum and oxygen; garnets are aluminum and silica; and jade is aluminum with sodium, oxygen, and silicon.

Alums are aluminum compounds which have been in widespread use since ancient times. Alums were employed by Egyptians and Babylonians to compound medicines and vegetable dyes.

In 1782, the French chemist, Antoine Laurent Lavoisier, stated his belief that alumine (alum) was an oxide of a metal having an affinity for oxygen so strong that it could not be isolated by then known means. In 1807, Sir Humphrey Davy attempted to isolate aluminum electrolytically, but was unsuccessful. However, he named the unisolated element aluminum, and in 1809 produced an iron-aluminum alloy by means of an electric arc.

In the year 1812, a body of aluminum ore was discovered at Les Baux, France. Named after the town of its discovery, bauxite is the most important commercial ore containing hydrated aluminum oxide. In 1825, H. C. Oerstedt succeeded in producing small bits of metallic aluminum by heating an amalgam of aluminum chloride and potassium. Twenty years later, Friedrich Wohler managed to produce aluminum particles as large as pin heads. He enthusiastically noted, "The metal is light, ductile, stable in air, and can be melted with a blow pipe." In 1854, Henri Sainte-Claire Deville announced the

production of aluminum "lumps the size of marbles." Limited production started, and the price of aluminum dropped from \$545 per pound in 1852 to \$17 per pound in 1859. In 1888, a German chemist, Karl Joseph Meyer, was issued a patent for a process of making aluminum oxide (alumina) from low silicon-content bauxite.

Further research that made possible the present-day processes was conducted in France by Paul Louis Herault, and in America by Charles Martin Hall. Unknown to each other, they independently found that electrolytic reduction of alumina could readily be achieved if alumina was dissolved in molten cryolite. Owing to the widespread distribution of accessible fields of bauxite, many of which can be mined by surface-strip methods, bauxite is readily obtained. Research and development for the benefit of both producers and users are economically practical.

The present-day process for primary production of aluminum ingot, subject to variation depending on alloy and properties required, is schematically shown by Figure 1-1. The Bayer process is used to convert bauxite into aluminum oxide, called *alumina* (upper part of Figure 1-1). The alumina is then reduced to metallic aluminum by the Hall process (lower part of Figure 1-1). The subsequent conversion of the aluminum ingots into rods for cold drawing of conductor wire or for making extruded bus bars is performed in fabricating plants as shown by Figure 1-2, subject to process variation by individual fabricators.

### Aluminum Metal-Working Processes

As an aid to understanding the function of the equipment shown on the flow sheet of Figure 1-2, a brief outline of the processes used for production of aluminum conductors either as stranded cable or as bus shapes and tubes is as follows (detailed consideration of many of these processes is discussed in subsequent chapters):

**Extruding.** The aluminum is forced under pressure through one or more die openings. To accomplish this, the aluminum billets are heated and placed in a cylindrical container fitted at one end with a die having an opening shaped to produce the desired section. A ram activated by a hydraulic piston forces the metal of the billet through the die opening onto a run-out table so it appears

aluminum—the metal

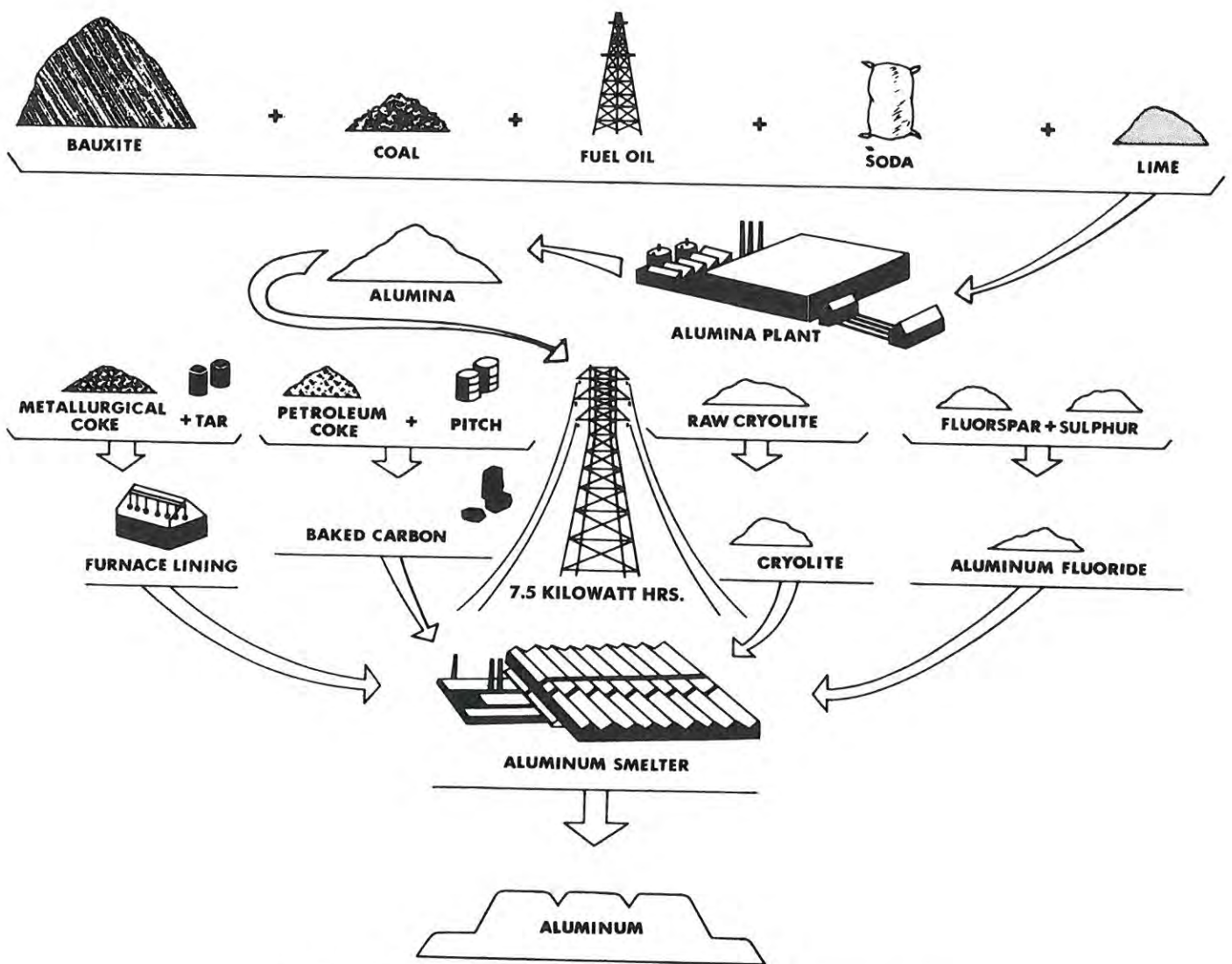

Fig. 1-1. What it takes to make aluminum: From bauxite to ingot.

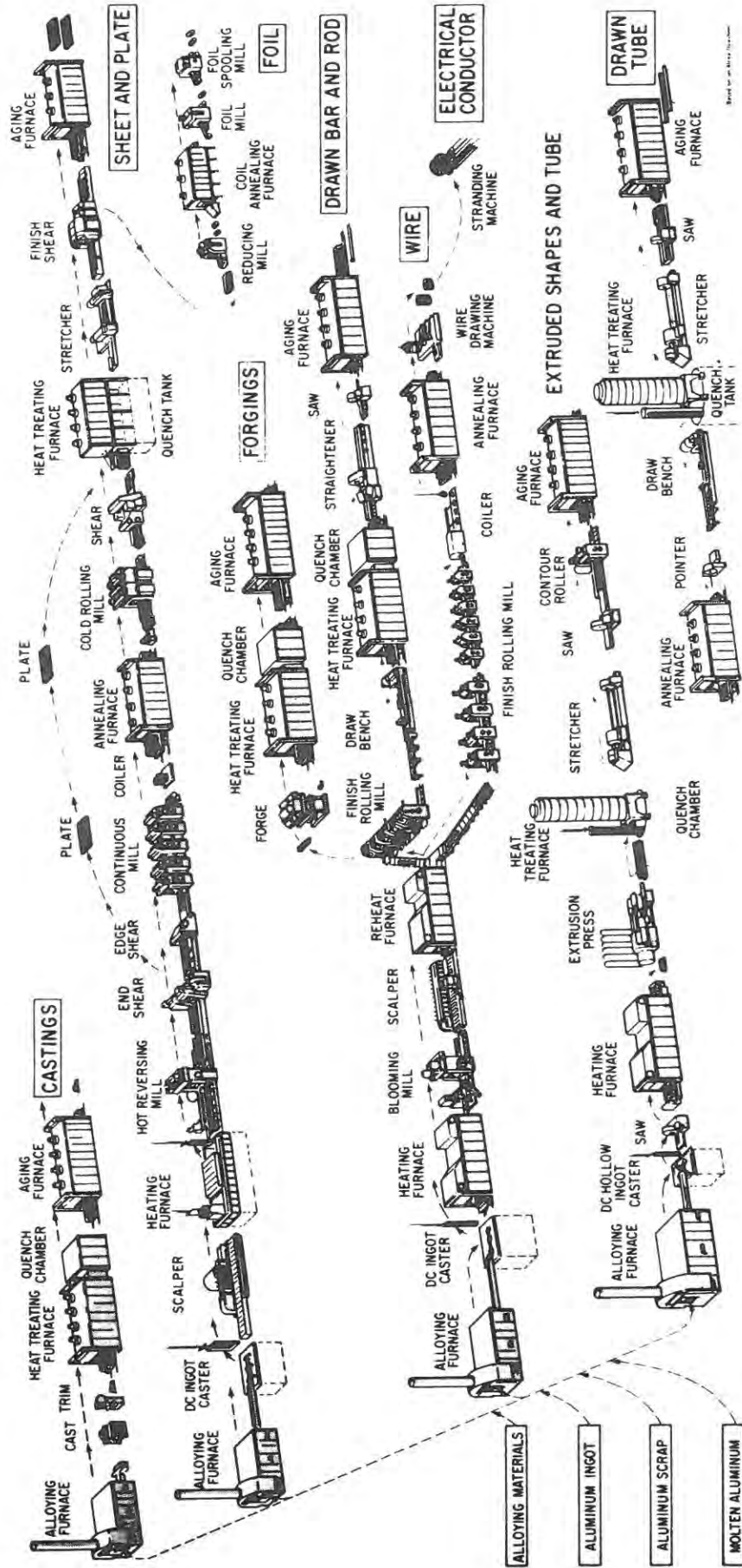

Fig. 1-2. How aluminum is fabricated.

## aluminum—the metal

in the required shape. Extrusions are used for many bus-conductor shapes and also for preliminary stages of production of rods that later are to be rolled and drawn to small diameter as wires.

**Rolling.** Mills fitted with suitable rolls are employed to reduce the diameter and increase the length of aluminum billets. A series of such rolling *stands* is required before the diameter is reduced to 3/8 inch. This is the usual size of rolled rod employed as stock for the wire-drawing machines which reduce the aluminum to the required final wire diameter.

**Wire-drawing.** In this operation the 3/8 inch diameter redraw rod is drawn through a series of successively smaller dies in a coarse-wire machine, and then through a fine-wire drawing machine. Intermediate annealing, coiling, and heat-treating may be done between the various operations.

**Stranding.** In production of most bare cable, stranding is the final operation. Aluminum conductor of 7, 19, 37, or 61 strands is produced on stranding machines. When these strandings surround an inner core of a single wire, or a core of 7 or 19 wires, the various strandings described in Chapter 3 are produced. Tubular or rigid-frame stranding machines are used, the latter for applying the last layers of wire. The various wires received from coils are spun around a central core and brought out in the shape of a cone. The apex of the cone is the core around which the wires are spirally wrapped.

Auxiliary devices relating to coiling, cutting, safety cut-outs, friction brakes, and the like are associated with much of the described equipment.

**Casting.** The production of single aluminum castings for conductor fittings is accomplished by pouring the desired molten alloy into sand or permanent molds, or into a die-casting machine. The castings may be heat treated, quenched, and aged as required.

Large, thick aluminum bus bars for station circuits in electrolytic plants and those of other large-current users often are made by a continuous casting process: the melted metal is run out through an orifice slightly larger than the section desired. Water cooling is applied at the orifice, and after shrinkage from cooling the required finished size is obtained, as a solid bar of the desired length.

A modification of this continuous casting process is also used for production of rod that is then finish-rolled to redraw size (3/8 inch diameter) for subsequent wire drawing.

### Sequence of Fabricating Operations

The aluminum ingots from the reduction plant (smelter) shown in Figure 1-1, plus alloying materials, are remelted as the first operation in the fabrication plant, Figure 1-2. Subsequent operations vary according to the end-product desired. The flow sheet shows a typical arrangement for the production of electrical conductors in the form of stranded conductors, and extruded bus

bars and tubes. Fabricators may not have fully integrated plants. For example, some cable fabricators start with 3/8-inch diameter round redraw rod of specified properties (ASTM B 233). The redraw rods are the result of rolling to that diameter by another fabricator. The finished stranded conductor, including drawing from 3/8-inch rod to the final wire diameter, is the work of the final fabricator.

### Aluminum and Aluminum Alloys for Electrical Conductors

Aluminum and aluminum alloys are listed according to the major alloying element, and are designated by four-digit numbers. The first digit of the number designates the major alloying element, and the remaining three-digits represent modifications of the basic alloy, according to its registration with The Aluminum Association. The alloy listing based upon this method is as follows:

Principal Alloying Element	4-digit Number	Heat-Treatable
(99.0% pure aluminum minimum)	1 X X X	no
Copper	2 X X X	yes
Manganese	3 X X X	no
Silicon	4 X X X	no
Magnesium	5 X X X	no
Magnesium and Silicon	6 X X X	yes
Zinc	7 X X X	yes
Other Elements	8 X X X	some

Aluminum 1350, the form of aluminum most widely used for electrical conductors, has a minimum aluminum content of 99.50 percent, and because of this high purity it is not considered to be an alloy. It has a conductivity of approximately 61.0 percent IACS minimum. It is also available with 62.0 percent IACS conductivity. Greater strength, however, is obtained if certain alloying ingredients are added, and though the resulting aluminum alloy conductors have less conductivity than aluminum 1350, considerations in which strength is a factor justify their use.

Practice has substantially limited wire for stranded electrical conductors to the alloys shown in Table 1-1, which also may be stranded in combination with steel wires or with other alloys of aluminum wire.

### Treatment for Improvement of Physical Properties

Improvement of strength, ductility, bending quality, and corrosion resistance often may be achieved by the addition of alloying elements, cold working (strain hardening), and heat treatment. The means of increasing strength classify the alloys roughly into two categories, non-heat-treatable and heat-treatable.

The initial strength of *non-heat-treatable* aluminum (1350, 5005, and the 8XXX series alloys) depends partly

**TABLE 1-1**  
**Mechanical and Physical Properties of Aluminum and Aluminum Alloy**  
**for Use in Electrical Conductors(1) (2)**

Designation	Tensile Strength <sup>(3)</sup> ksi (1000 lb/in <sup>2</sup> )		Yield Strength ksi <sup>(3)</sup> (Typical) <sup>(4)</sup>	Minimum Elongation % in 10 in.	Minimum Conductivity % IACS <sup>(5)</sup>	ASTM Spec	Temper
	Max	Min					
1350-H19	29.0	24.5	24.0	1.5	61.0	B 230	Hard
1350-H16 or -H26	22.0	17.0	16.0		61.0	B 609	3/4 Hard
1350-H14 or -H24	20.0	15.0	14.0		61.0	B 609	1/2 Hard
1350-H12 or -H22	17.0	12.0	12.0		61.0	B 609	1/4 Hard
1350-O	14.0	8.5	4.0	20.0 <sup>(6)</sup>	61.8	B 609	Fully Annealed
6201-T81		46.0		3.0	52.5	B 398	Hard
8017-H212	15.0	21.0		10.0 <sup>(7)</sup>	61.0	B 800	Intermediate
8030-H221	15.0	22.0		10.0	61.0	B 800	Intermediate
8176-H24	15.0	20.0		10.0	61.0	B 800	Intermediate
8177-H221	15.0	22.0		10.0	61.0	B 800	Intermediate

(1) For reduction in strength at joints, see applicable ASTM Specification.

(2) For strength and conductivity of bus-conductor and bolt alloys, see Tables 13-1 and 13-2, Chapter 13.

(3) There is a slight variation, depending on diameter. The listed strengths apply to wire between 0.1001 inch and 0.1100 inch diameter.

(4) There is no yield in the generally accepted sense of the term. The listed values are typical of stress when permanent elongation is 0.002 in. per in.

(5) Conductivity is measured in terms of that of annealed copper as established by the International Electro-Technical Commission as an International Annealed Copper Standard (IACS). See Chapter 3. Commercial hard-drawn copper wire has a conductivity of 96.16% IACS.

(6) Approximate, not minimum.

(7) Shall not be less than 10%.

on the hardening effect of elements such as manganese, silicon, iron, and magnesium, singly or in combinations. Additional strengthening is obtained by various degrees of cold-working, including that of the wire-drawing process. Heat treatment during processing does not increase strength, except that alloys containing appreciable amounts of magnesium when supplied in strain-hardened tempers are usually given a final elevated-temperature treatment called *stabilizing* to insure stability of properties. This heat treatment sometimes also produces a certain amount of annealing.

The strength of *heat-treatable alloy* 6201 is increased by subjecting it to thermal treatment. The complete process of obtaining the T81 temper involves a combination of solution heat treatment, quenching, wire drawing, and artificial aging. Strain hardening during wire-drawing also is a strengthening factor.

#### Temper Designations

The Aluminum Association issues a compilation\* (also ANSI H35.1-1988) of designations for alloys and tempers. The *alloy-number* designations are those shown on page 1-4 hereof. The principal *temper* designations are the H-numbers for non-heat-treatable alloys (1350 and 5005) and T-numbers for heat-treatable alloy (6201) and alloys used for bus conductors. Abstracts of designations applying to wrought electrical conductor aluminum or aluminum alloys are as follows:

\**Aluminum Standards & Data*; latest edition available from The Aluminum Association, or member companies.

**TABLE 1-2**  
**Chemical Composition Limits (Maximum) for Wrought Aluminum**  
**Alloys for Electrical Conductors in Percent(1)**

Principal Alloy Element	Aluminum-Alloy Numbers									
	Wire						Bus Conductor			Bolts
	1350	6201	8017	8030	8176	8176	6101	6063	6061	2024(2)
Copper	0.05	0.10	0.10-0.20	0.15-0.30	—	0.04	0.10	0.10	0.15-0.40	3.8-4.9
Iron	0.40	0.50	0.55-0.08	0.30-0.8	0.40-1.0	0.25-0.45	0.50	0.35	0.7	0.50
Silicon	0.10	0.50-0.9	0.10	0.10	0.03-0.15	0.10	0.30-0.7	0.20-0.6	0.40-0.8	0.50
Manganese	0.01	0.03	—	—	—	—	0.03	0.10	0.15	0.30-0.9
Magnesium	—	0.6-0.9	0.01-0.05	0.05	—	0.04-0.12	0.35-0.8	0.45-0.9	0.8-1.2	1.2-1.8
Zinc	0.05	0.10	0.05	0.05	0.01	0.05	0.10	0.10	0.25	0.25
Chromium	0.01	0.03	—	—	—	—	0.03	0.10	0.04-0.35	0.10
Boron	0.05	0.06	0.04	0.01-0.04	—	0.04	0.06	—	—	—
Titanium	(2)	—	(3)	—	(4)	—	—	0.10	0.15	—
Other, each	0.03	0.03	0.03	0.03	0.05	0.03	0.03	0.05	0.05	0.05
Other, total	0.10	0.10	0.10	0.10	0.15	0.10	0.10	0.15	0.15	0.15
Aluminum	99.50	Remainder					Remainder			

(1) Composition in weight percent unless shown as a range.

(2) 0.02 Vanadium plus Titanium.

(3) 0.003 Lithium.

(4) 0.03 Gallium.

(5) Bolts of 2024-T4 alloy should be anodized with adequate thickness and seal to impart adequate corrosion resistance for the application.

**F:** *as fabricated.* Applies to the shaping processes in which no special control over thermal conditions or strain-hardening is employed. For wrought products, there are no mechanical property limits.

**O:** *annealed.* Applies to wrought products which are annealed to obtain the lowest strength temper, and to cast products which are annealed to improve ductility and dimensional stability. The O may be followed by a digit other than zero.

**H:** *strain-hardened (wrought products only).* Applies to products which have their strength increased by strain-hardening, with or without supplementary thermal treatments to produce some reduction in strength. The H is always followed by two or more digits. The first digit following the H indicates the specific combination of basic operations, thus:

**H1:** *strain-hardened only,* without supplementary thermal treatment.

**H2:** *strain-hardened and then partially annealed.* The second digit following H1 or H2 indicates the final degree of strain hardening. They range from 0 to 9. "9" designates *fully hard* tempers whose minimum ultimate tensile strength exceeds that of the 8 temper by 2.0 ksi or more. The other numbers represent ultimate strength as related to "0" fully annealed and "8" representing *hard*.

Thus, "4" designates half-hard, "2" quarter hard, and "6" three quarters hard.

The third digit when used indicates a variation of two-digit H temper, thus:

**H111:** strain hardened less than the amount required for controlled H11 temper.



H112: some temper acquired from the shaping process but no special control over the amount of strain-hardening or thermal treatment, but there are mechanical property limits.

T: *thermally treated to produce stable tempers other than F, O, or H*, with or without supplementary strain-hardening to produce stable tempers. The T is always followed by one or more digits.

The numerals 1 through 10 following the T indicate specific sequences of basic treatments as follows, applying to bus conductors or to 6201 alloy:

T6: *solution heat-treated and then artificially aged*. Applies to products which are not cold worked after solution heat treatment, or in which the effect of cold work in flattening or straightening may not be recognized in applicable specifications.

T8: *solution heat-treated, cold worked, and then artificially aged*. Applies to heat-treated products which are cold-worked to improve strength, or in which the effect of cold work is recognized in applicable specifications.

Additional digits, the first of which shall not be zero, may be added to T6 or T8 to indicate a variation of treatment which significantly alters the characteristics of the product.

#### **Anodizing**

Aluminum bolts for bus-conductor assemblies, if likely to be used under moisture conditions, should be anodized. Anodizing is an electrolytic process which increases oxide layer thickness, first producing a porous layer which is then sealed. The result is a surface that is smooth, hard, and corrosion resistant. All aluminum bolts and nuts require suitable lubrication to reduce friction, prevent seizing, and improve corrosion resistance.

#### **Other Processes**

The chapters in this book describe other processes related to the fabrication of electrical conductor components and systems. Among these are welding, plating, forming, application of protective armor, and insulation, and the many that are related to installation and connection of the conductors.

Chapter 2

## Aluminum Conductor Properties and Advantages

The mechanical and electrical properties of bare aluminum wire and stranded conductor are tabulated in Chapter 4 and of bus conductor in Chapter 13. Certain general properties related to the use of aluminum, as distinct from other metals, in their application as electrical conductors are discussed in this chapter. Principally, these are:

1. *Conductivity:* More than twice that of copper, per pound.
2. *Light weight:* Ease of handling, low installation costs, longer spans, and more distance between pull-ins.
3. *Strength:* A range of strengths from dead soft to that of mild steel, depending on alloy. The highest strength alloys are employed in structural, rather than electrical conductor, applications.
4. *Workability:* Permitting a wide range of processing from wire drawing to extrusion or rolling. Excellent bend quality.
5. *Corrosion resistance:* A tough, protective oxide coating quickly forms on freshly exposed aluminum and it does not thicken significantly from continued exposure to air. Most industrial, marine, and chemical atmospheres do not cause corrosion, providing the proper alloy is selected. The corrosion resistance of all alloys can be improved by anodizing.
6. *Creep:* Like all metals under sustained stress, there is a gradual deformation over a term of years. With aluminum, design factors take it into account.
7. *Compatibility with insulation:* Does not adhere to or combine with usual insulating materials. No tin-coating required; clean stripping.

Other qualities of aluminum, such as thermal conductivity and fatigue resistance, have a bearing on conductor section. The high-reflectivity and non-magnetic characteristics, as well as the properties under extremes of temperature, are rarely associated with any commercial use of electrical conductors; hence are not considered herein.

### The Effect of Alloying

A detailed study of aluminum applications usually involves aluminum alloys that have properties markedly different from those of the basic metal. Thus, less than 2.0 percent addition of other metals supplemented by a specified heat treatment converts nearly pure aluminum to 6101-T6 electrical bus conductor with an increase in minimum yield strength from 3.5 ksi to 25.0 ksi. The reduction of conductivity associated with this major change of strength is only from 61.0 percent IACS to 55.0 percent IACS.

Merely adding the alloying elements to the mixture is not sufficient to produce the desired results. The strength of the non-heat-treatable alloys is brought to the value specified by the -H temper of the alloy by cold working and/or partial annealing, and the strength of the heat-treatable-alloys is brought to that of the specified -T temper by heat treatment as explained in greater detail in Chapter 1.

In the manufacture of heat-treatable aluminum alloy conductor wire, the supplemental treatment (cold working and heat treatment) usually is divided into two parts—often at different locations: (1) that performed during the production of redraw rod (0.375 inch diameter) and (2) that performed during or after reduction of diameter of the redraw rod to the finished wire size. Bus-conductor shapes have most of the necessary heat treatment performed during extrusion. Aging may be performed subsequently.

### Conductivity

The conductivity of pure aluminum is about 65.0 percent IACS. However, the conductivity of aluminum 1350 is 61.0 percent IACS minimum due to low level impurities inherent to commercial processing (up to 62.4% IACS is available in 1350 on a special order basis). The conductivity for bus conductor alloys is shown in Table 13-2. The conductivities of 6201 and the 8XXX series alloys in the tempers, which are used in the production of wires for cables, are also shown in Table 1-1.

A comparison of conductivities of metals sometimes used for electrical conductors is shown in Table 2-1. The

**TABLE 2-1**  
Relative Conductivities of Pure Metals(1)

Metal	Conductivity Percent IACS Vol. Basis(2)	Specific Gravity(3)	Conductivity Percent IACS Wgt. Basis(4)
Silver	108.4	10.49	91.9
Copper	103.1	8.93	102.6
Aluminum	64.9	2.70	213.7
Titanian	4.1	4.51	8.1
Magnesium	38.7	1.74	197.7
Sodium	41.0	0.97	376.2

- (1) Conductivities and densities taken from the ASM Metals Handbook, Volume 2, Ninth Edition.
- (2) Conductivity on a volume basis compares conductivities of metals for the same cross-sectional area and length.
- (3) Specific gravity is density of a material compared to that of pure water which has a density of one gm/cm<sup>3</sup>.
- (4) Conductivity on a weight basis compares the conductivities of metals for the same weight.

metals listed are those in almost pure form. As commercially supplied, the conductivity values are slightly less.

The reduction of conductivity caused by individual alloying agents in aluminum has been studied extensively. Iron, zinc, and nickel cause but small reductions in conductivity of aluminum. Copper, silicon, magnesium, and vanadium produce greater reductions. Chromium, titanium, and manganese are alloying elements that cause the greatest reduction of conductivity. Copper as an alloying agent adds much to strength, but it is not used as a *major* alloying element in electrical conductors because of a reduction in corrosion resistance. Aluminum alloy 2024-T4 bolts contain copper as an important alloying element, but it is customary to anodize such bolts for corrosion protection and to lubricate them to reduce friction and prevent seizing.

The variation of conductivity (and its reciprocal, resistivity) for usual applications is described in Chapter 3 where tables and formulas show the variation of coefficient of dc resistance with temperature and with alloy for the usual range of conductor temperatures, to 120°C. Temperature coefficients for bus-conductor alloys are listed in Table 13-3.

Direct current (dc) resistivity values for the usual aluminum alloys used for conductors are shown in Table 3-5. The resistance under alternating current (ac) conditions involves the concept of skin effect and  $R_{ac}/R_{dc}$  ratio as explained in Chapter 3.

### Light Weight

The relative conductor weights required for equal conductivity using various metals are listed in Table 2-2. These were developed from Table 2-1 (percent IACS mass conductivity and density values) applying conversion methods described in ASTM Specification B 193.

The lighter weight aluminum provides obvious handling cost reductions over heavier metals. Reduced capital and installation costs are an added advantage of aluminum conductors by reason of the long-span capability of ACSR and ACAR, and the greater distance between pull-in points in duct and conduit installation.

### Strength

The tables of mechanical properties in Chapter 4 show rated fracture strengths of aluminum and aluminum-alloy conductors as single wires or as stranded cables, or in combination with steel reinforcing wires for ACSR (aluminum-conductor steel-reinforced) or with high-strength aluminum-alloy reinforcement for ACAR (aluminum-cable alloy-reinforced). Cables of other types similarly are strength rated.

Chapter 13 contains similar tables of sizes and structural properties of usual bus-conductor shapes so that the strength of a bus installation under normal or short-circuit conditions may be readily computed, using the unit ksi values of tensile strength for the various alloys as listed in Table 13-1.

The reasons why alloying and associated cold-working and/or heat-treatment increase the strength of the basic metal are explained in texts on aluminum metallurgy.

### Workability

This term has to do with the ability of the electrical conductor to withstand single or repeated bending (the latter

**TABLE 2-2**  
Relative Weights of Bare Conductor to Provide Equal Direct Current Conductance (20°C) (as Related to the Weight of a Conductor of Aluminum 1350-61.0% IACS)

Metal	Percent IACS Volume Conductivity	Percent IACS Mass Conductivity	Relative Weight
Aluminum	1350 61.0% IACS	201	100
	6201-T81 52.5% IACS	174	116
	6101-T65 56.5% IACS	187	108
	8017-H212 61.0% IACS	201	100
	8030-H221 61.0% IACS	201	100
	8176-H24 61.0% IACS	201	100
	8177-H221 61.0% IACS	201	100
Copper	Comm'l. HD 96.0% IACS	96	209
Sodium	41.0% IACS	376	53

## aluminum conductor properties and advantages

for portable cables), and for bus bars to be bent to a specified radius either flatwise or edgewise. Aluminum compares favorably with other conductor metals in this regard.

The bend radii for flatwise and edgewise bending of aluminum bus bars depends on alloy and temper. They are listed in Tables 13-5 and -6 as a design guide to what can be expected during fabrication of a bus-bar assembly.

The excellent workability of aluminum is also apparent from noting the facility with which it may be extruded, rolled, formed, and drawn. That bus conductors also can be readily welded with only partial loss of rated strength, compared with that of the unwelded alloy, is further evidence of the workability of aluminum.

### Corrosion Resistance

The inherent corrosion resistance of aluminum is due to the thin, tough, oxide coating that forms directly after a fresh surface of metallic aluminum is exposed to air.

Another reason for the excellent corrosion resistance of aluminum conductors in ordinary atmospheres is that the alloy components are selected so as to minimize corrosion. Thus, suitable alloys of the 6000-series, though not listed as "marine" alloys, are well suited for oceanshore applications, as well as for usual industrial and chemical atmospheres, as are the aluminum 1350 conductors. Instances where corrosion has appeared are usually traceable to connections between dissimilar metals subjected to moisture conditions. Protective means should be employed to prevent this.

Present-day compression connectors act to break the oxide layer on the wires of stranded cable connections. Where unplated flat surfaces are joined, as with bus conductors or terminal pads, scratch brushing and the addition of oxide-inhibiting joint compound remove the oxide and prevent its further formation because the compound excludes oxygen.

### Creep

Creep is plastic deformation that occurs in metal at stresses below its yield strength. Normally, metal stressed below yield for a short time returns to its original shape and size by virtue of its elasticity. However, when the time period is sufficiently long, plastic deformation, called creep, occurs. This deformation is in addition to the expected elastic deformation.

The extent of creep is determined by the properties of the metal involved, applied stress, temperature and time under load. For example, hard-drawn 1350-H19 aluminum wire in stranded cables under a steadily applied load of 14 ksi at 20°C (70 percent of minimum yield strength) will creep approximately 0.4 to 0.6 percent of initial length in 10 years.

Creep can be considerably reduced by proper choice of metal, metal fabrication, shape and load, and the unwanted effects of creep may be nullified by proper design. Creep data have been incorporated in stress-strain curves for overhead conductors.

Cable manufacturers supply sag and tension data that include the effect of creep. From Fig. 5-11, the 10-year creep for a 1350-H19 cable at 10 ksi is estimated to be 0.23 percent: the horizontal distance between curves 2 and 4 at 10 ksi. Similarly, by comparing Fig. 5-2 and 5-3, a 1000-foot span of ACSR cable is estimated to increase its sag from 22 feet to 26 feet in 10 years at 60°F, and its tension drops from 5700 pounds to 5100 pounds. From the catenary Table 5-4, the ratio of arc length increase for this change of sag is about 0.17 percent; that is, the long time creep is about 1.7 feet of arc length for the 1000-foot span. Charts such as Fig. 5-11 also are available for many ACSR sizes to provide better accuracy.

Bus bars creep in compression, and because the metal is not hard drawn, a 10-year creep of 1.0 percent generally is considered allowable. Design stresses to limit creep to this amount in various alloys are in Table 13-4.

### Compatibility with Insulation

Aluminum does not have the sulphur-combining properties of copper; hence it has no effect on rubber or rubber-like compounds containing sulphur. Aluminum requires no tinning of the conductor metal before insulation is applied. Also, it does not produce stearates or soaps by combining with oil content of an insulation. Usual insulating materials do not adhere to the aluminum; hence removal is easily performed by simple stripping.

### Thermal Properties

The variation of electrical dc resistance with temperature was covered in the preceding discussion of conductivity. Other thermal properties that require consideration in applications are the expansion or contraction with changes in temperature and the thermal conductivity (the rate at which heat is conducted).

The usual design coefficients of linear expansion for the principal conductor metals as well as those to which the conductor might be joined are as follows:

Aluminum	0.0000230 in./in./°C
Copper	0.0000169 in./in./°C
Steel	0.0000115 in./in./°C

Slight differences occur for various alloys and temperature ranges, but they are not significant in usual engineering design. The coefficient for the bronze alloys commonly used for bolts is about the same as that listed for copper. Allowance must be made for differing rates of thermal expansion when aluminum is joined by steel or bronze bolts, or when aluminum pads are bolted to copper pads.

For overhead cables, changes in sag due to temperature changes are discussed in Chapter 5. Actual movement of

*aluminum—the metal*

insulated conductors in duct, conduit, tray, or when buried, is not proportional to increase in conductor length with temperature. Tests show that lateral displacement (snaking) of the cables will absorb 3 to 5 times the increase in length.

The thermal conductivity of aluminum depends on alloy and temper. For 1350-H19, it is about 0.56 cal/cm<sup>2</sup>/cm/°C/sec. whereas for alloys of lower electrical conductivity, it is less. For 6063-T6, it is about 0.48. For copper, it is about 0.98, hence heat is not conducted away from a hot spot in aluminum as rapidly as with some other metals, a factor taken into account when planning welding procedures. This subject is discussed in Chapter 13. Heat dissipation from bare suspended cable is about the same for aluminum and copper conductors of the same ampacity rating.

The rate at which heat is conducted from a hot spot (the thermal-conductivity rate) affects the “burn-off” characteristic of a conductor, i.e., the amperage at which the conductor will melt and separate at a ground point. This factor is important when locating underground faults (see Chapter 12), and to some extent it is related to short-circuit ampacity rating.

\* \* \* \* \*

The preceding discussions of general properties of aluminum conductors provide background for the design considerations described in the following chapters. They serve to explain why aluminum is such a satisfactory metal for electrical conductors, as proved by its excellent long-time operating-experience record.

Chapter 3

# Engineering Design

This chapter describes the principal design features of bare uninsulated conductors; however much that applies to bare conductors also pertains to the metallic part of insulated or covered conductors which are considered in Section III.

Many types of bare conductors are in use depending on application requirements. They may differ in electrical and physical properties, configuration, method of assembly, and corrosion resistance. Certain general physical properties have been described in previous chapters. Detailed physical and electrical properties of the various commercial sizes of bare conductors are listed in Chapter 4.

For many years it has been the practice to employ code words to identify and precisely define specific conductor constructions and designs (conductor size, stranding, insulation type, voltage rating, neutral configuration and size, number of phase conductors, type of assembly, etc.). In our text, code words are often used, as in the example under Table 3-6 wherein the code word "Bluebell" identifies a specific cable, in this case a 1,033,500 cmil, 37 strand, bare aluminum 1350 conductor. These code words are tabulated in Aluminum Association publications "Code Words for Underground Distribution Cables" and "Code Words for Overhead Aluminum Electrical Cables."

Symbols for types of aluminum conductors: AAC—all-aluminum conductors (of 1350 aluminum); AAAC—all-aluminum alloy-conductors (of 6201-T81); ACSR—aluminum-conductor steel-reinforced (steel wire reinforcement); ACAR—aluminum conductor aluminum alloy-reinforced (high strength 6201-T81 wire reinforcement).

Except as otherwise referenced, graphs and data in tables are taken from *Alcoa Aluminum Overhead Conductor Engineering Series* handbooks.

**Mechanical Design of Conductors**

*American Wire Gage (AWG)*

This wire system, formerly known as Brown & Sharpe (B&S) gage, was introduced by J. R. Brown in 1857, and is now standard for wire in the United States. Successive

AWG numbered sizes represent the approximate reduction in diameter associated with each successive step of wire drawing.

Fig. 3-1 shows typical full-size cross-sections, and approximate relationships between the sizes.

For wire sizes larger than 4/0 AWG, the size is designated in circular mils. Wire sizes of 4/0 AWG and smaller also are often designated in cir mils. One cir mil is the area of a circle 1 mil (0.001 in.) diameter; that is, the area in cir mils equals diameter-in-mils squared.

As one cmil =  $\pi/4$  sq mils (Eq. 3-1)

Area in cir mils =  $1.2732 \times 10^6 \times$  area in sq. in.

Expressing diameter of wire  $D$ , in inches

$D = 10^{-3} \text{ cmil}^{1/2}$  or  $\text{cmil} = 10^6 D^2$  (Eq. 3-2)

Thus a solid round conductor of 1,000,000 cir mils has an area of  $\pi/4$  sq. in., and a diameter of 1.00 in.

*Stranded Conductors*

Flexibility requirements for conductors vary widely. The conductors accordingly may be either lengths of single wires or a stranded group of smaller wires arranged in

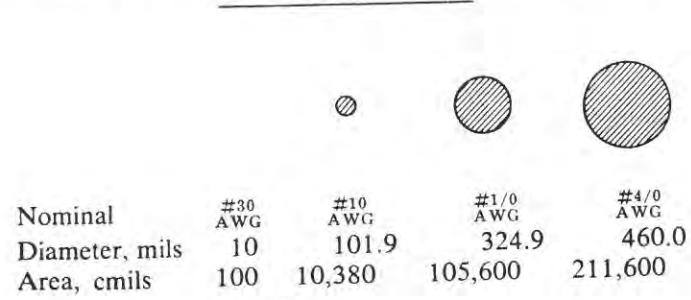

*Approximate Relationships*

- (1) An increase of three gage numbers doubles area and weight, and halves dc resistance.
- (2) An increase of six gage numbers doubles diameter.
- (3) An increase of ten gage numbers multiplies area and weight by 10 and divides dc resistance by 10.

Fig. 3-1. Typical cross-sections of solid-round AWG-size wires and approximate relationships. (Actual size.)

## bare aluminum wire and cable

some regular manner. In either case, the total cross-sectional area of all component conducting wires determines the AWG or cmil size of the assembled conductor.

### Concentric-Lay Stranding

Most bare power conductors are in concentric-lay stranded form; that is, a single straight core wire is surrounded by one or more helically curved wires. The direction of twist of lay is usually reversed in adjacent layers. All wires of a given layer generally are of same diameter. The direction of lay is either right- or left-hand depending on whether the top wire of the helix extends to right or left as the conductor is viewed axially in the direction away from the observer. The length of lay is the axial length parallel to the center line of the assembled conductor of one turn of the helix of a single wire. Bare aluminum conductors conventionally have a right-hand lay on outside layer.

American practice (ASTM) recognizes two classes of bare concentric-lay stranded conductors, AA and A, the former usually for bare-wire overhead applications and the latter for covered overhead lines.

Still greater flexibility of stranded conductors, mostly used for insulated conductors, are those with Class B, C, D, or even finer strandings. These have more wires for a given size of conductor than used for Class AA or A stranding. Wires of softer temper than the usual hard drawn wires can be used. Added flexibility also may be obtained by using small braided wires or those in "bunched" arrangement.

The stranding arrangement of each class is also specified in ASTM Conductor Standards. Fig. 3-2 shows typical examples of concentric-lay stranded bare conductors for various degrees of flexibility.

AAC/TW is a new design of all aluminum conductor composed of shaped wires (Trapezoidal) in a compact concentric-lay-stranded configuration. The design is described in ASTM B 778, and the properties are listed in Tables 4-10 and 4-11.

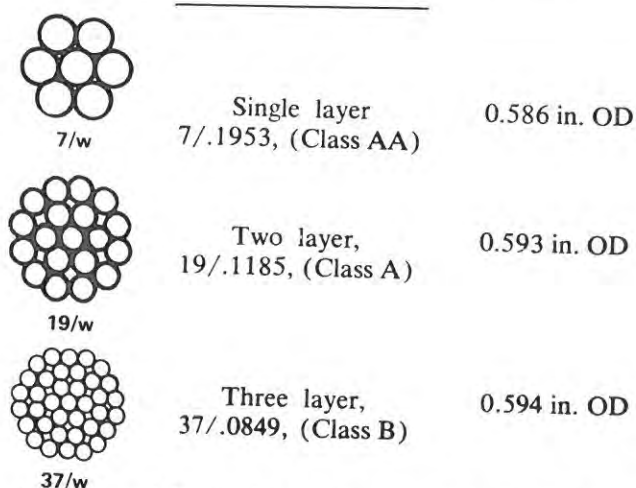

Fig. 3-2. Typical Examples of Concentric Lay Conductors. All 266.8 kcmil. (Illustrations are approximately to scale.)

TABLE 3-1  
Strand Lengths vs Solid Conductor  
Lengths for ASTM B 231

	Incremental Increase for Weight and dc Resistance of Stranded Over that of Solid Conductors
Sizes 4,000,000 to 3,000,001 cmil	4%
Sizes 3,000,000 to 2,000,001 cmil	3%
Sizes 2,000,000 cmil or under	2%

### Differences Between Stranded and Solid Conductors

Because of the helical path of the strand layers there is more length of metal in a given length of stranded conductor than in a solid round conductor of the same AWG size, hence both the weight and dc resistance per unit length are increased. The amount of increase for all-aluminum conductors may be computed according to a method described in ASTM B 231, or the standard increments of increase listed in Table 3-1 (also from ASTM B 231) may be used.

The tensile load on a conductor is not always equally divided among the strands. This effect can reduce the total load at which the first strand breaks as compared with that of a solid conductor of equal cross section. However, this effect is more than offset by the fact that the unit tensile strength of commercially cold-drawn wire generally increases as its diameter is reduced, as is evident by the comparison for H19 stranded conductor in Table 3-2.

According to ASTM Standards, aluminum conductors that are concentric-lay stranded of 1350 or 6201 alloys in the various tempers have their rated tensile strength (or minimum rated strength) taken as the following percentages of the sum of the minimum average tensile strengths of the component wires, multiplied by rating factors, as below:

7 wires per conductor	One layer	96%
19 wires per conductor	Two layers	93%
37 wires per conductor	Three layers	91%
61 wires per conductor	Four layers	90%
91 wires per conductor (and over)	Five layers (and over)	89%

Similarly, the rated strength of ACSR is obtained by applying rating factors of 96, 93, 91, and 90 percent, respectively, to the strengths of the aluminum wires of conductors having one, two, three, or four layers of aluminum wires, and adding 96 percent of the minimum stress in the steel wires at 1.0 percent elongation for cables having one central wire or a single layer of steel wires, and adding 93 percent of the minimum stress at 1.0 percent elongation if there are two layers of steel wires.

All strengths are listed in pounds to three significant figures, and these strengths also apply to compact-round conductors.

**Special Conductor Constructions**

Large conductors requiring exceptional flexibility may be of rope-lay construction. Rope-lay stranded cables are concentric-lay stranded, utilizing component members which are themselves either concentric stranded or bunched. Bunched members are cabled with the individual components bearing no fixed geometric relationship between strands. Rope-lay stranded conductors may be stranded with subsequent layers reversing in direction, or may be unidirectional with all layers stranded in the same direction but with different lay lengths.

Some cables are designed to produce a smooth outer surface and reduced overall diameter for reducing ice loads, and under some conditions wind loading. The stranded cables are smoothed in a compacting operation so that the outer strands lose their circularity; each strand keys against its neighbor and many interstrand voids disappear. (Fig. 3-3) A similar result is commonly obtained by use of trapezoidal strands that intertie with adjacent strands to create a smooth, interlocking surface. (Fig. 3-7)

Another cable design, expanded core concentric-lay conductor, uses fibrous or other material to increase the diameter and increase the ratio of surface area to metal cross-section or weight. (Fig. 3-3) Designed to minimize corona at voltages above 300 kV, they provide a more economical balance between cable diameter and current carrying capacity.

A "bundled" conductor arrangement with two or more conductors in parallel, spaced a short distance apart, is also frequently used for HV or EHV lines. Although the ratio of radiating area to volume increases as the individual conductor size decreases, the design advantages of bundling are not wholly dependent upon ampacity. Normal radio interference, etc., and the usual controlling design characteristics are discussed elsewhere, but the current carrying capacity relationship is similar. Thus, two 795 kcmil ACSR *Drake* under typical conditions of spacing and temperature provide 24 percent more ampacity per kcmil than a single 1780 kcmil ACSR *Chukar*.

**Composite Conductors**

Composite conductors, conductors made up of strands of different alloys or different materials, are used

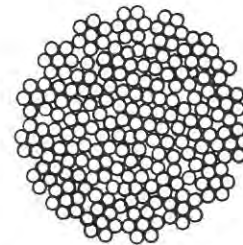

Rope lay Concentric Stranded Conductor

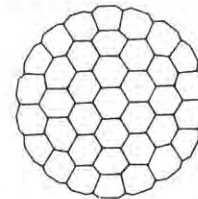

Compact Concentric Stranded Conductor

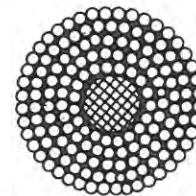

Expanded Core Concentric Stranded Conductor

Fig. 3-3. Typical cross-sections of some special conductor shapes.

where the required strength is greater than the strength obtainable with 1350-H19 grade aluminum strands. The principal kinds of composite conductors are (1) 1350 stranded conductors reinforced by a core of steel wires (ACSR), (2) 1350 stranded conductors reinforced by aluminum-clad steel wires which may be in the core or distributed throughout the cable (ACSR/AW), or (3) 1350 stranded conductors reinforced by wires of high-strength aluminum alloy (ACAR).

**Aluminum Conductor Steel Reinforced (ACSR) and Modifications**

ACSR has been in common use for more than half a century. It consists of a solid or stranded steel core surrounded by strands of aluminum 1350. Table 3-3 compares breaking strengths of several all-aluminum stranded conductors with ACSR and one of hard-drawn copper, all of approximately equal d-c resistance. The principal economic factors involved are weight, strength, and cost.

Historically, the amount of steel used to obtain higher strength soon increased to become a substantial portion of ACSR, but more recently as conductors became larger, the trend has been toward use of a smaller proportion of steel. To meet varying requirements, ACSR is available

TABLE 3-2

Strength of 1350-H19 Aluminum Conductors

AWG	Stranding	Strand Diam, In.	Rated Strength, Lb
2	Solid	0.2576	1225
2	7 Strand	0.0974	1350
2	19 Strand	0.0591	1410

Calculated from ASTM B 230 and B 231.



**TABLE 3-3**  
**Comparison of Properties of Typical ACSR Conductor With Those**  
**of Similar All-Aluminum and Hard-Drawn Copper Stranded Conductors\***

Size cmil	Type	Strand- ing	Diam. In.	dc Re- sistance Ohms per 1000 ft at 20°C	Weight lb per 1000 ft	Rated Breaking Strength lb	Relative	
							Strength %	Conduc- tance
336,400	1350-H19	19	0.666	0.0514	315.6	6,150	35.6	102.4
394,500	6201-T81	19	0.721	0.0511	370.3	13,300	76.8	101.8
336,400	ACSR	30/7	0.741	0.0502	527.1	17,300	100.0	100.0
211,600	HD Copper	7	0.522	0.0516	653.3	9,154	52.9	102.8

\*Abstracted from ASTM Standards and industry sources.

Resistances are based on IACS % conductivities of 61.2% for 1350-H19; 8% for steel; 52.5% for 6201-T81; and 97.0% for H.D. Copper. 5005-H19, although included in earlier editions of this handbook, has been deleted from this edition because it is no longer commercially available.

in a wide range of steel content—from 7% by weight for the 36/1 stranding to 40% for the 30/7. Today, for the larger-than-AWG sizes, the most used strandings are 18/1, 45/7, 72/7, and 84/19, comprising a range of steel content from 11% to 18%, and for the moderately higher strength ACSR 54/19, 54/7, and 26/7 strandings are much used, having steel content of 26%, 26% and 31%, respectively. Typical stranding arrangements for ACSR and high-strength ACSR are depicted in Fig. 3-4. The high-strength ACSR, 8/1, 12/7 and 16/19 strandings, are used mostly for overhead ground wires, extra long spans, river crossings, etc. Expanded ACSR, Fig. 3-6, is a conductor the diameter of which has been increased or expanded by aluminum skeletal wires between the steel core and the outer aluminum layers. This type of cable is used for lines above 300 kV.

The inner-core wires of ACSR may be of zinc-coated (galvanized) steel, available in standard weight Class A coating or heavier coatings of Class B or Class C thicknesses. Class B coatings are about twice the thickness of Class A and Class C coatings about three times as thick as Class A. The inner cores may also be of aluminum coated (aluminized) steel or aluminum-clad steel. The latter produces a conductor designated as ACSR/AW in which the aluminum cladding comprises 25 percent of the area of the wire, with a minimum coating thickness of 10 percent of overall radius. The reinforcing wires may be in a central core or distributed throughout the cable.

Galvanized or aluminized coats are thin, and are applied to reduce corrosion of the steel wires. The conductivity of these thin-coated core wires is about 8 percent (IACS). The apparent conductivity of ACSR/AW reinforcement wire is 20.3% (IACS).

The incremental increase for dc resistance over that of solid round conductors, because of stranding of ACSR,

differs from that stated in Table 3-1, and depends on type of stranding. The amount of increase also may be computed according to a method described in ASTM B232. Table V of B232 is reproduced on next page as Table 3-4A.

A description of the method of computing rated breaking strength of ACSR found in ASTM B 232 is abstracted in right-hand column of page 3-2.

ACSR/TW is a new design of ACSR composed of shaped aluminum wires (Trapezoidal) stranded around a standard steel core. It is fully described in ASTM B 779 and Tables 4-19 to 4-22.

#### *Aluminum Conductor Alloy Reinforced (ACAR)*

Another form of stranded composite conductor consists of 1350-H19 strands reinforced by a core or by otherwise distributed wires of higher-strength 6201-T81 alloy.

The ASTM approved method for determining ACAR rated strength is described in ASTM B 524 as follows: (The mentioned Table 4 is that of ASTM B 524.)

“The rated strength of completed conductors shall be taken as the aggregate strength of the 1350 aluminum and aluminum alloy components calculated as follows. The strength contribution of the 1350 aluminum wires shall be taken as that percentage according to the number of layers of 1350 aluminum wires indicated in Table 4 of the sum of the strengths of the 1350-H19 wires, calculated from their specified nominal wire diameter and the appropriate specified minimum average tensile strength given in ASTM Specification B 230. The strength contribution of the aluminum alloy wires shall be taken as that percentage, according to the number of layers of aluminum alloy wires, indicated in Table 4 of the sum of the strength of the aluminum wires calculated from their specified nominal wire diameter and the minimum stress as 1 percent extension. This shall be considered to be

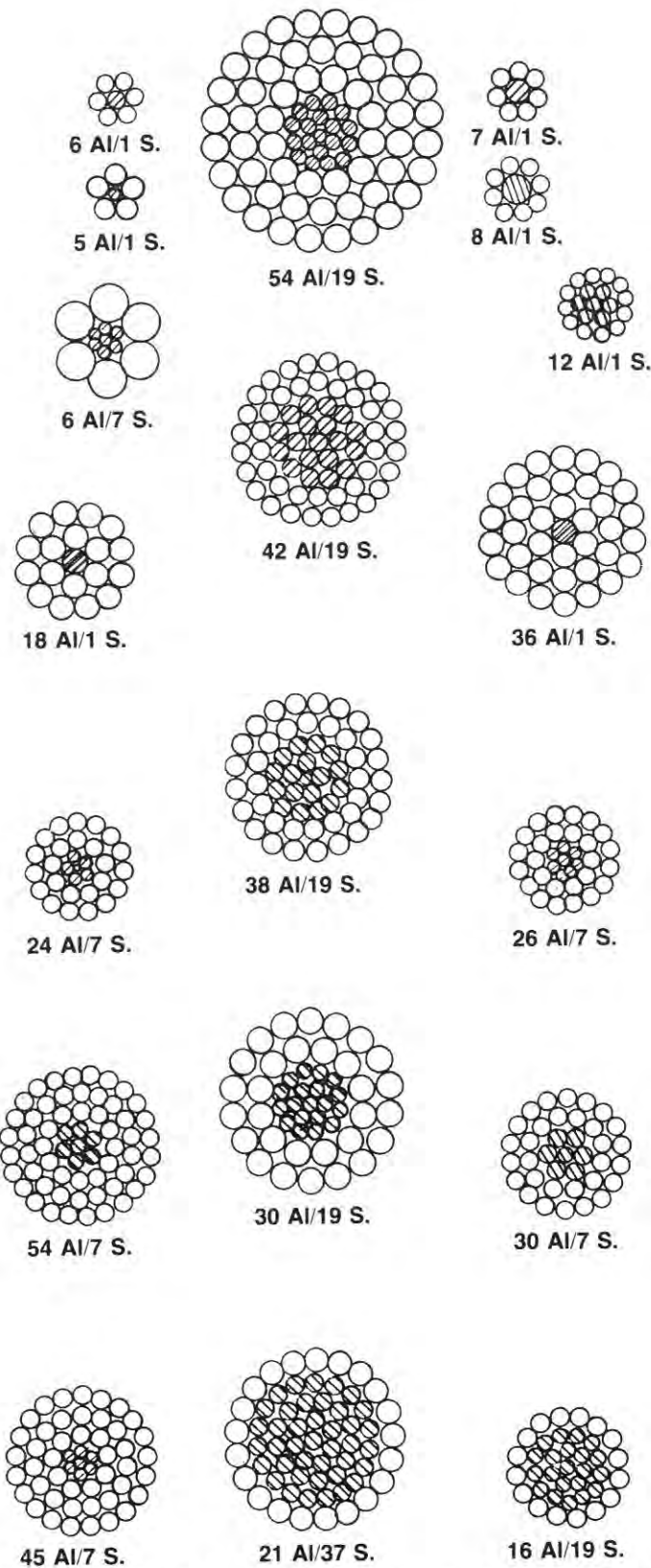

Fig. 3-4. Typical stranding arrangements of aluminum cable steel-reinforced (ACSR). The conductor size and ampacity for any arrangement depends on the size of the individual wires.

95 percent of the minimum average tensile strength specified for the wire diameter in Table 2 of ASTM Specification B 398. Rated strength and breaking strength values shall be rounded-off to three significant figures in the final value only . . ."

Because the 6201-T81 reinforcement wires in ACAR may be used in the core and/or for replacement of some of the 1350-H19 wires in the strands, almost any desired ratio of reinforcement 1350-H19 wires is achieved, thereby obtaining a range of strength-conductance properties be-

**TABLE 3-4A**  
Increase, Percent, of Electrical Resistance of Aluminum Wires in ACSR of Various Strandings (Table 5, ASTM B 232)

Stranding	% dc Resistance	Stranding	% dc Resistance
6/1	1.5	42/7	2.5
7/1	1.5	45/7	2.5
8/1	2.0	48/7	2.5
18/1	2.0	54/7	2.5
36/1	2.0	72/7	3.0
12/7	2.5	16/19	2.5
24/7	2.5	30/19	2.75
26/7	2.5	54/19	3.0
30/7	2.75	76/19	3.0
		84/19	3.0

The above resistance factors also are usually taken into account in tables of dc resistance for ACSR.

**TABLE 3-4B**  
Strength Rating Factors

Extract from ASTM Specification B 524 for Concentric-Lay-Stranded Aluminum Conductors, Aluminum Alloy Reinforced (ACAR) (Referenced in ASTM B 524 as Table 4)

Stranding				Rating Factor, per cent	
Number of Wires		Number of Layers*		1350	6201-T81
1350	6201-T81	1350	6201-T81		
4	3	1	1	96	96
15	4	2	1	93	96
12	7	1	1	96	96
33	4	3	1	91	96
30	7	2	1	93	96
24	13	2	2	93	93
18	19	1	2	96	93
54	7	3	1	91	96
48	13	3	2	91	93
42	19	2	2	93	93
33	28	2	3	93	91
72	19	3	2	91	93
63	28	3	3	91	91
54	37	2	3	93	91

\* For purposes of determining strength rating factors, mixed layers are considered to be full layers for each material.

bare aluminum wire and cable

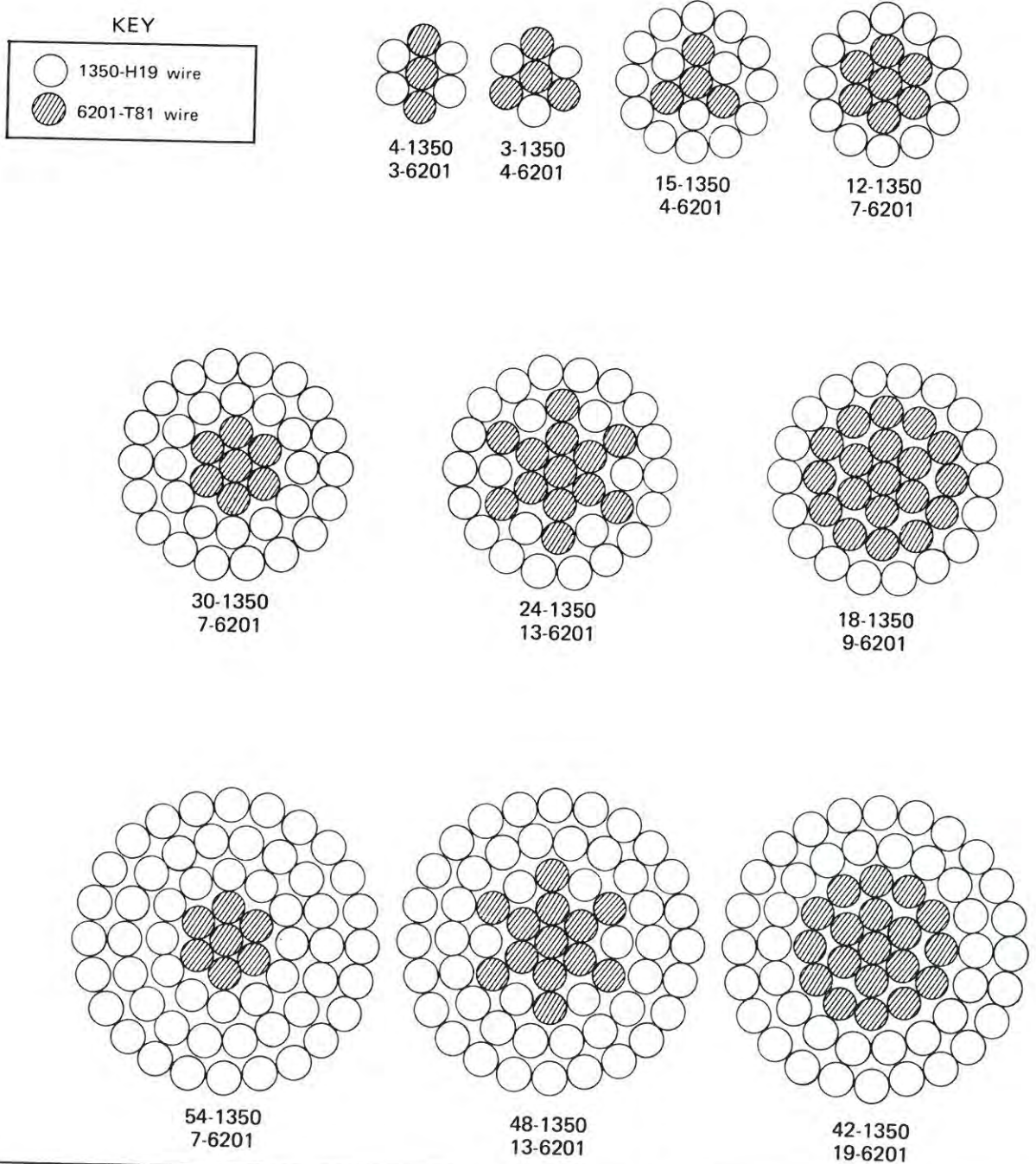

Stranding	Strength/ Wt ratio	Stranding	Strength/ Wt ratio	Stranding	Strength/ Wt ratio
4/3	26,000	30/7	21,800	48/13	21,600
15/4	22,100	24/13	24,100	42/19	23,500
12/7	25,100	18/19	26,800	54/7	20,200

Fig. 3-5. Typical stranding arrangements of aluminum cable alloy-reinforced (ACAR). Assuming the reinforcement is 6201-T81 alloy, and that individual wires are larger than 0.150 in. diameter the strength-weight ratios are as shown: (the strengths are slightly higher if smaller wires are used). The strength/wt. ratios compare rated strength per ASTM B 524 and conductor weight in lb/ft.

tween constructions of all 1350-H19 wires or those of all 6201-T81 wires. Fig. 3-5 depicts several stranding arrangements of ACAR cables of 1350-H19 and 6201-T81 wires.

The rating factors for various strandings of ACAR using 6201-T81 reinforcing wires are shown herewith as extracted from ASTM B 524. They are used as the basis for calculating the properties of ACAR listed in Chapter 4.

*International Annealed Copper Standard*

In 1913 the International Electro-Technical Commission established an annealed copper standard (IACS) which in terms of weight resistivity specifies the resistance of a copper wire 1 meter long that weighs one gram. Commercial hard drawn copper conductor is considered as having conductivity of 97% IACS.

**Calculation of dc Resistance**

USA practice is to express conductor conductivity in

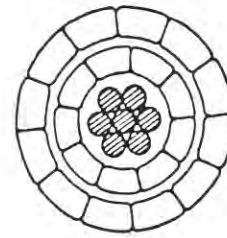

Fig. 3-7. Composite conductors similar to ACSR also may be manufactured by using trapezoidally shaped strands as shown above for self damping conductor.

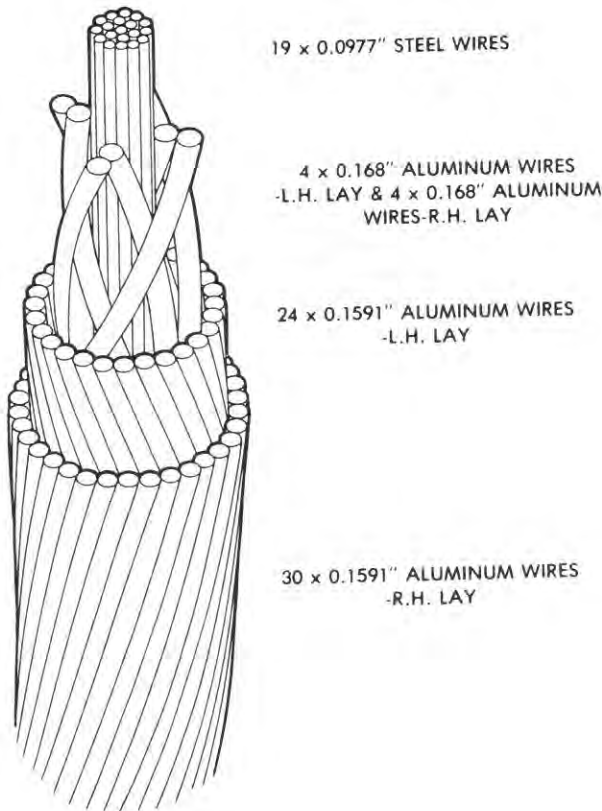

Fig. 3-6. Air-Expanded ACSR. The size shown is 1595 kcmil. OD is 1.75 in. The diameter of equivalent regular ACSR is 1.54 in.

terms of percent International Annealed Copper Standard (IACS) instead of in *mhos* (the unit of conductance). Resistivity is expressed as follows:

$$\text{Volume Resistivity} = \rho_v = \frac{A}{L} R \text{ in which} \quad (\text{Eq. 3-3})$$

$A$  = Cross-sectional area

$L$  = Length

$R$  = Resistance

$$\text{Weight Resistivity} = \rho_w = \frac{W}{L} 2R \text{ in which} \quad (\text{Eq. 3-4})$$

$W$  = Weight

These resistivity constants may be stated in whatever form is required by the units used for area, length, weight, and resistance, and if these units are used consistently  $R$  may be obtained for any  $A$ ,  $L$ , or  $W$ , by inverting the

equation; thus, from Eq. 3-3,  $R = \frac{\rho_v L}{A}$  or  $\frac{\rho_w L^2}{W}$  as the case may be.

For USA practice, two volume resistivity constants\* are used (Table 3-5):

1. Ohm-cmil/ft, representing the resistance in ohms of a round conductor 0.001 in. diameter 1 ft long.
2. Ohm-sq in./ft, representing the resistance in ohms of a conductor of 1 sq in. in cross-sectional area and 1 ft long. This constant is sometimes multiplied by 1000 which provides ohms per 1000 ft.

\*The resistivity constants are based on ohms when conductor is at ASTM Standard temperature of 20°C (68 F). Some tables are based on temperature of 25°C. If so, new resistivity constants can be computed for 25°C if considerable work is to be done (see Table 3-7), or a temperature coefficient can be applied to the 20°C value of  $R_{dc}$  to obtain that for 25°C, as below.

Multiply the 20° value by		
1350-H19	62.0% IACS	1.02048
1350-H19	61.0% IACS	1.02015
6201-T-81	52.5% IACS	1.01734

**TABLE 3-5**  
**Equivalent Direct Current (dc) Resistivity Values**  
**for Aluminum Wire Alloys at 20°C\***

Alloy	Volume Conductivity percent IACS	Volume Resistivity			Weight Resistivity Ohms-lb per mile <sup>2</sup>
		Ohm-cmil per ft	Ohm-mm <sup>2</sup> per m	Ohms-in <sup>2</sup> per 1000 ft	
1350-H19	61.2	16.946	0.02817	0.013310	435.13
6201-T81	52.5	19.754	0.03284	0.015515	507.24
Alumoweld	20.33	51.01	0.08481	0.04007	3191.2
Steel	8.0	129.64	0.21552	0.10182	9574.0
HD Copper	97.0	10.692	0.01777	0.0083974	902.27

\*Abstracted and calculated from ASTM Standards.

For stranded conductors, resistance values obtained by use of these factors are to be increased by the stranding-increment ratio, per Table 3-1 for all aluminum conductors, or per Table 3-4A for ACSR.

Example: Find dc resistance at 20°C of one mile of *Bluebell* cable of 1,033,500 cmil area of 1350 of 61.2% IACS conductivity, allowing 2% stranding increment.

$$\text{Applying resistivity factor from Table 3-5, } R = \frac{5280 \times 16.946 \times 1.02}{1,033,500} = 0.0883 \text{ ohms}$$

It is customary to compute the conductor resistance from known resistance at 20°C (68°F). Some tables, however, specify resistance at 25°C which are related to 20°C values by the factors in footnote on page 3-7, or may be read directly from Table 3-7. Temperature coefficients for 20°C resistance values are in Table 3-6.

#### Change of dc Resistance with Temperature

Over a moderate temperature range (0°C to 120°C) the resistance of a conductor increases linearly with increase of temperature, thus

$$R_2 = R_1 [1 + \alpha_1 (T_2 - T_1)] \quad (\text{Eq. 3-5})$$

in which

$R_1$  = Resistance at temperature  $T_1$

$R_2$  = Resistance at temperature  $T_2$

$\alpha_1$  = Temp. coefficient of resistance at  $T_1$

#### Temperature-Resistance Coefficients for Various Temperatures

From Eq. 3-5 it is apparent that the temperature coefficient for 20°C cannot be used when the known resistance is at some other temperature. For this condition

$$\alpha_x = \frac{1}{\frac{1}{\alpha_{20}} + (T_x - 20)} \quad (\text{Eq. 3-6})$$

in which  $\alpha_x$  = Temp. coefficient at  $T_x$  deg C.

$\alpha_{20}$  = Temperature coefficient at 20°C

Example: The 20°C temperature coefficient  $\alpha_{20}$  for 1350 (61.2% IACS) alloy is 0.00404. What is it for 50°C?

Applying Eq. 3-6

$$\alpha_{50} = \frac{1}{\frac{1}{0.00404} + (50 - 20)} = 0.00360$$

For coefficients for other temperatures see Table 3-7.

#### Calculation of ac Resistance\*

*Skin effect* is by convention regarded as inherent in the conductor itself; hence when the *ac resistance* of a conductor is stated, what is meant is the dc resistance usually in ohms, plus an increment that reflects the increased apparent resistance in the conductor caused *solely* by the skin-effect inequality of current density.

Skin effect results in a decrease of current density toward the center of a cylindrical conductor (the current tends to crowd to the surface).

A longitudinal element of the conductor near center is surrounded by more magnetic lines of force than is an element near the rim, hence the induced counter-emf is greater in the center element. The net driving emf at the

\*Reports of resistance and Kvar reactive requirements for large-size transmission-line conductors (single, twin, and expanded core) are in AIEE paper 59-897 *Power Apparatus and Systems*, December 1959, by Earl Hazan and AIEE paper 58-41 *Current-Carrying Capacity of ACSR*, February 1958, by H. E. House and P. D. Tuttle. These papers also refer extensively to the effect on ampacity of wind velocity and temperature rise. For a complete listing of the formulas covering these resistivity relationships see ASTM B 193, Table 3.

TABLE 3-6

Temperature Coefficients of dc Resistance of Wire Materials  
 $\propto_x$  20°C (68° F)  
 (Abstracted from ASTM Standards)

Material	Conductivity Percent IACS	Temperature Coefficient $\propto_x$ at 20°C per degree C
Aluminum		
1350-H19	61.2	0.00404
6201-T81	52.5	0.00347
Copper (h-d)	97.0	0.00381
Alumoweld	20.33	0.00360
Steel	9.0	0.00320

Example: The resistance of one mile of Bluebell stranded conductor of 61.2% (IACS) 1350-H19 at 20°C is 0.0883 ohms. What is it at 50°C?

Applying coefficient from Table 3-6

$$R_{50} = 0.0883 [1 + 0.00404 (50-20)] = 0.0990 \text{ ohms}$$

center element is thus reduced with consequent reduction of current density.

The ratio of ac resistance to dc resistance ( $R_{ac}/R_{dc}$ ) is almost unity for small all-aluminum conductors at power frequencies, regardless of load current. It increases to about 1.04 for the 1113.5 kcmil size and to about 1.09 in the 1590 kcmil size.

The basic calculations of  $R_{ac}/R_{dc}$  ratio have been made for round wires and tubes of solid material, and these values can be obtained from curves based on such calculations or tests. Fig. 3-8 shows  $R_{ac}/R_{dc}$  ratios for solid round or tubular conductors, and they also may be applied for stranded conductors by treating the stranded cross-section as if it were solid.

For use of the curves of Fig. 3-8,  $R_{dc}$  is first obtained and corrected for temperature.  $R_{ac}$  is then obtained from the  $R_{ac}/R_{dc}$  ratio read from the chart.

Example: All-aluminum Bluebell stranded conductor of 1350-H19 (61.2% IACS) has dc resistance of 0.0188 ohms per 1000 ft at 50°C. What is its approximate  $R_{ac}/R_{dc}$  ratio for 60 Hz?

Substituting in equation at bottom of Fig. 3-8 on basis of ohms per mile, and  $r_c/r_n = 0.00$ .

$$\text{Abscissa parameter} = [60/(0.0188 \times 5.28)]^{1/2} = 24.6 \text{ and } R_{ac}/R_{dc} = 1.031, \text{ which compares with a value from published tables of } 1.030.$$

**Skin Effect in Steel-Reinforced Stranded Conductors (ACSR, etc.)**

The  $R_{ac}/R_{dc}$  ratio of ACSR conductors that have an

even number of layers of aluminum wires (2,4 etc.) may be estimated from the curves of Fig. 3-8, provided  $r_c$  is the radius of the core and  $r_n$  is the external radius.\* By this method, no account is taken of the current in the steel core. Some tables include the effect of core conductance, hence show a slight variation of ratio.

If the number of aluminum layers is odd (1,3, etc.), the  $R_{ac}/R_{dc}$  ratio for ACSR conductors is affected by the magnetic flux in the core, which occurs because there is an unbalance of mmf due to opposite spiraling of adjacent layers. In such conductors the core flux varies with load current, hence the  $R_{ac}/R_{dc}$  ratio will vary with current. The effect is considerable in one-layer conductors, moderate in 3-layer conductors, and it may be disregarded for 5-layer conductors and more. This effect is further described and illustrated by Fig. 3-9 and Table 3-8A.

The comparison at 75% loading, shown in Table 3-8A illustrates the effect of core permeability in the one-layer ACSR whereas it has no effect in 2-layer ACSR. The one-layer ACSR may be less desirable electrically and it is used mostly where high strength is required at the sacrifice of conductance and for small sizes, 4/0 and under.

The  $R_{ac}/R_{dc}$  ratios for one-layer ACSR are obtained from tables or curves that show test results at various load currents.

Three-layer ACSR, as stated, similarly has the  $R_{ac}/R_{dc}$  ratio affected by load current. However, the effect may be allowed for by applying values from Fig. 3-9 which shows the correction factor to be applied to the ratio with varying load.

Example: A 54/7 ACSR conductor, Curlew of 1033.5 kcmil has an  $R_{ac}/R_{dc}$  ratio of 1.025 at 25°C, 60 Hz, without regard to core-magnetic effect. What are the ratios for load currents of 200, 400, 600, 800, and 1000 amp,\* respectively? See also footnote under Table 3-8.

From the upper curve of Fig. 3-9, values are tabulated in col. (3), and multiplying these values by the basic ratio provides the desired ratio in col. (5) of Table 3-8.

Calculation of skin-effect ratios for composite designs in which the steel reinforcement is located wholly or partly away from the central core, or in which the steel is surrounded by a thick aluminum coating is almost impossible except for the simplest configurations. Consequently such values are taken from tables that represent test results. Accepted catalog data for most commercial designs are available.

**Proximity Effect**

When two conductors are spaced relatively close to one another and carry alternating current, their mutual inductance affects the current distribution in each conductor. However, if the distance apart of the conductors exceeds ten times the diameter of a conductor the extra I<sup>2</sup>R loss

\*As  $r_c/r_n$  equals ratio of diameters, it usually is more convenient to use diameters which ordinarily can be read from conductor tables, see footnote, Table 3-8.

bare aluminum wire and cable

TABLE 3-7

Temperature Coefficients of dc Resistance of Wire Materials at Various Temperatures\*

Alloy Conductivity	1350-H19 61.2% IACS	6201-T81 52.5% IACS
Temp°C 0		
10	.00440	.00373
20	.00421	.00359
25	.00404	.00347
	.00396	.00341
30		
40	.00389	.00335
50	.00374	.00324
60	.00361	.00314
	.00348	.00305
70		
80	.00336	.00296
90	.00325	.00287
100	.00315	.00279
	.00306	.00272

\*Calculated per NBS Handbook .109.

Example: The resistance of one mile of *Bluebell* stranded conductor of 1350-H19 alloy at 50°C is measured at 0.0990 ohms. What is it at 20°C?

Applying the 50° coefficient from Table 3-7 in Eq. 3-5:  $R_{20} = 0.0990 [1 + 0.00361 (20 - 50)] = 0.0883$  ohms.

TABLE 3-8

Comparison of Basic and Corrected  $R_{ac}/R_{dc}$  Curlew Conductor

(1) Load amp	(2) Amps per cmil x 10 <sup>6</sup>	(3) Resistance multiplier Fig. 3-7	(4)* Basic $R_{ac}/R_{dc}$ Ratio	(5) Corrected Ratio (3) x (4)
200	194	1.007	1.025	1.032
400	388	1.013	1.025	1.038
600	581	1.018	1.025	1.044
800	775	1.022	1.025	1.048
1000	960	1.025	1.025	1.051

\*If these current variations occur in a conductor when ambient temperature is constant, the operating temperature will increase with load, hence the basic  $R_{ac}/R_{dc}$  ratio must be adjusted to reflect the variation of  $R_{dc}$  with temperature. Constants are available from the Aluminum Association that facilitate this adjustment of  $R_{ac}/R_{dc}$  ratio.

caused by this crowding is less than 1 percent, hence ordinarily can be neglected.

#### Hysteresis and Eddy Current Effects

Hysteresis and eddy current losses in conductors and adjacent metallic parts add to the effective a-c resistance. To supply these losses, more power is required from the line. They are only important in large ampacity conductors when magnetic material is used in suspension and dead-end clamps, or similar items which are closely adjacent to the conductor.

Usual tests that determine  $R_{ac}/R_{dc}$  ratios for conductors as reported in tables of properties take into account any hysteresis or eddy-current loss that is in the conductor itself, so no separate estimate of them is ordinarily required.

The calculation of eddy-current and hysteresis loss in adjacent metallic materials, (structures, housings, etc.) or its estimate by tests is beyond the scope of this book.

#### Radiation Loss

This component of power loss in a conductor is negligi-

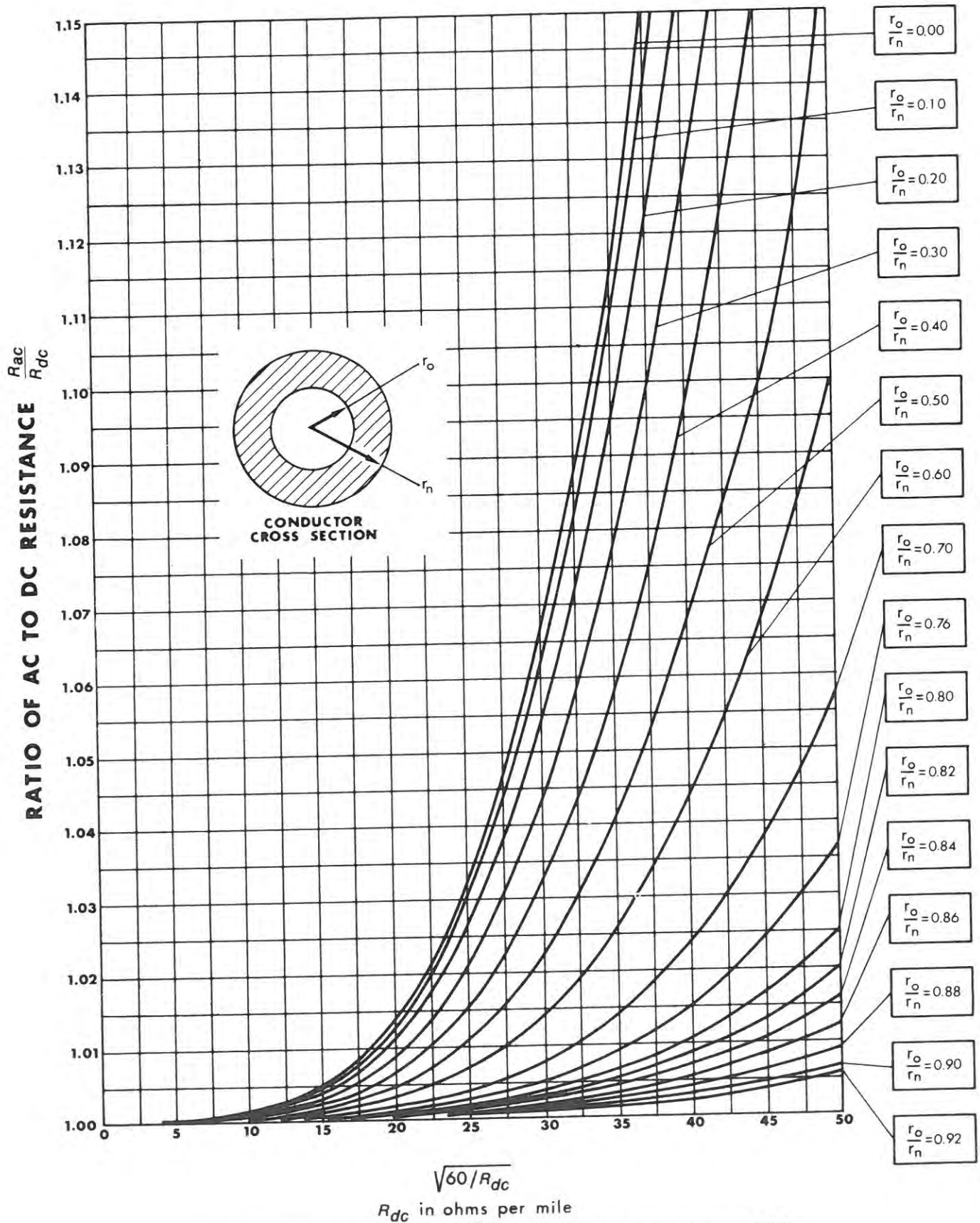

Fig. 3-8. Skin-effect factor for solid-round or tubular conductor at 60 Hz.

H. B. Wright, "Skin Effect in Tubular and Flat Conductors," 1923.



bare aluminum wire and cable

**TABLE 3-8A**  
**Comparison of  $R_{ac}/R_{dc}$  Ratios for All-Aluminum and ACSR,**  
**266.8 kcmil, Single-Layer Conductors, and Equivalent 2-Layer Conductor**

Resistance value in ohms per mile

Conductor	Stranding	Light Load at 25°C			75% Load at 50°C		
		Resistance		$R_{ac}/R_{dc}$	Resistance		$R_{ac}/R_{dc}$ Ratio
		dc	60 Hz		dc	60 Hz	
1350-H19, 61.2% IACS	7	0.349	0.350	1. +	0.384	0.386	1.005
ACSR (1 layer)	6/7	0.349	0.350	1. +	0.384	0.545	1.42
ACSR (2 layer)	26/7	0.349	0.349	1.	0.384	0.384	1.00

ble at usual power frequencies; it becomes important only at radio and higher frequencies. Accordingly no method of estimating such loss is considered herein.

**Corona\***

Corona occurs when the potential of the conductor is such that the dielectric strength of the surrounding air is exceeded. The air becomes ionized and bluish illuminated gaseous tufts or streamers appear around the conductor, being more pronounced where there are irregularities of the conductor surface. The discharge is accompanied by the odor of ozone, and there may be a hissing sound.

Corona discharge from a bare conductor power line may interfere with radio and TV reception, or adjacent carrier and signal circuits.

Bundled conductors are frequently used to obtain lower voltage stress on the air insulation for voltages above 350 kV.

**Inductive and Capacitive Reactance**

Variable current flow in an electrical conductor, either as alternating current or as a transient of any kind, gives rise to the parameters of inductance (usually expressed in millihenrys) and capacitance (usually expressed in microfarads) and their related properties of inductive and capacitive reactance, usually expressed as ohms per mile and megohm-miles, respectively. No energy loss is associated directly with these parameters, but the 90° out-of-phase voltage and current must be supplied to sustain the magnetic and electric fields created, so a slight increase

\*For further information regarding corona, see *Standard Handbook for Electrical Engineers*, McGraw-Hill Company, Sec. 14 which also contains references to the various research papers. An excellent text on corona and EHV line design is the EPRI Transmission Line Reference Book, 345 kV and above.

of  $I^2R$  loss in the conductors occurs because of them. Inductance and capacitance, however, influence system stability in high-voltage lines to a greater extent than resistance.

Only the reactances that are related to the conductors, either as parts of a single-phase or a three-phase circuit, are considered herein. The *total system* reactance also includes many factors not related to the conductors; among them leakage reactance of apparatus, and the extent that automatic tap-changing and power-factor control are used. These system conditions are taken into account as a part of circuit analysis for which a high degree of electrical engineering skill is required, and their consideration is beyond the scope of this book.

**Inductive Reactance**

The inductance  $L$  of a circuit is a measure of the number of interlinkages of unit electric current with lines of magnetic flux produced by the current, both expressed in absolute units.  $L$  also is defined by  $e = L (di/dt)$  in which  $di/dt$  indicates the rate of change of current with time.  $L$  is the coefficient of proportionality, and  $e$  is the momentary induced voltage.

The quantity  $X = 2\pi f L$ , in which  $f$  is frequency in Hz, is the *inductive reactance*, expressed in ohms, but in phasor notation the inductive-reactance drop is perpendicular to the resistance drop; that is, the current  $I$  in a conductor having both resistance and inductive reactance, but negligible capacitance, and at unity power factor is

$$I = E / (R + jX) \text{ in which } j = \text{Vector operator } (-1)^{1/2} \text{ (Eq. 3-7)}$$

$E =$  Emf, volts, to neutral

$I =$  Current in conductor, amp

$X =$  Inductive reactance, ohms

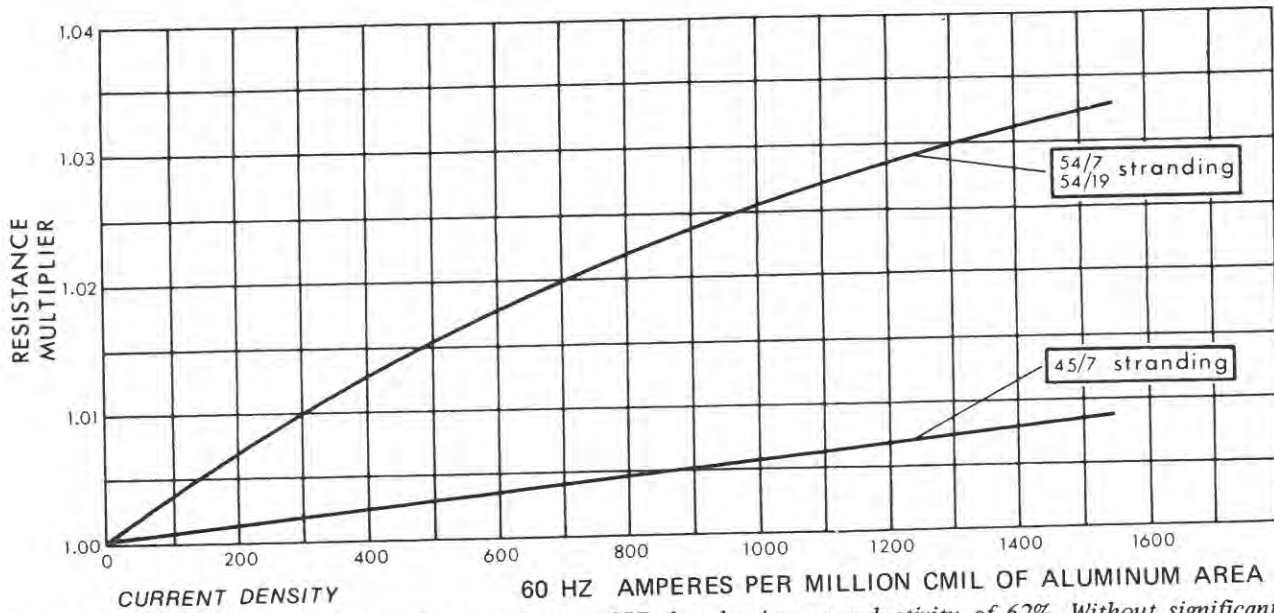

Fig. 3-9. Resistance multiplying factors for three-layer ACSR for aluminum conductivity of 62%. Without significant error, these factors also may be used for aluminum of 61.2% IACS conductivity. These data are used to reflect the increase in resistance due to magnetizing effects of the core.

Numerically  $(R + jX) = (R^2 + X^2)^{1/2}$  and is designated impedance, also expressed in ohms.

Normally, computations of  $R$  and  $X$  for transmission lines are made, for convenience, on the basis of unit lengths, usually one mile. Tables are set up in this manner.

The inductive reactances discussed herein and listed in tables of conductor properties are suitable for calculations of either positive- or negative-sequence reactance, as employed for usual transmission and distribution circuits. Zero-sequence values, as required for unbalanced conditions or fault-currents, may be obtained by methods later described. Inasmuch as zero-sequence inductive reactance is the principal factor that limits phase-to-ground fault currents, its value is important in conductor selection.

Simplifying of reactance calculations is effected if the reactance is considered to be split into two terms \* (1) that due to flux within a radius of 1 ft ( $X_a$ ) including the internal reactance within the conductor, and (2) that due to the flux between 1 ft radius and the center of the equivalent return conductor—( $X_d$ ). A further simplifying convention is that the tabulation of the latter distance is the distance between centers of the two conductors instead of the distance from one-foot radius of one conductor to

the surface of the adjacent one; thus, there will be minus  $X_d$  values tabulated for distance between conductors that are less than 1 ft apart.

Conductor spacing  $D$  for 3-phase circuits is the geometric mean distance (GMD) as later defined.

The sum of the two terms ( $X_a + X_d$ ) is the required inductive reactance of the conductor  $X$  under usual load conditions. The values also are useful as a basis for calculating impedance under fault conditions (zero-sequence). It is to be noted that  $X_a$  is an inherent conductor electrical property, taking into account the reactance due to the flux out to a distance of 1 ft from center of the conductor, and is so tabulated for round, stranded, and composite conductors, usually as ohms per mile. The values of  $X_d$ , however, depend on spacing of the conductors, and are unrelated to size of an individual conductor. Table 3-9 lists values of  $X_d$  at 60 Hz based on separation distance between centers of the conductors, in ohms per mile. The value for any other frequency is directly proportional; thus, for 25 Hz it is 25/60 of the 60-Hz value.

The conductor spacing for other than a simple two-conductor circuit is its geometric mean distance (GMD) in ft. A few of the usual arrangements and their GMD's are shown in Table 3-10. If the spacing is unequal, the GMD is a geometric average value which, however, usually is satisfactory for preliminary calculations. Thus, in a flat

\* First proposed by W. A. Lewis. See also W. A. Lewis and P. D. Tuttle, *The Resistance and Reactance of Aluminum Conductors, Steel Reinforced*. Trans. AIEE, Vol. 77, Part III, 1958.

**TABLE 3-9**  
**Separation Component ( $X_d$ ) of Inductive Reactance**  
**at 60 Hz (1) Ohms per Conductor per Mile**  
**Separation of Conductors**

feet	Inches											
	0	1	2	3	4	5	6	7	8	9	10	11
0	—	-0.3015	-0.2174	-0.1682	-0.1333	-0.1062	-0.0841	-0.0654	-0.0492	-0.0349	-0.0221	-0.0106
1	0	0.0097	0.0187	0.0271	0.0349	0.0423	0.0492	0.0558	0.0620	0.0679	0.0735	0.0789
2	0.0841	0.0891	0.0938	0.0984	0.1028	0.1071	0.1112	0.1152	0.1190	0.1227	0.1264	0.1299
3	0.1333	0.1366	0.1399	0.1430	0.1461	0.1491	0.1520	0.1549	0.1577	0.1604	0.1631	0.1657
4	0.1682	0.1707	0.1732	0.1756	0.1779	0.1802	0.1825	0.1847	0.1869	0.1891	0.1912	0.1933
5	0.1953	0.1973	0.1993	0.2012	0.2031	0.2050	0.2069	0.2087	0.2105	0.2123	0.2140	0.2157
6	0.2174	0.2191	0.2207	0.2224	0.2240	0.2256	0.2271	0.2287	0.2302	0.2317	0.2332	0.2347
7	0.2361	0.2376	0.2390	0.2404	0.2418	0.2431	0.2445	0.2458	0.2472	0.2485	0.2498	0.2511
8	0.2523											
9	0.2666											
10	0.2794											
11	0.2910											
12	0.3015											
13	0.3112											
14	0.3202											
15	0.3286											
16	0.3364											
17	0.3438											
18	0.3507											
19	0.3573											
20	0.3635											
21	0.3694											
22	0.3751											
23	0.3805											
24	0.3856											
25	0.3906											
26	0.3953											
27	0.3999											
28	0.4043											
29	0.4086											
30	0.4127											
31	0.4167											
32	0.4205											
33	0.4243											
34	0.4279											
35	0.4314											
36	0.4348											
37	0.4382											
38	0.4414											
39	0.4445											
40	0.4476											
41	0.4506											
42	0.4535											
43	0.4564											
44	0.4592											
45	0.4619											
46	0.4646											
47	0.4672											
48	0.4697											
49	0.4722											

From: *Electrical Transmission and Distribution Reference Book*, Westinghouse Electric Corporation, 1964.

(1) From formula: at 60 Hz  
 $X_d = 0.2794 \log_{10} d$   
 $d =$  separation in feet

3-phase arrangement of conductors A, B, and C with 5 ft between A and B, 7 ft between B and C, and 12 ft between A and C, the reactance voltage drop from any conductor to neutral does not vary more than 2.2% from the voltage based on average  $D (A \times B \times C)^{1/3}$ , or 7.5 ft.

*$X_a$  and Geometric Mean Radius (GMR)*

The calculation of inductive reactance to a radius of 1 ft ( $X_a$ ) is aided by the factor GMR, which represents the radius of an infinitely thin tube the inductance of which under the same current loading equals that of the conductor. For non-magnetic materials,

$$X_a = 0.2794 \frac{f}{60} \log_{10} \frac{1}{GMR} \tag{Eq. 3-8}$$

in which

$X_a =$  Inductive reactance to 1 ft radius, ohms/mile

$f =$  Frequency, Hz

GMR = Geometric mean radius, ft

The GMR of a single solid round conductor is  $0.7788r$ , in which  $r$  is radius of conductor in ft. Fig. 3-10 is a curve showing GMR for an annular ring.

The GMR of a stranded conductor without steel reinforcement or center voids is obtained by using the concept of concentric rings of solid round wires, each ring being a specified GMD apart.\*

The GMR of a stranded multi-layer ACSR or an expanded all-aluminum conductor with hollow center is

\*For methods of calculation see ref. at bottom of page 3-13.

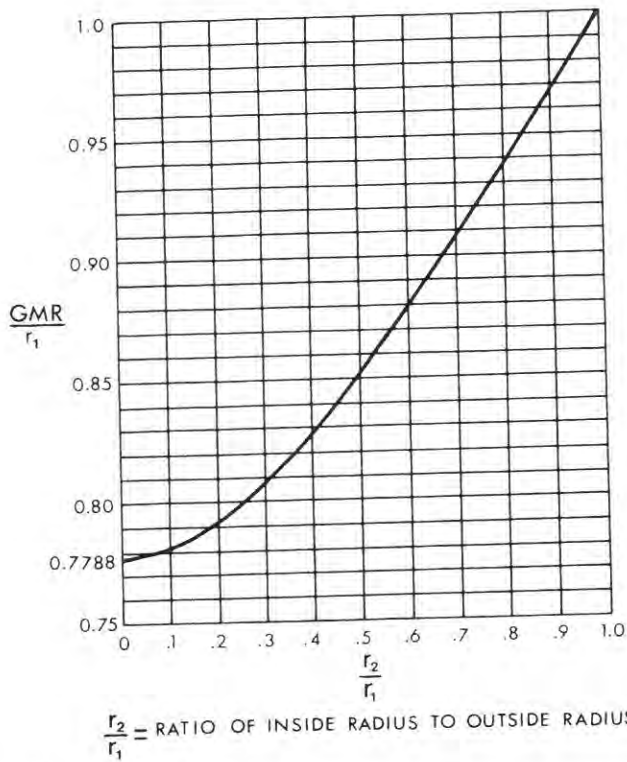

Fig. 3-10. GMR of annular rings.  
L. F. Woodruff, "Electric Power Transmission and Distribution," 1938.

similarly based on the assumption of a hollow tube of aluminum wires.

The GMR values (in ft) for the various kinds of conductors are listed as an electrical property of the conductor in the conductor tables herein.

The GMR values for single-layer ACSR are not constant because the  $X_a$  is affected by the cyclic magnetic flux which in turn is dependent on current and temperature. The  $X_a$  values for these conductors are experimentally determined and made available in tables or curves for various currents and temperatures.

The  $X_a$  values for 3-layer ACSR is so little affected by the variable core magnetization that it is customary to ignore it, hence the GMR values for 3-layer ACSR are included in tables of conductor properties in the same manner as are those of other multi-layer conductors.

The following examples show the application of some of the previous equations and the comparative magnitude of some of the relationships.

Bluebell 1033.5 kcmil stranded aluminum cable (overall diam. 1.170 in.) is listed with GMR as 0.0373 ft and  $X_a$  as 0.399 ohms per mile at 60 Hz. Check the  $X_a$  value, and how much it differs from that of a solid round conductor of the same diameter.

TABLE 3-10

Values of Geometric Mean Distance, GMD

CONDUCTOR GEOMETRY	GMD
	d
	d
	A or B or C
	1.122 A
	$\sqrt[3]{A \times B \times C}$
	1.26 A
	$\sqrt[3]{A \times B \times C}$

*Example:* A 115-kv 3-phase flat-arranged circuit has 6 ft A to B, 8 ft B to C, and 14 ft A to C, hence Avg GMD is  $(6 \times 8 \times 14)^{1/3} = 8.76$  ft.

Interpolating in Table 3-9 and from conductor table (assuming Bluebell)  
 $X_d = 0.263$  ohms per mile  
 $X_s = 0.399$  ohms per mile  
 Total inductive reactance of any conductor  $X = 0.662$  ohms per mile

**bare aluminum wire and cable**

Check of  $X_a$

$$X_a = 0.2794 \log_{10} \frac{1}{0.0373} = 0.399 \text{ which checks table.}$$

Comparison with solid round

$$\text{GMR} = 0.7788 \times \frac{1.170}{2 \times 12} = 0.0380 \text{ ft}$$

$$X_a = 0.2794 \times \log_{10} \frac{1}{0.0380} = 0.397$$

A corresponding size of ACSR, *Curlw*, diam. 1.246 in. is listed with  $X_a$  of 0.385 and GMR of 0.0420 ft, thereby showing the reduction of  $X_a$  because of the hollow-tube effect and increased diameter, as per Eq. 3-8.

The variation of  $X_a$  for different cable constructions of the same size, according to standard tables of electrical properties, is shown below for 266.8 kcmil conductors:

Kind of Cable	Code	Stranding	Overall diameter	$X_a$ Ohms per Mile
All-aluminum AAC	<i>Daisy</i>	7	0.586 in.	0.489
ACSR one-layer	<i>Owl</i>	6/7	0.633	0.55 @ 400 amps 0.50 @ 200 amps 0.48 @ 0 amps
ACSR two-layer	<i>Partridge</i>	26/7	0.642	0.465

The increased diameter of *Partridge* as compared with that of *Daisy* shows that  $X_a$  is reduced 5%, but the one-layer *Owl* has 18% greater  $X_a$  when fully loaded.

**Inductive Reactance of Bundled Conductors**

For increasing load stability and power capability in high-voltage lines, each of the individual phase lines is sometimes subdivided into 2, 3, or 4 subconductors but the distance between the conductors of a phase group is small compared with the distance between centers of the groups. The design of such a bundled-conductor circuit is beyond the scope of this book. However, for any such arrangement, the inductive reactances may be found as per the following example, provided the individual conductors are the same size, the same group arrangement is used for all phases, and skin and proximity effects are negligible.\*

*Example:* Consider the arrangement below in which each conductor is ACSR 795 kcmil, Code *Drake*, 26/7 stranding, 60-Hz.

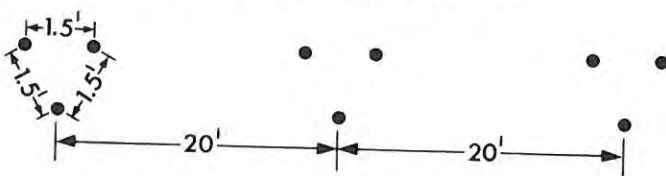

$X_a$  of *Drake* is 0.399 ohms per mile

The average  $X_s$  of a phase is  $1/3 (0.0492 + 0.0492 + 0.0492) = 0.0492$  ohms per mile, in which  $X_d$  for 1.5 ft is 0.0492 ohms per mile (see Table 3-9).

The reactance to 1 ft radius  $X_a^b$  for any group of 2 or 3 subconductors is

$[(1/m)(X_a - (m-1)X_s)]$  where  $m$  is the number of subconductors in each group.

For 4 subconductors,  $X_a^b$  is

$$[(1/m)(X_a - (m-1)X_s)] + X_d - 0.0105$$

Hence, for 3 subconductors

$$X_a^b = [1/3(0.399 - (2)0.0492)] = 0.1002 \text{ ohms per mile.}$$

As the distance between groups is comparatively large, an approximation for  $X_d^b$  for a single group is made by considering the inter-conductor distances  $d$  as 20 ft, 20 ft, and 40 ft, respectively, whence from Table 3-9,

$$X_d^b = \frac{1}{3} (0.3635 + 0.3635 + 0.4476) = 0.3915 \text{ ohms}$$

per mile. The total inductive reactance of a single group is thus  $X^b = X_a^b + X_d^b = 0.1002 + 0.3915 = 0.4917$  ohms per mile.

If a more accurate value of  $X_d^b$  is desired (usually when distances within a group are not small as compared with phase distances), an average of all  $X_d$  values for all distances between individual conductors is obtained. Thus, in the example there are 27 such distances. An  $X_d$  value from Table 3-9 is obtained for each of these distances, then totaled, and divided by 27 to obtain an average  $X_d^b$ .

**Zero-Sequence Resistance and Inductive Reactance**

Zero-sequence currents ( $I_0$ ) that occur under fault conditions are all equal and in phase. Hence they move out simultaneously through the phase conductors and return either through the earth or a combination of earth and ground-wire return paths. Zero-sequence currents are the three components of unbalanced phase currents that are equal in magnitude and common in phase. Note that  $I_0$  flows in each phase conductor, and  $3 I_0$  flows to ground.

The influence of the earth return can be given by two additional terms, an earth resistance and reactance, as follows:

$$R_e = 0.2858 \left( \frac{f}{60} \right) \text{ in ohms per mile} \quad (\text{Eq. 3-9})$$

and

$$X_e = 0.4191 \left( \frac{f}{60} \right) \log_{10} 77,760 \left( \frac{60}{f} \right) \rho_e =$$

approx 2.888 ohms per mile at 60 Hz, if  $\rho_e$  is taken at 100 (see Table 3-11)

$$(\text{Eq. 3-10})$$

\* See also AIEE papers 58-41 and 59-897, *ibid.* p. 3-8 footnote.

**TABLE 3-11**  
**Zero-Sequence Resistance and Inductive**  
**Reactance Factors ( $R_e$  and  $X_e$ )<sup>①</sup>**  
 Frequency (f) 60 Hz

Frequency (f)	60Hz	
Resistivity ( $\rho_e$ ) Ohm-meter	ohms per conductor per mile	
All values	$R_e$	0.2858*
1	$X_e$	2.050
5		2.343
10		2.469
50		2.762
100*		2.888
500		3.181
1,000		3.307
5,000	3.600	
10,000	3.726	

Westinghouse, "Transmission and Distribution Handbook," 1964.

① From formulas:

$$R_e = 0.2858 \frac{f}{60}$$

$$X_e = 0.4191 \frac{f}{60} \log 77,760 \frac{60}{f} \rho_e$$

where  $f$  = frequency

$\rho_e$  = resistivity (ohm-meter)

\* This is an average value which may be used in the absence of definite information.

in which  $\rho_e$  = ac resistivity of the earth return path in ohm-meters (the resistance between the faces of a one-meter cube of earth). This value depends on quality of the earth, and is in the range shown in Table 3-11, but an average value of 100 may be used in the absence of definite information.

$f$  = Frequency, Hz

In addition, the zero-sequence reactance and impedance is also affected by a mutual reactance term because of nearby ground wires or circuits. The zero-sequence impedance of one mile of a 3-phase transmission line without ground wires, but with ground return, not including capacitance effects, is

$$Z_o = R_{ac} + R_e + j(X_e + X_n - 2X_d) \quad (\text{Eq. 3-11})$$

in which  $R_{ac}$  = ac resistance in ohms per phase per mile

$R_e$  and  $X_e$  are given by Eqs. 3-9 and 3-10 above

$X_n$  and  $X_d$  are inductive reactances in ohms per mile

of a single conductor, as previously noted, or as taken from table.

Example: Consider the arrangement below in which conductor is ACSR 795 kcmil, Drake, 60 Hz.

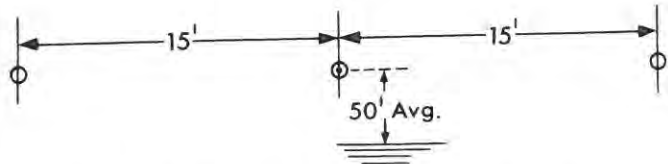

From Eq. 3-9  $R_e = 0.2858$ , and  $X_e = 2.888$ , ohms per mile  
 From tables,  $R_{ac} = 0.1370$  ohms per mile at 75°C

$$X_n = 0.399 \text{ ohms per mile}$$

$$X_d = \frac{1}{3} (0.3286 + 0.3286 + 0.4127) = 0.3566$$

ohms per mile in which  $X_d$  at 15 ft is 0.3286 and at 30 ft is 0.4127

Substituting in Eq. 3-11 for impedance  $Z_o$ .

$$Z_o = 0.1370 + 0.2858 + j(2.888 + 0.399 - 2(0.3566)) \text{ ohms/mile}$$

$$= 0.4228 + j 2.5738 \text{ ohms/mile} = 2.608 \text{ angle } 80.67^\circ$$

### Shunt Capacitive Reactance

In long high-voltage transmission lines the distributed capacitance caused by the electric field between and surrounding the conductors can attain high values which markedly affect circuit properties; among them voltage distribution, regulation, system stability, corona, lightning performance, and transients set up by faulting or line switching.

The shunt capacitive reactance of a conductor system

$$\text{is } X'_c = \frac{1}{2\pi f C} \text{ ohms} \quad (\text{Eq. 3-12})$$

In which if  $C$  is in farads;  $f$  is frequency Hz.

It is customary in engineering work to express shunt capacitance in microfarads per mile and  $X'_c$  the corresponding reactance in megohm-miles, usually for 60 Hz. The prime (') is affixed to the  $X'$  to prevent confusion with  $X$ -values that represent inductive reactance.

To obtain the megohms of shunt capacitive reactance that controls charging current of a line longer than one mile, the listed megohm-miles value is to be divided by length of line in miles; that is, for 100 miles of a line using 795 kcmil 54/7 ACSR at a phase spacing of 20 ft, the megohms of shunt capacitive reactance which determines the charging current will be the listed 0.1805 megohm-miles divided by 100 or 0.001805 megohms (1805 ohms).

Similar to the use of  $X_n$  to represent inductive reactance to radius of 1 ft and  $X_d$  to represent inductive reactance in the remaining space up to an adjacent conductor, the total capacitive reactance similarly may be divided into components as follows:

**TABLE 3-12**  
**Separation Component ( $X'_d$ ) of Capacitive Reactance**  
**at 60 Hz<sup>(1)</sup> Megohm-Miles Per Conductor**

		Separation of Conductors											
		inches											
feet	0	1	2	3	4	5	6	7	8	9	10	11	
0	—	-0.0737	-0.0532	-0.0411	-0.0326	-0.0260	-0.0206	-0.0160	-0.0120	-0.0085	-0.0054	-0.0026	
1	0	0.0024	0.0046	0.0066	0.0085	0.0103	0.0120	0.0136	0.0152	0.0166	0.0180	0.0193	
2	0.0206	0.0218	0.0229	0.0241	0.0251	0.0262	0.0272	0.0282	0.0291	0.0300	0.0309	0.0318	
3	0.0326	0.0334	0.0342	0.0350	0.0357	0.0365	0.0372	0.0379	0.0385	0.0392	0.0399	0.0405	
4	0.0411	0.0417	0.0423	0.0429	0.0435	0.0441	0.0446	0.0452	0.0457	0.0462	0.0467	0.0473	
5	0.0478	0.0482	0.0487	0.0492	0.0497	0.0501	0.0506	0.0510	0.0515	0.0519	0.0523	0.0527	
6	0.0532	0.0536	0.0540	0.0544	0.0548	0.0552	0.0555	0.0559	0.0563	0.0567	0.0570	0.0574	
7	0.0577	0.0581	0.0584	0.0588	0.0591	0.0594	0.0598	0.0601	0.0604	0.0608	0.0611	0.0614	
8	0.0617												
9	0.0652												
10	0.0683												
11	0.0711												
12	0.0737												
13	0.0761												
14	0.0783												
15	0.0803												
16	0.0823												
17	0.0841												
18	0.0858												
19	0.0874												
20	0.0889												
21	0.0903												
22	0.0917												
23	0.0930												
24	0.0943												
25	0.0955												
26	0.0967												
27	0.0978												
28	0.0989												
29	0.0999												
30	0.1009												
31	0.1019												
32	0.1028												
33	0.1037												
34	0.1046												
35	0.1055												
36	0.1063												
37	0.1071												
38	0.1079												
39	0.1087												
40	0.1094												
41	0.1102												
42	0.1109												
43	0.1116												
44	0.1123												
45	0.1129												
46	0.1136												
47	0.1142												
48	0.1149												
49	0.1155												

From: *Electrical Transmission and Distribution Reference Book*, Westinghouse Electric Corporation, 1964.

(1) From formula: for 60 Hz  
 $X'_d = 0.06831 \log_{10} d$   
 $d =$  Separation in feet

$$X'_c = 0.0683 \frac{60}{f} \log_{10} \frac{1}{r_n} + 0.0683 \frac{60}{f} \log_{10} d_{ab} \quad (\text{Eq. 3-13})$$

in which

$X'_c =$  Capacitive reactance in megohm-miles per conductor

$r_n =$  Overall radius of conductor, ft

$d_{ab} =$  Separation distance to return conductor, ft

$f =$  Frequency, Hz

The left-hand term of the above two-term equation represents  $X'_a$ , the capacitive reactance for 1 ft spacing (to 1-ft radius); the right-hand term represents  $X'_d$ , the separation component; both are in terms of megohm-miles. These two values have been tabulated for 60 Hz. Those for  $X'_a$  are listed in the tables of electrical properties of conductors and those for  $X'_d$  are in Table 3-12.

*Example:* For 795 kmil Drake, Radius of conductor 0.0461 ft, 60 Hz, 20 ft spacing.

Substituting in the terms of Eq. 3-13

$$X'_a = 0.0683 \log_{10} \frac{1}{0.0461} = 0.0683 \times 1.3365 = 0.0913$$

megohm-miles

$$X'_d = 0.0683 \log_{10} 20 = 0.0683 \times 1.3010 = 0.0889$$

megohm-miles

$$X'_c = 0.0913 + 0.0889 = 0.1802 \text{ megohm-miles}$$

*Zero-Sequence Capacitive Reactance*

An added term  $E'_c$  that affects zero-sequence capacitive reactance depends on distance above ground. It is represented by

$$X'_e = 0.0205 \frac{60}{f} \log_{10} 2h \text{ in which } h \text{ is height of conductor above ground, ft} \quad (\text{Eq. 3-14})$$

The zero-sequence capacitive reactance of one 3-phase circuit without ground wires in terms of megohm-miles per conductor is

$$X'_o = X'_a + X'_d - 2X'_e \quad (\text{Eq. 3-15})$$

in which the terms have previously been defined.

#### Capacitive Reactance of Bundled Conductors

The shunt capacitive reactance of bundled conductors can be found from equations identical with those used in the numerical example relating to inductive reactance of bundled conductors (page 3-17), except a prime is added to each  $X$ . Thus  $(X'_a)^b$  and  $(X'_d)^b$  may then be used in place of  $X'_a$  and  $X'_d$  in the corresponding equations for positive- or zero-sequence inductive reactance.

#### Ampacity of Bare Conductors\*

The major considerations involving the current-carrying capacity (ampacity) of overhead transmission conductors are the effect of conductor heating by the current and the consequent reduction of tensile strength. Most aluminum transmission conductors are hard-drawn and operate over predetermined ranges of maximum sags and tensions. Heating to relatively high temperatures for appreciable time periods anneals the metal, thus reducing the yield strength and increasing elongation. Hence the ampacity of such conductors is generally stated to be the current which under the assumed conditions of operation will not produce sufficient heating to affect significantly the tensile properties of the conductor.

Basic to the calculation is the establishment of an ambient temperature level. Obviously the ampacity is related to temperature rise, and the amount of the latter depends on temperature of the outside air.

Usual practice is to assume an ambient temperature of 40°C for overhead conductors, and the tables and charts herein are on that basis. However, lower ambients will be found in some applications, and the temperature rise for a given operating temperature must be altered accordingly.

The usual maximum operating temperature for tensioned bare conductors is 70° to 85°C, with 100°C and over permissible only in limited emergencies.

#### Heat Balance:

Temperature rise in a conductor depends on the balance between heat *input* ( $I^2R$  loss plus heat received from sunshine) and heat *output* (due to radiation from the conductor surface, and transfer because of convection of air currents). The heat loss arising from metallic conduction to supports is negligible, so is ignored. When the temperature of the conductor rises to the point where heat output

equals heat input the temperature remains steady, and the current for such condition is the ampacity for that temperature under the stated conditions.

The factors of importance that affect ampacity for a given temperature are wind velocity, conductor surface emissivity, atmospheric pressure (which affects ampacity at high altitudes), and of course the ambient temperature.

Neglecting sunshine heat input, the heat balance may be expressed as

$$I^2R_{eff} = (W_c + W_r) A, \text{ both terms in watts/linear ft.} \quad (\text{Eq. 3-16})$$

and in which

$W_c$  = Convection loss, watts/sq in. of conductor surface

$W_r$  = Radiation loss, watts/sq in. of conductor surface

$A$  = Surface area of conductor per ft of length, sq in.

$R_{eff}$  = Total effective resistance per ft of conductor, ohms, including the resistance-equivalent of pertinent components of loss under a-c conditions, (skin and proximity effects, reactance components, etc.)

which reduces to

$$I = \sqrt{\frac{37.7 \times d (W_c + W_r)}{R_{eff}}} \quad (\text{Eq. 3-16a})$$

in which  $d$  = Outside diameter of conductor, in.

$I$  = Current for balanced condition (the ampacity), amp

The convection heat loss  $W_c$  depends on wind velocity, temperature rise, and atmospheric pressure (altitude). The radiation heat loss  $W_r$  is considered to depend on temperature rise and an emissivity constant  $\epsilon$  that expresses the ability of the conductor to radiate internal heat.

A perfect non-radiative surface would have  $\epsilon = 0$ , and a body that radiates all heat would have  $\epsilon = 1$ . The emissivity factor  $\epsilon$  for aluminum conductor surfaces depends on the degree of oxidation and discoloration of surface, its roughness, and the stranding. Newly installed conductors may have  $\epsilon$  as low as 0.23, and may be 0.90 after being well-blackened after years of service. A value of  $\epsilon = 0.5$  provides a safety factor for the majority of exposed conductors which have been installed for several years. This value ( $\epsilon = 0.5$ ) is used for the tables and curves herein, which also show values based on a cross-wind of 2 ft per sec (1.36 miles per hr) as well as for still but unconfined air (Figs. 3-11 et seq).

The effect of sunlight and altitude as well as of variations of emissivity constants are shown by small auxiliary curves of Fig. 3-15.

The various factors entering the heat balance equations have been summarized by one conductor engineering group into the following:

1. Convection Heat Loss ( $W_c$ ) for 2 ft/sec wind, at sea level for 60°C rise above 40°C ambient.

\* Conductor ampacity has been reported extensively by Schurig and Frick, W. H. McAdams, House and Tuttle and others, and their results checked by test programs. The brief treatment herein is abstracted from many sources, principally the Alcoa Aluminum Overhead Conductor Engineering Data book: Section 6.



TABLE 3-13

Current Ratings for High-Strength ACSR with Single Layer of Aluminum Strands 40°C ambient  $\epsilon = 0.5$  emissivity; no sun.

Code Name	Size cmils	Stranding	Wind Condition	Current in Amperes		
				Temp Rise 10 C	Temp Rise 30 C	Temp Rise 60 C
Grouse	80,000	8Al- 1 St.	2 ft per sec	106	175	236
	80,000	8Al- 1 St.	Still Air	62	113	166
Petrel	101,800	12Al- 7 St.	2 ft per sec	125	204	263
	101,800	12Al- 7 St.	Still Air	75	133	190
Minorca	110,800	12Al- 7 St.	2 ft per sec	132	211	277
	110,800	12Al- 7 St.	Still Air	79	142	201
Leghorn	134,600	12Al- 7 St.	2 ft per sec	149	239	314
	134,600	12Al- 7 St.	Still Air	92	162	231
Guinea	159,000	12Al- 7 St.	2 ft per sec	166	266	352
	159,000	12Al- 7 St.	Still Air	104	182	262
Dotterel	176,900	12Al- 7 St.	2 ft per sec	178	285	374
	176,900	12Al- 7 St.	Still Air	111	196	280
Dorking	190,800	12Al- 7 St.	2 ft per sec	187	300	394
	190,800	12Al- 7 St.	Still Air	117	208	296
Cochin	211,300	12Al- 7 St.	2 ft per sec	199	319	422
	211,300	12Al- 7 St.	Still Air	126	223	318
Brahma	203,200	16Al-19 St.	2 ft per sec	188	301	389
	203,200	16Al-19 St.	Still Air	120	210	296

$W_c = 0.5388 (1.01 + 43.22 d^{0.52})$  watts per ft of length for  $d$  up to 1.6 in. diameter (Eq. 3-17)

$W_c = 22.15 d^{0.6}$  watts per ft of length for  $d$  1.6 in. diameter and over (Eq. 3-18)

2. Convection Heat Loss ( $W_c$ ) for still air, at sea level

$W_c$  (still) =  $0.072 d^{0.75} \Delta t_0^{1.25}$  watts per ft of length in which  $\Delta t_0$  is temperature rise above ambient (Eq. 3-19)

3. Radiation Heat Loss ( $W_r$ ) for 60°C rise above 40°C ambient

$W_r = 6.73 d$  watts per ft of length for  $\epsilon = 0.5$  (an average emissivity for weathered conductors) (Eq. 3-20)

4. Sun Heat Gain ( $W_s$ )—to be subtracted from ( $W_c + W_r$ ) in the above equations.

$W_s = 3.0 d$  watts per ft of length for mid latitudes (Eq. 3-21)

If the ambient temperature is less than 40°C, a small change in ampacity for a given temperature rise may be obtained because the resistance of the conductor is less (because of its reduced temperature). However, at the lower ambient and the same temperature rise, the radiated heat loss is less. The net result is that the current for a given temperature is little changed over a considerable range of ambient temperature.

#### Ampacity of 1350-H19 All-Aluminum Conductor and Standard-Strength ACSR Conductors

Ampacity graphs for 1350 all-aluminum conductors, and Standard-Strength ACSR are shown in Figs. 3-11, 12, 13, and 14 for still air and for 2fps wind at 40°C ambient for  $\epsilon = 0.50$  and 62% IACS aluminum without sunlight effect. For 61.2% IACS multiply by 0.994. Small graphs of multiplying factors for sunlight, altitude, and emissivity corrections are shown in Fig. 3-15. The  $W_c$  and  $W_r$  values for 60°C rise are from Eqs. 3-17, -18, and -20. The slope of the lines from the 60°C values is based on experimental data.

*Ampacity of Single-Layer High-Strength ACSR Conductors*

Table 3-13 can be used for ampacity values for high-strength ACSR in larger-than-AWG sizes for 10°, 30°, and 60°C rise. Values for intermediate temperatures may be obtained by plotting these values on log-log paper similar to that used for Figs. 3-13 and 3-14.

*Ampacity of 6201-T81 and ACAR Conductors*

Inasmuch as heat loss for a given temperature rise is proportional to conductor surface (or diameter) and heat input is proportional to I<sup>2</sup>R, the ampacity of any conductor of conductivity other than 62% IACS is found closely per the following example:

Find ampacity in still air for 30°C rise of 394.5 kcmil (0.684 in. diam.) cable of 6201-T81 of 52.5 % IACS conductivity.

By interpolating in Fig. 3-11, the ampacity of 62% IACS 1350 conductor of same diameter (if it could be obtained) would be 320 amp. Hence, the ampacity at 52.5% IACS is  $320 \times (52.5/62.0)^{1/2}$ ; or 294 amp.\*

For ACAR which has wires of two conductivities, the *equivalent* conductivity value is used; thus, for 42/19 ACAR (1350 and 6201-T81) of 1.165 in. outside diameter, the % IACS conductivity of the ACAR conductor, if the 1350 wires are 61.2% IACS, is

$$(42 \times 61.2 + 19 \times 52.5) / 61 = 58.5\% \text{ IACS}$$

*Examples of Ampacity Values Obtained from Figs. 3-11 to 15 Incl.*

The following typical examples illustrate the use of the various graphs:

1. Cable size 795 kcmil ACSR 26/7 stranding,  $\epsilon = 0.50$ , diam. 1.1 in. approx., wind of 2 ft per sec. What is ampacity for 35°C rise, or 75°C operating temperature?

At top of Graph Fig. 3-14 note the diagonal line that

extends downward from the designated size. It intersects the 35°C rise horizontal at 835 amp, which is the ampacity for the stated conditions.

2. For the cable of Example 1, what is ampacity if altitude is 10,000 ft with sun, and with emissivity factor reduced to 0.23?

Note: The multiplying factors of Fig. 3-15 are to be used. These strictly are applicable only for 100°C operating temperature, but inasmuch as the ampacity diagonals on Fig. 3-13 are almost straight lines, it is satisfactory to apply the multiplying factors directly to the 35°C rise ampacity of 835 amp.

The altitude factor with sun is taken from the left-hand diagram of Fig. 3-15D as being 0.83 (approx) for 1.1 in. diam., and the emissivity factor taken from the right-hand diagram with sun for  $\epsilon = 0.23$  is 0.90. The desired ampacity is  $835 \times 0.83 \times 0.90 = 630$  amp.

Note: If the multiplying factors are applied to the 60° Rise ampacity, for conditions stated in Example 1, the unadjusted ampacity is 1050 amperes. After applying the multiplying factors, this reduces to  $1050 \times 0.83 \times 0.90 = 785$  amp. Entering Fig. 3-14 at intersection of 60°C rise and 785 amp, and following down an imaginary diagonal that is parallel to an adjacent diagonal, it is noted that this intersects the 35°C line at 630 amp, the same value as previously obtained.

*Emissivity Limitations for Figs. 3-11 to 3-14*

An emissivity of  $\epsilon = 0.5$  is the maximum assumed for weathering conditions at high altitudes (10,000 ft). The maximum assumed emissivity for a fully weathered conductor in normal altitude is 0.91.

*Conductor Economics*

The high cost of energy and generation facilities has made it very important that power losses be evaluated when selecting the correct conductor size to be used in a given project. Construction and energy costs have increased dramatically during the past decade, and this trend seems likely to continue. The Aluminum Association publication, "The Evaluation of Losses in Conductors," provides details on how such an economic analysis could be done.

\* The method described is based solely on comparative I<sup>2</sup>R loss, and the values obtained are conservative. If correction is made for the slight change of R<sub>ac</sub>/R<sub>dc</sub> ratio caused by change of inductance, a slight increase of ampacity, of the order of 1% or 2% in this instance is obtained.

bare aluminum wire and cable

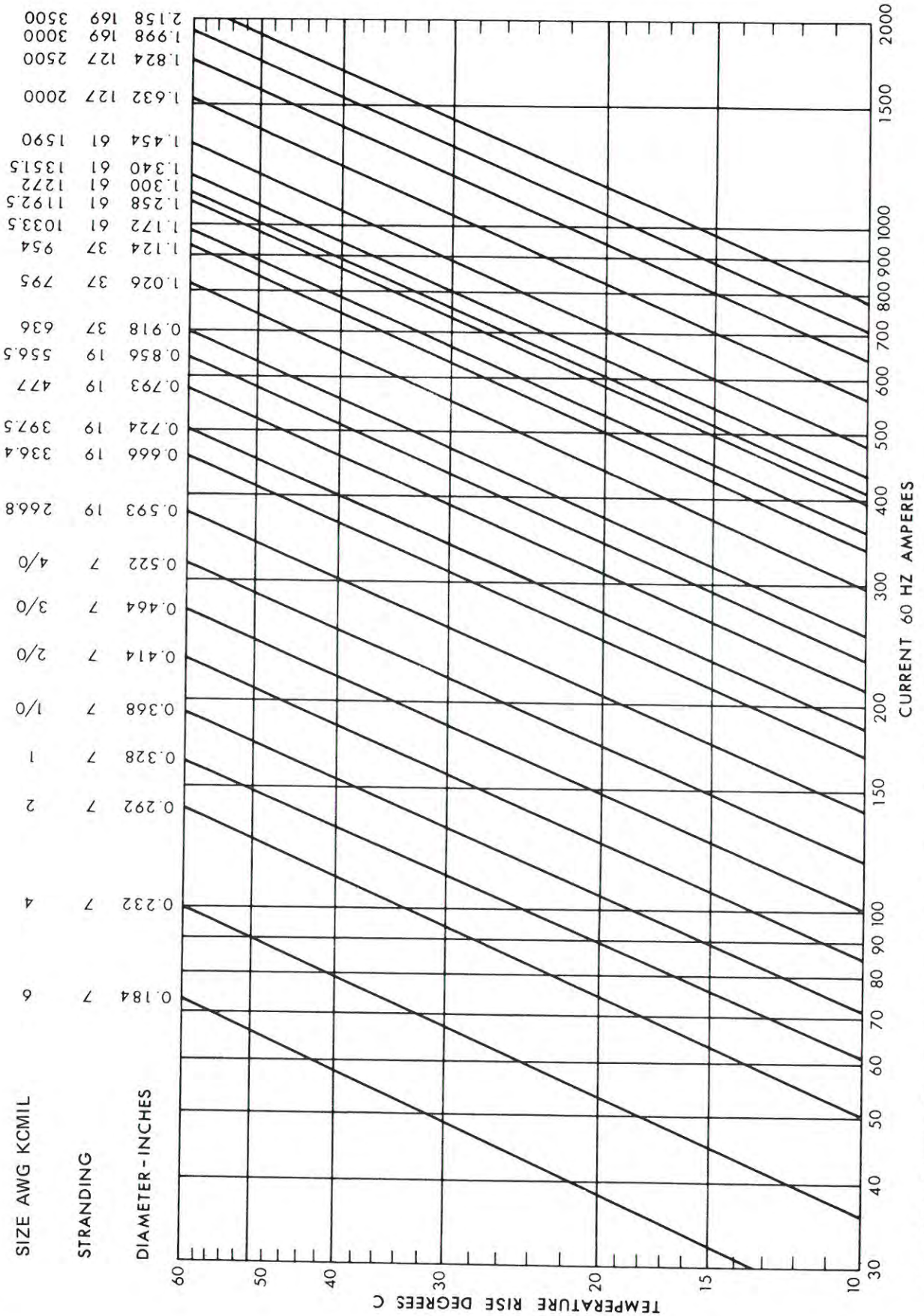

Fig. 3-11. Current-Temperature-Rise Graph for Ampacity of Bare Aluminum Cable Stranded 1350-H19 62% IACS Still Air, Ambient Temperature 40°C Emissivity (ε) 0.5. For 61.2% IACS, multiply values by 0.994. No Sun-Sea Level. For multiplying factors for various sun and emissivities, and for high altitudes, see Fig. 3-15, Chart A.

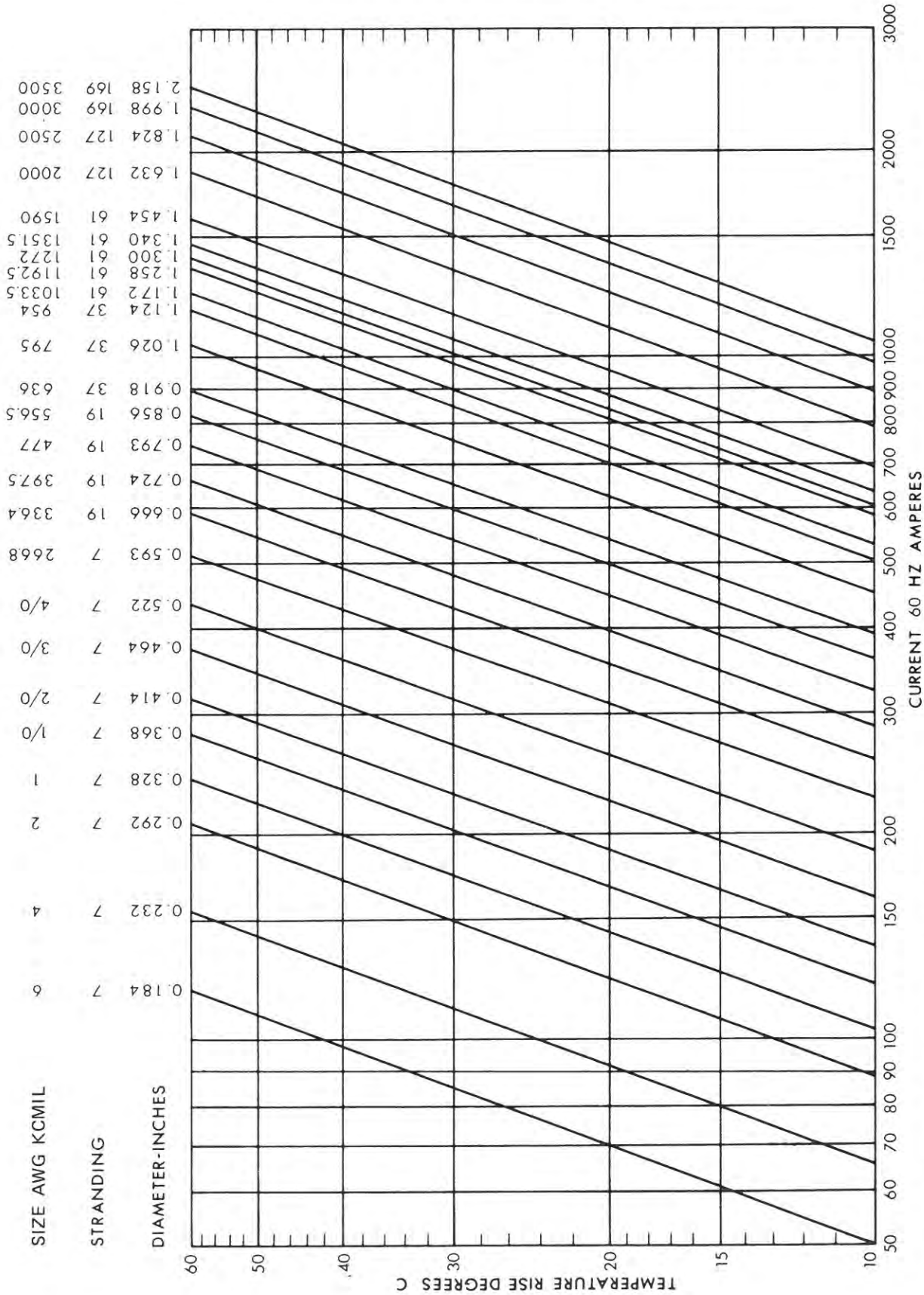

Fig. 3-12. Current-Temperature-Rise Graph for Ampacity of Bare Aluminum Cable Stranded 1350-H19 62% IACS Still Wind 2 fps, Ambient Temperature 40°C Emissivity (ε) 0.5. For 61.2% IACS, multiply values by 0.994. No Sun-Sea Level. For multiplying factors for various sun and emissivities, and for high altitudes, see Fig. 3-15, Chart B.

bare aluminum wire and cable

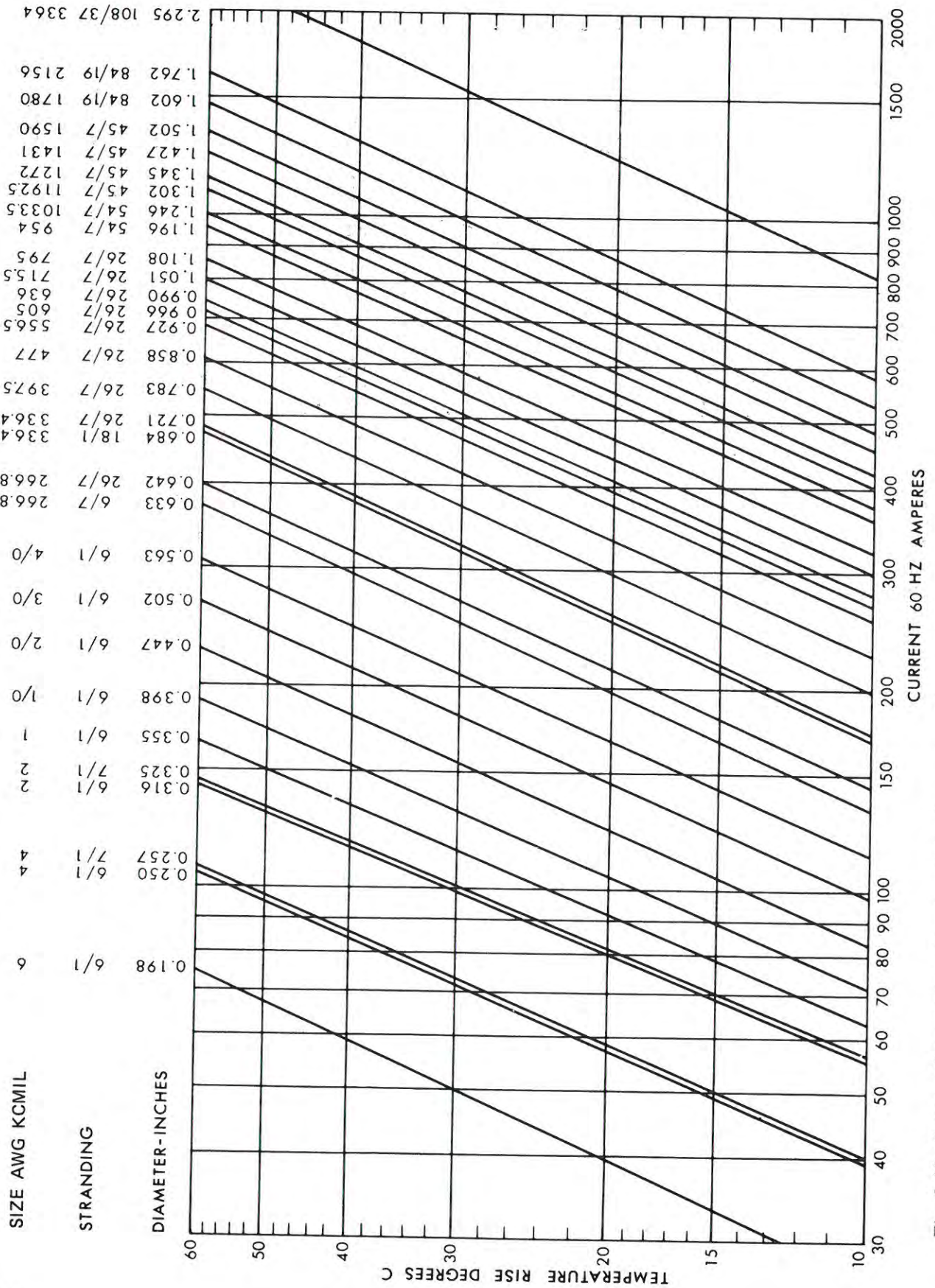

Fig. 3-13. Current-Temperature-Rise Graph for Ampacity of Bare ASCR 62% IACS Still Air, Ambient Temperature 40°C Emissivity (ε) 0.5. For 61.2% IACS, multiply values by 0.994. No Sun-Sea Level. For multiplying factors for various sun and emissivities, and for high altitudes, see Fig. 3-15, Chart C.

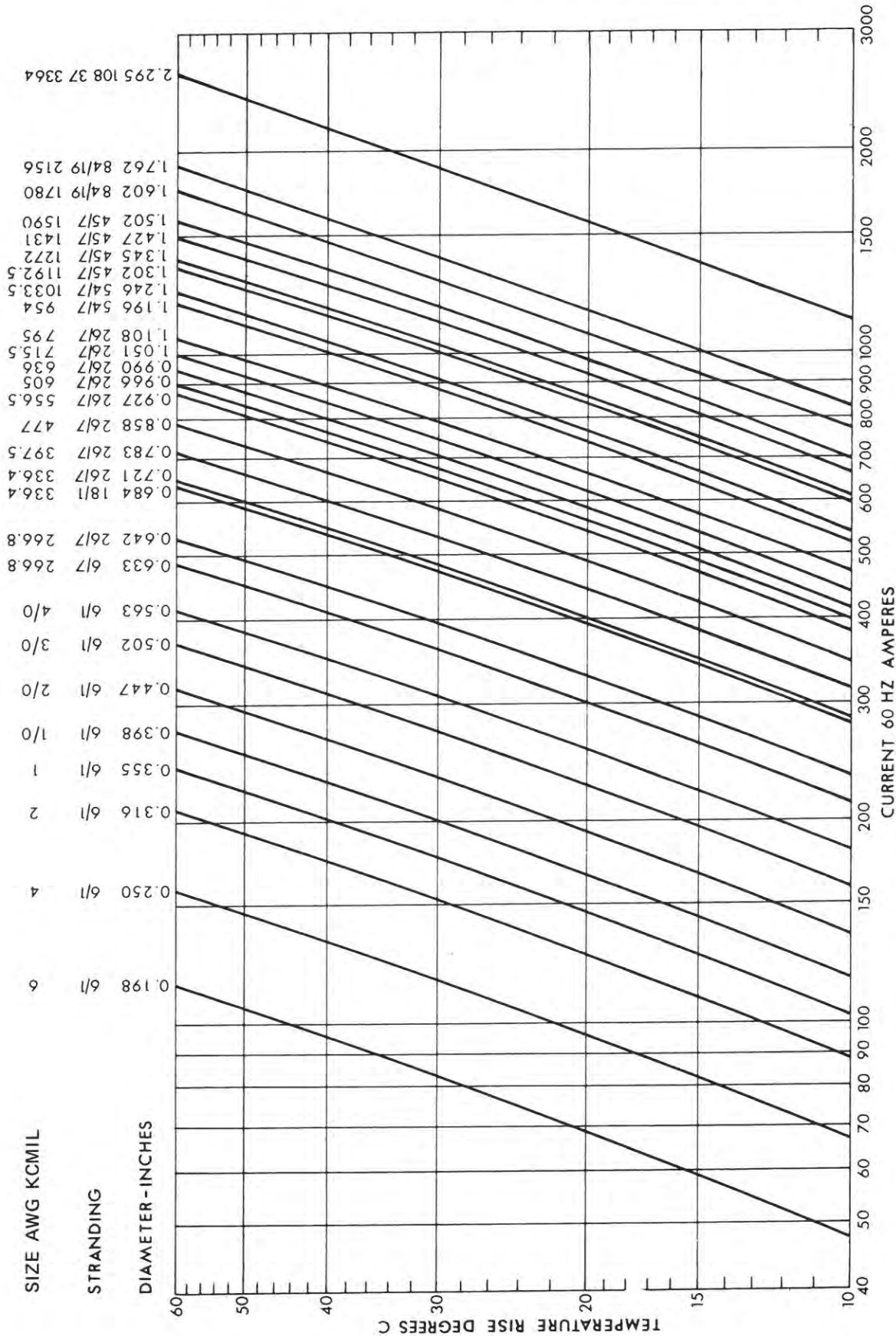
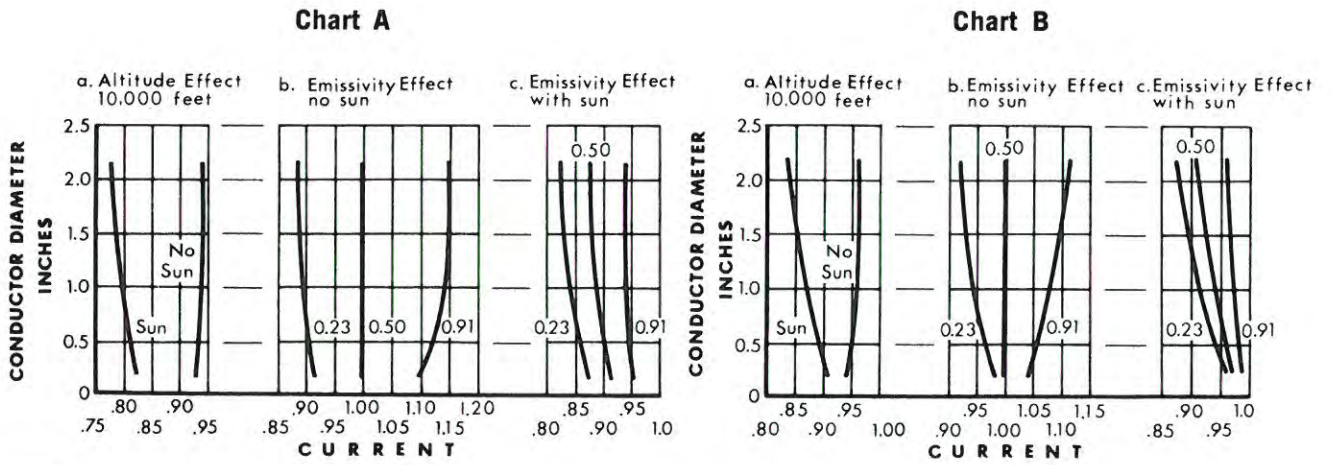

Fig. 3-14. Current-Temperature-Rise Graph for Ampacity of Bare ACSR 62% IACS Wind 2 fps, Ambient Temperature 40°C Emissivity (ε) 0.5. For 61.2% IACS, multiply values by 0.994. No Sun-Sea Level. For multiplying factors for various sun and emissivities, and for high altitudes, see Fig. 3-15, Chart D.

bare aluminum wire and cable



A—For stranded 1350 in still air. Fig. 3-11.

B—For stranded 1350-wind 2 fps. Fig. 3-12.

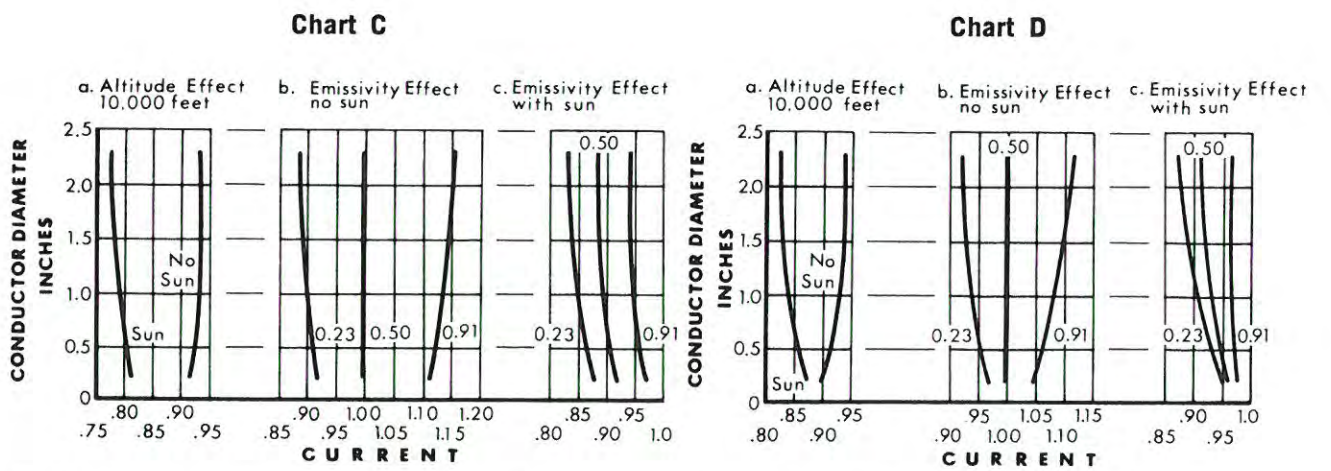

C—For stranded ACSR in still air. Fig. 3-13.

D—For stranded ACSR-wind 2 fps. Fig. 3-14.

Fig. 3-15 (A, B, C, and D)—Multiplying factor for various conditions of emissivity ( $\epsilon$ ), sun, and altitude.

Multiply the ampacity value obtained from Figs. 3-11 to 3-14 for 60°C rise inclusive by the applicable factor at bottom of diagram corresponding to the associated ampacity curve.

Chapter 4

## Product Identification and Data

This chapter supplements Chapter 3 with tables of mechanical and electrical properties of specified sizes of commercially available bare conductors. Some of the bare-conductor data is also applicable to conductors that are covered with weather-resistant materials, which provide moderate protection against corrosion and abrasion but have no voltage rating. Further information regarding weather-resistant coverings is in Chapters 7 and 8.

### *Service Application of Bare Conductors*

The typical electric power system has many applications for bare stranded conductors, from the strain bus at the generation plant substation through the transmission conductors and overhead ground wires to the distribution system and the neutrals for service drops.

### **Product Classification of Bare Aluminum Conductors**

The alloy and conductor-type designations used for bare aluminum conductors are described in Chapter 3. They are summarized below to aid reference to the various tables herein:

#### *1. Homogeneous designs of aluminum conductor consists of:*

- AAC (see Aluminum Conductor):  
1350-H19 (Standard Round of Compact Round)
- AAC/TW (Shaped Wire):  
1380-H19 (Trapezoidal wire)
- AAAC (see Aluminum Alloy Conductor):  
6201-T81

#### *2. Composite designs of aluminum conductor consist of:*

- ACSR (Aluminum Conductor Steel Reinforced):  
1350-H19 Aluminum strands with:  
Class A (Standard Weight) Coated  
Galvanized Steel Core (ACSR)
- ACSR (Compact Round):  
1350-H19 Strand. Outside diameter reduced  
after stranding.

ACSR/TW (Shaped Wire):  
1350-H19 Trapezoidal wire

ACAR (Aluminum Conductor Alloy Reinforced):  
1350-H19 and Strands of 6201-T81

Aluminum-Clad Steel Wire and Strand

3. *Expanded core designs for EHV generally use 1350-H19 strands for conductance along with steel reinforcement. Expansion is by open helices of aluminum wires, flexible concentric tubes or combinations of aluminum wires and fibrous ropes.*

No tables of properties of EHV cables are included herein because each project requires special analysis, and design practice is not as yet standardized. A typical example of an expanded-core cable is shown in Fig. 3-6.

*Note:* The above list comprises conductors that ordinarily are installed in bare condition; that is, without covering or insulation. As a convenience, tables also are included in this chapter that list modifications of the basic bare conductors which ordinarily are to be covered or insulated before use. Thus, all-aluminum conductors listed as with B, C, and D stranding are usually covered or insulated when in use, though may be bare for short lengths in apparatus, terminal leads, etc.

Tables 4-26 and 4-27 covering Aluminum Unilay 19 wire conductors and the 8000 series Aluminum Alloy conductors are included in this chapter in order to list the details of the various strandings for the bare condition. For information on their eventual applications reference should be made to the chapters in Section 3 on "Covered and Insulated Wire and Cable."

### **Product Identification**

For ease of reference, many of the various conductors are identified not only by size and description, but also by an industry *code word*, as registered with The Aluminum Association. The word may be that of a bird, flower, fish, etc. to which a suffix may be added to denote product variations. Other designations associated with the conductor such as AAC, AAAC, ACSR, ACAR, and the



## *bare aluminum wire and cable*

alloy temper designations, such as 1350-H19 and 6201-T81, have been explained in previous chapters. Use of the code word system and possible variations is described in the Aluminum Association publication "Code Words for Aluminum Electrical Conductors."

Common practice in conductor designation utilizes assumptions and abbreviations.

- A. For 1350 aluminum, the H19 temper is assumed.  
For 6201 alloy, the T81 temper is assumed.  
For ACSR, the core is assumed to have standard-weight galvanized class A steel core and 1350-H19 aluminum wires.
- B. Suffix notations that designate other than what is implied in *A* (above):

*For 1350-aluminum and Temper* (for physical properties, see Table 1-1)

- 1350-O designates fully annealed wire.
- 1350-H12 and -H22 designate 1/4-hard wire.
- 1350-H14 and -H24 designate 1/2-hard wire.
- 1350-H16 and -H26 designate 3/4-hard wire.

*For ACSR*

- GB designates Class B galvanized steel core wire.
- GC designates Class C galvanized steel core wire.
- AZ designates aluminized steel core wire.
- AW designates aluminum-clad steel core wire.
- "Comp" designates compact stranding.

### *Size Relationships*

The tables of properties of aluminum conductors herein show a larger number of sizes within a given range and

type of conductor than ordinarily would be expected. This comes about because replacement of one type of conductor by another is facilitated if they have equal dc resistance, or if their outside diameters are equal. Thus, the odd-size 477.0 kcmil 1350-H19 aluminum conductor has approximately the same dc resistance as 300.0 kcmil copper, and the 795.0 kcmil conductor corresponds to 500.0 kcmil copper. Similarly, some AAAC and ACAR conductors are sized for diameter equivalence with certain sizes of ACSR.

The wide range of breaking strengths of a given size of ACSR because of variations of steel-to-aluminum ratios also adds to the conductors available for transmission line design.

The trend in recent years, however, is toward reducing the number of generally available sizes that are based on equivalence with other conductors, and some larger-than-AWG all-aluminum conductors are now sized on the basis of 50,000 cmil increments. Hence each is not exactly the equivalent of any other type of conductor as to conductance or diameter.

### *Technical Data and Catalog Information*

The construction and properties of many kinds of bare aluminum conductors are covered by individual ASTM specifications and unless otherwise noted, data in this chapter are based on these specifications. Specification numbers and descriptions at time of this publication are shown in Table 4-1. Individual ASTM Specifications and a book, ASTM volume 02.03 Electrical Conductors, which includes all specifications pertaining to Metallic Electrical Conductors, are available at moderate cost from ASTM.\*

\* 1916 Race Street, Philadelphia, Pa. 19103

**LIST OF TABLES IN CHAPTER 4**

- 4-1 Titles and Numbers of ASTM Specifications for Bare Aluminum Conductors
- 4-2 Conductor Metals. Physical and Electrical Constants
- 4-3 Aluminum Wire Data. Tensile Strength and Elongation
- 4-4 Solid Round 1350 Aluminum Wires. Physical, Mechanical, and Electrical Properties.
- 4-5 AAC All-Aluminum 1350-H19 Stranded Conductors. Physical and Mechanical Properties.
- 4-6 AAC Electrical Properties of Conductors listed in Table 4-5
- 4-7 AAC All-Aluminum 1350-H19 Stranded Conductors. Physical and Electrical Properties for Even kcmil Sizes
- 4-8 AAC All-Aluminum 1350 of Various Hardnesses in Class B, C, and D Strandings. Physical and Mechanical Properties
- 4-9 AAC All-Aluminum 1350-H19 Compact Round Conductors. Physical and Electrical Properties
- 4-10 AAC/TW Shaped Wire Compact Conductors in Fixed Diameter Increments. Physical and Electrical Properties
- 4-11 AAC/TW Shaped Wire Compact Conductors. Areas Equal to Standard AAC Sizes. Physical and Electrical Properties
- 4-12 AAAC All-Aluminum Alloy Conductors 6201-T81 to ACSR Diameters. Physical and Electrical Properties
- 4-13 AAAC All-Aluminum Alloy Conductors 6201-T81 for Even AWG and kcmil Sizes. Physical and Electrical Properties
- 4-14 ACSR Aluminum Conductors, Steel Reinforced. Physical and Mechanical Properties of Galvanized A, B, and C and Aluminized (AZ) Core Sizes
- 4-15 ACSR Conductors Single-Layer sizes. Electrical Properties
- 4-16 ACSR Conductors Multi-Layer sizes. Electrical Properties
- 4-17 ACSR/AW Aluminum Conductors, Aluminum-Clad Steel Reinforced. Physical and Electrical Properties
- 4-18 ACSR Compact Round Conductors. Physical and Electrical Properties
- 4-19 ACSR/TW Shaped Wire Compact Conductors. Steel Reinforced, Sized to Standard ACSR Areas. Physical Properties
- 4-20 ACSR/TW Shaped Wire Compact Conductors. Steel Reinforced, Sized to Standard ACSR Areas. Electrical Properties
- 4-21 ACSR/TW Shaped Wire Compact Conductors. Steel Reinforced, Sized to Have Diameters Equal to Standard ACSR. Physical Properties
- 4-22 ACSR/TW Shaped Wire Compact Conductors. Steel Reinforced, Sized to Have Diameters Equal to Standard ACSR. Electrical Properties
- 4-23 ACAR Aluminum Conductor Alloy Reinforced. Physical and Electrical Properties
- 4-24 AW Aluminum-Clad Wire and Strand. Physical and Electrical Properties
- 4-25 AWAC Aluminum Conductors with Aluminum Clad Steel Wires as Reinforcement. Physical and Electrical Properties
- 4-26 AAC All-Aluminum 1350 Combination Unilay 19 Wire Stranded Conductors. Physical and Electrical Properties
- 4-27 AAAC All-Aluminum Alloy Conductors 8XXX Series. Physical and Electrical Properties

**TABLE 4-1**  
**ASTM Standard Specifications for Bare Aluminum Conductors**

---

Standard No.	
B 230	Aluminum 1350-H19 Wire for Electrical Purposes
B 231	Aluminum 1350 Conductors, Concentric-Lay-Stranded (AAC)
B 232	Concentric-Lay-Stranded Aluminum Conductors, Coated, Steel-Reinforced (ACSR)
B 258	Standard Nominal Diameters and Cross-sectional Areas of Solid Round Wires
B 341	Aluminum-Coated (Aluminized) Steel Core Wire for Aluminum Conductors, Steel Reinforced (ACSR/AZ)
B 396	Aluminum-Alloy 5005-H19 Wire for Electrical Purposes
B 397	Concentric-Lay-Stranded Aluminum-Alloy 5005-H19 Conductors
B 398	Aluminum-Alloy 6201-T81 Wire for Electrical Purposes
B 399	Concentric-Lay-Stranded Aluminum-Alloy 6201-T81 Conductors
B 400	Compact Round Concentric-Lay-Stranded 1350 Aluminum Conductors
B 401	Compact Round Concentric-Lay-Stranded Aluminum Conductors, Steel Reinforced (ACSR/COMP)
B 415	Hard-Drawn Aluminum-Clad Steel Wire
B 416	Concentric-Lay-Stranded Aluminum-Clad Steel Conductors
B 498	Zinc-Coated (Galvanized) Steel Core Wire for Aluminum Conductors, Steel Reinforced (ACSR)
B 500	Stranded Steel Core for Aluminum Conductor, Zinc-Coated (Galvanized), Steel-Reinforced (ACSR)
B 502	Aluminum-Clad Steel Core Wire for Aluminum Conductors, Aluminum-Clad Steel-Reinforced
B 524	Concentric-Lay-Stranded Aluminum Conductors, Aluminum Alloy Reinforced (ACAR and 1350/6201)
B 549	Concentric-Lay-Stranded Aluminum Conductors, Aluminum Clad Steel-Reinforced, (ACSR/AW)
B 606	High-Strength Zinc-Coated (Galvanized) Steel Core Wire for Aluminum and Aluminum-Alloy Conductors, Steel Reinforced
B 609	Aluminum 1350 Round Wire, Annealed and Intermediate Tempers for Electrical Purposes
B 682	Standard Metric Sizes of Electrical Conductors
B 701	Concentric-Lay-Stranded Self-Damping Aluminum Conductors, Steel Reinforced (ACSR/SD)
B 711	Concentric-Lay-Stranded Aluminum-Alloy Conductors, Steel Reinforced (AACSR) (6201)
B 778	Shaped Wire Compact Concentric-Lay-Stranded Aluminum Conductors (AAC/TW)
B 779	Shaped Wire Compact Concentric-Lay-Stranded Aluminum Conductors, Steel Reinforced (ACSR/TW)
B 786	19 Wire Combination Unilay-Stranded Aluminum 1350 Conductors
B 800	8XXX Series Aluminum Alloy Wire for Electrical Purposes
B 801	Aluminum Alloy 8XXX Concentric-Lay-Stranded Conductors for Subsequent Covering or Insulation

---

**TABLE 4-2**  
**Conductor Metals\***  
**Physical and Electrical Constants**

	1350-H19 Aluminum	8000-H12 -H22 Aluminum	6201-T81 Aluminum	HD Copper	Galvanized Steel	25% Aluminum-Clad Steel AW**
Min. average conductivity, percent IACS at 20°C	61.2	61.0	52.5	96.16	8.0	20.3
Max. average resistance at 20°C Ohm-cmil/ft	16.946	17.002	19.755	10.785	129.64	51.01
Temp. coefficient of resistance per degree C at 20°C	0.00404	0.00403	0.00347	0.00378	0.00290	0.0036
Density at 20°C***						
Grams per cubic centimeter	2.705	2.710	2.690	8.89	7.78	6.59
Lb. per cubic inch	0.0975	0.098	0.097	0.321	0.281	0.2381
Coefficient of Linear Expansion per degree F	0.0000128	0.0000128	0.0000128	0.0000094	0.0000064	0.0000072
Modulus of Elasticity, Solid Wire						
Approximate, Lb. per sq. in.	10,000,000	10,000,000	10,000,000	17,000,000	29,000,000	23,500,000

\*Drawn or finished wire.

\*\*Note: Aluminum-clad steel wire is being produced typically in a grade with the concentric aluminum covering comprising 25% of the cross-sectional area of the wire and a guaranteed minimum thickness of 10% of the wire radius.

\*\*\*For the purpose of calculating weights.

bare aluminum wire and cable

**TABLE 4-3**  
**Aluminum Wire Data**  
**Tensile Strength and Elongation**

(ASTM Specifications)

Wire Diameter (Inches)	1350-H19 Aluminum (B 230)			6201-T81 (B 398)		
	Tensile Strength ksi		Elongation in 10" for Indiv. Tests—Min. %	Tensile Strength ksi		Elongation in 10" for Indiv. Tests—Min. %
	Average for Lot	Individual Test		Average for Lot	Individual Test	
0.2600 to 0.2101	23.5	22.5	2.2	—	—	—
0.2100 to 0.1801	24.0	23.0	2.0	—	—	—
0.1878 to 0.1801	—	—	—	46.0	44.0	3.0
0.1800 to 0.1501	24.0	23.0	1.9	46.0	44.0	3.0
0.1500 to 0.1401	24.5	23.5	1.8	46.0	44.0	3.0
0.1400 to 0.1328	—	—	—	46.0	44.0	3.0
0.1400 to 0.1201	25.0	23.5	1.7	—	—	—
0.1327 to 0.1201	—	—	—	48.0	46.0	3.0
0.1200 to 0.1101	25.5	23.5	1.7	48.0	46.0	3.0
0.1100 to 0.1001	26.0	24.5	1.5	48.0	46.0	3.0
0.1000 to 0.0901	27.0	25.5	1.5	48.0	46.0	3.0
0.0800 to 0.0701	28.0	26.5	1.4	48.0	46.0	3.0
0.0700 to 0.0612	—	—	—	48.0	46.0	3.0
0.0700 to 0.0601	28.5	27.0	1.3	—	—	—
0.0600 to 0.0501	29.0	27.0	1.2	—	—	—
0.0500 to 0.0105	25.0	23.0	—	—	—	—

**TABLE 4-4**  
**Solid Round 1350 Aluminum Wires**  
**Sizes, Weights, dc Resistance, and Nominal Breaking Strength**

Wire Size AWG	Wire Diameter Inches	Area		1350 Aluminum Wire					Geometric Mean Radius GMR ft
		Circular Mils	Square Inches	Weight Per 1,000 ft lb	dc Resist- ance per Mile at 20°C Ohms	Nominal Breaking Strength lb			
						Full Hard 1350-H19	Three- quarter Hard 1350-H16 1350-H26	One- half Hard 1350-H14 1350-H24	
0000	0.4600	211,600	0.1662	194.7	0.4228	3822	2825	2493	0.0149
000	0.4096	167,800	0.1318	154.4	0.5333	3031	2241	1977	0.0133
00	0.3648	133,100	0.1045	122.5	0.6723	2404	1777	1568	0.0118
0	0.3249	105,600	0.08291	97.15	0.8476	1907	1409	1244	0.0105
1	0.2893	83,690	0.06573	77.03	1.0691	1512	1117	986.0	0.00939
2	0.2576	66,360	0.05212	61.07	1.348	1225	886.0	781.8	0.00836
3	0.2294	52,620	0.04133	48.43	1.700	971.3	702.6	620.0	0.00744
4	0.2043	41,740	0.03278	38.41	2.144	786.8	557.3	491.7	0.00663
5	0.1819	33,090	0.02599	30.45	2.704	623.7	441.8	389.9	0.00590
6	0.1620	26,240	0.02061	24.15	3.409	494.7	350.4	309.2	0.00526
7	0.1443	20,820	0.01635	19.16	4.297	400.7	278.0	245.3	0.00468
8	0.1285	16,510	0.01297	15.20	5.419	324.2	220.5	194.6	0.00417
9	0.1144	13,090	0.01028	12.04	6.837	262.1	174.8	154.2	0.00371
10	0.1019	10,380	0.00816	9.556	8.617	212.0	138.6	122.3	0.00331
11	0.0907	8,230	0.00646	7.57	10.876	174.4	109.8	96.9	0.00294
12	0.0808	6,530	0.00513	6.01	13.70	141.00	87.21	76.95	0.00262
13	0.0720	5,180	0.00407	4.77	17.26	114.00	69.19	61.05	0.00234
14	0.0641	4,110	0.00323	3.78	21.78	91.97	54.91	48.45	0.00208
15	0.0571	3,260	0.00256	3.00	27.44	74.26	43.52	38.40	0.00185
16	0.0508	2,580	0.00203	2.38	34.67	58.78	34.51	30.45	0.00165
17	0.0453	2,050	0.00161	1.890	43.60	40.29	27.37	24.15	0.00147
18	0.0403	1,620	0.00128	1.495	55.09	31.89	21.76	19.20	0.00131
19	0.0359	1,290	0.00101	1.186	69.42	25.31	17.17	15.15	0.00116
20	0.0320	1,020	0.000804	0.942	87.38	20.11	13.67	12.06	0.00104
21	0.0285	812	0.000638	0.748	110.2	15.95	10.85	9.57	0.00092
22	0.0253	640	0.000503	0.589	139.8	12.57	8.551	7.545	0.00082
23	0.0226	511	0.000401	0.470	175.2	10.03	6.817	6.015	0.00073
24	0.0201	404	0.000317	0.372	221.5	7.93	5.389	4.755	0.00065
25	0.0179	320	0.000252	0.295	279.3	6.29	4.284	3.780	0.00058
26	0.0159	253	0.000199	0.233	353.9	4.96	3.383	2.985	0.00052
27	0.0142	202	0.000158	0.186	443.7	3.96	2.686	2.370	0.00046
28	0.0126	159	0.000125	0.146	563.6	3.12	2.125	1.875	0.00041
29	0.0113	128	0.000100	0.118	700.7	2.51	1.700	1.500	0.00037

1. Data shown are subject to normal manufacturing tolerances.
2. Breaking strength value of 1350-H19 are based on minimum average tensile strength of ASTM B 230.
3. Three-quarter (3/4) and half hard wire shall not break at a value less than shown above. These strengths are based on minimum of 17,000 psi for 3/4 hard and 15,000 psi for half hard. Published values above take into account nominal wire area.
4. Electrical resistance is based on the electrical conductivity of 61.2% IACS.

**TABLE 4-5**  
**All-Aluminum Concentric-Lay Class AA and A Stranded Bare Conductors**  
**Area, Weight, and Strength of AWG and kcmil Sizes**  
**Physical Properties 1350-H19 ASTM B 231**

Bold face code words indicate sizes most often used.

Code Word	Size AWG or kcmil	Stranding Class	Total Number of Wires	Wire Diameter in.	Conductor Diameter in.	Area Square in.	Weight per 1000 ft lb	Rated Strength lb
Peachbell	6	A	7	0.0612	0.184	0.0206	24.6	583
<b>Rose</b>	4	A	7	0.0772	0.232	0.0328	39.1	881
<b>Iris</b>	2	A,AA	7	0.0974	0.292	0.0521	62.2	1,350
Pansy	1	A,AA	7	0.1093	0.328	0.0657	78.4	1,640
Poppy	1/0	A,AA	7	0.1228	0.368	0.0829	98.9	1,990
<b>Aster</b>	2/0	A,AA	7	0.1379	0.414	0.1045	124.8	2,510
Phlox	3/0	A,AA	7	0.1548	0.464	0.1318	157.2	3,040
<b>Oxlip</b>	4/0	A,AA	7	0.1739	0.522	0.1662	198.4	3,830
<b>Daisy</b>	266.8	AA	7	0.1952	0.586	0.2095	250.2	4,830
Laurel	266.8	A	19	0.1185	0.593	0.2095	250.1	4,970
Tulip	336.4	A	19	0.1331	0.666	0.2644	315.5	6,150
Canna	397.5	A,AA	19	0.1447	0.724	0.3122	372.9	7,110
Cosmos	477.0	AA	19	0.1584	0.792	0.3744	446.8	8,360
<b>Syringa</b>	477.0	A	37	0.1135	0.795	0.3744	446.8	8,690
Dahlia	556.5	AA	19	0.1711	0.856	0.4371	521.4	9,750
<b>Mistletoe</b>	556.5	A	37	0.1226	0.858	0.4371	521.3	9,940
<b>Orchid</b>	636.0	A,AA	37	0.1311	0.918	0.4995	596.0	11,400
<b>Violet</b>	715.5	AA	37	0.1391	0.974	0.5620	671.0	12,800
Nasturtium	715.5	A	61	0.1083	0.975	0.5620	671.0	13,100
<b>Arbutus</b>	795.0	AA	37	0.1466	1.026	0.6244	745.3	13,900
Lilac	795.0	A	61	0.1142	1.028	0.6244	745.7	14,300
Anemone	874.5	AA	37	0.1538	1.077	0.6868	820.3	15,000
Crocus	874.5	A	61	0.1198	1.078	0.6868	820.6	15,800
<b>Magnolia</b>	954.0	AA	37	0.1606	1.124	0.7493	894.5	16,400
Goldenrod	954.0	A	61	0.1251	1.126	0.7493	894.8	16,900
<b>Bluebell</b>	1,033.5	AA	37	0.1672	1.170	0.8117	968.4	17,700
Larkspur	1,033.5	A	61	0.1302	1.172	0.8117	969.2	18,300
<b>Marigold</b>	1,113.0	A,AA	61	0.1351	1.216	0.8741	1044	19,700
Hawthorn	1,192.5	A,AA	61	0.1398	1.258	0.9366	1117	21,100
<b>Narcissus</b>	1,272.0	A,AA	61	0.1444	1.300	0.9990	1192	22,000
Columbine	1,351.5	A,AA	61	0.1489	1.340	1.062	1266	23,400
<b>Carnation</b>	1,431.0	A,AA	61	0.1532	1.379	1.124	1342	24,300
Gladiolus	1,510.5	A,AA	61	0.1574	1.417	1.186	1417	25,600
<b>Coreopsis</b>	1,590.0	AA	61	0.1615	1.454	1.249	1489	27,000

1. Data shown are subject to normal manufacturing tolerances.

2. Class AA stranding is usually specified for bare conductors used on overhead lines. Class A stranding is usually specified for conductors to be covered with weather-resistant (weatherproof) materials and used for bare conductors where greater flexibility is required than afforded by Class AA. The direction of lay of the outside layer of wires with Class AA and Class A will be right-hand, unless otherwise specified.

**TABLE 4-6**  
**All-Aluminum Concentric-Lay Class AA and A Stranded Bare Conductors**  
**Electrical Properties of Sizes Listed in Table 4-5**  
**1350-H19 ASTM B 231**

**Bold face** code words indicate sizes most often used.

Code Word	Size AWG or kcmil	Resistance				GMR ft	Phase-to-Neutral 60 Hz Reactance at One ft Spacing	
		dc 20°C Ohms/ Mile	ac – 60 hz				Inductive Ohms/Mile X <sub>a</sub>	Capacitive Megohm-Miles X' <sub>a</sub>
			25°C Ohms/ Mile	50°C Ohms/ Mile	75°C Ohms/ Mile			
Peachbell	6	3.481	3.551	3.903	4.255	0.00555		
<b>Rose</b>	4	2.188	2.232	2.453	2.674	0.00700	0.630	0.145
<b>Iris</b>	2	1.374	1.402	1.541	1.680	0.00883	0.602	0.138
Pansy	1	1.091	1.114	1.224	1.334	0.00991	0.574	0.131
							0.560	0.127
Poppy	1/0	0.8646	0.882	0.970	1.057	0.0111	0.546	0.124
<b>Aster</b>	2/0	0.6856	0.700	0.769	0.838	0.0125	0.532	0.120
Phlox	3/0	0.5441	0.556	0.611	0.665	0.0140	0.518	0.117
<b>Oxlip</b>	4/0	0.4311	0.441	0.484	0.528	0.0158	0.504	0.114
<b>Daisy</b>	266.8	0.3418	0.350	0.384	0.419	0.0177	0.489	0.110
Laurel	266.8	0.3421	0.350	0.384	0.419	0.0187	0.483	0.110
Tulip	336.4	0.2711	0.278	0.305	0.332	0.0210	0.469	0.106
Canna	397.5	0.2294	0.235	0.258	0.282	0.0228	0.459	0.104
Cosmos	477.0	0.1914	0.197	0.216	0.235	0.0250	0.448	0.101
<b>Syringa</b>	477.0	0.1915	0.197	0.216	0.235	0.0254	0.446	0.101
Dahlia	556.5	0.1641	0.169	0.186	0.202	0.0270	0.438	0.0989
<b>Mistletoe</b>	556.5	0.1641	0.169	0.186	0.202	0.0275	0.436	0.0988
<b>Orchid</b>	636.0	0.1435	0.149	0.163	0.177	0.0294	0.428	0.0968
<b>Violet</b>	715.5	0.1275	0.132	0.145	0.158	0.0312	0.421	0.0951
Nasturtium	715.5	0.1276	0.133	0.145	0.158	0.0314	0.420	0.0950
<b>Arbutus</b>	795.0	0.1148	0.120	0.131	0.142	0.0328	0.415	0.0935
Lilac	795.0	0.1147	0.120	0.131	0.142	0.0331	0.414	0.0935
Anemone	874.5	0.1043	0.109	0.120	0.130	0.0344	0.409	0.0921
Crocus	874.5	0.1043	0.109	0.120	0.130	0.0347	0.408	0.0920
<b>Magnolia</b>	954.0	0.09563	0.101	0.110	0.120	0.0360	0.403	0.0908
Goldenrod	954.0	0.09560	0.101	0.110	0.119	0.0362	0.403	0.0908
<b>Bluebell</b>	1033.5	0.08823	0.0933	0.102	0.111	0.0374	0.399	0.0896
Larkspur	1033.5	0.08826	0.0933	0.102	0.111	0.0377	0.398	0.0896
<b>Marigold</b>	1113.0	0.08197	0.0872	0.0951	0.103	0.0391	0.393	0.0885
Hawthorn	1192.5	0.07655	0.0819	0.0893	0.0968	0.0405	0.389	0.0875
<b>Narcissus</b>	1272.0	0.07175	0.0772	0.0841	0.0911	0.0418	0.385	0.0865
Columbine	1351.5	0.06748	0.0731	0.0795	0.0861	0.0431	0.381	0.0856
<b>Carnation</b>	1431.0	0.06375	0.0695	0.0756	0.0817	0.0444	0.378	0.0847
Gladiolus	1510.5	0.06039	0.0663	0.0720	0.0778	0.0456	0.375	0.0839
<b>Coreopsis</b>	1590.0	0.06736	0.0634	0.0688	0.0743	0.0468	0.372	0.0832

1. Direct current (dc) resistance is based on 16.946 ohm-cmil/ft at 20°C for 1350 aluminum nominal area of conductor with standard stranding increments ASTM B 231.

2. Alternating current (ac) resistance is based on dc resistance corrected for temperature, using 0.00404 as temperature coefficient of resistivity per degrees C° at 20°C and for skin effect.

3. For ampacity ratings of bare conductors, see Fig. 3-11 and 3-12.



**TABLE 4-7**  
**All-Aluminum Concentric-Lay Class AA and A Bare Stranded Conductors 1350-H19 ASTM B 231**  
**Physical and Electrical Properties of Even kcmil Sizes**

**Bold face code words indicate sizes most often used.**

Code Word	Size kcmil	Stranding Class	Total Number of Wires	Wire Diameter in.	Conductor Diameter in.	Area Sq. in.	Weight per 1000 ft lb	Rated Strength lb	dc Ohms per Mile 20°C	Resistance ac—60 Hz			Phase-to-Neutral 60 Hz Reactance at One Foot Spacing		
										25°C Ohms/ Mile	50°C Ohms/ Mile	75°C Ohms/ Mile	GMR ft	Inductive Ohms per Mile X <sub>a</sub>	Shunt Capacitive Megohm- Miles X <sub>a</sub>
<b>Sneezewort</b>	250	AA	7	0.1890	0.567	0.1964	234.4	4,520	0.3650	0.373	0.410	0.447	0.0171	0.493	0.111
Valerian	250	A	19	0.1147	0.574	0.1964	234.3	4,660	0.3651	0.373	0.410	0.447	0.0181	0.487	0.111
<b>Peony</b>	300	A	19	0.1257	0.629	0.2356	281.4	5,480	0.3040	0.311	0.342	0.372	0.0198	0.476	0.108
<b>Daffodil</b>	350	A	19	0.1357	0.679	0.2749	327.9	6,390	0.2609	0.267	0.294	0.320	0.0214	0.466	0.106
<b>Goldentuft</b>	450	AA	19	0.1539	0.770	0.3534	421.8	7,890	0.2028	0.208	0.229	0.249	0.0243	0.451	0.102
Zinnia	500	AA	19	0.1622	0.811	0.3927	468.5	8,760	0.1826	0.188	0.206	0.225	0.0256	0.445	0.101
<b>Hyacinth</b>	500	A	37	0.1162	0.813	0.3927	468.3	9,110	0.1827	0.188	0.206	0.225	0.0260	0.443	0.100
Meadowsweet	600	AA,A	37	0.1273	0.891	0.4712	562.0	10,700	0.1522	0.157	0.172	0.188	0.0285	0.432	0.0977
<b>Verbena</b>	700	AA	37	0.1375	0.963	0.5498	655.7	12,500	0.1305	0.135	0.148	0.161	0.0308	0.422	0.0954
Flag	700	A	61	0.1071	0.964	0.5498	655.8	12,900	0.1304	0.135	0.148	0.161	0.0310	0.421	0.0954
<b>Petunia</b>	750	AA	37	0.1424	0.997	0.5890	703.2	13,100	0.1216	0.127	0.139	0.151	0.0319	0.418	0.0944
Cattail	750	A	61	0.1109	0.998	0.5890	703.2	13,500	0.1217	0.127	0.139	0.151	0.0321	0.417	0.0943
<b>Cockscomb</b>	900	AA	37	0.1560	1.092	0.7096	844.0	15,400	0.1014	0.106	0.116	0.126	0.0349	0.407	0.0917
Snapdragon	900	A	61	0.1215	1.094	0.7069	844.0	15,900	0.1014	0.106	0.116	0.126	0.0352	0.406	0.0916
<b>Hawkweed</b>	1,000	AA	37	0.1644	1.151	0.7854	937.3	17,200	0.09126	0.0963	0.105	0.114	0.0368	0.401	0.0901
Camellia	1,000	A	61	0.1280	1.152	0.7854	936.8	17,700	0.09132	0.0964	0.105	0.114	0.0371	0.400	0.0901
Jessamine	1,750	AA	61	0.1694	1.525	1.374	1641	29,700	0.05214	0.0585	0.0634	0.0683	0.0490	0.366	0.0818
<b>Cowslip</b>	2,000	A	91	0.1482	1.630	1.570	1873	34,200	0.04566	0.0525	0.0567	0.0609	0.0526	0.357	0.0798
Lupine	2,500	A	91	0.1657	1.823	1.962	2365	41,900	0.03689	0.0446	0.0479	0.0512	0.0588	0.344	0.0765
<b>Trillium</b>	3,000	A	127	0.1537	1.998	2.350	2840	50,300	0.03072	0.0392	0.0418	0.0445	0.0646	0.332	0.0737
Bluebonnet	3,500	A	127	0.1660	2.158	2.749	3345	58,700	0.02659	0.0357	0.0379	0.0402	0.0697	0.323	0.0715

1. Data shown are subject to normal manufacturing tolerances.  
 2. Class AA stranding is usually specified for bare conductors used on overhead lines. Class A stranding is usually specified for conductors to be covered with weather-resistant (weatherproof) materials and for bare conductors where greater flexibility is required than afforded by Class AA. The direction of lay of the outside layer of wires with Class AA and Class A will be right-hand unless otherwise specified.  
 3. Direct current (dc) resistance is based on 16.946 ohm-cmil/ft at 20°C for nominal area of the conductor with standard stranding increments ASTM B 231.  
 4. Alternating current (ac) resistance is based on dc resistance corrected for temperature, using 0.00404 as temperature coefficient of resistivity per degrees C° at 20°C and for skin effect.  
 5. For ampacity ratings of bare conductors, see Figs. 3-11 and 3-12.

**TABLE 4-8**  
**All-Aluminum Concentric-Lay Class B, C, and D Stranded Bare Conductors**  
**Physical Properties—ASTM B 231**  
**1350-H19 (Hard Drawn); 1350-H16 & -H26 (3/4 Hard); 1350-H14 & -H24 (1/2 Hard)**

Direct current (dc) resistance is the same as given in Tables 4-6 and 4-7 for corresponding sizes; ac resistance and reactance may be taken as the values for Class A conductors of equivalent size, as the slight difference caused by stranding variation is not significant in usual engineering calculations. For ampacity ratings of bare conductors, interpolate from Figs. 3-11 and 3-12.

Conductor Size		Stranding		Conductor Dia., in.	Rated Strength lb			Weight per 1,000 ft lb
		Class	Number and Dia. of Wires, in.		1350-H19	1350-H26 1350-H16	1350-H24 1350-H14	
AWG or kcmil	Square Inches							
6	0.0206	B	7x0.0612	0.184	563	336	297	24.6
6	0.0207	C	19x0.0372	0.186	480	326	287	24.6
6	0.0206	D	37x0.0266	0.186	468	318	280	24.6
4	0.0328	B	7x0.0772	0.232	881	535	472	39.1
4	0.0328	C	19x0.0469	0.235	763	519	458	39.1
4	0.0328	D	37x0.0336	0.235	746	508	448	39.1
2	0.0522	B	7x0.0974	0.292	1350	851	751	62.2
2	0.0521	C	19x0.0591	0.296	1405	824	727	62.2
2	0.0522	D	37x0.0424	0.297	1188	807	713	62.2
1	0.0658	B	19x0.0664	0.332	1740	1040	918	78.4
1	0.0658	C	37x0.0476	0.333	1500	1020	898	78.4
1	0.0656	D	61x0.0370	0.333	1480	1000	886	78.4
1/0	0.0828	B	19x0.0745	0.373	2160	1310	1160	98.9
1/0	0.0828	C	37x0.0534	0.374	2190	1280	1130	98.9
1/0	0.0829	D	61x0.0416	0.374	1870	1270	1120	98.9
2/0	0.1045	B	19x0.0837	0.419	2670	1650	1460	124.8
2/0	0.1046	C	37x0.0600	0.420	2760	1620	1430	124.8
2/0	0.1045	D	61x0.0467	0.420	2350	1600	1410	124.8
3/0	0.1319	B	19x0.0940	0.470	3310	2080	1840	157.2
3/0	0.1316	C	37x0.0673	0.471	3410	2040	1800	157.2
3/0	0.1315	D	61x0.0524	0.472	3430	2010	1780	157.2
4/0	0.1661	B	19x0.1055	0.528	4020	2630	2320	198.4
4/0	0.1661	C	37x0.0756	0.529	4230	2570	2270	198.4
4/0	0.1662	D	61x0.0589	0.530	4340	2540	2240	198.4
250	0.1964	B	37x0.0822	0.575	4910	3040	2680	234.3
250	0.1962	C	61x0.0640	0.576	5030	3000	2650	234.3
250	0.1962	D	91x0.0524	0.576	5070	2970	2620	234.3
300	0.2354	B	37x0.0900	0.630	5890	3640	3210	281.4
300	0.2354	C	61x0.0701	0.631	5930	3600	3180	281.4
300	0.2355	D	91x0.0574	0.631	6080	3560	3140	281.4
350	0.2751	B	37x0.0973	0.681	6760	4260	3760	327.9
350	0.2745	C	61x0.0757	0.681	6920	4200	3710	327.6
350	0.2747	D	91x0.0620	0.682	6970	4160	3670	327.9

(See footnotes at end of table.)

(Continued)

bare aluminum wire and cable

TABLE 4-8 (Continued)

Conductor Size		Stranding		Conductor Dia., in.	Rated Strength lb			Weight per 1,000 ft lb
		Class	Number and Dia. of Wires, in.		1350-H19	1350-H26 1350-H16	1350-H24 1350-H14	
kcmil	Square Inches							
400	0.3143	B	37x0.1040	0.728	7440	4860	4290	375.7
400	0.3143	C	61x0.0810	0.729	7780	4810	4240	375.7
400	0.3141	D	91x0.0663	0.729	7970	4750	4190	375.7
450	0.3535	B	37x0.1103	0.772	8200	5470	4830	421.8
450	0.3535	C	61x0.0859	0.773	8750	5410	4770	421.8
450	0.3532	D	91x0.0703	0.773	8800	5340	4720	421.8
500	0.3924	B	37x0.1162	0.813	9110	6070	5360	468.3
500	0.3924	C	61x0.0905	0.815	9540	6000	5300	468.3
500	0.3924	D	91x0.0741	0.815	9780	5940	5240	468.3
550	0.4324	B	61x0.0950	0.855	10500	6620	5840	516.2
550	0.4315	C	91x0.0777	0.855	10800	6530	5760	516.2
550	0.4318	D	127x0.0658	0.855	11000	6530	5760	516.2
600	0.4714	B	61x0.0992	0.893	11500	7210	6360	562.0
600	0.4712	C	91x0.0812	0.893	11500	7130	6290	562.0
600	0.4707	D	127x0.0687	0.893	11900	7120	6280	562.0
650	0.5102	B	61x0.1032	0.929	11900	7810	6890	609.8
650	0.5103	C	91x0.0845	0.930	12500	7720	6810	609.8
650	0.5099	D	127x0.0715	0.930	12700	7720	6810	609.8
700	0.5495	B	61x0.1071	0.964	12900	8410	7420	655.8
700	0.5497	C	91x0.0877	0.964	13500	8320	7340	655.8
700	0.5491	D	127x0.0742	0.965	13700	8310	7330	655.8
750	0.5892	B	61x0.1109	0.998	13500	9020	7950	703.2
750	0.5892	C	91x0.0908	0.999	14200	8920	7870	703.2
750	0.5883	D	127x0.0768	0.998	14700	8900	7850	703.2
800	0.6281	B	61x0.1145	1.031	14400	9610	8480	750.7
800	0.6288	C	91x0.0938	1.032	15100	9510	8390	750.7
800	0.6288	D	127x0.0794	1.032	15700	9510	8390	750.7
900	0.7072	B	61x0.1215	1.094	15900	10200	9550	844.0
900	0.7061	C	91x0.0994	1.093	17000	10700	9430	844.0
900	0.7071	D	127x0.0842	1.095	17300	10700	9440	844.0
1000	0.7849	B	61x0.1280	1.152	17700	12000	10600	936.8
1000	0.7850	C	91x0.1048	1.153	18200	11900	10500	936.8
1000	0.7847	D	127x0.0887	1.153	19200	11900	10500	936.8
1100	0.8632	B	91x0.1099	1.209	20000	13100	11500	1033
1100	0.8644	C	127x0.0931	1.210	20800	13100	11500	1033
1100	0.8644	D	169x0.0807	1.211	21200	13100	11500	1033
1200	0.9419	B	91x0.1148	1.263	21400	14300	12600	1126
1200	0.9423	C	127x0.0972	1.264	22600	14300	12600	1126
1200	0.9431	D	169x0.0843	1.265	23100	14300	12600	1126

(See footnotes at end of table.)

(Continued)

TABLE 4-8 (Continued)

Conductor Size		Stranding		Conductor Dia., in.	Rated Strength lb			Weight per 1,000 ft lb
		Class	Number and Dia. of Wires, in.		1350-H19	1350-H26 1350-H16	1350-H24 1350-H14	
kcmil	Square Inches							
1250	0.9817	B	91x0.1172	1.289	22300	14900	13100	1171
1250	0.9815	C	127x0.0992	1.290	23600	14900	13100	1171
1250	0.9817	D	169x0.0860	1.290	24000	14900	13100	1171
1300	1.021	B	91x0.1195	1.315	23200	15400	13600	1218
1300	1.021	C	127x0.1012	1.316	23600	15400	13600	1218
1300	1.021	D	169x0.0877	1.316	25000	15400	13600	1218
1400	1.099	B	91x0.1240	1.364	24500	16600	14700	1311
1400	1.100	C	127x0.1050	1.365	25400	16600	14700	1311
1400	1.099	D	169x0.0910	1.365	26400	16600	14700	1311
1500	1.178	B	91x0.1284	1.412	26200	17800	15700	1406
1500	1.178	C	127x0.1087	1.413	27300	17800	15700	1406
1500	1.178	D	169x0.0942	1.413	28300	17800	15700	1406
1600	1.258	B	127x0.1122	1.459	28500	19000	16800	1499
1600	1.257	C	169x0.0973	1.460	30200	19000	16800	1499
1600	1.267	D	217x0.0859	1.460	30800	19000	16800	1499
1700	1.335	B	127x0.1157	1.504	30300	20200	17800	1593
1700	1.335	C	169x0.1003	1.505	30900	20200	17800	1593
1700	1.335	D	217x0.0885	1.505	32700	20200	17800	1593
1750	1.375	B	127x0.1174	1.526	31200	20800	18400	1641
1750	1.376	C	169x0.1018	1.527	31800	20800	18400	1641
1750	1.374	D	217x0.0898	1.527	33600	20800	18300	1641
1800	1.415	B	127x0.1191	1.548	32100	21400	18900	1688
1800	1.414	C	169x0.1032	1.548	32700	21400	18900	1688
1800	1.414	D	217x0.0911	1.549	34000	21400	18900	1688
1900	1.492	B	127x0.1223	1.590	33200	22600	19900	1780
1900	1.491	C	169x0.1060	1.590	34500	22600	19900	1780
1900	1.493	D	217x0.0936	1.591	35900	22600	19900	1780
2000	1.571	B	127x0.1255	1.632	35000	23800	21000	1874
2000	1.571	C	169x0.1088	1.632	36400	23800	21000	1874
2000	1.571	D	217x0.0960	1.632	37700	23800	21000	1874
2500	1.963	B	127x0.1403	1.824	42800	29700	26200	2366
2500	1.963	C	169x0.1216	1.824	43700	29700	26200	2366
2500	1.962	D	217x0.1073	1.824	45400	29700	26200	2366
3000	2.355	B	169x0.1332	1.998	52400	35600	31400	2838
3000	2.357	C	217x0.1176	1.999	53500	35700	31400	2838
3000	2.356	D	271x0.1052	1.999	54500	35600	31400	2838
3500	2.748	B	169x0.1439	2.158	59900	41600	36700	3344
3500	2.749	C	217x0.1270	2.159	61200	41600	36700	3344
3500	2.747	D	271x0.1136	2.158	62300	41600	36700	3344

1. Data shown are subject to normal manufacturing tolerances.  
 2. Class B conductors are those normally insulated, and/or covered, also for uses indicated under Class A (see Table 4-5 footnote 2) where greater flexibility is required. Class C and D conductors are those for use where greater flexibility is required than is provided by Class B conductors. The outer layer of wires has left-hand lay.

**TABLE 4-9**  
**All-Aluminum Concentric-Lay Compact-Round Stranded Bare Conductors**  
**Physical and Electrical Properties**  
**1350-H19 Hard-Drawn ASTM B 400**

These conductors have right-hand lay of outer layer. The ac resistances at various temperatures are to be taken from Tables 4-6 and 4-7 for the corresponding AWG or kcmil sizes.

Conductor Size, AWG or kcmil	No. of Wires	Compact Conductor Dia., in.	Non-Compact Dia., in.	Sectional Area Sq. in.	Weight per 1000 ft lb	Rated Strength lb	dc 20°C Resistance Ohms per Mile
8	7	0.134	0.146	0.0130	15.5	311	5.520
6	7	0.169	0.184	0.0206	24.6	563	3.481
4	7	0.213	0.232	0.0328	39.1	881	2.188
2	7	0.268	0.292	0.0521	62.2	1,350	1.374
1	7	0.299	0.328	0.0657	78.4	1,640	1.091
1/0	7	0.336	0.368	0.0829	98.9	1,990	0.8646
1/0	19	0.336	0.373	0.0829	98.9	2,160	0.8654
2/0	7	0.376	0.414	0.1045	125	2,510	0.6856
2/0	19	0.376	0.419	0.1045	125	2,670	0.6856
3/0	7	0.423	0.464	0.1318	157	3,040	0.5441
3/0	19	0.423	0.478	0.1318	157	3,310	0.5436
4/0	7	0.475	0.522	0.1662	198	3,830	0.4311
4/0	19	0.475	0.528	0.1662	198	4,020	0.4316
250.0	7	0.520	0.567	0.1964	234	4,520	0.3380
250.0	19	0.520	0.574	0.1964	234	4,660	0.3651
266.8	7	0.537	0.586	0.2095	250	4,830	0.3418
266.8	19	0.537	0.593	0.2095	250	4,970	0.3421
300.0	7	0.570	0.621	0.2356	281	5,430	0.3043
300.0	19	0.570	0.629	0.2356	281	5,480	0.3040
336.4	7	0.603	0.658	0.2642	315	5,960	0.2714
336.4	19	0.603	0.666	0.2642	315	6,150	0.2711
350.0	19	0.616	0.679	0.2749	328	6,390	0.2609
397.5	19	0.659	0.724	0.3122	372	7,110	0.2294
477.0	19	0.722	0.793	0.3746	447	8,360	0.1912
500.0	19	0.736	0.811	0.3927	468	8,760	0.1826
556.5	19	0.780	0.858	0.4371	521	9,750	0.1641
795.0	19	0.932	1.023	0.6244	745	13,940	0.1148
874.5	37	0.981	1.079	0.6868	821	15,000	0.1043
954.0	37	1.024	1.124	0.7493	895	16,400	0.09563

1. Data shown are subject to normal manufacturing tolerances.
2. Direct current (dc) resistance is computed on same basis as that of Table 4-6.
3. The ampacity ratings of compact-round bare conductors differ slightly from those of regular types of same sizes because of reduction of exposed surface, but the compacting in the cable somewhat offsets this by improving thermal transfer within the cable.
4. The values of GMR and inductive and capacitive reactances listed in Tables 4-6 and 4-7 may be used for compacted cable without significant error for usual design applications.

**TABLE 4-10**  
**All-Aluminum Shaped Wire Concentric-Lay Compact Conductors AAC/TW**  
**Physical and Electrical Properties**  
**ASTM B 778 in Fixed Diameter Increments**

Code Word	Size kcmil	No. of Wires	No. of Layers	Conductor Diameter in.	Weight per 1000 ft lb	Rated Strength lb	Resistance				GMR ft	Phase-to-Neutral 60 Hz, Resistance at One ft Spacing	
							dc 20°C Ohms/Mile	ac—60 Hz				Inductive Ohms/Mile $X_a$	Capacitive Megohm-Miles $X_c$
								25°C Ohms/Mile	50°C Ohms/Mile	75°C Ohms/Mile			
Logan/TW	322.5	17	2	0.60	302.1	5,960	0.2789	0.2855	0.3140	0.3425	0.0188	0.482	0.1094
Wheeler/TW	449.4	17	2	0.70	421.0	8,030	0.2001	0.2055	0.2259	0.2463	0.0220	0.463	0.1048
Robson/TW	595.8	17	2	0.80	558.2	10,700	0.1510	0.1557	0.1710	0.1864	0.0252	0.447	0.1009
McKinley/TW	761.5	17	2	0.90	713.3	13,400	0.1181	0.1225	0.1344	0.1464	0.0284	0.432	0.0974
Rainier/TW	918.8	31	3	1.00	864.3	16,100	0.0983	0.1030	0.1129	0.1227	0.0319	0.418	0.0912
Helens/TW	1123.1	31	3	1.10	1056	19,700	0.0804	0.0853	0.0932	0.1012	0.0352	0.406	0.0915
Baker/TW	1346.8	31	3	1.20	1267	23,600	0.0670	0.0722	0.0788	0.0854	0.0385	0.395	0.0889
Hood/TW	1583.2	34	3	1.30	1489	27,200	0.0570	0.0625	0.0680	0.0736	0.0419	0.385	0.0865
Whitney/TW	1812.7	49	4	1.40	1713	31,100	0.0501	0.0563	0.0610	0.0658	0.0454	0.375	0.0843
Powell/TW	2093.6	49	4	1.50	1978	35,900	0.0433	0.0499	0.0540	0.0581	0.0489	0.366	0.0822
Jefferson/TW	2388.1	52	4	1.60	2256	40,100	0.0380	0.0450	0.0485	0.0520	0.0524	0.357	0.0803
Shasta/TW	2667.2	71	5	1.70	2528	45,200	0.0341	0.0418	0.0449	0.0480	0.0561	0.349	0.0785
Adams/TW	3006.2	71	5	1.80	2848	51,000	0.0303	0.0384	0.0411	0.0438	0.0578	0.342	0.0768

1. Data shown are subject to normal manufacturing tolerances.
2. Direct current (dc) resistance is based on 16.727 ohm-cmil/ft at 20° 62% IACS conductivity.
3. Alternating current (ac) resistance is based on dc resistance corrected for temperature and skin effect.
4. Properties of the industrial wires are those of the equivalent round wires of ASTM B 230.

**TABLE 4-11**  
**All-Aluminum Shaped Wire Concentric-Lay Compact Conductors AAC/TW**  
**Physical and Electrical Properties**  
**ASTM B 778**  
**Area Equal to Standard AAC Sizes**

Code Word	Size kcmil	No. of Wires	No. of Layers	Conductor Diameter in.	Weight per 1000 ft lb	Rated Strength lb	Resistance				GMR ft	Phase-to-Neutral 60 Hz, Resistance at One ft Spacing	
							dc 20°C Ohms/Mile	ac—60 Hz				Inductive Ohms/Mile X <sub>a</sub>	Capacitive Megohm-Miles X <sub>c</sub>
								25°C Ohms/Mile	50°C Ohms/Mile	75°C Ohms/Mile			
Tulip/TW	336.4	17	2	0.612	315.2	6,220	0.2673	0.2737	0.3010	0.3284	0.0192	0.480	0.1088
Canna/TW	397.5	17	2	0.661	372.4	7,230	0.2262	0.2319	0.2551	0.2781	0.0208	0.470	0.1066
Cosmos/TW	477.0	17	2	0.720	446.9	8,530	0.1885	0.1936	0.2128	0.2321	0.0226	0.460	0.1040
Zinnia/TW	500.0	17	2	0.736	468.4	8,940	0.1798	0.1848	0.2031	0.2215	0.0232	0.457	0.1033
Mistletoe/TW	556.5	17	2	0.775	521.3	9,950	0.1616	0.1664	0.1829	0.1993	0.0244	0.451	0.1018
Meadowsweet/TW	600.0	17	2	0.803	562.1	10,700	0.1498	0.1545	0.1697	0.1850	0.0253	0.446	0.1008
Orchid/TW	636.0	17	2	0.825	595.8	11,400	0.1414	0.1460	0.1603	0.1747	0.0260	0.443	0.0999
Verbena/TW	700.0	17	2	0.864	655.7	12,500	0.1285	0.1329	0.1459	0.1590	0.0272	0.437	0.0986
Nasturtium/TW	750.0	17	2	0.893	702.6	13,400	0.1199	0.1243	0.1364	0.1486	0.0281	0.433	0.0976
Arbutus/TW	795.0	17	2	0.919	744.7	13,900	0.1131	0.1175	0.1289	0.1404	0.0290	0.430	0.0968
Cockscomb/TW	900.0	17	3	0.990	846.6	15,800	0.1004	0.1051	0.1152	0.1253	0.0316	0.419	0.0946
Magnolia/TW	954.0	31	3	1.018	897.4	16,700	0.0946	0.0994	0.1089	0.1184	0.0325	0.416	0.0938
Hawkweed/TW	1000.0	31	3	1.041	940.6	17,500	0.0903	0.0951	0.1041	0.1131	0.0333	0.413	0.0931
Bluebell/TW	1033.5	31	3	1.057	972.2	18,100	0.0874	0.0922	0.1009	0.1096	0.0338	0.411	0.0927
Marigold/TW	1113.0	31	3	1.095	1047	19,500	0.0811	0.0860	0.0941	0.1022	0.0350	0.407	0.0916
Hawthorn/TW	1192.5	31	3	1.132	1122	20,900	0.0757	0.0807	0.0882	0.0957	0.0362	0.403	0.0906
Narcissus/TW	1272.0	31	3	1.168	1196	22,300	0.0710	0.0760	0.0830	0.0901	0.0374	0.399	0.0896
Columbine/TW	1351.5	31	3	1.202	1271	23,700	0.0668	0.0720	0.0785	0.0851	0.0386	0.395	0.0888
Carnation/TW	1431.0	31	3	1.236	1346	24,600	0.0631	0.0684	0.0745	0.0807	0.0397	0.391	0.0880
Coreopsis/TW	1590.0	49	4	1.315	1503	27,300	0.0570	0.0629	0.0684	0.0739	0.0425	0.383	0.0861
Jessamine/TW	1750.0	49	4	1.377	1654	30,000	0.0518	0.0579	0.0629	0.0679	0.0446	0.377	0.0848
Cowslip/TW	2000.0	49	4	1.468	1890	34,500	0.0453	0.0518	0.0561	0.0604	0.0478	0.369	0.0829
Lupine/TW	2500.0	71	5	1.648	2369	42,400	0.0364	0.0439	0.0472	0.0505	0.0543	0.353	0.0794
Trillium/TW	3000.0	71	5	1.799	2843	50,900	0.0303	0.0385	0.0412	0.0439	0.0597	0.342	0.0768

1. Data shown are subject to normal manufacturing tolerances.
2. Direct current (dc) resistance is based on 16.727 ohm-cmil/ft at 20° 62% IACS conductivity.
3. Alternating current (ac) resistance is based on dc resistance corrected for temperature and skin effect.
4. Properties of the industrial wires are those of the equivalent round wires of ASTM B 230.

**TABLE 4-12**  
**All-Aluminum Alloy Concentric-Lay Stranded Bare Conductors**  
**Physical and Electrical Characteristics**  
**6201-T81 ASTM B 399 ACSR Equivalent Diameter**

These conductors have right-hand lay of outer layer, unless otherwise specified. ASTM B 399 lists both Class AA and Class A stranding (see footnote 2 of Table 4-5 for explanation). As the difference is slight, it is trade custom to supply cables that meet the Class AA requirements unless otherwise specified, and the listings herewith apply to either Class AA or Class A.

Code Word	Size kcmil	No. of Wires	Diam. Each Wire in.	Conductor Diam. in.	Area Sq. in.	Size of ACSR of Equal Diameter AWG or kcmil and Stranding	Nearest AAC Size of Approx. Equal Resistance	Weight per 1000 ft lb	Rated Strength lb	Resistance			
										dc-20°C Ohms per Mile	ac—60 Hz		
											25°C Ohms/Mile	50°C Ohms/Mile	75°C Ohms/Mile
Akron	30.58	7	0.0661	0.198	0.02402	6-6/1	6	28.5	1110	3.479	3.54	3.84	4.14
Alton	48.69	7	0.0834	0.250	0.03824	4-6/1	4	45.4	1760	2.185	2.22	2.41	2.60
Ames	77.47	7	0.1052	0.316	0.06084	2-6/1	2	72.2	2800	1.373	1.40	1.52	1.64
Azusa	123.3	7	0.1327	0.398	0.09681	1/0-6/1	1/0	114.9	4460	0.8631	0.878	0.953	1.028
Anaheim	155.4	7	0.1490	0.447	0.1221	2/0-6/1	2/0	144.9	5390	0.6846	0.697	0.756	0.816
Amherst	195.7	7	0.1672	0.502	0.1537	3/0-6/1	3/0	182.5	6790	0.5437	0.554	0.601	0.648
Alliance	246.9	7	0.1878	0.563	0.1939	4/0-6/1	4/0	230.2	8560	0.4309	0.439	0.476	0.514
Butte	312.8	19	0.1283	0.642	0.2456	266.-26/7	266.8	291.6	11000	0.3402	0.347	0.376	0.406
Canton	394.5	19	0.1441	0.721	0.3098	336.-26/7	336.4	367.9	13300	0.2697	0.276	0.299	0.322
Cairo	465.4	19	0.1565	0.783	0.3655	397.-26/7	397.5	433.9	15600	0.2286	0.234	0.254	0.273
Darien	559.5	19	0.1716	0.858	0.4394	477.-26/7	477.0	521.7	18800	0.1902	0.195	0.211	0.228
Elgin	652.4	19	0.1853	0.927	0.5124	556.-26/7	556.5	608.3	21900	0.1631	0.168	0.182	0.196
Flint	740.8	37	0.1415	0.991	0.5818	636.-26/7	636.0	690.8	24400	0.1436	0.148	0.161	0.173
Greeley	927.2	37	0.1583	1.108	0.7282	795.-26/7	795.0	864.6	30500	0.1148	0.119	0.129	0.139

1. Data shown are subject to normal manufacturing tolerances.
2. Direct current (dc) resistance is based on 19.755 ohm-cmil/ft. at 20°C, 52.5% IACS, with standard stranding increment of 2 percent.
3. Alternating current (ac) is based on dc resistance corrected for temperature, using 0.00347 as temperature coefficient of resistivity per degree C at 20°C, and for skin effect.
4. For ampacity ratings of bare conductors, see Figs. 3-11 and 3-12 and adjust values according to method described in accompanying text.
5. As the values of GMR and inductive and capacitive reactances of any all-aluminum stranded cable of a specified outside diameter are closely equal, the values of GMR, etc., of Tables 4-6 and 4-7 may be used for the above table if the diameters are equal. If the same diameter is not found in Tables 4-6 and 4-7 as the above table, interpolation from the nearest diameters readily obtains the desired GMR, etc.



**TABLE 4-13**  
**All-Aluminum Alloy Concentric-Lay Stranded Bare Conductors**  
**Physical and Electrical Characteristics**  
**6201-T81 ASTM B 399 Even AWG and kcmil Sizes**

These conductors have right-hand lay of outer layer, unless otherwise specified. ASTM B 399 lists both Class AA and Class A stranding (see footnote 2 of Table 4-5 for explanation). As the difference is slight, it is trade custom to supply cables that meet the Class AA requirements unless otherwise specified, and the listings herewith apply to either Class AA or Class A.

Conductor Size AWG or kcmil	No. of Wires	Diam. Each Wire, in.	Conductor Diam. in.	Area Sq. in.	Weight per 1000 ft lb	Rated Strength lb	Resistance			
							dc-20°C Ohms per Mile	ac—60 Hz		
								25°C Ohms/ Mile	50°C Ohms/ Mile	75°C Ohms/ Mile
6	7	0.0612	0.184	0.0206	24.5	949	4.058	4.13	4.48	4.83
4	7	0.0772	0.232	0.0328	38.9	1510	2.550	2.60	2.59	3.04
2	7	0.0974	0.292	0.0521	61.9	2400	1.602	1.63	1.77	1.91
1/0	7	0.1228	0.368	0.0829	98.3	3820	1.008	1.03	1.11	1.20
2/0	7	0.1379	0.414	0.1045	124.1	4620	0.7993	0.814	0.883	0.952
3/0	7	0.1548	0.464	0.1317	156.4	5820	0.6343	0.646	0.701	0.756
4/0	7	0.1739	0.522	0.1663	197.4	7340	0.5026	0.512	0.556	0.599
250.	19	0.1147	0.574	0.1963	233.1	8760	0.4256	0.434	0.471	0.508
300.	19	0.1257	0.629	0.2358	280.0	10500	0.3544	0.361	0.392	0.423
350.	19	0.1357	0.679	0.2748	326.3	11800	0.3041	0.310	0.337	0.363
400.	19	0.1451	0.726	0.3142	373.0	13400	0.2660	0.272	0.295	0.318
450.	19	0.1539	0.770	0.3534	419.6	15100	0.2364	0.242	0.262	0.283
500.	19	0.1622	0.811	0.3926	466.1	16800	0.2128	0.218	0.236	0.255
550.	37	0.1219	0.853	0.4318	512.7	18900	0.1935	0.198	0.215	0.232
600.	37	0.1273	0.891	0.4709	559.1	20600	0.1774	0.182	0.198	0.213
650.	37	0.1325	0.928	0.5102	605.7	22300	0.1638	0.169	0.183	0.197
700.	37	0.1375	0.963	0.5494	652.3	23000	0.1521	0.157	0.170	0.183
750.	37	0.1424	0.997	0.5893	699.6	24700	0.1418	0.146	0.159	0.171
800.	37	0.1470	1.029	0.6280	745.6	26300	0.1331	0.138	0.149	0.160
900.	37	0.1560	1.092	0.7072	839.7	29600	0.1182	0.123	0.133	0.143
1000.	37	0.1644	1.151	0.7854	932.5	32900	0.1064	0.111	0.120	0.129

1. Data shown are subject to normal manufacturing tolerances.
2. Direct current (dc) resistance is based on 19.755 ohm-cmil/ft. at 20°C, 52.5% IACS, with standard stranding increment of 2 percent.
3. Alternating current (ac) is based on dc resistance corrected for temperature, using 0.00347 as temperature coefficient of resistivity per degree C at 20°C, and for skin effect.
4. For ampacity ratings of bare conductors, see Figs. 3-11 and 3-12 and adjust values according to method described in accompanying text.
5. As the values of GMR and inductive and capacitive reactances of any all-aluminum stranded cable of a specified outside diameter are closely equal, the values of GMR, etc., of Tables 4-6 and 4-7 may be used for the above table if the diameters are equal. If the same diameter is not found in Tables 4-6 and 4-7 as the above table, interpolation from the nearest diameters readily obtains the desired GMR, etc.

**TABLE 4-14**  
**Bare Aluminum Conductors, Steel Reinforced (ASCR), Concentric-Lay Stranded ASTM B 232**  
**with Class AA and A Stranding and Various Types of Steel Core**  
**Physical Properties**

Bold-face code words designate sizes most commonly used.

Code Word	Class	Conductor Size			Stranding		Outside Diameter		Weight per 1000 Feet			Rated Strength—lb		
		AWG or kcmil	Area Square Inches		Aluminum	Steel	Complete Conductor in.	Steel Core in.	Total lb	Aluminum lb	Steel lb	Type Zinc Coating or Core		
			Alumi- num	Total								Standard Weight	B	C
Turkey	AA-A	6	0.0206	0.0240	6x.0661	1x.0661	0.198	0.0661	36.0	24.4	11.6	1,190	1,160	1,120
Swan	AA-A	4	0.0328	0.0383	6x.0834	1x.0834	0.250	0.0834	57.4	39.0	18.4	1,860	1,810	1,760
Swanate	AA-A	4	0.0328	0.0411	7x.0772	1x.1029	0.257	0.1029	67.0	39.0	28.0	2,360	2,280	2,200
Sparrow	AA-A	2	0.0521	0.0608	6x.1052	1x.1052	0.316	0.1052	91.2	61.9	29.3	2,850	2,760	2,680
Sparate	AA-A	2	0.0521	0.0653	7x.0974	1x.1299	0.325	0.1299	102.0	62.3	44.7	3,640	3,510	3,390
Robin	AA-A	1	0.0657	0.0767	6x.1181	1x.1181	0.355	0.1181	115.0	78.1	36.9	3,550	3,450	3,340
Raven	AA-A	1/0	0.0829	0.0967	6x.1327	1x.1327	0.398	0.1327	145.0	98.4	46.6	4,380	4,250	4,120
Quail	AA-A	2/0	0.1045	0.1219	6x.1489	1x.1489	0.447	0.1489	183.0	124.2	58.8	5,310	5,130	5,050
Pigeon	AA-A	3/0	0.1318	0.1538	6x.1672	1x.1672	0.502	0.1672	230.0	155.9	74.1	6,620	6,410	6,300
Penguin	AA-A	4/0	0.1662	0.1939	6x.1878	1x.1878	0.563	0.1878	291.0	197.6	93.4	8,350	8,080	7,950
Waxwing	AA	266.8	0.2095	0.2211	18x.1217	1x.1217	0.609	0.1217	289.0	249.8	39.2	6,880	6,770	6,650
Partridge	AA	266.8	0.2095	0.2436	26x.1013	7x.0788	0.642	0.2364	366.0	250.4	115.6	11,300	11,000	10,600
Ostrich	AA	300.0	0.2355	0.2738	26x.1074	7x.0835	0.680	0.2505	412.0	282.2	129.8	12,700	12,300	12,000
Merlin	AA	336.4	0.2642	0.2789	18x.1367	1x.1367	0.684	0.1367	365.0	315.5	49.5	8,680	8,540	8,400
Linnet	AA	336.4	0.2640	0.3070	26x.1137	7x.0884	0.720	0.2652	462.0	316.5	145.5	14,100	13,700	13,300
Oriole	AA	336.4	0.2642	0.3259	30x.1059	7x.1059	0.741	0.3177	526.0	317.0	209.0	17,300	16,700	16,200
Chickadee	AA	397.5	0.3122	0.3295	18x.1486	1x.1486	0.743	0.1486	431.0	372.5	58.5	9,940	9,780	9,690
Ibis	AA	397.5	0.3120	0.3628	26x.1236	7x.0961	0.783	0.2883	546.0	374.1	171.9	16,300	15,800	15,300
Lark	AA	397.5	0.3121	0.3849	30x.1151	7x.1151	0.806	0.3453	622.0	375.1	246.9	20,300	19,600	18,900
Pelican	AA	477	0.3747	0.3955	18x.1628	1x.1628	0.814	0.1628	517.0	446.8	70.2	11,800	11,600	11,500
Flicker	AA	477	0.3747	0.4233	24x.1410	7x.0940	0.846	0.2820	614.0	449.5	164.5	17,200	16,700	16,200
Hawk	AA	477	0.3744	0.4353	26x.1354	7x.1053	0.858	0.3159	655.0	448.6	206.4	19,500	18,900	18,400
Hen	AA	477	0.3747	0.4621	30x.1261	7x.1261	0.883	0.3783	746.0	449.7	296.3	23,800	23,000	22,100
Osprey	AA	556.5	0.4369	0.4621	18x.1758	1x.1758	0.879	0.1758	603.0	521.1	81.9	13,700	13,500	13,400
Parakeet	AA	556.5	0.4372	0.4938	24x.1523	7x.1015	0.914	0.3045	716.0	524.2	191.8	19,800	19,300	18,700
Dove	AA	556.5	0.4371	0.5083	26x.1463	7x.1138	0.927	0.341	765.0	523.9	241.1	22,600	21,900	21,200
Eagle	AA	556.5	0.4371	0.5391	30x.1362	7x.1362	0.953	0.409	871.0	523.3	345.7	27,800	26,800	25,800

(See footnotes at end of table.)

(Continued)

TABLE 4-14 (Continued)

Code Word	Class	Conductor Size			Stranding in.		Outside Diameter		Weight per 1000 Feet			Rated Strength—lb		
		AWG or kcmil	Area Square Inches		Aluminum	Steel	Complete Conductor in.	Steel Core in.	Total lb	Aluminum lb	Steel lb	Type Zinc Coating or Core		
			Alumi-num	Total								Standard Weight	B	C
		Aluminum	Steel	Aluminum Coated (AZ) Core										
Peacock	AA	605	0.4753	0.5370	7x.1059	0.953	0.318	779.0	570.2	208.8	21,600	20,400	20,100	
Squab	AA	605	0.4749	0.5522	7x.1186	0.966	0.356	832.0	569.1	261.9	24,300	22,800	22,500	
Teal	AA	605	0.4751	0.5834	19x.0852	0.994	0.426	939.0	571.5	367.5	30,000	29,000	28,000	
Kingbird	AA	636	0.4997	0.5275	1x.1880	0.940	0.188	690.0	596.4	93.6	15,700	15,300	14,800	
<b>Rook</b>	AA	636	0.4956	0.5643	24x.1628	0.977	0.326	818.0	598.8	219.2	22,000	21,400	21,100	
<b>Grosbeak</b>	AA	636	0.4995	0.5808	26x.1564	0.990	0.365	873.0	598.7	275.3	25,200	24,400	23,900	
Swift	AA	636	0.4994	0.5133	36x.1329	0.930	0.133	643.0	596.0	47.0	13,800	13,500	13,400	
Egret	AA	636	0.4995	0.6135	30x.1456	1.019	0.437	987.0	600.2	386.8	37,500	30,500	29,400	
Flamingo	AA	666.6	0.5238	0.5917	24x.1667	1.000	0.333	858.0	628.2	229.8	23,700	23,100	22,400	
Crow	AA	715.5	0.5620	0.6347	54x.1151	1.040	0.345	920.0	674.0	246	26,000	25,300	24,200	
Starling	AA	715.5	0.5620	0.6535	26x.1659	1.051	0.387	984.0	674.2	309.8	28,400	27,500	26,600	
Redwing	AA	715.5	0.5617	0.6897	30x.1544	1.081	0.463	1109	675	434	34,600	33,400	31,600	
Coot	AA	795	0.6244	0.6417	36x.1486	1.040	0.148	804	745	59	16,800	16,600	16,300	
Cuckoo	AA	795	0.6244	0.7053	24x.1820	1.092	0.364	1024	750	274	27,900	27,100	26,400	
<b>Drake</b>	AA	795	0.6247	0.7264	26x.1749	1.108	0.408	1093	749	344	31,500	30,500	29,600	
Mallard	AA	795	0.6245	0.7669	30x.1628	1.140	0.489	1234	751	483	38,400	37,100	35,800	
Tern	AA	795	0.6242	0.6674	45x.1329	1.063	0.266	895	748.9	146.1	22,100	21,700	21,200	
Condor	AA	795	0.6240	0.7049	54x.1213	1.092	0.364	1022	748	274	28,200	27,400	26,600	
Crane	AA	874.5	0.6873	0.7764	54x.1273	1.150	0.382	1126	824	302	31,200	30,400	29,500	
Ruddy	AA	900	0.7066	0.7555	45x.1414	1.131	0.283	1013	847	166	24,400	24,000	23,500	
Canary	AA	900	0.7069	0.7985	54x.1291	1.162	0.387	1158	848	310	31,900	31,000	30,200	
Corncrake	AA	954	0.7492	0.8011	20x.2184	1.165	0.291	1074	899	175	25,600	25,100	24,300	
<b>Rail</b>	AA	954	0.7492	0.8010	45x.1456	1.165	0.291	1075	899	176	25,900	25,400	24,900	
Towhee	AA	954	0.7494	0.8156	48x.1410	1.175	0.329	1123	899	224	28,500	27,800	27,200	
Redbird	AA	954	0.7494	0.8465	24x.1994	1.196	0.399	1228	899	329	33,500	32,600	31,600	
<b>Cardinal</b>	AA	954	0.7491	0.8462	54x.1329	1.196	0.399	1228	899	329	33,800	32,900	32,000	
<b>Ortolan</b>	AA	1,033.5	0.8112	0.8673	45x.1515	1.212	0.303	1163	973	190	27,700	27,100	26,600	
Curlew	AA	1,033.5	0.8112	0.9164	54x.1383	1.245	0.415	1329	973	356	36,600	35,600	34,600	
<b>Bluejay</b>	AA	1,113	0.8745	0.9350	45x.1573	1.259	0.315	1254	1049	205	29,800	29,300	28,400	
Finch	AA	1,113	0.8745	0.9854	54x.1436	1.293	0.431	1430	1054	376	39,100	38,100	37,000	
Bunting	AA	1,192.5	0.9367	1.0014	45x.1628	1.302	0.326	1342	1123	219	32,000	31,300	30,700	
Grackle	AA	1,192.5	0.9365	1.0552	54x.1486	1.338	0.446	1531	1128	403	41,900	40,800	39,700	

(Continued)

(See footnotes at end of table.)

TABLE 4-14 (Continued)

Code Word	Class	Conductor Size			Stranding		Outside Diameter		Weight per 1000 Feet			Rated Strength—lb			
		AWG or kcmil	Area Square Inches		Aluminum	Steel	Complete Conductor in.	Steel Core in.	Total lbs	Aluminum lbs	Steel lbs	Type Zinc Coating or Core			
			Aluminum	Total								Standard Weight	B	C	
<b>Bittern</b>	AA	1,272	0.9987	1.0676	45x.168	7x.1121	1.345	0.336	1432	1198	234	34,100	33,400	32,800	Aluminum Coated (AZ) Core
<b>Pheasant</b>	AA	1,272	0.9993	1.1259	54x.1535	19x.0921	1.382	0.461	1634	1205	429	43,600	42,400	41,200	32,400
<b>Dipper</b>	AA	1,351.5	1.0614	1.1348	45x.1733	7x.1155	1.386	0.347	1521	1273	248	36,200	35,500	34,800	40,700
<b>Martin</b>	AA	1,351.5	1.0614	1.1958	54x.1582	19x.0949	1.424	0.475	1735	1279	456	46,300	45,100	43,800	34,400
<b>Bobolink</b>	AA	1,431	1.1235	1.2012	45x.1783	7x.1189	1.427	0.357	1611	1348	263	38,300	37,600	36,900	43,200
<b>Plover</b>	AA	1,431	1.1240	1.2664	54x.1628	19x.0977	1.465	0.489	1838	1355	483	49,100	47,700	46,400	36,500
<b>Nuthatch</b>	AA	1,510.5	1.1862	1.2681	45x.1832	7x.1221	1.466	0.366	1700	1422	278	40,100	39,300	38,500	45,700
<b>Parrot</b>	AA	1,510.5	1.1856	1.3357	54x.1672	19x.1003	1.505	0.502	1938	1429	509	51,700	50,300	48,900	37,700
<b>Lapwing</b>	AA	1,590	1.2492	1.3355	45x.1880	7x.1253	1.504	0.376	1790	1498	292	42,200	41,400	40,500	48,200
<b>Falcon</b>	AA	1,590	1.2489	1.4072	54x.1716	19x.1030	1.545	0.516	2042	1505	537	54,500	53,000	51,600	39,700
<b>Chukar</b>	AA	1,780	1.3986	1.5122	84x.1456	19x.0874	1.602	0.437	2072	1685	387	51,000	49,900	48,900	50,800
<b>Mockingbird</b>	AA	2,034.5	1.5979	1.6671	72x.1681	7x.1122	1.681	0.336	2163	1929	234	46,800	46,100	45,500	48,900
<b>Bluebird</b>	AA	2,156	1.6931	1.8309	84x.1602	19x.0961	1.762	0.481	2508	2040	468	60,300	59,000	57,700	45,100
<b>Kiwi</b>	AA	2,167	1.7022	1.7758	72x.1735	7x.1157	1.735	0.347	2300	2051	249	49,800	49,100	48,400	57,100
<b>Thrasher</b>	AA	2,312	1.8155	1.9144	76x.1744	19x.0814	1.802	0.407	2523	2188	335	56,700	55,800	54,800	48,100
<b>Jore</b>	AA	2,515	1.9750	2.0828	76x.1819	19x.0850	1.880	0.425	2749	2384	365	61,700	60,700	59,700	54,800
<b>HIGH-STRENGTH STRANDINGS</b>															
<b>Grouse</b>	AA	80.0	0.0628	.0847	8x.1000	1x.1670	0.367	0.1670	149.0	75.1	73.9	5,200	4,990	4,890	4,470
<b>Petrel</b>	AA	101.8	0.0800	.1266	12x.0921	7x.0921	0.461	0.2763	254.0	95.9	158.1	10,400	9,910	9,460	9,240
<b>Minorca</b>	AA	110.8	0.0870	.1378	12x.0961	7x.0961	0.481	0.2883	276.0	103.9	172.1	11,300	10,800	10,300	10,100
<b>Leghorn</b>	AA	134.6	0.1057	.1674	12x.1059	7x.1059	0.530	0.3177	336.0	127.0	209.0	13,600	13,000	12,400	12,100
<b>Guinea</b>	AA	159.0	0.1249	.1977	12x.1151	7x.1151	0.576	0.3453	396.0	149.1	246.9	16,000	15,300	14,600	14,200
<b>Dotterel</b>	AA	176.9	0.1389	.2200	12x.1214	7x.1214	0.607	0.3642	441.0	166.4	274.6	17,300	16,600	15,800	15,000
<b>Dorking</b>	AA	190.8	0.1499	.2373	12x.1261	7x.1261	0.631	0.3783	476.0	179.7	296.3	18,700	17,900	17,000	16,200
<b>Brahma</b>	AA	203.2	0.1598	.3020	16x.1127	19x.0977	0.714	0.4885	625.0	189.9	485.1	28,400	27,100	25,800	25,100
<b>Cochin</b>	AA	211.3	0.1660	.2628	12x.1327	7x.1327	0.663	0.3981	527.0	198.8	328.2	20,700	19,800	18,900	17,900

1. Data shown are subject to normal manufacturing tolerances.  
 2. Class AA stranding is for bare conductors on overhead lines. Class A stranding is for conductors to be covered with weather-resistant materials.  
 3. The High-Strength Conductors listed at bottom of Section 14B of this table have a high ratio of mechanical strength to ampacity, and are used for ground wires and for extra-long span construction.

bare aluminum wire and cable

**TABLE 4-15**  
**Bare Aluminum Conductors, Steel-Reinforced (ACSR)**  
**Electrical Properties of Single-Layer Sizes**

Code Word	Conductor Size kcmil	Stranding		Assumed 75°C Current Amps	Resistances				(Approximate) Inductive Reactance $X_L$ 1 ft Equivalent Spacing 60 Hz			Capacitive Reactance $X_C$ 1 ft Equivalent Spacing—60 Hz  Megohm-Miles
		Al.	Steel		dc	(Approximate) ac—60 Hz			25°C Ohms/ Mile	50°C Ohms/ Mile	75°C Ohms/ Mile	
						20°C Ohms/ Mile	25°C Ohms/ Mile	50°C Ohms/ Mile				
Turkey	6	6	1	110	3.3893	3.460	3.960	4.308	0.634	0.734	0.760	0.1423
Swan	4	6	1	145	2.1291	2.175	2.531	2.755	0.608	0.694	0.723	0.1354
Swanate	4	7	1	145	2.1060	2.150	2.446	2.727	0.598	0.654	0.688	0.1345
Sparrow	2	6	1	195	1.3381	1.368	1.626	1.774	0.580	0.652	0.674	0.1285
Sparate	2	7	1	195	1.3230	1.353	1.566	1.741	0.574	0.621	0.637	0.1276
Robin	1	6	1	220	1.0617	1.087	1.306	1.427	0.564	0.629	0.646	0.1250
Raven	1/0	6	1	255	0.8410	0.862	1.041	1.141	0.549	0.601	0.614	0.1216
Quail	2/0	6	1	295	0.6679	0.687	0.853	0.929	0.537	0.590	0.599	0.1182
Pigeon	3/0	6	1	340	0.5297	0.546	0.638	0.763	0.524	0.572	0.578	0.1147
Penguin	4/0	6	1	390	0.4199	0.434	0.563	0.611	0.509	0.553	0.556	0.113
Grouse	80.	8	1	200	1.0901	1.114	1.247	1.380	0.553	0.596	0.607	0.1240
Petrel	101.8	12	7	250	0.8360	0.858	1.094	1.264	0.538	0.613	0.677	0.1173
Minorca	110.8	12	7	265	0.7678	0.787	1.020	1.179	0.537	0.621	0.670	0.1160
Leghorn	134.6	12	7	300	0.6323	0.651	0.865	1.000	0.527	0.606	0.648	0.1131
Guinea	159.	12	7	330	0.5353	0.552	0.753	0.873	0.517	0.590	0.628	0.1107
Dotterel	176.9	12	7	350	0.4812	0.499	0.687	0.799	0.512	0.582	0.617	0.1091
Dorking	190.8	12	7	370	0.4460	0.462	0.649	0.752	0.505	0.577	0.607	0.1079
Cochin	211.3	12	7	390	0.4027	0.418	0.594	0.692	0.499	0.567	0.596	0.1064
Brahma	203.2	16	19	380	0.4035	0.417	0.575	0.712	0.493	0.553	0.592	0.1043

1. Direct current (dc) resistance is based on 16.946 ohm-cmil/ft. (61.2% IACS) at 20°C for the nominal aluminum area of the conductors and 129.64 ohm-circular mil/ft. (8.0% IACS) for the nominal steel area, with standard increments for stranding. ASTM B 232.
  2. Alternating current (ac) resistance is based on dc resistance corrected for temperature using 0.00404 as temperature coefficient of resistivity per degree C for aluminum 1350 and 0.0029 per degree C for steel core, and for effect of core magnetization using method of Lewis and Tuttle, Power Apparatus and Systems, Feb. 1959, pp. 1189-1214. Currents assumed for magnetization calculations in percent of assumed 75°C current: 25°C—10%; 50°C—75%.
  3. Inductive reactance includes magnetization effect of steel core calculated using method of Lewis and Tuttle, Power Apparatus and Systems, Feb. 1959, pp. 1189-1214. Currents assumed in calculating magnetization effect in percent of assumed 75°C current: 25°C—10%; 50°C—75%.
- NOTE: For ampacity ratings see Figs. 3-13 and 3-14, and adjust according to method described in the accompanying text.

**TABLE 4-16**  
**Bare Aluminum Conductors, Steel Reinforced (ACSR)**  
**Electrical Properties of Multi-Layer Sizes**

Code Word	Size kcmil	Stranding Al./St.	Number of Aluminum Layers	Resistance				GMR ft	Phase-to-Neutral, 60 Hz Reactance at One ft Spacing	
				dc 20°C Ohms/ Mile	ac-60 Hz				Inductive Ohms/Mile X <sub>a</sub>	Capacitive Megohm-Miles X <sub>a</sub>
					25°C Ohms/ Mile	50°C Ohms/ Mile	75°C Ohms/ Mile			
Waxwing	266.8	18/ 1	2	0.3398	0.347	0.382	0.416	0.0197	0.477	0.109
Partridge	266.8	26/ 7	2	0.3364	0.344	0.377	0.411	0.0217	0.465	0.107
Ostrich	300.	26/ 7	2	0.2993	0.306	0.336	0.366	0.0230	0.458	0.106
Merlin	336.4	18/ 1	2	0.2693	0.276	0.303	0.330	0.0221	0.463	0.106
Linnet	336.4	26/ 7	2	0.2671	0.273	0.300	0.327	0.0244	0.451	0.104
Oriole	336.4	30/ 7	2	0.2650	0.271	0.297	0.324	0.0255	0.445	0.103
Chickadee	397.5	18/ 1	2	0.2279	0.234	0.257	0.279	0.0240	0.452	0.103
Ibis	397.5	26/ 7	2	0.2260	0.231	0.254	0.277	0.0265	0.441	0.102
Lark	397.5	30/ 7	2	0.2243	0.229	0.252	0.274	0.0277	0.435	0.101
Pelican	477	18/ 1	2	0.1899	0.195	0.214	0.233	0.0263	0.441	0.100
Flicker	477	24/ 7	2	0.1889	0.194	0.213	0.232	0.0283	0.432	0.0992
Hawk	477	26/ 7	2	0.1883	0.193	0.212	0.231	0.0290	0.430	0.0988
Hen	477	30/ 7	2	0.1869	0.191	0.210	0.229	0.0304	0.424	0.0980
Osprey	556.5	18/ 1	2	0.1629	0.168	0.184	0.200	0.0284	0.432	0.0981
Parakeet	556.5	24/ 7	2	0.1620	0.166	0.183	0.199	0.0306	0.423	0.0969
Dove	556.5	26/ 7	2	0.1613	0.166	0.182	0.198	0.0313	0.420	0.0965
Eagle	556.5	30/ 7	2	0.1602	0.164	0.180	0.196	0.0328	0.415	0.0957
Peacock	605	24/ 7	2	0.1490	0.153	0.168	0.183	0.0319	0.418	0.0957
Squab	605	26/ 7	2	0.1485	0.153	0.167	0.182	0.0327	0.415	0.0953
Teal	605	30/19	2	0.1475	0.151	0.166	0.181	0.0342	0.410	0.0944
Kingbird	636	18/ 1	2	0.1420	0.147	0.162	0.175	0.0301	0.425	0.0951
Rook	636	24/ 7	2	0.1417	0.146	0.160	0.174	0.0327	0.415	0.0950
Grosbeak	636	26/ 7	2	0.1411	0.145	0.159	0.173	0.0335	0.412	0.0946
Swift	636	36/ 1	3	0.1410	0.148	0.162	0.176	0.0300	0.426	0.0964
Egret	636	30/19	2	0.1403	0.144	0.158	0.172	0.0351	0.406	0.0937
Flamingo	666.6	24/ 7	2	0.1352	0.139	0.153	0.166	0.0335	0.412	0.0943
Crow	715.5	54/ 7	3	0.1248	0.128	0.141	0.153	0.0372	0.399	0.0920
Starling	715.5	26/ 7	2	0.1254	0.129	0.142	0.154	0.0355	0.405	0.0928
Redwing	715.5	30/19	2	0.1248	0.128	0.141	0.153	0.0372	0.399	0.0920
Coot	795	36/ 1	3	0.1146	0.119	0.130	0.142	0.0335	0.412	0.0932
Cuckoo	795	24/ 7	2	0.1135	0.118	0.128	0.140	0.0361	0.403	0.0917
Drake	795	26/ 7	2	0.1129	0.117	0.128	0.139	0.0375	0.399	0.0912
Mallard	795	30/19	2	0.1122	0.116	0.127	0.138	0.0392	0.393	0.0904
Tern	795	45/ 7	3	0.1143	0.119	0.130	0.141	0.0352	0.406	0.0925
Condor	795	54/ 7	3	0.1135	0.117	0.129	0.140	0.0368	0.401	0.0917
Crane	874.5	54/ 7	3	0.1030	0.107	0.117	0.127	0.0387	0.395	0.0902
Ruddy	900	45/ 7	3	0.1008	0.106	0.115	0.125	0.0374	0.399	0.0907
Canary	900	54/ 7	3	0.1002	0.104	0.114	0.124	0.0392	0.393	0.0898

(See footnotes at end of table)

bare aluminum wire and cable

TABLE 4-16 (Continued)

Code Word	Size kcmil	Stranding Al./St.	Number of Aluminum Layers	Resistance				GMR ft	Phase-to-Neutral, 60 Hz Reactance at One ft Spacing	
				dc 20°C Ohms/ Mile	ac-60 Hz				Inductive Ohms/Mile $X_a$	Capacitive Megohm-Miles $X_c$
					25°C Ohms/ Mile	50°C Ohms/ Mile	75°C Ohms/ Mile			
Corncrake	954	20/ 7	2	0.0950	0.099	0.109	0.118	0.0378	0.396	0.0898
Rail	954	45/ 7	3	0.09526	0.0994	0.109	0.118	0.0385	0.395	0.0897
Towhee	954	48/ 7	3	0.0950	0.099	0.108	0.118	0.0391	0.393	0.0896
Redbird	954	24/ 7	2	0.0945	0.098	0.108	0.117	0.0396	0.392	0.0890
Cardinal	954	54/ 7	3	0.09452	0.0983	0.108	0.117	0.0404	0.389	0.0890
Ortolan	1033.5	45/ 7	3	0.08798	0.0922	0.101	0.110	0.0401	0.390	0.0886
Curlew	1033.5	54/ 7	3	0.08728	0.0910	0.0996	0.108	0.0420	0.385	0.0878
Bluejay	1113	45/ 7	3	0.08161	0.0859	0.0939	0.102	0.0416	0.386	0.0874
Finch	1113	54/19	3	0.08138	0.0851	0.0931	0.101	0.0436	0.380	0.0867
Bunting	1192.5	45/ 7	3	0.07619	0.0805	0.0880	0.0954	0.0431	0.382	0.0864
Grackle	1192.5	54/19	3	0.07600	0.0798	0.0872	0.0947	0.0451	0.376	0.0856
Bittern	1272	45/ 7	3	0.07146	0.0759	0.0828	0.0898	0.0445	0.378	0.0855
Pheasant	1272	54/19	3	0.07122	0.0751	0.0820	0.0890	0.0466	0.372	0.0847
Dipper	1351.5	45/ 7	3	0.06724	0.0717	0.0783	0.0848	0.0459	0.374	0.0846
Martin	1351.5	54/19	3	0.06706	0.0710	0.0775	0.0840	0.0480	0.368	0.0838
Bobolink	1431	45/ 7	3	0.06352	0.0681	0.0742	0.0804	0.0472	0.371	0.0837
Plover	1431	54/19	3	0.06332	0.0673	0.0734	0.0796	0.0495	0.365	0.0829
Nuthatch	1510.5	45/ 7	3	0.06017	0.0649	0.0706	0.0765	0.0485	0.367	0.0829
Parrot	1510.5	54/19	3	0.06003	0.0641	0.0699	0.0757	0.0508	0.362	0.0821
Lapwing	1590	45/ 7	3	0.05714	0.0620	0.0674	0.0729	0.0498	0.364	0.0822
Falcon	1590	54/19	3	0.05699	0.0611	0.0666	0.0721	0.0521	0.358	0.0814
Chukar	1780	84/19	4	0.05119	0.0561	0.0609	0.0658	0.0534	0.355	0.0803
Mockingbird	2034.5	72/ 7	4	0.04488	0.0507	0.0549	0.0591	0.0553	0.348	0.0788
Bluebird	2156	84/19	4	0.04229	0.0477	0.0516	0.0555	0.0588	0.344	0.0775
Kiwi	2167	72/ 7	4	0.04228	0.0484	0.0522	0.0562	0.0570	0.348	0.0779
Thrasher	2312	76/19	4	0.03960	0.0454	0.0486	0.0528	0.0600	0.343	0.0767
Joree	2515	76/19	4	0.03643	0.0428	0.0459	0.0491	0.0621	0.338	0.0756

1. Direct current (dc) resistance is based on 16.946 ohm-cmil/ft. (61.2% IACS) at 20°C for nominal aluminum area of the conductors, and 129.64 ohm-cmil/ft. (8% IACS) at 20°C for the nominal steel area, with standard increments for stranding. ASTM B 232.
2. Alternating current (ac) resistance is based on the resistance corrected for temperature using 0.00404 as temperature coefficient of resistivity per degree C for aluminum and 0.0029 per degree C for steel, and for skin effect.
3. The effective ac resistance of 3-layer ACSR increases with current density due to core magnetization. See Chapter 3 for details.
4. For ampacity ratings of bare conductors, see Figs. 3-13 and 3-14.

**TABLE 4-17**  
**Bare Aluminum Conductors, Aluminum-Clad Steel**  
**Reinforced (ACSR/AW)**  
**Physical and Electrical Properties**

**NOTE:** For a cable of same dimensions and Code Word, the values in Table 4-14 (A and B) may be used for cross-sectional area of aluminum wires; total cross-sectional; the number of wires and diameter of wires in strand; diameter of complete cable; and diameter of core. The values in Tables 4-15 and 4-16 may be used for GMR, inductive reactance, and capacitive reactance. For approximate ampacity, multiply value from Fig. 3-13 or 3-14 by the square root of the ratio of the total aluminum area to the aluminum wire area in circular mils. Thus, for Penguin at 60° rise Fig. 3-13 shows 305 amp. Hence,  $305 \times (220,460/211,600)^{1/2} = 311$  for Penguin/AW.

ACSR Code Word	Area of Aluminum Wires cmil	Total Aluminum Area cmil	Resistance				Weight per 1000 ft lb	Rated Strength lb
			dc 20°C Ohms/ mile	ac—60 Hz				
				25°C Ohms/ Mile	50°C Ohms/ Mile	75°C Ohms/ Mile		
Swan/AW	41,740	43,470	2.060	2.102	2.309	2.516	54.6	1,780
Swanate/AW	41,740	44,370	2.005	2.046	2.246	2.447	62.7	2,280
Swallow/AW	52,620	54,370	1.632	1.665	1.829	1.993	68.9	2,230
Sparrow/AW	66,360	69,170	1.295	1.321	1.451	1.581	86.8	2,760
Sparate/AW	66,360	70,630	1.260	1.285	1.411	1.537	99.9	3,510
Robin/AW	83,690	87,320	1.026	1.047	1.150	1.252	109.5	3,460
Raven/AW	105,600	110,100	0.9136	0.8304	0.9121	0.9938	138.2	4,250
Quail/AW	133,100	138,800	0.6457	0.6588	0.7235	0.7883	174.2	5,140
Pigeon/AW	168,800	174,700	0.5126	0.5233	0.5747	0.6262	219.4	6,300
Penguin/AW	211,600	220,400	0.4063	0.4149	0.4557	0.4965	276.8	7,690
Waxwing/AW	266,800	270,300	0.3360	0.3435	0.3767	0.4105	283.5	6,820
Partridge/AW	266,800	277,700	0.3257	0.3328	0.3654	0.3981	349.6	10,800
Ostrich/AW	300,000	312,100	0.2898	0.2962	0.3252	0.3543	392.9	12,100
Merlin/AW	336,400	341,000	0.2663	0.2726	0.2994	0.3261	357.6	8,540
Linnet/AW	336,400	350,400	0.2586	0.2644	0.2903	0.3162	440.3	13,500
Oriole/AW	336,400	356,100	0.2532	0.2588	0.2841	0.3094	495.1	16,700
Chickadee/AW	397,500	403,000	0.2254	0.2310	0.2536	0.2762	442.6	9,780
Brant/AW	397,500	410,400	0.2210	0.2262	0.2484	0.2705	491.0	14,060
Ibis/AW	397,500	413,400	0.2188	0.2239	0.2458	0.2678	520.3	15,800
Lark/AW	397,500	420,600	0.2143	0.2192	0.2407	0.2621	584.9	19,600
Pelican/AW	477,000	483,700	0.1878	0.1916	0.2105	0.2294	507.2	11,500
Flicker/AW	477,000	492,600	0.1841	0.1888	0.2072	0.2256	589.4	16,700
Hawk/AW	477,000	496,800	0.1823	0.1869	0.2051	0.2233	624.5	19,000
Hen/AW	477,000	504,900	0.1786	0.1829	0.2007	0.2185	702.0	23,400
Osprey/AW	556,500	564,000	0.1610	0.1658	0.1819	0.1980	591.6	13,200
Parakeet/AW	556,500	574,700	0.1578	0.1621	0.1779	0.1936	687.5	19,300
Dove/AW	556,500	579,200	0.1562	0.1603	0.1759	0.1915	729.1	21,900
Eagle/AW	556,500	589,000	0.1531	0.1570	0.1722	0.1875	819.0	26,800
Peacock/AW	605,000	624,800	0.1451	0.1493	0.1638	0.1783	747.7	21,000
Squab/AW	605,000	629,300	0.1464	0.1477	0.1621	0.1764	792.1	23,600

(See footnotes at end of table)



bare aluminum wire and cable

TABLE 4-17 (Continued)

ACSR Code Word	Area of Aluminum Wires cmil	Total Aluminum Area cmil	Resistance				Weight per 1000 ft lb	Rated Strength lb
			dc 20°C Ohms/ mile	ac—60 Hz				
				25°C Ohms/ Mile	50°C Ohms/ Mile	75°C Ohms/ Mile		
Teal/AW	605,000	639,400	0.1411	0.1448	0.1589	0.1729	883.2	28,500
Kingbird/AW	636,000	645,000	0.1408	0.1454	0.1594	0.1735	676.5	15,020
Rook/AW	636,000	656,700	0.1381	0.1422	0.1559	0.1697	785.6	22,000
Grosbeak/AW	636,000	661,900	0.1366	0.1406	0.1542	0.1678	833.0	24,800
Egret/AW	636,000	672,300	0.1342	0.1378	0.1512	0.1646	928.9	29,900
Flamingo/AW	666,600	638,500	0.1317	0.1357	0.1488	0.1620	823.7	23,100
Gannett/AW	666,600	693,600	0.1214	0.1252	0.1373	0.1494	873.0	26,000
Crow/AW	715,500	738,600	0.1228	0.1267	0.1389	0.1512	883.4	25,300
Starling/AW	715,500	774,700	0.1214	0.1252	0.1373	0.1494	937.3	27,500
Redwing/AW	715,500	775,900	0.1193	0.1228	0.1347	0.1466	1044	33,400
Tern/AW	795,000	808,500	0.1127	0.1169	0.1281	0.1393	873.4	21,500
Condor/AW	795,000	821,600	0.1104	0.1142	0.1251	0.1361	981.3	27,800
Drake/AW	795,000	827,700	0.1093	0.1129	0.1238	0.1346	1042	30,500
Mallard/AW	795,000	840,500	0.1073	0.1107	0.1213	0.1320	1161	37,100
Cuckoo/AW	795,000	820,700	0.1105	0.1143	0.1253	0.1363	981.8	27,520
Crane/AW	874,500	903,400	0.1004	0.1041	0.1141	0.1240	1081	30,600
Ruddy/AW	900,000	915,200	0.0996	0.1038	0.1136	0.1235	988.9	23,970
Canary/AW	900,000	927,200	0.0976	0.1014	0.1110	0.1207	1111	31,000
Rail/AW	954,000	970,500	0.0939	0.09812	0.1074	0.1167	1049	25,400
Cardinal/AW	954,000	984,700	0.0921	0.09585	0.1049	0.1141	1178	32,900
Ortolan/AW	1,033,500	1,052,000	0.0886	0.09087	0.09938	0.1079	1135	27,200
Curlew/AW	1,033,500	1,068,000	0.0850	0.08868	0.09704	0.1054	1275	35,200
Bluejay/AW	1,113,000	1,133,000	0.0805	0.08476	0.09264	0.1006	1224	29,300
Finch/AW	1,113,000	1,149,000	0.0794	0.08312	0.09091	0.09872	1374	37,500
Bunting/AW	1,192,500	1,213,000	0.0751	0.07949	0.08682	0.09418	1311	31,300
Grackle/AW	1,192,500	1,230,000	0.0741	0.07791	0.08515	0.09243	1471	40,200
Bittern/AW	1,272,000	1,294,000	0.0705	0.07491	0.08175	0.08863	1398	33,400
Pheasant/AW	1,272,000	1,313,000	0.0694	0.07332	0.08009	0.08689	1570	42,400
Dipper/AW	1,351,500	1,375,000	0.0663	0.07085	0.07726	0.08372	1485	35,400
Martin/AW	1,351,500	1,394,000	0.0654	0.06932	0.07567	0.08205	1667	45,100
Bobolink/AW	1,431,000	1,455,000	0.0626	0.06727	0.07330	0.07937	1572	37,600
Plover/AW	1,431,000	1,477,000	0.0617	0.06575	0.07172	0.07772	1766	47,700
Nuthatch/AW	1,510,500	1,536,000	0.0593	0.06407	0.06975	0.07548	1660	39,700
Parrot/AW	1,510,500	1,563,000	0.0583	0.06242	0.06804	0.07369	1862	50,500
Lapwing/AW	1,590,000	1,615,000	0.0564	0.06131	0.06669	0.07211	1748	41,700
Falcon/AW	1,590,000	1,641,000	0.0555	0.05974	0.06507	0.07044	1962	53,000
Chukar/AW	1,780,000	1,817,000	0.0504	0.05533	0.06008	0.06488	2015	49,700
Bluebird/AW	2,156,000	2,200,000	0.0416	0.04705	0.05088	0.05476	2439	59,000
Kiwi/AW	2,167,000	2,191,000	0.0419	0.04805	0.05187	0.05575	2265	49,130
Thrasher/AW	2,312,000	2,343,000	0.0391	0.04528	0.04883	0.05242	2475	55,300

(See footnotes at end of table)

TABLE 4-17 (Continued)

ACSR Code Word	Area of Aluminum Wires cmil	Total Aluminum Area cmil	Resistance				Weight per 1000 ft lb	Rated Strength lb
			dc 20°C Ohms/ mile	ac—60 Hz				
				25°C Ohms/ Mile	50°C Ohms/ Mile	75°C Ohms/ Mile		
Joree/AW	2,515,000	2,549,000	0.0360	0.04243	0.04564	0.04890		
Grouse/AW	80,000	86,970	1.0200	1.0408	1.1426	1.2445	2693	60,160
Petrel/AW	101,800	116,600	0.7524	0.7673	0.8419	0.9165	137.7	4,890
Minorca/AW	110,800	127,000	0.7001	0.7048	0.7733	0.8418	229.8	9,910
Leghorn/AW	134,600	154,200	0.5692	0.5804	0.6368	0.6932	250.2	10,800
Guinea/AW	159,000	182,200	0.4817	0.4914	0.5391	0.5869	303.9	13,000
Dotterel/AW	176,900	202,600	0.4330	0.4417	0.4847	0.5274	359.0	15,300
Dorking/AW	190,800	218,600	0.4013	0.4094	0.4492	0.48900	399.4	16,900
Cochin/AW	211,300	242,100	0.3624	0.3698	0.4057	0.4416	430.9	18,300
Brahma/AW	203,200	248,600	0.3469	0.3539	0.3880	0.4221	477.2	19,700
							602.6	27,100

1. The values listed above differ from the corresponding ones of tables for ACSR because the conductivity of the aluminum in the thick cladding of the core wires is taken into account. Electrical properties of the aluminum wires are those of ASTM B 230 and of the core wires are those of ASTM B 502.
2. The single and three-layer ACSR/AW ac resistances have not been corrected for the magnetic effect of the core wire. See text of Chapter 3.

**TABLE 4-18**  
**Compact-Round Concentric-Lay Stranded Aluminum Conductor**  
**Steel Reinforced (ACSR Compact Round) with Single Core**  
**Wire of Class B Zinc-Coated or Aluminized (AZ) Steel**  
**1350-H19 ASTM B 401**  
**Physical and Electrical Properties**

Size AWG or kcmil	Alumi- num Area Sq. in.	No. of Alum. Wires	Diam. of Single Core Wire, in.	Diam. of Complete Compact Cable, in.	Diam. of Non- Compact ACSR, in.	Weight per 1000 ft			Rated Strength-lb		Resistance dc—20°C Ohms/ Mile
						Total lb	Alum. lb	Steel lb	Class B Zinc Core	Aluminized AZ Core	
6	0.0206	6	0.0661	0.182	0.198	36.0	24.4	11.6	1160	1120	3.3893
4	0.0328	6	0.0834	0.229	0.250	57.3	38.9	18.4	1810	1760	2.1291
4	0.0328	7	0.1029	0.236	0.257	67.0	39.0	28.0	2280	2160	2.1060
2	0.0521	6	0.1052	0.290	0.316	91.2	61.9	29.3	2760	2640	1.3381
2	0.0521	7	0.1299	0.298	0.325	106.6	61.9	44.7	3510	3260	1.3230
1	0.0657	6	0.1181	0.326	0.353	115.0	78.1	36.9	3450	3290	1.0617
1/0	0.0829	6	0.1327	0.365	0.398	145.2	98.6	46.6	4250	3980	0.8410
2/0	0.1045	6	0.1489	0.410	0.447	182.8	124.0	58.8	5130	4880	0.6679
3/0	0.1318	6	0.1672	0.461	0.502	230.5	156.4	74.1	6410	5880	0.5297
4/0	0.1662	6	0.1878	0.517	0.563	290.8	197.4	93.4	8080	7420	0.4199
266.8	0.2095	18	0.1217	0.559	0.609	289.1	249.9	39.2	6770	6540	0.3398
300.0	0.2356	18	0.1291	0.593	0.646	326.0	282.0	44.0	7610	7360	0.3020
336.4	0.2642	18	0.1367	0.628	0.684	364.8	315.3	49.5	8540	8260	0.2693
477.0	0.3746	18	0.1628	0.742	0.814	518.0	447.8	70.2	11,600	11,100	0.1899
795.0	0.6244	36	0.1486	0.948	1.040	805.0	746.0	54.0	16,600	16,300	0.1144
874.5	0.6868	36	0.1559	0.994	1.091	885.0	821.0	64.0	17,900	17,500	0.1039
954.0	0.7493	36	0.1628	1.039	1.140	966.0	896.0	70.0	19,600	19,100	0.09530
1468.0	1.1532	36	0.2019	1.288	1.413	1494.0	1386.0	108.0	30,100	29,300	0.06196

1. Data shown above are subject to normal manufacturing tolerance.
2. Applicable footnotes of Table 4-15 and 4-16 also apply to the above table; that is, the magnetizing currents for single-layer cables are based on 10% of specified current for 25°C, 75% for 50°C, and 100% for 75°C. Allowance should also be made for core magnetization in the 36-wire cables.
3. For ampacity ratings see Figs. 3-13 and 3-14 and adjust according to the method described in the accompanying text.
4. Electrical data will be close enough to the equivalent size of non-compacted conductor that data for those conductors may be used for practical purposes.

**TABLE 4-19**  
**Shaped Wire Concentric-Lay Compact Aluminum Conductor Steel Reinforced (ACSR/TW)**  
**Physical Properties**  
**ASTM B 779**  
**Area Equal to Standard ACSR Sizes**

Code Word	Conductor Size			Type No.	Stranding		Outside Diameter		Weight per 1000 ft			Rated Strength lb
	kcmil	Area Square Inches			Aluminum	Steel	Complete Conductor in.	Steel Core in.	Total lb	Aluminum lb	Steel lb	
		Aluminum	Total									
Merlin/TW	336.4	0.2642	0.2788	6	14	1x0.1367	0.630	0.1367	365.0	315.5	49.5	8,560
Flicker/TW	477.0	0.3747	0.4233	13	18	7x0.0940	0.776	0.2820	612.8	448.4	164.4	17,200
Hawk/TW	477.0	0.3746	0.4356	16	18	7x0.1053	0.789	0.3159	655.0	448.7	206.3	19,400
Parakeet/TW	556.5	0.4371	0.4937	13	18	7x0.1015	0.835	0.3045	714.9	523.2	191.7	20,000
Dove/TW	556.5	0.4371	0.5083	16	20	7x0.1138	0.852	0.3414	764.5	523.5	241.0	22,600
Swift/TW	636.0	0.4995	0.5133	3	27	1x0.1329	0.850	0.1329	646.0	599.2	46.8	13,500
Rook/TW	636.0	0.4995	0.5643	13	19	7x0.1085	0.890	0.3255	816.0	597.9	219.1	22,900
Grosbeak/TW	636.0	0.4995	0.5808	16	20	7x0.1216	0.908	0.3648	873.5	598.4	275.1	25,400
Tern/TW	795.0	0.6244	0.6675	7	17	7x0.0886	0.960	0.2658	892.0	745.9	146.1	21,000
Puffin/TW	795.0	0.6244	0.6919	10	18	7x0.1108	0.980	0.3324	975.3	746.9	228.4	25,900
Condor/TW	795.0	0.6244	0.7053	13	20	7x0.1203	0.993	0.3639	1021	747.2	273.8	28,200
Drake/TW	795.0	0.6244	0.7261	16	20	7x0.1360	1.010	0.4080	1092	747.8	344.2	13,800
Phoenix/TW	954.0	0.7493	0.7876	5	30	7x0.0837	1.044	0.2511	1032	901.6	130.4	23,700
Rail/TW	954.0	0.7493	0.8011	7	32	7x0.0971	1.061	0.2913	1075	900.0	175.0	25,900
Cardinal/TW	954.0	0.7493	0.8464	13	20	7x0.1329	1.084	0.3987	1226	897.3	328.7	33,500
Snowbird/TW	1033.5	0.8117	0.8534	5	30	7x0.0871	1.089	0.2613	1115	973.8	141.2	25,700
Ortolan/TW	1033.5	0.8117	0.8678	7	32	7x0.1010	1.102	0.3030	1165	975.2	189.8	28,100
Curlew/TW	1033.5	0.8117	0.9169	13	22	7x0.1383	1.129	0.4149	1327	971.1	355.9	36,300
Avocet/TW	1113.0	0.8742	0.9191	5	30	7x0.0904	1.129	0.2712	1201	1048.9	152.1	27,500
Bluejay/TW	1113.0	0.8742	0.9347	7	33	7x0.1049	1.143	0.3147	1257	1052.2	204.8	30,300
Finch/TW	1113.0	0.8742	0.9851	13	38	19x0.0862	1.185	0.4310	1429	1052.6	376.4	39,100
Oxbird/TW	1192.5	0.9366	0.9848	5	30	7x0.0936	1.167	0.2808	1286	1123	163	29,500
Bunting/TW	1192.5	0.9366	1.0013	7	33	7x0.1085	1.181	0.3255	1343	1124	219	32,400
Grackle/TW	1192.5	0.9366	1.0554	13	38	19x0.0892	1.225	0.4460	1530	1127	403	41,900
Scissortail/TW	1272.0	0.9991	1.0505	5	30	7x0.0967	1.203	0.2901	1372	1198	174	31,400
Bittern/TW	1272.0	0.9990	1.0681	7	35	7x0.1121	1.220	0.3363	1433	1199	234	34,600
Pheasant/TW	1272.0	0.9990	1.1256	13	39	19x0.09210	1.264	0.4605	1632	1202	430	44,100
Dipper/TW	1351.5	1.0615	1.1348	7	35	7x0.1155	1.256	0.3465	1522	1274	248	36,700
Martin/TW	1351.5	1.0615	1.1959	13	39	19x0.0949	1.300	0.4745	1734	1278	456	46,800
Bobolink/TW	1431.0	1.1236	1.2017	7	36	7x0.1189	1.291	0.3567	1613	1350	263	38,900
Plover/TW	1431.0	1.1239	1.2664	13	37	19x0.0977	1.337	0.4885	1836	1353	483	49,600
Lapwing/TW	1590.0	1.2488	1.3351	7	36	7x0.1253	1.358	0.3759	1791	1499	292	42,200
Falcon/TW	1590.0	1.2488	1.4071	13	42	19x0.1030	1.408	0.5150	2040	1503	537	55,100
Chukar/TW	1780.0	1.3986	1.512	8	37	19x0.0874	1.445	0.4370	2063	1676	387	50,700
Bluebird/TW	2156.0	1.0934	1.8312	8	64	19x0.0961	1.608	0.4805	2515	2047	468	61,100

1. Data shown are subject to normal manufacturing tolerances.
2. Aluminum strands are of a trapezoidal shape and thus round wire size is not shown.
3. Rated strengths of the complete conductors are calculated in accordance with ASTM B 779.
4. Weights are based on 1350 aluminum and Class A zinc-coated steel.
5. The type no. is the ratio of the steel to aluminum areas expressed as a percentage.

bare aluminum wire and cable

**TABLE 4-20**  
**Shaped Wire Concentric-Lay Compact Aluminum Conductors Steel Reinforced (ACSR/TW)**  
**Electrical Properties**  
**Area Equal to Stranded ACSR Sizes**

Code Word	Size kcmil	Type No.	Stranding Al./St.	No. of Aluminum Layers	Resistance				GMR ft	Phase-to-Neutral 60 Hz Resistance at One ft Spacing	
					dc 20°C Ohms/ Mile	ac—60 Hz				Inductive Ohms/ Mile $X_a$	Capacitive Megohm- Miles $X_c$
						25°C Ohms/ Mile	50°C Ohms/ Mile	75°C Ohms/ Mile			
Merlin/TW	336.4	6	14/1	2	0.2654	0.2715	0.2986	0.3258	0.0200	0.475	0.1079
Flicker/TW	477.0	13	18/7	2	0.1860	0.1904	0.2094	0.2284	0.0257	0.444	0.1017
Hawk/TW	477.0	16	18/7	2	0.1854	0.1878	0.2087	0.2277	0.0264	0.441	0.1013
Parakeet/TW	556.5	13	18/7	2	0.1593	0.1633	0.1796	0.1959	0.0277	0.435	0.0994
Dove/TW	556.5	16	20/7	2	0.1588	0.1628	0.1790	0.1953	0.0286	0.431	0.0991
Swift/TW	636.0	3	27/1	3	0.1416	0.1461	0.1605	0.1748	0.0273	0.437	0.0991
Rook/TW	636.0	13	18/7	2	0.1395	0.1432	0.1574	0.1717	0.0296	0.427	0.0978
Grosbeak/TW	636.0	16	20/7	2	0.1390	0.1426	0.1568	0.1710	0.0305	0.423	0.0971
Tern/TW	795.0	7	17/7	2	0.1123	0.1160	0.1274	0.1388	0.0312	0.4209	0.0955
Puffin/TW	795.0	10	18/7	2	0.1118	0.1152	0.1266	0.1380	0.0323	0.4165	0.0949
Condor/TW	795.0	13	20/7	2	0.1113	0.1147	0.1260	0.1373	0.0331	0.4137	0.0945
Drake/TW	795.0	16	20/7	2	0.1111	0.1144	0.1257	0.1370	0.0339	0.4105	0.0940
Phoenix/TW	954.0	5	30/7	3	0.0942	0.0982	0.1077	0.1172	0.0343	0.4094	0.0928
Rail/TW	954.0	7	32/7	3	0.0940	0.0979	0.1073	0.1160	0.0349	0.407	0.0925
Cardinal/TW	954.0	13	20/7	2	0.0931	0.0962	0.1056	0.1151	0.0362	0.403	0.0919
Snowbird/TW	1033.5	5	30/7	3	0.0868	0.0908	0.0995	0.1083	0.0356	0.405	0.0917
Ortolan/TW	1033.5	7	32/7	3	0.0867	0.0906	0.0993	0.1081	0.0363	0.402	0.0914
Curlew/TW	1033.5	13	21/7	2	0.0859	0.0389	0.0976	0.1063	0.0377	0.398	0.0906
Avocet/TW	1113.0	5	30/7	3	0.0807	0.0847	0.0928	0.1009	0.0369	0.400	0.0906
Bluejay/TW	1113.0	7	33/7	3	0.0805	0.0845	0.0925	0.1005	0.0376	0.398	0.0903
Finch/TW	1113.0	13	38/19	3	0.0802	0.0837	0.0917	0.0998	0.0399	0.391	0.0891
Oxbird/TW	1192.5	5	30/7	3	0.0753	0.0794	0.0869	0.0945	0.0382	0.396	0.0896
Bunting/TW	1192.5	7	33/7	3	0.0752	0.0791	0.0866	0.0941	0.0390	0.394	0.0893
Grackle/TW	1192.5	13	38/19	3	0.0749	0.0783	0.0859	0.0934	0.0412	0.387	0.0883
Scissortail/TW	1272.0	5	30/7	3	0.0706	0.0747	0.0817	0.0889	0.0394	0.392	0.0888
Bittern/TW	1272.0	7	35/7	3	0.0705	0.0745	0.0815	0.0885	0.0403	0.390	0.0884
Pheasant/TW	1272.0	13	39/19	3	0.0701	0.0736	0.0806	0.0876	0.0426	0.383	0.0874
Dipper/TW	1351.5	7	35/7	3	0.0664	0.0704	0.0769	0.0836	0.0415	0.386	0.0874
Martin/TW	1351.5	13	39/19	3	0.0659	0.0694	0.0760	0.0826	0.0438	0.377	0.0865
Bobolink/TW	1431.0	7	36/7	3	0.0627	0.0668	0.0730	0.0792	0.0427	0.383	0.0867
Plover/TW	1431.0	13	39/19	3	0.0624	0.0659	0.0721	0.0784	0.0451	0.376	0.0860
Lapwing/TW	1590.0	7	36/7	3	0.0564	0.0606	0.0661	0.0717	0.0449	0.377	0.0851
Falcon/TW	1590.0	13	42/19	3	0.0561	0.0598	0.0653	0.0709	0.0476	0.370	0.0841
Chukar/TW	1780.0	8	37/19	3	0.0503	0.0545	0.0594	0.0644	0.0482	0.368	0.0832
Bluebird/TW	2156.0	8	64/19	4	0.0415	0.0465	0.0504	0.0544	0.0538	0.355	0.0801

1. Direct current (dc) resistance is based on 16.727 ohm-cmil/ft (62.0% IACS) at 20°C for nominal aluminum area of the conductors, and 129.64 ohm-cmil/ft (8.0% IACS) at 20°C for the nominal steel area.
2. Alternating current (ac) resistance is based on dc resistance corrected for temperature using 0.00409 as temperature coefficient of resistivity per degree C for aluminum and 0.0029 per degree C for steel, and for skin effect.
3. The effective ac resistance of a layer ACSR/TW increases with current density due to core magnetization. See Chapter 3 for details.
4. For ampacity ratings of TW conductors, approximate values can be obtained from Figs. 3-13 and 3-14.

**TABLE 4-21**  
**Shaped Wire Concentric-Lay Compact Aluminum Conductors Steel Reinforced (ACSR/TW)**  
**ASTM B 779 Physical Properties**  
**Sized to Have Diameters Equal to Standard ACSR Conductors**

Code Word	Conductor Size			Type No.	Stranding		Outside Diameter		Weight per 1000 ft			Rated Strength lbs	Size & Stranding of ACSR with equal diameter	
	kcmil	Area Square Inches			Alumi-num	Steel	Com-plete Conduc-tor in.	Steel Core in.	Total lbs	Alumi-num lbs	Steel lbs		kcmil	Stranding
		Alumi-num	Total											
Monongahela/TW	405.1	0.3181	0.3362	6	14	1x.1520	0.680	0.1520	441.0	379.8	61.2	10,200	336.4	18/1
Mohawk/TW	571.7	0.4490	0.5074	13	18	7x.1030	0.846	0.3090	734.7	537.3	197.4	20,700	477.0	24/7
Calumet/TW	565.3	0.4439	0.5165	16	18	7x.1147	0.858	0.3438	714.8	523.1	191.7	22,900	477.0	26/7
Mystic/TW	666.6	0.5236	0.5914	13	20	7x.1111	0.913	0.3330	856.3	626.6	229.7	24,000	556.5	24/7
Oswego/TW	664.8	0.5221	0.6072	16	20	7x.1244	0.927	0.3732	913.4	625.4	288.0	26,600	556.5	26/7
Nechako/TW	768.9	0.6039	0.6220	3	27	1x.1520	0.980	0.1520	781.9	720.7	61.2	16,400	636.0	36/1
Maumee/TW	768.2	0.6034	0.6819	13	20	7x.1195	0.977	0.3585	987.8	722.1	265.7	27,700	636.0	24/7
Wabash/TW	762.8	0.5992	0.6966	16	20	7x.1331	0.990	0.3343	1047	717	330	30,500	636.0	26/7
Kettle/TW	957.2	0.7518	0.8038	7	32	7x.0973	1.060	0.2919	1079	902.8	176.2	26,000	795.0	45/7
Fraser/TW	946.7	0.7436	0.8168	10	35	7x.1154	1.077	0.3462	1142	894	248	29,600	795.0	22/7
Columbia/TW	966.2	0.7589	0.8573	13	21	7x.1338	1.092	0.4014	1241	908	333	34,000	795.0	54/7
Suwannee/TW	959.6	0.7537	0.8762	16	22	7x.1493	1.108	0.4479	1318	903	415	37,000	795.0	26/7
Cheyenne/TW	1168.1	0.9175	0.9646	5	30	7x.0926	1.155	0.2778	1260	1100.4	159.6	28,900	954.0	42/7
Genesee/TW	1158.0	0.9095	0.9733	7	33	7x.1078	1.165	0.3234	1308	1092	216	31,600	954.0	45/7
Hudson/TW	1158.4	0.9098	1.0281	13	26	7x.1467	1.196	0.4401	1489	1089	400	39,600	954.0	54/7
Catawba/TW	1272.0	0.9991	1.0505	5	30	7x.0967	1.203	0.2901	1372	1198	174	31,400	1033.5	42/7
Nelson/TW	1257.1	0.9874	1.0557	7	35	7x.1115	1.213	0.3345	1417	1185.7	231.3	34,200	1033.5	45/7
Yukon/TW	1233.6	0.9689	1.0925	13	38	19x.0910	1.245	0.455	1586	1166.5	419.5	42,900	1033.5	54/7
Truckee/TW	1372.5	1.078	1.1334	5	30	7x.1004	1.248	0.3012	1481	1293.4	187.6	33,400	1113.0	42/7
Mackenzie/TW	1359.7	1.0679	1.1418	7	36	7x.1159	1.259	0.3477	1530	1280	250.0	36,900	1113.0	45/7
Thames/TW	1334.6	1.348	1.1809	13	39	19x.0944	1.290	0.4720	1713	1261.6	451.4	46,300	1113.0	54/19
St. Croix/TW	1467.8	1.1529	1.2124	5	33	7x.1041	1.292	0.3123	1585	1383	202	35,800	1192.5	42/7
Miramichi/TW	1455.3	1.1430	1.2222	7	36	7x.1200	1.302	0.3600	1640	1372	268	39,200	1192.5	45/7
Merrimack/TW	1433.6	1.125	1.2677	13	39	19x.0978	1.340	0.489	1840	1356	434	49,700	1192.5	54/19
Platte/TW	1569.0	1.2323	1.2957	5	33	7x.1074	1.334	0.3222	1693	1478	215	38,200	1272.0	42/7
Potomac/TW	1557.4	1.2232	1.3079	7	36	7x.1241	1.345	0.3723	1755	1468	287	41,900	1272.0	45/7
Rio Grande/TW	1533.3	1.2043	1.3571	13	39	19x.1012	1.382	0.5060	1968	1449	519	53,200	1272.0	54/1
Schuylkill/TW	1657.4	1.3020	0.3920	7	36	7x.1280	1.386	0.3840	1868	1563	305	44,000	1351.5	45/7
Pecos/TW	1622.0	1.2739	1.4429	13	39	19x.1064	1.424	0.5320	2107	1533	574	57,500	1351.5	54/19
Pee Dee/TW	1758.6	1.3810	1.4770	7	37	7x.1319	1.427	0.3957	1982	1658	324	46,700	1431.0	45/7
James/TW	1730.6	1.359	1.5314	13	34	19x.1075	1.470	0.5375	2221	1636	585	59,400	1431.0	54/19
Athabaska/TW	1949.6	1.5312	1.6377	7	42	7x.1392	1.504	0.4176	2199	1838	361	51,900	1590.0	45/7
Cumberland/TW	1926.9	1.5134	1.7049	13	42	19x.1133	1.545	0.5665	2471	1821	650	65,300	1590.0	54/19
Powder/TW	2153.8	1.6912	1.8290	8	64	19x.0961	1.602	0.4805	2498	2030	468	61,100	1780.0	84/19
Santee/TW	2627.3	2.063	2.2268	8	64	19x.1062	1.762	0.5310	3048	2477	571	74,500	2156.0	84/19

1. Data shown are subject to normal manufacturing tolerances.
2. Aluminum strands are of a trapezoidal shape and thus round wire size is not shown.
3. Rated strengths of the complete conductors are calculated in accordance with ASTM B 779.
4. Weights are based on 1350 aluminum and Class A zinc-coated steel.
5. The type no. is the ratio of the steel to aluminum areas expressed as a percentage.

bare aluminum wire and cable

**TABLE 4-22**  
**Shaped Wire Concentric-Lay Compact Aluminum Conductors Steel Reinforced (ACSR/TW)**  
**Electrical Properties**  
**Sized to Have Diameters Equal to Standard ACSR Conductors**

Code Word	Size kcmil	Type No.	Stranding Al./St.	No. of Aluminum Layers	Resistance				GMR ft	Phase-to-Neutral 60 Hz Resistance at One ft Spacing	
					dc 20°C Ohms/ Mile	ac—60 Hz				Inductive Ohms/ Mile X <sub>a</sub>	Capacitive Megohm- Miles X <sub>a</sub>
						25°C Ohms/ Mile	50°C Ohms/ Mile	75°C Ohms/ Mile			
Monongahela/TW	405.1	6	14/1	2	0.2205	0.2258	0.2483	0.2709	0.0218	0.464	0.1097
Mohawk/TW	571.7	13	18/7	2	0.1550	0.1590	0.1748	0.1907	0.0281	0.433	0.0991
Calumet/TW	565.3	16	20/7	2	0.1564	0.1603	0.1763	0.1923	0.0288	0.430	0.0988
Mystic/TW	666.6	13	20/7	2	0.1331	0.1367	0.1503	0.1638	0.0304	0.424	0.0970
Oswego/TW	664.8	16	20/7	2	0.1329	0.1364	0.1500	0.1635	0.0310	0.421	0.0964
Nechako/TW	768.9	3	27/1	3	0.1171	0.1214	0.1332	0.1451	0.0300	0.425	0.0965
Maumee/TW	768.2	13	20/7	2	0.1155	0.1189	0.1306	0.1424	0.0325	0.416	0.0949
Wabash/TW	762.8	16	20/7	2	0.1159	0.1191	0.1309	0.1428	0.0330	0.413	0.0946
Kettle/TW	957.2	7	32/7	3	0.0938	0.0976	0.1071	0.1166	0.0350	0.407	0.0925
Fraser/TW	946.7	10	35/7	3	0.0945	0.0982	0.1077	0.1173	0.0358	0.404	0.0919
Columbia/TW	966.2	13	21/7	2	0.0918	0.0949	0.1042	0.1136	0.0364	0.402	0.0917
Suwanee/TW	959.6	16	22/7	2	0.0922	0.0951	0.1045	0.1138	0.0373	0.399	0.0913
Cheyenne/TW	1168.1	5	30/7	3	0.0769	0.0810	0.0886	0.0963	0.0378	0.397	0.0901
Genesee/TW	1158.0	7	33/7	3	0.0774	0.0813	0.0891	0.0968	0.0384	0.395	0.0897
Hudson/TW	1158.4	13	25/7	2	0.0764	0.0794	0.0871	0.0948	0.0400	0.391	0.0889
Catawba/TW	1272.0	5	30/7	3	0.0706	0.0747	0.0817	0.0888	0.0394	0.392	0.0889
Nelson/TW	1257.1	7	35/7	3	0.0713	0.0753	0.0824	0.0895	0.0400	0.390	0.0886
Yukon/TW	1233.6	13	38/19	3	0.0723	0.0758	0.0830	0.0903	0.0420	0.385	0.0877
Truckee/TW	1372.5	5	30/7	3	0.0654	0.0697	0.0761	0.0826	0.0409	0.388	0.0877
Mackenzie/TW	1359.7	7	36/7	3	0.0658	0.0698	0.0764	0.0829	0.0420	0.386	0.0874
Thames/TW	1334.6	13	39/19	3	0.0668	0.0703	0.0770	0.0837	0.0436	0.380	0.0866
St. Croix/TW	1467.8	5	33/7	3	0.0612	0.0655	0.0716	0.0776	0.0424	0.840	0.0867
Miramichi/TW	1455.3	7	36/7	3	0.0616	0.0658	0.0718	0.0780	0.0431	0.382	0.0867
Merrimac/TW	1433.6	13	39/19	3	0.0622	0.0658	0.0720	0.0782	0.0450	0.376	0.0856
Platte/TW	1569.0	5	33/7	3	0.0573	0.0617	0.0673	0.0730	0.0439	0.379	0.0858
Potomac/TW	1557.4	7	36/7	3	0.0575	0.0617	0.0674	0.0731	0.0445	0.378	0.0853
Rio Grande/TW	1533.3	13	39/19	3	0.0582	0.0618	0.0676	0.0734	0.0466	0.372	0.0847
Schuykill/TW	1657.4	7	36/7	3	0.0541	0.0584	0.0637	0.0690	0.0459	0.374	0.0845
Pecos/TW	1622.0	13	39/19	3	0.0549	0.0585	0.0639	0.0690	0.0481	0.368	0.0839
Pee Dee/TW	1758.6	7	37/7	3	0.0510	0.0554	0.0603	0.0653	0.0473	0.370	0.0837
James/TW	1730.6	13	39/19	3	0.0516	0.0553	0.0604	0.0654	0.0494	0.365	0.0829
Athabaska/TW	1949.6	7	42/7	3	0.0460	0.0506	0.0550	0.0595	0.0500	0.363	0.0822
Cumberland/TW	1926.9	13	42/19	3	0.0462	0.0501	0.0546	0.0591	0.0523	0.358	0.0815
Powder/TW	2153.8	8	64/19	4	0.0414	0.0464	0.0503	0.0543	0.0538	0.355	0.0803
Santee/TW	2627.3	8	64/19	4	0.0341	0.0395	0.0427	0.0459	0.0594	0.343	0.0775

1. Direct current (dc) resistance is based on 16.727 ohm-cmil/ft (62.0% IACS) at 20°C for nominal aluminum area of the conductors, and 129.64 ohm-cmil/ft (8.0% IACS) at 20°C for the nominal steel area.
2. Alternating current (ac) resistance is based on dc resistance corrected for temperature using 0.00409 as temperature coefficient of resistivity per degree C for aluminum and 0.0029 per degree C for steel, and for skin effect.
3. The effective ac resistance of 3 layer ACSR/TW increases with current density due to core magnetization. See Chapter 3 for details.
4. For ampacity ratings of TW conductors, approximate values can be obtained from Figs. 3-13 and 3-14.

**TABLE 4-23**  
**ACAR Aluminum Alloy Conductors,**  
**1350-H19 with 6201-T81 Reinforcement**  
**ASTM B 524 Sizes**  
**Physical and Electrical Properties**

Size		Stranding		Outside Diameter in.	Weight per 1000 Feet			Rated Strength lbs	Resistance			
AWG or kcmil	Cross Section Square Inches	1350-H19	6201-T81		1350 Alumi-num	6201 Alumi-num	Total		dc 20°C Ohms/ Mile	ac—60Hz		
										25°C Ohms/ Mile	50°C Ohms/ Mile	75° Ohms/ Mile
30.6	0.0240	4x0.0661	3x0.0661	0.198	16.4	12.2	28.6	826	3.178	3.24	3.54	3.84
4	0.0328	4x0.0772	3x0.0772	0.232	22.3	16.7	39.0	1120	2.330	2.37	2.60	2.82
48.7	0.0382	4x0.0834	3x0.0834	0.250	26.1	19.5	45.6	1290	1.996	2.03	2.22	2.42
2	0.0521	4x0.0974	3x0.0974	0.292	35.6	26.5	62.1	1750	1.464	1.49	1.63	1.77
77.5	0.0608	4x0.1052	3x0.1052	0.316	41.5	31.0	72.5	2010	1.255	1.28	1.40	1.52
1/0	0.0829	4x0.1228	3x0.1228	0.368	56.5	42.2	98.7	2690	0.9207	0.939	1.03	1.11
123.3	0.0968	4x0.1327	3x0.1327	0.398	66.0	49.3	115.3	3140	0.7884	0.804	0.879	0.954
2/0	0.1045	4x0.1379	3x0.1379	0.414	71.3	53.2	124.5	3310	0.7301	0.744	0.814	0.884
155.4	0.1221	4x0.1490	3x0.1490	0.447	83.2	62.1	145.3	3830	0.6254	0.638	0.697	0.757
3/0	0.1317	4x0.1548	3x0.1548	0.464	89.8	67.0	156.8	4100	0.5794	0.591	0.646	0.701
195.7	0.1537	4x0.1672	3x0.1672	0.502	105.0	78.2	183.2	4790	0.4966	0.507	0.554	0.601
4/0	0.1663	4x0.1739	3x0.1739	0.522	113.0	84.6	197.6	5180	0.4591	0.469	0.512	0.556
246.9	0.1939	4x0.1878	3x0.1878	0.563	132.0	98.7	230.7	6040	0.3935	0.402	0.439	0.477
250	0.1963	15x0.1147	4x0.1147	0.574	185.0	49.1	234.1	5480	0.3764	0.385	0.422	0.458
250	0.1963	12x0.1147	7x0.1147	0.574	148.0	85.9	233.9	6200	0.3853	0.394	0.431	0.468
300	0.2358	15x0.1257	4x0.1257	0.629	222.0	58.9	280.9	6500	0.3134	0.321	0.351	0.382
300	0.2358	12x0.1257	7x0.1257	0.629	178.0	103.0	281.0	7380	0.3208	0.328	0.359	0.390
350	0.2748	15x0.1357	4x0.1357	0.679	359.0	68.7	327.7	7470	0.2689	0.275	0.302	0.328
350	0.2748	12x0.1357	7x0.1357	0.679	207.0	120.6	327.0	8410	0.2753	0.282	0.308	0.334
400	0.3142	15x0.1451	4x0.1451	0.726	296.0	78.5	374.5	8430	0.2352	0.241	0.264	0.287
400	0.3142	12x0.1451	7x0.1451	0.726	237.0	137.0	374.0	9520	0.2408	0.247	0.270	0.293
450	0.3534	15x0.1539	4x0.1539	0.770	333.0	88.3	421.3	9350	0.2091	0.215	0.235	0.256
450	0.3534	12x0.1539	7x0.1539	0.770	266.0	155.0	421.0	10600	0.2140	0.220	0.240	0.261
500	0.3926	15x0.1622	4x0.1622	0.811	370.0	98.1	468.1	10400	0.1882	0.194	0.212	0.230
500	0.3926	12x0.1622	7x0.1622	0.811	296.0	172.0	468.0	11800	0.1927	0.198	0.216	0.235
500	0.3924	33x0.1162	4x0.1162	0.813	418.0	50.4	468.4	10000	0.1855	0.191	0.209	0.228
500	0.3924	30x0.1162	7x0.1162	0.813	380.0	88.1	468.1	10800	0.1877	0.193	0.211	0.230
500	0.3924	24x0.1162	13x0.1162	0.813	304.0	164.0	468.0	11900	0.1923	0.198	0.216	0.234
500	0.3924	18x0.1162	19x0.1162	0.813	228.0	239.0	467.0	13200	0.1971	0.202	0.221	0.239
550	0.4318	15x0.1701	4x0.1701	0.851	407	108	515	11400	0.1711	0.176	0.193	0.210
550	0.4318	12x0.1701	7x0.1701	0.851	325	189	514	13000	0.1752	0.180	0.197	0.214
550	0.4320	33x0.1219	4x0.1219	0.853	460	55.4	515.4	10800	0.1686	0.174	0.190	0.207
550	0.4320	30x0.1219	7x0.1219	0.853	418	97	515	11700	0.1706	0.176	0.192	0.209
550	0.4320	24x0.1219	13x0.1219	0.853	334	180	514	12900	0.1747	0.180	0.197	0.213
550	0.4320	18x0.1219	19x0.1219	0.853	251	263	514	14400	0.1791	0.184	0.201	0.218

(See footnotes at end of table)



bare aluminum wire and cable

TABLE 4-23 (Continued)

Size		Stranding		Outside Diameter in.	Weight per 1000 Feet			Rated Strength lbs	Resistance			
AWG or kcmil	Cross Section Square Inches	1350-H19	6201-T81		1350 Aluminum	6201 Aluminum	Total		dc 20°C Ohms/Mile	ac—60Hz		
										25°C Ohms/Mile	50°C Ohms/Mile	75°C Ohms/Mile
600	0.4712	15x0.1777	4x0.1777	0.889	444	118	562	12500	0.1568	0.162	0.177	0.192
600	0.4712	12x0.1777	7x0.1777	0.889	355	206	561	14100	0.1605	0.166	0.181	0.196
600	0.4709	33x0.1273	4x0.1273	0.891	501	60	561	11800	0.1546	0.160	0.175	0.190
600	0.4709	30x0.1273	7x0.1273	0.891	456	106	562	12800	0.1564	0.161	0.177	0.192
600	0.4709	24x0.1273	13x0.1273	0.891	365	196	561	14100	0.1602	0.165	0.181	0.196
600	0.4709	18x0.1273	19x0.1273	0.891	273	287	560	15800	0.1642	0.169	0.184	0.200
650	0.5102	33x0.1325	4x0.1325	0.928	543	66	609	12800	0.1427	0.148	0.162	0.176
650	0.5102	30x0.1325	7x0.1325	0.928	494	115	609	13800	0.1444	0.149	0.163	0.177
650	0.5102	24x0.1325	13x0.1325	0.928	395	213	608	15300	0.1479	0.153	0.167	0.181
650	0.5102	18x0.1325	19x0.1325	0.928	296	311	607	17100	0.1516	0.156	0.171	0.185
700	0.5494	33x0.1375	4x0.1375	0.963	585	71	656	13600	0.1325	0.137	0.150	0.163
700	0.5494	30x0.1375	7x0.1375	0.963	532	123	655	14700	0.1341	0.139	0.152	0.165
700	0.5494	24x0.1375	13x0.1375	0.963	425	329	654	16100	0.1373	0.142	0.155	0.168
700	0.5494	18x0.1375	19x0.1375	0.963	319	335	654	17900	0.1407	0.146	0.159	0.172
750	0.5892	33x0.1424	4x0.1424	0.997	627	76	703	14400	0.1235	0.128	0.141	0.153
750	0.5892	30x0.1424	7x0.1424	0.997	570	132	702	15600	0.1250	0.130	0.142	0.154
750	0.5892	24x0.1424	13x0.1424	0.997	456	246	702	17100	0.1280	0.133	0.145	0.157
750	0.5892	18x0.1424	19x0.1424	0.997	342	359	701	19000	0.1312	0.136	0.148	0.160
800	0.6280	33x0.1470	4x0.1470	1.029	668	81	749	15300	0.1159	0.121	0.132	0.144
800	0.6280	30x0.1470	7x0.1470	1.029	608	141	749	16600	0.1173	0.122	0.134	0.145
800	0.6280	24x0.1470	13x0.1470	1.029	486	262	748	18200	0.1202	0.125	0.136	0.148
800	0.6280	18x0.1470	19x0.1470	1.029	365	383	748	20300	0.1231	0.128	0.139	0.151
850	0.6679	33x0.1516	4x0.1516	1.061	711	86	797	16000	0.1090	0.114	0.125	0.135
850	0.6679	30x0.1516	7x0.1516	1.061	646	150	796	17400	0.1103	0.115	0.126	0.137
850	0.6679	24x0.1516	13x0.1516	1.061	517	279	796	19200	0.1130	0.118	0.128	0.139
850	0.6679	18x0.1516	19x0.1516	1.061	388	407	795	21400	0.1158	0.121	0.131	0.142
900	0.7072	33x0.1560	4x0.1560	1.092	753	91	844	17000	0.1029	0.108	0.118	0.128
900	0.7072	30x0.1560	7x0.1560	1.092	684	159	843	18400	0.1042	0.109	0.119	0.129
900	0.7072	24x0.1560	13x0.1560	1.092	547	295	842	20300	0.1067	0.112	0.122	0.132
900	0.7072	18x0.1560	19x0.1560	1.092	411	431	842	22400	0.1093	0.114	0.124	0.134
950	0.7458	33x0.1602	4x0.1602	1.121	794	96	890	17900	0.09761	0.103	0.112	0.122
950	0.7458	30x0.1602	7x0.1602	1.121	722	167	889	19400	0.09877	0.104	0.113	0.123
950	0.7458	24x0.1602	13x0.1602	1.121	577	311	888	21400	0.1012	0.106	0.116	0.125
950	0.7458	18x0.1602	19x0.1602	1.121	433	455	888	23900	0.1037	0.109	0.118	0.128
1,000	0.7853	33x0.1644	4x0.1644	1.151	836	101	937	18900	0.09269	0.0977	0.107	0.116
1,000	0.7853	30x0.1644	7x0.1644	1.151	760	176	936	20400	0.09379	0.0988	0.108	0.117
1,000	0.7853	24x0.1644	13x0.1644	1.151	608	328	936	22600	0.09606	0.101	0.110	0.119
1,000	0.7853	18x0.1644	19x0.1644	1.151	456	479	935	25200	0.09845	0.103	0.112	0.121
1,000	0.7849	54x0.1280	7x0.1280	1.152	829	107	936	19700	0.09283	0.0978	0.107	0.116
1,000	0.7849	48x0.1280	13x0.1280	1.152	737	199	936	21100	0.09417	0.0991	0.108	0.117
1,000	0.7849	42x0.1280	19x0.1280	1.152	645	290	935	22900	0.09555	0.101	0.110	0.119
1,000	0.7849	33x0.1280	28x0.1280	1.152	507	428	935	27500	0.09769	0.103	0.112	0.121

(See footnotes at end of table)

TABLE 4-23 (Continued)

Size		Stranding		Outside Diameter in.	Weight per 1000 Feet			Rated Strength lbs	Resistance			
AWG or kcmil	Cross Section Square Inches	1350-H19	6201-T81		1350 Alumi-num	6201 Alumi-num	Total		dc 20°C Ohms/Mile	ac—60Hz		
										25°C Ohms/Mile	50°C Ohms/Mile	75° Ohms/Mile
1,100	0.8637	33x0.1724	4x0.1724	1.207	919	111	1030	20700	0.08429	0.0894	0.0975	0.106
1,100	0.8637	30x0.1724	7x0.1724	1.207	836	194	1030	22500	0.08528	0.0904	0.0985	0.107
1,100	0.8637	24x0.1724	13x0.1724	1.207	669	360	1029	24800	0.08735	0.0924	0.101	0.109
1,100	0.8637	18x0.1724	19x0.1724	1.207	501	547	1028	27700	0.08953	0.0945	0.103	0.111
1,100	0.8641	54x0.1343	7x0.1343	1.209	913	118	1031	21600	0.08433	0.0895	0.0976	0.106
1,100	0.8641	48x0.1343	13x0.1343	1.209	811	219	1030	22900	0.08554	0.0906	0.0988	0.107
1,100	0.8641	42x0.1343	19x0.1343	1.209	710	319	1029	24800	0.08679	0.0918	0.100	0.108
1,100	0.8641	33x0.1343	28x0.1343	1.209	558	471	1029	26600	0.08874	0.0937	0.102	0.110
1,200	0.9426	33x0.1801	4x0.1801	1.261	1003	121	1124	22600	0.07723	0.0825	0.0899	0.0973
1,200	0.9426	30x0.1801	7x0.1801	1.261	912	212	1124	24500	0.07815	0.0834	0.0908	0.0982
1,200	0.9426	24x0.1801	13x0.1801	1.261	730	393	1123	27100	0.08004	0.0852	0.0926	0.100
1,200	0.9426	18x0.1801	19x0.1801	1.261	547	575	1122	30200	0.08204	0.0871	0.0946	0.102
1,200	0.9430	54x0.1403	7x0.1403	1.263	996	128	1124	23100	0.07727	0.0826	0.0899	0.0974
1,200	0.9430	48x0.1403	13x0.1403	1.263	886	239	1125	24700	0.07838	0.0836	0.0910	0.0985
1,200	0.9430	42x0.1403	19x0.1403	1.263	775	349	1124	26700	0.07953	0.0847	0.0921	0.0996
1,200	0.9430	33x0.1403	28x0.1403	1.263	609	514	1123	28800	0.08131	0.0864	0.0939	0.101
1,250	0.9817	33x0.1838	4x0.1838	1.287	1045	126	1171	23600	0.07415	0.0795	0.0866	0.0937
1,250	0.9817	30x0.1838	7x0.1838	1.287	950	220	1170	25600	0.07503	0.0804	0.0874	0.0946
1,250	0.9817	24x0.1838	13x0.1838	1.287	760	410	1170	28200	0.07685	0.0821	0.0892	0.0964
1,250	0.9817	18x0.1838	19x0.1838	1.287	570	598	1168	31500	0.07877	0.0839	0.0911	0.0982
1,250	0.9810	54x0.1431	7x0.1431	1.288	1036	134	1170	24100	0.07427	0.0796	0.0867	0.0938
1,250	0.9810	48x0.1431	13x0.1431	1.288	921	248	1169	25700	0.07535	0.0807	0.0878	0.0949
1,250	0.9810	42x0.1431	19x0.1431	1.288	806	363	1169	27800	0.07645	0.0817	0.0888	0.0960
1,250	0.9810	33x0.1431	28x0.1431	1.288	633	535	1168	30000	0.07816	0.0834	0.0905	0.0976
1,300	1.0205	33x0.1874	4x0.1874	1.312	1086	131	1217	24500	0.07133	0.0768	0.0836	0.0904
1,300	1.0205	30x0.1874	7x0.1874	1.312	988	229	1217	26600	0.07218	0.0776	0.0844	0.0912
1,300	1.0205	24x0.1874	13x0.1874	1.312	790	426	1216	29300	0.07393	0.0793	0.0861	0.0929
1,300	1.0205	18x0.1874	19x0.1874	1.312	593	622	1215	32700	0.07577	0.0810	0.0878	0.0947
1,300	1.0212	54x0.1460	7x0.1460	1.314	1079	139	1218	25100	0.07135	0.0768	0.0836	0.0904
1,300	1.0212	48x0.1460	13x0.1460	1.314	959	258	1217	26800	0.07238	0.0778	0.0846	0.0914
1,300	1.0212	42x0.1460	19x0.1460	1.314	839	378	1217	28900	0.07344	0.0788	0.0856	0.0924
1,300	1.0212	33x0.1460	28x0.1460	1.314	659	557	1216	31200	0.07509	0.0804	0.0872	0.0940
1,400	1.0996	54x0.1515	7x0.1515	1.364	1162	150	1312	26500	0.06627	0.0719	0.0781	0.0844
1,400	1.0996	48x0.1515	13x0.1515	1.364	1033	278	1311	28400	0.06722	0.0728	0.0791	0.0854
1,400	1.0996	42x0.1515	19x0.1515	1.364	904	407	1311	30800	0.06821	0.0737	0.0800	0.0863
1,400	1.0996	33x0.1515	28x0.1515	1.364	710	599	1309	33300	0.06974	0.0752	0.0815	0.0878

(See footnotes at end of table)

bare aluminum wire and cable

TABLE 4-23 (Continued)

Size		Stranding		Outside Diameter in.	Weight per 1000 Feet			Rated Strength lbs	Resistance			
AWG or kcmil	Cross Section Square Inches	1350-H19	6201-T81		1350 Aluminum	6201 Aluminum	Total		dc 20°C Ohms/Mile	ac—60Hz		
										25°C Ohms/Mile	50°C Ohms/Mile	75°C Ohms/Mile
1,500	1.1779	54x0.1568	7x0.1568	1.411	1244	161	1405	28400	0.06186	0.0677	0.0735	0.0793
1,500	1.1779	48x0.1568	13x0.1568	1.411	1106	298	1404	30400	0.06275	0.0685	0.0743	0.0802
1,500	1.1779	42x0.1568	19x0.1568	1.411	968	436	1404	33000	0.06367	0.0694	0.0752	0.0811
1,500	1.1779	33x0.1568	28x0.1568	1.411	760	642	1402	35700	0.06510	0.0707	0.0766	0.0824
1,600	1.2573	54x0.1620	7x0.1620	1.458	1328	171	1499	30400	0.05795	0.0640	0.0693	0.0748
1,600	1.2573	48x0.1620	13x0.1620	1.458	1181	318	1499	32500	0.05879	0.0647	0.0701	0.0756
1,600	1.2573	42x0.1620	19x0.1620	1.458	1033	465	1498	35200	0.05965	0.0655	0.0710	0.0764
1,600	1.2573	33x0.1620	28x0.1620	1.458	812	685	1497	38100	0.06099	0.0668	0.0722	0.0777
1,700	1.3345	54x0.1669	7x0.1669	1.502	1410	182	1592	32200	0.05460	0.0608	0.0658	0.0709
1,700	1.3345	48x0.1669	13x0.1669	1.502	1253	338	1591	34500	0.05539	0.0615	0.0666	0.0717
1,700	1.3345	42x0.1669	19x0.1669	1.502	1097	494	1591	37400	0.05620	0.0623	0.0673	0.0725
1,700	1.3345	33x0.1669	28x0.1669	1.502	862	727	1589	40500	0.05746	0.0634	0.0685	0.0737
1,750	1.375	54x0.1694	7x0.1694	1.525	1452	187	1639	33200	0.05300	0.0593	0.0642	0.0691
1,750	1.375	48x0.1694	13x0.1694	1.525	1291	347	1638	35500	0.05377	0.0600	0.0649	0.0698
1,750	1.375	42x0.1694	19x0.1694	1.525	1130	508	1638	38500	0.05455	0.0607	0.0656	0.0706
1,750	1.375	33x0.1694	28x0.1694	1.525	888	749	1637	41700	0.05578	0.0619	0.0668	0.0717
1,800	1.4140	54x0.1718	7x0.1718	1.546	1494	193	1687	34100	0.05153	0.0579	0.0626	0.0674
1,800	1.4140	48x0.1718	13x0.1718	1.546	1328	358	1686	36500	0.05227	0.0586	0.0633	0.0681
1,800	1.4140	42x0.1718	19x0.1718	1.546	1162	523	1685	39600	0.05304	0.0593	0.0641	0.0689
1,800	1.4140	33x0.1718	28x0.1718	1.546	913	771	1684	42900	0.05423	0.0604	0.0652	0.0700
1,900	1.4924	54x0.1765	7x0.1765	1.589	1577	203	1780	36000	0.04882	0.0554	0.0598	0.0643
1,900	1.4924	48x0.1765	13x0.1765	1.589	1402	378	1780	38600	0.04953	0.0560	0.0605	0.0650
1,900	1.4924	42x0.1765	19x0.1765	1.589	1226	552	1778	41800	0.05025	0.0567	0.0612	0.0657
1,900	1.4924	33x0.1765	28x0.1765	1.589	964	813	1777	45300	0.05138	0.0577	0.0622	0.0668
2,000	1.5713	54x0.1811	7x0.1811	1.630	1660	214	1874	37900	0.04637	0.0531	0.0573	0.0616
2,000	1.5713	48x0.1811	13x0.1811	1.630	1476	398	1074	40600	0.04704	0.0538	0.0580	0.0622
2,000	1.5713	42x0.1811	19x0.1811	1.830	1291	581	1872	44000	0.04773	0.0544	0.0586	0.0629
2,000	1.5713	33x0.1811	28x0.1811	1.630	1014	856	1870	47600	0.04880	0.0553	0.0596	0.0639
2,000	1.570	72x0.1482	19x0.1482	1.630	1482	389	1871	41000	0.04706	0.0538	0.0580	0.0622
2,000	1.570	63x0.1482	28x0.1482	1.630	1297	573	1870	43400	0.04775	0.0544	0.0586	0.0629
2,000	1.570	54x0.1482	37x0.1482	1.630	1112	758	1870	46600	0.04846	0.0550	0.0593	0.0635
2,250	1.766	72x0.1572	19x0.1572	1.729	1640	442	2126	45500	0.04224	0.0494	0.0581	0.0568
2,250	1.766	63x0.1572	28x0.1572	1.729	1474	652	2126	48300	0.04286	0.0499	0.0536	0.0574
2,250	1.766	54x0.1572	37x0.1572	1.729	1263	861	2124	51900	0.04350	0.0505	0.0542	0.0580
2,500	1.962	72x0.1657	19x0.1657	1.823	1871	491	2362	50600	0.03801	0.0456	0.0489	0.0522
2,500	1.962	63x0.1657	28x0.1657	1.823	1637	724	2361	53700	0.03857	0.0461	0.0494	0.0527
2,500	1.962	54x0.1657	37x0.1657	1.823	1403	957	2360	57700	0.03915	0.0466	0.0499	0.0532

(See footnotes at end of table)

TABLE 4-23 (Continued)

Size		Stranding		Outside Diameter in.	Weight per 1000 Feet			Rated Strength lbs	Resistance			
AWG or kcmil	Cross Section Square Inches	1350-H19	6201-T81		1350 Alumi-num	6201 Alumi-num	Total		dc 20°C Ohms/Mile	ac—60Hz		
										25°C Ohms/Mile	50°C Ohms/Mile	75° Ohms/Mile
2,750	2.159	72x0.1738	19x0.1738	1.912	2058	543	2601	55600	0.03455	0.0425	0.0455	0.0484
2,750	2.159	63x0.1738	28x0.1738	1.912	1801	796	2597	59000	0.03506	0.0430	0.0459	0.0489
2,750	2.159	54x0.1738	37x0.1738	1.912	1544	1050	2594	63500	0.03558	0.0434	0.0464	0.0494
3,000	2.357	72x0.1816	19x0.1816	1.998	2247	590	2837	60700	0.03165	0.0400	0.0427	0.0453
3,000	2.357	63x0.1816	28x0.1816	1.998	1966	869	2835	64500	0.03211	0.0404	0.0431	0.0458
3,000	2.357	54x0.1816	37x0.1816	1.998	1686	1150	2836	69300	0.03259	0.0408	0.0435	0.0462

1. Data shown are subject to normal manufacturing tolerances.
2. Direct current (dc) resistance is based on 16.946 ohm-cmil/ft. for 1350-H19 wires and 19.755 ohm-cmil/ft. for 6201-T81 wire.
3. Alternating current (ac) resistance is based on dc resistance corrected for temperature and skin effect.
4. Properties of the individual wires are those of ASTM B 230 and B 398.
5. As the values of GMR and inductive and capacitive reactances of any all-aluminum stranded cable of a specific outside diameter are closely equal, the value of GMR, etc., of Tables 4-6 and 4-7 may be used for the above table if the diameters are equal. If the diameter is not found in Tables 4-6 or 4-7 as in the above table, interpolation from the nearest diameters readily obtains the desired GMR, etc.

bare aluminum wire and cable

**TABLE 4-24**  
**Aluminum-Clad Steel Wire and Strand (Alumoweld) for Overhead**  
**Ground Wire and for Limited Applications as a Neutral Messenger**  
**ASTM B 415 and B 416**  
**Physical and Electrical Properties**

No. and Size of Wires	Outside Diameter in.	Total Area Sq. in.	Weight per 1000 ft lb	Rated Strength lb	dc Resistance at 20°C Ohms/1000 ft
Solid Wire					
12	0.0808	0.00513	14.65	1000	7.811
11	0.0907	0.00646	18.47	1261	6.194
10	0.1019	0.008155	23.29	1590	4.912
9	0.1144	0.01028	29.37	2005	3.896
8	0.1285	0.01297	37.03	2529	3.089
7	0.1443	0.01635	46.69	3025	2.450
6	0.1620	0.02062	58.88	3608	1.943
5	0.1819	0.02600	74.25	4290	1.541
4	0.2043	0.03278	93.63	5081	1.222
Strand					
3 No. 10	0.220	0.02446	70.43	4532	1.651
3 No. 9	0.247	0.03085	88.81	5715	1.309
3 No. 8	0.277	0.03890	112.0	7206	1.038
3 No. 7	0.311	0.04905	141.2	8621	0.8232
3 No. 6	0.349	0.06184	178.1	10280	1.6528
3 No. 5	0.392	0.07796	224.5	12230	1.5177
7 No. 12	0.242	0.03590	103.6	6301	1.127
7 No. 11	0.272	0.04523	130.6	7945	0.8938
7 No. 10	0.306	0.05708	164.7	10020	0.7088
7 No. 9	0.343	0.07198	207.6	12630	0.5621
7 No. 8	0.385	0.09077	261.8	15930	0.4458
7 No. 7	0.433	0.1145	330.0	19060	0.3535
7 No. 6	0.486	0.1443	416.3	22730	0.2803
7 No. 5	0.546	0.1819	524.9	27030	0.2264
19 No. 10	0.509	0.1549	448.7	27190	0.2622
19 No. 9	0.572	0.1954	565.8	34290	0.2079
19 No. 8	0.642	0.2464	713.5	43240	0.1649
19 No. 7	0.721	0.3107	899.5	51730	0.1308
19 No. 6	0.810	0.3916	1134	61700	0.1037
19 No. 5	0.910	0.4938	1430	73350	0.08224
37 No. 10	0.713	0.3017	879.0	52950	0.1354
37 No. 9	0.801	0.3805	1108	66770	0.1074
37 No. 8	0.899	0.4798	1398	84200	0.08516
37 No. 7	1.01	0.6050	1762	100700	0.06754
37 No. 6	1.13	0.7626	2222	120200	0.05356
37 No. 5	1.27	0.9615	2802	142800	0.04247

1. Data shown are subject to normal manufacturing tolerances.

2. Direct current (dc) resistance is based on 51.01 ohm-cmil/ft at 20°C, 20.33% IACS with stranding increments as shown in ASTM B 416.

TABLE 4-25

**Bare Aluminum Conductors, 1350-H19 Wires Stranded with Aluminum-Clad Steel Wires (Alumoweld) as Reinforcement (AWAC) in Distribution and Neutral-Messenger Sizes**  
**Physical and Electrical Properties**

Equiv. AWG Size and Stranding	Total Aluminum Area cmil	Outside Diameter in.	Diameter of Each Wire in.	Total Area Sq. in.	Weight per 1000 ft lb	Rated Strength lb	Resistances				GMR ft	Phase to Neutral 60 Hz Reactance at One ft Spacing	
							dc 20°C Ohms/Mile	ac—60 Hz				Inductive X <sub>a</sub> Ohms/Mile X <sub>a</sub>	Capacitive X <sub>a</sub> Megohm-Miles X <sub>a</sub>
								25°C Ohms/Mile	50°C Ohms/Mile	75°C Ohms/Mile			
No. 4	6/1	41,740	0.245	0.03671	52.4	1,710	2.165	2.218	2.455	2.697	0.006738	0.6067	0.1360
	5/2	41,740	0.261	0.04172	69.7	2,790	2.126	2.172	2.459	2.717	0.004992	0.6431	0.1341
	4/3	41,740	0.281	0.04831	92.4	4,200	2.078	2.130	2.420	2.703	0.003899	0.6720	0.1320
	3/4	41,740	0.307	0.05737	123.7	6,160	2.011	2.068	2.377	2.657	0.003402	0.6896	0.1293
	2/5	41,740	0.340	0.1133	0.07061	169.4	8,990	1.930	1.992	2.294	2.572	0.002287	0.7389
No. 3	6/1	52,620	0.275	0.04629	66.1	2,140	1.115	1.757	1.952	1.151	0.007563	0.5927	0.1326
	5/2	52,620	0.293	0.0978	87.8	3,500	1.686	1.723	1.963	2.175	0.005604	0.6291	0.1307
	4/3	52,600	0.316	0.1053	116.5	5,260	1.645	1.686	1.940	2.173	0.004385	0.6588	0.1285
	3/4	52,620	0.344	0.1147	155.9	7,700	1.597	1.642	1.908	2.147	0.003812	0.6758	0.1260
	2/5	52,620	0.382	0.1273	0.08903	213.5	11,300	1.529	1.559	1.840	2.076	0.002547	0.7248
No. 2	6/1	66,360	0.309	0.1030	83.3	2,650	1.363	1.395	1.557	1.721	0.008498	0.5786	0.1291
	5/2	66,360	0.330	0.1099	110.8	4,370	1.335	1.364	1.565	1.740	0.006311	0.6147	0.1272
	4/3	66,360	0.355	0.1182	146.9	6,600	1.306	1.338	1.555	1.754	0.004926	0.6447	0.1250
	3/4	66,360	0.386	0.1288	196.6	9,690	1.266	1.302	1.525	1.735	0.004277	0.6618	0.1225
	2/5	66,360	0.429	0.1429	0.1123	269.3	13,500	1.213	1.237	1.479	1.681	0.002860	0.7107
No. 1	6/1	83,690	0.347	0.1157	105.1	3,310	1.080	1.106	1.240	1.376	0.009543	0.5645	0.1257
	5/2	83,690	0.370	0.1234	139.7	5,450	1.059	1.082	1.250	1.395	0.007076	0.6008	0.1238
	4/3	83,690	0.398	0.1327	185.3	8,100	1.036	1.062	1.248	1.417	0.005522	0.6309	0.1216
	3/4	83,690	0.434	0.1446	247.9	11,200	1.005	1.033	1.230	1.406	0.004809	0.6479	0.1191
	2/5	83,690	0.482	0.1605	0.1416	339.6	16,500	0.9620	0.9808	1.187	1.360	0.003212	0.6966
No. 1/0	6/1	105,600	0.390	0.1300	132.6	4,080	0.8554	0.8760	0.9900	1.106	0.010173	0.5503	0.1222
	5/2	105,600	0.416	0.1385	176.1	6,580	0.8406	0.8590	1.003	1.126	0.007956	0.5865	0.1203
	4/3	105,600	0.447	0.1490	233.5	9,680	0.8216	0.8422	1.008	1.158	0.006202	0.6167	0.1182
	3/4	105,600	0.487	0.1624	312.6	13,800	0.7968	0.8191	0.9957	1.152	0.005396	0.6337	0.1156
	2/5	105,600	0.541	0.1802	0.1785	428.0	19,500	0.7630	0.7781	0.9700	1.120	0.003607	0.6825
No. 2/0	6/1	133,100	0.438	0.1459	167.1	4,930	0.6780	0.6954	0.7960	0.8979	0.01205	0.5362	0.1188
	5/2	133,100	0.467	0.1556	222.1	8,030	0.6663	0.6806	0.8072	0.9148	0.008931	0.5725	0.1169
	4/3	133,100	0.502	0.1674	294.6	11,900	0.6510	0.6673	0.8203	0.9584	0.006965	0.6027	0.1147
	3/4	133,100	0.547	0.1824	394.3	16,400	0.6315	0.6494	0.7876	0.9587	0.006061	0.6196	0.1122
No. 3/0	6/1	167,800	0.492	0.1639	210.7	6,060	0.5380	0.5511	0.6377	0.7252	0.01353	0.5221	0.1153
	5/2	167,800	0.524	0.1747	280.6	9,660	0.5285	0.5399	0.6487	0.7403	0.01002	0.5585	0.1135
	4/3	167,800	0.564	0.1880	371.4	14,200	0.5161	0.5290	0.6650	0.7873	0.007826	0.589	0.1113
No. 4/0	6/1	211,600	0.552	0.1840	265.7	7,380	0.4270	0.4373	0.5142	0.5917	0.01518	0.5082	0.1119
	15/4	211,600	0.575	0.1150	0.1974	305.4	10,600	0.4264	0.4357	0.4865	0.5346	0.01375	0.5202

1. Data shown are subject to normal manufacturing tolerances.
2. Direct current (dc) resistance is based on 17.002 ohm-cmil/ft for aluminum wires and 51.01 ohm-cmil/ft for aluminum-clad wires in strands and cladding.
3. Alternating current (ac) resistance is based on dc resistance corrected for temperature and for skin effect.
4. Properties of the individual wires are those of ASTM B 502 and ASTM B 230.
5. Ampacity for 6/1 ratio is directly listed in Figs. 3-13 or 3-14. This value is also conservative for other ratios because the increase of radiating surface resulting from the larger diameter at the other ratios is partly offset by increased I<sup>2</sup>R loss in the additional steel.

bare aluminum wire and cable

**TABLE 4-26**  
**All-Aluminum Combination Unilay 19 Wire Stranded Bare Conductors**  
**Physical and Electrical Properties**  
**1350-H19, -H16, -H26, -H14, and -H24 ASTM B 786**

Conductor Size		Area sq. in.	Wire Diameter		Conductor Dia., in.	Rated Strength lb			Weight per 1000 ft lb	Resistance dc—20°C Ohms/Mile
kcmil	AWG		D <sub>1</sub> in.	D <sub>2</sub> in.		1350-H19	1350-H26 1350-H16	1350-H24 1350-H14		
6.53	12	0.00513	0.0201	0.0147	0.090	120	81	71	6.1	13.973
10.38	10	0.00816	0.0253	0.0185	0.113	188	128	113	9.7	8.790
13.09	9	0.01028	0.0284	0.0208	0.127	238	162	142	12.3	6.970
16.51	8	0.01297	0.0319	0.0234	0.143	300	205	180	15.5	5.526
20.82	7	0.01635	0.0358	0.0262	0.160	379	257	227	19.5	4.382
26.24	6	0.02061	0.0402	0.0294	0.179	477	324	287	24.6	3.481
33.09	5	0.02599	0.0452	0.0331	0.202	604	410	362	31.0	2.758
41.74	4	0.03278	0.0507	0.0371	0.226	857	516	456	39.1	2.188
52.62	3	0.04133	0.0570	0.0417	0.254	1080	653	576	49.3	1.734
66.36	2	0.05212	0.0640	0.0468	0.286	1350	824	726	62.1	1.374
83.69	1	0.06573	0.0718	0.0526	0.321	1720	1040	915	78.4	1.091
105.6	1/0	0.08291	0.0807	0.0591	0.360	2140	1310	1160	98.9	0.8646
133.1	2/0	0.1045	0.0906	0.0663	0.404	2660	1650	1460	124.6	0.6856
167.8	3/0	0.1318	0.1017	0.0745	0.454	3230	2080	1840	157.1	0.5441
211.6	4/0	0.1662	0.1142	0.0836	0.510	4000	2630	2320	198.1	0.4311
250.0		0.1963	0.1242	0.0909	0.554	4640	3110	2740	234.1	0.3650
266.8		0.2095	0.1283	0.0939	0.573	4950	3310	2920	249.8	0.3421
300.0		0.2356	0.1360	0.0996	0.607	5560	3720	3290	280.9	0.3041
336.4		0.2642	0.1440	0.1054	0.643	6090	4180	3690	315.0	0.2711
350.0		0.2749	0.1469	0.1075	0.656	6340	4340	3830	327.7	0.2483
397.5		0.3122	0.1566	0.1146	0.699	7060	4940	4360	372.2	0.2294
450.0		0.3534	0.1666	0.1219	0.744	7950	5590	4930	421.4	0.2028
477.0		0.3746	0.1715	0.1255	0.766	8430	5920	5220	446.6	0.1914
500.0		0.3927	0.1756	0.1285	0.784	8840	6210	5480	468.2	0.1825
556.5		0.4371	0.1853	0.1356	0.827	9760	6910	6100	521.1	0.1641

1. Data shown are subject to normal manufacturing tolerances.
2. The diameter of the larger wire D<sub>1</sub> is equal to  $\sqrt{\text{cmil area}/16.2149}$ .
3. The diameter of the smaller wire D<sub>2</sub> is equal to D<sub>1</sub> × 0.732.
4. The overall conductor diameter is equal to 3D<sub>1</sub> + 2D<sub>2</sub>.
5. The rated strengths of the -H14, -H24, -H16, and -H24 tempers are based on the minimum tensile requirements for these tempers as listed in ASTM B 609.
6. Direct current (dc) resistance is based on an electrical conductivity of 61.2% IACS.
7. The conductors listed in this table are stranded for subsequent insulation.

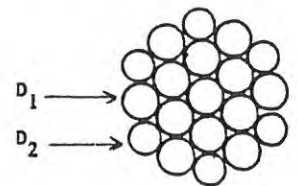

**TABLE 4-27**  
**All-Aluminum Alloy Concentric-Lay Stranded Conductors**  
**Physical and Electrical Properties ASTM B 801**  
**8XXX Series Alloy 0, -H12X and -H22X Tempers**

Conductor Size AWG or kcmil	Stranding No. and Dia. of Wires in.	Nominal Conductor Diameter			Weight per 1000 ft lb	Rated Strength lb				Resistance dc—20°C Ohms/ 1000 ft
		Conventional in.	Compressed in.	Compact in.		0 Temper		H12X, H22X Temper		
						Min.	Max.	Min.	Max.	
8	7x0.0486	0.146	0.142	0.134	15.5	106	207	187	285	1.0504
6	7x0.0612	0.184	0.178	0.169	24.7	168	330	297	453	0.6609
4	7x0.0772	0.232	0.225	0.213	39.3	267	524	472	721	0.4155
3	7x0.0867	0.260	0.252	0.238	49.5	337	661	595	909	0.3296
2	7x0.0974	0.292	0.283	0.268	62.5	425	833	750	1,150	0.2613
1	19x0.0664	0.332	0.322	0.299	78.8	519	1,050	916	1,450	0.2072
1/0	7x0.1228	0.368	0.357	0.336	99.4	676	1,330	1,190	1,820	0.1642
1/0	19x0.0745	0.373	0.362	0.336	99.4	655	1,330	1,160	1,820	0.1642
2/0	7x0.1379	0.414	0.402	0.376	125	853	1,670	1,500	2,300	0.1303
2/0	19x0.0837	0.419	0.406	0.376	125	826	1,670	1,460	2,300	0.1303
3/0	7x0.1548	0.464	0.450	0.423	158	1,070	2,110	1,900	2,900	0.1033
3/0	19x0.0940	0.470	0.456	0.423	158	1,040	2,110	1,840	2,900	0.1033
3/0	37x0.0673	0.471	0.457	0.423	158	1,020	2,110	1,800	2,900	0.1033
4/0	7x0.1739	0.522	0.506	0.475	199	1,360	2,660	2,390	3,650	0.0820
4/0	19x0.1035	0.528	0.512	0.475	199	1,310	2,660	2,320	3,650	0.0820
4/0	37x0.0756	0.529	0.513	0.475	199	1,280	2,660	2,270	3,650	0.0820
250	19x0.1147	0.574	0.557	0.520	235	1,550	3,140	2,740	4,320	0.0694
250	37x0.0822	0.575	0.558	0.520	235	1,520	3,140	2,680	4,320	0.0694
250	61x0.0640	0.576	0.559	0.520	235	1,500	3,140	2,650	4,320	0.0694
266.8	19x0.1185	0.593	0.575	0.537	251	1,660	3,350	2,920	4,610	0.0650
266.8	37x0.0849	0.594	0.576	0.537	251	1,620	3,350	2,860	4,610	0.0650
266.8	61x0.0661	0.595	0.577	0.537	251	1,600	3,350	2,830	4,610	0.0650
300.0	19x0.1257	0.629	0.610	0.570	282	1,860	3,770	3,290	5,180	0.0578
300.0	37x0.0900	0.630	0.611	0.570	282	1,820	3,770	3,210	5,180	0.0578
300.0	61x0.0701	0.631	0.612	0.570	282	1,800	3,770	3,180	5,180	0.0578
336.4	19x0.1331	0.666	0.646	0.603	317	2,090	4,230	3,680	5,810	0.0516
336.4	37x0.0954	0.668	0.648	0.603	317	2,040	4,230	3,600	5,810	0.0516
336.4	61x0.0743	0.669	0.649	0.603	317	2,020	4,230	3,560	5,810	0.0516
350.0	19x0.1357	0.679	0.659	0.616	329	2,170	4,400	3,830	6,040	0.0495
350.0	37x0.0973	0.681	0.661	0.616	329	2,130	4,400	3,750	6,040	0.0495
350.0	61x0.0757	0.681	0.661	0.616	329	2,100	4,400	3,710	6,040	0.0495
350.0	91x0.0620	0.682	0.661	0.616	329	2,100	4,400	3,710	6,040	0.0495
397.5	19x0.1447	0.724	0.702	0.659	374	2,470	4,990	4,350	6,860	0.0436
397.5	37x0.1036	0.725	0.703	0.659	374	2,410	4,990	4,260	6,860	0.0436
397.5	61x0.0807	0.726	0.704	0.659	374	2,390	4,990	4,210	6,860	0.0436
397.5	91x0.0661	0.727	0.705	0.659	374	2,390	4,990	4,210	6,860	0.0436
400.0	37x0.1040	0.728	0.706	0.659	376	2,430	5,020	4,290	6,910	0.0434
400.0	61x0.0810	0.729	0.707	0.659	376	2,400	5,020	4,240	6,910	0.0434
400.0	91x0.0663	0.729	0.707	0.659	376	2,400	5,020	4,240	6,910	0.0434

(See footnotes at end of table)



bare aluminum wire and cable

TABLE 4-27 (Continued)

Conductor Size kcmil	Stranding No. and Dia. of Wires in.	Nominal Conductor Diameter			Weight per 1000 ft lb	Rated Strength lb				Resistance dc—20°C Ohms/ 1000 ft
		Conventional in.	Compressed in.	Compact in.		0 Temper		H12X, H22X Temper		
						Min.	Max.	Min.	Max.	
450.0	37x0.1103	0.772	0.749	0.700	424	2,730	5,650	4,820	7,770	0.0385
450.0	61x0.0859	0.773	0.750	0.700	424	2,700	5,650	4,770	7,770	0.0385
450.0	91x0.0703	0.773	0.750	0.700	424	2,700	5,650	4,770	7,770	0.0385
477.0	37x0.1135	0.795	0.771	0.722	449	2,900	5,990	5,110	8,240	0.0364
477.0	61x0.0884	0.796	0.772	0.722	449	2,860	5,990	5,060	8,240	0.0364
477.0	91x0.0724	0.796	0.772	0.722	449	2,860	5,990	5,060	8,240	0.0364
500.0	37x0.1162	0.813	0.789	0.736	471	3,040	6,280	5,360	8,640	0.0347
500.0	61x0.0905	0.815	0.791	0.736	471	3,000	6,280	5,300	8,640	0.0347
500.0	91x0.0741	0.815	0.791	0.736	471	3,000	6,280	5,300	8,640	0.0347
550.0	37x0.1219	0.853	0.827	0.775	518	3,340	6,910	5,890	9,500	0.0315
550.0	61x0.0950	0.855	0.829	0.775	518	3,300	6,910	5,830	9,500	0.0315
550.0	91x0.0777	0.855	0.829	0.775	518	3,300	6,910	5,830	9,500	0.0315
550.0	127x0.0658	0.855	0.829	0.775	518	3,300	6,910	5,830	9,500	0.0315
556.5	37x0.1226	0.858	0.832	0.780	524	3,380	6,990	5,960	9,610	0.0312
556.5	61x0.0955	0.860	0.834	0.780	524	3,340	6,990	5,900	9,610	0.0312
556.5	91x0.0782	0.860	0.834	0.780	524	3,340	6,990	5,900	9,610	0.0312
556.5	127x0.0662	0.861	0.835	0.780	524	3,340	6,990	5,900	9,610	0.0312
600.0	37x0.1273	0.891	0.864	0.813	565	3,640	7,540	6,430	10,400	0.0289
600.0	61x0.0992	0.893	0.866	0.813	565	3,600	7,540	6,360	10,400	0.0289
600.0	91x0.0812	0.893	0.866	0.813	565	3,600	7,540	6,360	10,400	0.0289
600.0	127x0.0687	0.893	0.866	0.813	565	3,600	7,540	6,360	10,400	0.0289
650.0	37x0.1325	0.928	0.900	0.845	612	3,950	17,600	6,960	11,200	0.0267
650.0	61x0.1032	0.929	0.901	0.845	612	3,900	17,300	6,890	11,200	0.0267
650.0	91x0.0845	0.930	0.902	0.845	612	3,900	17,300	6,890	11,200	0.0267
650.0	127x0.0715	0.930	0.902	0.845	612	3,900	17,300	6,890	11,200	0.0267
700.0	61x0.1375	0.964	0.935	0.877	659	4,200	18,700	7,420	12,100	0.0248
700.0	91x0.1071	0.965	0.936	0.877	659	4,200	18,700	7,420	12,100	0.0248
700.0	127x0.0742	0.965	0.936	0.877	659	4,200	18,700	7,420	12,100	0.0248
750.0	61x0.1109	0.998	0.968	0.908	706	4,500	20,000	7,950	13,000	0.0231
750.0	91x0.0908	0.999	0.969	0.908	706	4,500	20,000	7,950	13,000	0.0231
750.0	127x0.0768	0.998	0.968	0.908	706	4,500	20,000	7,950	13,000	0.0231
800.0	61x0.1145	1.031	1.000	0.938	753	4,800	21,400	8,480	13,800	0.0217
800.0	91x0.0938	1.032	1.001	0.938	753	4,800	21,400	8,480	13,800	0.0217
800.0	127x0.0794	1.032	1.001	0.938	753	4,800	21,400	8,480	13,800	0.0217
900.0	61x0.1215	1.093	1.060	0.999	847	5,400	24,000	9,540	15,500	0.0193
900.0	91x0.0994	1.093	1.062	0.999	847	5,400	24,000	9,540	15,500	0.0193
900.0	127x0.0842	1.093	1.062	0.999	847	5,400	24,000	9,540	15,500	0.0193
1000.0	61x0.1280	1.152	1.117	1.060	941	6,010	26,700	10,600	17,300	0.0173
1000.0	91x0.1099	1.153	1.118	1.060	941	6,010	26,700	10,600	17,300	0.0173
1000.0	127x0.0931	1.153	1.119	1.060	941	6,010	26,700	10,600	17,300	0.0173

1. Data shown are subject to normal manufacturing tolerances.
2. Diameter of individual wires is shown for conventional round wire conductor.
3. Direct current (dc) resistance is based on an electrical conductivity of 61.2% IACS.
4. The conductors listed in these tables are stranded for subsequent insulation.

## Installation Practices

Once the route and length of a transmission or distribution line has been decided upon and the correct conductor size and type selected to carry the system load safely and economically, there are still several mechanical considerations which will have an effect on installation practices and may influence the final choice of conductor.

### Line Design Factors

The line designer must consider such factors as tower and pole locations and heights, span lengths, conductor tension and sags, ground clearances, etc. Technically, this means that he must have detailed knowledge of conductor sag-tension characteristics as a function of span length, temperature, and weight loading. Much of this information is supplied by wire and cable manufacturers in the form of tables and graphs that are to be used by the line designer.\* Supplementing these, the line designer prepares other graphs, tables, templates, etc., that are related to a specific installation.

Thus, there are two distinct types of study: (1) That which is ordinarily performed by the engineers of the wire and cable manufacturers, and (2) that which is performed by the line-design engineer to utilize the manufacturer-supplied information to best advantage. Users of this handbook probably are more likely to work with manufacturer-supplied graphs and data for application to a specific installation than to work on the analysis of physical properties of conductors. Hence the first section of this chapter endeavors to show how the line designer uses manufacturer-supplied data. This will be followed by a brief outline of the work ordinarily done under manufacturer's auspices. First, a few general statements that apply to both kinds of analysis are made.

The "tension limits" used as the basis for calculations in this chapter are stated as not exceeding a specified percentage of the rated strength of the conductor, and these strengths are calculated in accordance with current ASTM standards.

\*If not otherwise identified, charts and graphs in this chapter were supplied by conductor manufacturers.

An overhead conductor suspended between insulator supports assumes the shape of a catenary curve provided the conductor is of uniform weight per ft. Usually it is convenient, without significant error, to regard the curve as a parabola.\* A family of such curves exists for a given conductor and span, Fig. 5-1. The mid-point sag depends on tension in the conductor; the greater the tension the less the sag. To distinguish between span length and conductor length, the latter is usually designated *arc length*.

Anything that increases arc length after initial stringing increases the sag. Factors that may bring this about are (1) thermal expansion of the conductor because of increase of temperature above that during stringing, (2) increase of conductor apparent weight because of wind and/or ice load, (3) creep gradually lengthening the conductor wires as a result of tension being applied over a period of many years, (4) stressing of wires beyond their elastic limits.

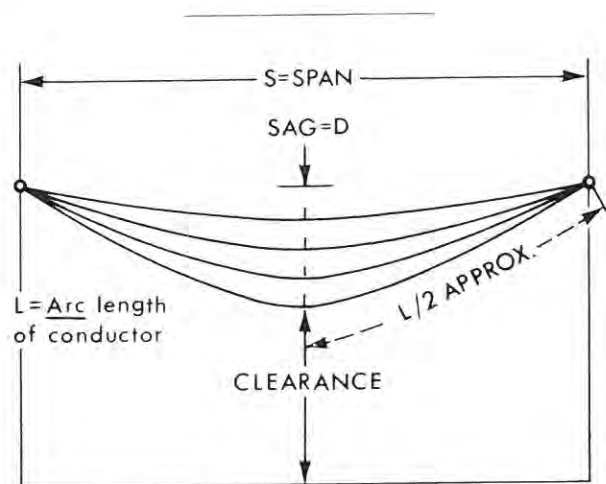

Fig. 5-1. Diagram showing family of sag curves. The sag is less with increase of conductor tension.

\* For sags up to 6% of span, the error is about 1/2%, and for a sag of 10% of span, the parabola results in a sag about 2% too small.

## bare aluminum wire and cable

Though it might appear that sag-tension problems relating to these subjects could be solved in a simple manner, there are interrelated factors that must be taken into account. For example, ACSR has components that have differing stress-strain characteristics, differing coefficients of thermal expansion, and they normally undergo differing unit tensile stresses.

Thus, it is evident that proper selection of span length and sags for a given profile and conductor in order to minimize installation and operational costs requires a high order of engineering skill. However, for many applications, the required sag-tension analysis has been made by others, and the results are available in tables and graphs supplied by wire and cable manufacturers for all commercially offered conductors. Only a moderate amount of additional work is necessary to utilize them for specific applications.\*

### Initial and Final Sag-Tension Charts for Variable-Length Spans

Two typical sag-tension charts are shown in Figs. 5-2 and 5-3. These charts apply to a 795 kcmil 54/7 ACSR Condor with standard class A steel core wire and include both bare and heavy loading as defined by the National Electric Safety Code (NESC) and listed in Table 5-1. The curves of these graphs show sags and tensions for various temperatures for spans from 400 to 1600 ft. Fig. 5-2 shows initial sags and tensions based on one-hour creep. Fig. 5-3 shows final sag and tension values. In this example, the sag after 10 year creep exceeds the final sag after heavy loading. Thus, creep is the governing condition in determining the final sag and tensions.

Referring to the explanatory table accompanying Fig. 5-2, the sag-tension values are shown for bare conductor (no ice or wind) at six different temperatures,\*\* 1/2 in. ice at 32° F and heavy loading of 1/2 in. ice plus 4 lb/sq ft wind plus a constant. The resultant of the conductor weight plus ice and side wind load (which is at right-angle to the line) is increased by a constant  $K=0.30$  lb per ft. In the example, the cable weight alone is 1.024 lb per ft. The resultant NESC Heavy loading on the conductor is 2.432 lb per ft.

The upper set of curves of Fig. 5-2 shows conductor tension in lb vs span in ft; the lower set shows sag in ft vs span in ft. The rated strength of this conductor is 28,200 lb. With full ice and wind load, the allowable tension as shown below the explanatory table is 40% of 28,200 or 11,280 lb. This value has been selected as the maximum allowable tension and the No. 1 sag curve is drawn correspondingly. However, it should be noted that for spans below 720 ft, the tension as shown by curve 9 on the initial chart (Fig. 5-2) is less than 40 percent of

the rated strength because, for spans shorter than this, the final tension limit of 25 percent of rated strength at 0° F is ruling. This can be noted from curve 15 of the final chart (Fig. 5-3) where the tension levels out at 7,100 lb for these shorter spans and does not exceed 25 percent of rated strength. In addition, the allowable initial tension on the unloaded or bare conductor, when installed, is 33.3 percent or 9400 lbs. Since curve 15 on the initial chart does not exceed 9000 lbs, this requirement is met.

Since the probable average span for an overhead conductor of this size is about 1000 ft, the strength margin for the conductor is even more favorable as seen by the reduced tensions above 720 ft.

TABLE 5-1

### National Electric Safety Code (1987 Edition) for Overhead Conductor—Mechanical Load Classifications

Loading District	Description and Method of Obtaining Loaded Weight per foot
Light	Cond., plus 9 lb sq ft horz. wind on projected area. To the resultant add $K = 0.05$ lb per ft. Applied at 30°F.
Medium	Cond., plus 1/4-in. ice, plus 4 lb/sq ft horz. wind on projected area. To the resultant add $K = 0.20$ lb per ft. Applied at 15°F.
Heavy	Cond., plus 1/2-in. ice, plus 4 lb/sq ft horz. wind on projected area. To the resultant add $K = 0.30$ lb per ft. Applied at 0°F.

Overhead conductor loadings of the three above classes are usually applicable to sections of the United States, according to the map below though heavier loadings are used if local conditions appear to require them.

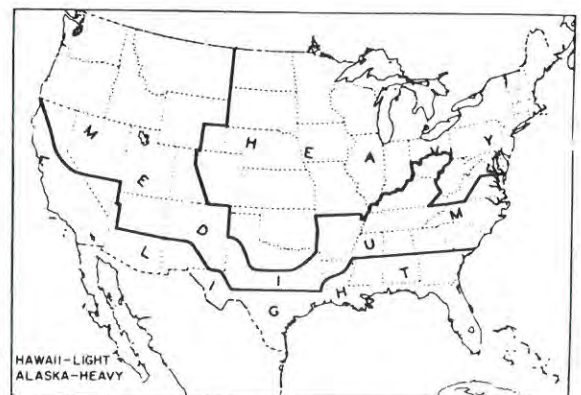

NESC district loading map of United States for mechanical loading of overhead lines (1987 edition)

\*In addition, several computer programs have been developed to do these calculations and they are available to utility and computer engineers so they can do this work themselves.

\*\*If the conductor is subject to electrical overloads, curves for the highest temperature likely to be encountered should be added.

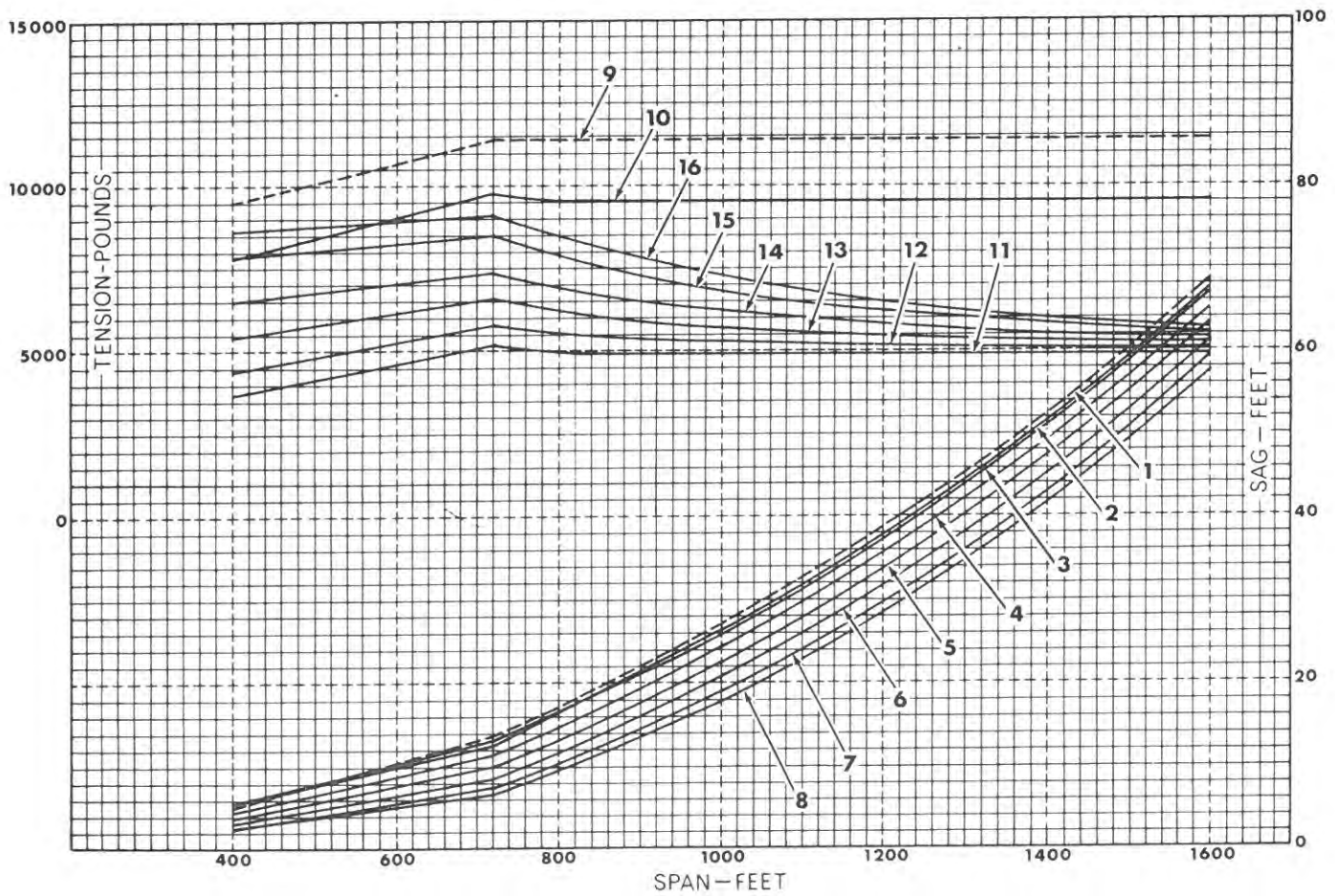

Fig. 5-2. Sags and Tensions, Initial. 795 kcmil, 54/7 Condor ACSR.

**TENSION LIMITS:**

- a. With 1/2" ice+4 lb wind+constant at 0°F not to exceed 40% of Rated Strength.
- b. Initial (when installed) with no ice or wind at 0°F not to exceed 33.3% of the Rated Strength.
- c. Final (after maximum load or ten year creep) with no ice or wind at 0°F not to exceed 25% of the Rated Strength.

Sag Curve	Tension Curve	Ice inches	Wind lb/sq/ft	Temperature °F	NESC Constant
1	9	1/2	4	0	0.30
2	10	1/2	0	32	
3	11	0	0	120	
4	12	0	0	90	
5	13	0	0	60	
6	14	0	0	30	
7	15	0	0	0	
8	16	0	0	-20	

Obvious relationships are shown by the curves. Thus, for a span of 1000 ft, the tension drops from 6800 lb\* to 4950 lb when temperature increases from 0°F to 120°F (curves 15 and 11), and sag increases from 19 ft to 26 ft (curves 7 and 3) as shown in Fig. 5-2. Some charts also include sag and tension curves for estimated maximum temperatures greater than 120°F. Where higher operating temperatures are anticipated, the user should consult his conductor manufacturer.

Fig. 5-3 showing the final sags and tensions can be interpreted in the same manner as Fig. 5-2. It shows the effect of long time elongation from 10-year creep or heavy loading if it happens to permanently stretch the conductor

\* Because of uncertainties of reading values from a chart, such values in this book may differ slightly from computed values from which the graph was made.

bare aluminum wire and cable

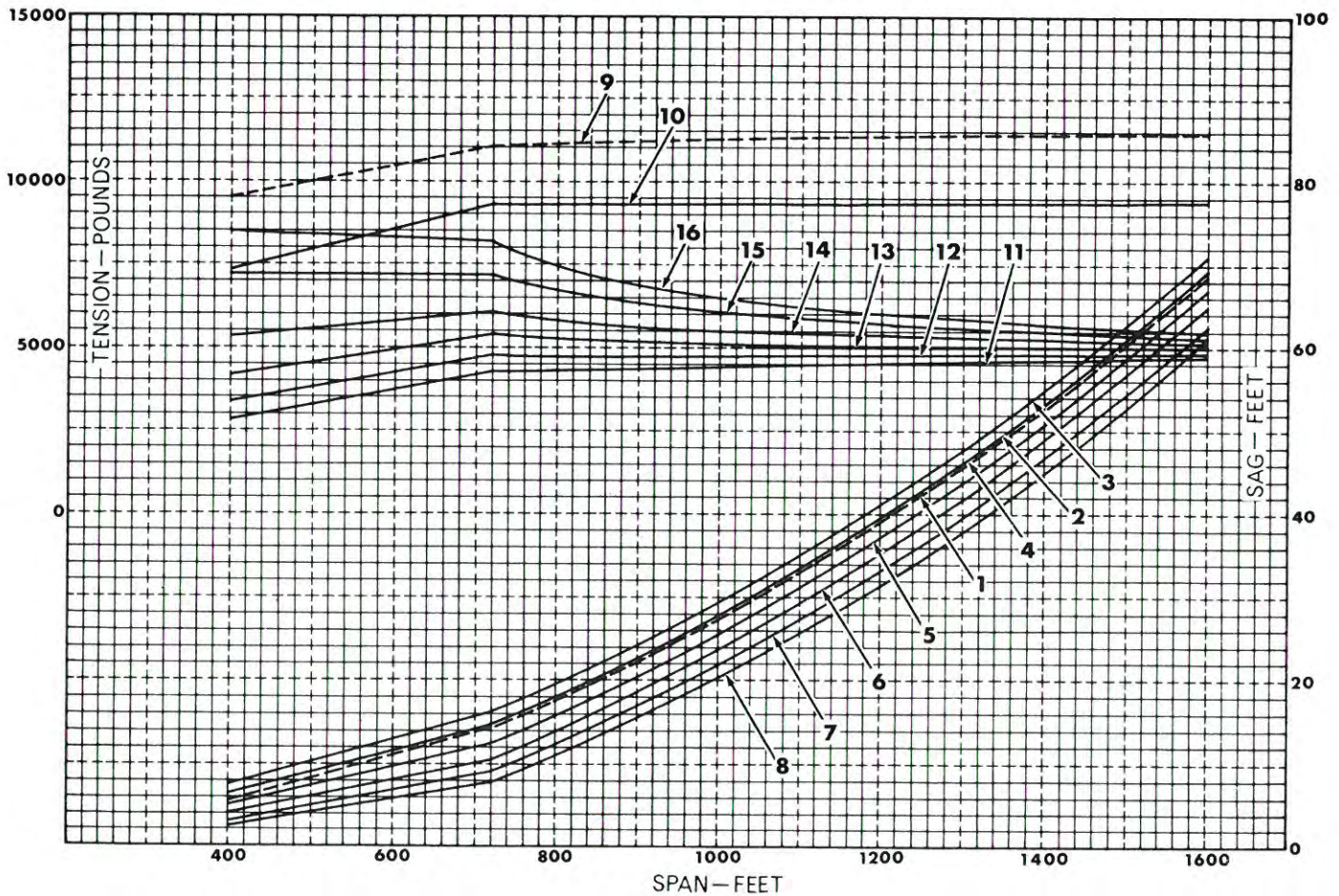

Fig. 5-3. Sags and tensions, final. 795 kcmil, 54/7 Condor ACSR.

to a greater degree than that resulting from creep. Thus, in this case, an initial sag of 22.4 ft at 60°F (Fig. 5-2 curve 5) increases to 25.5 ft. (Fig. 5-3 curve 5) and the tension (curve 13 in both figures) drops from 5700 lb to 5100 lb.

**Initial Stringing Chart**

Curves such as Figs. 5-2 and 5-3 provide basic information for use in the preliminary design of overhead lines and can be used directly for individual spans dead-ended at each end, but they cannot be used for a series of spans of different lengths because the tensions, if taken directly off Figs. 5-2 and 5-3, will be different for each span and in such a series of spans the line tensions must be equal so there will be no significant unbalanced longitudinal loads on structures, and so insulator strings will hang vertically.

The procedure for finding the initial sag and tension in a line, or section of line between dead-ends, having spans of differing lengths is based on taking the values off the initial sag-tension graph Fig. 5-2 for the ruling span as herein defined, and preparing an initial stringing sag chart such as is shown in Fig. 5-4. This chart shows

the amount of sag for a span of any length that will result from a constant tension in all spans of the line. This tension will require adjustment so as to allow for the conductor temperature at the time of stringing. This adjustment is obtained from the temperature-tension line (curve 1) on Fig. 5-4. Thus, the initial stringing chart, as shown here, is for a new 795 kcmil 54/7 ACSR based on a ruling span of 1000 ft and 11,280 lbs maximum tension with NESC heavy loading. Curve 1 for tension and temperature is obtained by taking the tension values from Fig. 5-2 for a 1000 ft span at the various temperatures and plotting them as shown in Fig. 5-4. From Fig. 5-2, it can be noted that the tension at 0°F is 6800 lbs, at 60°F is 5700 lb and at 120°F is 4950 lb. These and intermediate values are used to determine curve 1 of Fig. 5-4. Thus, this curve gives the value of the stringing tension to be used for the particular temperature at which new conductor is installed in a section of line having this particular ruling span.

**The Ruling Span**

The first step in the preparation of a stringing chart Fig. 5-4, from the sag-tension chart Fig. 5-2, (or Fig.

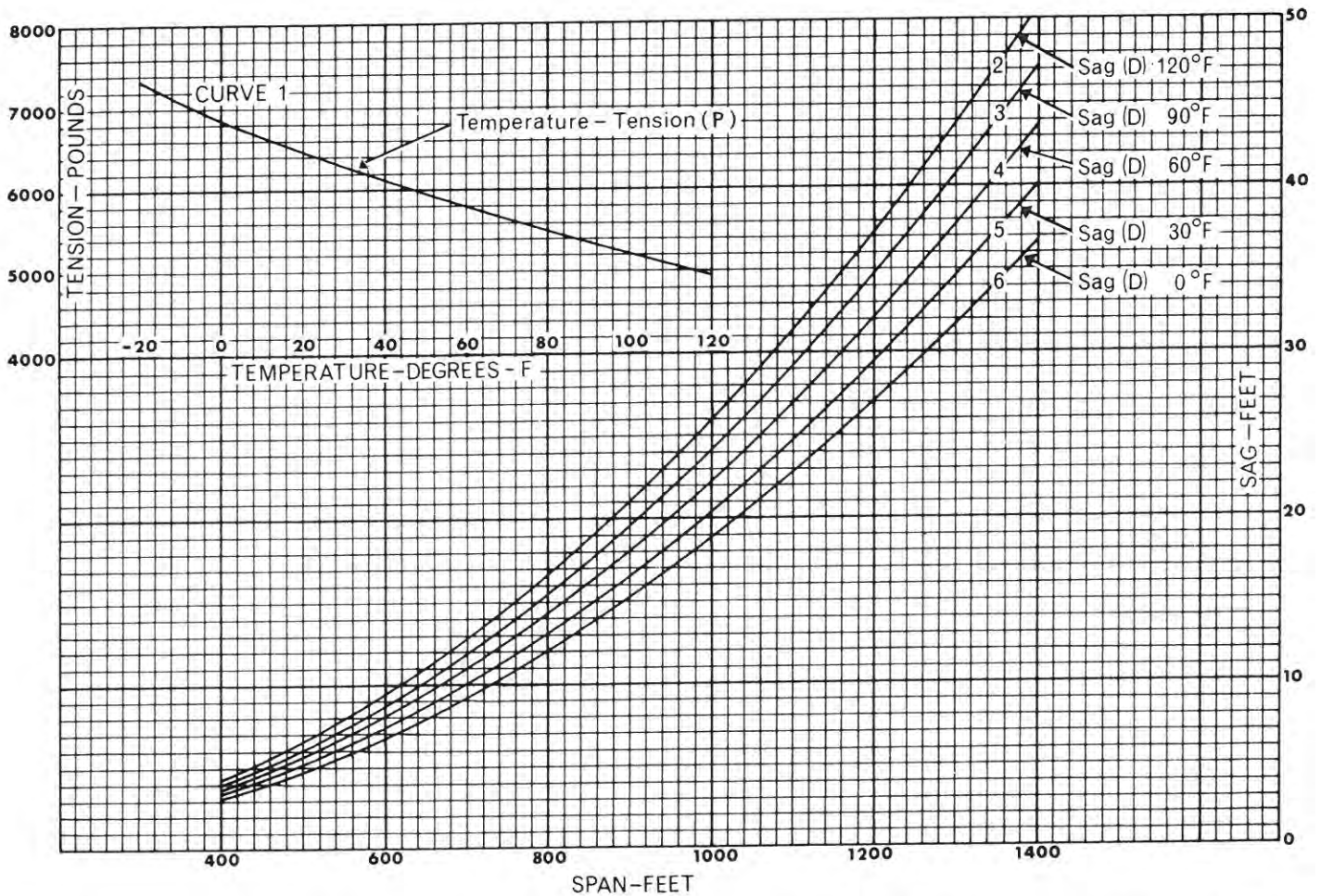

Fig. 5-4. Initial Stringing Chart. Stringing sags and tensions for constant tension at a given temperature for a 795 kcmil 54/7 Condor ACSR. For Ruling Span of 1,000 ft and 11,280 lb maximum initial tension with heavy loading. There is no loading during initial stringing, hence tension is per curve 1.

5-3 for pre-stressed conductor) is to find the Ruling Span, which in effect is a weighted average taken from the various span lengths that occur in the line between dead ends. The formula for Ruling Span is

$$\text{Ruling Span} = \left[ \frac{S_1^3 + S_2^3 + S_n^3 + \dots + S_n^3}{S_1 + S_2 + S_3 + \dots + S_n} \right]^{1/2} \text{ ft} \quad (\text{Eq. 5-1})$$

in which the successive S-values are actual spans in ft. The ruling span is somewhat longer than the average span. A frequently used approximate rule is to make the ruling span equal to the average span plus two-thirds of the difference between the maximum span and the average span. This rule, however, obtains results that often vary considerably from what is obtained by applying Eq. 5-1,

hence the use of Eq. 5-1 is preferred.

*Example:* A line having ten spans of 1000 ft, three spans of 800 ft, and two spans of 1200 ft, the Ruling Span by applying Eq. 5-1 is 1006 ft, and by applying the approximate rule it is 1129 ft. For this example a 1000 or 1006 ft ruling span should be used. If the ruling span calculated by the approximate rule were to be used, the actual final sags would be greater than the design final sags.

In order to establish the sag curves for the various temperatures shown in the stringing chart, the sags for the 1000-ft span of bare conductor (curves 3-8) are transferred from Fig. 5-2 to Fig. 5-4, that is, 18.8 ft for 0°F, 22.4 ft for 60°F, 25.8 ft for 120°F and similarly for the other temperatures. The method used for completing the curves and obtaining the sags for spans other than the 1000-ft ruling span is by using a parabola for the approximation of the sag values at various temperatures. In a parabola the sags are proportional to the square of

bare aluminum wire and cable

**TABLE 5-2**  
Stringing Sags for Various Spans of Bare Unloaded 795 kcmil ACSR 54/7 Wt 1.024 lb/ft, for Specified Constant Tension at Stated Temperatures, and Ruling Span of 1000 Ft

Temperature Tension, lb	0°F Initial 6800	30°F Initial 6200	60°F Initial 5700	90°F Initial 5300	120°F Initial 4950	120°F Final 4400
Span in Feet	Sag in Feet					
400	3.0	3.3	3.6	3.9	4.1	4.7
500	4.7	5.2	5.6	6.1	6.5	7.3
600	6.8	7.4	8.1	8.7	9.3	10.5
700	9.2	10.1	11.0	11.8	12.7	14.3
800	12.0	13.2	14.3	15.5	16.5	18.7
1000	18.8	20.7	22.4	24.2	25.8	29.2
1200	27.0	29.8	32.2	34.8	37.2	42.0
1400	36.8	40.6	43.9	47.4	50.6	57.2

Note: For initial values this table is compiled from the 1000-ft values of Fig. 5-2. If the conductor has been prestressed, Fig. 5-3 is to be used as basis for sag values, as explained in text. Fig. 5-3 is also used as basis for final sag values in right-hand column.

the span, thus the sag at 60°F for a 500-ft span is 1/4 that of a 1000-ft span (i.e. 5.6 ft). This value is on curve 4 of Fig. 5-4 at 500 ft.

The Initial Stringing Chart Fig. 5-4 is based on values obtained from the Initial Sag-Tension Chart, Fig. 5-2, because, as stated, the stringing of new conductor is assumed. However, conductor that has been removed from an old line or has been pre-stressed to final conditions should not be restrung to initial conditions. An approximate rule of thumb is to string old conductor half-way between initial and final sags because when conductor is removed from a line and rereeled it relaxes. If strung to supposedly final sags, the actual final sags will be greater than planned.

#### Completion of Stringing Graph by Use of Parabola Formula

As previously noted, the sag values for the 1,000-foot ruling span for the stringing chart Fig. 5-4 have been transferred from Fig. 5-2 as points on the vertical line for the 1,000-foot span on Fig. 5-4. Note that these values are also listed in Table 5-2 on the horizontal line for the 1,000-foot span. It is now necessary to find the other mid-point sag values to complete Table 5-2 and Fig. 5-4 under a constant tension for all spans at a given temperature.

For this purpose, the parabola formula is satisfactory for calculating the sags; thus,

$$D = \frac{W S^2}{8 H} \quad (\text{Eq. 5-2})$$

in which

$D$  = Sag, ft

$W$  = Weight of conductor, lb per ft

$S$  = Span length, ft

$H$  = Horizontal Tension, lb (a constant for each temperature)

The above sag value should be corrected if the sag exceeds about 5% of span length (see Eq. 5-4, below).

From the above formula the following ratio is derived as a simple means of obtaining the required sags. Since the horizontal tensions in each span of the section of line between deadends are to be equal,  $H_1 = H_2$  and therefore

$$\frac{W S_1^2}{8 D_1} = \frac{W S_2^2}{8 D_2}$$

Since  $W$  and the constant 8 are common to both sides we have

$$\frac{S_1^2}{D_1} = \frac{S_2^2}{D_2} \quad \text{or} \quad D_2 = \frac{D_1 S_2^2}{S_1^2} \quad (\text{Eq. 5-3})$$

Using this formula Table 5-2 and Fig. 5-4 can be completed. Thus, to complete the column for 60°F in Table 5-2 use sag for a tension of 5,700 lb. at 22.4 ft. and applying it to the ratio of the spans for the 400 ft. span the result is and so on up to spans for 1,400 ft. In

$$D_2 = \frac{(22.4)(400)^2}{(1,000)^2} = 3.6 \text{ ft}$$

a similar manner Table 5-2 is completed for the other temperatures. These sag values are then transferred to the Initial Stringing Graph (Fig. 5-4) and the curves drawn for each temperature.

*Sag Correction for Long Spans*

If the sag exceeds about 5% of span length, an amount should be added to the sag read from Fig. 5-4, computed as follows:

$$\text{Correction (ft)} = D^2 \times \frac{W}{6H} \quad (\text{Eq. 5-4})$$

in which  $D =$  Sag in feet obtained from Eq. 5-2, as previously described. Other values are as stated for Eq. 5-2.

This correction rarely is necessary (see footnote on page 5-1).

**Use of Stringing Charts**

A stringing chart such as Fig. 5-4, should be prepared and used for each line or section having different ruling spans and tensions between dead-ends.

Stringing charts are used to obtain the values used for the control of the tension and sag of the conductor. During the stringing operation, the conductor should be run through stringing sheaves which turn freely and are in good condition. As the conductor is brought up to initial sag it should be checked against the values taken from the chart, at different intervals, depending on the length of the section being sagged. Preferably this should be near each dead-end, in the middle, and in spans as close as possible to the ruling span. The sags should be checked even if the conductor is pulled, by means of a dynamometer, to the required tension. Normal sheave friction can result in uneven sag between spans. Sometimes the conductor will become caught in a stringing sheave, or the sheave does not move freely. In such cases some spans may be up to the required tension while others may not. The normal differences caused by sloping or offset contours are discussed on page 5-8.

When the conductor has mid-point sags according to the Initial Stringing Chart, in our example, the final maximum sag at 120°F (or estimated maximum conductor temperature if greater than 120°F) will not exceed the ten-year creep design sag. This sag is shown by curve 3 of Fig. 5-3 which indicates the unloaded condition at 120°F. Strung on this basis, the conductor ground clearance will not be less than that specified in the line design criteria.

For a more detailed treatment of stringing methods, equipment etc., reference should be made to the IEEE publication P-524 entitled "A Guide to the Installation of Overhead Transmission Line Conductors".

*Stringing-Sag Tables*

Figs. 5-2 and 5-3 are typical of manufacturer supplied

tension charts from which Stringing-Sag charts, such as 5-4, are made. Such stringing charts are used principally as an aid in line design of transmission and distribution lines where there is not much repetition. With the advent of computer programs it is much more common to use Stringing-Sag Tables instead of charts. These tables, for various ruling spans, are generally compiled by utilities for their own use. They avoid the need of reading from curves or interpolating from large-interval tables.

An extract from such a stringing sag table, Table 5-3 is from a book that contains 69 such tables for various ruling spans and for AWG sizes of ACSR in 6/1 and 7/1 strandings—with spans as short or as long as practicable for the specified ruling spans. Tables for NESC light, medium, and heavy loadings are included.

**The Sag-Span Parabola and Template**

For determining minimum clearance under a line over an irregular profile it is necessary to know the final sag at all points of the span. Only the mid-span initial sag is known from charts such as Fig. 5-4. These intermediate sag values are obtained graphically by plotting a parabolic curve between the point of maximum sag and the point of elevation of the support. The same parabola is used for inclined spans, as is described later in this chapter.

Depicted in Fig. 5-5 is the sag-span parabola\* for the conductor and conditions described in the legend. The values are based on a constant tension of 4400 lb and mid-point sag of 29.2 ft for ruling span of 1000 ft, as noted from Fig. 5-3 for 120°F. A similar parabola for emergency-overload temperature is also advisable. The mid-point sags for other spans are obtained from the parabola (also listed in the right hand column of Table 5-2). The mid-point sag for the ruling span of 1000 ft most probably was obtained from a catenary curve, but the use of the parabola for intermediate values introduces no significant error. The mid-point sags shown by Fig. 5-5 for spans that differ from the 1000 ft ruling span vary from those for the same spans as shown on Fig. 5-3 because the latter figure is drawn to cover a range of "ruling spans" whereas Fig. 5-5 is based on only the 1,000-foot ruling span.

The 120°F mid-point sag for the 1000-ft ruling span from Fig. 5-3 is used as the basis for Fig. 5-5, because from Fig. 5-3 it is seen that the sag of a bare conductor at 120°F is greater than that of a conductor carrying full ice load. The maximum possible sag for clearance investigations usually occurs when the conductor is at high temperature because of an emergency-load, depending on user's standard for emergency temperature of bare conductors.

\* Such parabolas are easily prepared. See Page 5-11.



bare aluminum wire and cable

**TABLE 5-3**  
**Stringing-Sag Values for 1/0 ACSR (6/1), for Ruling Span of 550 ft for NESC Heavy Loading for Various Temperatures, and Maximum Tension 60% of Rated Strength**

Span Length feet	Initial sag, inches, for various temperatures (F)								
	0°	15°	30°	45°	60°	75°	90°	100°	110°
230	12	13	14	15	16	18	19	21	22
thence continuing for span intervals of 10 ft to 700 ft									
530	61	66	72	79	87	95	103	111	118
540	63	69	75	82	90	98	107	115	122
550	65	71	78	85	93	102	111	119	126
560	68	74	81	88	96	106	115	124	131
570	70	77	84	91	100	109	119	128	136
700	106	115	126	138	151	165	179	193	205

If a parabola is used very much, it is convenient to cut its outline in a plastic sheet as a template marked with its vertical axis.

*Sag When Supports Are at Different Elevations*

The parabola template of Fig. 5-5 also may be used to find the low point of a conductor suspended between supports that are not at the same elevation. Thus, Fig. 5-6 denotes the application of the Fig. 5-5 template to an 800-ft span which has one support 25 ft above the other. Points *A* and *B* are located to the same scale as that of the parabola. The template is then shifted until both points *A* and *B* fall on the parabola outline and the parabola axis is vertical. The outline is then drawn as the curve *AFDB*, in which *F* is low point, and *D* is a tangent under *C*, at the mid-point of the span.

It can be shown that the mid-point sag *CD* is equal to that of a horizontal span equal in length to the inclined span (in this case 18.7 ft.). However, it is point *F* that is required in order to determine adequate clearance, and this is found graphically as illustrated in Fig. 5-6. Point *F* also may be found in terms of the mid-point sag on a horizontal span of the same length provided the difference in elevation is not greater than four times the mid-point sag, as follows:

$$AH = CD \left( 1 - \frac{GB}{4(CD)} \right)^2 \quad (\text{Eq. 5-5})$$

or in this case  $AH = 18.7 \left( 1 - \frac{25}{4(18.7)} \right)^2 = 8.3 \text{ Ft.}$

$$BJ = AH + \text{Diff. in elevation} = 33.3 \text{ Ft.}$$

$$\text{Horiz. distance HF} = \frac{\text{Span}}{2} \left( 1 - \frac{\text{Elev. Diff.}}{4 \times 18.7} \right) = 265 \text{ Ft.}$$

Formulas are also available for use when the difference of elevation is greater than four times the mid-point sag and also for critical work where a catenary curve is used instead of a parabola. A graphic method of drawing the parabola is described on Page 5-11.

**The Uplift Condition (Negative Sag)**

Transmission lines, in hilly and mountainous terrain, sometimes have steep inclines in some of the spans, and if the towers are not properly spaced a condition can exist similar to that depicted in Fig. 5-7. In cases such as this, the maximum sag is obtained in the usual manner from the applicable 120°F (or whatever maximum temperature the utility uses for this purpose) parabola template. This step will show the normal maximum sag between each support. However, if the temperature drops to the lowest likely to be encountered in the unloaded condition (with no ice load to increase the sag), the conductor may shorten sufficiently, because of thermal contraction, so that the force on the support at tower *C* is upward instead of downward. Such a condition is to be avoided and there should be a considerable downward force at the conductor support to prevent collapse of the suspension insulators or a pullout at the insulator caps. Under these conditions it is also possible that side winds will cause the suspension insulator to swing beyond a safe

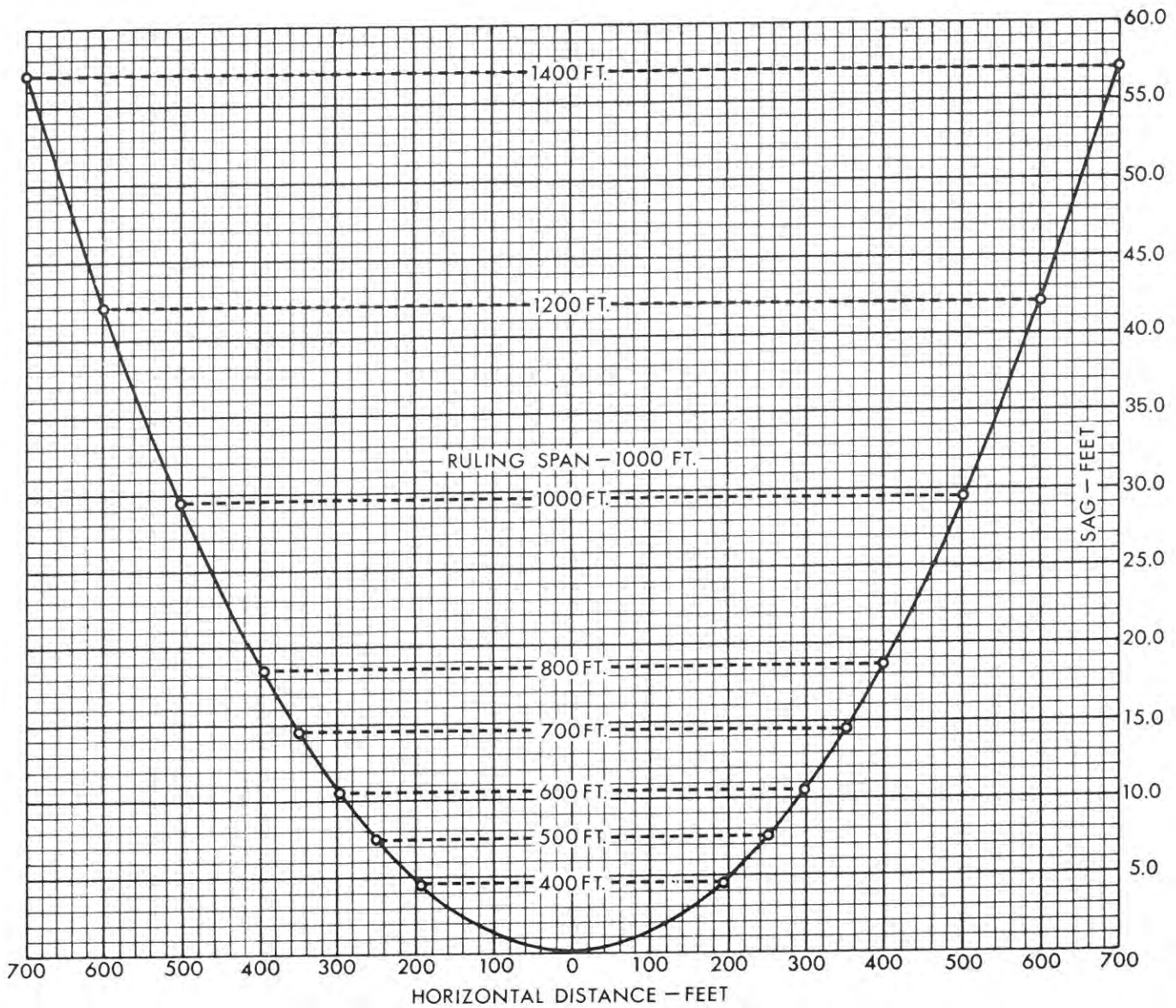

Fig. 5-5. Template parabola for final sags (after 10 years) of bare unloaded 795 kcmil ACSR 54/7, wt. 1.024 lb/ft, for 120°F at 4400 lb tension. Compiled from the 1000-ft Values of Fig. 5-3. Also see right-hand column of Table 5-2.

angle (usually 45° per NESC).

In order to predict and evaluate the possibility of such an occurrence, a parabola template similar to Fig. 5-5 is prepared based on the ruling span, but done for the lowest temperature likely to be encountered in the unloaded condition. In some areas this temperature may be well below 0°F. The template is based on Fig. 5-2 for initial stringing because this represents the period of minimum sag before load offsets or appreciable creep occurs. Thus, a template might be prepared for a 1,000-foot ruling span for -20°F, with a mid-point sag

of 18.8 feet and a tension of 7,300 lbs. (from curve 16 of Fig. 5-2). The resulting parabola, Fig. 5-8, is "flatter" than that of Fig. 5-5 because both the aluminum and the steel are carrying their full share of the load. When this curve is applied to a line layout similar to that shown in Fig. 5-7, it will indicate a condition of uplift at support C. This condition is usually corrected by altering the tower spacing, by increasing the height of the towers where this occurs, or by installing dead-ends where the slope from the tower is large. Usually both the maximum sag and uplift curves are drawn on the same template.

bare aluminum wire and cable

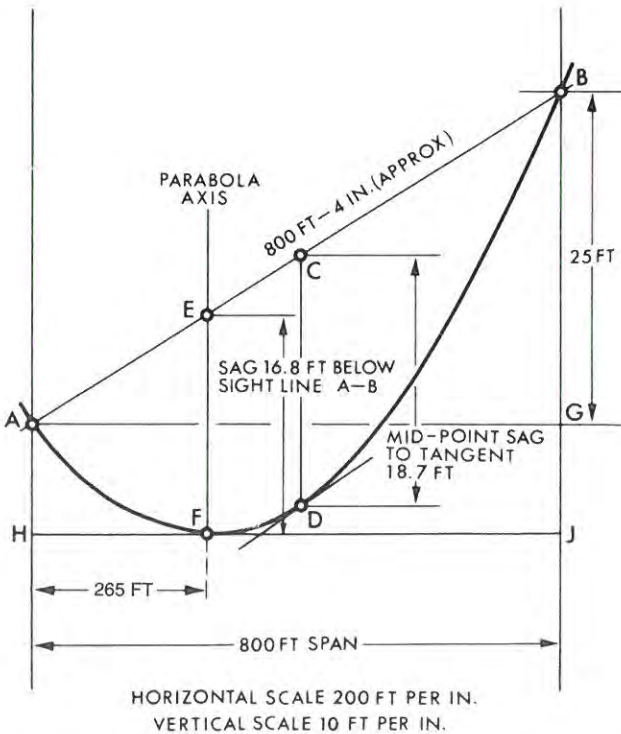

Fig. 5-6. Chart obtained by application of template of Fig. 5-5 to obtain sag when supports are at different elevations.

Unbalanced Forces at Support Points

In a series of spans between dead-ends, adjacent spans may differ in length, or their supports may be at different elevations. In addition, sleet may drop from one span and not from an adjacent one. These conditions cause an unbalance of longitudinal forces at the insulator support. This unbalance will cause a suspension insulator to swing from vertical positions, or a cantilever load will be applied to a cap-and-pin insulator. If the unbalance is greater than what is regarded as good practice, as often is the case in hilly country, dead-end connections at individual spans are used to avoid these forces on the insulators.

Note: For more information on this subject, reference should be made to the IEEE paper 64-146 "Limitations on Stringing and Sagging Conductors."

Preparation of Sag-Tension Charts

The sag-tension charts Figs. 5-2 and 5-3, that are the basis of line design, usually are prepared by wire and cable manufacturers. Differing methods are used for such work—principally those originated by P. H. Thomas, J. S. Martin, and H. H. Rodee, or a combination of them. References should be consulted for full explanation of these methods.\* All require considerable mathe-

matical or graphical analysis, particularly for composite conductors. The steel and aluminum components of ACSR, for example, differ as to stress-strain properties, coefficient of thermal expansion, and allowable stress, hence ACSR analysis is not a simple process.

Space does not permit a full discussion of these methods, but a brief outline of the Rodee Graphic Method is included, that applies to a non-composite AAC conductor, along with a worked-out example.

The Catenary Curve and Preliminary Sag-Tension Graph

The sag curves of Fig. 5-1 are catenaries if the conductor is of uniform weight per ft. Though such a curve can be approximated by a parabola, it is customary to obtain mid-point sags for sag-tension graphs Figs. 5-2 and 5-3, by the catenary formula, and to use the parabola for finding mid-point sags at constant stress as depicted in Fig. 5-4.

All catenary curves can be defined from the values in Table 5-4. Those in the two-left-hand columns apply to any catenary, regardless of material, weight per ft or length. Thus, for a 500-ft span in which the conductor arc length increases by 0.30%, or to 501.5 ft, the mid-point sag is 3.3576% of 500 ft, or 16.8 ft, or if it is a 1000-ft span, the sag is 33.6 ft. Mid-point sag values for any arc-length elongation are similarly found for the range of applicable sag percents. They are plotted as curve D on the Preliminary Sag-Tension Graph, Fig. 5-11, for the specified 500-ft span. This same Curve D is on all similar graphs for 500-ft spans, regardless of the kind or weight of the conductor.

The values in the three right-hand columns of Table 5-4 enable calculation of tension (lb) or tensile stress (psi) in the conductor for any arc-elongation percent for any weight of conductor and span. Thus, using symbols of Table 5-4, the tensile stress (psi) in the conductor is as follows:

$$\text{Stress (psi)} = \frac{P}{E} = \left( \frac{P}{W} \right) \times \frac{W}{E} \quad (\text{Eq. 5-6})$$

or, substituting:  $P/W$  from table as  $\frac{1}{2}$  of 3745 = 1873, for 500-ft span  
 $W$  = Weight of conductor = 0.3725 lb per ft  
 $E$  = Conductor Area 0.3122 sq in.

$$\text{Stress (psi)} = 1873 \times \frac{0.3725}{0.3122} = 2235 \text{ psi}$$

The value 2235 psi is the point on Curve B for 0.30% arc elongation and similarly the other values for Curve B are obtained. The designation B for the curve signifies *Bare-unloaded*.

\*See Sec. 14, 11th Edition, *Standard Handbook for Electrical Engineers*, McGraw-Hill Book Co., New York.

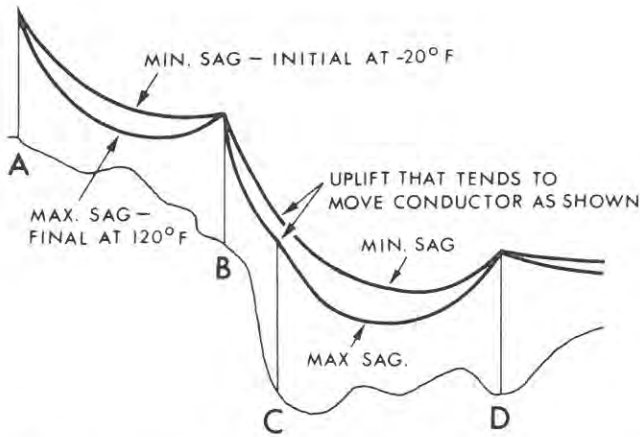

Fig. 5-7. Condition that causes uplift force which would collapse suspension insulators and damage ties on cap-and-pins.

If it be assumed that the conductor is to carry ice and wind load corresponding to the NESC *Heavy Loading* the conductor weight is 1.587 lb/ft, and the stress is increased proportionately to 9520 psi, which becomes a point on curve *H* for the 30% arc elongation. Similarly curves *B*, *L*, *M*, and *H* are completed. The *L* and *M* signify *Light* and *Medium* NESC loadings, per Table 5-1.

The completion of the Preliminary Sag-Tension Graph before it can be used for preparation of graphs such as Figs. 5-2 and 5-3 requires the additions of index points as indicated on Fig. 5-11 to show the stress limits that cannot be exceeded. Thus, for a conductor with a rated strength of 6880 lb and 0.3122 sq in. area, the breaking stress is 22,000 psi. If 50% of this amount is allowable as maximum stress at 0°F under *Heavy* loading, 33-1/3% thereof as initial stress at 0°F when installed, and 25% at 0°F without ice or wind load after 10-year creep, then the corresponding stress limits are marked by index points on Fig. 5-11 curve *H* (11,000 psi) and on curve *B* (7330 and 5500 psi). No index points are added to curves *L* and *M* because it is assumed that the design in this instance is for *Heavy* loading, so only values for bare unloaded conductor and for *Heavy* loaded conductor are required.

**Method of Drawing the Parabola**

Referring to Fig. 5-9 the horizontal and vertical scales may be as desired. Given half-span distance *O-4* and midpoint sag distance equal to *D-4*, a parabola fitted to points *O* and *D* is obtained by: (1) Divide lines *O-4* and *4-D* into the same number of equal parts; (2) Draw lines

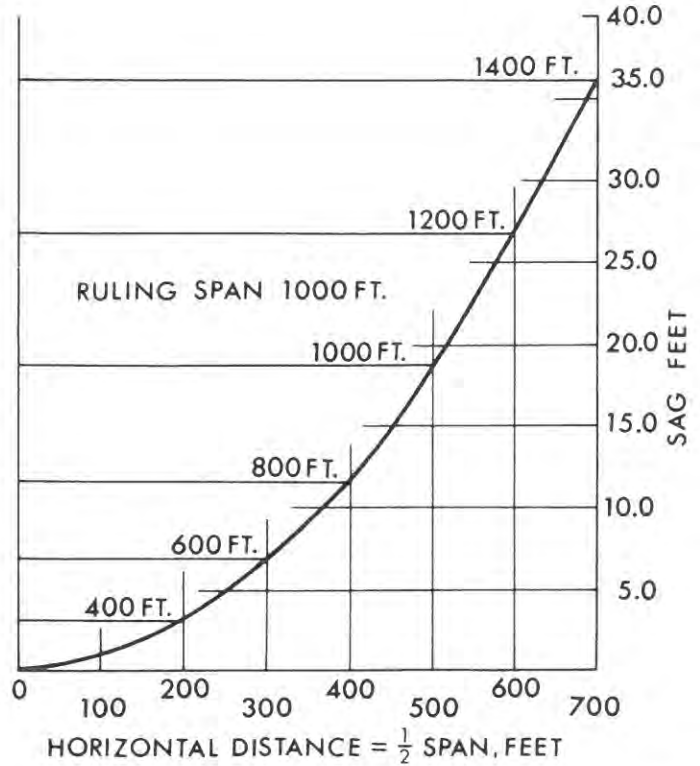

Fig. 5-8. Template half-outline for conductor used for Fig. 5-5, but for initial stringing at -20°F for 1000-ft ruling span—tension 7300 lb.

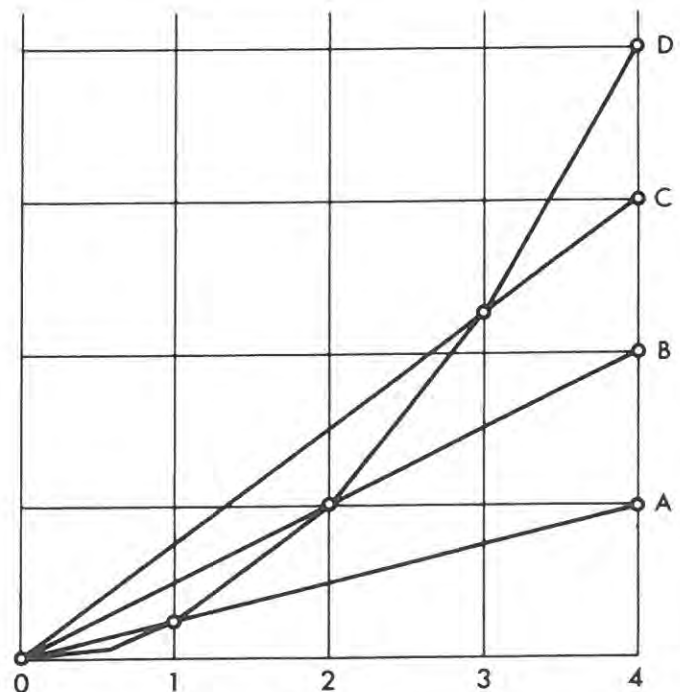

Fig. 5-9. Diagram for plotting points on a parabola.

**TABLE 5-4**  
**Catenary Constants for Horizontal Spans**  
**Listing Percent Change in Sag and Tension-Factors for**  
**Conductor Weighing 1-lb per ft for Various Percents**  
**of Elongation of Arc Length in a 1000-ft Span**

**SYMBOLS USED IN TABLE 5-4**

$L$  = Arc length of cable, ft       $T$  = Tension at Support, lb  
 $S$  = Horizontal Span, Ft       $H$  = Tension at Midpoint, lb  
 $D$  = Mid-point Sag, ft       $P$  = Average Tension  
 $W$  = Weight of conductor,       $(T + H)/2$ , lb  
 lb per ft

Though the T/W, H/W, and P/W values are for a 1000-ft span, they are suitable also for other spans; thus, for 100 ft span, divide table values by 10; for a 2000-ft span, multiply table values by 2.

$A-O$ ,  $B-O$ , etc. Their intersection with the ordinates above points 1, 2, etc., are points on the parabola. The vertical distances from the base line to the curve are proportional to the square of the distances of the ordinates from point  $O$ .

**The Stress-Strain Graph**

As has been stated, a sagging conductor comes to rest when the external force required to sustain its weight produces an arc-elongation percent in the conductor that equals the elongation-percent in the conductor that would be obtained by applying the same force to the conductor in a testing machine. It is customary to use stress (psi) instead of force (lb) when applying this principle to sag-tension analysis.

The relation of stress in the conductor (psi) and the resulting elongation (strain), herein expressed as percent of conductor length, is shown by a stress-strain graph, Fig. 5-10, which is typical for all-aluminum stranded conductor of 1350-H19 wires regardless of size, though there are slight variations depending on stranding. The curve of 6201 alloy is similar, except that they are extended to higher stress values (because of their greater strengths). For ACSR, a different graph is used for each temperature because of differing thermal-expansion rates of aluminum and steel. Fig. 5-16 shows typical curves for composite conductors of various kinds, but each curve applies only to one stranding for that kind of conductor.

Referring to Fig. 5-10 for AAC new conductor, curve 2 shows elongation percents that are obtained as stress gradually is increased to 70% of rated strength (sometimes called the "working limit"). During this increase the stress is held for one-half hour at 30% of rating, after which load is slowly withdrawn. It is then slowly reapplied until stress is 50% of rating, at which it

% Increase Arc Length Over Span Length $(\frac{L}{S}-1) 100$	% Sag of Span Length $(\frac{D}{S}) 100$	1000-Foot Span		
		$\frac{T}{W}$	$\frac{H}{W}$	$\frac{P}{W}$
.010	.6124	20419	20413	20416
.015	.7500	16675	16667	16671
.020	.8661	14443	14434	14439
.025	.9683	12920	12910	12915
.030	1.0608	11796	11786	11791
.040	1.2249	10219	10217	10213
.050	1.3695	9143	9129	9136
.075	1.6775	7471	7454	7463
.100	1.9372	6475	6456	6466
.150	2.3730	5295	5272	5284
.200	2.7405	4593	4566	4579
.250	3.0645	4115	4084	4099
.300	3.3576	3762	3728	3745
.350	3.6273	3488	3452	3470
.400	3.8784	3268	3229	3249
.450	4.1144	3086	3045	3066
.500	4.3377	2932	2889	2911
.550	4.5502	2800	2755	2777
.600	4.7534	2685	2638	2661
.650	4.9483	2584	2534	2559
.700	5.1360	2494	2442	2468
.750	5.3172	2413	2360	2386
.800	5.4925	2340	2285	2312
.900	5.8277	2213	2155	2184
1.000	6.1451	2106	2044	2075
1.100	6.4473	2014	1949	1982
1.200	6.7363	1934	1867	1900
1.300	7.0138	1864	1794	1829
1.400	7.2811	1802	1729	1765
1.500	7.5393	1746	1670	1708
1.600	7.7892	1695	1618	1657
1.700	8.0317	1650	1570	1610
1.800	8.2674	1608	1526	1567
1.900	8.4969	1570	1485	1528
2.000	8.7206	1535	1448	1491
2.100	8.9391	1502	1413	1458
2.200	9.1526	1472	1381	1426
2.300	9.3615	1444	1351	1397
2.400	9.5662	1418	1322	1370
2.500	9.7668	1393	1296	1345
2.600	9.9636	1370	1271	1321
2.700	10.1569	1349	1247	1298
2.800	10.3468	1328	1225	1277

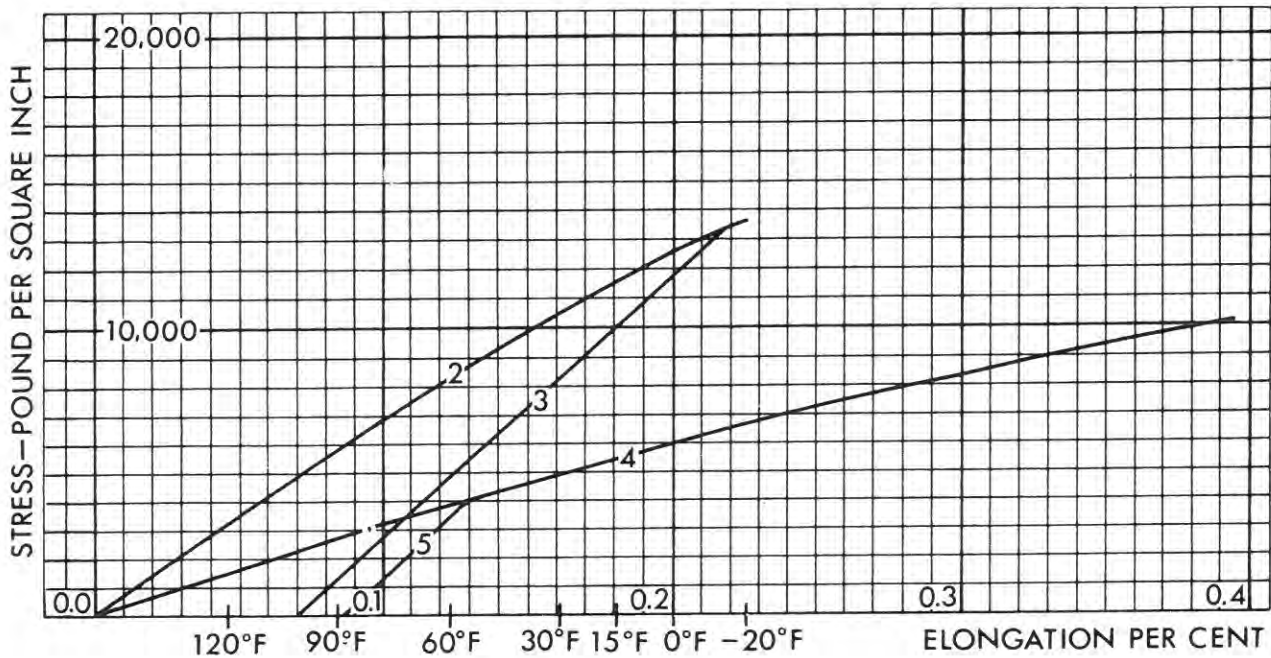

Fig. 5-10. Stress-strain curves.

Conductor: ..... 397.5 kcmil AAC Canna .....  
 Stranding: ..... 19 × .1447 .....  
 Temperature: ..... 73°F .....  
 2. Initial stress-strain curve after holding load 1 hour

3. Final stress-strain curve after holding load 1 hour  
 4. Creep for 10 years  
 5. Final stress-strain curve after holding load at 4000 psi for 10 years at 60°F

is held for one hour, followed by reduction as before. A final slow load application is made until 70% of rating at which point the final reading is not taken until after one hour. The values for curve 2 reflect the delay at 30%, 50%, and 70% of rated strength. By this process the conductor attains a high degree of compactness and stabilized length.

Line 3 shows the stress-elongation relationship while stress is decreased from the 70% point, or is subsequently increased again to that point. Line 3 is practically straight. Subsequent increase or decrease of stress causes elongations that are represented by this line or one parallel to it. The distance between the bottom of curve 2 and that of line 3 represents the permanent increase of elongation, caused by the settling of the cable strands and reduction of spaces between them, and also perhaps by a slight permanent set of the aluminum.

Line 4 represents conditions after 10-year creep at average temperature of 60°F, but no single application of an increasing stress produces such a line. The line is the locus of points each of which is a point on curve 2 from which a horizontal line extends to represent the elongation percent after 10-year 60°F creep at the indicated stress. Also line

5 represents the condition when stress is reduced after 10 years of 60°F creep at 4000 psi. An increase of load shortly thereafter will likewise show elongation percents indicated by line 5.

It is customary to place temperature indexes on the abscissa of such graphs as Fig. 5-10 to adapt the graph for use when the conductor is at various temperatures. The use of these temperature indexes is explained in the description of the application of the graph. Index-points for temperatures above 120°F are not normally shown on the stress-strain graph, though they may be added if required.

The stress-strain graphs for composite conductors, Fig. 5-16 show a sharp knee toward the bottom of curve 3 because the permanent elongation of the 1350-H19 part of the conductor is greater than that of the reinforcing component due to their different elastic limits. At stresses below the knee, the reinforcing wires carry the full load. The slope of the part of curve 3 below the knee is less than what is above the knee because the cross-sectional area of the reinforcing wires is small.

Because the 1350-H19 wires of steel-reinforced composite conductors creep more at a given temperature than do the reinforcing wires, the stress at which the curve 3 changes in slope increases during the 10-year creep period.

bare aluminum wire and cable

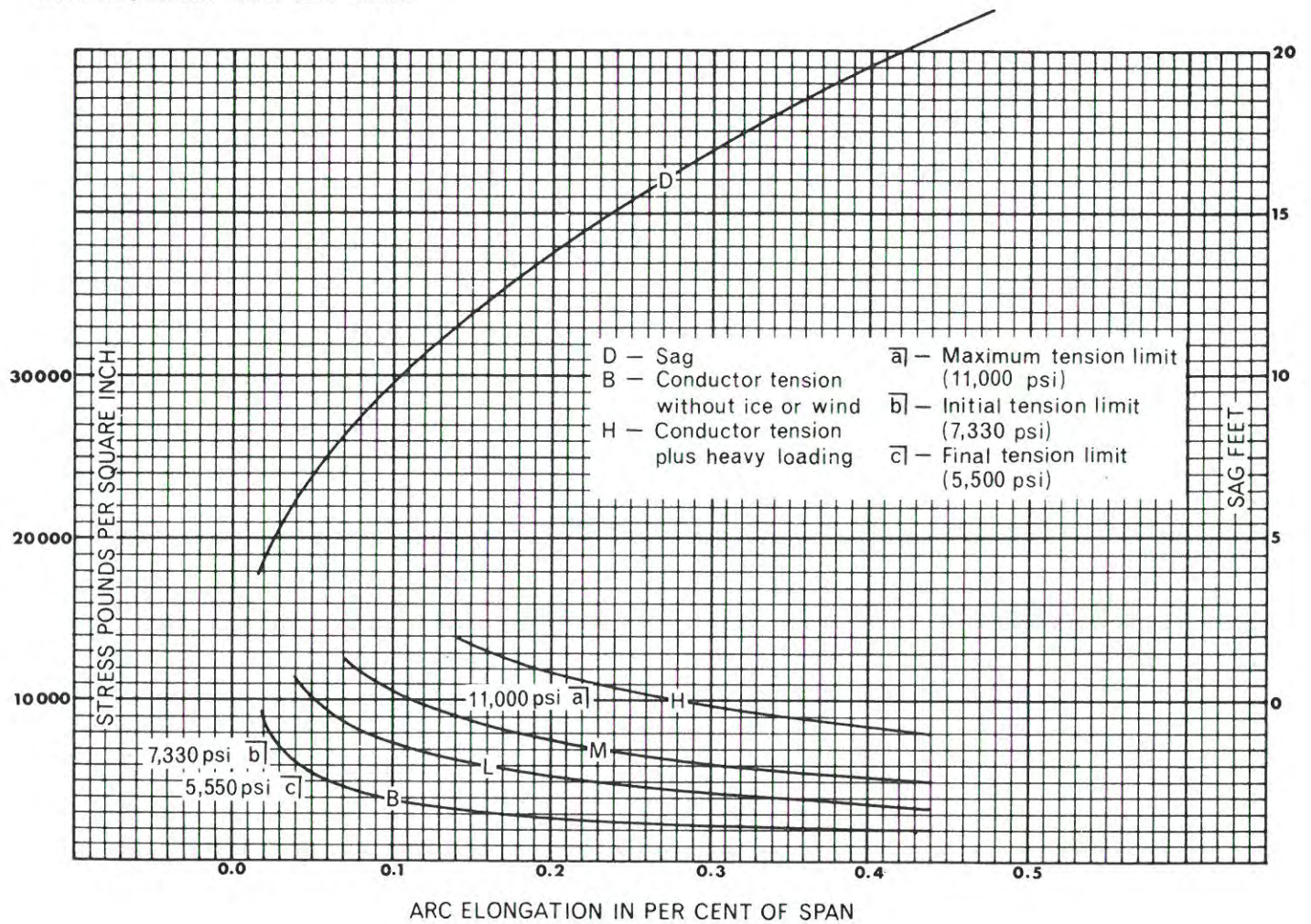

Fig. 5-11. Preliminary Sag-Tension Graph.

Conductor: 397.5 kcmil 19-strand aluminum, Canna, Span: 500 ft

*Initial and Final Sag and Tension of a Designated Conductor, Span and NESC Loading for Various Temperatures*

Given the applicable preliminary sag-tension graph, Fig. 5-11 and the stress-strain graph, Fig. 5-10, we can determine the sag-tension values at which the arc-elongation in percent of the conductor under sag, as shown in Fig. 5-11, equals the percent of elongation of the tested conductor under the same tension and temperature. Another requirement is that the stresses under the various conditions will not exceed the values indexed on Fig. 5-11 as  $\bar{a}$ ,  $\bar{b}$ , and  $\bar{c}$ , as previously

defined when describing Fig. 5-11. Essentially, the process is one of graphic comparison.

The temperature selected for the first comparison is the lowest likely to be encountered for the specified loading (in this case the *Heavy* loading). For average conditions, 0°F ordinarily may be taken. An infrequent below-zero temperature rarely occurs with full ice-and-wind load, and if it should, the margin of safety is ample; also, after long-time creep, the stress is likely to be below what it is initially. If the temperature, however, will be below 0°F for long periods, this lower value should be assumed for the first comparison.

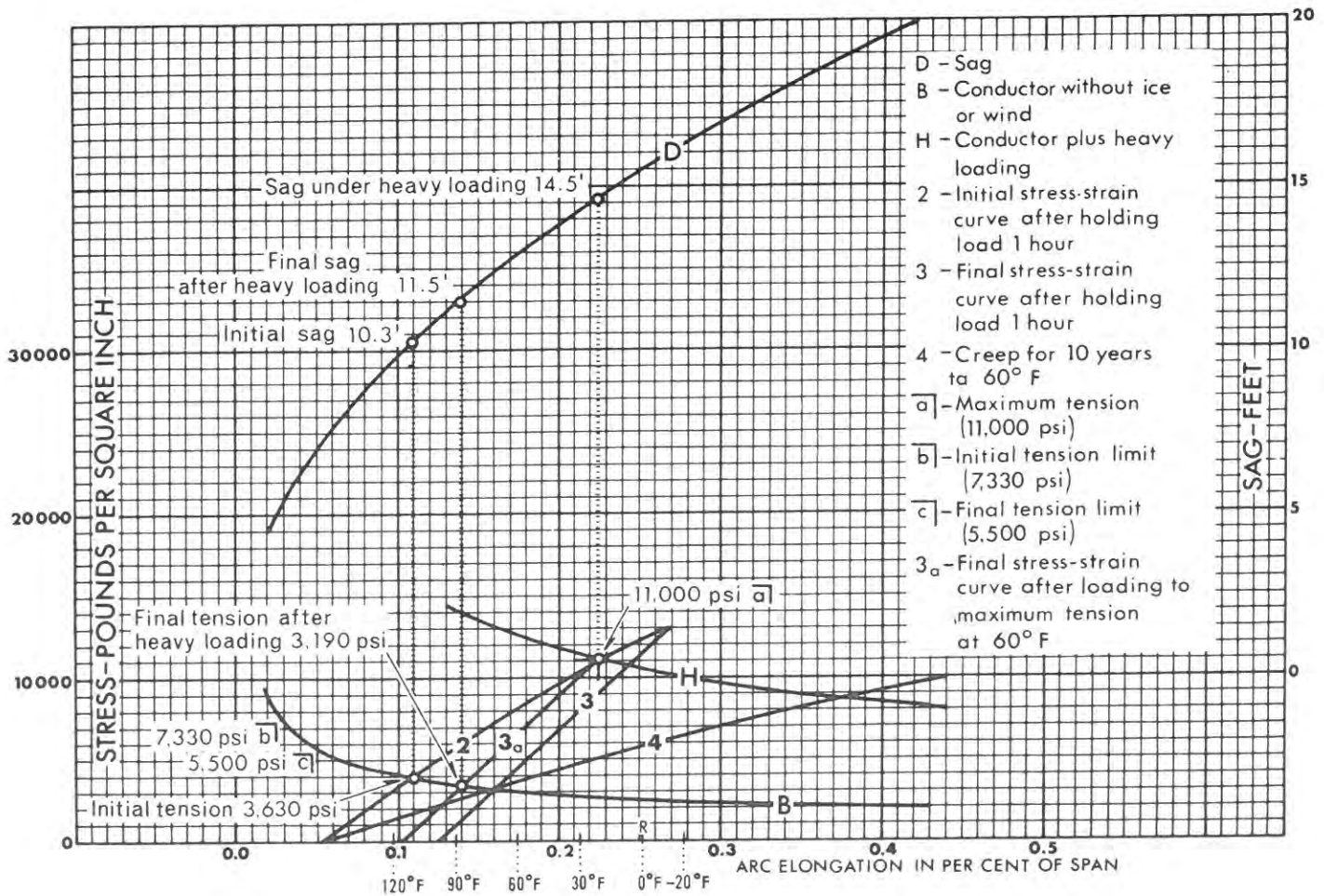

Fig. 5-12. First-trial check of tension limits.

Conductor: 397.5 kcmil 19-strand aluminum, Canna, Span: 500 ft

The comparison is made graphically by superposing a transparent-paper stress-strain graph, Fig. 5-10, (with its grid, ordinate, and abscissa values removed) over the preliminary sag-tension graph, Fig. 5-11, so their abscissas coincide and so the initial line 2 of Fig. 5-10 intersects the 11,000 psi index mark on line H. It is then apparent that neither tension limit b or c will be exceeded. Therefore, tension a is the governing condition. The superposed graphs then appear as Fig. 5-12.

The sag under heavy loading (14.5 ft) is found vertically above a on curve D. The initial tension at 0°F with-

out ice and wind (3,630 psi) is found at the intersection of curve 2 with curve B, and the corresponding sag (10.3 ft) is on curve D.

The final stress-strain curve 3a after heavy loading and holding for one hour is drawn from point a parallel to curve 3, and the final tension after heavy loading (3,140 psi) is found where it intersects curve B. The corresponding sag (11.5 ft) is found on curve D.

The next operation is to determine whether the final sag after 10-year creep at 60°F will exceed the final sag after heavy loading. Before moving the stress-strain graph from



bare aluminum wire and cable

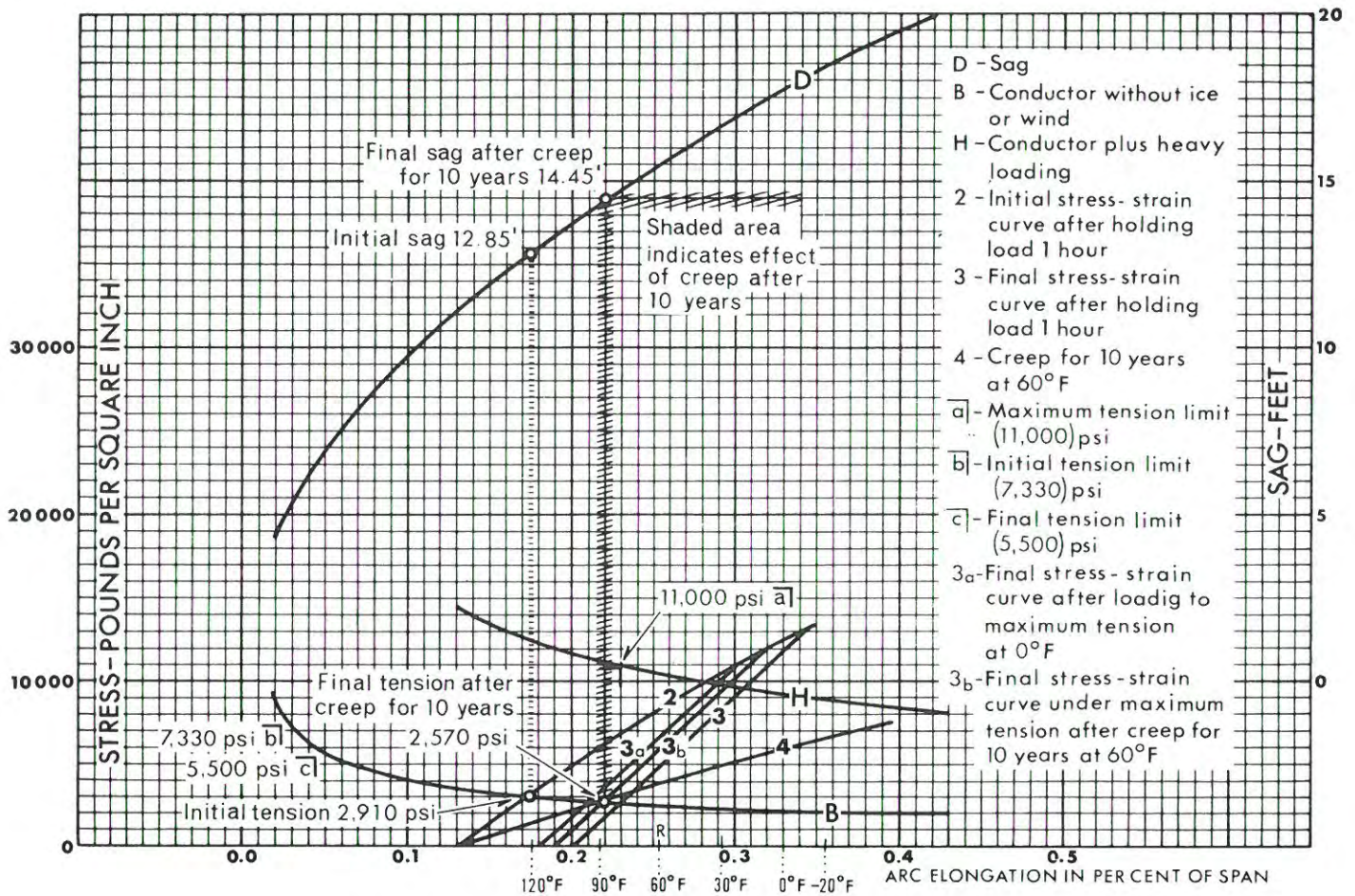

Fig. 5-13. Second trial to check effect of 10-year creep at 60°F.

Conductor: 397.5 kcmil 19-strand aluminum, Canna, Span: 500 ft

its present position, the location of 0°F on its temperature scale is marked on the first-trial check of tension limits (Fig. 5-12) as reference point *R*.

The stress-strain graph is then moved to the right until 60°F on the temperature scale coincides with reference point *R*, Fig. 5-13. The initial tension at 60°F (2,910 psi) is found at the intersection of curve 2 with curve *B*, and the corresponding sag (12.85 ft) is on curve *D*.

The final tension at 60°F after heavy loading is found at the intersection of curve 3<sub>a</sub> with curve *B*. It will be observed that curve 4, which shows the elongation of the

conductor after creep for 10 years, intersects curve *B* at 2,570 psi. The corresponding sag (14.45 ft) is found on curve *D*. Since this sag exceeds the final sag after heavy loading at 0°F creep is the governing condition.

A new final stress-strain curve 3<sub>b</sub> is now drawn parallel to curve 3 through the point on curve 4 where it intersects curve *B*. The final sag and tension at 0°F must now be corrected, using the revised stress-strain curve.

For this purpose the stress-strain graph is moved to its former position so that 0°F on the temperature scale coincides with reference point *R*, Fig. 5-14. The corrected final

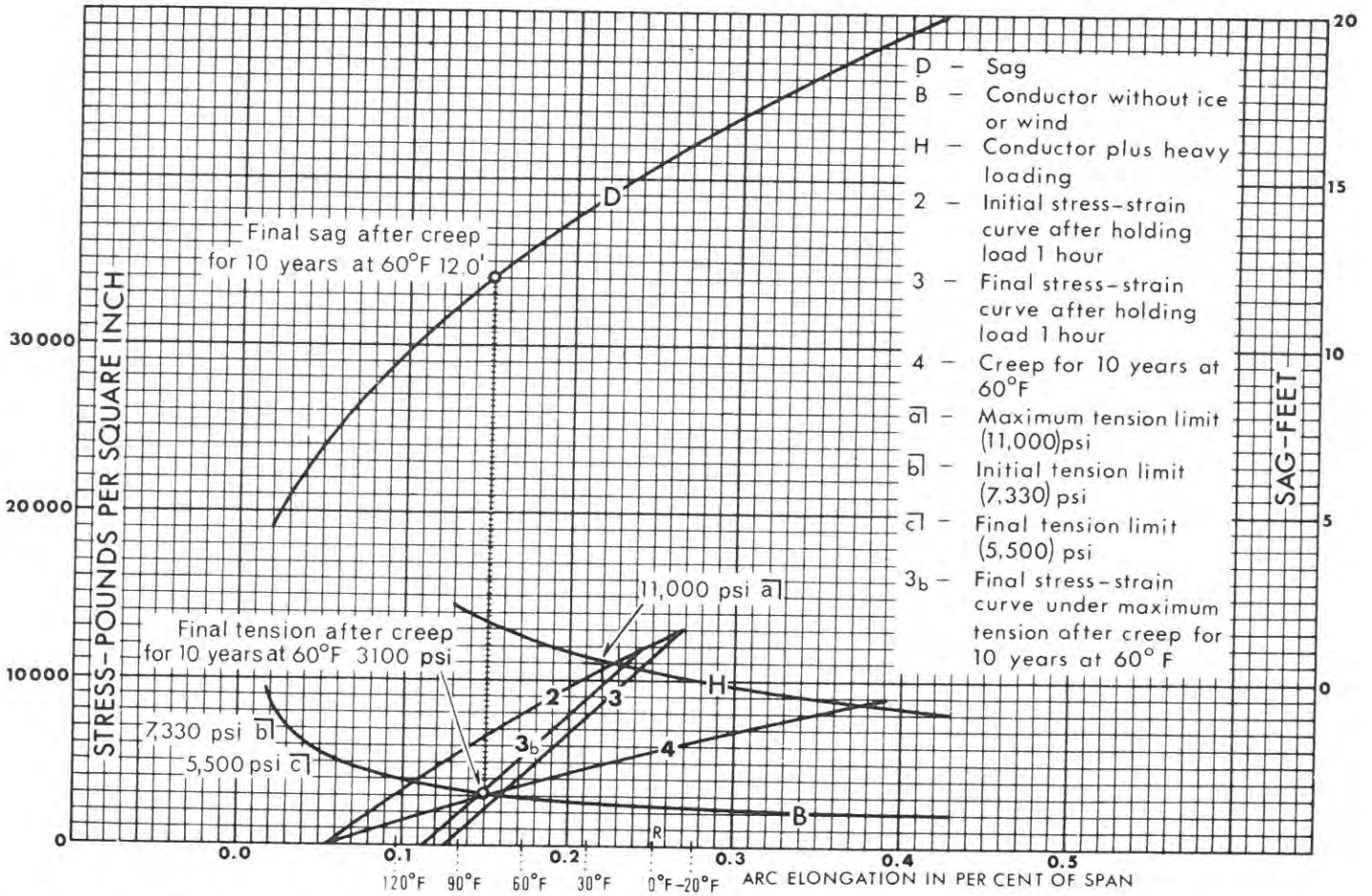

Fig. 5-14. Final trial for 0°F after adjustment for 10-year creep correction. Values for 0°F unloaded, and 0°F with heavy load are entered from this graph on Table 5-5.

Conductor: 397.5 kcmil 19-strand aluminum, Canna, Span: 500 ft

tension (3,100 psi) is found where curve 3<sub>b</sub> intersects curve B. The corresponding sag (12.0 ft) is on curve D.

The final sag after 10-years at 60°F after Heavy loading (14.7 ft) is found where the ordinate at intersection of curve 3<sub>b</sub> and curve H intersects curve D; the corresponding tension is 10,840 psi. These values are not indexed on the curves.

The sag and tension values thus far found are entered in Table 5-5 as the initial and final sags and tensions for

0°F, both unloaded and for Heavy loading. Sags and tensions for other temperatures are similarly found and entered in Table 5-5. Thus, for 120°F the stress-strain graph is shifted until the 120°F point is moved to reference mark R to produce Fig. 5-15, from which the initial tension (2,470 psi) is found at the intersection of curve 2 with curve B, and the corresponding sag (15.15 ft) is on curve D. Final tension (2,270 psi) is found at the intersection of curve 3<sub>b</sub> with curve B and the corresponding sag (16.5 ft) is on curve D.

bare aluminum wire and cable

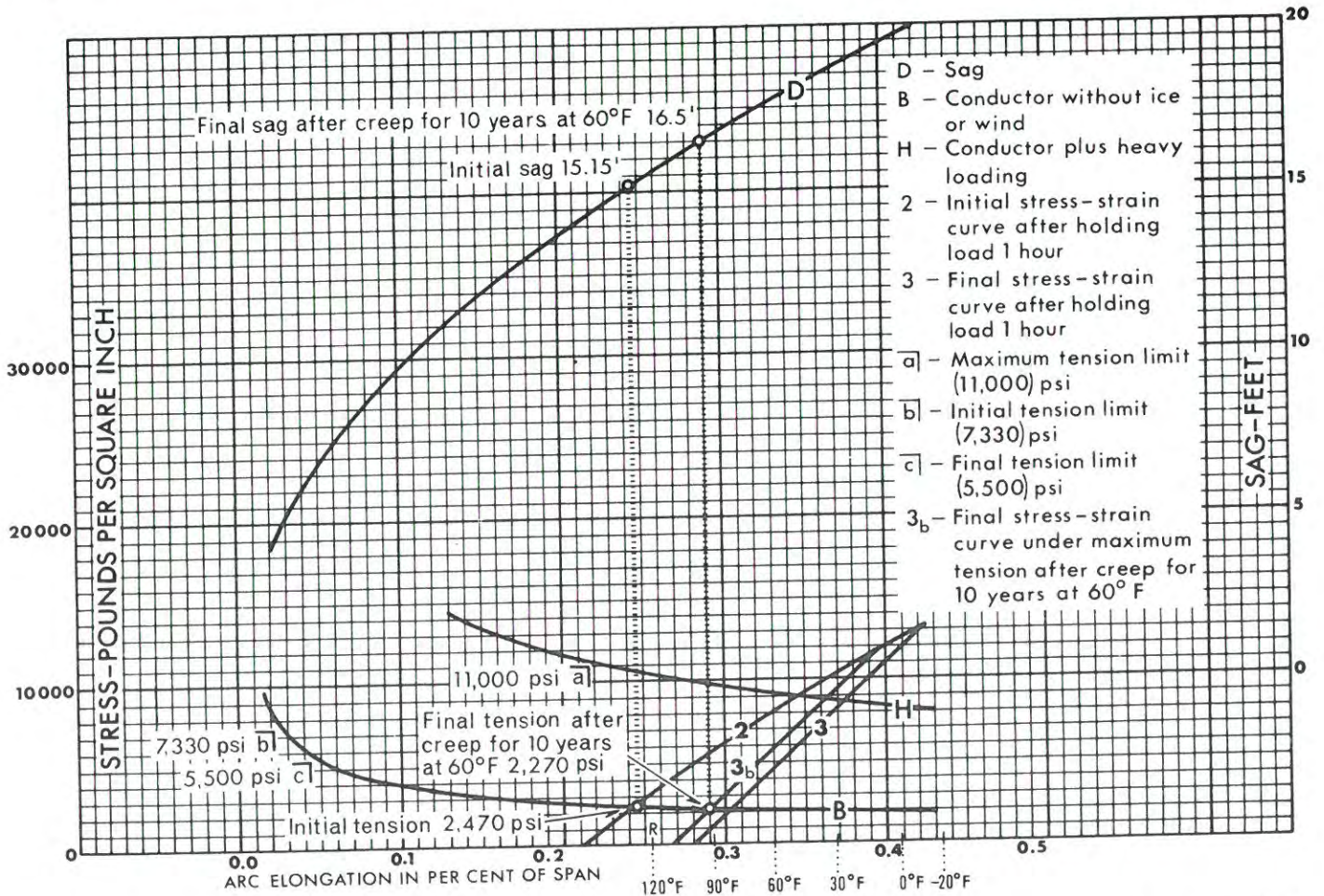

Fig. 5-15. Similar to Fig. 5-14, but for 120°F without load. Values for this temperature are entered in Table 5-5.

Conductor: 397.5 kcmil 19-strand aluminum, Canna, Span: 500 ft

In a similar manner, the values for other temperatures are obtained to complete Table 5-5. The load values in pounds  $P$  are obtained by multiplying the tensile stress values in psi by the conductor area (0.3122 sq in). The values from Table 5-5 are then transferred to Initial and Final Sag- and Tension Graphs (similar to Figs. 5-2 and 5-3) at the 500-ft span ordinate. Completion of a similar series of values for other spans and for Light, Medium and Heavy loading provides everything necessary to complete the sag-tension graphs that customarily wire and cable manufacturers supply to customers as a basis for their work as described in the early portion of this chap-

ter. The manufacturers also supply a wide variety of graphs, such as Figs. 5-10, 5-11, 5-16 and data for templates for various sizes of conductors and conditions.

**Sag-Tension Graphs for Composite Conductors**

The graphic method used for the preceding work similarly can be employed for obtaining sag-tension graphs for ACSR and ACAR, but with considerable difference in details because the reinforcing wires have different physical properties from those of the 1350-H19 wires (Fig. 5-16). Thus, for ACSR the components differ as to elastic modulus, temperature coefficient of expansion, elastic

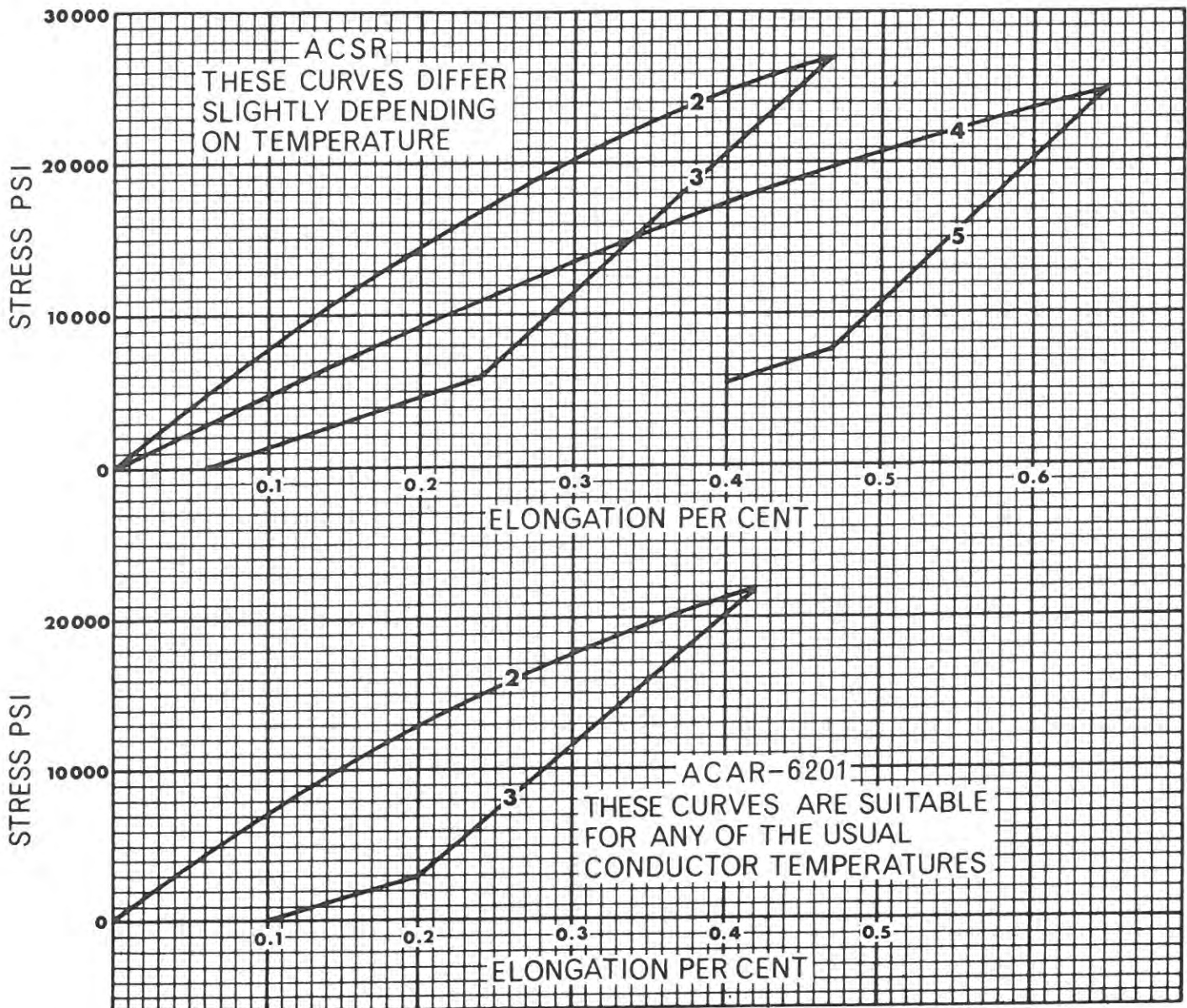

Fig. 5-16. Typical stress-strain curves for various kinds of composite conductors. The designation numbers of the curves have the same meaning as those of Fig. 5-10. Con-

sult cable manufacturer for accurate curves depending on reinforcement ratio. The location of the break in curves 3 and 5 depends on this ratio.

limit, rate of long-time creep, and allowable unit stress. In ACAR the creep rates and temperature coefficients are not significantly different, but because of differences of elastic limit the elastic moduli differ greatly in the upper range of stress. The allowable unit stress in the two kinds

of wire also differs.

For example, finding sag-tension data for ACSR at a specified temperature requires the use of three stress-strain graphs, one for the entire conductor, and one for each of the components (aluminum and steel). The graph for

TABLE 5-5

Listing of values obtained from Figs. 5-14 and 5-15

Temp. °F	Loading	AFTER 10 YEARS FINAL			INITIAL		
		Sag ft	Ta psi	P lb	Sag ft	Ta psi	P lb
0	Heavy	14.7	10,840	3,385	14.5	11,000	3,440
-20	0	10.8	3,460	1,080	9.1	4,100	1,280
0	0	12.0	3,100	979	10.3	3,630	1,132
30	0	13.05	2,860	895	11.45	3,260	1,018
60	0	14.45	2,570	803	12.78	2,910	907
90	0	15.4	2,430	759	14.0	2,670	834
120	0	16.5	2,270	709	15.15	2,470	772

the complete conductor (Fig. 5-16) is made by test in the usual manner. A similar graph for the steel core is made by test. The stress-strain graph for the aluminum is then obtained by subtracting the values for the steel from the values for the entire conductor. All three graphs, however, are plotted on the same sheet (Fig. 5-17). The effect of ratio of steel area to aluminum area is taken into account when preparing the graphs. The process is thus more complicated than what is used for AAC and AAAC, but the basic principle is the same.

Similarly for ACAR, stress-strain graphs are made for

the entire conductor, and also for the reinforcing alloy wires. The graph for the 1350-H19 wires is obtained by difference.

The preliminary sag-tension graph (such as Fig. 5-11) is used unchanged for composite-conductor analysis; it is only the superposed stress-strain curves that differ.

Because of the necessary space required for an adequate explanation of the details of preparing sag-tension graphs for composite conductors, a description of the method is not included herein, but readily available references provide full information.

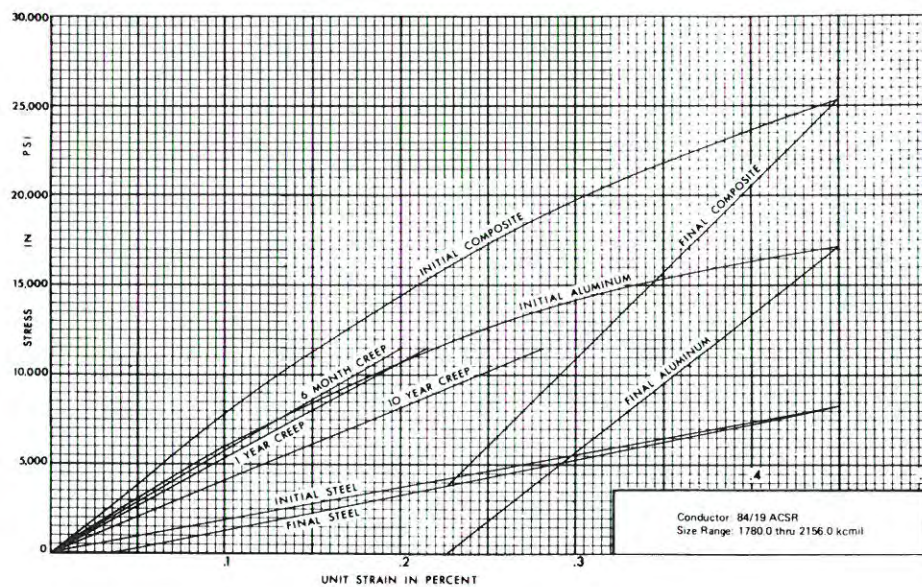

Fig. 5-17. Stress-Strain Curves.

Typical Stress-Strain-Creep Curves for a 84/19 ACSR conductor

### Overhead Conductor Accessories and Fittings

Wire and cable accessories for aluminum overhead lines are similar to those used for copper lines, but it is essential that they be designed for aluminum because of differences of physical properties of aluminum and copper. Fittings used at terminals, or where overhead lines connect to insulated cables, underground lines, or bus structures often are of combination types that embody design features described in Chapter 11 for insulated cables and Chapter 13 for bus conductors, to which reference should be made for details.

Customarily, the fittings and accessories for overhead lines are classified as follows:

#### Joints and Connectors

*Joints* carry full current and withstand at least 95 percent of the rated strength of the conductors. *Connectors* carry full current, and limited tension. Joints for line conductors are made by compression of the conductor ends within a long sleeve or tube. Connectors also may be of the compression type, or may be bolted or welded. Connectors also are designated according to use, such as for terminal, tee, parallel or tee tap, etc. See Figs. 5-18 and 5-19.

Sometimes the term *connector* also is applied to a small assembly of connectors, cables and terminals for a design-

nated use. Thus, a *jumper* connector may refer to a short length of cable to which connectors are attached at each end, used to "jump" across the insulation-support structure where adjacent conductor spans are dead-ends, or the term may refer to a connector fitting used in such an assembly (see Fig. 5-19A).

*Dead-Ends*: hold the mechanical tension and provide anchorage to a strain insulator at end of a span.

*Suspension Clamps*: support the conductor at tangent or light angle structures usually through suspension insulators.

*Armor Rods*: surround and reinforce cable near points of support.

*Flat Armor Wire*: used for wrapping around conductors to protect them from chafing, and sometimes is used instead of armor rods in short spans.

*Tie Wires*: attach the cable mechanically to the top of pin-type insulators.

*Vibration Dampers*: reduce resonant vibration. These are described in Chapter 6.

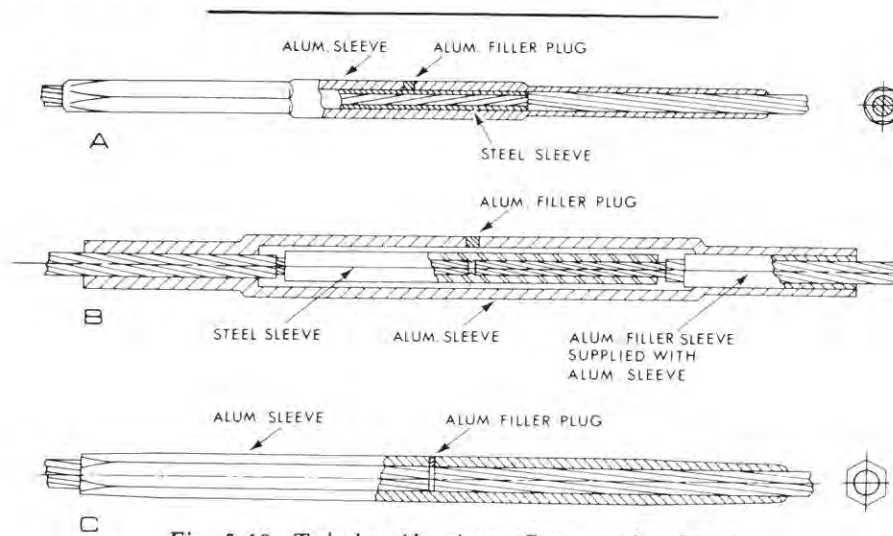

Fig. 5-18. Tubular Aluminum Compression Joints.

A joint is sufficiently strong to develop a tensile strength equal to at least 95 percent of the strength of the conductors it joins. Sometimes filler plugs are omitted in joints used in distribution circuits; in such cases the filler compound must be injected into the ends of each sleeve before inserting the conductor.

**A**—For ACSR. The aluminum sleeve is placed over one cable and run back. The aluminum wires are then cut away to provide room for the steel sleeve which is then inserted, cables joined, and steel sleeve compressed. The aluminum sleeve is then positioned, filler

compound injected, and filler plug driven in place, after which the aluminum sleeve is compressed.

**B**—For ACSR with extra large core. Installation is similar to A except that the filler sleeve is inserted in one end before injecting compound.

**C**—For all-aluminum conductors. Compression sleeves for high-strength-alloy conductors should be sufficiently large to match the increased tensile strength of the conductors, as compared with those of EC grade.

**bare aluminum wire and cable**

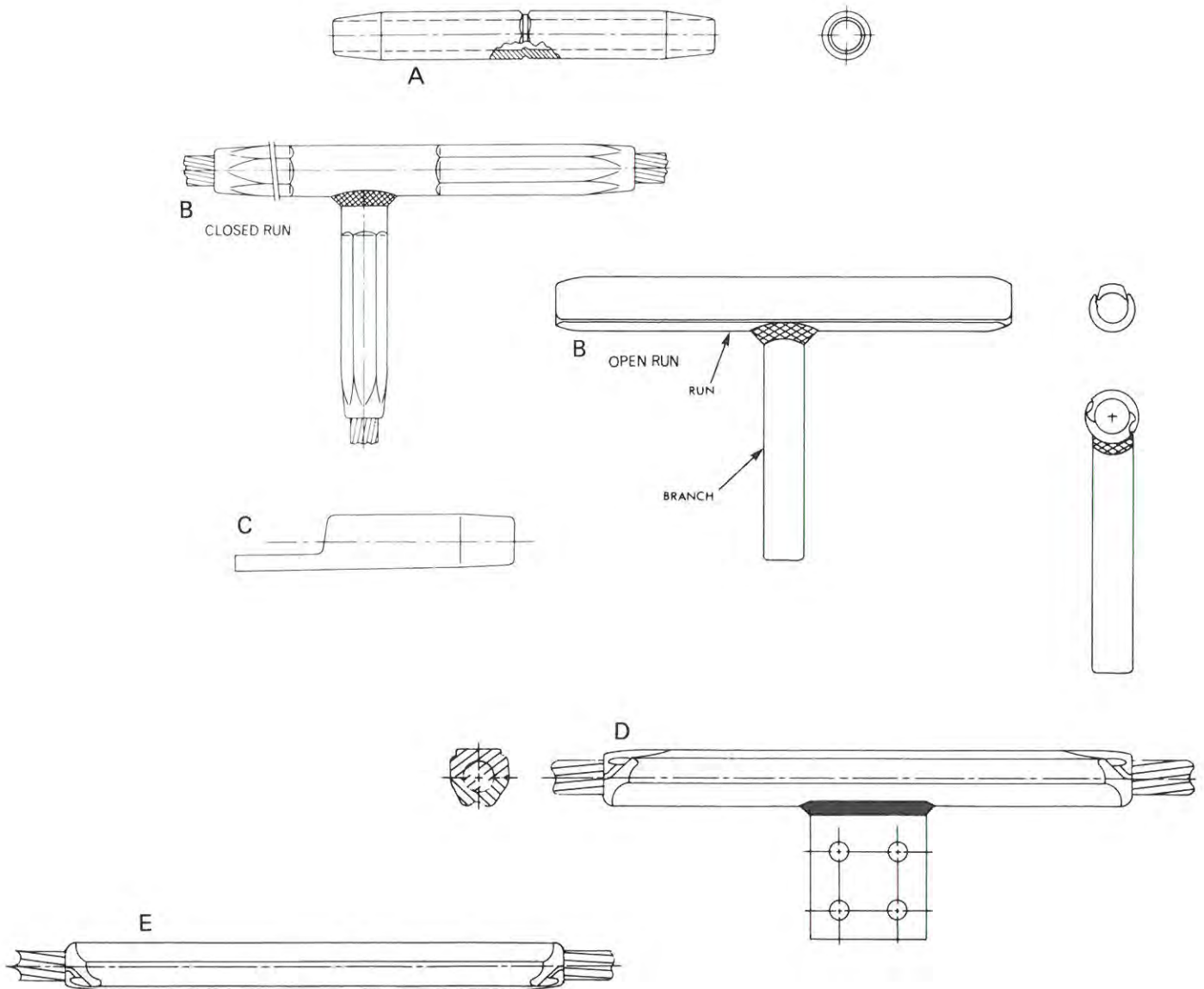

**Fig. 5-19. Tubular Aluminum Compression Connectors.**

Connectors are used for joining comparatively short lengths where full conductivity is required, but where the cable tension is comparatively low. The same connector is used for ACSR as for all-aluminum conductors because the added strength of the steel core is not required.

**A—For Jumpers.** Used on short lengths of all-aluminum conductors that join adjacent dead-ended conductors.

**B—For Tee Taps.** In the closed-run type, the long sleeve is placed on the conductor from its end, or it may serve as a joint between conductors of the run. In the open-run type the long sleeve is split longitudinally so it may be

placed sideways over an already-installed run conductor.

**C—For Flat-Pad End Terminals.** The compression sleeve is welded or forged to a flat-bar pad drilled according to NEMA standard. The direction of take-off may be straight or at an angle.

**D—For Flat-Pad Side Terminals—**The compression sleeve is usually of the open-run type, so the tap may be made from an installed conductor.

**E—For Cable Repair (Repair Sleeve)—**The repair sleeve is applied to strengthen a cable where strands have broken or local damage is suspected. It is of the split type.

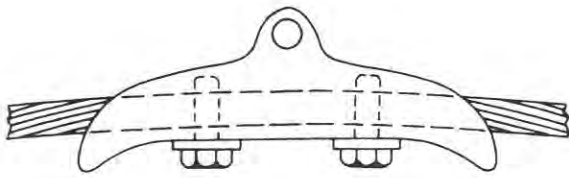

Fig. 5-20. Typical Cable Suspension Clamp for supporting cable at bottom of a suspension insulator.

#### Bolted Clamp Connectors

Bolted aluminum clamp connectors are used extensively in bus structures, and also for connecting or supporting bare aluminum cables at terminals or connecting them to other cables. Bolted fittings are available in a wide variety of types. They are easy to install and offer little handicap to future circuit re-arrangement, if required. Aluminum bolts (2024-T4) of the heavy series type or equivalent U-bolts are widely used, and the bodies may be of cast, forged or extruded aluminum.

Although the usual clamp-bolt connection of an ACSR or stranded aluminum cable will not withstand the full tensile strength of the cable, it is possible to achieve such strength by employing the snubbing principle. Thus, by looping the cable around a semi-circular grooved body of a snubber-type dead-end fitting, and providing a hump in the clamp between the two clamp bolts, the holding power of the fitting is increased a great deal.

The use of additional clamp-bolt assemblies in series is another way of increasing holding power.

#### Welded Connections

Welding as a means of joining components of an aluminum connector fitting is recognized standard procedure but direct welding of stranded aluminum line cables is presently limited to welding cable strands to the body of an aluminum terminal fitting, which in turn may be either bolted or welded to a matching flat pad or other fitting. The advantages of welding cables to terminal pads are most evident for the sizes of cables for which compression or bolted fittings are bulky and comparatively costly. So far as possible, welding of stranded cable to terminal pads should be a shop operation instead of being done in the field.

For example, a transmission line required hundreds of jumper cables to span the support towers where dead-ends are located. Both ends of the jumper cable were shop welded to a flat-pad bolt-type terminal, Fig. 5-22; by placing the pad fitting in a vertical clamp jig following suitable preparation of the cable wires. After preheating, weld metal was puddled in by gravity, then allowed to cool, after which the weld was completed to provide contact between the ends of all wires of the cable and the terminal pad.

#### Dead-Ends and Dead-End Clamps

Dead-end fittings hold the cable against span tension and provide attachment to the strain insulator. Continuation of the cable beyond a dead-end may be provided by a jumper cable with end connections suitable for attaching to the dead-end. In the snubber dead-end, Figs. 5-21A1 and A2, the line may be looped downward, across, and continued through the opposite dead end to the next span, or may be run downward to a terminal. Other compression-type and bolted-type dead-ends and dead-end clamps are also shown in Fig. 5-21.

For city distribution where design tensions are relatively low straight-line dead-end clamp fittings are much used. The cable is not looped around an insulator or thimble but is gripped in a horizontal body by U-bolts and pressure bar, Figs. 5-21A3, -4, and -5. None of the bolted dead-end fittings differ for ACSR or all-aluminum conductors, hence are mostly used for cables of moderate size.

Tubular aluminum compression dead ends for ACSR, all-aluminum and Alumoweld conductors are shown in Fig. 5-24.

#### Suspension Clamps

Suspension clamps support the cable at the bottom of insulator strings. Normally the clamp has two U-bolts and a pressure bar that clamps the cable. The ends are bell-mouthed to avoid sharp bends, Fig. 5-20.

#### Tie Wires

Aluminum tie wire for attaching cables to pin-type insulators comes in rolls, and is available as regular strength wire in Nos. 6, 4, and 2 AWG sizes and as Strong Aluminum Alloy Tie Wire in No. 6 AWG. The latter is used where maximum holding power is required. The greater ductility of the regular strength wire somewhat speeds completion of a tie, and it is also used under hot-line conditions. Added protection of the conductor at insulator supports usually is provided by armor rods, and the tie wires not only tie the rod-and conductor assembly to the insulator, but also bind the armor rods to the conductor.

The method of application of tie wires for attaching a cable to a pin-type insulator is depicted in Fig. 5-26.

#### Armor Rods

These are generally used on overhead lines to protect the strands from fatigue-effects of vibration near points of support. They consist of an assembly of aluminum rods, each somewhat larger in diameter than the conductor-strand diameter, arranged around the conductor to form a complete protective shield, Fig. 5-25. The rods are spirally twisted so they lie approximately parallel to the conductor strands.



bare aluminum wire and cable

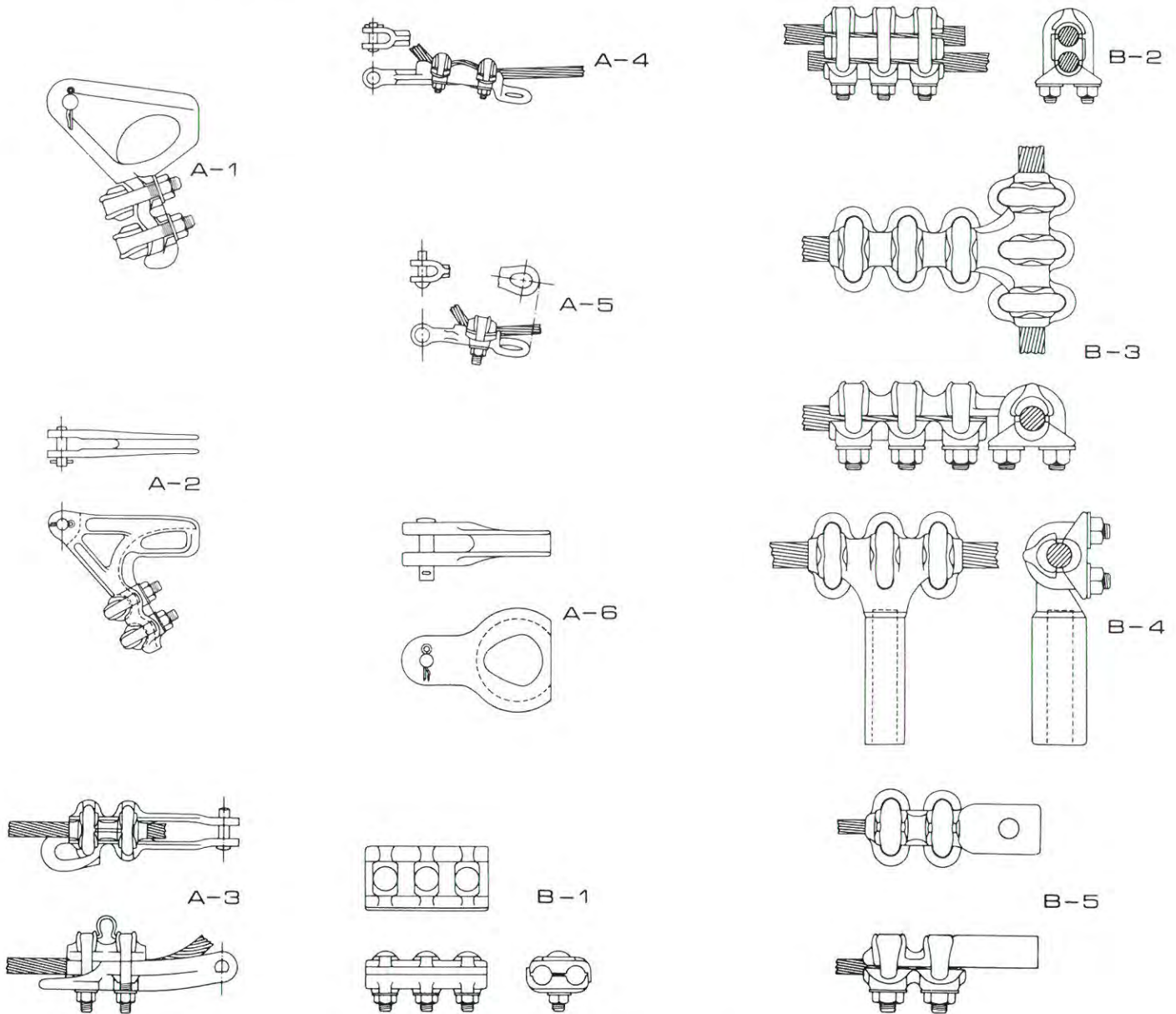

Fig. 5-21. Clamp-bolt connections.

Clamp-bolt connections are widely used, particularly for distribution circuits or where there is likelihood of future changes. Though single clamp connections usually are suitable for full conductivity, special construction is required if the full tensile strength of the cable is to be withstood. The use of multiple connections as well as employing the snubbing principle enables bolted connections to aluminum stranded cable to meet all usual requirements as to strength.

**A—Snubbing-Type Dead-End (A1 and A2).** The clevis is attached to the strain insulator. The line cable is looped around the fitting and clamped below by the double-U-bolt pressure joint. The hump between the bolts also aids holding power. In many cases, no separate jumper con-

ductor is necessary; the line conductor is merely looped down through the clamp fitting, run across to the adjacent dead-end and run upward and continued in the adjacent span.

Types A3, A4, and A5 are straight-line dead-end clamps for limited tensions. Type A6 is an aluminum thimble much used for connecting a looped-around cable to a clevis pin. Applying bolted clamps to the two cable ends completes the dead-end connection.

**B—Miscellaneous Clamp-Bolt Connections.** B-1 and B-2 are parallel-line clamps for making taps. B-3 is a typical tee tap in which the branch connection is bolted. B-4 is similar, except the branch is a compression fitting. B-5 is a terminal-pad bolted connection.

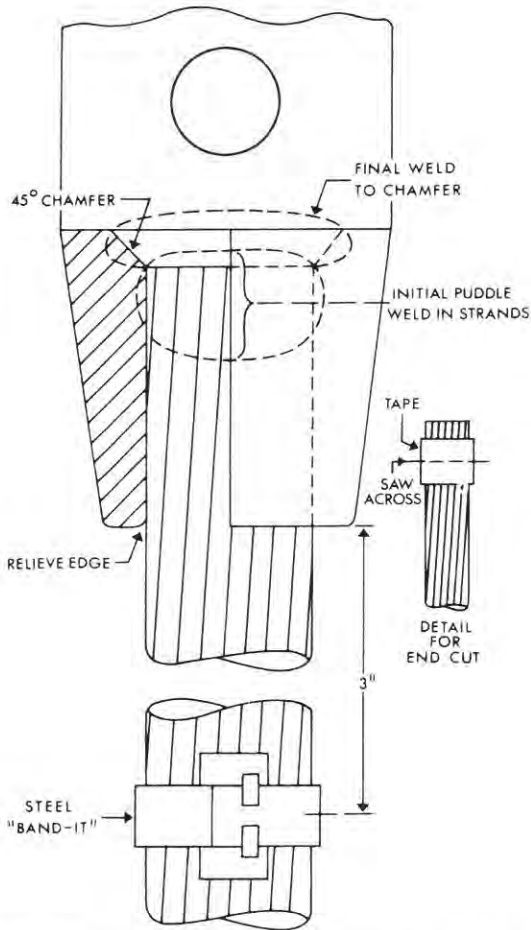

Fig. 5-22. Welded connection between stranded aluminum cable and terminal pad for transmission-line jumper cables.

Straight and helically formed *armor rods* are available. Each formed rod is essentially an open helix with a pitch length somewhat less than that of the "lay" of the outer strands of the cable.

### Aluminum-to-Copper Connections

Connecting aluminum cable to copper bushing studs and switch pads is often necessary, and this form of connection for the high current ratings has received extensive study to assure long-time reliability under normal and short-circuit conditions.

For connecting large aluminum conductors (500 kcmil and up) to heavy equipment having copper terminal studs and or pads, large compression-type lugs, preferably with two holes, should be used. In making such a connection (Figure 5-23) with other than aluminum bolts, Belleville spring washers and heavy flat washers in consecutive arrangement as shown in Figure 11-11 must be used. If aluminum bolts and nuts are used only the heavy washer, bearing on the aluminum lug, is necessary.

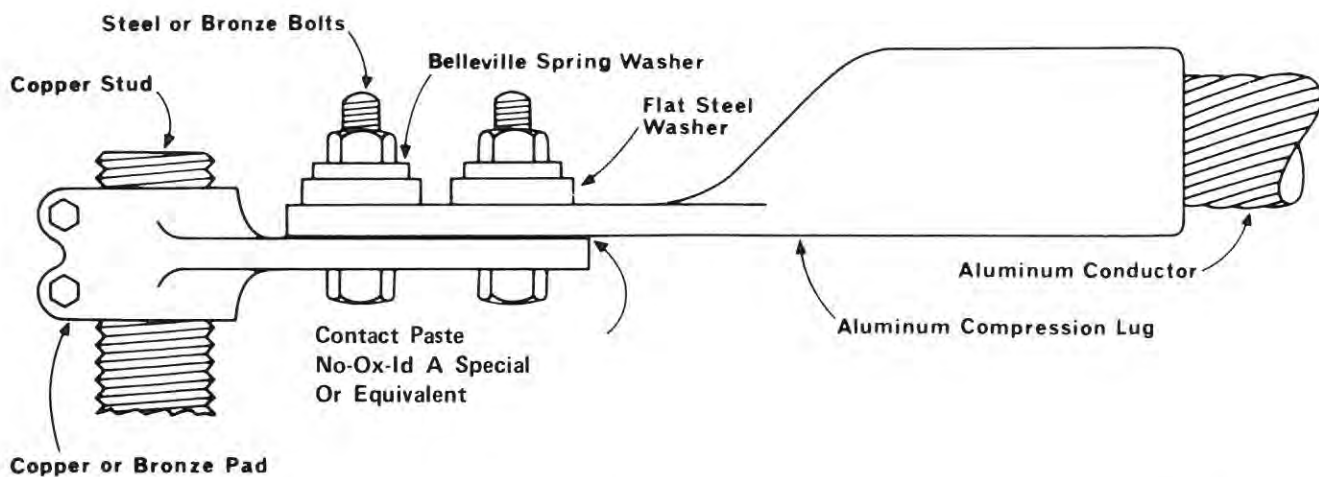

Fig. 5-23. Method for connecting large aluminum conductors to equipment studs or terminal pads made of copper. If bolts are made of aluminum it is not necessary to provide the Belleville spring washer.

bare aluminum wire and cable

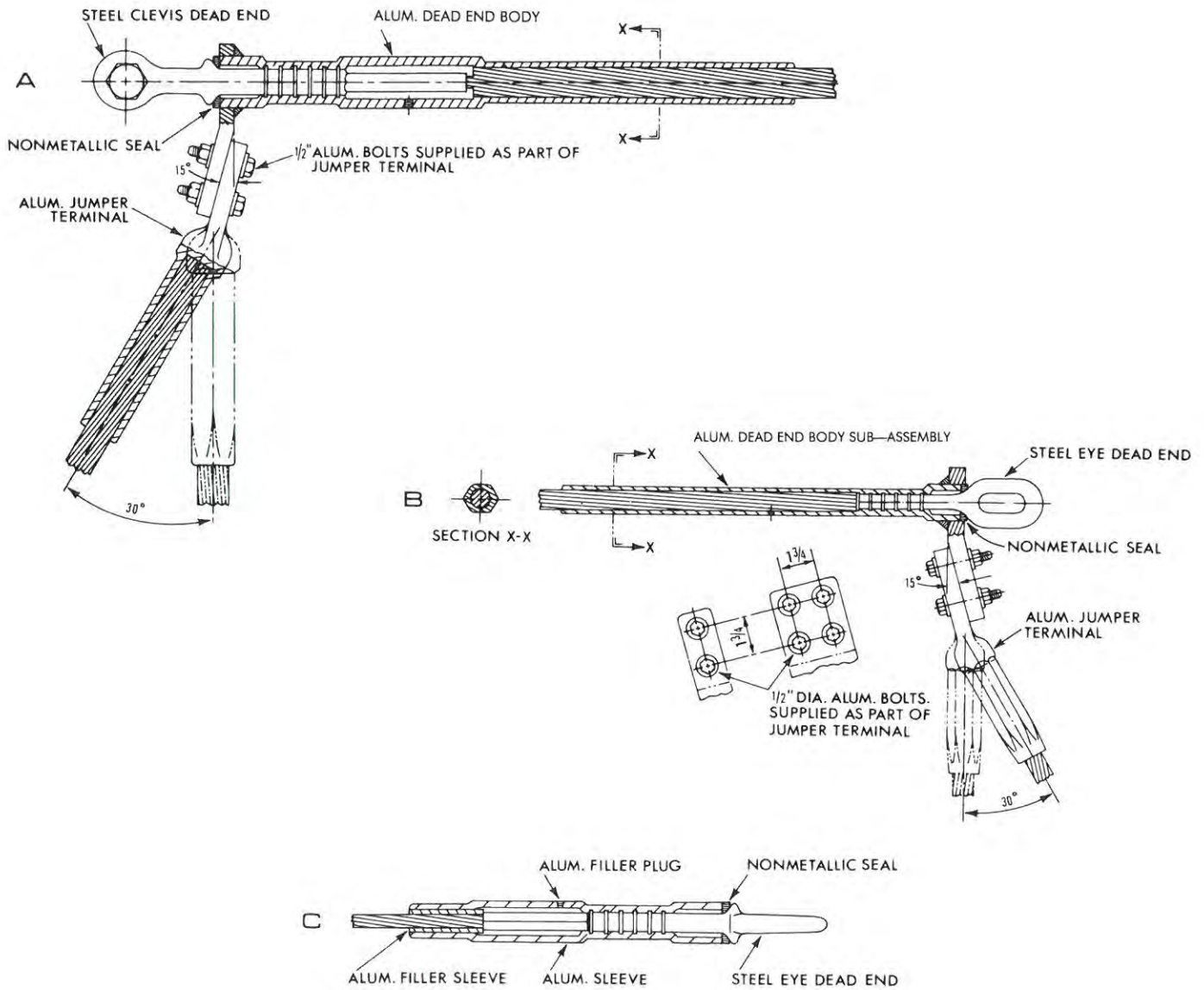

Fig. 5-24. Tubular Aluminum Compression Dead Ends.

A—For ACSR. The assembly comprises an inner steel dead end body and an outer aluminum dead end body. The conductor is run through the aluminum body, and the aluminum wires are cut away to expose steel strands for insertion in the sleeve of the steel body. After compression of the steel sleeve, the aluminum body is positioned so that after compression the aluminum body is clamped to the aluminum wires and also to the ridges around the steel body. The flange of the aluminum body extends outward for bolting the terminal pad of a jumper connector. The attachment to the strain insulator may be of eye or clevis type, and the tongue extension to the jumper may be single- or two-way.

B—For all-aluminum conductors. The steel eye or clevis dead end has a comparatively short shank which is ribbed to transfer the tensile stress from the aluminum compression sleeve to which is welded the flange and terminal pad for the jumper.

C—For Alumoweld conductors. The steel body includes steel sleeve which is first compressed on the entire conductor, after which the aluminum body is compressed over the ridges of the steel body and the conductor. An aluminum filler sleeve is placed between the conductor and the aluminum body.



Fig. 5-25. Formed armor rods.

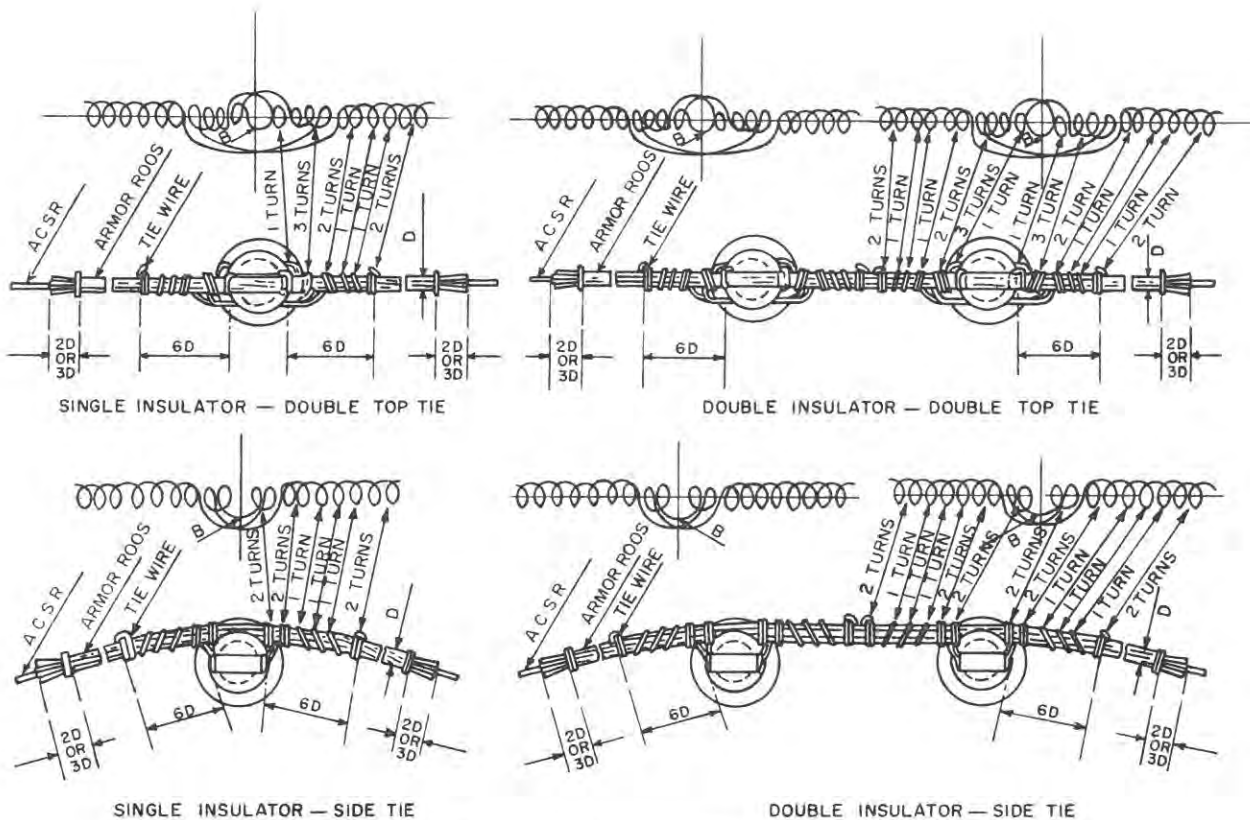

Fig. 5-26. Arrangement of tie wires for attaching a cable to pin-type insulator.

The looping arrangements are shown schematically, and the plan views show actual configurations for single and double insulators, both for side tie and across-top tie. The conductor is shown protected by armor rods. Though the sketches show the conductor as ACSR, the same arrangement is used for all-aluminum conductors. Field as-

sembly starts at points marked B and continues outwardly. Make ties as snug and tight as possible, twisting by hand except for the final two turns which should be made with pliers. For side ties be sure that the insulator has a large enough groove to hold three turns of the tie wire selected for use.

Chapter 6

## Operating Performance and Problems

Operating problems occurring in installations of bare overhead conductors are of several kinds. Only those related to the conductors themselves are considered herein. Such matters as voltage drop\*, system regulation, transients and calculation of probable short-circuit currents are in the province of the system electrical engineer and beyond the scope of this book. Subjects covered in this chapter include the ability of the conductor to withstand short circuits and their related mechanical forces, the extent that emergency overloads may be carried without serious damage and the effects of arcing-burndown. Reference is also made to aeolian vibration and conductor galloping with a brief description of devices that reduce their effects.

The terms used herein relating to overload matters are as follows:

**Thermal Limit** (as associated with steady-state overload conditions): The maximum temperature at which a conductor can operate continuously yet maintain the minimum tensile properties established by the manufacturer or the user.

**Arc-Current Burndown:** Rapid failure caused by the heat of an arc on the surface of the conductor, accompanied by the heat effect of current.

**Fault-Current Burndown:** Failure caused by overheating as a result of a current overload. The conductor strength decreases sufficiently to cause tension failure.

**Fault-Current Limit:** The current (temperature) and time combination which produces the maximum acceptable loss in conductor mechanical strength.

**Current Values:** Unless otherwise stated, all current values used in the discussion of overload conditions are in terms of rms symmetrical amperes.

\* Applying to bare transmission and distribution circuits only. The critical voltage-drop limitations of the National Electrical Code relating to circuits under NEC jurisdiction are mentioned in Sections 210-19(a) and 215-2(b) of the NEC, and the methods of computing drop or obtaining it from industry-supplied tables are described, applying to conductor sizes used mostly for interior circuits.

### Short-Circuit Performance

The ampacity data in Chapter 3, Figs. 3-11 to 3-15, apply to steady-state normal operation for bare ACSR and all-aluminum conductors for temperatures up to 100°C (60°C rise over 40°C ambient). This temperature is frequently used for 1350-H19 conductors since the strands retain approximately 90 percent of rated strength after 10,000 hours at temperature. (See Fig. 6-3.) For ACSR the strength is even less affected because the steel core is essentially unaffected at these temperatures.

Short circuits in a power system can result in extremely large currents in conductors from the time of fault initiation until its interruption by the protective device, such as circuit breaker or fuse. With modern relaying, the duration of the 60 Hz fault current is usually only from 3 to 20 cycles for transmission circuits but may be longer for distribution lines. If the circuit is immediately re-established by automatic reclosure and the fault has not cleared, the total fault-current time will be the sum of the interrupting times.

Heating will generally be more rapid than cooling, and loss-of-strength estimates would require integration of the temperature-time curve for temperatures above the arbitrary "damage" level. However, as temperature is not measured, a useful and practical alternative is to use the current-time product and neglect the temperature slopes. When limits have been established, the time in which the fault must be cleared can then be determined.

In establishing suitable fault-current limits, 340°C has been selected as the maximum temperature for all-aluminum conductors since momentary exposure to this temperature does not result in a significant loss of strength. For ACSR or AWAC conductors with sizeable steel content (not the 18/1 or 36/1 strandings) an upper limit of 645°C represents the threshold of melting for aluminum with the steel expected to supply the needed mechanical strength. The curves of Figs. 6-1 A, B, and C apply this criteria using an average specific heat and assume no heat loss from the aluminum strands during the short duration of the fault current. Figs. 6-2 A, B, and C do the same for ACSR conductors.

## bare aluminum wire and cable

### Adjustments for 6201-T81 and ACAR Conductors

Values from Fig. 6-1 may be adapted to 6201-T81 and ACAR conductors by applying suitable multiplying factors. Usually the value that is specified as the estimated fault current is the known quantity, and the corresponding time is found that will cause the upper temperature limit to reach 340°C over 40°C ambient for 61.2 percent IACS conductor, thereby enabling the current-limiting devices to be properly set. For other conductors, the time for the 1350-H19 conductor is multiplied by factors as below:

For 6201-T81 conductor, multiply by 0.903

For ACAR conductor, see the applicable portion of the following example:

*Examples:* Assume 500 kcmil conductor and 20,000 rms 60 Hz fault current. As this conductor size is not shown by Fig. 6-1, the time is obtained by interpolating between values for 477 kcmil and 566.5 kcmil to 2.80 sec for 1350 H19. Then for 6201-T81 it will be  $2.80 \times 0.903$ , or 2.53 sec.

For 24/13 ACAR, the time will be

$$(2.80 \times 0.65) + (2.53 \times 0.35) = 2.71 \text{ sec.}$$

### Adjustment for Upper Temperature Limit

Whereas the upper-limit temperatures specified in Figs. 6-1 and 6-2 are suitable for bare overhead conductors, there are conditions where a lower temperature-limit is advisable, such as when the bare cable is confined in switchgear or in switching compartments. Other conditions, such as the use of soldered-copper terminal pads; also may warrant a lower temperature limit. Multiplying factors for these conditions are as follows:

Multiply time from Fig. 6-1 by		
For	1350-H19	6201-T81
Upper Limit		
300°C	0.903	0.814
250°C	0.771	0.691
200°C	0.621	0.559

and multiply time from Fig. 6-2 by

For	ACSR
Upper Limit	
500°C	0.845
400°C	0.721
300°C	0.556

For 6201-T81 and ACAR, apply these factors after applying those as listed in the preceding section.

## Arcing

Caution must be exercised in applying the fault-current times, as described, for relay settings of protective devices on distribution lines that may be subject to arcing burn-down. Arcing locally cuts into the conductor quickly in

such cases. For example, a No. 4/0 AWG 6/1 ACSR under 1700-lb tension has *arcing* burndown time of 10 to 14 cycles (.167 to .233 sec.) at 15,250 amp, whereas the *fault-current limit* time (there being no local arcing) is 1.6 sec for that current, under assumptions applying to Fig. 6-2. Also see Table 6-1. For the usual transmission line, or those at the higher distribution voltages, relay co-ordination on the basis of fault-current limit time usually is satisfactory, but for lower distribution voltages in metropolitan environments consideration should be given to arcing burndown.

Table 6-1 contains representative data from arcing tests conducted with the conductor under tension.

While arcing failure times are so short that little if any change in tension can occur prior to failure, high fault currents can heat the entire line. The resulting increase in sag can establish contact with ground or other conductor, initiating an arcing problem. Clearances can, therefore, be as significant a constraint on maximum acceptable current as is conductor strength.

## Arcing Effects

Aluminum conductors resist damage by arcing better than conductors of other metals because the arc tends to cause less pitting and surface metal melting. When subjected to arc currents, the aluminum conductor surface frequently shows only a removal of sheen, slight roughening, and change of color over a considerable area. The effect described applies to arcs of less intensity than those that produce arc-current burndown. However, the advantage of aluminum in this respect aids measurably in reducing operating costs, particularly for the smaller sizes of ACSR, in the many instances where small arcs result from flashovers, lightning, momentary contact with a tree limb, and the like.

From one group of tests, aluminum's resistance to surface damage from such minor arcing was evident with arcs ranging up to about 78 cycles duration.\*

## Loss of Strength

The loss of conductor strength due to time at temperature is a cumulative effect. Heating due to short circuit occurrence should therefore be added to heating due to other circumstances to estimate the condition of the conductor. In actual practice, however, the total time of fault currents is usually very small relative to emergency operating time and is therefore ignored as an effect on conductor strength. The temperature-time strength loss relationship is covered in more detail in the section on emergency loading (Chapter 12).

\* C. A. Martens, "Power Arc-Over On Overhead Distribution Lines and New Developed Equipment for Protection Against Conductor Burndown From That Cause," AIEE Technical Paper No. 4145, 1941.

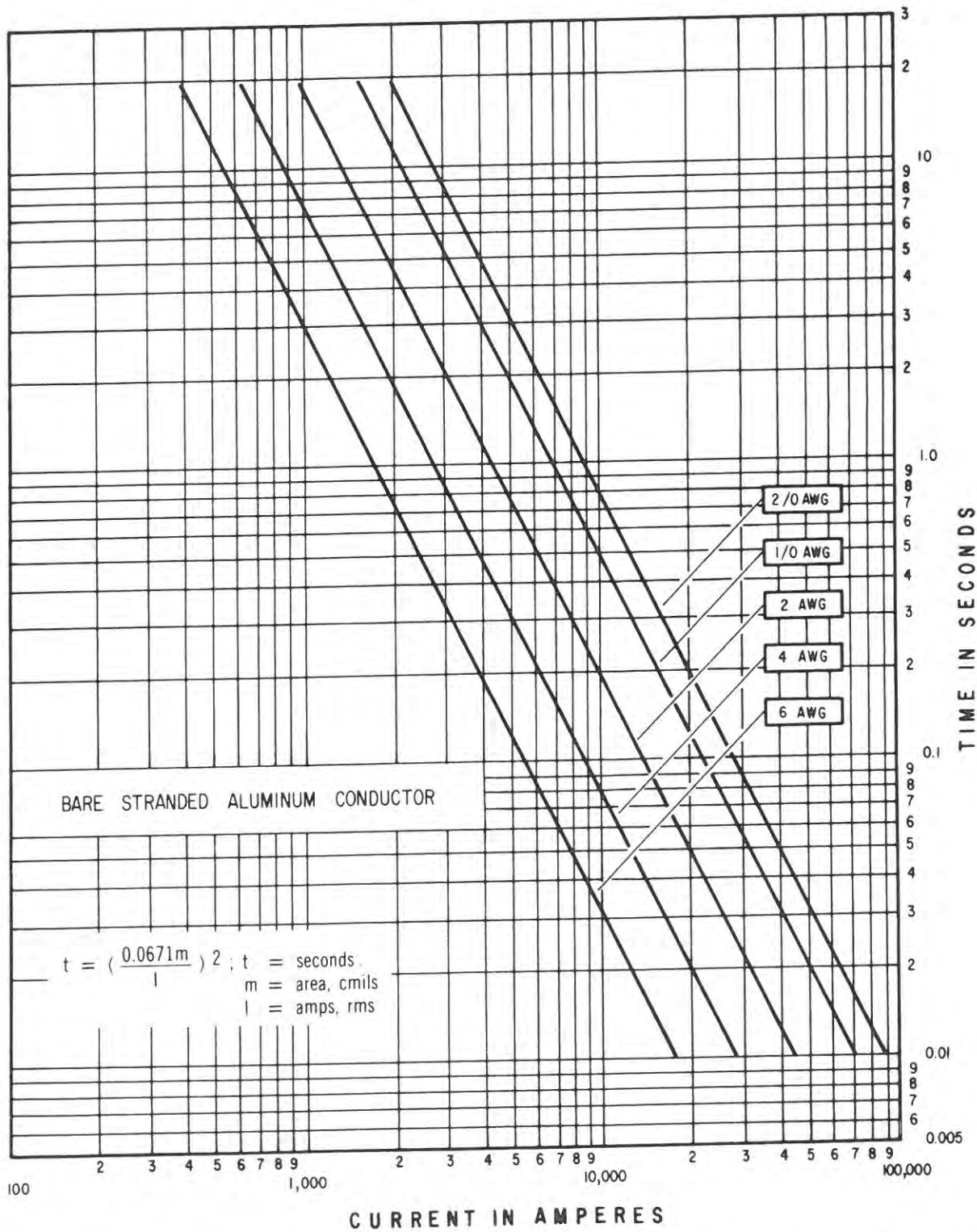

Fig. 6-1A. Maximum fault-current operating limit for stranded aluminum conductor. Upper temperature limit 340°C, ambient temperature 40°C.

Note 1. Time plotted is that required for a given rms fault current to cause conductor damage due to annealing.  
 Note 2. Graphs assume there is no heat loss in the conductor.

The curve for all aluminum conductors may be applied to alloy 6201-T81 and ACAR conductors by computing the equivalent 1350-H19 cross section. The current may then be determined by extrapolating for the computed cross section using Figs. 6-1, A, B, and C.

bare aluminum wire and cable

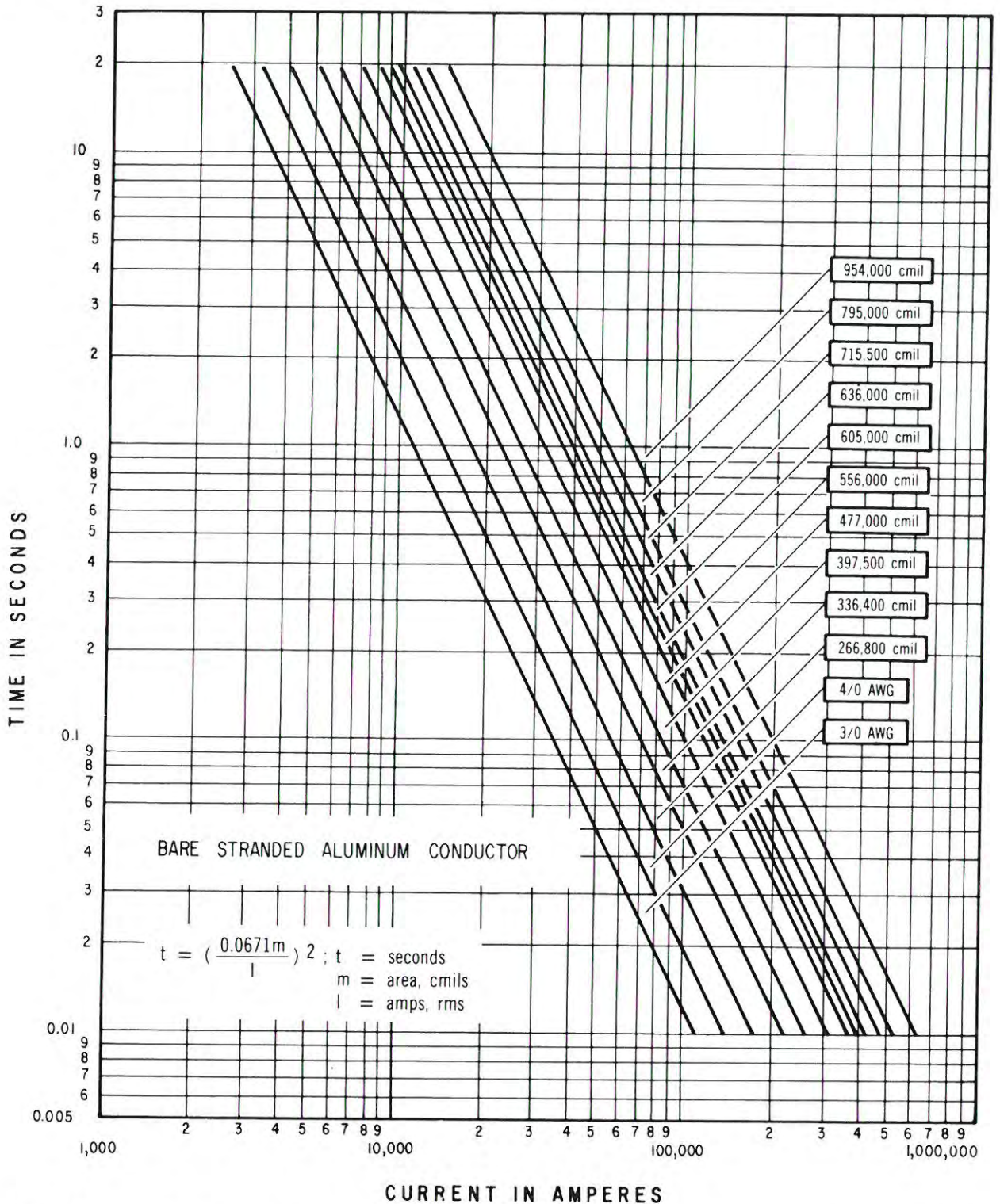

Fig. 6-1B. Maximum fault-current operating limit for stranded aluminum conductor. Upper temperature limit 340°C, ambient temperature 40°C.

Note: 1. Time plotted is that required for a given rms fault current to cause conductor damage due to annealing.  
2. Graphs assume there is no heat loss in the conductor.

The curve for all aluminum conductors may be applied to alloy 6201-T81 and ACAR conductors by computing the equivalent 1350-H19 cross section. The current may then be determined by extrapolating for the computed cross section using Figs. 6-1, A, B, and C.



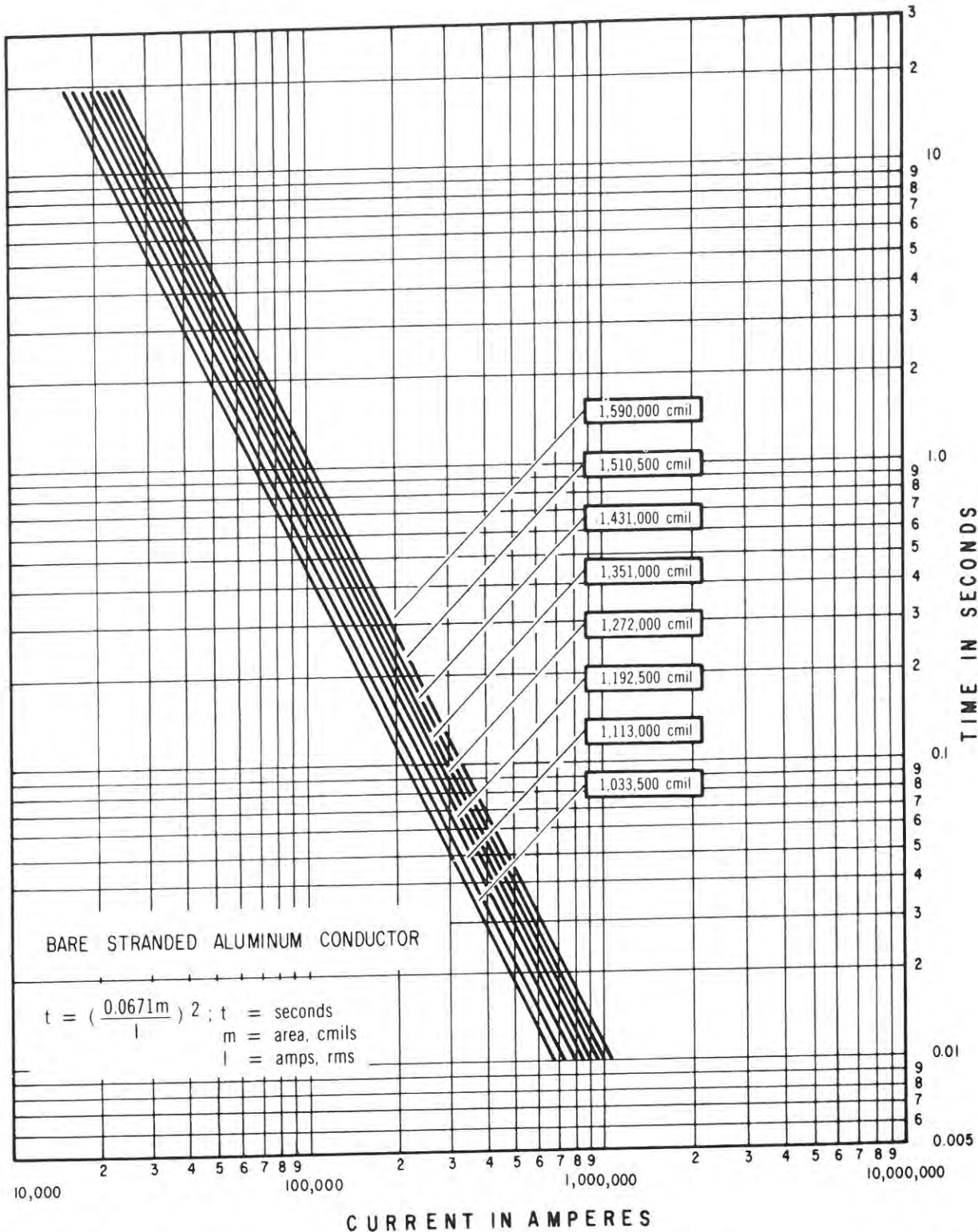

Fig. 6-1C. Maximum fault-current operating limit for stranded aluminum conductor. Upper temperature limit 340°C, ambient temperature 40°C.

Note: 1. Time plotted is that required for a given rms fault current to cause conductor damage due to annealing.  
2. Graphs assume there is no heat loss in the conductor.

The curve for all aluminum conductors may be applied to alloy 6201-T81 and ACAR conductors by computing the equivalent 1350-H19 cross section. The current may then be determined by extrapolating for the computed cross section using Figs. 6-1, A, B, and C.

bare aluminum wire and cable

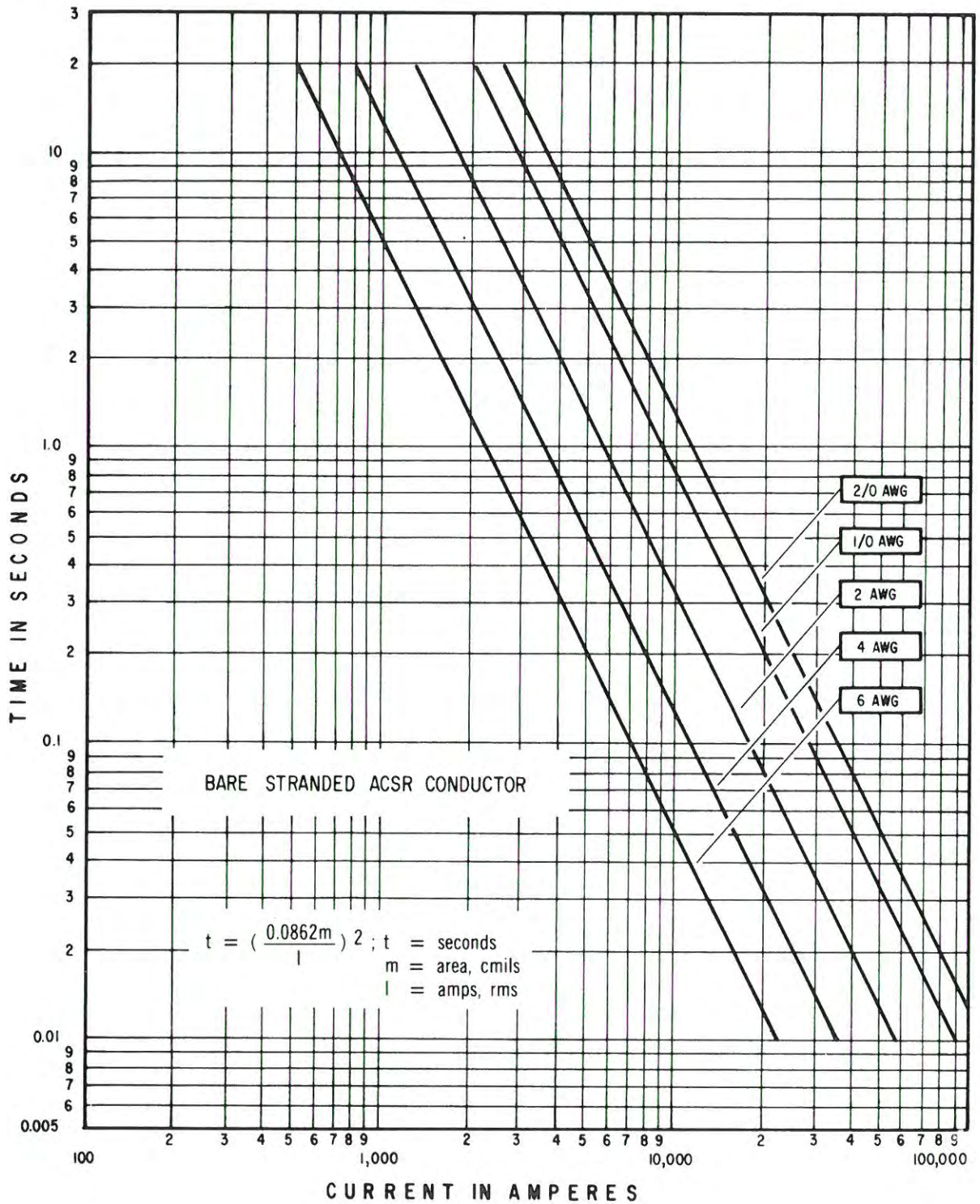

Fig. 6-2A. Maximum Fault-Current Operating Limit for Bare Stranded ACSR conductor. Upper temperature limit 645°C, ambient temperature 40°C.

Note: 1. Time plotted is that required for a given rms fault current to bring aluminum strands to the threshold of melting.  
 2. Graphs assume there is no heat loss in the conductor.

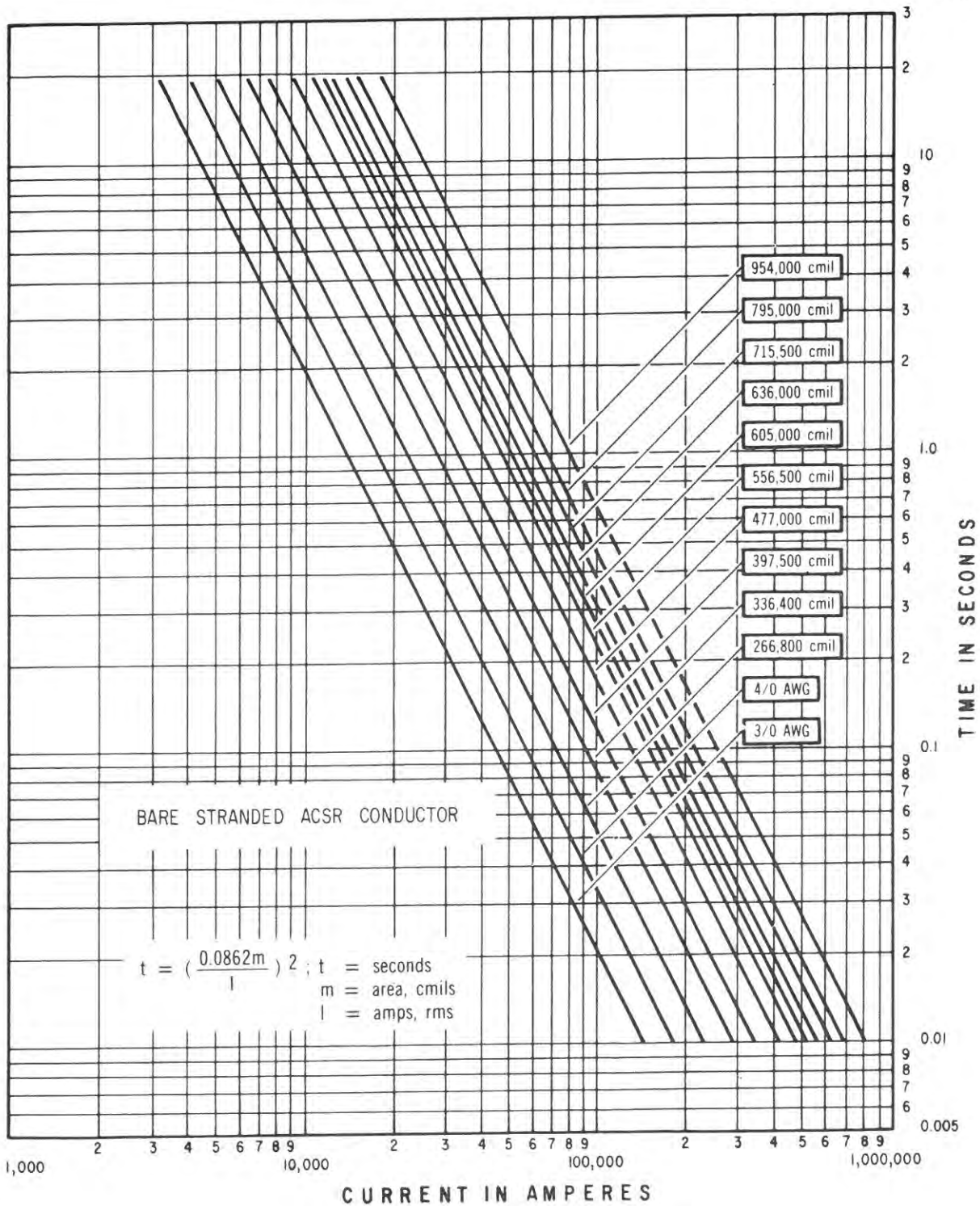

Fig. 6-2B. Maximum Fault-Current Operating Limit for Bare Stranded ACSR conductor. Upper temperature limit 645°C, ambient temperature 40°C.

Note: 1. Time plotted is that required for a given rms fault current to bring aluminum strands to the threshold of melting.  
2. Graphs assume there is no heat loss in the conductor.

bare aluminum wire and cable

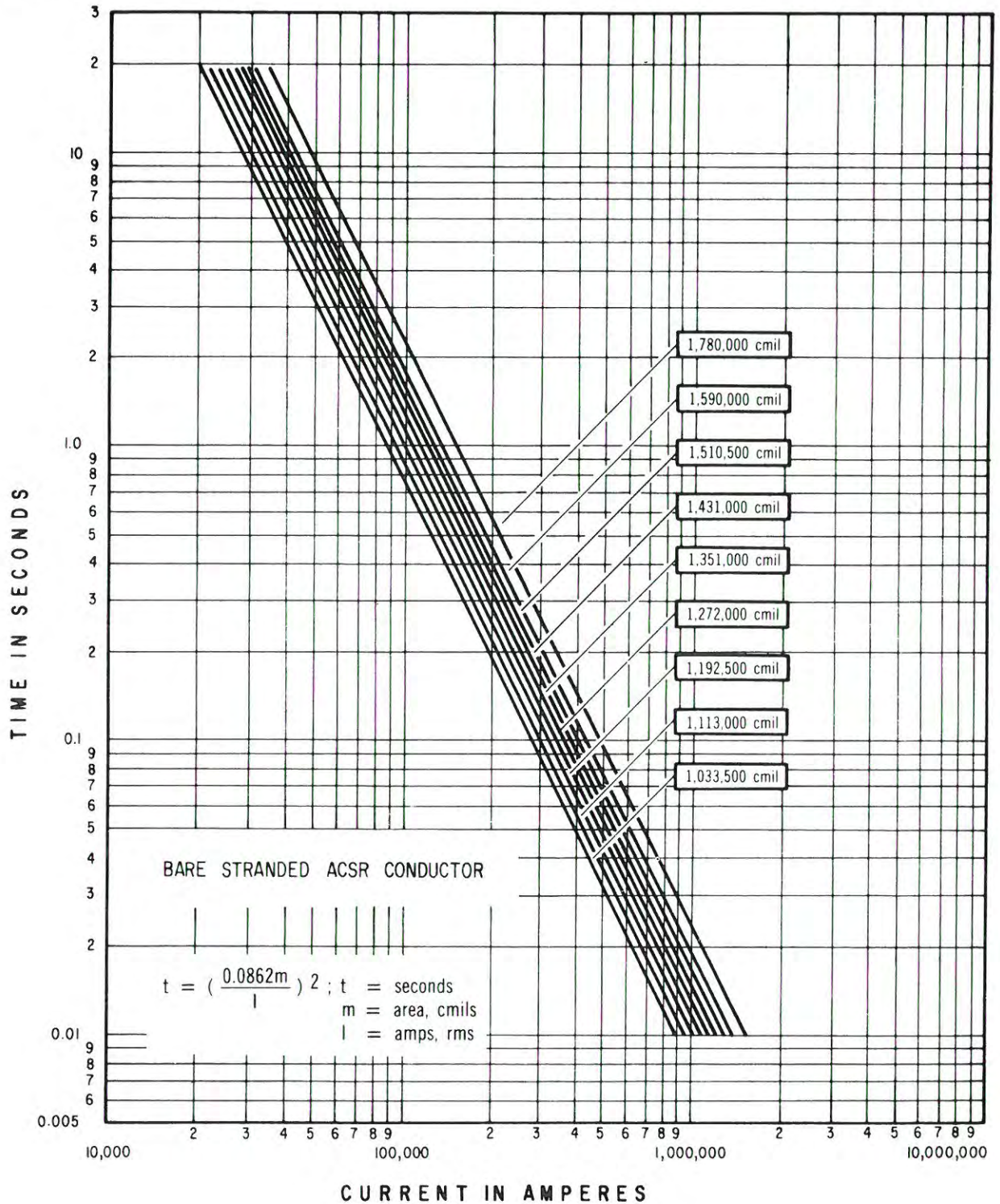

Fig. 6-2C. Maximum Fault-Current Operating Limit for Bare Stranded ACSR conductor. Upper temperature limit 645°C, ambient temperature 40°C.

Note: 1. Time plotted is that required for a given rms fault current to bring aluminum strands to the threshold of melting.  
2. Graphs assume there is no heat loss in the conductor.

**Fault-Current Electro-Magnetic Forces Between Parallel Bare Wires and Cables**

Fault currents are more likely to cause thermal damage to bare overhead conductors than mechanical damage. However, the high electro-magnetic forces of fault currents sometimes can be an important factor in line design and equipment selection.

The electro-magnetic lateral force between long parallel current-carrying conductors is proportional to the product of the *instantaneous* values of current in each conductor and inversely proportional to their distance apart. See Eq. 6-1. For three-phase circuits, the vector direction of the three forces as well as their instantaneous values must be known.

The *heat effects* of short-circuit currents, as previously mentioned, are stated in terms of root-mean-square symmetrical amperes ( $I_{rms}$ ) for alternating current (shown in line CT in Fig. 6-5). However, for calculating the force between parallel conductors under fault conditions, the higher instantaneous value is normally used. The point of initiation of a fault is usually referred to the voltage wave because this is the non-variable: the current in both magnitude and phase angle is dependent on the load while the voltage magnitude is practically constant and the phase angle is fixed in time.

Transmission-line faults are practically limited in magnitude only by the reactance of the faulted circuit. Under

this condition, with fault current lagging nearly 90°, the fault-current wave will be symmetrical if the fault is initiated at the peak of the voltage wave, but it will be offset (similar to Fig. 6-5) if the fault is initiated at a zero crossing of the voltage wave.

For a fully offset wave, the instantaneous peak value, *i*, approaches value OA, which for zero power factor approaches 2.828  $I_{rms}$  as a maximum. However, because the inertia of the conductor prevents an instantaneous deflection response to the applied force, some designers and test authorities consider that a suitable current value for computing maximum short-circuit *force* is the root-mean-square value of current in the first current loop, which approaches the value represented by the line OR of Fig. 6-5 (at zero power factor =  $1.732 \times I_{rms}$ ), designated maximum rms asymmetrical current.

By similar analysis, equivalent values are obtained for currents that provide electro-magnetic forces between the conductors of a balanced three-phase circuit.

The following equation shows the relation between the short-circuit current expressed in various ways, spacing between conductors and lateral force.

$$F = G \frac{5.4 \times I_1 I_2}{d^{10^7}} \quad (\text{Eq. 6-1})$$

TABLE 6-1

**Arc-Current Burndown Times on 60 Hz Basis For Bare Conductors Under Tension From Tests\***

Description	Conductor tension lb	Amp	Min cycles	Amp	Min cycles	Amp	Min cycles	Amp	Min cycles
2 AWG-7/1 ACSR	1456	1350	38	4800	10	9600	4.5	15,750	1
3/0 AWG-6/1 ACSR	1326	4550	26	9100	14	15,500	8	18,600	7
4/0 AWG-6/1 ACSR	1701	4450	53	8580	21	15,250	10	18,700	8
336.4 kcmil-18/1 ACSR	1701	8425	25	15,200	12	18,800	10		
350 kcmil-19 str. 1350	1076	4800	19	9600	11.3	15,200	12	18,200	8
500 kcmil-37 str. 1350	1456	4800	42	8800	22.5	15,400	14	18,450	11

\*The arc-current burndown times are reported from tests at Baltimore Gas & Electric Co. in a paper by W. B. Goode and G. H. Gaertner (Edison Electric Institute, Oct. 1965). These values, with those obtained from Figs. 6-1 and 6-2, show the comparative times for arc-current burndown and normal fault-current limit when there is no arcing to conductor sides.

**bare aluminum wire and cable**

where:

$F$  = Pounds per linear foot of conductor

$G$  = Multiplying factor, as in Table 6-2

$I_1$  and  $I_2$  = Short-circuit current in each conductor  
a-c symmetrical rms amp, or in d-c amp

$d$  = Spacing between centerlines of conductors in inches

*Example:* Assume a flat 3-phase circuit of 2/0 AWG-6/1 ACSR on 7-ft spacing, subjected to a fault current of 20,000 amp rms symmetrical (line CT of Fig. 6-5). What is the average lateral force exerted on the center conductor caused by an rms symmetrical fully inductive fault current in the first offset loop (line OR of Fig. 6-5) without allowing for mechanical damping, caused by inertia, elasticity, and side-sway friction?

From table 6-2(d) the applicable multiplying factor  $G$  is 4.17. Applying Eq. 6-1, the average force  $F$  during the first current loop, assuming zero power factor is

$$F = \frac{4.17 \times 5.4 \times 20,000^2}{7 \times 12 \times 10^7} = 10.7 \text{ lb per ft}$$

Under fault conditions, the mechanical action of stranded conductors, which usually have very long span distances compared to separation distances, is different from the action of more rigid bus conductors described in Chapter 13. The conductors can slap together violently—especially the subconductors of bundled conductor lines—and traveling waves move longitudinally along the line. Experience and testing have shown that this action is not damaging to the mechanical strength of conductors or insulators, but it must be carefully considered in the design and selection of spacers and dampers.

**Emergency Loading**

Transmission and distribution conductors are occasionally subjected to current overloads, due to emergency conditions, which produce temperatures beyond the normal thermal limit. Coincidence of peak loads with high summer ambients, shifting of additional loads to an already loaded conductor, and use of high loadings to prevent icing are some reasons for such overloads.

The question of what maximum conductor temperatures should be permitted for emergency operation depends on how much loss of strength is allowable and how long the emergency-load temperature continues. The effect of heating is cumulative. As an example, if a conductor is heated under emergency loading for ten hours each year for a period of ten years, the total effect is nearly the same as heating the conductor continuously at that temperature for 100 hours.

Fig. 6-3 delineates the effect of time on 1350-H19 aluminum strand strength at three temperatures which are of interest to power engineers. The curves permit estimates of the change in strength of conductors which have carried emergency overloads.

An example is cited, based on the following assumptions which should not be considered typical.

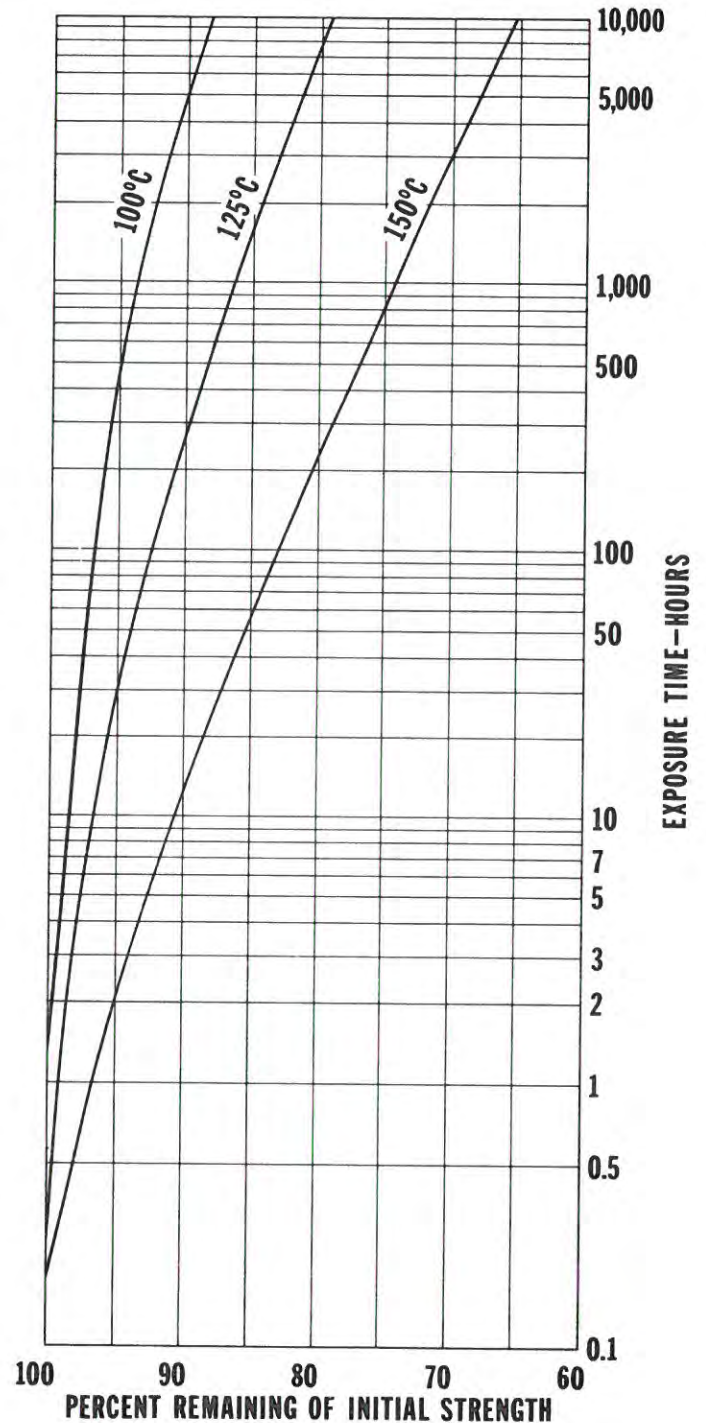

*Fig. 6-3. Time-temperature percent strength remaining in 1350-H19 wire. Tensile tests made at room temperature after wire exposure to the indicated temperatures.*

(3) Maximum temperature for emergency condition, 150°C (302°F)

(4) Conductor: 795 kcmil-37 str. 1350-H19

At the end of 30 years, the conductor will have been heated to 150°C for 720 hours. Using Fig. 6-3 as a guide for the estimate, the strength of 13,900 lb would be reduced to approximately 10,600 lb—about a 24% loss. If the conductor were of the same size, but 26/7 ACSR, the strength would be reduced from 31,500 lb to 28,200 lb, or a 10 percent reduction. The advantage for ACSR is due to the steel core, which is essentially unaffected by the temperature range considered for emergency overloads.

Short time exposure to even higher temperatures can occur, and Fig. 6-4 shows the effect of 1/2 hour of heating on similar conductors of three different aluminum alloys. Strength loss is rapid at temperatures above 150°C. For momentary exposure to elevated temperature, there is much less reduction in strength. The cumulative effect of a succession of short-time fault-currents during short circuits where high temperatures are possible plus emergency operation at lower temperature can cause conductor strength loss which is of concern. However, knowledge of the actual conditions—current, time, ambient temperature, wind velocity, conductor emissivity and the resulting actual conductor temperatures is seldom very precise. The “damage curves,” Figs. 6-3 and 6-4, are also drawn from data having inherent variability. They therefore may be used only as a basis for a very approximate estimate of the actual condition of the conductor.

The creep rates at 150°C of the all-aluminum and aluminum alloy conductor are considerably higher than those of corresponding sizes of ACSR at the same temperature. As was noted in Chapter 5, the creep rate used for predicting 10-year final sags and tensions is based on the creep rate at 60°F.

The analysis of the interaction of the thermal expansion rates, component stress levels and differing creep rates at elevated temperatures to determine the effect of high temperatures on final sags is very complex. High temperatures for time periods which may seem short in terms of the life of the conductor can result in significant changes in sag—especially for the conductor constructions which do not have significant proportions of steel. A method of practical calculations is presented in IEEE Paper TP 69-674-PWR by J. R. Harvey and R. E. Larson.

A typical practice is to limit emergency load temperatures to a maximum of 125°C.

#### Vibration and Fatigue of Overhead Conductors\*

An unprotected or improperly protected overhead conductor may undergo wind-induced vibrations under certain conditions to such an extent that fatigue failures of strands will develop at points of restraint or support. Similar failures have been observed at or near splices and

\* EPRI Handbook, “Wind Induced Conductor Motion,” contains an excellent treatment of this subject.

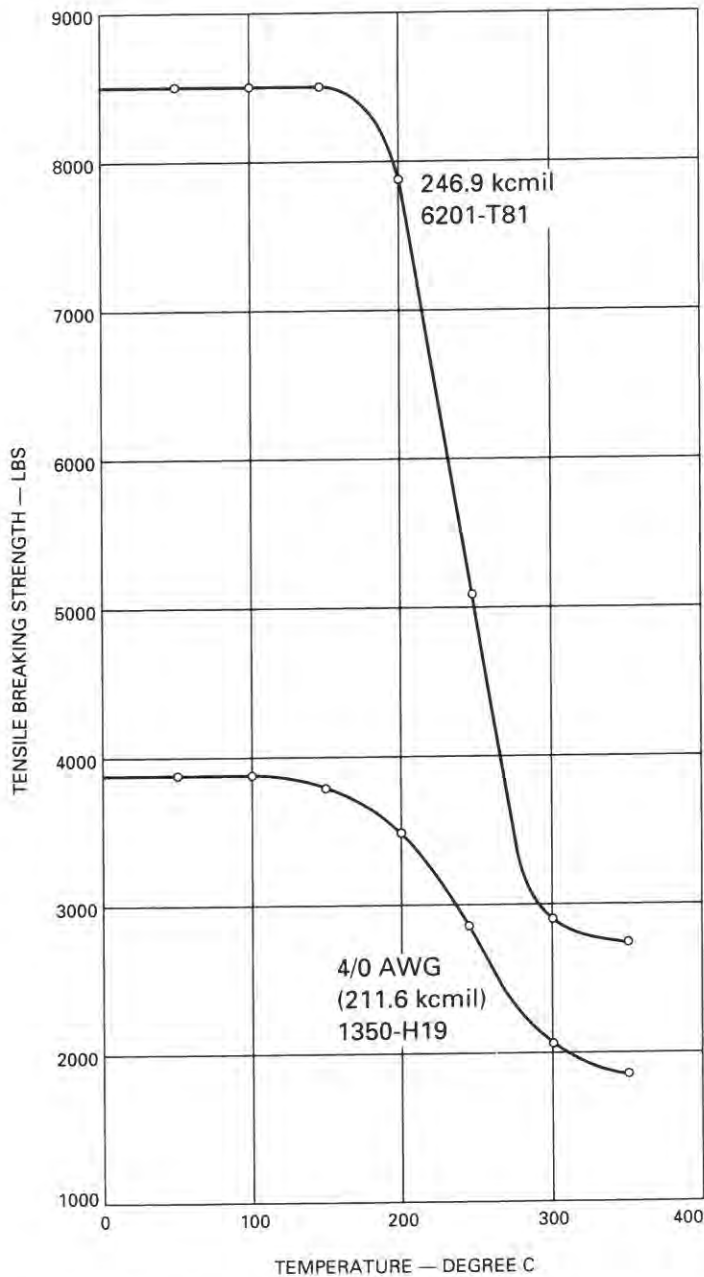

Fig. 6-4. Reduction of breaking strength of aluminum and aluminum alloy stranded conductors of equivalent conductance. Breaking strength tests were made at room temperature after 1/2 hour exposure to elevated temperatures.

- (1) Emergency conditions exist for 24 hours each year.
- (2) The useful life of the conductor is 30 years.

bare aluminum wire and cable

**TABLE 6-2**

Multiplying Factors for Maximum Short Circuit Lateral Force Acting Upon Suspended Parallel Wires and Cables in various Arrangements Assuming Balanced Loading, in Terms of Direct, or of Symmetrical RMS Alternating Fault Current, Amp (Line CT, Fig. 6-5) =  $I_{rms}$

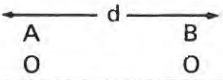
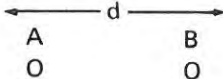
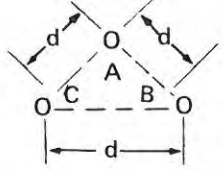
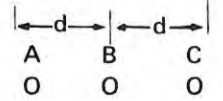
Arrangement of circuit	Type of circuit and designation of location on current-wave of fault-producing current	Conductor upon which force is applied	Multiplying factor G
(a) 	Direct current*	A or B	1.0
(b) 	1-phase a-c symmetrical	A or B	2.0
	1-phase a-c asymmetrical	A or B	8.0
	1-phase a-c rms of first loop	A or B	5.55
(c) 	3-phase a-c asymmetrical	A, B, or C	6.93
	3-phase a-c rms of first loop	A, B, or C	4.17
(d) 	3-phase a-c asymmetrical	B	6.93
	same	A or C	6.45
	3-phase a-c rms of first loop	B	4.17
	same	A or C	3.89

\*Although steady-state direct-current implies that a multiplying factor of 1.0 is satisfactory, the transient and over-shoot at fault initiation renders it common practice to use a factor of 2.0.

NOTES: All values assume a fully offset current wave in a fault of zero power factor without damping, or resonance effects from support vibration.

See NEMA BU-1 for adjustment factors if fault-current power factor differs from zero, as determined by X/R ratio.

This arrangement of factors differs from that of ANSI C37.32 because it is usual practice to designate fault currents of apparatus and lines in terms of rms symmetrical amperes ( $I_{rms}$ ).



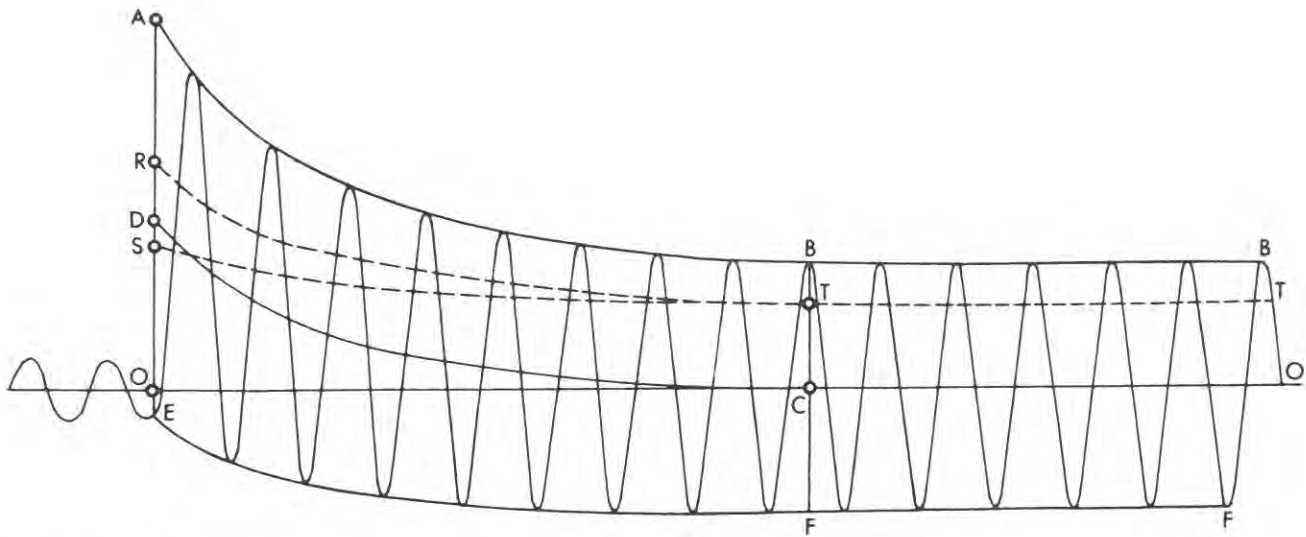

Distances represent comparative current values as follows:  
 CT =  $I_{rms}$  symmetrical; CB =  $I_{peak}$  symmetrical  
 OR =  $I_{rms}$  asymmetrical; limit to which value approaches  
 OA =  $I_{peak}$  asymmetrical; limit to which value approaches  
 OD = Peak of dc component; limit to which value approaches

OS =  $I_{rms}$  asymmetrical of ac component  
 EF = Minimum peak current values

Note: A value stated as closely approaching a designated limit is considered as coinciding with that limit for computation purposes. An oscilloscope trace shows that the difference is slight in most cases.

Fig. 6-5. Typical curve of alternating current wave during offset short-circuit ( $X/R$  about 15).

other discontinuities, and damage may also occur to supporting structures and hardware.

These phenomena have been extensively studied at outdoor test sites in which virtually any type of overhead conductor operating condition can be duplicated. The results of many years of such research have been made available to the utility industry by cooperating manufacturers and technical institutes and universities.

Conductor vibration and oscillation may be divided into three general types:

1. *Sway or side swing* is the most obvious and simplest form of conductor movement in an entire span. It is caused by crosswinds or short-circuit forces.
2. *Aeolian vibration* is a resonant vibration. It is the least readily observed and usually the most damaging type. It is caused by steady crosswinds. The conductors vibrate in much the same way as any string under tension. Frequencies range from 2 to 200 Hz.
3. *Galloping or dancing* is the movement that sometimes results when the interrelation of wind direction and velocity, as well as of moisture and temperature, is such that the conductor becomes eccentrically glazed or ice-coated. A movement pattern develops in which the entire span oscillates as a whole or in a few loops, with amplitudes of several feet and at low frequency, largely in a vertical direction. The envelope of motion usually is an inclined ellipse. Galloping is re-

ported to have been seen infrequently even with the conductors free of ice.

Aeolian vibration and galloping present the most serious problems, since either of them may lead to failure of conductor strands at points of support or at other discontinuities. The most common types of damage are actual failures of the conductor, the hardware, or components of the supports or towers. In addition, there might be damage and service interruptions caused by phase-to-phase or phase-to-ground contacts during severe galloping.

#### Aeolian Vibration of Conductors

The accepted explanation of the wind-induced phenomenon known as *aeolian vibration* is as follows: When a comparatively steady wind blows across an overhead conductor under tension, vortices are detached at regular intervals on the lee side of the conductor—alternately from the top and bottom portions. The conductor is thus repeatedly subjected to forces that are alternately impressed from above and below. The frequency of these forces increases with increasing wind velocity and with decreasing conductor diameter.

If the frequency of the forces corresponds approximately to the frequency of a mode of resonant vibration of the span, the conductor will tend to vibrate in many loops in a vertical plane. As the amplitude of vibration increases, the vortices tend to be detached in synchronism

## bare aluminum wire and cable

with the vibration to increase the amplitude. The forces impressed by the wind on the conductor produce traveling waves that move away from the points of application of the forces toward the ends of the span. Each wave, i.e., each crest and trough, stores part of the energy it receives from the wind during the course of its travel, in the form of increased amplitude—the crest becoming higher and the trough deeper.

When a wave reaches the end of an undamped span and is reflected, neither its amplitude nor the energy stored in it is significantly diminished by the reflection. During its subsequent travel, the wave acquires more energy and greater amplitude until an equilibrium amplitude is reached where dissipation in the conductor matches input energy. At the ends of the span the reflected traveling waves are superimposed on incoming traveling waves, thereby producing standing waves. The standing-wave loops thus formed have frequencies that are multiples of the fundamental frequency of the entire span.

The observed relative absence of vibrations at higher wind velocities can be attributed in part to wind turbulence. Conductor vibration is usually not observed at wind velocities above 15 mph, although where high tensions are used and where there are steady winds of up to about 30 mph, conductor vibration has been observed. Another reason why vibration of significant amplitude does not generally occur at high wind velocities is that these cause high vibration frequencies, and the self-damping or internal dissipation of energy in a stranded conductor increases rapidly with frequency.

The tendency of a conductor to vibrate increases rapidly as conductor tension is increased. Conductor vibration is almost never observed at low stringing tensions; i.e., less than about 10 to 12 percent of ultimate strength. Hence, even with dampers, limitations of 25 percent final tension and 33 percent of ultimate strength initial tension with no ice or wind at the design loading temperature were established for controlling aeolian vibration, and are now widely accepted.

No exact tension limit can be defined which will assure complete self-damping protection, but only rarely has fatigue damage been observed when tensions have been 12 percent of rated strength or less.

In certain areas where local wind turbulence caused by broken terrain or trees reduces the power input of wind, somewhat higher tensions have been used on otherwise unprotected spans without resultant vibration difficulties. In exposed areas with steady winds, however, a few lines with tensions as low as 11 percent of ultimate have suffered damage.

### *Fatigue of Conductor Strands\**

Close inspection of fatigue failures has shown that cracks begin at fretted regions where the strands have

rubbed repeatedly against each other or against an armor rod or clamp. Micrographic studies show that the surface layer of a strand is severely disturbed by the fretting. Cracks appear within the disturbed layer and—under the vibration stresses present in the conductor—may penetrate into the undisturbed metal below the fretted region.

The probable explanation of the phenomenon of fretting is as follows: Flexing of the conductor at the point of support results in a small amount of movement between adjacent strands in the conductor or between strands and adjacent members. At the microscopic level, the contact between metal surfaces is not a plane contact but rather a contact between asperities (minute projections). The intimate contact between asperities, aided by the wiping action—which removes surface films—results in microscopic welds between the asperities. Further movement between strands, however, breaks these welds or the metal adjacent to the welds. When movements between the strand surfaces are repeated a number of times, many welds are made and broken, and a disturbed layer is formed on the strand surface. Debris produced by the fretting can be seen as a fine dust surrounding the fretted area. Cracks are gradually opened in the disturbed surface layer by the forces involved.

### *Vibration Dampers*

Perhaps the first device of any value for reducing vibration was the *festoon damper*, with one or more somewhat loose auxiliary conductors from 4 to 12 ft. long clamped to the tensioned conductor at each side of a suspension point. It was not until about 1930 that successful damping control was achieved by the introduction of the *Stockbridge damper*, Fig. 6-7. This device consists of two weights attached rigidly to the ends of a resilient steel cable, which, in turn, is attached to the conductor by means of a clamp at the midpoint. Because of the relatively large mass of the damper weights, the steel supporting damper cable is not stiff enough to force them to follow accurately the motions of the cable clamp, and this causes flexure of the damper cable, which results in slipping between its strands with consequent dissipation of mechanical energy from interstrand friction. If the damper and conductor span can dissipate energy at a greater rate than that at which the wind imparts it, the vibration of the span is suppressed to harmless proportions.

The selection of damper sizes and the best placement of them on the spans are determined by the tension, weight, and diameter of the conductor and the expected range of wind velocities. With new efficient damper designs and usual conductor tensions and span lengths, one damper is installed near one span support point. For long spans, additional dampers may be required. Tension is normally taken as that for "final condition" at about 60°F. It has been found that protection from damaging vibration is most evenly balanced over the range of expected frequencies of line vibration when the damper is spaced so it is approximately 70 percent of a free-loop

\* IEEE Transaction on Power Apparatus and Systems, Vol. PAS-87, No. 6, June 1968, pp. 1381-1384, Fricke and Rawlins.

## operating performance and problems

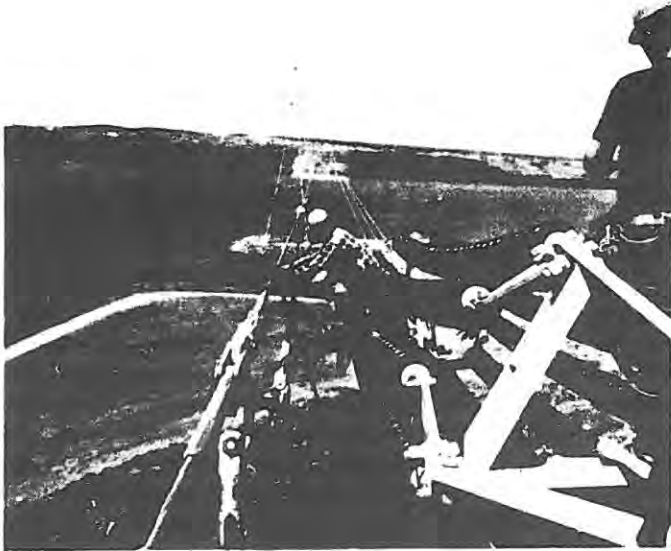

Fig. 6-6. Installing a 735,000-volt line of aluminum across the St. Lawrence River.

length from the fixed end of the span for the highest expected frequency, though this distance may vary with the design of the damper. Determination of the free-loop length is as follows:

$$f = 3.26 V/d \quad (\text{Eq. 6-2})$$

and

$$\text{FLL} = \frac{(Tg/w)^{1/2}}{2f} \quad (\text{Eq. 6-3})$$

where:

$f$  = Frequency of conductor vibration, cycles per sec

$V$  = Wind velocity, mph

$d$  = Conductor diameter, in

$\text{FLL}$  = Free-loop length between amplitude peaks of conductor vibration, ft

$g$  = Acceleration of gravity, 32.2 ft/sec<sup>2</sup>

$T$  = Conductor tension, lb

$w$  = Conductor weight, lb per ft

*Example:* Assume a span of 795 kcmil-26/7 ACSR at tension of 6250 lb (20% of rated strength) exposed to a steady transverse wind of up to 10 mph. Substituting values from the conductor tables . . .

From Eq. 6-2:  $f = 3.26 \times 10/1.108 = 29.4$  Hz, conductor vibration.

$$\text{From Eq. 6-3: FLL} = \frac{(6250 \times 32.2/1.094)^{1/2}}{2 \times 29.4} = 7.3 \text{ ft, free loop}$$

length (from crest to crest on the same side of conductor), hence the spacing would be approximately  $0.70 \times 7.3 = 5.11$  ft from support. Normally, the spacing is increased 0.2 ft to allow for approximately one-half length of the suspension clamp or insulator groove. Although damper spacings usually are given from the center of the suspension clamp or insulator groove the fixed end is more nearly the point of tangency near the end of the clamp or groove. At dead ends, spacing is measured from the mouth of the clamp. Precise data in this regard should be obtained from the damper supplier.

Values from Eq. 6-3, modified as noted above, are plotted on Fig. 6-8 for a maximum steady wind velocity of 15 mph. For other maximum steady wind velocities, factor the spacing by multiplying the 15 mph distance by (15/preferred velocity in mph). Fig. 6-9 shows a similar solution where armor rods are used. Armor rods shorten the end loop by 11 percent. When armor rods are used, they should be of such length that dampers can be mounted at proper spacings just beyond the rod ends.

Dimensions of Stockbridge-type dampers, weights, and recommendations as to the number to be used for various span lengths are obtainable from the manufacturers.

Other types of vibration dampers have been used including torsional, impact, spiral, dash-pot, visco-elastic, and variations of the Stockbridge with extra weights and eccentric weights. The most popular system, however, is the one described.

### Spacers and Dampers for Bundled Conductors

Undamped horizontally bundled conductors used on long-span high-voltage lines with spacers at the customary 250- to 300-ft intervals typically vibrate with about half the amplitude of a single conductor of the same size under identical conditions. It has been confirmed that the leeward conductor of the pair usually vibrates at greater amplitude than the windward conductor.

Stockbridge-type dampers are used on the individual conductors of a bundled line. Spacer-dampers, designed to dissipate vibration energy, are also used frequently. They are popular on lines employing three or four subconductors per phase, and provide vibration control as well as the spacing function.

Figs. 6-10 and 6-11 depict typical types of spacer-dampers. The spherical configuration of the end clamps of spacer-dampers used on EHV lines reduces surface gradients, thereby avoiding corona.

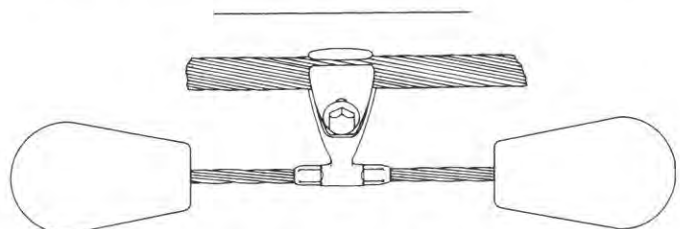
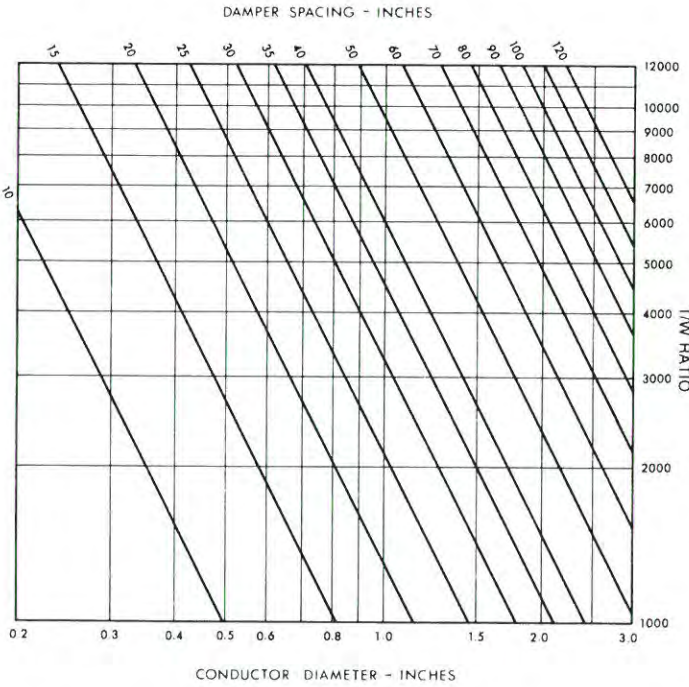

Fig. 6-7. A Stockbridge damper.

*bare aluminum wire and cable*



*(Use this graph when armor rods are not employed.)*

T = Conductor tension lb at average temperature.

W = Conductor weight lb/ft.

*Fig. 6-8. Spacing between damper and tangent support center to center or to mouth of dead end. 15 mph maximum vibration-inducing wind velocity assumed.*

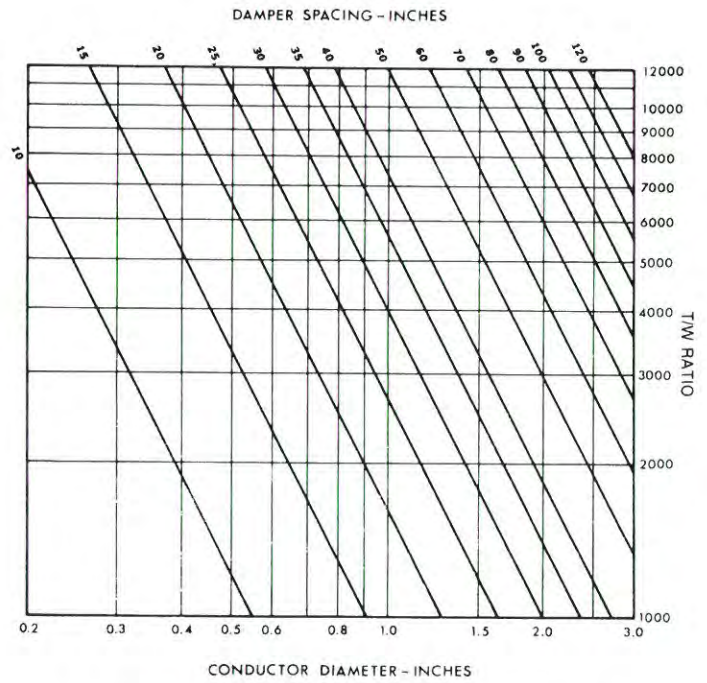

*(Use this graph when armor rods are employed.)*

T = Conductor tension lb at average temperature.

W = Conductor weight lb/ft.

*Fig. 6-9. Spacing between damper and tangent support center to center or to mouth of dead end. 15 mph maximum vibration-inducing wind velocity assumed.*

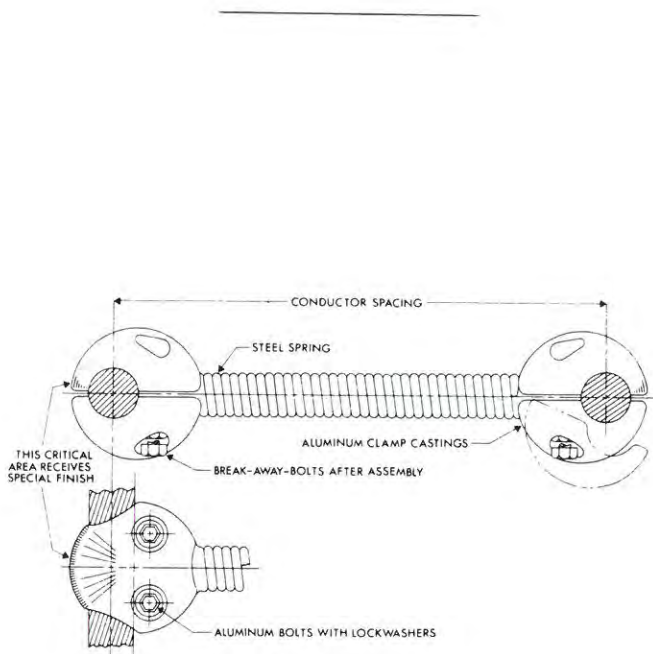

*Fig. 6-10. EHV 2/c bundle/phase spacer-damper.*

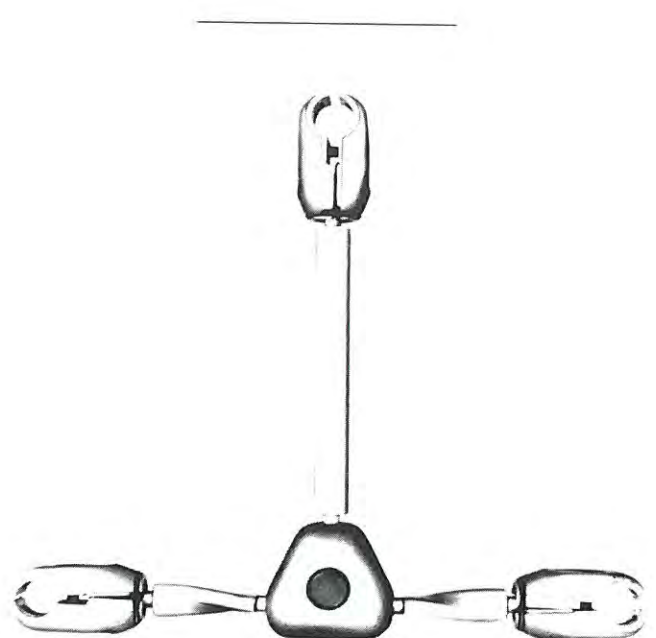

*Fig. 6-11. EHV 3/C bundle/phase spacer-damper.*

Chapter 7

## Review of Types and Applications

In their broadest application, electrical conductors are designated as (1) bare, (2) covered, or (3) insulated. In the preceding chapters, bare conductors have been described. This and several following chapters will deal with covered and insulated conductors.

### Conductors for Use with Covered or Insulated Wires or Cables

Aluminum conductors for insulated and covered power cables are most commonly 1350 aluminum, especially when used in overhead applications. However, conductors fabricated with an 8XXX series electrical grade alloy are now common among most building wire types in both AWG and kcmil sizes. The 8XXX series electrical grade alloys are a relatively new class of alloys notable for excellent thermal stability and creep strain resistance. Details on the various sizes of this type of conductor in the bare stranding are given in Table 4-27. ASTM Standards B 800 and B 801 cover other details of this alloy group in both the bare wire and stranded condition.

The hard-drawn, or H-19 temper, is acceptable for most stranded applications, with intermediate tempers half and three-quarters hard also being employed for some applications. Added flexibility may be obtained by various strandings using a larger number of smaller wires for a given cable size. Where extreme flexibility is desired, as for portable cords, bunched or rope lay strandings are used.

Bare and covered conductors generally have Class AA or A stranding; insulated power cables employ Class B, C or D stranding, except for portable cords with Class G or H. The number of strands varies with conductor size and Class of stranding. (See Table 4-8)

Descriptions of stranding Classes, including bunched and rope lay, are contained in Chapter 3. ASTM B 231 specifies details of the various strandings for all common wire sizes.

Insulated conductors are generally concentric stranded, with each succeeding layer of strands laid in the opposite direction and designed so the outer layer has left-hand lay. The direction of lay is defined as the direction the

strands diverge when the cable is viewed from the end, looking along its axis.

Concentric conductors for insulating are increasingly compressed or compacted. For compressed stranding, the concentric conductor strands are compressed to reduce the cable diameter by approximately three percent. Compact conductors, such as those used in most building wire types, have diameters approximately nine percent less than those of standard concentric cables and are the result of fully compressing the successive strand layers and eliminating most voids within the conductor. Generally in compact round construction, the concentric strands are all helically applied in the same direction (unilay).

Bare and covered overhead cables are generally of concentric construction with right-hand lay.

### The Distinction Between Covered and Insulated Conductors\*

It is important to distinguish between an *insulated* conductor and a *covered* conductor.

Insulated conductors are designed to confine electrical charge within the conductor at a predetermined maximum voltage gradient and operating temperature under wet or dry conditions. The ratings of insulated conductors are determined by appropriate tests and established in applicable industry standards.

Insulated conductors are generally designed as single conductors for direct burial or use in raceways, or as components for multiple-conductor cables. Temperature ratings of conductors range from 60°C to 105°C, with some cables designed for higher ratings dependent on the type of insulation used. Insulated conductor temperature ratings in the NEC are based on use in wet or dry locations. (See Section 310-13)

\* The National Electrical Safety Code defines covered conductor as "a conductor encased within material of composition or thickness that is not recognized by this code as electrical insulation."

Insulated conductor is defined as "A conductor encased within material of composition and thickness that is recognized by this code as electrical insulation" (NEC 1987). Also see definitions in Article 100 of 1987 NEC.

## **covered and insulated wire and cable**

Covered conductors, in contrast to insulated conductors, are used mostly by the utility industry under conditions where insulation is not required, and covering is applied for weatherability.

Used by utilities as open secondary distribution cable, covered conductors are installed on insulators and otherwise treated and respected as bare conductor. The coverings help reduce faults due to weather and wind where objects may contact the lines, or the lines come into close proximity with one another. Testing is designed only to establish physical properties and continuity of coverings.

Tree wire and spacer cable are also in the same category as covered line wire, but designed with considerably thicker coverings. These conductors, too, are installed on insulators and treated as bare conductors.

### **Covered Aluminum Line Wires and Cables**

#### *Covered Line Wires*

Covered aluminum conductors are generally all-aluminum 1350, alloy 6201, ACAR or ACSR.

The specification generally referenced for covered line wire is ANSI C8. 35. Conductors used in line wire (as with tree and spacer cable) meet the relative ASTM specifications for the conductors used. Conductor coverings have no associated voltage rating and are usually black polyethylene or crosslinked polyethylene. Occasionally high density polyethylene and gray coverings are applied.

#### *Tree Wire*

These conductors, with thicker covering than line wires, are used to permit utility companies' secondary line installation without extensive tree trimming, minimizing outages resulting from occasional tree contacts due to weather conditions.

#### *Spacer Cable*

Conductors described above as tree wires may be used as spacer cables by utilities though spacer cable does not require the heavy covering of abrasion-resistant compound used in tree wires. Spacer cables are installed with non-conducting spacers to reduce the amount of space and hardware needed. Plastic or ceramic spacers with provision for attachment to a messenger support maintain the conductors in a fixed relationship, allowing close spacings without shorts or flashovers. Depending on conductor size and length of run, spacers are usually placed 30 to 40 feet apart.

### **Insulated Conductors and Cables (0-600 Volts)**

The following brief descriptions of insulated aluminum conductors for use on circuits not exceeding 600 volts, either as single conductors, unjacketed assemblies of conductors, or as components of multiple-conductor cables, are to provide a general overall review. For more information on selection and use, see succeeding chapters.

Cables of this category are of two types: 1) conductors predominantly used by utility companies, and 2) those better known as premise-type wiring or building wire. Conductors of the first type are generally specified by utilities to comply with an industry specification, whereas building wire products are manufactured to comply with specifications of testing laboratories such as Underwriters Laboratories. The minimum requirements for building wire applications are given in the NEC, while utility companies are generally governed by the National Electric Safety Code.

Use and application of building wire is usually governed by NEC, while utility companies are generally governed by the National Electrical Safety Code.

#### *Aluminum Power and Lighting Insulated 600-Volt Cables*

Aluminum conductors of this classification are employed in the circuits in buildings, structures, yards and other low-voltage distribution systems for which the previously described covered cables are not suitable. Depending upon design, they may be installed in duct, trays, conduits or air. Insulated conductors where approved for that use are suitable for direct burial in earth.

The conductors range from No. 8 AWG to 2000 kcmil, Class A strandings, with various kinds of insulation, and with or without metallic or non-metallic outer sheaths or armor. The insulation required is governed by the specific application and will include both temperature and moisture conditions. Ampacity ratings for a given cable of a particular voltage and construction will vary with type of insulation and installation conditions.

For the reader's convenience, we will consider 600-volt wires and cables in three separate categories—single conductors, single conductors in unjacketed assemblies, and multiple-conductor cables surrounded by overall jacket, sheath, or armor.

#### **Single Conductors (0 to 600 Volts)**

Single conductors of standard insulation types in most cases must meet the requirements of the National Electrical Code. Conductors are required to be either direct buried in earth, or installed in conduits or other recognized raceways, except as permitted in specific NEC Articles.

Conductors manufactured to comply with the requirements of testing laboratories such as UL include types RHH, RHW, TW, THW, THHN, THWN, and XHHW, and are generally available in sizes through 2000 kcmil. Conductors are selected on the basis of application considerations such as temperature rating as related to ampacity, type of raceway, and installation location. In conductor selection, reference should be made to the NEC and Chapter 10 of this book.

Single 600-volt aluminum conductors are also widely used as underground service entrance, distribution, and feeder cables. (Covered in underground section, page 7-4).

Six-hundred-volt aluminum-armored cables are also available in single conductor constructions and are discussed on page 7-4. (See also NEC Article 334)

#### **Aerial Cable Assemblies (0 to 600 Volts)**

Messenger-supported aerial cables may be field assembled from single conductors. Factory assemblies in sizes through 4/0 AWG are generally available.

##### *Parallel Aerial Cables (PAC)*

These cables, manufactured to ICEA specifications, are rated at 600 volts phase-to-phase. Assemblies are either three- or four-conductor, with two or three insulated phase conductors assembled with a bare neutral messenger. These conductors are used to supply power to a limited number of customers and provide for "T"-type taps.

##### *Reverse Twist Secondary Cables (RTS)*

RTS cable meets the same ICEA specifications for 600 volt phase-to-phase conductors as PAC (above). Its basic design of reverse-lay twisting of phase conductors about the neutral messenger builds in additional length and eases separation of phase conductors for "T" taps.

##### *Service Drop Cables*

Service drop cables, sometimes referred to as multiplexed cable, are manufactured to meet the applicable requirements of ICEA specifications for neutral-supported service drop cables. They are used on circuits not exceeding 600 volts phase-to-phase to supply power from the utility source to the user's attachment point, where it is connected to the service entrance conductors. Assemblies consist of one, two, or three insulated phase conductors cabled around a bare neutral messenger. Phase conductors are commonly insulated with crosslinked polyethylene or polyethylene. Service drop cable is installed by and is generally within the jurisdiction of the utility company. (See NEC Article 230.)

Service drop conductors are also used by utility companies and other users to power security light systems or distribute power overhead from one structure to another.

#### **Multiple Conductor Power Cables (0-600 Volts)**

##### *Aluminum Interlocked or Seamless Armored Cables*

Metal-clad cable designated Type MC by the NEC (Article 334) consists of one or more insulated conductors, plexed under a binder tape. The assembly is covered by a metallic armor of interlocking tape, or by a smooth or corrugated tube. Aluminum sheathed cable consists of one or more insulated conductors enclosed in an impervious, continuous, closely fitting tube of aluminum.

Metal-clad cables are installed in racks, trays, troughs, or baskets, or are suspended from messengers. Type MC cable is generally available in sizes Nos. 6 through 1000

kcmil. A protective thermosetting or thermoplastic outer covering may be added where corrosive or other conditions warrant its use or for direct buried application.

Aluminum armor is nonmagnetic and thus does not add to the inductive reactance of the conductor as does galvanized steel. Because of this, the characteristic use of aluminum armor is favorable in ampacity and voltage drop comparisons. Aluminum armor is also particularly resistant to corrosion in many industrial atmospheres and is significantly lighter in weight, weighing about one-third the weight of steel.

Metal-clad cable principally is used in lieu of cable in conduit and where significant labor savings, provision for rearrangement, flexibility and installation, mechanical protection of the conductors, and small available space are factors.

##### *Aluminum Service-Entrance Cables (600-volt)*

The most commonly used service-entrance cables are designated Type SE-Style U (SEU), Fig. 10-4, or Type SE-Style R (SER), Fig. 10-5. Both styles are recognized for service entrance circuits and also for sub-service and branch circuits within a building. In SEU cables, one or two insulated conductors form the base around which bare aluminum strands are concentrically wrapped to make the uninsulated neutral conductor. A layer of moisture-seal tape covers the concentric wrap, and the entire assembly is protected by an overall jacket of polyvinyl chloride.

The Type SE-Style SER cable differs from the oval style SEU in that all conductors, neutral and phase, are cabled together to make a round construction. The three-conductor type includes two insulated phase wires and an insulated grounded conductor that serves as the circuit neutral as well as an equipment grounding wire (where codes permit dual use). The four-conductor type includes two insulated phase wires, one insulated conductor, and one bare grounding conductor, thereby separating the circuit neutral from the equipment grounding wire. The conductors are spirally assembled, wrapped with moisture-seal tape, and covered with a jacket.

NEC-recognized for single-unit dwelling services through 200 amperes, SER and SEU cables are available in sizes No. 8 AWG through 4/0 AWG. Conductors used in service entrance cable are generally RHH, RHW or XHHW.

Because these cables are also approved for certain interior circuits, they are used where many distribution panels and branch meters are connected to a single service entrance, such as in apartment buildings, and to equipment for which a three-wire service is required, such as electric ranges, laundry-room appliances, etc. Many UL-listed aluminum accessories are available for use with Type SE circuits.

## *covered and insulated wire and cable*

### **Aluminum Cables For Underground Installation (600-Volt)**

Insulated 600-volt aluminum cables are widely used for both secondary distribution feeders and service entrance conductors.

Both single conductors and preassembled cables, designated Type USE for service entrance and Type UF for underground feeders are available for this service.

*Underground services* — Type USE cables are available as single conductor, multiple conductor, and multiple conductor with an outer jacket. All are suitable for direct earth burial to complete the circuit from the utility source to the customer's meter. Single conductors and multiple-conductor cables without jackets must be protected by conduit upon emerging from the earth, while USE with an outer jacket may be installed as Type SE cable.

Multiple-conductor 600-volt underground cable constructions come in several forms. Among the most common:

1. The most frequently used arrangement is made up of two separately-insulated aluminum phase conductors twisted with a solid or stranded insulated reduced-neutral conductor, Fig. 10-9C. These cables also are available preassembled in plastic pipe, plain or corrugated, for duct installation, Fig. 10-9E.

2. Two separately insulated aluminum phase conductors are laid parallel, and covered overall with bare round or flat-ribbon copper wires, applied helically and of such size that they comprise the equivalent of a reduced neutral, Fig. 10-9B. Copper wires are used for the spiraled neutral bare conductors.

3. A single insulated reduced-neutral conductor is centered between insulated phase conductors, in parallel or "ribbon" configuration, Fig. 10-9D. The insulation is extruded over the three conductors simultaneously. A thin web of insulation is left between the conductors. The web is easily separated for making terminal connections, and it aids in handling and stringing.

Developments by the aluminum industry of such specialized conductors as those described have greatly aided the conversion to underground residential distribution by reducing conductor and installation costs, narrowing the margin between URD and conventional overhead construction.

*Underground feeders* — Type UF cable is similar to Type NMC cable, but has additional jacket thickness making it suitable for direct burial. UF is available in single, two- or three-conductor cable, with or without grounding, and is approved for installation as underground feeders on circuits not exceeding 600 volts.

### **Insulated Conductors—Above (600 Volts)**

Although bare aluminum conductors are extensively used for transmission and distribution circuits at all voltages, insulated aluminum conductors have not yet come into general use at transmission voltages 230 kV

and above. However, installation in conduit as well as direct burial of insulated aluminum conductor at 69 kV, 115 kV and 138 kV (and all intermediate and lower voltages) has been in successful use for many years.

### *Power Cables (above 600 volts)*

The general description of cables rated 600 volts with rubber or thermoplastic insulation on page 10-5, also applies to cables up to and including 2 kV, except for insulation thickness. However, for cables of the most-used types in the range 2001 V to 5 kV, NEC-designated Type MV (Medium Voltage), a layer of semi-conducting material known as conductor shielding is applied directly over the conductor and in contact with the inner surface of the insulation, Fig. 10-12. For most cable rated 5 kV and higher, an additional insulation shield of semi-conducting material is applied directly over and in contact with the outer surface of the insulation.

Insulation and conductor shielding are used to create a uniform voltage gradient within the insulation about the conductor. A metallic shield, which is to be suitably grounded, is always applied over a semi-conducting insulation shield. The metallic shield may be used as part of a relaying circuit and occasionally as a neutral.

The described customary shielding practice for the various voltages are subject to exceptions as described in NEC and ICEA standards, as further noted in Chapter 10.

The most commonly used insulated aluminum medium-voltage cables are in the range of 5 kV through 35 kV (phase-to-phase) for installation in air, or duct-bank, as two-conductor or three-conductor cables, Figs. 10-15 and 10-17. Special reference to their use as preassembled aerial cable, cabled conductors attached to a messenger, or as protected by interlocked or continuous armor, is in Chapter 8. See Fig. 10-16.

Conductors used in high voltage cable construction are generally Class B concentric or compressed stranded, though some solid conductors in the size range of No. 2 through No. 4/0 AWG are used. Chapter 8 of this book details types of insulation used in high and medium voltage cable constructions.

Cable constructions are sometimes tailored for specific use and the basic design modified to meet particular requirements.

### *Primary URD Cables for Underground Residential Distribution (5kV to 35 kV)*

In general, the two-conductor, concentric-neutral type is standard for primary URD cable, Fig. 10-18. The design is comprised of a standard medium voltage type cable (conductor, semi-conducting strand shield, insulation, and semi-conducting insulation shield) over which a bare concentric neutral is helically applied.

Primary URD cable is generally available in solid dielectric design with extruded insulation shielding. The



helically applied concentric neutral is generally composed of coated or uncoated copper strip or wires. Cable designs through 4/0 AWG often include a neutral, sized to match the conductance of the phase conductor, with one-third neutrals common for larger sizes.

#### *Medium-Voltage Shielded Single-Conductor Power Cables (5kV to 35 kV)*

Cables of this class are used principally for relatively high-voltage power distribution, and are suitable for installation in underground duct, direct earth burial, used as aerial cable conductors, and often as components in armored cable. The overall jacket of this construction provides protection for the metallic shielding and makes the cable suitable for a wide variety of uses, Fig. 10-13.

#### *Interlocked-Armor Cables*

Cables of this class installed on racks or cable trays provide ease of installation and re-routing of circuits where necessary.

Armored-multiple conductor cables are available utilizing shielded conductors as described above. These conductors are cabled together with the necessary components to construct a round cable over which is applied a moisture barrier separator and the armor. Some constructions are designed with grounding conductors placed in the cable interstices. Cables of this class are generally available in 5 kV through 15 kV ratings and may have either aluminum or steel armor.

In general, cable armor in previous years was of the interlocked type, where metallic strips were shaped and spirally applied about the cable in an interlocking design. Today this design basically applies to cables with steel armor. Cables with aluminum armor are now generally of corrugated design. Aluminum strip is applied longitudinally about the cable, continuously welded and corrugated to provide flexibility. In contrast to the interlocking design, the corrugated armor seals the constructions from the ingress of moisture.

Jackets of polyethylene or polyvinyl-chloride applied over both types of armor provide protection against corrosive environments and seal the interlocking type armor. Mechanical protection can also be provided by the use of concentrically applied round-wire armor, usually galvanized steel, for applications such as submarine and bore-hole cables, or cables in vertical risers where longitudinal stress is a factor.

#### *Preassembled Aerial Cables (to 35 kV)*

Preassembled self-supporting aerial aluminum conductors for primary distribution are available for voltage ratings through 35 kV. Shielded and jacketed conductors as described above are used in these constructions. Individual phases are cabled together and bound to a supporting messenger.

These cables are designed for aerial installation on poles, towers, or between buildings where the cost of

underground duct installation cannot be justified, or where aerial space and safety does not permit bare overhead conductors, or where congestion overhead or underground prohibits conventional installations.

Cables may be preassembled in the factory or field-spun using a binder applicator, Fig. 10-14.

#### **Aluminum Insulated Conductors for Special Conditions**

In addition to the applications previously described, there are other uses of aluminum conductors that require special consideration, because they differ in certain respects from the usual permanently installed circuits for power and lighting.

#### *Aluminum Pole-and-Bracket Cables for Series Street Lighting*

Cables for this service are usually single-conductor solid, with individual-conductor and belt insulations suitable for operation up to 9000 volts open circuit to ground, though the individual conductors may be insulated only to 600 volts, as required across a single fixture.

The conductor size for aluminum usually is No. 6 or No. 8 AWG either as single conductor or parallel two-conductor type. Cables are available for installations overhead, in underground ducts or conduit, and for direct burial.

#### *Aluminum Mine Power Cables*

The circuits in mines usually must be frequently re-located as mining progresses. The runs often are in cramped locations and also the supply often is through a vertical bored hole. Aluminum single and preassembled 3-conductor properly jacketed cables are excellent for this service because they provide needed flexibility, light weight for ease of handling, and the exterior jackets resist abrasion while being moved about.

Mine power cables, suitable for permanent or temporary installations, are available with rubber or cross-linked polyethylene insulation as single or 3-conductor aluminum phase cable which includes three copper grounding conductors (one of which may be insulated), for 600 V, 5 kV, 8 kV, 10 kV and 15 kV. The cables may be clamped without insulators to mine walls, run along the ground, or dropped vertically through a bore hole. For long drops, wire-armored cables are used. The insulated ground conductor, if used as a ground-check, is a safety feature that facilitates removal of power from the circuit if the other grounding conductors become broken. Three-conductor cables of this type also are supplied with an armored outer covering of steel wires to resist abrasion when the cables are dragged over the ground.

Preassembled aluminum self-supporting high-voltage aerial cables, as previously described, are often used for general supply on mining properties.

## *covered and insulated wire and cable*

### *Aluminum Portable Cables*

This highly specialized classification of electric conductors has heretofore mostly been available in copper, but more recently aluminum portables have become available in the heavy-duty sizes No. 6 AWG to 4/0 for 600-volt service, with single, two, three, or four conductors (and into the kcmil sizes for certain types). Also available are shielded portable cables to 5000 volts. Special extra-flexible light-weight portable single cables are also available for use with welding equipment. Flexibility is obtained by using Types G, H, or I stranding of  $\frac{3}{4}$ -hard, hard-drawn, or fully annealed aluminum, depending on requirements. The unidirectional method of stranding, as used for some designs, also aids flexibility; that is, all strands spiral in the same direction regardless of which layer they are a part.

Insulated molded fittings and couplings are available for many of the sizes so that quick connections can be made to terminals, electrode holders (of welding cable), and between cable sections.

The insulation and jackets are of materials that will withstand rough abuse when the cable is bent or dragged. Bending radii of eight times overall diameter are generally accepted for single- and multi-conductor cables over 5 kV, six times overall diameter for multi-conductor cables rated 5 kV and less.

Some of the uses of aluminum portable cables, in addition to the welding-equipment use mentioned, are those for locomotive reel equipment, mining machinery, magnetic hoists, dredges, motor leads, plug-in power drops from busways, and in and around shipyards.

### *Aluminum Submarine Cables*

Submarine cables have moisture-resisting insulation and sometimes are protected by lead sheaths. Heavy mechanical protection is required to prevent damage from ship anchors, sharp rocks, and river or tide currents. These cables usually consist of three thermosetting or thermoplastic insulated conductors cabled together and protected by a tape, jute bedding, and galvanized-steel-wire armor.

### *Special Applications Cables*

These cables usually consist of comparatively small conductors, often many within a single sheath. As current carrying requirements usually are small, little economic advantage accrues from the use of aluminum.

However, recent years have seen increased use of aluminum conductors in communications cables and automotive wiring harnesses, where weight is an important factor. Aluminum conductor manufacturers should be consulted for further information on this subject.

Chapter 8

## Insulation and Related Cable Components

This chapter describes in further detail the insulation and coverings mentioned previously and also describes the jackets, shields, sheaths, and other materials used in the assembly of a cable. An explanation of some of the dielectric terms is in Appendix 8A.

Standards are specifications for cable insulation and coverings are developed and set forth in the publications of ASTM, Underwriters Laboratories, Inc. (UL), and Insulated Cable Engineers Association (ICEA), and others. This chapter provides summary data and the reader is advised to consult the referenced standards for further detail.

Selection of insulating and other materials that surround the conductors is based on a number of performance factors:

**1. Electrical:** Dielectric constant; insulation power factor; insulation resistance (ac and 1-minute dc); charging current; arc resistance; tracking susceptibility; ozone resistance. Uniformity of potential gradient is influenced by shielding. Requirements in this category depend considerably on voltage.

**2. Mechanical:** Toughness and flexibility; tensile, compressive, and impact strengths; resistance to abrasion, crushing, and moisture; brittleness.

**3. Thermal:** Softening or flow temperature; expansion and contraction; compatibility with ambient, operating, emergency overload, and short-circuit conductor temperatures.

**4. Chemical:** Stability of materials on exposure to oils, flame, ozone, sunlight, acids, and alkalies; moisture absorption.

**5. Code Requirements:** Installation of cable in accordance with NEC and under the jurisdiction of separate electrical inspection authorities usually requires cable labeled by Underwriters Laboratories (UL).

### Typical 3-Conductor Cable Assemblies

The arrangement of layers of insulating and other materials around the bare conductors depends on voltage and the service application of the cable; that is, a cable for aerial or in-conduit installation may have a different ar-

range of shields, jackets, and sheaths than one for underground burial. A different arrangement also is required in a cable for series lighting circuits. Subject to such differences, and others depending on application conditions, the following represents a customary sequence of component layers if the insulation is of thermosetting or thermoplastic materials:

<i>Low-Voltage 600-2000 V</i>	<i>Non-Shielded 2001-5000 V</i>	<i>Shielded over 5000 V (or as low as 3001 V if required)</i>
1. Conductor	1. Conductor	1. Conductor
2. Phase-coded insulation	2. Strand shielding	2. Strand shielding
3. Assembly tape and fillers	3. Phase-coded insulation	3. Insulation
4. Jacket, sheath, or armor	4. Assembly tape and fillers	4. Insulation shielding—phase identification
	5. Jacket, sheath, or armor	5. Metallic insulation shielding
		6. Assembly tape and fillers
		7. Jacket, sheath, or armor

The directional control of static lines of force brought about by suitable strand and insulation shielding is depicted in Fig. 8-1.

Although details of cable construction and materials are supplied later in this chapter, the following briefly describes some of the items mentioned in the above tabulation of cable components.

The *strand and insulation* shielding is normally an extruded layer of semi-conducting material.

*Phase identification* on non-shielded 600-5000 V cables is accomplished by a number of means, including color-coding and printing on the surface of the insulation. For shielded cable, 5 kV and above, the insulation is covered with an extruded semi-conducting layer.

*Metallic shielding* is normally composed of pure zinc or copper tape, metallic braid or metal wire shields. See page 8-10.

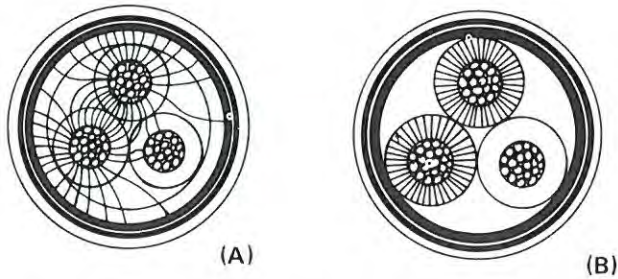

Fig. 8-1. Diagrams that show direction of potential "lines of force" that extend radially from conductors within a grounded sheath: A. Cable has neither strand nor insulation shielding; B. Cable has both strand and insulation shielding, assuming the latter is grounded. The diagrams show the condition at the instant when voltage is zero in one of the conductors of a three-phase circuit.

### Conductors for Insulated Cables

As described in Chapter 7, combination strandings are more likely to be used for insulated cables than in bare conductors. Thus, for the large sizes extra flexibility is obtained by *rope-concentric stranding*. In this arrangement the individual uninsulated conductor is a concentric stranded group in itself, and six of these groups around one will constitute an overall body of seven groups of seven strands each. Additional layers are added in the same concentric manner. Similarly, if the individual conductor is a bunch stranded group of small wires (the wires placed without regard to any geometric arrangement) the conductor is said to have *rope-bunch stranding*.

The compacting of stranded conductors, made by compressing the strands together to decrease voids, is increasing in use because it provides the flexibility of a stranded conductor and the conductors approach the diameter of a solid conductor. Some of these designs in round or sector form are shown by Fig. 8-2. The cable with a core of fibrous material (item *d*) or the segmental cable (item *e*) provide reduced skin effect as compared with one of equal resistance of conventional construction. The item *d* and item *e* cables, however, are little used commercially, except under special conditions.

### Coverings for Uninsulated Conductors

The distinction between insulated conductors and uninsulated covered conductors was mentioned in Chapter 7, where it was stated that braided weather-resistant coverings, used for decades have been superseded for power and lighting cables by thin extruded coverings of plastic-type materials, characteristics of which are covered in Table 8-1.

### Insulating Materials and Performance

By far the most used materials for insulating aluminum conductors are those of the extruded dielectric type, the principal component being one of several materials such as ethylene-propylene rubber, cross-linked polyethylene, high molecular weight polyethylene and polyvinyl chloride. Related to these, but of less insulating quality, and hence used mostly for jackets to protect the insulation from environmental conditions, are neoprene and special polyvinyl-chloride and polyethylene compounds. A brief description of these materials appears later in this chapter.

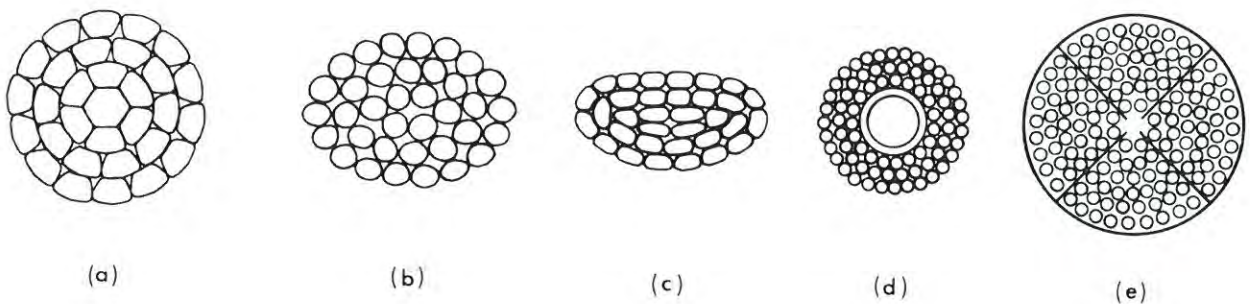

Fig. 8-2. Various methods of cable stranding for reducing diameter and minimizing skin effect.

(a) Compact round

(b) Non-compact 120-deg sector for 3-conductor cable

(c) Compact 120-deg sector for 3-conductor cable

(d) Hollow or fibrous core for reducing skin effect

(e) Segmental single conductor for reducing skin effect  
(Thin insulation is provided between segments)

TABLE 8-1

Some Typical Comparison Data on Extruded Materials for Non-Voltage-Rated Covered Conductors

	Extruded	
	Polyethylene Black Covering	Cross-Linked Polyethylene Covering
Specific Gravity	0.92	1.13
Tensile Strength, psi	1400	2600
Elongation %, Min.	300 min.	300 min.
Heat Distortion	90°C	121°C
Brittle Temp.	-51°C	-80°C
Cold Bend	-51°C	-55°C
Abrasion Resistance	Good	Good
Ice Forming Tendency	Very low	Low
Water Absorption, % increase	0.2 max.	0.2-0.8
Power Factor, 60 Hz 20°C, %	0.45 max. (immersed)	0.08 (immersed)
Dielectric Constant, 25°C	2.35 (immersed)	5.0 (immersed)
Insul. Resistivity, 25°C, ohm-cm	10 <sup>17</sup> (immersed)	10 <sup>16</sup> (immersed)
Breakdown strength, volts (# 6 sol.)	24 000 (immersed)	22 000 (immersed)
Resistance to:		
Age Cracking	Excellent	Excellent
Sunlight	Good	Excellent
Ozone	Unaffected	Unaffected
Acids	Excellent	Excellent
Alkalies	Excellent	Excellent
Alcohol	Excellent	Excellent
Gasoline	Fair-swells slowly	Good
Oil	Poor-softens slowly	Good (20°C)
Salt Solution	Excellent	Excellent

Test Methods are from ASTM, ANSI and UL. The listed values for extruded coverings apply to the grades of material used for *coverings*. See Tables 8-2, 8-3 and 8-4 for grades of similar materials used for *insulation*.

## covered and insulated wire and cable

These materials are classified broadly as *thermoplastic* or *thermosetting*. Thermoplastic compounds (polyvinyl chloride and polyethylenes — not cross-linked) soften upon exposure to heat. Rubber compounds (natural and synthetic) are thermosetting; that is, upon exposure to heat under suitable conditions a chemical reaction occurs and the compound becomes vulcanized into a tough, elastic condition. Although polyethylene is classed as a thermoplastic, it may be converted to a thermosetting compound by bringing about a cross-linking of components *after* the material in its thermoplastic state has been extruded around the conductor. Thus, whereas polyethylene in its typical thermoplastic form has melted at approximately 105°C, in its cross-linked form it retains about 90% of its unaged property even at 121°C. The other thermosetting rubber-like compounds if properly compounded also show high retention of initial hardness at high operating temperatures. However, comparisons of surface hardness at various temperatures may be misleading because the hardness usually can be controlled by additives, and too hard a surface may be undesirable.

The permissible temperature at which an insulated conductor can operate for the expected life of the cable without impairment of insulation quality determines the ampacity (current-carrying capacity) of the conductor. The higher the operating temperature the greater the ampacity. High operating temperatures imply high losses in the cable and despite the ability of an insulation to withstand certain temperature levels without losing its insulating properties, care must be exercised to determine economic conductor sizes to balance first cost and operating costs during the life of the installation.

The performance of thermosetting and thermoplastic insulations for power cables has improved remarkably in recent years, both as to permissible operating temperature and other electrical constants, but also as to increase of useful life. Early insulations were oxygen-sensitive; that is, they would age from exposure to oxygen in air. In comparison, modern insulations are compounded from materials that essentially are insensitive to oxygen. The early insulations for high-voltage cables also were required to pass an ozone test at 0.010-0.015% concentration for three hours. With the advent of modern insulations this concentration was doubled (0.025-0.030%). Although the official test time still remains at three hours, the test usually can be extended to 24 hours, or even 48 hours, without failure. At this concentration, the earlier materials would fail in minutes.

The effect on the elongation of an insulation (or jacket) under stress is also an acceptable measure of heat resistance. The air oven test at 121°C provides a relatively quick method of grading insulation materials for use at high conductor temperatures or in hot-spot areas. Although the ICEA 121°C air-oven test specifies that a minimum of 75% of the initial elongation must be retained after 7 days of exposure, representative modern insulations for high-voltage conductors actually show far better per-

formance, typically as follows:

	Air-oven aging at 121°C			
	Percent of Initial Elongation at Rupture, End of Period			
	7 Days	14 Days	21 Days	28 Days
XLPE*	98%	95%	91%	84%
EPM or EPDM**	98%	95%	90%	82%
Butyl	95%	90%	86%	77%

\* Cross-linked polyethylene

\*\* Ethylene propylene rubber (EPR)

Further evidence of improvements in insulation performance in these and other electrical and mechanical properties is evident from Tables 8-2, 8-3 and 8-4, if the standards established for the earlier 60°C insulations are compared with those of later types for 75°C and up. And from the above-mentioned values for air and oxygen aging and for retention of elongation it is evident that modern insulations in some respects far exceed the requirements of established standards.

The performance of a synthetic rubber or a similar plastic insulation depends not only on the largest proportionate component of the compound (from which the insulation sometimes is named) but also on its formulation with modifying ingredients and on the method of manufacture. The added ingredients are broadly grouped as vulcanizing agents or curatives; accelerators, that speed the reaction; reinforcing agents that improve strength, tear, and abrasion resistance; fillers such as carbon black, clay or talc; antioxidants that improve aging quality; and plasticizers that soften the compounds and provide control of flexibility.

As the exact proportions of each of these ingredients and the conditions of preparation and mixing may differ among cable manufacturers, insulations are not supplied to meet a component-and-process specification, but instead are supplied on a *performance* specification, according to standards and method of testing of American Society for Testing and Materials (ASTM), Underwriters' Laboratories, Inc. (UL), and Insulated Cable Engineers Assn. (ICEA). The National Electrical Code (NEC) refers to various kinds of insulation as "types," and the sequence of letters of the NEC Type (such as RHW, RHH, THWN, etc.) provides an approximate description of insulation performance. Page 8-12 explains the usual meaning of these NEC Type letters.

### Thermosetting Insulating Materials

#### *Styrene-Butadiene Synthetic Rubber (SBR)*

This insulating compound was introduced after World War II; it was originally called "GRS" (Government Rubber-Styrene), and was first made in government-owned plants. New improvements in manufacturing have resulted in compounds that are even more desirable in many re-

spects than natural-rubber base insulation. References to "synthetic rubber" in Table 8-2 imply the use of SBR.

The SBR compounds are suitable for many of the NEC Code rubber insulations of the RH, RHH, and RHW types, and by change of modifying components they can be adapted to various conditions; from 75°C wet or dry to low-temperature (—55°C) service where cold-bend, brittleness, and torsional stiffness requirements are severe. Though normally used in the 0-600 volts range, SBR can be compounded for high ozone resistance, hence made suitable for cables to 15 kV. It has limited resistance to oils and hydrocarbon fuels, and has little resistance to flame propagation, though this property can be improved by special compounding. Hence a flame-retardant jacket must be used unless this special compounding is used. Similarly, an oil-resistant jacket can be applied, if desired.

SBR has good dielectric properties and relatively high dielectric strength. As usually compounded it has excellent flexibility, strength, and resistance to tear and abrasion. If desired for chemical environments, the manufacturer should be consulted. SBR also is much used in jacket compounds, and particularly where a flexible jacket is required as on certain portable cables.

#### *Butyl Synthetic Rubber*

This compound is a copolymer of isoprene and isobutylene, and is inherently resistant to ozone, hence it principally came into use for insulation at the higher voltages. Butyl rubber has better electrical properties and greater heat and moisture resistance than either SBR or natural rubber. Because of these properties it is possible to produce an ozone-resistant insulation from butyl rubber of a given thickness that is superior to that of ozone-resistant SBR.

The ICEA listing of ozone-resisting butyl rubber specifies 85°C for 15 kV and 80°C for 28 kV (grounded neutral). Industry lists, however, place it in the 80°C class and as suitable for 15 kV (28 kV, grounded neutral) with ungrounded neutral. The air-aging and elongation tests (see page 8-4) show that this insulation liberally exceeds ICEA minimum requirements.

#### *Cross-Linked Polyethylene Insulation (XLPE, XHHW)*

This insulation, listed in NEC as Type XHHW and also suitable for underground service entrance (USE), is classified as thermosetting although its basic material is polyethylene which in usual form is thermoplastic. The compound is obtained by introducing what is known as a cross-linking agent to low-density *thermoplastic* polyethylene, thereby converting it to a thermosetting compound. The resulting compound still has the original excellent characteristics of polyethylene, but in addition has high heat resistance; it will no longer soften at 100°C. Because the cross-linking treatment is done at a higher temperature than that used for thermosetting most rubber compounds, special equipment is required for the final processing of

XLPE. Its high quality is evidenced by ICEA listings per Table 8-4 for wet and dry locations at 90°C for normal operation. The standard also lists it as suitable for 130°C for emergency-overload conditions and 250°C for short-circuit conditions. The usual availability of cables with this insulation is No. 2 AWG to 1000 kcmil.

While present ICEA standards only cover XLPE thru 35 kV, AEIC-5 recognizes higher voltages and considerable 46 kV cable is in service and smaller quantities of 69 and 115 kV cable have been furnished.

#### *Ethylene-Propylene Rubber (EPR)*

This ozone-resisting rubber insulation is recognized as suitable for up to 35 kV at 90°C, or 25 kV for ungrounded neutral (133% insulation level). The insulation consists substantially of ethylene-propylene copolymer (EPM) or ethylene-propylene terpolymer (EPDM). The insulation is principally used for medium-voltage cables; it has UL approval and is recognized under the RHH-RHW type.

#### *Fluorinated Ethylene Propylene Rubber (FEP)*

Commercially this insulation is sometimes referred to as Teflon. It has excellent ozone-resistance, and heat-aging within its 90°C dry and 75°C wet ratings. It is much used for control wiring, mostly in the smaller sizes up to No. 2 AWG for which it is UL approved. NEC lists this insulation as suitable for Type RHW conductors.

#### *Neoprene Synthetic Rubber*

Neoprene is described as a *Jacket* (page 8-9) because its relatively poor insulating quality limits its use as insulation. However, there are applications, mostly for small-size conductors, in which neoprene will be used as insulation because of its ability to withstand flame, oil and abrasion. Sometimes it is better to use a thick coating of neoprene as an offset to its poor insulating quality so as to obtain its other advantages without having to cover the conductor first with a high-quality insulation and follow it with a jacket of neoprene.

#### *Asbestos Insulations (SA, AVA, AVL)*

Aluminum conductor is better suited for high-temperature operation than most metals because its oxide coating does not become thicker as a result of repeated applications of heat. The Type SA power cable is NEC listed to 2000 kcmil with an outer covering of asbestos or glass braid over silicone-rubber insulation. The insulation is ICEA listed to 1000 kcmil for 125°C, and is of ozone-resisting type. The insulation compound is heat-cured fluorosilicon rubber, a semi-organic polymer.

Types AVA and AVL contain no rubber. The insulation is provided by a layer of varnished cloth between inner and outer walls of felted asbestos impregnated with a saturant. Type AVA has an asbestos-braid outer covering; Type AVL has a lead sheath. Type AVA is used in dry locations and AVL where the cable may be submerged or subjected to excessive condensation.

TABLE 8-2

Specifications for Natural- and Synthetic-Rubber Insulations  
Abstract from ICEA-NEMA Publication S-19-81

	S3.8 RW Synthetic Rubber	S3.10 RH Synthetic Rubber	S3.11 RH-RW Synthetic Rubber	S3.12 RH Natural Rubber	S3.13 RHW Synthetic Rubber	S3.14 Ozone-Resisting Natural or Synthetic Rubber	S3.15 Ozone-Resisting Butyl Rubber	S3.16 RHH Synthetic Rubber	S3.17 SA Ozone Resisting Silicone Rubber to 1000 Kemil
1. ICEA S-19-81 Paragraph No.									
2. Resembles UL, NEC.									
3. Description									
4. Temp dry not exceeding °C	60	75	75	75	75	75 70	85 80	90	125
5. Temp wet not exceeding °C	60		60		75	75 70	85 80		125
Max kV phase-to-phase									
6. with grounded neutral	2	2	2	2	2	8 kV 28 kV	15 kV 28 kV	2	5
7. with ungrounded neutral	2	2	2	2	2	8 kV 15 kV	15 kV 15 kV	2	5
8. Tensile strength, psi, min.	700	700	700	1500	700	450	600	700	800
9. Elongation % at rupture, min.	300	300	300	400	300	250	350	300	250
Aging requirements (air pressure)									
10. Test at ___°C for ___hrs		127-20	127-20	127-20	127-20	70-168*	100-168	121-168	200-168*
Values as % unaged value									
11. Tensile strength, min.		50	50	50	50	400**	60	60	500**
12. Elongation, min.		50	50	50	50	200**	60	60	125**
Aging requirements (oxygen)									
13. Test at ___°C for ___hrs		80-168	80-168	80-168	80-168	70-48	air pressure 127-40	air pressure 127-42	
Values as % unaged value									
14. Tensile strength, min.	75	50	50	75	50	400**	50	50	
15. Elongation, min.	65	50	50	75	50	200**	50	50	
Insulation resistance —									
16. Parameter K	2000	2000	2000	10,560	4000	2000	20,000	4000	4000
Accelerated water absorption EM60									
Increase in capacitance % max.									
17. 1 to 14 days	10.0		10.0		10.0	10.0	5.0		10.0
18. 7 to 14 days	3.0		3.0		4.0	3.0	3.0		3.0
19. Stability factor after 14 days	1.0		1.0		1.0	1.0	1.0		3.0
Gravimetric method, max. absorp- tion; milligrams/sq. in.	20.0		20.0		20.0		15.0		15.0
21. Dielectric constant at room temperature									
22. Power factor ___% at ___kV									
Ozone resistance. No cracks after 3 hrs exposure to concentra- tion of not less than ___% nor more than ___% by volume									
23. Min. Corona level, with grounded neutral at 5 kV						5.0 5.0% above 5 kV	4.5 3.5% above 5 kV		
24. same, at 15 kV									
25. same, at 15 kV									
26. at max. ___kV, ___kV						0.010-0.015	0.025-0.030		0.025-0.030
						4.0 11.0 28 kV 21.0	4.0 11.0 28 kV 21.0		4.0

\*Air-Oven Test.

\*\*Discrete minimum values for tensile strength (psi) and elongation (percent) rather than "percent of unaged value."

NOTE: The publications from which this table is an abstract contain exceptions and variations of certain of the values that apply under special conditions, hence this table should be used only for general reference. Actual design requires use of the complete specifications. Consult specifications also for explanation of the various items.

Item 13: Insulations S3.15 and S3.16 are subjected to an air-pressure test instead of an oxygen-pressure test. The XLPE and XLHHW insulations undergo a heat-distortion test.

Item 16: The listed "K" is used in the following formula for insulation resistance:  
 $R = K \log_{10} (D/d)$ , where R = resistance in megohms for 1000 ft; D = diameter over the insulation, and d = diameter under the insulation.

Items 6 and 7: Insulations specified for 15 kV are in extensive commercial use at least to 35 kV.



TABLE 8-3

**Specifications for Thermoplastic Insulations**  
**Abstract from ICEA-NEMA Standards S-61-402 WC-5**

1. ICEA S-61-402 Paragraph No.	S3.7	S3.8	S3.9
2. Description	Polyvinyl Chloride 60C	Polyvinyl Chloride 75C	Low Density Polyethylene HMW Type I Classes A, B or C
3. Temp dry not exceeding °C	60	75	75
4. Temp wet not exceeding °C	60	75	75
<b>Max. kV phase-to-phase</b>			
5. with grounded neutral	*0.6	*0.6	35.0
6. with ungrounded neutral	0.6	0.6	25.0
7. Tensile strength, psi, min.	1500	2000	1400
8. Elongation % at rupture, min.	100	150	350
<b>Aging requirements (air-oven)</b>			
9. Test at ___°C for ___hrs.	100–168	121–168	100–48
<b>Values as % unaged value</b>			
10. Tensile strength, min.	65	80	75
11. Elongation %, min.	45	50	75
<b>Aging requirements (oil immersion)</b>			
12. Test at ___°C for ___hrs.	70–4	70–4	
<b>Values as % unaged value</b>			
13. Tensile strength, min.	80	80	
14. Elongation %, min.	60	60	
15. Insulation resistance – Parameter K	500	2000	50,000
<b>Accelerated water absorption EM60</b>			
<b>Increase in capacitance % max.</b>			
16. 1 to 14 days	10.0	4.0	
17. 7 to 14 days	5.0	2.0	
<b>Gravimetric method, max. absorption;</b>			
18. milligrams/sq. in.	20.0	10.0	
<b>Min. Corona level, with</b>			
19. grounded neutral at 5 kV			4
20. same, at 15 kV			11
21. same, ___Max. kV ___kV			35 kV–26

Note: For information regarding *jackets* of these materials, see Table 8-5. See also *Note* on Table 8-2. (\*) The kV ratings for polyvinyl chloride insulation are increased to 1 kV for control circuits and to 5 kV for series lighting circuits. Carbon-black pigmented polyethylene is not to be used on power cable rated over 5 kV. Strength and elongation aging values apply to AWG sizes No. 6 and larger. See also AEIC-5 for thermoplastic primary cables.

covered and insulated wire and cable

TABLE 8-4

Specifications for Cross-Linked Thermosetting, Polyethylene and Ethylene-Propylene Rubber Insulations

Abstract from ICEA-NEMA Standards Publications S-66-524 and S-68-516

	3.6	3.7	
1. ICEA S-66-524 Paragraph No.			
2. ICEA S-68-516 Paragraph No.			3.6
3. Resembles UL, NEC	XLPE	XHHW & USE	EPR
4. Description	Cross-Linked Thermosetting Polyethylene	Cross-Linked Thermosetting Polyethylene	Ozone Resisting Ethylene Propylene Rubber
5. Temp dry not exceeding °C	90	90	90
6. Temp wet not exceeding °C	90	90	90
<b>Max kV phase-to-phase</b>			
7. with grounded neutral	35	2	35
8. with ungrounded neutral	25	2	25
9. Tensile strength, psi, min.	800	1800	700
10. Elongation % at rupture, min.	250	250	250
<b>Aging requirements (air-oven)</b>			
11. Test at ___°C for ___hrs.	121-168	121-168	121-168
<b>Values as % unaged value</b>			
12. Tensile strength, min.	75	75	75
13. Elongation %, min.	75	75	75
14. Insulation resistance – Parameter K	10,000	20,000	20,000
<b>Accelerated water absorption EM60 increase in capacitance % max.</b>			
15. 1 to 14 days	3.0	3.0	3.0
16. 7 to 14 days	1.5	1.5	1.5
17. Stability factor after 14 days	1.0	1.0	1.0
<b>Gravimetric method, max. absorption;</b>			
18. milligrams/sq. in.			10.0
19. Dielectric constant at room temp.	3.5	6.0	4.0 above
20. Power factor ___% at ___kV	2.0%	2.0% above 5 kV	5 kV
<b>Min. Corona Level, with</b>			
21. grounded neutral at 5 kV		4.0	4.0
22. same, at 15 kV		11.0	11.0
23. ___same, ___max. kV ___kV		35 kV-26.0	35 kV-26.0

See also AEIC-5 for XLPE primary cables and AEIC-6 for EPR primary cables.

### Thermoplastic Insulating Materials

Unlike thermosetting compounds thermoplastic insulations remain plastic regardless of temperature, and consequently will soften or melt at temperatures that would not significantly affect thermosetting insulations. The principal thermoplastic materials used for insulations have a resinous base, classified as polyvinyl chlorides and polyethylenes (not cross-linked). No vulcanization is required, although ingredients are added to the mixture for quality control and to facilitate extrusion on the conductor.

#### *Thermoplastic Polyvinyl Chloride (PVC)*

This compound is not a synthetic rubber. Basically it is a resin of high molecular weight polyvinyl chloride or the copolymer of vinyl chloride and vinyl acetate. Plasticizers, stabilizers, fillers, and lubricants are added to meet application conditions. PVC is often used for insulation and jackets, particularly in oil or petroleum environments. PVC loses from a third to half its hardness at 100°C and melts at about 140°C. For some of its other physical and its electrical properties, see Table 8-3.

PVC *insulating* compounds are available for Type TW (NEC) insulation rated 60°C wet and dry; for Type THW rated 75°C wet and dry; for THHN rated 90°C dry; and for higher temperatures as appliance wire, consideration of which is beyond the scope of this book.

#### *Thermoplastic Polyethylene (PE)*

This material, in its low density high-molecular weight grade, is used as the base from which *thermosetting* cross-linked polyethylene is made, as previously described. Polyethylene of the same grade without cross-linking is specified by ICEA as suitable for insulation of conductors for rated voltages to 35 kV for up to 75°C in dry or wet locations. This PE grade is subject to the ill-effects of ultraviolet light (sunshine exposure), which can be corrected by jacketing with a similar material containing not less than 2% carbon black (PE-Black), or if not over 5 kV the pigment may be incorporated in the insulation.

Polyethylene can be treated with chloro-sulphonic acid, resulting in *Hypalon*, which can be compounded in a manner similar to rubber. Its electrical and moisture-resisting properties do not equal those of untreated PE, but the aging characteristics are excellent.

There are numerous grades and classifications of polyethylenes, only a few of which are suitable for insulations. Table 8-3 lists the properties obtainable from Type I, high molecular weight low-density polyethylene.

The high-density low-molecular-weight polyethylene (black) is a compound used for insulation and covering on secondary line wire and service drops because of its excellent resistance to abrasion. The effect of repeated rubbing of tree branches and leaves that often surround such conductors is greatly reduced, as is the cost of tree trimming.

### Jacket Materials

As has been stated, often the most suitable insulation for resisting dielectric stress may not have an outer surface that is suitable for the conditions which the cable must meet in service. Thus, for improvement in resistance to flame, oil, abrasion, and chemical environment, a suitable jacket is extruded around the insulated conductor. Though the jacket may have moderate insulating quality its principal function is to protect the underlying cable components.

Because one side of the jacket is at ambient temperature and the other is one the outside of the insulation, the rated temperature for the jacket materials can be somewhat less than that of the insulation. For this reason jackets may be of thermoplastic material. Table 8-5 lists jacket properties according to ICEA.

#### *Polyvinyl Chloride Jackets*

The compound for polyvinyl chloride jackets closely resembles that used for PVC-60 insulation (S3.7 of Table 8-3). It is used for jacketing single- and multi-conductor cables, particularly when shielded. These jackets provide toughness, resistance to moisture and oil, and have good low-temperature properties. As regularly supplied, they withstand reel bending at installation temperatures of -10°C, and if specially compounded, as for mine cable, are suitable under oil conditions in the range -10°C to 90°C. Cables with PVC jackets are suitable for installation in conduit, trough or tray, underground ducts, direct-earth burial, and overhead on messengers.

#### *Polyethylene Jackets*

Black, low-molecular weight (high-density) and high-molecular weight (low-density) polyethylenes are frequently used as jacketing material. The 2 percent black pigment prevents deterioration from ultra-violet rays of sunlight. PE jackets have specific application where extreme resistance to moisture and abrasion is required.

#### *Neoprene Jackets*

Neoprene is a polymer of chloroprene containing about 38% of chlorine, which accounts for its excellent flame and oil resistance. It has comparatively high moisture absorption which, with only moderate dielectric properties, limits its use mostly for jackets. Though oil resistant, oil will pass through the material, hence cable components under a neoprene jacket also must be oil resistant if that quality is required. The properties of general-purpose neoprene and typical heavy-duty neoprene are listed in Table 8-5. General-purpose neoprene jackets are suitable for use on low-voltage cable or on high-voltage shielded cable when ozone resistance is not required. It is generally resistant to mechanical abuse, oils, water, chemicals, and flame. The heavy-duty neoprene jackets may be formulated to meet several conditions; either singly or in combination; thus, extra protection against mechanical

## covered and insulated wire and cable

damage, water, chemicals, or flame; extra-heavy duty for portable cables; arctic type for extremely low temperatures; and heat-resistant type for high temperatures.

### *Nylon Jackets*

Nylon is a generic term for polyamide polymers. This material is a tough abrasion-resistant thermoplastic which can be extruded as a thin protective covering over PVC or PE insulation, thereby improving its ability to withstand damage to insulation from mechanical abrasion and cold flow. Because of its poor electrical properties nylon is not used by itself as insulation.

Nylon jackets are specified for several of the thermoplastic insulations listed in NEC, thereby enabling thinner insulation to be used with resulting reduction of size of conduit, and it is also used on control wire, and similar constructions.

### *Nitrile-Butadiene/Polyvinyl-Chloride Jackets*

This jacket consists of a vulcanized acrylonitrile-butadiene/polyvinyl-chloride compound, based on a fluxed blend of acrylonitrile-butadiene synthetic rubber and polyvinyl-chloride resin. It is made in two forms: general-purpose and heavy duty, the latter having higher tensile strength and greater elongation at rupture (its tensile strength at 200 percent elongation is 500 psi), hence well suited where bending is a requirement as in portable cables.

### *"Unipass" Jackets*

This construction is obtained merely by increasing the thickness of the insulation which is extruded by a single pass. By virtue of the inherent toughness of the insulation surface, a nominal increase of the insulation thickness over what is required for the voltage rating is regarded as the equivalent of a separate jacket. This process is only suitable if the insulation surface is satisfactory to meet installation conditions.

### *No Jacket Requirements*

In this category are the single-conductor NEC Types TW and THW and the RHW-RHH and XHHW cross-linked polyethylene insulated cables. These cables have no jacket over the insulation, and the insulation is not increased in thickness because of lack of jacket. The normal insulation surface is considered sufficiently tough to resist normal conditions. Some of these conductors, however, require installation in conduit, duct, or on rigid supports to meet NEC requirements.

## **Tapes and Shielding Materials**

As outlined on page 8-1 the materials required to complete a cable other than conductor, insulation, and jacket depend on kV rating and whether or not the cable is to have conductor shielding and insulation shielding.

### *Insulating Tapes*

Insulating tapes of various kinds are sometimes used in the assembly of single- or multi-conductor cables, and they also are used for insulation at splices and terminals. The desired requirements for a tape suitable for the insulation body of a splice or terminal are as follows (1) dielectric constant not over 3.2; (2) can be stretched to just short of its breaking point during application; and (3) has a shelf life before use of at least 5 years without loss of quality. Polyvinyl chloride tape of lesser insulation quality (dielectric constant up to 10.0), but well suited for exterior use, is also used as a covering over the main insulation body of splices and terminals. Semi-conducting and metallic tapes also are used for shielding and for splicing the shielding. Care must be taken to ensure that the tape is compatible with the components on which it is placed.

### *Shielding Materials and Shielding Methods*

*Insulation shields* consist of metallic non-magnetic tape, braid, wires, or sheaths. A fibrous or other nonmetallic covering, either conducting or non-conducting, is applied over the insulation. An additional covering may be applied over the first one; if the first is conducting, the outer one also must be conducting. Metal-tape shields must be electrically continuous. Similar insulation shielding may be of metal braid or of concentric round wires.

Shielding of multiple-conductor cables is applied over the insulation of the individual conductors, except that if the shielding is only for the purpose of reducing shock it may be applied over the whole conductor assembly. For single-conductor cable, the shielding effect of tubular, corrugated, or interlocked armor is supplemented by auxiliary nonmetallic shielding in intimate contact with the insulation and the metallic outer covering or sheath. A separate metallic shield is not required. However, when an insulating tape is bonded to the insulation, the tape is considered to be a part of the insulation, and the auxiliary nonmetallic shield should be applied directly over the insulating tape.

Insulation shielding is sometimes used as part of a circuit for relaying or for locating fault position. Consideration of such uses are beyond the scope of this book, as is description of the conditions under which the shield is open-circuited, short-circuited, and grounded.

*Conductor shields* consist of conducting nonmetallic tape, extruded compound, or cement. They are applied over the surface of the conductor.

The various thicknesses of both insulation and conductor shields are specified by ICEA for the various types of cables and applications.

### *The Effect of Corona on Insulation and Shielding*

As described in Chapter 3, whenever air is stressed electrically beyond its breakdown point, the air will ionize

TABLE 8-5

Specifications for Rubber or Thermoplastic *Jackets* for Insulated Conductors and Cables  
 Abstract from ICEA-NEMA Publication S-19-81-WC-3

1. ICEA S-19-81 Paragraph No.	S4.13.2	S4.13.3	S4.13.4	S4.13.5	S4.13.6	S4.13.7	S4.13.8	S4.13.9
2. Description	Synthetic Rubber SBR	Neoprene Heavy Duty Black	Neoprene General Purpose Black & Colors	Polyvinyl Chloride	Polyethylene Black	Nitrile Butadiene PVC-Black & Colors Heavy Duty	Nitrile Butadiene PVC-Black & Colors General Purpose	Chloro-Sulphonate Polyethylene Heavy Duty
3. Minimum temperature* for cold weather applications				-10°C	-40°C	-25°C	-25°C	
4. Tensile strength, psi, min.	1800	1800	1500	1500	1400	1800	1500	1800
5. Elongation % at rupture, min.	300	300	250	100	350	500	250	300
6. Aging requirements (air-oven) Test at °C for hrs.	70-168	100-68	100-68	100-5 days	100-48	100-68	100-68	100-68
7. Tensile strength, min. Values as % unaged value	1600**	50	50	85	75	50	50	85
8. Elongation, min. Values as % unaged value	250**	50	50	60	75	50	50	65
9. Aging requirements (oxygen pressure) Test at °C for hrs.	70-96							
10. Tensile strength, min. Values as % unaged value	1600**							
11. Elongation, min. Values as % unaged value	250**							
12. Oil immersion at °C for hrs.		121-18	121-18	70-4		121-18	121-18	121-18
13. Tensile strength, min. Values as % unaged value		60	60	80		60	60	60
14. Elongation, min. Values as % unaged value		60	60	60		60	60	60

\*Because the temperature gradient through insulation and jacket during operation assures a comparatively cool jacket, the minimum air temperature at which jacket cracking will not occur is listed.

\*\*Discrete minimum values for tensile strength (psi) and elongation (percent) rather than "percent of unaged value."

Applicable to materials having a nominal thickness of 0.030 in. and up. See also NOTE on Table 8-2.

NOTE: The air-aging tests for neoprene jackets for portable cables are based on 70°C for 168 hrs instead of 127°C for 20 hrs. The oxygen test for S4.13.5 is omitted, but an oil-immersion test is made.

NOTE: Some of these jacket materials also are used as weatherproof semi-insulation coverings where conductor rating does not exceed 600 volts phases-to-phase.

## covered and insulated wire and cable

with the emission of ozone. The visible manifestation of this ionization is corona, the characteristic bluish glow that sometimes can be seen at night along bare overhead high-voltage transmission lines. It is not only necessary that the insulation have suitable resistance to the chemical action of ozone, but it also must withstand the tendency for burning that may occur as a result of corona-discharge current.

Corona-discharge effects are greatest in voids in the insulation or between conductor and insulation or shielding. A "corona-level" test determines the absence of such voids that can cause local deterioration of the insulation, provided the actual operating voltage is less than the rated corona-level voltage.

The corona-level values listed in Tables 8-2, 8-3 and 8-4 are to be considered in relation to phase-to-ground voltage. Thus, for insulation described in Col. S3.15 of Table 8-2 a cable used in a three-phase 15 kV circuit has line-to-neutral voltage of  $15.0/1.73 = 8.7$  kV. The corona-level requirement is listed as 11.0 kV; hence insulation thickness that meets this requirement is suitable, provided it is satisfactory otherwise.

The strand and insulation shields are so designed as to prevent ionization between the inner surface of the insulation and the conductor and its outer surface and the metallic insulation shield. A simpler form of insulation shielding is provided by the use of concentrically applied wires for potential-gradient control.

### Sheaths, Fillers and Binders

The various kinds of metal-clad, armored, or sheath-enclosed cables are described in other chapters. Additional details as to the sheath materials, as well as fillers, and binders, overall jacketing, etc., are in ICEA and NEC publications.

### ICEA Performance Specifications

As previously mentioned, insulation and related materials for cables are specified according to performance instead of by composition and processing. An abstract of the principal performance values applying to commercial insulations is in Tables 8-2, 8-3 and 8-4, which with the explanatory footnotes provide data as a guide to insulation selection. Similar information applying to jacket materials is in Table 8-5. Several early-type insulations still are listed in the ICEA publication from which Table 8-2 was compiled, but they are purposely omitted from Table 8-2 because they are obsolete.

The following explanation of some of the terms used in the tables may aid their use. Further details are in the referenced ICEA publications.

#### Insulation Resistance

(*K* (item 6) and formula in note to Table 8-2.)

The insulation resistance is obtained in megohms for a cable 1000 ft long, measured after one-minute's applica-

tion of constant dc potential. As the resistance is measured through the insulation to the outer surface, the elements of current are in parallel; hence the insulation resistance will be one-half as much for a cable length of 2000 ft, or ten times as much for a cable 100 ft long. The test to determine one-minute dc insulation resistance by use of an immersed cable is at 15.6°C, and made after a constant dc potential has been applied for one minute. The ICEA standards contain adjustment factors for other temperatures. This one-minute dc value of insulation resistance principally is used for rough comparison of insulation quality; and it is far from accurate because tests at other times than one minute may show wide differences and under *ac* conditions a different value is obtained. See Appendix 8A for further discussion of insulation resistance  $R_{(ac)}$  under ac conditions.

#### Water Absorption

By use of the *electric* method, the increase in capacitance above that of a dried block of insulating material when it is immersed and subjected to 60 Hz (EM 60 test) is an indication of the water absorption, as compared with results of similar tests on other insulations. By use of the *gravimetric* method, the actual increase in weight of the dried specimen of standard size after immersion for a specified time is divided by the total surface area of the specimen.

#### Temperature

Tables 8-2, 8-3 and 8-4 list only the maximum temperature for normal operation. Because of occasional operation at a higher temperature (emergency-overload conditions) or for an extremely short time (short-circuit conditions) additional data from the ICEA standards is supplied for some of the insulations in Table 9-7.

### NEC Designations

The following summary of the most commonly used NEC letter-designations used for describing insulations and cable constructions may be helpful for understanding specifications that include NEC abbreviations. This summary relates *only to power cables* of the usual kinds. There are limitations and exceptions, so the abbreviations must be used with caution. Refer to NEC for full information.

#### Insulation Materials:

R = Rubber (natural or synthetic).

T = Thermoplastic, usually flame-retardant polyvinyl chloride or polyethylene. However, TA and TBS are not flame retardant, though can be made so by suitable outer covering.

X = Cross-linked thermosetting polyethylene, as used in XHHW.

FEP = Fluorinated ethylene propylene.

*Heat-Resistant Quality*

Without "H" = Usually suitable for 60°C.

H = Usually suitable for 75°C.

HH = Usually suitable for 90°C (except XHHW only when dry).

*Moisture and Oil-Resistant Quality*

Without "W" = Usually suitable for dry locations.

W = Usually suitable for wet and dry locations.

M = Usually suitable for oily conditions (machine-tool circuits). Do not confuse with "M" for metal as part of MC (metal-clad) for instance.

*Jackets and Sheaths (as part of a single conductor)*

Note: NEC does not use abbreviations for several jacketing materials (see Table 8-5).

N = Nylon.

BS = Fibrous braid.

B = Glass, mica, or asbestos braid.

L = Lead sheath.

*NEC Cable Constructions*

MC Metal-clad, with interlocking armor or close-fitting corrugated tube.

AC Armor-clad, with flexible metal tape.

ACL Same as AC, but with lead sheath.

ACT Same as AC, but the moisture-resistant fibrous covering need only be on the individual conductors.

NM Nonmetallic sheathed cable.

NMC Same as NM, but must be fungus and corrosion resistant.

SE Service-entrance cable (also suitable for interior wiring under certain conditions). Not suitable for direct burial.

USE Underground service entrance cable, also suitable for direct burial.

UF Underground feeder cable, also suitable for direct burial under certain conditions.

*Insulating Compounds designated by NEC symbols*

If the symbol contains *R*, the compound is principally synthetic or natural rubber; if it contains *T*, it is a thermoplastic material; if it contains *X*, it is a cross-linked thermosetting material. Other letters are as previously indicated; e.g., *N* indicates nylon jacketing.

RW or TW for dry or wet locations at 60°C

RH for dry locations at 75°C

RHH or THHN for dry locations at 90°C

RHW, THW, or THWN for dry or wet locations at 75°C

XHHW for dry locations at 90°C and wet at 75°C

## APPENDIX 8A

### Elements of Dielectric Theory

This appendix contains information that is generally understood by electrical engineers, but it may be helpful as a reference to some of the terms used in the tables and as the basis for calculation of charging current.

*Dielectric Constant* ( $\epsilon_r$ ). Also designated *specific inductive capacity* (*k*), *relative permittivity*, and similar terms.

For a vacuum  $\epsilon_r = 1$ , and for air it is 1.0006, hence for engineering calculations, the difference is neglected. The dielectric constant ( $\epsilon_r$ ) of a substance is the ratio of the capacitance of a condenser with the substance as the dielectric to the capacitance of the condenser with air as the dielectric.

Thus, an insulator with a large  $\epsilon_r$  acquires a greater charge of electricity in coulombs *Q* for a given potential difference between its faces than will an insulator with a small  $\epsilon_r$ . The *capacitance C* of an insulator, usually measured in microfarads, is thus proportional to  $\epsilon_r$ , provided

conditions of temperature, time, dryness, and applied voltage are the same. A low  $\epsilon_r$  is an apparent indication of superior insulation quality. However, a low  $\epsilon_r$  when dry may be much increased because of water absorption or other factors, and such variations are different in various materials.

*Charging Current and Leakage-Conduction Current*

It is convenient to consider the current input into an insulator after voltage is applied as being in two parts: (1) a *charging* (or *displacement*) current *I<sub>c</sub>* that serves to increase the potential of the insulator by accumulating a quantity of electricity (coulombs *Q*) in the body of the insulator, and (2) a *leakage-conduction* current *I<sub>e</sub>*, in phase with the applied voltage, that supplies energy to heat the insulator (because of its internal dielectric stresses) and to supply the energy losses associated with the current that passes through the insulator or across its surface.

## covered and insulated wire and cable

The charging current  $I_c$  does not represent energy loss because after withdrawal of the voltage an equal current is discharged from the dielectric. The leakage-conduction current  $I_e$  represents energy loss,  $E I_e$ , or as indicated by the relationship  $R = E/I_e$ , in which  $R$  is the *insulation resistance\** as usually measured according to ICEA standard, assuming standard conditions (see page 8-12) of Chapter 8 and Tables 8-2 through 8-5). The insulation resistance varies through a wide range depending on the dielectric and temperature as shown by Table 8A-1, which is an abstract of Table 6-21 of ICEA Standard S-19-81.

### Charging and Leakage-Conduction Currents Under Direct and Alternating Potential

Because insulation resistance is found by test under continuous application of potential (for one minute, according to ICEA standard), the rate of increase of charge  $Q$  within the insulator and the consequent rate of reduction of input current  $I_c$  will differ from what occurs when the emf is alternating, as is the usual condition. When a constant dc emf is applied, an appreciable time is required for the insulation to acquire its full charge if its  $\epsilon_r$  is greater than 1. For some insulations, it may take a half hour or more for equilibrium to be achieved so no further charging current flows.

When subjected to alternating potential, however, the insulator (dielectric) is being charged and discharged at short intervals (1/120 sec at 60 Hz). Less than a full charge is acquired by the insulator at each voltage peak because the time is so short. This effect under alternating potential is taken into account by the concept of *Capacitive Reactance*  $X'_c$ , in ohms, as follows:

$$X'_c = 1 / (2\pi f C) \quad (\text{Eq. 8A-1})$$

where  $f$  = frequency, Hz;  $C$  = capacitance in farads for the stated frequency

Many tables only show  $X'_c$ . The corresponding value of  $C$  is readily determined by inverting the above equation to  $C = 1 / (2\pi f X'_c)$

The charging current  $I_c$  in amperes is as follows:

$$\overline{I_c} = \frac{E \text{ (to neutral)}}{X'_c} = 2\pi f C \overline{E} \quad (\text{Eq. 8A-2})$$

where  $E$  = volts to neutral, and the other terms are as previously defined. In practice,  $X'_c$  is obtained from tables, nomogram, or formula in a similar manner as described in Chapter 3 for bare conductors.

\*It is important to distinguish between the insulation resistance  $R$ , measured at one minute after applying dc potential according to the ICEA test method, and  $R(ac)$  that reflects the reduced capacitance under ac conditions. The latter value is a function of charging current  $I_c$  at the given frequency and insulation power factor; that is,  $R(ac) = E / (I_c \times \text{p.f.})$ , in which  $E$  is volts to neutral (see the next section and example at end of this Appendix).

The leakage-conduction current  $I_e$  may be calculated from data as to insulation resistance after correction for temperature, or by multiplying the charging current by the power factor that often is listed as a property of the insulation.

### Total Dielectric Current and Power Factor Under ac Conditions

The charging current  $I_c$  depends on rate of change of applied voltage, hence its peak occurs when the voltage is changing at its most rapid rate; i.e., when the voltage is at zero point of its wave. The leakage-conduction current  $I_e$  is in phase with voltage. The two currents, and voltage, are shown vectorially in Fig. 8A-1. The resultant of  $I_c$  and  $I_e$ , shown as  $I$ , is slightly out of phase with  $I_c$  by angle  $\delta$ . The *power factor* of the insulation is the ratio of  $I_e$  to  $I_c$ , closely equal to  $\tan \delta$ , and it is usually expressed as a percent; that is, if  $I_e/I_c$  is 0.005, the power factor is usually designated as 0.5%.

The *total dielectric current*  $\overline{I} = (I_c^2 + I_e^2)^{1/2}$ . Usually  $I_e$  is so small with reference to  $I_c$  that it is neglected and the charging current  $I_c$  is considered to be the total dielectric current  $I$ .

### Dielectric Constant ( $\epsilon_r$ ) Under ac Conditions

The calculation of dielectric constant by measuring capacitance under conditions of steadily applied constant potential is not practicable for insulated-conductor studies. Instead, the usual practice is to find the capacitance of a cable of specified size and length under ac potential of specified frequency, and to compute the dielectric constant from the known relation that the capacitance of the air space occupied by the volume of insulation is 1.0. Then by geometry and suitable conversion of terms,

$$\text{Dielectric Constant } (\epsilon_r) = 13\,600 C \log_{10} (D/d)$$

$$\text{where} \quad (\text{Eq. 8A-3})$$

$C$  = Capacity in microfarads of a 10-ft section of cable at 60 Hz.

$D$  = Diameter over the insulation in any units

$d$  = Diameter under the insulation in the same units

Capacitance of the cable also may be determined when frequency is 1000 Hz, but it should be so stated.

### Capacitance of Insulated Aerial Cables

The capacitance of an insulated cable with ungrounded sheath, suspended in an overhead distribution line and well separated from the return conductor, is practically the same as that of a bare conductor under the same conditions. The slight increase in capacity of the insulation caused by an  $\epsilon_r$  greater than 1.0 extends through such a small distance (the thickness of the insulation) that it does not significantly affect the capacity (or the capacitive reactance  $X'_c$ ) between the conductors. Hence the tables in Chapter 4 for shunt capacitive reactance may be used for both bare and insulated conductors suspended comparatively far apart.



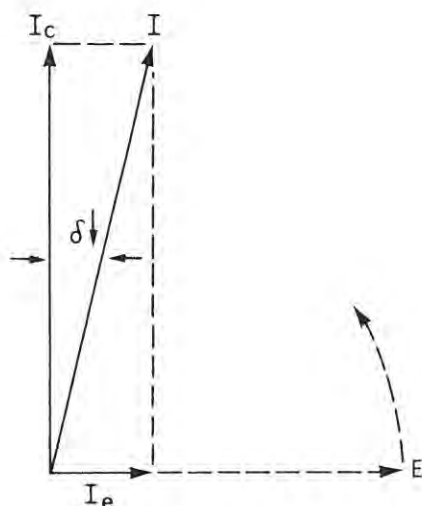

Fig. 8-A1. Vectorial Relationship of Charging Current  $I_c$ , Leakage-Conduction Current  $I_e$  and Total Dielectric Current  $I$  in an insulator, in time-relationship with EMF vector  $E$ .  $I_e/I_c = \tan \delta = \text{Power Factor}$ .

TABLE 8A-1

Typical Temperature Corrections for Insulation Resistance at 15.6°C (60°F) for Other Temperatures; An Abstract of Table 6-21 of ICEA S-19-81 (1980)

NOTE: From insulation test report, the ratio of insulation resistance at 61°F to its value at 60°F is noted, thereby obtaining Coefficient for 1°F which is used to select which vertical column is used. Thus, assuming the Coefficient is 1.06, and insulation resistance at 15.6°C is  $13.3 \times 10^{13}$  ohms for 1000 ft, the resistance at 23.9°C (75°F) is  $2.40 \times 13.3 \times 10^{13} = 31.9 \times 10^{13}$  ohms for 1000 ft. As the resistances for adjacent lengths are in parallel, the resistance of a 2000 ft length is one-half of that of 1000 ft; and for 100 ft is ten times as much.

Temperature		Coefficient for 1°F									
F°	C°	1.03	1.04	1.05	1.06	1.07	1.08	1.09	1.10	1.11	1.12
50	10.0	0.74	0.68	0.61	0.56	0.51	0.46	0.42	0.39	0.35	0.32
55	12.8	0.86	0.82	0.78	0.75	0.71	0.68	0.65	0.62	0.59	0.57
60	15.6	1.00	1.00	1.00	1.00	1.00	1.00	1.00	1.00	1.00	1.00
65	18.3	1.16	1.22	1.28	1.34	1.40	1.47	1.54	1.61	1.69	1.76
70	21.1	1.34	1.48	1.63	1.79	1.97	2.16	2.37	2.59	2.84	3.11
75	23.9	1.56	1.80	2.08	2.40	2.76	3.17	3.64	4.18	4.78	5.47
80	26.7	1.81	2.19	2.65	3.21	3.87	4.66	5.60	6.73	8.06	9.65
85	29.4	2.09	2.67	3.39	4.29	5.43	6.85	8.62	10.8	13.6	17.0

NOTE: Linear interpolation in the vertical columns is satisfactory, or a curve may be drawn.

**covered and insulated wire and cable**

*Capacitance of Insulated Conductors With Grounded Sheath or Directly Buried*

Where the insulated conductor has a grounded sheath, its capacitance is a function of diameter, insulation thickness, and dielectric constant of the insulating material  $\epsilon_r$ , as follows:

$$C = (0.00736 \times \epsilon_r) / \log_{10} (D/d),$$

where (Eq. 8A-4)

- $C$  = Capacitance in  $\mu$ farad per 1000 ft
- $\epsilon_r$  = Dielectric constant
- $D$  = Outside diameter of insulated conductor
- $d$  = Diameter of metallic conductor

An approximation of  $C$  for an insulated conductor without metallic grounded sheath but contained within a grounded metallic duct may be obtained from the above equation if an average  $D$  is estimated, and  $\epsilon_r$  is reduced to take into account that  $\epsilon_r$  of air is 1.0, applying to the space between the exterior of the conductor insulation and the metal duct.

*Example of Dielectric Computation*

The previously stated principles are the basis of the following computation:

*Given:*

A #4/0 AWG aluminum single conductor, 19 strands, 0.528" diameter, a semi-conducting tape strand shield and 0.110" wall of cross-linked polyethylene insulation, in metallic sheath, in 3-phase circuit at 2.4 kV with grounded neutral, 60 Hz. For this cable the dielectric constant  $\epsilon_r$  is 2.7, and power factor  $\tan \delta$  is .01, or 1.0%.

*Find:*

Capacitance, microfarads per 1000 ft.; designated as  $C$ . ac Resistance, megohms for 1000 ft.; designated as  $R(ac)$ . Charging current, amperes per 1000 ft.; designated as  $I_c$ . Dielectric loss, watts per 1000 ft.

From Eq. 8A-4

$D = 0.528 + 2(0.110) = 0.748$  in.;  $d = 0.528$  in.;  $D/d = 1.417$ ;  $\log_{10} 1.417 = 0.1513$ ; and substituting in Eq/8A-4.  $C = (0.00736 \times 2.7)/0.1513 = 0.1313$   $\mu$ farads per 1000 ft.

The following relationship is also known:  
 $\tan \delta = 0.01 = I_c/I_c = (E/R_{ac}) / (2\pi fC) = 1/1(2\pi fC R_{ac})$ , in which  $C$  is in farads

Substituting, transposing, and expressing 0.1313  $\mu$ farad as farads

$$R_{ac} = \frac{1}{2\pi \times 60 \times 0.1313 \times 10^{-6} \times 0.01} =$$

2 020 000 ohms for 1000 ft.  
(2.02 megohms)

$$\text{Charging current } I_c = \frac{E \text{ to neutral (volts)}}{1 / (2\pi f C \text{ (farads)})} =$$

$$\frac{2400 \times 2\pi \times 60 \times 0.1313}{3^{1/2} \times 1\,000\,000} = 0.0686 \text{ amp per 1000 ft.}$$

Watts loss

$$\text{per conductor } I_c E = \frac{0.0686 \times 2400 \times 0.01}{3^{1/2}} = \frac{0.951}{\text{watts per 1000 ft.}}$$

## Chapter 9

## Engineering Design as Related to Cable Applications

The data in this chapter provide the application engineer with certain formulas and tables that can be used to advantage when selecting cable for ordinary uses. It is assumed that he has available the latest National Electrical Code (NEC), and that the helpful supplementary tables prepared by wire and cable manufacturers to aid NEC applications are at hand. The mathematical basis for some of these tables is described herein, and a few are abstracted. The important comprehensive tables relating to cable construction, applications and ampacity issued by ICEA-NEMA are also explained. Many equations and tables principally relating to cable *design* as distinct from *applications* are omitted, as beyond the scope of this book.

Descriptions of cable components and their functions, and of the various kinds of insulations, are in Chapters 7 and 8.

The design factors that influence the selection of a suitable aluminum cable are electrical, mechanical, thermal, ability to withstand unusual environments, ampacity, short-circuit rating, and operational-costs, including investment charges. Some of these factors are considered in this chapter.

### Cable Diameter

Most lists of cables show the outside diameter from which a suitable duct size or other support provision may be determined, sufficient to accommodate any distortion that may occur in the cable because of thermal expansion. If the cable diameter is not known, it may be estimated from the dimension of its elements as follows:

$$D_i = d + 2T \text{ for single conductor cable} \quad (\text{Eq. 9-1})$$

$$D_i = 2(d + 2T) + 2t \text{ for round duplex cable} \quad (\text{Eq. 9-2})$$

$$D_i = 2.155(d + 2T) + 2t \text{ for 3-conductor cable} \quad (\text{Eq. 9-3})$$

$$D_i = 2.414(d + 2T) + 2t \text{ for four-conductor cable} \quad (\text{Eq. 9-4})$$

Where

$D_i$  = Inside diameter of sheath

$T$  = Insulation thickness over the conductor

$d$  = Conductor diameter

$t$  = Belt thickness (under outer sheath)

The diameters of cables of over four conductors contained within a single circular outer sheath are obtained, either as round conductors or as twisted pairs, as follows:

$$D_i = f(d + 2T) + 2t \quad (\text{Eq. 9-5})$$

where  $f$  = the factor in Table 9-1, and other values are as above stated.

*Example:* What is the minimum diameter of the inside of the outer sheath of a 12-conductor No. 2/0 AWG aluminum cable when conductors are assembled in parallel and in twisted pairs, assuming  $d = 0.419$  in.,  $T = 0.078$  in.,  $t = 0.080$  in.?

Substituting in Eq. 9-5

For single parallel conductors (for 12 conductors, " $f$ " = 4.155,

$$D_i = 4.155(0.419 + 0.156) + 0.160 = 2.55 \text{ in.}$$

For twisted pairs (6 pairs, " $f$ " = 4.60):

$$D_i = 4.60(0.419 + 0.156) + 0.160 = 2.81$$

### Duct, Conduit and Raceway Installations

The terms "duct" and "conduit" may be used interchangeably to refer to non-metallic raceways made of such materials as transite, fiber, concrete or plastic. Tubular metallic raceways of steel or aluminum are generally designated "conduit." The cable is run loosely into the duct or conduit as distinct from having the metallic outer covering closely fitting, as with a lead sheath. The electromagnetic field surrounding a cable carrying alternating current does not induce stray currents in a non-metallic raceway, but it does cause eddy-current loss in metallic conduit, and also hysteresis loss if the conduit is of magnetic material.

The eddy-current and hysteresis losses in conduit are reduced if the conduit contains the two or three conductors that comprise a single circuit because their external fields tend to cancel. The fields, however, will not exactly balance because the conductors are not located at exactly the same position with reference to the conduit wall, and also because of unbalanced loads, if any, in the conductors of the circuit.

Because the stray field surrounding a single conductor is not offset by an opposing field from an adjacent conductor, it is not customary to place a *single* conductor in a metallic conduit by itself because of the resulting high

**TABLE 9-1**  
**Factor "f" for Equation 9-5 for Use in**  
**Determining Cable Diameter Where Cable has More than Four Conductors**

Number of Conductors or Pairs	Factor "f"		Number of Conductors or Pairs	Factor "f"	
	Single Round Conductors	Twisted Pairs		Single Round Conductors	Twisted Pairs
1	1.0	—	21	5.310	8.10
2	2.	2.414*	22	5.610	8.25
3	2.155	3.50	23	5.610	8.45
4	2.414	3.85	24	6.000	8.80
5	2.700	4.35	25	6.000	8.95
6	3.000	4.60	26	6.000	9.15
7	3.000	4.75	27	6.155	9.25
8	3.310	5.20	28	6.240	9.35
9	3.610	5.50	29	6.240	9.50
10	4.000	5.85	30	6.414	9.70
11	4.000	6.10	31	6.550	9.80
12	4.155	6.25	32	6.550	9.95
13	4.240	6.40	33	6.700	10.20
14	4.414	6.70	34	7.000	10.30
15	4.550	6.90	35	7.000	10.35
16	4.700	7.20	36	7.000	10.40
17	5.000	7.35	37	7.000	10.50
18	5.000	7.50	61	9.000	—
19	5.000	7.60	81	10.550	—
20	5.310	7.80	91	11.000	—

\*Pairs cabled in the same direction of lay as the twist of the pairs.

losses. Instead, it is usual practice to place the cables that comprise a complete circuit in one conduit.

A 3-phase circuit requires at least three conductors. If the three-phase circuit includes a neutral, a fourth conductor is required. Three conductors also are suitable for the usual 3-wire single-phase lighting circuit. The three conductors may be parallel side-by-side or they may be triplexed as a spiraled assembly.

The interior of a duct or conduit must be large enough to accommodate cable flexing and distortion because of thermal expansion. NEC and other Standards specify the maximum number of cables of a given size that can be installed within a raceway.

Also, because cable ac/dc resistance ratio increases with cable size, it is sometimes advisable to divide a given load among several parallel circuits as a means of reducing losses, providing this practice can be economically justified. The cable-loss ratio for the condition depicted in Fig. 9-1 (the overall ac/dc ratio) is seen to be 1.30 for 1000 kcmil cable and 1.11 for 500 kcmil cable.

*Spacing Between Cables*

Calculation of series inductive reactance (and of shunt capacitive reactance of long high-voltage cables in duct) is usually on the basis that the outer surface of the cable insulation is at neutral potential, and that the cables in the duct touch each other, or nearly touch.

and shielding (but not external metallic armor) as used for cables of various voltages and insulations. Manufacturer's lists, NEC, ICEA and AEIC publications should be consulted for more accurate values.

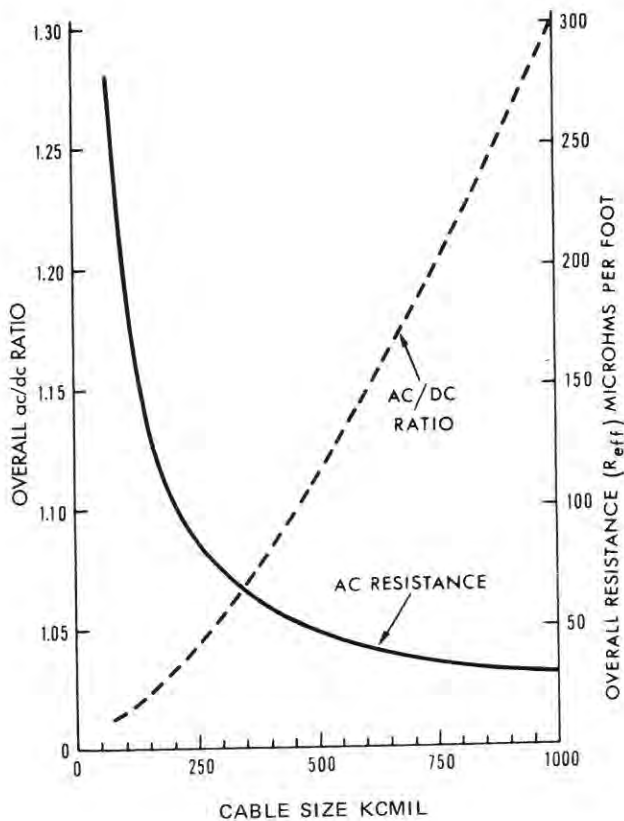

Fig. 9-1. Illustration of change in overall resistance ( $R_{eff}$ ) and ac/dc 60 Hz ratio as conductor size increases for each conductor of a triplexed 3-conductor assembly of insulated cable, Class B concentric stranded, in steel conduit at 25 kV, grounded-neutral, 75°C conductor temperature, insulation p.f. = 0.035, with short-circuited shields and sheaths.

Data from ICEA publication No. P-46-426, Vol. 2, page 265.

To facilitate obtaining this spacing Table 9-2 is provided, showing average outside diameter of typical cables of various kinds, taking into account the usual jacketing

### Cable-Conductor Resistance

The resistance of the conductor of a cable in ohms per unit length is required for computing voltage drop,  $IR$ , and for computing energy losses,  $I^2R_{eff}$ , in which  $R_{eff}$  is the resistance in the  $I^2R_{eff}$  term which includes all losses associated with the cable, such as skin and proximity effects, shield, sheath and conduit losses, and insulation losses.

The alternating current resistance of Class B concentric stranded aluminum cables at the secondary distribution voltages at 60°C, 75°C, and 90°C is listed in Table 9-3 for two typical conditions of installation. The corresponding direct current resistance also is shown. The ac resistance includes skin- and proximity-effects, and also the increase caused by use of steel conduit provided the two or three conductors of one circuit are contained within one conduit. If an aluminum conduit is used the resistance increase for conduit may be neglected for sizes 4/0 and smaller, and for larger sizes the amount of increase above that of the nonmetallic-conduit condition is estimated in the manner shown on the table (see also Eq. 9-6, page 9-8). An explanation of the various ac/dc ratios and their use follows:

When determining ampacities, it is a conservative assumption that all heat generated in any part of the cable originates in the conductor. This is not strictly true because, for example, heat generated from eddy-current losses in a sheath or conduit does not affect conductor temperature as much as will the same amount of heat generated in the conductor itself. Regardless of this variation of point of heat origin it is customary to assume that for energy-loss computations, as stated, the resistance of a cable carrying alternating current is increased above its resistance measured by direct current by such an amount as will reflect the above mentioned losses. However, for precise estimates of conductor temperature and ampacity it is sometimes necessary to separate the heat losses into two parts, (1) that caused by skin effect and proximity effect in the conductor itself and (2) that caused by losses in the insulation, shields, and sheaths, and in the latter category is loss arising from circulating eddy currents and hysteresis losses in the surrounding metallic conduit, depending on whether it is aluminum or steel.

The usual measure of these energy-loss effects is the ac/dc ratio; that is, for a given condition the dc resistance of the circuit is assumed to be increased by the ac/dc ratio so that when this ac resistance is multiplied by  $I^2$  the total energy losses are obtained.

insulated aluminum conductors

**TABLE 9-2**  
**Comparison of Conductor Diameter and Approximate Cable Outside Diameter of Typical**  
**Single, Class B Concentric-Stranded Aluminum Cables.**  
**Voltages are ac Line-to-Line with Grounded Neutral\* Except as Stated**  
 (See explanation at bottom of table regarding values in italics)

Size AWG or kcmil	Conductor Diameter (inches)	Approx. Outside Diameter of Cable (inches) Thermosetting or Thermoplastic Insulation							
		600V	1kV	Non-shielded 5kV**	Fully Shielded				
					5kV	15kV	25kV	35kV	46kV
6	0.184	0.32	0.34	0.62	0.74				
				<i>0.42</i>	<i>0.61</i>				
4	0.232	0.37	0.39	0.67	0.79				
				<i>0.47</i>	<i>0.64</i>				
2	0.292	0.43	0.45	0.73	0.88	1.16			
				<i>0.53</i>	<i>0.71</i>	<i>0.94</i>	1.16		
1	0.332	0.51	0.53	0.77	0.92	1.20	1.68		
				<i>0.57</i>	<i>0.75</i>	<i>0.98</i>	1.22		
1/0	0.373	0.55	0.57	0.85	0.96	1.24	1.72		
				<i>0.61</i>	<i>0.79</i>	<i>1.02</i>	1.26	1.45	
2/0	0.418	0.60	0.62	0.89	1.00	1.29	1.77		
				<i>0.66</i>	<i>0.89</i>	<i>1.07</i>	1.30	1.50	
3/0	0.470	0.65	0.67	0.95	1.06	1.34	1.83		
				<i>0.74</i>	<i>0.94</i>	<i>1.12</i>	1.35	1.55	1.82
4/0	0.528	0.71	0.73	1.01	1.11	1.40	1.92		
				<i>0.77</i>	<i>1.00</i>	<i>1.18</i>	1.40	1.61	1.87
250	0.575	0.79	0.81	1.08	1.20	1.44	1.96		
				<i>0.84</i>	<i>1.04</i>	<i>1.23</i>	1.46	1.65	1.92
350	0.681	0.90	0.92	1.18	1.31	1.56	2.06		
				<i>0.94</i>	<i>1.15</i>	<i>1.33</i>	1.58	1.80	2.03
500	0.813	1.03	1.05	1.32	1.44	1.75	2.17		
				<i>1.07</i>	<i>1.28</i>	<i>1.46</i>	1.76	1.97	2.24
750	0.998	1.25	1.27	1.50	1.63	1.93	2.38		
				<i>1.26</i>	<i>1.44</i>	<i>1.62</i>	1.95	2.14	2.34
1000	1.152	1.40	1.42	1.73	1.85	2.09	2.56		
				<i>1.46</i>	<i>1.65</i>	<i>1.88</i>	2.09	2.30	2.50
1250	1.289	1.58	1.60	1.91	2.02	2.26	2.73		
1500	1.412	1.70	1.72	2.04	2.13	2.38	2.96		
1750	1.526	1.82	1.84	2.15	2.22	2.49	3.07		
2000	1.632	1.92	1.94	2.29	2.36	2.61	3.13		

\*For voltages through 5 kV the diameters also apply if the neutral is ungrounded. For cables above 5 kV with ungrounded neutral or cables at 133% insulation level, consult manufacturer's lists.

\*\*The 5 kV non-shielded cable, as well as all shielded cables, have strand shielding.

The listed overall diameters of 600 volt cables are from Column 4 of Table 5 of NEC (1981) and are fairly representative of Type THW and triple-rated RHW/RHH/USE unjacketed cable with XLPE insulation; the values are increased by 0.02 in. for 1 kV. The values in the other columns that are in regular type correspond closely with those listed in ICEA No. P-46-426, Vol. II, 1962, when increased to allow for jackets. By omitting the jacket, sometimes a lead sheath

may be included without increase of diameter. The values in *italics* for 5 kV and above are representative of cables with XLPE insulation and include the thickness of PVC jackets on shielded cables. These diameters do not apply to cable with metallic armor.

Though the listed values are generally suitable for preliminary studies, important calculations should be made by use of actual diameter of the selected cable.

TABLE 9-3\*

**Resistance of Aluminum Cable with Thermosetting and Thermoplastic Insulation for Secondary Distribution Voltages (to 1 kV) at Various Temperatures and Typical Conditions of Installation**

Note: The metallic conduit is assumed to be steel. If aluminum is used, the effective resistance is about the same as for single conductor in nonmetallic conduit to 4/0 size, and for larger sizes is in the range ½%—2% more than the resistance of the conductor in non-metallic conduit, hence of little significance except in critical cases.

Class B—concentric strands  
Ohms per 1000 feet

Class B	*	60 Hz ac—60°C		*	60 Hz ac—75°C		*	60 Hz ac—90°C	
		One Single Conductor in Air, Buried, or in Nonmetallic Conduit	Multi-Cond. Cable or 2 or 3 Single Conductors in One Metallic Conduit		One Single Conductor in Air, Buried, or in Nonmetallic Conduit	Multi-Cond. Cable or 2 or 3 Single Conductors in One Metallic Conduit		One Single Conductor in Air, Buried, or in Nonmetallic Conduit	Multi-Cond. Cable or 2 or 3 Single Conductors in One Metallic Conduit
AWG or kcmil	dc at 60°C			dc at 75°C			dc at 90°C		
6	0.765	0.765	0.765	0.808	0.808	0.808	0.848	0.848	0.848
4	0.483	0.483	0.483	0.507	0.507	0.507	0.533	0.533	0.533
3	0.382	0.382	0.382	0.402	0.402	0.402	0.422	0.422	0.422
2	0.303	0.303	0.303	0.319	0.319	0.319	0.335	0.335	0.335
1	0.240	0.240	0.240	0.253	0.253	0.253	0.266	0.266	0.266
1/0	0.191	0.191	0.191	0.201	0.201	0.201	0.211	0.211	0.211
2/0	0.151	0.151	0.151	0.159	0.159	0.159	0.167	0.167	0.167
3/0	0.119	0.119	0.120	0.126	0.126	0.127	0.132	0.132	0.133
4/0	0.0953	0.0954	0.0963	0.101	0.101	0.102	0.105	0.106	0.107
250	0.0806	0.0808	0.0822	0.0847	0.085	0.0865	0.089	0.0892	0.0908
300	0.0672	0.0674	0.0686	0.0706	0.0708	0.072	0.0741	0.0744	0.0756
350	0.0575	0.0578	0.0593	0.0605	0.0608	0.0623	0.0635	0.0638	0.0654
400	0.0504	0.0507	0.0525	0.0530	0.0533	0.0552	0.0556	0.0560	0.058
500	0.0403	0.0406	0.0428	0.0424	0.0427	0.045	0.0445	0.0448	0.0472
600	0.0336	0.0340	0.0370	0.0353	0.0357	0.0381	0.037	0.0374	0.040
700	0.0288	0.0292	0.0320	0.0303	0.0307	0.0337	0.0318	0.0322	0.0353
750	0.0269	0.0273	0.0302	0.0282	0.0288	0.0317	0.0296	0.0302	0.0333
1000	0.0201	0.0207	0.0239	0.0212	0.0218	0.0253	0.0222	0.0228	0.0265
1250	0.0162	0.0176	0.0215	0.0169	0.0177	0.0216	0.0178	0.0186	0.0228
1500	0.0135	0.0143	0.0184	0.0141	0.015	0.0193	0.0148	0.0158	0.0203
1750	0.0115	0.0124	0.0168	0.0121	0.0131	0.0177	0.0127	0.0137	0.0186
2000	0.0101	0.0111	0.0158	0.0106	0.0117	0.0166	0.0111	0.0122	0.0173

\* Calculated from ICEA Resistance Tables for Class B stranding and corrected for temperature. For higher voltages or other installation conditions, see Table 9-4.

## insulated aluminum conductors

*Example:* A 15-kV, 1000 kcmil Triplexed rubber or thermoplastic insulated cable, class B concentric stranding, in steel conduit at 75°C, with insulation pf of 0.035, 60 Hz ac, and with short-circuited sheaths and shields (conduit grounded at end of run) has the following ac/dc resistance ratios for each cable:

Dc resistance at 75°C = 0.0212 ohms per 1000 ft

Ac resistance including skin- and proximity-effects = 0.02326 ohms per 1000 ft\*

Hence ac/dc ratio for conductor alone is  $0.02326/0.0212 = 1.096$

The ratio of sum of losses in conduit, sheath, and shields to loss in conductor is 1.167\*, designated by ICEA as the QE ratio.

The overall ac/dc ratio is  $1.167 \times 1.096 = 1.28$

The overall effective resistance for estimating total heating effect is  $1.28 \times 0.0212 = 0.0271$  ohms per 1000 ft ( $R_{eff}$ )

This example shows the high ac/dc ratio that may occur with cables of large diameter in steel conduit. The problem may further be aggravated by the low impedance shields on l/c cables of the URD/UD styles in use. For a 600-volt 1000 kcmil cable, the overall ac/dc ratio is only 1.126, and for a 4/0 cable it is less than 1.01.

Fig. 9-1 depicts a similar relationship for 25-kV cable.

The total heating effect, based on  $I^2R_{eff}$  is the basis of thermal calculations to determine ampacity ratings. These are not shown herein in detail, though ampacity tables based on them are explained in Appendix 9A.

### ac/dc Ratios for Aluminum Cables

Knowledge of ac/dc ratios applying to present-day types of aluminum insulated cables is essential for voltage-drop and ampacity calculations, and also for economic studies that compare investment and operating-cost factors.

Fortunately ICEA as part of its extensive report on ampacities of aluminum cables included data from which presently applicable ac/dc ratios may be obtained, and some of these values are listed in Table 9-4—for 1 kV as typical of the low voltage field, and for 15 kV as typical of moderate distribution voltages. The ICEA tables also list values for 8 kV and 25 kV for thermosetting and thermoplastic insulations, and up to 69 kV for solid impregnated paper insulated cables, which are sometimes used with aluminum. As present practice mostly applies for aluminum cables to those with thermosetting or thermoplastic insulations, Table 9-4 is based on these types. Values for the other standard cable voltages may be roughly estimated by extrapolation from the 1-kV and 15-kV values in Table 9-4, though reference to the source\*\* is required for accuracy.

\*Values from ICEA Pub. P-46-426, page 265, Vol. II.

\*\*The data in Table 9-4 are abstracted from ICEA Publication No. P-46-426 Vol. II (1962). Extensive additional information regarding ac/dc ratios is in ICEA *Publication Committee Report on Ac/Dc Resistance Ratios at 60 Cycles*, (1958). See also ICEA Pub. P-53-426.

The cable constructions to which Table 9-4 applies are as follows:

1. Single-conductor cables with metallic sheaths or shields installed in air, in separated ducts, or directly buried with separation, all with open-circuit sheaths or spiral concentric neutral (if directly buried).

Values are shown for air, and for duct and direct-burial (values are the same for duct and direct-burial) for a given voltage.

2. Triplexed 3-conductor cables with short-circuited sheaths or shields. The ac/dc ratios are the same for installations in air, duct, or direct burial, but are higher in conduit (all for a given voltage).

3. Three single-conductors arranged close together but not triplexed, with short-circuited sheaths or shields. The values at a given voltage are the same for installation in air, in duct, or directly buried, but are higher for conduit.

### General Conditions

#### Applying to Table 9-4

The insulations are rubber, rubber-like or thermosetting materials, or thermoplastic materials as indicated in the heading. These insulations are assumed to have 0.035 power factor, higher than generally accepted values, but the ICEA report specifies it as representative of average conditions after many years of use. In any event the contribution of dielectric loss to the total heat loss is small at voltages through 25 kV, hence an overly conservative value for p.f. is justified.

Other assumptions upon which the table is based are as follows:

Maximum conductor temperature is 75°C;

Conductor is Class B concentric stranded;

Grounded neutral is assumed, though for the 1-kV listing it may be ungrounded;

Strand and insulation shielding is assumed above 5 kV;

Nonmetallic jackets are included where required by cable design;

Losses in cable in air are based on no wind or solar radiation; in ducts, 30-in deep to cover; if buried, 36-in depth to cable axis;

Conduit grounded at end of run.

### Cables in Aluminum Conduit

The ICEA tables list ampacities and ac/dc ratios for cables in steel conduit. With aluminum conduit, there is no magnetic effect hence no hysteresis loss in the conduit. The eddy current loss also is much smaller in aluminum conduit than in steel because there is no increase of the field due to permeability. The eddy current loss in aluminum conduit is also less than it is in a lead sheath because the conduit wall is farther from the conductor. The increased loss because of eddy current in an alumi-





## insulated aluminum conductors

num conduit is so small that ordinarily it can be neglected in computations of ac/dc ratio where cables of one circuit are contained within a single conduit and each cable is 4/0 size or smaller. For larger cables, a conservative estimate of overall ac/dc ratio with aluminum conduit containing a complete circuit is obtained by using a QE value obtained as follows:

$$QE_{ac} = QS_d + (0.2 \times (QE_c - QS_d)) \quad (\text{Eq. 9-6})$$

where

$QE_{ac}$  = QE value for aluminum conduit

$QS_d$  = QS value from Table 9-4 for nonmetallic duct

$QE_c$  = QE value from Table 9-4 for steel conduit

*Example:* For the example appended to Table 9-4 the QS ratio at 75°C for duct is 1.070 and the QE ratio for steel conduit is 1.19. The QE for aluminum conduit, applying Eq. 9-6 is

$$QE_{ac} = 1.070 + (0.2 \times (1.119 - 1.070)) = 1.08$$

The overall ac/dc ratio, using the  $R_{ac}$  value for conduit from table (29.13), is ac/dc =  $(29.13/28.2) \times 1.08 = 1.11$  and  $R_{eff} = 28.3 \times 1.11 = 31.4$  microhms per ft (0.0314 ohms per 1000 ft).

### Series Inductive Reactance

The effect of series inductive reactance of a cable in a circuit is depicted by Fig. 9-2 (A and B) in which (A) shows volt-ampere vector relationship when the load power factor is almost 100%, and (B) shows it when load power factor is 80% ( $\cos \theta = 0.80$ ).

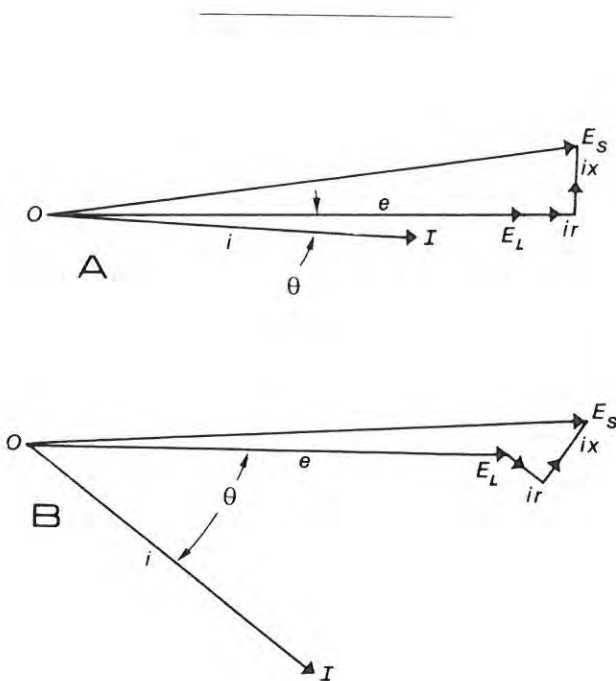

Fig. 9-2. Volt-Ampere Vector Relationship in Circuit Having Cable with Inductive Reactance: (A) for almost 100% p.f.; (B) for 80% pf.

where

$OE_s$  = Voltage vector at supply end

$OE_L$  = Voltage vector at load end

$OI$  = Current vector

$ix$  = Voltage-drop vector due to inductive reactance "x"

$ir$  = Voltage-drop vector due to resistance "r"

$\theta$  = Angle of lag of current vector in relation to  $OE_L$

As voltage drop  $ir$  is in phase with  $OI$ ,  $ir$  will be parallel to  $OI$ ; and as reactance drop  $ix$  is in quadrature with  $OI$ ,  $ix$  will be perpendicular to  $OI$ .

The diagrams are drawn to accentuate the relationships. In practice the  $ix$  vector is usually smaller than the  $ir$  vector and the angle between  $OE_s$  and  $OE_L$  is smaller. By reference to (A) it is noted that vector  $OE_s$  is almost the same length as vector  $(E_L + ir)$ , bearing out the well-known fact that inductive reactance does not significantly affect voltage drop in circuits of 100% load power factor. However, from (B) it is evident that  $ix$  considerably affects voltage drop (the difference between  $E_s$  and  $E_L$ ) when the power factor is significantly different from 100 percent.

### Series-Inductive-Reactance Calculation

The voltage-drop effect caused by series inductive reactance requires consideration for insulated cables in which the go-and-return conductors are close together as when triplexed or in duct or tray, and particularly if the load power factor is low. When cables are far apart, the inductive reactance is about the same as that of bare conductors, as described in Chapter 3.

The similar shunt capacitive reactance in short lines of moderate voltage usually may be neglected. Generally, it becomes significant only for insulated long lines, say 10 miles in length or over.

In the usual circuit supplying non-inductive load or one of lagging power factor, series inductive reactance in the supply conductors causes voltage drop at the load end; but if the load has leading power factor, such as with certain electric furnaces, the series inductive reactance may not be large enough to compensate for the capacitive reactance and the voltage in the load end would be greater than at the sending end.

Since the inductive reactance decreases with reduction of spacing between a conductor and the return conductor of the circuit which may be a ground, the minimum circuit inductance occurs when the insulation of both conductors touch. The distance between the centers of the conductors then is twice the thickness of insulation and covering plus the diameter of the metal conductor.

The method of computing inductive reactance may be according to the  $X_a X_d$  concept used in Chapter 3, but for small spacings it is convenient to apply Eq. 9-7, thus, for

2- or 3-conductors in non-magnetic duct or conduit:

$$X = 2\pi f (0.0153 + 0.1404 \log_{10} \frac{s}{r}) \times 10^{-3} \quad (\text{Eq. 9-7})$$

where

$X$  = Inductive reactance to neutral, of one conductor, ohms per 1000 ft.

$s$  = Spacing between centers of conductors, in.

$r$  = Radius of metal portion of the conductor, in., including strand shielding, if any

$f$  = Frequency, Hz (It is convenient to use 377 for  $2\pi \times 60$ )

The distance  $s$  (assumed average effective) for various conductor arrangements is per following diagrams:

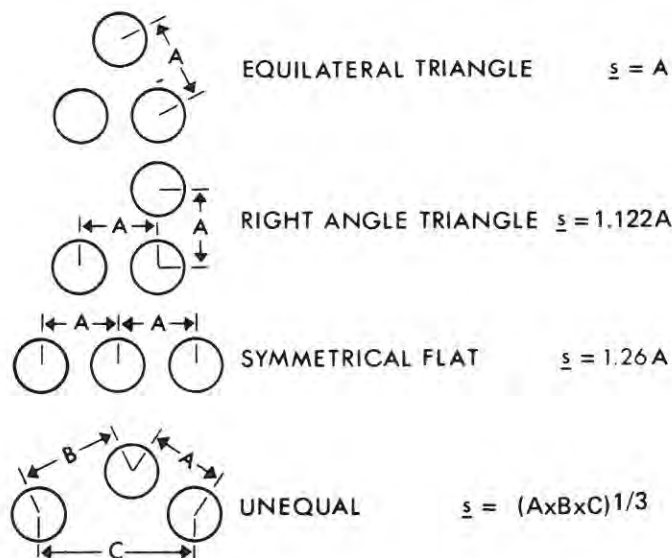

A useful nomogram, Fig. 9-3,\* aids use of Eq. 9-7. In the table of Corrections for Multi-Conductor Cables, the term "sector" refers to a single conductor in which the strands are arranged approximately as a 120° section of a circle (see Fig. 8-2b). The designation "single conductor" refers to one of several single conductors of a single circuit that lie loosely together in one conduit, not bound together or are closely adjacent on a support. The increase for "random lay" in this instance is the result of unequal spacing of the conductor in the conduit, perhaps caused by thermal flexing.

**Example 1:** From Fig. 9-3 find reactance of each of three single conductors in magnetic conduit, each 750 kcmil, concentric stranded. The outside diameter of each cable is 2.00 in., which is about average for a 15 kV cable, thus the arrangement is equilateral with outer jackets touching. Draw line from 750 kcmil to 2.00 in. spacing distance; it crosses the reactance scale at 0.038 ohms per 1000 ft. The random-lay plus magnetic-conduit adjustment is 1.5, hence the reactance per conductor is  $1.5 \times 0.038 = 0.057$  ohms per 1000 ft. This value, multiplied by rms amperes in the conductor, equals the  $i_x$  drop to neutral in volts for that conductor, per 1000 ft. length.

**Example 2:** Using the nomogram find reactance of each conductor of a 3-conductor 600-volt cable, each 250 kcmil, concentric stranded, 0.890 in. diameter in nonmagnetic conduit. The conductors are bound with tape as an equilateral triangle (triplexed). The outside diameter of each conductor is 0.89 in., which equals the spacing. From the nomogram the reactance is found to be 0.0315 ohms per 1000 ft, and from notation on the nomogram, no random-lay correction is necessary. If this cable is in a magnetic conduit, the reactance will be  $0.0315 \times 1.149$ , or 0.0362 ohms per 1000 ft. The presence of shield current in shielded cables alters the inductive reactance predicted by Eq. 9-7. Thus, care must be taken in the use of tables or nomograms neglecting this factor when dealing with cables having low resistance shields.

*Supplementary Table for Series Inductive Reactance*

For moderate insulation thicknesses, such as prevail in secondary distribution circuits, Table 9-5 provides closer numerical values for Eq. 9-7 than obtainable from the nomogram, but it is useful only for the particular condition stated in the table; namely, that the *separate* single conductors of one circuit are loose in the conduit, though in approximately equilateral arrangement. For any other of the usual conditions applying to single- or multi-conductor cables, it is generally simpler to use the nomogram together with the adjustment factors noted upon it.

**Example.** Three 250 kcmil conductors, each 0.890 in. diameter (insulation 155 mils thick) in non-magnetic conduit, approximately touching in equilateral arrangement. From Fig. 9-3, the reactance per conductor to neutral is 0.0315 ohms per 1000 ft, which adjusted for random lay is  $0.0315 \times 1.2 = 0.0378$  ohms per 1000 ft. Table 9-5 shows 0.0377. If these conductors are in a magnetic conduit, the adjustment factor is 1.5, and the reactance is increased to 0.0473 ohms per 1000 ft. Table 9-5 shows 0.0471.

*Reactance of Conductors on Rigid Cable Supports*

If a multi-conductor cable is placed alongside another multi-conductor cable on a flat tray or other rigid flat support, the inductive reactance of a conductor in that cable is not significantly increased by there being another similar adjacent cable, because the force fields around the conductors in each cable tend to neutralize, so there is little mutual-inductance effect unless loads are unbalanced. However, if *single* conductors are alongside of each other, each will have an average reactance to neutral which can be obtained from Fig. 9-3.

**Example.** Assume three 250 kcmil, 600-volt insulated steel-armored conductors arranged symmetrically flat on 4-in. centers. The effective spacing from diagram on page 9-9 is  $1.26 \times 4.0 = 5.0$  in. From Fig. 9-3, the reactance is 0.072 ohms per 1000 ft, which because of the magnetic-armor effect is increased by the applicable factor 50% -20% (as there is no random lay) or 30% to  $1.30 \times 0.072 = 0.094$  ohms per 1000 ft.

**Shunt Capacitive Reactance**

Although the capacitance of an insulated conductor between its outer grounded surface and its inner surface at

\* Source General Electric Company Data Book.

insulated aluminum conductors

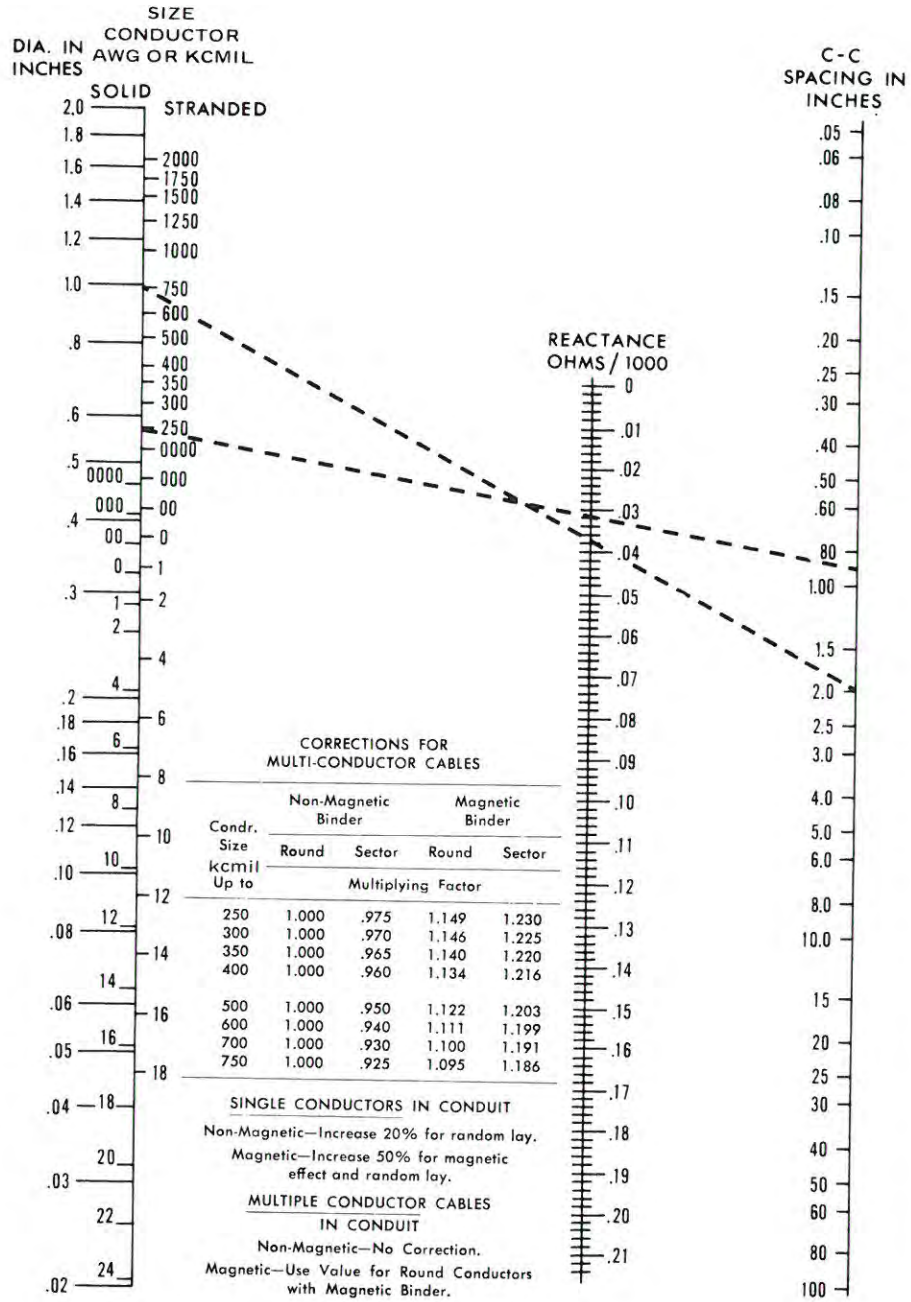

Fig. 9-3. Nomogram for Series Inductive Reactance of Insulated Conductors to Neutral (60 Hz) Based on Eq. 9-7. The dash lines apply to the two examples in the text.

**TABLE 9-5**  
**Inductive Reactance to Neutral**  
**2, 3, or 4 Single Conductor in Same Conduit**  
**Ohms Per 1000 Feet—60 Hz.**

NONMAGNETIC CONDUIT (ALUMINUM)										MAGNETIC CONDUIT (STEEL)									
Conductor Covering Thickness (Insulation + Cover)					Conductor Covering Thickness (Insulation + Cover)					Conductor Covering Thickness (Insulation + Cover)					Conductor Covering Thickness (Insulation + Cover)				
WIRE SIZE AWG OR kcmil	MILS 60	80	95	110	125	140	155	170	190	WIRE SIZE AWG OR kcmil	MILS 60	80	95	110	125	140	155	170	190
6	.0404	.0430	.0455							6	.0505	.0537	.0568						
4	.0386	.0402	.0424							4	.0475	.0503	.0530						
2	.0359	.0379	.0398							2	.0449	.0473	.0497						
1		.0367	.0384	.0400	.0415	.0430	.0443			1		.0458	.0480	.0500	.0519	.0538	.0554		
1/0		.0357	.0373	.0387	.0402	.0416	.0428			1/0		.0446	.0466	.0484	.0502	.0520	.0535		
2/0		.0348	.0363	.0376	.0389	.0402	.0414			2/0		.0435	.0453	.0470	.0487	.0503	.0517		
3/0		.0339	.0353	.0366	.0378	.0390	.0401			3/0		.0424	.0442	.0459	.0473	.0488	.0501		
4/0		.0332	.0344	.0356	.0367	.0378	.0388			4/0		.0415	.0431	.0445	.0459	.0473	.0486		
250			.0338	.0349	.0360	.0370	.0380	.0390	.0399	250			.0423	.0436	.0450	.0453	.0475	.0487	.0499
300			.0333	.0342	.0353	.0363	.0372	.0381	.0390	300			.0416	.0428	.0441	.0453	.0464	.0475	.0482
350			.0328	.0337	.0347	.0356	.0364	.0373	.0382	350			.0410	.0421	.0433	.0445	.0456	.0467	.0477
400			.0324	.0333	.0342	.0351	.0359	.0367	.0375	400			.0405	.0416	.0427	.0439	.0449	.0459	.0469
500			.0318	.0326	.0334	.0343	.0350	.0358	.0365	500			.0397	.0407	.0418	.0428	.0438	.0447	.0457
600				.0321	.0329	.0336	.0343	.0350	.0357	600				.0401	.0411	.0420	.0429	.0438	.0447
700				.0317	.0324	.0331	.0338	.0345	.0351	700				.0397	.0405	.0414	.0422	.0431	.0439
750				.0315	.0322	.0329	.0335	.0342	.0349	750				.0394	.0403	.0411	.0419	.0428	.0436

The above tabular values include 20% adjustment for random lay of single conductors in a nonmagnetic conduit and a 50% adjustment for random-lay and magnetic effect in steel conduit. If the conductors are part of a multi-conductor cable with fixed spacing, multiply the tabular values in the left-hand section by 0.833. For the right-hand section in such a case multiply the adjusted left-hand section values by the magnetic-binder adjustment factors shown in Fig. 9-3. Thus, for a triplexed 250 kcmil cable with minimum 155 mils insulation thickness of each conductor, the reactance when in non-magnetic conduit is  $0.0380 \times 0.0833 = 0.0316$  ohms per 1000 ft., and when in magnetic circuit is  $0.0316 \times 1.149 = 0.0363$  ohms per 1000 ft.

## insulated aluminum conductors

circuit potential is a factor that influences voltage drop and regulation in long runs of heavily insulated high-voltage cable, it is not often of significance for usual lengths of insulated conductor at moderate voltages, hence for usual calculations at distribution voltages the capacitive reactance may be ignored.

As noted in Appendix 8-A, the shunt capacitive reactance is obtained from the 60-Hz capacitance as follows:

$$X' = \frac{1}{2\pi f C_{ac}} \quad (\text{Eq. 9-8})$$

where  $X'$  = shunt capacitive reactance for stated length of insulated conductor in ohms (it will be half as much for twice the length)

$C_{ac}$  = Capacitance on 60-Hz basis of the insulation in farads. (If  $C_{ac}$  is in microfarads,  $X'$  will be in megohms.)

$f$  = Frequency, Hz

The shunt capacitance  $C_{ac}$  of a round insulated conductor with outer surface of the insulation (or shield) at ground potential is a function of dielectric constant and of insulation thickness. On 60-Hz basis, as follows:

$$C_{ac} = 0.00736 \times \epsilon_r \times \frac{1}{\log_{10}(D/d)} \quad (\text{Eq. 9-9})$$

where  $\epsilon_r$  = Dielectric constant of insulating material

$D$  = Diameter over insulation or under insulation grounded shield, if any

$d$  = Diameter under the insulation

$C_{ac}$  = Capacitance in microfarads per 1000 ft, on 60-Hz basis

*Example.\** No. 4/0 AWG aluminum single conductor, 19-strands; conductor diam. 0.528 in.; outside diam. 0.684 in.;  $\epsilon_r = 6.5$ . From Eq. 9-9

$$C_{ac} = 0.00736 \times 6.5 \times \frac{1}{\log_{10}(0.684/0.528)} = 0.426 \text{ microfarads per 1000 ft.}$$

Because capacitive reactance, as described, is a distributed *shunt* reactance, and the corresponding inductive reactance is a *series* reactance, they cannot directly be vectorially added (or subtracted). Approximate methods of combining them for voltage-drop calculations are employed based on lumping the total capacitance at one or more points of the line. Description of such methods is

\* The value  $\epsilon_r = 6.5$  is typical of synthetic rubber RHW insulation. For high-molecular-weight polyethylene a value 2.3 is used for estimates and similarly 2.3 for cross-linked polyethylene. A range of values for various insulations is in Tables 8-1, -2, and -4.

beyond the scope of this book. The value, however, will not exceed that represented by the combined vector reactance in ohms, computed as follows:

$$\text{Vector } X + X' = \frac{2\pi f L}{1 - [(2\pi f)^2 L C]} \quad (\text{Eq. 9-10})$$

where

$L$  = Series inductance of the conductor to neutral, henrys

$C$  = Shunt capacitance of the conductor to neutral, farads

$f$  = Hz

The inductance in henrys is obtained from inductive reactance, Eq. 9-7, or nomogram Fig. 9-3 and dividing by 377. The capacitance is obtained directly from the nomogram, Fig. 9-4, after multiplying by dielectric constant, noting however, that the microfarads so obtained must be converted to farads before use in Eq. 9-10.

Whether or not the capacitive reactance is of such amount that it should be taken into account for calculation of voltage drop and regulation is readily determined by Eq. 9-10, which is an approximation of its maximum effect. In the large majority of circuits employing aluminum insulated conductors it will be found that no further analysis beyond that indicated by Eq. 9-10 will affect the results significantly, and in most cases the capacitive reactance can be ignored.

## Voltage-Drop

The size of a conductor for a given installation is governed by the permissible voltage drop or the permissible ampacity. In long runs, voltage-drop often is the deciding factor, and for short runs and large currents, ampacity will govern.

The NEC (1981) voltage-drop limitation provides that the size of a conductor in either a feeder or branch circuit must be such that the voltage drop will not exceed 3% from source to the last outlet in the feeder or branch circuit, and that the combined voltage drop of feeder and branch in series will not exceed 5% from source to the last outlet of the longest combination of feeder and branch. Rules also are given in NEC for estimating loads where they are unknown at time of installation.

For most voltage-drop calculations only resistance, inductive reactance, and load power factor have to be considered (see Fig. 9-2). The relation is as follows for a stated length of run (from source to load only):

$$\text{Volts drop} = IZ = I(R \cos \theta + X \sin \theta) \quad (\text{Eq. 9-11})$$

where

$I$  = Current per conductor, rms amp

$Z$  = Impedance to neutral, ohms

$R$  = Resistance, at stated temperature, ohms

$X$  = Series inductive reactance, ohms

$\theta$  = Angle of lag of current vector in relation to emf vector for load end

The load power factor, expressed as a decimal fraction, equals  $\cos \theta$ , from which  $\sin \theta$  can be read from table, or computed from  $\sin \theta = (1 - \cos^2 \theta)^{1/2}$ .

*Example.* A 3-phase 480 Y/277 volt 60-Hz feeder circuit 250 kcmil single conductors with grounded neutral is in aluminum nonmagnetic conduit of a 600-ft run, carrying 150 amp per conductor at 80% load lagging power factor. The insulation is 6/64-in. thick (94 mils). What is voltage drop, and percent drop at 75°C operating temperature?

From Table 9-3,  $R = 0.085$  ohms per 1000 ft. From Table 9-5,  $X = 0.0338$  ohms per 1000 ft. For 80% p.f.  $\cos \theta = 0.80$ , and  $\sin \theta = 0.60$ . Then from Eq. 9-11 volts drop  $= IZ = 150 (0.085 \times 0.80 + 0.0338 \times 0.60) = 13.25$  volts per 1000 ft. or for 600 ft  $= 7.95$  volts. Percent voltage drop  $7.95/277 = 2.9\%$

Calculations of this kind are aided by tables in various forms supplied by wire and cable manufacturers. Table 9-6 is a typical short form supplied by The Aluminum Association applying to 3-phase 60-Hz circuits on basis of line-to-line volts. From the adjustment factors and formulas of the table, it is readily adapted to most other conditions. Applying it to the preceding example, "V" factor = 0.015, and substituting:

$$\text{Percent volts drop} = \frac{0.015 \times 150 \times 600}{480} = 2.8 \text{ (as a percent)}$$

Another example of the use of Table 9-6 is below:

Three-wire solidly grounded neutral, 230-115 volt single-phase, 75 ft run, 50 amp, 95% pf. No. 6 AWG in aluminum conduit, at 75°C.

From Table 9-6 and applicable formula: "V" is 0.132

$$\text{Percent voltage drop} = \frac{0.132 \times 50 \times 75 \times 0.577}{115} = 2.48$$

The voltage-drop values from Table 9-6 for aluminum conduit apply without significant error to cables in air or with any of the various kinds of non-metallic close-fitting sheaths or armors. With steel armors, the values for steel conduit of Table 9-6 also may be used for sizes 1/0 to 400 kcmil. Below this range a 2% increase is a conservative adjustment and above this range a decrease of 5% is justified. Although steel armor is thinner than the walls of steel conduit, the armor is closer to the conductor than the conduit wall. These differences tend to counteract each other in their effect on voltage drop.

### Ampacity of Insulated Conductors

The kind of insulation that surrounds a conductor determines the maximum continuous temperature which the

conductor can attain without long-time deterioration of the insulation. The *ampacity rating* of a conductor is the amount of current in amperes (rms) that will cause the temperature of the conductor to rise from the stated ambient temperature to, yet not above, the rated operating temperature of the insulation under specified conditions that affect the rate of heat emissivity. Thus, the ICEA ampacity rating of an isolated aluminum 15-kV, 4/0 AWG concentric stranded single cable having insulation of 0.035 p.f. at 75°C conductor temperature and 40°C ambient temperature of air is 265 amp, when the conductor is suspended in air and there is no wind and no solar radiation. The ampacity will differ under other conditions; thus, for this conductor it will vary from 231 amp to 299 amp if it is one of three conductors each in a non-metallic duct bank in earth so arranged that the duct ambient temperature is 20°C. The variation from 231 amp to 299 amp depends on the thermal conditions of the material surrounding the duct and the heat-sink effect of the bank in relation to the daily load factor of the circuit of which the conductor is a part.

The NEC ampacity ratings are on a simpler basis than those of ICEA; they do not include provision for many of the variations of environmental conditions, being shown only as two values (1) for single conductors in free air, and (2) for not more than three conductors in raceway or cable or direct burial. Provision is made in both the NEC and ICEA publications for variations of ampacity with ambient temperature.

Conductors for new installations should be selected so that their ampacity rating is sufficiently higher than the actual load to be carried at the start so that ample margin is provided for anticipated load growth. Also, consideration should be given to the cost of operating losses when selecting conductor size.

### Ampacity Ratings

Application engineers rarely find it necessary to compute the ampacity ratings of insulated cables or determine them by tests because this work has already been done for a large range of cable types and installation conditions by committees of ICEA and of the Insulated Conductor Committee of IEEE.\* The previously mentioned ICEA Publication No. P-46-426 Vol. II contains over 300 pages of such ampacity values\*\* for aluminum conductors

\*The leading reference as to methods of computing ampacity under various conditions is *The Calculation of the Temperature Rise and Load Capability of Cable Systems*, J. H. Neher and M. H. McGrath, *AIEE Transactions, pt III (Power Apparatus and Systems)* Vol. 76 Oct. 1957, pp. 752-72.

\*\*The ICEA Ampacity Tables are qualified by the statement that they "represent the conservative views of engineers based on operating experience and laboratory work and are intended as a guide to assist operating engineers in selecting cables for safety and reliability . . . (the) current carrying capacities are in no sense fixed standards or ratings."

insulated aluminum conductors

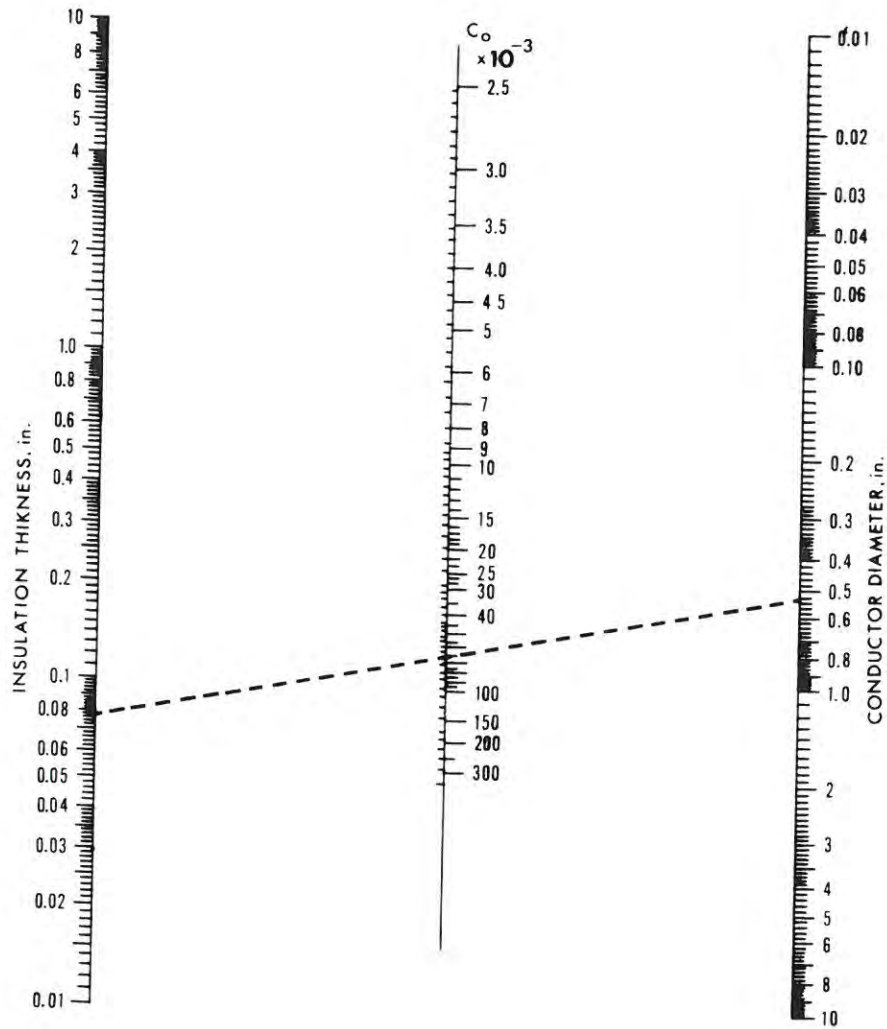

Fig. 9-4. Nomogram for 60-Hz capacitance across conductor insulation for 1000 ft length after immersion in water for one hour at 25°C.

Note: The capacitance  $C_{ac}$  in microfarads per 1000 ft is obtained by multiplying the scale value of  $C_0 \times$  dielectric constant  $\epsilon_r$ .

The nomogram, above, is a ready means of finding the 60-Hz capacitance  $C_{ac}$  when dielectric constant is known. The insulation thickness used when applying the nomogram is the thickness from conductor surface to the insulation shield, if any; not the thickness through an outer jacket or covering.

Example: For 4/0-19 cable dia. 0.528 in. 0.078 in. insulation thickness; dielectric constant  $\epsilon_r = 6.5$ ; intersection with middle line shows  $66 \times 10^{-3}$ , which multiplied by 6.5 = 0.429 microfarads per 1000 ft.



TABLE 9-6

"V" Factors for Calculation of Line-to-Line Voltage Drop for 3-Phase 60 Hz Circuits or Direct-Current Circuits. Multiplying factors are included for calculations of voltage drop in single-phase circuits, and for single-phase or 3-phase circuits to neutral. All voltage drops are valid up to and including conductor temperature of 75°C.

"V"—Volts Drop per Amp per 100 Ft. of Run

SIZE AWG or kcmil	ALUMINUM CONDUIT					NON- MAGNETIC AND MAGNETIC CONDUIT dc	STEEL CONDUIT				
	LOAD % LAGGING POWER FACTOR						LOAD % LAGGING POWER FACTOR				
	70	80	90	95	100		70	80	90	95	100
12	.380	.433	.485	.509	.533	.616	.381	.435	.485	.510	.533
10	.241	.274	.305	.322	.336	.388	.243	.274	.218	.323	.336
8	.153	.174	.193	.203	.211	.244	.155	.176	.195	.204	.211
6	.101	.113	.125	.132	.136	.156	.102	.114	.125	.132	.135
4	.065	.072	.080	.084	.085	.099	.066	.075	.081	.084	.086
2	.043	.047	.051	.053	.054	.062	.044	.048	.052	.054	.053
1	.035	.039	.041	.043	.043	.049	.036	.040	.042	.043	.043
1/0	.029	.032	.034	.035	.034	.039	.030	.033	.035	.035	.034
2/0	.024	.026	.027	.028	.027	.031	.025	.027	.028	.028	.027
3/0	.017	.022	.023	.023	.022	.025	.022	.023	.024	.023	.022
4/0	.016	.017	.018	.018	.017	.020	.017	.018	.018	.018	.017
250	.014	.015	.015	.015	.014	.016	.016	.016	.016	.016	.014
300	.013	.013	.013	.013	.012	.013	.014	.014	.014	.014	.012
350	.012	.012	.012	.011	.010	.012	.013	.013	.013	.012	.010
400	.011	.011	.011	.010	.0089	.010	.012	.012	.012	.011	.0093
500	.0094	.0094	.0091	.0087	.0072	.0082	.011	.010	.010	.0096	.0076
600	.0085	.0085	.0081	.0076	.0060	.0068	.010	.0097	.0090	.0085	.0063
700	.008	.0078	.0072	.0068	.0051	.0059	.0094	.0090	.0084	.0078	.0056
750	.0077	.0075	.0069	.0064	.0049	.0055	.0091	.0087	.0081	.0075	.0053

APPLICABLE FORMULAS:

$$\% \text{ VOLTS DROP} = \frac{\text{"V" X AMPS. X RUN DISTANCE (ft)}}{\text{LINE TO LINE VOLTS}}$$

$$\text{RUN DISTANCE} = \frac{\% \text{ VOLTS DROP X LINE TO LINE VOLTS}}{\text{"V" X AMPS.}}$$

$$\text{"V" FACTOR} = \frac{\% \text{ VOLTS DROP X LINE TO LINE VOLTS}}{\text{RUN DISTANCE X AMPS.}}$$

Voltage drop requirements for feeders and branch circuits are given in NEC 1987 articles 215-2(b) and 210-19(a) respectively.

NOTES:

- (a) For single-phase line-to-line voltage drop, multiply the "V" factor from the table by 1.155.
- (b) For single- or 3-phase line-to-neutral voltage drop, multiply the "V" factor from the table by 0.577 using line to neutral voltage.

## insulated aluminum conductors

that have the usual types of insulation and that are installed as cables in the various kinds of environments found in today's power systems. A more recent publication addressing URD/UD Style Cables is ICEA P-53-426.

Chapter 10 of this handbook contains ampacity tables, largely based on these ICEA tables, for many applications of insulated conductors.

A few cable types do not have ampacities listed in the above-mentioned ICEA publications. Ampacity tables for these have since been issued as follows:

- A. Ampacities for primary underground residential distribution cables of two-conductor concentric-neutral type, for direct burial and for installation in duct at 20°C ambient, polyethylene insulated and XLPE insulated. This table also includes a section for such cables in air at 40°C ambient, taken in part from ICEA Pub. S-61-402 2nd ed.

The values in this table relating to aluminum are shown in Tables 10-9A and 10-9B.

- B. A table similar to Table 10-9, except it is for 85°C and Butyl-rubber insulation (ICEA Pub. S-19-81, Jan. 1966 revision). This table shows values for buried cable of about 5% higher ampacity than the values for PE insulation in Table 10-9, and when in duct about 9% higher ampacity. The values for air installation are about 15% higher at 5 kV for cable only, and about 12% higher at 15 kV. The adjustment factors differ by not to exceed "1" in last place.

The ampacity values for aluminum portable cables should be obtained from the manufacturers.

The reason why it is not usually feasible to compute cable ampacities in the simple manner used for bare conductors is because there are many more factors in the calculation than simply the ac resistance of the conductor and the rate of surface emissivity that determine ampacity of bare conductors. Among the special conditions relating to ampacity of insulated conductors are the following:

1. Insulated conductors are often grouped in ducts so their insulated surfaces touch, or they touch a grounded metallic sheath, so heat-transfer across an assembly of such conductors is not easy to evaluate; also inductive and proximity effects often are prominent because of close spacing.
2. The insulation has *thermal* resistance, and this may differ for different layers (jackets, sheaths, etc.).
3. When cables are buried in earth or are in duct banks, the ambient temperature differs from that of cables in air, and also the heat transfer rate depends on the heat-sink quality of the environment, which in turn depends on the daily load factor of the circuit and on the specific heat of the earth.
4. The radiation of heat from insulated conductors placed singly or as a multi-conductor cable within a duct or conduit is influenced by the distance between insulation surface and inner duct wall.

5. Heat *originates* outside of the conductor from energy losses in insulation, eddy currents in shields, sheaths, armor, (also hysteresis in steel parts), etc.

For these reasons, unless the NEC or the supplementary ICEA tables are suitable, the application engineer most likely will obtain ampacity rates from the ICEA P-53-426, P-54-440 or the ICEA Vol. II tables. Appendix 9-A herein explains the ICEA tables and how to use them, not only for directly tabulated values but also for variations from the conditions for which listed values are shown. For instance, the tabular ampacities are based on a 20°C ambient for earth-burial or duct-bank installation and 40°C ambient for suspension in air or in metal conduit. The *Constants* that are listed in the tables provide means for finding ampacity for any other ambient temperature. In similar manner, the tabular values may be adjusted for variation of insulation power factor, daily load factor, operating temperature, etc. A working knowledge of all of these ICEA ampacity publications is almost essential for proper selection of insulated cables of various kinds.

### Emergency Overload Ratings

While maximum conductor operating temperature limits are based on maintaining insulation stability indefinitely, it is recognized that certain short periods of overloading are not only reasonably safe but inevitable in service.

Since most deteriorative reactions are enhanced by elevated temperature and are accumulative with time, emergency overload ratings always specify both a temperature and duration limit and a limit on the total number of emergency events. Emergency ratings have come about through long time experience in cable operation. They are subject to revision as better thermal performance is developed for insulating materials and more reliable field data are obtained. Emergency loading periods are limited to values given in AEIC and ICEA Standards as applicable. Note that the NEC does not recognize emergency overload operation, so such may not be considered in NEC installations. Table 9-7 lists emergency overload temperatures for the most-used insulations. For asbestos insulations that have 110°C operating limits (Types AVA and AVL) consult manufacturer.

### Short-Circuit Ratings

The subject of short-circuit currents in insulated cables that flow through metallic shields or sheaths if the insulation fails or if the shield is used for relaying currents is treated in Chapter 12. Many short-circuit currents in insulated cables, however, are those that occur in apparatus or switchgear, hence only the increased current resulting from the short circuit flows in the insulated conductor; there is no arc burn-down effect.

The ICEA rated temperature limits (also noted in Table 9-7) that an insulation can attain during and immediately after interruption of such a short-circuit current are as follows:

For thermoplastic insulations (polyvinyl chlorides and plain polyethylenes) 150°C  
 Rubber, rubber-like, and varnished cambric 200°C  
 Cross-linked polyethylene and EPR 250°C

Figs. 9-5, 9-6, and 9-7 show the time in cycles (60-Hz basis) that a short-circuit current of stated value can be withstood, on basis of 75°C operating temperature prior to the fault, without its temperature exceeding the specified upper limit. Special analysis is required if the circuit is protected in part by current-limiting fuses.

The diagrams are based on the assumption that no heat is emitted from the conductor metal during the short time that the fault current flows; that is, the basis is the same as that employed for short-circuit calculations of bare-conductor as described in Chapter 6.

The upper temperature limits established for the various insulations not only reflect the ability of the insulation to withstand the high temperature, but they also take into

account the rise in temperature of the insulation after the fault has been cleared and the heat content of the conductor transfers to the insulation. That is, after the fault has cleared and the conductor cools, the insulation slowly increases in temperature to some point that is lower than the peak temperature of the conductor itself (150°, 200°, or 250°C as the case may be), yet not so high that the insulation is damaged.

*Example:* Assume the maximum fault-clearing time is 30 cycles, including allowance for one reclose of the interrupting device. Also assume that the fault occurs sufficiently far from the conductor being considered so there is no arcing burn-down effect or insulation breakdown that causes current to flow through shield or sheath. What allowance for fault current can be made for a single 4/0 cable insulated for 150°C, 200°C, and 250°C maximum conductor temperature, if maximum operating temperature before fault is 75°C?

By reference to Fig. 9-5, the intersection of vertical line above 4/0 and diagonal line for 30 cycles is at 10,400 amp for 150°C

Also for Fig. 9-6 it is 12,500 amp for 200°C

and for Fig 9-7 it is 14,900 amp for 250°C

TABLE 9-7

Abstract of ICEA Standards for Maximum Emergency-Load and Short-Circuit-Load Temperatures for Insulations Listed in Tables 8-2, 8-3 and 8-4

Insulation	Normal Load Temperature °C	Emergency-Load Temperature* °C	Short-Circuit Temperature of Cable Conductor (less than 30 sec.) °C
Polyvinyl chloride	60	85	150
	75	95	
Thermoplastic polyethylene	75	95 (0-5kV)	150
		90 (5001-35kV)	
Rubber-insulated S3.7 to S3.17 on Table 8-2	60	85	200
	70	85 (over 8kV)	
	75	95 (0-5kV)	
		90 (5001-8kV)	
		95 (over 15kV)	
Thermosetting cross-linked polyethylene and EPR	80	95 (over 15kV)	250
	85	105 (0-5kV)	
		100 (5001-15kV)	
	90	130	

\*For short circuit capability of c cable shields, see ICEA P-45-482.

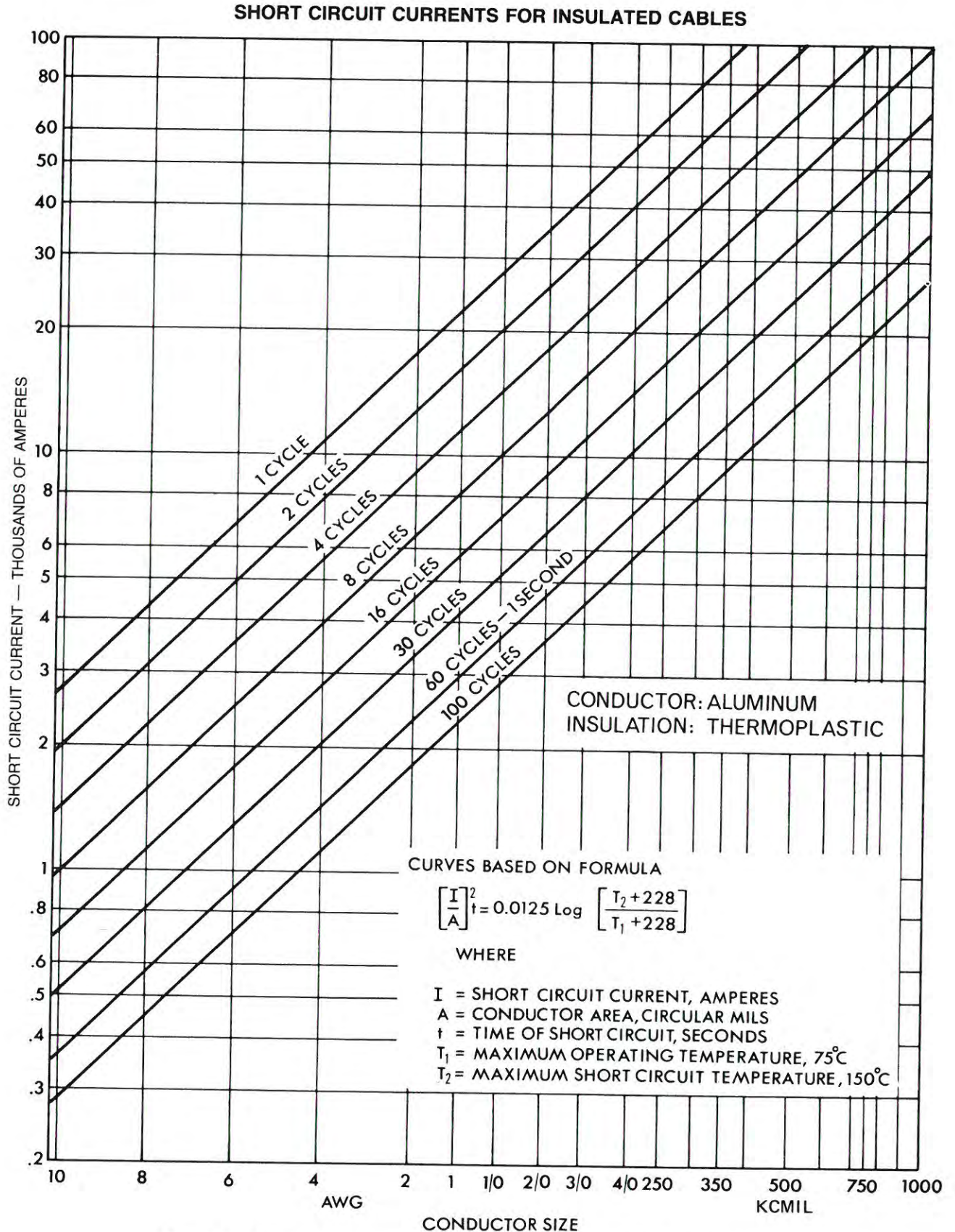

Fig. 9-5. Short circuit currents for insulated cables (150°C maximum).

### SHORT CIRCUIT CURRENTS FOR INSULATED CABLES

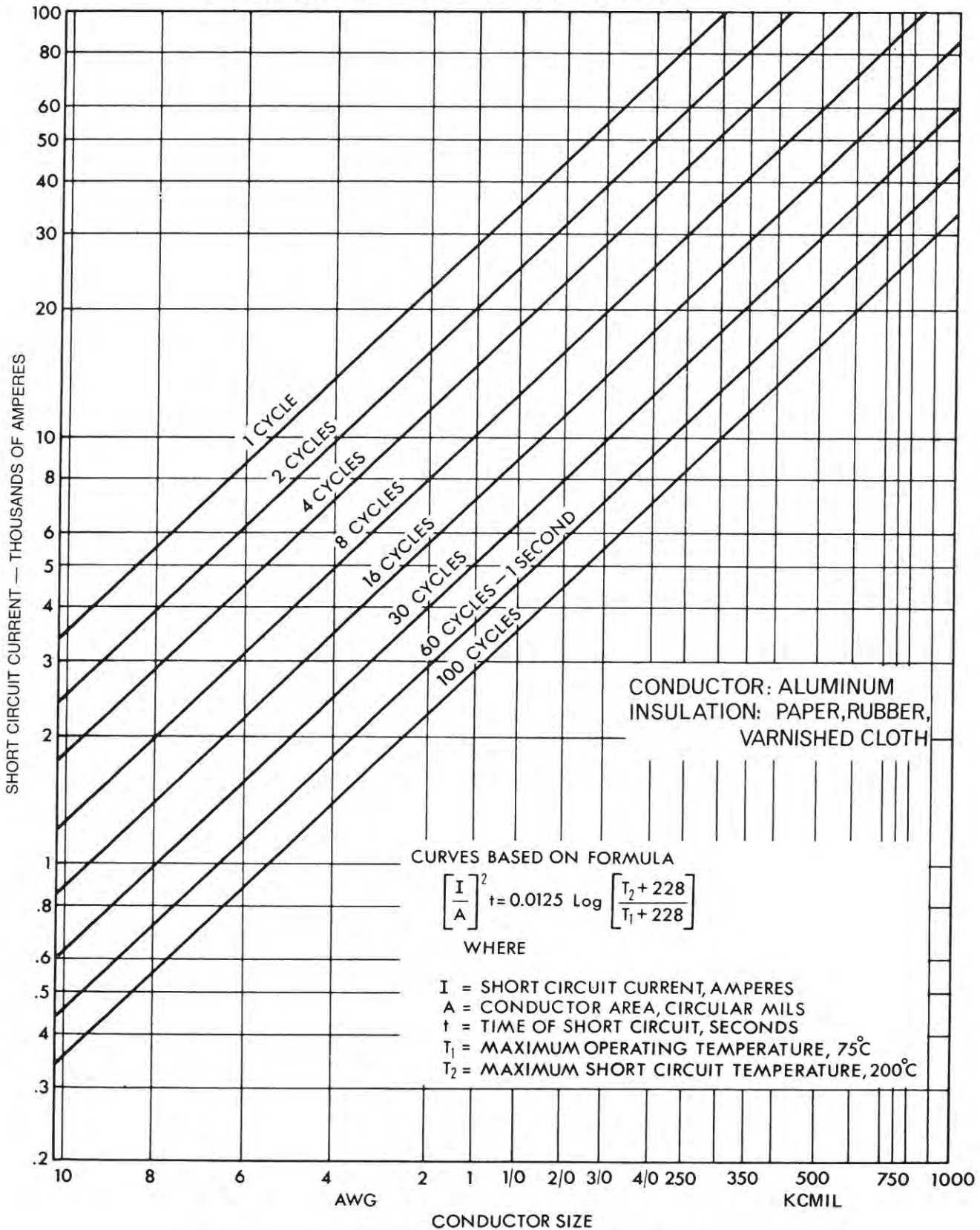

Fig. 9-6. Short circuit currents for insulated cables (200°C maximum).

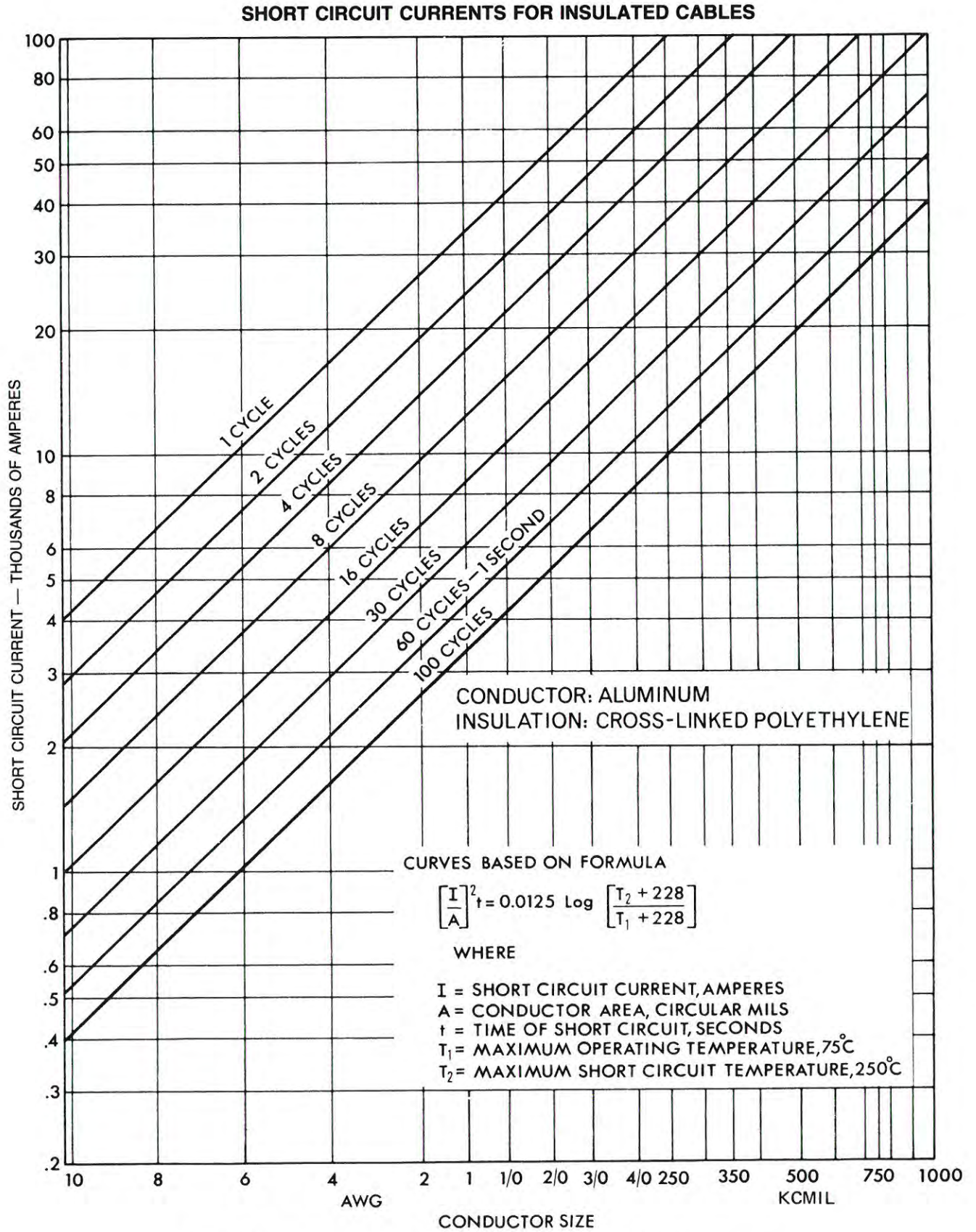

Fig. 9-7. Short circuit currents for insulated cables (250°C maximum).

## APPENDIX 9-A

### Explanation of ICEA-IEEE Tables of Ampacity of Insulated Aluminum Cables For Various Conditions of Installation

Based on 1978 Edition, ICEA Pub. No. P-46-426;  
IEEE Pub. No. S-135\*

A working knowledge of these tables is almost essential for economic studies of alternative proposals of cable selection because they embody comprehensive ampacity-temperature ratings for most of the types of cables and methods of installation currently used. The tables for aluminum cables comprise 317 pages, the result of years of research by leading authorities (see footnote on page 9-13). Although most of the space in the book is devoted to cables above the 600-volt NEC range, many of the 1-kV ratings provide comparative values that are useful, even where NEC requirements are mandatory.

Space does not permit inclusion of the tables themselves, and the originating bodies control their distribution. However, an abstract of the tables is included along with an explanation of their use. See also the ampacity tables in Chapter 10.

For aluminum conductors, the ampacity tables are grouped according to kind of insulation, method of installation, kV ratings, and conductor operating and ambient temperature. Sets of constants are provided that enable adjustment of the ampacity rating for conditions differing from those for which the table is compiled. Not every classification is included in every group, because some combinations are not practicable. The following are principal groups for *thermosetting or thermoplastic insulations*.

**Cable types:** *Single-conductor cable*; *triplexed cable*, comprising three insulated conductors in equilateral arrangement held in position by tape or by spiraling around a neutral; *three-conductor cable*, comprising three insulated conductors in equilateral arrangement, all surrounded

by a circular sheath which gives the assembly the appearance of a round cable. See also Note 1. Illustrations of many cable types are in Chapter 10.

The inclusion of a neutral conductor in triplexed or three-conductor cable does not affect the ampacity rating. Also a two-conductor cable has the ratings of a triplexed cable if the conductor assembly has an overall sheath. All ampacity ratings are those of one conductor of a triplexed or three-conductor assembly.

**Installation Methods** (See Figs. 9A-1 and 9A-2 for spacing, etc.)

*Single conductor cable:* in air; three cables in a 3-or 4-duct bank; six cables in a 6-duct bank; nine cables in a 9-duct bank; three cables closely adjacent directly buried; six cables in two-circuits directly buried. This cable is not expected to be installed singly in a steel conduit.\*\*

*Triplexed cable:* in air; in conduit exposed to air; and in duct-bank arrangements as described for single-conductor cable with the addition that one cable can be installed in a single duct; and one or two cables may be directly buried.

*Three-conductor cable* in same arrangements as listed above for triplexed cable.

*Voltage:* 1, 8, 15, 25 kV

*Operating temperature:* 60, 65, 70, 75, 80, 85, and 90°C where applicable.

*Ambient temperature:* 20°C in duct or for direct burial; 40°C in air or exposed conduit.

*Notes:*

1. ICEA-NEMA has since published additional ampacity tables for two-conductor concentric-neutral aluminum cable for URD

\*The description of the ICEA-IEEE tables herein, and elsewhere in this publication, that contain abstracts from the tables are reproduced by permission of the copyright owner, Insulated Cable Engineers Association (formerly IPCEA). These tables, originally published in 1962, were reissued unchanged in 1978.

\*\*Ampacities for cables in open-top cable trays are found in ICEA Pub. P-54-440, Aug. 1979.

covered and insulated wire and cable

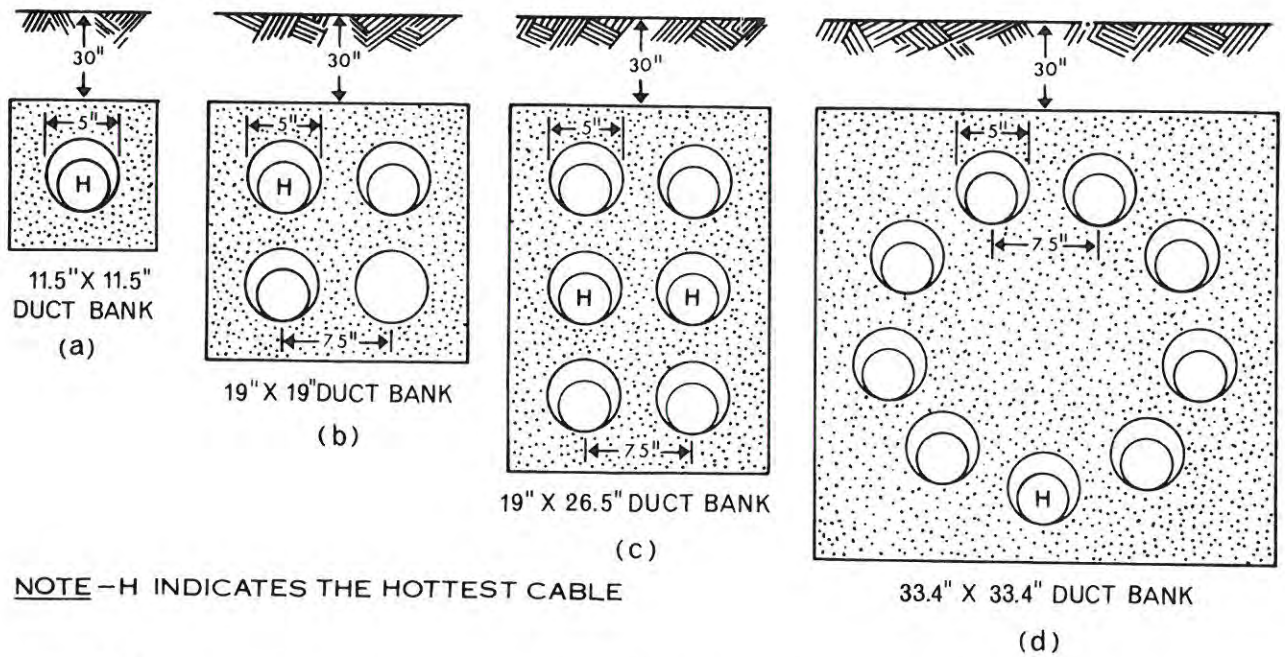

Fig. 9A-1. Arrangements of 1, 3, 6, and 9 cables in underground duct, as basis for ampacity calculations.

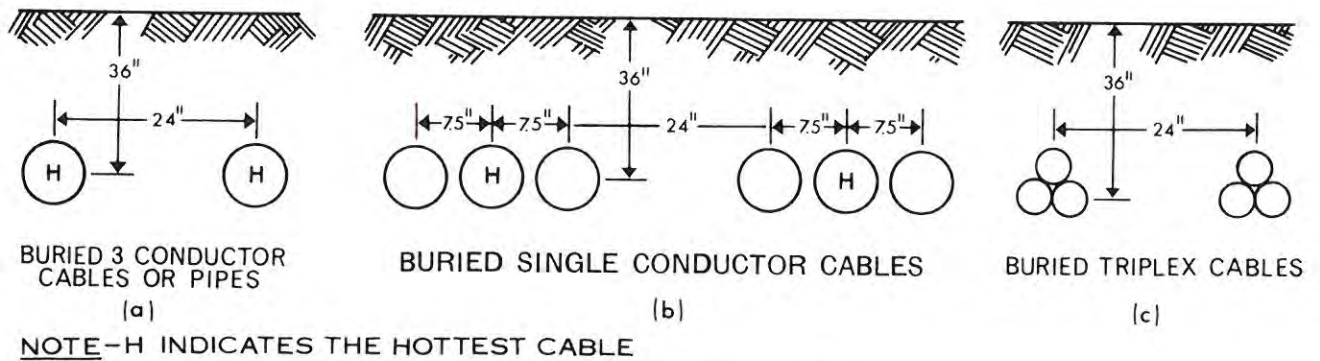

Fig. 9A-2. Arrangements of buried cables, as basis for ampacity calculations.

(as well as for air installation). This type of cable has spiral bare exterior round-wire copper neutral, suitable for direct earth burial (see Table 10-9).

2. The term "one-circuit" refers to two or three conductors of a single circuit, with or without an extra conductor for neutral, that comprise a two-wire or three-wire single-phase circuit, or a

three-wire 3-phase circuit.

3. The ICEA-IEEE set of tables also includes ampacity ratings for low- and high-pressure gas-filled and oil-filled cables of the kinds in limited commercial or experimental use with aluminum conductors.



## engineering design as related to cable applications

### Description of Typical Section of ICEA-IEEE Ampacity Table

For explanation of these tables, a typical section is reproduced as Table 9A-1 from top of page 167 of Vol. II on aluminum conductors. The three cables in duct bank are arranged and spaced according to Fig. 9A-1(b), in which the cables in each duct are single, and the duct bank is below ground as shown. The lining of the duct is non-metallic.

The designations RHO-60, RHO-90 and RHO-120 signify *Earth Thermal Resistivity* in terms of 60°, 90°, and 120°C—centimeters per watt (C°-cm/watt). Thus, earth of RHO-60 thermal resistivity transmits a given amount of heat at a lower temperature than will RHO-120 earth, hence a cable in a duct buried in aggregate or earth of RHO-60 resistivity will have a higher ampacity than if the duct were buried in earth of higher thermal resistivity. Where the earth thermal resistivity is unknown, ICEA suggests using the RHO-90 values.

The designations 30LF, 50LF, 75LF, and 100LF signify *Load Factor*; that is, the ratio of average load to peak load according to customary practice of electric power utilities when determining average load factor. The increased ampacity for low load factors is the result of the heat-sink property of the earth surrounding the conductors or the duct block. Thus, as load increases to a peak, the temperature of the conductor does not rise as rapidly as if it were exposed to air. Load factor variations of ampacity are not shown in the tables that apply to cables suspended in air or are in conduit exposed to air (see Table 9A-2). In selecting the LF value, consideration must be given to future load factors during the expected life of the cable; thus, initial conditions may indicate that the ampacity corresponding to 30LF is satisfactory, but perhaps the cable should be selected on the basis of 75LF or 100LF because during the period of load growth, suitable load dispatching may tend to flatten any peaks that exist early in the life of the cable.

Associated with load factor is a *Loss Factor*. Thus, a typical load curve of 50LF will have peaks and valleys. If the  $I^2R$  loss for one day is obtained from such a curve, it probably will be about 33 percent of the  $I^2R$  loss if the load were constant. Empirical loss factors corresponding to the various assumed LF's are 0.15, 0.33, 0.625, and 1.00 loss factors for 30LF, 50LF, 75LF, and 100LF values, respectively.

The three right-hand columns of Table 9A-1 are headed *DELTA TD* for 0.035 power factor (of insulation), applying to RHO-60, -90, and -120 conditions. The *Delta TD* values signify *dielectric-loss temperature rise*. For cables of equal dielectric constant, these values vary in direct proportion to insulation power factor. Any value of ampacity  $I$  appearing in the table may be corrected for a change of operating or ambient temperature or of insulation power factor by use of the following expression in which the prime mark indicates the desired new values:

$$I' = I \sqrt{\frac{T'_c - T'_a - \text{Delta TD}'}{T_c - T_a - \text{Delta TD}}} \times \frac{228.1 + T_c}{228.1 + T'_c} \text{ amperes} \quad (\text{Eq. 9A-1})$$

Where  $I$  = Ampacity as listed; and  $I'$  = Ampacity under new condition;

$T_c$  = Conductor temperature, C° as listed; and  $T'_c$  is same, under new conditions;

$T_a$  = Ambient temperature, C° as listed; and  $T'_a$  is same, under new conditions;

Delta TD factor is as listed; and Delta TD' is same under new conditions (Delta TD varies only when there is a change of dielectric constant or power factor of the insulation).

When ambient temperature only is changed, Eq. 9A-1 becomes

$$I' = I \sqrt{\frac{T'_c - T'_a - \text{Delta TD}}{T_c - T_a - \text{Delta TD}}} \text{ amperes} \quad (\text{Eq. 9A-2})$$

It will be noted that Eqs. 9A-1 and 9A-2 contain no provision for adjustment for variation of RHO values or for load factors. These adjustments are obtained by use of the curves of Figs. 9A-3 and 9A-4, as described on the curve sheets.

Examples:

1. The 4/0 ampacity under RHO-90 and 75LF conditions for 70°C conductor temperature and 20°C ambient, from Table 9A-1, is 252 amperes. What is it at 30°C ambient? Here apply Eq. 9A-2:

$$I' = 252 \times \sqrt{\frac{70 - 30 - 0.79}{70 - 20 - 0.79}} = 225 \text{ amperes}$$

2. The cable of example 1 (before adjustment for change of ambient) has an insulation power factor of 0.035 and insulation dielectric constant of 4.7, according to the data accompanying the ICEA tables for rubber and plastic insulation. What is the ampacity at 55°C for conductor, with 15°C ambient, if dielectric constant is 5.5 and power factor is 0.020?

$$\text{The adjusted Delta TD}' = 0.79 \times \frac{0.02 \times 5.5}{0.035 \times 4.7} = 0.53$$

Applying Eq. 9A-2 and substituting:

$$I' = 252 \times \sqrt{\frac{55 - 15 - 0.53}{70 - 20 - 0.79}} \times \frac{228.1 + 70}{228.1 + 55} = 232 \text{ amperes}$$

### Interpolation Charts for Variation of RHO and Load Factor

If the values of RHO and LF differ from those used in

**TABLE 9A-1**  
Ampacities of Single Conductor Concentric Stranded Rubber Insulated Cable in Ducts

COND. SIZE	RHO-60				RHO-90				RHO-120				DELTA TD FOR .0350 PF AND RHO		
	30LF	50LF	75LF	100LF	30LF	50LF	75LF	100LF	30LF	50LF	75LF	100LF	60	90	120
ALUMINUM CONDUCTOR CONCENTRIC STRAND															
3 CABLES IN DUCT BANK 15 KV – 70 C CONDUCTOR 20 C AMBIENT EARTH															
2	144	140	134	127	143	137	129	121	141	134	125	116	0.55	0.61	0.68
1	165	160	153	145	163	157	148	138	162	154	143	132	0.57	0.64	0.71
1/0	190	184	175	166	188	180	169	158	186	176	164	151	0.60	0.68	0.75
2/0	218	210	200	189	215	206	193	180	213	201	186	171	0.63	0.71	0.79
3/0	250	241	229	216	247	236	220	205	244	230	213	195	0.66	0.75	0.84
4/0	287	277	263	247	284	271	252	234	280	264	243	222	0.70	0.79	0.89
250	317	306	289	272	313	298	277	256	309	291	267	244	0.72	0.83	0.93
350	389	374	353	330	384	364	337	311	379	355	324	294	0.79	0.90	1.01
500	483	463	434	404	476	449	414	380	469	437	397	359	0.86	0.99	1.12
750	617	589	549	509	607	570	522	476	597	553	499	448	0.95	1.10	1.26
1000	734	697	648	598	720	674	614	557	708	653	585	523	1.02	1.20	1.37
1250	836	793	734	675	820	765	694	628	805	739	660	588	1.04	1.22	1.41
1500	927	877	810	743	908	845	764	689	891	816	725	645	1.10	1.29	1.49
1750	1010	954	878	804	989	918	827	744	969	885	784	695	1.15	1.36	1.56
2000	1086	1023	940	858	1062	983	884	793	1040	947	837	740	1.19	1.41	1.63

See text for explanation of Delta TD values.

the tables, the charts of Fig. 9A-3 may be used for interpolation or extrapolation for values of RHO and LF for cables installed in duct banks, and those of Fig. 9A-4 may be used for directly buried cables. For both sets of charts the upper family of curves shows variation of ampacity for LF-100 in terms of  $I_1$ , the ampacity for RHO-60 and LF-50. Each curve is designated for a particular ratio  $I_2/I_1$ , where  $I_2$  is the ampacity at RHO-120 and LF-100. The lower family of curves shows the relationship between RHO and LF which will give substantially the same ampacity as the indicated value of RHO at LF-100.

Example:

3. Assume that it is desired to find the ampacity of the 4/0 cable of Table 9A-1 at RHO-140 and LF-60. The base values and ratio are as follows:

$I_1$  = ampacity at RHO-60 and LF-50, from table, = 277 amperes

$I_2$  = ampacity at RHO-120 and LF-100%, from table = 222 amperes

Ratio  $I_2/I_1$ ,  $222/277 = 0.80$

Enter lower section of Fig. 9A-3 at RHO-140 and LF-60. The intersection lies on curve for RHO-50 at 100LF. Following the value vertically to the upper family of curves at intersection of

RHO-50 and  $I_2/I_1 = 0.80$ , the corresponding value of F (at left) is 0.91. The desired ampacity for RHO-140 and LF-60 is  
 $0.91 \times 277 = 252$  amperes

*Tables for Installation in Air or in Conduit Exposed to Air*

If there is no heat-sink effect, as when cables are in duct bank or directly buried, the ampacity table is in simpler form than the one used for Table 9A-1. The sample shown as Table 9A-2 is for Triplexed rubber-insulated cable in air. Ampacities for all listed voltages are in a single section of the table for a given temperature.

*Triplexed vs Three-Conductor Cable:* A triplexed cable, Fig. 9A-2(c) comprises three single conductors arranged equilaterally as shown; the assembly may be taped to a messenger or grounded neutral as a preassembled aerial cable or in duct, or directly buried. A three-conductor cable, Fig. 9A-2(a) is similar, except that the assembly of three conductors is surrounded by a jacket or sheath to form a cylindrical exterior. Because the radiating insulating surface exposed to ambient temperature is greater in a triplex cable, the ampacity rating of the triplex cable is the

TABLE 9A-2

**Triplexed Concentric Stranded Rubber Insulated Cable  
In Air-Isolated Circuit 40 C Ambient Air**

COND. SIZE	VOLTAGE kV				VOLTAGE kV		
	1	8	15	25	8	15	25
AMPACITY				DELTA TD			
ALUMINUM CONDUCTOR CONCENTRIC STRAND CONDUCTOR TEMPERATURE 75°C INSULATION P F .0350							
8	44						
6	59	65			0.16		
4	78	85			0.17		
2	106	112	115		0.19	0.44	
1	123	129	133	135	0.19	0.45	0.81
1/0	143	149	153	155	0.20	0.46	0.83
2/0	165	172	175	178	0.21	0.48	0.85
3/0	192	198	202	204	0.21	0.49	0.87
4/0	224	229	233	235	0.22	0.50	0.89
250	251	254	258	260	0.23	0.52	0.91
350	312	315	318	318	0.23	0.54	0.94
500	392	392	395	394	0.24	0.56	0.98
750	512	502	504	500	0.26	0.59	1.03
1000	612	595	594	589	0.26	0.61	1.05

The Delta TD factors are used for adjustments when there is a change of dielectric constant. See text for further explanation.

*Construction of Cables Used as Basis for Ampacity Tables:*

Metallic insulation shielding is a part of rubber and thermoplastic cables listed as 8-kV and above. Ampacities for lead-sheathed rubber and thermoplastic cables assume metallic shielding. Nonmetallic jackets, if any, are assumed with rubber, thermoplastic, and asbestos (AVA) insulations. Depth for direct burial and duct banks are as in Fig. 9A-1 and 9A-2. Open-circuit sheath operation is assumed for single-conductor cables with metallic sheaths, installed in separated ducts or directly buried with separation. Ampacity values for short circuit sheath operation of single-conductor cables, including the effect of circulating current losses, are available in ICEA Pub. P-53-426. Short-circuited sheaths or shields, if used, are assumed for each conductor of triplexed cables with rubber and thermoplastic insulations. The insulation thicknesses for cables with rubber and thermoplastic insulations are according to ICEA S-19-81 (Fourth Edition revised) and S-61-402 (Second Edition revised). The insulation power factor for rubber and thermoplastic insulations is taken as 0.035 (3½%), but adjustment for other values may be made by applying Eq. 9A-1. This assumed power factor applies to this insulation after some years of use under average conditions. A lower power factor may be expected with new cables, but use of the higher value is recommended for estimates. An average Dielectric Constant for the rubber and thermoplastic insulation after years of use is assumed as 4.5, and this value also applies to cables with neoprene or plastic jackets.

*Supplementary Constants*

The set of ampacity tables also includes supplementary tables of design constants that can be used for computing ampacity for non-tabulated conditions. These are all for 75°C, and include the following values:

PD = Outside diameter, inches

WD = Dielectric loss, watts per conductor foot =  $W_d$

$R_i$  = Thermal resistance of insulation, thermal ohm-ft =  $\overline{R}_i$

RSD = Thermal resistance between cable and duct wall, or pipe ( $\overline{R}_{sd}$ ), or air for cable in air ( $\overline{R}_a$ ), thermal ohm-feet

QS = Ratio of sum of the losses in the conductors and sheaths or shields to the losses in the conductors

QE = Ratio of the sum of the losses in the conductors, sheath or shield, and pipe to losses in the conductors.

$R_{ac}$  = ac resistance of the conductor, including skin and proximity effects only, microhms per foot.

Note: The Symbol  $\overline{R}$  with line over top designates thermal resistance

The values in these tables of constants are helpful in more ways than merely for computing ampacity values. They

greater. These relations are shown by the following comparison:

Ampacity for 1 kV 4/0 AWG cable at 60°C	Amperes	
	Triplex Cable	3-Conductor Cable
20°C ambient		
In duct bank	191	173
Directly buried	240	227
40°C ambient		
In air	174	149
In conduit, in air	144	133

*Ambient Temperature:* It is assumed that there is no wind and no solar radiation. An average 40°C ambient for air is suitable for initial ampacity estimates, subject to adjustment by applying Eq. 9A-2. A similar average for underground duct bank is 20°C ambient. The increased ampacity for directly buried installations is a factor that should be evaluated when the economics of URD for a given installation are considered.

insulated aluminum conductors

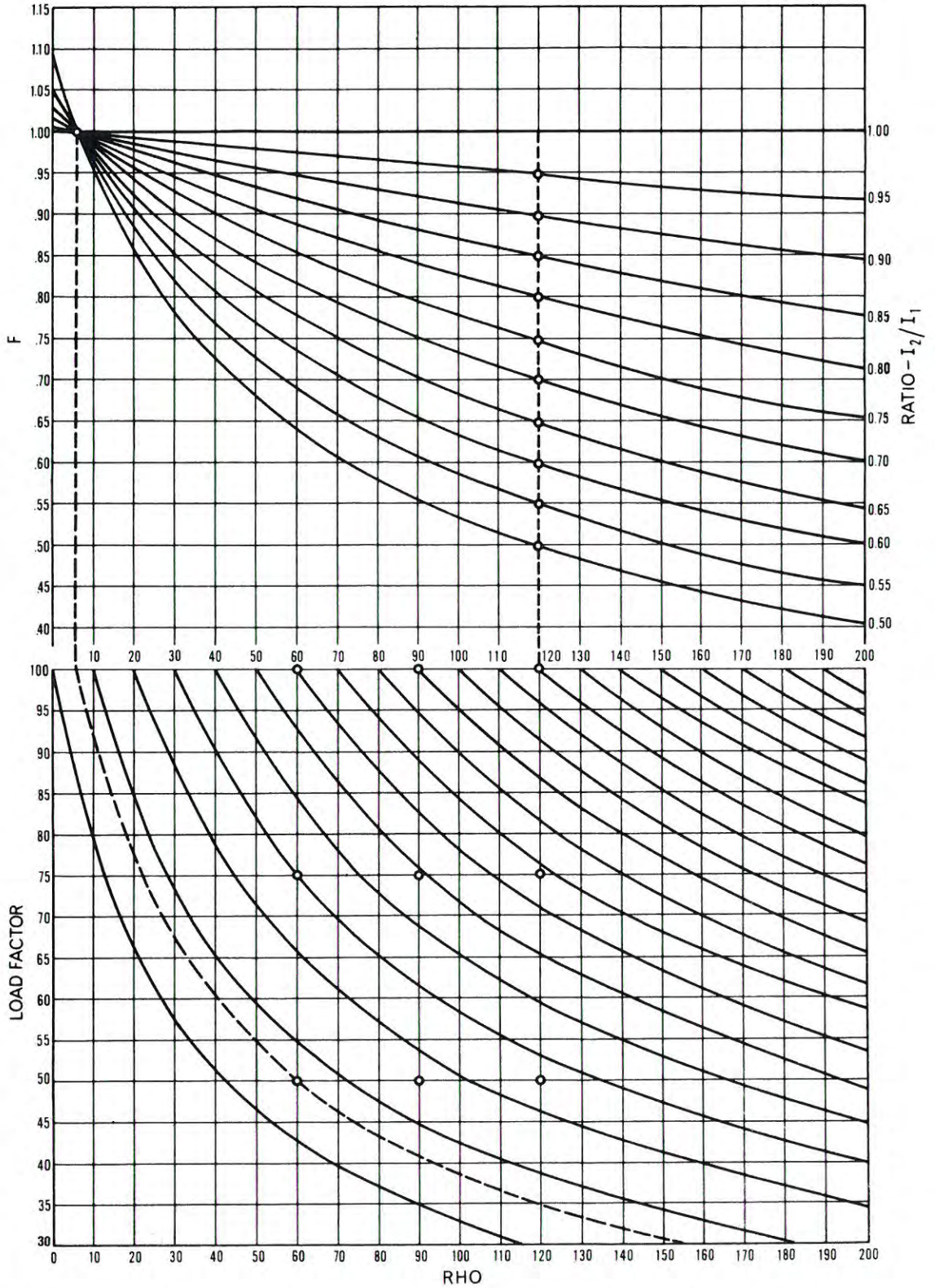

Fig. 9A-3. Interpolation chart for cables in a duct bank.  $I_1$  = ampacity for RHO-90, 50 LF;  $I_2$  = ampacity RHO-120, 100 LF; desired ampacity =  $F \times I_1$ .

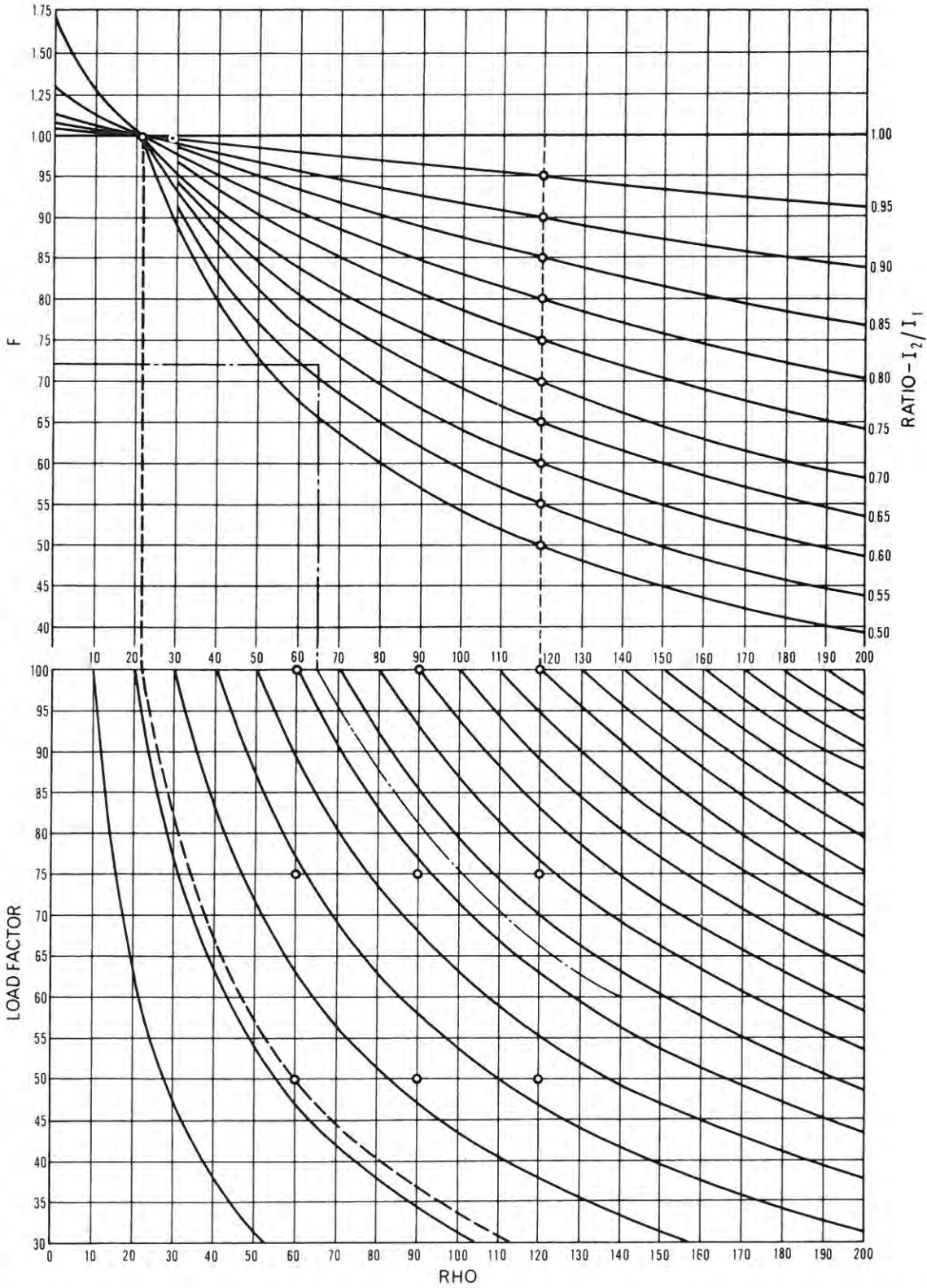

Fig. 9A-4. Interpolation chart for pipe-type and directly buried cables  $I_1 = \text{ampacity for RHO-60, 50 LF}$ ;  $I_2 = \text{ampacity for RHO-120, 100 LF}$ ; desired ampacity =  $F \times I_1$ .

## insulated aluminum conductors

represent the results of research, both experimental and analytical, relating to single as well as closely adjacent conductors, values that are difficult to find in usual sources.

*Example:* A 1000-kcmil 1350-H19 aluminum cable of 61-strands has dc resistance at 20°C of 17.34 microhms per ft; at 75°C it is 19.44 microhms per ft. The ac resistance, including skin and proximity effects ( $R_{ac}$ ) and the ratio of total losses to conductor losses (QS or QE) for a cable insulated with rubber or thermoplastic for 15 kV, is as follows for various methods of installation:

Installation Condition	$R_{ac}$ microhms/ft	QS or QE ratio
Single conductor in duct or buried	21.75	1.001
same, in air	21.70	1.002
Triplexed, in duct or buried	22.41	1.102
same, in air	22.41	1.102
same, in steel conduit*	23.26	1.167
3-Conductor, in duct or buried	22.61	1.069
same, in air	22.61	1.069
same, in steel conduit*	23.58	1.112

The dielectric loss in the insulation for all of the above conditions is 0.180 watts per conductor foot for 15 kV; for 1 kV it is 0.001 watts per conductor ft.

From values such as the above, the application engineer obtains useful relationships that might not be evident from a direct comparison of ampacities under the respective conditions.

### ICEA Ampacity Grouping Factors

Where cables or conduit that contain not more than three current-carrying conductors with neutral are maintained at more than one cable or conduit diameter apart (from surface to surface) no correction of ampacity ratings need be made. This covers cables in free air installed in expanded metal troughs and trays, mounted on ladder-type supports or supported on hangers. For conduits, this covers groups of conduits in free air.

### Cable Spacing Maintained

Where cables are in metal conduit or are armored and maintained at between one-quarter to one cable diameter apart under the above noted conditions in air, the ICEA standards permit derating in accordance with Table 9A-3.

**TABLE 9A-3**

**ICEA Derating Factors for Cables in Metal Conduit or with Armor and Set Spacing**

No. of Conduits Vertical	No. of Conduits-Horizontal						
	1	1.00	.94	.91	.88	.87	.86
2	.92	.87	.84	.81	.80	.79	
3	.85	.81	.78	.76	.75	.74	
4	.82	.78	.74	.73	.72	.72	
5	.80	.76	.72	.71	.70	.70	
6	.79	.75	.71	.70	.69	.68	

Note: Multiply the ampacity of the cable in isolated aluminum or steel conduit by the above adjustment factors.

Where cables are installed on ladder supports or in expanded metal troughs, at a maintained spacing of from 1/4 to 1 cable diameter, apply the appropriate factors from the ICEA as shown in Table 9A-4.

**TABLE 9A-4**  
**ICEA Derating Factors for Cables in Ladder Supports or Metal Troughs with Set Spacing**

Number Vertically	Number of Cables Horizontally					
	1	2	3	4	5	6
1	1.00	0.93	0.87	0.84	0.83	0.82
2	0.89	0.83	0.79	0.76	0.75	0.74
3	0.80	0.76	0.72	0.70	0.69	0.68
4	0.77	0.72	0.68	0.67	0.66	0.65
5	0.75	0.70	0.66	0.65	0.64	0.63
6	0.74	0.69	0.64	0.63	0.62	0.61

### Cable Spacing Not Maintained

Where cables are installed on ladder supports or in expanded metal troughs and where spacing is not maintained:

(a) For single conductor shielded or unshielded 3-conductor triplex-shielded, and 3-conductor shielded cables, apply the appropriate factor from the ICEA Table 9A-5 below to the ampacity of a 3-conductor shielded cable of the same conductor size, operating temperature, and voltage rating given in the tables for cables in air.

(b) For 3-conductor non-shielded cables, apply the appropriate factor from Table 9A-5 to the ampacity of the identical cable given in the tables for cables in air.

Where cables are installed in solid metal trays:

(a) For single-conductor 9A-5 cables apply the appropriate factor from Table 9A-5 below to the ampacity for three identical single-conductor cables in isolated conduit in air.

(b) For 3-conductor cables apply the appropriate factor from the table below to the ampacity of the identical cable in isolated conduit in air.

**TABLE 9A-5**  
**ICEA Derating Factors for Cables Where Set Spacing Is Not Maintained**

Total Number of Conductors	Factor
3	1.00
4-6	0.80
7-9	0.70
10-24*	0.70
25-42*	0.60
43 and up*	0.50

\*These factors include the effects of load diversity.

\* The QE value for conductor in aluminum conduit as an average will be only 0.01 more than the QS value in air, and for cables 4/0 or smaller even less (see Page 9-8).

Articles 310 and 318 of the 1987 edition of the NEC impose more restrictive regulations than those provided by the ICEA.

Note No. 8 of Article 310 states: Where the number of conductors in a raceway or cable exceeds three, the ampacity shall be as given in Tables 310-16, -18, -22, -26 to -31, but the maximum allowable load current of each conductor shall be reduced as shown in the following table:

**TABLE 9A-6**  
**NEC Derating Factors Where Conductors in Raceway or Cable Exceed Three**

<b>Number of Conductors</b>	<b>Percent of Values in Tables 310-16, -18, -22 to -31</b>
4 thru 6	80
7 thru 24	70
25 thru 42	60
43 and above	50

Exceptions to the table above are provided in the above-referenced NEC Articles and should be adhered to when installations fall under NEC jurisdiction.

Chapter 10

## Product Classification and Technical Data

This chapter deals with cable types available for power distribution, including related user applications. Insulated conductors for instrumentation, communications, and protection are not described. Considerable information regarding applications, engineering design, and insulation is in previous chapters. Installation practices and connector selection are covered in Chapter 11. For ease of reference some Chapter 7 descriptions of cable types are repeated in part.

Manufacturers' catalogs should be consulted for detailed specifications, and particularly as to sizes available in each category. To save space, not all available sizes are included in the description of each classification. Omissions, however, do not imply lack of use or demand. Similarly, only a few of the available insulations are listed as a part of the description of each type of cable. Other varieties of insulation including those mentioned in Chapter 8 may be available upon inquiry.

The product classifications in this chapter follow the plan of previous chapters by proceeding from the low-voltage cables to those of high-voltage. First to be considered are the service cables.

The usual table of ampacity ratings is omitted in the descriptions of each style of conductor. Instead, reference is made to a specified vertical column of Tables 10-1, 10-7, and 10-9, in which typical ampacity ratings are listed for the applicable conductor size, insulation, and temperature.

Ampacity listings for installations to 35 kV are found in NEC Article 310, Tables 310-16 to 310-31, and except for utility installations, the NEC is the governing document. See Appendix 9A of this Handbook for discussion of ampacity ratings as listed by ICEA.

In addition, a modified type of stranding, 19 wire combination "Unilay," is now available as described in ASTM B 786 in its uninsulated form. Details of the various sizes of this conductor are listed in Table 4-26.

### Service and Secondary Cables

#### Class 10-1

*Messenger-Supported, Service-Drop and Secondary Cable (Duplex, Triplex and Quadruplex) (Figure 10-1)*

This cable ordinarily is installed by the power supplier

(utility) for both secondary runs and service drops. The cable construction consists of a bare neutral-messenger support member, which serves as a neutral, cabled with one, two or three insulated conductors. Service-drop and secondary cable are commonly manufactured to comply with the appropriate ICEA Specification S-66-524 for crosslinked polyethylene (XLPE) insulated conductors rated at 90°C maximum; and S-61-402 for polyethylene (PE) insulated conductors rated at 75°C maximum. Cables of this type are suitable for applications where phase-to-phase voltage does not exceed 600 volts.

The following are typical sizes and insulation thicknesses for phase conductors:

Conductor size AWG or kcmil	Thickness	
	mils	millimeters
8 through 2	45	1.14
1 through 4/0	60	1.52
250 through 500	80	2.03

Available sizes — Generally all constructions are available in sizes No. 6 through 4/0, with large sizes through 500 kcmil available upon special inquiry.

Neutral-Messengers—Constructions are available with full or reduced sizes AAC, ACSR, ACSR/AW and Aluminum Alloy (6201) neutral-messengers.

Based on the referenced guide below Table 10-1, ampacities at a fixed condition of 40°C ambient, no wind or sun, are tabulated in Table 10-1.

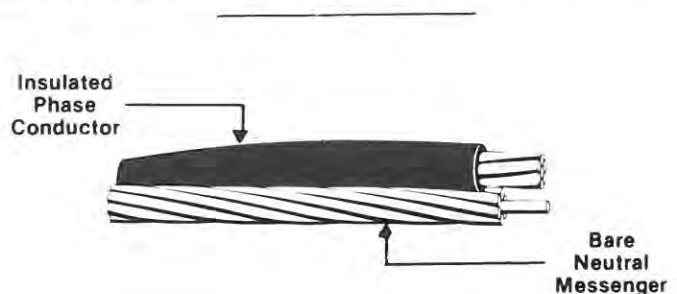

Fig. 10-1. Neutral-supported duplex secondary cable with solid or stranded power conductor and bare, stranded neutral.



covered and insulated aluminum wire and cable

Type insulation and construction	Table 10-1 Col. Reference
Polyethylene Duplex, Triplex	3
Quadruplex	4
Crosslinked Polyethylene Duplex, Triplex	1
Quadruplex	2

**Class 10-2**

**Preassembled Parallel Secondary Cable (Fig. 10-2)**

This cable serves a similar purpose as Class 10-1, except it is used more for secondary runs than for service drops. The introductory comments for Class 10-1 also apply to it. The two or three insulated power conductors are laid parallel and are secured to a bare neutral messenger by means of flat aluminum-alloy binder ribbon applied helically about the assembly. The usually available insulations are cross-linked polyethylene (XLPE) rated 90°C, high density polyethylene (HDPE) and conventional polyethylene (PE) rated 75°C of the same thicknesses as listed for Class 10-1. The neutral messenger used with cables of Class 10-2 is the same as those specified for Class 10-1 cables, either full size or reduced size. Ampacities are the same as those for duplex-triplex Class 10-1, according to the kind of insulation.

**Class 10-3**

**Reverse Twist Secondary Cable (RTS) (Fig. 10-3)**

This cable is similar to Class 10-1 and the introductory comments also apply. RTS cable is generally used as secondary distribution cable and occasionally used for service drops. Cable construction consists of two or three insulated phase conductors cabled about a straight neutral-messenger with direction of lay reversed at regular specified intervals throughout the length of the cable. The conductors are bound to the messenger with an aluminum flat strap binder. This cable is particularly useful in secondary distributions and where T-taps are required since "slack" can be obtained by untwisting the cable conductors. Ampacities for these constructions are listed in Table 10-1.

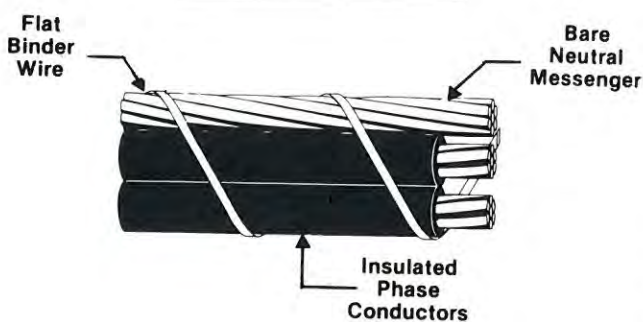

Fig. 10-2. Preassembled parallel secondary cable.

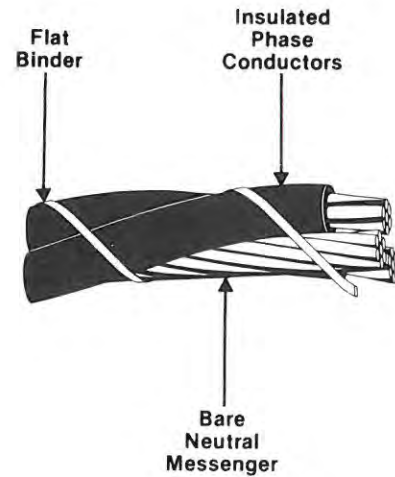

Fig. 10-3. Preassembled reverse lay twist cable.

**Class 10-4**

**Type SE-Style U Service Entrance Cable (Fig. 10-4)**

Cable construction includes two or three insulated conductors with a bare concentric neutral considered as a conductor. Three-conductor SE-Style "U" (SEU) cable is the more widely used construction. It is employed as service entrance from the attachment point of the service drop cable down through the meter socket and then to the service panel. Three-conductor cables consist of two insulated conductors paralleled, about which is applied a bare concentric conductor. The assembly is compacted, protected and strengthened by a reinforcement tape, and an extruded polyvinyl chloride (PVC) jacket applied overall. SEU cable is manufactured to comply with the UL standard for service entrance cables (UL 854). Application is governed by local building codes which generally reference the NEC. Phase conductors in service entrance cable are usually NEC types XHHW and RHW. SE cables are recognized in Article 338 of the NEC for use as feeder and branch circuit conductors with certain limitations. Typical applications include range and dryer circuits.

**Class 10-5**

**Type SE-Style SER Service Entrance Cable (Fig. 10-5)**

SER cables meet all of the requirements of Class 10-4 above for SEU cables. Style SER cables differ from SEU in that the neutral conductor is insulated and cabled with the phase conductors. This difference produces a round configuration for three- and four-conductor cables. Available constructions are: three-conductor cable (two insulated phase conductors cabled with an insulated neutral conductor); and four-conductor cable (the same as three-conductor, plus a cabled bare equipment-grounding conductor).

SER cables are suitable for voltages not exceeding

**TABLE 10-1**  
**Typical Ampacities for Various Sizes and Types of Stranded Conductors**  
**in Cables of the Class**  
**Descriptions Mentioned in the Text\***  
**(600 Volts or Less)**

NOTE: It is suggested that this table not be used directly, but only to supply information as a supplement to the Class Descriptions which should be consulted first. Except for Classes 10-4, -5, and -8, the listed ampacities are based on 40°C ambient for cable in air or in conduits in air, and 20°C ambient for cables in buried duct or direct earth burial, assuming 100% load factor and RHO-90 earth thermal resistivity. The listed ampacities for Classes 10-4, -5, and -8 are based on 30°C ambient.

Insulated Conductors AWG kcmil	Temp °C	Class 10-6										Class 10-7			Class 10-8			Class 10-9				Class 10-10														
		90	75	90	75	90	75	90	75	90	75	90	75	90	75	90	75	90	75	90	75	90	75	90	75	90	75	90	75							
	Col.No.	1	(2)	(3)	(4)	(5)	(6)	(7)	(8)	(9)	(10)	(11)	(12)	(13)	(14)	(15)	(16)	(17)	(18)	(19)	(20)	(21)	(22)	(23)	(24)	(25)	(26)	(27)								
12																			15																	
10																			25																	
8						40	64	55	51	44	43	37	50	45					30																	
6				60	75	50	85	73	69	59	58	50	66	60	65	53	58	50																		
4			90	80	75	65	115	97	91	78	76	65	86	78	85	70	76	65																		
2		130	125	110	105	#100	150	128	123	106	102	87	116	103	115	92	102	87																		
1		185	175	150	140	#125	201	172	167	143	139	119	150	136	155	125	139	119																		
1/0		215	200	175	165	#150	232	199	193	165	159	137	172	156	180	144	159	137																		
3/0		250	235	205	195	#175	269	230	224	192	189	162	196	178	205	166	189	162																		
4/0		295	275	240	230	#200	312	268	262	224	217	186	226	205	240	192	217	186																		
250							347	297	292	251	249	213	250	227	265	214	249	213																		
350							431	370	364	312	303	259	304	276	330	265	303	259																		
500							544	466	458	392	381	326	372	338	410	330	381	326																		
750							707	606	598	512	488	417	468	425	530	424	488	417																		
1000							853	730	716	612	578	493	546	494	625	500	578	493																		
1250							982	840																												
1500							1103	944																												
1750							1216	1039																												
2000							1321	1128																												

\*The listed ampacities generally are from ICEA tables, and may differ from ratings in NEC 310 tables as qualified by footnotes, and after adjustment for difference of ambient temperatures. If differences occur, use adjusted NEC values when NEC conditions must be met.

Some ratings are in even figures, and others are rounded to nearest 5-ampere values. This lack of uniformity is explained by noting that ampacity ratings of successive batches may show a variation of +2%, hence the rounding to nearest 5 amperes is allowable. Some listings from industry sources are based on 62% IACS aluminum conductivity, but most tabulated values are based on 61% conductivity. The effect on ampacity is only 8/10 of 1% in favor of the 62% aluminum, hence the difference is ignored in the tables.

Adjustment of ampacity values for cables closely adjacent in rigid cable supports, troughs, or where there is no maintained spacing, should be made according to factors in Appendix 9A. # Ampacities are from the NEC for three-wire, single-phase residential services.

covered and insulated aluminum wire and cable

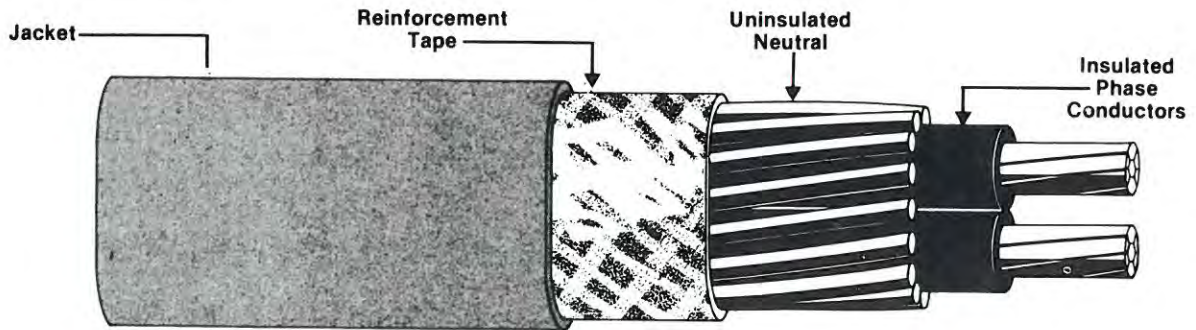

Fig. 10-4. Type SE-style U three-conductor service-entrance cable.

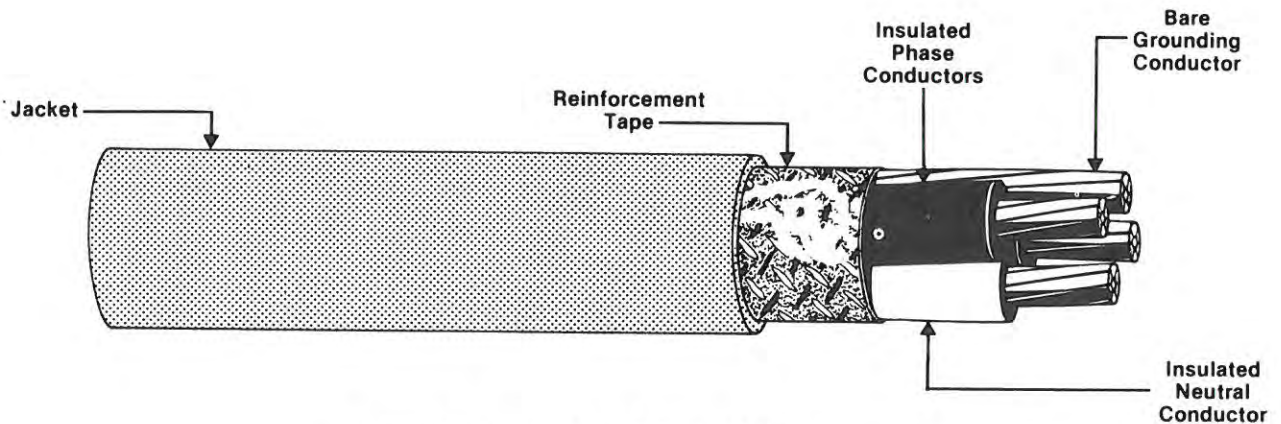

Fig. 10-5. Typical type SE-style SER cable.

600 volts. SER cable is primarily used in residential wiring to subfeed distribution panels in multi-unit dwellings. The four-conductor cable provides an insulated neutral required by the NEC for feeders and branch circuits, as well as an equipment-grounding conductor. Cable is sized per NEC requirements. Where cables are used as branch circuit conductors, cable ratings are based on the type of conductor insulation within the cable — for example, XHHW for 90°C dry locations at the applicable ampacity called for in NEC tables.

*Class 10-6*

*600-1000 Volt Power and Lighting Cable (not especially designed for direct burial) (Fig. 10-6)*

Cables of the 600-volt and 1000-volt class are similar except for a slight difference of insulation thickness. NEC describes the 600-volt class completely for code applications, and its Art. 710 refers to requirements for "over 600 volts." Under NEC conditions, the 1000-volt cables mostly are applied for certain circuits related to

industrial processes, motor loads, large fluorescent lighting installations, and sometimes where ungrounded neutrals are used. Some manufacturers include the 1000-volt cables in a group specified for 601-2000 volts.

Cables of the 600-volt class sometimes are referred to as building wires because of the extensive use of single conductors for interior circuits. The *Aluminum Building Wire Installation Manual and Design Guide* of The Aluminum Association lists sizes of the 600-volt class and NEC designations of insulation for various temperatures and environments, hence they are not repeated in this handbook. This classification includes insulated single or multiplexed cables for installation in air, duct, cable tray, metallic or non-metallic conduit, or suspended from messenger. It does not include multi-conductor cables (an assembly of several conductors under one jacket or sheath) nor cables designed especially for underground direct burial, though some cables of this class may be suitable for direct burial.

Table 10-2 shows the usual range of sizes and kinds

*product classification and technical data*

of insulation generally used for the 600-volt class on the basis of 100 percent insulation level, with grounded neutral. The insulation thickness for 1000 volts is slightly more than for 600 volts. If the thickness is shown as a double number, the right-hand value applies to the jacket only.

The EPM-EPDM insulation, listed in Table 10-2, represents the formulation used for 1000 volts or less of the EPR ozone-resistant insulation listed in Table 8-2.

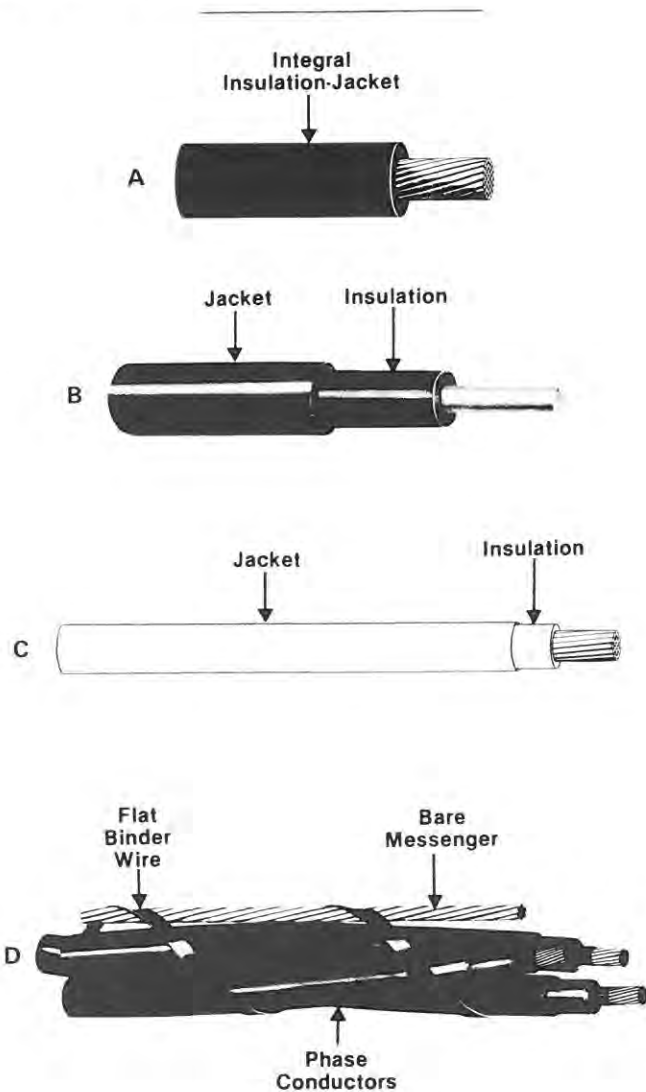

Fig. 10-6. Typical 600-volt insulated power and light cables.

- A—No outer covering required.
- B—Comparatively thick jacket, neoprene, etc.
- C—Comparatively thin jacket, nylon, etc.
- D—Assembled aerial cable; phase conductors, either cabled or layed up with reverse lay twist to facilitate side taps.

Ampacity ratings\* for these conductors in air at 40°C ambient (not buried or in underground duct) are listed in the following designated columns of Table 10-1:

	90°C	75°C
Single conductor, in air	Col. 6	Col. 7
Each conductor of a triplexed assembly in air	Col. 8	Col. 9
Each conductor of a triplexed assembly in steel conduit in air	Col. 10	Col. 11

Ampacity rating of each conductor of a triplexed assembly in buried duct at 20°C ambient is listed in columns of Table 10-1 as below:

	90°C	75°C
Each conductor in triplexed assembly in nonmetallic duct, buried, of two phase conductors and neutral	Col. 12	Col. 13

*Class 10-7*

*Three-Conductor Cable (600-1000 Volts) (Fig. 10-7)*

Although a triplexed cable has three conductors, it was included in Class 10-6 because essentially it is comprised of three closely spaced single conductor cables and is not designated as a multi-conductor cable.

A multi-conductor cable, on the other hand, as usually defined, has two or more phase conductors, usually cabled, and the entire assembly is enclosed in a close-fitting tubular jacket or sheath which may contain fillers to round out its circular shape. It may also have an insulating jacket under the sheath.

Sector stranded conductors are sometimes used in three-conductor cable as a means of reducing diameter. The Type SER service-entrance 600-volt cable qualifies as a three-conductor cable, but because of its special application it is listed as Class 10-5. The Types NM and NMC also are three-conductor cables, but because of availability only in small sizes for branch circuits they are separately considered as Class 10-8. It is characteristic of three-conductor cables that the outer jacket must fit closely, hence pre-assembled cables in a comparatively large duct are not included. Many portable power cables are three-conductor cables, with flexible neoprene or plastic jackets.

Armored aluminum multi-conductor power cables, Fig. 10-7, available as Type MC (metal clad) with NEC conductors No. 12 AWG and larger, have an outer protective covering of corrugated or interlocked design. A modification in branch-circuit and feeder sizes, Type AC (armor clad), has an internal bonding strip of aluminum in intimate contact with the armor for its entire length. Another style of Type MC aluminum corrugated cable has the tube formed around the assembly of insulated conductors, with the longitudinal seam closed

\* Ampacity ratings for this class are from ICEA Pub. P-46-462 (1962) as described in Chapter 9.

**TABLE 10-2**  
**Typical Insulation Thicknesses\* of Power and**  
**Lighting Secondary Cables (600 volts)**  
**Thickness of Insulation in Mils (1/1000 in.)**

Conductor Size AWG-kcmil Class B Stranded	Cross Linked Polyethylene		Polyvinyl Chloride		SBR Rubber 75°C Wet Neoprene Jacket RHW-USE Mils mm	Butyl 90°C Dry 75°C Wet Neoprene Jacket RHH-RHW-USE++ Mils mm	EPM-EPDM Ethylene Propylene Rubber 90°C Dry 75°C Wet Syn-Rubber Jacket RHH-RHW-USE++ Mils mm			
	90°C Dry		Nylon Jacket							
	90°C Dry 75°C Wet XHHW Mils mm	90°C Dry 75°C Wet USE-RHW- RHH++ mm	75°C Wet THW Mils mm	THHN++ 90°C Dry THWN 75°C Wet Mils mm						
12-10	30	45	45	1.14	**	**	45-15***	1.14-.38	30-15	0.76-.38
8-2	45	60	60	1.52	**	**	60-30	1.52-.76	#	#
1-4/0	55	80	80	2.03	50-7	1.27-.18	80-45	2.03-1.14	55-45	1.40-1.14
213-500	65	95	95	2.41	60-8	1.52-.20	95-65	2.16-1.65	65-65	1.65-1.65
501-1000	80	110	110	2.79	70-9	1.78-.23	110-65	2.79-1.65	80-65	2.03-1.65
1001-2000	95	125	125	3.18						

\*100% insulation may also be used with ungrounded neutrals provided the fault-clearing devices clear the fault in less than one minute and completely de-energize the faulted section. If this condition cannot be met, it may be necessary to use insulation for 133 percent level (see manufacturer). (If thickness is shown as a double number, right-hand number indicates thickness of jacket).

\*\*For No. 12, values are 15-4 mils (.38-.10 mm); for No. 10, values are 20-4 mils (.51-.10 mm); for No. 8 and No. 6, values are 30-5 mils (.76-.13 mm); for No. 4 and No. 2, values are 40-6 mils (1.02-.15 mm).

\*\*\*A 30-mil jacket is required for aerial installation.

++NEC limits wet-location rating to 75°C, but ICEA and industry ratings allow 90°C wet or dry for cables having these insulation thicknesses.

#For sizes No. 8 and No. 7, values are 45-15 mils (1.14-.38 mm); for sizes No. 6-2, values are 45-30 mils (1.14-.76 mm).

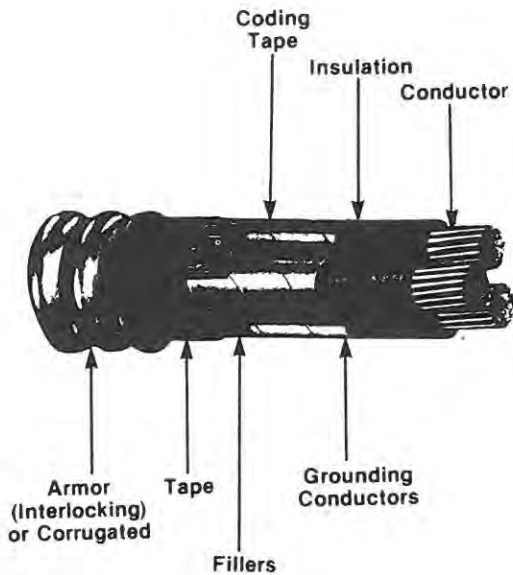

Fig. 10-7. Typical three-conductor impervious-corrugated or interlocked, corrugated armored cable.

by welding, and the corrugations roll-formed to provide flexibility.

Still another MC type is aluminum sheathed cable, formerly Type ALS. This cable has a smooth tubular aluminum sheath surrounding three or more NEC conductors of branch-circuit size with ampacity ratings from 20-amp to 90-amp. The insulation of individual conductors used in this cable type may be any listed for Class 10-6 cables. These cables are particularly useful in control circuit wiring, where provision for growth is not necessary. Its use eliminates cost of conduit installation and wire pulling.

In any of these MC types, a fourth insulated conductor can be included for three-phase, Y-connected applications.

The equivalent of a separate bare or covered grounding conductor may be included as one or more conductors in the interstices of the cable arrangement. The grounding conductors for Type MC cables are tabulated in Section 7.9 of ICEA Standard S-66-524 and Section 7.10 of S-19-81. The protective sheath or armor is not designed for use as a neutral conductor and for interlocked metal strip design is not recognized as a grounding conductor.

The exterior surface of metal clad cables must be additionally protected by a suitable jacketing material when exposed to destructive corrosive conditions. Colored PVC jackets are commonly used for this purpose.

There are moderate NEC limitations as to where Type MC and similar cables may be installed. Generally, they are placed in trays or on other rigid supports in power stations, industrial plants and commercial installations, though some types are suitable for embedded or underground use.

For calculating voltage drop in 600-volt three-conductor armored cable, the factors of Table 9-6 may be applied, using those for aluminum conduit for cables with aluminum armor, and those for steel conduit for cables with steel armor. The armor is thinner than the wall of standard conduit, but since it is closer to the conductors, its inductive effect is about the same.

The ampacity of the three-conductor unarmored or aluminum-armored cables in air at 75°C with 40°C ambient is per Col. 15 of Table 10-1 and at 90°C per Col. 14. For three single-conductor cables in steel conduit, the ampacity is as shown in Col. 17 for 75°C and Col. 16 for 90°C. The range of available sizes of cables with welded-tube corrugated armor differs from that of cable with interlocked armor. For further information consult manufacturers' lists.

#### Three-conductor non-metallic-jacketed cable

This cable is similar to Type MC armored or sheathed cable except that the protective covering is a round plastic jacket instead of a metallic sheath or armor. This design is used where it is desired to maintain a fixed configuration of the conductors along with moderate protection against crushing and abrasion, such as when pulling through a duct or after installation on supports, particularly in wet locations. The insulation of the individual conductors may be any listed for Class 10-6 cables, though the conductors usually do not require additional jacketing. In wet locations, the insulation should be selected for wet conditions. The outer jacket is usually of neoprene or polyvinyl chloride. If the cable is in air at 40°C ambient, the ampacity rating of Col. 15 for 75°C and Col. 14 for 90°C of Table 10-1 may be used. If installed in underground duct at 20°C ambient, Col. 13 for 75°C and Col. 12 for 90°C may be used.

These plastic-jacketed three-conductor cables may be installed in the same manner as single power cables (Class 10-6).

#### Class 10-8

##### Types NM and NMC Nonmetallic Sheathed Cable (Fig. 10-8)

This two-, three- or four-conductor cable is used extensively for interior wiring of branch circuits through the 75-amp ratings. It is listed by UL for sizes No. 12 through No. 2 for aluminum. The insulated conductors in the usual sizes of No. 12 and No. 10 are arranged in parallel for two-conductor cables; three and four-conductor cables are cabled into a round configuration. Assemblies are enclosed in a moisture and abrasion resistant extruded PVC jacket. The three-insulated-conductor round style is suitable for 3-wire circuits with one insulated conductor serving as neutral.

NM and NMC cable is satisfactory for use in circuits not exceeding 600 volts and where conductor temperatures

covered and insulated aluminum wire and cable

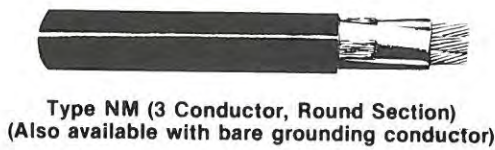

Fig. 10-8. Type NM branch-wiring cables.

do not exceed 60°C. Cable constructions are available with or without a bare grounding conductor.

Conductors of No. 10 size or smaller are solid, and annealed for flexibility, because an advantage of this type of cable is that it readily may be bent into place. The Type NM cable is approved for installation in both exposed and concealed work in normally dry locations, but not for exposure to corrosive conditions, nor may it be run in masonry, concrete, or plaster.

Type NMC cable resembles type NM but has an

integral jacket which is fungus- and corrosion-resistant. Installation in moist or corrosive locations is approved and under certain conditions it may be used where Type NM is prohibited. Neither type is approved for service-entrance use, nor for locations as limited in NEC Section 336-3. Ampacities, based on 30°C ambient, are in Col. 18, Table 10-1.

*Class 10-9  
Secondary-Distribution Single- or Three-Conductor  
Cables for Underground Residential Distribution  
(URD) 600 Volts (Fig. 10-9)*

Although these cables are usually designated as for URD, they are of course suitable for any other direct burial use within their ratings. NEC cables designated Type UF (underground feeder) are included to 4/0. Certain other conductors in Class 10-6 are also suitable for direct burial, such as USE or the combination Type USE-RHW-RHH available in several insulations. Some sizes are available in both solid and concentric-stranded aluminum conductors; the solid type is an intermediate temper.

Bare aluminum neutrals are usually not permitted for URD cables because of the possibility of corrosion in wet earth. A popular cable is a triplexed assembly of which one conductor is an insulated neutral, Fig. 10-9C.

A less frequently used form has a copper-wire neutral spiraled closely around one or two paralleled insulated conductors. (Fig. 10-9A & 9B) Copper is used for the earth contact because of its resistance to corrosion under buried conditions. Still another form is the ribbon

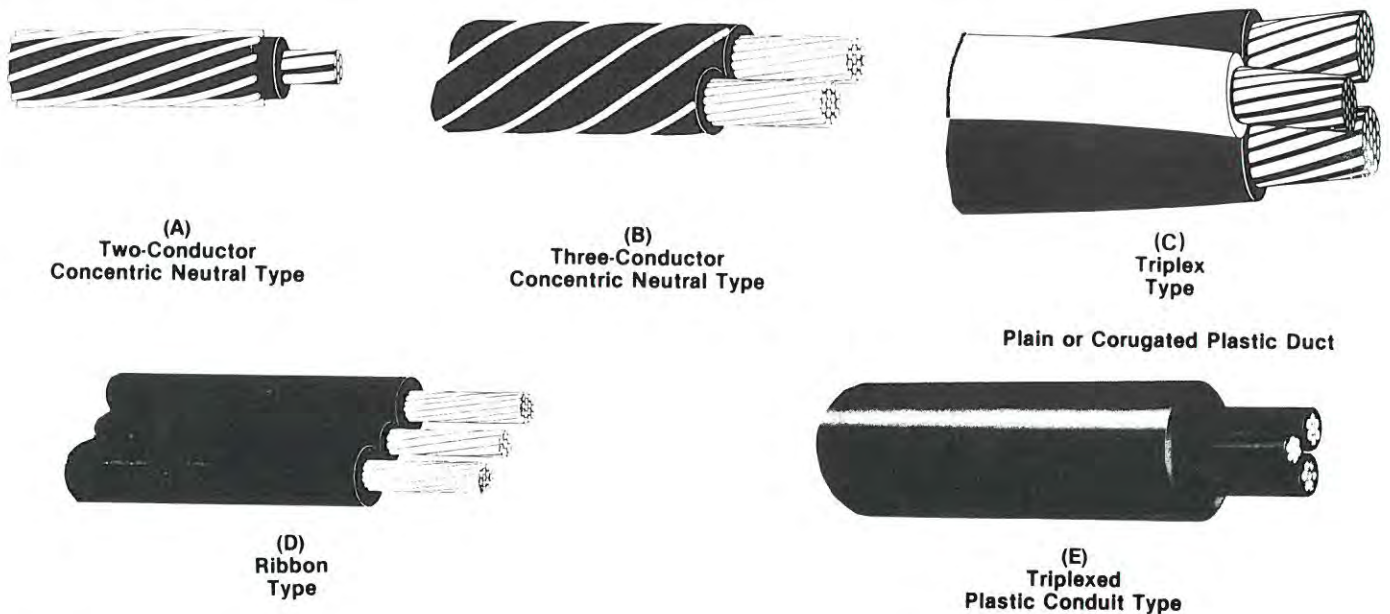

Note: A concentric-neutral cable may be used instead of the triplexed as shown for installation in plastic conduit (E).

Fig. 10-9. Typical 600-volt cables for direct burial.

**TABLE 10-3**  
**Typical Insulation Thicknesses of Secondary Cables (600V) for Direct Burial or**  
**Underground in Duct**  
**Thickness of Insulation in Mils (1/1000 in.), Millimeters**

(1) Conductor Size AWG-kcmil	(2) Cross-Linked Polyethylene				(4) Polyvinyl Chloride or				(5) Low-Density Polyethylene			
	Concentric Neutral, or Triplexed 90°C		Parallel Ribbon Type* 90°C		Concentric Neutral, or Triplexed 75°C		Parallel Ribbon Type* 75°C		Plastic Conduit Type 75°C			
	Mils	mm	Mils	mm	Mils	mm	Mils	mm	Mils	mm		
4-2	60	1.52	75	1.91	60	1.52	95	2.41	60	1.52		
1-4/0	80	2.03	85	2.16	80	2.03	125	3.18	80	2.03		
225-500	95	2.41	95	2.41	95	2.41	—	—	95	2.41		

Sizes are concentric stranded conductors; for solid-conductor sizes (except for Column 5) refer to manufacturer. Special inquiry also is required for availability of sizes for Column 2 for sizes above 300 kcmil.

\*The thicknesses shown include 30 mils for jacket.

cable in which two parallel insulated phase conductors have an insulated neutral between them, Fig. 10-9D. The insulation is extruded over the three conductors simultaneously so there is a thin connecting web between the conductors, or the web may be only a part of a jacket. The web is easily torn away during installation.

Available constructions include cable in a duct. This construction consists of two or more conductors pre-assembled at the factory in a plastic duct (Figure 10-9E). Use of this product provides for conductor replacement after installation. Duct sizes are compatible with existing accessories and, through supplier inquiry, may be sized to allow for some degree of enlargement on the system as installed.

The insulated conductors in any of the above-described cable assemblies can be any of the conductors of Class 10-6 listed by NEC as suitable for direct burial.

Table 10-3 shows the usual range of sizes and kinds of insulation generally used for the 600-volt cables of the types described and Table 10-1, Cols. 19 to 26 summarizes ampacities that conform to ICEA requirements, and to local codes requiring that underground secondary service cables leading directly to the home be UL-listed. Care should be taken by the purchaser to assure that the product offered is UL-labeled for these applications where required.

The three-conductor URD cables for 600 volts in the arrangements shown in Fig. 10-9 are for three-wire single-phase circuits. If the cables are for three-phase (3 or 4 conductors), the ampacities shown in Table 10-1 should be reduced. Consult suppliers.

Cols. 19 and 20 of Table 10-1 list ampacities of 600-volt buried cables of the concentric-neutral type (having spiraled bare copper neutrals) at 20°C ambient for insulation suitable for 90°C and 75°C, respectively. The

ampacities of triplexed buried cables are listed in Cols. 25 and 26. The ribbon type has ampacities according to industry sources and tests as listed in Col. 21 for 90°C and for 75°C as in Col. 22.

In all cases of direct burial or duct installation an earth thermal resistance of RHO-90 is assumed with a load factor of 100 percent; that is, the cables will withstand these ampacity ratings for continuous operation.

The ampacity ratings of the cables pre-assembled in plastic ducts for the 90°C ratings are in Col. 23 and for the 75°C ratings in Col. 24.

#### Class 10-10

##### Portable Aluminum Cables (600 Volts or less) (Fig. 10-10)

Portable aluminum cables, either single or multiple conductor, are constructed to yield a high degree of flexibility. Flexible cables usually employ an intermediate tempered aluminum conductor which is insulated with a synthetic rubber or thermoplastic material. These conductors are phase-identified for circuit applications. Two or three conductor cables, with or without equipment grounding conductors, are cabled together with the necessary fillers to construct a round cable and employ an overall jacket of thermoplastic or synthetic rubber. Flat constructions are also available with conductors arranged parallel to one another and with a common overall jacket. Portable aluminum cables possess a lighter weight than other constructions, which facilitates their use. Single-conductor portable cables are available for special applications where flexibility is a requirement due to installation handling or vibration is a consideration.

Single-conductor portable cables usually are available from No. 8 to 1000 kcmil, and multiple conductor portable cables from No. 12 to 4/0 AWG. Ampacity ratings are usually approximately as follows for 75°C



covered and insulated aluminum wire and cable

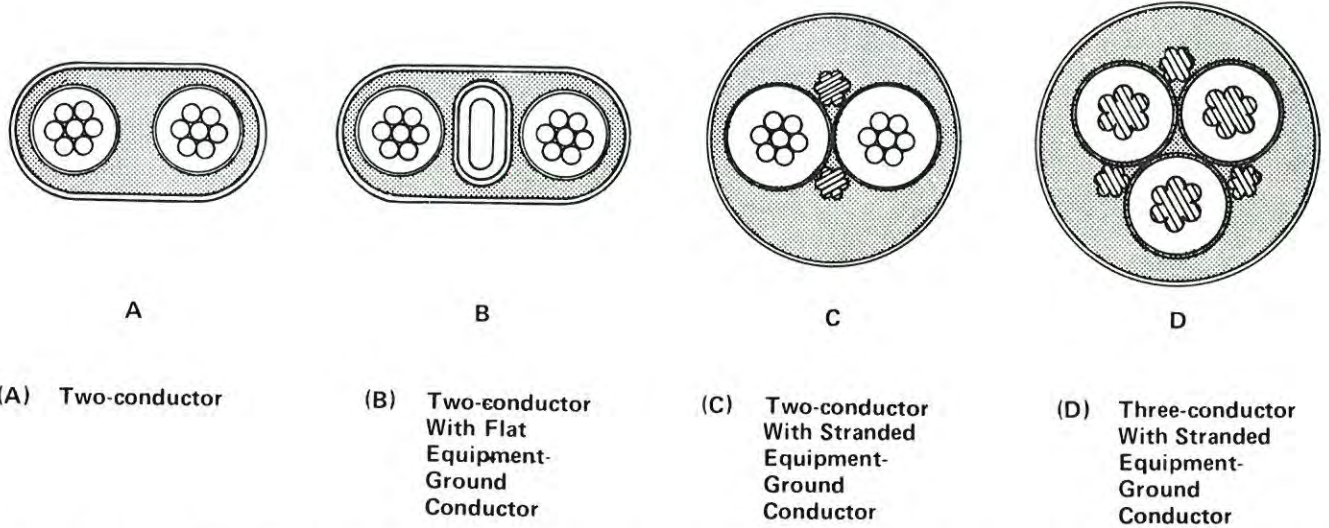

Fig. 10-10. Typical cross-sections of portable cables, comprising aluminum conductors, insulation, web-tape cushion, and overall jacketing.

Note: The web-tape cushion prevents longitudinal separation of insulation and jacket during bending of the cable.

operating temperatures and 40°C ambient temperatures:

Single-conductor cables	Col. 3 in Table 10-1
Two-conductor parallel or round type	Col. 4 in Table 10-1
Three-conductor, round	Col. 27 in Table 10-1

Often a long portable cable is partly held on a gathering reel. The above ampacity values are reduced for such cases by multiplying by the following correction factors:

One layer on roll	0.85
Two layers on roll	0.65
Three layers on roll	0.45
Four layers on roll	0.35

**Class 10-11 (Fig. 10-11)**  
**Aluminum Control Cables (for 600 Volts or less)**

Because of the wide variety of multi-conductor cables used for control and signal circuits and the generally small size of the individual conductors, no detailed descriptive listing of them is attempted for this book. The individual conductors (either stranded or solid) are insulated with compounds that best meet conditions, and the whole assembly is contained within a round thick overall jacket of neoprene or thermoplastic material. Where the application environment is severe, constructions are available with reinforced overall jackets or armoring.

These control cables have wide application in utilities, industrial, municipal, and railroad installations for control and signal purposes. The automatic control of machine-tool operations is a recent application for which control cables of oil-resistant type are used. Manufacturers' lists should be consulted.



Fig. 10-11. Typical aluminum multi-conductor control and signal cable, available with 2 to 18 conductors, AWG 9 to 14, suitable for installation in ducts, direct burial, or for aerial suspension from messenger.

**Cables For Primary Distribution Voltages**

The types and voltage range of primary distribution cables with aluminum conductors were briefly described in Chapter 7. Those with rubber or thermoplastic insulations mostly are for 5-, 15-, 25-, and 35-kV all with grounded neutral. The 3-kV and 8-kV ratings sometimes are listed, but are less used because the trend is toward the next higher voltage in anticipation of load growth, even though the actual increase from the lower circuit levels may be long delayed.

Customarily, primary-distribution insulated cables are voltage-rated on the basis on the phase-to-phase voltage of a three-phase circuit of which they are a part, or would be a part if the three-phase circuit were complete. Thus, an insulated conductor of a single-phase branch circuit including a phase wire and a ground wire that is connected to the wye ground of a 25-kV three-phase wye-grounded circuit is still rated 25 kV although the actual rms kV of the single-phase circuit is only  $25/\sqrt{3}$  or 14.4 kV. This notation applies principally to the single insulated primary conductor of the two-conductor cable that supplies the single-phase transformer that feeds the secondary three-wire circuits.

Cable descriptions in this book and in the literature distinguish between the insulation thicknesses required for high-voltage cables in circuits with grounded neutral and those with ungrounded neutral, the latter requiring thicker insulation. It is recognized, however, that there are other conditions than lack of neutral ground that may make a thicker insulation desirable. To meet this condition the concept of grounded and ungrounded neutral is in the process of being eliminated as a sole criterion. Instead the insulation thicknesses are assigned based on *insulation level* (AEIC #5 and 1987 NEC, Table 310-13).

The selection of the cable insulation level to be used in a particular installation shall be made on the basis of the applicable phase-to-phase voltage and the general system category as outlined below:

**100 Percent Level**—Cables in this category may be applied where the system is provided with relay protection such that ground faults will be cleared as rapidly as possible, but in any case within one minute. While these cables are applicable to the great majority of cable installations which are on grounded systems, they may be used also on other systems for which the application of cables is acceptable provided the above clearing requirements are met in completely de-energizing the faulted section.\*

**133 Percent Level**—This insulation level corresponds to that formerly designated for ungrounded systems. Cables in this category may be applied in situations where the clearing time requirements of the 100 percent level category cannot be met, and yet there is adequate assurance that the faulted section will be de-energized in a time not exceeding one hour. Also they may be used when additional insulation strength over the 100 percent level category is desirable.

**173 Percent Level**—Cables in this category should be applied on systems where the time required to de-energize a grounded section is indefinite. Their use is recommended also for resonant grounded systems. Consult the manufacturer for insulation thicknesses.

The AEIC reference to the preceding statement regarding insulation levels also includes the following:

In common with other electrical equipment, the use of cables is not recommended on systems where the ratio of zero to positive sequence reactance of the system at the point of cable application lies between -1 and -40, since excessively high voltages may be encountered in the case of ground faults.

Consideration of this requirement is in the province of the system electrical engineer.

#### *Tabular Voltages for Determining Insulation Thickness*

For three-phase systems with grounded or ungrounded neutral the thickness values are those given in the respective columns of Table 10-4. For three-phase delta systems where one leg may be grounded for periods of over one hour, consult the 173 percent insulation level referenced above. For single- and two-phase grounded systems, multiply the voltage to ground by 1.73 and select thickness for that voltage in the grounded neutral column. For a direct-current system up to and including 2000 volts consider it the same as a single-phase alternating-current system of the same rms voltage.

#### *Jacket Thickness*

The insulation of *unshielded* cables may be of such quality that it will withstand all environmental conditions likely to be encountered, such as moisture, oil, sunlight, and abrasion in handling. If so, no jacket has to be added. Several of the modern insulations meet this requirement, but often a slight increase in insulation thickness is used to provide for expected surface wear and to equal other advantages obtained by a jacket.

*Shielded* cables, on the other hand, unless protected by armor, require a jacket, not necessarily for improving surface quality, but as protection for the insulation shielding. The jacket material selected is the most suitable to meet conditions, and usually it is a different compound than that of the insulation.

The minimum thickness that qualifies a coating as a jacket on cables 2 kV and above is 30 mils, but the thickness also depends on diameter of the cable and voltage. Jacket thicknesses have substantially become standardized as shown in Tables 10-5 and 10-6. The relative suitability of jackets of various materials can be determined from Table 8-4. Jacket thicknesses generally conform to those listed in Table 10-5, based on diameter, and in Table 10-6 for single conductor cables, based on AWG-kcmil size. The individual conductors of a multi-conductor cable that has a jacket surrounding all conductors may have thinner jackets than those specified in Table 10-6, and conform to column 3 of Table 10-5. Column 4 lists thickness of the *overall* jacket.

It is necessary to distinguish between an overall jacket

\* Where additional insulation thickness is desired, it shall be the same as for the 133 percent insulation level.

## covered and insulated aluminum wire and cable

and a band of belt insulation, as found in some kinds of cable, such as for series-lighting circuits.

### Primary Unshielded Cables 3 kV and 5 kV

The 5 kV rating is the most used of this type, Fig. 10-12. If the insulation does not have a satisfactory surface for withstanding environmental conditions a jacket is added.

The usual cable construction without jacket comprises a Class-B stranded conductor (or it may be solid round in small sizes), a resistive conductor-shield and insulation of the thickness listed in Table 10-4. The insulation must be ozone and corona discharge-resistant, suitable for wet or dry locations, flame retardant, and suitable for sunlight exposure, although the latter two qualities may be obtained by jacketing, if not a characteristic of the insulation. The jacket, if used, must also be corona discharge resistant.

### Primary Cables with Insulation Shielding (to 35 kV)

The conditions that require shielding at 5 kV are stated in ICEA\* and pertain principally to single conductors at 133 percent insulation level or where cables are installed underground directly buried, in ducts or in wet locations. The shields are also required if the insulation or jacket is not one that protects against ozone or its effects. Insulation thicknesses are listed in Table 10-4. Generally, except for the shielding, the same

construction applies as for nonshielded cables. Fig. 10-13 is typical.

Triplexed preassembled cable, or three-conductor cable, either jacketed or in metallic armor of constructions previously described is often used in the 5-kV-and-above ratings, Figs. 10-14 to -16. For ampacities see Table 10-7.

### Primary Interlocked-Armor Cables (Fig. 10-16)

The description of interlocked corrugated armor used on cables for 600 volts (page 10-5) applies to cables for the primary voltages except for strand and insulation shielding requirements. However, the impervious seamless corrugated armor is not as yet available in as many voltage ratings or sizes as the interlocked armor. Three-conductor armored cables are the most used. Single-conductor cables are available for special applications with non-magnetic aluminum armor.

The cables are available both with and without an extruded outer covering under the armor. Either aluminum or steel armor is available. Voltage drop at circuit power factors less than 100 percent is increased if steel armor is used, but is negligibly affected by aluminum armor. The ampacity rating of a three-conductor cable with aluminum corrugated armor is substantially the same and may be somewhat more than that of the insulated three-conductor cable in air; the increase in area because of the corrugations and the closeness of the conductors to the armor both serve to increase the rate of heat transfer. For ampacities, see Table 10-7.

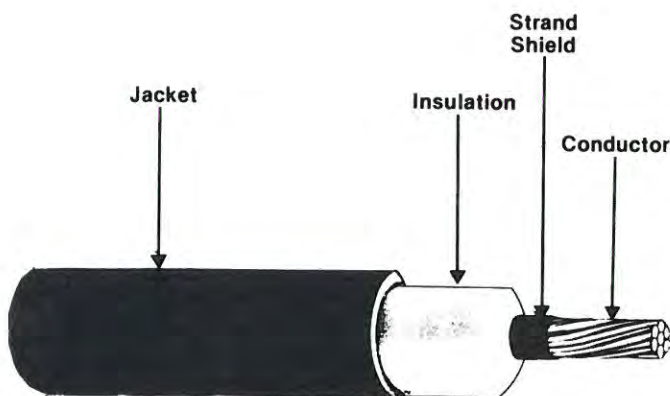

Fig. 10-12. Typical unshielded aluminum insulated primary cable 5 kV with jacket.

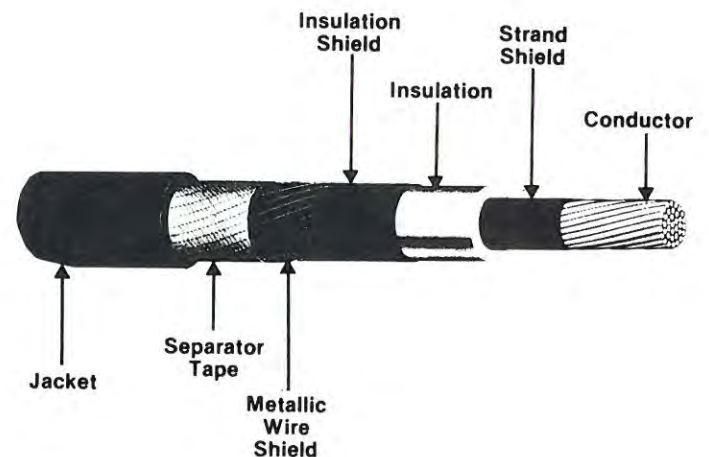

Fig. 10-13. Typical 5 kV to 35 kV shielded insulated primary cable.

Note: The metallic shielding may be tape as shown, or helically applied closely spaced small wires.

\*ICEA S-61-402 Table 4.

TABLE 10-4

**Insulation Thickness (not including jackets) for High-Voltage Conductors in Three-Phase Systems with 100% and 133% Insulation Levels, (or Grounded Neutral and Ungrounded Neutral, respectively).**

Thickness in Mils (=1/1000 in.)

Note: The values in this table are obtained from ICEA or industry designations of thickness for the insulations named. However, because of variations of dates at which the values were issued, and because of lack of uniformity of the size-steps, slight variations occur. Also some cable manufacturers issue specifications that in some respects show more favorable values. The insulations are those used for ozone-resistant conditions. In the 5000-volt class certain other insulations listed in Table 8-2 and 8-3 may be used but not necessarily at the listed thickness.

Voltage and Size AWG and kcmil	XLPE or PE <sup>(1)</sup>				EPR				Butyl				Silicone (SA)	
	(2) Grounded Neutral		Un- Grounded Neutral		Grounded Neutral		Un- Grounded Neutral		Grounded Neutral		Un- Grounded Neutral		Grounded or Ungrounded Neutral	
	mils	mm	mils	mm	mils	mm	mils	mm	mils	mm	mils	mm	mils	mm
UNSHIELDED 2001-5000V <sup>(3)</sup>														
8-4/0	110	2.79	110	2.79	*90	2.29	*90	2.29	**155	3.94	**155	3.94	155	3.94
225-500	120	3.05	120	3.05	*90	2.29	*90	2.29	**170	4.32	**170	4.32	170	4.32
525-1000	130	3.30	130	3.30	*90	2.29	*90	2.29	**170	4.32	**170	4.32	170	4.32
SHIELDED 2001-5000V														
8-4/0	90	2.29	90	2.29	90	2.29	90	2.29	155	3.94	155	3.94		
225-500	90	2.29	90	2.29	90	2.29	90	2.29	170	4.32	170	4.32		
525-1000	90	2.29	90	2.29	90	2.29	90	2.29	170	4.32	170	4.32		
5001-8000V														
6-500	115	2.92	140	3.56	115	2.92	140	3.56	190	4.83	250	4.83		
525-1000	115	2.92	140	3.56	115	2.92	140	3.56	190	4.83	250	4.83		
8001-15000V														
2-1000	175	4.45			175	4.45			295	7.49				
1-1000			215	5.46			215	5.46			420	10.67		
15001-25000V														
1-1000	260	6.60	345	8.76	260	6.60	345	8.76	455	11.56				
25001-28000V														
1-1000	280	7.11	420	7.11	280	7.11	420	7.11	500	12.70				
28001-35000V														
1/0-1000	345	8.76	420	7.11	345	8.76	420	7.11						

2-Conductor Concentric<sup>(4)</sup>  
Helical Bare Grounded Neutral

	XLPE	HPE
5 kV	90	90
#4-350		
15 kV		
#4-350	175	175
25 kV		
#2-350	260	260
35 kV		
1/0-350	345	345

\*Required by specification to have an outer jacket; maximum 3-phase voltage for 133% insulation level 3000V

JACKET AWG or kcmil	THICKNESS	
	Mils	mm
8-6	30	0.76
4-2/0	45	1.14
3/0-1000	65	1.65

\*\*Required by specification to have an outer jacket

NOTE: The difference of thickness between unshielded and shielded 5 kV cables using XLPE or PE insulations reflects the fact that the unshielded cable has a potential distribution not as even as that of the shielded cable.

See page 10-15 for additional notes.

JACKET AWG or kcmil	THICKNESS	
	Mils	mm
8-1	45	1.14
1/0-4/0	65	1.65
225-750	65	1.65
1000	95	2.41

covered and insulated aluminum wire and cable

**TABLE 10-5**  
**Jacket Thicknesses for Single- and Multiple-Conductor**  
**Power Cables According to Diameter Under Jacket**  
 For all uses; Conduit, Tray, Trough, Underground Duct, Aerial, and  
 Direct Burial† but does not include Communication or Portable Cables

Calculated Diameter of Cable Under Jacket inches                      mm		Jacket Thickness							
		Single-conductor Cable				Multiple-conductor Cables*			
		(1)		(2)		(3)		(4)	
		Nonshielded		Shielded**		Individual Conductors †		Overall	
		mils	mm	mils	mm	mils	mm	mils	mm
0.250 or less	6.35 or less	15	0.38	45	1.14	15	0.38	45	1.14
0.251-0.425	6.38-10.80	30	0.76	45	1.14	25	0.64	45	1.14
0.426-0.700	10.82-17.78	45	1.14	60	1.52	30	0.76	60	1.52
0.701-1.500	17.71-38.10	65	1.65	80	2.03	50	1.27	80	2.03
1.501-2.500	38.13-63.50	95	2.41	110	2.79	80	2.03	110	2.79
2.501 and larger	63.53 and larger	125	3.18	140	3.56	..	...	140	3.56

\* Under common jacket.

† These thicknesses apply to jackets only and do not apply to colored coatings used for the purpose of circuit identification on the individual conductors of multiple-conductor cables.

‡ Single-conductor cables in sizes 9 AWG and smaller shall not be used for direct earth burial.

\*\* In calculating the diameter under the jacket of single-conductor *shielded* conductors that are part of a multi-conductor cable, add 45 mils to the insulation thickness to allow for thickness of the insulation shield. Also add the thickness of the separator and strand tapes. Eqs. 9-3, 9-4, and 9-5 provide a means for calculation of diameter, provided  $D_i$  is the inside diameter of the jacket instead of the outer sheath.

Two-conductor cables for direct burial having helical bare copper wire ground conductors have an outer protective covering of conducting material that also serves as an insulation shield. The layer is not less than 30 mils thick.

NOTE—For flat twin cable, use the calculated major core diameter under the jacket to determine the jacket thickness from Column 4.

Source: ICEA S-61-402

**TABLE 10-6**  
**Jacket Thicknesses for Single-Conductor Power Cables, According to AWG-kcmil Sizes**

For all uses: Conduit, Trays, Troughs, Underground Duct, Aerial and Direct Burial, not including Communication or Portable Cables.

It is assumed that the jacket material is compatible with the insulation for the designated kV ratings. These thicknesses also apply to single-conductor cables if they are triplexed, but they do not necessarily apply to the cables that are a part of a three-conductor cable, for which the thickness may be according to column (3) of Table 10-5

Volts	Percent Insulation Level	Thickness of Jacket, Mils (= 1/1000 in.), (mm)					
		30 (0.76)	45 (1.14)	60 (1.52)	65 (1.65)	80 (2.03)	110 (2.79)
UNSHIELDED 2001 - 5000	100 & 133%	# 8 - # 6	# 4 - 2/0			3/0 - 1000	
SHIELDED							
2001 - 5000	100 & 133%		# 8	# 6 - 2/0		3/0 - 1000	
5001 - 8000	100%			# 6 - 1/0		2/0 - 1000	
	133%			# 6 - 2		# 1 - 750	1000
8001 - 15000	100%					# 2 - 750	1000
	133%					# 1 - 600	750 - 1000
15001 - 25000	100%					# 1 - 500	600 - 1000
	133%					# 1 - 350	400 - 1000
25001 - 28000	100%					# 1 - 500	600 - 1000
28001 - 35000	100%					1/0 - 350	400 - 1000

Source: ICEA S-61-402

TABLE 10-4 NOTES

- (1) The characteristics for the kinds of insulation shown are listed in Tables 8-2, 8-3, and 8-4, for which also see rated temperatures.
- (2) If insulation is rated according to "percent insulation level," use column "grounded neutral" for 100% level, and column for "ungrounded neutral" for 133% level.
- (3) Solid dielectric insulated conductors operated above 2000 volts generally require shielding under the NEC. Conditions under which shielding is not required in the 2000-8000 volts range are detailed in NEC Section 310-6.
- (4) The cables listed in the main body of the table are generally available in the sizes shown as single conductors or cabled for aerial-messenger support, or in tray or duct, and with some insulations are suitable for direct burial. The two-conductor concentric-neutral cables are mostly used for direct burial, but they also may be used in duct or be aerial-supported. The insulation thickness for coaxial cables (in which the neutral is tubular) are similar.

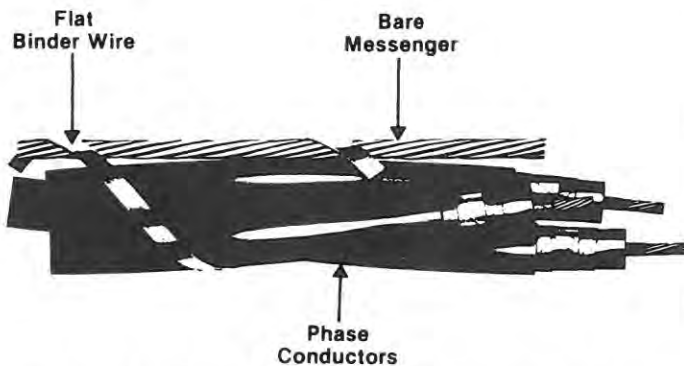

Fig. 10-14. Typical pre-assembled triplexed 5-kV to 25-kV shielded primary cable bound to composite aluminum-steel (ACSR or ACSR/AW) or aluminum-alloy messenger with aluminum tape. A fourth insulated neutral may be included if required.

The construction of each conductor is similar to that depicted in Fig. 10-13. Also available with one, or two phase conductors.

For certain sizes reverse-lay may be obtained (see Fig. 10-3). Also for parallel lay (not triplexed) field-spinning equipment is available so that the assembly with lashing wire may be performed at the site.

Similar pre-assembled triplexed (or parallel) cables are available without insulation shielding to 5 kV.

#### Primary Cables for Underground Residential Distribution-URD

Directly buried URD/UD style cables are increasingly being used as "main-line" three-phase distribution feeders.

However, by far the most used primary cables for URD are those that supply single-phase primary voltage to the single-phase transformers supplying 120-240 V three-wire circuits to the residences or other use-points in the area. These single-phase primary cables are of

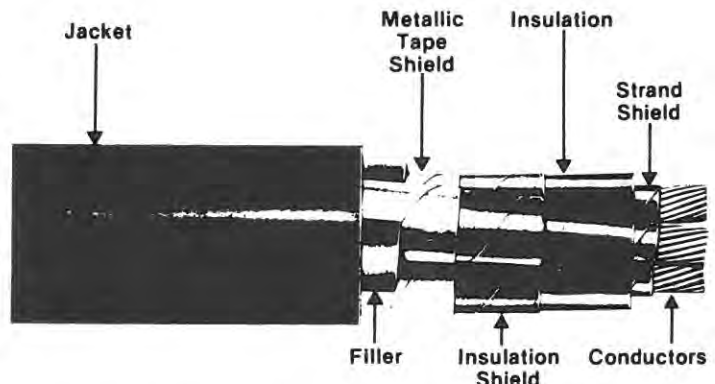

Fig. 10-15. Typical three-conductor 5-kV to 35-kV shielded primary cable in jacket.

The construction of each conductor is similar to that depicted in Fig. 10-13. Triangular fillers in the interstices aid in forming a cylindrical exterior that still will withstand bending from reel. Bare grounding conductors may be used in the interstices if required.

the two-conductor type. One conductor is an insulated phase wire. The other is either a copper-wire concentric neutral conductor of equal conductivity to that of the aluminum insulated conductor, Fig. 10-17, or a concentric flat strap neutral, Fig. 10-18, particularly adapted to conditions where substantially full metallic coverage is desired. These copper neutrals are directly in contact with the ground when buried.

The phase conductors of these cables have semi-conducting strand shielding and semi-conducting compound underneath the concentric wires or straps to serve as an insulation shield.

The insulation thickness around the phase conductor is generally the same as listed in Table 10-4. For ampacities see Tables 10-9A and 10-9B.

covered and insulated aluminum wire and cable

High Voltage Primary Cables

Aluminum cables are commonly available through 115 kV levels. Advances in materials and manufacturing expertise have resulted in available cables in this and higher voltage levels. While previous cable constructions employed paper insulation, with some gas-filled designs, today's market offers some cables of this type with solid dielectric insulations. Polyethylene and crosslinked polyethylene and similar materials are being employed in cable designs. Information concerning availability and design should be directed to individual cable manufacturers.

As typical of such construction, a 115-kV, 500-kcmil aluminum cable for direct burial, with strand and insulation shielding has 0.740 in. XLPE insulation thickness (0.525-in. for 69 kV), with a 0.140-in. thick PVC jacket, and 2.90-in. overall diameter (2.37 in. for 69-kV).

Ampacity of High Voltage Aluminum Cables

The ampacity values listed in Table 10-7A, -B, and -C for the designated cable types and installation conditions mostly are those listed in ICEA Pub. 46-426 Vol. II for aluminum, as explained in Chapter 9, applying to rubber- or thermoplastic-insulated cables. The insulation is assumed to have a power factor of 0.035, dielectric constant of 4.5, and thicknesses for the various voltages that were listed in ICEA Standards in 1962 when the ampacity values were published. Cables directly buried or in under-

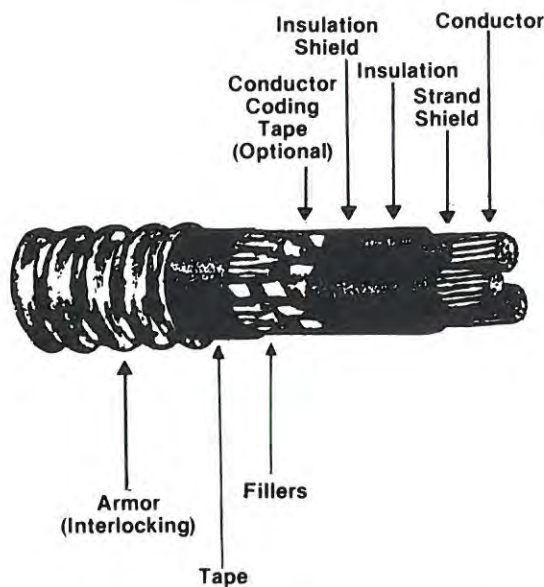

Fig. 10-16. Three-conductor shielded cable 5 kV to 15 kV with interlocked or impervious corrugated steel or aluminum armor.

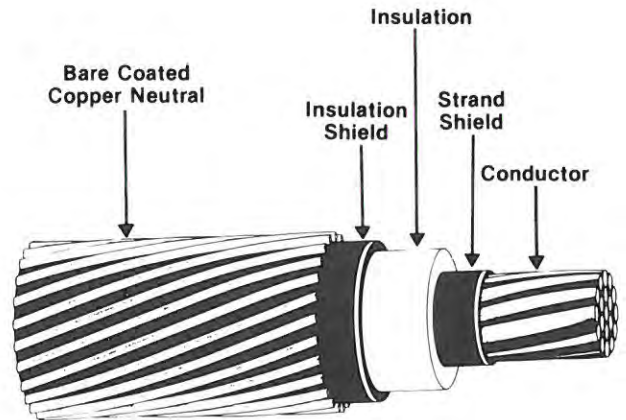

Fig. 10-17. Typical 5 to 35 kV two-conductor concentric-wire neutral primary cable for direct burial, duct or aerial application.

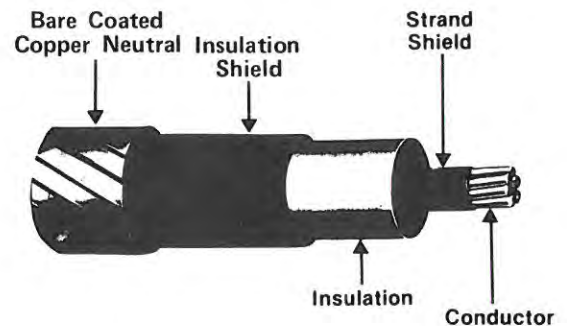

Fig. 10-18. Typical 15-35 kV two-conductor concentric flat-strap neutral primary cable for direct burial or duct.

ground ducts are assumed to be in circuits of 100% load factor and RHO-90 earth resistivity. For 75% load factor, direct burial, increase ampacity by 6%, or for duct 3%; and for 50% l.f. by 14% and 6% respectively. Table 10-7 is based on 40°C ambient for cables in air, and 20°C ambient if underground. Adjustment factors for other ambients are in Table 10-8.

Separate tables 10-9A and 10-9B list the ampacities of concentric-neutral primary cables for direct burial in duct, at 20°C ambient, and also for installation of the cables in air, or in duct in air, at 40°C ambient, as necessary for leads into air from an underground installation. Table 10-9A also includes ampacities for 35 kV cable when buried directly or in duct.

Inasmuch as ICEA and industry standards now allow some reduction of thickness of certain kinds of insulations as compared with the values that prevailed in 1962, and also because most insulations have a lower p.f. than 0.035,

**TABLE 10-7A**  
**Typical Ampacities of 5 kV Cables with Aluminum Conductors**  
**of Various Types and for Various Installation Conditions**

Conductor Size AWG kcmil	5 kV in Air 40°C Ambient Unshielded†								5 kV in Duct 20°C Ambient Unshielded†						5 kV Directly Buried 20°C Ambient Unshielded†			
	Grounded or Ungrounded Neutral								RHO-90 100 LF						RHO-90 100 LF			
	1C in Air		Triplexed 1C of 3		Three Cond. 1 of 3C		Interlocked Armor 1 of 3C		1C		Triplexed 1C of 3		Three Cond. 1 of 3C		1C		Triplexed 1C of 3	
	(1)*		(2)		(3)*		(4)**		(5)*		(6)		(7)*		(8)*		(9)	
	75°C	90°C	75°C	90°C	75°C	90°C	75°C	90°C	75°C	90°C	75°C	90°C	75°C	90°C	75°C	90°C	75°C	90°C
8	55	64	44	51	39	46	—	—	56	62	45	50	42	46	77	84	65	72
6	73	85	59	69	53	61	54	63	73	81	60	66	55	61	98	108	84	92
4	97	113	78	91	70	81	71	82	96	105	78	86	72	80	127	140	108	119
2	128	150	106	123	92	108	95	111	125	137	103	114	94	104	163	180	139	153
1	149	174	123	144	108	126	113	131	143	157	119	131	109	120	184	203	158	174
1/0	172	201	143	167	125	145	137	150	163	180	136	150	125	138	210	231	180	198
2/0	199	232	165	193	144	168	153	174	187	205	156	172	143	158	239	263	205	226
3/0	230	269	192	224	166	194	170	198	213	235	178	196	164	180	272	299	233	257
4/0	268	312	224	262	192	224	198	232	244	269	205	226	187	206	307	338	265	291
250	297	347	251	292	214	250	218	256	269	296	227	250	207	228	335	368	289	319
350	370	431	312	364	265	309	270	320	327	360	276	304	252	278	403	444	349	385
500	466	544	392	458	330	385	335	398	401	442	338	372	308	340	490	540	424	467
750	606	707	512	598	424	495	435	515	505	556	425	468	386	426	605	667	525	579
1000	730	853	612	716	499	584	515	605	593	653	494	546	447	495	706	778	608	672
1250	840	982							668	738					787	868		
1500	944	1103							736	813					862	952		
1750	1039	1216							796	880					930	1027		
2000	1128	1321							850	940					990	1094		

Applicable notes may be found under Table 10-7C

Source: ICEA P-46-426

**TABLE 10-7B**  
**Typical Ampacities of 15 kV Cables with Aluminum Conductors**  
**of Various Types and for Various Installation Conditions**

Conductor Size AWG kcmil	15 kV in Air 40°C Ambient Shielded Grounded Neutral								15 kV in Duct 20°C Ambient-Shielded RHO-90 10 LF Grounded Neutral						15 kV Directly Buried 20°C Ambient-Shielded RHO-90 100 LF Grounded Neutral			
	1C in Air		Triplexed 1C of 3		Three Cond. 1 of 3C		Interlocked Armor Three Cond. 1 of 3C		1C		Triplexed 1C of 3		Three Cond. 1 of 3C		1C		Triplexed 1C of 3	
	(1)*		(2)		(3)		(4)**		(5)*		(6)		(7)		(8)*		(9)	
	75°C	90°C	75°C	90°C	75°C	90°C	75°C	90°C	75°C	90°C	75°C	90°C	75°C	90°C	75°C	90°C	75°C	90°C
	4																	
2	130	152	115	135	109	128	95	119	126	139	110	121	106	117	149	164	133	147
1	150	175	133	155	125	146	111	139	144	159	125	138	120	133	170	187	152	167
1/0	173	202	153	178	143	168	127	158	164	181	142	157	137	151	194	213	173	191
2/0	199	232	175	205	164	192	146	183	187	206	161	178	156	172	220	243	196	217
3/0	229	268	202	237	189	221	168	208	213	235	184	203	177	196	250	276	223	246
4/0	265	310	233	273	217	254	194	243	243	268	209	231	201	222	285	314	254	280
250	293	343	258	302	240	281	216	267	267	295	229	253	221	244	313	345	278	307
350	363	424	318	372	294	344	264	332	323	357	276	305	266	294	378	417	335	369
500	454	531	395	462	362	424	328	409	395	436	334	370	322	356	461	508	405	447
750	587	687	504	591	459	539	422	529	496	547	412	457	397	440	574	634	499	552
1000	705	825	594	698	539	634	496	622	580	641	473	525	456	506	670	740	573	635
1250	810	948							654	723					752	831		
1500	905	1060							715	795					823	910		
1750	994	1165							776	859					887	987		
2000	1076	1263							827	917					945	1047		

Applicable notes may be found under Table 10-7C.

Source: ICEA P-46-426



covered and insulated aluminum wire and cable

the ampacity listings of Table 10-7 are conservative for some applications, and cable manufacturers may offer moderately larger ampacities. However, as previously stated, the 0.035 p.f. value is an ICEA estimate of what the p.f. may become after many years of exposure and use.

The ampacity ratings of the types shown in Table 10-7 for 35 kV and 46 kV are practically the same as those of 25 kV for installations in air, and only up to about 2 percent less for direct burial, hence values for 35 kV and 46 kV are omitted from Table 10-7. Also inasmuch as

high-voltage cables are not used in rigid conduit to the extent formerly (cables in interlocked armor have largely superseded them), ampacities for high-voltage conduit installations are not listed. Ampacities to 35 kV conduit installations are listed in NEC Article 310 Tables, along with ampacities for cables in free air, direct burial and underground ducts. For both underground duct and direct burial special attention must be paid to the number of circuits and/or ducts.

**TABLE 10-7C**  
**Typical Ampacities of 25 kV Cables with Aluminum Conductors**  
**of Various Types and for Various Installation Conditions**

Conductor Size AWG kcmil	25 kV in Air 40°C Ambient Shielded Grounded Neutral						25 kV in Duct 20°C Ambient-Shielded RHO-90 100 LF Grounded Neutral						25 kV Directly Buried 20°C Ambient-Shielded RHO-90 100 LF Grounded Neutral					
	1C in Air		Triplexed 1C of 3		Three Cond. 1 of 3C		1C		Triplexed 1C of 3		Three Cond. 1 of 3C		1C		Triplexed 1C of 3			
	(1)*		(2)		(3)		(5)*		(6)		(7)		(8)*		(9)			
	75°C	90°C	75°C	90°C	75°C	90°C	75°C	90°C	75°C	90°C	75°C	90°C	75°C	90°C	75°C	90°C		
2	—	—	—	—	—	—	—	—	—	—	—	—	—	—	—	—		
1	148	173	135	158	127	149	143	157	126	139	122	134	161	177	148	163		
1/0	170	198	155	182	145	170	163	180	143	158	138	152	184	203	168	186		
2/0	195	228	178	208	166	195	185	204	163	180	156	172	209	231	191	211		
3/0	225	263	204	240	190	203	211	233	185	204	177	196	239	264	217	240		
4/0	259	303	235	276	217	255	240	265	210	232	201	222	271	300	247	273		
250	286	334	260	306	240	282	263	291	229	253	220	243	298	329	270	298		
350	353	412	318	373	292	343	318	351	275	304	264	292	360	398	325	360		
500	440	514	394	463	359	422	388	428	332	367	319	353	439	485	394	435		
750	567	661	500	588	454	534	486	537	408	451	392	433	550	608	486	537		
1000	677	780	589	692	532	625	567	626	467	516	450	498	641	708	558	617		
1250	776	906					639	706					720	796				
1500	868	1004					701	774					790	873				
1750	952	1100					757	836					852	942				
2000	1029	1203					806	880					907	1000				

Source: ICEA P-46-426.

FOOTNOTES FOR TABLES 10-7A, -7B, and -7C.

Allowable ampacities are the maximum continuous ampacities under stated conditions. All ampacity values, except as noted, are from ICEA Publication No. P-46-426 Vol. II for the nearest comparable cables. See Table 10-9A and 9B for ampacity values of two-conductor concentric-neutral cables for direct burial, in duct and in air. Additional ampacity ratings and information on ampacity calculations are available from ICEA P-53-426 (NEMA WC50) and Tables in NEC Article 310.

\*The Ampacity listing for single-conductor (1/C) cables assumes they are spaced 7.5 in. center-to-center, or at least one cable diameter apart, surface-to-surface, that shield is grounded at only one point with negligible shield losses.

\*\*These values are taken from an industry source. The armor is of aluminum.

†For ampacities of shielded 5 kV cables refer to cable manufacturer. Shielded cables usually have slightly more ampacity because the metallic shielding tends to increase the radial thermal heat transfer from the conductor.

**TABLE 10-8**  
**Adjustment Factors for Ampacity Values in Table 10-7 for**  
**Variations of Ambient Temperature**

The following factors\* may be used to adjust ampacities for various ambient temperatures:

If the ampacity is known for:	Conductor Temperature	90°C	75°C	90°C	75°C
	Ambient Temperature	40°C	40°C	20°C	20°C
Multiply by the indicated factor to obtain the new ampacity for the new ambient temperature:	New Ambient Temperature	Multiplication Factor (MF)			
	0°C	1.34	1.46	1.13	1.17
	10°C	1.26	1.36	1.07	1.09
	20°C	1.18	1.25	1.00	1.00
	30°C	1.09	1.13	0.93	0.89
	40°C	1.00	1.00		
	50°C	0.89	0.85		

For example: A cable may have a known ampacity of 100 amps when operating at a 90°C conductor temperature in a 40°C ambient. The same cable operated at 90°C conductor temperature in a 30°C has an ampacity of 109 amps; while in a 50°C ambient, 89 amps.

\*Table factors are derived from the following equation:

$$MF = \sqrt{\frac{TC - TA_2}{TC - TA_1}}$$

$$I_2 = I_1(MF)$$

- where:  $I_1$  = ampacity from tables at ambient  $TA_1$   
 $I_2$  = ampacity at desired ambient  $TA_2$   
 $TC$  = conductor temperature in degrees C  
 $TA_1$  = ambient from tables in degrees C  
 $TA_2$  = desired ambient in degrees C

covered and insulated aluminum wire and cable

**TABLE 10-9A**  
**Ampacities of Two-Conductor Concentric-Neutral**  
**+Underground Distribution Cable for Direct Burial**  
**and for Installation in Buried Duct**  
**(see Figs. 10-17 and 10-18)**

Ambient Temperature 20°C Load Factor 100 Percent\*  
 The 75°C ratings apply to cable with Hi-Mol Polyethylene Insulation.  
 The 90°C ratings apply to cables with Cross-Linked Polyethylene Insulation.

The left-hand entries of any pair are ampacities when directly buried.  
 The right-hand entries are ampacities when in duct.

Conductor Size AWG or kcmil	5 kV		15 kV		25 kV		35 kV	
	75°C	90°C	75°C	90°C	75°C	90°C	75°C	90°C
4	120-80	132-88	116-83	128-91	—	—	—	—
2	158-104	174-115	152-108	168-119	145-105	165-115	—	—
1	181-120	199-132	175-124	193-137	165-120	190-135	—	—
1/0	205-136	226-150	198-141	218-155	190-135	210-150	190-135	210-150
2/0	232-156	256-172	225-161	248-177	215-155	240-170	215-155	240-170
3/0	264-177	291-195	258-182	284-201	245-170	275-195	245-170	275-195
4/0	304-205	335-226	294-209	324-230	280-200	315-225	280-200	315-225
250	336-229	370-252	327-233	360-257	310-220	350-250	—	—
300	379-260	418-287	366-264	403-291	350-250	395-280	—	—

Ampacity values for 5 kV and 15 kV cables are from ICEA tables; those 25 kV and 35 kV are from other industry sources.

\*Multiplying Correction Factors for Load Factors of 75 and 50 percent

Cable Rating kV	75 percent Load Factor		50 percent Load Factor	
	Cable Buried	Cable in Duct	Cable Buried	Cable in Duct
5 kV	1.09	1.04	1.16	1.07
15 kV	1.08	1.04	1.16	1.07
25 kV	1.08	1.04	1.16	1.07

+Refer to The Aluminum Association's *Aluminum Underground Distribution Reference Book* for additional typical information.

**TABLE 10-9B**  
**Ampacities of Two-Conductor Concentric-Neutral**  
**Underground Distribution Cable when**  
**Installed in Air or in Duct in Air**  
**(usually as leads from**  
**an underground buried or duct installation)**  
**(see Figs. 10-17 and 10-18)**

Ambient Temperature 40°C

The 75°C ratings apply to cable with Hi-Mol Polyethylene Insulation.

The 90°C ratings apply to cable with Cross-Linked Polyethylene Insulation.

The left-hand entries of any pair are ampacities for cable only in air.

The right-hand entries are ampacities when cable is in duct, in air.

Cond. AWG/kcmil	5 kV		15 kV	
	75°C	90°C	75°C	90°C
4	75-65	90-76	81-68	95-79
2	103-86	120-100	107-88	125-103
1	119-99	139-116	124-102	145-119
1/0	137-112	160-131	142-116	166-135
2/0	159-128	186-149	163-132	190-154
3/0	181-146	211-170	187-151	218-176
4/0	212-169	247-197	217-172	253-201
250	238-188	278-219	244-193	285-225
300	273-214	319-250	278-218	324-254

Ampacity values are from ICEA tables.



## Chapter 11

# Installation Practices\*

Aluminum was first used on an overhead transmission line more than 85 years ago. Today virtually all overhead transmission lines have conductors of aluminum or aluminum reinforced with steel (ACSR).

The performance record of aluminum on overhead transmission lines led to its use in conductors of other types so that today most overhead distribution, service drop, and service entrance cables are aluminum. More recently, insulated aluminum cable has come into widespread use in underground distribution and building wire applications.

Aluminum building wire installation procedures are basically the same as those for copper. However, because aluminum is a different metal with different properties, several differences in installation practices must be followed. Connectors tested and approved for aluminum conductors must be employed and equipment to which aluminum conductors are to be connected must have terminals intended for use with aluminum conductors.

Aluminum wire and cable are available in sizes to meet all needs and with the same types of insulation as copper (See Table 11-1). Connectors for all types and sizes of aluminum conductors and equipment with suitable terminals are available. Such equipment, UL-listed and designated for use with aluminum or copper conductor (AL/CU), and connectors designated "AL7CU" or "AL9CU" are available as stock merchandise in leading supply houses.

The types and electrical properties of wires and cables used in secondary distribution and interior wiring circuits are listed in previous chapters. However, the dimensions for a wide range of sizes and various types of insulation are listed, for convenience, in Table 11-1. The method of

*connecting\*\** a single wire or cable (or the individual conductors of a multi-conductor cable) to other conductors or to switch-gear depends on the size of the conductor, the type of connector, and whether the components to be joined are both aluminum or one is of another metal such as copper.

### Aluminum Conductor Connections

The electrical conductor has no functional value until it has been properly connected to complete the electrical circuit. Experience indicates that, apart from damage due to faulty installation or operation, most of the problems encountered in the field are at connections. Therefore, it is apparent that care taken in making a proper termination or splice is time well spent.

A similar record can be attained with insulated aluminum conductors if there is proper attention to the connecting methods. The basic function of extending the conducting path is the same whether the conductor is bare or insulated, overhead or underground, inside building walls, or in cable trays or conduit.

In the joining process, the oxide film on the contact surface of the aluminum must be ruptured to expose base metal. This fissured contact surface must be entrapped and collapsed against the adjoining contact member to establish metal-to-metal conducting areas. In addition, the joining process must protect these conducting areas against the degrading effects of service. In this respect the use of joint compound is most important. Its main function is to prevent the entry of moisture. Electrical connections are particularly vulnerable to this when the

---

\* For further information on the installation of aluminum building wire see the AA booklet "Aluminum Building Wire Installation Manual and Design Guide."

\*\* For purposes of this discussion, *splicing and terminating* will refer to conductors in circuits above 1000 volts which require not only connecting the separate conductor elements, but also the restoration of sometimes complex installation systems over the splice or terminal and, under some circumstances, application of added protection. Splicing and terminating are described separately, page 11-11 et. seq.

covered and insulated aluminum wire and cable

**TABLE 11-1**  
**Nominal Dimensions\* and Areas, Aluminum Building Wire (Taken From 1987 NEC)**

Bare Conductor**			Type THW		Type THHN		Type XHHW		Size AWG or KCMIL
Size AWG or KCMIL	Number of Strands	Diam. Inches	Approx. Diam. Inches	Approx. Area Sq. In.	Approx. Diam. Inches	Approx. Area Sq. In.	Approx. Diam. Inches	Approx. Area Sq. In.	
8	7	.134	.255	.0510	—	—	.224	.0394	8
6	7	.169	.290	.0660	.240	.0452	.260	.0530	6
4	7	.213	.335	.0881	.305	.0730	.305	.0730	4
2	7	.268	.390	.1194	.360	.1017	.360	.1017	2
1	19	.299	.465	.1698	.415	.1352	.415	.1352	1
1/0	19	.336	.500	.1963	.450	.1590	.450	.1590	1/0
2/0	19	.376	.545	.2332	.495	.1924	.490	.1885	2/0
3/0	19	.423	.590	.2733	.540	.2290	.540	.2290	3/0
4/0	19	.475	.645	.3267	.595	.2780	.590	.2733	4/0
250	37	.520	.725	.4128	.670	.3525	.660	.3421	250
300	37	.570	.775	.4717	.720	.4071	.715	.4015	300
350	37	.616	.820	.5281	.770	.4656	.760	.4536	350
400	37	.659	.865	.5876	.815	.5216	.800	.5026	400
500	37	.736	.940	.6939	.885	.6151	.880	.6082	500
600	61	.813	1.050	.8659	.985	.7620	.980	.7542	600
700	61	.877	1.110	.9676	1.050	.8659	1.050	.8659	700
750	61	.908	1.150	1.0386	1.075	.9076	1.090	.9331	750
1000	61	1.060	1.285	1.2968	1.255	1.2370	1.230	1.1882	1000

\*Dimensions are from industry sources.

\*\*Compact conductor per ASTM B 400. Article 310-14 of the 1987 NEC calls for AA 8000 series electrical grade aluminum alloy conductor material.

power is off and the conductors are cool. To the extent these are accomplished, the connection will have low and stable contact resistance during its service life. (For more information on electrical contact theory, the reader is referred to the bibliography at the end of Chapter 13.)

In this, as in preceding chapters, we will first consider conductors for secondary circuits (0 to 1000 volts) and the installation practices associates with them.

### Building Wire Connectors

Only pressure-type connectors marked AL7CU or AL9CU to indicate they have been tested and are listed by UL for aluminum, copper, or aluminum to copper connections interchangeably should be used. The connectors are usually plated to avoid the formation of oxide and to resist corrosion.

Pressure connectors are of two basic types—mechanical screw type and compression type applied with a tool and die.

Both types are designed to apply sufficient pressure to shatter the brittle aluminum oxide from the strand surfaces and provide low resistance metal to metal contact.

Both basic types are suitable for use with aluminum, although many contractors believe that compression connectors are less susceptible to installation error.

UL Standard 486, covering connectors for use with aluminum wire, has been revised. A number of connectors have already been tested under the more stringent requirements of the new standard, UL 486B, and are currently available.

Installers are cautioned to avoid mechanical pressure connectors with too wide a range of wire sizes because the screw may not adequately engage the strands of the smaller conductors. Installers are also advised to contact conductor manufacturers for recommendations concerning specific connectors for use with their products.

Connectors for every conceivable need are available. Some typical connectors are shown in Fig. 11-1. Whichever type you use, follow the manufacturer's instructions carefully.

### Compression Connectors

Aluminum conductors are particularly suitable for connecting to each other or to an equipment terminal by use of solderless compression type sleeves because the conductor strands tend to weld together as a result of high compression pressure.

Compression connectors similar to those used for bare conductors (see Chapter 5) are widely used for connecting insulated conductors (Fig. 11-1). Various styles are available, along with special tools, representing the "system" of a particular manufacturer. Depending on

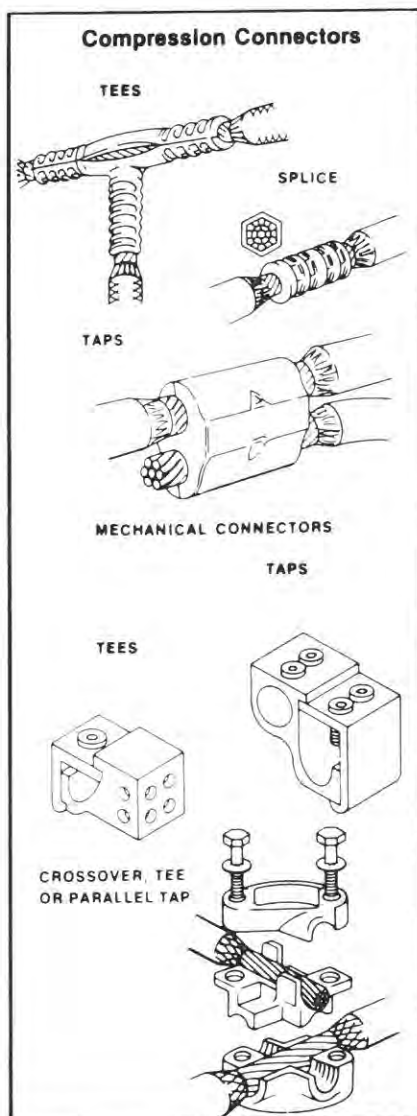

Fig. 11-1 Connectors have been designed and manufactured for every conceivable contingency. Make sure connector is UL listed for aluminum.

the size of the conductors, compression is obtained by use of hand tools or from hydraulic pressure.

#### Mechanical Connectors

Pressure connectors of the setscrew or bolted mechanical type, Fig. 11-2, also provide a rapid means of making connections particularly where space is limited and where many taps are taken from a main as in panel boards or junction boxes. Aluminum connector bodies are machined from extruded high-strength aluminum, such as 6061-T6. The setscrews are of the Allen head type and tightening of screws or bolts by wrench compresses the aluminum conductor strands against the side wall of the

recess, causing the strands to intermingle, Fig. 11-1. Mechanical connectors should be tightened to manufacturer's recommended torque levels. In the absence of manufacturer's recommended torque levels, values in Table 11-2 should be followed.

#### Connector Plating

UL standards require that connectors for use with aluminum conductors be plated with tin or some other suitable contact metal and the face of any pad or lug that is plated should not be scratch-brushed but merely cleaned with a suitable solvent cleaner. Scratching the plated surface is likely to remove the plating. It should be noted that zinc plated connectors have an adverse effect on aluminum and should never be used on systems where aluminum wire is used.

#### Building Wire Terminations

UL-listed terminal lugs marked AL7CU or AL9CU are used to connect aluminum conductors to transformers, switches, bus bar, motors and other equipment. Aluminum terminals are usually plated and plated connectors should not be scratch-brushed or abraided.

Like connectors, they are of two basic types—mechanical screw type and compression type applied by tool and die. Some typical terminal lugs are shown in Fig. 11-2. They are applied to the conductor ends in the same manner as described under "Connectors."

All equipment should be furnished with UL-listed, all aluminum terminals. Mechanical terminal lugs that are copper bodied and tin plated should not be used with aluminum conductors larger than #6 unless they have passed the 500-cycle requirements of new UL Standard 486B.

Care should be taken that the conductor temperature and ampacity ratings are compatible with the terminals and equipment to which they are to be connected.

When all components are aluminum (bus, sluds, lugs) only aluminum bolts should be used to make the connections.

The following procedures should be used:

1. Aluminum bolts should be anodized alloy 2024-T4 and conform to ANSI B18.2.1 specifications and to ASTM B 211 or B 221 chemical and mechanical property limits.
2. Nuts should be aluminum alloy 6061-T6 or 6262-T9 and conform to ANSI B18.2.2.
3. Washers should be flat aluminum alloy Alclad 2024-T4, Type A plain, standard wide series conforming to ANSI B27.2 SAE or narrow series washers should not be used.
4. Hardware should be assembled as shown in Fig. 11-3.



covered and insulated aluminum wire and cable

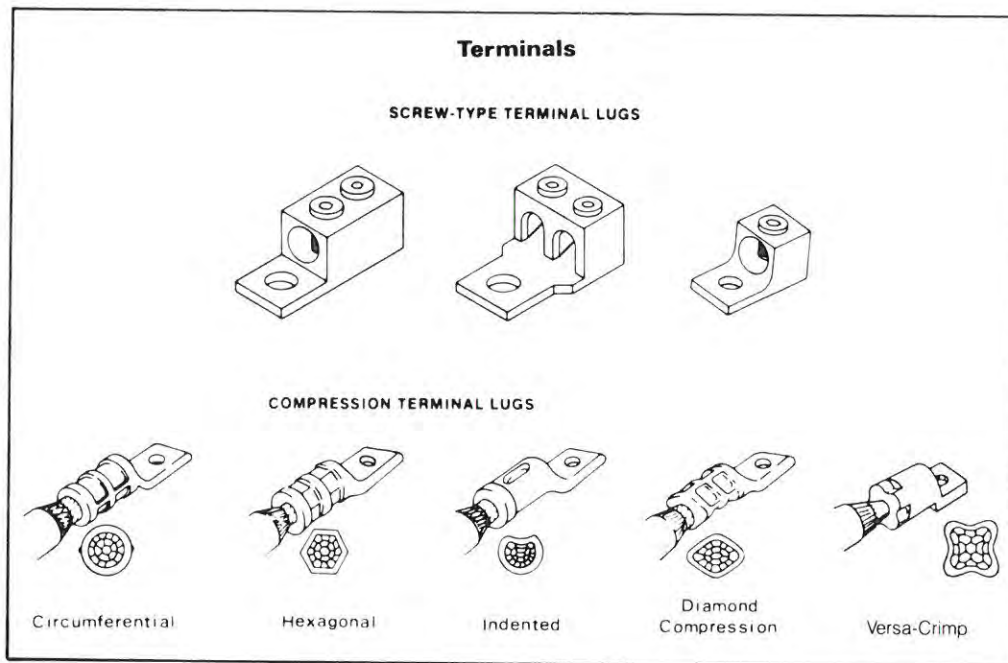

Fig. 11-2. Typical plated aluminum terminal lugs come in variety of styles.

**TABLE 11-2**  
**STANDARD PRESSURE-CONNECTOR TORQUE TABLES**

**Torque For Slotted Head Screws<sup>a</sup>**  
Smaller Than No. 10 For Use With  
No. 10 AWG or Smaller Conductors

Screw-Slot Length—Inches <sup>c</sup>	Torque—Lb-Inches	
	Screw-Slot Width—Inches	
	Less Than 3/64	More Than 3/64
To 5/32	7	9
5/32	7	12
3/16	7	12
7/32	7	12
1/4	9	12
9/32	—	15
9/32 +	—	20

**Torque For Socket Head Screws<sup>a</sup>**

Socket Size Across Flats—Inches	Torque, Pound-Inches
1/8	45
5/32	100
3/16	120
7/32	150
1/4	200
5/16	275
3/8	375
1/2	500
9/16	600

- Clamping screws with multiple tightening means: for example, for a slotted hexagonal head screw, use the highest torque value associated with the different tightening means.
- For values of slot width or length other than those specified, select the largest torque value associated with conductor size.
- For slot lengths of intermediate values, select torques pertaining to next shorter slot length.

**Tightening Torque For Screws<sup>a</sup>**

Wire Size	Torque, Pound-Inches			
	Slotted Head No. 10 and Larger <sup>b</sup>		Hexagonal Head-External Drive Socket Wrench	
	Slot Width—Inches		Split-Bolt Connectors	Other Connectors
	To 3/64	Over 3/64		
	Slot Length—Inches			
	To 1/4	Over 1/4		
18-10 AWG	20	35	80	75
8	25	40	80	75
6	35	45	165	110
4	—	45	165	110
3	—	50	275	150
2	—	50	275	150
1	—	50	275	150
1/0	—	50	385	180
2/0	—	50	385	180
3/0	—	50	500	250
4/0	—	50	500	250
250 kcmil	—	50	650	325
300	—	50	650	325
350	—	50	650	325
400	—	50	825	325
500	—	50	825	375
600	—	50	1000	375
700	—	50	1000	375
750	—	50	1000	375
800	—	50	1100	500
900	—	50	1100	500
1000	—	50	1100	500
1250	—	—	1100	600
1500	—	—	1100	600
1750	—	—	1100	600
2000	—	—	1100	600

**Note:** The torque tables presented here are taken from UL Standard 486B, but are representative of those published in other UL Standards, in NEMA equipment installation instruction publications, and in the Canadian Electrical Code. The same values apply to pressure connectors for both copper (UL Standard 486A) and aluminum conductors.

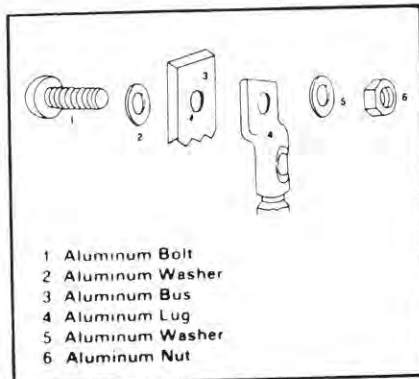

Fig. 11-3. When all components are aluminum, aluminum hardware should be used and installed as above.

TABLE 11-3

Lug Bolting Torques*	
Bolt Diameter Inch	Tightening Torque Pound-Feet
1/4 or less	6
5/16	11
3/8	19
7/16	30
1/2	40
5/8 or more	55

\*From UL 486 Standards.

NOTE: If bolts are not lubricated with silicon spray or other suitable lubricant, torques may vary widely and result in high contact resistance at joints.

- All hardware should be suitably lubricated before tightening.
- Bolts securing lugs should be tightened to the manufacturer's recommended torque. In the absence of such recommendations, torque values listed in UL 486 Standards should be used. (See Table 11-3)

If adding to an existing installation containing copper bus or studs or if it is impossible to obtain the required equipment with aluminum terminations, then a steel bolt should be used with a Belleville spring washer to allow for the differing rates of thermal expansion of the materials. The following procedures should be used:

- The steel bolt should be plated or galvanized, medium carbon steel heat treated, quenched and tempered equal to ASTM A 325 or SAE grade 5.

- Nuts should be heavy semi-finished hexagon, conforming to ANSI B18.2.2, threads to be unified coarse series (UNC), class 28.
- Flat washers should be steel, Type A plain standard wide series, conforming to ANSI B27.2. SAE or narrow series washers should not be used.
- Belleville conical spring washers come in sizes for use with bolts ranging in sizes indicated in Table 11-4.
- Hardware should be assembled as shown in Fig. 11-5.
- All hardware should be suitably lubricated before tightening.
- In the absence of specific manufacturer's instructions, bolts should be tightened sufficiently to flatten the spring washer and left in that position.

TABLE 11-4

BELLEVILLE SPRING WASHERS				
Bolt size	O.D.	Thick-ness	Lb. nom. load to flat	In-lbs. torque to flat
1/4	11/16	050	800	50-75
5/16	13/16	060	1000	125-150
3/8	15/16	070	1400	150-175
1/2	1-3/16	085	2700	175-200
5/8	1-1/2	100	4000	222-250

Note: Torque values to be used as guides only. Actual installation conditions will vary considerably. Bolt should be tightened until a sudden increase in torque is felt. In this manner, no torque wrench is required and washer will be flattened.

Material: Hardened Steel

Table Courtesy of Thomas & Betts Co.

covered and insulated aluminum wire and cable

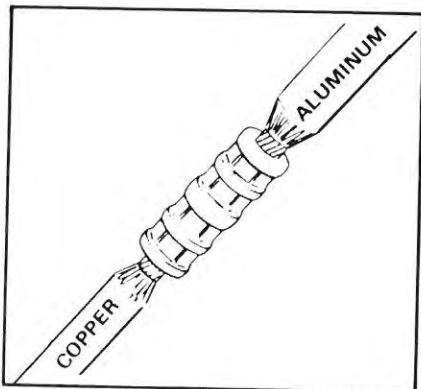

Fig. 11-4. Gutter splice is used when terminal lugs are not removable and are approved for copper cable connection only.

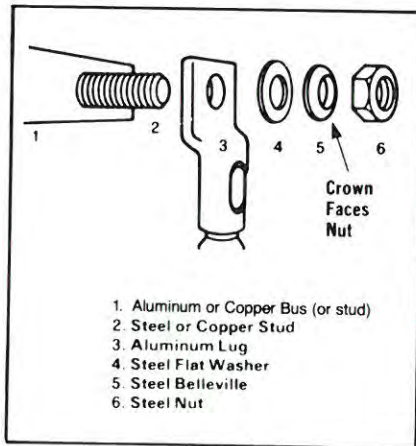

Fig. 11-5. Belleville washer is used to make an aluminum-to-copper or steel joint. Note: Crown of Belleville washer should be under the nut.

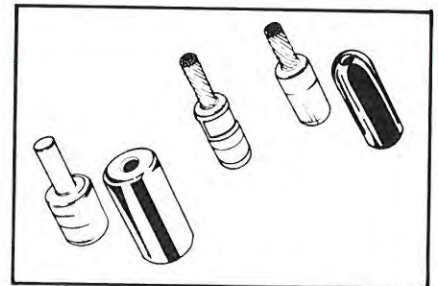

Fig. 11-6. There are a number of UL-listed adaptor fittings available for use with terminals not suitable for direct connection of aluminum conductors.

With equipment having terminals that will accommodate only copper conductors, a "gutter splice" may be used to connect the aluminum conductor. The aluminum conductor is spliced to a short length of copper conductor, and the copper conductor stub is then connected to the equipment terminal (Fig. 11-4). An AL7CU or AL9CU compression type connector is used to make the splice.

Instead of a gutter splice, one of the many UL-listed AL7CU or AL9CU adaptor fittings specifically designed for this purpose may be used (Fig. 11-6).

For connecting large aluminum conductors (500 kcmil and up) to heavy equipment having copper terminal studs and/or pads, large compression type lugs, preferably with two holes, should be used in making such a connection (Fig. 5-2). With other than aluminum bolts, Belleville spring washers and heavy flat washers in consecutive arrangement as shown in Fig. 11-5 must be used. If

aluminum bolts and nuts are used, only the heavy washer, bearing on the aluminum lug, is necessary.

Figures 11-7 to 11-12 show some typical connections of aluminum conductors to equipment terminals.

Because of the differing rates of thermal expansion of aluminum and other conducting or support metals, it is preferable to have all parts of the circuit, including studs and clamp bolts, of aluminum. The aluminum bolts should be of alloy 2024-T4 and the nuts compatible, though preferably not of identical alloy and temper. Bolts and nuts should be of heavy series design to reduce stress beneath the head. NC (coarse) threads are preferred for the 2024-T4 aluminum bolts. Components should be assembled as shown in Fig. 11-9. More information about aluminum bolted connections will be found in Chapter 13.

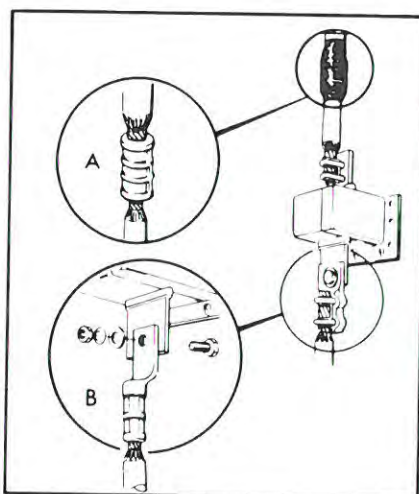

Fig. 11-7. Where possible, current transformer terminals should be replaced with compression type (B). If not possible to remove, section of copper cable should be spliced to aluminum (A).

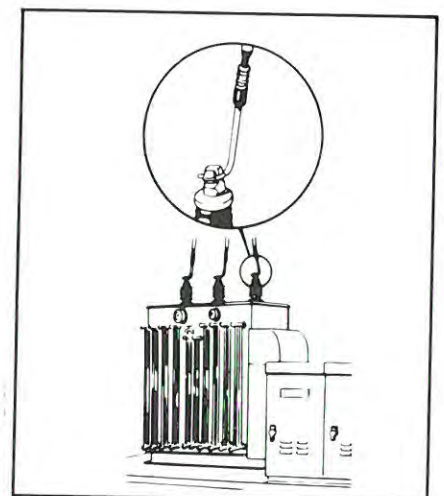

Fig. 11-8. Power transformer terminals, if copper, must employ short copper stub spliced to aluminum cable.

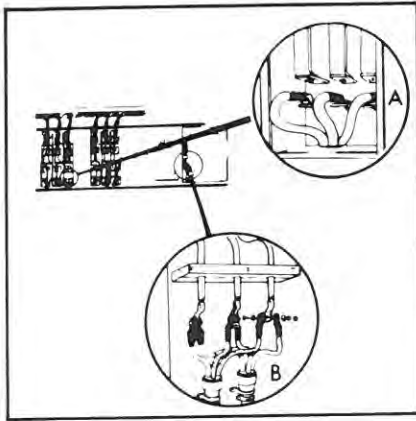

Fig. 11-9. When connecting aluminum conductors to a unit substation with copper bus, use compression type aluminum lugs attached with a steel bolt, a flat washer, and a Belleville washer (A). Copper primary leads on transformer feeders in aluminum connectors and bolted back-to-back using a steel bolt, a flat washer, and a Belleville washer (B).

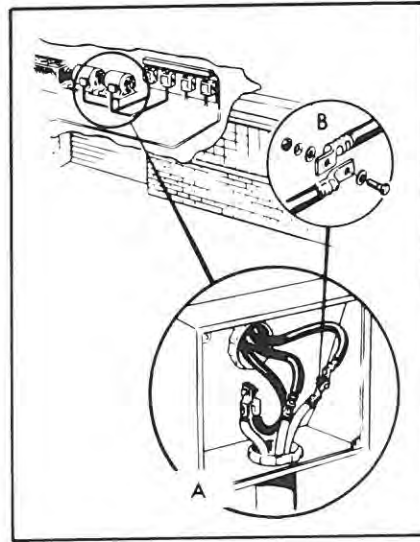

Fig. 11-10. Three methods of making motor connections are shown in detail A. All terminals are preferably aluminum. Where bolt is steel or copper, Belleville washer is necessary (B).

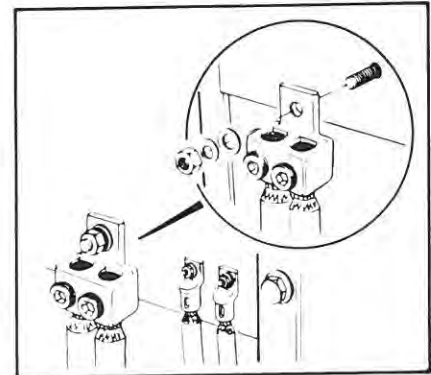

Fig. 11-12. Copper lug connections on switchgear are replaced with equivalent aluminum connectors. Belleville washer is used with copper or steel studs.

## Basic Installation Techniques

### 1. Stripping Insulation

Never use a knife or pliers to ring a conductor when stripping insulation. One way to avoid this is to pencil or whittle the insulation (Fig. 11-13).

Another method is to skin the insulation back from the cut end of the conductor and then cut outward (Fig. 11-14).

Several types of insulation stripper are available for quick, easy removal of insulation. One of these, useful for small size conductors, is shown in Fig. 11-15.

### 2. Making Connections

Preparation of aluminum conductors for connection to an equipment terminal or another conductor requires stripping of the insulation and rupture and dispersal of the nonconducting oxide film that appears quickly on a fresh aluminum surface exposed to air. Care must be taken not to nick the wires when removing insulation in order to avoid broken strands in installation or service. Several types of insulation stripper are available for quick, easy penciling or square-cut removal of insulation. One type is shown in Fig. 11-16.

Abrading the conductor strands with a wire brush or other appropriate tool will serve to clean the conductor

and disperse the oxide coating prior to application of joint compound.

The conductor end is then inserted into a compression sleeve of adequate thickness or a suitable mechanical type pressure connector. If the connector does not come factory-filled with an acceptable joint compound, such paste should be applied to the conductor end before insertion into the connector. (Some manufacturers' connectors may not require the use of compound but it should be used in the absence of specific instructions to the contrary.) The compression sleeve should then be compressed with a hydraulic compression device, or the setscrew of a mechanical connector tightened, in a manner prescribed by the connector manufacturer. Excess compound should be removed from the conductor insulation, but not from the joint itself where it will serve to prevent air from entering.

Solid aluminum wires are prepared in a similar manner, and the smaller sizes may be fastened under a binding-head screw\* (without joint compound) after looping in a clockwise direction.

\* Note: The AL7CU or AL9CU marking is not required on equipment connectors. However the equipment in which they are installed must indicate suitability for use with aluminum and connector tightening torques.

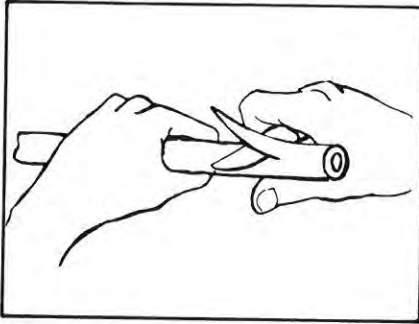

Fig. 11-13. Never ring a cable—it may lead to a break. Insulation should be removed as one would sharpen a pencil.

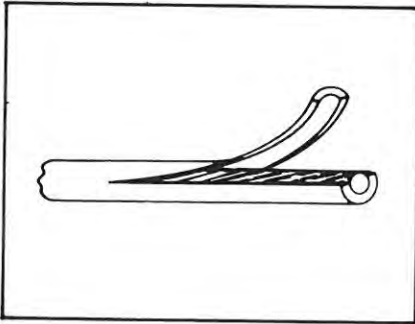

Fig. 11-14. Another safe way of removing insulation from conductor is to peel the insulation back and then cut outward.



Fig. 11-15. Use wire stripper for removing insulation from smaller wire sizes. Match stripper notch to wire size.

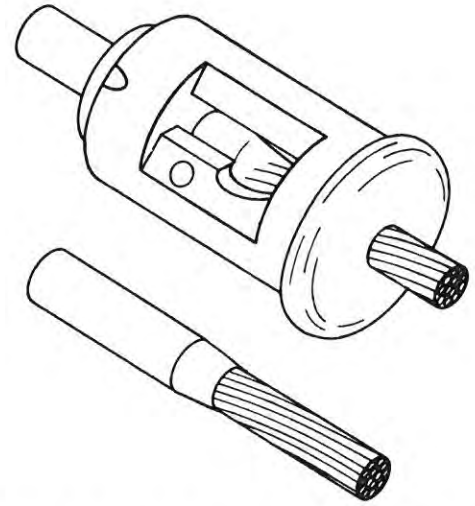

Fig. 11-16. Penciling tool for removal of insulation in bevel configuration by rotation. Several sizes are available, which by proper selection of bushing are applicable to all usual sizes of cables. This tool is particularly suitable for primary cables, which have comparatively thick insulation.

In making connections, first strip the insulation as instructed heretofore. Then apply joint compound if it is not already contained in the connector.

If the connector is a mechanical screw type, apply the manufacturer's recommended torque (Fig. 11-17). In absence of specific torque recommendations, use UL 468B torque values shown in Table 11-1. If a compression type, crimp it as recommended by the manufacturer (Fig. 11-18). Be sure to select the correct size die and close the tool completely for full compression. Wipe off any excess compound. Then tape the joint as instructed under Section B2 or apply the insulating enclosure that comes with some types of connectors.

### 3. Pulling Conductors in Conduit or Electrical Tubing

The following procedures are applicable to conduit of all types including aluminum:

- Run a "fish" line through the conduit. This may be done by attaching the line to a piston-type device which is propelled through the conduit by compressed air. Another method is to push a round flexible speedometer type steel wire through the conduit. Polyethylene fish tapes may be used for shorter runs—up to about 100 feet.
- Attach a clean-out brush to the fish line and behind it attach the pull line, then pull both through the conduit by means of the fish line.
- Attach the pull line to the conductor or conductors. A basket grip over the insulation may be used for this purpose (Fig. 11-19).

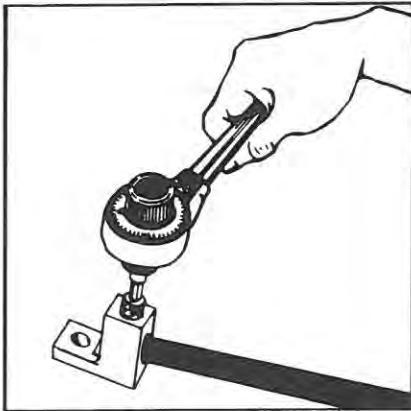

Fig. 11-17. Proper torque is important—over-tightening may sever the wires or break the fitting; under-tightening may lead to overheating and failure. (See Table 11-2.)

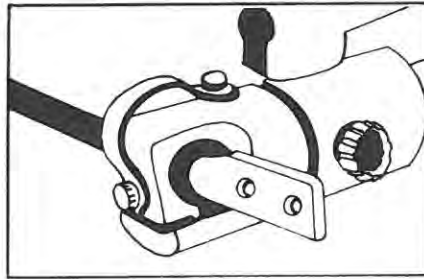

Fig. 11-18. Crimping tool must be fully closed. Failure to close crimping tool will lead to an unsatisfactory and weak joint.

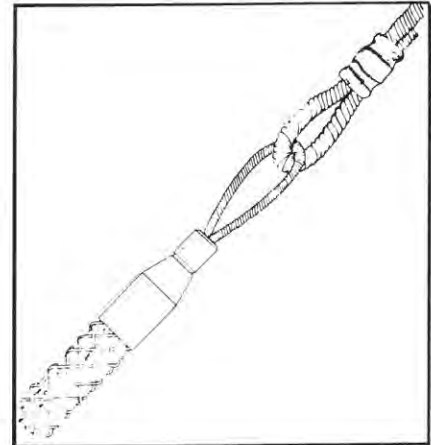

Fig. 11-19. Basket grip.

- d. Where conductors are pulled with a rope, stagger the conductor ends and anchor in position with tape, to provide maximum flexibility around bends (Fig. 11-20).

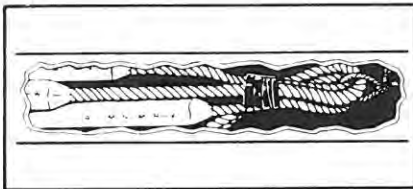

Fig. 11-20. When a rope pull has to be used, skin the cable ends and stagger them after locking with tape. This will hold tie to a minimum cross section.

- e. Try to feed conductors into conduit end closest to the sharpest bend, to reduce pulling tension.
- f. Have pulling equipment with adequate power available to make a steady pull on the cables without “jerks” during the pulling operations.
- g. Use pulling compound compatible with the conductor insulation as the conductors are fed into the conduit, to reduce coefficient of friction and required pulling tension.
- h. For single conductors on a reel, stagger reels, one behind the other, while feeding in conduit, to maintain equal pulling tensions and prevent conductors from “crossing over” and jamming in the conduit.
- i. Wherever possible, pull conductors in a downward direction, to allow gravity to assist in pulling with reduced tension.

- j. When conductor ends are prepared for pulling, be sure not to nick the stranded aluminum conductor during insulation removal. Damaged strands can reduce the pulling tension capabilities of the conductor. To avoid this, pencil the insulation for removal, as described above; do not ring cut the insulation.
- k. Follow all NEC requirements.

For a detailed description of calculating pulling tensions, see the example given on page 11-11 on underground installations. See Chapter 17 for a complete treatment of aluminum conductors in conduit.

#### 4. Installation of Cables in Trays

Where aluminum cable is to be pulled in trays or cable racks, take the following precautions, plus those applicable to conduit:

- a. Where pulling attachments are used on the conductors, cover them with rubber-like or plastic tapes to prevent scoring of the trays and installation sheaves during a conductor pull.
- b. Use large-radius sheaves around bends and smaller sheaves on the straight sections of cable support trays to facilitate cable installations, to reduce the required pulling tensions and to prevent damage to stranded conductors or insulations.
- c. Where cables are anchored on trays, be sure straps or other cable anchoring devices do not cut into the insulation.
- d. Cables installed in trays should follow the requirements of NEC Article 318 for the allowable number of cables permitted in trays and their respective ampacities.

*covered and insulated aluminum wire and cable*

- e. Straight cable tray runs may often be installed by simply laying the lightweight aluminum cables in place.
- f. Be sure tray supports are capable of handling maximum weight of conductors and planned conductor additions in the future.

**5. Minimum Training Radii**

Where permanent bends are made at terminations using aluminum building wire, Table 11-5 indicates the minimum bending radius as a multiple of the overall cable diameter. Such bends should be made before the terminal is applied to minimize electrical contact distortion.

**6. Conductors in Vertical Raceways**

The NEC under section 300-19 stipulates that conductors in vertical raceways shall be supported. As a general rule one cable support shall be provided at the top of the vertical raceway or as close to the top as is practical plus an additional support for each interval of spacing as shown in Table 11-6. An exception to this rule is that if the vertical riser is less than 25% of the spacing listed in the Table, no cable support shall be required.

**Installing Cable in Conduit or Duct**

The procedures for inserting a "fish" line or tape through a conduit or duct, followed by a pull line and/or cable as required for the pull, are well known and established as field practice and do not need extensive description here. Aluminum conductors may be attached to pull line or cable by means of a factory-installed pulling eye, by placing a basket grip around the conductors' insulation (Fig. 11-21), or by tying the line to a loop in the uninsulated part of the conductor (Fig. 11-20). Steel pull cables used to pull conductors around bends in aluminum conduit runs may damage the conduit at the bend. This is often avoided by using steel elbows with aluminum conduit or by use of a pull line that will not damage aluminum elbows.

Pulls should be accomplished with steady tension and pulling speeds not exceeding 50 feet per minute. Hard pulls can be eased if the reel is hand controlled and slack cable is guided into the conduit.

Pulling tensions may be reduced by lubricating the cable surface. However, some lubricating materials have been found to adversely affect cable insulations or outer jackets. In addition to cable pulling compounds, this

**TABLE 11-5  
TRAINING RADII**

**For 600 V Cable Not in Conduit, on Sheaves or While Under Tension**

**POWER CABLES WITHOUT METALLIC SHIELDING ON ARMOR.**

The minimum recommended bending radii as multiples of the overall cable diameter given in the following tabulation are for both single and multi-conductor cable with or without lead sheath and without metallic shielding or armor.

Thickness of Conductor Insulation mils	Minimum Training Radius as multiple of cable diameter Overall Diameter of Cable—Inches		
	1.000 and Less	1.001 to 2.000	2.001 and over
155 and less	4	5	6
170 to 310	5	6	7
325 and over		7	8

**POWER CABLES WITH METALLIC SHIELDING OR ARMOR**

**(a) Interlocked Armored Cables**

The minimum recommended bending radius for all interlocked armored cables is in accordance with table above but not less than 7 times the overall diameter of the cable, except as noted below (c) for tape shielded cable.

**(b) Flat Tape and Wire Armored Cables**

The minimum recommended bending radius for all flat tape armored and all wire armored cables is 12 times the overall diameter of cable.

**(c) Tape Shielded Cables**

For all cables having metallic shielding tapes the minimum recommended bending radius is 12 times the overall diameter of the completed cable.

**(d) Wire Shielded Cables**

Wire Shielded Cables should have the same bending radius as power cables without metallic shielding tape.

Reprinted from ICEA 5-66-524, NEWA WC-7

**TABLE 11-6**  
**SUPPORTING CONDUCTORS IN VERTICAL RACEWAYS**

From 1987 NEC Table 300-19 (a)

		Conductors	
		Aluminum	Copper
No. 18 to No. 8	Not greater than	100 feet	100 feet
No. 6 to No. 0	Not greater than	200 feet	100 feet
No. 00 to No. 0000	Not greater than	180 feet	80 feet
211.6 kcmil to 350 kcmil	Not greater than	135 feet	60 feet
350 kcmil to 500 kcmil	Not greater than	120 feet	50 feet
500 kcmil to 750 kcmil	Not greater than	95 feet	40 feet
Above 750 kcmil	Not greater than	85 feet	35 feet

applies to potting and joint compounds, adhesives, tapes, etc. If in doubt, compatibility of materials foreign to the insulation should be cleared through the cable manufacturer.

A number of proprietary wire pulling lubricants and compounds are UL-listed and labeled to indicate the compound's compatibility with conductor coverings. In all cases, the manufacturers' instructions should be observed.

**Allowable Pulling Tension**

The following formulas can be used to calculate the maximum allowable tension that should be applied to the cables. Note that these allowable tensions assume the pulling eye is attached to the conductor. Where the pulling line is attached to a basket grip that surrounds the insulation, the pulling tension should not exceed 1000 lbs. It should be kept in mind that tension developed for straight runs per unit length is less than that for the portion of the cable in bends.

1. The maximum allowable pulling tension, if the pulling eye is attached to the conductor

$$P_m = K N A \tag{Eq. 11-1}$$

where  $P_m$  = Maximum allowable tension, lb  
 $N$  = Number of conductors being pulled simultaneously  
 $A$  = Circular mil area of each conductor  
 (If conductors are of various sizes, add the individual NA values)  
 $K$  = Conductor stress factor

2. The maximum allowable pulling tension ( $P_m$ ) cannot exceed 1000 lb where cables are pulled with a basket grip; however, the tension per Eqs. 11-1 or 11-2 should not be exceeded.

3. The maximum allowable pulling tension for cable in conduit

or duct bends (to prevent cable damage because of rubbing on sides of bend) must not exceed the following:

$$P_b = 100 r \tag{Eq. 11-2}$$

where  $P_b$  = Maximum allowable bend tension, lb  
 $r$  = Radius of curvature of the conduit or duct bend, ft

Note: The maximum allowable tension determined from Eqs. 11-1 or 11-2 should not be exceeded.

4. For straight section of conduit or duct, the pulling tension (lb) likely to be developed can be determined as follows:

$$P_s = L w f \tag{Eq. 11-3}$$

where  $P_s$  = Pulling tension in straight section, lb  
 $L$  = Length of conduit or duct straight section, ft  
 $w$  = Weight of cable (or cables), lb per ft  
 $f$  = Coefficient of friction

Note: For a well constructed conduit or duct with a lubricated cable, "f" approximates 0.5. For less favorable conditions or with considerable curvature, "f" may approximate 0.75.

5. For curved sections of conduit or duct, the pulling tension (lb) likely to be developed can be determined as follows:

$$P_c = P_2 + P_1 e^{f\alpha} \tag{Eq. 11-4}$$

where  $P_c$  = Total pulling tension, lb  
 $P_2$  = Tension for straight section at pulling end, lb  
 $P_1$  = Tension for straight section at feeding end, lb  
 $\alpha$  = Angle of bend in radians (1 radian = 57.3 deg)  
 $e$  = Base of Napierian logarithms (2.718)  
 $f$  = Coefficient of friction

*Example:* Determine the maximum pulling tension required to install three single-conductor cables in a duct, according to the arrangement in Fig. 11-22. The cable specifications are:

Three single conductor #4/0 AWG 600-volt aluminum cables with cross-linked PE insulation

Weight, 3 @ 290 lb/M ft = 0.87 lb per ft

Cable diameter, each 0.690 in.

Coefficient of friction=0.5; K value=0.008\*

\*K = 0.008 for 3/4 hard aluminum conductors, or 0.004 for 1/2 or 1/4-hard aluminum.



covered and insulated aluminum wire and cable

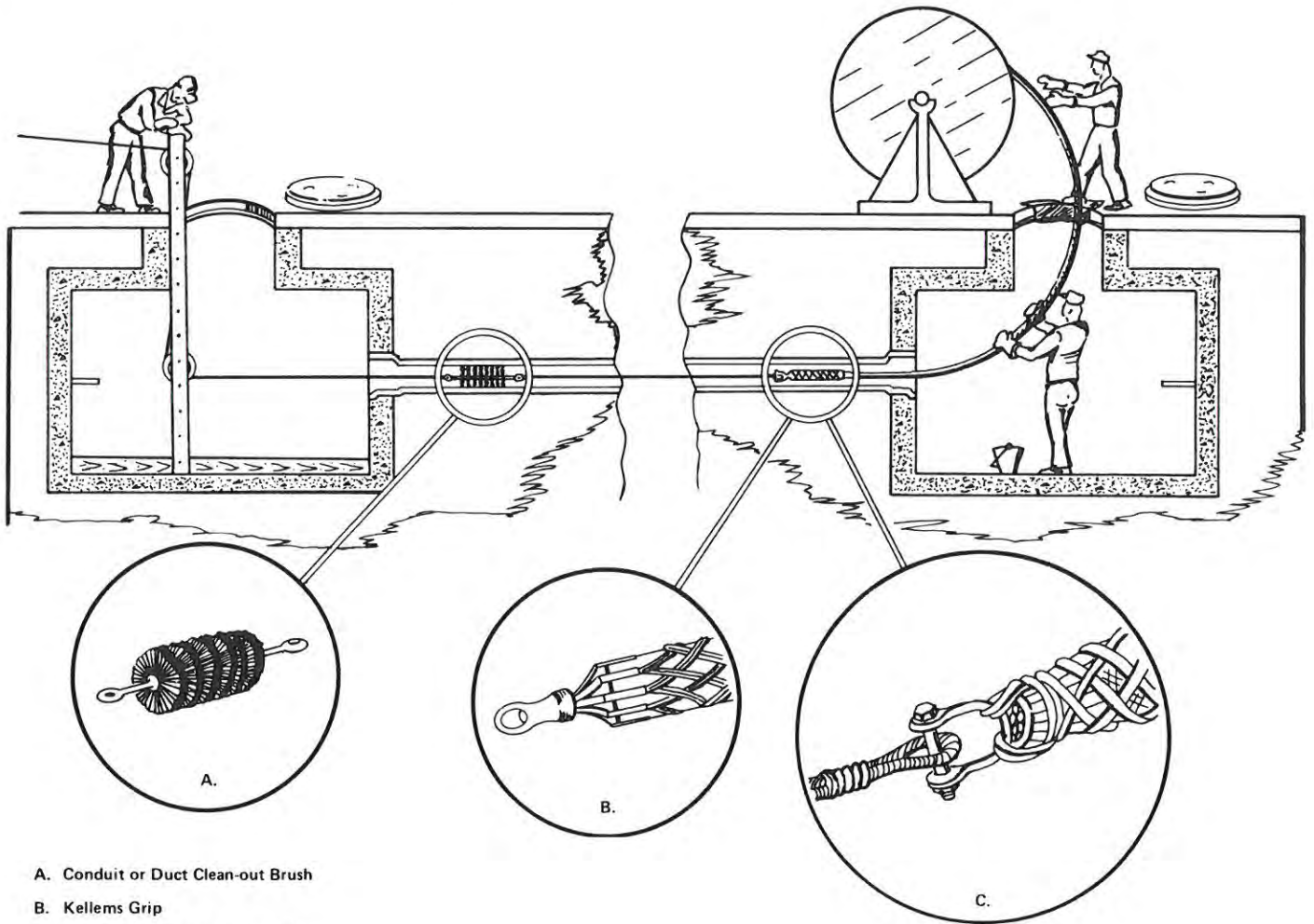

- A. Conduit or Duct Clean-out Brush
- B. Kellems Grip
- C. "Job Fashioned" Pulling Basket

Fig. 11-21. Pulling cable in duct. Pulling cable between junction boxes of conduit installations is similar.

Using a single pulling eye attached to the three conductors and applying Eq. 11-1, the maximum allowable pulling tension is

$$P_m = 0.008 \times 3 \times 211,600 = 5078 \text{ lb} \quad \text{per Eq. 11-1}$$

For the entire run from pull-box (1) to pull box (6), the tension increments are as follows:

Eq.

$$11-3: \text{ At box (2) } P_2 = L_{1-2} \times w \times f = 100 \times 0.87 \times 0.5 = 43.5 \text{ lb}$$

$$11-4: \text{ At box (3) } P_3 = P_2 \times e^{f \alpha} = 43.5 \times e^{0.5 \times 1.571} = 43.5 \times 2.194 = 95.4$$

$$11-3: \text{ At box (4) } P_4 = 95.4 + (L_{3-4} \times w \times f) = 95.4 + (50 \times 0.87 \times 0.5) = 117.2 \text{ lb}$$

$$11-4: \text{ At box (5) } P_5 = 117.2 \times e^{0.5 \times 1.571} = 117.2 \times 2.194 = 257.1 \text{ lb}$$

$$11-3: \text{ At box (6) } P_6 = 257.1 + (L_{5-6} \times w \times f) = 257.1 + (15 \times 0.87 \times 0.5) = 263.7 \text{ lb}$$

The total pulling tension of 254 lb is far below the 5080 lb limitation, and the tension at each bend is far below the

recommendation per Eq. 11-2 of  $100 \times 10$ , or 1000 lb. Study of such examples shows that there is an advantage in pulling cables from the pull box or manhole closest to the first bend. This aids in reducing tension on the installed cable. In this instance, if the pull started at box (6), the final tension would be about half the above-found value.

For a more complete treatment of cable pulling in conduit, the reader is referred to R.C. Rifenberg, AIEE Transactions, Dec. 1953.

#### Installing Directly Buried Power Cables\*

If cable placement can be started before sidewalks and other obstructions are installed, the plowing-in method usually is the most economical method of burying power cable. If soil conditions are unsuitable for plowing, the

\*See also *Aluminum Underground Distribution Reference Book*.

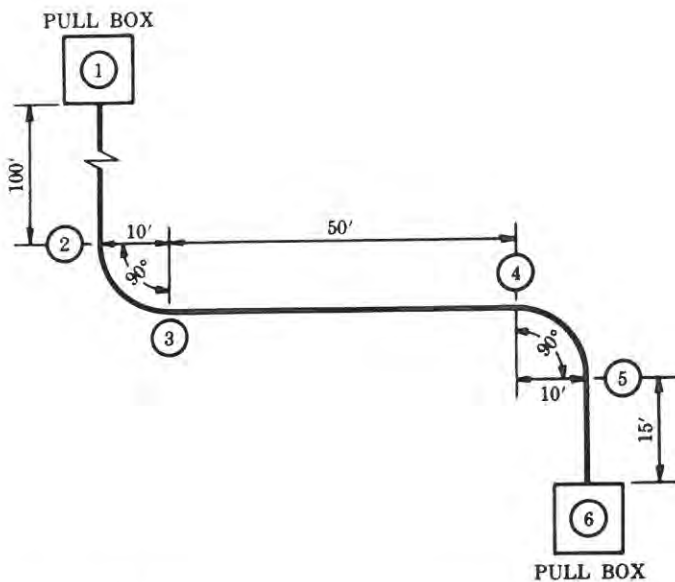

Fig. 11-22. Diagram of circuit layout to illustrate method of computing pulling tension.

use of trenchers, back hoes, or manual digging is customary. If the soil is rocky, it should be screened to prevent cable damage. If it is not sufficiently fine to closely cover the cable surface, a four-inch thickness of sandy loam placed under and over the cable will improve the heat radiating quality of the soil.

Duct or conduit also should be used under streets or where access by digging to a buried cable is not practicable.

Sufficient cable slack should be provided at risers and terminals to permit earth movement that may occur because of conductor thermal expansion, frost, and also as an allowance for future repair.

Boards or slabs placed over the cable for mechanical protection should not be directly in contact with the cable but should be laid on an earth fill over the cable.

Depth of burial ranges from about 30 to 48 inches for primary cable and from about 24 to 42 inches for secondary cable when buried separately. On many systems, both primary and secondary cables are buried in the same trench with no separation. In many areas, the trenches are shared jointly with other utilities, notably communications—both telephone and television cables. Joint use of trenches requires close collaboration on installation schedules but offers substantial economies to the sharing utilities.

Initially, a separation of one foot was required between primary power and communication cables and many companies still require this separation. An amendment to the NESC, however, permits random-lay (no deliberate separation) installation of communication and power cables in the same trenches with grounded wye power systems operating at voltages not in excess of 22 kV to

ground or delta systems operating at voltages not in excess of 5.3 kV phase to phase, under certain conditions described in NESC Section 35, Article 354. However, joint use with very long single-phase primary circuits is not recommended because of the inductive pickup of harmonics by the communication cables from the power cables.

Care exercised in handling the cable during installation will help to avoid trouble later, for damage sustained by the cable during installation has proved to be a major cause of subsequent cable failure.

Many of these precautions have to do with making sure there is no insulation damage. The cable is not susceptible to corrosion failure when insulation is unbroken, even where moisture has gained entry into the conductor in some manner; this fact has been determined in cable manufacturer laboratory tests and from research by utilities. Migration of moisture through damaged insulation in the presence of ac potential concentrates ions and promotes ac electrolysis.

Cable transitions between overhead and underground usually employ the conventional factory-molded pothead, of which special types are available for use in URD systems. A termination is not required, however, if the insulated aerial cable is also suitable for direct burial. Such a cable can be carried directly down the pole. Riser shields or conduit should be used to protect the cable on the riser pole to a point at least eight feet above ground level, and should extend at least 12 inches below ground. The riser shield must be solidly grounded to the system neutral, and bonded to the lightning arrester to avoid transient potentials.

Many other practices relating to buried cables and their connection to transformers, to service entrances, and tap connections in junction boxes and vaults are described in industry manuals.\* Practice is gradually becoming standardized in the direction of increasing reliability and lowering installation and maintenance costs in this most important segment of power distribution.

The following suggestions will help to avoid failures from this cause; they apply equally to cable and cable in pipe:

1. Make sure that end seals are intact both while the cable is stored and installed to avoid entrance of water into the strands.
2. If plowing is not used, cables, if at all possible, should be payed out along the side of the trench from moving reels, or carefully laid in the trench from stationary reels.
3. The trench should not be dug before final grading is determined, so cable will not be exposed or be too close to the surface.

\* See also IEEE Conference Record 31C35 *Special Technical Conference on Underground Distribution*, Sept. 27-29, 1966.

**TABLE 11-7**

ICEA MINIMUM BENDING RADII* FOR POWER CABLES WITHOUT METALLIC SHIELDING**			
	Minimum Bending Radii as a Multiple of Cable Diameter		
	Cable OD, Inches		
Thickness of Insulation, Inch	1.000 and less	1.001 to 2.000	2.001 and over
0.156 and less	4	5	6
0.157 to 0.312	5	6	7
0.313 and over	—	7	8

\* Only applicable for cable training; bearing pressure limitation may require larger bending radii for cable tension.

\*\* Data apply to single and multiple conductor cable; also to wire-shielded cable. Minimum bending radius for cables with metallic shielding tape is 12 times the completed cable OD. The National Electrical Code Section 300—34 requires 8 times for non-shielded and 12 times for shielded medium voltage cable bending radii.

4. In rocky soil areas, use screened backfill or sand to protect direct buried cable. A 2-inch bedding is sufficient below; but there should be a minimum cover of about 4 inches. (The bedding and cover can be omitted when duct in conduit is used).
5. If boards, concrete slabs, etc., are used above the cable for mechanical protection, they should not be in direct contact, to avoid shearing action when the soil settles. Make sure boards are treated with preservatives that will not harm the cable's insulation.
6. Check the cable visually for damage before burial or installation in duct.
7. When primaries are pulled into ducts or open trenches, the use of a pulling grip *over* the cable is common rather than a pulling eye or other attachment connected directly to the conductor. Duct should be carefully cleaned by pulling a plug through it to remove all burrs and obstructions. To keep the cable-pulling tension within safe limits, a lubricant approved for use with the specific insulation and insulation shield should be used.
8. When doing permanent training make sure that the minimum bending radii are observed (see Table 11-7). Make every effort to provide more radius than these values at reel payout, risers, plow guides, duct bend, etc.
9. Make sure splices and other connections are made in accordance with manufacturers' recommendations.
10. Double check to make sure proper backfilling is done. Rock fill should be kept away from the cables to

prevent damage. Compacting should be carefully done, and air spaces minimized.

11. Proof test the cable after installation to insure integrity of insulation and splices. (See Table 11-8).
12. Don't overfuse the cable. Because of the paucity of failures, many utilities prefer to use one-shot fuses as an added protective measure for the cable.

Many of these precautions have to do with making sure there is no insulation damage. The conductor in 600 volt cables is not susceptible to corrosion failure when insulation is unbroken and moisture has not gained entry into the conductor. When moisture enters a break in insulation, however, ac electrolysis begins.

#### Splicing and Terminating in Underground Systems

The revolution in underground distribution system design has included the devices and methods used for making splices, connections, and terminations. The objective here has been to reduce the amount of skill and time required in the field so as to reduce the installation costs. More prefabrication is being done under factory-controlled conditions, and the need for heating and pouring of insulating compounds or extensive taping in the field has been greatly reduced.

Aluminum connectors and terminating devices should be used with aluminum conductors so as to avoid differential thermal expansion and contraction upon heating and cooling that could result from the use of connectors of dissimilar metals. Compression type connectors and lugs applied with a tool and die are widely used. It is

**TABLE 11-8**

ICEA RECOMMENDED dc PROOF-TEST VOLTAGES (15 Minute Test)		
Polyethylene or Cross-Linked Polyethylene Insulated Cables		
Rated Circuit Voltage	Insulation Thickness (Mils)	Proof-Test Voltage (KV)
		Installation
2001 - 5000	90	25
5001 - 8000	115	35
8001 - 15000	175	55
15001 - 25000	260	80
25001 - 28000	280	85
28001 - 35000	345	100

important in installing these devices that a die of the correct size be used and full pressure be applied in order to obtain permanently sound connections.

**600 Volt Secondary Circuits**

In this regard connector manufacturers have made important advances in the design of connection devices for secondary circuits. There are far too many types to describe them all in this handbook. However, a couple of examples are given below to indicate the types of pre-molded splices and terminations that are currently available for this type of service.

(a) Underground Direct Burial Splice 600 volt insulated cable splices are available for conductor sizes #6 AWG stranded through 1000 kcmil and can be completely installed and sealed without taping or compound filling. Typical installation procedure is (Fig. 11-23) as follows:

**Step A**

Lubricate both insulating splice caps by applying a small amount of the supplied lubricant to the inside diameter of the cap at both the housing end and also to the inside diameter at the conductor hole end. For easier assembly of the insulating caps to the conductor, it is recommended that the insulation at the end of the conductor be penciled before stripping. Then place the proper caps over each conductor end.

**Step B**

Strip correct length of conductor insulation for the splice connector being used. Place splice housing over end of conductor and assemble one cap to housing. Large end of cap should cover the knurled line of the housing body.

**Step C**

Wire brush exposed cable ends and then immediately

insert cables into connector. Start crimping splice onto conductor as per manufacturer's instructions. Continue crimping to ends of splice, overlapping crimps 1/8 inch minimum. Wipe away all excess oxide inhibitor.

**Step D**

Place housing with the assembled cap over splice connection and snap remaining cap in place on housing to complete the sealed splice. When caps are correctly installed, the large ends should cover the knurled lines on both ends of the housing body.

(b) Secondary 600 V Underground Terminations. There are several different designs of connector products which are approved for use in underground 600 V electric power systems. They supply the needs of connectors required for residential or commercial use; direct burial, below grade vaults; pedestal or pad mounted equipment; bolted or compression fittings, and in any combination.

Fig. 11-24 shows a representative group of these fittings which are designed to accommodate a wide range of conductors. Their installation is straightforward and requires no field cutting or hand taping for insulation or environmental sealing. The threaded stud connector for transformers is such that the connector can be detached from the transformer without disconnecting the conductors.

**Primary Circuits**

Termination of primary underground cables requires some type of stress relief. Initially, these were made up by taping a stress cone, which proved to be one of the most tedious and time-consuming jobs for the field man. Today most utilities use some form of preshaped or prefabricated stress cone, which can be installed in a fraction of the time.

covered and insulated aluminum wire and cable

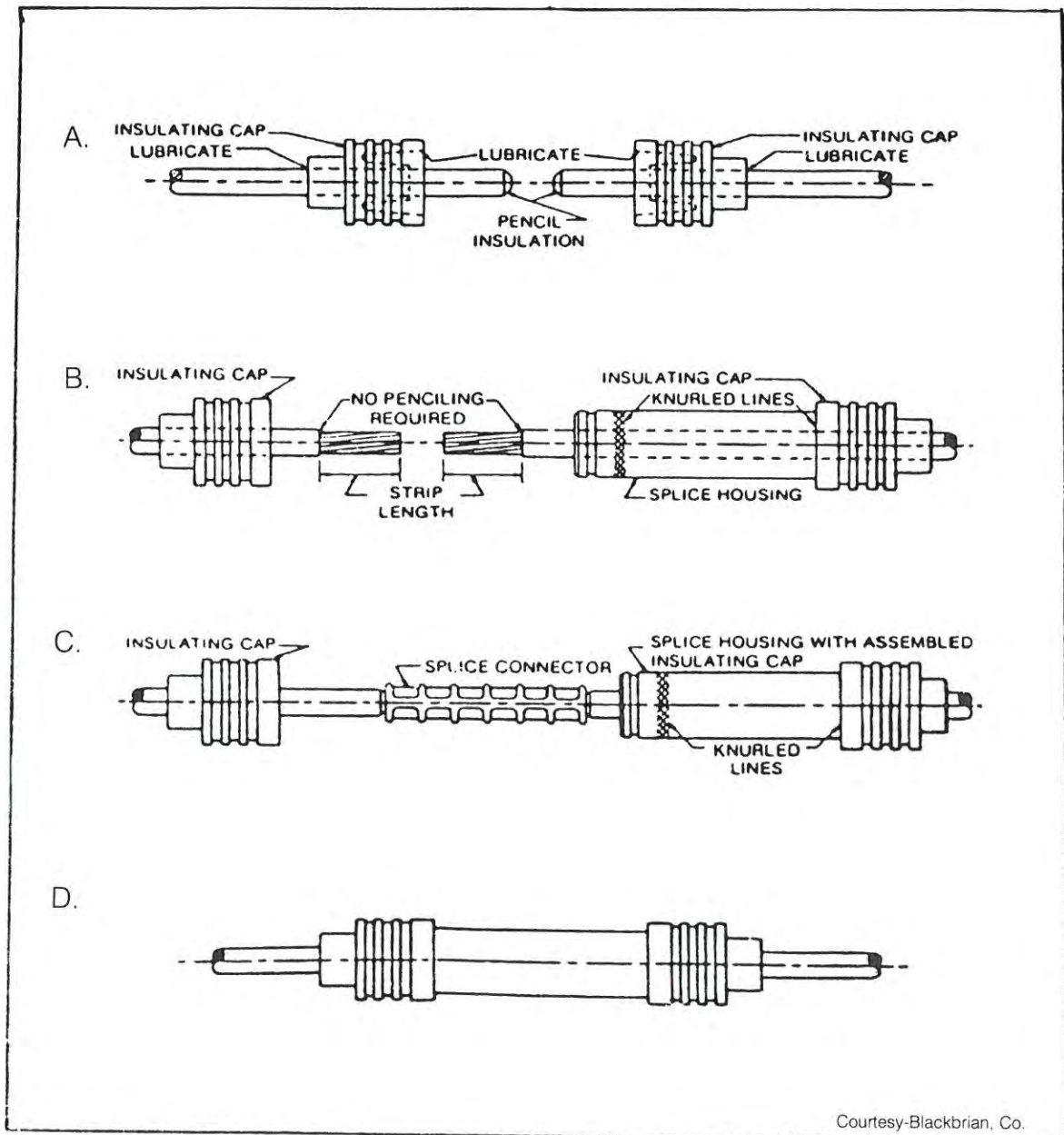

Fig. 11-23. Secondary 600 V Underground Splice Kit showing sequence of assembly steps.

Typical terminations for primary cables indicate that molded, precut tape, and porcelain types are used indoors while porcelain units are most often used outdoors. One of the most significant developments in primary cable terminations has been the introduction of plug-in connectors for joining the cables to equipment or other cables. With these devices it is almost as easy to connect a primary cable as to plug in or remove an appliance cord from a convenience outlet.

The concept of premolded stress relief takes the fabrication of a stress relief core away from the field and into the factory with its controlled environment, leaving just the assembly to the field installer. Elastomeric connections form a very convenient, inexpensive, and reliable method of connecting or terminating high voltage cables. Power cable loadbreak elbows in the 35 kV class were introduced to the industry in 1983, with designs for 15 kV and 25 kV following in 1985.

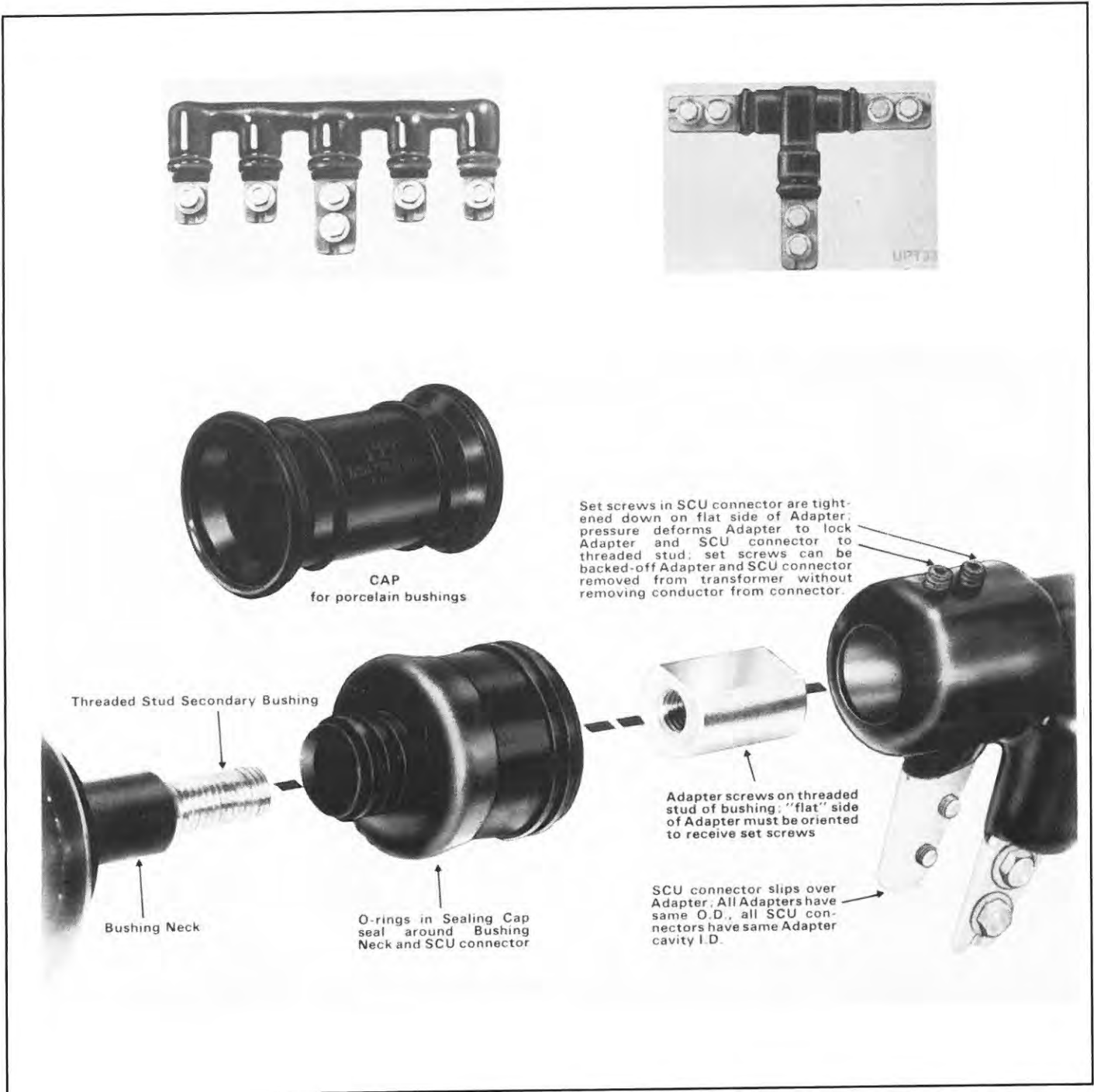

Fig. 11-24. Some typical 600 V underground termination fittings.

Through the combined efforts of the connector and apparatus manufacturers and the utilities, there is available today an array of premolded products that exhibit a high degree of safety, reliability, and flexibility.\*

\*See James W. Fitzhugh's paper, "Exploring the Application of Premolded Products for High Voltage Power Systems."

Some typical applications of premolded products are at pulling or junction boxes, cable to equipment connections, and cable to cable connections. All of these components are designed and tested to be in compliance with ANSI/IEEE Standard 386—1985 Separable Insulated Connectors for Power Distribution Systems above 600 Volts.

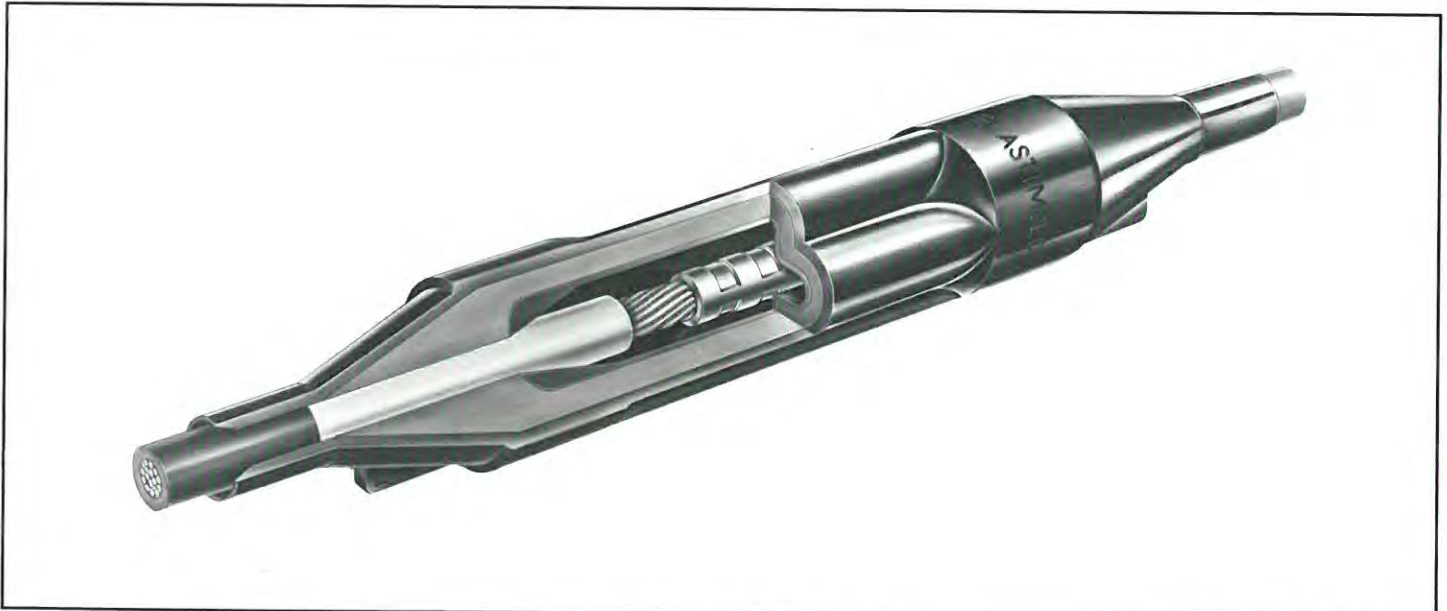

Fig. 11-25. Power cable joint for use at 15 kV or 25 kV.

Photo courtesy of ELASTIMOLD

### Primary Voltage Circuits

A cutaway view of an up-to-date power cable joint is shown in Fig. 11-25. The cloverleaf design allows the joint to operate at lower temperatures.

While installation of premolded devices are similar, conditions may vary depending on the device, the cable, and the manufacturer of the splice or termination. In all cases, full instructions will be provided and should be followed. Additional typical designs are shown in Fig. 11-26.

Development work in splicing, connecting, and terminating devices is still proceeding. Users thus are advised to keep posted on the latest designs being offered by the connector manufacturers in order to achieve greatest economies in making cable splices, connections, and terminations.

Though recent trends have been toward the use of premolded splicing and terminating devices, it is still necessary or desirable in some circumstances to make hand-taped joints by traditional methods. Because of this the details of making a hand-taped, concentric neutral, straight splice are given below. Details of the joint are shown in Fig. 11-27.

The following are the instructions to be generally based in making the joint illustrated in Fig 11-27. They are for a typical hand-taped primary cable splice. All splices and terminations should be made by a qualified cable splicer in accordance with the manufacturer's instructions and recommendations.

1. Study splice drawing and instructions:
2. Train cables into final position and overlap for 18 inches to afford enough excess concentric wire for final jointing.

3. Temporarily wrap a number of turns of tape over the outer concentric wires at least 18 inches from the centerline of the splice.
4. Carefully unwrap outer concentric wires and temporarily remove them out of the splice area, being sure not to damage or kink them.

TABLE 11-9  
Recommending Taping Dimensions

Insulation Thickness	A	B	C	D	K
15KV					
.175" or .220"	One-half Connector Length	2"	4 1/4"	2A + 14 1/2"	3/8"
25KV					
.260"	One-half Connector Length	2 1/2"	5 1/4"	2A + 17 1/2"	7/16"
35KV					
.345"	One-half Connector Length	3"	7"	2A + 22"	9/16"

5. Cut off excess cable at splice centerline.
6. Remove outer semiconducting jacket for a distance of (A + 1 + B + C) inches from each cable, making sure that the insulation is not damaged during the removal operation. All traces of the semiconducting jacket must be removed by a nonconductive abrasive or rasp.
7. Remove the insulation from each conductor for a distance of (A + 1) inches, *making sure that the conductor is not nicked during the removal operation.*

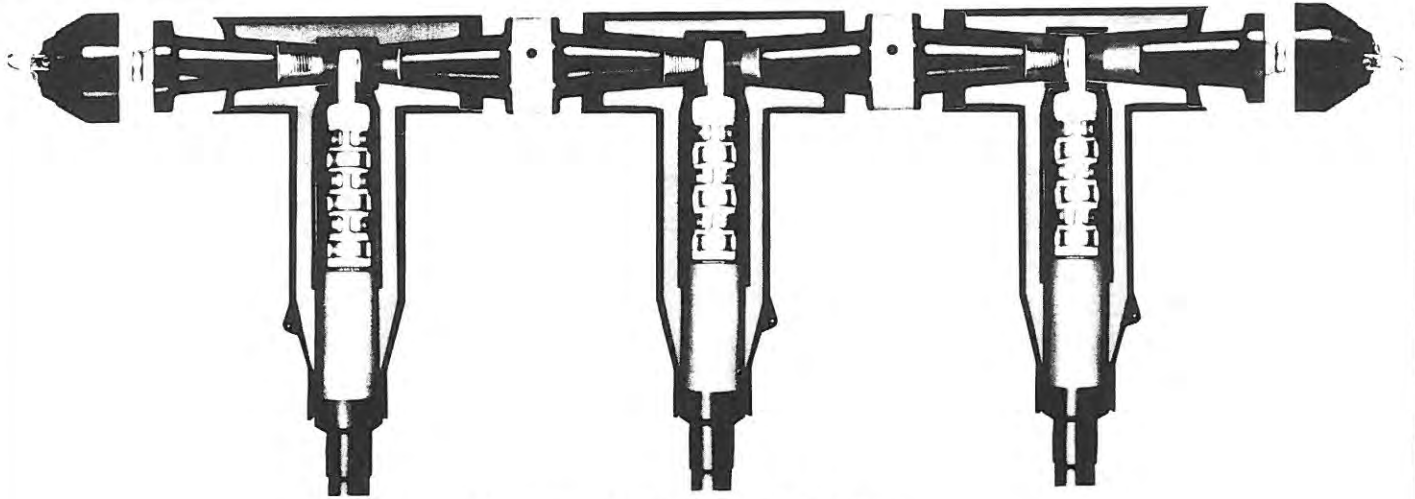

Assembly of Tee Splice and Tap Devices

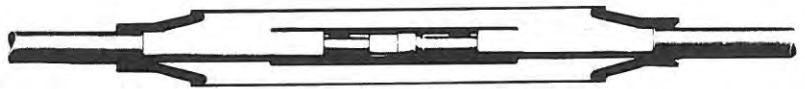

Straight Line Splice



Disconnectible Straight Line Splice

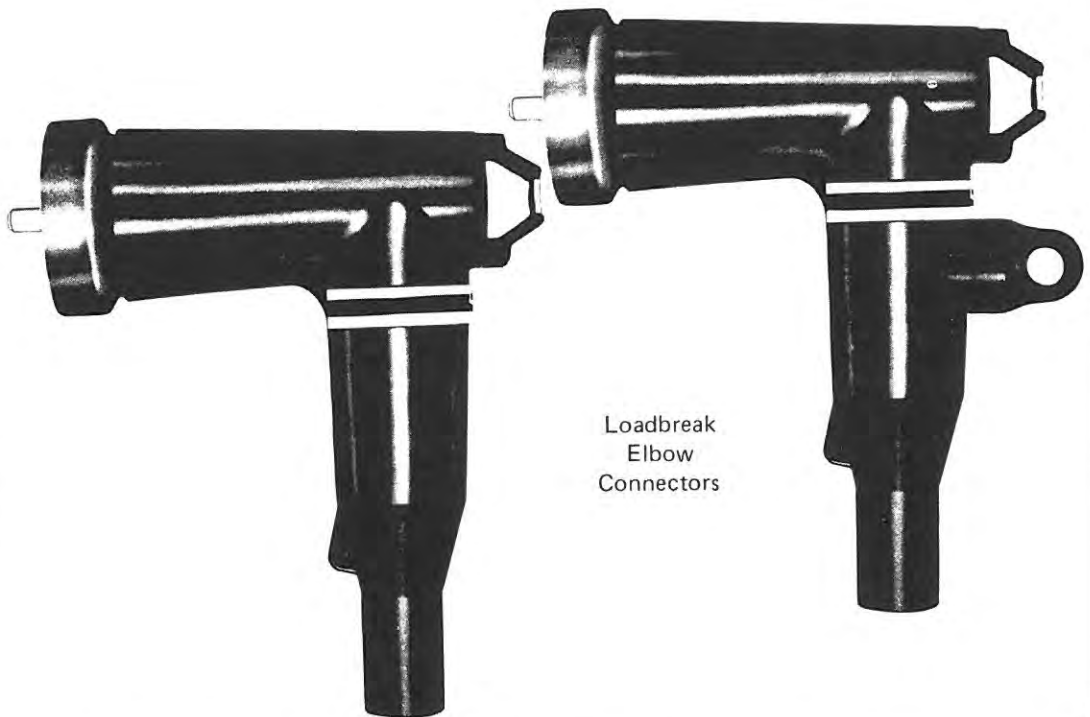

Loadbreak  
Elbow  
Connectors



Modular Cable  
Terminator

Fig. 11-26. Some typical primary voltage premolded splicing and terminating devices.



covered and insulated aluminum wire and cable

### Splicing\*—15kV—25kV—35kV Primary Cables—Hand Taped Splice

Single conductor with concentric neutral, straight splice (conventional or cross-linked polyethylene insulated, solid or stranded) for grounded neutral service.

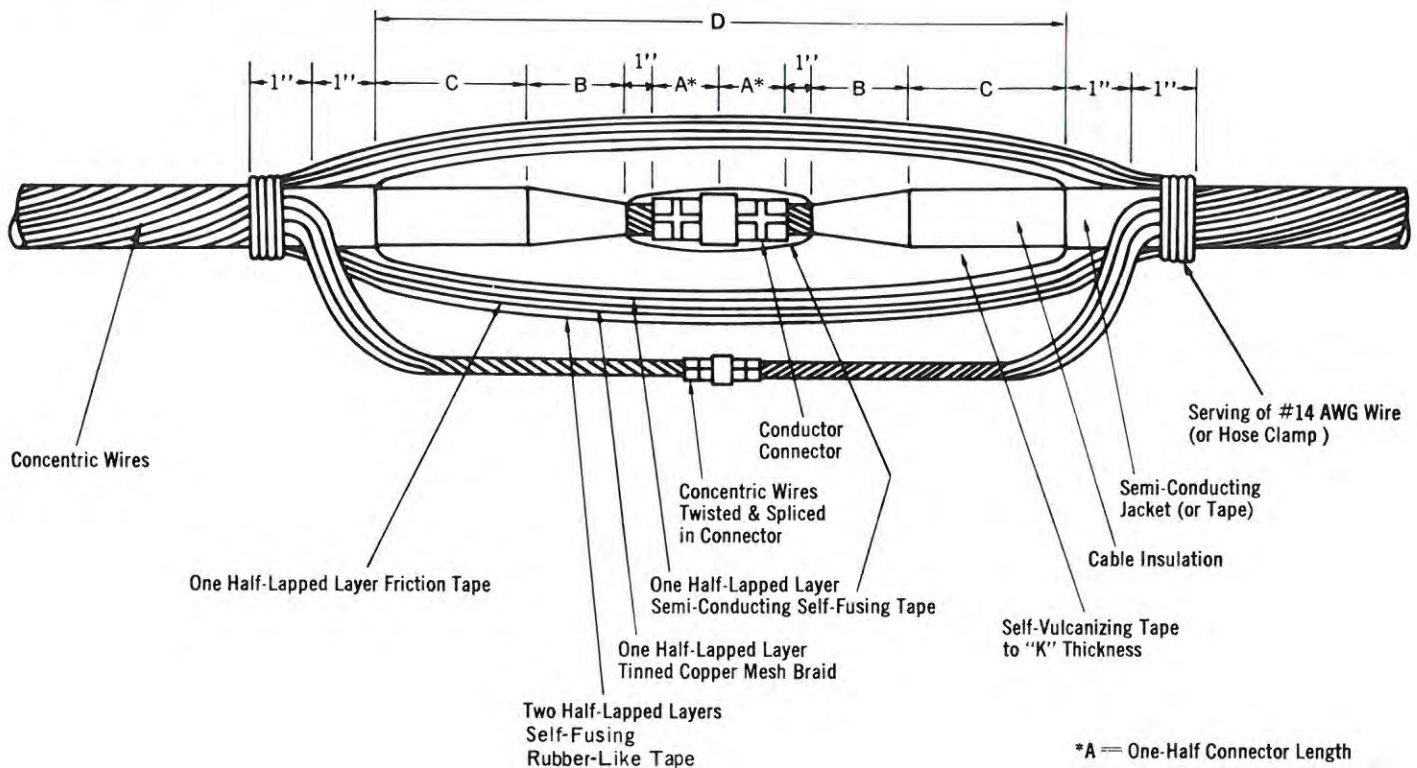

Fig. 11-27. Details of a taped primary cable joint.

Pencil ing tools will remove the insulation, as well as provide smooth penciled surface.

8. Apply the required compression connector on each cable, following the connector manufacturer's recommended procedure. Note: It is recommended that a smooth surface type connector be used—not an indented type. If an indented type is used, fill the indents with a pliable insulation putty.
9. Remove all sharp edges from compressed connector, using a file or heavy abrasive cloth.
10. Pencil the ends of the polyethylene insulation for a distance of (B) inches. Be sure not to cut into the insulation or damage the conductor during the penciling procedure. Buff the insulation pencils if they are not smooth with a nonconductive abrasive or rasp. This step would be completed with a penciling tool. (See Step 7 above.)
11. Clean all exposed surfaces with a nontoxic and nonflammable solvent and allow to dry. Care must be taken in wiping the black conducting jackets, since this may smear over the insulation surface.
12. Apply one half-lapped layer of semiconducting tape (Bishop Tape No. 17 or equivalent) over the exposed conductor and connector. Tape should just contact the edge of the cable insulation and be applied with enough tension to conform to the connector.
13. Apply half-lapped layer of high voltage, self-fusing tape with manufacturer's recommended tension, starting at connector centerline and building up to the level of the connector in areas between insulation pencil and connector by evenly wrapping tape back and forth across the connector. Apply splice tape buildup to a thickness of "K" inches over the connector and for a longitudinal distance of "D" inches, tapering at the ends.
14. Apply one half-lapped layer of self-fusing semiconducting tape over insulating tape buildup, extending 1 inch beyond insulating tape onto the semiconducting jacket on each side of splice. The semiconducting tape should be applied with adequate tension.
15. Apply one half-lapped layer of tinned copper mesh braid over the semiconducting tape and extend 1 inch at each end of splice. The tinned copper mesh braid

- should be wrapped as tight as possible, and taping should be started at the centerline of the splice, using two portions of tinned copper mesh braid.
16. Apply two solder lines 180 degrees apart for the full length of the mesh braid, making sure that the heat does not remain in one spot too long to damage the cable insulation or tapes.
  17. Tie the concentric outer wires in place using wraps of No. 14 AWG tinned or bare copper wire and tack solder in place.
  18. Apply two half-lapped layers of a self-fusing high voltage tape over the outer braid with minimum tension.
  19. Apply one half-lapped layer of jacket tape over the mesh braid to the edge of the concentric wires at each end of the splice.
  20. Twist the concentric wires together and cut off excess length. Place the formed wires into the proper sized mechanical (or compression) connector and splice in place to form low resistance joint, following the connector manufacturer's recommended procedure.

*Terminating Detail*

The construction details of secondary or primary cable terminations depend on whether the termination is outdoor, indoor, or from underground and whether it is horizontal for connection to an equipment terminal or vertical for connection to another conductor. Trifurcating assemblies are also used for terminating a three-conductor cable so the uninsulated terminals are well separated (Fig. 11-28).

Terminations usually are either of the pothead type or the built-up stress-relief type. Both types provide extra insulation close to the actual termination of the conductor to provide protection against the extra voltage at these locations.

Primarily, potheads of plastic insulating materials are used with primary and secondary URD systems, although porcelain potheads and semi-assembled, built-up stress relief cones (or kits that facilitate their quick assembly) are still used for this application. (Fig. 11-16)

Stress-relief cones are also required in cable splices

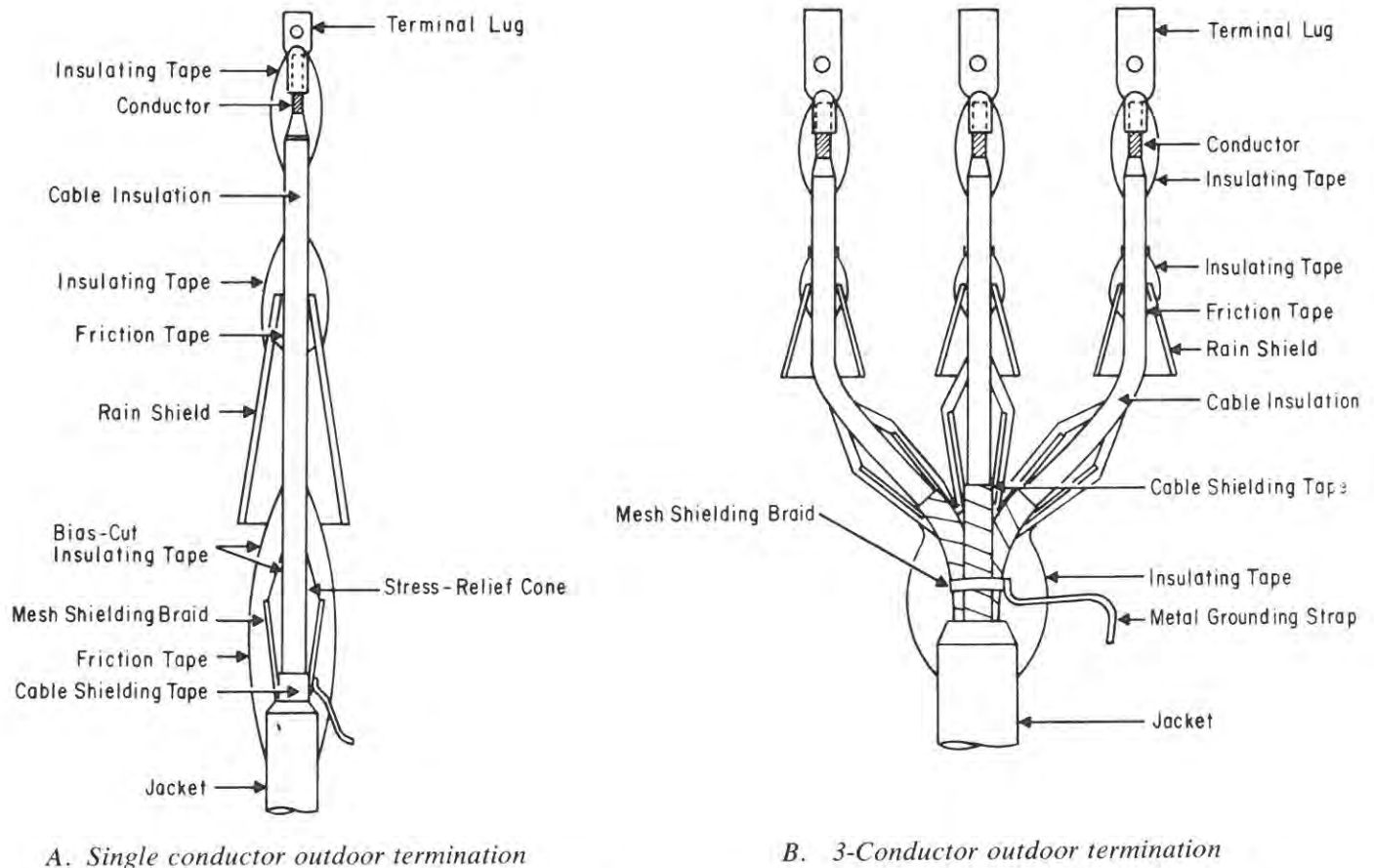

Fig. 11-28. Typical terminations 5-15kV.

## covered and insulated aluminum wire and cable

where there is a change of conductor size; the variation of current density in the adjacent conductors creates dielectric stress variations that occur when a cable is terminated.

The detailed methods of terminating shielded and non-shielded cables closely resemble those used for splicing, except that the termination process requires the inclusion of a stress-relief cone or a pothead, and if the installation is outdoor and vertical the addition of a rain shield to shed water from the cable insulation is customary. Descriptive details are supplied by cable and accessory manufacturers with dimensions for various sizes and voltages. The accompanying illustrations list the successive operations. The precautionary recommendations mentioned in relation to cable splicing also apply to terminating procedure, subject

to such changes as appear in manufacturer's instructional manuals.

The cross-section of a molded terminal connector is shown in Fig. 11-29, illustrating the component part of a connector designed for conductors up to 25 kV. It is suitable for use on solid dielectric cables and can be applied directly on cables with extruded semi-conductive shields including full neutral concentric. It will accommodate aluminum conductors in the range of No. 6 to 4/0 AWG with an insulation thickness of 0.495 to 1.115". After proper cable preparation, the terminal connector is slid down over the bared cable insulation until it bottoms on the cable shield. No special tools or potting compounds are required for the assembly of this type of fitting.

### 1. TERMINAL CONNECTOR

The universal rod connector attaches to the power source.

### 2. MOLDED RUBBER CAP

Presses over top of terminator with an interference fit to provide complete waterseal integrity.

### 3. RETAINING WASHER

Mechanically prevents any cable slippage within terminator.

### 4. TERMINATOR HOUSING

Molded of special EPDM compounds for functional reliability and long life. Actual creep distance is 18" (45,7 cm).

### 5. CABLE INSULATION

Primary insulation is provided since cable insulation carries through the terminator.

### 6. INTERFERENCE FIT

Molded insulating EPDM exerts uniform concentric pressure on insulation of cable to provide required creep-path length and waterseal.

### 7. MOLDED STRESS RELIEF

Factory-tested molded stress relief assures proper stress relief for terminating cable. A patented Elastimold feature.

### 8. GROUND STRAP

Provides a convenient point to connect a ground wire to the molded conductive shield and places the molded shield at ground potential.

Courtesy Amerace Corp., Elastimold Div.

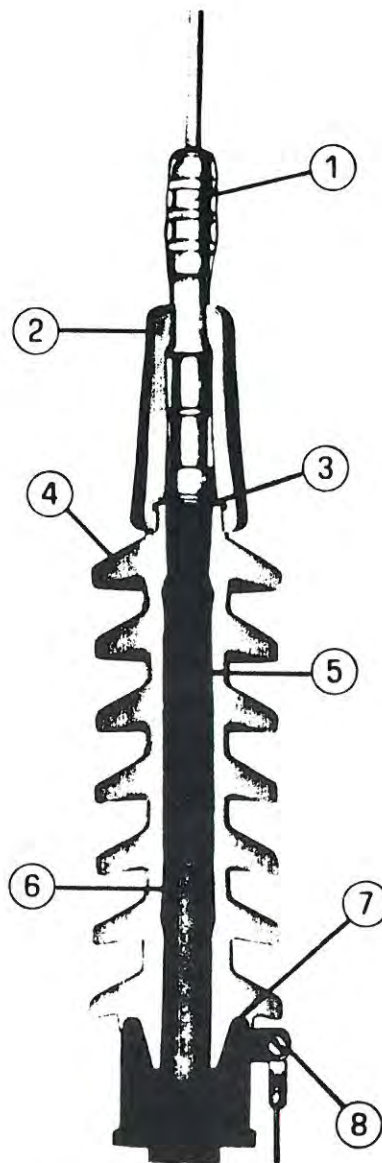

Fig. 11-29. Typical single conductor molded pothead for cable termination.

## Installing Aerial Insulated Cables

Single insulated or covered overhead primary aluminum conductors suspended from insulators sometimes are used in tree areas or similar locations. Their installation is similar to that of bare conductors, as described in Chapter 5. The span lengths usually are moderate so that sag and tension values generally are obtained from tables. However, for unusual spans, sag-tension charts can be computed or are available from conductor suppliers. For aluminum 1350 conductors or less than hard tempers, adjustment must be made for reduction of strength.

For economic reasons, however, most overhead spans of insulated power conductors are in the form of preassembled or field-assembled multi-conductor cables suspended from a bare messenger. Insulator support is not required and space is saved by using a single-multi-conductor cable. The conductors may be spiraled around the messenger or arranged parallel to it, as described in Chapter 7. Messenger supported cables are in two groups:

- Preassembled aerial cables (to 35 kV)
- Aerial cable assemblies (0 to 600 volts).

### Primary Aerial Cables

The messenger size for primary cables is determined by the required strength, except that for single-phase primary circuits (No. 2 AWG or smaller) where the messenger also serves as a neutral conductor, the conductance of the messenger must equal that of the insulated conductor. Bare messengers not used as neutral conductors are often used also as a part of relaying circuits, as a part of the grounding circuit for the insulation shielding, and as an auxiliary to a common-neutral. For these reasons specifications for multi-conductor primary cables with bare messengers usually specify the ohmic resistance of the messenger. The combination of strength and moderate electrical resistance requirements of such non-neutral messengers has led to wide acceptance of composites of aluminum and of steel (Alumoweld) for the make-up of the messenger.

Messenger sizes are such that the normal initial sagging tension at 60°F will not exceed 30% of its rated strength, and its maximum tension will not exceed 50% of its rated strength at the fully loaded condition. Physical details of the cables used for the messengers listed in Tables 11-10 and 11-11 can be found in Tables 4-5 (1350-H19), 4-12 (6201-T81) and 4-14 (ACSR). These messenger sizes conform to the ICEA recommendation that the initial sag be such that the final sag be not less than 1.667% of the span length.

Stringing sag and tension charts are supplied by cable manufacturers as an aid to circuit design for light, medium, or heavy loading conditions (NESC, see Table 5-1) for use as described in Chapter 5. However, in most instances the spans are of moderate length so suitable sag-tension values may be obtained directly or interpolated from manu-

facturer-supplied tables that list initial and final values for 100, 125, and 150 ft spans.

For the installer of the cable the most useful tabular values are those for *initial* sag and tension, usually for 60°F, but a correction factor is applied if the installation temperature differs from 60°F. The *final* sag and tension values for the various NESC loading districts then will meet requirements as to the percent that messenger tension bears to its ultimate breaking strength, and the manufacturer's table will confirm this if required. The messengers for preassembled primary cables are not neutral conductors, but high conductance is useful for grounding or signal purposes, hence the equivalent conductor rating is usually listed for the messenger. For this reason various combinations of steel, 1350 aluminum, and high-strength alloy aluminum are often used for primary aerial messengers.

Table 11-10 is extracted from more complete tables in order to show the form in which such tables are supplied. Although this table shows use of a combination messenger made of 1350 aluminum strands assembled with strands of aluminum-clad steel, other messengers are similarly used of high strength ACSR, as well as combinations of 6201 aluminum with steel reinforcement (AACSR).

Fig. 11-30 depicts several kinds of fittings and accessories used when installing messengers and preassembled aerial cables, some of which also apply to preassembled secondary and service-drop cables.

### Neutral-Supported Secondary and Service-Drop Cables

Preassembled aluminum insulated multi-conductor cables supported by bare neutral messenger conductors have practically become standard for secondary aerial circuits and service drops. Subject to the NEC limitation of 300 volts to ground for bare neutrals, the triplex form (two insulated conductors preassembled with a bare neutral) supplies the usual single-phase three-wire circuits. Similar quadruplex cables (three insulated conductors) if connected to a three-phase Y source supplies low-voltage three-phase loads.

The neutral messengers of such cables are selected on basis of strength and conductivity; either with conductivity equal to that of a phase conductor or as a "reduced" neutral having conductivity not less than one-half that of a phase conductor, depending on service requirements. Tables in Chapter 4 show, as mentioned above, data regarding bare neutral messengers for such cables. Chapter 10 describes various types of cables. Fig. 11-31 depicts installation details for usual conditions of installation of the secondary cable and the service-drop taps extending from it. Initial sag-and-tension data for preassembled triplex aluminum cables with full- and reduced-size neutrals are in Table 11-11 for the various NESC loadings for 125 ft spans.

covered and insulated aluminum wire and cable

The notation on Table 11-11 with regard to initial sag values for other spans than 125 ft is based on Eq. 5-2, but it is only approximate; hence it is available to obtain correct values from the cable manufacturer.

The sag-tension values of Table 11-11 are for *initial* unloaded conditions at 60°F. The sag eventually will increase to the *final* value and the tension correspondingly will decrease as a result of long-time creep. When fully loaded according to NESC values the sag and tension both will increase, and as temperature drops to 0°F under Heavy-Loading conditions the sag decreases and tension

increases. Thus, for 2/0—2/0 cable with aluminum-alloy 6201 messenger, the initial stringing sag-tension of 13 in.—865 lb becomes 24 in.—1955 lb (see Chapter 5).

The sag-tension values under conditions of maximum NESC loading are useful for circuit design because they indicate minimum clearances under the cable, and also verify that there is the specified margin between actual tension and the rated breaking strength of the messenger. However, tables similar to Table 11-11 for initial stringing conditions are used as a basis for installation, which is the subject considered in this chapter.

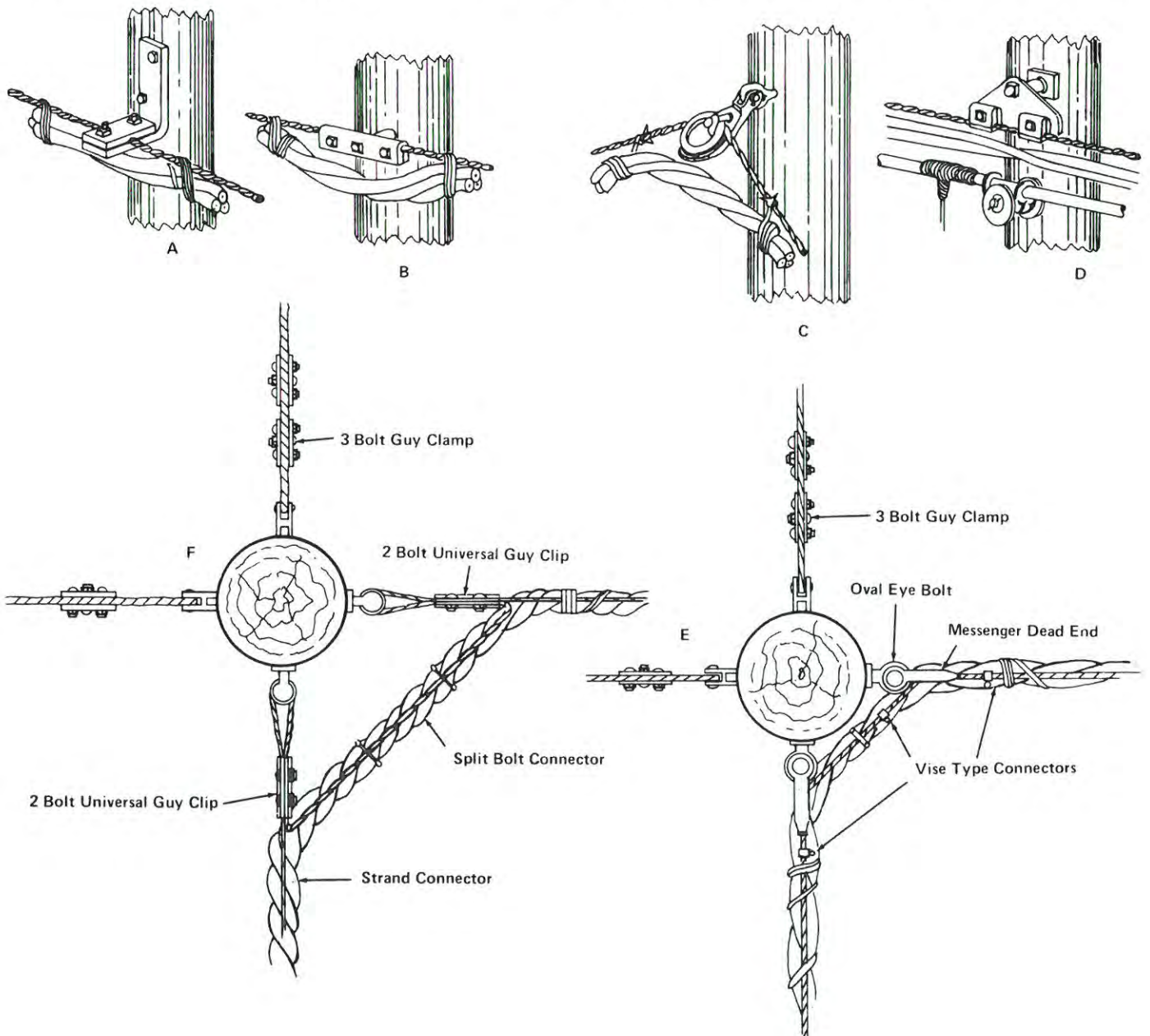

Fig. 11-30. Typical details for supporting and dead-ending cables, messengers, and guy wires on poles.

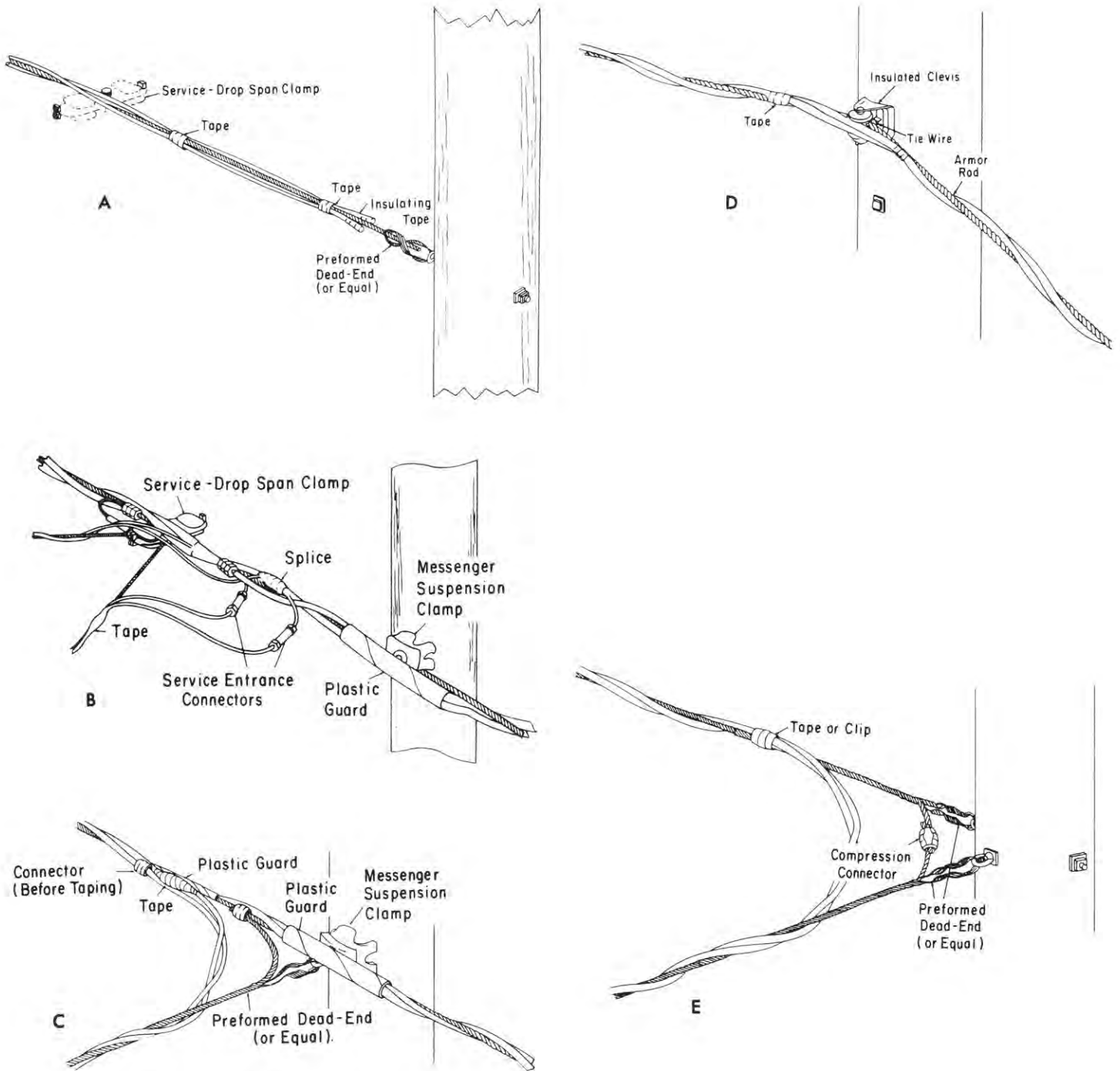

Fig. 11-31. Typical installation details for secondary triplex cables, neutral-messenger-supported, showing service-drop taps and other details.

A—Dead-end at pole, showing also application of service-drop span clamp.

B—Double service-drop taps at service-drop span clamp, and messenger suspension clamp at pole.

C—Service-drop “T” tap near pole.

D—Clevis support at pole for directional change of less than 45°.

E—Dead-end support at pole for directional change of more than 45°.

Notes: Compression connections are to be taped, even though not so shown. Poles are to be suitably guyed to resist unbalanced forces. Armor rods are used where abrasion is likely. See Chapter 5 for additional details of armor rods and the like.

covered and insulated aluminum wire and cable

**TABLE 11-10**

Representative Values Extracted from Tables Supplied by  
Cable Manufacturer for *Initial Sag-and-Tension Values* at  
60°F, suitable for Light or Heavy NESC Districts

For Preassembled Primary Aerial 3-1/C Cables with AWAC Messenger

Conductor Size AWG or Kcmil	Messenger		Cable Assembly (2)		Span Length in Feet					
	Size	Rated Strength	Diam. in.	Weight lb/ft	100 125 150 Sag-inches (3)			100 125 150 Tension-lb (1)		
					100	125	150	100	125	150
<i>5000 Volt Unshielded</i> (Class B concentric stranded aluminum, cross-linked polyethylene insulation)										
		(lb)								
6	#3-3/4	7700	1.251	0.421	19	23	28	337	428	509
1	"	"	1.575	0.645	"	"	"	516	655	780
2/0	"	"	1.770	0.827	"	"	"	662	840	1000
4/0	"	"	2.007	1.100	19	23	27	880	1118	1364
350	"	"	2.374	1.600	"	"	"	1280	1626	1983
500	#3-2/5	11300	2.693	2.158	"	"	"	1726	2193	2675
750	#2-2/5	13500	3.215	3.076	"	"	"	2461	3126	3813
1000	#1/0-2/5	19500	3.695	4.053	"	"	"	3242	4119	5024
<i>15,000 Volt Shielded, Grounded Neutral</i> (Class B concentric stranded aluminum; semi-con tape; strand shield; 0.175 in. XLPE insulation; extruded semi-con PE, No. 22 AWG copper concentric; Mylar tape; PVC jacket)										
2	#3-3/4	7700	2.459	1.379	19	23	27	1122	1418	1739
1/0	"	"	2.618	1.606	"	"	"	1306	1645	2024
4/0	#3-2/5	11300	3.006	2.215	"	"	28	1801	2269	2679
350	#1/0-2/5	19500	3.504	3.075	"	"	"	2500	3151	3720
500	"	"	3.789	3.696	"	"	27	3005	3787	4659
750	556,500(30/7)	26900	4.575	5.039	"	"	28	4032	5040	6048
1000	"	"	5.079	6.390	"	"	31	5031	6400	7051

1. Initial tension is such that the final tension will not exceed 25 percent of rated strength at 60°F, for Light or Heavy NESC loading districts.
2. Includes weight of messenger and binder tape.
3. Initial sag is such that final sag approximately conforms to ICEA recommendation of 1.667 percent of span length.

**TABLE 11-11**

**Typical Initial Stringing Sag and Tension Values for  
Three-Conductor Self-Supported Polyethylene Service-Drop and  
Secondary Cable (Triplex), for 125 ft span at 60°F  
for Various NESC Loading Districts (see Table 5-1)\***

Note: For roughly approximate values for spans of 100 ft and 150 ft, multiply the initial sag values for 125 ft span by 0.64 for 100-ft span and by 1.45 for 150-ft span, retaining the initial tension values for 125 ft span. These approximations are less accurate for the Heavy Loading District. More accurate values for spans other than for 125 ft, are obtainable from cable manufacturers.

Con- ductor Size AWG	Neutral Messenger		NESC Light-Loading District		NESC Medium-Loading District		NESC Heavy-Loading District	
	Size AWG (or Equiv.)	Rated Strength lb	Initial Sag	Initial Tension	Initial Sag	Initial Tension	Initial Sag	Initial Tension
<b>ALUMINUM ALLOY 6201 NEUTRAL MESSENGER</b>								
4	4	1760	8	467	10	410	16	250
2	2	2800	8	750	10	680	12	553
1/0	1/0	4460	8	1195	8	1060	11	875
2/0	2/0	5390	8	1415	10	1255	13	865
<b>ACSR NEUTRAL MESSENGER</b>								
6	6	1190	10	290	10	305	29	98
4	4	1860	10	445	8	415	11	375
2	2	2850	10	660	11	575	11	600
1/0	1/0	4380	10	1005	12	865	12	840
2/0	2/0	5310	10	1255	12	1070	13	975
<b>REDUCED ACSR NEUTRAL MESSENGER</b>								
4	6	1190	12	295	12	350	34	105
2	4	1860	13	445	13	435	17	330
1/0	2	2850	13	670	14	600	13	655
2/0	1	3550	13	835	16	730	14	755
<b>ALUMINUM NEUTRAL MESSENGER (Aluminum 1350)</b>								
6	6	560	26	91	54	44	104	23
4	4	881	19	195	19	195	72	53
2	2	1350	17	385	19	295	49	115
1/0	1/0	1990	19	485	23	410	40	230

\* These initial sag-tension values are based on NESC loading limits for REA systems; that is, loaded tension is not to exceed 50% of messenger rated strength; final stringing tension is not to exceed 25% of rated strength; and initial stringing tension is not to exceed 33-1/3% of rated strength.





## Chapter 12

## Operation and Operating Problems

Operation of power cables under their normal conditions of intended use seldom presents major problems. Reference data in previous chapters (mostly Chapter 9) enable the designer and user to predict voltage drop as a function of load and to specify the maximum current to be carried per conductor (at 100% or reduced load factors) on a thermal limitation basis. Circuit fuses, limiters, circuit breakers, cut-outs, etc., are usually selected or adjusted to limit the current in the cable to its design short-circuit capability, and relays, regulators, and signal circuits enable the load dispatcher to maintain the load within operating limits or control its extension into the emergency load range, as required.

The basic relationship of kV, ampere, kW and kVA factors in the usual power circuit are well understood by designers and operating employees but, as a reminder, Fig. 12-1 is included. It lists equations for two-phase systems that are frequently encountered. The designation "star" is used instead of the term "Y-connected." For the probable approximate ampacity loading of branch and main circuits for residential and light industrial uses, refer to NEC Articles Nos. 220, 230 and 430.

The load factors and corresponding loss factors that apply to typical daily load curves are explained in Chapter 9. These factors are related to the heat-sink effect of the surrounding earth on conductors that are directly buried or are in underground ducts. A load factor of 100 percent is used for circuits in air or conduit in air. It is important to consider the worst case "limiting factor" when deciding the load carrying capability of a circuit.

### Emergency Overloads

The conditions that permit the cable to be subjected to temporary emergency overloads, within recognized limits of good practice, were outlined in Chapter 9, and the emergency-load temperatures that the insulation can sustain are listed in Table 9-7. The load dispatcher, however, does not measure insulation temperature to indicate that the emergency-overload limit has been reached. Instead, he is supplied with the ammeter readings that correspond to the emergency-load temperatures. Precomputing of these ampacity values for the emergency-overload temperature is an operating problem solved by applying the constants

from the ICEA—IEEE Ampacity Tables, described in Appendix 9A, principally Eq. 9A-1.

*Example:* 4/0 triplexed concentric standard rubber insulated cable in air; 40°C ambient; operating temperature 75°C; 15 kV

From Table 9A-2, rated ampacity is 233 amp and Delta TD is 0.50. What is the corresponding emergency-load ampacity if the emergency-load temperature of the insulation is 90°C?

Applying Eq. 9A-1

$$I' = 233 \sqrt{\frac{90 - 40 - 0.50}{75 - 40 - 0.50}} \times \frac{228.1 + 75.0}{228.1 + 90.0} = 272 \text{ amp}$$

The Delta TD value is unchanged because it is assumed that the dielectric constant and insulation pf are the same at both temperatures.

Appendix 9A describes further adjustments of the above relationship for variations of ambient temperature, and properties of the insulation.

### Short-Circuit Loading

Short circuits, either between the conductors of a power cable or from the conductors to ground or occurring in some part of the load being served by the cable, can cause a rapid rise of current values, as much as 100 times normal or more.

A discussion of short-circuit currents in aluminum conductors insulated with various materials is in Chapter 9 (see Figs. 9-5, -6, and -7). Additional information applying to bare conductors is in Chapter 6, and much of it is applicable to insulated conductors. The essential difference is that insulated conductors fail under short-circuit conditions because of loss of insulation value, whereas bare conductors fail because of loss of strength of the conductor caused by high-temperature annealing. The allowable temperatures under short-circuit conditions for insulated aluminum conductors are 150°C, 200°C, and 250°C, depending on the kind of insulation, as listed in Table 9-7.

The problem of system fault-current is beyond the scope of this publication. The reference to zero-sequence impedance of bare aluminum conductors in Chapter 3, applying to elementary circuits and to average earth resistance, may aid such calculations, but for network analysis and where terminal impedances must be considered, the method of computation is the same for aluminum as for copper, except for differences of electrical properties of the conductors.

covered and insulated aluminum wire and cable

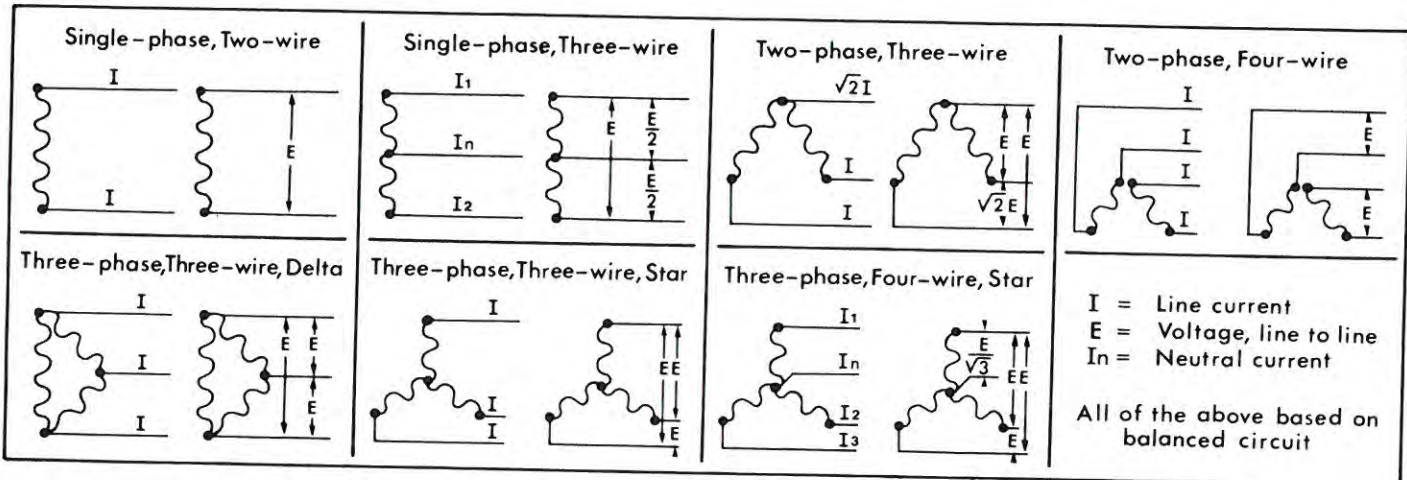

CURRENT, HORSEPOWER, KILOWATTS AND KILOVOLT-AMPERES

To Find the Value	When Value Below Is Known	SYSTEM			
		Direct Current	Single-Phase	Two-Phase, Four-Wire*	Three-Phase
FORMULAS					
Amperes (1)	Horsepower (Hp)	$I = \frac{746 \text{ Hp}}{E \times \text{eff}}$	$I = \frac{746 \text{ Hp}}{E \times \text{eff} \times \text{pf}}$	$I = \frac{746 \text{ Hp}}{2 \times E \times \text{eff} \times \text{pf}}$	$I = \frac{746 \text{ Hp}}{1.73 \times E \times \text{eff} \times \text{pf}}$
Amperes (1)	Kilowatts (kW)	$I = \frac{1000 \text{ kW}}{E}$	$I = \frac{1000 \text{ kW}}{E \times \text{pf}}$	$I = \frac{1000 \text{ kW}}{2 \times E \times \text{pf}}$	$I = \frac{1000 \text{ kW}}{1.73 \times E \times \text{pf}}$
Amperes (1)	Kilovolt-Amperes (kVA)		$I = \frac{1000 \text{ kVA}}{E}$	$I = \frac{1000 \text{ kVA}}{2E}$	$I = \frac{1000 \text{ kVA}}{1.73E}$
Kilowatts Input (kW)		$\text{kW} = \frac{1 \times E}{1000}$	$\text{kW} = \frac{I \times E \times \text{pf}}{1000}$	$\text{kW} = \frac{I \times E \times 2 \times \text{pf}}{1000}$	$(\text{kW}) = \frac{1 \times E \times 1.73 \times \text{pf}}{1000}$
Kilovolt-Amperes (kVA)			$\text{kVA} = \frac{1 \times E}{1000}$	$\text{kVA} = \frac{I \times E \times 2}{1000}$	$\text{kVA} = \frac{I \times E \times 1.73}{1000}$
Horsepower Output (Hp)		$\text{Hp} = \frac{I \times E \times \text{eff}}{746}$	$\text{Hp} = \frac{I \times E \times \text{eff} \times \text{pf}}{746}$	$\text{Hp} = \frac{1 \times E \times 2 \times \text{eff} \times \text{pf}}{746}$	$\text{Hp} = \frac{I \times E \times 1.73 \times \text{eff} \times \text{pf}}{746}$

I = Line Current, Amperes  
 E = Line-to-Line Voltage, Volts  
 eff = Efficiency, decimals  
 pf = Power Factor, decimals

kW = Input, Kilowatts  
 kVA = Input, Kilovolt-Amperes  
 Hp = Output, Horsepower

\*For two-phase, three-wire, balanced circuits, the amperes in common conductor = 1.41X that in either of the other two.

Fig. 12-1. Diagrams and formulas showing relationships between electrical and power quantities in various types of circuits.

Note: The expression "decimals" refers to notation as a decimal fraction; that is, an efficiency of 85% is used in the formula as 0.85.

Some of the operating conditions that bring about short-circuits of various kinds are considered herein as a guide to what is to be avoided, if possible.

Short Circuits in Shields and Sheaths

Consideration should be given to the performance of the cable metallic shield under the influence of a line-to-ground fault.

Though several other metals are sometimes employed as sheath/shield material, (see Tables 12-4 and 12-5) copper is by far the most commonly used.

Cable shielded with these helically applied copper tapes or concentric servings of fine (20-24 AWG) copper wires have generally performed satisfactorily in the past because of relatively low fault currents and because these circuits were often installed in ducts in three-conductor groups with a bare ground conductor.

The increasing use of solid dielectric power cable on electric utility distribution systems with higher available fault currents underlines the importance of proper shield size for the expected fault duty.

Equation 12-1\* gives the minimum effective cross-sectional area of metallic shield required for a given fault time period.

Table 12-1 shows the corresponding formulae for calculating the effective cross-sectional area of various types of sheaths/shields.

Table 12-2 shows the approximate shield normal operating temperature for various steady-state conductor operating temperatures for cables rated 5 kV through 69 kV.

TABLE 12-1

Type of Shield or Sheath	Formula for Calculating A (See notes 1 and 2)
1. Wires applied either helically, as a braid or serving; or longitudinally with corrugations	$nd_s^2$
2. Helically applied tape, not overlapped	$1.27 nwb$
3. Helically applied flat tape, overlapped	$4bd_m \sqrt{\frac{100}{2(100-L)}}$ see note 3
4. Corrugated tape, longitudinally applied	$1.27 [\pi(dis+50)+B] b$
5. Tubular sheath	$4bd_m$

NOTE 1: Meaning of Symbols

- A = Effective cross-sectional area, shield or sheath.
- B = Tape overlap, mils (usually 375).
- b = Thickness of tape, mils.
- dis = Diameter over semiconducting insulation shield, mils.
- d<sub>m</sub> = Mean diameter of shield or sheath, mils.
- d<sub>s</sub> = Diameter of wires, mils.
- w = Width of tape, mils.
- n = Number of serving or braid wires or tapes.
- L = Overlap of tape, percent.

NOTE 2: The effective area of composite shields is the sum of the effective areas of the components. For example: the effective area of a composite shield consisting of a helically applied tape and a wire serving would be the sum of the areas calculated from Formula 2 (or 3) and Formula 1.

NOTE 3: The effective area of thin, helically applied overlapped tapes depends also upon the degree of electrical contact resistance of the overlaps. Formula 3 may be used to calculate the effective cross-sectional area of the shield for new cable. An increase in contact resistance may occur after cable installation during service exposed to moisture and heat. Under these conditions, the contact resistance may approach infinity where Formula 2 could apply.

\*From ICEA publication P-45-482, 2nd Edition, 1979. The user is cautioned to read this publication in order to fully understand the derivation and basis for this calculation and the associated parameters.

TABLE 12-2

Values of T<sub>1</sub>, Approximate Shield or Sheath Operating Temperature, °C, at Various Conductor Temperatures

Rated Voltage, kV	Shield or Sheath Temp. °C at Conductor Temp.						
	95°C	90°C	85°C	80°C	75°C	70°C	65°C
5	90	85	80	75	70	65	60
15	90	85	80	75	70	65	60
25	90	85	80	75	70	65	60
35	85	80	75	70	65	60	55
46	85	80	75	70	65	60	55
69	80	75	70	65	60	55	50

NOTE:

The maximum conductor temperature should not exceed the normal temperature rating of the insulation used.

Table 12-3 shows the maximum allowable transient temperature for shields in contact with various materials.

Tables 12-4 and 12-5 give the "M" values for use in Equation 12-1. As shown by the tables, the "M" values are constants and depend upon the shield material, the shield normal operating temperature and the maximum allowable transient temperature of the shield.

Example calculation: Determine the size copper wire shield required to carry a fault current of 10000 amperes for 10 cycles for a 15 kV XLP cable having a semi-conducting thermoplastic insulation shield and a thermoplastic overall jacket.

Step 1

Determine the approximate shield operating temperature for 90°C conductor temperature (which is the maximum temperature for normal operation of XLP insulated cables). From Table 12-2:

$$T_1 = 85^\circ\text{C}$$

Step 2

Determine the maximum allowable shield transient temperature for the cable materials in contact with the shield, which in this case is thermoplastic. From Table 12-3:

$$T_2 = 200^\circ\text{C}$$

Step 3

Determine the "M" value for a copper shield with T<sub>1</sub> equal to 85°C and T<sub>2</sub> equal to 200°C. From Table 12-4:

$$M = 0.063$$

covered and insulated aluminum wire and cable

TABLE 12-3

Values of T <sub>2</sub> * Maximum Allowable Shield or Sheath Transient Temperature, °C	
Cable Material in Contact with Shield or Sheath	T <sub>2</sub>
Crosslinked (thermoset)	350°
Thermoplastic	200°
Impregnated Paper	200°
Varnished Cloth	200°

NOTE:  
The temperature of the shield or sheath shall be limited by the material in contact with it. For example, a cable having a crosslinked semi-conducting shield under the metallic shield and a crosslinked jacket over the metallic shield would have a maximum allowable shield temperature of 350°C. With a thermoplastic jacket, it would be 200°C.

\*For lead sheaths this temperature is limited to 200°C.

Step 4

Calculate the required shield cross-section for a fault duration of 10 cycles (0.167) seconds. Applying Equation 12-1:

$$A = \frac{10000 \sqrt{0.167}}{0.063} = 64866 \text{ circular mils}$$

Step 5

Determine the number and size of the wires necessary to equal or exceed 64866 circular mils. Inspection of Table 12-1 shows that the effective cross-sectional area of a wire shield is equal to  $nd_s^2$  or the number of wires multiplied by the circular mil area of each wire. The number required for any specific wire size is simply the total cross-section calculated in step 4 divided by the individual wire circular mil area and rounded up to the nearest whole number:

$$\text{Number of 14 AWG wires} = 64866 \div 4110 = 15.8 \text{ or } 16$$

Similarly, the number of any other wire size may be determined:

$$A = \frac{I \sqrt{t}}{M} \quad (\text{Eq. 12-1})$$

where: I = short-circuit current in shield, amperes  
t = time of short-circuit, seconds  
M = constant, see Tables 12-4 and 12-5

Causes of Insulation Failure

The majority of cable failures occur unexpectedly. Most often, the power dissipated in the failed area burns the insulation to the extent that the cause is destroyed.

Examination of the areas near the fault and the external appearance of the cable may also provide evidence which helps determine the apparent cause of failure. The reasons for insulation failures which are not obviously the result of physical damage may be found during laboratory investigation by electrically testing cable samples to destruction. A brief review of the most frequent causes found by this method is found in the following paragraphs.

Imperfections in extruded insulations are a major cause of failure. They are often found as voids, contaminants

TABLE 12-4

Shield/Sheath Material	Values of M for the Limiting Condition Where T <sub>2</sub> = 200°C								
	Shield/Sheath Operating Temperature (T <sub>1</sub> ), °C								
	90	85	80	75	70	65	60	55	50
Aluminum	0.041	0.042	0.043	0.044	0.045	0.046	0.047	0.048	0.049
Commercial Bronze	0.045	0.046	0.047	0.048	0.049	0.050	0.051	0.052	0.053
Copper	0.062	0.063	0.065	0.066	0.068	0.070	0.071	0.073	0.074
Lead	0.012	0.012	0.012	0.012	0.013	0.013	0.014	0.014	0.014
Steel	0.023	0.024	0.024	0.025	0.026	0.026	0.027	0.027	0.028
Zinc	0.030	0.031	0.032	0.033	0.034	0.034	0.035	0.036	0.037
Cupro-Nickel	0.018	0.019	0.019	0.020	0.020	0.021	0.021	0.021	0.022

TABLE 12-5

Shield/Sheath Material	Values of M for the Limiting Condition Where T <sub>2</sub> = 350°C								
	Shield/Sheath Operating Temperature (T <sub>1</sub> ), °C								
	90	85	80	75	70	65	60	55	50
Aluminum	0.058	0.059	0.060	0.060	0.061	0.062	0.063	0.063	0.064
Commercial Bronze	0.065	0.067	0.068	0.068	0.069	0.070	0.070	0.071	0.072
Copper	0.088	0.089	0.090	0.091	0.092	0.093	0.094	0.096	0.097
Steel	0.032	0.033	0.033	0.034	0.034	0.035	0.035	0.036	0.036
Zinc	0.044	0.044	0.045	0.045	0.046	0.046	0.047	0.047	0.48
Cupro-Nickel	0.028	0.028	0.029	0.029	0.029	0.029	0.030	0.030	0.030

or sharp projections into the insulation at the conductor shield or insulation shield interface. The presence of some voids is inevitable due to the chemical reaction and medium used to vulcanize insulation.

Contaminants are found in the raw materials purchased from reputable compound suppliers. To a lesser extent, they may also be introduced through inadequate quality control procedures and poor handling techniques at the cable manufacturing plant. Screens are used in the insulation extruders to help filter out solid contamination. However, some inevitably passes through into the cable insulation.

Sharp projections into the insulation may be formed as a cable is extruded. These create points of high electrical stress which can lead to premature cable failure.

In recent years, much has been learned about deterioration of insulation known as "treeing." Treeing of two types is known to occur in solid dielectric cables — water or electrochemical and electrical. Treeing sites are usually at high stress points at the insulation/shielding interface or at voids or contaminants which cause discontinuities in the insulation. Such trees can be seen by optical examination when suitably stained and magnified. If cables without a moisture-proof barrier are operated in a wet environment, water trees will likely form at high stress points in the insulation since moisture can easily penetrate the insulation. It is believed that these trees will ultimately lead to cable failure. The failure mechanism is not completely understood. Cable manufacturers have introduced compounds which retard tree growth and much research is taking place to develop improved tree-resistant insulating materials.

The major cause of failure in paper insulated cable is sheath deterioration or rupture. This permits water or other harmful liquids to penetrate the laminated insulation. Voids occur in such cable due to expansion of the cable core under electrical load. Upon cooling, the core can contract away from the sheath leaving voided areas. Ionization of the voids can polymerize the oil, forming wax. The wax may fill the voids and retard further ionization.

Surface discharge or tracking will deteriorate cable insulation. It may occur at cable terminations where the insulation is exposed. Serious discharge can also develop on non-shielded cable. In each of these instances, differences in voltage gradient on the insulation surface produces current flow. Over long periods of time, the current will erode and char the insulation, leaving tracks.

#### *External Causes of Cable Failure*

Failures of 600 volt cable are most often caused by mechanical damage. The cables are often directly buried at a shallow depth. Digging into the cable occurs quite frequently. Often, little attention is paid to the quality of the fill used to cover the cable. When tamped, sharp

rock may pierce the insulation. Also, multiple cables may be laid across each other or in such close contact that poor heat dissipation results in insulation embrittlement.

Other trouble may occur from poor connections, inadequate short-circuit protection and contact with harmful chemicals. Occasionally, water may enter the conductor from inadequate or non-existent sealing. Conductor corrosion can result, particularly in aluminum cable.

High voltage cable is usually carefully installed and protected. Thus, mechanical damage is less prevalent. "Dig-ins" do occur, however. Cables that are plowed in are susceptible to damage unless care is taken to feed them into the equipment smoothly, without jerking. In some areas of the country, rodents attack buried high voltage cable. For these conditions, special metal protected cables are often used.

#### **Installation and Maintenance Proof-Testing**

Proof-testing is an accepted procedure by which higher than normal operating voltage is applied to cable. Most often this is done on high voltage cable after installation and before the cable is placed in service. The test is quick and simple, only requiring the cable to withstand the voltage for a period of minutes. However, a short time test can only detect gross defects or damage.

Normally, d-c voltage is applied because such equipment can be made lightweight and portable. Often, leakage current is read and recorded. However, the readings can vary greatly since leakage is readily influenced by the condition of the terminations. Humidity, cleanliness and the leakage distance all permit wide variations which may be mistaken for insulation deterioration. Leakage current is of value if a record is maintained over a long period of time. In this way, comparison from one year to previous years will indicate any deterioration.

Table 12-6 lists the present industry-recommended voltages after installation and for subsequent maintenance evaluation.

#### **Fault Location**

The necessity of developing good cable-fault locating techniques is probably more important today than ever before. The growing direct-buried residential distribution system has dramatized the need for reliable techniques to pinpoint cable faults as quickly as possible to minimize downtime and unnecessary excavating. Many power utilities are now staffed with well equipped, specialized crews, trained in the methods for locating faults.

The following material outlines in general the types of equipment commercially available for the many different kinds of fault conditions. Unfortunately, no one piece of apparatus is sufficient in itself. However, they are divided into two general categories, as follows:

covered and insulated aluminum wire and cable

**Terminal Equipment** — is employed where the entire test and determination of the fault location is made at one or more terminals of the cable.

**Tracer Equipment** — is employed where some form of electrical signal is injected into the cable at one of its terminations. The signal is traced to the fault by patrolling the cable with some form of detector used as a signal sensor.

**TABLE 12-6**  
**dc Proof Test Voltage**  
**(kV)**

System Voltage kV	After Installation (15 minute duration)	During Maintenance
2.5	25	20
5.0	35	25
8.7	40	30
15	55	40
25	80	60
28	85	65
34.5	100	75
46	120	90
69	170	125

**NOTE:**  
When equipment such as cable terminals, motors, transformers, etc. are connected to the cable circuit voltage, limitations of such equipment may require the use of lower values. In such instances, it would be advisable to contact the equipment manufacturer before testing. It is recommended the rate of increase of the voltage to the desired value be done uniformly. The voltage level should be reached within 60 seconds but not sooner than 10 seconds. The voltages in the table are 80 percent and 60 percent respectively, of the factory dc test voltages applied to the cable prior to shipment.

**Identify and Isolate**

The faulted section in any branch circuit should be clearly identified, de-energized and isolated. For all of the locating techniques discussed here, it is necessary to disconnect and free all terminals. Ground connections may be left intact, if desired.

The fault resistance can be measured with an ohmmeter or megohmmeter and then classified as a parallel or grounded fault (conductor-to-conductor, conductor-to-sheath or conductor-to-ground) or a series or open fault (open circuit or excess resistance in series).

In many cases, the relative magnitude of resistance determines the type of equipment to be used to achieve good results. High resistance sometimes requires reduction of the fault resistance by "burning."

**Location**

The method of locating a fault is influenced by such variables as type of cable, fault resistance and equipment available. Having meggered the affected circuit, several important factors are determined:

Parallel Fault — Conductor-to-conductor  
(grounded) Conductor-to-sheath  
Conductor-to-ground

Series Fault — Open circuit  
(open) Open sheath

**Fault Resistance**

The types of equipment described below are among those commercially available which can, individually or in combination, locate power cable breakdowns. The *Cable Radar Test*, *Bridge* and *Capacitance Instruments* are classified as terminal instruments since they provide an approximate location as a percentage of circuit length. The longer the length, the greater the actual error, therefore, additional equipment is usually required to pinpoint the exact fault location.

Pulse and tone generators with companion detectors (Acoustic, Electromagnetic, Earth Gradient) are known as tracer methods and these function without knowledge of the circuit length. The tracer methods apply an input signal to either end of the faulted cable. The signal is then physically traced along the cable route until a change is detected which will reveal the location of the fault.

**Radar**

Radar transmits a series of high frequency pulses along the cable and observes the reflections from changes or discontinuities. In essence, it takes an electronic picture of the cable under test and displays it on an oscilloscope. The time required for the generated pulse to reach a discontinuity and return is measured, converted to feet and shown on a digital display. Locations better than 1 percent of the range are possible for circuits up to 80,000 feet.

For parallel faults, the fault resistance should be less than 2000 ohms. However, no limitation is placed on open circuits, loose connections or series type faults.

**Bridge**

The Murray-Loop Bridge with numerous variations has been used for many years to calculate parallel fault locations. The faulted conductor is normally joined to a similar unfaulted conductor and the bridge measurement made on the resulting loop at the opposite open end. The fault resistance should be relatively low. Higher sensitivity is possible in a high voltage adaptation of the bridge where fault resistance can be as high as 5 megohms.

A low voltage version inverted Murray-Loop Bridge having electronic null indicator can provide good results with fault resistance as high as 200 megohms. Accuracies within 0.5 percent of the loop length are possible with resolution to 0.01 percent.

#### Capacitance

A capacitance bridge is useful on very high series resistance, open-circuit faults. The capacitance of conductor-to-shield fault is measured from one end of the de-energized circuit. Knowing the capacitance per unit length, the distance to the open circuit can be calculated. This location can be verified by repeating the procedure from the remote end. Accuracies within  $\pm 3$  percent are possible.

#### Impulse Generator (Thumper)

High voltage, high energy impulses generated from a capacitor bank are applied to one end of a faulted circuit. The impulse energy in the form of a traveling wave will either dissipate noiselessly at a low resistance fault or spark-over (break down) at a high resistance fault. The spark-over results in an explosive release of sound, light and current at the fault location.

For the low resistance discharge, the location can be detected by an electromagnetic or earth gradient device. For the high resistance discharge, the location can be detected as an audible thump or an amplified thump with the aid of the acoustical detector. The electromagnetic and earth gradient devices may also be used for the high resistance discharge.

#### Earth Gradient Detection

This detector system is used to pinpoint high and low resistance faults on direct-buried non-shielded cable. A continuous d-c, interrupted d-c or audio tone is applied at one end of the faulted cable, similar to the impulse generator but is usually limited to 1000 volts. The current through the fault will travel back to the generator ground connection via the earth, thereby creating a voltage gradient. A compatible detector measures the gradient between two moveable earth probes. The probes are applied as a pair over the surface route in football chain fashion. The accuracy with this method of detection is extremely high.

#### Acoustic Detection

The sharp report of the periodic discharging from a high-resistance fault reveals the location when exposed. On direct-buried cable this can be heard as a dull thump on the surface through several feet of earth; however, an acoustic pickup detector is applied along the surface to amplify a weak thump and thus locate the fault at the point of maximum intensity.

#### Electromagnetic Detection

The field generated by any transmitted impulse along a cable is sensed by means of an electromagnetic pickup

coil and detector. Often, at the fault, there is a change of signal strength and if a d-c impulse is used there will be a change in the signal direction.

The electromagnetic surface coil can also be used to trace the cable route and a sheath pickup coil can be used to find faults on ducted cable.

#### Audio Tone

As a preliminary step of fault locating, a low voltage audio frequency (e.g. 1000 Hz) is sometimes matched to one end of the cable in order to transmit a signal. A selectively tuned pickup coil and amplifier is used to trace the signal which can indicate a null or peak over the cable route.

On direct-buried non-shielded cable, the same pickup coil can be used for earth gradient fault location. Some tracers also respond to energized 60 Hz current and incorporate filters for dual operations.

#### Burndown

The level of fault resistance must sometimes be reduced to enable pinpoint location with some methods. This is true for radar, Murray-Loop Bridge and some signal generators. Fault resistance may be reduced by burning the insulation at the fault with a repeated arc, or continuous ac or dc current.

A high voltage d-c, impulse or a-c resonant generator may be used to initiate the lowering of fault resistance. Ac without resonance would lose considerable effect in capacitive charging current.

#### Recommendations

Generally most faults can be detected successfully by selecting a limited number of methods and equipment.

Recommendations:

*High voltage, shielded conductor faults in a trench lay system* — should first be generally located with radar. An impulse generator with the appropriate detector, either electromagnetic or acoustical, can then be applied to pinpoint the exact fault location.

*High voltage, shielded conductor faults in a conduit system* — should be located with a radar set and impulse generator as with trench lay systems. However, the impulse generator with detector is usually sufficient in most instances.

*Low voltage trench lay, non-shielded, insulated neutral cable fault* — can be very successfully located with any of the voltage gradient devices available. Faults can be located quickly with excellent accuracy.

*Low voltage, non-shielded cable faults in a conduit* — can usually be located with a bridge. However, most repairs on this kind of system can be more economically performed by replacing the faulted cable section.





Chapter 13

## Bus Conductor Design and Applications

The selection of material for bus conductors is usually based on a balance of mechanical and electrical characteristics, economics, and availability. The materials that have been used for bus conductors in large quantity, listed in order of volume conductivity, are: silver, copper, aluminum and iron.

Although silver has the highest volume conductivity, it was used as a bus conductor only during World War II when millions of pounds (mostly  $\frac{3}{4}$ " x 9" bars) were used at various aluminum smelters. The service record was excellent but costs prohibit peacetime use of silver for such applications.

Iron in various forms was also used in large volume for bus conductors during World War II. In recent years its use is primarily for power rails for rapid transit systems and overhead electrical cranes. However, even for these applications its use is declining due to the advantages of aluminum and aluminum-steel combinations (Fig. 13-5 m and n).

Copper has excellent mechanical and electrical characteristics and for many years was the metal of choice for use as bus conductor. However, the trend has been toward wider use of aluminum for all types of bus installation.

Aluminum has less than one-third the density of copper and, making allowance for conductivity, an aluminum bus bar will weigh about half as much as copper for equal conductance. For large installations requiring millions of pounds of metal, bus system designers have used the low cost of aluminum as the basis for optimum economic current density. The purpose of this chapter is to provide technical data on numerous bus conductor shapes and alloys as well as answers to basic questions on design and joining.

Typical physical properties given in figures and tables are not guaranteed and may not be exact. They are intended for general information only and should not be specified as engineering requirements. Minimum properties for various aluminum product forms, sizes and methods of manufacture are available in the Aluminum Association's *Aluminum Standards and Data*.

Many standard works on bus conductor are listed at the end of this chapter, and numbered references in the text relate to this bibliography.

Figures 13-1, 2, 9, 10, 11, 17, 18 and Tables 13-9, 10, 11, 12, 13, 14, 16, 23 have been reprinted with permission from the Alcoa Aluminum Bus Conductor Handbook (1957) and other Alcoa Technical Publications; Figures 13-4, 28 and Tables 13-3, 7 from the Kaiser Aluminum Bus Conductor Technical Manual.

### Alloys and Tempers

Pure aluminum has a conductivity of about 65 percent of the International Annealed Copper Standard (IACS). Aluminum can be produced 99.99 percent pure; however, this purity is costly to achieve and the mechanical properties are low.

Aluminum 1350 is a commercial high-purity aluminum with 61 percent conductivity. The tensile strength of each 1350 temper is determined by the amount of work given the metal during fabrication. Today, most 1350 aluminum bus conductors are of -H111 temper for extrusions, -H112 for sawed rolled plate, and -F for cast bars.

After World War II, a new conductor alloy, 6101, was developed which had considerably higher yield strength and better creep resistance than 1350. The alloy contained magnesium and silicon for high mechanical strength without significant reduction in conductivity. The strength of this alloy (6101) is obtained by suitable heat treatments, occasionally combined with some cold work.

Alloy 6063 has been widely used for outdoor high-voltage substation buses because of its excellent mechanical and electrical properties and its availability and economy. Where high strength is desirable and conductivity requirements are lower, alloy 6061-T6 bus is used. Where high conductivity is required, with a minimum sacrifice in mechanical properties, alloy 6101 is used in a variety of shapes.

Other aluminum alloys may be used for bus conductors. However, they should be used with care since conductivity and mechanical properties can be greatly affected by small

TABLE 13-1

**Mechanical Properties of Aluminum Bus Conductor and Related Alloys  
(The Aluminum Association; ASTM B 236, B 317, B 241, and B 429; and Manufacturer's Listings)**

Product	Alloy and Temper	Thickness in Inches	Tensile Strength (ksi) at 20° C (68° F)		Typical Ultimate	Typical Yield	Typical (a) Elongation (Percent – in 2 in. or 4 Dia)
			Minimum Ultimate	Minimum Yield			
Extruded rod, bar tube, pipe and shapes	1350-H111	All	8.5	3.5			35.0
	6101-T6	0.125-0.500	29.0	25.0	32.0	28.0	15.0
	6101-T61	0.125-0.749	20.0	15.0			
		0.750-1.499	18.0	11.0			
		1.500-2.000	15.0	8.0			
	6101-T63	0.125-0.500	27.0	22.0	14.0	11.0	
	6101-H111	0.250-2.000	12.0	8.0			
6101-T64	0.125-1.000	15.0	8.0				
6101-T65	0.125-0.749	25.0	20.0				
Extruded pipe (c)	6061-T6	Pipe size 1.0 & over	38.0	35.0	45.0	40.0	10.0 min
	6063-T6	Pipe sizes, all	30.0	25.0	35.0	31.0	8.0 min
Rolled bar	1350-H12	0.125-1.000	12.0	8.0	14.0	12.0	
Sawed-plate bar or sheet	1350-H112	0.125-0.499	11.0	6.0			10.0 min
		0.500-1.000	10.0	4.0			16.0 min
		1.001-3.000	9.0	3.5			22.0 min
Rolled sheet (for shearing or forming)	1350		8.0		12.0	4.0	20-30 min (e)
	1350-H12	0.020-0.249	12.0		14.0	12.0	4-9 min
	1350-H14		14.0		16.0	14.0	3.6 min
	1350-H16	0.020-0.125	16.0		18.0	16.0	2-4 min (e)
	1350-H18		18.0				2-4 min
Bolts (b)	2024-T4	1/2-5/8-3/4 NC	62.0	40.0			10.0
Cast Alloy for Bus (d)	1350-F 1050	1 in. and up			8.5	3.5	35.0
Cast Alloy for Fittings (f)	A356.0-T61		37.0				5.0

- (a) Elongation values apply to specimens of sizes related to product uses.
- (b) Values apply to ANSI net stress area of regular or semi-finished bolts.
- (c) Values apply to ASTM B 429 structural pipe and ASTM B 241 seamless pipe.
- (d) The designations 1350-F and 1050 are often used in the trade for designating cast bus bars made by run-out into sand molds, or continuous run-out through an orifice.
- (e) The lower elongation value applies to the thinnest sheet.
- (f) Several casting alloys are suitable for aluminum sand-or die-casting of connector fittings. The most frequently used for normal conditions is A356.0-T6 (an Aluminum Association registered number), suitable both for bolted and welded connections. For special shapes and unusual conditions of installation, where considerable water may be held in the fitting and freeze, some employ a softer alloy having about 12.5 and 4.6 ksi minimum ultimate and yield strengths, respectively, and 35.0 percent or better elongation. There is no registered Association number for this alloy, but in the trade it is often referred to as A-100.

**TABLE 13-2**  
**Physical and Electrical Properties of Aluminum Wrought Bus Conductor Alloys**  
**(ASTM B 236, B 317, and The Aluminum Association)**

Property	Alloy and Temper						
	1350 Any Temper	6101-T6	6101-T61	6101-T63	6101-T64	6101-T65	6063-T6 Typical
Applying to all alloys and tempers of wrought alloys, typical values	Modulus of Elasticity, Typical, psi $10 \times 10^6$ . Up to 2% higher in compression						
Weight, lb/cu in. (rounded) 0.098	Note: If two values are shown, the more favorable is "typical"; the less favorable is designated "minimum" provided a higher value is favorable. Otherwise the term "guaranteed" is sometimes used.						
Specific heat, cal/gm/°C or BTU/lb/°F 0.214 at 70°C for 1350 and 0.220 for 6101 <sup>(c)</sup>							
Coefficient of thermal expansion (linear)/°C 0.000023							
Specific gravity - 2.70							
Thermal conductivity at 20°C watts/sq. in./in./°C	5.9-6.0	5.3-5.4	5.5-5.6	5.4-5.5	5.7-5.8	5.7-5.8	3.9
Volume electrical conductivity at 20°C percent IACS <sup>(a)</sup>	61-62	55-56	57-58	56-57	59.5-60.5	56.5-57.5	42-43
Electrical resistivity (dc) at 20°C (68°F) microhms/sq. in./ft <sup>(b)</sup>	13.35-13.14	14.81-14.55	14.29-14.04	14.55-14.29	13.69-13.46	14.42-14.17	19.39-18.94
Temperature coefficient of electrical resistance at 20°C/°C <sup>(d)</sup>	0.00403-0.00410	0.00363-0.00370	0.00377-0.00383	0.00370-0.00377	0.00393-0.00400	0.00373-0.00380	0.00284-0.00277

(a) Typical conductivities of 6101 alloys from Standards of The Aluminum Association. The conductivity of 6063-T6 alloy pipe for outdoor service may be taken as 55% IACS for current ratings, per NEMA Standard.  
 (b) To obtain dc resistance at 20°C in microhms multiply table value by length in feet and divide by cross sectional area in sq. in.  
 (c) Increasing by 0.018 for each 100°C above 70°C (specific heat).  
 (d) The higher of a pair of coefficients corresponds to the higher value of the pair of conductivity values.

TABLE 13-3

Temperature Coefficients of Resistance (dc) for Bus-conductor Aluminum Alloys and Representative Value for Commercial Copper Bus Bar

Aluminum Alloys and Tempers, and Conductivity % (IACS) (a)

	6061-T6 Typical	6063-T6 Typical	6101-T6 Minimum	6101-T63 Minimum	6101-T61 Minimum	6101-T61 Typical		6101-T64 Minimum		1350 Minimum	1350 Typical	Representative Value Commercial Copper Bus Bar
% IACS	40%	53% (b)	55%	56%	57%	58%	59%	59.5%	60%	61%	62%	98%
Temp. C.												
0	.00279	.00377	.00392	.00400	.00407	.00415	.00423	.00427	.00431	.00438	.00446	.00417
10	.00271	.00363	.00377	.00384	.00391	.00398	.00406	.00409	.00413	.00420	.00427	.00401
20	.00264	.00350	.00363	.00370	.00377	.00383	.00390	.00393	.00396	.00403	.00410	.00385
25	.00261	.00344	.00357	.00363	.00370	.00376	.00382	.00386	.00388	.00395	.00401	.00378
30	.00257	.00338	.00351	.00357	.00363	.00369	.00375	.00378	.00381	.00387	.00393	.00371
40	.00251	.00327	.00339	.00344	.00350	.00356	.00362	.00364	.00367	.00373	.00379	.00358
50	.00245	.00317	.00328	.00333	.00338	.00344	.00349	.00352	.00354	.00360	.00365	.00345
60	.00239	.00307	.00317	.00322	.00327	.00332	.00337	.00340	.00342	.00347	.00352	.00334
70	.00233	.00298	.00307	.00312	.00316	.00322	.00326	.00329	.00331	.00335	.00340	.00323
80	.00228	.00289	.00298	.00303	.00307	.00312	.00316	.00318	.00320	.00325	.00329	.00313
90	.00223	.00281	.00290	.00294	.00298	.00302	.00306	.00308	.00310	.00314	.00318	.00303
100	.00218	.00274	.00282	.00285	.00289	.00293	.00297	.00299	.00301	.00305	.00309	.00294

(a) For alloys not shown, obtain conductivities from Table 13-2, and interpolate from the listed values.

(b) Per note on Table 13-2, 55% conductivity is much used as design basis for 6063-T6 alloys for tubes, hence coefficients should be taken from the column, headed 55%.

Formula for Temperature Coefficient of Resistance:

$$R_{T_2} = R_{T_1} \left[ 1 + \alpha_{T_1} (T_2 - T_1) \right]$$

Example: the dc resistance of an extruded channel section of aluminum alloy 6063-T6 is 8.35 microhms per foot at 20°C. Find the same channel's resistance at 30°C.

$$\begin{aligned} R_{30^\circ\text{C}} &= (8.35) [1 + 0.0035 (30-20)] \\ &= 8.35 (1.035) \\ &= 8.64 \text{ microhms per foot} \end{aligned}$$

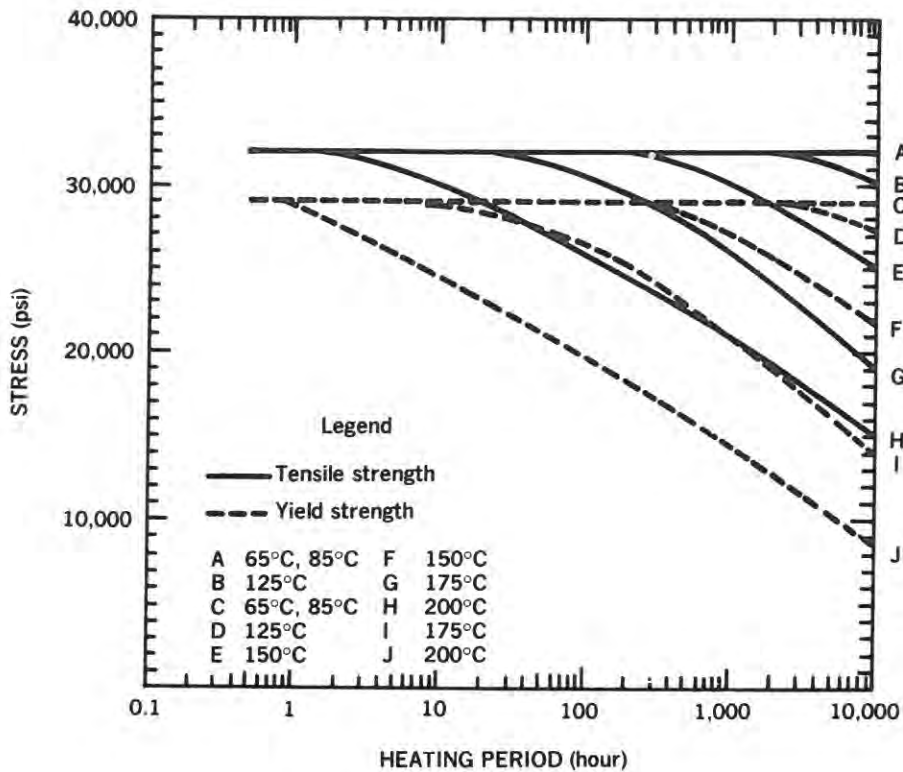

Fig. 13-1. Tensile and yield strength of 6101-T6 bus conductor at room temperature after heating.

amounts of alloying elements.

Table 13-1 lists mechanical properties and Table 13-2, the physical and electrical properties of the aluminum alloys commonly used for bus conductors. Table 13-2 gives the percent volume conductivity (IACS) and resistivity for the common bus bar alloys. It also lists their temperature coefficients of resistance for 20°C and Table 13-3 shows them for other temperatures in the range normally occurring in bus design.

#### Mechanical Properties

The mechanical properties of the different aluminum alloys and tempers commonly used for bus conductors are shown in Table 13-1. The designer is offered a broad range of properties from which to select the alloy and temper best suited for his particular application. For example, high electrical conductivity alloys are the best choice for heavy duty buses for the electrochemical industry where cost of power is an important consideration. For outdoor high voltage substation buses, mechanical considerations rather than electrical, govern the selection. Where bending and forming characteristics are important, it is desirable to

have a generous spread between yield strength and tensile strength (see *Bending and Forming*, page 13-7).

#### Effects of Heating

The generally accepted maximum continuous operating temperature (see UL 857) for open electrical buses is 70°C (30° rise over 40°C ambient) to prevent heat flowing from bus to connected apparatus which is generally limited to 70°C at terminals. Temperatures of 90°C (50°C rise over 40°C ambient) are acceptable for switchgear assemblies and metal-enclosed bus. The effects of these temperatures on the mechanical properties of aluminum bus conductors are negligible. However, short circuits or prolonged overloads may generate temperatures high enough to require consideration of the effects of heating on the bus properties. The effect of heating up to 200°C for as long as 10,000 hours on the tensile and yield strength is shown in Fig. 13-2 for Aluminum 1350-H12; Fig. 13-1 for Alloy 6101-T6.

#### Stress-strain and Creep Factors

Fig. 13-3 depicts stress-strain curves for the listed alloys and tempers, based on minimum values from Table 13-1. The intersection of the 0.002 in./in. strain line that is

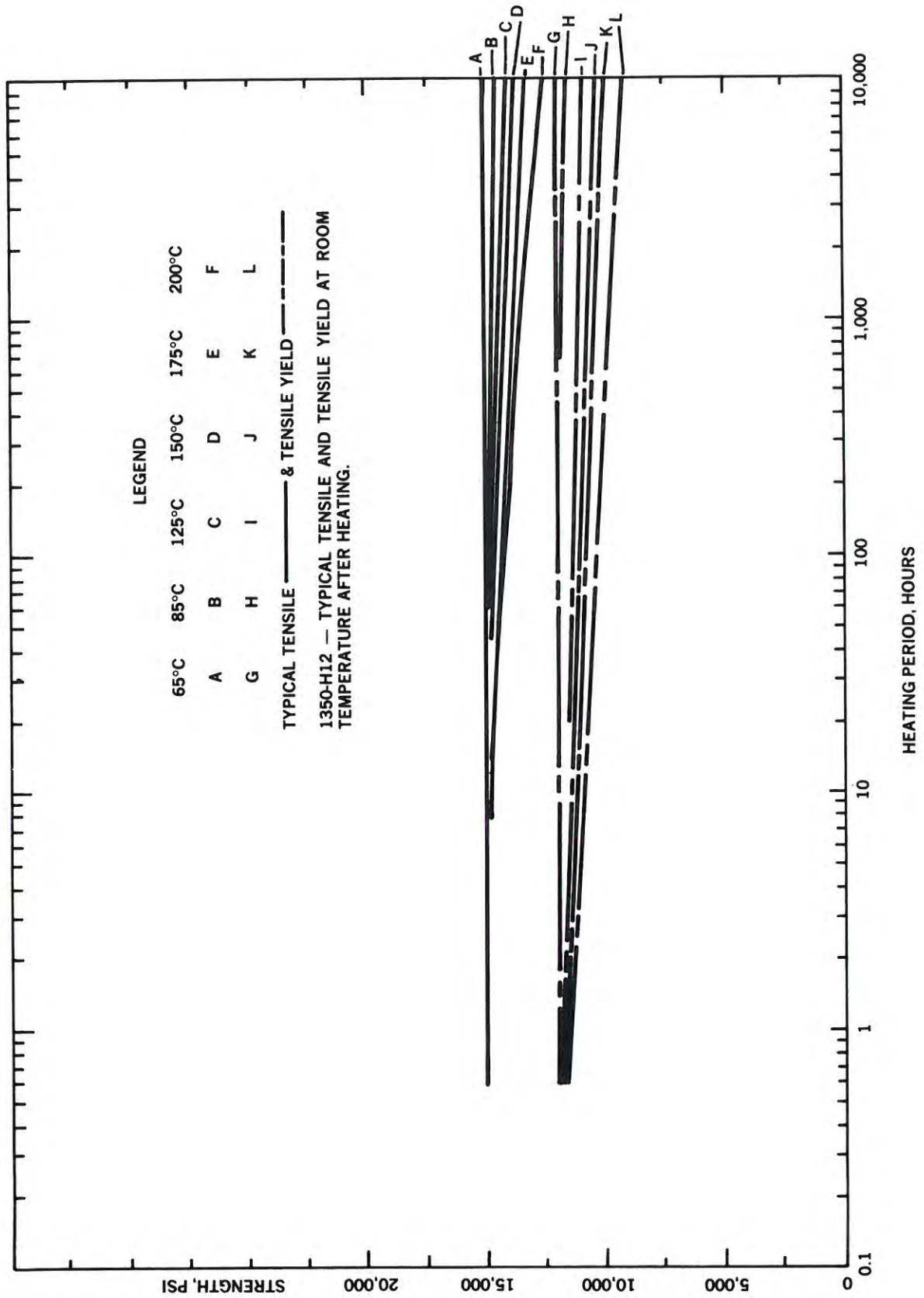

Fig. 13-2. Typical tensile and yield strengths of aluminum 1350-H12 at room temperatures after heating.

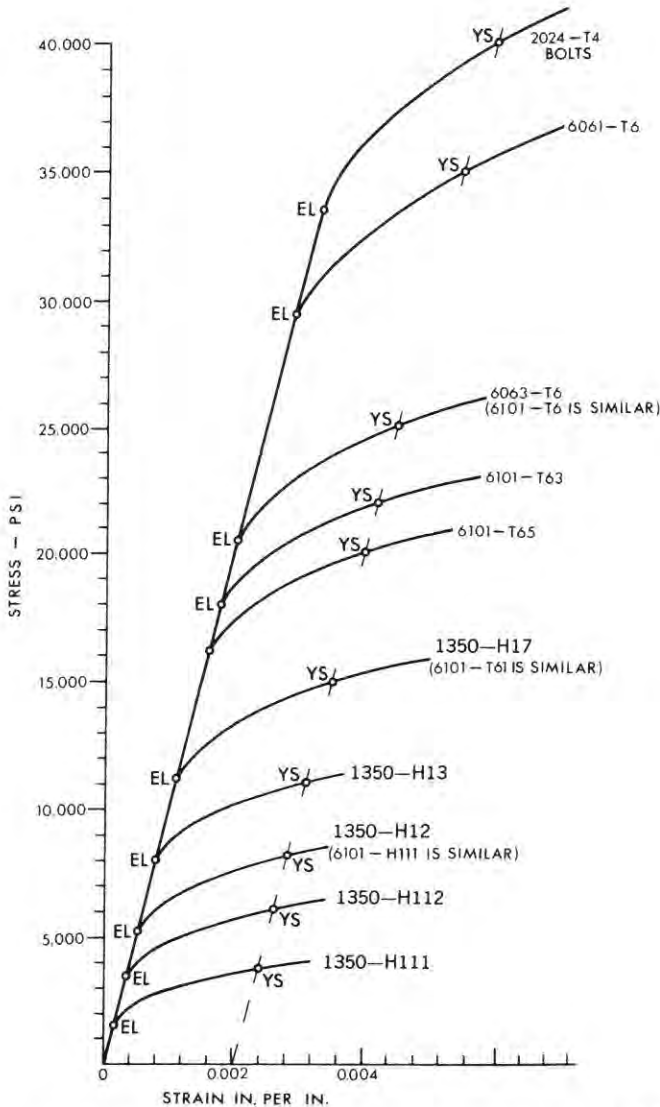

Fig. 13-3. Approximate tension stress-strain curves at 70°C on guaranteed minimum basis for aluminum bus conductor alloys—½ in. thickness bus bars and ½ in. diam. 2024-T4 bolts. Yield strength (YS) is arbitrary at 0.2% offset per ASTM Standard. Elastic limit is estimated as point of tangency (EL).

Note: The shape of the curve between EL and YS is not always consistent, but the EL values are believed to be conservative.

parallel to the initial straight diagonal line denotes the yield strength (YS) of the alloy, according to ASTM designation. The elastic limit (EL) of an alloy is represented as the stress value of the point of tangency of the curved part of the stress-strain line and the straight part of the line.

Creep resistance and compressive yield strength are both important factors to be considered in the design of bolted joints, especially if thermal cycling as the result of variations in electrical loading is involved. Table 13-4 lists 10-year estimated creep factors for various bus conductor alloys.

### Bending and Forming

Aluminum bus conductors can be formed by the same procedures and practices that are used for other metals. The most important factors governing the bending of bus conductors are: (1) the ductility of the conductor, (2) the size and shape of the conductor, (3) the method of bending, and (4) the bending equipment used.

A metal must be ductile enough to permit both stretching and compression to take place. However, elongation alone is not a complete criterion for ductility. The ratio of yield strength to tensile strength must also be taken into account. A combination of a high elongation value and a low ratio of yield strength to tensile strength provides the most satisfactory ductility.

Another factor that governs bending is the size and shape of the bus conductor. For example, in the case of a tube, the sharpness of a bend depends not only on the diameter of the tube, but also on the ratio of wall thickness to diameter. In the case of edgewise bends of rectangular

TABLE 13-4

### Creep Factors for Aluminum Bus Conductors

(Average stress required during a 10-year period to produce 1.0% creep at 100°C, assuming well-designed bolted connections.)

Alloy and Temper	Estimated Average Stress PSI
1350-H111	2,500
1350-H12	5,000
1350-H17 and 6101-T61	6,500
6101-T6	18,000
6063-T6	24,000
6061-T6	25,000



**TABLE 13-5**

**Flatwise Bending Radii**

TYPE OF BAR	ALLOY AND TEMPER	THICKNESS in.	RADIUS min. ①
	1350-H11	All	1 x thickness
Extruded	6101-H11	0.250-0.750 0.751-1.000	1 x thickness 2 x thickness
	6101-T6	0.125-0.375 0.376-0.500	2 x thickness 2½ x thickness
	6101-T61	0.125-0.500 0.501-0.749 0.750-1.000 1.001-1.625	1 x thickness 2 x thickness 3 x thickness 4 x thickness
	6101-T63	0.125-0.375 0.376-0.500 0.501-1.000	1 x thickness 1½ x thickness 2½ x thickness
	6101-T64	0.125-0.750 0.751-1.000	1 x thickness 2 x thickness
	6101-T65	0.125-0.500 0.501-0.749	1 x thickness 2 x thickness
Rolled	1350-H12	All	1 x thickness
Sawed plate	1350-H112	All	1 x thickness

①Applicable to widths up through 6 inches in the T6, T61, T63 and T65 tempers and to widths up through 12 inches for all other listed tempers. Bend radii for greater widths are subject to inquiry.

**TABLE 13-6**

**Edgewise Bending Radii  
1350-H12, H111**

WIDTH OF BAR in.	MANDREL RADIUS in.
Up thru 0.500	½
0.501-1.000	1
1.001-1.500	1½
1.501-2.000	2
2.001-2.500	2½
2.501-3.000	3
3.001-3.500	3½
3.501-4.000	4

bar, tests have shown that the radius (in terms of width of bar) around which a bar can be bent satisfactorily depends not only on the ductility of the bar but also on its ratio of width to thickness.

**Bend Properties of Bus Bar**

Extruded, rolled, and sawed-plated bus bars are capable of being bent flatwise at room temperature through an

angle of 90 degrees to minimum inside radii as shown in Table 13-5. Edgewise bending radii are shown in Table 13-6.

**Bending Tubular Conductors**

Tubular conductors, alloys 6063-T6 and 6061-T6, are often bent to form turns and offsets. For installations where considerable bending is required, the supplier should be advised and specifications written to require seamless pipe made by the hollow ingot process (ASTM B241). For best forming capability, the ratio of tensile yield to tensile ultimate should not be greater than about .85. Producers do not normally control to such ratios so it is important to specify that critical, severe forming will be encountered and optimum heat treatments are required.

For substation construction, inside radii of five to seven times the nominal pipe size for ASA schedules 40 and 80 pipe of alloys 6063-T6 and 6061-T6 should prove satisfactory with most types of conventional bending tools. More generous radii may be used for appearance.

For the occasional problem job where material of high yield to tensile strength ratio is used, it may be necessary to apply heat. This can be done readily by applying a torch for short time to the opposite sides. When doing this, care must be taken to avoid overheating. A calibrated crayon type indicator is recommended. Heating to 200°C (392°F) will cause little loss of strength.

For shop work, a forming-roll bender should be considered. Benders having formed hubs and/or followers provide minimum bending radius for 6063-T6, 6061-T6, and 6101-T6 tubes, Fig. 13-4.

**Lubrication**

The need for lubrication depends on the bending method and technique used. Lubrication is seldom required when bending with roll or ram type benders. However, lubrication is essential in fully tooled draw-bending operations, as well as in some compression and stretch-bending techniques. Best results are obtained if lubrication is provided wherever a relative motion or sliding action occurs between the work and the tools.

**Resistance to Corrosion**

Aluminum bus is highly resistant to corrosion. Its uses are, therefore, particularly widespread in applications where strong atmospheric corrosive factors are at work, as in industrial and chemical plants and seacoast environments.

**Bus Conductor Shapes and Shape Selection**

Choice of a bus conductor shape for a given installation is dependent on a number of factors, including operating voltage, ampacity requirements, available short circuit cur-

rents, available space, mechanical strength requirements, ambient conditions of sun, wind, ice, etc. The following review of the most common shapes and their typical characteristics is intended as a guide to bus shape selection and an introduction to bus system design.

**Rectangular Bar**

The most common form of bus conductor is bar stock of rectangular cross section. (Fig. 13-5a) This shape is inherently easy to fabricate, store, handle and erect. A relatively large surface area can be provided for the dissipation of heat by the use of multiple-bar buses. Joints and taps are readily made by either bolting or welding. Off-sets and 90-degree bends are easily made.

For direct current, as well as for alternating current up to certain limits, the capacity of a bus constructed of flat bar can be controlled by merely varying the size of bars or number of bars in parallel. For high-amperage alternating current, however, special arrangements of laminations are used (See ac Applications, page 13-12).

Because bars are more rigid in the direction of the large cross-sectional axis, supports must be more closely spaced to resist load and short-circuit forces that are applied perpendicular to the wider surface.

**Tubular Conductors**

Round tubular bus conductors (Fig. 13-5h) are used primarily for outdoor substations and switching structures where long spans between supports are required. The inherent rigidity of a tubular shape in all directions resists wind and ice loads, as well as the forces of short circuits. Since strength is a primary requirement of tubular bus, the higher-strength aluminum alloys are used.

6063-T6 alloy in ANSI Schedule 40 pipe is used widely for outdoor tubular buses because of excellent mechanical and electrical properties and availability. 6061-T6 tubular conductors are used where particularly high strength is desired and conductivity requirements are lower.

For maximum uniformity of mechanical properties at all points of the circumference, tubes are produced from hollow ingot and extruded by use of the die and mandrel method (ASTM B241). If requirements are less severe, "structural" tubes made by the bridge-die process are often used (ASTM B429). Where tubular bus is to be used for high voltage circuits (230 kV and higher), the smooth surface finish (industry class IV) should be specified, to reduce corona and radio-TV interference.

The round tubular bus is the most efficient electrical shape for an a-c bus conductor because it has the lowest skin-effect ratio of the commonly used types. The current rating is limited, however, as compared with that of flat bar, because of the smaller ratio of heat-dissipating surface area to volume. (See "Skin Effect," page 13-12, for optimum wall thickness.) Internal cooling of the tube by forced air or circulating coolants overcomes this handicap, but

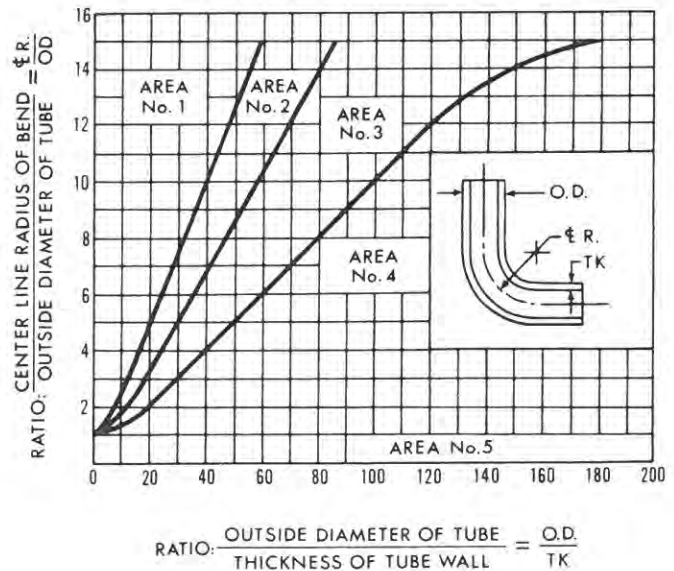

- Area No. 1—No Mandrel or Wiper Die
- Area No. 2—Plug Mandrel and Wiper Die
- Area No. 3—One Ball Mandrel
- Area No. 4—Two Ball Mandrel and Wiper Die
- Area No. 5—Not Practical

Fig. 13-4. Tube bending chart (with modern equipment). Showing limits of cold-bending radius for 90° bends of usual sizes of aluminum tubes of alloys 6063-T6 and 6101-T61. Tubes of alloy 6061-T6 also can be bent but more care must be exercised, and at slower speed.

is not often commercially practical except for electric furnaces.

The electrical characteristics of round tubular bus have led to its use for heavy-duty generator and switching buses in central stations. Since the design of modern isolated phase buses is such that short circuit forces are not a problem, Aluminum 1350 is preferred because of its high conductivity.

Square tubular bus (Fig. 13-5e) has low skin-effect ratio, similar to that of round tubes, and has the advantage of requiring comparatively simple adapter plates for mounting the bus on pedestal insulators and the other flat sides facilitate attaching pads for taps. For this reason it is used for generator-phase and station bus, often in protective enclosures. 6101-T61 and 6063-T6 alloys are principally used, and staggered ventilation holes often are provided in top and bottom surfaces.

**Integral Web Channel Bus (IWCB)**

The integral web channel bus conductor (Fig. 13-5f and g) is extruded in the form of two channel-shaped conduc-

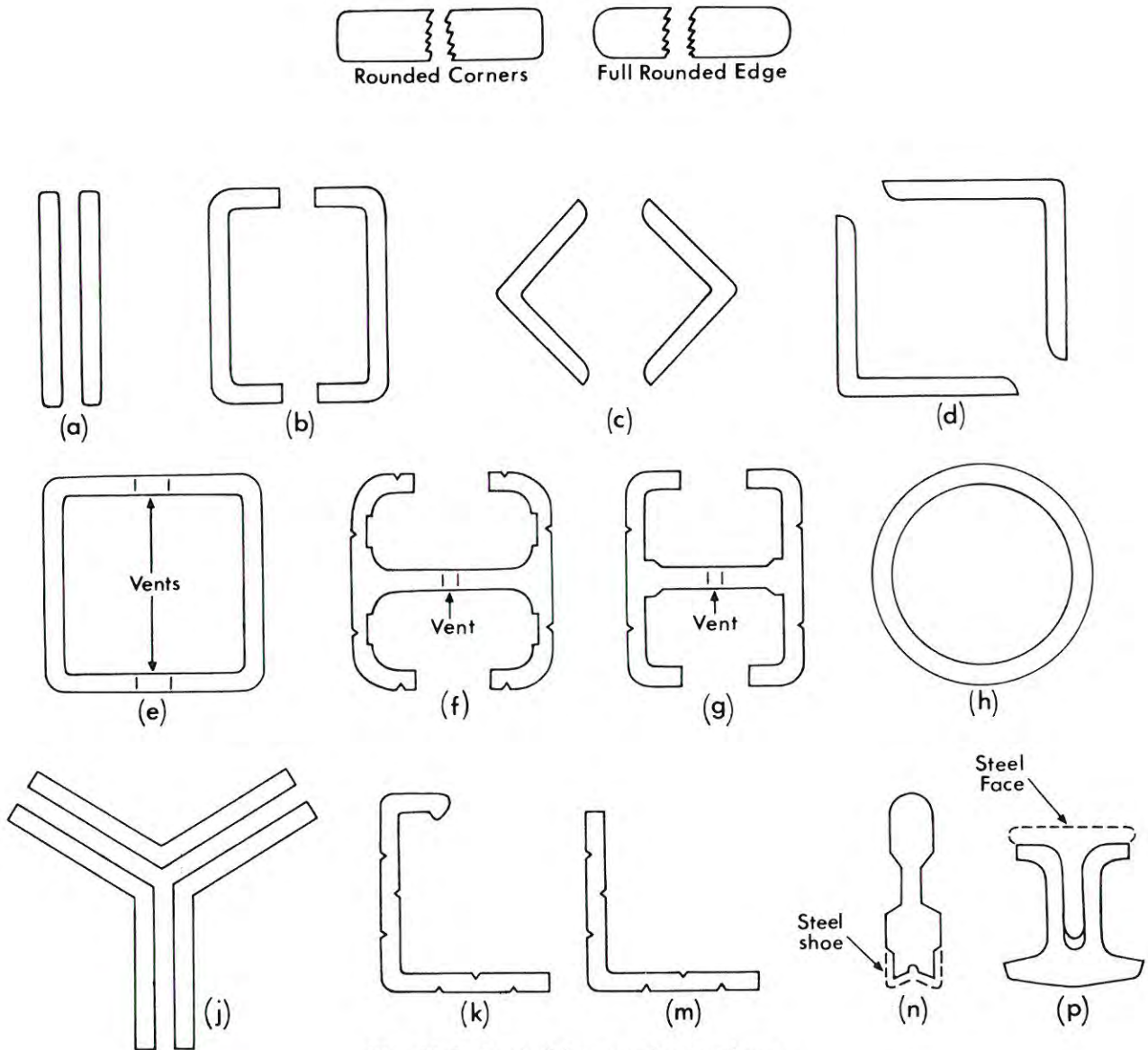

Fig. 13-5. Typical bus conductor shapes.

Notes: (1) If extruded, slightly indented grooves can be extruded horizontally along the outer surface to provide centers for drilling or punching holes for attachment of supports or take-offs. (2) Shapes such as *b* and *d* may have equal thickness along any element of the section, or if rolled as a structural shape the thick-

ness will vary to correspond to the slight level of structural I-beams and L's. (3) Lugs that facilitate attachments as well as add conductivity may be included as an integral part of the extrusion. (4) Flat bars may have squared corners (up to 1/32 in. radius for thicknesses to 1 in.), rounded corners (1/16 in. radius, nominal for 0.189 to 1.000 in. thickness), or full rounded edge.

tors held together by a ventilated web. The continuous web eliminates the need for spacer clamps or welded tie-bars that are normally required across the two channels between insulator supports. IWCB combines some of the advantages of the double-channel bus and the square tubular bus. Convection air flow is less than that of the face-to-face channel arrangement, but the transverse strength is greater. These buses have narrow shallow grooves extruded on the surfaces for convenience in locating centers of drilled or punched holes for attachment of taps and base plates. The shape is used for station bus, open or enclosed, and for the high-current buses of outdoor substations for distribution voltages, and also for 600-volt bus for industrial plants.

#### *Channels - Structural Shape and Uniform Thickness*

Structural shape aluminum channels consist of a pair of channels forming a hollow, ventilated square. Such a conductor is very efficient and practical for high-ampere direct or alternating current, especially above 2,000 amperes per circuit.

For dc circuits, where skin effect is not a factor, aluminum channels are sometimes placed back-to-back—that is, with flanges pointing outward—to form a conductor. Such an arrangement may be more convenient to support than a hollow square. Additional capacity is readily obtained by merely adding one or more flat bars, properly spaced, between the webs of the two channels.

Channel shapes of uniform thickness (Fig. 13-5b) may be desirable for enclosed station buses where the space occupied by the conductor is critical. This type of channel has a small inside radius and provides the maximum flat surface inside for connections. Approaching the electrical efficiency of a split tube, this bus has the added convenience of flat surfaces for making taps and connections.

#### *Angles*

The face-to-face paired angles (Fig. 13-5c and d) provide excellent transverse rigidity and ampacity, but require special spacer fittings. Angles are commonly used as singles.

Structural shape angles with slightly beveled legs, similar to the type used for steel structural shapes are sometimes used. Their use has largely been supplanted by the uniform thickness angle.

Uniform thickness angle, (Fig. 13-5m), commonly called UABC (Universal Angle Bus Conductor) is a bus form used for moderate-size outdoor substations at distribution voltages. Center-line grooves facilitate location of bolt holes, and since both legs are of equal thickness at all points, the bus may be mounted directly on insulator caps. An adaptor plate is sometimes used for expansion mountings and to accommodate various bolt-circle diameters. Direct application of pads and connector plates is aided by the uniform thickness of the legs. The semi-channel form

(Fig. 13-5k) has more transverse strength, and the upper flange does not extend far enough to interfere with hole drilling. 6101-T6 alloy is principally used for these angle shapes.

#### *Round Rod*

Some installations, especially in the high-voltage field, may require round rod bus conductors. This type of conductor, however, is not recommended for large alternating current because of the tendency of the current to flow only near the “skin” (outer surface) of the rod. This results in uneconomical use of the metal in the central portion of the conductor. Fittings used are similar to those on tubular buses.

#### *Special Shapes*

The extrusion process provides the designer of aluminum bus conductors with the means of making special shapes when none of the previously described shapes is wholly suitable.

Crane-runway bus shapes (Fig. 13-5n and p) are illustrative of how low-cost extrusions can be produced for special needs. The aluminum body of these bus conductors is shaped to combine ampacity and structural adequacy. In some applications, steel facing is fitted to the aluminum bar against which the collector shoe slides.

#### **Factors Affecting Bus Design**

It is important to start with a tabulation of the factors that may affect bus design, such as: d-c or a-c current, frequency, ampacity required, allowable voltage drop, operating voltage, maximum possible short circuit currents, space available, taps and connections required. Where large currents are involved the factors that affect the economic current density should also be tabulated. For outdoor substations, other factors should be tabulated, such as: maximum anticipated wind speeds, maximum expected icing conditions, corona, etc.

For industrial bus the decisive factors are generally: (1) ampacity for allowable temperature rise, (2) voltage drop, (3) power loss economics. Because of the various bus shapes available to the designer and their possible physical arrangement, the design problem may result in successive calculations involving all the factors affecting the design. A flow diagram illustrative of this iterative design process for outdoor substation bus is shown in IEEE “Guide for Design of Substation Rigid-Bus Structures” (1).\*

#### **Temperature Rise**

##### *Effect of Conductivity*

The ratio of currents that will produce the same

\*Numbered references in the text relate to bibliography at the end of this chapter.

## bus conductors

temperature rise in aluminum and commercial copper bars of same size and same surface conditions can be determined from the following formulas:

$$I^2R_{al} = I^2R_{cu} \quad (\text{Eq. 13-1})$$

$$\frac{I_{al}}{I_{cu}} = \sqrt{\frac{61.0}{98.0}} = 78.9 \text{ percent for 1350 alloy}$$

$$= \sqrt{\frac{57}{98}} = 76.26 \text{ percent for 6101-T61 alloy}$$

### Effect of Dimensions

Tests show that for practical purposes, copper bus bar sizes can be converted to aluminum sizes for equal temperature rise by either of the following two methods:

1. Increase the width of the aluminum bar 27 percent. For example, a 5" x 1/4" aluminum bar is equivalent to a 4" x 1/4" copper bar.
2. Increase the thickness of the aluminum bar about 50 percent. A 4" x 3/8" aluminum bar is equivalent to a 4" x 1/4" copper bar.

Increasing the cross-sectional area by increasing the width not only reduces the resistance heating but also substantially increases the area for heat dissipation. A change in thickness of a rectangular bar does not appreciably affect the amount of exposed surface area. For example, increasing the area of a 1/4-in. bar by changing the width from 4 in. to 8 in. increases the capacity by about 87 percent, but increasing the thickness of a 4-in. bar from 1/4-in. to 1/2-in. increases the capacity by only about 45 percent.

### Temperature Rise - Ampacity Tables

The ampacity for popular shapes and sizes is shown in Tables 13-25 through 13-32 for 30°C rise over 40°C ambient or a maximum of 70°C. Experience has shown that designs using these temperatures have good service records. Although aluminum conductors may be operated at 90°C continuously, such use is generally limited to switchgear assemblies and metal enclosed bus (IEEE Standard No. 27, ASA C37.20). Operation at 100°C for emergency conditions causes very little loss of strength for alloys 6101, 6063 and 6061. However, it becomes progressively more difficult to maintain good bolted joints as the temperature increases. Also, the designer should not overlook the fact that the  $I^2R$  losses are higher for the higher temperatures. In some cases the user may pay for these losses twice; once to produce the heat and again for air conditioning to remove the heat.

## Energy Loss (2,61,62)

The cost of energy lost through resistance is important in the case of bus installations where heavy currents are used as, for instance, in the electrochemical industry. In such cases, it may pay to use larger conductors than those used in the ampacity tables. Energy savings due to lower current densities are, of course, equally applicable to all conductor materials. Designers of heavy-current bus systems are advised to factor in the cost of energy,  $I^2R$  losses associated with bus-size choices, and the probable "pay-back" time for the additional expense of larger conductors. Many industrial and utility bus systems are designed according to this practice.

### ac Applications

In addition to the factors that affect the design of a dc bus, the design of an ac bus is also influenced by such factors as skin effect, proximity effect, induced circulating currents, hysteresis losses, and mutual heating effect.

### Skin Effect

The ratio of effective ac resistance of an isolated conductor to its dc resistance is called "skin-effect ratio."

The 60 Hz  $R_{ac}/R_{dc}$  ratios at 70°C for the commonly used shapes are shown in Tables 13-25 through 13-32. The skin effect ratio depends not only on the size, shape and configuration of the conductor, but also on frequency of the current and the resistance and magnetic properties of the material.

Skin effect takes place not only in single conductors, but also in buses made of several bars. Flat bars can be arranged to minimize skin effect to some extent by the use of hollow square and modified hollow square arrangements. Interlacing of the bars or the paired-phase arrangement offers an excellent solution to the unequal distribution of alternating current in low voltage bus systems.

Considerable work, both of an experimental and a theoretical nature has been done on skin effect of conductors (3,4). Perhaps the most useful work for an engineer are the curves developed by Dwight as shown in Figs. 13-6, 13-7, 13-8. Lewis developed formulas applicable for computer studies (5).

Fig. 13-6 applies to a single rectangular bar per circuit. For two bars in parallel, separated by an air space, the skin effect ratio is approximately the same as would apply for a single bar equal in size to the two bars plus air space but of  $R_{dc}$  the same as that of the two bars. For three or more bars in parallel, the skin effect ratio may be taken from the curve  $t/d = 0.50$  in Fig. 13-8 (4).

Fig. 13-7 applies to square tubular conductor, to squares made up of two channels in box form, to squares made up of four bars, and to squares made up of angles.

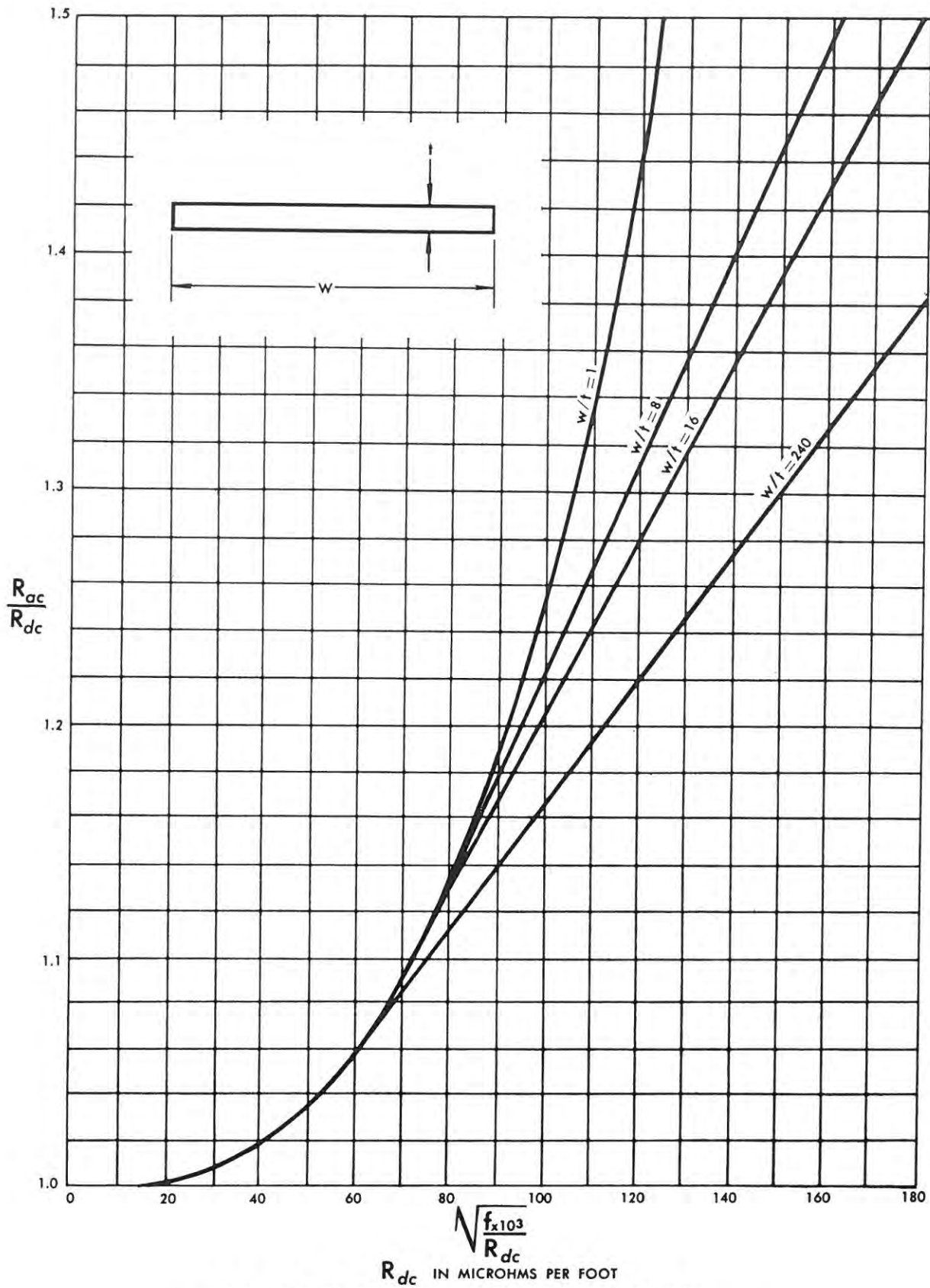

II. B. Dwight, "Electrical Coils and Conductors," McGraw-Hill Book Co.

Fig. 13-6. Curves for skin effect of isolated flat rectangular conductors.

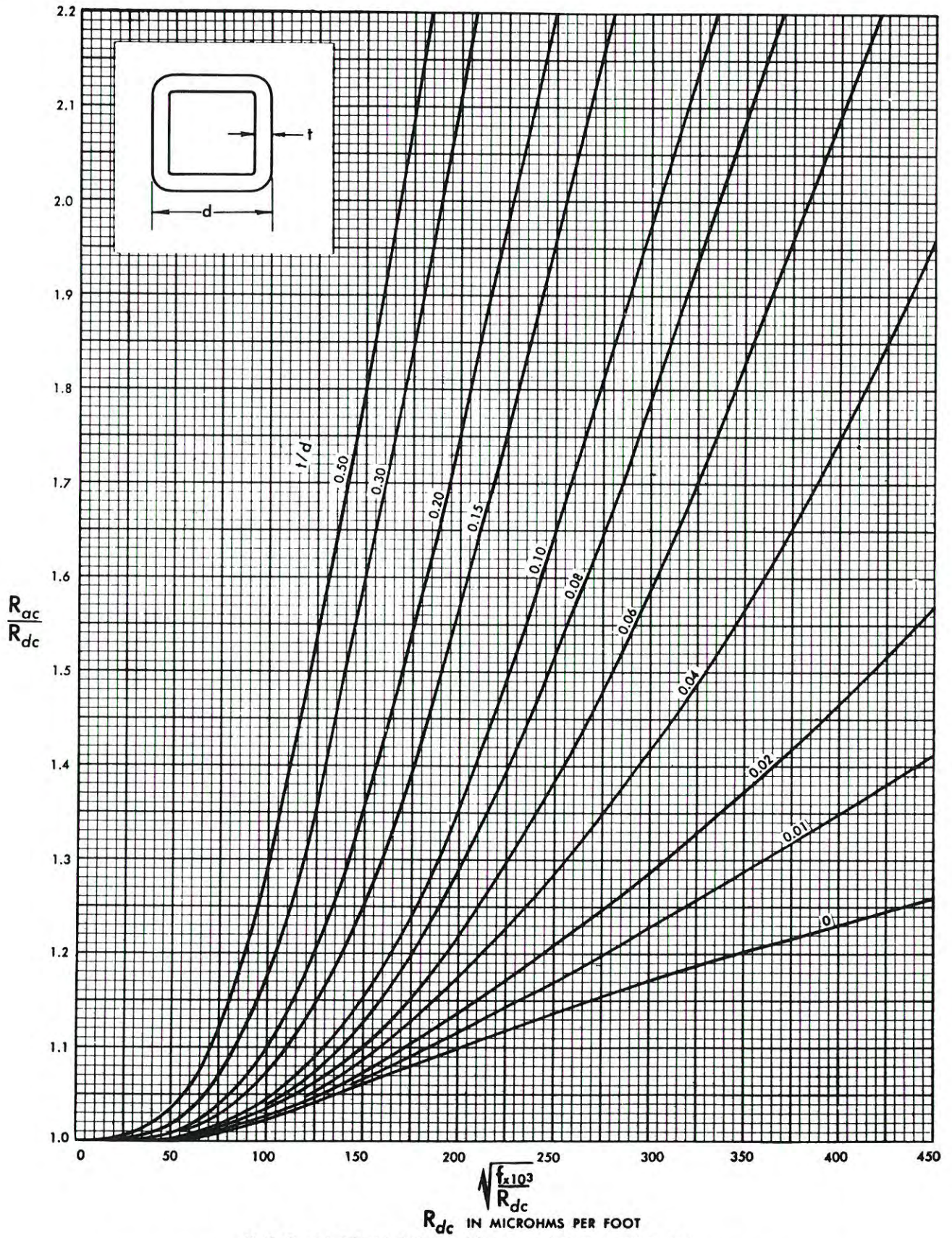

H. B. Dwight, "Electrical Coils and Conductors," McGraw-Hill Book Co.  
 Fig. 13-7. Curves for skin effect of isolated square rod and square tubular conductors.

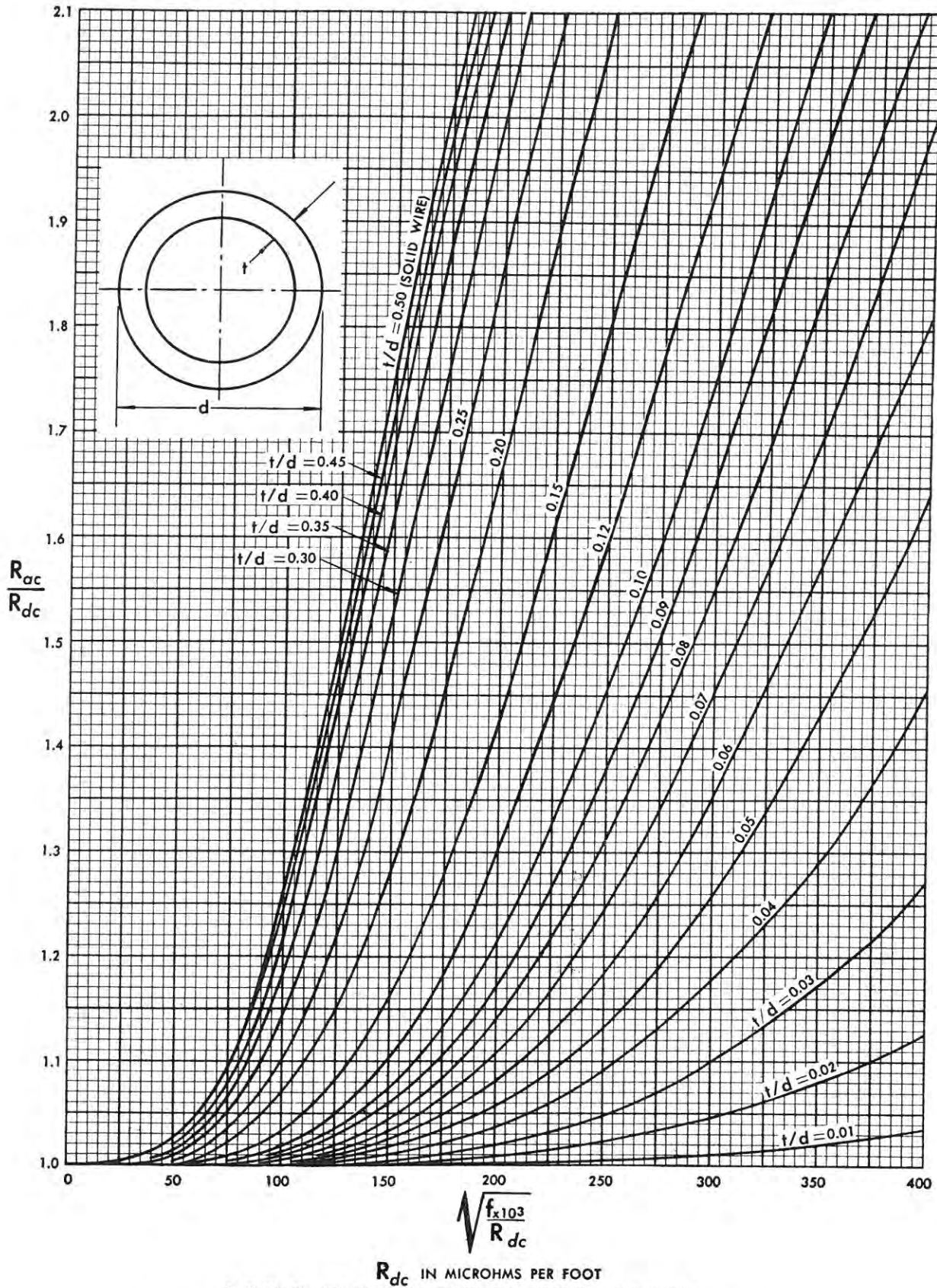

H. B. Dwight, "Electrical Coils and Conductors," McGraw-Hill Book Co.

Fig. 13-8. Curves for skin effect of isolated round rod and tubular conductors.



## bus conductors

Fig. 13-8 applies to isolated tubular conductors. The magnitude of skin effect increases with wall thickness. Curves plotted for a-c ampacity ( $I_{ac}$ ) and  $R_{ac}$  at 70°C versus wall thickness (all sizes of tube) show that  $R_{ac}$  will be a minimum and  $I_{ac}$  a maximum at about 0.7 inch for Aluminum 1350 and about 0.8 inch for 6101 alloy.

### Proximity Effect (4, 6, 7)

When conductors are close together, a distortion of current density results from the interaction of the magnetic fields of the conductors. This distortion of current distribution, known as "proximity effect," causes an increase in the effective resistance. The amount of distortion depends on a number of factors—the spacing and arrangement of conductors, conductor shape, cross-section dimensions, frequency of current and dc resistance.

The usual frequency found in industrial work in North America is 60 hz. Here, the proximity-effect factor will not be more than 1.20 of ac resistance, when isolated, for round tubes whose distance between centers is twice their diameters. With spacings of about five times the diameter,

the increase is negligible. As a rule, proximity effects are negligible for phase spacings of more than three or four times the largest dimension of the cross-section. For frequencies higher than 50 or 60 Hz, the approximations should not be used. More accurate proximity effect calculations are available (4,6,7).

### Interlaced and Paired Phase Arrangements

The interlacing of bars and paired phase arrangements (Fig. 13-9) offer an excellent solution to the unequal distribution of currents in low voltage systems. These arrangements have low reactance and greatly reduced skin effect and proximity effect. Dwight (4) states that the skin-effect ratio is very low for interlaced construction where bars are close together in parallel planes and where neighboring bars have currents that are always either 180° or 120° out of phase. The essence of paired-phase performance is that the currents in each closely spaced pairs of bars are essentially equal and opposite (8). This makes for an efficient use of bus bar material in that the ac ampacity approaches the dc ampacity.

The paired-phase arrangements (8) are widely used by

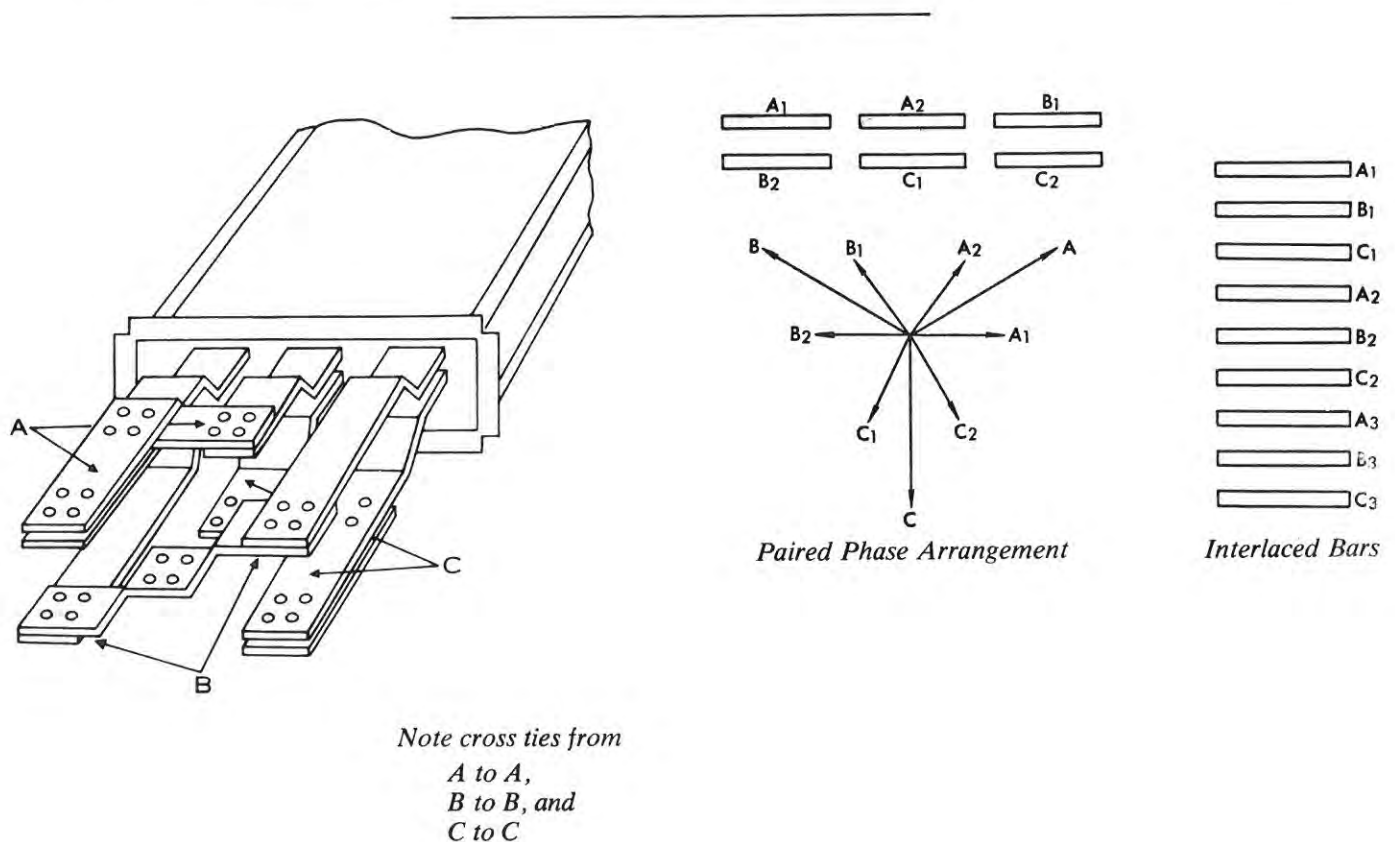

Fig. 13-9. Paired-phase feeder busway (left) showing end-connections for AB AC BC arrangement. The proximity of A-A and C-C bars serves to reduce crowding of current into the middle pair of bars (A-C). There are several other paired-phase arrangements in common use.

manufacturers of prefabricated bus systems. Interlaced arrangements are used primarily in high current electric furnace installations (9).

#### *Transposition*

High current a-c buses, such as "side bars" for carbon baking furnaces, are sometimes designed so that the bus assembly is divided into several sections where the individual conductors, insulated from each other, are transposed so that each individual conductor runs for an equal distance in each of the available positions thereby making the mutually induced voltages equal. By this means, each individual conductor of the bus assembly can be made to share the current equally. Aluminum channel and IWCB shapes provide structural stiffness needed for the portable single-phase bus assembly. Welded connections are preferred for both mechanical and electrical reasons.

#### *Mutual Heating (10)*

Mutual heating is due to the interference of one conductor on the heat dissipation of the other. The mutual heating varies with bar spacing, vertical or horizontal arrangement, and open or enclosed bus. The designer should check the notes of the ampacity tables to ensure that the values given apply to his design conditions. Mutual heating occurs for both ac and dc current flow.

#### *Heating Due to Magnetic Materials Near the Buses (11)*

A bus carrying high current creates a magnetic field of considerable magnitude. If there are steel members in the field of an ac bus, such pieces will be heated not only by the current induced in them but also by hysteresis. In the case of dc buses, there is no loss in the steel since the magnetic field for a non-pulsating dc bus is static.

The frame in the wall of a building for the passage of the bus should either be of non-magnetic materials throughout or constructed so there is no complete magnetic ring. Even though all of the three phase conductors pass through the same opening, the magnetic fields of the flat bus arrangement do not cancel out and undue heating results unless preventative measures are taken.

#### *Induced Circulating Currents (12,13)*

Induced circulating currents in nearby metal items require energy which must be supplied from the inducing circuit. The effect is an increase of the  $R_{ac}$  for the circuit. The magnitude of the loss is a function of the amount of induced current, the conductance of the metal item, and the distance of the bus to the metal item. This problem is encountered chiefly in the design of switchgear isolated phase bus.

#### *Calculation of ac Resistance*

The calculation of ac resistance is based on the assumption the  $R_{ac}$  is affected only by skin effect and possibly

proximity effect, e.g., no magnetic losses or induced current losses. To find the ac resistance, it is first necessary to determine the  $R_{dc}$  at the design temperature. The magnitude of the skin-effect ratio can be conveniently determined from the tables for electrical characteristics of commonly used shapes or from Dwight's curves, Figs. 13-6, 13-7, 13-8. Where proximity-effect may be a factor, formulas for calculation have been developed for conductors of simple shapes (6). Having determined the skin-effect ratio and the proximity-effect ratio, then  $R_{ac} = R_{dc} \times \text{skin-effect ratio} \times \text{proximity-effect ratio}$ .

#### *Temperature Rise - Ampacity Tables*

The a-c ratings of commonly used shapes included in Tables 13-25 through -32 have been determined for 30°C rise over 40°C ambient in still but unconfined air, and at spacings where proximity effect is negligible. Allowance must be made for proximity effect where applicable, other temperatures, other surface finish, resistance for other alloys and tempers, other air conditions, altitude, and sun effect for outdoor installations.

#### *Reactance (4,14,15)*

Maxwell, Schurig, Arnold, Dwight, Higgins, Lewis and others have developed equations, tables and charts for the determination of reactance for many conductor shapes and arrangements. Because the physical shapes of bus conductors do not lend themselves to simple formulas, the basic calculation of reactance is a complex mathematical problem.

In order to simplify the problem, Lewis suggested breaking the total reactance of conductors into two parts so they could be tabulated as a convenience to engineers (16).

The total reactance in microhms per ft. at 60 Hz is expressed:

$$X = X_a + X_d \quad (\text{Eq. 13-2})$$

$X_a$  values are given in Tables 13-25 and 13-27 through 13-32, together with other characteristics such as resistance, current capacity and weight, for conductors that are normally used as a unit. Although  $X_d$  is actually based on the GMD between the conductors, a sufficiently accurate approximation for heavy-current conductors can usually be made if GMD is taken as the distance between center lines of the conductors. Values of  $X_d$  which are functions of GMD for various distances are given in Table 13-7. For close spacings, relative to the size of the bus bars, corrections for GMD must be taken into account.

*Example:* Assume a three-phase symmetrical flat bus arrangement in which each conductor comprises a pair of 8-in. x 8-in. x 0.375-in. face-to-face equal thickness channels spaced 36-in. apart (center-to-center). The equivalent GMD spacing is  $1.26 \times 36 = 45.3$ -in. The inductive reactance per pair at 60 Hz is as follows:

TABLE 13-7  
Inductive Reactance Spacing Factors  $X_d^*$   
Microhms per foot at 60 Hz for 1-in. to 107-in. GMD Spacing

Feet	Separation - Inches, and Feet per Left-Hand Column											
	0	1	2	3	4	5	6	7	8	9	10	11
1	-	-57.71	-41.18	-31.86	-25.25	-20.12	-15.93	-12.39	-9.32	-6.61	-4.19	-2.00
2	0	1.84	3.54	5.13	6.61	8.00	9.32	10.56	11.74	12.86	13.93	14.95
3	15.93	16.87	17.77	18.64	19.47	20.28	21.06	21.81	22.54	23.25	23.93	24.60
4	25.25	25.88	26.49	27.09	27.67	28.24	28.79	29.33	29.86	30.39	30.88	31.38
5	31.86	32.33	32.80	33.25	33.70	34.14	34.57	34.99	35.40	35.81	36.21	36.60
6	36.99	37.37	37.74	38.11	38.47	38.83	39.18	39.52	39.86	40.20	40.55	40.86
7	41.18	41.49	41.81	42.12	42.42	42.72	43.02	43.31	43.60	43.88	44.17	44.44
8	44.72	44.99	45.26	45.53	45.79	46.05	46.31	46.56	46.81	47.06	47.30	47.55
9	47.79	48.03	48.26	48.50	48.73	48.96	49.18	49.41	49.63	49.85	50.07	50.28

\*The inductive reactance spacing factor (also called separation component)  $X_d$  from the above table represents the inductance of a conductor at 60 Hz caused by flux that is more than 1-ft distant from the conductor. Spacings less than 12-in. have minus signs as these represent deductions from the  $X_a$  (1 ft radius value) obtained from tables of conductor properties.

For usual single-phase bus circuits the spacing to be used is the center-to-center distance between conductors. For 3-phase circuits the spacing is the GMD distance.

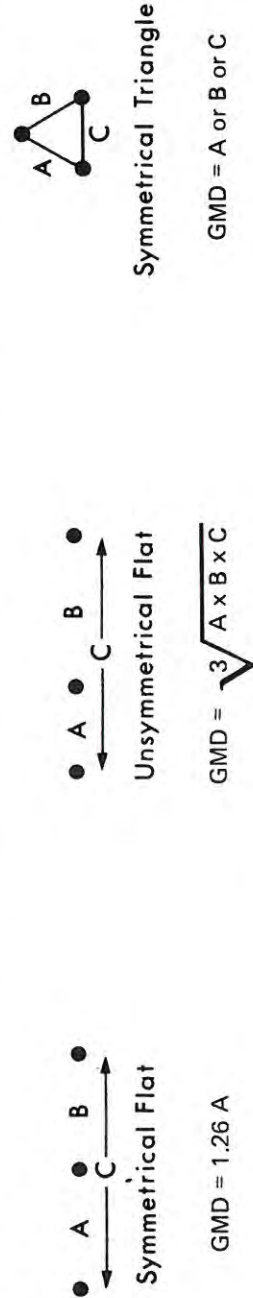

For voltage drop calculations the  $X_a$  plus  $X_d$  values are *per conductor*, and the associated voltage is that to neutral. For other than 60 Hz, the values are in proportion to Hz; that is, for 50 Hz, the value is 50/60 of the value of 60 Hz.

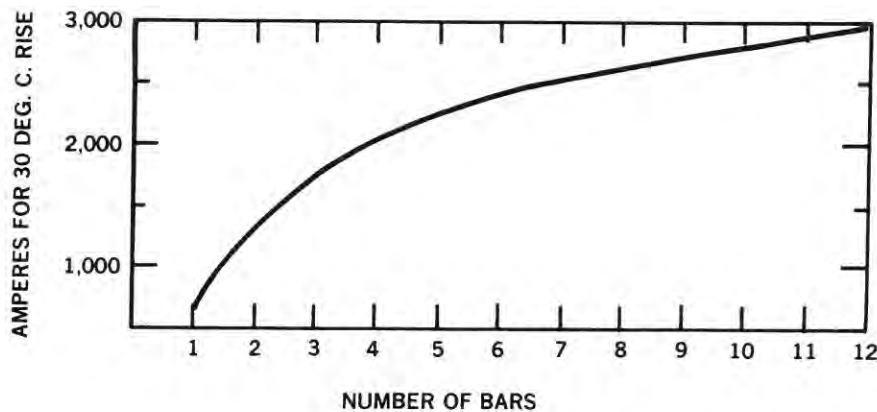

Fig. 13-10. Current capacity not increased proportionately to number of bars in parallel.

$X_a$ (from Table 13-30)	22.0 microhms per ft
$X_d$ (from Table 13-7)	<u>30.4</u> microhms per ft
Total reactance $X$	52.4 microhms per ft

**Consolidation of Multiple Bars — Reactance**

When there are two or more closely spaced bars per phase, such as bars with separation equal to the bar thickness, the group may be replaced, for rough calculations, by a single solid bar occupying the space taken up by the group (15).

**Corona and Radio-Influence Voltage (RIV)**

Corona forms when the voltage gradient at the surface of a conductor exceeds the dielectric strength of the surrounding air and ionizes the air molecules. RIV is caused exclusively by corona. Corona usually is not a factor in rigid-bus design at 115 kV, and lower.

The shape of the bus conductor is probably the most critical factor in reducing corona. Circular shapes will generally give the best performance. The four basic factors that determine voltage gradient are: (1) conductor diameter (or shape), (2) distance from ground, (3) phase spacing, and (4) voltage. A smooth surface condition may be important if operating near the critical voltage gradient.

To avoid corona and RIV, bus shapes and fittings should have corners rounded to at least 1/16 in. radius at 69 kV, and to larger radii at higher voltages. Corona rings are also used to shield fittings and flexible connections.

**Ampacity of Aluminum Bus Conductors**

The subject of ampacity or “current carrying capacity” has intrigued engineers from the beginning of electrical

power usage. Carlson and Van Nostrand made an extensive search of the literature and found more than 1500 titles, but only about 25 proved of interest to their study (17). With little to guide them, early engineers tended to use the “rule-of-thumb” of 1000 amperes per square inch for copper and 600 amperes per square inch for aluminum for any conductor shape, size or arrangement.

The industry’s need for scientific ampacity information led to the first extensive tests toward developing ampacity data and formulas for calculating ampacity for both copper and aluminum bus conductors by Melson and Booth, British National Physical Laboratory (18). Their report gave the first experimentally determined formulas for calculating the ampacity of bus conductors based on temperature rise. Although this work was a big step forward, the limitations of the formulas led to many specific tests.

The next extensive experimental work leading to formulas for calculating ampacity was done under Dwight and covered multiple bars, square tubes and round tubes (4). Dwight’s formulas give values for a single bar with a dull paint surface that closely approximates Melson and Booth’s values. Dwight’s work was another big step forward in that the scope of conductors tested was expanded and also gave engineers formulas that check test results closely for the range of conductor sizes tested. However, for large buses, particularly buses composed of a large number of bars (Fig. 13-29), the equations tend to be on the conservative side.

The most recent extensive test work that led to general equations for calculating bus ampacity is by House and Tuttle. Although the published work is for current carrying capacity of ACSR, additional work was done on bus conductors using the same fundamental heat balance equations (19).

TABLE 13-8  
Heat Loss Equations — Indoor Bus

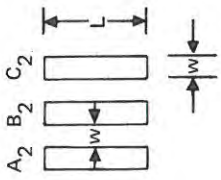
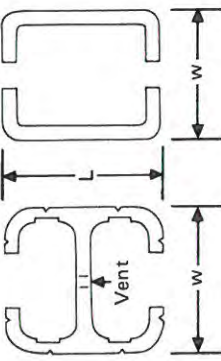
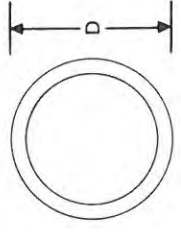
Bus Shape	Flat Bar	IWCB or Hollow Square Channel	Round Tubular
<p>Configuration</p> 			
<p><math>W_c</math> Convected Heat Watt/ft</p>	$0.0275 P_c \left( \frac{\Delta t}{L} \right)^{.25} \cdot \Delta t$ $P_c = 2N(L+w)$	$0.026 P_c \left( \frac{\Delta t}{M} \right)^{.25} \cdot \Delta t$ $P_c = 2(L+w)$	$0.072D^{0.75} \cdot (t_c - t_a)^{1.25}$
<p><math>W_r</math> Radiated Heat Watt/ft</p>	$0.0439 P_r \cdot e \left[ \left( \frac{K_c}{100} \right)^4 - \left( \frac{K_a}{100} \right)^4 \right]$ $P_r = 2(L + NW) \text{ (Bars)} \quad (\epsilon = 0.35)$ $= 2(N - 1)W \text{ (Spaces)} \quad (\epsilon = 0.95)$	$0.0439 P_r \cdot e \left[ \left( \frac{K_c}{100} \right)^4 - \left( \frac{K_a}{100} \right)^4 \right]$ $P_r = 2(L+w)$	$0.138D \cdot e \left[ \left( \frac{K_c}{100} \right)^4 - \left( \frac{K_a}{100} \right)^4 \right]$

- $W_c$  = Convected heat loss — Watt/ft
- $W_r$  = Radiated heat loss — Watt/ft
- $L$  = Height in inches
- $P_c$  = Perimeter for convection in inches
- $P_r$  = Perimeter for radiation in inches
- $D$  = Conductor diameter in inches
- $w$  = Bar width in inches
- $N$  = Number of flat bars
- $t_c$  = Conductor temperature °C
- $t_a$  = Ambient temperature °C
- $\Delta t$  =  $t_c - t_a$
- $K_c$  = Conductor temperature °K
- $K_a$  = Ambient temperature °K
- $e$  = Emissivity (see Table 13-9)
- $M$  =  $\frac{Lxw}{L+w}$

\*Equation must be modified if  $\frac{L}{w} < 12/1$

*Heat-Balance Equation of Electrical Conductors (General) (20)*

Under steady-state conditions of wind velocity, ambient and conductor temperature, solar radiation and electric current, the following general equation is valid.

$$I^2 R_{\text{eff}} + W_s = W_c + W_r + W_{\text{cond}} \quad (\text{Eq. 13-3})$$

$$I = \frac{\sqrt{W_c + W_r + W_{\text{cond}} - W_s}}{R_{\text{eff}}}$$

Where:

- $W_c$  = Convected heat loss, Watts/ft
- $W_r$  = Radiated heat loss, Watts/ft
- $W_{\text{cond}}$  = Conductive heat loss, Watts/ft
- $W_s$  = Solar heat gain, Watts/ft
- $R_{\text{eff}}$  = Effective resistance
- $I$  = Current, amperes

For indoor locations where  $W_s = 0$  and  $W_{\text{cond}} = 0$ :

$$I = \frac{\sqrt{W_c + W_r}}{R_{\text{eff}}}$$

Equations for use in calculating convection and radiation heat losses have been developed by House and Tuttle and are summarized in Table 13-8.

*Ampacity (Vertical Bars)*

The ampacity values for standard sizes of bar and commonly used bar arrangements are shown in Table 13-26 for ac and dc current, using 30°C rise over 40°C ambient in still air.

*Multiple Bar Arrangements*

For direct current the capacity of a bus constructed of rectangular bar can be controlled by merely varying the size or number of laminations in parallel. However, the efficient use of flat bars for ac buses (60 Hz) in conventional same plane arrangement is limited to about four 1/2 in. aluminum bars per phase.

Fig. 13-10 illustrates the decrease in value for each bar added from 1 to 12 bars (3 x 1/2 in. cu., 3/8 in. apart, 60 Hz) for the same plane arrangement. The curve shows that four bars will carry about 70 percent as much current as 12 bars. Papst conducted a great number of tests on various arrangements of bars in efforts to find the most economical ones (18).

One arrangement, the hollow square arrangement, has a low skin effect ratio similar to a square tubular conductor. However, the supports are more costly and must be spaced closer together than for square tubing or box channel

shapes.

*Ampacity (IWCB)*

The ampacity values for standard sizes of IWCB are shown in Table 13-32 for dc and ac current, using 30°C rise over 40°C ambient in still air.

*Ampacity (Round Tubular Bar)*

The ampacity values of the most commonly used large tube conductors are shown in Table 13-28 for a-c current, using 30°C rise over 40°C ambient in still air.

*Ampacity for Outdoors Bus Conductors*

The most extensive tests of tubular bus conductors for outdoor service were done by Schurig and Frick in 1930 (21). Since then, several investigators have conducted tests on a limited scale. However, the same rigorous combination of tests and theoretical study that was done on standard conductors by House and Tuttle (19) has not been done for tubular bus and shape conductors outdoors. The closest agreement of theoretical work with tests for pipe sizes shown in the tables appears to be the formulas listed in the House and Tuttle paper (using McAdams formula for convection for Reynolds numbers 1000 to 50,000) and the formulas given in a paper by Prager, Pemberton, Craig and Bleshman (22). The formulas and computation methods used are similar to indoor, taking into account different coefficients for outdoor convection losses and including solar heat gain.

*Emissivity and Absorptivity*

Emissivity (heat radiating characteristic) and absorptivity are not precisely the same since they apply to different energy spectra, but the difference is so small that for ordinary calculations they may be taken as equal.

The emissivity coefficient varies with the surface condition of the conductor. Table 13-9 lists approximate emissivity constants for typical conditions.

*Effect of Painting*

The ampacity of bus conductors can be increased for a given temperature rise indoors by painting with a dull finish paint of non-metallic pigment. The ampacity of a single conductor can be increased by 15 to 25 percent for the same temperature rise (18,23). For example, the effect of painting a single 1" x 10" bar is to increase the ampacity about 15 percent. As multiple bars are added, the percentage drops off since the effect of improved emissivity applies only to the outside surfaces. This leads one to consider that it is more desirable to paint the outside bars of multiple ac bar buses than dc buses since the outer bars in an ac system tend to run hotter than the inner bars because of skin effect. Painting of the outer bars very closely equalizes the temperature differential for four bar ac buses.

TABLE 13-9

Radiation Emissivity  
Aluminum and Copper Surfaces

1350 Aluminum Surface	Radiation Emissivity Coefficient	Copper Surface	Radiation Emissivity Coefficient
New Bar—Extruded	0.05—0.15	Polished	0.03
New Bar—Cold Rolled	0.05—0.20	Shiny	0.07
New Bar—Hot Rolled	0.10—0.20	Slightly Oxidized	0.30
Old Bar—2 Year Indoors	0.24—0.45	Normally Oxidized	0.50
Old Bar—2 Year Outdoors	0.50—0.90	Heavily Oxidized	0.70—0.85
Flat Paint (non-metallic base)	0.90—0.95	Flat Paint	0.95

For calculations, the following emissivity values are assumed to be representative:

New Bus	0.10
Indoor current ratings (partially oxidized surface)	0.35
Outdoor current ratings (normally oxidized surface)	0.50
Painted surfaces (dull finish)	0.90
Openings between members of built-up bars	0.95

Isolated phase bus, because of space limitations and high heat concentrations, is a particularly good application for painted conductors. The conductors, usually tubes or structural shapes, are painted for maximum emissivity, the inside of the enclosure is painted for absorptivity, the metal of the enclosure is chosen for heat conductivity, the outside of the enclosure is painted for maximum emissivity.

*Ampacity Tables*

The ampacities shown in the tables are based on calculations using modern heat transfer technology. Agreement within the range of test accuracy has been obtained between test values and calculated values. Unavoidable variations show up in test values because of the physical impossibility of exactly duplicating every test condition. When calculating temperature rise, it is necessary to use the proper value of emissivity for the conductor. The heat loss will vary considerably with various surface conditions. An exception is the table on flat arrangement of bars which is based on limited test data. This arrangement has not

been given the rigorous study that vertical bar arrangements have received. The designer should remember that ampacity tables are based on thermal conditions for the conductor and may not represent the most economical overall design. Craig, in comments on Carlson and Van-Norstrand's paper, states that with today's emphasis on energy conservation the economic effect of losses in any conductor system should be carefully considered (17).

*Current vs. Temperature Rise*

Fugill (24) derived the formula which shows that the temperature rise varies as the 1.7 power of the current:

$$\frac{T_1}{T_2} = \left(\frac{I_1}{I_2}\right)^{1.7} \tag{Eq. 13-4}$$

where I = amperes

T = Temperature Rise  
in °C

Papst (17) also found that when the hot-spot

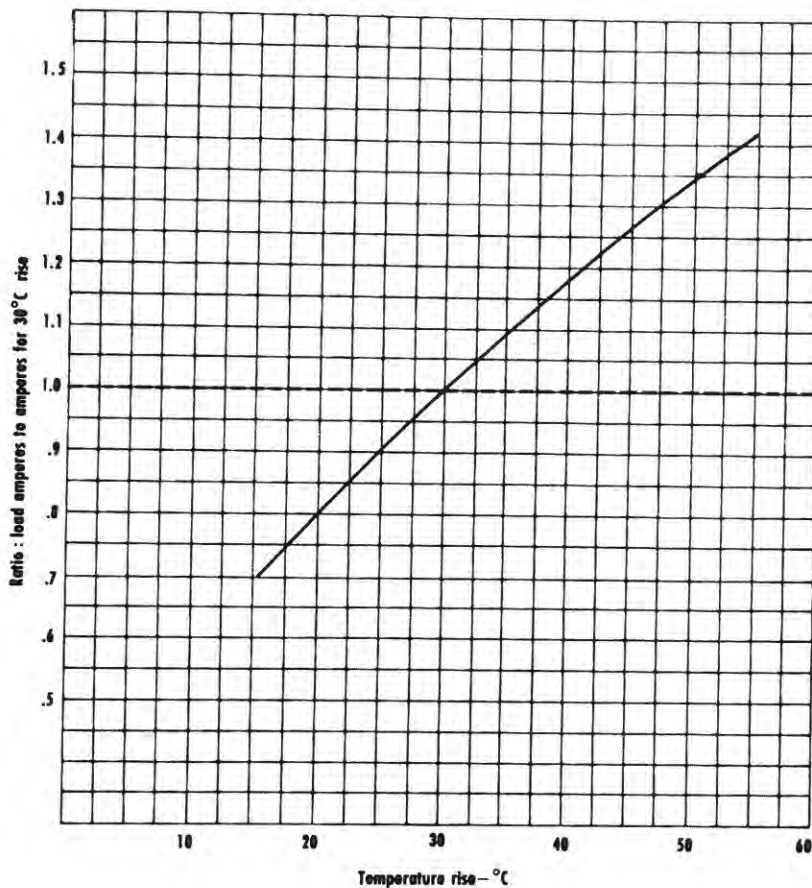

Fig. 13-11. Temperature rise vs. load ratio curve for aluminum bus conductors. Note: Based on calculations for dc current using formulas from Chapter 9, "Heat Transfer" of *Electrical Coils and Conductors*, 1945 McGraw-Hill Book Co. Checks approximately formula by Fugill. (See Eq. 13-4, page 13-22).

temperatures of test bars vs. test current were plotted on log-log paper that the curves were straight lines having the same positive slope of 1.7. Calculations based on Dwight's work (4) show essentially the same relationship. Fig. 13-11 shows the relationship in terms of load ratio in amperes to temperature rise as a convenient means of estimating current for a different temperature rise than that shown in the ampacity tables (indoors) for various conductor shapes.

#### Enclosed Bus Conductors

The design of enclosed bus conductors is considerably more complicated than open buses. Space limitations mean closer bus arrangements where proximity effect is a factor. Additional  $I^2R$  losses, as a result of induced currents in the

metal enclosure may be encountered as well as hysteresis losses in frame of enclosure. In addition, other factors such as dimensions, shape and arrangement of conductors, finish of conductors, finish of housing all have their effects on ampacity of enclosed buses. These effects are such that calculation is impossible except from test data on prototypes. Such proprietary data rarely is reported in the literature. However, some general comments may be helpful.

The greatest reduction in ampacity occurs with enclosed buses that depend mainly on free circulation of air for cooling. when such buses are enclosed in reasonably large nonmagnetic enclosures, the ampacity rating may be reduced to between 55 and 60 percent of open-air rating.

The current-carrying capacity of single tubes and bars is



Source: DWIGHT, H. B., *Repulsion Between Strap Conductors*. *Electrical World*, Vol. 70, 1917.

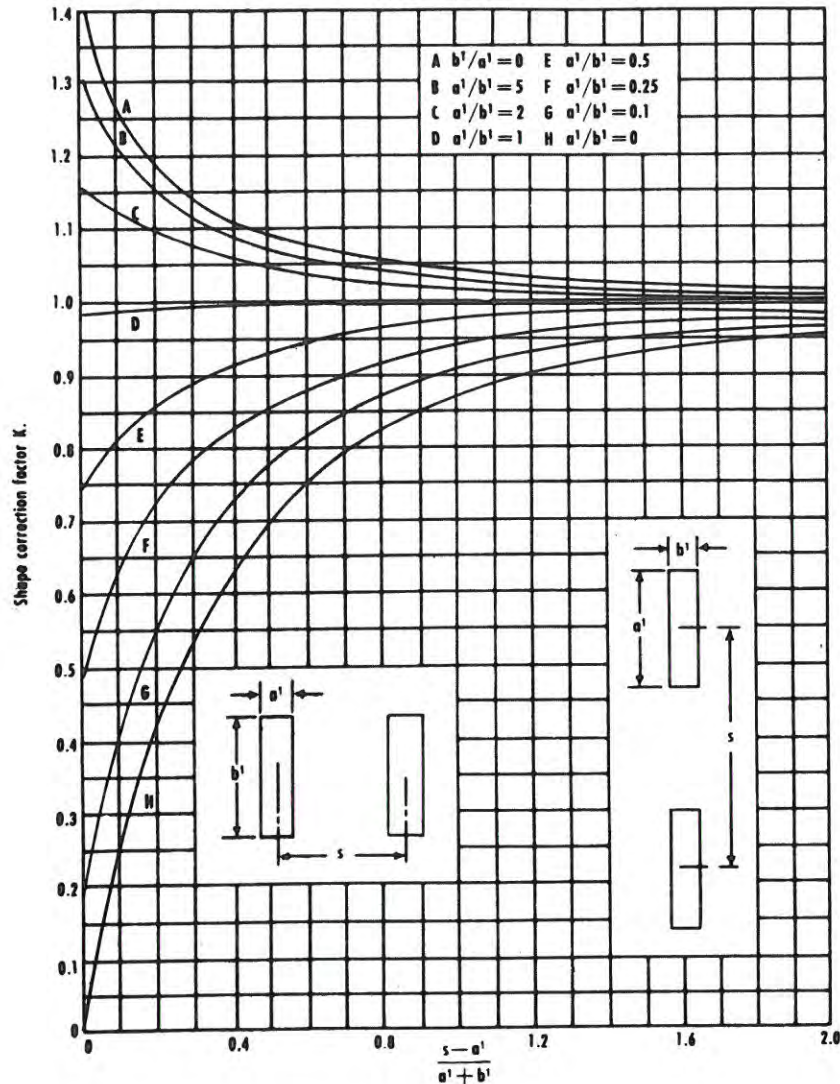

Fig. 13-12. Shape correction factor  $K$  for the calculation of electromagnetic force.

least affected by enclosure. The ratings of enclosed buses of this type may be reduced to between 70 and 75 percent of the ratings in still but confined air for standard temperature rises (24).

**Isolated Phase Bus**

Isolated phase bus, because of its use in connecting the output of generators to step-up transformers, is a key element in a power station and therefore deserves special attention by utility engineers. Power losses in the bus system are covered in detail in *IEEE Guide For Calculating Losses in Isolated Phase Bus* (25). Swerdlow and Buchta (11) give data for estimating temperature rise due to hysteresis and

eddy currents in steel members in proximity to unenclosed buses carrying large currents and include rules for application to isolated phase buses. Continuity of service is of primary importance for isolated phase generator buses. The design of modern isolated phase bus with its dust-tight and weather-tight aluminum covers has already reduced the frequency of periodic inspections. By using welded aluminum conductors, the inspection period may be spread over a longer interval.

**Short-Circuit Conditions**

The electromagnetic forces between conductors are pro-

TABLE 13-10

Maximum Instantaneous Electromagnetic Forces Between ac Bus Conductors

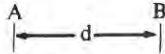
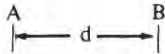
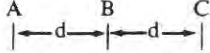
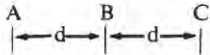
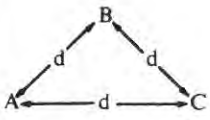
Type of Fault	Conductor Arrangement	Instantaneous Maximum Force on Conductor <sup>①</sup>	
Single Phase Symmetrical		A or B	$F = \frac{10.8 I^2}{10^7 d}$
Single Phase Asymmetrical		A or B	$F = \frac{43.2 I^2}{10^7 d}$
Three Phase Asymmetrical		B	$F = \frac{37.4 I^2}{10^7 d}$
		A or C	$F = \frac{34.9 I^2}{10^7 d}$
		A, B or C	$F = \frac{37.4 I^2}{10^7 d}$

<sup>①</sup>The current (*I*) is in terms of RMS Symmetrical.  
*F* = lb/ft of conductor  
*d* = conductor spacing in inches  
 Note: In computing short-circuit currents in networks, the subtransient reactance of rotating machinery is used.

portional to the currents flowing in the conductors, and inversely proportional to the distance between them. The instantaneous force between two long, straight, parallel, round conductors can be found from the classic equation (4):

$$F = 5.4 \frac{i_1 i_2}{d} 10^{-7} \text{ pounds per foot} \quad (\text{Eq. 13-5})$$

where *i*<sub>1</sub> and *i*<sub>2</sub> are instantaneous currents in amperes, and *d* is the distance between conductors in inches.

If the two currents flow in the same direction, the force will be one of attraction. If they flow in opposite directions, a force of repulsion is created.

**Direct Current**

For direct current, the repulsive force between positive and negative buses may be expressed as follows:

$$F = K5.4 \frac{I^2}{d} 10^{-7} \text{ pounds per foot} \quad (\text{Eq. 13-5a})$$

where *K* is the shape correction factor (Fig. 13-12).

NOTE: The shape correction factor is useful for adjusting the formula in cases where the dimensions of the

conductors are relatively large compared to the distance between conductors. Generally, for high capacity buses, the shape of the conductors and the distances between them are such that the shape factor can be considered as unity.

**Alternating Current (ac)**

The maximum force on conductors carrying alternating current depends, for practical purposes, on the point in the voltage wave at which the fault occurs and on the conductor arrangement. Formulas have been developed which show the maximum possible instantaneous force on conductors under various conditions (4,26,27). The value of current (*I*) in the formulas in Table 13-10 is the initial rms value in amperes of the alternating or symmetrical portion of the current. In asymmetrical faults, however, a dc component also is present. The effect of this dc component is included in the formulas for maximum force. Table 13-11 lists the relative value of the components of electromagnetic force for short-circuit.

**Application of Formulas (28,29,30)**

The use of the formulas in Table 13-10 results in values of maximum possible instantaneous magnetic force between conductors. Conductors subjected to such forces, and supporting insulators and structures, form dynamic systems that contain mass, elasticity and damping. Such

TABLE 13-11

Components of Electromagnetic Force  
ac Bus Conductors—Relative Values

Current	Direct Component ①	First Harmonic	Second Harmonic	Instantaneous Maximum Electro-magnetic Force ②	Ratio of Average to Instantaneous Maximum Force ②
Symmetrical Sine Current	0.333	0.0	0.333	0.667	0.500
Totally Displaced Sine Current	1.000	1.333	0.333	2.667	0.370

① Average value of total electromagnetic force.

② See Table 13-10 for values of maximum instantaneous force.

Note: Comparison of electromagnetic-force components for fully displaced and for symmetrical short-circuit currents, for two-wire short circuit.

The ac component of the fully displaced short-circuit current has the same amplitude as the symmetrical current. Wave-shape sinusoidal in both cases. Current decrement neglected.

TABLE 13-12

Deflection and Stress Formulas  
Bus Conductors

	Simple Beam	Beam Fixed at Both Ends	Continuous Beam	
			2 Spans	More Than 2 Spans
Maximum Deflection	$D = \frac{5wl^4}{384EI}$	$D = \frac{wl^4}{384EI}$	$D = \frac{wl^4}{185EI}$	①
Maximum Moment	$M = \frac{wl^2}{8}$ ②	$M = \frac{wl^2}{12}$ ③	$M = \frac{wl^2}{8}$ ④	$M = 0.107wl^2$ ④
Fiber Stress	$f' = \frac{wl^2}{8S}$ ②	$f' = \frac{wl^2}{12S}$ ③	$f' = \frac{wl^2}{8S}$ ④	$f' = \frac{0.107wl^2}{S}$ ④
Maximum Load	$W = \frac{8fS}{l}$	$W = \frac{12fS}{l}$	$W = \frac{8fS}{l}$	$W = \frac{fS}{0.1072}$
Maximum Span	$l = \sqrt{\frac{8fS}{w}}$	$l = \sqrt{\frac{12fS}{w}}$	$l = \sqrt{\frac{8fS}{w}}$	$l = \sqrt{\frac{fS}{0.107w}}$

D = deflection in inches  
w = load in lb/in. of

length  $\left(\frac{\text{Lbs per ft}}{12}\right)$

W = total uniform load in pounds (wl)

l = span in inches

E = modulus of elasticity, lb/sq in.

① Maximum deflection occurs in the end spans and is only slightly more than that for a continuous beam of 2 spans.

② Maximum moment and fiber stress for simple beams occur at the center of the span.

③ Maximum moment and fiber stress for beams fixed at both ends occur at the points of support.

④ Maximum moment and fiber stress for continuous beams occur at the second support from each end.

I = moment of inertia, inches 4

M = bending moment in pound-inches

S = section modulus, inches ③

f' = fiber stress in lb/sq in.

f = maximum allowable fiber stress in lb/sq in.

(The value of minimum yield strength is commonly used. See Table 13-1.)

systems have resonant frequencies. The deflections of conductors, insulators and structures under short-circuit conditions depend on (1) the magnetic forces, (2) the relationship between the frequency of the current and the natural frequencies of the dynamic system (3) the duration and variation of the magnetic forces, and (4) damping in the dynamic system.

#### Direct Current Buses

Short circuit forces can be appreciable for large dc bus systems. A knowledge of the short circuit characteristics of the power rectifier is essential for the design of the dc bus.

Mercury arc rectifiers, once in common use in the electro-chemical industry, were subject to failure of the rectifying action of the tube. This type of rectifier failure, known as "backfire," acts as a fault to the rectifier transformer and to the dc bus. The rates of current rise through a rectifier and its transformer windings for a large system could be as high as three to six million amperes per second. High speed breakers are used to limit current to mercury arc rectifiers and protect connected equipment.

The probability of damage from a short-circuit in solid-state rectifiers is much less than for mercury arc rectifiers. However, damaging short-circuits have occurred and cannot be ignored. ANSI Standards specify that the diode-diode fuse coordination be capable of interrupting a diode failure if the fault is fed from its own rectifier transformer. The standard does not require the diode or diode fuse to be designed to withstand a positive to negative fault. The bus designer may wish to consult with the supplier of the rectifier equipment regarding a comprehensive study of regulation curves and current transients during dc fault since a system analysis is quite complicated.

#### Low-voltage Alternating Current Buses (31)

Predictions of possible short-circuit currents for high-voltage circuits, where arcs are of a sustained character, can be made fairly accurately. However, in ac circuits operating at low voltages (440 volts or less), the effect of fault resistance and circuit reactance is such that the actual current resulting from a fault is usually much smaller than that calculated, even though the power source is large. If this difference is not recognized, needlessly high expenses for bus structures may be incurred.

Low-voltage buses with short spans and relatively rigid supports may have natural frequencies that coincide with the natural frequency of the current. In such cases, resonant vibration can occur. The stresses resulting therefrom could be several times greater than those calculated on the basis of the maximum force applied to a static system (32,33). (See page 13-28).

#### High-voltage Substations

The IEEE "Guide for Design of Substation Rigid Bus

Structures" (1) suggests that the interrupting capability of the substation equipment be considered as the maximum symmetrical RMS short-circuit current. The Guide recognizes the presence of reactance in the system and suggests using a value of 1.6 as the current offset. The classical general equation then becomes:

$$F = \frac{5.4 (1.6 \sqrt{2} I)^2 \cdot 10^{-7}}{d}$$

$$= \frac{27.6 I^2 \cdot 10^{-7}}{d} \text{ pounds per foot} \quad (\text{Eq. 13-6})$$

If a system's maximum current offset is less than the assumed value of 1.6, the force F can be further reduced.

Because of flexibility, the bus structure and support stands are capable of absorbing kinetic energy during a fault. Depending on the type of support structures and their height, the short-circuit forces can be further reduced as follows:

$$F = k_s \frac{27.6 I^2 \cdot 10^{-7}}{d} \quad (\text{Eq. 13-7})$$

Values of  $k_s$  are given in Fig. 13-13.

$k_s$  is usually assumed to be unity for three-phase bus supports.

#### Longitudinal Forces

Longitudinal forces may be encountered during short-circuit for long span flexible conductors. The greater the lateral deflection of the bus during short-circuit, the greater will be this force tending to pull the insulator supports together (34).

#### Torsional Forces

Torsional forces are encountered in the end support of a bus, being more pronounced for flexible conductors where lateral movement is greater than for stiffer conductors (34).

#### Stresses Caused by Short-circuit Currents

The forces acting on a conductor that carries current are uniformly distributed along the length of the conductor. The conductor may be analyzed as a uniformly loaded beam.

#### Heating Caused by Short-circuit Currents

The time during which a short-circuit current flows is usually so short that for all practical purposes it can be assumed that no heat loss occurs by convection and radiation. The temperature rise is then determined by only the specific heat of the metal, the size of the conductor and the heat input. The following formula should be sufficiently

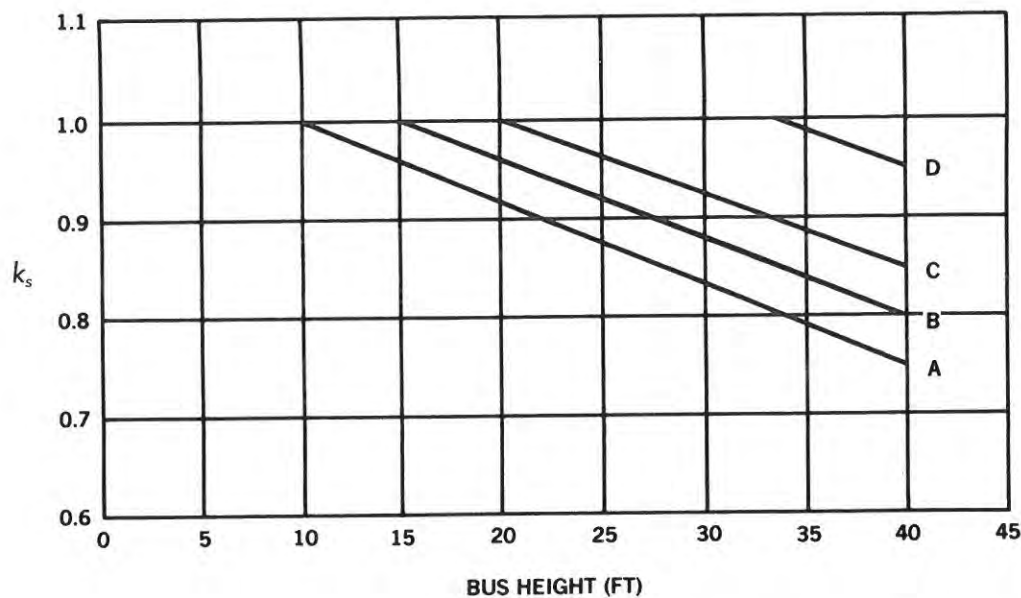

Fig. 13-13.  $k_s$  for various types of bus supports. (A) lattice and tubular aluminum; (B) tubular and wide flange steel, and wood pole; (C) lattice steel; (D) concrete.

accurate for practical (1). Increase in resistance with temperature rise has been taken into consideration.

For aluminum conductors (40 to 64 percent IACS conductivity),

$$I_{sc} = 0.144 \times 10^6 A \left( \frac{1}{t} \log_{10} \frac{T_f - 20 + (15150/G)}{T_i - 20 + (15150/G)} \right)^{1/2} \quad (\text{Eq. 13-8})$$

where:

- $I_{sc}$  = the rms value of fault current (amperes)
- A = conductor cross-sectional area (sq. in.)
- G = conductivity, % IACS
- t = duration of fault (seconds)
- $T_f$  = allowable final conductor temperature (C)
- $T_i$  = conductor temperature at fault initiation (C)

### Mechanical Design

A bus installation must be designed as a structure with enough stiffness and strength to support its own weight without excessive sag and to withstand those external forces, such as short circuits, wind and ice loads, which may act upon it. The spans should be checked for susceptibility to electromagnetic and aeolian vibration.

High voltage buses have relatively large spacing and usually relatively low currents. Thus, the mechanical

design will generally be determined by the total mechanical load, e.g. weight of conductor, ice, damping material, and any concentrated loads. Short-circuit forces and electromagnetic vibration are usually not a major factor in design. However, aeolian vibration should receive careful consideration for outdoor buses.

Low voltage buses, for the same power, have higher currents and generally smaller spacings. Here, short-circuit forces are more likely to be a major factor in the mechanical design. Also, electromagnetic vibration should receive careful study since buses with short spans and relatively rigid supports may have natural frequencies that coincide with the natural frequency or a harmonic of the current.

The mechanical design of outdoor buses is covered in considerable detail in IEEE "Guide for Design of Substation Rigid Bus Structures" (1).

After the minimum size that will satisfy the current-carrying requirements has been determined, the maximum span may be calculated from the conventional formulas in Table 13-12 or the formulas for particular end conditions as shown in IEEE Guide. Tables 13-13 and 13-14 are useful in selecting pipe size conductors.

### Vibration

#### Electro-magnetic (Resonance) (32,33)

A bus conductor installation will have a frequency of vibration depending upon the span length, rigidity of supports, degree of damping and flexibility of the conductor

**TABLE 13-13**  
**Deflection Values**  
**Schedule 40 Aluminum Pipe**

Conditions	Nominal Pipe Size in.									
		10	15	20	25	30	35	40	45	50
Bare	1/2	0.39	1.96	.....	.....	.....	.....	.....	.....	.....
	3/4	0.24	1.20	.....	.....	.....	.....	.....	.....	.....
	1	0.15	0.76	2.39	.....	.....	.....	.....	.....	.....
	1 1/4	0.09	0.46	1.45	3.55	.....	.....	.....	.....	.....
	1 1/2	0.07	0.35	1.09	2.67	.....	.....	.....	.....	.....
	2	0.04	0.21	0.68	1.65	3.46	.....	.....	.....	.....
	2 1/2	0.03	0.15	0.47	1.15	2.38	4.22	.....	.....	.....
	3	0.02	0.10	0.31	0.76	1.58	2.93	5.00	.....	.....
	3 1/2	0.02	0.08	0.24	0.58	1.20	2.21	3.78	6.07	.....
	4	0.01	0.06	0.19	0.45	0.94	1.74	2.96	4.76	7.26
	5	0.01	0.04	0.12	0.29	0.61	1.12	1.91	3.08	4.69
	6	0.01	0.03	0.08	0.20	0.42	0.79	1.34	2.15	3.28
1/2 in. Ice	1/2	1.48	7.51	.....	.....	.....	.....	.....	.....	.....
	3/4	0.81	4.12	.....	.....	.....	.....	.....	.....	.....
	1	0.43	2.20	6.96	.....	.....	.....	.....	.....	.....
	1 1/4	0.24	1.23	3.89	9.62	.....	.....	.....	.....	.....
	1 1/2	0.17	0.88	2.80	6.83	.....	.....	.....	.....	.....
	2	0.10	0.52	1.63	4.00	8.36	.....	.....	.....	.....
	2 1/2	0.06	0.30	0.96	2.30	4.89	9.05	.....	.....	.....
	3	0.04	0.19	0.60	1.47	3.06	5.72	9.75	.....	.....
	3 1/2	0.03	0.14	0.44	1.08	2.24	4.16	7.16	11.46	.....
	4	0.02	0.11	0.34	0.83	1.71	3.17	5.42	8.73	13.31
	5	0.01	0.07	0.21	0.51	1.05	1.95	3.34	5.37	8.19
	6	0.01	0.04	0.14	0.34	0.71	1.32	2.25	3.60	5.49
1/2 in. Ice, 4 lb Wind Plus Constant	1/2	2.10	10.62	.....	.....	.....	.....	.....	.....	.....
	3/4	1.12	5.63	.....	.....	.....	.....	.....	.....	.....
	1	0.56	2.85	9.02	.....	.....	.....	.....	.....	.....
	1 1/4	0.30	1.53	4.84	11.81	.....	.....	.....	.....	.....
	1 1/2	0.21	1.08	3.40	8.30	.....	.....	.....	.....	.....
	2	0.12	0.61	1.93	4.70	9.75	.....	.....	.....	.....
	2 1/2	0.07	0.34	1.09	2.65	5.49	10.17	.....	.....	.....
	3	0.04	0.21	0.67	1.64	3.40	6.30	10.76	.....	.....
	3 1/2	0.03	0.15	0.49	1.19	2.47	4.58	7.81	12.51	.....
	4	0.02	0.12	0.37	0.90	1.86	3.45	5.89	9.43	14.38
	5	0.01	0.07	0.22	0.55	1.13	2.10	3.57	5.72	8.72
	6	0.01	0.05	0.15	0.36	0.75	1.39	2.37	3.80	5.79
1 in. Ice	1/2	3.40	17.20	.....	.....	.....	.....	.....	.....	.....
	3/4	1.76	8.92	.....	.....	.....	.....	.....	.....	.....
	1	0.88	4.44	14.03	.....	.....	.....	.....	.....	.....
	1 1/4	0.47	2.37	7.47	18.49	.....	.....	.....	.....	.....
	1 1/2	0.34	1.69	5.35	13.07	.....	.....	.....	.....	.....
	2	0.18	0.92	2.91	7.09	14.95	.....	.....	.....	.....
	2 1/2	0.10	0.50	1.59	3.87	8.03	15.06	.....	.....	.....
	3	0.06	0.31	0.97	2.37	4.91	9.20	15.69	.....	.....
	3 1/2	0.04	0.22	0.70	1.70	3.53	6.53	11.14	18.06	.....
	4	0.03	0.16	0.52	1.27	2.63	4.88	8.32	13.49	20.56
	5	0.02	0.10	0.31	0.76	1.57	2.91	4.97	8.05	11.74
	6	0.01	0.06	0.21	0.50	1.04	1.92	3.28	5.26	8.02

Note: These are maximum deflection values in inches for a simple beam with uniformly distributed load. For beams fixed at both ends the deflection will be one-fifth of the values given.

Deflection  $d_1$  for any other span  $L_1$  may be obtained from the relation:  $d_1 = d \left( \frac{L_1^4}{L^4} \right)$

**TABLE 13-14**  
**Deflection Values**  
**Schedule 80 Aluminum Pipe**

Conditions	Nominal Pipe Size in.	Span in Feet								
		10	15	20	25	30	35	40	45	50
		Deflection in Inches								
Bare	1/2	0.42	2.13	....	....	....	....	....	....	....
	3/4	0.25	1.29	....	....	....	....	....	....	....
	1	0.16	0.81	2.56	....	....	....	....	....	....
	1 1/4	0.10	0.49	1.54	3.77	....	....	....	....	....
	1 1/2	0.07	0.36	1.15	2.82	....	....	....	....	....
	2	0.04	0.23	0.72	1.76	3.65	6.76	....	....	....
	2 1/2	0.03	0.16	0.49	1.21	2.50	4.64	7.92	....	....
	3	0.02	0.10	0.33	0.80	1.66	3.08	5.25	8.40	....
	3 1/2	0.01	0.08	0.25	0.60	1.25	2.32	3.97	6.36	9.69
	4	0.01	0.06	0.19	0.47	0.98	1.82	3.11	4.98	7.58
	5	0.01	0.04	0.12	0.31	0.63	1.17	2.01	3.21	4.89
	6	0.01	0.03	0.09	0.21	0.44	0.82	1.40	2.25	3.43
1/2 in. Ice	1/2	1.35	6.85	....	....	....	....	....	....	....
	3/4	0.73	3.75	....	....	....	....	....	....	....
	1	0.40	2.01	6.34	....	....	....	....	....	....
	1 1/4	0.22	1.11	3.51	8.65	....	....	....	....	....
	1 1/2	0.16	0.79	2.51	6.12	....	....	....	....	....
	2	0.09	0.46	1.45	3.54	7.40	13.72	....	....	....
	2 1/2	0.05	0.28	0.88	2.15	4.46	8.33	14.20	....	....
	3	0.03	0.17	0.55	1.35	2.80	5.23	8.93	14.30	....
	3 1/2	0.02	0.13	0.40	0.99	2.05	3.80	6.50	10.47	15.96
	4	0.02	0.10	0.31	0.75	1.56	2.89	4.95	7.96	12.14
	5	0.01	0.06	0.19	0.46	0.96	1.78	3.04	4.89	7.46
	6	0.01	0.04	0.13	0.31	0.64	1.19	2.04	3.26	4.97
1/2 in. Ice, 4 lb Wind Plus Constant	1/2	1.86	9.44	....	....	....	....	....	....	....
	3/4	0.97	4.92	....	....	....	....	....	....	....
	1	0.50	2.53	7.99	....	....	....	....	....	....
	1 1/4	0.27	1.34	4.24	10.36	....	....	....	....	....
	1 1/2	0.19	0.94	2.97	7.24	....	....	....	....	....
	2	0.10	0.53	1.66	4.06	8.42	15.60	....	....	....
	2 1/2	0.06	0.31	0.98	2.39	4.95	9.17	15.65	....	....
	3	0.04	0.19	0.60	1.47	3.06	5.66	9.66	15.47	....
	3 1/2	0.03	0.14	0.44	1.07	2.21	4.10	7.00	11.21	17.08
	4	0.02	0.10	0.33	0.81	1.67	3.09	5.28	8.45	12.88
	5	0.01	0.06	0.20	0.49	1.01	1.88	3.20	5.13	7.81
	6	0.01	0.04	0.13	0.32	0.67	1.24	2.11	3.38	5.15
1 in. Ice	1/2	2.98	15.10	....	....	....	....	....	....	....
	3/4	1.51	7.67	....	....	....	....	....	....	....
	1	0.76	3.86	12.21	....	....	....	....	....	....
	1 1/4	0.40	2.02	6.39	15.80	....	....	....	....	....
	1 1/2	0.28	1.40	4.42	10.79	....	....	....	....	....
	2	0.15	0.77	2.43	5.94	12.46	23.09	....	....	....
	2 1/2	0.09	0.44	1.38	3.37	6.99	13.10	22.34	....	....
	3	0.05	0.26	0.84	2.04	4.24	7.93	13.53	21.67	....
	3 1/2	0.04	0.19	0.60	1.46	3.03	5.61	9.60	15.52	23.65
	4	0.03	0.14	0.45	1.09	2.26	4.19	7.16	11.54	17.59
	5	0.02	0.08	0.26	0.65	1.34	2.48	4.25	6.85	10.44
	6	0.01	0.05	0.17	0.42	0.87	1.61	2.75	4.41	6.72

Note: These are maximum deflection values in inches for a simple beam with uniformly distributed load. For beams fixed at both ends the deflection will be one-fifth of the values given.

Deflection  $d_1$  for any other span  $L_1$  may be obtained from the relation:  $d_1 = d \left( \frac{L_1^4}{L^4} \right)$

TABLE 13-15

Maximum Vibration-Free Span Length

Tubular Bus		Universal Angle Bus Conductor		Integral Web Channel Bus	
Nominal Pipe Size	Maximum Safe Span Length <sup>(4)</sup>	UABC Size	Maximum Safe Span Length <sup>(1)(2)(3)</sup>	IWCB Size	Maximum Safe Span Length <sup>(1)(2)</sup>
1	5' - 0"	3 1/4 x 3 1/4 x 1/4	12' - 0"	4 x 4	14' - 6"
1 1/4	6' - 3"	4 x 4 x 1/4	15' - 0"	6 x 4	20' - 9"
1 1/2	7' - 0"	4 x 4 x 3/8	14' - 9"	6 x 5	21' - 3"
2	9' - 0"	4 1/2 x 4 1/2 x 3/8	16' - 9"	6 x 6	21' - 9"
2 1/2	10' - 9"	5 x 5 x 3/8	18' - 6"	7 x 7	26' - 3"
3	13' - 3"			8 x 5	29' - 0"
3 1/2	15' - 3"				
4	19' - 0"				
4 1/2	19' - 0"				
5	21' - 3"				
6	25' - 3"				

- (1) Lengths based on one loop of vibration.
- (2) Lengths can be increased approximately 20 percent with reasonable certainty there will be no vibration.
- (3) Does not apply for double angles in back-to-back configurations.
- (4) Lengths apply to both Schedule 40 and Schedule 80 tubular bus.

TABLE 13-16

Recommended Sizes of ACSR to Be Inserted in Tubular Bus to Prevent Vibration

Based on No Energy Absorption by Supports

Nominal Pipe Size Inches	Recommended Min. Size of ACSR cmil
2	266,800
2 1/2	266,800
3	266,800
3 1/2	397,500
4	795,000
5	1,431,000
6	1,590,000

Notes:

- (1) ACSR should have a multi-strand core.
- (2) Since any bus system has some damping capacity, similar sizes of ACSR may be used depending upon the damping characteristics of the particular installation. The design factors, installation, and cost favor consideration of dampers.

in the plane of vibration.

The general formula (33) for "clamped-clamped" (rigid support) uniform beam vibration in the transverse or bending mode is as follows for single loop:

$$f = \frac{22.0}{2\pi(L^2)} \left( \frac{EI}{N} \right) \quad (\text{Eq. 13-9})$$

where:

f = frequency in cycles per second

L = span length in inches

E = modulus of elasticity (10<sup>7</sup> for aluminum), psi

I = moment of inertia of conductor in plane of vibration, in.<sup>4</sup>

$$N = \frac{W}{g} = \frac{\text{lb/in.}}{386} \text{ for conductor}$$

Electro-magnetic vibration has been observed chiefly on buses for electric furnaces. Here, the buses experience the equivalent of a short-circuit repeatedly in normal operation. Fatigue breaks have occurred. Curves, based on Eq. 13-9, are shown in Fig. 13-14 as a guide to avoid critical lengths for bars. The span and depth in the plane of vibration are the major factors in determining the frequency.



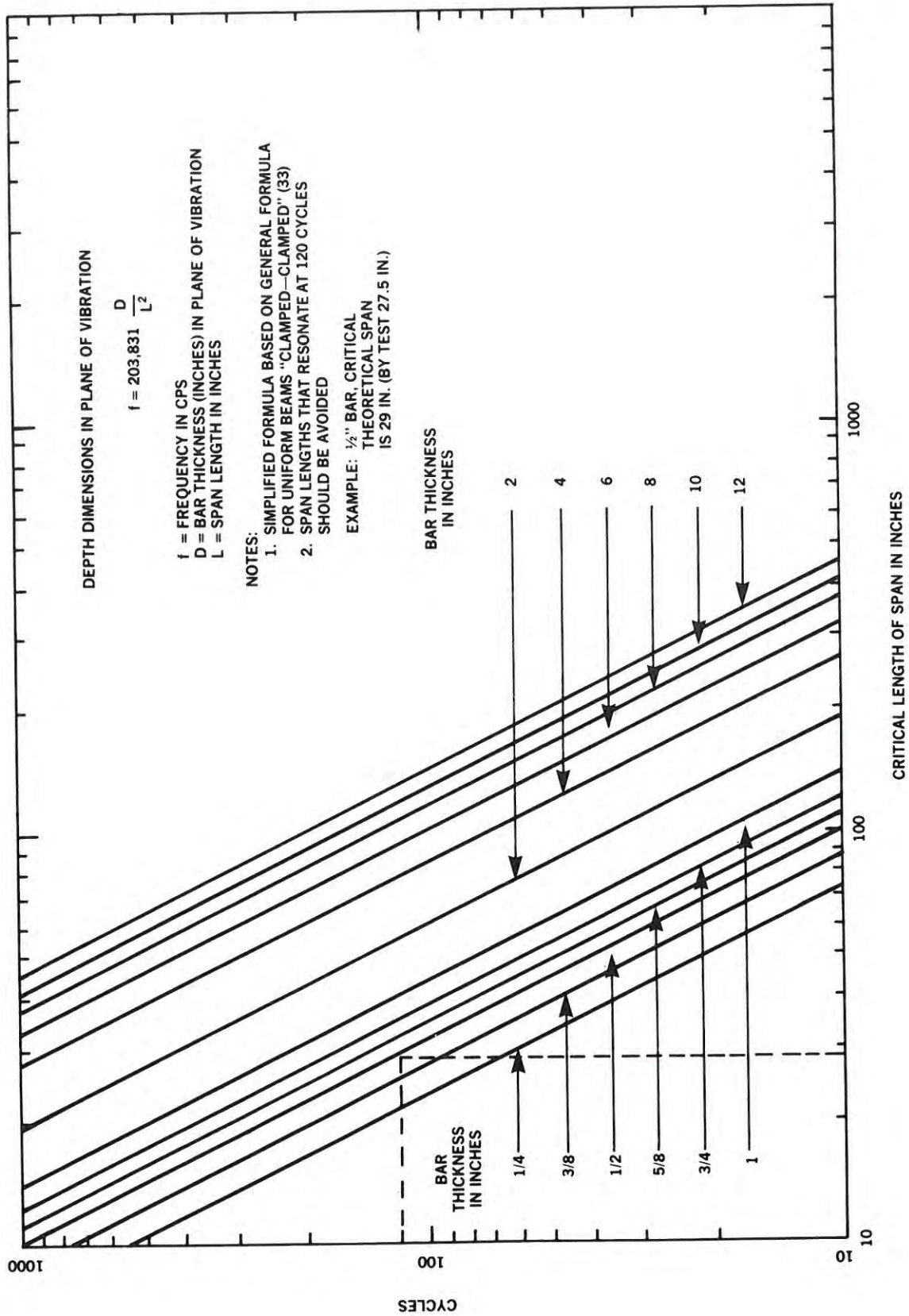

Fig. 13-14. Resonant frequencies — rectangular aluminum bars clamped at each end.

The width of the bar in the commonly used sizes has little effect on  $I_{y-y}$  and on the natural frequency.

For reasons of clearance and economy, high voltage substations are generally designed with relatively long spans, pedestal-type insulators, and relatively flexible structures. Such high-voltage "bus systems" (which include bus, supports and structures) have a marked degree of flexibility. As a result, the natural frequencies of such high-voltage bus systems are normally much lower than the frequency of the current in the bus. A short circuit normally could not excite a long span bus system with flexible supports in one of its natural frequencies.

#### *Aeolian Vibration*

Bus vibration is caused by a low steady wind blowing across the bus at approximately right angles to the span. Under certain low velocity wind conditions, eddies will break off alternately from the top and bottom surfaces causing the bus to vibrate in a vertical plane. The bus will vibrate at its natural frequency provided that this frequency is within the range that can be excited by the wind. The classical formula for frequency of vibration of round conductors by wind is as follows:

$$f = \frac{3.26V}{d} \quad (\text{Eq. 13-10})$$

where:

- $f$  = aeolian vibration frequency in cps.
- $V$  = wind velocity (miles per hour)
- $d$  = conductor diameter (inches)

Tests by Alcoa on tubular conductors of various diameters, wall thicknesses and alloys showed that internal damping of the conductor itself caused only minor deviations from the theoretical formula. The conductors were suspended on piano wires to eliminate damping effect of supports (Table 13-15).

Winds causing vibration are low steady winds under 15 mph; winds over 15 mph are generally too turbulent to induce vibration. A span that is "sheltered" from the wind will not be as prone to vibrate as an exposed span. This shelter can be caused by trees around the station, equipment in the station or by the location of the station, as in a valley.

Tests and experience show that all shapes of bus will vibrate provided the following conditions are present: (1) suitable winds are present, (2) span lengths are long enough to vibrate and (3) support losses are less than input by wind.

There are too many variables involved to definitely state that a given span will vibrate; only that due to the fact of its length it has the potential to vibrate. The possibility of

vibration should be considered if the span lengths are greater than lengths listed in Table 13-15.

Until recently, the most commonly used damping method was by inserting flexible cable in the bus. The size and type of cable was determined by trial and error for each installation and there was little consistency (Table 13-16).

In recent years, specially designed bus dampers have found increasing use for vibration protection. Specific sizes of flexible conductor, particularly in the short lengths required for damping purposes, are not always available or practical to acquire. Furthermore, dampers may be installed in an existing station where vibration problems have occurred.

#### *Expansion Joints for Bus Conductors*

When the temperature of a bus conductor changes, there is a change in length due to thermal expansion.

Long, continuous buses should be provided with expansion joints at intervals. Expansion calculations are covered in detail in the IEE Guide (1) and are applicable to both indoor and outdoor bus.

#### *Rectangular Bars*

For flat-bar construction where the continuous length of bus is not more than 50 to 75 ft, and where the bus is subject to only normal variations in temperature, it is common practice to neglect any special consideration of expansion. Support clamps are installed tight, and the small change in length of bus is absorbed by the lateral flexibility of the flat bars.

#### *Structural Shape*

Buses designed with structural shape conductors should be allowed freedom of longitudinal movement except at anchor points; otherwise, the force exerted on the insulating supports may be higher than advisable. This is necessary, because structural shapes have much greater lateral stiffness than flat bars, and changes in length are not so easily absorbed by lateral bowing of the conductor.

#### *Tubular*

Runs of considerable length require expansion joints, particularly if the tube terminates at both ends in electrical equipment that should not be highly stressed. At section points either an expansion connector can be used, or the section is anchored at a central point of a long run, with slip-supports on far distant insulators. Usually the maximum slip on such a support is about one inch, which limits the run to about 100 ft. each way from a mid-anchor point for usual temperature variation. A favored expansion connection is the straddle-type (Fig. 13-16) that is mounted on an insulator cap.

## bus conductors

### Positioning Expansion Joints — Continuous Spans

The following are some common arrangements for placing expansion and slide supports in continuous bus spans, designed to accommodate bus expansion without placing undue stress on fixed supports or other components under various installation conditions (35).

#### Fixed Supports in Center Only

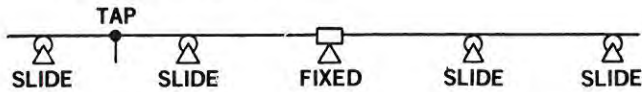

#### Fixed Supports at One End Only

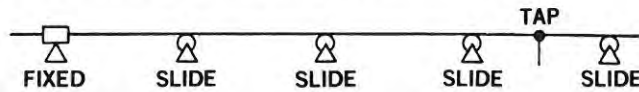

#### Fixed Supports at Both Ends



#### Fixed Supports at Intermediate Points

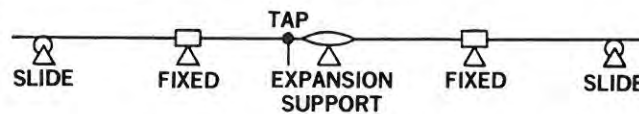

#### Fixed Supports at Center and Both Ends

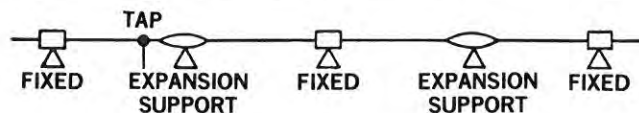

### Expansion Joint Types

There are many variations in the design of expansion joints. They generally consist of terminal lugs joined by flexible thin sheet of 1350 aluminum laminations or rope lay cable welded or compressed to the lugs at each end. The gauge of aluminum sheets is 0.010 in. to 0.016 in. thick and for heavy, stiff buses, thicker laminations may be used. If greater flexibility is required woven braid is suitable. The latter type, however, makes the assembly somewhat bulky because of the large number of fine strands that may be needed. Copper braids should not be used for outdoor service on aluminum since copper salts from weathering of copper are corrosive to aluminum. Typical expansion joints for different kinds of aluminum buses are illustrated in Fig. 13-16.

### Bus Supports

Bus supports should have a cantilever strength equal to or greater than the strength of the NEMA station post insulators used with the supports. High strength aluminum alloy bodies with aluminum alloy bolts (never bronze) is the best combination of materials. Slip-fit supports that have a rocker pin may be a problem for spans prone to aeolian vibration. ANSI C119.3 lists industry standards for heights of supports.

Standard supports are satisfactory for cables, flat bar and flexible tubes since the movement of the conductors largely absorbs suddenly developed forces of short-circuit currents. However, channel conductors, stiff tubes and flat bars mounted edgewise to the direction of force convey the total impact to the support. Papst (36) conducted extensive tests that showed when the bus is used with spring-mounted supports the reduction in stress is substantial. The springs may be mounted between the bus and its insulator or between the insulator and its supporting structure.

Rigid bus swing-suspended from insulators is sometimes used where short-circuit forces are high, Fig. 13-15. Shock stress from short circuits is partly absorbed by the inertial swing of the bus and, for a sustained short circuit, the bus swing stops at such a position that the balance of forces, including tension in the insulator links, offsets the short-circuit force. Support bumpers sometimes are provided into which the bus enters at full swing, thereby reducing tension on the insulator. This swing principle also sometimes is employed for indoor bus in industrial plants where short-circuit forces otherwise would make it necessary to provide more supports (37).

### Clearances and Phase Spacings

There are no industry standards for all aspects of clearances and phase spacings. However, many are covered by National Electrical Code and the various

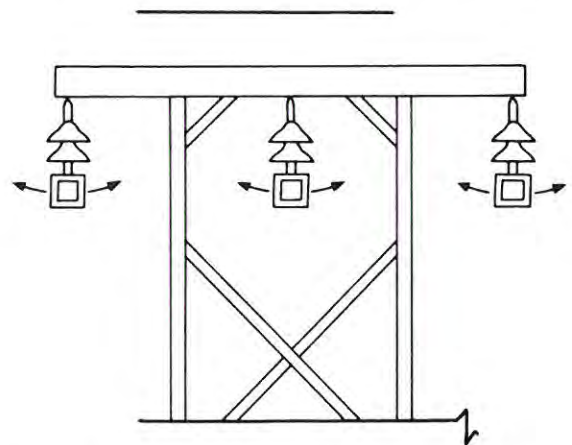
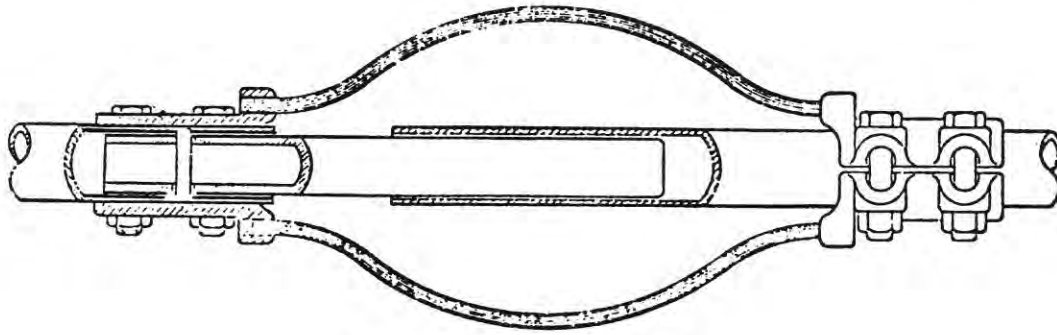
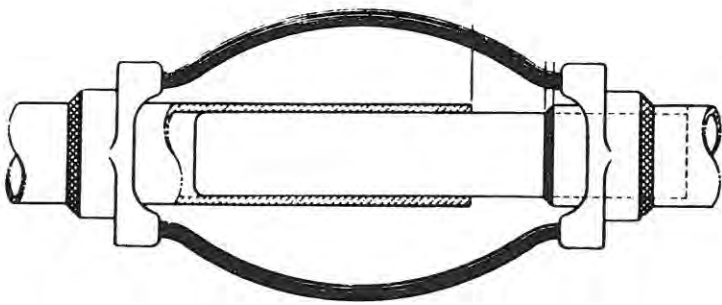

Fig. 13-15. Swinging suspension for high-current bus.



**a. Bolted Expansion Coupler Connector**



**b. Welded Expansion Coupler Connector**

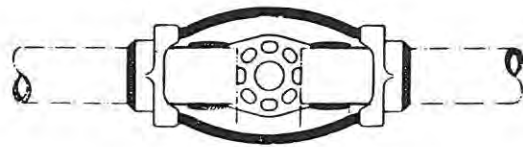

**c. Welded Expansion Support**

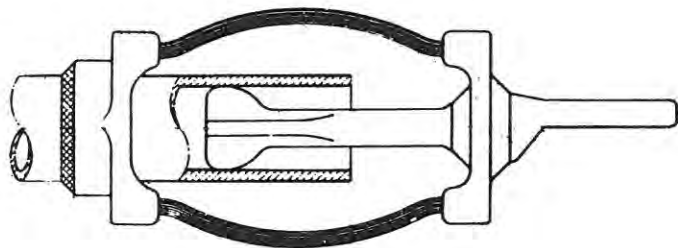

**d. Welded Expansion Terminal Connector**

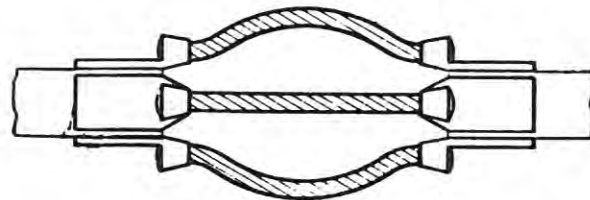

**e. Welded Expansion Connectors for IWCB**

*Fig. 13-16. Typical expansion connectors.*

TABLE 13-17

Minimum Spacing Between Bare Metal Parts

(NEC Table 384-26)

	Opposite Polarity Where Mounted On the Same Surface	Opposite Polarity Where Held Free in Air	Live Parts* to Ground
Not over 125 volts, nominal	3/4 inch	1/2 inch	1/2 inch
Not over 250 volts, nominal	1 1/2 inch	3/4 inch	1/2 inch
Not over 600 volts, nominal	2 inches	1 inch	1 inch

For SI units: one inch = 25.4 millimeters.

\*For spacing between live parts and doors of cabinets, see Section 373-11(a) (1), (2), and (3).

Minimum Spacing Between Bottom of Enclosure and Bus Bars, Their Supports, or Other Obstructions (Inches)

(NEC Sect. 384-10)

Conductor	Inches
Insulated bus bars, their supports, or other obstructions	8 (203 mm)
Non-insulated bus bars	10 (254 mm)

manufacturers have their own standards (Tables 13-17, 13-18 and 13-19).

**Jointing and Connecting**

Properly designed bolted, clamp-fitted, or welded bus bar connections provide equally satisfactory service. Welding is generally preferred for permanent connections and bolting is used where connections may be periodically broken. Bolting and clamping are also used where welding equipment and trained welders are not available.

*Nature of Contact Interface*

There are similarities in the contact interfaces between any two conductors. The surface of a piece of metal — no matter how well polished — consists of innumerable microscopic hills and valleys. Theoretically, the initial contact of two mating surfaces occurs at only three points. When increasing pressure is applied, the initial points are broken down and multiple points of contact are established.

The natural oxide films on both copper and aluminum, particularly aluminum, are poor electrical conductors. They must be ruptured or otherwise penetrated to bring about the required conducting path. The quality of conducting path across the contact interface must approach that of the continuous conductor if significant resistance concentrations are to be avoided.

Photomicrographs of contact surfaces have shown how metal is extruded into the fissures in the oxide surface during interfacial collapse to provide the bridges by which current can traverse the interface. Resistance measurements of completed connections reveal the degree to which these bridges are effective in providing a low resistance path (38).

The installing force on a connection disrupts the natural oxide film on the contact surface, allowing metal-to-metal contact for low contact resistance. Contact resistance may be sensitive to subsequent micro-movement from creep or differential thermal expansion. If the increase in joint resistance causes a significant increase in temperature the deterioration may be cumulative until the circuit opens or high temperature provides more conducting areas at the in-

**TABLE 13-18**  
**Minimum Clearance of Live Parts<sup>(1)</sup>**

(NEC Table 710-33)

Nominal Voltage Rating kV	Impulse Withstand, B.I.L., kV		Minimum Clearance of Live Parts in Inches			
			Phase-to-Phase		Phase-to-Ground	
	Indoors	Outdoors	Indoors	Outdoors	Indoors	Outdoors
2.4-4.16	60	95	4.5	7	3.0	6
7.2	75	95	5.5 <sup>(2)</sup>	7	4.0	6
13.8	95	110	7.5	12	5.0	7
14.4	110	110	9.0	12	6.5	7
23.0	125	150	10.5	15	7.5	10
34.5	150	150	12.5	15	9.5	10
	200	200	18.0	18	13.0	13
46.0		200		18		13
		250		21		17
69.0		250		21		17
		350		31		25
115.0		550		53		42
138.0		550		53		42
		650		63		50
161.0		650		63		50
		750		72		58
230.0		750		72		58
		900		89		71
		1050		105		83

For SI units: one inch = 25.4 millimeters.

(1) The values given are the minimum clearance for rigid parts and bare conductors under favorable service conditions. They shall be increased for conductor movement or under unfavorable service conditions, or wherever space limitations permit. The selection of the associated impulse withstand voltage for a particular system voltage is determined by the characteristics of the surge protective equipment. These values shall not apply to interior portions or exterior terminals of equipment designed, manufactured, and tested in accordance with accepted national standards.

(2) ANSI C 37.46 lists 6 in. for 8. 25 kV.

terface. Al-Cu bolted interfaces between flat bus may exhibit this characteristic (39).

Contact resistance of two metallic surfaces appears to consist of two parts: (1) the constriction resistance caused by non-uniform flow of current in the body of the conductors as the result of the constrictive nature of the small metal extrusion contacts at points of oxide fracture, and (2) film resistance caused by random areas of less perfect

contact.

Although the contact resistance consists of film resistance in parallel with the constriction resistance, the latter is by far the most important.

*Constriction Resistance*

The distribution of dc current in a long thin rod is uniform. The resistance of such rod can be calculated by

**TABLE 13-19**  
**Electrical Clearances**  
**Outdoor Substations — Basic Parameters**

(Table 1, NEMA STD SG 6)

Line No.	Rated Max. Volt kV rms	Rated Withstand Voltage		Minimum Metal-to-Metal Distance Between Rigidly Supported Energized Conductors Inches(Meters)	Ground Clearance Inches(Meters)		Recommended Phase Spacing Center to Center - Inches(Meters)			Recommended Minimum Clearance Between Overhead Conductor and Ground for Personal Safety Feet (Meters)	Withstand S. S. Crest kV
		Impulse 1.2 x 50 μs Wave kV Crest	60 Hz kV rms Wet 10 Seconds		Recommended	Minimum	Horn Gap Switch & Expulsion Type Fuses	Horizontal Break Disc. Switches	Bus Supports, Disc. Switches Power Fuses Non-expulsion Type Rigid Conductors		
1	8.25	95	30	7 (.18)	7-1/2 (.19)	6 (.15)	36 (.91)	30 (.76)	18 (.46)	8 (2.44)	...
2	15.5	110	45	12 (.30)	10 (.25)	7 (.18)	36 (.91)	30 (.76)	24 (.61)	9 (2.74)	...
3	25.8	150	60	15 (.38)	12 (.30)	10 (.25)	48 (1.22)	36 (.91)	30 (.76)	10 (3.05)	...
4	38.0	200	80	18 (.46)	15 (.38)	13 (.33)	60 (1.52)	48 (1.22)	36 (.91)	10 (3.05)	...
5	48.3	250	100	21 (.53)	18 (.46)	17 (.43)	72 (1.83)	60 (1.52)	48 (1.22)	10 (3.05)	...
6	72.5	350	145	31 (.79)	29 (.74)	25 (.64)	84 (2.13)	72 (1.83)	60 (1.52)	11 (3.35)	...
7	121	550	230	53 (1.35)	47 (1.19)	42 (1.07)	120 (3.05)	108 (2.74)	84 (2.13)	12 (3.66)	...
8	145	650	275	63 (1.60)	52-1/2 (1.33)	50 (1.27)	144 (3.66)	132 (3.35)	96 (2.44)	13 (3.96)	...
9	169	750	315	72 (1.83)	61-1/2 (1.56)	58 (1.47)	168 (4.27)	156 (3.96)	108 (2.74)	14 (4.27)	...
10	242	900	385	89 (2.26)	76 (1.93)	71 (1.80)	192 (4.88)	192 (4.88)	132 (3.35)	15 (4.57)	...
11	242	1050	455	105 (2.67)	90-1/2 (2.30)	83 (2.11)	216 (5.49)	216 (5.49)	156 (3.96)	16 (4.88)	...
12	362	1050	455	119 (3.02)	106 (2.69)	84 (2.13)**	240 (6.10)	...	192 (4.88)	18 (5.49)	650
13	362	1300	525	...	...	104 (2.64)**	...	...	...	...	759
14	550	1550	620	...	...	124 (3.15)**	...	...	...	...	808
15	550	1800	710	...	...	144 (3.66)**	...	...	300 (7.62)	...	898
16	800	2050	830	...	...	166 (4.22)**	...	...	...	...	982

Note--For insulator data, see the NEMA Standards Publication for High Voltage Insulators, Pub. No. HV 1-1973.

\* Ground clearance for voltages 362 kV and above are selected on the premise that at this level, selection of the insulation depends on switching surge levels of the system. The values were selected from Table 1 of IEEE Transaction paper T-72-131-6 (Vol. No. 5, page 1924) which is a report of the Transmission Substation Subcommittee. For additional switching surge values refer to the above noted paper.

Source: KOUWENHOEN, W. B. and SACKETT, W. T. JR.,  
*Contact Resistance—The Contribution of Non-Uniform  
 Current Flow.* AIEE Trans., Vol. 70, 1951.

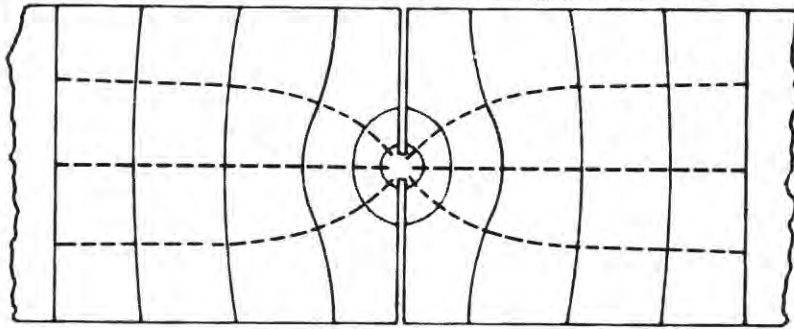

Fig. 51B—Spreading resistance of flat strips.

Source: KOUWENHOEN, W. B. and SACKETT, W. T. JR.,  
*Contact Resistance—The Contribution of Non-Uniform  
 Current Flow.* AIEE Trans., Vol. 70, 1951.

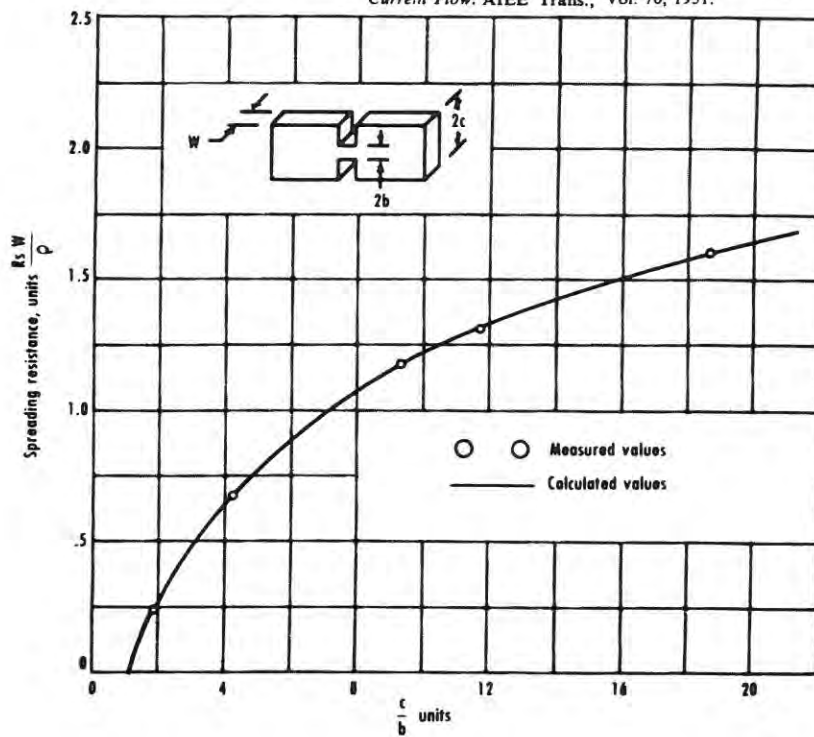

Fig. 13-17. (Top) Equipotential and flow lines on flat strip with constrictions. (Bottom) Spreading resistance of flat strips.

$R = \rho L/A$ , where  $\rho$  is the resistivity,  $L$  is the length and  $A$  the cross-sectional area. When a constriction (Fig. 13-17) is interposed in such rod or strip, the current flow is no longer uniform. The distortion of the lines of current flow results in an increase in resistance, called "constriction resistance."

Greenwood (40) showed mathematically that, with a large number of small contacts, the self-resistance term in the constriction resistance at asperities becomes very small. Thus with a large number of small paths through a surface film, the total resistance may be almost as low as with no film.



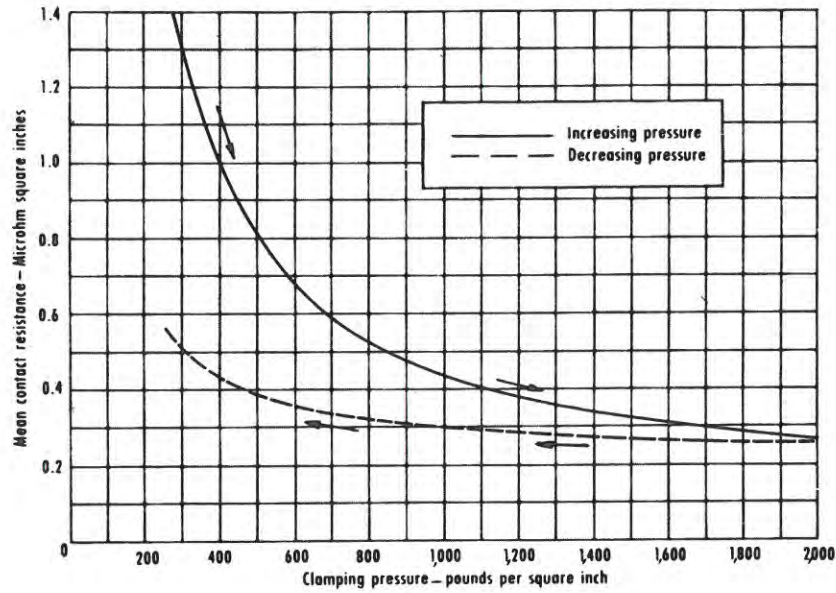

Fig. 13-18. Mean contact resistance of various clamping forces in stacks of 1/4" by 1" 1350-H12 bus bar with contact surfaces abraded through an electrical joint compound. (See contact surface preparation, page 13-41).

**Film Resistance**

The natural oxide film, in air, may be said to have a thickness ranging from 10 to 100Å (one angstrom unit =  $1 \times 10^{-7}$ mm). Thick films (multimolecular) without fissures, such as oxides, sulfides and others, can as a rule be regarded as insulating. Thick films in the order of 20Å may be regarded as barrier films. Thin films pass electric current practically without perceptible resistance (41).

According to Mott's application of quantum mechanics (42), conduction through very thin films depends upon the fact that electrons in the metal can penetrate a distance of a few angstrom units into an insulating layer without receiving energy of excitation.

**Design Factors Of Bolted And Clamped Joints**

Research on the nature of the contact interface points out the importance of those combination of connection elements—contact members, contact surfaces, and means of assembly—that minimize differential thermal expansion, creep, relaxation, and other stress changes. Therefore, in the design of bolted connections, consideration should be given to: (1) contact area, (2) contact pressure, (3) contact surface preparation, (4) characteristics of the metals involved (both mechanical and relative thermal expansion), (5) jointing hardware, (6) sealing the joint against possible oxidizing or corrosive agents, (7) operating temperature and (8) possible hot

spots due to short-circuit currents.

**Contact Surface Area (Overlap)**

Melsom and Booth (43) in their extensive work in 1922 presented practical recommendations regarding size of overlap, surface preparation, and use of petroleum jelly as a valuable guide for both aluminum and copper conductors.

Experience has shown that good performance is obtained if the current density for bare contact surface is in the order of 90 to 100 amperes per square inch, calculated on the basis of total area of overlap, when the overlap equals the width of the bar for field fabricated bus. For factory fabricated apparatus, such as busways, switchgear, and isolated phase bus, where joints are electro-plated and tested, a current density of 200 amp. sq. in. is permissible (UL 857).

**Contact Resistance—Clamping Force**

The initial contact resistance in clean contacts depends on (1) the resistivity of the contact members, and (2) the area and distribution of the conducting spots in the interface between the contact members. The area and distribution of the conducting spots are generally determined by the magnitude of the clamping force and the manner in which it is applied. For example, Fig. 13-18 shows the relative change of resistance with increasing and decreasing

pressure.

For practical purposes, the problem of adequate clamping force for a joint of satisfactorily low initial resistance can be simplified by considering the clamping force as uniformly distributed over the apparent contact area. In this way, rule-of-thumb limits of unit pressure can be applied to serve as guides when making joints. A practical design range for average clamping pressures is 800 to 1200 psi for 1350 alloy conductors. Higher average clamping pressures may be used for 6101 and other strong alloy conductors.

#### *Contact Surface Preparation*

A flat, unplated, aluminum contact surface for a bolted connection requires some treatment prior to assembly to reduce the contact surface resistance. The most effective treatment is to abrade the aluminum to disrupt the oxide film and immediately coat with an electrical joint compound containing an active chemical that attacks and disperses the oxide film on the aluminum. The chemical action not only reduces the thickness of the film, but also imparts lubricity which assists in the seating of the contact members.

Plated bus is normally used in industrial equipment to avoid the necessity of field joint preparation. Plating is required where plug-in contacts are used. UL specifications permit 15°C higher temperature rating, hence increased ampacity, where plated connections are used, or an allowable temperature rise of 55°C above 30°C ambient. Silver plating was once generally specific but tin plating has largely taken its place.

#### *Characteristics of Dissimilar Metal Interfaces*

Different contact materials have different capabilities for maintaining interfacial fixity—lack of relative movement—against nonplated aluminum.

Bolted Al-Cu connections, installed with joint compound in accordance with instructions, have given satisfactory performance under normal operating conditions. Where operating temperatures have been high, generally in excess of 100°C, resistance increases have been experienced in certain connections. Such increases are greatest where the Al is soft and the Al contact surface is not severely deformed. Although these increases are frequently attributed to a lack of spring follow-up in the fastening system, data indicate that interfacial shear strain—strain resulting from the shear component of contact force—is by far the more important cause (38). One solution is to interpose a bi-metal wafer (Al-Cu) to establish Al-Al and Cu-Cu contact surfaces.

An area of more concern is the problem of bolting nonplated aluminum to silver or tin plated surfaces. Bond's tests (44,45) show that heavier silver and tin plated surfaces had poor capability for interfacial fixity while nickel was quite good.

With increased plating thickness the creep and expansion properties of the plated contact surface become more like those of the plating material than the substrate. Therefore, plating thickness is a factor in determining whether or not fixity will be maintained.

Plating thicknesses in excess of 0.2 mil have shown significant resistance increases in joints with nonplated soft Al. With harder Al or thinner plating, the resistance is more stable. Therefore, 0.2 mil has been considered the limit of plating thickness below which special precautions are not required in properly designed connections to nonplated Al.

If one has a thick-plate silver or tin contact member that must be electrically connected to nonplated aluminum by bolting, the possibility of trouble can be reduced by interposing a bi-metal wafer. The connection would then be installed in accordance with standard recommendations. Another method is to plate the aluminum contact surface.

#### **Bolted Joints and Jointing Hardware**

When the electric load on a bus increases in the course of normal load cycles, the joints are heated, the aluminum tends to expand more than the steel bolts and looseness of the joint may result for certain conditions.

Reasonably constant clamping force can be maintained with any one, or a combination, of the following methods: (1) use of aluminum alloy bolts; (2) use of Belleville spring washers with quality steel bolts; (3) use of clamps with built-in elasticity; (4) use of thick flat washers in conjunction with steel bolts designed to operate as elastic members.

#### *Bolts—Size and Number*

The size and number of bolts in electric joints are of particular importance, since the bolting pressure must be adequate to establish a high initial joint efficiency without subjecting the bolts to stresses beyond their yield strengths. The work of Shand and Valentine (46) on the effects resulting from the use of different quantities and sizes of bolts and of different thicknesses of bars disclosed some interesting facts:

(1) Thickness of Bar—Provided that surface preparation, overlap and bolting remain the same, the different thicknesses of material commonly used do not appreciably affect the joint efficiency.

(2) Bolt Size—For a given thickness of material, where joint surface preparation and the number of bolts remain constant, the joint resistance for bolt sizes between 3/8 in. and 3/4 in. diameter may be lower for the larger bolts.

(3) Number of Bolts—As the number of bolts is increased, the joint resistance is definitely decreased. Joint efficiency increases most sharply as the number of bolts is increased from one to four. When five or six bolts are used, however, the additional increase in joint efficiency is

TABLE 13-20

Bolting Schedule for Field Erected Buses

Bar Width, Inches		Arrangement	Bolt Spacing, Inches				No. of Bolts	Bolt Size	
A	B		C	D	E	F		Aluminum	Steel
2	1	1	1/2	1			2	3/8	5/16
2	1 1/2	1	1/2	1			2	3/8	5/16
2	2	1	1/2	1			2	3/8	5/16
3	1	1	3/4	1 1/2			2	3/8	5/16
3	1 1/2	1	3/4	1 1/2			2	3/8	3/8
3	2	1	3/4	1 1/2			2	3/8	3/8
3	3	2	3/4	1 1/2	3/4	1 1/2	4	3/8	3/8
4	2	1	1	2			2	1/2	1/2
4	3	2	1	2	3/4	1 1/2	4	3/8	3/8
4	4	2	1	2	1	2	4	1/2	1/2
5	2	1	1 1/4	2 1/2			2	1/2	1/2
5	3	2	1 1/4	2 1/2	3/4	1 1/2	4	3/8	3/8
5	4	2	1 1/4	2 1/2	1	2	4	1/2	1/2
5	5	2	1 1/4	2 1/2	1 1/4	2 1/2	4	1/2	1/2
6	2	1	1 1/2	3			2	1/2	1/2
6	3	2	1 1/2	3	3/4	1 1/2	4	1/2	3/8
6	4	2	1 1/2	3	1	2	4	1/2	1/2
6	5	2	1 1/2	3	1 1/4	2 1/2	4	5/8	1/2
6	6	2	1 1/2	3	1 1/2	3	4	5/8	5/8
8	4	3	1 1/4	2 3/4	1	2	6	1/2	1/2
8	5	3	1 1/4	2 3/4	1 1/4	2 1/2	6	1/2	1/2
8	6	3	1 1/4	2 3/4	1 1/2	3	6	5/8	5/8
8	8	4	1 1/4	2 3/4	1 1/4	2 3/4	9	5/8	5/8

Tangent or Right-Angle Joints

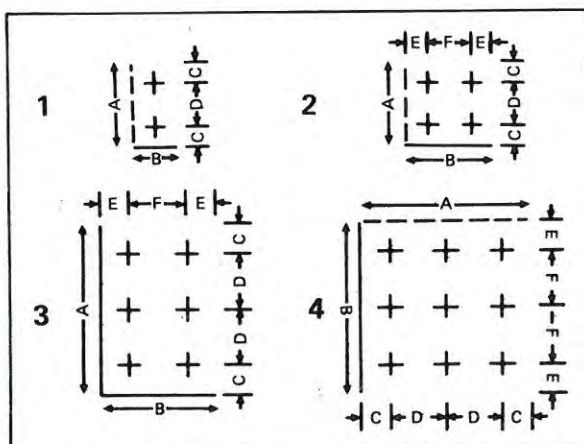

Bolts	
Aluminum	Steel

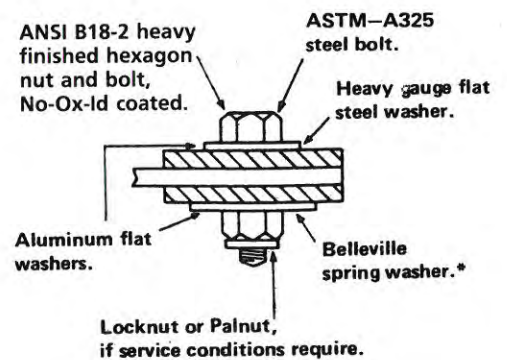

small.

Donati's work (62) shows that, for bolted joints using multiple through bolts inline with the axis of the bus, the current will traverse the contact surface only in the vicinity of the two outer bolts, while the intermediate ones have no practical influence on the current distribution over the contact. It is, therefore, of little electrical value to use the intermediate bolts.

The use of thick, wide-series flat washers under the bolt heads, nuts and Belleville washers, serves to distribute the high contact pressures over a larger area. Most of the current transfer occurs in the area of high pressure under the bolt heads (Fig. 13-19).

The series of designs of bolted joints for bars, shown in Table 13-20, is offered as a guide for heavy-duty service.

#### *Bolts—Torque vs. Clamping Pressure*

The relation between tightening torque and clamping pressure in a bolted joint is greatly dependent on the finish and lubrication of the threads and other bearing surfaces. The average relation between tightening torque and clamping forces for specified conditions is shown in Fig. 13-20.

Many factors are relevant to the performance of bolted overlap bus joints involving aluminum and other metals. However, the greatest single concern should be relative movement at the film-coated surface of the aluminum. Whether this movement is caused by differential thermal expansion, elastic deformation, or permanent deformation (creep, etc.), if it shears the current-carrying spots by which the current traverses the interface, the contact resistance is increased.

#### *Aluminum Alloy Bolts*

Aluminum bolts have the same thermal expansion as the aluminum bus, therefore loosening of the joint because of temperature cycling will never result from thermal expansion.

Aluminum alloy 2024-T4 bolts have the tensile strength of mild steel. Hence, the same clamping force can be achieved with the same size bolt. Aluminum alloy bolts, however, are somewhat lower in torsional strength than mild steel. To offset the lower torsional strength, alloy bolts 1/8-inch larger than the equivalent steel bolts are sometimes used.

Since the compressive stress in a bolted joint is concentrated under the head and nut of the bolt, flat washers are recommended to increase the bearing area. The larger bearing area is helpful in reducing stress concentrations and in increasing effective contact area. Aluminum alloy bolts are non-magnetic and, therefore, not subject to heating due to hysteresis losses in ac fields.

Table 13-21 shows dimensions of heavy-series aluminum bolts, and Table 13-22 lists the recommended loadings of the usual sizes of aluminum 2024-T4 bolts for bus connec-

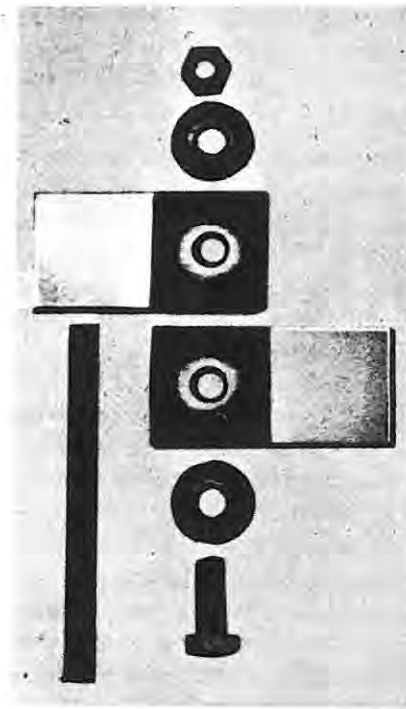

*Fig. 13-19. The bright areas around the bolt holes are the only areas of intimate contact when bars are fastened with standard bolt and flat steel washers.*

tions together with the resulting stresses in shank, in root area, and under the bolt head. The torque necessary to produce these bolt loadings is also shown, assuming suitable lubrication on threads, under bolt and nut bearing surfaces.

#### *Steel Bolts and Belleville Spring Washers (47)*

Another method of avoiding a potential problem as a result of differential expansion of bolts and conductors is the use of Belleville washers under the nut of a steel bolt. Experience over many years in North America and France has shown that very satisfactory results can be obtained by using Belleville spring washers. A flat washer should be used under the Belleville. The flat washer should be larger than the spring washer, and the nut should be tightened until the spring washer is in a completely flattened position. In the absence of specific instructions to the contrary, it should be left in flattened position and the normal relaxation of the metals will restore some crown to the washer (See Chapter 11).

#### *Steel Bolts and Pressure Plates*

Stainless steel pressure plates have been used successful-

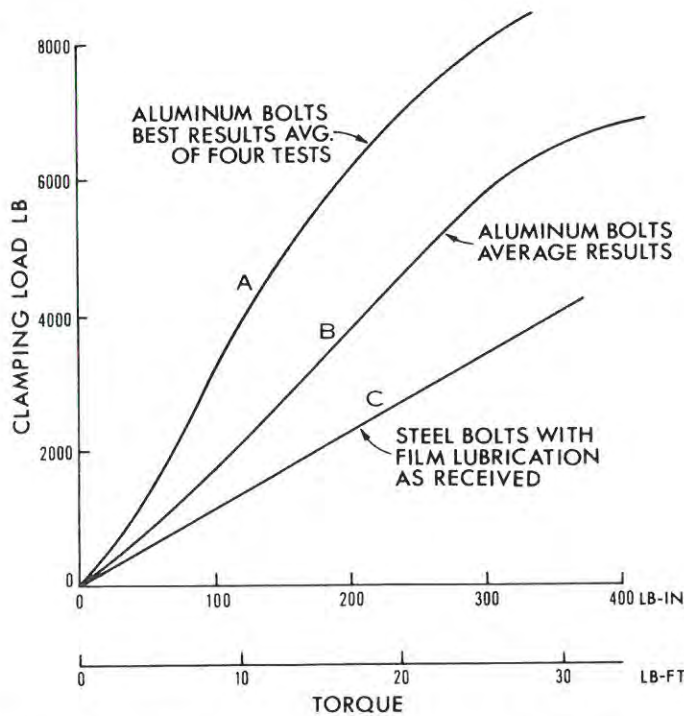

Fig. 13-20. Torque-clamping force for 1/2-in.-13 bolts of various materials and lubrication.

A—ANSI B18.2-1 heavy-series semi-finished anodized 2024-T4 aluminum bolts with overall No-Ox-Id XX,\* or equal, inhibitor lubrication under favorable conditions (no side friction in bolt hole, straight shank, accurate threading, and fresh lubrication).

B—ANSI regular-series aluminum bolt of same specifications as above under average conditions. It is assumed that the inhibitor lubricant is as applied before the bolt is sealed in a plastic bag, and the quality of the lubricant and its application may not be up to full standards. This curve also is suitable for heavy-series bolts under similar conditions. It is the basis for the loadings and stresses shown in Table 13-13.

C—Industry curve long used for unlubricated steel bolts, but the thin oil film that is on the bolts when packaged is retained.

Note: Curves A and B, and similar curves for 5/8-in. and 3/4-in. aluminum bolts, are from AIEE Conference Paper CP-59-930 which exhaustively analyzes the torque-load relationships of aluminum and steel bolts.

\* Product of Dearborn Chemical Co., Chicago, Ill.

ly for bolted joints. These plates, drilled to conform to the bolting layout, expand the pressure area around the bolts.

Steel Bolts and Standard Flat Washers

The higher yield strength and better creep characteristics of 6101 alloy make it easier to obtain stable electric joints with this alloy than with aluminum 1350. Tests and field experience show that as a rule-of-thumb Belleville spring washers are not necessary to the satisfactory performance of bolted overlap joints secured with quality steel fasteners if the tensile strength of the aluminum bus is in excess of 20 ksi and provided the contact surfaces have been properly prepared. Dimensions of flat washers are shown in Table 13-23.

TABLE 13-21

Dimensions of Heavy-Series Aluminum Bolts 2024-T4 Aluminum Alloy, (N.C.) National Coarse Thread (Dimensions in inches: F and G are maximum; H is nominal)

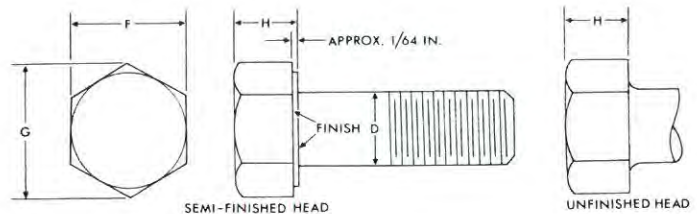

Threads Per In.	D Nominal Diam.	F Across Flats	G Across Corners	H Un-Finished Head	H Semi-Finished Head	J Pitch Diam.
13	1/2	7/8	1.010	7/16	13/32	0.4500
11	5/8	1-1/16	1.227	17/32	1/2	0.5660
10	3/4	1-1/4	1.443	5/8	19/32	0.6850

Note:

The unthreaded shank length and overall length of the bolt should be selected so that there is little excess of thread length above nut thickness. If the bolts have rolled threads, the shank diameter D closely equals pitch diameter J. Bolts should be anodized with adequate thickness and seal to impart suitable corrosion resistance for the application. It is recommended that unanodized nuts of 6061-T6 or 6262-T9 alloy be used. The corrosion resistance of these unanodized nuts is compatible with that of anodized 2024-T4 bolts.

TABLE 13-22

**Initial Tightening Torque and Probable Resulting Stresses in New Inhibitor-Lubricated 2024-T4 UNC Anodized Regular- or Heavy-Series Aluminum Bolts under Recommended Application Conditions.**

(It is assumed that the nuts are semi-finished and of same or a compatible aluminum alloy. Areas under head and are based on hole 1/16-in. larger than bolt diameter. The inhibitor lubricant is assumed to be No-Ox-ld XX, or equal.) If bolt has rolled threads the shank area is reduced, and the stress in the shank may be as much as 25% greater than the stresses listed as in the shank.

Nominal Bolt Size	1/2"-13	5/8"-11	3/4"-10
Net stress area under thread* ANSI Std. sq. in.	0.1416	0.2256	0.3340
Shank area, sq. in.	0.196	0.307	0.442
Area under regular bolt head and nut (semi-finished)**	0.164	0.273	0.412
Same, but for heavy-series bolt, min.	0.318	0.462	0.637

A. Torque and stress under average conditions—with stresses suitable for optimum creep conditions. Recommended for connecting aluminum bus bars with either regular or heavy series aluminum bolts.

Torque, lb-ft (approx.)***			
Load on bolt, lb (probable)	5,500	8,800	13,000
Stress in thread area, psi	38,800	39,000	39,000
Stress in shank, psi	28,100	28,600	29,400
Stress under regular head, psi**	33,500	32,200	31,500
Stress under heavy-series head, psi	17,300	19,100	20,400

\* In accordance with ANSI Standard, the net stress area is slightly larger than the area of a circle of same diameter as thread root, thereby allowing for the slight spiral stress transfer that is characteristic of ANSI threads.

\*\* Stresses under bolt heads in this table are computed on the basis of minimum width across flat of a semi-finished bolt, and that nut area is same as head area.

\*\*\* IEEE paper 63-280, *Use of Aluminum in Substation Buses*, a report of Working Group 57.1, Substation Committee, Power Division, recommends 25 lb-ft as torque for 1/2-13 NC bolts, and 40 lb ft for 5/8-11 NC bolts, which is same as NEMA Std. CC1 Table 4-2 for aluminum bolts that fasten connectors to flat conducting surfaces.

*Quality Steel Bolts*

Bolts, unless purchased to a specification, vary widely in mechanical properties. For bus bar joints, it is desirable to use bolts that have a known elastic proof load, such as those meeting ASTM A 325. High-strength bolts such as SAE Grades 7 or 8 (ASTM A 354, Grade BD) are recommended for thick packs of bars where it is customary to use fewer bolts and larger Belleville washers.

*Special Clamps*

Fairly uniform pressure may be obtained over a wide range of operating temperatures by the use of special clamps. The "curved back" clamp, designed so that the convex faces will be parallel when the bolts are drawn down to the rated capacity of the clamp, have given satisfactory service. Assembly of bus using clamp joints is relatively simple because pre-drilling and aligning of bolt holes is not required.

**Aluminum-To-Copper Connection**

Aluminum and copper are both ideally suited for use as electrical conductors, not only because of their conductivity, but also because both metals have an excellent inherent resistance to atmospheric weathering. Because these two metals are almost exclusively used as electrical conductors,

TABLE 13-23

**Outside Diameter & Thickness of Flat Washers—Inches**

Bolt Size Diam.	Medium		Heavy		Extra Heavy (Aluminum only)		Extra Thick*	
	O.D.	Thk.	O.D.	Thk.	O.D.	Thk.	O.D.	Thk.
3/8-in.	7/8	0.083	1	0.083	1-3/8	0.083	—	—
1/2-in.	1-1/4	0.109	1-3/8	0.109	1-7/8	0.109	1-1/4	0.25
5/8-in.	1-1/2	0.134	1-3/4	0.134	2-3/8	0.165	1-1/2	0.313
3/4-in.	1-3/4	0.148	2	0.148	2-7/8	0.165	1-3/4	0.375

"Medium" washers are specified in NEMA SG1.4.10 for joining power connectors to flat contact surfaces.

\*Extra-thick washers of Heavy or Extra-Heavy series of aluminum often are available on special order, and larger outside diameters similarly are usually obtainable. Generally, the thickness of a washer should be increased with increased washer diameter.

Note: As bolt holes usually are 1/16 in. larger in diameter than the nominal bolt size, the bearing area of the washer, in sq. in. is 0.7854 (O.D.<sup>2</sup> - (Size + 0.0625)<sup>2</sup>)

The rim effect of washers applied to aluminum that is not stressed above its elastic limit is sometimes taken into account, if "medium" washers are used, by assuming that the effective bearing area under the washer is the same as that of an area the diameter of which equals the outside diameter of the washer plus twice the washer thickness.

## bus conductors

connections between the two metals have to be made frequently. Such joints, when properly made with well-designed fittings of good quality, have given satisfactory outdoor service for many years. It must be remembered, however, that because of the electrochemical relation of the two metals, aluminum is anodic to copper. As a consequence, the joint in the presence of an electrolyte will be susceptible to galvanic corrosion. The accumulation of films or corrosion products on the contact surfaces may adversely affect the electrical resistance of the joint.

The factors that influence the degree or the severity of the galvanic action are numerous and complex. They are covered in Chapter 2. For protection of installations in environments that are known or expected to have severe galvanic action, the joint should be thoroughly sealed with a suitable grease-type compound to prevent the entrance of moisture into the contact surfaces. Such compounds are also used to minimize the formation of oxide films on the contact surfaces. If possible, the copper side of the joint should be placed on the bottom for outdoor applications to prevent copper salts washing over the aluminum.

For ordinary applications (normal conductor temperatures of 70°C), both outdoor and indoors, protective grease-type compounds are effective and suitable for controlling corrosion and maintaining low resistance in direct aluminum-to-copper electric connections.

### Welded Aluminum-to-Aluminum Connections

Welding of aluminum in electrical construction offers a superior and economical means of joining conductors. Electric arc welding using an inert gas shield produces mechanically and electrically sound joints requiring no flux or special surface preparation other than the cleaning of the surface to be welded.

A welded connection that is mechanically satisfactory is also electrically satisfactory. With welded connections, there is an essentially homogeneous union that gives a permanent stable connection. It is not necessary to try to produce a connection with the same resistance as bus itself in order to have a stable permanent joint. This can be observed from Fig. 13-17.

There are bus connections where it is important to insure a resistance ratio of unity with the conductor itself. Small differences in resistance can affect the current distribution in some bus systems. Some bus systems require equalization bars. Welded connections are an ideal solution to both problems. Such connections can be made by following procedures outlined in The American Welding Society Handbook "Welding Aluminum". When the bead is not ground off, the result is a welded joint that usually has a lower resistance than an equal length of conductor for the recommended filler metal.

For outdoor substation applications, the criterion of "mechanically satisfactory" means "electrically satisfactory" is applicable.

There are a number of excellent papers on designs using welded aluminum bus for outdoor substations. Some of the earlier papers (48,49,50) give considerable data on design features and test information. Substations using these design features have given trouble free service for over 25 years.

### Welding Processes

The most used welding processes for joining bus are the *gas tungsten-arc welding* method (GTAW) which employs a non-consumable tungsten electrode with filler metal fed by hand or automatically, and the *gas metal-arc welding* method (GMAW) in which the filler wire is power-fed continuously through the torch, thereby constituting a consumable electrode.

Both GTAW and GMAW processes employ inert gas shielding (argon, helium, or a mixture of these) that keeps air away from the arc and the molten weld pool, thereby eliminating need for welding flux.

Basic joint designs and welding procedures are shown in "Welding Aluminum". Details of GMAW and GTAW welding as to shaping of the edges to be welded, current density, size and kind of filler wire, speed of welding, and manipulation of the torch are described in specialized publications of aluminum producers and welding equipment manufacturers. For bus work 4043 and 1100 alloy filler wires are commonly used with GMAW, however alloy 4043 is easier and faster to use.

### Strength of Aluminum in Weld-Heat Zone

Bolted joints lose strength because of bolt holes. Properly made GMAW and GTAW welded joints also lose strength in the heat-affected zone that extends about two or three times the metal's thickness from the center of the weld. Average strength values are shown in Table 13-24.

The value for 6101-T6 is about the same as for 6063-T6. If the weld bead is left on, the average yield strength in the

TABLE 13-24

Typical Alloy Strength Values As Welded

Alloy and Temper	Minimum Yield Strength of Parent Metal	Typical Yield Strength Fully Annealed "O" Temper	Filler Metal	Minimum Expected Tensile Yield Strength As Welded ksi
1350-H111	3.4 ksi	4.0 ksi	4043	4.5
6063-T6	25.0 ksi	7.0 ksi	4043	11.0
6061-T6	35.0 ksi	8.0 ksi	4043	15.0

### Welded Straight Connector

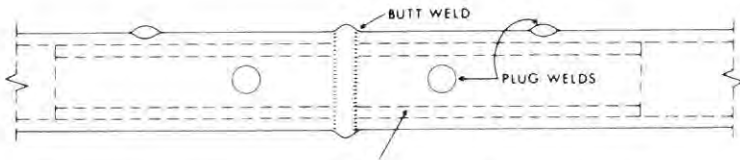

Slotted insert tube next smaller pipe size. Locate slot in region of lowest tensile stress of conductor tube.

Insert tube held by plug welds provides back-up for the butt weld and also reinforces tube strength.

### Welded Branch for Bottom of A-Frame Assembly

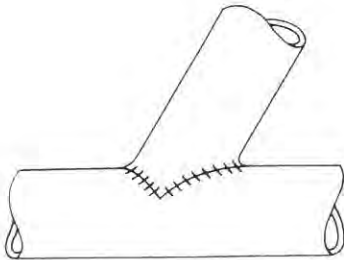

Direct weld after upper tube is cut to shape by means of special cutting template.

### Welding to Intermediate Aluminum Connector Fitting

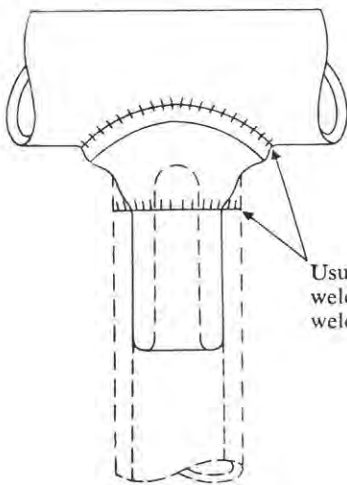

Usually one of these welds may be a shop weld at reduced cost.

Fig. 13-21. Typical welded tubular bus connections.

heat-affected zone is about 75 percent of minimum yield strength of the parent metal. Locating the weld in the region of moderate stress is a usual method of offsetting the effect of partial weld annealing. For situations where locating the weld in a region of moderate stress is not practical for tubular conductors, reinforcing inserts (Fig. 13-21) may be used. Static bending tests of such joints show developed stresses as high as 28,000 to 32,500 psi without failure for 6063-T6 tubing. (See ref. 48 and 50).

### Other Welding and Bonding Methods

Other less often used welding and bonding techniques for joining aluminum bus are available for special circumstances and applications. Among these methods are: GMAW spot welding, gas welding, resistance (flash) butt welding, resistance spot welding, capacitor discharge welding, pressure welding, ultrasonic welding, exothermic welding, explosion welding, diffusion bonding, brazing and soldering.

To cover all these methods in detail is beyond the scope of this chapter and the reader is advised to consult the American Welding Society's *Welding Handbook* for further information.

### Bus Installations

The descriptions of bus installations in this section are only sufficient to enable recognition of the various types, with emphasis on the conductors, and with supports and protective housings only incidentally described. The various types of installations are considered in the order in which they occur as the energy is generated, transmitted, distributed and utilized.

#### Generator and Station Bus

The generator in a large power station will generally be rated at 23 kV or higher with current rating up to 40,000 amperes, three phase, 60 (N. American std.) or 50 Hz. The bus runs from the generator terminals to the main transformer terminals are generally metal enclosed buses of the isolated phase bus construction. In cases where lower current ratings are involved, the bus may be of segregated or non-segregated phase construction.

ANSI Standard C37.20 contains the following definitions for various types of bus construction.

**Non-Segregated Phase Bus** - One in which all phase conductors are in a common metal enclosure without barriers between the phases (Fig. 13-22a). Another configuration has triangular bus arrangement in a circular enclosure.

**Segregated Phase Bus** - One in which all phases are in a common metal enclosure, but are segregated by metal barriers between phases (Fig. 13-22b).

**Isolated Phase Bus** - One in which each phase conductor is enclosed by an individual metal housing separated from adjacent conductor housings by an air space (Fig. 13-23).



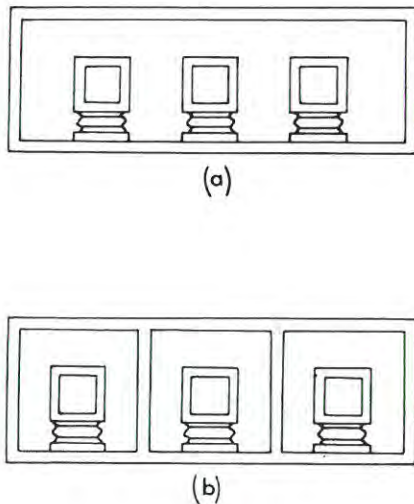

Fig. 13-22. (a) Unsegregated bus in which the enclosure surrounds the assembly, but there is no wall between phases; (b) Segregated three-phase bus, in which a common wall separates phases.

**Isolated Phase Bus** - In the case of the isolated phase bus, one of three different support insulator arrangements may be used (Fig. 13-23a,b,c). In each case, the insulators are designed to fit the requirements for momentary conditions, system voltage and test requirements. All buses have provision for expansion and contraction of the conductors and enclosures due to thermal changes.

The typical arrangement of isolated phase bus as used in a generating station is shown in Fig. 13-24.

For a more detailed discussion of isolated phase bus design and application, refer to references (11,12,51,52,53).

#### Switchyard Bus

The trend in switchyard design for 230 kV and below favors the flat-type of switchyard in which all bus is on one or two levels, supported by insulators (Fig. 13-25). A typical method of providing for two levels is the A-frame, as illustrated (54). Round tubular bus is mostly used, although IWCB or angles also are used, particularly for distribution voltages.

There are a number of technical papers that give considerable detail on design of substations using tubular aluminum bus. Two papers giving unusual information are: (1) Quick's paper (49) on welded construction using 11" x 11" IWCB for low voltage bus and 4-1/2 in. nps for 132 kV bus, and (2) Massey's paper (55) using bolted construction for 6" x 4" IWCB at 230 kV.

Distribution switchyards that serve local areas at moderate voltages also use rigid bus for principal circuits. Fig. 13-26 is typical for 13.8 kV distribution. Round tubular bus also may be mounted on inverted insulators, and the take-offs are similarly tubular, though connections between the low-voltage breakers and the disconnects may be of flexible cable. Angle bus and double-channel web bus, Figs. 13-5k, -f, and -g, also are widely used in distribution switchyards because the flat surfaces aid the connecting of side taps and reduce fitting costs.

Detailed information on design of moderate voltage substation using UABC and IWBC are given in a number of technical papers (56,57).

High voltage substations require special care in regard to corona. The supplier should be advised when tubular bus conductors, 3 in. nps and larger, are to be used in substations over 230 kV so that "High Voltage Finish" can be supplied, i.e. special attention given to the exterior surface finish to avoid sharp protrusions.

The maximum allowable height of a sharp protrusion is controlled to some extent by operating voltage. High voltages require better surface conditions, as shown:

Operating Voltage	Maximum Height	Finish Specification
230 kV or lower	1.5 mm (0.062)	Standard Mill
230 kV to 345 kV	1.2 mm (0.047)	High Voltage
345 kV to 500 kV	0.6 mm (0.025)	High Voltage
500 kV	0.1 mm (0.004)	High Voltage

Defects should be smoothed to a height not exceeding the appropriate value based on the operating voltage. Complete removal is not necessary, but repaired area should be blended into the remaining surface and should not exceed 250 micro-inch (AA).

#### Gas Insulated Bus (58)

Compressed gas insulated bus is becoming popular for switchyard installations where space is at a premium.

#### Busways

Often called "bus duct," busways are enclosed, sectionalized, prefabricated bus-bar assemblies with associated fittings for distribution of ac or dc power at 600 volts or less in ratings of 100 amp or more. They are used for transmitting power in industrial and commercial buildings where concealment of circuits is not necessary. They are particularly advantageous for vertical risers of large buildings, and in machine shops where current-using equipment is likely to be relocated with process changes.

Feeder busways supply power to a distribution center. Plug-in busways are similar, but provide for plug-in attachment of power takeoffs at spaced intervals by insertion of grip contacts or "stabs". Protective or indicating

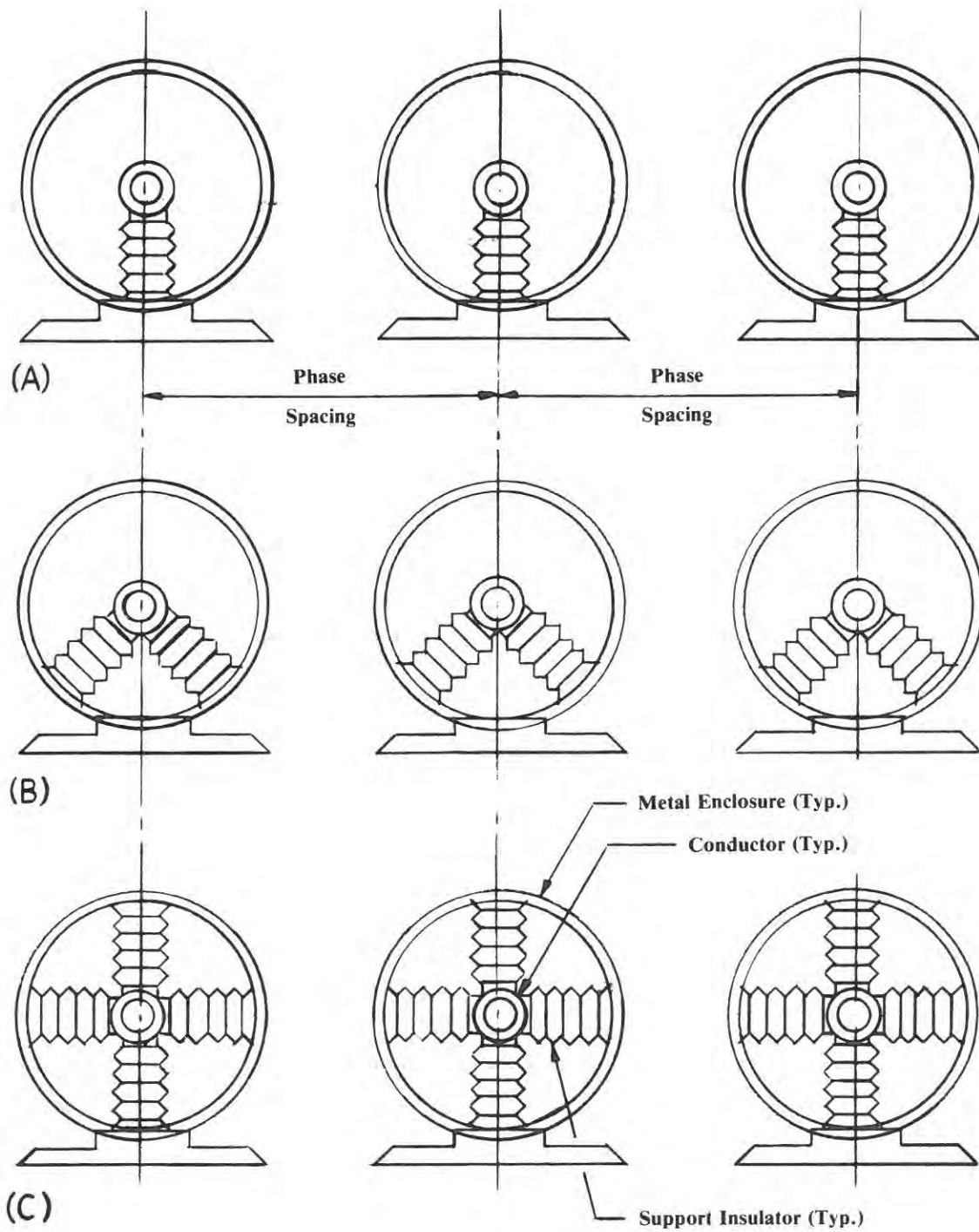

Fig. 13-23. Isolated phase bus — typical support arrangement.

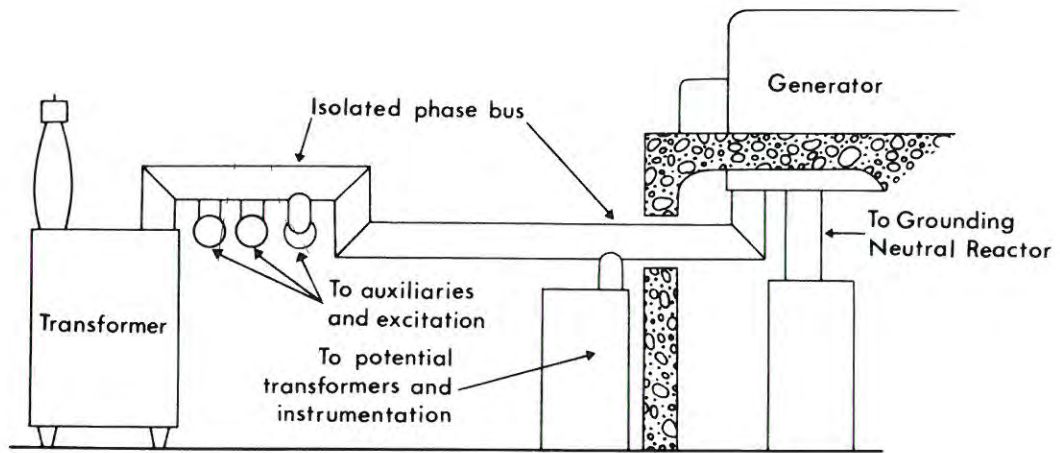

Fig. 13-24. Typical isolated-phase bus commonly used in generating station.

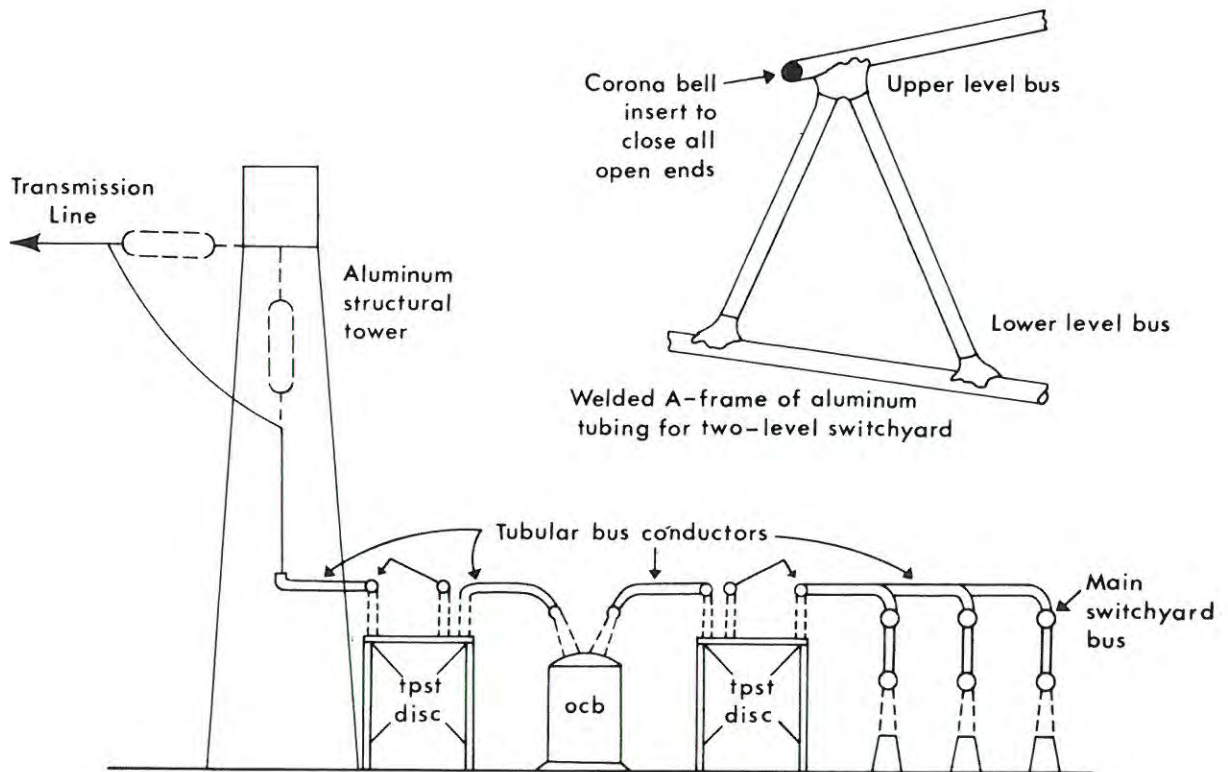

Fig. 13-25. Schematic of ground-type outdoor switchyard for high-voltage transmission. A switchyard for distribution voltage may be on same level and supplied through transformers from the high voltage main bus.

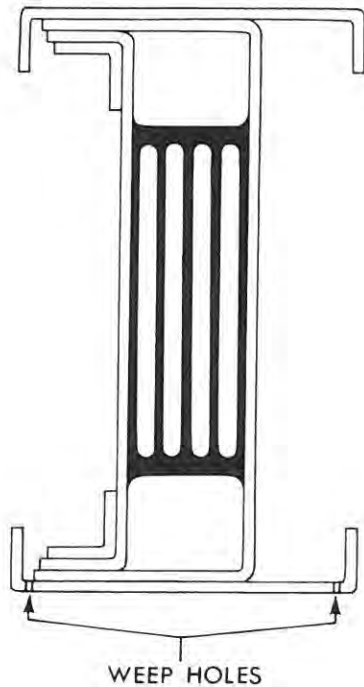

Fig. 13-27. Section through fully insulated feeder busway—cooled by conduction only.

The aluminum phase and neutral bars are solidly encased in laminated insulation, and the assembly housed in an all-aluminum weathertight enclosure, which is held between top and bottom steel channels. Weep holes in bottom channel prevent water accumulation.

Another much-used form of feeder bus provides air ventilation between the vertical bars.

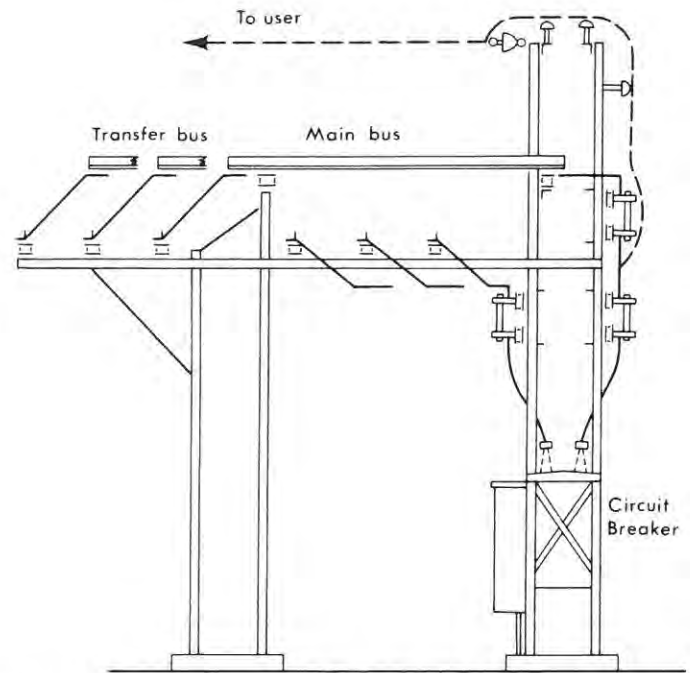

Fig. 13-26. Typical switchyard for 14.4 kV substation. The bus conductors are Types k and m of Fig. 13-3 either single or back-to-back. Types f and g, or other flat-face types are equally suitable.

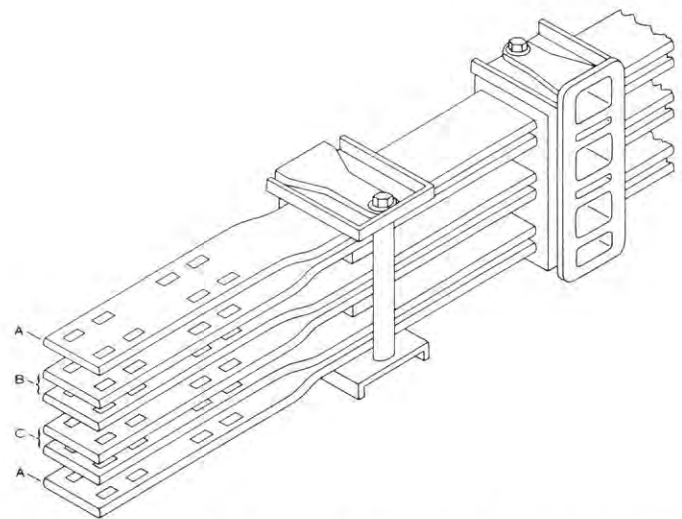

Fig. 13-28. Typical plug-in busway. The molded plastic plug-in blocks open alternately on opposite sides so connection can be made to any pair. The bars are immersion insulated between plug-in blocks and terminals. They are paired to reduce reactance AB BC CA. The arrangement shown is suitable for three-phase delta. By adding a neutral bar three-phase wye loads can be supplied. There are many varieties of plug-in busways for each of which advantages are claimed.

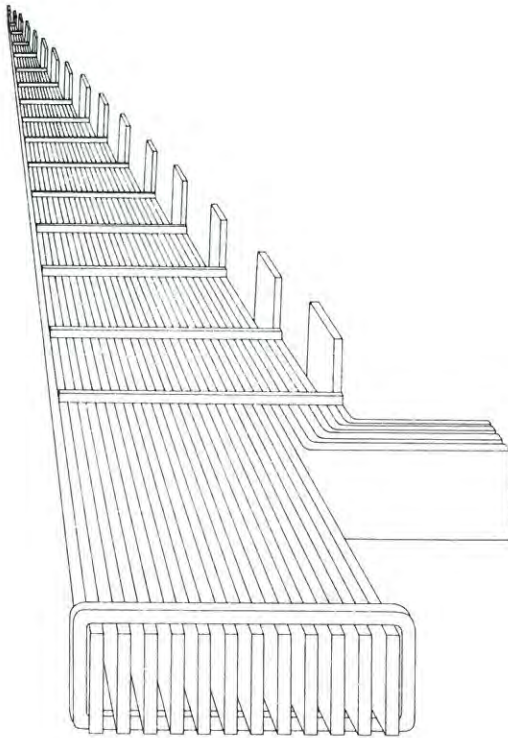

Fig. 13-29. Multi-bar stepped parallel arrangement for large dc bus for electrolytic supply. Aluminum bars are welded as an assembly by means of top and bottom cross members.

devices also may be plugged in or permanently connected. Feeder busways often have bars paired or interlaced to reduce reactance. However, some are purposely designed for high reactance to reduce short-circuit currents.

Busway bars may be arranged flat or on edge; they may be unplated between contact areas but must be suitably plated at bolted joints or at plug-ins. The housings may be ventilated or fully enclosed, and also are available in weather-resistant construction for outdoor runs. Standard operating temperature for plated busways is 55°C rise above 30°C ambient, with 85°C hot-spot temperature. A few designs are shown in Figs. 13-9, -27, and -28, but others having important and valuable features also are available from manufacturers literature.

Industry standards applying to busways are NEC Art. 364, NEMA BU-1 and UL 857.

### Switchgear

Rectangular bar is the most commonly used shape for switchgear bus because this shape is inherently easy to fabricate and lends itself to connector and space re-

quirements of switchgear. Capacity can readily be varied by multiple bar arrangements. Switchgear standards are covered by NEMA No. SG5 and ANSI C37.20.

The major switchgear manufacturers use aluminum bus as a standard conductor material. Some designs use silver or tin plated joints while other designs utilize welded joints. The bus system is phase isolated/insulated to preclude accidental contact with live bus.

### Buses for the Chlor-Alkali Industry (59)

In large chlor-alkali plants, the bus amperages involved are such that the  $I^2R$  losses in the bus system can amount to an appreciable cost. Designers of bus systems for such plants should consider an economic design based on a balance of cost of power losses with bus investment (1). Although the total bus current may be quite large, connection requirements usually require moderate size bars of extruded 1350-H111 or sawed plate, 1350-H112. The type of cell and the plant layout are major factors influencing the bus design. In the stepped-parallel design Fig. 13-29 the individual bars extend far enough to reach the cell group they supply.

### Buses for the Aluminum Industry (60)

Although aluminum smelters vary in type of installation and size, some of the larger installations use from 15 to 22 million pounds of aluminum bus. The buses for these large installations may carry as much as 225,000 amperes. The larger installations use primarily very large thick cast bars of 1350 aluminum and some sawed plate. Sawed plate or extruded bar, mostly 1350 aluminum, are used for connections. Welded joints are used wherever possible.

### Buses for the Magnesium Industry

Buses for the magnesium industry, like the aluminum industry, optimize the conductor cross section on the basis of economics. Aluminum "log" bus (rectangles in the order of 14" x 16") 1350 aluminum appears to be the favorite bus shape (61).

### Buses for Electric Furnaces (9,62)

Buses for electric furnaces present a different problem from buses for electrolytic installations since alternating current is involved and reactance of the bus system must be kept low. Bars are interlaced to obtain low reactance (Fig. 13-9). Aluminum, sawed plate and extruded bar in relatively thin wide sizes are used. Here the change in cross section from copper to larger cross section for aluminum should always be in the width dimension to gain the added benefit of lower reactance.

TABLE 13-25

Aluminum Rectangular Square-Corner Bus Bars Physical and Electrical Properties(1)  
6101-T61 Alloy 57% IACS Min.

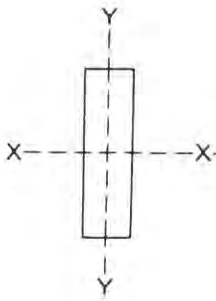

Size in.	Area Sq. in.	Wt lb/ft	(See diagram at left) Moment of inertia in. <sup>4</sup>		Single Bar			
					dc(2) Resis- tance at 20°C mi- crohms per ft	Rac/Rdc at 70°C	ac Resis- tance 60 Hz at 70°C microhms per ft	X <sub>a</sub> Inductive reactance 1 ft spacing microhms per ft
			1 x-x	1 y-y				
1/8 x 1/2	0.0625	0.074	0.00130	0.0000814	228.6	1.00	271.7	102.38
3/4	0.0938	0.110	0.00440	0.0001221	152.4	1.00	181.1	94.65
1	0.1250	0.147	0.01042	0.0001628	114.3	1.00	135.8	88.87
1 1/4	0.1563	0.184	0.02035	0.0002035	91.46	1.00	108.7	84.26
1 1/2	0.1875	0.221	0.03516	0.0002441	76.22	1.00	90.57	80.42
2	0.2500	0.294	0.08333	0.0003255	57.16	1.01	68.60	74.26
3/16 x 1/2	0.0938	0.110	0.00195	0.0002747	152.4	1.00	181.1	100.19
3/4	0.1406	0.165	0.00659	0.0004120	101.6	1.00	120.8	93.06
1	0.1875	0.221	0.01563	0.0005493	76.22	1.00	90.57	87.63
1 1/4	0.2344	0.276	0.03052	0.0006866	60.97	1.01 <	73.18	83.24
1 1/2	0.2813	0.331	0.05273	0.0008240	50.81	1.01 <	60.98	79.55
2	0.3750	0.441	0.1250	0.001099	38.11	1.01 <	45.74	73.59
1/4 x 1/2	0.1250	0.147	0.00260	0.0006510	114.3	1.01 <	137.2	98.19
3/4	0.1875	0.221	0.00879	0.0009766	76.22	1.01 <	91.47	91.58
1	0.2500	0.294	0.02083	0.001302	57.16	1.01 <	68.15	86.45
1 1/4	0.3125	0.368	0.04069	0.001628	45.73	1.01 <	54.88	82.26
1 1/2	0.3750	0.441	0.07031	0.001953	38.11	1.0079	45.64	78.72
2	0.5000	0.588	0.1667	0.002604	28.58	1.0142	34.44	72.94
1/4 x 2 1/2	0.6250	0.735	0.3255	0.003255	22.86	1.03 <	27.98	68.33
3	0.7500	0.882	0.5625	0.003906	19.05	1.031	23.34	64.49
3 1/2	0.8750	1.029	0.8932	0.004557	16.33	1.05 <	20.38	61.20
4	1.0000	1.176	1.133	0.005208	14.29	1.0505	17.84	58.33
5	1.2500	1.470	2.604	0.006510	11.43	1.0713	14.55	53.47
6	1.5000	1.764	4.500	0.007812	9.527	1.0916	12.36	49.86
8	2.0000	2.352	10.7	0.0104	7.145	1.1286	9.58	43.08
3/8 x 1	0.3750	0.441	0.03125	0.004395	38.11	1.01 <	45.74	84.26
1 1/4	0.4688	0.552	0.06104	0.005493	30.49	1.02 <	36.95	80.42
1 1/2	0.5625	0.662	0.1055	0.006592	25.41	1.03 <	31.09	77.13
1 3/4	0.6563	0.772	0.1675	0.007690	21.78	1.04 <	26.91	74.26
2	0.7500	0.882	0.2500	0.008789	19.05	1.04	23.55	71.70
3/8 x 2 1/4	0.8438	0.992	0.3560	0.009888	16.94	1.04	20.93	69.40
2 1/2	0.9375	1.103	0.4883	0.01099	15.24	1.05	19.02	67.31
3	1.1250	1.323	0.8438	0.01318	12.70	1.07	16.15	63.62
4	1.5000	1.764	2.000	0.01758	9.527	1.10	12.45	57.66
5	1.8750	2.205	3.906	0.02197	7.622	1.13	10.23	52.93
6	2.2500	2.646	6.750	0.02637	6.351	1.16	8.755	49.01
8	3.000	3.528	16.00	0.03516	4.763	1.21	6.849	42.74
10	3.750	4.410	31.250	0.04395	3.811	1.24	5.615	37.82
12	4.500	5.292	54.00	0.527	3.176	1.27	4.792	33.76

(Continued)

TABLE 13-25 (Continued)

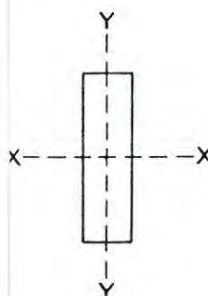

Size in.	Area Sq. in.	Wt lb/ft	(See diagram at left) Moment of inertia in. <sup>4</sup>		Single Bar			
			1 x-x	1 y-y	dc(2) Resis- tance at 20°C mi- crohms per ft	Rac/Rdc at 70°C	ac Resis- tance 60 Hz at 70°C microhms per ft	X <sub>a</sub> Inductive reactance 1 ft spacing microhms per ft
1/2 x 1	0.5000	0.588	0.04167	0.01042	28.58	1.02	34.64	83.26
1/4	0.6250	0.735	0.08138	0.01302	22.86	1.03	27.98	78.72
1/2	0.7500	0.882	0.1406	0.01563	19.05	1.04	23.55	75.65
3/4	0.8750	1.029	0.2233	0.01823	16.33	1.05	20.38	72.94
2	1.0000	1.176	0.3333	0.02083	14.29	1.06	18.00	70.52
1/2 x 2 1/2	1.250	1.470	0.6510	0.02604	11.43	1.08	14.67	66.33
3	1.500	1.764	1.125	0.03125	9.527	1.0951	13.397	62.79
3 1/2	1.750	2.058	1.786	0.03646	8.166	1.120	10.868	59.72
4	2.000	2.352	2.667	0.04167	7.145	1.1402	9.681	57.01
5	2.500	2.940	5.208	0.05208	5.716	1.1782	8.003	52.40
6	3.000	3.528	9.000	0.06250	4.763	1.2097	6.847	48.56
8	4.000	4.704	21.33	0.08333	3.573	1.2587	5.344	42.40
10	5.000	5.880	41.667	0.10410	2.858	1.2951	4.398	37.54
12	6.000	7.056	72.0	0.125	2.382	1.330	3.764	33.53
5/8 x 2 1/2	1.5625	1.838	0.8138	0.05086	9.146	1.11	12.06	65.39
3	1.8750	2.205	1.406	0.06104	7.622	1.13	10.23	61.98
4	2.5000	2.940	3.333	0.08138	5.716	1.18	8.015	56.38
5	3.1250	3.675	6.510	0.1017	4.573	1.24	6.738	51.88
6	3.7500	4.410	11.25	0.1221	3.811	1.28	5.796	48.12
8	5.000	5.880	26.67	0.1628	2.858	1.34	4.551	42.06
10	6.250	7.550	52.083	0.2034	2.286	1.39	3.777	37.27
12	7.500	8.820	90.00	0.2441	1.905	1.44	3.260	33.31
3/4 x 3	2.2500	2.646	1.688	0.1055	6.351	1.17	8.830	61.20
4	3.0000	3.528	4.000	0.1406	4.763	1.22	6.906	55.77
5	3.7500	4.410	7.813	0.1758	3.811	1.28	5.796	51.38
6	4.5000	5.292	13.50	0.2109	3.176	1.34	5.057	47.69
8	6.0000	7.056	32.00	0.2813	2.382	1.40	3.962	41.73
10	7.5000	8.820	62.50	0.3515	1.905	1.46	3.306	37.00
12	9.0000	10.584	108.0	0.422	1.588	1.51	2.849	33.08
1 x 8	8.0000	9.408	42.667	0.6666	1.7863	1-inch bar not used for A-C		
10	10.0000	11.760	83.333	0.8333	1.4290			
12	12.0000	14.112	144.000	1.0000	1.1909			
14	14.0000	16.464	228.667	1.1666	1.0207			
16	16.0000	18.816	341.333	1.3333	0.8932			
18	18.0000	21.168	486.000	1.5000	0.7939			

(Continued)

TABLE 13-25 (Continued)

Size in.	Two Bars				Three Bars				Four Bars			
	dc Resistance at 70°C microhms per ft	Rac/Rdc at 70°C	ac Resistance at 70°C microhms per ft	X <sub>o</sub> Inductive reactance 1 ft spacing microhms per ft	dc Resistance at 70°C microhms per ft	Rac/Rdc at 70°C	ac Resistance at 70°C microhms per ft	X <sub>o</sub> Inductive reactance 1 ft spacing microhms per ft	dc Resistance at 70°C microhms per ft	Rac/Rdc at 70°C	ac Resistance at 70°C microhms per ft	X <sub>o</sub> Inductive reactance 1 ft spacing microhms per ft
1/4 x 1	33.96	1.02	34.64	77.39	22.64	1.04	23.55	71.54	16.98	1.06	18.00	67.02
1 1/2	22.64	1.04	23.55	71.81	15.09	1.07	16.15	67.10	11.32	1.10	12.45	63.31
2	16.98	1.06	18.00	67.36	11.32	1.10	12.45	63.41	8.49	1.15	9.76	60.14
1/4 x 3	11.33	1.089	12.33	59.97	7.55	1.168	8.82	56.77	5.66	1.27	7.19	54.89
4	8.49	1.140	9.68	54.35	5.66	1.247	7.06	51.64	4.25	1.38	5.86	50.63
5	6.79	1.183	8.04	49.76	4.53	1.307	5.92	47.41	3.40	1.45	4.92	47.04
6	5.66	1.22	6.91	45.92	3.77	1.352	5.10	43.84	2.83	1.51	4.27	43.93
8	4.25	1.28	5.43	39.72	2.83	1.414	4.00	38.05	2.12	1.60	3.40	38.76
3/8 x 2	11.32	1.10	12.45	64.21	7.55	1.18	8.91	59.16	5.66	1.28	7.25	55.16
3	7.55	1.18	8.91	58.05	5.03	1.32	6.64	54.09	3.78	1.51	5.70	50.82
4	5.66	1.26	7.13	53.21	3.77	1.43	5.40	49.95	2.83	1.63	4.61	47.19
5	4.53	1.31	5.93	49.22	3.02	1.51	4.56	46.45	2.26	1.72	3.89	44.06
6	3.77	1.36	5.13	45.83	2.52	1.58	3.97	43.42	1.89	1.79	3.38	41.31
8	2.83	1.42	4.02	40.26	1.89	1.68	3.17	38.34	1.42	1.91	2.70	36.64
10	2.26	1.45	3.28	35.79	1.51	1.77	2.67	34.19	1.13	2.00	2.26	32.76
1/2 x 2 1/2	5.66	1.226	6.94	55.06	3.77	1.418	5.35	49.88	2.83	1.72	4.87	47.38
3	4.25	1.326	5.63	50.13	2.83	1.578	4.47	45.67	2.12	1.89	4.01	44.21
4	3.40	1.399	4.75	46.06	2.26	1.690	3.83	42.14	1.70	2.00	3.40	41.43
5	2.83	1.455	4.12	39.66	1.89	1.77	3.34	39.13	1.42	2.08	2.94	38.96
6	2.12	1.536	3.26	37.04	1.42	1.89	2.67	34.16	1.06	2.20	2.33	34.70
8	1.70	1.591	2.70	32.57	1.13	1.96	2.22	30.20	0.849	2.30	1.95	31.11

(1) Structural properties (moment of inertia, etc.) are also suitable for bars having rounded edge within accuracy limits that are regarded as satisfactory for bus-conductor applications.

(2) dc resistance at 20°C is based on minimum conductivity of 57% IACS for 6101-T61 alloys.

Note: See also pages 13-63 to 13-67 for additional information regarding Tables 13-25 through 13-32.



TABLE 13-26

Current Rating of Rectangular Aluminum Bus-Bar Arrangements  
Amperes, for 6101-T61 Alloy 57% IACS Conductivity (see footnotes)

Size (Inches)	1 Bar		2 Bars		3 Bars		4 Bars	
	dc	60 Hz ac	dc	60 Hz ac	dc	60 Hz ac	dc	60 Hz ac
1/4 x 1	308	308	607	601	905	887	1203	1168
1 1/2	430	429	833	817	1235	1194	1637	1561
2	549	545	1051	1021	1552	1480	2053	1915
3	780	768	1472	1410	2162	2000	2851	2530
4	1005	980	1878	1760	2749	2462	3619	3081
5	1225	1184	2275	2092	3321	2905	4365	3625
6	1443	1381	2665	2413	3881	3338	5095	4146
7	1870	1760	3427	3034	4974	4183	6517	5152
3/8 x 2	691	678	1340	1278	1989	1831	2638	2332
3	974	941	1857	1709	2739	2384	3620	2946
4	1249	1191	2356	2099	3460	2893	4563	3574
5	1519	1429	2842	2483	4162	3387	5479	4178
6	1785	1657	3320	2847	4848	3857	6375	4765
8	2308	2098	4253	3569	6188	4774	8119	5875
10	2822	2534	5165	4289	7493	5632	9817	6941
1/2 x 3	1145	1074	2205	1991	3265	2742	4324	3297
4	1462	1369	2782	2416	4100	3264	5417	3940
5	1774	1634	3345	2828	4912	3778	6477	4580
6	2081	1892	3897	3230	5706	4284	7514	5210
8	2685	2393	4975	4014	7255	5276	9531	6246
10	3278	2880	6209	4779	8763	6256	11493	7579

Size (Inches)	1 Bar		2 Bars		3 Bars		4 Bars	
	dc	60 Hz ac	dc	60 Hz ac	dc	60 Hz ac	dc	60 Hz ac
1/4 x 1	300	300	585	580	775	765	905	880
1 1/2	420	415	800	785	1060	1020	1240	1180
2	535	530	1010	980	1340	1280	1560	1460
3	750	735	1380	1310	1850	1700	2180	1940
4	955	930	1720	1600	2300	2050	2740	2330
5	1160	1120	2000	1830	2670	2330	3160	2610
6	1320	1270	2220	2010	2970	2540	3440	2800
8	1620	1520	2640	2320	3410	2840	3900	3080
3/8 x 2	670	660	1230	1170	1620	1490	1920	1700
3	935	905	1680	1550	2250	1960	2730	2220
4	1190	1130	2080	1860	2800	2340	3360	2630
5	1420	1340	2420	2110	3250	2650	3850	2940
6	1630	1520	2710	2330	3680	2940	4280	3200
8	2000	1820	3240	2700	4210	3270	4820	3490
1/2 x 3	1100	1050	1870	1650	2560	2080	3070	2340
4	1390	1300	2290	1960	3150	2470	3800	2750
5	1650	1520	2680	2240	3630	2780	4370	3090
6	1890	1710	3050	2490	4060	3050	4800	3330
8	2310	2050	3640	2900	4790	3490	5510	3720

1. Ratings based on 30°C rise over 40°C ambient in still but unconfined air (e = 0.35), corresponding to usual indoor temperature. For other temperature rise values see Fig. 13-11. Vertical bar ampacity based on work by House and Tuttle. Horizontal bar ampacity from industry sources.
2. Space between bars is assumed equal to bar thickness.
3. For a-c phase spacings less than 18-in. an allowance for proximity effect must be made.
4. Ratings are based on horizontal mounting, in air with no attachments.
5. For dc ratings of other alloys, multiply by:  
For 1350, 1.035; 6101-T6, 0.982; 6101-T63, 0.992; 6101-T64, 1.02; 6101-T65, 0.996.  
For 60 Hz, the use of these multipliers is conservative.

TABLE 13-27

Physical and Electrical Properties of Aluminum Standard Pipe-Size Conductors at Typical Conductivities  
53% IACS for 6063-T6 and 43% for 6061-T6

Nominal Size in.	Outside Diam. of Tube in.	Wall Thickness in.	Area sq. in.	Weight lb/ft	Inductive Reactance 1 ft spacing 60 Hz-Xa microhm/ft	6063-T6			6061-T6				
						dc Resistance at 20°C microhms per ft	60 Hz R <sub>ac</sub> /R <sub>dc</sub> at 70°C	ac Resistance at 70°C microhms/ft	Current Ratings Amp at 60 Hz (1)(2)(3)(4) Outdoor	dc Resistance at 20°C microhms per ft	60 Hz R <sub>ac</sub> /R <sub>dc</sub> at 70°C	ac Resistance at 70°C microhms/ft	Current Ratings Amp at 60 Hz (1)(2)(3)(4) Outdoor
SCHEDULE 40 PIPE													
1/2	0.84	0.109	0.2503	0.294	79.01	61.40	1.00024	72.16	416	75.68	1.00017	86.44	380
3/4	1.05	0.113	0.3326	0.391	73.55	46.20	1.00031	54.31	517	56.95	1.00024	65.05	473
1	1.315	0.133	0.4939	0.581	68.29	31.12	1.00039	36.58	681	38.36	1.00032	43.82	622
1 1/4	1.660	0.140	0.6685	0.786	62.68	22.99	1.0005	27.03	859	28.34	1.00039	32.37	705
1 1/2	1.90	0.145	0.7995	0.940	59.45	19.22	1.00064	22.60	984	23.69	1.00046	27.07	900
2	2.375	0.154	1.075	1.264	54.15	14.30	1.00082	16.82	1234	17.63	1.00055	20.14	1128
2 1/2	2.875	0.203	1.704	2.004	49.85	9.019	1.0022	10.62	1663	11.12	1.0015	12.71	1520
3	3.500	0.216	2.228	2.621	45.19	6.897	1.0030	8.128	2040	8.500	1.0018	9.725	1865
3 1/2	4.000	0.226	2.680	3.151	42.04	5.736	1.0038	6.765	2347	7.070	1.0022	8.091	2145
4	4.500	0.237	3.174	3.733	39.28	4.842	1.0047	5.717	2664	5.968	1.0027	6.834	2436
4 1/2	5.001	0.247	3.689	4.338	36.80	4.166	1.0057	4.923	2984	5.135	1.0033	5.884	2728
5	5.563	0.258	4.300	5.057	34.31	3.574	1.0068	4.229	3348	4.406	1.0040	5.051	3063
6	6.625	0.280	5.581	6.564	30.23	2.754	1.0095	3.266	4064	3.394	1.0054	3.897	3719
SCHEDULE 80 PIPE													
1/2	0.84	0.147	0.3200	0.376	79.68	48.02	1.00053	56.46	470	59.19	1.00038	67.62	429
3/4	1.05	0.154	0.4335	0.510	74.14	35.45	1.00074	41.69	590	43.70	1.00053	49.93	539
1	1.315	0.179	0.6338	0.751	68.81	24.06	1.0010	28.30	774	29.65	1.00075	33.89	707
1 1/4	1.660	0.191	0.8815	1.037	63.14	17.44	1.0014	20.52	985	21.49	1.00105	24.57	901
1 1/2	1.900	0.200	1.068	1.256	59.89	14.39	1.0020	16.94	1137	17.73	1.0015	20.28	1039
2	2.375	0.218	1.477	1.737	54.56	10.40	1.0028	12.26	1446	12.82	1.0021	14.68	1322
2 1/2	2.875	0.276	2.254	2.650	50.23	6.820	1.0072	8.072	1907	8.406	1.0039	9.637	1746
3	3.500	0.300	3.016	3.547	45.55	5.096	1.0103	6.050	2363	6.281	1.0049	7.208	2166
3 1/2	4.000	0.318	3.678	4.326	42.39	4.178	1.0138	4.977	2735	5.150	1.0075	5.925	2507
4	4.500	0.337	4.407	5.183	39.61	3.487	1.0171	4.168	3118	4.298	1.0095	4.955	2862
4 1/2	5.000	0.355	5.180	6.092	37.13	2.967	1.0210	3.559	3505	3.657	1.0116	4.236	3221
5	5.563	0.375	6.112	7.188	34.63	2.515	1.0260	3.032	3949	3.099	1.0165	3.598	3631
6	6.625	0.432	8.405	9.884	30.58	1.829	1.0457	2.247	4891	2.254	1.0212	2.629	4532

(1) Current ratings listed in the Tables are based on 30°C temperature rise over 40°C ambient horizontally mounted conductors, with spacing sufficient to eliminate proximity effects, generally assumed not to be significant if spacing is 18-in. or over. Conduction of heat by supporting structures and taps can appreciably affect the ratings.

(2) Conductors outdoors with a 2-ft/sec crosswind. Nominal oxidized surface (e = 0.50).

(3) Current ratings for direct current are close to those of alternating currents for all except the larger sizes; and for them the increase for dc bus is about 1.5 percent.

(4) NEMA Standard SG1-3.02 (7/13/60) lists current ratings for tubes of 57%-61% IACS conductivity, but without stated emissivity factors. However, even after adjustment for the 53% IACS conductivity of 6063-T6 alloy (and 43% for 6081-T6 alloy), the ratings differ somewhat from those of this Table.

TABLE 13-28

Physical and Electrical Properties of Large-Diameter Round-Tube Bus Conductors 6101-T61 Aluminum Alloy 57% IACS Conductivity (Minimum)(1)

Out-side diam. in.	Wall thick-ness in.	Area sq. in.	Weight lb/ft	Moment of Inertia 1 in. <sup>4</sup>	Inductive Reactance 1 ft spacing 60 Hz—X <sub>a</sub> microhms/ft	dc Resistance at 20°C microhms/ft	R <sub>ac</sub> /R <sub>dc</sub> at 70°C	ac Resistance at 70°C 60 Hz microhms/ft	Current Rating 60 Hz Amp	
									Indoor	Outdoor
6	0.312	5.58	6.56	22.62	32.6	2.563	1.014	3.088	3195	4020
	0.375	6.63	7.79	26.33	32.8	2.156	1.030	2.639	3465	4360
	0.500	8.64	10.16	39.94	33.1	1.654	1.089	2.140	3845	4840
	0.625	10.55	12.41	38.63	33.4	1.354	1.200	1.931	4070	5125
7	0.250	5.30	6.23	30.23	28.9	2.696	1.006	3.222	3360	4190
	0.375	7.80	9.18	43.0	29.2	1.831	1.030	2.241	4015	5010
	0.500	10.21	12.01	54.2	29.5	1.400	1.090	1.813	4465	5575
	0.625	12.52	14.72	64.2	29.7	1.142	1.203	1.632	4635	5785
8	0.250	6.09	7.16	45.75	25.8	2.348	1.006	2.807	3805	4720
	0.375	8.98	10.56	65.44	26.0	1.591	1.030	1.947	4555	5645
	0.500	11.78	13.85	83.20	26.2	1.213	1.091	1.573	5045	6250
	0.625	14.48	17.03	99.2	26.5	0.987	1.206	1.414	5190	6435
9	0.250	6.87	8.08	65.8	23.2	2.079	1.006	2.486	4255	5245
	0.375	10.16	11.95	94.7	23.3	1.406	1.030	1.721	5100	6285
	0.500	13.35	15.70	121.0	23.4	1.070	1.092	1.389	5650	6965
	0.625	16.44	19.34	145.0	23.6	0.869	1.208	1.247	5980	7370
10	0.312	9.50	11.17	111.5	20.6	1.505	1.015	1.815	5185	6355
	0.375	11.34	13.33	131.5	20.7	1.260	1.031	1.544	5635	6910
	0.500	14.92	17.55	168.8	20.9	0.958	1.092	1.243	6255	7670
	0.625	18.41	21.65	203.1	21.0	0.776	1.210	1.116	6640	8140
12	0.312	11.46	13.47	195.8	16.3	1.247	1.015	1.504	6155	7480
	0.375	13.70	16.11	231.6	16.4	1.043	1.031	1.278	6685	8125
	0.500	18.06	21.24	299.2	16.6	0.791	1.093	1.027	7415	9015
	0.625	22.33	26.27	362.3	16.7	0.640	1.213	0.9222	7850	9545
14	0.500	21.21	24.94	483.8	12.7	0.674	1.094	0.8761	8570	10345
	0.677	28.34	33.32	630.3	12.9	0.504	1.284	0.7695	9160	11059
	0.750	31.22	36.71	687.3	13.0	0.458	1.399	0.7610	9425	11380

1. Current ratings are on same basis as per Notes 1, 2, and 3 of Table 13-27.

TABLE 13-29

**Physical and Electrical Properties of Square Aluminum Tubular Conductors 6101-T61 Alloy  
57% IACS Conductivity (minimum)**

Tabulated values apply to unventilated tubes. Ventilated tubes have about 8 percent less weight. Add 15 percent to current ratings of ventilated tubes having staggered ventilating holes spaced 4-in. apart longitudinally with hole diameters as follows: For 3-in. tube, 1¼ in.; for 4-in. tube, 1½ in.; for 5-in. tube, 1⅝ in.; for 6-in tube, 1¾ in.

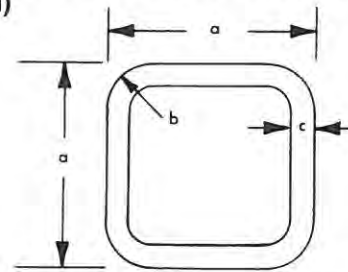

Inches (a) Square Size (b) Outside Corner Radius (c) Web Thickness			Area sq. in.	Weight lb/ft	Moment of Inertia 1 in. <sup>4</sup>	Inductive Reactance 1 ft spacing 60 Hz—X <sub>a</sub> microhms/ft	For 6101-T61				
							dc Resistance at 20°C microhms/ft	R <sub>ac</sub> /R <sub>dc</sub> at 70°C 60 Hz	ac Resistance of 70°C 60 Hz microhms/ft	ac Current Ratings 60 Hz Amp (1) (2)	
(a)	(b)	(c)							e = 0.35	e = 0.90	
3	⅜	¼	2.643	3.108	3.272	45.5	5.407	1.04	6.683	1880	2300
3	½	⅜	3.736	4.394	4.215	46.1	3.825	1.09	4.954	2170	2640
3	¾	½	4.571	5.375	4.598	46.9	3.126	1.18	4.384	2250	2760
4	½	¼	3.589	4.221	8.215	38.7	3.982	1.05	4.968	2450	3020
4	½	⅜	5.236	6.158	11.30	39.0	2.729	1.11	3.600	2880	3550
4	¾	½	6.571	7.727	13.06	39.6	2.175	1.21	3.127	3040	3760
5	¾	¼	4.482	5.271	16.26	33.5	3.189	1.06	4.016	2980	3700
5	¾	⅜	6.575	7.733	22.76	33.8	2.173	1.13	2.918	3490	4340
5	¾	½	8.571	10.08	28.32	34.1	1.667	1.24	2.457	3810	4730
6	¾	¼	5.482	6.447	29.36	29.1	2.607	1.08	3.346	3540	4420
6	¾	⅜	8.075	9.497	41.59	29.4	1.770	1.15	2.418	4170	5200
6	¾	½	10.57	12.43	52.35	29.6	1.352	1.28	2.056	4570	5640

1. Current ratings are based on 30°C rise over 40°C ambient, conductors horizontally mounted and spaced sufficiently to eliminate proximity effects. For temperature rise of 50°C above 40°C ambient, increase ratings by about 30 percent. (See Fig. 13-11). The e = 0.35 rating applies to tubes in still but unconfined air (usual indoor condition) with normal oxidized surface. The e = 0.90 rating applies similarly but with surface painted with flat nonmetallic paint.

TABLE 13-30

Properties of Uniform Thickness Aluminum Channel Bus Conductors

Physical properties are for single channels; electrical properties are for two channels in face-to-face arrangement. 6101-T61 alloy 57.0% IACS Conductivity (minimum)

Outside Corner Radius – in.

Web Thickness	Corner Radius
0.25 in.	3/8 in.
0.375	1/2
0.500	5/8
0.625	3/4

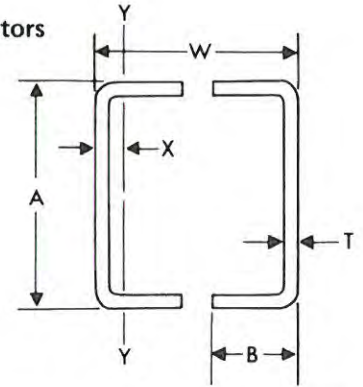

Dimensions in. see sketch				Single Channel					Face-to-Face Pair					
				Area Sq. in.	Wt. lb/ft	Moment of Inertia in <sup>4</sup>		Distance to Neutral X in.	Inductive Reactance 1 ft spacing 60 Hz—X <sub>s</sub> microhms/ft	dc Resistance at 20°C microhms/ft	R <sub>ac</sub> /R <sub>dc</sub> at 70°C 60 Hz	ac Resistance at 70°C 60 Hz microhms/ft	ac Current Ratings 60 Hz Amp	
A	B	T	W			lx-x	ly-y						e = 0.35	e = 0.50
3	1.312	0.25	3.933	1.23	1.44	1.49	0.18	0.397	46.2	5.82	1.04	7.19	2300	2760
4	1.75	0.25	4.188	1.70	1.99	3.79	0.46	0.500	39.2	4.21	1.04	5.21	2910	3500
4	1.75	0.625	4.375	3.67	4.30	6.72	0.74	0.627	40.2	1.946	1.32	3.05	3660	4400
5	2.187	0.625	5.	4.84	5.68	13.5	1.60	0.750	33.8	1.475	1.36	2.38	4760	5700
6	2.687	0.437	6.	4.46	5.23	21.3	2.83	0.794	29.7	1.602	1.13	2.15	5800	6950
7	3.187	0.375	7.	4.63	5.43	33.7	4.33	0.893	24.8	1.542	1.16	2.13	6140	7350
7	3.187	0.562	7.	6.69	7.87	44.4	6.15	0.935	25.2	1.068	1.35	1.71	6790	8150
7	3.187	0.625	7.	7.34	8.61	47.7	6.72	0.989	25.4	0.973	1.44	1.66	6820	8450
8	3.687	0.375	8.	5.38	6.31	49.9	6.91	1.02	22.0	1.327	1.21	1.41	6240	7500
8	3.687	0.500	8.	7.03	8.33	63.4	8.64	1.07	22.1	1.017	1.29	1.56	6560	7900
8	3.687	0.625	8.	8.59	10.07	74.9	11.1	1.10	22.4	0.832	1.37	1.35	7900	9400
9	4.125	0.625	9.	9.77	11.44	109.2	14.9	1.21	19.1	0.732	1.47	1.28	8610	10500
11	5.312	0.250	11.	5.23	6.13	91.8	14.4	1.40	14.3	1.367	1.11	1.80	8100	9750
11	5.312	0.312	11.	6.49	7.60	119.8	17.7	1.42	14.4	1.102	1.18	1.54	8940	10800
11	5.312	0.562	11.	11.32	13.27	198.2	29.8	1.51	14.7	0.631	1.44	1.08	10400	12400
12	5.812	0.25	12.	5.73	6.71	128.5	19.0	1.53	12.1	1.248	1.15	1.70	8980	10800
12	5.812	0.315	12.	7.11	8.40	186.0	27.5	1.57	12.4	0.997	1.35	1.60	10500	12100
12	5.812	0.625	12.	13.75	16.11	288.5	45.3	1.67	12.7	0.520	1.53	1.945	11550	13700

1. Ratings are based on 30°C rise over 40°C ambient temperature in still but unconfined air for usual indoor conditions (e = 0.35), and for 2 ft/sec cross wind for usual outdoor conditions (e = 0.50).
2. For temperature rise of 50°C above 40°C ambient, an increase of about 30 percent of current rating indoors is generally in accordance with tests. (See Fig. 13-11.)

TABLE 13-31

Properties of Uniform Thickness Angle Bus Conductors  
6101-T6 Alloy 55.0% IACS Conductivity (minimum)(4)

Size See Sketch		Area Sq. in.	Wt lb/ft	(2) Moment of inertia in. <sup>4</sup>		Minimum Distance to Neutral Axis		Inductive Reactance 1 ft spacing 60 Hz— $X_L$ microhms/ft	dc Resistance at 70°C microhms/ft	$R_{ac}/R_{dc}$ at 70°C 60 Hz	ac Resistance at 70°C microhms/ft	ac (1) Current Ratings Amp—60 Hz	
W in.	T in.			$I_x$ or y	$I_z$	x or y	z					Indoor e = 0.35	Outdoor e = 0.50
3¼	¼	1.56	1.83	1.60	0.65	0.91	1.28	51.41	11.23	1.024	11.50	1300	1902
4	¼	1.93	2.27	3.04	1.22	1.09	1.55	46.60	9.06	1.045	9.46	1550	2236
4	¾	2.85	3.36	4.36	1.77	1.14	1.61	46.62	6.13	1.115	6.84	1850	2654
4½	¾	3.23	3.80	6.30	2.55	1.26	1.79	43.93	5.42	1.145	6.20	2050	2885
5	¾	3.60	4.24	8.74	3.54	1.39	1.96	41.52	4.86	1.175	5.70	2250	3130

1. Indoor current ratings are based on 30°C rise over 40°C ambient in still but unconfined air, normally oxidized surface (e = 0.35). Outdoor ratings are based similarly, but with 2 ft/sec crosswind (e = 0.50). Horizontal mounting is assumed with spacing sufficient to eliminate proximity effects, generally assumed to be 18-in. or over. Indoor ratings based on work by House and Tuttle. Outdoor ratings from IEEE paper by Prager, Pemberton, Craig, Bleshman (22).
2. Back-to-back angles are to be considered as separate members; not as a composite.
3. Alignment grooves are extruded to facilitate centering of holes according to NEMA standard spacings.
4. A modification of this design (see Fig. 13-5k) has a lug at top that does not interfere with bolting, yet it strengthens the shape against tendency to roll-over to the z-z axis in long spans subjected to large lateral short circuit forces. For equal weight of shape, the z-z radius of gyration is increased 20 percent. The stress that causes roll-over is thereby increased about 40 percent.
5. See page 13-66 for additional information regarding this table.

Angle	Notching Dimensions			
	A	B	C	D
3¼ x ¼	1.50	1.75	—	2.375
4 x ¼	1.875	1.75	2.00	2.813
4 x ¾	1.875	1.75	2.00	2.813
4½ x ¾	2.187	1.75	2.00	3.006
5 x ¾	2.313	1.75	2.00	3.256

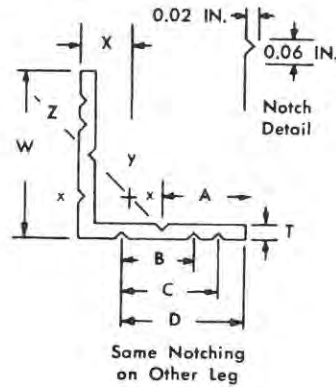

**TABLE 13-32**  
**Properties of Integral-Web Channel Bus Conductors**  
**6101-T61 Alloy (IACS 58% typical)**

Size (See Sketch)	Wall Thickness		Area sq. in.	Wt lb/ft	Moment of Inertia, in. <sup>4</sup>		dc Resistance $R_{dc}$ -70°C microhms per ft	Current Rating dc 70°C $e = 0.35$ Indoors	Inductive Reactance 1 ft spacing 60 Hz— $X_s$ microhms per ft	$R_{ac}/R_{dc}$ 70°C 60 Hz	ac 60 Hz Resistance $R_{ac}$ -70°C microhms per ft		Current Rating ac—60 Hz	
	A in.	B in.			$I_{xx}$	$I_{yy}$					Indoor $e = 0.35$	Outdoor $e = 0.50$		
4	4	0.156	2.439	2.87	3.876	6.213	6.88	2260	39.02	1.020	7.000	2240	2520	
4	4	0.250	3.781	4.45	5.788	9.216	4.42	2810	39.76	1.035	4.581	2276	3115	
4	4	0.312	4.46	5.25	6.892	10.94	3.75	3050	40.8	1.05	3.94	2980	3360	
6	4	0.250	4.78	5.62	16.35	12.74	3.50	3480	34.8	1.050	3.68	3400	3780	
6	4	0.375	6.02	7.08	14.5	14.0	2.78	3900	36.6	1.08	3.00	3760	4180	
6	4	0.375	6.95	8.17	22.91	17.45	2.41	4200	—	1.09	2.62	4020	4470	
6	5	0.375	7.60	8.94	25.19	29.78	2.20	4500	32.5	1.11	2.44	4320	4800	
6	6	0.375	8.60	10.15	29.73	45.98	1.95	5020	27.6	1.11	2.16	4760	5270	
6	6	0.550	11.22	13.19	40.05	60.86	1.49	5730	31.4	1.22	1.82	5190	5740	
7	7	0.500	12.84	15.10	64.83	95.87	1.30	6530	27.6	1.21	1.58	5940	6540	
8	5	0.375	9.08	10.68	52.88	37.59	1.84	5350	29.1	1.12	2.064	5060	5560	
8	5	0.500	11.75	13.82	66.84	46.67	1.42	6090	30.0	1.28	1.82	5380	5910	
8	8	0.500	16.12	18.96	103.5	152.3	1.04	7740	24.7	1.26	1.31	6890	7550	
9	9	0.625	20.04	23.57	162.3	240.1	0.84	9060	21.6	1.37	1.14	7740	8450	
10	10	0.625	23.50	27.64	255.6	362.4	0.71	10260	19.1	1.42	1.01	8610	9350	
11	11	0.625	26.16	30.76	281.7	451.8	0.64	11260	16.9	1.43	0.91	9390	10170	
12	12	0.625	32.28	37.96	312.0	653.0	0.52	12980	15.8	1.53	0.79	10490	11330	

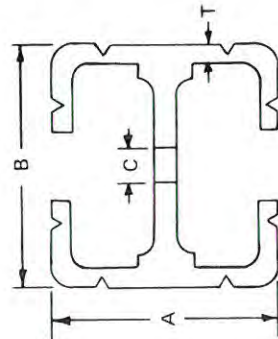

See also page 13-67 for additional information regarding this table.  
 For standard vent diameter and spacing, and notch-groove arrangements, consult suppliers.

1. Current ratings are based on 6101-T61 alloy with standard vent-holes in web. For 6101-T6 reduce rating by 2 percent. Indoor ratings are based on 30°C rise over 40°C ambient in still but unconfined air, normally oxidized surface ( $e=0.35$ ) and similarly for outdoor ratings, except 2 ft/sec cross wind ( $e=0.50$ ). Horizontal mounting is assumed with spacing sufficient to eliminate proximity effects, generally assumed to be 18-in. or over. For temperature rise of 50°C above 40°C ambient, the indoor ratings for 30°C rise may be increased about 30 percent. (See Fig. 13-11.)

Indoor ratings (dc and ac) calculated by computer and verified by tests, rounded. Outdoor ratings are calculations only. More test work is needed for outdoor.  
 2. The sketch only approximates a typical outline. For vent and notch arrangements consult supplier. The interior perimeter varies according to the washer diameters that are to be accommodated, and as to their location per NEMA spacing. The 12 in. x 12 in. size is a composite of two symmetric extrusions bolted together.

## APPENDIX 13A

### Notes To Tables 13-25 Through 13-32

#### General

1. Aluminum weights are computed on basis of 0.098 lb. per cu. in.
2. Elements of sections for rectangles, tubes and equal angles calculated from following relationships.

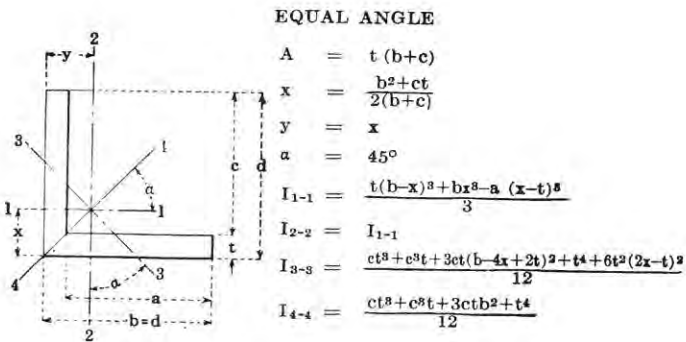
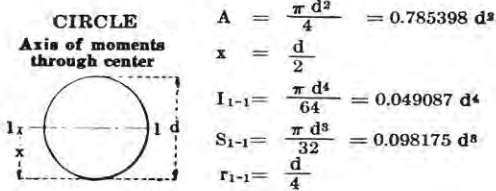
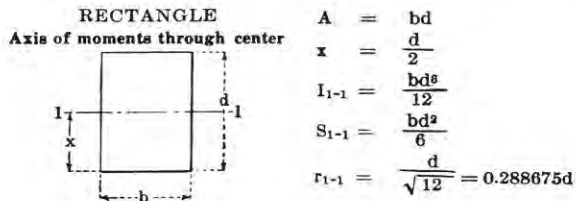

Fig. 13A-1.

Source: Carnegie Steel Company, Pocket Companion, 1920.

#### Table 13-25

##### Aluminum Rectangular Square Corner Bus Bars

1. Direct current (dc) ampacity values calculated from House-Tuttle formulas for vertical arrangements
2.  $R_{dc}$  at 70°C is listed for 2, 3 and 4 bars as a convenience for d-c applications.
3.  $R_{ac}/R_{dc}$  and  $x_a$  values from Mak and Lewis paper (5) for some sizes,  $X_a$  for other sizes from tables by W.A. Lewis for Alcoa. Other  $R_{ac}/R_{dc}$  values from Dwight's Charts (4).

#### Table 13-26

##### Current Rating of Rectangular Aluminum Bus Bar Arrangements

1. Direct current (dc) ampacity values calculated from House-Tuttle formulas for vertical arrangements
2. Example (Refer to Ampacity discussion)  
4-1/4 in. x 4 in. 6101-T61 bars, vertical arrangement with 1/4 in. spacing

$$e = 0.35, T_a = 40^\circ\text{C}, T_c = 70^\circ\text{C}, R_{dc} \text{ at } 70^\circ\text{C} = 4.245 \times 10^{-6} \text{ ohms}$$

$$W_c = 0.0275 P_c \left( \frac{t_c - t_a}{L} \right)^{0.25} (t_c - t_a)$$

$$\text{where } P_c = 4 \times 8.5 = 34 \text{ in.}$$

$$L = 4 \text{ in.}$$

$$= 0.0275 \times 34 \left( \frac{30}{4} \right)^{0.25} \quad (30)$$

$$= 46.419 \text{ watt/ft.}$$



bus conductors

$$W_{r_m} = 0.0439 P_{r_m} \cdot e \left[ \left( \frac{K_c}{100} \right)^4 - \left( \frac{K_a}{100} \right)^4 \right]$$

where  $P_{r_m} = 10$  in.

$$e = .35 \text{ bars}$$

$$= .95 \text{ openings}$$

$$= 0.0439 \times 10 \times .35 \left[ \left( \frac{343}{100} \right)^4 - \left( \frac{313}{100} \right)^4 \right]$$

$$= 6.520 \text{ watt/ft. for metal surfaces}$$

$$W_{r_i} = 0.0439 P_{r_i} \cdot e \left[ \left( \frac{K_c}{100} \right)^4 - \left( \frac{K_a}{100} \right)^4 \right]$$

where  $P_{r_i} = 2 \times 3 \times .25 = 1.5$  in.

$$= 0.0439 \times 1.5 \times .95 (42.33) = 2.655 \text{ watt/ft. for open bar spacing}$$

$$W = 46.419 + 6.520 + 2.655 = 55.594$$

$$I = \left( \frac{\Sigma W}{R_{dc} \text{ at } 70^\circ\text{C}} \right)^{1/2} = \left( \frac{55.594}{4.245 \times 10^{-6}} \right)^{1/2}$$

$$= 3,619 \text{ amperes}$$

**Table 13-27**

*Physical and Electrical Properties of Aluminum Standard Pipe Size Conductors at Typical Conductivities*

1. Ampacity values calculated from House-Tuttle formulas
2. Example (Refer to Ampacity discussion):  
4 in. Schd. 40 6063-T6 Pipe Conductor Outdoor Services,  $e = 0.5$ , wind 2 ft/sec., no sun.

$$W_c = 0.1695 \left( \frac{D_{pf} V}{\mu f} \right)^{0.6} K_f (t_c - t_a)$$

whole  $D = 4.5$  in.

$$pf = .0672 \text{ (from Table 13A-1)}$$

$$V = 2 \times 3600 \text{ (for 2 ft/sec wind)}$$

$$\mu f = .0478 \text{ (from Table 13A-1)}$$

$$K_f = .00864 \text{ (from Table 13A-1)}$$

$$t_c = 70^\circ\text{C}$$

$$t_a = 40^\circ\text{C}$$

$$W_c = 0.1695 \left( \frac{4.5 \times .0672 \times 7200}{0.0478} \right)^{0.6} \times .00864 (70-40)$$

$$= (4.5)^{0.6} 11.1165$$

$$= 27.409 \text{ watts/ft.}$$

$$W_r = 0.138 D e \left[ \left( \frac{K_c}{100} \right)^4 - \left( \frac{K_a}{100} \right)^4 \right]$$

where  $D = 4.5''$

$$e = 0.5$$

values of  $K$  from Table 13A-1.

$$W_r = 0.138 \times 4.5 \times 0.5 [138.41 - 95.98]$$

$$= 13.1745$$

$$\Sigma W = 27.409 + 13.1745 = 40.5835$$

$$I_{ac} = \left( \frac{\Sigma W}{R_{ac} \text{ at } 70^\circ\text{C}} \right)^{0.5}$$

$$= \left( \frac{40.5835}{5.717 \times 10^{-6}} \right)^{0.5}$$

$$= 2,664 \text{ amperes}$$

TABLE 13A-1

Viscosity, Density at Sea Level to 15,000 Ft, and Thermal Conductivity of Air

Temperature			$\left(\frac{K}{100}\right)^4$	Absolute Viscosity, $\mu_f$	Density, $\rho_f$				Thermal Conductivity $k_f$
F*	C	K			Sea Level	5,000 ft	10,000 ft	15,000 ft	
32	0	273	55.55	0.0415	0.0807	0.0671	0.0554	0.0455	0.00739
41	5	278	59.73	0.0421	0.0793	0.0660	0.0545	0.0447	0.00750
50	10	283	64.14	0.0427	0.0779	0.0648	0.0535	0.0439	0.00762
59	15	288	68.80	0.0433	0.0765	0.0636	0.0526	0.0431	0.00773
68	20	293	73.70	0.0439	0.0752	0.0626	0.0517	0.0424	0.00784
77	25	298	78.86	0.0444	0.0740	0.0616	0.0508	0.0417	0.00795
86	30	303	84.29	0.0450	0.0728	0.0606	0.0500	0.0411	0.00807
95	35	308	89.99	0.0456	0.0716	0.0596	0.0492	0.0404	0.00818
104	40	313	95.98	0.0461	0.0704	0.0586	0.0484	0.0397	0.00830
113	45	318	102.26	0.0467	0.0693	0.0577	0.0476	0.0391	0.00841
122	50	323	108.85	0.0473	0.0683	0.0568	0.0469	0.0385	0.00852
131	55	328	115.74	0.0478	0.0672	0.0559	0.0462	0.0379	0.00864
140	60	333	122.96	0.0484	0.0661	0.0550	0.0454	0.0373	0.00875
149	65	338	130.52	0.0489	0.0652	0.0542	0.0448	0.0367	0.00886
158	70	343	138.41	0.0494	0.0643	0.0535	0.0442	0.0363	0.00898
167	75	348	146.66	0.0500	0.0634	0.0527	0.0436	0.0358	0.00909
176	80	353	155.27	0.0505	0.0627	0.0522	0.0431	0.0354	0.00921
185	85	358	164.26	0.0510	0.0616	0.0513	0.0423	0.0347	0.00932
194	90	363	173.63	0.0515	0.0608	0.0506	0.0418	0.0343	0.00943
203	95	368	183.40	0.0521	0.0599	0.0498	0.0412	0.0338	0.00952
212	100	373	193.57	0.0526	0.0591	0.0492	0.0406	0.0333	0.00966

\*Degrees Fahrenheit.

$\mu_f$  = absolute viscosity, lb/(hr)(ft).

$\rho_f$  = density, lb of air/ft<sup>3</sup>.

$k_f$  = thermal conductivity of air, watts/(sq ft)(C) at  $t_f = (t_c + t_a)/2$ .

$t_a$  = ambient temperature C.

$t_c$  = conductor temperature C.

Source: "Current Carrying Capacity of ACSR," H.E. House-P.D. Tuttle, AIEE Transactions, Paper 58-41, 1958.

bus conductors

**Table 13-28**

*Physical and Electrical Properties of Large Diameter Round-Tube Bus Conductors, 6101-T61*

1. Ampacity values calculated from House-Tuttle formulas.
2. Example (Refer to Ampacity discussion)  
8 in. O.D. by 0.500 in. wall, 6101-T61 indoor service,  $e = .35$

$$W_c = 0.072 \times D^{0.75} \times (t_c - t_a)^{1.25}$$

where  $D = 8$  in.,  $t_c = 70^\circ\text{C}$ ,  $t_a = 40^\circ\text{C}$

$$W_c = 0.072 \times (8)^{0.75} \times (70 - 40)^{1.25} = 24.046$$

$$W_r = 0.138 \times D \times e \left[ \left( \frac{K_c}{100} \right)^4 - \left( \frac{K_a}{100} \right)^4 \right]$$

where  $D = 8$  in.,  $K_c = 343^\circ\text{K}$ ,  $K_a = 313^\circ\text{K}$ ,  $e = 0.35$

$$W_r = 0.138 \times 8 \times .35 [138.41 - 95.98] = 16.395$$

$$I = \left( \frac{\Sigma W}{R_{ac} \text{ at } 70^\circ\text{C}} \right)^{1/2}$$

$R_{ac} \text{ } 70^\circ\text{C}$  from table =  $1.59 \times 10^{-6}$

$$I = \left( \frac{40.441}{1.59 \times 10^{-6}} \right)^{1/2} = 5,043 \text{ amperes}$$

**Table 13-31**

1.  $X_a$  values from work by W.A. Lewis for Alcoa.
2. Outdoor ampacity from IEEE paper by Prager, Pemberton, Craig, Bleshman (22)
3. Indoor ampacity based on formulas developed by House-Tuttle and verified by extensive tests.

Example:

3-1/4 in. x 3-1/4 in. x 1/4 in. UABC, 6101-T6

Indoor service,  $e = .35$ ,  $R_{ac} \text{ at } 70^\circ\text{C} = 11.47$

$$W_c = 0.027 P_c \left( \frac{\Delta t}{L} \right)^{0.25} (t_c - t_a)$$

$$P_c = LH_1 + LV_1 + LV_2 = 6.75 \text{ in.}$$

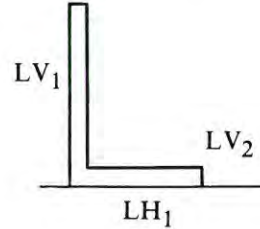

$$\frac{1}{L} = \frac{1}{LV_1 + LV_2} + \frac{1}{LH_1 + LH_2} = 1.685$$

$$\Delta t = 30$$

$$t_c = 70^\circ\text{C}$$

$$t_a = 40^\circ\text{C}$$

$$W_c = 0.027 \times 6.75 \left( \frac{30}{1.685} \right)^{0.25} \times (70 - 40) = 11.23 \text{ watts/ft.}$$

$$W_r = 0.0439 P_r e \left[ \left( \frac{K_c}{100} \right)^4 - \left( \frac{K_a}{100} \right)^4 \right]$$

$P_r =$  total exposed perimeter (13 in.)

$$W_r = 0.0439 \times 13 \times .35 (138.41 - 95.98) = 8.48 \text{ watts/ft.}$$

$$\Sigma W = 11.23 + 8.48 = 19.71$$

$$I = \left( \frac{\Sigma W}{R_{ac} \text{ at } 70^\circ\text{C}} \right)^{1/2} = \left( \frac{19.71}{11.47 \times 10^{-6}} \right)^{1/2}$$

$$= 1,311 \text{ rounded to } 1,300$$

**Table 13-32**

*Properties of Integral - Web Channel Bus Conductors*

1.  $X_a$  values from work by W.A. Lewis for Alcoa
2. Ampacity based on formulas developed by House-Tuttle. Indoor values based on tests data. Typical conductivity used because of better correlation with test points. Test work needed for outdoor values since it is not known how wind would affect this shape. However, it appears from theoretical studies that the results may have an accuracy of  $\pm 10\%$ .

Example:

6 in. x 6 in. x .0550 in., ventilated, 30°C rise over 40°C

Radiated Heat

$$W_r = 0.0439 P_r e \left[ \left( \frac{K_c}{100} \right)^4 - \left( \frac{K_a}{100} \right)^4 \right]$$

where:  $P_r$  = exposed perimeter in inches

$$= (2 \times \text{heights} + 2 \times \text{width})$$

$e$  = emissivity

Test showed value of 0.47, combination of surface and slots for new bus.

0.35 is conservative.

$$W_r = 0.0439 \times 24 \times .35 \left[ \left( \frac{343}{100} \right)^4 - \left( \frac{313}{100} \right)^4 \right]$$

$$= 15.65 \text{ watts/ft.}$$

Convection Loss (Free Air)

$$W_c = 0.026 P_c \left( \frac{\Delta t}{L} \right)^{0.25} (t_c - t_a)$$

$$\Delta t = t_c - t_a \text{ in degrees C} = 70 - 40 = 30$$

$$\frac{1}{L} = \frac{1}{\text{height}} + \frac{1}{\text{width}}$$

$$L = \frac{H \times W}{H + W} = \frac{36}{12} = 3.00$$

$$W_c = 0.026 \times 24 \left( \frac{30}{3.00} \right)^{0.25} \times (30)$$

where  $P_c$  = nominal perimeter-inches

$$= 33.29 \text{ watts/ft.}$$

$$I = \left( \frac{\Sigma W}{R_{ac} \text{ at } 70^\circ\text{C}} \right)^{1/2}$$

where  $R_{ac}$  at 70°C = 1.82, typical

$$I = \left( \frac{15.65 + 33.29}{1.82 \times 10^{-6}} \right)^{1/2}$$

$$= 5,186 \text{ rounded to } 5,190 \text{ amperes}$$

## APPENDIX 13B

### Bibliography

#### General

Alcan Aluminum Bus Conductors, Design Manual - Aluminum Company of Canada, Ltd.

Alcoa Aluminum Bus Conductor Handbook -Aluminum Company of America.

Kaiser Aluminum Bus Conductor Manual - Kaiser Aluminum & Chemical Sales, Inc.

Reynolds Aluminum Bus Conductors, Brochure - Reynolds Metals Company.

Aluminum Busbar, Thomas, A.G. and Rata, P.J.H. -Northern Aluminum Company Ltd., London.

L'Aluminium Dans Les Postes Exteriurs de Transformation - L'Aluminium Français, Paris.

Aluminum Busbars - Swiss Aluminum Ltd., Zurich

Aluminum in Busbars and Connections, The British Aluminum Company, Ltd., London.

Aluminum Electrical Conductor Handbook, 1982 - The Aluminum Association, Washington, D.C.

Higgins, Thomas James, "The Design of Busbar Industrial Distribution Systems: An Epitomization of Available Data," 1945, Technical Paper 45-25.

Deans, W., "Electrical Buses and Bus Structures," Bulletin 4211 of ITE Circuit Breaker Company, 1942.

"Use of Aluminum for Substation Buses," IEEE Trans. Vol. 5-82, pp. 72-79.

#### Numbered References

1. IEEE, "Guide for Design of Substation Rigid-Bus Structures."

2. Guess, L.T. and Crow, C.K., "Advances in Bus

Design for the Chlor-Alkali Industry," Electrochemical Technology, Vol. 5, No. 3-4, March, April 1967.

3. Arnold, A.H.M., "The Alternating-Current Resistance of Hollow, Square Conductors," JIEE Vol. 78, 1936, pp. 580-593.

4. Dwight, H.B., "Electrical Coils and Conductors," McGraw-Hill Book Company, 1945.

5. Mak, S.T. and Lewis, W.A., "Alternating Current Distribution in Parallel Conductors of Arbitrary Cross-Sectional Shape," 1973, IEEE Conference Paper C70169.0.

6. Arnold, A.H.M., "Proximity Effects in Solid and Hollow Round Conductors", JIEEE Vol. 88, 1948, pp. 349-359.

7. Sigg, Hans-Jurg and Strutt, Max J.O., "Skin Effect and Proximity Effect in Polyphase Systems of Rectangular Conductors Calculated on an RC Network," IEEE Trans. Vol. Pas-89, No. 3, 1970, pp. 470-477.

8. Fisher, L.E. and Frank, R.L., "Paired-Phase Bus Bars for Large Polyphase Circuits," AIEE Trans. Vol. 62 (1943) pp. 71-77.

9. Paschkis, V. and Persson, J., "Industrial Electric Furnaces and Appliances," (book), Interscience Publications (1960).

10. Perry, John H., "Chemical Engineers Handbook", McGraw-Hill Book Company, 1950, Chapter-Heat Transmission by Conduction and Convection.

11. Swerdlow, Nathan and Buchta, Marion, "Practical Solutions of Inductive Heating Problems Resulting from High Current Buses," AIEE Trans. Vol. 78, pp. 1736-1746, 1959.

12. Skeats, W.F. and Swerdlow, Nathan, "Minimizing the Magnetic Field Surrounding the Isolated Phase Bus by

- Electrically Continuous Enclosures," AIEE Power Apparatus and Systems, Feb. 1963, pp. 655-666.
13. Killian, S.C. "Induced Currents in High-Capacity Bus Enclosures," AIEE Trans. Vol. 69, 1950, pp. 1388-1395.
  14. Maxwell, J.C. "A Treatise on Electricity and Magnetism," (book) 3rd Ed. Clarendon Press, Oxford, England, 1892.
  15. Schurig, O.R., "Engineering Calculation of Inductance and Reactance for Rectangular Bar Conductors," General Electric Review, Vol. 36, No. 5 (May 1933).
  16. Lewis, W.A., "Transmission of Electric Power," Litho Ed., Chicago, Ill., Illinois Institute of Technology, 1948.
  17. Carlson, C.L. and Van Nostrand, R., "Ampacities of Copper and Aluminum Bus Bars," IEEE Paper F 76-080-2, January, 1976.
  18. Melsom, S.W. and Booth, H.C., "Current Carrying Capacity of Solid Bare Copper and Aluminum Conductors," JIEE Vol. 62, pp. 909-915.
  19. House, H.E. and Tuttle, P.D., "Current-Carrying Capacity of ACSR," AIEE Trans. Paper 58-41, February, 1958.
  20. McAdams, W.H., "Heat Transmission," (book) McGraw-Hill Book Company, New York, 1954.
  21. Schurig, O.R. and Frick, C.W., "Heating and Current-Carrying Capacity of Bare Conductors for Outdoor Service," General Electric Review, Vol. 33, No. 3, March 1930, pp. 141-157.
  22. Prager, M., Pemberton, D.L., Craig, A.G., and Bleshman, N., "Thermal Considerations for Outdoor Bus Conductor Design," IEEE Trans. Power Apparatus and Systems, Vol. Pas 90, No. 4, pp. 1361-1368, July/August 1976.
  23. "Busbar Current Capacity, Paint Treatment and Its Effects on Cooling," Electrician, Vol. 126 (March 21, 1941) pp. 178.
  24. Fugill, A.P., "Carrying Capacities of Enclosed Buses," Electrical World, Vol. 99 (1932), pp. 539-540.
  25. IEEE Committee Report, "A Guide for Calculating Losses in Isolated Phase Bus," presented IEEE New York Meeting, 1968.
  26. Tripp, W.A., "Forces on Conductors During Short Circuits," Electric Journal, Vol. 34, (Dec. 1937), pp. 493-497.
  27. Killian, S.C., "Forces Due to Short Circuit Currents," Delta-Star Magazine (January-February 1943).
  28. Taylor, D.W. and Stuehler, C.M., "Short Circuit Tests on 138 kV Buses," AIEE Trans. Vol. 75, 1956, pp. 739-741.
  29. Milton, R.M. and Chambers, Fred, "Behavior of High-Voltage Buses and Insulators During Short Circuits," AIEE Trans. Vol. 75, 1956, pp. 741-749.
  30. Moorer, S.D., "1150-230 kV Bus Design Practices with Emphasis on Short Circuit Requirements," Trans. & Substa. Committee, Southeast Electric Exchange, October 21, 1965.
  31. Schurig, O.R., "Fault Voltage Drop and Impedance at Short Circuit Currents in Low Voltage Circuits," AIEE Trans. Vol. 60 (1941), pp. 478-486.
  32. Woodruff, L.F., "Discussion on the Natural Frequency of Bus Bars," AIEE Trans. 1923, p. 568.
  33. Den Hartog, J.P., "Mechanical Vibrations," (book) 3rd Ed., McGraw-Hill Book Company.
  34. Tanberg, R., "Stresses in Bus Supports," Electrical Journal, Vol. 24 (October 1972), pp. 517-524.
  35. Brenner, M., "Basic Principles to Support Aluminum and Copper Buses," Electrical World, July 1953, pp. 118-119.
  36. Papst, H.W., "Stresses in Bus Bars and Design Features to Meet These Stresses—the Spring Mounted Bus," Westinghouse Electric Corp. Bulletin, 1933.
  37. Grier, L.N. and Guess, L.T., "Suspended Buses Carry Heavy Current," Electrical World, Vol. 116 (1941) p. 1889.
  38. N.T. Bond, "Aluminum Contact Surfaces in Electrical Transition Interfaces," Proceedings of the Holm Seminar on *Electrical Contacts 1968*, pp. 13-25.
  39. N.T. Bond, D.L. Robinson, and M. Mohajery, "Fundamental Consideration of Aluminum Electrical Contact Interfaces," *Electrical Contacts 1977* Proceedings of the Annual Holm Conference on Electrical Contacts, pp. 213-222.
  40. J.R. Greenwood, "Area of Contact Between Rough Surfaces and Falts."
  41. Holm, Ragnar, "Electric Contact Handbook," 3rd Ed., 1958, Springer-Verlag, Berlin.
  42. N.F. Mott, "Theory of the Formation of Protective Oxide Films on Metals-II," *Transaction of the Faraday Society*, Vol. 36 (1940) pp. 472.
  43. S.W. Melsom and H.C. Booth, "The Efficiency of Overlapping Joints in Copper and Aluminum Bus Bar Conductors," *Journal of Institute of Electrical Engineers*, Vol. 60, No. 312 (1922).

44. N.T. Bond and F.L. McGeary, "Nickel Plating for Improved Electrical Contact to Aluminum," Conference Record of the 1968 Second Annual Meeting of the IEEE Industry and General Applications Group, pp. 375-387.
45. N.T. Bond, "Electrical Transition Interfaces at Aluminum Terminations," *Electrical Contacts 1978* Ninth International Conference on Electric Contact Phenomena, pp. 93-98.
46. Shand, E.B. and Valentine, C.E., "Bolting of Busbar Joints," *Electric Journal* (September 1933), pp. 397-380.
47. Stewart, H.J., "Belleville Spring Washers," *Fasteners*, Vol. 9, No. 5
48. Asbury, C.E. and Hartmann, C.J., "Development of a Welded Aluminum Bus for Substations," Proceedings of the Conference on Electrical Utilization of Aluminum, AIEE (March, 1955) pp. 4-9.
49. Quick, D.M., "Welded Aluminum Bus in Outdoor Transfer Yard of the Sewaren Generating Station," *Electric Light and Power*, Vol. 27 (December 1949), pp. 58-63.
50. Ray, J.J. and Calhoun, J.K., "Aluminum Bus in High Voltage Substations on the Philadelphia Electric Company System," Proceedings of the Conference on the Electrical Utilization of Aluminum AIEE (March 1955) pp. 9-14.
51. ANSI Standard C37.23
52. Conangla, Amado and Harris, F.W., "Isolated Bus Enclosure Loss Factors," IEEE Vol. Pas 87, No. 7, pp. 1622-1628, 1968.
53. Elgar, E.C., Rehder, R.H., and Swerdlow, Nathan, "Measured Losses in Isolated-Phase Bus and Comparison with Calculated Values," IEEE Vol. Pas 87, No. 8, pp. 1724-1730, 1968.
54. Christensen, A.H., "Rigid Bus A-Frames," IEEE Conference Paper T&S pp. 33, December 1978.
55. Massey, John R., "Integral Web Channel Bus Construction IEEE Trans. and Large Substa. Committee Paper, April 1967, Roanoke, VA.
56. Milton, R.M., St. Clair, R.C., Wilhoite, G.M., "Design Criteria for Integral Web and Universal Angle Buses," AIEE Paper 63-101, 1963.
57. Weber, L.C., Fossum, H., "Aluminum Angle Substation Bus Conductor," AIEE Conference Paper CP-58-1286, 1958.
58. "Bibliography of Gas Insulated Substations," IEEE Pas Vol. 99, No. 1, p. 389.
59. Hagemoen, S.W., "Improving the Capacity of a High Current D-C Bus," Ref: IEEE PCI-76-52, Conference Record 76CH1109 8-1A.
60. Gerald, G., "Extractive Metallurgy of Aluminum," Vol. 2, Interscience, 1963.
61. Frothro, T.B., "Design and Specification Considerations for Construction of Large Industrial Rectifiers and Their Associated Facilities," IEEE Trans. on Industry Applications, Vol. 1A-11, No. 2, March-April 1975.
62. Rols, Rene, "Aluminum Conductors in Electrolysis Installations and Electric Furnaces," L'Aluminum Francais, Paris.
63. Donati, E. "Overlapping Joints in Electric Furnace Circuits," L'Energie Electrica, Vol. 12, No. 6 (June 1935) pp. 433-440.

Chapter 14

## Aluminum Magnet Conductor

During the 1950-1960 period when aluminum conductors began to displace copper in overhead transmission and distribution and a large effort was started to evaluate aluminum in the insulated cable field, some attention was also directed to aluminum magnet wire. These early efforts were confined to round 1350 aluminum wire in the fully annealed or partly annealed condition using conventional and new magnet wire insulations. Results from an economic viewpoint were only moderately successful and, in order to achieve better space factors, an anodized film was used as turn insulation. However, at almost this same time it became apparent that thin aluminum strip conductor in the form of anodized foil or foil interleaved with a suitable insulating film would eliminate many of the magnet wire problems previously experienced. The subsequent development of aluminum foil or strip magnet conductor has successfully achieved a new order of improvement in electromagnetic coil design.

In transformer practice, aluminum conductors have lower stray losses than copper conductors for a given size. This is because the eddy current losses are an inverse function of resistivity of the conductor. This advantage for aluminum is offset by the fact that larger conductor sizes are needed for equal resistances. On balance, aluminum windings, with resistances equal to copper windings of similar design, have about 3% lower stray losses.

### Aluminum Magnet Wire (Round, Square, Rectangular)

As previously indicated, the first use of aluminum magnet wire was as a film-insulated round wire. This type of conductor is now available in virtually all AWG sizes as it is for copper magnet wire (No. 4 through No. 26 or finer AWG) and with all conventional insulation including class 105, class 130, class 155 and class 200.

Certain small, fractional horsepower motors, mainly in the washer and dryer appliance field, are designed now exclusively with round aluminum insulated wire. However, the greatest increase in growth has been in the use of rectangular and square aluminum magnet wire in distribution, small power and dry type transformers, both bare and tape insulated with Aramid, thermally upgraded paper and crepe paper. Tape-insulated aluminum, in comparison

to film-insulated aluminum of the same temper, size and shape, usually has a higher tensile strength due to the tape. Film-insulated conductors must be processed through a curing oven which results in total or partial anneal of the wire. Therefore, taped conductor can have a higher temper which results in much higher tensile and yield strengths. Taped conductors also have greater resistance to mechanical stresses and abuse, making them easier to wind and more resistant to the effects of electrical short circuit forces at elevated temperatures. Many of these applications can be served by 1350 aluminum, but there is a substantial demand for commercially available alloys possessing higher yield strength while maintaining conductivity of 61 percent as a minimum.

Since annealed 1350 aluminum has a tensile strength of 12,000 psi as compared to 35,000 psi for annealed copper, coil winding operations must be modified somewhat but once the necessary adjustments have been made aluminum magnet wire may be handled readily and rapidly.

Conventional aluminum magnet wire possesses a number of advantages over copper in both economic and technical aspects.

### Light Weight

Aluminum, with a density of 2.703 grams per cubic centimeter at 20° C has less than one-third the density of copper and weighs one-half as much as a copper conductor of equal resistance and equal length.

The lighter-weight conductor is of advantage in most electrical equipment for transformers, especially coils, and motors in portable equipment or in air-borne, missile, or space-vehicle applications where reduced component weight allows vital additional payload.

Generally superior performance can be expected when aluminum magnet wire is used for rotating and other moving windings. The lower mass of aluminum designs results in lower inertia—improving performance of a wide variety of equipment.

In rotary equipment, low mass simplifies dynamic balancing. Because vibration from dynamic imbalance is



**TABLE 14-1**  
**Springback Comparison Chart**

Wire Size (AWG)	Degree of Angular Springback* (Typical figures)	
	Copper	Aluminum
AWG 18	54°	38°
AWG 16	46°	32°
AWG 14	38°	26°

\* In "degrees per turn" when tested per NEMA publication MW-1000/1967 Part 3, Par. 2.2.5.

reduced, aluminum construction contributes to longer operating life of rotary apparatus.

Lower mass also results in higher sensitivity and response in moving coil applications. Manufacturers can take advantage of this characteristic in the design of electrical instruments and acoustical devices.

Significant weight reductions of coils can also lower shipping and handling costs. Dramatically lower spool weights reduce operator fatigue by making it easier to load the winding machines.

#### Windability

Because annealed aluminum magnet wire has a low yield strength (approximately 4000 psi), little strain energy is required to conform it to an arbor. This quality is noticeable in practice: rectangular coil sides have less bow than similar copper coils; end turns on a motor stator are shorter; all coils are more compact; and operator fatigue is reduced in hand winding operations. The most striking aspect of this lower springback is reduction in winding tension. Even though aluminum wire may be two gauges larger than copper, machines run faster, and they readily handle aluminum wire four sizes larger than the largest copper gauge they can handle. Operators have no problem threading machines or advancing the wire. Table 14-1 presents some comparative springback data provided by a manufacturer of magnet wire.

#### Thermal Characteristics

Tests indicate that insulations applied to aluminum can be expected to operate one IEEE temperature classification\* higher than the same insulation applied to copper, and still have equal life; for example, a class 105 insulation for copper can be used as class 130 insulation for aluminum.

\* IEEE Standards Pub. No. 1, April 1969— "General Principles for Temperature Limits in the Rating of Electric Equip."

Insulations applied to aluminum have longer life at the same operating temperature than the same insulation applied to copper. The mechanical properties of insulation on thermally aged magnet wire show a marked advantage for aluminum. In certain applications, where electrical losses are not a problem, designers have used these advantages (higher temperature operation and good mechanical properties after aging) for both economic and space reasons by using aluminum magnet wire only one or one-and-a-half sizes larger than copper, rather than the rule-of-the-thumb two sizes.

Fig. 14-1 was provided by a manufacturer of aluminum magnet wire and gives data on the aging of aluminum vs. copper magnet wire insulated with a variety of materials.

#### Economic Factors

Through lower initial cost and other savings due to aluminum's advantages, manufacturers can realize significant improvements in product cost control.

In the size range No. 8 AWG through No. 24 AWG, aluminum film-insulated round magnet wire costs less per unit of length than its equivalent copper conductor. These savings run from 15 to 25 percent and more in the heavy gauges.

#### Coil Design

Engineering with aluminum magnet wire is not different fundamentally from engineering with copper wire, but some allowances do have to be made. Because aluminum has a lower conductivity than copper, designers often must find space to increase the wire gauge by two sizes. In changing from copper to aluminum, some engineers may prefer to develop an entirely new coil design. Sometimes modification of existing designs will be sufficient. Sometimes, it is discovered that an existing unit allows sufficient space to accommodate the larger aluminum coil without any major revisions. Usually, however, for optimum results it is necessary to redesign the unit (e.g., distribution transformer primaries).

*Apparatus with Stamped Laminations:* When there is insufficient space for an easy substitution of aluminum for copper, redesign of transformers and similar apparatus using scrapless laminations will usually involve one or two kinds of changes. It may be necessary to increase stack height to accommodate an aluminum coil of fewer turns of large wire, or a different lamination may be necessary. If the designer must change lamination size, he has, in effect, developed an entirely new design.

*Apparatus with Wound Cores:* For apparatus using wound cores the procedure is nearly the same as for scrapless lamination. However, considering the moderate increase in cost for special core designs, this family of electrical devices yields the greatest return when completely new designs are used.

Optimum designs for aluminum wire require different

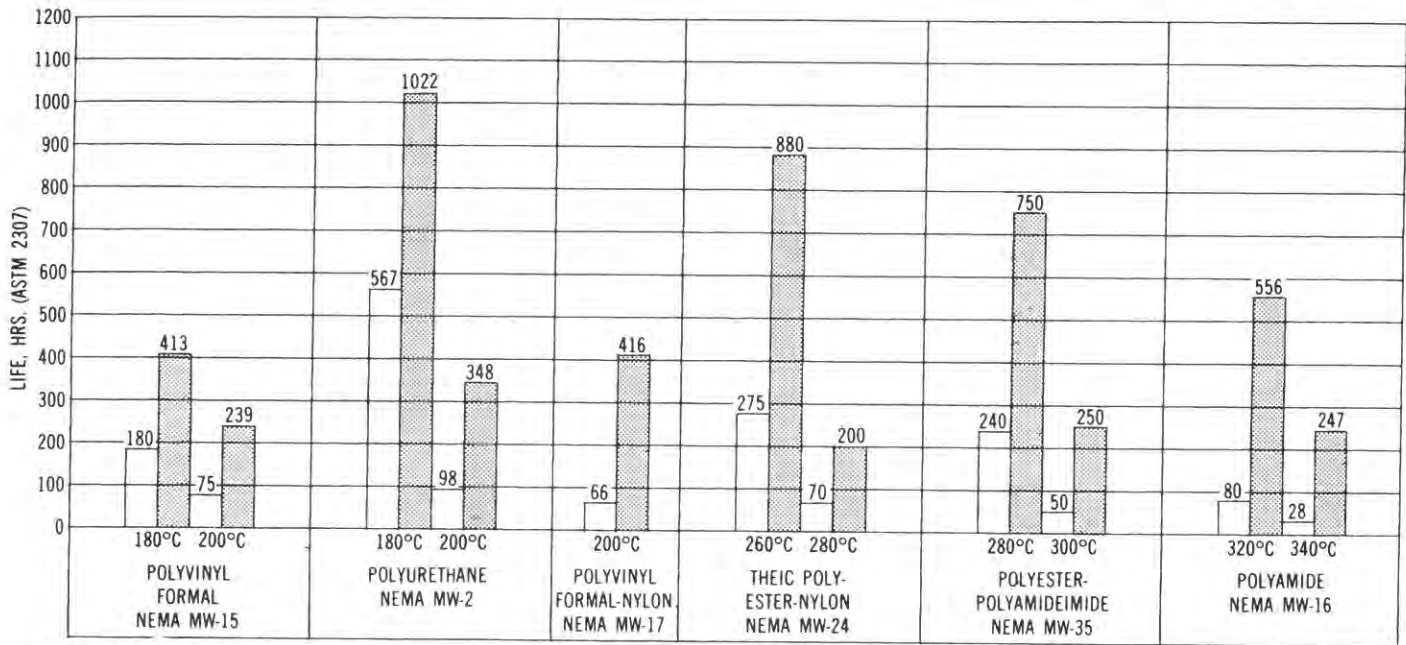

Fig. 14-1. Thermal aging of 1350 aluminum and copper magnet wires with various enamels. Bars in gray indicate aluminum life.

core dimensions than are used with copper. A typical copper design has a window area one-half of its central core area, stack height  $1\frac{1}{2}$  times core width, and a window length  $1\frac{1}{2}$  times window width. In the finished product, coil weight is about 33% of the total. Such a design probably is very close to minimum material costs.

But for aluminum, the window area is approximately 75% greater than core area, stack height 2 to  $2\frac{1}{2}$  times core width and the window length 2 to  $2\frac{1}{2}$  times window width. In the finished product, aluminum-coil weight would be approximately 40% of the total. Such a design, which constitutes a complete departure from standard practice, is most practical with tape-wound cores.

**Motors:** Many classes of motors lend themselves readily to redesign with aluminum magnet wire. In particular, shaded-pole types often have sufficient space for an easy substitution of aluminum. Induction motors may have space for a change in wire size of one or one-and-a-half gauges. This change together with shortened end turns may be sufficient for a simple substitution. As with transformers, stack length can be increased or a larger lamination can be used.

**Other Devices:** In general, the same information applies to all other magnetic devices which a designer wishes to convert to aluminum windings. If the necessary extra space does not already exist, it must be provided by modification

or redesign on the entire device.

**Means of Minimizing Coil Size:** In copper-wound electromagnets, the design flux density of the pole piece is often conservative, and the pole-piece diameter can safely be reduced by 10 to 15 percent. This approach of reducing the inside diameter of the coil is better than increasing the outside coil diameter because it lowers the mean turn length while it provides the extra space required for larger gauge wire.

There are various measures available for minimizing size of wound coils. Coils can be precision wound instead of random wound. Bobbins can be made smaller—sometimes they can be eliminated altogether. Coil operating temperatures can be raised—with moderate temperature increases, aluminum coils still have longer life than copper coils. Finally, as a result of a thoroughgoing redesign particularly of an older item in a product line, the new device and its aluminum coil may operate cooler.

Often overlooked are the opportunities to modify existing windings, if only slightly, to take advantage of aluminum magnet wire's economic benefits. Through close attention to coil configuration, the designer can employ previously wasted space to accommodate windings even though it may alter the basic shape of the coil. Sometimes, only one additional turn per layer or special contouring of the winding to fit special cavities will use a space for maxi-

mum ampere turns.

Since cases of redesign for aluminum wire are highly individual, some manufacturers maintain a coil-prototype laboratory to help customers with aluminum application designs by winding experimental coils and demonstrating techniques of joining.

### Coil Connections

Joining aluminum coils to lead wires is not a laboratory curiosity; it is done in everyday production. The joining and termination of insulated aluminum wire—which has been a source of concern to many coil makers—can be easily done with mechanical connectors.

**Mechanical Termination:** Mechanical termination and splicing methods have been developed which are highly effective and low in cost. These methods employ machine-applied compression terminals with serrated barrels, such as those shown in Fig. 14-2.

This mechanical connection has numerous features that make it more efficient and more economical than conventional joining and termination methods. A one-step, machine-applied process combines low labor costs with high production speeds of up to 4000 terminations per hour. Top quality terminations and splices are exceptionally reproducible—and the resulting low rejection rate helps increase output while reducing scrap costs.

A considerable number of environmental tests, developed by the manufacturers, have proved this method to be highly reliable. Millivolt drops and temperature rise are essentially the same as the best of connections made carefully by other methods. There's no damage to insulation from heat, stripper residues, or soldering fluxes.

**Soldering:** A secondary method of splicing and terminating is by soldering. Aluminum can be soldered using the same tools and techniques as copper, but requires special procedures and solder and flux. Information about procedures for soldering aluminum is available from various manufacturers on request.

### Aluminum Strip Magnet Conductor

Strip conductor by definition is a flat, flexible metal strip usually produced by slitting a supply roll of proper gage metal into required widths for the finished product. The resulting conductor has a rectangular cross-section with a large width to thickness ratio; a broad range of widths and thicknesses are available.

Aluminum strip magnet conductor is usually made from either 1350 grade aluminum or 1235 aluminum alloy. Although 1350 grade metal will be principally discussed in what follows, technical data are included for both alloys and are compared to electrolytic copper.

#### Strip Magnet Conductor Insulation

Aluminum strip magnet conductor may be insulated by

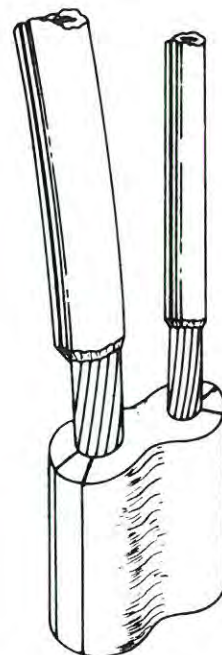

Fig. 14-2. Compression terminals for aluminum wire. This mechanical connection has features that make it more efficient and economical than conventional joining and termination methods. A one-step, machine-applied process combines low labor costs with speeds of up to 4000 terminations per hour. Top quality terminations and splices are exceptionally reproducible.

extremely thin, high dielectric strength anodized films; by interleaved (wider) films of a variety of high grade insulating materials; or by the deposition and bonding of insulating coatings. All of these methods require some special treatment of the strip surfaces and edges.

**Anodized Films:** Early developments by the aluminum industry clearly recognized the possibilities of using anodic films for the electrical insulation of aluminum conductors. Aluminum oxide exists to some extent on all aluminum in the form of a microscopically thin layer and provides aluminum with its excellent corrosion resistance. By the use of anodizing techniques, this thin layer can be expanded into a hard, inelastic and highly insulating film in the order of three ten-thousandths of an inch thick. This anodic film is desirable in many applications because of its hardness, abrasion resistance and high breakdown potential for a given thickness and high temperature rating.

Early work was directed at anodizing round aluminum conductors. A satisfactory film was obtained on straight conductor but bending sometimes resulted in crazing at

the outside radius of the bend and an actual extrusion of metal through similar cracks on the inside radius. Developments were directed toward anodizing a relatively wide and thin strip of aluminum having the same cross-sectional area as the round conductor. The bending problem was overcome by going to a strip, but the edges were almost impossible to anodize. By utilizing a chemical and mechanical treatment of the ragged, non-uniform edges, a surface that could be anodized adequately was obtained. The results of the fabrication process for anodized strip are considerably improved insulation efficiency and overall strength.

*Interleaved Insulation:* The thermal, mechanical, chemical and electrical requirements must be defined before an interleaving material can be selected.

Paper and polyester interleaves as thin as .0005 inch have been used as turn insulation in electromagnetic coils wound with edge-conditioned strip conductor.

The width of the interleave is usually about 0.125 inch wider than the strip. Of course, this dimension may vary considerably—depending on the interleaving material, the coil and the equipment used to wind the coil.

*Paper:* Paper has a thermal rating of 90°C (Class O) and 105°C (Class A) or better when submerged in oil or impregnated. Because it is able to withstand large compressive forces and has good dielectric strength, it is usually the interleaving material used in oil-filled transformers and in coils that do not operate above 105°C.

*Polyester:* Polyester interleaving materials have a thermal rating of approximately 150°C which is between Class B, 130°C and Class F, 155°C. They have excellent dielectric strength, resistance to most chemicals and solvents and very high tensile strength. Polyester films are not compatible with some varnishes and are not generally recommended for use in oil-filled equipment. Under certain electrostatic conditions they have a tendency to attract foreign matter while being wound.

*Aramid:* Polyamide, such as DuPont "Nomex," has a thermal rating of 200°C (Class K). It is available in thicknesses of 2 mils and over. It has good abrasion resistance and can be wound on automatic equipment.

*Asbestos:* Asbestos treated with silicone or other high temperature varnish has a thermal rating of 220°C (Class H). It acts as a positive spacer and varnish absorbent. Silicone, polyester, epoxy and other varnishes are generally used to treat the asbestos fibers. (Lower thermal varnishes like epoxy bring the thermal rating down.) The use of this interleaving material is limited because it is a bulky insulation.

*Teflon:* Teflon has a thermal rating of 200°C per MIL-W-16878. (Teflon backed up by glass cloth to prevent cut-through has a much higher rating than 200°C.) It is very resistant to abrasion and has good chemical resistance and good dielectric strength. Teflon is more expensive

than most other interleaving materials which limits its major application to aircraft and missile work.

*Mica:* Mica has a thermal rating of 220°C (Class C). It is sometimes used without a binder, but normally it is impregnated with silicone or other resins which may limit the temperature classification. Mica has good electrical properties but its tensile strength is low and it is bulky.

*Glass:* Glass has a thermal rating of 220°C (Class C). It also depends on binder thermal rating for its rating. It has excellent thermal endurance, acts as a positive spacer and is able to withstand the elements that deteriorate other insulations. It is used where dependability is an important factor. The major limitation is its poor space factor. Glass is sometimes used as a backing for other interleaving materials to provide tensile strength.

*Coated Strip:* Coated aluminum strip has also been developed for use in commercially available distribution transformers. Epoxy (Class B, 135°C), polyvinyl formal (Class A, 105°C), polyesters (Class F, 155°C), and the amid-imide polymer enamel coatings (200°C+) are used. Epoxy and polyamide-imide appear to be growing in favor.



*Fig. 14-3. An aluminum to copper transition piece may be used to make aluminum to aluminum connection at the strip and to make a copper connection to a lead or terminal. The transition pieces are usually made by cold or flash welding.*

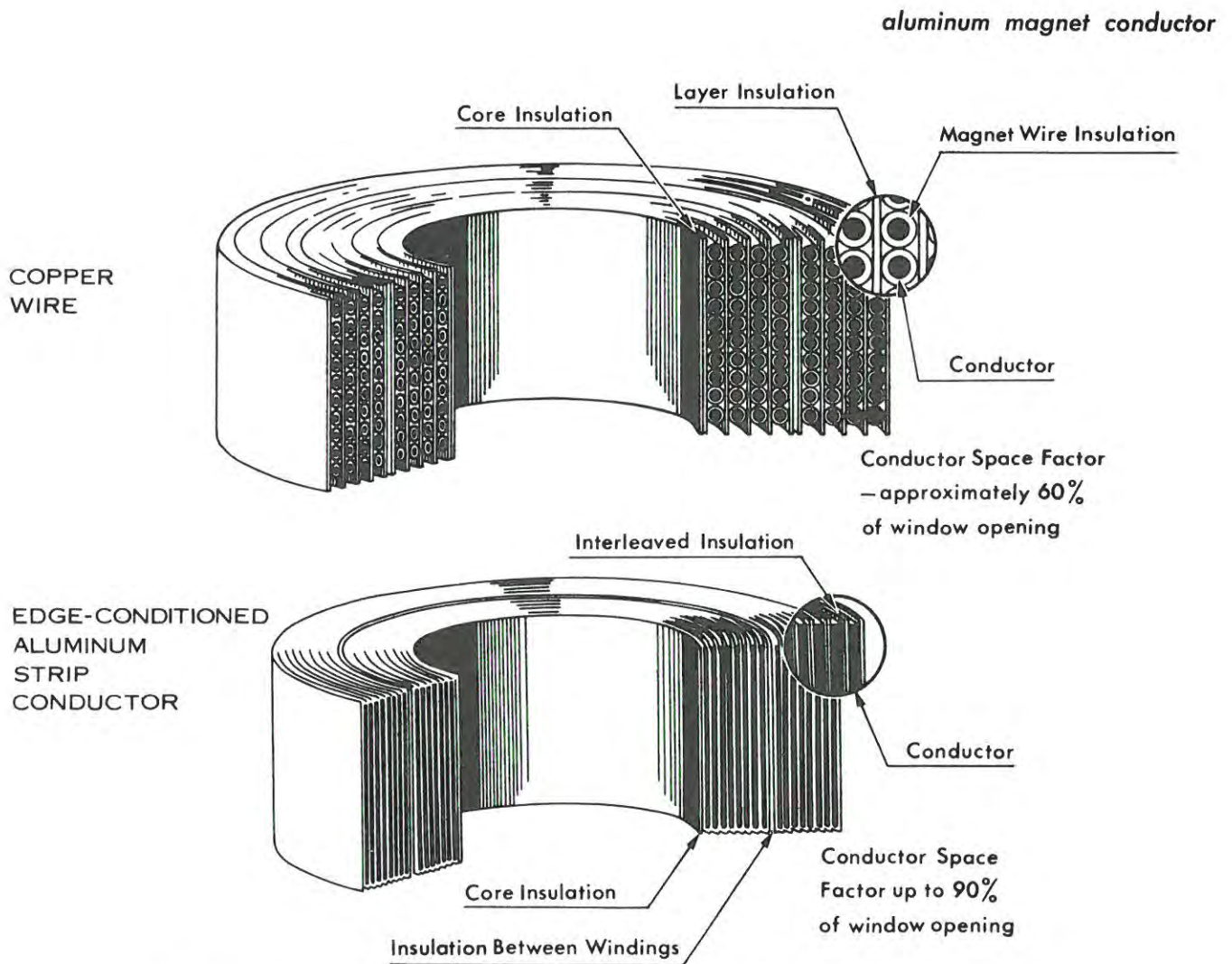

Fig. 14-4. Space comparison of coil wound with round magnet wire and strip conductor.

### Coil Design with Aluminum Strip Magnet Conductor

Aluminum strip magnet conductor can be designed into most electromagnetic devices when all of the parameters of the device as well as the characteristics of aluminum are taken into consideration.

Strip made of electrical conductor grade aluminum 1350 has a guaranteed conductivity from 61 to 62 percent IACS. 1350 aluminum strip conductors designed for equal direct current (DC) resistance compared to a copper conductor must, therefore, have a larger cross-section area.

This means that the aluminum strip conductor will require about 60 percent more space than is needed for an equivalent copper conductor. Therefore, space conservation must be employed in designs where dimensions are critical. Because of its geometric shape, the aluminum strip conductor will utilize more of the allocated coil space than the equivalent round wire. This is graphically shown in Fig. 14-4. It is noted that for the same coil "window"

opening the utilization of space by the conductor is much greater in the foil or strip form than for the usual insulated round shape. This, in large part, is due to the elimination of need for the wire insulation.

In addition to better space utilization, strip conductor offers the following advantages:

1. More rigid construction results in greater strength. No side supports are necessary for the strip wound coil.
2. Better heat dissipation—each turn is exposed to the outside and in flat surface contact with insulation of the next turn.
3. Lower voltage stress between turns—turn voltage gradient is layer voltage gradient.
4. Easier winding—no traverse guiding necessary.
5. Less supplementary insulation necessary.
6. Elimination of hot spots.
7. Better short-circuit performance in transformer since each turn is centered in the magnetic field.

*Winding Design Techniques With Strip Magnet Conductors*

Many techniques can be employed to adapt strip conductor to coils previously wound only with round insulated wire. Coils for field windings of rotating equipment, for example, previously considered only for winding with round wire because of shape, are now wound with strip conductor and used in many different types and sizes of motors and generators.

This ability to post-form coils after winding allows the designer more flexibility. Coils can be wound on a round mandrel then formed into rectangular shape. This is advantageous because round coils are more easily adapted to winding on automatic high speed machines than are rectangular coils.

The per unit cost of conductor increases as the size decreases. It is, therefore, advantageous to control the amount of smaller conductor used on a coil assembly. A transformer is an assembly where this design technique can be utilized. The smaller winding of the primary containing many turns can be located next to the core where the mean turn length will be minimized. The amount of smaller conductor is kept to a minimum and the larger conductor of the secondary, which is the lower cost, is placed to the outside of the coil.

Coils containing two or more windings that must be balanced in impedance can be wound bifilar; that is, with the conductors of each winding physically paralleled and wound together with proper insulation between. The close coupling of the flat conductors results in the best possible balance in impedance between these windings.

The higher cost thin gauge conductors can sometimes be economically replaced by strip of heavier gauge and narrower width. This approach also decreases the amount of insulation required. The narrower coils can be wound and placed side by side on the core to utilize the available space. The cores can then be electrically paralleled with the same results as obtained with a coil of thinner, wider strip conductor.

These are but a few techniques the designer has at his disposal to arrive at the proper coil design.

**Determination of Foil Size and Coil Characteristics**

Direct current (dc) resistance of the aluminum strip magnet conductor coil can be determined by using the following formula:

$$R_w = \frac{\rho \times 12(MLT)N \times 10^{-6}}{A} \text{ ohms} \quad (\text{Eq. 14-1})$$

- Where:  $\rho$  = microhm-inches resistivity of 1350  
 $\rho$  = 1.09483 microhm-inches at 20°C  
 MLT = mean length turn in feet  
 N = number of turns  
 A = cross sectional area of strip in square inches = W x t (width times thickness)

Then the winding resistance is:

**TABLE 14-2**  
**Formulas**  
**For Calculating Weights**  
**And Resistances at 20°C**

	Aluminum*	Copper
Weight, lb per 1000 ft	1173 X A	3854 X A
Length, ft per lb	$\frac{0.85336}{A}$	$\frac{0.25947}{A}$
dc resistance, ohms per 1000 ft	$\frac{13.138 \times 10^{-3}}{A}$	$\frac{8.1455 \times 10^{-3}}{A}$
dc resistance, ohms per lb	$\frac{11.212 \times 10^{-6}}{A^2}$	$\frac{2.1135 \times 10^{-6}}{A^2}$

\*Based on aluminum at 62% conductivity  
 where: A=nominal cross-sectional area of the wire in square inches.

$$R_w = \frac{13.138(MLT)N \times 10^{-6}}{W \times t} \text{ ohms at } 20^\circ\text{C} \quad (\text{Eq. 14-2})$$

Ohms per 1000 feet is calculated as:

$$R_{1000} = \frac{13.138 \times 10^{-3}}{W \times t} \text{ ohms/1000 ft. at } 20^\circ\text{C} \quad (\text{Eq. 14-3})$$

Inductance values for strip magnet conductor coils can be determined approximately by using conventional formulae for round wire wound coils. Tests performed to date indicate that inductance values for coils of the same number of turns and of the same shape and size will be approximately equal regardless of conductor shape.

Bunet\* gives formulae for round and rectangular shaped coils of round wire which are beyond the scope of this work. These formulae generally yield accuracies between -4% and +4.7% depending on the coil dimensions. Since they are for approximation of inductance, they suffice for engineering needs and can be used for strip wound coils as mentioned above.

If the round copper wire size used in a coil is known, the conversion to aluminum strip conductor for an approximate equivalent coil is simple. The cross sectional area of the round copper conductor is increased by 64% to obtain the required cross sectional area of aluminum for equal dc resistance in a coil having equal length. This area of aluminum conductor is then dimensioned to obtain the required thickness and width. Fig. 14-5 provides a ready means for determining strip dimensions and also the corresponding dc resistance per 1000 ft. at 20°C.

The following example illustrates the ease with which aluminum strip conductor can be sized for an equivalent round copper wire wound coil:

\*Revue Generale de l'Electricite. Bunet. Tome LXIII No. 4, Pg. 99, January 22, 1938.

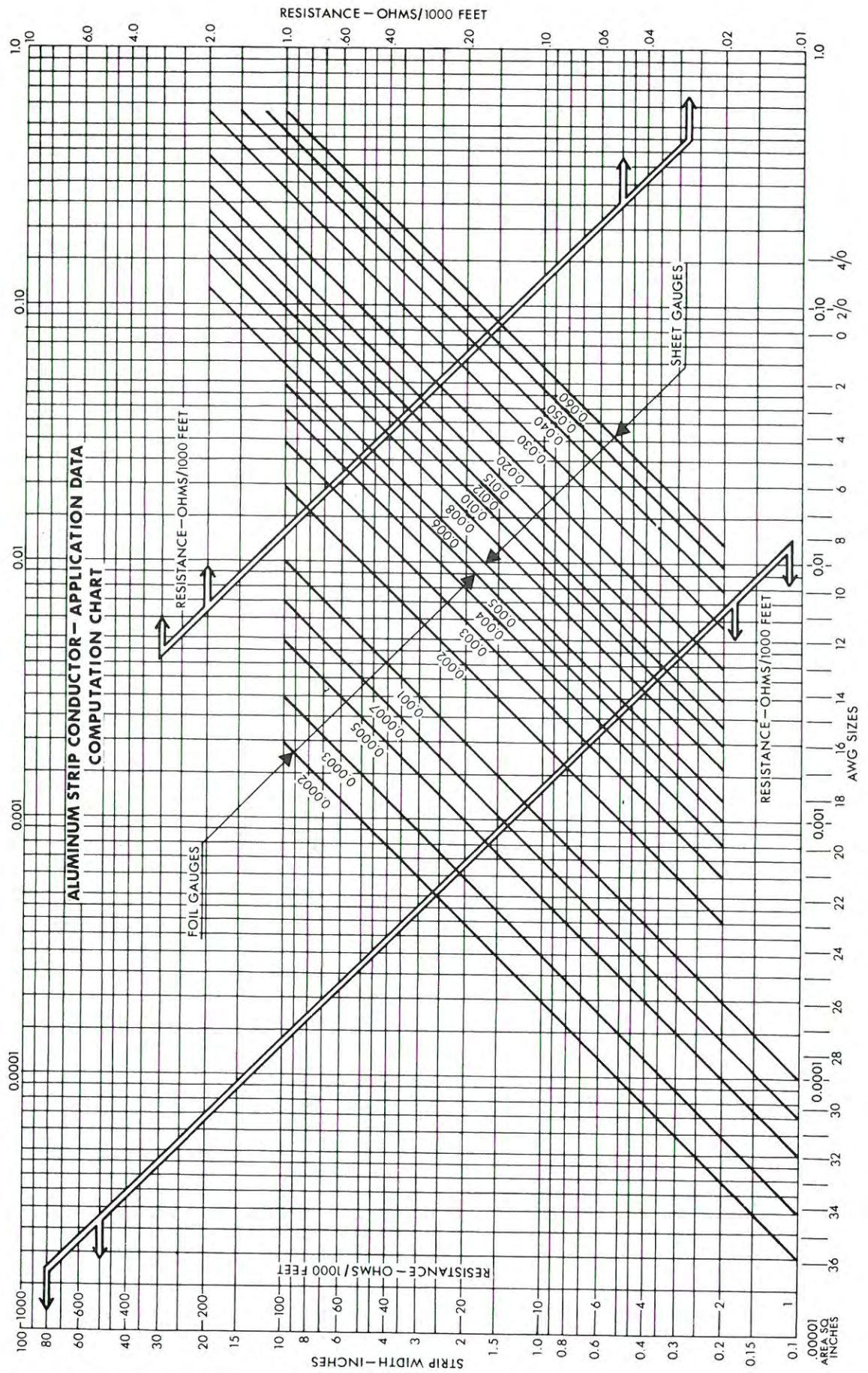

Fig. 14-5. Aluminum strip conductor application. (Notes and data on Fig. 14-5 may be found on page following.)

### Strip Conductor Equivalents

(Notes and data on Fig. 14-5 preceding)

The computation chart is used for obtaining approximate data useful in coil design.

Since the electrical conductivity of 1350 aluminum in this chart is 61% of copper, approximately 64% more aluminum by volume is required. A useful rule of thumb is: for equal conductivity—use 2 wire sizes larger than round copper, and 3 wire sizes larger than square copper.

#### Example:

A small solenoid coil is wound with 100 turns of No. 19AWG enameled round copper on a coil width of ½ inch. Aluminum Strip, electrically equivalent to No. 19 AWG copper, must have an area of .00167 sq. inches (approximately No. 17 AWG). From the chart a strip width of ½ inch requires a .0033 thickness. Slight adjustments may be necessary for choosing exact dimensions.

Resistance is determined by intersection of the .00167 area line and the appropriate resistance line. This resistance is found to be 7.8 ohms per 1000 ft. Weight calculated by formula 2 is found to be 2 lbs. per 1000 ft.

#### FORMULAS FOR STRIP WOUND COILS

1. Resistivity 
$$r = \frac{.013138}{A}$$

(Example continued from page 14-7)

A coil is wound with 100 turns of No. 1/0 AWG\* square copper wire (.1022 sq. in.) and is 3 inches wide. Based on an aluminum conductivity of 62 percent IACS, the equivalent aluminum strip conductor will have an area of .1648 square inch (.1022/.62). From the Fig. 14-5 computation chart, the intersection of the lines corresponding to a 3-inch width and a .1648 square inch area gives a thickness of .055 inch. The resistivity is found to be .08 ohms per 1000 feet by locating the intersection of the .1648 sq. in. area line and the resistivity line.

Tables 14-2, -3, -4 and -5 provide additional data and formulas which are useful in strip conductor wound coil design calculations.

#### Dielectric and Thermal Advantages of Strip Magnet Conductor

Since a strip wound coil consists of a number of turns of film-insulated aluminum strip or strip interleaved with thin layers of strip insulation, the number of layers is equal to the number of turns and the layer to layer voltage is equal to the turn to turn voltage. This eliminates the high layer to layer voltage common on copper magnet wire coils and the expensive layer insulation

\* See ASTM-B324 for additional information on rectangular and square wires of aluminum.

- |                                     |                                  |
|-------------------------------------|----------------------------------|
| 2. Density                          | $w = 1200A$                      |
| 3. Mean Length Turn of Coil         | $MLT = \frac{\pi (D + d)}{12}$   |
| 4. Winding Depth of Coil of N Turns | $d = \frac{N (T + t)}{K}$        |
| 5. Resistance of Coil of N Turns    | $R = \frac{(r) (MLT) (N)}{1000}$ |
| 6. Weight of Coil of N Turns        | $W = \frac{(w) (MLT) (N)}{1000}$ |

In the above formulas:

- r = resistivity in ohms/1000 feet
- A = cross section areas in sq. inches
- w = density in lb./1000 feet
- D = inside diameter of coil in inches
- d = winding depth of coil in inches
- MLT = mean length turn of coil in feet
- N = number of turns of coil
- T = thickness of strip conductor in inches
- t = thickness of layer insulation in inches
- k = winding space factor
- = 0.97 for typical foil wound coils with interleaved insulation
- R = resistance of coil in ohms at 25°C
- W = weight of coil in lbs.

normally used. The result is a compact coil with no air voids and a minimum of insulation.

The system is flexible since many arrangements of strip width and thicknesses may be used. Two or more strips multiple wound may result in lower cost coils, since the lower cost of thicker strips and the elimination of almost 50% of the insulation may more than offset the slitting costs and the additional labor to handle two coils.

The excellent heat transfer characteristics of strip wound coils result in lower average operating temperatures and in much lower hot-spot temperatures. Fig. 14-6 showing temperatures vs. conductor location for an actual case amply demonstrates this principle. As noted, average operating temperature is reduced in this instance about 12°C and hot-spot temperatures are reduced approximately 40°C. These reductions may be significant when the choice of insulating materials is considered. Cooling ducts may be eliminated under certain conditions with significant cost savings.

#### Joining

Electrical connection of an aluminum strip wound coil to external circuits requires that a suitable lead be attached to the strip which can then be soldered or bolted into the external circuit. These leads usually are round copper wire or flat copper strip. Common methods of joining such leads to the aluminum strip and for making aluminum to aluminum splices are:

*Coldwelding:* Pressure welding at room temperature is an accepted method of joining aluminum strip conductor



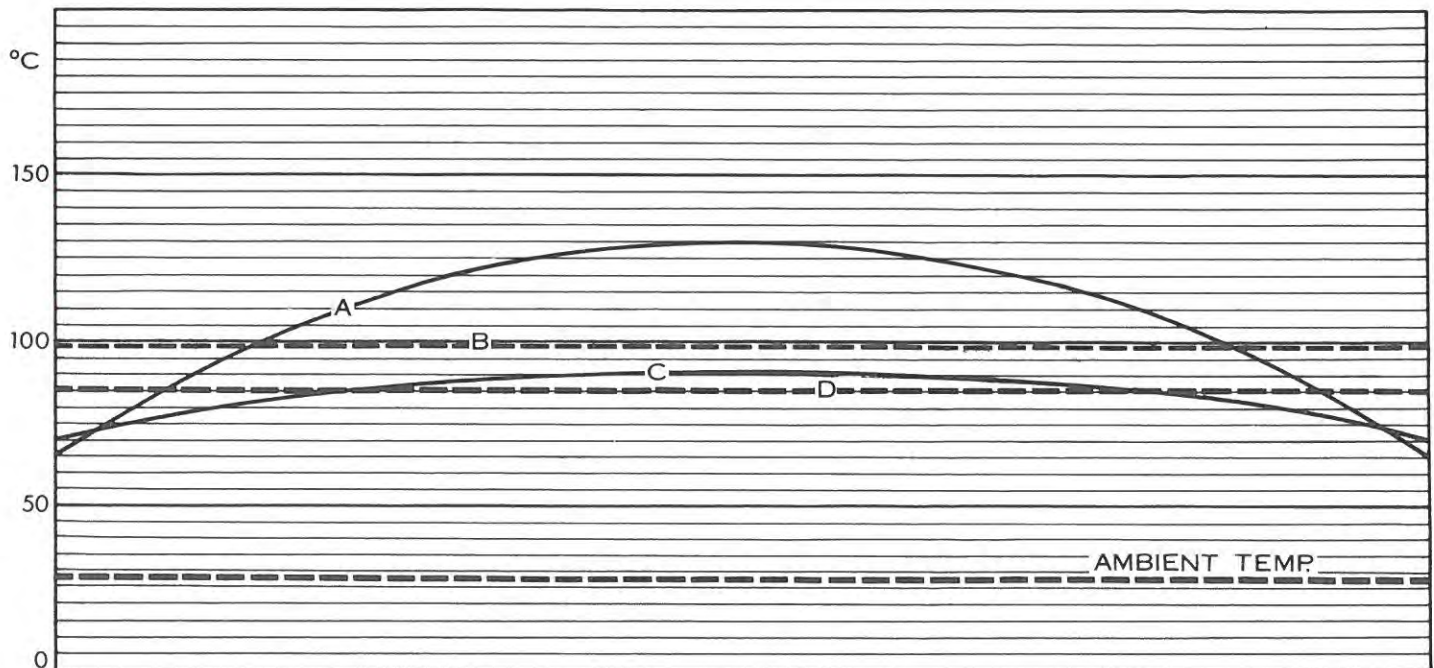

A (130)—Max. operating temperature—copper  
 B (96) —Normal operating temperature—copper

C (90) —Max. operating temperature—aluminum  
 D (34) —Normal operating temperature—aluminum

Fig. 14-6. Heat transfer characteristics of aluminum strip conductor.

to aluminum or copper in production. Cold-welding anodized aluminum to anodized aluminum, bare aluminum or copper requires no wire brushing of the aluminum surface. Tests have proven that the joints formed by this method have high conductance and high strength. Commercial equipment is available for joining a wide range of thicknesses and widths of strip conductor.

**Mechanical Joints:** Use of mechanical joints in aluminum and copper has been successful when joints have been properly designed. Riveted joints have been successfully used for years in the small strip conductor wound horn coil and the larger welder reactor coils. Mechanical connectors are available for joining solid or stranded wire leads to strip conductor.

**Fold Out Parent Metal:** The end of the strip may be slit or folded by various techniques and brought out at 90° to form a narrow laminated lead. A flexible lead can then be attached by welding, by mechanical connectors, or by bolted connections. In Fig. 14-7, C is a strip slit in four equal widths folded out individually—one on top of the other.

**Shielded Inert Arc Welding:** All types of inert gas shielded arc welding which do not require a flux are acceptable for joining aluminum to aluminum. Two methods are most commonly used:

1. A tungsten electrode with the filler rod being fed by hand as in gas welding. (TIG)

2. A consumable electrode of aluminum welding wire fed through the inert gas envelope. This is a particularly fast method and is used for automatic set-ups. The weld has 80-90% of the original strength of the parent metal. (MIG)

**High Temperature Solder:** Effective solder joints can be made without the use of corrosive fluxes. Abrasive means must be employed in pre-tinning the surfaces of the metals for subsequent soldering without fluxes.

**Ultra-Sonic Welding:** Lap joints may be made between aluminum to aluminum and to copper by a vibrating technique to result in a metallurgical bond without the application of heat.

**Transition Pieces:** An aluminum to copper transition piece (Fig. 14-3) may be used to make aluminum to aluminum connection at the strip and to make a copper connection to a lead or terminal. The transition pieces are usually made by cold or flash welding.

**Strip Magnet Conductor Types**

Magnet strip is available in gauges ranging from .001 inches to .0959 inches. It is supplied bare for use with interleaving materials, or coated with conventional film insulations and special high temperature types including anodized strip.

Magnet strip conductor from .008 inch and heavier can be supplied with a fully contoured round edge, both bare and insulated. Magnet strip conductor is supplied insu-

TABLE 14-3

Comparative Cross Section Area—Equal Volume Conductance

AWG WIRE SIZE	SQ. IN. COPPER  100% IACS	ALUMINUM EQUIVALENT	
		SQ. IN. 1350-0 62% IACS	SQ. IN. 1235-0 61% IACS
6	.02062	.03325	.03380
7	.01635	.02637	.02680
8	.01297	.02091	.02126
9	.01028	.01659	.01686
10	.008155	.01315	.01337
11	.00647	.01043	.01060
12	.00513	.00827	.00841
13	.00407	.00656	.00667
14	.00323	.00521	.00529
15	.00256	.00413	.00419
16	.00203	.00327	.00333
17	.00161	.00259	.00264
18	.00128	.00206	.00208
19	.00101	.00163	.00166
20	.000802	.00129	.00132
21	.000636	.00103	.00104
22	.000505	.000814	.000827
23	.000400	.000645	.000656
24	.000317	.000512	.000520
25	.000252	.000406	.000413
26	.000200	.000322	.000327

TABLE 14-4

Useful Formulas for Aluminum Strip Wound Coils

Area	$A = W \times T$	Square Inches
Resistance @ 20° C	$R = .013138 L/1000A$	Ohms
Weight	$M = 1.172 \times L \times A$	Pounds
Length	$L = N \times MLT$	Feet
Mean Length Turn	$MLT = P + \pi D/12$	Feet
Winding Depth	$D = N(T + t) / .975$	Inches

- W = Strip width in inches
- T = Strip thickness in inches
- t = Interleave thickness in inches
- N = Number of turns
- P = Perimeter of core insulation in feet

lated only in gauges from .001 inches through .0759 inches. In this range, the heavier gauge materials are edge-treated by contouring process, and the lighter gauges by electrochemical means.

In general, aluminum strip magnet conductor is supplied in widths ranging from 1 inch to 36 inches, as specified by the customer. Bare strip in thickness from .001 to approx. .003 inches can be fabricated on special equipment so that contouring is usually unnecessary for many applications.

Some Basic Considerations Relating to Aluminum Magnetic Wire

When a current passes through a loop or turn of the electrical conductor, a magnetic field is set up within and around the turn. The magnetic field increases and decreases directly as the current varies. Adding turns also increases the magnetic field. The reverse of this process is that when a magnetic field varies within a turn or turns

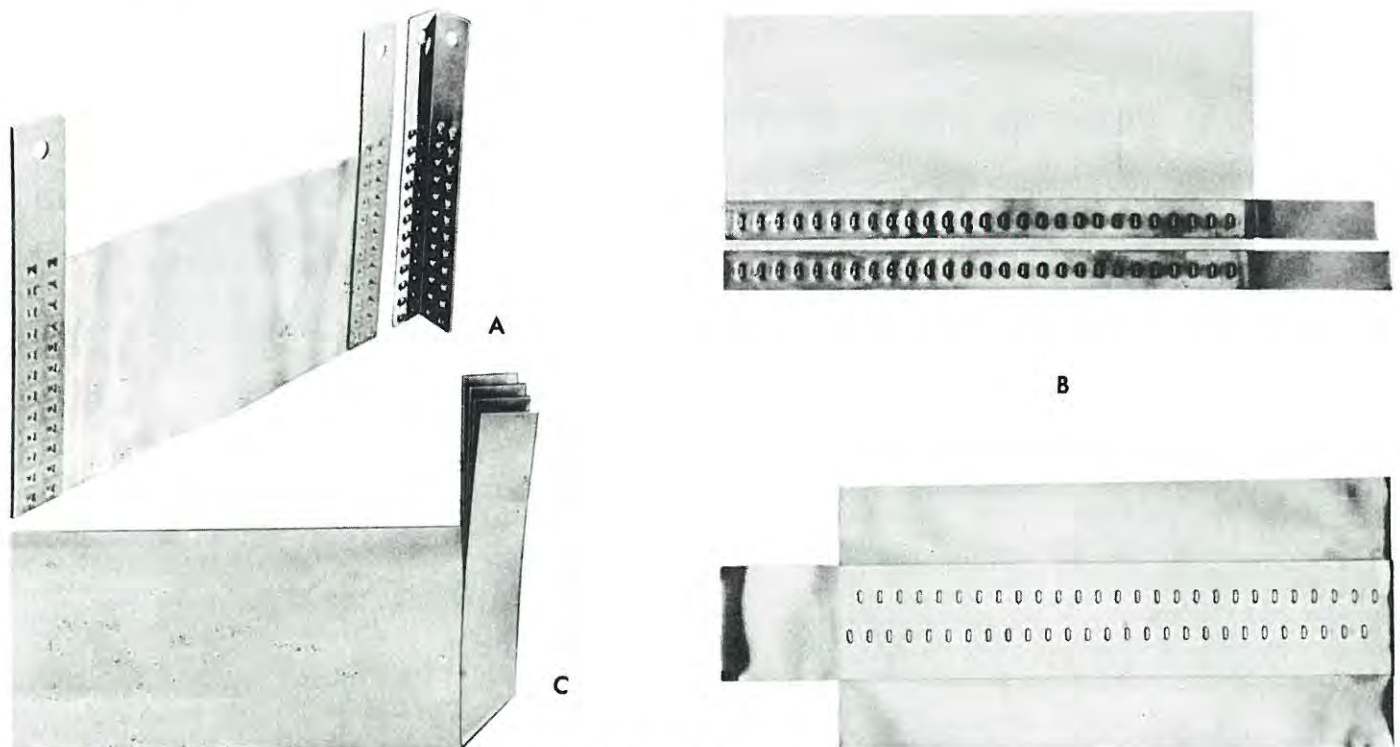

Fig. 14-7. Various methods of applying terminals to aluminum strip conductor.

*A. Mechanical joints.* Use of mechanical joints in aluminum and copper has been successful when joints have been properly designed. Riveted joints have been successfully used for years in the small strip conductor wound horn coil and the larger welder reactor coils. Mechanical connectors are available for joining solid or stranded wire leads to strip conductor.

*B. Coldwelding.* Pressure welding at room temperature is an accepted method of joining aluminum strip conductor to aluminum or copper in production. Coldwelding anodized aluminum to anodized aluminum, bare aluminum or cop-

per requires no wire brushing of the aluminum surface. Tests have proven that the joints formed by this method have high conductance and high strength. Commercial equipment is available for joining a wide range of thickness and widths of strip conductor.

*C. Fold out parent metal.* The end of the strip may be slit or folded by various techniques and brought out at 90° to form a narrow laminated lead. A flexible lead can then be attached by welding, by mechanical connectors, or by bolted connections. Shown is a strip slit in four equal widths folded out individually—one on top of the other.

of an electrical conductor, there is induced in the conductor an electromagnetic force which will cause current to flow if the turn is connected to a load. This action forms the basis of a fundamental law of electricity, the application of which underlies the design and operation of most electrical apparatus and circuitry.

Electrical energy may be transformed from one circuit to another with possible change of voltage and isolation of the two circuits by sharing of a magnetic field in which one component forms the magnetic field (must be alternating) and the other has induced in it the electromagnetic force from the changing magnetic field. This is known as mutual coupling.

A second method of transforming energy is by direct coupling — the sharing of a resistor, inductor or capacitor.

The magnitude of the induced emf (  $e$  ) depends on two fundamental factors, as follows:

$$e = N \frac{d\phi}{dt} \tag{Eq. 14-4}$$

where:  $N$  = number of turns  
 $\frac{d\phi}{dt}$  = time rate of change of flux (the magnetic field)

$$\text{and } e = L \frac{di}{dt} \tag{Eq. 14-5}$$

where:  $L$  = coefficient of self inductance  
 $\frac{di}{dt}$  = time rate of change of current

From (4) and (5) it is seen that:

$$\phi = \frac{LI}{N} \text{ (for a non-magnetic core coil)} \tag{Eq. 14-6}$$

TABLE 14-5  
Strip Conductor Alloys – Physical Constants at 20°C

	Aluminum		Copper Electrolytic
	1350-0	1235-0	
Volume electrical conductivity minimum percent IACS	62	61	100
Density lb./in. <sup>3</sup>	0.09765	0.09765	0.32117
Volume resistivity microhm – in.	1.09482	1.11277	0.67879
Weight resistivity microhm –lb./ft. <sup>2</sup>	15.40	15.65	31.39
Temperature co-efficient of resistance ohm/°C	0.00410	0.00403	0.00393
Specific heat cal/gram/°C	0.214	0.225	0.092
Co-efficient of thermal conductivity cal/sec/ CM <sup>2</sup> /CM/°C	0.57	0.55	0.934
Co-efficient of linear expansion per °C	23.8 × 10 <sup>-6</sup>	23.6 × 10 <sup>-6</sup>	16.8 × 10 <sup>-6</sup>

Where:  $\phi$  = flux or field  
I = current in conductor

For a coil with a magnetic core (iron) with permeability  $\mu$  and reluctance R:

$$\phi = \frac{N}{R} I \quad (\text{Eq. 14-7})$$

and  $R = \frac{l}{\mu A} \quad (\text{Eq. 14-8})$

Therefore:  $\phi = \frac{N I \mu A}{l} \quad (\text{Eq. 14-9})$

Where: A = area of flux path in iron  
l = length of flux path in iron

The conditions for a strong field are large number of turns, high current, no air gaps in iron path, and use of high permeability iron.

To achieve a coil with high magnetic field capability and low cost, size, weight, and energy consumption has been the goal of designers since the time of Faraday who did fundamental work in the area of electromagnetic induction in the last century.

Electromagnetic coils consist of coils of many turns of magnet wire (insulated conductor) wound around soft iron cores whose ends are connected in loops, if design permits. Improvements over the years have been (1) lamination of the iron to reduce losses, (2) increasing the permeability of the iron, (3) reducing the thickness of the magnet wire insulation and layer insulation to permit more turns per unit space, (4) improving the thermal stability of the magnet wire insulation to allow more current to flow at higher temperatures, (5) use of rectangular wire and strip (interleaved) to gain in space factor, (6) improved thermal dissipation for cooler operation.

Other more recent advances in rapid-chilled iron with amorphous internal structure (glass-like) promise a drastic reduction in iron losses for next generation coils and transformers.



## Chapter 15

## Capacitor Foil

Capacitors both fixed and variable are used today in almost every electrical system. From great power generating and distributing networks to electric organs, including telephone and radio systems, computers and motors, elevators and x-ray apparatus and so on, the use of a capacitor almost always is a fundamental necessity.

Any arrangement of electrodes whatsoever upon which electric charges accumulate or move will exhibit the incidence of capacitance. Where the electrode geometry is extensive in space such as a wire or cable, the charges are distributed likewise and we speak of such a structure as being a *distributed* capacitance. When the electrodes are deliberately concentrated in space, the charges are concentrated and this is termed a *lumped* capacitance. All electrical components used specifically as capacitors are looked upon as providing lumped capacitance.

Aluminum has been and is the preferred metal for capacitor electrodes whether used in rigid plate form or in varying thicknesses of foil for d-c, a-c low voltage, high voltage, high frequency, high or low power, impulse discharge, etc.

## Capacitor Design Considerations

Under given conditions of electrical, physical and environmental factors, a capacitor may be called upon to provide a precise amount of capacitance, a required time constant of charge and discharge (with proper circuit resistance) or a specified impulse release of stored energy. The selection of electrode and insulation materials and the design of their electrical and mechanical arrangements can be optimized to produce an economical capacitor that will perform properly in its intended service.

In Section III, Chapter 8, the general conditions governing the relation of potential and charge to capacitance were discussed as well as the influence of the dielectric medium. The equations for capacitance relating to a wide variety of electrode geometries were given and the nature of the dielectric polarization of the insulation discussed. All of this is applicable to capacitor design.

A common economic consideration in capacitor design is to obtain the largest amount of capacitance per unit volume of material used. This is, of course, obtained by using the thinnest electrodes and the thinnest insulating material possessing the highest dielectric constant. How far one can go in these directions depends upon the circuit voltage to be withstood, the conductance and/or dielectric loss that can be tolerated and the stability of the assembly under the operating conditions.

## Equivalent Network of a Capacitor

All capacitors possess a certain amount of series resistance and inductance as well as shunt capacitance and conductance. Fig. 15-1 shows a simple, unrolled foil capacitor and its equivalent electrical circuits. The series impedance ( $r + j\omega L$ ) is made up of the resistance and inductance of the capacitor leads plus those inherent in the electrode material, shape and extent. Usually the inductance is negligibly small as compared to the other factors. Actually, the inductance is approximately the same as a wire loop equal in area to that formed by the two leads and the capacitor unit itself. The foil electrodes appear as a uniformly distributed series resistance.

The overall impedance of the equivalent network shown in Fig. 15-1 (c) is:

$$Z = r + \frac{g}{g^2 + \omega^2 C^2} - j \frac{\omega C}{g^2 + \omega^2 C^2} + j\omega L \quad (\text{Eq. 15-1})$$

where:

$\omega = 2\pi f$   
 $f$  in Hz  
 $g$  in mhos  
 $C$  in farads  
 $L$  in henrys  
 $r$  in ohms

or since  $g^2$  is usually very small compared to  $\omega^2 C^2$ ,

$$Z \cong \left( r + \frac{g}{\omega^2 C^2} \right) + \frac{j(\omega^2 CL - 1)}{\omega C} \quad (\text{Eq. 15-2})$$

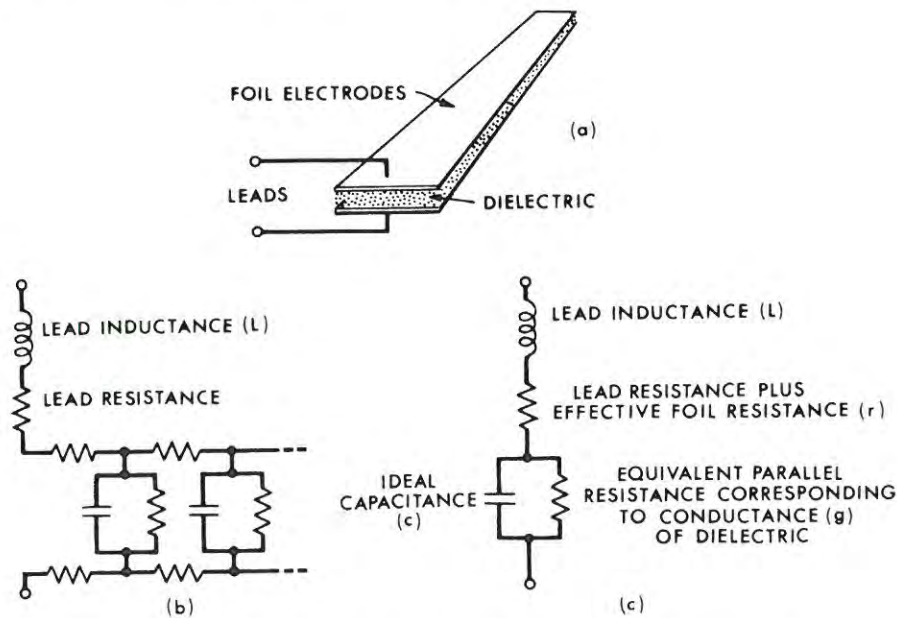

Fig. 15-1. Equivalent electrical circuit of a capacitor.

From the above it is obvious that the effective capacitance seen across the terminals of a capacitor is  $\left(\frac{C}{\omega^2 CL - 1}\right)$

and that this will vary with frequency. For low frequencies it will be equal to C; as frequency increases, the effect of the inductance increasingly reduces the capacitance and the capacitive reactance. At a frequency where resonance occurs (usually very high), the overall impedance is entirely made up of the effective resistance of the leads and the foil electrodes at that frequency. Above the resonant frequency, the capacitor acts as an inductance coil with some series capacitance. Although theoretically every practical capacitor will exhibit resonance at some high frequency, it is always possible to arrange the electrode and terminal wires to obtain the effect of a low impedance, long transmission line free of apparent resonance over a wide high-frequency band. Fig. 15-2 shows the reactance vs. frequency effect for a waxed paper insulated capacitor designed for audio frequency circuits.

*Effective Resistance and Loss of a Capacitor:* At frequencies below which parasitic inductance becomes significant, the dissipated watt loss in a capacitor is occasioned by both the ohmic loss in the foils and leads and the dielectric loss in the insulating material. However, as the ohmic loss is almost always insignificant it is usually ignored in commercial practice and power loss is computed with the following formula:

$$W = E^2 \omega C \tan \delta \quad (\text{Eq. 15-3})$$

Where: E = volts  
 $\omega = 2\pi f$  (frequency in Hz)  
 $\tan \delta =$  dissipation factor  
 $\delta =$  loss angle

Reduction of losses in a capacitor is quite important from the standpoints of both adequate performance and stable life. In capacitors carrying heavy currents, the energy loss is a source of heating which, if not adequately reduced or carried off by thermal conduction, can cause rapid deterioration and failure of the insulation. Control of heat loss enters into the design and use of capacitors for low frequency operation in connection with power factor correction and, at high frequencies, in radio transmitting capacitors. In radio frequency circuits, effective resistance becomes important in series coil and capacitor combinations required to have low impedance at the resonance frequencies or parallel combinations required to have high impedance at the anti-resonance frequency. This is because resistance may add appreciably to the desired low impedance at the resonance frequency or reduce the desired high impedance at the anti-resonant frequency.

In electric wave filters intended to pass a single band of frequencies and suppress others, the transmission loss is ideally zero over the pass-band and rises sharply beyond the edge or edges. Parasitic loss in the reactive elements is unwanted loss which varies over the pass-band and reaches a maximum at the edges resulting in distorted transmission. This source of loss is generally objectionable, for example, in carrier-telephone systems where the cumulative loss of many filters in tandem may result in considerable distortion which must be compensated for by means of attenuation-equalizing networks.

In his efforts to limit the losses in capacitors required to pass alternating current in telephone and electronic circuits, the capacitor engineer is usually primarily concerned with the effect of frequency on series and shunt resistance.

This is because the effective resistance undergoes large changes with changing frequency and because of the wide frequency-range which circuits are often required to cover.

**Loss in Foil and Leads:** At a first approximation, the effective impedance of the foil and leads of a capacitor appears as a straight-line factor over a wide range of frequency. At higher frequencies, impedance increases due to eddy-current and other losses including skin effect where only the outer portion of the metallic components carry the current.

From the watt loss (Eq. 15-3) above, it is seen that the heat loss in the foil and leads increases as the square of the frequency for constant applied voltage. In general, this condition applies over the operating frequency-range of many capacitors.

*Effective Resistance of Foil Electrodes*

In the case of wound paper capacitors, there is a simple relationship between the effective resistance of the foil electrodes and their dc resistance. With reference to Fig. 15-1, it is clear that alternating current entering the foil electrodes at the lead-in wires decreases as it spreads or distributes along the foil, and the current flowing at points remote from the lead-in wires may be only a small fraction of the entering current. It may be shown theoretically and demonstrated experimentally that for the long, narrow

electrodes of wound paper capacitors the effective foil resistance is approximately equal to 1/3 of the loop dc resistance obtained by adding the dc resistance values of the two foils. In other words, due to current attenuation along the foils only 33 percent of the total d-c foil resistance is effective with respect to alternating current. Fig. 15-3 shows the effect of several laid-in terminals in reducing effective foil resistance especially at the higher frequencies.

Where, as is more usual in practice, the terminals are laid-in at approximately the middle of the foil electrodes, the current spreads in opposite directions along the foils. The effective resistance of the loop in each direction is then  $R/6$  and, since the two loops are in parallel, the total effective resistance becomes  $R/12$ . When "n" terminals are laid-in on a foil of length "L", it may be shown that the lowest resistance is obtained by spacing the terminals at intervals of  $L/n$ , with each end terminal located  $L/2n$  from the end of the foil. With this arrangement, the effective resistance is inversely proportional to the square of the number of terminals.

In the limiting case, the edge of the foil is connected together along its entire length. This, known as "extended foil" or "overlapped foil" construction, gives the lowest attainable effective foil resistance for a foil of given material and dimensions. In addition, by providing an efficient

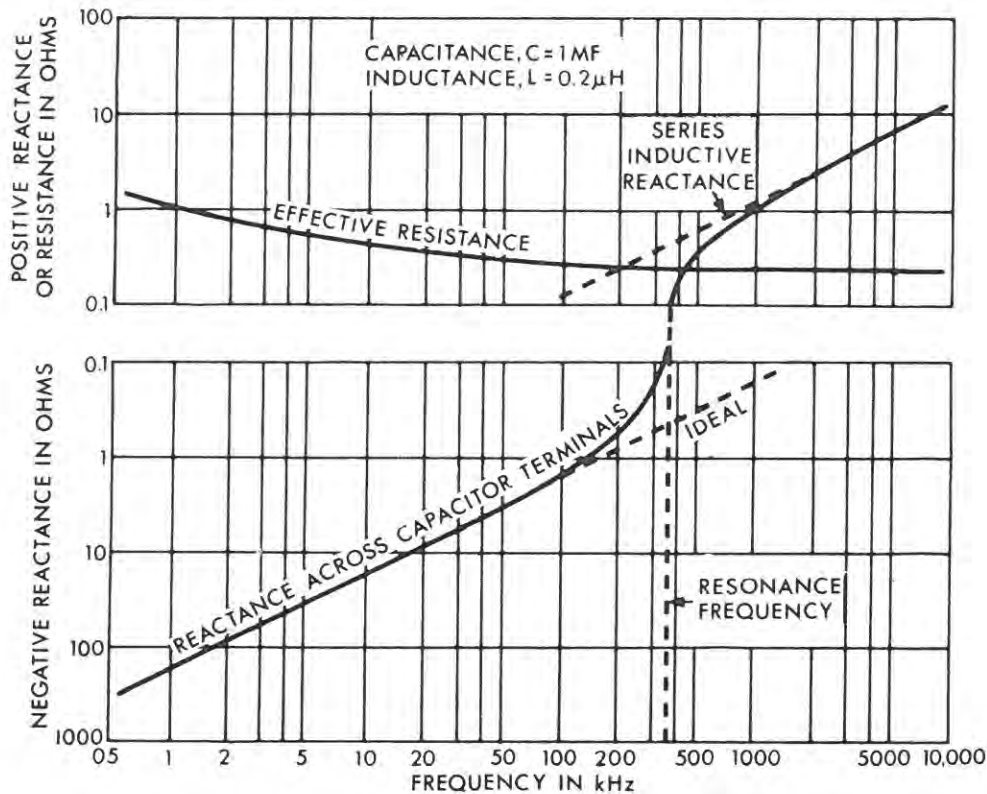

Fig. 15-2. Impedance versus frequency of paper capacitors at audio frequencies.



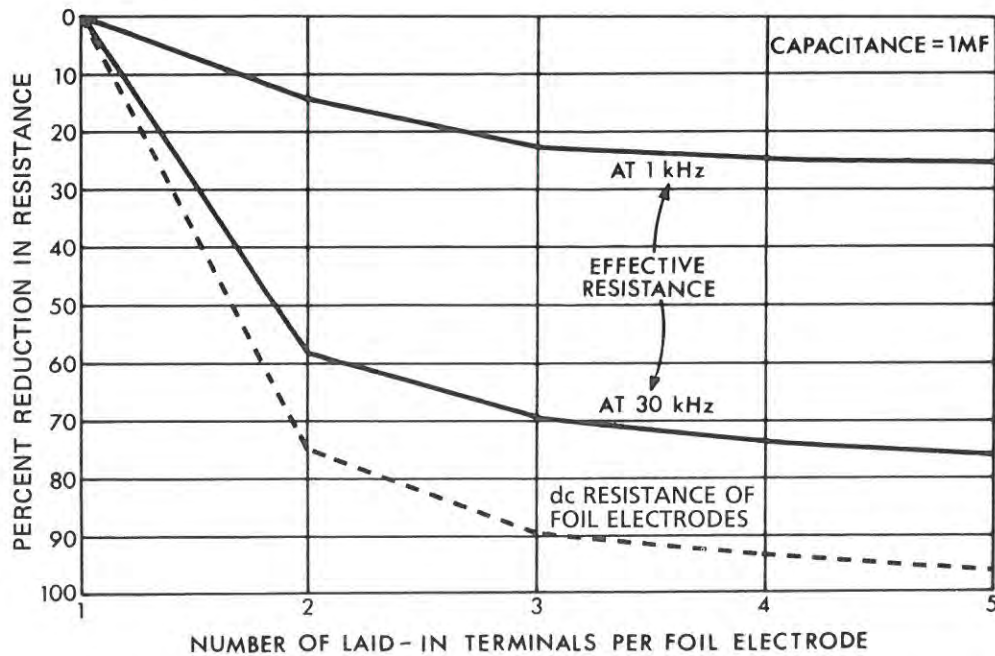

Fig. 15-3. Impedance at high frequency is reduced by adding terminals.

conduction path for heat from the inside to the outside of the unit, extended foil construction is advantageous in high-power capacitors having large heat dissipation. Fig. 15-5 illustrates the relation between heat loss and frequency in a waxed paper capacitor.

**Electrolytic Capacitors**

The electrolytic capacitor provides the most capacitance in a given space at the lowest cost per microfarad. Primarily a filtering capacitor, this type is largely used in connection with dc circuits at working voltages less than 500 volts. For example, at low voltage, several thousand microfarads may be contained in a one cubic inch electrolytic capacitor using etched aluminum foil electrodes. Fig. 15-4 shows a typical electrolytic capacitor design.

The high capacitance per unit volume of electrolytic capacitors comes from the extreme thinness of the dielectric which is an anodic oxide film previously built up by an electrolytic process on one of the foil electrodes, known as the anode (capacitance per cubic inch is inversely proportional to the thickness of the dielectric). The thickness of this insulating film is but a few millionths of an inch and the working voltage gradient can be of the order of 10 million volts per inch. Etching the anode increases the effective area so as to increase the capacitance as much as 7 to 30 times.

With the voltage applied in one direction, the film has a high resistance to the flow of current and behaves like a dielectric. With the voltage reversed, the film behaves like a relatively low resistance and, if the voltage is high enough, it passes large currents, heats up and soon breaks down. Because of this unidirectional property, the film is

suitable only for direct voltage in a single direction and the anode terminal is usually marked "positive" to indicate in which direction the voltage shall be applied.

Electrolytic capacitors are used extensively in low voltage ac applications. One type consists virtually of two capacitors with their cathodes connected together so that the two capacitors operate in series but in opposite directions. One capacitor absorbs the applied voltage on one half of the ac cycle and the other capacitor comes into

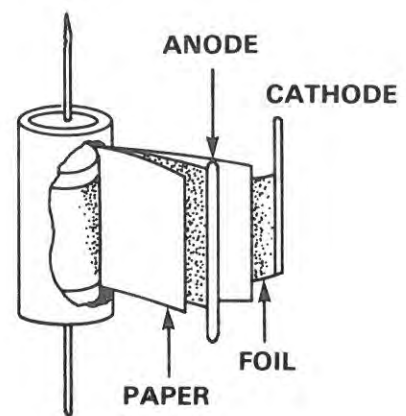

Fig. 15-4. Cross-sectional view of a typical capacitor.

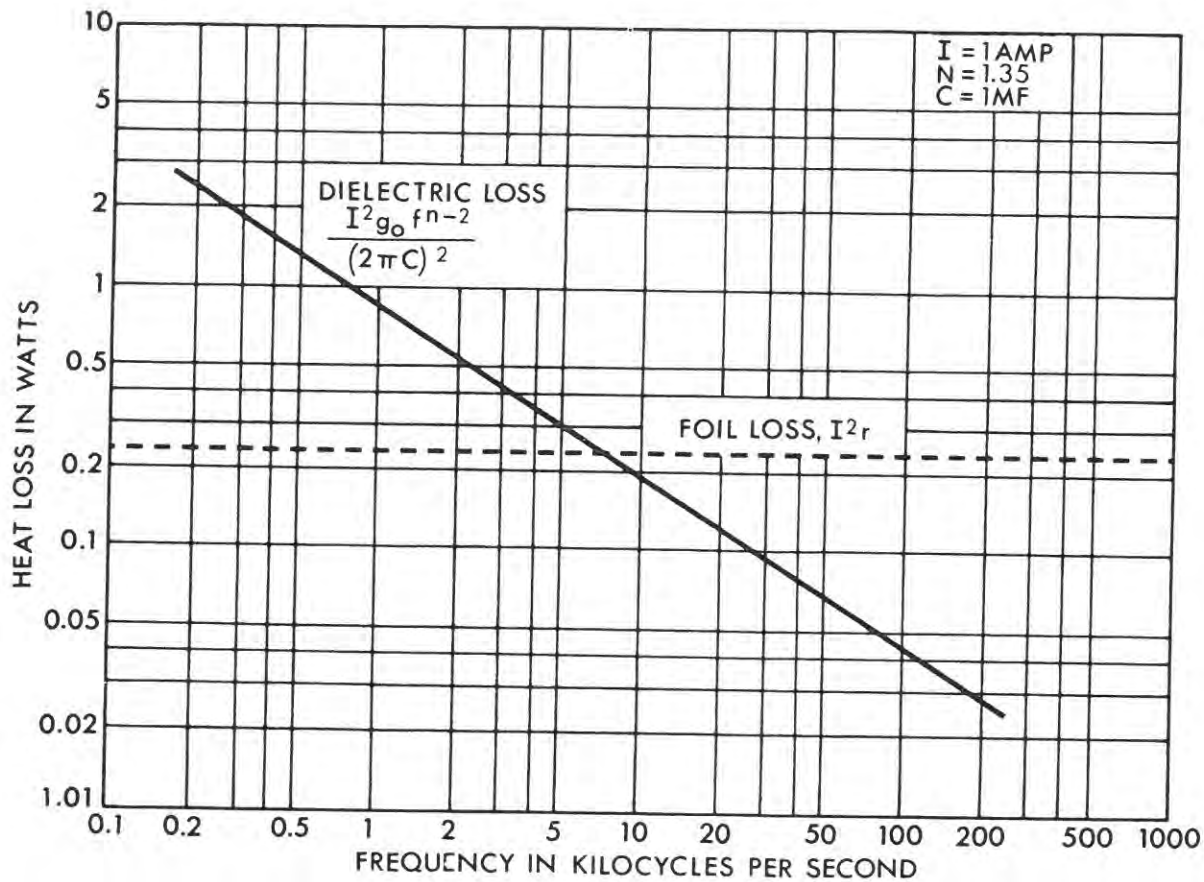

Fig. 15-5. Heat loss versus frequency at constant current in paper capacitor

play during the succeeding half-cycle when the voltage reverses. The most common type is a capacitor wound as a non-polar capacitor utilizing two anodes instead of an anode and a cathode. Such capacitors are used extensively on low ac voltages; for example, as motor-starting capacitors when the full voltage is of short duration. Where the voltage is very low, they can be used continuously; for example, to filter audio frequencies in radio sets. In general, they are limited on ac with respect to voltage because of the high power factor.

Improvements made in the design and manufacture of aluminum electrolytic capacitors allow for use in a wide variety of commercial and industrial precision circuit applications. Common usage today is in the telecommunications industries. The highest aluminum purities, for example 1199, allow for the manufacture of high reliability capacitors with extended life and temperature characteristics and long, stable storage life.

### Capacitor Foil Availability

Precise capacitor design begins with high-purity aluminum capacitor foil of precise thickness and desired sur-

face and edge treatment. High purity aluminum capacitor foil is produced by a number of manufacturers and is available in a wide range of thicknesses, widths and alloys. Precision processing assures control of impurities, foil uniformity and continuity, freedom of sticking during unwinding, excellent gauge control, perfectly slit burr-free edges, and tightly wound compact coils. A full range of purities are available—from 99.35% to 99.99% pure aluminum.

Foil is produced either in the dry condition, or with a so-called slick finish, or etched and anodized.

*Dry Foil:* Specialized annealing technique provides a surface free from residual oil contamination. A thoroughly wet surface will show no droplet formations indicative of oil residue.

*Slick Foil:* A slightly lubricated surface developed in combination with annealing practices overcomes friction generated by winding equipment, but will not contaminate the dielectric.

**TABLE 15-1**  
**Chemical Composition—Maximum Allowable Impurities in Weight Percent**

Alloy	Silicon	Iron	Iron & Silicon	Copper	Manganese	Titanium	Magnesium	Zinc	Other	Minimum Aluminum
1235			.65	.05					.05	99.35
1145			.55	.05	.05				.03	99.45
1180	.09	.09		.01		.02			.02	99.80
1188	.06	.06		.005	.01	.01	.01	.02	.01	99.88
1193	.04	.04		.006				.01	.01	99.93
1199	.006	.006		.006			.006	.006	.002	99.99

*Anodized Foil:* High purity aluminum foil is specially treated to provide a very thin oxide film on its surface. This film acts as a dielectric and results in high capacitance as compared to paper capacitors. It can be etched to increase the surface area 7 to 30 times, thereby providing even greater capacitance in a given volume.

A typical group of product data tables of one aluminum foil manufacturer is reproduced here.

Table 15-1 gives chemical composition of the aluminum alloys most used in condenser foil production. It is to be recalled, in this connection, that the addition of other metals to aluminum usually lowers its electrical conductivity. Also that heat treatment putting other metals in solid solution with the aluminum also lowers conductivity.

Table 15-2 gives typical properties.

Table 15-3 gives thickness and width limitations.

Table 15-4 gives weight-area conversion factors.

Table 15-5 gives typical splice data.

Table 15-6 gives foil roll sizes and weights.

**TABLE 15-2**  
Typical Physical Properties—O Temper

Alloy	Gauge	Tensile-psi	% Elongation
1199	.003"	5,000	3.2
1193	.003"	8,100	6.6
1188	.003"	6,300	5.7
1180	.003"	6,500	6.0
1145	.003"	10,000	7.0
1235	.003"	10,500	8.1

**TABLE 15-3**  
Thickness And Width Limitations

Alloy	Gauge	Finish*	Widths
1235; 1145	.00017"-.0002"	MIS	$\frac{3}{8}$ "-26"
1235; 1145	.0002"-.00023"	MIS	$\frac{3}{8}$ "-31"
1235; 1145	.00025"	MIS	$\frac{3}{8}$ "-43"
1235; 1145	.0003"	MIS	$\frac{3}{8}$ "-50"
1235; 1145	.00035"-.0004"	MIS	$\frac{3}{8}$ "-64"
1235; 1145	.00045"-.001"	MIS	$\frac{3}{8}$ "-72"
1235; 1145	.0015"-.0059"	MIS, 2SB	$\frac{1}{4}$ "-72"
1235; 1145	.002"-.0059"	2SB	$\frac{1}{4}$ "-52"
1180; 1188	.0004"-.0015"	MIS	$\frac{3}{8}$ "-36"
1180; 1188	.002"-.0059"	2SB	$\frac{1}{4}$ "-36"
1193; 1199	.001"-.0015"	MIS	$\frac{3}{8}$ "-36"
1193; 1199	.002"-.0059"	2SB	$\frac{1}{4}$ "-36"

\*MIS designates *Matte one side*.  
2SB designates *Two sides bright*.

**TABLE 15-5**  
Splices (Annealed Foil—Dry or Slick)

Gauge	Width	Splice
.00017"-.0004"	23" Maximum	Knurl
.00017"-.0015"	All Widths	Foil Tape
.002"-.005"	All Widths	(Electric Weld)
(Electrolytic Foil)		(Ultrasonic Splice)

**TABLE 15-4**  
Weight-Area Conversion Factors

Thickness (In.)	Sq In./Lb	Sq Ft/Lb	Lb/432,000 Sq In.*
.00017	60,300	418.75	7.16
.0002	51,300	356.25	8.42
.00023	44,600	309.72	9.69
.00025	41,000	284.72	10.54
.00030	34,200	237.50	12.63
.00035	29,300	203.47	14.74
.00040	25,600	177.78	16.88
.00045	22,800	158.33	18.95
.00050	20,500	142.36	21.07
.00055	18,600	129.17	23.23
.00060	17,100	118.75	25.26
.00065	15,800	109.72	27.34
.0007	14,600	101.39	29.59
.00075	13,667	94.91	31.61
.00080	12,800	88.89	33.75
.00085	12,058	83.74	35.83
.00090	11,400	79.17	37.89
.00095	10,789	74.92	40.04
.0010	10,250	71.18	42.15
.0015	6,830	47.43	63.25
.0020	5,130	35.63	84.21
.0025	4,100	28.47	105.37
.0030	3,420	23.75	126.32
.0035	2,930	20.35	147.44
.0040	2,560	17.78	168.75
.0045	2,280	15.83	189.47
.0050	2,050	14.24	210.73
.0055	1,860	12.92	232.26

\*432,000 sq. in. signifies one ream (500 sheets) of 24 in. x 36 in. sheets.

**TABLE 15-6(a)**  
**Roll Size**

Width	Type of Core	Maximum OD
1/4"-3"	1 5/16" Aluminum	6"
3"-31"	1 5/16" Aluminum	12"
1/4"-3"	3" Aluminum	8"
3"-72"	3" Aluminum	13"
17"-72"	3" Iron	30"

**TABLE 15-6(b)**  
**Roll Weight Data—Unmounted Foil**

SPOOLED ROLL Outside Diameter (Inches)	WEIGHT OF FOIL PER INCH OF WIDTH—(POUNDS)			
	ALUMINUM CORE		IRON CORE	
	ID-1-5/16" OD-1-1/2"	ID-3" OD-3-3/16"	ID-2-1/2" OD-3"	ID-3" OD-3-1/4"
2"	0.3 lb	—	—	—
2½"	0.3	—	—	—
3"	0.5	—	—	—
3½"	0.7	0.2 lb	0.3 lb	0.2 lb
4"	1.0	0.4	0.5	0.4
4½"	1.3	0.7	0.8	0.7
5"	1.7	1.1	1.2	1.1
5½"	2.1	1.5	1.6	1.5
6"	2.6	2.0	2.1	2.0
6½"	3.1	2.5	2.6	2.5
7"	3.6	3.0	3.1	3.0
7½"	4.1	3.5	3.6	3.5
8"	4.7	4.1	4.2	4.1
8½"	5.3	4.7	4.8	4.7
9"	6.0	5.4	5.5	5.4
9½"	6.7	6.1	6.2	6.1
10"	7.5	6.9	7.0	6.9
10½"	8.3	7.7	7.8	7.7
11"	9.1	8.5	8.6	8.5
11½"	10.0	9.3	9.4	9.3
12"	10.9	10.2	10.3	10.2
12½"	11.8	11.2	11.3	11.2
13"	12.8	12.2	12.3	12.2
13½"	13.8	13.2	13.3	13.2
14"	14.8	14.2	14.3	14.2
14½"	15.9	15.3	15.4	15.3
15"	17.0	16.4	16.5	16.4
15½"	18.2	17.6	17.7	17.6

NOTES: ID and OD dimensions represent the Inside and Outside Diameter, respectively, of the metal core.

The above figures are approximate and do not include core weight.

For approximate net weight of Foil per roll, exclusive of core weight, multiply the figure under the applicable roll OD and type of core by the inches of roll width.

Chapter 16

## Cast Aluminum Rotors and Switchgear

Squirrel cage induction motors are the most popular form of motor design for both household appliances and heavy industrial equipment.

Before the advent of present aluminum die casting techniques, rotors for squirrel cage motors were built up in a step by step fashion using iron laminations and wound copper wire conductors or conducting rods of copper or bronze alloys welded to end-rings of copper or bronze.

Experimental work with aluminum castings conducted in the 1930's focused serious attention on the lower cost and engineering advantages of making an integrally cast aluminum/iron lamination squirrel cage rotor.

### The Cast Rotor

The cast rotor has two essential components. These are the punched iron disks or laminations containing the holes for the conducting bars, the shaft, and any cooling holes or vents, and the aluminum which is used in integrally casting the conductor bars and collector rings. A stack of laminations is assembled for a particular rotor, the diameter and height of which are determined by the motor design. The laminations may have either open or closed slots (See Fig. 16-1, A and B), however in recent years, the closed-slot design is much more commonly used.

The stack of laminations is placed in a permanent mold or die-casting die containing a space at the top and bottom for the simultaneous casting of end-rings. These end-rings serve to connect electrically all of the rotor bars. The mold is clamped together and the selected molten aluminum alloy is poured or forced into the mold. The resultant cast rotor is shown in Fig. 16-2. The particular rotor shown is of the open-slot type. If this particular rotor were of the closed-slot type, the flash would not be in evidence.

The rotor shaft may or may not be inserted in the rotor bore at this point, depending on the succeeding finishing steps required and the particular manufacturing process being used.

Fig. 16-3 shows a typical cast rotor from which all of the iron laminations have been eaten away by acid in order

to reveal the interior construction.

### Comparative Performance of Cast Aluminum Rotors

Casting rotors in aluminum makes it possible to fill all the conductor bar slots, bind the entire assembly together, and produce the end-rings and cooling fan vanes in a single economical operation. The resultant assembly is sturdier and less noisy than a copper-cage rotor. It gives motor designers greater latitude and makes better use of the slots by filling them completely. Because of this, a cast rotor should maintain its balance indefinitely whereas a welded, brazed or wound cage, in which the conductors do not fill the slots completely, may lose its balance in time.

*Electrical Conductivity:* In an induction motor, the higher the electrical conductivity of the rotor, the greater the efficiency of the motor under normal load. On the other hand, the lower the conductivity the higher the starting torque and the lower the starting current. The use to which the motor will be subjected determines motor design and selection of alloy for a desired conductivity. Since, on a volume basis, aluminum has lower conductivity than copper, the required conductivity in a cast aluminum rotor is achieved simply by increasing the size of the slots and of the end rings over that required by an equivalent copper-cage. The overall dimensions remain approximately the same.

*Weight:* Because of the relative densities of the two metals the weight of an aluminum conductor is half that of an equivalent copper conductor. This means that an aluminum rotor is subject to less stress from centrifugal forces, less starting inertia, less vibration while running and is more portable than an equivalent copper rotor.

*Heat Capacity:* Temperature rise is one of the limiting factors in motor design. The greater the heat capacity of the rotor the cooler it remains during temporary overloads. Pound for pound aluminum has more than twice the heat capacity of copper but, since its weight in a rotor is about half that of an equivalent copper-cage, heat capacity remains on an equivalent basis.

*Thermal Conductivity:* The higher the thermal conduc-

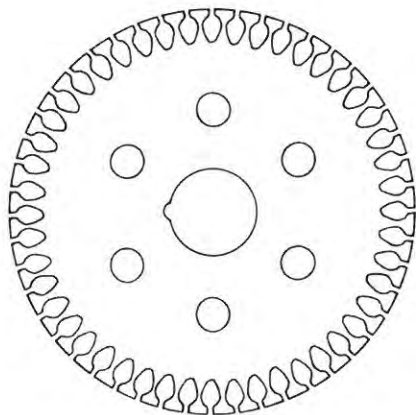

Fig. 16-1(a). A typical open-slot rotor punching.

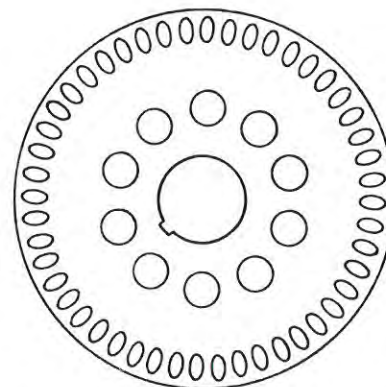

Fig. 16-1(b). A typical closed-slot rotor punching.

tivity the greater the ability of the rotor to dissipate heat. Aluminum has half the thermal conductivity of copper. On the other hand an equivalent aluminum cage has a relatively larger volume and better heat transmission conditions between conductor and core. In this respect, therefore, equivalent performance is attained.

#### Alloy Selection

Rotor casting demands relatively high conductivity for most applications, exceptionally clean metal that will completely fill the conductor-bar slots and form sound end-rings and fan vanes around the assembled core of steel laminations. The aluminum must solidify without cracks or excessive porosity to provide the necessary electrical circuits, and develop adequate strength to bind the entire unit together.

The important factors, therefore, in cast rotor alloy selection are: conductivity, castability, cleanliness and strength. Unfortunately not all of these factors are optimized by the same alloy composition. For most applications rotor manufacturers strive for maximum conductivity but as the size and complexity of the rotor increases some sacrifice is unavoidable if the needed castability and strength are to be secured.

Manufacturers generally provide several recommended aluminum rotor alloys whose use depends upon the size of the rotor. For smaller rotor sizes the aluminum content is higher and the conductivity approaches 59 to 60% IACS. For larger rotors a greater amount of alloyed silicon and iron is provided so that the conductivity may be from 54 to 57% IACS. The higher alloy content is controlled carefully and provides greater castability, greater freedom from hot cracking and shrinkage during casting. Manufacturers recommend the use of the higher iron/silicon alloy when one or more dimensions of the rotor is greater than five inches.

For a listing of rotor alloys and their chemical compo-

sitions, see Table 16-1 on page 16-5.

**Conductivity from Composition:** Conductivity measurements on the ingot itself are not a reliable measure of the conductivity of connector bars and collector rings because rotor casting processes affect such conductivity measurements. Yet rotor manufacturers need a means for identifying consistent electrical characteristics in the rotor metal they purchase. This is accomplished by specifying the chemical composition limits and a range or the minimum electrical conductivity of the ingot.

**Rotor Ingot:** Manufacturers of aluminum rotor alloys supply such metal in ingot form to specifications for composition and conductivity. The rotor alloys are particularly free from non-metallic and harmful oxide inclusions resulting in better fluidity and improved castability than commercial grades of unalloyed aluminum.

### Manufacture of Cast Aluminum Rotors

#### Melting and Metal Preparation Equipment

Fuel fired, induction and electric resistance furnaces are used to melt and hold aluminum for the casting of motor rotors. The choice of melting equipment will depend on the type and volume of rotors to be cast and on the cost of fuel for any given locality.

The following types of furnace equipment can be used to melt and hold aluminum for motor rotors:

**Crucible Furnaces:** Underfired crucible furnaces are available with capacities that range from just a few pounds to 1500 pounds. Although it is possible to use the same crucible furnace for both the melting and casting processes, it is preferable to melt and flux in one unit and transfer the molten metal to a second furnace for casting. The use of a single furnace for melting and casting does not provide good temperature control since ingot and gates charged into the melt drop the temperature of the metal making it impossible to maintain a uniform

pouring or casting temperature. A single furnace for melting and holding also complicates the fluxing of the melt for cleaning the metal.

The use of a refractory crucible such as silicon carbide or clay graphite is recommended as iron pickup can result from the use of cast iron crucibles. Where cast iron crucibles are employed, they must be kept coated with a refractory pot wash to minimize iron pickup since iron is readily soluble in molten aluminum and reduces the electrical conductivity of aluminum. Proprietary salt fluxes are used to dry the surface skim on the melt and remove build up from crucibles.

**Reverberatory Furnaces:** Reverberatory furnaces may be built in sizes varying from about 1000 pounds capacity to as high as 100,000 pounds. The reverberatory furnace is usually employed as a "breakdown" furnace with the molten metal transferred to crucible type or induction holding furnaces at the casting machine. Reverberatory furnaces with a dipping well or wells are also employed as combination melt and hold furnaces. The advantage of the dip well type of furnace is in the elimination of molten metal transfer and a low cost for melting and holding. The principal disadvantage of this type of furnace, aside from its higher original cost, is that salt fluxing and cleaning of the furnace is more difficult than with the crucible type. In all rotor casting work, the degree of cleanliness of the melting and holding furnaces is an important factor in preventing low or variable conductivity and casting problems due to the occurrence of oxide inclusions in the rotor castings. The combination of rotor grades of ingot and clean furnaces provides optimum metal quality.

**Induction Furnaces:** Electric induction furnaces are employed by a number of motor rotor manufacturers for the melting and holding of aluminum. Induction furnaces provide a high quality melt with uniform composition and excellent temperature control; however, where ingot and scrap are charged into a single chamber induction furnace, some variation in metal temperature and oxide content can be expected.

Successful operation of core-type induction furnaces requires regular maintenance of the inductor channels. These channels usually require "rodding out" at regular intervals to prevent the channel from plugging up. The non-metallic deposit in the channels of an induction furnace consists of the oxides and nitrides of aluminum and other elements which are formed during continuous melting and holding. The non-metallics are concentrated in the channels by the electromagnetic field and form a hard deposit. Complex intermetallic compounds of iron and impurities may also settle in the furnace channels if the original rotor alloy is contaminated with impurity elements.

The proprietary fluxing compounds required to clean crucible and reverberatory furnaces in induction furnaces have been shown to promote channel plugging. The metal salts in fluxing compounds form oxides which are deposited on the walls of the inductor channels. Where fluxing is deemed necessary, a degassing flux of the hexachloroethane type or chlorine-nitrogen gas mixture is recommended. With rotor grade ingots, it is not necessary to flux the melt when 100% ingot is charged. The charging of gates and the biscuits from the shot chamber may necessitate fluxing of the melt at times to cleanse the metal and the channels.

#### *Casting Methods Employed for Aluminum Rotors*

The horizontal cold chamber die-casting method is recommended for high volume production of fractional horsepower motor rotors. The die casting process provides a good quality rotor casting at a low unit cost. The process lends itself to automation providing further production economics. Multiple cavity dies are usually employed to cast several rotors of the same or different design at one time. In volume production the high original investment cost of the die casting machine, dies and suitable metal melting and holding equipment is justified. In the die-casting process, the steel lamination stack is usually loaded into the die without preheating. Conventional die casting practices are used to produce rotors.

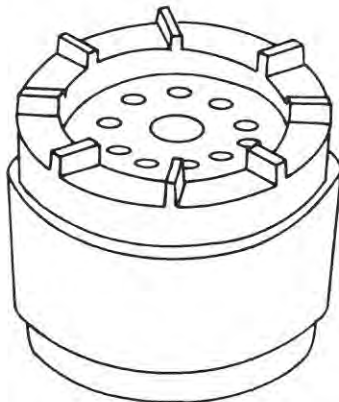

Fig. 16-2. A typical die-cast rotor of the open-slot type.

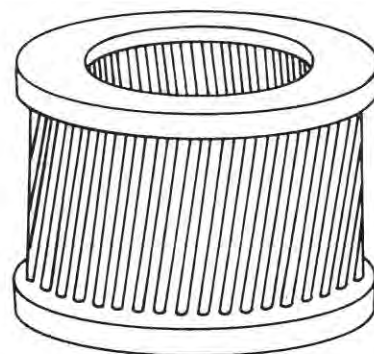

Fig. 16-3. Iron surrounding the cast-aluminum squirrel cage has been removed to reveal construction.



The vertical press method of pressure casting aluminum rotors has been used for many years to cast both fractional and large integral horsepower motor rotors. The original investment is lower than die casting equipment. In this process the lower platen of the press usually contains a round well or sump into which the molten metal is poured. The sump may be lined with mica and/or asbestos paper to prevent excessive metal temperature loss or is sometimes sprayed with an aqueous graphite or similar type coating to prevent the metal from sticking. The rotor mold and the lamination stack are mounted on the upper platen. The molten metal is forced by the stroke of the press through a series of small gates into the rotor die. The gates into the rotor usually consist of a number of tapered holes through the base plate of the mold into the collector ring part of the cavity. In this casting method, it is desirable to preheat the lamination stack to a temperature of from 400°-1000° F. prior to loading the stack into the casting die. The required preheat temperature of the laminations will vary depending on the size of the rotor to be cast and the size of the slots in the laminations.

#### *Casting Problems*

Problems usually show up as low conductance or high starting torque of the rotors. The major casting problem in the production of aluminum rotors is the presence of entrapped air and/or gas from the die lubricant. This type of defect manifests itself as a number of smooth rounded (or slightly elongated) gas holes within the end rings and conductor bars. This type of defect reduces the conductance of the rotor and the electrical efficiency of the motor. Some porosity of this type is experienced in varying degrees in all of the casting methods employed for rotors. This type of defect may be reduced by providing adequate venting of the die or mold during the casting cycle and by avoiding excessive use of die or mold lubricants. The rate of metal injection into the die can also influence the occurrence of this type of defect. The optimum metal injection rate must be determined by the producer as it will vary depending on the type of casting equipment, mold design and design of rotor being cast.

Other casting defects encountered in rotors are dross or oxide films, shrinkage, cracks and poor fill (usually in conductor bars). The dross defect can be the result of poor metal melting and handling practice and is discussed under the previous section on melting. Aluminum alloys undergo a 5 to 6 percent volume decrease in solidifying from the liquid state. Since it is impractical to supply molten metal to feed or make up for this volume change in most designs of cast rotors, some internal shrinkage porosity may occur, particularly in large integral rotors with heavy end rings. Cracks in the end rings or in the conductor bars are extremely detrimental to the service of the rotor. Unalloyed aluminum, 99.80 or 99.85, is more prone to cracks and shrinks than the rotor alloys. Other casting alloys such as 380.0 are prone to cracking in rotor casting because of their relatively long solidification range. In large rotors, it may be possible to provide excess metal in the form of risers to aid in overcoming

the shrinkage tendency in the top ring. Careful control of the metal temperature and mold temperature is necessary in minimizing cracks and poor fill in 380.0 alloy rotors.

Loss of conductivity and poor casting characteristics may occur if the rotor alloy becomes contaminated with other metals. Iron is readily soluble in molten aluminum and iron contamination in the melt is quite often the cause of low conductivity and poor fill or cold shuts.

*Steel Laminations:* In the stamping of laminations the formation of burrs at the slot edges should be kept to a minimum by proper maintenance of punches and dies. Excessive burring can contribute to metallurgical bonding with the aluminum during casting, and lead to loss of motor efficiency.

To assist in the casting of sound conductor bars and end rings (whether by gravity, centrifugal or pressure die casting) it is recommended that the steel lamination stacks be preheated. This greatly facilitates metal flow and the filling of intricate passages. Preheating the laminations also oxidizes freshly sheared edges of the slots thereby reducing the tendency for metallurgical bonding to occur between the steel and aluminum. Preheating at 250-350°C for 1-2 hours is usually adequate though bulky lamination stacks may require higher temperatures for a somewhat longer period.

*Casting:* Casting temperatures for rotor metal may lie anywhere in the range 700-800°C (1290-1470°F) depending upon individual foundry practices. Once casting temperature is established it should be held within  $\pm 10^\circ\text{C}$ . In production, uniform casting cycles should be maintained so as to properly control die and mold temperatures. Dies should be preheated to 250-300°C (480-570°F). Cold dies are the cause of scrap which can be reduced by maintaining uniform and continuous production cycling.

In pressure die-casting an important factor in the production of sound rotors is adequate venting of the cavity. Excessive use of die lubricants can lead to venting problems. If asbestos paper is used to line the mold (vertical pressure die casting of larger rotors) it should be thoroughly furnace dried just before use to eliminate this source of gas pick-up.

*Thermal Treatment:* Two considerations are important for the efficient electrical operation of a squirrel cage motor. These are (1) there should be a reasonably high inter-laminar resistance and (2) there should be a high resistance between the iron laminations and the die-cast aluminum conductors and end rings. The second item is particularly important and even a partial separation of aluminum from iron immediately results in noticeably better performance.

Thermal treatment of rotor castings, 1-2 hours at 300-450°C (570-840°F), is helpful in breaking metallurgical bonds between steel laminations and the aluminum conductor bars. This is due to a large differential in thermal expansion of the two metals. For pressure die cast rotors,

**TABLE 16-1**  
**Rotor Metal Alloys**

Alloy*	Aluminum Grade Min. Purity*	Rated Conductivity % IACS — Min.
100.1	99.00%	54
130.1	99.30%	55
150.1	99.50%	57
170.1	99.70%	59

**Chemical Composition of Rotor Alloys**

Alloy	Silicon	Iron	Copper	Manga- nese	Chro- mium	Zinc	Tita- nium	Others	
								Each	Total
100.1	0.15	0.6–0.8	0.10	(a)	(a)	0.05	(a)	0.03 (a)	0.10
130.1	(b)	(b)	0.10	(a)	(a)	0.05	(a)	0.03 (a)	0.10
150.1	(c)	(c)	0.05	(a)	(a)	0.05	(a)	0.03 (a)	0.10
170.1	(d)	(d)	---	(a)	(a)	0.05	(a)	0.03 (a)	0.10

- (a) Manganese plus chromium plus titanium plus vanadium is 0.025% max.
- (b) Iron to silicon ratio is 2.5 minimum.
- (c) Iron to silicon ratio is 2.0 minimum.
- (d) Iron to silicon ratio is 1.5 minimum.

\*In judging the rotor alloy to be used, it should be noted that the highest purity alloy (170.1) is the most difficult to cast and is subject to a greater degree of shrink cracking. By contrast, the lesser purity 100.1 alloy is easier to cast with a minimum of cracks.

For high torque rotors (37% IACS — typical) the standard foundry alloy 443.0 (Nominal 5.2% Si) is applicable. Also for high torque 30% IACS conductivity, the standard foundry alloy 380.0 (Nominal 3.5% cu, 8.5% Si) is applicable.

treatment temperatures at the lower end of the indicated range are less likely to cause blistering. The heating also tends to introduce some further oxide film between the aluminum and iron thus assisting electrical isolation further.

**Aluminum in Power Switchgear**

Aluminum and its alloys have become increasingly important in the manufacture of all types of electrical switchgear. Its applications in switchgear vary from small

rivets, sheet metal enclosures and hardware to important current-carrying and structural parts.

High electrical and thermal conductivity, high strength-to-weight ratio, excellent corrosion resistance, non-magnetic properties and superb fabrication capability are some of the most important characteristics favoring the use of aluminum.

Fig. 16-4 shows an example of modern switchgear using aluminum in various forms.

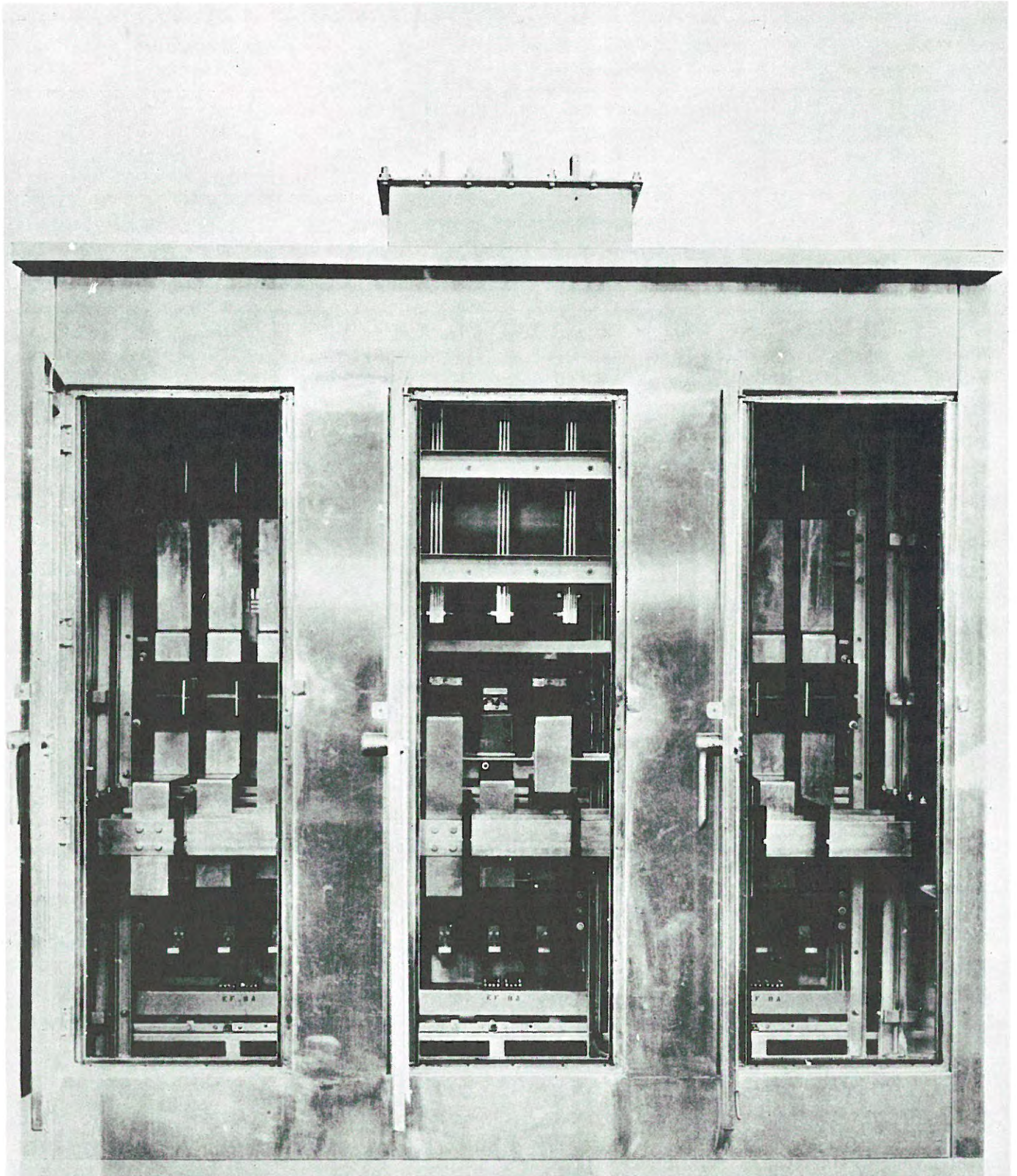

*Figure 16-4. Modern aluminum switch gear capable of handling 50,000 ampere short circuit current.*

Chapter 17

## Rigid Aluminum Conduit

One of the earliest, and still most effective, methods of installing concealed electrical cable within the structure of a building, in the building foundations or the subgrade is the use of rigid conduit. The many advantages rigid conduit provides include:

- A very high order of mechanical and flame protection for the enclosed cables.
- A high order of safety to personnel who might otherwise accidentally come in contact with the ungrounded portion of the electrical system.
- An easy pulling, smooth, snag-free pathway for the cables through an otherwise intricate, many-turned run.
- Pull-boxes to enable straight pulls as required.
- An easy means for replacing conductors or pulling in additional ones.
- Permanent, built-in cable runways in cast concrete structures.

### *Elements of Conduit Design*

Important elements in the design of electrical conduit are related to:

- Adequate strength in relation to size for self-support over reasonable lengths.
- Smooth, round, burr-free interior.
- Capability of being cut and threaded readily and bent smoothly (no flattening) with normal field methods and tools.
- Provision and maintenance of good electrical conductivity through the conduit proper and across all threaded joints.
- Development of a compatible line of accessories, such as elbows, couplings, unions, tees, pull and junction boxes.
- Freedom from destructive corrosion in the working environment.
- Provision for expansion fittings for long lengths operating under widely varying temperature conditions.
- Installation and construction requirements for electrical

conduit are set by the National Electrical Code (NEC). These include rigid aluminum, galvanized steel, IMC (intermediate metal conduit) and nonmetallic conduit, as well as conduit fittings, conduit bodies and boxes in aluminum, galvanized steel and PVC. Individual product lines must be manufactured to conform to the standards set forth by Underwriters Laboratories, in order to qualify for UL Labels.

The factors involved in NEC rigid conduit specifications relate to installation and operating requirements.

For example, the Code specifies maximum allowable fill areas for given conduit sizes. Table 17-1, abstracted from the 1987 NEC, shows the allowable fill area for each conduit trade size.\* Table 17-3 gives cross-sectional areas for typical conductor sizes insulated with both thermosetting and thermoplastic materials. Table 17-4 converts these area limitations to the number of typical conductor sizes permitted in one conduit based on both thermosetting and thermoplastic insulations. Tables 17-5a and 17-5b give dimensions of rigid aluminum, galvanized steel, and IMC. Table 17-6 gives comparative weights for the three types of metallic conduit.

The NEC also recognizes the effect of the conduit or raceway on temperature rise of the encased conductor. In Chapter 9 of this book, Tables 9-3, 9-4, 9-5, 9-6 and 9-7 show characteristics of wires and feeders in magnetic and non-magnetic conduit or raceways. Metallic conduits can contribute a small amount of heating due to hysteresis (if the conduit is magnetic) and eddy current losses. Of greatest importance in its effect on ampacity, however, is the number of loaded conductors in a given conduit. The tables referenced above give ampacity data for the case of not more than three loaded conductors per conduit. When the number of conductors increases to from 4 to 6 the ampacity values are reduced to 80% of the tabulated value. If there are 7 to 24 conductors in the conduit, the allowable currents are to be reduced to 70% of the tabulated value. (The neutral conductors, since they only carry the unbalanced currents in normally balanced circuits, are not to be considered in determining

\* Table 17-2 shows the maximum number of compact conductors allowable in conduit or tubing.

**TABLE 17-1**  
**Conduit—Allowable Fill Area**  
**Square Inches**

Conduit Trade Size Inches	Total Internal Area Sq. In.	1-Cond. 53%	2-Cond. 31%	3 or more 40%
½	.30	.16	.09	.12
¾	.53	.28	.16	.21
1	.86	.46	.27	.34
1¼	1.50	.80	.47	.60
1½	2.04	1.08	.63	.82
2	3.36	1.78	1.04	1.34
2½	4.79	2.54	1.48	1.92
3	7.38	3.91	2.29	2.95
3½	9.90	5.25	3.07	3.96
4	12.72	6.74	3.94	5.09
5	20.00	10.60	6.20	8.00
6	28.89	15.31	8.96	11.56

**TABLE 17-2**  
**Maximum Number of Compact Conductors**  
**in Trade Sizes of Conduit or Tubing**

Conductor Size AWG or kcmil	Insulation Type												Conduit Trade Size											
	T T X			T T X			T T X			T T X			T T X			T T X			T T X					
	H	H	H	H	H	H	H	H	H	H	H	H	H	H	H	H	H	H	H	H	H	H	H	H
	W	H	H	W	H	H	W	H	H	W	H	H	W	H	H	W	H	H	W	H	H	W	H	H
	N W			N W			N W			N W			N W			N W			N W					
	1 in.			1¼ in.			1½ in.			2 in.			2½ in.			3 in.			3½ in.			4 in.		
6	5	7	6	9	13	11	12	15	15															
4	4	4	4	7	8	8	9	11	11	15	18	18												
2	3	3	3	5	6	6	7	8	8	11	13	13												
1				3	4	4	5	6	6	8	10	10	11	14	14									
1/0				3	3	3	4	5	5	7	8	8	9	12	12									
2/0					3	3	3	4	4	5	7	7	8	10	10	12	15	15						
3/0							3	3	3	5	6	6	7	8	8	10	13	13						
4/0								3	3	4	5	5	6	7	7	9	10	10	12	14	14			
250										3	4	4	4	5	5	7	8	8	9	11	11			
300										3	3	3	3	4	4	6	7	7	8	9	10	10	12	12
350											3	3	3	3	4	5	6	6	7	8	8	9	11	11
400													3	3		5	5	6	6	7	8	8	9	10
500																4	4	5	5	6	6	7	8	8
600																3	4	4	4	5	5	5	6	7
700																3	3	3	4	4	4	4	6	6
750																3	3	3	4	4	4	4	5	5
1000																			3	3	3	4	4	4

**TABLE 17-3**  
**Conductor Cross-Sectional Areas**  
 (Based on Table 5, Chapter 9, 1987 NEC)

WIRE SIZE AWG, kcmil	APPROXIMATE AREA, SQUARE INCHES				
	INSULATED CONDUCTOR				BARE
	Types RHH & RHW*	Type THW	Type THHN THWN	Type XHHW	
12	.038	.025	.012	.017	.005
10	.046	.031	.018	.022	.008
8	.085	.060	.037	.046	.017
6	.124	.082	.052	.062	.027
4	.161	.109	.084	.084	.042
3	.182	.126	.099	.099	.053
2	.207	.147	.118	.118	.067
1	.272	.203	.159	.159	.087
1/0	.311	.237	.189	.189	.109
2/0	.358	.278	.226	.226	.137
3/0	.415	.329	.271	.271	.173
4/0	.484	.390	.328	.328	.219
250	.592	.488	.403	.403	.260
300	.684	.558	.467	.467	.312
350	.762	.629	.531	.531	.364
400	.836	.697	.593	.593	.416
500	.983	.832	.716	.716	.520
600	1.194	1.026	.879	.904	.626
700	1.336	1.158	1.001	1.030	.730
750	1.408	1.225	1.062	1.094	.782
800	1.478	1.291	1.123	1.150	.833
900	1.617	1.421	1.245	1.267	.933
1000	1.753	1.548	1.362	1.389	1.039
1250	2.206	1.953		1.767	1.305
1500	2.548	2.275		2.061	1.561
1750	2.890	2.593		2.378	1.829
2000	3.208	2.901		2.659	2.087

\*RHH and RHW without outer covering are the same as THW.

the derating amounts given above. Note 10 to NEC Tables 310-16 to 310-31 specifies when the neutral must be counted as a current-carrying conductor).

### Rigid Aluminum Conduit

Aluminum rigid conduit has been widely used during the past five decades due to recognition that lightweight aluminum conduit offers several advantages over steel, including reduced costs of installation, increased corrosion resistance and improved ground path.

### Advantages of Aluminum Conduit

Aluminum's combination of light weight, relatively high electrical and thermal conductivity, protective oxide

film, and excellent ductility and machinability are basic factors in its present wide acceptance. The following material examines in some detail how these plus factors compare with steel.

*Composition and Manufacture:* Rigid aluminum conduit is usually extruded from the magnesium-silicide, 6063-T1 alloy, though other alloys can be used which meet UL requirements.

Being an extrusion, aluminum conduit is completely moisture-and vapor-tight. Also, extruded pipe provides a smooth, uniform interior surface.

*Weight Comparison:* Aluminum conduit with aluminum couplings weighs approximately one-third of its galvanized steel counterpart, and one-half that of steel IMC. This difference in weight is reflected in substantially greater ease and cost savings in installation. For example, a 10-foot standard length of 4-inch steel conduit weighs over 98 pounds and requires two men or a hoist to place it. The same size aluminum conduit weighs only 34 pounds and is handled easily by one man. The larger the conduit size, the greater the savings in labor.

### Electrical Characteristics

Aluminum conduit alloy 6063 has about 1/4 the electrical resistance of the usual galvanized mild steel conduit. In the installed condition, with couplings, elbows and boxes, a run of aluminum conduit will show about 4-1/2 times greater electrical conductivity, and if the installation is properly made will maintain its high value.

*Protective Capability:* In a conduit/cable system when a phase-to-ground fault occurs, the conduit will normally carry most of the fault current—which can be quite high in value. Usually, the wiring system neutral is grounded at one point. The conduit may be grounded at many points. In any event, the fault current flowing in the conduit raises its potential above ground by an amount equal to the impedance drop to ground. The lower the installed conduit impedance to ground the less danger there is from fault/ground shocks, and in this respect the advantage of aluminum conduit is obvious. The lower resistance of aluminum conduit also means that ground current fault relaying is more reliable.

It must be understood that rigid electrical conduit as installed per NEC requirements is normally not supposed to carry any ground currents; it is to act as a mechanical protection and carry current only in the case of a fault. The Code specifically\* indicates that any neutral wires shall not be installed in electrical continuity with the conduit and, if accidental continuities are found to exist between the neutral and the conduit, such neutral faults shall be cleared. This separation of neutral ground current

\*1987 National Electrical Code, Section 250-21

**TABLE 17-4**  
**Typical Number of Conductors Allowable in Trade Sizes of Conduit or Tubing**

Wire Size AWG or kcmil	Maximum Number of Conductors in Conduit*																								
	½"		¾"		1"		1¼"		1½"		2"		2½"		3"		3½"		4"		5"		6"		
	A	B	A	B	A	B	A	B	A	B	A	B	A	B	A	B	A	B	A	B	A	B	A	B	
14	6	13	10	24	16	39	29	69	40	94	65	154	93		143		192								
12	4	10	8	18	13	29	24	51	32	70	53	114	76	164	117		157								
10	4	6	6	11	11	18	19	32	26	44	43	73	61	104	95	160	127				163				
8	1	3	3	5	5	9	10	16	13	22	22	36	32	51	49	79	66	106	85	136	133				
6	1	1	2	4	4	6	7	11	10	15	16	26	23	37	36	57	48	76	62	98	97	154	141		
4	1	1	1	2	3	4	5	7	7	9	12	16	17	22	27	35	36	47	47	60	73	94	106	137	
3	1	1	1	1	2	3	4	6	6	8	10	13	15	19	23	29	31	39	40	51	63	80	91	116	
2	1	1	1	1	2	3	4	5	5	7	9	11	13	16	20	25	27	33	34	43	54	67	78	97	
1			1	1	1	1	3	3	4	5	6	8	9	12	14	18	19	25	25	32	39	50	57	72	
1/0			1	1	1	1	2	3	3	4	5	7	8	10	12	15	16	21	21	27	33	42	49	61	
2/0			1	1	1	1	1	2	3	3	5	6	7	8	10	13	14	17	18	22	29	35	41	51	
3/0			1	1	1	1	1	1	2	3	4	5	6	7	9	11	12	14	15	18	24	29	35	42	
4/0				1	1	1	1	1	2	3	4	5	6	7	9	10	12	13	15	20	24	29	35		
250					1	1	1	1	1	1	2	3	4	4	6	7	8	10	10	12	16	20	23	28	
300					1	1	1	1	1	1	2	3	3	4	5	6	7	8	9	11	14	17	20	24	
350						1	1	1	1	1	1	2	3	3	4	5	6	7	8	9	12	15	18	21	
400							1	1	1	1	1	1	2	3	4	5	5	6	7	8	11	13	16	19	
500								1	1	1	1	1	1	2	3	4	4	5	6	7	9	11	14	16	
600									1	1	1	1	1	1	1	3	3	4	4	5	5	7	9	11	13
700										1	1	1	1	1	1	2	3	3	4	4	5	7	8	10	11
750										1	1	1	1	1	2	2	3	3	4	4	6	7	9	11	
800											1	1	1	1	1	2	3	3	4	4	6	7	9	10	
900												1	1	1	1	1	3	3	3	4	5	6	8	9	
1000													1	1	1	1	2	2	3	3	5	6	7	8	
1250															1		1		2		4		6		
1500																1		1		3		5			
1750																	1		1		3		4		
2000																		1		2		4		4	

A — THW, RHH, RHW (without outer covering).  
 B — THWN and THHN. (XHHW in sizes #4 AWG through 500 kcmil) see NEC, Chapter 9, Table 3 for other sizes and types.

flow from the conduit is very helpful in minimizing ac electrolytic corrosion, and interference with communication circuits.

**Short Circuit Capability:** Comparative short circuit tests\* on aluminum and galvanized steel conduits have been made to determine their relative behavior under heavy fault conditions. Fig. 17-1 shows the temperature rise vs. time of 2-inch aluminum and steel conduits joined in series and subjected to a short circuit current flow of 22,200 amperes RMS. The steel conduit at the end of 10 seconds was buckling and dully glowing and its temperature rise was about 4-1/2 times as great as that of the aluminum

conduit. The steel couplings all smoked profusely and showed thread damage. In contrast, the aluminum conduits still retained their gummed labels and showed no signs of the heavy current passage after the test. Thus, despite the considerably lower melt-point of aluminum conduit, its ability to carry short circuit currents is greatly superior to galvanized steel.

**Circuit Voltage Drop:** Aluminum conduit, being non-magnetic, exhibits no hysteresis losses from alternating current fields. The net effect is that voltage drop in a typical three-phase feeder or branch circuit in aluminum conduit may be from 10 percent to as much as 20 percent lower than with a corresponding steel conduit. For conductor sizes 250 kcmil and higher, this overall reduced voltage drop may permit the use of conductors one size

\*AIEE Paper DP 60-652, L. F. Roehman, 1960.

**TABLE 17-5a**  
**Dimensions—Rigid Aluminum and**  
**Galvanized Steel Conduit**

Trade Size	O.D. Inches	I.D. Inches	Wall Thickness	Length W/O Coupling	Threads Per Inch
½	.840	.622	.109	9'-11¼"	14
¾	1.050	.824	.113	9'-11¼"	14
1	1.315	1.049	.133	9'-11"	11½
1¼	1.660	1.380	.140	9'-11"	11½
1½	1.900	1.610	.145	9'-11"	11½
2	2.375	2.067	.154	9'-11"	11½
2½	2.875	2.469	.203	9'-10½"	8
3	3.500	3.068	.216	9'-10½"	8
3½	4.000	3.548	.226	9'-10¼"	8
4	4.500	4.026	.237	9'-10¼"	8
5	5.563	5.047	.258	9'-10"	8
6	6.625	6.065	.280	9'-10"	8

**TABLE 17-5b**  
**Dimensions—IMC Conduit Types I & II**

Trade Size	O.D. Inches		I.D. Inches		Wall Thickness		Length W/O Coupling	Threads Per Inch
	I	II	I	II	I	II		
½	.815	.833	.675	.673	.070	.080	9'-11¼"	14
¾	1.029	1.043	.879	.873	.075	.085	9'-11¼"	14
1	1.290	1.308	1.120	1.098	.085	.105	9'-11"	11½
1¼	1.638	1.653	1.468	1.437	.085	.108	9'-11"	11½
1½	1.883	1.893	1.703	1.677	.090	.108	9'-11"	11½
2	2.360	2.368	2.170	2.152	.095	.108	9'-11"	11½
2½	2.857	2.863	2.597	2.553	.130	.155	9'-10½"	8
3	3.476	3.488	3.216	3.178	.130	.155	9'-10½"	8
3½	3.971	3.988	3.711	3.668	.130	.160	9'-11¼"	8
4	4.466	4.488	4.206	4.168	.130	.160	9'-11¼"	8

or in some cases two sizes smaller — where voltage drop is the governing concern.

#### Corrosion Characteristics of Rigid Aluminum Conduit

Alloy 6063, which is commonly used for rigid aluminum conduit, has an industry maximum limit of 0.1 percent copper content and 0.35 percent for iron (Table 17-7). Aluminum conduit has been used successfully for more than 50 years in many marine and corrosive industrial installations under conditions where galvanized steel conduit should not be used.

The galvanizing on a steel conduit acts as an anodic sacrificial metal coating and is continuously "wearing out." On the other hand, aluminum quickly builds up its refractory oxide layer which is relatively inert to most chemicals except strong alkalis and acids. This tough, protective skin automatically renews itself whenever the bare metal becomes exposed.

Aluminum's resistance to atmospheric corrosion has

been demonstrated repeatedly by tests and research studies. Some of the results:

No signs of corrosion were evident on rigid aluminum conduit when inspected 5 years after it was installed on cooling towers. Severe combinations of moisture and chemical-laden atmospheres at the installation had required frequent replacement of rigid galvanized conduit, according to Paper CP 58-1072 of the American Institute of Electrical Engineers.

Aluminum alloy 6063 was exposed to marine, industrial and rural atmospheres. After exposures of 1, 2, 3, 4 and 5 years, there appeared no significant effects on yield and tensile strengths.

Atmospheric corrosion rates of four solid metals, as determined by a 10-year study project of an ASTM committee, are shown in Table 17-8.

*Broad Industrial Application:* Installations of rigid aluminum conduit usually require no maintenance painting



**TABLE 17-6**  
**Weight Comparison per Hundred Feet\***

Trade Size	Rigid Aluminum	Galvanized Steel	IMC Type I
½	28.1	80.3	57.0
¾	37.4	106.4	78.0
1	54.5	154.5	112.0
1¼	71.6	203.7	144.0
1½	88.7	251.0	176.0
2	118.5	338.0	235.0
2½	187.5	541.0	393.0
3	246.3	697.0	483.0
3½	295.6	837.0	561.0
4	305.2	1003.0	625.0
5	478.9	1343.0	
6	630.4	1823.0	

\*Nominal

**TABLE 17-7**  
**Composition of Aluminum Conduit Alloy (6063)**

	Percentage Limits per Industry Standards
Copper	0.10 max.
Silicon	0.20 to 0.6
Iron	0.35 max.
Magnesium	0.45 to 0.9
Manganese	0.10 max.
Chromium	0.10 max.
Titanium	0.10 max.
Zinc	0.10 max.
Others	0.15 max.
Aluminum	Remainder

\*Alloys with up to 0.40% copper are acceptable to Underwriters' Laboratories, Inc., for use in rigid aluminum conduit and fittings.

or protective treatment, as may be required on steel conduit. Because its resistance to corrosion is greater than steel's, it is the choice for many severely corrosive industrial environments such as: sewerage plants, water treatment stations, filtration plants and chemical plants.

**Exposure to Galvanic or Electrolytic Attack:** Aluminum conduit should not be direct-buried in earth due to unpredictable soil conditions of moisture, possible presence of strong electrolytes and stray electrical currents. If it is necessary to bury aluminum conduit, in accordance with the NEC, it should be thoroughly coated with coal-tar epoxy or given a layer of half-lapped approved tape. Also, factory-applied PVC coatings are commercially available.

Galvanic attack can occur when the aluminum forms the anode of a battery created by two dissimilar metals in contact with an electrolytic medium. Stray alternating or direct currents can aggravate the galvanic action, eventually destroying the buried or embedded conduit.

**Conduit Embedded in Concrete:** In accordance with the NEC, aluminum conduit should not be embedded in concrete without approved protection because of the possibility of galvanic or electrolytic corrosion. Stray currents can aggravate the corrosion, severely damaging the conduit. If it is necessary to embed aluminum conduit in concrete, it should be given the same protection recommended for direct-earth burial.

Additionally, to mitigate the corrosion of all metallic conduit embedded in concrete:

1. The concrete should contain no extraneously added chloride. Such chlorides can originate from concrete addi-

tives (to speed setting time), use of sea or brackish water, use of unwashed beach sand or other saline aggregate and similar materials.

2. A low resistance conduit run should be maintained.

3. The circuit neutral should be grounded at one point and be insulated from and have no electrical contact with the conduit. The conduit should not carry any of the ground currents associated with normal operation.

**Hazardous Locations:** Requirements of Article 500 of the NEC covering conduit installations in hazardous locations can be easily met with properly installed rigid aluminum conduit. The characteristics of aluminum conduit facilitate the installation of a tight explosion-proof system.

#### Installation of Aluminum Conduit\*

Easier, safer workability adds to the many advantages of rigid aluminum conduit at every step of installation.

**Cutting:** Fast, easy cuts are handled well by standard cutting tools, which are generally used. Power saws and cutting wheels work fast and neatly on 1-1/2-inch and larger conduit; for smaller sizes (as for smaller steel conduit), an 18-tooth hacksaw is recommended for easy, neat cuts. Reaming, as required by the NEC, can be easily accomplished by conventional means.

**Threading:** Standard dies, used according to accepted good practices, thread aluminum rigid conduit faster than

\* See also Chapter 11 sections describing methods of installing cable in conduit and calculations of pulling tension.

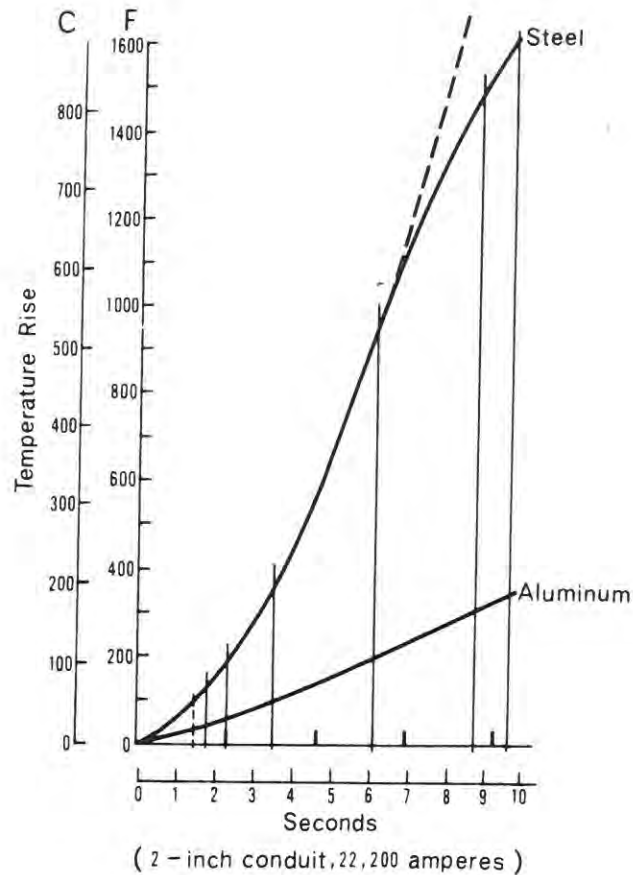

Fig. 17-1. Measured temperature rise vs time for aluminum and steel conduit under short circuit conditions.

steel and with less effort. Hand threaders produce good threading on smaller sizes. Power threaders, however, can be used on all sizes and operated at maximum drive speeds. When using top drive speeds, and for longer tool life, dies with 30° to 35° rake angles should be used. Standard cutting oils of known good quality are recommended for uniform threads.

**Bending:** Sweeps, elbows, cross-overs, offsets—every type of bend is easily made in rigid aluminum conduit. Standard hand and power benders produce smooth and exact bends in all conduit sizes.

Standard EMT benders can be used on 1-inch or smaller aluminum conduit for one-shot bends. Use an EMT bender one size larger than the conduit. Mechanical or power benders can be used on all sizes, provided they have shoes and action similar to those of an EMT bender.

**Joining:** Adequate electrical conductance in a conduit system requires tight joints. To simplify field joining, both threads of every length of rigid aluminum conduit should be lubricated in the field if not lubricated at the factory.

(On field-cut threads, of course, a reliable quality lubricant containing zinc or graphite should be used). Proper lubrication aids in assuming tight joints, a system that can be easily dismantled, and a permanent, low-resistant electrical ground path.

**Pulling:** Modern equipment and faster, safer techniques that work well with aluminum conduit have been introduced for fishing and pulling through all types of wireways.

**Propelled Lines:** CO<sub>2</sub> or air propelled lines of nylon or other plastic shoot through all sizes of rigid aluminum conduit.

**Small Conduit:** In sizes up to 1-1/2-inch and on shorter runs — up to 100 feet — polyethylene fish tapes can be used effectively. Also recommended are round, flexible, speedometer-type steel cables. Use of flat steel tapes should be avoided since they tend to jam in the bends or, if not used carefully, scrape and cut conduit walls.

**TABLE 17-8**  
**Atmospheric Corrosion of Solid Metals over a 10 Year Period**

Atmosphere	Location	Aluminum*	Copper	Zinc**	Lead
Desert	Phoenix, Arizona	0.000	0.005	0.010	0.009
Rural	State College, Pa.	0.001	0.023	0.042	0.019
Coastal	Key West, Fla.	0.004	0.020	0.021	0.022
Coastal	La Jolla, Calif.	0.028	0.052	0.068	0.016
Industrial	New York, N.Y.	0.031	0.047	0.190	0.017
Industrial	Altoona, Pa.	0.025	0.046	0.190	0.027

Corrosion rate shown in average mils per year. Table based on ASTM data (Committee report).

\*Aluminum 1100. Aluminum conduit is usually made from aluminum alloy 6063, generally considered to be equivalent in corrosion resistance to aluminum 1100.

\*\*Prime western zinc.

**Larger Conduit:** For pulling large conductors through larger conduit or longer runs, polypropylene rope is recommended. Steel pulling cables, especially when old or frayed, can damage steel or aluminum conduit.

**Fittings for Rigid Aluminum Conduit:** Although galvanized or plated steel fittings are permitted by the 1987 NEC and can be safely used with rigid aluminum conduit, good aluminum fittings result in a superior installation.

An all-aluminum conduit run has better conductivity and provides safer ground protection. And aluminum's

non-magnetic property, in fittings as well as conduit, reduces ground current losses and voltage drops.

**Expansion Joints:** Linear expansion of rigid aluminum conduit is not a factor in most installations. If a straight run is unusually long or subjected to extremes of temperature, expansion fittings might be needed. A good general rule: use an expansion joint if the degree-feet of a run may exceed 10,000. (Degree-feet is the length of the run in feet multiplied by the temperature rise, °F.)

## Street-Lighting Poles, Transmission Towers, and Station Structures

This book would be incomplete without a brief mention of the specialized structures related to the everyday use of aluminum electrical conductors.

Recent years have witnessed a steady gain in the use of aluminum for many types of structures required by the electrical industry. This is based on very sound considerations. Research programs have led to the development of high strength aluminum alloys, new effective structural designs and strong, economical fastening and joining methods. These factors, coupled with aluminum's traditionally known high resistance to corrosion, account for the wide use of aluminum structures today. We will discuss just a few of these in this chapter.

### Aluminum Lighting Standards

A lighting standard is many things to many people.

It must be tall enough to cast its light from the luminaire it carries above any normal eye level and the angle of sighting along the thoroughfare.

It must be strong enough to resist high winds. On interstate highways it must be safe enough that its base breaks away when hit by a subcompact car at 20 mph.

It must be graceful in appearance and at the same time unobtrusive and uncluttered.

It must resist the effects of industrial and traffic induced corrosion for 25 years at least.

It must be designed to provide inherent concealment for transformer and wires or protective components and for easy cleaning of lenses and replacement lamps.

It must be versatile in that signs (either permanent or not) may be hung on the standard or flag poles provided at the top, or Christmas street decorations mounted from special brackets or used for a number of other accessories.

It must be low in installation and maintenance costs.

Aluminum, taking advantage of its good looks, light weight, high strength-to-weight ratio possibilities and high corrosion resistance has been accepted as an ideal material for street and highway lighting poles. This has been a steadily growing application of aluminum since the 1940's.

Aluminum lighting standards extend their versatility into highway safety by reducing vehicular damage and driver injury in collisions either as an intrinsic aspect of their design or by the simple installation of accessory breakaway devices.

Modern aluminum lighting standards are a combination of sheet, extruded and cast alloy sections. Shafts are usually 6063-T6 or 6005-T6 extrusions or 5086-H34 sheet; luminaire arms are 6061-T6 or 6063-T6 extrusions; bases and arm holders may be 356 casting alloy (Fig. 18-1).

Aluminum lighting standards can be designed with classic simplicity so that they may complement virtually every type of architectural or landscape background. Although aluminum has a pleasing appearance in its natural state, it can be made to take on a variety of finishes applied mechanically, chemically or electrochemically. The surface can be polished, buffed or electro-brightened to give a wide range of interesting and attractive appearances. Through the anodizing process the natural surface oxide film can be deepened and strengthened to a substantial, hard refractory coating not only providing a very high degree of corrosion resistance but a surface that can also be impregnated with permanent coloring dyes.

With the high strength-to-weight ratios provided by these alloys, aluminum lighting standards form an assembly that is rugged enough for the severest service, yet light enough for installation crews to handle without special equipment.

Aluminum lighting standards are available for mounting luminaires up to 50 feet above the roadway with various arm configurations. (See Table 18-1).

Aluminum lighting standards may be of a tapered or uniform cross section. The former is fabricated by spin-tapering extruded 6063-T4 tubes about 1/8" per foot and then artificially aging to the T6 temper. The profile may also be fabricated from trapezoidal sheet sections pressformed and longitudinally welded into a tapered shaft. Uniform cross sectional lighting standards can be made in any cross sectional geometry with extrusions or press forming of sheet.

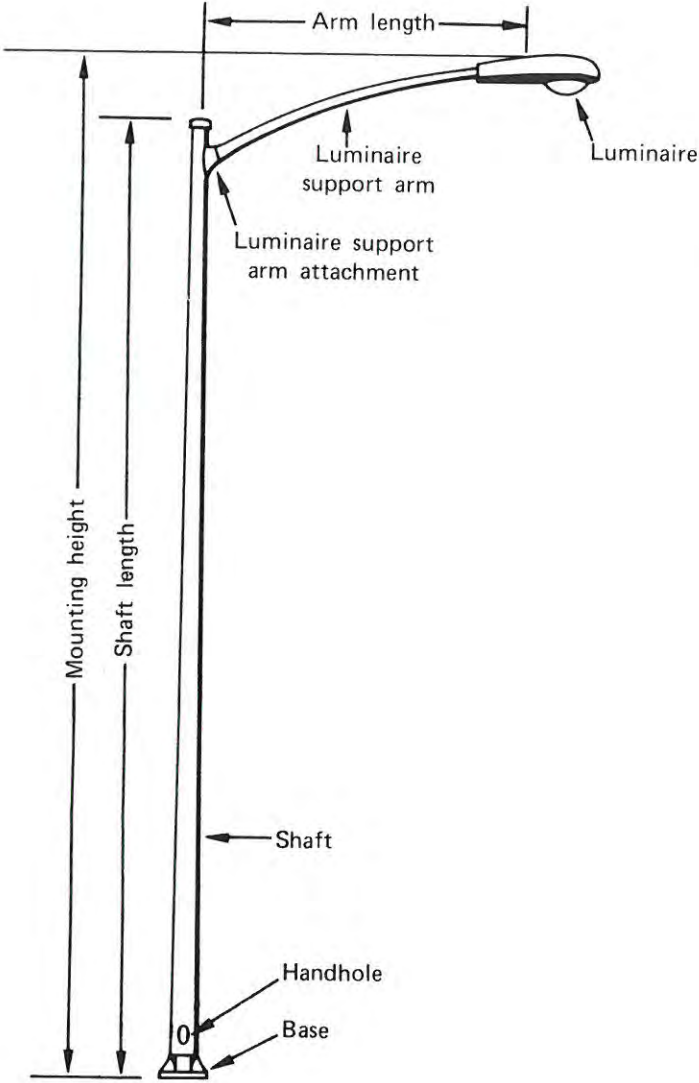

Alloys and Temper

Spun Aluminum Standard	Welded Tapered Sheet Aluminum Standard
6063-T6, 6005-T6	5086-H34

Fig. 18-1. Typical street lighting standard using aluminum.

**TABLE 18-1**  
**Typical Aluminum Highway Light Standard Dimensions**

Mounting Height	Shaft Length	Alloy	ARM OUTREACH					
			8 ft. Arm		12 ft. Arm		15 ft. Arm	
			Single	Double	Single	Double	Single	Double
30	25	6063	8 x 6 x 0.156	8 x 6 x 0.219	8 x 6 x 0.188	8 x 6 x 0.312	8 x 6 x 0.188	8 x 6 x 0.375
		6005	8 x 6 x 0.156	8 x 6 x 0.188	8 x 6 x 0.156	8 x 6 x 0.188	8 x 6 x 0.156	8 x 6 x 0.219
		5086	9 x 4.52 x 0.135	9 x 4.52 x 0.135	9 x 4.94 x 0.135	9.1 x 5.04 x 0.188	9 x 4.94 x 0.135	9.1 x 5.04 x 0.188
35	30	6063	8 x 6 x 0.219	10 x 6 x 0.188	8 x 6 x 0.250	10 x 6 x 0.25	8 x 6 x 0.312	10 x 6 x 0.312
		6005	8 x 6 x 0.156	10 x 6 x 0.156	8 x 6 x 0.156	10 x 6 x 0.170	8 x 6 x 0.188	10 x 6 x 0.188
		5086	9 x 4.06 x 0.135	9.1 x 4.17 x 0.188	9 x 4.48 x 0.135	9.1 x 4.59 x 0.188	9.1 x 4.59 x 0.188	9 x 4.59 x 0.188*
40	35	6063	10 x 6 x 0.188	10 x 6 x 0.250	10 x 6 x 0.188	10 x 6 x 0.312	10 x 6 x 0.219	10 x 6 x 0.375
		6005	10 x 6 x 0.156	10 x 6 x 0.170	10 x 6 x 0.156	10 x 6 x 0.219	10 x 6 x 0.156	10 x 6 x 0.250
		5086	13.5 x 7.59 x 0.135	13.5 x 7.59 x 0.135	13.5 x 8.01 x 0.135	13.5 x 8.01 x 0.135	13.5 x 8.01 x 0.135	13.5 x 8.01 x 0.135
45	40	6063	10 x 6 x 0.219	12 x 6 x 0.219	10 x 6 x 0.250	12 x 6 x 0.312	10 x 6 x 0.250	10 x 6 x 0.312
		6005	10 x 6 x 0.156	12 x 6 x 0.219	10 x 6 x 0.170	12 x 6 x 0.219	10 x 6 x 0.188	12 x 6 x 0.219
		5086	13.5 x 6.76 x 0.13	13.5 x 6.76 x 0.135	13.5 x 7.17 x 0.135	13.5 x 7.17 x 0.135	13.5 x 7.17 x 0.135	13.5 x 7.17 x 0.135*
50	45	6063	10 x 6 x 0.250	12 x 6 x 0.250	10 x 6 x 0.312	12 x 6 x 0.312	10 x 6 x 0.375	12 x 6 x 0.375
		6005	10 x 6 x 0.170	12 x 6 x 0.219	10 x 6 x 0.188	12 x 6 x 0.219	10 x 6 x 0.219	12 x 6 x 0.219
		5086	13.5 x 5.92 x 0.135	13.5 x 5.92 x 0.135	13.5 x 6.34 x 0.135*	13.5 x 6.34 x 0.135*	13.5 x 6.34 x 0.135	

\*All dimensions are for poles designed for 90 mph wind load, except those marked with asterisk which are designed for 80 mph load.

### Aluminum Transmission Towers

Use of prefabricated metal towers for 138 kV and higher transmission is widespread today. However the traditional place held by steel in tower construction due to its high strength and relatively low cost is now being effectively challenged by selected high-strength aluminum alloys such as 6061-T6. The keys to this challenge are high strength-to-weight ratio, high corrosion resistance, multi-form shape extrudability and reasonably low, stable prices. The two factors of (1) dramatic reduction of installation costs and (2) virtual elimination of maintenance costs account in large part for the present serious consideration given to aluminum towers. Surfaces of aluminum transmission tower structures can be treated with various coatings to meet "non-glare" requirements often specified. These coatings need little or no maintenance in service.

Although aluminum cross-arms had been used in combination with steel towers for a complete transmission system before 1950, the first all-aluminum tower lines were placed into operation in 1959 by several utilities. These early aluminum towers were of the self-supporting type similar to existing steel tower designs. Structural angles in sizes from 2" x 2" x 3/16" to 10" x 10" x 1 1/4" and plates in thicknesses from 1/4" to 3/4" were employed using the excellent structural alloy 6061-T6.

Since pound for pound, aluminum represents a significantly higher metal cost than steel, it is to be expected that the shop-fabricated cost of an aluminum tower will be higher than for a comparable loading design in steel. This increase, however, can be fully offset in some cases because of lower field erection costs plus credit from much lower maintenance over the life of the structure. Also there are circumstances where interruptions of service for maintenance work cannot be tolerated; this factor alone justifies the use of aluminum.

**Weight Reduction:** Aluminum tower structures afford weight reductions of 50 to 75% from steel structures

having equivalent capabilities.

This weight advantage of aluminum works as an important cost reduction factor in the construction of transmission towers. Lighter, conventional erection equipment can be used, as well as faster methods. Lightweight aluminum structurals can be assembled into components or complete towers at convenient locations, then transported easily and quickly to erection sites.

Still more time can be saved by using helicopters to transport components or even fully assembled towers.

With the many advantages of aluminum's light weight, shorter schedules are easily met when installing any type of transmission line.

**Corrosion Resistance:** Pre-painting inspections, initial painting and subsequent upkeep repainting are unnecessary when aluminum structurals are used to build transmission towers. Dangers of repainting "hot line" towers (or the expense of de-energizing to make them safe) is avoided. Even without expensive painting and repainting, however, corrosion-resistant aluminum retains its good looks and remains structurally dependable longer than any other metal.

**Extrusion Design Capabilities:** As designers and users gained experience with aluminum towers, the advantages of special component shapes over conventional structural shapes became apparent. More opportunities in design innovation and economy are made available to the designer of transmission towers by aluminum than by any other material. Thus, the unique structural shapes into which aluminum can be extruded can be designed for optimum efficiency. Extrusion dies made to design specifications add only negligible amounts to the cost of the line system. Made-to-order steel members, on the other hand, would require highly expensive rolling equipment and operations.

With extruded aluminum structurals, maximum torsional rigidity and radii of gyration can be realized. And, since both assembly and erection are simpler with aluminum structurals, transmission lines can be designed more

easily and with less risk of problems in the field.

#### *Aluminum Transmission Tower Designs*

**Guyed "V" Towers** (Fig. 18-2): A guyed-V tower is basically two guy-supported vertical masts having a common footing and supporting a horizontal section for carrying electrical conductors and overhead ground wires. Design of a guyed-V tower is such that overturning moments are resisted by guy wires serving as tension members, and by latticed masts serving as compression members.

Guyed-V towers built with extruded aluminum structurals average approximately 30% of the weight of self-supporting steel structures designed to the same performance specifications.

Because aluminum guy-supported line towers use guy wires as tension members, they weigh substantially less than equivalent aluminum self-supporting towers. (And the weight which has to be carried by the tower masts is reduced as the spread between the vertical masts

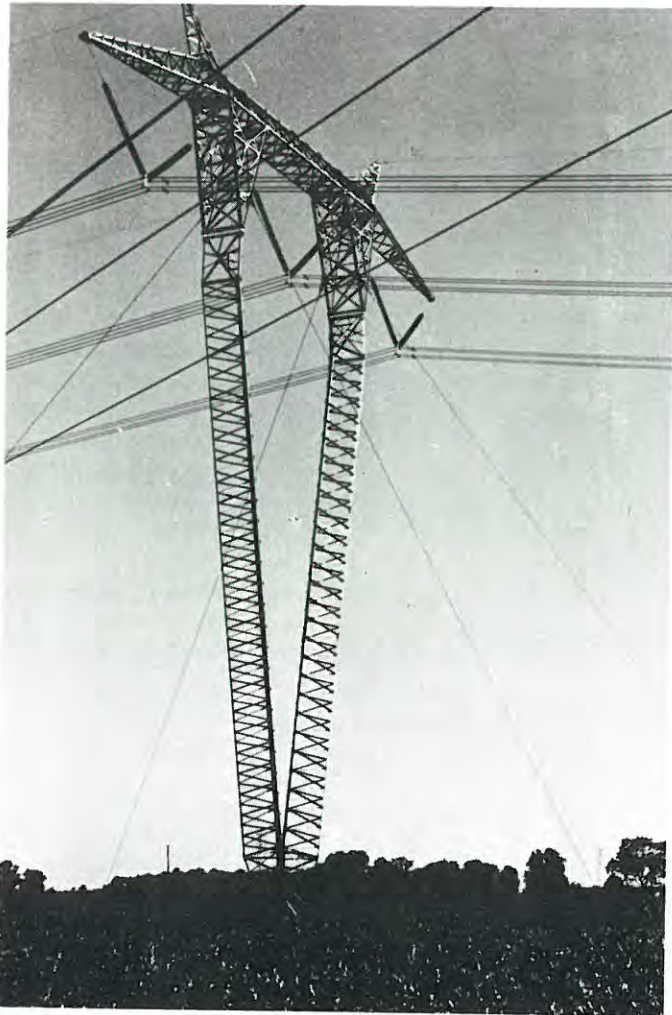

*Fig. 18-2. Guyed "V" aluminum structure on Indiana & Michigan Electric Company 765 kV line.*

and guy wires is increased. This spread, which represents the arm of the resisting moment, can be made as wide as the right-of-way will allow.)

**Guyed "Y" Towers** (Fig. 18-3): A guyed-Y transmission tower can be described as a guyed-V mounted on a guyed vertical mast. Like the V tower, the guyed-Y has 4 guy wires serving as tension members of its upper section. But it also has 4 guys stabilizing its lower, vertical section. These 4 lower, inside guys take shear from a guyed-Y tower at the junction point where the vertical mast meets the upper V section. Thus, the only shear load remaining on the tower foundation is that of the wind load on the slim vertical mast.

The guyed-Y tower, because of its unique geometry, has fewer members than a guyed-V. Further, it has less column length—and the effect of wind on a long, unsupported column varies as the square of the length of the column. For tall towers, therefore, and for towers which will have to withstand heavy wind loads, the guyed-Y design will satisfy performance requirements at considerably lower cost than a guyed-V tower.

An aluminum guyed-Y transmission tower weighs considerably less than an equivalent guyed-V tower. And a guyed-V, for reasons noted on earlier pages, weighs less than an equivalent self-supporting tower.

Guyed-Y towers built with extruded aluminum structurals weigh only 25%, on an approximate average, of self-supporting steel towers designed to same performance specifications.

**Guyed "Delta" Towers** (Fig. 18-4): This design has all the advantages inherent in the guyed "V" and "Y". Having a single mast requiring fewer pieces, it is a very economical structure to assemble. The "Delta" configuration has an electrical and lower noise advantage over the flat and vertical configurations.

**Guyed "Gull Wing" Towers** (Fig. 18-5): This design is similar to the guyed "Delta" with further advantages in the unique design, increasing the spread of the guy wire attachments, minimizing the torsional forces and reducing guy tensions.

**Three-Pole Guyed Towers** (Fig. 18-6): Sharp angles in direction of a power transmission line pose problems best solved by the 3-pole tower. Recommended for lines having changes of direction greater than 15°, the 3-pole design provides a separate pole to support each phase of the line system.

Introduction of aluminum guyed "pole" transmission towers further refined this proven design. As with other 3-pole towers, each conductor on a 3-pole guyed aluminum transmission tower traverses the angle in the line supported by its own pole. Guy wires for the poles can be placed easily at those points where they will most effectively overcome the tangential forces created by the angles in the line.

*Fig. 18-4. Guyed "Delta" aluminum structure on Southwestern Electric Power Company 345 kV line.*

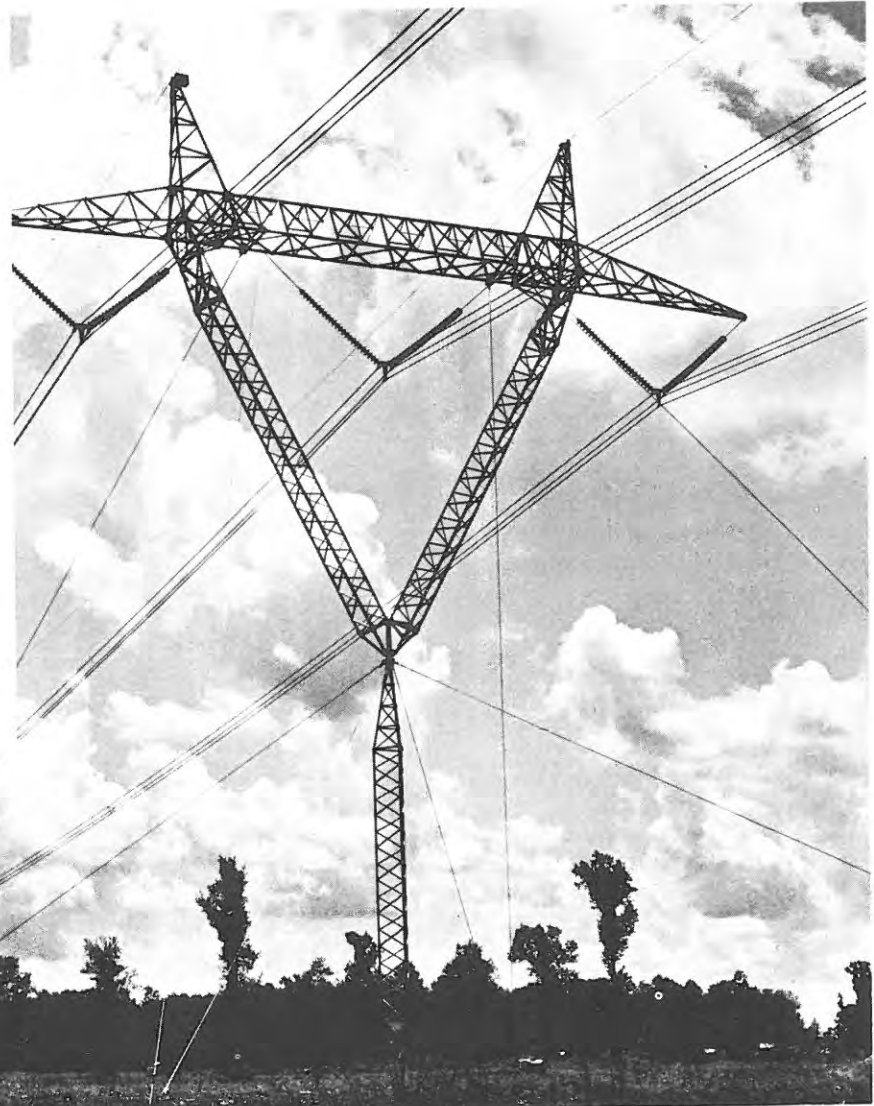
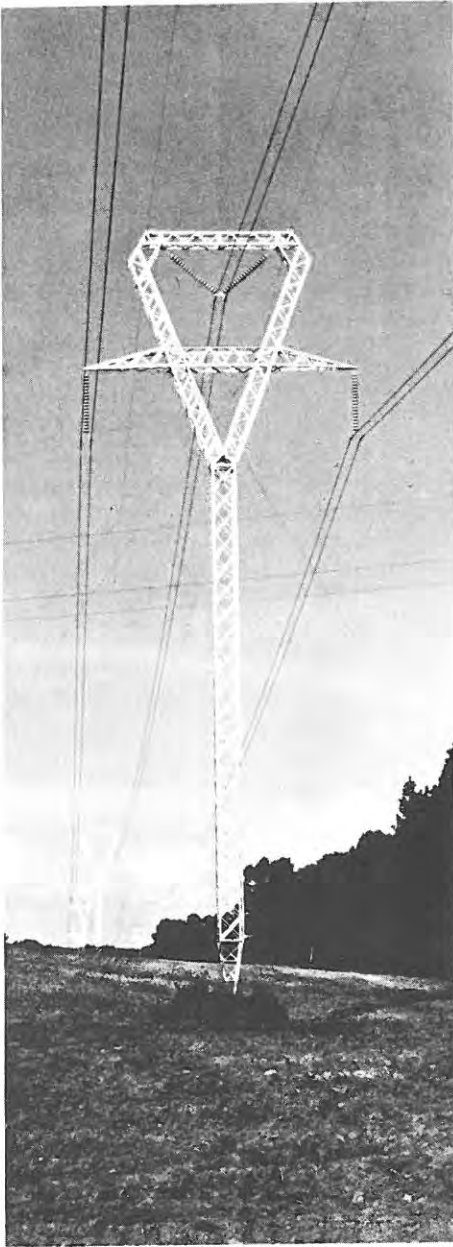

*Fig. 18-3. Guyed "Y" aluminum structure on Louisiana Power & Light Company 500 kV line.*



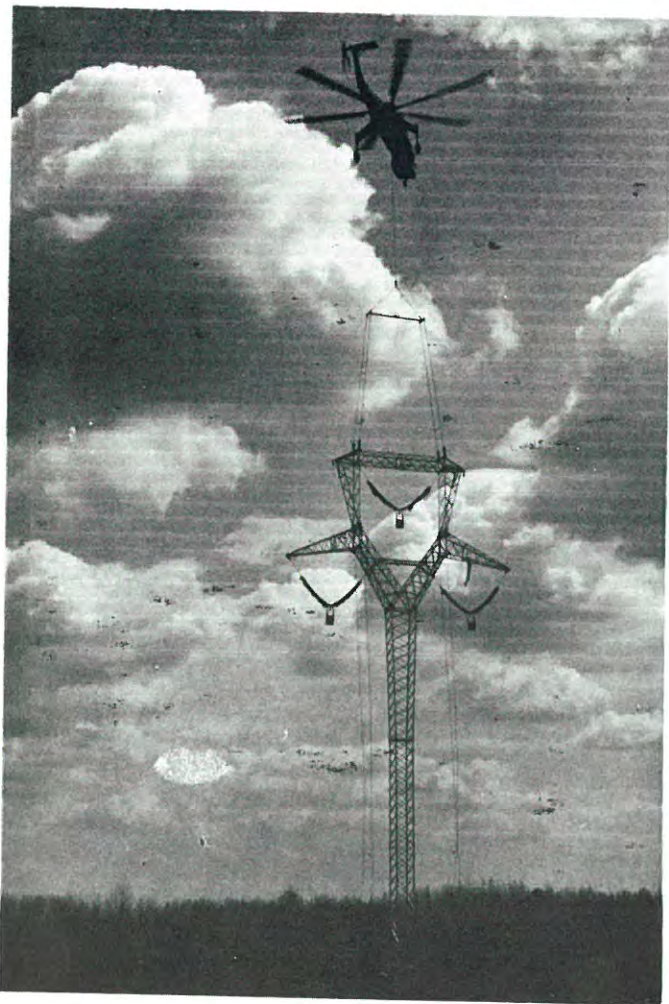

Fig. 18-5. Guyed "Gull Wing" being set with "Flying Crane" on the Northern States Power Company 500 kV line interconnecting with Canada.

An aluminum 3-pole guyed angle tower weighs approximately 20% of a self-supporting steel angle tower.

Guy-supported transmission towers have radically smaller bases than self-supporting towers. In terrain too difficult for locating conventional towers, therefore, the guyed tower—with its small footing and easily placed guy anchors—can be installed with relative ease.

Substantial savings in foundation costs are possible with guyed transmission towers. The central footing for a guyed tower need be designed for compression only; guy anchors, for uplift only. A self-supporting tower, on the other hand, requires costly multi-purpose foundations, designed for both compression and uplift.

Foundations on a self-supporting tower, in addition, are precisely interrelated—to each other and to the tower legs—and must be designed and installed with a high degree of exactness to avoid unnecessary stresses.

On a guyed tower, however, easily adjusted guys serve as tension members so that anchor points and central footing are not dependent on one another. Since each can be installed with little concern for the others, time and effort are saved and costs reduced.

Three types of foundations are generally used for guyed towers—galvanized grillage, pre-cast concrete and poured-in-place concrete. Screw anchors, piles and floating bases are also used.

Guyed transmission towers require no more right-of-way than equivalent self-supporting towers, since the towers' supporting guy wires require no greater width along the right-of-way—usually less than needed for mid-span blow-out of the conductors. This holds true with any design of guyed tower and regardless of whether the conductors are strung by V-strings or by single-string, free-swinging insulators.

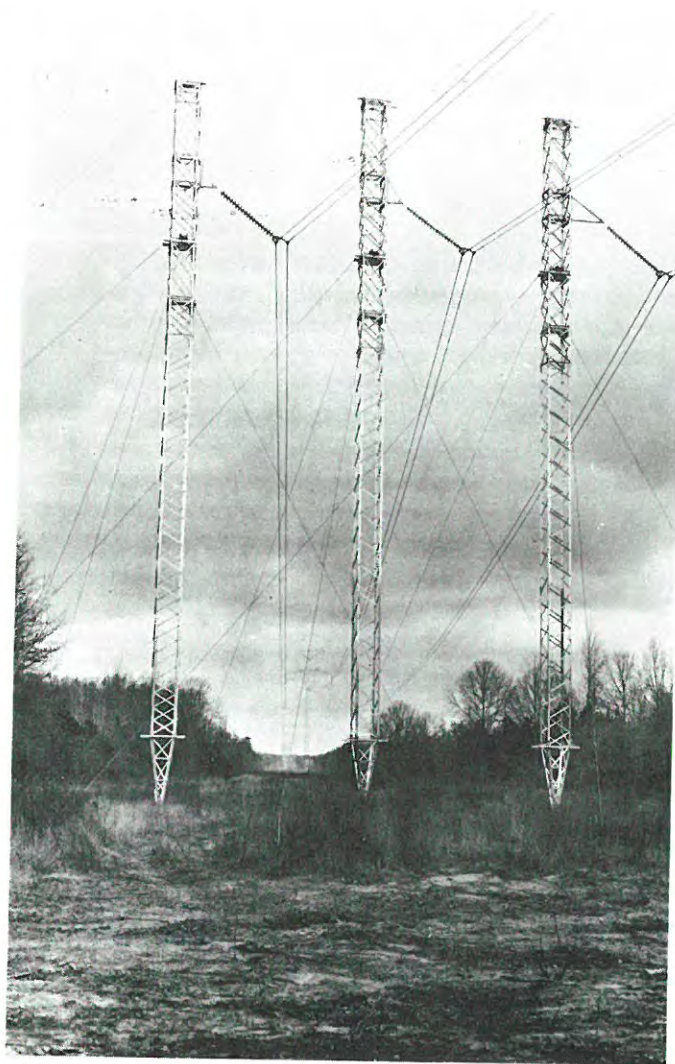

Fig. 18-6. Three-Pole guyed 345 kV aluminum tower on Southwestern Electric Power Company line.

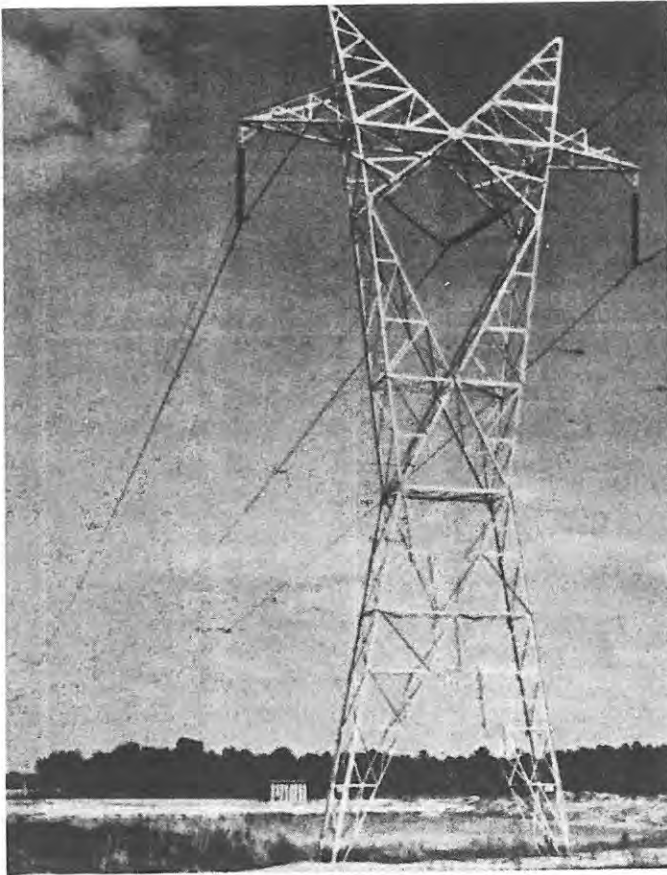

Fig. 18-7. Semiflexible tower of aluminum deflects under load.

**Semi-Flexible Towers** (Fig. 18-7): The semi-flexible transmission tower reflects a unique basic tower geometry. It is built with a transverse side as slender as stresses allow, thus is able to deflect under longitudinal loads produced at the conductor and ground wire attachment levels. Such deflection allows a portion of the unbalanced load to be carried by the other conductors or ground wires.

As a structural material, aluminum has far greater elasticity and flexibility than steel. In a semi-flexible transmission tower, this permits greater movement under given loading conditions than with steel. Economies in tower weight result as well as substantial savings in erection.

**H-Frame Towers** (Fig. 18-8): The "old reliable" H-frame transmission tower takes on new usefulness when constructed with extruded aluminum structurals. The aluminum version is similar in outline to X-braced wood pole structures but has columns and cross-arm assemblies that make maximum use of extruded shapes designed specifically for this application. It can be built not only taller than usual wooden pole H-frame towers but also stronger. Fewer towers are needed, therefore, for any given length of line. And fewer towers mean fewer sets of hardware in installation costs and fewer insulators to service and replace.

In H-frame towers, the economies inherent in aluminum because of its light weight and minimal maintenance needs are added to by generally lower material costs. This is especially so with line voltages through 345 kV, since tall wooden poles are continually becoming scarcer and more and more costly.

Variations of the all-aluminum H-frame include wooden poles with aluminum cross-arms and aluminum pole structures with wooden cross-arms. Two types of aluminum cross-arms are being used for this purpose. A single tube, 8 to 10 inches in diameter, 3/16 to 3/8 in. in thickness, of extruded 6061-T6 alloy makes a simple, strong, easily installed cross-arm. For the heaviest loadings, latticed cross-arms of extruded structural shapes in aluminum alloys are available.

**Conventional Self-Supporting Towers:** Overall weight reductions averaging 55 to 60 percent can be made by using extruded aluminum structurals instead of steel in building conventional, self-supporting types of transmission towers. When the design of a system calls for self-supporting towers—either 3- or 4-legged—the light weight of aluminum provides installation advantages at any tower site, but particularly at difficult, hard-to-reach locations. Fig. 18-8 is of a typical aluminum self-supported transmission tower (also called free-standing).

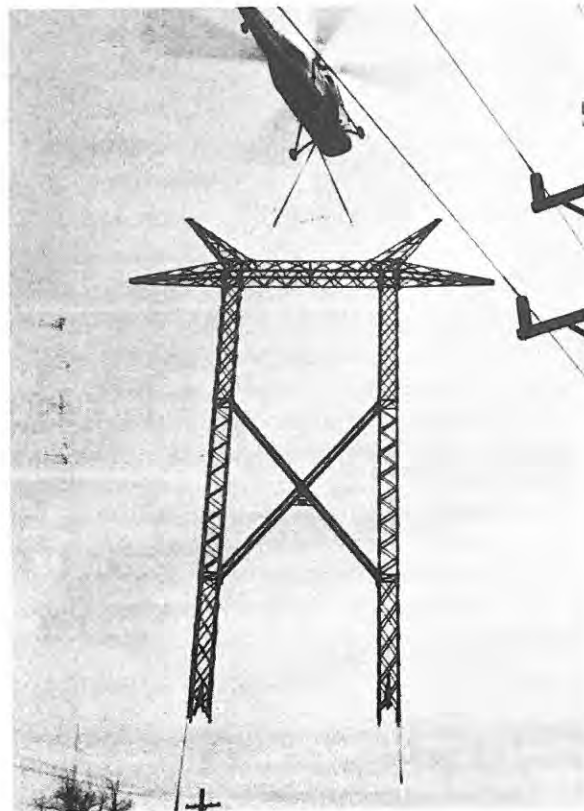

Fig. 18-8. Helicopter leaving assembly yard with "H" frame on Public Service Company of Indiana 345 kV line.

Savings realized from aluminum's minimal need for maintenance are especially pronounced on lines using self-supporting towers.

*Single Mast Self-Supporting Towers* (Fig. 18-9): This structure, designed for simplicity and limited right-of-way widths through urban or farm areas, has all the advantages inherent in an aluminum structure. The structure is designed using a rotating crossarm. Under minimal unbalanced longitudinal loads a pattern of bolts shears, allowing the arm to rotate reducing the longitudinal and torsional load on the mast and minimizing any domino effect due to structural failure.

*Internally Guyed Self-Supporting Towers* (Fig. 18-10): This structure satisfies conditions where external guy wires cannot be used. The internal guys act as structural members, increasing transverse strength with a considerable reduction in structural members.

*Self-Supporting Composite Towers* (Fig. 18-11): The self-supporting tower of conventional design can be built with steel base and aluminum top. This composite variation minimizes the cost premium. Like an all-aluminum tower, however, it requires no maintenance in the dangerous and high-cost vicinity of the conductors.

*Helicopters and Aluminum Towers:* The transmission line industry has developed ingenious and valuable short-cuts in its use of helicopters to transport and erect lightweight aluminum transmission towers and components.

This has been most dramatic in rough country, where tower installations virtually impossible by ordinary methods have been completed with relative ease by the versatile aircraft.

In all types of country, however, helicopters have proven highly economical, and aluminum tower crews are using them in many different operations.

Components of aluminum transmission towers—bundled or partly assembled—can be lifted, shifted or moved by helicopter. Use of 'copters is especially helpful when running power lines through rough country. Towers assembled on pipe racks in marshaling areas reduce heavy equipment needs and dramatically increase productivity. Assembled towers can be carried by 'copter from assembly points directly to tower sites and set, no matter how inaccessible the site might be.

Aluminum towers can be assembled on the ground at installation sites and then a helicopter can be used to tilt the towers easily and quickly to vertical positions.

When guyed-Y towers are being installed, a 'copter can be used, first, to erect the vertical mast of the Y. The upper part of the Y can then be lifted by helicopter and attached with perfect alignment to the vertical mast.

Even the erection crews on tower jobs can be transported by helicopter—to and from the tower sites and from site to site—fast, efficiently in any terrain.

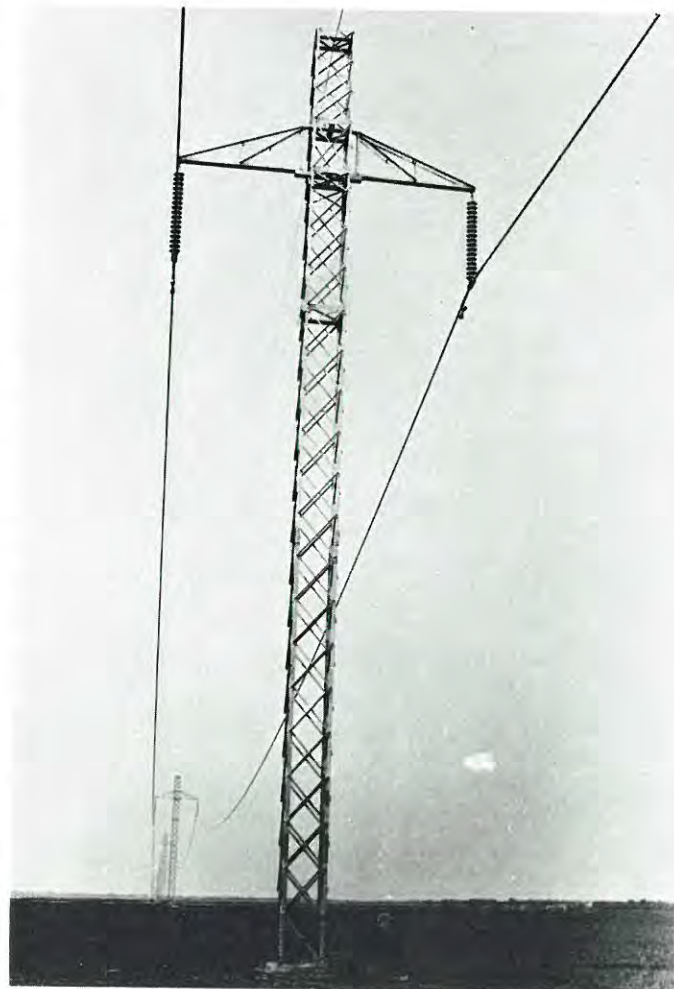

Fig. 18-9. Square Butte Electric Coop., 250 ± D-C line crossing North Dakota.

### Aluminum Station Structures

Most of what has been presented above on the advantages of aluminum transmission line towers is directly applicable to aluminum supporting structures used in outdoor electrical substations. Despite a higher cost per unit weight, a comparable aluminum structure can often be completely erected at a cost equal to or somewhat less than steel. Thereafter the virtual elimination of maintenance costs for aluminum structures is an important bonus factor.

Station structures fully designed in aluminum will have the following economic and performance advantages:

*Light Weight:* The use of aluminum can mean a reduction in weight of up to 70% over a steel structure . . . a weight reduction without loss of structural integrity.

The weight advantage of aluminum can represent a major saving in erection costs. Aluminum allows a greater amount of sub-assembly prior to shipment and

construction site erection. More work can be done in the shop, thereby reducing the number of man hours in the field. Assembled sections that would be difficult to handle in steel are easily handled in aluminum. For example, where one man can lift an aluminum section, a similar steel section would require two or three men. The need for high cost heavy equipment also may be drastically reduced or often eliminated.

A further cost reduction is possible because aluminum's exceptionally high conductivity can simplify structural grounding and may eliminate a groundwire system.

Thus faster erection times and reduced labor, equipment and shipping costs are possible with aluminum.

*Corrosion Resistance:* The economy of aluminum's corrosion resistance should also be considered. Aluminum resists chemically corrosive atmospheres, salt air and industrial fumes and does not require protective coatings. And unlike steel that eventually rusts and requires painting, aluminum substations stay attractive without major maintenance.

The savings by not having to repaint the structure with attendant costly shutdowns may more than pay for the cost of the aluminum substation structure over a period of years.

*Safety Factors:* Safety is a very important advantage of aluminum substations. Since aluminum never requires painting, there is no need to run the risk of having painters climb or work in proximity to energized parts. Costly and inconvenient shutdowns in the interest of safety for painting purposes are unnecessary.

*Appearance:* Because of their excellent corrosion resistance and freedom from rust, aluminum substations remain modern looking year-in and year-out with a minimum of maintenance. Properly designed with the new, low silhouette, they offer improved appearance to metropolitan and suburban areas.

*Fabrication.* The relative ease of extruding aluminum makes it possible to offer special as well as standard structural shapes and sizes. This means aluminum can



Fig. 18-10. Pacific Gas & Electric Company 500 kV "internally" guyed structure in the test rack at Adelphon, Inc. Fort Worth, Texas.



Fig. 18-11. Aluminum top on steel body eliminates costly maintenance on 230 kV double circuit tower.

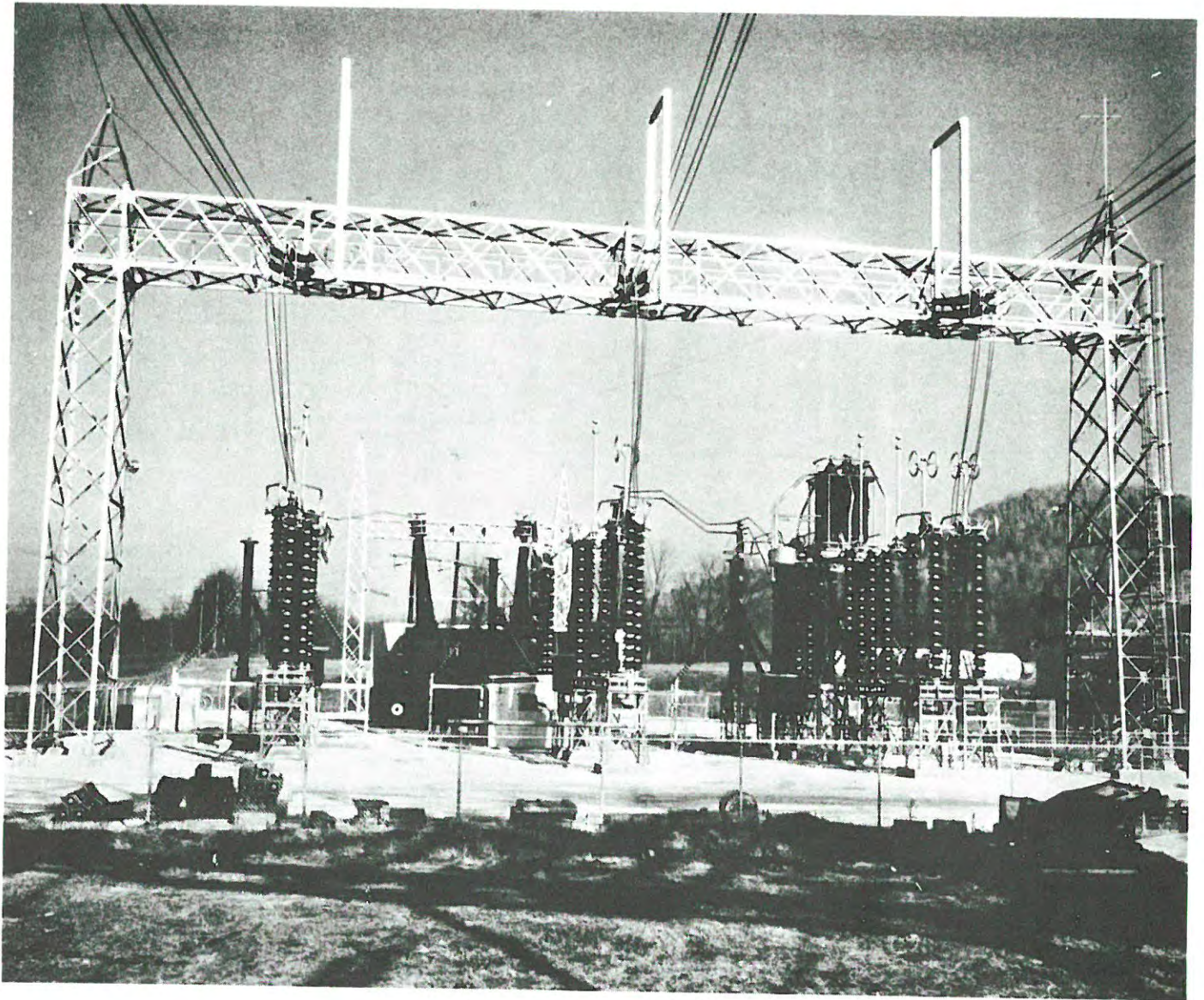

*Fig. 18-13. All-aluminum substation designed to operate at 750 kV.*

---

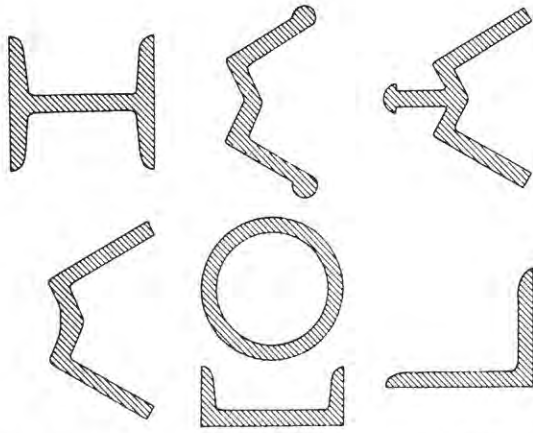

Fig. 18-12. Extruded aluminum structural shapes.

be tailored to fit many different design requirements that utilize sizes, shapes, and lengths unobtainable with steel. As a result, a more efficient use can be made of the metal. Fig. 18-12 shows some of the structural shapes readily extruded.

In the field, when cutting and drilling operations are required, aluminum is a much easier metal to work with than steel, and it is easier to handle because of its light weight. Since there is no galvanizing, no special precautions are necessary to prevent corrosion after field cutting or drilling.

**High Scrap Value:** An important economic factor to consider is aluminum's recognized high scrap value. When a structure has fulfilled its useful life, aluminum will bring a much higher scrap return than other structural materials.

**Aluminum Structural Alloys:** The two most commonly used aluminum substation alloys are 6061-T6 and 6063-T6. Alloy 6061-T6 is a high strength metal used for tension and compression members. Alloy 6063-T6 has less strength and finds principal use in redundant structural members.

Tables 18-2 and 18-3 contain condensed but rather complete technical and availability information on the above two structural alloys.

**Structural Design:** Fabricators of aluminum structural components and assemblies maintain complete engineering design information which is available on request. Structural design handbooks for aluminum have been prepared and published by several manufacturers and by the Aluminum Association, and these may be obtained by writing to them.

See *Specifications for Aluminum Structures and Engineering Data for Aluminum Structures*, The Aluminum Association.

**Fastening Methods: Bolting**—Where bolting is the desired method of fastening, 5/8" and 3/4" diameter bolts are recommended. Normally, aluminum bolts of high strength alloy 2024-T4, anodized and either chromate or nickel acetate sealed, are used with recessed nuts of alloy

6061-T6 lubricated with a wax coating to prevent galling. Recessed nuts preclude the need for washers. Aluminum coated steel bolts, aluminum lock bolts, and galvanized steel bolts may have applications under certain conditions. It is accepted practice to restrict bolts to one size in a given structure.

**Riveting:** In substation construction alloy 6061-T6 rivets are recommended because of their high shear value. They are available in sizes ranging up to 1" shank diameter. These rivets are cold driven as received.

To avoid corrosion, the rivet alloy selected should have equal or greater corrosion resistance than the alloys being joined. The rivet alloy should also be somewhat softer.

Rivets offer the advantage of an approximate 15% shear advantage over aluminum bolts. Additionally, shop riveted sub-assemblies eliminate deflections caused by bolt slippage.

**Welding:** All types of inert gas shielded arc welding (not requiring a flux) are acceptable for aluminum. However, two methods are most commonly used:

1. A tungsten electrode with the filler rod being fed by hand as in gas welding. (GTAW)
2. A consumable electrode of aluminum welding wire fed through the inert gas envelope. This is a fast method and is used also for automatic set-ups. (GMAW)

The strength of the weld generally varies from 60-90 percent of the original strength of the parent metal, depending on the alloy and temper. In many cases, proper arrangement of the seams may compensate for possible loss of strength. Butt seams offer the highest efficiency.

**TABLE 18-2**  
**Alloy 6061**  
**Minimum Mechanical Properties—Values Are Given in Units of ksi (1000 lb/in<sup>2</sup>)**

Alloy And Temper	Product*	Thickness Range* in.	TENSION		COMPRESSION $F_{cy}$ ksi	SHEAR		BEARING		Compressive Modulus of Elasticity‡ $E$ ksi
			$F_{tu}†$ ksi	$F_{ty}†$ ksi		$F_{su}$ ksi	$F_{sy}$ ksi	$F_{bu}$ ksi	$F_{by}$ ksi	
6061-T6, T651	Sheet & Plate	0.010-4.000	42	35	35	27	20	88	58	10,100
-T6, T651**	Extrusions	All	38	35	35	24	20	80	56	10,100
-T6, T651	Rolled Rod & Bar	up thru 8.000	42	35	35	27	20	88	56	10,100
-T6	Drawn Tube	0.025-0.500	42	35	35	27	20	88	56	10,100
-T6	Pipe	up thru 0.999	42	35	35	27	20	88	56	10,100
-T6	Pipe	over 0.999	38	35	35	24	20	80	56	10,100

\* Most product and thickness ranges are taken from The Aluminum Association's "Aluminum Standards and Data."

†  $F_{tu}$  and  $F_{ty}$  are minimum specified values of ultimate (u) and yield (y) tensile (t) strengths. Other strength properties are corresponding minimum expected values.

‡ For deflection calculations an average modulus of elasticity is used; numerically this is 100 ksi lower than the values in this column.

\*\* Values also apply to -T6511 temper.

**Typical Characteristics and Applications**

ALLOY AND TEMPER	RESISTANCE TO CORROSION		Workability (Cold) <sup>3</sup>	Machineability <sup>3</sup>	WELDABILITY <sup>4</sup>		TYPICAL APPLICATIONS
	General <sup>1</sup>	Stress-Corrosion Cracking <sup>2</sup>			Arc	Resistance Spot and Seam	
6061-0	B	A	A	D	A	B	Heavy-Duty Structures Requiring Good Corrosion Resistance, Truck and Marine, Railroad Cars, Furniture, Pipelines
T4, T451, T4510, T4511	B	B	B	C	A	A	
T6, T651, T652, T6510, T6511	B	A	C	C	A	A	

<sup>1</sup> Ratings A through E are relative ratings in decreasing order of merit, based on exposures to sodium chloride solution by intermittent spraying or immersion. Alloys with A and B ratings can be used in industrial and seacoast atmospheres without protection. Alloys with C, D and E ratings generally should be protected at least on faying surfaces.

<sup>2</sup> Stress-corrosion cracking ratings are based on service experience and on laboratory tests of specimens exposed to the 3.5% sodium chloride alternate immersion test.

A = No known instance of failure in service or in laboratory tests.

B = No known instance of failure in service; limited failures in laboratory tests of short transverse specimens.

C = Service failures with substained tension stress acting in short transverse direction relative to grain structure; limited failures in laboratory tests of long transverse specimens.

D = Limited service failures with sustained longitudinal or long transverse stress.

<sup>3</sup> Ratings A through D for Workability (cold), and A through E for Machineability, are relative ratings in decreasing order of merit.

<sup>4</sup> Ratings A through D for Weldability and Brazeability are relative ratings defined as follows:

A = Generally weldable by all commercial procedures and methods.

B = Weldable with special techniques or for specific applications which justify preliminary trials or testing to develop welding procedure and weld performance.

C = Limited Weldability because of crack sensitivity or loss in resistance to corrosion and mechanical properties.

D = No commonly used welding methods have been developed.

**TABLE 18-3**  
**Alloy 6063**  
**Minimum Mechanical Properties—Values Are Given in Units of ksi (1000 lb/in<sup>2</sup>)**

Alloy And Temper	Product*	Range* Thickness	TENSION		COMPRESSION $F_{cy}$ ksi	SHEAR		BEARING		Compressive Modulus of Elasticity <sup>‡</sup> $E$ ksi
			$F_{tu}$ <sup>†</sup> ksi	$F_{ty}$ <sup>†</sup> ksi		$F_{su}$ ksi	$F_{sy}$ ksi	$F_{bu}$ ksi	$F_{by}$ ksi	
6063-T5	Extrusions	up thru 0.0500	22	16	16	13	9	46	26	10,100
-T5	Extrusions	over 0.500	21	15	15	12	8.5	44	24	10,100
-T6	Extrusions Pipe	All	30	25	25	19	14	63	40	10,100

\* Most product and thickness ranges are taken from The Aluminum Association's "Aluminum Standards and Data."

<sup>†</sup>  $F_{tu}$  and  $F_{ty}$  are minimum specified values, other strength properties are corresponding minimum expected values.

<sup>‡</sup> For deflection calculations an average modulus of elasticity is used; numerically this is 100 ksi lower than the values in this column.

**Typical Characteristics and Applications**

ALLOY AND TEMPER	RESISTANCE TO CORROSION		Workability (Cold) <sup>3</sup>	Machinability <sup>5</sup>	WELDABILITY <sup>4</sup>		TYPICAL APPLICATIONS
	General <sup>1</sup>	Stress-Corrosion Cracking <sup>2</sup>			Arc	Resistance Spot and Seam	
6063-T1	A	A	B	D	A	A	Pipe Railing Furniture Architectural Extrusions
T4	A	A	B	D	A	A	
T5, T52	A	A	B	C	A	A	
T6	A	A	C	C	A	A	
T83, T831, T832	A	A	C	C	A	A	

See footnotes below Table 18-2 on page 18-11.



## A

- A class of bare concentric-lay stranded conductors, 3-2
- AA class of bare concentric-lay stranded conductors, 3-2
- AAC, 3-1
- AAAC, 3-1
- 6201-T81 stranded. ACSR diameters, physical and electrical properties, table 4-12
  - in even AWG and kcmil diameters, table 4-13
- abrasion resistance, 8-1
- ac electrolysis corrosion, 17-3
- ac resistance, calculation of 3-8
- ac/dc ratios, 9-3
- ac/dc ratio, 60 cycle, estimating, table 9-4
- ac/dc ratio for triplexed 3-conductor assembly, fig. 9-1
- ac/dc ratios for aluminum cable, 9-6
- ACAR, 3-1, 3-4
- composite conductors, 3-3
  - 1350-H19 with 6021-T81 reinforcement ASTM B 524 sizes, table 4-23
  - strength, 3-4
  - strength rating factors, table 3-4B
  - typical stranding arrangements, fig. 3-5
- accessories for overhead conductor, 5-21
- acoustic fault detection, 12-7
- acrylonitrile-butadiene/polyvinyl-chloride compound, vulcanized, 8-10
- ACSR, 3-1
- compact-round, physical and electrical properties, table 4-18
  - composite conductors, 3-3
  - current ratings, table 3-13
  - electrical properties of multi-layer sizes, table 4-6
  - electrical properties of single-layer sizes, table 4-15
  - electrical resistance of aluminum wires in, table 3-4A expanded, fig. 3-6
  - mechanical properties of galvanized A, B, and C core and aluminized A core, class AA and A strandings, 1350-H19, table 4-14
  - modifications, 3-3
  - properties compared with similar conductors, table 3-3
  - rated strength, 3-2
  - resistance multiplying factors, fig. 3-9
  - skin effect in, 3-9
  - stranding arrangements, fig. 3-4
  - suffix notations, 4-2
- ACSR/AW, 3-3, 3-4
- physical and electrical properties, table 4-17
- ACSR/TW
- physical and electrical properties, tables 4-19, 4-20, 4-21, 4-22
- advantages of aluminum as a conductor, 2-1
- aeolian vibration, 6-13, 13-33
- aerial cable assemblies, 7-2
- installing, 11-23
  - parallel (PAC), 7-3
  - preassembled, above 600 volts, 7-5
  - primary, 11-23
  - initial sag-tension values, table 11-10
  - reverse twist, 7-3
  - service drop, 7-3
- aging of aluminum vs. copper magnet wire, 14-2, fig. 14-1
- AIEE
- Paper 58-41, Current-Carrying Capacity of ACSR, 3-8n
  - Paper CP 58-1072 on corrosion, 17-5
  - Paper 59-897, Power Apparatus and Systems, 3-8n
  - Paper, CP 59-930 on bolt torque-load relationships, 13-44n
  - Technical Paper No. 4145, 6-2n
  - Transactions Paper, Dec. 1953, 11-10
  - Transactions Paper, 58-41, 13-12
  - Transactions, pt. III (Power Apparatus and Systems), v. 76, Oct. 1957 on temperature rise and load of cable systems, 9-13n
- air-oven test, 8-4
- Alcoa Aluminum Overhead Conductor Engineering Data Book*, 3-19n
- Alcoa Aluminum Bus Conductor Handbook*, 13-1
- alkalis, caustic, 7-4
- all-aluminum alloy 6201-T81 concentric-lay stranded bare conductors, physical and electrical properties, tables 4-12, 4-13
- all-aluminum alloy-conductors, 3-1
- all-aluminum conductors, 3-1
- all-aluminum connection, 11-1
- all-aluminum 1350 of various hardnesses in Class B, C, and D stranding, physical properties of, table 4-8
- all-aluminum 1350-H19 Class AA and Class A stranded conductors, electrical properties, table 4-6
- physical properties, table 4-5
- allowable pulling tension, 11-11
- alloy 6061, structural, table 18-11
- alloy 6061-T6, 18-3
- alloy 6063, 17-4
- table 18-3
- alloy 6063-T6, 18-11
- alloy 6101-T6, tensile and yield strength, fig. 13-1
- alloy 6201, heat-treatable 1-5
- alloy composition of aluminum conduit, 6063, table 17-7
- alloy listing, method of, 1-4
- alloy-number, 1-5
- alloy selection for cast rotors, 16-2
- alloying, effect of, 2-1
- alloys
- for bus conductors, 13-1
  - for electrical conductors in percent, chemical composition limits (maximum) for wrought aluminum, table 1-2
  - heat-treatable 1-4, 2-1
  - for induction motor rotors, table 16-1
  - "marine," 2-3
  - non-heat-treatable 1-4, 2-1
  - structural, 18-10
- ALS type three-conductor cable, 10-7
- alternating current busses, low voltage, 13-27
- alternating potential, 8-13
- altitude, sun, emissivity, multiplying factor for various conditions of, fig. 3-15
- alumina, 1-1
- alumine, 1-1
- aluminized inner-core wires for ACSR, 3-4
- aluminum (def.), 1-4
- aluminum alloy (def.), 1-4, table 1-1
- Aluminum Association, 1-4, 1-5, 4-1, 9-13, 10-4, 13-1, 13-2, 13-3
- Aluminum Building Wire Installation Manual*, 10-4
- aluminum cable alloy-reinforced stranding arrangements, fig. 3-4
- aluminum chloride, 1-1
- aluminum clad steel conductors, (AW), table 4-24
- aluminum conductor alloy-reinforced, 3-1, 3-4
- aluminum conductor steel-reinforced, 3-1, 3-3
- aluminum conductors (1350-H19) stranded with aluminum clad steel (AWAC) conductors, physical and electrical properties, table 4-25
- aluminum conductor connections, 11-1
- aluminum conduit, advantages, 17-2
- vs. steel, electrical characteristics, 17-4
  - installation ease, 17-2
  - weight, 17-2
- aluminum magnet wire vs. copper, economic advantages, 14-2
- technical advantages, 14-2
- aluminum oxide, 1-1, 14-4
- Aluminum Standards & Data*, 1-5, 13-1
- Aluminum Underground Distribution Reference Book*, 11-12n
- aluminum, 1350, 1-4
- 1350 aluminum, suffix notations, 4-2
  - 1350 aluminum wires, solid-round, mechanical and electrical properties, table 4-4
  - 1350-F, 13-2
  - 1350-H12, tensile and yield strength, fig. 13-2
  - 1350-H19, aluminum conductors, strength of, table 3-2
  - aluminum conductors stranded with aluminum clad steel (AW) conductors, physical and electrical properties, table 4-25
  - aluminum wire, time-temperature percent strength, remaining, fig. 6-3
  - composite conductor, 3-4
  - with 6201-T81 core, 3-4
- aluminum to copper connections, 11-5
- aluminum vs. copper, comparative cross-section for equal volume conductance, table 14-3
- aluminum wrought bus conductor alloys, physical and electrical properties, table 13-2
- aluminum-to-aluminum connections, welded, 13-46
- aluminum-to-copper connection, 5-25, fig. 5-23
- Alumoweld conductors, 5-26, 11-23, table 11-10
- alums, 1-1
- ambient temperature, 3-19, 9-26
- ASTM, 4-2
- American Welding Society Handbook*, 13-46, 13-47
- American Wire Gage, 3-1
- amid-imide polymer enamel coating, 14-5
- ampacity, 6-1, 9-6, 9-13, 17-1
- 1350 AAC and standard-strength ACSR conductors, 3-20
  - 6201-T81 and ACAR conductors, 3-21
  - bare conductors, 3-19
  - bus conductor, 13-19, 13-21, 13-22, tables 13-26 to 13-32, 13-63, 13-64, 13-66
  - conductor, 9-3
  - conductor cable, table 10-1
  - current-temperature-rise graph, 3-22, 3-23, 3-24, 3-25
  - derating factors on metal conduit, table 9A-3
  - derating factors on troughs, table 9A-4
  - derating factors, unequal spacing, table 9A-5
  - derating factors NEC more than three conductors, table 9A-6
  - design constants, 9-25
  - effect of temperature, 3-8
  - grouping, factors for spacing adjacent cables, 9-28
  - high-voltage aluminum cables, 10-16
  - high-voltage cables with aluminum conductors, tables 10-7A, 10-7B, 10-7C
  - insulated conductors, 9-13
  - interpolation chart for duct bank cables, 9-26
  - for pipe-type and directly buried cables, 9-27
  - ratings for varying bus bar arrangements, 13-21
  - fig. bus bars carrying a-c at 60 Hz, comparative, 13-23
  - ratings, insulated cables, 9-13
  - Sched. 40 and Sched. 80 std. alum. pipe, table 13-27
  - single-layer high-strength ACSR conductors, 3-21, table 3-8A
  - underground distribution cable, two-conductor concentric-neutral, direct burial and buried duct, table 10-9A
  - installed in air or in duct in air, table 10-21
  - value adjustment factors for variation of ambient temperature, table 10-8
- angles, uniform thickness, 13-11
- paired, 13-11
- annealed copper standard, 3-7
- annular rings, GMR of, fig. 3-15
- anode, 15-4, 17-6
- anodic oxide film, 15-4
- anodized films, 14-4
- anodized foil, 15-6
- ANSI
- standard C8-35, 7-2, C37.20, 1347, 13-52
  - C119.3, 13-34

ANSI (continued)  
 H35.1-1978, 1-5  
 net stress area, 13-2  
 apartment-house wiring, 10-4  
 appearance, station structure, 18-9  
 appliance cable, 10-2  
 arc length, 5-1  
 arc resistance, 8-1  
 arc welding, shielded inert, 14-10  
 arc-current burndown, 6-1, 6-2  
 times, table 6-1  
 arcing, 6-2  
 arcing burndown, 6-2  
 arcing effects, 6-2  
 armor, round-wire, 7-5  
 armor rods, 5-21, 5-25, 6-15  
 installation, fig. 5-26  
 preformed, 5-27  
 armor wire, flat, 5-21  
 armored cable, 7-3  
 interlocked, 7-5  
 arrangement of insulating layers, 8-1  
 ASA, C37-20, 13-12  
 asbestos insulations, 8-5, 14-5  
 ASTM, 4-3, 7-2  
 ASTM A 325, 13-45  
 ASTM A 354, 13-45  
 ASTM B 231, 3-2, 7-1  
 ASTM B 232, 3-4  
 ASTM B 236, 13-2, 13-3  
 ASTM B 241, 13-2, 13-8, 13-9  
 ASTM B 317, 13-2, 13-3  
 ASTM B 429, 13-2, 13-9  
 ASTM B 524, 3-4, 3-7  
 ASTM corrosion testing, 17-5  
 Specifications, 4-2  
 Standards, strength ratings, 5-1  
 audio tone fault locating, 12-7  
 AWG, 3-1  
 AWG-size wire, cross-sections of solid round, 3-1

**B**

B class of stranded conductors, 3-2  
 B&S gage, 3-1  
 Baltimore Gas & Electric Co., 6-9  
 bare aluminum conductors  
 ampacity of, 3-19  
 composite designs of, 4-1  
 homogeneous designs of, 4-1  
 product classification, 4-1  
 service classification, 4-1  
 titles and numbers of ASTM specifications, table 4-4  
 bauxite, 1-1  
 Bayer process, 1-1  
 Belleville spring washer, 5-25, 11-5, 11-8, 13-43, 13-44,  
 table 11-4, fig. 11-5  
 bending, 2-3, fig. 13-4  
 bending properties, bus conductor mechanical, 13-7,  
 13-8  
 bending radii, bus, tables 13-5, 13-6  
 bending rigid conduit, 17-7  
 bibliography, bus conductor, 13-68 thru 13-70  
 bifilar winding, 14-7  
 bi-metallic pads in flat-pad connections, 13-41  
 binders, 8-12  
 bobbins, 14-3  
 bolt clamp connections for bus bars, 13-45  
 bolt creep factors, 13-6, table 13-7  
 joint design, 13-40  
 spacing, 13-41  
 stresses, 13-45  
 torque vs. clamping load, 13-43  
 torque clamping forces, fig. 13-20

bolted bus connections, 13-40 to 13-45  
 bolted clamp connector, 5-23  
 clamp bolt connections, fig. 5-21  
 surface preparation for, 13-41  
 bolted connections, 11-3  
 bolting, station structures, 18-10  
 bolts, 2024-T4, 2-2, 13-43  
 bolts, heavy series, torque and stresses in, table 13-45  
 Bond, N.T., 13-41  
 braided coverings, 8-2  
 brazing, 13-47  
 "breakdown" furnace, 16-3  
 bridge-loop methods, 12-7  
 brittleness, 8-1  
 bronze alloys, 2-3  
 Brown & Sharpe gage, 3-1  
 Brown, J.R., 3-1  
 building wire, 7-2, 10-4, 11-1  
*Building Wire Installation Manual, Aluminum*, 10-4, 11-1  
 "bunched" stranded conductors, 3-2  
 "bundled" conductor, 3-3, 3-12  
 capacitive reactance of, 3-19  
 inductive reactance of, 3-19  
 spacers and dampers for, 6-15  
 Bunet, 14-7  
 burial depth of cable, 11-12  
 buried cable ampacity interpolation chart, 9-27  
 buried cables, arrangements of, for ampacity calculations,  
 fig. 9A-2  
 burndown  
 arc-current, 6-1, 6-2  
 arcing, 6-2  
 fault-current, 6-1  
 times, arc-current, table 6-1  
 "burn-off" characteristics, 2-4  
 burring, 16-4  
 bus  
 alternating current, low voltage, 13-27  
 channel, 13-11  
 connections, bolted, 13-40 thru 13-45  
 connectors, expansion, fig. 13-35  
 design, 13-11, 13-40, 13-41  
 expansion joints, 13-34  
 flat, 13-9  
 gas-insulated, 13-48  
 generator, 13-47  
 high-current, swinging suspension for, fig. 13-15  
 installations, 13-47  
 integral web channel, 13-9  
 interlaced and paired phase, arrangements of, 13-16  
 isolated phase, 13-24, 13-50, fig. 13-23  
 mechanical design, 13-28  
 non-segregated three phase, 13-47, fig. 13-22  
 paired, arrangement of, fig. 13-9  
 rectangular, 13-9  
 resonant frequencies, fig. 13-14  
 rigid, 13-34  
 round rod, 13-11  
 round tubular, 13-9  
 segregated, 13-47  
 shape selection, 13-8  
 shapes, typical, fig. 13-5  
 special shapes, 13-11  
 square tubular, 13-9  
 station, 13-47  
 supports, 13-34  
 switchyard, 13-48, fig. 13-25  
 tubular, 13-9  
 tubular, expansion support for, fig. 13-16  
 uniform thickness angle, 13-11  
 bus assemblies, interlaced, 13-16  
 bus assembly for heavy short circuit conditions, 13-34  
 bus bar  
 arrangement, 13-21  
 current ratings, table 13-26  
 for electrolytic supply, fig. 13-29  
 bolted clamp connections, 13-45

bus bar (continued)  
 clearances, 13-34, tables 13-18, 13-19  
 effects of heating, 13-5  
 housing, 13-50, 13-51  
 mechanical properties, 13-5  
 spacing, 13-34, table 13-17  
 bus bars  
 bolted, interface compressive stress, 13-40, 13-41  
 extruded, 1-1  
 heating due to magnetic materials, 13-17  
 in parallel, fig. 13-19  
 square-corner, physical and electrical properties, table  
 13-25  
 transposition, 13-17  
 bus conductor  
 absorptivity, 13-21  
 alloys, temperature coefficients of resistance for, table  
 13-3  
 ampacity, 13-12  
 corona, 13-19  
 corrosion, 13-8  
 effect of painting, 13-21  
 electrical properties, table 13-2  
 emissivity, 13-21  
 formability requirements, 13-7  
 heat balance equation, 13-21  
 heat loss equations, table 13-8  
 mechanical properties, table 13-1  
 mutual heating, 13-17  
 proximity effect, 13-17  
 radio influence voltage, 13-19  
 reactance, 13-17  
 selection, 13-8  
 shapes, 13-8, 13-9, 13-11, fig. 13-5  
 short circuit forces on, 13-24 thru 13-28  
 skin effect, 13-12, figs. 13-6, 13-7, 13-8  
 vibration, 13-28  
 electromagnetic, 13-27, 13-28  
 aeolian, 13-33  
 bus conductor, 13-5  
 bibliography, 13-68 thru 13-70  
 deflection and stress formulas, table 13-12  
 enclosed, 13-23  
 integral-web channel, physical and electrical proper-  
 ties, table 13-32  
 internal damping of tubular, 13-33, table 13-16  
 parallel, lateral short circuit forces in, 13-24 thru  
 13-27  
 properties, table 13-32  
 round-tube, physical and electrical properties, table  
 13-28  
 short circuit currents, 13-27  
 longitudinal forces, 13-27  
 torsional forces, 13-27  
 heating, 13-27  
 span length, vibration free, table 13-15  
 square-tube, physical and electrical properties, table  
 13-29  
 temperature rise, 13-11  
 effect of conductivity, 13-11  
 effect of dimensions, 13-12  
 uniform thickness aluminum channel, physical and  
 electrical properties, table 13-30  
 uniform-thickness angle, physical and electrical prop-  
 erties, table 13-31  
 "bus duct," 13-48  
 bus expansion, 13-33  
 joints, 13-33, 13-34  
 joints positioning, 13-34  
 rectangular, 13-33  
 structural shape, 13-33  
 tubular, 13-33  
 bus swing, 13-34  
 busses  
 for aluminum industry, 13-52  
 for chlor-alkali industry, 13-52  
 for electric furnaces, 13-52

# index

- busses (continued)
    - for magnesium industry, 13-52
  - busways, 13-48
    - feeder, cross section, 13-16
    - plug-in, fig. 13-28
  - butt weld, 13-46, fig. 13-21
  - butyl synthetic rubber, 8-5
- C**
- C class of stranded conductors, 3-2
  - cable
    - a-c/d-c ratios, 9-6
    - aluminum sheathed, 7-4
    - assemblies, 3-conductor, 8-1
    - burial depth, 11-12
    - covered aluminum, 7-2
    - design, 9-1
    - diameter, 9-1
      - determination of, table 9-1
      - outside, and conductor diameter compared, table 9-2
    - economic study of, 9-6
    - failure, external causes, 12-5
    - in aluminum conduit, 9-6
    - installation, duct, fig. 11-21
      - pulling in conduit, 17-7
    - maintenance inspection, 12-4
    - mechanical damage to, 12-5
    - selection, economics of, 9-21
    - spacing, 9-2
    - stranding, methods of, fig. 8-2
    - supports, rigid, reactance of conductors on, 9-10
    - underground installation, insulated, (600 v), 7-4
  - cable-conductor resistance, 9-3
  - Calculation of the Temperature Rise and Load Capability of cable systems, The*, 9-13
  - capacitance
    - across conductor insulation, nomogram, 9-14
    - insulated aerial cables, 8-14
    - insulated conductors directly buried, 8-16
      - with grounded sheath, 8-16
  - capacitive and inductive reactance, 3-12
  - capacitive reactance, 8-14, 9-9
  - bundled conductors, 3-19
  - bus bar, 13-17
    - separation component of, at 60 Hz megohm-miles per conductor, table 3-12
  - capacitor
    - design, 15-1
    - electrolytic, 15-4
    - equivalent electrical circuit, fig. 15-2
    - equivalent network of a, 15-1
    - filtering, 15-4
    - losses, 15-2
    - paper, heat loss vs. frequency, fig. 15-5
    - impedance vs. frequency, fig. 15-2
    - waxed paper, 15-4
    - wound paper, 15-3
  - Carnegie Steel Co., *Pocket Companion*, 13-63n
  - cast alloy for bus 1050, 13-2
  - cast iron crucibles, 16-3
  - cast rotors, comparative performance, 16-1
  - casting, 1-4
    - methods, aluminum rotors, 16-3
    - problems, 16-4
    - temperature, rotor, 16-4
    - thermal treatment of rotor, 16-4
  - catalog information and technical data, 4-2
  - catenary constants for horizontal spans, table 5-4
  - catenary curve and preliminary sag-tension graph, 5-10
  - channel plugging, furnace, 16-3
  - chemical composition limits (maximum) for wrought aluminum alloys for electrical conductors in percent, table 1-2
  - chemical factors in selecting
    - cable covering, 8-1
    - insulation, 8-1
  - charging current, 8-1, 8-13
  - chloride, in concrete, 17-6
  - chlorine, 7-4
  - chloro-sulphonic acid, 8-9
  - chromium, 2-2
  - circuit breaker, 6-1
  - circuit voltage drop, rigid conduit, 17-4
  - circuits, diagrams and formulas of electrical and power
    - quantity relationships, fig. 12-1
  - city-distribution lines, 5-23
  - clamp-bolt connectors, fig. 5-24, 11-1
    - mechanical compression, 11-5
  - clamps, dead-end, 5-23
    - suspension, 5-23, fig. 5-20
  - Class A bare concentric-lay stranded conductors, 3-2
  - Class AA bare concentric-lay stranded conductors, 3-2
  - Class B stranded conductors, 3-2
  - Class C stranded conductors, 3-2
  - Class D stranded conductors, 3-2
  - clearance between live parts or bare conductors in air, table 13-17, 13-18
  - clearances, in outdoor substations, table 13-19
  - clevis support at pole, fig. 11-31
  - coated strip, 14-5
  - code word, 4-1
  - Code Words for Aluminum Electrical Conductors*, 4-1
  - coil
    - characteristics, 14-7
    - connections, 14-4
    - design, 14-2
    - computation chart, 14-8
    - strip magnet conductor, 14-6
    - size, 14-3
    - strip wound, useful formulae, table 14-11
    - wound with aluminum and copper, space comparison, fig. 14-6
  - coldwelding aluminum strips, 14-9
  - cold working, 1-4, 2-1
  - cold-bend characteristics of flat bus bars, table 13-8
  - compact concentric stranded conductor, fig. 3-3
  - compact stranding, 7-1
  - compacting of stranded conductors, 8-2
  - composite conductors, 3-3
    - sag-tension graphs for, 5-18
  - composite towers, 18-8
  - composition, rigid conduit, 17-2
  - compressed stranding, 7-1
  - compression connector fittings, fig. 11-2
  - compression connectors, 5-21, 11-4
    - tubular, fig. 5-19
  - compression joints, 5-21
    - tubular, fig. 5-18
  - compression terminals for magnet wire, fig. 14-2
  - compressive stress, 13-41, 13-43
  - concentric-flat-ribbon neutral, fig. 10-9b
  - concentric-lay conductors, examples of, fig. 3-2
  - concentric-lay stranding, 3-2
  - concrete, embedding rigid conduit in, 17-6
  - conductivity, 2-1, 2-2
    - bus conductor, table 13-2
    - of high-purity metals for electrical conductors, comparative, table 2-1
    - thermal, 2-1, 2-3
  - conductor cable ampacity, table 10-1
  - conductor cross-sectional areas, table 17-3
  - conductor metal, physical and electrical constants, table 4-2
  - conductor shields, 8-10
  - conductors
    - bare uninsulated, 3-1
    - "bundled," 3-3, 3-12
    - capacitive reactance of, 3-19
    - inductive reactance of, 3-16
    - building wire dimensions, table 11-1
  - composite, 3-3
  - constructions, special, 3-3
  - designation, 4-2
  - diameter and cable outside diameter compared, table 9-2
  - "expanded" core concentric-lay, 3-3
  - insulated, 2-3, 7-1
  - in vertical raceways, 11-10
  - shapes, cross-sections of, special, 3-3
  - spacing, 9-8
  - stranded, 3-1
  - stranded and solid, differences between, 3-2
  - symbols for types of, 3-1
- conduit (def.), 9-1
    - alloy composition, table 17-7
    - aluminum vs. steel, dimensions and comparative weights, table 17-6
    - cables in, 9-6
      - installing, 11-8, fig. 11-20
      - staggering ends of, fig. 11-20
    - circuit voltage drop, 17-4
    - concrete, embedded in, 17-6
    - corrosion characteristics, 17-4
    - design, 17-1
    - electrolytic attack, exposure to, 17-6
    - expansion joints, 17-7
    - fault protection capability, 17-3
    - fill area, 17-1, table 17-1
    - fittings, 17-7
    - galvanic attack, exposure to, 17-6
    - industrial applications, 17-6
    - installation, 9-1, 17-1, 17-6
      - labor, aluminum vs. steel, 17-2
    - max no. of compact conductors in conduit or tubing, table 17-2
    - number of conductors allowable in different sizes of, table 17-4
    - resistance, 17-3
    - short-circuit capability, 17-4
    - size, 17-7
  - connecting procedures, 11-1, 11-3 to 11-7
  - connecting single-conductor, secondary wires and cables, 11-1, 11-3 to 11-7
  - connection
    - aluminum-to-copper, 5-25, fig. 5-23
    - bolted, surface preparations for, 13-41
    - bus conductor, 13-36
    - copper-aluminum, 13-45
    - expansion, bus, fig. 13-35
    - making, 11-7
    - welded aluminum-to-aluminum, 13-46
  - connections, typical 5-15 kV, fig. 11-28
  - connectors, 5-21
    - bolted clamp, 5-23
    - building wire, 11-2
    - clamp-bolt, fig. 5-24
    - compression, 11-2, fig. 11-1
    - jumper, 5-21
    - mechanical, 11-3, fig. 11-1
    - plating, 11-3
    - splice kit, fig. 11-23
  - constants, physical and electrical, conductor metal, table 4-2
  - constriction resistance, 13-37, fig. 13-17
  - constructions, power cable, NEC designations for, 8-12
  - rope-lay, 3-3
  - special conductor, 3-3
- consumable electrode, 13-46
  - continuous casting, 1-4
  - contact interface, nature of, 13-36
  - contact resistance, 13-40, fig. 13-18
  - contact surface area, 13-40
  - control wiring, 8-5
  - convection heat loss, 3-19, 3-20
  - copper, 2-2, 2-3, 5-21, 5-25, 10-9
  - copper bus bar, temperature coefficients of resistance for bus conductor alloys and representative values for

## index

copper bus bar (continued)  
  commercial, table 13-3  
copper conductors, 7-6  
  hard drawn, 3-3  
copper magnet wire, 14-1  
copper standard, international annealed, 3-7  
copper vs. aluminum: comparative cross-section for equal volume conductance, table 14-3  
copper-aluminum  
  connections, 13-45  
cores, wound, 14-2  
corona, 3-12, 13-19  
  insulation, effect on, 8-10  
  shielding, effect on, 8-10  
"corona level" test, 8-12  
corrosion  
  a-c electrolysis, 17-3  
  atmospheric, of solid metals over 10 years, table 17-7  
  galvanic, 13-45, 13-46  
  reduction of, 3-4  
  resistance, 2-1, 2-3  
  station structures, 18-10  
  transmission tower, 18-3  
covered conductor (def.), 7-1  
covered wires or cables, conductors for use with, 7-1  
coverings  
  availability, 8-1  
  braided, 8-2  
  selection: chemical, electrical, mechanical, thermal factors, 8-1  
  for uninsulated conductors, 8-2  
  comparison of, table 8-1  
covering temperature, 8-12  
cracks in rotors, 16-4  
creep, 2-1, 2-3, 13-5, 13-36, 13-40  
  rate, 6-11  
  short-time, 2-3  
creep factors, bus conductor, 13-6, table 13-4  
cross arms, 18-3  
cross-linked polyethylene insulation, 8-5, table 8-4  
crosswind damage, 6-13  
crucible furnaces, 16-2  
crushing resistance, insulation, 8-1  
cryolite, molten, 1-1  
*Current-Carrying Capacity of ACSR*, H.E. House & P.D. Tuttle, 3-8n  
current, charging, 8-13  
current, displacement, 8-13  
current, leakage-conduction, 8-13  
current in sheath before insulation damage, computing, 12-2  
current overload, 6-10  
current per unit area of contact interface, 13-41  
current ratings  
  for ACSR, table 3-21  
  for bus bar arrangements, table 13-26  
current values, 6-1  
current-temperature-rise graph for ampacity, 3-22, 3-23, 3-24, 3-25  
current vs. temperature rise, 13-22  
currents in an insulator, vectorial relationship of, fig., 8-15  
cutting rigid conduit, 17-6

## D

D class of stranded conductors, 3-2  
damper cable, 6-16  
damper spacing, fig. 6-8, 6-9  
dampers  
  for bundled conductors, 6-15  
  festoon, 6-14  
  Stockbridge, 6-14, fig. 6-7  
  vibration, 6-14  
dancing, 6-13

## iv

Davy, Sir Humphrey, 1-1  
dc resistance  
  calculation of, 3-7  
  change with temperature, 3-8  
  temperature coefficients, table 13-3  
dc resistivity values for aluminum wire alloys at 20°C, table 3-5  
dead-end, 5-21, 5-23  
  clevis, fig. 5-26  
  preformed, 5-24, fig. 5-26  
  steel eye, fig. 5-26  
  tubular compression, fig. 5-4  
dead-end at pole, fig. 11-30  
dead-end clamps, 5-21, 5-23  
dead-end support at pole, fig. 11-31  
dead-ending cables, messengers, guy wires on poles, fig. 11-30  
Dearborn Chemical Co., 13-44n  
deflection and stress formulas, bus conductors, table 13-12  
deflection values  
  Sched. 40 pipe, table 13-13  
  Sched. 80 pipe, table 13-14  
Delta TD values, 9-23  
design  
  of cables, 9-1  
  of conduit, 17-1  
  station structural, 18-8  
  transmission towers, 18-4  
designations  
  of conductors, 4-2  
  of insulators and coverings, NEC, 8-12  
  of power cable constructions, 8-13  
Deville, Henri Sainte-Claire, 1-1  
die-cast rotor, open-slot, fig. 16-3  
die-cast rotors, 16-3  
dielectric advantages, strip magnet conductor, 14-9  
dielectric computation, 8-16  
dielectric constant, 8-1, 8-14  
  under a-c conditions, 8-14  
dielectric loss, 9-6  
  temperature rise, 9-23  
dielectric stress, 8-9  
dielectric theory, 8-13 to 8-16  
dimensions of heavy-series aluminum bolts, national coarse threads, table 13-21  
direct current busses, 13-27  
direct potential, 8-14  
direct-burial cables, 10-8, 10-15, 11-12  
direction of lay, 7-1  
displacement current, 8-13  
dissimilar metal interfaces, 13-41  
drawing the parabola, method of, 5-11  
drawn aluminum round wires for use in electrical conductor cables, table 1-1  
dross defect, rotors, 16-4  
dry foil, 15-6  
duct bank cables, ampacity interpolation chart, 9-26  
ducts (def.), 9-1  
  installing, 9-1  
  installing cable in, 11-10, fig. 11-21  
  staggering cable ends in, fig. 11-20  
dynamic balancing, 14-2  
dynamometer, 5-7

## E

earth thermal resistivity, 9-23  
economic study of cables, 9-6  
economics  
  aluminum magnet wire, 14-1, 14-2  
  bus conductor, 13-1  
  of cable selection, 9-21  
  of capacitor design, 15-1  
eddy-current loss, 3-10, 9-1, 9-3, 9-6, 17-1  
hysteresis and, 3-10

Edison Electric Institute, 6-9, 11-23  
effective resistance of foil electrodes, 15-3  
EHV lines, 3-3  
  design, 3-12n  
  expanded core designs for, 4-1  
elastic limit, 13-7  
*Electric Equipment, General Principles for Temperature Limits in the Rating of*, IEEE Pub., 14-2  
electric furnace, 9-9  
  busses, 13-52  
electric method, insulation, water absorption, 8-12  
electric wave filters, 15-2  
electric-arc welding, 13-46  
electrical and physical constants, conductor metal, table 4-2  
electrical and mechanical properties  
  of all-aluminum 1350-H19 compact-round stranded conductors, table 4-9  
  solid-round 1350-H19 aluminum wires, table 4-4  
electrical and physical properties  
  AACR, 6201-T81 stranded, ACSR diameters, table 4-12  
  in even AWG and kcmil diameters, table 4-13  
  ACSR compact-round, table 4-18  
  ACSR/AW, table 4-17  
  ACSR/TW, table 4-19, 4-20, 4-21, 4-22  
  all-aluminum 1350-H19 Class AA and A stranded conductors of even kcmil sizes, table 4-7  
  aluminum conductors, 1350-H19, stranded with aluminum clad steel (AW) conductors, tables 4-37, 4-38  
  integral-web channel bus conductors, table 13-62  
  pipe-size conductors, standard, table 13-57  
  round-tube bus conductors, table 13-58  
  square aluminum tubular conductors, table 13-59  
  square-corner bus bars, tables 13-53, 13-54  
  uniform-thickness aluminum channel bus conductors, table 13-60  
  uniform-thickness angle bus conductors, table 13-61  
electrical characteristics  
  of aluminum conduit vs. steel, 17-3  
  of rotor metal, 16-2  
electrical circuit of a capacitor, equivalent, fig. 15-1  
electrical conductors, aluminum and aluminum alloys for, 1-4  
electrical factors in selecting cable coverings, 8-1  
  insulation, 9-1  
electrical properties of bus conductors, 13-3  
electrical resistance of aluminum wires in ACSF table 3-4A  
electrode, consumable, 13-46  
electrolytic attack on rigid conduit, 17-6  
electrolytic capacitor design, fig. 15-4  
electrolytic capacitors, 15-4  
electrolytic supply  
  bus bar arrangement, fig. 13-29  
electromagnetic coil, 14-1  
electromagnetic forces, 14-13  
  on bus conductors, 13-24, 13-25, tables 13-10, 13-11  
  fault-current, 6-9  
elongation and tensile strength, aluminum conductor alloy data, table 4-3  
elongation of insulation, 8-4  
emergency loading, 6-10  
emergency overload ratings, 9-16  
emergency overloads, 12-1  
emissivity, radiation, table 13-9  
emissivity, sun, altitude, multiplying factor for various conditions of, fig. 3-15  
emissivity, limitations, 3-21  
EMT benders, 17-7  
energy loss, 9-3, 13-12  
EPDM, 8-5, 10-5  
EPM, 8-5, 10-5  
EPR, 8-5  
*EPRI Transmission Line Reference Book*, 3-12  
ethylene-propylene copolymer, 8-5  
ethylene-propylene insulating material, 8-5

## index

ethylene-propylene rubber, 8-2, 8-5  
ethylene-propylene terpolymer, 8-5  
exothermic welding, 13-47  
"expanded" core concentric-lay conductor, 3-3  
expanded core designs for EHV, 4-1  
expansion connectors, bus, fig. 13-16  
expansion joints for rigid conduit, 17-7  
"extended foil," 15-3  
extruded aluminum, 18-10  
extruded aluminum structural shapes, fig. 18-12  
extruding, 1-1  
extrusion design capability, transmission towers, 18-3

## F

F (temper designation), 1-6  
fabrication  
  of aluminum, fig. 1-2  
  sequence of operations, 1-4  
  station structure, 18-9  
factor K, shape correction, fig. 13-12  
fastening methods, station structures, 18-10  
fatigue  
  of conductor strands, 6-14  
  of overhead conductors, 6-11  
fatigue resistance, 2-1  
fault conditions, 3-16  
  impedance under, 3-13  
fault-current  
  adjustment factors, table 6-2  
  burndown, 6-1  
  in a conduit, 17-3, 17-5  
  electromagnetic forces between parallel bare wires and cables, 6-9  
  in sheath, 12-3  
  in shield, 12-3  
fault-current limit, 6-1  
  maximum for bare stranded ACSR aluminum conductor, figs. 6-6 to 6-8  
  maximum for stranded aluminum conductor, figs. 6-1, 6-2  
fault-current wave, 6-9  
fault location, 12-6  
fault-time adjustment factors, table 6-2  
faults  
  transmission line, 6-9  
  underground, 2-4  
feeder busways, 13-48, fig. 13-27  
FEP, 8-5  
festoon damper, 6-14  
fill area, 17-1, table 17-1  
fillers, 8-12  
film-insulated round wire, 14-1  
film resistance, 13-40  
films, anodized, 14-4  
filtering capacitor, 15-4  
fish line, for cable installation, 11-10  
fishing through conduit, 17-7  
fittings, overhead conductor, 5-21  
fittings for rigid conduit, 17-7  
flat armor wire, 5-21  
flash welding, 13-47  
flashover, 6-2  
flat bus, 13-9  
flat bus bars, cold-bend characteristics, table 13-5  
flat washers, outside diameter and thickness, table 13-23  
flexibility, insulation, 8-1  
fluorinated ethylene propylene rubber, 8-5  
fluxing, 16-3  
foil  
  anodized, 15-6  
  dry, 15-6  
  electrodes, effective resistance of, 15-3  
  production, alloy physical properties—O temper, table, 15-2

foil (continued)  
  per, table 15-2  
  alloy thickness and width limitations, table 15-3  
  chemical composition of alloys used, table 15-1  
  roll size, weight, table 15-6  
  slick, 15-5  
  splice data, table 15-5  
  yield limitations, table 15-7  
fold-out parent metal strip conductor lead, 14-10  
formability, bus conductor, 13-7  
foundations for transmission towers, 18-5  
free-loop length, 6-14  
frequencies, resonant, rectangular bus, fig. 13-14  
fretting, 6-14  
friction, interstrand, 6-14  
furnaces  
  "breakdown," 16-3  
  channel plugging, 16-3  
  equipment for rotor manufacture, 16-2  
  induction, 16-3  
  reverberatory, 16-3  
fuse, 6-1

## G

Gaertner, G.H., 6-9  
galloping, 6-13  
galvanic attack on rigid conduit, 17-6  
galvanic corrosion, 13-46  
galvanized inner-core wires of ACSR, 3-4  
garnets, 1-1  
gas holes, 16-4  
gas welding, 13-26  
General Electric Company Data Book, 9-9  
*General Principles for Temperature Limits in the rating of Electric Equipment*, IEEE Pub., 14-2  
generator bus, 13-47  
geometric mean distance, 3-13  
  values of, table 3-15  
geometric mean radius,  $X_g$  and, 3-14  
glass, 14-5  
GMAW welding, 13-46, 18-10  
GMD, 3-13, 13-17  
  values of, tables 3-10, 13-7  
GMR  
  of annular rings, fig. 3-10  
   $X_g$  and, 3-14  
Godde, W.B., 6-9  
Government Rubber-Styrene, 8-4  
graphite, aqueous, 16-4  
gravimetric method, insulation water absorption, 8-12  
GRS, 8-4  
GTAW welding, 13-46, 18-10  
*Guide for Design of Substation Rigid-Bus Structures*, IEEE, 13-11, 13-27, 13-28  
guyed "Delta" tower, 18-4  
guyed "Delta" transmission line tower, fig. 18-4  
guyed "Gull Wing" transmission line tower, fig. 18-5  
guyed three-pole transmission line tower, fig. 18-6  
guyed "V" transmission line tower, fig. 18-4  
guyed "Y" transmission line tower, fig. 18-2

## H

H (temper designation), 1-6  
H1 (temper designation), 1-6  
H111 (temper designation), 1-6  
H112 (temper designation), 1-6  
H2 (temper designation), 1-6  
Hall, Charles Martin, 1-1  
Hall process, 1-1  
Harvey, J.R., 6-11  
Hazan, Earl, 3-8  
heat balance, 3-19

heat balance, equation, 13-21  
heat effects of short-circuit currents, 6-9  
heat loss, 15-2  
  total, 9-6  
  equation, indoor bus, table 13-20  
heat-sink effect, 9-24, 12-1  
heat treatment, 2-1  
heat transfer characteristics of strip conductor, fig. 14-10  
helicopters and aluminum towers, 18-8, fig. 18-8  
Herault, Paul L., 1-1  
H-frame towers, 18-7, fig. 18-8  
high-voltage cable, ampacity of, 10-16  
high-voltage substations, 13-27, 13-48  
hollow-ingot process, 13-8  
horizontal cold chamber die-casting, 16-3  
House, H.E., 3-8  
housing for bus bars, 13-52  
HV lines, 3-3  
Hypalon, 8-9  
hysteresis, 3-10, 17-1  
  and eddy current effects, 3-10  
  loss, 3-10, 9-1, 9-3, 9-16, 17-6

## I

$I^2R$  losses, bus, 13-12  
IACS, 3-7  
ice load, 3-3  
ice-coating, 6-13  
ICEA, 7-5, 8-5  
  ampacity ratings, 9-13  
  ampacity, report on cable, 9-6  
  installation practices, 11-1  
  performance specifications, 8-12  
  Pub. No. P-45-482, 12-3  
  P-46-426, v. II, 1962, 9-4, 9-6, 9-21, 10-18, 10-22  
  Resistances, Table 9-3  
  S-61-402, Table 4, 10-1, 10-12, 10-14  
  S-66-524, 10-1  
  P-53-426, 10-18n  
  shield specifications, 8-10  
  Standards for emergency-load and short-circuit load temperatures for insulation, table 9-7  
ICEA-AIEE ampacity tables 9A-1  
ICEA-IEEE ampacity tables, explanation, 9-22 to 9-29  
ICEA-NEMA  
  publication S-19-81-WC-3, 8-11, 9-16  
  Standards, specifications for thermoplastic insulations, table 8-3  
identification of product, 4-1  
IEEE  
  IEEE *Guide for Calculating Losses in Isolated Phase Bus*, 13-24  
  IEEE *Guide for Design of Substation Rigid-Bus Structures*, 13-11, 13-27, 13-28  
  IEEE Paper 64-146, *Limitations on Stringing and Sagging Conductors*, 5-10  
  IEEE publication P-524, *Guide to the Installation of Overhead Transmission Conductors*, 5-7  
  *Special Technical Conference on Underground Distribution*, 11-11  
  TP 674 PWR, 6-11  
  Transaction Paper T-72-131-6, 13-38  
  Paper 63-280, 13-12  
  Pub. No. S-135, 9-21  
  Stds. Pub. No. 1, April 1969, 14-2  
  Standard No. 27, 13-12  
  *Transaction on Power Apparatus and Systems*, 6-14n  
impedance, 15-1  
  reduction of, by adding terminals, fig. 15-3  
  under fault conditions, 3-15  
  zero-sequence, 3-16  
improvement of physical properties, treatment for, 1-4  
impulse/detector method, 12-7  
impulse generator, 12-7

inductance, 15-1  
of strip magnet conductor coils, 14-7  
induction furnaces, 16-3  
induction motor rotors, alloys for, table 16-1  
inductive reactance, 3-12, 9-8  
of bundled conductors, 3-16  
bus bar, 13-17  
and capacitive reactance, 3-12  
to neutral 2, 3, 4 single conductor in same conduit, table 9-5  
separation component, at 60 Hz ohms/conductor/mile, table 3-9  
series, 9-2, 9-8  
spacing factors, table 13-7  
and zero-sequence resistance, 3-16, table 3-11  
industrial applications of rigid conduit, 17-5  
industry code word, 4-1  
inert-gas shielded welding, 13-46  
ingots, production of, 1-1  
inhibitor joint compound, 2-3, 11-1, 13-41  
initial and final sag-tension charts for variable-length spans, 5-2  
initial stringing chart, 5-4  
initial stringing sag chart, 5-4  
installation of cables  
aerial insulated, 11-23, table 11-10  
cables in trays, 11-9  
in conduit or duct, 11-8  
directly buried, 11-10  
dead ending secondary cables, fig. 11-30  
secondary triplex, neutral-messenger-supported, fig. 11-31  
techniques, 11-7  
installation of conduit, 9-1, 17-6  
installation of duct, 9-1  
practices ins. cable, 11-1  
installation proof-testing, 12-5  
insulated cables  
conductors for, 8-2  
short-circuit currents for, figs. 9-18 to 9-20  
insulated conductors (def.), 7-1  
0-600 volts, 7-2  
above 600 volts, 7-4  
ampacity of, 9-13  
series inductance reactance nomogram, 9-10  
for special conditions, 7-5  
insulated wires or cables, conductors for use with, 7-1  
insulating materials, 8-2  
selection of, 8-1  
thermosetting, 8-4  
insulation  
arrangement of layers, 8-1  
asbestos, 14-5  
breakdown, causes, 12-4  
cable, portable 10-9  
cleaning, 11-7  
compatibility with, 2-1, 2-3  
damage, maximum current before, 12-3  
failure, causes, 12-4  
for strip magnet conductor, 14-4  
interleaved, 14-5  
level, 10-11  
paper, 14-4  
performance, 8-2  
performance specifications, 8-5  
polyamide, 14-4  
polyester, 14-4  
power factor, 8-1, 8-14  
quality, 8-4  
resistance, 8-1, 8-12, 8-14  
temperature corrections, table 8A-1  
selection, chemical factors, 8-1  
electrical factors, 8-1  
mechanical factors, 8-1  
thermal factors, 8-1  
shielding, 7-4, 8-1, 8-2, 8-10  
primary cables (to 46 kV), 10-12

insulation (continued)  
tapering, fig. 11-16  
temperatures, 8-12  
limits, 8-4  
thermal characteristics, 14-2  
thickness, determining, 10-11  
for high-voltage conductors in three-phase systems, table 10-4  
of secondary cables for direct burial or underground in duct, table 10-3  
of secondary cables for power and lighting, table 10-2  
unshielded cable, 10-12  
insulator  
pin-type, 5-23  
support spacing, 13-33, 13-34  
unbalanced force at, 5-10  
vectorial relationships of currents in an, fig. 8-A1  
integral-web channel bus, 13-9  
electrical and physical properties, table 13-32  
interface compressive stress, 13-36  
interface, contact, nature of, 13-36  
interfaces, dissimilar metals, 13-41  
interior wiring (branch circuits to 30 amps), 10-7  
interlaced bus assemblies, 13-16  
interlaced bus arrangement, fig. 13-9  
interleaved insulation, 14-5  
interlocked armored cable, 7-6  
international annealed copper standard, 3-7  
International Electro-Technical Commission, 3-7  
ionization voids, 8-12  
iron, 1-4, 2-2, 13-1  
isolated bus, 13-24  
isolated-phase bus, fig. 13-23, 13-24

**J**

jacket  
materials, 8-9  
neoprene, 8-9  
to protect insulation, 8-2  
PVC, 8-9  
requirements, cables with no, 8-10  
specifications, rubber or thermoplastic, table 8-5  
thickness, 10-11  
for single- and multi-conductor power cables, table 10-5  
for single-conductor power cables (AWG-kcmil sizes), table 10-5  
jade, 1-1  
joining aluminum strips, 14-9, 14-10  
joining rigid conduit, 17-7  
joint compound, 11-1, 13-41  
joints, 5-21  
design, 13-40  
power, cable 15kV or 25kV, fig. 11-25  
jumper connector, 5-21

**K**

Kaiser Aluminum *Bus Conductor Technical Manual*, 13-1  
Kvar reactive requirements, 3-8n

**L**

laminations, 16-1  
stamped, 14-2  
steel, 16-4  
Larson, R.E., 6-11  
lateral displacement, 2-4  
Lavoisier, Antoine L., 1-1  
leakage reactance, 3-12

leakage-conduction current, 8-13  
lengths of conductor, solid vs. stranded, 3-2  
Les Baux, France, 1-1  
Lewis, W.A., 3-13n  
LF, 9-24  
lighting  
cables  
600v insulated, fig. 10-6  
600-1000v, 10-5  
insulation thicknesses, table 10-6  
highway standards, dimensions, table 18-1  
series street, 7-5  
standards, 18-1, fig. 18-1  
lightning, 6-2  
line design factors, 5-1, 6-9  
linear expansion, design coefficients of, 2-3  
linear expansion, thermal, 2-3  
lines of force from conductors in grounded sheath, fig. 8-1  
load factor, 9-23  
load power factor, 9-9  
loading, emergency, 6-10  
locomotive reel equipment cable, 7-6  
long spans, sag corrections for, 5-7  
loss, energy, bus, 13-12  
loss factor, 9-24  
loss in a capacitor, 15-2  
foil, 15-3  
leads, 15-3  
lubrication  
of conduit joints, 17-7  
of bus conductor bends, 13-8

**M**

McAdams, W.H., 3-19  
McGrath, M.H., 9-13  
magnesium, 1-4, 2-2  
magnesium-silicide 6063-T1 alloy, 17-2  
magnet wire, 14-1  
compression terminals, fig. 14-2  
mechanical termination, 14-4  
in motors, 14-3  
soldering, 14-4  
splicing, 14-4  
magnetic effect, 9-6  
magnetic hoist cable, 7-6  
maintenance proof testing, 12-5  
manganese, 1-5, 2-2  
manufacture, rigid conduit, 17-2  
manufacturing cast aluminum rotors, 16-2  
Martens, C.A., 6-2  
Martin, J.S., 5-10  
materials for insulation, 8-2  
maximum current in sheath before insulation damage, computing, 12-3  
mechanical bending properties, bus conductor, 13-8  
mechanical clamp-bolt connector, fig. 11-1  
mechanical damage to cable, 12-5  
mechanical design of conductors, 3-1  
mechanical factors in selecting cable covering, 8-1  
mechanical factors in selecting insulation, 8-1  
mechanical joining of strip conductor, 14-10  
mechanical load classifications, NESC for overhead conductor, table 5-1  
mechanical properties, bus conductors, 13-6, table 13-1  
mechanical set-screw connectors, 11-3, figs. 11-1, 11-2  
mechanical termination, magnet wire, 14-4  
messenger size of primary cables, 11-23  
messenger-supported, service-drop and secondary cable (duplex, triplex and quadruplex), 10-1  
messenger suspension clamp at pole, fig. 11-31  
messengers, 11-23  
messengers, neutral, 10-1

## index

- metal-working processes, aluminum, 1-1
  - Metallic Electrical Conductors, 4-2
  - metallic shielding, 8-1
  - Meyer, Karl Joseph, 1-1
  - mhos, 3-7
  - mica, 14-5, 16-4
  - mine power cables, 7-7
  - minimum training radii, 11-10, table 11-5
  - minimum bending radii, table 11-7
  - moisture resistance, 8-1
  - motor lead cable, 7-6
  - motor rotors,
    - fractional horsepower, 16-3, 16-4
    - induction, alloys for, table 16-5
    - integral horsepower, 16-4
    - motors, magnet wire in, 14-3
    - squirrel cage induction, 16-1
  - multi-conductor cables, corrections for, 9-9, table 9-11
  - multiple conductor power cables, (0-600 volts), 7-3
  - multiplying factor for various conditions of emissivity, sun, altitude, fig. 3-15
  - multiplying factors for maximum short-circuit lateral force, table 6-2
  - Murray Loop, 12-7
- ## N
- National Electrical Code, 6-1
  - National Electric Safety Code, 5-2, 7-1, 7-2
  - NBS Handbook 109, 3-10
  - NEC, 6-1, 7-1, 7-2, 7-3, 7-5, 8-1, 8-4
    - ampacity ratings, 9-13
    - Articles referenced from the code
      - 220, 12-1
      - 230, 12-1
      - 250-21, 17-3
      - 310, 10-1, 10-18
      - 310-6, 10-15
      - 310-13, 7-1, 10-11
      - 310-16 to 19, 17-1
      - 318-2, 10-8
      - 334, 7-2
      - 336-3, 10-8
      - 338, 10-2
      - 364, 13-52
      - 430, 12-1
      - 500, explosion-proofing, 17-6
      - 710, 10-4
    - Code rubber insulations, 8-5
    - designations, insulators and coverings, 8-12
      - for power cable construction, 8-12
    - installation practices, 11-1
    - requirements for rigid conduit, 17-1
    - standard for cables in duct, 9-2
    - types of insulation, 8-4
    - voltage drop, 9-12
    - voltage-drop limitation, 9-12
  - negative sag, 5-8
  - Neher, J.H., 9-13
  - NEMA
    - Pub. No. HU-1, 1973, 13-38
    - Standards
      - BU-1, 13-52
      - SG-1-3.02, 13-57n
      - SG-1-4.05, 13-45n
      - SG-5, 13-52
      - SG-6, 13-38
  - neoprene
    - insulation jackets, 8-2, 8-9
    - synthetic rubber, 8-5
  - NESC 5-2, 7-1n
    - burial, cable separation, 11-11
    - for overhead conductor, mechanical load classifications, table 5-1
  - neutral messengers, 10-1
  - neutral-supported cables, 11-23
    - service-drop cable, 11-23
  - nickel, 2-2
  - nitrile-butadiene/polyvinyl-chloride jackets, 8-10
  - NM type branch-wiring cables, fig. 10-8
  - MN type non-metallic sheathed cable, 10-7
  - NMC type non-metallic sheathed cable, 10-8
  - "Nomex," 14-5
  - non-segregated three-phase bus, 13-47
  - nylon jackets, 8-10
- ## O
- O (temper designation), 1-6
  - Oerstedt, H.C., 1-1
  - ohmic loss, 15-2
  - oil-resistant control cable, 10-10
  - open-slot die-cast rotor, fig. 16-2
  - oscillation, 6-13
  - overhead conductors
    - accessories, classification, 5-21
    - fittings, classification, 5-21
    - National Electric Safety Code for, mechanical load classifications, table, 5-2
    - vibration and fatigue, 6-11
  - "overlap," contact surface area, 13-40
  - "overlapped foil," 15-3
  - overload, emergency, 6-10, 12-1
  - overload conditions, steady-state, 6-1
  - overload ratings, emergency, 9-16
  - oxide film, removing, 11-1, 11-7
  - oxide inhibitors, 13-41
  - oxygen, 1-1
  - oxygen-sensitive insulation, 8-4
  - ozone, 8-12, 10-13
  - ozone-resisting butyl rubber, 8-5
  - ozone-resisting rubber insulation, 8-5
- ## P
- paired angles, 13-11
  - paired bus arrangement, fig. 13-9
  - paper capacitor
    - heat loss vs. frequency, fig. 15-5
    - impedance vs. frequency, fig. 15-2
  - paper insulation, 14-5
  - parabola, diagram for plotting points on a, fig. 5-9
  - parabola, method of drawing the, 5-11
  - parabola, template for final sags, fig. 5-5
  - parabola formula, completion of stringing graph by use of, 5-6
  - parallel conductors, 6-9
  - parasitic losses, 15-2
  - PE, 8-9
  - pencil tool, fig. 11-16
  - Pennsylvania Department of Mines, 10-11
  - performance specifications, ICEA, insulation, 8-4, 8-12
  - phase conductors, insulated aluminum, 7-4
  - phase identification, 8-1
  - physical and electrical properties
    - of AAAC 6201-T81 stranded, ACSR diameters, table 4-12
      - table for even AWG and kcmil diameters, 4-13
    - of ACSR compact-round, table 4-18
    - of ACSR/TW, table 4-19 to 4-22
    - of ACSR/AW, table 4-27, 4-28, 4-29
    - of AAC 1350-H19 Class AA and A stranded conductors of even kcmil sizes, table 4-7
    - of AAC/TW, table 4-10, 4-11
    - of all aluminum conductors, 1350-H19, stranded with aluminum clad steel (AW) conductors, table 4-25
    - of aluminum standard pipe-size conductors, table 13-27
    - of integral-web channel bus conductors, table 13-32
  - physical and electrical properties (continued)
    - of round-tube bus conductors, table 13-28
    - of square aluminum tubular conductors, table 13-29
    - of square-corner bus bars, table 13-25
    - of uniform-thickness aluminum channel bus conductors, table 13-30
    - of uniform-thickness angle bus conductors, table 13-31
  - physical properties
    - of AAC concentric-lay Class A and AA stranded bare conductors, 1350 H-19, table 4-5, 4-7
    - of all-aluminum 1350 of various hardnesses in Class B, C, and D stranding, table 4-8
    - of aluminum wrought bus conductor alloys, table 13-2
      - treatment for improvement of, 1-4
  - pipe-size conductors, standard, physical and electrical properties, table 13-29
  - pipe-type cables, ampacity interpolation chart, 9-27
  - plastic insulation, 8-4
  - plastic-jacketed three-conductor cable, 10-7
  - plastic pipe assembly, 10-9
  - plastic-type coverings, 8-2, 8-4
  - plates, pressure, 13-43
  - plating, connector, 11-3
  - plating thicknesses, 13-41
  - plowing-in method, 11-12
  - plug-in busways, 13-48, fig. 13-28
  - plug-in connections, fig. 11-26
  - plug-in power drop cable, 7-6
  - pole support for cables, messengers, guy wires, fig. 11-30
  - pole-and-bracket cables, 7-5
  - polyamide insulation, 14-5
  - polyamide-imide, 14-5
  - polyester insulation, 14-5
  - polyethylene
    - cross-linked, insulating material, 8-2, 8-4
    - cross-linked, thermosetting, specifications for insulations, table 8-4
    - high-molecular insulating materials, 8-2
    - insulations, 8-2
    - jackets, 8-9
    - thermoplastic, 8-9
    - thermosetting cross-linked, 8-5
  - polyvinyl chloride
    - insulating material, 8-2
    - insulation jacket, 8-2
    - thermoplastic, 8-9
  - portable cables, 7-6, 10-9, fig. 10-10
  - potassium, 1-1
  - potential gradient, uniformity, 8-1
  - potheads for cable termination, single-conductor, fig. 11-29
  - power cables
    - 600 volt, 7-2
    - 600 volt, insulated, fig. 10-6
    - above 600 volts, 7-4, 10-5
    - construction, NEC designations, 8-12
    - joints 15kV, 25kV, fig. 11-25
    - installing directly buried, 11-12
    - insulation thickness, table 10-2
    - insulators and coverings, NEC designations, 8-12
  - power factor of insulations, 8-14
  - power rails
    - electric cranes, 13-1
    - rapid transit, 13-1
  - preassembled aerial cable above 600 volts, 7-5
  - preassembled parallel secondary cables, 10-2
  - preliminary sag tension graph, fig. 5-17
  - premolded splicing and terminating devices, 11-15 to 11-22, fig. 11-26
  - pressure casting rotors, 16-4
  - pressure plates, 13-43
  - primary aerial cables, 11-23
    - initial sag and tension values, table 11-11

primary cable  
 aerial cables, 11-23  
 15-35 kV two-conductor concentric flat-strap neutral, fig. 10-18  
 for direct burial, duct, or aerial use, two-conductor concentric-wire neutral, fig. 10-16  
 with insulation shielding, (to 35 kV), 10-12  
 pre-assembled triplexed 5 kV to 25 kV, shielded, fig. 10-14  
 joint, taped, 11-18, fig. 11-27  
 shielded insulated, figs. 7-5, 10-13  
 unshielded insulated, fig. 10-12  
 URD, 7-5, 10-15  
 primary distribution cable, 10-10  
 primary interlocked armored cables, 10-12, fig. 10-16  
 primary voltage circuits, 11-18  
 product identification, 4-1  
 production of aluminum, Flow Sheet illustrating, 1-2  
 proof-testing, 12-5  
 propelled lines shot through rigid conduit, 17-7  
 properties of aluminum as a conductor, 2-1  
 protective capabilities of aluminum conduit, 17-3  
 proof test voltages ICEA, table 11-7  
 proximity effect, 3-9, 9-3, 13-16, 13-17  
 pull line, for cable installation, 11-8  
 pulling cable in duct, fig. 11-10, fig. 11-21  
 pulling tension, 11-11  
 allowable, 11-11  
 computing, 11-11  
 reducing, 11-10  
 pulling through conduit, 17-7  
 PVC, 8-9  
 PVC-60 insulation, 8-9

**R**

$R_{ac}/R_{dc}$  curlew conductor, comparison of basic and corrected, table 3-8  
 $R_{ac}/R_{dc}$  ratios  
 for AAC and ACSR, comparison of, table 3-8A  
 skin effect in isolated rectangular conductor expressed as, fig. 13-6  
 skin effect in isolated square rod and square tubular conductors expressed as, fig. 13-7  
 skin effect in isolated round rod and tubular conductors expressed as, fig. 13-8  
 radar test, 12-6  
 radiation coefficient, 13-21  
 radiation emissivity, table 13-9  
 radiation heat loss, 3-20  
 radiation loss, 3-10  
 radii of gyration, 18-3  
 radio influence voltage, 13-19  
 radio transmitting capacitors, 15-2  
 "random lay," 9-10  
 ratios  
 60-cycle ac/dc, estimating, table 9-4  
 ac resistance to dc resistance, 3-9  
 $R_{ac}/R_{dc}$ , 3-9  
 reactance  
 of bundled conductors, inductive, 3-16  
 bus bar, 13-17, 13-19  
 calculation, series inductive, 9-9  
 capacitive, 8-14  
 of bundled conductors, 3-9  
 separation component of, at 60 Hz megohm-miles per conductor, table 3-12  
 of conductors on rigid cable supports, 9-9  
 factors, inductive, and zero-sequence resistance, table 3-11  
 inductive, 13-5  
 bus bar, 13-17, table 13-7  
 and capacitive, 3-12  
 separation component of, at 60 Hz ohms per conductor per mile, table 3-9  
 spacing factors, table 13-7

reactance (continued)  
 and zero-sequence resistance, 3-16  
 leakage, 3-12  
 series inductive, 9-2, 9-8  
 shunt capacitive, 3-17, 9-9, 9-12  
 total system, 3-12  
 values, 9-3  
 zero-sequence capacitive, 3-18  
 reaming rigid conduct, 17-6  
 reduction of alumina, electrolytic, 1-1  
 reduction of breaking strength, fig. 6-4  
 refractory crucible, 16-3  
 relative permittivity, 8-13  
 relaying, shield, 8-10  
*Resistance and Reactance of Aluminum Conductors, Steel Reinforced, The*, 3-13  
 resistance  
 of aluminum cable with rubber and thermoplastic insulation, table 9-5  
 bus bar, 13-17  
 cable-conductor, 9-3  
 calculation of ac, 3-8  
 conduit, 17-5  
 constriction, 13-37, fig. 13-17  
 contact, 13-40, fig. 13-18  
 effective, of a capacitor, 15-2  
 of foil electrodes, 15-3  
 film, 13-40  
 insulation, 8-12, 8-14  
 temperature corrections for, table 8-15  
 multiplying factors for three-layer ACSR for aluminum conductivity of 62%, fig. 3-9  
 overall, for triplexed three-conductor assembly, fig. 9-3  
 of strip magnet conductor, calculating dc, 14-6, 14-7  
 welding, 13-46  
 zero-sequence, and inductive reactance, 3-16  
 factors, table 3-11  
 resistance-bridge loop method, 12-7  
 resistivity  
 calculation of, 3-7  
 constants, 3-7n  
 earth thermal, 9-23  
 values for aluminum wire alloys at 20°C, dc, table 3-5  
 resonance, 15-2  
 resonance pulsations, bus conductor, 13-27  
 resonant frequencies, rectangular bus, fig. 13-14  
 reverberatory furnaces, 16-3  
 reverse twist (RTS), aerial cable assemblies, 7-3  
 reverse twist, secondary cable, 10-2  
*Revue Generale d'Electricite*, 14-7  
 RHO, 9-24, 9-23  
 ribbon cable, fig. 10-8  
 Rifenbert, R.C., 11-10  
 rigid conduit  
 advantages, 17-1  
 composition, 17-2  
 manufacture, 17-2  
 riser shields, 11-13  
 RIV, radio-influence voltage, 13-19  
 riveting, 8-10  
 "rodding out," 16-3  
 Rodee, H.H., 5-10  
 Rodee Graphic Method, 5-10  
 Roehman, L.F., 17-4n  
 rolling, 1-4  
 rope-bunch stranding, 8-2  
 rope-concentric stranding, 8-2  
 rope-lay construction, 3-3  
 rotors  
 alloys, contamination of, 16-4  
 for induction motor, table 16-1  
 selection, 16-2  
 cast, comparative performance, 16-1  
 casting, methods, 16-3  
 problems, 16-4

rotors (continued)  
 thermal treatment, 16-4  
 temperature, 16-4  
 vertical press method, 16-4  
 closed-slot, fig. 16-1(b)  
 construction, squirrel cage, fig. 16-3  
 cracks, 16-4  
 die-casting, 16-3  
 dross defect, 16-4  
 electrical conductivity, 16-1  
 fractional horsepower motor, 16-3, 16-4  
 heat capacity, 16-1  
 heat conductivity, 16-1  
 ingot, 16-2  
 electrical conductivity, 16-1  
 manufacture, 16-2  
 furnace equipment, 16-2  
 melting equipment, 16-2  
 pressure casting, 16-4  
 open-slot, fig. 16-1(a)  
 die-cast, fig. 16-2  
 shrinkage, 16-4  
 weight, 16-1  
 round-tube bus, 13-9  
 round-tube bus conductors, physical and electrical properties, table 13-28  
 round tubular bus conductors, 13-9  
 round wire, film-insulated, 14-1  
 round-wire armor, 7-5  
 rubber, 2-3  
 ethylene-propylene, 8-5  
 fluorinated ethylene propylene, 8-5  
 jacket specifications, table 8-5  
 natural specifications for insulations, table 8-2  
 synthetic, insulation, 8-4  
 specifications for, tables 8-2, 8-4  
 neoprene, 8-5  
 rubies, 1-1  
 ruling span, 5-4

**S**

safety factors, station structure, 18-9  
 sag  
 and arcing, 6-2  
 chart, initial stringing, 5-4  
 chart when supports differ in elevation, fig. 5-6  
 correction for long spans, 5-7  
 curves, fig. 5-1  
 final, template parabola for, fig. 5-5  
 negative, 5-8  
 temperature effect on final, 6-11  
 when supports are at different elevations, 5-8  
 sag-span parabola and template, 5-7  
 sag-tension, 5-2  
 charts for variable-length spans, initial and final, 5-2  
 graphs, for composite conductors, 5-18  
 preliminary, fig. 5-12  
 preliminary, and catenary curve, 5-10  
 preparation of, 5-10  
 final, fig. 5-4  
 initial, fig. 5-2  
 initial and final, of a designation conductor, span, and NESC loading for various temperatures, 5-14  
 values, initial, for primary aerial cables, table 11-10  
 for service-drop and secondary cable, table 11-11  
 at various temperatures, table 5-5  
 salt fluxing, 16-3  
 sapphires, 1-1  
 SBR, 8-4  
 SBR insulating material, 8-4  
 Schurig, O.R., 3-19, 13-30  
 Schurig & Frick, 3-19  
 scrap value, 18-10  
 scratch-brush abrasion, 11-4, 13-41



- screw, binding head, 11-3
- secondary cables
  - circuits-600 V, 11-15
  - initial stringing sag and tension values, tables, 11-11
  - insulation thicknesses, direct burial, underground in duct, table 10-3
    - power and lighting, table 10-2
  - neutral-supported, 11-23
  - neutral-supported duplex, fig. 10-1
  - neutral-supported, triplex, quadruplex and duplex, 10-1
  - neutral-supported triplex reverse-twist, 10-2
  - preassembled parallel, 10-2, fig. 10-2
  - splice kit, fig. 11-23
    - for URD, 7-4
- secondary triplex cable, neutral-messenger-supported, installation details, fig. 11-31
- secondary-distribution cable for underground residential distribution, 10-8
- secondary line wire covering, 8-9
- sector bus, 13-8
- segregated bus, 13-47
- self-damping protection, 6-14
- self-supporting towers, 18-7, figs. 18-7, 18-9, 18-11
- semi-flexible towers, 18-7
- separation component, table 13-7
  - capacitive reactance at 60 Hz megohm miles per conductor, table 3-12
  - inductive reactance at 60 Hz megohm miles per conductor, table 3-9
- SER cable, Type SE, fig. 10-5
- aerries inductive reactance, 9-2, 9-8
  - calculation, 9-8
  - of insulated conductors, nomogram, 9-10
- series street lighting, 7-5
- service drop, 7-3, 10-1
  - initial stringing sag and tension values, table 11-11
  - line covering, 8-9
  - neutral-supported, 11-8
  - neutral-supported duplex, triplex, and quadruplex, 10-1
  - neutral-supported, fig. 10-1
  - three-conductor concentric neutral, fig. 10-9
  - span clamp, fig. 11-31
  - taps, double, at service-drop span clamp, fig. 11-24
- service-entrance
  - cable, type SE-style U, 7-3, 10-2, fig. 10-4
  - type SE-style SER, 7-3, 10-2
- shape correction, factor K, 13-24
- Sharpe gage, Brown and, 3-1
- sheath, grounded, lines of force in, fig. 8-1
- sheath, grounded metallic, 12-2
- sheathed cable, 7-3
- sheaths, 8-12
  - short circuit in, 12-2
- sheave, stringing, 5-7
- sheave friction, 5-7
- shield
  - conductor, 8-10
  - insulation, 8-10
  - relaying, 8-10
  - short circuit in, 12-2
  - specifications, ICEA, 8-10
- shielded cable, 7-6
  - jacket, 10-11
- shielded inert arc welding of strip conductor, 14-11
- shielded portable cables, 7-6
- shielded primary cable in jacket, three-conductor, fig. 10-5
- shielding
  - insulation, 7-4
  - materials, 8-10
  - metallic, 8-1
  - methods, 8-10
  - strand, 8-1
- shipyard cable, 7-6
- short-circuits, 13-24
- short-circuits (continued)
  - currents, calculation of, 6-1, 12-1
    - for insulated cables, fig. 9-18 to 9-20
  - curve of a-c wave during offset, fig. 6-13
  - on bus conductors, 13-25, 13-27
  - computing, 6-9
  - lateral, acting on suspended parallel conductors, multiplying factors for, table 6-12
    - heat effects, 6-9
  - loading, 12-1
  - performance, 6-1
  - ratings, 9-16
  - in shields and sheaths, 12-2
  - temperature limit for insulated aluminum conductors, 12-1
  - temperature rise for aluminum and steel conduit, fig. 17-1
- shrinkage
  - casting, 1-4
  - rotor, 16-4
- shunt capacitive reactance, 3-17, 8-14, 9-2, 9-9
- of bundled conductors, 3-19
- side swing, 6-13
- silica, 1-1
- silicon, 1-1, 1-4, 2-2
- silicone, 14-5
- silver, 13-1
- size relationships, 4-2
- skin effect, 3-9, 8-2, 9-3, 13-12, 13-16
  - factor for solid-round or tubular conductor at 60 Hz, fig. 3-11
  - in isolated rectangular conductor, fig. 13-6
- slick foil, 15-6
- snaking, 2-4
- snubbing principle, 5-23
- sodium, 1-1, 2-2
- solder joints, strip conductor, 14-10
- soldering, 13-47
  - magnet wire, 14-4
- solid and stranded conductors, difference between, 3-2
- solid-round 1350 aluminum wires, mechanical and electrical properties, table 4-4
- spacer cable, 7-2
- spacers for bundled conductors, 6-15
- spacing
  - between cables, 9-2
  - between bare metal parts, table 13-17
  - cables, ampacity grouping factors, 9-28
  - conductors, 9-8, 9-9
  - factors, inductive reactance, table 13-7
  - insulator supports, 13-34
  - not maintained, 9-28
  - phase-to-phase, in outdoor substations, table 13-19
- specific gravity, 1-1
- specific inductive capacity, 8-13
- specifications
  - for cross-linked thermosetting, polyethylene and ethylene-propylene rubber insulations, table 8-8
  - for natural and synthetic rubber insulations, table 8-6
  - for rubber and thermoplastic jackets, table 8-5
  - for thermoplastic insulations, table 8-3
- splice
  - data for electrolytic foil, table 15-7
  - gutter, 11-6, fig. 11-6
  - insulation, 8-10
  - three-conductor, fig. 11-28
- splicing, 11-14
  - details of method, 11-15 to 11-18
  - insulated cables, 11-14
  - magnet wire, 14-4
  - u/g systems 11-14
- springback, 14-2
- comparison chart, 14-2
- square-tube bus, 13-9
- square tubular conductors, physical and electrical properties, table 13-29
- squirrel cage induction motors, 16-1
- squirrel cage motor, 16-4
- squirrel cage rotor with surrounding iron removed to show construction, fig. 16-3
- stabilizing, 1-5
- stamped laminations, 14-2
- Standard Handbook for Electrical Engineers*, 3-12, 5-10
- standard designations for alloys and tempers, 1-5
- stands, rolling, 1-4
- station bus, 13-47
- station structures, 18-8 thru 18-13
- steel, 2-3
  - conduit, 9-1
    - vs. aluminum, corrosion, 17-4
    - vs. aluminum, electrical characteristics, 17-3
    - vs. aluminum measured temperature rise under short-circuit conditions, fig. 17-1
    - vs. aluminum, weight of, 17-2, table 17-5
  - laminations, 16-4
  - use in ACSSR, 3-3
- steel-reinforced
  - aluminum conductor, 3-3
    - stranded conductors, skin effect in, 3-9
- stepped-parallel bus bar arrangement, 13-14
- Stockbridge damper, 6-14, fig. 6-7
- strain hardening, 1-4
- strand shielding, 8-1
- stranded conductors, 3-1
  - all-aluminum 1350-H19 compact-round, mechanical and electrical properties, tables 4-9, 4-10
  - and solid conductors, differences between, 3-2
- stranding, 1-4
  - arrangements, ACAR, fig. 3-5
  - compact, 7-1
  - compressed, 7-1
  - concentric-lay, 3-2
  - methods of cable, fig. 8-2
  - rope-bunch, 8-2
  - rope-concentric, 8-2
- street lighting, series, 7-5
- street lighting standard, fig. 18-1
- strength, 2-1, 2-2
  - bus conductor, 13-2
  - and elongation, aluminum conductor alloy data, table 4-3
  - loss of conductor, 6-9
  - rating factors ACAR, table 3-4B
  - ratings of conductors in ASTM Standards, 5-1
  - tensile, compressive, impact, 8-1
  - 1350 aluminum conductors, 3-3
  - tensile and yield, 1350-H12, fig. 13-2
  - tensile and yield, 6101-T6, fig. 13-1
  - time-temperature for 1350-H19 aluminum wire, fig. 6-3
  - values for welding, 13-46
  - in weld-heat zone, 13-46
- strength loss
  - due to overload, 6-11
  - temperature-time, 6-10
- stress
  - bolt, 13-43
  - in heavy series bolts, table 13-22
  - interface compressive, 13-40
- stress-relief cones, 11-16
- stress-strain, bus conductor, 13-1, 13-5
- stress-strain curves, fig. 5-10
  - typical for various kinds of composite conductors, fig. 5-16
- stress-strain graph, 5-12, fig. 13-3
- stringing chart
  - completion of, by use of parabola formula, 5-6
  - initial, 5-4
  - use of, 5-7
- stringing sag chart, initial, 5-4
- stringing sag-tension values for primary cable, table 11-10
- stringing sag and tension values for service-drop and secondary cables, table 11-11

# index

stringing sags and tensions for constant tension of a given temperature, fig. 5-4  
stringing sags for various spans, table 5-2  
stringing sheaves, 5-7  
stringing sag tables, 5-7  
stringing sag values, table 5-3  
strip, coated, 14-5  
strip conductor alloys, table 14-5  
strip magnet conductor, 14-4  
  coil design, 14-6  
  coil inductance, 14-7  
  dielectric advantages, 14-9  
  insulation, 14-4  
  thermal advantages, 14-9  
  winding design techniques, 14-7  
strip wound coils, useful formulae, table 14-4  
structural alloys, 18-10  
  6061, table 18-2  
  6063, table 18-3  
structural design, substation, 18-8  
structural shapes, extruded aluminum, fig. 18-12  
styrene-butadiene synthetic rubber insulation, 8-4  
submarine cables, 7-6  
substation, fig. 18-13  
substation structures, 18-8 to 18-13  
substations, high-voltage, 13-37, 13-48  
sulphur, 2-3  
sun, altitude, emissivity, multiplying factor for various conditions of, fig. 3-15  
sun heat gain, 3-20  
support, unbalanced force at, 5-10  
supporting cables, messengers, and guy wires on poles, fig. 11-30  
  in vertical raceways, table 11-6  
surface area, contact, 13-40  
surface preparation for bolted connections, 13-41  
suspension clamp, 5-21, 5-23, 5-25, fig. 5-20  
sway, 6-13  
swinging suspension for high-current bus, fig. 13-15  
switchboard  
  clearances, tables 13-17, 13-18  
switchgear  
  power, 16-5  
  use of aluminum in, fig. 16-4  
switchyard  
  for 14.4 kV substation, fig. 13-26  
  bus, 13-49  
  ground-type outdoor, schematic, 13-50  
symbols  
  for types of aluminum conductors, 3-1  
synthetic rubber insulation, 8-4  
system regulation, 6-1

## T

T (temper designation), 1-7  
T6 (temper designation), 1-7  
T8 (temper designation), 1-7  
tables, list of in chapter 4, 4-3  
tapes, 8-10  
  dimensions, table 11-9  
  insulating, 8-10  
taping insulation, 11-18, fig. 11-27  
technical advantages, aluminum magnet wire vs. copper, 14-1  
Teflon, 8-5, 14-5  
telephone circuits, 15-2  
temper designations, 1-5  
temperature  
  ambient, 3-19  
  for casting rotors, 16-4  
  coefficients of dc resistance, 13-4  
  of wire materials, table 3-6  
  of wire materials at various temperatures, table 3-7

temperature (continued)  
  coefficients of resistance for bus conductor alloys and representative value for copper bus bar, table 13-3  
  conductor, 9-3  
  corrections for insulation resistance, table 8A-1  
  covering, 8-12  
  emergency-load, 6-13  
  for insulation, table 9-7  
  insulation, 8-12  
  limit of insulation and ampacity, 8-4  
  limit, short-circuit, for insulated aluminum conductors, 12-1  
  "*Limits in the Rating of Electric Equipment, General Principles for*," IEEE Pub., 14-2  
  rise during short circuit, steel conduit vs. aluminum, fig. 17-1  
  rise in bus, 13-12  
  short-circuit load, for insulation, table 9-7  
  temperature-resistance coefficients for various temperatures, 3-8  
  temperature-time strength loss, 6-10, 6-11  
  tempers used for bus conductors, 13-1  
  template half-outline for conductor, fig. 5-8  
  template parabola for final sags, fig. 5-5  
  tensile load, 3-2  
  tensile strength, 3-2  
  and elongation, aluminum conductor alloy data, table 4-3  
  1350-H12, fig. 13-2  
  "tension limits," 5-1  
  allowable pulling, 11-11  
tensions and sags, final, fig. 5-3  
  initial, fig. 5-2  
  initial and final, of a designated conductor, span and NESC loading for various temperatures, 5-14  
  values at various temperatures, table 5-5  
tension stress-strain curves, bus conductor alloys, fig. 13-7  
terminal insulation, 8-10  
terminals, reduction of impedance by adding, fig. 15-3  
terminating, 11-2  
  insulated cable, 11-21, fig. 11-26  
terminations  
  building wire, 11-3  
  lugs, 11-3, fig. 11-2  
  mechanical, magnet wire, 14-4  
  single conductor, fig. 11-28  
  single-conductor potheads for cable, fig. 11-29  
  strip conductor, fig. 14-7  
  three-conductor outdoor, fig. 11-28  
  URD 600V fig. 11-24  
thermal  
  advantages, trip magnet conductor, 14-9  
  aging aluminum and copper magnet wire, fig. 14-1  
  characteristics insulation applied to aluminum, 14-2  
  conductivity, 2-3  
  damage, 6-9  
  factors in selecting cable coverings, 8-1  
  factors in selecting insulation, 8-1  
  limit, 6-1  
  linear expansion, 2-3  
  properties, 2-3  
  resistivity, earth, 9-23  
  surface emissivity, 13-21  
  treatment of rotor castings, 16-4  
thermoplastic insulating materials, 8-4, 8-9  
  specifications, table 8-3  
thermoplastic jacket specifications, table 8-5  
thermoplastic polyethylene, 8-9  
thermoplastic polyvinyl chloride, 8-9  
thermosetting cross-linked polyethylene, 8-5  
thermosetting insulating materials, 8-4  
  thickness, plating, 13-41  
Thomas, P.H., 5-10  
threading rigid conduit, 17-6  
three-conductor 5 kV to 35 kV shielded primary cable in jacket, fig. 10-15

three-conductor cable, 600-1000v, 10-5  
three-conductor non-metallic jacketed cable, 10-4  
three-conductor shielded cable with interlocked or corrugated armor, fig. 10-16  
three-pole guyed towers, 18-4, fig. 18-6  
thumper, 12-7  
tie wires, 5-23, fig. 5-26  
time-temperature percent strength in 1350-H19 aluminum wire, fig. 6-3  
titanium, 2-2  
torque, bolt, 13-43  
torque in heavy series bolts, table 13-22  
torque clamping force for bolts, fig. 13-20  
torque, tables 11-2, 11-3  
torsional rigidity, 18-3  
total system reactance, 3-12  
towers  
  assembly by helicopter, 18-8, fig. 18-8  
  composite, 18-9  
  designs, 18-4  
  foundations, 18-6  
  guyed "Delta," 18-4, fig. 18-4  
  guyed "gull Wing," 18-4, fig. 18-5  
  guyed "V," 18-4, fig. 18-2  
  guyed "Y," 18-4, fig. 18-3  
  H-frame, 18-7, fig. 18-8  
  semi-flexible, 18-7, fig. 18-7  
  single-mast, self supporting, 18-8, fig. 18-9  
  three-pole guyed, 18-4, fig. 18-6  
tracer current fault detection, 12-6  
tracer/detector method, 12-6, 12-7  
tracer equipment, 12-6  
tracking, 12-5  
tracking susceptibility, 8-1  
transition pieces to join strip conductors, 14-10  
transmission towers, 18-3 thru 18-8  
  designs, 18-4  
transmission line faults, 6-9  
trapezoidal wires in composite conductor, fig. 3-7  
trapezoidal strands, 3-3  
traveling waves, 6-10, 6-14  
treatment for improvement of physical properties, 1-4  
tree wire, 7-2  
treeing, 12-5  
triplexed three-conductor assembly, overall resistance and ac/dc ratio, fig. 9-1  
tube bending chart, fig. 13-4  
tube welding, fig., 13-21  
tubular bus, 13-8, 13-9  
  expansion support for, fig. 13-16  
tubular bus conductors, 13-8  
turn insulation, 14-5  
Tuttle, P.D., 3-8, 3-13  
two-conductor, concentric-wire neutral primary cable, fig. 10-16  
Type MC cable, 10-5, 10-7  
Type NM cable, 10-7, fig. 10-8  
Type NMC cable, 10-8  
Type USE cable, 7-4

## U

UD splice diagram, fig. 11-27  
UF, underground feeder cable, 10-8  
USE, underground service entrance cable, 10-8  
UL-857, 13-5, 13-52  
  conduit alloy composition requirements, 17-6  
  labeling of cable, 8-1  
ultra-violet light, ill effects, 8-9  
unbalanced force at support, 5-10  
*Underground Distribution Reference Book, Aluminum*, 11-12, 10-20  
*Underground Distribution, Special Technical Conference on*, IEEE, 11-13  
underground duct, arrangements of cables in, for ampacity ratings, figs. 9A-1, 9A-2

## index

underground residential distribution primary cables, 10-15  
underground service entrance insulation material, 8-5  
Underwriters Laboratories, 7-2  
uniform-thickness aluminum channel bus conductors, physical and electrical properties, table 13-30  
uniform-thickness angle, 13-11  
uniform-thickness angle bus conductors, physical and electrical properties, table 13-31  
uniform-thickness channel, 13-11  
uninsulated conductors—  
coverings for, 8-2  
comparison of coverings, table 8-1  
“unipass” jackets, 8-10  
unshielded cable insulation, 10-12  
uplift condition, 5-8  
uplift force, fig. 5-7  
upper temperature limit adjustment, 6-2  
URD primary cables, 7-5, 10-16  
URD secondary cables (600 volts), 7-4, fig. 11-24  
URD secondary-distribution cable, 600 volt, 10-8

## V

vectorial relationships of currents in an insulator, fig. 8-A1  
venting problems, 16-4  
vertical press method of rotor casting, 16-4  
vertical raceways, 11-10, table 11-16  
vibration  
aeolian, 6-13, 13-33  
bus conductor, 13-27, 13-28  
dampers, 5-21, 6-14  
overhead conductors, 6-11  
vibration-free span length, bus, table 13-15  
vinyl chloride, 8-9  
volt-ampere vector relationship, fig. 9-2  
voltage-drop, 6-1, 9-3, 9-6, 9-8, 9-12  
line-to-line, calculation of, table 9-6  
rigid conduit circuit, 17-4  
voltages for determining insulation thickness, 10-11, table 10-4

voltage wave, 6-9

## W

washers, 13-41  
Belleville, 11-7, 13-44  
flat, diameter and thickness, table 13-23  
water absorption, 8-12, 8-13  
watt loss in a capacitor, 15-2  
waxed paper capacitor, 15-4  
weather-resistant coverings, URC 8-2  
weight  
aluminum conduit vs. steel, 17-5  
of bare conductor in direct-current conductance, comparative, table 2-2  
light, 2-1, 2-2  
of station structures, 18-8  
transmission tower, 18-3  
weld strength values, 13-46  
welded aluminum-to-aluminum connections, 13-46  
welded connections, 5-23, fig. 5-22  
welding, 18-10  
exothermic, 13-47  
flash, 13-47  
gas, 13-47  
GMAW, 13-46  
GTAW, 13-46  
inert-gas shielded, 13-46  
tungsten inert-gas, 13-46  
ultra-sonic, strip conductor, 14-10  
*Welding Aluminum*, AWS Handbook, 13-46, 13-47  
welding-equipment cable, 7-6  
Westinghouse, *Electrical Transmission & Distribution Reference Book*, 3-14  
wind damage, 6-11  
wind load, 3-3  
windability, 14-2  
winding design techniques, strip magnet conductor, 14-6  
window area, 14-3  
wire-drawing, 1-4  
wiring, apartment-house, 10-4

wiring (continued)

interior (branch circuits to 30 amps), 10-8, 11-2  
Wohler, Friedrich, 1-1  
workability, 2-1, 2-2  
“working limit,” 5-12  
wound cores, 14-3  
wound paper capacitor, 15-3  
Wright, H.B., *Skin Effect in Tubular and Flat Conductors*, 3-11  
wrought aluminum alloys for electrical conductors in percent, chemical composition limits (maximum) for, table 1-6

## X

$X_a$  and geometric mean radius, 3-14  
 $X_c$  of capacitive reactance of 60 Hz megohm-miles per conductor, table 3-12  
 $X_L$  of inductive reactance at 60 Hz ohms per conductor per mile, table 3-9  
XHHW, 8-5  
XLPE, 8-5

## Y

yield limitations, capacitor, foil, table 15-3  
yield strength, bus alloy, 13-7  
yield strength, 6101-T6, fig. 13-1  
yield strength, 1350-H12, fig. 13-2

## Z

zero-sequence  
capacitive reactance, 3-18  
impedance bare conductor, 12-1, 3-16  
resistance and inductive reactance, 3-16, table, 3-11  
zinc, 2-2  
shielding, 8-1