

MUSIC ATELIER

AT80

Owner's Manual

Thank you, and congratulations on your choice of the Roland AT-80 "Atelier Series" Organ.

Before using this unit, carefully read the sections entitled: "IMPORTANT SAFETY INSTRUCTIONS" (page 2), "USING THE UNIT SAFELY" (page 3), and "IMPORTANT NOTES" (page 9). These sections provide important information concerning the correct operation of the unit. Additionally, in order to feel assured that you have gained a good grasp of every feature provided by your new unit, this manual should be read in its entirety. The manual should be saved and kept on hand as a convenient reference.

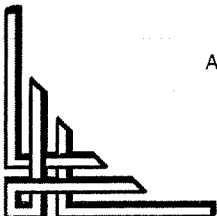

Copyright © 1996 ROLAND CORPORATION

All rights reserved. No part of this publication may be reproduced in any form without the written permission of ROLAND CORPORATION.

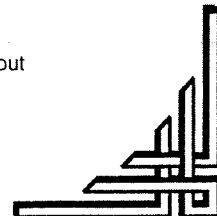

Roland®



 CAUTION RISK OF ELECTRIC SHOCK DO NOT OPEN	
ATTENTION RISQUE DE CHOC ELECTRIQUE NE PAS OUVRIE	
CAUTION: TO REDUCE THE RISK OF ELECTRIC SHOCK, DO NOT REMOVE COVER (OR BACK). NO USER-SERVICEABLE PARTS INSIDE. REFER SERVICING TO QUALIFIED SERVICE PERSONNEL.	



The lightning flash with arrowhead symbol, within an equilateral triangle, is intended to alert the user to the presence of uninsulated "dangerous voltage" within the product's enclosure that may be of sufficient magnitude to constitute a risk of electric shock to persons.



The exclamation point within an equilateral triangle is intended to alert the user to the presence of important operating and maintenance (servicing) instructions in the literature accompanying the product.

INSTRUCTIONS PERTAINING TO A RISK OF FIRE, ELECTRIC SHOCK, OR INJURY TO PERSONS.

IMPORTANT SAFETY INSTRUCTIONS

SAVE THESE INSTRUCTIONS

WARNING - When using electric products, basic precautions should always be followed, including the following:

1. Read all the instructions before using the product.
2. Do not use this product near water — for example, near a bathtub, washbowl, kitchen sink, in a wet basement, or near a swimming pool, or the like.
3. This product should be used only with a cart or stand that is recommended by the manufacturer.
4. This product, either alone or in combination with an amplifier and headphones or speakers, may be capable of producing sound levels that could cause permanent hearing loss. Do not operate for a long period of time at a high volume level or at a level that is uncomfortable. If you experience any hearing loss or ringing in the ears, you should consult an audiologist.
5. The product should be located so that its location or position does not interfere with its proper ventilation.
6. The product should be located away from heat sources such as radiators, heat registers, or other products that produce heat.
7. The product should be connected to a power supply only of the type described in the operating instructions or as marked on the product.
8. The power-supply cord of the product should be unplugged from the outlet when left unused for a long period of time.
9. Care should be taken so that objects do not fall and liquids are not spilled into the enclosure through openings.
10. The product should be serviced by qualified service personnel when:
 - A. The power-supply cord or the plug has been damaged; or
 - B. Objects have fallen, or liquid has been spilled onto the product; or
 - C. The product has been exposed to rain; or
 - D. The product does not appear to operate normally or exhibits a marked change in performance; or
 - E. The product has been dropped, or the enclosure damaged.
11. Do not attempt to service the product beyond that described in the user-maintenance instructions. All other servicing should be referred to qualified service personnel.

For the USA

This product may be equipped with a polarized line plug (one blade wider than the other) . This is a safety feature. If you are unable to insert the plug into the outlet, contact an electrician to replace your obsolete outlet. Do not defeat the safety purpose of the plug.

For Canada

For Polarized Line Plug

CAUTION: TO PREVENT ELECTRIC SHOCK, MATCH WIDE BLADE OF PLUG TO WIDE SLOT, FULLY INSERT.
ATTENTION: POUR ÉVITER LES CHOCs ÉLECTRIQUES, INTRODUIRE LA LAME LA PLUS LARGE DE LA FICHE DANS LA BORNE CORRESPONDANTE DE LA PRISE ET POUSSER JUSQU' AU FOND.

For the U.K.

IMPORTANT: THE WIRES IN THIS MAINS LEAD ARE COLOURED IN ACCORDANCE WITH THE FOLLOWING CODE.

BLUE: NEUTRAL
 BROWN: LIVE

As the colours of the wires in the mains lead of this apparatus may not correspond with the coloured markings identifying the terminals in your plug, proceed as follows:

The wire which is coloured BLUE must be connected to the terminal which is marked with the letter N or coloured BLACK.
 The wire which is coloured BROWN must be connected to the terminal which is marked with the letter L or coloured RED.
 Under no circumstances must either of the above wires be connected to the earth terminal of a three pin plug.

USING THE UNIT SAFELY

INSTRUCTIONS FOR THE PREVENTION OF FIRE, ELECTRIC SHOCK, OR INJURY TO PERSONS

About ⚠ WARNING and ⚠ CAUTION Notices

⚠ WARNING	Used for instructions intended to alert the user to the risk of death or severe injury should the unit be used improperly.
⚠ CAUTION	Used for instructions intended to alert the user to the risk of injury or material damage should the unit be used improperly. * Material damage refers to damage or other adverse effects caused with respect to the home and all its furnishings, as well to domestic animals or pets.

About the Symbols

	The ⚠ symbol alerts the user to important instructions or warnings. The specific meaning of the symbol is determined by the design contained within the triangle. In the case of the symbol at left, it is used for general cautions, warnings, or alerts to danger.
	The ⓧ symbol alerts the user to items that must never be carried out (are forbidden). The specific thing that must not be done is indicated by the design contained within the circle. In the case of the symbol at left, it means that the unit must never be disassembled.
	The ● symbol alerts the user to things that must be carried out. The specific thing that must be done is indicated by the design contained within the circle. In the case of the symbol at left, it means that the power-plug must be unplugged from the outlet.

ALWAYS OBSERVE THE FOLLOWING

⚠ WARNING

- Before using this unit, make sure to read the instructions below, and the Owner's Manual.
- Do not open or perform any internal modifications on the unit.
- Make sure you always have the unit placed so it is level and sure to remain stable. Never place it on stands that could wobble, or on inclined surfaces.
- Avoid damaging the power cord. Do not bend it excessively, step on it, place heavy objects on it, etc. A damaged cord can easily become a shock or fire hazard. Never use a power cord after it has been damaged.
- In households with small children, an adult should provide supervision until the child is capable of following all the rules essential for the safe operation of the unit.
- Protect the unit from strong impact. (Do not drop it!)
- Do not force the unit's power-supply cord to share an outlet with an unreasonable number of other devices. Be especially careful when using extension cords—the total power used by all devices you have connected to the extension cord's outlet must never exceed the power rating (watts/amperes) for the extension cord. Excessive loads can cause the insulation on the cord to heat up and eventually melt through.
- Before using the unit in a foreign country, consult with your dealer, or qualified Roland service personnel.

⚠ CAUTION

- Always grasp only the plug on the power-supply cord when plugging into, or unplugging from, an outlet or this unit.
- Try to prevent cords and cables from becoming entangled. Also, all cords and cables should be placed so they are out of the reach of children.

⚠ CAUTION

- Never climb on top of, nor place heavy objects on the unit.
- Never handle the power cord or its plugs with wet hands when plugging into, or unplugging from, an outlet or this unit.
- If you need to move the instrument, take note of the precautions listed below. At least two persons are required to safely lift and move the unit. It should be handled carefully, all the while keeping it level. Make sure to have a firm grip, to protect yourself from injury and the instrument from damage.
 - Check to make sure the knob bolts securing the unit to the stand have not become loose. Fasten them again securely whenever you notice any loosening.
 - Disconnect the power cord.
 - Disconnect all cords coming from external devices.
 - Close the lid.
 - Fold down the music stand.
- Before cleaning the unit, turn off the power and unplug the power cord from the outlet (page 13).
- Whenever you suspect the possibility of lightning in your area, pull the plug on the power cord out of the outlet.
- Be careful when opening/closing the lid so you do not get your fingers pinched (page 13). Adult supervision is recommended whenever small children use the unit.
- When using the bench, please observe the following points.
 - Do not use the bench as a toy or as a stepping stool.
 - Do not allow two or more persons to sit on the bench.
 - Do not sit on the bench if the bolts holding the bench legs are loose. (If the bolts are loose, immediately re-tighten them using the included wrench.)
 - When opening or closing the seat lid, be careful not to pinch your fingers. In particular, be careful not to pinch your fingers in the folding metal support. (page 15)

CONTENTS

FEATURES.....	8
IMPORTANT NOTES	9
PANEL DESCRIPTIONS.....	10

BEFORE YOU BEGIN

Connecting the Power Cord	13
Setting up the music stand	13
Opening the cover.....	13
Using Headphones.....	13
Using a Microphone	14
Using the Output jacks	14
Using the Input jacks	14
Turning on the Panel lights	15
Cautions regarding the panel illumination	15
Caution when using the bench.....	15
Restoring all the factory default settings	15

Basic Operation – Introduction To Frequently-Used Functions

Start playing the AT-80.....	16
Listen to the Demo songs	17
Selecting voices	18
● Upper and Lower.....	18
● Pedal Bass.....	19
● Solo.....	20
Adding variety to a voice.....	21
● Adding harmony to a melody (Harmony Intelligence button)	21
○ Changing the Harmony Type	21
● Rotary Effect	23
Use the Rhythm (Music Style) Functions.....	24
Selecting a Rhythm (Music Style).....	25
Try the automatic accompaniment (One Touch Program button).....	26
Changing all the AT-80 settings at once (Registration).....	27
● Storing Registrations	27
● How to recall settings.....	27
● How to use the Manual button.....	27

More Advanced Applications

Using the Others buttons.....	28
Use a Rhythm (Music Style) from a disk.....	30
Use the Lower keyboard to play the drums	31
● Playing drums from the entire Lower keyboard (Manual Drums button)	31
○ Changing the Drum Set Type	31
● Playing drums together with the Lower Voices (Manual Perc button)	32

Add various effects to a voice	33
● Chorus effect	33
● Reverb effect	33
● Sustain effect	34
Try out the performance functions	34
● Adjusting overall volume using the Expression Pedal	34
● Adding decay to the sound (Damper or Sustain pedal)	34
● Using the Lower keyboard to play the Bass voice <1> (To Lower button)	35
● Using the Lower keyboard to play the Bass voice <2> (Bass Split button)	35
● Play the Solo voice on the Lower keyboard (To Lower button)	35
● Effective ways to use the Lower keyboard	36
● Pitch Bend and Vibrato Effects	37
● Adjusting the brightness of the sound (Brilliance)	37
● Using the foot switches	37
Playing Rhythms (Music Styles) and automatic accompaniment	38
● Switching Automatic Accompaniment On/Off (Arranger On/Off button)	38
● Using the Sync Start function (Sync Start button)	38
● Changing the Tempo (Tempo button)	39
● Selecting an Intro (Intro/Ending button)	39
● Selecting an Ending (Intro/Ending button)	39
● Using easy fingering to play chords (Chord Intelli button)	40
● Leading Bass function (Leading Bass button)	40
● Sustaining notes played on the Lower keyboard (Lower Voice Hold button)	41
Recalling panel settings appropriate for a Rhythm (Music Style)	41

Recording/Playing Back Performances

About Floppy Disks	42
● Handling the Disk Drive	42
● Handling floppy disks	42
● Formatting disks	42
Record and playback your playing	43
● Recording performances (Rec button)	43
○ Recording for the first time	43
○ To record each Part separately	44
○ To re-record	44
● Erasing performance data (Clear)	45
● Playing back performance data (Play button)	45
○ Silencing a specific track (Track mute)	45
● Saving performance data (Save button)	45
○ Changing the name of performance data (Rename)	46
○ Saving onto disk (Save button)	46
● Loading performance data into the AT-80 (Load button)	46
● Playing back performance data on disk (All Song Play button and Play button)	47

- Erasing performance data on a disk.....48
- Display basic screens (Display/Exit button)48

Saving/Loading A Set Of Registrations To/From A Disk

- Saving a registration set (Save button)49**
 - Assigning a name to a registration set49
 - Saving to disk (Save button).....49
- Loading a previously saved registration set (Load button)50**
 - Loading a set of registrations50
 - Loading an individual registration50
- Deleting a previously saved set of registrations (Clear)50**

Other Kinds of Settings

- Adjust the volume balance (Part Balance buttons)51**
- Transpose the pitch in octave units (Oct Shift button)51**
- Transpose to a different key (Transpose button).....52**
- Make fine adjustments to the effect of a voice (Effect button)52**
 - Reverb Type52
 - Reverb Depth.....53
 - Sustain Length.....53
 - Rotary Speed.....53
 - Rotary Color53
- Various other settings (Utility button)54**
 - Aftertouch (Aftertouch ON/OFF).....54
 - Aftertouch Sense (Aftertouch Sensitivity).....54
 - Initial Touch (Initial Touch ON/OFF).....54
 - Pedal Bass Mode (How the Bass Pedals can be played)55
 - Regist Shift (Use the right foot switch to switch registrations).....55
 - Left / Right Foot Switch Assignment55
 - Damper Pedal Assignment.....55
 - Bender/Vibrato Destination.....56
 - Pitch Bend Range56
 - Manual Drums Set56
 - Harmony Intelligence Type56
 - Solo Split Point56
 - Bass Split Point56
 - Chord Hold (Chord Hold ON/OFF)56
 - Registration Arranger Update (Registration recall timing)57
 - Expression Curve (The depth of the Expression Pedal effect)57
 - Tx MIDI Channel (MIDI output channel)57
 - Master Tune57
 - LCD Contrast.....57

Settings for the Composer (Function button)	58
● Count-In Recording	58
● Metronome	58
● Metronome Volume	58
● Setting the beat (Time Signature)	58
● Exp. Source (how the Expression Pedal functions)	58
○ Recording (function during recording)	58
○ Playback (function during playback)	59
● Edit Menu (editing music data)	59
○ Delete Measure (delete part of the recorded data)	59
○ Delete Track (delete music data from a track)	60
○ Erase (erase music data)	60
○ Copy (copy music data)	61
○ Quantize (correct timing inaccuracies)	61
● Channel Mute	62

Connecting MIDI Devices Or Computers

Connections with a MIDI device	63
Connections with a computer	64
● Connection with an Apple Macintosh	64
● Connection with an IBM PC	64

Troubleshooting	65
Display messages	67
Drum Set list	69
Composer Profiles	70
MIDI Implementation	71
MIDI Implementation Chart	87
Specifications	88
Index	90
Setting up the AT-80 and the ATS-80 stand	94

FEATURES

The AT-80 is an electronic organ which provides a generous collection of rich organ sounds. In addition, it is designed to be easy to learn and use.

● Luxurious top-quality cabinet (with illuminated panel)

Real wood is used with luxurious high-quality finish. Since the front panel is illuminated, you can comfortably play in locations where the lighting has been dimmed.

● Harmony Intelligence function

When the Harmony Intelligence function is used, the melody played on the upper keyboard will be automatically accompanied by a accompanying harmony based on the chords played on the Lower keyboard. Ten types of harmony are provided.

● Keyboard Split function for performance versatility

The Lower keyboard can be split into different areas to play multiple parts, such as the Solo part or Bass part, allowing a degree of performance versatility that rivals three and four-manual organs. Drum sounds and sound effects can also be played.

● Compatible with music style disks

Additional Rhythms and automatic accompaniments can be selected from the disk included or optional music style disks (MSA series), allowing you to enjoy an even wider selection of Rhythms (Music Styles).

● SMF Music Data (sold separately) can be utilized

The built-in Composer allows cassette recorder-like operation. Not only can you record your own performance, but also load and play back a wide variety of SMF Music Data for your listening pleasure or to play and sing along with.

● A dedicated computer connector and a mic input with echo are also provided



General MIDI System

The General MIDI System is a set of recommendations which seek to provide a way for going beyond the limitations of proprietary designs, and standardize the MIDI capabilities provided by sound generating devices.

If you use a sound generating unit which carries the General MIDI logo, you will be able to faithfully reproduce any song data which also carries the General MIDI logo.



GS Format

The GS Format is Roland's set of specifications for standardizing the performance of sound generating devices. In addition to including support for everything defined by the General MIDI System, the highly-compatible GS Format offers an expanded number of sounds, provides for the editing of sounds, and spells out many details for a wide range of extra features, including effects such as reverb and chorus. Designed with the future in mind, the GS Format can readily be augmented with new sounds and support new hardware features as they become available. Since it is downward compatible with the General MIDI System, Roland's GS Format is capable of reliably playing back GM Scores equally as well as performing GS Music Data (music data that has been created based on the GS Format).

This product supports both General MIDI and GS. Song data which carries either of these logos can be accurately reproduced.

SMF

This device can playback (SMF) Standard MIDI Files (2DD/2HD format 3.5 inch floppy disks) such as SMF Music Data.

- Apple is a registered trademark of Apple Computer, Inc.
- Macintosh is a registered trademark of Apple Computer, Inc.
- IBM is a registered trademark of International Business Machines Corporation.
- IBM PC is a registered trademark of International Business Machines Corporation.
- The GS logo () is a trademark of Roland Corporation.
- All product names mentioned in this document are trademarks or registered trademarks of their respective owners.

IMPORTANT NOTES

In addition to the items listed under "IMPORTANT SAFETY INSTRUCTIONS" and "USING THE UNIT SAFELY" on pages 2 and 3, please read and observe the following:

Power Supply

- Do not use this unit on the same power circuit with any device that will generate line noise (such as an electric motor or variable lighting system).
- Before connecting this unit to other devices, turn off the power to all units. This will help prevent malfunctions and/or damage to speakers or other devices.

Placement.....

- This device may interfere with radio and television reception. Do not use this device in the vicinity of such receivers.
- Observe the following when using the unit's floppy disk drive. For further details, refer to "About Floppy Disks" (p.42).
 - Do not place the unit near devices that produce a strong magnetic field (e.g., loudspeakers).
 - Install the unit on a solid, level surface.
 - Do not move the unit or subject it to vibration while the drive is operating.
- Do not expose the unit to direct sunlight, place it near devices that radiate heat, leave it inside an enclosed vehicle, or otherwise subject it to temperature extremes. Excessive heat can deform or discolor the unit.

Maintenance.....

- For everyday cleaning wipe the unit with a soft, dry cloth or one that has been slightly dampened with water. To remove stubborn dirt, use a cloth impregnated with a mild, non-abrasive detergent. Afterwards, be sure to wipe the unit thoroughly with a soft, dry cloth.
- Never use benzene, thinners, alcohol or solvents of any kind, to avoid the possibility of discoloration and/or deformation.

Repairs and Data.....

- Please be aware that all data contained in the unit's memory may be lost when the unit is sent for repairs. Important data should always be backed up on a floppy disk, or written down on paper (when possible). During repairs, due care is taken to avoid the loss of data. However, in certain cases (such as when circuitry related to memory itself is out of order), we regret that it may not be possible to restore the data, and Roland assumes no liability concerning such loss of data.

Memory Backup

- If the power to this unit is not switched on for an extended period of time (about 1 month), the contents of memory will be lost, and the unit will revert to its factory defaults. To avoid the loss of important data that has been placed in memory, a backup of your data should be periodically created on a floppy disk.

Additional Precautions.....

- Please be aware that the contents of memory can be irretrievably lost as a result of a malfunction, or the improper operation of the unit. To protect yourself against the risk of losing important data, we recommend that you periodically save a backup copy of important data you have stored in the unit's memory on a floppy disk.
- Unfortunately, it may be impossible to restore the contents of data that was stored on a floppy disk once it has been lost. Roland Corporation assumes no liability concerning such loss of data.
- Use a reasonable amount of care when using the unit's buttons, sliders, or other controls; and when using its jacks and connectors. Rough handling can lead to malfunctions.
- Never strike or apply strong pressure to the display.
- When connecting / disconnecting all cables, grasp the connector itself—never pull on the cable. This way you will avoid causing shorts, or damage to the cable's internal elements.
- A small amount of heat will radiate from the unit during normal operation.
- To avoid disturbing your neighbors, try to keep the unit's volume at reasonable levels. You may prefer to use headphones, so you do not need to be concerned about those around you (especially when it is late at night).
- If you need to transport the unit, whenever possible, package it in the original shipping box (including padding). Otherwise, you will need to use equivalent packaging materials.
- Do not pull the music stand too far forward when setting/releasing its latches.

PANEL DESCRIPTIONS

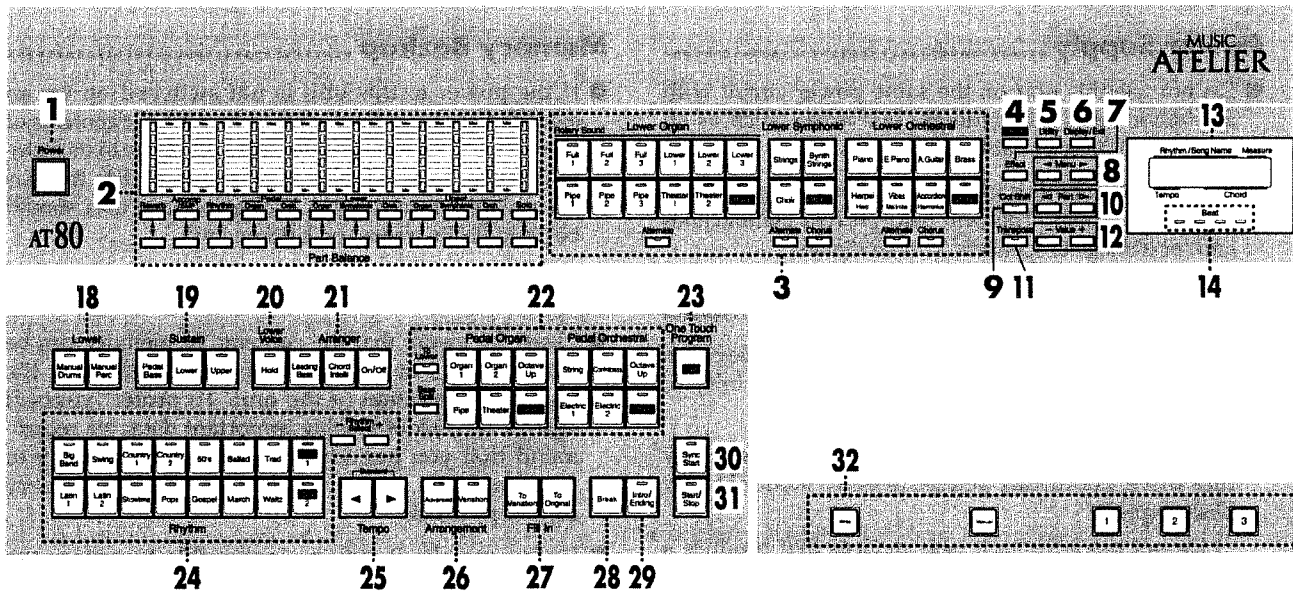

1. Power switch (→p.16)

2. Part Balance buttons (→p.51)

The button located at the upper left adjusts the Reverb effect. (→p.33)

3. Lower voice select buttons (→p.18)

Lower Organ
Lower Symphonic
Lower Orchestral

4. Others button (→p.28)

5. Utility button (→p.54)

6. Display/Exit button (→p.48)

7. Effect button (→p.52)

8. Menu buttons (→p.52, 54)

9. Oct Shift button (→p.51)

10. Part buttons (→p.51, 52, 54)

11. Transpose button (→p.52)

12. Value buttons

13. Display (→p.48)

14. Beat Indicator (→p.39)

15. Harmony Intelligence button (→p.21)

16. Upper voice select buttons (→p.18)

Upper Organ
Upper Symphonic
Upper Orchestral

17. Solo voice select buttons (→p.20)

18. Lower

Manual Drums button (→p.31)
Manual Perc button (→p.32)

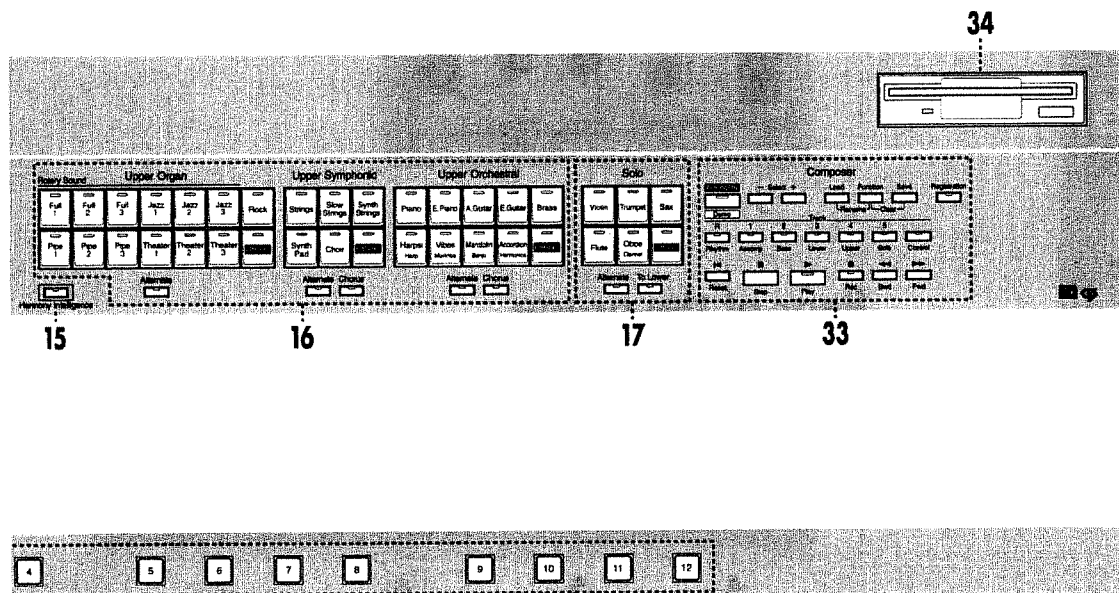
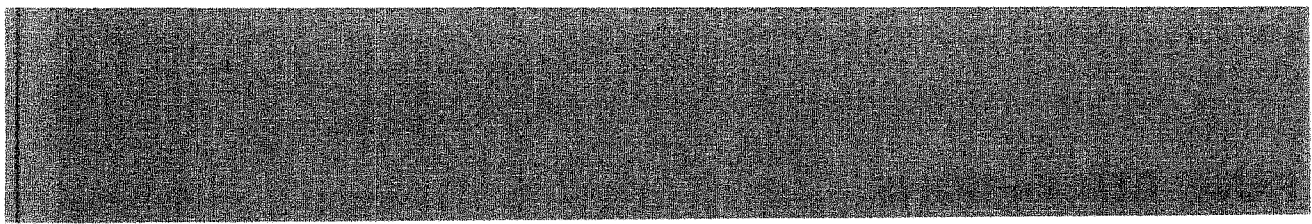

19. Sustain buttons (→p.34)

20. Lower Voice Hold button (→p.41)

21. Arranger

- Leading Bass button (→p.40)
- Chord Intelli button (→p.40)
- Arranger On/Off button (→p.38)

22. Pedal Bass voice select buttons (→p.19)

- Pedal Organ
- Pedal Orchestral

23. One Touch Program button (→p.26, 41)

24. Rhythm select buttons (→p.25, 30)

25. Tempo buttons (→p.39)

26. Arrangement

- Advanced button (→p.26)
- Variation button (→p.24, 26)

27. Fill In

- To Variation button (→p.24, 26)
- To Original button (→p.24, 26)

28. Break button (→p.24, 26)

29. Intro/Ending button (→p.26, 39)

30. Sync Start button (→p.38)

31. Start/Stop button (→p.24)

32. Registration buttons (→p.27, 41)

33. Composer

- All Song play/Demo button (→p.17, 47)
- Load button (→p.46, 50)
- Function button (→p.58–62)
- Save button (→p.46, 49)
- Registration button (→p.49, 50)

34. Disk Drive (→p.42)

PANEL DESCRIPTIONS

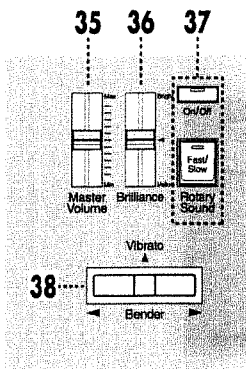

Under the Lower left of the keyboard

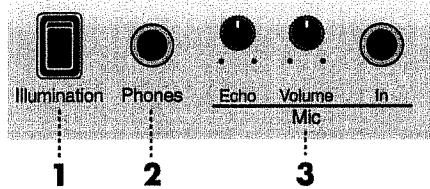

Rear of the organ

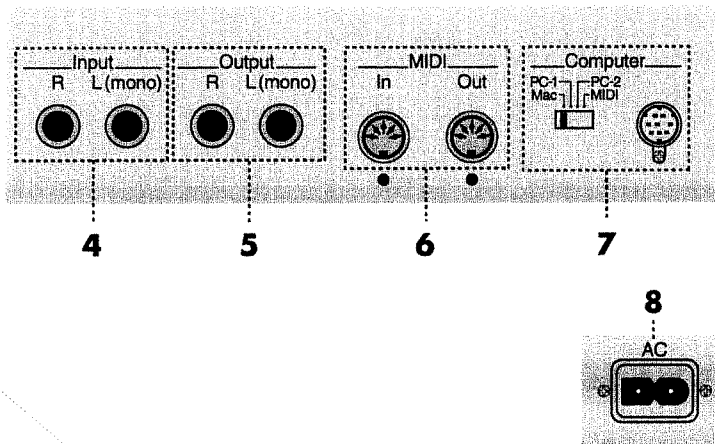

35. Master Volume slider (→p.16)

36. Brilliance slider (→p.37)

37. Rotary Sound

On/Off button (→p.23)

Fast/Slow button (→p.23)

38. Pitch Bender/Vibrato Lever (→p.37)

1. Panel illumination switch (→p.15)

2. Phones (Headphones) jack (→p.13)

3. Mic (→p.14)

Echo control
Mic Volume control
Mic In jack

4. Input jacks L (mono)/R (→p.14)

5. Output jacks L(mono)/R (→p.14)

6. MIDI connector Out/In (→p.63)

7. Computer connector (→p.64)

8. AC Inlet (→p.13)

BEFORE YOU BEGIN

Connecting the Power Cord

1. First, make sure that the Power switch at the panel's left side is OFF (not pushed in).
2. Connect the supplied power cord to the AC Inlet connector, then plug the other end into an AC outlet.

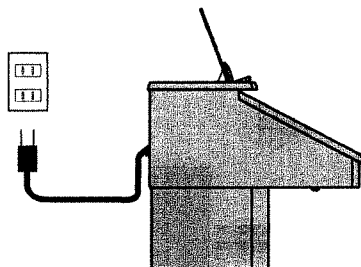

- * Only use the power cord supplied with this instrument.
- * Whenever you do not intend to use the instrument for extended periods of time, pull out the power cord from the AC outlet.

Setting up the music stand

- ◇ Lift the music stand, and adjust the metal joints as shown in the illustration below.

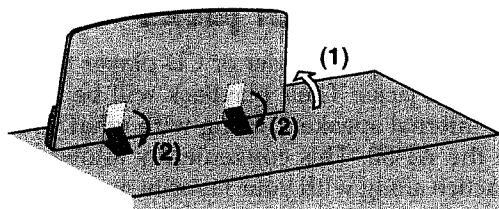

- * Do not pull the music stand too far forward when setting/releasing its latches.

Opening the cover

- ◇ To open the cover, hold it with both hands and lift it straight up. Then, slide it to the rear.

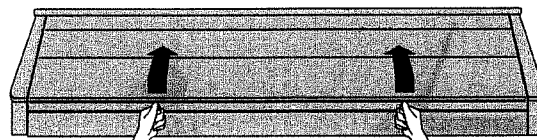

To close the cover, slowly pull it forward until it stops. Then, gently lower it into place.

- * Be careful not to get your fingers caught when opening or closing the cover. Adult supervision is recommended when small children are going to be using the instrument.
- * Make sure you don't have anything (such as sheet music) on the keyboard when you close the cover.

Using Headphones

- ◇ Accepts connection of headphones .

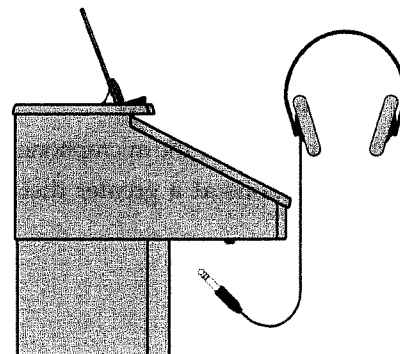

Because sound will no longer be output from the AT-80's speakers when headphones are connected, you can practice late at night without disturbing others.

The volume level heard through headphones can be adjusted with either the Master Volume slider or the Expression Pedal.

- * Be careful, though, since excessive volume levels can cause damage to your hearing.
- * Be careful to avoid pulling the headphone cable. Applying excessive force will cause malfunctions.

Using a Microphone

1. Make sure that the Mic Volume control is lowered, then connect the Microphone (Dynamic) to the Mic In jack.

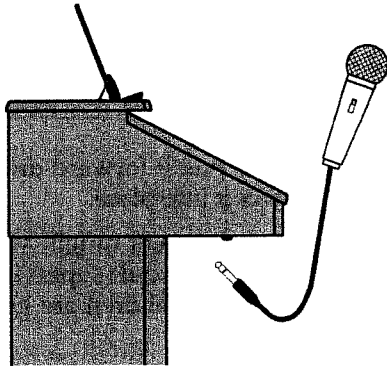

2. Adjust the Microphone volume and the amount of echo using the Volume and Echo controls, respectively.

You can enjoy singing as you play the AT-80, or singing along while music data (SMF Music Data, etc.: sold separately) is played back (→p.47).

- * Howling could be produced by acoustical feedback which is dependent on the location of the microphone relative to the speakers.
 1. Changing the orientation of the microphone.
 2. Relocating microphone at a greater distance from speakers.
 3. Lowering volume levels.

Using the Output jacks

If you wish to play your music through an external keyboard amplifier or hi-fi system, connect the AT-80 output jacks to the input of your external amplification devices. To record your performance, you may also connect the AT-80 output jacks to the input of your audio recording device, such as a cassette or Mini Disk recorder.

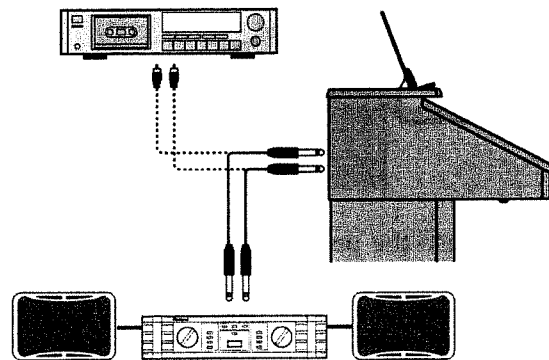

- * To prevent malfunction and/or damage to speakers or other devices, always turn down the volume, and turn off the power on all devices before making any connections.

Using the Input jacks

Connect a tape recorder or CD player to the AT-80 input jacks. Their playback will be heard on the internal speakers, along with what you play on the AT-80. This conveniently allows you to practice along with your favorite music.

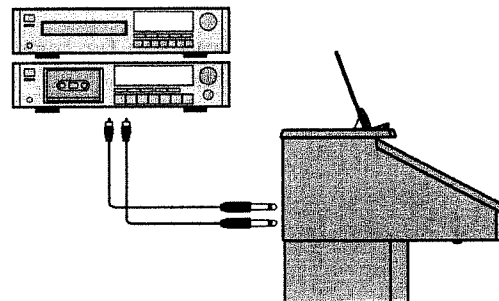

- * To prevent malfunction and/or damage to speakers or other devices, always turn down the volume, and turn off the power on all devices before making any connections.

Turning on the Panel lights

- ◇ After turning on the power, turn on the Illumination switch (located underneath the left-hand side of the keyboard).



The light bulb at the lower front of the top panel will light.

Cautions regarding the panel illumination

When illumination is used for an extended period, the light bulbs and the metal parts near the light bulb (see diagram below) will become hot. Be careful not to touch these areas. In particular, be careful of the following two locations.

- 1. Panel illumination bulb cover**
The entire cover will become hot. Be careful not to touch it. When closing the lid, be sure to hold it by the handles.
- 2. Metal portion of lid**
After closing the lid, do not touch this area.

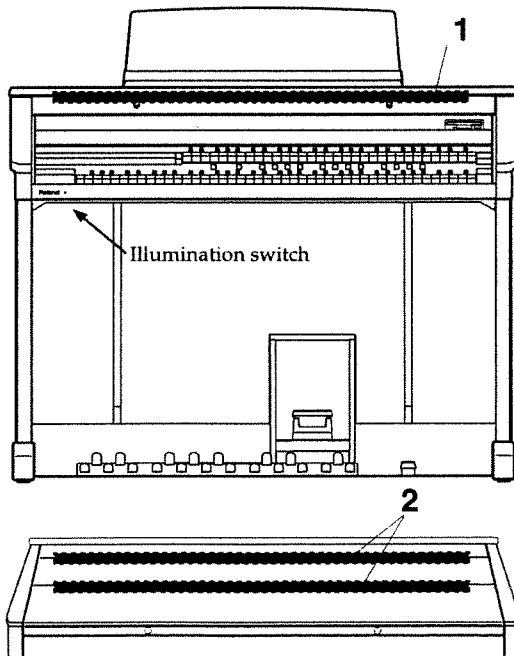

Caution when using the bench

The bench seat can be opened, and sheet music etc. can be stored inside.

CAUTION

When opening/closing the seat, be careful not to pinch your fingers.

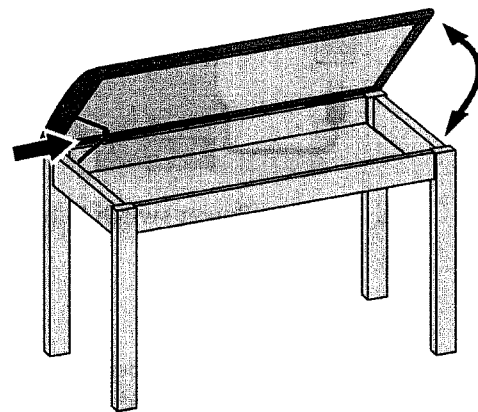

Restoring all the factory default settings

Perform the procedure below to return all the Settings of the AT-80 to those preset by the factory (when the instrument was delivered).

- * Make sure there is no floppy disk in the disk drive before carrying out the procedure.
- ◇ Turn on the power while holding down the One Touch Program button.

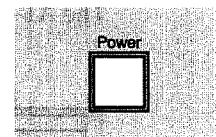

Factory Setup
is Loaded.

- * When you are using the instrument for the very first time, or it has remained unused for about a month or so, it will automatically be returned to the factory default settings when the power is turned on.

Basic Operation – Introduction To Frequently-Used Functions

Start playing the AT-80

Once the connections have been completed (p.13 and 14), turn on the power to your various devices in the order specified. By turning on devices in the wrong order, you risk causing malfunction and/or damage to speakers and other devices.

1. First, check that the power cord is connected, that the Master Volume slider is turned down.

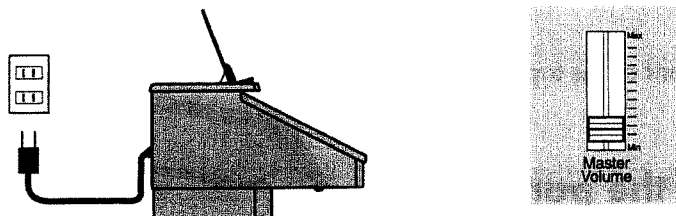

2. Press the Power switch to turn ON the power.

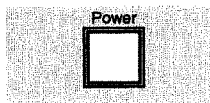

* This unit is equipped with a protection circuit. A brief interval (a few seconds) after power up is required before the unit will operate normally.

3. Use the Master Volume slider and the Expression Pedal to adjust the volume to an appropriate level.

The volume will be increased when the Expression Pedal is pressed down, and decreased when the pedal is returned.

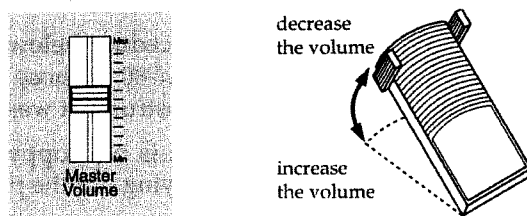

4. Play each keyboard to hear the sounds.

The AT-80 has two keyboards and one Bass pedalboard, as shown below.

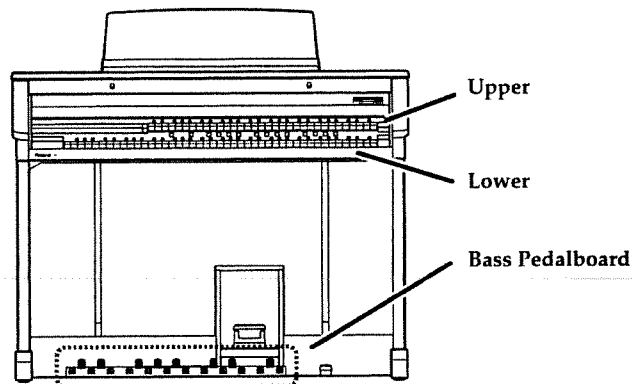

Listen to the Demo songs

The AT-80 contains four Demo songs. Here's how to play to the Demo songs to fully appreciate the sounds, rhythms, and automatic accompaniment that are available on the AT-80.

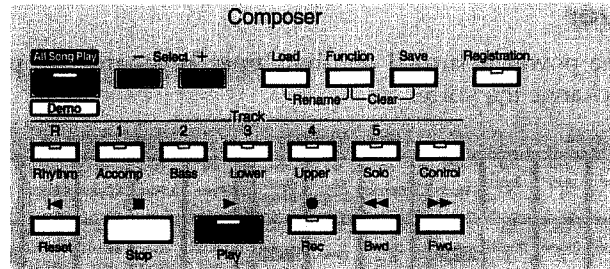

1. Make sure that a floppy disk is not inserted in the disk drive.
2. Press the Demo button (the indicator will light).

```
Big Band      :01
DEMO [-/+/PLAY]
```

3. Use the Select buttons to select a Demo song.

There are a total of four internal Demo songs.

1.	Big Band	by Stewart Cary and Joe Millward	© 1996 Roland Corporation
2.	Country	by Stewart Cary and Joe Millward	© 1996 Roland Corporation
3.	Theater Organ	by Jonas Nordwall	© 1996 Rodgers Corporation
4.	Jazz Organ	by Akio Sasaki	© 1996 Roland Corporation

- * Portions of Demo songs 1 and 2 were composed using equipment other than the AT-80.
4. Press the Play button.
The selected Demo song will playback.
 5. To stop playback in the middle of the song, press the Stop button (or the Demo button or the Reset button).

When playback ends or is stopped, the basic display will reappear.

- * For profiles of the composer, refer to page 70.
- * If the performance data in the unit has not been saved to disk, the following message will appear, and it will not be possible to play the Demo songs.

```
Clear Song Sure?
Yes:REC No:RST
```

If you don't mind erasing this song, press the Rec button. However, if you wish to save this song, press the Reset button to cancel the procedure, and then save the song on a floppy disk. (→p.46)

- * All rights reserved. Unauthorized use of this material for purposes other than private, personal enjoyment is a violation of applicable laws.
- * The data for the song that is being played is not available at the MIDI OUT connector.

Selecting voices

The AT-80 is able to produce the sounds of various instruments. These sounds are called “voices.” It is very easy to select voices.

● Upper and Lower

Immediately after the power is turned on, the Upper keyboard will play Full Organ 1. Here’s how you can change the voice.

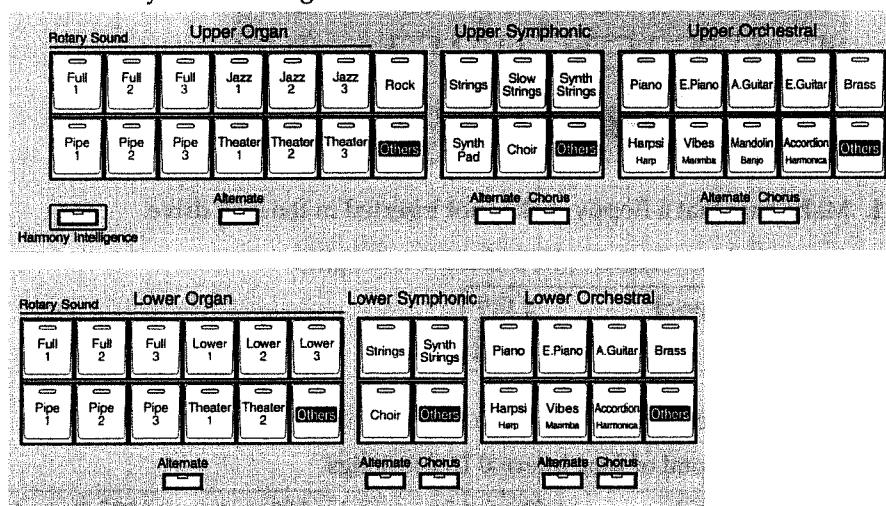

1. Press the Upper Organ Full 2 button (indicator lights).

The name of the selected voice will appear in the display for several seconds.

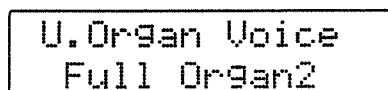

Now when you play the Upper keyboard, the Full Organ 2 will sound.

2. Press the Alternate button, and the indicator will light.

When you play the Upper keyboard, the Full Organ 5 will sound.

Similarly, two voices are assigned to each voice button. (Buttons with voices from two different families, will have the names of both voices printed on them.)

The Alternate button switches between these two voices.

3. Press the Upper Organ Full 2 button (the indicator is turned off).

Playing the Upper keyboard now will no longer produce any sound.

Each time you press the voice button, the indicator will alternate between being lit and being turned off, and voices whose button indicator is lit can be played.

4. Press the Upper Organ Full 1 button and the Upper Symphonic Strings button (their indicators will light).

Now when you play the Upper keyboard, the two voices Full Organ 4 and Strings 5 will sound simultaneously (mixed together).

-
5. Press the Upper Orchestral Piano button (indicator lights).

When you play the Upper keyboard, Piano 1 will be added, producing a mixture of three different voices.

The Upper and Lower keyboards each have three parts; Organ, Symphonic, and Orchestral. One voice can be selected from each part, allowing you to layer (mix) up to 3 voices. Voices can be selected for the Lower keyboard in the same way as for the Upper keyboard.

● Pedal Bass

Immediately after the power is turned on, the Pedal Bass voice will sound single notes using the Organ Bass 1 voice. Here's how to select Bass voices played by the Pedalboard.

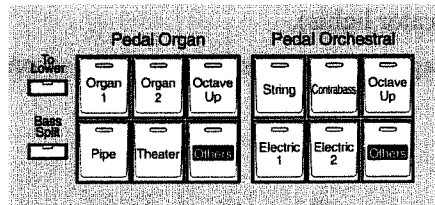

1. Press the Pedal Organ Pipe button (indicator lights).

The name of the selected voice will appear in the display for several seconds.

```
P.Organ Voice
Pipe Org. Bs
```

Now when you play the Pedalboard, Pipe Organ Bass will be heard.

2. Press the Pedal Organ Octave Up button (indicator lights).

Play the Pedalboard once more. Notice that when the Octave Up button is on, the selected Bass voice will sound an octave higher.

3. Press the Pedal Orchestral Electric 1 button (indicator lights).

Now when you play the Pedalboard, the two voices Pipe Organ Bass and Electric Bass 1 will sound simultaneously (mixed together).

The Bass voice is selected in the same way as the voices of the Upper and Lower keyboards. Each time you press a voice button, the indicator will alternate between being lit and being turned off, allowing you to play the voice for which the indicator is lit.

If all indicators are turned off (not lit), the Bass voice will not sound.

- * If you press the To Lower button (indicator lights →p.35) or Bass Split button (indicator lights →p.35), the Bass voice can now be played by the Lower keyboard, not by the Pedalboard.
- * Settings can be adjusted to allow multiple notes to be played on the Pedalboard (→p.55)

● Solo

The Solo voice normally sounds for the highest note played on the Upper keyboard. Let's try selecting a Solo voice.

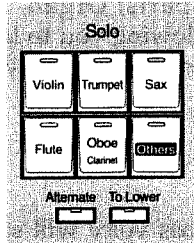

1. Press the Solo Trumpet button (indicator lights).

The name of the selected voice will appear in the display for a few seconds.

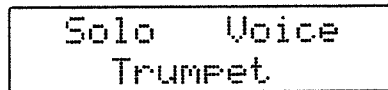

Play the Upper keyboard, the Trumpet voice will sound by the highest note played.

2. Press the Alternate button (indicator lights).

Play the Upper keyboard, now the Mute Trumpet voice will sound by the highest note played.

In the same way as for the Upper and Lower sections, two voices of the same category are assigned to each of the Solo buttons. (Buttons with voices from two different families, will have the names of both voices printed on them.)

Use the Alternate button to switch between these two voices.

The Solo voice is selected in the same way as for the Upper and Lower keyboards. Each time you press a voice button, the indicator will alternate between being lit and being turned off, allowing you to play the voice for which the indicator is lit.

If all indicators are turned off (not lit), the Solo voice will not sound.

- * If you press the To Lower button (indicator lights), the Solo voice can now be played on the right-hand side of Lower keyboard. (→p.35)

Adding variety to a voice

The AT-80 allows you to add a variety of effects to voices, and to use various playing techniques to make your performance more expressive. Here are some of the most frequently used effects and functions.

● Adding harmony to a melody (Harmony Intelligence button)

Harmony Intelligence is a function that adds harmony to a single note being played on the Upper keyboard, the harmony being dependant on the chord played on the Lower keyboard.



- ◆ Press the Harmony Intelligence button (indicator lights).

On the Lower keyboard, simultaneously hold down a chord such as C/E/G (C major) or F/A/C (F major), and then play the Upper keyboard. The harmony will change according to the chord that you play.

Immediately after the power is turned on, the TRADITIONAL type Harmony Intelligence will be selected.

Each time you press the Harmony Intelligence, the indicator will alternate between lit (on) and dark (off).

- * When the TRADITIONAL type Harmony Intelligence is selected but only a Solo is selected, no harmony will be added. Please select an Upper Organ, Symphonic or Orchestral voice.

○ Changing the Harmony Type

There are 10 Harmony types available on your AT-80.

TRADITIONAL, BROADWAY, DUET, ORGAN COMBO, STRINGS, HYMN, BLOCK, BIG BAND, COUNTRY

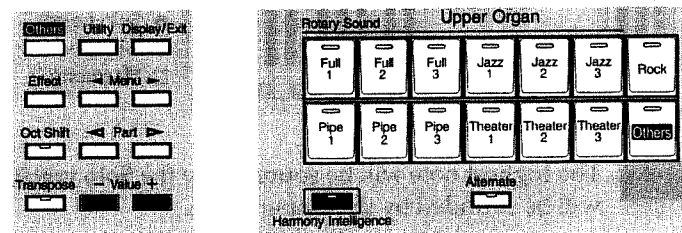

Here's how to select the desired one:

1. Press the Harmony Intelligence button (indicator lights).
2. When the Harmony Type name is displayed in the screen, press the Value buttons (- or +). The Harmony Intelligence button indicator will begin to flash.

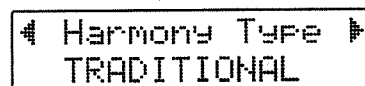

3. Use the Value buttons to select the Harmony Type.
4. Press the Harmony Intelligence button once again.

The Harmony Intelligence button will be lit constantly, and the selected Harmony Type will be applied.

- * To stop mid-way through a procedure, press the Display/Exit button.
- * The Harmony Type can also be selected from the Utility menu. (→p.56)

Only the TRADITIONAL type, will use the voice that was sounding in the Upper part before the Harmony Intelligence button was pressed. For the other Types of Harmony, the most appropriate voice(s) will be automatically set.

The manner in which notes will sound also depends on the Harmony type.

Type	Parts sounded
TRADITIONAL	Solo & Upper *1
BROADWAY	Solo & Upper
DUET	Solo
ORGAN	Upper
COMBO	Solo
STRINGS	Solo & Upper
HYMN	Solo & Upper
BLOCK	Solo & Upper
BIG BAND	Solo
COUNTRY	Solo & Upper

*1 If the TRADITIONAL type is selected, notes will be sounded as "Solo & Upper" if both a Solo voice and an Upper voice were selected before the Harmony Intelligence button was pressed. If only an Upper section voice was selected, notes will be sounded from that Upper section.

- * You may change the selected Solo voice or / and the Upper voice to one of your choice.

How notes are sounded by the different Harmony Intelligence types

Solo & Upper The highest note will be sounded by the Solo voice and the Upper voice, and the harmony will be sounded by the Upper voice.

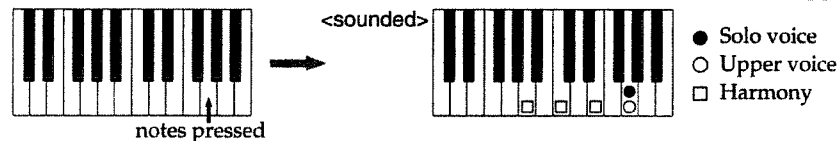

Solo The highest note will be sounded by the Solo voice, and the harmony will be sounded by the Upper voice.

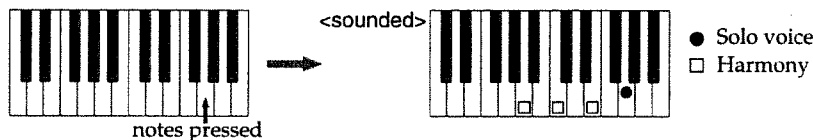

Upper Both the highest note and the harmony will be sounded by the Upper voice.

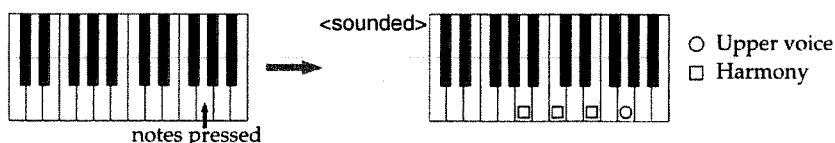

● Rotary Effect

Rotary is an effect which simulates the sound you hear when speakers are rotated. There are two settings; Fast and Slow.

Rotary is effective only for the Voices assigned to the upper row of buttons for Upper Organ (except Rock Organ) and Lower Organ.

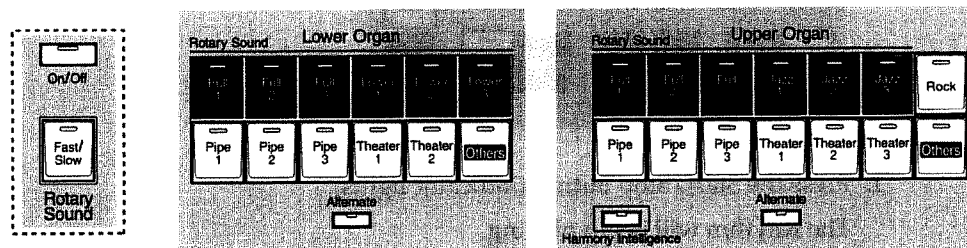

1. Select the Voice to which you wish to apply the Rotary effect.
 2. Press the Rotary Sound On/Off button (confirm that its indicator is lit).
 3. Press the Rotary Sound Fast/Slow button.
 - Lit → Fast : The effect obtained is equivalent to speakers being rapidly rotated.
 - Turned off → Slow : Effect simulating the slow rotation of speakers.
- * The Rotary effect can be used for voices 1–12, 15–20, 33, and 38–40 (→p.29), including the voices that are assigned to the upper row of the Upper Organ (except Rock Organ) and Lower Organ buttons. It can also be used when these voices have been assigned to the Others buttons (except the Others buttons for Pedal Organ and Pedal Orchestral). (Others buttons →p.28)
 - * You can also finely adjust the speed of the speaker's rotation, and alter the brightness of the sound obtained when Rotary is applied.(→p.53)
 - * You can assign the Rotary Sound Fast/Slow button function to the foot switches located on each side of the Expression Pedal. (→p.55)

Use the Rhythm (Music Style) Functions

The AT-80 lets you enjoy playing along with a rhythmic accompaniment. Use the following procedure to add a rhythmic accompaniment.

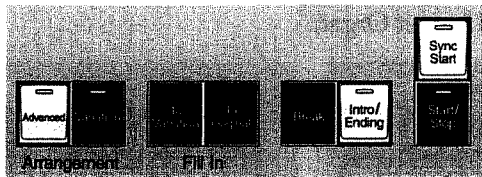

1. Press the Start/Stop button (indicator lights).
The Rhythm will begin playing.
 2. Press the Variation button.
Two types are provided for each rhythm.
Lit → Variation : a variant rhythm pattern
Turned off → Original : the basic rhythm pattern
 3. Press the To Original button.
After a Fill-in is played, the Rhythm will change to the Original pattern. A Fill-in is a phrase that is inserted between breaks in the melody or in locations where the mood of a song changes.
 4. Press the To Variation button.
The Variation button indicator will light, and after a Fill-in is played, the Rhythm will change to the Variation pattern.
Since the To Original and To Variation buttons change the Rhythm pattern after playing a Fill-in, it is effective to use them in locations where the mood of the song changes.
 5. Press the Break button.
The Rhythm will stop for one measure.
 6. To stop the Rhythm, press the Start/Stop button (the indicator is turned off).
By making effective use of the Variation, To Variation, To Original, and Break buttons in this way, you can play along to a varied and interesting rhythmic accompaniment.
- * It is often convenient to press the Sync Start button (indicator is lit), so that the Rhythm will begin at the instant you play the Lower keyboard or the Pedalboard. (→p.38)
 - * You can assign the Start/Stop, To Original and To Variation button functions to the foot switches located on each side of the Expression Pedal. (→p.55)

Selecting a Rhythm (Music Style)

The AT-80 provides 51 types of Rhythms. These are organized into 14 groups.

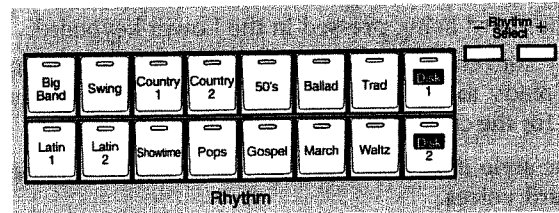

1. Press a Rhythm button.
The indicator will light, and the Rhythm will be selected.
2. To select a different Rhythm within the same group, press the Rhythm Select buttons.
The indicator will blink.



3. Press the Rhythm button once again (indicator lights constantly).
The Rhythm has now been selected. Now press the Start/Stop button to play the Rhythm.

Rhythms are organized as follows.

<u>Big Band</u>	<u>Swing</u>	<u>Country 1</u>	<u>Country 2</u>	<u>50's</u>	<u>Ballad</u>	<u>Trad</u>
1 Big Band	1 Vocal Swing	1 Cntry Ballad	1 Easy Country	1 50's Ballad	1 Love Songs	1 Piano Boogie
2 Blues	2 Combo	2 CountrySwing	2 Hoe Down	2 Slow Dance	2 Ballad	2 Foxtrot
3 BigBndBallad	3 Swing	3 Bluegrass	3 Two Step	3 50's	3 Classic	3 Dixieland
4 Standard	4 Club Piano	4 CntryWltz		4 Rock'n'Roll	4 Torch Song	4 Charleston
<u>Latin 1</u>	<u>Latin 2</u>	<u>Showtime</u>	<u>Pops</u>	<u>Gospel</u>	<u>March</u>	<u>Waltz</u>
1 Bossa Nova	1 Samba	1 ChooChooSwg	1 EasyListen 1	1 Gospel	1 March 4/4	1 Slow Waltz
2 Chacha	2 Rhumba	2 Music Hall	2 EasyListen 2	2 Revival	2 March 6/8	2 Musette
	3 Beguine	3 Bubbles	3 PopularPiano	3 Anthem	3 German March	3 Vienna Waltz
	4 Tango					4 Waltz
<u>Disk 1</u>						
1 Hawaiian						
<u>Disk 2</u>						
1 Polka						

Try the automatic accompaniment (One Touch Program button)

The Arranger function of the AT-80 can add an automatic accompaniment to each Rhythm. Based on the selected Rhythm, the Arranger function automatically adds an accompaniment that is suitable for the chord being pressed in the Lower keyboard.

The AT-80 provides a very convenient One Touch Program button. By simply pressing this button once, you will be ready to add an automatic accompaniment and keyboard voices that are most appropriate for the currently selected Rhythm.

- * If a Rhythm from a music style disk is selected, pressing the One Touch Program button will not select any keyboard voices.

Here's how you can select a Rhythm and add an automatic accompaniment.

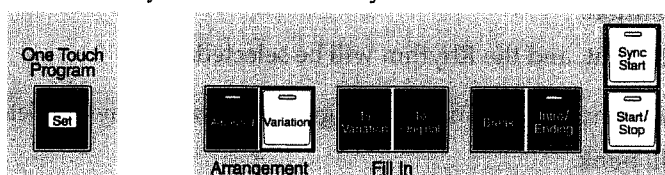

1. Select a Rhythm. (→p.25)
2. Press the One Touch Program button.
The Lower voices will be turned off.
3. On the Lower keyboard, simultaneously press the C/E/G keys (C Major chord).
When you press the chord, the accompaniment will begin automatically with the Introduction. The accompaniment will continue even if you take your hand off the keyboard.
The display will show the name of the chord that you played.

```
Big Band
J:130 C Maj
```

4. Next play an F chord (F/A/C keys) in the Lower keyboard.
The accompaniment will change appropriately for the chord you played. Try various other chords.
5. Press the To Variation button.
In the same way as for Rhythm play, after a Fill-in, the accompaniment will change to a Variation type.
6. Press the To Original button.
The Variation button indicator will be turned off, and after a fill-in, the accompaniment will return to the Original type.
7. Press the Advanced button.
The arrangement of the automatic accompaniment can be alternated not only by using the Variation button, but also by using the Advanced button.
Lit → Advanced : Selects an advanced arrangement with more instruments
Off → Basic : Selects a simpler arrangement with fewer instruments
8. Press the Break button.
The Rhythm and automatic accompaniment will stop for one measure.
9. Press the Intro/Ending button.
After the Ending is played, the accompaniment will stop automatically.

With the functions described on the previous pages, you can use the AT-80 for even more musical enjoyment by simply playing a chord in the Lower keyboard, and using the To Variation, To Original, Variation, Advanced, Break, and Intro/Ending buttons.

- * While the Intro or Ending is being played, the Lower keyboard voices will not play.
- * The functions of the: To Original, To Variation, Advanced and Intro/Ending buttons, can be assigned to the foot switches located on each side of the Expression Pedal (→p.55)

Changing all the AT-80 settings at once (Registration)

The AT-80 has a "Registration" function that allows you to record panel settings and recall those settings with a single press of a button.

It is convenient to use this function when you wish to make many changes in panel settings as you play, or when you wish to reproduce a complex panel setting at a later time. Up to 12 panel settings can be recorded at one time.

● Storing Registrations



1. Make all the panel settings that you wish to have stored.
 2. While holding down the Write button, press a button from 1 to 12.
- * Stored settings will be retained in memory even after the main power is turned off.
 - * Sets of Registrations can be saved onto floppy disk. The complete group of settings stored for buttons 1–12, considered as one set, can be stored on a disk. (→p.49)
 - * A total of 99 sets of Registrations can be stored onto one floppy disk.

● How to recall settings

To recall settings for everything other than Rhythm performances and automatic accompaniment:

- ◇ Press a button from 1 to 12.
The indicator lights, and the settings for everything (other than a Rhythm performance and automatic accompaniment) are instantly recalled.

To recall settings that include Rhythm performances and automatic accompaniment:

- ◇ Continue holding one of the buttons, 1 to 12, for several seconds until the buttons related to the Rhythm and automatic accompaniment performances start flashing.
- * It is possible to shorten the time required for recalling settings that include those related to Rhythm and automatic accompaniment play. (→p.57)
- * You can set the unit so that the registrations will change in the order as 1 → 2 → 3 →... → 12 → 1 →... each time you press the right foot switch. (→p.55)

● How to use the Manual button

When the Manual button is ON (lit), all panel settings you make will be stored automatically as they are made, thus updating the Registration that had been previously saved.



More Advanced Applications

Using the Others buttons

There is one Others button in each of the nine voice parts. Any desired two voices can be assigned to each of these Others buttons, with the exception of the buttons in the Pedal Organ and Pedal Orchestral parts, to which only one voice can be assigned. The Others buttons will enable you to quickly select and play a larger number of voices.

Layering voices from the different voice parts will also permit you to create many new sound combinations.

- * The voices assigned to the Others buttons can be alternated using the Alternate button.
- * You cannot assign a set consisting of the same voice to the two available locations under each Others button. Please select and assign a set of two different voices.

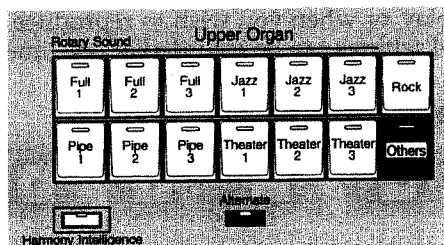
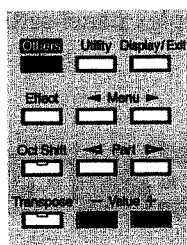

1. Press the Others button to the left of the display (all Others buttons and Alternate buttons begin to flash).
2. Press the Others button for the Part to which you wish to assign a Voice (only the Others button selected will flash).
3. Press the Alternate button to select on (lit) or off (dark).

The setting of the Alternate button: on (lit) or off (dark), determines to which of the two available locations a newly selected voice will be assigned.

This step is unnecessary in the case of Pedal Organ and Pedal Orchestral.

4. Use the Value buttons (-/+) to select the desired Voice.

The name of the selected Voice is shown in the display.

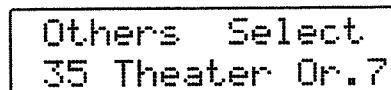

5. Once again, press the Others button to the left of the display, or the Others button for the part to which the selected voice will be assigned.
- * To stop mid-way through a procedure, press the Display/Exit button.
 - * Instead of pressing the Others button in step 2, you can press the Alternate button for the Part to which the voice is assigned, so that the voice can be assigned to the Alternate button on (lit) position.
 - * After pressing the Others button for the Part that you wish to set, you will still be able to assign a voice to the Others button if you press the Value buttons when the voice name is shown in the display.

The following voices can be assigned to an Others button. However, you cannot assign voices that are already assigned to the regular buttons each Part.

1	Full Organ1	*1	35f	T.Oboe 8'	*2	66a	Sax.Section2	*2	102	Clarinet	*2
2	Full Organ4	*1	35g	T.Krumet 8'		67	Harpsichord		102a	Clarinet2	*2
3	Full Organ2	*1	35h	Eng.Horn 8'		68	Harp	*2	102b	Clarinet3	*2
4	Full Organ5	*1	36	Synth. Org.1	*2	68a	Koto	*2	102c	Clarinet4	*2
5	Full Organ3	*1	36a	Synth. Org.3	*2	68b	Taisho Koto	*2	103	Viola	*2
6	Full Organ6	*1	37	Synth. Org.2		69	Vibraphone	*2	104	Flugel Horn	*2
7	Jazz Organ1	*1	37a	Synth. Org.4	*2	70	Marimba		105	Trombone	*2
8	Jazz Organ4	*1	38	Pop. Organ1	*1	71	Mandolin		105a	Trombone2	*2
9	Jazz Organ2	*1	39	Pop. Organ2	*1	72	Banjo	*2	106	Soprano Sax	*2
10	Jazz Organ5	*1	40	Pop. Organ3	*1	73	Accordion		106a	Soprano Sax2	*2
11	Jazz Organ3	*1	41	Strings1		74	Harmonica	*2	107	Bassoon	*2
12	Jazz Organ6	*1	41a	Strings3	*2	75	Org. Attack1		108	Shakuhachi	*2
13	Rock Organ1		41b	Strings5		76	Org. Attack2		109	HumanWhistle	*2
14	Rock Organ2		41c	Strings6		77	Org. Attack3		110	Synth. Lead1	*2
15	Lower Organ1	*1	41d	Strings7	*2	78	Org. Attack4		111	Synth. Lead2	*2
16	Lower Organ4	*1	42	Strings2		79	Org. Click		112	Synth. Lead3	*2
17	Lower Organ2	*1	42a	Strings4	*2	80	Piano2		113	Synth. Lead4	*2
18	Lower Organ5	*1	43	Slow Str.1		81	Clavi.		114	Synth. Lead5	*2
19	Lower Organ3	*1	44	Slow Str.2		82	Celesta		115	Organ Bass1	
20	Lower Organ6	*1	45	Synth. Str.1		83	Glockenspiel		116	Organ Bass2	
21	Pipe Organ1		46	Synth. Str.2		84	Xylophone		117	Pipe Org. Bs	
21a	FluteCeleste		47	Synth. Pad1		85	Tubular-bell		117a	Theater Bass	
22	Pipe Organ4		48	Synth. Pad2		85a	Organ Bell		118	String Bass	*2
23	Pipe Organ2		49	Choir		86	Bandoneon	*2	118a	String Bass2	*2
24	Pipe Organ5		50	Pop Voice	*2	87	Hawaiian Gt.	*2	119	E.Bass1	*2
25	Pipe Organ3		51	Synth. Choir		88	Organ Harp	*2	119a	E.Bass3	*2
26	Pipe Organ6		52	Synth. Voice	*2	89	Fr.Horn Sect		120	E.Bass2	*2
27	Theater Or.1	*2	53	Space Voice		89a	Fr.HornSect2		120a	E.Bass4	*2
28	Theater Or.4	*2	54	Synth. Str.3		90	Synth. Brass	*2	121	Contrabass1	*2
29	Theater Or.2	*2	55	Synth. Flute		91	Sitar	*2	122	Contrabass2	
30	Theater Or.5	*2	56	Pizzicato	*2	91a	Kalimba	*2	123	Tuba	
31	Theater Or.3	*2	57	Piano1		92	Steel Drums		123a	Tuba2	*2
32	Theater Or.6	*2	57a	Piano3		93	Violin	*2	124	Synth. Bass1	
33	Full Organ7	*1	58	Honky-tonk		94	Cello	*2	125	Synth. Bass2	
34	Pipe Organ7		59	E.Piano1		95	Trumpet	*2	126	Bass+Cymbal	*2
34a	Gemshorn 8'		59a	E.Piano3		95a	Trumpet2	*2	126a	Ride Cymbal	
34b	Trompet 8'		60	E.Piano2		96	Mute Trumpet	*2	126b	Crush Cymbal	*2
34c	Hautbois 8'		61	Nylon-str.Gt	*2	96a	MuteTrumpet2	*2	126c	Tambourine	
34d	Viola 8'		61a	Nylon Gt 2	*2	97	Alto Sax	*2	126d	Woodblock	
34e	ViolaCeleste		62	Steel-str.Gt	*2	97a	Alto Sax2	*2	126e	Jingle Bell	*2
35	Theater Or.7	*2	63	Jazz Guitar	*2	98	Tenor Sax	*2	126f	Snare Drum	
35a	T.String 8'	*2	63a	Clean Guitar	*2	98a	Tenor Sax2	*2	126g	Bass Drum	
35b	VoxHumana8'	*2	63b	JC E.Guitar	*2	99	Flute	*2	127	Perc. Set1	
35c	T.Tuba 8'	*2	64	Overdrive Gt	*2	99a	Flute2	*2	127a	Timpani	
35d	T.Trumpet8'	*2	65	Tp. Section	*2	100	Pan Flute	*2	128	Perc. Set2	
35e	T.Sax 8'	*2	66	Sax. Section	*2	101	Oboe	*2	128a	Perc. Set3	*2

*1 Rotary: effective, Chorus: ineffective

*2 Vibrato: effective, Aftertouch: effective

Use a Rhythm (Music Style) from a disk

The AT-80 contains 51 types of built-in Rhythms, and additional Rhythms are available on the music style disk included and Optional disks available. Here's how to select a Rhythms from a disk.

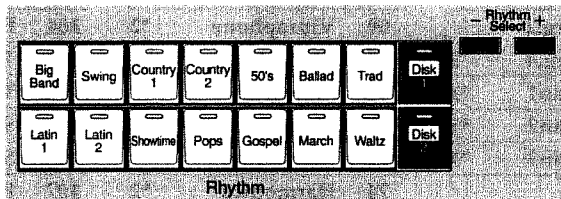

1. Insert the Music Style disk into the disk drive.
Be sure that you insert the disk in the correct direction with the label facing upwards.

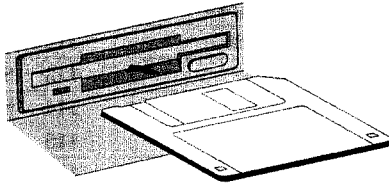

2. Press the Disk 1 or Disk 2 button (indicator lights).
3. Press a Rhythm Select button to select a Rhythm (indicator begins to flash).

```
Jazz Band
♩:124
```

While the Rhythm is being loaded into the memory, the Disk button indicator will flash. (A short time will be required for the Rhythm to be loaded.)

When loading has been completed, the Disk button indicator will light constantly, and the selected Rhythm will be available to play. Then follow the normal procedure (→p.24, 26) to play the Rhythm or automatic accompaniment.

- * Immediately after the power is turned on, even if the included disk is not inserted in the disk drive, you can press the Disk 1 button to play the Hawaiian Rhythm as included on the disk or Disk 2 button to play the Polka Rhythm as included on the disk. Refer to the "Music Style Disk Rhythm List (separate sheet)."
- * If a large amount of music data exists in the internal memory, the following message will appear, and it will not be possible to transfer Rhythm data from disk.

```
Clear Song Sure?
Yes:REC No:RST
```

If it is OK to erase the music data in memory, press the Rec button. If you do not wish to erase the data, press the Reset button to cancel the operation, and save the data to disk. (→p.46)

- * While recording, it will not be possible to transfer Rhythm data from the disk.

Use the Lower keyboard to play the drums

● Playing drums from the entire Lower keyboard (Manual Drums button)

You can use the Lower keyboard to play various drum sounds (drum set). In this case, the Lower voices will no longer sound.

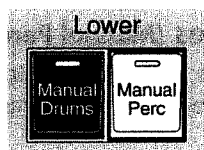

- ◇ Press the Manual Drums button (indicator lights).

Play the Lower keyboard and listen to the various drum sounds on each key.

Immediately after the power is turned on, the STANDARD drum set will sound.

The button will alternate between lit (on) and dark (off) each time it is pressed.

- * Refer to "Drum Set list" (→p.69) for details on which drum sound or Sound Effect will be played by each note.
- * It is not possible to select and play both Manual Drums and Manual Perc simultaneously.

○ Changing the Drum Set Type

You can select from eight Drum Sets and one set of Sound Effects.

STANDARD, ROOM, POWER, ELECTRONIC, TR-808, JAZZ, BRUSH, ORCHESTRA, SOUND EFFECTS

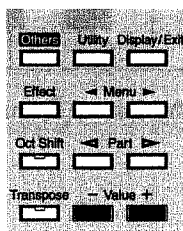
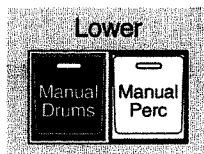

Let's try selecting a different Drum Set or the Sound Effect set.

1. Press the Manual Drums button (indicator lights).
2. When the Drum Set name is displayed on the screen, press the Value buttons (- or +).
The Manual Drums button indicator will begin to flash.

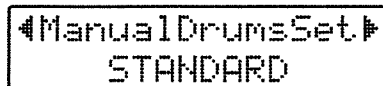

3. Press the Value buttons to select a Drum Set or the Sound Effect set.
4. Press the Manual Drums button once again.

The Manual Drums button indicator will be lit constantly, and the selected Drum Set Type will be applied.

- * To stop mid-way through the procedure, press the Display/Exit button.
- * The Drum Set Type can also be selected from the Utility menu. (→p.56)

● Playing drums together with the Lower Voices (Manual Perc button)

You can play various drum sounds and Sound Effects using the bottom 15 keys of the Lower keyboard. This is convenient when you wish to play the Lower voice as well as drum sounds or Sound Effects.

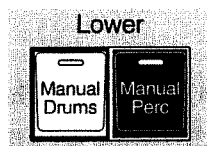

- ◇ Press the Manual Perc button (indicator lights).

The button will alternate between lit (on) and dark (off) each time it is pressed.

The notes will play different drum sounds or Sound Effects as follows:

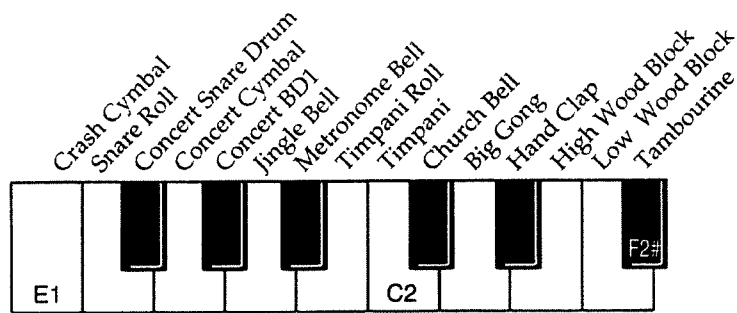

- * It is not possible to select both Manual Drums and Manual Perc simultaneously.

Add various effects to a voice

On the AT-80, a variety of effects (in addition to the rotary effect) can be added to a voice.

● Chorus effect

Chorus is an effect that adds expansiveness to a sound, making one instrument sound like several. The Chorus effect can be used on the four Parts: Upper Symphonic, Upper Orchestral, Lower Symphonic and Lower Orchestral. (There is a Chorus button for each Part.) Additionally, you can set Chorus to be ON/OFF for each Voice.

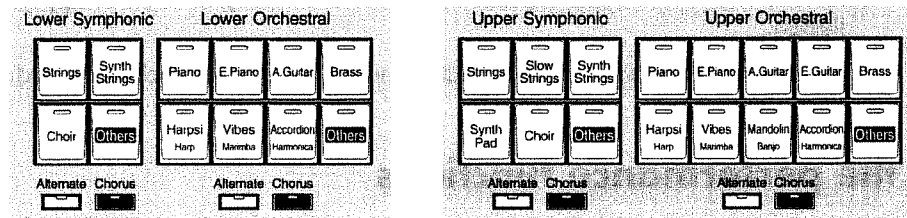

1. Select the Voice you wish the Chorus effect to be added.
 2. Press the Chorus button that corresponds to the Part of the selected Voice. (Confirm that the indicator lights.)
- * Chorus cannot be applied to voices no. 1–12, 15–20, 33 and 38–40 (→ p.29).
 - * These settings remain stored in memory even while the power is off.

● Reverb effect

Reverb is an effect that adds a sense of spaciousness to the sound, creating the sonic illusion of playing in a large/small concert hall, large/small room, small club, etc.

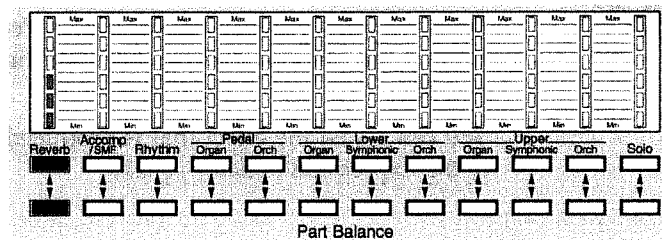

- ◇ Press the Reverb buttons (▲) (▼) to adjust the overall Reverb amount. When you press the up button (▲), more Reverb is applied. Pressing the down button (▼) decreases the Reverb level. If all the Reverb indicators are dark, the Reverb effect will not be added.
- * You can also select the type of Reverb you wish and the level for each Part. (→ p.52, 53)

● Sustain effect

Sustain allows you to add a sustain effect or decay to each voice after the key(s) are released. The Sustain effect can be added to the Upper (except the Solo Voice), Lower, and Pedal Bass Voices.

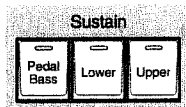

- ◇ Press the Sustain button for the keyboard to which you wish to apply Sustain (indicator lights).
- * The length of Sustain can be modified independently for each keyboard. (→p.53)

Try out the performance functions

Here's how to use the other performance functions.

● Adjusting overall volume using the Expression Pedal

When you depress the Expression Pedal, the volume increases. The volume decreases as you pull the pedal back up.

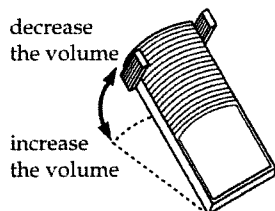

- * You can specify whether or not the Expression Pedal will affect the playback and what you play while Atelier music data is being played back. (→p.59).
- * The volume of musical data that has not been created on an Atelier, cannot be controlled from the Expression Pedal.
- * You can specify whether the Expression Pedal will or will not control the volume during the recording of music data. (→p.58).
- * You can adjust the effect that is produced by the activation of the Expression Pedal. (→p.57)

● Adding decay to the sound (Damper or Sustain pedal)

When you depress the pedal, the sustain effect will be applied to the Voices.

By default the sustain effect will be applied to the Voices played on the Lower keyboard.

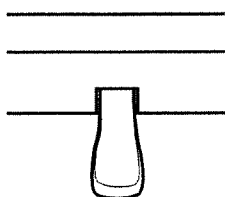

- * You can modify the setting so that sustain is applied to notes played on the Upper keyboard (→p.55)
- * No sustain will be added to Solo voices.
- * Sustain can not be applied to Bass voices played on the Lower keyboard (when the To Lower or Bass Split button indicators are lit). (→p.35)

● Using the Lower keyboard to play the Bass voice <1> (To Lower button)

This feature allows you to play the Bass part voice from the Lower keyboard.

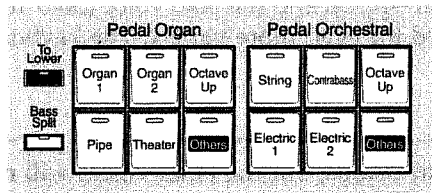

◇ In the Bass Part, press the To Lower button (indicator lights).

When you play C/E/G on the Lower keyboard, the C (bottom note) will also sound the Bass voice. In this way, the Bass voice will be sounded by the root note of the chord you play on the Lower keyboard.

- * If there is no Lower area in which the Lower voice sounds (e.g., if Solo To Lower is ON and the Solo Split Point is set to E1, etc.), the Bass voice will not sound.
- * It is not possible to select both To Lower and Bass Split simultaneously.

● Using the Lower keyboard to play the Bass voice <2> (Bass Split button)

This feature allows you to play the Bass part voice from the Lower keyboard in the area that extends to the left of C3, and includes C3 (C3 is referred to as the Bass Split Point).

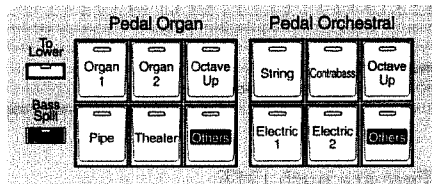

◇ Press the Bass Split button (indicator lights).

- * You can adjust the Bass Split Point. (→p.56)
- * It is not possible to select both To Lower and Bass Split simultaneously.

● Play the Solo voice on the Lower keyboard (To Lower button)

This feature allows you to play the Solo part voice from the Lower keyboard in the area that extends to the right of B4, and includes B4 (B4 is referred to as the Solo Split Point).

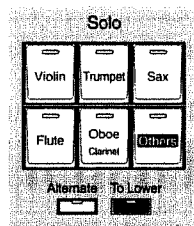

◇ In the Solo Part, press the To Lower button (indicator lights).

- * You can adjust the Solo Split Point. (→p.56)

● Effective ways to use the Lower keyboard

The Lower keyboard allows you to play Drums (Manual Drums→p.31, Manual Perc→p.32), the Bass voice (Bass Split→p.35), and the Solo voice (Solo To Lower→p.35) in various ways which can be combined for even more variety. The keyboard range of each voice is as follows.

When Manual Drums is ON

The entire keyboard can play Manual Drums, but the other voices will not sound regardless of their settings.

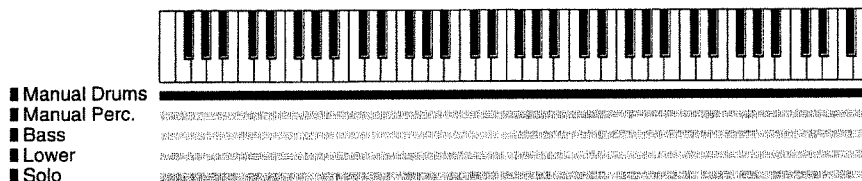

When Manual Drums is OFF and Manual Perc is ON.....

Manual Percussion can be played only by the lowest 15 notes (E1–F2#). The rest of the keyboard area will play the Bass/Lower/Solo voices as assigned by the Bass Split and Solo To Lower settings.

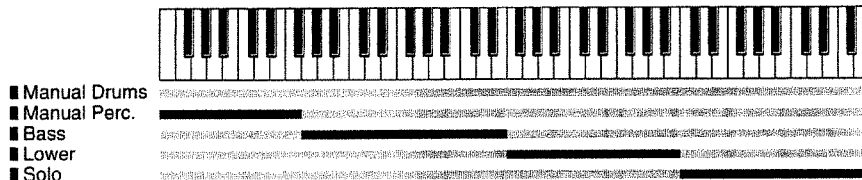

When Manual Drums and Manual Perc are both OFF.....

The entire keyboard can play the Bass/Lower/Solo voices as assigned by the Bass Split and Solo To Lower settings.

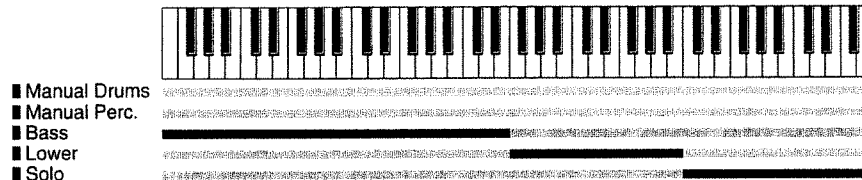

When Bass and Solo areas overlap.....

Depending on the settings of the Bass Split Point and the Solo Split Point, the Bass and Solo areas may overlap. In this case, both the Bass and the Solo voice will sound in the overlapping area, and there will be no area in which the Lower voice sounds.

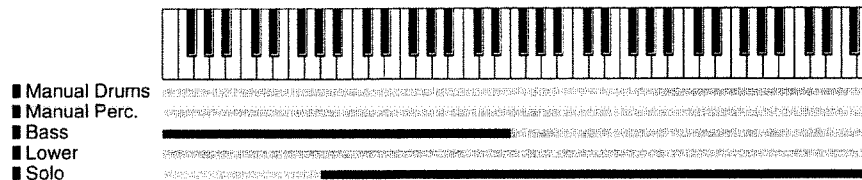

● Pitch Bend and Vibrato Effects

When you move the Pitch Bend/Vibrato lever to the left or right, you can obtain a smooth change in the pitch of the notes being played (pitch bend effect). Move the lever to the right to raise the pitch, and to the left to lower it.

Also, when you push the lever away from you, a vibrato effect can be obtained.

By default (immediately after the power is turned on) the pitch bend effect is added to the voices being played on the Upper keyboard.

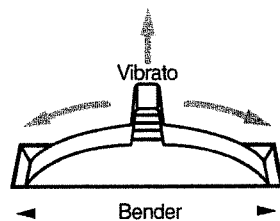

- * Please note that not all of the Voices will allow vibrato to be added. (→p.29)
- * You can change the settings so that the effect is applied to the Lower keyboard or Pedalboard. (→p.56)
- * You can also specify a different value for the maximum amount of change in the pitch that can be obtained. (→p.56)

● Adjusting the brightness of the sound (Brilliance)

◇ Use the Brilliance slider to make adjustments.

For a brighter sound, push the slider away from you. For a mellower sound, pull the slider toward you.

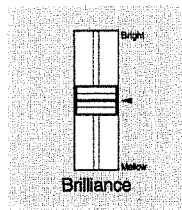

● Using the foot switches

The instrument is provided with two foot switches, one on each side of the Expression Pedal. Pushing the left switch with your foot will produce a 'glide' effect on the notes being played (the pitch is momentarily lowered). Releasing the switch will return the notes to their original pitch. You can also switch between Fast/Slow for the Rotary effect by pushing the right switch with your foot.

By default, (when the power is turned on), the Glide effect will be applied to the sounds being played by the Upper keyboard.

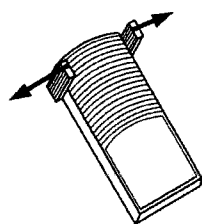

- * You can also change the functions assigned to the left and right switches. (→p.55)
- * The Glide effect will only be applied to the keyboard section that has been specified as being the destination for the Pitch bend/Vibrato lever. (→p.56)
- * If the Utility menu item Regist Shift is ON, the right foot switch will be dedicated to switching the registration. (→p.55)

Playing Rhythms (Music Styles) and automatic accompaniment

● Switching Automatic Accompaniment On/Off (Arranger On/Off button)

This setting allows you to choose (by switching the Arranger On/Off) whether or not you wish to add automatic accompaniment to a Rhythm performance.

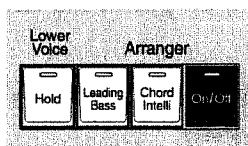

◇ Press the Arranger On/Off button (indicator lights).

Lit → ON : Rhythm performance + automatic accompaniment

Turned off → OFF : Rhythm performance only

* When the Arranger On/Off button is on, the Bass will be played by the automatic accompaniment (if a Bass voice is not selected).

● Using the Sync Start function (Sync Start button)

Sync Start is a function that will start the Rhythm and automatic accompaniment as soon as you play any key on the Lower keyboard.



◇ Press the Sync Start button (confirm that its indicator is lit).

Play the Lower keyboard.

If the Arranger On/Off button is on, the Rhythm and automatic accompaniment will begin to play.

If the Arranger On/Off button is off, only the Rhythm will sound.

* When the Arranger On/Off button is off, the Rhythm can also be started by playing a Bass pedal.

● Changing the Tempo (Tempo button)

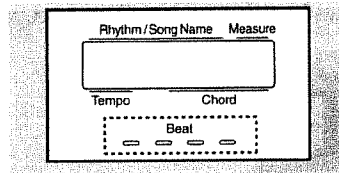
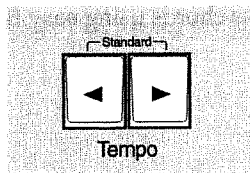

- ◇ Press the Tempo buttons to change the tempo of the Rhythm or automatic accompaniment. The tempo becomes faster when you press the [▶] Tempo button, and becomes slower when you press [◀].
The current Tempo value (30–250 beats per minute) can be checked in the display.

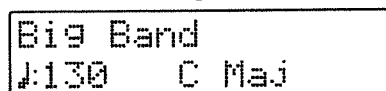

You can also check the tempo by viewing the Beat indicator. The indicator flashes red on the first beat, and green on the remaining beats.

- * By pressing the [◀] and [▶] Tempo buttons simultaneously, the tempo is returned to the standard (preset) tempo for the selected Rhythm.

● Selecting an Intro (Intro/Ending button)

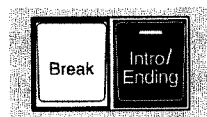

- ◇ Press the Intro/Ending button.
When Sync Start is selected, the button will begin flashing (indicating it is in standby mode). Then play a chord on the Lower keyboard, an Intro of the selected Rhythm/automatic accompaniment will be played and then continues into the Rhythm/automatic accompaniment.
When Sync Start is OFF, pressing the Intro/Ending button will start the Intro immediately and continue with the selected Rhythm (Music Style).
- * If the Arranger On/Off button is OFF, only the Rhythm will begin to play.
- * While the Intro of the Automatic Accompaniment is playing, no sounds can be played on the Lower keyboard.

● Selecting an Ending (Intro/Ending button)

- ◇ Press the Intro/Ending button while a Rhythm/automatic accompaniment (or only a Rhythm) is playing.
An Ending phrase will be inserted after the current measure is completed after which the Rhythm Automatic Accompaniment playback will stop automatically.
- * While the Ending of the Automatic Accompaniment is playing, no sounds can be played on the Lower keyboard.
- * You can assign the Intro/Ending button functions to either of the foot switches located at each side of the Expression Pedal. (→p.55)

● Using easy fingering to play chords (Chord Intelli button)

On the Lower keyboard, you can play six representative chords using easy fingering.

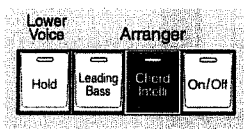

- ◇ Press the Chord Intelli button (confirm that its indicator is lit).

The types of chords that can be used with the Chord Intelligence function, and the notes that should be used, are as follows.

Chord Intelligence : ON

Maj	Maj 7	7th	Min	Min 7	Dim
C	B/C	B _b /C	C/E _b	B _b /C/E _b	C/F#
C#	C/C#	B/C#	C#/E	B/C#/E	C#/G
D	C#/D	C/D	D/F	C/D/F	D/A _b
E _b	D/E _b	C#/E _b	E _b /F#	C#/E _b /F#	E _b /A
E	E _b /E	D/E	E/G	D/E/G	E/B _b
F	E/F	E _b /F	F/A _b	E _b /F/A _b	F/B
F#	F/F#	E/F#	F#/A	E/F#/A	F#/C
G	F#/G	F/G	G/B _b	F/G/B _b	G/C#
A _b	G/A _b	F#/A _b	A _b /B	F#/A _b /B	A _b /D
A	A _b /A	G/A	A/C	G/A/C	A/E _b
B _b	A/B _b	A _b /B _b	B _b /C#	A _b /B _b /C#	B _b /E
B	B _b /B	A/B	B/D	A/B/D	B/F

● Leading Bass function (Leading Bass button)

When automatic accompaniment is used, and the To Lower switch for the Pedal Bass Part is ON, the Bass will normally play the root of the chord you play on the Lower keyboard. If the Leading Bass function is enabled, the lowest note of the chord you play on the Lower keyboard will be used as the bass note. This allows the bass to be a note other than the root of the chord you play and the bass note will change when inverted chords are played.

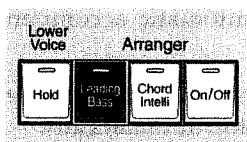

- ◇ Press the Leading Bass button (confirm that the indicator is lit).

* You can assign the Leading Bass button functions to either of the foot switches located on each side of the Expression Pedal. (→p.55)

● Sustaining notes played on the Lower keyboard (Lower Voice Hold button)

When Lower Voice Hold is ON, the note(s) played on the Lower keyboard will continue to sound until you play the next note(s) — even if you release the keys you have played.

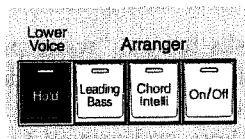

- ◇ Press the Lower Voice Hold button (confirm that the indicator is lit).

Recalling panel settings appropriate for a Rhythm (Music Style)

For each of the Rhythms (Music Styles) built into the AT-80, there are four types of panel settings appropriate for use with that Rhythm (Music Style), and these can be stored into Registration buttons 1–4.

- * If this is done, the Registrations that were previously in Registration buttons 1–4 will be lost. If you wish to retain them, use the procedure explained on page 49 to save them to floppy disk.

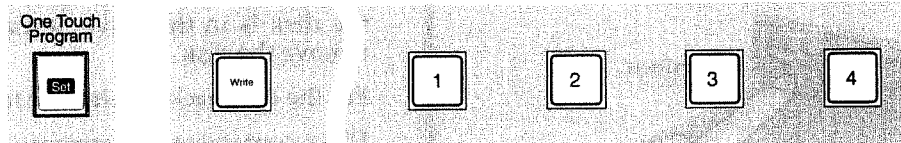

1. Select a Rhythm (Music Style). (→p.25)
2. While holding the Registration Write button, press the One Touch Program button.

To use the panel settings that were recalled, press one of the Registration buttons 1–4. (→p.27)

Recording/Playing Back Performances

About Floppy Disks

● Handling the Disk Drive

Avoid using the unit immediately after it has been moved to a location with a level of humidity that is greatly different than its former location. Rapid changes in the environment can cause condensation to form inside the drive, which will adversely affect the operation of the drive and/or damage floppy disks. When the unit has been moved, allow it to become accustomed to the new environment (allow a few hours) before operating it.

To insert a disk, push it gently but firmly into the drive—it will click into place. To remove a disk, press the EJECT button firmly. Do not use excessive force to remove a disk which is lodged in the drive.

To prevent damage to the disk drive's heads, always try to hold the floppy disk in a level position (not tilted in any direction) while inserting it into the drive. Push it in firmly, but gently. Never use excessive force.

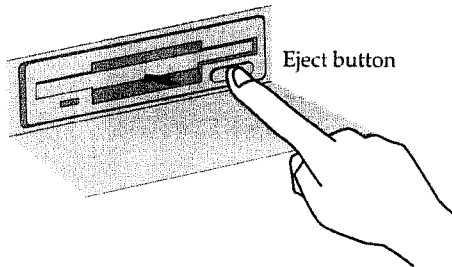

Never attempt to remove a floppy disk from the drive while the drive is operating (the indicator is lit); damage could result to both the disk and the drive.

Remove any disk from the drive before powering up or down.

● Handling floppy disks

Floppy disks contain a plastic disk with a thin coating of magnetic storage medium. Microscopic precision is required to enable storage of large amounts of data on such a small surface area. To preserve their integrity, please observe the following when handling floppy disks:

- Never touch the magnetic medium inside the disk.
- Do not use or store floppy disks in dirty or dusty areas.

- Do not subject floppy disks to temperature extremes (e.g., direct sunlight in an enclosed vehicle). Recommended temperature range: 10 to 50° C (50 to 122° F).
- Do not expose floppy disks to strong magnetic fields, such as those generated by loudspeakers.

Floppy disks have a "write protect" tab which can protect the disk from accidental erasure. It is recommended that the tab be kept in the PROTECT position, and moved to the WRITE position only when you wish to write new data onto the disk.

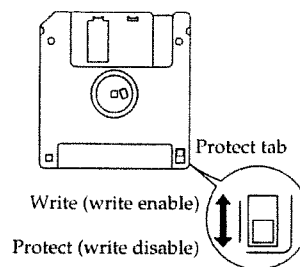

The identification label should be firmly affixed to the disk. Should the label come loose while the disk is in the drive, it may be difficult to remove the disk.

Put the disk back into its case for storage.

Disks containing performance data for this unit should always be locked (have their write protect tab slid to the "Protect" position) before you insert them into the drive on some other unit (except the PR-300, or a product in the HP-G, MT, KR, or Atelier families), or into a computer's drive. Otherwise (if the write protect tab remains in the "Write" position), when you perform any disk operations using the other device's disk drive (such as checking the contents of the disk, or loading data), you risk rendering the disk unreadable by this unit's disk drive.

● Formatting disks

Before any disk (new or used) can be used with the AT-80 it must first be formatted (prepared).

- * Formatting a disk will erase any data that may have been stored on it. Carefully check any previously used disk to be sure it doesn't contain any valuable data.

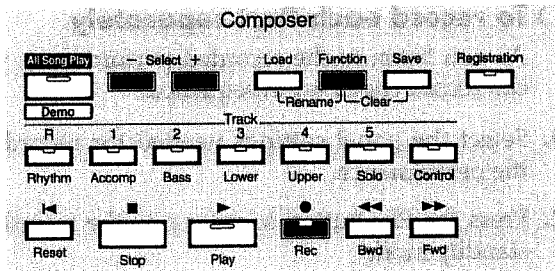

1. Slide the protect tab on the disk to the "Write" position.

Insert the disk into the disk drive (label side up, shutter facing forward).

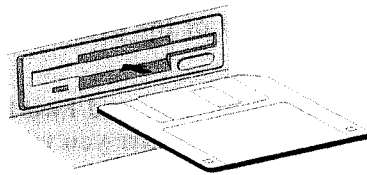
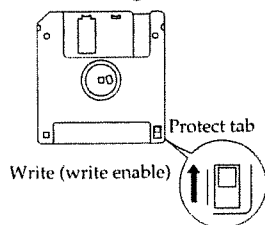

- * Please don't insert the disk into the gap between the cabinet lid.

2. Press the Function button.
3. Use the Select buttons to select "Disk Utility," and press the Rec button.

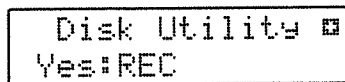

4. Use the Select buttons to select "Format Disk," and press the Rec button.

The following message, asking you to confirm, will be displayed.

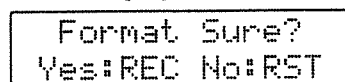

5. Press the Rec button again to perform the Format.
- When formatting is completed, the basic screen will reappear.

To cancel the procedure, press the Reset button.

Record and playback your playing

The AT-80's Composer allows you to record (in digital form) what is played on the instrument.

● Recording performances (Rec button)

The Composer operates like a tape recorder with the capability of recording seven separate tracks. You can record different kinds of performance data into each track:

Rhythm : Rhythm performances, Manual Drums, Sound Effects

Accomp : Automatic accompaniment (except Bass)

Bass : Pedal Bass Voice, Bass part of the automatic accompaniment

Lower : Lower Voice

Upper : Upper Voice

Solo : Solo Voice

Control : Panel operations, Expression Pedal operations

- * Manual Percussion cannot be recorded.

- * Be aware that if the Function menu Exp.Source setting Recording is set to COMPOSER, the Expression Pedal will not function, nor will its movements be recorded. (→p.58)

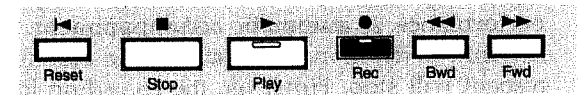

○ Recording for the first time

1. Select the panel settings needed for recording the performance.

2. Enter the recording standby mode by pressing the Rec button.

The Rec indicator is lit. The Play and all track indicators flash.

3. Press the Play button to start recording.

When you press the Play button, the metronome will play two measures of count-in before recording begins.

In the Rhythm and automatic accompaniment mode, recording begins the moment you start the Rhythm.

4. Press the Stop button when you have completed your recording.

The Track indicator where the performance data is recorded will change from a flashing to a constant light.

If you press the Reset button instead of the Stop button, the unit resets (returns) to the beginning of the data just recorded.

- * The Play and Stop functions can both be assigned to one of the foot switches located on each side of the Expression Pedal. Each depression of the switch will alternate the operation between the Play and Stop functions. (→p.55)
- * If you press the Rec button when a song has been selected from the disk (→p.46), the selected music data will be loaded into the AT-80 and the Composer will enter into the recording standby mode. If you wish to record a new song, use the Select buttons to first select "NEW SONG" before pressing the Rec button. Alternatively, eject the disk from the disk drive before pressing the Rec button.

```
NEW SONG      :  
#120
```

- * When you press the Intro/Ending button (or Start/Stop button) while recording a Rhythm performance or automatic accompaniment, the Rhythm performance and automatic accompaniment will stop. However, the recording itself will continue. Press the Stop button (or Reset button) to stop recording.
- * In the following instances, a message will be displayed:

When the instrument's memory is nearing capacity.

```
Internal Memory  
Near Limit
```

When recording was canceled because the memory limit was reached.

```
Internal Memory  
is Full.
```

- * You can also choose to cancel the metronome count-in before recording starts. (→p.58)

○ To record each Part separately

As you listen to the recorded performance, you can record each Part in sequence.

1. Select the panel settings needed for recording the performance.
2. Press the Rec button to enter into the recording standby mode.
The light indicators on the Tracks that are available for recording will flash. Constant lights will identify the Tracks that contain recorded data (with the exception of the Control Track). On these Tracks, performance data cannot be recorded.
3. Press the Play button to start recording.
As you listen to the performance data previously recorded, record the data into a new Track.
4. Press Stop when your recording is completed.

○ To re-record

You can re-record a part of the performance data previously recorded.

1. Use the Reset button or the Bwd and Fwd buttons to move to the measure where you wish to start re-recording.
2. Select the desired panel settings for your performance.
3. Press the Rec button to enter into the recording standby mode.
4. Press the button of the Track where you wish to record and confirm that its indicator light is flashing.

The data of the specified Track (with the exception of the Control Track) will be erased as new data is recorded.

When the indicator of a Track is lit constantly, no data will be recorded on that Track.

For the control track, data will be handled as follows.

Panel operations:

The new data will be added to the previously-recorded data.

Expression Pedal operations:

After the power is turned on, the previous data will be erased as recording proceeds.

5. Press the Play button to start recording.
 6. Press Stop when your recording is completed.
- * If you wish to keep the existing Expression Pedal data, and record only the panel operations, you can make settings to prevent the operation of the Expression Pedal from being recorded. (→p.58)

● Erasing performance data (Clear)

The following procedure will erase your performance data and clear the Tracks for a new recording.

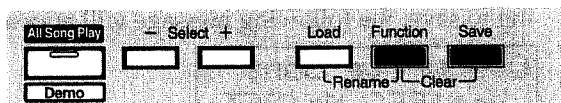

1. Press the Function and Save buttons simultaneously. The following message, asking you to confirm your choice, will be displayed.

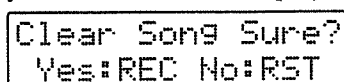

2. If you are sure that you wish to erase the song, press the Rec button. To cancel the procedure, press the Reset button.

● Playing back performance data (Play button)



1. Press the Reset button to return to the beginning of the first measure. When you wish to play performance data from a specific point, use the Bwd and Fwd buttons to select the desired measure.
 2. Press the Play button to start playback.
 3. To stop playback at any point, press the Stop button. If you press the Reset button instead of the Stop button, the unit resets (returns) to the beginning of the data.
- * The Play and Stop functions can both be assigned to one of the foot switches located on each side of the Expression Pedal. Each depression of the switch will alternate the operation between the Play and Stop functions. (→p.55)

- * You can specify whether or not the Expression Pedal will affect the playback and what you play while Atelier music data is being played back. (→p.59)
- * If you press the Play button while holding down the Stop button, the metronome will play two measures of count-in before playback starts.
- * If you use the Rhythm or automatic accompaniment immediately after having loaded and played back music data other than Atelier music data, such as SMF's, etc. (→p.46), the playback may not sound right (the voices may have changed, etc.) To prevent this from happening, press the Reset button before playback.
- * When music data other than Atelier music data (i.e., SMF music data, etc.) is loaded (→p.46) and played back, the Expression Pedal will have no effect on the playback volume.

○ Silencing a specific track (Track mute)

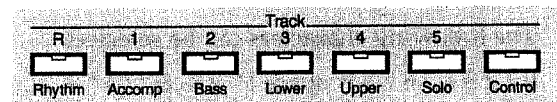

- ◇ Press the Track button that is lit and the indicator will go out.

That Track has now been muted and will not be heard if the data is played back. Press the Track button again and that Track will be heard during playback. If all the Track indicators are turned off, no sound will be heard during playback.

● Saving performance data (Save button)

The performance data that you record will be lost the instant you turn off the instrument. If you wish to preserve your performance data, you need to save it onto a disk.

If performance data has never been saved onto the disk, a " " symbol appears in the display. (This symbol disappears once you have saved the data on disk.)

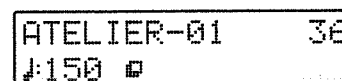

○ Changing the name of performance data (Rename)

A name is automatically assigned to the performance data that you record. However, at some point you may wish to change the name to something more meaningful.

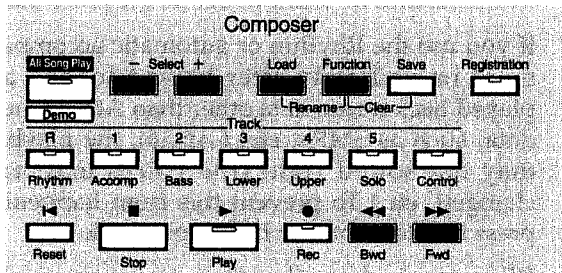

1. Press the Load and Function buttons simultaneously.
2. Using the Select buttons to move the cursor, select the character that you wish to change (characters will flash). Then use the Bwd/Fwd buttons to change the selected character.

The following characters can be selected.

0 1 2 3 4 5 6 7 8 9 space ! " # % & ' () * + , - . / : ;
 = ? ^ _ A B C D E F G H I J K L M N O P Q R S T
 U V W X Y Z a b c d e f g h i j k l m n o p q r s t u
 v w x y z

To delete a character, press the Reset button. A space can be inserted by pressing the Rec button.

3. To enter the new name, simultaneously press the Load and Function buttons once again.
- * You cannot directly change or edit the name of performance data stored on a disk. The data must first be loaded into the instrument, edited, and then saved to disk again.
 - * It is not possible to save during the Rename procedure. If you press the Save button during the Rename procedure, the following message will appear.

```
Can't Save
while Renaming.
```

○ Saving onto disk (Save button)

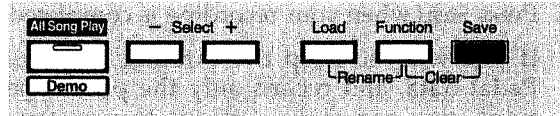

1. Insert a disk formatted on the AT-80 into the disk drive.
 2. Press the Save button to perform the save.
- * When the disk already contains performance data with the same name as the data you're trying to save, the following message will appear.

```
Overwrite Song ?
Yes:REC No:RST
```

If you are just updating that data, and want to overwrite it, press the Rec button. If, however, you wish to save the new data separately, press the Reset button to cancel the procedure, change the name of the new data, and then save it.

● Loading performance data into the AT-80 (Load button)

To edit (→p.59) or re-record performance data that is on disk, you must first load that data into the instrument.

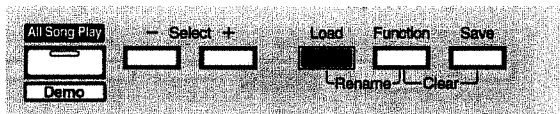

1. Insert the correct disk into the disk drive.
 2. Press the Select buttons to select the performance data you wish to load.
- * The message below is shown when the performance data in the unit has not been saved to disk. If you don't mind erasing it, press the Rec button. If you wish to save this data, press the Reset button to cancel the procedure, and then save the data on disk. (→p.46)

```
Clear Song Sure?
Yes:REC No:RST
```

3. Press the Load button (or Rec button) to carry out the load operation.

When you press the Rec button, after the data is loaded, the AT-80 goes into the recording standby mode.

- * If you load music data other than Atelier music data (SMF music data, etc.), the Rhythm (drum) data will be loaded into the Rhythm track, and the other data will be loaded into the Accomp track.
- * If loading is canceled because the memory limit has been reached, the following message will be displayed:

```
Internal Memory
is Full.
```

● Playing back performance data on disk (All Song Play button and Play button)

In addition to playing back the music you recorded on the instrument and saved to disk, AT-80 also lets you enjoy a wide variety of commercially available music data, such as defined below.

SMF Music Data

- * The Standard MIDI File format was designed to provide a means for exchanging performance data among a wide variety of devices. In addition to the music data described earlier, the AT-80 is also capable of playing back any Standard MIDI Files compatible with GM or GS formats.
- * When the performance data is a Standard MIDI File, "※" will be displayed after the file name.

```
My Song      ※:05
♩:180
```

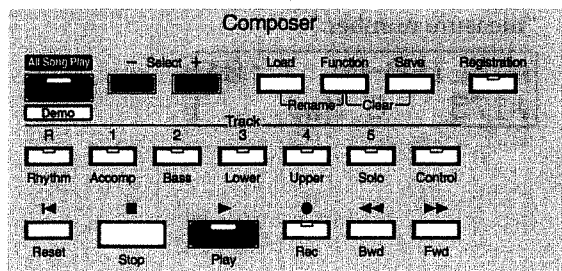

1. Insert the correct disk into the disk drive.

2. When you wish to play back all the performance data in order, press the All Song Play button. When you only wish to play back one song, use the Select buttons to select the song and press the Play button.

- * To play back performance data from a disk, any data that may already be in the AT-80 must first be erased. The message below appears when there is some performance data already in the instrument that has not been saved on disk. If you don't mind erasing it, press the Rec button. If you do not want to lose this data, press the Reset button to cancel the procedure, and then save the data on disk. (→p.46)

```
Clear Song Sure?
Yes:REC No:RST
```

3. To stop playback, press the Stop button (or Reset button).

- * When the All Song Play button is used to start playback, pressing the same button again will also stop the playback.

- * The Play and Stop functions can both be assigned to one of the foot switches on the Expression Pedal. Each depression of the switch will alternate the operation between the Play and Stop functions. (→p.55)

- * You can specify whether or not the Expression Pedal will affect the playback and what you play while Atelier music data is being played back. (→p.59)

- * The Expression Pedal will not control the playback volume of music data which is not specifically created for the Atelier.

- * By holding down the Stop button when you press the Play button, you can have the metronome sound two measures of count-in before playback starts.

- * When "Please Wait" is shown in the display, it means the unit is searching for performance data. Please wait until the message disappears.

```
My Song      ※123
Please Wait.
```

● Erasing performance data on a disk

Follow the steps below to erase performance data that was saved on a disk.

1. Insert the disk into the disk drive.
2. Press the Function button.
3. Press the Select buttons to select "Disk Utility," and press the Rec button.

```
Disk Utility ▣
Yes:REC
```

4. Press the Select buttons to select "Delete Song," and press the Rec button.

```
▣ Delete Song
Yes:REC No:RST
```

5. Using the Bwd/Fwd buttons, select the performance data to be erased.
6. Press the Rec button.

You will see the following:

```
ATELIER-01 :01
Del Sure?REC/RST
```

7. To go ahead with the erasure, press the Rec button again.

When erasing is completed, the basic screen will reappear.

To cancel the procedure, press the Reset button.

● Display basic screens (Display/Exit button)

The instrument's display provides a large variety of information. Of importance are the two "basic screens." You can alternate from one to the other by pressing the Display/Exit button. If another screen is displayed, pressing the Display/Exit button will always recall to the display one of the basic screens.

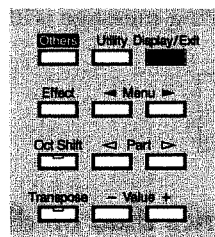

The following information is displayed on the basic screens:

Rhythm Screen:

Upper line : Rhythm Name

Lower line : Tempo/Name of Chord Played

```
Big Band
♩:130 C Maj
```

Composer Screen:

Upper line : Song Name/Measure Number

Lower line : Tempo/Name of Chord Played

```
ATELIER-01 123
♩:175 C Maj
```

When you have selected performance data on disk, the "file number" is shown in place of the "measure number."

```
ATELIER-01 :01
♩:175 C Maj
```

Saving/Loading A Set Of Registrations To/From A Disk

Saving a registration set (Save button)

You may record the AT-80 panel settings into each of the 12 Registration buttons. A registration set contains the registrations saved in all 12 Registration buttons, and up to 99 of such sets can be saved onto a floppy disk.

● Assigning a name to a registration set

When saving registration settings, names of REGIST-01-99 will be assigned by default, but you can assign a name that will help you later to identify the contents of the registration set.

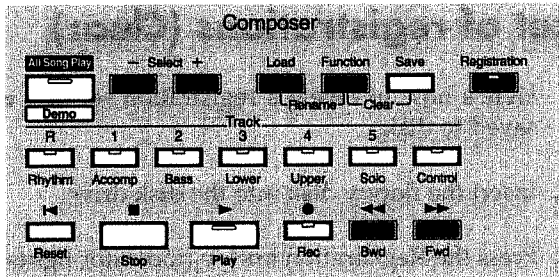

1. Make sure that the disk drive contains a disk that was formatted by the AT-80.
2. Press the Registration button (indicator lights).
3. Press the Load button and the Function button simultaneously.
4. Use the Select buttons to move the cursor, and use the Bwd/Fwd buttons to select a character.

The following characters can be selected.

0 1 2 3 4 5 6 7 8 9 space ! " # % & ' () * + , - . / : ;
= ? ^ _ A B C D E F G H I J K L M N O P Q R S T
U V W X Y Z a b c d e f g h i j k l m n o p q r s t u
v w x y z

You can also use the Reset button to delete a character, and the Rec button to insert a space.

5. When you have finished assigning the name, simultaneously press the Load button and the Function button once again.

The registration set in the AT-80's internal memory has now been named.

```
REGIST-01  ---
Mem:My Regist
```

- * It is not possible to save during the process of assigning a name. If you press the Save button during this process, the following message will appear.

```
Can't Save
while Renaming.
```

● Saving to disk (Save button)

1. Make sure that the disk drive contains a disk that was formatted by the AT-80.
2. If the Registration button indicator is not lit, press the Registration button to make the indicator light.
3. Use the Select buttons to select the number that you wish to save to.

Numbers which have not been used in the Saving operation will be displayed as "----".

```
REGIST-01  ----
Mem:
```

4. Press the Save button to execute the save operation.

When saving is completed, the basic screen will reappear.

To cancel the operation, press the Registration button.

When the data is saved to floppy disk, the indication of "----" will change to "USE".

If you have assigned a name, the data will be saved to floppy disk with that name.

```
My Regist  USE
Mem:My Regist
```

- * If you press the Save button for a registration number with the "USE" indication, the following message will appear:

```
OverwriteRegist?
Yes:REC No:RST
```

To change the contents of an existing registration set, press the Rec button. To save a new registration set, press the Reset button to cancel the procedure, use the Select buttons to select a number for which "----" is displayed, and then save the data.

Loading a previously saved registration set (Load button)

Here's how to recall a previously saved registration set from disk into the memory of the AT-80.

- * Be aware that when you load registrations from a disk, the registrations that were previously in internal memory will be lost.

● Loading a set of registrations

Once the registrations are saved to disk, they can be loaded back into the instrument.

1. Insert the floppy disk into the disk drive.
2. Press the Registration button (indicator lights).
3. Use the Select buttons to select the registration set that you wish to load.
4. Press the Load button to execute loading.

When loading is complete, the basic screen will reappear.

To cancel the procedure, press the Registration button.

● Loading an individual registration

You can load any desired individual registration to any desired button.

1. Follow the procedure "Loading a set of registrations" through step 3.
2. Press the Function button.
3. Specify the registration to be loaded and the loading destination. Use the Bwd/Fwd buttons to specify the numerical value, and use the Rec/Reset buttons to select setting pages.

The following items can be set.

from : Button number of the registration to be loaded

to : Button number of the loading destination

For example if you wish to load the registration of button 2 to button 5, specify "from:2 to:5."

After specifying the "to" setting, press the Rec button and the following display will appear.

```
Load Sure?  
Yes:REC No:RST
```

4. To execute the load operation, press the Rec button once again.

When the data has been loaded, the basic screen will reappear.

To cancel the operation, press the Reset button.

Deleting a previously saved set of registrations (Clear)

Here's how to delete a registration set that was saved to disk.

1. Insert the floppy disk into the disk drive.
2. Press the Registration button (indicator lights).
3. Use the Select buttons to select the registration set that you wish to delete.
4. Simultaneously press the Function button and the Save button.

The following display will appear.

```
Delete Regist?  
Yes:REC No:RST
```

5. If you are sure that you wish to delete the data, press the Rec button.

When the data has been deleted, the basic screen will reappear.

To cancel the operation, press the Reset button.

When a registration set has been deleted, the indication of "USE" will change to "--". If you had assigned a name to the set you deleted, the name will revert back to REGIST-XX.

Other Kinds of Settings

Adjust the volume balance (Part Balance buttons)

The instrument allows you to adjust the volume balance individually for each Part.

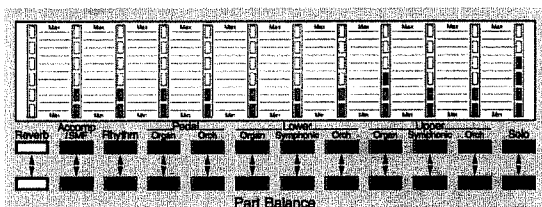

- ✧ The various volume levels are adjusted using the corresponding buttons.

When you press the up button (▲), the volume increases; when you press the down button (▼), the volume decreases.

Note however, that the following buttons are used to adjust the volume of a multiple number of Parts.

Accomp/SMF button:

Automatic accompaniment (except bass)
Playback of performance data from something other than the Atelier

Rhythm button:

- When Manual Perc is ON
Manual Percussion
- When Manual Perc is OFF
Rhythm performance, Manual Drums, Sound Effects

Pedal Organ button:

Pedal Organ, Bass part of automatic accompaniment

Transpose the pitch in octave units (Oct Shift button)

Octave Shift is a function that allows you to alter the pitch of what is played by one or more octaves.

You can apply an Octave shift to a total of nine Parts; all the Upper and Lower Parts (Organ/Symphonic/Orchestral), all the Bass Parts (Organ/Orchestral), and the Solo Part.

For example in the Upper or Lower keyboards, you might select the same voice for two parts but shift them 1 octave apart to create a richer sounding voice. This function can also be used to play voices in a range that the keyboard would not normally reach.

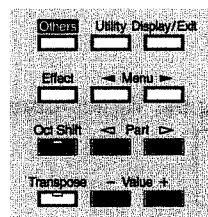

1. Press the Oct Shift button.
2. Press the Part buttons to select a performance Part to which you wish to apply an Octave Shift.

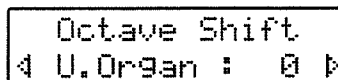

3. Use the Value buttons to set the amount of shift.
The value can be set within the range of +/- 2 octaves.

Press the Oct Shift button or the Display/Exit button to return to the basic screen.

When any Part is set to any value other than 0, the Oct Shift button indicator will light.

- * When the Pedal Bass Octave Up button is turned on, the Octave Shift setting for each pedal bass part (Organ/Orchestral) will automatically be set to "0." When the button is turned off, the setting will automatically be set to "-1." (→p.19)
- * Please note that when you apply Octave Shifts to certain Voices, their pitch could be stretched beyond their recommended note ranges, and they may not sound as expected.

Transpose to a different key (Transpose button)

This function allows you to transpose the keyboard to another key in semitone steps. You may play in the familiar C major scale while your music will sound in any key of your choice.

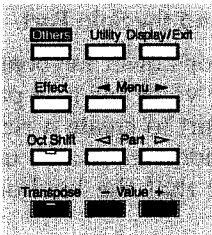

1. Press the Transpose button.
2. Set the transpose value using the Value buttons.



Acceptable values range from A flat to G (in semitone steps).

Press the Transpose button or the Display/Exit button to return to the basic screen.

If the transpose function is set to any key other than C, the Transpose button indicator will be lit.

- * By pressing the + and - Value buttons simultaneously, you can restore the default setting (C).

Make fine adjustments to the effect of a voice (Effect button)

You can customize the Reverb, Sustain and Rotary effects by adjusting their values. The effects values are available for editing in the following five menus:

- Reverb Type
- Reverb Depth
- Sustain Length
- Rotary Speed
- Rotary Color

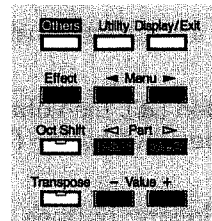

1. Press the Effect button.
2. Press the Menu buttons to select a menu.
3. When adjusting Reverb Depth or Sustain Length, press the Part buttons to select the part or keyboard.
4. Use the Value buttons to set the desired value.

Press the Effect button or the Display/Exit button to return to the basic screen.

● Reverb Type

You can select from the following eight types of reverb:

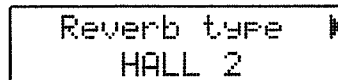

- ROOM 1 : Reverberation of a small room
- ROOM 2 : Reverberation of a small club
- ROOM 3 : Reverberation of a large room
- HALL 1 : Reverberation of a large concert hall
- HALL 2 : Reverberation of a small concert hall
- PLATE : A bright, metallic Reverberation
- DELAY : An echo-like sound repeated several times
- PAN DELAY : A delay which pans the sound back and forth between the left and right speakers

● Reverb Depth

The depth of the reverb can be set (0-10) for the following 14 Parts. You can make independent settings for each Part.

Accomp, Rhythm, Manual Drums, Manual Percussion, Accomp Bass, Pedal Organ, Pedal Orchestral, Lower Organ, Lower Symphonic, Lower Orchestral, Upper Organ, Upper Symphonic, Upper Orchestral, Solo

For the three Parts of Accomp, Rhythm, and Accomp Bass, you have the option of selecting the AUTO setting. Parts for which AUTO is selected will be set to the Reverb Depth that is most suitable for the currently selected Rhythm.

```
◀ Reverb Depth ▶  
◀ U.Organ : 8 ▶
```

Accomp refers to automatic accompaniment (except Bass); while Accomp Bass is the bass for an automatic accompaniment.

● Sustain Length

The sustain length can be set independently (SHORT, MIDDLE or LONG) for the Upper and Lower keyboards and Bass pedals. You can make a separate setting for each keyboard.

```
◀ Sustain Length  
Upper : LONG ▶
```

Upper, Lower, Pedal Bass

● Rotary Speed

This setting allows you to finely adjust the speed of the Rotary effect. You can select from the three available speeds (SLOW, NORMAL, FAST).

```
◀ Rotary Speed ▶  
NORMAL
```

* This setting remains stored in memory even while power is turned off.

● Rotary Color

This setting allows you to choose the brightness of the Rotary sound (BRIGHT, MELLOW) obtained when using the Rotary effect.

```
◀ Rotary Color  
MELLOW
```

* This setting remains stored in memory even while power is turned off.

Various other settings (Utility button)

You can make settings for the following 20 items (menus).

Aftertouch (Aftertouch ON/OFF)

Aftertouch Sens (Aftertouch Sensitivity)

Initial Touch (Initial Touch ON/OFF)

Pedal Bass Mode

(How the Bass pedals can be played)

Register Shift

(Use the right foot switch to switch registrations)

Left Foot Switch Assignment

(Selects function for left foot switch)

Right Foot Switch Assignment

(Selects function for right foot switch)

Damper Pedal Assignment

Bender/Vibrato Destination

Pitch Bend Range

Manual Drums Set

Harmony Intelligence Type

Solo Split Point

Bass Split Point

Chord Hold (Chord Hold ON/OFF)

Registration Arranger Update

(Registration recall timing)

Expression Curve

(The depth of the Expression Pedal effect)

Tx MIDI Channel (MIDI output channel)

Master Tune

LCD Contrast

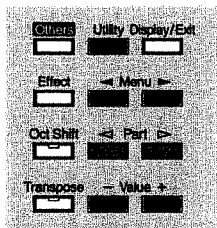

1. Press the Utility button.
2. Press the Menu buttons to select a menu.

3. For Initial Touch or Tx MIDI Channel, press a Part button to select the keyboard or part.

4. Use the Value buttons to set the desired value.

Press the Utility button or the Display/Exit button to return to the basic screen.

● Aftertouch (Aftertouch ON/OFF)

This setting is used to turn ON/OFF the Aftertouch feature. (Aftertouch applies vibrato when additional pressure is placed on keys that are being played.)

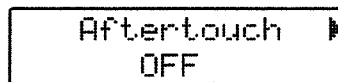

* Aftertouch can be obtained only from the Upper keyboard.

* Please note that not all the Voices are responsive to Aftertouch, even if it is set to ON.(→p.29)

● Aftertouch Sens (Aftertouch Sensitivity)

This adjusts the depth of the Aftertouch effect. (Setting: 1-10)

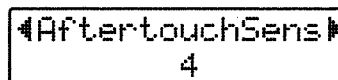

Higher settings of this value will allow deeper vibrato to be applied when you apply pressure to the keyboard.

* This setting remains stored in memory even while power is turned off.

● Initial Touch (Initial Touch ON/OFF)

Initial Touch is a function that translates the force used in playing the keys into a directly proportional amount of volume. It can be switched on/off independently for the Upper and Lower keyboards.

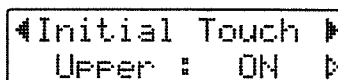

ON: The harder you play, the higher the volume.

OFF: Volume remains constant regardless of how hard you play.

● Pedal Bass Mode (How the Bass Pedals can be played)

You can set the Bass Pedals to play simultaneous multiple notes or single notes only.

```
◀ PedalBass Mode ▶  
MONOPHONIC
```

MONOPHONIC:

Only single notes can be played.

POLYPHONIC:

Multiple notes can be played.

● Regist Shift (Use the right foot switch to switch registrations)

You can use the right foot switch as a dedicated switch for switching registrations.

```
◀ Regist Shift ▶  
OFF
```

If Regist Shift is turned ON, each time you press the right foot switch, the registrations will be switched in the following order: 1 → 2 → 3 → ... → 12 → 1 → ...

- * This setting is remembered even when the power is turned off.

● Left / Right Foot Switch Assignment

You can select any of the following functions and assign them to either foot switch on the right or left side of the Expression Pedal.

```
◀ Left Foot Sw ▶  
GLIDE
```

```
◀ Right Foot Sw ▶  
ROTARY FAST/SLOW
```

- * You cannot assign the same function to both the left and right switches.
- * If the Utility menu Regist Shift setting is ON, the right foot switch will be dedicated to switching the registration, and the Right Foot Switch Assignment setting will be ignored.

ROTARY FAST/SLOW

GLIDE

LEADING BASS

RHYTHM START/STOP

COMPOSER PLAY/STOP

INTRO/ENDING

FILL IN TO VARIATION

FILL IN TO ORIGINAL

ADVANCED/BASIC

DAMPER OF UPPER

GLIDE: Upon depressing the foot switch this feature lowers the pitch. When the switch is released the sound will gradually return to its original pitch.

LEADING BASS: The Leading Bass function will be active only while you are pressing the switch.

COMPOSER PLAY/STOP: The switch will serve as a Play/Stop button for the Composer.

Performance data will either start or stop playing each time the switch is pushed.

DAMPER OF UPPER: While the switch is pressed, only the Upper keyboard notes will be sustained.

The action obtained with the other items will be the same as pressing the relevant buttons on the panel.

● Damper Pedal Assignment

You can specify the keyboard which will be affected when you press the Damper pedal.

```
◀ Damper Pedal ▶  
to LOWER
```

UPPER: The effect is applied to the sound played on the Upper keyboard.

LOWER: The effect is applied to the sound played on the Lower keyboard.

● Bender/Vibrato Destination

This setting determines which keyboard will be controlled by the Pitch Bend/Vibrato lever.

◀ Bender/Vibrato ▶
to UPPER

UPPER: The effect is applied to the sound played on the Upper keyboard.

LOWER: The effect is applied to the sound played on the Lower keyboard.

PEDAL BASS: The effect is applied to the sound played on the Pedalboard.

● Pitch Bend Range

This setting allows you to choose the maximum amount of change (range) permissible when using Pitch Bend. The range can be set anywhere between 1-12 (in semitone units; maximum of one octave).

◀ PitchBendRange ▶
2

* Manual Drums, Sound Effects and Manual Percussion are fixed at one octave, regardless of this setting.

● Manual Drums Set

This setting allows you to choose one of the following eight Drum Sets or one Sound Effects Set.

◀ ManualDrumsSet ▶
STANDARD

STANDARD	JAZZ
ROOM	BRUSH
POWER	ORCHESTRA
ELECTRONIC	SOUND EFFECTS
TR-808	

● Harmony Intelligence Type

The following 10 types of Harmony Intelligence can be selected.

◀ Harmony Type ▶
TRADITIONAL

TRADITIONAL
BROADWAY
DUET
ORGAN
COMBO

STRINGS
HYMN
BLOCK
BIG BAND
COUNTRY

● Solo Split Point

This setting is used to set the Solo Split Point (lower limit of the playable range of the Solo Voice) of the Lower keyboard to any desired position. (E1 to G7)

◀ SoloSplitPoint ▶
E 4

* By simultaneously pressing the + and - Value buttons, you can restore the default setting B4.

● Bass Split Point

You can assign the Bass Split Point (the highest key, up to which the Bass voice will sound), to any key of the Lower Keyboard, from E1 to G7.

◀ BassSplitPoint ▶
C 3

* If you simultaneously press the + and - Value buttons, this will be reset to the initial value (C3).

● Chord Hold (Chord Hold ON/OFF)

The Chord Hold function can be switched ON/OFF. When Chord Hold is ON, the automatic accompaniment will continue playing while you lift your hand from the keyboard to play a new chord.

◀ Chord Hold ▶
ON

ON: The chord that was played on the Lower keyboard is sustained (even if you release the keys), and automatic accompaniment continues.

OFF: When you release the keys that you played in the Lower keyboard, the automatic accompaniment is not heard. Only the Rhythm performance will continue.

● Registration Arranger Update (Registration recall timing)

You can specify how the settings related to Rhythm performances and automatic accompaniment will be recalled when you press a Registration button 1–12.

◀ ArrangerUpdate ▶
DELAYED

DELAYED: Settings related to rhythm performances and automatic accompaniment will be recalled when you hold a button 1–12 for several seconds. If you quickly release the Registration button after pressing it, only the panel settings that are not related to Rhythm and automatic performance will be updated.

INSTANT: Settings related to Rhythm performances and automatic accompaniment will be recalled the instant you press a button 1–12.

- * This setting will be remembered even if the power is turned off.

● Expression Curve (The depth of the Expression Pedal effect)

Specify how the effect will be applied when the Expression Pedal is pressed.

◀ ExpressionCurve ▶
1

1: The Expression Pedal will change the volume of the Rhythm and automatic accompaniment playback to a lesser degree than the volume of the keyboard voices.

2: The Expression Pedal will change the volume of the Rhythm playback, automatic accompaniment playback and the keyboard voices to the same degree.

- * This setting will be remembered even if the power is turned off.

● Tx MIDI Channel (MIDI output channel)

For each keyboard (Upper, Lower, and Pedal) you can specify the channel on which your playing will be transmitted as MIDI messages. (Value: 1–16)

When you use the MIDI connectors or the computer connector of the AT-80 to transmit musical data to external devices, you can modify these Tx (Transmit) MIDI settings as needed. (For details refer to p. 63.)

◀ TxMIDI Channel ▶
Upper : 13 ▶

- * It is not possible to set Upper, Lower, and Pedal Bass to the same channel.
- * MIDI messages for the Solo part will be transmitted only when To Lower is ON.

● Master Tune

This function allows you to reference the AT-80 tuning to the pitch of the note A between 415.3 Hz and 466.2 Hz. The tuning can be increased or decreased in 0.1 Hz steps.

◀ Master Tune ▶
440.0 Hz

- * By pressing the + and - Value buttons simultaneously, you can restore the default setting (440.0 Hz).
- * This setting remains stored in memory even while power is turned off.

● LCD Contrast

This setting allows you to adjust the contrast of the display. (Available settings: 1–10)

◀ LCD Contrast ▶
5

- * This setting remains stored in memory even while power is turned off.

Settings for the Composer (Function button)

● Count-In Recording

This setting (ON/OFF) determines whether or not a metronome count-in (2 measures) will be heard after pressing the Play button on recording. (The count-in helps you establish the tempo before you begin playing.)

1. Press the Function button.
2. Using the Select buttons, select "Count-In Rec."

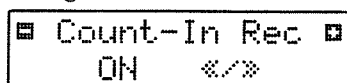

Count-In Rec
ON ⏪ ⏩

3. Use the Bwd/Fwd buttons to turn it ON or OFF.
Press the Function button or the Display/Exit button to return to the basic screen.

● Metronome

This setting determines whether or not the metronome will sound.

OFF: Not heard at all
REC: Heard only while recording
ON: Heard constantly

1. Press the Function button.
2. Using the Select buttons, select "Metronome."

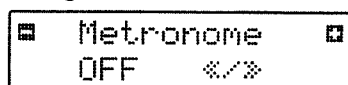

Metronome
OFF ⏪ ⏩

3. Use the Bwd/Fwd buttons to select OFF, REC, or ON.
Press the Function button or the Display/Exit button to return to the basic screen.

● Metronome Volume

Carry out the steps below to adjust the volume of the metronome.

1. Press the Function button.
2. Using the Select buttons, select "Metronome Vol."



Metronome Vol.
10 ⏪ ⏩

3. Press the Bwd/Fwd buttons to select the desired volume level (1–10).

Press the Function button or the Display/Exit button to return to the basic screen.

● Setting the beat (Time Signature)

This setting determines the beat (time signature) to be used when recording performances.

Numerator: 1 or higher (denominator x 2-1)

Denominator: 2, 4, 8, 16

1. Press the Function button.
2. Select "Beat" using the Select buttons.

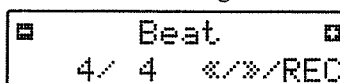

Beat
4/4 ⏪ ⏩/REC

3. Use the Bwd/Fwd buttons to set the numeric value for the numerator. To set the denominator, use the Rec button to move the cursor from the numerator to the denominator. Press the Rec button again if you wish to return to the numerator.

Press the Function button or the Display/Exit button to return to the basic screen.

- * When recording rhythm performances or automatic accompaniment, the beat is set automatically.
- * You cannot change the beat of previously recorded data.

● Exp. Source (how the Expression Pedal functions)

Specify how the Expression Pedal will function when your performance is being recorded and when Atelier music data is being played back.

○ Recording (function during recording)

Specify whether Expression Pedal operations will be recorded or not while your performance is being recorded.

1. Press the Function button.
2. Press the Select buttons to select "Exp. Source", and press the Rec button.
3. Press the Select buttons to select "Recording."
4. Use the Bwd/Fwd buttons to specify the pedal function.

```

Recording  [ ]
PEDAL     [ ]
  
```

PEDAL: Pedal movements will be recorded. The previous data will be erased as new data is recorded.

COMPOSER: Pedal movements will not be recorded. The previous data will remain without being erased.

Press the Function button or the Display/Exit button to return to the basic screen.

○ Playback (function during playback)

You can specify whether or not the Expression Pedal will function while Atelier music data is being played back.

1. Press the Function button.
2. Press the Select buttons to select "Exp. Source", and press the Rec button.
3. Press the Select buttons to select "Playback."
4. Press the Bwd/Fwd buttons to specify the pedal function.

```

[ ] Playback
PEDAL+COMP [ ]
  
```

PEDAL: The pedal will function. The Expression Pedal data within the music data will be ignored.

COMPOSER: The pedal will not function. The Expression Pedal data within the music data will take priority.

PEDAL+COMP: The Expression Pedal will function. Expression Pedal data within the music data will also be effective.

Press the Function button or the Display/Exit button to return to the basic screen.

● Edit Menu (editing music data)

Music data that you record can be edited using five functions.

○ Delete Measure (delete part of the recorded data)

This function lets you delete specified measures (bars) of music data from all tracks.

When data is deleted, subsequent data will be moved forward to fill the gap.

Example: To delete measures 5–8

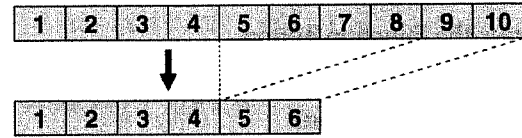

1. Press the Function button.
2. Use the Select buttons to select "Edit Menu," and press the Rec button.

```

[ ] Edit Menu  [ ]
Yes:REC
  
```

3. Use the Select buttons to select "Delete Measure," and press the Rec button.

```

Delete Measure [ ]
Yes:REC No:RST
  
```

4. Specify the area to be deleted. Use the Bwd/Fwd buttons to set the numerical values, and use the Rec/Reset buttons to switch between pages of the display.

The following items can be set.

from: beginning measure (bar)

for: number of measures (bars) from the beginning measure

For example if you wish to delete measures 4–12, set these items to "from:4 for:9".

If you wish to delete from a certain measure to the last measure, set for:ALL.

After setting "for," press the Rec button to advance to the following display.

```

Delete Measure?
Yes:REC No:RST
  
```

5. To execute the delete operation, press the Rec button once again.

When the data has been deleted, the basic screen will reappear.

To cancel the operation, press the Reset button.

○ **Delete Track (delete music data from a track)**

This function lets you delete music data from a track that you specify.

1. Press the Function button.
2. Use the Select buttons to select "Edit Menu" and press the Rec button.
3. Use the Select buttons to select "Delete Track" and press the Rec button.

```

┌ Delete Track ─┐
│ Yes:REC No:RST │
└────────────────┘
    
```

4. Use the Bwd/Fwd buttons to select the track that you wish to delete.
Settings: RHYTHM, ACCOMP, BASS, LOWER, UPPER, SOLO, CONTROL

5. Press the Rec button.
 The following display will appear.

```

┌ Delete Track? ─┐
│ Yes:REC No:RST │
└────────────────┘
    
```

6. To execute the Delete Track function, press the Rec button once again.
 When the data has been deleted, the basic screen will reappear.
 To cancel the operation, press the Reset button.

○ **Erase (erase music data)**

The Erase function erases a specified portion of music data, leaving a blank area. This function is like using a pencil eraser to erase notes from a musical score.

Example: Erasing measures 5-8

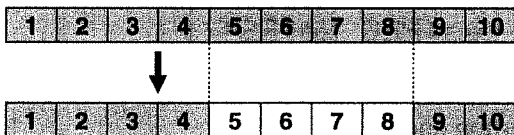

1. Press the Function button.
2. Use the Select buttons to select "Edit Menu" and press the Rec button.
3. Use the Select buttons to select "Erase Event" and press the Rec button.

```

┌ Erase Event ─ ─┐
│ Yes:REC No:RST │
└────────────────┘
    
```

4. Use the Bwd/Fwd buttons to select the data to be erased, and press the Rec button.

ALL: all music data
NOTE: notes played on the keyboard
EXPRESSION: expression pedal data
CONTROL: panel operations

5. Use the Bwd/Fwd buttons to select the part from which you wish to erase data, and press the Rec button.

Settings: RHYTHM, ACCOMP, BASS, LOWER, UPPER, SOLO, ALL

If you select ALL, data will be erased from all parts.

- * If you have selected EXPRESSION as the type of data to be erased, the part selection will not be available because the expression control data is common to all parts.

6. Specify the area in which the data will be erased. Use the Bwd/Fwd buttons to make settings, and use the Rec/Reset buttons to switch between pages of the display.

The following items can be set.

from: beginning measure
for: the number of measures from the beginning measure

For example if you wish to erase measures 4-12, set "from: 4 for: 9".

If you wish to erase to the last measure, set "for: ALL".

When you set "for" and then press the Rec button, the following display will appear.

```

┌ Erase Event? ─┐
│ Yes:REC No:RST │
└────────────────┘
    
```

7. To execute the Erase function, press the Rec button once again.

When erasure is complete, the basic screen will reappear.

To cancel the operation, press the Reset button.

○ Copy (copy music data)

This function lets you copy a portion of music data to a different measure location in the same track.

- * If music data already exists at the copy destination, it will be erased.

Example : If you wish to copy measures 5–7 to measure 8

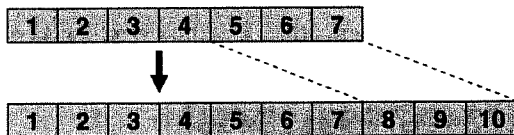

1. Press the Function button.
2. Use the Select buttons to select "Edit Menu" and press the Rec button.
3. Use the Select buttons to select "Copy" and press the Rec button.

```

┌ ┌ Copy ┌ ┌
│ Yes:REC No:RST
└ └ └ └
  
```

4. Use the Bwd/Fwd buttons to select the track whose data you wish to copy, and press the Rec button.

Settings: RHYTHM, ACCOMP, BASS, LOWER, UPPER, SOLO, CONTROL, ALL

If you select ALL, the data of all tracks will be copied.

5. Specify the area, the copy destination, and the number of times that the data will be copied. Use the Bwd/Fwd buttons to make settings, and use the Rec/Reset buttons to switch between pages of the screen.

The following settings can be made.

from: beginning measure
for: number of measures from the beginning measure
to : measure number of the copy destination
time: number of times that the data will be copied

For example if you wish to copy measures 4–12 twice after the last measure, make settings of "from: 4 for: 9 to: END time: 2".

To specify until the last measure, set "for: ALL".

After making the "time" setting, press the Rec button and the following display will appear.

```

┌ ┌ Copy Sure? ┌ ┌
│ Yes:REC No:RST
└ └ └ └
  
```

6. To execute the Copy function, press the Rec button once again.

When copying is complete, the basic screen will reappear.

To cancel the operation, press the Reset button.

○ Quantize (correct timing inaccuracies)

Quantize is a function that corrects the timing of notes to a specified interval.

1. Press the Function button.
2. Use the Select buttons to select "Edit Menu" and press the Rec button.
3. Use the Select buttons to select "Quantize" and press the Rec button.

```

┌ ┌ Quantize ┌ ┌
│ Yes:REC No:RST
└ └ └ └
  
```

4. Use the Bwd/Fwd buttons to select the track whose data you wish to quantize, and press the Rec button.

Settings: RHYTHM, ACCOMP, BASS, LOWER, UPPER, SOLO, ALL

If you select ALL, data of all tracks will be quantized.

5. Specify the area that will be quantized. Use the Bwd/Fwd buttons to set the values, and use the Rec/Reset buttons to switch between pages of the screen.

The following items can be set.

from: beginning measure
for: number of measures from the beginning measure
Res: timing to which notes will be corrected (Resolution)

For example if you want to quantize the notes of measures 4–12 to the nearest 16th note, set "from: 4 for: 9 Res: ♩".

To specify the data to the last measure, set "for: ALL".

“Res”(Resolution) can be set to the following values.

♪ Half note	♪ 8th note triplet
♪ Quarter note	♪ 16th note
♪ Quarter note triplet	♪ 16th note triplet
♪ 8th note	♪ 32nd note

After setting “Res,” press the Rec button and the following display will appear.

```
Quantize Sure?  
Yes:REC No:RST
```

6. To execute the Quantize function, press the Rec button once again.

When quantization is completed, the basic screen will reappear.

To cancel the operation, press the Reset button.

● Channel Mute

This function allows you to mute performance data on an individual channel basis.

- * Channel Mute settings are remembered until the power is turned off. This means that even if you playback different musical data, notes whose channel is muted will not be played back.

1. Press the Function button.
2. Press the Select buttons to select “Ch. Mute.”

```
■Ch. Mute<*/*/REC  
1234567890123456
```

3. Using the Bwd/Fwd buttons, select the channel you wish to Mute.

From the left, they are: 1Ch, 2Ch.....15Ch, 16Ch.

4. Press the Rec button.

```
■Ch. Mute<*/*/REC  
-234567890123456
```

The number changes to “-” showing that it is muted.

The mute function can be released by pressing the Rec button again.

When you press the Function button or the Display/Exit button, you will return to the basic screen.

Connecting MIDI Devices Or Computers

The AT-80 provides MIDI connectors and a computer connector to allow music data to be exchanged with external devices. By using these connectors to connect other devices to the AT-80, you can enjoy an even wider range of possibilities.

* Set the MIDI transmit channels as needed. (→p.57)

Connections with a MIDI device

The AT-80 has two MIDI connectors; MIDI IN and MIDI OUT.

MIDI OUT connector

Only the data produced when you play each keyboard or press the Damper pedal is transmitted from this connector to external MIDI devices.

MIDI messages for the Solo part will be transmitted only when To Lower is ON.

MIDI IN connector

MIDI data transmitted by an external MIDI device is received at this connector. In response to receiving MIDI data, sound can be produced or voices can be selected, etc.

1. Set the Computer switch located on the back of the AT-80 to the "MIDI" position.
 - * Before changing the setting of the Computer switch, make sure that the AT-80's power is turned off.
2. Use MIDI cables to connect the AT-80 MIDI connectors to external MIDI devices.
 - * It is not always necessary to connect both MIDI cables. Make the MIDI connections as required by your particular setup.

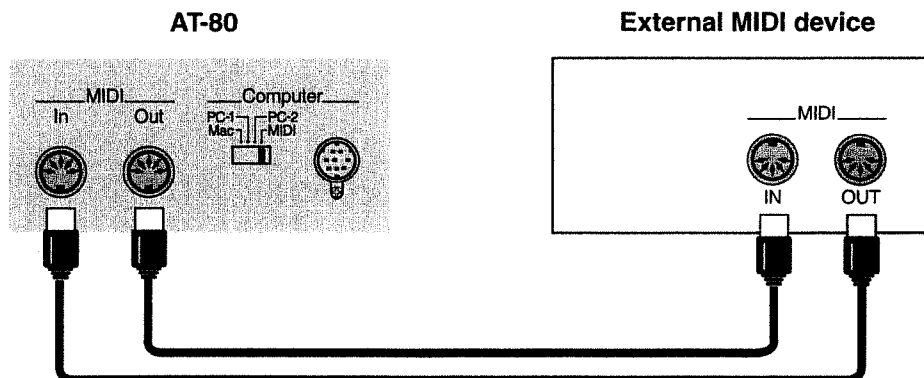

Connections with a computer

By connecting the AT-80's Computer connector to the serial port of a computer, bi-directional transmission of music data can take place. The method of connection will depend on the type of computer.

- * Before changing the setting of the Computer switch, make sure that the AT-80's power is turned off.

● Connection with an Apple Macintosh

1. Set the Computer switch located on the back of the AT-80 to the "Mac" position.
2. Use a computer cable to connect the modem port (or the printer port) of the Apple Macintosh to the Computer connector of the AT-80.

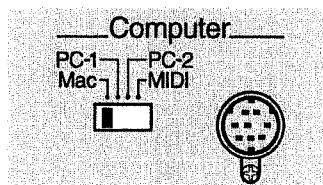

3. Using the Apple Macintosh "PatchBay" utility, set the Interface Type (MIDI interface clock) to 1 MHz.

● Connection with an IBM PC

1. Set the Computer switch located on the back of the AT-80 to the "PC-2" position.
2. Use a computer cable to connect the serial port (COM1, COM2, etc.) of the IBM PC to the Computer connector of the AT-80.

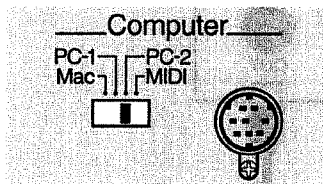

The only types of data transmitted from the MIDI OUT and Computer connectors are the messages produced when you play the Upper and Lower keyboards, Bass pedals and the Damper pedal messages. MIDI messages for the Solo part will be transmitted only when To Lower is ON.

It is not possible to output Composer data, Style Playback data, Demo song data, and the messages when you move the Expression Pedal and the Pitch Bend/Vibrato lever.

Troubleshooting

● When you press the POWER switch, the AT-80's LEDs do not light.

- ❑ Power cord is not connected correctly (→p.13).

● Sound is not produced

- ❑ The Master Volume slider is set too low (→p.16).
- ❑ Headphones are connected (→p.13).
- ❑ The volume is set too low on the Part Balance buttons (→p.51).
- ❑ The volume is set too low on the Expression Pedal (→p.16, 34).
- ❑ You do not have a Voice selected (→p.18–20).
- ❑ The pedal cord and the speaker cord are not connected correctly (→p.94).
- ❑ Manual Drums is turned on, and you are playing keys to which drums or sound effects have not been assigned (→p.31, 69).

● Damper Pedal does not operate

- ❑ The pedal cord is not properly connected (→p.94).
- ❑ The damper pedal can be active for either the Upper keyboard or the Lower keyboard (not both). (→p.55)

● Expression Pedal does not operate

- ❑ The pedal cord is not properly connected (→p.94).
- ❑ The Expression Pedal has no effect on the volume of music data other than Atelier music data.
- ❑ If "Playback" (Exp. Source, Function menu) is set to COMPOSER, the Expression Pedal will have no effect with respect to the playback itself and what you play while Atelier music data is being played back. (→p.59)
- ❑ If "Recording" (Exp. Source, Function menu) is set to COMPOSER, the Expression Pedal will have no effect on the volume during recording. (→p.58)

● The right foot switch does not function

- ❑ If the Utility menu Regist Shift setting is ON, the right foot switch will be dedicated to switching the registration, and the Right Foot Switch Assignment setting will be ignored. (→p.55)

● When you release your fingers from keys in the Lower keyboard while Automatic Accompaniment + Rhythm is playing, the Rhythm performance only remains playing.

- ❑ Chord Hold is at OFF (→p.56).

● When you release your fingers from keys in the Lower keyboard, the notes continue sounding.

- ❑ Lower Voice Hold is at ON (→p.41).

● Even though you press only one key, a multiple number of notes sound.

- ❑ Harmony Intelligence is at ON (→p.21).
- ❑ Chord Intelligence is turned ON (→p.40).

● Harmony is not applied

- ❑ When the Harmony Type selected is TRADITIONAL, and only a Solo voice has been selected for the Upper keyboard, harmony notes will not be added to your playing, even if the Harmony Intelligence button is on. Select an Upper voice. (→p.18).

● Automatic accompaniment sounds odd

- ❑ The keys for a chord were not pressed simultaneously.
- ❑ Even though Chord Intelligence is OFF, you think it is ON, and are abbreviating chords (→p.40).
- ❑ If performance data other than Atelier music data is played simultaneously with the automatic accompaniment, the automatic accompaniment may not sound as expected. This is not a malfunction.

● **Rhythm sounds odd**

- ❑ If performance data other than Atelier music data is played simultaneously with the Rhythm, the Rhythm may not sound as expected. This is not a malfunction.

● **Pitch is off**

- ❑ Transpose is in effect (→p.52).
- ❑ The tuning is incorrect (→p.57).
- ❑ While set for an octave shift, you are playing keys beyond the recommended range. This does not indicate a malfunction (→p.51).

● **Performance data cannot be played back**

- ❑ While the Function menu appears in the display (with the exception of Channel Mute), playback is not allowed.

● **Cannot record**

- ❑ While the Function menu appears in the display, recording is not allowed.

● **Movements of the Expression Pedal are not recorded**

- ❑ If the Function menu Exp. Source setting Recording is set to COMPOSER, movements of the Expression Pedal will not be recorded (→p.58).

● **Sound of metronome is strange**

- ❑ If the metronome is sounded while a Standard MIDI File is played back, the metronome can sometimes sound different than usual. This does not indicate a malfunction.

Display messages

▣ Delete Song
Can't Execute.

Cause:

- There is no disk in the disk drive.
- The disk drive contains a disk that was formatted by another device.
- Music data does not exist.

Solution:

- Before executing the procedure, insert a disk into the disk drive.
- Before executing the procedure, insert a disk that was formatted by the AT-80 and contains music data that you wish to delete.

Can't Execute
Regist Function.

Cause:

The disk drive contains a disk that was formatted by another device.

Solution:

Before executing the procedure, insert a disk that was formatted by the AT-80.

Can't Load
This Rhythm.

Cause:

The Rhythm data is excessively large, and cannot be loaded.

Can't Load
This Song.

Cause:

- The performance data is excessively large, and cannot be loaded.
- The performance data contains data incompatible with the AT-80, and cannot be loaded.

Can't Modify
This Song.

Cause:

- You have pressed the Rec button in an attempt to load and then enter recording standby mode, but the performance data is too large to be loaded.
- You have pressed the Rec button in an attempt to load and then enter recording standby mode, but loading is not possible since the performance data contains data incompatible with the AT-80.

Can't Play
This Song.

Cause:

- The performance data is excessively large, so it cannot be played back.
- Playback is not possible since performance data incompatible with the AT-80 is included.

Can't Save
onto This Disk.

Cause:

- You cannot save performance data on disks containing Standard MIDI Files.
- You cannot save performance data on master disks.
- You cannot save performance data on disks formatted for MS-DOS or other computer operating systems.

Solution:

Insert a disk formatted on the AT-80 into disk drive, then try the procedure again.

Can't Save
This Song.

Cause:

The performance data you are attempting to save contains data designed to prevent unauthorized copying. As a result, it cannot be saved onto disk.

Can't Save
while Renaming.

Cause:

It is not possible to save during the Rename operation.

Solution:

Complete the Rename operation by simultaneously pressing the Load button and the Function button, and then save the data.

Clear Song Sure?
Yes:REC No:RST

Cause:

To carry out the procedure, you first need to erase performance data in the unit. This message asks you to confirm that you don't mind doing this.

Solution:

To erase the data, press the Rec buttons. When you do not want to erase it, press the Reset button, then save the data on disk.

```
Disk Problem
has Occurred.
```

Cause:

The data transfer could not be processed correctly.

Solution:

Try taking it out, then inserting the disk again (or replace the disk with a different one), then try the procedure over again.

```
Factory Setup
is Loaded.
```

Cause:

The internal settings were lost (Registrations, etc.) because the instrument was not turned on for about a month.

Solution:

The basic display will appear after the instrument has been returned automatically to all the factory default settings.

```
Improper Disk:
Please Format.
```

Cause:

- The disk is one that was used with some other device.
- The disk is brand new, and has not been formatted yet.

Solution:

Format the disk according to the steps on page 42.

```
Format Disk
Insert New Disk.
```

Cause:

A disk is not inserted in the disk drive.

Solution:

Insert a disk to be formatted into the disk drive, then try the procedure again.

```
Internal Memory
is Full.
```

Cause:

Because the unit's memory is full to capacity, recording or loading was canceled.

```
Internal Memory
Near Limit
```

Situation:

The unit is warning you that its memory will soon become full to capacity, so not much more recording can be done.

```
No Room
on Disk
```

Cause:

- Because the disk is full, nothing further can be stored on it.
- Up to a maximum of 99 songs (2HD), or 56 songs (2DD) can be stored on disk.

Solution:

Replace the disk with a different one, or erase some of the data that is on the disk.

```
Overwrite Regist?
Yes:REC No:RST
```

Cause:

This Registration is already being used.

Solution:

To overwrite the previous Registration data in this memory, press the Rec button. If you decide to keep the previous Registration data in this memory and save your settings in an unused memory, press the Reset button, press the Select button to select a number for which "--" is displayed, and then save the data.

```
Overwrite Song ?
Yes:REC No:RST
```

Cause:

There already is performance data having the same name on the disk.

Solution:

To replace the existing data with the new version, press the Rec button. To save it as a separate new file, press the Reset button first. Then, after changing the name (→p.46), save it on disk.

```
Write-Protected
Disk
```

Cause:

The disk's protect tab is at the "ON" position.

Solution:

Slide the disk's protect tab to the "OFF" position, and perform the procedure over again.

Drum Set list

Note No.	STANDARD/JAZZ	ROOM	POWER	ELECTRONIC	TR-808	BRUSH	ORCHESTRA	Sound Effects
28	Slap						Pedal Hi-Hat [EXC1]	
29	Scratch Push						Open Hi-Hat [EXC1]	
30	Scratch Pull						Ride Cymbal	
31	Sticks							
32	Square Click							
33	Metronome Click							
34	Metronome Bell							
35	Kick Drum 2						Concert BD 2	
C2 36	Kick Drum 1		MONDO Kick	Elec BD	808 Bass Drum		Concert BD 1	
37	Side Stick				808 Rim Shot			
38	Snare Drum 1		Gated SD	Elec SD	808 Snare Drum	Brush Tap	Concert SD	
39	Hand Clap					Brush Slap	Castanets	High Q
40	Snare Drum 2			Gated SD		Brush Swirl	Concert SD	Slap
41	Low Tom 2	Room Low Tom 2	Room Low Tom 2	Elec Low Tom 2	808 Low Tom 2		Timpani F	Scratch Push
42	Closed Hi-Hat [EXC1]				808 CHH [EXC1]		Timpani F#	Scratch Pull
43	Low Tom 1	Room Low Tom 1	Room Low Tom 1	Elec Low Tom 1	808 Low Tom 1		Timpani G	Sticks
44	Pedal Hi-Hat [EXC1]				808 CHH [EXC1]		Timpani G#	Square Click
45	Mid Tom 2	Room Mid Tom 2	Room Mid Tom 2	Elec Mid Tom 2	808 Mid Tom 2		Timpani A	Metronome Click
46	Open Hi-Hat [EXC1]				808 OHH [EXC1]		Timpani A#	Metronome Bell
47	Mid Tom 1	Room Mid Tom 1	Room Mid Tom 1	Elec Mid Tom 1	808 Mid Tom 1		Timpani B	Guitar sliding finger
C3 48	High Tom 2	Room Hi Tom 2	Room Hi Tom 2	Elec Hi Tom 2	808 Hi Tom 2		Timpani c	Guitar cutting noise (down)
49	Crash Cymbal 1				808 Cymbal		Timpani c#	Guitar cutting noise (up)
50	High Tom 1	Room Hi Tom 1	Room Hi Tom 1	Elec Hi Tom 1	808 Hi Tom 1		Timpani d	String slap of double bass
51	Ride Cymbal 1						Timpani d#	Fl. Key Click
52	Chinese Cymbal			Reverse Cymbal			Timpani e	Laughing
53	Ride Bell						Timpani f	Screaming
54	Tambourine							Punch
55	Splash Cymbal							Heart Beat
56	Cowbell				808 Cowbell			Footsteps1
57	Crash Cymbal 2						Concert Cymbal 2	Footsteps2
58	Vibra Slap							Applause
59	Ride Cymbal 2						Concert Cymbal 1	Door Creaking
C4 60	High Bongo							Door
61	Low Bongo							Scratch
62	Mute High Conga				808 High Conga			Windchime
63	Open High Conga				808 Mid Conga			Car-Engine
64	Low Conga				808 Low Conga			Car-Stop
65	High Timbale							Car-Pass
66	Low Timbale							Car-Crash
67	High Agogo							Siren
68	Low Agogo							Train
69	Cabasa							Jet plane
70	Maracas				808 Maracas			Helicopter
71	Short Hi Whistle [EXC2]							Starship
C5 72	Long Low Whistle [EXC2]							Gun Shot
73	Short Guiro [EXC3]							Machine Gun
74	Long Guiro [EXC3]							Lasergun
75	Claves				808 Claves			Explosion
76	High Wood Block							Dog
77	Low Wood Block							Horse-Gallop
78	Mute Cuica [EXC4]							Birds
79	Open Cuica [EXC4]							Rain
80	Mute Triangle [EXC5]							Thunder
81	Open Triangle [EXC5]							Wind
82	Shaker							Seashore
83	Jingle Bell							Stream
C6 84	Belltrees							Bubble
85	Castanets							
86	Mute Surdo [EXC6]							
87	Open Surdo [EXC6]							
88							Applause	

Blank: same percussion instruments as the Standard Set

-- : no sound

[EXC]: will not sound simultaneously with other percussion instruments of the same number

Composer Profiles

Stewart Cary and Joe Millward

Stewart Cary and Joe Millward have been involved in musical performance and production over the last 20 years. Their company, The Works Music Productions, has been producing MIDI files for the last 10 years and was one of the first companies to offer MIDI files to the public. Mr. Cary and Mr. Millward are members of the Roland style development team and have been involved in the composition of numerous product demonstration songs.

Jonas Nordwall

A native of Portland, Mr. Nordwall received his Bachelor of Music Degree in 1970 from the University of Portland studying with Arthur Hitchcock. Additional study was done with Frederick Geoghegan, the noted English/Canadian organist. As a teenager, Jonas had the privilege to study with Richard Ellsasser, one of the greatest virtuoso organists of this century. Besides serving as Director of Music for the First United Methodist Church in Portland, Oregon and as the Organist for the Oregon Symphony Orchestra, he has been a featured recitalist for national conventions of the American Theater Organ Society and was Organist of the year for 1987.

Akio Sasaki

Akio Sasaki began his study of the classical piano when he was nine years old; and when he was fifteen, he started learning the electronic organ and composition. He won a prize at the Yamaha International Competition in 1970, and was given the opportunity of playing with Jimmy Smith. After playing as an organ demonstrator, mainly in Europe, he began studying at the Berklee College of Music in 1976. He graduated in 1979 with excellent grades. As a college student, he played many gigs with bands in Boston. In 1980, his album "Berklee Connection" was released by a major label. Since returning to Japan, he has garnered a position as one of Japan's leading jazz organists, and now has his own group, the "Akio Sasaki Quintet."

He also maintains an interest in education, and teaches at the Osaka College of Music and the Kyoto Conservatory of Music. Many books that include his arrangements have been published in Japan.

Section 1. Receive data

Received data is available only for Accompaniment/SMF Play Voices.

■ Channel Voice Messages

● Note off

Status	2nd byte	3rd byte
8nH	kkH	vvH
9nH	kkH	00H

n = MIDI channel number: 0H-FH (ch.1-ch.16)
kk = note number: 00H-7FH (0-127)
vv = note off velocity: 00H-7FH (0-127)

- For Drum Parts, these messages are received when Rx.NOTE OFF = ON for each Instrument.
- The velocity values of Note Off messages are ignored.

● Note on

Status	2nd byte	3rd byte
9nH	kkH	vvH

n = MIDI channel number: 0H-FH (ch.1-ch.16)
kk = note number: 00H-7FH (0-127)
vv = note on velocity: 01H-7FH (1-127)

- Not received when Rx.NOTE MESSAGE = OFF. (Initial value is ON)
- For Drum Parts, not received when Rx.NOTE ON = OFF for each Instrument.

● Polyphonic Key Pressure

Status	2nd byte	3rd byte
AnH	kkH	vvH

n = MIDI channel number: 0H-FH (ch.1-ch.16)
kk = note number: 00H-7FH (0-127)
vv = key pressure: 00H-7FH (0-127)

- Not received when Rx.POLY PRESSURE (PA) = OFF. (Initial value is ON)
- The resulting effect is determined by System Exclusive messages. With the initial settings, there will be no effect.

● Control Change

- When Rx.CONTROL CHANGE = OFF, all control change messages except for Channel Mode messages will be ignored.
- The value specified by a Control Change message will not be reset even by a Program Change, etc.

○ Bank Select (Controller number 0, 32)

Status	2nd byte	3rd byte
BnH	00H	mmH
BnH	20H	llH

n = MIDI channel number: 0H-FH (ch.1-ch.16)
mm, ll = Bank number: 00H, 00H-7FH, 7FH (bank.1-bank.16384),
Initial Value = 00 00H (bank.1)

- Not received when Rx.BANK SELECT = OFF. "Rx.BANK SELECT" is set to OFF by "Turn General MIDI System On," and set to ON by "GS RESET" or the arranger playback. (Power-on default value is ON.)
- Bank number LSB will be handled as 00H regardless of the received value. However, when sending Bank Select messages, you have to send both the MSB (mmH) and LSB (llH), the value should be 00H) together.
- Bank Select processing will be suspended until a Program Change message is received.

○ Modulation (Controller number 1)

Status	2nd byte	3rd byte
BnH	01H	vvH

n = MIDI channel number: 0H-FH (ch.1-ch.16)
vv = Modulation depth: 00H-7FH (0-127)

- Not received when Rx.MODULATION = OFF. (Initial value is ON)
- The resulting effect is determined by System Exclusive messages. With the initial settings, this is Pitch Modulation Depth.

○ Portamento Time (Controller number 5)

Status	2nd byte	3rd byte
BnH	05H	vvH

n = MIDI channel number: 0H-FH (ch.1-ch.16)
vv = Portamento Time: 00H-7FH (0-127), Initial value = 00H (0)

- This adjusts the rate of pitch change when Portamento is ON or when using the Portamento Control. A value of 0 results in the fastest change.

○ Data Entry (Controller number 6, 38)

Status	2nd byte	3rd byte
BnH	06H	mmH
BnH	26H	llH

n = MIDI channel number: 0H-FH (ch.1-ch.16)
mm, ll = the value of the parameter specified by RPN/NRPN

○ Volume (Controller number 7)

Status	2nd byte	3rd byte
BnH	07H	vvH

n = MIDI channel number: 0H-FH (ch.1-ch.16)
vv = Volume: 00H-7FH (0-127),
Initial Value = 3FH 63 (ch.1, 3-16)
35H 53 (ch.2)

- Volume messages are used to adjust the volume balance of each Part.
- Not received when Rx.VOLUME = OFF. (Initial value is ON)

○ Pan (Controller number 10)

Status	2nd byte	3rd byte
BnH	0AH	vvH

n = MIDI channel number: 0H-FH (ch.1-ch.16)
vv = pan: 00H-40H-7FH (Left-Center-Right),
Initial Value = 40H (Center)

- For Rhythm Parts, this is a relative adjustment of each Instrument's pan setting.
- Not received when Rx.PANPOT = OFF. (Initial value is ON)

○ Expression (Controller number 11)

Status	2nd byte	3rd byte
BnH	0BH	vvH

n = MIDI channel number: 0H-FH (ch.1-ch.16)
vv = Expression: 00H-7FH (0-127),
Initial Value = 7FH (127)

- It can be used independently from Volume messages. Expression messages are used for musical expression within a performance; e.g., expression pedal movements, crescendo and decrescendo.
- Not received when Rx.EXPRESSION = OFF. (Initial value is ON)

○ **Hold 1 (Controller number 64)**

Status	2nd byte	3rd byte
BnH	40H	vvH

n = MIDI channel number: 0H-FH (ch.1-ch.16)
 vv = Control value: 00H-7FH (0-127) 0-63 = OFF, 64-127 = ON

* Not received when Rx.HOLD1 = OFF. (Initial value is ON)

○ **Portamento (Controller number 65)**

Status	2nd byte	3rd byte
BnH	41H	vvH

n = MIDI channel number: 0H-FH (ch.1-ch.16)
 vv = Control value: 00H-7FH (0-127) 0-63 = OFF, 64-127 = ON

* Not received when Rx.PORTAMENTO = OFF. (Initial value is ON)

○ **Sostenuto (Controller number 66)**

Status	2nd byte	3rd byte
BnH	42H	vvH

n = MIDI channel number: 0H-FH (ch.1-ch.16)
 vv = Control value: 00H-7FH (0-127) 0-63 = OFF, 64-127 = ON

* Not received when Rx.SOSTENUTO = OFF. (Initial value is ON)

○ **Soft (Controller number 67)**

Status	2nd byte	3rd byte
BnH	43H	vvH

n = MIDI channel number: 0H-FH (ch.1-ch.16)
 vv = Control value: 00H-7FH (0-127) 0-63 = OFF, 64-127 = ON

* Not received when Rx.SOFT = OFF. (Initial value is ON)

○ **Portamento control (Controller number 84)**

Status	2nd byte	3rd byte
BnH	54H	kkH

n = MIDI channel number : 0H-FH (ch.1-ch.16)
 kk = source note number : 00H-7FH (0-127)

- * A Note-on received immediately after a Portamento Control message will change continuously in pitch, starting from the pitch of the Source Note Number.
- * If a voice is already sounding for a note number identical to the Source Note Number, this voice will continue sounding (i.e., legato) and will, when the next Note-on is received, smoothly change to the pitch of that Note-on.
- * The rate of the pitch change caused by Portamento Control is determined by the Portamento Time value.

Example 1.

On MIDI	Description	Result
90 3C 40	Note on C4	C4 on
80 54 3C	Portamento Control from C4	no change (C4 voice still sounding)
90 40 40	Note on E4	glide from C4 to E4
80 3C 40	Note off C4	no change
80 40 40	Note off E4	E4 off

Example 2.

On MIDI	Description	Result
80 54 3C	Portamento Control from C4	no change
90 40 40	Note on E4	E4 is played with glide from C4 to E4
80 40 40	Note off E4	E4 off

○ **Effect 1 (Reverb Send Level) (Controller number 91)**

Status	2nd byte	3rd byte
BnH	5BH	vvH

n = MIDI channel number: 0H-FH (ch.1-ch.16)
 vv = Control value: 00H-7FH (0-127),
 Initial Value = 28H 40 (except ch.9)
 29H 41 (ch.9)

* This message adjusts the Reverb Send Level of each Part.

○ **Effect 3 (Chorus Send Level) (Controller number 93)**

Status	2nd byte	3rd byte
BnH	5DH	vvH

n = MIDI channel number: 0H-FH (ch.1-ch.16)
 vv = Control value: 00H-7FH (0-127), Initial Value = 00H (0)

* This message adjusts the Chorus Send Level of each Part.

○ **NRPN MSB/LSB (Controller number 98, 99)**

Status	2nd byte	3rd byte
BnH	63H	mmH
BnH	62H	llH

n = MIDI channel number: 0H-FH (ch.1-ch.16)
 mm = upper byte of the parameter number specified by NRPN
 ll = lower byte of the parameter number specified by NRPN

- * NRPN can be received when Rx.NRPN = ON. "Rx.NRPN" is set to OFF by power-on reset or by receiving "Turn General MIDI System On," and it is set to ON by "GS RESET."
- * The value set by NRPN will not be reset even if Program Change or Reset All Controllers is received.

****NRPN****

The NRPN (Non Registered Parameter Number) message allows an extended range of control changes to be used.

To use these messages, you must first use NRPN MSB and NRPN LSB messages to specify the parameter to be controlled, and then use Data Entry messages to specify the value of the specified parameter. Once an NRPN parameter has been specified, all Data Entry messages received on that channel will modify the value of that parameter. To prevent accidents, it is recommended that you set RPN Null (RPN Number = 7FH/7FH) when you have finished setting the value of the desired parameter. Refer to Section 4. Supplementary material "Examples of actual MIDI messages" <Example 4> (page 83). On the GS devices, Data entry LSB (llH) of NRPN is ignored, so it is no problem to send Data entry MSB (mmH) only (without Data entry LSB).

On the AT-80, NRPN can be used to modify the following parameters.

NRPN	Data entry		Description
	MSB	LSB	
01H 08H	mmH	mmH	Vibrato rate (relative change on specified channel) mm: 0EH-40H-72H (-50 - 0 - +50)
01H 09H	mmH	mmH	Vibrato depth (relative change on specified channel) mm: 0EH-40H-72H (-50 - 0 - +50)
01H 0AH	mmH	mmH	Vibrato delay (relative change on specified channel) mm: 0EH-40H-72H (-50 - 0 - +50)
01H 20H	mmH	mmH	TVF cutoff frequency (relative change on specified channel) mm: 0EH-40H-72H (-50 - 0 - +50)
01H 21H	mmH	mmH	TVF resonance (relative change on specified channel) mm: 0EH-40H-72H (-50 - 0 - +50)
01H 63H	mmH	mmH	TVF&TVA Env. Attack time (relative change on specified channel) mm: 0EH-40H-72H (-50 - 0 - +50)

NRPN	Data entry		Description
MSB LSB	MSB	LSB	
01H 64H	mmH		TVF&TVA Env. Decay time (relative change on specified channel) mm: 0EH-40H-72H (-50 - 0 - +50)
01H 66H	mmH		TVF&TVA Env. Release time (relative change on specified channel) mm: 0EH-40H-72H (-50 - 0 - +50)
18H rrH	mmH		Pitch coarse of drum instrument (relative change on specified drum instrument) rr: key number of drum instrument mm: 00H-40H-7FH (-64 - 0 - +63 semitone)
1AH rrH	mmH		TVA level of drum instrument (absolute change on specified drum instrument) rr: key number of drum instrument mm: 00H-7FH (zero-maximum)
1CH rrH	mmH		Tanpot of drum instrument (absolute change on specified drum instrument) rr: key number of drum instrument mm: 00H, 01H-40H-7FH (Random, Left-Center-Right)
1DH rrH	mmH		Reverb send level of drum instrument (absolute change on specified drum instrument) rr: key number of drum instrument mm: 00H-7FH (zero-maximum)
1EH rrH	mmH		Chorus send level of drum instrument (absolute change on specified drum instrument) rr: key number of drum instrument mm: 00H-7FH (zero-maximum)

- * Parameters marked "relative change" will change relative to the preset value.
- * Parameters marked "absolute change" will be set to the absolute value of the parameter, regardless of the preset value.

○ RPN MSB/LSB (Controller number 100, 101)

Status	2nd byte	3rd byte
BnH	65H	mmH
BnH	64H	llH

n = MIDI channel number: 0H-FH (ch.1-ch.16)

mm = upper byte of parameter number specified by RPN

ll = lower byte of parameter number specified by RPN

- * Not received when Rx.RPN = OFF. (Initial value is ON)
- * The value specified by RPN will not be reset even by messages such as Program Change or Reset All Controller.

RPN

The RPN (Registered Parameter Number) messages are expanded control changes, and each function of an RPN is described by the MIDI Standard.

To use these messages, you must first use RPN MSB and RPN LSB messages to specify the parameter to be controlled, and then use Data Entry messages to specify the value of the specified parameter. Once an RPN parameter has been specified, all Data Entry messages received on that channel will modify the value of that parameter. To prevent accidents, it is recommended that you set RPN Null (RPN Number = 7FH/7FH) when you have finished setting the value of the desired parameter. Refer to Section 4. "Examples of actual MIDI messages" <Example 4> (page 83).

On the AT-80, RPN can be used to modify the following parameters.

RPN	Data entry		Explanation
MSB LSB	MSB	LSB	
00H 00H	mmH	llH	Pitch Bend Sensitivity mm: 00H-18H (0-24 semitones) Initial Value = 02H (2 semitones) ll: ignored (processed as 00H) specify up to 2 octaves in semitone steps
00H 01H	mmH	llH	Master Fine Tuning mm, ll: 00 00H - 40 00H - 7F 7FH (-100 - 0 - +99.99 cents) Initial Value = 40 00H (±0 cent)
00H 02H	mmH	llH	Master Coarse Tuning mm: 28H-40H-58H (-24 - 0 - +24 semitones) Initial Value = 40H (±0 semitone) ll: ignored (processed as 00H)
7FH 7FH	---	---	RPN null Set condition where RPN and NRPN are unspecified. The data entry messages after set RPN null will be ignored. (No Data entry messages are required after RPN null). Settings already made will not change. mm, ll: ignored

● Program Change

Status	2nd byte
CnH	ppH

n = MIDI channel number: 0H-FH (ch.1-ch.16)

pp = Program number: 00H-7FH (prog.1-prog.128)

- * Not received when Rx.PROGRAM CHANGE = OFF. (Initial value is ON)
- * After a Program Change message is received, the sound will change beginning with the next Note-on. Voices already sounding when the Program Change message was received will not be affected.
- * For Drum Parts, Program Change messages will not be received on bank numbers 129-16384 (the value of Control Number 0 is other than 0 (00H)).

● Channel Pressure

Status	2nd byte
DnH	vvH

n = MIDI channel number: 0H-FH (ch.1-ch.16)

vv = Channel Pressure: 00H-7FH (0-127)

- * Not received when Rx.CH PRESSURE (CAI) = OFF. (Initial value is ON)
- * The resulting effect is determined by System Exclusive messages. With the initial settings there will be no effect.

● Pitch Bend Change

Status	2nd byte	3rd byte
EnH	llH	mmH

n = MIDI channel number: 0H-FH (ch.1-ch.16)

mm, ll = Pitch Bend value: 00 00H - 40 00H - 7F 7FH (-8192 - 0 - +8191)

- * Not received when Rx.PITCH BEND = OFF. (Initial value is ON)
- * The resulting effect is determined by System Exclusive messages. With the initial settings the effect is Pitch Bend.

■ Channel Mode Messages

● All Sounds Off (Controller number 120)

Status	2nd byte	3rd byte
BnH	78H	00H

n = MIDI channel number: 0H-FH (ch.1-ch.16)

- * When this message is received, all currently-sounding notes on the corresponding channel will be turned off immediately.

● Reset All Controllers (Controller number 121)

Status	2nd byte	3rd byte
BnH	79H	00H

n = MIDI channel number : 0H-FH (ch.1-ch.16)

- * When this message is received, the following controllers will be set to their reset values.

Controller	Reset value
Pitch Bend Change	± 0 (center)
Polyphonic Key Pressure	0 (off)
Channel Pressure	0 (off)
Modulation	0 (off)
Expression	127 (max)
Hold 1	0 (off)
Portamento	0 (off)
Sostenuto	0 (off)
Soft	0 (off)
RPN	unset; previously set data will not change
NRPN	unset; previously set data will not change

● All Notes Off (Controller number 123)

Status	2nd byte	3rd byte
BnH	7BH	00H

n = MIDI channel number: 0H-FH (ch.1-ch.16)

- * When All Notes Off is received, all notes on the corresponding channel will be turned off. However if Hold 1 or Sostenuto is ON, the sound will be continued until these are turned off.

● OMNI OFF (Controller number 124)

Status	2nd byte	3rd byte
BnH	7CH	00H

n = MIDI channel number : 0H-FH (ch.1-ch.16)

- * The same processing will be carried out as when All Notes Off is received.

● OMNI ON (Controller number 125)

Status	2nd byte	3rd byte
BnH	7DH	00H

n = MIDI channel number : 0H-FH (ch.1-ch.16)

- * OMNI ON is only recognized as "All notes off"; the Mode doesn't change (OMNI OFF remains).

● MONO (Controller number 126)

Status	2nd byte	3rd byte
BnH	7EH	mmH

n = MIDI channel number: 0H-FH (ch.1-ch.16)

mm = mono number: 00H-10H (0-16)

- * The same processing will be carried out as when All Sounds Off and All Notes Off is received, and the corresponding channel will be set to Mode 4 (M = 1) regardless of the value of "mono number."

● POLY (Controller number 127)

Status	2nd byte	3rd byte
BnH	7FH	00H

n = MIDI channel number: 0H-FH (ch.1-ch.16)

- * The same processing will be carried out as when All Sounds Off and All Notes Off is received, and the corresponding channel will be set to Mode 3.

■ System Realtime Message

● Active Sensing

Status
FEH

- * When Active Sensing is received, the unit will begin monitoring the intervals of all further messages. While monitoring, if the interval between messages exceeds 420 ms, the same processing will be carried out as when All Sounds Off, All Notes Off and Reset All Controllers are received, and message interval monitoring will be halted.

■ System Exclusive Message

Status	Data byte	Status
F0H	iiH, ddH,eeH	F7H

F0H:	System Exclusive Message status
ii = ID number:	an ID number (manufacturer ID) to indicate the manufacturer whose Exclusive message this is. Roland's manufacturer ID is 41H. ID numbers 7EH and 7FH are extensions of the MIDI standard; Universal Non-realtime Messages (7EH) and Universal Realtime Messages (7FH).
dd.....ee = data:	00H-7FH (0-127)
F7H:	EOX (End Of Exclusive)

The System Exclusive Messages received by the AT-80 are; messages related to mode settings, Universal Realtime System Exclusive messages, and Data Set (DT1).

● System exclusive messages related to mode settings

These messages are used to initialize a device to GS or General MIDI mode. When creating performance data, a "Turn General MIDI System On" message should be inserted at the beginning of a General MIDI score, and a "GS Reset" message at the beginning of a GS music data. Each song should contain only one mode message as appropriate for the type of data. (Do not insert two or more mode setting messages in a single song.)

"Turn General MIDI System On" use Universal Non-realtime Message format. "GS Reset" use Roland system exclusive format "Data Set 1 (DT1)."

○ Turn General MIDI System On

This is a command message that resets the internal settings of the unit to the General MIDI initial state (General MIDI System-Level 1). After receiving this message, AT-80 will automatically be set to the proper condition for correctly playing a General MIDI score.

Status	Data byte	Status
F0H	7EH, 7FH, 09H, 01H	F7H

Byte	Explanation
F0H	Exclusive status
7EH	ID number (Universal Non-realtime Message)
7FH	Device ID (Broadcast)
09H	Sub ID#1 (General MIDI Message)
01H	Sub ID#2 (General MIDI On)
F7H	EOX (End Of Exclusive)

- When this message is received, Rx.BANK SELECT will be OFF and Rx.NRPN will be OFF.
- There must be an interval of at least 50 ms between this message and the next message.

○ GS reset

GS Reset is a command message that resets the internal settings of a device to the GS initial state. This message will appear at the beginning of GS music data, and a GS device that receives this message will automatically be set to the proper state to correctly playback GS music data.

Status	Data byte	Status
F0H	41H, 10H, 42H, 12H, 40H, 00H, 7FH, 00H, 41H	F7H

Byte	Explanation
F0H	Exclusive status
41H	ID number (Roland)
10H	Device ID
42H	Model ID (GS)
12H	Command ID (DT1)
40H	Address MSB
00H	Address
7FH	Address LSB
00H	Data (GS reset)
41H	Checksum
F7H	EOX (End Of Exclusive)

- When this message is received, Rx.NRPN will be ON.
- There must be an interval of at least 50 ms between this message and the next.

● Universal Realtime System Exclusive Messages

○ Master volume

Status	Data byte	Status
F0H	7FH, 7FH, 04H, 01H, 01H, mmH	F7H

Byte	Explanation
F0H	Exclusive status
7FH	ID number (universal realtime message)
7FH	Device ID (Broadcast)
04H	Sub ID#1 (Device Control messages)
01H	Sub ID#2 (Master Volume)
01H	Master volume lower byte
mmH	Master volume upper byte
F7H	EOX (End Of Exclusive)

- The lower byte (01H) of Master Volume will be handled as 00H.

● Data transmission

AT-80 can receive the various parameters using System Exclusive messages. The exclusive message of GS format data has a model ID of 42H and a device ID of 10H (17), and it is common to all the GS devices.

○ Data set 1 DT1

This is the message that actually performs data transmission, and is used when you wish to transmit the data.

Status	Data byte	Status
F0H	41H, 10H, 42H, 12H, aaH, bbH, ccH, ddH, ... eeH, sum	F7H

Byte	Explanation
F0H	Exclusive status
41H	ID number (Roland)
10H	Device ID
42H	Model ID (GS)
12H	Command ID (DT1)
aaH	Address MSB: upper byte of the starting address of the transmitted data
bbH	Address: middle byte of the starting address of the transmitted data
ccH	Address LSB: lower byte of the starting address of the transmitted data
ddH	Data: the actual data to be transmitted. Multiple bytes of data are transmitted starting from the address.
:	:
eeH	Data
sum	Checksum
F7H	EOX (End Of Exclusive)

- The amount of data that can be transmitted at one time depends on the type of data, and data can be received only from the specified starting address and size. Refer to the Address and Size given in Section 3 (page 76-82).
- Data larger than 128 bytes must be divided into packets of 128 bytes or less. If "Data Set 1" is transmitted successively, there must be an interval of at least 40 ms between packets.
- Regarding the checksum please refer to section 4 (page 84).

Section 2. Transmit data

Arranger and composer data can not be transmitted.

■ Channel Voice Message

● Note off

○ Upper Keyboard

Status	2nd byte	3rd byte
8nH	kkH	40H

n = MIDI channel number: 0H-FH (ch.1-ch.16)
Initial Value = CH (ch.13)

kk = note number: 30H-67H (48-103)

- Note off message is sent out with the velocity of 40H.

○ Lower Keyboard

Status	2nd byte	3rd byte
8nH	kkH	40H

n = MIDI channel number: 0H-FH (ch.1-ch.16)
Initial Value = BH (ch.12)

kk = note number: 1CH-67H (28-103)

- Note off message is sent out with the velocity of 40H.

○ Bass Pedalboard

Status	2nd byte	3rd byte
8nH	kkH	40H

n = MIDI channel number: 0H-FH (ch.1-ch.16)
Initial Value = DH (ch.14)

kk = note number: 24H-37H (36-55)

- Note off message is sent out with the velocity of 40H.

● **Note on**

○ **Upper Keyboard**

Status	2nd byte	3rd byte
9nH	kkH	vvH

n = MIDI channel number: 0H-FH (ch.1-ch.16)
Initial Value = CH (ch.13)

kk = note number: 30H-67H (48-103)

vv = Velocity: 01H-7FH (1-127)

○ **Lower Keyboard**

Status	2nd byte	3rd byte
9nH	kkH	vvH

n = MIDI channel number: 0H-FH (ch.1-ch.16)
Initial Value = BH (ch.12)

kk = note number: 1CH-67H (28-103)

vv = Velocity: 01H-7FH (1-127)

○ **Bass Pedalboard**

Status	2nd byte	3rd byte
9nH	kkH	64H

n = MIDI channel number: 0H-FH (ch.1-ch.16)
Initial Value = DH (ch.14)

kk = note number: 24H-37H (36-55)

* Note on message is sent out with the velocity of 64H.

● **Control change**

○ **Hold1 (Controller number 64)**

Status	2nd byte	3rd byte
BnH	40H	vvH

n = MIDI channel number: 0H-FH (ch.1-ch.16)
Initial Value = BH (ch.12)

vv = Control Value: 00H/7FH (0/127)
0=OFF, 127=ON

■ **System Realtime Message**

● **Active sensing**

Status
FEH

* This will be transmitted constantly at intervals of approximately 250 ms.

Section 3. Parameter Address Map (Model ID = 42H)

This map indicates address, size, Data (range), Parameter, Description, and Default Value of parameters which can be transferred using "Data set 1 (DT1)." All the numbers of address, size, Data, and Default Value are indicated in 7-bit Hexadecimal form.

■ **Address Block map**

An outlined address map of the Exclusive Communication is as follows;

Address (H)	Block	
40 00 00		
40 01 3F	SYSTEM PARAMETERS	Individual
40 1x 00		
40 2x 5A	PART PARAMETERS (x = 0-F)	Individual
41 m0 00		
41 m8 7F	DRUM SETUP PARAMETERS (m = 0-1)	Individual
48 00 00		
48 01 10	SYSTEM PARAMETERS	Bulk
48 1D 0F	PART PARAMETERS	Bulk
49 m0 00		
49 mE 17	DRUM SETUP PARAMETERS (m = 0-1)	Bulk

There are two ways in which CS data is transmitted: Individual Parameter Transmission in which individual parameters are transmitted one by one, and Bulk Dump Transmission in which a large amount of data is transmitted at once.

■ Individual Parameters

Individual Parameter Transmission transmits data (or requests data) for one parameter as one exclusive message (one packet of "F0 F7").

In Individual Parameter Transmission, you must use the Address and Size listed in the following "Parameter Address Map." Addresses marked at "#" cannot be used as starting addresses.

● System Parameters

Parameters related to the system of the device are called System Parameters.

Address (H)	Size (H)	Data (H)	Parameter	Description	Default Value (H)	Description
40 00 00	00 00 04	0018-07E8	MASTER TUNE	-100.0 - +100.0 [cent]	00 04 00 00	0 [cent]
40 00 01#			Use nibblized data.			
40 00 02#						
40 00 03#						
40 00 04	00 00 01	00-7F	MASTER VOLUME (= F0 7F 7F 04 01 00 vv F7)	0-127	7F	127
40 00 05	00 00 01	28-58	MASTER KEY-SHIFT	-24 - +24 [semitones]	40	0 [semitones]
40 00 06	00 00 01	01-7F	MASTER PAN	-63 (LEFT) - +63 (RIGHT)	40	0 (CENTER)
40 00 7F	00 00 01	00	MODE SET (Rx. only)	00 = GS Reset		

* Refer to "System exclusive messages related to mode settings" (page 74).

40 01 10	00 00 10	00-1C	VOICE RESERVE	Part 10 (Drum Part)	02	2
40 01 11#				Part 1	06	6
40 01 12#				Part 2	02	2
40 01 13#				Part 3	02	2
40 01 14#				Part 4	02	2
40 01 15#				Part 5	02	2
40 01 16#				Part 6	02	2
40 01 17#				Part 7	02	2
40 01 18#				Part 8	02	2
40 01 19#				Part 9 (Drum Part)	02	2
40 01 1A#				Part 11	00	0
40 01 :#				:		
40 01 1F#				Part 16	00	0

* The sum total of voices in the voice reserve function must be equal to or less than the number of the maximum polyphony. The maximum polyphony of the AT-80 from MIDI IN is 28. For compatibility with other GS models, it is recommended that the maximum polyphony be equal or less than 24.

40 01 30	00 00 01	00-07	REVERB MACRO	00: Room 1 01: Room 2 02: Room 3 03: Hall 1 04: Hall 2 05: Plate 06: Delay 07: Panning Delay	04	Hall 2
40 01 31	00 00 01	00-07	REVERB CHARACTER	0-7	04	4
40 01 32	00 00 01	00-07	REVERB PRE-LPF	0-7	00	0
40 01 33	00 00 01	00-7F	REVERB LEVEL	0-127	2B	43
40 01 34	00 00 01	00-7F	REVERB TIME	0-127	40	64
40 01 35	00 00 01	00-7F	REVERB DELAY FEEDBACK	0-127	00	0
40 01 36	00 00 01	00-7F	REVERB SEND LEVEL TO CHORUS0-127		00	0

* REVERB MACRO is a macro parameter that allows global setting of reverb parameters. When you select the reverb type with REVERB MACRO, each reverb parameter will be set to the most suitable value.

* REVERB CHARACTER is a parameter that changes the reverb algorithm. The value of REVERB CHARACTER corresponds to the REVERB MACRO of the same number.

Address (H)	Size (H)	Data (H)	Parameter	Description	Default Value (H)	Description
40 01 38	00 00 01	00-07	CHORUS MACRO	00: Chorus 1 01: Chorus 2 02: Chorus 3 03: Chorus 4 04: Feedback Chorus 05: Flanger 06: Short Delay 07: Short Delay (FB)	02	Chorus 3
40 01 39	00 00 01	00-07	CHORUS PRE-LPF	0-7	00	0
40 01 3A	00 00 01	00-7F	CHORUS LEVEL	0-127	40	64
40 01 3B	00 00 01	00-7F	CHORUS FEEDBACK	0-127	08	8
40 01 3C	00 00 01	00-7F	CHORUS DELAY	0-127	50	80
40 01 3D	00 00 01	00-7F	CHORUS RATE	0-127	03	3
40 01 3E	00 00 01	00-7F	CHORUS DEPTH	0-127	13	19
40 01 3F	00 00 01	00-7F	CHORUS SEND LEVEL TO REVERB0-127		00	0

* CHORUS MACRO is a macro parameter that allows global setting of chorus parameters. When you use CHORUS MACRO to select the chorus type, each chorus parameter will be set to the most suitable value.

● Part Parameters

AT-80 has 16 parts. Parameters that can be set individually for each Part are called Part parameters.

If you use exclusive messages to set Part parameters, specify the address by Block number rather than Part Number (normally the same number as the MIDI channel). The Block number can be specified as one of 16 blocks, from 0 (H) to F (H).

The relation between Part number and Block number is as follows.

x...BLOCK NUMBER (0-F), Part 1 (MIDI ch = 1) x = 1
 Part 2 (MIDI ch = 2) x = 2
 : : :
 Part 9 (MIDI ch = 9) x = 9
 Part10 (MIDI ch = 10) x = 0
 Part11 (MIDI ch = 11) x = A
 Part12 (MIDI ch = 12) x = B
 : : :
 Part16 (MIDI ch = 16) x = F

Address (H)	Size (H)	Data (H)	Parameter	Description	Default Value (H)	Description
40 1x 00	00 00 02	00-7F	TONE NUMBER	CC#00 VALUE 0-127	00	0
40 1x 01#		00-7F		P.C. VALUE 1-128	00	1
40 1x 02	00 00 01	00-10	Rx. CHANNEL	1-16, OFF	Same as the Part Number	
40 1x 03	00 00 01	00-01	Rx. PITCH BEND	OFF/ON	01	ON
40 1x 04	00 00 01	00-01	Rx. CH PRESSURE (CAf)	OFF/ON	01	ON
40 1x 05	00 00 01	00-01	Rx. PROGRAM CHANGE	OFF/ON	01	ON
40 1x 06	00 00 01	00-01	Rx. CONTROL CHANGE	OFF/ON	01	ON
40 1x 07	00 00 01	00-01	Rx. POLY PRESSURE (PAf)	OFF/ON	01	ON
40 1x 08	00 00 01	00-01	Rx. NOTE MESSAGE	OFF/ON	01	ON
40 1x 09	00 00 01	00-01	Rx. RPN	OFF/ON	01	ON
40 1x 0A	00 00 01	00-01	Rx. NRPN	OFF/ON	00 (01*)	OFF (ON*)

* Rx. NRPN is set to OFF by power-on, by receiving "Turn General MIDI System On" or by the arranger playback, and it will be set ON when "GS RESET" is received.

40 1x 0B	00 00 01	00-01	Rx. MODULATION	OFF/ON	01	ON
40 1x 0C	00 00 01	00-01	Rx. VOLUME	OFF/ON	01	ON
40 1x 0D	00 00 01	00-01	Rx. PANPOT	OFF/ON	01	ON
40 1x 0E	00 00 01	00-01	Rx. EXPRESSION	OFF/ON	01	ON
40 1x 0F	00 00 01	00-01	Rx. HOLD1	OFF/ON	01	ON
40 1x 10	00 00 01	00-01	Rx. PORTAMENTO	OFF/ON	01	ON
40 1x 11	00 00 01	00-01	Rx. SOSTENUTO	OFF/ON	01	ON
40 1x 12	00 00 01	00-01	Rx. SOFT	OFF/ON	01	ON
40 1x 13	00 00 01	00-01	MONO/POLY MODE	Mono/Poly	01	Poly
			(= CC# 126 01 / CC# 127 00)			
40 1x 14	00 00 01	00-02	ASSIGN MODE	0 = SINGLE 1 = LIMITED-MULTI 2 = FULL-MULTI	00 at x = 0 01 at x ≠ 0	SINGLE at x = 0 LIMITED-MULTI at x ≠ 0

* ASSIGN MODE is the parameter that determines how voice assignment will be handled when sounds overlap on identical note numbers in the same channel (i.e., repeatedly struck notes). This is initialized to a mode suitable for each Part, so for general purposes there is no need to change this.

Address (H)	Size (H)	Data (H)	Parameter	Description	Default Value (H)	Description
40 1x 15	00 00 01	00-02	USE FOR RHYTHM PART	0 = OFF 1 = MAP1 2 = MAP2	00 at x ≠ 0, x ≠ 9 01 at x = 0 02 at x = 9	OFF at x ≠ 0, x ≠ 9 MAP1 at x = 0 MAP2 at x = 0
<p>* This parameter sets the Drum Map of the Part used as the Drum Part. AT-80 can simultaneously (in different Parts) use up to two Drum Maps (MAP1, MAP2). With the initial settings, Part10 (MIDI CH = 10, x = 0) is set to MAP1 (1), Part9 (MIDI CH = 9, x = 9) is set to MAP2 (2), and other Parts are set to normal instrumental Parts (OFF (0)).</p>						
40 1x 16	00 00 01	28-58	PITCH KEY SHIFT	-24 - +24 [semitones]	40	0 [semitones]
40 1x 17	00 00 02	08-F8	PITCH OFFSET FINE	-12.0 - +12.0 [Hz]	08 00	0 [Hz]
40 1x 18#			Use nibblized data.			
<p>* PITCH OFFSET FINE allows you to alter, by a specified frequency amount, the pitch at which notes will sound. This parameter differs from the conventional Fine Tuning (RPN #1) parameter in that the amount of frequency alteration (in Hertz) will be identical no matter which note is played. When a multiple number of Parts, each of which has been given a different setting for PITCH OFFSET FINE, are sounded by means of an identical note number, you can obtain a Celeste effect.</p>						
40 1x 19	00 00 01	00-7F	PART LEVEL (= CC# 7)	0-127	64	100
40 1x 1A	00 00 01	00-7F	VELOCITY SENSE DEPTH	0-127	40	64
40 1x 1B	00 00 01	00-7F	VELOCITY SENSE OFFSET	0-127	40	64
40 1x 1C	00 00 01	00-7F	PART PANPOT (= CC# 10, except RANDOM)	-64(RANDOM), -63(LEFT)+63(RIGHT)	40	0 (CENTER)
40 1x 1D	00 00 01	00-7F	KEY RANGE LOW	(C-1)-(G9)	00	C-1
40 1x 1E	00 00 01	00-7F	KEY RANGE HIGH	(C-1)-(G9)	7F	G 9
40 1x 1F	00 00 01	00-5F	CC1 CONTROLLER NUMBER	0-95	10	16
40 1x 20	00 00 01	00-5F	CC2 CONTROLLER NUMBER	0-95	11	17
40 1x 21	00 00 01	00-7F	CHORUS SEND LEVEL (= CC# 93)	0-127	00	0
40 1x 22	00 00 01	00-7F	REVERB SEND LEVEL (= CC# 91)	0-127	28 at x ≠ 9 29 at x = 9	40 at x ≠ 9 41 at x = 9
40 1x 23	00 00 01	00-01	Rx. BANK SELECT	OFF/ON	01 (00*)	ON (OFF*)
<p>* Rx. BANK SELECT is set to ON by power-on or by receiving "GS RESET," and will be set OFF when "Turn General MIDI System On" is received.</p>						
40 1x 30	00 00 01	0E-72	TONE MODIFY 1 Vibrato rate (= NRPN# 8)	-50 - +50	40	0
40 1x 31	00 00 01	0E-72	TONE MODIFY 2 Vibrato depth (= NRPN# 9)	-50 - +50	40	0
40 1x 32	00 00 01	0E-72	TONE MODIFY 3 TVF cutoff frequency (= NRPN# 32)	-50 - +50	40	0
40 1x 33	00 00 01	0E-72	TONE MODIFY 4 TVF resonance (= NRPN# 33)	-50 - +50	40	0
40 1x 34	00 00 01	0E-72	TONE MODIFY 5 TVF&TVA Env.attack (= NRPN# 99)	-50 - +50	40	0
40 1x 35	00 00 01	0E-72	TONE MODIFY 6 TVF&TVA Env.decay (= NRPN# 100)	-50 - +50	40	0
40 1x 36	00 00 01	0E-72	TONE MODIFY 7 TVF&TVA Env.release (= NRPN# 102)	-50 - +50	40	0
40 1x 37	00 00 01	0E-72	TONE MODIFY 8 Vibrato delay (= NRPN# 10)	-50 - +50	40	0
40 1x 40	00 00 0C	00-7F	SCALE TUNING C	-64 - +63 [cent]	40	0 [cent]
40 1x 41#		00-7F	SCALE TUNING C#	-64 - +63 [cent]	40	0 [cent]
40 1x 42#		00-7F	SCALE TUNING D	-64 - +63 [cent]	40	0 [cent]
40 1x 43#		00-7F	SCALE TUNING D#	-64 - +63 [cent]	40	0 [cent]
40 1x 44#		00-7F	SCALE TUNING E	-64 - +63 [cent]	40	0 [cent]
40 1x 45#		00-7F	SCALE TUNING F	-64 - +63 [cent]	40	0 [cent]
40 1x 46#		00-7F	SCALE TUNING F#	-64 - +63 [cent]	40	0 [cent]
40 1x 47#		00-7F	SCALE TUNING G	-64 - +63 [cent]	40	0 [cent]
40 1x 48#		00-7F	SCALE TUNING G#	-64 - +63 [cent]	40	0 [cent]
40 1x 49#		00-7F	SCALE TUNING A	-64 - +63 [cent]	40	0 [cent]
40 1x 4A#		00-7F	SCALE TUNING A#	-64 - +63 [cent]	40	0 [cent]
40 1x 4B#		00-7F	SCALE TUNING B	-64 - +63 [cent]	40	0 [cent]

* SCALE TUNING is a function that allows fine adjustment to the pitch of each note in the octave. The pitch of each identically-named note in all octaves will change simultaneously. A setting of ± 0 cent (40H) is equal temperament. Refer to section 4. Supplementary material, "The Scale Tune Feature".

Address (H)	Size (H)	Data (H)	Parameter	Description	Default Value (H)	Description
40 2x 00	00 00 01	28-58	MOD PITCH CONTROL	-24 - +24 [semitone]	40	0 [semitones]
40 2x 01	00 00 01	00-7F	MOD TVF CUTOFF CONTROL	-9600 - +9600 [cent]	40	0 [cent]
40 2x 02	00 00 01	00-7F	MOD AMPLITUDE CONTROL	-100.0 - +100.0 [%]	40	0 [%]
40 2x 03	00 00 01	00-7F	MOD LFO1 RATE CONTROL	-10.0 - +10.0 [Hz]	40	0 [Hz]
40 2x 04	00 00 01	00-7F	MOD LFO1 PITCH DEPTH	0-600 [cent]	0A	47 [cent]
40 2x 05	00 00 01	00-7F	MOD LFO1 TVF DEPTH	0-2400 [cent]	00	0 [cent]
40 2x 06	00 00 01	00-7F	MOD LFO1 TVA DEPTH	0-100.0 [%]	00	0 [%]
40 2x 07	00 00 01	00-7F	MOD LFO2 RATE CONTROL	-10.0 - +10.0 [Hz]	40	0 [Hz]
40 2x 08	00 00 01	00-7F	MOD LFO2 PITCH DEPTH	0-600 [cent]	00	0 [cent]
40 2x 09	00 00 01	00-7F	MOD LFO2 TVF DEPTH	0-2400 [cent]	00	0 [cent]
40 2x 0A	00 00 01	00-7F	MOD LFO2 TVA DEPTH	0-100.0 [%]	00	0 [%]
40 2x 10	00 00 01	40-58	BEND PITCH CONTROL	0-24 [semitone]	42	2 [semitones]
40 2x 11	00 00 01	00-7F	BEND TVF CUTOFF CONTROL	-9600 - +9600 [cent]	40	0 [cent]
40 2x 12	00 00 01	00-7F	BEND AMPLITUDE CONTROL	-100.0 - +100.0 [%]	40	0 [%]
40 2x 13	00 00 01	00-7F	BEND LFO1 RATE CONTROL	-10.0 - +10.0 [Hz]	40	0 [Hz]
40 2x 14	00 00 01	00-7F	BEND LFO1 PITCH DEPTH	0-600 [cent]	00	0 [cent]
40 2x 15	00 00 01	00-7F	BEND LFO1 TVF DEPTH	0-2400 [cent]	00	0 [cent]
40 2x 16	00 00 01	00-7F	BEND LFO1 TVA DEPTH	0-100.0 [%]	00	0 [%]
40 2x 17	00 00 01	00-7F	BEND LFO2 RATE CONTROL	-10.0 - +10.0 [Hz]	40	0 [Hz]
40 2x 18	00 00 01	00-7F	BEND LFO2 PITCH DEPTH	0-600 [cent]	00	0 [cent]
40 2x 19	00 00 01	00-7F	BEND LFO2 TVF DEPTH	0-2400 [cent]	00	0 [cent]
40 2x 1A	00 00 01	00-7F	BEND LFO2 TVA DEPTH	0-100.0 [%]	00	0 [%]
40 2x 20	00 00 01	28-58	CAf PITCH CONTROL	-24 - +24 [semitone]	40	0 [semitones]
40 2x 21	00 00 01	00-7F	CAf TVF CUTOFF CONTROL	-9600 - +9600 [cent]	40	0 [cent]
40 2x 22	00 00 01	00-7F	CAf AMPLITUDE CONTROL	-100.0 - +100.0 [%]	40	0 [%]
40 2x 23	00 00 01	00-7F	CAf LFO1 RATE CONTROL	-10.0 - +10.0 [Hz]	40	0 [Hz]
40 2x 24	00 00 01	00-7F	CAf LFO1 PITCH DEPTH	0-600 [cent]	00	0 [cent]
40 2x 25	00 00 01	00-7F	CAf LFO1 TVF DEPTH	0-2400 [cent]	00	0 [cent]
40 2x 26	00 00 01	00-7F	CAf LFO1 TVA DEPTH	0-100.0 [%]	00	0 [%]
40 2x 27	00 00 01	00-7F	CAf LFO2 RATE CONTROL	-10.0 - +10.0 [Hz]	40	0 [Hz]
40 2x 28	00 00 01	00-7F	CAf LFO2 PITCH DEPTH	0-600 [cent]	00	0 [cent]
40 2x 29	00 00 01	00-7F	CAf LFO2 TVF DEPTH	0-2400 [cent]	00	0 [cent]
40 2x 2A	00 00 01	00-7F	CAf LFO2 TVA DEPTH	0-100.0 [%]	00	0 [%]
40 2x 30	00 00 01	28-58	PAf PITCH CONTROL	-24 - +24 [semitone]	40	0 [semitones]
40 2x 31	00 00 01	00-7F	PAf TVF CUTOFF CONTROL	-9600 - +9600 [cent]	40	0 [cent]
40 2x 32	00 00 01	00-7F	PAf AMPLITUDE CONTROL	-100.0 - +100.0 [%]	40	0 [%]
40 2x 33	00 00 01	00-7F	PAf LFO1 RATE CONTROL	-10.0 - +10.0 [Hz]	40	0 [Hz]
40 2x 34	00 00 01	00-7F	PAf LFO1 PITCH DEPTH	0-600 [cent]	00	0 [cent]
40 2x 35	00 00 01	00-7F	PAf LFO1 TVF DEPTH	0-2400 [cent]	00	0 [cent]
40 2x 36	00 00 01	00-7F	PAf LFO1 TVA DEPTH	0-100.0 [%]	00	0 [%]
40 2x 37	00 00 01	00-7F	PAf LFO2 RATE CONTROL	-10.0 - +10.0 [Hz]	40	0 [Hz]
40 2x 38	00 00 01	00-7F	PAf LFO2 PITCH DEPTH	0-600 [cent]	00	0 [cent]
40 2x 39	00 00 01	00-7F	PAf LFO2 TVF DEPTH	0-2400 [cent]	00	0 [cent]
40 2x 3A	00 00 01	00-7F	PAf LFO2 TVA DEPTH	0-100.0 [%]	00	0 [%]
40 2x 40	00 00 01	28-58	CC1 PITCH CONTROL	-24 - +24 [semitone]	40	0 [semitones]
40 2x 41	00 00 01	00-7F	CC1 TVF CUTOFF CONTROL	-9600 - +9600 [cent]	40	0 [cent]
40 2x 42	00 00 01	00-7F	CC1 AMPLITUDE CONTROL	-100.0 - +100.0 [%]	40	0 [%]
40 2x 43	00 00 01	00-7F	CC1 LFO1 RATE CONTROL	-10.0 - +10.0 [Hz]	40	0 [Hz]
40 2x 44	00 00 01	00-7F	CC1 LFO1 PITCH DEPTH	0-600 [cent]	00	0 [cent]
40 2x 45	00 00 01	00-7F	CC1 LFO1 TVF DEPTH	0-2400 [cent]	00	0 [cent]
40 2x 46	00 00 01	00-7F	CC1 LFO1 TVA DEPTH	0-100.0 [%]	00	0 [%]
40 2x 47	00 00 01	00-7F	CC1 LFO2 RATE CONTROL	-10.0 - +10.0 [Hz]	40	0 [Hz]
40 2x 48	00 00 01	00-7F	CC1 LFO2 PITCH DEPTH	0-600 [cent]	00	0 [cent]
40 2x 49	00 00 01	00-7F	CC1 LFO2 TVF DEPTH	0-2400 [cent]	00	0 [cent]
40 2x 4A	00 00 01	00-7F	CC1 LFO2 TVA DEPTH	0-100.0 [%]	00	0 [%]
40 2x 50	00 00 01	28-58	CC2 PITCH CONTROL	-24 - +24 [semitone]	40	0 [semitones]
40 2x 51	00 00 01	00-7F	CC2 TVF CUTOFF CONTROL	-9600 - +9600 [cent]	40	0 [cent]
40 2x 52	00 00 01	00-7F	CC2 AMPLITUDE CONTROL	-100.0 - +100.0 [%]	40	0 [%]
40 2x 53	00 00 01	00-7F	CC2 LFO1 RATE CONTROL	-10.0 - +10.0 [Hz]	40	0 [Hz]
40 2x 54	00 00 01	00-7F	CC2 LFO1 PITCH DEPTH	0-600 [cent]	00	0 [cent]
40 2x 55	00 00 01	00-7F	CC2 LFO1 TVF DEPTH	0-2400 [cent]	00	0 [cent]
40 2x 56	00 00 01	00-7F	CC2 LFO1 TVA DEPTH	0-100.0 [%]	00	0 [%]
40 2x 57	00 00 01	00-7F	CC2 LFO2 RATE CONTROL	-10.0 - +10.0 [Hz]	40	0 [Hz]
40 2x 58	00 00 01	00-7F	CC2 LFO2 PITCH DEPTH	0-600 [cent]	00	0 [cent]
40 2x 59	00 00 01	00-7F	CC2 LFO2 TVF DEPTH	0-2400 [cent]	00	0 [cent]
40 2x 5A	00 00 01	00-7F	CC2 LFO2 TVA DEPTH	0-100.0 [%]	00	0 [%]

● Drum Setup Parameters

- * m: Map number (0 = MAP1, 1 = MAP2)
- * rr: drum part note number (00H-7FH)

Address (H)	Size (H)	Data (H)	Parameter	Description
41 m1 rr	00 00 01	00-7F	PLAY NOTE NUMBER	Pitch coarse
41 m2 rr	00 00 01	00-7F	LEVEL (= NRP# 26)	TVA level
41 m3 rr	00 00 01	00-7F	ASSIGN GROUP NUMBER	Non, 1-127
41 m4 rr	00 00 01	00-7F	PANPOT (= NRP# 28, except RANDOM)	-64 (RANDOM), -63 (LEFT) - +63 (RIGHT)
41 m5 rr	00 00 01	00-7F	REVERB SEND LEVEL (= NRP# 29)	0.0-1.0 Multiplicand of the part reverb depth
41 m6 rr	00 00 01	00-7F	CHORUS SEND LEVEL (= NRP# 30)	0.0-1.0 Multiplicand of the part chorus depth
41 m7 rr	00 00 01	00-01	Rx. NOTE OFF	OFF/ON
41 m8 rr	00 00 01	00-01	Rx. NOTE ON	OFF/ON

- * When the Drum Set is changed, DRUM SETUP PARAMETER values will all be initialized.

■ Bulk Dump

Bulk Dump allows you to transmit a large amount of data at once.

Addresses marked at “#” cannot be used as starting addresses.

Bulk Dump data which include large amount of data (more than 128 bytes) will sent out in separate packets at an interval of about 40 ms. In this case, the subsequent packets may contain the address marked “#.”

To send several packets of large DT1 messages at a time, insert intervals of at least 40 ms. in between those packets.

● System and Part Parameters

Address (H)	Size (H)	Description	Number of packets
48 00 00	00 1D 10	ALL (All of the System parameters and Part parameters can be sent sequentially.)	30 packets
	#		
48 1D 0F#			
48 00 00	00 00 10	SYSTEM 1	1 packet
	#		
48 00 0F#			
48 00 10	00 01 00	SYSTEM 2	1 packet
	#		
48 01 0F#			
48 01 10	00 01 60	BLOCK 0	2 packets
	#		
48 02 6F#			
48 02 70	00 01 60	BLOCK 1	2 packets
	#		
48 04 4F#			
48 04 50	00 01 60	BLOCK 2	2 packets
	#		
48 06 2F#			
48 06 30	00 01 60	BLOCK 3	2 packets
	#		
48 08 0F#			
48 08 10	00 01 60	BLOCK 4	2 packets
	#		
48 09 6F#			
48 09 70	00 01 60	BLOCK 5	2 packets
	#		
48 0B 4F#			
48 0B 50	00 01 60	BLOCK 6	2 packets
	#		
48 0D 2F#			

Address (H)	Size (H)	Description	Number of packets
48 0D 30 48 0F 0F#	00 01 60 #	BLOCK 7	2 packets
48 0F 10 48 10 6F#	00 01 60 #	BLOCK 8	2 packets
48 10 70 48 12 4F#	00 01 60 #	BLOCK 9	2 packets
48 12 50 48 14 2F#	00 01 60 #	BLOCK A	2 packets
48 14 30 48 16 0F#	00 01 60 #	BLOCK B	2 packets
48 16 10 48 17 6F#	00 01 60 #	BLOCK C	2 packets
48 17 70 48 19 4F#	00 01 60 #	BLOCK D	2 packets
48 19 50 48 1B 2F#	00 01 60 #	BLOCK E	2 packets
48 1B 30 48 1D 0F#	00 01 60 #	BLOCK F	2 packets

● DRUM SETUP PARAMETERS

m: map number (0 = MAP1, 1 = MAP2)

Address (H)	Size (H)	Description	Number of packets
49 m0 00 49 m1 7F	00 02 00	PLAY NOTE NUMBER	2 packets
49 m2 00 49 m3 7F	00 02 00	LEVEL	2 packets
49 m4 00 49 m5 7F	00 02 00	ASSIGN GROUP NUMBER	2 packets
49 m6 00 49 m7 7F	00 02 00	PANPOT	2 packets
49 m8 00 49 m9 7F	00 02 00	REVERB SEND LEVEL	2 packets
49 mA 00 49 mB 7F	00 02 00	CHORUS SEND LEVEL	2 packets
49 mC 00 49 MD 7F	00 02 00	Rx. NOTE ON/OFF	2 packets
49 ME 00 49 ME 17	00 00 18	DRUM MAP NAME	1 packet

Section 4. Supplementary material

● Decimal and Hexadecimal table

In MIDI documentation, data values and addresses/sizes of exclusive messages etc. are expressed as hexadecimal values for each 7 bits. The following table shows how these correspond to decimal numbers.

D	H	D	H	D	H	D	H
0	00H	32	20H	64	40H	96	60H
1	01H	33	21H	65	41H	97	61H
2	02H	34	22H	66	42H	98	62H
3	03H	35	23H	67	43H	99	63H
4	04H	36	24H	68	44H	100	64H
5	05H	37	25H	69	45H	101	65H
6	06H	38	26H	70	46H	102	66H
7	07H	39	27H	71	47H	103	67H
8	08H	40	28H	72	48H	104	68H
9	09H	41	29H	73	49H	105	69H
10	0AH	42	2AH	74	4AH	106	6AH
11	0BH	43	2BH	75	4BH	107	6BH
12	0CH	44	2CH	76	4CH	108	6CH
13	0DH	45	2DH	77	4DH	109	6DH
14	0EH	46	2EH	78	4EH	110	6EH
15	0FH	47	2FH	79	4FH	111	6FH
16	10H	48	30H	80	50H	112	70H
17	11H	49	31H	81	51H	113	71H
18	12H	50	32H	82	52H	114	72H
19	13H	51	33H	83	53H	115	73H
20	14H	52	34H	84	54H	116	74H
21	15H	53	35H	85	55H	117	75H
22	16H	54	36H	86	56H	118	76H
23	17H	55	37H	87	57H	119	77H
24	18H	56	38H	88	58H	120	78H
25	19H	57	39H	89	59H	121	79H
26	1AH	58	3AH	90	5AH	122	7AH
27	1BH	59	3BH	91	5BH	123	7BH
28	1CH	60	3CH	92	5CH	124	7CH
29	1DH	61	3DH	93	5DH	125	7DH
30	1EH	62	3EH	94	5EH	126	7EH
31	1FH	63	3FH	95	5FH	127	7FH

- Decimal values such as MIDI channel, bank select, and program change are listed as one (1) greater than the values given in the above table.
- A 7-bit byte can express data in the range of 128 steps. For data where greater precision is required, we must use two or more bytes. For example, two hexadecimal numbers aa bbH expressing two 7-bit bytes would indicate a value of $aa \times 128 + bb$.
- In the case of values which have a \pm sign, 00H = -64, 40H = ± 0 , and 7FH = +63, so that the decimal expression would be 64 less than the value given in the above chart. In the case of two types, 00 00H = -8192, 40 00H = ± 0 , and 7F 7FH = +8191. For example if aa bbH were expressed as decimal, this would be $aa \text{ bbH} - 40 \text{ 00H} = aa \times 128 + bb - 64 \times 128$.
- Data marked "nibbled" is expressed in hexadecimal in 4-bit units. A value expressed as a 2-byte nibble 0a 0bH has the value of $a \times 16 + b$.

<Example 1>

What is the decimal expression of 5AH ?

From the preceding table, 5AH = 90

<Example 2>

What is the decimal expression of the value 12 34H given as hexadecimal for each 7 bits?

From the preceding table, since 12H = 18 and 34H = 52
 $18 \times 128 + 52 = 2356$

<Example 3>

What is the decimal expression of the nibbled value 0A 03 09 0D ?

From the preceding table, since 0AH = 10, 03H = 3, 09H = 9, 0DH = 13
 $((10 \times 16 + 3) \times 16 + 9) \times 16 + 13 = 41885$

<Example 4>

What is the nibbled expression of the decimal value 1258?

```

16) 1258
   78
  ---
   4
   0
  ---
   0
  
```

Since from the preceding table, 0 = 00H, 4 = 04H, 14 = 0EH, 10 = 0AH, the answer is 00 04 0E 0AH.

● Examples of actual MIDI messages

<Example 1> 92 3E 5F

9n is the Note-on status, and n is the MIDI channel number. Since 2H = 2, 3EH = 62, and 5FH = 95, this is a Note-on message with MIDI CH = 3, note number 62 (note name is D4), and velocity 95.

<Example 2> CE 49

CnH is the Program Change status, and n is the MIDI channel number. Since EH = 14 and 49H = 73, this is a Program Change message with MIDI CH = 15, program number 74 (Flute in GS).

<Example 3> EA 00 28

EnH is the Pitch Bend Change status, and n is the MIDI channel number. The 2nd byte (00H = 0) is the LSB and the 3rd byte (28H = 40) is the MSB, but Pitch Bend Value is a signed number in which 40 00H ($= 64 \times 128 + 0 = 8192$) is 0, so this Pitch Bend Value is $28 \text{ 00H} - 40 \text{ 00H} = 40 \times 128 + 0 - (64 \times 128 + 0) = 5120 - 8192 = -3072$

If the Pitch Bend Sensitivity is set to 2 semitones, -8192 (00 00H) will cause the pitch to change -200 cents, so in this case $-200 \times (-3072) / (-8192) = -75$ cents of Pitch Bend is being applied to MIDI channel 11.

<Example 4> B3 64 00 65 00 06 0C 26 00 64 7F 65 7F

BnH is the Control Change status, and n is the MIDI channel number. For Control Changes, the 2nd byte is the control number, and the 3rd byte is the value. In a case in which two or more messages consecutive messages have the same status, MIDI has a provision called "running status" which allows the status byte of the second and following messages to be omitted. Thus, the above messages have the following meaning.

B3	64 00	MIDI ch.4, lower byte of RPN parameter number:	00H
(B3)	65 00	(MIDI ch.4) upper byte of RPN parameter number:	00H
(B3)	06 0C	(MIDI ch.4) upper byte of parameter value:	0CH
(B3)	26 00	(MIDI ch.4) lower byte of parameter value:	00H
(B3)	64 7F	(MIDI ch.4) lower byte of RPN parameter number:	7FH
(B3)	65 7F	(MIDI ch.4) upper byte of RPN parameter number:	7FH

In other words, the above messages specify a value of 0C 00H for RPN parameter number 00 00H on MIDI channel 4, and then set the RPN parameter number to 7F 7FH.

RPN parameter number 00 00H is Pitch Bend Sensitivity, and the MSB of the value indicates semitone units, so a value of 0CH = 12 sets the maximum pitch bend range to ± 12 semitones (1 octave). (On GS sound sources the LSB of Pitch Bend Sensitivity is ignored, but the LSB should be transmitted anyway (with a value of 0) so that operation will be correct on any device.)

Once the parameter number has been specified for RPN or NRPN, all Data Entry messages transmitted on that same channel will be valid, so after the desired value has been transmitted, it is a good idea to set the parameter number to 7F 7FH to prevent accidents. This is the reason for the (B3) 64 7F (B3) 65 7F at the end.

It is not desirable for performance data (such as Standard MIDI File data) to contain many events with running status as given in <Example 4>. This is because if playback is halted during the song and then rewound or fast-forwarded, the sequencer may not be able to transmit the correct status, and the sound source will then misinterpret the data. Take care to give each event its own status.

It is also necessary that the RPN or NRPN parameter number setting and the value setting be done in the proper order. On some sequencers, events occurring in the same (or consecutive) clock may be transmitted in an order different than the order in which they were received. For this reason it is a good idea to slightly skew the time of each event (about 1 tick for TPQN = 96, and about 5 ticks for TPQN = 480).

- TPQN: Ticks Per Quarter Note

● Example of an Exclusive message and calculating a Checksum

Roland Exclusive messages (DT1) are transmitted with a checksum at the end (before F7) to make sure that the message was correctly received. The value of the checksum is determined by the address and data (or size) of the transmitted exclusive message.

○ How to calculate the checksum (hexadecimal numbers are indicated by 'H')

The checksum is a value derived by adding the address, size and checksum itself and inverting the lower 7 bits.

Here's an example of how the checksum is calculated. We will assume that in the exclusive message we are transmitting, the address is aa bb ccH and the data or size is dd ee ffH.

aa + bb + cc + dd + ee + ff = sum
 sum / 128 = quotient ... remainder
 128 - remainder = checksum

<Example> Setting REVERB MACRO to ROOM 3

According to the "Parameter Address Map," the REVERB MACRO Address is 40 01 30H, and ROOM 3 is a value of 02H. Thus,

F0 41 10 42 12 40 01 30 02 ?? F7
 (1) (2) (3) (4) (5) address data checksum (6)

(1) Exclusive Status (2) ID (Roland) (3) Device ID (17)
 (4) Model ID (GS) (5) Command ID (DT1) (6) End of Exclusive

Next we calculate the checksum.

40H + 01H + 30H + 02H = 64 + 1 + 48 + 2 = 115 (sum)
 115 (sum) / 128 = 0 (quotient) ... 115 (remainder)
 checksum = 128 - 115 (remainder) = 13 = 0DH

This means that F0 41 10 42 12 40 01 30 02 0D F7 is the message we transmit.

● GS Tone Mapping

PC	CC00	Instrument	No. of voices	Remark
Piano				
001	000	Piano 1	1	
	008	Piano 1w	2	
	016	Piano 1d	1	
002	000	Piano 2	1	
	008	Piano 2w	2	
003	000	Piano 3	1	
	008	Piano 3w	2	
004	000	Honky-tonk	2	
	008	Honky-tonk w	2	
005	000	E.Piano 1	1	
	008	Detuned EP 1	2	
	016	E.Piano 1v	2	
	024	60's E.Piano	1	
006	000	E.Piano 2	1	
	008	Detuned EP 2	2	
	016	E.Piano 2v	2	
007	000	Harpsichord	1	
	008	Coupled Hps.	2	
	016	Harpsi.w	2	
	024	Harpsi.o	2	
008	000	Clav.	1	

Chromatic percussion

009	000	Celesta	1	
010	000	Glockenspiel	1	
011	000	Music Box	1	
012	000	Vibraphone	1	
	008	Vib.w	2	
013	000	Marimba	1	
	008	Marimba w	2	
014	000	Xylophone	1	
015	000	Tubular-bell	1	
	008	Church Bell	1	
	009	Carillon	1	
016	000	Santur	1	

Organ

017	000	Organ 1	1	
	008	Detuned Or.1	2	
	016	60's Organ 1	1	
	032	Organ 4	2	
018	000	Organ 2	1	
	008	Detuned Or.2	2	
	032	Organ 5	2	
019	000	Organ 3	2	
020	000	Church Org.1	1	
	008	Church Org.2	2	
	016	Church Org.3	2	
021	000	Reed Organ	1	
022	000	Accordion Fr	2	
	008	Accordion It	2	
023	000	Harmonica	1	
024	000	Bandoneon	2	

PC	CC00	Instrument	No. of voices	Remark
Guitar				
025	000	Nylon-str.Gt	1	
	008	Ukulele	1	
	016	Nylon Gt.o	2	
	032	Nylon Gt.2	1	
026	000	Steel-str.Gt	1	
	008	12-str.Gt	2	
	016	Mandolin	1	
027	000	Jazz Gt.	1	
	008	Hawaiian Gt.	1	
028	000	Clean Gt.	1	
	008	Chorus Gt.	2	
029	000	Muted Gt.	1	
	008	Funk Gt.	1	
	016	Funk Gt.2	1	
030	000	Overdrive Gt	1	
031	000	DistortionGt	1	
	008	Feedback Gt.	2	
032	000	Gt.Harmonix	1	
	008	Gt.Feedback	1	
Bass				
033	000	Acoustic Bs.	1	
034	000	Fingered Bs.	1	
035	000	Picked Bs.	1	
036	000	Fretless Bs.	1	
037	000	Slap Bass 1	1	
038	000	Slap Bass 2	1	
039	000	Synth Bass 1	1	
	001	Synth Bass101	1	
	008	Synth Bass 3	1	
040	000	Synth Bass 2	2	
	008	Synth Bass 4	2	
	016	Rubber Bass	2	
Strings / orchestra				
041	000	Violin	1	
	008	Slow Violin	1	
042	000	Viola	1	
043	000	Cello	1	
044	000	Contrabass	1	
045	000	Tremolo Str	1	
046	000	PizzicatoStr	1	
047	000	Harp	1	
048	000	Timpani	1	
Ensemble				
049	000	Strings	1	
	008	Orchestra	2	
050	000	Slow Strings	1	
051	000	Syn.Strings1	1	
	008	Syn.Strings3	2	
052	000	Syn.Strings2	2	
053	000	Choir Aahs	1	
	032	Choir Aahs 2	1	
054	000	Voice Coahs	1	
055	000	SynVox	1	
056	000	Orchestrahit	2	

PC	CC00	Instrument	No. of voices	Remark
Brass				
057	000	Trumpet	1	
058	000	Trombone	1	
	001	Trombone 2	2	
059	000	Tuba	1	
060	000	MutedTrumpet	1	
061	000	French Horns	2	
	001	French Horn2	2	
062	000	Brass 1	1	
	008	Brass 2	2	
063	000	Synth Brass1	2	
	008	Synth Brass3	2	
	016	AnalogBrass1	2	
064	000	Synth Brass2	2	
	008	Synth Brass4	1	
	016	AnalogBrass2	2	
Reed				
065	000	Soprano Sax	1	
066	000	Alto Sax	1	
067	000	Tenor Sax	1	
068	000	Baritone Sax	1	
069	000	Oboe	1	
070	000	English Horn	1	
071	000	Bassoon	1	
072	000	Clarinet	1	
Pipe				
073	000	Piccolo	1	
074	000	Flute	1	
075	000	Recorder	1	
076	000	Pan Flute	1	
077	000	Bottle Blow	2	
078	000	Shakuhachi	2	
079	000	Whistle	1	
080	000	Ocarina	1	
Synth lead				
081	000	Square Wave	2	
	001	Square	1	
	008	Sine Wave	1	
082	000	Saw Wave	2	
	001	Saw	1	
	008	Doctor Solo	2	
083	000	Syn.Calliope	2	
084	000	Chiffer Lead	2	
085	000	Charang	2	
086	000	Solo Vox	2	
087	000	5th Saw	2	
088	000	Bass & Lead	2	
Synth pad, etc				
089	000	Fantasia	2	
090	000	Warm Pad	1	
091	000	Polysynth	2	
092	000	Space Voice	1	
093	000	Bowed Glass	2	
094	000	Metal Pad	2	
095	000	Halo Pad	2	
096	000	Sweep Pad	1	

PC	CC00	Instrument	No. of voices	Remark	PC	CC00	Instrument	No. of voices	Remark
Synth SFX					SFX				
097	000	Ice Rain	2		121	000	Gt.FretNoise	1	
098	000	Soundtrack	2		001	Gt.Cut Noise	1		**
099	000	Crystal	2		002	String Slap	1		**
	001	Syn Mallet	1		122	000	Breath Noise	1	
100	000	Atmosphere	2		001	Fl.Key Click	1		**
101	000	Brightness	2		123	000	Seashore	1	
102	000	Goblin	2		001	Rain	1		**
103	000	Echo Drops	1		002	Thunder	1		**
	001	Echo Bell	2		003	Wind	1		**
	002	Echo Pan	2		004	Stream	2		**
104	000	Star Theme	2		005	Bubble	2		**
Ethnic, etc.					124	000	Bird	2	
105	000	Sitar	1		001	Dog	1		**
	001	Sitar 2	2		002	Horse-Gallop	1		**
106	000	Banjo	1		003	Bird 2	1		**
107	000	Shamisen	1		125	000	Telephone 1	1	
108	000	Koto	1		001	Telephone 2	1		**
	008	Taisho Koto	2		002	DoorCreaking	1		**
109	000	Kalimba	1		003	Door	1		**
110	000	Bagpipe	1		004	Scratch	1		**
111	000	Fiddle	1		005	Windchime	2		**
112	000	Shanai	1		126	000	Helicopter	1	
Percussive					001	Car-Engine	1		**
113	000	Tinkle Bell	1		002	Car-Stop	1		**
114	000	Agogo	1		003	Car-Pass	1		**
115	000	Steel Drums	1		004	Car-Crash	2		**
116	000	Woodblock	1	**	005	Siren	1		**
	008	Castanets	1	**	006	Train	1		**
117	000	Taiko	1	**	007	Jetplane	2		**
	008	Concert BD	1	**	008	Starship	2		**
118	000	Melo. Tom 1	1	**	009	Burst Noise	2		**
	008	Melo. Tom 2	1	**	127	000	Applause	2	
119	000	Synth Drum	1	**	001	Laughing	1		**
	008	808 Tom	1	**	002	Screaming	1		**
	009	Elec Perc	1	**	003	Punch	1		**
120	000	Reverse Cym.	1	**	004	Heart Beat	1		**
					005	Footsteps	1		**
					128	000	Gun Shot	1	
					001	Machine Gun	1		**
					002	Lasergun	1		**
					003	Explosion	2		**

Remark **: a percussive sound which cannot be played melodically. Use near C4 (note number 60).

MIDI Implementation Chart

Function...		Transmitted	Recognized	Remarks
Basic Channel	Default Changed	12(Lower), 13(Upper), 14(Bass) 1-16	1-16	
Mode	Default Messages Altered	x x *****	Mode 3 Mode 3, 4(M=1)	* 2
Note Number :	True Voice	28-103 *****	0-127 0-127	
Velocity	Note ON Note OFF	O * 1 x 8n v=64	O x	
After Touch	Key's Ch's	x x	O O	
Pitch Bend		x	O	
Control Change	0, 32 1 5 6, 38 7 10 11 64 65 66 67 84 91 93 98, 99 100, 101	x x x x x x O x x x x x x x x x x	O O O O O O O O O O O O O O O (Reverb) O (Chorus) O O	Bank select Modulation Portamento time Data entry Volume Panpot Expression Hold 1 Portamento Sostenuto Soft Portamento control Effect1 depth Effect3 depth NRPN LSB, MSB RPN LSB, MSB
Prog Change	: True #	x *****	O 0-127	Prog. 1-128
System Exclusive		x	O	
System Common	: Song Pos : Song Sel : Tune	x x x	x x x	
System Real Time	: Clock : Commands	x x	x x	
Aux Message	: All sound off : Reset all controllers : Local ON/OFF : All Notes OFF : Active Sense : Reset	x x x x O x	O (120, 126, 127) O x O (123-127) O O x	
Notes		* 1 O x is selectable. * 2 Recognized as M=1 even if M≠1.		

Mode 1 : OMNI ON, POLY Mode 2 : OMNI ON, MONO
 Mode 3 : OMNI OFF, POLY Mode 4 : OMNI OFF, MONO

O : Yes
 X : No

Specifications

Keyboard (Organ)

AT-80: Atelier

● Keyboard

Upper 56 Keys Lower 76 Keys;
Pedalboard 20 notes

● Voices (184 Voices)

Upper Organ:

Full, Jazz, Pipe, Theater, Rock etc.

Upper Symphonic:

Strings, Slow Strings, Synth Strings, Synth Pad,
Choir, etc.

Upper Orchestral:

Piano, E.Piano, A.Guitar, E.Guitar, Brass,
Harpsi, Harp, Vibes, Marimba, Mandolin, Banjo,
Accordion, Harmonica, etc.

Lower Organ:

Full, Lower, Pipe, Theater, etc.

Lower Symphonic:

Strings, Synth Strings, Choir, etc.

Lower Orchestral:

Piano, E.Piano, A.Guitar, Brass, Harpsi, Harp,
Vibes, Marimba, Accordion, Harmonica, etc.

Solo:

Violin, Trumpet, Sax, Flute, Oboe, Clarinet, etc.

Pedal Organ:

Organ, Pipe, Theater, etc.

Pedal Orchestral:

String, Contrabass, Electric, etc.

* Any two of the 184 voices (except the preset ones) can be assigned to each Others button. (One for Pedal Organ and Pedal Orchestral Others buttons.)

● Rhythms (51 Rhythms, Variation/Original)

Big Band, Swing, Country1, Country2, 50's,
Ballad, Trad, Latin1, Latin2, Showtime, Pops,
Gospel, March, Waltz, etc.

* Music Style Disks (MSA series; sold separately) can provide additional Music Styles.

● Number of accompaniment/SMF play voices

226 Voices

● Number of Manual Drums sets

8 Sets

● Number of Sound Effects sets

1 Set

● Number of Manual Percussion sets

1 Set

● Effects

Rotary Sound, Chorus, Reverb, Sustain, Vibrato,
Pitch Bend, Glide

● Harmony Intelligence

Traditional, Broadway, Duet, Organ, Combo,
Strings, Hymn, Block, Big Band, Country

● Arranger function

Arranger On/Off, Chord Intelligence, Leading
Bass, Advanced/Basic, Break, One Touch
Program

● Number of Registration memories

12

● Composer

Tracks : 7
Note Storage : approx. 40,000 notes
Song Length : max. 999 measures
Tempo : Quarter note = 30 to 250
Resolution : 120 ticks per quarter note
Recording : Realtime

● Storage: 3.5 inch micro floppy disk

Disk format:

720K bytes (2DD), 1.44M bytes (2HD)

Songs:

max. 56 (2DD), max. 99 (2HD)

● Rated power output

60 W × 2, 120 W (low-range)

● Speakers

Body:

full-range: 8 cm × 2 (monitor)
3-3/16 inches × 2 (monitor)

Stand:

full-range: 16 cm × 4
6-5/16 inches × 4

woofer: 30 cm × 1
11-13/16 inches × 1

● Display

16 characters, 2 lines (backlit LCD)

● Disk drive

3.5 inch micro floppy disk drive (2DD/2HD)

● Pedals

Damper pedal
Expression pedal
Two foot switches (assignable)

● Connectors

Phones jack (Stereo)
AC inlet
MIDI connectors (In/Out)
Audio output jacks (L(MONO)/R)
Audio input jacks (L(MONO)/R)
Mic jack
Computer connector

● Power supply

AC 117 V, AC 230 V or AC 240 V

● Power consumption

436 W (AC 117 V)
327 W (AC 230 V)
327 W (AC 240 V)

● Finish

Cherry Wood

● Dimensions

Body:

1350(W) × 616(D) × 521.5(H) mm
(Including music rest)

53-3/16(W) × 24-1/4(D) × 20-9/16(H) inches

Stand:

1328(W) × 564(D) × 759.5(H) mm

52-5/16(W) × 22-1/4(D) × 29-15/16(H) inches

Total:

1350(W) × 616(D) × 1273(H) mm

53-3/16(W) × 24-1/4(D) × 50-1/8(H) inches

● Weight

Body: 60 kg/132 lbs 5 oz

Stand: 60 kg/132 lbs 5 oz

Total: 120 kg/264 lbs 10 oz

● Accessories

Bench
Owner's manual
3.5 inch micro floppy disk (2HD)
Music style disk
Power cord

● Optional Accessories

Music style disk (MSA series)
Microphone (Dynamic)
SMF Music Data (disk)

** In the interest of product development, the specifications and/or appearance of this product are subject to change without prior notice.*

Index

A	
Advanced	26
Aftertouch	54
Aftertouch Sens	54
All Song Play.....	47
Alternate	
Lower	18
Solo	20
Upper.....	18
Arrangement	
Advanced.....	26
Variation.....	24, 26
Arranger	26, 38
Arranger Update	57
Automatic accompaniment.....	26
B	
Basic screens.....	48
Bass Split.....	35
Bass Split Point	35, 56
Beat.....	58
Beat indicator	39
Bender/Vibrato Destination	56
Brilliance	37
Bwd	44, 45
C	
Channel Mute	62
Chord	40
Chord Hold	56
Chord Intelligence.....	40
Chorus.....	33
Clear	45, 50
Composer	43
Computer	64
Contrast	57
Copy	61
Count-In Recording	58
D	
Damper pedal	34
Delete	
Music data from a track.....	60
Part of the recorded data	59
Performance data.....	48
Registration	50
Demo	17
Display	48
Drums	31
E	
Edit Menu	59
Effect.....	52
Ending.....	26, 39
Erase	
Performance data.....	45
Specified portion of music data.....	60
Exp. Source.....	58
Expression Curve	57
Expression Pedal	16, 34
F	
Fill In	
To Original.....	24, 26
To Variation	24, 26
Floppy disk.....	42
Foot Switches	37, 55
Format.....	42
Function.....	58-62
Fwd.....	44, 45
G	
Glide.....	37, 55
H	
Harmony Intelligence.....	21
Harmony Type.....	21, 56
I	
Illumination.....	15
Initial Touch	54
Intro	26, 39
L	
LCD Contrast	57
Leading Bass	40
Load	
Performance data.....	46
Registration	50
Lower	16, 18
Lower Voice Hold.....	41
M	
Manual	27
Manual Drums.....	31, 56
Manual Perc	32
Master Tune.....	57
Master Volume.....	16
Metronome	58
Metronome Volume	58
MIDI	57, 63
Music style disk.....	30

N		
NEW SONG	44	
O		
Octave Shift	51	
Octave Up	19	
One Touch Program	26, 41	
Original	24, 26	
Others	28	
Output	14	
P		
Part Balance	51	
Pedal Bass	19	
Pedal Bass Mode	55	
Phones	13	
Pitch Bend	37	
Pitch Bend Range	56	
Play	45, 47	
Power	16	
Protect tab	43	
Q		
Quantize	61	
R		
Recording	43	
Regist Shift	55	
Registration		
Delete	50	
Load	50	
Recall	27	
Save	49	
Store	27	
Rename	46	
Reset	17, 44, 45	
Resolution	61	
Reverb	33	
Reverb Depth	53	
Reverb Type	52	
Rhythm	24, 25, 30	
Rotary	23	
Rotary Color	53	
Rotary Speed	53	
S		
Save		
Performance data	46	
Registration	49	
Solo	20	
Solo Split Point	35, 56	
Sound Effects	31, 56	
Standard MIDI File	47	
Start		
Recording	43, 44	
Rhythm	24, 38, 39	
Automatic accompaniment	26, 38, 39	
Stop		
Recording	43, 44	
Rhythm	24, 39	
Automatic accompaniment	26, 39	
Sustain	34	
Sustain Length	53	
Sync Start	38	
T		
Tempo	39	
To Lower		
Bass	35	
Solo	35	
To Original	24, 26	
To Variation	24, 26	
Track	43	
Track mute	45	
Transpose	52	
Tx MIDI Channel	57	
U		
Upper	16, 18	
Utility	54	
V		
Variation	24, 26	
Vibrato	37	
Voice		
Lower	18	
Pedal Bass	19	
Solo	20	
Upper	18	
Volume	16	
Volume balance	51	
W		
Write	27, 41	

MEMO

Information

When you need repair service, call your nearest Roland Service Center or authorized Roland distributor in your country as shown below.

ARGENTINA

Instrumentos Musicales S.A.
Florida 638
(1005) Buenos Aires
ARGENTINA
TEL: (01) 394 4029

BRAZIL

Roland Brasil Ltda.
R. Coronel Octaviano da Silveira
203 05522-010
Sao Paulo BRAZIL
TEL: (011) 843 9377

CANADA

Roland Canada Music Ltd.
(Head Office)
5480 Parkwood Way Richmond
B. C., V6V 2M4 CANADA
TEL: (604) 270 6626

Roland Canada Music Ltd.
(Toronto Office)
Unit 2, 109 Woodbine Downs
Blvd, Etobicoke, ON
M9W 6Y1 CANADA
TEL: (0416) 213 9707

MEXICO

Casa Veerkamp, s.a. de c.v.
Av. Toluca No. 323 Col. Olivar de
los Padres 01780 Mexico D.F.
MEXICO
TEL: (525) 668 04 80

La Casa Wagner de
Guadalajara s.a. de c.v.
Av. Corona No. 202 S.J.
Guadalajara, Jalisco Mexico
C.P. 44100 MEXICO
TEL: (03) 613 1414

PANAMA

Productos Superiores, S.A.
Apartado 655 - Panama 1
REP. DE PANAMA
TEL: 26 3322

U. S. A.

Roland Corporation U.S.
7200 Dominion Circle
Los Angeles, CA. 90040-3696,
U. S. A.
TEL: (0213) 685 5141

VENEZUELA

Musicaland Digital C.A.
Av. Francisco de Miranda,
Centro Parque de Cristal, Nivel
C2 Local 20 Caracas
VENEZUELA
TEL: (02) 285 9218

AUSTRALIA

Roland Corporation
Australia Pty. Ltd.
38 Campbell Avenue
Dee Why West. NSW 2099
AUSTRALIA
TEL: (02) 982 8266

NEW ZEALAND

Roland Corporation (NZ) Ltd.
97 Mt. Eden Road, Mt. Eden,
Auckland 3, NEW ZEALAND
TEL: (09) 3098 715

CHINA

Beijing Xinghai Musical
Instruments Co., Ltd.
2 Huangmunchang Chao Yang
District, Beijing, CHINA
TEL: (010) 6774 7491

HONG KONG

Tom Lee Music Co., Ltd.
Service Division
22-32 Pun Shan Street, Tsuen
Wan, New Territories,
HONG KONG
TEL: 2415 0911

INDONESIA

PT Galestra Inti
Kompleks Perkantoran
Duta Merlin Blok E No.6-7
Jl. Gajah Mada No.3-5,
Jakarta 10130,
INDONESIA
TEL: (021) 6335416

KOREA

Cosmos Corporation
Service Station
261 2nd Floor Nak-Won Arcade
Jong-Ro ku, Seoul, KOREA
TEL: (02) 742 8844

MALAYSIA

Bentley Music SDN BHD
No.142, Jalan Bukit Bintang 55100
Kuala Lumpur, MALAYSIA
TEL: (03) 2443333

PHILIPPINES

G.A. Yupango & Co. Inc.
339 Gil J. Puyat Avenue
Makati, Metro Manila 1200,
PHILIPPINES
TEL: (02) 899 9801

SINGAPORE

Swee Lee Company
BLOCK 231, Bain Street #03-23
Bras Basah Complex,
SINGAPORE 0718
TEL: 3367886

CRISTOFORI MUSIC PTE LTD

335, Joo Chiat Road SINGAPORE
1542
TEL: 3450435

TAIWAN

ROLAND TAIWAN
ENTERPRISE CO., LTD.
Room 5, 9th. No. 112 Chung Shan
N.Road Sec.2, Taipei, TAIWAN,
R.O.C.
TEL: (02) 561 3339

THAILAND

Theera Music Co., Ltd.
330 Vergm Nakorn Kasem, Soi 2,
Bangkok 10100, THAILAND
TEL: (02) 2248821

BAHRAIN

Moon Stores
Bad Al Bahrain Road,
P.O.Box 20077
State of BAHRAIN
TEL: 211 005

IRAN

TARADIS
Mir Emad Ave. No. 15, 10th street
P. O. Box 15875/4171 Teheran,
IRAN
TEL: (021) 875 6524

ISRAEL

Halilit P. Greenspoon &
Sons Ltd.
8 Retzif Ha aliya Hashnya St.
Tel-Aviv-Yafo ISRAEL
TEL: (03) 6823666

JORDAN

AMMAN Trading Agency
Prince Mohammed St. P. O. Box
825 Amman 11118 JORDAN
TEL: (06) 641200

KUWAIT

Easa Husain Al-Yousifi
P.O. Box 126 Safat 13002
KUWAIT
TEL: 5719499

LEBANON

A. Chahine & Fils
P.O. Box 16-5857 Gergi Zeidan St.
Chahine Building, Achrafieh
Beirut, LEBANON
TEL: (01) 335799

OMAN

OHI Electronics & Trading
Co. LLC
P. O. Box 889 Muscat
Sultanate of OMAN
TEL: 706 010

QATAR

Badie Studio & Stores
P.O.Box 62,
DOHA QATAR
TEL: 423554

SAUDI ARABIA

Abdul Latif S. Al-Ghamdi
Trading Establishment
Middle East Commercial Center
Al-Khobar Dharan Highway
W/hamood st.
P. O. Box 3631 Al-Khobar
31952 SAUDIARABIA
TEL: (03) 898 2332

SYRIA

Technical Light & Sound
Center
Khaled Ebn Al Walid St.
P.O.Box 13520
Damascus - SYRIA
TEL: (011) 2235 384

TURKEY

Barkat Sanayi ve Ticaret
Siraselvler Cad. Guney Ishani No.
86/6 Taksim, Istanbul TURKEY
TEL: (0212) 2499324

U.A.E

Zak Electronics & Musical
Instruments Co.
Zabeel Road, Al Sherouq Bldg.,
No. 14, Grand Floor DUBAI
U.A.E.
P.O. Box 8050DUBAI, U.A.E
TEL: (04) 360715

EGYPT

Al Fanny Trading Office
9, Ebn Hagar Ai Askalany Street,
Ard El Golf, Heliopolis, Cairo,
11341 EGYPT
TEL: (02) 4171828
(02) 4185531

KENYA

Musik Land Limited
P.O. Box 12183 Moi Avenue
Nairobi Republic of KENYA
TEL: (2) 338 346

MAURITIUS

Philanne Music Center
4th, Floor Noll, Happy World
House Sir William Newton Street
Port Luis MAURITIUS
TEL: 242 2986

REUNION

FO - YAM Marcel
25 Rue Jules MermanZL
Chaudron - BP79 97491
Ste Clotilde REUNION
TEL: 28 29 16

SOUTH AFRICA

That Other Music Shop
(PTY) Ltd.
11 Melle Street (Cnr Melle and
Juta Street)
Braamfontein 2001
Republic of SOUTH AFRICA
TEL: (011) 403 4105

Paul Bothner (PTY) Ltd.
17 Werdmuller Centre Claremont
7700
Republic of SOUTH AFRICA
TEL: (021) 64 4030

AUSTRIA

E. Dematte & Co.
Neu-Rum Siemens-Strasse 4
A-6040 Innsbruck P.O.Box 83
AUSTRIA
TEL: (0512) 26 44 260

BELGIUM/HOLLAND/ LUXEMBOURG

Roland Benelux N. V.
Houtstraat 1 B-2260 Oevel-
Westerlo BELGIUM
TEL: (014) 575811

BELORUSSIA

TUSHE
UL. Rabkorovskaya 17
220001 MINSK
TEL: (0172) 764-911

CYPRUS

Radex Sound Equipment Ltd.
17 Diagorou St., P.O.Box 2046,
Nicosia CYPRUS
TEL: (02) 453 426
(02) 466 423

DENMARK

Roland Scandinavia A/S
Langebrogade 6 Post Box 1937
DK-1023 Copenhagen K.
DENMARK
TEL: 32 95 3111

FRANCE

MUSIKENGRO
Zac de Follieuses 01706
Les Echets Miribel FRANCE
TEL: 472 26 2700

FINLAND

Roland Scandinavia As,
Filial Finland
Lauttasaarentie 54 B
Fin-00201 Helsinki, FINLAND
P. O. Box No. 109
TEL: (0) 682 4020

GERMANY

Roland Elektronische
Musikinstrumente
Handelsgesellschaft mbH.
Oststrasse 96, 22844 Norderstedt,
GERMANY
TEL: (040) 52 60090

GREECE

V. Dimitriadis & Co. Ltd.
20, Alexandras St. & Bouboulinas
54 St. 106 82 Athens, GREECE
TEL: (01) 8232415

HUNGARY

Intermusica Ltd.
Warehouse Area 'DEPO' Pf.83
H-2046 Torokbalint, HUNGARY
TEL: (23) 338 041

IRELAND

The Dublin Service Centre
Audio Maintenance Limited
11 Brunswick Place Dublin 2
Republic of IRELAND
TEL: (01) 677322

ITALY

Roland Italy S. p. A.
Viale delle Industrie, 8
20020 Arese Milano, ITALY
TEL: (02) 93581311

NORWAY

Roland Scandinavia Avd.
Kontor Norge
Lilleakerveien 2 Postboks 95
Lilleaker N-0216 Oslo
NORWAY
TEL: 273 0074

POLAND

P. P. H. Brzostowicz Marian
UL. Blokowa 32, 03624 Warszawa
POLAND
TEL: (022) 679 44 19

PORTUGAL

Caius - Tecnologias Audio e
Musica, Lda.
Rue de Catarina 131
4000 Porto, PORTUGAL
TEL: (02) 38 4456

RUSSIA

PETROSHOP Ltd.
11 Sayanskaya Street Moscow
11531, RUSSIA
TEL: 095 307 4892

Slami Music Company
Sadojava-Triumfalnaja st., 16
103006 Moscow, RUSSIA
TEL: 095 209 2193

SPAIN

Roland Electronics
de España, S. A.
Calle Bolivia 239 08020 Barcelona,
SPAIN
TEL: (93) 308 1000

SWEDEN

Roland Scandinavia A/S
Danvik Center 28 A, 2 tr.
S-131 30 Nacka SWEDEN
TEL: (08) 702 0020

SWITZERLAND

Roland (Switzerland) AG
Musitronic AG
Gerberstrasse 5, CH-4410 Liestal,
SWITZERLAND
TEL: (061) 921 1615

UKRAINE

TIC-TAC
Mira Str. 19/108
P.O.Box 180
295400 Munkachevo, UKRAINE
TEL: (03131) 414-40

UNITED KINGDOM

Roland (U.K.) Ltd., Swansea
Office
Atlantic Close, Swansea
Enterprise Park SWANSEA
West Glamorgan SA7 9FJ,
UNITED KINGDOM
TEL: (01792) 702701

As of April, 18, 1997

Setting up the AT-80 and the ATS-80 stand

• Check this list first

Before you begin assembling the stand, check the list below to make sure you received all the items you should have.

A : Stand C : Hand bolts x2
B : Organ

• Assembly

- * Do not attempt to assemble the unit alone. At least two persons are needed to safely set up the organ.
- * Be very careful when lifting and moving the organ, since it is quite heavy.
- * Check the site where you intend to set up your organ to make sure it will provide enough support and that it is level.

Assembly procedure

1. Assembling the stand/attaching the organ

- (1) Detach the speaker cable and pedal cable which are temporarily attached to the bottom of the organ.

Detach the speaker cord and pedal cord which are temporarily attached to the side board of the stand.

- (2) Align the joint screws (one each on the left and right) on the bottom of the organ with the metal fixtures of the side board, and pull the organ toward yourself to hook the joint screws into the metal fixtures.

* Be careful that the pedal cord and speaker cord are not caught between the organ and the stand.

- (3) Use the hand bolts to fasten the organ and stand together (one each on the left and right).

* When holding the organ, grasp the front and back of the organ unit, and be careful not to pinch your hand.

2. Connecting the pedal/speaker/power cords

- (4) Connect the pedal cord and speaker cord which extend from the bottom of the organ to the pedal cord and speaker cord which respectively extend from the top of the stand.

* After making connections, you may push the pedal cord and speaker cord between the organ and stand, if desired.

- (5) Connect the power cord included to the AC inlet located on the back of the organ.

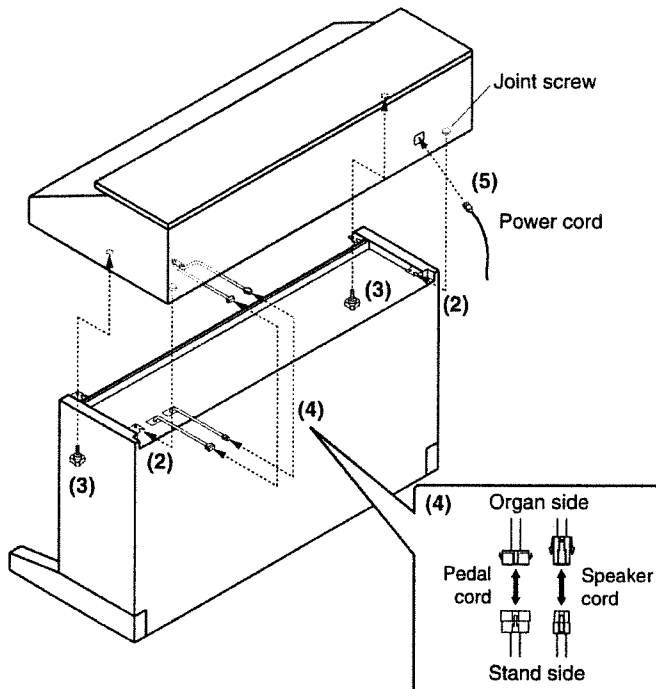

Moving the instrument

* You must use the following procedure when moving the instrument

- 1 Disconnect the power cord.
- 2 Disconnect the pedal cord and speaker cord connections.

To disconnect the pedal cord and speaker cord, hold down the protruding portion of the connector (on the stand side) and pull the connectors apart.

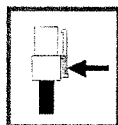

- 3 Make sure that the pedal cord, speaker cord, and power cord are disconnected.
- 4 Remove the hand bolts.
- 5 Separate the organ from the stand, and transport them separately.

At this time, be careful not to pinch your hand or drop the unit on your foot.



Voice/Rhythm List

ボイス／リズム対応表

Voice List

AT-R		AT-90R/ AT-80R	AT-60R	AT-30R	AT-20R	AT-90/AT-80 Voice No.	AT-30 Voice No.
Voice No.	Tone Name						
A11	Full Organ1	o	o	o	o	001	001
A12	Full Organ2	o	o	o	o	003	003
A13	Full Organ3	o	o	o	o	005	005
A14	Full Organ4	o	o	o	o	002	002
A15	Full Organ5	o	o	o	o	004	004
A16	Full Organ6	o	o	o	o	006	006
A17	Full Organ7	o	o	o	-	033	033
A18	Full Organ8	o	-	-	-	-	-
A19	Full Organ9	o	-	-	-	-	-
B11	Jazz Organ1	o	o	o	o	007	007
B12	Jazz Organ2	o	o	o	o	009	009
B13	Jazz Organ3	o	o	o	o	011	011
B14	Jazz Organ4	o	o	o	o	008	008
B15	Jazz Organ5	o	o	o	o	010	010
B16	Jazz Organ6	o	o	o	o	012	012
B21	Rock Organ1	o	o	o	o	013	013
B22	Rock Organ2	o	o	o	o	014	014
C11	Lower Organ1	o	o	o	o	015	015
C12	Lower Organ2	o	o	o	o	017	017
C13	Lower Organ3	o	o	o	o	019	019
C14	Lower Organ4	o	o	o	o	016	016
C15	Lower Organ5	o	o	o	o	018	018
C16	Lower Organ6	o	o	o	o	020	020
D11	Pipe Organ1	o	o	o	o	021	021
D12	Pipe Organ2	o	o	o	o	023	023
D13	Pipe Organ3	o	o	o	o	025	025
D14	Pipe Organ4	o	o	o	o	022	022
D15	Pipe Organ5	o	o	o	o	024	024
D16	Pipe Organ6	o	o	o	o	026	026
D17	Pipe Organ7	o	o	o	o	034	034
D21	Diapason 8'	o	o	o	o	-	-
D22	FluteCeleste	o	o	o	-	021a	-
D23	Gemshorn 8'	o	o	-	-	034a	-
D24	Trompet 8'	o	o	-	-	034b	-
D25	Hautbois 8'	o	o	-	-	034c	-
D26	Viola 8'	o	o	-	-	034d	-
D27	ViolaCeleste	o	o	-	-	034e	-
D28	Bombarde16'	o	o	-	-	-	-
D31	T.String 8'	o	o	-	-	035a	-
D32	VoxHumana 8'	o	o	-	-	035b	-
D33	T.Tuba 8'	o	o	-	-	035c	-
D34	T.Trumpet 8'	o	o	-	-	035d	-
D35	T.Sax 8'	o	o	-	-	035e	-
D36	T.Oboe 8'	o	o	-	-	035f	-
D37	T.Krumet 8'	o	o	-	-	035g	-
D38	Eng.Horn 8'	o	o	-	-	035h	-
E11	Theater Or.1	o	o	o	o	027	027
E12	Theater Or.2	o	o	o	o	029	029
E13	Theater Or.3	o	o	o	o	031	031
E14	Theater Or.4	o	o	o	o	028	028
E15	Theater Or.5	o	o	o	o	030	030
E16	Theater Or.6	o	o	o	o	032	032
E17	Theater Or.7	o	o	o	-	035	035
F11	Synth. Org.1	o	o	o	o	036	036
F12	Synth. Org.2	o	o	o	o	037	037
F13	Synth. Org.3	o	o	-	-	036a	-
F14	Synth. Org.4	o	o	-	-	037a	-
F15	Digi Church	o	-	-	-	-	-
F16	Metalic Org	o	-	-	-	-	-
F21	Pop. Organ1	o	o	o	-	038	038
F22	Pop. Organ2	o	o	o	-	039	039
F23	Pop. Organ3	o	o	o	-	040	040

AT-R		AT-90R/				AT-90/AT-80		AT-30
Voice No.	Tone Name	AT-80R	AT-60R	AT-30R	AT-20R	Voice No.	Voice No.	
G11	Strings1	0	0	0	0	041	041	
G12	Strings2	0	0	0	0	042	042	
G13	Strings3	0	0	-	-	041a	-	
G14	Strings4	0	0	-	-	042a	-	
G15	Strings5	0	0	-	-	041b	-	
G16	Strings6	0	0	-	-	041c	-	
G17	Strings7	0	0	-	-	041d	-	
G18	Strings8	0	0	-	-	-	-	
H11	Slow Str.1	0	0	0	0	043	043	
H12	Slow Str.2	0	0	0	-	044	044	
H13	Slow Str.3	0	0	-	-	-	-	
H21	Synth. Str.1	0	0	0	0	045	045	
H22	Synth. Str.2	0	0	0	0	046	046	
H23	Synth. Str.3	0	0	0	-	054	054	
H31	Synth. Pad1	0	0	0	0	047	047	
H32	Synth. Pad2	0	0	0	0	048	048	
I11	Violin	0	0	0	0	093	093	
I12	Viola	0	0	0	0	103	103	
I13	Cello	0	0	0	0	094	094	
I14	Pizzicato	0	0	0	0	056	056	
J11	Jazz Scat	0	0	0	0	-	-	
J12	Pop Voice	0	0	0	0	050	050	
J13	Jazz Doo	0	0	0	0	-	-	
J14	Jazz Doot	0	0	0	0	-	-	
J15	Jazz Dat	0	0	0	0	-	-	
J16	Jazz Bap	0	0	0	0	-	-	
J17	JazzDowfall	0	0	0	0	-	-	
J18	Soprano	0	-	-	-	-	-	
J19	Tenor	0	-	-	-	-	-	
J21	Choir	0	0	0	0	049	049	
J22	Gregorian	0	0	0	-	-	-	
J23	Classical	0	0	-	-	-	-	
J24	Boys Choir	0	0	-	-	-	-	
J25	Female 1	0	-	-	-	-	-	
J26	Female 2	0	-	-	-	-	-	
J27	Gospel	0	-	-	-	-	-	
J31	Synth. Choir	0	0	0	-	051	051	
J32	Synth. Voice	0	0	0	-	052	052	
J33	Space Voice	0	0	0	-	053	053	
J41	Vocal Menu	0	0	-	-	-	-	
K11	Grand Piano	0	0	0	0	-	-	
K12	Piano1	0	0	0	-	057	057	
K13	Piano2	0	0	0	-	080	080	
K14	Piano3	0	0	0	-	057a	-	
K21	Honky-tonk	0	0	0	0	058	058	
K22	Honky-tonk2	0	0	0	-	-	-	
K31	E.Piano1	0	0	0	0	059	059	
K32	E.Piano2	0	0	0	0	060	060	
K33	E.Piano3	0	0	0	-	059a	-	
K34	E.Piano4	0	0	0	-	-	-	
K41	Harpsichord	0	0	0	0	067	067	
K42	Clavi.	0	0	0	0	081	081	
L11	Accordion	0	0	0	0	073	073	
L12	Bandoneon	0	0	0	-	086	086	
L21	Harmonica	0	0	0	0	074	074	
M11	Nylon-str.Gt	0	0	0	0	061	061	
M12	Nylon Gt.2	0	0	0	-	061a	-	
M21	Steel-str.Gt	0	0	0	0	062	062	
M22	12str Guitar	0	-	-	-	-	-	
M31	Jazz Guitar	0	0	0	0	063	063	
M32	Clean Guitar	0	0	0	-	063a	-	
M33	JC E.Guitar	0	0	0	-	063b	-	

AT-R		AT-90R/				AT-90/AT-80	AT-30
Voice No.	Tone Name	AT-80R	AT-60R	AT-30R	AT-20R	Voice No.	Voice No.
M41	Overdrive Gt	0	0	0	0	064	064
M42	OverdriveGt2	0	-	-	-	-	-
M43	Power Guitar	0	-	-	-	-	-
M44	Rock Rhythm	0	-	-	-	-	-
N11	Hawaiian Gt.	0	0	0	0	087	087
N12	Banjo	0	0	0	0	072	072
N13	Mandolin	0	0	0	-	071	071
N14	Koto	0	0	0	-	068a	-
N15	Taisho Koto	0	0	0	-	068b	-
N16	Shamisen	0	0	0	-	-	-
N21	Harp	0	0	0	0	068	068
N22	Celtic Harp	0	-	-	-	-	-
N23	Nylon Harp	0	-	-	-	-	-
N24	Harpvox	0	-	-	-	-	-
N31	Sitar	0	0	0	0	091	091
N41	Organ Harp	0	0	0	-	088	088
O11	Vibraphone	0	0	0	0	069	069
O12	Glockenspiel	0	0	0	0	083	083
O13	Celesta	0	0	0	0	082	082
O14	Music Box	0	-	-	-	-	-
O21	Marimba	0	0	0	0	070	070
O22	Xylophone	0	0	0	0	084	084
O23	Barafon	0	-	-	-	-	-
O31	Tubular-bell	0	0	0	0	085	085
O41	Steel Drums	0	0	0	0	092	092
O42	Kalimba	0	0	-	-	091a	-
O51	Organ Bell	0	0	-	-	085a	-
O52	Vibra Bells	0	0	-	-	-	-
O53	Digi Bells	0	-	-	-	-	-
P11	Tr. Section	0	0	0	0	065	065
P12	Brass 1	0	-	-	-	-	-
P13	Brass 2	0	-	-	-	-	-
P14	Brass 3	0	-	-	-	-	-
P21	Fr.Horn Sect	0	0	0	0	089	089
P22	Fr.HornSect2	0	0	-	-	089a	-
P23	Fr.HornSect3	0	-	-	-	-	-
P24	Fr.HornSect4	0	-	-	-	-	-
P25	Orch.Brs Ens	0	-	-	-	-	-
P26	Muted Fr.Horn	0	-	-	-	-	-
P31	Sax.Section	0	0	0	0	066	066
P32	Sax.Section2	0	0	-	-	066a	-
P41	Synth. Brass	0	0	0	0	090	090
Q11	Trumpet	0	0	0	0	095	095
Q12	Trumpet2	0	0	-	-	095a	-
Q21	Mute Trumpet	0	0	0	0	096	096
Q22	MuteTrumpet2	0	0	-	-	096a	-
Q23	Cup Mute Tp	0	-	-	-	-	-
Q31	Trombone	0	0	0	0	105	105
Q32	Trombone2	0	0	-	-	105a	-
Q41	Flugel Horn	0	0	0	0	104	104
Q42	F.Horn Solo1	0	0	-	-	-	-
Q43	F.Horn Solo2	0	-	-	-	-	-
Q51	Soprano Sax	0	0	0	0	106	106
Q52	Soprano Sax2	0	0	-	-	106a	-
Q61	Alto Sax	0	0	0	0	097	097
Q62	Alto Sax2	0	0	-	-	097a	-
Q63	Blow Sax	0	-	-	-	-	-
Q71	Tenor Sax	0	0	0	0	098	098
Q72	Tenor Sax2	0	0	-	-	098a	-
R11	Flute	0	0	0	0	099	099
R12	Flute2	0	0	-	-	099a	-
R13	Flute3	0	0	-	-	-	-
R14	Tin Whistle	0	-	-	-	-	-

AT-R Voice No.	Tone Name	AT-90R/ AT-80R	AT-60R	AT-30R	AT-20R	AT-90/AT-80 Voice No.	AT-30 Voice No.
R21	Synth. Flute	0	0	0	-	055	055
R22	Pan Flute	0	0	0	0	100	100
R31	Oboe	0	0	0	0	101	101
R32	Bassoon	0	0	0	0	107	107
R33	English Horn	0	-	-	-	-	-
R34	Wood Winds	0	-	-	-	-	-
R41	Clarinet	0	0	0	0	102	102
R42	Clarinet2	0	0	-	-	102a	-
R43	Clarinet3	0	0	-	-	102b	-
R44	Clarinet4	0	0	-	-	102c	-
R45	Bs Clarinet	0	0	-	-	-	-
R51	Shakuhachi	0	0	0	0	108	108
R52	HumanWhistle	0	0	0	-	109	109
R61	Bagpipe	0	-	-	-	-	-
R62	Uilleann Pipe	0	-	-	-	-	-
S11	Synth. Lead1	0	0	0	0	110	110
S12	Synth. Lead2	0	0	0	0	111	111
S13	Synth. Lead3	0	0	0	-	112	112
S14	Synth. Lead4	0	0	0	-	113	113
S15	Synth. Lead5	0	0	0	-	114	114
S16	CC Solo	0	-	-	-	-	-
T11	Organ Bass1	0	0	0	0	115	115
T12	Organ Bass2	0	0	0	0	116	116
T21	Pipe Org. Bs	0	0	0	0	117	117
T22	Theater Bass	0	0	-	-	117a	-
T23	Bombarde	0	0	-	-	-	-
T31	String Bass	0	0	0	0	118	118
T32	Bass+Cymbal	0	0	0	0	126	126
T33	String Bass2	0	0	-	-	118a	-
T41	Contrabass1	0	0	0	0	121	121
T42	Contrabass2	0	0	0	-	122	122
T51	E.Bass1	0	0	0	0	119	119
T52	E.Bass2	0	0	0	0	120	120
T53	E.Bass3	0	0	-	-	119a	-
T54	E.Bass4	0	0	-	-	120a	-
T61	Tuba	0	0	0	0	123	123
T62	Tuba2	0	0	-	-	123a	-
T71	Synth. Bass1	0	0	0	0	124	124
T72	Synth. Bass2	0	0	0	-	125	125
T81	Voice Thum	0	0	0	0	-	-
U11	Org. Attack1	0	0	0	-	075	075
U12	Org. Attack2	0	0	0	-	076	076
U13	Org. Attack3	0	0	0	-	077	077
U14	Org. Attack4	0	0	0	-	078	078
U15	Org. Click	0	0	0	-	079	079
V11	Timpani	0	0	0	-	127a	-
V12	Timpani2	0	0	-	-	-	-
V21	Ride Cymbal	0	0	-	-	126a	-
V22	Crash Cymbal	0	0	-	-	126b	-
V23	Tambourine	0	0	-	-	126c	-
V24	Woodblock	0	0	-	-	126d	-
V25	Jingle Bell	0	0	-	-	126e	-
V26	Snare Drum	0	0	-	-	126f	-
V27	Bass Drum	0	0	-	-	126g	-
V28	Church Bell	0	-	-	-	-	-
V31	Perc. Set1	0	0	0	-	127	127
V32	Perc. Set2	0	0	0	-	128	128
V33	Perc. Set3	0	0	-	-	128a	-
V34	Orch.HitMenu	0	0	-	-	-	-
V35	DanceHitMenu	0	-	-	-	-	-

Rhythm List (AT-90R/80R/60R/30R/20R)

	90R	80R	60R	30R	20R
Fast BigBand	0	0	0	0	-
New Big Band	0	0	0	-	-
BigBandSwing	0	0	0	0	0
BigBndBallad	0	0	0	0	-
Jazz Band	0	0	0	-	-
Big Band	0	0	0	0	0
Big Band 2	0	0	0	-	-
Boogie	0	0	-	-	-
Blues	0	0	-	-	-
A Cappella	0	0	0	0	0
Combo	0	0	0	0	0
Club Swing	0	0	-	-	-
Medium Swing	0	0	0	-	-
Slow Swing	0	0	0	-	-
Vocal Swing	0	0	-	-	-
Swing	0	0	0	-	-
Shuffle	0	0	0	-	-
CountryRoads	0	0	0	-	-
CountryPiano	0	0	0	0	-
CtrySerenade	0	0	-	-	-
Western	0	-	-	-	-
CountrySwing	0	0	0	-	-
Hoedown	0	0	0	0	0
Twostep	0	0	0	-	-
CountryWaltz	0	0	0	0	0
Easy Country	0	0	0	0	0
Cajun	0	0	-	-	-
Beach Sound	0	0	0	-	-
Rock'n'Roll	0	0	0	-	-
Twist	0	0	0	0	0
50'sBallad	0	-	-	-	-
Slow Dance	0	0	0	0	0
Dreamin'	0	0	0	0	-
50's Pop 1	0	0	0	0	0
50's Pop 2	0	0	-	-	-
Love Romance	0	0	0	0	0
Torch Song	0	0	0	0	0
Torch Song 2	0	0	-	-	-
Love Songs	0	0	0	0	0
MediumBallad	0	0	0	-	-
Pop Ballad	0	0	-	-	-
Ballad	0	0	0	0	-
Classic	0	0	0	-	-
Dixieland	0	0	0	0	0
Polka	0	0	0	0	-
Foxtrot	0	0	0	-	-
Charleston	0	0	0	-	-
PianoBoogie1	0	0	0	-	-
PianoBoogie2	0	-	-	-	-
Rag Time	0	0	-	-	-

	90R	80R	60R	30R	20R
G.Pop	0	0	0	0	0
G.Fast Pop	0	0	0	0	-
P.Slow	0	0	0	0	0
P.Jazz	0	0	0	0	-
G.Slow	0	0	-	-	-
G.Shuffle	0	0	0	-	-
P.Night	0	0	0	0	0
P.Pop	0	0	-	-	-
P.Concerto	0	0	-	-	-
Hawaiian	0	0	0	0	0
French Waltz	0	0	0	-	-
D Marsch 6/8	0	0	0	-	-
Scotland	0	0	0	-	-
Ireland	0	0	0	-	-
Reggae	0	0	0	0	-
Habanera	0	0	-	-	-
Sevilla	0	0	-	-	-
Bossa Nova	0	0	0	0	0
Bossa Nova2	0	0	0	-	-
FastBosaNova	0	0	0	-	-
Slow Bossa	0	0	0	0	0
NewBossaNova	0	0	-	-	-
Chacha	0	0	0	0	-
Chacha 2	0	0	-	-	-
Salsa	0	0	0	0	0
Samba	0	0	-	-	-
Rhumba	0	0	0	0	0
Rhumba 2	0	-	-	-	-
Beguine	0	0	0	0	-
Mambo	0	0	0	0	0
Tango 1	0	0	0	0	0
Tango 2	0	0	0	-	-
Latin Fusion	0	0	-	-	-
Samba Rio	0	0	0	0	0
Screen 1	0	0	0	0	-
Screen 2	0	0	0	-	-
Music Hall	0	0	0	-	-
Broadway	0	0	0	0	-
ChooChooSwg	0	0	0	-	-
Bubbles	0	0	-	-	-
Balloon Trip	0	0	-	-	-
Raindrops	0	0	0	0	0
Festival	0	0	0	0	-
Little Steps	0	0	-	-	-
WesternMovie	0	-	-	-	-

	90R	80R	60R	30R	20R
8Beat Pop	0	0	0	-	-
Swing Pop	0	0	0	0	0
PopularPiano	0	0	0	0	-
Acoustic Pop	0	0	0	-	-
Pop'n Roll	0	0	-	-	-
Easy Listen1	0	0	0	0	0
Easy Listen2	0	0	0	0	0
Easy Listen3	0	0	-	-	-
Easy Listen4	0	0	-	-	-
Easy Listen5	0	-	-	-	-
Rollin'	0	0	0	-	-
16BeatShuffl	0	0	-	-	-
Motown	0	0	0	0	-
ShufflePop 1	0	0	0	-	-
ShufflePop 2	0	0	0	-	-
Rock'n'Shffl	0	0	-	-	-
Light Fusion	0	0	-	-	-
Rock'n Pop	0	0	0	-	-
Gospel Piano	0	-	-	-	-
Gospel Pop	0	0	0	0	-
GospelBallad	0	0	-	-	-
Gospel 1	0	0	0	-	-
Gospel 2	0	0	-	-	-
Anthem	0	0	0	0	-
Revival	0	0	0	-	-
Chapel	0	-	-	-	-
Last Dance	0	0	0	0	-
Jazz Waltz	0	0	0	-	-
StringsWaltz	0	0	0	-	-
Slow Waltz	0	0	0	0	0
Waltz	0	0	-	-	-
Musette	0	0	0	0	-
Vienna Waltz	0	0	-	-	-
March 4/4	0	0	0	0	0
March 6/8	0	0	0	0	0
March 2/4	0	0	-	-	-
Simple March	0	0	-	-	-
Cute Pop	0	0	0	-	-
R&B	0	0	-	-	-
Slow Rock	0	-	-	-	-
Rock'n'Roll2	0	0	-	-	-
60'sBallad	0	0	0	-	-
Crystal	0	0	-	-	-
Bossa Nova 3	0	0	0	-	-
Bossa Nova 4	0	0	0	-	-
Cinema	0	0	-	-	-
Entertaining	0	0	-	-	-
70's Disco	0	-	-	-	-
16Beat Pop 1	0	0	0	-	-
16Beat Pop 2	0	0	0	-	-
AcousticRock	0	0	-	-	-
Rock 1	0	-	-	-	-
Rock 2	0	-	-	-	-

Rhythm List

左ページ (P.8, 10) は AT-90/80/30、右ページ (P.9, 11) は AT-90R/80R/60R/30R/20R のリズム一覧表です。

The lists on left pages (p.8, 10) are AT-90/80/30 Rhythm List.

The lists on right pages (p.9, 11) are AT-90R/80R/60R/30R/20R Rhythm List.

AT-90	AT-80	AT-80 for Japan	AT-30
Jazz Band	-	Jazz Band	Jazz Band
Big Band	-	-	Big Band
-	Big Band	Big Band	-
-	Blues	-	-
BigBndBallad	-	-	BigBndBallad
-	BigBndBallad	BigBndBallad	-
Boogie	-	Boogie	-
Standard	Standard	Standard	-
-	Vocal Swing	-	-
Combo	Combo	Combo	Combo
Medium Swing	-	Medium Swing	-
Shuffle	-	-	-
Swing	Swing	Swing	Swing
-	Club Piano	Club Piano	-
Cntry Ballad	Cntry Ballad	-	-
CountrySwing	CountrySwing	-	-
-	-	Two Step	Two Step
Bluegrass	Bluegrass	Bluegrass	-
-	-	-	Bluegrass
CountryWaltz	CntryWltz	-	CountryWaltz
-	Easy Country	-	-
Hoe Down	Hoe Down	-	-
New Country	-	New Country	-
-	-	Western	-
Two Step	Two Step	-	-
-	-	Country Rock	-
-	-	DancePop 1	-
-	-	DancePop 2	-
-	-	70's Disco	-
-	-	Light Fusion	-
-	-	Rock 1	-
-	-	Rock 2	-
-	50's Ballad	-	-
Slow Dance	Slow Dance	50'sBallad 1	-
50's	50's	-	-
-	-	-	Twist
Rock'n'Roll1	Rock'n'Roll	Rock'n'Roll1	Rock'n'Roll1
Rock'n'Roll2	-	Rock'n'Roll2	Rock'n'Roll2
-	-	R&B	-
-	-	AcousticRock	-
Love Songs	Love Songs	-	Love Songs
Ballad	Ballad	Ballad 1	Ballad
-	-	50'sBallad 2	-
-	-	16BeatBallad	-
Classic	Classic	-	Classic
-	Torch Song	-	-
-	Piano Boogie	-	-
-	-	Festival	-

- ※ Disk と書かれているのは、添付のミュージック・スタイル・ディスクのリズム番号です。
 ※ World と書かれているのは、添付のワールド・スタイル・セットアップ・ディスクのリズム番号です。

- * Disk-**: Rhythm Number of Music Style Disk
 * World-**: Rhythm Number of World Style Setup Disk

AT-90R	AT-80R	AT-60R	AT-30R	AT-20R
Jazz Band	Jazz Band	Jazz Band	Disk-03	Disk-03
Big Band	Big Band	Big Band	Big Band	Big Band
Big Band2	Big Band2	Big Band2	-	-
Blues	Blues	-	-	-
Disk1-01	Disk1-01	Disk1-01	Disk-01	Disk-01
BigBndBallad	BigBndBallad	BigBndBallad	BigBndBallad	-
Boogie	Boogie	Disk1-05	-	-
Disk1-02	Disk1-02	Disk1-02	-	-
Vocal Swing	Vocal Swing	-	-	-
Combo	Combo	Combo	Combo	Combo
Disk1-07	Disk1-07	Disk1-07	Disk-08	Disk-08
Shuffle	Shuffle	Shuffle	-	-
Swing	Swing	Swing	Disk-07	Disk-07
Club Swing	Club Swing	-	-	-
Disk1-13	Disk1-13	Disk1-13	Disk-14	Disk-14
CountrySwing	CountrySwing	CountrySwing	Disk-15	Disk-15
Disk1-15	Disk1-15	Disk1-15	Disk-16	Disk-16
Disk1-10	Disk1-10	Disk1-10	Disk-10	Disk-10
Disk1-11	Disk1-11	Disk1-11	Disk-11	Disk-11
CountryWaltz	CountryWaltz	CountryWaltz	CountryWaltz	CountryWaltz
Easy Country	Easy Country	Easy Country	Easy Country	Easy Country
Hoedown	Hoedown	Hoedown	Hoedown	Hoedown
Cajun	Cajun	Disk2-01	Disk-12	Disk-12
Western	Disk2-02	Disk2-02	-	-
Twostep	Twostep	-	-	-
Disk2-02	Disk2-03	-	-	-
Disk2-32	Disk2-29	Disk2-14	-	-
Disk2-33	Disk2-30	Disk2-15	Disk-62	Disk-62
Disk2-31	Disk2-28	-	-	-
Light Fusion	Light Fusion	-	-	-
Rock 1	Disk2-24	Disk2-12	-	-
Rock 2	Disk2-25	Disk2-13	-	-
50'sBallad	Disk2-05	-	-	-
Slow Dance	Slow Dance	Slow Dance	Slow Dance	Slow Dance
50's Pop 1	50's Pop 1	50's Pop 1	50's Pop 1	50's Pop 1
Twist	Disk1-17	Disk1-17	Disk-18	Disk-18
Disk1-49	Disk1-49	Disk1-49	Disk-57	Disk-57
Disk1-50	Disk1-50	Disk1-50	Disk-58	Disk-58
R&B	R&B	-	-	-
AcousticRock	AcousticRock	-	-	-
Love Songs	Love Songs	Love Songs	Love Songs	Love Songs
Ballad	Ballad	Ballad	Ballad	-
Dreamin'	Dreamin'	Dreamin'	Dreamin'	-
Easy Listen5	Disk2-15	Disk2-06	Disk-42	Disk-42
Classic	Classic	Classic	Disk-21	Disk-21
Torch Song	Torch Song	Torch Song	Torch Song	Torch Song
PianoBoogie2	Disk2-06	-	-	-
Festival	Festival	Festival	-	-

AT-90	AT-80	AT-80 for Japan	AT-30
Foxtrot	Foxtrot	Foxtrot	Foxtrot
Dixieland	-	-	Dixieland
-	Dixieland	Dixieland	-
Charleston	Charleston	-	-
-	-	Reggae	-
-	-	Folk Dance	-
-	-	Kayou	-
Bossa Nova	Bossa Nova	-	-
-	-	Bossa Nova	Bossa Nova
Fast Bossa	-	FastBosaNova	-
Chacha	Chacha	Chacha	Chacha
Mambo	-	Mambo	Mambo
-	-	Salsa	-
Samba	Samba	Samba	-
Rhumba	Rhumba	Rhumba	Rhumba
-	-	-	Samba
Beguine	-	-	Beguine
-	Beguine	Beguine	-
Tango	Tango	-	-
-	-	Tango 1	-
-	-	Tango 2	-
-	-	-	Tango
-	-	Latin Fusion	-
-	ChooChooSwg	-	-
Music Hall	Music Hall	Music Hall	-
Broadway	-	-	-
Bubbles	Bubbles	-	-
-	-	Pop 1	-
-	-	Pop 2	-
-	-	Pop 3	-
-	-	Pop 4	-
-	-	Simple 8Beat	-
-	-	Contemporary	-
Easy Listen1	Easy Listen1	-	-
Easy Listen2	Easy Listen2	-	Easy Listen1
PopularPiano	PopularPiano	-	PopularPiano
Pop	-	ShufflePop 1	Pop
-	-	ShufflePop 2	-
-	-	Rock'n'Shffl	-
-	-	16Bt Shuffle	-
-	-	-	Easy Listen2
Gospel	Gospel	Gospel 1	-
-	-	Gospel 2	-
Revival	Revival	New Gospel	-
Anthem	Anthem	Slow Gospel	-
GospelBallad	-	GospelBallad	-
March 4/4	March 4/4	March 4/4	March 4/4
March 6/8	March 6/8	March 6/8	March 6/8
-	German March	March 2/4	-
-	-	Simple March	-
Slow Waltz	Slow Waltz	Slow Waltz	Slow Waltz
Slow Waltz 2	-	-	-
Musette	Musette	Musette	Musette
Vienna Waltz	Vienna Waltz	Vienna Waltz	Vienna Waltz
-	Waltz	Waltz	-
Hawaiian	Hawaiian	Hawaiian	Hawaiian
Polka	Polka	Polka	Polka

AT-90R	AT-80R	AT-60R	AT-30R	AT-20R
Foxtrot	Foxtrot	Foxtrot	Disk-24	Disk-24
Disk1-22	Disk1-22	Disk1-22	Disk-23	Disk-23
Dixieland	Dixieland	Dixieland	Dixieland	Dixieland
Charleston	Charleston	Charleston	Disk-22	Disk-22
Disk2-5	Disk2-7	-	-	-
Disk2-25	Disk2-21	-	-	-
World-33	World-33	World-33	World-33	-
Bossa Nova2	Bossa Nova2	Bossa Nova2	Disk-31	Disk-31
Disk1-29	Disk1-29	Disk1-29	Disk-33	Disk-33
FastBosaNova	FastBosaNova	FastBosaNova	Disk-32	Disk-32
Chacha	Chacha	Chacha	Chacha	-
Disk1-32	Disk1-32	Disk1-32	Disk-36	Disk-36
Salsa	Salsa	Salsa	Salsa	Salsa
Samba Rio	Samba Rio	Samba Rio	Samba Rio	Samba Rio
Rhumba	Rhumba	Rhumba	Rhumba	Rhumba
Disk1-33	Disk1-33	Disk1-33	Disk-37	Disk-37
Disk1-36	Disk1-36	Disk1-36	Disk-39	Disk-39
Beguine	Beguine	Beguine	Beguine	-
Disk1-34	Disk1-34	Disk1-34	-	-
Tango 1	Tango 1	Tango 1	Tango 1	Tango 1
Disk2-11	Disk2-10	-	-	-
Disk1-35	Disk1-35	Disk1-35	Disk-38	Disk-38
Latin Fusion	Latin Fusion	-	-	-
ChooChooSwg	ChooChooSwg	ChooChooSwg	-	-
Music Hall	Music Hall	Music Hall	-	-
Broadway	Broadway	Broadway	Broadway	-
Bubbles	Bubbles	-	-	-
Disk2-13	Disk2-11	-	-	-
Disk1-41	Disk1-41	Disk1-41	Disk-45	Disk-45
Disk2-14	Disk2-12	-	-	-
Disk2-15	Disk2-13	-	-	-
Disk2-16	Disk2-14	-	-	-
Disk1-52	Disk1-52	Disk1-52	Disk-59	Disk-59
Easy Listen1	Easy Listen1	Easy Listen1	Easy Listen1	Easy Listen1
Easy Listen2	Easy Listen2	Easy Listen2	Easy Listen2	Easy Listen2
PopularPiano	PopularPiano	PopularPiano	PopularPiano	-
ShufflePop 1	ShufflePop 1	ShufflePop 1	Disk-46	Disk-46
ShufflePop 2	ShufflePop 2	ShufflePop 2	-	-
Rock'n'Shffl	Rock'n'Shffl	-	-	-
Disk2-21	Disk2-17	-	-	-
Easy Listen3	Easy Listen3	Disk2-04	Disk-40	Disk-40
Gospel 1	Gospel 1	Gospel 1	-	-
Gospel 2	Gospel 2	Disk2-07	Disk-47	Disk-47
Revival	Revival	Revival	-	-
Anthem	Anthem	Anthem	Anthem	-
GospelBallad	GospelBallad	Disk2-08	Disk-48	Disk-48
March 4/4	March 4/4	March 4/4	March 4/4	March 4/4
March 6/8	March 6/8	March 6/8	March 6/8	March 6/8
March 2/4	March 2/4	Disk2-10	Disk-54	Disk-54
Simple March	Simple March	-	-	-
Slow Waltz	Slow Waltz	Slow Waltz	Slow Waltz	Slow Waltz
Disk1-43	Disk1-43	Disk1-43	Disk-52	Disk-52
Musette	Musette	Musette	Musette	-
Vienna Waltz	Vienna Waltz	Disk2-09	Disk-50	Disk-50
Waltz	Waltz	-	-	-
Hawaiian	Hawaiian	Hawaiian	Hawaiian	Hawaiian
Polka	Polka	Polka	Polka	-



Roland Organ AT80

Music Style Disk

■ Rhythm List

Big Band

Jazz Band
Big Band 2
Big Band 3
BigBandBald2
Boogie

Swing

Medium Swing
Slow Swing
Shuffle
Ragtime

Country

Two Step 2
Bluegrass 2
Train Beat
Slow Country
Western 1
Western 2
New Country

50/60/Rock

Rock'n'Roll2
Twist
R&B
Blues 1
Blues 2

Ballad

Slow Rock
Ballad 2
Ballad 3

Trad

Baroque
Hawaiian
Hawaiian 2
Polka

Latin

Fast Bossa
Mambo
Samba 2
Modern Samba
Chacha 2
Tango 2
Salsa
Merengue
Macarena
Miami
Tequila
Reggae

Pops

Pop
Easy Listen3
Easy Listen4
Easy Listen5
Easy Listen6
Easy Listen7
Pop Piano 2
Contemp 1
Contemp 2
Dance
Funk

Gospel

Gospel 2
GospelBallad

March

D Marsch 6/8

Waltz

Slow Waltz 2
Folk Waltz
Swing Waltz
French Waltz

World

S 8Beat
Schlager 1
Schlager 2
Schlager 3
Sevilla
Volk Musik
DeutchWalzer

For EU Countries



This product complies with the requirements of European Directives EMC 89/336/EEC and LVD 73/23/EEC.

For the USA

FEDERAL COMMUNICATIONS COMMISSION RADIO FREQUENCY INTERFERENCE STATEMENT

This equipment has been tested and found to comply with the limits for a Class B digital device, pursuant to Part 15 of the FCC Rules. These limits are designed to provide reasonable protection against harmful interference in a residential installation. This equipment generates, uses, and can radiate radio frequency energy and, if not installed and used in accordance with the instructions, may cause harmful interference to radio communications. However, there is no guarantee that interference will not occur in a particular installation. If this equipment does cause harmful interference to radio or television reception, which can be determined by turning the equipment off and on, the user is encouraged to try to correct the interference by one or more of the following measures:

- Reorient or relocate the receiving antenna.
- Increase the separation between the equipment and receiver.
- Connect the equipment into an outlet on a circuit different from that to which the receiver is connected.
- Consult the dealer or an experienced radio/TV technician for help.

Unauthorized changes or modification to this system can void the users authority to operate this equipment.
This equipment requires shielded interface cables in order to meet FCC class B Limit.

For Canada

CLASS B

NOTICE

This digital apparatus does not exceed the Class B limits for radio noise emissions set out in the Radio Interference Regulations of the Canadian Department of Communications.

CLASSE B

AVIS

Cet appareil numérique ne dépasse pas les limites de la classe B au niveau des émissions de bruits radioélectriques fixés dans le Règlement des signaux parasites par le ministère canadien des Communications.

 Roland®

70899956

UPC 70899956



10981

Roland