

Roland

MIDI MULTI TIMBRAL LINEAR SYNTHESIZER

D-5

Owner's Manual (Edit Volume)

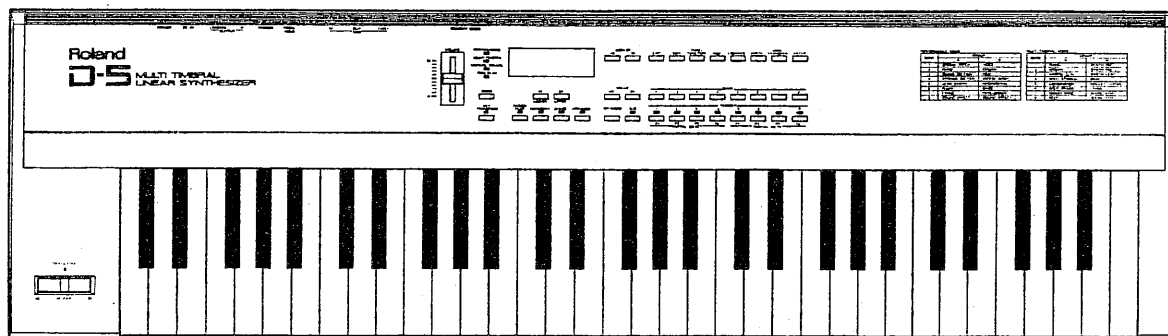

D-5 Quick Operation Table (1)



Setting of Rhythm

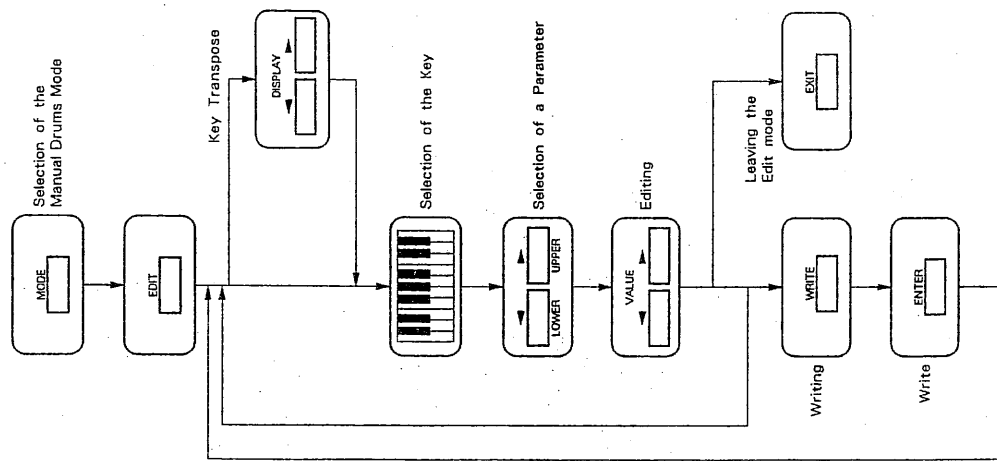

Editing of Timbre

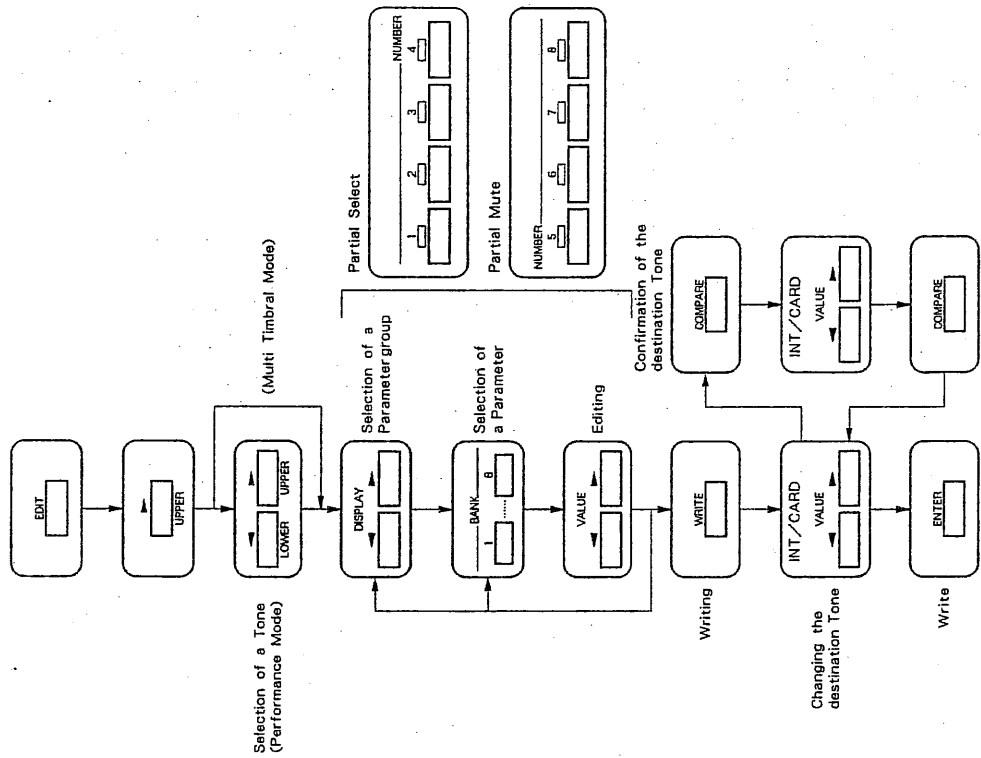

Setting of Patch/Timbre

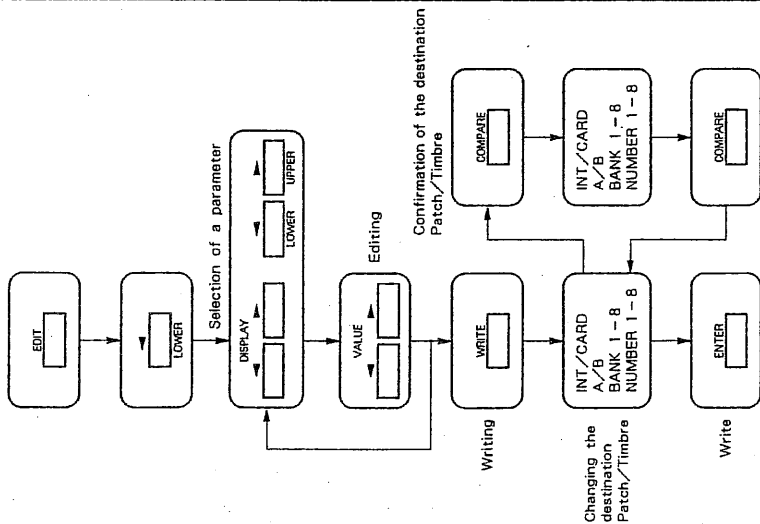

Q-5 Quick Operation Table (2)



Editing MIDI Functions

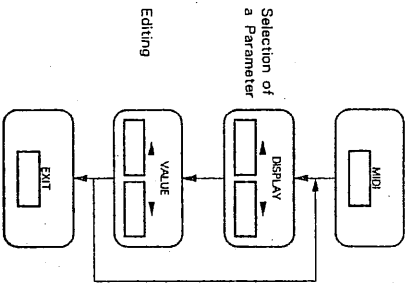

Editing Tone Functions

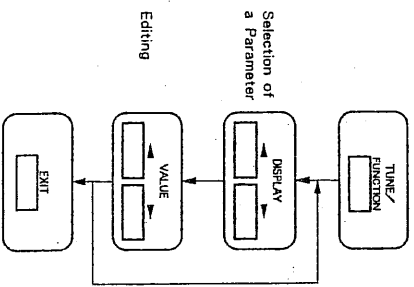

Saving and Loading Data

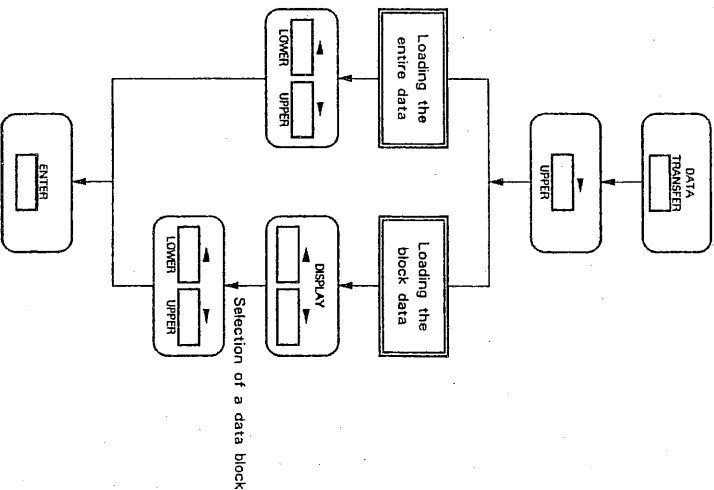
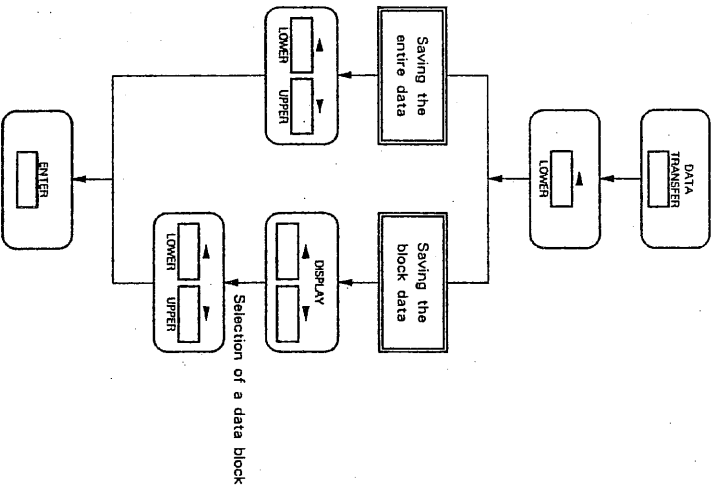

CONTENTS

[EDIT volume]

Overall Organization of the D-5	5
1.Operation	5
2.About Patches/Timbres and Tones	7
a. Tones	7
b. Patches and tones	8
c. Timbres and tones	9

Section I

System Settings

1 Tune/Function	12
1. Tune/Function functions	12
2. Tune/Function Editing Operations	15
2 MIDI Functions	16
1. About MIDI Functions	17
2. MIDI Function Editing Procedure	22

Section II

Patch/Timbre Settings

1 Patch Editing	24
1. Patch Parameter Functions	24
2. Patch Editing Procedure	31
2 Timbre EDIT	32
1. Timbre Parameter Functions	32
2. Timbre Editing Procedure	35
3 Patch/Timbre Write Procedure	37

Section III

Rhythm Setup

1.Rhythm Edit Operations	40
2.Rhythm Writing Procedure	42

Section IV

Tone Settings

1 How a Tone is Constructed	44
1. About Sound	44
a. Natural sound and LA synthesis	44
b. Three elements of sound	45
c. Overtones determine the tone	47
d. The envelope creates natural change	48
2. Partials and Structures	49
a. What the structure does	49
b. Types of structure	50
3. Partials	53
2 Tone Parameter Functions	55
1. Common Parameters	55
2. Partial Parameters	57
a. WG (Wave Generator) parameters	57
b. TVF (Time Variant Filter) parameters	67
c. TVA (Time Variant Amplifier) parameters	73
3 Editing a Tone	76
1. Editing a Tone	76
a. Selecting a tone	76
b. Selecting and modifying tone parameters	78
2. Edit Functions	80
a. Partial mute	80
b. Previous value	81
c. Compare	82
3. Tone writing procedure	83
4 Hints for Sound Creating	85
1. Check the Combination of Partials	85
a. Acoustic instrument simulations using PCM sounds	86
b. Combined partials for thick sounds	86
c. Modify the tone using keyboard dynamics	87
d. Modify the tone by keyboard range	88
e. Using the ring modulator	90

I 1
 I 2
 II 1
 II 2
 II 3
 III
 IV 1
 IV 2
 IV 3
 IV 4
 V 1
 V 2
 APP.

Supplementary Information

2. Tone Creating Procedures	91
a. Creating Strings sounds	91
b. Creating Brass sounds	94
c. Creating Piano sounds	97
d. Creating Organ sounds	100
e. Creating Guitar sounds	104
f. Creating Bass sounds	107
g. Creating Wind instrument sounds	109
h. Creating other types of sound	112

Section V

Other Functions

1 Using the Memory Card	118
1. Saving Data into a Memory Card (RAM)	118
a. About the protect switch	119
b. When using a new memory card	120
c. Saving patches/timbres (Writing procedure)	122
d. Storing tones (Writing procedure)	124
e. Storing data by block (Save)	126
2. Copying Memory Card Data into the D-5 (Load)	128
3. Compatibility with the D-10/D-20	130
2 Transmitting Data Via MIDI	132
1. Transmitting Individual Data	135
a. Patch Dump	135
b. Timbre Dump	137
c. Temporary Dump	139
2. Transmitting by Block	140

1. Error Messages	144
2. Troubleshooting	148
3. Performance Mode List	150
4. Multi Timbral Mode List	151
5. Tone Parameter List	152
6. PCM Sound List	153
7. Rhythm Setup (Factory Settings)	155
8. Preset Tones	156
9. Blank Charts	157
a. Patch/Timbre	157
b. Tone	158
c. Rhythm setup	159
MIDI Implementation Chart	164
INDEX	178

Copyright ©1989 by ROLAND CORPORATION

All rights reserved. No part of this publication may be reproduced in any form without the permission of ROLAND CORPORATION.

OVERALL ORGANIZATION OF THE D-5

1. Operation

D-5 operation is divided into four modes, selected using the **MODE**. Edit/Write/Data transfer operations are organized as follows.

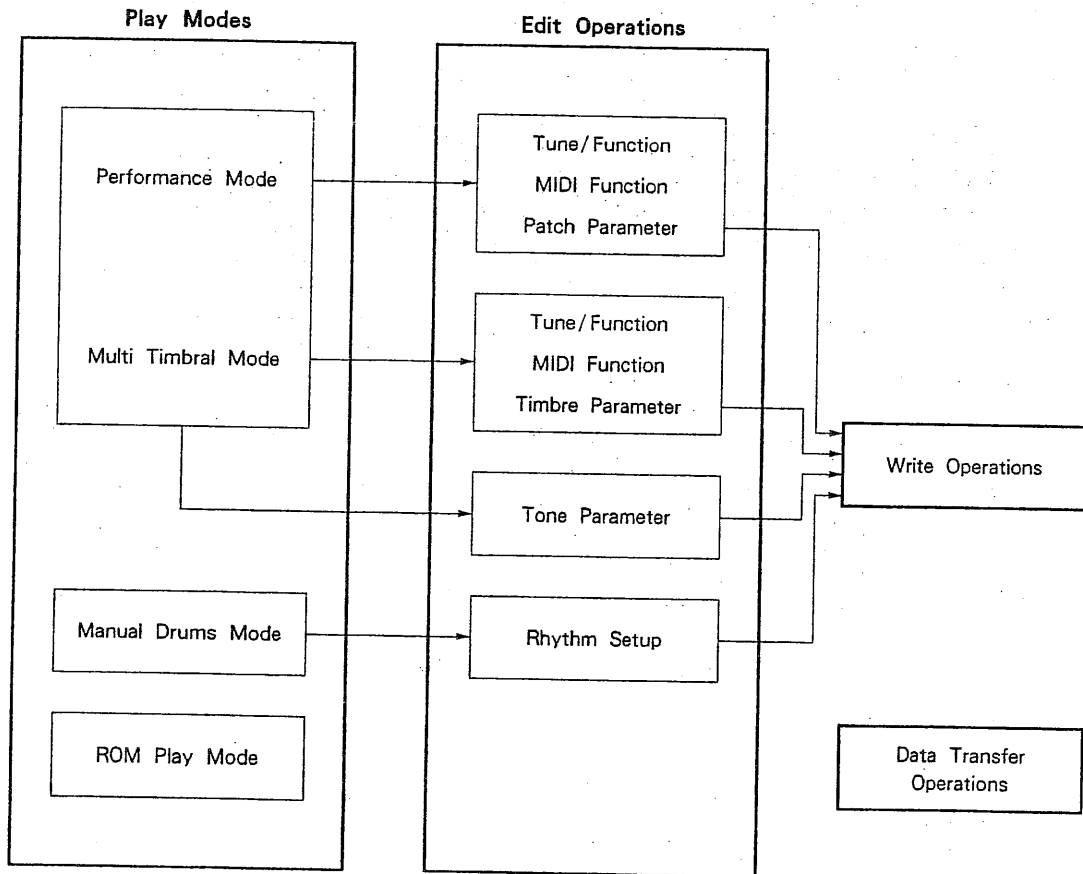

■ Play modes

In play mode, you can select one of the four playing modes.

● Performance Mode

This mode is used mainly when playing the D-5 from its keyboard. In Performance mode, you can switch sounds by selecting patches.

● Multi Timbral Mode

In Multi Timbral mode, the D-5 can function as eight independent synthesizers and a rhythm tone generator. This means that when used with a MIDI sequencer, a single D-5 can produce all the sounds of an entire ensemble. In Multi Timbral mode, you can switch sounds by selecting timbres.

● Manual Drums Mode

In Manual Drums mode, you can play percussion sounds from the keyboard.

● ROM Play Mode

In ROM Play mode, you can hear a demo performance that demonstrates the D-5's multi-timbral capabilities.

■ Edit operations

These operations set or modify various parameters to create or modify sounds and determine how the sounds will be controlled.

Some edited settings are stored immediately, but settings for patch, timbre, rhythm setup, tone, etc. are temporary, and are not directly stored. After editing these parameters, remember to write them into memory if you want to keep the changes you made.

■ Write operations

These operations store edited settings into the D-5's internal memory or into a memory card.

For Tune/Function and MIDI functions, the edited settings are stored directly into memory, so there is no need to write them. (Some of these settings are not memorized.)

■ Data transfer operations

These operations copy (transfer) data between the D-5 and memory card, or between two D-5s. When using a newly-purchased memory card (RAM) for the first time, use the data transfer functions to temporarily store all internal data into the memory card.

2. About Patches/Timbres and Tones

This section will explain how D-5 sound data is organized.

a. Tones

The tones used by patches in Performance mode, by timbres in Multi Timbral mode, and by rhythm setups consist as follows.

Tones are organized in the following groups.

● **Internal**

- a group (preset tones): 64 tones (a01 — a64)
- b group (preset tones): 64 tones (b01 — b64)
- i group (programmable tones): 64 tones (i01 — i64)
- r group (preset tones): 63 tones (r01 — r63, OFF)

● **Memory Card**

- c group: 64 tones (c01 — c64)

Each tone is shared by patches, timbres, and rhythm setup. A rhythm setup can use tones from the internal r group or i group.

Settings can be edited for tones which are assigned to the currently selected patch or timbre. If you want to edit a tone which is currently not assigned to any patch/timbre, you will first have to select that tone in patch/timbre edit.

Edited tone settings can be stored in i group or in c group of the memory card (RAM). Internal groups a, b, and r contain basic D-5 tone settings, and cannot be rewritten.

b. Patches and tones

In Performance mode, patches and tones are made up as follows.

Patches are divided into two groups, A and B. Each group is organized as 8 banks with 8 numbers in each bank.

Internal memory can contain 128 patches, and a memory card can contain an additional 128 patches. D-5 panel operations can switch between these 256 patches.

● Internal

Sixty-four patches in bank A (11—18, 21—28, …… 81—88)

Sixty-four patches in bank B (11—18, 21—28, …… 81—88)

● Memory Card

Sixty-four patches in bank A (11—18, 21—28, …… 81—88)

Sixty-four patches in bank B (11—18, 21—28, …… 81—88)

A patch consists of a tone with settings for performance functions, but the patch itself does not contain tone data. This means that even if you select a different tone to be used in a patch, the settings of that tone are not lost.

However, if you edit the settings of a tone, all patches (or timbres) that use that tone will be affected.

Tones can be used by a patch as follows ;

- group "a", "b", and "r" preset tones can be used by either internal or memory card patches.
- group "i" programmable tones can be used only by internal patches.
- group "c" tones can be used only by memory card patches.

When storing patches from internal to memory card, or from memory card to internal, note the following points.

When a patch which uses group "i" tones is stored to memory card, the tones used by that patch will be changed to group "c". In this case, if group "i" contains a different set of tones than group "c", the patch will sound unexpectedly different. This also applies when storing from memory card to internal.

To avoid confusion, we recommend that you store identical sets of tones in both internal and memory card. If group "i" and group "c" contain different sets of tones, and the sound changes, you will need to write the tones into memory.

c. Timbres and tones

In Multi Timbral mode, timbres and tones are made up as follows.

Like patches, timbres are divided into two groups A and B. Each group is organized as 8 banks with 8 numbers in each bank.

Internal memory contains 128 timbres, and a memory card can contain an additional 128 timbres. D-5 panel operations can switch between these 256 timbres.

● **Internal**

Sixty-four timbres in bank A (11—18, 21—28, 81—88)

Sixty-four timbres in bank B (11—18, 21—28, 81—88)

● **Memory Card**

Sixty-four timbres in bank A (11—18, 21—28, 81—88)

Sixty-four timbres in bank B (11—18, 21—28, 81—88)

In Multi Timbral mode, timbres can be assigned to each part. Timbres can be independently selected and edited for each part.

A timbre consists of a tone with performance settings, but the timbre itself does not contain tone data. This means that even if you select a different tone to be used in a patch, the settings of that tone are not lost. However, if you edit the settings of a tone, all timbres (or patches) that use that tone will be affected.

Tones can be used in a timbre as follows ;

- Group a, b, and r preset tones can be used by either internal or memory card timbres.
- Group i programmable tones can be used only by internal timbres.
- Group c tones can be used only by memory card timbres.

When storing timbres from internal to memory card, or from memory card to internal, note the following points.

When a timbre which uses group i tones is stored to memory card, the tones used by that timbre will be changed to group c. In this case, if group i contains a different set of tones than group c, the timbre will sound unexpectedly different. This also applies when storing from memory card to internal.

To avoid confusion, we recommend that you store identical sets of tones in both internal and memory card. If group i and group c contain different sets of tones, and the sound changes, you will need to write the tones into memory.

MEMO

SECTION I

SYSTEM SETTINGS

Settings for Tune/Function and MIDI functions affect the entire D-5. These functions will set different parameters, depending on the currently selected play mode. In this section, we will explain all of the parameters which can be set in the various play modes.

1 TUNE/FUNCTION	12
1. Tune/Function functions	12
2. Tune/Function Editing Operations	15
2 MIDI FUNCTIONS	16
1. About MIDI Functions	17
2. MIDI Function Editing Procedure	22

1 TUNE / FUNCTION

Tune/Function contains settings such as master tuning and memory protect, and in Multi Timbral mode, the level setting for each part.

The Tune/Function parameters that can be set in the various modes are as follows. Some parameters are shared between all play modes. When these parameters are modified, the setting will apply in all play modes.

*Except for the memory protect setting, all settings are remembered even when the power is turned off. When the power is turned on, memory protect will be on.

Performance Mode Parameter	Value	Multi Timbral Mode Parameter	
Master Tuning	428 — 453Hz	Master Tuning	(Common)
Memory Protect	ON, OFF	Memory Protect	(Common)
Rhythm Level	0 — 100	Rhythm Part Level	(Common)
	Pan : 7 > — > < — < 7 Level : 0 — 100	Pan, Level (Part 1 — 8)	
	0 — 32	Partial Reserve (Part 1 — 8, Rhythm Part)	

1. Tune / Function functions

In this section we will be explaining the Tune/Function operations for all modes.

*Parameters that can be set in Performance mode will be indicated by **PERFORMANCE**. Parameters that can be set in Multi Timbral mode will be indicated by **MULTI TIMBRAL**.

- **Master Tuning (Value : 428 — 453Hz (the frequency of the A4 key))**
Common to **PERFORMANCE** and **MULTI TIMBRAL**.

Master Tune
440 Hz

Use this to adjust the pitch of the D-5 to other instruments. The display will change in steps of 1Hz, but the actual pitch change is nearly continuous.

*Depending on the tone settings (type of PCM sound), there will be some cases in which master tuning does not affect the pitch.

● Memory Protect (Value : ON, OFF)

Common to **PERFORMANCE** and **MULTI TIMBRAL**.

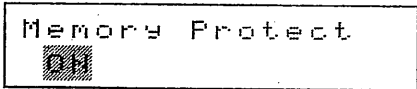

This prevents the data in D-5 memory from being accidentally erased. To protect your valuable data, leave this on except when writing data into memory.

Memory protect can be temporarily turned off when writing data into memory. However, when you need to successively perform many writing operations, for example when rearranging patches or timbres, it will be easier to temporarily turn memory protect off.

*When the power is turned on, memory protect will be on.

● Rhythm Level/Rhythm Part Level (Value : 0—100)

Common to **PERFORMANCE** and **MULTI TIMBRAL**.

< Performance Mode >

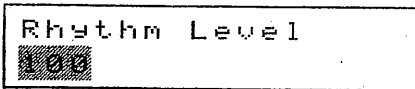

< Multi Timbral Mode >

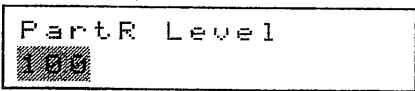

This adjusts the overall volume of the various rhythm sounds.

In Performance mode, use this to adjust the volume balance between rhythm sounds and the patch.

In Multi Timbral mode, use this to adjust the volume balance between the rhythm part and the other parts.

● Pan (Value : 7 > — >< — <7) and Level (Value : 0—100)

MULTI TIMBRAL

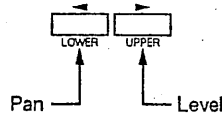
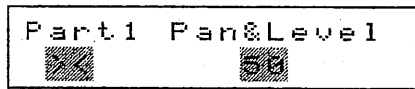

(The display is the same for parts 2—8)

Set the pan and volume for each part 1—8. Pan (pan pot) determines the position of the sound in the stereo output. Use it with the level setting to set the output balance of each part.

To set pan, press **◀/LOWER** (the value being set will blink). Make settings over a range of 7 > — >< — <7. >< puts the sound at the center, 7 > at the left, and <7 at the right.

To set level, press **UPPER/▶** (the value being set will blink). The sound will become louder as you increase the value.

- *To set pan and level for each rhythm part, see page 40.
- *Depending on the tone setting (structure), there will be cases when the pan setting value does not correspond to the actual stereo position.
- *For tones created with one partial, the actual panning will be in 8 steps.

● Partial Reserve (Value : 0—32)

MULTI TIMBRAL

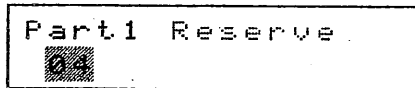

(The display is the same for parts 2—8 and part R.)

This sets the minimum number of partials reserved for each part when note data exceeding the maximum polyphony (32 partials) is received. It is not possible to make partial reserve settings where the total for all parts would exceed 32 partials.

- *When the D-5 is shipped, partial reserve for each part is set as follows.
Part 1 = 04 Part 2 = 06 Part 3 = 04 Part 4 = 04
Part 5 = 04 Part 6 = 04 Part 7 = 00 Part 8 = 00
Part R = 06
- *In Performance mode, the following partial reserve settings are fixed, and cannot be changed.
Upper = 12 Lower = 12 Rhythm = 08

2. Tune/Function Editing Operations

In this section we will explain Tune/Function editing operations.

From any play mode other than ROM play, perform the following steps. In Manual Drums mode, you can set the same parameters as in Multi Timbral mode.

- 1 Press **TUNE/FUNCTION**.
- 2 Press **DISPLAY** and select the parameter to set.
Each time you press the button, the next parameter screen will be displayed.
- 3 Use **◀VALUE▶** to modify the number. (During input, the number will blink.)
- 4 When you have finished making settings, press **EXIT**.
You will return to the screen before you began editing.

2 MIDI FUNCTIONS

In this section, we will explain how MIDI channels and MIDI data are handled.

MIDI function parameters that can be set in the two play modes are as follows.

When parameters that are common to both play modes are set, the new setting will apply to the other mode as well.

*Settings other than local control and patch (timbre) dump are retained even when the power is turned off. Local control is always turned on when the power is turned on. Patch (timbre) dump is always turned off when the power is turned on.

Performance Mode Parameter	Value	Multi Timbral Mode Parameter	
Receive Channel	1—16		
Transmit Channel	1—16		
	1—16	Part Receive Channel (Parts 1—8)	
Rhythm Receive Channel	1—16	Rhythm Part Receive Channel	(Common)
Local Control	ON, OFF	Local Control	(Common)
Bender	ON, OFF		
Modulation	ON, OFF		
Volume (Receive)	ON, OFF		
Hold	ON, OFF		
Program Change	ON, OFF		
Expression	ON, OFF	Expression	(Common)
Breath	OFF, EXP, MOD, E & M	Breath	(Common)
Unit Number	17—32, OFF	Unit Number	(Common)
Patch Dump	ON, OFF	Timbre Dump	(Common)
	1—16	Keyboard Transmit Channel	

1. About MIDI Functions

This section explains what the MIDI functions do in each play mode.

*Parameters which can be set in Performance mode are indicated by **PERFORMANCE**, and parameters which can be set in Multi Timbral mode are indicated by **MULTI TIMBRAL**.

● Receive Channel (Value : 1—16)

PERFORMANCE

MIDI R×CH
5

This sets the receive channel used when controlling the D-5 from an external MIDI device.

● Transmit Channel (Value : 1—16)

PERFORMANCE

MIDI T×CH
5

This sets the transmit channel used when controlling an external MIDI device from the D-5. In Manual Drums mode, you can play rhythm sounds from the keyboard, and your playing will be transmitted on this transmit channel.

● Part Receive Channel (Value : 1—16)

MULTI TIMBRAL

MIDI Part1 CH
2

(The display is the same for parts 2—8.)

This sets the receive channel for each part.

● Rhythm Receive Channel/Rhythm Part Receive Channel (Value : 1—16)

Common to **PERFORMANCE** and **MULTI TIMBRAL**.

< Performance Mode >

MIDI Rhythm CH
2

< Multi Timbral Mode >

MIDI Part R CH
5

In Performance mode, this sets the receive channel used when controlling the D-5's rhythm tone generator from an external MIDI device.

In Multi Timbral mode, this sets the receive channel for the rhythm part.

● Local Control (Value : ON, OFF)

Common to **PERFORMANCE** and **MULTI TIMBRAL**.

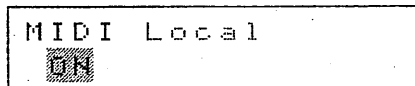

This turns local control ON/OFF.

Local control can separate the D-5's keyboard and panel from its tone generator. When set OFF, performance data from the keyboard will be transmitted from MIDI OUT, but will not sound the D-5's own tone generator. However, the D-5's tone generator will produce sound in response to data received at its MIDI IN.

*When the power is turned on, local control will be ON.

● Bender (Value : ON, OFF)

PERFORMANCE

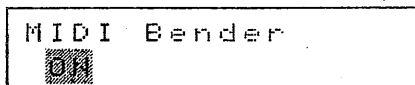

When you want pitch bender data to be transmitted and received, set this ON. If not, set this OFF. If you want to conserve sequencer memory by not recording bender data, set this OFF.

● Modulation (Value : ON, OFF)

PERFORMANCE

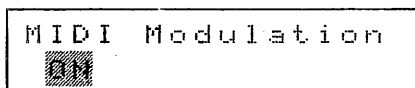

When you want modulation data such as vibrato to be transmitted and received, set this ON. If not, set this OFF. If you want to conserve sequencer memory by not recording modulation data, set this OFF.

● Volume (Value : ON, OFF)

PERFORMANCE

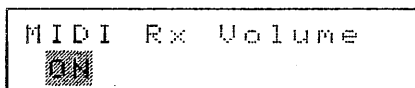

When you want volume data to be received, set this ON. If not, set this OFF.

● Hold (Value : ON, OFF)

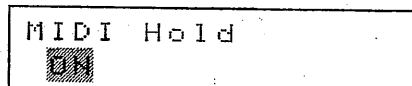
PERFORMANCE

When you want hold data to be received and transmitted, set this ON. If not, set this OFF.

● Program Change (Value : ON, OFF)

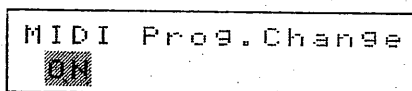
PERFORMANCE

When you want program change data to be received and transmitted, set this ON. If not, set this OFF.

Program change numbers correspond to patches as follows. The same numbers apply to both internal and memory card.

		Number							
Bank		1	2	3	4	5	6	7	8
A Group	1	1	2	3	4	5	6	7	8
	2	9	10	11	12	13	14	15	16
	3	17	18	19	20	21	22	23	24
	4	25	26	27	28	29	30	31	32
	5	33	34	35	36	37	38	39	40
	6	41	42	43	44	45	46	47	48
	7	49	50	51	52	53	54	55	56
	8	57	58	59	60	61	62	63	64
B Group	1	65	66	67	68	69	70	71	72
	2	73	74	75	76	77	78	79	80
	3	81	82	83	84	85	86	88	88
	4	89	90	91	92	93	94	95	96
	5	97	98	99	100	101	102	103	104
	6	105	106	107	108	109	110	111	112
	7	113	114	115	116	117	118	119	120
	8	121	122	123	124	125	126	127	128

*MIDI program change messages are transmitted over a range of 0—127.

*It is not possible to switch between internal and memory card from an external MIDI device.

*In Multi Timbral mode, program change receive and transmit is always possible.

- Expression (Value : ON, OFF)
Common to **PERFORMANCE** and **MULTI TIMBRAL**.

MIDI Expression
ON

When you want expression data to be received, set this ON. If not, set this OFF.

*Expression can be set independently for each play mode.

- Breath (Value : OFF, EXP, MOD, E & M)
Common to **PERFORMANCE** and **MULTI TIMBRAL**.

MIDI Breath
E&M

This determines how breath data is received. Set this when using a wind synthesizer or breath controller to control the D-5.

OFF.....Breath control data will not be received.
EXP.....Breath control data will control expression (volume).
MOD.....Breath control data will control modulation (vibrato/tremolo).
E & M.....Breath control data will control both expression and modulation.

- Unit Number (Value : 17—32, OFF)
Common to **PERFORMANCE** and **MULTI TIMBRAL**.

MIDI Exclu Unit#
17

The unit number is the identification number used when transmitting and receiving exclusive messages regardless of the MIDI channel number (only those with a Roland ID number). When transmitting and receiving exclusive messages regardless of the MIDI channel, make sure that the unit numbers of the two MIDI units match. System exclusive data can be transferred only between units that are set to the same unit number. The range of settings is 17—32, or OFF. When set OFF, system exclusive messages will not be transmitted or received. When using a programmer (PG-10), set this to match the unit number of the programmer.

*Even when receiving and transmitting exclusive messages on the MIDI channel, set this to a setting of 17—32.

*When the power is turned on, the unit number will be set to 17.

● Patch Dump/Timbre Dump (Value : ON, OFF)

Common to **PERFORMANCE** and **MULTI TIMBRAL**.

< Patch Dump >

MIDI Patch Dump
OFF

< Timbre Dump >

MIDI Timbre Dump
OFF

Patch/Timbre bulk dump allows you to transmit the sound data of the selected patch/timbre as an exclusive message. When you want to transmit the sound data of the selected patch/timbre, set this ON.

In either play mode, when you select a patch/timbre from the front panel, the corresponding sound data will be transmitted.

If you record sound data into a sequencer along with the musical data, the patches you recorded with will always be used, even if the patch/timbres of the D-5 have been edited.

Patch/Timbre dump transmits exclusive messages using the unit number.

*When the power is turned on, patch/timbre dump will be turned OFF.

● Keyboard Transmit Channel (Value : 1—16)

MULTI TIMBRAL

MIDI Keyboard CH.
01

This sets the channel on which D-5 keyboard playing and panel operations will transmit control data.

2. MIDI Function Editing Procedure

This section explains the procedure for editing MIDI functions.

In any play mode other than ROM Play, perform the following operations. In Manual Drums mode, you will be able to make the same settings as in Multi Timbral mode.

- 1 Press **MIDI**.
- 2 Press **DISPLAY**, and select the parameter to set.
Each time you press the button, the screen for the next parameter will appear.
- 3 Use **◀VALUE▶** to modify the value. (While entering, the value will blink.)
- 4 When you have finished making settings, press **EXIT**.
You will return to the screen that was displayed before you began editing.

SECTION II

PATCH/TIMBRE SETTINGS

This section will explain the function of the patch/timbre parameters, and edit and write operations.

1 PATCH EDITING	24
1. Patch Parameter Functions	24
2. Patch Editing Procedure	31
2 TIMBRE EDIT	32
1. Timbre Parameter Functions	32
2. Timbre Editing Procedure	35
3 PATCH/TIMBRE WRITE PROCEDURE	37

1 PATCH EDITING

This explains the function of the patch parameters, and patch editing procedure.

1. Patch Parameter Functions

Patch parameters determine how a combination of two tones is played, and how the various patch effects are used.

Patches have the following parameters.

Parameter	Value
Patch Effect Select	OFF, Chord Play, Harmony, Chase, Arpeggio
Key Mode	WHOLE, DUAL, SPLIT
Split Point	C2—C # 7
Lower Tone Select	Tone Group : a, b, i(c), r Tone No. : 1—64
Upper Tone Select	Tone Group : a, b, i(c), r Tone No. : 1—64
Key Shift (☆)	- 24 — + 24
Fine Tune (☆)	- 50 — + 50
Bender Range (☆)	0—24
Assign Mode (☆)	1, 2, 3, 4
Effect Rate	0—100
Harmony Balance	- 12—0
Chase Shift	- 12—+ 12
Chase Level	0—100
Arpeggio Mode	UP, DOWN, U & D, RND
Tone Balance	0—100
Patch Level	0—100
Patch Name	(space) A—Z a—z 0—9 & # ! ? . , ; ' " * + - / < = > (within 16 characters)

* (☆) indicates independent settings for upper/lower tones.

● **Patch Effect Select (Value : OFF, Chord play, Harmony, Chase, Arpeggio)**

This allows you to select which Patch effect (Chord play, Harmony, Chase, or Arpeggio) should be turned on in each Patch. The Effect mode can be set using a Patch Effect button on the front panel.

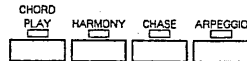

● **Key Mode (Value : WHOLE, DUAL, SPLIT)**

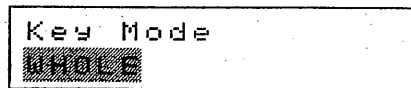

Select one of the following to determine how the two tones chosen by tone select will be sounded.

WHOLE :

Only the upper tone will sound. This is effective when you need a lot of polyphony, as for piano sounds.

DUAL :

The upper and lower tones will be stacked. This is effective when creating thick sounds such as strings or organ.

SPLIT :

Different tones will sound for each area of the keyboard divided by the split point. Notes below the split point will sound the lower tone, and notes above the split point will sound the upper tone. This is effective when you need to use two different sounds at once, such as bass and piano.

● **Split Point (Value : C2 — C # 7 (semitone steps))**

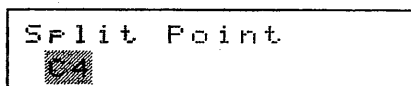

When key mode is set to split, this determines the point at which upper and lower tones will be divided.

When using patch effects such as chord play/harmony/arpeggio, this split point will divide the range. In such cases, the split point is effective even when the key mode is set to dual or whole.

● Lower Tone Select (Value : a1 — a64, b1 — b64, i(c)1 — i(c)64, r1 — r63, OFF)

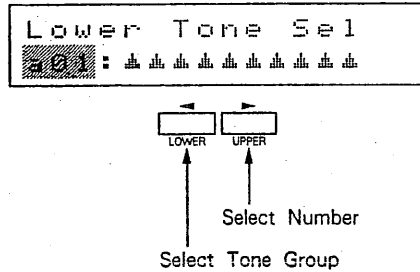

This selects the tone for the lower side.
 Tones are arranged in groups. The selectable groups will be different for internal patches and memory card patches. When this is set OFF, there will be no sound.

Tone Group	Internal Patches		Memory Card Patches	
	a, b, i	r	a, b, c	r
Number	1 — 64	1 — 63, OFF	1 — 64	1 — 63, OFF

- a : Preset Tones (Internal)
- b : Preset Tones (Internal)
- r : Preset Rhythm Tones (Internal)
- i : Programmable Tones (Internal)
- c : Memory Card Tones (Memory Card)

● Upper Tone Select (Value : a1 — a64, b1 — b64, i(c)1 — i(c)64, r1 — r63, OFF)

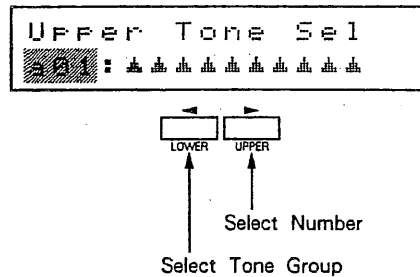

This selects the tone for the upper side.
 Tones are arranged in groups. The selectable groups will be different for internal patches and memory card patches. (See the explanation for lower tone select.) When this is set OFF, there will be no sound.

● Key Shift (Value : -24 — +24 (semitone stpes))

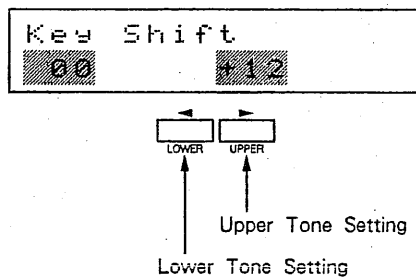

This shifts the pitch produced by each tone in semitone steps. Negative (-) settings will lower the pitch, and positive (+) settings will raise the pitch.

● Fine Tune (Value : -50 — +50 (approximately ± 50 cents))

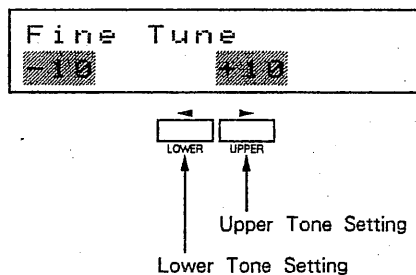

This is a fine adjustment for the pitch produced by each tone. Negative (-) settings will lower the pitch, and positive (+) settings will raise the pitch.

● Bender Range (Value : 0 — 24 (semitone stpes))

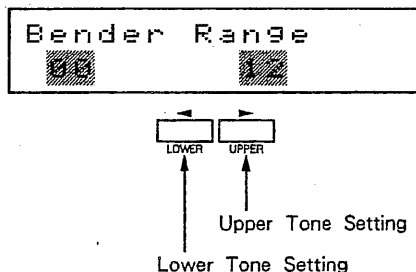

This determines the range of pitch change when using the bender lever to control the pitch. The value set here is the amount of pitch change from normal (bender lever at the center) for fully left/right positions of the bender lever.

● Assign Mode (Value : 1—4)

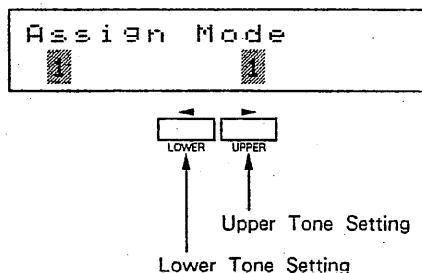

From the following four, select how key data (note data) will sound the tones.

- 1 : single assign, last-note priority
- 2 : single assign, first-note priority
- 3 : multi assign, last-note priority
- 4 : multi assign, first-note priority

Single assign :

When note data overlaps the same key number (for a sound which sustains after the key is released, if the same key has been pressed before the sound disappears), the sound for that key will be turned off, and then re-sounded.

Multi assign :

When note data overlaps the same key number, the new sound for that key will be added to the previous sound.

Last-note priority :

If the number of simultaneously sounding partials exceeds 32, key data arriving later will be given priority, and currently sounding notes will be turned off.

First-note priority :

If the number of simultaneously sounding partials exceeds 32, currently sounding notes will be given priority, and notes arriving later will be ignored.

● Effect Rate (Value : 0—100)

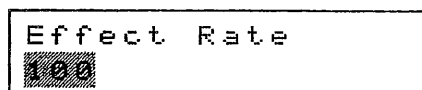

This adjusts the speed of change for the chase and arpeggio functions. Higher settings will result in faster change.

● **Harmony Balance (Value : -12—0)**

Harmony Balance

10

This adjusts the volume balance of the top note (the sound of the key pressed in upper) and the harmony sound. Lower values will decrease the volume of the harmony sound.

● **Chase Shift (Value : -12—+12 (semitone steps))**

Chase Shift

0

This sets the pitch change of the chase sound (repeated sound) in the chase function.

Negative settings (-) will make the pitch of the chase sound gradually become lower, and positive settings (+) will make the pitch gradually become higher. With a setting of 0, the pitch will not change.

*Notes exceeding the limit (C1—C9) will not be sounded.

● **Chase Level (Value : 0—100)**

Chase Level

100

This determines how the chase sound (repeated sound) in the chase function will diminish.

Lower values will make the sound diminish more rapidly, and higher values will make the sound diminish more slowly.

● **Arpeggio Mode (Value : UP, DOWN, U & D, RND)**

Arpeggio Mode

U & D

Select one of the following four types of pattern for the arpeggio function.

UP :

Repeatedly sound the notes of the chord in order from lowest to highest.

DOWN :

Repeatedly sound the notes of the chord in order from highest to lowest.

U & D (Up & Down) :

Repeatedly sound the notes of the chord from low to high to low.

RND (Random) :

Randomly (in an irregular pattern) sound the notes of the chord.

● **Tone Balance (Value : 0—100)**

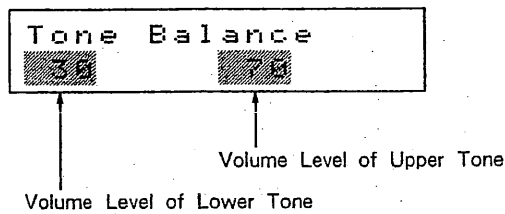

This adjusts the volume balance of upper and lower tones.

The total volume of upper and lower is 100, and increasing one value will automatically diminish the other value.

● **Patch Level (Value : 0—100)**

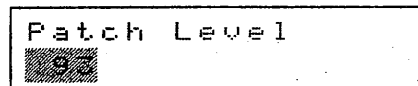

This adjusts the overall level of the entire patch. Use this to adjust the volume of a patch to match it with the volumes of other patches, to avoid a sudden or undesired volume change when switching patches.

● **Patch Name (Value : (space) A—Z a—z 0—9 & # ! ? . , ; ' " * + - / < = >)**

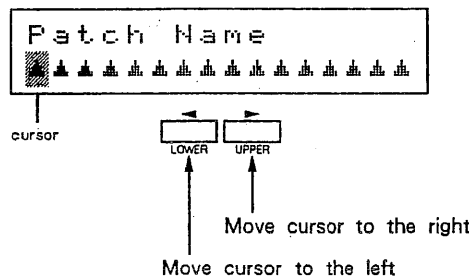

Each patch can be given a 16-character name.

Use **◀/LOWER** **UPPER/▶** to move the cursor to the character you want to change, and use **◀VALUE▶** to select a character.

2. Patch Editing Procedure

This explains the procedure for editing a patch.

*Edited settings are temporary, and when you turn the power off, or select a patch or play mode, they will return to the previous settings. To store your edited settings, remember to write them into memory (see page 37).

Before we begin the procedure, make sure that you are in Performance mode (the **PERFORMANCE** indicator is lit).

1 Select the patch you want to edit.

2 Press **EDIT**.

```

Edit Select
Patch      Tone
  
```

3 Press **◀/LOWER** to select Patch.

```

Key Mode
EDIT
  
```

4 Use **◀/DISPLAY** to select the parameter to edit.

When editing the Key shift, Fine tune, Bender range and Assign mode parameters, press **◀/LOWER** **UPPER/▶** to select whether to edit the upper or lower tone. The value on the selected side will blink, and can be edited.

5 Use **◀/VALUE** to modify the parameter value.

*While editing, you can press **COMPARE** to hear how the patch sounded before you began editing (At this time, the upper right of the display will show a * mark). Press **COMPARE** again to resume editing.

6 Repeat steps **4**—**5** to edit other parameters as desired.

*If while editing, you decide to quit, press **EXIT** to return to play mode.

7 If you want to store the newly edited settings, you will have to write them into memory as explained in Patch/Timbre write procedure (see page 37).

2 TIMBRE EDIT

This section explains the function of the timbre parameters, and timbre editing procedure.

1. Timbre Parameter Functions

Timbre parameters determine how a single tone is sounded. A timbre includes the following parameters.

Parameter	Value
Tone Select	Tone Group : a, b, i(c), r Tone No. : 1—64
Key Shift	- 24 — + 24
Fine Tune	- 50 — + 50
Bender Range	0—24
Assign Mode	1, 2, 3, 4

● **Tone Select (Value : a1 — a64, b1 — b64, i(c)1 — i(c)64, r1 — r63, OFF)**

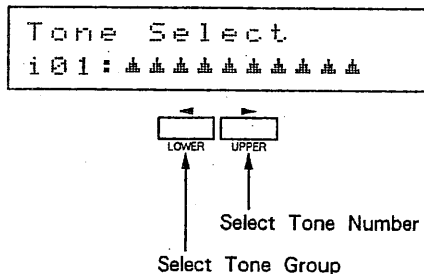

This selects the tone assigned to the timbre.

Tones are arranged in groups. Selectable groups will differ, depending on whether internal timbres or memory card timbres are being used. When set to OFF, there will be no sound.

Tone Group	Internal Timbre		Memory Card Timbre	
	a, b, i	r	a, b, c	r
Number	1—64	1—63, OFF	1—64	1—63, OFF

- a : Preset Tones (Internal)
- b : Preset Tones (Internal)
- r : Preset Rhythm Tones (Internal)
- i : Programmable Tones (Internal)
- c : Memory Card Tones (Memory Card)

- Key Shift (Value : -24 — +24 (semitone steps))

Key Shift
12

This adjusts the pitch of the tone in semitone steps.

- Fine Tune (Value : -50 — +50 (approximately ± 50 cents))

Fine Tune
00

This is a fine adjustment for the pitch of the tone.

- Bender Range (Value : 0 — 24 (semitone steps))

Bender Range
22

This determines the range of pitch change when using the bender lever to control the pitch. The value set here is the amount of pitch change from normal (bender lever at the center) for fully left/right positions of the bender lever.

- Assign Mode (Value : 1 — 4)

Assign Mode
1

From the following four, select how key data (note data) will sound the tones.

- 1 : single assign, last-note priority
- 2 : single assign, first-note priority
- 3 : multi assign, last-note priority
- 4 : multi assign, first-note priority

Single assign :

When note data overlaps the same key number (for a sound which sustains after the key is released, if the same key has been pressed before the sound disappears), the sound for that key will be turned off, and then re-sounded.

Multi assign :

When note data overlaps the same key number, the new sound for that key will be added to the previous sound.

1. Timbre Parameter Functions

Last-note priority :

If the number of simultaneously sounding partials exceeds 32, key data arriving later will be given priority, and currently sounding notes will be turned off.

First-note priority :

If the number of simultaneously sounding partials exceeds 32, currently sounding notes will be given priority, and notes arriving later will be ignored.

2. Timbre Editing Procedure

This explains the procedure for timbre editing.

*Edited settings are temporary, and when you turn the power off, or return to play mode and select a timbre or play mode, your edits will be replaced by the previous settings. To store your edited settings, remember to write them into memory (see page 37).

Before we begin the procedure, make sure that you are in Multi Timbral mode (the **MULTI TIMBRAL** indicator is lit).

1 Get the keyboard display.

Unless you select a part which can be played from the keyboard, you will not be able to hear the sound as you edit.

2 Select a timbre to edit.

3 Press **EDIT**.

```

Edit Select
Timbre Tone
  
```

4 Press **←/LOWER** to select Timbre.

```

Tone Select
█ : ▲▲▲▲▲▲▲▲▲▲▲▲▲▲
  
```

5 Use **←/DISPLAY** to select the parameter to edit.

6 Use **←/VALUE** to modify the parameter value.

*While editing, you can press **COMPARE** to hear how the timbre sounded before you began editing (At this time, the upper right of the display will show a * mark). Press **COMPARE** again to resume editing.

7 Repeat steps **5**—**6** to edit other parameters as desired.

*If while editing, you decide to quit, press **EXIT** to return to play mode.

2. Timbre Editing Procedure

- 8** If you want to store the newly edited settings, you will have to write them into memory as explained in the following section **3** Patch/Timbre write procedure.

3 PATCH/TIMBRE WRITE PROCEDURE

This section explains how to write patches or timbres into memory.

A patch can be written into memory either during patch editing, or in Performance play mode.

A timbre can be written into memory either during timbre editing (in any timbre parameter display), or in Multi Timbral play mode. If you write while in play mode, the currently displayed timbre will be written into memory.

- 1 Press **WRITE** to get the writing display as follows.

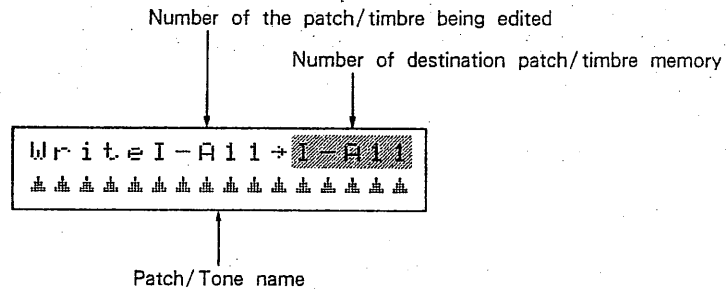

- 2 If you have been editing a memory card patch/timbre, press **INT/CARD** to switch the destination to "i" (internal).

*If you write a patch/timbre into internal memory with c group selected, it will change to an i group tone. If the i group and c groups contain different tones, the sound will be unexpectedly different.

To avoid such accidents, we recommend that you keep the same tones in both internal and memory card. If internal and memory card contain different tones, and there is an unexpected change in the sound you have just written, you will also need to write the tones into memory (see page 83).

SECTION III

RHYTHM SETUP

This section explains how to modify the assignments of key numbers and rhythm sounds, and how to play the rhythm sounds. These settings let you adjust the D-5 rhythm sounds be triggered by rhythm data recorded in a MIDI sequencer, or adjust the balance of the rhythm sounds.

1.Rhythm Edit Operations	40
2.Rhythm Writing Procedure	42

1. Rhythm Edit Operations

This section explains how to edit the rhythm setup.

■ Parameters functions

Tones can be assigned to each key number C1—C8 as rhythm sounds. In addition to the tone assignment for each key number, the following parameters can also be set.

● Tone Select (Value : r1—r63, OFF, i1—i64)

This assigns a rhythm tone to a key. In addition to the preset rhythm tones (r1—r63), you can select from your own original internal tones (i1—i64). When OFF is selected, there will be no sound.

*When internal tones are selected, the pitch will change depending on the key number to which it is assigned.

● Level (Value : 0—100)

This adjusts the volume of the tone. Higher settings will result in a louder volume.

● Pan (Value : 7>—><—<7)

This determines the position of the sound when stereo output is used. >< is center, <7 is right, and 7> is left.

*Depending on the tone settings (structure), the pan setting and the actual position may differ.

*For tones created using one partial, the actual panning will be in 8 steps.

■ Editing procedure

Before you begin editing, check to make sure that you are in Manual Drums mode (the **MANUAL DRUMS** indicator is lit), and use the following procedure.

*Edited settings are temporary, and will return to the original settings when the power is turned on. If you want to keep your edited settings, use the writing procedure (page 42) for each key number.

1 Press **EDIT**.

At this time, pressing a key will sound its rhythm tone.

- 2** Press the key to edit.
The tone, level, and pan settings for that key will be displayed.

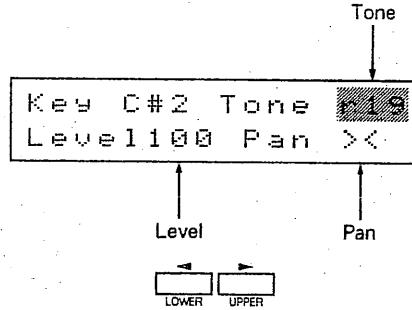

To select a key outside the keyboard range (C1 — B1, C # 7 — C8), press **◀ DISPLAY ▶** to move the key range, and then press a key. The **KEY TRANSPOSE** indicator will light.

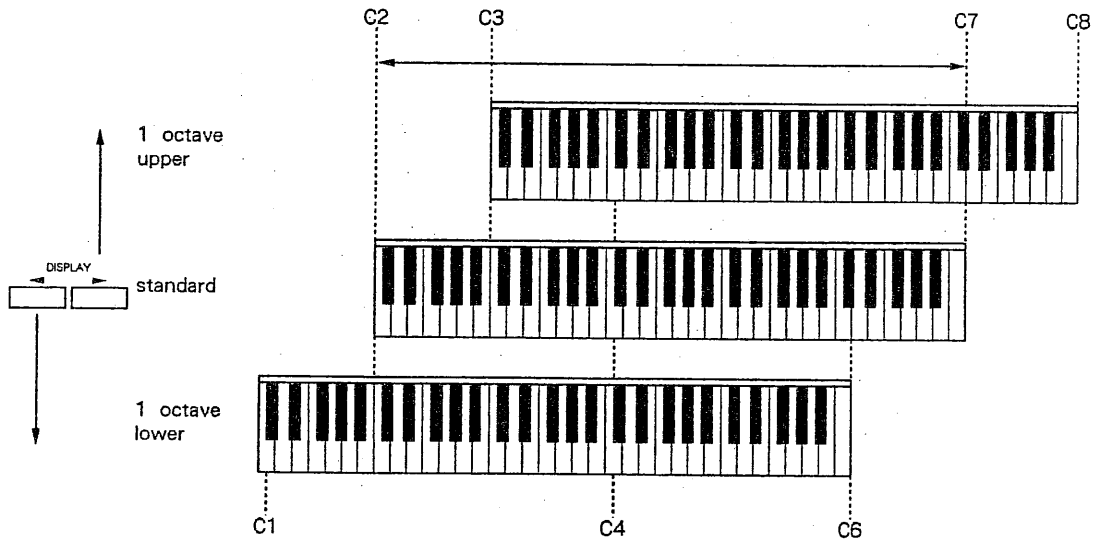

- 3** Press **◀/LOWER UPPER/▶** to select the parameter to edit.
The value of the selected item will blink.
- 4** Use **◀VALUE▶** to modify the setting.
- 5** If you want to keep the edited value, use the write procedure (explained immediately following).
If you want to quit editing without keeping the edited value, press **EXIT** to return to the previous Manual Drums mode display.



2. Rhythm Writing Procedure

Edited rhythm settings must be written into memory for each key.

From rhythm editing, perform the following procedure.

- 1 Press **WRITE**.

```
Write C#2 Setup
Sure?          Enter
```

- 2 Press **ENTER**.

If memory protect is on, the following display will appear.
If memory protect is off, the settings will be written into memory, and you will return to the editing display.

```
Turn Protect off
once? Write/Exit
```

*To exit without writing, press **EXIT** to return to the previous editing display.

- 3 Press **WRITE**.

Memory protect will temporarily be turned off, then you will return to the display of 1.

- 4 Press **ENTER** once more.

If write is successfully executed, the following display will appear, and then you will be returned to the rhythm editing display.

```
Completed
```

SECTION IV

TONE SETTINGS

In this section, we will explain the procedure for tone editing and basic concepts of the LA synthesis used in the D-5, and give actual examples and ideas for creating sounds. By following these guidelines, you will learn to create your own sounds.

1 HOW A TONE IS CONSTRUCTED	44
1. About Sound.....	44
a. Natural sound and LA synthesis.....	44
b. Three elements of sound.....	45
c. Overtones determine the tone.....	47
d. The envelope creates natural change.....	48
2. Partials and Structures.....	49
a. What the structure does.....	49
b. Types of structure.....	50
3. Partials.....	53
2 TONE PARAMETER FUNCTIONS	55
1. Common Parameters.....	55
2. Partial Parameters.....	57
a. WG (Wave Generator) parameters.....	57
b. TVF (Time Variant Filter) parameters.....	67
c. TVA (Time Variant Amplifier) parameters.....	73
3 EDITING A TONE	76
1. Editing a Tone.....	76
a. Selecting a tone.....	76
b. Selecting and modifying tone parameters.....	78
2. Edit Functions.....	80
a. Partial mute.....	80
b. Previous value.....	81
c. Compare.....	82
3. Tone writing procedure.....	83
4 HINTS FOR SOUND CREATING	85
1. Check the Combination of Partials.....	85
a. Acoustic instrument simulations using PCM sounds.....	86
b. Combined partials for thick sounds.....	86
c. Modify the tone using keyboard dynamics.....	87
d. Modify the tone by keyboard range.....	88
e. Using the ring modulator.....	90
2. Tone Creating Procedures.....	91
a. Creating Strings sounds.....	91
b. Creating Brass sounds.....	94
c. Creating Piano sounds.....	97
d. Creating Organ sounds.....	100
e. Creating Guitar sounds.....	104
f. Creating Bass sounds.....	107
g. Creating Wind instrument sounds.....	109
h. Creating other types of sound.....	112

1 HOW A TONE IS CONSTRUCTED

Synthesizers in the D series, including the D-5, can be used to create sound in a similar way as conventional analog synthesizers. However the D series are not simply "digitalized" analog synthesizers ... they can create new types of sound that were very difficult to achieve with conventional analog synthesizers. This section will explain the basic concepts of LA synthesis, starting with basic ideas about sound, and then explaining the various tone parameters.

1. About Sound

We will be explaining LA synthesis by way of some basic concepts of sound.

a. Natural sound and LA synthesis

Acoustic instruments such as piano and violin are sounds similar to the complex sounds found in nature, such as the wind.

Think of the sound of the wind. We often consider this as a swooshing or howling sound, but detailed analysis shows that this includes many different sounds. The sound of the wind sweeping between buildings, the sound of leaves swept by the wind, the sound of the rain, ... Wind actually includes many sounds.

Now let's think of the sound of a piano. This includes the sound of the hammer striking the string, the sound of the vibrating string, and the sound of the other strings sympathetically vibrating. Restricting our attention to the vibration of the string, we can see that this includes a strong attack when the hammer strikes the string, a sustained sound that briefly decays, and a long decaying sound that eventually decays to silence. This too, is composed of many elements.

LA synthesis is based on the concept that a sound consists of a large number of sounds. In LA synthesis, sounds of completely different character can be created (partials), and combined to make a single sound.

Each partial creates sound using the principles of analog synthesis. And we can use PCM sounds to efficiently create sounds that would be difficult to create using analog synthesis techniques.

*LA is an abbreviation of Linear Arithmetic Synthesis. LA synthesis uses advanced digital technology, but allows you to create sounds using the accumulated know-how of conventional analog synthesizers.

b. Three elements of sound

Here we will explain about the three elements that make up a sound.

In our daily lives, we are constantly in contact with various sounds. These sounds reach our ears as vibrations in the air. By expressing this vibration as an electrical signal, we can view it as a "waveform".

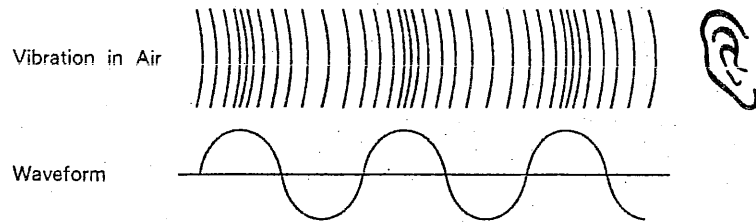

This waveform is determined by the three elements of pitch, tone, and volume. In addition to this, the way in which these elements change over time is also very important.

The character of a sound is determined by these three elements. For example, a tuba has a low pitch, a piccolo has a high pitch, brass instruments have bright sounds with many overtones, woodwinds have soft sounds with few overtones, organ sounds continue as long as a key is pressed, snare drums have a sharp percussive sound, etc.

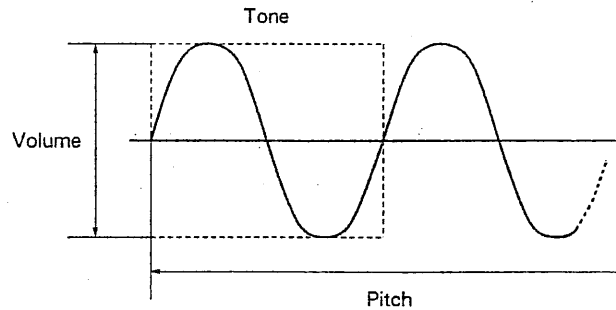

● **Pitch**

Pitch is determined by the speed of repetition (frequency) of the waveform. As the frequency increases, the pitch will rise. In general, pitch is expressed as frequency (the number of cycles per second), and shown in units of Hz (hertz).

In the D-5, the WG (page 54) determines the pitch.

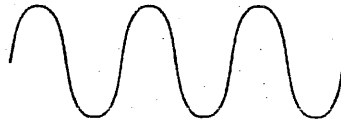

Low Sound

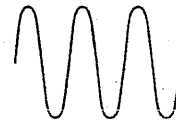

High Sound

● **Tone**

Tone is determined by the shape of the waveform (the overtone structure). In general, more rounded waveforms have a softer sound, and more irregular waveforms have a brighter, harder sound. For details of waveform shape and overtone structure, see the following section "Overtones determine the tone".

In the D-5, this is determined by the TVF (page 54).

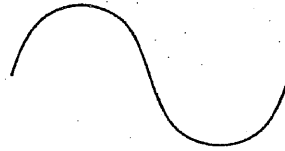

Soft Sound



Bright Sound

● **Volume**

Volume is determined by the height (amplitude) of the waveform. As the waveform increases in height, the volume becomes louder.

In the D-5, this is determined by the TVA (page 54).



Small Sound

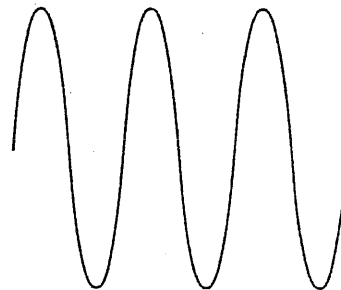

Loud Sound

c. Overtones determine the tone

We have already explained that tone is the "shape of the waveform". Here we will explain how that shape is determined.

It is possible to think of any sound as being a combination of various sine waves. For example, if we take a sine wave as the fundamental, and continue adding sine waves of frequencies that are multiples of the fundamental, we get a "sawtooth wave (SAW)". If we add sine waves of frequencies that are odd multiples of the fundamental, we get a "square wave (SQU)".

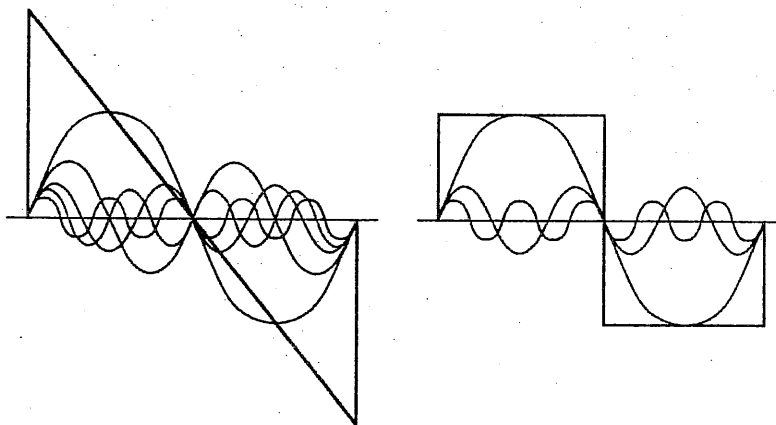

Sawtooth Wave

Square Wave

The various sine waves added to the fundamental (the sine wave whose frequency determines the pitch of the sound) are known as "overtones". Overtones at integer multiples of the fundamental are called "harmonic" overtones, and other overtones are called "non-harmonic" overtones.

In general, string sounds such as violin and brass sounds such as trumpet are similar to sawtooth waves, and wind instruments such as flute and clarinet are similar to square waves. The D-5 uses sawtooth waves and square waves as basic waveforms, and uses the cutoff frequency of the TVF (Time Variant Filter, page 67) to adjust the overtone structure in order to create various sounds. In general, the more high frequency waves (high overtones) included in a sound, the brighter it will be.

In this way, tone is determined by the type and strength of the overtones.

*The ring modulator in the D-5's structure setting (page 52) can be used to modify the overtone structure.

d. The envelope creates natural change

The "envelope" is the change in a sound over time.

For every instrument, there is a characteristic way in which the three elements of sound change as time passes. This change in the sound over time is called the envelope. Every instrument has its own, unique envelope. Sounds that have the same basic tone but different envelopes can often be dramatically different.

● Pitch envelope

In some instruments (for example, brass), pitch is controlled by human lip pressure, and thus there is always a bit of pitch uncertainty at the beginning of a note. For example, if the beginning of a note is a bit low, the musician will raise the pitch. If he over-corrects, he will bring the pitch back down again. This change takes place in a moment, but results in a unique movement that gives the instrument its character.

The pitch envelope can be used to simulate this type of change. The pitch envelope can simulate not only subtle changes, but also drastic changes such as for electronic drums that have a quick pitch sweep, or the gradually rising whine of a jet airplane taking off.

● Tone envelope (TVF envelope)

For most natural instruments, the beginning of the sound contains the most overtones, and as the sound decays, the overtones decrease. This decay is different for each instrument, and by making the overtones decay in an appropriate way, it is possible to simulate a specific instrument. In addition to simulating natural instruments, it is possible to create overtone changes that would not be found in natural instruments.

● Volume envelope (TVA envelope)

Sounds such as a piano begin at nearly the same instant as the key is pressed, and gradually decay in volume as long as the key is pressed. On the other hand, sounds such as organ continue sounding at a certain volume as long as the key is pressed.

In this way, volume change over time is an important factor in determining the character of a sound.

Various Volume Envelopes

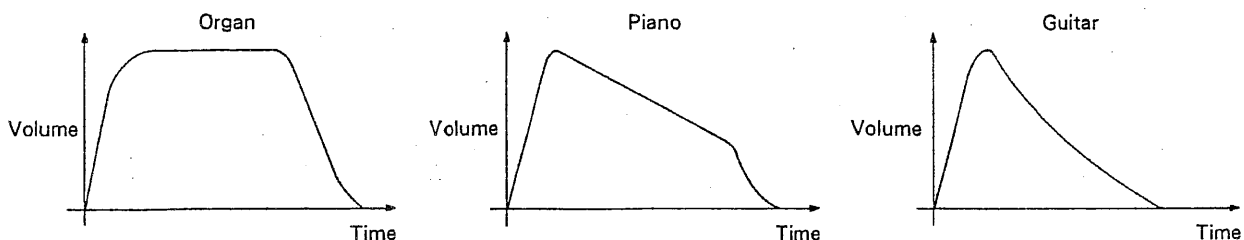

2. Partials and Structures

A tone consists of four "partials" (the basic units of tone generation) and "common" parameters which determine how the partials are combined to work together. The most important factor in a tone is the common "structure". This section will explain how the "structure" and "partials" are related.

Each partial can independently produce its own sound. A tone consists of the combined sound produced by the partials, and the "structure" determines how the sounds of the partials are combined. Each tone has two structures, and each structure determines how two of the partials are used.

When modifying an already created tone, all you need to do is edit the parameters according to the structure setting. However when creating a sound from scratch, you will first need to decide which structure you want to use. If you change the structure while editing a partial, the configuration of the partial will change, which may produce unexpected results.

a. What the structure does

The structure determines how partials are used and combined. You can select from 13 different types of structure. The procedure is as follows.

① **Select the type of tone generator to use for each partial.**

Select whether each partial will function as a synthesizer sound generator or as a PCM sound generator.

Synthesizer sound generator :

A synthesizer sound generator creates sound in the same way as a conventional analog synthesizer.

PCM sound generator :

A PCM sound generator uses a PCM recording to create sound. A variety of PCM sounds are provided. They can be used as instrument attacks, as complete sounds in themselves, or as sound effects.

② **Decide how the partials will be combined.**

The 13 structures (combinations of partials) can be divided into those that use the ring modulator and those that do not.

b. Types of structure

Structures can be classified as follows, and used in various ways as explained.

■ Structures not using the ring modulator

- **Structures 1, 3, 6** Structures which output the combined signals of two partials.

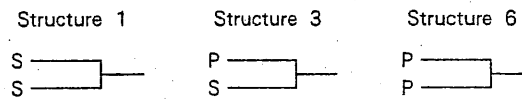

These are basic structures which can be used in a variety of ways.

- (1) Create the same sound with each partial, and slightly detune the pitch to make a thick sound. Or, it is often effective to tune partials an octave or fifth apart. This is also effective when creating string or organ sounds.
- (2) When simulating acoustic sounds, it is often effective to use a PCM sound for the attack. For example, when simulating a brass instrument, the breath sound can be created using a PCM sound, and the sustained sound can be created using a looped PCM sound or a synthesizer sound.
- (3) Use separate partials to create bright sounds and soft sounds, and reverse the polarity of the TVA velocity so that key velocity will affect the tone.
- (4) Use separate partials to create the low range and high range, and reverse the TVA bias settings so that the sound will change depending on the keyboard area you play.

- **Structures 8, 9**

These can be used in the same ways as structures 1 and 6, and are used when you want to create a stereo effect using a single sound.

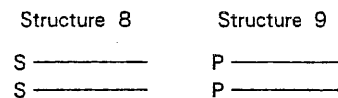

This is effective when playing timbres and rhythm tones in stereo. In such cases, pan settings will modify the stereo placement of each partial as follow.

Pan Setting			Actual Stereo Placement of the Partial		
(Left) 7		7 (Right)	(Left) 7		7 (Right)
>	><	<	>	><	<

① : Partial 1 (3) ② : Partial 2 (4)

*When playing in mono, the result will be the same as when the two partials are mixed (as previously explained).

■ Structures using the ring modulator

A ring modulator creates non-harmonic overtones (often found in metallic sounds) by multiplying the sound of two partials.

Using the ring modulator means that, instead of combining partials, you are using one partial to modulate another partial (the fundamental).

● Structures 2, 4, 5, 7

These structures mix the sound of partial 1 (3) with the ring modulated sound of partial 1(3)/partial 2(4).

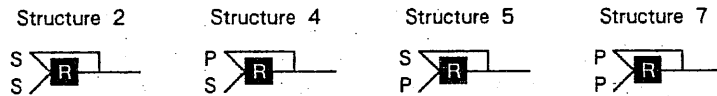

● Structures 10, 11, 12, 13

These structures output the ring modulated sound of partial 1(3)/partial 2(4).

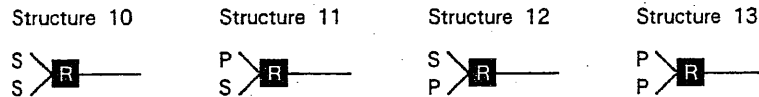

When using the ring modulator, be aware of the following points.

- When one of the partials is muted, the sound of the other partial will be output just as it originally was (i.e., without being ring modulated).
- Partial 1 (3) forms the fundamental, and partial 2 (4) forms the overtones.
- Partial 1 (3) controls the overall volume.
- Partial 2 (4) controls the pitch and level of the overtones.
- If the pitches of the two partials are in a consonant ratio (a perfect fifth or octave, etc.), the resulting sound will be fairly clear. When creating clear brass sounds, it is useful to keep partial 1 (3) close to a sine wave.

*The TVF cannot be used to change the tone of a PCM sound. However, the ring modulator can be used to add complex overtones to a PCM sound, thus modifying the tone. Also, the TVA envelope of partial 2 (4) can be used to control the overtones, and modify them over time.

3. Partial

Here we will explain how partial parameters are affected by the structure, and the function of each parameter.

The arrangement of a partial will depend on whether it is being used as a synthesizer sound generator or as a PCM sound generator, as follows.

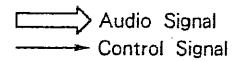

Synthesizer Sound Generator Flow Diagram

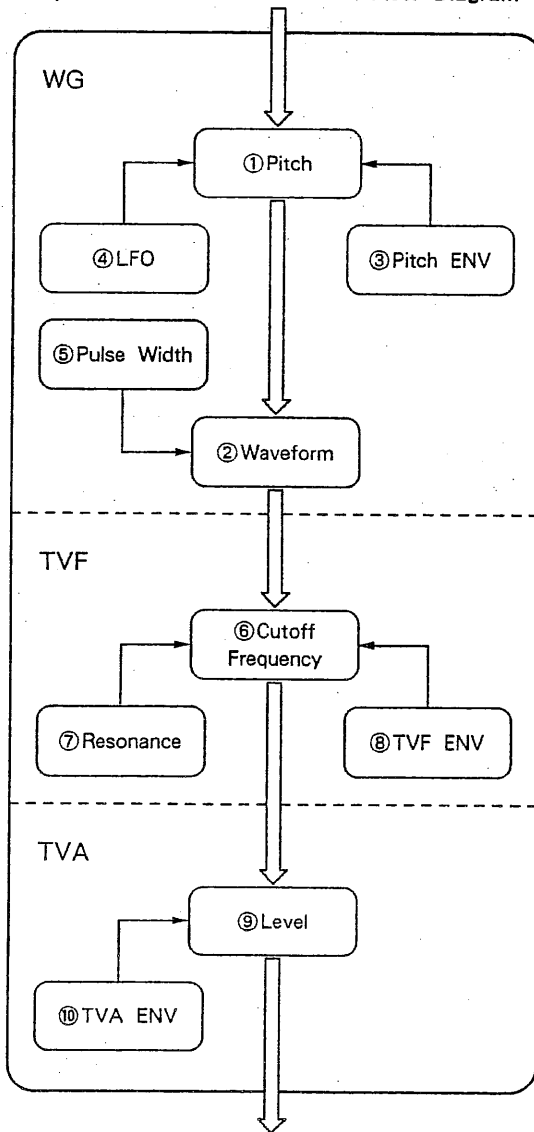

PCM Sound Generator Flow Diagram

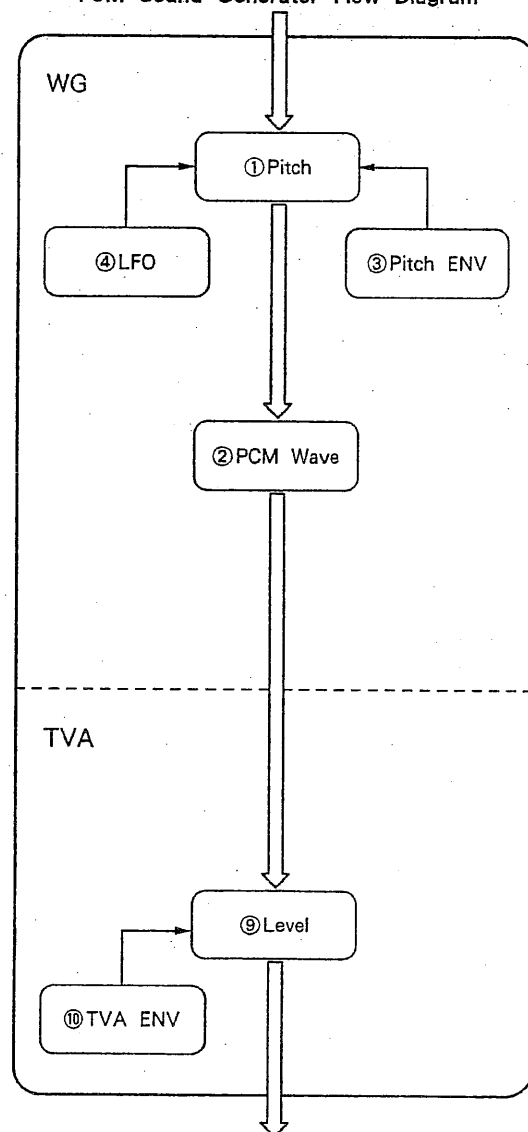

● **WG (Wave Generator)**

In addition to controlling the standard pitch of the partial, this determines the basic waveform.

① **Pitch**

Set the standard pitch of the partial (the pitch at C4 "middle C").

② **Waveform/PCM Wave Number**

Select the sound generator waveform.

③ **Pitch ENV**

Determine how the pitch will change over the time from key on to key off.

④ **LFO (Low Frequency Oscillator)**

The LFO is an oscillator with an extremely slow period (low frequency), and is used to create a cyclic change in pitch (vibrato).

⑤ **Pulse Width**

This changes the shape of the sound generator waveform. (This cannot be used for a PCM sound generator).

● **TVF (Time Variant Filter)**

This allows frequencies lower than a certain frequency (the cutoff frequency) to pass, and removes the upper portion (i.e., this is a low pass filter), thus changing the overtone structure and modifying the tone. In the case of a PCM sound generator, since the PCM sound itself has its own tone, the TVF cannot be used to control tone.

⑥ **Cutoff Frequency**

This sets the cutoff point of the time variant filter.

⑦ **Resonance**

This allows you to emphasize the overtones near the cutoff point, to create a region of tonal emphasis.

⑧ **TVF ENV**

This determines how the cutoff point will change over the time from key on to key off.

● **TVA (Time Variant Amplifier)**

This controls the volume of the partial.

⑨ **Level**

Set the volume level.

⑩ **TVA ENV**

This determines how the volume will change over the time from key on to key off.

2 TONE PARAMETER FUNCTIONS

A tone consists of various parameters. Here we will be explaining what the various parameters do, grouped by their function.

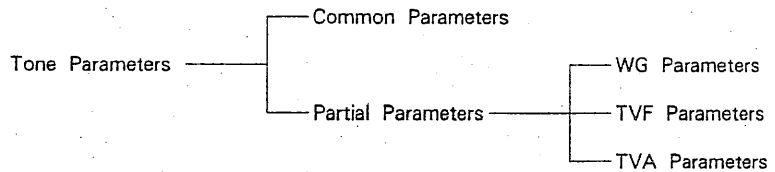

1. Common Parameters

The following common parameters affect the overall tone, and determine how partials are combined.

Common Parameters	Value
Tone Name	(space) A—Z a—z 0—9 & # ! ? . , ; ' " * + - / < = >
Structure 1 & 2	1—13
Structure 3 & 4	1—13
ENV Mode	NORMAL, NO SUSTAIN

- **Tone Name** (Value : (space) A—Z a—z 0—9 & # ! ? . , ; ' " * + - / < = >)

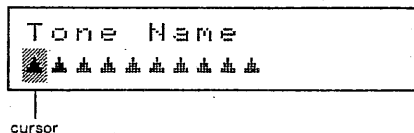

A tone can be given a 10-character name. Use **◀/LOWER** **UPPER/▶** to move the cursor to the character you wish to change, and use **◀|VALUE|▶** to modify it.

1. Common Parameters

● Structures 1 & 2/3 & 4 (Value : 1—13)

Structure 1&2 <input checked="" type="checkbox"/>	Structure 3&4 <input type="checkbox"/>
--	---

Select a structure from the following 13 types:

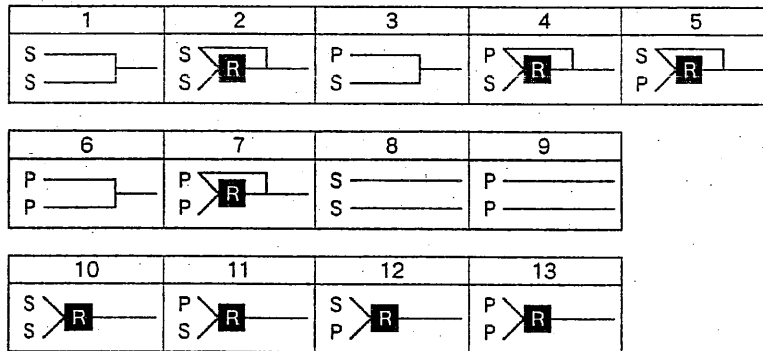

S : Synthesizer Sound Generator
P : PCM Sound Generator

*For a detailed explanation of how to use the various structures, see page 49 "2. Partials and Structures".

● ENV Mode (Value : NORMAL, NO SUSTAIN)

ENV Mode
 NORMAL

This determines whether or not the envelope of each partial will ignore the key off timing. Usually, you will set this to NORMAL, but when creating rhythm tones, set it to NO SUSTAIN.

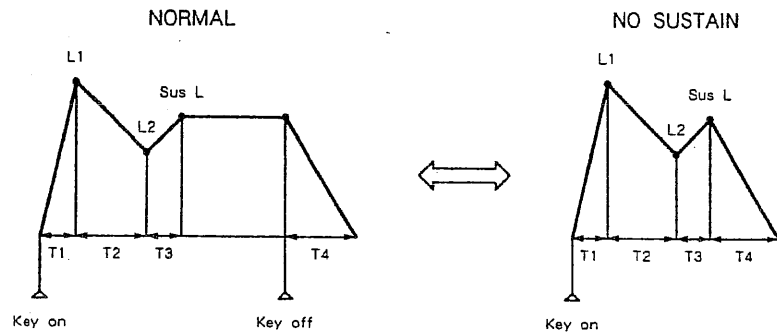

*When the ENV mode is set to NO SUSTAIN, the end level of the pitch envelope will sound at the level of point 3.

2. Partial Parameters

Partial parameters can be divided by function into WG/TVF/TVA. Here we will be explaining the parameters in each of the editing groups.

SYNTH indicates a parameter that is effective for a synthesizer sound generator.

PCM indicates a parameter that is effective for a PCM sound generator.

a. WG (Wave Generator) parameters

The WG determines the standard pitch of a partial, and the basic waveform of the sound generator.

S : Parameters effective for a synthesizer sound generator

P : Parameters effective for a PCM sound generator

Group	Partial Parameters	Effective (○) Ignored (×)		Value
		S	P	
WG Pitch/Mod	Pitch Coarse	○	○	C1—C9
	Pitch Fine	○	○	-50—0—+50
	Key Follow (Pitch)	○	○	-1, -1/2, -1/4, 0, 1/8, 1/4, 3/8, 1/2, 5/8, 3/4, 7/8, 1.5/4, 3/2, 2, s1, s2
	LFO Rate	○	○	0—100
	LFO Depth	○	○	0—100
	Modulation Sensitivity	○	○	0—100
	Bender Switch	○	○	OFF, ON
WG Form/ENV	Waveform	○	×	SQU, SAW
	PCM Wave Bank	×	○	1, 2
	PCM Wave Number	×	○	1—128
	Pulse Width	○	×	0—100
	Pulse Width Velocity Sensitivity	○	×	-7—0—+7
	Pitch ENV Depth	○	○	0—10
	Pitch ENV Velocity Sensitivity	○	○	0—4
WG P-ENV	Pitch ENV Key Follow (Time)	○	○	0—4
	Pitch ENV Time 1, 2, 3, 4	○	○	0—100
	Pitch ENV Level 0, 1, 2, End	○	○	-50—0—+50

■ **WG Pitch/Modulation Group**

● **Pitch Coarse (Value : C1 — C9)**

SYNTH **PCM**

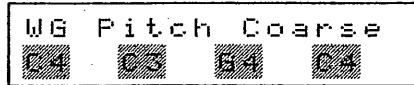

This determines the standard pitch of the partial.

* Standard pitch is the pitch of the C4 key (middle C).

● **Pitch Fine (Value : -50 — +50 (approximately ± 50 cents))**

SYNTH **PCM**

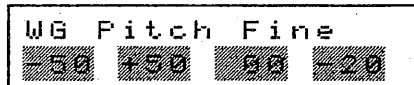

This is a fine adjustment for the pitch of the coarse setting.

● **Pitch Key Follow (Value : -1, -1/2, 1/4, 0, 1/8, 1/4, 3/8, 1/2, 5/8, 3/4, 7/8, 1, 5/4, 3/2, 2, s1, s2)**

SYNTH **PCM**

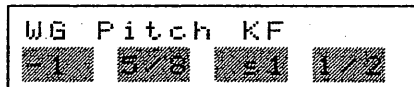

Most electronic instruments and synthesizers use the equal tempered scale, producing a half step pitch change for each key. On the D-5, this pitch ratio (slope) can be changed, with C4 as the center value. This allows you to use ethnic scales, or create subtle changes in pitch such as found on a piano.

PCM sounds vary greatly in character when transposed. Percussive and scraping sounds do not usually have much variation in pitch, so leaving such sounds near their original pitch area will retain their realism.

The setting indicates the number of octaves of pitch change that occurs when you move up or down the keyboard 12 notes (one octave).

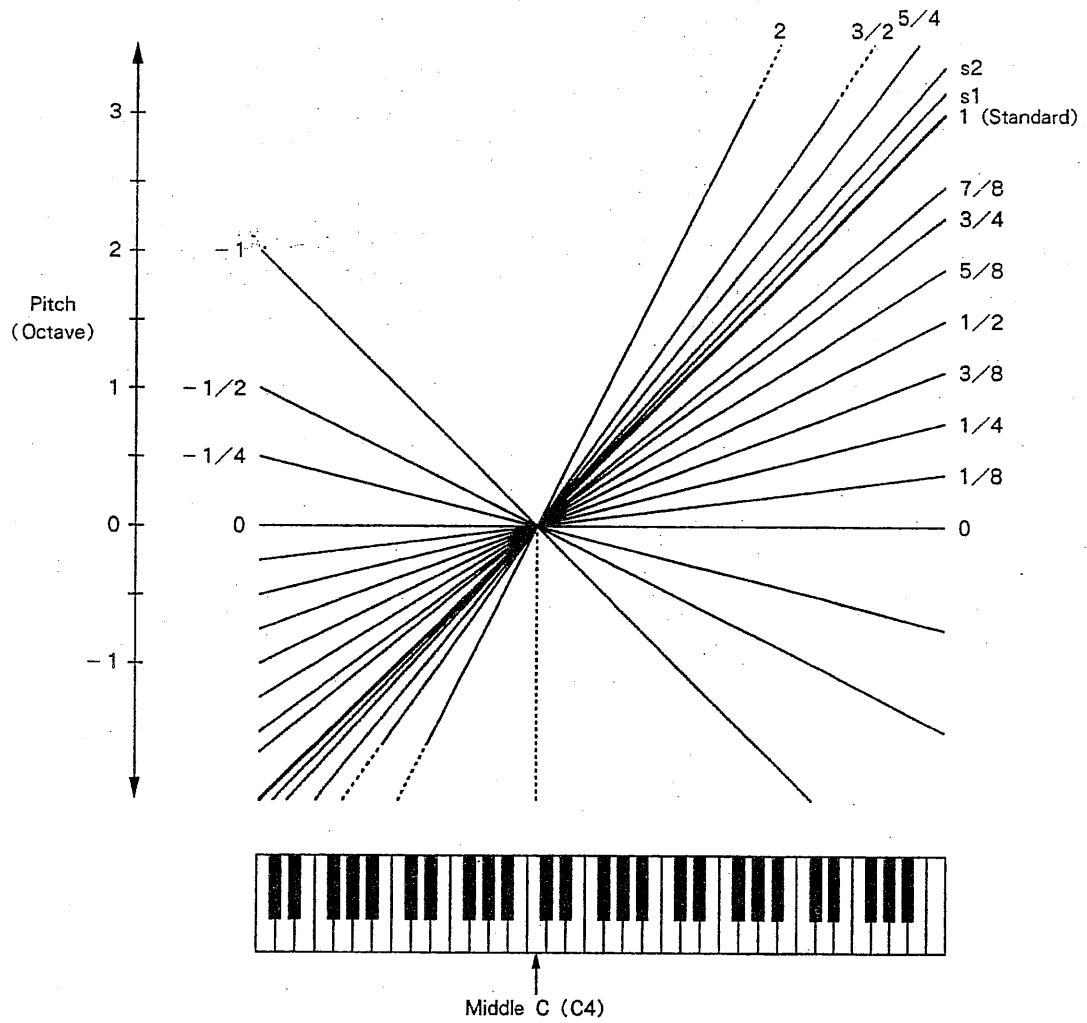

s1 and s2 are used when you want to make a subtle change in octave spacing.

- s1: The pitch of each octave will be 1 cent higher than an octave.
- s2: The pitch of each octave will be 5 cents higher than an octave.

● LFO Rate (Value : 0—100)

SYNTH **PCM**

LFO Rate			
00	50	00	100

You can add vibrato by using the LFO to continue modify the pitch. The LFO rate adjusts the speed of the vibrato. Higher values will result in a faster vibrato.

● LFO Depth (Value : 0—100)

SYNTH **PCM**

LFO Depth			
100	50	00	50

You can add vibrato by using the LFO to continuously modify the pitch. The LFO depth adjusts the depth of the vibrato. Higher values will result in deeper vibrato.

*Vibrato will function only from point 3 of the Pitch ENV (page 66) to when the key is released.

● Modulation Sensitivity (Value : 0—100)

SYNTH **PCM**

WG Modulation			
00	50	20	100

This adjusts the sensitivity when using the bender lever to control vibrato. Higher values will result in greater sensitivity, and a slight movement of the bender lever will cause vibrato.

*Vibrato will function only from point 3 of the Pitch ENV (page 66) to when the key is released.

● Bender Switch (Value : ON, OFF)

SYNTH **PCM**

WG Bender Switch			
OFF	ON	ON	OFF

This determines whether or not the bender lever will control the pitch. When this is set ON, the bender lever will control the pitch.

*The amount of pitch change caused by the bender lever is determined by the bender range of the patch/timbre.

■ **WG Form/Pitch ENV Group**

- **Waveform (Value : SQU, SAW)**

SYNTH

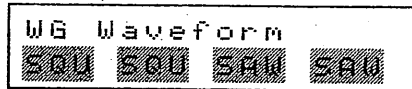

Display	Waveform
SQU (Square Wave)	
SAW (Sawtooth Wave)	

*The D-5 creates a sawtooth wave by using the TVF to modify a square wave and then re-calculating the result. This means that even if sawtooth wave is selected, you will be able to use Pulse Width (page 64) to modify the waveform.

- **PCM Wave Bank (Value : 1, 2)/PCM Wave Number (Value : 1 — 128)**

PCM

< PCM Wave Bank >

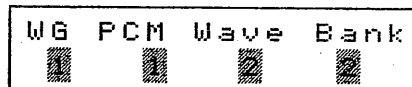

< PCM Wave Number >

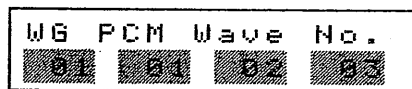

Select one of the 256 types of PCM sound to be used as the basic sound for the PCM sound generator. The PCM sounds are organized in two banks, with 128 numbers in each bank. In the PCM wave bank display, select the bank, and in the PCM wave number display, select the number. (See the following page.)

If you select just one partial in partial select of the PCM wave number display, the PCM sound name will be displayed.

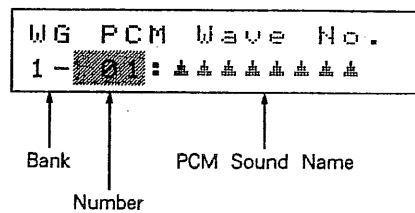

*For bank 1 PCM sounds 112—128, there may be noticeable noise during the decay, depending on the TVA Envelope settings (page 75).

2. Partial Parameters

Bank 1

No.	PCM Sound Name	Comment	No.	PCM Sound Name	Comment	
1	Bass Drum - 1	Rhythm Sounds	65	Steel Guitar	Sustained Sounds	
2	Bass Drum - 2		66	Dirty Guitar		
3	Bass Drum - 3		67	Pizzicato		
4	Snare Drum - 1		68	Harp		
5	Snare Drum - 2		69	Contrabass		
6	Snare Drum - 3		70	Cello		
7	Snare Drum - 4		71	Violin - 1		
8	Tom Tom - 1		72	Violin - 2		
9	Tom Tom - 2		73	Koto		
10	High - Hat		74	Draw bars (Loop)		Sustained Sounds
11	High - Hat (Loop)		75	High Organ (Loop)		
12	Crash Cymbal - 1		76	Low Organ (Loop)		
13	Crash Cymbal - 2 (Loop)		77	Trumpet (Loop)		
14	Ride Cymbal - 1		78	Troumbone (Loop)		
15	Ride Cymbal - 2 (Loop)		79	Sax - 1 (Loop)		
16	Cup		80	Sax - 2 (Loop)		
17	China Cymbal - 1		81	Reed (Loop)		
18	China Cymbal - 2 (Loop)		82	Slap Bass (Loop)		
19	Rim Shot		83	Acoustic Bass (Loop)		
20	Hand Clap		84	Electric Bass - 1 (Loop)		
21	Mute High Conga		85	Electric Bass - 2 (Loop)		
22	Conga		86	Gut Guital (Loop)		
23	Bongo		87	Steel Guitar (Loop)		
24	Cowbell		88	Electric Guitar (Loop)		
25	Tambourine		89	Clav (Loop)		
26	Agogo		90	Cello (Loop)		
27	Claves		91	Violin (Loop)		
28	Timbale High		92	Electric Piano - 1 (Loop)		
29	Timbale Low		93	Electric Piano - 2 (Loop)		
30	Cabasa		94	Harpichord - 1 (Loop)		
31	Timpani Attack	Attack Sounds	95	Harpichord - 2 (Loop)	Sustained Sounds	
32	Timpani		96	Telephone Bell (Loop)		
33	Acoustic Piano High		97	Female Voice - 1 (Loop)		
34	Acoustic Piano Low		98	Female Voice - 1 (Loop)		
35	Piano Forte Thump		99	Male Voice - 1 (Loop)		
36	Organ Percussion		100	Male Voice - 2 (Loop)		
37	Trumpet		101	Spectrum - 1 (Loop)		
38	Lips		102	Spectrum - 2 (Loop)		
39	Trombone		103	Spectrum - 3 (Loop)		
40	Clarinet		104	Spectrum - 4 (Loop)		
41	Flute High		105	Spectrum - 5 (Loop)		
42	Flute Low		106	Spectrum - 6 (Loop)		
43	Steamer		107	Spectrum - 7 (Loop)		
44	Indian Flute		108	Spectrum - 8 (Loop)		
45	Breath		109	Spectrum - 9 (Loop)		
46	Vibraphone High		110	Spectrum - 10 (Loop)		
47	Vibraphone Low		111	Noise (Loop)		
48	Marimba		112	Shot - 1		Decaying Sounds
49	Xylophone High		113	Shot - 2		
50	Xylophone Low		114	Shot - 3		
51	Kalimba		115	Shot - 4		
52	Wind Bell		116	Shot - 5		
53	Chime Bar		117	Shot - 6		
54	Hammer		118	Shot - 7		
55	Guero		119	Shot - 8		
56	Chink		120	Shot - 9		
57	Nails		121	Shot - 10		
58	Fretless Bass		122	Shot - 11		
59	Pull Bass		123	Shot - 12		
60	Slap Bass		124	Shot - 13		
61	Thump Bass	125	Shot - 14			
62	Acoustic Bass	126	Shot - 15			
63	Electric Bass	127	Shot - 16			
64	Cut Guitar	128	Shot - 17			

Bank 2

No.	PCM Sound Name	Comment	No.	PCM Sound Name	Comment
1	Bass Drum - 1 *	Rhythm Sounds (master tune will not affect the pitch)	65	Loop - 35	
2	Bass Drum - 2 *		66	Loop - 36	
3	Bass Drum - 3 *		67	Loop - 37	
4	Snare Drum - 1 *		68	Loop - 38	
5	Snare Drum - 2 *		69	Loop - 39	
6	Snare Drum - 3 *		70	Loop - 40	
7	Snare Drum - 4 *		71	Loop - 41	
8	Tom Tom - 1 *		72	Loop - 42	
9	Tom Tom - 2 *		73	Loop - 43	
10	High - Hat *		74	Loop - 44	
11	High - Hat * (Loop)		75	Loop - 45	
12	Crash Cymbal - 1 *		76	Loop - 46	
13	Crash Cymbal - 2 * (Loop)		77	Loop - 47	
14	Ride Cymbal - 1 *		78	Loop - 48	
15	Ride Cymbal - 2 * (Loop)		79	Loop - 49	
16	Cup *		80	Loop - 50	
17	China Cymbal - 1 *		81	Loop - 51	
18	China Cymbal - 2 * (Loop)		82	Loop - 52	
19	Rim Shot *		83	Loop - 53	
20	Hand Clap *		84	Loop - 54	
21	Mute High Conga *		85	Loop - 55	
22	Conga *		86	Loop - 56	
23	Bongo *		87	Loop - 57	
24	Cowbell *		88	Loop - 58	
25	Tambourine *		89	Loop - 59	
26	Agogo *		90	Loop - 60	
27	Claves *		91	Loop - 61	
28	Timbale High *		92	Loop - 62	
29	Timbale Low *		93	Loop - 63	
30	Cabasa *		94	Loop - 64	
31	Loop - 1	Sound Effects (a loop of the same sound)	95	Jam - 1 (Loop)	Sound Effects (a loop of several sounds)
32	Loop - 2		96	Jam - 2 (Loop)	
33	Loop - 3		97	Jam - 3 (Loop)	
34	Loop - 4		98	Jam - 4 (Loop)	
35	Loop - 5		99	Jam - 5 (Loop)	
36	Loop - 6		100	Jam - 6 (Loop)	
37	Loop - 7		101	Jam - 7 (Loop)	
38	Loop - 8		102	Jam - 8 (Loop)	
39	Loop - 9		103	Jam - 9 (Loop)	
40	Loop - 10		104	Jam - 10 (Loop)	
41	Loop - 11		105	Jam - 11 (Loop)	
42	Loop - 12		106	Jam - 12 (Loop)	
43	Loop - 13		107	Jam - 13 (Loop)	
44	Loop - 14		108	Jam - 14 (Loop)	
45	Loop - 15		109	Jam - 15 (Loop)	
46	Loop - 16		110	Jam - 16 (Loop)	
47	Loop - 17		111	Jam - 17 (Loop)	
48	Loop - 18		112	Jam - 18 (Loop)	
49	Loop - 19		113	Jam - 19 (Loop)	
50	Loop - 20		114	Jam - 20 (Loop)	
51	Loop - 21		115	Jam - 21 (Loop)	
52	Loop - 22		116	Jam - 22 (Loop)	
53	Loop - 23		117	Jam - 23 (Loop)	
54	Loop - 24		118	Jam - 24 (Loop)	
55	Loop - 25		119	Jam - 25 (Loop)	
56	Loop - 26		120	Jam - 26 (Loop)	
57	Loop - 27		121	Jam - 27 (Loop)	
58	Loop - 28		122	Jam - 28 (Loop)	
59	Loop - 29		123	Jam - 29 (Loop)	
60	Loop - 30		124	Jam - 30 (Loop)	
61	Loop - 31		125	Jam - 31 (Loop)	
62	Loop - 32		126	Jam - 32 (Loop)	
63	Loop - 33		127	Jam - 33 (Loop)	
64	Loop - 34		128	Jam - 34 (Loop)	

● Pulse Width (Value : 0—100)

SYNTH

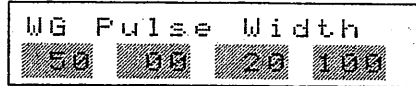

The ratio of the upper width to the length of one square waveform is called the pulse width. The overtone structure (and therefore the tone) is highly dependent on the pulse width.

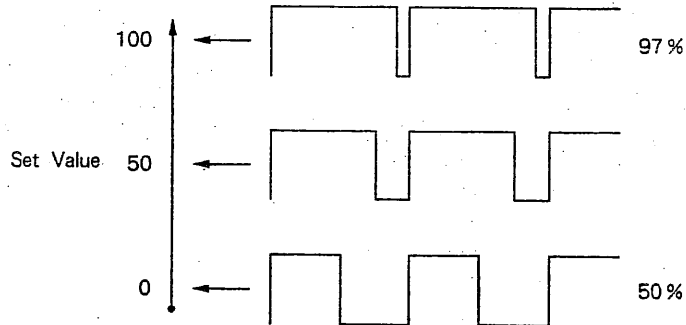

*If the WG waveform is set to sawtooth, 50% pulse width (i.e., a setting of 0) will produce a pitch that is one octave higher.

● Pulse Width Velocity Sensitivity (Value : -7—0—+7)

SYNTH

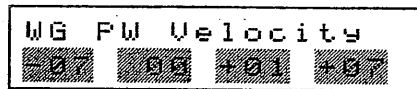

This adjusts the sensitivity of the pulse width to velocity. Positive settings (+) will make the pulse width increase as you play more strongly. Negative settings (-) will make the pulse width decrease as you play more strongly. This allows you to affect the tone by the dynamics of your keyboard playing. When using a sawtooth wave, some settings will allow you to increase the pitch an octave.

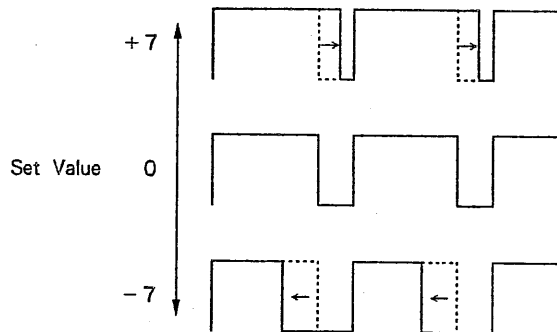

● Pitch ENV Depth (Value : 0—10)

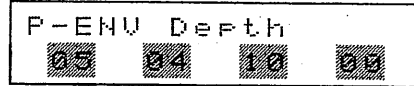
SYNTH **PCM**

This adjusts the overall depth of the pitch ENV. Higher settings will result in greater pitch change.

● Pitch ENV Velocity Sensitivity (Value : 0—3)

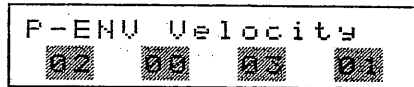
SYNTH **PCM**

This adjusts the sensitivity of the pitch ENV to velocity. Higher settings will result in greater pitch ENV change as you play more strongly.

● Pitch ENV Key Follow (Time) (Value : 0—4)

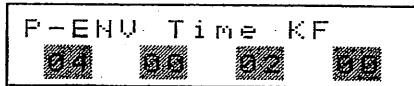
SYNTH **PCM**

The rate at which the pitch ENV changes can be made to change depending on the key position. Higher settings will result in faster change for higher notes and slower change for lower notes.



■ Pitch ENV Group

● Pitch ENV Time/Level

SYNTH PCM

These parameters determine the levels and times of pitch change throughout the note (i.e., the pitch envelope).

Drastic or slow changes in pitch can create interesting sound effects.

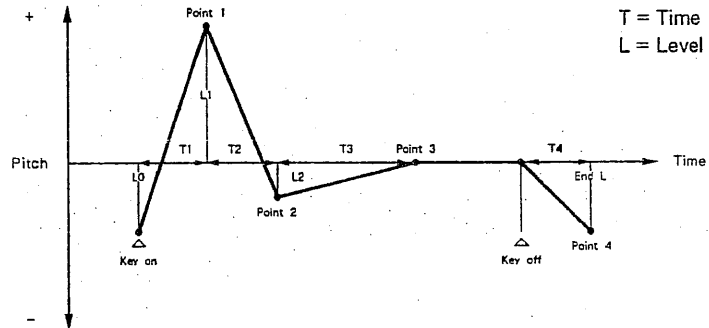

Time 1/Time 2/Time 3/Time 4
(Value : 0—100)

This determines the time required to reach each point.

Level 0/Level 1/Level 2/End level
(Value : -50—+50)

This sets the pitch level of each point.

P-ENV Time 1			
50	50	50	50

P-ENV Level 0			
50	00	-50	+20

P-ENV Time 2			
50	50	50	50

P-ENV Level 1			
+50	+50	00	-20

P-ENV Time 3			
70	70	70	70

P-ENV Level 2			
-20	-10	00	+20

P-ENV Time 4			
30	30	30	30

P-ENV End Level			
-50	00	-10	00

*If the ENV mode is set to NO SUSTAIN, the end level will be sounded at point 3.

*If the levels of two adjacent points are set to similar values, the time of change between these points will be shorter than the actual setting (or even zero).

*If the pitch ENV depth setting is at a low value, changing the pitch ENV levels will have little effect.

b. TVF (Time Variant Filter) parameters

This group of parameters determines the tone of a partial PCM sound generator partials are not affected by TVF settings.

S: Parameters effective for a synthesizer sound generator
P: Parameters effective for a PCM sound generator

Group	Partial Parameters	Effective (O) Ignored (x)		Value
		S	P	
TVF Freq/ENV	Cutoff Frequency	O	x	0—100
	Resonance	O	x	0—30
	Key Follow	O	x	-1, -1/2, -1/4, 0, 1/8, 1/4, 3/8, 1/2, 5/8, 3/4, 7/8, 1, 5/4, 3/2, 2
	Bias Point	O	x	<A1—<C7, >A1—>C7
	Bias Level	O	x	-7—0—+7
	ENV Depth	O	x	0—100
	ENV Velocity Sensitivity	O	x	0—100
	ENV Key Follow (Depth)	O	x	0—4
TVF ENV	ENV Key Follow (Time)	O	x	0—4
	ENV Time 1, 2, 3, 4	O	x	0—100
	ENV Level 1, 2, Sustain	O	x	0—100

■ TVF Frequency/ENV Group

- Cutoff Frequency (Value: 0—100)

SYNTH

TVF Cutoff Freq
50 70 100 80

This sets the cutoff frequency of the TVF. Higher settings will result in a brighter (sharper) sound. Lower settings will cause more of the higher frequencies to be cut, resulting in a softer sound (more like a sine wave).

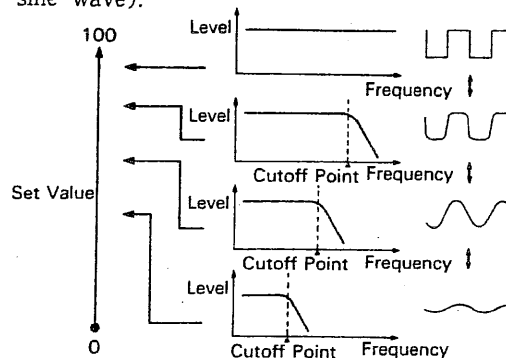

*If this is set too low, there will be no sound at all.

● Resonance (Value : 0—30)

SYNTH



This determines the level of the area around the cutoff frequency. Higher settings will raise the level of the overtones in the area near the cutoff frequency, producing a peak of tonal emphasis.

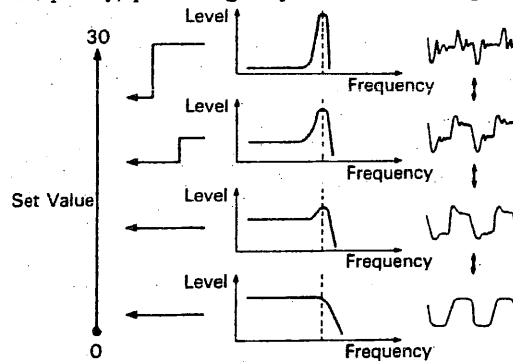

*If this is set too high, the sound may distort.

● Frequency Key Follow (Value : -1, -1/2, 1/4, 0, 1/8, 1/4, 3/8, 1/2, 5/8,

SYNTH

3/4, 7/8, 1, 5/4, 3/2, 2)

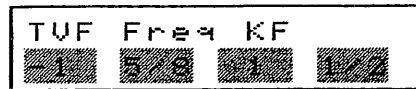

The cutoff frequency can be made to change according to the key which is played.

In the same way as for WG pitch key follow, this setting determines how many octaves the cutoff frequency will change for every 12 notes on the keyboard. (However there is no setting for s1/s2.)

Positive settings (+) will result in a brighter sound for higher notes, and a softer sound for lower notes.

Negative settings (-) will result in a softer sound for higher notes, and a brighter sound for lower notes.

*This depends also on the cutoff frequency, but extreme settings of frequency key follow can cause the cutoff frequency to be so low that some areas of the keyboard will produce no sound at all.

● Bias Point/Bias Level

SYNTH

Bias point and Bias level settings determine the key position from which the frequency key follow setting will begin to apply.

Bias Point (Value : < A1 — < C7, > A1 — > C7)

This sets the point (key number) at which to begin biasing, and the direction of the keyboard range to be biased.

TVF Bias Point			
C4	<C4	>C4	C4

[Example] >C4: Bias the range to the right of the C4 key.
<C4: Bias the range to the left of the C4 key.

Bias Level (Value : -7—+7)

This determines the amount of bias that is applied to the frequency key follow. Positive settings (+) will cause upward bias, resulting in brighter sound. Negative settings (-) will cause downward bias, resulting in softer sounds.

TVF Bias Level			
0	00	+07	+05

[Example setting]
A TVF key follow (cutoff frequency) of 0, and
a bias point of >C4.

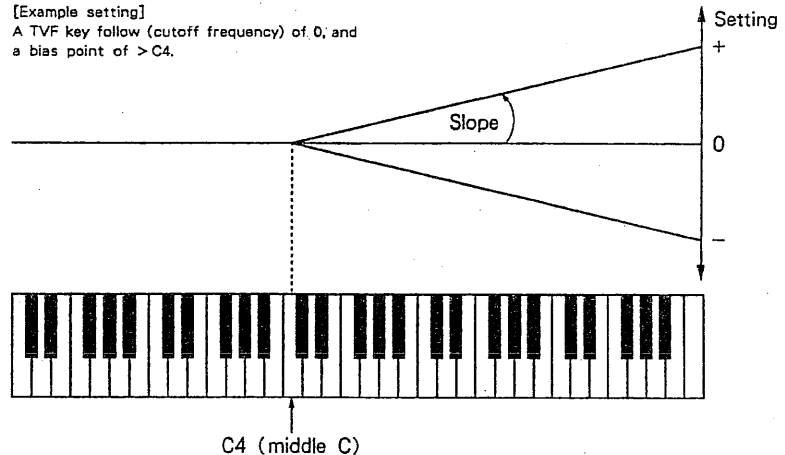

*In the above figure, key follow is 0. However, the actual slope will be the slope specified by key follow + the slope specified by bias level.

● ENV Depth (Value : 0—100)

SYNTH

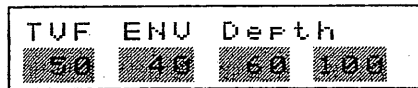

This adjusts the overall depth of the TVF ENV. Higher settings will result in greater change.

● ENV Velocity Sensitivity (Value : 0—100)

SYNTH

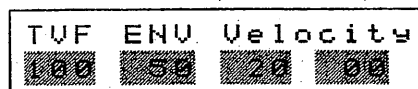

This adjusts the sensitivity of the TVF ENV to velocity. Higher settings will result in greater TVF ENV changes for stronger playing.

● ENV Key Follow (Depth) (Value : 0—4)

SYNTH

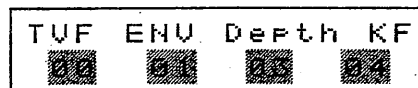

The TVF ENV depth can be adjusted according to the key that is played. Higher settings will result in greater changes in depth.



■ TVF ENV Group

- ENV Key Follow (Time) (Value : 0—4)

SYNTH

TUF	ENV	Time	KF
00	02	03	04

The TVF ENV time can be made faster or slower according to the key that is played. Higher settings will result in faster change for higher notes, and slower change for lower notes.



- ENV Time/Level

SYNTH

This adjusts the change in cutoff frequency over time (the envelope). The level points determine cutoff frequency levels, and T1—4 determine the time required to reach these levels.

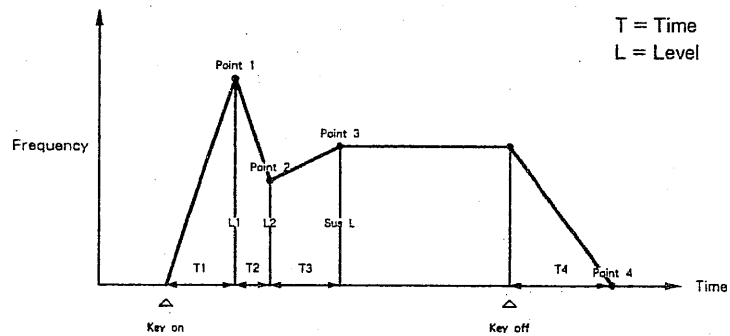

2. Partial Parameters

Time 1/Time 2/Time 3/Time 4
(Value: 0—100)

This sets the time required to reach each point.

Level 1/Level 2/Sustain level
(Value: 0—100)

This sets the level of each point.

TVF	ENV	Time 1	
40	40	40	40

TVF	ENV	Level 1	
100	00	50	70

TVF	ENV	Time 2	
20	20	20	20

TVF	ENV	Level 2	
50	50	40	20

TVF	ENV	Time 3	
70	70	70	70

TVF	ENV	Sus	Levl
50	70	80	100

TVF	ENV	Time 4	
50	50	50	50

*If the levels of two adjacent points are set to similar values, the time of change between these points will be shorter than the actual setting (or even zero).

*If the TVF ENV depth setting is at a low value, changing these levels will have little effect on the tone.

c. TVA (Time Variant Amplifier) parameters

This group of parameters determines the volume of the partial.

S: parameters effective for synthesizer sound generators

P: parameters effective for PCM sound generators

Group	Partial Parameters	Effective (○) Ignored (×)		Value
		S	P	
TVA Level	Level	○	○	0—100
	Velocity Sensitivity	○	○	-50—0—+50
	Bias Point 1	○	○	<A1—<C7, >A1—>C7
	Bias Level 1	○	○	-12—0
	Bias Point 2	○	○	<A1—<C7, >A1—>C7
	Bias Level 2	○	○	-12—0
	ENV Velocity Follow (Time 1)	○	○	0—4
TVA ENV	ENV Key Follow (Time)	○	○	0—4
	ENV Time 1, 2, 3, 4	○	○	0—100
	ENV Level 1, 2, Sustain	○	○	0—100

■ TVA Level Group

- Level (Value : 0—100)

SYNTH **PCM**

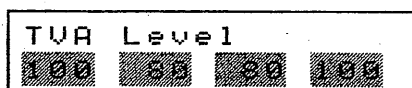

This adjusts the standard volume of the partial. Higher settings will result in a louder volume. This can be used to adjust the volume balance of the partials.

*Some sounds will be distorted if the volume is too high. If so, lower the volume.

*For high TVA ENV settings, it is possible that there will be some sound even if this TVA level is set to zero.

- Velocity Sensitivity (Value : -50—+50)

SYNTH **PCM**

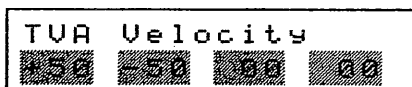

This setting allows key velocity to affect the volume. Positive (+) settings will result in a louder volume as you play more strongly. Negative (-) settings will result in a softer volume as you play more strongly. Larger settings will result in a greater range of volume change in response to key velocity.

● **Bias Point/Bias Level**

SYNTH **PCM**

Bias point and Bias level settings allow you to adjust the volume around a specified key position.

Bias Point (Value : < A1 — < C7, > A1 — > C7)

This specifies the key at which to begin adjusting volume, and the direction of adjustment. Two separate positions can be set.

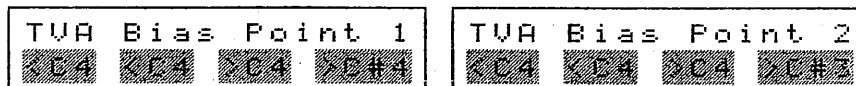

[example] >C4 : Bias the range to the right of the C4 key.
 <C4 : Bias the range to the left of the C4 key.

Bias Level (Value : - 12 — 0)

This determines the amount of bias from each point. Lower settings will result in a lower volume after the bias point. As the setting is lowered, the volume change will become more pronounced.

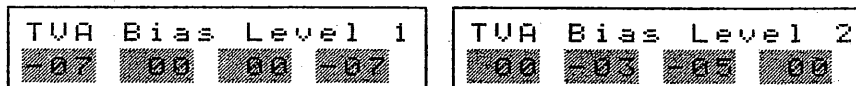

[Example setting] Lower the volume of the lower and upper ranges.
 Bias Point 1 : >C6 Bias Level 1 : -3
 Bias Point 2 : <C3 Bias Level 2 : -5

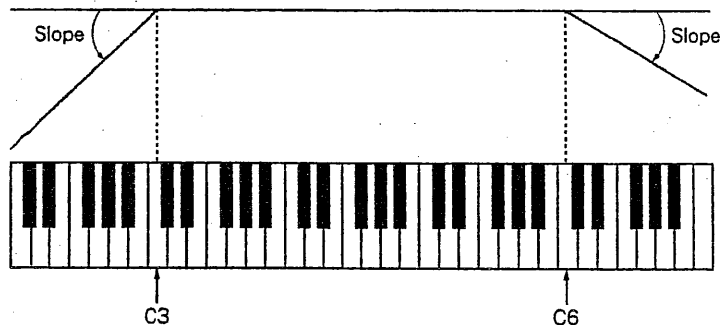

● **ENV Velocity Follow (Time 1) (Value : 0 — 4)**

SYNTH **PCM**

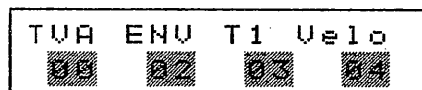

This adjusts the sensitivity of TVA ENV time 1 to velocity. Higher settings will result in a shorter time 1 for strongly played notes.

■ TVA ENV group

● ENV Key Follow (Time) (Value: 0—4)

SYNTH PCM

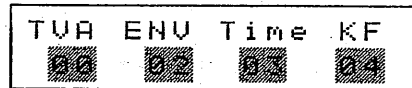

The time change of the TVA ENV can be made faster or slower depending on the key position. Higher settings will result in faster change for higher notes and slower change for lower notes.

● TVA ENV Time/Level

SYNTH PCM

This determines how the volume will change over time (i.e., the volume envelope), by specifying the level of each point and the time required to reach each point.

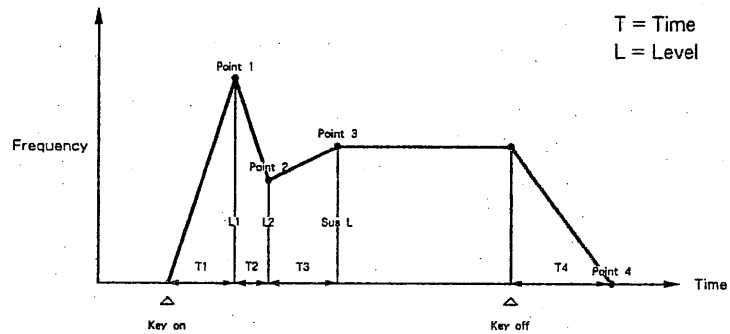

Time 1/Time 2/Time 3/Time 4
(Value: 0—100)

This sets the time required to reach each point.

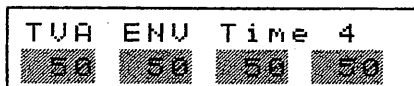
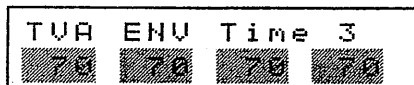
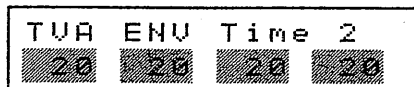
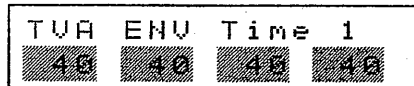

Level 1/Level 2/Sustain level
(Value: 0—100)

This sets the volume level of each point.

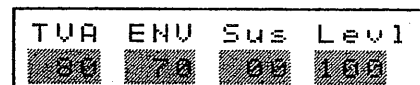
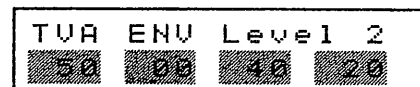
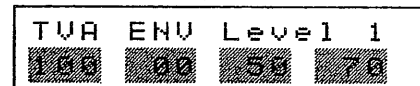

*If the levels of two adjacent points are set to similar values, the time of change between these points will be shorter than the actual setting (or even zero).

3 EDITING A TONE

This section explains how to edit tone parameters.

1. Editing a Tone

This explains the tone editing procedure, and the various edit functions. Tone parameters can be edited from either Performance mode or Multi Timbral mode.

Serious synthesizer programmers may wish to purchase an optional PG-10 programmer, which allows you to edit parameters quickly and intuitively, just as on an analog synthesizer.

*Edited settings are temporary. When the power is turned off or when another tone is selected, edited settings will revert to the original settings. If you want to keep your edits, be sure to write them into memory (page 83).

a. Selecting a tone

When you want to partially modify an existing tone, select a tone similar to the sound you have in mind. When you want to create a tone from scratch, select an unwanted tone from group i. The procedure for selecting a tone differs in Performance mode and Multi Timbral mode.

● Selecting a tone in Performance mode

To edit a tone while in Performance mode, use the following procedure to select a tone.

1 Select a patch which uses the tone you want to edit.

2 Press **EDIT**.

```
Edit Select
Patch Tone
```

3 Press **UPPER/▶** to select Tone.

```
Edit Tone Select
Lower Upper
```

- 4 If editing the lower tone, press **◀/LOWER**. If editing the upper tone, press **UPPER/▶**.

```
Common
Select Parameter
```

The tone editing display (common group) will appear. Now follow the procedure explained in the following section "Selecting and modifying tone parameters".

● Selecting a tone while in Multi Timbral mode

To edit a tone while in Multi Timbral mode, use the following procedure to select a tone.

- 1 Get the keyboard display.
Unless you select a part which can be played by the keyboard, you will not be able to hear the sound as you edit.

- 2 Select a timbre which uses the tone you want to edit.

- 3 Press **EDIT**.

```
Edit Select
Timbre Tone
```

- 4 Press **UPPER/▶** to select Tone.

```
Common
Select Parameter
```

The tone editing display (common group) will appear. Now follow the procedure explained in the following section "Selecting and modifying tone parameters".

1. Editing a Tone

b. Selecting and modifying tone parameters

After using the previously explained procedure to select a tone, edit parameter values using the following procedure.

Tone parameters are organized as follows.

The parameters effective for each partial will differ, depending on how the sound generator is used (synthesizer sound generator or PCM sound generator). During editing, parameters will be displayed regardless of whether they are effective, so be aware which generator you are using.

Group	BANK							
	1	2	3	4	5	6	7	8
Common	Tone Name	Structure 1 & 2	Structure 3 & 4	ENV Mode				
WG Pitch/Modulation	Pitch Coarse	Pitch Fine	Key Follow (Pitch)	LFO Rate	LFO Depth	LFO Modulation Sensitivity	Bender Switch	
WG Form/Pitch ENV	Waveform	PCM Wave Bank	PCM Wave No.	Pulse Width	PW Velocity	ENV Depth	ENV Velocity	ENV Key Follow (Time)
WG Pitch ENV	Time 1	Time 2	Time 3	Time 4	Level 0	Level 1	Level 2	End Level
TVF Frequency	Cutoff Frequency	Resonance	Key Follow	Bias Point	Bias Level	ENV Depth	ENV Velocity	ENV Key Follow (Depth)
TVF ENV	Key Follow (Time)	Time 1	Time 2	Time 3	Time 4	Level 1	Level 2	Sustain Level
TVA Level	Level	Velocity	Bias Point 1	Bias Level 1	Bias Point 2	Bias Level 2	ENV Velocity Follow (Time)	
TVA ENV	Key Follow (Time)	Time 1	Time 2	Time 3	Time 4	Level 1	Level 2	Sustain Level

1 Press DISPLAY to select the group of the parameter to edit.

2 Press BANK to select the parameter to edit.

If a partial parameter has been selected, parameter settings for all four partials will be displayed.

- 3** If a partial parameter has been selected, press NUMBER **1**—**4** to select the partial to be edited.

The indicator of the button you pressed will light, and the (blinking) value of the parameter can be modified. Each press of a button will turn its indicator on/off, allowing you to simultaneously edit the value of more than one partial.

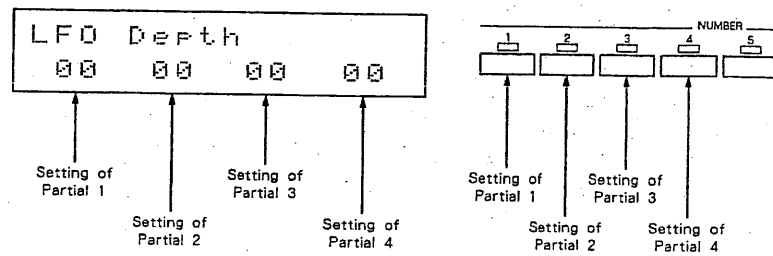

- 4** Using **◀VALUE▶** modify the value of the selected parameter.
- 5** If you want to save your edits, remember to write them into memory (page 83).

*To quit editing, press **EXIT**. If you have not written your edits into memory, the settings will return to the unedited values when you select another tone.

2. Edit Functions

The D-5 has a variety of functions to make editing easy.

a. Partial mute

Partial mute is a tone parameter that lets you mute (turn off) the sound for specified partials. This is useful when you want to compare the sound of individual partials, or want to temporarily turn off partials not being edited.

Use **NUMBER** **5**–**8** to mute or unmute partials. Indicators will be turned off to show which partials are muted. Each press of a button will turn the indicator on/off.

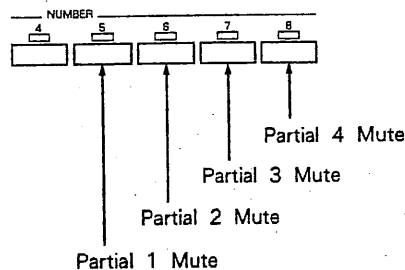

Since each partial mute is a tone parameter, if you write into memory while partials are muted, they will be stored as muted. This means that partials whose indicator is off will not be used. Since partial mute settings determine the number of partials in a tone, the number of unmuted partials will affect the number of sounds that can be produced simultaneously.

- *It is possible to edit the values of a muted partial.
- *When using the ring modulator, muting one partial will cause the sound of the other partial to be directly output without passing through the ring modulator. When checking the effect of the ring modulator, unmute the pair of partials that are connected to it.

b. Previous value

Previous value is a function which returns the settings of the currently displayed screen to the values shown when the screen was selected. This allows you to return to the unedited value, or compare the edited and unedited sounds.

- 1 While editing, press **COMPARE**.

The unedited values will be displayed with an "+", and you will be able to hear the unedited sound.

Lights to indicate previous value

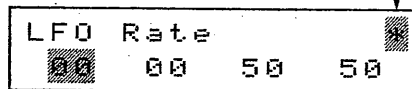

To return the settings to their unedited values, you can either switch partial select, or move to another screen (the "+" mark disappears). You can also modify parameter settings in this screen to continue editing from the displayed values.

- 2 Press **COMPARE** once more to return to the values displayed before you pressed **COMPARE**.

*If you move to another parameter screen while the "+" is shown, or if you turn off the "+" mark, pressing **COMPARE** will not return you to your edited settings.

c. Compare

Compare is a function which allows you to hear the tone in the destination to which you are about to store a edited tone, to confirm whether you really want to replace that tone. This function can also be used to compare the original and edited sounds.

1 Press **WRITE**.

2 Press **COMPARE**.

When you play the keyboard, you will hear the tone as it was before you began editing.

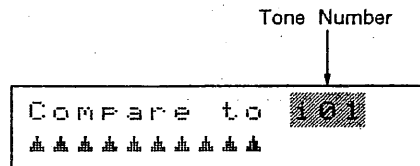

In this display you can press **◀VALUE▶** to switch the tone number of the writing destination, and hear the selected tones.

*When editing a preset tone, the tone number will not be displayed (the screen will show *:*:*).

3 Press **COMPARE** once again.

You will return to the tone being edited.

4 Press **EXIT**.

You will return to the tone editing display.

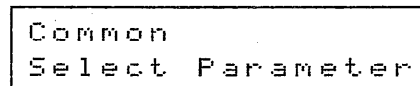

3. Tone Writing Procedure

If you want to keep the tone you have just finished editing, or if you need to turn the power off while you are in the middle of editing, you must use this writing procedure to store a tone into either the D-5's memory (internal) or into an optional memory card.

This section will explain how to write an edited tone into the D-5's memory. To write into a memory card, see "Saving Data into a Memory Card" (page 118).

Edited tones can be stored in either internal group i, or in memory card (RAM) group c. They can not be stored in preset tone groups a, b, r or a ROM card.

While in tone edit, use the following procedure.

- 1 Press **WRITE**.
The tone write display will appear.

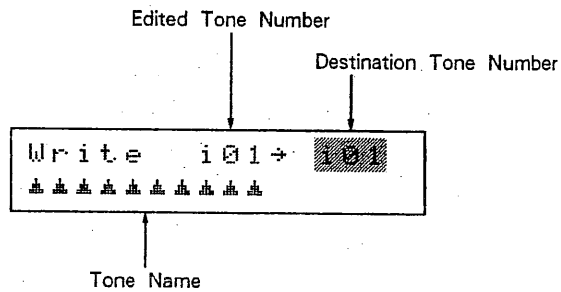

*If you have been editing a preset tone, the destination tone number will not be displayed (the screen will show **:*)).

- 2 If you have been editing a memory card tone, press **INT/CARD** to switch the destination to "i" (internal).

- 3** Use **◀VALUE▶** to select the destination tone number.
Select any tone 1—64 that you don't need to keep.

If you want to hear the sound of the destination tone number to make sure that it is one that you don't mind losing, use the following procedure.

- ① Press **COMPARE**.

```
Compare to 151
▲▲▲▲▲▲▲▲▲▲▲▲▲▲▲▲
```

When you press **COMPARE**, you will be able to play the keyboard to hear the selected tone. You can select other tones and play them as well.

- ② Press **COMPARE** once again to return to the writing display.

- 4** Press **ENTER**.

- If memory protect has been turned off (in the PLAY volume, page 99), the following display will briefly appear if writing is successful, and then you will return to play mode.

```
Completed
```

- If memory protect is on, the following display will appear.

```
Turn Protect off
once? Write/Exit
```

To temporarily turn memory protect off and then write into memory, press **WRITE** and then press **ENTER** once again.

*To stop without writing, press **EXIT** to return to the previous editing display.

*If writing was unsuccessful, an error message will appear. Consult the "Error Messages" section (page 144) and follow the appropriate directions.

4 HINTS FOR SOUND CREATING

The D-5 provides a wide variety of preset tones, which you should take advantage of. It's great to be able to create your own sounds from scratch, but this can be a rather time-consuming process. It is often more efficient to find a tone that is fairly close to what you have in mind, and make minor edits to get exactly what you want.

1. Check the Combination of Partial

A single tone consists of 4 partials. Settings for each partial are important, but the way in which the partials are combined is also very important.

When you have found a tone that is fairly close to what you want, don't jump right in and start editing. Instead, take a moment to see what the tone settings are. It is also important to check the settings of the patch/timbre that is using that tone, especially when the patch parameter for key mode is set to dual.

It is possible to use functions such as previous value to check the original settings while editing, but it is more efficient to look through the parameters before you start. Once you have identified the important parameters, you will know which parameters need to be modified to get the desired sound.

Here are two hints to help you achieve the sound you want.

● **Check the structure**

The structure determines how partials are used. There are 13 types of structure, and you should check the following points.

- Does the structure use the ring modulator?
- Are the sound generators PCM or synthesizer?

● **Determine the role of each partial**

Find out how each partial contributes to the tone. Partial which are already muted are not being used, and can be ignored. Next, listen to the individual partials one by one, to see what each one is doing.

For example, you might consider the following points ;

- Are similar-sounding partials combined?
- Are attack and sustain partials combined?
- Are partials differentiated by velocity sensitivity?
- Are partials of different pitch ranges being used?

a. Acoustic instrument simulations using PCM sounds

PCM sound generators are used to create sounds that would be difficult for the synthesizer sound generators.

For example when creating wind instruments such as a flute, the initial breath sound contains complex overtones that would be impossible to create using a synthesizer sound generator. In such cases, use a PCM sound to create the breath sound.

PCM sounds are not simply sampled sounds, but have been processed to make them usable as ingredients. Each PCM sound has been given a name to help you identify it as a potential ingredient of sound, but you should use your ears in determining how to use each one.

b. Combined partials for thick sounds

When two partials that have similar sounds are given slightly different tunings and combined, the two waveforms will interfere with each other to create a chorusing effect. This is interpreted by the human ear as a thick or rich sound. (Giving two sounds slightly different tunings is known as "detuning".) Or, one of the sounds can be transposed one octave up or down to strengthen the overtone structure and create a richer sound. Combining partials in this way is an effective way to quickly make "fat" sounds.

c. Modify the tone using keyboard dynamics

Acoustic instruments change in tone depending on how they are played. Softly played notes will often have a slightly slower attack, and be slightly softer in tone as well as volume. Synthesizers can simulate the dynamics of acoustic instruments using "velocity".

The D-5 can use velocity to control the WG, TVF, and TVA.

● **Pulse width velocity**

(For synthesizer sound generators)

Pulse width velocity can be used to control pulse width. When using a square wave, this will make the tone become brighter or softer depending on the dynamics of your playing. When using a saw tooth wave, this will not only affect the tone, but can also raise or lower the pitch by an octave.

● **Pitch ENV velocity**

(For synthesizer/PCM sound generators)

Playing dynamics can affect the pitch change produced by the pitch ENV.

● **TVF ENV velocity**

(For synthesizer sound generators)

Playing dynamics can affect the volume. By appropriate settings of TVA velocity, you can make one partial sound for strongly played notes, and another partial sound for softly played notes. This lets you shift to a completely different sound just by varying the strength of your playing.

● **TVA ENV velocity follow (Time 1)**

(For synthesizer/PCM sound generators)

Playing dynamics can create variations in attack (time 1 of the TVA ENV).

d. Modify the tone by keyboard range

Think of a piano. As you play higher notes, the sound becomes brighter with more high frequencies, the volume decreases, and the decay becomes more rapid. On the other hand as you play lower notes, the volume increases, and the decay time becomes longer. Also, the attack is faster for high notes and slower for low notes. The D-5's key follow and bias parameters can be used to simulate this.

Key follow can also be set for WG, TVF, and TVA.

● **Key follow (Pitch)**

(For synthesizer/PCM sound generators)

This changes the pitch ratio of the keyboard. In place of the standard equal temperament, this can be used to produce ethnic scales, or create subtle change in octave spacing. Or, you can set this so that all note produce the same pitch, or produce lower pitches as you play toward the right side of the keyboard.

● **WG ENV key follow (Time)**

(For synthesizer/PCM sound generators)

The pitch ENV can be made to change faster or slower depending on the key that is played.

● **TVF key follow (Frequency)**

(For synthesizer sound generators)

The cutoff frequency can be made to change depending on the key that is played. If you set this so that the cutoff frequency will rise for higher notes, higher notes will have more high frequencies and be brighter, and lower notes will be softer. The opposite effect is also possible.

● **TVF bias point/level**

(For synthesizer sound generators)

The slope of the TVF key follow can be adjusted, starting with a specified key. TVF key follow modifies the tone in a single, fixed way across the keyboard. If further adjustment is desired, bias can be used to make changes in specified areas. This could be used to make the tone abruptly brighter from a certain point on the keyboard, or to keep the tone from changing over a certain area.

● **TVF ENV key follow (Depth)**

(For synthesizer sound generators)

The depth of TVF ENV change can be adjusted according to the key that is played.

● **TVF ENV key follow (Time)**

(For synthesizer sound generators)

The speed of TVF ENV change can be adjusted according to the key that is played.

● **TVA bias point 1/2, level 1/2**

(For synthesizer/PCM sound generators)

The volume can be adjusted over the keyboard, beginning from two specified points.

● **TVA ENV key follow**

(For synthesizer/PCM sound generators)

The depth of TVA ENV change can be adjusted according to the key that is played.

On most acoustic instruments, lower-pitched sounds have a slower attack, and higher pitches have a faster attack. The TVA ENV key follow can be used to simulate this.

e. Using the ring modulator

The ring modulator multiplies the sound of two partials to add complex overtones.

Depending on the structure, there are three ways in which the ring modulator is used.

- ① Ring modulator is not used.
- ② The direct sound of the fundamental partial is combined with the ring modulated sound.
- ③ Only the ring modulated sound is output.

When using the ring modulator, be aware of the following points.

- When one partial is muted, the sound of the other partial will be output directly (i.e., without passing through the ring modulator).
- Partial 1 (3) determines the fundamental, and partial 2 (4) determines the overtones.
- Partial 1 (3) determines the overall volume.
- Partial 2 (4) determines the pitch and level of the overtones.
- If the pitches of the two partials are on a consonant ratio (a perfect fifth, an octave, etc.), then the resulting sound will be fairly clear. When creating clear brass sounds, it is effective to make partial 1 (3) close to a sine wave.

The TVF cannot modify the tone of PCM sounds, but by using the ring modulator, complex overtones can be added to PCM sounds. The TVA envelope of partial 2 (4) (which determines the overtones) can be used to modify the overtone content over time. PCM sounds naturally include non-harmonic overtones, so overly high settings for partial 2 (4) TVA level will result in very complex sounds. It is best to use this in moderation.

2. Tone Creating Procedures

Here we will be explaining actual setting examples and procedures for creating 10 types of sounds.

a. Creating Strings sounds

Strings include a wide variety of sounds. In this example we will be creating an analog synthesizer string sound, and an acoustic string sound typical of a violin or cello.

■ Analog Synth-type Strings

- Select a structure 1 or 8, and use only partials 1/2 (mute partials 3/4).
- For waveform, select SAW (sawtooth) for both partials 1/2.
- Set both the TVA ENV and the TVF ENV to envelopes with a slow attack and a long release.

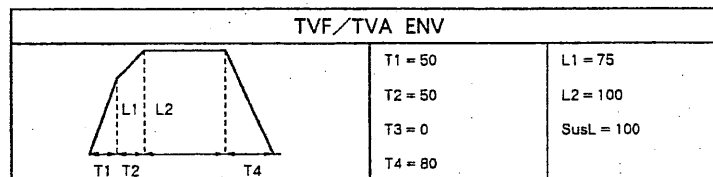

- Set the TVA Velocity fairly high, to create a greater variation in volume.
(about +30)
- Set the Pitch LFO to add vibrato.
(Rate = 60, Depth = 20, Mod.Sens = 50)
- Use the Pitch Fine to detune the pitch of the partials, adding warmth to the sound. (Partial 1 = +5, Partial 2 = -5)

After making the above settings, adjust the envelope and LFO Rate of each partial to add finishing touches to the sound. Adjust tone using the TVF Freq. and TVF ENV Depth.

*For an example, see the ex-1 sample chart.

2. Tone Creating Procedures

ex-1 : STRINGS

Tone No.						
OPERATION		PARAMETER	VALUE			
GROUP	BANK					
Common	1	Tone Name	Strings EX			
	2	Structure 1&2	1			
	3	Structure 3&4				
	4	ENV Mode	NORMAL			
WG Pitch/Mod	1	WG Pitch Coarse	C4	C4		
	2	WG Pitch Fine	+3	-3		
	3	WG Pitch KF	1	1		
	4	LFO Rate	59	63		
	5	LFO Depth	27	46		
	6	WG Modulation	58	73		
	7	WG Bender Switch	ON	ON		
WG Form/ENV	1	WG Waveform	SAW	SAW		
	2	WG PCM Wave Bank	-	-		
	3	WG PCM Wave No.	-	-		
	4	WG Pulse Width	48	0		
	5	WG PW Velocity	0	0		
	6	P-ENV Depth	0	0		
	7	P-ENV Velocity	0	0		
	8	P-ENV Time KF	0	0		
WG P-ENV	1	P-ENV Time 1	0	0		
	2	P-ENV Time 2	0	0		
	3	P-ENV Time 3	0	0		
	4	P-ENV Time 4	0	0		
	5	P-ENV Level 0	0	0		
	6	P-ENV Level 1	0	0		
	7	P-ENV Level 2	0	0		
	8	P-ENV End Level	0	0		
Partial Mute			○	○	×	×
Partial			1	2	3	4
OPERATION		PARAMETER	VALUE			
GROUP	BANK					
TVF Freq/ENV	1	TVF Cutoff Freq	75	75		
	2	TVF Resonance	0	0		
	3	TVF Freq KF	5/8	5/8		
	4	TVF Bias Point	<A1	<A1		
	5	TVF Bias Level	0	0		
	6	TVF ENV Depth	61	61		
	7	TVF ENV Velocity	0	0		
	8	TVF ENV Depth KF	4	4		
TVF ENV	1	TVF ENV Time KF	0	0		
	2	TVF ENV Time 1	21	21		
	3	TVF ENV Time 2	36	36		
	4	TVF ENV Time 3	0	0		
	5	TVF ENV Time 4	90	90		
	6	TVF ENV Level 1	83	83		
	7	TVF ENV Level 2	100	100		
	8	TVF ENV Sus Lev1	100	100		
TVA Level	1	TVA Level	80	80		
	2	TVA Velocity	+33	+33		
	3	TVA Bias Point 1	>C4	>C4		
	4	TVA Bias Level 1	0	0		
	5	TVA Bias Point 2	<C4	<C4		
	6	TVA Bias Level 2	0	0		
	7	TVA ENV Ti Velo	3	3		
TVA ENV	1	TVA ENV Time KF	4	4		
	2	TVA ENV Time 1	43	43		
	3	TVA ENV Time 2	50	50		
	4	TVA ENV Time 3	0	0		
	5	TVA ENV Time 4	80	80		
	6	TVA ENV Level 1	76	76		
	7	TVA ENV Level 2	100	100		
	8	TVA ENV Sus Lev1	100	100		
Partial Mute			○	○	×	×
Partial			1	2	3	4

■ **Acoustic Strings**

- Select structure 3, and use only partials 1/2 (mute partials 3/4).
- For waveform, select a PCM sound 1-70—72 for partial 1, and a synthesizer sound SAW for partial 2.
- Set the envelopes as follows.

Partial 1

TVA ENV		
	T1 = 0	L1 = 100
	T2 = 30	L2 = 75
	T3 = 60	SusL = 0
	T4 = 65	

Partial 2

TVF ENV			TVA ENV		
	T1 = 15	L1 = 100		T1 = 15	L1 = 80
	T2 = 30	L2 = 75		T2 = 30	L2 = 100
	T3 = 60	SusL = 50		T3 = 0	SusL = 100
	T4 = 80			T4 = 65	

- Use TVA Level to adjust the volume of the two partials (Partial 1 < Partial 2).
- Set a Pitch LFO for only partial 2, to add vibrato.
(Rate = 64, Depth = 30, Mod.Sens = 50)

In addition, it is possible to create a string sound using only PCM by selecting structure 6, PCM sound 1-90, 91 for partial 2. Experiment with a variety of waveforms.

By using the above two in combination for a total of four partials, you can create a hybrid strings sound that utilizes the unique capabilities of LA synthesis.

b. Creating Brass sounds

Here we will explain how to create brass sounds, using the examples of a synth brass and a trumpet/trombone.

■ Synth Brass

- Select a structure 1 or 8, and use only partials 1/2 (mute partials 3/4).
- Select a synthesizer sound waveform of SAW (sawtooth) for both partials 1/2.
- Set the envelopes as follows.

Partial 1/2

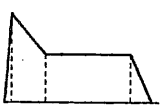
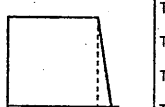
TVF ENV			TVA ENV		
	T1 = 10	L1 = 100		T1 = 0	L1 = 100
	T2 = 60	L2 = 50		T2 = 0	L2 = 100
	T3 = 0	SusL = 50		T3 = 0	SusL = 100
	T4 = 30			T4 = 20	

- For more realism, create a bit of unsteadyness in the pitch using the Pitch ENV settings below.

Partial 2

Pitch ENV		
	T1 = 10	L1 = -30
	T2 = 25	L2 = +10
	T3 = 20	L3 = -5
	T4 = 0	EndL = 0

- Use the Pitch LFO to add vibrato.
(Rate = 63, Depth = 10, Mod.Sense = 50)
- Set the TVF Cutoff Freq. and TVF ENV Depth fairly high. On the other hand, for horn sounds, keep these settings low, and raise the T1 settings of the TVF ENV and TVA ENV to make a slow attack.

*For an example, see the ex-2 sample chart.

ex-2 : SYNTH BRASS

Tone No.							
OPERATION		PARAMETER	VALUE				
GROUP	BANK						
Common	1	Tone Name	Brass EX				
	2	Structure 1&2	1				
	3	Structure 3&4					
	4	ENV Mode	NORMAL				
WG Pitch/Mod	1	WG Pitch Coarse	C4	C4			
	2	WG Pitch Fine	+6	-6			
	3	WG Pitch KF	1	1			
	4	LFO Rate	63	63			
	5	LFO Depth	7	13			
	6	WG Modulation	38	60			
	7	WG Bender Switch	ON	ON			
WG Form/ENV	1	WG Waveform	SAW	SAW			
	2	WG PCM Wave Bank	-	-			
	3	WG PCM Wave No.	-	-			
	4	WG Pulse Width	0	0			
	5	WG PW Velocity	0	0			
	6	P-ENV Depth	6	0			
	7	P-ENV Velocity	3	0			
	8	P-ENV Time KF	0	0			
WG P-ENV	1	P-ENV Time 1	10	0			
	2	P-ENV Time 2	26	0			
	3	P-ENV Time 3	24	0			
	4	P-ENV Time 4	0	0			
	5	P-ENV Level 0	-27	0			
	6	P-ENV Level 1	+11	0			
	7	P-ENV Level 2	-4	0			
	8	P-ENV End Level	0	0			
Partial Mute			○	○	x	x	
Partial			1	2	3	4	
OPERATION		PARAMETER	VALUE				
GROUP	BANK						
TVF Freq/ENV	1	TVF Cutoff Freq	85	90			
	2	TVF Resonance	0	0			
	3	TVF Freq KF	1/2	1/2			
	4	TVF Bias Point	>C5	>D#4			
	5	TVF Bias Level	-2	-3			
	6	TVF ENV Depth	55	60			
	7	TVF ENV Velocity	70	85			
	8	TVF ENV Depth KF	0	0			
TVF ENV	1	TVF ENV Time KF	0	0			
	2	TVF ENV Time 1	6	25			
	3	TVF ENV Time 2	12	63			
	4	TVF ENV Time 3	75	72			
	5	TVF ENV Time 4	25	25			
	6	TVF ENV Level 1	70	100			
	7	TVF ENV Level 2	100	79			
	8	TVF ENV Sus Levl	46	10			
TVA Level	1	TVA Level	85	87			
	2	TVA Velocity	+17	+20			
	3	TVA Bias Point 1	>C4	>C4			
	4	TVA Bias Level 1	0	0			
	5	TVA Bias Point 2	<C4	<C4			
	6	TVA Bias Level 2	0	0			
	7	TVA ENV T1 Velo	0	3			
TVA ENV	1	TVA ENV Time KF	0	0			
	2	TVA ENV Time 1	0	11			
	3	TVA ENV Time 2	0	14			
	4	TVA ENV Time 3	0	0			
	5	TVA ENV Time 4	15	15			
	6	TVA ENV Level 1	100	82			
	7	TVA ENV Level 2	100	100			
	8	TVA ENV Sus Levl	100	100			
Partial Mute			○	○	x	x	
Partial			1	2	3	4	

- **Trumpet/Trombone** • Select structure 3, and use only partials 1/2 (mute partials 3/4).
- For waveform, select a PCM sound 1-37—39 for partial 1, and a synthesizer sound SAW for partial 2.
- Set the envelopes as follows.

Partial 1

TVA ENV		
	T1 = 0	L1 = 100
	T2 = 30	L2 = 75
	T3 = 60	SusL = 0
	T4 = 65	

Partial 2

TVF ENV			TVA ENV		
	T1 = 20	L1 = 100		T1 = 10	L1 = 100
	T2 = 50	L2 = 65		T2 = 0	L2 = 100
	T3 = 0	SusL = 65		T3 = 0	SusL = 100
	T4 = 30			T4 = 20	

- Adjust the volume level of the two partials using TVA Level. (Partial 1 = Partial 2)
- To add vibrato, set a Pitch LFO only for partial 2. (Rate = 63, Depth = 20, Mod.Sense = 50)
- Adjust the TVA Cutoff Freq. and TVF ENV Depth of partial 2 to match partial 1 sound.

c. Creating Piano sounds

Here we will explain how to create sounds such as piano, electric piano, and clavi (clavichord).

■ Acoustic Piano

- Select structure 3, and use only partials 1/2 (mute partials 3/4).
- Select a PCM sound 1-33—35 for partial 1, and a synthesizer sound SQU for partial 2.
- Set the envelopes as follows.

Partial 1

TVA ENV		
	T1 = 0	L1 = 100
	T2 = 40	L2 = 80
	T3 = 60	SusL = 0
	T4 = 70	

Partial 2

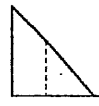
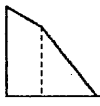
TVF ENV			TVA ENV		
	T1 = 0	L1 = 100		T1 = 0	L1 = 100
	T2 = 50	L2 = 60		T2 = 50	L2 = 80
	T3 = 70	SusL = 0		T3 = 80	SusL = 0
	T4 = 80			T4 = 70	

- Set the TVA Velocity fairly high to allow larger changes in volume (higher than +40).
- Use TVA Level to adjust the volume levels of the two partials. (Partial 1 < Partial 2)
- When using 1-35 (Piano Forte Thump) as the PCM sound for partial 1, Pitch KF can be other than 1.

*For an example, see the ex-3 sample chart.

2. Tone Creating Procedures

ex-3 : ACOUSTIC PIANO

Tone No.							
OPERATION		PARAMETER	VALUE				
GROUP	BANK						
Common	1	Tone Name	Piano EX				
	2	Structure 1&2	3				
	3	Structure 3&4					
	4	ENV Mode	NORMAL				
WG Pitch/Mod	1	WG Pitch Coarse	C3	C4			
	2	WG Pitch Fine	0	0			
	3	WG Pitch KF	s1	1			
	4	LFO Rate	0	0			
	5	LFO Depth	0	0			
	6	WG Modulation	0	0			
	7	WG Bender Switch	ON	ON			
WG Form/ENV	1	WG Waveform	-	SQR			
	2	WG PCM Wave Bank	01	-			
	3	WG PCM Wave No.	33	-			
	4	WG Pulse Width	-	58			
	5	WG PW Velocity	-	+1			
	6	P-ENV Depth	0	0			
	7	P-ENV Velocity	0	0			
	8	P-ENV Time KF	0	0			
WG P-ENV	1	P-ENV Time 1	0	0			
	2	P-ENV Time 2	0	0			
	3	P-ENV Time 3	0	0			
	4	P-ENV Time 4	0	0			
	5	P-ENV Level 0	0	0			
	6	P-ENV Level 1	0	0			
	7	P-ENV Level 2	0	0			
	8	P-ENV End Level	0	0			
Partial Mute			○	○	×	×	
Partial			1	2	3	4	

OPERATION		PARAMETER	VALUE			
GROUP	BANK					
TVF Freq/ENV	1	TVF Cutoff Freq	-	58		
	2	TVF Resonance	-	0		
	3	TVF Freq KF	-	3/4		
	4	TVF Bias Point	-	<A4		
	5	TVF Bias Level	-	+3		
	6	TVF ENV Depth	-	28		
	7	TVF ENV Velocity	-	58		
	8	TVF ENV Depth KF	-	0		
TVF ENV	1	TVF ENV Time KF	-	3		
	2	TVF ENV Time 1	-	4		
	3	TVF ENV Time 2	-	51		
	4	TVF ENV Time 3	-	82		
	5	TVF ENV Time 4	-	82		
	6	TVF ENV Level 1	-	100		
	7	TVF ENV Level 2	-	57		
	8	TVF ENV Sus Levl	-	0		
TVA Level	1	TVA Level	100	100		
	2	TVA Velocity	+40	+40		
	3	TVA Bias Point 1	>F5	>C4		
	4	TVA Bias Level 1	-4	0		
	5	TVA Bias Point 2	<A4	<C4		
	6	TVA Bias Level 2	-1	0		
	7	TVA ENV Tl Velo	0	0		
TVA ENV	1	TVA ENV Time KF	3	3		
	2	TVA ENV Time 1	0	0		
	3	TVA ENV Time 2	44	50		
	4	TVA ENV Time 3	67	78		
	5	TVA ENV Time 4	70	70		
	6	TVA ENV Level 1	100	100		
	7	TVA ENV Level 2	87	83		
	8	TVA ENV Sus Levl	0	0		
Partial Mute			○	○	×	×
Partial			1	2	3	4

- **Electric Piano/Clavi** • Select structure 2, and use only partials 1/2 (mute partials 3/4).
 - For waveform, select a synthesizer SQU sound for both partials 1/2.
 - Set both envelopes the same as for partial 2 of an acoustic piano.
 - Raise the Pitch Coarse of partial 2.
 - Use TVA Level to adjust the volume levels of the two partials (Partial 1 = Partial 2). If noise is apparent in the higher ranges, use TVA Bias to lower the level.
 - The trick is to set partial 1 to a soft sound (nearly a sine wave), and use partial 2 to add sound which contains a lot of overtones. Using the ring modulator will be difficult, since the sound will be unpredictable. Try this over and over, without being afraid to experiment. "Practice makes perfect."
 - It is also possible to create the attack portion of an electric piano or a clavi using the ring modulator. In this case, set the envelope of partial 2 to decay quickly.
 - It is advisable to create Guitar sound in the same way.

d. Creating Organ sounds

Here we will explain how to create electric organ, pipe organ, and voice sounds.

■ Electric Organ/Pipe Organ

- Select structure 6, and use only partials 1/2 (mute partials 3/4).
- For both partials, select an organ-type loop from PCM sounds 1-74—76.
- Set the envelopes as follows.

Partial 1/2

TVA ENV		
	T1 = 0	L1 = 100
	T2 = 0	L2 = 100
	T3 = 0	SusL = 100
	T4 = 20	

- Use the Pitch LFO to add vibrato.
(Rate = 60—65, Depth = 40, Mod.Sense = 70)
- It is also effective to set different Pitch LFO Rates for partials 1 and 2.

Square envelopes as shown above will result in an electric organ sound. To create a pipe organ, modify the envelopes as shown in the following diagram.

Partial 1/2

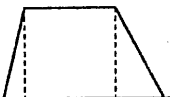
TVA ENV		
	T1 = 30	L1 = 100
	T2 = 0	L2 = 100
	T3 = 0	SusL = 100
	T4 = 70	

- To make an even warmer sound, it is effective to separate the pitch of the partials by one octave. For example, use the same waveform for partials 1/2, and set their Pitch Coarse settings at C3 and C4.

*For an example, see the ex-4 sample chart.

ex-4 : ORGAN

Tone No.							
OPERATION		PARAMETER	VALUE				
GROUP	BANK						
Common	1	Tone Name	Organ EX				
	2	Structure 1&2	6				
	3	Structure 3&4	3				
	4	ENV Mode	NORMAL				
WG Pitch/Mod	1	WG Pitch Coarse	C3	C4	C4		
	2	WG Pitch Fine	+7	-7	-31		
	3	WG Pitch KF	s2	s2	s2		
	4	LFO Rate	62	65	0		
	5	LFO Depth	37	20	0		
	6	WG Modulation	73	56	0		
	7	WG Bander Switch	ON	ON	ON		
WG Form/ENV	1	WG Waveform	SAW	SAW	-		
	2	WG PCM Wave Bank	01	01	01		
	3	WG PCM Wave No.	75	76	35		
	4	WG Pulse Width	85	98	-		
	5	WG PW Velocity	0	0	-		
	6	P-ENV Depth	0	0	0		
	7	P-ENV Velocity	0	0	0		
	8	P-ENV Time KF	0	0	0		
WG P-ENV	1	P-ENV Time 1	0	0	0		
	2	P-ENV Time 2	0	0	0		
	3	P-ENV Time 3	0	0	0		
	4	P-ENV Time 4	0	0	0		
	5	P-ENV Level 0	0	0	0		
	6	P-ENV Level 1	0	0	0		
	7	P-ENV Level 2	0	0	0		
	8	P-ENV End Level	0	0	0		
Partial Mute			○	○	○	×	
Partial			1	2	3	4	
OPERATION		PARAMETER	VALUE				
GROUP	BANK						
TVF Freq/ENV	1	TVF Cutoff Freq	19	16	-		
	2	TVF Resonance	0	0	-		
	3	TVF Freq KF	5/8	1	-		
	4	TVF Bias Point	>C4	>B5	-		
	5	TVF Bias Level	+3	-4	-		
	6	TVF ENV Depth	56	46	-		
	7	TVF ENV Velocity	0	100	-		
	8	TVF ENV Depth KF	0	0	-		
TVF ENV	1	TVF ENV Time KF	0	0	-		
	2	TVF ENV Time 1	0	0	-		
	3	TVF ENV Time 2	0	0	-		
	4	TVF ENV Time 3	0	0	-		
	5	TVF ENV Time 4	42	42	-		
	6	TVF ENV Level 1	100	100	-		
	7	TVF ENV Level 2	100	100	-		
	8	TVF ENV Sus Levl	100	100	-		
TVA Level	1	TVA Level	90	93	92		
	2	TVA Velocity	+31	+31	+18		
	3	TVA Bias Point 1	>C4	>C4	>A3		
	4	TVA Bias Level 1	0	0	-5		
	5	TVA Bias Point 2	<C4	<C4	<C4		
	6	TVA Bias Level 2	0	0	0		
	7	TVA ENV T1 Velo	0	0	0		
TVA ENV	1	TVA ENV Time KF	0	0	0		
	2	TVA ENV Time 1	0	0	0		
	3	TVA ENV Time 2	0	0	37		
	4	TVA ENV Time 3	0	0	45		
	5	TVA ENV Time 4	50	50	50		
	6	TVA ENV Level 1	100	100	100		
	7	TVA ENV Level 2	100	100	70		
	8	TVA ENV Sus Levl	100	100	0		
Partial Mute			○	○	○	×	
Partial			1	2	3	4	

■ Voice

- Select structure 6, and use only partials 1/2 (mute partials 3/4).
- For waveform, select a voice loop such as PCM sound 1-97—100 for both partials 1/2.
- Set the envelopes as follows.

Partial 1/2

TVA ENV		
	T1 = 20	L1 = 50
	T2 = 40	L2 = 80
	T3 = 50	SustL = 100
	T4 = 90	

- Give the partials different Pitch Fine settings of ± 10 to create a more spacious sound. It is also effective to use structure 9.
- Set different Pitch LFO Rates for partials 1 and 2 to give the sound some motion. (Partial 1 = 60, Partial 2 = 63)
- It is also possible to create a voice sound by using a synthesizer sound SAW, raising the TVF Resonance, and lowering the TVF Cutoff Frequency.
- In addition, use a looped PCM noise sound 1-111 partials or spectrum sound 1-103 for partials 3/4, and add it to partials 1/2 to create realistic breath sounds. (In this case, lower TVA Level, and set Pitch KF to about 1/2, to reduce the pitch change of partials 3/4 over the keyboard.)

*For an example, see the ex-5 sample chart.

ex-5 : VOICE

Tone No.												
OPERATION		PARAMETER	VALUE									
GROUP	BANK											
Common	1	Tone Name	Voice EX									
	2	Structure 1&2	6	<table border="1"> <tr><td>P</td><td></td><td>R</td></tr> <tr><td>P</td><td></td><td></td></tr> </table>			P		R	P		
	P		R									
	P											
3	Structure 3&4	9	<table border="1"> <tr><td>P</td><td></td><td>R</td></tr> <tr><td>P</td><td></td><td></td></tr> </table>			P		R	P			
P		R										
P												
4	ENV Mode	NORMAL										
WG Pitch/Mod	1	WG Pitch Coarse	C4	C4	C4	C4						
	2	WG Pitch Fine	0	+5	+10	-10						
	3	WG Pitch KF	1	1/4	1	1						
	4	LFO Rate	62	100	60	63						
	5	LFO Depth	44	100	30	30						
	6	WG Modulation	74	0	79	79						
	7	WG Bander Switch	ON	ON	ON	ON						
WG Form/ENV	1	WG Waveform	-	-	-	-						
	2	WG PCM Wave Bank	01	01	01	01						
	3	WG PCM Wave No.	97	103	98	98						
	4	WG Pulse Width	-	-	-	-						
	5	WG PW Velocity	-	-	-	-						
	6	P-ENV Depth	0	0	0	0						
	7	P-ENV Velocity	0	0	0	0						
	8	P-ENV Time KF	0	0	0	0						
WG P-ENV	1	P-ENV Time 1	0	0	0	0						
	2	P-ENV Time 2	0	0	0	0						
	3	P-ENV Time 3	0	0	0	0						
	4	P-ENV Time 4	0	0	0	0						
	5	P-ENV Level 0	0	0	0	0						
	6	P-ENV Level 1	0	0	0	0						
	7	P-ENV Level 2	0	0	0	0						
	8	P-ENV End Level	0	0	0	0						
Partial Mute			0	0	0	0						
Partial			1	2	3	4						

OPERATION		PARAMETER	VALUE			
GROUP	BANK					
TVF Freq/ENV	1	TVF Cutoff Freq	-	-	-	-
	2	TVF Resonance	-	-	-	-
	3	TVF Freq KF	-	-	-	-
	4	TVF Bias Point	-	-	-	-
	5	TVF Bias Level	-	-	-	-
	6	TVF ENV Depth	-	-	-	-
	7	TVF ENV Velocity	-	-	-	-
	8	TVF ENV Depth KF	-	-	-	-
TVF ENV	1	TVF ENV Time KF	-	-	-	-
	2	TVF ENV Time 1	-	-	-	-
	3	TVF ENV Time 2	-	-	-	-
	4	TVF ENV Time 3	-	-	-	-
	5	TVF ENV Time 4	-	-	-	-
	6	TVF ENV Level 1	-	-	-	-
	7	TVF ENV Level 2	-	-	-	-
	8	TVF ENV Sus Levl	-	-	-	-
TVA Level	1	TVA Level	96	60	82	82
	2	TVA Velocity	+35	+43	+35	+35
	3	TVA Bias Point 1	>F6	>A4	>C6	>C6
	4	TVA Bias Level 1	-6	-2	-7	-7
	5	TVA Bias Point 2	<C4	<C4	<C4	<C4
	6	TVA Bias Level 2	0	-6	0	0
	7	TVA ENV T1 Velo	4	4	4	4
TVA ENV	1	TVA ENV Time KF	0	0	0	0
	2	TVA ENV Time 1	21	21	21	21
	3	TVA ENV Time 2	41	42	41	41
	4	TVA ENV Time 3	50	89	50	50
	5	TVA ENV Time 4	86	86	86	86
	6	TVA ENV Level 1	43	73	43	43
	7	TVA ENV Level 2	80	100	79	79
	8	TVA ENV Sus Levl	100	0	100	100
Partial Mute			0	0	0	0
Partial			1	2	3	4

e. Creating Guitar sounds

Here we will explain how to create acoustic guitar and electric guitar sounds.

■ Acoustic Guitar

- Select structure 3, and use only partials 1/2 (mute partials 3/4).
- Select a bank 1 PCM sound 64/65 for partial 1, and select a synthesizer sound SQU for partial 2.
- Set the envelopes as follows.

Partial 1

TVA ENV		
	T1 = 0	L1 = 100
	T2 = 50	L2 = 40
	T3 = 60	SusL = 0
	T4 = 60	

Partial 2

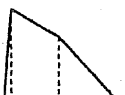
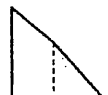
TVF ENV			TVA ENV		
	T1 = 10	L1 = 100		T1 = 0	L1 = 100
	T2 = 70	L2 = 70		T2 = 60	L2 = 60
	T3 = 80	SusL = 0		T3 = 70	SusL = 0
	T4 = 60			T4 = 60	

- This is basically similar to a piano envelope, but the decay is a bit faster, and more guitar-like.
- Attack overtones can be created by using the ring modulator (Structure 2) and shortening the decay portion (T2, T3) of partial 2.

*For an example, see the ex-6 sample chart.

ex-6 : ACOUSTIC GUITAR

Tone No.						
OPERATION		PARAMETER	VALUE			
GROUP	BANK					
Common	1	Tone Name	Guitar EX			
	2	Structure 1&2	2			
	3	Structure 3&4	3			
	4	ENV Mode	NORMAL			
WG Pitch/Mod	1	WG Pitch Coarse	C4	G5	C4	
	2	WG Pitch Fine	0	0	0	
	3	WG Pitch KF	s1	s1	1	
	4	LFO Rate	63	0	0	
	5	LFO Depth	13	0	0	
	6	WG Modulation	67	0	0	
	7	WG Bender Switch	ON	ON	ON	
WG Form/ENV	1	WG Waveform	SGR	SAW	-	
	2	WG PCM Wave Bank	-	-	01	
	3	WG PCM Wave No.	-	-	64	
	4	WG Pulse Width	100	0	-	
	5	WG PW Velocity	0	0	-	
	6	P-ENV Depth	0	6	0	
	7	P-ENV Velocity	0	0	0	
	8	P-ENV Time KF	0	0	0	
WG P-ENV	1	P-ENV Time 1	0	18	0	
	2	P-ENV Time 2	0	8	0	
	3	P-ENV Time 3	0	26	0	
	4	P-ENV Time 4	0	20	0	
	5	P-ENV Level 0	0	+12	0	
	6	P-ENV Level 1	0	-8	0	
	7	P-ENV Level 2	0	+5	0	
	8	P-ENV End Level	0	0	0	
Partial Mute			○	○	○	×
Partial			1	2	3	4

OPERATION		PARAMETER	VALUE			
GROUP	BANK					
TVF Freq/ENV	1	TVF Cutoff Freq	48	0	-	
	2	TVF Resonance	0	0	-	
	3	TVF Freq KF	1/2	5/8	-	
	4	TVF Bias Point	<A6	<D#4	-	
	5	TVF Bias Level	-3	+1	-	
	6	TVF ENV Depth	53	0	-	
	7	TVF ENV Velocity	0	0	-	
	8	TVF ENV Depth KF	0	0	-	
TVF ENV	1	TVF ENV Time KF	0	0	-	
	2	TVF ENV Time 1	10	0	-	
	3	TVF ENV Time 2	66	0	-	
	4	TVF ENV Time 3	87	0	-	
	5	TVF ENV Time 4	60	0	-	
	6	TVF ENV Level 1	100	0	-	
	7	TVF ENV Level 2	74	0	-	
	8	TVF ENV Sus Lev!	0	0	-	
TVA Level	1	TVA Level	97	85	69	
	2	TVA Velocity	+25	+50	+36	
	3	TVA Bias Point 1	>C4	>C4	>C4	
	4	TVA Bias Level 1	-3	0	0	
	5	TVA Bias Point 2	<C4	<C4	<C4	
	6	TVA Bias Level 2	-5	0	0	
	7	TVA ENV T1 Velo	0	0	0	
TVA ENV	1	TVA ENV Time KF	3	3	3	
	2	TVA ENV Time 1	0	0	0	
	3	TVA ENV Time 2	58	64	48	
	4	TVA ENV Time 3	71	82	64	
	5	TVA ENV Time 4	61	61	61	
	6	TVA ENV Level 1	100	100	100	
	7	TVA ENV Level 2	59	67	38	
	8	TVA ENV Sus Lev!	0	0	0	
Partial Mute			○	○	○	×
Partial			1	2	3	4

■ **Electric Guitar**

- Select structure 3, and use only partials 1/2 (mute partials 3/4).
- Select PCM sound 1-66 for partial 1, and select a synthesizer sound SQU for partial 2.
- Envelopes are similar to those for acoustic guitar, but a slower decay should be set for electric guitars (Increase T2 and T3, and decrease T4).
- As you raise the TVF Cutoff Freq., distortion will increase.
- Add vibrato using the Pitch LFO.
(Rate = 65, Depth = 0, Mod.Sense = 100).
Pressing the bender lever to the modulation side will result in extreme vibrato.
- When using the ring modulator (Structure 2) to create the sustained sound, lower the Pitch Coarse of partial 2 one octave below partial 1, to create distortion.
- It is also possible to use PCM sounds 1-58—63 as the attack of a bass sound. Setting Pitch KF to less than 1 (1/2—3/4) is also interesting.

f. Creating Bass sounds

Here we will explain how to create sounds such as acoustic bass, electric bass, and synth bass.

■ Acoustic/Electric Bass

- Select structure 3, and use only partials 1/2 (mute partials 3/4).
- Select PCM sound 1-58—63 for partial 1, and synthesizer sound SQU for partial 2.
- Set the envelopes as follows.

Partial 1

TVA ENV		
	T1 = 0	L1 = 100
	T2 = 40	L2 = 40
	T3 = 40	SusL = 0
	T4 = 30	

Partial 1

TVF ENV			TVA ENV		
	T1 = 10	L1 = 100		T1 = 0	L1 = 100
	T2 = 70	L2 = 50		T2 = 40	L2 = 50
	T3 = 0	SusL = 0		T3 = 70	SusL = 0
	T4 = 60			T4 = 60	

- For acoustic bass, keep the TVF Freq. and TVF ENV Depth at low settings, to create a softer sound. On the other hand for electric bass, raise these settings to create harder sound.
- It is also effective to modify the pulse width of the partial 2 synthesizer sound.

■ Synth Bass

- Select structure 1, and use only partials 1/2 (mute partials 3/4).
- Select either waveform of synthesizer sound for both partials 1/2.
- Set the envelopes as follows.

Partial 1/2

TVF ENV			TVA ENV		
	T1 = 10	L1 = 100		T1 = 0	L1 = 100
	T2 = 5	L2 = 70		T2 = 0	L2 = 100
	T3 = 0	SusL = 0		T3 = 0	SusL = 100
	T4 = 20			T4 = 20	

- When the TVF ENV is set as shown above, the attack will be characteristic of a synth bass.
- In addition, raising the TVF Resonance will make the sound even more like a synth bass.
- In order to emphasize the attack, it may be interesting to add a PCM attack sound.

*For an example, see the ex-7 sample chart.

2. Tone Creating Procedures

ex-7 : SYNTH BASS

Tone No.							
OPERATION		PARAMETER	VALUE				
GROUP	BANK						
Common	1	Tone Name	Bass EX				
	2	Structure 1&2	1				
	3	Structure 3&4	3				
	4	ENV Mode	NORMAL				
WG Pitch/Mod	1	WG Pitch Coarse	C4	C3	C4		
	2	WG Pitch Fine	0	0	+3		
	3	WG Pitch KF	s2	s2	s2		
	4	LFO Rate	65	64	0		
	5	LFO Depth	0	0	0		
	6	WG Modulation	100	100	0		
	7	WG Bender Switch	ON	ON	ON		
WG Form/ENV	1	WG Waveform	SAW	SAW	-		
	2	WG PCM Wave Bank	-	-	01		
	3	WG PCM Wave No.	-	-	79		
	4	WG Pulse Width	100	0	-		
	5	WG PW Velocity	+3	0	-		
	6	P-ENV Depth	10	0	9		
	7	P-ENV Velocity	3	0	0		
	8	P-ENV Time KF	0	0	0		
WG P-ENV	1	P-ENV Time 1	2	0	3		
	2	P-ENV Time 2	9	0	0		
	3	P-ENV Time 3	20	0	0		
	4	P-ENV Time 4	0	0	0		
	5	P-ENV Level 0	+35	0	+50		
	6	P-ENV Level 1	-4	0	0		
	7	P-ENV Level 2	0	0	0		
	8	P-ENV End Level	0	0	0		
Partial Mute			○	○	○	×	
Partial			1	2	3	4	

OPERATION		PARAMETER	VALUE			
GROUP	BANK					
TVF Freq/ENV	1	TVF Cutoff Freq	57	45	-	
	2	TVF Resonance	17	0	-	
	3	TVF Freq KF	1/2	1/2	-	
	4	TVF Bias Point	<A1	<A1	-	
	5	TVF Bias Level	0	0	-	
	6	TVF ENV Depth	62	80	-	
	7	TVF ENV Velocity	25	100	-	
	8	TVF ENV Depth KF	0	0	-	
TVF ENV	1	TVF ENV Time KF	0	0	-	
	2	TVF ENV Time 1	0	0	-	
	3	TVF ENV Time 2	32	21	-	
	4	TVF ENV Time 3	87	49	-	
	5	TVF ENV Time 4	50	50	-	
	6	TVF ENV Level 1	100	100	-	
	7	TVF ENV Level 2	37	82	-	
	8	TVF ENV Sus Levl	0	33	-	
TVA Level	1	TVA Level	100	100	100	
	2	TVA Velocity	+10	+10	+13	
	3	TVA Bias Point 1	>C4	>C4	>C4	
	4	TVA Bias Level 1	0	0	0	
	5	TVA Bias Point 2	<C4	<C4	<C4	
	6	TVA Bias Level 2	0	0	0	
	7	TVA ENV T1 Velo	0	0	0	
TVA ENV	1	TVA ENV Time KF	0	0	3	
	2	TVA ENV Time 1	0	0	0	
	3	TVA ENV Time 2	65	0	38	
	4	TVA ENV Time 3	0	0	0	
	5	TVA ENV Time 4	15	15	15	
	6	TVA ENV Level 1	100	100	100	
	7	TVA ENV Level 2	85	100	0	
	8	TVA ENV Sus Levl	85	100	0	
Partial Mute			○	○	○	×
Partial			1	2	3	4

g. Creating Wind instrument sounds

Here we will explain how to create sax and flute sounds.

■ Sax

- Select structure 3, and use only partials 1/2 (mute partials 3/4).
- Select a PCM sound 1-79—81 for partial 1, and a synthesizer sound SQU for partial 2.
- Set the envelopes as follows.

Partial 1

TVA ENV		
	T1 = 0	L1 = 100
	T2 = 60	L2 = 30
	T3 = 0	SusL = 30
	T4 = 30	

Partial 2

TVF ENV		TVA ENV			
	T1 = 30	L1 = 100		T1 = 20	L1 = 100
	T2 = 70	L2 = 70		T2 = 0	L2 = 100
	T3 = 0	SusL = 70		T3 = 0	SusL = 100
	T4 = 40			T4 = 30	

- To create vibrato, set a Pitch LFO only for partial 2.
(Rate = 64, Depth = 20, Mod.Sense = 50)
- As with voice sounds, adding a PCM sound noise or spectrum loop will make a realistic breath sound. In this case, set the envelope as follows.

Partial 3 or 4

TVA ENV		
	T1 = 20	L1 = 100
	T2 = 10	L2 = 30
	T3 = 80	SusL = 0
	T4 = 30	

2. Tone Creating Procedures

- It is even more effective to set a Pitch ENV as follows, so that the pitch will be unsteady during the attack.

Partial 1/2

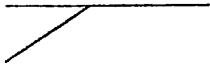
Pitch ENV			
	T1 = 30	L1 = - 40	Depth = 3 - 6
	T2 = 0	L2 = 0	
	T3 = 0	L3 = 0	
	T4 = 0	EndL = 0	

*For an example, see the ex-8 sample chart.

■ Flute

- Select structure 3, and use only partials 1/2 (mute partials 3/4).
- Select a PCM sound 1-40—45 for partial 1, and a synthesizer sound SQU for partial 2.
- Set the envelopes as shown above for sax.

ex-8 : SAX

Tone No.						
OPERATION		PARAMETER	VALUE			
GROUP	BANK					
Common	1	Tone Name	Reed EX			
	2	Structure 1&2	3			
	3	Structure 3&4	3			
	4	ENV Mode	NORMAL			
WG Pitch/Mod	1	WG Pitch Coarse	C5	C4	C3	
	2	WG Pitch Fine	-6	0	0	
	3	WG Pitch KF	1	s1	1/8	
	4	LFO Rate	64	64	0	
	5	LFO Depth	22	22	0	
	6	WG Modulation	50	100	0	
	7	WG Bender Switch	ON	ON	OFF	
WG Form/ENV	1	WG Waveform	-	SCR	-	
	2	WG PCM Wave Bank	01	-	01	
	3	WG PCM Wave No.	79	-	111	
	4	WG Pulse Width	-	68	-	
	5	WG PW Velocity	-	0	-	
	6	P-ENV Depth	5	5	0	
	7	P-ENV Velocity	3	3	0	
	8	P-ENV Time KF	1	1	0	
WG P-ENV	1	P-ENV Time 1	25	25	0	
	2	P-ENV Time 2	25	25	0	
	3	P-ENV Time 3	0	0	0	
	4	P-ENV Time 4	0	0	0	
	5	P-ENV Level 0	-40	-40	0	
	6	P-ENV Level 1	-5	-5	0	
	7	P-ENV Level 2	0	0	0	
	8	P-ENV End Level	0	0	0	
Partial Mute			○	○	○	×
Partial			1	2	3	4

OPERATION		PARAMETER	VALUE			
GROUP	BANK					
TVF Freq/ENV	1	TVF Cutoff Freq	-	48	-	
	2	TVF Resonance	-	16	-	
	3	TVF Freq KF	-	1/2	-	
	4	TVF Bias Point	-	>A4	-	
	5	TVF Bias Level	-	+2	-	
	6	TVF ENV Depth	-	56	-	
	7	TVF ENV Velocity	-	50	-	
	8	TVF ENV Depth KF	-	0	-	
TVF ENV	1	TVF ENV Time KF	-	1	-	
	2	TVF ENV Time 1	-	28	-	
	3	TVF ENV Time 2	-	77	-	
	4	TVF ENV Time 3	-	0	-	
	5	TVF ENV Time 4	-	32	-	
	6	TVF ENV Level 1	-	100	-	
	7	TVF ENV Level 2	-	70	-	
	8	TVF ENV Sus Lev	-	70	-	
TVA Level	1	TVA Level	100	100	94	
	2	TVA Velocity	+45	+6	+28	
	3	TVA Bias Point 1	>A3	>C4	>G3	
	4	TVA Bias Level 1	-7	-3	-3	
	5	TVA Bias Point 2	<C4	<C4	<C4	
	6	TVA Bias Level 2	0	-3	0	
	7	TVA ENV T1 Velo	1	1	1	
TVA ENV	1	TVA ENV Time KF	2	0	2	
	2	TVA ENV Time 1	22	9	20	
	3	TVA ENV Time 2	58	26	24	
	4	TVA ENV Time 3	82	70	70	
	5	TVA ENV Time 4	22	22	38	
	6	TVA ENV Level 1	100	71	100	
	7	TVA ENV Level 2	50	100	6	
	8	TVA ENV Sus Lev	0	90	0	
Partial Mute			○	○	○	×
Partial			1	2	3	4

h. Creating other types of sound



Here we will explain how to create other types of sound such as unique, synthesizer-like sound effects.

Synthesizers can produce any number of unique sounds, and each person will have his own preferences. Here we will be explaining how to create a synth lead sound, but we encourage you to use your own ears, to imitate your favorite sounds and modify them to your own liking. As a sound effect, we will be explaining how to make a noise sound.

■ Synthesizer Lead sounds

- Select structure 1, and use only partials 1/2 (mute partials 3/4).
- Select either waveform of synthesizer sound for both partials 1/2.
- Set the envelopes as follows.

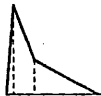
Partial 1/2

TVF ENV			TVA ENV		
	T1 = 10	L1 = 100		T1 = 0	L1 = 100
	T2 = 30	L2 = 40		T2 = 0	L2 = 100
	T3 = 90	SusL = 0		T3 = 0	SusL = 100
	T4 = 80			T4 = 20	

- To emphasize the attack, set the TVF ENV as shown above. It is effective to raise Resonance to about 25.
- If you set PW Velocity to ± 5 , your playing dynamics will affect the tone.
- It is also effective to add strong vibrato using the Pitch LFO. (Rate = 66, Depth = 30, Mod.Sense = about 100)
- It is also interesting to use PCM sounds 1-94, 95.

*For an example, see the ex-9 sample chart.

ex-9 : SYNTH LEAD

Tone No.						
OPERATION		PARAMETER	VALUE			
GROUP	BANK					
Common	1	Tone Name	Lead EX			
	2	Structure 1&2	1			
	3	Structure 3&4				
	4	ENV Mode	NORMAL			
WG Pitch/Mod	1	WG Pitch Coarse	C4	C4		
	2	WG Pitch Fine	0	0		
	3	WG Pitch KF	1	1		
	4	LF0 Rate	66	66		
	5	LF0 Depth	22	17		
	6	WG Modulation	72	88		
	7	WG Bender Switch	ON	ON		
WG Form/ENV	1	WG Waveform	SQR	SQR		
	2	WG PCM Wave Bank	-	-		
	3	WG PCM Wave No.	-	-		
	4	WG Pulse Width	55	100		
	5	WG PW Velocity	-2	0		
	6	P-ENV Depth	0	0		
	7	P-ENV Velocity	0	0		
	8	P-ENV Time KF	0	0		
WG P-ENV	1	P-ENV Time 1	0	0		
	2	P-ENV Time 2	0	0		
	3	P-ENV Time 3	0	0		
	4	P-ENV Time 4	0	0		
	5	P-ENV Level 0	0	0		
	6	P-ENV Level 1	0	0		
	7	P-ENV Level 2	0	0		
	8	P-ENV End Level	0	0		
Partial Mute			○	○	×	×
Partial			1	2	3	4
OPERATION		PARAMETER	VALUE			
GROUP	BANK					
TVF Freq/ENV	1	TVF Cutoff Freq	60	72		
	2	TVF Resonance	28	0		
	3	TVF Freq KF	5/8	1/2		
	4	TVF Bias Point	<A1	<A1		
	5	TVF Bias Level	0	0		
	6	TVF ENV Depth	69	49		
	7	TVF ENV Velocity	0	0		
	8	TVF ENV Depth KF	0	0		
TVF ENV	1	TVF ENV Time KF	2	3		
	2	TVF ENV Time 1	8	0		
	3	TVF ENV Time 2	32	32		
	4	TVF ENV Time 3	79	66		
	5	TVF ENV Time 4	63	63		
	6	TVF ENV Level 1	100	100		
	7	TVF ENV Level 2	36	82		
	8	TVF ENV Sus Levl	0	0		
TVA Level	1	TVA Level	84	75		
	2	TVA Velocity	+26	+30		
	3	TVA Bias Point 1	>C4	>B4		
	4	TVA Bias Level 1	0	-4		
	5	TVA Bias Point 2	<C4	<C4		
	6	TVA Bias Level 2	0	0		
	7	TVA ENV T1 Velo	0	0		
TVA ENV	1	TVA ENV Time KF	0	3		
	2	TVA ENV Time 1	2	8		
	3	TVA ENV Time 2	0	18		
	4	TVA ENV Time 3	0	0		
	5	TVA ENV Time 4	24	30		
	6	TVA ENV Level 1	100	85		
	7	TVA ENV Level 2	100	100		
	8	TVA ENV Sus Levl	100	100		
Partial Mute			○	○	×	×
Partial			1	2	3	4

■ Sound Effects

- Select structure 3, and use only partial 1 (mute partials 2/3/4).
- Select PCM sound 1-111.
- Set the envelopes as follows. The Pitch ENV settings are the key to this example.

Partial 1

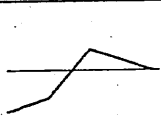
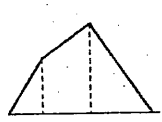
Pitch ENV			TVA ENV		
	T1 = 70	L0 = -50		T1 = 50	L1 = 60
	T2 = 70	L1 = -35		T2 = 70	L2 = 100
	T3 = 100	L2 = +30		T3 = 90	SusL = 0
	T4 = 0	EndL = 0		T4 = 90	

- It is also effective to set the ENV Mode to NO SUSTAIN.

To create other types of sound effect, note the following points.

- Make good use of PCM sounds 2-95—128 (Jam Loop). For example, set each partial to a PCM sound Jam Loop, and use the ring modulator with structure 13 for some interesting results.
- Make good use of PCM sound 1-111 Noise.
- Use structures 8/9 with stereo output, and make different TVF ENV and TVA ENV settings for each partial to create panning effects.

Partial 1 Partial 2

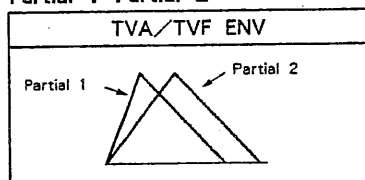

*For an example, see the ex-10 sample chart.

ex-10 : SOUND EFFECT

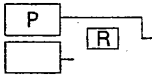
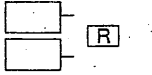
Tone No.							
OPERATION		PARAMETER	VALUE				
GROUP	BANK						
Common	1	Tone Name	SE EX				
	2	Structure 1&2	3				
	3	Structure 3&4					
	4	ENV Mode	NO Sustain				
WG Pitch/Mod	1	WG Pitch Coarse	C4				
	2	WG Pitch Fine	0				
	3	WG Pitch KF	s1				
	4	LFO Rate	0				
	5	LFO Depth	0				
	6	WG Modulation	0				
	7	WG Bender Switch	ON				
WG Form/ENV	1	WG Waveform	-				
	2	WG PCM Wave Bank	01				
	3	WG PCM Wave No.	111				
	4	WG Pulse Width	-				
	5	WG PW Velocity	-				
	6	P-ENV Depth	8				
	7	P-ENV Velocity	3				
	8	P-ENV Time KF	2				
WG P-ENV	1	P-ENV Time 1	68				
	2	P-ENV Time 2	72				
	3	P-ENV Time 3	96				
	4	P-ENV Time 4	0				
	5	P-ENV Level 0	-50				
	6	P-ENV Level 1	-35				
	7	P-ENV Level 2	+31				
	8	P-ENV End Level	0				
Partial Mute			○	×	×	×	
Partial			1	2	3	4	
OPERATION		PARAMETER	VALUE				
GROUP	BANK						
TVF Freq/ENV	1	TVF Cutoff Freq	-				
	2	TVF Resonance	-				
	3	TVF Freq KF	-				
	4	TVF Bias Point	-				
	5	TVF Bias Level	-				
	6	TVF ENV Depth	-				
	7	TVF ENV Velocity	-				
	8	TVF ENV Depth KF	-				
TVF ENV	1	TVF ENV Time KF	-				
	2	TVF ENV Time 1	-				
	3	TVF ENV Time 2	-				
	4	TVF ENV Time 3	-				
	5	TVF ENV Time 4	-				
	6	TVF ENV Level 1	-				
	7	TVF ENV Level 2	-				
	8	TVF ENV Sus Lev	-				
TVA Level	1	TVA Level	95				
	2	TVA Velocity	+37				
	3	TVA Bias Point 1	>C3				
	4	TVA Bias Level 1	-4				
	5	TVA Bias Point 2	<C4				
	6	TVA Bias Level 2	0				
	7	TVA ENV T1 Velo	1				
TVA ENV	1	TVA ENV Time KF	2				
	2	TVA ENV Time 1	49				
	3	TVA ENV Time 2	70				
	4	TVA ENV Time 3	84				
	5	TVA ENV Time 4	90				
	6	TVA ENV Level 1	62				
	7	TVA ENV Level 2	100				
	8	TVA ENV Sus Lev	0				
Partial Mute			○	×	×	×	
Partial			1	2	3	4	

MEMO

SECTION V

OTHER FUNCTIONS

I USING THE MEMORY CARD	118	2 TRANSMITTING DATA VIA MIDI	132
1. Saving Data into a Memory Card		1. Transmitting Individual Data	135
(RAM)	118	a. Patch Dump	135
a. About the protect switch	119	b. Timbre Dump	137
b. When using a new memory card	120	c. Temporary Dump	139
c. Saving patches/timbres		2. Transmitting by Block	140
(Writing procedure)	122		
d. Storing tones (Writing procedure)	124		
e. Storing data by block (Save)	126		
2. Copying Memory Card Data into the D-5			
(Load)	128		
3. Compatibility with the D-10/D-20	130		

1 USING THE MEMORY CARD

Two types of optional memory card are provided; ROM type and RAM type. Here we will explain how to store data into a memory card (RAM), and how to store RAM/ROM data into internal memory.

1. Saving Data into a Memory Card (RAM)

RAM type memory cards (M-256D, M-256E) can be used to store your original patch/timbre/tone sound data, or rhythm setup data. You can store your own sounds to create a personal sound library.

When using a memory card, note the following points.

- When using a new memory card, you must first store the data of the entire internal memory into the memory card (page 120) before the memory card can be used. This operation is called "save". In the same way, if a memory card has been used by other devices, you must save the entire memory into the memory card before using it with the D-5. If data has been saved to a memory card, the D-5 will be able to use memory card patches/timbres. In the same way as internal patches/timbres, settings in a memory card can be edited one by one, and written.

- The tone groups that can be used by internal and memory card are different. a, b, and r groups can be used by both, but i group tones can be used only by internal, and c group tones can be used only by memory card.

This means that if a patch/timbre which uses i group tones is written into a memory card, it will change to c group tones. If i group and c group contain different tone settings, the sound will be different. The same is true when storing from memory card into internal. To avoid such accidents, keep the same tone settings in both internal and memory card.

a. About the protect switch

A memory card has a protect switch to keep data from being accidentally erased.

If the protect switch is on, card sound data can be used, but it will not be possible to store edited settings into the card. Normally, you will keep the protect switch on, but when writing or saving data into a memory card, turn its protect switch off.

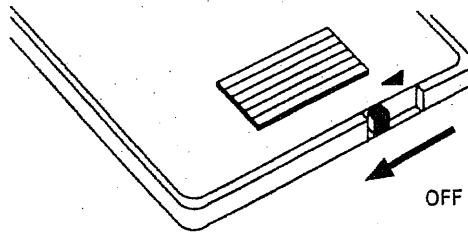

*For details of the D-5's memory protect, see in the PLAY volume page 99.

1. Saving Data into a Memory Card (RAM)

b. When using a new memory card

When using a new memory card, you must first store the entire data of the D-5 into the card before it can be used.

- 1 Insert the memory card into the card slot on the rear panel of the D-5.

*Check that the correct side of the memory card is facing upwards, and push it into the slot.

- 2 Turn the memory card's memory protect switch off.
(See the previous explanation of the protect switch.)

- 3 Press **DATA TRANSFER**.

```
Card Select
Save      Load
```

- 4 Press **◀/LOWER** to select "Save".

```
Card Save Select
All
```

- 5 Press either of **◀/LOWER** **UPPER/▶** to select "All".

```
Card Save      All
Sure?          Enter
```

- 6 Press **ENTER**.

```
Wrong Card
Enter
```

- 7** Press **ENTER** once again.

The following display will appear for a short time, and you will return to the previous play mode display, indicating that save has been completed.

Completed

*If the data was not correctly written, an error message will be displayed. Consult "Error Messages" on page 144, and take appropriate action.

- 8** Turn the memory card's protect switch on again.

c. Saving patches/timbres (Writing procedure)

Saving individual patch/timbre settings into a memory card one by one is called "writing".

A timbre can be written while editing (in any timbre parameter display) or in Multi Timbral play mode. When writing from play mode, the currently displayed timbre will be written.

1 Insert the memory card into the card slot.

*Check that the correct side of the memory card is facing upwards, and push it into the slot.

2 Turn the memory card's memory protect switch off.

3 Press **WRITE**.

The patch/timbre writing display will appear.

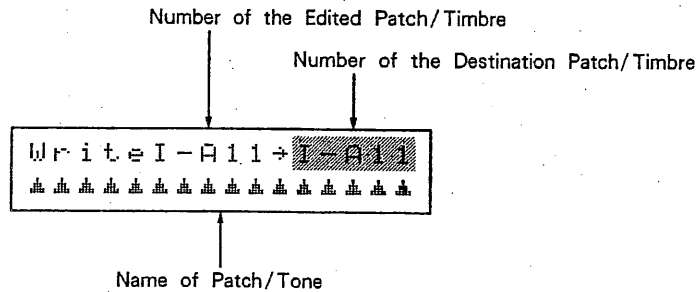

4 When editing internal patches/timbres, press **INT/CARD** to switch the writing destination to "C" (card).

5 Press **A/B**, **BANK 1-8**, **NUMBER 1-8** to select the storage destination of the edited patch/timbre. If you intend to store it into the same patch/timbre location, there is no need to select the destination. If you want to hear the sound of the writing destination patch/timbre to check whether or not it is ok to replace it, use the following procedure.

① Press **COMPARE**.

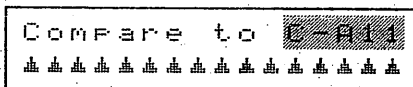

After pressing **COMPARE**, you will be able to hear the sound of the selected timbre when you play the keyboard. At this time you can select and hear other timbres as well.

② Press **COMPARE** once again to return to the writing display.

6 Press **ENTER**.

If writing is successfully completed, the following display will briefly appear, and you will return to play mode.

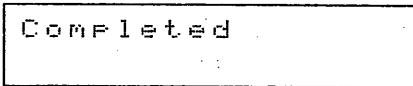

*If you press **EXIT** during the write procedure, you will return to the patch/timbre editing display. If you want to continue the write procedure, press **WRITE** once again. If you select another patch/timbre without pressing **WRITE**, your edits will be lost.

*If the data was not correctly written, an error message will be displayed. Consult "Error Messages" on page 144, and take appropriate action.

7 Turn the memory card's protect switch on again.

d. Storing tones (Writing procedure)

This explains the procedure for writing edited tone settings into a memory card one by one.

While in tone editing, use the following procedure.

- 1 Insert the memory card into the card slot.

*Check that the correct side of the memory card is facing upwards, and push it into the slot.

- 2 Turn the memory card's memory protect switch off.

- 3 Press **WRITE**.
The tone writing display will appear.

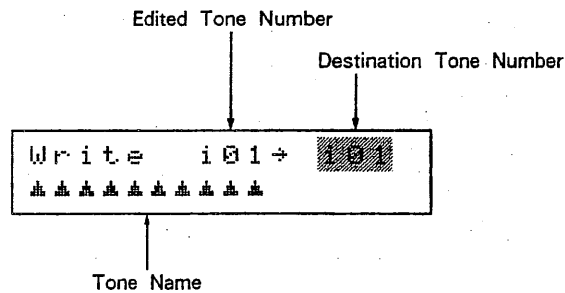

*When editing a preset tone, the tone number of the destination will not be shown. (The display will show *:*:*)

- 4 When editing an internal tone, press **INT/CARD** to switch the writing destination to "c" (card).

- 5 Press **◀VALUE▶** to select the storage destination of the tone. Select a tone 1—64 which you don't mind writing over.

If you want to hear the sound of the writing destination tone to check whether or not it is ok to replace it, use the following procedure.

- ① Press **COMPARE**.

```
Compare to 64
▲▲▲▲▲▲▲▲▲▲▲▲▲▲▲▲
```

After pressing **COMPARE**, you will be able to hear the sound of the selected tone when you play the keyboard. At this time you can select and hear other tones as well.

- ② Press **COMPARE** once again to return to the writing display.

- 6 Press **ENTER**.

If writing is successfully completed, the following display will briefly appear, and you will return to play mode.

```
Completed
```

- *If you press **EXIT** during the write procedure, you will return to the tone editing display. If you want to continue the write procedure, press **WRITE** once again. If you select another tone without pressing **WRITE**, your edits will be lost.
- *If the data was not correctly written, an error message will be displayed. Consult "Error Messages" on page 144, and take appropriate action.

- 7 Turn the memory card's protect switch on again.

e. Storing data by block (Save)

Storing an entire group of internal data into the memory card is called "saving". Normally, you will save patch/timbre/tone sound data together with rhythm setup data. However, it is also possible to save data in separate blocks.

1 Insert the memory card into the card slot.

2 Turn the memory card's memory protect switch off.

3 Press **DATA TRANSFER**.

```
Card Select
Save      Load
```

4 Press **◀/LOWER** to select "Save".

```
Card Save Select
All
```



5 Select the block of data you want to save.

○ If you want to save all data, press either of **◀/LOWER** **UPPER/▶**.

```

Card Save      All
Sure?         Enter
    
```

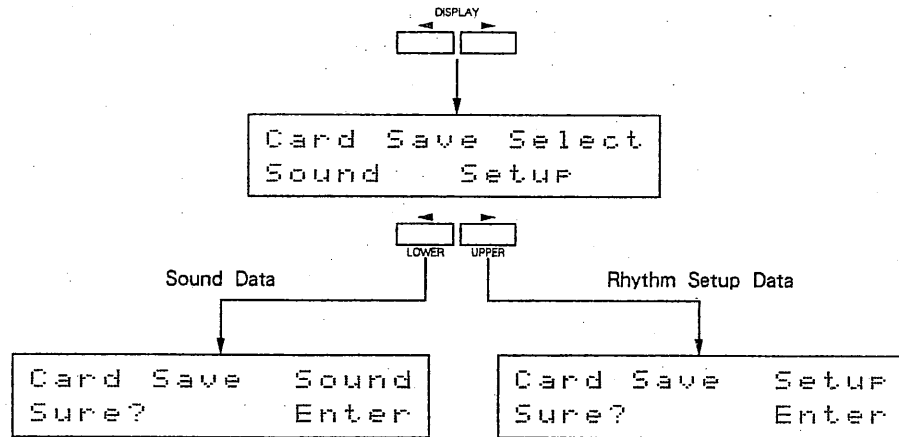
○ If you want to save individual blocks of data, press **◀/DISPLAY** **▶** to switch the display, and press **◀/LOWER** **UPPER/▶** to select a block.



6 Press **ENTER**.

If saving is successfully completed, the following display will briefly appear, and you will return to play mode.

```

Completed
    
```

*If the data was not correctly saved, an error message will be displayed. Consult "Error Messages" on page 144, and take appropriate action.

7 Turn the memory card's protect switch on again.

2. Copying Memory Card Data into the D-5 (Load)

Storing an entire set of memory card data into internal memory is called "loading". Normally, you will load patch/timbre/tone sound data along with rhythm setup data, but it is also possible to load individual blocks of data.

*The D-5 can use sound libraries (PN-D10-01 etc.) for the D-10/D-20, but is not compatible with some data for the D-10 etc. When using sound libraries, consult the section on page 130 concerning D-10/D-20 compatibility.

■ Loading procedure

1 Insert a memory card into the card slot.

2 Press **DATA TRANSFER**.

```
Card Select
Save      Load
```

3 Press **UPPER/▶** to select "Load".

```
Card Load Select
All
```

4 Select the block of data to be loaded.

○When loading all data blocks, press either of **◀/LOWER** **UPPER/▶**.

```
Card Load      All
Sure?          Enter
```

○ When loading individual data blocks, press either of **◀ DISPLAY ▶**, and then press **◀ / LOWER** **UPPER / ▶** to select a block.

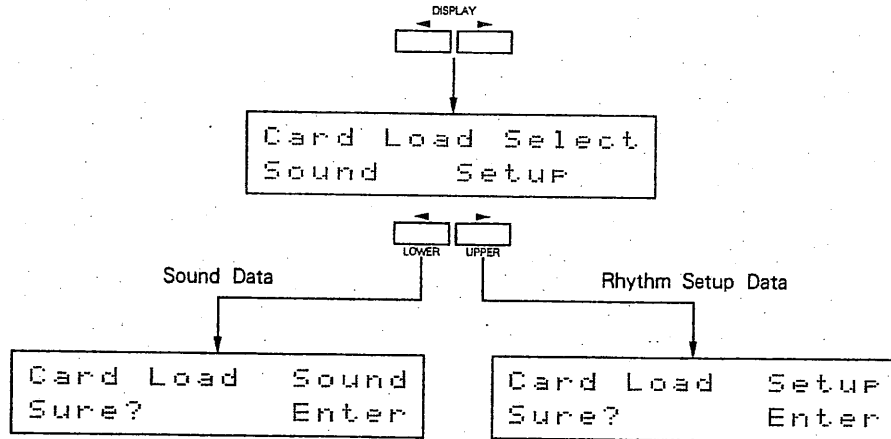

5 Press **ENTER**.

Turn Protect off
once? Write/Exit

6 Press **WRITE**.

Memory protect will be temporarily defeated, and you will return to the display of **4**.

7 Press **ENTER** once more.

When the data has been correctly loaded, the following display will briefly appear, and you will return to the previous play mode display.

Completed

*If the data was not correctly loaded, an error message will be displayed. Consult "Error Messages" on page 144, and take appropriate action.

3. Compatibility with the D-10/D-20

The D-5 can use the commercially available sound library memory cards for the D-10/D-20. However, since it is not compatible with some of the D-10/D-20 parameters, there are some limitations. Here we will explain the points to be aware of when using D-10/D-20 memory cards with the D-5.

The D-5 is compatible with the D-10/D-20 except for the following differences.

- The D-5 does not have the reverb and rhythm recording functions of the D-10/D-20.
- The D-10/D-20 do not have the patch effect functions of the the D-5.

Parameters compare as follows.

- Patch parameters: The D-10/D-20 do not have parameters for the four types of patch effect. The D-5 does not have the reverb-related parameters of the D-10/D-20.
- Timbre parameters: Compatible.
- Tone parameters: Compatible.
- Rhythm setup: The D-5 does not have a reverb switch setting for each key number.

■ Playing

When playing the D-5 using D-10/D-20 memory cards, be aware of the following points.

● In Performance mode

When a patch is selected from a D-10/D-20 memory card in Performance play mode, the reverb settings will be ignored, and the patch effect settings will have their initial values.

Effect mode: OFF
Effect rate: 70
Harmony balance: -02
Chase level: 70
Arpeggio mode: UP

● In Multi Timbral mode

When a memory card timbre is selected from a D-10/D-20 memory card in Multi Timbral mode, operation will be as usual.

■ **Data transfer**

When transferring data between the D-5 and a D-10/D-20 memory card, be aware of the following points.

● **From memory card to D-5**

There will be no problem when editing patch/timbre from a D-10/D-20 memory card and writing it into D-5 memory.

In the previously mentioned load operation, when data from a D-10/D-20 memory card is copied to the D-5, patch effect settings will have their initial value, and reverb settings will be ignored. Also, reverb settings for rhythm setup data will be ignored.

● **From D-5 to memory card**

Due to data compatibility, we do not recommend storing D-5 data into a memory card (RAM) which contains D-10/D-20 data. When using such a memory card with the D-5, see page 120 "When using a new memory card", and convert it into a D-5 memory card.

2 TRANSMITTING DATA VIA MIDI

Using Roland system exclusive messages, data can be transmitted to MIDI sequencers or other D-5's for storage.

■ Data for transmission

Data can be transmitted in the following three ways.

Bulk dump (Bulk load) :

Transmit data by block (All/Sound/Rhythm).

Patch dump/Timbre dump :

Transmit the data of the selected patch/timbre.

Temporary dump :

Transmit the currently edited patch/timbre, tone, rhythm setup.

Transmission procedure for each method is as follows.

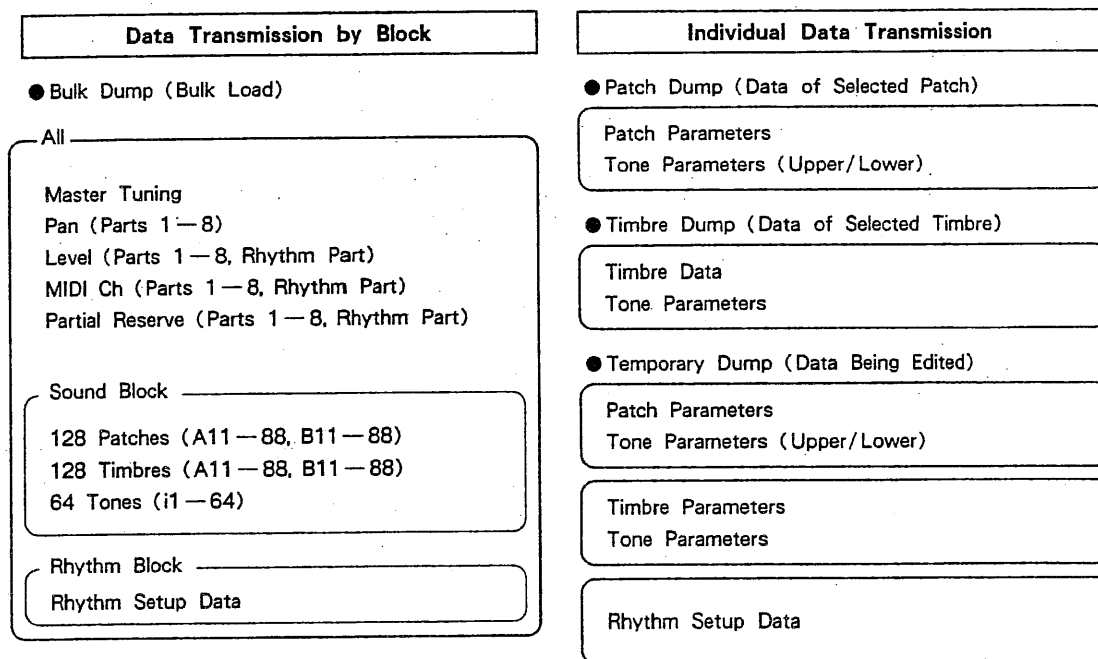

*The data referred to here indicates the settings of the various parameters.

■ The possibilities of exclusive messages

Here are some of the ways in which exclusive messages can be used to transmit D-5 data to other MIDI devices.

By transmitting individual blocks such as Sound and Rhythm into the memory of a MIDI sequencer etc., you will be able to store a much large quantity of data than when using a memory card. Or, by transmitting "All" to another D-5, all of its settings can be precisely matched to the transmitting D-5.

When using a MIDI sequencer to play the D-5, you will normally use program change messages to switch patches and timbres. However, if the same sequencer data is used to play a D-5 that contains different patch/timbre data, the sounds being selected will be different than those you had intended. If you want to sequence another D-5 using the same sounds as when recording, record the desired patch/timbre settings instead of program change data. In other words, record single patch/timbre data into the MIDI sequencer.

■ Transmission methods

There are two methods of data transmission; handshake and one-way. Each one is explained below. When transmitting data by blocks, either handshake or one-way can be used. Other data is transmitted using only the one way method.

● Handshake

In the handshake method, the two communicating devices (D-5) transmit while exchanging confirmation signals. This allows speedy and secure data transmission. When using the handshake method to transmit, make connections as follows.

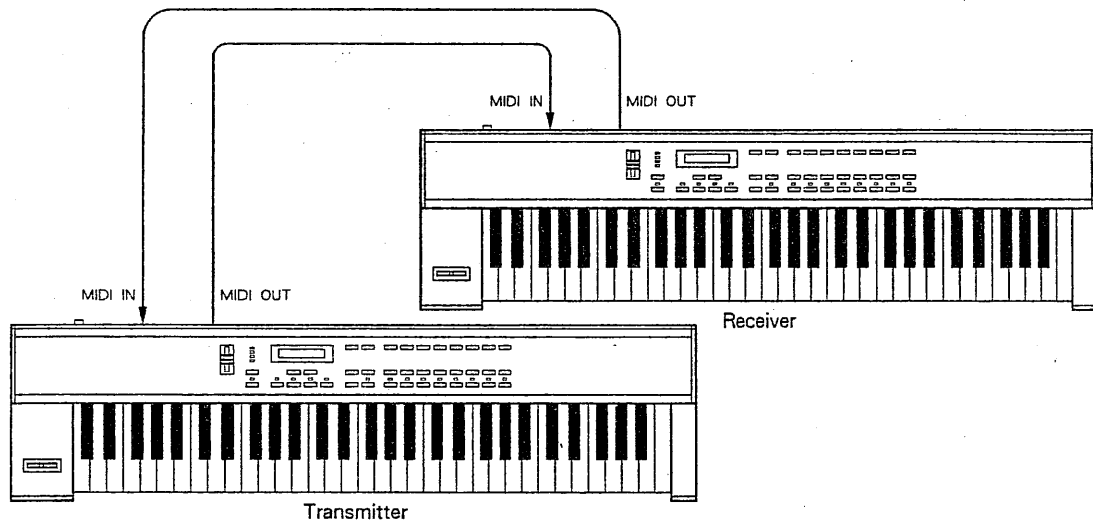

● One-way

In the one-way method, data is transmitted regardless of the condition of the receiver. Connections are simple, but the one-way method is a bit slower than handshake. When using the one-way method to transmit, make connections as follows.

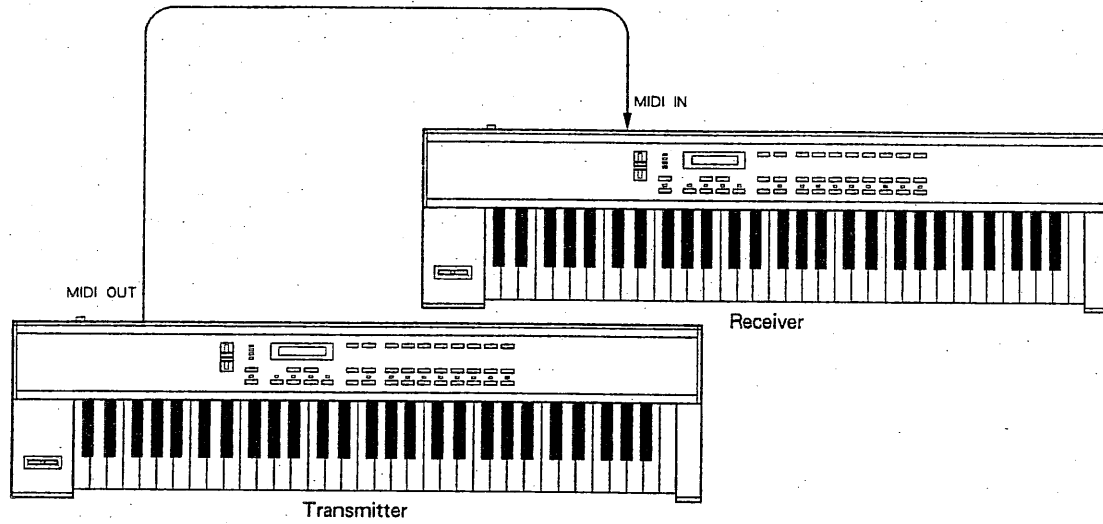

1. Transmitting Individual Data

It is possible to individually transmit the data of the selected patch/timbre, or the data (patch/timbre, rhythm setup) currently being edited. When transmitting patch/timbre data, the tone data specified in that patch/timbre will also be transmitted. This is used when you want to record sound data into a MIDI sequencer instead of program change numbers.

Transmission uses the one-way method, so make the appropriate connections.

a. Patch Dump

The data of the selected patch and the upper/lower tone data specified by that patch can be transmitted. This is known as "patch dump".

Before you begin, make sure that you are in Performance mode (the **PERFORMANCE** indicator is lit).

When transmitting data from the D-5 to a MIDI sequencer or to another D-5, use the following procedure.

*Patch dump uses the MIDI unit number to transmit data. When the power is turned on, the MIDI unit number is set to 17.

1 Turn on the patch dump (MIDI function) of the (transmitting) D-5.

① Press **MIDI**.

② Press **◀DISPLAY▶** several times to get the patch dump display.

```
MIDI Patch DUMP
OFF
```

③ Press **VALUE▶** to turn patch dump ON.

*When patch dump is left ON, patch selection will become slower, so for normal playing, you should leave this OFF. When the power is turned on, patch dump will be OFF.

*When using patch dump, you must match the MIDI unit numbers of the transmitter and receiver. To change the MIDI unit number, press **◀DISPLAY** and select the MIDI unit number display, and make the desired setting.

④ When you press **EXIT**, you will return to Performance play mode.

2 Select the patch whose data you want to transmit.

Whenever you select patches, the data of that patch will be transmitted.

When transmitting to a MIDI sequencer, set the MIDI sequencer to receive exclusive messages.

When transmitting to another D-5, data can be received whenever the receiving D-5 is in Performance play mode.

*When using exclusive messages from an external MIDI device (a MIDI sequencer, etc.) to change D-5 patches, make sure that the MIDI unit numbers of both sides match. Patches cannot be changed unless the MIDI unit numbers match.

b. Timbre Dump

The data of the selected timbre and the tone data specified by that timbre can be transmitted. This is known as "timbre dump".

Before you begin, make sure that you are in Multi Timbral mode (the **MULTI TIMBRAL** indicator is lit).

When transmitting data from the D-5 to a MIDI sequencer or to another D-5, use the following procedure.

*Timbre dump uses the MIDI unit number (or the MIDI transmission channel of the keyboard) to transmit data. When the power is turned on, the MIDI unit number is set to 17.

1 Turn on the timbre dump (MIDI function) of the (transmitting) D-5.

① Press **MIDI**.

② Press **◀DISPLAY▶** several times to get the timbre dump display.

```
MIDI Timbre Dump
OFF
```

③ **VALUE▶** to turn timbre dump ON.

*When timbre dump is left ON, timbre selection will become slower, so for normal playing, you should leave this OFF. When the power is turned on, timbre dump will be OFF.

*When using timbre dump, you must match the MIDI unit numbers of the transmitter and receiver. To change the MIDI unit number, press **◀DISPLAY** and select the MIDI unit number display, and make the desired setting.

④ When you press **EXIT**, you will return to Multi Timbral play mode.

- 2** After selecting the display of the part whose sound you want to change, select the patch whose data you want to transmit. Whenever you select a timbre, the data of that timbre will be transmitted using the MIDI unit number.

When transmitting to a MIDI sequencer, set the MIDI sequencer to receive exclusive messages.

When transmitting to another D-5, data can be received whenever the receiving D-5 is in Multi Timbral play mode.

- *If you want to transmit on the keyboard MIDI transmission channel without using the MIDI unit number, select timbres while in the keyboard display.
- *When using exclusive messages from an external MIDI device (a MIDI sequencer, etc.) to change D-5 timbres, make sure that the MIDI unit numbers of both sides match. Timbres cannot be changed unless the MIDI unit numbers match. Also, when switching timbres using the MIDI channel, set the MIDI unit number to any setting other than OFF.

c. Temporary Dump

Temporary Dump is to transmit the data of the patch/timbre, tone, and rhythm setup data being edited.

When transmitting the patch/timbre being edited, the tone data specified by that patch/timbre will also be transmitted. When transmitting the rhythm setup data that is being edited, setup data for all 85 keys will be transmitted.

*To use temporary dump, there is no need to turn on the MIDI functions patch dump and timbre dump.

Temporary dump uses the MIDI unit number to transmit data. When the power is turned on, the MIDI unit number is set to 17. If you need to change this, use the following procedure.

① Press **MIDI**.

② Press **◀ DISPLAY ▶** several times to get the MIDI unit number display.

```
MIDI Exclu Unit#
█
```

③ Press **◀ VALUE ▶** to change the MIDI unit number.

④ Press **EXIT** to return to previous play mode.

● To transmit patch data

While in patch edit, press **ENTER** to transmit the data (patch parameters and the parameters of the two tones assigned to the patch) being edited.

● To transmit timbre data

While in timbre edit, press **ENTER** to transmit the data (timbre parameters and the tone parameter assigned to the timbre) being edited.

● To transmit rhythm setup data

While editing rhythm setup data, press **ENTER** to transmit the data (the entire setup for 85 keys) being edited.

2. Transmitting by Block

Here we will explain how to transmit blocks of data from one D-5 to another D-5, and how the D-5 receives and transmits data. When using a device such as a MIDI sequencer, you will need to consult the owner's manual for that device.

Data can be transmitted by block using either the handshake method or the one-way method. Before you begin, decide which method you will use, and make the appropriate connections.

- 1** Match the MIDI unit numbers of the transmitting and receiving sides. When the power is turned on, the MIDI unit number is set to 17. If you need to change this, use the following procedure.

① Press **MIDI**.

② Press **◀ DISPLAY ▶** several times to get the MIDI unit number display.

```
MIDI Exclu Unit#
 17
```

③ Press **◀ VALUE ▶** to change the MIDI unit number.

④ Press **EXIT** to return to the previous play mode.

- 2** Press **DATA TRANSFER** on both the transmitting and on the receiving device.

- 3** Press **◀ DISPLAY ▶** on both the transmitting and on the receiving device to get the following display.

<When Using Handshake (transmitting side/receiving side)>

```
H-shake Bulk Sel
DUMP      Load
```

<When Using One-way (transmitting side/receiving side)>

```
One-Way Bulk Sel
DUMP      Load
```

(The rest of the procedure is the same for both handshake and one-way.)

4 On the transmitting device, press **◀/LOWER** to select "Dump" On the receiving device, press **UPPER/▶** to select "Load".

5 For the transmitting device, select the type of data to be transmitted For the receiving device, select the same type of data.

When transmitting all data at ocne, press **◀/LOWER** or **UPPER/▶** to select All.

When transmitting individual blocks, first press either **◀DISPLAY▶** to switch the display. When transmitting sound data, press **◀/LOWER** (sound), and when transmitting rhythm setups data, press **UPPER/▶** (Rhythm).

6 Press **ENTER** on the receiving device.

```
Turn Protect off
once? Write/Exit
```

7 Press **WRITE** on the receiving device.

Memory protect will be temporarily defeated, and you will return to the display of **5**.

8 Once again, press **ENTER** on the receiving device, and it will be ready to receive data.

```
H-shake Load ▲▲▲
Waiting
```

9 Press **ENTER** on the transmitting device, and the data will be transmitted.

When the data has been correctly transmitted, the display will show "Completed" for a short time, and then return to the previous play mode.

*If data was not correctly transmitted, an error message will be displayed. Consult "Error Messages" on page 144, and take appropriate action.

MEMO

SUPPLEMENTARY INFORMATION

1. Error Messages	144
2. Troubleshooting	148
3. Performance Mode List	150
4. Multi Timbral Mode List	151
5. Tone Parameter List	152
6. PCM Sound List	153
7. Rhythm Setup (Factory Settings)	155
8. Preset Tones	156
9. Blank Charts	157
a. Patch/ Timbre	157
b. Tone	158
c. Rhythm setup	159

1. Error Messages

When operations are incorrectly executed, or when some unexpected condition arises, an error message will be displayed. Use this section to determine the cause of the error message, and take the actions indicated.

*If the same error message is displayed even though operations are correct, consult a Roland service station.

● Messages which appear when the battery is low

```
Check
Internal Battery
```

Problem :

The backup battery of the D-5 is low.

Action :

Consult a Roland service station.

```
Check
Card's Battery
```

Problem :

The backup battery of the optional memory card (M-256D, M-256E) is low.

Action :

Read the owner's manual of the card, and replace the battery (CR2016).

● Messages which appear while playing

```
Card Not Ready
```

Problem :

The memory card is not correctly inserted.

Action :

Correctly insert the memory card, and repeat the operation.

```
Wrong Card
```

Problem :

A memory card which contains no data or which contains data for devices other than the D-5 (or D-10/D-20) is inserted.

Action :

Insert the correct type of memory card, and repeat the operation.

```
MIDI Buffer Full
```

Problem :

This will be displayed when data is received beyond capacity.

Action :

After a short time, you will return to same the condition as when the power has been turned on.

● Messages which appear during writing or data transfer.

```
Turn Protect off
once? Write/Exit
```

Problem :

The memory protect of the D-5 is turned on.

Action 1 :

If you want to temporarily defeat the memory protect and continue, press **WRITE** and then press **ENTER** again. (See "About memory protect", in the PLAY volume page 99)

Action 2 :

To abort the operation, press **EXIT**.

```
Card Protected
```

Problem :

The memory protect of the card is turned on.

Action 1 :

Turn the protect switch off, and press **ENTER**.

Action 2 :

To abort the operation, press **EXIT**.

```
Wrong Card
```

Problem :

A memory card which contains no data or which contains data for devices other than the D-5 (or D-10/D-20) is inserted.

Action 1 :

Insert the correct type of memory card and press **ENTER**.

Action 2 :

To abort the operation, press **EXIT**.

```
Wrong Card
Enter
```

Problem :

When saving data, a memory card which contains no data or which contains data for devices other than the D-5 (or D-10/D-20) is inserted.

Action 1 :

Insert the correct type of memory card and press **ENTER**.

Action 2 :

To use a new memory card (or a memory used by other devices) as a D-5 memory card, press **ENTER** and the data will be saved.

Action 3 :

To abort the operation, press **EXIT**.

```
Card Not Ready
```

Problem :

The memory card is not correctly inserted.

Action :

Press **EXIT**, correctly insert the memory card, and repeat the operation.

1. Error Messages

Insert Card

Problem :

The memory card is not correctly inserted.

Action :

Correctly insert the memory card, and repeat the operation.

No data

Problem :

The memory card does not contain the specified data (when the inserted memory card is a D-10/D-20 memory card, or a memory card which contains only sound/rhythm data).

Action :

Correctly insert the memory card, and repeat the load operation.

No Space

Problem :

The specified data cannot be stored in this memory card (when the inserted memory card is a D-110 memory card, or a memory card which contains only sound/rhythm data).

Action :

Correctly insert the memory card, and repeat the save operation.

Card Error
Exit

Problem :

Data was not correctly saved.

Action :

Press **EXIT**, and repeat the save operation.

Data Mismatch
Exit

Problem :

The data settings of the transmitting and receiving devices did not match.

Action :

Press **EXIT**, make the correct settings, and repeat the data transfer operation.

MIDI Communicat
Error Exit

Problem :

Data was not correctly received.

Action :

Press **EXIT**, and repeat the data transfer operation.

● Other messages

Cancel

EXIT was pressed to cancel the operation.

Completed

Write/data transfer has been completed.

2. Troubleshooting

The D-5 has many functions, and some settings may have unexpected results. In some cases, problems in equipment such as the amp/speaker system may be the cause of failure to produce sound. Here, we will be explaining some common problems and what to do about them.

● No sound/volume is low

- Is the **VOLUME** set low?
Raise the D-5 or amp/speaker system volume to an appropriate level.
- Is there sound in the headphones?
If you hear in a pair of headphones, the problem is in the audio cables or the amp/speaker system. Check the connections.
- Is the MIDI function local control off?
See page 12 "■ Tune/Function".
- (In Multi Timbral mode,) does the keyboard transmit channel match the MIDI channel of the part?
See page 12 "■ Tune/Function".
- (In Multi Timbral mode,) is the volume level of the part too low?
See page 12 "■ Tune/Function".
- Has MIDI volume data been received from an external MIDI device to lower the volume level of the D-5?
Press the **MODE**, and select the previous mode once again to return to normal.

● Can't hear the rhythm sounds

- Is the rhythm sound volume level too low?
See page 39 "Section III Rhythm Setup".
- Is the MIDI channel of the rhythm part set correctly?
See page 16 "■ MIDI Functions".

● The pitch is wrong

- Is key transpose being used?
See in the PLAY volume page 40, "Key transpose".
 - Is the master tuning incorrect?
See page 12 "■ Tune/Function".
- *If the pitch of a specific patch/timbre is incorrect, check the settings of that patch/timbre or tone. (Key shift, fine tune, pitch coarse, pitch fine, etc.)

● **Can't change patches/timbres**

- Is ROM play or Manual Drums mode selected? (Check the indicators.)
Press **MODE** so that the **PERFORMANCE** or **MULTI TIMBRAL** indicator lights.
- Are you not in play mode? (editing, etc.)
Press **EXIT**, return to Play mode.

● **Pan settings do not have the expected result**

- Does the tone use only one partial?
Tones created using one partial are panned over eight steps.
- Is the tone parameter (common group) structure set to 8 or 9?
When structures 8 or 9 are used, each partial is positioned in a different way. See page 49 "2 Partials and Structures".

● **MIDI data is incorrectly transmitted/received**

- Are the MIDI functions of the transmitting and receiving sides correctly set?
See page 16 "2 MIDI Functions".

● **The programmer cannot be used for editing**

- Are the programmer and the D-5 set to matching unit numbers?
See page 16 "2 MIDI Functions".

3. Performance Mode List

Tune/Function	Value
Master Tune (*1)	428—453
Memory Protect (*1)(*2)	OFF, ON
Rhythm Level (*1)	0—100

MIDI Function	Value
MIDI RxCH	1—16
MIDI TxCH	1—16
MIDI Rhythm CH (*1)	1—16
MIDI Local (*1)(*2)	OFF, ON
MIDI Bender	OFF, ON
MIDI Modulation	OFF, ON
MIDI Rx Volume	OFF, ON
MIDI Hold	OFF, ON
MIDI Program Change	OFF, ON
MIDI Expression (*1)	OFF, ON
MIDI Breath (*1)	OFF, EXP, MOD, E & M
MIDI Unit No. (*1)(*2)	OFF, 17—32
MIDI Patch Dump (*1)(*2)	OFF, ON

(*1) Also effective in Multi Timbral mode.

(*2) Returns to the initial value when power is turned on.

Memory Protect ON
 MIDI Local ON
 MIDI Unit No. 17
 MIDI Patch Dump OFF

Patch Parameter	Value
Patch Effect Select (*3)	OFF, Chord Play, Harmony, Chase, Arpeggio
Key Mode	WHOLE, DUAL, SPLIT
Split Point	C2—C #7
Tone Select (LOWER/UPPER)	Tone Group : a, b, i(c), r Tone No. : 1—64
Key Shift (LOWER/UPPER)	-24—+24
Fine Tune (LOWER/UPPER)	-50—+50
Bender Range (LOWER/UPPER)	0—24
Assign Mode (LOWER/UPPER)	1, 2, 3, 4
Effect Rate	0—100
Harmony Balance	-10—0
Chase Shift	-12—+12
Chase Level	0—100
Arpeggio Mode	UP, DOWN, U & D, RND
Tone Balance (LOWER/UPPER)	0—100
Patch Level	0—100
Patch Name	(space) A—Z a—z 0—9 & # ! ? . : ; ' " * + - / < = >

(*3) Set using the four effect buttons on the panel.

4. Multi Timbral Mode List

Tune/Function	Value
Master Tune (*1)	428—453
Memory Protect (*1)(#2)	OFF, ON
Part R Level (*1)	0—100
Part1—8 Pan & Level	Pan : 7>—><—<7 Leve : 0—100
Part1—8, R Reserve	0—32

Timbre Parameter	Value
Tone Select	Tone Group : a, b, i(c), r Tone No. : 1—64
Key Shift	- 24 — + 24
Fine Tune	- 50 — + 50
Bender Range	0—24
Assign Mode	1, 2, 3, 4

MIDI Function	Value
MIDI Part1—8 RxCH	1—16
MIDI PartR RxCH (*1)	1—16
MIDI Local (*1)	OFF, ON
MIDI Expression (*1)	OFF, ON
MIDI Breath (*1)	Exp, Mod, E & M, OFF
MIDI Unit No. (*1)(#2)	OFF, 17—32
MIDI Timbre Dump (*1)(#2)	OFF, ON
MIDI Keyboard CH	1—16

- (* 1) Also effective in Performance mode.
 (* 2) Returns to the initial value when power is turned on.
 Memory Protect ON
 MIDI Unit No. 17
 MIDI Timbre Dump OFF

5. Tone Parameter List

5. Tone Parameter List

Parameter Group	Parameter	Sound generator (#1)		Value
		S	P	
Common	Tone Name	/		(space) A—Z a—z 0—9 & # ! ? . , ; ' " * + - / < = >
	Structure 1 & 2	/		1—13
	Structure 3 & 4	/		1—13
	ENV Mode	/		NORMAL, NO SUSTAIN
	Partial Mute	/		OFF, ON (* 2)
WG Pitch/Mod (Partial 1/2/3/4)	Pitch Coarse	○	○	C1—C9
	Pitch Fine	○	○	-50—0—+50
	Keyfollow	○	○	-1, -1/2, -1/4, 0, 1/8, 1/4, 3/8, 1/2, 5/8, 3/4, 7/8, 1, 5/4, 3/2, 2 s1, s2
	LFO Rate	○	○	0—100
	LFO Depth	○	○	0—100
	Modulation Sensitivity	○	○	0—100
	Bender Switch	○	○	OFF, ON
WG Form (Partial 1/2/3/4)	Waveform	○	×	SQU, SAW
	PCM Wave Bank	×	○	1, 2
	PCM Wave No.	×	○	1—128
	Pulse Width	○	×	0—100
	PW Velocity Sensitivity	○	×	-7—0—+7
Pitch ENV (Partial 1/2/3/4)	ENV Depth	○	○	0—10
	ENV Velocity Sensitivity	○	○	0—3
	ENV Keyfollow (Time)	○	○	0—4
Pitch ENV (Partial 1/2/3/4)	Time 1, 2, 3, 4	○	○	0—100
	Level 0, 1, 2, End	○	○	-50—0—+50
TVF Frequency (Partial 1/2/3/4)	Cutoff Frequency	○	×	0—100
	Resonance	○	×	0—30
	Keyfollow (Frequency)	○	×	-1, -1/2, -1/4, 0, 1/8, 1/4, 3/8, 1/2, 5/8, 3/4, 7/8, 1, 5/4, 3/2, 2
	Bias Point	○	×	< A1 — < C7, > A1 — > C7
	Bias Level	○	×	-7—0—+7
TVF ENV (Partial 1/2/3/4)	ENV Depth	○	×	0—100
	ENV Depth Velocity Sensitivity	○	×	0—100
	ENV Keyfollow (Depth)	○	×	0—4
TVF ENV (Partial 1/2/3/4)	ENV Keyfollow (Time)	○	×	0—4
	Time 1, 2, 3, 4	○	×	0—100
	Level 1, 2, Sustain	○	×	0—100
TVA Level (Partial 1/2/3/4)	Level	○	○	0—100
	Velocity Sensitivity	○	○	-50—0—+50
	Bias Point 1	○	○	< A1 — < C7, > A1 — > C7
	Bias Level 1	○	○	-12—0
	Bias Point 2	○	○	< A1 — < C7, > A1 — > C7
	Bias Level 2	○	○	-12—0
TVA ENV (Partial 1/2/3/4)	ENV Velocity Follow (T1)	○	○	0—4
	ENV Keyfollow (Time)	○	○	0—4
	Time 1, 2, 3, 4	○	○	0—100
	Level 1, 2, Sustain	○	○	0—100

(* 1) S: effective for the synthesizer sound generator

P: effective for the PCM sound generator

(* 2) Set using panel number buttons 5—8

6. PCM Sound List

Bank 1

No.	PCM Sound Name	Comment	No.	PCM Sound Name	Comment
1	Bass Drum - 1	Rhythm Sounds	65	Steel Guitar	
2	Bass Drum - 2				
3	Bass Drum - 3				
4	Snare Drum - 1				
5	Snare Drum - 2				
6	Snare Drum - 3				
7	Snare Drum - 4				
8	Tom Tom - 1				
9	Tom Tom - 2				
10	High - Hat				
11	High - Hat (Loop)				
12	Crash Cymbal - 1				
13	Crash Cymbal - 2 (Loop)				
14	Ride Cymbal - 1				
15	Ride Cymbal - 2 (Loop)				
16	Cup				
17	China Cymbal - 1				
18	China Cymbal - 2 (Loop)				
19	Rim Shot				
20	Hand Clap				
21	Mute High Conga				
22	Conga				
23	Bongo				
24	Cowbell				
25	Tambourine				
26	Agogo				
27	Claves				
28	Timbale High				
29	Timbale Low				
30	Cabasa				
31	Timpani Attack	Attack Sounds	74	Draw bars (Loop)	Sustained Sounds
32	Timpani				
33	Acoustic Piano High				
34	Acoustic Piano Low				
35	Piano Forte Thump				
36	Organ Percussion				
37	Trumpet				
38	Lips				
39	Trombone				
40	Clarinet				
41	Flute High				
42	Flute Low				
43	Steamer				
44	Indian Flute				
45	Breath				
46	Vibraphone High				
47	Vibraphone Low				
48	Marimba				
49	Xylophone High				
50	Xylophone Low				
51	Kalimba				
52	Wind Bell				
53	Chime Bar				
54	Hammer				
55	Guio				
56	Chink				
57	Nails				
58	Fretless Bass				
59	Pull Bass				
60	Slap Bass				
61	Thump Bass				
62	Acoustic Bass				
63	Electric Bass				
64	Cut Guitar				
			75	High Organ (Loop)	
			76	Low Organ (Loop)	
			77	Trumpet (Loop)	
			78	Troumbone (Loop)	
			79	Sax - 1 (Loop)	
			80	Sax - 2 (Loop)	
			81	Reed (Loop)	
			82	Slap Bass (Loop)	
			83	Acoustic Bass (Loop)	
			84	Electric Bass - 1 (Loop)	
			85	Electric Bass - 2 (Loop)	
			86	Gut Guital (Loop)	
			87	Steel Guitar (Loop)	
			88	Electric Guitar (Loop)	
			89	Clav (Loop)	
			90	Cello (Loop)	
			91	Violin (Loop)	
			92	Electric Piano - 1 (Loop)	
			93	Electric Piano - 2 (Loop)	
			94	Harpichord - 1 (Loop)	
			95	Harpichord - 2 (Loop)	
			96	Telephone Bell (Loop)	
			97	Female Voice - 1 (Loop)	
			98	Female Voice - 1 (Loop)	
			99	Male Voice - 1 (Loop)	
			100	Male Voice - 2 (Loop)	
			101	Spectrum - 1 (Loop)	
			102	Spectrum - 2 (Loop)	
			103	Spectrum - 3 (Loop)	
			104	Spectrum - 4 (Loop)	
			105	Spectrum - 5 (Loop)	
			106	Spectrum - 6 (Loop)	
			107	Spectrum - 7 (Loop)	
			108	Spectrum - 8 (Loop)	
			109	Spectrum - 9 (Loop)	
			110	Spectrum - 10 (Loop)	
			111	Noise (Loop)	
			112	Shot - 1	Decaying Sounds
			113	Shot - 2	
			114	Shot - 3	
			115	Shot - 4	
			116	Shot - 5	
			117	Shot - 6	
			118	Shot - 7	
			119	Shot - 8	
			120	Shot - 9	
			121	Shot - 10	
			122	Shot - 11	
			123	Shot - 12	
			124	Shot - 13	
			125	Shot - 14	
			126	Shot - 15	
			127	Shot - 16	
			128	Shot - 17	

6. PCM Sound List

Bank 2

No.	PCM Sound Name	Comment	No.	PCM Sound Name	Comment
1	Bass Drum - 1 *	Rhythm Sounds (master tune will not affect the pitch)	65	Loop - 35	
2	Bass Drum - 2 *		66	Loop - 36	
3	Bass Drum - 3 *		67	Loop - 37	
4	Snare Drum - 1 *		68	Loop - 38	
5	Snare Drum - 2 *		69	Loop - 39	
6	Snare Drum - 3 *		70	Loop - 40	
7	Snare Drum - 4 *		71	Loop - 41	
8	Tom Tom - 1 *		72	Loop - 42	
9	Tom Tom - 2 *		73	Loop - 43	
10	High - Hat *		74	Loop - 44	
11	High - Hat * (Loop)		75	Loop - 45	
12	Crash Cymbal - 1 *		76	Loop - 46	
13	Crash Cymbal - 2 * (Loop)		77	Loop - 47	
14	Ride Cymbal - 1 *		78	Loop - 48	
15	Ride Cymbal - 2 * (Loop)		79	Loop - 49	
16	Cup *		80	Loop - 50	
17	China Cymbal - 1 *		81	Loop - 51	
18	China Cymbal - 2 * (Loop)		82	Loop - 52	
19	Rim Shot *		83	Loop - 53	
20	Hand Clap *		84	Loop - 54	
21	Mute High Conga *		85	Loop - 55	
22	Conga *		86	Loop - 56	
23	Bongo *		87	Loop - 57	
24	Cowbell *		88	Loop - 58	
25	Tambourine *		89	Loop - 59	
26	Agogo *		90	Loop - 60	
27	Claves *		91	Loop - 61	
28	Timbale High *		92	Loop - 62	
29	Timbale Low *		93	Loop - 63	
30	Cabasa *		94	Loop - 64	
31	Loop - 1	Sound Effects (a loop of the same sound)	95	Jam - 1 (Loop)	Sound Effects (a loop of several sounds)
32	Loop - 2		96	Jam - 2 (Loop)	
33	Loop - 3		97	Jam - 3 (Loop)	
34	Loop - 4		98	Jam - 4 (Loop)	
35	Loop - 5		99	Jam - 5 (Loop)	
36	Loop - 6		100	Jam - 6 (Loop)	
37	Loop - 7		101	Jam - 7 (Loop)	
38	Loop - 8		102	Jam - 8 (Loop)	
39	Loop - 9		103	Jam - 9 (Loop)	
40	Loop - 10		104	Jam - 10 (Loop)	
41	Loop - 11		105	Jam - 11 (Loop)	
42	Loop - 12		106	Jam - 12 (Loop)	
43	Loop - 13		107	Jam - 13 (Loop)	
44	Loop - 14		108	Jam - 14 (Loop)	
45	Loop - 15		109	Jam - 15 (Loop)	
46	Loop - 16		110	Jam - 16 (Loop)	
47	Loop - 17		111	Jam - 17 (Loop)	
48	Loop - 18		112	Jam - 18 (Loop)	
49	Loop - 19		113	Jam - 19 (Loop)	
50	Loop - 20		114	Jam - 20 (Loop)	
51	Loop - 21		115	Jam - 21 (Loop)	
52	Loop - 22		116	Jam - 22 (Loop)	
53	Loop - 23		117	Jam - 23 (Loop)	
54	Loop - 24		118	Jam - 24 (Loop)	
55	Loop - 25		119	Jam - 25 (Loop)	
56	Loop - 26		120	Jam - 26 (Loop)	
57	Loop - 27		121	Jam - 27 (Loop)	
58	Loop - 28		122	Jam - 28 (Loop)	
59	Loop - 29		123	Jam - 29 (Loop)	
60	Loop - 30		124	Jam - 30 (Loop)	
61	Loop - 31		125	Jam - 31 (Loop)	
62	Loop - 32		126	Jam - 32 (Loop)	
63	Loop - 33		127	Jam - 33 (Loop)	
64	Loop - 34		128	Jam - 34 (Loop)	

7. Rhythm Setup (Factory Settings)

[Preset Rhythm Tones]

No.	Rhythm Tones	Number of Partials
r01	Closed High Hat - 1	1
r02	Closed High Hat - 2	1
r03	Open High Hat - 1	2
r04	Open High Hat - 2	2
r05	Crash Cymbal	2
r06	Crash Cymbal (short)	1
r07	Crash Cymbal (mute)	1
r08	Ride Cymbal	2
r09	Ride Cymbal (short)	1
r10	Ride Cymbal (mute)	1
r11	Cup	2
r12	Cup (mute)	1
r13	China Cymbal	2
r14	Splash Cymbal	1
r15	Bass Drum - 1	2
r16	Bass Drum - 2	1
r17	Bass Drum - 3	2
r18	Bass Drum - 4	1
r19	Snare Drum - 1	1
r20	Snare Drum - 2	1
r21	Snare Drum - 3	1
r22	Snare Drum - 4	2
r23	Snare Drum - 5	1
r24	Snare Drum - 6	1
r25	Rim Shot	1
r26	Brush - 1	2
r27	Brush - 2	2
r28	High Tom Tom - 1	1
r29	Middle Tom Tom - 1	1
r30	Low Tom Tom - 1	1
r31	High Tom Tom - 2	1
r32	Middle Tom Tom - 2	1
r33	Low Tom Tom - 2	1
r34	High Tom Tom - 3	2
r35	Middle Tom Tom - 3	2
r36	Low Tom Tom - 3	2
r37	High Pitch Tom Tom - 1	1
r38	High Pitch Tom Tom - 2	1
r39	Hand Clap	1
r40	Tambourine	1
r41	Cowbell	1
r42	High Bongo	1
r43	Low Bongo	1
r44	High Conga (mute)	1
r45	High Conga	1
r46	Low Conga	1
r47	High Timbale	1
r48	Low Timbale	1
r49	High Agogo	1
r50	Low Agogo	1
r51	Cabasa	1
r52	Maracas	1
r53	Short Whistle	2
r54	Long Whistle	2
r55	Quijada	3
r56	Claves	1
r57	Castanets	2
r58	Triangle	2
r59	Wood Block	1
r60	Bell	2
r61	Native Drum - 1	1
r62	Native Drum - 2	1
r63	Native Drum - 3	1
OFF		0

[Preprogrammed Rhythm Setup]

Rhythm Tones (Tone No.)	Note Number	
Native Drum - 3 (r63)	97	C7
Native Drum - 2 (r62)	96	
Native Drum - 1 (r61)	95	
Ride Cymbal (short) (r09)	94	C6
High Tom Tom - 3 (r34)	93	
Crash Cymbal (short) (r06)	92	
Middle Tom Tom - 3 (r35)	91	C5
Closed High Hat - 2 (r02)	90	
Low Tom Tom - 3 (r36)	89	
Snare Drum - 6 (r24)	88	C4
Snare Drum - 5 (r23)	87	
Snare Drum - 4 (r22)	86	
Bass Drum - 4 (r18)	85	C3
Bass Drum - 3 (r17)	84	
Bell (r60)	83	
Wood Block (r59)	82	C2
High Pitch Tom Tom - 1 (r37)	81	
Triangle (r58)	80	
High Pitch Tom Tom - 2 (r38)	79	C1
Castanets (r57)	78	
Brush - 2 (r27)	77	
Brush - 1 (r26)	76	C0
Claves (r56)	75	
Cup (mute) (r12)	74	
Quijada (r55)	73	C7
Long Whistle (r54)	72	
Short Whistle (r53)	71	
Maracas (r52)	70	C6
Cabasa (r51)	69	
Low Agogo (r50)	68	
High Agogo (r49)	67	C5
Low Timbale (r48)	66	
High Timbale (r47)	65	
Low Conga (r46)	64	C4
High Conga (r45)	63	
High Conga (mute) (r44)	62	
Low Bongo (r43)	61	C3
High Bongo (r42)	60	
Ride Cymbal (mute) (r10)	59	
Snare Drum - 3 (r21)	58	C2
Crash Cymbal (mute) (r07)	57	
Cowbell (r41)	56	
Splash Cymbal (r14)	55	C1
Tambourine (r40)	54	
Cup (r11)	53	
China Cymbal (r13)	52	C0
Ride Cymbal (r08)	51	
High Tom Tom - 2 (r31)	50	
Crash Cymbal (r05)	49	C7
High Tom Tom - 1 (r28)	48	
Middle Tom Tom - 2 (r32)	47	
Open High Hat - 1 (r03)	46	C6
Middle Tom Tom - 1 (r29)	45	
Open High Hat - 2 (r04)	44	
Low Tom Tom - 2 (r33)	43	C5
Closed High Hat - 1 (r01)	42	
Low Tom Tom - 2 (r30)	41	
Snare Drum - 2 (r20)	40	C4
Hand Clap (r39)	39	
Snare Drum - 1 (r19)	38	
Rim Shot (r25)	37	C3
Bass Drum - 2 (r16)	36	
Bass Drum - 1 (r15)	35	

8. Preset Tones

a Group

No.	Tone Name	Number of Partials
01	AcouPiano1	3
02	AcouPiano2	2
03	AcouPiano3	2
04	Honky-Tonk	3
05	ElecPiano1	3
06	ElecPiano2	3
07	ElecPiano3	2
08	ElecPiano4	1
09	ElecOrgan1	4
10	ElecOrgan2	2
11	ElecOrgan3	2
12	ElecOrgan4	1
13	PipeOrgan1	3
14	PipeOrgan2	3
15	PipeOrgan3	2
16	Accordion	2
17	Harpsi 1	3
18	Harpsi 2	2
19	Harpsi 3	1
20	Clav 1	3
21	Clav 2	2
22	Clav 3	2
23	Celesta 1	3
24	Celesta 2	2
25	Violin 1	3
26	Violin 2	2
27	Cello 1	3
28	Cello 2	2
29	Contrabass	2
30	Pizzicato	3
31	Harp 1	3
32	Harp 2	2
33	Strings 1	4
34	Strings 2	3
35	Strings 3	2
36	Strings 4	3
37	Brass 1	4
38	Brass 2	3
39	Brass 3	4
40	Brass 4	4
41	Trumpet 1	3
42	Trumpet 2	2
43	Trombone 1	3
44	Trombone 2	2
45	Horn	3
46	Fr Horn	2
47	Engl Horn	2
48	Tuba	2
49	Flute 1	4
50	Flute 2	2
51	Piccolo	3
52	Recorder	2
53	Pan Pipes	3
54	Bottleblow	3
55	Breathpipe	4
56	Whistle	2
57	Sax 1	2
58	Sax 2	2
59	Sax 3	2
60	Clarinet 1	2
61	Clarinet 2	3
62	Oboe	3
63	Bassoon	2
64	Harmonica	2

b Group

No.	Tone Name	Number of Partials
01	Fantasy	4
02	Harmo Pan	4
03	Chorale	3
04	Glasses	3
05	Soundtrack	4
06	Atmosphere	4
07	Warm Bell	4
08	Space Horn	4
09	Echo Bell	3
10	Ice Rains	4
11	Oboe 2002	2
12	Echo Pan	2
13	Bell Swing	3
14	Reso Synth	2
15	Steam Pad	3
16	VibeString	4
17	Syn Lead 1	4
18	Syn Lead 2	2
19	Syn Lead 3	2
20	Syn Lead 4	2
21	Syn Bass 1	3
22	Syn Bass 2	2
23	Syn Bass 3	2
24	Syn Bass 4	3
25	AcouBass 1	2
26	AcouBass 2	1
27	ElecBass 1	2
28	ElecBass 2	2
29	SlapBass 1	2
30	SlapBass 2	3
31	Fretless 1	4
32	Fretless 2	2
33	Vibe	2
34	Glock	3
35	Marimba	3
36	Xylophone	2
37	Guitar 1	3
38	Guitar 2	3
39	Elec Gtr 1	4
40	Elec Gtr 2	4
41	Koto	2
42	Shamisen	2
43	Jamisen	2
44	Sho	4
45	Shakuhachi	4
46	WadaikoSet	4
47	Sitar	4
48	Steel Drum	4
49	Tech Snare	4
50	Elec Tom	4
51	Revrse Cym	2
52	Ethno Hit	4
53	Timpani	2
54	Triangle	2
55	Wind Bell	3
56	Tube Bell	4
57	Orche Hit	4
58	Bird Tweet	1
59	OneNoteJam	4
60	Telephone	1
61	Typewriter	2
62	Insect	2
63	WaterBells	3
64	JungleTune	4

9. Blank Charts

a. Patch/Timbre

Patch Parameters

No.	Patch Name		
Patch Effect			
Key Mode			
Split Point			
Tone	Upper		
	Lower		
		Lower	Upper
Key Shift			
Fine Tune			
Bender Range			
Assign Mode			
Effect Rate			
Harmony Bal.			
Chase Level			
Chase Shift			
Arp. Mode			
Tone Bal.			
Patch Level			

No.	Patch Name		
Patch Effect			
Key Mode			
Split Point			
Tone	Upper		
	Lower		
		Lower	Upper
Key Shift			
Fine Tune			
Bender Range			
Assign Mode			
Effect Rate			
Harmony Bal.			
Chase Level			
Chase Shift			
Arp. Mode			
Tone Bal.			
Patch Level			

Timbre Parameters

No.	Tone Select	
Key Shift		
Fine Tune		
Bender Range		
Assign Mode		

No.	Tone Select	
Key Shift		
Fine Tune		
Bender Range		
Assign Mode		

No.	Tone Select	
Key Shift		
Fine Tune		
Bender Range		
Assign Mode		

No.	Tone Select	
Key Shift		
Fine Tune		
Bender Range		
Assign Mode		

9. Blank Charts

b. Tone

Tone No.						
OPERATION		PARAMETER	VALUE			
GROUP	BANK					
Common	1	Tone Name				
	2	Structure 1&2	<input type="text"/>	<input type="text"/>	<input type="text"/>	<input type="text"/>
	3	Structure 3&4	<input type="text"/>	<input type="text"/>	<input type="text"/>	<input type="text"/>
	4	ENV Mode				
WG Pitch/Mod	1	WG Pitch Coarse				
	2	WG Pitch Fine				
	3	WG Pitch KF				
	4	LFO Rate				
	5	LFO Depth				
	6	WG Modulation				
	7	WG Bender Switch				
WG Form/ENV	1	WG Waveform				
	2	WG PCM Wave Bank				
	3	WG PCM Wave No.				
	4	WG Pulse Width				
	5	WG PW Velocity				
	6	P-ENV Depth				
	7	P-ENV Velocity				
	8	P-ENV Time KF				
WG P-ENV	1	P-ENV Time 1				
	2	P-ENV Time 2				
	3	P-ENV Time 3				
	4	P-ENV Time 4				
	5	P-ENV Level 0				
	6	P-ENV Level 1				
	7	P-ENV Level 2				
	8	P-ENV End Level				
Partial Mute						
Partial			1	2	3	4

OPERATION		PARAMETER	VALUE			
GROUP	BANK					
TVF Freq/ENV	1	TVF Cutoff Freq				
	2	TVF Resonance				
	3	TVF Freq KF				
	4	TVF Bias Point				
	5	TVF Bias Level				
	6	TVF ENV Depth				
	7	TVF ENV Velocity				
	8	TVF ENV Depth KF				
TVF ENV	1	TVF ENV Time KF				
	2	TVF ENV Time 1				
	3	TVF ENV Time 2				
	4	TVF ENV Time 3				
	5	TVF ENV Time 4				
	6	TVF ENV Level 1				
	7	TVF ENV Level 2				
	8	TVF ENV Sus Levl				
TVA Level	1	TVA Level				
	2	TVA Velocity				
	3	TVA Bias Point 1				
	4	TVA Bias Level 1				
	5	TVA Bias Point 2				
	6	TVA Bias Level 2				
	7	TVA ENV TI Velo				
TVA ENV	1	TVA ENV Time KF				
	2	TVA ENV Time 1				
	3	TVA ENV Time 2				
	4	TVA ENV Time 3				
	5	TVA ENV Time 4				
	6	TVA ENV Level 1				
	7	TVA ENV Level 2				
	8	TVA ENV Sus Levl				
Partial Mute						
Partial			1	2	3	4

c. Rhythm setup

Note No.	Tone No.	Tone name	Level	Pan	
108					C8
107					
106					
105					
104					
103					
102					
101					
100					
99					
98					
97					
96					C7
95					
94					
93					
92					
91					
90					
89					
88					
87					
86					
85					
84					C6
83					
82					
81					
80					
79					
78					
77					
76					
75					
74					
73					
72					C5
71					
70					
69					
68					
67					
66					
65					
64					
63					
62					
61					
60					C4

Note No.	Tone No.	Tone name	Level	Pan	
59					
58					
57					
56					
55					
54					
53					
52					
51					
50					
49					
48					C3
47					
46					
45					
44					
43					
42					
41					
40					
39					
38					
37					
36					C2
35					
34					
33					
32					
31					
30					
29					
28					
27					
26					
25					
24					C1

Roland Exclusive Messages

1. Data Format for Exclusive Messages

Roland's MIDI implementation uses the following data format for all exclusive messages (type IV):

Byte	Description
F0H	Exclusive status
41H	Manufacturer ID (Roland)
DEV	Device ID
MDL	Model ID
CMD	Command ID
[BODY]	Main data
F7H	End of exclusive

MIDI status : F0H, F7H

An exclusive message must be flanked by a pair of status codes, starting with a Manufacturer - ID immediately after F0H (MIDI version 1.0).

Manufacturer - ID : 41H

The Manufacturer - ID identifies the manufacturer of a MIDI instrument that triggers an exclusive message. Value 41H represents Roland's Manufacturer - ID.

Device - ID : DEV

The Device - ID contains a unique value that identifies the individual device in the multiple implementation of MIDI instruments. It is usually set to 00H - 0FH, a value smaller by one than that of a basic channel, but value 00H - 1FH may be used for a device with multiple basic channels.

Model - ID : MDL

The Model - ID contains a value that uniquely identifies one model from another. Different models, however, may share an identical Model - ID if they handle similar data.

The Model - ID format may contain 00H in one or more places to provide an extended data field. The following are examples of valid Model - IDs, each representing a unique model:

01H
02H
03H
00H, 01H
00H, 02H
00H, 00H, 01H

Command - ID : CMD

The Command - ID indicates the function of an exclusive message. The Command - ID format may contain 00H in one or more places to provide an extended data field. The following are examples of valid Command - IDs, each representing a unique function:

01H
02H
03H
00H, 01H
00H, 02H
00H, 00H, 01H

Main data : BODY

This field contains a message to be exchanged across an interface. The exact data size and contents will vary with the Model - ID and Command - ID.

2. Address - mapped Data Transfer

Address mapping is a technique for transferring messages conforming to the data format given in Section 1. It assigns a series of memory - resident records -- waveform and tone data, switch status, and parameters, for example -- to specific locations in a machine - dependent address space, thereby allowing access to data residing at the address a message specifies.

Address - mapped data transfer is therefore independent of models and data categories. This technique allows use of two different transfer procedures: one - way transfer and handshake transfer.

One - way transfer procedure (See Section 3 for details.)

This procedure is suited for the transfer of a small amount of data. It sends out an exclusive message completely independent of a receiving device status.

Connection Diagram

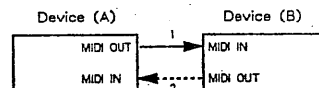

Connection at point 2 is essential for "Request data" procedures. (See Section 3.)

Handshake - transfer procedure (See Section 4 for details.)

This procedure initiates a predetermined transfer sequence (handshaking) across the interface before data transfer takes place. Handshaking ensures that reliability and transfer speed are high enough to handle a large amount of data.

Connection Diagram

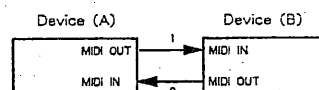

Connection at points 1 and 2 is essential.

Notes on the above two procedures

- * There are separate Command - IDs for different transfer procedures.
- * Devices A and B cannot exchange data unless they use the same transfer procedure, share identical Device - ID and Model ID, and are ready for communication.

3. One - way Transfer Procedure

This procedure sends out data all the way until it stops and is used when the messages are so short that answerbacks need not be checked.

For long messages, however, the receiving device must acquire each message in time with the transfer sequence, which inserts intervals of at least 20 milliseconds in between.

Types of Messages

Message	Command ID
Request data 1	RQ1 (11H)
Data set 1	DT1 (12H)

Request data #1 : RQ1 (11H)

This message is sent out when there is a need to acquire data from a device at the other end of the interface. It contains data for the address and size that specify designation and length, respectively, of data required.

On receiving an RQ1 message, the remote device checks its memory for the data address and size that satisfy the request.

If it finds them and is ready for communication, the device will transmit a "Data set 1 (DT1)" message, which contains the requested data. Otherwise, the device will send out nothing.

Byte	Description
F0H	Exclusive status
41H	Manufacturer ID (Roland)
DEV	Device ID
MDL	Model ID
11H	Command ID
aaH	Address MSB
⋮	⋮
⋮	LSB
ssH	Size MSB
⋮	⋮
⋮	LSB
sum	Check sum
F7H	End of exclusive

- *The size of the requested data does not indicate the number of bytes that will make up a DT1 message, but represents the address fields where the requested data resides.
- *Some models are subject to limitations in data format used for a single transaction. Requested data, for example, may have a limit in length or must be divided into predetermined address fields before it is exchanged across the interface.
- *The same number of bytes comprises address and size data, which, however, vary with the Model - ID.
- *The error checking process uses a checksum that provides a bit pattern where the least significant 7 bits are zero when values for an address, size, and that checksum are summed.

Data set 1 : DT1 (12H)

This message corresponds to the actual data transfer process. Because every byte in the data is assigned a unique address, a DT1 message can convey the starting address of one or more data as well as a series of data formatted in an address - dependent order.

The MIDI standards inhibit non - real time messages from interrupting an exclusive one. This fact is inconvenient for the devices that support a "soft - through" mechanism. To maintain compatibility with such devices, Roland has limited the DT1 to 256 bytes so that an excessively long message is sent out in separate segments.

Byte	Description
FOH	Exclusive
41H	Manufacturer ID (Roland)
DEV	Device ID
MDL	Model ID
12H	Command ID
aaH	Address MSB
⋮	⋮
	LSB
ddH	Data
⋮	⋮
sum	Check sum
F7H	End of exclusive

- *A DT1 message is capable of providing only the valid data among those specified by an RQ1 message.
- *Some models are subject to limitations in data format used for a single transaction. Requested data, for example, may have a limit in length or must be divided into predetermined address fields before it is exchanged across the interface.
- *The number of bytes comprising address data varies from one Model - ID to another.
- *The error checking process uses a checksum that provides a bit pattern where the least significant 7 bits are zero when values for an address, size, and that checksum are summed.

Example of Message Transactions

- Device A sending data to Device B
Transfer of a DT1 message is all that takes place.

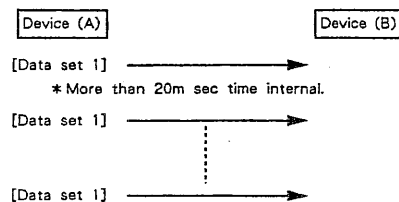

- Device B requesting data from Device A
Device B sends an RQ1 message to Device A. Checking the message, Device A sends a DT1 message back to Device B.

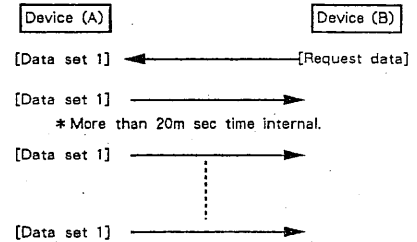

4 Handshake - Transfer Procedure

Handshaking is an interactive process where two devices exchange error checking signals before a message transaction takes place, thereby increasing data reliability. Unlike one - way transfer that inserts a pause between message transactions, handshake transfer allows much speedier transactions because data transfer starts once the receiving device returns a ready signal.

When it comes to handling large amounts of data -- sampler waveforms and synthesizer tones over the entire range, for example -- across a MIDI interface, handshaking transfer is more efficient than one - way transfer.

Types of Messages

Message	Command ID
Want to send data	WSD (40H)
Request data	RQD (41H)
Data set	DAT (42H)
Acknowledge	ACK (43H)
End of data	EOD (45H)
Communication error	ERR (4EH)
Rejection	RJC (4FH)

Want to send data : WSD (40H)

This message is sent out when data must be sent to a device at the other end of the interface. It contains data for the address and size that specify designation and length, respectively, of the data to be sent.

On receiving a WSD message, the remote device checks its memory for the specified data address and size which will satisfy the request. If it finds them and is ready for communication, the device will return an "Acknowledge (ACK)" message. Otherwise, it will return a "Rejection (RJC)" message.

Byte	Description
FOH	Exclusive status
41H	Manufacturer ID (Roland)
DEV	Device ID
MDL	Model ID
40H	Command ID
aaH	Address MSB
⋮	⋮
	LSB
ssH	Size MSB
⋮	⋮
	LSB
sum	Check sum
F7H	End of exclusive

- *The size of the data to be sent does not indicate the number of bytes that make up a "Data set (DAT)" message, but represents the address fields where the data should reside.
- *Some models are subject to limitations in data format used for a single transaction. Requested data, for example, may have a limit in length or must be divided into predetermined address fields before it is exchanged across the interface.
- *The same number of bytes comprises address and size data, which, however, vary with the Model - ID.
- *The error checking process uses a checksum that provides a bit pattern where the least significant 7 bits are zero when values for an address, size, and that checksum are summed.

Request data : RQD (41H)

This message is sent out when there is a need to acquire data from a device at the other end of the interface. It contains data for the address and size that specify designation and length, respectively, of data required.

On receiving an RQD message, the remote device checks its memory for the data address and size which satisfy the request. If it finds them and is ready for communication, the device will transmit a "Data set (DAT)" message, which contains the requested data. Otherwise, it will return a "Rejection (RJC)" message.

Byte	Description
F0H	Exclusive status
41H	Manufacturer ID (Roland)
DEV	Device ID
MDL	Model ID
41H	Command ID
aaH	Address MSB
⋮	⋮
	LSB
ssH	Size MSB
⋮	⋮
	LSB
sum	Check sum
F7H	End of exclusive

- *The size of the requested data does not indicate the number of bytes that make up a "Data set (DAT)" message, but represents the address fields where the requested data resides.
- *Some models are subject to limitations in data format used for a single transaction. Requested data, for example, may have a limit in length or must be divided into predetermined address fields before it is exchanged across the interface.
- *The same number of bytes comprises address and size data, which, however, vary with the Model - ID.
- *The error checking process uses a checksum that provides a bit pattern where the least significant 7 bits are zero when values for an address, size, and that checksum are summed.

Data set : DAT (42H)

This message corresponds to the actual data transfer process. Because every byte in the data is assigned a unique address, the message can convey the starting address of one or more data as well as a series of data formatted in an address - dependent order.

Although the MIDI standards inhibit non - real time messages from interrupting an exclusive one, some devices support a "soft - through" mechanism for such interrupts. To maintain compatibility with such devices, Roland has limited the DAT to 256 bytes so that an excessively long message is sent out in separate segments.

Byte	Description
F0H	Exclusive status
41H	Manufacturer ID (Roland)
DEV	Device ID
MDL	Model ID
42H	Command ID
aaH	Address MSB
⋮	⋮
	LSB
ddH	Data
⋮	⋮
sum	Check sum
F7H	End of exclusive

*A DAT message is capable of providing only the valid data among those specified by an RQD or WSD message.

- *Some models are subject to limitations in data format used for a single transaction. Requested data, for example, may have a limit in length or must be divided into predetermined address fields before it is exchanged across the interface.
- *The number of bytes comprising address data varies from one model ID to another.
- *The error checking process uses a checksum that provides a bit pattern where the least significant 7 bits are zero when values for an address, size, and that checksum are summed.

Acknowledge : ACK (43H)

This message is sent out when no error was detected on reception of a WSD, DAT, "End of data (EOD)", or some other message and a requested setup or action is complete. Unless it receives an ACK message, the device at the other end will not proceed to the next operation.

Byte	Description
F0H	Exclusive status
41H	Manufacturer ID (Roland)
DEV	Device ID
MDL	Model ID
43H	Command ID
F7H	End of exclusive

End of data : EOD (45H)

This message is sent out to inform a remote device of the end of a message. Communication, however, will not come to an end unless the remote device returns an ACK message even though an EOD message was transmitted.

Byte	Description
F0H	Exclusive status
41H	Manufacturer ID (Roland)
DEV	Device ID
MDL	Model ID
45H	Command ID
F7H	End of exclusive

Communications error : ERR (4EH)

This message warns the remote device of a communications fault encountered during message transmission due, for example, to a checksum error. An ERR message may be replaced with a "Rejection (RJC)" one, which terminates the current message transaction in midstream.

When it receives an ERR message, the sending device may either attempt to send out the last message a second time or terminate communication by sending out an RJC message.

Byte	Description
F0H	Exclusive status
41H	Manufacturer ID (Roland)
DEV	Device ID
MDL	Model ID
4EH	Command ID
F7H	End of exclusive

Rejection : RJC (4FH)

This message is sent out when there is a need to terminate communication by overriding the current message. An RJC message will be triggered when :

- a WSD or RQD message has specified an illegal data address or size.
- the device is not ready for communication.
- an illegal number of addresses or data has been detected.
- data transfer has been terminated by an operator.
- a communications error has occurred.

An ERR message may be sent out by a device on either side of the interface. Communication must be terminated immediately when either side triggers an ERR message.

Byte	Description
FOH	Exclusive status
41H	Manufacturer ID (Roland)
DEV	Device ID
MDL	Model ID
4FH	Command ID
F7H	End of exclusive

Example of Message Transactions

- Data transfer from device (A) to device (B).

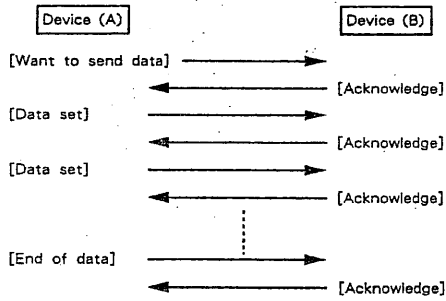

- Device (A) requests and receives data from device (B).

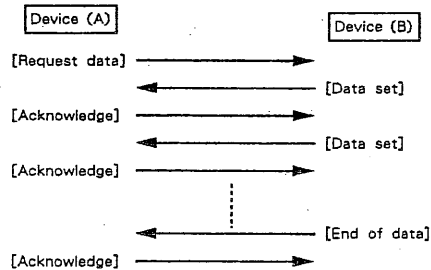

- Error occurs while device (A) is receiving data from device (B).

- 1) Data transfer from device (A) to device (B).

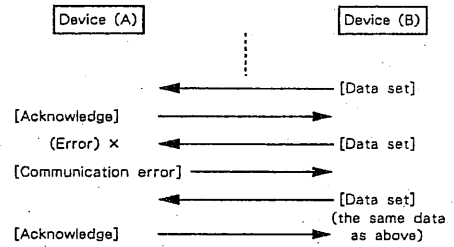

- 2) Device (B) rejects the data re-transmitted, and quits data transfer.

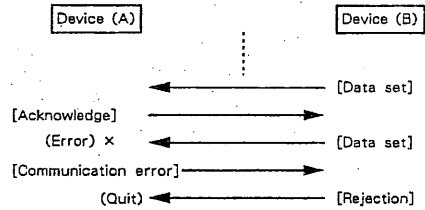

- 3) Device (A) immediately quits data transfer.

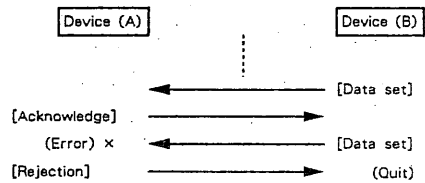

1. TRANSMITTED DATA (Synthesizer section)

■ Note event

Note off

Status	Second	Third
8nH	kkH	vvH

kk = Note number

* In Performance mode : 0H - 7FH (0 - 127)

* In Multi Timbral mode : 18H - 6CH (24 - 108)

vv = Velocity 0H - 7FH (0 - 127)

n = MIDI channel No. 0H - FH (1 - 16)

Note on

Status	Second	Third
9nH	kkH	vvH

kk = Note number

* In Performance mode : 0H - 7FH (0 - 127)

* In Multi Timbral mode : 18H - 6CH (24 - 108)

vv = Velocity 01H - 7FH (1 - 127)

n = MIDI channel No. 0H - FH (1 - 16)

■ Control change

Modulation depth

Status	Second	Third
BnH	01H	vvH

vv = Modulation depth 00H - 7FH (0 - 127)

n = MIDI channel No. 0H - FH (1 - 16)

In Performance mode, transmitted when MIDI Modulation function is on.

Hold 1

Status	Second	Third
BnH	40H	vvH

vv = 00H (0) : off

vv = 7FH (127) : on

n = MIDI channel No. 0H - FH (1 - 16)

In Performance mode, transmitted when MIDI Hold function is on.

Reset all controllers

Status	Second	Third
BnH	79H	00H

n = MIDI channel No. 0H - FH (1 - 16)

Transmitting upon changing modes (Performance <-> Multi Timbral) or MIDI channels (on the previous channel).

■ Program change

Status	Second
CnH	ppH

pp = Program number 00H - 7FH (1 - 128)

n = MIDI channel No. 0H - FH (1 - 16)

Transmitted when changing Patches/Timbres using A/B, BANK, NUMBER buttons on the D-5, and under following conditions.

In Performance mode, transmitted when MIDI Program change function is on.

In Multi Timbral mode, transmitted only when the LCD is showing the status of keyboard.

pp	A/B	BANK	NUMBER
00H (01)	A	1	1
:	:	:	:
3FH (64)	A	8	8
40H (65)	B	1	1
:	:	:	:
7FH (128)	B	8	8

■ Pitch bender

Status	Second	Third
EnH	lIH	mmH

ll = Pitch bend change value (LSB)

mm = Pitch bend change value (MSB)

n = MIDI channel No. 0H - FH (0 - 16)

In Performance mode, transmitted when MIDI Bender function is on.

■ Mode messages

Omni off

Status	Second	Third
BnH	7CH	00H

n = MIDI channel No. 0H - FH (1 - 16)

This message is transmitted on the following conditions and always accompanied by 'Poly'.

1. When D-5 is power-up, the message is transmitted through the MIDI transmit channel that has been set by MIDI function.
2. When changing MIDI TX channel, the message is transmitted through the new channel.

Poly

Status	Second	Third
BnH	7FH	00H

This message is transmitted on the following conditions and always accompanied by 'Omni off'.

1. When D-5 is power-up, the message transmitted on the MIDI transmit channel that has been set by MIDI function.
2. When changing MIDI TX channel, the message transmitted on the new channel.

■ Exclusive

Status	
F0H	: System exclusive
F7H	: End of Exclusive

A set of Patch/Timbre parameters is transmitted using MIDI Exclusive messages. Also used for Bulk dump/load operation. Refer to section 5 and 'Roland Exclusive Messages' for details.

■ Active sensing

Status
FEH

Transmitted for checking MIDI connection between D-5 and external equipment.

2. TRANSMITTED DATA (Rhythm section)

■ Exclusive

Status	
F0H	: System exclusive
F7H	: End of Exclusive

Bulk dump/load can be operated using the Exclusive messages. Refer to section 5 and 'Roland Exclusive Messages' for details.

3. RECOGNIZED RECEIVE DATA (Synthesizer section)

■ Note event

Note off

Status	Second	Third
8nH	kkH	vvH
9nH	kkH	00H

kk = Note number 00H - 7FH (0 - 127)
 vv = Velocity ignored
 n = MIDI channel No. 0H - FH (1 - 16)

Note on

Status	Second	Third
9nH	kkH	vvH

kk = Note number 00H - 7FH (0 - 127)
 vv = Velocity 01H - 7FH (1 - 127)
 n = MIDI channel No. 0H - FH (1 - 16)

Note numbers outside of the range 12 - 108 are transposed to the nearest octave inside the range.

■ Control change

Modulation depth

Status	Second	Third
BnH	01H	vvH

vv = Modulation depth 00H - 7FH (0 - 127)
 n = MIDI channel No. 0H - FH (1 - 16)

In Performance mode, recognized when MIDI Modulation function is on.
 In Multi Timbral mode, always recognized.

Breath

Status	Second	Third
BnH	02H	vvH

vv = Breath 00H - 7FH (0 - 127)

Recognized as expression or modulation according to MIDI Breath function.

Data entry

Status	Second	Third
BnH	06H	vvH

vv = Value of RPN (see RPN MSB section)
 n = MIDI channel No.

Main volume

Status	Second	Third
BnH	07H	vvH

Can control the volume of the Part played through the same MIDI channel. The maximum volume is determined also by the Volume knob and Expression message.
 In Performance mode, recognized when MIDI Volume function is on.
 In Multi Timbral mode, always recognized.

Panpot

Status	Second	Third
BnH	0AH	vvH

vvH = Panpot value 00H - 7FH (0 - 127)
 n = MIDI channel No. 0H - FH (1 - 16)

Expression

Status	Second	Third
BnH	0BH	vvH

vv = Expression value 00H - 7FH (0 - 127)
 n = MIDI channel No. 0H - FH (1 - 16)

Can control the volume of the Parts played through the same MIDI channel. The maximum volume is determined also the Volume knob and Main Volume message.
 In Performance mode, recognized when MIDI Expression function is on.
 In Multi Timbral mode, always recognized.

Hold 1

Status	Second	Third
BnH	40H	vvH

vv = 00H - 3FH (0 - 63) : off
 vv = 40H - 7FH (64 - 127) : on
 n = MIDI channel No. 0H - FH (1 - 16)

In Performance mode, recognized when MIDI Hold function is on.
 In Multi Timbral mode, always recognized.

RPN LSB

Status	Second	Third
BnH	64H	vvH

vv = LSB of the parameter number controlled by RPN (see RPN MSB section)
 n = MIDI channel No. 0H - FH (1 - 16)

RPN MSB

Status	Second	Third
BnH	65H	vvH

vv = MSB of the parameter number controlled by RPN
 n = MIDI channel No. 0H - FH (1 - 16)

Using MIDI RPN, parameters can be changed by Control change messages.
 RPN MSB and LSB specify the parameter to be controlled, while Data entry shows the parameter value.

Only the Bender range is controllable by RPN on D-5.

RPN	data entry	comments
MSB LSB		
00H 00H	vvH	Bender range
		vv = 0 - 24
		can be set within
		2 octaves by semitone

Reset all controllers

Status	Second	Third
BnH	79H	00H

n = MIDI channel No. 0H - FH (1 - 16)

When Reset all controllers is recognized, each of the controllers is set as follows.

Controller	Setting
Pitch bender	+/- 0 (center)
Hold	0 (off)
Modulation	0 (min)

■ Program change

<u>Status</u>	<u>Second</u>
CnH	ppH

pp = Program change number 00H - 7FH (1 - 128)
n = MIDI channel No. 0H - FH (1 - 16)

In Performance mode, recognized when MIDI Program change function is on and then patch is changed.

In Multi Timbral mode, always recognized and the timbre is changed.

<u>pp</u>	<u>A/B</u>	<u>BANK</u>	<u>NUMBER</u>
00H (01)	A	1	1
:	:	:	:
3FH (64)	A	8	8
40H (65)	B	1	1
:	:	:	:
7FH (128)	B	8	8

■ Pitch bender

<u>Status</u>	<u>Second</u>	<u>Third</u>
EnH	lIH	mmH

ll = LSB of Pitch bend change value 00H - 7FH (0 - 127)
mm = MSB of Pitch bend change value 00H - 7FH (0 - 127)
n = MIDI channel No. 0H - FH (1 - 16)

In Performance mode, recognized when MIDI Bender function is on.
In Multi Timbral mode, always recognized.

■ Mode

Local control

<u>Status</u>	<u>Second</u>	<u>Third</u>
BnH	7AH	vvH

vv = 00H (0) : off
vv = 7FH (127) : on
n = MIDI channel No. 0H - FH (1 - 16)

All notes off

<u>Status</u>	<u>Second</u>	<u>Third</u>
BnH	7BH	00H

n = MIDI channel No. 0H - FH (1 - 16)

When All notes off is recognized, all the notes which have been turned on by MIDI Note on message are turned off.

Omni off

<u>Status</u>	<u>Second</u>	<u>Third</u>
BnH	7CH	00H

Recognized as All notes off only.
The D-5 stays in Mode 3 (Omni off, Poly).

Omni on

<u>Status</u>	<u>Second</u>	<u>Third</u>
BnH	7DH	00H

Recognized as All notes off only.
The D-5 stays in Mode 3 (Omni off, Poly).

Mono

<u>Status</u>	<u>Second</u>	<u>Third</u>
BnH	7EH	mmH

mm = MONO channel range ignored
n = MIDI channel 0H - FH (1 - 16)

Recognized as All notes off only.
The D-5 stays in Mode 3 (Omni off, Poly).

Poly

<u>Status</u>	<u>Second</u>	<u>Third</u>
BnH	7FH	00H

n = MIDI channel No. 0H - FH (1 - 16)

Recognized as All notes off only.

The D-5 stays in Mode 3 (Omni off, Poly).

■ Exclusive

<u>Status</u>	
F0H	: System Exclusive
F7H	: End of Exclusive

A set of Patch/Timbre parameters is transmitted using MIDI Exclusive messages. Also use Bulk dump/load operation.

Refer to section 5 and 'Roland Exclusive Messages' for details.

■ Active sensing

<u>Status</u>
FEH

Once receiving this message, the D-5 expects to accept status or data in sequence, at last within 300 msec intervals.

If the unit fails to receive a message 300 msec after previous one, it judges there is a problem somewhere in MIDI path, muting the current sound and setting each of controllers as below, then stopping 300 msec - interval monitoring of incoming signal.

```

+-----+
| Controller | Setting |
+-----+
| Pitch bender | +/- 0 (center) |
| Hold1 | 0 (off) |
| Modulation | 0 (min) |
+-----+

```

4. RECOGNIZED RECEIVE DATA (Rhythm section)

MIDI channel is the channel assigned for Rhythm part.

■ Note event

Note off

<u>Status</u>	<u>Second</u>	<u>Third</u>
8nH	kkH	vvH

kk = Note number 18H - 6CH (24 - 108)
vv = Velocity ignored
n = MIDI channel No. 0H - FH (1 - 16)

Note on

<u>Status</u>	<u>Second</u>	<u>Third</u>
9nH	kkH	vvH

kk = Note number 18H - 6CH (24 - 108)
vv = Velocity 01H - 7FH (1 - 127)
n = MIDI channel No. 0H - FH (1 - 16)

Note number outside of 24 - 108 are ignored.

■ Control change

Modulation depth

Status	Second	Third
BnH	01H	vvH

vv = Modulation depth 00H - 7FH (0 - 127)
 n = MIDI channel No. 0H - FH (1 - 16)

In Performance mode, recognized when MIDI Modulation function is on.
 In Multi Timbral mode, always recognized.

Breath

Status	Second	Third
BnH	02H	vvH

vv = Breath 0H - 7FH (0 - 127)

Recognized as expression or modulation according to MIDI Breath function.

Data entry

Status	Second	Third
BnH	06H	vvH

vv = Value of RPN (see RPN MSB section)
 n = MIDI channel No. 0H - FH (1 - 16)

Main volume

Status	Second	Third
BnH	07H	vvH

vv = Main volume 00H - 7FH (0 - 127)
 n = MIDI channel No. 0H - FH (1 - 16)

Can control volume of the Rhythm section. The maximum volume is determined also by the Volume knob and Expression message.

In Performance mode, recognized when MIDI Volume function is on.
 In Multi Timbral mode, always recognized.

Expression

Status	Second	Third
BnH	08H	vvH

vv = Expression 00H - 7FH (0 - 127)
 n = MIDI channel No. 0H - FH (1 - 16)

Can control volume of the Rhythm section. The maximum volume is determined also by the Volume knob and Main volume message.

Recognized when MIDI Expression function is on.

RPN LSB

Status	Second	Third
BnH	64H	vvH

vv = LSB of parameter number controlled by RPN (see RPN MSB)
 n = MIDI channel No. 0H - FH (1 - 16)

RPN MSB

Status	Second	Third
BnH	65H	vvH

vv = MSB of parameter number controlled by RPN
 n = MIDI channel No. 0H - FH (1 - 16)

RPN MSB and LSB specify the parameter to be controlled, while Data entry shows the parameter value.

Only the Bender range is controllable by RPN on D-5.

RPN	data entry	comments
MSB LSB		
00H 00H	vvH	Bender range
		vv = 0 - 24
		can be set within
		2 octaves by semitone

Reset all controllers

Status	Second	Third
BnH	79H	00H

n = MIDI channel No. 0H - FH (1 - 16)

When Reset all controllers is recognized, each of the controllers is set as follows.

Controller	Setting
Pitch bender	+/- 0 (center)
Hold	0 (off)
Modulation	0 (min)

■ Pitch bender

Status	Second	Third
EnH	0H	mmH

ll = LSB of Pitch bend change value 00H - 7FH (0 - 127)
 mm = MSB of Pitch bend change value 00H - 7FH (0 - 127)
 n = MIDI channel No. 0H - FH (1 - 16)

■ Exclusive

Status	Setting
F0H	: System Exclusive
F7H	: End of Exclusive

A set of Patch/Timbre parameters is transmitted using MIDI Exclusive messages. Also use Bulk dump/load operation.

Refer to section 5 and 'Roland Exclusive Messages' for details.

■ Active sensing

Status
FEH

Once receiving this message, the D-5 expects to accept status or data in sequence, at last within 300 msec intervals.

If the unit fails to receive a message 300 msec after previous one, it judges there is a problem somewhere in MIDI path, muting the current sound and setting each of controllers as below, then stopping 300 msec-interval monitoring of incoming signal.

Controller	Setting
Pitch bender	+/- 0 (center)
Hold	0 (off)
Modulation	0 (min)

5. EXCLUSIVE COMMUNICATIONS

A set of parameters of a patch or timbre can be transmitted to/from D-5 using one way MIDI exclusive message.

Bulk dumping/loading of internal memory can be performed using either of one way or handshaking communication.

Model-ID# in the exclusive message : 16H

In addition to usual MIDI channel, each D-5 can be provided with a unique ID# called unit # through which any part is made accessible independently of its MIDI channel.

MIDI channel : 1 - 16 Unit # : 17 - 32

Whether to use MIDI channel or unit # is dependent on application -- refer to description on each message.

NOTE : MIDI standard states that channel starts with "0". So the actual Device # is a number that is "1" subtracted from the above-mentioned channel number or unit #.

■ One-way communication

Request data RQ1 11H

When the RQ1 received contains start address listed in the Parameter base address table, and the address size is 1 or more, D-5 sends the data stored in that address location and the subsequent locations, if any, using DT1 format.
D-5 never sends this message.

Value of Device ID is always Unit number less 1.

Byte	Comments
FOH	Exclusive status
41H	Manufactures ID (Roland)
DEV	Device ID
16H	Model ID
11H	Command ID (RQ1)
aaH	Address MSB * 7 - 1
aaH	Address
aaH	Address LSB
ssH	Size MSB
ssH	Size
ssH	Size LSB
sum	Check sum
F7H	EOX (End Of eXclusive)

Data set 1 DT1 12H

When D-5 is receiver :

a. D-5 recognizes this message when it has a unit # (17 - 32) which is indicated on MIDI function display. If the address specified in the message corresponds to the current mode (Performance or Multi Timbral) parameter base address, D-5 stores the data into that and subsequent address locations.
Device - ID # = MIDI channel # less 1 or Unit # less 1

b. When D-5 receives this message while executing one way bulk loading in data transfer mode with or without having unit # ; And if the address specified in the message corresponds to one of the following parameter base address, D-5 stores coming data into that and subsequent address locations.

Timbre memory
Patch memory
Tone memory
Rhythm setup

Device - ID number is always Unit # less 1, and when MIDI Unit # is not specified, it is 10H.

When D-5 is transmitter :

a. With unit # (17 - 32) set
Transmit data directed by RQ1.
Device - ID # = Unit # less 1

b. With unit # (17 - 32) set and Patch/Timbre dump on
Switching Patch/Timbre from the D-5 panel causes it to send program change message and parameter data of Patch/Timbre.
Device - ID # :
Performance mode -- Unit # less 1 (always)
Multi Timbral mode --
LCD is showing part status : Unit # less 1
LCD is showing keyboard : Transmitting channel number less 1

c. D-5 sends this message when the Enter button is pressed under editing of Patch, Timbre, Rhythm setup (This is temporary dump).
Transferable addresses :
Timbre temporary
Patch temporary
Patch effect temporary
Tone temporary
Rhythm setup temporary
Device - ID # is Unit # less 1, and when MIDI Unit # is not specified, it is 10H.

d. D-5 sends this message when one way dump is executed in Data transfer mode.
Transferable addresses :
Timbre memory
Patch memory
Patch effect memory
Tone memory
Rhythm setup memory
System area
Device - ID # is Unit # less 1, and when MIDI Unit # is not specified, it is 10H.

See section 6 (Parameter address map) for details of TX/RX parameters.

Byte	Comments
FOH	Exclusive status
41H	Manufactures ID (Roland)
DEV	Device ID
16H	Model ID
12H	Command ID (DT1)
aaH	Address MSB * 7 - 1
aaH	Address
aaH	Address LSB
ddH	Data * 7 - 2
:	:
sum	Check sum
F7H	EOX (End Of eXclusive)

■ Hand shaking communication

Bulk dump/load to and from D-5 through handshaking communication in Data transfer mode starts with the following message.

Device - ID number is Unit # less 1, and when MIDI Unit # is not specified, it is 10H.

Addresses containable in the bulk dump/load messages :

Timbre memory
Patch memory
Patch effect memory
Tone memory
Rhythm setup memory
System area

Want to send data WSD 40H

Recognizing this message, D-5 sends ACK (acknowledge) message and waits for coming data.

Byte	Comments
FOH	Exclusive status
41H	Manufactures ID (Roland)
DEV	Device ID
16H	Model ID
40H	Command ID (WSD)
aaH	Address MSB * 7 - 1
aaH	Address
aaH	Address LSB
ssH	Size MSB
ssH	Size
ssH	Size LSB
sum	Check sum
F7H	EOX (End Of eXclusive)

Request data RQD 41H

When RQD received contains start address listed in the Parameter base address table, and the address size is 1 or more, D-5 sends the data stored in that address location and the subsequent locations, if any.

Byte	Comments
FOH	Exclusive status
41H	Manufactures ID (Roland)
DEV	Device ID
16H	Model ID
41H	Command ID (RQD)
aaH	Address MSB * 7 - 1
aaH	Address
aaH	Address LSB
ssH	Size MSB
ssH	Size
ssH	Size LSB
sum	Check sum
F7H	EOX (End Of eXclusive)

Data set DAT 42H

When the DAT received contains address listed in the Parameter base address table, D-5 stores the data in that address location.

Byte	Comments
FOH	Exclusive status
41H	Manufactures ID (Roland)
DEV	Device ID
16H	Model ID
42H	Command ID (DAT)
aaH	Address MSB *7-1
aaH	Address
aaH	Address LSB
ddH	Data *7-2
:	
sum	Check sum
F7H	EOX (End Of eXclusive)

Acknowledge ACK 43H

Upon receiving this message in reply to DAT, D-5 sends the next data; when receives in reply to EOD, ceases current handshaking communication.
D-5 sends this message upon receipt of WSD or DAT.

Byte	Comments
FOH	Exclusive status
41H	Manufactures ID (Roland)
DEV	Device ID
16H	Model ID
43H	Command ID (ACK)
F7H	EOX (End Of eXclusive)

End of data EOD 45H

Upon receipt of this message, D-5 sends acknowledge and terminates the current handshaking communication.

Byte	Comments
FOH	Exclusive status
41H	Manufactures ID (Roland)
DEV	Device ID
16H	Model ID
45H	Command ID (EOD)
F7H	EOX (End Of eXclusive)

Communication error ERR 4EH

Should failure in data reception occur (e.g. disagreement of checksum), D-5 sends this message.
If D-5 receive this message, it sends the last message again.

Byte	Comments
FOH	Exclusive status
41H	Manufactures ID (Roland)
DEV	Device ID
16H	Model ID
4EH	Command ID (ERR)
F7H	EOX (End Of eXclusive)

Rejection RJC 4FH

D-5 ends communication upon receipt of this message.

Byte	Comments
FOH	Exclusive status
41H	Manufactures ID (Roland)
DEV	Device ID
16H	Model ID
4FH	Command ID (RJC)
F7H	EOX (End Of eXclusive)

*7-1 Address and size must specify the address where data exist.
*7-2 If the receiving data are system partial parameters, D-5 recognized these data only after it has received all the partial reserve parameters. (See Table 7 System area)

6. PARAMETER ADDRESS MAP

Addresses are shown in 7-bit hexadecimal.

Address	MSB	LSB
Binary	0aaa aaaa	0bbb bbbb
7-bit hex.	AA	BB

The actual address of a parameter in a block is the sum of the start address of each block and one or more offset address.
Parameters marked by *Table3 have two offset addresses : one in the Table3 and the other one in the Common parameter table (Table3-1) or in the Partial parameter table (Table3-2).

Parameter base address

Temporary area (Accessible on each basic channel)

Start address	Description
00 00 00	Tiambre Temporary Area (synth part) *Table1
01 00 00	Setup Temporary Area (rhythm part) *Table2
02 00 00	Tone Temporary Area (synth part) *Table3

Whole part (Accessible on UNIT #)

Start address	Description
03 00 00	Tiambre Temporary Area (part 1)*Table1
03 00 10	Tiambre Temporary Area (part 2)
:	:
03 00 60	Tiambre Temporary Area (part 7)
03 00 70	Tiambre Temporary Area (part 8)
03 01 00	Tiambre Temporary Area (rhythm part)
03 01 10	Rhythm Setup Temporary Area *Table2
03 04 00	Patch Temporary Area *Table4
03 04 40	Patch Temporary Area (Patch effect)*Table5
:	:
04 00 00	Tone Temporary Area (part 1/upper) *Table3
04 01 76	Tone Temporary Area (part 2/lower)
:	:
04 08 44	Tone Temporary Area (part 7)
04 0D 3A	Tone Temporary Area (part 8)
:	:
05 00 00	Tiambre Memory #1(A-11) *Table6
05 00 08	Tiambre Memory #2(A-12)
:	:
05 07 70	Tiambre Memory #127(B-87)
05 07 78	Tiambre Memory #128(B-88)
:	:
07 00 00	Patch Memory #1(A-11) *Table4
07 00 26	Patch Memory #2(A-12)
:	:
07 25 34	Patch Memory #127(B-87)
07 25 5A	Patch Memory #128(B-88)
:	:
08 00 00	Tone Memory #1(101) *Table3
08 02 00	Tone Memory #2(102)
:	:
08 7C 00	Tone Memory #53(163)
08 7E 00	Tone Memory #64(164)
:	:
09 00 00	Rhythm Setup #1(Note# 24) *Table2
09 00 04	Rhythm Setup #2(Note# 25)
:	:
09 02 4C	Rhythm Setup #84(Note#107)
09 02 50	Rhythm Setup #85(Note#108)
:	:
0D 00 00	Patch Memory (Patch Effect) #1 *Table5
0D 00 06	Patch Memory (Patch Effect) #2
:	:
0D 05 74	Patch Memory (Patch Effect) #127
0D 05 7A	Patch Memory (Patch Effect) #128
:	:
10 00 00	System Area *Table7
:	:
20 00 00	Display *Table8
:	:
40 00 00	Write Request *Table9

Notes :

*Table1 Timbre temporary area
D-5 accepts the data for the area below only in Multi Timbral mode.

Offset address	Description
00 00H 0000 00aa	TONE GROUP 0 - 3 (a, b, i, r)
00 01H 00aa aaaa	TONE NUMBER 0 - 63 (1 - 64)
00 02H 00aa aaaa	KEY SHIFT 0 - 48 (-24 - +24)
00 03H 0aaa aaaa	FINE TUNE 0 - 100 (-50 - +50)
00 04H 000a aaaa	BENDER RANGE 0 - 24
00 05H 0000 00aa	ASSIGN MODE 0 - 3 (POLY 1, POLY 2, POLY 3, POLY 4)
00 06H 0000 0000	dummy (ignored if received)
00 07H 0000 0000	dummy (ignored if received)
00 08H 0aaa aaaa	OUTPUT LEVEL 0 - 100
00 09H 0000 aaaa	PANPOT 0 - 14 (L - R)
00 0AH 0000 0000	dummy (ignored if received)
:	:
00 0FH 0000 0000	dummy
Total size	00 00 10H

*Table2 Rhythm Setup

Offset address	Description
00 00H 0aaa aaaa	TONE 0 - 127 (101-164, r01-r63, OFF)
00 01H 0aaa aaaa	OUTPUT LEVEL 0 - 100
00 02H 0000 aaaa	PANPOT 0 - 14 (L - R)
00 03H 0000 0000	dummy
Total size	00 00 04H

*Table3 Tone Temporary area / Tone Memory

Offset address	Description
00 00 00	Common parameter #Table3-1
00 00 0E	Partial parameter (for Partial# 1) #Table3-2
00 00 48	Partial parameter (for Partial# 2)
00 01 02	Partial parameter (for Partial# 3)
00 01 3C	Partial parameter (for Partial# 4)
Total size	00 01 76H

*Table3 - 1 Common parameters

Offset address	Description
00H 0aaa aaaa	TONE NAME 1 32 - 127 (ASCII)
09H 0aaa aaaa	TONE NAME 10
0AH 0000 aaaa	Structure of Partial# 1 & 2 0 - 12 (1 - 13)
0BH 0000 aaaa	Structure of Partial# 3 & 4 0 - 12 (1 - 13)
0CH 0000 aaaa	PARTIAL MUTE 0 - 15 (0000 - 1111)
0DH 0000 000a	ENV MODE 0 - 1 (Normal, No sustain)
Total size	00 00 0EH

*Table3 - 2 Partial parameters

Offset address	Description
00 00H 0aaa aaaa	WG PITCH COARSE 0 - 96 (C1, C#1, - C9)
00 01H 0aaa aaaa	WG PITCH FINE 0 - 100 (-50 - +50)
00 02H 000a aaaa	WG PITCH KEYFOLLOW 0 - 16 (-1, -1/2, -1/4, 0, 1/8, 1/4, 3/8, 1/2, 5/8, 3/4, 7/8, 1, 5/4, 3/2, 2, s1, s2)
00 03H 0000 000a	WG PITCH BENDER SW 0 - 1 (OFF, ON)
00 04H 0000 00aa	WG WAVEFORM/PCM BANK 0 - 3 (SQU/1, SAW/1, SQU/2, SAW/2)
00 05H 0aaa aaaa	WG PCM WAVE # 0 - 127 (1 - 128)
00 05H 0aaa aaaa	WG PULSE WIDTH 0 - 100
00 07H 0000 aaaa	WG PW VELO SENS 0 - 14 (-7 - +7)
00 08H 0000 aaaa	P-ENV DEPTH 0 - 10
00 09H 0000 00aa	P-ENV VELO SENS 0 - 3
00 0AH 0000 0aaa	P-ENV TIME KEYF 0 - 4
00 0BH 0aaa aaaa	P-ENV TIME 1 0 - 100
00 0CH 0aaa aaaa	P-ENV TIME 2 0 - 100
00 0DH 0aaa aaaa	P-ENV TIME 3 0 - 100
00 0EH 0aaa aaaa	P-ENV TIME 4 0 - 100
00 0FH 0aaa aaaa	P-ENV LEVEL 0 0 - 100 (-50 - +50)
00 10H 0aaa aaaa	P-ENV LEVEL 1 0 - 100 (-50 - +50)
00 11H 0aaa aaaa	P-ENV LEVEL 2 0 - 100 (-50 - +50)
00 12H 0aaa aaaa	dummy (for MT-32)
00 13H 0aaa aaaa	END LEVEL 0 - 100 (-50 - +50)
00 14H 0aaa aaaa	P-LFO RATE 0 - 100
00 15H 0aaa aaaa	P-LFO DEPTH 0 - 100
00 16H 0aaa aaaa	P-LFO MOD SENS 0 - 100
00 17H 0aaa aaaa	TVF CUTOFF FREQ 0 - 100
00 18H 000a aaaa	TVF RESONANCE 0 - 30
00 19H 0000 aaaa	TVF KEYFOLLOW 0 - 14 (-1, -1/2, -1/4, 0, 1/8, 1/4, 3/8, 1/2, 5/8, 3/4, 7/8, 1, 5/4, 3/2, 2)
00 1AH 0aaa aaaa	TVF BIAS POINT 0 - 127 (<1A - <7C >1A - >7C)
00 1BH 0000 aaaa	TVF BIAS LEVEL 0 - 14 (-7 - +7)
00 1CH 0aaa aaaa	TVF ENV DEPTH 0 - 100
00 1DH 0aaa aaaa	TVF ENV VELO SENS 0 - 100
00 1EH 0000 0aaa	TVF ENV DEPTH KEYF 0 - 4
00 1FH 0000 0aaa	TVF ENV TIME KEYF 0 - 4
00 20H 0aaa aaaa	TVF ENV TIME 1 0 - 100
00 21H 0aaa aaaa	TVF ENV TIME 2 0 - 100
00 22H 0aaa aaaa	TVF ENV TIME 3 0 - 100
00 23H 0aaa aaaa	dummy (for MT-32)
00 24H 0aaa aaaa	TVF ENV TIME 4 0 - 100
00 25H 0aaa aaaa	TVF ENV LEVEL 1 0 - 100
00 26H 0aaa aaaa	TVF ENV LEVEL 2 0 - 100
00 27H 0aaa aaaa	dummy (for MT-32)
00 28H 0aaa aaaa	TVF ENV SUSTAIN LEVEL 0 - 100
00 29H 0aaa aaaa	TVA LEVEL 0 - 100
00 2AH 0aaa aaaa	TVA VELO SENS 0 - 100 (-50 - +50)
00 2BH 0aaa aaaa	TVA BIAS POINT 1 0 - 127 (<1A - <7C >1A - >7C)
00 2CH 0000 aaaa	TVA BIAS LEVEL 1 0 - 12 (-12 - 0)
00 2DH 0aaa aaaa	TVA BIAS POINT 2 0 - 127 (<1A - <7C >1A - >7C)
00 2EH 0000 aaaa	TVA BIAS LEVEL 2 0 - 12 (-12 - 0)
00 2FH 0000 0aaa	TVA ENV TIME KEYF 0 - 4
00 30H 0000 0aaa	TVA ENV TIME V_FOLLOW 0 - 4

00 31H	0aaa aaaa	TVA ENV TIME 1	0 - 100
00 32H	0aaa aaaa	TVA ENV TIME 2	0 - 100
00 33H	0aaa aaaa	TVA ENV TIME 3	0 - 100
00 34H	0aaa aaaa	dummy (for MT-32)	
00 35H	0aaa aaaa	TVA ENV TIME 4	0 - 100
00 36H	0aaa aaaa	TVA ENV LEVEL 1	0 - 100
00 37H	0aaa aaaa	TVA ENV LEVEL 2	0 - 100
00 38H	0aaa aaaa	dummy (for MT-32)	
00 39H	0aaa aaaa	TVA ENV SUSTAIN LEVEL 0	0 - 100
Total size		00 00 3AH	

* Example of RQ1 and DT1 application

Unit number is set at 17 in this example.
Sending the following data string lets D-5 Part 2/Lower tone data from the temporary area.

F0 41 10 16 11 04 01 76 00 01 76 0E F7

* Table4 Patch Temporary area / Patch Memory
D-5 accepts the data for the area below only in Performance mode.

Offset address	Description
00 00H 0000 00aa	KEY MODE 0 - 2 (whole, dual, split)
00 01H 00aa aaaa	SPLIT POINT 0 - 61 (C2 - C#7)
00 02H 0000 00aa	LOWER TONE GROUP 0 - 3 (a, b, l, r)
00 03H 00aa aaaa	LOWER TONE NUMBER 0 - 63 (1 - 64)
00 04H 0000 00aa	UPPER TONE GROUP 0 - 3 (a, b, l, r)
00 05H 00aa aaaa	UPPER TONE NUMBER 0 - 63 (1 - 64)
00 06H 00aa aaaa	LOWER KEY SHIFT 0 - 48 (-24 - +24)
00 07H 00aa aaaa	UPPER KEY SHIFT 0 - 48 (-24 - +24)
00 08H 0aaa aaaa	LOWER FINE TUNE 0 - 100 (-50 - +50)
00 09H 0aaa aaaa	UPPER FINE TUNE 0 - 100 (-50 - +50)
00 0AH 000a aaaa	LOWER BENDER RANGE 0 - 24
00 0BH 000a aaaa	UPPER BENDER RANGE 0 - 24
00 0CH 0000 00aa	LOWER ASSIGN MODE 0 - 3 (POLY 1, POLY 2, POLY 3, POLY 4)
00 0DH 0000 00aa	UPPER ASSIGN MODE 0 - 3 (POLY 1, POLY 2, POLY 3, POLY 4)
00 0EH 0000 0000	dummy (ignored if received)
00 0FH 0000 0000	dummy (ignored if received)
00 10H 0000 0000	dummy (ignored if received)
00 11H 0000 0000	dummy (ignored if received)
00 12H 0000 0000	dummy (ignored if received)
00 13H 0aaa aaaa	U/L BALANCE 0 - 100 (L max<-->U max)
00 14H 0aaa aaaa	PATCH LEVEL 0 - 100
00 15H 0aaa aaaa	PATCH NAME CHAR. 1 32 - 127 (ASCII CODE)
:	:
00 24H 0aaa aaaa	PATCH NAME CHAR. 16
00 25H 0000 0000	dummy (ignored if received)
Total size 00 00 26H	

* Table5 Patch (Patch Effect) Temporary area / Patch (Patch Effect) Memory
D-5 accepts the data for the area below only in Performance mode.

Offset address	Description
00 00H 0000 0aaa	EFFECT MODE 0 - 4 (off, chord play, harmony, chase, arpeggio)
00 01H 0aaa aaaa	RATE 0 - 100 (0 - 100)
00 02H 0000 aaaa	HARMONY BALANCE 0 - 12 (-12 - 0)
00 03H 000a aaaa	CHASE SHIFT 0 - 24 (-12 - +12)
00 04H 0aaa aaaa	CHASE LEVEL 0 - 100 (0 - 100)
00 05H 0000 00aa	ARPEGGIO MODE 0 - 3 (UP, DOWN, U&D, RND)
Total size 00 00 06H	

* Example of RQ1 and DT1 application

Unit number is set at 17 in this example.
When D-5 receive following messages in Performance mode, it sends Patch data from the temporary area.

F0 41 10 16 11 03 04 00 00 00 26 53 F7

* Table6 Timbre memory

Offset address	Description
00 00H 0000 00aa	TONE GROUP 0 - 3 (a, b, l, r)
00 01H 00aa aaaa	TONE NUMBER 0 - 63 (1 - 64)
00 02H 00aa aaaa	KEY SHIFT 0 - 48 (-24 - +24)
00 03H 0aaa aaaa	FINE TUNE 0 - 100 (-50 - +50)
00 04H 000a aaaa	BENDER RANGE 0 - 24
00 05H 0000 00aa	ASSIGN MODE 0 - 3 (POLY 1, POLY 2, POLY 3, POLY 4)
00 06H 0000 0000	dummy (ignored if received)
00 07H 0000 0000	dummy (ignored if received)
Total size 00 00 08H	

* Table7 System area

When All is selected for bulk dump/load in data transfer mode, data in this area are transmitted or received together with associated sound data and rhythm data. Partial reserve must be sent as a package of 9 parts, which in total, should contain no more than 32 partials.

Offset address	Description	
00 00H 0aaa aaaa	MASTER TUNE	0 - 127 (432.1Hz - 457.6Hz)
00 01H 0000 0000	dummy (ignored if received)	
00 02H 0000 0000	dummy (ignored if received)	
00 03H 0000 0000	dummy (ignored if received)	
00 04H 00aa aaaa	PARTIAL RESERVE (Part 1)	0 - 32
00 05H 00aa aaaa	PARTIAL RESERVE (Part 2)	0 - 32
00 06H 00aa aaaa	PARTIAL RESERVE (Part 3)	0 - 32
00 07H 00aa aaaa	PARTIAL RESERVE (Part 4)	0 - 32
00 08H 00aa aaaa	PARTIAL RESERVE (Part 5)	0 - 32
00 09H 00aa aaaa	PARTIAL RESERVE (Part 6)	0 - 32
00 0AH 00aa aaaa	PARTIAL RESERVE (Part 7)	0 - 32
00 0BH 00aa aaaa	PARTIAL RESERVE (Part 8)	0 - 32
00 0CH 00aa aaaa	PARTIAL RESERVE (Part R)	0 - 32
00 0DH 0000 aaaa	MIDI CHANNEL (Part 1)	0 - 15
00 0EH 0000 aaaa	MIDI CHANNEL (Part 2)	0 - 15
00 0FH 0000 aaaa	MIDI CHANNEL (Part 3)	0 - 15
00 10H 0000 aaaa	MIDI CHANNEL (Part 4)	0 - 15
00 11H 0000 aaaa	MIDI CHANNEL (Part 5)	0 - 15
00 12H 0000 aaaa	MIDI CHANNEL (Part 6)	0 - 15
00 13H 0000 aaaa	MIDI CHANNEL (Part 7)	0 - 15
00 14H 0000 aaaa	MIDI CHANNEL (Part 8)	0 - 15
00 15H 0000 aaaa	MIDI CHANNEL (Part R)	0 - 15
00 16H 0000 0000	dummy (for D-110)	
00 20H 0000 0000		
00 21H 0aaa aaaa	OUTPUT LEVEL (Part 1)	0 - 100
00 22H 0aaa aaaa	OUTPUT LEVEL (Part 2)	0 - 100
00 23H 0aaa aaaa	OUTPUT LEVEL (Part 3)	0 - 100
00 24H 0aaa aaaa	OUTPUT LEVEL (Part 4)	0 - 100
00 25H 0aaa aaaa	OUTPUT LEVEL (Part 5)	0 - 100
00 26H 0aaa aaaa	OUTPUT LEVEL (Part 6)	0 - 100
00 27H 0aaa aaaa	OUTPUT LEVEL (Part 7)	0 - 100
00 28H 0aaa aaaa	OUTPUT LEVEL (Part 8)	0 - 100
00 29H 0aaa aaaa	OUTPUT LEVEL (Part R)	0 - 100
00 2AH 0000 aaaa	PANPOT (Part 1)	0 - 14
00 2BH 0000 aaaa	PANPOT (Part 2)	0 - 14
00 2CH 0000 aaaa	PANPOT (Part 3)	0 - 14
00 2DH 0000 aaaa	PANPOT (Part 4)	0 - 14
00 2EH 0000 aaaa	PANPOT (Part 5)	0 - 14
00 2FH 0000 aaaa	PANPOT (Part 6)	0 - 14
00 30H 0000 aaaa	PANPOT (Part 7)	0 - 14
00 31H 0000 aaaa	PANPOT (Part 8)	0 - 14
Total size		00 00 32H

* Example of RQ1 and DT1 application

Unit number is set at 17 in this example.

The byte string shown below will set Partial reserve of each part as follows:

Part 1 : 8 Part 3 thru 8 : 0

Part 2 : 10 Rhythm part : 8

F0 41 10 16 12 10 00 04 08 0A 00 00 00 00 00 08 52 F7

* Table8 DISPLAY

D-5 deciphers incoming data and sends then to the LCD as a string of ASCII code characters.

The display data in this area cannot brought outside D-5 through MIDI message, such as RQ1 and DT1.

Offset address	Description	
00H 0aaa aaaa	DISPLAYED LETTER	32 - 127 (ASCII)
1FH 0aaa aaaa	DISPLAYED LETTER	
Total size		00 00 20H

* Table9 Write Request

This message simulates write switch : D-5 stores the data of each part in the temporary area into individual memory locations specified by two byte data.

Timbre write is effective only in Multi Timbral mode; Patch write only in Performance mode.

The data in this area cannot be brought outside D-5 through MIDI message, such as RQ1 and DT1.

D-5 returns the result to the transmitter.

Offset address	Description	
00 00H 00aa aaaa	Tone Write	0 - 63 (part 1/upper) 0, 1 (Internal, Card)
00 01H 0000 000a		
00 02H 00aa aaaa	Tone Write	
00 03H 0000 000a		(part 2/lower)
00 0EH 00aa aaaa	Tone Write	
00 0FH 0000 000a		(part 8)
01 00H 0aaa aaaa	Timbre Write	0 - 127 (A11 - B88) 0, 1 (Internal, Card)
01 01H 0000 000a		
01 02H 0aaa aaaa	Timbre Write	
01 03H 0000 000a		(part 2)
01 0EH 0aaa aaaa	Timbre Write	
01 0FH 0000 000a		(part 8)
03 00H 0aaa aaaa	Patch Write	0 - 127 (A11 - B88) 0, 1 (Internal, Card)
03 01H 0000 000a		
10 00H 0000 00aa	Result	0 - 3 0 = Function Completed 1 = Card Not Ready 2 = Write Protected 3 = Incorrect Mode

* Example of RQ1 and DT1 application

Unit number is set at 17 in this example.

Sending the following byte string will enable D-5 to write data in Part3 in temporary data into I-B24.

F0 41 10 16 12 40 01 04 4B 00 70 F7

----- Address Map -----

[Multi timbre mode Basic CH access]

address	Block	Sub Block	Reference
00-00-00	Timbre Temp		Table1
00-00-10			
01-00-00	Setup Temp	Note # 24	Table2
01-02-54		Note # 25	
		:	
		Note # 107	
		Note # 108	
02-00-00	Tone Temp	Common	Table3-1
02-01-76		Partial 1	Table3-2
		Partial 2	
		Partial 3	
		Partial 4	
03-00-00			
[Unit # access]			
address	Block	Sub Block	Reference
03-00-00	Timbre Temp		Table1
	Part 1		
03-00-10		Part 2	
03-00-20		Part 3	
03-00-30		Part 4	
03-00-40		Part 5	
03-00-50		Part 6	
03-00-60		Part 7	
03-00-70		Part 8	
03-01-00		Part 8	
03-01-10	Setup Temp	Note # 24	Table2
03-03-64		Note # 25	
		:	
		Note # 107	
		Note # 108	
03-04-00	Patch Temp		Table4
03-04-26			
03-04-40	Patch Temp		Table5
	(Key effect)		
03-04-46			
04-00-00	Tone Temp	Common	Table3-1
	Part 1, Upper		
04-01-76		Partial 1	Table3-2
	Part 2, Lower		
04-03-6C		Partial 2	
	Part 3		
04-05-62		Partial 3	

	Part 4		
04-07-58		Partial 4	
	Part 5		
04-09-4E			
	Part 6		
04-08-44			
	Part 7		
04-0D-3A			
	Part 8		
04-0F-30			
05-00-00	Timbre Mem All		Table6
05-00-08			
	:		
05-07-78	Timbre Mem B88		
05-08-00			
07-00-00	Patch Mem All		Table4
07-00-26			
	:		
07-25-5A	Patch Mem B88		
07-25-00			
08-00-00	Tone Mem 101	Common	Table3-1
08-02-00		Partial 1	Table3-2
	:		
	:		
08-7E-00		Partial 2	
	Tone Mem 164		
09-00-00		Partial 3	
	Setup Memory		
	(Note #24)	Partial 4	
09-00-04			
	:		
09-02-50	Setup Memory		Table2
	(Note #108)		
09-02-54			
0D-00-00	Patch Mem All		Table5
	(Key effect)		
0D-00-06			
	:		
0D-05-7A	Patch Mem B88		
	(Key effect)		
0D-05-00			
10-00-00	System Area		Table7
10-00-32			
20-00-00	Display		Table8
20-00-20			
40-00-00	Write request		Table9

MIDI Implementation Chart

Function ...		Transmitted	Recognized	Remarks
Basic Channel	Default Changed	× ×	1 - 16 1 - 16	Memorized
Mode	Default Messages Alterd	× × *****	Mode 3 ×	
Note Number	True Voice	× *****	0 - 127 12 - 108	
Velocity	Note ON Note OFF	× ×	○ v = 1 - 127 ×	
After Touch	Key's Ch's	× ×	× ×	
Pitch Bender		×	○ 0 - 24 semi	9 bit resolution
Control Change	1	×	○	Modulation
	2	×	* (Memorized)	Breath
	6	×	**	Data Entry
	7	×	○	Volume
	10	×	○	Panpot
Control Change	11	×	* (Memorized)	Expression
	64	×	○	Hold 1
	100, 101	×	** (0)	RPN LSB, MSB
Control Change	121	×	○	Reset All Controllers
	Prog Change	True #	× *****	○ 0 - 127 0 - 127
System Exclusive		○	*	Tone Parameters
System Common	Song Pos	×	×	
	Song Sel	×	×	
	Tune	×	×	
System Real Time	Clock	×	×	
	Commands	×	×	
Aux Message	Local ON/OFF	×	×	
	All Notes OFF	×	○ (123 - 127)	
	Active Sense	×	○	
	Reset	×	×	
Notes	<p>* Can be set to ○ or × manually. **RPN = Registered Parameter Number RPN # 0 : Pitch Bend Sensitivity The value of parameter is to be determined by entering data.</p>			

Mode 1 : OMNI ON, POLY
 Mode 3 : OMNI OFF, POLY

Mode 2 : OMNI ON, MONO
 Mode 4 : OMNI OFF, MONO

○ : Yes
 × : No

LINEAR SYNTHESIZER (Multi Timbral mode Keyboard)
 Model D - 5 MIDI Implementation Chart

Date : Jan. 30. 1989

Version : 1.00

Function ***		Transmitted	Recognized	Remarks
Basic Channel	Default	1 - 16	x	Memorized
	Changed	1 - 16	x	
Mode	Default	Mode 3	x	
	Messages Altered	POLY OMNI OFF *****	x	
Note Number	True Voice	24 - 108	x	
		*****	x	
Velocity	Note ON	○ v = 1 - 127	x	
	Note OFF	○ v = 0 - 127	x	
After Touch	Key's	x	x	
	Ch's	x	x	
Pitch Bender		○	x	9 bit resolution
Control Change	1	○	x	Modulation
	64	○	x	Hold 1
	121	○	x	Reset All Controllers
Prog Change	True #	* 0 - 127 *****	x	
System Exclusive		x	x	
System Common	Song Pos	x	x	
	Song Sel	x	x	
	Tune	x	x	
System Real Time	Clock	x	x	
	Commands	x	x	
Aux Message	Local ON/OFF	x	○	
	All Notes OFF	x	x	
	Active Sense	○	x	
	Reset	x	x	
Notes		* Can be transmitted when the LCD displays the status of keyboard.		

Mode 1 : OMNI ON, POLY
 Mode 3 : OMNI OFF, POLY

Mode 2 : OMNI ON, MONO
 Mode 4 : OMNI OFF, MONO

○ : Yes
 x : No

MIDI Implementation Chart

Function ...		Transmitted	Recognized	Remarks
Basic Channel	Default Changed	1 - 16 1 - 16	1 - 16 1 - 16	Memorized
Mode	Default Messages Altered	Mode 3 POLY OMNI OFF *****	Mode 3 x	
Note Number	True Voice	0 - 127 *****	0 - 127 12 - 108	
Velocity	Note ON Note OFF	○ v = 1 - 127 ○ v = 0 - 127	○ v = 1 - 127 x	
After Touch	Key's Ch's	x x	x x	
Pitch Bender		* (Memorized)	* (Memorized) 0-24 semi	9 bit resolution
Control Change	1	*	* (Memorized)	Modulation
	2	x	* (Memorized)	Breath
	6	x	**	Data Entry
	7	x	* (Memorized)	Volume
	11	x	* (Memorized)	Expression
Control Change	64	* (Memorized)	* (Memorized)	Hold 1
	100, 101	x	** (0)	RPN LSB, MSB
	121	○	○	Reset All Controllers
Prog Change	True #	* (Memorized) 0 - 127 *****	* (Memorized) 0 - 127 0 - 127	
System Exclusive		○	*	Tone Parameters
System Common	Song Pos Song Sel Tune	x x x	x x x	
System Real Time	Clock Commands	x x	x x	
Aux Message	Local ON/OFF All Notes OFF Active Sense Reset	x x ○ x	○ ○ (123 - 127) ○ x	
Notes		* Can be set to ○ or x manually. **RPN = Registered Parameter Number RPN # 0 : Pitch Bend Sensitivity The value of parameter is to be determined by entering data.		

Mode 1 : OMNI ON, POLY
Mode 3 : OMNI OFF, POLY

Mode 2 : OMNI ON, MONO
Mode 4 : OMNI OFF, MONO

○ : Yes
x : No

MIDI Implementation Chart

Function ...		Transmitted	Recognized	Remarks
Basic Channel	Default Changed	x x	1 - 16 1 - 16	Memorized
Mode	Default Messages Altered	x x *****	Mode 3 x	
Note Number	True Voice	x *****	24 - 108 24 - 108	
Velocity	Note ON Note OFF	x x	○ v = 1 - 127 x	
After Touch	Key's Ch's	x x	x x	
Pitch Bender		x	* (Memorized) 0-24 semi	9 bit resolution
Control Change	1	x	* (Memorized)	Modulation
	2	x	* (Memorized)	Breath
	6	x	**	Data Entry
	7	x	* (Memorized)	Volume
	11	x	* (Memorized)	Expression
	100, 101	x	** (0)	RPN LSB, MSB
	121	x	○	Reset All Controllers
Prog Change	True #	x *****	x	
System Exclusive		○	*	Setup Data
System Common	Song Pos Song Sel Tune	x x x	x x x	
System Real Time	Clock Commands	x x	x x	
Aux Message	Local ON/OFF All Notes OFF Active Sense Reset	x x x x	x ○ ○ x	
Notes		* Can be set to ○ or x manually. **RPN = Registered Parameter Number. RPN # 0 : Pitch Bend Sensitivity		

Mode 1 : OMNI ON, POLY
 Mode 3 : OMNI OFF, POLY

Mode 2 : OMNI ON, MONO
 Mode 4 : OMNI OFF, MONO

○ : Yes
 x : No

INDEX

A		K	
Arpeggio Mode	29	Keyboard Transmit Channel	21
Assign Mode (Patch)	28	Key Mode	25
Assign Mode (Timbre)	33	Key Shift (Patch)	27
		Key Shift (Timbre)	33
B		L	
Bender	18	Level (Part 1~8)	14
Bender Range (Patch)	27	Level (Rhythm Part)	40
Bender Range (Timbre)	33	LFO Depth	60
Bender Switch	60	LFO Rate	60
Bias Level (TVF)	69	Local Control	18
Bias Level 1/2 (TVA)	74	Lower Tone Select	26
Bias Point (TVF)	69		
Bias Point 1/2 (TVA)	74	M	
Breath	20	Master Tuning	12
		Memory Protect	13
C		Modulation	18
Chase Level	29	Modulation Sensitivity	60
Chase Shift	29		
Common Parameters	55	P	
Cutoff Frequency	67	Pan (Part 1~8)	14
		Pan (Rhythm Part)	40
E		Partial Mute	80
Effect Rate	28	Partial Reserve	14
ENV Mode	56	Part Receive Channel	17
Expression	20	Patch Dump	21
		Patch Effect Select	25
F		Patch Level	30
Fine Tune (Patch)	27	Patch Name	30
Fine Tune (Timbre)	33	PCM Wave Bank	61
Frequency Key Follow	68	PCM Wave Number	61
		Pitch Coarse	58
H		Pitch ENV Depth	65
Harmony Balance	29	Pitch ENV Key Follow (Time)	65
Hold	19	Pitch ENV Level	66
		Pitch ENV Time	66
		Pitch ENV Velocity Sensitivity	65
		Pitch Key Follow	58

Pitch Fine	58
Program Change	19
Pulse Width	64
Pulse Width Velocity Sensitivity	64
R	
Receive Channel	17
Resonance	68
Rhythm Level/Rhythm Part Level	13
Rhythm Receive Channel/ Rhythm Part Receive Channel	17
S	
Split Point	25
Structure 1 & 2	56
Structure 3 & 4	56
T	
Timbre Dump	21
Tone Balance	30
Tone Name	55
Tone Select (Timbre)	32
Tone Select (Rhythm)	40
Transmit Channel	17
TVA Level Group	73
TVA ENV Group	75
TVA ENV Key Follow (Time)	75
TVA ENV Level	75
TVA ENV Time	75
TVA ENV Velocity Follow (Time 1)	74
TVA ENV Velocity Sensitivity	73
TVF ENV Group	71
TVF ENV Depth	70
TVF ENV Key Follow (Depth)	70
TVF ENV Key Follow (Time)	71
TVF ENV Level	71
TVF ENV Time	71
TVF ENV Velocity Sensitivity	70
TVF Freq/ENV Group	67
U	
Unit Number	20
Upper Tone Select	26
V	
Volume (Receive)	18
W	
Waveform	61
WG Form/Pitch ENV Group	61
WG Pitch ENV Group	66
WG Pitch/Modulation Group	58

