

# String Ensemble M-SE1

取扱説明書  
Owner's Manual

## はじめに

このたびは、ローランド サウンド・エクspansion・シリーズ「M-SE1」をお買い上げいただきまして、ありがとうございます。本機の優れた機能と音質を十分にご理解いただき、未永く愛用していただくために、この取扱説明書とサウンド・エクspansion・シリーズ取扱説明書を良くお読みくださるようお願い申し上げます。

本書では、サウンド・エクspansion・シリーズの音源の中でM-SE1が独自に持っている機能や、内蔵されているパッチ、パフォーマンスなどについて解説しています。操作方法やエラー・メッセージなどについてはサウンド・エクspansion・シリーズ取扱説明書をご覧ください。

## 主な特長

- M-SE1はストリングス専用音源です。多数の音色を内蔵しており、弦楽器特有の演奏を表現できます。ソロ、小編成、大編成を問わず幅広いジャンルでお使いいただけます。
- ライブでの演奏に適したパッチ・モードと、シーケンサーを使った自動演奏に適したパフォーマンス・モードがあります。
- 本機独自のレガート・コントロール機能により、従来にないリアルな演奏表現が得られます。
- リバースとコーラスのエフェクトにより、コンサート・ホールで演奏しているような音の広がりを出したり、音作りの機能として活用できます。
- インput・ジャックを装備していますので、ミキサーなどを用意しなくても他の音源の出力とミックスしてアウトput・ジャックから出力できます。
- GMシステム/GSフォーマットのミュージック・データを利用する際に便利な音色配列も用意しています。
- RSS (ローランド・サウンド・スペース) の効果を持った波形も内蔵していますので、内蔵エフェクターでは得られない立体感のある演奏も可能です。



## Introduction

Thank you, and congratulations on your choice of the Roland M-SE1 Sound Expansion Series. To take full advantage of the M-SE1's convenient features and extraordinary sounds, please take the time to read this manual and the Sound Expansion Series Owner's Manual.

This manual explains the unique functions and built-in Patches and Performances of the M-SE1, a sound module in the Sound Expansion Series. For details on how to operate it, or a list of error messages, you should refer to the Sound Expansion Series Owner's Manual.

## Features

- The M-SE1 sound module is dedicated to the production of string sounds. An extensive selection of sounds is included, and many of them are designed to support the playing techniques unique to string instruments. As a result, you can reliably express the finest nuances of the sounds created by string instruments — whether you are producing a solo performance, or a complete orchestral section.
- The M-SE1 offers two modes: the "Patch" mode (which is ideal for playing live), and the "Performance" mode, which is the normal mode to use when playing the module using a sequencer.
- A "Legato Control" feature allows you to obtain a degree of realism for string instruments that has not before been available.
- Comes with an effects processor (reverb and chorus), so you can try your hand at applying a full range of modifications, and enjoy the sonic illusion of playing in a large concert hall!
- An input jack allows you to route sound from another device to this unit and have both be mixed, thus eliminating the need for separate mixing equipment.
- Offers a selection of sound mappings, so music data for the General MIDI System/GS Format can be conveniently enjoyed.
- Waveforms that have RSS (Roland Sound Space) effects are also built in, so performances with a three-dimensional effect that can't be obtained with the built-in effects are also possible.

 <b>CAUTION</b> RISK OF ELECTRIC SHOCK DO NOT OPEN	
<b>ATTENTION</b> RISQUE DE CHOC ELECTRIQUE NE PAS OUVRIIR	
<b>CAUTION:</b> TO REDUCE THE RISK OF ELECTRIC SHOCK, DO NOT REMOVE COVER (OR BACK). NO USER-SERVICEABLE PARTS INSIDE. REFER SERVICING TO QUALIFIED SERVICE PERSONNEL.	



The lightning flash with arrowhead symbol, within an equilateral triangle, is intended to alert the user to the presence of uninsulated "dangerous voltage" within the product's enclosure that may be of sufficient magnitude to constitute a risk of electric shock to persons.



The exclamation point within an equilateral triangle is intended to alert the user to the presence of important operating and maintenance (servicing) instructions in the literature accompanying the product.

INSTRUCTIONS PERTAINING TO A RISK OF FIRE, ELECTRIC SHOCK, OR INJURY TO PERSONS.

## IMPORTANT SAFETY INSTRUCTIONS SAVE THESE INSTRUCTIONS

**WARNING** - When using electric products, basic precautions should always be followed, including the following:

1. Read all the instructions before using the product.
2. Do not use this product near water — for example, near a bathtub, washbowl, kitchen sink, in a wet basement, or near a swimming pool, or the like.
3. This product should be used only with a cart or stand that is recommended by the manufacturer.
4. This product, either alone or in combination with an amplifier and headphones or speakers, may be capable of producing sound levels that could cause permanent hearing loss. Do not operate for a long period of time at a high volume level or at a level that is uncomfortable. If you experience any hearing loss or ringing in the ears, you should consult an audiologist.
5. The product should be located so that its location or position does not interfere with its proper ventilation.
6. The product should be located away from heat sources such as radiators, heat registers, or other products that produce heat.
7. The product should be connected to a power supply only of the type described in the operating instructions or as marked on the product.
8. The power-supply cord of the product should be unplugged from the outlet when left unused for a long period of time.
9. Care should be taken so that objects do not fall and liquids are not spilled into the enclosure through openings.
10. The product should be serviced by qualified service personnel when:
  - A. The power-supply cord or the plug has been damaged; or
  - B. Objects have fallen, or liquid has been spilled onto the product; or
  - C. The product has been exposed to rain; or
  - D. The product does not appear to operate normally or exhibits a marked change in performance; or
  - E. The product has been dropped, or the enclosure damaged.
11. Do not attempt to service the product beyond that described in the user-maintenance instructions. All other servicing should be referred to qualified service personnel.

For the USA

### GROUNDING INSTRUCTIONS

This product must be grounded. If it should malfunction or breakdown, grounding provides a path of least resistance for electric current to reduce the risk of electric shock.

This product is equipped with a cord having an equipment-grounding conductor and a grounding plug. The plug must be plugged into an appropriate outlet that is properly installed and grounded in accordance with all local codes and ordinances.

**DANGER:** Improper connection of the equipment-grounding conductor can result in a risk of electric shock. Check with a qualified electrician or serviceman if you are in doubt as to whether the product is properly grounded. Do not modify the plug provided with the product — if it will not fit the outlet, have a proper outlet installed by a qualified electrician.

For the U.K.

**WARNING:** THIS APPARATUS MUST BE EARTHED

**IMPORTANT:** THE WIRES IN THIS MAINS LEAD ARE COLOURED IN ACCORDANCE WITH THE FOLLOWING CODE.  
 GREEN-AND-YELLOW: EARTH, BLUE: NEUTRAL, BROWN: LIVE

As the colours of the wires in the mains lead of this apparatus may not correspond with the coloured markings identifying the terminals in your plug, proceed as follows:

The wire which is coloured GREEN-AND-YELLOW must be connected to the terminal in the plug which is marked by the letter E or by the safety earth symbol  or coloured GREEN or GREEN-AND-YELLOW.

The wire which is coloured BLUE must be connected to the terminal which is marked with the letter N or coloured BLACK.

The wire which is coloured BROWN must be connected to the terminal which is marked with the letter L or coloured RED.

The product which is equipped with a THREE WIRE GROUNDING TYPE LINE PLUG must be grounded.

#### 安全にお使いいただくために

この製品の取り扱いについては、次の基本的な安全事項に、ご注意ください。

- 次のような場所での使用や保存は、故障の原因となりますので、ご注意ください。
  - 温度が極端に高い場所（直射日光の当たる場所、暖房機器の近く、発熱する機器の上など）
  - 水気の近く（風呂場、洗面台、濡れた床など）や湿度の高い場所
  - ホコリの多い場所
  - 振動の多い場所
- 電源プラグは、必ずAC100Vの電源コンセントに差し込んでください。
- 電源コードの上に重いものをのせたり、踏みつけたりして傷をつけないでください。
- 電源プラグをコンセントから抜く場合は、電源コードの断線やショートによる危険防止のため、必ず電源プラグを持ってください。
- 長時間使用しない場合は、電源プラグをコンセントから抜いてください。
- 本機には、異物（硬貨や針金など）や液体（水やジュースなど）が入らないように注意してください。
- 感電や故障の原因になりますので、本機の内部に手を入れたり、改造しないでください。
- 本機に異常や故障が生じた場合は、直ちに使用を中止し、お買い上げ店またはローランド・サービスにご連絡ください。

# ご使用上の注意

表紙裏に記載されている安全事項以外に、次のことにご注意ください。

## ■電源について

- 他の機器と接続する際は、誤動作やスピーカーなどの破損を防ぐため、必ずすべての機器の電源をオフにしてください。
- 雑音を発生する装置（モーター、調光器など）や消費電力の大きな機器とは、別のコンセントをご使用ください。

## ■設置について

- 本機の近くにパワー・アンプなどの大型トランスを持つ機器がある場合、ハム（うなり）を誘導することがあります。その場合は、本機との間隔や方向を変えてください。
- テレビやラジオの近くで本機を動作させると、テレビ画面に色ムラが出たり、ラジオから雑音が出ることがあります。このような場合は、本機を遠ざけてご使用ください。

## ■お手入れについて

- 通常のお手入れは、柔らかい布で空拭きするか、強く絞った布で汚れを拭き取ってください。汚れが激しいときは、中性洗剤で汚れを拭き取ってから、必ず柔らかい布で空拭きしてください。
- 変色や変形の原因となるベンジン、シンナー及びアルコール類は、絶対にご使用にならないでください。

## ■その他の注意について

- 本機に強い衝撃を与えないでください。
- ディスプレイを強く押ししたり、叩いたりしないでください。
- 本機は多少発熱することがありますが、故障ではありません。
- 外国でご使用になる場合は、前もって最寄りのローランド・サービスにご相談ください。
- ディスプレイから多少音がすることがありますが、故障ではありません。

## ■メモリー・バックアップについて

- 本体には、電源オフ後も記憶した内容を保持するための電池を装備しています。5年を目安に交換してください（電池の寿命は使用条件によって異なります）。交換の際は、必ずローランド・サービスにご相談ください。
- 電池が消耗してくると、ディスプレイに次のように表示されます。電池が消耗してしまうと記憶した内容が失われますので、早めに交換してください。

bEtL

- 修理に出される場合や万一異常な動作をしたときには、記憶した内容が失われることがあります。大切なデータは、他のMIDI機器（シーケンサーなど）に保存するか、データをメモしておいてください。修理の際のデータ保存には細心の注意を払っておりますが、メモリー部の故障などでデータが復元できない場合はご容赦ください。

# Important Notes

In addition to the items listed under Important Safety Instructions inside the front cover, please read and observe the following:

## Power Supply

- Before connecting this unit to other devices, turn off the power to all units; this will help prevent damage or malfunction.
- Do not use this unit on the same power circuit with any device that will generate line noise; an electric motor or variable lighting system for example.

## Placement

- Using the unit near power amplifiers (or other equipment containing large power transformers) may induce hum.
- This device may interfere with radio and television reception. Do not use this device in the vicinity of such receivers.

## Maintenance

- For everyday cleaning wipe the unit with a soft, dry cloth or one that has been slightly dampened with water. To remove stubborn dirt, use a mild, non-abrasive detergent. Afterwards, be sure to wipe the unit thoroughly with a soft, dry cloth.
- Never use benzene, thinners, alcohol or solvents of any kind, to avoid the possibility of discoloration and/or deformation.

## Additional Precautions

- Protect the unit from strong impact.
- Never strike or apply strong pressure to the display.
- A small amount of heat will radiate from the unit during normal operation.
- Before using the unit in a foreign country, consult with qualified service personnel.
- A small amount of noise may be heard from the display during normal operation.

## Memory Backup

- This unit contains a battery which powers the unit's memory circuits while the main (AC) power is off. The expected life of this battery is 5 years or more. However, to avoid the untimely loss of memory data, it is strongly recommended that you change the battery every 5 years. Please be aware that the actual life of the battery will depend upon the physical environment — especially the temperature — in which the unit is used. When it is time to change the battery, consult with qualified service personnel.
- When the battery becomes weak the following message will appear in the display: "bEtL ." Please change the battery as soon as possible to avoid the loss of memory data.
- Please be aware that the contents of memory may at times be lost; when the unit is sent for repairs or when by some chance a malfunction has occurred. Important data should be stored in another MIDI device (eg., a sequencer), or written down on paper (if possible). During repairs, due care is taken to avoid the loss of data. However, in certain cases (such as when circuitry related to memory itself is out of order), we regret that it may not be possible to restore the data.

# レガート・コントロール機能

# Legato Control Feature

M-SE1は弦楽器の演奏をリアルに再現するために、レガート・コントロール機能を持っています。

弦楽器の演奏では、弓を動かしたときのみアタック感のある音が鳴り、動かしている最中はアタックのない緩やかな音が鳴ります。レガート・コントロール機能はパッチ中の特定のボイスをキーボードの弾き方によりオン/オフし、このアタック感の違いをシミュレートします。

┌ 3 | のように、パッチ・ナンバーの左側に「L」と表示されるパッチではレガート・コントロール機能を使って演奏できます。実際にこのパッチを使って演奏してみましょう。

あるひとつの鍵を弾いて、その鍵を離さずに別の鍵を弾いてください。最初の音はアタック成分を含んでいますが、ふたつ目の音はアタック成分が無く、音がなめらかにつながります。

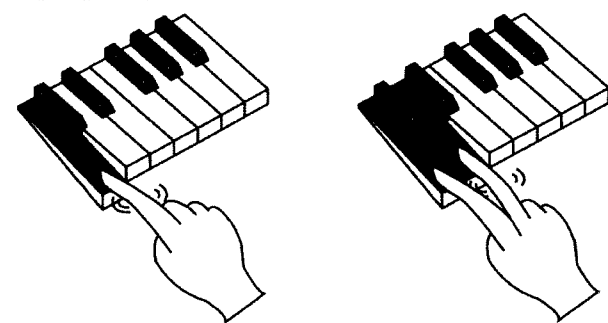

アタックが欲しいときは、今押さえている鍵を完全に放してから次の鍵を弾きます。

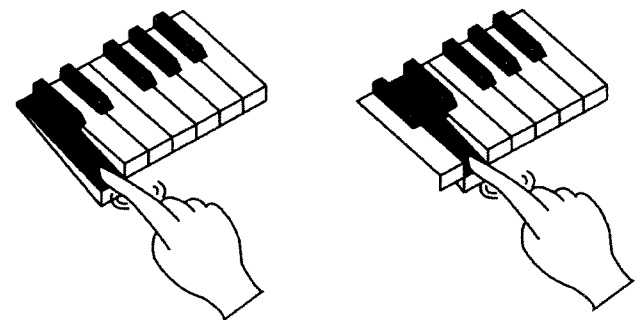

このようにして、リアルな弦楽器の演奏を楽しめます。

## ■システム・エクスクルーシブ・メッセージを使って

パッチをエディットするときの注意 .....  
各パッチのレガート・コントロール機能をオン/オフすることはできません。使用目的にあったパッチを選んでエディットしてください。本機のレガート・コントロールはパッチを構成するボイス1~4のうち、3と4を鍵盤の弾き方により自動的にオン/オフしてアタック音に変化を付けています。

Since the M-SE1 is geared toward the faithful reproduction of string instruments, it comes equipped with a unique Legato Control feature.

To understand this feature, consider how most string instruments produce sound. Usually, a brief attack-like sound will be heard only at the very instant the string is made to vibrate. After that a much mellower, attack-free sound continues to emanate during the string's vibration. The Legato Control feature simulates such variable attack-portion characteristics of string sounds by switching on or off certain special voices within a Patch according to the way the keyboard is played.

Any Patch which has an "L" to the left of its number (such as ┌ 3 | ) allows for use of the Legato Control feature. Try out one of these Patches to hear how it works. If you are using a keyboard, play a note and keep your finger on that key while playing another note.

You should hear a distinct attack portion with the first note you play, while the second one contains almost no attack components, and sounds much smoother.

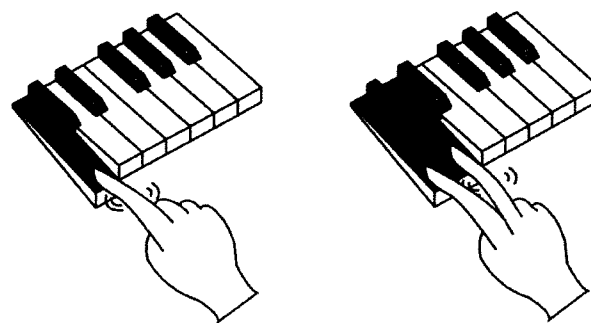

If you want to sound the attack portion each time, simply release your finger from a key before playing the next note.

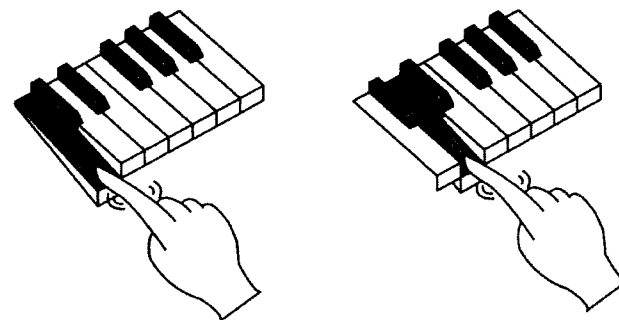

Once you get used to this feature, you should be able to play string music that sounds very realistic.

## ■ Important Notes on Editing Patches Using System Exclusive Messages

Legato Control cannot be switched on and off on a Patch basis. You should choose and edit a Patch that meets your intended usage. Of the four Voices that make up each Patch, two of them (3 & 4) modify the attack sound by automatically switching Voices 3 and 4 on or off according to how the keyboard is played.

# デモ曲について

M-SE1には5曲のデモ曲が内蔵されています。曲名と作曲者などは以下の通りです。デモ曲をお聴きになりたいときは、サウンド・エクステンション・シリーズ取扱説明書の「デモ曲の聴き方」(p. 6)をご覧ください。

曲番号/曲名	S-1/Cascade
作曲者	Scott Tibbs
著作権	©1995 Buoy Music

曲番号/曲名	S-2/組曲「ホルベアの時代」より「プレリュード」
作曲者	グリーグ
プログラマー	久光浩
著作権	©1995 ローランド

曲番号/曲名	S-3/MIDORI
作曲者/プログラマー	小室弥須彦
著作権	©1995 ローランド
*RSS (p.10) の効果を使ったパッチを使用しています	

曲番号/曲名	S-4/Waltz for Diane
作曲者/プログラマー	平下政志&平下和子
著作権	©1995 ローランド

曲番号/曲名	S-5/弦楽四重奏曲「アメリカ」より 第1楽章
作曲者	ドヴォルザーク
プログラマー	久光浩
著作権	©1995 ローランド

## ■作曲者、プログラマーのプロフィール.....

**Scott Tibbs (スコット・ティブス)**  
スコット・ティブスは演奏家/指揮者として、アトランタ交響楽団など、数々のオーケストラでの演奏経験を持つ。全米各地はもとより、カナダ、中南米そして日本にも演奏旅行をしている。演奏/指揮だけでなく作曲も数多く手がけ、映画音楽はもとより劇場やTV用の音楽、コンサートのための音楽など、その範囲は幅広い。ここ数年は、自らが作曲の博士号を修得した母校UCLAで、作曲と音楽理論の教鞭をとっている。ディジー・ガレスピー (Dizzy Gillespie)、ビル・コスビー (Bill Cosby)、ジェリー・シーンフェルド (Jerry Seinfeld) やボビー・シュウ (Bobby Shew) など数多くの有名アーティストとも共演している。

**久光浩 (ひさみつ ひろし)**  
学生時代から、数多くのオーケストラ作品、アレンジを手掛ける一方、コンピューター・ミュージックの分野にも興味を持ち、作品を発表するようになる。その幅広い音楽性と知識に裏打ちされたテクニックで、特にアコースティックな表現には定評がある。現在、“Team-khy”メンバー、京都教育大学にてコンピューター・ミュージックの講師もつとめている。

**小室弥須彦 (こむろ やすひこ)**  
関西在住のクラシック系フリーランスの作・編曲・ピアニスト。1990年、大田川恭子、久光浩と“Team-khy”(チーム・カイ)を結成、その堅実なスタイルによる作品群は高い評価を受けている。

**平下政志&平下和子 (ひらした まさし、ひらした かずこ)**  
政志氏は、幼少からクラシック・ピアノを学び、学生時代には作曲を専攻すると共に、キーボーディスト兼作曲家としての活動を始める。ジャズ、フュージョン、ポップスなど様々なジャンルのスタジオ・セッションや、サポート・ミュージシャンとして活動する。また、そのかわらCM、アニメーション・ビデオ、ミュージカル、TVやFM番組などの音楽を手がける。現在は夫人の和子氏とともに作曲、演奏活動を行い、ローランドからSMF Music Dataをリリースするなど、コンピューターを駆使した音楽制作に幅広く活躍中である。

\*これらのデモ・ソングを個人で楽しむ以外に権利者の許諾なく使用することは法律で禁止されています。

# About the Demo Songs

Contained within the M-SE1 are five demo songs. The names of these songs and their composers are listed below. See page 6 in the Sound Expansion series Owner's Manual for instructions on how to listen to the demo songs.

Song No./Title	S-1/Cascade
Composer	Scott Tibbs
Copyright	©1995 Buoy Music

Song No./Title	S-2/"Prelude" from "Holberg Suite" Op. 40
Composer	Edvard H. Grieg
Programmer	Hiroshi Hisamitsu
Copyright	©1995 Roland Corporation

Song No./Title	S-3/MIDORI
Composer/Programmer	Yasuhiko Komuro
Copyright	©1995 Roland Corporation
* This song uses the Patches which use the effects of RSS.	

Song No./Title	S-4/Waltz for Diane
Composer/Programmer	Kazuko Hirashita & Masashi Hirashita
Copyright	©1995 Roland Corporation

Song No./Title	S-5/String Quartet "America" Op. 96 in F-Major, 1st movement
Composer	Antonín Dvořák
Programmer	Hiroshi Hisamitsu
Copyright	©1995 Roland Corporation

## ■ Biographies of Composers and Programmers .....

**Scott Tibbs**  
Scott Tibbs has performed and conducted for several orchestral groups, including the Atlanta Symphony Orchestra, throughout the United States, Canada, Latin America, and Japan. His diverse compositional output ranges from numerous film, theater and television projects to the symphonic concert stage. For the past four years, he has been teaching music composition and theory at UCLA where he has received a Ph.D. degree in composition. He has performed with well-known artists Dizzy Gillespie, Bill Cosby, Jerry Seinfeld, and Bobby Shew, amongst numerous others.

**Hiroshi Hisamitsu**  
Since his schooldays, Hiroshi Hisamitsu has been active in orchestral composition and in arranging. He has also had an interest in computer music which led to compositions in that field as well. His compositional technique is supported by broad musical knowledge and experience, and he is especially known for his acoustic expressiveness. At present, he is a member of "Team-khy," and an instructor in computer music at Kyoto University of Education.

**Yasuhiko Komuro**  
Yasuhiko Komuro is a freelance classical composer/ arranger/pianist who lives in the Kansai area. In 1990 he joined Kyoko Ootagawa and Hiroshi Hisamitsu to form "Team-khy," and their compositions in their own solid style are highly acclaimed.

**Masashi Hirashita & Kazuko Hirashita**  
Masashi and Kazuko both started studying classical piano when they were in their infancy. Both went on to study composition. At the same time, they had started their own music careers as keyboardist and composers. Their work covers a wide spectrum of styles and activities, including pop, fusion and jazz music as well as many writing and producing jobs.

\* All right reserved. Unauthorized use of this material is a violation of applicable laws.

# 音色一覧表 / Tone List

各リストの解説は p. 10 をご覧ください。 / For information that will help you better understand these lists, see page 11.

## パフォーマンス一覧表 Performance List

### <PC No.1: P01 Strings Ens.>

Part	No.	Patch Name
1	L51	Vns div 1
2	L53	Vns div 2
3	L60	Vas div 1
4	L68	Vcs div 1
5	L78	Cbs div 2
6	55	Vns pizz.
7	72	Vcs pizz.
8	d 1	Standardset

Reverb: Hall 2; Chorus: Chorus 1

### <PC No.2: P02 Chamber Ens.>

Part	No.	Patch Name
1	L51	Vns div 1
2	L53	Vns div 2
3	L60	Vas div 1
4	L68	Vcs div 1
5	L78	Cbs div 2
6	89	Solo Horn
7	90	Harpsichord1
8	d 2	Timpani + Harp

Reverb: Hall 2; Chorus: Chorus 1

### <PC No.3: P03 RSS Strings>

Part	No.	Patch Name
1	93	RSS Whirling
2	94	RSS Floating
3	95	RSS Wide
4	103	RSS+Stereo 4
5	104	RSS Sweep 1
6	111	Depth Charge
7	108	Harp w/Delay
8	d 1	Standardset

Reverb: Hall 1; Chorus: Chorus 3

### <PC No.4: P04 Trio 1>

Part	No.	Patch Name
1	L12	Violin 1 f
2	22	Violin spic1
3	L24	Viola 1 f
4	28	Viola spic.
5	L29	Cello 1 f
6	36	Cello spic.
7	90	Harpsichord1
8	d 2	Timpani + Harp

Reverb: Stage 2; Chorus: Chorus 1

### <PC No.5: P05 Trio 2>

Part	No.	Patch Name
1	13	Violin 2 p
2	21	Violin pizz.
3	25	Viola 2 p
4	27	Viola pizz.
5	30	Cello 2 p
6	35	Cello pizz.
7	88	Concert Harp
8	d 1	Standardset

Reverb: Stage 2; Chorus: Chorus 1

### <PC No.6: P06 Quartet>

Part	No.	Patch Name
1	L12	Violin 1 f
2	L14	Violin 3 f2
3	L24	Viola 1 f
4	L29	Cello 1 f
5	21	Violin pizz.
6	27	Viola pizz.
7	35	Cello pizz.
8	d 2	Timpani + Harp

Reverb: Stage 2; Chorus: Chorus 1

### <PC No.7: P07 Quintet>

Part	No.	Patch Name
1	L12	Violin 1 f
2	L14	Violin 3 f2
3	L24	Viola 1 f
4	L29	Cello 1 f
5	L37	C.Bass w/vib
6	27	Viola pizz.
7	35	Cello pizz.
8	d 2	Timpani + Harp

Reverb: Stage 2; Chorus: Chorus 1

### <PC No.8: P08 Sextet>

Part	No.	Patch Name
1	L12	Violin 1 f
2	L14	Violin 3 f2
3	L24	Viola 1 f
4	25	Viola 2 p
5	L29	Cello 1 f
6	30	Cello 2 p
7	27	Viola pizz.
8	d 2	Timpani + Harp

Reverb: Stage 2; Chorus: Chorus 1

### <PC No.9: P09 ConcertHall1>

Reverb: Hall 1; Chorus: Chorus 1

### <PC No.10: P10 ConcertHall2>

Reverb: Hall 2; Chorus: Chorus 1

### <PC No.11: P11 Chamber Hall>

Reverb: Stage 2; Chorus: Chorus 1

### <PC No.12: P12 Salon>

Reverb: Room 2; Chorus: Chorus 1

### <PC No.13: P13 HolbergSuite>

Part	No.	Patch Name
1	L51	Vns div 1
2	L54	Vns div 2 e
3	L60	Vas div 1
4	L63	Vas div 2 e
5	L68	Vcs div 1
6	L71	Vcs div 2 e
7	L76	Cbs div 1
8	d 1	Standardset

Reverb: Hall 1; Chorus: Chorus 1

### <PC No.14: P14 MIDORI #1>

Part	No.	Patch Name
1	110	LastFrontier
2	109	Harp w/RSStr
3	157	CS Sweep
4	96	RSS Strings1
5	135	Galeria
6	93	RSS Whirling
7	169	Psychos
8	d 1	Standardset

Reverb: Pan-Delay; Chorus: Chorus 1

### <PC No.15: P15 MIDORI #2>

Part	No.	Patch Name
1	L16	Violin 5 f/p
2	22	Violin spic1
3	166	7th Runner
4	110	LastFrontier
5	135	Galeria
6	93	RSS Whirling
7	120	7th Harppizz
8	d 1	Standardset

Reverb: Hall 1; Chorus: Chorus 1

### <PC No.16: P16 Waltz for...>

Part	No.	Patch Name
1	6	Slow Str 1
2	6	Slow Str 1
3	L58	Vas uni
4	89	Solo Horn
5	L66	Vcs uni
6	80	Cbs pizz.
7	88	Concert Harp
8	d 1	Standardset

Reverb: Hall 1; Chorus: Chorus 1

### <PC No.17: America>

Part	No.	Patch Name
1	L12	Violin 1 f
2	L14	Violin 3 f2
3	L24	Viola 1 f
4	L29	Cello 1 f
5	22	Violin spic1
6	22	Violin spic1
7	28	Viola spic.
8	d 1	Standardset

Reverb: Hall 1; Chorus: Chorus 1

### <PC No.18: P18 Default Perf>

Part	No.	Patch Name
1	L1	Strings 1
2	L1	Strings 1
3	L1	Strings 1
4	L1	Strings 1
5	L1	Strings 1
6	L1	Strings 1
7	L1	Strings 1
8	d 1	Standardset

Reverb: Hall 1; Chorus: Chorus 1

PC No.:  
プログラム・ナンバー  
(パフォーマンス・ナンバー)  
Program Number  
(Performance Number)  
No.:  
パッチ・ナンバーまたは  
リズム・セット・ナンバー  
Patch Number  
(Rhythm set Number)

## パッチ一覧表 Patch List

■ CC0: 80; CC32: 0

No.	PC No.	Name	Voice	Note On	Note Off	Mod.	Press.	Express.
L1	1	Strings 1	3	✓	✓	attack	level	filter
L2	2	Strings 2	4	✓	✓	attack	level	filter
L3	3	Strings 3	4	✓	✓	attack	level	filter
4	4	Strings 4	3	✓	✓	attack	level	filter
5	5	Strings 5	2		✓	vibrato	level	filter
6	6	Slow Str 1	2	✓	✓	vibrato	level	filter
7	7	Slow Str 2	2	✓	✓	vibrato	level	filter
8	8	Slow Str 3	2	✓	✓	vibrato	level	filter
9	9	Slow Str 4	2	✓	✓	vibrato	level	filter
10	10	Pizzicato 1	4	✓	✓	vibrato	vibrato	filter
11	11	Pizzicato 2	2	✓	✓	vibrato	vibrato	filter
L12	12	Violin 1 f	3		✓	attack	level	filter
13	13	Violin 2 p	1		✓		level	filter
L14	14	Violin 3 f2	2		✓	attack	level	filter
L15	15	Violin 4 f	4			attack	level	filter
L16	16	Violin 5 f/p	3			attack	level	filter
17	17	Violin 6 f/p	4			attack	level	filter
18	18	Violin 7 f	3	✓	✓	attack	level	filter
L19	19	Violin nvib1	3	✓		vibrato	vibrato	filter
20	20	Violin nvib2	1		✓	vibrato	level	filter
21	21	Violin pizz.	2		✓	vibrato	vibrato	filter
22	22	Violin spic1	2			attack		filter
23	23	Violin spic2	2			attack		filter
L24	24	Viola 1 f	2	✓	✓	attack	level	filter
25	25	Viola 2 p	2	✓	✓	attack	level	filter
L26	26	Viola nvib.	3	✓		vibrato	vibrato	filter
27	27	Viola pizz.	2		✓	vibrato	vibrato	filter
28	28	Viola spic.	1					filter
L29	29	Cello 1 f	2	✓	✓	attack	level	filter
30	30	Cello 2 p	1	✓	✓		level	filter
L31	31	Cello 3 f	2			attack	level	filter
L32	32	Cello 4 f/p	4			attack	level	filter
L33	33	Cello 5 p	3			attack	level	filter
34	34	Cello nvib.	1		✓	vibrato	vibrato	filter
35	35	Cello pizz.	2		✓	vibrato	vibrato	filter
36	36	Cello spic.	1					filter
L37	37	C.Bass w/vib	3	✓	✓	attack	level	filter
38	38	C.Bass nvib.	1		✓	vibrato	vibrato	filter
39	39	C.Bass pizz.	2		✓	vibrato	vibrato	balance
40	40	C.Bass spic.	1					filter
L41	41	C.Bass Brk.	3			vibrato	vibrato	balance
L42	42	Vn & Va Duo1	4	✓	✓	attack	level	filter
L43	43	Vn & Va Duo2	4	✓	✓	attack	level	filter
L44	44	Va & Vc Duo1	4	✓	✓	attack	level	
L45	45	Va & Vc Duo2	4	✓	✓	attack	level	
L46	46	Vc & Cb Duo1	4	✓	✓	attack	level	filter
L47	47	Vc & Cb Duo2	4	✓	✓	attack	level	
L48	48	Quartet	3			attack	level	filter
L49	49	Vns uni	4		✓	attack	level	balance
L50	50	Vns uni e	3		✓		level	balance
L51	51	Vns div 1	3		✓	attack	level	filter
L52	52	Vns div 1 e	2		✓		level	filter
L53	53	Vns div 2	3		✓	attack	level	filter
L54	54	Vns div 2 e	2		✓		level	filter

No.	PC No.	Name	Voice	Note On	Note Off	Mod.	Press.	Express.
55	55	Vns pizz.	1			vibrato	vibrato	filter
56	56	Vns spic.	1					filter
57	57	Col Legno	4					balance
L58	58	Vas uni	4		✓	attack	level	balance
L59	59	Vas uni e	3		✓		level	balance
L60	60	Vas div 1	3		✓	attack	level	filter
L61	61	Vas div 1 e	2		✓		level	filter
L62	62	Vas div 2	3		✓	attack	level	filter
L63	63	Vas div 2 e	2		✓		level	filter
64	64	Vas pizz.	2			vibrato	vibrato	filter
65	65	Vas spic.	1					filter
L66	66	Vcs uni	4		✓	attack	level	balance
L67	67	Vcs uni e	3		✓		level	balance
L68	68	Vcs div 1	3		✓	attack	level	filter
L69	69	Vcs div 1 e	2		✓		level	filter
L70	70	Vcs div 2	3		✓	attack	level	filter
L71	71	Vcs div 2 e	2		✓		level	filter
72	72	Vcs pizz.	2			vibrato	vibrato	filter
73	73	Vcs spic.	1					filter
L74	74	Cbs uni	4		✓	attack	level	balance
L75	75	Cbs uni e	3		✓		level	balance
L76	76	Cbs div 1	3		✓	attack	level	filter
L77	77	Cbs div 1 e	2		✓		level	filter
L78	78	Cbs div 2	3		✓	attack	level	filter
L79	79	Cbs div 2 e	2		✓		level	filter
80	80	Cbs pizz.	2			vibrato	vibrato	filter
81	81	Cbs spic.	1					filter
L82	82	Vns & Vas	4	✓	✓	attack	level	filter
L83	83	Vas & Vcs	4	✓	✓	attack	level	filter
L84	84	Vcs & Cbs	4	✓	✓	attack	level	filter
85	85	Section 1 f	4				level	filter
86	86	Section 2 p	4			vibrato	vibrato	filter
87	87	Section 3	4			vibrato	vibrato	filter
88	88	Concert Harp	1			vibrato	vibrato	filter
89	89	Solo Horn	1	✓		vibrato	level	level
90	90	Harpichord1	2			vibrato		filter
91	91	Harpichord2	2			vibrato		filter
92	92	Harpichord3	1			vibrato		filter
93	93	RSS Whirling	2	✓	✓		level	filter
94	94	RSS Floating	2	✓	✓		level	filter
95	95	RSS Wide	2	✓	✓		level	filter
96	96	RSS Strings1	2	✓	✓		level	filter
97	97	RSS Strings2	2	✓	✓		level	filter
98	98	RSS Strings3	2	✓	✓		level	filter
99	99	RSS Strings4	2	✓		vibrato	filter	filter
100	100	RSS+Stereo 1	4	✓	✓		level	balance
101	101	RSS+Stereo 2	4	✓	✓		level	balance
102	102	RSS+Stereo 3	4	✓	✓		level	balance
103	103	RSS+Stereo 4	3			vibrato	vibrato	
104	104	RSS Sweep 1	2	✓		LFO	filter	filter
105	105	RSS Sweep 2	2	✓		LFO	filter	filter
106	106	Mind Sweeper	4					
107	107	Ssstheowzzz	3			LFO	filter	
108	108	Harp w/Delay	4				attack	balance

## 音色一覧表 / Tone List

No.	PC No.	Name	Voice	Note On	Note Off	Mod.	Press.	Express.
109	109	Harp w/RSStr	4	✓	✓			balance
110	110	LastFrontier	4				balance	balance
111	111	Depth Charge	3					
112	112	Circulation	2			LFO	level	LFO
113	113	SynStringz 1	2			LFO	filter	filter
114	114	SynStringz 2	1			LFO	filter	filter
115	115	Arco Solo	2			LFO	LFO	filter
116	116	Tremolo	4					
117	117	Tape Strings	3			LFO	LFO	filter
118	118	Reso Pizz	3			LFO	LFO	

No.	PC No.	Name	Voice	Note On	Note Off	Mod.	Press.	Express.
119	119	Bonanza	4			LFO	LFO	balance
120	120	7th Harppizz	3			LFO	LFO	balance
121	121	Harpette	3			LFO	LFO	balance
122	122	Harp w/pad	4			LFO	balance	balance
123	123	Hyper Harpo	4			LFO	LFO	filter
124	124	Dulcimation	4			LFO	filter	filter
125	125	Time+Motion	4	✓		LFO	LFO	balance
126	126	Nocturne	4			LFO	filter	filter
127	127	Stringtasia	4			LFO	LFO	balance
128	128	Lovers Pluck	4			LFO	LFO	filter

### ■CC0: 81; CC32: 0

No.	PC No.	Name	Voice	Note On	Note Off	Mod.	Press.	Express.
129	1	Harmonius	3			LFO	filter	LFO
130	2	Harpanicity	4			filter	filter	filter
131	3	Sinlee	4			LFO	LFO	level
132	4	Naimtech	3			LFO	filter	filter
133	5	Logisfix	4			LFO	level	filter
134	6	OffLand	3			LFO	filter	filter
135	7	Galeria	3			LFO	LFO	filter
136	8	Harmon.Pad	3	✓	✓	LFO	LFO	filter
137	9	Heaven Padd	3			LFO	LFO	filter
138	10	Digivox	4			filter	filter	balance
139	11	Eternium	4			LFO	LFO	
140	12	Orchestratz	4				level	
141	13	Spread Hornz	3			LFO	filter	
142	14	Synth Brass1	2			LFO	LFO	filter
143	15	Synth Brass2	3			LFO	LFO	filter
144	16	Vento Hornz	4			LFO	filter	LFO
145	17	Touch Brass	3			LFO	balance	filter
146	18	Plukkk Brass	4			LFO	filter	level
147	19	Sow Thorn	4			LFO	LFO	filter
148	20	Synth Bass 1	3			LFO	LFO	filter
149	21	Synth Bass 2	3			LFO	LFO	filter

No.	PC No.	Name	Voice	Note On	Note Off	Mod.	Press.	Express.
150	22	Synth Bass 3	3			LFO	LFO	filter
151	23	Angry Bases	4				LFO	
152	24	Syntholo	3			LFO	LFO	filter
153	25	Old Timer	4			LFO	filter	filter
154	26	Rosine Leed	3			LFO	LFO	filter
155	27	Scrap Lead	3			LFO	LFO	filter
156	28	Bogpipe Leed	2			LFO	LFO	filter
157	29	CS Sweep	3			LFO	LFO	filter
158	30	Koetar	4			pitch	LFO	balance
159	31	Stickley	3			LFO	LFO	filter
160	32	Sneaky!!	4			LFO	LFO	LFO
161	33	Tripolet	4			LFO	LFO	filter
162	34	Are Ko Compi	3			LFO	LFO	balance
163	35	Pizz Shuffle	4					
164	36	Pizzsteps	4			LFO	LFO	
165	37	Bubbles	4					
166	38	7th Runner	4			LFO	LFO	
167	39	Jen Orate	3			pitch	LFO	filter
168	40	Krasher	4		✓	LFO	filter	filter
169	41	Psychos	3			pitch		
170	42	Jungle Attak	4					

## 音色テーブル 2 一覧表 Patch Table 2 List

### ■ Part 1 - 7

#### <Piano>

PCNo.	CC0	CC32	Patch No.	Patch Name	Voice
7	0	0	92	Harpsichord3	1
	24	0	91	Harpsichord2	2

#### <Bass>

PCNo.	CC0	CC32	Patch No.	Patch Name	Voice
33	0	0	L41	C.Bass Btrk	3
39	0	0	148	Synth Bass 1	3
	8	0	150	Synth Bass 3	3
40	0	0	149	Synth Bass 2	3
	8	0	151	Angry Bases	4

#### <Strings>

PCNo.	CC0	CC32	Patch No.	Patch Name	Voice
41	0	0	L16	Violin 5 f/p	3
	8	0	13	Violin 2 p	1
42	0	0	L24	Viola 1 f	2
43	0	0	L29	Cello 1 f	2
44	0	0	L37	C.Bass w/vib	3
46	0	0	11	Pizzicato 2	2
47	0	0	88	Concert Harp	1

#### <Ensemble>

PCNo.	CC0	CC32	Patch No.	Patch Name	Voice
49	0	0	5	Strings 5	2
50	0	0	6	Slow Str 1	2
51	0	0	113	SynStringz 1	2
	8	0	96	RSS Strings1	2
52	0	0	114	SynStringz 2	1

#### <Synth Pad>

PCNo.	CC0	CC32	Patch No.	Patch Name	Voice
89	0	0	127	Stringtasia	4
90	0	0	137	Heaven Padd	3

### ■ Part 8 (Rhythm Set)

PCNo.	CC0	CC32	Rhythm Set No.	Rhythm Set Name
49	---	---	d 1	Standard Set
50	---	---	d 2	Timpani + Harp

PC No.: プログラム・ナンバー

Program Number  
CC0: コントローラー・ナンバー0の値  
Value of Controller Number 0

CC32: コントローラー・ナンバー32の値  
Value of Controller Number 32

Voice: 使用ボイス数  
Number of Voices

---: 無視されます  
Ignored



## リズム・セット一覧表

## Rhythm Set List (CC0: 80; CC32: 0)

<PC No.1: d 1 StandardSet>		
Key	Note No.	Rhythm Tone Name
C2	36	none
C#2	37	none
D2	38	none
D#2	39	none
E2	40	none
F2	41	Timpani f F
F#2	42	Timpani f F#
G2	43	Timpani f G
G#2	44	Timpani f G#
A2	45	Timpani f A
A#2	46	Timpani f A#
B2	47	Timpani f B
C3	48	Timpani f C
C#3	49	Timpani f C#
D3	50	Timpani f D
D#3	51	Timpani f D#
E3	52	Timpani f E
F3	53	Timpani f F
F#3	54	Tambourine
G3	55	none
G#3	56	none
A3	57	none
A#3	58	none
B3	59	none
C4	60	none
C#4	61	none
D4	62	none
D#4	63	none
E4	64	none
F4	65	none
F#4	66	none
G4	67	none
G#4	68	none
A4	69	none
A#4	70	Slapstick
B4	71	none
C5	72	none
C#5	73	none
D5	74	none
D#5	75	none
E5	76	none
F5	77	none
F#5	78	Castanets 1
G5	79	none
G#5	80	Triangle [EXC 1]
A5	81	Triangle [EXC 1]
A#5	82	none
B5	83	Sleigh Bell
C6	84	none
C#6	85	none
D6	86	none
D#6	87	none
E6	88	none
F6	89	none
F#6	90	none
G6	91	none
G#6	92	none
A6	93	none
A#6	94	none
B6	95	none
C7	96	none

<PC No.2: d 2 Timpani + Harp>		
Key	Note No.	Rhythm Tone Name
C2	36	Vn fing noiz
C#2	37	Slapstick
D2	38	Triangle
D#2	39	Sleigh Bell
E2	40	Tambourine
F2	41	Timpani f F
F#2	42	Timpani f F#
G2	43	Timpani f G
G#2	44	Timpani f G#
A2	45	Timpani f A
A#2	46	Timpani f A#
B2	47	Timpani f B
C3	48	Timpani f C
C#3	49	Timpani f C#
D3	50	Timpani f D
D#3	51	Timpani f D#
E3	52	Timpani f E
F3	53	Timpani f F
F#3	54	Harp F#
G3	55	Harp G
G#3	56	Harp G#
A3	57	Harp A
A#3	58	Harp A#
B3	59	Harp B
C4	60	Harp C
C#4	61	Harp C#
D4	62	Harp D
D#4	63	Harp D#
E4	64	Harp E
F4	65	Harp F
F#4	66	Harp F#
G4	67	Harp G
G#4	68	Harp G#
A4	69	Harp A
A#4	70	Harp A#
B4	71	Harp B
C5	72	Harp C
C#5	73	Harp C#
D5	74	Harp D
D#5	75	Harp D#
E5	76	Harp E
F5	77	Harp F
F#5	78	Harp F#
G5	79	Harp G
G#5	80	Harp G#
A5	81	Harp A
A#5	82	Harp A#
B5	83	Harp B
C6	84	Harp C
C#6	85	Harp C#
D6	86	Harp D
D#6	87	Harp D#
E6	88	Harp E
F6	89	Harp F
F#6	90	Harp F#
G6	91	Harp G
G#6	92	Harp G#
A6	93	Harp A
A#6	94	Harp A#
B6	95	Harp B
C7	96	Harp C

## ウェーブフォーム一覧表

## Waveform List

Wave No.	Wave Name	Wave No.	Wave Name	Wave No.	Wave Name
1	Vn f w/vib 1	55	Cb attack	109	StereoStr B
2	Vn attack	56	Cb spic A	110	StereoStr C
3	Vn p w/vib	57	Cb spic B	111	StereoStr A
4	Vn f w/vib 2	58	Cb pizz C	112	STR Attack A
5	Vn f nvib A	59	Cb pizz A	113	Str attack B
6	Vn f nvib B	60	Cb pizz B	114	Str attack C
7	Vn f nvib C	61	Cb pizz C	115	Harp A
8	Vn spic 1 A	62	Cb brk pizz	116	Harp B
9	Vn spic 1 B	63	Cb pizz mute	117	Harp C
10	Vn spic 1 C	64	Cb harm	118	JP Strings A
11	Vn spic 2 A	65	Cb harm noiz	119	JP Strings B
12	Vn spic 2 B	66	Vns arco A	120	JP Strings C
13	Vn spic 2 C	67	Vns arco B	121	JP-B Saw A
14	Vn pizz A	68	Vns arco C	122	JP-B Saw B
15	Vn pizz B	69	Vns attack	123	JP-B Saw C
16	Vn pizz C	70	Vns spic A	124	JP-B Sqr A
17	Vn pizz 2	71	Vns spic B	125	JP-B Sqr B
18	Vn harm	72	Vns spic C	126	JP-B Sqr C
19	Vn harm noiz	73	Vns pizz A	127	P5 Saw 1 A
20	Vn col leg A	74	Vns pizz B	128	P5 Saw 1 B
21	Vn col leg B	75	Vns pizz C	129	P5 Saw 1 C
22	Vn col leg C	76	Vns arco A	130	P5 Saw 2 A
23	Vn fing noiz	77	Vns arco B	131	P5 Saw 2 B
24	Va f w/vib	78	Vns arco C	132	P5 Saw 2 C
25	Va attack	79	Vns attack	133	CS Saw A
26	Va f nvib A	80	Vns spic A	134	CS Saw B
27	Va f nvib B	81	Vns spic B	135	CS Saw C
28	Va f nvib C	82	Vns spic C	136	OB Saw A
29	Va spic A	83	Vns pizz A	137	OB Saw B
30	Va spic B	84	Vns pizz B	138	OB Saw C
31	Va spic C	85	Vns pizz C	139	Soft Pad A
32	Va pizz high	86	Vcs arco A	140	Soft Pad B
33	Va pizz A	87	Vcs arco B	141	Soft Pad C
34	Va pizz B	88	Vcs arco C	142	Quartet arco
35	Va pizz C	89	Vcs attack	143	Quartet spic
36	Va harm	90	Vcs spic A	144	Quartet pizz
37	Va harm noiz	91	Vcs spic B	145	Chamber arco
38	Vc f w/vib	92	Vcs spic C	146	Chamber spic
39	Vc attack	93	Vcs pizz A	147	Chamber pizz
40	Vc p w/vib	94	Vcs pizz B	148	Harpicode
41	Vc f nvib A	95	Vcs pizz C	149	Steel Guitar
42	Vc f nvib B	96	Cbs arco A	150	Timpani f
43	Vc f nvib C	97	Cbs arco B	151	Triangle
44	Vc spic A	98	Cbs arco C	152	Castanets 1
45	Vc spic B	99	Cbs attack	153	Slapstick
46	Vc spic C	100	Cbs spic A	154	Sleigh Bell
47	Vc pizz A	101	Cbs spic B	155	Tambourine 2
48	Vc pizz B	102	Cbs spic C	156	F.Horn Solo
49	Vc pizz C	103	Cbs pizz A	157	RSS Move F L
50	Vc harm	104	Cbs pizz B	158	RSS Move F R
51	Vc harm noiz	105	Cbs pizz C	159	RSS Fixed L
52	Cb f nvib A	106	StereoStr L A	160	RSS Fixed R
53	Cb f nvib B	107	StereoStr R A	161	RSS Move S L
54	Cb f nvib C	108	StereoStr L B	162	RSS Move S R

システム・エクスクルーシブ・メッセージを使うことでパッチに割り当てられているウェーブフォームを変えることができます。

System Exclusive (SysEx) messages can be used to change waveforms that are assigned to Patches.

## 音色一覧表について

### ■パフォーマンス一覧表について .....

パフォーマンスP09～P12はエフェクターの選択用にご使用ください。それぞれのパフォーマンスはリバーブとコーラスの種類が違っただけで、各パートには下記のようにパッチやリズム・セットが割り当てられています。

Part No.	Patch Name
1	L1 Strings 1
2	11 Pizzicato 2
3	L48 Quartet
4	85 Section 1 f
5	88 Concert Harp
6	89 Solo Horn
7	91 Harpsichord2
8	d1 Standardset

パフォーマンスP13～P16はデモ曲で使用しています。

パフォーマンスP18はGSリセット、GMシステム・オンを受信したときに呼び出されます。

●外部MIDI機器からのパフォーマンスの切り替えがたMIDIメッセージを使って外部機器からパフォーマンスを切り替えたいときは、以下の手順で本機に各MIDIメッセージを送信してください。

1. システム・エクスクルーシブ・メッセージを送信して、コントロール・チャンネル（パフォーマンス切り替えに使うMIDIチャンネル）を設定する（工場出荷時はOFFに設定されています）。  
（例）コントロール・チャンネルを16に設定する  
F0 41 10 46 12 00 00 00 20 0F 51 F7
2. コントローラー・ナンバー0の値を、本機の「バンク・セレクト・メッセージ受信スイッチ」で設定した値に合わせて送信する。その後、コントロール・ナンバー32の値として0を送信する。
3. プログラム・ナンバー1～18を送信する。

### ■パッチ一覧表について .....

#### ●RSSについて

「RSS」の文字が含まれるパッチは、RSS（ローランド・サウンド・スペース）の効果を使い、ディレイ、リバーブやコーラスなどでは表現できない広がりを出しています。これらのパッチをお聞きになるときは、スピーカーを以下のように設置されることをおすすめします。また、スピーカーは側面の壁から十分離してください。

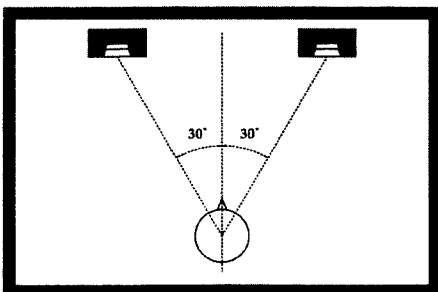

左右のスピーカーの距離が離れすぎている場合や、残響が多すぎる部屋では、RSSの効果は十分現れないことがあります。

#### ●各項目について

**Voice**：本機のパッチを構成する最小単位は「ボイス」です。パッチは1～4のボイス数で構成されています。ここでは、パッチによって使用されているボイス数を表します。

**Note On**：チェック・マークの付いたパッチでは、ノート・オン・メッセージのペロシティーによってアタックの鋭さをコントロールできます。

**Note Off**：チェック・マークの付いたパッチでは、ノート・オフ・メッセージのペロシティーによって音が消えるまでの時間をコントロールできます。

※一部のMIDIキーボードやシーケンサー・ソフトではノート・オフ・メッセージのペロシティーを0などと決まった値で送信するものがあります。このような場合、思ったような効果が得られなくなります。

**Mod./Press./Express.**：本機に外部のMIDI機器からモジュレーション（コントローラー・ナンバー1）、チャンネル・プレッシャー、エクスプレッション（コントローラー・ナンバー11）などのMIDIメッセージを送信すると、各パッチの鳴り方が以下のように変化します。

LFO：シンセサイザー特有のビブラート効果がつきます。

attack：アタックが変化します。

filter：明るい音、こもった音といった変化がつきます。

level：音量が変化します。

pitch：音の高さが変化します。

balance：パッチを構成している各ボイスの音量バランスが変化します。

vibrato：ビブラートの深さが変化します。

vib.rate：ビブラートの揺れの速さが変化します。

コントローラー・ナンバー0の値は工場出荷時のものです。本機のバンク・セレクト・メッセージ受信スイッチの設定（サウンド・エクステンション・シリーズ取扱説明書p.5参照）を変更している場合は、その値を使用してください。

実用音域を越えると発音しないパッチもあります。

### ■音色テーブル2について .....

M-SE1にはGM/GS音源用のSMFミュージック・データを利用する際に便利な「音色テーブル2」という音色配列があります。MIDI INからGMシステム・オン、またはGSリセットを受信すると音色テーブル2に切り替わり、パフォーマンスNo.18（Default Perf）が呼び出されます。

音色テーブル2に切り替えると、本機のバンク・セレクト・メッセージ受信スイッチの設定（サウンド・エクステンション・シリーズ取扱説明書p.5参照）が無効になり、表のプログラム・ナンバー、コントローラー・ナンバー0の値、コントローラー・ナンバー32の値にしたがってパッチが切り替わります。

表に示されている以外の値を受信するとディスプレイに「noP.」と表示されそのパートは発音しません。ただし、パネルの操作ではすべてのパッチ、リズム・セットを選ぶことができます。

### ■リズム・セット一覧表について .....

none：音色が割り当てられていません。

[EXC]：同じ番号の打楽器音は同時に鳴りません。

※プログラム・チェンジ・メッセージで実際に送受信されるデータは、PCNo.から1を引いた値になりますのでご注意ください。

## About the Tone List

### ■ About the Performance List .....

The Performances P09 through P12 have common settings for the Patches and Rhythm Sets assigned to the Parts, and for the Part Parameters — only the Effect settings for each Performance are different. When making your own music data, you can easily modify and use these Performances. The settings for each of the Parts are shown below.

Part No.		Patch Name
1	L1	Strings 1
2	11	Pizzicato 2
3	L48	Quartet
4	85	Section 1 f
5	88	Concert Harp
6	89	Solo Horn
7	91	Harpsichord2
8	d1	Standardset

Performances P13 through P16 are used in the built-in Demo Songs.

The M-SE1 switches to Performance P18 when a General MIDI System On or GS Reset is received.

• **How to Switch Performances from an External Instrument**  
If you want to connect an external instrument to switch Performances using MIDI messages, you need to carry out the following steps to send the required MIDI messages to the M-SE1.

1. Send System Exclusive (SysEx) messages to set the control channel (the MIDI channel used for changing Performances).

At the factory defaults, this parameter is set to OFF.

Example:

To set the control channel to "16," send:

F0 41 10 46 12 00 00 00 20 0F 51 F7

2. Send a value for Controller Number 0 that matches the value set for Bank Select Message Reception on the M-SE1. Then, send "0" as the value for Controller Number 32.

3. Send the Program Number (PC #1 through #18).

### ■ About the Patch List .....

#### • About the RSS Effects

A Patch that has "RSS" as part of its name rely on RSS (Roland Sound Space) effects to produce a fullness of sound that cannot be expressed with Delay, Reverb, Chorus, or the like. If you want to hear these Patches, we recommend setting up the speakers as shown below. Make sure to position the speakers far enough away from walls to either side.

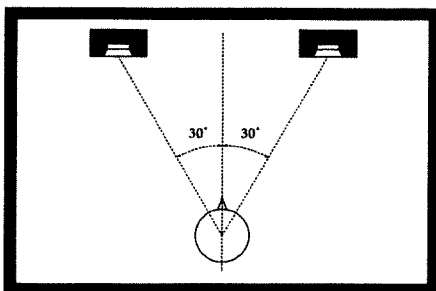

The full expressiveness of the RSS effects may not be obtained if the left and right speakers are placed too far apart, or if used in a room with too much echo.

#### • About Each Column

**Voice:** The smallest unit of the elements that make up a Patch on the M-SE1 is a "Voice." A Patch is made up of from 1 to 4 Voices. In this case, this indicates the number of Voices used by a Patch.

**Note On:** A Patch with a checkmark for this allows the sharpness of the attack to be controlled by the Velocity of the Note On message.

**Note Off:** A Patch with a checkmark for this allows the time until the sound stops to be controlled by the Velocity of the Note Off message.

\* Some MIDI keyboards and sequencer software packages send a fixed value of 0 or some other number for the Velocity of the Note Off message. In such cases, the desired effect will not be obtained.

**Mod./Press./Express.:** The way Patches are played changes as follows when you use an external MIDI instrument to send a MIDI message for Modulation (Controller Number 1), Channel Pressure, Expression (Controller Number 11), or the like to the M-SE1.

LFO: A distinctive synthesizer vibrato effect is applied.

attack: The attack changes.

filter: A distinctive synthesizer sound is produced.

level: The volume level changes.

pitch: The sound's pitch changes.

balance: The volume balance of the Voices that make up the Patch changes.

vibrato: The depth of vibrato changes.

vib.rate: The speed of the vibrato undulations changes.

The Controller No. 0 (CC0) value shown in the lists is the value when at the factory defaults. If you have altered the setting for "Bank Sel" (Bank Select Message Reception; see p. 5 in the Sound Expansion Series manual), remember to take the current value into account.

Some Patches don't produce sound outside of their practical sound range.

### ■ Tone Table 2 .....

The M-SE1 offers a tone layout called Tone Table 2 that comes in handy when using a GM score or music data for a GS sound module.

When a General MIDI System On message or GS Reset message is received from the MIDI IN connector, the M-SE1 switches to Tone Table 2 and calls up Performance Number 18.

When switched to Tone Table 2, the setting for Bank Select Message Reception on the M-SE1 (see page 5 of the Sound Expansion Series Owner's Manual) is disabled, and Patches are switched according to the Program Number shown in the list and the values for Controller Number 0 and Controller Number 32.

If a value other than those in the list is received, the message "noP." appears on the display and that Part is not played. However, you can use the panel to choose any Patch or Rhythm Set.

### ■ About the Rhythm Set List .....

none: No Tone is assigned.

[EXC]: Percussion sounds with the same number are not played at the same time.

\* Please be aware that the Program Change data that is actually sent or received is one less than the value of the PC number described above.

# 主な仕様

サウンド・エクステンション・シリーズ M-SE1  
：マルチティンバー・サウンド・モジュール

- パート  
パート1～7、リズム・パート
- 最大同時発音数  
28音
- エフェクト  
リバーブ(8種類)  
コーラス(3種類)
- メモリー  
システム・セットアップ：1  
パフォーマンス：18  
パッチ：170(レガート・コントロール搭載50種類)  
リズム・セット：2
- 接続端子  
MIDIコネクター(イン、アウト、スルー)  
インプット・ジャック(L, R)  
アウトプット・ジャック(L, R)  
ヘッドホン・ジャック(ステレオ)
- ディスプレイ  
7セグメント3桁(LED)
- 電源  
AC100V
- 消費電力  
7W
- 外形寸法  
482(幅)×165(奥行)×44(高さ)mm  
(EIA-1Uラック・マウント・タイプ)
- 重量  
2.65kg
- 付属品  
サウンド・エクステンション・シリーズ取扱説明書  
M-SE1取扱説明書  
AC電源コード
- 別売品  
ステレオ・ヘッドホン：RH-20/80/120  
システム・ラック：SYRシリーズ

※本機の仕様および外観は、改良のため予告無く変更することがあります。

# Specifications

Sound Expansion Series M-SE1  
：Multi-timbral Sound Module

- Parts  
Parts 1 — 7, Rhythm Part
- Maximum Polyphony  
28 Voices
- Effects  
Reverb (8 types)  
Chorus (3 types)
- Internal Memory  
System Setups: 1  
Performances: 18  
Patches: 170 (Including 50 Legato controlled Patches)  
Rhythm Sets: 2
- Connectors  
MIDI Connectors (In, Out, Thru)  
Input Jacks (L, R)  
Output Jacks (L, R)  
Phone Jack (Stereo)
- Display  
7 Segments, 3 Characters (LED)
- Power Supply  
AC 117 V, AC 230 V or AC 240 V
- Power Consumption  
10 W (AC 117 V, AC 230 V) or 11 W (AC 240 V)
- Dimensions  
482 (W) x 165 (D) x 44 (H) mm  
19 (W) x 6-1/2 (D) x 1-3/4 (H) inches  
(EIA-1U Rack Mount Type)
- Weight  
2.65 kg  
5 lbs., 14 oz.
- Accessories  
Sound Expansion Series Owner's Manual  
M-SE1 Owner's Manual  
AC Cord

\* In the interest of product development, the specifications and/or appearance of this unit are subject to change without prior notice.

## サービスの窓口

商品と修理に関するお問い合わせは . . . . . 最寄りの営業所までご相談ください。

札幌営業所  
〒060 札幌市中央区大通西6-2-6  
三井生命札幌大通ビル7F TEL (011) 281-0708

名古屋営業所  
〒460 名古屋市中区栄2-11-7  
伏見大島ビル2F TEL (052) 202-1881

仙台営業所  
〒980 仙台市青葉区本町2-10-33  
第2日本オフィスビル1F TEL (022) 225-6221

大阪営業所  
〒530 大阪市北区堂島浜1-4-16  
大和堂島ビル5F TEL代表 (06) 345-9521

大宮営業所  
〒331 大宮市桜木町1-441  
GINZA YAMATO3 6F TEL (048) 648-8977

広島営業所  
〒730 広島市中区紙屋町1-1-17  
広島MIDビル4F TEL (082) 247-2731

東京営業所  
〒101 東京都千代田区神田須田町2-7  
タームスビル7F TEL 代表(03) 3251-5595

福岡営業所  
〒812 福岡市博多区店屋町1-31  
東京生命福岡ビル7F TEL (092) 282-4190

横浜営業所  
〒221 横浜市神奈川区鶴屋町2-11-3  
KMビル5F TEL (045) 313-3841

修理に関するお問い合わせは . . . 商品をお求めの販売店か上記営業所、または下記のサービス・ステーション  
あるいはサービス・スポットまでご相談ください。 なお、保証期間内の場合は保証書を添えてご依頼ください。

東京サービス・ステーション  
〒101 東京都千代田区神田須田町2-7  
タームスビル7F TEL (03) 3251-1391

函館サービス・スポット〈(有)ドルビィ〉  
〒042 函館市柏木町35-25 TEL (0138) 53-6249

浜松サービス・ステーション  
〒433 浜松市高丘町1006-14  
TEL (053) 437-3212

秋田サービス・スポット〈(有)音響サービス〉  
〒010 秋田市南通亀の町12-16  
TEL (0188) 33-3465

大阪サービス・ステーション  
〒559 大阪市住之江区新北島3-8-53  
TEL (06) 681-5321

新潟サービス・スポット〈サウンド・リペア北越〉  
〒940 長岡市荻野1-7-16 TEL (0258) 29-2732

福岡サービス・ステーション  
〒812 福岡市博多区店屋町1-31  
東京生命福岡ビル7F TEL (092) 282-4190

金沢サービス・スポット〈オリバー電子(有)〉  
〒921 金沢市額谷1-32 TEL (0762) 98-8309

姫路サービス・スポット〈ギター ワークショップ PEG〉  
〒670 姫路市総社本町214 TEL (0792) 82-6529

商品のお取り扱いに関するお問い合わせは . . . お客様相談センターまでご相談ください。

お客様相談センター 受付時間：午前10時～午後5時（土、日曜、祝日を除く）

■東京 TEL (03) 3251-6150

〒101 東京都千代田区神田須田町2-7 タームスビル7F

■大阪 TEL (06) 345-9500

〒530 大阪市北区堂島浜1-4-16 大和堂島ビル5F

\*上記窓口の名称、所在地、電話番号等は、予告なく変更することがありますのでご了承ください。

## Apparatus containing Lithium batteries

### ADVARSEL!

Lithiumbatteri - Eksplosjonsfare ved feilagtig håndtering.  
Udskiftning må kun ske med batteri af samme fabrikat og type.  
Levér det brugte batteri tilbage til leverandøren.

### VARNING!

Explosionsfara vid felaktigt batteribyte.  
Använd samma batterityp eller en ekvivalent typ som rekommenderas av apparattillverkaren.  
Kassera använt batteri enligt fabrikanterns instruktion.

### ADVARSEL!

Lithiumbatteri - Eksplosjonsfare.  
Ved utskifting benyttes kun batteri som anbefalt av apparatfabrikanten.  
Brukt batteri returneres apparatleverandøren.

### VAROITUS!

Paristo voi räjähtää, jos se on virheellisesti asennettu.  
Vaihda paristo ainoastaan laitevalmistajan suosittelemaan tyyppiin. Hävitä käytetty paristo valmistajan ohjeiden mukaisesti.

## Bescheinigung des Herstellers/Importeurs

Hiermit wird bescheinigt, daß der/die/das

M-SE1 SOUND MODULE

(Gerät, Typ, Bezeichnung)

in Übereinstimmung mit den Bestimmungen der BMPT-AmtsblVfg 243/1991 funk-entstört ist. Der vorschriftsmäßige Betrieb mancher Geräte (z. B. Meßsender) kann allerdings gewissen Einschränkungen unterliegen. Beachten Sie deshalb die Hinweise in der Bedienungsanleitung.

Dem Zentralamt für Zulassungen im Fernmeldewesen wurde das Inverkehrbringen dieses Gerätes angezeigt und die Berechtigung zur Überprüfung der Serie auf die Einhaltung der Bestimmungen eingeräumt.

Roland Corporation

4-16 Dojimahama 1-Chome Kita-ku Osaka 530 Japan

(Name und Anschrift des Herstellers/Importeurs)

## FEDERAL COMMUNICATIONS COMMISSION RADIO FREQUENCY INTERFERENCE STATEMENT

This equipment has been tested and found to comply with the limits for a Class B digital device, pursuant to Part 15 of the FCC Rules. These limits are designed to provide reasonable protection against harmful interference in a residential installation. This equipment generates, uses, and can radiate radio frequency energy and, if not installed and used in accordance with the instructions, may cause harmful interference to radio communications. However, there is no guarantee that interference will not occur in a particular installation. If this equipment does cause harmful interference to radio or television reception, which can be determined by turning the equipment off and on, the user is encouraged to try to correct the interference by one or more of the following measures:

- Reorient or relocate the receiving antenna.
- Increase the separation between the equipment and receiver.
- Connect the equipment into an outlet on a circuit different from that to which the receiver is connected.
- Consult the dealer or an experienced radio/TV technician for help.

Unauthorized changes or modification to this system can void the users authority to operate this equipment.  
This equipment requires shielded interface cables in order to meet FCC class B Limit.

### CLASS B

### NOTICE

This digital apparatus does not exceed the Class B limits for radio noise emissions set out in the Radio Interference Regulations of the Canadian Department of Communications.

### CLASSE B

### AVIS

Cet appareil numérique ne dépasse pas les limites de la classe B au niveau des émissions de bruits radioélectriques fixés dans le Règlement des signaux parasites par le ministère canadien des Communications.

## Information

When you need repair service, call your local Roland Service Station or the authorized Roland distributor in your country as shown below.

### U. S. A.

**Roland Corporation U.S.**  
7200 Dominion Circle  
Los Angeles, CA. 90040-3696, U. S. A.  
TEL: (213) 685 5141

### CANADA

**Roland Canada Music Ltd.**  
**(Head Office)**  
5480 Parkwood Way  
Richmond B. C., V6V 2M4  
CANADA  
TEL: (604) 270 6626

**Roland Canada Music Ltd.**  
**(Montreal Office)**  
9425 Transcanadienne  
Service Rd. N., St Laurent,  
Quebec H4S 1V3, CANADA  
TEL: (514) 335 2009

**Roland Canada Music Ltd.**  
**(Toronto Office)**  
346 Watline Avenue,  
Mississauga, Ontario L4Z  
1X2, CANADA  
TEL: (416) 890 6488

### AUSTRALIA

**Roland Corporation**  
**Australia Pty. Ltd.**  
38 Campbell Avenue  
Dee Why West. NSW 2099  
AUSTRALIA  
TEL: (02) 982 8266

### NEW ZEALAND

**Roland Corporation**  
**(NZ) Ltd.**  
97 Mt. Eden Road, Mt. Eden,  
Auckland 3, NEW  
ZEALAND  
TEL: (09) 3098 715

### UNITED KINGDOM

**Roland (U.K.) Ltd.**  
Rye Close Ancells Business  
Park Fleet, Hampshire GU13  
8UY, UNITED KINGDOM  
TEL: (0252) 816181

**Roland (U.K.) Ltd.,**  
**Swansea Office**  
Atlantic Close, Swansea  
Enterprise Park, Swansea,  
West Glamorgan SA79FJ,  
UNITED KINGDOM  
TEL: (0792) 700 139

### IRELAND

**The Dublin Service**  
**Centre Audio**  
**Maintenance Limited**  
11 Brunswick Place Dublin 2  
Republic of Ireland  
TEL: (01) 677322

### ITALY

**Roland Italy S. p. A.**  
Viale delle Industrie 8 20020  
ARESE MILANO ITALY  
TEL: (02) 93581311

### SPAIN

**Roland Electronics**  
**de España, S. A.**  
Calle Bolivia 239 08020  
Barcelona, SPAIN  
TEL: (93) 308 1000

### GERMANY

**Roland Elektronische**  
**Musikinstrumente**  
**Handelsgesellschaft mbH.**  
Oststrasse 96, 22844  
Norderstedt, GERMANY  
TEL: (040) 52 60090

### FRANCE

**Guillard Musiques Roland**  
ZAC de Rosarge Les Echets  
01700  
MIRIBEL, FRANCE  
TEL: (72) 26 5060

**Guillard Musiques Roland**  
**(Paris Office)**  
1923 rue Léon Geoffroy  
94400 VITRY-SUR-SEINE  
FRANCE  
TEL: (1) 4680 86 62

### BELGIUM/HOLLAND/ LUXEMBOURG

**Roland Benelux N. V.**  
Houtstraat 1 B-2260 Oevel-  
Westerlo BELGIUM  
TEL: (014) 575811

### DENMARK

**Roland Scandinavia A/S**  
Langebrogade 6 Box 1937  
DK-1023 Copenhagen K.  
DENMARK  
TEL: 31 95 31 11

### SWEDEN

**Roland Scandinavia A/S**  
Danvik Center 28 A, 2 tr.  
S-131 30 Nacka SWEDEN  
TEL: (08) 702 0020

### NORWAY

**Roland Scandinavia**  
**Avd. Kontor Norge**  
Lilleakerveien 2 Postboks 95  
Lilleaker N-0216 Oslo 2  
NORWAY  
TEL: (02) 73 0074

### FINLAND

**Fazer Musik Inc.**  
Länsituulentie POB 169,  
SF-02101 Espoo FINLAND  
TEL: (00) 43 5011

### SWITZERLAND

**Roland (Switzerland) AG**  
**Musitronic AG**  
Gerberstrasse 5, CH-4410  
Liestal, SWITZERLAND  
TEL: (061) 921 1615

### AUSTRIA

**E. Dematte & Co.**  
Neu-Rum Siemens-Strasse 4  
A-6040 Innsbruck P.O.Box  
83  
AUSTRIA  
TEL: (0512) 26 44 260

### GREECE

**V. Dimitriadis & Co. Ltd.**  
20, Alexandras St. &  
Bouboulinas 54 St. 106 82  
Athens, GREECE  
TEL: (01) 8232415

### PORTUGAL

**Caius - Tecnologias**  
**Audio e Musica , Lda.**  
Rue de Catarina 131  
4000 Porto, PORTUGAL  
TEL: (02) 38 4456

### HUNGARY

**Intermusica Ltd.**  
Warehouse Area 'DEPO'  
Pf.83 H-2046 Torokbalint,  
Budapest HUNGARY  
TEL: (1) 1868905

### ISRAEL

**D.J.A. International Ltd.**  
Twin Towers, 33 Jabntinsy St.  
Room 211, Ramat Gan 52511  
ISRAEL  
TEL: (03) 751 8585

### CYPRUS

**Radex Sound**  
**Equipment Ltd.**  
17 Diagorou St., P.O.Box  
2046, Nicosia CYPRUS  
TEL: (2) 453 426  
(2) 466 423

### U.A.E

**Zak Electronics &**  
**Musical Instruments Co.**  
P.O. Box 8050  
DUBAI, U.A.E  
TEL: 360715

### KUWAIT

**Easa Husain Al-Yousifi**  
P.O. Box 126 Safat 13002  
KUWAIT  
TEL: 5719499

### LEBANON

**A. Chahine & Fils**  
P.O. Box 16-5857  
Beirut, LEBANON  
TEL: (01) 335799

### TURKEY

**Barkat Sanayi ve Ticaret**  
Siraselviler Cad. 86/6  
Taksim Istanbul, TURKEY  
TEL: (0212) 2499324

### EGYPT

**Al Fanny Trading Office**  
9, Ebn Hagar Ai Askalany  
Street, Ard El Golf,  
Heliopolis, Cairo, 11341  
EGYPT  
TEL: (02) 4171828  
(02) 4185531

### QATAR

**Badie Studio & Stores**  
P.O.Box 62,  
DOHA Qatar  
TEL: 423554

### SYRIA

**Technical Light &**  
**Sound Center**  
Khaled Ebn Al Walid St.  
P.O.Box 13520  
Damascus - Syria  
TEL: (11) 2235 384

### BAHRAIN

**Moon Stores**  
Bad Al Bahrain Road,  
P.O.Box 20077  
State of Bahrain  
TEL: 211 005

### REUNION

**FO - YAM Marcel**  
25 Rue Jules MermanZL  
Chaudron - BP79 97491  
Ste Clotilde REUNION  
TEL: 262 28 29 16

### BRAZIL

**Roland Brasil Ltda.**  
R. Coronel Octaviano da  
Silveira 203 05522-010  
Sao Paulo BRAZIL  
TEL: (11) 843 9377

### MEXICO

**Casa Veerkamp, s.a. de**  
**c.v.**  
Mesones No. 21 Col. Centro  
MEXICO D.F. 06080  
TEL: (905) 709 3716

**La Casa Wagner de**  
**Guadalajara s.a. de c.v.**  
Av. Corona No. 202 S.J.  
Guadalajara, Jalisco  
MEXICO C.P.44100  
TEL: (36) 13 1414

### VENEZUELA

**Musicland Digital C.A.**  
Av. Francisco de Miranda,  
Centro Parque de Cristal,  
Nivel C2 Local 20 Caracas  
VENEZUELA  
TEL: (2) 285 9218

### PANAMA

**Productos Superiores,**  
**S.A.**  
Apartado 655 - Panama 1  
REP. DE PANAMA  
TEL: 26 3322

### ARGENTINA

**Instrumentos Musicales**  
**S.A.**  
Florida 638  
(1005) Buenos Aires  
ARGENTINA  
TEL: (1) 394 4029

### HONG KONG

**Tom Lee Music Co., Ltd.**  
**Service Division**  
22-32 Pun Shan Street, Tsuen  
Wan, New Territories,  
HONG KONG  
TEL: 852 2 737 7688

### KOREA

**Cosmos Corporation**  
**Service Station**  
261 2nd Floor Nak-Won  
Arcade Jong-Ro ku, Seoul,  
KOREA  
TEL: (02) 742 8844

### SINGAPORE

**Swee Lee Company**  
BLOCK 231,  
Bain Street #03-23  
Bras Basah Complex,  
Singapore 0718  
TEL: 3367886

### CRISTOFORI MUSIC PTE LTD

335, Joo Chiat Road  
SINGAPORE 1542  
REPUBLIC OF SINGAPORE  
TEL: 3450435

### PHILIPPINES

**G.A. Yupangco & Co. Inc.**  
339 Gil J. Puyat Avenue  
Makati, Metro Manila 1200,  
PHILIPPINES  
TEL: (02) 817 0013

### THAILAND

**Theera Music Co., Ltd.**  
330 Verng Nakorn Kasem,  
Soi 2, Bangkok 10100,  
THAILAND  
TEL: (02) 2248821

### MALAYSIA

**Bentley Music SDN BHD**  
No.142, Jalan Bukit Bintang  
55100 Kuala Lumpur,  
MALAYSIA  
TEL: (03) 2443333

### INDONESIA

**PT CITRARAMA**  
**BELANTIKA**  
Kompleks Perkantoran Duta  
Merlin Blok E No.6—7  
Jl. Gajah Mada No.3—5,  
Jakarta 10130,  
INDONESIA  
TEL: (021) 3850073

### TAIWAN

**Siruba Enterprise**  
**(Taiwan) Co., LTD.**  
Room. 5, 9F. No. 112 Chung  
Shan N. Road Sec.2 Taipei,  
TAIWAN, R.O.C.  
TEL: (02) 571 5860

### SOUTH AFRICA

**That Other Music Shop**  
**(PTY) Ltd.**  
11 Melle Street (Cnr Melle  
and Juta Street)  
Braamfontein 2001  
Republic of South Africa  
TEL: (011) 403 4105

**Paul Bothner (PTY) Ltd.**  
17 Werdmuller Centre  
Claremont 7700  
Republic of South Africa  
TEL: (021) 64 4030

As of Feb. 23, 1995

サウンド・エクspansion・シリーズ取扱説明書の記載に誤りがありました。お詫びするとともに、下記のように訂正させていただきます。

p.6 「バルクダンプのしかた」

**【追加】**

Part Param 1に含まれるパラメーターの情報はコントロール・チェンジ・メッセージを使って管理されるため、バルク・ダンプでは保存されません。

**【誤】**

**ALL** 下記のすべてのデータとフロント・パネルで調節できる Master、MIDI Rxに含まれるパラメーターの設定を送信します。

**PF** パフォーマンスの設定と、フロント・パネルで調節できる Part Param 1、Part Param 2に含まれるパラメーターの設定を送信します。

**【正】**

**ALL** 本機のすべての設定情報を送信しますが、下記の設定は送信されません。

- Part Param 1に含まれるすべてのパラメーター
- MIDI RxのBank Selパラメーター、SysExパラメーター
- NRPN受信スイッチ
- MasterのDevice ID
- Monitorの設定

**PF** パフォーマンスの設定を送信しますが、Part Param 1に含まれるパラメーターの設定情報は送信されません。フロント・パネルで調節できるパラメーターについては、Part Param 2に含まれるパラメーター、MIDI RxのVol&Holdパラメーター、Prog Chgパラメーター、そして各パートのミュートの設定を送信します。

p.14 「リセット・オール・コントローラー」

**【誤】**

コントローラー	設定値
モジュレーション	0 (最小)
ボリューム	127 (最大)
パンポット	64 (中央)
エクspレッション	0 (最小)
ホールド1	0 (オフ)
チャンネル・プレッシャー	0 (最小)
ピッチ・ベンド・チェンジ	±0 (中点)
RPN	RPNナンバー未設定状態、内部データは変化しない
NRPN	NRPNナンバー未設定状態、内部データは変化しない

**【正】**

コントローラー	設定値
モジュレーション	0 (最小)
ソフト	0
ソステヌート	0
エクspレッション	0 (最小)
ホールド1	0 (オフ)
チャンネル・プレッシャー	0 (最小)
ピッチ・ベンド・チェンジ	±0 (中点)
RPN	RPNナンバー未設定状態、内部データは変化しない
NRPN	NRPNナンバー未設定状態、内部データは変化しない

The Sound Expansion Series Owner's Manual contained errors. We apologize for any inconvenience. Please make the following corrections.

**p. 6 "How to Make a Bulk Dump"**

**[Addition]**

Because the information for parameters included in Part Param 1 is controlled by Control Change messages, it cannot be stored using Bulk Dump.

**[Wrong]**

**ALL** Sends all of the data as well as the Parameter settings for Master and MIDI Rx that can be adjusted from the front panel.

**PF** Sends Performance settings and the Parameter settings for Part Param 1 and Part Param 2 that can be adjusted from the front panel.

**[Correct]**

**ALL** The information for all settings (except the ones listed below) is sent.

- All parameters included in Part Param 1
- Bank Sel and SysEx parameters for MIDI Rx
- NRPN receive switch
- Master device ID
- Monitor settings

**PF** Performance settings are sent, but the setting information for parameters included in Part Param 1 is not sent. For parameters that can be adjusted from the front panel, the settings that are sent are the parameters included in Part Param 2, Vol & Hold parameters for MIDI Rx, Prog Chg parameters, and the mute settings for each Part.

**p.9: "Pitch Is Strange"**

**[Wrong]**

Are the settings for Key Shift and Tune (p. 4) appropriate?

**[Correct]**

Are the settings for Key Shift and Tune (p. 4-5) appropriate?

**p.9: "Patch Table 2 Not Obtained With GM System On or GS Reset"**

**[Wrong]**

Make sure the "Sys Ex" setting (a switch for enabling reception of System Exclusive messages) is not set at "OFF."

**[Correct]**

Make sure the "Sys Ex" setting (a switch for enabling reception of System Exclusive messages) is not set at "OFF" or "PAR."

**p.14: "Reset All Controllers"**

**[Wrong]**

Controller	Value
Modulation	0 (minimum)
Volume	127 (maximum)
Panpot	64 (center)
Expression	0 (minimum)
Hold 1	0 (off)
Channel pressure	0 (minimum)
Pitch bend change	±0 (center)
RPN	No specified parameter, no value is changed.
NRPN	No specified parameter, no value is changed.

**[Correct]**

Controller	Value
Modulation	0 (minimum)
Soft	0
Sostenuto	0
Expression	0 (minimum)
Hold 1	0 (off)
Channel pressure	0 (minimum)
Pitch bend change	±0 (center)
RPN	No specified parameter, no value is changed.
NRPN	No specified parameter, no value is changed.



## ***SOUND EXPANSION*** Sound Expansion Series

### Owner's Manual

#### **Using This Manual...**

This owner's manual is for use with all models in the Sound Expansion Series. It covers virtually all the available functions, and explains how to use them. However, each model in the Sound Expansion Series also provides its own unique features, designed to deliver a great deal more expressiveness and realism within the musical realism that the model is specialized for. Since each model also has its own individual owner's manual, please refer to that manual as well.

© 1995 ROLAND CORPORATION

All rights reserved. No part of this publication may be reproduced in any form without the written permission of Roland Corporation.

#### **Contents**

<b>Part Names and Descriptions</b>	<b>2</b>
<b>Quick Start</b>	<b>3</b>
■ <b>Connections and Power-up</b> .....	<b>3</b>
Making the Connections .....	3
Before Turning On the Power .....	3
Turning On the Power.....	3
■ <b>About the Unit's Operation Modes</b> .....	<b>3</b>
<About the Temporary Area> .....	3
■ <b>Try Listening to Sounds in the Performance Mode</b> .....	<b>3</b>
Switching to the Performance Mode .....	3
Choosing a Performance .....	4
Changing Performance Settings.....	4
About the Functions for the Parameters.....	4
Muting a Part .....	5
Monitoring a Part .....	5
■ <b>Try Listening to Sounds in the Patch Mode</b> .....	<b>5</b>
Switching to the Patch Mode.....	5
Setting Patches.....	5
■ <b>Storing the Unit's Settings</b> .....	<b>6</b>
<How to DO a Bulk Dump> .....	6
Saving Settings .....	6
Returning Saved Settings to the Unit.....	6
■ <b>Returning Settings to Their Factory Defaults (Factory Preset)</b> .....	<b>6</b>
■ <b>NRPN Receive Switch</b> .....	<b>6</b>
■ <b>How to Listen to the Demo Songs</b> .....	<b>6</b>
■ <b>Other Handy Functions</b> .....	<b>7</b>
Level Meter Function.....	7
MIDI Monitor Function.....	7
■ <b>Error Messages</b> .....	<b>7</b>
<b>Using MIDI Messages to Control the Unit</b>	<b>8</b>
Changing Patches.....	8
Changing Performances.....	8
Changing the Patch Table.....	8
<b>Reference</b>	<b>9</b>
■ <b>Parameters</b> .....	<b>9</b>
■ <b>Troubleshooting</b> .....	<b>9</b>
<b>Roland Exclusive Messages</b>	<b>10</b>
<b>MIDI IMPLEMENTATION</b>	<b>12</b>
<b>MIDI Implementation Chart</b>	<b>20</b>



# Part Names and Descriptions

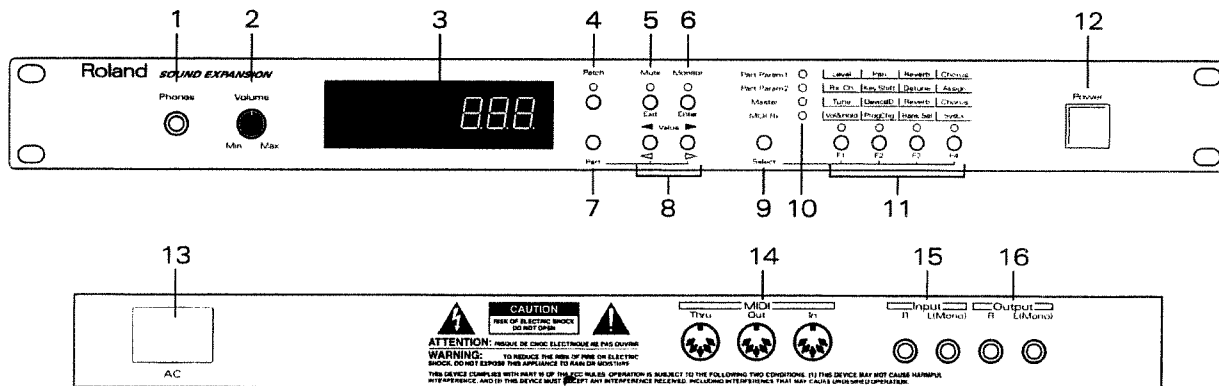

## 1. Phones (headphones) Jack

This is for connecting headphones. Sound still comes out of the Output L/R jacks even when headphones are plugged in.

## 2. Volume Knob

Used to adjust the volume of the sound output to the Output L/R jacks and the headphones jack.

## 3. Display

Shows the numbers assigned to Patches and the values of Parameters. It also displays messages in the event of an error.

## 4. Patch Button

Patches can be selected by using Value buttons when the indicator for this button is lit up or flashing.

## 5. Mute Button

To stop the part sounding, press this button and the indicator for this button is lit up.

## 6. Monitor Button

Parts for which the indicator on this button is lighted are played — all other Parts will be silent.

## 7. Part Button

To switch Parts, hold down the Part button while you press the Value button.

## 8. Value Buttons

These buttons are used to change various settings. You can reduce a value rapidly by holding down the ◀ Value button and pressing the ▶ button. In the same way, you can increase a value rapidly by holding down the ▶ Value button and pressing the ◀ button.

## 9. Select Button

## 10. Select Indicator

## 11. Function Buttons

These are used to change the settings for this sound module. They are also used to return values to their factory defaults (p. 6). The Select indicator also serves as a level meter for the unit (p. 7).

## 12. Power Switch

This is used to switch the power on and off. Press the button once to switch the power on, and press it again to return it to its original position and switch the power off.

## 13. AC Jack

Insert the power cord included with the unit into this jack, and plug the other end into an AC power outlet.

## 14. MIDI In/MIDI Out/MIDI Thru Connectors

**MIDI In:** Receives messages from external MIDI devices.

**MIDI Out:** Transmits messages from the unit to external MIDI devices (Bulk Dump: p. 6).

**MIDI Thru:** Provides duplicate of the complete MIDI message stream received via MIDI In, without change.

## 15. Input L/R Jacks

By connecting the output jacks of another sound module to these jacks, you can obtain the mixed output for the two sound modules from the Output L/R jacks and the Phones jack. If you want monaural input, connect the cable to the L jack.

The volume of the sound input to the Input L/R jacks remains constant regardless of the position of this unit's Volume knob.

## 16. Output L/R jacks

These jacks provide output of the audio signals. If you want monaural output, connect the audio cable to the L jack.

# Quick Start

## Connections and Power-up

### ■ Making the Connections .....

First make sure that the power off this unit, and on all other external devices is switched off. Then hook up the unit and the other equipment as shown below.

Use cables with 1/4" phone plugs to connect the unit's Output jacks to a keyboard amp; or to connect the unit's Input jacks with the output jacks on another device. Use MIDI cables to make connections between MIDI connectors.

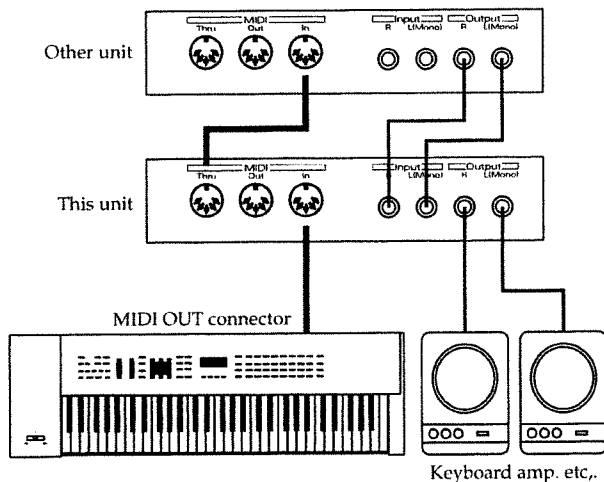

If you connect the output jacks on another sound module to the unit's Input jacks, you can listen to the sounds output from the two sound modules without using a mixer.

You can listen to the unit even if you have no keyboard amp or audio set. Just plug in headphones to the Phones jack.

### ■ Before Turning On the Power.....

Before you switch on the power, make sure that the unit's Volume knob is at "Min," and make sure that the volume knobs for the keyboard amp and any other external equipment are also at their lowest settings.

### ■ Turning On the Power .....

First switch on the power for the unit, and then turn on the keyboard amp or other connected equipment. After you've done that, adjust the unit's Volume knob and the volume controls on the other equipment to get the appropriate sound level. When switching off the power, first turn off the keyboard amp or other equipment, and then switch off the unit.

\* This unit is equipped with a protection circuit. A brief interval (a few seconds) after power up is required before the unit will operate normally.

## About the Unit's Operation Modes

This unit has a Performance mode and a Patch mode. In the Performance mode, it functions as a multi-timbral sound generator capable of playing eight Parts. In the Patch mode, it works as a sound generator which focuses on playing just a single Part.

The Performance mode can be used for ensemble play with a sequencer, and the Patch mode works well for live-stage performances with a MIDI keyboard hooked up.

### About the Temporary Area

When a Performance or Patch is called up, the information for its settings is stored in a temporary area. The only Performances and Patches that you can play with MIDI messages from the MIDI In connector, or can manipulate with the buttons on the front panel are the Performances and Patches that have been read into the temporary area.

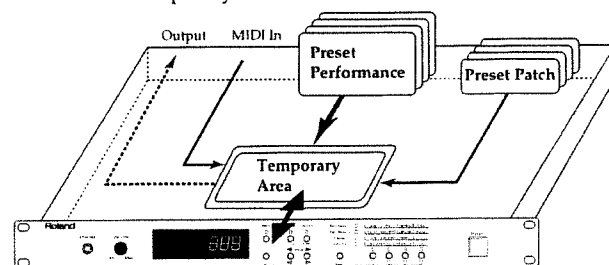

You can change the parameters for Performance or Patch that has been called up into the temporary area. You can also change parameters remotely using an external MIDI device connected to the MIDI in connector.

The data in the temporary area is preserved in memory even while the power is off.

Note, however, that if you select another Performance or Patch, settings data in the temporary area before that is discarded.

You can also output the setting values through the MIDI Out connector for storage on an external MIDI device (p. 6).

## Try Listening to Sounds in the Performance Mode

This unit has a large number of built-in Performances. A "Performance" is a collection of many settings, including Patches assigned to Parts 1 to 7, Rhythm Set values assigned to Part 8, and the values for Level, Pan, and Effects for each of these Parts.

### ■ Switching to the Performance Mode.....

You can start up the unit in the Performance mode by switching on the power while holding down the Part button. This setting remains in memory even after the power is switched off.

\* The unit is set to the Performance mode when shipped from the factory.

## Quick Start

### ■ Choosing a Performance.....

Hold down the Select button and press the F1 button. "PF" appears on the display. Then the currently selected Performance number appears on the display, as shown below.



While in this state, you can use the Value buttons to choose a Performance. Pressing the Enter button makes it possible to start playing with the selected Performance. To cancel instead, press the Exit button.

For more information on the settings for each Performance, refer to the Performance Chart in the owner's manual for the particular model that you're using.

### ■ Changing Performance Settings .....

If the MIDI receive channels set for the various Parts don't match the MIDI send channels used by the connected MIDI keyboard, no sound is played.

Try changing the settings for the Patches and Effects assigned to the Parts to modify a Performance to suit your own style of play. Here's how to change these settings.

#### • Choosing a Part

To switch Parts, hold down the Part button while you press / . The display shows you which Part is selected — for example, "P-1" on the display indicates "Part 1"; and "P-2" means "Part2."

The figure below shows how the display looks when Part 1 has been selected.



#### • Changing the Patches and Rhythm Set

Press the Patch button to make the indicator light up, and then use the Value buttons to choose the desired Patches or Rhythm Set.

\* A Rhythm Set can be assigned only to Part 8.

#### • Changing Parameter Settings

You can make changes to the various Parameters printed on the right-hand side of the unit's front panel.

Choose the Parameter Group with the Select button, and then use the F1, F2, F3, or F4 button to select the Parameter. The lit-up indicator shows you which Parameter has been selected.

In the example below, the Key Shift Parameter is selected.

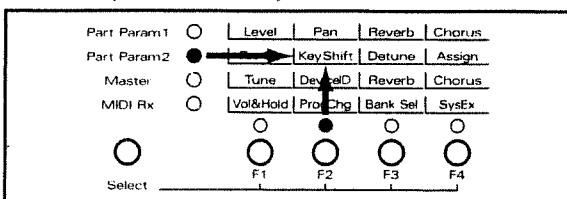

View the value shown in the display while using the Value buttons to change the value.

### ■ About the Functions for the Parameters .....

The Parameters that make up Part Param 1, Part Param 2 and a part of MIDI Rx (Vol&Hold, Prog Chg) can be set independently for each Part. The Parameters contained in Master and a part of MIDI Rx (Bank Sel, SysEx) are set commonly for all Parts.

See the Parameter Chart on page 9 for a description of each Parameter's possible range and their default values.

#### • Part Param 1 (Part Parameter 1)

**Level:** This adjusts the volume level for each Part.

**Pan:** Allows you to localize the sound image for each Part. At "0," the sound is centered in the stereo field. Settings of "L1" to "L64" place the sound at positions toward the left, with a larger number indicating a further distance away from the center. In the same way, settings of "r1" to "r63" position the sound to the right, with a larger number indicating a further distance away from the center.

**Reverb (Reverb Level):** This sets the depth of the Reverb effect (reverberation effect) for each of the Parts.

**Chorus (Chorus Level):** This sets the depth of the Chorus effect (an effect that makes the sound "fatter") that is applied to each Part.

There are patches that are set the chorus output send to reverb. The chorus level is changed, and the reverb level changes when using the these patches.

#### • Part Param 2 (Part Parameters 2)

**Rx Ch (MIDI Receive Channel):** This sets the MIDI receive channel for each Part.

**Key Shift:** This alters, in half-steps, the pitch at which each Part is played. This pitch is raise (or lowered) by an octave for each setting of +12 (or -12).

This parameter is set to too high or low value, and this unit might not sound or make strange sound in key range.

**Detune:** This is used to make fine adjustments in the pitch for each Part. The pitch is raised (or lowered) by half a semitone for each setting of +50 (or -50).

**Assign (Voice Assign):** This assigns a minimum number of voices available for play by a Part. This unit can simultaneously play a maximum of 28 voices. If you are using a sequencer to play complex arrangements, the number of voices available may not be enough, and some notes could be dropped.

If this happens, you may want to assign a number of voices that are required for certain Parts to prevent voices for such important Parts from being stolen, even when the total number of simultaneous notes exceeds 28. Remember, however, that the total number of voices assigned to all Parts together cannot be greater than 28.

• **Master Parameters**

**Tune:** This adjusts the pitch that becomes the overall standard for the unit (middle A = A4). This display shows "27.4 Hz" to "52.6 Hz," which represents a value of from 427.4 Hz to 452.6 Hz.

**Device ID:** The same model ID may be held by other sound modules in this series, or by the JV-80, JV-90, JV-1000, or JV-880. The device ID is information that is used to individually distinguish each device when MIDI devices are used together. If you are using any of the above units at the same time, change the device ID when sending system exclusive (SysEx) messages to them.

**Reverb (Reverb Switch):** This toggles the reverb effect for the entire unit on or off.

**Chorus (Chorus Switch):** This toggles the chorus effect for the entire unit on or off.

• **MIDI Rx (MIDI Message Reception)**

**Vol&Hold (Volume/Hold Message Reception Switch):** Determines whether Volume and/or Hold messages are to be received or not. The meaning of the settings shown in the display is as follows:

- ON* Volume messages and hold messages are both received.
- HLd* Hold messages are received, but volume messages are not.
- Vol* Volume messages are received, but hold messages are not.
- OFF* Neither volume messages nor hold messages are received.

**Prog Chg (Program Change Message Receive Switch):** Allows you to enable/disable reception of Program Change messages. Program Change messages are accepted when "on" is displayed, and ignored when "off" is selected.

**Bank Sel (Bank Select Message Reception):** This changes the unit's Patch, using a Bank Select message (Controller Number 0 or 32) in combination with a Program Change message. When shipped from the factory the Patch can be changed with a Controller Number 0 value of 80 or 81. The display reads "80" at this time. When the display shows "0," Patches can be switched with Controller Number 0 values of 0 and 1. Similarly, Patches can be switched with Controller Number 0 values of 10 and 11 when "10" is shown. You can set this value to any number from 0 to 126. When set to "off," no Bank Select messages are received. When the Patch Table set to "2," this parameter cannot be work.

**SysEx (System Exclusive Message Receive Switch):** This setting determines whether or not system exclusive messages are received. Bulk Dump data is also one type of system exclusive message.

- ON* System Exclusive message is received.
- PAR* System Exclusive message other than "GS Reset," "Exit GS," "GM System On," or "GM System Off" is received.
- OFF* System Exclusive message is not received.

■ **Muting a Part .....**

Parts for which the Mute button is pressed (the indicator lights) will remain silent.

■ **Monitoring a Part .....**

After pressing the Monitor button to light up the indicator, only one Part will be heard at a time, with all other Parts muted out. During ensemble play with a sequencer, it can sometimes be hard to tell how each Part is being played. At such times, you can activate the Monitor button (get its indicator to light) and then switch through the Parts to listen to how each is played.

■ **Try Listening to Sounds in the Patch Mode**

In the Patch mode, the unit functions as a sound generator for just one Part. Reverb and Chorus can be selected for each Patch in this mode, which can give you powerful sounds for live performances.

■ **Switch to the Patch Mode .....**

The Patch mode is enabled by switching on the power while holding down the Patch button. This setting remains in memory even after the power is switched off. The indicator for the Patch button flashes when in the Patch mode.

■ **Setting Patches .....**

In the same way as for the Performance mode, you can make changes to the various Parameters printed on the right-hand side of the unit's front panel. The functions of the Parameters are no different from the Performance mode — check out "Changing Parameter Settings" (p. 4) for more information. However, Key Shift, Detune and Assign parameter of the Part Param 2 and Vol&Hold, Prog Chg parameter of the MIDI Rx doesn't work in the Patch mode. When these parameters are selected, "--" appears on the display as shown below.



## Quick Start

### Storing the Unit's Settings

You can transmit the information for the unit's settings from the MIDI Out connector. This function is called a "Bulk Dump." This sends the unit's data to a sequencer or some other MIDI device in real-time for storage on the other device. You can also use this function to return settings stored on another device to the unit.

#### How to Do a Bulk Dump

Hold down the select button and press the F2 button. "bd" appears on the display. Then use the Value buttons to select the information that you want to send.

- ALL* Sends all of the data as well as the Parameter settings for Master and MIDI Rx that can be adjusted from the front panel.
- PF* Sends Performance settings and the Parameter settings for Part Param 1 and Part Param 2 that can be adjusted from the front panel.
- PdE* Sends the information for Patches assigned to Parts 1 to 7.
- rhy* Sends the settings for the Rhythm Set assigned to Part 8.

\* The display and operation shown above explain the usage when in the Performance mode. In the Patch mode, the selections "PF" and "rhy" are not available. Also, selecting "Pat" causes the information for only one Patch to be sent.

After starting recording on the sequencer, press the unit's Enter button. The Bulk Dump is executed when you press this button. If you want to cancel the Bulk Dump, press the Exit button.

#### ■ Saving Settings.....

To save the unit's setting data, connect its MIDI Out connector to the MIDI In connector on a sequencer (or some other MIDI device), and then set the unit's Device ID number (p. 5). When you've done this, start recording on the sequencer and execute a Bulk Dump. After the Bulk Dump has finished, stop recording on the sequencer.

#### ■ Returning Saved Settings to the Unit .....

To load settings data back into the unit, connect the MIDI Out connector on the sequencer to the unit's MIDI In connector. Make sure that the unit's Device ID number (p. 5) is set to the same number that was used when the settings were save. Also check to make sure that the System Exclusive Message Receive Switch (p. 5) is set to "on."

After you have checked these, send the settings data stored on the sequencer to the unit.

If you record Bulk Dump data at the start of a batch of music data, you can set up the unit simply by sending the song data to the unit.

### Returning Settings to Their Factory Defaults (Factory Preset)

This returns all of the unit's settings to the data in effect when the unit was shipped from the factory.

Hold down the Select button and press F3. When the message "FP" flashes on the display, confirm that you want to go ahead by pressing the Enter button. Press the Exit button instead if you change your mind.

### NRPN Receive Switch

If you hold down the Select button and press F4, "nrP" flashes on the display. After this disappears, you can use the Value button to select "on" or "oFF." When set to "on," you can use an NRPN (non-registered parameter number) to edit the unit's Patches and Rhythm Sets. This is automatically set to "on" when a GS Reset or GM System On message is received.

When at "oFF," a Patch or Rhythm Set cannot be edited even when an NRPN is received. The setting is always at "oFF" when the power is switched on.

\* No GS Reset or GM System On messages are received when the SysEx parameter is set to "oFF" or "PAR."

### How to Listen to the Demo Songs

Holding down the Select button as you switch on the power makes it possible to listen to the demo songs. Use the Value buttons to choose a song number. The Demo song is played back when you press the Enter button. Pressing the Exit button stops playback.

Press the Exit button once more, you can play this unit it was.

For more information on the Demo songs, see the owner's manual for the particular model that you're using.

## Other Handy Functions

### ■ Level Meter Function .....

When the indicator for a Patch button is lit up or flashing, the Select indicator works like a level meter for the unit. It normally indicates the total level for all Patches taken together, but when you're monitoring a Part it indicates only the level for that Part.

### ■ MIDI Monitor Function.....

You can display the status of receiving MIDI messages for each Part (Note messages only). If you hold down the Part button, the Select indicator and the indicators for the F1 to F4 buttons will light up while the Part button is held down. The following figure shows the relationship between the Part and the indicators.

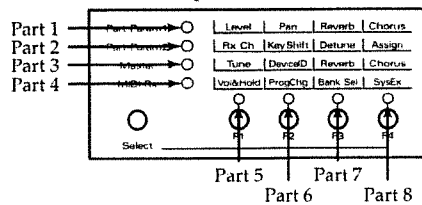

## Error Messages

### *nP* (No Patch)

Patch not found in the Bank specified by means of Program Change and/or Controller No. 0 & 32 messages.

### *bL* (Battery Low)

The battery required for preserving parameter settings is nearly depleted. Consult with the nearest Roland Service Station.

### *oFL* (MIDI Off Line)

MIDI communications have been disrupted. Consider if the cable connected to MIDI In is faulty, or if there could be a problem with the external device. (The error will appear if the external device has been switched off.)

### *bFL* (MIDI Buffer Full)

Data could not be processed successfully because too much was received within a short period of time.

### *cSE* (MIDI Checksum Error)

A checksum contended in System Exclusive messages received by the unit was found to be in error.

\* Should an error other than those explained above (such as Er1, Er2, etc.) appear, you should consult with the nearest Roland Service Center or other authorized service personnel.

# Using MIDI Messages to Control the Unit

This unit can send and receive the MIDI messages indicated by "O" in the MIDI Implementation Chart on page 20. You can use these MIDI message external device. For details, see "MIDI Implementation" (p. 12). Read on for an explanation of some typical functions that you can use.

## ■ Changing Patches .....

This unit has more than 128 built-in Patches, so it's not possible to select every Patch with just Program Change messages. For this reason, Patches can be switched by using Program Change messages together with Bank Select messages.

A Bank Select message is a combination of Controller Number 0 and Controller Number 32, but this unit always treats the value of Controller Number 32 as "0" (zero).

When the unit is shipped from the factory, you can select Patches from 1 to 128 with a value of 80 for Controller Number 0 and with the Program Number. You can select Patches from 129 to 255 with a value of 81 for Controller Number 0 and with the Program Number. This is shown in the following figure.

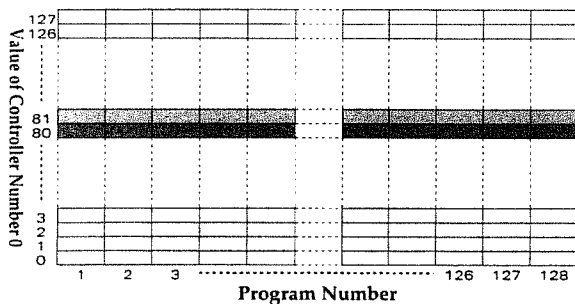

To change a Patch, send MIDI messages from the external device in the sequence shown below.

- Controller Number 0
  - Value: 80 (Patches 1 to 128)
  - Value: 81 (Patches 129 to 256)
- Controller Number 32
  - Value: 0
- Program Number
  - Value: 1 to 128

The Patch is changed when the MIDI messages are received in this sequence. If you sent only a Program Number without sending Controller Number 0, the previously sent value for Controller Number 0 and the Program Number just sent are used to choose the Patch.

- \* When shipped from the factory, the unit is set up for switching patches with a value of 80 or 81 for Controller Number 0, but you can modify the Bank Sel parameter (p. 5) to change the value for Controller Number 0 that is used to switch Patches.
- \* The number of Patches varies from one model to another.
- \* If you specify a Bank in which a Patch is not assigned, the message "noP" (no Patch) appears on the display and no sound is played. Press the Value button to return to the previous display. Refer to the owner's manual for the particular model you are using for descriptions of the Patches assigned to the different Banks.

## ■ Changing Performances.....

You can also use Program Change messages to change the Performance. When shipped from the factory, however, the unit was set so this feature is disabled. See "MIDI Implementation" (p. 16: Control channel) for more details.

## ■ Changing the Patch Table .....

This unit has two Patch Tables. Patch Table 1 (details of which can be found in the owner's manuals for the particular model that you're using) is enabled when the unit's power is switched on, but changes to Patch Table 2 when a General MIDI System On or GS Reset message is received. You can switch back to Patch Table 1 by sending a General MIDI System Off or Exit GS message to the unit; or by switching the power off, then on again.

See the owner's manual for the particular model that you're using for information on the Patch Table 2.

- \* This unit receives GS reset or GM system on message when it is set to Patch mode, automatically change to Performance mode.
- \* If SysEx parameter (p.5) set to "oFF" or "PAr," this unit doesn't change to Patch Table 2 because of this unit doesn't receive GM system on and GS reset message.

## Important!

When Patch Table 2 has been selected, a dot appears in the lower left corner of the display, as shown below.





# Reference

## Parameters

### • Part Param 1

Parameter	Value
Level	0 — 127
Pan	L64 — 0 — r63
Reverb	0 — 127
Chorus	0 — 127

### • Part Param 2

Parameter	Value
Rx Ch	1 — 16
Key Shift	-48 — 0 — +48
Detune	-50 — 0 — +50
Assign	0 — 28

### • Master

Parameter	Value
Tune (*)	427.4 — 452.6 Hz
Device ID	1 — 32
Reverb	oFF, on
Chorus	oFF, on

### • MIDI Rx Sw

Parameter	Value
Vol&Hold	oFF, voL, hLd, on
Prog Chg	oFF, on
Bank Sel	oFF, 0 — 126
Sys Ex	oFF, PAr, on

(\*) The hundreds digit (always 4) is not displayed.

## Troubleshooting

If your unit is not providing the expected response, check through the following for a ready solution.

### • Power Doesn't Come On

Make sure the power cord is connected properly (both the plug going to this unit and the one at the outlet).

### • Sound Not Produced

Recheck that power is indeed switched on — on this unit as well as any other devices (keyboard amp, mixer, etc.).

Could the volume be turned down too low on this unit, or on your keyboard amp, mixer, or other device?

Are all your cable connected properly?

Could any of the cables possibly be faulty?

Check settings for "Level" (p. 4) to make sure they are not at "0."

Could the volume possibly have been lowered by MIDI messages sent to the unit by another device (such as Controller Number 7 or 11)?

Have you checked to make sure that the channel number being used by the keyboard or sequencer for transmission is the same as what this unit is set to be receiving on?

Could you futility be trying to play while a Demo is playing?

Have you checked that relevant Parts are not set to be muted?  
Could you be sending an invalid Bank Select message?

### • Reverb/Chorus Not Obtained

Could the Master setting for Reverb or Chorus be set to "oFF"?  
Are you sure that the Part Param 1 settings for Reverb or Chorus are not set to a value that is too low?

### • Distortion or Other Noise Is Heard

Is the volume at a suitable level on this unit, or on your keyboard amp, mixer, or other device?

Could you possibly be using an excessively high level for this unit's Level (p. 4) and Master Level? (These settings are alterable only through System Exclusive messages.)

Have the Output or Phones jacks gotten very dirty?

### • Pitch Is Strange

Are the settings for Key Shift (p. 4) and Tune (p. 5) appropriate?  
Are Pitch Bend messages being constantly sent to the unit?

### • Sound Doesn't Change

Could you have Prog Chg or Bank Sel (p. 5) switched off?  
If sending Bank Select messages and/or Program Change message, make sure you are sending them in the correct order.

### • Multiple Sounds Heard at the Same Time

Check the channels you have assigned to Parts. The same channel could be assigned to more than one Part.

### • Notes Get Dropped

The maximum polyphony of the unit is 28 notes. Not all notes can be played if you attempt to sound more than this at the same time. To avoid having voices stolen from your most important Parts, use the (Voice) Assign setting to reserve a minimum number of voices for those Parts you want to sound.

### • Patch Table 2 Not Obtained With GM System On or GS Reset

Make sure the "Sys Ex" setting (a switch for enabling reception of System Exclusive messages) is not set at "oFF."

# Roland Exclusive Messages

## 1. Data Format for Exclusive Messages

Roland's MIDI implementation uses the following data format for all Exclusive messages (type IV):

Byte	Description
F0H	Exclusive Status
41H	Manufacturer ID (Roland)
DEV	Device ID
MDL	Model ID
CMD	Command ID
[BODY]	Main data
F7H	End of exclusive

### •MIDI status: F0H, F7H

An Exclusive message must be flanked by a pair of status codes, starting with a Manufacturer ID immediately after F0H (MIDI version 1.0).

### •Manufacturer ID: 41H

The Manufacturer ID identifies the manufacturer of a MIDI instrument that sends an Exclusive message. Value 41H represents Roland's Manufacturer ID.

### •Device ID: DEV

The Device ID contains a unique value that identifies individual devices in the implementation of several MIDI instruments. It is usually set to 00H-0FH, a value smaller by one than that of a basic channel, but value 00H-1FH may be used for a device with several basic channels.

### •Model ID: MDL

The Model ID contains a value that identifies one model from another. Different models, however, may share an identical Model ID if they handle similar data.

The Model ID format may contain 00H in one or more places to provide an extended data field. The following are examples of valid Model IDs, each representing a unique model:

01H  
02H  
03H  
00H, 01H  
00H, 02H  
00H, 00H, 01H

### •Command ID: CMD

The Command ID indicates the function of an Exclusive message. The Command ID format may contain 00H in one or more places to provide an extended data field. The following are examples of valid Command IDs, each representing a unique function:

01H  
02H  
03H  
00H, 01H  
00H, 02H  
00H, 00H, 01H

### •Main data: BODY

This field contains a message to be exchanged across an interface. The exact data size and content will vary with the Model ID and Command ID.

## 2. Address-mapped Data Transfer

Address mapping is a technique for transferring messages conforming to the data format given in Section 1. It assigns a series of memory-resident records—waveform and tone data, switch status, and parameters, for example, to specific locations in a machine-dependent address space, thereby allowing access to data residing at the address a message specifies.

Address-mapped data transfer is therefore independent of models and data categories. This technique allows use of two different transfer procedures: one-way transfer and handshake transfer.

### •One-way transfer procedure (See Section 3 for details.)

This procedure is suited to the transfer of a small amount of data. It sends out an Exclusive message completely independent of the receiving device's status.

Connection Diagram

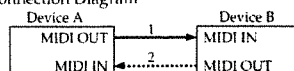

Connection at point 2 is essential for "Request data" procedures. (See Section 3.)

### •Handshake-transfer procedure (This device does not use this procedure)

This procedure initiates a predetermined transfer sequence (handshaking) across the interface before data transfer takes place. Handshaking ensures that reliability and transfer speed are high enough to handle a large amount of data.

Connection Diagram

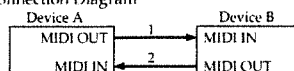

Connection at points 1 and 2 is essential.

## Notes on the above procedures

- \* There are separate Command IDs for different transfer procedures.
- \* Devices A and B cannot exchange data unless they use the same transfer procedure, share identical Device ID and Model ID, and are ready for communication.

## 3. One-way Transfer Procedure

This procedure sends out data until it has all been sent and is used when the messages are so short that answerbacks need not be checked.

For longer messages, however, the receiving device must acquire each message in time with the transfer sequence, which inserts 20 milliseconds intervals.

Types of Messages

Message	Command ID
Request data 1	RQ1 (11H)
Data set 1	DT1 (12H)

### •Request data #1: RQ1 (11H)

This message is sent out when there is a need to acquire data from a device at the other end of the interface. It contains data for the address and size that specify designation and length, respectively, of data required.

On receiving an RQ1 message, the remote device checks its memory for the data address and size that satisfy the request.

If it finds them and is ready for communication, the device will transmit a "Data set 1 (DT1)" message, which contains the requested data. Otherwise, the device won't send out anything.

Byte	Description
F0H	Exclusive Status
41H	Manufacturer ID (Roland)
DEV	Device ID
MDL	Model ID
11H	Command ID
aaH	Address MSB
	LSB
ssH	Size MSB
	LSB
sum	Check sum
F7H	End of exclusive

- \* The size of the requested data does not indicate the number of bytes that will make up a DT1 message, but represents the address fields where the requested data resides.
- \* Some models are subject to limitations in data format used for a single transaction. Requested data, for example, may have a limit in length or must be divided into predetermined address fields before it is exchanged across the interface.
- \* The same number of bytes comprises address and size data, which, however, vary with the Model ID.
- \* The error-checking process uses a checksum that provides a bit pattern where the last 7 bits are zero when values for an address, size, and that checksum are summed.

#### •Data set 1: DT1 (12H)

This message corresponds to the actual data transfer process. Because every byte in the data is assigned a unique address, a DT1 message can convey the starting address of one or more bits of data as well as a series of data formatted in an address-dependent order.

The MIDI standards inhibit non real-time messages from interrupting an Exclusive one. This fact is inconvenient for devices that support a "soft-thru" function. To maintain compatibility with such devices, Roland has limited the DT1 to 256 bytes so that an excessively long message is sent out in separate 'segments'.

Byte	Description
F0H	Exclusive Status
41H	Manufacturer ID (Roland)
DEV	Device ID
MDL	Model ID
12H	Command ID
aaH	Address MSB
	LSB
ddH	Data MSB
	LSB
sum	Check sum
F7H	End of exclusive

- \* A DT1 message is capable of providing only the valid data among those specified by an RQ1 message.
- \* Some models are subject to limitations in data format used for a single transaction. Requested data, for example, may have a limit in length or must be divided into predetermined address fields before it is exchanged across the interface.
- \* The number of bytes comprising address data varies from one Model ID to another.
- \* The error-checking process uses a checksum that provides a bit pattern where the last 7 bits are zero when values for an address, size, and that checksum are summed.

#### •Example of Message Transactions

##### •Device A sending data to Device B

Transfer of a DT1 message is all that takes place.

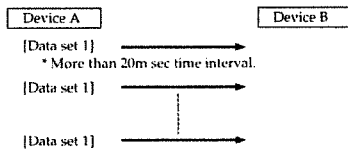

##### •Device B requesting data from Device A

Device B sends an RQ1 message to Device A. Checking the message, Device A sends a DT1 message back to Device B.

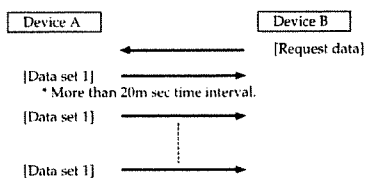

## 1. RECEIVE DATA

### Channel Voice Message

#### • Note Off

Status	Second	Third
8nH	kkH	vvH
9nH	kkH	00H

n = MIDI channel number: 0H — FH (ch.1 — ch.16)  
kk = Note number: 00H — 7FH (0 — 127)  
vv = velocity: 00H — 7FH (0 — 127)

In the performance mode, ignored when the "MIDI receive switch" is OFF for each part.  
In the rhythm part (part 8), ignored when "ENV mode" is at "NO-SUSTAIN" for each rhythm tone.

#### • Note On

Status	Second	Third
9nH	kkH	vvH

n = MIDI channel number: 0H — FH (ch.1 — ch.16)  
kk = Note number: 00H — 7FH (0 — 127)  
vv = velocity: 01H — 7FH (1 — 127)

In the performance mode, ignored when the "MIDI receive switch" is OFF for each part.

### Control change

#### • Bank select

Status	Second	Third
BnH	00H	mmH
BnH	20H	llH

n = MIDI channel number: 0H — FH (ch.1 — ch.16)  
mm = MSB of the bank number: 50H — 51H (80 — 81)  
"mm" is adjustable from 0, 1 to 126, 127.  
ll = LSB of the bank number: 0H (0)

The Bank Select is suspended until receiving a program change.  
This message is ignored when "Program bank sel" of the system common is OFF.  
If the part which MIDI receive channel is set the same as the control channel, the performance is changed when receive the bank select message.

The bank number specified as following.

Bank select		Program change	Media (Patch number)
MSB	LSB		
80	0	1 — 128	Preset A (#1 — #128)
81	0	1 — 127	Preset B (#129 — #255)

When the module receives bank select LSB, it will always count as 0.

#### • Modulation

Status	Second	Third
BnH	01H	vvH

n = MIDI channel number: 0H — FH (ch.1 — ch.16)  
vv = Modulation depth: 00H — 7FH (0 — 127)

The effect of the modulation depends on the value of "Mod1 — 4" of the patch tone.  
This message is ignored when "Receive Modulation" of the system common is OFF.

#### • Portamento time

Status	Second	Third
BnH	05H	vvH

n = MIDI channel number: 0H — FH (ch.1 — ch.16)  
vv = Portamento time: 00H — 7FH (0 — 127)

You can adjust the portamento time of the patch common.  
This message is ignored when "Receive Control change" of the system common is OFF.

#### • Volume

Status	Second	Third
BnH	07H	vvH

n = MIDI channel number: 0H — FH (ch.1 — ch.16)  
vv = Volume: 00H — 7FH (0 — 127)

You can adjust the volume of specified channel.  
This message is ignored when "Receive volume" of the system common is OFF.

In the performance mode, ignored when the "Receive volume switch" is OFF for each part.  
This message is ignored when "Volume switch" of the patch tone is OFF.

#### • Pan

Status	Second	Third
BnH	0AH	vvH

n = MIDI channel number: 0H — FH (ch.1 — ch.16)  
vv = Pan: 00H — 7FH (0 — 127)

0 represents the left end, 64 the center, and 127 the right end.  
This message is ignored when "Receive Control Change" of the system common is OFF.

#### • Expression

Status	Second	Third
BnH	0BH	vvH

n = MIDI channel number: 0H — FH (ch.1 — ch.16)  
vv = Expression: 00H — 7FH (0 — 127)

The effect of the expression depends on the value of "Exp1 — 4" of the patch tone.  
This message is ignored when "Receive Control Change" of the system common is OFF.

#### • Hold 1

Status	Second	Third
BnH	40H	vvH

n = MIDI channel number: 0H — FH (ch.1 — ch.16)  
vv = Control value: 00H — 7FH (0 — 127) 0 — 63 = OFF, 64 — 127 = ON

Note played can be sustained for as long as the time that elapses between turning hold on and off.  
This message is ignored when "Receive Control Change" of the system common is OFF.  
In the performance mode, ignored when the "hold1 receive switch" is OFF for each part.  
In the rhythm part (part 8), ignored when "ENV mode" is at "NO-SUSTAIN" for each rhythm tone.  
This message is ignored when "Hold-1 switch" of patch tone is OFF.

#### • Portamento

Status	Second	Third
BnH	41H	vvH

n = MIDI channel number: 0H — FH (ch.1 — ch.16)  
vv = Control value: 00H — 7FH (0 — 127) 0 — 63 = OFF, 64 — 127 = ON

Switches over "Portamento sw" of patch common.  
This message is ignored when "Receive control change" of the system common is OFF.

#### • Sostenuto

Status	Second	Third
BnH	42H	vvH

n = MIDI channel number: 0H — FH (ch.1 — ch.16)  
vv = Control value: 00H — 7FH (0 — 127) 0 — 63 = OFF, 64 — 127 = ON

#### • Soft

Status	Second	Third
BnH	43H	vvH

n = MIDI channel number: 0H — FH (ch.1 — ch.16)  
vv = Control value: 00H — 7FH (0 — 127)

The value is changed, and the "Soft" effect change.

#### • Effect 1 depth (Reverb send level)

Status	Second	Third
BnH	5BH	vvH

n = MIDI channel number: 0H — FH (ch.1 — ch.16)  
vv = Control value: 00H — 7FH (0 — 127)

You can adjust the Reverb send level of specified channel.  
This message is ignored when "Receive control change" of the system common is OFF.

#### • Effect 3 depth (Chorus send level)

Status	Second	Third
BnH	5DH	vvH

n = MIDI channel number: 0H — FH (ch.1 — ch.16)  
vv = control value: 00H — 7FH (0 — 127)

You can adjust the Chorus send level of specified channel.  
This message is ignored when "Receive control change" of the system common is OFF.

## • NRPN MSB/LSB

Status	Second	Third
BnH	63H	mmH
BnH	62H	llH

n = MIDI channel number: 0H — FH (ch.1 — ch.16)  
mm = MSB of the specified parameter by NRPN  
ll = LSB of the specified parameter by NRPN

When the power is turned on, or "General MIDI System On" is received, Rx.NRPN will be set OFF, and NRPN will not be received.

When "GS reset" or Rx.NRPN = 0H is received, NRPN can be received.  
The value set by NRPN will not be reset even if Program change or Reset all controller is received.

## \*\* NRPN \*\*

The NRPN (Non Registered Parameter number) message allows an extended range of control changes to be used, letting you use control messages which are not part of the MIDI Specification and may be unique to an individual model. To use these messages, you must first use NRPN MSB and NRPN LSB message to specify the parameter to be controlled, and then use Data Entry messages to specify the value of the specified parameter. Once an NRPN parameter has been specified, all Data Entry messages received on that channel will modify the value of that parameter. To prevent accidents, it is recommended that you set RPN Null (RPN Number = 7FH/7FH) when you have finished setting the value of the desired parameter.

On This module, the following NRPN can be received.

NRPN MSB LSB	Data entry MSB	Function and range
01H 08H	mmH	Vibrato Rate (relative change) mm: 0EH — 40H — 72H (-50 — 0 — +50)
01H 09H	mmH	Vibrato Depth (relative change) mm: 0EH — 40H — 72H (-50 — 0 — +50)
01H 0AH	mmH	Vibrato Delay (relative change) mm: 0EH — 40H — 72H (-50 — 0 — +50)
01H 20H	mmH	TVF Cutoff Frequency (relative change) mm: 0EH — 40H — 72H (-50 — 0 — +50)
01H 21H	mmH	TVF Resonance (relative change) mm: 0EH — 40H — 72H (-50 — 0 — +50)
01H 63H	mmH	TVF&TVA Envelope Attack Time (relative change) mm: 0EH — 40H — 72H (-50 — 0 — +50)
01H 64H	mmH	TVF&TVA Envelope Decay Time (relative change) mm: 0EH — 40H — 72H (-50 — 0 — +50)
01H 66H	mmH	TVF&TVA Envelope release Time (relative change) mm: 0EH — 40H — 72H (-50 — 0 — +50)
18H rrH	mmH	Rhythm Instrument Pitch Course (relative change) rr: Rhythm Instrument note number mm: 00H — 40H — 7FH (-64 — 0 — +63 semitone)
1AH rrH	mmH	Rhythm Instrument TVA level (absolute change) rr: Rhythm Instrument note number mm: 00H — 7FH (0 — max)
1CH rrH	mmH	Rhythm Instrument Panpot (absolute change) rr: Rhythm Instrument note number mm: 00H, 01H — 40H — 7FH (random, left-center-right)
1DH rrH	mmH	Rhythm instrument Reverb Send Level (absolute change) rr: Rhythm Instrument note number mm: 00H — 7FH (0 — max)
1EH rrH	mmH	Rhythm Instrument Chorus Send Level (absolute change) rr: Rhythm Instrument note number mm: 00H — 7FH (0 — max)

Data entry LSB (llH) is ignored  
Parameters marked "relative change" change relative to the preset value (40H). Even among different GS devices, "relative change" parameters may sometimes differ in the way the sound changes or in the range of change.  
Parameters marked "absolute change" will be set to the absolute value of the parameter, regardless of the preset value.

## • RPN MSB/LSB

Status	Second	Third
BnH	65H	mmH
BnH	64H	llH

n = MIDI channel number: 0H — FH (ch.1 — ch.16)  
mm = MSB of the specified parameter by RPN  
ll = LSB of the specified parameter by RPN

## \*\* RPN \*\*

RPN (registered parameter number) is a parameter number of tone color or musical expression defined in MIDI specification.

With the Sound Expansion Series as the receiver, RPN#0 (pitch bend sensitivity), RPN#1 (fine tuning) and RPN#2 (coarse tuning) are effective. when sending an RPN to the Sound Expansion Series, first specify the MSB and LSB of the RPN to be used to control a parameter and then set the value in the data entry field.

RPN MSB LSB	Data entry MSB LSB	Description
00H 00H	mmH —	Pitch bend sensitivity mm: 00H — 0CH (0 — 12 semitone) ll: Ignored Up to 1 octave You can adjust "BENDER — RANGE DOWN" and "BENDER — RANGE UP" at same time. In the rhythm part (partB), this message is not recognized.
00H 01H	mmH llH	Fine tuning mm, ll: 20H, 00H — 40H, 00H — 60H, 00H (-8192 x 50 / 8192 — 0 — +8192 x 50 / 8192 cent) In the patch mode, the master tune is adjusted. In the performance mode, fine tune at each part is adjusted. In the performance mode, when received as specified control channel, the master tune is adjusted.
00H 02H	mmH —	Coarse tuning mm: 10H — 40H — 70H (-48 — 0 — +48 semitone) ll: Ignored In the patch mode, this message is not recognized. In the performance mode, coarse tune for each part is adjusted.
7FH 7FH	— —	RPN reset mm, ll: Ignored It returns to the state where no RPN parameters are specified. Current setting value is no change.

## • Data entry MSB/LSB

Status	Second	Third
BnH	06H	mmH
BnH	26H	llH

n = MIDI channel number: 0H — FH (ch.1 — ch.16)  
mm = MSB of the value of the parameter specified with RPN  
ll = LSB of the value of the parameter specified with RPN

This message is ignored when "Receive control change" of the system common is OFF.

## • Program Change

Status	Second
CnH	ppH

n = MIDI channel number: 0H — FH (ch.1 — ch.16)  
pp = Program number: 00H — 7FH (prog.1 — prog.128)

This message is ignored when "Receive program change" of the system common is OFF.  
If the part which MIDI receive channel is set the same as the control channel, the performance is changed when receive the program change message.

## • Channel pressure

Status	Second
DnH	vvH

n = MIDI channel number: 0H — FH (ch.1 — ch.16)  
vv = value: 00H — 7FH (0 — 127)

The effect of the Channel pressure depends on the value of "After 1 — 4" of the patch tone.  
This message is ignored when "Receive Channel pressure" of the System common is OFF.

## • Pitch bend change

Status	Second	Third
EnH	llH	mmH

n = MIDI channel number: 0H — FH (ch.1 — ch.16)  
mm, ll = value: 00H, 00H — 7FH, 7FH (-8192 — +8191)

This message is ignored when "Receive Pitch bend" of the system common is OFF.

# MIDI IMPLEMENTATION

## Channel Mode Message

### • All Sound Off

Status	Second	Third
BnH	7BH	00H

n = MIDI channel number: 0H — FH (ch.1 — ch.16)

When this message is received, all currently-sounding notes on this corresponding channel will be turned off immediately.

This message is ignored when the "MIDI receive switch" is OFF for each part.

### • Reset All Controllers

Status	Second	Third
BnH	79H	00H

n = MIDI channel number: 0H — FH (ch.1 — ch.16)

If this message is received, the values of following controllers will be changed.

Controller	Value
Modulation	0 (off)
Volume	127 (maximum)
Panpot	64 (center)
Expression	0 (off)
Hold 1	0 (off)
Channel pressure	0 (off)
Pitch bend change	0 (center)
RPN	No specified parameter, no value is changed.
NRPN	No specified parameter, no value is changed.

### • All note off

Status	Second	Third
BnH	7BH	00H

n = MIDI channel number: 0H — FH (ch.1 — ch.16)

When this message is recognized, all the note which have been turned on by "MIDI note on" message are turned off. However if Hold 1 or Sostenuto is on, the sound will be continued until these are turned off.

### • OMNI Off

Status	Second	Third
BnH	7CH	00H

n = MIDI channel number: 0H — FH (ch.1 — ch.16)

Recognized as "All note off".

### • OMNI On

Status	Second	Third
BnH	7DH	00H

n = MIDI channel number: 0H — FH (ch.1 — ch.16)

This message is recognized as "All note off". (Sound Expansion Series doesn't recognize OMNI on.)

### • MONO

Status	Second	Third
BnH	7EH	mmH

n = MIDI channel number: 0H — FH (ch.1 — ch.16)

mm = number of mono: 00H — 10H (0 — 16)

"Assign mode" of patch common is Switched to "SOLO."

Recognize as "All notes off", and sets each patch MODE4 (M = 1).

### • POLY

Status	Second	Third
BnH	7FH	00H

n = MIDI channel number: 0H — FH (ch.1 — ch.16)

Switched over "Assign mode" of patch common.

Recognized all notes off, and set MODE3 at each patch.

## System Realtime message

### • Active sensing

Status
FEH

When Sound Expansion Series receives an "Active sensing," it measures time intervals between incoming messages. If the subsequent message does not come within 350 ms after the previous one, Sound Expansion Series will turn off all MIDI-on notes as if it received "Reset all controllers," stop measuring message interval.

### • System Exclusive message

status	data bytes
FOH	iiH, ddH, ..., eeH
F7H	

FOH System exclusive

ii = manufacturer ID :41H (65)

dd, ..., ee = data: 00H — 7FH (0 — 127)

F7H: EOX (End of Exclusive/System common)

System exclusive message is ignored when "Receive Exclusive" of the system common is OFF.

Refer to section 3,4

## System Exclusive Message for setting the Modes

"Data set 1 (DT1)", the Roland's Exclusive format, is used for "GS reset" and "Exit GS Mode." The "Universal non-realtime message" format is used for "General MIDI system on" and "General MIDI system off."

### • General MIDI system on

This model will be in an operational mode of "Patch Table 2" when receiving this message.

Status	Data byte	Status
FOH	7EH, 7FH, 09H, 01H	F7H

Byte	Description
FOH	Exclusive status
7EH	ID number (Universal Non-realtime Message)
7FH	Device ID (Broadcast)
09H	Sub ID#1 (General MIDI Message)
01H	Sub ID#2 (General MIDI On)
F7H	EOX (End Of Exclusive)

When this message is received, Rx.BANK SELECT will be OFF and Rx.NRPN will be OFF.

This message will not be received when "Exclusive" parameter of "MIDI Rx Sw" group = OFF.

Make an interval of 50ms or more, before receiving the next message.

### • General MIDI system off

This model will be in an operational mode of "Patch Table 1" when receiving this message.

Status	Data byte	Status
FOH	7EH, 7FH, 09H, 02H	F7H

Byte	Description
FOH	Exclusive status
7EH	ID number (Universal Non-realtime Message)
7FH	Device ID (Broadcast)
09H	Sub ID#1 (General MIDI Message)
02H	Sub ID#2 (General MIDI On)
F7H	EOX (End Of Exclusive)

This message will not be received when "SysEx" parameter of "MIDI Rx Sw" group = OFF.

Make an interval of 50ms or more, before receiving the next message.

### • GS reset

This model will be in an operational mode of "Patch Table 2" when receiving this message.

Status	Data byte	Status
FOH	41H, dev, 42H, 12H, 40H, 00H, 7FH, 00H, 41H	F7H

Byte	Description
FOH	Exclusive status
41H	ID number (Roland)
dev	Device ID (dev: 00H — 1FH (1 — 32), Initial value is 10H (17))
42H	Model ID (GS)
12H	Command ID (DT1)
40H	address MSB
00H	address
7FH	address LSB
00H	data (GS reset)
41H	Check sum
F7H	EOX (End Of Exclusive)

When this message is received, Rx.NRPN will set ON.  
 This message will not be received when "SysEx" parameter of "MIDI Rx Sw" group = OFF.  
 Make an interval of 50ms or more, before receiving the next message.

### • Exit GS mode

This model will be in an operational mode of "Patch Table 1" when receiving this message.

Status	Data byte	Status
FDH	41H, dev, 42H, 12H, 40H, 00H, 7FH, 7FH, 42H	F7H

Byte	Description
FDH	Exclusive status
41H	ID number (Roland)
dev	Device ID (dev: 00H — 1FH (1 — 32), Initial value is 10H (17))
42H	Model ID (GS)
12H	Command ID (DT1)
40H	Address MSB
00H	Address
7FH	Address LSB
7FH	Data (Exit GS mode)
42H	Check sum
F7H	EOX (End Of Exclusive)

This message will not be received when "Exclusive" parameter of "MIDI Rx Sw" group = OFF.  
 Make an interval of 50ms or more, before receiving the next message.

## 2. TRANSMIT DATA

### System realtime

#### • Active sensing

status
FEH

This message is transmitted with 250 milli seconds interval.

#### • System exclusive message

status	data bytes
FDH	iiH, ddH, ..., eeH
F7H	

FDH: System exclusive

ii = manufacturer ID: 41H (65)

dd, ..., ee = Data: 00H — 7FH (0 — 127)

F7H: EOX (End of Exclusive/System common)

Refer to section 3.4.

## 3. Exclusive communications

The Sound Expansion Series can send and receive patch parameter, etc using the system exclusive message.

The model ID code of the Sound Expansion Series is 46H. The device ID code is to be determined by the "Device ID" setting of Master.

The Sound Expansion Series ignores GS exclusive message other than "GS reset," "Exit GS mode" and "Scale tune parameter," General MIDI system on, General MIDI system off, GS reset and Exit GS.

The model ID of the GS is 42H.

### One way communication.

#### • Request data 1 RQ1 (11H)

Bytes	Description
FDH	Exclusive status
41H	Manufacturer ID (Roland)
Dev	Device ID
46H	Model ID (Sound Expansion Series)
11H	Command ID (RQ 1)
aaH	Address MSB
bbH	Address
ccH	Address
ddH	Address LSB
ssH	Size MSB
ttH	Size
uuH	Size
vvH	Size LSB
sum	Check sum
F7H	EOX (End of exclusive)

Receive only: the Sound Expansion Series does not send this message.

### Data set 1 DT1 (12H)

#### • 1. Sound Expansion Series (MODEL ID = 46H)

Bytes	Description
FDH	Exclusive status
41H	Manufacturer ID (Roland)
Dev	Device ID
46H	Model ID
12H	Command ID (DT 1)
aaH	Address MSB
bbH	Address
ccH	Address
ddH	Address LSB
eeH	Data
:	:
ffH	Data
sum	Check sum
F7H	EOX (End of exclusive)

#### 2. GS (MODEL ID = 42H)

Bytes	Description
FDH	Exclusive status
41H	Manufacturer ID (Roland)
Dev	Device ID
42H	Model ID (GS)
12H	Command ID (DT1)
aaH	Address MSB
bbH	Address
ccH	Address
eeH	Data
:	:
ffH	Data
sum	Check sum
F7H	EOX (End of Exclusive)

Note: When the device ID is 7FH, Sound Expansion Series can receive the exclusive message even if the unit number is anything.

#### • Parameter address map

Address and size are configured in 7 bits, hexadecimal notation.

Address	MSB	LSB		
Binary	0aaa 0aaa	0bbb bbbb	0ccc cccc	0ddd dddd
7-bits hex	AA	BB	CC	DD

Size	MSB	LSB		
Binary	0sss ssss	0ttt ttH	0uuu uuuu	0vvv vvvv
7-bits hex	SS	TT	UU	VV

#### • Parameter base address

1) A pair of two addresses preceded by the symbol # represents a divided — by -two data. e.g. the data ABH (hex) is divided into 0AH and 0BH and sent in that order.

2) Parameter associated with address following the symbol % are for Sound Expansion Series

#### • Example of exclusive data

Data Set 1 (1 byte data)

To Select Pan-Delay for the Reverb Type.

FD 41 10 46 12 00 00 10 0D 07 5C F7

Note that the 5th byte value is 12H in order to "Set" the data.

Send the data (07 for Pan-Delay) with the address (00 00 01 0D for reverb type) of the "Performance common" parameter.

Data set 1 (2 byte data)

To Select Wave Number 141 for Patch Tone 1 in Part 1.

FD 41 10 46 12 00 00 28 01 08 0C 43 F7

The Address for Patch Tone 1 in Part 1 is 00 00 28 01.

If you want to send 140 as a data, first you need to change it to hex-decimal notation which is 8C.

Then divide this in 2 byte, which is called "nibblizing", and send 08 0C as data.

Request Data

Make the module to send the chorus level.

FD 41 10 46 11 00 00 10 12 00 00 00 01 5D F7

Note that the 5th byte value is 11H, in order to "Request" the data.

Send 00 00 10 12 as an Address for Chorus Level and 00 00 00 01 as "Size of the data" for it, which is 1 byte.

When the module receives this data, it will automatically send back the following data from MIDI OUT.

FD 41 10 46 12 00 00 10 12 3C 22 F7

# MIDI IMPLEMENTATION

You will notice that the Chorus Level is 3C (60).

## Check sum

The error checking process uses a checksum and provides a bit pattern where the last significant 7 bits are zero, when values for an address, data (or size) and the checksum are summed.

< Example >

F0 41 10 46 12 00 00 10 0D 06 5D F7

[80H - ((00H + 00H + 10H + 0DH + 06H) & 7FH)] & 7F = 5DH  
 Address                      data

## 1. Sound Expansion Series <MODEL ID = 46H>

### \* 1 - 1 System Common

Address	Description	
00 00 00 00	0000 000a	Panel mode 0 — 1 (PERFORMANCE, PATCH)
00 00 00 01	000a 000a	Master tune 1 — 127 (427.4 — 452.6)
%00 00 00 02	000a 000a	Key transpose 28 — 100
%00 00 00 03	0000 000a	Transpose Switch 0 — 1
00 00 00 04	0000 000a	Reverb switch 0 — 1 (OFF, ON)
00 00 00 05	0000 000a	Chorus switch 0 — 1 (OFF, ON)
%00 00 00 06	0000 000a	Hold polarity 0 — 1
%00 00 00 07	0000 000a	Pedal 1 polarity 0 — 1
%00 00 00 08	0000 000a	Pedal 1 mode 0 — 3
%00 00 00 09	000a 000a	Pedal 1 assign 0 — 100
%00 00 00 0A	0000 000a	Pedal 2 polarity 0 — 1
%00 00 00 0B	0000 000a	Pedal 2 mode 0 — 3
%00 00 00 0C	000a 000a	Pedal 2 assign 0 — 100
%00 00 00 0D	0000 000a	C1 mode 0 — 3
%00 00 00 0E	000a 000a	C1 assign 0 — 100
%00 00 00 0F	000a 000a	Aftertouch threshold 0 — 127
MIDI receive switch		
00 00 00 10	0000 000a	Volume 0 — 1 (OFF, ON)
00 00 00 11	0000 000a	Control change 0 — 1 (OFF, ON)
00 00 00 12	0000 000a	Channel pressure 0 — 1 (OFF, ON)
00 00 00 13	0000 000a	Modulation 0 — 1 (OFF, ON)
00 00 00 14	0000 000a	Pitch bend 0 — 1 (OFF, ON)
00 00 00 15	0000 000a	Program change 0 — 1 (OFF, ON)
00 00 00 16	0000 000a	Bank select 0 — 1 (OFF, ON)
MIDI transmit switch		
%00 00 00 17	0000 000a	Volume 0 — 1
%00 00 00 18	0000 000a	Control change 0 — 1
%00 00 00 19	0000 000a	Channel pressure 0 — 1
%00 00 00 1A	0000 000a	Modulation 0 — 1
%00 00 00 1B	0000 000a	Bender 0 — 1
%00 00 00 1C	0000 000a	Program change 0 — 1
%00 00 00 1D	0000 000a	Bank select 0 — 1
00 00 00 1E	0000 000a	Patch receive channel 0 — 15 (1 — 16)
%00 00 00 1F	000a 000a	Patch transmit channel 0 — 17
00 00 00 20	000a 000a	Control channel 0 — 16 (1 — 16, OFF)
%00 00 00 21	0000 000a	Output mode 0 — 1 (OUT2, OUT4)
%00 00 00 22	0000 000a	Rhythm edit key 0 — 1 (INT&MIDI, INT)
00 00 00 23	0000 000a	Scale tune switch 0 — 1 (OFF, ON)
00 00 00 24	000a 000a	Scale Tune Part1 C 0 — 127 (-64 — +63)
00 00 00 25	:	C#
00 00 00 26	:	D
00 00 00 27	:	D#
00 00 00 28	:	E
00 00 00 29	:	F
00 00 00 2A	:	F#
00 00 00 2B	:	G
00 00 00 2C	:	G#
00 00 00 2D	:	A
00 00 00 2E	:	A#
00 00 00 2F	:	B
00 00 00 30	000a 000a	Scale Tune Part2 C 0 — 127 (-64 — +63)
:	:	
00 00 00 38	:	B
00 00 00 3C	000a 000a	Scale Tune Part3 C 0 — 127 (-64 — +63)
:	:	
00 00 00 47	:	B

00 00 00 48	000a 000a	Scale Tune Part4 C 0 — 127 (-64 — +63)
:	:	
00 00 00 53	:	B
00 00 00 54	000a 000a	Scale Tune Part5 C 0 — 127 (-64 — +63)
:	:	
00 00 00 5F	:	B
00 00 00 60	000a 000a	Scale Tune Part6 C 0 — 127 (-64 — +63)
:	:	
00 00 00 6B	:	B
00 00 00 6C	000a 000a	Scale Tune Part7 C 0 — 127 (-64 — +63)
:	:	
00 00 00 77	:	B
00 00 00 78	000a 000a	Scale Tune Part8 C 0 — 127 (-64 — +63)
:	:	
00 00 01 03	:	B
00 00 01 04	000a 000a	Scale Tune Patch C 0 — 127 (-64 — +63)
:	:	
00 00 01 0F	:	B
00 00 01 10	0 — —	(Dummy)
00 00 01 11	000a 000a	Master volume 0 — 127
Total Size	00 00 01 12	

### 1-2 Performance

#### 1-2-1 Performance Common

Address	Description	
00 00 10 00	000a 000a	Performance name 1 32 — 127
00 00 10 01	000a 000a	Performance name 2 32 — 127
00 00 10 08	000a 000a	Performance name 12 32 — 127
00 00 10 0D	0000 000a	Reverb type 0 — 7
(ROOM1, ROOM2, STAGE1, STAGE2, HALL1, HALL2, DELAY, PAN-DLY)		
00 00 10 0E	000a 000a	Reverb level 0 — 127
00 00 10 0F	000a 000a	Reverb time 0 — 127
00 00 10 10	000a 000a	Reverb feedback 0 — 127
00 00 10 11	0000 000a	Chorus type 0 — 2 (CHORUS1, CHORUS2, CHORUS3)
00 00 10 12	000a 000a	Chorus level 0 — 127
00 00 10 13	000a 000a	Chorus depth 0 — 127
00 00 10 14	000a 000a	Chorus rate 0 — 127
00 00 10 15	000a 000a	Chorus feedback 0 — 127
00 00 10 16	0000 000a	Chorus output 0 — 1 (OUTPUT, REV)
If this parameter set to "OUTPUT," chorus signal send to "Output."		
If this parameter set to "REV," chorus signal send to reverb.		
00 00 10 17	000a 000a	Part 1 Voice assign 0 — 28
00 00 10 18	000a 000a	Part 2 Voice assign 0 — 28
00 00 10 1E	000a 000a	Part 8 Voice assign 0 — 28
Total Size	00 00 01 1F	

Note: The sum of Voice reserves must be less than or equal to 28

#### 1-2-2 Performance Part

00 00 1x dd

x = 08H — 0FH (Part1 — part8), dd = Description

Address	Description	
%00 00 1x 00	0000 000a	Transmit switch 0 — 1
%00 00 1x 01	0000 000a	Transmit channel 0 — 15
%00 00 1x 02	0000 000a	Transmit program change 0 — 128
	0000 bbbb	
%00 00 1x 04	0000 000a	Transmit volume 0 — 128
	0000 bbbb	
%00 00 1x 06	0000 000a	Transmit pan 0 — 128
	0000 bbbb	
%00 00 1x 08	000a 000a	Transmit key range lower 0 — 127
%00 00 1x 09	000a 000a	Transmit key range upper 0 — 127
%00 00 1x 0A	000a 000a	Transmit key transpose 28 — 100
%00 00 1x 0B	000a 000a	Transmit velocity sense 1 — 127
%00 00 1x 0C	000a 000a	Transmit velocity max 0 — 127
%00 00 1x 0D	0000 000a	Transmit velocity curve 0 — 6
%00 00 1x 0E	0000 000a	Internal switch 0 — 1
%00 00 1x 0F	000a 000a	Internal key range lower 0 — 127
%00 00 1x 10	000a 000a	Internal key range upper 0 — 127
%00 00 1x 11	000a 000a	Internal key transpose 28 — 100
%00 00 1x 12	000a 000a	Internal velocity sense 1 — 127
%00 00 1x 13	000a 000a	Internal velocity max 0 — 127



# MIDI IMPLEMENTATION

%00 00 1x 14	0000 0000	Internal velocity curve	0 — 6
00 00 1x 15	0000 000a	Receive switch	0 — 1 (OFF, ON)
00 00 1x 16	0000 0000	Receive channel	0 — 15 (1 — 16)
#00 00 1x 17	0000 0000	Patch number	0 — 254
	0000 bbbb		
00 00 1x 19	0000 0000	Part level	0 — 127
00 00 1x 1A	0000 0000	Part pan	0 — 127 (L64 — 63R)
00 00 1x 18	0000 0000	Part coarse tune	16 — 112 (-48 — +48)
00 00 1x 1C	0000 0000	Part fine tune	14 — 114 (-50 — +50)
00 00 1x 1D	0000 0000	Reverb switch	0 — 1 (OFF, ON)
00 00 1x 1E	0000 000a	Chorus switch	0 — 1 (OFF, ON)
00 00 1x 1F	0000 000a	Receive program change	0 — 1 (OFF, ON)
00 00 1x 20	0000 000a	Receive volume	0 — 1 (OFF, ON)
00 00 1x 21	0000 000a	Receive hold-1	0 — 1 (OFF, ON)
%00 00 1x 22	0000 0000	Output select	0 — 2 (M, S, PAT)
%00 00 1x 23	0000 0000	Patch media	2 (EXP)
%00 00 1x 24	0000 000a	Sequencer switch	0 — 1 (ON, OFF)
Total Size	00 00 00 25		

Note: The value of the Transmit key range upper must be greater than or equal to the Transmit key range lower.  
 Note: The value of the Internal key range upper must be greater than or equal to the Internal key range lower.

## \* 1-3 Patch

00 0s 2y dd  
 0s = 00H — 06H (Performance Mode Temporary patch)  
 0BH (Patch Mode Temporary patch)  
 dd = Description

### \* 1-3-1 Patch Common

Address	Description
00 0s 20 00	0000 0000 Patch name 1 32 — 127
00 0s 20 01	0000 0000 Patch name 2 32 — 127
00 0s 20 08	0000 0000 Patch name 12 32 — 127
00 0s 20 0C	0000 000a Velocity switch 0 — 1 (OFF, ON)
00 0s 20 0D	0000 0000 Reverb type 0 — 7 (ROOM1, ROOM2, STAGE1, STAGE2, HALL1, HALL2, DELAY, PAN-DLY)
00 0s 20 0E	0000 0000 Reverb level 0 — 127
00 0s 20 0F	0000 0000 Reverb time 0 — 127
00 0s 20 10	0000 0000 Delay feedback 0 — 127
00 0s 20 11	0000 0000 Chorus type 0 — 2 (CHORUS1, CHORUS2, CHORUS3)
00 0s 20 12	0000 0000 Chorus level 0 — 127
00 0s 20 13	0000 0000 Chorus depth 0 — 127
00 0s 20 14	0000 0000 Chorus rate 0 — 127
00 0s 20 15	0000 0000 Chorus feedback 0 — 127
00 0s 20 16	0000 000a Chorus output 0 — 1 (OUTPUT, REV) If this parameter set to "OUTPUT," chorus signal send to "Output." If this parameter set to "REV," chorus signal send to reverb.
00 0s 20 17	0000 0000 Analog feel 0 — 127
00 0s 20 18	0000 0000 Patch level 0 — 127
00 0s 20 19	0000 0000 Patch pan 0 — 127 (L64 — 63R)
00 0s 20 1A	0000 0000 Bender range down 16 — 64 (-48 — 0)
00 0s 20 1B	0000 0000 Bender range up 0 — 12
00 0s 20 1C	0000 000a Key assign 0 — 1 (POLY, SOLO)
00 0s 20 1D	0000 0000 Salo legato 0 — 1 (OFF, ON)
00 0s 20 1E	0000 0000 Portamento switch 0 — 1 (OFF, ON)
00 0s 20 1F	0000 0000 Portamento mode 0 — 1 (LEGATO, NORMAL)
00 0s 20 20	0000 0000 Portamento type 0 — 1 (TIME, RATE)
00 0s 20 21	0000 0000 Portamento time 0 — 127
Total Size	00 00 00 22

### \* 1-3-2 Patch Tone

y = 0BH — 0BH (Patch Tone 1 — Patch Tone 4)

Address	Description
%00 0s 2y 00	0000 0000 Wave group 1 (EXP)
#00 0s 2y 01	0000 0000 Wave number 0 — 254 (1 — 255)
00 0s 2y 03	0000 0000 Tone switch 0 — 1 (OFF, ON)
00 0s 2y 04	0000 000a FXM switch 0 — 1 (OFF, ON)
00 0s 2y 05	0000 0000 FXM depth 0 — 15 (1 — 16)
00 0s 2y 06	0000 0000 Velocity range lower 0 — 127
00 0s 2y 07	0000 0000 Velocity range upper 0 — 127 (Turn "On" the Velocity switch of the Patch common parameters to make "Velocity Range" work.)
00 0s 2y 08	0000 0000 Volume switch 0 — 1 (OFF, ON)
00 0s 2y 09	0000 0000 Hold-1 switch 0 — 1 (OFF, ON)
00 0s 2y 0A	0000 0000 Modulation 1 destination 0 — 12 (*1)
00 0s 2y 0B	0000 0000 Modulation 1 depth 1 — 127 (-63 — +63)
00 0s 2y 0C	0000 0000 Modulation 2 destination 0 — 12 (*1)
00 0s 2y 0D	0000 0000 Modulation 2 depth 1 — 127 (-63 — +63)

00 0s 2y 0E	0000 0000 Modulation 3 destination 0 — 12 (*1)
00 0s 2y 0F	0000 0000 Modulation 3 depth 1 — 127 (-63 — +63)
00 0s 2y 10	0000 0000 Modulation 4 destination 0 — 12 (*1)
00 0s 2y 11	0000 0000 Modulation 4 depth 1 — 127 (-63 — +63)
00 0s 2y 12	0000 0000 Aftertouch 1 destination 0 — 12 (*1)
00 0s 2y 13	0000 0000 Aftertouch 1 depth 1 — 127 (-63 — +63)
00 0s 2y 14	0000 0000 Aftertouch 2 destination 0 — 12 (*1)
00 0s 2y 15	0000 0000 Aftertouch 2 depth 1 — 127 (-63 — +63)
00 0s 2y 16	0000 0000 Aftertouch 3 destination 0 — 12 (*1)
00 0s 2y 17	0000 0000 Aftertouch 3 depth 1 — 127 (-63 — +63)
00 0s 2y 18	0000 0000 Aftertouch 4 destination 0 — 12 (*1)
00 0s 2y 19	0000 0000 Aftertouch 4 depth 1 — 127 (-63 — +63)
00 0s 2y 1A	0000 0000 Expression 1 destination 0 — 12 (*1)
00 0s 2y 1B	0000 0000 Expression 1 depth 1 — 127 (-63 — +63)
00 0s 2y 1C	0000 0000 Expression 2 destination 0 — 12 (*1)
00 0s 2y 1D	0000 0000 Expression 2 depth 1 — 127 (-63 — +63)
00 0s 2y 1E	0000 0000 Expression 3 destination 0 — 12 (*1)
00 0s 2y 1F	0000 0000 Expression 3 depth 1 — 127 (-63 — +63)
00 0s 2y 20	0000 0000 Expression 4 destination 0 — 12 (*1)
00 0s 2y 21	0000 0000 Expression 4 depth 1 — 127 (-63 — +63)

(1) 0 to 12 of (1) refer to the followings

(OFF, PITCH, CUTOFF, RESONANCE, LEVEL, PITCH LFO1, PITCH LFO2, TVF LFO1, TVF LFO2, TVA LFO1, TVA LFO2, LFO1 RATE, LFO2 RATE)

00 0s 2y 22	0000 0000 LFO-1 form 0 — 5 (TRI, SIN, SAW, SQW, RND1, RND2)
00 0s 2y 23	0000 0000 LFO-1 offset 0 — 4 (-100, -50, 0, +50, +100)
00 0s 2y 24	0000 0000 LFO-1 synchro 0 — 1 (OFF, ON)
00 0s 2y 25	0000 0000 LFO-1 rate 0 — 127
#00 0s 2y 26	0000 0000 LFO-1 delay 0 — 128 (0 — 127, KEY-OFF)
00 0s 2y 28	0000 0000 LFO-1 fade polarity 0 — 1 (IN, OUT)
00 0s 2y 29	0000 0000 LFO-1 fade time 0 — 127
00 0s 2y 2A	0000 0000 LFO-1 pitch depth 1 — 127 (-63 — +63)
00 0s 2y 2B	0000 0000 LFO-1 TVF depth 1 — 127 (-63 — +63)
00 0s 2y 2C	0000 0000 LFO-1 TVA depth 1 — 127 (-63 — +63)
00 0s 2y 2D	0000 0000 LFO-2 form 0 — 5 (TRI, SIN, SAW, SQW, RND1, RND2)
00 0s 2y 2E	0000 0000 LFO-2 offset 0 — 4 (-100, -50, 0, +50, +100)
00 0s 2y 2F	0000 0000 LFO-2 synchro 0 — 1 (OFF, ON)
00 0s 2y 30	0000 0000 LFO-2 rate 0 — 127
#00 0s 2y 31	0000 0000 LFO-2 delay 0 — 128 (0 — 127, KEY-OFF)
00 0s 2y 33	0000 0000 LFO-2 fade polarity 0 — 1 (IN, OUT)
00 0s 2y 34	0000 0000 LFO-2 fade time 0 — 127
00 0s 2y 35	0000 0000 LFO-2 pitch depth 1 — 127 (-63 — +63)
00 0s 2y 36	0000 0000 LFO-2 TVF depth 1 — 127 (-63 — +63)
00 0s 2y 37	0000 0000 LFO-2 TVA depth 1 — 127 (-63 — +63)
00 0s 2y 38	0000 0000 Pitch coarse 16 — 112 (-48 — +48)
00 0s 2y 39	0000 0000 Pitch time 14 — 114 (-50 — +50)
00 0s 2y 3A	0000 0000 Random pitch 0 — 15 (0, 5, 10, 20, 30, 40, 50, 70, 100, 200, 300, 400, 500, 600, 800, 1200)
00 0s 2y 3B	0000 0000 Pitch key follow 0 — 15 (-100, -70, -50, -30, -10, 0, +10, +20, +30, +40, +50, +70, +100, +120, +150, +200)
00 0s 2y 3C	0000 0000 P-ENV velocity sense 1 — 127 (-63 — +63)
00 0s 2y 3D	0000 0000 P-ENV T1 velocity 0 — 14 (-100, -70, -50, -40, -30, -20, -10, 0, +10, +20, +30, +40, +50, +70, +100)
00 0s 2y 3E	0000 0000 P-ENV T4 velocity 0 — 14 (-100, -70, -50, -40, -30, -20, -10, 0, +10, +20, +30, +40, +50, +70, +100)
00 0s 2y 3F	0000 0000 P-ENV time key follow 0 — 14 (-100, -70, -50, -40, -30, -20, -10, 0, +10, +20, +30, +40, +50, +70, +100)
00 0s 2y 40	0000 0000 P-ENV depth 52 — 76 (-12 — +12)
00 0s 2y 41	0000 0000 P-ENV time 1 0 — 127
00 0s 2y 42	0000 0000 P-ENV level 1 1 — 127 (-63 — +63)
00 0s 2y 43	0000 0000 P-ENV time 2 0 — 127
00 0s 2y 44	0000 0000 P-ENV level 2 1 — 127 (-63 — +63)
00 0s 2y 45	0000 0000 P-ENV time 3 0 — 127
00 0s 2y 46	0000 0000 P-ENV level 3 1 — 127 (-63 — +63)
00 0s 2y 47	0000 0000 P-ENV time 4 0 — 127
00 0s 2y 48	0000 0000 P-ENV level 4 1 — 127 (-63 — +63)
00 0s 2y 49	0000 0000 TVF mode 0 — 2 (OFF, LPF, HPF)
00 0s 2y 4A	0000 0000 Cutoff frequency 0 — 127
00 0s 2y 4B	0000 0000 Resonance 0 — 127
00 0s 2y 4C	0000 0000 Resonance mode 0 — 1 (SOFT, HARD)
00 0s 2y 4D	0000 0000 TVF key follow 0 — 15 (-100, -70, -50, -30, -10, 0, +10, +20, +30, +40, +50, +70, +100, +120, +150, +200)
00 0s 2y 4E	0000 0000 TVF-ENV velocity curve 0 — 6 (1 — 7)
00 0s 2y 4F	0000 0000 TVF-ENV velocity sense 1 — 127 (-63 — +63)
00 0s 2y 50	0000 0000 TVF-ENV T1 velocity 0 — 14 (-100, -70, -50, -40, -30, -20, -10, 0, +10, +20, +30, +40, +50, +70, +100)
00 0s 2y 51	0000 0000 TVF-ENV T4 velocity 0 — 14 (-100, -70, -50, -40, -30, -20, -10, 0, +10, +20, +30, +40, +50, +70, +100)

# MIDI IMPLEMENTATION

00 0s 2y 52	0000 aaaa	TVF-ENV time key follow	0 — 14 (-100, -70, -50, -40, -30, -20, -10, 0, +10, +20, +30, +40, +50, +70, +100)
00 0s 2y 53	0aaa aaaa	TVF-ENV depth	1 — 127 (-63 — +63)
00 0s 2y 54	0aaa aaaa	TVF-ENV time 1	0 — 127
00 0s 2y 55	0aaa aaaa	TVF-ENV level 1	0 — 127
00 0s 2y 56	0aaa aaaa	TVF-ENV time 2	0 — 127
00 0s 2y 57	0aaa aaaa	TVF-ENV level 2	0 — 127
00 0s 2y 58	0aaa aaaa	TVF-ENV time 3	0 — 127
00 0s 2y 59	0aaa aaaa	TVF-ENV level 3	0 — 127
00 0s 2y 5A	0aaa aaaa	TVF-ENV time 4	0 — 127
00 0s 2y 5B	0aaa aaaa	TVF-ENV level 4	0 — 127
00 0s 2y 5C	0aaa aaaa	Level	0 — 127
00 0s 2y 5D	0000 aaaa	TVA key follow	0 — 14 (-100, -70, -50, -40, -30, -20, -10, 0, +10, +20, +30, +40, +50, +70, +100)
#00 0s 2y 5E	0000 aaaa	Pan	0 — 128 (L64 — 63R, RND)
00 0s 2y 60	0000 aaaa	Panning key follow	0 — 14 (-100, -70, -50, -40, -30, -20, -10, 0, +10, +20, +30, +40, +50, +70, +100)
00 0s 2y 61	0000 00aa	TVA delay mode	0 — 2 (NORMAL, HOLD, PLAY-MATE)
#00 0s 2y 62	0000 aaaa	TVA delay time	0 — 128 (0 — 127, KEY-OFF)
00 0s 2y 64	0000 00aa	TVA-ENV velocity curve	0 — 6 (1 — 7)
00 0s 2y 65	0aaa aaaa	TVA-ENV velocity sense	1 — 127 (-63 — +63)
00 0s 2y 66	0000 aaaa	TVA-ENV T1 velocity	0 — 14 (-100, -70, -50, -40, -30, -20, -10, 0, +10, +20, +30, +40, +50, +70, +100)
00 0s 2y 67	0000 aaaa	TVA-ENV T4 velocity	0 — 14 (-100, -70, -50, -40, -30, -20, -10, 0, +10, +20, +30, +40, +50, +70, +100)
00 0s 2y 68	0000 aaaa	TVA-ENV time key follow	0 — 14 (-100, -70, -50, -40, -30, -20, -10, 0, +10, +20, +30, +40, +50, +70, +100)
00 0s 2y 69	0aaa aaaa	TVA-ENV time 1	0 — 127
00 0s 2y 6A	0aaa aaaa	TVA-ENV level 1	0 — 127
00 0s 2y 6B	0aaa aaaa	TVA-ENV time 2	0 — 127
00 0s 2y 6C	0aaa aaaa	TVA-ENV level 2	0 — 127
00 0s 2y 6D	0aaa aaaa	TVA-ENV time 3	0 — 127
00 0s 2y 6E	0aaa aaaa	TVA-ENV level 3	0 — 127
00 0s 2y 6F	0aaa aaaa	TVA-ENV time 4	0 — 127
00 0s 2y 70	0aaa aaaa	Dry level	0 — 127
00 0s 2y 71	0aaa aaaa	Reverb send level	0 — 127
00 0s 2y 72	0aaa aaaa	Chorus send level	0 — 127
%00 0s 2y 73	0000 000a	Output select	0 — 1 (MAIN, SUB)
00 0s 2y 74	0000 000a	Redamper switch	0 — 1 (OFF, ON)
Total Size	00 00 00 75		

The values of the Velocity Range Upper must be greater than or equal to the values of Velocity Range Lower.

## \* 1-4 Rhythm Setup 1

00 mm rr cc  
mm = 07  
rr = 40H — 7CH (Note #36 — Note #96)  
cc = Description

### \* 1-4-1 Rhythm Note 1

Address	Description
00 mm rr 00	0000 00aa Wave group 1 (EXP)
#00 mm rr 01	0000 aaaa Wave number 0 — 254
0000 bbbb	(1 — 255)
00 mm rr 03	0000 000a Tone switch 0 — 1 (OFF, ON)
00 mm rr 04	0aaa aaaa Coarse tune 0 — 127 (C-1 — G9)
00 mm rr 05	000a aaaa Mute group 0 — 31 (OFF, 1 — 31)
00 mm rr 06	0000 000a Envelope mode 0 — 1 (NO-SUSTAIN, SUSTAIN)
00 mm rr 07	0aaa aaaa Pitch fine 14 — 114 (-50 — +50)
00 mm rr 08	0000 aaaa Random pitch 0 — 15 (0, 5, 10, 20, 30, 40, 50, 70, 100, 200, 300, 400, 500, 600, 800, 1200)
00 mm rr 09	0000 aaaa Bender range 0 — 12
00 mm rr 0A	0aaa aaaa P-ENV velocity sense 1 — 127 (-63 — +63)
00 mm rr 0B	0000 aaaa P-ENV time velocity sense 0 — 14 (-100, -70, -50, -40, -30, -20, -10, 0, +10, +20, +30, +40, +50, +70, +100)
00 mm rr 0C	0aaa aaaa P-ENV depth 52 — 76 (-12 — +12)
00 mm rr 0D	0aaa aaaa P-ENV time 1 0 — 127
00 mm rr 0E	0aaa aaaa P-ENV level 1 1 — 127 (-63 — +63)
00 mm rr 0F	0aaa aaaa P-ENV time 2 0 — 127
00 mm rr 10	0aaa aaaa P-ENV level 2 1 — 127 (-63 — +63)
00 mm rr 11	0aaa aaaa P-ENV time 3 0 — 127
00 mm rr 12	0aaa aaaa P-ENV level 3 1 — 127 (-63 — +63)
00 mm rr 13	0aaa aaaa P-ENV time 4 0 — 127
00 mm rr 14	0aaa aaaa P-ENV level 4 1 — 127 (-63 — +63)
00 mm rr 15	0000 00aa TVF mode 0 — 2 (OFF, LPF, HPPF)
00 mm rr 16	0aaa aaaa Cutoff frequency 0 — 127
00 mm rr 17	0aaa aaaa Resonance 0 — 127

00 mm rr 18	0000 000a	Resonance mode	0 — 1 (SOFT, HARD)
00 mm rr 19	0aaa aaaa	TVF-ENV velocity sense	1 — 127 (-63 — +63)
00 mm rr 1A	0000 aaaa	TVF-ENV time velocity sense	0 — 14 (-100, -70, -50, -40, -30, -20, -10, 0, +10, +20, +30, +40, +50, +70, +100)
00 mm rr 1B	0aaa aaaa	TVF-ENV depth	1 — 127 (-63 — +63)
00 mm rr 1C	0aaa aaaa	TVF-ENV time 1	0 — 127
00 mm rr 1D	0aaa aaaa	TVF-ENV level 1	0 — 127
00 mm rr 1E	0aaa aaaa	TVF-ENV time 2	0 — 127
00 mm rr 1F	0aaa aaaa	TVF-ENV level 2	0 — 127
00 mm rr 20	0aaa aaaa	TVF-ENV time 3	0 — 127
00 mm rr 21	0aaa aaaa	TVF-ENV level 3	0 — 127
00 mm rr 22	0aaa aaaa	TVF-ENV time 4	0 — 127
00 mm rr 23	0aaa aaaa	TVF-ENV level 4	0 — 127
00 mm rr 24	0aaa aaaa	Level	0 — 127
#00 mm rr 25	0000 aaaa	Pan	0 — 128 (L64 — 63R, RND)
0000 bbbb	(L64 — 63R, RND)		
00 mm rr 27	0aaa aaaa	TVA-ENV velocity sense	1 — 127 (-63 — +63)
00 mm rr 28	0000 aaaa	TVA-ENV time velocity sense	0 — 14 (-100, -70, -50, -40, -30, -20, -10, 0, +10, +20, +30, +40, +50, +70, +100)
00 mm rr 29	0aaa aaaa	TVA-ENV time 1	0 — 127
00 mm rr 2A	0aaa aaaa	TVA-ENV level 1	0 — 127
00 mm rr 2B	0aaa aaaa	TVA-ENV time 2	0 — 127
00 mm rr 2C	0aaa aaaa	TVA-ENV level 2	0 — 127
00 mm rr 2D	0aaa aaaa	TVA-ENV time 3	0 — 127
00 mm rr 2E	0aaa aaaa	TVA-ENV level 3	0 — 127
00 mm rr 2F	0aaa aaaa	TVA-ENV time 4	0 — 127
00 mm rr 30	0aaa aaaa	Dry level	0 — 127
00 mm rr 31	0aaa aaaa	Reverb send level	0 — 127
00 mm rr 32	0aaa aaaa	Chorus send level	0 — 127
%00 mm rr 33	0000 000a	Output select	0 — 1 (MAIN, SUB)
Total Size	00 00 00 34		

## \* 1-5 Rhythm Setup 2

00 mm rr cc  
mm = 20  
rr = 38H — 3FH (Note #28 — Note #35)  
= 40H — 46H (Note #97 — Note #103)  
cc = Description

### \* 1-5-1 Rhythm Note 2

Same as 1-4-1.

## 2 GS

### < MODEL ID = 42H >

#### 2-1 Scale Tune

w = 0 — 7 (Scale tune Part8, 1, 2, ..., 7)

Address	Description
40 1w 40	0aaa aaaa Scale Tune C 00 — 127 (-64 — +63)
40 1w 41	: : C#
40 1w 42	: : D
40 1w 43	: : D#
40 1w 44	: : E
40 1w 45	: : F
40 1w 46	: : F#
40 1w 47	: : G
40 1w 48	: : G#
40 1w 49	: : A
40 1w 4A	: : A#
40 1w 4B	: : B
Total Size	00 00 0C

Note: If you send the Scale Tune data, must send from "C" to "B" (1 oct) per packet.

## / Example of DT1 application /

To set the tune (C — B) of the performance part 1 Arabia, send the data as follow:  
 FOH 41H 10H 42H 12H 40H 11H 40H 3AH 6DH 3EH 34H 0DH 38H 6BH 3CH 6FH 40H 36H 0FH 50H 7FH

**Table A-1: Decimal to Hexadecimal**

The MIDI message are expressed in hexadecimal configured in 7 bits.  
 This table is useful when you read or write MIDI messages.

(D) = decimal  
 (H) = Hexadecimal

(D)	(H)	(D)	(H)	(D)	(H)	(D)	(H)
0	00H	32	20H	64	40H	96	60H
1	01H	33	21H	65	41H	97	61H
2	02H	34	22H	66	42H	98	62H
3	03H	35	23H	67	43H	99	63H
4	04H	36	24H	68	44H	100	64H
5	05H	37	25H	69	45H	101	65H
6	06H	38	26H	70	46H	102	66H
7	07H	39	27H	71	47H	103	67H
8	08H	40	28H	72	48H	104	68H
9	09H	41	29H	73	49H	105	69H
10	0AH	42	2AH	74	4AH	106	6AH
11	0BH	43	2BH	75	4BH	107	6BH
12	0CH	44	2CH	76	4CH	108	6CH
13	0DH	45	2DH	77	4DH	109	6DH
14	0EH	46	2EH	78	4EH	110	6EH
15	0FH	47	2FH	79	4FH	111	6FH
16	10H	48	30H	80	50H	112	70H
17	11H	49	31H	81	51H	113	71H
18	12H	50	32H	82	52H	114	72H
19	13H	51	33H	83	53H	115	73H
20	14H	52	34H	84	54H	116	74H
21	15H	53	35H	85	55H	117	75H
22	16H	54	36H	86	56H	118	76H
23	17H	55	37H	87	57H	119	77H
24	18H	56	38H	88	58H	120	78H
25	19H	57	39H	89	59H	121	79H
26	1AH	58	3AH	90	5AH	122	7AH
27	1BH	59	3BH	91	5BH	123	7BH
28	1CH	60	3CH	92	5CH	124	7CH
29	1DH	61	3DH	93	5DH	125	7DH
30	1EH	62	3EH	94	5EH	126	7EH
31	1FH	63	3FH	95	5FH	127	7FH

The decimal value of MIDI channel, Program change, etc is the decimal number in the table plus 1.  
 In the hexadecimal notation in configured 7 bits, the maximum data of 1 byte is 128. If the data is more than 128, used plural bytes.  
 The signed value is 00H = -64, 40H = 0, 7FH = +63. In decimal notation, the value is the decimal number in the table minus 64.  
 The signed value of dual bytes is 00 00H = -8192, 40 40H = 0, 7F 7FH = 8191. For example, converted aah bbH (hex) to decimal to the following: aa bbH — 40 00H = aa x 128 + bb - 64 x 128

**Table A-2: ASCII code**

Patch Name and Performance Name of MIDI data are described the ASCII code in the table below.

(H) = hexadecimal

Character	(H)	Character	(H)	Character	(H)	Character	(H)
(Space)	20H						
A	41H	Q	51H	j	6AH	1	31H
B	42H	R	52H	k	6BH	2	32H
C	43H	S	53H	l	6CH	3	33H
D	44H	T	54H	m	6DH	4	34H
E	45H	U	55H	n	6EH	5	35H
F	46H	V	56H	o	6FH	6	36H
G	47H	W	57H	p	70H	7	37H
H	48H	Y	59H	q	71H	8	38H
I	49H	Z	5AH	r	72H	9	39H
J	4AH	a	61H	s	73H	0	30H
K	4BH	b	62H	t	74H	+	2BH
L	4CH	c	63H	u	75H	-	2DH
M	4DH	d	64H	v	76H	*	2AH
N	4EH	e	65H	w	77H	/	2FH
O	4FH	f	66H	x	78H	#	23H
P	50H	g	67H	y	79H	!	21H
		h	68H	z	7AH	,	2CH
				i	69H	.	2EH

# MIDI Implementation Chart

Function...	Transmitted	Recognized	Remarks
Basic Channel Default Changed	X X	1 — 16 1 — 16	Memorized
Mode Default Messages Altered	X X *****	Mode 3 Mode 3, 4 (M = 1)	
Note Number : True Voice	X *****	0 — 127 0 — 127	
Velocity Note ON Note OFF	X X	O O	
After Touch Key's Ch's	X X	X O	
Pitch Bend	X	O	Resolution: 9 bits
Control Change 0, 32 1 5 6, 38 7 10 11 64 65 66 67 91 93 98, 99 100, 101	X X X X X X X X X X X X X X X X X	O *1 O *2 O *2 O *2 O *1 O *2 O *2 O *1 O *2 O *2 O *2 O *2 O *2 O *2 O *1 O *2	Bank select Modulation Portamento time Data entry Volume Panpot Expression Hold 1 Portamento Sostenuto Soft Reverb Chorus NRPN LSB, MSB RPN LSB, MSB
Prog Change : True #	X *****	O *1 0 — 127	
System Exclusive	O	O	
System Common : Song Pos : Song Sel : Tune	X X X	X X X	
System Real Time : Clock : Commands	X X	X X	
Aux Message : All Sound Off : Reset All Controllers : Local ON/OFF : All Notes Off : Active Sense : Reset	X X X X O X	O O X O (123 — 127) O X	
Notes	* 1 O X is selectable * 2 O X is selectable using external MIDI device		

Mode 1 : OMNI ON, POLY  
Mode 3 : OMNI OFF, POLY

Mode 2 : OMNI ON, MONO  
Mode 4 : OMNI OFF, MONO

O : Yes  
X : No



 Roland®

---

**11260**

UPC

11260



10991

**Roland**