

# Roland



## DIGITAL SAMPLER

# S-770

with SYS-772 Version 2.0 operating system

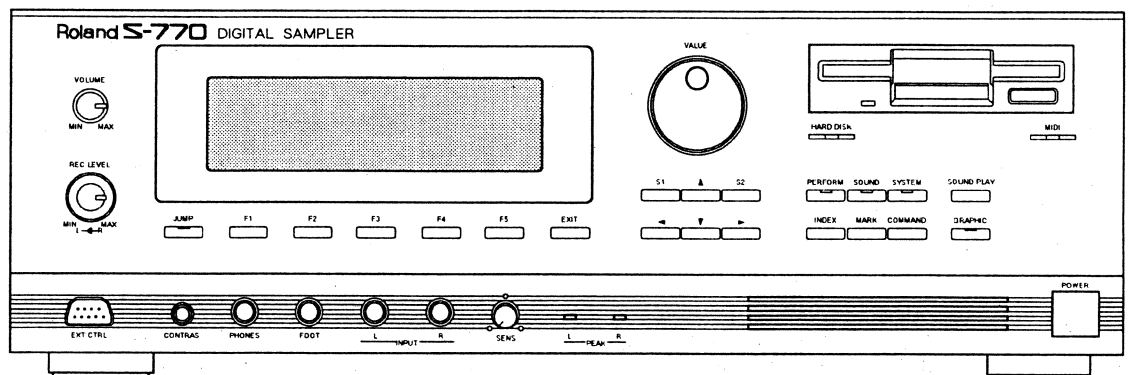
## OWNER'S MANUAL



	<b>CAUTION</b> RISK OF ELECTRIC SHOCK DO NOT OPEN	
<b>ATTENTION:</b> RISQUE DE CHOC ELECTRIQUE NE PAS OUVRIR		
<b>CAUTION:</b> TO REDUCE THE RISK OF ELECTRIC SHOCK, DO NOT REMOVE COVER (OR BACK). NO USER-SERVICEABLE PARTS INSIDE. REFER SERVICING TO QUALIFIED SERVICE PERSONNEL.		



The lightning flash with arrowhead symbol, within an equilateral triangle, is intended to alert the user to the presence of uninsulated "dangerous voltage" within the product's enclosure that may be of sufficient magnitude to constitute a risk of electric shock to persons.



The exclamation point within an equilateral triangle is intended to alert the user to the presence of important operating and maintenance (servicing) instructions in the literature accompanying the product.

INSTRUCTIONS PERTAINING TO A RISK OF FIRE, ELECTRIC SHOCK, OR INJURY TO PERSONS.

## IMPORTANT SAFETY INSTRUCTIONS SAVE THESE INSTRUCTIONS

**WARNING** - When using electric products, basic precautions should always be followed, including the following:

1. Read all the instructions before using the product.
2. Do not use this product near water — for example, near a bathtub, washbowl, kitchen sink, in a wet basement, or near a swimming pool, or the like.
3. This product should be used only with a cart or stand that is recommended by the manufacturer.
4. This product, either alone or in combination with an amplifier and headphones or speakers, may be capable of producing sound levels that could cause permanent hearing loss. Do not operate for a long period of time at a high volume level or at a level that is uncomfortable. If you experience any hearing loss or ringing in the ears, you should consult an audiologist.
5. The product should be located so that its location or position does not interfere with its proper ventilation.
6. The product should be located away from heat sources such as radiators, heat registers, or other products that produce heat.
7. The product should be connected to a power supply only of the type described in the operating instructions or as marked on the product.
8. The power-supply cord of the product should be unplugged from the outlet when left unused for a long period of time.
9. Care should be taken so that objects do not fall and liquids are not spilled into the enclosure through openings.
10. The product should be serviced by qualified service personnel when:
  - A. The power-supply cord or the plug has been damaged; or
  - B. Objects have fallen, or liquid has been spilled onto the product; or
  - C. The product has been exposed to rain; or
  - D. The product does not appear to operate normally or exhibits a marked change in performance; or
  - E. The product has been dropped, or the enclosure damaged.
11. Do not attempt to service the product beyond that described in the user-maintenance instructions. All other servicing should be referred to qualified service personnel.

**For the USA**

This product may be equipped with a polarized line plug (one blade wider than the other) . This is a safety feature. If you are unable to insert the plug into the outlet, contact an electrician to replace your obsolete outlet. Do not defeat the safety purpose of the plug.

**For Canada**

For Polarized Line Plug

**CAUTION:** TO PREVENT ELECTRIC SHOCK, MATCH WIDE BLADE OF PLUG TO WIDE SLOT, FULLY INSERT.  
**ATTENTION:** POUR ÉVITER LES CHOCS ÉLECTRIQUES, INTRODUIRE LA LAME LA PLUS LARGE DE LA FICHE DANS LA BORNE CORRESPONDANTE DE LA PRISE ET POUSSER JUSQU' AU FOND.

**For the U.K.**

**WARNING:** THIS APPARATUS MUST BE EARTHED  
**IMPORTANT:** THE WIRES IN THIS MAINS LEAD ARE COLOURED IN ACCORDANCE WITH THE FOLLOWING CODE.  
GREEN-AND-YELLOW: EARTH, BLUE: NEUTRAL, BROWN: LIVE  
As the colours of the wires in the mains lead of this apparatus may not correspond with the coloured markings identifying the terminals in your plug, proceed as follows:  
The wire which is coloured GREEN-AND-YELLOW must be connected to the terminal in the plug which is marked by the letter E or by the safety earth symbol  or coloured GREEN or GREEN-AND-YELLOW.  
The wire which is coloured BLUE must be connected to the terminal which is marked with the letter N or coloured BLACK.  
The wire which is coloured BROWN must be connected to the terminal which is marked with the letter L or coloured RED.

The product which is equipped with a THREE WIRE GROUNDING TYPE LINE PLUG must be grounded.

Owner's Manual  
for the  
**Roland S-770 Digital Sampler**

with SYS-772 Version 2.0 operating system

by Paul D. Lehrman

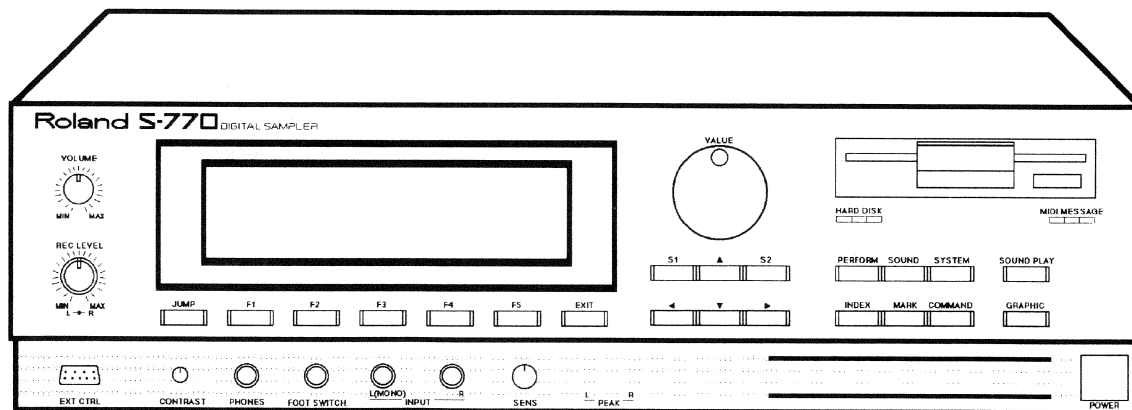

© Copyright 1991 by ROLAND CORPORATION  
All rights reserved. No part of this publication may be reproduced in any form without the permission of ROLAND CORPORATION.

\*Macintosh is a registered trademark of Apple Computer Inc., U.S.A.

# PRECAUTIONS

In addition to the precautions listed under Important Safety Instructions inside the front cover, please observe the following:

## Power supply

- If the power supply to the S - 770 is interrupted, all memory data will be lost. Take care not to hit the power switch or accidentally pull out the AC cord.
- Be sure to use only an AC outlet of the correct voltage.
- Do not connect the S - 770 to the same outlet as other devices which produce noise (motors, lighting dimmers, etc.) or devices which consume large amounts of power.

## Location

- Operating the S - 770 near devices containing large transformers (eg. power amplifiers) may induce hum.
- Operating the S - 770 near CRT displays or radios may cause interference. Do not use this unit near such devices.
- If the room is rapidly heated, or if the S - 770 is brought from a cold location into a warm room, condensation may form on the Hard Disk and other electronic components, which can cause damage. Wait for one hour or more before operating the S - 770.
- Install the unit on a solid, level surface in an area free from vibration.
- Observe the following when using the unit's disk drive. For further details, refer to "Before using disks".
  - Do not place the unit near devices that produce a strong magnetic fields (eg. loudspeakers).
  - Install the unit on a solid, level surface.
  - Do not move the unit or subject it to vibration while it is operating.

## Care

- For everyday cleaning, wipe the unit with a soft dry cloth (or one that has been slightly dampened with water). To remove stubborn dirt use a mild neutral detergent. Afterwards be sure to wipe the unit thoroughly with a soft, dry cloth.
- Never use benzene, thinner, alcohol, or solvents of any kind to avoid the risk of discoloration and/or deformation.

## Other

- Do not subject the S - 770 to strong shocks.
- Do not press hard on the LCD or allow it to be hit. During operation, some sound may be produced, but this is normal.
- The S - 770 may produce some heat when operating normally.
- Before using the S - 770 in a foreign country, contact a nearby Roland service center.

## Before using disks

- Install the unit on a solid, level surface in an area free from vibration. If the unit must be installed at an angle, be sure that the angle of installation falls within the tolerance range (upward ; 10 degrees : downward ;10 degrees).
- Avoid using the drive in areas of high humidity (eg. condensation). High levels of moisture can adversely affect the operation of the drive and/or damage disks. When the unit has been transported, allow it to warm to room temperature before operating.
- To insert a disk, push it firmly into the drive. To remove a disk, press the eject button firmly. Do not use excessive force to remove a disk which is lodged in the drive.

## □ Floppy disk handling

- Floppy disks are very delicate. Observe the following points when handling them.
  - Do not touch the surface of the magnetic sheet.
  - Do not bend disks, or place heavy objects on them.
  - Do not store disks in dusty locations.
  - Do not leave disks in direct sunlight, near heating or cooling equipment, or in a closed automobile.
  - Do not allow disks to come near magnets or speakers, or devices which produce strong magnetic fields.
- Floppy disks have a protect tab that can be used to keep valuable data from accidentally being overwritten. When not writing data to the disk, leave the protect tab in the protected position.

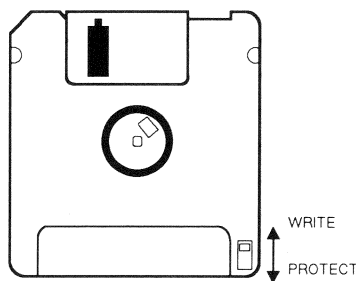

- Remove the floppy disk from the disk drive before turning the power on or off.
- Never remove the floppy disk while the disk drive is operating (while the indicator is lit). Doing so could not only damage the data, but also make the disk unusable.
- As a precaution against emergency, remember to save your important data in the internal Hard Disk onto a floppy disk.
- When attaching a label to a disk, make sure that the label is firmly attached. If the label comes off while the disk is in the drive, you may be unable to remove the disk.

## □ Hard Disk handling

- A Hard Disk is a very delicate storage device. Do not subject it to shock or vibration of any kind. Be especially careful not to move or bump the unit while the power is ON.
- When transporting the unit, be sure to use the Park Head command to park the Hard Disk heads. And pack the unit in the shipping carton or a special flight case.
- It will take about 30 seconds for the Hard Disk to "boot up" after the power is turned on.
- Never turn the power off while the Hard Disk is operating (when the Hard Disk indicator is lit).
- After turning the power off, wait approximately 30 seconds before moving the S - 770.
- If the Hard Disk cooling fan is obstructed, overheating may cause data to be lost or malfunctions to occur. The cooling fan should always be running (except when sampling).
- When handling external Hard Disks, refer to the manual for each device.
- Roland cannot be responsible for any data lost while using the S - 770. It is strongly suggested that you use floppy disks to make backup copies of Hard Disk data.

# Table of Contents

## **Introduction ..... i**

Acknowledgements ..... ii

## **Chapter 1a: An Introductory Tour of the S-770..... 1**

Installation .....	1
Booting up .....	3
Loading Some Sounds .....	5
Selecting Sounds to Play .....	7
Exploring a Sound .....	8
Phrase Sampling .....	14
Advanced Sample Editing .....	19

## **Chapter 1b: Upgrading to version 2.0 .....21**

Installing the New System .....	21
Using version 1.0 files .....	23
The New Features .....	24

## **Chapter 2: Installation, Controls, and Connections.....29**

The Controls and Connectors .....	30
The Front Panel .....	30
The Rear Panel .....	35
Making Connections .....	36
Power .....	36
MIDI .....	36
Audio .....	37
Video Display .....	40
Mouse .....	40
RC-100 .....	41
SCSI .....	43

**Chapter 3: Structural and Operational Overview .....44**

A few notes before we begin this chapter..... 44

The Operating Screens ..... 45

Modes ..... 45

Menus, Functions, and Pages ..... 46

    The Command (“Com”) Menu ..... 46

Parameters ..... 47

Switches ..... 48

Other things ..... 48

Tools and Techniques ..... 49

    Index ..... 49

    Jumping Pages ..... 50

The Select Window and the Scroll Arrows ..... 51

Getting to a Function through Another Function ..... 52

How the S-770 is organized ..... 53

    Samples ..... 55

    Partials ..... 56

    Patches ..... 57

    Performances ..... 58

    Volumes ..... 59

Working With Disks ..... 60

    Loading ..... 60

    Saving ..... 65

    Delete ..... 66

    Copy ..... 68

    Using floppies ..... 69

    Using external SCSI disks ..... 71

Naming Files ..... 72

**Chapter 4: Patches .....76**

Looking at a Patch — Basic Parameters ..... 77

    MIDI Program Number ..... 78

    Outputs and Levels ..... 78

    Patch Priority ..... 80

    Offsets ..... 81

    Tuning ..... 81

Splits ..... 83

    Multisampling ..... 83

    Drum and effects mapping ..... 85

    Examining the Split ..... 85

    Designing the Split ..... 86

    Assignment Types ..... 90

MIDI Control ..... 93

    Controllers and controllers ..... 93

    The Parameters ..... 94

    The controller Matrix ..... 96

The “Part” Parameter ..... 99

Other Patch Functions ..... 100

**Chapter 5: Partial** ..... **103**

- Basic Parameters ..... 104
  - Putting Samples into the Partial ..... 105
  - Tuning Individual Samples ..... 106
    - Transposition Limits ..... 106
    - Changing the Scale ..... 107
- Outputs and Levels ..... 109
- SMT ..... 110
  - Panning and Level ..... 110
  - Velocity Switching ..... 111
  - Velocity fading ..... 113
- TVF ..... 116
  - The Parameters ..... 116
  - The Envelope ..... 121
- TVA ..... 123
  - The Parameters ..... 123
  - The Envelope ..... 124
- Using the Templates ..... 125
- LFO ..... 127
  - Parameters ..... 127
- Editing Partial
- Other Partial Functions (the Com menu) ..... 132
- The Partial Map ..... 134

**Chapter 6: Sampling 1— Recording and Looping**..... **136**

- Recording a Sample ..... 138
  - Setting the Parameters ..... 138
    - .... Choosing Inputs ..... 141
    - .... Triggering ..... 142
    - .... Other Parameters ..... 145
  - Doing the deed ..... 146
  - Listening to the Results ..... 147
- Recording Samples from a Partial or Patch ..... 148
- Recording Samples from a Performance ..... 149
- Other Sampling Functions ..... 149
- Working with Stereo Samples ..... 150
- Editing Samples ..... 152
- Looping ..... 152
  - Loop Mode ..... 154
  - KeyOn Mode ..... 156
  - Other Parameters ..... 157
  - The Loop Point Parameters ..... 158
  - The Graphic Window ..... 160
  - Editing in the Loop field ..... 163
  - Advanced Loop Editing ..... 166
  - Looping in Stereo ..... 171
  - Looping tricks ..... 172
- Smoothing ..... 173



**Chapter 7: Sampling 2 — Editing and Resampling .....177**

Normalizing ..... 177  
 Truncating ..... 178  
     Truncating and Reversing in the Edit Sample2 function ..... 182  
 The Patchwork Operations ..... 187  
     Cut & Splice ..... 187  
     Area Erase ..... 188  
     Insert ..... 188  
     Mixing ..... 191  
     Combine ..... 192  
 Digital Filter ..... 193  
 Compressor/Expander ..... 194  
 Time Stretch ..... 196  
     Pitch Change with Constant Length ..... 198  
 Rate Converting ..... 200  
     Retuning ..... 201  
     Range Extension ..... 201  
 Wave Draw ..... 202  
 Resampling ..... 204  
     The Resampling Algorithms ..... 205  
     Filter and Volume Envelopes ..... 207  
 Performance Resampling ..... 210

**Chapter 8: Performances, Volumes, and MIDI Program Changes .....212**

Creating a Performance ..... 212  
 Performance Editing ..... 216  
 Saving a performance ..... 220  
 Editing Patches Through a Performance ..... 221  
     Part Numbers ..... 221  
     The Part Map ..... 222  
 Other Performance Functions ..... 223  
 MIDI Program Changes ..... 224  
     The Patch MIDI Map ..... 224  
     Patch Conflicts and Sustained Notes ..... 225  
     The Performance MIDI Map and Control Channel ..... 225  
     Calling up Volumes ..... 227  
 MIDI Filters ..... 228  
 Volumes ..... 232  
     Volume ID ..... 233  
     Saving Volumes ..... 236  
     Program Changes ..... 236  
     Initial Volume ..... 237  
     Deleting Volumes ..... 237

**Chapter 9: System Functions .....238**

System Parameters ..... 238  
    System PRM Page 1 ..... 238  
    System PRM Page 2 ..... 240  
Disk Tools ..... 242  
    Selecting the Current Drive ..... 242  
    ID ..... 243  
    Utilities ..... 247  
    Save System ..... 250  
Using Disks from Other Samplers (Option/Convert Load) ..... 251  
SCSI ..... 253  
MIDI ..... 255  
    Configure ..... 255  
    Dump (Sample Dump Standard) ..... 257  
MIDI Monitor ..... 257

**Chapter 10: Data Transfer and Storage .....260**

SCSI ..... 260  
    Connecting a single device ..... 260  
    Connecting multiple devices ..... 264  
    Connecting non-storage SCSI devices ..... 266  
Digital I/O ..... 267  
MIDI Sample Dump ..... 268

**Chapter 11: Upgrades and Service .....270**

System Software ..... 270  
Adding Memory ..... 272  
Cleaning and Maintenance ..... 274  
Returning for Service ..... 275  
Troubleshooting: Why Won't It...? ..... 276

<b>Appendices .....</b>	<b>280</b>
Specifications .....	280
Video Display Wiring .....	282
Roland Exclusive Messages .....	284
MIDI Implementation .....	286
MIDI Implementation Chart.....	296
Contents of the Internal Hard Disk .....	297
Menu Structure .....	299
Index of the Index Screen .....	300
Complete Index .....	302

# Introduction

The Roland S-770 Digital Sampler is the most advanced sampler available today. Drawing on Roland's extensive experience in sampler and synthesizer technology, it provides all the features that musicians want and need. The power and capacity of the S-770 removes many of the limitations of previous samplers, and make the S-770 a musical instrument and post-production tool that requires from the user no compromises or apologies.

## Features

Among the many important features are:

- Two megabytes of internal (RAM) memory, expandable to 16 megabytes using standard easily-available SIMMs, for over 90 seconds of on-line stereo sample recording.
- A 40-megabyte internal hard drive for massive storage and quick access, a floppy disk drive for easy off-line storage, plus a SCSI connector for external file storage on a wide variety of devices including CD-ROM, fixed and removable hard disks, and Magneto-Optical read/write drives.
- True 16-bit sampling, with a choice of sampling rates at both inputs and outputs, plus the ability to combine samples recorded at different rates.
- Stereo inputs and outputs for true stereo sampling, plus eight assignable outputs for isolating sounds in a mix.
- Digital inputs and outputs for direct access to CDs, DATs, processors, and other digital sources without A-to-D or D-to-A conversion.
- Internal resampling of stored samples, from single Samples to an entire multi-timbral Performance, using multiple algorithms, entirely in the digital domain for highest quality and flexibility.
- Twenty-four-voice polyphony for reproduction of many layers and the most complex timbres.
- Advanced MIDI implementation including multi-channel operation, assignable controllers, polyphonic aftertouch, monitoring of incoming data, and support for MIDI Sample Dump Standard.

- Analog-style resonant digital filters and envelopes for greatest flexibility in manipulating sound.
- Advanced performance features such as splits, multisampling, layering, velocity switching and fading, and positional crossfades.
- Compatibility with files from the S-550/W-30 sampler family (Convert Load).
- A user-friendly graphics-based operating system with mouse control.

In addition, the Version 2.0 operating system offers many new features, including:

- Advanced editing and DSP functions including time stretching, rate conversion, splicing and mixing, reversing, scrubbing, filtering, and compression/expansion.
- Resampling an entire multi-timbral Performance and storing it as a single Sample.

## **Copyright warning**

The S-770's large memory makes it easy to record large segments of sound from live or pre-recorded sources. Keep in mind that using material belonging to other persons without their consent may be a violation of copyright law. When sampling material from CDs, cassettes, DATs, LPs, or broadcasts, please respect other people's copyrights and do not break the law.

## **Acknowledgements**

The author wishes to thank the following for their assistance in preparing this manual: Larry Garcia, Mark Tsuruta, Muneaki Ohkubo, Eric Persing, Nancy Kewin, Paul Young, Chris Gill, Akira Matsui, Robert Daspit, Chris Meyer, Steve Peha, Al Dugas, Jerry Antonelli, and Microtech International.

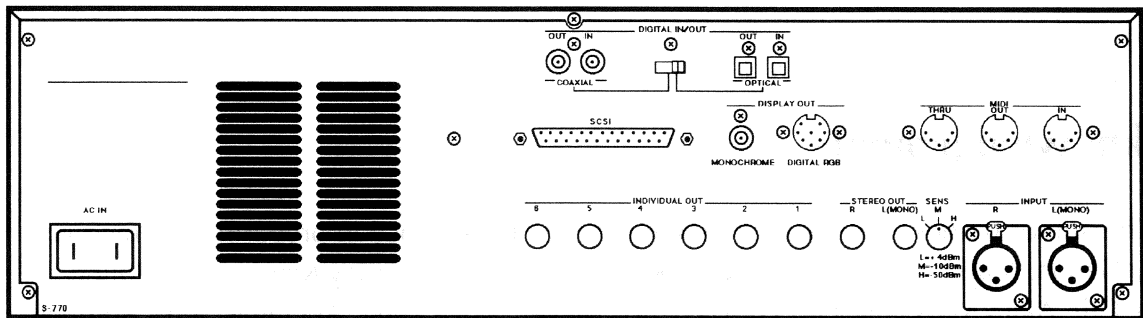
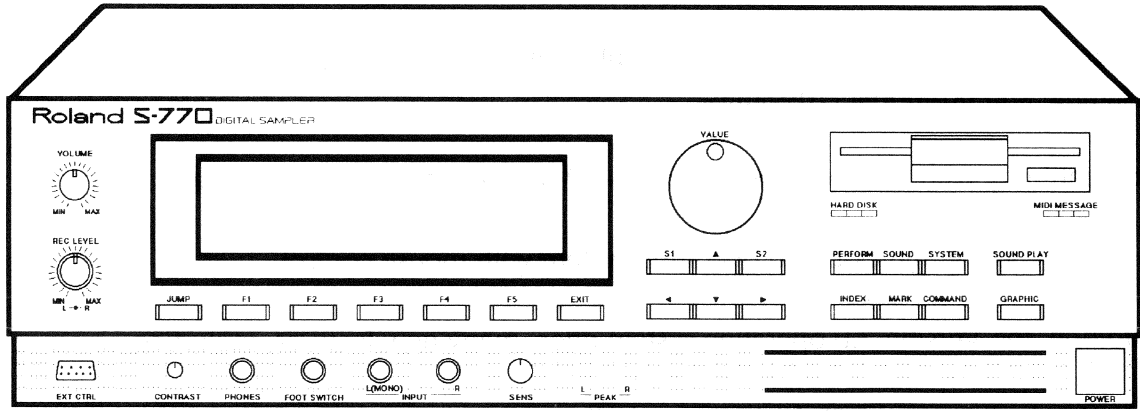

# Chapter 1a: An Introductory Tour of the S-770

If you've just purchased your Roland S-770 Digital Sampler, no doubt you are very excited about it, and would like to put it to good use immediately. The S-770 is a complex device, which is why this manual is so big, but it's not necessary to know everything about it right away, so in this chapter we will get you started with a few basic tasks. If you want to take a more formal, slower approach, feel free to skip ahead to Chapter 2. But if you want a quick tour of some of the unit's capabilities, read on.

When you are done with this chapter, you'll know a little bit about the S-770, but there is much, much more to learn. It is only intended to whet your appetite, so to get the most out of your sampler, it really is necessary to go through the entire manual.

## *If you are a veteran user of the S-770...*

skip ahead to **Chapter 1b** for instructions about how to upgrade your software to Version 2.0, as well as a summary of the new features provided by the upgrade. Then refer to the appropriate sections of the rest of the manual for more details.

## **Installation**

When you remove the S-770 from its packing carton, place the unit on a solid flat surface, making sure you have access to the rear panel. Do not put anything heavy, like a video monitor or speaker, on top of the unit.

### **Power**

Locate the AC power cord, and insert the female end into the socket on the rear panel marked "AC IN". Check to see that the **POWER** switch on the front panel is off (the button is out), and then plug the AC power cord's male end into an AC socket. Make sure the AC voltage matches the power requirements stated on the S-770's back panel.

## 2 • Quick Tour

### Mouse

Locate the mouse, and insert its connector into the socket marked “EXT CTRL” at the bottom left corner of the front panel. Be careful of the orientation of the connector: it must be inserted with the *shorter* row of holes (4 holes, not 5) at the *top*.

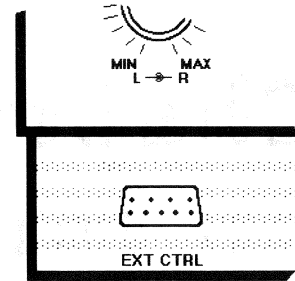

Lay the mouse onto a flat surface, like a table top or a pad of paper, where you will have room to move it freely at least 6 inches in all directions. A mousepad is ideal, otherwise any surface with some friction will work (a high-gloss desk top or sheet of glass is not recommended).

### Video

Connect the video monitor you will be using. If you have an RGB monitor with a cable designed for use with Roland products, insert the round end of the cable into the **DIGITAL RGB** jack on the rear panel, and connect the other end of the cable to the input of the monitor. If you have a monochrome monitor, use a video cable with a male RCA plug, and insert it into the **MONOCHROME** jack on the rear panel. Connect the other end of the cable to the input of the monitor.

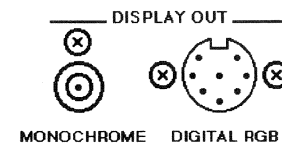

Note: a CGA-compatible RGB video monitor is highly recommended for use with the S-770, but in a pinch — at least for now — you can use a standard television set with a “composite” video input (the picture will be black-and-white). Connect the **MONOCHROME** jack to that input using a video cable with an RCA male plug at each end. If your TV does not have a composite input, you can go through a VCR: connect the **MONOCHROME** jack to the VCR’s “Video” input, and connect the VCR’s “TV” output to the television’s antenna input. If a VCR and TV are not available, you can use the LCD display on the front panel, but you will have to be very patient, and you won’t be able to access some features.

### Audio

Now connect the **STEREO OUT** jacks on the rear panel, using cables terminating in 1/4-inch phone plugs, to your mixer or amplifier and speakers. Alternatively, plug a pair of stereo headphones (with a stereo 1/4-inch phone plug) into the front-panel **PHONES** jack.

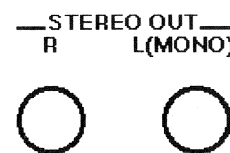



We will do a little sampling in this chapter, so an output from a CD player or cassette deck into the **L(MONO)** jack above the label **INPUT** on the front panel (this takes a mono 1/4-inch phone plugs also). (The S-770 will sample in stereo, but we'll save that for later.)

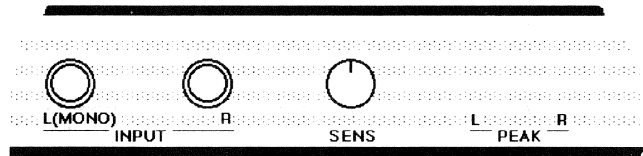

## MIDI

Connect the MIDI output of a MIDI keyboard to the **MIDI IN** jack on the rear panel, using a standard MIDI cable.

**IMPORTANT:** set the keyboard to transmit on MIDI Channel 1.

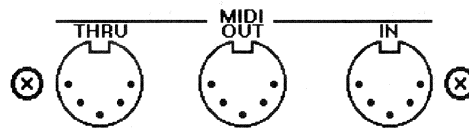

## Anything else?

If you have an RC-100 Remote Controller, a CD-ROM player, or a Magneto-Optical or external hard-disk drive, leave them alone for now. We'll deal with them in due time.

## Booting up

Do **NOT**, repeat **DO NOT**, insert a floppy disk into the disk drive on the front panel. The S-770's internal hard disk has the entire operating system already on it.



#### 4 • Quick Tour

Double check all your connections, and turn down the **VOLUME** and **REC LEVEL** controls on the front panel. Find the **F2** button on the front panel, and press and hold it while you push the **POWER** switch on until it locks. (Don't worry — you won't have to do this every time.) Next turn on the power to the video monitor and the MIDI keyboard you are using to play the S-770. Last, turn on the power to the mixer or amplifier you are monitoring with.

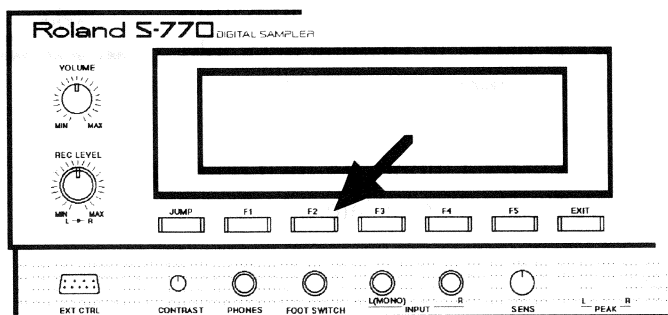

The LCD display on the front panel will light, and you will hear the hard disk and fan in the S-770 start up. The amber "**HARD DISK**" LED will also light.

The video monitor will come to life, and will show a variety of messages in sequence, including **System Initialize in Progress**, **SCSI Device Scanning**, **Wave Memory Check**, and **SCSI Device Check**. (Depending on how the S-770 was configured at the factory, there may be other messages as well.) It will pause for a moment, then a "**Message**" screen will appear with the words "**Volume Load...**", followed by a rapid progression of letters and numbers.

Finally, everything will quiet down, and the following screen will appear on the video monitor:

This screen is known as **Play Page1**, and its name appears in the upper-left.

Mode Index Mark S-770/01

Play Page1 Com Exit

Performance L01: Stereo Piano Name

Ch	Patch Name	Lev	Mix	Pan	O
<input checked="" type="checkbox"/> 01	1 L01:Piano L	62	127	L32	-
<input checked="" type="checkbox"/> 02	1 L01:Piano R	127	127	R32	-
<input type="checkbox"/> 03	3 -----Off-----	127	---	---	-
<input type="checkbox"/> 04	4 -----Off-----	127	---	---	-
<input type="checkbox"/> 05	5 -----Off-----	127	---	---	-
<input type="checkbox"/> 06	6 -----Off-----	127	---	---	-
<input type="checkbox"/> 07	7 -----Off-----	127	---	---	-
<input type="checkbox"/> 08	8 -----Off-----	127	---	---	-

Display OmniOn [-----]

Page1 Page2 Page3 Page4 P.Map

The operating system has automatically loaded an initial “Volume” of sounds, consisting of piano samples. The name of the first “Performance” in that Volume is on the first line of text, and the two “Patches” that make up the Performance are immediately below it. If you turn the front-panel **VOLUME** control up, and play notes on your MIDI keyboard (make sure it’s transmitting on Channel 1), you will hear a piano from the S-770 outputs. Little arrows will appear to the left of the Part numbers when you play a note, showing that there is MIDI activity on the channels where those Patches are located.

## Loading Some Sounds

In the S-770, sounds are stored on disks — hard, floppy, or optical — but before they can be played they must be loaded into the unit’s Internal Memory, or RAM. The operating system has already done this for us, but let’s load in something else.

Take the mouse in hand, and move it around, watching the video screen. As you move it, you will see a cross-hair cursor on the screen following your movements. As you pass the cursor over certain words or numbers on the screen, they become highlighted, changing to reverse video (that is, the letters and the background exchange colors). When an item changes this way, it is being “selected” by the mouse.

Select the word “**Com**” in the upper right-hand corner, and while the word is in reverse video, press the left mouse button once and release it. This is called “clicking” the mouse.

A box with a blue outline appears, which is known as the “Command menu”. Without touching the buttons, move the mouse down to select the word “**Disk**”. When it is highlighted, click the left mouse button.

Command	Exit
<b>Disk</b>	
Copy	
Delete	
Resample2	
Edit Patch	

The screen is replaced with a new screen, called a “Disk Page”. There are five Disk Pages in all, and the one you are on is called “Disk Load”. (If the words “**Disk Load**” do not appear in the upper-left portion of the screen, move the mouse to the bottom-left corner where the word “**Load**” appears. Select **Load** and click the left button.)

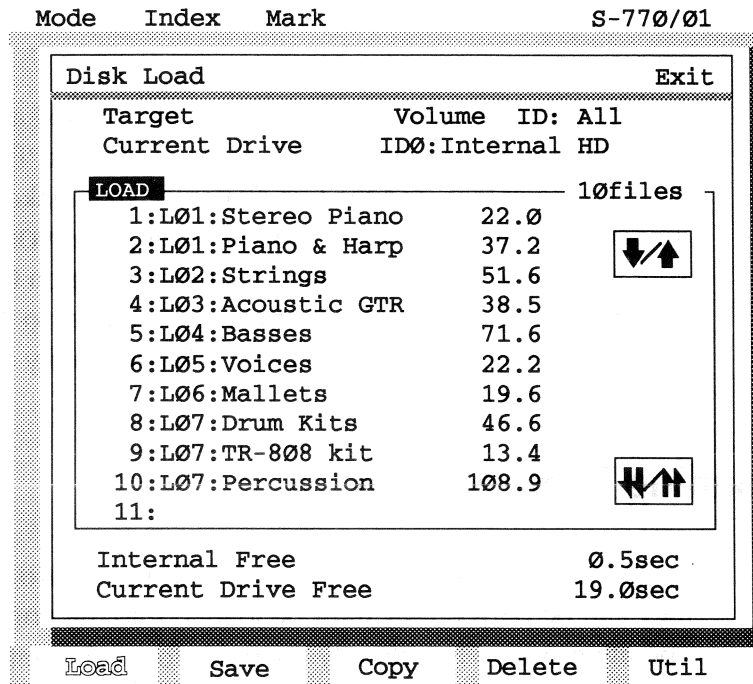

Look at the top of the screen where the word “**Target**” appears. Select that word. Within the same reverse-video “field”, on the right side of the screen, will be another word. This should be “**Volume**”. If it is not, then while the field is still in reverse video, click the left mouse button repeatedly until “**Volume**” appears.



Now move the mouse down until you have selected “**6:L05:Voices**”. Click the left button. A window opens asking you about Internal Memory being cleared. Don’t panic, nothing will be erased permanently — just select and click on the box labelled “**Yes**”.

The **HARD DISK** LED lights, and you can hear the disk spinning. At the bottom of the screen, the words “**Now Working**” appear, along with five little arrows, rolling and tumbling. Soon a list of names starts to scroll down the screen. When it finishes, the “Now Working” changes briefly to “**Complete**”, and then the screen returns to the Disk Load page.

You have just loaded a Volume called “Voices” into memory from the S-770’s internal hard disk into RAM. But you can’t play any of the sounds quite yet. Move the mouse up to the word **Exit** in the upper-right corner. Select it and click the mouse. The blue Command menu re-appears and then quickly disappears.

We are back on **Play Page1**. As you play notes on your MIDI keyboard, the **MIDI MESSAGE LED** on the front panel should light. Hold the notes for a little while, and you will hear sampled human voices. If you don't hear anything, check your connections again, and also make sure your MIDI keyboard is still transmitting on Channel 1.

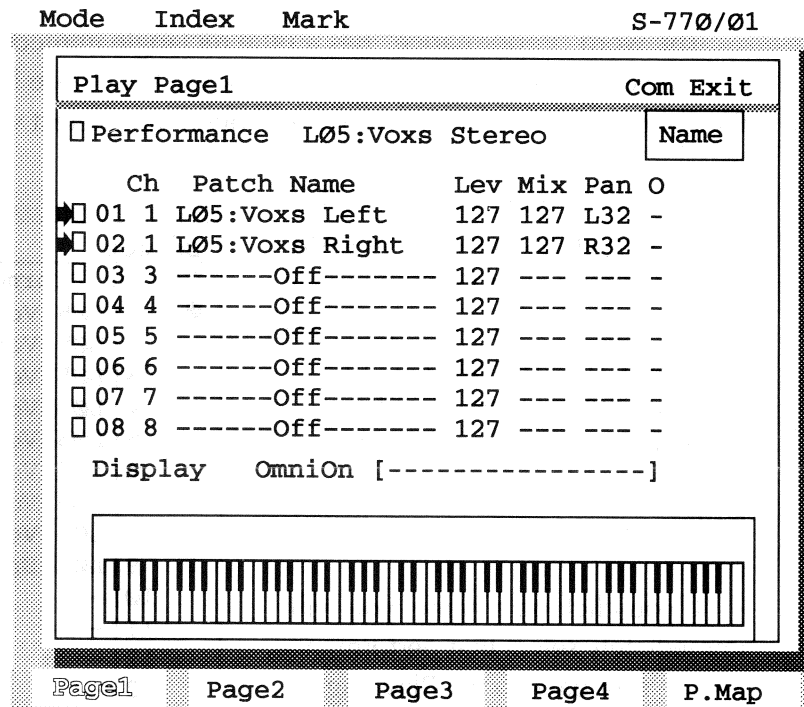

## Selecting Sounds to Play

What you are hearing is a "Performance". A Performance is a group of sounds arranged on different MIDI channels, with various other characteristics including stereo panning and level. This Performance is a fairly simple one — it uses two sounds, or "Patches", which are shown on the screen, both of which are set to respond to MIDI channel 1.

The Volume you loaded into RAM contains several Performances. You can only hear one at a time, but you can change which one you're listening to without re-loading from disk. Move the mouse up to the line labelled "Performance" until it is in reverse video. Now click the left *or right* mouse button, and with each click the name of the Performance (the right side of the field) changes. Hold down the mouse button to scroll more quickly through the list.

All told, there are nine Performances in this Volume. Theoretically, a Volume has room for 64 Performances, but in this Volume only the first nine "slots" are used — if you try to access the tenth slot, it has no name and you will hear no sound. As you change Performances, you will see the different Patches that make them up. Some of the Performances use one Patch, and some use three. You can also see the different Pan settings they use. Some of the stereo effects are quite nice.

## 8 • Quick Tour

The word “Performance” has a little rectangle immediately to its left. This is known as a “Select icon”. If you select and click the left mouse button on the name of any Parameter with a Select icon, you will open up a Select window. Try this now.

This Select window shows all of the Performances currently in RAM as a list. The current Performance is shown with a red arrow. If you pass the mouse over one of the names (without clicking) and play the keyboard, you will hear the Patch assigned to Channel 1 in that Performance.

If you click on a name, you will immediately select that performance, and be sent back to the Play page, with the selected Performance sounding. This feature allows you to move quickly through a long list of files without scrolling through each one.

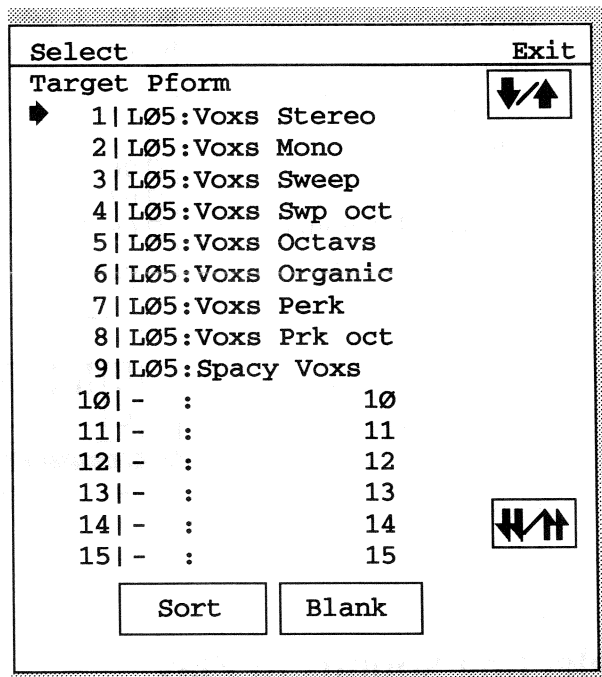

As you play the Performances, you will hear that while they all use the same basic vocal sounds, the sounds are treated quite differently in terms of attack and decay, stereo placement, register, and filtering (especially the “sweep” Performances). This gives you some idea of how Samples can be modified once they are recorded into the S-770.

## Exploring a Sound

Next on our tour we’ll examine how a sound in a Performance is constructed. We’ll work our way downwards from the most complex structure to the simplest.

## Patches

A Patch is an entire “instrument”, with all of its internal and MIDI control parameters set. It’s essentially the same as a “Patch” that you would find in a single-timbre sampler or synthesizer.

Move the mouse all the way up to the top-left corner of the screen and select the word “**Mode**”. Click with the left mouse button.

A blue-outlined box appears, the “**Mode Change**” menu. Select and click on “**Sound**”.

This opens the **Sound** menu which is where you get access to the sound-editing Functions. Select and click on “**Edit Patch**”.

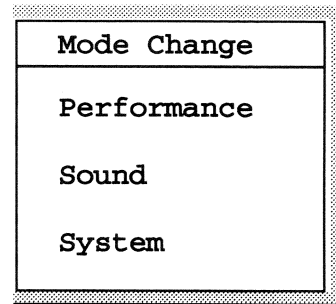

## Common

The screen that now appears is the **Edit Patch Common** page. Select white letters on the line labelled “**Patch**”, and click the left or right mouse buttons until you see “**L05:Voxs Sweep m**” appear. Play the MIDI keyboard, and you can hear this Patch by itself, without any others that may be combined with it in a Performance.

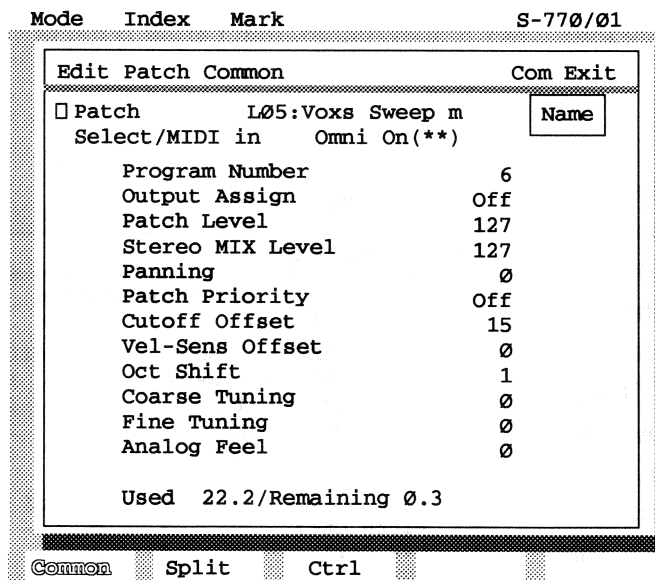
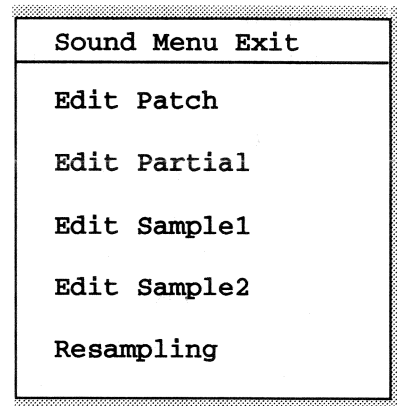

## Split

At the bottom of the page, select the word “**Split**” and click the left button. This brings you to the **Edit Patch Split** page, which show how various sounds (or “Partials”, the next level down) can be arranged on the MIDI keyboard, using the technique known as “Multisampling”, to build the Patch.

## 10 • Quick Tour

As you play on the keyboard, red dots appear on the picture of the keyboard on the screen, showing the notes you are playing. Above the keyboard picture is a yellow bar with a number of divisions. These show the split points. Bring the mouse to the line of white letters immediately to the right of where the word **Partial** appears in yellow. Select this parameter, and then click the left and right buttons. This will let you “scroll” through the various Partials that make up this Patch. As certain Partials’ names appear, an area of the yellow bar will turn red. This indicates the region of the keyboard that this particular Partial is “mapped” to — when you play a key in that region, that Partial is the one that sounds.

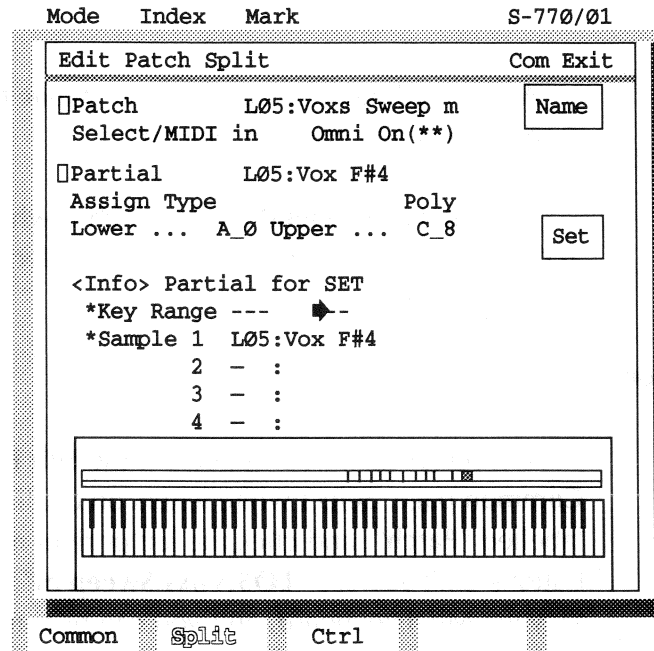

## Control

Move the mouse to the bottom of the screen where the word **Ctrl** appears, and click. This opens the **Edit Patch Ctrl** page, where you can determine how various types of MIDI data will affect the Patch. Move the mouse to the line that says **Bend – Up**. This is a “Parameter”, which is currently set to 2. That means that when you move the Pitch Bend control up to its furthest position, the pitch of the sound will go up by 2 semitones (a whole step). Use the mouse buttons to increase (right button) or decrease (left) this number, and note how it affects the action of the Pitch Bend control as you play.

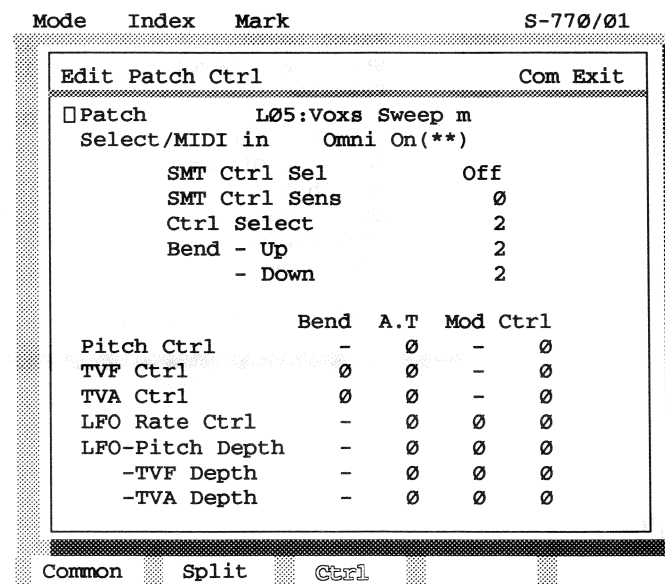



## Partials

As we've seen, Partials are the constituent parts of a Patch, and within a Patch, different Partials are played from different regions within the MIDI note range. Let's go down a level and look at Partials.

Make sure you still have "LØ5:Voxs Sweep m" selected as the Patch. Move the mouse to **Com** in the upper-right and click the left button. Move the mouse down to the word "Edit Partial" and click.

### Common

We are now at the Partial level. Let's look first at the "Edit Partial Common" page. If the name at the upper left corner of the screen doesn't say "\*Edit Partial Common\*", click on the word "Common" in the bottom left corner).

Mode Index Mark S-770/01

\*Edit Partial Common\* Com Exit

Partial LØ5:4Vox E6 Name

Edit Mode Single

Sample	K.F	C.T	F.T
[*] <input type="checkbox"/> LØ5:Vox E6	Norm	-17	-50
<input type="checkbox"/> -----Off-----	Norm	0	0
[*] <input type="checkbox"/> -----Off-----	Norm	0	0
<input type="checkbox"/> -----Off-----	Norm	0	0

Output Assign 1

Partial Level 127

Stereo MIX Level 127

Panning 0

Coarse Tuning 0

Fine Tuning 0

SMT Velocity Ctrl On

Used 1.4/Remaining 0.3

Common SMT TVF TVA LFO

This Page shows the current Partial that is sounding. When you play different notes on the keyboard, the Partial displayed changes. Each Partial is made up of one or more Samples (in this case, they all have only one), which are displayed in four "slots" in the upper half of the screen. As you move around the keyboard, those change as well.

### TVF

Move the mouse to the bottom of the screen and click on "TVF" (we'll skip the SMT page for now). This brings us to the "Edit Partial TVF" page, where filter envelopes are created and edited. As you play different notes on the keyboard, the different filter envelopes for the different Partials are shown in the graphic in the lower part of the screen.

Mode Index Mark S-770/01

\*Edit Partial TVF\* Com Exit

Partial LØ5:4Vox E6 Name

Edit Mode Single

Filter Mode LPF Envelope

Cutoff Freq 31 -TVF Depth 63

-Key Follow 0 -Vel Sens 0

Resonance 16 -Pitch Depth 0

Vel-Curve 2 Time

-C.Sens 0 -Vel Sens 0

KF Point C\_4 -Key Follow 0

	1	2	3	4
Time	0	100	75	115
Level	40	127	60	0

Common SMT TVF TVA LFO

Let's play with the filter envelope. Play a note on the keyboard, and then move the mouse to one of the little blue squares that are at the envelope's "break points". Press the left mouse button and *hold* it down, and then move the mouse slowly in one direction or another, dragging the blue square with it. The envelope will re-draw itself as the square moves. Let go of the mouse button, and play the same key you played before (so that you make sure you are playing the same Partial), and listen to the effect of the change you've made to the envelope.

**TVA**

Move the mouse to the word "**TVA**" at the bottom of the page and click. This opens the "**Edit Partial TVA**" page, where you can work on the Partial's "Time Variant Amplifier", or volume envelope. The volume envelope is displayed at the bottom of the screen (and the TVF envelope you just played with is in the background in dark blue). Grab one of the envelope break points with the mouse and drag it around, and then listen to its effect.

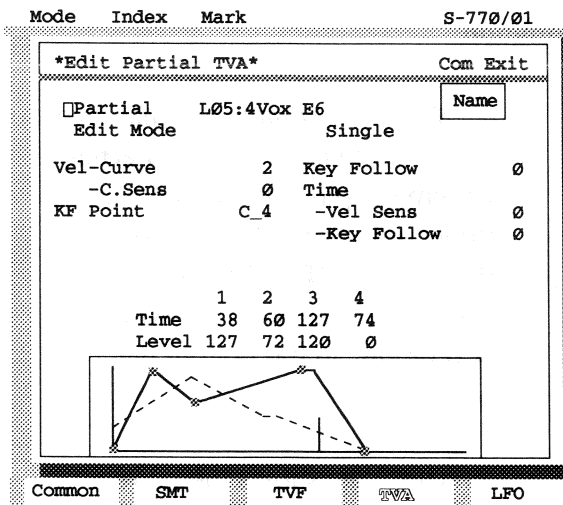

**LFO**

Move the mouse to "**LFO**" at the bottom and click. This is the "**Edit Partial LFO**" page, where various types of vibrato can be applied to the Partial. Play with the Parameters "**Pitch Mod Depth**", which control the amount of frequency-based vibrato; "**TVA Mod Depth**", which controls the amount of amplitude-based vibrato (what used to be known as "tremolo"); and "**TVF Mod Depth**", which imparts vibrato onto the filter (which can often result in a "wah-wah" effect). Also try adjusting the Rate and Delay parameters. Remember that each Partial has its own set of

Parameters, so if you play different notes on the MIDI keyboard, the Partial will change and the Parameters on the screen will change.

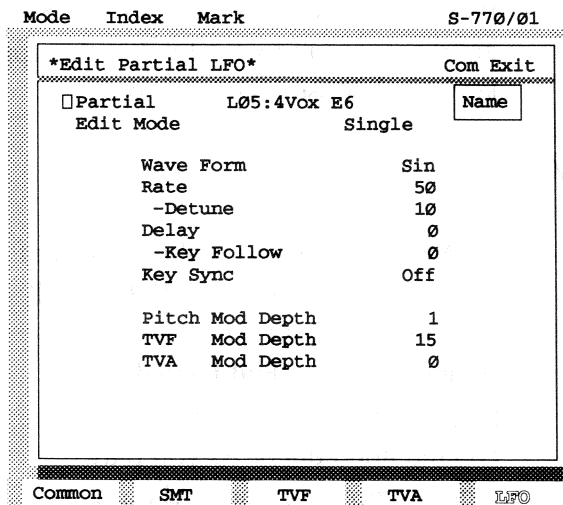

## Samples

Samples are the most elementary structure in the S-770. They are the actual sounds recorded by the unit, or transferred to it from another medium. Click on **Exit** twice to get back to the **Sound** menu, and select and click on “**Edit Sample1**”.

## Looping

This is the Sample editing level, and we are looking at the **Edit Sample Loop1** page (there’s a Loop2 page, but it will have to wait until Chapter 6). Play the MIDI keyboard and you can hear this Sample, unadorned, with no envelopes or vibrato, and as you move around the keyboard, the Sample doesn’t change.

Move the mouse to the parameter **Loop** on the right side of the screen. Select it, and press the *right* mouse button and hold it. The number in the parameter will increase. Look at the graphic waveform display at the bottom of the screen, and above the picture of the waveform (yes, that’s what the Sample looks like), you can see a long blue rectangle shrink towards the right as the number increases.

Hold down a MIDI key, and listen to the sound. After an initial period, the sound starts to repeat, or loop. The number in the Loop parameter is the number of the specific word within the Sample where the loop will start. As that number gets larger, the loop starts *later*, and the repeat time is shorter. The blue rectangle is a graphic representation of the loop. As the loop starts later, the rectangle gets smaller.

You will notice that at the point at which the loop repeats, it often “pops”. Trying to get a good loop-repeat point without a pop or click is one of the fine arts of sampling. The S-770 is very good at that, and we will discuss it in detail in Chapter 6, as well as other operations available at this level.

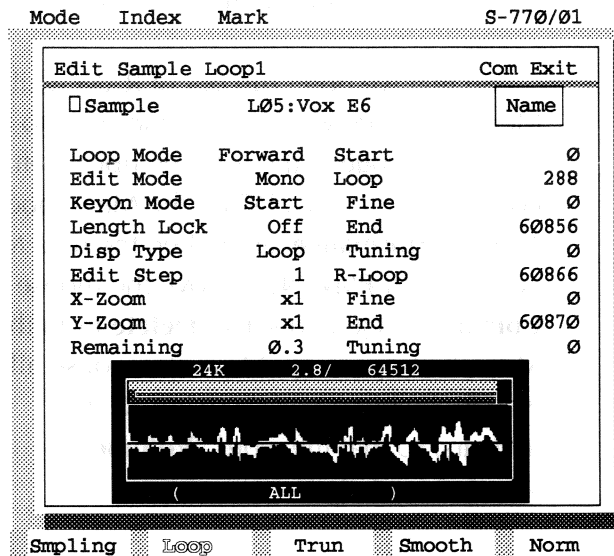

## Phrase Sampling

The S-770 has a lot of memory, which means it can deal with the most complex instrument sounds. But it also makes it ideal for working with longer sounds, like sound effects or entire musical or spoken phrases, manipulating them in various ways and playing them back on cue. Using the unit this way is often called “phrase sampling”. Depending on how much memory you have installed, recorded sounds and phrases can be anywhere from a few seconds to several minutes in length.

So that we don’t run out of RAM while we do this, we should clear the Internal Memory before we proceed. Go back to the Performance **Play** Page by moving the mouse to **Mode** at the extreme upper-left corner and clicking. When the Menu opens select **Performance**, and when the next Menu opens select **Play**. Now move the mouse to **Com** and click, and select **Delete** from the Menu that opens up. Move the mouse all the way to the bottom of the window that appears, so that the word “**Volume**” is selected, and click.

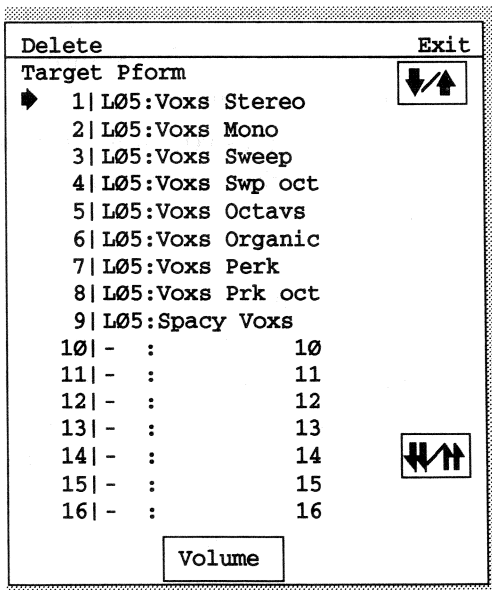

This operation removes all information that is currently in RAM, but it does *not* affect anything on the disk (all disk operations have to go through a Disk page). When the “**CAUTION!!!**” window opens, click on “**Yes**”. A message window appears that says “**Now working**”, and in a second or two it and the Delete window will close, and you will be back on the **Play** Page.

Now let's get some sound. Select **Mode** again, and when the **Mode Change** menu opens, click on **Sound**. When the **Sound** menu opens, click on **Edit Sample1**. If the “Sampling” page doesn’t appear, click on the far lower-left corner of the screen, on the word “**Smplng**”.

This page is where you record samples. To keep things simple, we’ll record a mono Sample. Put the cursor on the “**Mode**” parameter in the left-hand column. If it says “**Stereo**”, click the left mouse button until it says “**Mono**”. Next, select the “**Time(sec)**” parameter three lines down, and press and hold the right mouse button until “**5.0**” appears (if you overshoot, go back with the left mouse button). Now move to the “**Type**” parameter in the right-hand column, and press the right mouse button until this parameter reads “**Manual**”. Three lines down, set the “**Monitor**” parameter to “**On**”.

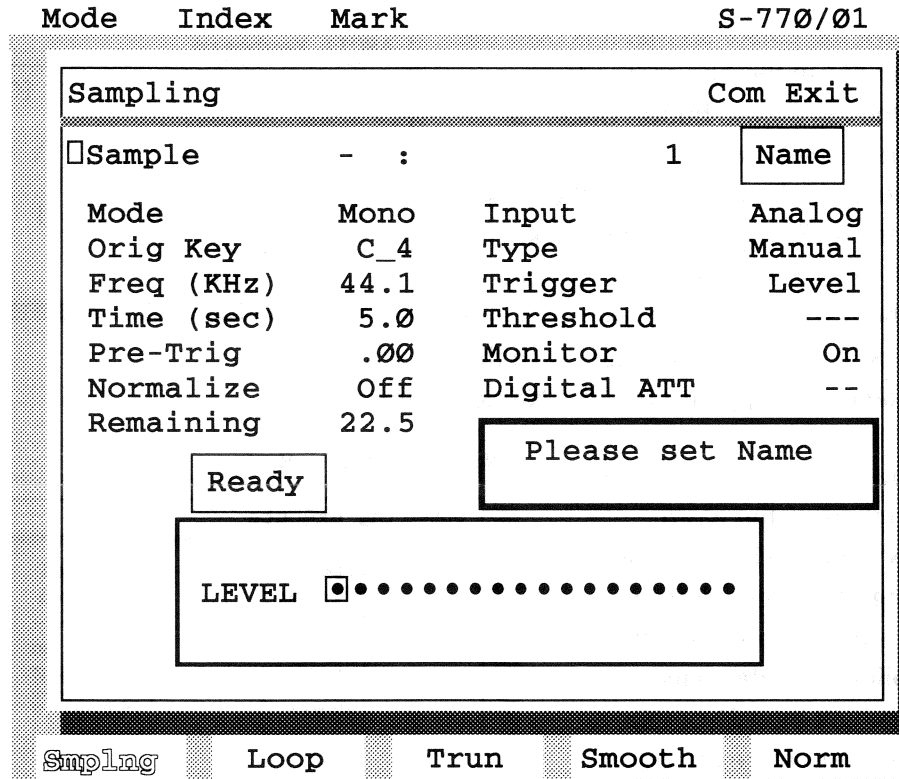

Earlier in this chapter you connected a CD or cassette player into the jacks on the front panel, didn't you? Now's your chance to use it. Put a tape or disk into the player, and start it playing. Adjust the "SENS" control on the front panel next to the input jacks so that the red LEDs immediately to the right of the control (they are hard to see when they aren't on — they're above the label "HEAD AMP") flash only occasionally at the loudest moments.

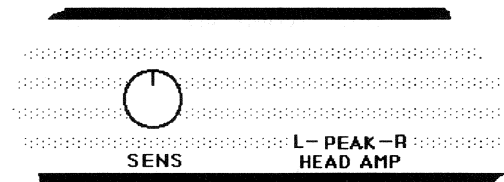

Now look back up at the video screen, and watch the window at the bottom with the word "LEVEL" in it. A little blue box is dancing back and forth, showing the level of the incoming audio signal. If the box is jumping off to the right, turning red in the process, the level is too high. If it is barely moving, or not getting past the mid-point of the window at any time, the level is too low. Adjust the "REC LEVEL" knobs on the left side of the front panel until the level is comfortable.

Before you record a Sample, you must name it. This gets a little complex but we'll keep it as simple as possible for now. Move the cursor to the "Name" box at the upper-right and click. A special "ASCII Keyboard" window opens. Towards the top of this window is a black area containing a yellow colon and a short red horizontal line.

16 • Quick Tour

Move the cursor so that it is over the number "5" in the line of numbers. Click the left mouse button once. "5" appears in the black area and the red line moves to the right. Move the cursor to where "[CR]" appears, and click. You've just named your new sample "5". The ASCII window closes, and you are back to the Sampling Page, with the new name now appearing in the Name parameter.

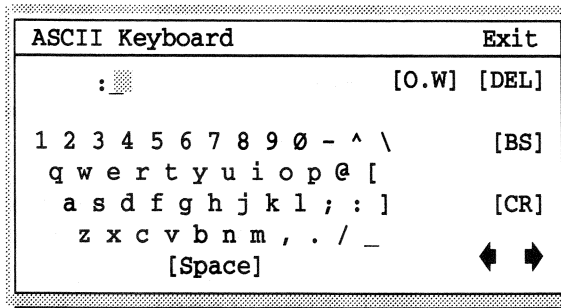

Now move the cursor to the box containing the word "Ready" and click. A "Now working" message window appears briefly, and then the "Sampling execute" page appears. Get the CD or tape cued up just before the point that you want to sample, and start it playing. When it reaches the point where you want to start, click on the box with the word "Start".

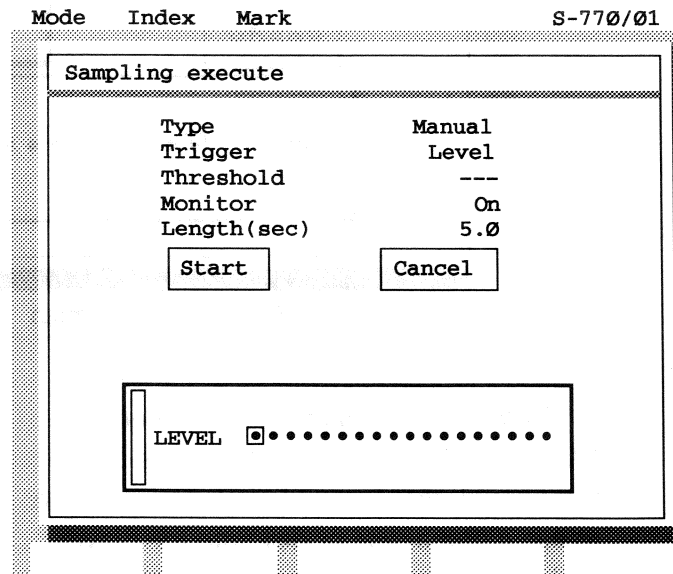

At the bottom of the screen, a red "thermometer" will fill up as the recording progresses. (If you would like to stop recording in the middle for any reason, click the mouse or press the EXIT button on the front panel.) At the end of five seconds, the recording will stop, and a small "Now working" box shows itself briefly. Then the "Sampling Over" page appears. In the graphic window is a picture of the recording you just made. To hear it, play a Middle C on your MIDI keyboard. To hear it sped up or slowed down, play a different note.

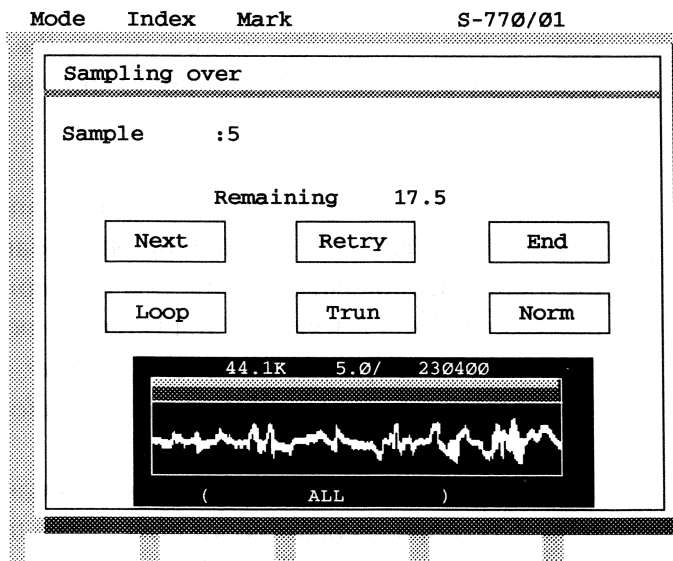

Move the cursor to the “**Loop**” box and click. This brings you to the **Edit Sample Loop 1** page, which we saw earlier.

Put the cursor on “**Loop Mode**” and press the left mouse button until it changes to “**Fwd+R**”. Move the cursor to “**Loop**” in the right-hand column, and press and hold the left button. As you hold it, the blue rectangle at the top of the graphic display in the lower half of the screen grows larger. When it gets about halfway across the graphic window, let go of the mouse button.

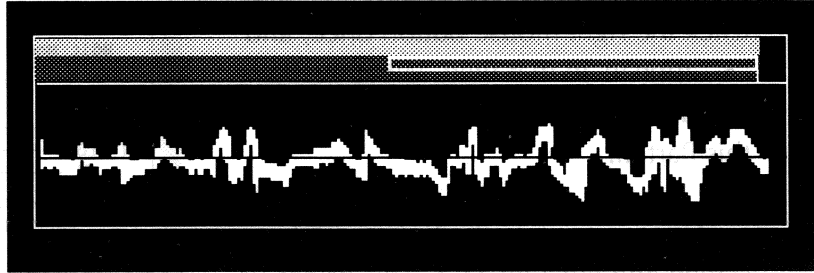

Now move the cursor to “**End**” just below “**Loop**”, and press and hold the left mouse button until the *right* side of the blue rectangle moves about a quarter of the way across the screen.



Play the MIDI keyboard, and listen to the loop you have set up. Adjust the **Loop** and **End** parameters with the left and right mouse buttons, until you have a loop that is sonically interesting, such as one bar of music, a complete spoken word, or a couple of beats of drum fill. What you are setting up is known as the “Sustain loop”.

Move the cursor up to “**KeyOn Mode**”, and press the right mouse button twice, so that “**R-Loop**” appears. Move the cursor to the “**R-Loop**” parameter in the right-hand column, and press and hold the left mouse button until a second blue rectangle makes itself seen. This is the “Release Loop”, and you can hear what it sounds like by playing a MIDI key.

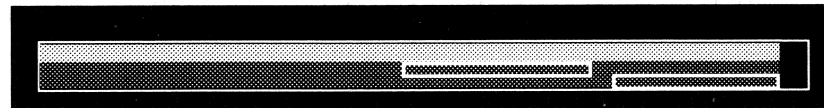

The **KeyOn Mode** setting won't let you hear the Sustain loop, just the Release loop.

Adjust the beginning and end of the Release loop with the **R-Loop** parameter and the **End** parameter just below it, until you get a Release loop that sounds interesting.

Now let's put these together. Click on **Exit**, and the **Sound** menu appears. Select **Edit Partial**. If the **Edit Partial Common** page doesn't appear, click on **Common** at the bottom of the screen.

Place the cursor on the word "Off" immediately under the yellow "Sample". Click the right mouse button once, and "5" appears in that field. What we have just done is to load the Sample "5" into this Partial.

Now go back to the bottom of the screen and click on **TVA**. This brings us to the volume envelope Page. If you play a note on the MIDI keyboard at this point, the sampled sound starts immediately, and then when the loop that you established on the Loop page is reached, it repeats as long as you hold the key down. We're going to do better than that.

Underneath the number "4", to the right of the word "Time", is the number "10". Move the cursor to highlight that number, and press and hold the right mouse button until it changes to 80. Now play a MIDI key. The sound starts immediately, and as long as you hold down the key the Sustain loop repeats, but when you let go of the key, the Release loop can be heard, and it repeats until it fades away.

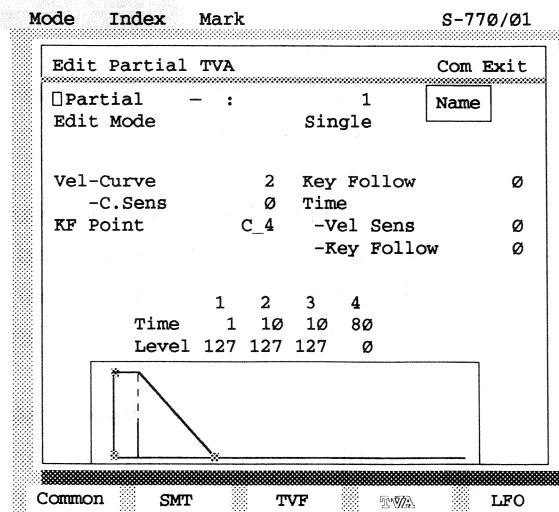
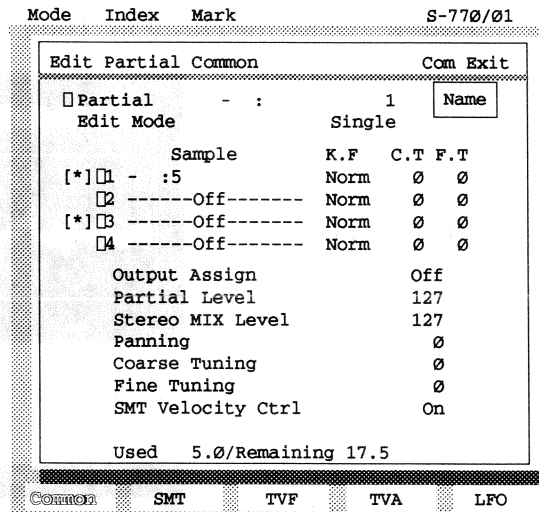



## Advanced Sample Editing

There is a lot more you can do with Samples. Let's try combining two of them together. First we have to record a second Sample. **Exit** the **Partial TVA** page and when the **Sound** menu appears click **Edit Sample1**. Click **Smpling** at the bottom of the screen to get to the **Sampling** page.

Click on the **Name** box and when the **ASCII Keyboard** window opens, click on **[BS]** until the horizontal red cursor is underneath the "5". Move the mouse so "6" is highlighted and click the left button. Click on **[CR]**. We've named the new sample "6". Exit the window and record another phrase sample like the one before, but use different material.

Click on **Exit** and when the **Sound** menu appears click on **Edit Sample2**. This opens a new menu, and here click on **Patchwork**. The **Edit Sample Patchwork Param** screen appears.

In the middle of the screen, on the left-hand side, put the cursor right under the yellow words "**Source Sample1**". Click the left mouse button until this line reads " :5". Move the cursor over to the right, until it is under the yellow words "**Source Sample2**". Click the left and right mouse buttons until this line reads " :6".

Now go to the bottom of the screen and click on "**Graph-1**". The page

changes, and a graphic representation of the sample you called "5" is drawn towards the top of the screen. (If you don't have a video monitor, this screen will not be visible.) Move the mouse so the cursor is in the center of the long rectangle just above the drawing. The rectangle will turn purple. Press and hold the left mouse button and move the mouse slowly to the right. The sample will start to play. The further you move the mouse, the faster the sample plays.

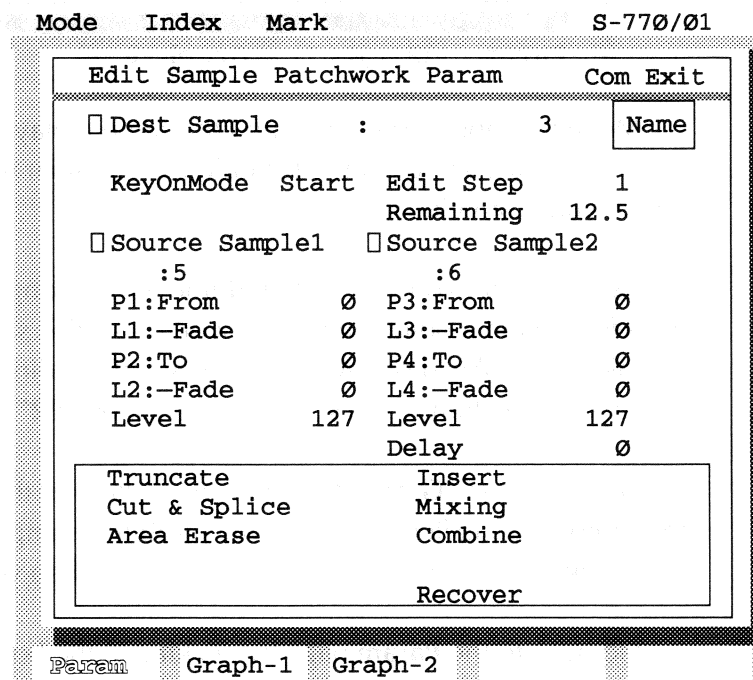

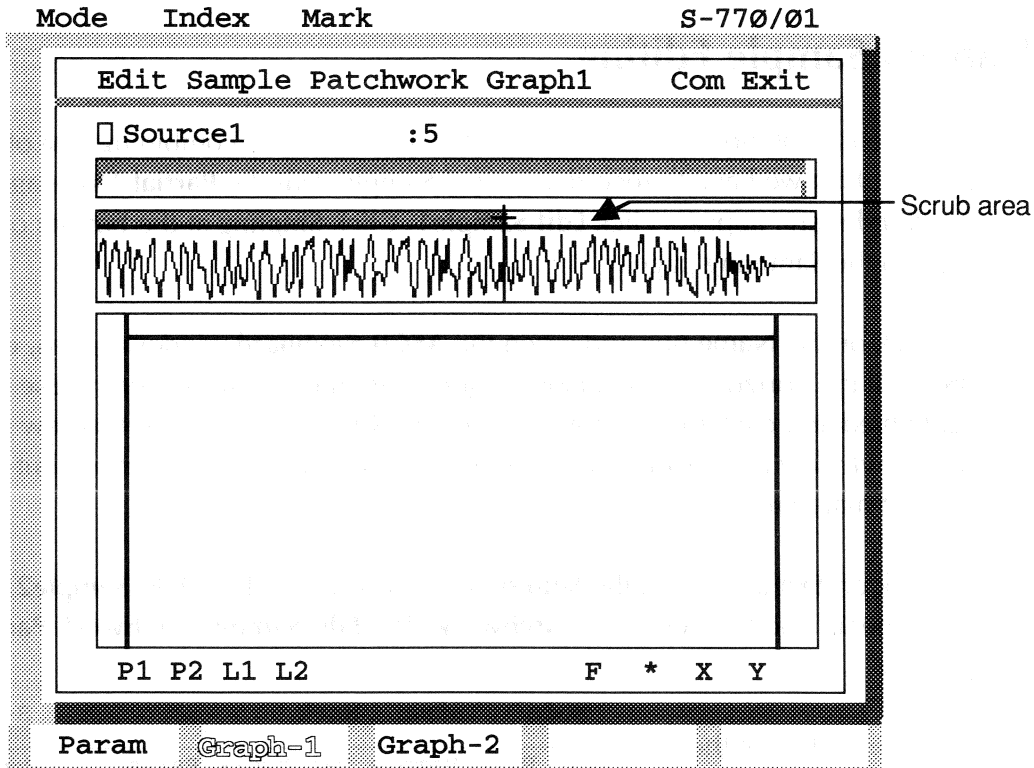

Move the mouse to the left, and the sample plays backwards. This is called “scrubbing” the sample, and it should be a familiar technique for anyone who has ever edited audio or video tape.

As you scrub, you will see a red line move along the picture of the sample waveform. Find a point where you would like this sample to end, and the second sample to be spliced on. When you’ve got that point, let go of the mouse button. Go down to the bottom of the screen and click on “**P2**”.

Now click on “**Graph-2**” at the very bottom of the screen. The page changes, and the sample you called “6” is drawn. Scrub this sample. Find the place where you would like this sample to *begin* playing, and when you’ve got it, click on “**P3**”.

Go back to the **Param** page by clicking at the bottom of the screen, and click on the word “**Combine**”. The two samples will be spliced together, with the section of “5” you’ve selected followed by the section of “6”. Play the MIDI keyboard to hear it.

## Onwards!

That’s it for the quick tour. In the chapter 2, we’ll start working with the S-770 in a more formal, comprehensive manner. But don’t think the fun’s over. It’s really just begun.

# Chapter 1b: Upgrading to version 2.0

This chapter is for veteran S-770 users who are familiar with the version 1.0 software. It will show you how to upgrade quickly your unit to version 2.0, and how to make sure all previously-created files work properly. Then it will give you a summary of the many exciting new features provided by the upgraded software.

When you are done with this chapter, you can find more information about the new features in the chapters specified. The manual has been largely rewritten to accomodate all the new features, and it wouldn't be a bad idea to go through the whole thing to make sure you've picked up everything there is.

## Installing the New System

The new system is on the disk labelled "SYS-772 SYSTEM DISK Ver. 2.0". Before you do anything else, write-protect this disk by moving the write-protect tab towards the edge of the disk. If your fingernails aren't up to it, use a pen point or a small paper clip (don't use a pencil, which might break).

With the power to the S-770 turned ***off***, put the floppy disk containing your new software in the drive. If you're using a mouse, hold down the **F2** key on the front panel while you turn on the power. If you're using the RC-100 remote controller, hold down **F3** while you turn on the power. When "**System Loading...**" appears on the screen, you can let go of the button.

When the boot-up is all done (and it will take somewhat longer than you're used to), move the mouse to **Index** at the top of the screen and click. The **Index** window opens. Look for "**Save System**" towards the bottom of the right column, and click on it. A few windows close and open, and eventually the **Save System** window appears.

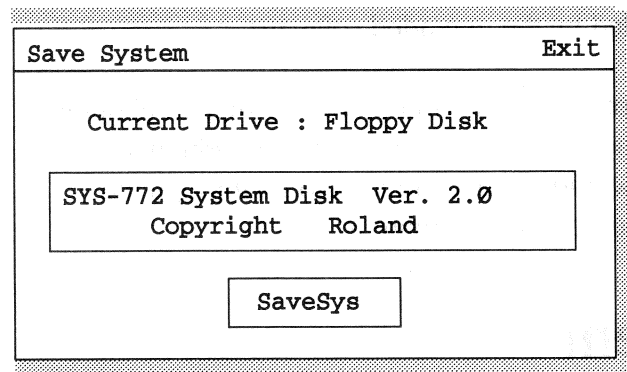
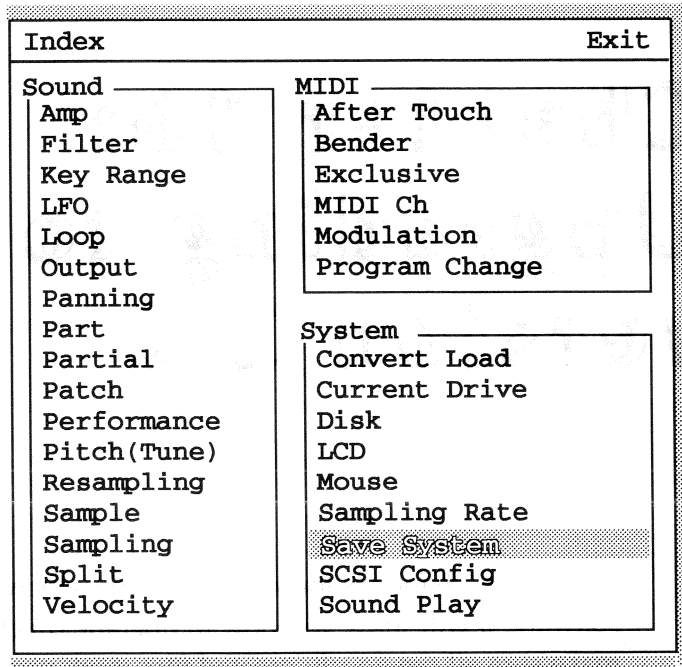

Click on the words "**Current Drive**". The **Drive Select** window opens. Find the line of text where the words "**Internal HD**" appear. (It will be at "**ID0**", unless you've changed it since you first installed the S-770.) Click on the *blue* number at the left of that line. The window closes, and you're back on **Save System**.

Click on the box labelled **SaveSys**. A yellow "**Now Saving System**" message appears, and then the window closes. Congratulations. You have successfully saved the new software to your hard disk.

Remove the floppy disk from the drive, and put it in a safe place. Turn off the S-770, and turn it on again. It should now reboot from the hard disk, and "**HardDisk Sys Ver 2.0**" should appear on the screen as it boots.

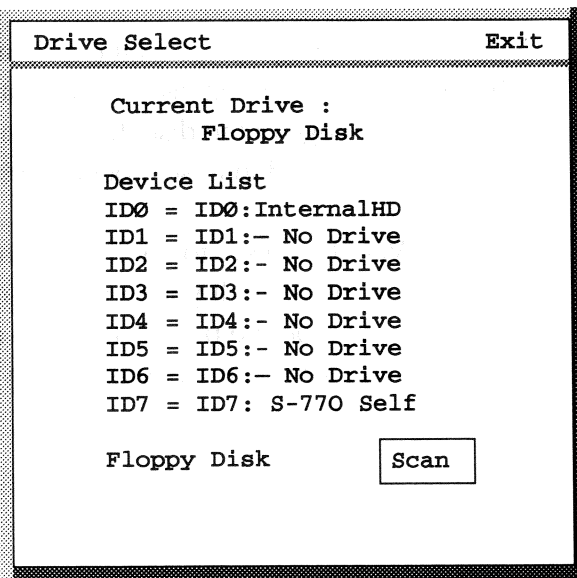

If something goes wrong, turn the S-770 off, re-insert the floppy, and try again.

## Using version 1.0 files

Files created with version 1.0 of the S-770 software should work perfectly with version 2.0, but there are a couple of minor things to watch out for:

If a Partial has a pitch envelope (**Pitch Depth** on the **Edit Partial TVF** page is not zero), it will have to be reset. In version 1.0 the maximum pitch change using this parameter was up or down one-half octave. In version 2.0, the maximum pitch change is two octaves up and four octaves down. Maintaining the same pitch change on a Partial with a pitch envelope will probably involve some experimentation.

If you have any Volumes on a hard or magneto-optical disk that you created with version 1.0 software and that you want to be able to access using Program Changes, you will have to sort them on the disk before you load them into the version 2.0 software. (You can load them without sorting them, but then you won't be able to get to them with Program Changes.)

To do this, go to the **Disk Utility** page (page 5 in the Disk function) and click on **HD/MO File Sort**.

The files will be sorted alphabetically. The Internal hard disk should take only a couple of minutes to sort, but a full magneto-optical disk may take quite a bit longer.

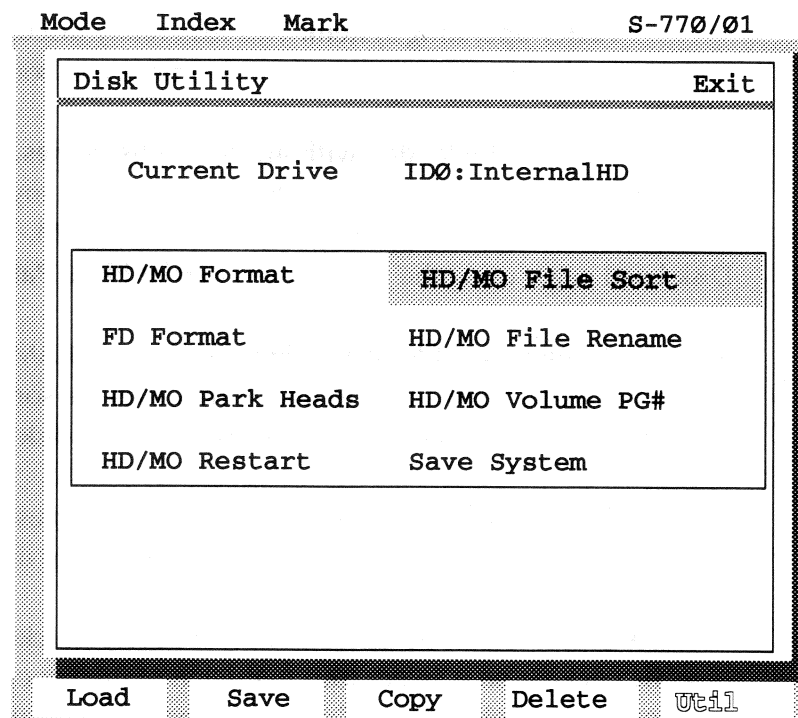

## The New Features

Here are the major new features of the version 2.0 software, organized by chapter. There are a number of small changes that are not included in this list, but they will be obvious when you come across them, and are explained in the appropriate chapter in the manual.

### Installation — Chapter 2

- **8 outs mode.** The S-770 can now be configured so that all eight outputs (the six individual and the two analog stereo) can be used individually. The digital outputs always carry the stereo mix, however. The switch for this is on **System Parameters Page 2**.

### Structure — Chapter 3

- **Less restrictive Index.** When you go to a Page using the Index, leaving that Page no longer takes you back to the Index, but instead takes you to the appropriate Menu. This makes the Index a lot more useful for advanced users.

- **Faster operating system.** This isn't really discussed in the chapter, but you'll notice a marked increase in speed the first time you boot up.

- **Files can be loaded without their subsidiaries.** High-level files, from Partial to Performances, can be loaded without Samples or any other subsidiary files, so they can be used as templates for existing Samples in RAM. This is accomplished from the Disk Load page, using the new Targets **Partial PRM**, **Patch PRM**, and **Perform PRM**.

- **Alphabetical file sorting in RAM.** Files in RAM can be sorted alphabetically, which can make them easier to find. If new files are sorted in RAM before they are saved to disk, they will be saved alphabetically on disk as well.

- **Two sets of Jump pages.** There are now *ten* user-programmable Jump pages. You toggle between the two sets by pressing the right mouse button one or two times.

- **Select icon.** You can look at and access quickly a scrollable list of files at any level by clicking on a Select icon to the left of the Function name. On disk pages, you can no longer scroll through Current Drives, but *must* use this list (which will actually speed things up considerably).

- **Com menus close automatically.** If you've gone through the Com menu to get to a page, like disk load or save, closing that window automatically closes the Com menu as well, saving a mouse movement.
- **Enhanced RAM copy function.** Files can now be copied within RAM more easily, and when a file is copied, its name need not be changed before it is saved.

## Patches — Chapter 4

- **Full editing from within Performances.** You can now go directly to the Patch level (and down) from within a Performance. An alternative "Part Map" provides Patch editing from the Performance level itself.
- **Automatic renaming of Partials.** You can rename every Partial in a Patch so that it has the same name as the Patch, along with a differentiating suffix, in one fast operation.
- **Instant Patch and Partial creation when you record a new Sample.** When you record a Sample from within a Patch (using the Sampling function on the Com menu), it automatically creates a new Partial and Patch with the same name as the Sample.
- **Alternative Partial editing.** A "Partial Map" feature allows you to view a specific parameter for all of the Partials in a Patch simultaneously, and edit them.
- **Analog feel.** A new Parameter allows for random detuning of the Samples within a Patch while it is being played.

## Partials — Chapter 5

- **Programmable Templates.** You can create and store up to ten of your own custom TVA/TVF Templates, by memorizing the envelopes from the current Partial.
- **Global editing includes Samples.** When editing a Partial in Subsidiary mode, if Edit Mode is Global, changing the Sample in a slot will change the Sample for all of the Partials in the Patch.
- **Instant Partial creation when you record a new Sample.** When you record a Sample from within a Partial, using the Sampling function on the Com menu, it automatically creates a new Partial with the same name as the Sample.

- **Pitch envelope range wider.** The Pitch envelope created on the TVF page now has a maximum range upwards of two octaves and a range downwards of four octaves.

## Samples — Chapters 6 and 7

- **Two chapters.** Sample recording and editing have now been split into two chapters. Recording, looping, and smoothing are in Chapter 6, while all other functions (and there are a lot of them!) are in Chapter 7.

- **Parameter editing resolution is independent of display resolution.** Parameters now have an “Edit Step” parameter for setting coarse or fine adjustments.

- **Editing functions have “Recover”.** The software automatically stores the current version of a Sample so you can instantly “undo” any operation. It also makes backing up Samples much less crucial.

- **Samples can be edited “in place”.** Samples can be changed or re-recorded without changing their names or slots.

- **Samples can start to play in the middle of a loop.** The Start and Loop parameters can now be in any order.

- **Truncate with fade-in and reversing.** On the new Edit Sample2 pages, Truncate can be performed with both a fade-in and a fade-out, and the Sample can be turned around and played backwards.

- **Auto-loop function** for looking for loop points quickly.

- **New parametric and high-resolution graphic editing pages, with scrubbing.** The Edit Sample2 pages for editing and looping feature high-resolution graphics, with two-speed bi-directional scrubbing, and adjustable resolution.

- **New editing functions for samples.** A portion of a Sample can be removed and the ends spliced together (“Cut & Splice”) or a gap left (“Area Erase”).

- **DSP operations for Samples.** Digital filtering, compression/expansion, time stretching without pitch change, rate conversion, and individual graphic byte editing.



- **Editing functions for combining Samples.** Two samples can be spliced, faded into each other, or mixed, forwards or backwards.
- **Performance Resampling.** The S-770 in full multitimbral mode can be played and the output automatically recorded as a new Sample.
- **Resampling envelopes re-designed.** In the Resampling function, the background envelope on the TVF or TVA page is the same type envelope for the other Sample — not the other envelope for the same Sample.

## Performances — Chapter 8

- **Keyboard display selectable to channel or part.** The live keyboard graphic can be restricted to show incoming notes on an individual MIDI channel, or on an individual Part. The Splits for the Patch on that Part or channel are displayed too.
- **Patch editing through Performance.** You can now go directly to the Patch level from within a Performance. An alternative “Part Map” provides Patch editing from within the Performance level itself.
- **Part Parameter can act as a Solo switch.** When editing a Patch through a Performance, you can isolate an individual MIDI channel or Part using the Part parameter.

## Volumes — Chapter 8

- **User-assigned Program Change numbers.** Program Change numbers for Volumes no longer default to the Volume’s position on the disk, but can be set, and also turned off.
- **Volumes can be loaded without clearing memory.** Once a Volume is loaded, additional Volumes can be loaded without deleting the first one from RAM, provided there’s sufficient memory available. The combination of the two is now considered a single Volume, and its name is that of the last Volume loaded.
- **More flexible and usable Volume IDs.** Volume IDs can be applied to all files within a Volume or just to certain levels. Not giving new Volume IDs to existing Samples can save disk space.
- **Automatic assignment of Volume IDs when saving files.**

## System — Chapter 9

- **Sort function.** Files on disk can be sorted alphabetically to make them easier to find.
- **File rename.** Files on disk can be renamed after they are saved.
- **Floppy and hard-disk formatting operations well separated.** It is now much more difficult to format a hard disk by mistake.
- **Double arrow boxes on disk pages scroll by 10.** This allows faster scrolling, and they behave more consistently.
- **Unit number shown on screen.** The Unit Number (Device ID) of the S-770 is now shown in the upper-right corner, to avoid confusion in multiple-sampler studios.

### *That's it...*

Enjoy your new software!

# Chapter 2: Installation, Controls, and Connections

This chapter will discuss in detail the various options you have for installing the S-770, and how to connect it to other components in your studio. It will also describe all of the front-panel and rear-panel controls and connectors.

## Installation

The S-770 can be put on a flat surface, like a shelf or tabletop, or installed in a standard 19-inch equipment rack. There are three sets of ventilation holes: in the front, near the power switch; on the bottom, directly behind the ones on the front panel; and on the rear panel. Do not defeat them — if the unit is on a shelf, make sure the shelf is large enough so that none of the four round feet hang over the edge.

Do not place any heavy objects (like a video monitor) directly on top of the S-770. Do not put any devices near it (like a video monitor) that might cause hum or electrical or radio interference. Do not put a video monitor on top of the S-770. Got that?

The S-770 contains a hard disk, which needs to be treated with respect. Never turn the power off when the hard disk is running (which you'll know because the amber **HARD DISK** LED on the front panel will be lit). Always park the heads of the hard disk before moving the S-770 — see Chapter 9 for how to do this. If you have brought the S-770 into a warm, humid room from outdoors, condensation may form inside the unit which could damage it. Allow about an hour for the unit to come up to room temperature before turning it on.

## Rackmounting

The S-770 takes 3U of space in a 19-inch rack. If you have been using the unit prior to rackmounting it, park the heads (Chapter 9), turn off the power, and wait 30 seconds for the hard disk to stop spinning. With a Philips screwdriver, remove the four round feet. Locate the four square self-adhesive rubber feet, and attach them to the bottom panel near the corners — these provide a minimum air space below the unit if you are mounting it directly on top of something else, and will also prevent the cases from scratching each other.

Locate the two rackmount brackets. Remove the four screws on each side of the S-770 just behind the front panel, and use them to attach the brackets. Make sure the brackets are oriented so that the rackmounting flange is in front of the screws.

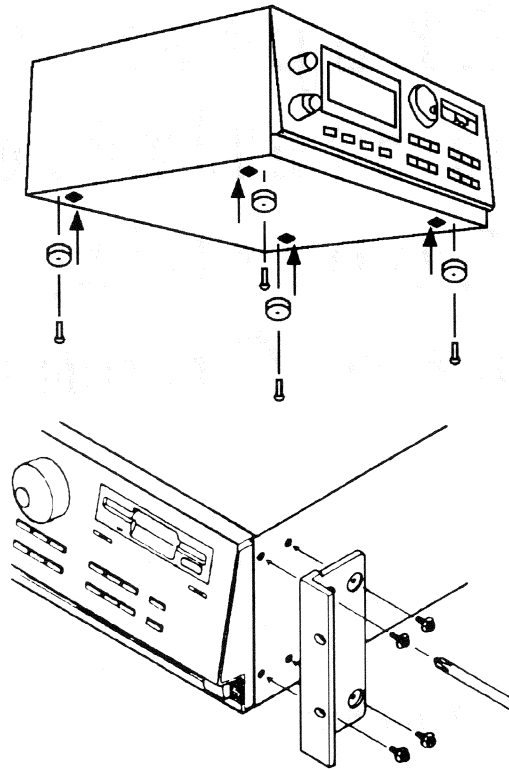

## The Controls and Connectors

Before we start wiring up the S-770, let's look at what everything on it is for.

### The Front Panel

Unlike most musical equipment you are used to, it's quite possible to operate the S-770 and almost never touch the front panel controls. That's because most of them are duplicated, often in a more convenient way, by the action of the mouse. Sometimes, however, it can be more convenient to use the front panel, and it does have a few controls that are unique.

The **VOLUME** knob controls the signal level at the stereo analog outputs and the headphone (**PHONES**) output. It has no effect on the six individual numbered outputs, or on the digital outputs. It should normally be set to "**MAX**", because the S-770's signal-to-noise ratio is highest at that point.

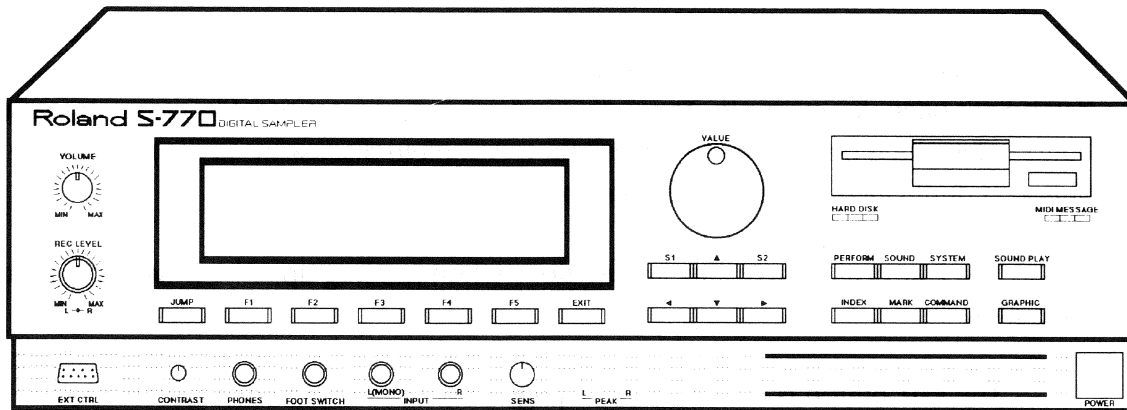

The S-770 has a muting function built into its power-up and power-down procedures, but it is still generally a good idea to turn down the **VOLUME** control when switching the unit on and off.

The **REC LEVEL** knobs control the level of the incoming analog audio signals which are being sampled. It works on both the front-panel and rear-panel analog inputs, but not on the digital inputs.

The **EXT CTRL** socket is for plugging in the mouse or the RC-100 Remote Controller which you have. (When the RC-100 is used, the mouse plugs into *it*.)

The **LCD screen** shows the current Menu, Page, or Window when operating the S-770. Normally, you will be monitoring these displays using an external video monitor, but on those occasions when a monitor is not available, the LCD can be of help. It only shows a *part* of the screen, but when you move the mouse up or down, or use the Cursor buttons to access a Parameter, the screen scrolls. Some screens, however (the high-res graphic editing ones), are not available on the LCD screen. The action of the LCD screen is much slower than that of a video monitor, so move the mouse slowly or you may lose track of the cursor. The LCD screen can be shut off, which can make the video monitor respond slightly faster — see Chapter 9.

The row of buttons **F1** through **F5**, below the LCD screen, are used to move among Pages in a Function — for example, when you are editing a Partial, you can use these switches to move from the volume envelope Page (“TVA”), to the filter envelope Page (“TVF”), to the vibrato Page (“LFO”), and so on. The name of the Page which corresponds to each button appears at the bottom of the LCD screen. These buttons’ action is duplicated on the video monitor by “page switches” at the bottom of the screen.

When the **JUMP** button is pressed, **F1** through **F5** become switches that can move to Pages in other Functions — so you can instantly go from a Partial TVA page to a Patch Split page, for example. These “Jumps” are user-programmable, using the **MARK** button, described below (see Chapter 3 for a complete discussion of this). The **JUMP** button is duplicated by the right mouse button.

The **F** keys also have special functions when booting up, which we’ll get to a little later.

The **EXIT** button is used to leave a page or window, and often to cancel an operation. Most video screens have an **Exit** switch in the upper right corner that has the same function.

The **CONTRAST** knob adjusts the contrast of the LCD screen. Normally this needs to be set only once after installation.

The **PHONES** jack takes a standard stereo 1/4-inch (tip/ring/sleeve) headphone plug. As mentioned above, its level is controlled with the **VOLUME** knob.

The **FOOT SWITCH** jack is for a 1/4-inch plug from a normally-closed, single-pole foot switch such as the Roland DP-2 (available separately), which can be used to control certain functions such as Sample recording.

The **INPUT** jacks — **L(MONO)** and **R** — are for 1/4-inch plugs from unbalanced analog audio sources, that are to be sampled by the S-770. Stereo sources will use both jacks, while mono sources will use only the **L(MONO)** jack. There are also input jacks on the rear panel, which we’ll talk about shortly.

The **SENS** control is a pad between the front-panel **INPUT** jacks and the **REC LEVEL** control. Its furthest counterclockwise setting is appropriate for line level (+4 dBm) signals, and its furthest clockwise setting is good for mic level (–50 dBm) signals. (It does not affect the rear-panel inputs.)

Above the labels **HEAD AMP** and **L—PEAK—R** are two LEDs hidden behind the panel. They are there to help you set the **SENS** control. (They *are* active when using the rear-panel inputs.)

The **VALUE** wheel is used to dial in Parameter settings, and also to scroll through items in a list. Its action is duplicated by the left and right mouse buttons, and usually by the **S1** and **S2** buttons, but it is often a more efficient way of adjusting Parameters than the buttons.

The **S1** button is used for choosing menu items and activating switches. The **S2** button sometimes acts as an auxiliary to the **S1** button. The two together are used to adjust Parameters and access items on a list, duplicating the actions of the left and right mouse buttons in most functions.

The four **cursor** buttons or keys (↑, ←, ↓, →) move the cursor from item to item on the display, up, left, down, or right, allowing you to select parameters to adjust, menu items to choose, and switches to activate (with the **VALUE** wheel and/or **S** buttons). Moving the mouse around does the same thing, although the cursor buttons, because they jump instantly from one item to the next (and never miss), can sometimes be faster.

The **floppy disk drive** is for backing up files on 3-1/2-inch floppy disks. Both double-density (800K Macintosh/1 Meg IBM) and high-density (1.44 Meg Macintosh/2 Meg IBM) disks can be used. You can insert a disk at any time (as long as there isn't one already in there). Remove the disk by pushing the rectangular button on the right side of the drive. When the drive is in use, a yellow LED on its left side will light. When the operating system requires you to insert a disk, the yellow LED will flash.

**WARNINGS! DO NOT** remove a disk when the LED is steadily lit. Also, **DO NOT BOOT THE S-770 WITH A DISK IN THE DRIVE!!** There is one exception to this rule, which is when you are updating the System software, which will be explained in Chapter 11.



The **HARD DISK** LED lights when the unit is reading or writing to the hard disk. Do not move the S-770 or turn the power off while this LED is lit, or you will damage the hard disk drive.

**PERFORM**, **SOUND**, and **SYSTEM** are three operating Modes of the System software. Pressing each of them opens up a Menu showing the various functions available within that Mode, which can then be selected using the cursor keys and **S1** button, or the mouse. You can also change modes with the mouse, by selecting "**Mode**" at the top of the screen. When you do this, LEDs in all three buttons will flash, and you can select a Mode, either with a button or with the mouse. After you select a Mode, the LED in the button corresponding to that Mode will be lit.

**INDEX** calls up a special Index function on the display, which lets you access operating Pages by selecting their topic. It's a very fast way for getting around the S-770, especially when you are first learning it.

**MARK** calls up a window from within a Page that lets you "mark" it as a "Jump" Page — one of the Pages that can then be accessed instantly using the **JUMP** button and one of the **F** buttons (see Chapter 3).

**COMMAND** opens a Command (or **Com**) Menu from within a Page, within which various Functions are available, including disk input and output, memory management, and other specialized tasks.

**SOUND PLAY** can be used to simulate a MIDI keyboard input while editing sounds if no MIDI keyboard is available, or it can be used just for convenience. Pressing it "sends" the S-770 a specific MIDI note with a specific velocity, both of which are user-programmable, and the note is sustained as long as the button is held in.

**GRAPHIC** instantly changes the LCD screen to show the bottom portion of the screen, if there is a graphic present (picture of a keyboard, drawing of an envelope, etc.). It has an internal red LED that lights when it has been pressed. Press it again and it returns the LCD screen to wherever it was before. It has no effect on the video display.

**MIDI MESSAGE** is a green LED that lights when the S-770 receives a valid MIDI message. It is somewhat more intelligent than an ordinary MIDI data indicator, and actually lights whenever the S-770 is *producing sound* under MIDI control. For example, if it receives a Note-On command on a channel to which it is programmed to respond, it will light and *stay* lit until it receives the corresponding Note-Off. If it receives a Note-On followed by a Sustain Pedal On (Controller # 64 with a value of 127), it will stay lit even *after* it receives the Note-Off, until it receives a Sustain Pedal Off (Controller # 64 value 0).

The **POWER** turns on and off the AC power to the unit. "In" is on and "out" is off. Do not connect or disconnect the AC power cord with the switch on.



## The Rear Panel

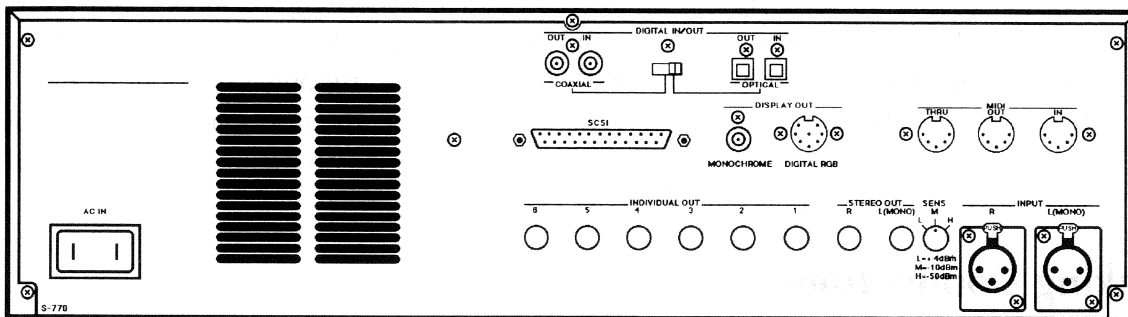

**AC IN** is where you plug the AC power cord. Be sure the AC line voltage in your studio matches the voltage requirements of the unit, as printed on the plate above this jack. Insert the cord here first, making sure the **POWER** switch is off, then plug the other end into the AC socket.

The **DIGITAL IN/OUT** connectors are used for digital audio signals that are in the AES/EBU (Consumer) format for direct interfacing with other digital audio equipment.

The **SCSI** connector is a standard 25-pin connector conforming to the Small Computer System Interface standard. It can be used to connect high-speed storage and data-processing devices to the S-770.

The **MONOCHROME** video output (under the **DISPLAY OUT** label) sends a black-and-white screen image to any video monitor equipped with a standard composite video input. The **DIGITAL RGB** video output sends a 200-line digital color signal to a compatible color monitor. See the next section and the Appendix for more details.

The **MIDI** connectors are standard. **IN** is for receiving performance data from a controller or sequencer, as well as System Exclusive data and Samples in the MIDI Sample Dump Standard format. **OUT** is for sending System Exclusive and MIDI Sample Dump Standard data. **THRU** echoes all MIDI data received at the IN port.

The six **INDIVIDUAL** output jacks can be programmed to send specific sounds or groups of sounds. The **VOLUME** knob on the front-panel does not affect these outputs.

The **STEREO** outputs either send a mixed audio signal, with individual sounds programmable as to level and pan position within the stereo field; or they can act as the seventh and eighth individual outputs. The mode they operate in is determined on the **System Parameters Page 2** (see Chapter 9). Regardless of what signal they are carrying, these outputs *are* controlled by the **VOLUME** knob.

The **INPUT** connectors are balanced XLR jacks for use with microphones or any other analog audio sources that are to be sampled. The **SENS** switch (which is independent of the **SENS** control on the front panel) selects among three input-level ranges: +4 dBm, -10 dBm, and -50 dBm. Stereo sources will use both jacks, while mono sources will use only the **L(MONO)** jack. You can use only one input jack — front-panel or rear-panel — on each channel at a time. The front-panel **PEAK** LEDs will show clipping at either set of inputs. The **REC LEVEL** knobs on the front-panel control the input level for both inputs *after* the **PEAK** LEDs.

## Making Connections

Now that we know what everything does, let's start hooking things up.

### Power

Before applying power to the S-770, make sure the line voltage is the same as the voltage rating of the unit, as stated on the metal panel above the **AC IN** socket (120, 230, or 240 volts). The S-770 will accept either 50 Hz or 60 Hz current.

As with any computer or sound-generating device, clean AC power is essential for proper operation of the S-770. Do not operate it on a line with any devices containing large motors, like refrigerators or air conditioners; with any devices that can generate electrical or radio-frequency interference, such as fluorescent lights, heating devices, or dimmers; or with any devices that consume a large amount of power and can cause fluctuations in the voltage level.

Do not connect or disconnect the power cord with the **POWER** switch on (pushed in).

### MIDI

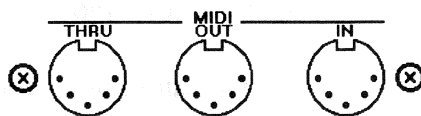

The S-770's **MIDI IN** jack should be connected to the **MIDI OUT** of whatever device is going to be controlling the unit: keyboard, drum controller, wind controller, guitar controller, hardware sequencer, or a MIDI interface from a computer running sequencing, sound editing, or other compositional software.

The **MIDI OUT** jack should be used if you plan to send or store sounds externally using the MIDI Sample Dump Standard. Sounds can be transmitted this way to other samplers, and to computers equipped with sample-editing software, where they can be manipulated, and then returned to the S-770 (through the **MIDI IN** jack), or sent to other samplers, or stored.

The **MIDI THRU** jack provides an “echo” of the data going to the **MIDI IN** jack. It is provided as a convenience for “daisy-chaining” multiple MIDI devices together. Connect it to the MIDI IN jack of any other MIDI device that you would like to receive data from the same controller (keyboard, sequencer, etc.) that is controlling the S-770.

## Audio

The S-770 provides a wide range of audio inputs and outputs, both analog and digital.

### Analog Outputs

The main analog outputs are the **STEREO L** and **R** outputs on the rear panel. They carry a stereo mix which can contain any or all of the sounds the S-770 produces. They are unbalanced, high-level, medium impedance, and are designed for connection to a mixing console, patch bay, or amplifier. Their level is controlled by the **VOLUME** knob on the front panel. The same signal is paralleled to the **PHONES** output on the front-panel, which is in the form of a single stereo 1/4-inch jack.

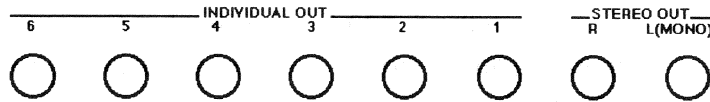

The other analog outputs are the **INDIVIDUAL** jacks, numbered 1 through 6. These are also unbalanced, high-level, medium-impedance, but they are not controlled by the **VOLUME** knob. The **INDIVIDUAL** outputs are available on an instrument-by-instrument basis, at the Performance, Patch, or Partial level, so that individual sounds can be isolated for separate mixing or processing. Their use is optional — all sounds can be programmed to appear at the **STEREO** outputs — but having access to them at a mixing console or patch bay enhances the flexibility of the S-770 considerably. If you have room for them in your studio setup, use them.

For even more flexibility, the main outputs can serve as an additional two individual outputs, numbers 7 and 8, if the **Analog Outs Mode** parameter on the **System Parameters Page 2** is set to **8outs** (see Chapter 9). In this case the **PHONES** output will carry the same individual signals. Regardless of how they are used, the **STEREO OUT** and **PHONES** outputs are *always* affected by the **VOLUME** control.

## Analog Inputs

There are two sets of analog inputs, which are used for signals that the S-770 will record for Samples. On the rear panel are two balanced XLR connectors, for use with professional mono or stereo sound sources ranging from microphones to console line outputs. A three-position **SENS**itivity control determines the nominal input level: -50, -10, or +4 dBm.

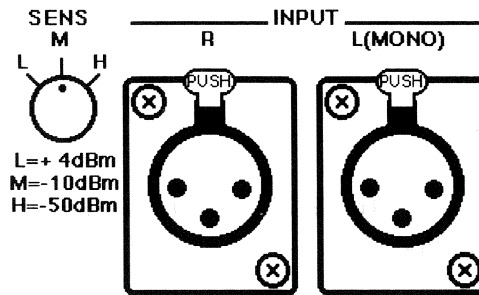

On the front panel are two unbalanced 1/4-inch connectors, which can be used with sources like synthesizers, electric guitars, or consumer tape decks or CD players. These inputs also have an input-level range of approximately -50 to +4 dBm, but they have a continuous **SENS**itivity control. Both inputs are further controlled by the **REC LEVEL** knobs on the front panel.

When the S-770 is recording in Mono mode, it only recognizes signals at the Left analog audio inputs, so if you are planning to record mono samples, make sure that's the channel you use.

The rear-panel input jacks are normalled through the front-panel jacks, so if a plug is inserted into one of the front-panel jacks, the rear-panel jack for that channel will be disconnected.

## Digital

### Rear-Panel input

### Front-Panel input

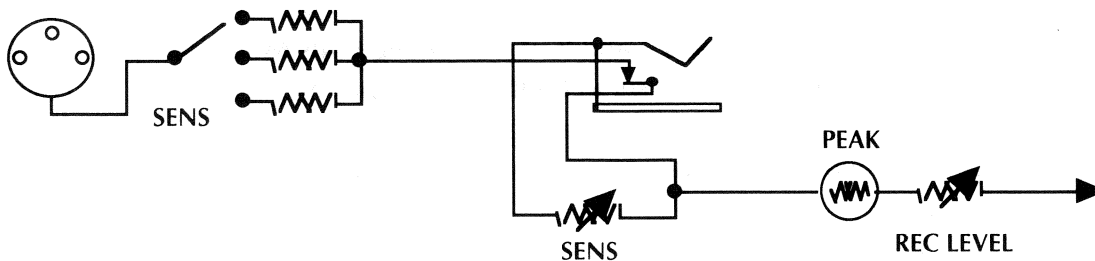

There are two types of digital audio connectors provided, which allow the S-770 to connect directly to other devices that conform to the AES/EBU Digital Audio standard. The AES/EBU standard mandates that both audio channels of a stereo pair be transmitted on one cable, and so there is only one jack of each type labelled “OUT” and one of each type labelled “IN”.

The two types are “COAXIAL”, using shielded coaxial cable and RCA plugs; and “OPTICAL”, using optical-fibre cables and connectors. Use whichever format is compatible with the other digital equipment in your studio, and set the switch accordingly. Only one of these types may be used at a time — you cannot use the coaxial input and the optical output simultaneously, for example.

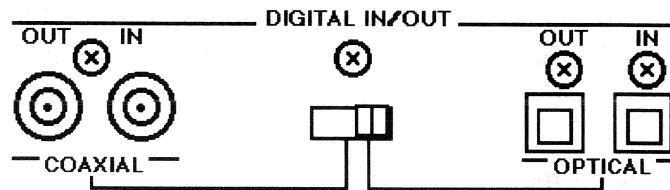

When recording digital signals, the **SENS** and **REC LEVEL** controls are not operative. However, you can increase or decrease the digital signal level in software — see Chapter 6. When sampling a digital signal monaurally, you have the choice (this is also done in software) of having the S-770 listen to either the Left or Right channel.

The S-770 can record at four different sampling rates: 48 kHz, 44.1 kHz, 24 kHz, and 22.05 kHz. The sampling-rate frequency must be equal to or exactly half of the sampling rate of the incoming digital signal, or you will not be able to record. Most professional digital tape recorders, including DAT decks, sample at 48 kHz. CD players with digital outputs use 44.1 kHz. (CD-ROM players, however, use the SCSI port, not the digital audio connectors.) The sampling-rate frequency is set by the **Freq** parameter on the **Smplng** page (see Chapter 6) and by the **Master Freq** parameter on the **System Parameters Page 2** (see Chapter 9).

The digital outputs will operate at the sampling rate set by the **Master Freq** parameter: either 48 kHz or 44.1 kHz.

The digital outputs always carry the main stereo mix, regardless of the setting of the **Analog Outs** parameter. Any sounds assigned to the **INDIVIDUAL** outputs are not part of the digital signal (unless they are also assigned to the **STEREO** outputs), and the digital signal is not affected by the **VOLUME** knob.

## Video Display

### RGB

An external video monitor is very highly recommended for efficient operation of the S-770. The best alternative is an RGB color monitor. If you have been using a Roland S-550 or S-330, you may already have an appropriate monitor and cable. You may use either an RGB-25I or RGB-25N cable. If you wish to design your own, the pinouts and electrical characteristics are in the Appendix to this manual.

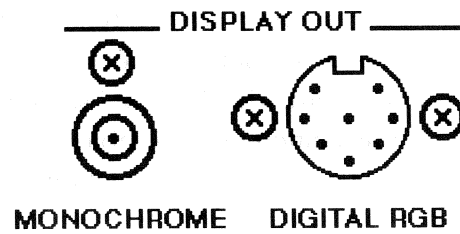

### Monochrome

If an RGB monitor is not available, a monochrome (black-and-white, green, amber, etc.) computer monitor is acceptable. However, the colors — which are an important part of the S-770 display — will not be visible, and some screen elements may be difficult to see. Use a cable designed for video signals with an RCA plug on each end, and connect the monitor to the **MONOCHROME** output. A television set with a “Video” input can be used this way as well, although the display will be in black-and-white, even on a color set.

If none of these are available, an ordinary television set that lacks a Video input can be used, as long as you have a VCR or some other device to modulate the signal onto a VHF carrier. Connect the **MONOCHROME** output to the VCR’s Video input, and then connect the VCR’s Antenna output to the TV’s antenna terminals. Set the VCR input switch to “Video” (not “Tuner”), and set the TV to receive on the channel that the VCR transmits on (usually Channel 3 or 4). The picture quality may not be great, but it should be readable. It is not recommended that you use this as a permanent setup, however, because you’ll end up hurting your eyes.

### Mouse

The only mouse that should be used with the S-770 is the one supplied with the unit (the S-550 mouse is also compatible). Do not attempt to use any other computer mouse. The mouse is connected to the **EXT CTRL** jack on the front panel, or to the RC-100 if you’re using one (see below). Observe the plug orientation carefully — the shorter side of the plug, with four holes, not five, is on *top*.

Use the mouse on a flat surface with some friction — a mouse pad is ideal. A composition-topped desk will usually be okay, as will a pad of paper or sheet of cardboard. A high-gloss desk or sheet of glass will probably not give satisfactory results.

The S-770 should recognize and respond to the mouse the first time you turn it on. If it doesn't, turn the power off, and wait about 10 seconds. Press the **F2** button and hold it, and then turn the power on. When the "**System Initialize in Progress**" message appears, you can let go of the **F2** button.

This setting is memorized—the next time you boot up, the S-770 will recognize the mouse without you holding in the **F2** button.

If for some reason you should want the S-770 *not* to recognize the mouse, do the same procedure holding in the **F1** button. There is also a "**Controller**" parameter you can set on the **System Parameters Page 2** that tells the S-770 what to recognize.

## RC-100

The RC-100 Remote Controller which you have is a lightweight and portable, but sturdy, control surface that can be used with the S-770. It is designed to sit on a console or small table, and can even be used in your lap. It duplicates all of the controls on the S-770's front panel, except the input and output level knobs. When it is combined with a video monitor, it provides a complete remote editing and control interface for the unit. This can be a major convenience, in that it uses up much less space than the S-770 itself, which can then be placed somewhere out of the way.

## Installation

Installing the RC-100 is very simple. Run its output cable to the **EXT CTRL** socket on the front panel of the S-770 (where the mouse was plugged in). Be careful of the orientation of the plug when you insert it (short side on top). Now plug the mouse cable into the socket labelled "**MOUSE**" on the back of the RC-100, checking that plug's orientation as well. If you are using a foot switch, such as the Roland DP-2, you can plug that into the **FOOT SWITCH** jack on the S-770 front panel.

The RC-100 is designed for use with several Roland products. To "customize" it for the S-770, a plastic overlay sheet is provided. Align the sheet over the buttons and wheel, and attach it with the double-sided tape supplied.

The S-770 will probably not recognize and respond to the RC-100 the first time you turn it on. You can get it to do so by turning on the power while holding the **F3** button in. When the “**System Initialize in Progress**” message appears, you can let go. Like the **F2** setting to recognize the mouse, this is memorized. You can also get the S-770 to recognize the RC-100 while it is running by using the “**Controller**” parameter on the **System Parameters Page 2** (see Chapter 9).

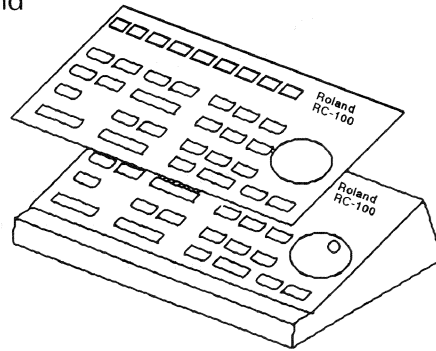

If the S-770 does not immediately start to respond to the RC-100, press the **RESET** button on the back of the RC-100. (Don't worry, it won't reset the S-770.)

If you want to disconnect the RC-100 and just use the mouse, power up holding the **F2** button. If you want to use neither, power up holding the **F1** button.

## Numeric Keypad

Besides duplicating the front-panel controls, the RC-100 adds a few controls and features of its own. It contains a numeric keypad, for directly entering numeric values into Parameters. Pressing the desired digits followed by the **ENTER** key enters the value. If a value entered this way is too high or too low for the particular Parameter, the software will assign the highest or lowest permissible value.

Negative values can be entered, even though there is no “-” key. Press “0” twice in a Parameter, and a minus sign appears. Then follow it with the other digits, and the **ENTER** key. The keypad can also be used to enter letters into file names — see the section on the **ASCII Keyboard** window in Chapter 3.

## Other features

The **F** keys along the top of the RC-100 all have red LEDs built into them, and when you are viewing a particular Page, the LED in the button corresponding to that Page will light. When the **JUMP** button is pressed (either on the front panel or the RC-100), all five of the LEDs will blink until you press one of them (or you press the **JUMP** button two more times).



Below the **VALUE** wheel are two extra buttons, **DEC**(rement) and **INC**(rement). They are used to help you set values or find items on a list when you are also using the wheel. They have no unique functions, and most of the time duplicate the action of the **S1** and **S2** buttons, except that they don't "repeat" when they are held down. They are placed near the wheel for convenience.

The **RESET** button on the back of the RC-100, mentioned earlier, does not reset the S-770, so feel free to press it at any time. It merely re-establishes communication between the RC-100 and the S-770 if it has been lost — for example, if the cable has been accidentally pulled out. When you press it, all the LEDs do a little dance before settling back down to work.

## SCSI

Up to six external SCSI devices can be connected to the S-770 through the **SCSI** port on the rear panel. These can include fixed and removable hard-disk drives, CD-ROM players, and Magneto-Optical drives such as the Roland MO-7.

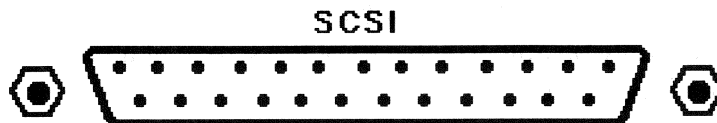

Although hardware connections for SCSI are fairly well standardized, software is not, and for a particular SCSI device to be recognized by the S-770, a software "driver" must exist in the S-770's operating system. Enclosed with the S-770 is a leaflet containing brands and models of SCSI devices that have been shown to work with the sampler. There are certainly other such devices, but you should consult with your dealer or Roland before attempting to connect any SCSI device not listed, to make sure that it will work properly.

In addition, certain protocols must be followed carefully when working with SCSI devices. Please read Chapter 10 before working with any external SCSI devices.

# Chapter 3: Structural and Operational Overview

## A few notes before we begin this chapter...

For best results, it is strongly recommended that you use an external RGB video monitor with your S-770 (see the previous chapter), and this manual will assume that you have one. If you are using a monochrome monitor or TV set, all of the references to screen colors will obviously not apply. If you are relying on the front-panel LCD display, you will only be able to see part of the screen at a time, and some screens you won't be able to see at all.

This manual will also assume that you are using the mouse. Many movements around the screen that are done with the mouse can also be done with the four cursor buttons on the front panel and the RC-100. In addition, most actions that require a click or press of the left or right mouse button, except those specifically having to do with screen graphics, can be done by the S1 and S2 front-panel buttons (respectively).

In general, references to front-panel buttons apply equally to the RC-100, and if there is a special way to do something with the RC-100, it is mentioned. Any time the VALUE wheel is mentioned as a control, the RC-100's numeric keypad and DEC and INC buttons can be used as well.

## The Operating Screens

The S-770 has seven basic types or levels of operation: Modes, Menus, Functions, Pages, Parameters, Switches, and Windows.

### Modes

At the top of the operational hierarchy are the three **Modes**: Performance, Sound, and System. The current Mode determines in an overall sense what the S-770 is going to be doing. In Performance mode, the unit is a polyphonic, multitimbral, MIDI-controlled sound generator. In Sound mode, sounds can be recorded, edited, and combined. In System mode, basic operating parameters are set up.

The Mode is determined from the **Mode Change** menu. Open it by moving the mouse cursor to the upper-left corner of the screen until the word "Mode" goes into reverse video. Then click (press and release quickly) the left mouse button, and the menu appears. Make a selection from the menu by moving the mouse up and down (*don't* hold the mouse button while you do this — this is not a Macintosh), or by pressing the up or down cursor keys on the front panel, so that one of the three items on it goes into reverse video. Then execute your selection by pressing the left mouse button or the **S1** button.

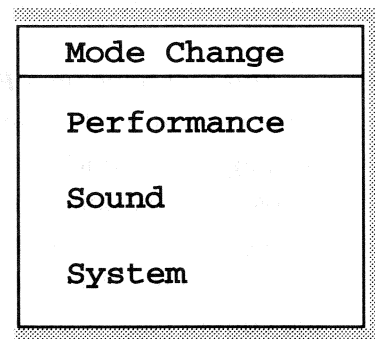

Alternatively, the Mode can be selected using the dedicated buttons on the right side of the front panel. At just about any time, you can change the Mode by pressing the corresponding button: **PERFORM**, **SOUND**, or **SYSTEM**.

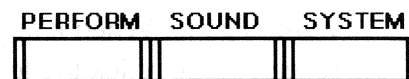

Although the Modes are essentially separate, there are various paths for moving between them, as we shall see.

## Menus, Functions, and Pages

Each Mode has a **Menu**, which appears when you have selected the Mode. The menu shows the various **Functions**, or types of operations, available within the Mode. Choose a Function in the same way you chose the Mode: select the item you want on the menu with the mouse or cursor keys so that it goes into reverse video, and execute the selection with the left mouse button or S1 button.

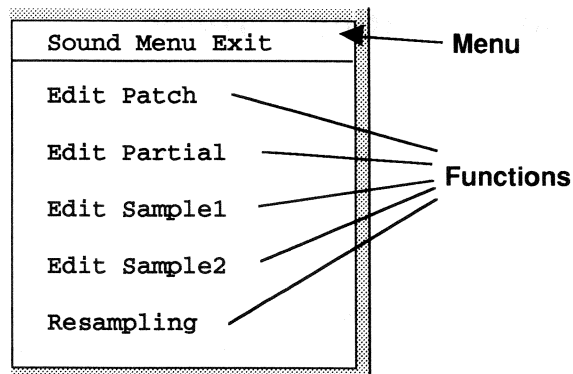

This will bring up a **Page**. Each Function contains between one and five Pages. Short versions of the names of all the pages in a Function appear across the very bottom of the screen, with the current page showing in red. The full name of the current Page is shown in the upper-left corner of the page.

Change Pages by moving the mouse cursor to the bottom of the screen, to the name of the Page you want to go to. When it appears in reverse video, click the left button. You can also change Pages using the F-keys on the front panel: F1 selects the first page of the current Function, F2 the second, and so on.

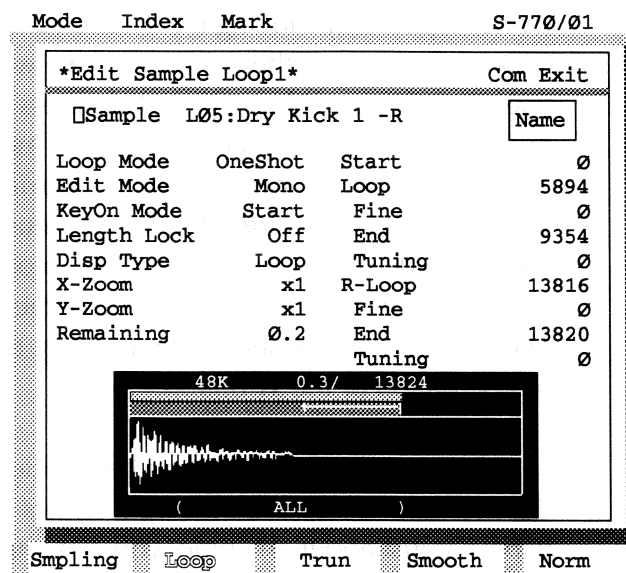

There are also ways to get quickly to Pages in *different* Functions, which are known as Index and Jump. We'll discuss these a little later.

## The Command ("Com") Menu

A special type of menu is the Command or "**Com**" menu. It appears in many Pages towards the upper-right corner. Open it by selecting its name with the mouse and clicking. The **Com** menu is *not* accessible with the cursor keys but instead has its own dedicated front-panel button, marked "**COMMAND**".

The **Com** menu contains functions for accessing disks, managing internal memory (RAM), moving around the operational hierarchy in special ways, and various housekeeping chores. Whenever you execute a function in a **Com** menu, after execution is done, the **Com** menu automatically closes.

Command	Exit
Disk	
Copy	
Delete	
Set Stereo	
Set Mono	

## Parameters

Parameters are the items on the Pages that do all the work. A Parameter can be a numeric value, or it can be the name of a file or other item chosen from a “list”. Parameters can be accessed with the mouse or by using the four cursor keys on the front panel. As usual, a Parameter will go into reverse video when it is selected. Parameter names are generally in yellow, while Parameter values (the things that change) are in white.

Since Parameters can usually be adjusted up or down, *both* mouse buttons are used, the left one to lower the Parameter value (or go to the previous item on a list), and the right one to raise the value (or go to the next item). On the front panel, the **S1** and **S2** buttons perform these same functions, and the **VALUE** wheel does too.

When you are adjusting a Parameter, if you *hold down* the appropriate button after pressing it, the value will start to change faster. In many (but not all) cases, if you are adjusting a Parameter with the mouse, holding down the appropriate button and then *momentarily pressing the opposite button* will cause the Parameter to change *much* faster. For instance, if you are decrementing a value with the left mouse button and you momentarily press the right mouse button, the value will very quickly go to zero, or whatever its minimum is. This function does not work with the **S1** and **S2** buttons.

If you have an RC-100, Parameters can also be adjusted using the numeric keypad: press the numbers on the keypad for the value you wish to enter, and then press the **ENTER** key. The numbers don’t have to be a legitimate value — if you enter a value that’s too high, the Parameter will simply go to its highest allowable value. Negative values can be entered by pressing “0” twice — the second time, a “-” sign will appear, and you can then enter the rest of the digits.

Even if the Parameter is not a numerical one, you can use the RC-100 keypad to set it. For example, every Sample has a numbered “slot” in RAM that keeps track of its position. You will not see the number of the slot, because it is not normally part of the Sample’s name. The usual way to select a Sample in one of the editing Pages is to scroll through the list of Samples, one at a time, until you arrive at the one you want. However, if you know that Sample’s number, you can enter it on the keypad, press **ENTER**, and the Sample will appear on the screen instantly. All other types of S-770 files also have numbered slots, and can be accessed this way from their Edit Pages.

## Switches

Switches are items that you select and click on just once (with the left mouse button), and something happens. Almost every Page or Window (see below) has an **Exit** switch towards the upper right corner, which closes the Page or Window and goes to the next item up on the hierarchy — another Page or a Menu. Often when you leave a Page with the Exit switch, and go to a Menu, the S-770 behaves as if the Page is still showing, and you can still have it make sounds.

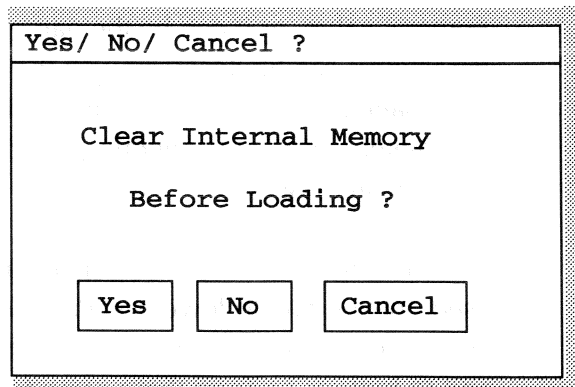

The **Exit** switch can be clicked with the mouse, but like the **Com** menu, it cannot be accessed with the cursor keys. Instead has its own dedicated front-panel button, marked (not surprisingly) “**EXIT**”.

Other Switches appear in other screens in various places, and may be labelled “**Execute**”, “**Set**”, “**YES**”, “**NO**”, “**Name**”, etc. Those switches can generally be accessed either with the mouse or with the cursor keys, and activated with the left mouse button or the **S1** button.

## Other things

Besides these categories, there are a few special items that you will encounter as you learn your way around the S-770, such as **ASCII** windows, graphic editing displays, and message and alert windows, which we will explain as we come to them.

## Tools and Techniques

### Index

An alternative way to move around the Pages in the S-770 is by using the on-screen Index. The Index is particularly helpful when you are first learning the unit, as it can find a Page or Parameter for you whose location you may be unsure about, without making you go searching through the Menus.

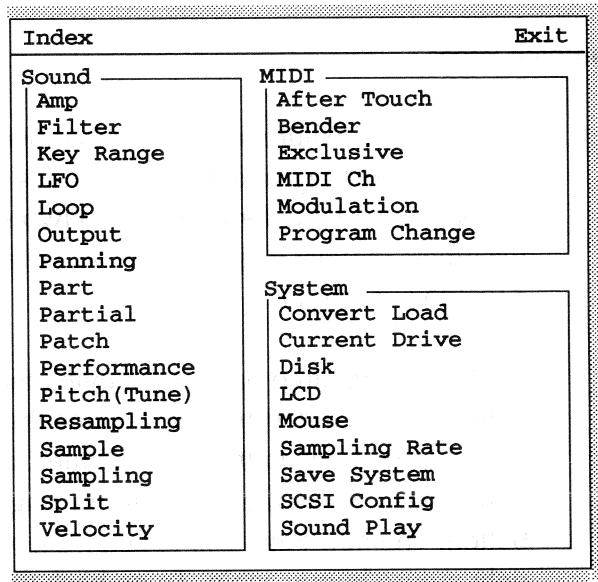

The Index can be called up any time by moving the mouse cursor to the top of the screen where the word "Index" appears, and clicking. It can also be called up by pressing the INDEX button on the front panel.

The Index displays a large number of "topics", arranged in three groups. Topics under **Sound** deal with editing the sounds. Topics under **MIDI** deal with controlling the S-770 via MIDI. Topics under **System** deal with system operating parameters and disk access. Unlike the Modes, the organization of topics in the Index is not formal, and does not strictly follow the hierarchies and divisions of the S-770's operating system.

With the mouse or cursor keys, choose a topic, and the software will jump to the page where that topic is dealt with. Choose "Split", for example, and the **Edit Patch Split** page will appear. Choose "Exclusive", and the **MIDI Sample Dump** page will appear.

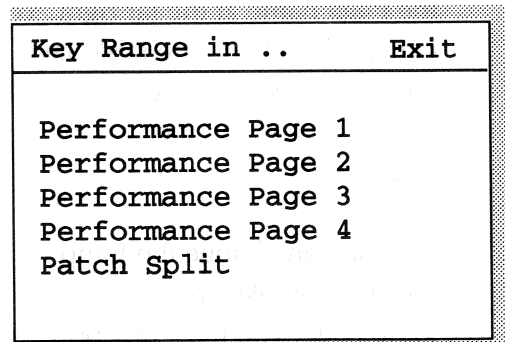

Most of the Index topics, however, refer to more than one Page. When you choose one of these, a "subtopic" window opens. For example, there are various levels at which key ranges can be set for a sound, so if you choose "Key Range", a window will open asking whether you want to work with key ranges at the Performance or Patch level. Choose one of those, and the appropriate Page will appear.

When you leave the Index (by clicking on **Exit**), you will go back to the Menu or Page you were on previously.

## Jumping Pages

The Jump feature allows you to move *immediately* between Pages located in different Functions and different Modes, bypassing the menus and the Index. There are ten pages available for Jumping, in two sets of five, and they are always available, regardless of what Page you are on. (They are not available, however, when a menu or a window is open.)

Access the Jump pages by moving the mouse down to a Page name on the bottom of the screen, and instead of clicking the left mouse button, click the *right* one. The Page names at the bottom will all turn red, and will change to show the first set of five Jump pages. Move the mouse to the Page you want to Jump to and click the left mouse button. The new Page will appear. Or, to see the second set of Jump pages, click the right mouse button again. To go back to the normal Page names, click a third time.

Alternatively, you can press the **JUMP** button on the front panel once or twice, and then one of the five F keys to do a Jump. The screen will respond the same way.

The S-770 comes pre-programmed with Jump pages in each of the ten "slots", as illustrated here. For instance, you can get right to the **Disk Load** page by pressing the right mouse button and then clicking the left button on the Page name at the far right. You can get directly to the **Disk Save** page by clicking *twice* on the right mouse button and then on the Page name.

You can change the Jump pages if you like. To program a Jump page, you must first bring up the Page you are going to want to Jump *to*, using the conventional menus and page names. Then move the cursor to the top of the screen and click on "**Mark**" (or press the **MARK** button on the front panel). A window will appear showing the ten numbered Jump "slots" and the Pages currently installed in them, with both their full names (which due to space restrictions may be truncated) and their abbreviations as they appear on the screen. Move the cursor to the slot where you want to install the current Page and click the left mouse button. The name in the slot will change to the name of the current Page. Close the window by clicking on **Exit**, and you will go back to the current Page.

Mark Set	Exit
<#1>	
F1 Play Page1	[ Play1 ]
F2 Edit Patch Split	[ Split ]
F3*Edit Partial TVA*	[ TVA ]
F4 Sampling from patch	[ Smpling ]
F5 Disk Load	[ Load ]
<#2>	
F1 Performance Common	[ PrfmCom ]
F2 Edit Sample Time Str	[ Stret-P ]
F3*Edit Partial TVF*	[ TVF ]
F4 Edit Sample Loop1	[ Loop1 ]
F5 Disk Save	[ Save ]
Mark Stack 72%Free	



To program the rest of the Jump pages, go to each Page that you want to jump to, click on **Mark**, and then click on the Jump slot where you want that current Page to appear. Windows and Menus cannot be programmed as Jump destinations, and when a Window or Menu is open, the word “**Mark**” is dimmed, indicating you can’t select it. If a name appears with \*’s around it, it means the page being jumped to is in “Subsidiary” mode, and that it is arrived at *through* another Page. We’ll deal with exactly what this means shortly.

After you’ve programmed the Jump pages, there is one more thing you must do to make the programming permanent (so you don’t lose the Jump pages when you turn off the power). Go to the **Index** and select “**Save System**” — it’s down towards the bottom of the right column. The **Save System** window opens. Check to see that the **Current Drive** parameter says “**Internal HD**”, and click on the **SaveSys** switch. The hard disk will spin for a moment, saving your programming to the hard disk. Click on **Exit**, and you’ll go to **System** menu. Click on **Exit** again to get back to the **Mode Change** menu. (**Note:** a lot more than just the Jump pages gets saved in this operation — see Chapter 9.)

Now the next time, and every subsequent time, you call up the Jump pages with the right mouse button or the **JUMP** button, the Pages you have installed will appear at the bottom of the screen, and you can Jump to any of them from wherever you are.

You will discover as you read this manual that the path you take to get to a Page is often very important. When you Mark a Jump page, the software memorizes not only the Page, but the path you took to get there. It’s certainly possible, and sometimes useful, to have the same Page with two different paths in two different Jump slots.

## The Select Window and the Scroll Arrows

When a Parameter is the name of a file in a list, next to it is a little rectangle, which is known as the “Select Icon.” Clicking on it opens the “Select Window”. This window shows all of the items in that file list. Rather than scroll the Parameter to see every item in the list, which can get very tedious with a long list (like all of the Samples in a Volume), you can open the Select Window, view them all, and just click on the one you want to select. If you pass the mouse cursor over the name of a file without clicking on it, you can play that file from MIDI to hear what it sounds like before committing to it.

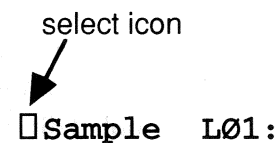

The window shows 15 items at a time, at the file level indicated by the “Target” line: i.e., Sample, Partial, etc. A red arrow points to the item currently selected in the Page you just came from.

52 • Structure

If there are more than 15 items in the list, you can scroll the window using the Scroll Arrow boxes at the upper and lower right corners of the window. Place the cursor on the top box (with the single arrows) and click the left mouse button (or press the **S1** button or move the **VALUE** wheel counter-clockwise). The list moves down — that is, towards the beginning — by one item at a time. Click the right mouse button (or press **S2** or move the **VALUE** wheel clockwise), and the list moves up one item at a time. The lower box with the double arrows moves the list *ten* items at a time, so use this box to scroll quickly through a very long list. Scroll Arrow boxes show up in other places, too, as we shall see shortly.

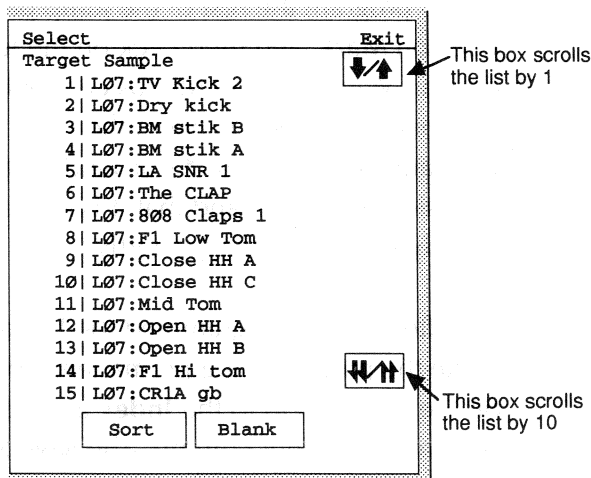

Two other options are available in the Select Window. The “**Sort**” switch organizes all the files in RAM alphabetically, not only at the Target level but at every other level as well. Although it does not change the order in which the files appear on disk, it is a convenience for finding files when there are many in RAM. If you do it just before saving a large number of new files to a disk, they will be saved alphabetically on the disk as well. (There is a way to sort files once they’re on the disk, which we’ll show you in Chapter 9.) The “**Blank**” switch sets the first available empty slot as the Current file. This is useful when you want to work on a new file from scratch.

**Getting to a Function through Another Function**

Yet one more way of moving around the pages is available in a few circumstances. If you are working on any file that has subsidiary files — and this includes Performances, Patches, and Partial — you can move to a lower-level Function without exiting the Function you are in. For example, you can go from a **Partial Edit** page to a **Sample Edit** page (so that you can edit a Sample within a Partial) without going to the **Sound** menu. Then when you are done with the **Sample Edit**, you can click on **Exit** and you will go right back to the **Partial Edit** page you were working on previously. This is accomplished through the **Com** menu, and will be explained in more detail in the chapters on sound editing.

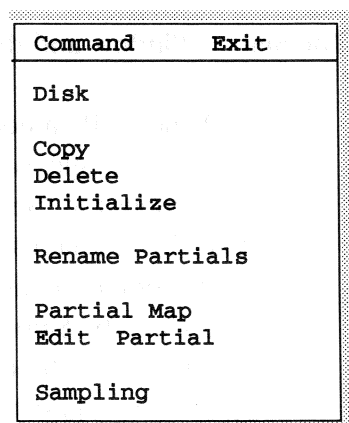

When you are working on the lower-level editing, it is called being in “Subsidiary mode”.

## How the S-770 is organized

Like most samplers, the S-770 records sounds and plays them back under MIDI control. The sounds are recorded in Internal Memory, or RAM, where they can be played back as they were recorded, or modified in a number of ways before or during playback. Some modifications to the sounds are destructive, meaning their basic identity is changed, while some are non-destructive, meaning they remain stored exactly as they were recorded.

Once recorded, sounds can be stored on disk, either the unit's internal hard disk or an external floppy, hard, or magneto-optical disk. The S-770's RAM is volatile, that is, it erases itself whenever you turn the power off. Disks, however — including the S-770's internal hard disk — are non-volatile: they can store data indefinitely without power. Therefore, if you want to keep a sound you've recorded or altered in RAM, you *must* save it to a disk in order to be able to use it the next time you turn on the unit. Sounds can only be *played* from RAM, so to use a sound stored on disk, you must first re-load it into RAM.

Besides permanence, disks have the advantage of much greater storage capacity than RAM. Disk procedures are discussed later in this chapter.

When working with a sound (in RAM or on disk), there are five organizational levels to deal with. Each of these organizational levels is a Function (as described earlier), and has its own set of Pages. We will examine these Functions starting at the bottom. The first three are accessed in the **Sound** mode, and the others in the **Performance** mode.

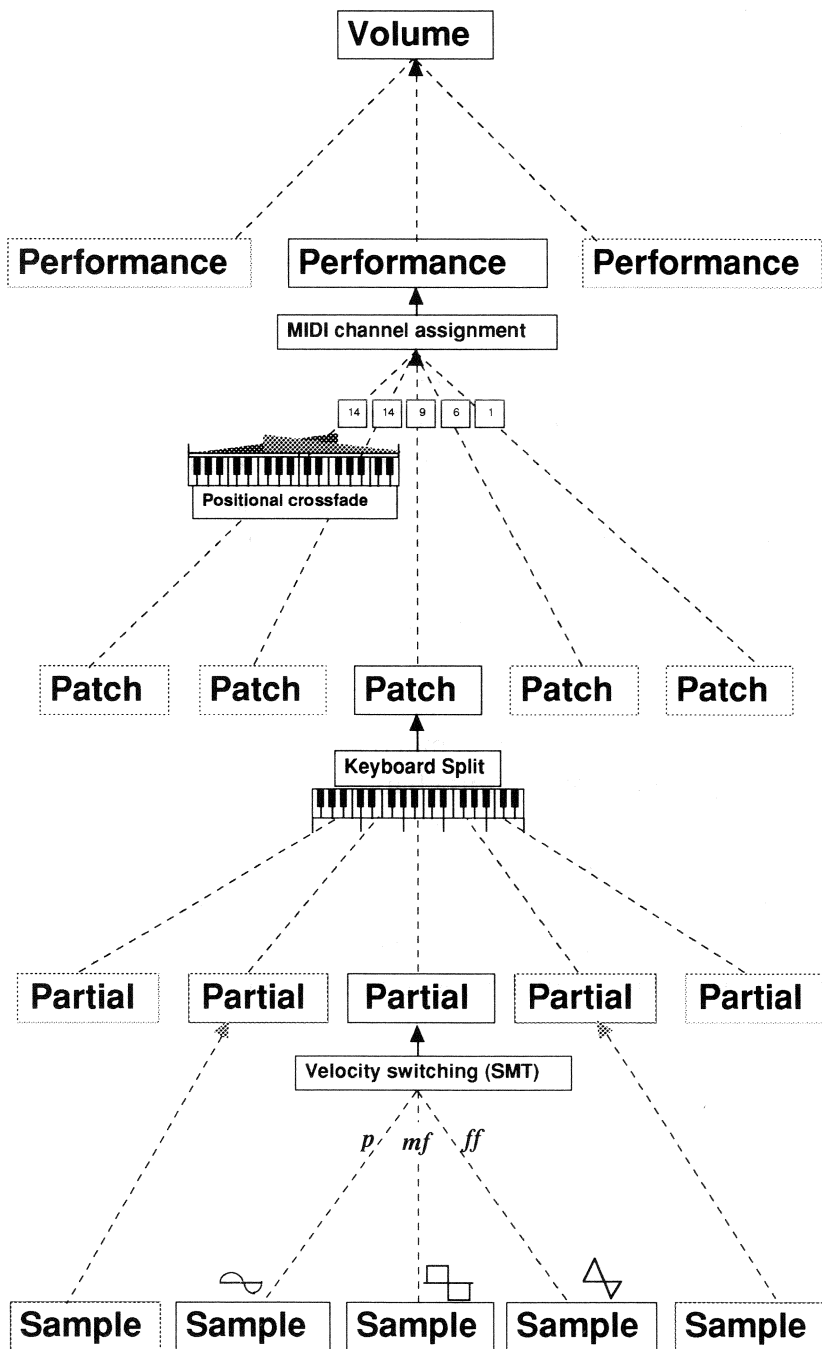

• Everything in RAM

- Patch layering
- MIDI channel number
- Keyboard splits and positional crossfades
- Output assigns and levels

- Keyboard splits and poly/mono modes
- MIDI Program change number
- MIDI control assignments
- Tuning
- Output assigns and levels
- Velocity and filter offsets

- Sample layering, Velocity switching/fading (**SMT**)
- Filter envelope (**TVF**)
- Volume envelope (**TVA**)
- Tuning
- Output assigns and levels
- Key following
- Vibrato (**LFO**)

- Original key
- Loop modes and points

## Samples

The basic element of sound is the Sample. A Sample is a single recording, mono or stereo, of an actual sound. It can be recorded by the S-770 itself, or recorded by some other device and transferred electronically into the S-770. A Sample can be any length from very short (a few bytes, or so short you can't hear it) to very long (up to several minutes).

Samples are recorded on the **Sampling** page and edited on the **Sample Edit** pages, which make up the **Edit Sample1** and **Edit Sample2** Functions, which are selected from the **Sound** menu, or entered (in subsidiary mode) from one of the other Functions. On the Edit pages, Samples can be looped, smoothed, truncated, normalized, cut, pasted, compressed, time stretched, digitally filtered, and redrawn. With the exception of looping, all of these functions are destructive, and will alter the Sample permanently. However, you can "Recover" any operation you don't like, and go back to the original version. More in Chapters 6 and 7.

Samples are placed in RAM or on disk in numbered "slots", like the patches on a programmable synthesizer. There are a fixed number of slots available for Samples on any one hard disk or in RAM: a hard disk has 8192 available slots for Samples, and RAM has 512. (The *actual* number of Samples you can get into RAM or onto a disk will often be lower, however, depending on the size of the Samples and the amount of space on the disk and in RAM.)

When a Sample is in a slot it has a name. (Empty slots are referred to by their numbers.) When you record a new Sample, you must name it first.

The amount of space a Sample takes up in RAM or on a disk is a function of its length, its Sampling Rate Frequency, and whether it is stereo or mono. Samples use a lot of memory: even the shortest Samples you will be dealing with take several thousand bytes, and longer Samples can be in the Megabyte range.

When the memory capacity of RAM or a disk is referred to in this manual or on the screen (it's also sometimes called "Wave Memory"), it's always in terms of the amount of memory available for storing Samples. Files from other levels of the S-770's organization, as we shall see, take up essentially no room at all.

Memory capacities and Sample lengths are usually referred to in seconds, but sometimes also in words. Some screens show a "Remaining" parameter, which tells you how much space is available in RAM or on disk for Samples. (Although this Parameter is in "seconds", it may not always reflect the actual amount of time a Sample lasts. This will be explained later in this chapter.)

## Partials

Samples are combined into Partials. Each Partial contains from one to four Samples, which are layered — that is, they can all sound simultaneously. Each Sample within a Partial can have its own level, tuning (relative to the pitch it was recorded at), and pan position in the stereo outputs. Samples within a Partial can also be velocity-switched, that is, different MIDI key velocities on the same note can sound different Samples, using the Sample Mix Table (“SMT”).

Partials are constructed and edited using the Pages in the **Edit Partial** and **Partial Map** Functions. Partials as a whole can be given a volume envelope (known as a Time Variant Amplifier, or “TVA”), and an analog-style filter with an envelope (Time Variant Filter, or “TVF”). In addition, a Low-Frequency Oscillator (“LFO”) can be applied to a Partial to provide pitch, volume, or filter vibrato.

Like Samples, Partials are stored on disk. The Samples that make up a Partial are known as its “subsidiary files”, and they are stored separately from the Partial itself. This means that the space on the disk that the Partial takes up *by itself* is actually quite small: it consists merely of a listing of the names of the subsidiary Samples, plus a couple of dozen parameters.

The same Sample can be shared among a number of different Partials — for example, a bass drum Sample might be used as part of a drum kit, or as a basis for an explosion effect. If you change it in one Partial, the change takes effect in *every* Partial in which the Sample is used. If you don’t want this to happen, then the changed Sample should be copied and given a different name (which can be done in one operation) before it is altered.

When a Partial is loaded into RAM, the amount of memory it takes up is dependent on the size of the Samples that are associated with that Partial. If the Samples are already in RAM (because the same Samples have been loaded in previously with a different Partial), then loading in the new Partial will take up no additional RAM. You can also load a Partial without any of its Samples if you want to apply its Parameters to Samples already in RAM.

Partials, like Samples, occupy numbered slots when they are in RAM or on a hard disk. The maximum number of Partials in RAM is 255, and for any one hard disk, 4096. These numbers may be lower, however, depending on the size of the Samples associated with the Partials, and the amount of space on the disk and in RAM.

Unlike Samples, you can create a new Partial without naming it first, and you can access it within RAM by its slot number. If you want to save it to *disk*, however, you must name it first — you cannot save a Partial that just has a reference number.

## Patches

Partials are in turn combined into Patches. Patches are normally dealt with on the **Edit Patch** pages (although they can also be edited from the **Part Map** page, which is accessed from the **Performance Play** Function). Within a Patch, different Partials are assigned to different portions of the MIDI note range. A Partial's range within a Patch can be anywhere from 1 to 88 notes wide, and the notes need not be contiguous. (However, a particular note can have only one Partial assigned to it.) This feature, known as **Split**, and set up on the **Edit Patch Split** page, allows "Multisampling", a highly useful sampling technique. Multisampling avoids the "Mickey Mouse" effect that can occur when you play back a Sample at a pitch far removed from the pitch it was originally recorded at.

Each Patch has a MIDI Program Change number, which means that when the S-770 receives a Program Change command on the appropriate MIDI channel, this Patch becomes active.

Each Patch also contains a MIDI control matrix, which takes incoming MIDI data like Pitchbend, Channel Pressure, and Continuous Controllers and assigns them to various musical parameters, such as pitch, volume, filter (**TVF**) depth, and vibrato (**LFO**).

In addition, the **Edit Patch** pages have level, tuning, and output assignment settings that can be used to augment or override the settings in the Partials.

The Partials and Samples in a Patch are "subsidiary files" of that Patch. Like a Partial, a Patch is merely a brief list of parameters, and by itself takes up essentially no room in RAM or on disk.

As with Samples, the same Partial can be shared among a number of different Patches. To go back to the bass drum example, you might want to use it as a bass drum in one Patch and tune it higher to use as a tom-tom in another Patch. If you alter the Partial in one Patch, then it will be altered in every other Patch in which it appears. Since saving a Partial by itself requires no extra memory, it is a good idea that every time you alter a Partial which may appear somewhere else, you copy it and save it with a new name.

The absolute maximum number of Patches that can be stored on any one hard disk is 1024, and the maximum number of Patches that can be in RAM at any time is 128. These numbers may be lower, however, depending on the size of the Samples associated with the Patches, and the amount of space on the disk and in RAM.

Patches can be created without names (just reference numbers), but they must be named before they can be saved to disk.

## Performances

Performances are groups of Patches. A Performance is what you will have loaded into RAM most of the time when you are actually playing a piece of music with the S-770, whether it's live from a MIDI controller, or from a sequencer. A Performance is what allows the S-770 to be a fully multitimbral sound generator, that is, one that can play different sounds on different MIDI channels.

Performances have their own Mode and Menu. Selecting **Performance** from the **Mode** menu or pressing the **PERFORM** button on the front panel opens the **Perform** Menu. Performances are edited using two different Functions in the **Perform** menu, **Play** and **Edit Performance**. (Note that you *can* edit a Patch or other subsidiary file from within Performance mode — see Chapter 8).

Up to 32 Patches can be combined in a Performance. Each Patch is assigned a MIDI channel, so that the S-770 can respond to different MIDI channels with different sounds. Patches can also be layered by assigning two or more to the *same* MIDI channel. In addition, each Patch is given a keyboard range, which provides yet another opportunity for setting up multisampling splits, with the added feature that crossfades between Patches based on their keyboard position can be set up. Volume, output assignments, and pan positions can be assigned here as well to augment or override the settings in the Patches and Partials.

Like Patches and Partials, Performances themselves take up little room in RAM or on disk, but since they usually have quite a few subsidiary Samples associated with them, if you are loading a new Performance into RAM, it can take a little while. Also, changing a Patch in one Performance will change it in any other Performance in which it is used, so when making an alteration to a Patch that has multiple uses, it is a good idea to copy it and change its name.

The absolute maximum number of Performances that can be stored on any one hard disk is 512, and the maximum number of Performances that can be in RAM at any time is 64. These numbers may be lower, however, depending on the size of the Samples associated with the Performances, and the amount of space on the disk and in RAM.

Performances can be created without names (just reference numbers), and they can even be called up via MIDI Program Changes (see Chapter 8) that way, but they must be named before they can be saved to disk.



## Volumes

Performances can be organized into Volumes. Volumes are very convenient: selecting a Volume to load into memory means a large number of Performances and their many subsidiary files can be accessed with a single operation. They also provide a good way to organize your data, and in fact the unit comes from the factory with all of the sounds on the hard disk organized into Volumes.

Only one Volume can be in RAM at a time. Conversely, the entire contents of RAM can be considered as a single Volume. When a Volume is loaded in, another volume can be loaded in after it without clearing out the Internal memory, but now the contents of the two Volumes are considered as a single Volume. The name of that Volume will be the name of the most recently loaded Volume.

A Performance or other high-level file can draw its subsidiary files from different Volumes. Volumes can also share files — the same file can be in more than one Volume. Like Performances, Volumes can be called up by MIDI Program Changes, but when you call a Volume that way, rather than switching sounds in RAM, it actually loads it from disk. This can have serious consequences, which will be discussed in Chapter 8.

Volumes are a bit of a special case — you won't see the word "**Volume**" on any Mode menu or even in the **Index**. The first three characters of the name of every file on the disk (from Samples to Volumes) make up the "Volume ID". The Volume ID helps the system software keep track of files, and makes system functions more efficient. It is an integral part of the name: two files with identical names but different Volume IDs are considered to be different files. When loading, copying, or deleting files, you can choose to have only files with a particular Volume ID visible on the screen. This can make finding a particular file much easier.

The absolute maximum number of Volumes that can be stored on any one hard disk is 128. This number may be lower, however, depending on the size of the Samples associated with the Volumes, and the amount of space on the disk.

## Working With Disks

As we mentioned earlier, sound files in RAM will disappear when you turn the S-770's power off. In addition, when you load in a new Volume (or any new file, if you tell the unit to clear its Internal Memory), all of the files in RAM will be erased. To store them permanently, they must go onto a disk. Unlike some computer systems, the software does not automatically save RAM files for you, or give you a second or third chance to save them — you must take that initiative yourself. The unit's internal hard disk is the obvious first choice for file storage, so we'll talk about it first.

There are four ways to get to the Disk Function, which is how you move files from RAM to disk and vice versa. One is through the Command (**Com**) menu, available from all of the sound-editing Pages: open that menu and select **Disk**. This is the method you will use most of the time. The second is from the **System** menu: choose **System** from the **Mode** menu or press the front-panel **SYSTEM** button, and then select the item **Disk Tools**. The third is through the Index: under **System**, select **Disk**. Finally, you can **Jump** there.

The Disk Function (no matter how you get to it) has five Pages: **Load**, **Save**, **Copy**, **Delete**, and **Util**.

### Loading

Click on **Load** at the bottom of the screen or press the F1 button to go to the **Disk Load** page. (You can also Jump to it using **JUMP** and **F5**.) The center of the screen will show a numbered directory of the current files on the hard disk, at one particular Function level — Samples, Partials, Patches, Performances, or Volumes — as well as their total lengths, in seconds. (In some cases, these lengths might not seem quite right — don't worry, we'll get to that.)

Just above the length numbers will be a number in yellow showing how many of this type of file are on the disk: for example, "**308 files**".

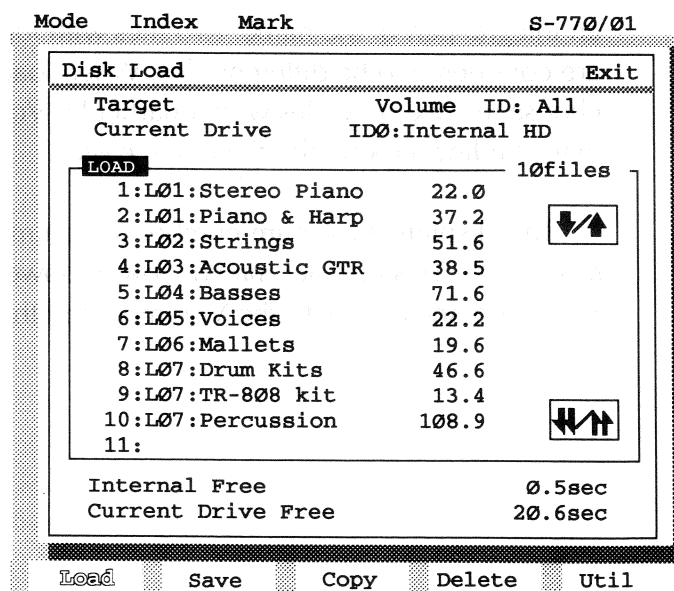

Move the mouse or the cursor buttons to select the file you want to load. There is room for only 11 file names to appear on the screen at a time, so if there are more files that you want to look at, use the Scroll Arrows at the right side of the screen. As in the Select window, the upper arrows scroll by one, and the lower by 10.

### Changing the Function Level (Target)

The directory shows one Function level at a time. Changing the level is accomplished by selecting the “**Target**” parameter at the top of the page, and using the mouse buttons, S buttons, or VALUE wheel to choose the Function level you want to see — use the left mouse button to go higher (up towards Volume) and the right one to go lower (down towards Sample). You can go beyond Sample as well to special “**PRM**” targets — we’ll get to these shortly.

### Changing the disk

The “**Current Drive**” parameter shows you which disk the S-770 will load files from. If you want to load from a different disk, either a floppy or a SCSI device, you will have to change this parameter. Although it does not have a Select icon, clicking anywhere on this parameter opens up a special Select window, called “**Drive Select**”.

In this window, click on the blue ID number (on the left side of the “=” sign) of the drive you want to load from, or on the words “**Floppy Disk**” at the bottom of the window. *Don’t* click on the name in white: if you do, you will be asked to re-name the drive, which is a nice thing to be able to do, but not right now. The window will close, and you’ll be back on the **Disk Load** page. If you change your mind and don’t want to switch drives, click on **Exit**. Using floppy and external disks is covered in more detail later in the chapter.

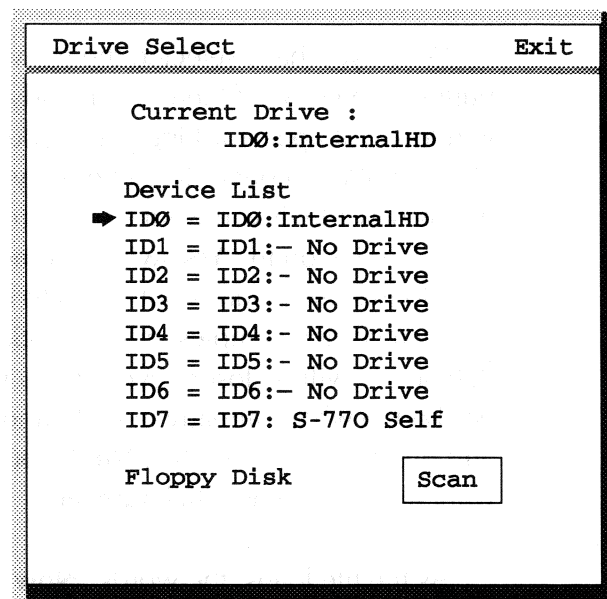

You can use a wide variety of SCSI devices with the S-770, including fixed hard drives, removable hard drives such as SyQuest mechanisms, and CD-ROM drives, provided the disk itself is designed for the S-770 (if it’s designed for the S-550, it has to be dealt with differently, as we’ll see in Chapter 9.) More about SCSI is in Chapter 10.

## Changing the Volume ID

The “ID” parameter in the upper-right corner is set to “All”. This means that files in all Volumes will be displayed on the screen. If you want to limit the display to only those files belonging to a particular volume, you can click on this Parameter and the **Volume ID Select** window opens. You can then choose a particular Volume (or group of Volumes) to display, or select **All**. More on this in Chapter 8.

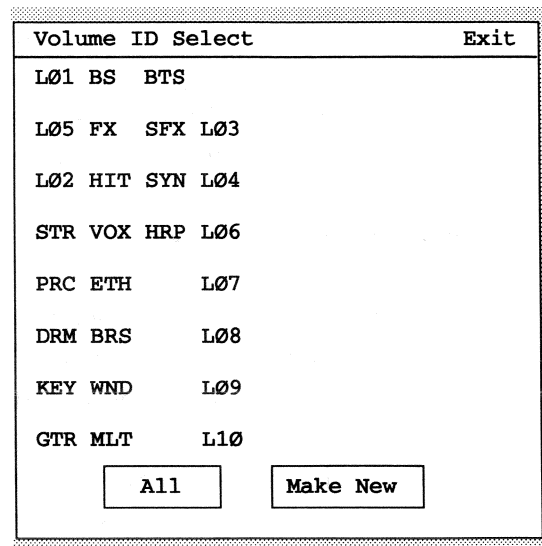

## Loading into RAM

When you have selected the file you want to load into RAM, click the left mouse button or press **S1**. If there are already sounds loaded into the S-770’s memory, a window will appear asking you if you want to clear all of them out of RAM before you load in this new file. If you want to start from scratch, click on the **Yes** switch. Remember if you do this, any sounds not saved to disk — newly recorded Samples, edited Partials or Patches — will be lost forever. If you want to hold on to what’s already in RAM and just add this new file to it, click **No**. If you don’t want to do anything, click **Cancel**.

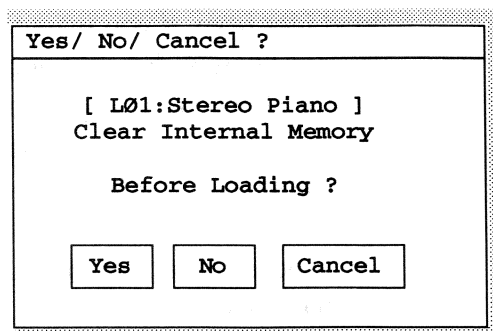

As the file loads, the words “**Now Working**” appear at the bottom of the screen, and some white arrows will also appear, rolling and tumbling, while the disk is read. These arrows will become very familiar as you work with the S-770. They don’t actually mean very much, but are provided to show that, in case you were worried by the apparent pause in activity, yes, the machine is working.

**Now working**



If you are loading in a Volume, Performance, Patch, or Partial, all of the Samples and other subsidiary files associated with the file will be loaded in as well. The screen will display the name of every file as it loads. (Here’s where the dancing arrows mean something: how many there are indicates how many levels of files are being dealt with.) The files are loaded in ascending order: all the Samples first, then the Partials, Patches, and Performances. Since the Samples are the only ones with any real length, they take the longest.

However, if the Target is **Partial PRM**, **Patch PRM**, or **Performance PRM**, then the subsidiary files are *not* loaded. This is to allow you to use existing higher-level files as templates for working with different Samples. For example, if you wanted to use an existing drum map (a set of keyboard split assignments in a Patch) with a completely different set of Samples than it was designed for, you could load the Samples first, then the Patch without the Samples. This way you don't have to redesign the Patch from scratch.

If a file to be loaded has the same name as a file already in RAM, a window will appear asking you if you wish to replace the file in RAM. (If you're loading a high-level file, there may be several subsidiary files that need to be replaced.) Click "**Yes**" and the RAM files are replaced with those from the disk. Click "**No**" and those files will not be replaced, but any *other* files that are not already in RAM will load. Click "**Cancel**" and the Load operation is cancelled.

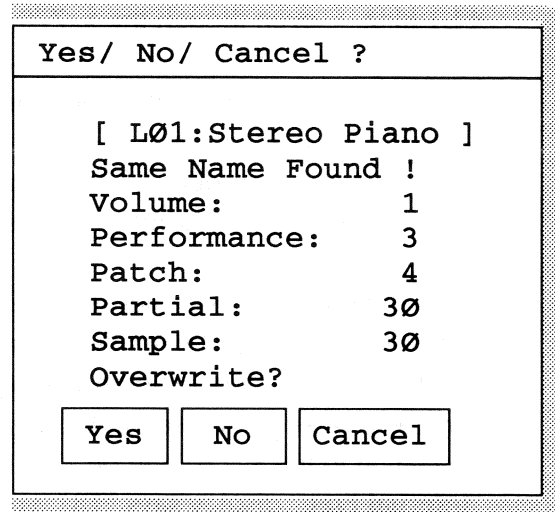

You can eliminate this step, and have the Load take place automatically without checking whether any RAM files that will be replaced, by turning on the **Overwrite** switch, which is on the **SCSI Config** page (from the **System** menu, select **SCSI**). We'll talk more about this in Chapter 9.

## How Much Room?

At the bottom of the screen is a line of text labelled "**Internal Free**". This shows how much RAM is available for Samples, in seconds. As one or more Samples get loaded in, this number will go down. (Although if a Sample has been loaded previously, this number probably will not change, because the new Sample is replacing an old Sample of the same length.) Since the directory shows the size in seconds of each file on the list, it makes it easy to determine beforehand whether there is room in RAM to accommodate it.

## A Note About Lengths of Time

When any time length — whether it refers to a file, or to the space remaining in RAM or on disk — is shown on the screen, the number may not correspond to the actual length in real time of the file or the memory. This is because time lengths are generally calculated as if the file or space were being processed at a sampling rate of 44.1 kHz — even though the S-770 is capable of operation at several different sampling rates. The reason for this is so the display can be consistent: otherwise you might find yourself in a situation where there are 2.5 seconds free in RAM at one sample rate, and you have a Sample on disk 2.3 seconds long but it won't fit into RAM because it was recorded at a faster sample rate. By having all timings referenced to the same sample rate, this kind of confusion is avoided.

Therefore, if the Samples in a file were recorded at 48 kHz, the number shown for their total length will be greater than their actual length. If they were recorded at 22.05 or 24 kHz, the number shown will be less than the length. Here's an example: if a Sample on disk is 24.2 seconds long and was recorded at 22.05 kHz, its length according to the S-770 will be 12.1 seconds. If you intend to load that Sample and the “**Internal Free**” display says “13”, you've got plenty of room to spare.

There are two exceptions to this: when you are *recording* a new Sample on the **Smplng** page, or when you are **Resampling**. These are discussed further in Chapters 6 and 7.

## Filling RAM Up

When the RAM gets close to full, the loading operation may take longer, because the unit has to re-shuffle memory to accommodate new files. If you run out of RAM in the middle of a loading operation, you will get an error message: “**Wave Memory Full**”. No more Samples will be loaded, but the other files (if there are any) will be. You can always load files from a “PRM” target, because those files take up no memory.

## Saving

Saving files in RAM to disk is done on the second Disk page, **Disk Save**. (You can Jump to this page — it's the fifth page in the second set.) Select a **Target**, and all files of that type currently in RAM will appear in the directory window. If you have more than a screen's full, use the Up/Down boxes to scroll.

You can change which drive to save to by clicking on the **Current Drive** parameter, and selecting the new drive in the **Drive Select** window.

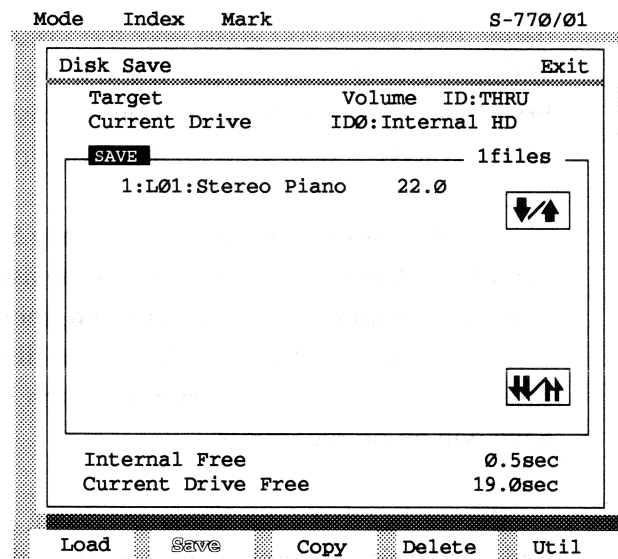

Next to the file name is the size of the file in seconds, which takes into account all of the Samples associated with the file. (As with loading, if you save any high-level file, all of its subsidiary files are saved along with it.) This number should be compared with the “**Current Drive Free**” display at the bottom of the screen, which shows the Sample memory available on the disk. If the file size is bigger than the amount of free space on the disk, you *may* have trouble saving it.

## Checking Disk Space

We say you *may* have trouble, because these numbers do not take into consideration Samples that you are saving that are *already on* the disk. Therefore, if you are saving high-level files that contain nothing but unaltered Samples which were previously loaded in from the current disk (and not altered in any way at the Sample level), you will be able to save them even if there is no room at all available on the disk, because the Samples will simply replace other Samples on the disk of the same length.

For example, if you load in a Volume that contains 47.8 seconds worth of Samples, tweak a few filter and keyboard-split parameters, and then try to save it to a disk that has only 5.5 seconds of free memory, you will have no problem, because you haven't added any new Samples to the file.

If, however, given the same circumstances, you do a *destructive* edit like a Truncate on a Sample which is 7.2 seconds long, *and* you give the new version a name, then when you go to save the Volume, you won't be able to do it. The system will start saving Samples, but when it encounters the new Sample it will give you a red **Error!** message, and not save it on the disk. The rest of the Volume, however, will save correctly. (We'll deal with all this more in Chapter 9.)

As with loading Samples, if you Save Samples to a disk which already contains Samples of the same name, you will be asked if you want to replace the disk's Samples with those from RAM. If you click **No**, then the Samples in question will be skipped over, but any other files not already on disk will be saved. Clicking **Cancel** cancels the save completely. If the **Overwrite** switch is on, this warning will not appear and the Save will go on regardless.

Remember that even if you are doing a *non-destructive* edit on a Partial or Patch, and that Partial or Patch is used in more than one higher-level file, the new version of the Partial or Patch will show up everywhere the old version did. So if you are making changes that might affect other files, save the changes with a new name (see the end of this chapter for information about naming files).

The **ID** parameter in the upper-right corner determines if files will be saved with their original names, or new versions of them will be created with a new Volume ID. Leaving it on **Thru** preserves the original names, and also means they won't take up any extra space. More on using this parameter in Chapter 8.

To leave the Save Page and get back to the Menu or Page you started from, click on the **Exit** switch or press the **EXIT** button.

## Delete

The **Disk Delete** page lets you erase files from the disk, thereby making room for other files. Delete is permanent — once it's gone, it's gone — so make sure that you can afford to lose the files you're deleting forever, or else make backups using the **Copy** page (discussed next).

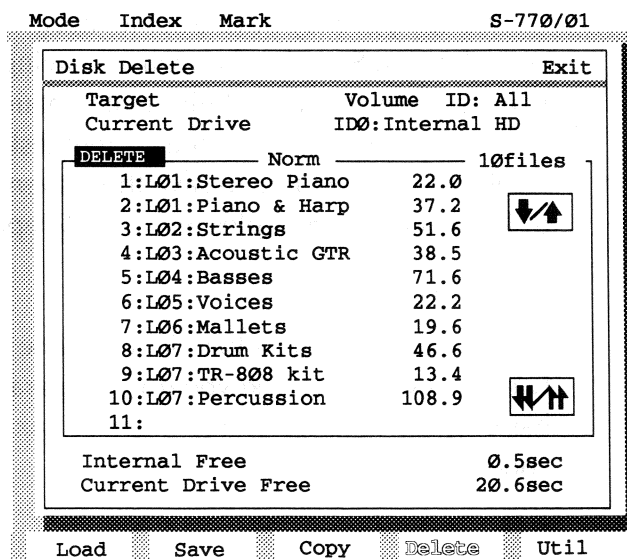



Any time you delete a high-level file, the system will tell you, in the **Delete** window, how many subsidiary files of each type are being deleted with it, and will give you one last chance (using **Yes** and **No** switches) to change your mind.

You can change which drive you are working on by clicking on the **Current Drive** parameter, and selecting the new drive in the **Drive Select** window.

### Deleting shared files

If any subsidiary files in the file you're deleting are being used by *another* file on the same disk (for example, you have two brass-ensemble Patches built out of the same trumpet and horn Partials and Samples), whether those files' subsidiary files are deleted will depend on the setting of the "**Fast Delete Mode**" switch. This setting is shown at the top of the file-list window: either "**Fast**" or "**Norm**". It is set on the **SCSI Config** page.

Yes/No ? Norm	
[ L01:Stereo Piano ]	
Delete, as Follows	
Volume:	1
Performance:	1
Patch:	2
Partial:	17
Sample:	17
Are You Sure?	
<input type="button" value="YES"/>	<input type="button" value="NO"/>

Normally, you will want this switch **Off (Normal mode)**. In this mode, the system checks to see if the high-level file you're deleting contains any subsidiary files that are also being used by another high-level file. If there are, then it leaves those subsidiary files alone. When the switch is **On (Fast mode)**, this checking is not done, and all subsidiary files are deleted, whether or not they are needed elsewhere.

The advantage of setting the switch **On** is that the Delete function can be accomplished faster — sometimes *much* faster. The disadvantage is that there's no protection to keep you from inadvertently losing an important Sample when all you're trying to do is clean up your disk.

Keep in mind when deleting a high-level file that it's not the deleting of the file *itself* that frees up memory, it's the deleting of all of its subsidiary Samples. Therefore, deleting a file whose subsidiary Samples are all in use by other files may make your file list one item shorter, but it won't give you any more disk space.

## Copy

The Copy feature lets you do file backups from one SCSI drive to another in one step — you don't have to load in a file from one disk and then save it to another. (It does not work, however, with floppy disks. We'll explain how to get files to and from floppies in moment.)

Go to the **Disk Copy** page, and click on the **Current Drive** parameter to open the **Drive Select** window, and choose the disk drive you want to copy the file *from*. Now click on the **Destin Drive** parameter, and choose

the drive you want to copy *to*. (You can set the two parameters to the same disk if you're feeling particularly perverse, but you won't accomplish anything.) Then select the **Target** and file in the usual way. Make sure there's sufficient space on the Destination Drive (check the **Destin Drive Free** value at the bottom of the screen) to accept the new file. When you're done, hit the **Exit** switch.

The Copy function has an additional **Target** level: "**All**". This is used when you want to copy the entire contents of one SCSI device to another at one time. If there is a lot of data involved, the operation may take a while, but you don't have to baby-sit it, as you would if you were copying all of the volumes or other files individually.

Select **All** as the Target — it's before "Volume". The filenames will disappear from the window and are replaced with the single line "Copy All Execute". Select that line and click, and the copying will commence.

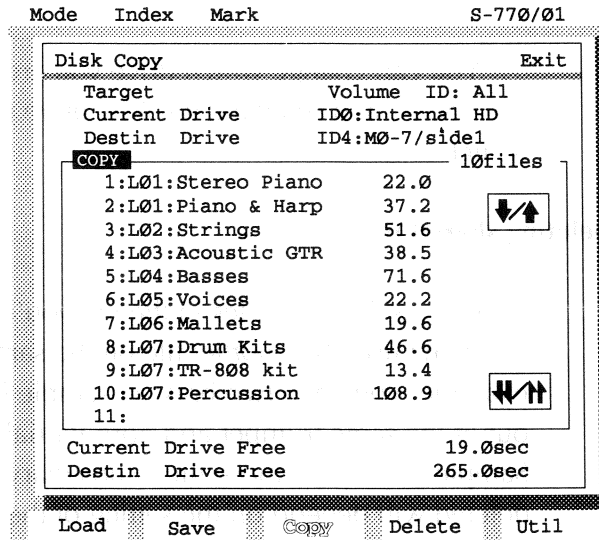

## Using floppies

Floppy disks are a convenient way to store files “off-line”. You can Save to them or Load from them just the way you do with the internal hard disk. Their advantages are that they are cheap, easy to transport, universally compatible, and readily available. Their disadvantages are that they are relatively slow and do not hold a large amount of data. One 10-second 48-kHz Sample, for example, will require two 800k floppies to store.

To access a floppy disk in the drive from one of the Disk pages, click on the **Current Drive** parameter at the top of the Load or Save page, and when the **Drive Select** window opens, select [**Floppy Disk**] at the bottom.

## Disk types and Formatting

The S-770 can use both standard double-sided/double-density (800k) and high-density (1.44M) 3-1/2” diskettes, just like those you would buy for many personal computers. As with all devices that use floppies, new disks must be formatted before using. However, you can Save a file to a floppy without pre-formatting it — the formatting operation is handled automatically.

On the other hand, if you are planning to use many floppies in an operation (to store either one large file or several small ones), you can save time by formatting the disks ahead of time. This is handled on the **Disk Util** page, the fifth Page of the Disk Function. Go to that page by clicking on **Util** at the bottom of the screen, or pressing **F5**. (We’ll deal with the other functions on this page in Chapter 9.)

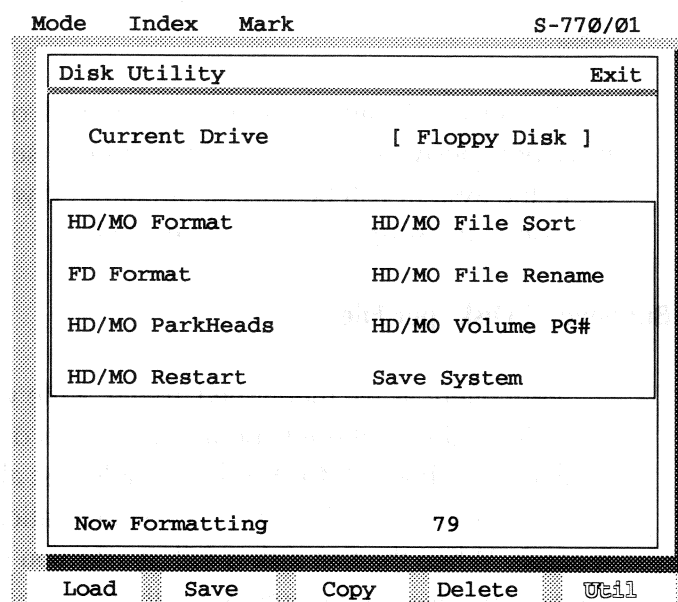

Insert the disk you want to format into the drive, making sure it is not write-protected: the write-protect tab should be snapped towards the center of the disk. Click on **FD Format** (you don’t need to worry about what the **Current Drive** is set to).

**Note:** Be careful not to click on **HD/MO Format**, or you will format the Hard Disk! You do not want to do this!

The S-770 knows what kind of disk is in the drive, and formats it accordingly. Remember that formatting a disk erases everything on it. If the disk was previously formatted for the S-770 and contains either any Sample files or an operating system, the software will tell you so (“**Sound Data Disk!**” or “**This is a System Disk!**”), and ask you again whether you want to format it .

If you have a disk in the drive you don’t want to format, you can push the eject button on the right side of the drive to get it out of there, and replace it with another disk. If you get confused or for some reason want to forget the whole thing, click on **Exit**.

### One File per Disk...

You can only save **one** file on a floppy disk. If you try to save another file, the first one will be erased (the software will warn you before this happens). However, the file that you save can be at *any level*, so you can, for example, store a Performance containing many Patches, Partials, and Samples on a floppy. You can then *load* in any of the subsidiary files to RAM just as you would from the hard disk. You just can’t save any of the subsidiary files individually to the floppy, without wiping out everything else.

A floppy disk can be either a System disk or a sound data disk, but not both. If you have previously used a disk to Save System (see Chapter 9), and you Save a sound file on it, the System will be erased. Similarly, if you Save System on a disk that has sound data on it, the sound files will be erased.

### ...But Several Disks per File

Very often, as we mentioned above, a file will need more than one floppy to hold it. An 800k disk will hold about 6.6 seconds of Samples at the 44.1 kHz Sampling Frequency, while a 1.44M disk will hold just about 14.6 seconds. If the file you’re saving is bigger than that, the S-770 automatically splits it up among as many disks as it needs. When the first disk is full, it asks you to insert another one. It automatically formats this disk (and warns you if there’s already something on it), and then continues to save the file. It will keep asking for more disks until its hunger is satiated.

As you use a disk, put a label on it and **number it!** Don’t put the disks away just yet — when the procedure is done, the S-770 will ask for all of them again, for just a moment, so that it can do its own numbering.

Keep track of all of these disks; if you lose or damage just one, you will not be able to load the file back in. Remember that none of the disks you've just saved can have anything else written to it, or the contents will be lost, which will likely make the *other* disks containing the rest of the file useless.

If you need to cancel a multiple-disk operation in the middle, you can do so. On a **Save**, if you run out of blank disks halfway through the operation, when the screen tells you to insert another disk and asks if you want to continue, click on **No** and the whole thing will be cancelled. If you click **Yes** and only *then* discover you have no more blanks, click the *right* mouse button and you will be given another chance to exit gracefully. If you cancel a multiple-disk save, some of the files may get saved to disk anyway.

On a **Load**, if you can't find a disk in a set, or just change your mind, click *either* mouse button when the screen asks for the next disk, and the operation will be cancelled. Files that have already loaded in when you cancel will be in RAM.

## Restrictions and Warnings

You cannot use the **Copy** feature with floppy disks. If you want to move a file from a SCSI disk to a floppy or vice versa, you must first Load it into RAM and then Save it to the appropriate disk. You also cannot use the **Delete** feature with floppies. Since you can only store one file at a time on a disk anyway, there's no reason to delete anything — just format it or write over it.

**Note: Do not boot the S-770 with a floppy disk in the drive.** This will cause the unit to ignore the operating system software on the hard disk, and it may not run properly, or at all. There is one exception to this rule, and that is when you are updating the system software. This is discussed in Chapter 11.

Never remove a floppy disk while the drive is running (the yellow LED on the drive is lit steadily). This could damage both the disk and the drive. However, don't be afraid to *insert* a disk when the yellow LED is *flashing*, which will happen fairly often.

## Using external SCSI disks

The S-770 will work with external disks that use the Small Computer System Interface ("SCSI") protocol, including fixed hard disks, SyQuest removable hard disks, CD-ROM players, and Magneto-Optical Read/Write disks like the Roland MO-7. Up to six external SCSI devices can be supported on line at a time — the limit for a SCSI line is eight devices, but the S-770 itself counts as one of those, and the internal hard disk is another.

If you have changed (or with a magneto-optical drive, flipped over) a disk in an external SCSI drive any time after booting up, the S-770 will not recognize the new disk, and when you open the **Drive Select** window, its name will not appear on the list of available drives. If this happens, click on the “**Scan**” box in the lower-right corner of the window. The software will scan everything on the SCSI “network”, and will update its list to show any changes.

The S-770 will load sounds from floppy disks or CD-ROM disk libraries created for the Roland S-550, S-330, and W-30. This is a special operation called “**Convert Load**”, which is described in Chapter 9.

**WARNING!** Setting up SCSI devices to work with the S-770 is a procedure that must be followed carefully. It is discussed in detail in Chapter 10. Please read that chapter before attempting to use any external SCSI devices.

## Naming Files

Every file at every level in the S-770 has a name. Names are given to files only when they are in RAM, and those names stick with the files when they go to and from disk.

Every name has two parts: the Volume ID, mentioned earlier in this chapter, and the filename. The Volume ID is the first three characters preceding the colon, while the filename is everything after the colon, and can be up to 12 characters. The last two or three characters are sometimes used for special suffixes: “-L” and “-R” for the two halves of a stereo sample; “-N” for a Sample that’s just been copied; and “AA”, “AB”, etc. for a higher-level file that’s been copied.

Filenames must be unique within a given Volume ID and a given level. For example, you cannot have two Samples named “DRM:LoTom1”. You can, however, use the same name at *different* levels, so you could, for example, have a Sample named “DRM:LoTom1” and a *Partial* named “DRM:LoTom1”, and a Patch and even a Performance, both named “DRM:LoTom1”. In fact, the S-770 sometimes creates this kind of situation automatically (see Chapters 4 and 5).

You could also have one Sample named “DRM:LoTom1” and another named “PRC:LoTom1” — since the Volume IDs are different, there is no conflict.

## The ASCII Keyboard Window

Names are given to files from within their respective Edit Pages. Click on the **Name** switch, and a window labelled **ASCII Keyboard** opens. Here is where you construct the name.

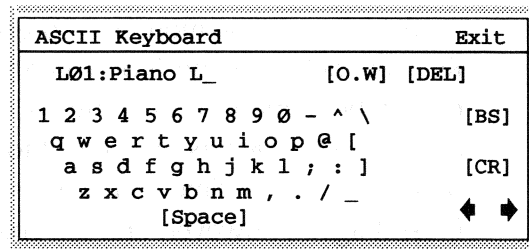

The top line of the **ASCII Keyboard** window shows the name, with Volume ID, colon, and filename. If you are renaming a file that already has a name, that name will be displayed. If you are constructing a new file, the line will contain the last name that happened to be displayed in this window — this makes it easy to name, for example, a new Partial with the same name you just used for a new Patch (and since the files are at different Function levels, there is no conflict). If this is the first time you have entered the window since powering up, it will be blank, except for the colon.

A red “underline” cursor appears on the name line. The position of this cursor shows where you are about to insert a character. Move the cursor back and forth by clicking (with the left mouse button) on the left and right arrows in the lower-right corner of the window. For now, let’s stay to the right of the colon.

When the underline cursor is in position, move the mouse (or front-panel cursor keys) into the “qwerty” typewriter-keyboard area below it. Put the mouse on the letter, number, or punctuation mark (or **[Space]**) you want to insert at the underlined position, and click the left button (or press **S1**). The character will be inserted and the cursor will move one space to the right.

The first time you use this window in a session, it will be in “Overwrite” mode — “[O.W]” will appear to the right of the name. This means that any character you insert on the name line will replace the character previously in that space. If you click on [O.W], it changes to “[INS]”, for “Insert” mode. Now any character you insert will move all characters after it one space to the right. Characters that get pushed off the right edge are lost.

You can also enter or change a character directly on the name line by moving the *mouse* cursor (not the underline cursor) to the position where you want the character to go so that it turns yellow. Use the left and right mouse buttons or **VALUE** wheel to scroll through the available character set until you reach the character you want, and then simply move the mouse cursor away.

And there's one more way to get a character into a position, if you are using an RC-100. Select the position with the mouse, as in the last paragraph, and then press one of the numeric keys on the RC-100. You will notice on the RC-100 control panel there are small letters in red next to each numeric key. These are the letters the key will produce. The first time you press, say, the "2" key, the character produced will be "2". Press it again, however, and the character changes to "D". Press it again and it becomes "E", and another press makes it "F" (only upper-case letters are produced this way). One more press and it goes back to "2", and the cycle starts over again. The **ENTER** key doubles as a Space bar.

To remove a character, click on "[DEL]" (Delete) or "[BS]" (Backspace) with the mouse. Delete eliminates the character above the cursor, while Backspace takes out the character one position *to the left* of the cursor. All characters to the right of the cursor are moved one position to the left.

## The Character Set

The character set available to you includes a full set of upper-case letters (as we just saw with the RC-100) and alternative punctuation. You can get to these by first pressing and holding the *right* mouse button, before selecting a character with the left button. When you press the right button, the "qwerty" area changes to show the upper-case characters. Keep holding the right button while you select the character you want and click the left button. (Here the **S2** front-panel button does *not* duplicate the right mouse button. **S1** can be used for inserting characters, but **S2** will not work as a Shift key.)

## Name Suffixes and Volume IDs

The Suffixes at the end of the filenames are important, and should be left alone for now. For two Samples to be recognized as a single Stereo Sample, for example, they must have identical names except for the "**-L**" and "**-R**" suffixes. Changing or eliminating either of the suffixes will make it impossible for the software to work properly with the Samples. The "**-N**" suffix appears after a Sample is copied, to differentiate it from the original version. When other files are copied, they get a two-letter suffix: "**AA**", "**AB**", etc. Any of these copies can be saved to disk, with or without re-naming.

The Volume ID portion of the name should be left alone. You will only want to change the Volume ID of an individual file in very rare cases — normally, you will set the Volume ID for a large group of files at once. More on this in Chapter 8.



## Executing the Name

When you are done naming the file, click on **[CR]** (Carriage Return). If you have given the file a name which is already in use by a file at the same level in RAM, you will get a “**Please Rename**” window, asking you to try another name. If all is well, the **ASCII Keyboard** window will close, and the new name will be applied to the file currently on the screen. (If it had an “-N” suffix, that suffix will be dropped.) You can now save it to disk under that name if you like.

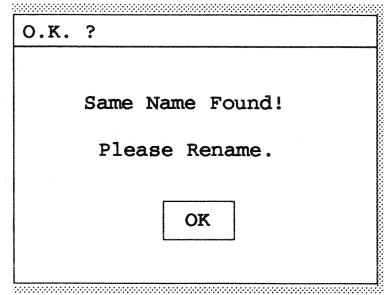

If you do not want to keep the name you’ve created, click on **Exit** (or press the **EXIT** button) and the **ASCII Keyboard** window will close without changing anything.

## Naming Disks and Files on Disks

Although names are applied to new files in RAM, you can also change the name of an existing file after it has been saved to disk. This is done with the **HD/MO File Rename** Function, which is on the **Disk Utility** page. The procedure is essentially the same as naming a file in RAM, and is described in Chapter 9.

You can also name the disk itself. From any Disk page, open the **Drive Select** window by clicking on the **Current Drive** parameter. You can now select and change any of the names of the devices on the SCSI list, even inactive ones. Click on the name of the disk, and the ASCII window opens up. You can name it whatever you like.

You cannot change the first part of the name, before the colon, because it is the SCSI ID number. (SCSI ID numbers are changed elsewhere — see Chapter 10.) You also cannot name a floppy disk — anything you put in the floppy drive will always be known as “Floppy Disk”. And as much as you might like to, you cannot change the name of “S-770 Self”. (It’s colored purple to show you it’s unchangeable.) This would create a very serious identity crisis.

# Chapter 4: Patches

As you've already learned, the organization of the S-770 is complex, and the more you get into it, the more complex (and more interesting) it gets. To guide you through this in as smooth a fashion as possible, we're going to start working with the unit's system software in the middle of the organizational table, and work our way downwards, then we'll go back up to the top. As you go through the manual, you will see how this approach makes sense.

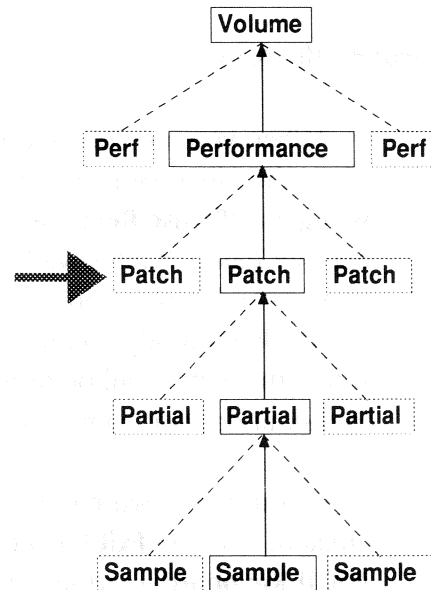

At the top of the **Sound** menu is **Edit Patch**. Patches incorporate Partials, which in turn incorporate Samples. Patches are complete, performable instruments. They have envelopes, they cover the entire keyboard range (if you want them to), they have output assignments, and they can have several MIDI controllers assigned to various parameters for real-time performance control.

When editing a Patch, it can be played from a MIDI keyboard. In most cases the S-770 will be in Omni mode, so the MIDI keyboard can be set to transmit on any channel.

There are several ways to get to one of the **Edit Patch** Function's three Pages:

- open the **Sound** menu and select **Edit Patch**,
- select **Patch** from the **Index**, and **Patch Common** from the subtopic window,
- select any of the other possible topics in the **Index** that apply to the Patch pages, which are numerous, and then selecting the appropriate subtopic (for example, **Panning In...Patch Common**) from the menu that appears,
- use a Jump page that has been previously programmed (Page 2 in Jump Set 1 is **Edit Patch Split** as the unit comes from the factory)
- go through any of the Performance pages. You move from a Performance page by opening the **Com** menu, and then selecting **Edit Patch**. When you call up a Patch page from a Performance page, the Patch page behaves a little differently, which we will explain at the end of this chapter and also in Chapter 8.

In all cases, when you **Exit** a Patch page, you will go back to the page or window you came from: either the **Sound** menu or the Performance page.

## Looking at a Patch — Basic Parameters

Let's start by loading in a new set of Patches to play with. Select **Edit Patch** from the **Sound** menu. Make sure you're looking at the **Edit Patch Common** page. If you're not, click on **Common** at the bottom of the screen or press **F1** on the front panel.

Now Open the **Com** menu, and select **Disk**. Make sure the **Disk Load** page is showing, and set the **Target** parameter to **Volume**. Click on Volume 6, **LØ5:Voices**. If the screen asks if you want to delete all Internal Sound Data, click on **Yes**. When the Volume is done loading, click on **Exit**, and you will be back on the **Edit Patch Common** page.

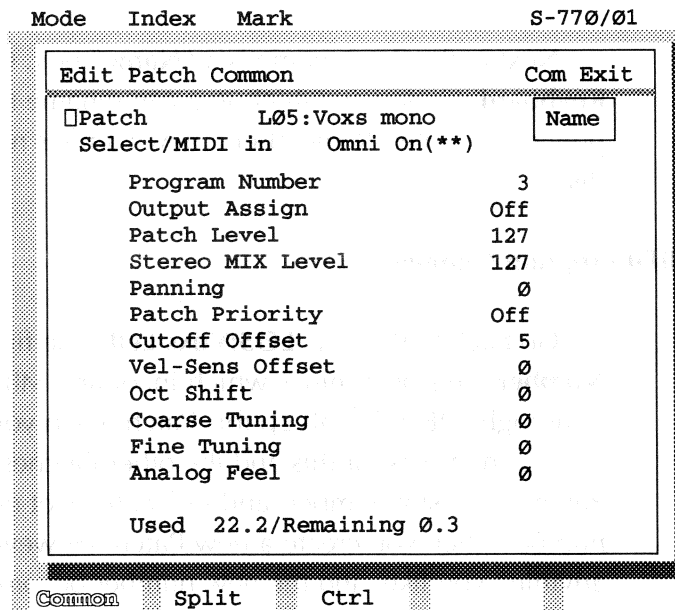

### Selecting the Patch

At the top of the Page, you can select the Patch you want to work on — the “Current Patch” — from any Patch in RAM. Highlight the name of the Patch on the first line of the screen with the mouse or cursor keys, and then move through the list of available Patches with the left and right mouse buttons, **S1** and **S2** front-panel buttons, or the **VALUE** wheel. There are 14 Patches available in the Volume you've just loaded.

Besides a name, every Patch also has a number, denoting its “slot”, or position on the list of Patches in RAM. Generally, you don't see the number (because it doesn't normally appear in the name) unless the slot is empty. If you know that number, however, and you have an RC-100, you can enter the number on the numeric keypad of the RC-100, and then press **ENTER**. The Patch you've designated will appear. For example, press **6**, and **ENTER**. The **Patch** changes to **LØ5:Voixs Sweep m**. Press **1** and **5** and **ENTER**, and the display will show an empty slot, with the number **15**.

There's another way to select a Patch. The word “**Patch**” has a Select Icon next to it, so you can click on it and open a Select window. Here you can view all the Patches currently in RAM and choose one as the current Patch — just click on the Patch's name. You can also sort them alphabetically, or set up a blank Patch from which you can construct a new Patch from scratch.

Back on the **Common** page, below the name of the Patch is the “**Select/MIDI in**” setting. This determines which MIDI channel the S-770 will respond to while you are editing the Patch. For now, it should be set to “**Omni On**” — if it isn’t, select it and hold down the right mouse button until it is. More about this Parameter at the end of this chapter.

Next to the Patch name is a “**Name**” box. Clicking on this opens the **ASCII Keyboard** window in which you can rename the current patch, as discussed in the previous chapter. Remember a new name is not permanent until the Patch is saved to disk.

## MIDI Program Number

Go back to Patch 1, **LØ5:Voxs Left**. The first parameter below the name is **Program Number**. This determines which incoming MIDI Program Change command number, 1 through 128, will call up this Patch when you use it in a Performance. The Program Change numbers for this and the other Patches in the Performance are the same as the Patch’s own slot number, and in fact the slot number is the default Program Change number when you create a new Patch. However, you can change this Parameter to anything you like, and the new number becomes part of the Patch when you save it.

Although obviously it is to be avoided, it is possible to assign the same Program Number to more than one Patch. What happens when this is the case we’ll also deal with in Chapter 8. Be aware as well that Program Changes are used to call up entirely new Performances and even Volumes, as well as Patches, and if there is a conflict — if both a Performance and a Patch are assigned to the same Program Change on the same MIDI channel — the Performance will take precedence, and the Patch will not change. The S-770 has a special “Control Channel” to handle Performance and Volume changing, and it is usually best to avoid changing Patches on that channel. More on this in (you guessed it) Chapter 8.

## Outputs and Levels

**Output Assign** sends the sound of the Patch to one of the six (or eight if you are in that mode) individual analog outputs on the S-770’s back panel. If this parameter is **Off**, then the Patch appears only at the stereo outputs. If it is **P** (the default setting for new Patches), then the individual output assignment is determined by the Partials that make up the Patch (see the next chapter). The current Patch has the individual outputs turned **Off**.

**Patch Level** sets an overall output level, from 0 to 127, for the Patch at all outputs: digital, stereo analog, and the individual outputs.

**Stereo MIX Level** sets an output level (0-127) for the Patch *only* at the stereo outputs (both analog and digital), without affecting the individual outputs. To set up this Patch so it appears only at a numbered output, you would set **Output Assign** to the number of the output, **Patch Level** to 127, and **Stereo MIX Level** to 0.

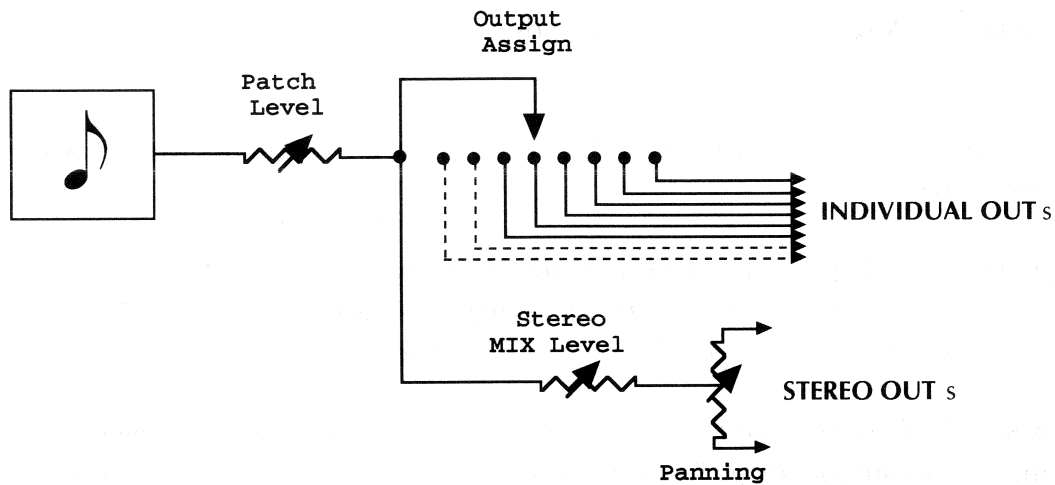

**Panning** moves the sound of the Patch in the stereo field (it does not affect the numbered outputs). The range is L32 (hard left), to 0 (center), to R32 (hard right). This parameter *influences*, but does not replace, similar parameters in the Partials, which we'll discuss in the next chapter. If a Partial has Pan characteristics of its own, then setting this Parameter to L32, for example, will not cause all of the sound to emanate from the left channel only; but it will "bias" the image so that the sound will never emerge any further right in the stereo image than dead center.

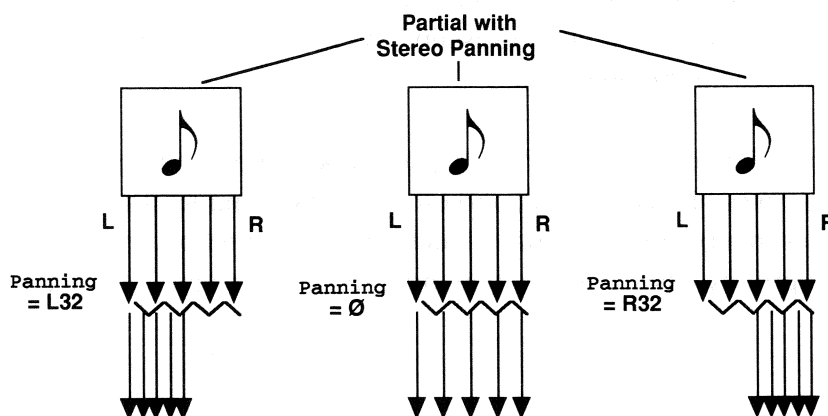

Here's an example. Select Patch 13, **LØ5:Vox Space L**. Its **Panning** parameter is set to **L32**. Play notes on the keyboard and listen carefully to how they place themselves in the stereo field. Each note occurs at a different place between extreme left and center (the placement is not pitch-related, it is random — we'll see how this is done in the next chapter). Change the **Panning** parameter to **Ø**. Notice how the sound now spreads out so that different notes appear across the entire stereo field. Now change **Panning** to **R32**, and hear that the sounds now occur between center and extreme right.

While you're playing with this Parameter, there are two things worth paying attention to:

- First, changing the Parameter does not affect any notes currently sounding — it affects the *next* note to sound after the change. This is true of most S-770 Parameters, although some will change the sound in “real time”.
- Second, the mouse and screen action of the display tends to slow down when one or more notes are sounding. This is because the S-770's central processor, which is controlling both the sound and the visual display, is giving first priority to responding to incoming MIDI data and maintaining the sound quality.

## Patch Priority

This Parameter, if turned **On**, will override the normal “voice-stealing” algorithm of the S-770. The S-770 normally works on a last-note priority basis. It is not impossible, especially when it is being used multitimbrally, to use up all of the S-770's 24 voices, especially if one or more of the voices are layered from multiple Samples. If at any time all 24 voices are in use, and a new note is struck, the note that has been sounding the longest will lose one or more voices to accommodate the new one(s). However, if that oldest-living note belongs to a Patch with Priority turned On, it will not give up any voices, but will continue to sustain. The *next*-oldest-living note will be asked to give up voices for the newcomer.

In normal practice, Patch Priority should be turned on for sustained lead lines and held bass notes (if it is needed), and off for background tracks and drums. Note that if *all* Patches in a performance have Patch Priority turned on, the S-770 will operate on a *first*-note priority basis, and any new notes that exceed the 24-voice limit will be ignored.

## Offsets

**Cutoff Offset** is a bias control that acts on the TVF (Time Variant Filter) in all of the Partial that make up the Patch (see next chapter). The range is –63 to +63. Positive values will make the sound brighter by raising the filter’s cutoff frequency, and negative values will make it duller, by lowering the cutoff frequency. Play with this Parameter in the current patch and see how the tone is affected.

**Vel-Sens Offset** is a bias control that acts on any parameters that are programmed to respond to MIDI velocity, such as the TVF (for brightness) or the TVA (Time Variant Amplifier, for volume), or an envelope’s speed. The range is –63 to +63. Positive values increase the effect of velocity, while negative values dampen it.

Patch number 6, **LØ5:Voxs Sweep m**, can demonstrate how this Parameter is used. **Vel-Sens Offset** is set to 0. Change it to 32. First, play a note softly, and listen to the speed of the sweep filter. Then play the note harder, and listen to the sweep speed up. Now set the Parameter to –32: at low velocities the filter envelope is slow, but at high velocities it becomes *v-e-r-y s-l-l-o-o-o-w-w-w*.

## Tuning

**Oct Shift** changes the position of the Patch on the MIDI keyboard up or down one or two octaves. Another way of looking at it is that it transposes the MIDI data going to this particular Patch by an octave or two. It not only alters the pitch of all of the Partial (relative to MIDI note numbers), but it also moves the Splits up and down (we’ll get to Splits in a moment). For example, if a particular Partial is assigned to the octave C\_3 to C\_4, setting **Oct Shift** to 1 will move that Partial to the octave C\_2 to C\_3.

**Oct Shift** is useful for adjusting the ranges of Patches within a Performance, and makes it easy to set up two Patches to double at the octave, or conversely, to make a unison out of two simultaneous-sounding Patches that are sounding an octave apart. Different Patches in this Volume use different **Oct Shift** settings, and you can hear that they play in different ranges.

**Coarse Tuning** adjusts the pitch of the entire Patch in semitone steps, up or down over a range of 48 semitones (4 octaves). If a note is sounding when you change this Parameter, the note’s pitch will change. Note that Samples have an upper limit beyond which they cannot be transposed higher (normally two or three octaves above their original pitch, depending on the sampling rate), so after a certain point, this Parameter will not do anything.

Unlike the **Oct Shift** parameter, this Parameter does *not* move the Splits. Using our previous example, setting Coarse Tuning to 1 would leave the Partial in the original octave C<sub>3</sub> to C<sub>4</sub>, but those notes would sound a semitone higher.

**Fine Tuning** adjusts the pitch of the Patch in cents, or hundredths of a semitone. The range is  $\pm 50$  cents, or 1/4-tone up or down. You can adjust this Parameter and hear its effect while a note is sounding (which makes it a whole lot easier to use!).

The Tuning Parameters have many uses, including bringing different musical sounds into tune with each other, and creating harmony, doubling, or chorusing effects. Sounds can be tuned at the Partial and Sample levels as well.

**Analog Feel** is a pitch randomizer, which causes each occurrence of a note in the Patch to play at a slightly different tuning. Used subtly, this can be very helpful in making a performance sound more “live”. The range is 0 to 127, with the highest value causing the pitch to vary up to a semitone above or below the nominal pitch. If a Patch contains more than one Partial, the randomization operates independently on each Partial, detuning them so that flanging and chorusing effects can be created. Pitched instruments, especially woodwinds and vocals, work best with small values. Unpitched instruments, like drums, work well with larger values.

The **Used** number tells you how much memory (in seconds at 44.1 kHz) the Samples in the current Patch occupy. The Remaining number tells you how much memory is available after *all* of the Samples in RAM are taken into account.

**Oct Shift = 0**  
**Coarse Tuning = 0**

**Coarse Tuning = 1**

**Oct Shift = 1**

**Oct Shift = 1**  
**Coarse Tuning = 1**



## Splits

The second Page of the Patch Function is **Edit Patch Split**. On this page, PartialS are laid out across the MIDI keyboard in regions called Splits. A Split can be as narrow as one note, and as wide as 88 notes (the range of the S-770). A Patch can contain just one Partial, or as many as 88. Splits cannot overlap (if you want to overlap sounds on a keyboard, you can do it with Patches at the Performance level — see Chapter 8). However, the same Partial can be assigned to different, non-contiguous regions of the keyboard. Not every note on the keyboard must be part of a Split, and any notes that are not assigned to a Split will make no sound.

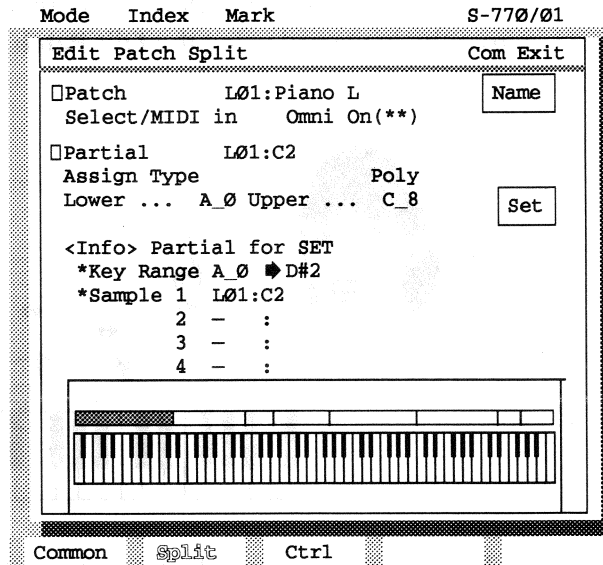

## Multisampling

Splits are used for several purposes. When you are trying to reproduce the sound of a natural instrument that covers a wide range, one Sample of the instrument rarely will be sufficient. A Sample that is transposed too far up or down from its source pitch often will suffer from the “chipmunk” effect — the formal technical name for this is “munchkinization” — in which it sounds like a tape recording of itself being played at the wrong speed (which is essentially what is going on, although there’s no tape involved).

The transposing distance you can get away with from a single Sample will vary widely depending on the nature of the Sample: a grand piano, with its rich, out-of-tune harmonics, will start to sound unnatural if you transpose it more than about a minor third (three semitones); while a vocal “ooh” Sample can sometimes be transposed an octave or even more before it sounds strange. Samples generally transpose downwards better than they do upwards, and in some cases, with low-pitched Samples, you can safely do very large downward transpositions. The S-770 will not let you transpose a Sample up more than two (or three if it was sampled at a low rate) octaves. (If you really need to do so, however, you can transpose as much as you want with the Rate Convert or Resampling functions — see Chapter 7.)

Therefore, a technique known as “Multisampling” is used with many sounds, in which a different Sample is taken at regular intervals up and down the scale. In the S-770, each of those Samples is put into a Partial, and then the Partials are mapped across the keyboard using the **Edit Patch Split** page.

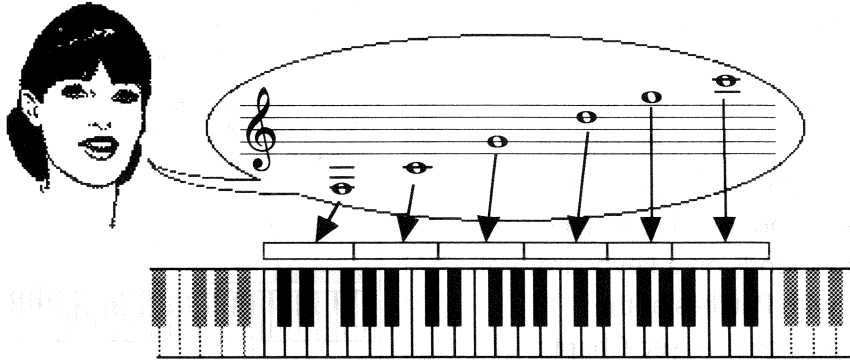

Because you can usually transpose a Sample down further than up, the original pitch of a Sample will typically be mapped at or near the top of a Split range — for example, a Sample of a piano playing E5 may be assigned to the notes from C#5 to F5, and another Sample of the piano playing A5 will then be assigned to the notes F#5 to A#5, and so on.

When a Sample is recorded, it has an “Original Key” parameter, which usually corresponds to the pitch of the Sample — for example, if a sound at 440 Hz is sampled, its Original Key would normally be set to “A\_4” (A above Middle C). If the Original Key does not match the pitch, then when you place the Sample (actually, the Partial containing the Sample) into a Split, it will be way out of tune, and will suffer from munchkinization. You *cannot* adjust the relative pitch of a Sample within a Patch — you can only adjust the tuning of the Patch as a whole — but you *can* do it at the Partial level (next chapter).

To see a Multisample in action, load in the Patch **LØ1:Piano L** (open the **Com** menu, select **Disk**, make sure you’re on the **Disk Load** Page, set **Target** to **Patch**, and click on **LØ1:Piano L**). To avoid any confusion, click on **Yes** when it asks if you want to Clear Internal Memory. Be sure the **Target** is not **Patch PRM**, or you will load in only the Patch parameters without any of the right Partials or Samples.

**Exit** back to the Patch Split page, and move the cursor to the Partial name, which is to the right of the word **Partial**. Scroll through the Partials that make up this Patch. As you do so, the keyboard region where each Partial is assigned will show as a red area in the larger of the two horizontal “bars” just above the picture of the keyboard. Other Partials that are assigned to keys in this Patch will show as yellow areas in the horizontal bar, and areas that are not assigned will be in white.

## Drum and effects mapping

Another reason for using Splits is to be able to play totally different sounds from different notes within a Patch. A common example of this is a drum set, in which each note plays a different drum. Another example is a set of sound effects residing in RAM, which are called up using a MIDI sequencer locked to SMPTE timecode on a videotape. Each sound effect can be assigned its own note, so getting one to fire at the proper time is merely a matter of telling the sequencer to play its note at the prescribed SMPTE time. (In both of these instances, you don't want the actual note number to change the sound's pitch, so the **K.F** [Key Follow] parameter on the **Partial Common** page for that Sample should be set to **Off**. But that's the next chapter.)

A good example of a individual sound-mapped Patch is **LØ7:TR-808!** No fewer than 19 Partials are used in this Patch, and several of them are arranged in non-contiguous Splits. All of the Splits are a single note wide.

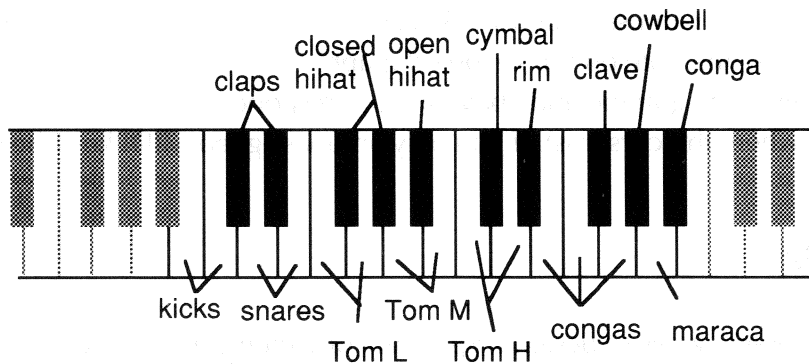

## Examining the Split

The Split page gives other important information about each Partial in a Patch, which appears in blue. This includes the **Samples** (up to four) that are in each Partial, and the overall **Key Range** for that Partial. If the Partial is mapped to two or more non-contiguous regions in the Split, only one key range will be displayed: from the lowest note of the lowest region to the highest note of the highest region. The **(Info)** line says "**Partial for SET**", meaning that the information being given is for the Partial named in the **Partial** parameter, close to the **Set** switch.

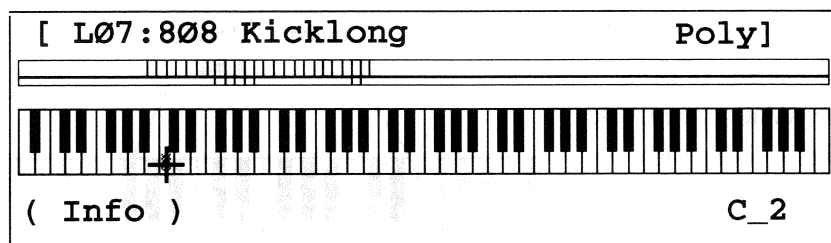

There are various ways to look at how the Partial is laid out in a Split. As described above, you can scroll the **Partial** parameter to see where the Splits are. Note that there is a Select Icon next to the word **Partial**. Click on it, and you will open a Select window from which you can choose any Partial in RAM, and see if and where it belongs in the current Patch — areas of the keyboard assigned to that Partial will show a red area in the horizontal bar above the keyboard graphic.

You can also use the mouse to move the cursor over the keyboard graphic. As the cursor passes over each key, the name of the Partial assigned to that key and other information appears in the box around the keyboard. The **(Info)** line changes to read “**Partial in Patch**”, telling you the **Key Range** and **Sample** list now refer to the Partial you’re pointing to on the keyboard. Click the left mouse button on a key, and you can hear the Partial assigned to that key. (Notice that in order to access a white key, you must put the mouse cursor on the lower part of the key.)

Additionally, you can use your MIDI keyboard. Playing a note that is assigned to a Partial will display the note on the keyboard graphic on the screen, and will also change the **Info** in the graphic and above it to correspond to the Partial being played (regardless of where the cursor is). If you play an unassigned MIDI key, the screen will not respond.

## Designing the Split

There are several ways to design a Split, any of which can be used in conjunction with any other. The first step in all of them is to use the **Partial** parameter and the mouse buttons to select the Partial you want to assign to a region of the keyboard. We’ll look at the Patch we’ve just loaded as an example.

## Using Parameters

One method for designing a Split is to select a Partial and set its range using the **Lower** and **Upper** parameters. They can be adjusted with the mouse buttons, panel buttons, **VALUE** wheel, or numeric keypad (by entering the MIDI note number). The lowest note you can use is **A\_0** (21) and the highest is **C\_8** (108). Note that these parameters are *inclusive*, which means that the low- and high-limit keys are included in the Split. If you set both limits to the same note, the Split will consist of only that note. When you click on the **Set** switch, the Partial assignment goes into effect.

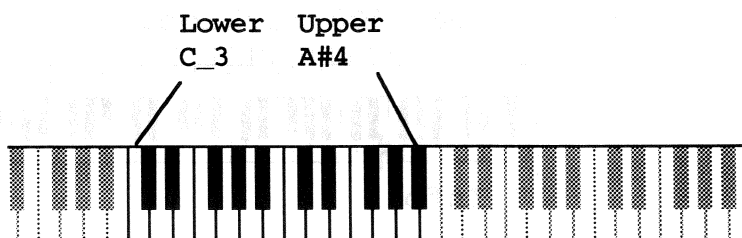

Let's try one. In the **Partial** parameter, select the third Partial in the **TR-808!** Patch, **808 Claps 1**. (We can dispense with Volume IDs by now, okay?) If you look carefully at the larger horizontal bar above the keyboard graphic, you'll notice a small area directly above C#2 has turned red. Move the mouse down to that note to confirm this visually (watch the text inside the box) and audibly (click the left button).

Now let's design a new Split for this sound. Set **Lower** to **G\_5** and **Upper** to **B\_5**. Click on the **Set** switch. You'll see a new red area appear in the bar far up the keyboard. If you click on any of the notes in that area (or play any of them on the MIDI keyboard), you'll hear the handclaps. (The pitch doesn't change because this Partial has its **Key Follow** parameter turned off.) Notice the original Split is still in effect.

Try this with other Partials in the Patch, assigning them to different regions. Set the limits and the Partial, and click **Set**. If you assign a Partial to a note that has already been assigned, the latest assignment will take precedence. For example, if you set **606 Tom L** to D#5 and F#5, and then set **606 Tom M** to F5 and G#5, the result will be that the low tom sound will be heard on D#5 and E5 only, and the high tom sound will start at F5.

To remove one or more notes from a Split, set their lower and upper points and assign them to a different Partial or, if you want nothing to sound on those notes at all, set the **Partial** parameter to "**—Off—**" and assign them to that. (You could also assign them to an unused Partial, but that would be dangerous if you used that Partial slot later on.) You can de-assign notes using the mouse and the graphic display, which we'll get to in a moment.

## Using the MIDI keyboard

You can also design a Split using the MIDI keyboard. After you've selected the **Partial**, move the mouse so it is away from any

parameter or Page switch, and also outside the box surrounding the keyboard graphic at the bottom of the screen. Press and hold the right mouse button. (If you have a foot-switch plugged into the S-770, you can instead press and hold the foot-switch.) The message "**(Set by MIDI)**" will appear in red below the keyboard graphic.

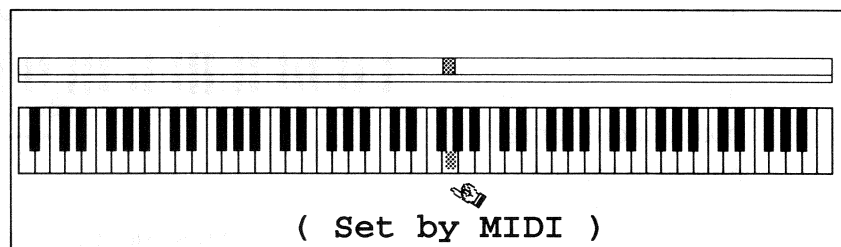

Now play all the notes within the range that you want this Split to cover. You can play a chromatic scale, or skip some notes if you like, or even play individual notes anywhere on the keyboard. As you play each note, the larger horizontal bar above the note's image in the keyboard graphic will turn red. When you've played all the notes you want to include, let go of the mouse button (or footswitch).

For example, select **808 Cymbal** (number 11) as the current **Partial**. Move the mouse to the middle of the screen, but away from any of the Parameters, and press and hold the right button. When you see "**(Set by MIDI)**", play some notes that you'd like to assign the Cymbal. As you play, if there are any Partials assigned to a note *previously*, you will hear that old assignment, which is about to be discarded. If a note has not had a previous assignment, you will hear nothing.

When you're done, let go of the right mouse button. Now when you play notes in the new Split you've just defined, you will hear the cymbal (which, again, plays at a constant pitch).

### Using the graphic display

A third way to set up a Split is to use the graphic display directly. Set **Partial** to the Partial you want to place. Move the mouse cursor onto the graphic keyboard, and press and hold the *right* button. The name of the current Partial will appear just above the keyboard, and the text in the lower-left corner of the box will change to "**(Set)**".

Put the mouse onto one of the keys on the keyboard that you want to include in this Split. Still holding the right button, press and hold the *left*

button. All the text now turns red. Holding both buttons, drag the mouse to the left or right. A little line graphic appears just above the keyboard and follows your motion. In addition, the text at the lower-right corner of the box tells you what note the mouse cursor is on. Any old assignments made to the keys you're going over will

sound, just to say goodbye.

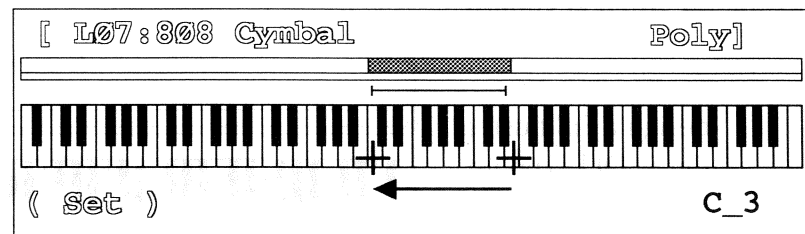

**press right button, select high note,  
press left button, drag to low note,  
release left button, release right button**

Still holding both buttons, continue to drag to the end of the note range you want included in this Split. Let go of the *left* button. The horizontal bar will then fill in red over the range you've just defined. Notice that *all* notes in the range, black and white, are included. Now let go of the right button.

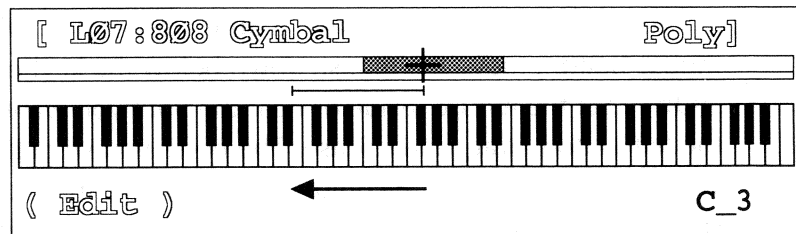

If you grab the end of a range at the wrong place, or you just decide you don't want to assign these notes to the Partial, let go of the right button *first*, and nothing will be set.

To check your work, drag the mouse (without holding any buttons) up and down the keyboard. The lower-left text in the graphic box will say "**(Info)**", the lower-right text will show the note position of the cursor, and the upper line of text in the box will show the name of the Partial assigned to the note where the cursor is currently located. Press the left mouse button and you can hear the note. (The MIDI keyboard is also always active for monitoring.)

You can also expand or reduce an existing Split in the graphic window. To expand a Split, press and hold the *right* mouse button, and move the mouse vertically above the keyboard, into the larger of the two horizontal bars, until the lower-left text changes to "**(Edit)**". Then move the mouse horizontally until it's inside the range of the existing Split, and — still holding the right button — press and hold the *left* mouse button. Now drag to the left or right out of the Split range. The linear graphic you saw earlier appears, and the lower-right text tracks your motion. (If there are any old assignments, you will hear them say goodbye.)

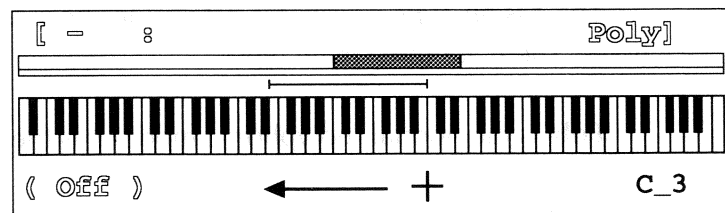

When you've dragged the mouse to the key where you want the range to extend to, let go of the *left* button. The colored region of the horizontal bar will expand to show the new notes in the Split. Note that the region will only be red if the **Partial** parameter is the same as the Partial in the Split you just expanded — otherwise it will be yellow.

If you're watching closely, you may notice that all of these procedures assign both a Partial and a Type to the selected region. Don't get confused — we'll deal with Types next.

You can de-assign notes from a Split graphically. When you first grab the right mouse button, move the mouse *down* below the keyboard until the lower-left text says "**(Off)**". Set the mouse inside or near the Split you want to take notes away from, hold the left button, drag, and release. The notes you've outlined will now be removed. Unlike the "expansion" technique you just saw, this "removal" technique is not Split-specific — you can drag the mouse across any part of the keyboard, and wherever it goes, the notes will be removed from Splits — so if you want to erase an entire keyboard of Splits in a hurry, drag the mouse across the whole thing. You can also de-assign a single note by moving the mouse below that note, holding the right button and clicking and letting go of the left button without dragging.

Try these techniques with some of the **TR-808!** partials. If you really screw things up, remember that nothing is permanent on the S-770 until it gets saved to disk, so feel free to re-load the original version of the Patch whenever you want, and you can wipe out all your experiments. If you want to save them, feel free to do that as well (using the **Disk Save** page), only be sure to change the name of the Patch first. Since you are not changing any Samples, alternate versions of the Patch will not take up any additional room on the disk where you save them.

## Assignment Types

The **Assign Type** parameter determines how a Split will respond to multiple MIDI notes. There are three main types.

**Poly** is the normal, polyphonic mode. It is the default mode.

**Mono** is a special mode which normally behaves like Poly, except when you play the *same* note twice. If the note has a long envelope (TVA) release, or if you are holding the Sustain pedal, you will hear the note cut off and be re-triggered. It can be used for that well-known st-st-st-stuttering effect. On the other hand, if a sound has a fast release, playing it in this mode will not sound much different than **Poly** mode.

**Exc** (it stands for "exclusive") is an expanded version of what you might normally think of as Mono mode: notes within a Split of this type can only sound one at a time. However, there is not just one **Exc** mode — there are 16 of them, and each one is independent of the others. So you will be able to play only one note within a Split whose Type is **Exc1**, and only one within a Split whose Type is **Exc2**, but you can play those two notes simultaneously.



Our **TR-808** patch contains an example of an **Exc** assignment. Play the note A#2 (with the mouse or a MIDI keyboard). It's an open hihat, with a long envelope. Now play G#2. It's a closed hihat. If you play A#2 first, and then quickly play G#2, the second note will cut off the first, just as a real hihat stops ringing when you close it. If you put the mouse on those keys, you will see they both have an **Assign Type** of **Exc 2**, in other words, they belong to the same exclusive group. A little investigation will show that F#2 (which is also closed hihat) belongs to **Exc 2** as well, as does A3 (maraca). Therefore, playing any of these notes will cut off any others in the group that are sounding.

Let's make a change. C#3 is a ride cymbal. Why not make it part of the same group? Set **Lower** and **Upper** both to **C#3**, set **Assign Type** to **Exc 2**, and set **Partial** to **808 Cymbal**. Click on **Set**. Now, any of the other sounds in the group will choke the ride cymbal.

Normally speaking, **Partials** and **Types** are assigned to a **Split** at the same time, but if you like you can change the **Type** of a **Split** without changing its **Partial**. Here's an example. From the **Disk Load** page, load in **L04:Pick Bass 1** Patch (clear RAM if you have to). Go back to the **Split** page.

This Patch consists of only two **Partials**, both in **Poly** mode. But if we wanted to simulate a real bass guitar, we would break the Patch up into four exclusive regions, each one representing one string. You can't play two notes on one string, right? But you can play all four strings at the same time. Instead of using real bass string ranges, however, let's expand them a bit. Do the following, clicking **Set** between each operation:

Assign Mode = Poly

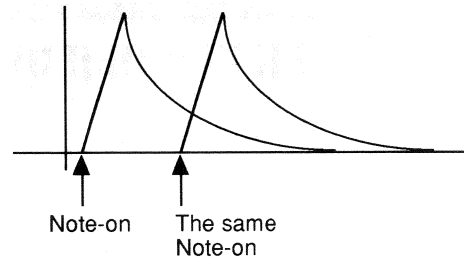

Assign Mode = Mono

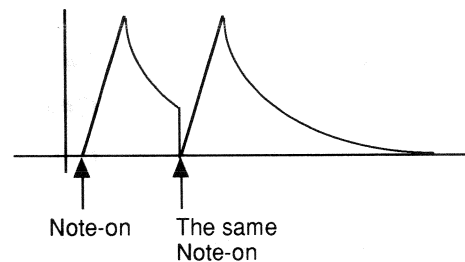

Assign Mode = Exc n

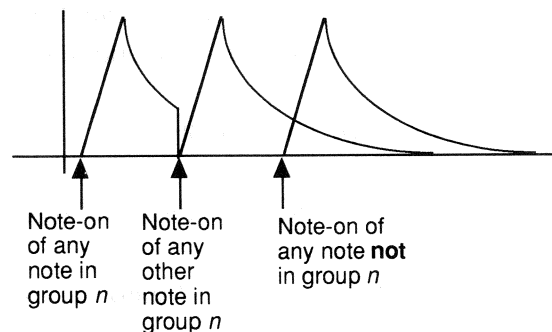

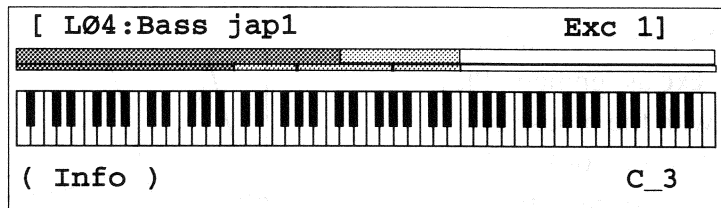

<u>Partial</u>	<u>Lower</u>	<u>Upper</u>	<u>Assign Type</u>
Bass jap1	A_Ø	C_3	Exc 1
"	C#3	G_3	Exc 2
"	G#3	C_4	Exc 3
Bass jap2	C#4	G_4	Exc 3
"	G#4	E_5	Exc 4
—————Off—————	F_5	C_8	

So now we have a bass guitar that has four “strings”, and one of the strings (**Exc 3**) uses two different Partials.

Another way to set up a Split might be to simulate a saxophone, using a number of Samples (ranging all the way from Bass Sax to Soprano Sax), but all assigned to a single **Exc** group, so that only one note can sound at a time.

### Setting the Type Graphically

The bottom (smaller) horizontal bar above the keyboard graphic shows the Type. The color-coding will be determined by the setting of the **Assign Type** parameter: if it says **Mono**, areas in **Mono** will be red, while notes belong to one or another **Exc** group will be in yellow. If it is displaying an **Exc** number, areas in *that particular Exc* group will be in red, while notes in other groups or in **Mono** will be in yellow. Areas in white are either unassigned, or in **Poly**.

We saw earlier that when you make a Split assignment graphically, both a Partial and a Type get assigned. However, using the lower horizontal bar, you can change the region of a Type without changing the Partial assignment, so that you can, for example, move other sounds into an **Exc** group.

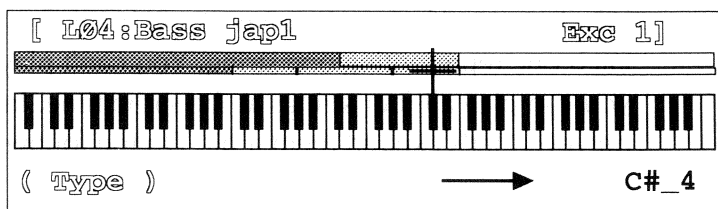

Move the mouse into the lower bar, and press the right button. The text in the lower-left corner of the graphic box changes to “**(Type)**”. Now move into a region that has been assigned a Type whose range you would like to expand. The upper-right corner will tell you the Type. Still holding the right mouse button, press the left button and hold it. Those two bits of text turn red. Holding both buttons, drag the mouse left or right to the point at which you want the expanded region to end (any assigned notes will speak as you do this). Let go of the left button, and then the right. The new region is set.

There is no “Off” mode in Type Assignment. If you wish to *remove* a region from an **Exc** group, make it **Poly**. Do this by selecting an adjacent **Poly** region and expand it into the **Exc** group as far as you need. If there is no adjacent **Poly** region adjacent to a group you wish to shrink, you’ll have to do it the old-fashioned way, setting the **Upper**, **Lower**, and **Assign Type** parameters by hand.

## Renaming Partials

Once you’ve finished designing a Split, you can change all the names of the Partials in it to the same name as the Patch itself, with various suffixes. This can help quite a bit to keep things organized when you’re working with lots of Partials. More on this at the end of this chapter.

## MIDI Control

The S-770 allows much in the way of real-time MIDI control over various sound functions. This control is set up on the third Patch-editing Page, **Edit Patch Ctrl**. These MIDI assignments work globally on all of the Partials in the Patch.

## Controllers and controllers

Before we go any further, let’s distinguish between a MIDI *Controller* (upper-case “C”) and a MIDI *controller* (lower-case “c”). The distinction is subtle, but important. In this manual, upper-case Controller refers specifically to one of the 121 Continuous Controllers defined in the MIDI Specification. These include Modulation Wheel (#1), Breath Control (#2), Volume (#7), Sustain pedal (#64), Registered and Non-registered Parameters, unassigned Controllers, etc. etc. Lower-case controller refers to *any* MIDI message that contains data which can change over time, which includes all the Controllers, *plus* Pitch Wheel, Channel Pressure (also known as monophonic aftertouch), and Key Pressure (polyphonic aftertouch). So “Controllers” is a subset of “controllers”.

And just to make things more complicated, “MIDI controllers” (lower-case again) can also refer to a MIDI performing device, like a keyboard, drum pad, guitar, wind controller, etc. Fortunately, this usage will be obvious in context.

## The Parameters

Back to our screen. On the top line, as usual, you select the Patch you want to work on. On the second line you can select the MIDI channel the S-770 will respond to, but the setting is not completely straightforward, so best to leave it on **Omni** for now.

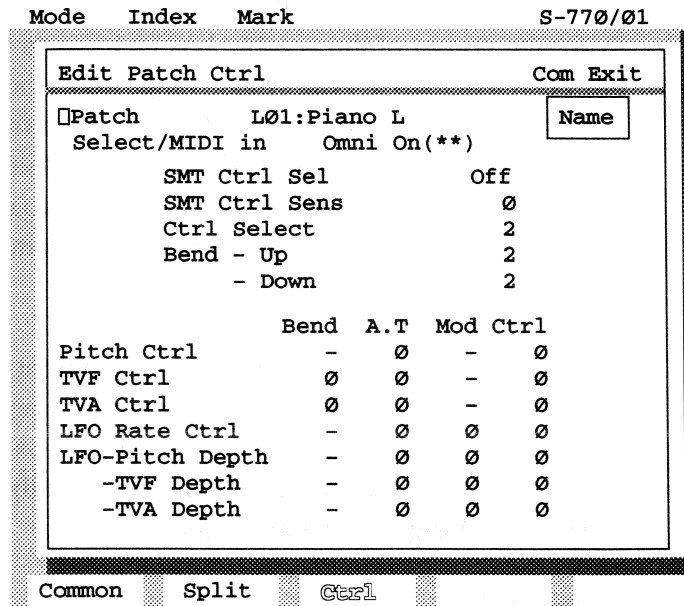

## Sample Shifting

**SMT Ctrl Sel** stands for “Sample Mix Table Control Selection”, and **SMT Ctrl Sens** stands for “Sample Mix Table Control Sensitivity”. The Sample Mix Table is a feature of each Partial (that’s right — next chapter), which allows velocity-based switching and crossfading between two or more Samples in a Patch — so that hitting the note harder not only changes the volume, it can also change *which* Sample is playing. These parameters allow this Sample-changing feature to be controlled not only by velocity, but also by a MIDI controller (that’s the lower-case “c”). That way the MIDI controller can act as a real-time “fader” between the sounds, changing the sounds *after* the key is struck which is, of course, impossible to do with velocity, since any single note only gets one velocity value.

There are four choices (besides **Off**) available for **SMT Ctrl Sel: Bend** (Pitchbend), **A.T** (Aftertouch), **Mod** (Modulation Wheel, Controller #1), and **Ctrl** (a Controller number to be named later). The **Sens** parameter determines how much influence this control will have over the SMT. The range is -63 to 63. At 0, it will not affect the SMT at all. At positive values it will add to the velocity, and at negative values it will subtract from the velocity.

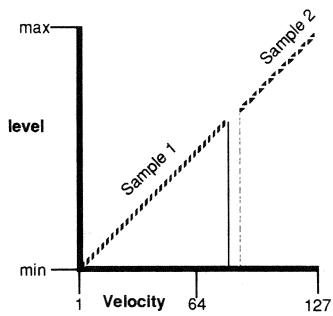

Velocity switching using Sample Mix Table (SMT) with  
**SMT Ctrl Sens** set to 0

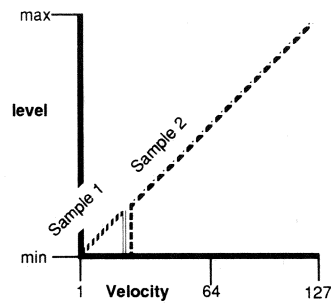

Velocity switching using Sample Mix Table (SMT) with  
**SMT Ctrl Sel** set to Mod,  
**SMT Ctrl Sens** set to 63,  
and Modulation wheel at full value

The controller doesn't replace the velocity control over the SMT, but it does "bias" it, by adding (or subtracting, if the **Sens** parameter is negative) its own current value to the velocity. For example, if **SMT Ctrl Sel** is set to **Mod** and **Sens** is set to 63, and you move the modulation wheel to its full-on position, the effect on the SMT will be as if there are no velocities being produced below 63, and only the Samples mapped to the upper portion of the SMT (above 63) will sound. If **Sens** is set to -63, then the effect will be as if no velocities are being produced by the keyboard higher than 64 — that is, 127 (maximum MIDI velocity) minus 63.

Let's try one. Load in from the hard disk Patch number 73, **LØ7:LA Fat Kit**. On note A#2 is an open hihat (it's quite different from the one in **TR-8Ø8!**). Listen carefully to the sound as you play it. When you play the note with a low velocity, it sounds like a small cymbal. When you play with a high velocity, however, it acquires a distinctly pitched "ring". That's because this sound is actually two Samples, one without the ring and one with, and they are arranged on the Partial's Sample Mix Table so that the ring sounds when the note is played above a certain velocity.

The SMT Ctrl parameters can change where that velocity break point is. Set **SMT Ctrl Sel** to **Mod**, and **SMT Ctrl Sens** to **63**. Now play the note with a steady, medium velocity, and slowly advance the modulation wheel on your keyboard. At a certain point you will hear the plain cymbal sound switch over to the ring sound, even if the velocity is rock steady. The harder you play, the sooner that point will come, and conversely, the higher the wheel setting, the softer you need to play to make the change.

Note that when **Bend** is selected for **SMT Ctrl Sel**, it will *either* add to *or* subtract from the velocities, depending on whether you move the Pitchbend up or down.

## Stalking the Wild Controller

The next Parameter on the page is **Ctrl Select**, and this is the previously-mentioned “Controller to be named later”. The S-770 responds to Pitchbend, Aftertouch, and Modulation Wheel in fairly normal ways, plus one other “wild” controller per Patch. This parameter determines the nature of the “wild” controller. It can be any MIDI Controller number 0 to 95 (higher Controllers are reserved for System Mode messages). This controller can then be assigned to any of a number of parameters, including **SMT Ctrl Sel**.

Note that this Parameter only affects this Patch, and other Patches — even if they’re used at the same time in a Performance — can have different wild controllers, which can give you a lot of flexibility.

## Pitchbend

**Bend-Up** and **-Down** are the range, in semitones, of the Pitchbend control for this Patch. They can be set anywhere from 0 to 48 (four octaves). Remember that Samples in the S-770 cannot be transposed more than two or three octaves up from their original pitch, so extreme settings for **Bend-Up** may not give you quite the results you expect. If you want to use the Pitchbend control for something other than pitch bend (such as SMT control), here’s where you can turn it off.

## The controller Matrix

At the bottom of the page is a matrix of MIDI controllers and the possible effects they can have on the sound. Across the top of the matrix are the controllers, which are the same as the ones available for SMT Control: Pitchbend, Modulation Wheel, and the Wild Controller. Aftertouch in this case can be either monophonic (Channel Pressure) or polyphonic (Key Pressure), depending on the settings of the **MIDI Filters**, which are discussed in Chapter 8. At the left side are the “Control Destinations”.

The Control Destinations are discussed in detail in the next chapter (except **Pitch Ctrl**, which is easy).

**Pitch Ctrl** — what the Pitch Wheel normally does, you can also do with Aftertouch and the wild controller. Letting Aftertouch do small amounts of pitch changing gives you real-time “finger vibrato” (and using polyphonic Aftertouch, so you can do it on a note-by-note basis, is particularly cool).

**TVF Ctrl** — this increases or decreases the effect of the Time Variant Filter, which we met earlier when dealing with the Cutoff Offset parameter on the Common page. It essentially controls the Patch’s brightness.

**TVA Ctrl** — increases or decreases the effect of the Time Variant Amplifier, or volume envelope, which we also met on the Common page. This essentially deals with overall volume. (Note, however, that MIDI Controller #7 — Volume — is *always* responded to by the S-770.)

**LFO Rate Ctrl** — influences the vibrato rate(s) of the various Partials. Each Partial has its own vibrato rate, and this will increase or decrease all of them at the same time (but it will not make them all the same). The vibrato LFO can be set to change pitch, volume, or timbre on the **Edit Partial LFO** page.

**LFO-Pitch Depth** — increases or decreases the effect the LFO has on pitch. This has two default settings: under **A.T** it is 35, and under **Mod** it is 30. This means that in a new Patch, aftertouch and modulation wheel both control the pitch change of the LFO.

**-TVF Depth** — increases or decreases the effect the LFO has on timbre (“wah-wah” effect).

**-TVA Depth** — increases or decreases the effect the LFO has on volume (what guitar amplifier manufacturers used to call tremolo).

When a “-” appears in the matrix, it means that that controller cannot be used to influence that Control Destination. For instance, **Bend** cannot be assigned to **Pitch Ctrl**, because it already is (using the **Bend-Up** and **-Down** parameters). A “Ø” in the matrix means the controller can be assigned to that Control Destination, but isn’t at the moment. All of the matrix entries have a range of -63 to 63. Negative values affect the Control Destination upside-down.

### Some examples

Play around with this Page by loading various Patches into RAM (drum sounds won’t do much — try vocal and string sounds), and creating MIDI controller mappings for them. Here are some examples you might find useful.

This mapping lets Modulation Wheel control vibrato depth while Aftertouch controls vibrato speed.

<u>Controller</u>	<u>Target</u>	<u>Setting</u>
<b>A.T</b>	<b>LFO Rate Control</b>	63
<b>Mod</b>	<b>LFO-Pitch Depth</b>	63

This mapping lets Foot Pedal control the brightness while Aftertouch imparts a bit of vibrato onto the timbre. (Set **Ctrl Select** to 4.)

<u>Controller</u>	<u>Target</u>	<u>Setting</u>
<b>Ctrl</b>	<b>TVF Ctrl</b>	63
<b>A.T</b>	<b>LFO-TVF Depth</b>	25

This mapping brightens the timbre of a sound when you apply Aftertouch — sort of a finger-pressure wah-wah effect — and at the same time reduces any pitch vibrato already on the sound.

<u>Controller</u>	<u>Target</u>	<u>Setting</u>
<b>A.T</b>	<b>TVF Ctrl</b>	63
<b>A.T</b>	<b>LFO-Pitch Depth</b>	-20

### Combining controllers

If more than one controller is mapped to a Control Destination, they will both be operable. However, if you send data from two controllers that are mapped to the same Control Destination at the same time, what happens is not what you might expect. Instead of the *last* controller event being the operative one (which is how MIDI deals with the world), the two controllers work together, and their values are *added* together to determine the effect on the Control Destination.

Here's an example: Assign **A.T** to **LFO-Pitch Depth** with a setting of 63, and do the same thing with **Mod**. Play a MIDI note and hold the key down lightly. Now move the Modulation Wheel to its full-on position (value 127), and you will hear a certain amount of pitch vibrato. Now press down hard on the key, and the vibrato depth will increase. When you back off the pressure on the key (still holding it down), even though the Aftertouch goes to 0, you will still hear vibrato, because the Modulation Wheel is still full on, and the two controllers are being added together.

### MIDI Settings at Lower Function Levels

Before we finish with Patches, it must be mentioned that any settings made on the **Edit Patch Ctrl** page *will be in effect when you move lower down through the S-770's organizational structure*. If you are editing a Partial or Sample and want to play it from a MIDI keyboard, the way that the Partial or Sample will respond to incoming MIDI data will be dictated by the settings on the **Edit Patch Ctrl** page that belong to the *last Patch selected* on any Patch Edit page.



Therefore, if you select a Patch whose **Bend-Up** is 13, and which maps Aftertouch to TVA rate and Breath Control to TVF, and then go to edit a Partial, all those MIDI controllers will be active — even if the Partial you’re editing has *nothing at all* to do with the last Patch you looked at.

If you haven’t been on any Patch Edit page since you booted up, then default settings will be in effect: **LFO-Pitch Depth** under **A.T** is 35 and under **Mod** is 30; all other sensitivities are set to 0; **SMT Ctrl** is Off; and **Bend-Up** and **-Down** are both set to 2. As always, Controller #7 — Volume — is responded to.

It should also be mentioned that, because Performances are made up of Patches (see Chapter 8), and it is quite possible for a particular Patch to appear in more than one Performance, if you change a Patch in any way, that change will be effective in every Performance in which the Patch is used. If you are unsure of whether a Patch has multiple uses, to be safe you can make a copy of it (we’ll get to how to do this in a moment) and work with the copy. You can even save the copy to disk — unless you have altered any of the Samples within it, it will not take up any extra disk space.

## The “Part” Parameter

The **Part** parameter on the **Patch Common** page is used primarily when working on Patches within a Performance, and it will be discussed in that context in Chapter 8. It serves as a kind of MIDI channel filter. Normally speaking, it will be set to **Omni**. This means that the Patch on display will respond to all MIDI data coming into the S-770, on all channels.

When you’re playing the Patch from a keyboard, this is fine. But what if you are working with a sequence, which has data on several MIDI channels at once, and you want to edit the Patch? If you just go to this page as it is, the Patch will respond to every incoming MIDI note, which would be awfully confusing. You can filter out the unwanted tracks by changing the **Part** parameter.

When you set **Select/MIDI in** to **Part 1**, the S-770 no longer responds on all channels, but instead only responds to data on the MIDI channel which is assigned to Part 1 in the current Performance. The current Performance is the Performance that was displayed the last time you accessed one of the Performance pages. If you haven’t accessed a Performance page since boot-up, the current Performance is the default Performance.

A Performance contains up to 32 Parts. In the default Performance, the first 16 Parts are set to the 16 MIDI channels, respectively. Parts 17 through 32 are assigned to no MIDI channel. So when you set the Parameter to **Part 1**, the S-770 will respond only to data on MIDI Channel 1 (unless you've changed the MIDI assignment of Part 1 at the Performance level — but of course you haven't, because that's in Chapter 8 and you are reading this manual in order, aren't you?). If you change the **Select/MIDI in** parameter to some other value, the MIDI channel the S-770 will respond to will appear in parentheses: e.g., "**Part 6( 6)**". If you set it to a Part which has no MIDI Channel assignment, you will hear no response at all.

## Other Patch Functions

Several other functions that affect Patches are available through the **Com** menu on any of the **Patch Edit** pages.

### Disk

The **Disk** function (**Load, Save, Copy, Delete, Util**) is the same as in other modes and is described in Chapters 3 and 9. When you **Load** a Patch, it loads in all subsidiary Partials and Samples, unless you set the **Target** to **Patch PRM**, in which case it loads in only the Patch parameters, but not the Partials or the Samples. This way an existing Patch can easily be used as a template to organize a different set of Samples.

When you **Save** a Patch, any new Samples or Partials you have created get saved with it. In addition, any old Samples or Partials that are subsidiary to the Patch will be saved as new files if you have changed the name or the **Volume ID** since you loaded in those files from disk (see Chapter 8). If you delete a Patch from disk, all subsidiary Samples and Partials are deleted as well, unless they are being used in another Patch and the **Fast Delete Mode** switch is **Off**.

### Copy

**Copy** lets you make a duplicate of the Current Patch into another slot in RAM. This allows you to make multiple clones of a Patch easily which can then be edited individually, or to allow you to keep the original version of a patch safe while you edit it. (The same function can be performed by changing the name of a Patch and then re-loading the original version from disk into a different slot, but this is much quicker.)

Command	Exit
<b>Disk</b>	
<b>Copy</b>	
<b>Delete</b>	
<b>Initialize</b>	
<b>Rename Partials</b>	
<b>Partial Map</b>	
<b>Edit Partial</b>	
<b>Sampling</b>	

To make a copy of the Current Patch, choose a slot to copy *into* from the **Copy** window.

The duplicate has two letters added to its name: the first copy will have “**AA**” tacked onto the end; the second will have “**AB**”, etc. You can freely copy copies, and the alphabetic progression will continue regardless of whether you are copying an original or a copy.

If the slot you are copying into is occupied by another Patch, that Patch will be deleted. If the slot is occupied by another copy of the Patch you are copying, the name will not change — that is, a new suffix will not be assigned. Any of these copies can be saved to disk, modified or unmodified.

## Delete

The **Delete** function on the **Com** menu lets you select a Patch to remove from RAM. It is useful when you want to clean up RAM prior to saving a Volume (Chapter 8). The **Delete** function only works on RAM — the files on disk are not changed unless you go through the **Disk** function. If one or more Partials or Samples in the Patch are shared by other Patches in RAM, they are not deleted when this operation is executed (regardless of the setting of the **Fast Delete Mode** switch.)

As you pass the cursor over the names of the Patches in the Delete window (without clicking the mouse), you can hear each one if you play the MIDI keyboard. This can help you determine which Patch you want to lose.

## Initialize

**Initialize** sets the current Patch to an initialized state: all Parameters are set to their default values, and all Splits are cancelled. It does not remove any subsidiary files from RAM, it simply erases their assignments as far as the current Patch is concerned. You are given a warning window before the Initialization takes place.

## Rename Partials

This function renames all of the Partials in the Current Patch to the same name as the Patch, and adds a suffix. The lowest-placed Partial gets the suffix “**AA**”, the next lowest “**AB**”, and so on. (If any suffixes are in use because of a previous **Copy** operation on a Partial with the same name, the software will start assigning them with the first one available.)

The main use for this function is when you need to create a new version of an existing Patch in which the Partials are modified. Remember if a Partial belongs to more than one Patch, editing it changes it for every Patch. So, for example, if you have a fast-attack string Patch, and you want to create a slower-attack version without losing the original, you can **Copy** the Patch, change its name, and then select **Rename Partials**. Now you have a whole *new* set of Partials whose envelopes you can edit, without affecting the envelopes of the Partials in the original Patch. This doesn’t use up any additional RAM or disk space, because the Samples are unchanged.

## Partial Map and Edit Partial — Moving on Down

These two commands let you move down to the **Partial Edit** level and work with one or more Partials that are associated with the current Patch. Getting to the Partial level this way (“Subsidiary mode”) is not exactly the same as getting to it from the **Sound** menu, and there are certain extra features and restrictions that come into play. They are discussed in detail in the next chapter. When you **Exit** the Partial level, you will come back up to the **Patch Edit** level.

## Sampling — All the Way Down

This command takes you down to the Sampling page, where you can record a new Sample. There is one important difference between going to that page through the Patch page and going there direct from the **Sound** menu: when you go through a Patch page, as soon as you record a Sample, the software automatically creates a new Partial and Patch with the same name as the Sample. More about this in Chapter 6.

## The Part Map

The **Part Map** provides another way of viewing and adjusting many of the Patch parameters — from another dimension, you might say — from within a Performance. Rather than looking at a group of parameters for a single Patch, you get to look at the settings for a single parameter on all Patches within a Performance, simultaneously. The **Part Map** page is accessed at the **Performance Play** level. We will discuss this more in Chapter 8.

# Chapter 5: Partials

The next layer below Patches in the S-770's operating system are Partials. A Partial consists of between one and four Samples, along with information about how they are to be played. This includes level, tuning, pan position and output assignment, velocity switching, LFO (vibrato) action, and envelopes, both volume ("TVA") and filter ("TVF"). One or more Partials are arranged across the MIDI note range to form a Patch, as we saw in the previous chapter.

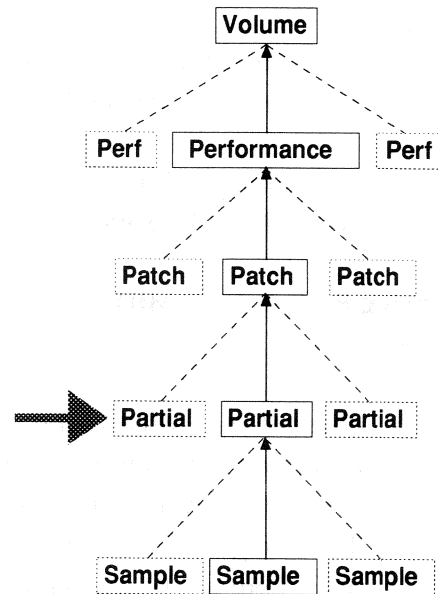

Partials are constructed and edited on the **Edit Partial** pages, of which there are five. There are several ways to reach these Pages:

- select **Edit Partial** from the **Sound** menu,
- select **Partial** from the **Index**, and **Partial Common** from the subtopic window,
- select any of the possible topics in the **Index** that apply to the Partials pages (**Amp, Filter, LFO, Output, Panning, Pitch, Velocity**) and then selecting the appropriate subtopic (for example, **Partial TVA**) from the menu that appears,
- use a Jump page that has been previously programmed (Jump Page 3 in each set of the factory-programmed Jumps is a Partial page),
- or go through any of the Patch pages. You move from a Patch page by opening the **Com** menu, and then selecting **Edit Partial**. When you call up a Partial page from a Patch page, it's in Subsidiary mode, and the Partial page behaves a little differently, which we will explain later in this chapter. (The Jumps in fact go through the Patch pages.)

Mode Index Mark S-770/01

Edit Partial Common				Com	Exit
<input type="checkbox"/>	Partial	L05:4Vox F#4		Name	
	Edit Mode		Single		
		Sample	K.F	C.T	F.T
[*]	<input type="checkbox"/> 1	L05:Vox F#4	Norm	5	-50
	<input type="checkbox"/> 2	-----Off-----	Norm	0	0
[*]	<input type="checkbox"/> 3	-----Off-----	Norm	0	0
	<input type="checkbox"/> 4	-----Off-----	Norm	0	0
	Output Assign			1	
	Partial Level			127	
	Stereo MIX Level			127	
	Panning			0	
	Coarse Tuning			0	
	Fine Tuning			0	
	SMT Velocity Ctrl			On	
Used 1.6/Remaining 0.3					

Common SMT TVF TVA LFO

In addition, there is another set of pages for editing Partials called the **Partial Map**, which we will also deal with later in the chapter.

When you **Exit** a Partials page, you will go back to the Page or window you came from: either the **Sound** menu or the last selected Patch page.

## Playing Partials from MIDI

The Partial pages normally respond to MIDI in Omni mode, so no matter what channel your MIDI keyboard is transmitting on, the S-770 will respond (although this is not necessarily true in Subsidiary mode, which we'll get to at the end of the chapter). The MIDI controller functions (LFO response, pitchbend range, etc.) are determined by the settings made on the **Edit Patch Ctrl** page of the last Patch to be loaded or edited or, if there has been no Patch loaded or edited since you booted up, the default settings will be used (**LFO-Pitch Depth** under **A.T** set to 35 and under **Mod** set to 30; all other parameter sensitivities set to 0; **SMT Control** Off; and **Bend-Up** and **-Down** both set to 2).

Let's load a few Partials into RAM to help us understand the functions of the Edit Partial pages. Go to the **Disk Load** page (through the **Com** menu), and set **Target** to **Partial** (not **Partial PRM**). Then load the following Partials, in any order you like. Clear Internal Memory before loading the first one, but not when loading subsequent ones:

**LØ2:String Pad m**  
**LØ5:4Vox F#4**  
**LØ7:FAT tom A**  
**LØ7:K snr center**  
**LØ7:Ride/cup**

## Basic Parameters

The first page, **Edit Partial Common**, is where the basic parameters for constructing the Partial are set up. At the top of the page is the name of the current Partial — if you are creating a Partial from scratch, this line will be blank. Next to it is a "**Name**" box: click in this and the ASCII Keyboard window appears and you can rename the Partial. The second line, **Edit Mode**, will normally be set to "**Single**". At the bottom of the screen, as on the **Patch Common** page, the **Used** parameter refers to the amount of sample memory in the current Partial, while the **Remaining** parameter refers to available memory in RAM.

Remember that if you alter a Partial that is being used in more than one Patch, the alterations will affect the Partial wherever it's used. If you don't want this to happen, copy the altered Partial before you edit it (use the **Copy** function described at the end of the chapter).

### Putting Samples into the Partial

The lines labelled "1" through "4" are the four "slots" for Samples that can be combined to form this Partial. Move the mouse or cursor keys so that the first line is highlighted, and then use the mouse buttons or value wheel to scroll through the available Samples, or click on the Select icon to the left of the Sample number to open the **Select** window. Any of the Samples currently in RAM (that is, any Samples that have been loaded in by themselves, or as part of another Partial, a Patch, a Performance, or a Volume) will be available. The same Sample can appear in more than one slot. To get an idea of how Partials use combinations of Samples, scroll through the ones you've just loaded in.

Stereo Samples require two slots. You can enter the two halves of a stereo Sample individually, but there is also a shortcut. Next to the Select icons for slots 1 and 3 is a blue "[\*]". Putting the cursor on this and clicking the right mouse button scrolls the Samples in RAM but ignores all the mono ones. Instead, it finds the next *stereo* Sample, and enters its two halves into the chosen slot and the slot directly beneath it. (It also does more than that, which we'll get to in a moment.) We have a stereo Sample in memory at the moment, so you can see this work: **Fat Toms 1**. Select **4Vox F#4** as the Current Partial and click on the [\*] next to slot 1. **Fat toms 1—L** gets entered in slot 1, and **Fat toms 1—R** goes into slot 2.

As with normal scrolling, clicking the left mouse selects the next lowest stereo Sample in memory. Since at the moment there are no others to choose from, clicking the left button will do nothing. (Since we will want to use this Partial again later in this chapter, set Sample 1 back to **Vox F#4** and Sample 2 to **Off** before going on.)

The number of Samples in a Partial determines the number of S-770 "voices" that will be used when the Partial — or a Patch containing the Partial — is played. The S-770 has a limit of 24 simultaneous voices, and Partials with multiple Samples will use those voices up more quickly than single-Sample Partials. However, as we shall see, multiple-Sample Partials don't always use all their voices all the time. (See also the discussion of voice-stealing in the previous chapter under "Patch Priority".)

## Tuning Individual Samples

Each Sample can then be tuned individually, relative to the overall Partial tuning. **C.T** is coarse tuning, and has a range of  $\pm 4$  octaves in semitone increments, while **F.T** is fine tuning, and has a range of  $\pm$  half a semitone (a quarter-tone), in increments of 1 cent (1/100th of a semitone). The entire Partial can also be tuned, using the **Tuning Parameters** at the *bottom* of the screen, which we'll discuss in a moment.

This is the best place to tune a Sample that was recorded with an Original Key parameter that does not reflect the Sample's true pitch (we discussed this in the section on Multisampling in the previous chapter). If the Parameter and the pitch don't match, then when you place the Sample (actually the Partial containing it) into a particular keyboard range as part of a Patch Split, the pitches that sound will be different from the notes you play. This can be corrected with these Parameters.

Toggle back and forth between **4Vox F#4** and **String Pad m** and look at the differences in their tuning parameters. The Samples that make up both of these Partials were recorded out of tune, and quite differently so, but by correcting them at this level, they can be made to sound in tune. While in **String Pad m**, select **Sample** slot 2 and click on the mouse buttons until the vocal Sample **Vox F#4** appears. Now adjust the **C.T** and **F.T** parameters until the two Samples sound in tune.

Another use of these Parameters is to create tuned layers within a Partial. For example, you could load **Vox F#4** into two slots, and then detune one slightly (set **F.T** to **4**) for a flanging or chorusing effect, or detune one by an octave (set **C.T** to **12**) for a dramatic doubling effect. (Remember that the **Analog Feel** parameter on the Patch Common page randomly detunes each Sample in the Partial independently.)

## Transposition Limits

Samples in the S-770 can only be transposed a total of two octaves above their original pitch (three if they were recorded at a low rate), whether that transposition is done by incoming MIDI data, or by a re-tuning of the sound at the Partial or Patch level. If you try to transpose a note higher than that — for instance, if you try to play a four-octave scale up from the original pitch — when you reach the two- or three-octave limit, the note will continue to play, but the pitch will not go any higher.



Therefore, if you layer two Samples in a Partial and one of them has been transposed up by a large amount, when you play the Partial up the scale, at one point the pitches will stop being an octave apart, and one of them will “freeze” while the other continues to go up. This can be avoided by making sure the Split range (at the Patch level) for that Partial doesn’t go so high that one of the Samples is being transposed up more than the two- or three-octave limit.

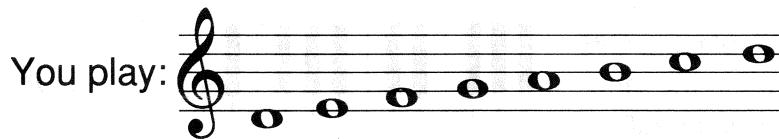

Sample Orig Key = G\_3  
 Sample CoarseTunings = +12, Ø

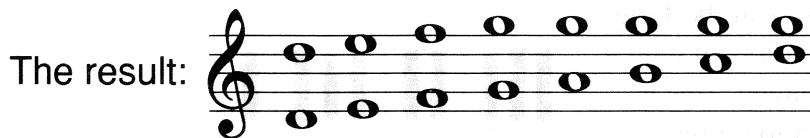

### Changing the Scale

**K.F.**, or Key Follow, lets you change the scale of the Sample relative to incoming MIDI notes, by “stretching” or “shrinking” it. When **K.F.** is set to **Norm**, the Sample plays normally, i.e., moving a semitone up on the MIDI keyboard raises the Sample’s pitch by a semitone. When it is set to one of the ratios, which range from 1/8 to 16/8, the scale is changed by that ratio.

For example, if the ratio is **16/8**, playing two keys a semitone apart will result in two notes sounding a *whole* tone apart; playing two notes a minor third (three semitones) apart will sound a diminished fifth (six semitones); and playing two notes an octave apart will result in two notes *two* octaves apart. Going the other way, if the ratio is **1/8**, a semitone on the keyboard will result in a pitch change of only 1/16th-tone, while a minor sixth (eight semitones) on the keyboard will sound a semitone. A two-octave spread will sound a minor third. (You will notice that **Norm** is equivalent to a ratio of “8/8”.)

Negative ratios are allowed, which make the pitch go down as you move up the keyboard and vice versa. The “zero point” — the key which the ratios are calculated *from* — is the **Orig Key** set in the Sample itself (see the next chapter). If the **Orig Key** is G#5, playing G#5 will always result in the same pitch, regardless of the **K.F** setting (although it may not actually *be* a G#, because of the setting of the **Tune** parameters). There is also an **Off** position for this parameter, which makes the Sample always play back at the **Orig Key** pitch regardless of which key is being played. This is useful for mapping drums and other sounds that you may want to use on more than one key without having their pitch change.

(Orig Key = B<sub>4</sub>)

K.F = Norm

K.F = 16/8

K.F = 1/8

K.F = -8/8

K.F = Off

The “spread scales” that result from various settings of the **K.F** ratio are good for simulating non-Western ethnic music, or creating or modifying non-musical sound effects. Try setting up 1/8 or 2/8 ratios on some of the drum sounds in RAM, or on the vocal sounds for a Ligeti-like effect. When constructing a soundtrack, playing an ambient sound on several keys pitched a fraction of a semitone apart can create a thicker ambience, with varied loop times, without imparting any unwanted “pitchness” to the sound.

Small **K.F** ratios are also useful when working with sounds which have an “unpitched” and a “pitched” portion, like a breathy flute, a guitar with string-sliding noises before the note, or a spoken word. By putting the different portions in different layers in the Partial, and giving the “unpitched” portion (the breath, the slide, or the consonant) a small **K.F** ratio, so it stays relatively constant in pitch as the rest of the sound moves up the scale, you can make the sound much more natural.

For a crude but effective example of this, go to an empty Partial, and put the Sample **Bass Str C5l** (from the **String Pad m** Partial) into slot 1, and the Sample **K snr 1** (from the **K snr center** Partial) into Slot 2. Set **K.F** on the snare Sample to **1/8**, and **C.T** to **-14**. Now play up and down the scale. The snare acts as a “chiff” to the string sound, and changes in pitch with it, but the change is relatively quite small, and so it still sounds like a drum.

## Outputs and Levels

**Output Assign** lets you designate one of the six (or eight) numbered individual audio outputs for this Partial. The Partial will appear at the stereo outputs as well, and if this is set to **Off**, it will appear *only* at the stereo outputs. Individual outputs are very useful for Patches that contain many different types of sounds, like drum sets. They allow individual instruments to be processed and mixed by themselves. Notice that **FAT tom A** and **K snr center** already have output assignments of 4 and 2, respectively, so that when they are used in a patch, those sounds can be isolated.

A Partial which uses stereo Samples can only play those Samples in stereo using the stereo outputs — when the Partial is played from a numbered output, it is in mono. (However, you can force two numbered outputs to act as a stereo pair at the Performance level — see Chapter 8.)

This parameter will be overridden by the **Output Assign** parameter on the **Patch Common** page (in the previous chapter) and Performance Edit page (Chapter 8), unless that Parameter is set to “**P**”.

**Partial Level** lets you set a general level for the Partial (from 0 to 127) as it appears at all of the outputs (numbered and stereo) to which it is assigned.

**Stereo Mix Level** controls how much of the Partial will appear at the stereo outputs (analog and digital), without affecting the numbered outputs. If you want the Partial to appear at one of the numbered outputs and *not* at the stereo outputs, you would set **Output Assign** to the numbered output, **Partial Level** to a high number, and **Stereo MIX Level** to **Ø**.

**Panning** also refers to the stereo outputs only, and sets the pan position of the Partial as a whole, from **L 32** (hard left), to **Ø** (center), to **R 32** (hard right). The individual Samples get Pan positions too, on the next page, **SMT**, and if the Samples are set up with pan positions (for example, if they are halves of a stereo pair), this control acts as a “bias”, moving the overall stereo image left or right, but not collapsing it into mono.

## Other Parameters

**Coarse Tuning** and **Fine Tuning** (the ones in the lower half of the screen) adjust the tuning of *all* of the Samples in the Partial simultaneously. They do not override the **C.T** and **F.T** parameters for the individual Samples, but instead add to (or subtract from) those settings.

**SMT Velocity Ctrl** enables the Sample Mix Table, which is on the next Page (and coming right up) to be controlled by velocity. When it is Off, all four Samples will maintain the same relative balance to each other, regardless of the velocity. However, they can still be controlled by the **SMT Ctrl** set at the Patch level, described in the previous chapter.

## SMT

The Sample Mix Table (**SMT**) page allows you to balance the Samples that make up the Partial in several different ways.

### Panning and Level

As on the **Common** page, the top line of the **Edit Partial SMT** page shows the name of the current Partial, and the first four lines below that show the names of the Samples. You can select which Samples will be included in the Partial on this page as well as on the **Common** page; any changes made here will appear on the **Common** page and vice versa.

Mode Index Mark S-770/01

Edit Partial SMT Com Exit

Partial L07:Ride/cup Name

Edit Mode Single

	Sample	Pan	Level
[*] <input checked="" type="checkbox"/> 1	L07:ET Ride	Rnd	127
<input checked="" type="checkbox"/> 2	L07:Ride Cup	Rnd	97
[*] <input type="checkbox"/> 3	-----Off-----	Ø	127
<input type="checkbox"/> 4	-----Off-----	Ø	127

	Vel	Low	Vel	Hi	Fade	L	Fade	H
1	1		110		Ø		Ø	
2		111		127		Ø		Ø
3		1		127		Ø		Ø
4		1		127		Ø		Ø

Common SMT TVF TVA LFO

The **Pan** parameter allows each Sample to be located spatially in the stereo outputs. The range is from hard left (**L32**) to center (**Ø**) to hard right (**R32**). If you are using a stereo Sample, you would normally select the two halves of the Sample (which bear the suffixes “-L” and “-R” in their names), and pan one to **L32** and the other to **R32**. **FAT tom A** is an example of this.

This parameter can be influenced, and the stereo field for the Sample shifted one way or the other, by the **Panning** parameters on the **Partial Common** and **Patch Common** pages.

When you enter a stereo Sample into a Partial using the **[\*]** function on either the Common or SMT page, the **Pan** parameters of the two halves of the Sample are automatically set to **L32** and **R32**, respectively. After the Sample is entered, the **Pan** settings can be changed, if you like.

Samples recorded in stereo are not the only Samples that can have stereo characteristics. It's quite possible to take two unrelated sounds and set them up on opposite sides of the stereo field, or to take two identical sounds and, by changing one slightly and panning them to opposite sides, "synthesize" a stereo sound. We'll get to an example of this in a moment.

You can also *create* a stereo image from a *single* Sample using the three other options for this Parameter. **Rnd** randomly places each individual note in the stereo field as it sounds (**Ride/cup** uses this — each time you play the cymbal, it appears somewhere else). **Ky+** places the sound according to the MIDI note number, with lower notes on the left and higher notes on the right. **Ky-** reverses the process, and places the higher notes on the left and the lower notes on the right. Try either of these last two on the **Bass Str C5l** Sample in **String Pad m** — it instantly turns it into a stereo orchestra, with basses on one side and high violins on the other.

If you want to try something interesting, go back to the **Partial Common** page, and put that same **Bass Str C5l** Sample into the first two slots. Set the **C.T** Parameter of both Samples to **-1**, and set **F.T** of one to **-50** and the other to **-48**. Return to the **SMT** page, and set **Pan** for one to **Ky+** and the other to **Ky-**. You'll end up with a marvelous flanged string sound, most definitely in stereo, but without specific notes emanating from particular locations.

The **Level** parameter (adjustable from 0 to 127) allows you to adjust the volume of each Sample individually, so you can balance them.

## Velocity Switching

The bottom half of the **SMT** page is used to set up velocity-based switches and crossfades for the various Samples within the Patch. Velocity switching allows different Samples to sound depending on how hard a MIDI key is hit. **Ride/cup** is an excellent example of a velocity switch: notes with velocities of 110 and below sound the ride cymbal edge, while notes with velocities of 111 and above sound the cymbal cup.

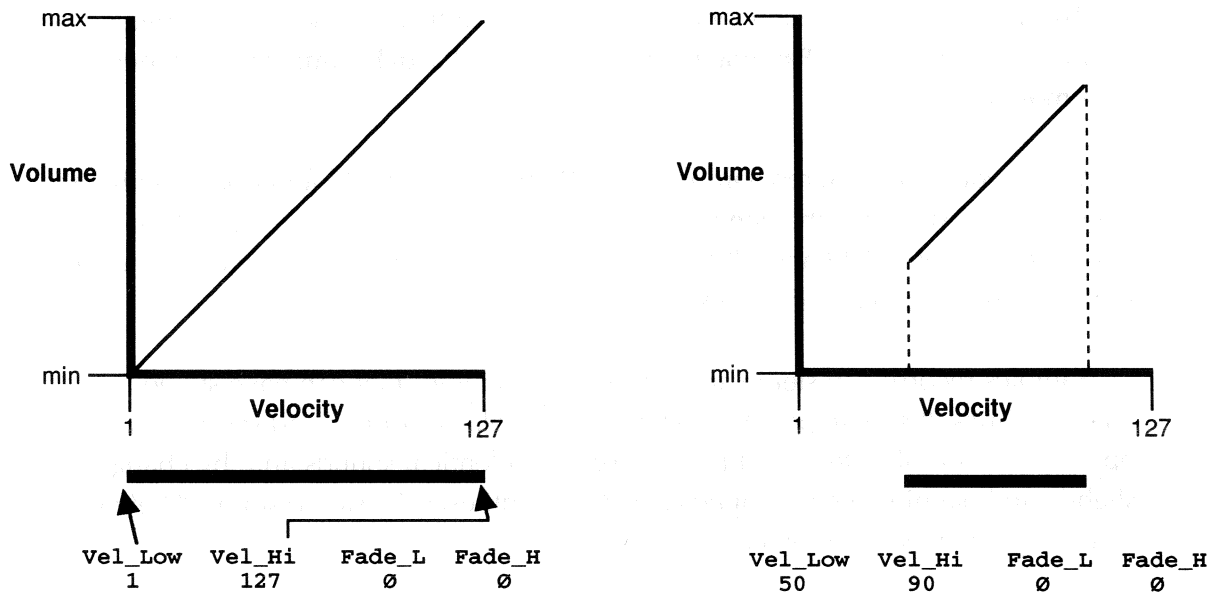

Another use for a velocity switch would be a sax Sample: at lower velocities, you use a mellow tone, while higher velocities call for a more strident sound. You can also set up velocity switches so that more Sample layers are added as the velocity increases, providing not only a louder sound, but also a brighter, thicker, or more complex sound at higher velocities.

Each of the four Samples can be assigned a velocity range within which it will respond. If a velocity level is received that is below the **Vel Low** level or above the **Vel Hi** level for a particular Sample, that Sample will not sound. Note that this range does not *change* the velocity response, it simply limits it. This means that regardless of whether the **Vel Low** level for a Sample is 1 or 74, a MIDI note-on with a velocity of 75 will always play that Sample at the same volume. But if the **Vel Low** setting is 76, a MIDI note-on with velocity 75 will make no sound at all.

The window at the bottom of the screen shows the velocity ranges of the four Samples as horizontal lines, each three pixels high. (If a Sample slot is “Off”, its line will be only one pixel high.) When you select any parameter relating to one of the four Samples (with the mouse or cursor keys), the horizontal line corresponding to that Sample will be highlighted in red. When you move the mouse over one of the horizontal lines themselves, it will be highlighted in yellow.

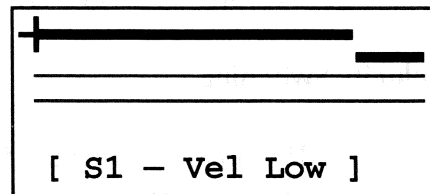

The window also displays an arrow showing the velocity of the last MIDI note-on received. As you play the keyboard and listen to the sounds, the arrow will jump around. This can be a big help in determining how to set up your velocity range values.

You can adjust the **Vel Low** and **Vel Hi** levels for each Sample by selecting the individual parameter and incrementing or decrementing it with the mouse buttons or the **VALUE** wheel. Or, you can do it graphically: move the mouse to one of the ends of the horizontal lines, and click and hold the left mouse button. The line will turn red, and the slot number of the Sample and the name of the parameter being adjusted (**Vel Low** or **Vel Hi**) will appear at the bottom of the window (this is called the "Title" area). Without letting go of the mouse button, drag the mouse left or right to decrease or increase the value. The end of the line will move with you, and the numeric value of the parameter you are adjusting will change as you drag the mouse.

## Velocity fading

A transition between two velocity-switched Samples can be made smooth by overlapping their velocity ranges. But for even more smoothness you can "fade" the Samples into each other. An example of this is **K snr center**.

The **Fade L**(ow) parameter for each Sample in the Sample Mix Table sets a range of velocities, above the **Vel Low** value, over which the sound will fade in as the velocity increases. For example, look at the settings for Sample 2. The **Vel Low** parameter is 58 and the **Fade L** parameter is 17. This means that an incoming note with a velocity of 58 will sound that Sample at minimum volume, and as the velocity rises from 58 to 75 ( $58 + 17$ ), the volume will increase relatively sharply. At 76 and above, the velocity response is linear (up to 90, the **Vel Hi** limit). It could be said that the **Fade L** parameter scales the bottom of the velocity response curve for a particular Sample.

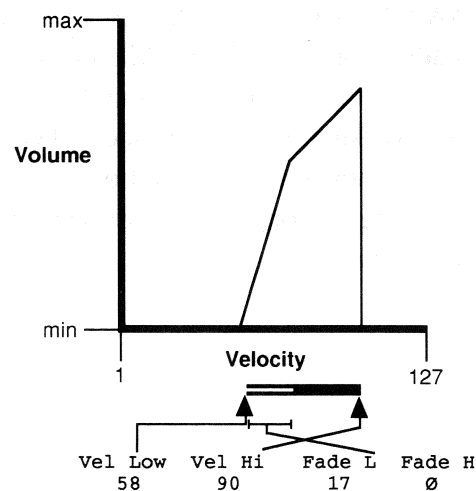

The **Fade H(igh)** parameter does a similar thing with the **Vel Hi** parameter — it sets a range of velocities over which the volume of the Sample will *decrease* as the velocity increases, with the **Vel Hi** parameter as its upper limit, at which point the volume will be at minimum. Sample 3 illustrates this: **Vel Hi** is 122 and **Fade H** is 11. Therefore, velocity response will be linear up to 111 (122 – 11), and then notes will get progressively softer as the velocity increases to 122. When the velocity is above 122, the Sample won't sound at all.

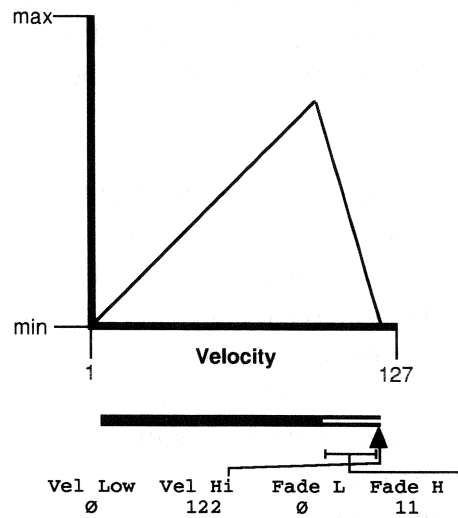

The combination of limits and fades can give you very complex switching algorithms. Also keep in mind that the **SMT Ctrl** that you selected at the Patch level will also act on these functions, not by increasing or decreasing the actual velocities (or the volumes), but by *shifting the break points* of the switches up and down. (More on this in a moment.)

You can adjust the **Fade L** and **Fade H** parameters by selecting them and then pressing the mouse buttons or turning the **VALUE** wheel. Notice that when you set a **Fade** parameter, the middle portion of the horizontal line representing the Sample you are working on (i.e., the second vertical pixel) moves away from the end of the line, creating an “open” line, showing the extent of the Fade.

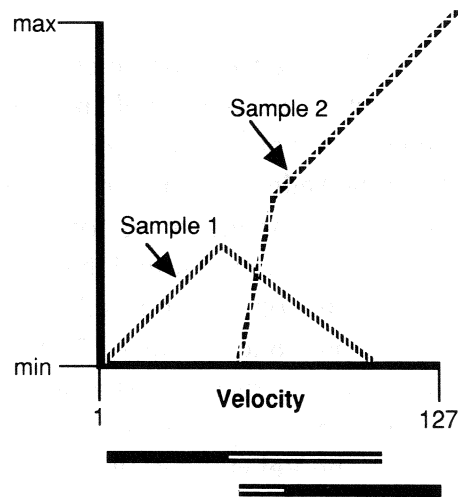

	Vel Low	Vel Hi	Fade L	Fade H
1	0	100	0	55
2	55	127	20	0



You can also adjust the **Fade** parameters graphically: use the mouse to locate one of the ends of the fade line (that is, where the middle portion of the line ends), and then click and hold the *right* mouse button, and, without letting go, click and hold the left button. If you do this correctly, the number of the Sample and “**Fade L**” or “**Fade H**” will appear in the Title at the bottom of the window, and you can then drag the mouse to extend or shorten the fade line. Note that you cannot extend the fade line past either end of the overall velocity line, nor can you shrink the line so it is smaller than one pixel.

When you enter a stereo Sample into a Partial using the [\*] function on either the Common or SMT page, the **Vel** and **Fade** parameters of the right half of the Sample will automatically be set to the same values as the left half. If you like, you can change any of these values afterwards.

### Other SMT controls

As we saw in the previous chapter, The Sample Mix Table can also be operated in real time (before or after a note has been played) by a MIDI controller, such as Pitchbend, Modulation Wheel, or Aftertouch. Therefore, a certain velocity value may cause one Sample to sound, and then by applying aftertouch to the key, a different Sample fades in. The SMT controller doesn't *replace* the velocity data operating the SMT, but *adds* to or *subtracts* from that data, to the degree determined by the **SMT Ctrl Sens** parameter on the **Edit Patch Ctrl** page.

## TVF

**TVF** stands for Time Variant Filter. It determines how the timbre of the Partial will change over time, by boosting or attenuating certain frequencies. The filter has two main parts: the Parameters defining the filter itself, and the envelope to control how the filter changes over time. The Parameters on this page can also influence the *pitch* of the Partial as it plays.

Mode Index Mark S-770/01

Edit Partial TVF Com Exit

Partial L05:4Vox F#4 Name

Edit Mode Single

Filter Mode	LPF	Envelope	
Cutoff Freq	31	-TVF Depth	63
-Key Follow	13	-Vel Sens	0
Resonance	20	-Pitch Depth	0
Vel-Curve	2	Time	
-C.Sens	0	-Vel Sens	0
KF Point	C_4	-Key Follow	0
	1 2 3 4		
Time	0 100	72 115	
Level	40 127	44 0	

Common SMT TVF TVA LFO

### The Parameters

**Filter Mode** can be set to Low-Pass (**LPF**) which cuts off high frequencies, and is the most common mode; Band-Pass (**BPF**) which accentuates a narrow band of frequencies; or High-Pass (**HPF**), which cuts off low frequencies. It can also be turned **Off**, which renders everything else on the page meaningless.

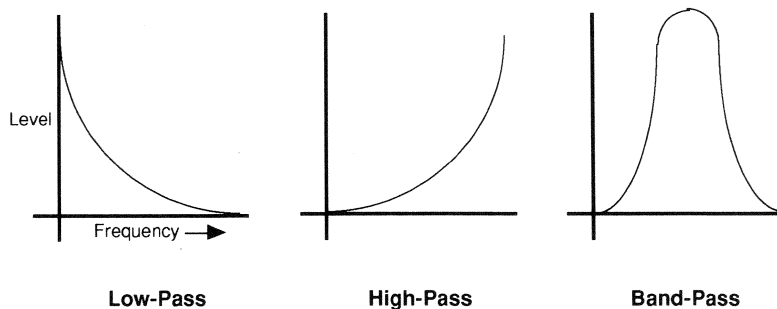

**Note:** If you are not using the filters on a Partial then it is best to leave this Parameter **Off** (rather than disable them in some other way), because the S-770 responds slightly faster when you do this.

**Cutoff Freq** controls the frequency that the filter's action will take place at — the "knee" of the filter, or when the mode is Band-pass, the center point of the filter's action. Higher numbers are higher frequencies.

**Key Follow** determines whether the Cutoff Frequency is going to be constant over the entire keyboard range, or whether it will change with changing incoming MIDI notes (this is sometimes called a “tracking filter”). At 0, the Cutoff Frequency will be constant across the keyboard range. At positive values, the Cutoff Frequency will rise as the MIDI note goes up, and the higher the parameter, the steeper the rise.

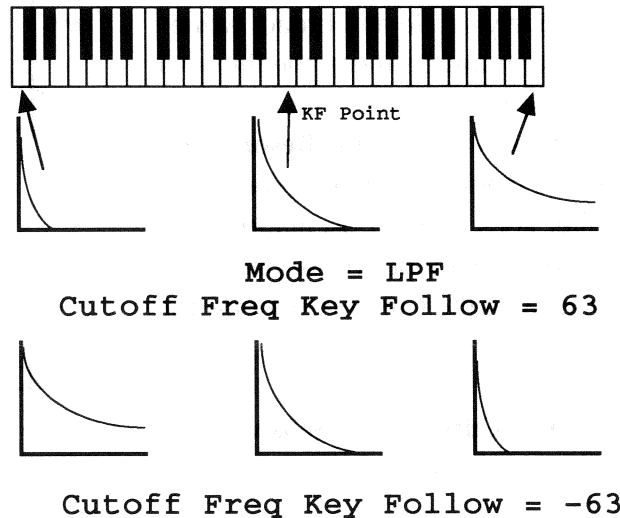

At negative values, the Cutoff Frequency will go *down* as the MIDI note goes up, so that higher notes contain fewer high frequencies. The range is -63 to +63. The “median” point for the filter — that is, the note at which this Parameter has no effect — is determined by the **KF Point** at the bottom of the column.

Key Follow can help to make a sampled sound more “natural” — on a real instrument, high notes usually have more high-frequency partials than low notes. Proper use of this filter can extend the good-sounding range of a Sample. Listen to **4Vox F#4** (which, after all, contains only one Sample) over several octaves to see how well this can work.

Another important use is to eliminate any high-frequency noise that might have been recorded with the original Sample when transposing it down by a large interval. Any noise that is present in the original Sample will be transposed down as well, and can sound very ugly. (Although because the S-770 uses constant sample-rate playback and differential interpolation, aliasing noise will not be a problem.) By using a Low-Pass Filter whose Cutoff Frequency goes down with the pitch, the noise can be eliminated easily.

**Resonance** refers to the depth, or “Q”, of the filter action. Low numbers mean the filter will be relatively subtle and broad, while higher numbers mean the filter will be sharper. As with an analog synthesizer, when the **Resonance** value reaches a certain point, the filter goes into self-oscillation, producing a tone whose pitch will vary with the Cutoff frequency and the filter envelope.

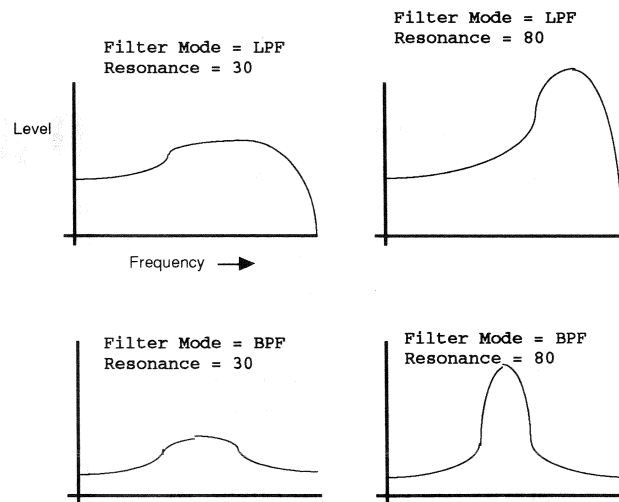

**Vel-Curve** and **C.Sens** will be discussed in a moment.

**Envelope** has three parameters, all of which have a range of  $-63$  to  $+63$ :

**TVF Depth** determines how much the cutoff frequency of the filter will respond to the envelope described at the bottom of the screen. At 0, the filter will remain at a constant frequency and the envelope will have no effect. As you increase the value of the parameter, the cutoff frequency of the filter will change more with the rising and falling of the envelope. At negative values, the cutoff frequency will respond to the envelope “upside-down”: as the envelope rises, the cutoff frequency will fall, and vice versa. If you use negative values in a Low-Pass or Band-Pass filter, you should use a high **Cutoff Freq**, or you might find *everything* filtered out.

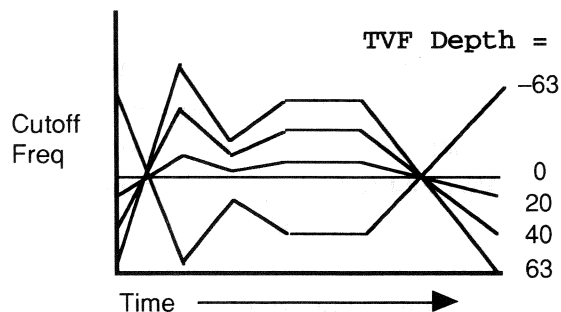

**Vel Sens** determines how the filter envelope responds (if at all) to MIDI velocity. At high values of the parameter, high incoming MIDI velocities will make the cutoff frequency more sensitive to the envelope — which means if you hit the note harder, the filter envelope action becomes stronger. At negative values, the effect of Envelope will be inverted and low velocities will flatten out the envelope, so that as you hit the note softer, the filter action becomes less strong, and hard notes will produce the most change in the filter. A value of 0 means that velocity will have no effect on the filter.

**Vel Sens** is influenced by **Vel-Curve** and **C.Sens**, on the left side of the screen:

**Vel-Curve** selects from one of four velocity curves which are illustrated below. Curve **1** is a constant value, so that changes in velocity don't affect the filter at all (like setting **Vel Sens** to  $\emptyset$ ). Curve **2** is linear, meaning that velocity changes cause filter changes proportionately throughout the velocity range. Curve **3** curves downward, so that velocity changes at *low* velocities affect the filter less than those at *high* velocities. Curve **4** curves upward, so that low-range velocity changes will affect the filter *more* than high-range ones.

**C.Sens**, which stands for Curve Sensitivity, is set up the same way as **Vel Sens**, and determines how much, and in which direction, the cutoff frequency will respond to velocity changes. It is not redundant, however, because it is a common parameter for both the **Envelope Vel Sens** and the **Time Vel Sens**, described next.

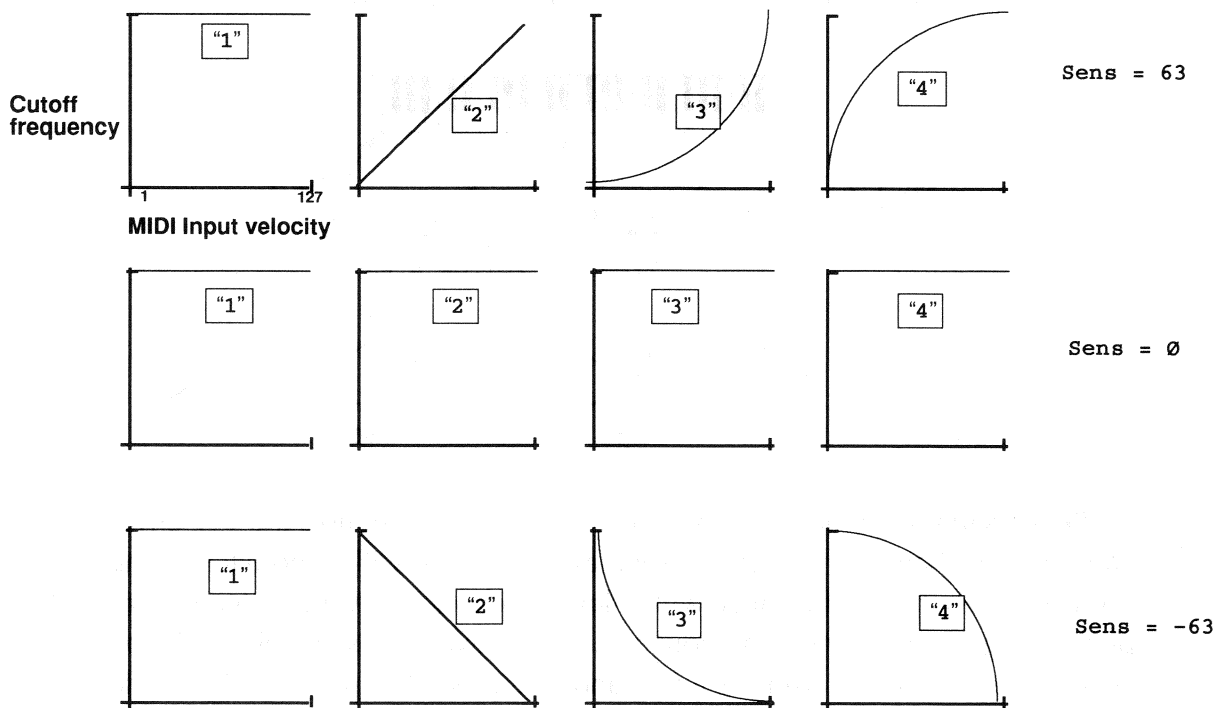

The separate **Vel Sens** parameters for **Envelope** and **Time** mean they can operate independently: setting **C.Sens** to a positive value and **Envelope Vel Sens** to a positive value will cause the cutoff frequency to increase with velocity, while at the same time if you set **Time Vel Sens** to a *negative* value, it will cause the envelope to slow down as the velocity increases. Admittedly, this can all get very complicated, but some day you'll thank us for allowing this degree of flexibility.

**Time** has two parameters, both of which range from -63 to + 63:

**Vel Sens** expands or contracts the filter envelope in *time*, according to incoming MIDI velocities. With a positive setting, higher note velocities will cause the filter envelope to act faster, opening or closing in a shorter period of time, while lower note velocities will stretch the envelope out, causing it to open or close more slowly. Negative settings will produce the opposite effect. This parameter is affected by the **Vel-Curve** and **C.Sens** parameters.

**Key Follow** expands or contracts the filter envelope in *time* according to incoming MIDI note numbers (don't confuse it with the *frequency*-affecting **Key Follow** described earlier). With a positive setting, higher notes will cause the filter envelope to act faster, while lower notes will stretch the envelope out, and negative settings will produce the opposite effect. The "median" point, that is, the note which always plays the envelope at its normal rate, is determined by the **KF Point** parameter.

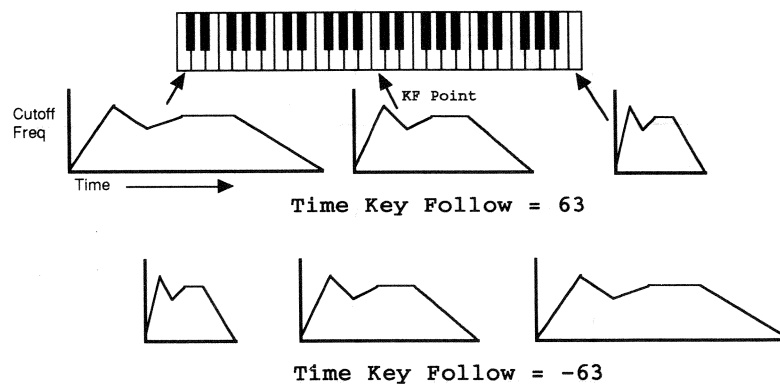

**Pitch Depth** has almost nothing to do with the filter, but uses the TVF envelope to effect a pitch change in the Partial as it plays. At 0 there will be no pitch change. At positive values, the pitch change will follow the envelope. As the value increases, the pitch change becomes more pronounced. At negative values, the pitch will follow the envelope upside-down, rising as it falls and vice versa. The pitch change is affected by velocity, but it does follow any changes in the *speed* of the envelope dictated by the **Time Vel Sens** and **Key Follow** parameters. If the **Filter Mode** is **Off**, there is no pitch change.

The maximum pitch change upwards (when this parameter is 63 and the envelope level is 127) is two octaves, while the maximum pitch change downwards (when this parameter is -63) is *four* octaves. Version 1.0 users note that this is quite different from the previous version, in which the maximum shift both up and down was one-half octave. If you are using Partials created with Version 1.0 software that use this parameter, you will have to reset it.

## The Envelope

The envelope changes the Cutoff Freq over time, giving the sound timbral “motion”. **String Pad m** has a simple TVF envelope, while **4Vox F#4** has a complex one. (The percussive sounds have envelopes that simply open and close with the note-on and -off.)

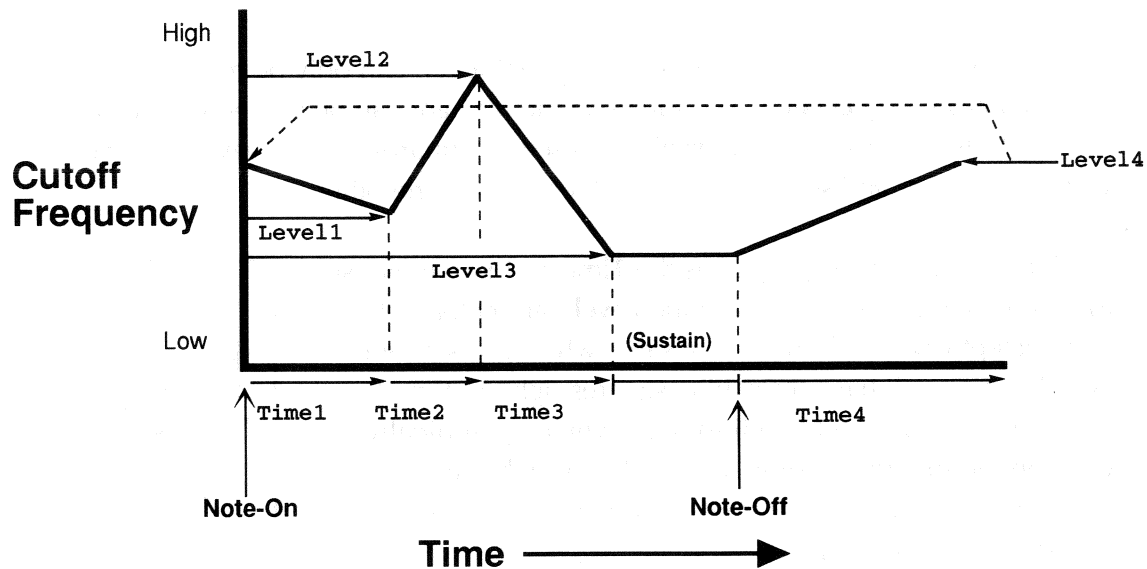

The envelope itself is a standard five-segment Attack/Decay1, 2/Sustain/Release envelope, and a graphic representation of it appears in the window at the bottom of the screen. (The TVF envelope is in white — the dark blue lines behind it are the TVA, coming up soon.) Time for each segment ranges from 0 (essentially instantaneous) to 127 (up to about 2 minutes). Level for each segment ranges from 0 to 127.

The envelope starts at the level specified under **Level 4** when you press the MIDI key (Level 4 and Level “zero” are always the same). During the period specified by **Time 1** (the Attack), it rises or falls to the level specified by **Level 1**. It then immediately goes to **Level 2**, in the period specified by **Time 2** (the Decay 1), and then to **Level 3** in the period specified by **Time 3** (the Decay 2). It holds at this level until the key (or Sustain pedal, if it’s in use) is released — a short green line will appear at the right of the square and a vertical green line will appear below it and to the right, reminding you that this is the Sustain level (unless Level 3 is 0). When the key is released, it goes to **Level 4** in **Time 4** (the Release). Like most ADSR envelopes, if the key is released before the envelope has time to play all the way through, it proceeds to the Release segment (4) immediately.

The envelope parameters can be changed by moving the cursor to the desired parameter and clicking the left and right mouse buttons or moving the **VALUE** wheel. They can also be adjusted graphically: use the mouse to grab one of the little blue squares in the graphic representation of the envelope, press the left button and hold it, and then drag it up or down, left or right. The segments affected by the move will turn red, and the parameters being adjusted (Time and Level for the appropriate segment) will change as the mouse moves.

Note that the square at the far left, the initial level, can only be moved vertically, and it controls only **Level 4**. The square at the far right can be moved in any direction and controls both **Time 4** and **Level 4**. These two squares must always be at the same vertical position, and so moving one of them moves the other.

The default TVF envelope has the **Time 1, 4** parameter set to 0, the **Time 2, 3** set to 10 and the **Level** parameters set to 127 (except **Level 4**), which means that when you start with a new TVF you will have three blue squares right on top of each other. If you want to adjust the envelope graphically, click on the square and drag it to the left or right, up or down. If you adjust the parameters numerically, the squares will sort themselves out.

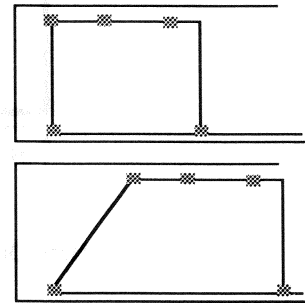

You've probably noticed another envelope lurking in dark blue behind the TVF envelope. This is the TVA envelope, which will be discussed next. The two envelopes are always shown together. This can help prevent a situation in which you are gleefully designing a complex filter envelope but somehow it doesn't seem to affect the sound at all, because you've inadvertently made all the filter action take place long after the TVA envelope has shut off the sound. For example, if you were to extend the decay, sustain, and/or release segments of the TVF envelope on one of the percussion Partials, it wouldn't do much.

Note, however, that the diagrams only *approximate* the real envelope values — because the envelopes can be changed so significantly by velocity and note number, two envelopes that appear similar in length on the screen may end up being very different lengths when you actually play them.



# TVA

**TVA** stands for Time Variant Amplifier, and is the volume envelope for the Partial, determining how the loudness of the sound will respond to MIDI velocities and notes, and how that loudness will change over time. The parameters all behave similarly to their counterparts on the **TVF** page.

## The Parameters

**Vel-Curve** uses one of the four velocity curves to determine how the envelope (and therefore the overall volume of the Partial) will respond to changes in incoming MIDI velocity. Curve **1** is a constant value, so that changes in velocity don't affect the volume at all, and the Partial always sounds at the same level. Curve **2** is linear, meaning that velocity changes cause proportional volume changes throughout the velocity range.

Curve **3** curves downward, so that differences in velocity at low velocities affect the volume less than those at high velocities, and curve **4** curves upward, so that low-range velocity changes do more to change the volume than high-range ones.

**C.Sens** determines directly how the volume will respond to velocity. At  $-63$ , there will be no change in volume with changes in velocity. At higher values, volume will be dependent on velocity. At  $0$ , the volume will respond to velocity as described at **Vel-Curve**.

**Key Follow** determines whether the volume of the Partial will be consistent over the entire keyboard range, or whether it will change with changing MIDI notes. At  $0$ , the level will be constant. At positive values, higher incoming MIDI notes will play the Partial louder. At negative values, higher incoming MIDI notes will play the Partial softer. The note at which the volume doesn't change regardless of this setting is determined by the **KF Point** parameter (which, by the way, is independent of the **KF Point** in the filter envelope).

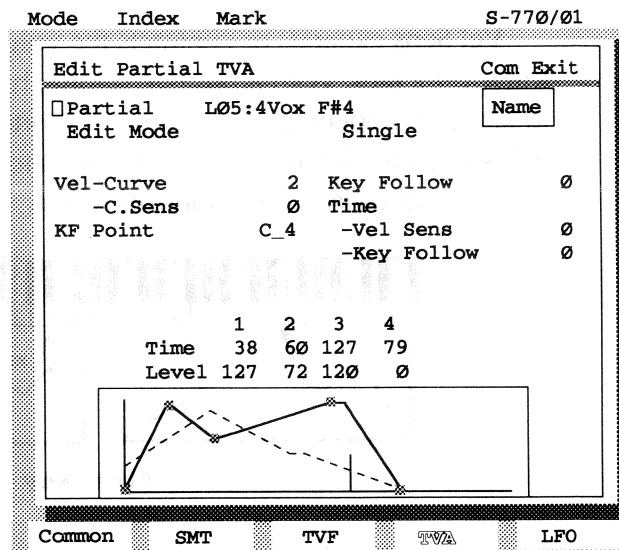

**Time** has two parameters:

**Key Follow** expands or contracts the envelope in time according to incoming MIDI note numbers. With a positive setting, higher notes will cause the envelope to act faster, while lower notes will stretch the envelope out, and negative settings will produce the opposite effect. The “origin” point, that is, the note which plays the envelope at its normal rate, is determined by the **KF Point** parameter.

**Vel Sens** expands or contracts the volume envelope in time according to incoming MIDI velocities. With a positive setting, higher note velocities will cause the envelope to act faster, opening or closing in a shorter period of time, while lower note velocities will stretch the envelope out, causing it to open or close more slowly. Negative settings will produce the opposite effect.

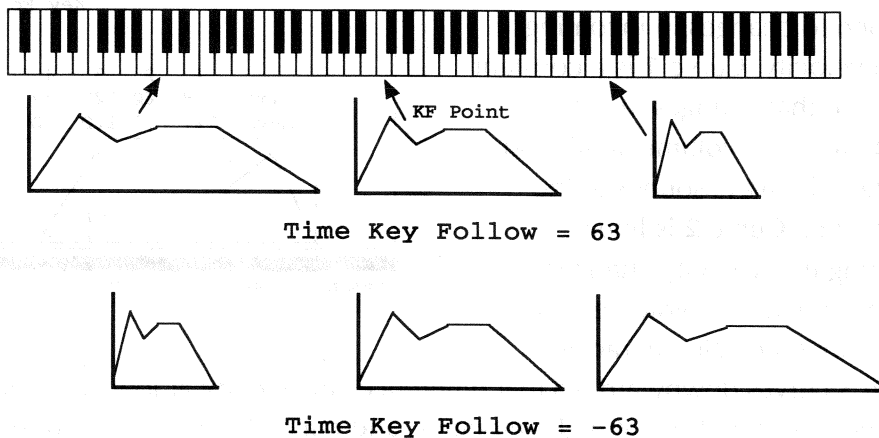

## The Envelope

The envelope parameters for the TVA are adjusted the same way as the parameters for the TVF, either numerically or graphically. One major difference, however, is that **Level 4** (Release level) must always be  $\emptyset$  — if it were some other value, the envelope would never shut down and the note would go on forever! This parameter is colored yellow to remind you it’s unchangeable. Therefore, the last blue square can only be moved horizontally (**Time 4**), and the first blue square cannot be moved at all. Similar to the **TVF** page, the TVF envelope appears in dark blue behind the TVA envelope.

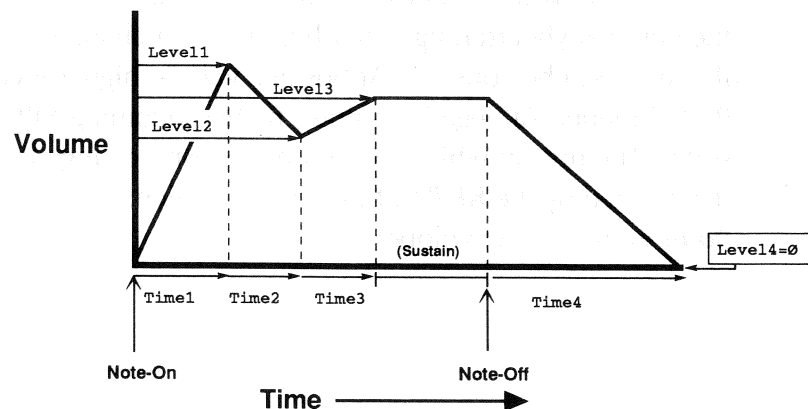

Here’s a hint for when you’re playing with TVAs and the S-770 seems to get stuck: If you set **Time 4** on a TVA to a high value and play some notes, the notes may go on for a very long time, even if you change the **Time 4** value afterwards (changes in envelope parameters only apply to notes played *after* you make the change). The screen action, including the movement of the cursor, may slow down considerably, to the point of seeming to stop, as the S-770 gives priority to the sound. Don’t panic. Just press the **EXIT** button on the S-770 front panel or the RC-100. When everything settles down and shuts up, select where you want to go and resume your work.

## Using the Templates

Programming filter and volume envelopes from scratch can be complicated, so the S-770 software includes several factory Templates to help get you started. These Templates give you complete TVF and TVA setups, which you can then tweak to suit your needs. You also have the ability to create your own Templates, from Partials whose TVF and TVA parameters you might find yourself using often.

The Templates are accessed from the **Com** menu on any of the **Edit Partial** pages. Select **Template**, and the Template window opens. To choose a factory Template (the ones under the word “<Preset>”), click on its name. The window will close, and you will be back on the **Edit Partial** page you came from, with the Template’s TVA and TVF settings imposed on the current Partial. (Although you can select a Template from any of the pages, the only pages it will affect are **TVF** and **TVA**.)

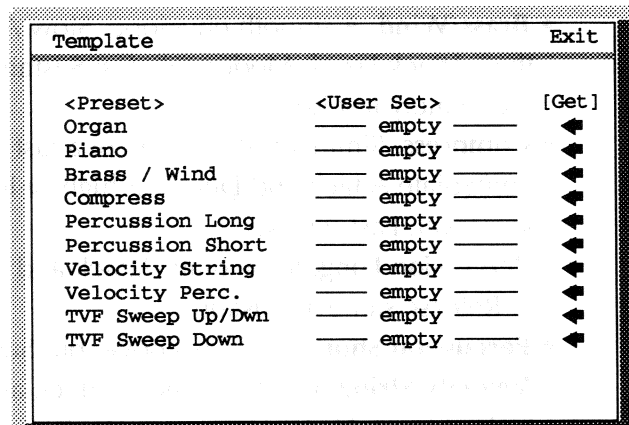

You create a Template for the “<User Set>” by taking the TVF and TVA envelopes from the Current Partial and telling the S-770 to memorize them. After you open the Template window, click on the blue arrow under the word “<Get>” which corresponds to the user slot you would like this Template to be in. You can use any of the 10 slots you like, but obviously if there is a Template already in that slot, it will be replaced. The name of the Template will be the same as the Current Partial.

To use one of the Templates in the User Set, simply click on its name. If you click on an “empty” slot, the Current Partial will become “**Organ**”. If you change your mind and don’t want to use any template, click on **Exit**.

You can't edit a User Set Template, but you can replace it by the same procedure: load and/or select the Partial whose envelopes you want to use, and enter it using the <Get> arrow. Changing the parameters of the Current Partial after you've created a Template, or deleting it from memory or even from disk, will not affect the Template.

The Templates stored in the User Set are made permanent with the "Save System" operation, like the Jump pages. If you don't do this before the end of your session, the Templates will be lost (or revert to their former state) when you turn off the power. **Save System** is available from the **Index**.

The factory Templates, and what they do, are as follows. Except for the last two, the TVF is disabled (**Filter Mode** set to **Off**), but the **TVF** page is given an envelope identical to the **TVA** page.

- **Organ.** Immediate Attack, maximum Sustain level, and immediate Release.
- **Piano.** Immediate Attack, moderately fast Decay, moderately slow Sustain to 0, but fast Release for "damping" on Note-Off.
- **Brass/Wind.** A smooth envelope. Slow Attack and Decay, with Decay Level higher than Attack Level. Moderately fast Sustain to fairly high level, followed by moderately fast Release.
- **Compress.** Simulates the action of a fast limiter, and adds "punch" to a sound. Immediate Attack and Decay at highest level, then very fast Sustain to a moderately low level. Fast release.
- **Percussion Long.** Immediate Attack and Decay at highest level, then slow Sustain to 0. Release same as Sustain.
- **Percussion Short.** Same as above, but Sustain and Release faster.
- **Velocity String.** Relatively slow Attack and Release, immediate Decay and Sustain at highest level. Near-maximum velocity sensing enabled, using Curve 2.
- **Velocity Perc.** Faster Attack and slower Release than above, Sustain level 0, Sustain time equal to Release time. Maximum velocity sensing enabled, using Curve 2.
- **TVF Sweep Up/Dwn.** For those spacey "analog" sounds. TVF has moderately slow Attack from 0 to full level, followed immediately by moderately slow Sustain back down to 0. Release is slightly faster than Sustain. Filter is Low-Pass, with medium Cutoff Frequency and Resonance. TVA has immediate Attack to full level, full Sustain level. Release the same as TVF.
- **TVF Sweep Down.** For "analog" sounds, and also useful for damping a bright loop over time. TVF has immediate Attack from 0 to full level, followed immediately by moderately slow Sustain down to 0. Release is slightly faster than Sustain. Filter is the same as above, and TVA is the same as above.

Remember there is no “Recover” or “Undo” function available, so if you have created a Partial you really like, save it on disk before sticking a Template on it. Once you’ve done that, try the factory Templates on all sorts of sounds, and see what you come up with. Even short Samples with no Sustain loops (discussed in the next chapter) can have interesting things done to them with the Templates (try, for example, **TVF Sweep Up/Dwn** on **Ride/cup**).

## LFO

One more thing you can do to a Partial is apply vibrato of various kinds using a Low-Frequency Oscillator. This is done on the **Edit Partial LFO** page. Vibrato can be applied to a Partial’s pitch, to its TVF, and/or to its TVA.

### Parameters

The LFO parameters are set at the top of the screen:

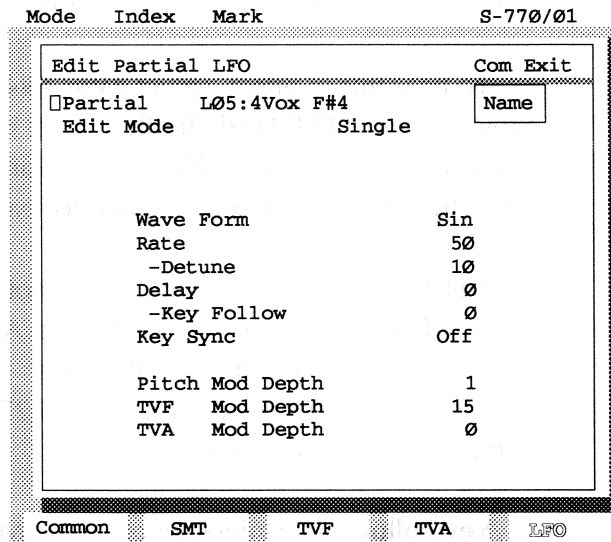

**Wave Form** lets you select among several waves for the LFO: **Sin(e)**, **Tri(ngle)**, **Saw(tooth) Up**, **Saw(tooth) D(o)wn**, **Square**, **Random**, **B(e)nd Up** (a non-repeating bend which starts below the note and slides up to it), and **B(e)nd D(o)wn** (which starts above the note and slides down to it).

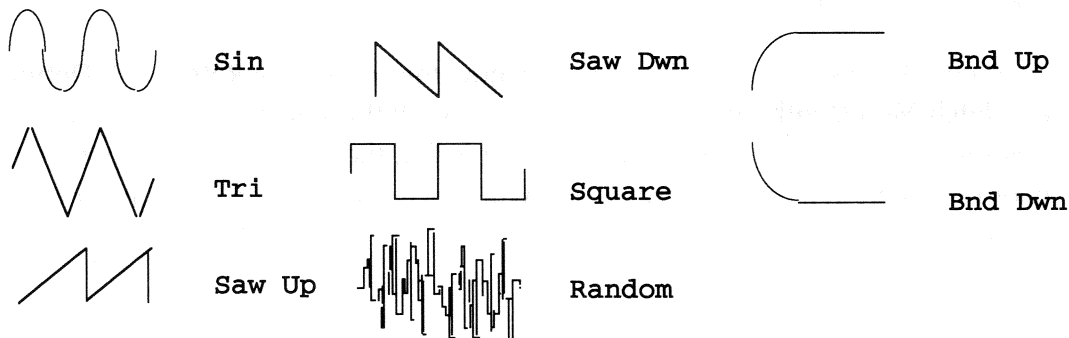

**Rate** controls the basic speed of the LFO. It can be set from 0 (which is not Off, but is very slow) to 127.

**Detune** is a randomizer for the **Rate** parameter. It will change the LFO rate somewhat with each new Note-On, so that each note as it plays has a slightly different vibrato speed. (Allow the author a personal observation here: this is an incredibly neat feature for doing realistic orchestral simulations.) The value of the parameter (from 0 to 127) determines the overall spread of the randomization: at low values, the vibrato speed differences between subsequent notes will be very subtle, almost like a phasing effect. At the highest values, the difference in vibrato speed from one note to another will vary as much as 100%, that is, one note may have vibrato twice as fast as another.

To hear this in effect, select **4Vox F#4** and crank the **Detune** parameter up to 127. Move down to **TVF Mod Depth** and set it to about 39 (yes, we know we're getting ahead of ourselves here). Play a chord and hold it. You'll hear a wah-wah vibrato effect that goes at a different speed for each note.

**Delay** sets a period of time after a note starts before the LFO begins to affect it. At 0 there is no delay, and the vibrato starts immediately. At the maximum value, 127, the delay is about 22 seconds.

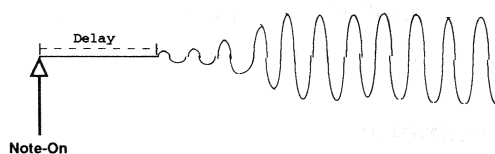

**Key Follow** determines whether the MIDI Note-On number will have an effect on the **Delay**. At 0, all MIDI notes will have the same delay. As the value is increased (the maximum is 63), higher MIDI notes will have progressively shorter delays.

**Key Sync** determines whether the vibrato waveform will start in the same place for every Note-On. If it is On, then the vibrato for every note will begin at the same point in the LFO waveform. If it is Off, the starting point of the vibrato waveform for each note will be different.

A chord gives us a good illustration of how this works. Set **Rate** to 48, **Detune** to 0, and **Pitch Mod Depth** (there we go again!) to 45. If this parameter is On, then all the notes in the chord will move in parallel. If it is Off, the vibrato for each note in the chord will start in a different place, and will move against each other in various phase combinations.

## The LFO Assignments

What the LFO actually *does* to the sound is determined at the bottom of the screen. The LFO can be applied, in any combination, to:

- the Partial's pitch (**Pitch Mod Depth**);
- the TVF, periodically raising or lowering the filter Cutoff Frequency as the TVF envelope progresses (**TVF Mod Depth**); or
- the TVA, periodically raising and lowering the volume as the TVA envelope progresses (**TVA Mod Depth**).

If the LFO waveform is **Bend Up** or **Bend Down**, then the effect of the LFO on the pitch, TVA, or TVF is not periodic, but is a single occurrence.

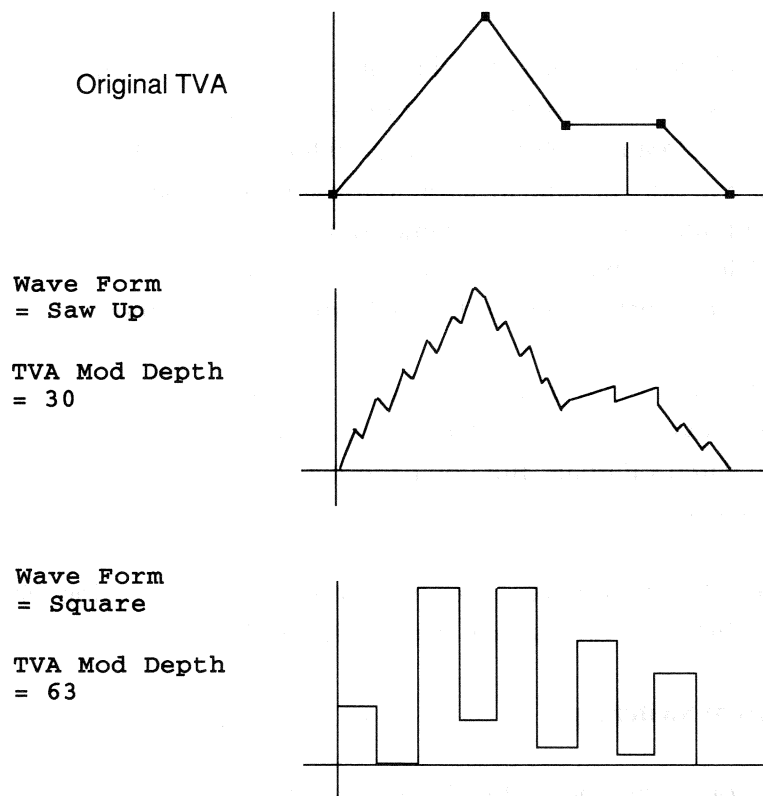

The Depth parameters have a range of -63 to +63. Negative values apply the waveform with its phase reversed.

## Editing Partials through the Patch page

As mentioned in Chapter 3, the **Edit Partial** pages behave slightly differently when you enter them through a Patch page's **Com** menu (in Subsidiary mode), instead of the **Sound** menu or the **Index**. There are four main points to be aware of.

To illustrate, let's load in a complex Patch. From the **Disk Load** page, select **Patch** as the **Target**, and load **LØ7:Orch. Toys**. When the file is loaded, go to a Patch page, not a Partial page, open the **Com** menu and select **Edit Partial**. When the Edit Partial page opens (whichever one it is), its name will appear with "stars" around it, indicating that you are in this special mode.

**\*Edit Partial LFO\***

### 1) Restricted access to Partials

First of all, the Partials you will be able to select for editing will be limited to *only* those Partials that are *subsidiary files of the Patch* that you came from, even if there are other Partials already in RAM. If you scroll the Current Partial line at the top of the page, you will only be able to scroll to those Partials that are in the current Patch. If you click on the Select box, the names of the Partials you can access will appear in the Select window in white, while those you can't access will be colored purple. You will not be able to select "Blank" to be the Current Partial either.

You can load a new Sample from disk and put it into one of the Patch's Partials, and you can even load a new Partial from disk, and put the Samples *it* contains into one of the Patch's Partials. But you cannot access the newly loaded Partial itself, because that Partial is not a subsidiary of the Patch.

This restriction, however, does not apply if you are working with a *brand-new* Patch, to which no Partials have been assigned. In that case, all Partials are accessible.

### 2) Automatic Partial Switching

The second difference is that if the Patch contains a Split, the Split will *remain active* while you are on the Partial page. As you play notes on your MIDI keyboard, you will hear the different Partials, and the *display* will also change to show which Partial is sounding.

This makes it easy to keep track of which Partials are assigned to which notes, and how they sound in the proper context. However, it also means you have to be careful not to hit a wrong MIDI key while editing, or you may end up editing the wrong Partial.



### 3) Not Omni Mode

The S-770 will no longer necessarily respond to incoming MIDI data on all channels. Instead, it will respond only to MIDI signals on the channel selected in the Patch page that you came from. If the **Select/MIDI in** parameter is set to **Omni On**, that will be all channels. If it is set to an individual Part, then the unit will only respond on the MIDI channel corresponding to that Part.

In addition, if you are editing a Partial from a *Performance*, any range restrictions or fades imposed on the Part by that Performance will be in effect (see Chapter 8).

### 4) Global Editing

Finally, when editing a Partial from within a Patch, you may choose to have the changes that you make affect *all* of the Partials in the Patch simultaneously. This is done by selecting the word “**Single**” on the **Edit Mode** line and clicking the right mouse button once. It will change to “**Global**”. Now any changes that you make in any Parameter on any of the Partial pages will change *that particular Parameter* for *all* of the Partials in the patch at the same time. This includes Samples — if you change the Sample in any one of the four slots in a Partial, *all* of the Partials in the Patch will now have that Sample occupying that slot. This switch is inactive if the current Patch has only one Partial assigned to it.

While this feature is not of great value in mapped Patches like this one, it can be a convenience when dealing with multisampled Patches. Global editing of envelopes, for example, makes it much faster to get consistent response over the entire keyboard range for a Patch that uses several Samples.

If you want a parameter change to affect only one Partial, click the left mouse button to change **Global** back to **Single**, and now any changes will only affect the Current Partial.

### The Partial Map

Another way to edit Partials from within a Patch is to use a special set of pages called the Partial Map, which are accessible only through one of the Patch pages. We’ll discuss the Partial Map momentarily.

## Other Partial Functions (the Com menu)

Several other functions that affect Partials are available through the **Com** menu on any of the **Partial Edit** pages.

### Disk

The **Disk** function (**Load, Save, Copy, Delete, Util**) is the same as in other modes and is described in Chapters 3 and 9. When you **Load** a Partial, it loads in all subsidiary Samples, unless you set the **Target** to **Partial PRM**, in which case only the Partial's Parameters are loaded. This way an existing Partial can easily be used as a template to organize a different set of Samples.

When you **Save** a Partial, any new Samples you have created get saved with it. In addition, any old Samples that are subsidiary to the Partial will be saved as new files if you have changed the **Volume ID** since you loaded in those Samples from disk (see Chapter 8). If you **Delete** a Partial from disk, all subsidiary Samples are deleted as well, unless they are being used in another Partial *and* the **Fast Delete Mode** switch is **Off**.

### Copy

**Copy**, as in the Patch mode, lets you make a duplicate of a Partial into another slot in RAM so that you can keep the original version safe while you edit. To make a copy of the Current Partial, choose a slot to copy *into* from the **Copy** window.

The duplicate has two letters added to its name: the first copy will have "**AA**" tacked onto the end; the second will have "**AB**", etc. You can freely copy copies, and the alphabetic progression will continue regardless of whether you are copying an original or a copy.

If the slot you are copying into is occupied by another Partial, that Partial will be deleted. If the slot is occupied by another copy of the Partial you are copying, the name will not change — that is, a new suffix will not be assigned. Any of these copies can be saved to disk, modified or unmodified.

### Delete

As with Patches, the **Delete** function on the **Com** menu lets you select a Partial to remove from RAM. The **Delete** function only works on RAM — the files on disk are not changed unless you go through the **Disk** function.

As you pass the cursor over the names of the Partials in the Delete window (without clicking the mouse), you can hear each one if you play the MIDI keyboard. This can help you determine which Partial you want to lose. If you are editing Partials through a Patch, the Partials belonging to the current Patch will be displayed in white, while all others will be in purple. You can delete *any* of them, however.

### Down and Down: Moving to the Sample Level

The last three commands let you move down to the **Sample Edit** level and work with one or more Samples, similar to the way you can move to the Partials function directly from a Patch page. One major difference, however, is that your access to Samples in RAM is *not* restricted to those Samples that are subsidiary to the Partial you're coming from — the Sample pages always behave the same way no matter how you get to them. More on this in the next chapter. When you **Exit** the Sample level, you will come back up to the **Partial Edit** level.

**Edit Sample1** moves you to the first set of sample pages, and **Edit Sample2** moves you to the second, advanced set. **Sampling** moves you directly to the **Sampling** page (the first page of the **Edit Sample1** level). When you go to the **Sampling** page from a Partial page, what happens is similar to what happens when you go from a Patch page: the page is labelled **Sampling from partial**, and when you record a Sample, the software automatically creates a new Partial with the same name that you've given the Sample. This happens whether you select **Sampling** from the **Com** menu, or you select **Edit Sample1** from the **Com** menu and then move to the **Sampling** page.

When you exit any Sampling page, you will go back to the Partial page you came from.

## The Partial Map

The Partial Map provides you with an alternative view — from another dimension, some might say — of the parameters for the Partials in a Patch. Instead of showing you groups of parameters on an individual Partial basis, Partial Map lets you look at only one parameter at a time, but you can see how that parameter is set in many Partials simultaneously.

The Partial Map can be accessed only from a Patch page, by opening the **Com** menu and selecting **Partial Map**.

There are three Partial Map pages, and they differ only in the pitch range that they show you. The first page, **A 0~**, shows the notes from A0 (MIDI note number 21 decimal) to C4, a total of three octaves plus four semitones. The other two pages show you a four-octave range starting from either C#2 or C#4.

Select the patch you want to look at just as if you were in a Patch page, and select the appropriate Part number and MIDI channel to receive on.

(Notice that, unlike the Edit Partial pages, you can change the name of the *Patch* on these pages, but not the name of a Partial.) On the line labelled **Parameter**, use the left and right mouse buttons to scroll among all of the parameters found on the **Partial Common**, **TVF**, **TVA**, and **LFO** page (except the parameters on the Common and SMT pages that deal with individual Samples): they start with **Output Assign** from the **Common** page, include all of the envelopes and other TVF and TVA settings, and end with **LFO TVA Mod Depth** from the **LFO** page.

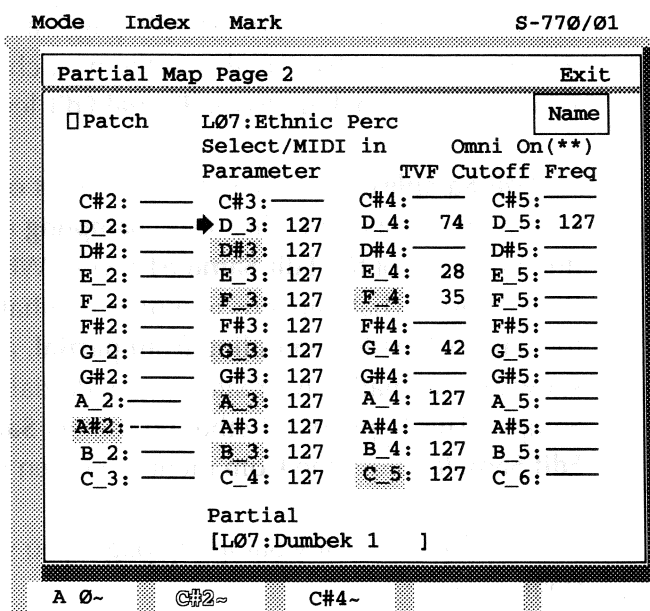

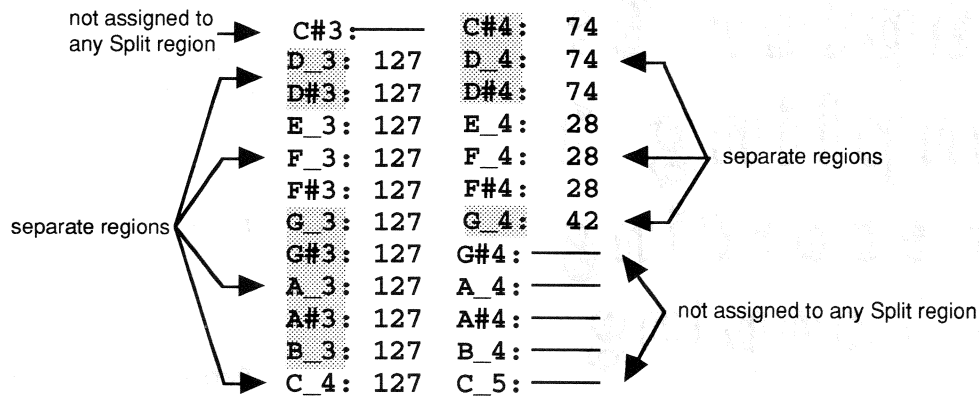

When you select a parameter, the display shows the current setting of that parameter for each note on the screen. Names of notes that are not assigned in the current Patch are displayed in black. Names of notes that are assigned are in yellow. However, different split regions adjacent to each other (which will be the case most of the time), the notes in one of the two regions will be displayed in reverse video (blue on yellow). All contiguous notes in a split region will be in the same color, either normal or reverse — for example, if a region ends at C4 and a new region begins at C#4 and extends to D#4, C4 will be displayed normally, and all of the notes C#4 to D#4 will be in reverse video.

Move the mouse over the parameter value next to the note, and use the mouse buttons (or **VALUE** wheel) to raise or lower the parameter. The values for all other notes that are assigned to the same Partial will change at the same time. Also, the name of the Partial whose values you are adjusting will appear at the bottom of the screen under the word **Partial**.

If you're not sure which note names correspond to which MIDI keys, at any time you can play one or more notes on your MIDI keyboard, and a red arrow will appear next to each note you play.

When you are done with a Partial Map, you must go back to the Patch page you came from by clicking **Exit**. (The Partial Map pages have no **Com** menu.) You can then go to the other Partial Edit pages if you like. Any changes made on the **Partial Map** page will of course be visible on the other Partial Edit pages as well.

# Chapter 6: Sampling 1 — Recording and Looping

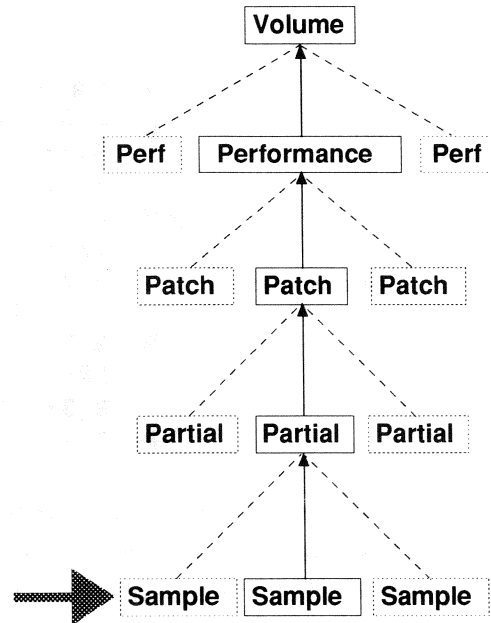

Up to now, we've been working with Samples already recorded on the S-770's hard disk. Of course, besides the sample-manipulation features we've been exploring, the S-770 has extensive sample *recording* and editing facilities. In this chapter we will discuss how to record samples and also how to loop them. Looping is usually a non-destructive technique that preserves all of the original sample data. In the next chapter we will discuss more sophisticated editing functions, which change the sample data.

Samples are recorded and edited using the two **Edit Sample** functions. The **Sample1** functions fit onto five Pages. They can be reached by a wide variety of ways, and each route has its own specific destination:

- Select **Edit Sample1** from the **Sound** menu, and you will go to the Sample1 page you were on the last time you were at this level. If this is the first time you are entering this function, you will go to the **Loop1** page.
- From a Patch page, open the **Com** menu and select **Sampling**, and you will go to the **Sampling** page.
- From any of the Partial pages, open the **Com** menu and select **Sampling**, and you will go to the **Sampling** page. Select **Edit Sample1**, and you will go to the **Loop1** page.

*Note:* Going to a Sample page through a Patch or Partial page places no restrictions on the Samples that can be worked with, but when you record a Sample after coming through a Partial or Patch page, it automatically creates a Partial and (if you came through a Patch page) a Patch with the same name as the Sample. We'll discuss the ramifications of this later in this chapter.

- Use a Jump page. The fourth Pages in the two Jump sets are factory programmed for Edit Sample1 Pages. Or program one yourself.
- From the **Index**, under the **Sound** category, a number of Topics and Subtopics will lead you to Sample1 pages. Look at the "Index of the Index" (Appendix) of this manual for a complete list.

When you **Exit** a **Sample1** page, you will go back to either the **Sound** menu, if you came from there or the **Index**, or else the Patch or Partial page you came from.

The **Sample2** functions have their own *menu*, which contains seven items. Each of these items, in turn, has one, two, or three pages. To get to the **Edit Sample2** menu, there are again several paths:

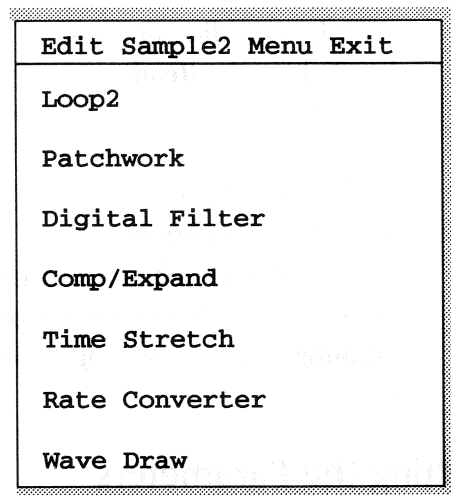

- Select **Edit Sample2** from the **Sound** menu.
- From any of the Partial pages, open the **Com** menu and select **Edit Sample2**.
- Use a Jump page to go to a **Sample2** page that you have programmed.
- From the **Index**, under the **Sound** category, a number of Topics and Subtopics will lead you to Sample2 pages. See Appendix for a complete list.

When you leave a Sample2 page, you will always go to the **Sample2** Menu.

## Recording a Sample

The first page of the Sample1 function, **Smpling**, is used for recording Samples. Before you record a Sample, you must select a slot for the Sample, name it, and set the Parameters on this page according to how you want to record. After that is done, start the sample recording process by clicking the **Ready** switch.

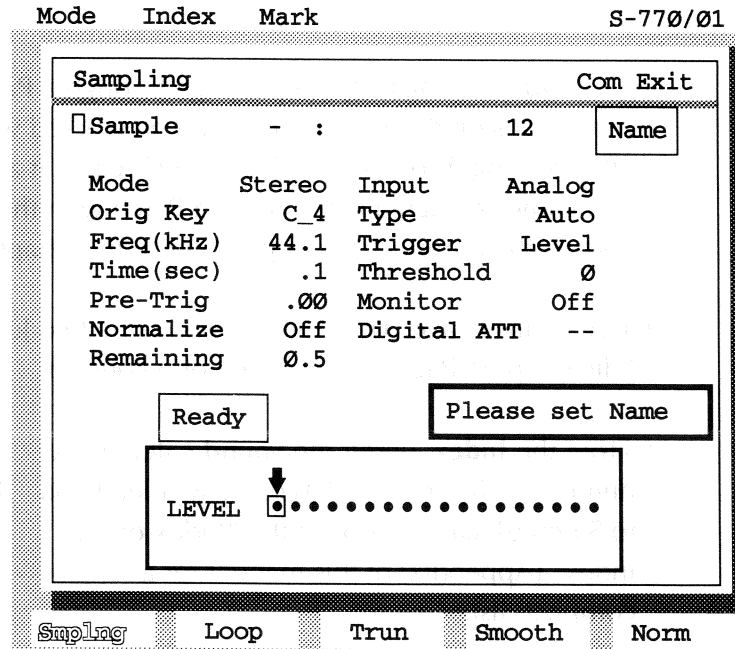

To keep this simple, let's look at recording a Sample all by itself, not in the context of a Partial or Patch. To take the most direct path to the Sampling page, open the **Sound** menu, select **Edit Sample1**, and go to the **Smpling** page by clicking on its name at the lower-left corner of the screen.

## Setting the Parameters

### Selecting the Slot and Naming

The first thing to do is decide where you want to put the Sample. Select a slot by scrolling in the Current Sample line at the top of the screen, or using the Select icon. If you already have sounds in RAM, one or more Sample slots will already be occupied. If you select one of those slots to record in, the Sample already in it will be erased. If you don't want this to happen, select a blank slot, either by scrolling with the right mouse button until a slot appears that has no name, only a slot number, or by opening the **Select** window and clicking on **Blank**.

Now click on the **Name** box and open the **ASCII Keyboard** window to name your new Sample. The S-770 will not let you record a Sample without a name. If the name happens to be identical to a Sample already in RAM, the software will warn you of this. If you insist on going ahead, the Current Sample slot will jump to the slot containing the Sample that already has that name, and you will be forced to record over it. This is to avoid a situation in which two Samples with the same name exist in RAM.



## Mode: Mono or Stereo

The next decision you must make is whether you want to sample a mono source or a stereo one. Stereo Samples, obviously, take up twice as much memory as mono ones. Stereo Samples are actually two mono Samples that are manipulated together. They can be easily split into individual mono Samples, and in some cases recombined — see “Working with Stereo Samples” later in this chapter.

Stereo Samples, by the way, have special suffixes on their names, but don’t worry about that quite yet.

## Original Key

This will determine the “base” note for your sample. It defaults to **C\_4**, which is normally Middle C (MIDI note 60 decimal). If you are sampling a sound whose actual pitch is F#5, you would normally assign its original key to F#5 so that when you play it back, it is in tune with other samples and other instruments.

This is especially important when you are Multisampling, that is, using several Samples of an instrument taken at different pitches to cover a wide range of notes without “munchkinization” (see the section on Splits in Chapter 4). By setting the **Orig Key** of each Sample to the pitch of the actual sound, it will be much easier to keep track of the Samples, and you will need to make fewer adjustments when you assemble them in a Patch.

If you are recording a sound that you want to map later to a specific MIDI key, like an individual drum or a sound effect, you can assign that key here. This setting can be overridden at the **Partial** level (and if you turn off **Key Follow** on the Partial, this Parameter is essentially irrelevant), but you can avoid some possible confusion by setting it up correctly here. It can also be reset on some of the sample editing pages, if you need to adjust it after it’s been recorded.

## Freq

This selects the sampling frequency, which when you first turn on the S-770 will be settable to either 44.1 kHz or 22.05 kHz. The higher frequency gives the best quality. The lower frequency will still give good quality on sounds without too much treble content, and will allow you to store twice as much sound in RAM or on disk.

You can also sample at a rate of 48 kHz, as well as its double-length partner, 24 kHz, which is most useful when sampling directly from a DAT player or other 48-kHz digital source. Enable the 48 kHz rate with the **Master Freq** parameter on Page 2 of the **System Parameters** (see Chapter 9). Within a Partial or Patch, samples recorded at different rates can be mixed freely. A Sample's rate can also be changed after the fact with the **Rate Convert** feature — see Chapter 7.

If you are sampling a signal through the digital input, the **Freq** *must* be the same as (or exactly half of) the sampling rate of the incoming digital signal, or else you will get a “**Digital Unlock**” error message, and you won't be able to sample. Check the **Master Freq** parameter if you get this message. Most digital tape decks work at 48 kHz, while CD players work at 44.1 kHz. (You will also get this message if the **COAXIAL/OPTICAL** switch on the rear panel — we'll discuss this in a moment — is set incorrectly, or if there are problems with the input signal.)

Samples that are loaded from an S-550/S-330/W-30 disk will have a sampling rate of 30 kHz. Even though you can't get the S-770 to sample at 30 kHz, these Samples can be treated like any others. We mention this so you don't get confused when you encounter one of these.

## Time

This reserves a specified amount of RAM for your sample. It can be set anywhere from 0.1 second (0.2 second at the slower sampling rates), up to the maximum time currently available in RAM. Set it so you have a comfortable margin of error — if you know a sound is 2 seconds long, give it 2.5 seconds of RAM. You will not waste any memory by setting this too high, because you can always truncate the sample afterwards (see the next chapter), and whatever memory you cut is then put back into the available RAM.

In Chapter 3, we mentioned that time-length Parameters in the S-770 are usually displayed referenced to a 44.1 kHz sampling rate, so that accurate and consistent comparisons can be made between sizes of files. The **Time** Parameter and the **Remaining** parameter at the bottom of the column, however, don't follow this rule.

On this Page *only*, the times are shown referenced to the *current* (that is, full-speed or half-speed) sampling rate. This is to allow you to set up a specific amount of memory for the Sample you are recording without going through a lot of mental calculations in case you're using a sampling rate other than 44.1 kHz. Once you *leave* the **Smplng** page after the Sample is recorded, any **Remaining** Parameter you see will be referenced to 44.1 kHz. (The **Resampling** function, discussed in the next chapter, also has this Parameter referenced to the current sampling rate, but let's not get ahead of ourselves.)

If the **Remaining** parameter is **0.0**, you will not be able to record a Sample. You will also see a message in red in the middle of the screen that says "**Wave Memory full**". If this is the case, you will have to remove one or more Samples from RAM. Use the **Delete** function from the **Com** menu — see later in this chapter for details.

One more thing about the **Remaining** parameter: if the line at the top of the screen is showing a Sample (as opposed to an empty slot), the software assumes that you want to record over this Sample, and so adds its length to the available memory. Therefore, the parameter will change as you change the current Sample.

## Choosing Inputs

You have a choice of four different sets of inputs for your input signal, two analog and two digital.

### Analog

If you are sampling an analog signal, set the **Input** parameter to **Analog**. The front-panel inputs are for unbalanced sources, and the rear-panel inputs are for balanced ones. Each has its own input pad (**SENS**), which work independently. You can use only one analog input to a given channel at a time — inserting a plug into one of the front-panel jacks disconnects that channel's rear-panel jack.

If you are sampling in mono, use only the jack (balanced or unbalanced) marked "**L(MONO)**" — the "**R**" jacks are disabled when **Mode** is set to **Mono**.

Adjust the **SENS** control for the input you are using to get a good level. If it is too low, you won't be able to get a reading on the level meter on the screen. If it is too high, the peak indicators on the front panel next to the **SENS** control (labelled "**HEAD AMP**") will light. These indicators are before the "**REC LEVEL**" control, and indicate possible distortion at the preamp stage — it is okay for them to flash occasionally, but more than that shows clipping.

Monitor the level of the incoming signal using the graphic display at the bottom of the page (if you're sampling in stereo, there will be a double display), and adjust the front-panel **REC LEVEL** knob(s) for a good reading. The signal should make the boxes in the display jump as far as possible to the right without activating the last box on the right, which will show red. To aid in monitoring the input level, the display has a "peak-hold" function in which the loudest level is displayed for about a second after the level has dropped off. If the level is too loud or too soft for the **REC LEVEL** knobs to deal with, change it either with the **SENS** control associated with the inputs you are using (front or rear), or with the output level control of the device producing the signal.

## Digital

The two sets of digital audio inputs are on the rear panel. They are enabled by setting the **Input** parameter to **Digital**. These inputs are designed to accept AES/EBU digital signals, as generated by CD and tape players with digital outputs, digital consoles, and processors such as the Roland E-660 equalizer and R-880 reverb. You can use either the coaxial digital audio jacks or the optical ones, and you must set the switch directly below the jacks on the rear panel accordingly.

The digital input jacks both receive two channels — the AES/EBU standard does not use separate inputs for the left and right channels. If you wish to record only one channel of a digital input signal, set **Mode** to **Mono** and use the **Input** parameter to specify which channel to sample: **Digital L** or **Digital R**.

The **SENSitivity** and **REC LEVEL** controls have no effect on the digital inputs, but you can adjust the incoming digital level using the **Digital ATT** parameter, which allows the signal to be cut  $-3$  or  $-6$  dB, or boosted  $+3$  dB.

## Triggering

You have several choices of how to get the sample recording process started. These choices are selected by the **Type**, **Trigger**, and **Threshold** parameters. Remember that the sample recording process won't actually start until you click the "**Ready**" switch, so feel free to experiment with the different Parameters.

## Automatic Triggering

When **Auto** is selected for **Type**, the S-770 will start recording when it receives a particular signal. The type of signal it's looking for is determined by the **Trigger** parameter.

If **Level** is selected for **Trigger**, then the S-770 will start recording when an audio signal exceeding the **Threshold** level is received. The **Threshold** is adjustable in units from 0 (recording will start immediately even if no signal is present) to 127 (a very high level is necessary). As the **Threshold** is adjusted, an arrow appears in the "Level" window on the screen, showing the position of the **Threshold** setting, relative to the level of the incoming signal. Any input signal that shows up to the right of the arrow will start the recording, while if the signal stays to the left of the arrow, the recording will not start. Once recording starts, it keeps going until the time allotted in the **Time** parameter is used up, even if the signal drops below the **Threshold** level.

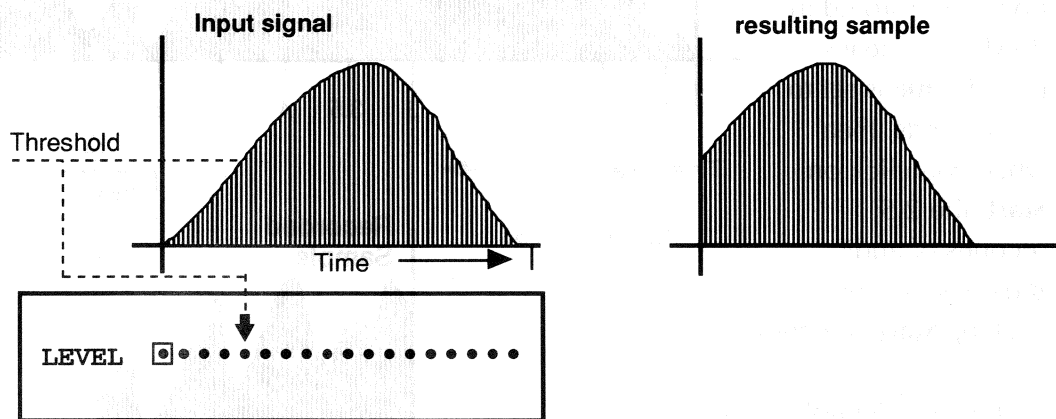

Selecting **MIDI** means recording will start when a MIDI note-on (but not a controller or program change) command is received by the S-770. The S-770 is in MIDI Omni mode when the **Sample** pages are showing, so any MIDI channel will work for a trigger.

Selecting **Pedal** means recording will start when a footswitch which is plugged into the "FOOT SWITCH" jack on the front panel is pressed. The footswitch should be a normally-closed, single-pole type, like the Roland DP-2.

## Manual Triggering

Setting **Type** to **Manual** means that the S-770 will start recording only when the **Start** switch on the **Sampling Execute** page appears. This page will appear after you've clicked **Ready**.

Setting **Type** to **Prev(ious)** means that the sampler is always "listening" to the incoming audio signal and storing it in a circular buffer, which is constantly being cleared and refilled. The size of the circular buffer is determined by the **Time**

parameter. The moment you click on **Start** on the **Sampling Execute** page, the buffer is frozen and stored in RAM. This means that, if **Time** is set to 2.5 seconds, then when you click on **Start**, the 2.5 seconds of audio *previous* to your clicking **Start** is recorded.

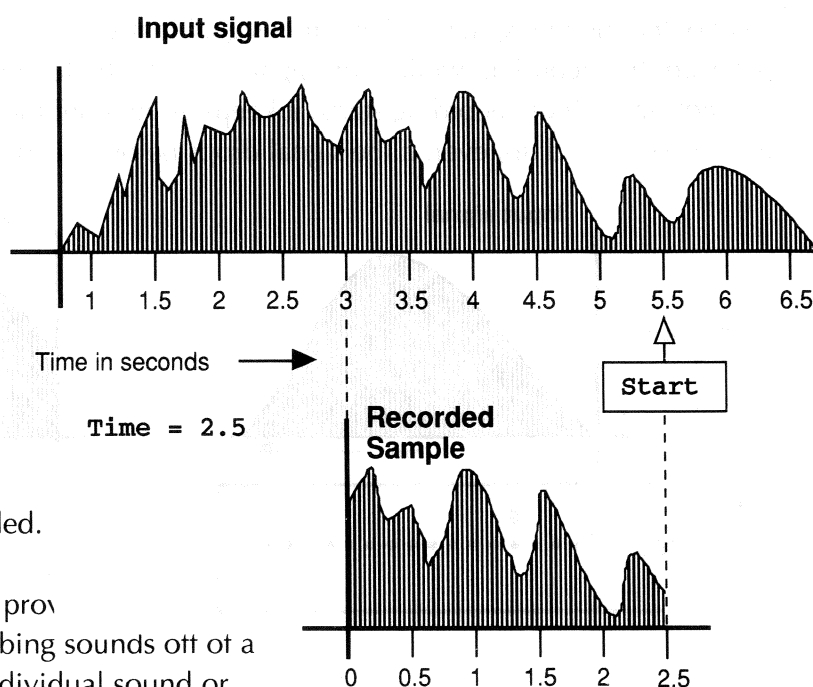

Previous Sampling provides an excellent way for grabbing sounds off of a recording, either an individual sound or an entire phrase, because you don't have to anticipate when the sound you want will occur — you can tell the sampler to capture it right *after* it happens.

**1-Way** is a special quick sampling mode that processes the sample faster than other modes, so that you don't have to wait after recording to hear it. It can be triggered from level, MIDI, or foot pedal. You can use it when you are recording a series of similar samples, one right after another. However, you cannot set up a **Pre-trigger** buffer (coming up) with this mode.

## Other Parameters

**Pre-trig** sets up a buffer that will hold a small amount of sound prior to the actual recording. It is used with level-threshold triggering to make sure that the transient at the very beginning of a sound does not get cut off when the level threshold opens. It is calibrated in 1/100ths of a second. You can be generous with this Parameter — if you end up with extra space at the beginning of the Sample after it is recorded, cutting it off is easy (see **Truncate** in the next chapter).

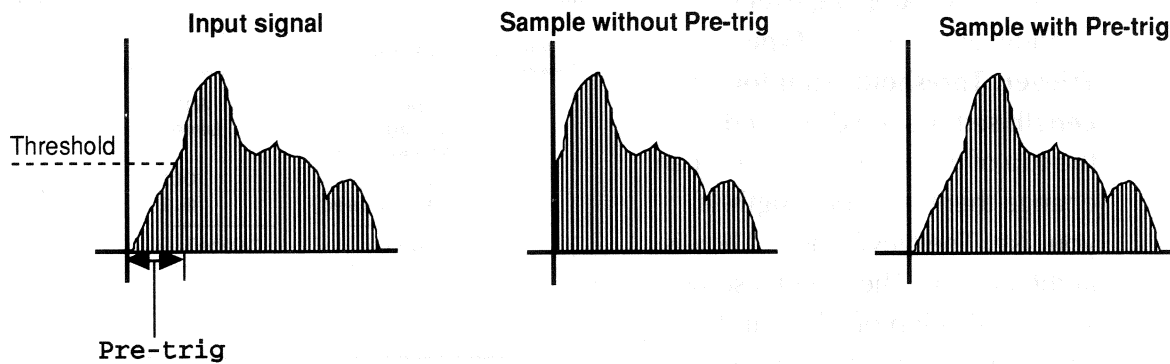

**Normalize** automatically normalizes the sample — that is, brings its overall volume up to the highest level possible without distortion — right after it is recorded. You can also normalize a sample after the fact, using the **Normalize** page (see next chapter).

**Monitor**, when switched **On**, means that the analog input signal to the S-770 appears at the Stereo analog audio outputs and the front-panel **PHONES** output. Turn this on when sampling electronic sources, and turn it off when sampling with microphones, to prevent feedback. This switch has no effect on the digital outputs: they *always* carry the signal at the digital inputs when you are on the **Smpling** page. However, you can't monitor the digital input at the analog outputs. Normally, the individual outputs never carry any input signal, but when the S-770 is in **8outs** mode (see Chapter 9), the monitor signal *does* appear at the Stereo analog and **PHONES** outputs.

*A hint:* If you are using the digital inputs to sample a CD and you would like to monitor the sound through the **PHONES** jack, send an *analog* signal from the CD player to the analog inputs in addition to the digital signal, and turn **Monitor** on. The analog signal will come through the headphones, but will *not* be sampled.

## Doing the deed

Enough preparation already! When the Parameters are all set the way you want, and you have assigned a name to the new Sample, click on **Ready**. There will be a brief pause while the S-770 allocates the amount of RAM you specified for the sample (if you reserved a lot of RAM, this pause may be a few seconds long). In addition, the fan on the hard disk will stop spinning, to assure as much silence in the room as possible. (You can defeat this with the **Fan Control** parameter — see Chapter 9.)

Now the **Sampling execute** window appears. The **Type**, **Trigger**, **Threshold**, **Monitor**, and **Length** settings are displayed at the top of the screen, and you can change them (except **Length**) if you like. The “level meter” box is at the bottom. There will also be some indication of what kind of triggering you’re using in the box: a threshold arrow, the word “MIDI”, or the word “pedal”.

To “arm” the sampler — that is, have it start listening for its trigger, or if the **Type** is **Manual**, have it start to record — click on **Start**. If you chicken out, click on **Cancel**, and you will go back to the **Smpling** page.

**Warning:** don’t stay in this window too long with the fan off, or you may damage the S-770. If you’re not going to record the Sample right away, click on **Cancel**. Come back here when you’re ready.

As you are recording, the red vertical “thermometer” next to the Level window will fill up, as the memory you have reserved (in the **Time** parameter) fills up.

When the thermometer reaches the top, there is a pause. (This pause can be fairly long if the Sample is long; using the **1-Way** mode will eliminate the pause.) Then the **Sampling Over** window appears, containing six switches and a graphic picture of the sample. The numbers above the graphic show the sampling rate, the length in seconds, and the length in samples. You can play the Sample from your MIDI keyboard (the S-770 will be in Omni mode) to see how it sounds, and decide what you want to do with it. (The “**(ALL)**” at the bottom doesn’t mean anything.)

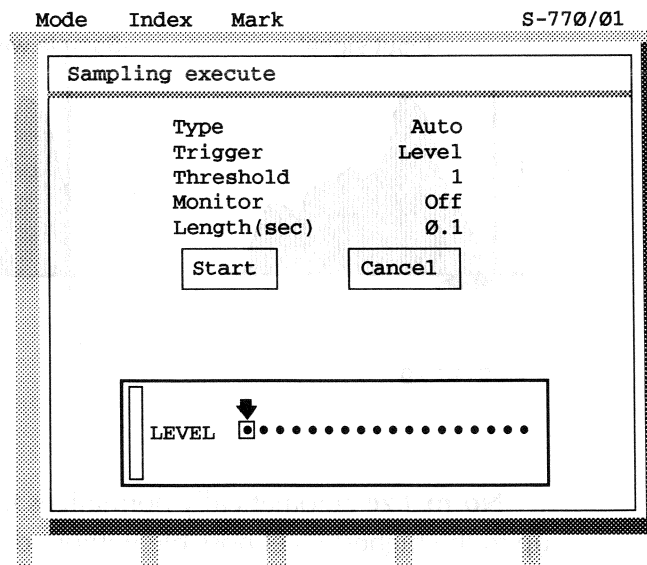



If something goes wrong during the recording, or if the sound ends before memory is filled up, you can cut off the recording any time after you click on **Start** by clicking either mouse button or pressing the **EXIT** button. This takes you right to the **Sampling over** window.

## Listening to the Results

Play the MIDI key named in the **Orig Key** parameter to hear the Sample just as it was recorded. Play up and down the keyboard to hear how it sounds transposed. You can go up two octaves (three if you're sampling at half speed), or down any distance. You can play notes above the top of that range, but the sound won't go any higher.

If you are sampling an instrument that you want to use over a wide keyboard range, this is a good time to determine how far you can transpose it in either direction before it starts to sound strange, so you can get an idea of how many more Samples you will need to take to create a good Multisample, and at what intervals.

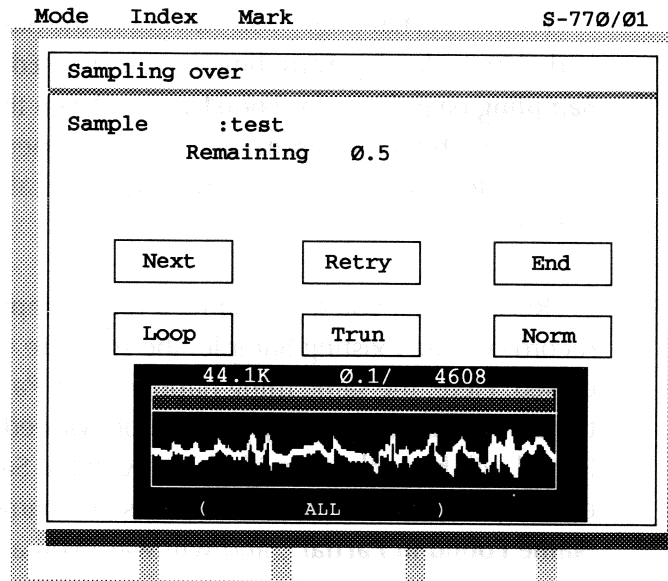

The switches in the **Sampling Over** window work as follows:

**Next** stores the Sample and takes you back to the **Sampling** page, so that you can record another sample, after choosing a slot, and setting the name and Parameters.

**Retry** takes you back to the **Sampling** page without storing the sample, and leaves the Parameters and name undisturbed. Click on **Ready** to do it again.

**End** stores the sample and takes you back to the **Sound** menu, where you can put the Sample into a Partial.

The other three switches take you directly to the various sample-editing pages at this level. **Loop** is discussed shortly; **Trun** and **Norm** are discussed in the next chapter.

## Recording Samples from a Partial or Patch

When you record a Sample from within a Partial or Patch, not only do you create a new Sample, you also create a new Partial or Patch. This feature is designed to help make Patch and Partial construction much faster.

From a **Partial** page, you can get to the **Sampling** page by opening the **Com** menu and either selecting **Sampling**, or selecting **Edit Sample1** and then going to the **Sampling** page from the **Loop1** page. When the **Sampling** page is open, its name appears with \*'s around it, indicating it's operating in Subsidiary mode. Now when you create a new Sample on this page, you also automatically create a new Partial with the same name.

Recall that if you try to name a new Sample with a name that's already in use, or record over an existing Sample, the software warns you that the old Sample will be erased. Here, the same thing happens: if a *Partial* with the name you are about to give the Sample already exists, you will be warned when you click on **Ready** that the old Partial will be replaced with the new. If the Sample you are erasing is used in an existing Partial (with or without the same name), the screen will say in red "**Same Name Found in Partial**", and will warn you a second time when you click on **Ready**.

When you finish recording the Sample, and click **End** in the **Sampling Over** window, instead of going to the **Sound** menu, you will go directly to the **Edit Partial** page you came from. The new Sample will be loaded into slot 1 of the Partial (or slots 1 and 2 if the Sample is stereo). All of the parameters for the new Partial will be set to default values.

Similarly, you can create a new Sample from within a Patch by opening the **Com** menu on a **Patch** page and selecting **Sampling**. When you create the Sample, it also creates a new Partial *and* a new Patch, all with the same name. If either a Partial or Patch already exists with that name, it will be overwritten, after the appropriate warnings.

When you finish recording the Sample, you will go back to the **Edit Patch** page you came from. The new Sample will be loaded into slot 1 (or 1 and 2) of the Partial, and the new Partial will be assigned to cover the *entire* keyboard range of the Patch. All of the parameters for the new Partial and Patch will be default values. (If you get to the **Sampling** page from a Patch page *through* one of the **Edit Partial** pages, instead of directly from the Patch page's **Com** menu, a new Patch is *not* created — only a new Partial.)

## Recording Samples from a Performance

You can also record a Sample from a **Performance Play** Page. Opening the **Com** menu and selecting **Resample2** opens a special version of the **Sampling** Page, called **Performance Resampling**. This Page works the same way as **Sampling**, but is simpler: recording can only be triggered by a MIDI note-on (on any channel), and monitoring is not available. Automatic normalization, however, is available.

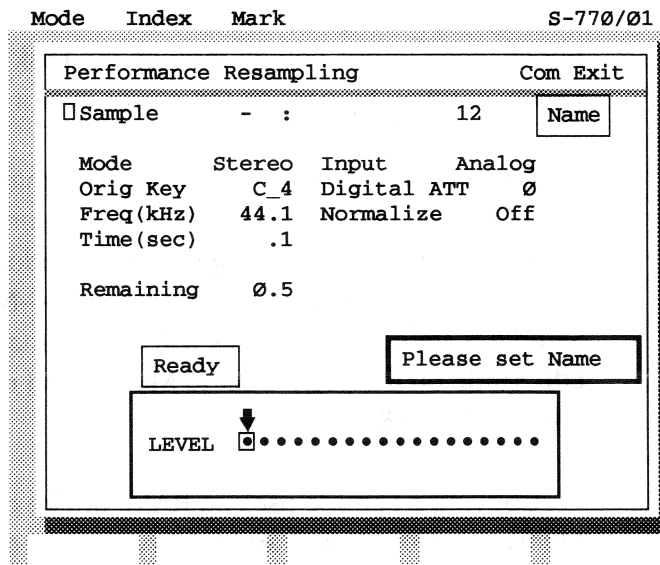

The **Input** Parameter has two new choices: **Internal L** and **Int R**. These are used for resampling complex multi-channel sounds, and will be discussed in the section on resampling in the next chapter.

After the Sample is recorded, the **Performance Resampling over** page allows you to **Retry** the recording, go on to the **Next** Sample you want to record, or **End** the procedure and go back to the **Performance Play** page you came from. There is also a graphic window for adjusting loop points, which is identical to the window on the **Edit Loop1** Page (coming up). You can't hear any loops on this page, so you're much better off going to the Loop page to make those adjustments. You can, however, change the beginning and end of the Sample and those adjustments *are* audible.

When you record a Sample on this Page, a Partial and Patch with the same name are created as well. Back on the **Performance Play** page, you can immediately put this new Patch into a slot in the current Performance.

## Other Sampling Functions

Before we go on to editing, we need to look at several other functions that affect Samples, which are available through the **Com** menu on any of the **Sample Edit1** or **2** pages.

The **Disk** functions are the same as in other modes and are described in Chapters 3 and 9.

As with Partials and Patches, the **Delete** function removes the currently selected Sample from RAM. It is useful when you need to free up RAM for recording, editing, or loading more Samples. The **Delete** function only works on RAM — the files on disk are not changed unless you go through the **Disk** menu. You can hear each Sample in the Delete window by passing the cursor over it (but not clicking the mouse).

**Copy**, as in the other modes, lets you make a duplicate of the Current Sample and place it elsewhere in RAM. Select the Current Sample in any Edit page, then open up the **Com** menu and click **Copy**. In the window that opens, choose an empty slot to place the copy. The new version has an “-N” suffix attached to its name. If the Sample is stereo, both halves will be automatically copied into two slots (even if the **Edit Mode** on the page is set to **Mono**), and one half will appear with “-NL” and the other with “-NR” .

Copying a Sample uses up RAM, unlike copying a Partial or a Patch. If Internal Memory is close to full and you try to copy a Sample that won't fit the remaining RAM, you will get a “Can't Execute” error message.

You can save a copied Sample to disk (complete with suffix) without changing its name. You might usually be better off, however, giving it a more informative name to differentiate it from its older version. You cannot, however, *copy* a Sample with an -N suffix; if you want to make a copy of a copy, you must rename the first copy. You also cannot *record* a Sample with a name that is already in use with the -N suffix, even if the original Sample that was used to create the -N copy is gone. Here's an example: you have a Sample called **LØ1:PianoC#**, and you **Copy** it so that a new Sample **LØ1:PianoC# -N** is created. Then you **Delete LØ1:PianoC#**. You cannot now record a *new* Sample called **LØ1:PianoC#** until you rename **LØ1:PianoC# -N**.

## Working with Stereo Samples

A stereo Sample actually consists of two mono Samples, which have the same names, except that one ends in the suffix “-L” and the other in “-R”. Once they are set up as a stereo Sample, they can be linked throughout the Sample-editing process. Each editing page has an **Edit Mode** parameter, and as long as it is set to **Stereo**, then anything you do on one side of the Sample — setting a loop, changing the name, truncating, or smoothing — will automatically apply to the other side as well. When you play a MIDI key to hear a stereo Sample when one side of it is showing on the screen, you will hear the other side as well. The sound comes out of the stereo outputs, analog and digital, with each Sample playing on the audio channel it was recorded on.

Note that this link only is in effect on the Sample editing pages, and when you use the “[\*]” switches on the Partial pages to load the Sample into a Partial. Otherwise, when stereo Samples are put into a Partial, or more importantly, loaded from or saved to disk, they must be handled individually as two separate Samples.

Once you switch the **Edit Mode** on any Sample editing page to **Mono**, the links between the two Samples are temporarily broken, and they are treated as two mono Samples. However, you can re-establish the link any time by setting **Edit Mode** back to **Stereo**, as long as you haven’t done any destructive editing or changed the name of either of the Samples. (If you have, you won’t be able to change the **Edit Mode** parameter.)

### Converting Mono Samples to Stereo

If you *have* edited one or both halves of a stereo sample, you can still re-combine the two mono Samples (or for that matter, any two mono Samples that are the same length) into a stereo Sample, using the “**Set Stereo**” function from the **Com** menu.

Open the **Com** menu and select **Set Stereo**. A window will open asking you which two Samples you wish to combine, **Source 1** and **Source 2**. After you select them, you can assign a new name to the resulting stereo sample by clicking in the Name box. The two halves will have this new name, plus the **-L** and **-R** suffixes. If you don’t assign a new name, the new stereo pair will have the same name as the Source 1 sample, plus the suffixes. Click on the **Execute** switch, and the two Samples will be re-named and linked.

When combining two Samples in this way, both Samples must be in RAM, and be of identical lengths. (But they don’t have to have the same sampling rate or original key.) Therefore, if you have truncated one of the halves of the original stereo Sample, you must truncate the other half by exactly the same amount before you can re-combine them. Loop settings, however, can be maintained separately, so you could end up with two halves of a stereo Sample that have very different loops. We’ll discuss the implications of this later in the chapter.

### Converting Stereo Samples to Mono

You can also convert one side of a stereo Sample into a mono one. Open the **Com** menu, and select **Set Mono**. In the **Source** parameter line, select the Sample you want to convert. Again you will be asked for a name for the new Sample you’re creating, and the default will be the name of the **Source** sample, *without* any channel suffix. If you have already converted one side of the Sample without changing the name, then if you try to convert the other side without changing the name, you will get an error message.

Click **Execute** and the operation is done. The old version is gone, and the new version has no channel suffix and no link to another Sample. Incidentally, you can perform essentially the same task by changing the **Edit Mode** on the Sample to Mono, and then saving it under a new name.

You can *mix* the two sides of a stereo Sample into a single mono one using the Resampling function, described in the next chapter.

## Editing Samples

Remember that when editing Samples, one Sample may be used in two or more different Partials, Patches, or Performances, and if you alter it, you alter it for *all* of its uses. If you are working on a Sample that you are using in a particular context and don't want to change it in its other contexts, give it a new name and save it to disk.

### Playing Samples while editing

The **Edit Sample** pages always respond to MIDI in Omni mode, so no matter what channel your MIDI keyboard is transmitting on, the S-770 will respond. The MIDI controller functions (LFO response, pitchbend range, etc.) are determined by the settings made on the **Edit Patch Ctrl** page of the last Patch to be loaded or edited, or if there has been no Patch loaded or edited since boot-up, the default settings will be used.

You can also listen to a Sample (or any other file) by pressing the **SOUND PLAY** button on the front panel. This is the equivalent of striking a particular MIDI key at a particular velocity. Holding the button is the same as holding the key. The identity of the key and the velocity value are set on **System Parameter Page1** — see Chapter 9.

## Looping

Often when a sampled sound is being used, all that's needed is for it to play through directly from the beginning to the end — which is known as “one-shot” playback. But there are many musical circumstances in which it is desirable to sustain a sampled sound for a longer period of time than simple one-shot playback will allow.

For example, if you wanted to play a horn note and hold it for ten seconds, you would need a ten-second horn Sample. You would therefore need to have available Samples that are long enough to accommodate the longest possible duration anyone would *ever* want, and this would create impossible demands on memory and storage.

To avoid this, a section of the Sample, where the sound is relatively stable and unchanging, can be “looped”. Now when a key is struck and held, the Sample plays from the beginning and through the looped area, and then when it reaches the end of the loop, it starts again at the beginning of the loop. The loop repeats as long as the key is held down. The *sound* can change while the loop is playing, if the Partial containing the Sample has a TVA, TVF, or LFO that makes it change, but the loop itself (known as the **Sustain loop**) repeats unaltered until the key is released.

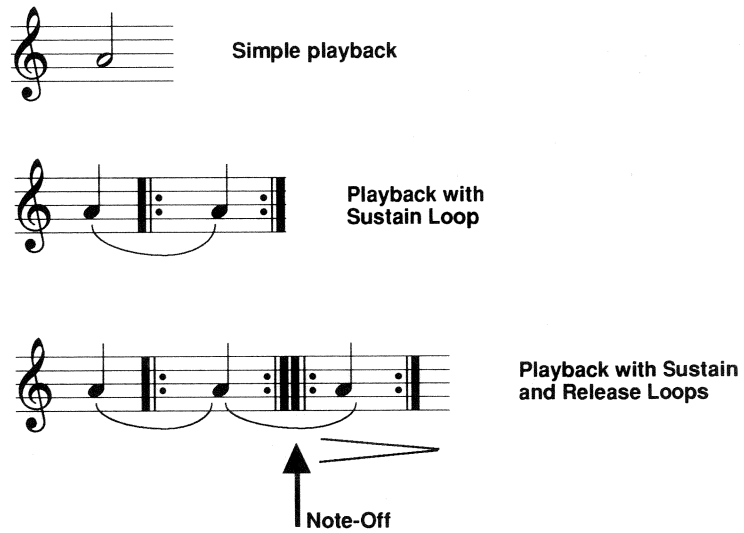

At or after that point, often a second loop, known as the **Release loop**, may start, and it plays or repeats until the volume envelope (TVA) fades it out.

Loop editing in the S-770 is a non-destructive process — the entire Sample being looped is always maintained intact in RAM and on disk, regardless of the loop settings. However, since the loop points are saved on disk as part of the Sample, if you make major changes in a loop and also want to keep your original version, you should copy the Sample to a new slot before working on it.

Mode Index Mark S-770/01

Edit Sample Loop1			Com	Exit
<input type="checkbox"/> Sample	:test		Name	
Loop Mode	Forward	Start	0	
Edit Mode	Mono	Loop	4078	
KeyOn Mode	Start	Fine	0	
Length Lock	Off	End	4590	
Disp Type	Loop	Tuning	0	
Edit Step	1	R-Loop	4600	
X-Zoom	x1	Fine	0	
Y-Zoom	x1	End	4604	
Remaining	0.5	Tuning	0	

44.1K 0.1/ 4608

( ALL )

Smplng Loop Trun Smooth Norm

The Sustain and Release loops are set up on the **Edit Sample Loop1** and **Edit Sample Loop2** pages. Let’s look at **Loop1** first.

The top line of the page lets you select which Sample to work on, either by scrolling the parameter or clicking on the Select icon. You can also rename the Sample.

## Loop Mode

**Loop Mode** is a very important Parameter. It determines how the Sample and its loop(s) are going to be played, both while you are on this page and when the Sample gets “kicked upstairs” into a Partial.

- **Forward** means the Sample will play from the beginning, go through the Sustain loop and repeat while the key is held down. At the Partial level, when the key is released, it will fade out, still repeating, according to the Partial TVA’s release time. The TVA is *not* in effect, however, when you are working on this and the other **Edit Sample** pages, so you won’t hear this fade unless you go up to the Partial level. Here, the sound will simply stop when you release the key.
- **Fwd+R** is the same, except that when the key is released, it finishes the current iteration of the Sustain loop, and then plays the next part of the Sample after the Sustain loop. When the Release loop is reached, it starts to play, and it repeats for as long as the Partial TVA’s release time lets it. Again, since the TVA is not in effect, you won’t be able to hear this. You will be able to hear the Release loop, however, if you change the **KeyOn** Mode, which we’ll discuss in a moment.
- **OneShot** plays through the sample once, from the very beginning to the end of the Sustain loop, without repeating.
- **Fwd+One** plays from the beginning, repeats the Sustain loop until the key is released, finishes the loop, and then plays the rest of the sample and the Release loop one time only (if the TVA release time allows).
- **Alt** plays from the beginning and repeats the Sustain loop, with each alternate iteration of the loop being backwards — so that the loop plays alternatively forward, backward, forward, backward, etc. — until the key is released. This gives the effect of a loop that’s twice as long.
- **Rev One** plays the sample once, backwards, from the end of the Sustain loop to the very beginning.
- **Rev** sets up a new loop, which extends backwards from the *beginning* of the Sustain loop point to the beginning of the sample. It then plays the sample backwards, starting from the *end* of the original Sustain loop, and when it reaches the beginning of the loop, it repeats the *new* loop, also backwards, until the key is released.

The Loop Modes are shown graphically on the next page.



	Sample	Sustain loop	Release loop
<b>Forward</b>	Play	Loop	none
<b>Fwd+R</b>	Play	Loop	Loop
<b>OneShot</b>	Play	1x	none
<b>Fwd+One</b>	Play	Loop	1x
<b>Alt</b>	Play	Loop, alternating forwards and backwards	none
<b>Rev One</b>	Backwards (after Sustain loop)	1x, backwards	none
<b>Rev</b>	Backwards, looped (after Sustain loop)	1x, backwards	none

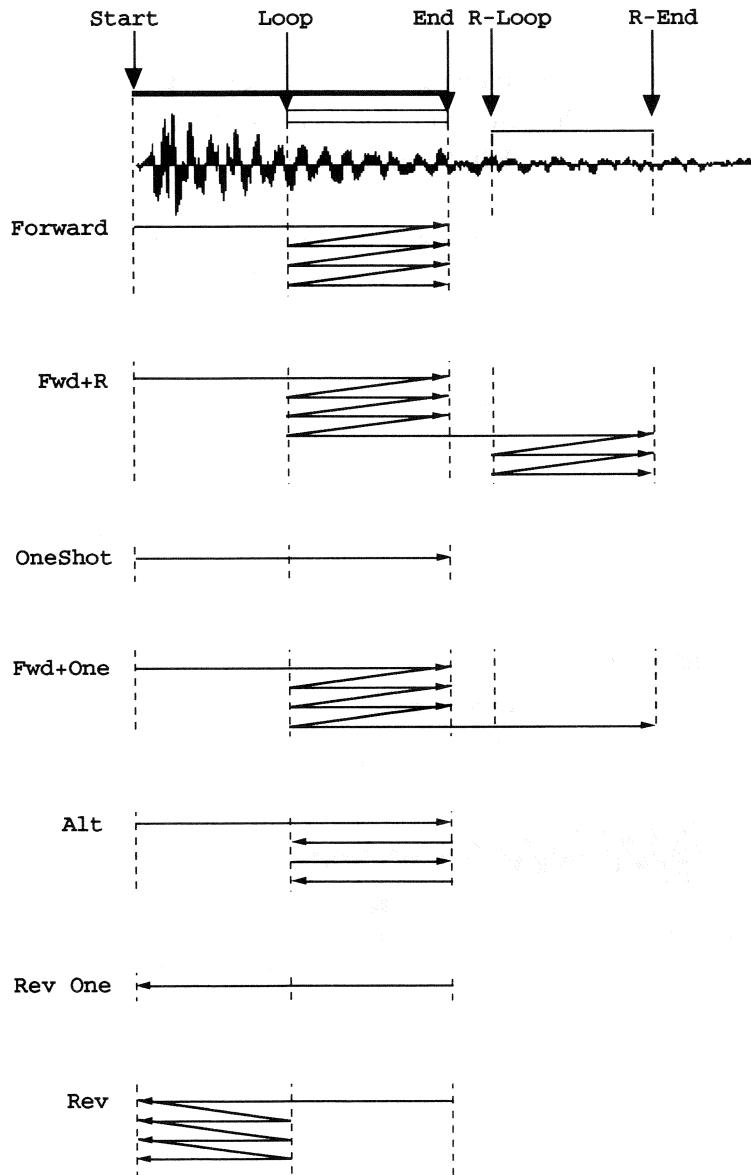

## KeyOn Mode

**KeyOn Mode** determines what happens when you strike a MIDI key while you are working on the Sample. (Remember that the S-770 is in MIDI Omni mode when editing Samples.) It is *only* applicable to the **Edit Sample** pages, and has *no effect* on what happens to the Sample when it is used in a Partial.

- **Start** means that the Sample will start playing from the beginning, and play through the end of the Sustain loop. The Release loop will not sound.
- **Loop** means it will start playing from the beginning of the Sustain loop and play through the loop's end. The Release loop will not sound.
- **R-Loop** means it will start playing from the beginning of the Release loop and play through the end of the Release loop. This is the *only* way to hear the Release loop while you are on any of the **Edit Sample** pages.
- **R-End** lets you hear what remains of the sample *after* the end of the Release loop — in other words, what is being left out at the end.

### KeyOn Mode:

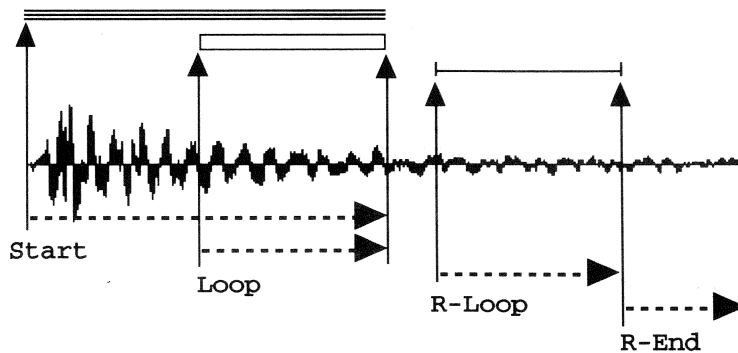

## Other Parameters

**Edit Mode**, as explained earlier, determines whether you will edit both sides of a stereo Sample simultaneously (**Stereo**) or one channel at a time (**Mono**). If the Sample is mono, this Parameter will always be **Mono**. We'll talk more about looping stereo samples at the end of this section.

**Length Lock** we'll get to in a minute. Leave it **Off** for now.

**Display Type** is discussed below under "Using the Waveform display". Most of the time you will want this to be set to "**Loop**".

**Edit Step** lets you set how much the **Start**, **Loop**, **R-Loop**, and **End** Parameters in the right-hand column will change when you select them and click the mouse buttons or move the **VALUE** wheel. It is adjustable in powers of 10, from 1 to 10000. High values are used for coarse adjustments, and low values for fine adjustments. Note that the RC-100's numeric keypad is not affected by this setting, and is therefore particularly useful for entering exact values for the various Parameters in this column.

**X-Zoom** and **Y-Zoom** control the magnification of the graphic Waveform display at the bottom of the screen. **X-Zoom** controls the horizontal magnification, and **Y-Zoom** the vertical. Set to their lowest value (**x1**), these controls let you see an entire Sample. Increasing the value of **X-Zoom**

makes it easier to edit loop points, which we'll discuss in detail in the section on the Waveform display. Increasing the value of **Y-Zoom** can help in the editing process when the signal level at a loop point is low. (If you set the Y value too high, the sample will appear to "clip" at the top and bottom of the display, but actually the sound is not affected.)

Both Parameters can be set to **x1**, **x4**, **x16**, **x64**, and **Max**. (If the sample is short, **X-Zoom** settings of **x64** and **Max** will give the same display.) When **X-Zoom** is **x1** the **Y-Zoom** setting has no effect.

**X-Zoom**            **x4**  
**Y-Zoom**            **x64**

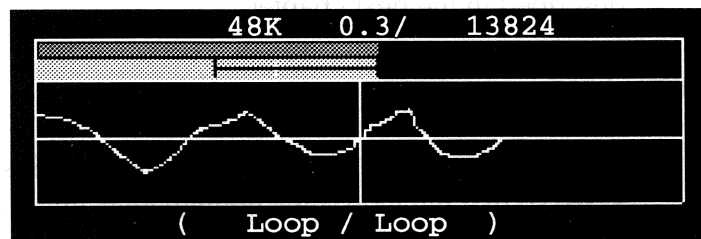

## The Loop Point Parameters

### Start

**Start**, at the top of the right-hand column of Parameters, sets the beginning point for the Sample playback, both on this page and when the Sample is placed in a Partial. While normally we deal with Samples in terms of their length in seconds, here we have to get more precise, and deal in words. The number of words in a Sample is equal to its length in seconds multiplied by its sampling rate. The **Start** parameter tells you on which word the Sample will start playing at, which can be anywhere from  $\emptyset$ , the very first word, to very nearly the last word in the Sample.

The **Start** parameter can be critical if you are transposing a Sample downwards any great distance. If there is any delay at the beginning of the Sample, as you transpose it down the delay will be multiplied, and can seriously affect the sound's keyboard response. Butting the Start point right up against the beginning of the actual sound can minimize this. The Start point can also be in the *middle* of a loop, so you can play a Sample from the middle, and then have it jump back and start looping at an earlier point. However, the Start point cannot be located past the *end* of the Sustain loop.

Remember that looping is non-destructive, so that words before the **Start** point are still there as part of the Sample, you're just not hearing them. If you want to *permanently* eliminate words at the beginning of a Sample, use the **Truncate** function, described in the next chapter.

### Sustain Loop

**Loop** determines the starting point of the Sustain loop. It can be set to be equal to **Start**, so that the loop starts immediately, and it can be set to a lower number, so the Sample starts playing in the middle of the loop.

**Fine** adjusts the location of the **Loop** point by interpolating between the individual words. Its effect is quite subtle, and will mostly be noticed on loops of very short duration.

**End** determines the ending point of the Sustain loop. It must be higher than **Loop** or Start (whichever is higher) by at least 4 words.

**Tuning** changes the pitch of the Sustain loop relative to the rest of the Sample. It is useful when a Sample makes a slight rise or dip in pitch as it progresses, and you don't want that pitch change to be sustained, so you nudge it up or down. It is also useful with a very short loop which may not be in tune with the rest of the Sample.

Being able to adjust the tuning can be useful even when you're not looping at all (in **OneShot** or **RevOne** mode), but just want one section of the Sample to be at a different pitch than the rest of it. The range is  $\pm 50$  cents, equal to 1/4-tone up or down. (Remember on the numeric keypad of the RC-100, the way to enter a negative value is to hit the "0" key twice, followed by the one or two digits desired.)

## Release Loop

**R-Loop** determines the starting point of the Release loop. It must be at least 10 words after the **End** of the Sustain loop.

**Fine** subtly adjusts the **R-Loop** point.

**End** determines the ending point of the Release loop, which must be at least 4 words after **R-Loop**.

**Tuning** adjusts the pitch of the Release loop relative to the rest of the sample.

## Restrictions and Relationships of the Loop Points

If you find yourself in a situation in which you cannot adjust a Parameter to the value you want, it may be because another Parameter is preventing it from changing. For example, if the Sustain loop **End** is at 27890, and the **R-Loop** starts at 27900, you won't be able to set Sustain loop **End** to a higher value unless you first increase the value of **R-Loop** higher to get it out of the way.

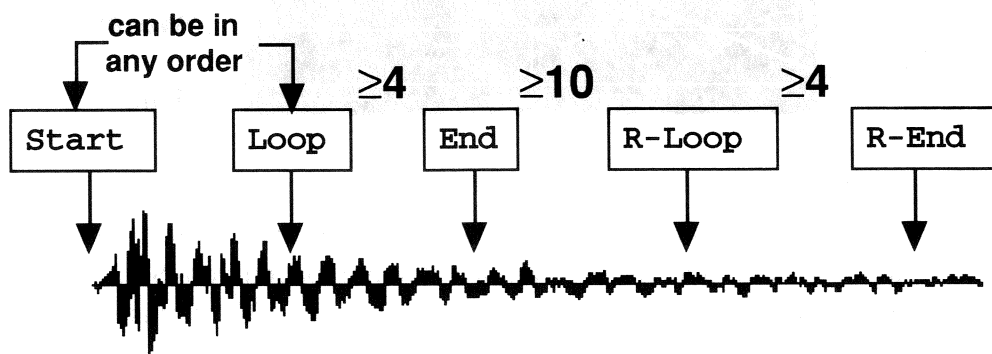

If you have set up a loop which is the perfect length, and you want to move it to a different point in the sample without losing its length (or being forced to recalculate it), you can turn on the **Length Lock** parameter (I promised we'd get to it!) on the left side of the screen. When this is on, if you change the **Loop** or **R-Loop** parameter, the corresponding **End** parameter will automatically change by the same value, and vice versa.

## Timed Loops

The Loop Parameters allow you to design loops that are a specific length of time with a great degree of accuracy. If you have, for example, a Sample recorded at 44.1 kHz, then a loop that is 44,100 words long will be *exactly* one second long. If you know the tempo of a song, and you want to create a Loop that fits a precise number of beats, here is a formula you can use to calculate the loop length:

$$\begin{aligned} \text{Length of Loop (in words)} = & \text{ number of beats} \\ & \times 60,000 \\ & \times \text{ sampling rate (in kHz)} \\ & \div \text{ tempo (in beats per minute)} \end{aligned}$$

If you design a Loop of a particular length and want to adjust it for smoothness, turn on the **Length Lock** parameter, to be sure the timing of the Loop doesn't change.

## The Graphic Window

The graphic window at the bottom of the **Edit Sample Loop** page allows the Sample to be edited graphically. It contains four elements:

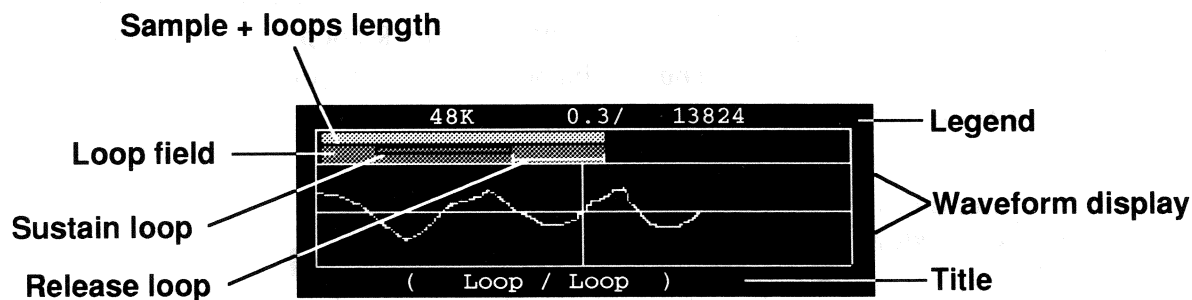

- A line of text, known as the “Legend”, shows the current Sample’s sampling rate and total length, in seconds and words. (Samples that are loaded from S-550 disks have a sampling rate of 30 kHz, so don’t get confused if you see “30” in this line. They can be treated just like any other Samples.)
- A dark blue field, known as the “Loop field”, which contains three horizontal light blue lines or rectangles, and which changes as you change the **Loop Mode**. These lines show the placement of the **Start** point and the length and placement of the Sustain and Release loops, relative to the entire Sample in memory. Adjustments can be made to the various Parameters right in the Loop field using the mouse — we’ll get to these in a moment.

- A drawing of the actual Sample waveform, known as the “Waveform display”.
- Another line of text, the “Title”, which describes what the Waveform display is showing.

## The Waveform display

The Waveform display is the most important part of the graphic window when it comes to editing Samples. It can give you a graphic overview of the entire sample and can also provide precise visual feedback when editing and designing loops and other Parameters.

As mentioned earlier, the **X-Zoom** and **Y-Zoom** parameters determine the horizontal and vertical magnifications of the Waveform display. When **X-Zoom** is set to **x1**, the entire sample appears, and the Title at the bottom of the display says “**ALL**”. (The **Y-Zoom** setting has no effect when **X-Zoom** is **x1**.)

Setting the **X-Zoom** value to anything else changes the display significantly. The display will show a vertical blue line in the center (the “loop point”), with the beginning of the loop to the *right* of the line, and the end of the loop to the *left*.

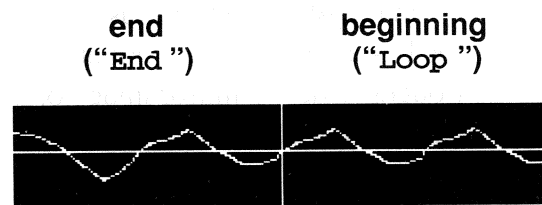

## Making it Sound Good

For a loop to repeat in a useful way, without clicks, buzzes, or sudden volume changes, the beginning and end of the loop must be matched carefully as to level, wave shape, and slope. You can adjust the loop point with the **Loop** and **End** parameters, and look at the Waveform display for the smoothest possible transition. Increasing the value of **Loop** slides the waveform on the right-hand half of the display to the left (since it starts later), while decreasing the value slides the waveform to the right. Increasing the value of **End** slides the waveform on the left-hand half of the display to the left, and decreasing it slides it to the right.

It’s considered good practice to have the loop point occur where the instantaneous level of the waves on both sides is zero (that is, on the horizontal line in the center of the Waveform display), which is known as a “zero-crossing” point. Sometimes, however, this is impractical, in which case as long as the slopes of the two waveforms match and form a continuous wave which looks the same on both sides of the loop point, the loop can often work.

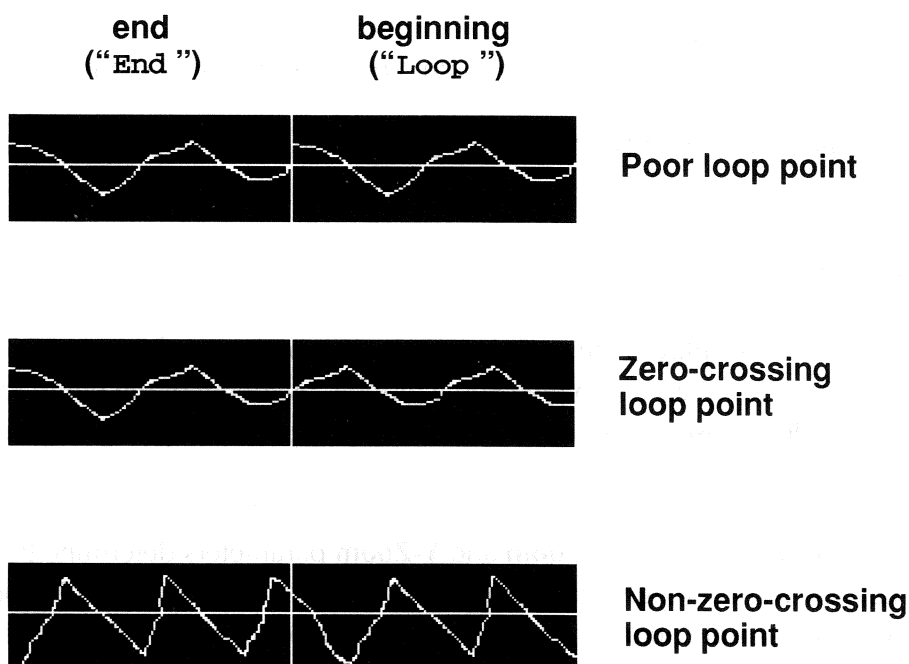

In the **Alt** mode, because the waveform “turns around” on itself at the loop points, the best loop points are not at zero-crossings but at zero-*slope* points, such as peaks or troughs, where a mirror image of the waveform resembles as closely as possible the waveform itself.

Make sure **Loop Mode** is set to one of the modes in which the loop repeats, and hold down a MIDI key (or the **SOUND PLAY** button). Listen to the loop adjust itself as you move the loop point. As you get closer, lower the **Edit Step** value. To find the perfect loop point, it probably be necessary to go all the way to **1**. Increase **X-Zoom** to the next level if you need to see what’s going on more precisely. If at the higher magnifications the waveforms seem to flatten out (because their level might be low), raise the value of **Y-Zoom** to increase the vertical scale.

You can adjust the Release loop in the same way. Set the **Loop Mode** to **Fwd+R** to enable the Release loop, and **KeyOn Mode** to **R-Loop** so that you can hear what you are doing.

As you change the **X-Zoom** value and adjust the various loop Parameters, the Title below the Waveform display will change to reflect what you are doing. For example, as you adjust the **Loop** parameter, the Title will read “**Loop/Loop**”. As you adjust the **R-Loop** parameter, the Title will read “**Loop/R-loop**”.



## Point Mode

There is a second mode for displaying the waveforms in a Sample. This mode is enabled by setting the **Disp Type** parameter to **Point**. It is used when trimming the beginning and/or end of a Sample.

The Waveform display will no longer show the loop beginning and end side by side, but instead will show just one section of the sample.

Which section it shows is determined by the cursor

position. If you put the cursor

on **Start**, the display will show the beginning of the sample, in whatever magnification you've chosen, with the position of the vertical blue line corresponding to the **Start** value — if it is  $\emptyset$ , the waveform will appear entirely to the right of the line. The Title will change to "**Point/Start**".

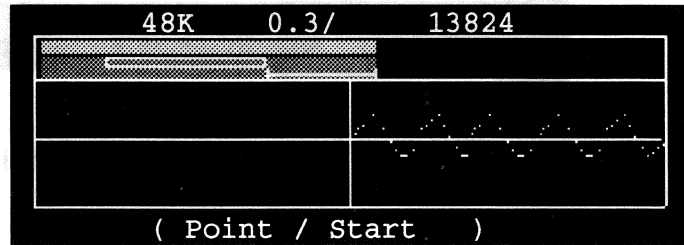

If you put the cursor on **Loop**, the display will show the part of the sample surrounding the Sustain loop's starting point, and the Title will change accordingly. If you put the cursor on **End**, it will show the part of the sample surrounding the end of the Sustain loop; and so on for the Release loop Parameters.

This display mode allows you to set the **Start** point precisely at the beginning of the actual sound, the importance of which we mentioned earlier. It can also help you put the **Start** on a zero-crossing point, to avoid clicks when the sound starts, which can be an issue when using the Sample with a fast TVA attack. In addition, **Point** mode can help you set the end of the sample right where the sound ends, so the S-770 doesn't use up voices playing silence.

## Editing in the Loop field

While the Waveform display is useful for zeroing in on small sections of the Sample, the Loop field at the top of the window shows what is happening with the Sample in a larger sense.

The dark blue Loop field itself shows how much of the Sample will actually be played when a MIDI key is struck. It extends from the **Start** value (or **Loop**, whichever is lower) to the end of the Sustain loop, or if the Release loop is engaged (that is, if the **Loop Mode** is **Fwd+R** or **Fwd+One**), it will extend to the end of the Release loop.

Sample + loops length

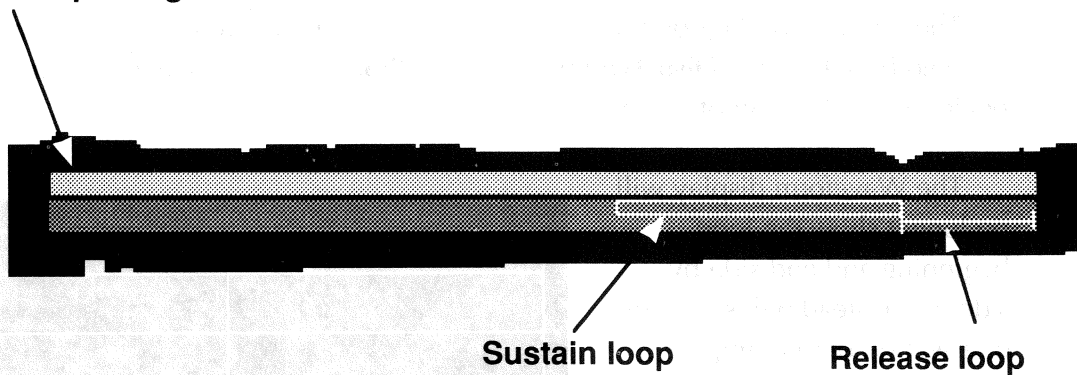

The first line in the field, which is light blue and three pixels high, shows the length of the Sample including the active loops. This will be the same as the overall length (the dark blue field itself), except in the **Fwd+One** mode, in which case the line cuts off at the beginning of the Release loop.

The second line represents the Sustain loop. If the **Loop Mode** is set so that this loop repeats, it will appear as a long rectangular box. If the mode is set so that this loop only plays once (**OneShot** or **RevOne**), it will appear as a single-pixel line with short vertical lines at the beginning and end.

The third line represents the Release loop. If the **Loop Mode** is set so that this loop repeats (**Fwd+R**), it will appear as a long rectangular box. If it is set so that it plays only once (**Fwd+One**), it will appear as a three-pixel line. In all of the other modes the Release loop doesn't play at all, but it still shows up, as a single-pixel line with short vertical lines at the beginning and end.

You can edit any of the Parameters represented in the Loop field with the mouse. To adjust the **Start** point, for example, move the mouse to the beginning of the first line and click and hold the left button. The line will change to red, and the Legend will change to read "**Get=Start**". Drag it to the left or right, and while the line stretches or shrinks, the value of the **Start** parameter changes as well. When you have set the line where you want it, let go of the mouse button. The line changes back to blue, and the Legend changes back to whatever it said before. You can do the same with the beginning or end point of either of the loops.

Editing a Parameter with the mouse is a low-resolution operation: the smallest amount you can change a Parameter with the mouse is one screen pixel's worth, and the value of a screen pixel does not change with the **Edit Step** setting. The value of one pixel happens to be the length of the Sample divided by 192. For example, if a Sample is 184,320 words long, a movement with the mouse of one screen pixel will change the value of the corresponding Parameter by 960. For this reason, graphic editing of a loop will often be only the first step in the process, and further editing using the numerical Parameters with finer values of **Edit Step** will be necessary.

When you grab the end of a line with the mouse, any other line that is directly linked to that Parameter will also turn red, and will move accordingly. For example, if you are in **Forward** mode, the play length (the top line) and the end of the Sustain loop (the second line) are locked together, and if you click on the right end of one of the lines the other will turn red as well, and both lines will move together to the left or right. In the **Fwd+R** mode, in which the play length ends at the end of the Release loop, grabbing the right end of the top line will cause the end of the Release loop (the third line) to be highlighted as well, and it will move accordingly.

If **Length Lock** is turned on, moving one end of either loop with the mouse will drag the other end of that loop along with it, so that a constant length is maintained.

As with the numerical Parameter fields, you cannot move a loop line to an illegal place — if another object is in the way, you must move it out of the way first.

## Advanced Loop Editing

A different and more elaborate approach to loop editing is found on the **Edit Sample Loop2** pages. To get to these, go to the **Sound** menu, select **Edit Sample2**, and then from the menu that opens select **Loop2**.

**Loop2** has three pages, putting all the parameters on one, and using the other two for expanded graphics. Most of the items on the **Loop2 Param** page should look familiar. One important addition is that the various loop-editing parameters now have “P numbers”, which serve as shorthand names for those parameters when you’re in the graphics pages. The **Start** point, for example, is referred to as **P1** on the graphics pages, while the **Sustain Loop** and **End** points are known as **P2** and **P3** respectively, and the **Release Loop** and **End** points are **P4** and **P5**. (We’ll deal with the **Smoothing** parameters a little later.)

Mode	Index	Mark	S-770/01
Edit Sample Loop2 Param			Com Exit
<input type="checkbox"/> Sample	L01:pf G#4		Name
Loop	Forward	P1:Start	0
Edit	Mono	P2:Loop	4871
KeyOn	Start	Fine	0
LoopLock	Off	P3: End	16385
		Tuning	12
Edit Step	1	P4:R-Loop	19344
		Fine	0
		P5: End	23489
		Tuning	25
A. Loop P2⇒P3		Loop-Smoothing	
A. Loop P2⇐P3		P6: Length	450
A.R-LoopP4⇒P5		R-Loop-Smoothing	
A.R-LoopP4⇐P5		P7: Length	120
Smoothing			
Recover			
Remaining			0.5

You can set all of your parameters on this page, just as on **Loop1**. An additional set of functions on this page are the “Auto Loop” operations, which are in the blue box at the lower left. Auto Loop automatically finds a point in the loop of your choice, which can make it much easier to find good loop points. Clicking on **A. Loop P2⇒P3** increases the **Loop** parameter (**P2**) until the Sustain loop’s start point is at a good loop point. Clicking on **A. Loop P2⇐P3** decreases the **End** parameter (**P3**) until the loop’s end point is at a good loop point. **A.R-LoopP4⇒P5** and **A.R-LoopP4⇐P5** do the same thing for the Release loop.

### Scrubbing for Loop Points

The graphics pages in the **Sample Loop2** function provide more information and a higher degree of precision than the **Loop1** page. **Graph-1** displays a larger version of the Loop field at the top, in which the various loop points can be adjusted with the mouse, just as on **Loop1**. A movement of one pixel is equal to 1/270th of the length of the entire Sample. Directly below that field is a second field for adjusting Smoothing ranges (which we will get to soon, I promise). Whenever the cursor is located inside an active area, such as the Loop field, on this or the **Graph-2** page, the rectangle defining that area turns purple.

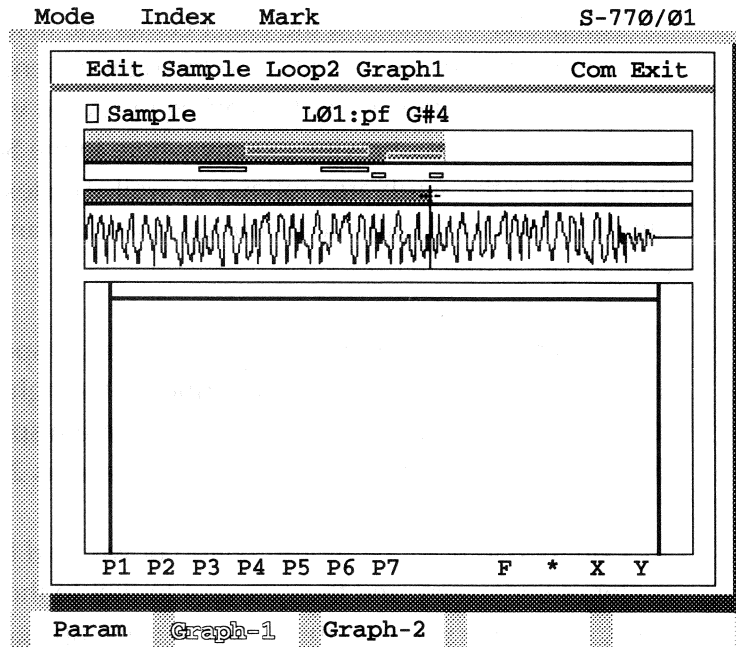

Below that is a full-width picture of the sample. It appears either as a detailed volume envelope (the **Normal mode**), or as a quick-drawing set of line segments (the **Fast mode**). Toggle between these modes by clicking on the **N** or **F** at the bottom of the screen. (Note that none of the graphics on this or any other **Edit Sample2** page are displayed on the front-panel LCD screen — they are only visible on the external monitor.)

Directly above the waveform display is a black rectangle known as the “scrub area”. Put the cursor in this area, press the mouse button(s) and move the mouse. This lets you “scrub” the sample, or hear it play backwards or forwards, depending on how you move the mouse.

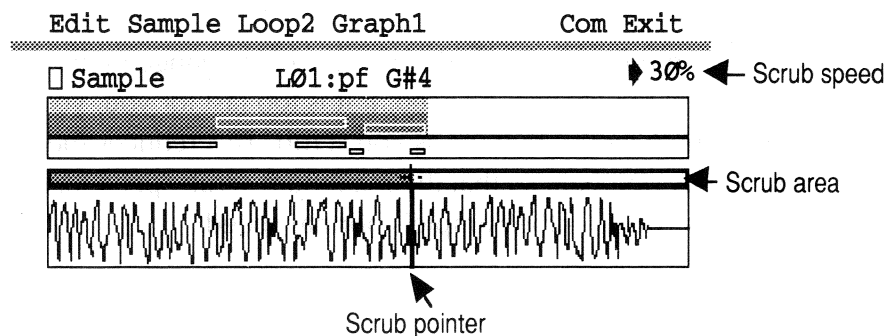

Here's how it works: if you place the mouse in the exact center of this area and press the left mouse button, there will be no sound, but the scrub area will turn red and the text "0%" accompanied by a left or right arrow will appear at the upper-right corner of the screen.

You probably won't hit the exact center the first time you try this, so let's assume you've placed the cursor slightly to the right of center. The sample will start to play slowly, just like a tape recorder starting up. A red vertical line will move across the graphic to the right, showing exactly where in the Sample it is currently playing, and the red fill in the scrub area follows as well. The text, which tells you how fast the sample is playing relative to its normal speed, changes to "14%" or something like it, with a right arrow.

The sample will continue to play at the slow speed as long as you hold the mouse in that position. Move the mouse further to the right, and it speeds up, while the text tells you how much it speeds up. The maximum speed you can scrub, with the mouse all the way against the right edge of the screen, is 200%.

Continue to hold the mouse button down, and bring the mouse back past the center of the screen, and then move it further to the left. The sample slows down and stops, and when you pass the center, it starts up again, only this time it is playing backwards. The vertical line changes direction as well, and the speed number in the upper-right now has a left arrow next to it. The maximum speed you can scrub backwards is, again, 200%.

Scrubbing is used to find points for setting up loops in the Sample quickly and audibly. (It is also used for other editing functions, which will be discussed in the next chapter.) When the red vertical line is at a point where you want to set the beginning or end of the sample playback or one of the loops, let go of the mouse button, move the cursor to the bottom of the screen and click on the appropriate "P" number. If you click on **P2**, for example, wherever the red line is will become the beginning of the Sustain loop. The Loop field at the top of the screen will change when you click on a **P** number, to reflect the new settings of the Loop parameters.

The scrub function is fairly fast — a little change in the position of the mouse makes for a big change in speed. If it is too fast for you, you can slow it down by holding *both* mouse buttons as you scrub. This reduces the action of the mouse position by one-half, so that the maximum scrub speed forwards or backwards is limited to 100% — the Sample's normal speed.

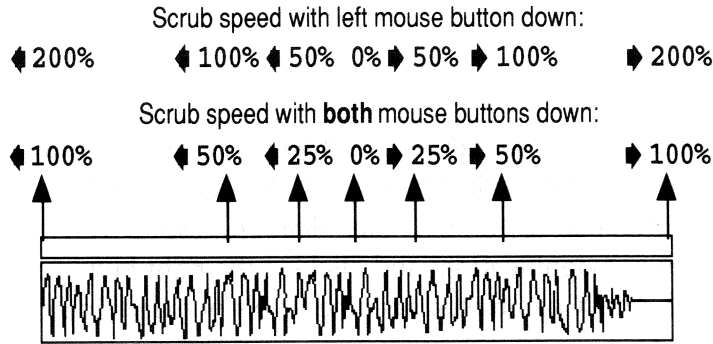

You don't *need* to use the scrub function to set up Loop points on this page. If it is obvious from the waveform display where a loop point should be, you can merely click at that spot in the display. The red vertical line appears, and you can then assign it to a **P** number.

Numbers assigned to loop points on this page can be changed on the **Param** page, and any changes made on the **Param** page will be reflected on this page when you return to it. Final adjustments will usually be made on the **Param** page, because of its higher Parameter resolution.

### Loop matching

The **Graph-2** page is an expanded version of the Waveform display on the **Loop1** page. It shows the beginning and end of the loops in great detail, and is extremely useful for matching waveforms, either at zero-crossings or at zero-slope points (for Samples playing in **Alt** mode).

The expanded Loop Field is again at the top of the page, and loops can be adjusted with the mouse in the Field. The numbers below it are for selecting which field to work on. Clicking on either **P2** or **P3** puts the Sustain loop in the large display. Clicking on **P4** or **P5** displays the Release loop. When you click on a number, it turns (and stays) red, so you can refer to it if you forget which loop you're looking at.

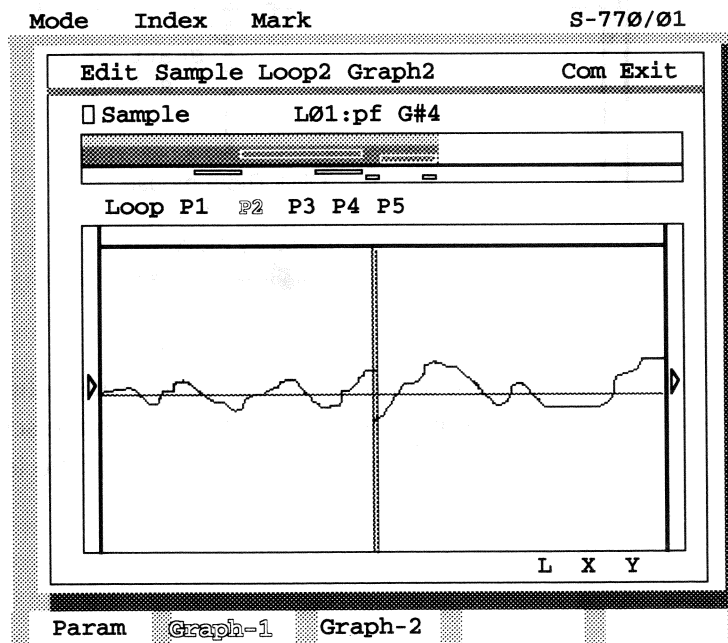

The main body of the screen shows the end (at the left, in white) and the beginning (at the right, in red) of the selected loop. At the bottom of the screen, clicking on **X** or **Y** changes the horizontal or vertical magnification, respectively. Clicking the left button zooms out (lower magnification) and clicking the right button zooms in (higher magnification). The **X** parameter has nine levels of magnification, while the **Y** parameter has four.

To change a loop point, click in the areas at the far left or right of the screen in which two blue triangles appear. The area at the left controls the end point, while the area at the right controls the beginning. Clicking the left mouse button moves the loop point earlier in the Sample, so the waveform will appear to be moving to the right. Clicking the right button moves the loop point later, so the waveform appears to move to the left. As with a numerical Parameter, if you hold the button down, the waveform keeps moving until you let go.

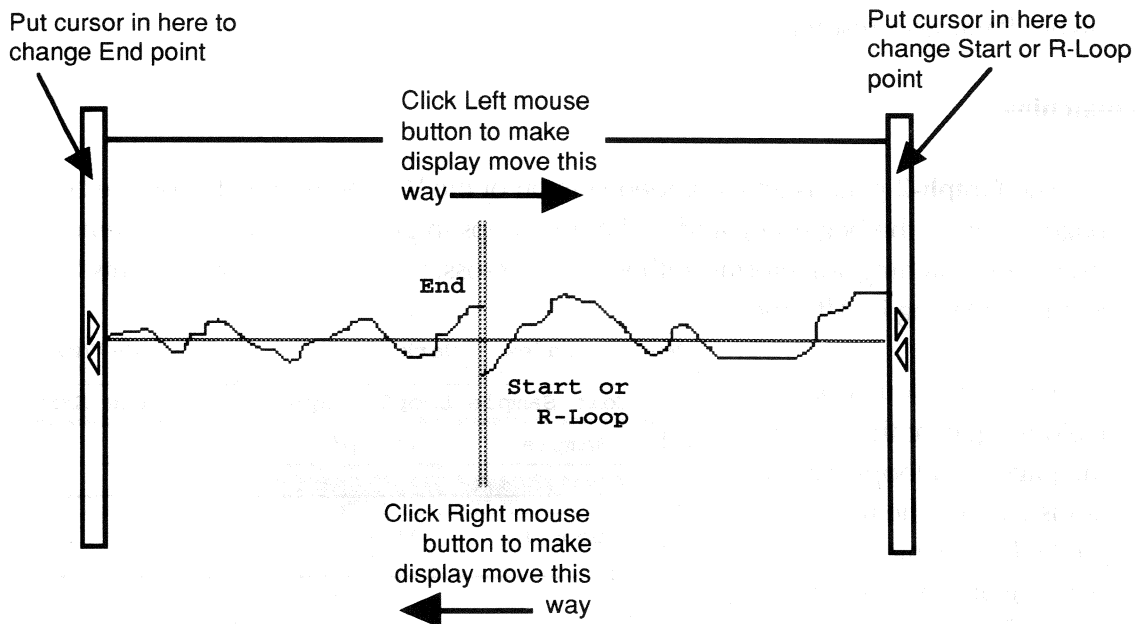

The amount of movement for each mouse click is one screen pixel, and how many samples that translates into will depend on the screen resolution: obviously, the higher the resolution, the smaller the movement of the loop point (fewer samples) for each pixel.



This screen allows you to view the waveforms either as line segments or as discrete dots. Line segments are easier to see, but dots can sometimes provide more accuracy. The letter at the bottom of the screen next to the **X** and **Y** tells you what mode you are in. If it shows **L**, you're looking at lines, and if it shows **D**, it's dots. Click on the letter to toggle it to the other mode.

As in all other **Edit Sample** pages, you can listen to the Sample by playing a note on a MIDI keyboard. If you would like to hear the Sample as you adjust it and keep your hands free, you can move the cursor to the area at the top of the graphic window and click the left mouse button. The Sample will sound as if you were playing a middle C (MIDI note 60 decimal) on a keyboard and holding it. You can adjust your loops while the note plays, so you can hear instantly what you are doing. To turn off the note, click again in the same area with the left mouse button, or change pages.

## Looping in Stereo

An interesting feature of the loop-editing function is that you can set up different loops for the two halves of a stereo Sample. This can be very useful for producing chorusing effects, or when working with long “phrase” Samples, for doing Steve Reich-style composition.

Normally, when you are working with **Edit Mode** set to **Stereo**, any loop editing you do on one half of the Sample will affect the other half in exactly the same way. However, if you set **Edit Mode** to **Mono** on one half, you can set a loop for that half which will *not* affect the other half. Any of the Parameters on the page, including **Loop Mode** and **Length Lock**, can be modified.

Once you've done one Mono change, you can then, if you like, go to the other half of the Sample, and set **Edit Mode** to **Mono** and do the same thing. When the loops are set, you can reset the **Edit Mode** to **Stereo**, and the two halves of the Sample are once again treated as a stereo Sample — when you play one, both will sound.

Beware, however, that as soon as you leave one Sample (to select the other half, or any other Sample), the **Edit Mode** will automatically be reset to **Stereo**, no matter how you left it, and when you come back to that Sample, you will find it set to **Stereo**. You must be careful: *if either of the halves of a stereo Sample is in stereo Edit Mode*, then should you change *any* loop Parameter, *it will cancel all of the differences* between the two halves, and make all of the Parameters of the other half conform to the Parameters of the current half.

## Looping tricks

Making good Sample loops is as much of an art as anything in music production, and there have been many thousands of words written about the subject in many books and magazines. If you would like to improve your looping skills, search them out, and practice, practice, practice!

In the meantime, here are a few ideas that might help.

Long loops are better than short loops, because short loops often impart a “periodicity” to the sound. But long loops can be trickier, because waveforms do change over time. The Smoothing function (discussed next) can help.

If you plan to loop a Sample, it should be recorded as dry as possible, without reverb, chorusing, etc. A dry sound is a simple sound, and a simple sound is much easier to find good loop points in.

Finding a truly stable group of waveforms in a sample to make a loop out of might not always be possible. If that’s the case, loop a short section (just a few cycles) of a complex part of the Sample, and use the Partial’s TVF to filter out the higher harmonics over time, making the sound “settle down” as it progresses.

## Smoothing

Sometimes finding the best possible loop point using the visual Waveform display still does not produce a usable loop. This could be because the waveforms at the beginning and end of the loop are so different that the sudden change causes a glitch, which then occurs regularly as the loop repeats.

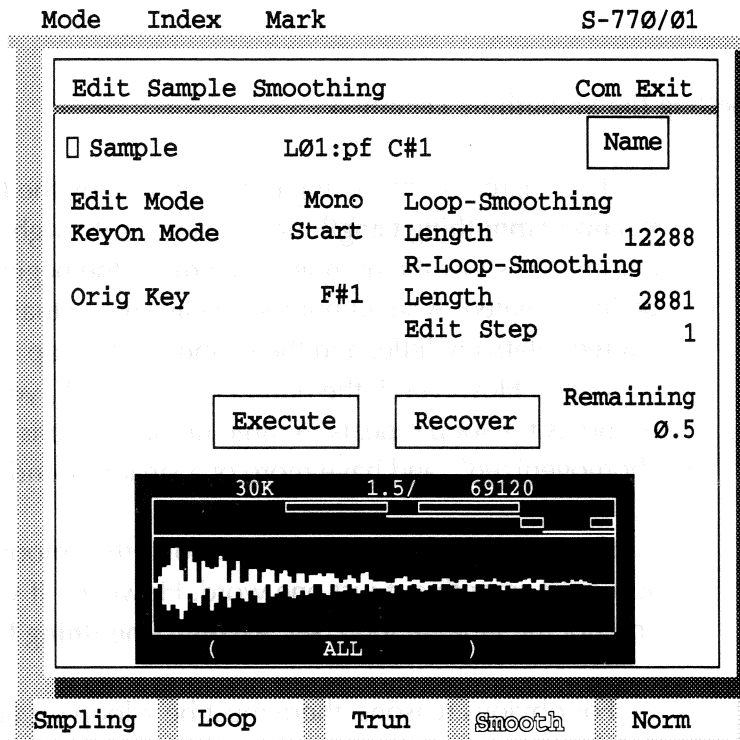

To overcome this problem the S-770 includes a “Smoothing” function, which irons out waveform differences at loop points. It does this by taking a number of words at the very beginning and very end of the loop and mathematically interpolating them so they are as identical as possible at the loop point. It also interpolates the words at the beginning of the loop point with the words *before* the loop point, to make sure there is no glitching when the loop starts.

Smoothing is available in both **Edit Sample1** and **Edit Sample2** functions. We’ll deal with **Edit Sample1** first. From any of the **Sample1** pages, use the mouse or F4 button to get to the **Edit Sample Smoothing** page.

Select the Current Sample at the top of the page. The **Edit Mode** and **KeyOn Mode** parameters are the same as on the Loop page. The **Orig Key** parameter can be used to change the placement of the sample’s original pitch on the keyboard. This is useful if you want to change the keyboard range of the sample.

The **Edit Step** parameter determines the resolution of any parameter changes you make. The **Remaining** parameter shows how much RAM is available. Since you are over-writing the same Sample, this parameter is not very important, except if you need to undo the Smoothing operation, which is discussed below.

## Setting the Smoothing Length(s)

The degree of smoothing is determined by the **Loop-Smoothing Length** and **R-Loop-Smoothing Length** parameters on the right side of the screen. These Parameters show the number of words at the beginning and end of the loop that will be interpolated. A small number means the actual waveforms in the loop will be altered relatively little, and the sound in the loop will maintain most of its original character. However, if the number is too small, you may still hear a “bump” in the sound as the loop repeats. A large number means the loop will be more “homogenized”, and have more of a steady sound as it repeats.

If **Loop-Smoothing Length** is set to **1**, the Smoothing operation will not execute — you can’t smooth out just one word. However, if you want to Smooth the Sustain loop and not the Release loop, set **R-Loop-Smoothing Length** to **1**.

For obvious reasons, there must be a loop set up on the Loop page for Smoothing to take place — if there isn’t, you will not be able to adjust any of the Parameters on this page. You can move freely between this page and the Loop page, and if you change a loop’s length on the Loop page, that change will show up immediately on this page. Note that a Sample can only be Smoothed if its **Loop Mode** is **Forward** or **Forward+R**. If the mode is set to something else, then performing the Smoothing operation will automatically *change* the mode to one of those two.

Also for obvious reasons, you cannot set a Smoothing Length longer than the loop itself. In addition, if the Sustain loop starts early in the sample, you cannot set a Smoothing Length that would cause the Smoothing operation to start before the beginning of the Sample. So a loop that starts at 7560 cannot have a Smoothing Length greater than 7560.

Similarly, you cannot set a **R-Loop-Smoothing Length** which would cause the Release loop-smoothing operation to *cross into* the Sustain loop. If, for example, the Release loop begins 128 words after the Sustain loop ends, the maximum value for **R-Loop-Smoothing Length** will be 128. If the Release loop starts *immediately* (10 words) after the Sustain loop, you cannot smooth it at all.

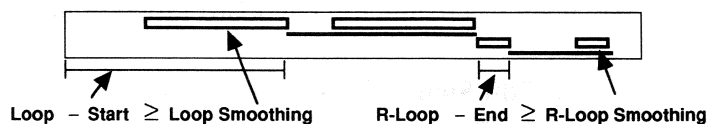

## Setting the Lengths Graphically

You can also adjust the Smoothing Lengths graphically. The Loop field at the top of the graphic window (which is black on this page) shows which loops are currently active. With the mouse you can grab either end of either loop, hold down the left button, and drag to the left. A rectangle will appear at *both* ends of the loop, showing the smoothing length (the loops themselves are not changed), and the appropriate Parameter will change accordingly.

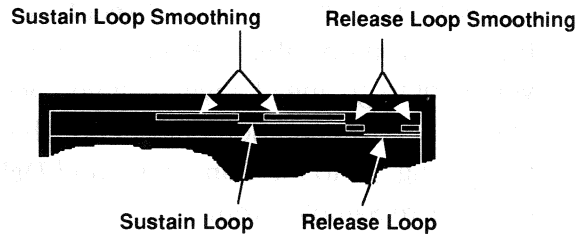

As on the Loop page, the resolution available when editing graphically is much lower than when editing numerically (each pixel is equal to the Sample length/192), but on this page precise setting of the Parameters is not as crucial, so often this resolution will be sufficient.

## Executing the Smooth

Move the cursor to the **Execute** switch. The legend in the graphic window says “New”, tells you the length of the new Sample (which should be the same as the current Sample), and whether it is stereo or mono. Click, and the Smooth is accomplished. Play a MIDI key and hold it down long enough for the loop to repeat a few times to hear how effective the Smoothing has been.

## Recovering From a Bad Smooth

The Smoothing operation is destructive, which means that, unlike the looping operation, it changes the Sample in RAM by actually altering the values of individual words within the Sample.

Fortunately, for those of us who occasionally make mistakes, it is easy to “undo” a smooth that turns out badly. Merely click on “**Recover**”, and the current sample is returned to its previous, un-smoothed state. If you want to smooth it again, either with the same parameter settings or different ones, click on **Execute** again. You can do this as many times as you like. The **Recover** function will, however, only undo the last execution, so if you smooth a Sample twice, you can only Recover from the second operation.

If the **Remaining** parameter is less than the length of the Sample, you will not be able to Recover from a Smooth, because the S-770 has nowhere to store the recoverable Sample. If this is the case, a warning box will open after you click **Execute**, telling you that you won't be able to Recover, and asking if you want to go ahead anyway. If you need to be able to Recover and don't have enough room Remaining, go to the **Com** menu and **Delete** one or more spare Samples from RAM.

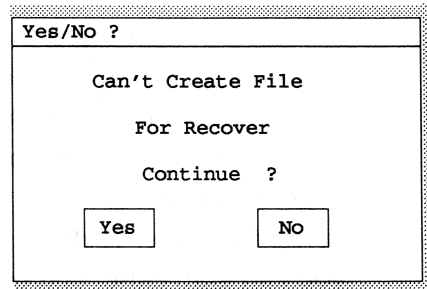

### Smoothing on the Loop2 Pages

On the **Edit Sample Loop2** pages, you have the same options for Smoothing — they're just laid out a little differently. On the **Param** page, the **Smoothing Length** parameters are at the lower right, number **P6** for the Sustain loop and **P7** for the Release loop. On the

#### **Graph-1** and **Graph-2**

pages, you can set up a smoothing range in the field that appears right under the Loop field at the top of each screen.

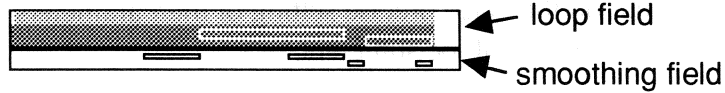

Or, on the **Graph-1** page, you can use the Graphic Waveform display: scrub or point to where you want the Sustain loop smoothing to begin, and when you have the vertical red line where you want it, click on **P6** at the bottom of the screen. Set the smoothing for the Release loop the same way, but instead click on **P7**. You are bound by the same restrictions as if you were on the **Smoothing** page: the software will not let you set up an illegal smoothing range.

Wherever you set up the Smoothing ranges, you must go back to the **Param** page to execute the actual operation, by clicking on **Smoothing**. As on the **Smoothing** page, you can cancel the operation by clicking on **Recover**.

# Chapter 7: Sampling 2 — Editing and Resampling

In the last chapter, we dealt with recording Samples and editing them in primarily non-destructive ways. In this chapter we will look at the more radical ways you can work with S-770 Samples.

Normalizing is done from its page in the **Edit Sample1** function. Truncating can be accessed either on its page in the **Edit Sample1** function, or from the **Patchwork** page on the **Edit Sample2** submenu, where the operation is quite a bit more versatile. The other features are only accessible from the **Edit Sample2** submenu.

## Normalizing

Normalizing increases the signal level of a Sample. It is useful when a Sample has a limited dynamic range, perhaps because it was recorded poorly, or the loudest parts of the sample were Truncated out, leaving only softer parts. As with all audio recording systems, it's a good idea to have the Samples in RAM and on disk at the highest possible level, to maximize the signal-to-noise ratio. Also, having all the Samples at roughly the same levels makes it easier to mix them in a Partial. Normalizing is available when you record a Sample initially (see the previous chapter), as well as with some other operations (described later in this chapter), but it is also available as a separate feature for working on Samples after they are already in RAM.

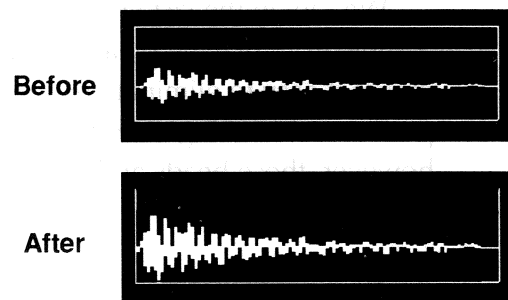
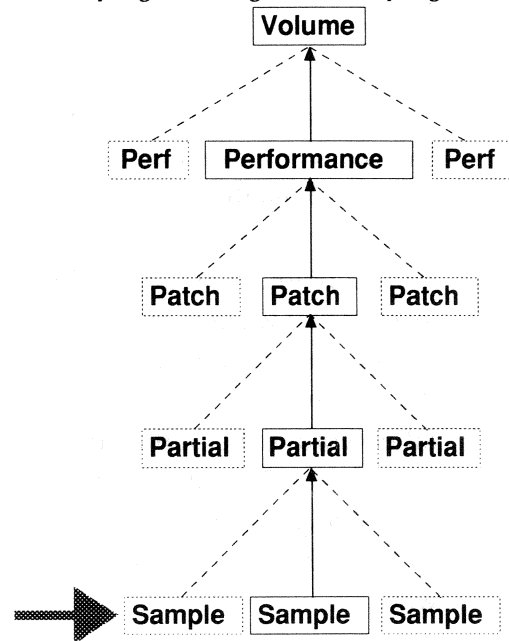

Normalizing ensures that a Sample is at maximum level by first searching through the Sample and determining its loudest point, then raising the level of that word to the maximum level possible, and multiplying the level of every other word in the sample by the same factor. This increases the overall level of the Sample without changing it in any other way.

To get to the **Normalize** page, go to the **Edit Sample1** function, and then press **F5** or

click on **Norm**. The page is very simple to use. Besides choosing the Sample, the only Parameters to adjust are **Orig Key**, **Edit Mode**, and **Name**, all of which function the same as on the other Sample Edit pages.

As with Smoothing, which is also a destructive operation, you can **Recover** if you change your mind after Normalizing. If there is not enough memory **Remaining** to duplicate the current Sample, however, you will not be able to Recover.

## Truncating

We saw in the last chapter that you can prevent sounds at the beginning or end of a Sample from playing by adjusting the **Start** and **End** points in the Loop pages. This makes it easy to eliminate extraneous sounds like microphones being switched on, producers knocking over equipment, etc. Because Looping is non-destructive, however, those heads and tails are still part of the Sample, and are taking up room in RAM and on disk.

To use memory most efficiently, particularly on long Samples that you are only using a part of, it can be very helpful to be able to permanently trash those unneeded words. While the S-770 has plenty of RAM to work with and a big hard disk, neither one of these is unlimited in capacity, and efficient use of them is important. In addition, shorter Samples are easier and faster to deal with. Samples can be permanently shortened with the Truncate feature.

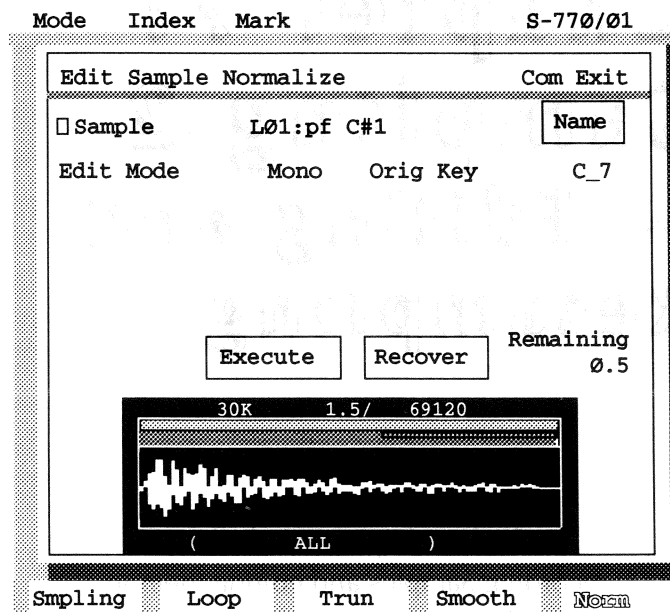



There are two ways to Truncate a Sample: the quick way, and the fancy way. The quick way is on the **Edit Sample Truncate** Page in the **Edit Sample1** function. We'll look at that first.

## The Truncate Page

At the top of the page, you select the Sample you want to truncate. You can rename it, with the usual restrictions against using a name already in use.

**Orig Key** lets you retune the base note of the Sample as you truncate. **Edit Step** sets the resolution for adjusting the numerical Parameters. **X-Zoom** and **Y-Zoom** set the horizontal and vertical magnification of the Waveform display. **Orig Length** shows the length of the Sample in its current state, while **New Length** shows how long it will be after you Truncate. The **Remaining** Parameter shows how much space is left in RAM; if this Parameter is lower than **New Length**, you won't be able to Recover the operation.

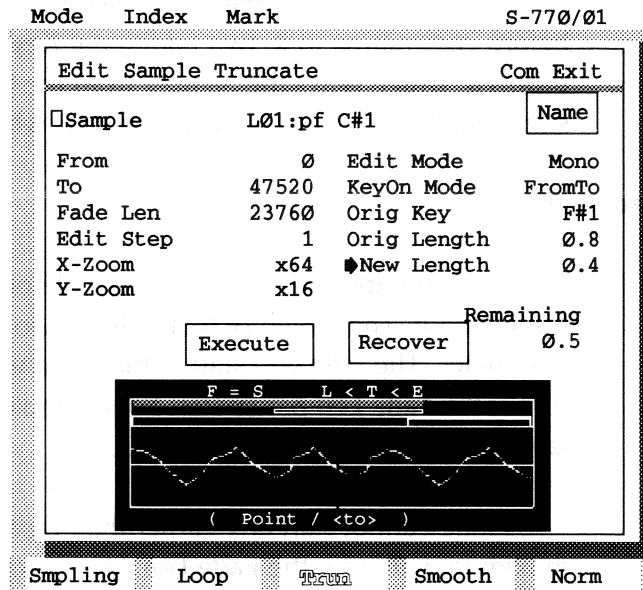

If the Sample is stereo, you can truncate both sides simultaneously if **Edit Mode** is set to **Stereo**. However, if it is set to **Mono**, because the Truncate operation is destructive, it will permanently break the link between the two halves of the Sample. The halves can be rejoined only if you then truncate the other half of the Sample (also in **Mono** mode) so it is *exactly* the same length, and then re-link the two halves using the **Set Stereo** command.

## Setting the Truncate Points

The Parameters that you want to deal with are **From**, which sets the truncation point at the beginning of the Sample, and **To**, which sets the truncation point at the end. If you don't want to truncate the beginning, set **From** to  $\emptyset$ ; if you don't want to truncate the end, set **To** to the highest number you can.

The minimum number of words in a Sample is 4608, which is just about 0.1 second, or 0.2 second at the lower sampling rate. If you set **To** so that it is less than 4608 words after **From**, it will be ignored, and the Sample will end up 4608 words long, starting at **From**.

To help you set the **From** and **To** parameters and let you audition the operation before committing to it, two additional **KeyOn Modes** are available on this page: **FromTo**, which plays the Sample from the **From** to the **To** words, and **To**, which plays starting at the **To** word, so you can hear what it is you're losing at the end.

### Fading the End

You can impose a smooth linear fade on the end of the Sample while you are truncating it. The length of that fade, in words, is determined by the **Fade Len** parameter. The fade will start at the word whose value is equal to the **To** parameter *minus* the **Fade Len** parameter. For example, if **To** is 1000 and **Fade Len** is 250, the fade will start at word number 750.

A fade cannot start any earlier than *halfway* through the truncated Sample, so the maximum value for the **Fade Len** parameter is the overall truncated length (the **To** value minus the **From** value), divided by 2. So for example, if **From** is 200 and **To** is 1200, the maximum allowable value for **Fade Len** will be 500. If you change the **From** or **To** point to shorten the Sample such that the truncated length would end up being less than twice the **Fade Len**, the **Fade Len** will automatically shorten.

### The Graphic Window

Adjustment of the Truncate points and Fade Length can also be done with the mouse in the graphic window.

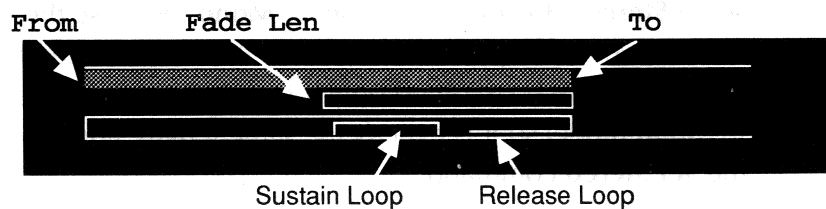

The top line in the black field at the top of the window shows the **From** and **To** points: move the left end of the line to adjust **From** and the right end to adjust **To**. The second line, which becomes a rectangle when you stretch it, is the **Fade Len**. Move the left side of the rectangle to lengthen or shorten the fade. The right side of the rectangle cannot be moved — it is locked to the right end of the line above it. Below the Fade Length line is a line showing the overall Sample length, and below that two lines showing the locations of the Sustain and Release loops, for reference.

**S < F < L      RL < T < RE**

The Legend immediately above the waveform display describes the position of the **From** and **To** points relative to the other points in the Sample. If one of the points falls exactly on another, it will be displayed with an “=” sign — for example, if the **From** point is the same as the Sample **Start** point, the Legend will say “**F=S**”. If there is no exact correspondence, the Legend will show which points the **From** and **To** points fall between — for example, “**S<F<L**” means the **From** point is between the **Start** and the beginning of the Sustain **Loop**; “**RL<T<RE**” means the **To** point is between the beginning (**R-Loop**) and **End** of the Release loop; and so on.

The Waveform display itself is always in **Point** mode, and shows (except when **X-Zoom** is set to **x1**) the **From** or **To** point, depending on which one was selected most recently, at the current magnification. The Title will show which point is being displayed. If **X-Zoom** is at **x1**, it will say “**All**”, and during graphic editing the Title will say “**Get =**” and the Parameter being adjusted.

## Recovering

Like Smoothing and Normalizing, Truncating is a destructive edit, and so a **Recover** switch is available to undo a Truncate operation. The **Recover** switches on all of the different **Edit Sample** pages (on both levels **1** and **2**) are linked. This means that if you do an operation on the **Truncate** page and then go to the **Smoothing** page and only then realize you made a mistake, no worries: click the **Recover** switch on the **Smoothing** page, and the Sample will return to its previous state. Obviously you cannot Recover a Truncate once you’ve done a Smooth, or done any operation on a *different* Sample. Nor can you Recover any operation after you’ve gone to any **Disk** page. But you *can* Recover a Sample if you’ve left the **Edit Sample** level, to go to a Patch or Performance, for example, and come back to it.

## Truncating and Reversing in the Edit Sample2 function

Doing a Truncate in the **Edit Sample2** function (the fancy way) gives you a lot more options. You can move the Sample around in memory, you can fade it both in and out, and you can even reverse it. From the **Edit Sample2** submenu, select **Patchwork**.

On the **Truncate** page, you truncated Samples “in place” — the Sample stayed in the same slot it came from. This page is

different: you can elect to move the Sample as you truncate it. **Source Sample1**, at the left side of the screen, is the Sample you are truncating. The slot you are going to put it in is the **Dest Sample** at the *top* of the screen. The two slots can be the same: just choose the same Sample for both.

Do be careful: if there is already a Sample, either the same one or a different one, in the **Dest Sample** slot, it will be erased, and you will *not* be given any warning. If you choose an empty slot, you must name it before you can execute the operation.

**Edit Step** is the same as on other pages, as is the **Remaining** parameter. **KeyOn Mode** has some small differences, which are not relevant yet, so we’ll deal with them shortly.

The **P1:From** and **P2:To** parameters at the left side of the screen are the beginning and end points of the truncation. Instead of one fade parameter, this page gives you two: **L1:Fade** lets you set a length to fade the beginning of the sample in, while **L2:Fade** lets you set a length to fade the end of the Sample out (as on the **Truncate** page). Neither of these can be set to a value more than half of the Sample length. (The **Level** Parameter doesn’t do anything as far as truncating is concerned.)

Mode	Index	Mark	S-770/01	
Edit Sample Patchwork Param			Com	Exit
☐ Dest Sample L01:pf G#4			Name	
KeyOnMode	Start	Edit Step	1	
		Remaining	0.5	
☐ Source Sample1			☐ Source Sample2	
L01:pf G#4			L01:C2	
P1:From	1248	P3:From	0	
L1:-Fade	1344	L3:-Fade	0	
P2:To	8456	P4:To	27672	
L2:-Fade	1920	L4:-Fade	0	
Level	127	Level	127	
		Delay	0	
Truncate		Insert		
Cut & Splice		Mixing		
Area Erase		Combine		
		Recover		

Param    Graph-1    Graph-2

When truncating in the **Edit Sample1** function, the **To** parameter must be higher than the **From** parameter. Here this is not the case. You can set **From** higher than **To**, in which case not only will the Sample be truncated, but what remains will play *backwards*. **L1** becomes the fade-in time of the new version of the Sample, and **L2** becomes the fade-out time.

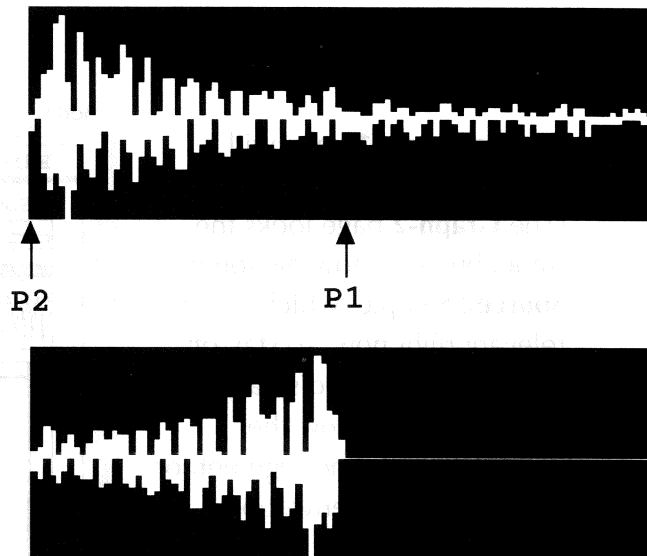

You can preview what the Truncated Sample will sound like, after you set the **P1** and **P2** Parameters. Put the cursor on any of the parameters under **Source Sample1** (including the name of the Sample itself), and play a MIDI key (the Sample's original key is best). You will hear the portion of the Sample between **P1** and **P2**. If **P2** is larger than **P1**, you will hear it backwards. You will not, however, hear any of the fading effects of **L1** or **L2**.

To do the truncate, click on **Truncate** in the blue box at the bottom of the screen. To undo it, click on **Recover**. If you want to Truncate it a second time, and if you have moved the truncated Sample to a different slot, you must change **Source Sample1** slot to the new slot.

If you have moved the Sample to an empty slot, the **Recover** switch will have no effect. That's because you haven't overwritten any existing data, you've simply created new data, so there's nothing to recover. However, if you then Truncate *again* to the same slot, which now has data in it, **Recover** will work normally.

## Graphic Editing

The **Graph-1** page will show you the Sample in detail. (The **Graph-2** page looks the same, but it is showing you the **Source2** Sample, which is not relevant right now, so stay off it.) The Waveform display in the middle can show the Sample in **Fast** (line segment) or **Normal** (volume envelope) mode — toggle it at the lower right corner of the screen.

The black field at the top of the screen shows the segment of the Sample defined by the **From** and **To** points as a solid blue bar. You can move either end of it by grabbing it with the mouse, holding the left button, and dragging it. The blue rectangle immediately below the bar is the fade-in (**L1**). You can stretch its right edge with the mouse. If the blue bar is not flush against the left edge of the screen (i.e., if **P1** is not  $\emptyset$ ), as you stretch the fade-in rectangle to the right, it also grows to the left. This is helpful when combining two Samples, which we'll get to in a bit.

Note that you can stretch the rectangle all the way to the right edge of the screen, if you like. However, if its length is greater than half of the blue bar's, you won't be able to Truncate.

The other blue rectangle is the fade-out (**L2**). Adjust its left edge with the mouse. This too, can be stretched further than halfway through the Sample, but don't do it. It also grows a mirror image of itself when you stretch it.

Again, none of the graphics on this or any other **Edit Sample2** page are displayed on the front-panel LCD screen — they are only visible on the external monitor.

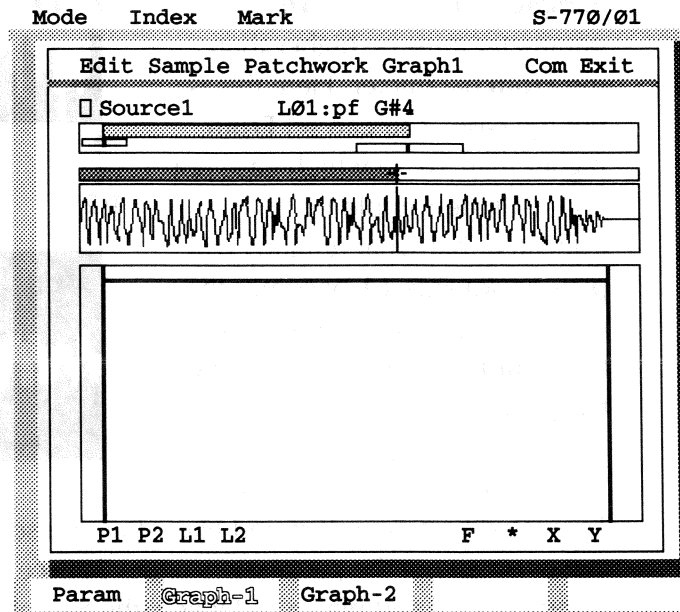

## Scrubbing

As on the **Loop2 Graph-1** page, you can scrub the Sample on this page to find truncation points. Put the mouse into the small rectangle immediately above the Waveform display and hold the left button. The rectangle turns purple. Move the mouse left or right to hear to Sample backwards or forwards, respectively. A red vertical line follows the playback. The further you move the mouse, the faster the Sample plays. The speed and direction of the playback are displayed in the upper right corner. To limit the scrub speed to 100%, hold down the right mouse button as well as the left.

When you find a good truncation point, and the red line comes to rest, click on the appropriate Parameter at the bottom of the screen. The Field display changes to show the new setting. You can set the **From (P1)**, **To (P2)**, fade-in length (**L1**), or fade-out length (**L2**) this way.

If it is obvious from the Waveform display where a Parameter should be, you can simply click in the display and the red vertical line appears. Then click on the appropriate Parameter, and it's set.

You cannot execute a truncate from the **Graph-1** page — go back to the **Param** page and click on **Truncate**. You can then come back here and see what you've done. (If the **Source1** and **Dest** samples were different, be sure that the truncated Sample is now in the **Source1** slot.)

## Truncating Looped and Stereo Samples

Truncating can drastically change the characteristics of a loop, so it is advisable to do it in a Sample without loops, or else be prepared to redo your loops afterwards. If you truncate a Sample so that the new end of the Sample (the **To** parameter) falls inside a Release loop, the Release loop will be shortened so that it ends when the truncated Sample ends. This will throw all the careful loop-point editing you've done on the Release loop out the window. If the **To** parameter falls within a Sustain loop, the Sustain loop editing will be rendered essentially worthless, while any Release loop will be totally eliminated.

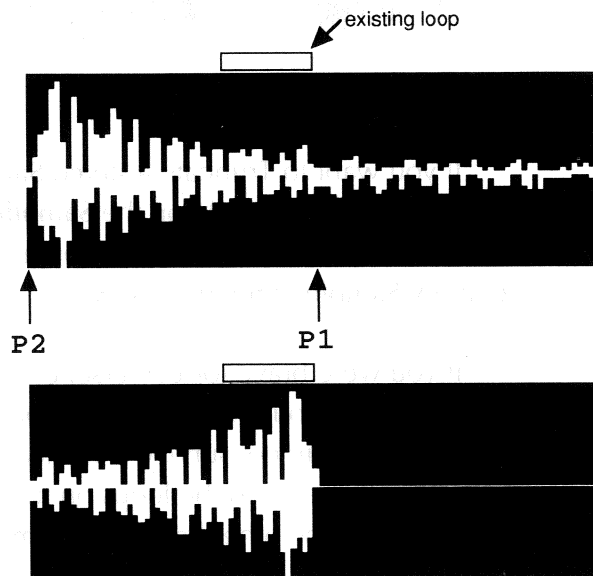

If you Truncate and Reverse a Sample with loops, the loops stay at their original locations, so what was previously the beginning of the sound will now be a looped tail.

If you set up a Fade so that the fade point falls within a loop, the loop points will be maintained, but because the level at the end of the loop will now be lower than the level at the beginning, there will be an audible glitch every time the loop repeats, and you will probably not want to use it.

Truncating a stereo Sample requires special care. Although there is no stereo/mono switch on this page, the software knows when **Source Sample1** is part of a stereo pair. If the **Dest Sample** is *also* part of a stereo pair (it can be the same pair or a different one), then the Truncate operation will work on both halves of the pair. If **Dest Sample** is *mono* (which will also be the case if it is Blank), then *only the half* of the stereo Sample showing as **Source Sample1** will be truncated. The other half will be unaffected, and the link between the two halves will be broken.

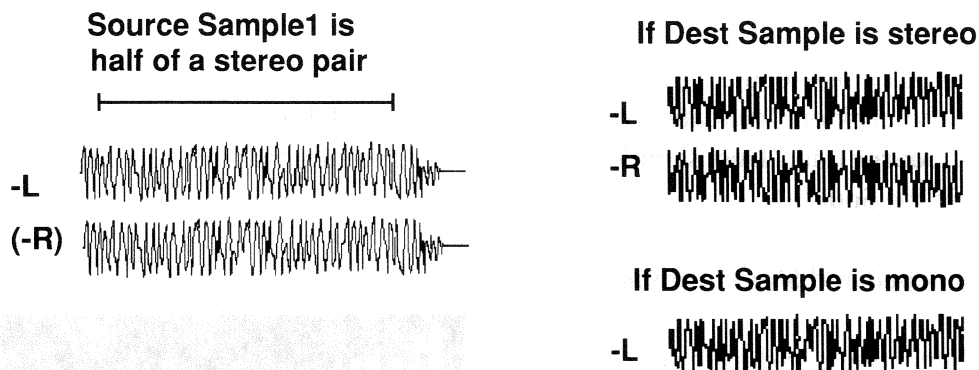

If you want to Truncate a stereo Sample into a new Sample, you must first create a “dummy” stereo Sample on the **Sampling** page. Although it needs to contain no actual audio, and you can make it as short as you like, you must name and record this dummy Sample in the normal way.

If you were brave (or perverse) enough to set up a stereo Sample with different-length loops as outlined in the previous chapter, you should know that such an arrangement will not survive a Truncate operation. When you Truncate, the loops realign themselves, and the loops on the half of the Sample that is **Source Sample1** will be applied to the other half of the Sample.



## The Patchwork Operations

Besides **Truncate**, there are five other operations on the **Edit Sample2 Patchwork** pages that let you do fancy things with Samples. All are destructive, and are **Recoverable** unless the **Dest Sample** is in a previously unused slot, or unless there is insufficient RAM **Remaining**.

**Cut & Splice** and **Area Erase** deal with only one Sample, and so work done on the **Graph-1** page only is relevant. **Insert**, **Mixing**, and **Combine** are ways of putting two Samples together. In these operations the **Graph-1** page can be used to work on **Source Sample1**, and **Graph-2** to work on **Source Sample2**.

As with **Truncate**, you must be careful performing these operations on stereo Samples. If **Source Sample1** is part of a stereo pair but **Dest Sample** is mono or Blank, only the half of the Source Sample currently displayed will be affected by the operation, and the link between the two halves will be broken. (**Source Sample2**, however, does *not* need to be stereo.)

### Cut & Splice

**Cut & Splice** is the opposite of **Truncate**. The area of the Sample between **P1** and **P2** is eliminated, and the two remaining ends are joined together. If **L1** is  $\emptyset$ , the two ends are “butt-spliced.”

If **L1** is greater than  $\emptyset$ , the two ends are faded together over a length of time equal to **L1**. This time is “borrowed” from the portions of the Sample just before **P1** and **P2**, so the overall length of the new Sample is the same regardless of the **L1** setting. (see diagram next page)

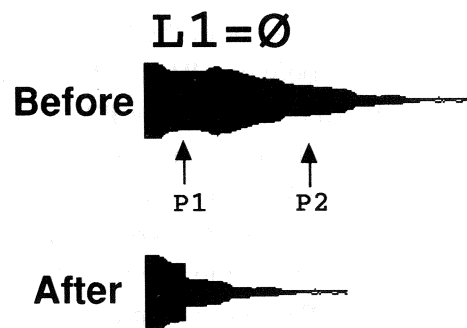

The maximum setting for **L1** is **P1** — you can't fade up from a point before the beginning of the Sample. Other than that, you can make the fade as long as you like.

**Cut & Splice** will not reverse a Sample: if **P1** is greater than **P2**, the operation will not execute.

Note that when you are adjusting the Parameters, you are listening to the part of the Source Sample that will be *cut out*, not the part that will remain.

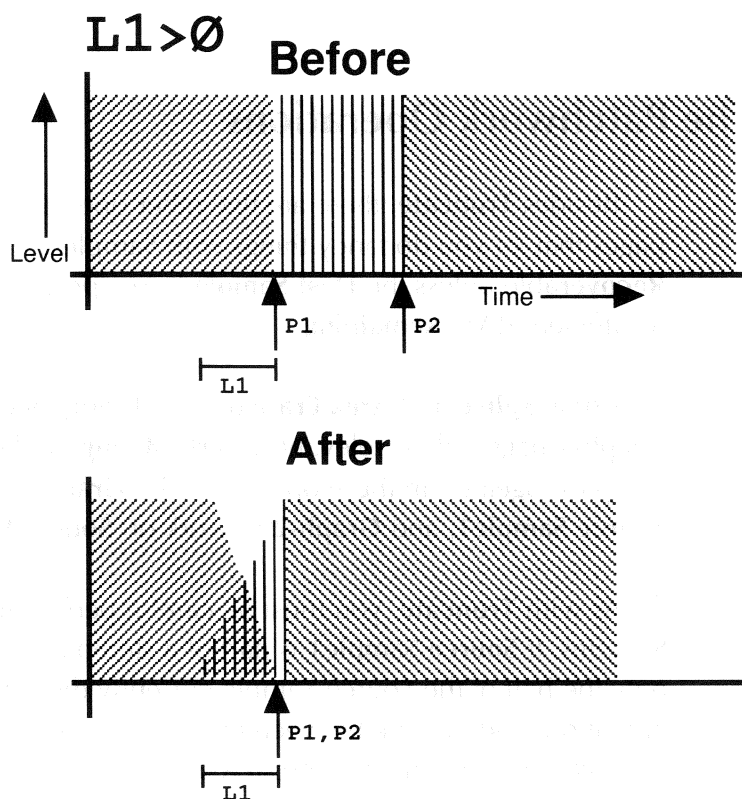

## Area Erase

This works like **Cut & Splice**, except without the Splice action. The area between **P1** and **P2** is removed, but the section after **P2** stays where it is, and there is a gap of silence left. Both **L1** and **L2** are active: **L1** is the length of the fade-down before **P1**, while **L2** is the length of the fade-up after **P2**. The maximum values of the fades are the lengths of the segments themselves.

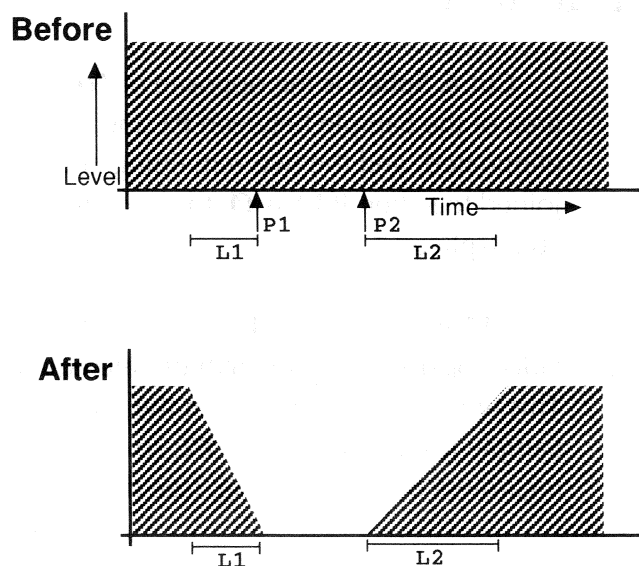

## Insert

This splices a piece of one Sample into the middle of another Sample. **Source Sample1** plays from the beginning, up to the **P1:From** point. Then **Source Sample2** interrupts it, and starts playing from its **P3:From** point. When Sample2 reaches its **P4:To** point, it stops, and Sample1 resumes playing at its **P2:To** point, and plays to the end. The result is placed in the **Dest Sample**. The length of the resulting Sample is [Sample1's length] — [**P2** — **P1**] + [**P4** — **P3**].

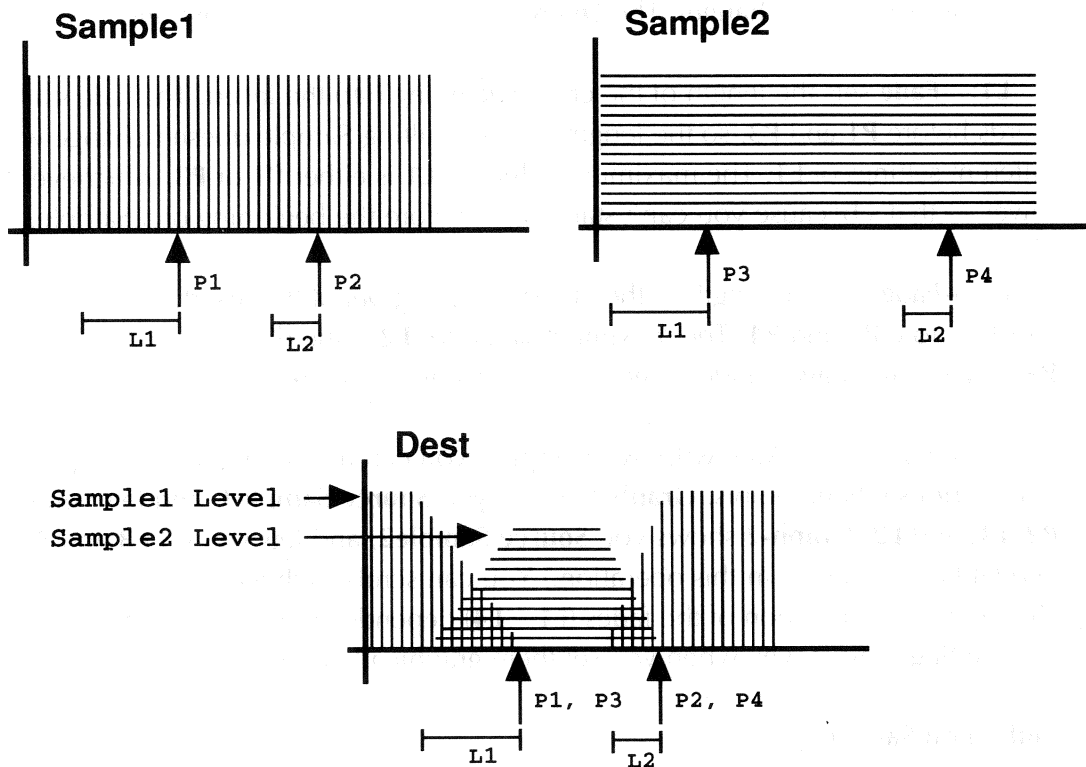

If you want **Source Sample2** to start from its beginning, set **P3** to  $\emptyset$ . The part of **Sample1** that lies between **P1** and **P2** will be eliminated, so if you want all of **Sample1** to remain, set **P1** and **P2** to the same value. (You cannot set **P1** higher than **P2**.) If you set **P3** higher than **P4**, **Sample2** will play backwards.

To hear what the portions of the Samples you are using sound like, put the cursor on a parameter under the Sample of your choice, and play a MIDI key (again, the Sample's original key is best). If you are under **Source Sample1**, you will hear the portion of the Sample between **P1** and **P2**, that is, the portion being *eliminated*. If you are under **Source Sample2**, you will hear the portion of that Sample between **P3** and **P4**, which is the portion being *inserted*. To hear what's in the **Dest Sample** slot (if there is anything), move the cursor up to its name, or down into the blue operations box, and play a key.

Alternatively, you can use the special settings provided on this page for the **KeyOn Mode**. Setting it to **FromTo1** will let you hear the portion between **P1** and **P2**, and **FromTo2**, will let you hear from **P3** to **P4**. When **KeyOn Mode** is set to either of these modes, the position of the cursor is ignored.

You can balance the relative levels of the two Samples using the **Level** parameters. 127 is unity gain (no change). The **Delay** parameter doesn't do anything.

**L1:—Fade** sets the length of the crossfade going into the insert. The fade starts L1 words before **P1** and **P3**, so the length of the resulting Sample doesn't change with different settings of **L1**. The maximum value for **L1** is either **P1** or **P3**, whichever is lower — that's because you can't start a fade before the beginning of a Sample.

**L2:—Fade** sets the length of the crossfade going *out* of the insert. The fade starts L2 words before **P2** and **P4**. The maximum value for **L2** is the difference between **P3** and **P4** — you can't have a fade longer than the Sample you are inserting.

Since you are working with two Samples, you can use both graphics pages to set your various editing points. **Graph-1** shows you **Source Sample1**, and lets you set **P1**, **P2**, **L1**, and **L2**. **Graph-2** shows you **Source Sample2**, and lets you set **P3** and **P4** (**L3** and **L4** have no effect in this operation.) You can scrub each Sample on its own page. Notice that the direction of the fades (**L1** – **L4**) depends on which operation follows their setting. This is why when you set them graphically they grow in two directions.

## Stereo and Mono Samples

As with Truncate, care must be taken when using this operation (and the following two) with stereo Samples. If either **Source Sample** is part of a stereo pair, and you want to use both parts, the **Dest Sample** must be stereo as well. If you want to create a new **Dest Sample** (as opposed to using a slot currently occupied by a stereo Sample), you must create a “dummy” stereo Sample on the **Sampling** page.

If a **Source Sample** is mono and the **Dest Sample** is stereo, the mono sample will be inserted into both halves of the stereo **Dest Sample**. This is true even if *both Source Samples* are mono, in which case you will end up with a stereo Sample whose two halves are identical (interesting, but not very useful).

## Dealing with Different Sample Rates

Special care has to be taken if you are working with Samples recorded at different sampling rates in this and the following two operations. A message box will appear after you click on **Insert** if the two Samples are at different rates, and you can opt to go ahead or cancel. If you proceed, the **Dest Sample** will be created with the same sampling rate as **Source Sample1**. The part of **Source Sample2** you are using will be converted to the Sample1 rate as it is processed into the Dest Sample. This process, however, *changes the pitch* of the material from Sample2. (It doesn't alter the original Sample2 itself, however.)

For example, if Sample1 was recorded at 44.1 kHz, and Sample2 at 48 kHz, then when Sample2 is **Inserted** into Sample1, the portion of the resulting Sample that came from Sample2 will be about 10% flat.

If you want to avoid this situation (and that's probably a wise idea), use the **Rate Convert** feature, described later in this chapter, to make sure both Samples are at the same rate prior to merging them.

The same feature, by the way, can be used with two Samples that are at the same rate, but are not in tune with each other. Check it out.

## Mixing

This operation lays the two Samples on top of each other, mixing them together in the same period of time. The sections of the Samples that are mixed are determined by the respective **From** and **To** points. Putting one or both of the Sources backwards in the mix is allowed: set **P1:From** higher than **P2:To** to reverse Source Sample1 when it is put into the Dest Sample, and/or set **P3:From** higher than **P4:To**, to do the same for Sample2.

All four —**Fade** Parameters are active. The fade-in of Sample1 starts on **P1** and lasts for **L1** words. The fade-out starts **L2** words before **P2**, and ends on **P2**. **L3** and **L4** do the same for Sample2. If a Sample is set up to play backwards, its fades will be reversed, e.g., **L1** will determine the fade-*in* of Sample1, etc.

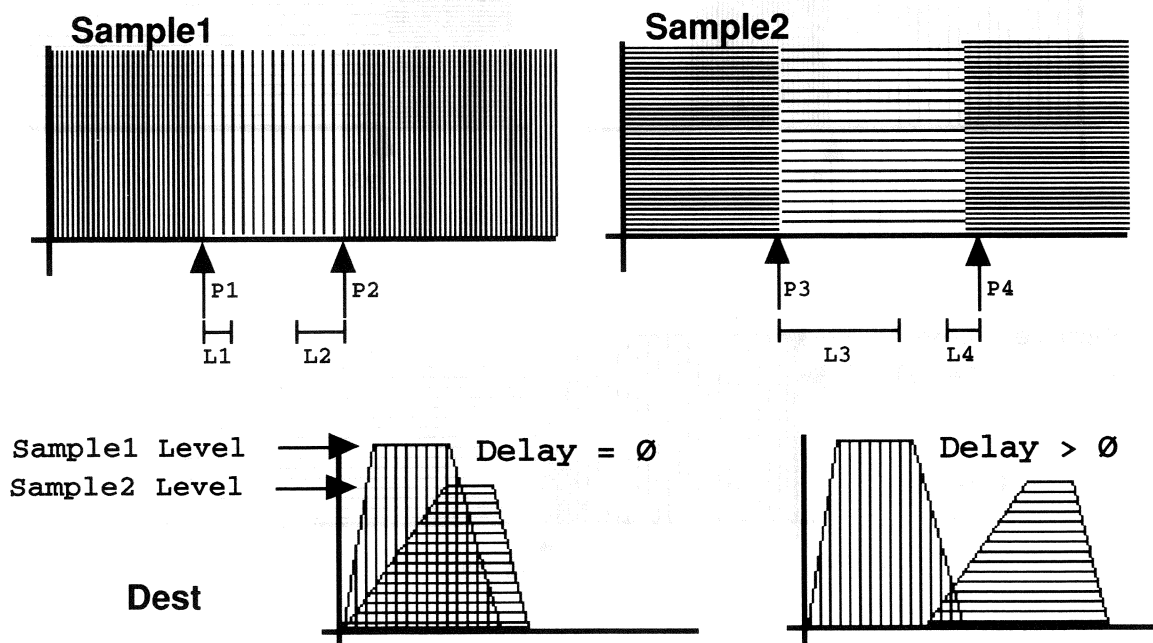

The relative levels of the two Samples are determined by their respective **Level** parameters. Normally, both Samples start to play immediately at their respective **From** points, but Sample2 can be delayed, using the **Delay** Parameter. This can be set to any value up to the total length of Source Sample1.

Since you are arithmetically combining two Samples, it is possible to create a situation in which the instantaneous combined level of the samples goes above the maximum allowable digital level. If this happens, a message window will appear that says “**LEVEL OVERFLOW**”. Click **OK** to get rid of it, but before you panic, listen to your new Sample. Chances are good you won’t hear any problems. However, if you do notice some digital clipping (and it will sound awful), click on **Recover**. Then lower the **Level** settings for both Samples, and try, try again.

## Combine

This operation splices the two Samples together. It takes Sample1 from the beginning to the **P2:To** point (**P1** is ignored), and joins it with Sample2 from its **P3:From** point to its end (**P4** is ignored). There is no gap.

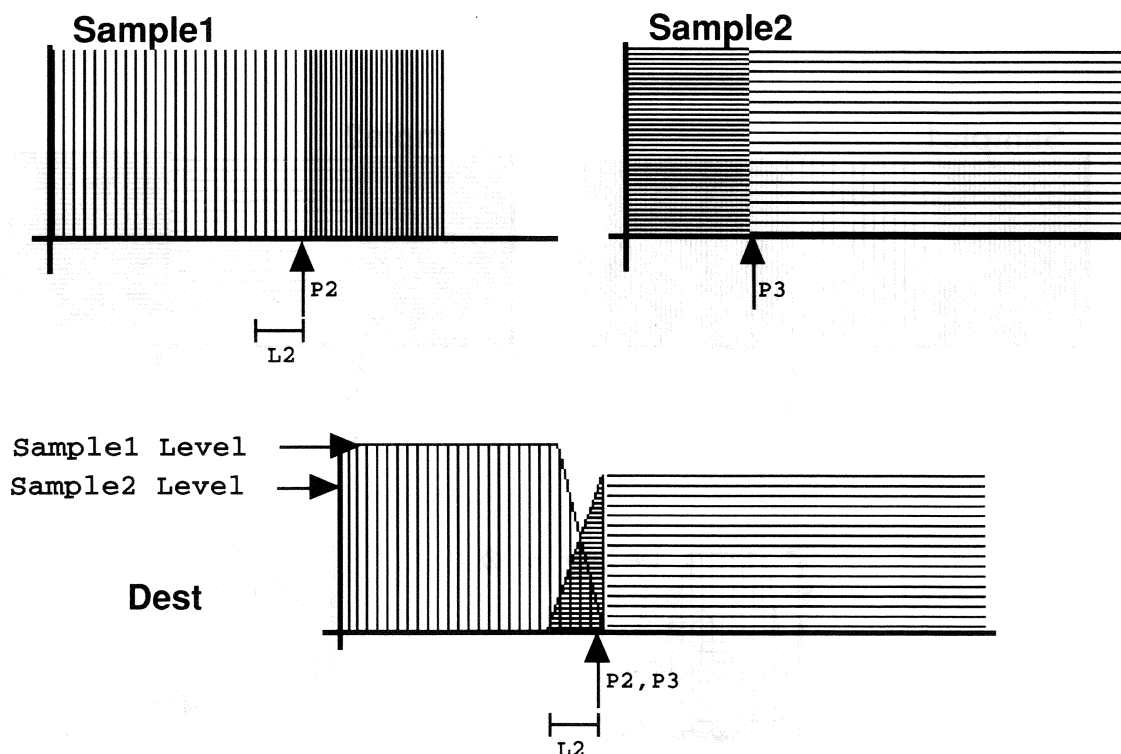

The Samples can be butt-spliced or crossfaded. The crossfade time is determined by **L2**. Sample1 will start to fade out **L2** words before **P2**, and Sample2 will start to fade in **L2** words before **P3**. The maximum value of **L2** is **P3** — again, you can't start to fade a Sample in before its beginning. The relative levels of the two Samples are determined by their respective **Level** parameters.

## Digital Filter

The **Digital Filter** allows a Sample to be permanently altered in terms of its frequency content. It is useful for eliminating hums or whistles, for making a Sample brighter so it cuts through a mix better, or making it less bright so that it blends better. Unlike the Partial function's TVF, the Digital Filter is not dynamic, so that it cannot be changed over time or by MIDI action, and it is destructive, permanently altering the Sample. If you want to keep a copy of the unaltered Sample, use the **Copy** function from the **Com** menu before filtering.

**Digital Filter** has only one Page, which you get to from the **Edit Sample2** submenu. The **Filter Mode** can be set to **LPF** (Low-Pass) or **HPF** (High-Pass). The **CutOff Frequency** is in arbitrary units from 0.1 to 10.0. The high value is equal to half the sampling rate of the current Sample. **Resonance** is similar to the same Parameter on the Edit Partial TVF page, and adjusts the filter's Q for an analog-style effect

In High-Pass mode, the **CutOff Freq** can also be set to "**D.C.**". This is for removing any DC offset that might have crept into the Sample, if it was recorded by a device other than the S-770 and transferred in.

**Level** is normally set to 127. However, if high values of **Resonance** are used, the resulting waveform may have one or more points where the maximum allowable level is exceeded. As with the **Mixing** operation, you will get a window warning you of this, and if it creates audible distortion, lower the **Level** parameter and try again.

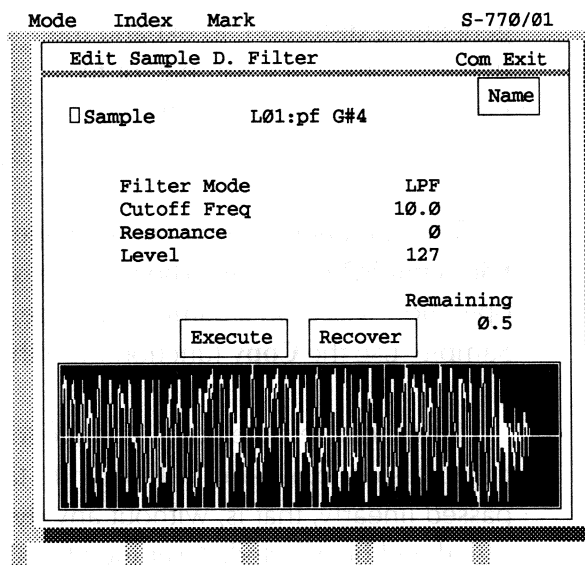

Two additional settings for **Filter Mode** are **+Emphasis** and **-Emphasis**, which are used to add or remove (respectively) high-frequency pre-emphasis from a Sample. The S-770 normally uses emphasis with its Samples to ensure the best fidelity, but many other Samplers don't. If a Sample is transferred to the S-770 from another sampler via MIDI Sample Dump (see Chapter 10), it may not have emphasis, but you can use this function to add it. Conversely, if you are sending an S-770 Sample to another sampler, you can use this to remove the emphasis beforehand.

Emphasis might also be added after a Rate Convert operation (coming up soon) to restore some high end that might be lost. When **Filter Mode** is in either of these positions, the **Resonance** and **Cutoff Freq** Parameters are ignored.

Since the action of the filter is destructive, and the new Sample is written to the same slot as the original version, a **Recover** switch is provided. If, however, there is not enough memory **Remaining** to hold a copy of the current Sample, you will not be able to use **Recover**.

## Compressor/Expander

The **Compressor/Expander** allows the dynamic contour of a Sample to be permanently altered. The feature acts like a standard audio compressor/limiter/expander, with highly adjustable parameters. It can be used to flatten out a signal's dynamic peaks, to raise the overall level of a Sample without generating distortion, to expand the dynamic range of a Sample, or to eliminate low-level noise from a Sample.

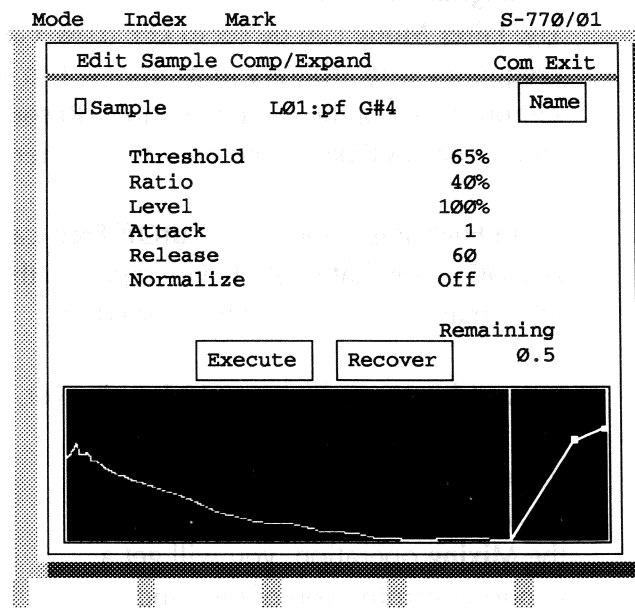

The operation is done on one page: **Edit Sample Comp/Expand**. Select it from the **Edit Sample2** submenu. The top line is for choosing the Sample to work on. The operation works on a Sample in place, so if you want to keep a copy of the unaltered Sample, use the **Copy** function from the **Com** menu before executing.

**Threshold** sets the point, relative to the overall dynamic range of the S-770, that the compression/expansion will begin to take place. Any signal below that point will be passed linearly, that is, without any dynamic change. A setting of 0% means all of the signal will be affected. A setting of 100% means the signal will not be affected at all.



**Ratio** determines the dynamic change to the signal that is above the **Threshold** point. A setting of 100% means no change at all. Settings below 100% mean the signal is compressed, so that large dynamic changes are made smaller, and a setting of 0% means the signal is hard-limited, so no volume change can occur. Settings above 100% expand the signal, so that dynamic changes are exaggerated. The maximum setting is 1000%, at which the Sample is fully expanded, with low-level signals essentially silenced and high-level signals made higher.

At high expansion settings, it is possible that the Sample level will end up instantaneously higher than the permissible maximum, in which case a “Level Overflow” window will appear. Don’t panic if this happens: chances are pretty good you won’t hear any distortion after the expansion is done. If you do, **Recover**, set **Ratio** lower, and try again.

The **Threshold** and **Ratio** settings can also be adjusted in the graphic at the lower-right corner of the screen. The little blue square in the middle of the box sets the **Threshold**: move it down and to the left to lower it, up and to the right to raise it. The blue square on the right of the window sets the **Ratio**: move it up and to the left for expansion, and down and to the right for compression and limiting.

Note that the left-hand part of the graphic shows the Sample differently than other pages: here we are looking at the Sample’s dynamic level plotted against time, which of course is what is of most concern to us on this page.

**Level** sets the level of the processed Sample relative to the original Sample. In many cases, leaving this at 100% should be satisfactory, but if heavy compression is used, a higher setting might help to maintain the signal-to-noise ratio of the Sample. Setting **Level** to 0% creates a silent Sample. You probably don’t want to do this.

**Attack** and **Release** set the attack and release times for the compression or expansion. The range is 0 to 127, with smaller numbers faster.

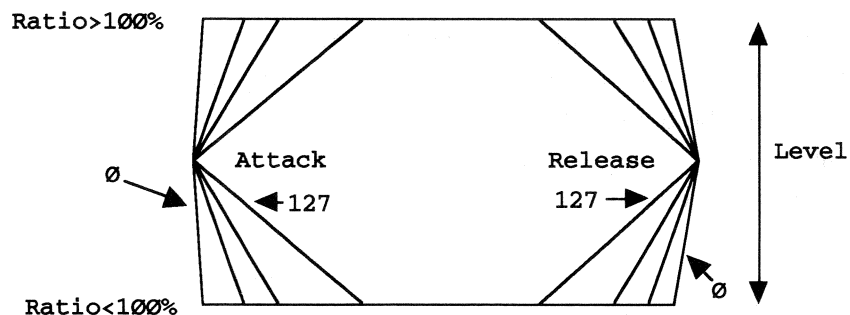

Action of Comp/Expand on signals above **Threshold** level

**Normalize** ensures that the resultant Sample is at its highest possible dynamic range after executing. Setting this parameter to **After** will normalize the Sample after compression/limiting. Setting it to **Only** means that the Sample will be normalized *without* compression/limiting — just as on the **Normalize** page.

Again, the action of this operation is destructive. The new Sample is written to the same slot as the original version, so a **Recover** switch is provided. If there is not enough memory **Remaining** to hold a copy of the current Sample, you will not be able to use **Recover**, and the Secretary will disavow all knowledge of your existence.

## Time Stretch

The S-770 can alter the length of a Sample without changing its pitch, or vice versa. A Sample can be sped up or slowed down by up to a factor of four. This operation is useful in a variety of contexts. It can be used to fit dialog, sound effects, or a musical phrase into specific periods of time, especially in film or video production. It can change the rhythm or length of a musical phrase to conform with a sequenced or

recorded rhythm track. And it can be used to great creative effect, to transform familiar sounds into unfamiliar ones, or to create totally new sounds.

Time Stretching is handled on the **Time Stretch P**(arameter) Page, selected from the **Edit Sample2** submenu. (It is also one of the factory Jump pages: Set 2, Page2.) The top line is for choosing the Sample to work on. The operation works on a Sample in place, so if you want to keep a copy of the unaltered Sample, use the **Copy** function from the **Com** menu before executing.

Let's skip the first few Parameters for now — they are used if you don't want to Stretch the whole Sample. Do, however, look at the blue "**—Time**" Parameter. This tells you the length, to the nearest millisecond, of the current Sample.

Mode	Index	Mark	S-770/01	
Edit Sample Time Stretch P			Com	Exit
<input type="checkbox"/> Sample	L01:pf G#2T		Name	
P1:From	0	Length	93084	
P2:To	93084	-Time	3.102s	
Ratio	50%	Coarse	-12	
Fade	29	Fine	0	
Mode	Manual	Length	46542	
E.Step	1	-Time	1.551s	
KeyOn	Start	Total Length	50226	
		-Time	1.674s	
Search			Execute	
			Recover	
Remaining 0.5				
Param	Graph			

## Ratio

**Ratio** sets the stretching factor, which can be from 25% to 400%. Ratios less than 100% speed up the Sample and make it shorter, while ratios greater than 100% slow it down and make it longer.

As you adjust **Ratio**, you'll see the numbers in the blue box on the right

half of the screen change. They are showing you what will happen to the pitch, the length in words, and the duration in seconds of the Sample at the selected **Ratio**. If the ratio, for example is 150%, then the length and duration will be 1.5 times that of the original.

Original  
Sample



Ratio  
= 150%

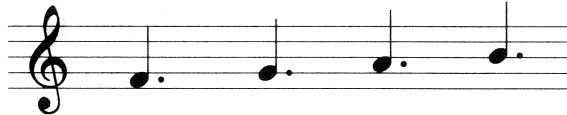

Ratio  
= 50%



Click on **Execute** to do the change. As usual, you can **Recover** the original Sample if you don't like what you've done, provided there is sufficient memory **Remaining**.

If there are any Sustain or Release loops in the Sample, they will be stretched or shrunk accordingly, so they should sound the same in the new Sample as they did in the original. Changing the **KeyOn** parameter lets you listen to the different parts of the Sample so you can check this.

## Fade

When a Sample (meaning a sound) is Time-Stretched, the software takes "chunks" of the original Sample and interpolates, crossfades, and creates many new samples (meaning individual words) to put into those chunks. The size of the chunks is determined by the software (invisibly to the user), and the **Fade** parameter determines how much the chunks will be overlapped when the new sample words are calculated. Generally speaking, the larger the fade, the smoother the resulting sound. However, the operation also takes longer with longer fades. Simple sounds, like sine waves, will stretch fine with low settings of the **Fade** parameter, while complex, reverberant sounds will need higher settings if they are not to come out sounding weird.

When Mode is set to **Manual**, you can adjust **Fade** as you like. **E.Step**, as usual, changes the resolution of the adjustment.

Life, however, is not quite that simple — it's not enough just to set a high value for **Fade**, it also has to be just the *right* value for the particular sound. For you to find that value could require hours of trial and error. Fortunately, the S-770 can help. When you click on **Search**, the S-770 calculates a new set of chunk sizes that might be appropriate for the current Sample, and resets the **Fade** parameter to accommodate the new chunks. When it's done, you can click **Execute** and listen to the result. If you don't like it, click **Recover**, then **Search** again, and try the next set. (If you find a **Fade** value that "sort of" works, you might want to save the stretched Sample under a new name, just in case nothing better comes along.)

For the ultimate in assistance, change **Mode** to **Auto**. Now you can't adjust **Fade** at all, and **Search** is disabled. When you click **Execute**, the S-770 looks through *all* possible chunk sizes, and decides which one it likes best. It then executes the Time Stretch using that number. While this process consistently yields the best results, the software algorithm it uses is extremely complex, and so there's a trade-off: it can take a while. With complex sounds, the operation might take as long as 100 times the length of the Sample.

### Pitch Change with Constant Length

This operation works just as well if you want to do the opposite to a Sample: alter its pitch without changing its length. This can be useful for creating unusual vocal or sound effects (Darth Vader comes to mind), or fattening a Sample by doubling it at a different pitch. While the same operation is used, the information you need to know is different.

The pitch numbers in the blue box will tell you how far the pitch of the original Sample will deviate for a given **Ratio**. If you then want to play the new Sample so that it fits into the same *time* as the original, you will have to change its pitch by the numbers displayed: in half-steps (**Coarse**) and 1/100ths of a half-step (**Fine**). Use **Ratios** above 100% for creating higher-pitched versions of the Sample, and **Ratios** below 100% for lower-pitched versions.

Here's an example: you have sampled a piece of dialogue matched to picture. The actor's voice is wimpy and you want to lower it by a major third. Select the **Ratio** parameter, and hold down the left mouse button to lower it. Watch the pitch parameters change. Set the **Ratio** so that the **Coarse** parameter says **-4** (four half-steps is a major third) and the **Fine** parameter is as close to zero as possible. We'll save you some suspense: the **Ratio** will be **79%**, and **Fine** will be **-8**, which is pretty good. Now **Execute**.

**Original note**

**Original Sample**

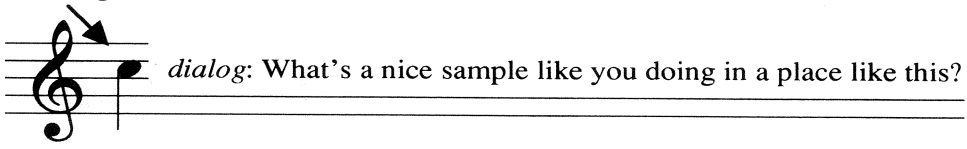

*dialog: What's a nice sample like you doing in a place like this?*

**Ratio = 79%, Sample is squeezed**

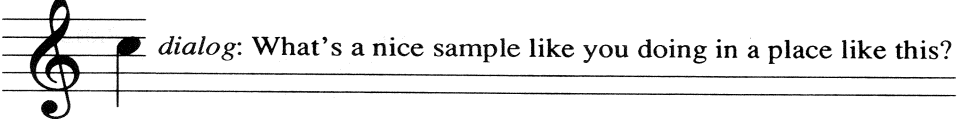

*dialog: What's a nice sample like you doing in a place like this?*

**Play this note to restore original timing at new pitch**

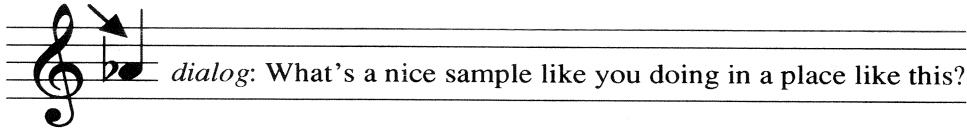

*dialog: What's a nice sample like you doing in a place like this?*

If you now play back the new Sample from the MIDI keyboard a major third lower than the original key, the pitch will be indeed lowered a major third, but the length (and rhythm) will be very nearly unchanged.

To get a closer match, load the Sample into a Partial, where it can be more finely tuned: set the **C.T** in the Partial to -4 and the **F.T** to -8, and play it back on the *original* key. The new Sample will match the timing of the old perfectly.

The same technique can be used to “harmonize” a Sample: create three different versions of a vocal or instrumental Sample at three different pitches, and you’ve got an ensemble.

### Stretching Part of a Sample

If you only need to stretch or shrink a part of a Sample, you can set the limits of the operation using **P1:From** and **P2:To**. Only the portion of the Sample between those two points will be affected. You can set them either from the **Param** page or from the graphic (**Sample Time Stretch G**) page, using the usual scrubbing and pointing techniques. Setting **KeyOn** to **FromTo** lets you hear the region you’ve set up. As usual you can move more quickly through the numbers by setting **E.Step** to a higher value.

If you happen to know exactly how many words (or seconds) the stretch region should be, you can use the **Length** parameter to set it up. When you change it the **P2:To** point changes along with it — **P1:From** won’t move.

## Rate Converting

The situation often arises in which it is necessary to give a Sample a different sampling rate. For example, as we discussed earlier in this chapter, if you Mix, Combine, or Insert two Samples that are recorded at different rates, one or both of them will change pitch. If you change them so the rates are the same, there is no pitch change.

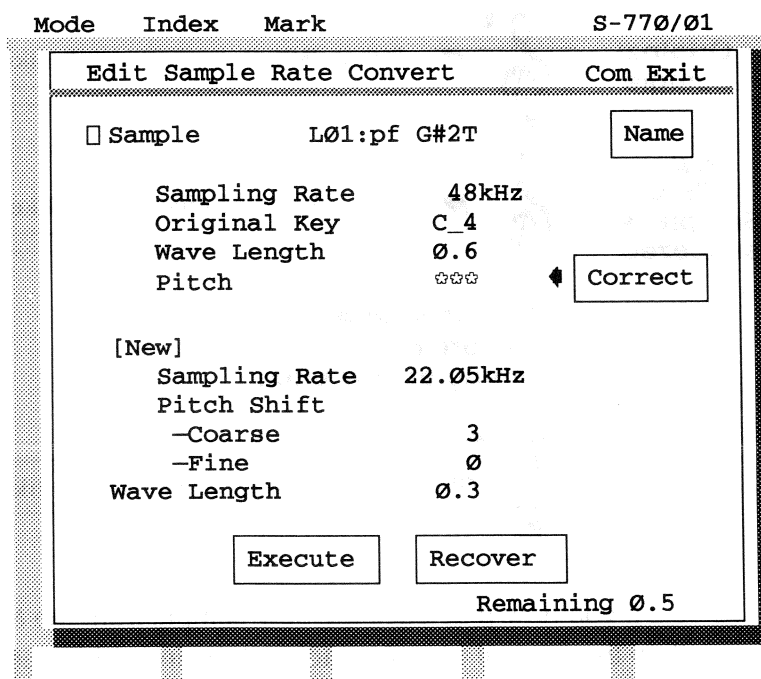

Another situation that might call for sample-rate conversion is if you have a lot of long, high-sampling-rate Samples in RAM which don't really need to be at that high rate, and therefore are taking up more space than necessary. By down-converting these Samples, you can free up more memory, hopefully without sacrificing sound quality.

Or, you may have a Sample that needs to be transferred to another device — another sampler, a computer, a digital processor or tape deck — which only accepts samples at certain rates, and your Sample is at the wrong rate. Converting it internally assures a perfect transfer, without the dangers of D-to-A and A-to-D conversion that would otherwise be necessary.

There are six sample rates available: 48, 44.1, 30, 24, 22.05, and also 15, which should only be used for truly low-fi sounds.

The operation is straightforward, and is done on the **Edit Sample Rate Convert** Page, of which there is only one, selected from the **Edit Sample2** submenu. Select the Sample to convert at the top of the page. Its **Original Key** and **Wave Length** (that is, the number of seconds of RAM it occupies relative to 44.1 kHz) are displayed. Go down under the word **[New]**, and set **Sampling Rate** to the rate you want. The **Wave Length** (again, relative to 44.1 kHz) for the new version is shown.

Click **Execute** and it's done. Click **Recover** (assuming there's enough RAM available), and the Sample goes back to its original rate.

## Retuning

If you like, you can change the **Original Key** of the Sample for conversion, thereby shifting the Sample up or down. You can do this while you're converting to a different **Sampling Rate**, but you may also find it helpful to change the **Original Key** while converting to the *same* **Sampling Rate**, just to bring the Sample into tune with other Samples. This can be especially useful when working on the **Patchwork** page. If you want to Insert, Mix, or Combine two Samples that are not in tune with each other, here's where you can fix them.

Resetting the **Original Key** can be done on many of the Sample Edit pages as we have seen, but this one has a twist: when you are working on a Sample, the **Correct** switch can analyze its absolute pitch, and guide you in assigning it a key. Clicking on the switch doesn't change the Sample, it just analyzes it. After a short wait, the **Pitch** parameter will display the true musical pitch of the Sample, and any tuning offset in 1/100ths of a semitone.

For example, if you have sampled a musical sound at a pitch of 440 Hz (A above middle C), regardless of where you assigned the Sample's **Orig Key**, when you click on **Correct**, it will tell you the Sample should be at **A\_4**. If you set the **Orig Key** to **A\_4**, you'll have a Sample that's in tune with the rest of the world. (Of course, you don't *have* to re-assign the note.) Note that this feature only makes sense with *musical* sounds — if you try to Correct an unpitched sound, you may get an **Error** message, or you may get a real note, but it will not be much help.

## Range Extension

Another interesting feature of this page is that it can extend the range of a Sample. Normally Samples can be transposed up a maximum of two octaves (three if they are recorded at a slower rate). With the **Pitch Shift** option on this page, however, Samples can have their range extended. Setting both **Sampling Rates** the same, and then setting **Pitch Shift** to 3 will raise the pitch of the Sample a minor third, and at the same time raise its upper transposition limit by a minor third.

Original Sample range

Pitch Shift = 3

Original Key = D#4

If you want to extend the upper limit of the Sample without shifting its position on the keyboard, set the **Original Key** parameter to the same interval as **Pitch Shift**: if you want to extend the range a minor third, set **Pitch Shift** to **3**, and the **Original Key** (assuming it is **C\_4**) to **D#4**. Now the Sample will play back at the same pitch, but you'll have an extra three half steps available at the top.

This operation is not without a trade-off. Pitch shifting a Sample upwards actually shortens it (the Wave Length parameter shows you this), and that means that the quality of the Sample isn't quite as good. If you go a long distance with Pitch Shift, you may be able to hear audible deterioration of the Sample at the original pitch.

**Pitch Shift** can be set as high as **48** (four octaves) for truly radical changes. The **Fine** parameter adjusts it in 1/100ths of a half-step.

## Wave Draw

The S-770 gives you the ability to physically alter individual words within a Sample. This is useful when a Sample has a pop, glitch, or some other kind of anomaly in the middle, where it can't be easily trimmed. If such a beast can be somehow smoothed out, a dirty Sample can be turned into a clean one.

That's the purpose of the **Wave Draw** Page, chosen from the **Edit Sample2** submenu. Select the Sample to work on at the top of the Page. Immediately below its name is a graphic of the entire Sample. There are several active areas on this Page, and as you move the cursor around among them, each one turns purple as you enter it.

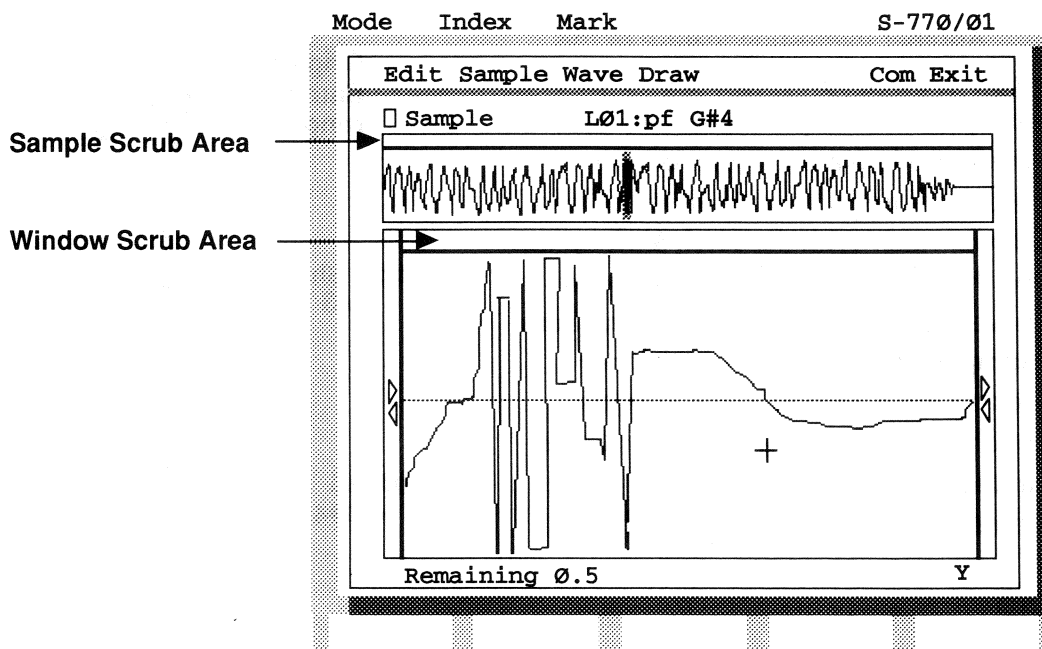



As on the other graphics pages, you can put the cursor in the horizontal rectangle above the Sample graphic and scrub it. When you find the glitch, click the mouse on the corresponding spot on the Sample graphic.

The area you have clicked on will turn blue, and a 270-word segment of the Sample right where you clicked will appear in the window below. As on the **Loop2 Graph2** Page in the previous chapter, you can scroll this window by putting the cursor in one of the areas containing the small triangles at the extreme left and right of the window. On this page, however, both areas do the same thing: click the left mouse button in either area to view the 135 words of the Sample immediately preceding the current segment, or click the right mouse button to move to the next segment of the Sample.

Click on the letter **Y** in the lower-right corner to change the vertical (Y-axis) resolution of the window. There are four levels available: click the right mouse button to zoom in and the left to zoom out.

You can also scrub *this* window: put the cursor in the middle of the horizontal rectangle at the top of the large window, and press and hold the left mouse button. Instead of scrubbing the entire Sample, you are only scrubbing the 270 words in the window. Therefore, you will hear a continuous waveform whose pitch varies with the scrubbing speed. As usual, the position of the mouse will determine the speed and direction of the scrub, and a speed and direction indicator will appear at the top right corner of the screen when you scrub. The limit is 200% in either direction, and you can cut the speed in half by pressing the right mouse button.

When the mouse is in any area of the screen except the large window, the graphic in the large window consists of line segments. When the mouse enters that window, however, it changes to dots, for highest accuracy. You can now redraw any dot in the window, by placing the cursor and pressing the left mouse button. You can draw one dot, or you can drag the mouse and draw a line or curve. The dots you draw while you hold the mouse button are red, and as soon as you let go of the button, they turn white. Move the mouse out of the window to restore the line-segment view, which will make it easier to see what effect you are having.

The best way to get rid of glitches is simply to draw a smooth line or curve through them, connecting the waveform before the glitch as fluidly as possible with the waveform after it. Use the large-window scrub function to check your work: if the glitch remains, the sound will be harsh and raspy. If the glitch has been effectively removed, the sound will be much smoother.

Wave Draw can also be a lot of fun for experimenting with what different-looking waveforms sound like. However, you have to have a real Sample selected before you can start playing with the words — you can't draw into a Blank Sample.

## Resampling

Samples can be combined, with various modifications applied, entirely in the digital domain within the S-770, using the Resampling function. Resampling is not one of the **Sample Edit** pages; it has its own set of pages, and is accessed directly from the **Sound** menu. It can also be accessed from the **Index** (select **Resampling** twice) or through a Jump page. **Performance Resampling**, the other item on the **Resampling** subtopic of the **Index**, is a special case that is discussed at the end of this chapter.

The resampling function takes two mono Samples — the **Source Samples** — and mixes them into one mono Sample. One or both of the Samples can be delayed or tuned relative to each other. Filter and volume (**TVF** and **TVA**) envelopes can be applied to one or both Samples. If a stereo Sample is selected as a Source Sample, only the half of the pair named will be included.

Resampling has many uses. Two identical Samples, slightly detuned, can be combined to create a “chorus” effect that only uses up one voice. Or they can be grossly detuned for harmonizing effects. Volume and Filter envelopes that sweep across the two source Samples, either together or in opposition to each other, can create very dynamic sounds. Because Resampling is done entirely on the digital level, with no conversion to analog, there is no generational degradation of the sound, and Resampled sounds can themselves be Resampled without problems.

### Resampling Complex Events

Resampling involves “playing” the source samples from the MIDI keyboard (the **SOUND PLAY** button is inactive). If a Sample contains Sustain and/or Release loops, they will play as long as the key is held down and the TVAs allow, just as if you were playing a Partial. The newly-created Sample will not have any loops of its own, but will treat those repetitions as part of the one-shot Sample itself. Sustain Pedal (Controller #64), Pitchbend, and other MIDI controllers are responded to as well, in accordance with the settings made the last time you were on the **Edit Patch Ctrl** page (or if you haven’t been to that page since power-up, the default settings). As on the **Edit Sample** pages, the S-770 is in Omni mode on the **Resampling** pages.

In addition, *multiple* MIDI notes (up to the S-770’s polyphony limit) can be played during the Resampling. Each incoming MIDI note triggers the Source Samples at the pitch corresponding to the note’s pitch, and at a volume proportional to the note’s velocity. All of the sounds thus generated become part of the new Sample. Therefore, a Resample can easily be made up of multiple copies of the Source Samples at different pitches, loudnesses, and/or times, which can be in the form of a chord, a “stutter”, an arpeggio, or an entire musical phrase.

## Timing, Tuning, and Naming

The first Resampling page is **Resampling Common**. Here is where the **Source Samples** are chosen. Samples 1 and 2 can be selected from any Samples currently in RAM. If you only want to use one Sample (to make a chord or pattern out of it), set one of the Source Samples to **Off**.

Each Sample can be tuned, using **C.T** (in semitones,  $\pm 4$  octaves) and **F.T** (in cents,  $\pm 1/4$ -tone). Small values of **F.T** give a flanging or chorusing effect. The triggering of either Sample can also be delayed relative to the other, using the **Dly** parameter. The range available is from a couple of milliseconds to several minutes.

The name of the resulting Sample appears at the top of the screen. You can overwrite an existing slot, or use a blank slot and give it a new name.

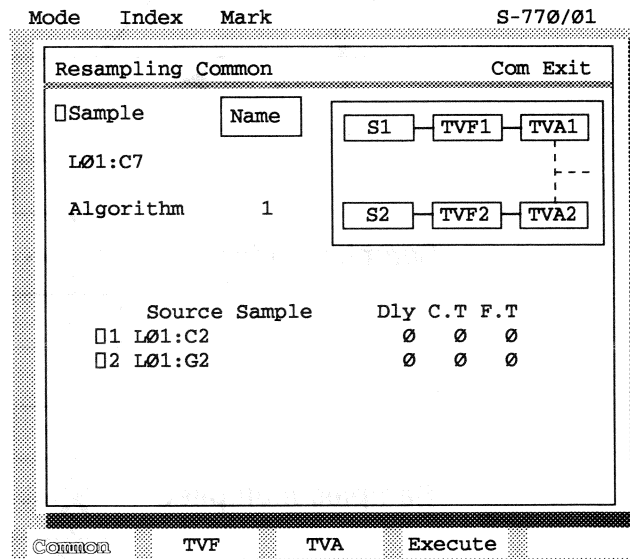

## The Resampling Algorithms

The other item on the **Common** page is "**Algorithm**". As on a digital synthesizer, the **Algorithm** determines how the various source and processing modules that make up the Resampling function will be arranged, and whether the Source Samples will be *added* or *multiplied*.

Adding Samples does just what it sounds like: the two sounds are combined into one. This can be a very useful feature for layering sounds, in that fewer S-770 voices are then needed to produce the same complexity of timbre.

Multiplying Samples produces non-harmonic partials similar to a ring modulator. The result is a metallic sound, which, in moderation, can be useful for bell-like timbres or, in excess, for totally weird, sci-fi sounds. Keep in mind when two sounds are *added* together and one is at zero level, the other will come through, but when two sounds are *multiplied* together and one is at zero level, there will be no sound produced.

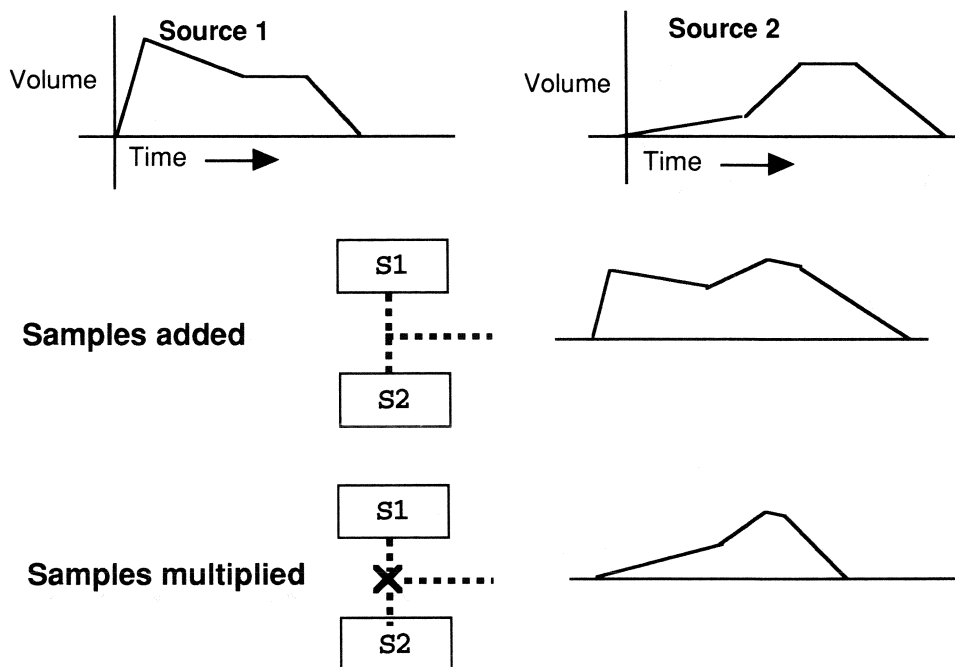

Besides the Source Samples, the algorithms give you two TVFs and two TVAs to work with.

- In Algorithm 1, each Sample has its own TVF and TVA, and the outputs of the TVAs are added.
- In Algorithm 2, the Samples are added first, then put through the two TVFs in series, and then through a TVA.
- In Algorithm 3 the Samples are multiplied, but before that happens, one of them goes through a TVA. The combined signal then feeds the two TVFs in series and the remaining TVA.
- Algorithm 4 is similar to Algorithm 3, except that the signal from Sample 2 (the one without a TVA), besides being multiplied with Sample 1, is also *added* to the product signal before it all goes to the TVFs. Unlike Algorithm 3, this algorithm can be used with just one Sample (Sample 2), giving it two TVFs to play with.
- Algorithm 5 takes the output of Sample 1 and puts it through a TVF and TVA, and then multiplies it with Sample 2, which has also been put through a TVF. The product then goes through the remaining TVA.
- Algorithm 6 is similar to Algorithm 5, except that the Sample 2 signal, after it passes through its TVF, is added to the product signal before it goes to the final TVA.

## Filter and Volume Envelopes

The two TVFs are set up on the **Resampling TVF** page. These are simplified versions of the TVFs found on the **Partial Edit** page. (Remember, we're dealing directly with Samples here, so any envelopes set up at the Partial level will have no effect.)

For each of the two Source Samples you can set **Filter Mode** (Low-pass, Band-pass, or High-pass), **Cut Off** frequency, and **Resonance**, and design an envelope graphically or numerically. The filter has no "Off" position, so if you want to have no filter action, use the default settings: **Mode = LPF**; **Cut Off = 127**; **Reso. = Ø**.

The **G-Edit** parameter ("Graphic edit") determines which Sample's envelope will be frontmost in the graphic window at the bottom of the screen. If **G-Edit** is set to **Sample 1**, then Sample 1's TVF envelope will be white and green, and can be altered with the mouse, while Sample 2's TVF envelope will be dark blue, and can't be changed with the mouse (but it can be changed with the numeric Parameters). If **G-Edit** says **Sample 2**, then Sample 2 will be brighter and will be adjustable with the mouse.

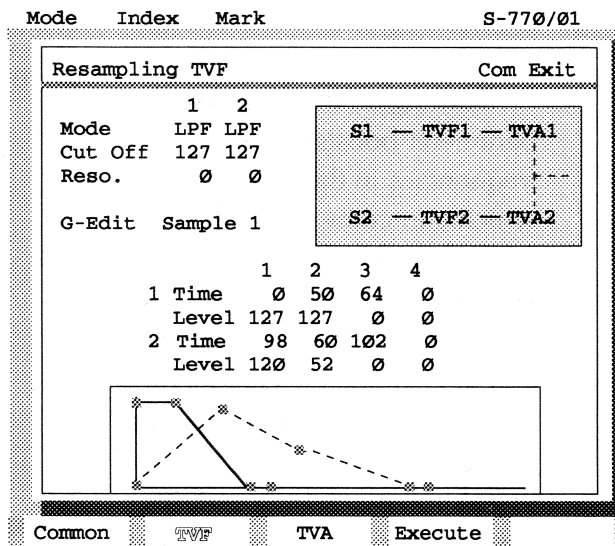

The two TVAs are set up on the **Resampling TVA** page. The **Depth** parameter for each Sample sets an overall loudness level for the envelope, so that you can balance the two. The envelope itself can be designed graphically or numerically. If you want no envelope action at all, set all of the **Time** parameters to 0 and the three **Level** parameters to 127 (**Level 4** must always be 0). The **G-Edit** parameter again determines which Sample's envelope will be frontmost and adjustable with the mouse.

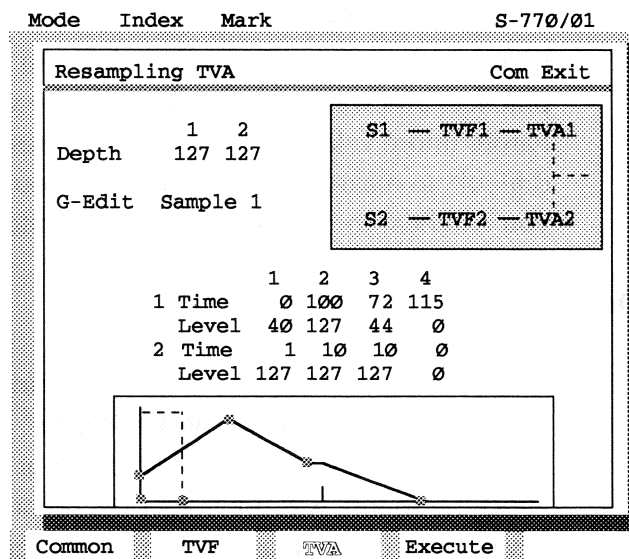



When the Resampling is finished, a “**Now Working**” box appears briefly, and then the **Resampling Over** window comes up. It shows the new Sample in a Waveform display window, and you can play the keyboard and hear what it sounds like. Three switches on the screen let you reject what you’ve just done and try again (**Retry**); keep what you’ve done and do another (**Next**); or keep what you’ve got and go do something else, like edit it (**End**).

If you keep the new Sample, it now resides in RAM under the name you’ve assigned it, and it can be used, edited, stored, and resampled just like any other Sample.

### Tricks and Warnings

Resampling provides a nice way to link two Samples together sequentially: set up the first Sample with a **Dly** of 0, and the second Sample with a **Dly** equivalent to the length of the first Sample. Since the **Dly** parameter is not calibrated in real-time units, this may require a little experimentation.

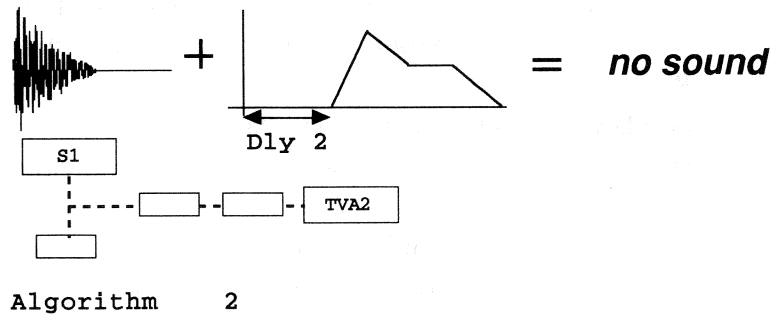

While we’re on the subject of delays, the timings of the TVA and TVF envelopes are tied to the **Dly** parameters on the **Common** page. If the Delay for Sample 1 is set to five seconds, then TVA 1 will not start until five seconds after the MIDI key has been pressed. This is all well and good when the envelopes are operating directly on their respective Samples. However, in Algorithms 2, 3, and 4 the envelopes are *not* directly attached to their respective Samples. Therefore, you may possibly find yourself in a situation where a Sample has a short delay time, but the TVA controlling it has a very long delay time, and you end up hearing nothing, because the Sample is over before the envelope begins. Be careful.

Resampling can also be used to stretch the top end of a Sample’s range. For example, set **C.T** on the **Common** page to **2**, and play a Sample on its original key. It will now be transposed up a whole step, and the pitch range will be extended at the top by a whole step. You can re-position the new Sample to the correct pitch in one of the **Edit Sample1** pages, or within a Partial. This method isn’t quite as clean as stretching the range on the **Rate Convert** page, because it doesn’t preserve loops, and it takes into account your key velocity, but it will work in many circumstances, especially when you want to extend the range of a Sample and combine it with another at the same time.

## Performance Resampling

We looked at Performance Resampling in the previous chapter, in terms of sampling from within a Performance. Now we'll talk about *Resampling* from a Performance.

The **Performance Resampling** page is accessed from a Performance **Play Page** by opening the **Com** menu and selecting **Resample2**, or from the **Index**.

As we've seen, if the **Input** parameter is set to **Analog** or **Digital**, this acts just like the **Sampling** page, recording signals coming in through the inputs, although there are fewer choices (triggering must be from a MIDI note, and monitoring is not available), but you do have the option to automatically **Normalize** the new Sample.

However, if you set **Input** to **Int(ernal)**, the page will resample sounds from *within* the S-770. The main stereo outputs of the S-770 are effectively wired back into the inputs, without the signals ever leaving the box. If the **Mode** is **Stereo**, both outputs are routed back. If it is **Mono**, you can record either the left output (**Int L**) or the right (**Int R**). The physical output and input level controls do not affect the signal, but the **Mix** and **Lev** parameters on the **Play Page** do, as do all level and panning controls at subsidiary levels. Signals coming out of the individual outputs are ignored.

In ordinary Resampling, you are making a recording of simple playback of one or two Samples, with some rudimentary performance aspects applied. In Performance Resampling, you are making a recording of the S-770 in full operation, using multiple MIDI channels, and as many keys and controllers as you want to throw at it.

Although it is not visible, the entire **Play Page** you came from is completely active when you are on the **Performance Resampling** page. (If you came from the **Index**, the operating system actually brought you through a **Play Page**.) You can play the S-770 *multimbrally* using multiple MIDI channels just as if you were on the **Play Page** itself, either from a single-channel MIDI source like a keyboard, or from a sequencer. It will respond to notes, controllers, program changes, pitchbend, or any other valid data.

Click **Ready**, and after a few seconds (and appropriate warnings if you are overwriting existing data) the screen tells you it's waiting for a trigger. As soon as it receives the first MIDI note on any channel (it doesn't have to be a channel that's active in the Current Performance), it will start recording. Now any sound that the S-770 produces will be captured as part of the new Sample.



When the time limit is reached (the thermometer fills up red), the resampling stops. (You can also cut off the resampling early by clicking the mouse or pressing **EXIT**.) Then you are taken to the **Resampling over** page, where you can play and accept or reject the result.

When you accept the new Sample by clicking on **End**, a new Partial and a new Patch, both with the same name as the Sample, are created. You are taken back to the **Play Page**, where you can load the new Patch right into a slot in the Current Performance.

Creating and editing Performances is the subject of the next chapter.

# Chapter 8: Performances, Volumes, and MIDI Program Changes

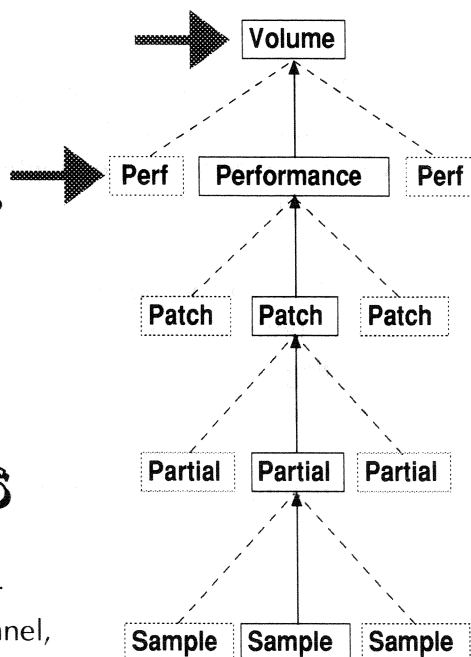

A Performance contains all the information for making the S-770 a fully multitimbral, multi-channel, multi-output sound generator, capable of playing a single musical selection or an entire album's or film's worth of material. While a Patch is a single "instrument", responding on one MIDI channel to produce one kind of sound at a time, a Performance is a group of Patches all responding to MIDI at the same time, on the same or different channels. While several Performances can be loaded into RAM at a time, only one can be active.

A Performance is made up of from 1 to 32 "Parts", each of which contains a Patch and a MIDI channel assignment for playing that Patch on, as well as a few other Parameters. Patches assigned to a Part can be changed in real time over MIDI, using Program Change commands that are received on the Part's MIDI channel.

## Creating a Performance

While there are a number of Performances already on the S-770's internal hard disk, to best illustrate their potential, let's create a new one. Open the **Performance** menu (either from the **Mode** menu, or by pressing the **PERFORMANCE** button), and then select **Play**. (Or, use Page1 of the first Jump set.)

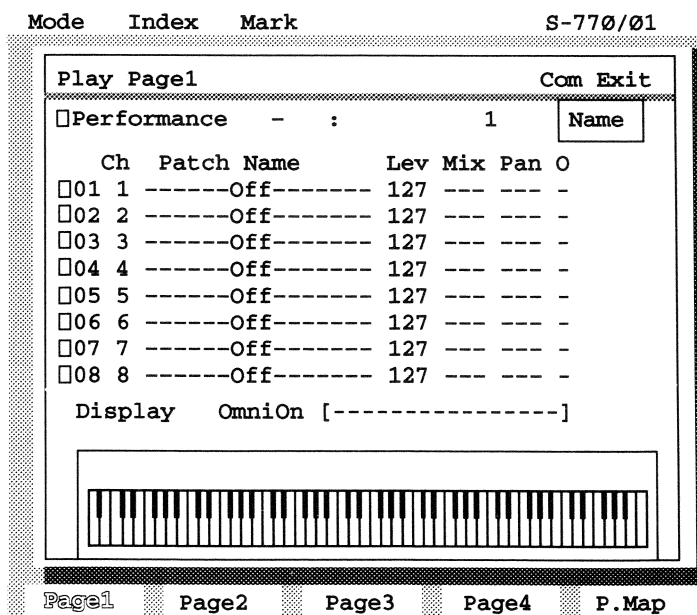

Now open the **Com** menu, and select **Disk**. Go to the **Load** page, and set **Target** to **Patch**. Select **LØ1:Piano L**, and click the left mouse button to load it into RAM. If the screen asks if you want to clear all Internal Memory, select **Yes**.

When it's done, load the following Patches, in any order, making sure you *do not* clear Internal Memory with each load:

- LØ1:Harp Short**
- LØ4:Upright Bass**
- LØ7:LA Fat Kit**

Now **Exit** the Disk Load page, and you will be back on Performance **Play Page1**. (If you're on a different Performance page, click on **Page1** at the bottom of the screen or press the **F1** button.)

This Page shows the first eight Parts that make up the Performance. Each Part has a MIDI channel, an overall **Level**, **Mix** level and **Pan** setting for the stereo outputs, and an assignment for the individual outputs.

### Entering the Patches

Put a Patch into Part number 1 by selecting the first **Patch** field on the Page (it currently says “---Off---”). Click the right mouse button, and the names of the Patches you just loaded into RAM will appear, one at a time. Set Part 1 to **LØ1:Piano L**. Move the mouse down to the Patch field for Part number 2, and click until **LØ1:Harp Short** appears. Go to Part number 3, and set it to **LØ4:Upright Bass**, and set Part number 4 to **LØ7:LA Fat Kit**.

S-770/01

Play Page1						Com	Exit
☐ Performance - :						1	Name
Ch	Patch Name	Lev	Mix	Pan	O		
☐01	1 LØ1:Piano L	127	127	L32	-		
☐02	2 LØ1:Harp Short	127	127	R32	-		
☐03	3 LØ4:Upright Bass	127	127	Ø	-		
☐04	4 LØ7:LA Fat Kit	127	127	Ø	P		
☐05	5 -----Off-----	127	---	---	-		
☐06	6 -----Off-----	127	---	---	-		
☐07	7 -----Off-----	127	---	---	-		
☐08	8 -----Off-----	127	---	---	-		
Display MIDI 1 [LØ1:Piano L ]							
(part 1)							

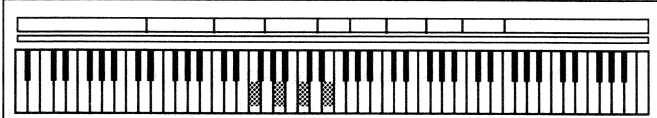

Page1
Page2
Page3
Page4
P.Map

## Setting the MIDI Channels

The column just to the left of the Patch name shows the MIDI channel (**Ch**) for that Part. The first 16 Parts default to the 16 MIDI channels, but you can change any of them you like, including setting more than one Part to a particular channel, thereby layering the Patches. You can also set the channel to "--", in which case the Part will not respond to MIDI. Use this when you want to keep a Patch in a Performance for use at a later time.

## Setting the Outputs

The other Parameters except **Lev** are the same as on the **Patch edit** pages, and reflect the settings you made there for each Patch. Notice that **LØ1:Piano L** has a **Pan** setting of **L32**. That's because this is part of a stereo Sample, and it was saved as part of the Patch with this **Pan** setting (even though it's only "half" of a sound, it sounds pretty good by itself). Set the **Pan** parameter for Part 2 (**Harp Short**) to **R32**, to put the piano and harp on opposite sides of the stereo spectrum.

Remember that the Pan control serves as a "bias", not an absolute position setting, when using Samples panned in stereo. The piano and harp patches have note-number-based **Pans** at the Partial level (**Key+**), so these settings will not place them hard left and hard right, but will arrange them so that the piano plays left-to-center and the harp plays center-to-right. Make sure the bass and drums have their **Pans** set at **Ø**.

The only Part here that has an **Out** assignment here is **LØ7:LA Fat Kit**. That's because this Patch has various drums assigned to the different individual outputs at the Partial level, and these assignments are preserved at both the Patch and Performance level by setting this Parameter to "**P**".

The **Lev** parameter is affected by incoming MIDI Controller #7 (Volume) data, so when you send Controller #7 on a particular MIDI channel, you will see the **Lev** parameter change on any Part set to that channel. If you have two different Parts set to the same MIDI channel, they can have two different *initial Lev* settings, but as soon as you send Controller #7 on that channel, the two **Lev** settings will respond to the MIDI data and become identical. Remember the **Lev** parameter is an overall level for the Patch, while the **Mix** parameter only determines how much signal goes to the stereo outputs.

The S-770 is now a four-part multitimbral sound generator. Set your MIDI controller keyboard to MIDI channel 1, then 2, then 3, then 4, and hear the different sounds. As you send data on a particular MIDI channel to the S-770, an arrow appears to the left of all Part numbers with Patches in them that are assigned to that channel.

The keyboard display at the bottom of the screen shows which notes you are playing in red. It defaults to "**OmniOn**", so that it shows incoming MIDI notes on all channels, but you can change it to respond to a particular channel if you like, or just to a specific Part. When displaying a Part, it will also show the name of the Patch assigned to that Part, as well as all Splits in the Patch. When displaying a MIDI channel, it will show the name of the Patch *and the Part number* assigned to that channel (if there is more than one, it will show the lowest Part), plus the Splits.

The keyboard graphic will not respond, however, to a note on a channel which has no Part assigned to it, or if you play a note which is unassigned *within the Patch* on that channel — for example, if you are playing the drum Patch on channel 4 and you play G<sub>6</sub>, which is not assigned as part of a Split in that Patch, not only won't you hear anything, you won't see anything either.

One other interesting thing about the keyboard display is that if a Patch contains an **Octave Shift**, then when you play a note on the channel of that Patch, it will appear on the graphic transposed up or down by the **Octave Shift** value. (Before you ask, **Coarse Tuning** a Patch doesn't have the same effect.)

If you use a sequencer to record a piece that uses the four instruments, when you play it back, you'll see the arrows appear as each channel is played. If you have more than the standard 2 Megabytes of memory in your S-770, you can load in additional Patches into other Parts, until RAM is full ("**Internal Free**" is zero).

### More Parts, More Performances

**Page2**, **Page3**, and **Page4** are continuations of the Parts list. A Performance can have up to 32 different Parts, each with its own Patch. Parts 17-32 (on Pages 3 and 4) default to no MIDI channel, so if you want to hear any of these Parts, it must first be assigned a MIDI channel. Although in our example, we have loaded the Parts in strict numerical order, there is no requirement that you do so, so feel free to load any of the 32 Parts in any order you like.

If you want to create different Performances using the same set of Patches already in RAM (for example, you want to try a different set of channel assignments or Pan positions), you can select a new blank Performance (scroll to an empty slot, or click on the Select icon and then on "**Blank**"). If you want to save a Performance, make sure you **Name** it first.

The fifth page in this function, **Part Map**, we'll come back to a little later.

## Performance Editing

On the **Play** pages, you can put Patches into Parts and set basic Parameters. Another set of Pages, **Edit Performance**, is for setting up keyboard limits and crossfades for the various Patches in the Performance. Go back to the **Performance** menu (click on **Exit**) and select **Edit Performance**. (Or use Page1 of the *second* Jump set.)

The first page to appear is called **Performance Common**. (If you see something else, select **Common** at the bottom of the screen or press F1.) This page is mostly for reference. It gives you information about the current status of the S-770: how much RAM is used by the Current Performance, how much RAM is available (after *all* the data in RAM is accounted for), the current settings of **Master Freq**, **Master Tune**, and **Analog Outs Mode** parameters (see next chapter), and how many files at what levels are in RAM at the moment. Also, you can select and name the Current Performance.

The next page, **Edit Performance Page1**, is where the action is. (Note that you can press F2 to get to it — don't be confused: in this Function F2 opens **Page1**, F3 opens **Page2**, etc.)

Mode Index Mark S-770/01

Performance Common Com Exit

Volume L07:Percussion Name

Performance L07:TR-808 kit Name

Used 22.1  
Remaining 0.4

Existing Files		Master Freq	
Performance	1	48kHz	
Patch	4		
Partial	24	Master Tune	
Sample	28	0cent	

Analog Outs Mode  
Stereo+6outs

Common Page1 Page2 Page3 Page4

Mode Index Mark S-770/01

Edit Performance Page1 Com Exit

Performance - : 1 Name

Ch	Patch	Name	L.P	U.P	L.W	U.W
<input type="checkbox"/> 01	1	L01:Piano L	A_0	C_8	0	0
<input type="checkbox"/> 02	2	L01:Harp Shor	A_0	C_8	0	0
<input type="checkbox"/> 03	3	L04:Upright B	A_0	C_8	0	0
<input type="checkbox"/> 04	4	L07:LA Fat Ki	A_0	C_8	0	0
<input type="checkbox"/> 05	5	-----Off----	A_0	C_8	0	0
<input type="checkbox"/> 06	6	-----Off----	A_0	C_8	0	0
<input type="checkbox"/> 07	7	-----Off----	A_0	C_8	0	0
<input type="checkbox"/> 08	8	-----Off----	A_0	C_8	0	0

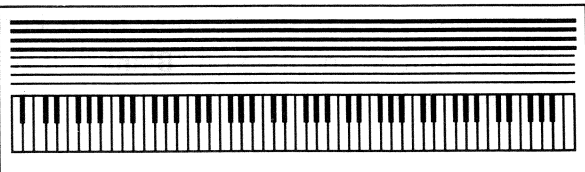

Common Page1 Page2 Page3 Page4

As on the **Play Page**, there are eight Parts visible, and you can assign each one a Patch and a MIDI channel. (The space available for the **Patch Name** is slightly shorter than on the **Play** page, so some names may get truncated.) Any changes you make on this Page will be reflected on the **Play** page, and vice versa. Parts 9 through 32 appear on Pages 2, 3, and 4.

Also as on the **Play Page**, an arrow will appear to the left of a Part number when MIDI data is received on its channel, and notes on active MIDI channels are displayed on the graphic keyboard. The display is in Omni mode.

### Keyboard Splits and Fades

A Part does not necessarily have to play over the entire MIDI range — even if the Patch it contains is set up to do so. The Parameters on this Page are for assigning different Parts to different areas of the MIDI keyboard. As on the **Patch Split** page, different sounds can be set to respond to specific MIDI note ranges, but the setup here is a little different, and so is the way the splits are used.

Performance-level splits are most often used with different Parts and Patches assigned to a single MIDI channel. However, there may be times when you might want to use a split simply to limit a sound's range without putting another Patch on the same channel. The S-770 places no restrictions on how these splits are set up.

**L.P** stands for “Lower Point”, which is the lowest MIDI note a Part will respond to. **U.P**, not surprisingly, is “Upper Point”, or the highest note. They are both adjustable over the S-770's normal note range, **A\_Ø** to **C\_8**.

Unlike **Patch Splits**, on this Page you can set the various keyboard regions to *blend into* each other. **L.W** is “Lower Width”, which describes a “fade width” region. The value of the Parameter is the size of the region, in semitones *above* the Lower Point. Notes within the Lower Width region will sound progressively softer as you go down the scale, and when you go past the Lower Point, they do not sound at all. For example, if **L.P** is set to **C\_3** and **L.W** to **12**, then notes above C4 (12 semitones above C3) will play normally, notes from C4 to C3 will play progressively softer, and notes below C3 will not play.

Similarly, **U.W** is “Upper Width”, and describes a fade width in semitones below the Upper Point. If **U.P** is **A\_6** and **U.W** is **7**, notes below D6 (which is 7 semitones below A6) will play normally; notes from D6 to A6 will get softer as you play higher; and notes above A6 will make no sound.

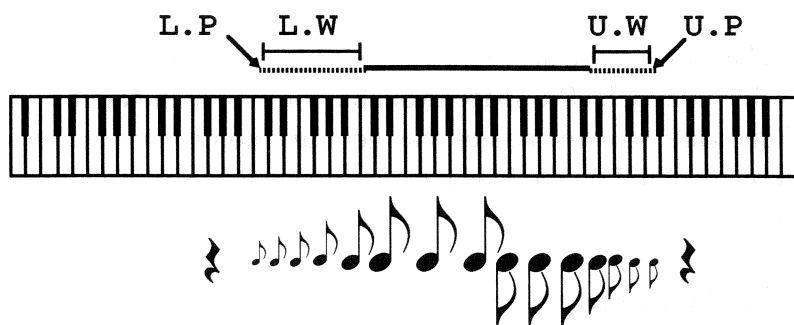

You cannot specify a fade width that is larger than the entire active keyboard region of a Part, so for example, if the Upper Point of a Part is G#6 and the Lower Point is G#4, the maximum you will be able to set either **L.W** or **U.W** will be 23. Similarly, the *sum* of the fade widths cannot be larger than the Part's active region, so using the same example, if **L.W** were set to 14, the maximum you could set **U.W** to would be 9.

You can set the Point and Width parameters by selecting them with the mouse or cursor keys, and entering the value with the mouse buttons, **S** buttons, **VALUE** wheel, or numeric keypad, with which you can enter the MIDI note number (**A\_Ø** = 21; **C\_8** = 108).

### Setting Splits Graphically

You can also set these Parameters graphically. In the window at the bottom of the Page, directly above the keyboard graphic, are eight horizontal lines, each of which corresponds to a Part on the upper half of the Page. If a Part has a Patch assigned to it, the line will be three pixels high. If the Part is "Off", it will be one pixel high.

As you pass the mouse over each line, it turns yellow. Grab the right or left end of one of the lines with the mouse, and press and hold the left button. The line will turn red. Drag inwards to where you want to set a Lower (left end) or Upper (right end) Point, and let go of the button.

To set a fade width, when you grab the end of the line, first press and hold the *right* mouse button, then the left button, and keeping *both* buttons down, drag to the left or right as far as you want (you will have to stop if you bump up against the other end of the range, or the other fade region). When a fade width region is set, you can shrink, or expand it the same way by grabbing the end of the fade region with both mouse buttons and moving it.



The text at the bottom of the keyboard graphic tells you what note the mouse cursor is currently positioned at, and what Parameter you are adjusting: e.g., **Part 2 Lo**, **Part 3 Up**, **Part 1 L.W**, **Part 6 U.W**, and so forth.

## Using the Splits

This feature can be used to set up “positional crossfades”, in which you spread Patches across the keyboard without the “brick-wall” splitting that is done within a Patch. To make it work, set complementary Points and Widths in two different Parts that are

assigned to the same MIDI channel. For example, set up the Performance as described earlier, but set the MIDI Channel for both Parts 1 (piano) and 2 (harp) to **1**. Set the **U.W** for Part 1 to 86 (the maximum) and the **L.W** for Part 2 to 86. Now you have a new instrument that is a piano at the bottom, a harp at the top, and a combination of the two in the middle.

Ch	Patch	L.P	U.P	L.W	U.W
1	L01:Piano L	A_0	C_8	0	86
2	L01:Harp Shor	A_0	C_8	86	0

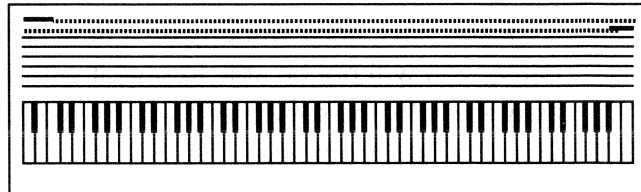

You can also use this feature to make a stereo pair out of two of the numbered outputs (we mentioned this in Chapter 5): set one Part to a high **L.W** and send it (on the **Play** page) to Output **1**, and set the other Part to a high **U.W** and send it to Output **2**.

## A note on using Program Changes

We’ll have a full discussion of MIDI Program Changes later in this chapter, but at this point it’s worth noting that when the S-770 is in Performance mode, it receives and acts on Program Change commands on a channel-by-channel basis. Therefore, if two Parts are set to the same MIDI channel, and a Program Change command is received on that channel, both Parts will change Patches to reflect that Program Change. (The correspondence between Program Changes and S-770 Patches, you will recall, is handled on the **Edit Patch Common** Page. It’s also dealt with on the **Patch MIDI Map** page, coming up.)

This is all reasonable, unless you have set up two Parts with a positional crossfade between two different patches on the same MIDI channel. If you then send a Program Change command on that channel, the two Parts will change to the same Patch, *with the same Pan and Output settings*, which will render the crossfade (although *it* will not change) meaningless. So be careful.

## Saving a performance

Performances are saved the same way as Patches, Partials, and Samples: from the **Com** menu select **Disk**, and then go to the **Save** page and select **Performance** as the **Target**. All Performances currently in RAM will appear in the window, along with their size (in sample-seconds, referenced to 44.1 kHz).

If you have been working on a new Performance and have neglected to give it a name, you will not be able to save it with just the temporary reference number assigned it by the software (if you try, you'll get a "File Not Found" error message). Don't be lazy: name it.

When you save a Performance, all of its subsidiary files are saved with it. However, if you are saving to the same hard or optical disk that the Samples which make up the Performance were loaded in from, and you have *not* recorded any new Samples, altered any existing ones, or changed any Sample's name or Volume ID, then the new Performance will take up no additional room on the disk. Any new, altered, or re-named Samples, however, will be saved as new files, and will take up space on the disk.

Note that only the Patches that are *currently in Parts* are saved when a Performance is saved. If you change the contents of a Part using a MIDI Program Change command, say from piano to guitar, and you then save that Performance, the piano Patch will *not* be saved, unless it happens to also be in another Part in the same Performance. It's important, therefore, if you plan to use a lot of Program Changes to switch Patches, to make sure that every Patch you plan to use has a Part to call its own. Use all the extra Parts on Pages 2, 3, and 4 if you need room. If you don't want those Parts to sound when you first load the Performance, simply set their MIDI channel to "--".

Just before you save a Performance, by the way, is a good time to do a Sort. Open any **Select** window (click on a Select Icon), and click on **Sort**. Every file in RAM at every level will be arranged alphabetically. When you save the Performance, any files that are not already on the disk will be saved in alphabetical order as well, which makes them much easier to find later on.

## Editing Patches Through a Performance

Just as you can edit Samples through a Partial and Partials through a Patch, you can edit Patches through a Performance. From any Performance Page, open the **Com** menu, and select **Edit Patch**. You will go to a Patch-level page, and the name of the Page will be framed by \*'s, indicating you are editing in Subsidiary mode.

In most ways, this page behaves just as if you went to it from the **Sound** menu. You are not restricted to using Patches that are part of the current Performance — you can access any Patch currently in RAM. You can edit and even save the Patches as you listen, and you can move down to the Partial and Sample edit levels as well.

All keyboard ranges and fades that you have created in the current Performance will be in effect as you play each Part.

### Part Numbers

The S-770 will respond in Omni mode if the **Select/MIDI in** parameter is set to **Omni On(\*\*)**. When you change that Parameter to a Part number, however, the Patch will change too, in accordance with the assignments in the Performance. That makes the **Select/MIDI in** parameter act like a "Solo" switch on a mixing console: when you are playing a multichannel sequence, it allows you to choose which part you are hearing, with the correct Patch. It goes one better than simply soloing the MIDI channel: it will also isolate Parts that share the *same* MIDI channel.

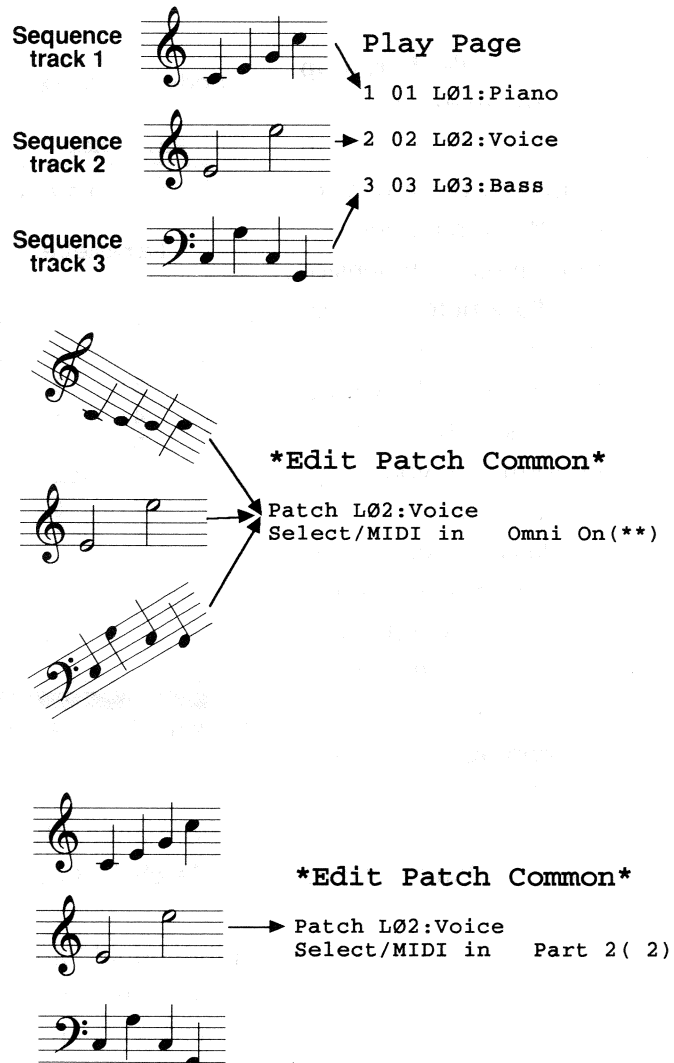

For example, if **Piano L** and **Piano R** are two Patches in a Performance both set to MIDI channel 1, you cannot listen to them individually at the Performance level without changing one of their MIDI channels. On this page, however, you can, by changing the **Select/MIDI in** parameter.

In you change the Patch, on the other hand, the Part number will *not* follow. This lets you quickly audition different sounds in a given Part. However, any change you make in the Patch parameter will *not* be reflected in the Performance when you **Exit** the Patch page. If you want to make the change permanent, you will have to enter it again on the Performance page.

## The Part Map

There's another way to edit Patches from within a Performance. Go back to the **Performance** Menu, and click **Play**. Look at the fifth Page, **P.Map**.

This is the **Part Map**. Like the Partial Map at the Patch level, the Part Map provides a way to edit Patch parameters from another dimension. The **Parameter** line lets you select which Parameter of the various Patches in the current Performance you want to look at, and it displays the settings for that Parameter in the Patches assigned to all 32 Parts *simultaneously*. For example, if you set it to **Panning**, it will show you the Pan position for all of the 32 Patches in the Performance. There are 37 Parameters available, which cover the **Patch Common** and **Patch Ctrl** pages (you can't edit the Splits from here).

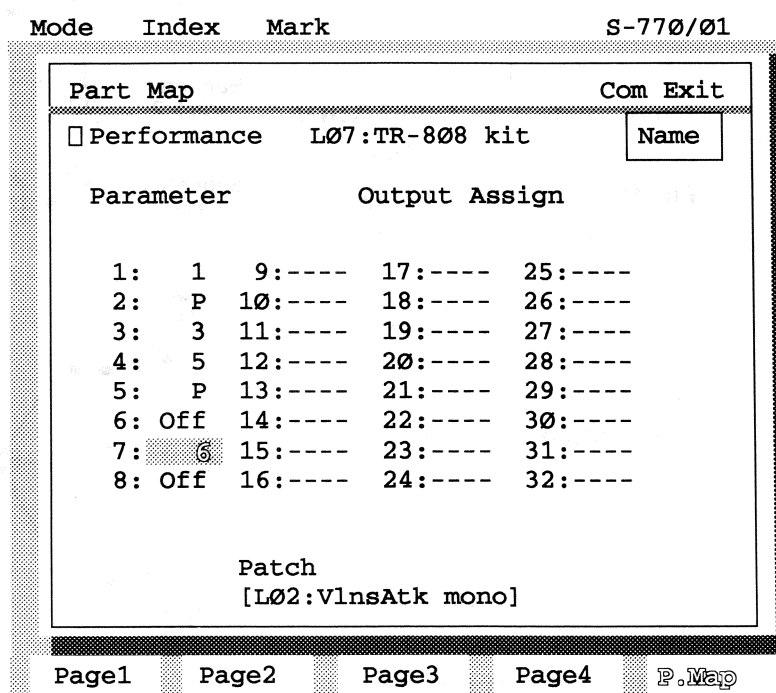

When the cursor is on an individual Part number, the name of the Patch assigned to that Part appears at the bottom of the screen. At the same time, the Parameter next to the Part number highlights, and you can change it using the mouse buttons or **VALUE** wheel. You cannot change a Parameter for a Part with no assigned Patch.

This page is useful for comparing Patches in a global context, for balancing levels, and for spotting anomalies or conflicts between Patches. If, for example, you inadvertently set two different Patches to the same MIDI **Program Number**, it will show up clearly here. So will a **Bender** setting radically different from all of the others, or an **Output Assignment** that is sending a signal some place you don't want it.

Any changes you make on this page will be reflected when you go to a Patch page and look at the corresponding parameter.

## Other Performance Functions

### Initializing a Performance

If you want to start working on a Performance from scratch, you can either select an empty Performance (with 64 to choose from in RAM at any time, it's usually not hard to find one); you can choose **Blank** from the **Select** window; or you can use the **Initialize** function on the current Performance.

This is chosen from the **Com** menu on any of the **Edit Performance** pages (but not the **Play** pages). Select **Initialize** and a window will open asking "Are You Sure?". If you're sure, click on **Execute**; if not, click **Exit**. When you initialize a Performance, all of the Parts are turned **Off**, and all other Parameters return to their default settings.

### Copy and Delete

The **Copy** and **Delete** functions on the Performance **Com** menu work the same way as their counterparts on the Patch and Partial Pages. **Copy** lets you create a copy of the currently selected Performance in another Performance slot, so that you can edit it without disturbing the original. The new Performance gets an "AA" suffix, and subsequent copies of the same Performance get "AB", "AC", etc.

**Delete** removes a Performance and its subsidiary files from RAM (but not from disk), to give you more room to move around in. You can hear each

Performance in the window if you pass the cursor over its name without clicking.

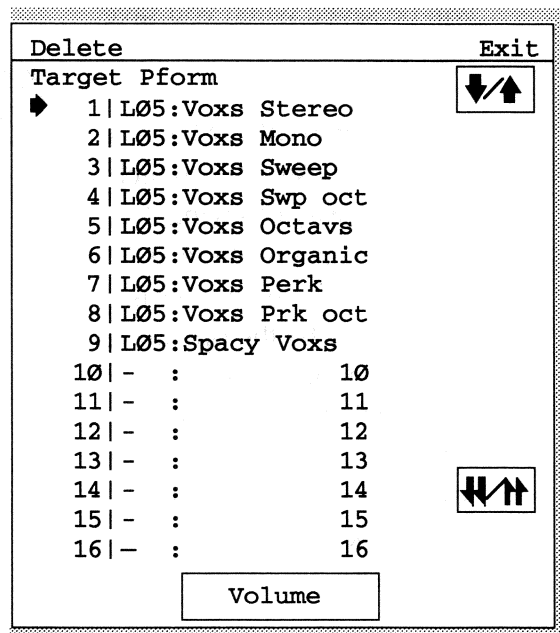

This window has an extra feature at the Performance level, which clears RAM out *completely*. Click on the **Volume** switch at the bottom of the window, and the S-770 will revert to an unloaded state. You get a warning box before the operation actually executes. You can always clear RAM by loading something into it and selecting the Internal Memory-clearing feature, but with this function you can have a completely empty memory in one operation. (We used this feature back in Chapter 1a.)

## MIDI Program Changes

### The Patch MIDI Map

The S-770 is capable of dealing with MIDI Program Changes in a number of ways. As we've seen, each Patch is assigned a **Program Change** number. You can view the numbers for all of the Patches in a Performance using the Part Map (**P.Map**), or you can go further than that and view the numbers for all of the Patches in RAM. This is the **Patch MIDI Map**: from the **Perform** menu, select **MIDI**, and then Page 3, **PtchMap**.

This is another good way to check for Program Change conflicts. You can change the Program Change ("**Prog#**") assignment for any Patch on the list by moving the cursor to the Patch's name, and then pressing the left or right mouse button or turning the **VALUE** wheel to lower or raise the Program Change number. You can set **Prog#** anywhere from 1 to 128. Any changes made here to a Patch's Program Change assignment will show up on the **Edit Patch Common** page when you go back to it and will be saved when you save the Patch.

The Patch MIDI Map is a dynamic construct — which is a fancy way of saying that it isn't saved anywhere as a single "thing", but rather is constructed by the operating system on the fly, from the Patches that are currently in RAM. You can't save a Patch MIDI Map by itself — it is "saved" when the Patches are saved.

Mode	Index	Mark	S-770/01
Patch MIDI Map			Com Exit
No.	Name	Prog#	↓↑
1	L07:Latin set	1	
2	L07:Shaker&stuff	2	
3	L07:Ethnic Perc	3	
4	L01:Piano L	1	
5	L01:Piano R	2	
6	L07:Orch. Toys	12	
7	L07:Timpani X	10	
8	L07:Timpani Hard	11	
9	L02:Violins Left	12	
10	L02:Slow Vlns R	13	
11	L04:Wow! Bass	16	
12	L04:Spike Bass 1	17	
13	L04:Spike Bass 2	18	
14	L04:M.M. Bass 1	11	
15	L04:M.M. Bass 2	12	

Fill   Fill   PtchMap   PfrmMap

## Patch Conflicts and Sustained Notes

If you happen to give two Patches the same **Prog#**, then when that Program Change is received the Patch with the lower number on the Patch MIDI Map will be the one called.

If a note is being sustained and the channel it's on receives a Program Change, the note will continue as if nothing had happened, until the key (or if the Sustain Pedal is being held, the pedal) is released. The *next* note to be played on the channel — whether the previous note has actually stopped or not — will sound the new Patch.

When playing a Performance, all slots in the Patch MIDI Map are active at all times. This means that if the S-770 receives a Program Change that is mapped to an empty slot on the Map (that is, a slot with a **Prog#** but no Patch), it will call up an empty Patch for the Part assigned to that MIDI channel, and that channel will now make no sound. (Empty slots in the Patch MIDI Map are assigned a **Prog#** that is the same as the slot number.) If, however, the S-770 receives a Program Change that is not mapped to *any* slot, the Patch will not change. This situation could arise if, for example, Patch **No. 1** was set to **Prog# 13**, and no other Patch had been set to **Prog# 1**.

## The Performance MIDI Map and Control Channel

MIDI Program Changes can also be used to change Performances, so you can instantaneously change the entire character of the S-770. This is set up on the Performance MIDI Map page, but before we look at that, we need to discuss the **Control Channel** parameter.

While *Patches* can be changed from MIDI on any channel that is active in the current Performance, to change a *Performance* over MIDI, the command must be sent on the S-770's **Control Channel**. Setting this up requires going to a totally different section of the S-770's software. Open the **Mode** Menu and select **System**, or press the **SYSTEM** button. From this Menu select **MIDI**. Then go to Page1, **Config**, which is short for "Configure".

Set the **Control Channel** to the channel you want to use to change Performances. (This channel also *may* be the channel that the S-770 accepts System Exclusive data on, but we'll deal with that in Chapter 9.) It is very strongly recommended that this be set to a MIDI channel that you will not be using *within* any Performance to change Patches. In fact, many users will not want to bother with changing Performances over MIDI at all, and they can set the **Control Channel** to **Off**.

Assigning a Program Change number to a Performance is handled on the **Performance MIDI Map**, which is Page 4 of the **Performance MIDI** function (**PfrmMap**). Unlike Patches, which can be assigned Program Change numbers on several pages, this is the *only* place you can assign Program Changes to Performances. The procedure is the same as on the Patch Map: put the cursor on the Performance you want to set the Program Change number for, and raise or lower the **Prog#**. You can only use Program Numbers between 1 and 64.

If you do set the **Control Channel** to a channel being used in the current Performance, either because you have run out of channels or you just like to ignore good advice, you will *not* be able to change Patches over MIDI on that channel. And if you should send a Program Change to that channel which is not assigned to a Performance, you will call up an empty Performance — the S-770 will be totally silent. Bad bumper.

The Performance MIDI Map is also a dynamic construct. Each Performance's Program Change assignment is stored when you save the Performance itself. If you have two Performances assigned the same Program Change number, the lower-numbered one on the list will take priority.

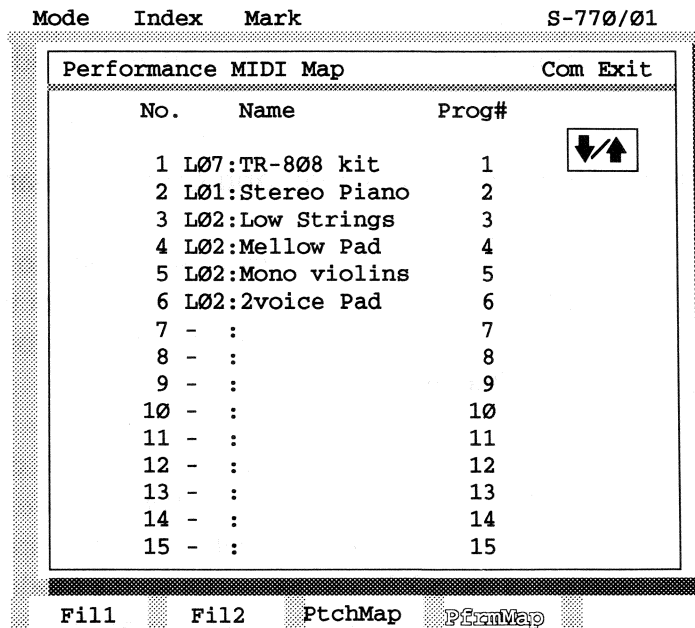
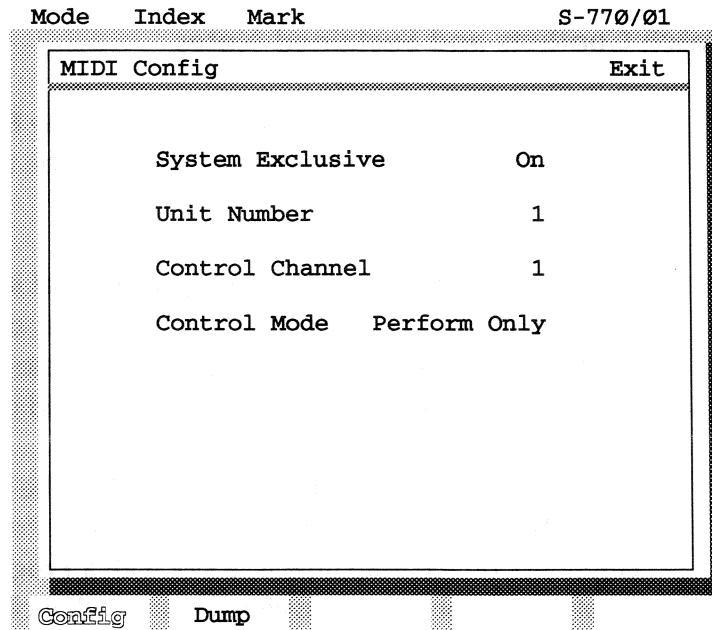



## Calling up Volumes

You can also use MIDI Program Changes to load in new Volumes (we'll talk about Volumes more a little later in this chapter). The **Control Mode** Parameter on the **MIDI Config** page lets you set this up. If it is set to "**Perform Only**", then incoming Program Changes on the Control Channel will select Performances, and any numbers above 64 will be ignored. If it is set to "**Perform/Volume**", then Program Changes 65 and up will cause Volumes to be loaded in from whatever the Current Drive was last set to (Floppy Disk is, however, not available).

Volumes are assigned Program Change numbers in yet another place: the **Disk Utility** page. Open the **Com** menu and select **Disk**, or go through the **System** mode Menu, and select **Disk**. Now go to the **Util** page. Make sure the **Current Drive** is set to the correct drive, and click on **HD/MO Volume PG#**.

The **Volume PG#** page opens, and you are shown a list of all Volumes on the current drive, along with their Program Change assignments, if any. The S-770 comes from the factory with **L01:Stereo Piano** assigned to 65, and all other volumes unassigned. Highlight the Volume you want to assign a number to, and use the mouse to set the number. **Exit** the page and go back to **Play**.

Now when you send that Program Change, the S-770 will stop what it's doing and load in the new Volume from disk. If you have two Volumes assigned the same Program Change number, the Volume which is firstly found by the system software will take priority. If you send an unassigned Program Change number above 65, the unit will stop playing briefly and attempt to load something in, and when it realizes it can't, it will go back to the **Play** page without major damage.

Mode	Index	Mark	S-770/01
Disk Utility - Volume PG#			Exit
Target	Volume	ID: All	
Current Drive	ID0:Internal	HD	
<b>VolPG#</b>			10files
1:L01:Stereo Piano	65		
2:L01:Piano & Harp	----		↕
3:L02:Strings	----		
4:L03:Acoustic GTR	66		
5:L04:Basses	----		
6:L05:Voices	----		
7:L06:Mallets	----		
8:L07:Drum Kits	71		
9:L07:TR-808 kit	----		
10:L07:Percussion	----		↕
11:			
Internal Free			0.4sec
Current Drive Free			20.6sec

We recommend that, unless you have a crying, specific need to be able to load Volumes in on the fly (perhaps you might need to do it between selections on a live gig), leave **Control Mode** set to **Perform Only**. There are two reasons for this:

1) loading a Volume from a disk, unlike switching Performances in RAM, takes time, and the S-770 cannot be played while the loading is going on. If you make a mistake, and send a Volume-load command (e.g., Program Change 65) when what you really wanted was a Performance-switch (e.g., 64), you will have to wait until the S-770 stops loading before you can play a note.

2) While you may load a Volume in the conventional way from a Disk Page (coming later in this chapter) *without* clearing Internal Memory, when you load a Volume from a MIDI Program Change command, Internal Memory *is* automatically cleared, with no warning. If you have any files in RAM that have not been saved to disk, they will be lost.

## MIDI Filters

Within a Performance, selected MIDI messages can be enabled or disabled on individual channels (*not* Parts). This is handled on the first two pages of the **Performance MIDI Function: Fil 1** and **Fil 2**.

Disabling the reception of unwanted MIDI data at this level can help to avoid possible processing delays within the S-770 when it is sent large amounts of data. For example, some MIDI keyboards generate Channel Pressure (aftertouch) at all times, and if the S-770 has to interpret that data constantly, even if there are no Patches in use that respond to it, its overall response to MIDI may be affected. Turning off Channel Pressure on one or more channels can prevent this from becoming a problem. This Page also determines whether a channel will respond to polyphonic aftertouch (Key Pressure), whose use is becoming increasingly common in high-end MIDI studios.

Mode	Index	Mark								S-770/01
MIDI Filter Page1										
Com Exit										
<input type="checkbox"/>	Performance	L07:Latin set							Name	
Ch.	1	2	3	4	5	6	7	8	All	
Prog	0	0	0	0	0	0	0	0	*	
Bend	0	0	0	0	0	0	0	0	*	
Mod	0	0	0	0	0	0	0	0	*	
Hold	0	0	0	0	0	0	0	0	*	
A.T	-	-	-	-	-	-	-	-	*	
Vol	0	0	0	0	0	0	0	0	*	
P.L	-	-	-	-	-	-	-	-	*	
Vel	-	-	-	-	-	-	-	-	*	
<span>Fil1</span> <span>Fil2</span> <span>PtchMap</span> <span>PfrmMap</span>										

MIDI channels 1–8 are set on the **Fil 1** page, and channels 9–16 are set on the **Fil 2** page. To enable or disable MIDI reception of a specific type on a specific channel, move the cursor (with the mouse or cursor keys) to a position directly underneath the channel number you have in mind and in a line with the Parameter you want to deal with. An “**O**” means the data type is enabled for that channel, while a “—” means it is disabled. Click the right mouse button to enable, and the left button to disable.

You can also enable or disable a data type on all MIDI channels simultaneously: put the cursor on the asterisk under the word **All**, across from the Parameter you want to adjust. Click the mouse button, and the Parameter will be set for *all 16* MIDI channels (not just the eight on the current Page) at once.

The Parameters are as follows:

**Prog** determines whether Patches on the channel will change with incoming Program Change messages. If you are layering multiple Patches on a channel in a Performance, you may want to disable this Parameter so that you don’t accidentally make all the Patches on that channel the same. If you are using the Control Channel as a Part Channel (despite what we told you), disabling it from responding to Program Changes can help prevent confusion. This parameter does *not* disable the Control Channel as far as Performances and/or Volumes are concerned — that channel is always active unless you set it **Off** on the **MIDI Config** page.

**Bend** is Pitchbend, whether it will be recognized or ignored.

**Mod** is Modulation wheel, or Controller #1, whether it will be recognized or ignored.

**Hold** is Sustain Pedal, or Controller #64, whether it will be recognized or ignored.

**A.T** is aftertouch. This has three settings: Set to “**C**”, the channel will respond to Channel Pressure (mono aftertouch), in which all notes are affected equally. Set to “**P**”, the channel will respond to Key Pressure (polyphonic aftertouch), in which each note can be controlled individually. You should only use this setting if you have a MIDI controller or sequencer that generates Key Pressure — not many of them do. Or you can shut it off (“—”), and the channel will respond to neither.

**Vol** is MIDI Volume, or Controller #7. When this is shut off, the **Lev** parameter on the Performance Play page will not change when you send MIDI Volume to that particular channel.

**P.L** stands for “Phase Lock”. When the S-770 is playing multitimbrally, its response to incoming MIDI data under some circumstances is not instantaneous. When it receives, for example, five simultaneous note-ons on a same channel, it will play the notes in sequence, starting with the one assigned to the lowest Part number, then the next highest Part number, and so on. The time interval involved is minuscule, but if there are two fast-attacking sounds in two different Parts which are supposed to start simultaneously, some “blurring” or phasing may be audible.

To prevent this, simultaneous notes on a same channel that have this Parameter enabled will sound *exactly* at the same time. So if, for example, you had two Pianos on Parts assigned to channel 1, you would turn **P.L** on for that channel, and they would sound precisely together.

**Input**

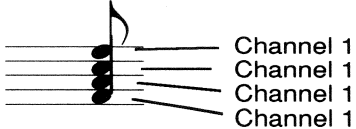

**normal result (greatly exaggerated)**

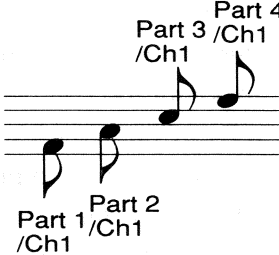

**result with Phase Lock on:**

	1	2	3	4
<b>P.L</b>	O	-	-	-

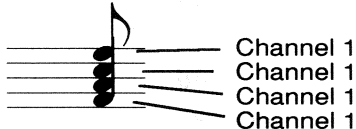

There’s a slight trade-off for this feature, which is that notes on Phase-Locked channels might be slightly delayed to achieve the lock. Therefore, you might find that sequenced tracks using this feature might have to be advanced slightly. It also means that in general, if you don’t need this feature, you should leave it off.

**Vel** determines the velocity response curve of the channel, to compensate for the way different keyboards generate MIDI velocity data, or just to give the instrument a different “feel”. Set to “–”, the response is linear: what goes in, comes out. The seven available curves are illustrated below. Note that they are quite different, and completely independent, from the velocity curves in the Partial TVA and TVF.

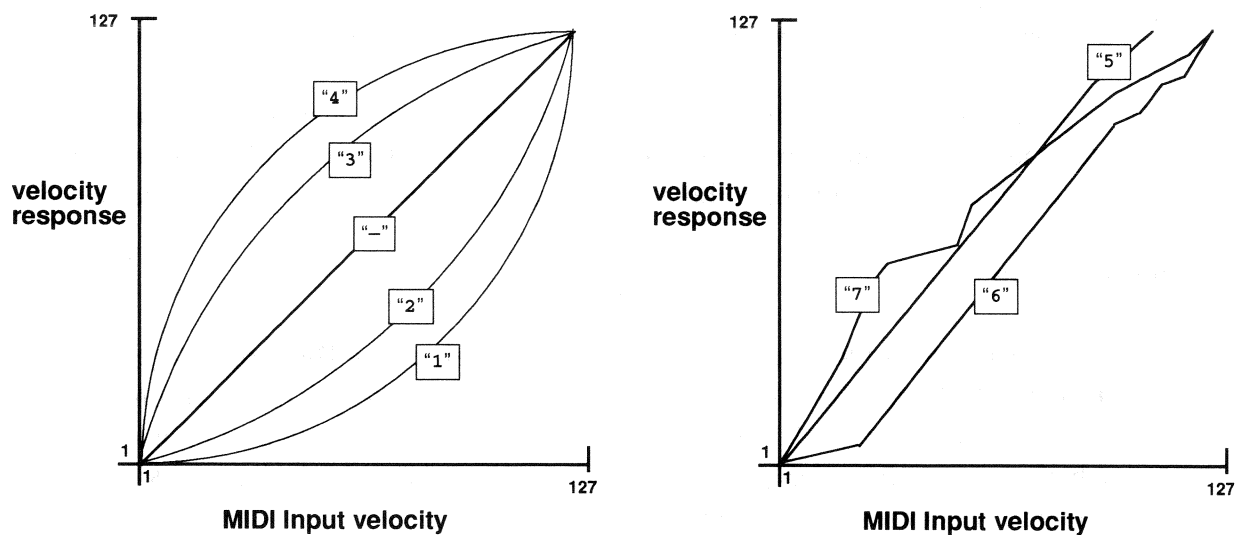

The **MIDI Filter** settings are applied only to the current Performance, and are saved with the Performance. When you change Performances, the filters will change.

## MIDI Monitor

The MIDI Monitor (the last item on the **Perform** Menu), is a special function that allows you to view MIDI data coming into the S-770 in real time, and also to see how many of the S-770's 24 voices are being used at any one time. It will be described in detail in Chapter 9.

## Volumes

We've been referring to Volumes in this and previous chapters, so now it's time to look at them in detail.

A Volume is a set of files, grouped together for convenience of storage and manipulation. It can be as small as a single Sample, or as large as several dozen Performances, each with its own Patches, Partials, and Samples. In actual practice, Volumes are usually quite large, so that a single Load or Save operation can handle a complete S-770 setup, containing perhaps hundreds of individual files, in one shot.

The entire contents of RAM comprise a single Volume. Even though you can load a Volume and then additional Volumes without clearing the first Volume from memory, the result is still considered to be a single Volume. We'll see how this works in a bit.

### Loading Volumes

Like any other file, you load a Volume from disk on the **Disk Load** page, setting **Target to Volume**. The Page provides you with the total length of the Volume, so you can determine whether it will fit into RAM. As usual, you are given a choice as to whether you wish to clear Internal memory and just have this Volume in RAM, or to add it to whatever's already in there.

After a Volume is loaded, any other file, from Sample to Volume, can be loaded subsequently, and as long as you don't clear Internal memory, the newly-loaded file will be combined with the current contents of RAM into the current Volume. If you are combining Volumes in this way, it's a good idea to watch extra carefully for Program Change conflicts among the various Patches and Performances you are loading in.

### Naming Volumes

The name of the current Volume is shown on the **Performance Common** page from the **Performance Edit** function. Note that if you have loaded in more than one Volume, the name of the current Volume will be that of the *most recent* Volume loaded. You can change the name of the Volume using the **Name** box.

## Volume ID

As we have seen earlier, the Volume ID is the first three characters of the Volume name, and it is also used for subsidiary files in the Volume. The Volume ID helps to keep things organized: it's easy to tell that a file belongs to a particular Volume if it has the appropriate ID. Similar files with similar names that are used in different Volumes can be distinguished by their IDs.

The Volume ID also helps with disk operations. When loading, copying, or deleting a file, you can set the **ID** parameter in the upper right corner of the disk page to filter out all files that don't have the selected ID. Those files are still on the disk, but they are temporarily hidden, which makes the list shorter and easier to deal with. For example, all of your string sounds might be in Volumes with the ID "STR". Setting **ID** to **STR** means that only string sounds will be displayed in the list, and you won't have to scroll through your collection of 250 gated snare Samples to see them.

In addition, when deleting a Volume from a disk, if all of the subsidiary files have the same Volume ID, the operation will go considerably faster than if they don't.

To give all of the files in RAM the same Volume ID, you don't have to individually re-name each file. The S-770 provides two ways of doing it automatically. One is to go to any **Edit Performance** page, open the **Com** menu, and choose **Set Volume ID**. This opens a window called, you guessed it, **Set Volume ID**.

The name of the current Volume is shown at the top. The second line lets you select the current Volume ID, or a different one. Clicking on the ID in that line opens another window, **Volume ID Select**, where you can select one of the displayed IDs, go back to the current ID, or click on "**Make New**" to open an ASCII Keyboard window where you can design your own.

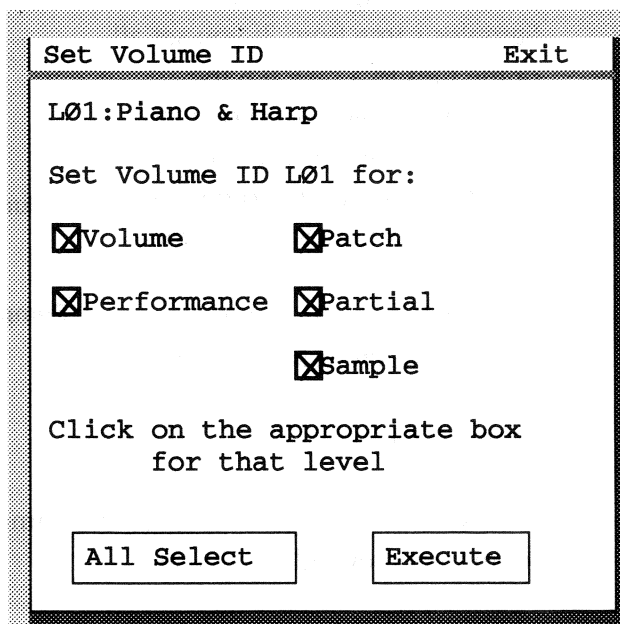

Once you've decided on an ID, you have to decide which levels of files within the Volume you want to have this new ID. Click in the box next to the name of each level to want to take on the ID, so that an "X" is showing. Generally speaking, you will want to select either all levels (click on **All Select** to do this quickly) or all levels except **Sample**. When this is done, click **Execute** and all of the files of the types you've selected will have their IDs reset.

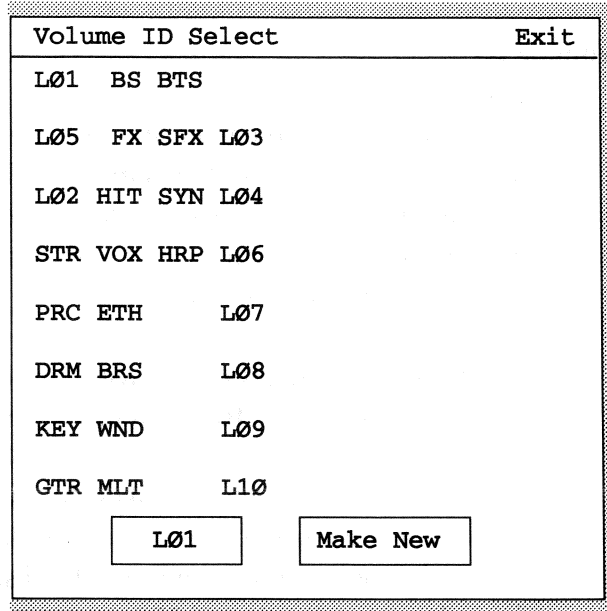

### New IDs and Samples

The reason you might want to *not* change the Volume IDs of the Samples in RAM has to do with storage space. Say you've created a humongous Volume to use in an upcoming session, and it includes Samples from a number of different Volumes, which have different IDs. Now you want to save it, so that you can call it up in one operation when the session starts, but you don't want to lose the original Volumes the Samples came from. If you set all of the files to a new ID, the Samples will get saved on disk with their new ID, and are therefore considered to be *new Samples*. As new Samples, they need space of their own on the disk, and they end up taking twice as much disk space as they would have if you had not changed their ID.

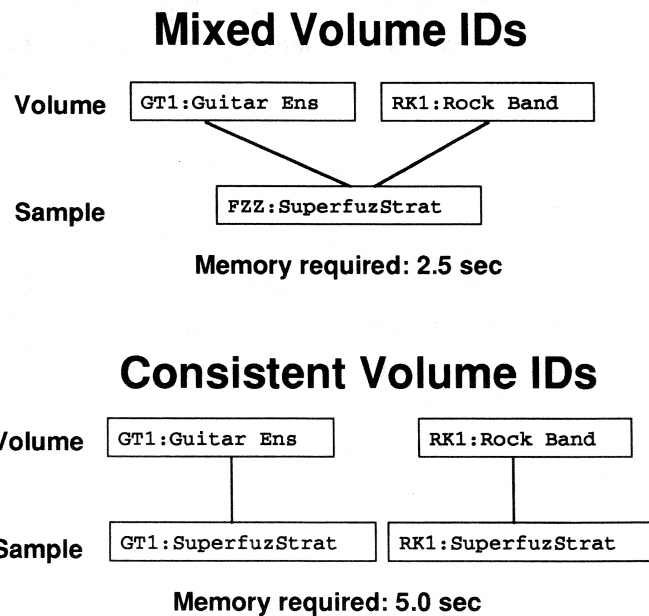

If you don't assign a new ID, the Samples remain the same, and require no more room than they did previously.



Therefore, if space is an issue, it is sometimes better to forego the convenience of consistent IDs throughout a Volume, and leave the IDs of the Samples alone. The files at other levels can be duplicated without taking up any extra disk space, so there's no reason not to include them when you set the new ID.

The second way to assign IDs to an entire Volume is when you save it to disk. We'll deal with that shortly.

### Volumes with Common IDs

As we've just seen, it is possible to have a Volume containing files with different IDs. The reverse is also true: two or more Volumes can have the same ID. This makes the most sense if the Volumes draw from a common pool of Samples, because it avoids duplication of those Samples. For examples of this, look at the Volumes **LØ1:Stereo Piano** and **LØ1:Piano & Harp**, or the three drum and percussion Volumes (**LØ7:**) on the S-770's internal hard disk as it comes from the factory.

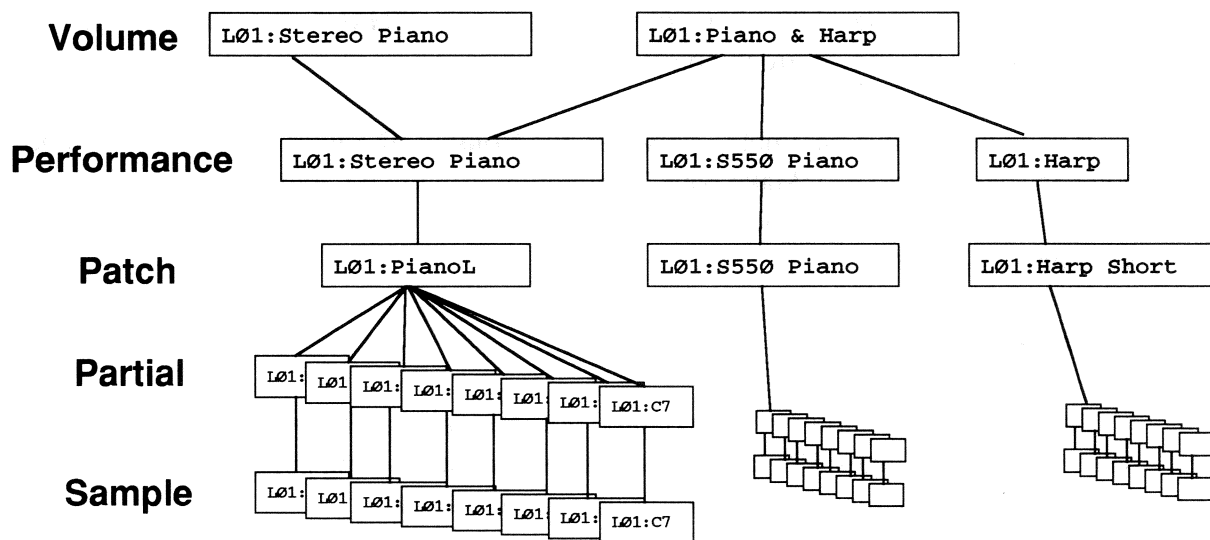

### Cleaning Files from Volumes

Like any other file, a Volume is not permanently stored until it is saved to disk. Unlike other files, however, which only save themselves and their direct subsidiaries when they go to disk, when you save a Volume, *everything* in RAM gets saved, whether or not it is actually used anywhere. Samples that never made it into Partials, or Partials not assigned to any Patch, get saved along with everything else. Therefore it's important before saving a Volume to find any extraneous files that will take up disk space, and Delete them from RAM.

Be sure, however, not to delete any files that you'll need, even if they are on disk already. If a file is not part of the Volume in RAM when you save it, then the next time you load the Volume, the file will not be loaded.

## Saving Volumes

Volumes are saved to disk, not surprisingly, on the **Disk Save** page. Select **Target** to be Volume, and select the **Current Drive** desired. (Yes, you can save Volumes on floppies, but be prepared to have a lot of the little suckers on hand, as well as some good reading material.) The screen tells you the length of the current Volume and the amount of space available on the current Drive. Before you save a Volume is a good time to **Sort** the files in RAM, so that you can find them more easily on the disk afterwards.

When you save a Volume, every file in RAM gets saved with it. While you are saving, you also have the option of setting the Volume IDs of all the files. If the **ID** parameter in the upper-right corner of the screen reads "**THRU**", then all of the files are saved with the IDs they currently have in RAM.

If you click on this parameter, however, the **Volume ID Select** window opens, and you can select or create ("**Make New**") a different Volume ID, which will be applied to every file as it is saved to disk. So that's the other quick way to give all the files in a Volume the same ID.

## Program Changes

As we discussed earlier in this chapter, you can call up Volumes from disk using MIDI Program Changes. We know how much you hate turning pages, especially backwards, so here are the main points you need to know:

The **Control Channel** Parameter on the **MIDI Config** page must *not* be set to "**Off**" and the **Control Mode** Parameter must be set to "**Perform/Volume**". Volumes are assigned Program Change numbers using the **HD/MO Volume PG#** function on the **Disk Utility** page. Only Program Change numbers 65 and up can be assigned to a Volume. When that Program Change is received on the Control Channel, the S-770 will stop what it's doing and load in the new Volume from disk. Unlike when loading a Volume the normal way, Internal Memory is always cleared when the new Volume is loaded, whether you like it or not.

## Initial Volume

The S-770 comes from the factory with all of the sounds on the hard disk organized into Volumes. When you first boot the S-770, it loads the Volume **LØ1: Stereo Piano** automatically. As we've seen, this Volume contains 1 Performance, 2 Patches, 20 Partials, and 20 Samples.

You can program the S-770 to load a different Volume into RAM when it first boots up. First you must assign the Volume you want to load a Program Change number, from 65 to 128, on the **Disk Utility** page (we did this earlier). Now go to the **System** mode Menu and select **System PRM**. On Page 1 (**PRM1**) of this Function, set the **Initial Volume** parameter to the Program Change number you just assigned. Now the next time the S-770 boots (assuming it's booting from the same disk) that Volume will automatically load.

## Deleting Volumes

Deleting a Volume from RAM is the same as emptying RAM. You can do this by turning off the S-770 and turning it back on again (not recommended), by loading in a new file at any level and telling the S-770 to clear Internal memory, or by opening the **Com** menu from any **Performance** page (**Edit** or **Play**), selecting **Delete**, and then clicking on the **Volume** switch at the bottom of the window that opens.

Deleting Volumes from a disk is another matter. Deleting a Volume deletes all of its subsidiary files, regardless of their Volume IDs. If the **Fast Delete Mode** switch is On, then it deletes files regardless of whether they're used by other Volumes. If that switch is Off, however, the system will check to see if any files are needed elsewhere, and if so, it leaves them alone. However, this makes the operation much slower.

As mentioned earlier, Volumes delete faster if all of their files share a common ID. This becomes even more important on a Magneto-Optical disk drive like the Roland MO-7, because the delete time on such a huge medium can be quite long if different IDs are used in a Volume. However, there is so much room available on each disk that file redundancy is much less of a problem. Therefore, it makes sense with these devices to use a unique ID for each Volume, and the same ID for all the files within a Volume.

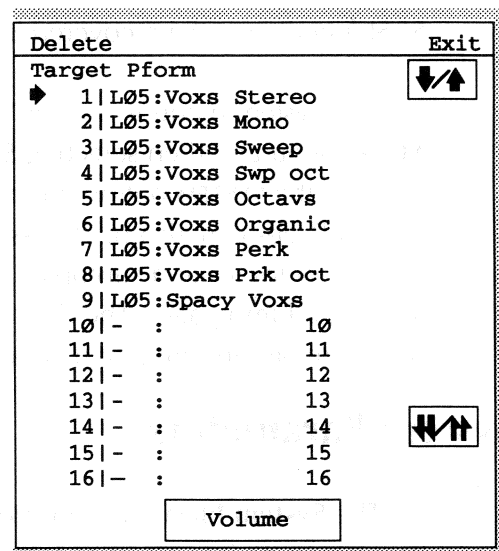

# Chapter 9: System Functions

The System Functions, most of which are accessed from the **System** menu, contain controls and parameters of the S-770 that are not directly sound-related. The tasks they cover include setting up input and output devices, working with storage media, and configuring the basic operating parameters of the software. Many of these functions have been touched on in earlier chapters. Some of the disk functions have been covered in Chapter 3, and the SCSI functions will be covered in Chapter 10.

The System menu is opened by opening the **Mode** menu and then selecting **System**, or by pressing the **SYSTEM** button on the front panel. System Pages can also be accessed through a number of topics and subtopics in the **Index**, or through a Jump page. (The Disk Load and Save pages are factory-programmed Jump Page 5 in Set 1 and Set 2, respectively.)

<b>System Menu Exit</b>
<b>System PRM</b>
<b>Disk Tools</b>
<b>SCSI</b>
<b>MIDI</b>
<b>Option</b>

## System Parameters

The **System PRM** Function from the **System** Menu has two Pages. **Page 1**'s Parameters go into effect as soon as you set them. **Page 2**'s have a special "Execute" switch that must be clicked before they take effect.

### System PRM Page 1

**Master Tune** allows the entire S-770 to be tuned up or down to match other instruments in an ensemble or on a recording. The range is  $\pm 50$  cents, or a quarter-tone in each direction.

**Initial Volume** determines which Volume of sounds, if any, will be automatically loaded into the S-770 from the startup System disk when you first turn the power on. (It has nothing to do with the output level!) We saw in the last chapter that Volumes can be assigned MIDI Program Change numbers from 65 through 128. If you assign a Volume a Program Change number, and enter that number here, that Volume will load when you boot up the S-770. The unit is delivered from the factory with **LØ1: Stereo Piano** assigned to Program Change 65, and **Initial Volume** set to 65.

Mode	Index	Mark	S-770/01
System PRM Page 1			Exit
Master Tune			Ø cent
Initial Volume			65
Sound Play PRM			
- Note			C_4
- Velocity			127
Fan Control			Off
PRM 1	PRM 2		

If you don't want a Volume to load, set this Parameter **Off**. You can also set it to a number which is not assigned to any Volume, and nothing will be loaded, but it will take a little longer to boot.

The **Sound Play PRMs** determine what happens when you press the **SOUND PLAY** button on the front panel or on the RC-100. When you are in any of the Sound functions except for Resampling, pressing **SOUND PLAY** "sends" a MIDI note to the current sound being edited, and continues to send it until the button is released. The button is there for convenience when a MIDI keyboard is not connected, or perhaps is on the other side of the room. The pitch and velocity of that note are determined with these Parameters. The pitch range is the entire S-770 range, **A\_Ø** to **C\_8**, with **C\_4** (the factory setting) equal to Middle C. The velocity range is **1** to **127** (velocity 0, remember, is the equivalent of a MIDI note-off).

**Fan Control** does not turn off the S-770 fan. That would damage the unit rather efficiently. Instead, it determines whether the fan will shut off automatically when you are recording a Sample, so that the ambient noise level in the studio can be kept to a minimum. With this Parameter **On**, whenever the **Sampling execute** window appears (which happens after you have set a **Name** and clicked on **Ready** on the **Smpling** page), the fan will turn itself *off*. It will come back on as soon as the Sample is recorded (that is, when the **Sampling over** window appears). If the Parameter is **Off**, then the fan does not turn off.

Use this feature when you are recording Samples through a microphone in the same room as the S-770. (It comes from the factory set to **Off**.) Leave it off if you are sampling from “live” sources in a different room, or electronic sources. Serious damage can result to the S-770 if the fan is off for a long period of time, so try not to linger excessively in the **Sampling execute** window if this Parameter is **On**.

## System PRM Page 2

The Parameters on this Page do not take effect until you click on the **Execute** switch below them. If you set a Parameter and leave the Page without clicking on **Execute**, then when you return to the Page, the Parameter will be at its old setting.

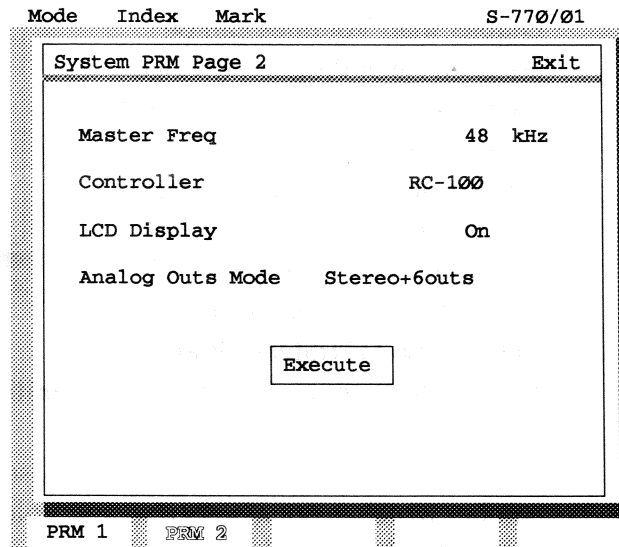

### Master Freq

This sets the sampling rate for all sounds coming into the S-770, through both the analog and digital inputs. It has two settings: **48 kHz** and **44.1 kHz**. The S-770 sounds equally good at either frequency, and the difference in the amount of sound memory that is available at one frequency or the other — in RAM or on disk — is about 10%. The major reason for this Parameter is so that the unit can send and receive digital signals to and from AES/EBU-format sources that work at either rate.

Most digital open-reel and DAT (cassette) decks, for example, operate at 48 kHz. CD players operate at 44.1 kHz. With this Parameter, signals from any digital source can be sampled directly into the S-770 or recorded directly from the S-770 in the digital domain, without any D-to-A or A-to-D conversion.

If you are sampling from the digital input and the **Master Freq** setting does not match the sampling rate of the incoming digital signal, you will get a “**Digital Unlock**” message when you try to record the Sample on the **Smpling** page. Reset this parameter here and try again. (The **Digital Unlock** message will also appear if the **COAXIAL/OPTICAL** switch on the rear panel is set wrong, or if there are other problems with the signal.)

Samples recorded at different rates can be mixed in a Partial, Patch, or Performance without degradation or changing of pitch. The S-770 will take care of them completely transparently as far as you're concerned, (except on the **Patchwork** page, as described in Chapter 7).

When you are sampling from *analog* sources, this Parameter will determine your choices of sampling rate, as set on the **Smpling** (the "Freq(kHz)" parameter): if it is set to **48**, you will be able to sample at 48 or 24 kHz; if it is set to **44.1**, you will be able to sample at 44.1 or 22.05 kHz. It also applies to the same Parameter on the **Resampling** pages.

## Controller

This tells the S-770 which devices, if any, are connected to the **EXT CTRL** jack on the front panel. The factory-set position is **Mouse**, which means the mouse will be recognized. The other positions are **RC-100**, which recognizes the RC-100 Remote Controller which you have (*along with* the mouse, which plugs into the RC-100), and **Off**, which only lets you control the S-770 from the front panel. This last might be a nice option if you find yourself in a situation where there are too many hands grabbing for the mouse all the time.

The setting of this Parameter (among others) is shown in the **System Initialize** window that appears as soon as you turn on the power to the S-770 — look at "**EXT CTRL**" in the lower-left corner. You can also alter it when you first turn on the power. If you press the **F3** button on the front panel (*not* on the RC-100), and hold it while you push in the **POWER** switch, the Parameter will automatically set itself to **RC-100**, enabling the Remote Controller and the mouse. Press **F2** while powering up, and the Parameter sets itself to **Mouse**. Press **F1** and it sets itself to **Off**.

However you set the Parameter, it will appear with its new setting the next time you power-up.

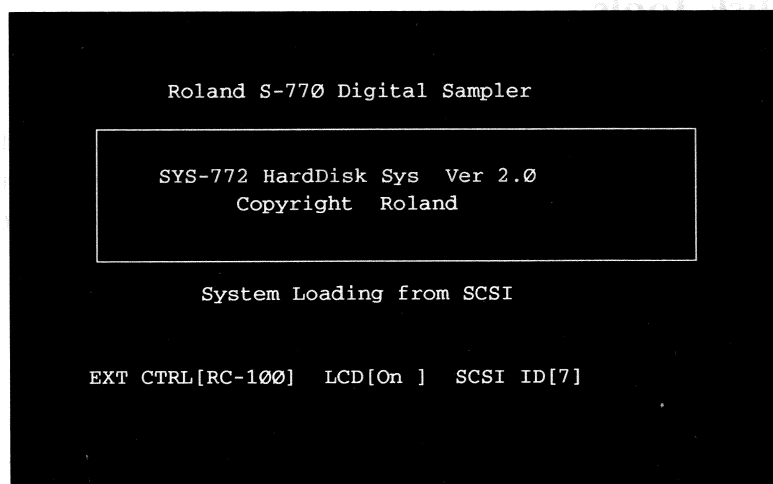

## LCD display

This controls whether or not the front-panel LCD screen is on. If you turn it off, you will experience a modest improvement in the response of the mouse on the external video monitor.

## Analog Outs Mode

The analog outputs on the back of the S-770 are configurable in two ways. The six individual outputs are always available. However, the main **STEREO** outputs can either be fed the Stereo mix (as set up by the **Stereo Mix Level** parameters on the various sound-editing pages), or they can be treated as two additional independent outputs, numbered 7 and 8. This parameter determines the configuration: it is set to either **Stereo+6outs** or **8outs**.

Since the headphone jack on the front panel is hard-wired to the stereo output jack, it is affected by this setting as well. The digital outputs, on the other hand, always get the Stereo mix, and are not affected by this setting.

The **Output Assign** parameter in a Performance, Patch, or Partial is affected by this setting as well. You can only set an **Output Assign** parameter to 7 or 8 if you are in **8outs** mode. If you set an **Output Assign** to 7 or 8 and then change the **Analog Outs** mode, the **Output Assign** will reset itself to **Off**.

## Disk Tools

Most of the Disk Pages we have already examined in Chapter 3. Opening **Disk Tools** from the **System** Menu is just another way of getting to them. You can also get to them through the Index ("**Disk**"). We'll provide brief summaries of them here. There are, however, a few topics that have not yet been covered, and these are discussed here in detail.

### Selecting the Current Drive

On all of the disk pages, clicking on the parameter **Current Drive** opens the **Drive Select** window (even though there's no Select icon next to it). This is the only way to change the Current Drive — you cannot scroll the parameter.



To change the **Current Drive**, you must click on one of the blue numbers at the left side of the window. These are SCSI ID numbers, and each drive on the SCSI chain connected to the S-770 will have a unique ID. If you click on a number that has no corresponding drive, you will get an error message. You can also click on **Floppy Disk** to select the floppy disk drive for saving, loading, or other operations.

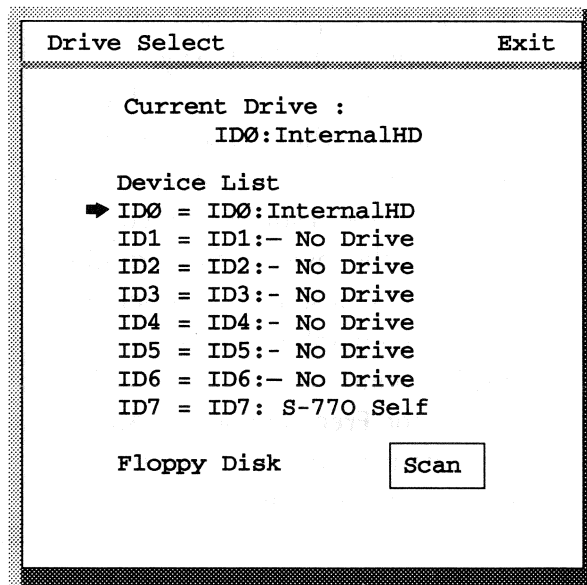

If something on the SCSI chain has changed since the last time you opened this window — for example, a new CD-ROM has been inserted in the player, or a different SyQuest cartridge has been inserted, or the disk in a magneto-optical drive has been turned over — that change will not automatically be recognized by the S-770. Clicking on the **Scan** switch causes the S-770 to “poll” all of the connected SCSI devices to find out their current status and name.

(**Warning:** although you can insert and remove cartridges and disks with no fear, do not connect or disconnect any cable to a SCSI device when there is power on it, or on any other device connected to it. Serious damage may result.)

You can change the name of any SCSI disk (except a CD-ROM) by clicking on its name on the right side of the window. This will bring up an **ASCII Keyboard** window. Do not change the ID number at the beginning of the name — the system won't like that.

## ID

The Volume **ID** parameter at the upper-right lets you limit the number of files that will show on the Disk page when you are loading, copying, or deleting files. When you click on it, it opens the **Volume ID Select** window.

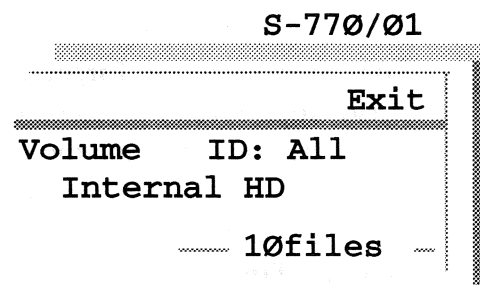

Here you can select a Volume ID from the display. When you have done so, the Disk page returns, and the only files visible will be those whose names begin with that particular Volume ID (which is now displayed in red). Note that the invisible files are still there, and will still be considered in the total number of files displayed just above the list, as well as the **Free** parameters. All this parameter does is make the lists more manageable.

Volume ID	Select	Exit
L01	BS BTS	
L05	FX SFX L03	
L02	HIT SYN L04	
STR	VOX HRP L06	
PRC	ETH L07	
DRM	BRS L08	
KEY	WND L09	
GTR	MLT L10	
<input type="button" value="All"/>		<input type="button" value="Make New"/>

If the Volume ID you want is not on the list, or you want to create a new Volume ID, click on **Make New**, and an **ASCII Keyboard** window opens where you can write the new Volume ID. Any characters you put on the right side of the colon will be ignored.

If you want to go back to looking at all of the files, click on **All**.

This Parameter works slightly differently on the Disk Save page, as we saw in the previous chapter. Its default setting is "**Thru**", not All. When it is set to **Thru**, all files in RAM will be visible on the page, regardless of their Volume IDs, and their names will not change when they are saved to disk. However, if this parameter is set to a particular Volume ID, then when any files are saved, their Volume IDs *will become* the selected Volume ID.

## Load

The **Load** page lets you select a file, at any level, from a disk, and move it into RAM for editing and playing. Use the **Current Drive** parameter to select which disk to load from. Then select the **Target** (the file level) and the specific file, using the mouse or cursor keys. Scroll the screen using the Up/Down switches — the top switch scrolls the screen by one entry, and the bottom switch by 10. The screen shows the size of every file (in seconds, referenced to 44.1 kHz sampling rate), which will help you determine whether you need to clear Internal Memory before you load it (compare it with the "**Internal Free**" parameter at the bottom of the screen). If you attempt to load in a file which is too big for the available RAM, you will get an error message.

You can also load in files from a Roland S-550, S-330, or W-30, either on floppy disk(s) or CD-ROM. This is a special function, **Convert Load**, which is described at the end of this section. (If you try to load a file in one of these formats on this page you will get a communication error.)

In addition, you can load just the Parameters of a Partial, Patch, or Performance, without its attendant Samples (set **Target** to one of the "PRM" levels), so you can easily use those as templates for Samples already in memory, or for other Samples on disk not associated with the higher-level files.

## Save

The **Save** page lets you select any file currently in RAM and write it to the disk of your choice. Select the drive, target level, and file using the mouse or cursor keys, and scroll the screen using the Up/Down switches. If you attempt to save a file to a disk which does not have enough room (assuming the file contains new and/or altered Samples which are not already on the disk), you will get an error message. Use the file sizes on the screen to help you determine this. You can only save one file (of any type) to a floppy disk. If the file is too big to fit on a single floppy, you will be told how many floppies you will require, and then as each one is filled, you will be prompted to insert the next one.

As mentioned earlier, setting the **ID** parameter on this page will cause any files saved to have their Volume ID changed to that ID.

## Copy

The **Copy** page lets you move a file from one SCSI disk to another without going through the process of loading it into RAM and saving it. It does not work with floppy disks. Select the **Current** and **Destination** drives at the top of the Page. The **Target** parameter has one additional level on this Page, **All**, which when selected copies the entire contents of the Current drive. If you haven't selected **All**, choose the file you want to copy, scrolling the screen with the Up/Down switches. If you attempt to copy a file to a disk which does not have enough room, you will get an error message.

## Delete

**Delete** lets you erase a file from a disk to free up more space. (It is different from the **Delete** function on the **Com** menu, which only removes the file from RAM.) Select the current drive, target, and file, scrolling the page if necessary. It does not work with floppy disks.

If you select a file to delete at any **Target** level above **Sample**, the software will also erase every file that is subsidiary to that file (e.g., all the Samples that make up a Partial, all the Samples and Partials that make up a Patch, etc.) *unless*:

1) a subsidiary file is being used by a different higher-level file (e.g., the same Partial is being used in another Patch than the one you are deleting)

— and —

2) the **Fast Delete Mode** switch is **Off**.

If the **Fast Delete Mode** switch is **On**, the subsidiary file will be erased *whether or not* it is in use elsewhere.

The status of the Fast Delete mode is shown at the top of the list window: “**Norm**” means the switch is off, and “**Fast**” means it is on. The switch itself is set on the **SCSI Config** page — coming up soon.

Yes	No	? Norm
[ L01:Stereo Piano ]		
Delete, as Follows		
		Volume: 1
		Performance: 1
		Patch: 2
		Partial: 17
		Sample: 17
Are You Sure?		
<input type="button" value="YES"/>		<input type="button" value="NO"/>

Before a Delete operation is completed, the Software displays a “**Delete As Follows: Are You Sure?**” box to let you know how many files are actually being erased, and at what levels, and to give you a final chance to change your mind.

Be forewarned that Deleting an entire Volume can be a fairly long operation, especially if the different files that make up the Volume do not all have the same Volume ID.

## Util

The **Disk Utility (Util)** page contains eight operations for managing files on disks.

### HD/MO Format

Selecting this item erases everything from the hard or magneto-optical disk selected in the Current Drive parameter. If the disk has any S-770 data on it (either sound files or system software), a “**CAUTION!**” window will appear telling you so, and asking you to confirm your decision. Formatting a disk is an operation that can take a little while, but if there are multiple volumes on a hard disk that you plan to erase completely, formatting can still take much less time than Deleting them individually and it does it with just one command, so you don’t have to monitor the operation. If you want to start a session with a clean hard disk, this can be the best way to do it — just make sure all your sounds are backed up somewhere else.

If you do choose to start a session by formatting the hard disk, you must realize that the operation not only erases the sound data on the disk, but **it also erases the system software**. The system software **must** then be re-installed before you turn the power off. This is a simple and quick procedure (described later in this chapter), but it is **ESSENTIAL** — **failure to do it will mean the S-770 will be unable to boot from the internal hard disk the next time you turn it on**. Therefore, if you’re not sure what you’re doing, don’t format the hard disk, but use Delete instead.

**Warning!** Do not turn off the power to the S-770 when you are formatting a hard disk. You will damage the hard disk, quite possibly permanently. If you start to format the hard disk by accident, you cannot stop it. Let the operation finish, then do the “Save System” procedure described later in this chapter.

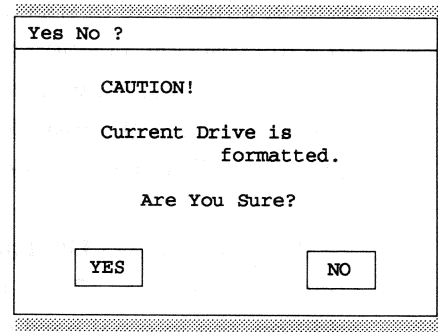
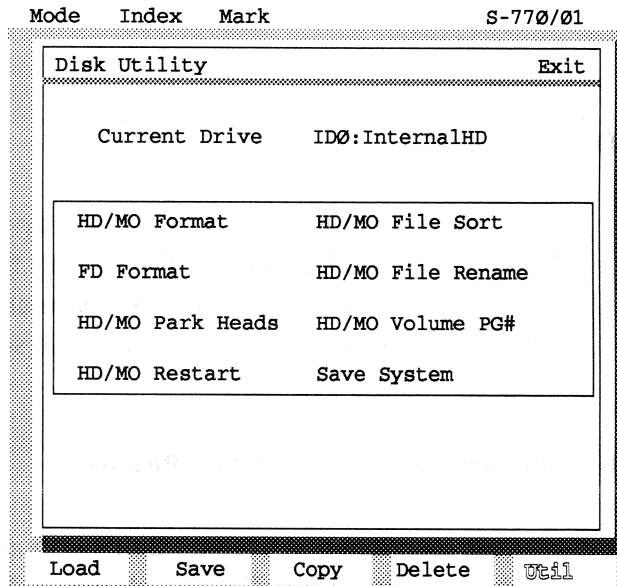

## FD Format

This formats the floppy disk in the drive. When you save a file to an unformatted floppy, the S-770 automatically formats the disk first, so this operation is not essential. It is helpful, however, if you know you are going to be doing a lot of floppy-saving during a session, because you can save some time by pre-formatting a supply of floppies before you start.

## HD/MO Park Heads and HD/MO Restart

As mentioned in Chapter 2, it's important to park the heads of the internal hard disk before moving the S-770, or subjecting it to any shocks. In a hard disk system, the disk spins at a high rate of speed, and the head that reads and writes the data floats above it on a microscopic cushion of air. If the head makes physical contact with the disk, a "head crash" results, which at the very least will cause data to be lost, and in the worst case will destroy the disk. Parking the heads puts them in a special area where they cannot possibly damage the disk.

When you select **HD Park Heads**, the heads of *all* hard and magneto-optical disks connected to the S-770 — regardless of the **Current Drive** setting — will be parked. In addition, the internal hard disk will stop spinning. (The rear-panel fan, however, will keep going, so attempting to lower the ambient noise level with this operation won't accomplish all that much.) The S-770 can operate perfectly well with the hard disk stopped, but you won't be able to load or save any sounds, except to floppies.

Restart all of the disks by selecting **HD/MO Restart**. Wait until the word "**Complete**" appears (it only takes a couple of seconds) before trying to do anything else.

## HD/MO File Sort

In earlier chapters, we've used the **Sort** button at the bottom of the **Select** window to alphabetize files in RAM prior to saving them to disk. That operation takes only a couple of seconds, but it can help save lots of time later when you're searching for files. Just click on this Parameter and it's done.

You can also Sort files *after* they're saved on a hard or magneto-optical disk. If you've done a lot of editing and saving files to disk, you may find files belonging to a particular volume spread out discontinuously all over the disk. Since the Volume ID is part of the name and the sorting process is alphabetical, it will bring them back together. The process takes a couple of minutes for a hard disk; somewhat longer for a full magneto-optical disk.

This operation should also be done on any removable hard disks or magneto-optical disks that contain Volumes created by the S-770 using Version 1.0 software, and that you would like to be able to access with MIDI Program Changes. It modifies the data slightly so that Volumes can accept Program Change assignments. (You can load Volumes without sorting them first, but you won't be able to give them Program Changes.)

## HD/MO File Rename

This allows you to rename any file at any level on a hard or magneto-optical disk. Clicking on this parameter opens up a page similar to a **Disk Load** page. Select the current drive, target level, and file. An **ASCII Keyboard** window opens, and you can use it to rename the file, or click **Exit** and cancel the operation. For obvious reasons, you can't give a file a name that is already in use by another file.

## HD/MO Volume PG#

This function lets you set MIDI Program Change numbers for any or all of the Volumes on the disk. We discussed its use in Chapter 8. Program Change numbers can be used to allow a Volume to be loaded from a MIDI command, provided the **Control Mode** parameter on the **MIDI Config** page is set to **Perform/Volume**. If a Volume is going to be designated as the Initial Volume when the S-770 is booted up, it must have a Program Change number. That number is assigned to the **Initial Volume** parameter on **System Parameters Page1**.

Clicking on this opens a page similar to a Disk Load page. The Target is fixed on **Volume**, but the Current Drive can be changed. Move the cursor to the Volume you wish to assign a number, and click the left and right mouse buttons until the number you want appears. Only Program Changes 65 through 128 are assignable to Volumes.

## Save System

This function records the operating system software and several system parameters onto the current drive. It has a number of uses:

- Restoring the operating system to the Internal hard disk after a Format operation, as mentioned earlier. (Make sure you do this procedure *before you turn the power off* to the S-770. If you turn the power off without saving the operating system, then the next time you boot up, you will have to use a floppy disk.)
- Installing a new or upgraded version of the operating system onto the hard disk, which will be discussed in Chapter 11.
- Storing a copy of the operating system onto a floppy disk for safekeeping or transfer to another S-770. Note that saving the system on a floppy will erase any sound files on it.
- Putting the operating system onto a different drive, in order to allow *it* to be the system's startup device. More on this in the next chapter.

The following parameters are stored with the operating system when you click on **SaveSys**, and will therefore be recalled the next time you boot the S-770:

- the two sets of Jump pages
- the 10 User Set templates from the Partials function
- the contents of the Volume ID Select window (including all the custom IDs you created with Make New)
- the **Type** and **Trigger** parameters on the **Smplng** page, as well as whether sampling is done at full- or half-speed.

In addition, whichever Pages were last opened at the Performance, Patch, Partial, and Sample levels are memorized when you execute **SaveSys**. Here's an example of what this means:

Let's say that the last time you were in the **Edit Sample** function before you executed this **SaveSys**, you happened to be on the **Truncate** page. Also, the last time you were in the **Edit Partial** function, you were on the **TVF** page.

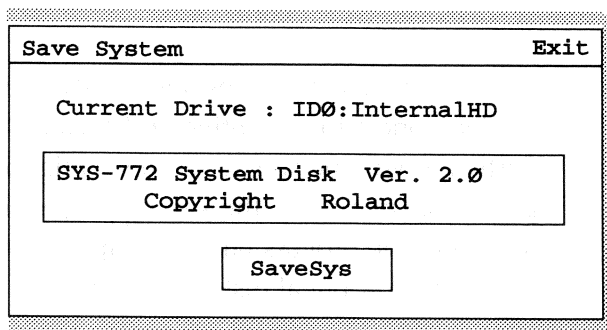



Okay, execute the **SaveSys**. Now turn off the S-770 and turn it back on again. When you select **Edit Sample** from the **Sound** menu, it will automatically open to the **Truncate** page, and when you select **Edit Partial** from the **Sound** menu, it will open to the **TVF** page. If you didn't access a particular Function during the current session with the S-770, these "Page defaults" will remain unchanged from the previous session.

This is mostly a matter of convenience, and you should try to set the Function pages up so that the ones you will be using first in a typical session are the ones that open first.

## Using Disks from Other Samplers (Option/Convert Load)

If you have any disks — either floppy or SCSI (such as CD-ROM) — containing sounds created with a Roland S-550 or S-330 Digital Sampler or W-30 Music Workstation, you can load them into the S-770's Internal Memory. Their data formats, however, are quite different from the S-770's, and so a special operation is needed to load them. This operation is called Convert Load. If you try to load such files from the **Disk Load** page, you will get a communications error. (For purposes of this discussion, let's assume the files have come from an S-550.)

Mode	Index	Mark	S-770/01	
Convert Load			Exit	
Target	Current Drive		Tone to Partial	
Area #			[ Floppy Disk ]	
			1	
-----				
T11:	E2	J1	0.2	<input type="checkbox"/> <input checked="" type="checkbox"/> <input type="checkbox"/>
T12:	A2	J1	0.2	
T13:	C#4	2 SH	0.2	
T14:	B3	2	0.2	
T15:	C#4	1	0.2	
T16:	F#3	2	0.2	
T17:	F#2	1	0.3	
T18:	E4	POP	0.2	
T21:	G2	1	0.2	
T22:	F#3	1	0.2	
T23:	E3	1	0.3	
Internal Free			0.5sec	

From the **System** Menu, select **Option**. This Function has only one Page: **Convert Load**.

The **Target** parameter determines which files on the disk will be loaded. **All** means everything on the disk (which you probably don't want to use with a CD-ROM). **Patch to Patch** means S-550 "Patches" will become S-770 Patches. **Tone to Partial** means S-550 "Tones" will become S-770 Partials.

**Current Drive** should be set to the drive where the S-550 files are currently located, either **Floppy Disk**, or if you are using an external SCSI device, its ID number. If you are loading from a SCSI device, you must also specify the **Area** number where the files you want to load are located. When you select an Area, its name appears right below the number. Click on the name, and a Select window opens showing the names of all Areas on the disk. (This doesn't apply when convert-loading from a floppy.)

If you select a drive or insert a floppy that is not in the S-550 format, you will get a message telling you so. When you insert a valid floppy disk, the system takes a few seconds to verify and catalogue the disk, and asks you, in polite yellow letters, to "**Please Wait**".

The names of all files at the **Target** level you have chosen will then appear in the window. If there are more file names than the window can display, you can scroll the list with the Up/Down arrow box. The numbering may look a little strange, because these samplers use an octal system: the first item is "11", the ninth is "21", etc. If the **Target** level is **All**, then "**Convert All Execute**" will be the only text showing.

Select the file you want to load and click. As with any other disk Load operation, you will first be asked if you want to clear the Internal Memory (if there is anything currently in it). If the **Overwrite** switch is Off, and any of the files have been previously loaded, the **Same Name Found!** box will appear, and you can tell it to skip any files already in RAM.

You will then see the words "**Now Working**", and the name of each file and subsidiary file in the window as it loads. At the same time, the **Internal Free** parameter will decrease as the sounds go into RAM. If there is not enough space in RAM for a particular file, an error message "**Wave Memory Full**" will appear, but the operation will continue. When the operation is finished, the screen goes back to its previous state. Click on **Exit** to get back to the **System** menu.

You can now work with these sounds just like any other sound created in the S-770, editing them, playing them, and saving them to disk. (If you have loaded in a Patch, all of the subsidiary Samples and Partials have been loaded as well.) The names will be slightly modified versions of the names as they appear on the **Convert Load** screen. The slot numbers on the screen (P11, P21, T11, T21, etc.) will become the files' Volume IDs. In addition, Patch names will end with a "/". If an S-550 Patch is made up of two Tones, then it will be converted into *two* S-770 patches. The name of the first S-770 Patch will end with "/", and the name of the second Patch will end with "\". (You can recombine them in a Performance.)

Since the analog sections of the S-550, S-330, and W-30 are somewhat different from the S-770's, you may find that the files do not sound exactly the same, but will require a bit of tweaking to get them just right. On the **Edit Sample Loop** page, the sampling rate for these Samples is displayed as 30 kHz. Although the S-770 cannot *record* a Sample at 30 kHz, it has no trouble playing back one recorded at that rate.

Note that these sounds have been loaded into RAM, and are not stored on disk until you execute a Save.

**Convert Load** is a very specific operation — it only loads. You cannot Save S-770 sounds in S-550/S-330/W-30 format, nor can you load sounds from an S-50 disk. However, if you have S-50 disks, you can use an S-550, S-330, or W-30 to convert those sounds to *its* format, and *then* **Convert Load** them into the S-770.

## SCSI

Working with SCSI devices in a network will be discussed in detail in the next chapter, but there are two Parameters on the **SCSI Config** page (the only Page in the Function) that actually have little to do with SCSI, and should be explained here.

Although the SCSI settings (inside the box) do not go into effect until you re-boot the S-770, the Parameters we're talking about here go into effect immediately.

The **Fast Delete Mode** switch has been discussed earlier. To reiterate, when this switch is **Off**, and you delete a high-level file (Partial, Patch, Performance, or Volume) from a disk, the software checks all of the file's subsidiary files, to see if they are being used by any other high-level files. If a file is found to be in use by another, it will not be deleted. If the switch is **On**, the checking is not done, and all subsidiary files are erased, regardless of whether they are needed in other files.

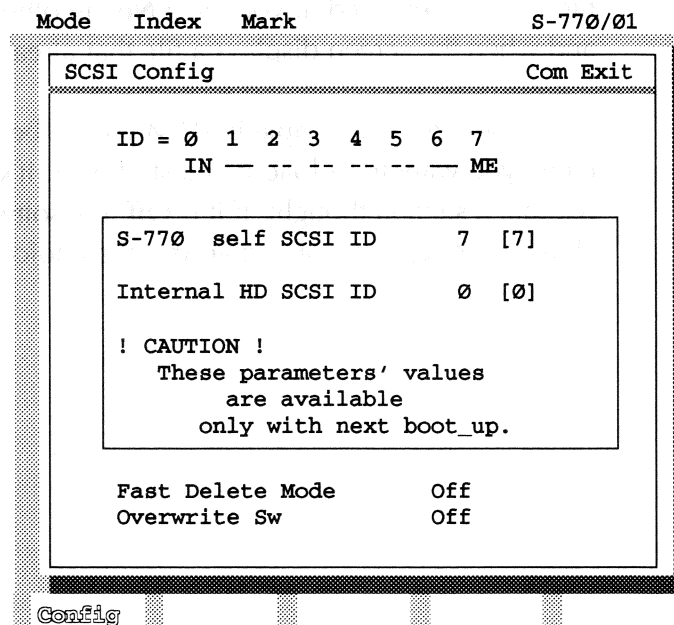

The advantage of having the switch **Off** is protection: in case you forget, for example, that a Sample you're using in a "French Horn" Patch in an "Orchestral" Volume is also being used in an "Elephant Stampede" Patch in a Volume called "Jungle Sounds". The advantage to turning the switch **On** is that the Delete operation becomes significantly faster.

The **Overwrite Switch** determines whether or not the software will warn you when you are about to replace or overwrite an existing file in RAM or on a disk with a new version. If it is **On**, overwriting will occur automatically, and you will get no warning. If it is **Off**, you will be warned and given a chance to back out before anything gets overwritten.

Here are a couple of examples. You're saving a Performance that you've loaded some new Patches into, and you want to save the whole thing, but not the Patches that were already there when you started working. The **Overwrite** switch is **Off**. When you save the Performance from the **Disk Save** page, after a few seconds you get a warning box that tells you how many files, and at which levels, you will write over. If you click **Yes**, the files will be replaced. If you click **No**, all other files in the Performance will be saved, and when the screen displays a file that already exists, it will say "**-Skip-**" as it skips it.

Or, you have a Sample in RAM you've been editing, and you've screwed it up so badly you want to re-load it and start over. If **Overwrite** is **On**, you can re-load it without a second thought. If it is **Off**, the software will warn you that the Sample is about to be replaced, and give you the choice of going ahead or not.

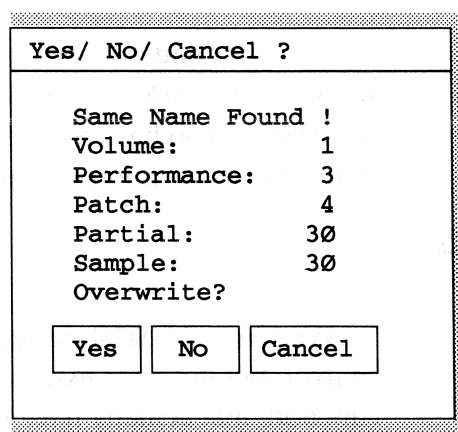

## MIDI

Most of the MIDI functions of the S-770, as we have seen, are set on the Performance, Patch, and Partial editing pages. A few others are accessible through the **System** menu, by selecting **MIDI**. MIDI Sample Dumps are discussed in detail in the next chapter.

### Config

The **Config** page, which was discussed briefly in the previous chapter, contains four parameters. **System Exclusive** determines whether the S-770 will respond to System Exclusive messages from a MIDI device, such as a computer editor or another S-770. The S-770 responds to two types of System Exclusive messages: Roland System Exclusive and Universal System Exclusive.

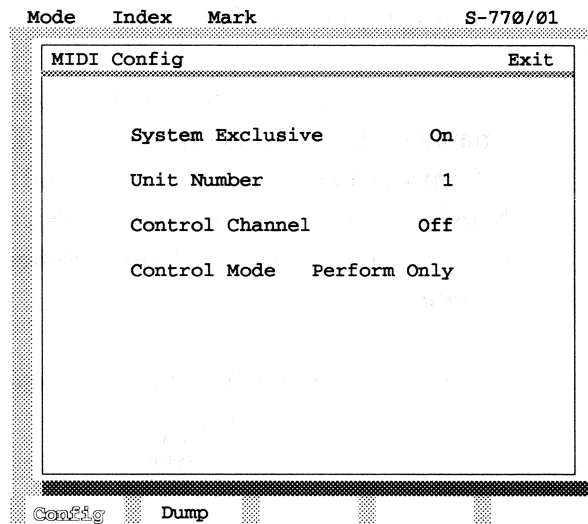

Roland System Exclusive messages can be used to control almost every Parameter in the S-770, and a complete chart appears in the Appendix of this manual. The Universal System Exclusive messages that the S-770 responds to are MIDI Sample Dump Standard commands. See Chapter 10 and the Appendix for more details.

The **Unit Number** and the **Control Channel** work together to allow an individual S-770 to have a specific “address” when it receives System Exclusive messages, so that different S-770s in a system can be controlled individually from a common source, such as a computer. The Unit Number appears on the monitor screen in the far upper-right corner, after “S-770/”. If you have more than one S-770 connected to the same video monitor with a switch, you can keep track of which unit you’re looking at with this number.

The **Control Channel** also determines (as we discussed in the previous chapter) whether the S-770 will call up Performances from RAM and/or load Volumes from disk when it receives Program Change commands. If **Control Channel** is **Off**, incoming Program Change commands will select S-770 Patches in RAM from within a Performance, but will not select Performances or Volumes. In addition, Universal System Exclusive messages will be ignored and MIDI Sample Dumps will not be possible with Control Channel (but possible with Unit Number).

If **Control Channel** is set to a number from 1–16, Program Change commands on that channel number will call up Performances and/or Volumes, depending on the setting of the **Control Mode** parameter (below), and MIDI Sample Dumps can take place on that channel except when Unit Number is set 17 to 32. (Some editing programs and samplers refer to the channel number as the “Device ID”, for purposes of exchanging Sample Dump information.)

Roland System Exclusive messages are responded to regardless of the **Control Channel** setting. If it is **Off**, then the “Device ID” for the unit will be the **Unit Number**. If **Control Channel** is set to 1–16, and **Unit Number** is also set to 1–16, then the **Unit Number** will be ignored, and the Device ID will be the same as the **Control Channel**. If, on the other hand, the **Unit Number** is set to 17–32, the Device ID will be the **Unit Number**.

This chart shows how the Parameters on this Page interact.

Parameter settings			MIDI commands responded to		
System Exclusive	Control Channel	Unit Number	Program Changes	Universal System Exclusive (MIDI Sample Dump)	Roland System Exclusive
On	Off	1–32	Patches only	Device ID = Unit Number	Device ID = Unit Number
	1–16	1–16	Performances and/or Volumes	Device ID = Control Channel	Device ID = Control Channel
		17–32		Device ID = Unit Number	Device ID = Unit Number
Off	Off	1–32	Patches only	Ignored	Ignored
	1–16	1–32	Performances and/or Volumes	Ignored	Ignored

The **Control Mode** parameter, as we saw in Chapter 8, determines how the S–770 responds to Program Change commands above 64 when the Control Channel is enabled. When it is set to **Perform Only**, Program Changes above 64 are ignored. When it is set to **Perform/Volume**, a Program Change of 65 or above will cause a Volume to be loaded from the current disk, provided the particular Program Change has been assigned to a Volume on the **HD/MO Volume PG#** page. If no Volume has been assigned, the S-770 will pause briefly, and then return to its previous mode of operation. For various reasons (read Chapter 8 again if you don’t remember them), it is suggested that this Parameter be set to **Off** unless you have a crying need to be able to load in Volumes on the fly.

## Dump

This page is where you initiate a MIDI Sample Dump, if it needs to be done from the S-770. It will be explained in detail in the next chapter.

Briefly, the **Unit Number** and **Control Channel** parameters are the same as on the **Config** page. The **Source** parameter chooses a Sample from RAM to transmit out the **MIDI OUT** jack on the rear panel in MIDI Sample Dump Standard format. The **Execute** switch initiates the transmission. This function is not necessary in most cases when using a computer sample editor, but it can be used to send a Sample from one S-770 to another over MIDI.

Mode	Index	Mark	S-770/01
MIDI Sample Dump			Exit
Unit Number			1
Control Channel			Off
<input type="checkbox"/> Source		L01:C2	
Execute			
Config	Dump		

## MIDI Monitor

The **MIDI Monitor** is not part of **System Mode** — instead, it appears on the **Performance Menu**. It's more appropriately discussed here, however. As on the other Performance pages, the S-770 is fully operational on all channels while this Function is active.

### MIDI

The first Page of the function, **MIDI**, is a “real-time” monitor of incoming MIDI data. The lower portion of the screen shows the “raw” MIDI data, in hexadecimal. When the screen fills up with data, it starts writing again from the top. Status (command) bytes are in red, while data bytes are in white.

The line immediately above the raw data shows the last received event, with an English interpretation of the **Status** byte, and then the one or two **Data** bytes that follow. Note that the settings on the **MIDI Filter** pages do not affect the data being displayed.

Perform Menu	Exit
Play	
Edit Performance	
MIDI	
Monitor	

The **MIDI Ch** parameter determines which MIDI channel's data the display will show. It can be set to any channel 1 through 16, plus "All", in which case it responds to all incoming data. You can change this Parameter at any time, even while data is being displayed.

The **Trigger** parameter tells the S-770 to wait for a specific type of MIDI event on the selected channel before it starts to display the incoming data.

The choices available, in order, are **Note Off**, **Note On**, Key Pressure (**Poly After**), any numbered Controller (**Ctrl**), **Program** Change, Channel Pressure (**Ch After**), Pitchbend (**Bender**), and System **Exclusive**.

This does not filter data out of the display, it merely disables the display until the Trigger event type is received. Setting the Parameter to **Ctrl**, for example, means that notes played on a keyboard will not be displayed, but as soon as the Sustain pedal (Controller #64) is pressed, *all* the data will start being displayed.

After the **Trigger** parameter is set, it then has to be enabled. This is done from the **Com** menu.

Open **Com**, and select "**Wait Trigger**". The menu will close, and the display will tell you it is waiting for the trigger. You can change the **MIDI Ch** or **Trigger** parameter while it is waiting.

The other item on the **Com** menu is "Clear Display". This, as you might well guess, clears the screen of the accumulated MIDI data.

**Real Time MSG** determines whether Timing Clock (F8 hex), Active Sensing (FE), Start (FA), Stop (FC), Continue (FB), and Reset (FF) messages will be displayed. Setting this Parameter to **Off** means they will not be displayed.

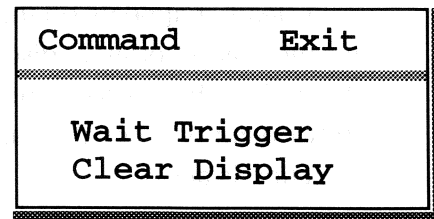
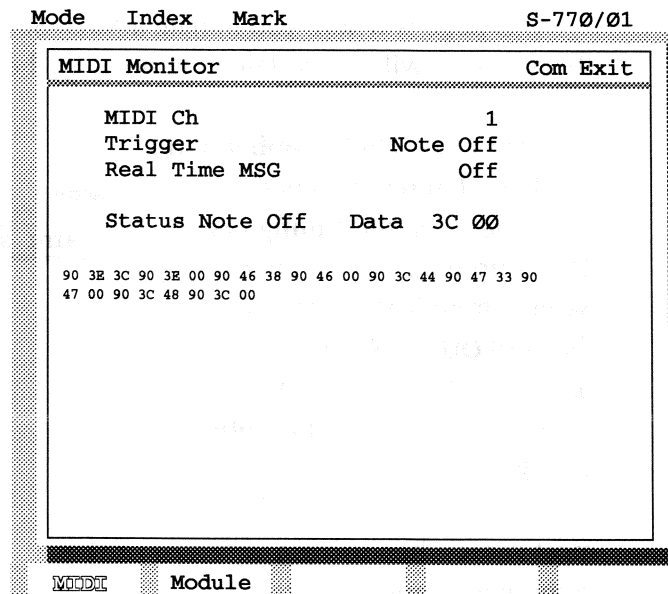



## Module

The Module display is a way to let you see what is going on inside the S-770 while it is being played. The S-770 has 24 available voices. When MIDI notes are received on active channels, blue squares appear on the line labelled "Voice", and also on the lines corresponding to the notes' channel numbers. The Voice line shows the total voices received, while the other lines show the distribution by MIDI channel.

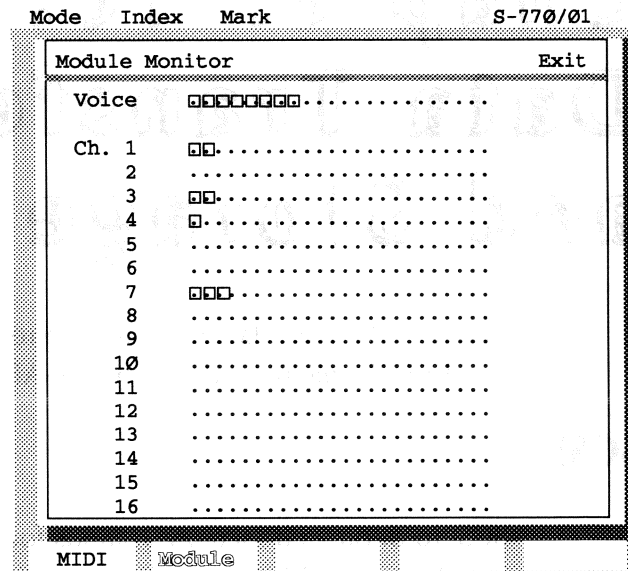

If the incoming note triggers two voices (in, for example, a Partial that contains two Samples), two squares will appear. If an entire multi-channel sequence is being received, many squares will appear. When the number of voices received approaches the S-770's limit of 24, the last few squares on the right will be in red.

As long as the key triggering the voice is held down (or a Sustain pedal holding it is on), the square for that voice will remain visible. When the key or pedal is released, *and* when the voice's amplitude envelope (TVA) lets it go, the square disappears. Notes that come in on MIDI channels not active in the current Performance will not show up on the display.

The S-770 uses dynamic voice allocation to ensure that it makes the most out of the available voices, but it is certainly possible to run out of voices if you use a lot of multi-Sample Partials in a complex multitimbral Performance. Looking at this display while a sequence is running can help you diagnose such a situation and decide the best way to overcome it. Perhaps one of the Partials doesn't really need all four Samples to sound at once, or perhaps the TVA on a sound is longer than it has to be.

# Chapter 10: Data Transfer and Storage

The S-770 allows data to be transferred in digital form using three different protocols: SCSI; digital audio using the AES/EBU format; and MIDI Sample Dump.

## SCSI

SCSI (pronounced “scuzzy”) stands for Small Computer System Interface, and is a popular high-speed protocol for transferring large amounts of data among digital devices. One SCSI network or “chain” can contain up to eight devices.

The S-770 itself is a SCSI device, and its internal hard disk drive is considered to be another SCSI device. Therefore, only a total of six SCSI devices can be hooked up to an S-770.

The S-770 uses SCSI for “off-line” storage of files. Files at any level can be saved to or loaded from any device in a SCSI chain. The particular device is selected with the “**Current Drive**” parameter on any of the Disk pages. SCSI devices that the S-770 can be hooked up to include CD-ROM players, Magneto-Optical read/write drives such as the Roland MO-7, fixed hard disks, and removable hard disks using SyQuest mechanisms. Special “driver” software must be designed for the S-770 to work with a particular model of SCSI device. A table of devices known to work with the S-770 is packaged with the sampler. If you are interested in using a device not on this list, consult your dealer or Roland to see if it is compatible.

## Connecting a single device

The SCSI port on the rear panel of the S-770 allows connection to other SCSI devices. If you are attaching a single device to the S-770, simply connect its SCSI port with the S-770’s port. The S-770’s SCSI port uses a 25-pin connector, and most SCSI drives use a 50-pin connector, so you will need an appropriate cable. A cable designed to connect a SCSI device to an Apple Macintosh will work just fine.

Whenever you connect or disconnect any SCSI devices, make sure the power on the entire chain is off. SCSI cables contain some fairly high voltages, and crossed or sparking terminals can cause serious damage to the connected devices.

When the cables are secure, turn on the power to the external device, and then to the S-770. The S-770, as part of its initialization procedure, scans everything on the SCSI chain (during the “SCSI Device Scanning” routine) and identifies it. The next time you go to a Disk page, as you scroll through the various values for the **Current Drive** parameter, the name of the external SCSI device should appear.

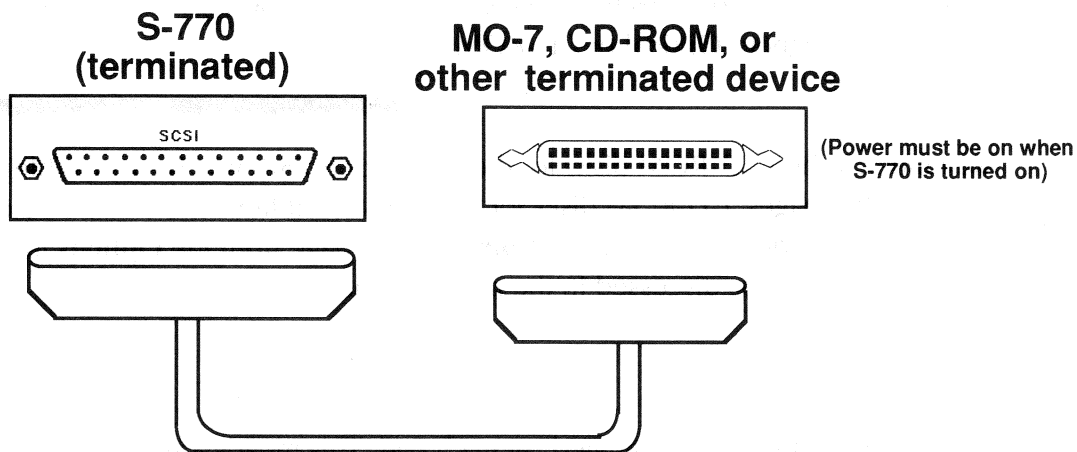

### Turning on and off devices

Although it is necessary to have the external SCSI device powered on when you turn on the S-770, it is not necessary to *keep* it on. For example, at one point in a session you may have all the sounds you need in RAM, and you no longer need to access an external drive like the MO-7 (and would prefer not to deal with the noise it makes). After you boot up, you can turn off the MO-7, and when you want to load something in from it later, you can turn it on again.

Note that when it is off, however, you won't be able to access *anything* on the SCSI chain, including the internal hard disk, for reasons we'll get into in a moment. In addition, after you have turned it back on, the network won't recognize it until you perform a "Scan".

Here's how to do a Scan: from any *disk* page, click on the **Current Drive** parameter to open the **Drive Select** window. At the lower-right corner of this menu is the "Scan" box. Click in the box and the operating system will scan the entire SCSI chain, and make note of any changes in the network since the last time it did this. These changes, as we explained in the previous chapter, not only include new devices on the network, but also any changes within the devices themselves, such as a new Magneto-Optical or CD-ROM disk in the drive.

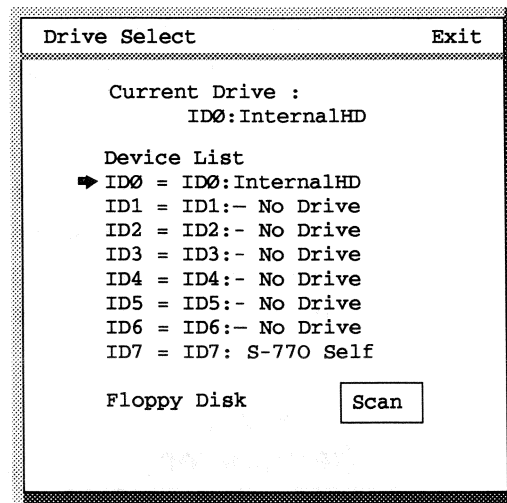

Reminder: While CD-ROM disks for the S-770 (or S-750) will be accessible from the normal Disk pages, CD-ROM disks for the S-550 (and family) are not. You can only load sounds from them using the **Convert Load** page from the **Options** function on the **System** menu, as discussed in the previous chapter.

## Terminators

A SCSI chain must be "terminated" at each end. This means a special resistive circuit must be placed on one of the SCSI connectors at each end, to prevent signals from reflecting back through the cable and causing errors. The S-770 is terminated internally. The Roland MO-7 has a switchable internal terminator, which is in the "on" position when the unit leaves the factory. Therefore, hooking an MO-7 to an S-770 requires no special preparation. However, when you are using more than one external SCSI device on a chain, precautions must be taken to ensure proper termination. We'll discuss these shortly.

## ID numbers

Every device in a SCSI chain must have a unique ID number, from 0 to 7. The initial ID number for the S-770 is 7, and the number for the internal hard disk is 0. Any device you connect to the SCSI port *must* have a number different from these, or the S-770 will not boot.

You can change the ID numbers for the S-770 and its internal hard drive from the **SCSI Config** page, which is accessed by selecting **SCSI** from the **System** menu. Across the top of the Page are the eight available ID numbers, and the identity of any devices currently on the network that have those IDs. “**IN**” stands for the S-770 internal disk, and “**ME**” means the S-770 itself. Other abbreviations you might see are “**CD**” (CD-ROM), “**MO**” (Magneto-Optical), “**HD**” (hard disk), and “**SQ**” (SyQuest).

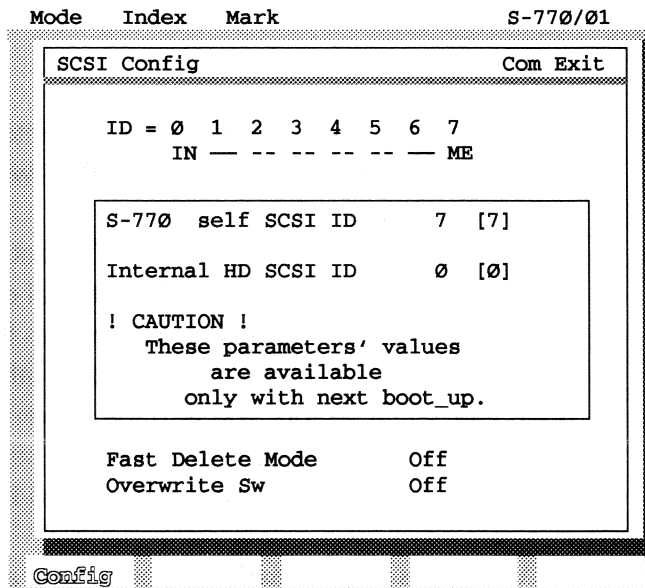

In the box in the middle of the screen, put the cursor on the name of the device you want to change (either S-770 self or Internal HD). Click the left or right mouse button to decrement or increment the number. Note that the ID number change (in brackets) does not take effect until you turn off the S-770 and turn it back on again.

Changing the SCSI ID of an external device is a whole ‘nother story — it has to be done at the device itself. Some devices make it relatively simple, using external DIP, push-button, or rotary switches; some devices make it more difficult, using internal jumpers or switches; and some devices do not let you change their IDs, period. Consult the manual for each device to find out how to change its ID number. Keep in mind that every device must have a unique ID, or the network will not operate.

## Priority

SCSI ID numbers are not assigned randomly: the order of the numbers in a SCSI chain has significance. When the S-770 boots up, it needs to find its System software right away, or else it can’t run. The first place it looks is the floppy disk drive (which is why you shouldn’t have a floppy in the drive at boot-up except under special circumstances). The second place it looks is a device on the SCSI network whose number is 0. If there is no such device, or if it doesn’t find the System software there, it looks to the device whose number is 1, and so on up the line until it finds a valid device that contains the System.

For greatest efficiency, therefore, the internal hard disk should have the System on it, and should have its SCSI ID set to 0 — which is the way it comes from the factory.

If you like, you can have the S-770 boot from an external drive. To do this, first save the System software onto the external drive with the “SaveSys” function described in Chapter 8, selecting the desired drive as the **Current Drive**. Then reset the SCSI ID of the S-770’s Internal drive to a number other than 0, and turn off the power to both drive and S-770. Before you turn the power back on, reset the external drive’s SCSI ID to 0 (or a number less than what you just set the Internal drive to). When you turn everything back on, the external drive will be the startup drive.

While this is not a bad idea for making a backup in case the internal drive fails (or you accidentally format it and turn off the S-770 without replacing the System), there are actually no normal situations which would benefit from this — there should always be a backup System available on a floppy disk (which, you will remember, the S-770 looks at first when it boots up), and any software upgrades will also be provided from Roland on floppy disks (see the next chapter).

## Connecting multiple devices

When you have more than one SCSI device connected to the S-770, special precautions must be taken. First of all, it is essential that all devices have unique ID numbers. If there are any duplicate IDs on the network, it will not run correctly, and quite possibly not at all.

Secondly, the chain must be properly terminated at both ends. SCSI devices normally have two connectors, which allows them to be connected in a chain-like manner (hence the name “chain”) with the “output” of one device going to the “input” of the next, and the “output” of that device going to the “input” of the next, etc. (Actually, the connectors are identical, and it doesn’t matter which is the input and which is the output on a particular device.) The last device at each end of the chain will have only one cable connected to it, and these last devices must be terminated.

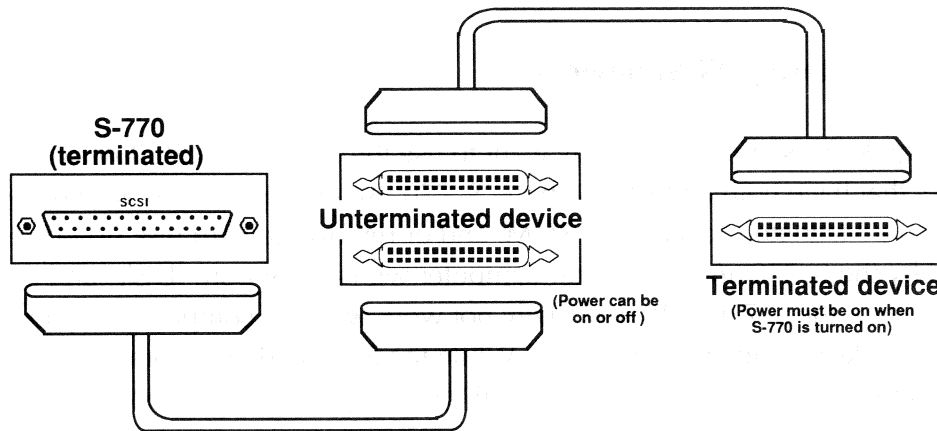

The S-770 will normally be at one end of the chain (it has only one SCSI connector), and it is always terminated, so that solves half the problem. But whichever device is at the other end must be terminated, and none of the devices in between should be terminated. Like setting its ID number, terminating a SCSI device can be relatively simple or very difficult. Consult your manuals for instructions. Often, terminating a device simply involves buying a special terminator plug and attaching it to one of the device's SCSI connectors. If you have one device on the chain that is significantly easier to terminate than all of the others, you should consider putting that one at the end.

Note that the ID numbers in a chain have nothing to do with the devices' physical or electrical locations, so there's no need to arrange the devices in any special order, as long as they are terminated properly.

SCSI devices in a chain can be turned on and off freely at any time, with one exception: **any device that contains a terminator generally must have its power on at all times** whenever you want to use any device on the network. If the power to that device is off when you boot up, the S-770 may not boot, and if you turn it off any time afterwards, the network will stop responding (although sounds in RAM will work fine).

SCSI termination is, unfortunately, something of a "black art" — you can't make any hard and fast rules about it, because inevitably you will find yourself in a situation where they don't apply, and you have to do something "illegal" to make everything work. So if you have done everything correctly and your network still is not running right, try disconnecting a terminator, or putting a terminator in between two devices, or replacing an internal terminator with an external one. Just make sure the power is off to every device in the network before disconnecting *any* of them.

## Connecting non-storage SCSI devices

It is quite possible that you may want to use the S-770 on a SCSI network with devices that have nothing to do with the S-770. An example of this would be a system in which a Magneto-Optical, CD-ROM, and/or removable hard disk drive are being shared by the S-770 and a personal computer with a SCSI port. (Disks and cartridges formatted for the S-770 will most likely not work with the computer, so you will need separate disks for each type of usage.) While the S-770 and the computer will not be able to talk directly to each other, you still don't want to have to re-wire the network each time you want to switch from using your computer to using the S-770.

In this case, you need to be aware of some more SCSI terminology: Initiators and Terminals. Put somewhat simplistically, an "Initiator" is a device that controls the other devices on the SCSI network, while a "Terminal" (don't confuse this with a "terminator", or even Arnold Schwarzenegger for that matter) is a device that is controlled by an Initiator. The S-770 is an Initiator, as are most computers. Storage devices are Terminals. You can have two Initiators on a SCSI chain at the same time, but they cannot both talk to the same Terminal *at the same time*, nor can they talk to each other. Also, obviously, they must have different SCSI ID numbers.

Therefore, you might be able to hook your S-770 up to your Mac or PC through various drives, but don't be surprised if when you do an S-770 "Scan", the computer doesn't show up on the device list. Be very careful about ID numbers and terminators, and don't try to save Samples and spreadsheets to the same disk.



## Digital I/O

As discussed earlier, the S-770 features digital inputs and outputs that conform to the AES/EBU “Consumer” format, also known as CP-340 Type II.

This is the same format used by the Roland R-880 Digital Reverb and E-660 Digital Equalizer, as well as a continually growing number of DAT decks, CD players, mixers, and signal processors. Two types of connectors are available for digital signals, coaxial (terminating in an RCA plug) and optical. You can use either type, selecting it with the switch on the S-770’s rear panel. You cannot mix types — if you use the coaxial inputs, you cannot use the optical outputs at the same time. The AES/EBU format is for stereo audio, so each connector carries two channels.

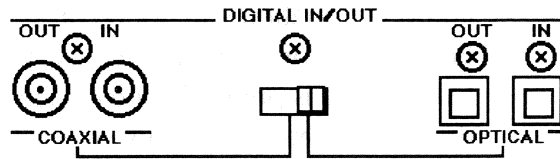

### Inputs and Outputs

The digital inputs are used during the Sampling process (Chapter 6). You may record an incoming digital signal one channel at a time, or both channels simultaneously. There is no continuous level control over the incoming signal, however the **Digital ATT** parameter lets you boost the signal 3 dB or attenuate it 3 or 6 dB. You must set the S-770’s clock (sampling) rate to match that of the incoming signal (or be exactly half of it), or you won’t be able to record anything. The S-770’s sampling rate is set with the **Master Freq** parameter on **System Parameters Page 2**.

The digital outputs are wired in parallel with the main stereo analog outputs of the S-770. The **Master Freq** parameter controls their clock rate. Any sounds assigned to the “Stereo” outputs will appear at the digital outputs, while any sounds assigned only to the individual numbered outputs will not appear. The front-panel **VOLUME** control does not affect the digital outputs, nor does the setting of the **Analog Outs Mode** parameter.

### Compatibility

The S-770’s digital inputs will accept signals that conform to the S/P DIF (Sony/Philips Digital Interface Format) standard. This is a kind of “superset” of AES/EBU Consumer, which contains some additional, non-audio information. When S/P DIF signals are recorded by the S-770, that extra information is not recorded. The inputs will also accept signals in the AES/EBU “Professional” format, also known as CP-340 Type I.

Similarly, the S-770's digital outputs will drive an S/P DIF input, although the non-audio information will not be present. In addition, you *may* be able to drive an AES/EBU Professional-format input with the S-770's output — the difference between the two formats is primarily one of signal level, and if the input of the device you are driving is relatively tolerant of low levels, you should be successful.

## MIDI Sample Dump

The S-770 supports the MIDI Sample Dump Standard, and can transfer sample data over MIDI to another device which also supports the standard. This can be another sampler, another S-770, or a computer equipped with sample-editing software. Samples are transferred to and from Internal Memory, not disk.

Only a single Sample can be transferred at a time. Stereo Samples must be transferred as two separate mono Samples. The Sample Dump Standard contains information about sample rate, length, and number of bits per individual sample. When setting up a program or sampler to send data to the S-770, be sure the **Master Freq** parameter matches the sampling rate of the original source. When receiving data from the S-770, make sure its sampling rate is the same as the S-770 Sample being sent. The S-770 is a 16-bit machine, and all transfers should be done in that format.

The Sample Dump Standard also contains information about loop start and stop points, although not the "loop mode". Originally, the Standard only supported a single loop in each sample, but a recent extension to it allows for multiple loops. Some programs and samplers don't yet recognize this extension, however, and if an S-770 sample with a Release loop is sent to one of these, the Release loop data will be ignored.

The Sample Dump Standard uses MIDI channel information, so make sure that the receiving device and the transmitting device are set to the same channel (or "Device ID"). When you are transferring a Sample from one S-770 to another, make sure both the **Unit Numbers** and the **Control Channels** for the two units are the same.

### Closed-loop Transfers

MIDI Sample Dumps work best in a "closed-loop" setup, that is, one in which MIDI cables run in both directions, from the MIDI Out of the S-770 to the MIDI In of the computer or other sampler, and from the MIDI Out of the other device to the MIDI In of the S-770. When wired this way, the Standard can automate the transfer process to a great degree, using commands for dump requests, acknowledgements, cancelling, and other operational aspects.

For example, to download a sample into a typical sample editor, all you have to do is tell the editor the number of the sample you want to work on (which the S-770 interprets as its “slot” number in RAM), and then tell it to get it. The software requests the S-770 to send its sample data, and the rest of the operation is automatic.

Sample Dumps can be requested while the S-770 is on almost any Page. The exceptions are the **Disk** pages (regardless of whether they are accessed through the **Com** or **System** menus), and the **Smplng** page. If you request a Sample number for which there is no Sample in RAM, you will get an error message.

Similarly, Samples can be sent to the S-770 on most pages. When a Sample is sent, it has a number attached to it, which the S-770 will interpret as a RAM slot number. If there is another Sample already in that slot, it will be erased and replaced with the new one. Make sure when sending a Sample to the S-770 that there is enough free RAM (check the **Remaining** parameter) to accept it all.

## Open-loop Transfers

Under some circumstances, the Sample Dump procedure isn't quite so well automated. This is true when an “open-loop” configuration is being used (only one MIDI cable is connected, from the MIDI Out of the dump-er to the MIDI In of the dump-ee), or when the device receiving the dump does not have a “Request” function (such as when transferring from one S-770 to another). In these cases, the receiving device must be told that a Sample is coming its way.

To send a Sample from the S-770, you must initiate the Sample Dump by going to the **Dump** page (choose **MIDI** from the **System** menu). Select the Sample you wish to send with the **Source** parameter, and then click on **Execute**. The software will pause briefly to wait for an acknowledgement from the receiving device, and will then proceed with the dump regardless of whether it gets one.

Mode	Index	Mark	S-770/01
MIDI Sample Dump			Exit
Unit Number			1
Control Channel			Off
<input type="checkbox"/> Source		L01:C2	
<div style="border: 1px solid black; padding: 5px; display: inline-block;">Execute</div>			
Config		Dump	

# Chapter 11: Upgrades and Service

## System Software

Because the operating system of the S-770 is entirely software based, it can be easily changed and upgraded. Roland will periodically release new versions of the system software to fix problems or add new features. These upgrades will be distributed on floppy disks, and you can then transfer the new software to your unit's internal hard disk. Installing new system software on the hard disk does not affect the sound files on the disk in any way.

When you receive a new system-software disk, insert it into the floppy-disk drive **before** turning on the power to the S-770. This is the exception to the rule, stated previously, that you never boot with a floppy in the drive.

When you turn on the unit, it will load the system software from the floppy disk. This procedure is slower than booting from the hard disk — it takes about a minute — so be patient. When the booting is done and the **Performance Play** screen appears, select **Index** from the top of the screen. When the Index opens, select **Save System** (under **System**, at the lower right).

Click on the words "Current Drive", and the **Drive Select** window opens. Move the cursor to the line directly underneath the words "Device List", and click on the "**ID0**" at the *left* side of that line. This selects the internal hard drive as the current drive. A red arrow will appear next to where you clicked, and the name of the internal hard drive (which is "ID0:InternalHD" unless you've done something to change it) will appear as the **Current Drive** in yellow at the top of the window.

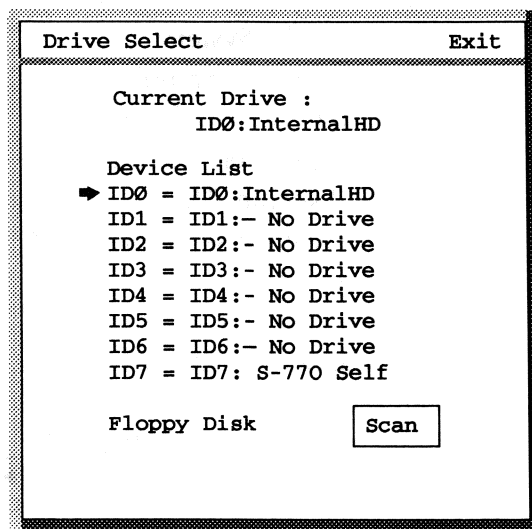

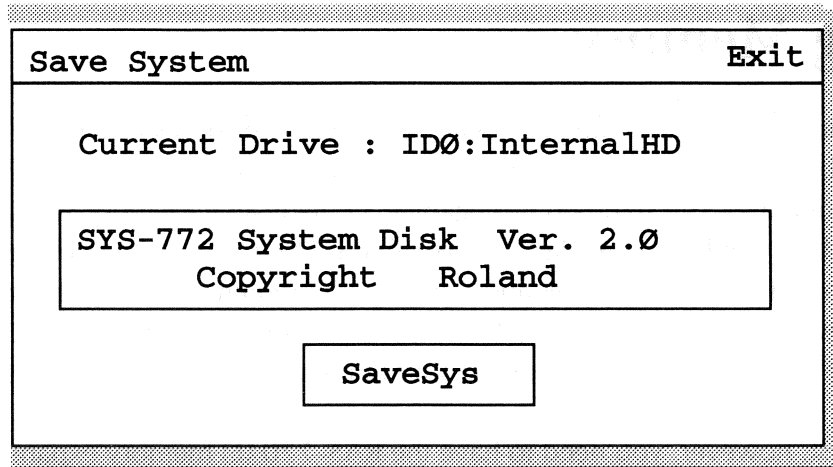

Now click on **SaveSys**. After a few seconds the word “**Complete**” appears, and then you are placed on the **Disk Utility** page (see Chapter 9 for details about this). You may now go wherever you like, or turn off the S-770.

The operating system on the floppy disk has now been installed on the hard disk. The next time you boot up, do so in the normal manner (without the floppy), and the new operating system will be loaded automatically. You can put the floppy away in a safe place, quite possibly forever — you will only need it if some disaster befalls your hard disk.

As explained in Chapter 9, when **SaveSys** is executed, many of the current operating parameters are saved, including Jump pages, envelope templates, startup pages, and some Parameter settings. You might want to set all these up before you save the system from the floppy to the hard disk, so that everything is where you expect it next time you boot up — otherwise the settings you saved previously on the hard disk will be lost, and replaced by those on the floppy.

Remember you can save the operating system on *any* disk, floppy or SCSI, either for safety purposes or because you want to make the other disk the startup disk.

If you accidentally format the hard disk, this erases the system software along with the files. However, you can perform the **SaveSys** operation on it without inserting a floppy **as long as you don't turn the power off**. On the other hand, if you turn the power off *without* saving the system, you will *have* to boot from a floppy the next time you power up.

## Adding Memory

The S-770 comes equipped with two megabytes of RAM. Up to 14 additional megabytes can be added, in increments of 2 megabytes, for a total of 16 megabytes. RAM upgrades use standard 1-megabyte Single In-line Memory Modules (SIMMs), available from Roland as Part Number OMS-1M (OMS-770). These are identical to those used in Macintosh® SE and II computers, which are available from many sources. However, be sure to use only SIMMs that are rated with a speed of 100 nanoseconds (ns) or faster (i.e., a lower number), and purchase them only from a reputable dealer.

First, however, you need to have the RAS-770 (E) memory expansion board installed in your S-770. This must be done by an authorized service center. Some S-770's are shipped with this board installed, but if yours does not have it, see your dealer.

Installation of the SIMMs on the board, however, is relatively simple. However, if you are not experienced with disassembling and reassembling electronic gear, it is strongly suggested you ask your dealer or a qualified technician to do the job. Make sure all connections, especially the AC cord, are removed from the S-770 before opening the case.

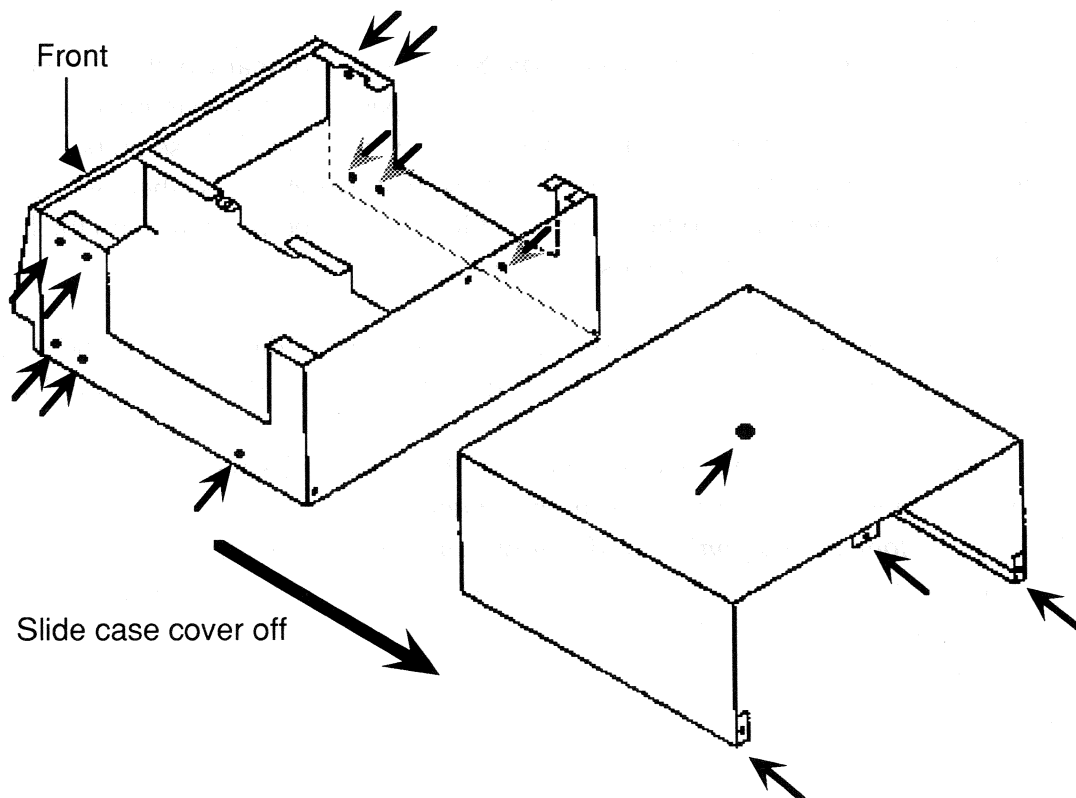

With a Phillips screwdriver, remove the 14 screws that hold the metal case cover to the chassis: one on top, five on each side panel, and three on the back (in the lower corners and at the middle of the top, and no others). Gently slide the case cover back until you can remove it completely.

The SIMMs must be installed in groups of two, and if you are not filling all 14 slots at once, you must start with the slots in the back (the first one is labelled "RAM1/IC33") and move forward.

As you face the front of the S-770, hold the SIMM circuit board so the chips are facing you, and the metal edge connector is pointing down. Lean the SIMM board back about

45 degrees, and gently insert the edge connector into the socket. When it is in as far as it will go, lean the board back further, so that the black plastic tabs at either side of the board are pushed outwards. Keep leaning it back, until the tabs snap back *inwards*, locking the board into place. The two tabs *behind* the SIMM will poke through the holes at each end of the board.

When you have installed all of the SIMMs you have, put the case cover back on, replace the screws, and reconnect the unit. The next time you boot up, the second startup screen will say "**Wave Memory Check**" followed by the number of megabytes of RAM now in the unit. If the number doesn't agree with what you've installed (plus the 2 megabytes in there to start with), disconnect the S-770 and do the installation again, making extra sure the SIMMs are properly seated.

If you should want to remove a SIMM for any reason, use your fingers to push the black plastic tabs out to the side, and lean the board forward until it's in front of the tabs. Then pull the board straight up and out of the socket, letting the tabs snap back. Don't leave any empty slots in back of any filled ones.

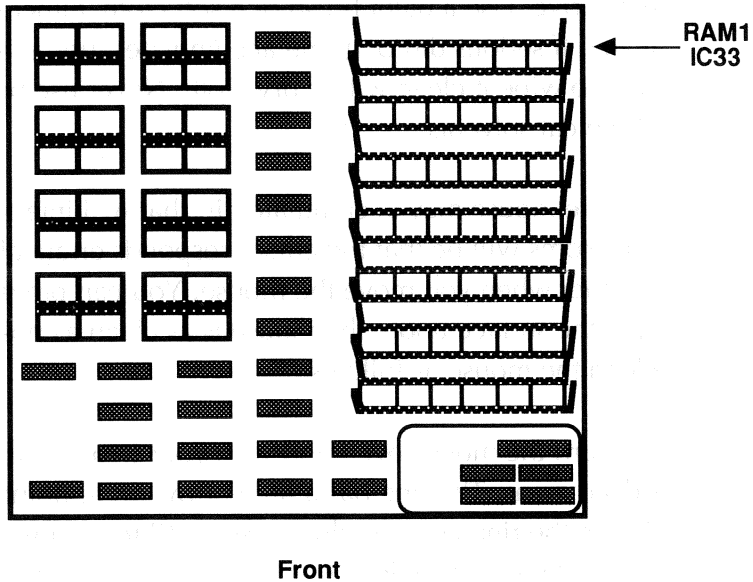

Mode	Index	Mark
Wave Memory Check	181.8 sec	[16 Mbytes]
SCSI Device check	Ø	

## Cleaning and Maintenance

As far as maintenance is concerned, the S-770 should require a minimum of attention. Keep dust away from the unit, especially the ventilation holes and the floppy disk drive. Use a paint brush or a soft cloth, either dry or very slightly dampened with water. If serious dirt or grime accumulates, use a mild detergent, and afterwards make sure to wipe it clean with a dry cloth. Never use benzene, alcohol, turpentine, or any chemical solvents.

The mouse may accumulate dirt that will interfere with its operation. The symptoms will be that the cursor responds erratically, or not at all, in one direction or another when you move the mouse. You can prevent this from happening by making sure the surface under the mouse is as clean as possible, but if it does happen, you can clean the mouse as follows:

Turn the mouse over, and with your two thumbs grab the inner plastic ring on the ridged areas. The ring has a little arrow on it, pointing to the letter "C" (as in "Closed"). Rotate the ring counter-clockwise, until the arrow is at "O" ("Open"). Turn the mouse back over and, keeping your hand underneath it to catch them, let the ring and the rubber ball fall out. Put them aside, where the cat can't get to them.

With a dry cloth, wipe out the cavity. Look at the plastic rollers inside. If there are accumulations of dirt on or next to them, remove it with a cotton swap (be careful not to leave cotton fibers behind), and if it is really stubborn, use a wooden toothpick (watch out for splinters). Now wipe the rubber ball with the cloth, and flipping the mouse on its back once again, drop the ball back in. Put the ring back on with the arrow pointing to "O", and when it is in place, turn it clockwise until the arrow points to "C".

**Note:** do not attempt to disassemble the mouse in any way other than this.

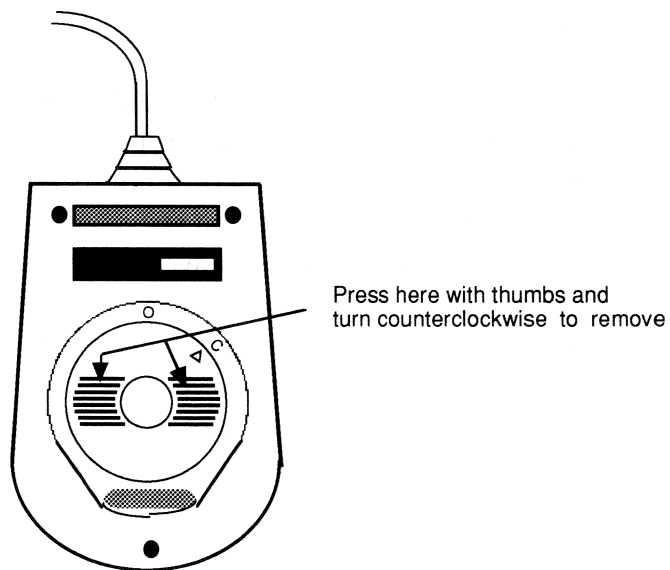



## Returning for Service

Except for the mouse and the memory SIMMs, the S-770 has no user-serviceable parts. Attempts by unauthorized personnel to repair or modify the S-770 will void the warranty and are generally considered not smart. If you have trouble with the unit, you must bring or send it to an authorized Roland repair facility. Consult your dealer before sending it anywhere.

When preparing to ship the unit, first be sure to park the internal hard disk drive. This is done from the **Disk Util** page. From any page, open the **Com** menu, select **Disk**, and then from the bottom of the page that opens, select **Util**, or else press the **F5** button. Move the cursor to "**HD/MO Park Heads**" (stay away from "**HD/MO Format**"!) and click the left mouse button. When the word "**Complete**" appears, shut off the power. Wait about 30 seconds before moving the unit.

Use the original packing material that came with the S-770 to ship the unit. The diagram at right will remind you how the pieces all fit together. If the original packing material is not available, use a reinforced, sealable, foam-lined case. Remember, there's a hard disk in there.

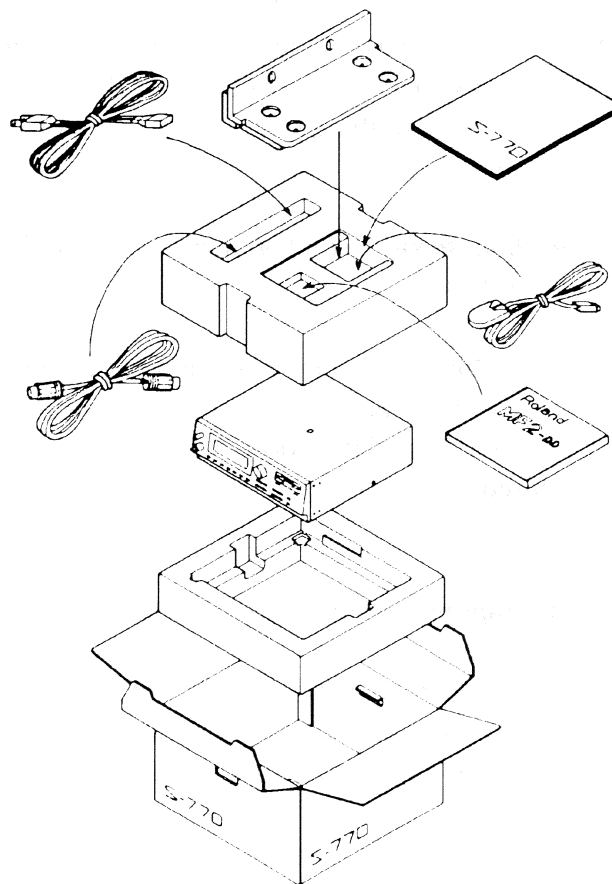

## Troubleshooting: Why Won't It...

***It doesn't recognize the mouse — I move it around, but the cursor doesn't move.***

Assuming your connections are okay, this may happen because the S-770 was left with a “**Controller**” setting that is different from what you need. If you are using the mouse without the RC-100 Remote Controller, turn off the S-770, and hold down the F2 button on the front panel as you turn the power back on. If you are using the RC-100 (with or without the mouse), hold down the F3 button as you re-boot. If you don't want to use an external controller, but just the front-panel buttons, hold down F1 as you re-boot.

***I have an audio line plugged into the rear inputs, but the signal is not showing up on the “Level” display.***

Make sure you have “**Analog**” selected as your **Input** parameter, and make sure the rear-panel **SENS** control is not set for a higher-level signal than you are providing. Also make sure there is nothing plugged into the front-panel inputs, as this will disconnect the rear-panel ones.

***Everything seems to be behaving normally, but I'm getting no signal at the analog audio outputs.***

If the **Analog Out** mode on **System Parameter Page 2** is set to “**8outs**”, then the main stereo outputs and the headphone outputs are acting as individual outputs, numbers 7 and 8, and they don't carry the stereo mix. Either set that Parameter to “**6out+stereo**”, or reconfigure the sounds at the Performance, Patch, or Partial level to come out of outputs 7 and 8 (or the other numbered outputs, if you like).

***I am sampling a Mono analog source, but nothing seems to be coming in.***

When the **Mode** parameter is set to **Mono**, only the left inputs (front and rear) are recognized. Make sure your input cable is connected to the **L(MONO)** input, and not the **R** input. The digital inputs are stereo; individual channels are selected using the **Input** parameter.

***I'm trying to use the digital audio inputs to make a Sample, but the red "Digital Unlock" box is showing.***

You have a sampling-rate conflict between what the S-770 is seeing and what it wants to see. Check the sampling rate of the source of the digital signal, and then go to **System Parameter Page 2**, and check the **Master Freq** parameter. They should both read either 44.1 kHz or 48 kHz. If they don't match, change one or the other so they do.

Another reason that this box might be displayed is if you are using the Coaxial digital input, but the rear-panel switch is set to **OPTICAL**, or vice-versa. Make sure the switch setting matches the input you are using.

***I have deleted a Patch to make more room on my disk, but the "Free" parameter hasn't changed.***

All of the Samples in the Patch you've deleted are being used by other Patches on the same disk. Also, the **Fast Delete Mode** switch is off. Therefore, no Samples are being erased and no Sample memory (which is what the **Free** parameter measures) is being freed up. Samples are only erased if they are used by only one file at the given level, or if the **Fast Delete Mode** is on.

The same thing is true when deleting files in RAM to make more room, except there is no **Fast Delete Mode** switch. If a subsidiary file in RAM is shared by two or more high-level files, deleting only one of the high-level files will not delete the subsidiary file, and therefore the **Remaining** parameter will not change.

***I call up a Patch to play from disk, but there's no sound.***

This is the reverse of the previous question. If there are Samples or other subsidiary files shared by two or more higher-level files on a disk, and you delete one of those high-level files with the **Fast Delete Mode** on, the Samples will be erased as well. Then when you try to load one of the other higher-level files in, the deleted Samples cannot be found, and will not be loaded. Therefore, only use **Fast Delete Mode** if you're sure you can afford to erase all of the subsidiary files.

***I'm working on adjusting the Release loop of a Sample, but I can't hear what I'm doing. Or, I've constructed a Release loop, but when I play the Partial it's in, I don't hear it.***

You can *only* hear the Release loop from the **Loop** page (or any of the **Edit Sample** pages) if the **KeyOn Mode** parameter is set to "**R-Loop**". Any other setting, and the Release loop will not sound.

When you get up to the Partial level, remember the Release loop will only start to play after the key is released (hence the name). Therefore, for it to be audible, and not cut off by the TVA envelope as soon as the key is released, the envelope must have a relatively long release time (**Time 4**).

***I've created a new Sample and loaded it into a Partial, but now when I move up to Patch level and load the Partial in, I don't hear anything.***

Just selecting a Partial to go into the **Partial** parameter on the **Edit Patch Split** page does not automatically enter it — it has to be deliberately assigned to a Split first. An easy way to do this is after selecting the Partial, simply click on **Set**. This will assign the Partial to the entire keyboard range (assuming you have not changed the **Upper** and **Lower** parameters) in the Patch.

However, there's an easier way to do this and that is to record the Sample in Subsidiary mode coming from the Patch level. This automatically creates a new Partial and a new Patch, and assigns the Partial to the Patch automatically.

***I have formatted my hard disk. Now what do I do?***

First thing is, *don't* shut off the power. If this was an accident, don't try to abort the formatting by turning the power off — you will damage the hard disk. Wait for the formatting to stop, then go to the **Index** and choose **Save System**. When the **Save System** window opens, click on **SaveSys**. At least now, the next time you boot up, the hard disk will work, although it will have no files on it.

If you have done this deliberately, in order to erase all the files from the disk prior to loading it with new ones, you should first do the same thing: choose **Save System** from the **Index** and execute the operation, to replace the current system on the hard disk. Now you can use the **Disk Copy** page to bring in files from other SCSI disks, or **Disk Load** to bring in files from floppies, and **Disk Save** to store files in RAM to the disk.

***I turn on the S-770 and it asks for a system disk.***

Three possibilities:

1) You booted it with a disk in the floppy drive that is not a system disk. Never boot with a disk in the floppy drive unless you plan to upgrade the system software (as discussed earlier in this chapter). Once the S-770 *thinks* it should be reading the system software from the floppy-disk drive, it will not read the internal hard disk, or anything else. Turn off the unit, remove the disk from the drive, and start again.

2) You formatted the internal hard disk and turned off the S-770 without doing a **Save System**. Turn off the S-770. Find your original system-software floppy disk and insert it into the drive, and turn the unit back on. Now follow the procedure at the beginning of this chapter for upgrading the system software (use **Drive Select** to make the Internal HD the **Current Drive**, and save the system to it.)

3) You have a SCSI device hooked up to the S-770 which contains a terminator, and the device is not turned on. The entire SCSI network must be operational for the S-770 to recognize anything on the network, including its internal hard disk (which is itself a SCSI device). If an external SCSI device with a terminator is connected to the chain, then that device must be turned on *before* the S-770, or else the terminator will not be operational, and the S-770 will not recognize it, or anything else on the chain. So turn off the S-770, turn on the external SCSI device, and turn the S-770 back on. (Devices without terminators do not need to be powered up before the S-770.)



**Display:**

LCD: 64 X 240 dot  
 RGB CRT Out: 200 X 320 dot

**Internal Memory:**

Volume 1  
 Performance 64  
 Patch 128  
 Partial 255  
 Sample 512

**Internal Hard Disk:**

Volume 128  
 Performance 512  
 Patch 1024  
 Partial 4096  
 Sample 8192

**Front Panel:**

Volume Knob  
 Recording Level Knob (stereo)  
 LCD  
 Jump Switch  
 Function Switch (F1-F5)  
 Exit Switch  
 Value Dial  
 Cursor Switches  
 S1, S2 Switches  
 Hard Disk Indicator  
 Disk Drive Indicator  
 MIDI Message Indicator  
 Performance Mode Switch  
 Sound Mode Switch  
 System Mode Switch  
 Index Window Switch  
 Mark Window Switch  
 Command Window Switch  
 Sound Play Switch  
 Graphic Switch  
 Auxiliary Control Connector  
 LCD Contrast Knob  
 Headphone Jack  
 Foot Switch Jack  
 Input Jack

Input Level Adjustment Knob  
 Peak Indicator  
 Power Switch

**Rear Panel:**

AC Inlet  
 Hard Disk Cooling Fan  
 Digital I/O (Coaxial/Optical)  
 Coaxial/ Optical Select Switch  
 SCSI Connector  
 Display Out (monochrome/RGB)  
 MIDI Jacks (IN / OUT / THRU)  
 Individual Out Jacks ( 1 - 6 )  
 Stereo Out Jacks ( L/R )  
 Input Gain Selector  
 Input Connector ( XLR type)

**Power Consumption:** 40 W

**Dimensions:**

16 15/16" W x 5 3/16" H x 16 9/16"D  
 (430 x 132 x 420mm)

**Weight:** 26 lb. 6 oz. (12kg)

**Included Items:**

Owner's Manual  
 SCSI Compatible Devices  
 Mouse (MU-1)  
 Rack Mounting Angles (one set)  
 Rubber feet x 4  
 MIDI Cable x 1  
 3.5 inch (2DD) System Disk x 1  
 Overlay Sheet (for RC-100)

**Options:**

Foot Switch - DP-2/6, BOSS FS-5U  
 Memory Board - RAS-770 (E)  
 Memory Expander - OMS-IM  
 (OMS-770)  
 CRT Cable - RGB-25I, RGB-25N  
 Magnetic Optical Disk Drive - MO-7  
 CD-ROM disks - L-CD series

# Video Display Wiring

The **DIGITAL RGB** connector (output impedance 100 ohms) is for 200-line TTL RGB displays with the following specifications. Use only a display with compatible specifications.

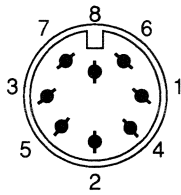

Pin No.	Signal		Specification
1	+5V	+5V power supply output	
2	GND	ground	
3	open		
4	HSYNC	horizontal sync signal output	TTL level
5	VSYNC	vertical sync signal	negative polarity
6	R	video output (red)	TTL level positive polarity
7	G	video output (green)	
8	B	video output (blue)	

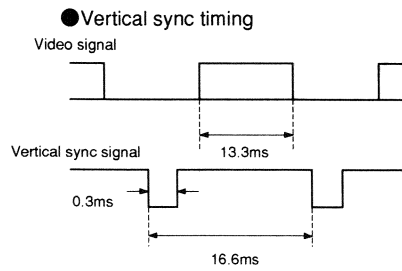
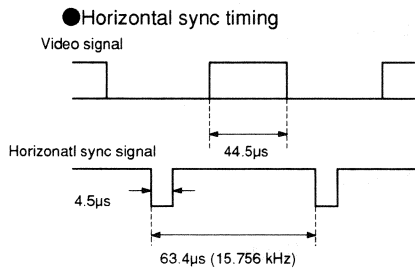



These are the pinout diagrams for the Roland RGB interface cables:

### RGB CABLE

RGB-25I

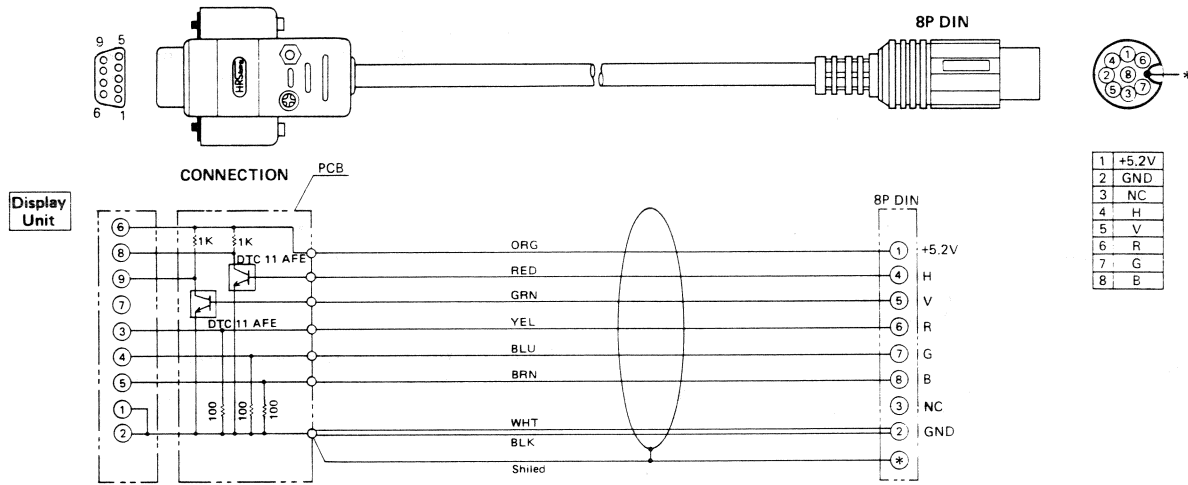

RGB-25N

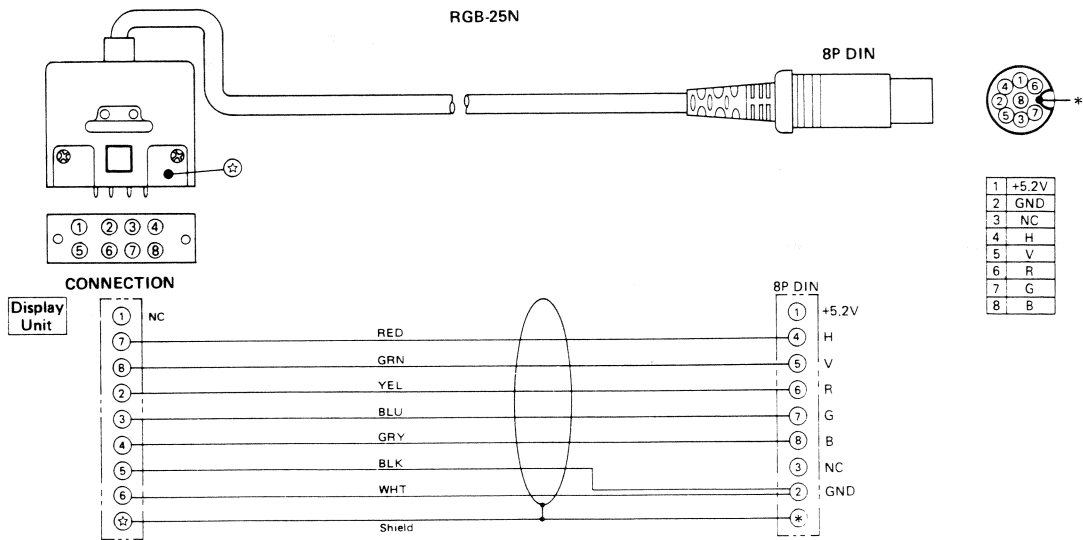

# Roland Exclusive Messages

## 1 Data Format for Exclusive Messages

Roland's MIDI implementation uses the following data format for all exclusive messages (type IV):

Byte	Description
F0H	Exclusive status
41H	Manufacturer ID (Roland)
DEV	Device ID
MDL	Model ID
CMD	Command ID
[BODY]	Main data
F7H	End of exclusive

### # MIDI status : F0H, F7H

An exclusive message must be flanked by a pair of status codes, starting with a Manufacturer-ID immediately after F0H (MIDI version1.0).

### # Manufacturer-ID : 41H

The Manufacturer-ID identifies the manufacturer of a MIDI instrument that triggers an exclusive message. Value 41H represents Roland's Manufacturer-ID.

### # Device-ID : DEV

The Device-ID contains a unique value that identifies the individual device in the multiple implementation of MIDI instruments. It is usually set to 00H - 0FH, a value smaller by one than that of a basic channel, but value 00H - 1FH may be used for a device with multiple basic channels.

### # Model-ID : MDL

The Model-ID contains a value that uniquely identifies one model from another. Different models, however, may share an identical Model-ID if they handle similar data.

The Model-ID format may contain 00H in one or more places to provide an extended data field. The following are examples of valid Model-IDs, each representing a unique model:

- 01H
- 02H
- 03H
- 00H, 01H
- 00H, 02H
- 00H, 00H, 01H

### # Command-ID : CMD

The Command-ID indicates the function of an exclusive message. The Command-ID format may contain 00H in one or more places to provide an extended data field. The following are examples of valid Command-IDs, each representing a unique function:

- 01H
- 02H
- 03H
- 00H, 01H
- 00H, 02H
- 00H, 00H, 01H

### # Main data : BODY

This field contains a message to be exchanged across an interface. The exact data size and contents will vary with the Model-ID and Command-ID.

## 2 Address-mapped Data Transfer

Address mapping is a technique for transferring messages conforming to the data format given in Section 1. It assigns a series of memory-resident records-waveform and tone data, switch status, and parameters, for example-to specific locations in a machine-dependent address space, thereby allowing access to data residing at the address a message specifies.

Address-mapped data transfer is therefore independent of models and data categories. This technique allows use of two different transfer procedures: one-way transfer and handshake transfer.

### # One-way transfer procedure (See Section 3 for details.)

This procedure is suited for the transfer of a small amount of data. It sends out an exclusive message completely independent of a receiving device status.

#### Connection Diagram

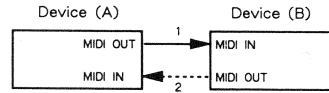

Connection at point 2 is essential for "Request data" procedures. (See Section 3.)

### # Handshake-transfer procedure (This device does not cover this procedure)

This procedure initiates a predetermined transfer sequence (handshaking) across the interface before data transfer takes place. Handshaking ensures that reliability and transfer speed are high enough to handle a large amount of data.

#### Connection Diagram

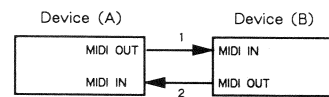

Connection at points 1 and 2 is essential.

### Notes on the above two procedures

- \* There are separate Command-IDs for different transfer procedures.
- \* Devices A and B cannot exchange data unless they use the same transfer procedure, share identical Device-ID and Model ID, and are ready for communication.

## 3 One-way Transfer Procedure

This procedure sends out data all the way until it stops and is used when the messages are so short that answerbacks need not be checked. For long messages, however, the receiving device must acquire each message in time with the transfer sequence, which inserts intervals of at least 20 milliseconds in between.

#### Types of Messages

Message	Command ID
Request data 1	RQ1 (11H)
Data set 1	DT1 (12H)

### # Request data # 1 : RQ1 (11H)

This message is sent out when there is a need to acquire data from a device at the other end of the interface. It contains data for the address and size that specify designation and length, respectively, of data required.

On receiving an RQ1 message, the remote device checks its memory for the data address and size that satisfy the request. If it finds them and is ready for communication, the device will transmit a "Data set 1 (DT1)" message, which contains the requested data. Otherwise, the device will send out nothing.

Byte	Description
F0H	Exclusive status
41H	Manufacturer ID (Roland)
DEV	Device ID
MDL	Model ID
11H	Command ID
aaH	Address MSB
⋮	⋮
⋮	⋮
⋮	LSB
ssH	Size MSB
⋮	⋮
⋮	⋮
⋮	LSB
sum	Check sum
F7H	End of exclusive

- \* The size of the requested data does not indicate the number of bytes that will make up a DT1 message, but represents the address fields where the requested data resides.
- \* Some models are subject to limitations in data format used for a single transaction. Requested data, for example, may have a limit in length or must be divided into predetermined address fields before it is exchanged across the interface.
- \* The same number of bytes comprises address and size data, which, however, vary with the Model-ID.
- \* The error checking process uses a checksum that provides a bit pattern where the least significant 7 bits are zero when values for an address, size, and that checksum are summed.

# Data set 1 : DT1 (12H)

This message corresponds to the actual data transfer process. Because every byte in the data is assigned a unique address, a DT1 message can convey the starting address of one or more data as well as a series of data formatted in an address-dependent order.

The MIDI standards inhibit non-real time messages from interrupting an exclusive one. This fact is inconvenient for the devices that support a "soft-through" mechanism. To maintain compatibility with such devices, Roland has limited the DT1 to 256 bytes so that an excessively long message is sent out in separate segments.

Byte	Description
F0H	Exclusive
41H	Manufacturer ID (Roland)
DEV	Device ID
MDL	Model ID
12H	Command ID
aaH	Address MSB
⋮	⋮
⋮	⋮
ddH	Data
⋮	⋮
⋮	⋮
sum	Check sum
F7H	End of exclusive

- \* A DT1 message is capable of providing only the valid data among those specified by an RQ1 message.
- \* Some models are subject to limitations in data format used for a single transaction. Requested data, for example, may have a limit in length or must be divided into predetermined address fields before it is exchanged across the interface.
- \* The number of bytes comprising address data varies from one Model-ID to another.
- \* The error checking process uses a checksum that provides a bit pattern where the least significant 7 bits are zero when values for an address, size, and that checksum are summed.

# Example of Message Transactions

- Device A sending data to Device B  
Transfer of a DT1 message is all that takes place.

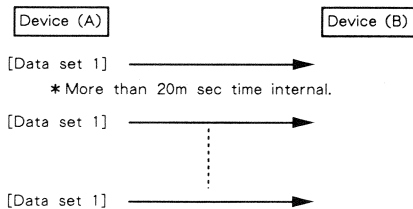

- Device B requesting data from Device A  
Device B sends an RQ1 message to Device A. Checking the message, Device A sends a DT1 message back to Device B.

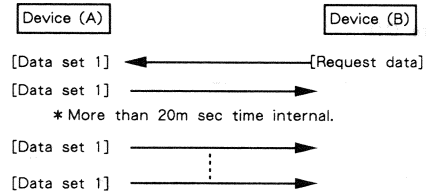

**1. RECOGNIZED RECEIVE DATA**

**■ Channel Voice Message**

**● Note Off**

Status	Second	Third		
8nH	kkH	vvH		
9nH	kkH	00H		
n = MIDI Channel	:0H - FH (0 - 15)	0 = ch.1	15 = ch.16	
kk = Note Number	:15H - 6CH (21 - 108)			
vv = Velocity	:ignored			

**● Note On**

Status	Second	Third		
9nH	kkH	vvH		
n = MIDI Channel	:0H - FH (0 - 15)	0 = ch.1	15 = ch.16	
kk = Note Number	:15H - 6CH (21 - 108)			
vv = Velocity	:01H - 7FH (1 - 127)			

**● Polyphonic Key Pressure**

Status	Second	Third		
AnH	kkH	vvH		
n = MIDI Channel	:0H - FH (0 - 15)	0 = ch.1	15 = ch.16	
kk = Note Number	:15H - 6CH (21 - 108)			
vv = Value	:00H - 7FH (0 - 127)			

\* Received when MIDI aftertouch function is ON in POLY mode.

**● Channel Pressure**

Status	Second			
DnH	vvH			
n = MIDI Channel	:0H - FH (0 - 15)	0 = ch.1	15 = ch.16	
vv = Value	:00H - 7FH (0 - 127)			

\* Received when MIDI aftertouch function is ON in CH mode.

**● Control Change**

**○ Modulation**

Status	Second	Third		
BnH	01H	vvH		
n = MIDI Channel	:0H - FH (0 - 15)	0 = ch.1	15 = ch.16	
vv = Modulation Depth	:00H - 7FH (0 - 127)			

\* Received when MIDI modulation function is ON.

**○ Breath**

Status	Second	Third		
BnH	02H	vvH		
n = MIDI Channel	:0H - FH (0 - 15)	0 = ch.1	15 = ch.16	
vv = Breath	:00H - 7FH (0 - 127)			

\* Received when MIDI controller select is at breath.

**○ Main Volume**

Status	Second	Third		
BnH	07H	vvH		
n = MIDI Channel	:0H - FH (0 - 15)	0 = ch.1	15 = ch.16	
vv = Main Volume	:00H - 7FH (0 - 127)			

\* Can control the volume of part corresponding to MIDI channel of received message.

\* Received when MIDI main volume function is ON.

**○ Hold 1**

Status	Second	Third		
BnH	40H	vvH		
n = MIDI Channel	:0H - FH (0 - 15)	0 = ch.1	15 = ch.16	
vv = Control Value	:00H - 7FH (0 - 127)	0 - 63 = OFF	64 - 127 = ON	

\* Received when MIDI hold function is ON.

**○ PRN MSB, LSB**

Status	Second	Third		
BnH	65H	mmH		
BnH	64H	11H		
n = MIDI Channel	:0H - FH (0 - 15)	0 = ch.1	15 = ch.16	
mm = Upper byte of the parameter No. specified by the RPN.				
11 = Lower byte of the parameter No. specified by the RPN.				

**○ Data Entry**

Status	Second	Third		
BnH	06H	mmH		
BnH	26H	11H		
n = MIDI Channel	:0H - FH (0 - 15)	0 = ch.1	15 = ch.16	
mm = Upper byte of the parameter data specified by the RPN.				
11 = Lower byte of the parameter data specified by the RPN.				

**\*\*\* PRN \*\*\***

Control change is provided with RPN (Registered Parameter Number) which is a message registered to the MIDI standard for use with MIDI world. By using RPN, parameters in a MIDI unit can be changed. In practice, specify the parameter to controlled, using PRN MSB and LSB and then set the parameter value using data entry.

SYS-772 Ver.2.0 will recognize such RPNs as Pitch Bend Sensitivity and Master Fine Tune.

**1) Pitch Bend Sensitivity**

Can be used to set the pitch bend sensitivity of each patch set in the 32 parts of performance. When transmitting, set the MIDI channel to that of each pat.

RPN	Data entry
MSB LSB	MSB LSB
00H 00H	mmH 11H

mm = 0 - 48

Can be used to bend up to 4 octaves in one and semitone steps. The value is common to Bender Range up and down.

11 = 00H - 7FH : Value ignored

Note: mm made valid only when 11 is received.

Example: Set the bender range of the part, whose MIDI channel No. is 1, to 2.

MIDI DATA [HEX]	Description
B0 64 00	:PRN LSB = 00
B0 65 00	:PRN MSB = 00
B0 06 02	:MSB of data entry
B0 26 00	:LSB of data entry

**2) Master Fine Tune**

Set the master tune of SYS-772 Ver.2.0. When transmitting this message, set the MIDI channel to the control channel number.

RPN	Data Entry
MSB LSB	MSB LSB
00H 01H	mmH 11H

mm = Upper master fine tune vlue :00H - 7FH (0 - 127)

11 = Lower master fine tune value :00H - 7FH (0 - 127)

Tune can be raised or lowered up to +/- 50 cents with respect to the standard pitch (middle A = 440 Hz) in step of 100/8192 cents. The actual pitch shift is in step of 1 cent. Value less than 20H 00H results in -50 cents and more than 60H 00H +50 cents.

MSB LSB	
20H 00H	-50 cents
:	
40H 00H	0 cent
:	
60H 00H	+50 cents

Example: Set the master tune of SYS-772 Ver.2.0 whose control channel No. is 16, to A = 440 Hz.

MIDI DATA [HEX]	Description
BF 64 01	:PRN LSB = 01
BF 65 00	:PRN MSB = 00
BF 06 40	:MSB of Data Entry
BF 26 00	:LSB of Data Entry

\*\*\* Other Control Changes \*\*\*

One of control numbers 0-85 can be received as a controller by using MIDI controller select.

<u>Status</u>	<u>Second</u>	<u>Third</u>			
BnH	mmH	vvH			
n = MIDI Channel	:0H - FH (0 - 15)	0 = ch. 1	15 = ch. 16		
mm = Control Number	:00H - 5FH (0 - 95)				
vv = Control Data	:00H - 7FH (0 - 127)				

● Program Change

<u>Status</u>	<u>Second</u>			
CnH	ppH			
n = MIDI Channel	:0H - FH (0 - 15)	0 = ch. 1	15 = ch. 16	
pp = Program Number	:00H - 7FH (0 - 127)			

\* Will perform patch change, performance change or volume load according to the MIDI channel number that the SYS-772 Ver.2.0 has received.

\* Patch Change  
Can be received when MIDI program change switch is on. Will act as Patch change when received on the channel number of a part. Program number of the patch can be set to a number.

\* Performance Change, Volume Load  
Will act as performance change or volume load when received on the control channel number with function depends on the control mode being selected. The program number of performance and volume can be set to a number. Performance change and volume load have priority when the channel number and control channel number of a part conflict.

When control mode is "Perform Only":  
pp = 00H - 3FH (0 - 63) Performance Change  
pp = 40H - 7FH (64 - 127) Performance Change (same as pp - 64)

When control mode is "Perform/Volume":  
pp = 00H - 3FH (0 - 63) Performance Change  
pp = 40H - 7FH (64 - 127) Volume Load

Volume load is ignored if current drive is not a hard disk drive or MO disk drive to which the SYS-772 Ver.2.0 can load and if the current drive does not contain a loadable volume file.

● Pitch Bend Change

<u>Status</u>	<u>Second</u>	<u>Third</u>	
EnH	11H	mmH	
n = MIDI Channel	:0H - FH (0 - 15)	0=ch. 1	15=ch. 16
mm, 11 = Value	:00H, 00H - 40H, 00H - 7FH, 7FH		
	(-8192 - 0 - +8191)		

■ Channel Mode Message

● All Note Off

<u>Status</u>	<u>Second</u>	<u>Third</u>	
BnH	7BH	00H	
n = MIDI Channel	:0H - FH (0 - 15)	0 = ch. 1	15 = ch. 16

\* Turns off all MIDI keys on the corresponding MIDI channel except that the damper on has been received. In such a case MIDI-on keys are held on until the damper off is received.

● OMMO OFF

<u>Status</u>	<u>Second</u>	<u>Third</u>	
BnH	7CH	00H	
n = MIDI Channel	:0H - FH (0 - 15)	0 = ch. 1	15 = ch. 16

\* Will act the same as all note off.

● OMNI ON

<u>Status</u>	<u>Second</u>	<u>Third</u>	
BnH	7DH	00H	
n = MIDI Channel	:0H - FH (0 - 15)	0 = ch. 1	15 = ch. 16

\* Will act the same as all note off.

● MONO

<u>Status</u>	<u>Second</u>	<u>Third</u>	
BnH	7EH	mmH	
n = MIDI Channel	:0H - FH (0 - 15)	0 = ch. 1	15 = ch. 16
mm = Mono Channel Range	:Ignored		

\* Will act the same as all note off.

● POLY

<u>Status</u>	<u>Second</u>	<u>Third</u>	
BnH	7FH	00H	
n = MIDI Channel	:0H - FH (0 - 15)	0 = ch. 1	15 = ch. 16

\* Will act the same as all note off.

■ System Exclusive Message

<u>Status</u>	
FOH	:System Exclusive
F7H	:EOX ( End Of Exclusive )

\* For details refer to "Roland Exclusive Message" and Section 3.

■ System Real Time Message

● Active Sensing

<u>Status</u>
FEH

\* When SYS-772 Ver.2.0 receives Active sensing, it measures time intervals between incoming messages. If the subsequent message has not come within 300 ms after the previous one, SYS-772 Ver.2.0 judges that there is some trouble on MIDI/path (broken wiring, etc.) and turns off all MIDI-on notes and then returns to normal operation mode (will not check MIDI message interval).

## 2. TRANSMITTED DATA

### ■ System Exclusive Message

Status	
F0H	:System Exclusive
F7H	:EOX (End Of Exclusive)

\* For details refer to "Roland Exclusive Message" and Section 3.

## 3. Exclusive Communications

### ■ Exclusive Messages Handled by SYS-772 Ver. 2.0

The SYS-772 Ver. 2.0 transfers the following messages as exclusive messages.

#### ● System Exclusive Message (in special format designed by Roland) Sound Parameter Information and others

#### ● Universal System Exclusive Message (in MIDI standard format) Sample Dump Standard (Sampling data body)

### ■ System Exclusive Message

#### ● General

With the SYS-772 Ver. 2.0 the system exclusive message can be used to transmit sound parameter and some other information. Exclusive message can be used in two ways: one way communications and handshake communications, each in different format from the other.

#### ● Terminology

##### ○ Model ID

The model ID of the SYS-772 Ver. 2.0.0 is 34H.

##### ○ Control Channel

This is the channel used to control entire SYS-772 Ver. 2.0. The channel can be set to 1-16.

##### ○ Unit Number

Parameters like MIDI Channel are not available in Exclusive message. Therefore, separate parameters are provided for controlling various parameters.

Parameter	Value
Control Channel	1-16 or OFF
Unit Number	17-32 or 1-32

\* When unit number is 1-16, its value is synchronized with that of control channel. When the unit number is 17-32, the value can be set independently.

##### ○ Device ID

Device ID is set to a value smaller than the unit number by one.

With Roland exclusive message, the device ID is used which contains a unique value that identifies the individual device in the multiple implementation of MIDI instruments. It is usually set to 00H-1FH, a value smaller by one than that of a basic channel (MIDI note information receiving channel). With multiple basic channel unit like the SYS-772 Ver. 2.0, a value is set to 001H-1FH.

### ● One-way Communications

#### ○ Request Data RQ1 11H

When the SYS-772 Ver. 2.0 receives this message, it first checks whether the specified address matches the parameter base address and the specified address size is all even numbers beginning with 2. When these checks are satisfactory, it sends the corresponding parameter by using the Data Set 1 (DT1) message. The SYS-772 Ver. 2.0 does not send this message.

Byte	Description
F0H	Exclusive Status
41H	Manufacturer ID (Roland)
DEV	Device ID
34H	Model ID
11H	Command ID (RQ1)
aaH	Address MSB *3-1
aaH	Address
aaH	Address
aaH	Address LSB
ssH	Size MSB
ssH	Size
ssH	Size
ssH	Size
ssH	Size LSB
sum	Checksum
F7H	EOX (End Of Exclusive)

#### ○ Data Set DT1 12H

◇ The SYS-772 Ver. 2.0 accepts this message when the following conditions are met.

Matches the MIDI unit number of the MIDI function; and the address specified corresponds to the parameter base address. The SYS-772 Ver. 2.0 stores the received data into location starting with this address.

◇ The SYS-772 Ver. 2.0 transmits this message in the following case.

Having received the request data (RQ1) and to send the data specified by the RQ1.

For details of parameters to be transferred, refer to the parameter address map.

Byte	Description
F0H	Exclusive Status
41H	Manufacturer ID (Roland)
DEV	Device ID
34H	Model ID
12H	Command ID (DT1)
aaH	Address MSB *3-1
aaH	Address
aaH	Address
aaH	Address LSB
ddH	Data
:	
sum	Checksum
F7H	EOX (End Of Exclusive)

### ● Handshake Communications

#### ○ Want to Send Data WSD 40H

When SYS-772 Ver. 2.0 receives this message, it transmits acknowledge (ACK) and waits a Data Set (DAT) message.

Byte	Description
F0H	Exclusive Status
41H	Manufacturer ID (Roland)
DEV	Device ID
34H	Model ID
12H	Command ID (DT1)
aaH	Address MSB *3-1
aaH	Address
aaH	Address
aaH	Address LSB
ssH	Size MSB
ssH	Size
ssH	Size
ssH	Size
ssH	Size LSB
sum	Checksum
F7H	EOX (End Of Exclusive)

○ Request Data RQD 41H

When the SYS-772 Ver.2.0 receives this message, it first checks whether the specified address matches the parameter base address and the specified address sizes all even numbers beginning with 2. When these checks are satisfactory, it sends the corresponding parameter by using the Data Set (DAT) message.

The SYS-772 Ver.2.0 does not send this message.

Byte	Description
F0H	Exclusive Status
41H	Manufacturer ID (Roland)
DEV	Device ID
34H	Model ID
41H	Command ID (RQD)
aaH	Address MSB *3-1
aaH	Address
aaH	Address
aaH	Address LSB
ssH	Size MSB
ssH	Size
ssH	Size
ssH	Size LSB
sum	Checksum
F7H	EOX (End Of Exclusive)

○ Data Set DAT 42H

When SYS-772 Ver.2.0 receives this message and the address specified corresponds to the parameter base address, it stores the received data into location starting with this address.

When SYS-772 Ver.2.0 receives this message, it sends data located within the specified start address and subsequent length of address size, along with the parameter base address.

Byte	Description
F0H	Exclusive Status
41H	Manufacturer ID (Roland)
DEV	Device ID
34H	Model ID
42H	Command ID (DAT)
aaH	Address MSB *3-1
aaH	Address
aaH	Address
aaH	Address LSB
ddH	Data
:	
sum	Checksum
F7H	EOX (End Of Exclusive)

○ Acknowledge ACK 43H

When the SYS-772 Ver.2.0 receives this message in response to Data Set (DAT), it sends the next data following the data sent in the previous Data Set message, also using Data Set. When the SYS-772 Ver.2.0 receives this message in response to End Of Data (EOD), it terminates handshake communication. The SYS-772 Ver.2.0 sends this message upon receiving Want to send data (WSD), Endo of data or Data set (DAT).

Byte	Description
F0H	Exclusive Status
41H	Manufacturer ID (Roland)
DEV	Device ID
34H	Model ID
43H	Command ID (ACK)
F7H	EOX (End Of Exclusive)

○ End Of Data EOD 45H

When the SYS-772 Ver.2.0 receives this message, it terminates handshake communication by sending an acknowledge.

The SYS-772 Ver.2.0 sends this message when the data is end during bulk dumping.

Byte	Description
F0H	Exclusive Status
41H	Manufacturer ID (Roland)
DEV	Device ID
34H	Model ID
45H	Command ID (EOD)
F7H	EOX (End Of Exclusive)

○ Communication Error ERR 4EH

The SYS-772 Ver.2.0 sends this message upon detecting receiving error (checksum fails).

Upon receiving this message, the SYS-772 Ver.2.0 sends rejection and then terminates handshake communication.

Byte	Description
F0H	Exclusive Status
41H	Manufacturer ID (Roland)
DEV	Device ID
34H	Model ID
4EH	Command ID (ERR)
F7H	EOX (End Of Exclusive)

○ Rejection RJC 4FH

The SYS-772 Ver.2.0 sends this message upon receiving a communication error.

Upon receiving this message, the SYS-772 Ver.2.0 terminates current communications.

Byte	Description
F0H	Exclusive Status
41H	Manufacturer ID (Roland)
DEV	Device ID
34H	Model ID
4FH	Command ID (RJC)
F7H	EOX (End Of Exclusive)

● Parameter Address Map

Address is in Hex. and in unit of 7 bits.

Address	MSB			LSB
Binary	0aaa aaaa	0bbb bbbb	0ccc cccc	0ddd dddd
7 bit Hex	AA	BB	CC	DD

Actual address is the start address of a block plus offset address.

\*3-1 Address and Size must specify a location in which data exist.

● Parameter Base Address

○ Temporary Area

Size should not cover more than one parameter area.

Start address	Size	Description
00 00 00 00	64 x 1	Volume Parameter
00 01 00 00	512 x 64	Performance Parameter
00 04 00 00	512 x 128	Patch Parameter
00 08 00 00	256 x 255	Partial Parameter *
00 0C 00 00	96 x 512	Sample Parameter
00 0E 7F 7F		End address

\* Do not execute Data Set command to the 256th Partial with exclusive communications.

○ Table 1: Volume Parameter.

Offset address	Description
00 00H   0000 aaaa	Volume Name 1
00 01H   0000 bbbb	aaaa bbbb 32 - 127 (ASCII)
:	
00 1EH   0000 aaaa	Volume Name 16
00 1FH   0000 bbbb	aaaa bbbb 32 - 127 (ASCII)

○ Table 2: Performance Parameter.

Offset address	Description
00 00H   0000 aaaa	Performance Name 1
00 01H   0000 bbbb	aaaa bbbb 32 - 127 (ASCII)
:	
00 1EH   0000 aaaa	Performance Name 16
00 1FH   0000 bbbb	aaaa bbbb 32 - 127 (ASCII)
00 20H   0000 aaaa	Part 1 Patch Select
00 21H   0000 bbbb	aaaa bbbb 0 - 127, Off (FF)
:	
00 5EH   0000 aaaa	Part 32 Patch Select
00 5FH   0000 bbbb	aaaa bbbb 0 - 127, Off (FF)
00 60H   0000 aaaa	Part 2 MIDI Ch
00 61H   0000 aaaa	aaaa 0 - 15
:	
00 7EH   0000 aaaa	Part 32 MIDI Ch
00 7FH   0000 aaaa	aaaa 0 - 15
01 00H   0000 caaa	Part 1 Level
01 01H   0000 bbbb	caaa bbbb 0 - 127 (C=0: MIDI Ch Off, C=1: MIDI Ch On)
:	
01 3EH   0000 caaa	Part 32 Level
01 3FH   0000 bbbb	caaa bbbb 0 - 127 (C=0: MIDI Ch Off, C=1: MIDI Ch On)
01 40H   0000 aaaa	Part 1 Zone Range Lower
01 41H   0000 bbbb	aaaa bbbb 0 - 127
:	
01 7EH   0000 aaaa	Part 32 Zone Range Lower
01 7FH   0000 bbbb	aaaa bbbb 0 - 127
02 00H   0000 aaaa	Part 1 Zone Range Upper
02 01H   0000 bbbb	aaaa bbbb 0 - 127
:	
02 3EH   0000 aaaa	Part 32 Zone Range Upper
02 3FH   0000 bbbb	aaaa bbbb 0 - 127
02 40H   0000 aaaa	Part 1 Zone Fade Width Lower
02 41H   0000 bbbb	aaaa bbbb 0 - 127
:	
02 7EH   0000 aaaa	Part 32 Zone Fade Width Lower
02 7FH   0000 bbbb	aaaa bbbb 0 - 127
03 00H   0000 aaaa	Part 1 Zone Fade Width Upper
03 01H   0000 bbbb	aaaa bbbb 0 - 127
:	
03 3EH   0000 aaaa	Part 32 Zone Fade Width Upper
03 3FH   0000 bbbb	aaaa bbbb 0 - 127
03 40H   0000 hgfe	Program Change Switch
03 41H   0000 dcba	a Ch 1
03 42H   0000 ponm	: 0:Off 1:On
03 43H   0000 lkji	p Ch 16
03 44H   0000 hgfe	Pitch Bender & Bend Range Switch
03 45H   0000 dcba	a Ch 1

03 46H   0000 ponm	:	0:Off 1:On
03 47H   0000 lkji	p Ch 16	
03 48H   0000 hgfe	Modulation Switch	
03 49H   0000 dcba	a Ch 1	
03 4AH   0000 ponm	:	0:Off 1:On
03 4BH   0000 lkji	p Ch 16	
03 4CH   0000 hgfe	Hold Pedal Switch	
03 4DH   0000 dcba	a Ch 1	
03 4EH   0000 ponm	:	0:Off 1:On
03 4FH   0000 lkji	p Ch 16	
03 50H   0000 hgfe	Phase Lock Switch	
03 51H   0000 dcba	a Ch 1	
03 52H   0000 ponm	:	0:Off 1:On
03 53H   0000 lkji	p Ch 16	
03 54H   0000 hgfe	MIDI Volume Switch	
03 55H   0000 dcba	a Ch 1	
03 56H   0000 ponm	:	0:Off 1:On
03 57H   0000 lkji	p Ch 16	
03 58H   0000 hgfe	After Touch Switch	
03 59H   0000 dcba	a Ch 1	
03 5AH   0000 ponm	:	0:Off 1:On
03 5BH   0000 lkji	p Ch 16	
03 5CH   0000 hgfe	After Touch Mode	
03 5DH   0000 dcba	a Ch 1	
03 5EH   0000 ponm	:	0:Ch 1:Poly (0ExH) (0AxH)
03 5FH   0000 lkji	p Ch 16	
03 60H   0000 aaaa	Vel Curve Type Ch 1	
03 61H   0000 bbbb	aaaa bbbb 0 - 4	
:		
03 7EH   0000 aaaa	Vel Curve Type Ch 16	
03 7FH   0000 bbbb	aaaa bbbb 0 - 4	
Total size		00 04 00H

○ Table 3: Patch Parameter.

Offset address	Description
00 00H   0000 aaaa	Patch Name 1
00 01H   0000 bbbb	aaaa bbbb 32 - 127 (ASCII)
:	
00 1EH   0000 aaaa	Patch Name 16
00 1FH   0000 bbbb	aaaa bbbb 32 - 127 (ASCII)
00 20H   0000 aaaa	Program Change #
00 21H   0000 bbbb	aaaa bbbb 0 - 127
00 22H   0000 aaaa	Stereo MIX Level
00 23H   0000 bbbb	aaaa bbbb 0 - 127
00 24H   0000 aaaa	Total Panning
00 25H   0000 bbbb	aaaa bbbb -32 - -1 : L32 - L1 0 : Center 1 - 32 : R1 - R32
00 26H   0000 aaaa	Patch Level
00 27H   0000 bbbb	aaaa bbbb 0 - 127
00 28H   0000 aaaa	Output Assign
00 29H   0000 bbbb	aaaa bbbb -1 : Off 0 - 5 : 1 - 6 6 : Partial
00 2AH   0000 aaaa	Priority
00 2BH   0000 bbbb	aaaa bbbb 0 : Off 1 : On
00 2CH   0000 aaaa	Cutoff
00 2DH   0000 bbbb	aaaa bbbb -63 - +63
00 2EH   0000 aaaa	Velocity Sense
00 2FH   0000 bbbb	aaaa bbbb -63 - +63



00 30H	0000	aaaa	Octave Shift	
00 31H	0000	bbbb	aaaa bbbb	-2 - +2
00 32H	0000	aaaa	Coarse Tune	
00 33H	0000	bbbb	aaaa bbbb	-48 - +48
00 34H	0000	aaaa	Fine Tune	
00 35H	0000	bbbb	aaaa bbbb	-50 - +50
00 36H	0000	aaaa	SMT Ctrl Select	
00 37H	0000	bbbb	aaaa bbbb	-1 : Off 0 : Bend 1 : A.T 2 : Mod 3 : Ctrl
00 38H	0000	aaaa	SMT Ctrl Sense	
00 39H	0000	bbbb	aaaa bbbb	-63 - +63
00 3AH	0000	aaaa	Out Assign (8outs Mode)	
00 3BH	0000	bbbb	aaaa bbbb	-1 : Off 0 - 7 : 1 - 8 8 : Partial
00 3CH	0000	aaaa	Analog Feel	
00 3DH	0000	bbbb	aaaa bbbb	0 - 127
00 3EH	0000	aaaa	Dummy	
00 3FH	0000	bbbb	aaaa bbbb	
00 40H	0000	aaaa	Partial Select Key # 21	
00 41H	0000	bbbb	aaaa bbbb	0 - 254
:				
01 6EH	0000	aaaa	Partial Select Key # 108	
01 6FH	0000	bbbb	aaaa bbbb	0 - 254
01 70H	0000	aaaa	Dummy	
01 71H	0000	bbbb	aaaa bbbb	
:				
01 7EH	0000	aaaa	Dummy	
01 7FH	0000	bbbb	aaaa bbbb	
02 00H	0000	aaaa	Assign Type	Key # 21
02 01H	0000	bbbb	aaaa bbbb	
:				
03 2EH	0000	aaaa	Assign Type	Key # 108
03 2FH	0000	bbbb	aaaa bbbb	0 : Poly 1 : Mono 2 - 17 : Ext 1 - Ext 16
03 30H	0000	aaaa	Dummy	
03 31H	0000	bbbb	aaaa bbbb	
:				
03 3EH	0000	aaaa	Dummy	
03 3FH	0000	bbbb	aaaa bbbb	
03 40H	0000	aaaa	Bender Pitch Ctrl Up	
03 41H	0000	bbbb	aaaa bbbb	0 - +48
03 42H	0000	aaaa	Bender Pitch Ctrl Down	
03 43H	0000	bbbb	aaaa bbbb	0 - +48
03 44H	0000	aaaa	Bender TVA Ctrl	
03 45H	0000	bbbb	aaaa bbbb	-63 - +63
03 46H	0000	aaaa	Bender TVF Ctrl	
03 47H	0000	bbbb	aaaa bbbb	-63 - +63
03 48H	0000	aaaa	After Touch Pitch Ctrl	
03 49H	0000	bbbb	aaaa bbbb	-48 - +48
03 4AH	0000	aaaa	After Touch TVA Ctrl	
03 4BH	0000	bbbb	aaaa bbbb	-63 - +63
03 4CH	0000	aaaa	After Touch TVF Ctrl	
03 4DH	0000	bbbb	aaaa bbbb	-63 - +63
03 4EH	0000	aaaa	After Touch LFO Rate Ctrl	
03 4FH	0000	bbbb	aaaa bbbb	-63 - +63
03 50H	0000	aaaa	After Touch LFO Pitch Depth	
03 51H	0000	bbbb	aaaa bbbb	-63 - +63
03 52H	0000	aaaa	After Touch LFO TVA Depth	
03 53H	0000	bbbb	aaaa bbbb	-63 - +63
03 54H	0000	aaaa	After Touch LFO TVF Depth	
03 55H	0000	bbbb	aaaa bbbb	-63 - +63
03 56H	0000	aaaa	Modulation LFO Rate Ctrl	
03 57H	0000	bbbb	aaaa bbbb	-63 - +63
03 58H	0000	aaaa	Modulation LFO Pitch Depth	
03 59H	0000	bbbb	aaaa bbbb	-63 - +63
03 5AH	0000	aaaa	Modulation LFO TVA Depth	

03 5BH	0000	bbbb	aaaa bbbb	-63 - +63
03 5CH	0000	aaaa	Modulation LFO TVF Depth	
03 5DH	0000	bbbb	aaaa bbbb	-63 - +63
03 5EH	0000	aaaa	Dummy	
03 5FH	0000	bbbb	aaaa bbbb	
03 60H	0000	aaaa	Controller Select	
03 61H	0000	bbbb	aaaa bbbb	0 - 95
03 62H	0000	aaaa	Controller Pitch Ctrl	
03 63H	0000	bbbb	aaaa bbbb	-48 - +48
03 64H	0000	aaaa	Controller TVA Ctrl	
03 65H	0000	bbbb	aaaa bbbb	-63 - +63
03 66H	0000	aaaa	Controller TVF Ctrl	
03 67H	0000	bbbb	aaaa bbbb	-63 - +63
03 68H	0000	aaaa	Controller LFO Rate Ctrl	
03 69H	0000	bbbb	aaaa bbbb	-63 - +63
03 6AH	0000	aaaa	Controller LFO Pitch Depth	
03 6BH	0000	bbbb	aaaa bbbb	-63 - +63
03 6CH	0000	aaaa	Controller LFO TVA Depth	
03 6DH	0000	bbbb	aaaa bbbb	-63 - +63
03 6EH	0000	aaaa	Controller LFO TVF Depth	
03 6FH	0000	bbbb	aaaa bbbb	-63 - +63
03 70H	0000	aaaa	Dummy	
03 71H	0000	bbbb	aaaa bbbb	
:				
03 7EH	0000	aaaa	Dummy	
03 7FH	0000	bbbb	aaaa bbbb	
Total size			00 04 00H	

○Table 4: Partial Parameter

Offset address	Description
00 00H	0000 aaaa Partial Name 1
00 01H	0000 bbbb aaaa bbbb 32 - 127 (ASCII)
:	
00 1EH	0000 aaaa Partial Name 16
00 1FH	0000 bbbb aaaa bbbb 32 - 127 (ASCII)
00 20H	0000 cccc Sample 1 Sample Select
00 21H	0000 dddd aaaa bbbb cccc dddd 0 - 511, Off(-1)
00 22H	0000 aaaa
00 23H	0000 bbbb
00 24H	0000 aaaa Sample 1 Pitch KF
00 25H	0000 bbbb aaaa bbbb -16 - +16
00 26H	0000 aaaa Sample 1 Level
00 27H	0000 bbbb aaaa bbbb 0 - 127
00 28H	0000 aaaa Sample 1 Panning
00 29H	0000 bbbb aaaa bbbb -32 - -1 : L32 - L1 0 : Center 1 - 32 : R1 - R32 33 : Random 34 : Key+ 35 : Key-
00 2AH	0000 aaaa Sample 1 Coarse Tune
00 2BH	0000 bbbb aaaa bbbb -48 - +48
00 2CH	0000 aaaa Sample 1 Fine Tune
00 2DH	0000 bbbb aaaa bbbb -50 - +50
00 2EH	0000 aaaa Sample 1 SMT Vel Lower
00 2FH	0000 bbbb aaaa bbbb 0 - 127
00 30H	0000 aaaa Sample 1 SMT Lower Fade Width
00 31H	0000 bbbb aaaa bbbb 0 - 127
00 32H	0000 aaaa Sample 1 SMT Vel Upper
00 33H	0000 bbbb aaaa bbbb 0 - 127
00 34H	0000 aaaa Sample 1 SMT Upper Fade Width
00 35H	0000 bbbb aaaa bbbb 0 - 127
00 36H	0000 aaaa Dummy
00 37H	0000 bbbb aaaa bbbb
00 38H	0000 aaaa Output Assign (8outs Mode)
00 39H	0000 bbbb aaaa bbbb -1 : Off 0 - 7 : 1 - 8
00 3AH	0000 aaaa Stereo MIX Level
00 3BH	0000 bbbb aaaa bbbb 0 - 127

00 3CH	0000	aaaa	Partial Level	
00 3DH	0000	bbbb	aaaa bbbb	0 - 127
00 3EH	0000	aaaa	Output Assign	
00 3FH	0000	bbbb	aaaa bbbb	-1 : Off 0 - 5 : 1 - 6
00 40H	0000	cccc	Sample 2 Sample Select	
00 41H	0000	dddd	aaaa bbbb cccc dddd	0 - 511, Off(-1)
00 42H	0000	aaaa		
00 43H	0000	bbbb		
00 44H	0000	aaaa	Sample 2 Pitch KF	
00 45H	0000	bbbb	aaaa bbbb	-16 - +16
00 46H	0000	aaaa	Sample 2 Level	
00 47H	0000	bbbb	aaaa bbbb	0 - 127
00 48H	0000	aaaa	Sample 2 Panning	
00 49H	0000	bbbb	aaaa bbbb	-32 - -1 : L32 - L1 0 : Center 1 - 32 : R1 - R32 33 : Random 34 : Key+ 35 : Key-
00 4AH	0000	aaaa	Sample 2 Coarse Tune	
00 4BH	0000	bbbb	aaaa bbbb	-48 - +48
00 4CH	0000	aaaa	Sample 2 Fine Tune	
00 4DH	0000	bbbb	aaaa bbbb	-50 - +50
00 4EH	0000	aaaa	Sample 2 SMT Vel Lower	
00 4FH	0000	bbbb	aaaa bbbb	0 - 127
00 50H	0000	aaaa	Sample 2 SMT Lower Fade Width	
00 51H	0000	bbbb	aaaa bbbb	0 - 127
00 52H	0000	aaaa	Sample 2 SMT Vel Upper	
00 53H	0000	bbbb	aaaa bbbb	0 - 127
00 54H	0000	aaaa	Sample 2 SMT Upper Fade Width	
00 55H	0000	bbbb	aaaa bbbb	0 - 127
00 56H	0000	aaaa	Dummy	
00 57H	0000	bbbb	aaaa bbbb	
00 58H	0000	aaaa	Panning	
00 59H	0000	bbbb	aaaa bbbb	-32 - -1 : L32 - L1 0 : Center 1 - 32 : R1 - R32
00 5AH	0000	aaaa	Coarse Tune	
00 5BH	0000	bbbb	aaaa bbbb	-48 - +48
00 5CH	0000	aaaa	Fine Tune	
00 5DH	0000	bbbb	aaaa bbbb	-50 - +50
00 5EH	0000	aaaa	SMT Velocity Ctrl	
00 5FH	0000	bbbb	aaaa bbbb	0 : Off 1 : On
00 60H	0000	cccc	Sample 3 Sample Select	
00 61H	0000	dddd	aaaa bbbb cccc dddd	0 - 511, Off(-1)
00 62H	0000	aaaa		
00 63H	0000	bbbb		
00 64H	0000	aaaa	Sample 3 Pitch KF	
00 65H	0000	bbbb	aaaa bbbb	-16 - +16
00 66H	0000	aaaa	Sample 3 Level	
00 67H	0000	bbbb	aaaa bbbb	0 - 127
00 68H	0000	aaaa	Sample 3 Panning	
00 69H	0000	bbbb	aaaa bbbb	-32 - -1 : L32 - L1 0 : Center 1 - 32 : R1 - R32 33 : Random 34 : Key+ 35 : Key-
00 6AH	0000	aaaa	Sample 3 Coarse Tune	
00 6BH	0000	bbbb	aaaa bbbb	-48 - +48
00 6CH	0000	aaaa	Sample 3 Fine Tune	
00 6DH	0000	bbbb	aaaa bbbb	-50 - +50
00 6EH	0000	aaaa	Sample 3 SMT Vel Lower	
00 6FH	0000	bbbb	aaaa bbbb	0 - 127
00 70H	0000	aaaa	Sample 3 SMT Lower Fade Width	
00 71H	0000	bbbb	aaaa bbbb	0 - 127
00 72H	0000	aaaa	Sample 3 SMT Vel Upper	
00 73H	0000	bbbb	aaaa bbbb	0 - 127
00 74H	0000	aaaa	Sample 3 SMT Upper Fade Width	
00 75H	0000	bbbb	aaaa bbbb	0 - 127
00 76H	0000	aaaa	Dummy	
00 77H	0000	bbbb	aaaa bbbb	
:				
00 7EH	0000	aaaa	Dummy	
00 7FH	0000	bbbb	aaaa bbbb	
01 00H	0000	cccc	Sample 4 Sample Select	
01 01H	0000	dddd	aaaa bbbb cccc dddd	0 - 511, Off(-1)
01 02H	0000	aaaa		
01 03H	0000	bbbb		
01 04H	0000	aaaa	Sample 4 Pitch KF	
01 05H	0000	bbbb	aaaa bbbb	-16 - +16
01 06H	0000	aaaa	Sample 4 Level	
01 07H	0000	bbbb	aaaa bbbb	0 - 127
01 08H	0000	aaaa	Sample 4 Panning	
01 09H	0000	bbbb	aaaa bbbb	-32 - -1 : L32 - L1 0 : Center 1 - 32 : R1 - R32 33 : Random 34 : Key+ 35 : Key-
01 0AH	0000	aaaa	Sample 4 Coarse Tune	
01 0BH	0000	bbbb	aaaa bbbb	-48 - +48
01 0CH	0000	aaaa	Sample 4 Fine Tune	
01 0DH	0000	bbbb	aaaa bbbb	-50 - +50
01 0EH	0000	aaaa	Sample 4 SMT Vel Lower	
01 0FH	0000	bbbb	aaaa bbbb	0 - 127
01 10H	0000	aaaa	Sample 4 SMT Lower Fade Width	
01 11H	0000	bbbb	aaaa bbbb	0 - 127
01 12H	0000	aaaa	Sample 4 SMT Vel Upper	
01 13H	0000	bbbb	aaaa bbbb	0 - 127
01 14H	0000	aaaa	Sample 4 SMT Upper Fade Width	
01 15H	0000	bbbb	aaaa bbbb	0 - 127
01 16H	0000	aaaa	TVF Filter Mode	
01 17H	0000	bbbb	aaaa bbbb	-1 : Off 0 : LPF 1 : BPF 2 : HPF
01 18H	0000	aaaa	TVF Cutoff	
01 19H	0000	bbbb	aaaa bbbb	0 - 127
01 1AH	0000	aaaa	TVF Resonance	
01 1BH	0000	bbbb	aaaa bbbb	0 - 127
01 1CH	0000	aaaa	TVF Vel Curve Type	
01 1DH	0000	bbbb	aaaa bbbb	0 - 3
01 1EH	0000	aaaa	TVF Vel Curve Sens	
01 1FH	0000	bbbb	aaaa bbbb	-63 - +63
01 20H	0000	aaaa	TVF Time Vel Sense	
01 21H	0000	bbbb	aaaa bbbb	-63 - +63
01 22H	0000	aaaa	TVF Cutoff Vel Sense	
01 23H	0000	bbbb	aaaa bbbb	-63 - +63
01 24H	0000	aaaa	TVF Level 0.4	
01 25H	0000	bbbb	aaaa bbbb	0 - 127
01 26H	0000	aaaa	TVF Level 1	
01 27H	0000	bbbb	aaaa bbbb	0 - 127
01 28H	0000	aaaa	TVF Level 2	
01 29H	0000	bbbb	aaaa bbbb	0 - 127
01 2AH	0000	aaaa	TVF Level 3	
01 2BH	0000	bbbb	aaaa bbbb	0 - 127
01 2CH	0000	aaaa	TVF Time 1	
01 2DH	0000	bbbb	aaaa bbbb	0 - 127
01 2EH	0000	aaaa	TVF Time 2	
01 2FH	0000	bbbb	aaaa bbbb	0 - 127
01 30H	0000	aaaa	TVF Time 3	
01 31H	0000	bbbb	aaaa bbbb	0 - 127
01 32H	0000	aaaa	TVF Time 4	
01 33H	0000	bbbb	aaaa bbbb	0 - 127
01 34H	0000	aaaa	ENV TVF Depth	
01 35H	0000	bbbb	aaaa bbbb	-63 - +63
01 36H	0000	aaaa	ENV Pitch Depth	
01 37H	0000	bbbb	aaaa bbbb	-63 - +63
01 38H	0000	aaaa	TVF KF Point	
01 39H	0000	bbbb	aaaa bbbb	21 - 108

01 3AH	0000	aaaa	ENV Time KF	
01 3BH	0000	bbbb	aaaa bbbb	-63 - +63
01 3CH	0000	aaaa	Dummy	
01 3DH	0000	bbbb	aaaa bbbb	-63 - +63
01 3EH	0000	aaaa	Dummy	
01 3FH	0000	bbbb	aaaa bbbb	
01 40H	0000	aaaa	TVA Vel Curve Type	
01 41H	0000	bbbb	aaaa bbbb	0 - 3
01 42H	0000	aaaa	TVA Vel Curve Ratio	
01 43H	0000	bbbb	aaaa bbbb	-63 - +63
01 44H	0000	aaaa	TVA Time Vel Sense	
01 45H	0000	bbbb	aaaa bbbb	-63 - +63
01 46H	0000	aaaa	Dummy	
01 47H	0000	bbbb	aaaa bbbb	0 - 127
01 48H	0000	aaaa	TVA Level 1	
01 49H	0000	bbbb	aaaa bbbb	0 - 127
01 4AH	0000	aaaa	TVA Level 2	
01 4BH	0000	bbbb	aaaa bbbb	0 - 127
01 4CH	0000	aaaa	TVA Level 3	
01 4DH	0000	bbbb	aaaa bbbb	0 - 127
01 4EH	0000	aaaa	TVA Time 1	
01 4FH	0000	bbbb	aaaa bbbb	0 - 127
01 50H	0000	aaaa	TVA Time 2	
01 51H	0000	bbbb	aaaa bbbb	0 - 127
01 52H	0000	aaaa	TVA Time 3	
01 53H	0000	bbbb	aaaa bbbb	0 - 127
01 54H	0000	aaaa	TVA Time 4	
01 55H	0000	bbbb	aaaa bbbb	0 - 127
01 56H	0000	aaaa	Dummy	
01 57H	0000	bbbb	aaaa bbbb	
01 58H	0000	aaaa	TVA KF Point	
01 59H	0000	bbbb	aaaa bbbb	21 - 108
01 5AH	0000	aaaa	TVA ENV Time KF	
01 5BH	0000	bbbb	aaaa bbbb	-63 - +63
01 5CH	0000	aaaa	Dummy	
01 5DH	0000	bbbb	aaaa bbbb	
01 5EH	0000	aaaa	TVA Level KF	
01 5FH	0000	bbbb	aaaa bbbb	-63 - +63
01 60H	0000	aaaa	LFO Wave Form	
01 61H	0000	bbbb	aaaa bbbb	0 : Sin 1 : Tri 2 : Saw+ 3 : Saw- 4 : Squ 5 : Rnd 6 : Bend+ 7 : Bend-
01 62H	0000	aaaa	LFO Rate	
01 63H	0000	bbbb	aaaa bbbb	0 - 127
01 64H	0000	aaaa	LFO Key Sync	
01 65H	0000	bbbb	aaaa bbbb	0 : Off 1 : On
01 66H	0000	aaaa	LFO Delay	
01 67H	0000	bbbb	aaaa bbbb	0 - 127
01 68H	0000	aaaa	LFO Delay KF	
01 69H	0000	bbbb	aaaa bbbb	0 - 63
01 6AH	0000	aaaa	LFO Detune	
01 6BH	0000	bbbb	aaaa bbbb	0 - 127
01 6CH	0000	aaaa	LFO Pitch Mod Depth	
01 6DH	0000	bbbb	aaaa bbbb	-63 - +63

01 6EH	0000	aaaa	LFO TVF Mod Depth	
01 6FH	0000	bbbb	aaaa bbbb	-63 - +63
01 70H	0000	aaaa	LFO TVA Mod Depth	
01 71H	0000	bbbb	aaaa bbbb	-63 - +63
01 72H	0000	aaaa	Dummy	
01 73H	0000	bbbb	aaaa bbbb	
:				
01 7EH	0000	aaaa	Dummy	
01 7FH	0000	bbbb	aaaa bbbb	
Total size			00 02 00H	

Table 5: Sample Parameter

Offset address	Description
00 00H   0000 aaaa	Sample Name 1
00 01H   0000 bbbb	aaaa bbbb 32 - 127 (ASCII)
:	
00 1EH   0000 aaaa	Sample Name 16
00 1FH   0000 bbbb	aaaa bbbb 32 - 127 (ASCII)
:	
00 20H   0000 gggg	Start Point
00 21H   0000 hhhh	
00 22H   0000 eeee	aaaa bbbb cccc dddd
00 23H   0000 ffff	eeee ffff.gggg hhhh
00 24H   0000 cccc	
00 25H   0000 dddd	7000000H - FFFFFFFFH
00 26H   0000 aaaa	
00 27H   0000 bbbb	
:	
00 28H   0000 gggg	Sustine Loop Start Point
00 29H   0000 hhhh	
00 2AH   0000 eeee	aaaa bbbb cccc dddd
00 2BH   0000 ffff	eeee ffff.gggg hhhh
00 2CH   0000 cccc	
00 2DH   0000 dddd	7000000H - FFFFFFFFH
00 2EH   0000 aaaa	
00 2FH   0000 bbbb	
:	
00 30H   0000 gggg	Sustine Loop End Point
00 31H   0000 hhhh	
00 32H   0000 eeee	aaaa bbbb cccc dddd
00 33H   0000 ffff	eeee ffff.gggg hhhh
00 34H   0000 cccc	
00 35H   0000 dddd	7000000H - FFFFFFFFH
00 36H   0000 aaaa	
00 37H   0000 bbbb	
:	
00 38H   0000 gggg	Release Loop Start Point
00 39H   0000 hhhh	
00 3AH   0000 eeee	aaaa bbbb cccc dddd
00 3BH   0000 ffff	eeee ffff.gggg hhhh
00 3CH   0000 cccc	
00 3DH   0000 dddd	7000000H - FFFFFFFFH
00 3EH   0000 aaaa	
00 3FH   0000 bbbb	
:	
00 40H   0000 gggg	Release Loop End Point
00 41H   0000 hhhh	
00 42H   0000 eeee	aaaa bbbb cccc dddd
00 43H   0000 ffff	eeee ffff.gggg hhhh
00 44H   0000 cccc	
00 45H   0000 dddd	7000000H - FFFFFFFFH
00 46H   0000 aaaa	
00 47H   0000 bbbb	
:	
00 48H   0000 aaaa	Loop Mode
00 49H   0000 bbbb	aaaa bbbb 0 : Forward 1 : Fwd+R 2 : OneShot 3 : Fwd+One 4 : Alt 5 : Rev One 6 : Rev
:	
00 4AH   0000 aaaa	dummy
00 4BH   0000 bbbb	aaaa bbbb

00 4CH	0000 aaaa	Sustine Loop Tune	
00 4DH	0000 bbbb	aaaa bbbb	-50 - +50
00 4EH	0000 aaaa	Release Loop Tune	
00 4FH	0000 bbbb	aaaa bbbb	-50 - +50
00 50H	0000 aaaa	Segment Top	
00 51H	0000 bbbb	aaaa bbbb cccc dddd	0 - 2044
00 52H	0000 cccc		
00 53H	0000 dddd		
00 54H	0000 aaaa	Segment Length	
00 55H	0000 bbbb	aaaa bbbb cccc dddd	0 - 2045
00 56H	0000 cccc		
00 57H	0000 dddd		
00 58H	0000 aaaa	Sampling Frequency	
		aaaa	0 : 48k 1 : 24k 2 : 44.1k 3 : 22.05k 4 : 30k 5 : 15k
00 59H	0000 aaaa	dummy	
		aaaa	
00 5AH	0000 aaaa	Original Key	
00 5BH	0000 bbbb	aaaa bbbb	21 - 108
00 5CH	0000 aaaa	Dummy	
00 5DH	0000 bbbb	aaaa bbbb	
00 5EH	0000 aaaa	Dummy	
00 5FH	0000 bbbb	aaaa bbbb	
Total size		00 00 60H	

Address Map

address	Block	Sub Block	Reference
00-00-00-00	Volume Parameter		Table 1
00-01-00-00	Performance Parameter	Performance #1 Performance #2 : Performance #64	Table 2
00-04-00-00	Patch Parameter	Patch # 1 Patch # 2 : Patch #128	Table 3
00-08-00-00	Partial Parameter	Partial # 1 Partial # 2 : Partial #256	Table 4
00-0C-00-00	Sample Parameter	Sample # 1 Sample # 2 : Sample #512	Table 5
00-0E-7F-7F			

■ Universal System Exclusive Message

● Sample Dump Standard

With sample dump standard, the following messages are used to transfer data.

○ Dump Request

This command requires the sample specified by the number is to be sent. When the SYS-772 Ver.2.0 receives this command, it first performs checksum of the sample number to see it is within the valid range. If legal, it sends the required data to the command sender. If illegal, the SYS-772 Ver.2.0 ignores this command.

The SYS-772 Ver.2.0 will not send this message.

Byte	Description
FOH	Exclusive Status
7EH	Sample Dump Command
cCH	Channel Number
03H	Command ID (Dump Req)
ss ss	Request Sample (LSB first)
F7H	EOX

\* Channel Number is the device ID of the System Exclusive Message.

○ Dump Header

The SYS-772 Ver.2.0 the Dump header when it receives the request dump or it wants to start dump. It terminates dumping upon receiving a cancel. The SYS-772 Ver.2.0 starts data transfer upon receiving an ACK and will stop sending upon receiving a Wait until it receives the next message. If the SYS-772 Ver.2.0 has not received any message from the receiving party within 2 seconds after it sent the dump header, it judges the current communication is open loop (one-way communications) and starts data transmission again.

When the SYS-772 Ver.2.0 receives this message, it checks whether the memory has more space to accommodate the data and whether the start and end points of sustain loop are correct. If everything is OK to accept the data, it sends ACK and waits for data packet. If not OK, sends a cancel message.

Byte	Description
FOH	Exclusive Status
7EH	Sample Dump Command
cCH	Channel Number
01H	Command ID (Dump Head)
ss ss	Request Sample (LSB first)
10H	Sample Format (16 bits)
ff ff ff	Sample Period (1/sampling rate nS)
gg gg gg	Data(word) Length
hh hh hh	Sustain Loop Start Point (word number)
ii ii ii	Sustain Loop End Point (word number)
jjH	Loop Type 00H = Forwards only (unidirectional) 01H = Backwards/Forwards (bi-directional) 7FH = Off
F7H	EOX

\* Channel Number is the Device ID of the System Exclusive Message.

○ **Data Packet**

Data is sent in a form of 7 bits, at 3 bytes/word (40 words/packet), left justified, upper byte first with a "0" placed at lower 5th bit of the 3rd byte of a word.

Upon receiving the data packet, the SYS-772 Ver.2.0 checks the checksum: when checksum agrees, it sends ACK and waits for the next packet; if not, sends NAK and requests retransmission of the previous packet.

When the SYS-772 Ver.2.0 receives Cancel message after sending the data packet, it immediately stops dumping; when receives ACK, it sends the next data packet; when receives Wait, it will not send until it receives the next message.

Byte	Description
FOH	Exclusive • Status
7EH	Sample Dump Command
ccH	Channel Number
02H	Command ID (Data Packet)
ppH	Packet Number
:	}
:	}
:	} 120 Byte • Data
:	}
:	}
11H	Checksum
F7H	EOX

\* Channel Number is the Device ID of the System Exclusive Message.

○ **ACK**

This handshake flag is sent out when no error was detected on reception of the last packet and the next data is requested to be sent. The Packet Number is the last packet received correctly.

Byte	Description
FOH	Exclusive • Status
7EH	Sample Dump Command
ccH	Channel Number
7FH	Command ID (ACK)
ppH	Packet Number
F7H	EOX

\* Channel Number is the device ID of the System Exclusive Message.

○ **NAK**

This handshake flag is sent out when error was detected on reception of the last packet and the same data is requested to be sent again. The Packet Number is the last packet failed to be received.

Byte	Description
FOH	Exclusive • Status
7EH	Sample Dump Command
ccH	Channel Number
7EH	Command ID (NAK)
ppH	Packet Number
F7H	EOX

\* Channel Number is the device ID of the System Exclusive Message.

○ **Cancel**

This is a handshake flag indicating that the current dump is cancelled. The Packet Number is the packet number cancelled. The cause of this transmission may be overflow at the receiving memory.

Byte	Description
FOH	Exclusive • Status
7EH	Sample Dump Command
ccH	Channel Number
7DH	Command ID (Cancel)
ppH	Packet Number
F7H	EOX

\* Channel Number is the device ID of the System Exclusive Message.

○ **Wait**

This is a handshake flag inhibiting packet transmission until another message requiring transmission is issued. The Packet Number represents the packet that was not received. This flag is sent out when the receiving device requires a time to become ready for the next reception. An ACK is used to resume transfer; and Cancel is used to cancel the current transmission.

The SYS-772 Ver.2.0 will not send this message.

Byte	Description
FOH	Exclusive • Status
7EH	Sample Dump Command
ccH	Channel Number
7CH	Command ID (Wait)
ppH	Packet Number
F7H	EOX

\* Channel Number is the device ID of the System Exclusive Message.

# MIDI Implementation Chart

Function ...		Transmitted	Recognized	Remarks
Basic Channel	Default Changed	× ×	1 - 16, OFF * 4 1 - 16, OFF * 4	* 2
Mode	Default Messages Altered	× × *****	3 × ×	
Note Number	True Voice	× *****	21 - 108 21 - 108	* 3
Velocity	Note ON Note OFF	× ×	* 1 ×	v = 1 - 127
After Touch	Key's Ch's	× ×	* 1 * 1	
Pitch Bend		×	* 1	
Control Change	1	×	* 1	Modulation Volume Hold 1 * 5 RPN LSB, MSB Data Entry LSB, MSB RPN = 0 Pitch Bend Sensitivity RPN = 1 Master Tune
	7	×	* 1	
	64	×	* 1	
	0 - 95	×	* 1	
	100, 101	×	×	
	6, 38	×	×	
Prog Change	True #	× *****	0 - 127 * 1 0 - 127	* 3
System Exclusive		○	* 1	
System Common	Song Pos Song Sel Tune	× × ×	× × ×	
System Real Time	Clock Commands	× ×	× ×	
Aux Messages	Local ON/OFF All Notes OFF Active Sense Reset	× × × ×	× * 2 ○ (123 - 127) ○ ×	
Notes		*1 Selectable between ○ and ×; result can be saved onto disk. *2 Memorized internally. *3 Program change number for each volume, performance, or patch can be set. *4 One or more basic channels can be set. *5 Can be set and stored onto disk.		

Mode 1 : OMNI ON, POLY  
Mode 3 : OMNI OFF, POLY

Mode 2 : OMNI ON, MONO  
Mode 4 : OMNI OFF, MONO

○ : Yes  
× : No

# Contents of the Internal Hard Disk

- [ ]: The size (sec) of the sampling data (44.1kHz).
- The standard memory configuration for the S - 770 consists of 2 megabytes. This allows for 22.5 seconds worth of sampling (44.1kHz). For this reason, you may need to add on additional memory before you will be able to load sound data such as that above.
- Before beginning sampling or other tasks...  
Whenever you encounter a situation where, due to a lack of remaining space on the internal hard disk, you are unable to save the sound data contained in the unit's internal memory, you should first back up onto floppy disks.

Volume	Performance	Patch	
L01 : Stereo Piano [22. 0]	L01 : Stereo Piano [22. 0]	L01 : Piano L [8. 5]	
		L01 : Piano R [13. 5]	
L01 : Piano & Harp [37. 2]	L01 : Harp [3. 5]	L01 : Harp Short [3. 5]	
	L01 : S550 Piano [15. 9]	L01 : S550 Piano [15. 9]	
	L01 : Stereo Piano [22. 0]	L01 : Piano L [8. 5] L01 : Piano R [13. 5]	
L02 : Strings [51. 6]	L02 : 2voice Pad [12. 0]	L02 : Rosin Pad 1m [2. 4] L02 : X8 lo pad [9. 6]	
	L02 : Big Cellos [21. 3]	L02 : Arco Cellos [13. 7] L02 : RadicalRosin [7. 6]	
	L02 : Hi Strings [18. 1]	L02 : Slow Vlns R [9. 6] L02 : Violins Left [8. 5]	
	L02 : Low Strings [16. 1]	L02 : Mono Violins [8. 5] L02 : RadicalRosin [7. 6]	
	L02 : Mellow Pad [13. 6]	L02 : Rosin Pad 1 [4. 0] L02 : X8 lo pad [9. 6]	
	L02 : Mono Violins [16. 7]	L02 : Marc Vlns mo [4. 0]	L02 : Mono Violins [8. 5]
		L02 : Mono Violins [8. 5]	L02 : Pizz Vlns mo [4. 2]
		L02 : VlnsAtk mono [4. 0]	L02 : RadicalRosin [7. 6]
		L02 : String Orch1 [21. 2]	L02 : Slow Violins [9. 6] L02 : VlnsAtk mono [4. 0]
	L02 : String Orch2 [16. 1]	L02 : Mono Violins [8. 5] L02 : RadicalRosin [7. 6]	
	L02 : String Pad [12. 5]	L02 : Mono Violins [8. 5] L02 : Rosin Pad 2 [4. 0]	
	L02 : Vlns mono [18. 1]	L02 : Mono Violins [8. 5] L02 : Slow Violins [9. 6]	
	L02 : X Violins M [12. 5]	L02 : Mono Violins [8. 5] L02 : VlnsAtk mono [4. 0]	
	L03 : Acoustic GTR [38. 5]	L03 : 6Str Guitar [15. 9]	L03 : 6Str Guitar [15. 9]
		L03 : 6Str detune [15. 9]	L03 : 6Str detune [15. 9]
		L03 : 12Str Guitar [17. 8]	L03 : 12Str Guitar [17. 8]
L03 : 12Str detune [17. 8]		L03 : 12Str Guitar [17. 8] L03 : 12Str detune [17. 8]	
L03 : 18Str Guitar [33. 7]		L03 : 6Str Guitar [15. 9] L03 : 12Str Guitar [17. 8]	
L03 : Guiano [6. 3]		L03 : Guiano [6. 3]	
L03 : Guitpass [6. 1]		L03 : GuitpassA [6. 1] L03 : GuitpassB [4. 8]	
L04 : Basses [71. 6]	L04 : Bass Guitar [7. 3]	L04 : Bass G.Slap [1. 6]	
		L04 : Bass G.Thmp [0. 8]	
		L04 : Bass Guitar [4. 9]	
	L04 : Real Basses [17. 4]	L04 : Pick Bass 1 [11. 4]	
		L04 : Pick Bass 2 [2. 0]	
		L04 : Pick > Pop Bs [9. 6]	
		L04 : Slam Pop Bs [7. 2]	
		L04 : Somebody Bs [0. 2]	
		L04 : Stinger Bass [0. 3] L04 : Upright Bass [0. 3]	
	L04 : Synth Bass 1 [21. 4]	L04 : M.M Bass 1 [3. 3]	
		L04 : M.M Bass 2 [6. 0]	
		L04 : M.M Bass 3 [6. 0]	
		L04 : M.M Bass 4 [5. 9]	
		L04 : M.M Bass 6 [3. 3]	
		L04 : M.M square [3. 0]	
		L04 : Rob Bass [0. 2]	
		L04 : Spike Bass 1 [6. 0] L04 : Spike Bass 2 [6. 0]	
	L04 : Synth Bass 2 [19. 0]	L04 : Wow ! Bass [3. 0] L04 : M.M Bass 5 [1. 4] L04 : Omnibus Bass [14. 6]	
	L04 : Synth Bass 3 [17. 1]	L04 : Tight Syn B [8. 4] L04 : MIDI Bass [8. 4] L04 : MIDI Bass 2 [14. 1]	
L04 : Wave Basses [7. 9]	L04 : Fuzzy Bas [2. 5] L04 : Mondo Cho [3. 6] L04 : Oct wave Bs [1. 8]		

Volume	Performance	Patch			
L05 : Voices [22.2]	L05 : Spacy Voxs [22.2]	L05 : Vox Space L [5.6] L05 : Vox Space R [4.2]			
	L05 : Voxs Mono [22.2]	L05 : Voxs mono [22.2]			
	L05 : Voxs Octavs [22.2]		L05 : Voxs Left [11.2] L05 : Voxs Right [10.9]		
			L05 : Voxsmono Oct [22.2]		
	L05 : Voxs Organic [22.2]		L05 : Voxs L Organ [11.3] L05 : Voxs R Organ [10.9]		
			L05 : Voxs Perk L [11.3] L05 : Voxs Perk R [10.9]		
	L05 : Voxs Perk [22.2]		L05 : Voxs Perk [22.2] L05 : Voxs Perk L [11.3] L05 : Voxs Perk R [10.9]		
			L05 : Voxs Stereo [20.1]		
	L05 : Voxs Sweep [22.2]		L05 : Voxs Sweep L [11.3] L05 : Voxs Sweep R [10.9]		
			L05 : Voxs Swp oct [22.2]		
	L06 : Mallets [19.6]	L06 : Mallets [19.6]	L06 : Agogomelan [5.8] L06 : D Log Drum [0.5] L06 : Gamelagogo [4.4] L06 : Gamelan 1 [3.4] L06 : Gamelan 2 [4.6] L06 : Marimbaphone [4.3]		
			L07 : Boomin Kit [18.2]		L07 : Boomin Kit [10.4] L07 : China mono [2.9] L07 : Cup mono [2.6] L07 : Mono Crash [2.3]
					L07 : Gated Kit [14.8]
			L07 : LA Fat Kit 1 [13.9]		L07 : Gated Kit [9.9] L07 : Mono Crash [2.3]
L07 : LA Fat Kit 2 [13.9]					
L07 : LA Fat Kit 2 [13.9]				L07 : LA Fat Kit [9.8] L07 : Mono Crash [2.3] L07 : Ride mono [1.8]	
				L07 : Natural Kit1 [15.9]	
L07 : Natural Kit2 [11.4]		L07 : LA kit [9.8] L07 : Mono Crash [2.3] L07 : Ride mono [1.8]			
		L07 : Pop Kit 1 [17.4]			
L07 : Pop Kit 2 [18.2]		L07 : Cup mono [2.6] L07 : Mono Crash [2.3]			
		L07 : Pop Kit 3 [19.3]			
L07 : Pop Kit 4 [13.2]		L07 : Natural Kit1 [11.0] L07 : Natural Kit2 [7.0] L07 : Ride/Cupmono [4.4]			
		L07 : Rock & R Kit 1 [22.1]			
L07 : Rock & R Kit 2 [18.5]		L07 : China mono [2.9] L07 : Cup mono [2.6] L07 : Mono Crash [2.3] L07 : Pop kit 1 [9.6] L07 : Pop kit 2 [10.4] L07 : Pop kit 3 [11.5] L07 : Pop kit 4 [10.9]			
		L07 : TR - 808 kit [13.4]			
L07 : Percussion [108.9]	L07 : TR - 808 kit [13.4]	L07 : China mono [2.9] L07 : Cup mono [2.6] L07 : Mono Crash [2.3] L07 : Rock Kit 1 [14.3] L07 : Rock Kit 2 [10.7]			
		L07 : Ethnic Perc [17.2]			
		L07 : Latin set [19.0]			
		L07 : Orch.Perc 1 [22.1]			
		L07 : Orch.Perc 2 [20.6]		L07 : TR - 808 ! [13.4] L07 : Ethnic Perc [17.2] L07 : Latin set [19.0] L07 : Orch. Kit 1 [22.1] L07 : Gong [3.8] L07 : Orch. Kit 2 [9.0] L07 : Timpani Med [7.8] L07 : Gong [3.8] L07 : Timpani Soft [6.6] L07 : Tubular Bell [10.0]	
				L07 : Orch.Toys [19.6]	
		L07 : Shakers etc. [14.0]		L07 : Orch. Toys [19.6] L07 : Shaker & stuff [14.0] L07 : Timpani Hard [7.1] L07 : Timpani Med [7.8] L07 : Timpani Soft [6.6] L07 : Timpani X [21.5]	
				L07 : Timpani All [21.5]	



# Menu Structure

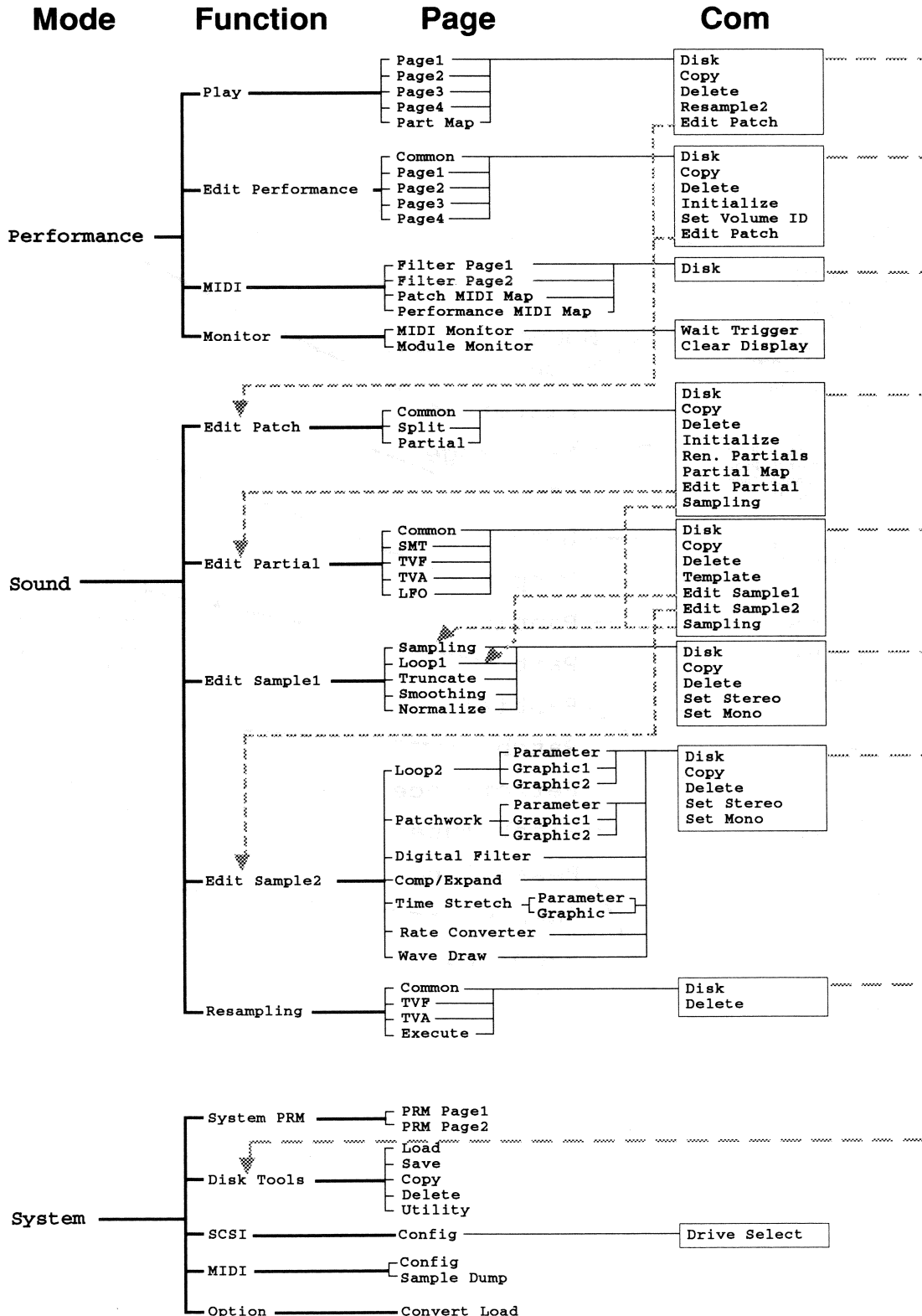

# Index of the Index Screen

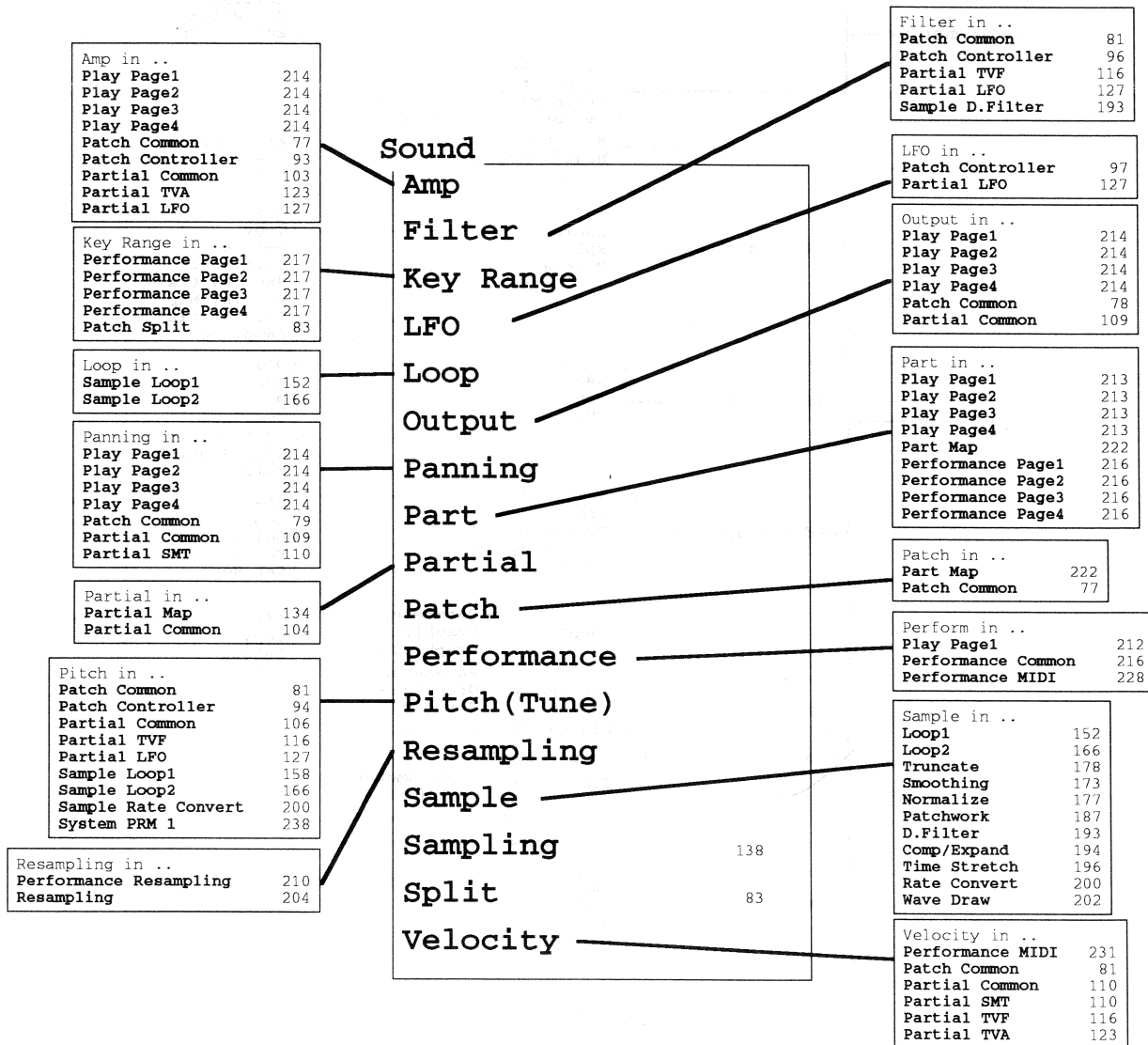

**MIDI**

MIDI Ch in ..	214
Play Page1	214
Play Page2	214
Play Page3	214
Play Page4	214
Performance Page1	217
Performance Page2	217
Performance Page3	217
Performance Page4	217

After Touch	
Bender	
Exclusive	255
MIDI Ch	
Modulation	
Program Change	

After in ..	
Performance MIDI	228
Patch Controller	96

Bender in ..	
Performance MIDI	228
Patch Controller	94

Modulation in ..	
Performance MIDI	228
Patch Controller	96

P. Change in ..	
Part Map	222
Performance MIDI Map	225
Patch MIDI Map	224
Patch Common	78
Volume PG#	227

**System**

Convert Load	251
Current Drive	242
Disk	
LCD	242
Mouse	241
Sampling Rate	240
Save System	250
SCSI Config	253
Sound Play	239

Disk in ..	
Load	60
Save	65
Copy	68
Delete	66
Utility	247

# Index

- **Bold name** refers to an item on the screen display.
- **Bold number** refers to a primary reference, if a topic has more than one.
- **SMALL CAPS** refers to a labelled control or connector on the front panel, rear panel, or RC-100

- AC IN ..... 35
- Adding Samples ..... 205-206
- ADSR ..... see TVA and TVF
- AES/EBU Digital Audio Standard ..... **39**, 240, 267
- Aftertouch ..... 94, 96, **228-229**, 258
- Algorithm** ..... **205**, 209
- All** ..... 68
- Alt** ..... **154**, 162
- A.Loop** ..... 166
- Analog** ..... 141
- Analog Feel** (Patch) ..... 25, **82**
- Analog Inputs ..... 38, **141**
- Analog outputs ..... 37
- Analog Outs Mode** ..... 24, 37, **242**, 267
- Analog sampling ..... 141
- Area** (Convert Load) ..... 252
- Area Erase** ..... 188
- Arrows, Channel indicator ..... 215
- Arrows, dancing ..... 62
- ASCII Keyboard** ..... 15, **73**, 138
- Assign Type** ..... 90-93
- A.T** ..... see Aftertouch
- Attack** (Compressor/Expander) ..... 195
- Audio ..... 2
- Auto** (Time Stretch) ..... 198
- Auto** (Trigger) ..... 143
- Auto-loop ..... 26
- Backup** ..... 146, **149**
- Band Pass Filter ..... see **BPF**
- Bend** ..... 229
- Bend-Down** ..... 96
- Bend-Up** ..... 10, **96**
- Blank** ..... 52
- Booting up ..... 3
- BPF** (Digital Filter) ..... 193
- BPF** (Partial TVF) ..... 116
- CD player ..... 39, 145, 240, 267
- CD-ROM ..... 39, 43, **260**
- CD-ROM players ..... 61, 71
- Chain (SCSI) ..... 264
- Channel Pressure ..... see Aftertouch
- Chunk ..... 197
- Circular Buffer ..... 144
- Cleaning ..... 274
- Clear Display** ..... 258
- Clear Internal Memory** ..... **62**, 104, 228
- Closed Loop Sample Dumps ..... 268
- Coarse Tuning** ..... **81**, 110
- COAXIAL** ..... **39**, 149, 267
- Com** menu ..... see Command menu
- Combine** ..... 192
- Combining Controllers ..... 98
- COMMAND** (button) ..... 34
- Command (**Com**) menu ..... 5, **46**, 60
- Common** (Partial) ..... 11, **104**
- Common** (Patch) ..... 9, **77**, 219, 224
- Common** (Performance) ..... **216**, 232
- Common** (Resampling) ..... 205
- Compressor/Expander ..... 194
- Computer ..... 266
- Connecting non-storage SCSI devices ..... 266
- Consistent Volume IDs ..... 234
- CONTRAST** ..... 21
- Control Channel** ..... **225**, 255, 268
- Control Destinations ..... 96
- Control Mode** ..... **227**, 236, 255-256
- Controller** (S-770) ..... 241
- Controller Matrix** ..... 96
- Controllers ..... see MIDI Controllers
- Convert All Execute** ..... 252
- Convert Load** ..... 251-253
- Converting mono samples to stereo ..... 151
- Converting stereo samples to mono ..... 151
- Copy** (Disk) ..... **66**, 245
- Copy** (Partial) ..... 132
- Copy** (Patch) ..... 100
- Copy** (Performance) ..... 223
- Copy** (Sample) ..... 150
- CP-340 Type I and Type II ..... 267
- C.Sens** (TVA) ..... 123
- C.Sens** (TVF) ..... 119
- C.T** ..... **106**, 205
- Ctrl** ..... 93
- Ctrl Sel** ..... 96
- Ctrl Sens** ..... 94
- CTune** ..... see **Coarse Tuning**
- Current Drive** ..... 61, **242-243**
- Current Drive Free** ..... 65
- Cursor buttons ..... 33
- Cut & Splice** ..... 187
- Cutoff Freq** (Digital Filter) ..... 193
- Cutoff Freq** (TVF) ..... 116
- Cutoff Offset** (Patch) ..... 81
- DAT ..... 240

- Data** ..... 257
- D.C** (Digital Filter) ..... 193
- Dec**(rement) ..... 43
- Delay** (Partial LFO) ..... 128
- Delete** (Disk) ..... 66, 67, 246
- Delete** (Partial) ..... 132
- Delete** (Patch) ..... 101
- Delete** (Performance) ..... 223
- Delete** (Sample) ..... 150
- Delete** (Volume) ..... 237
- Depth** ..... 207
- Destin Drive** ..... 68
- Destructive editing ..... 55
- Detune** (Partial LFO) ..... 128
- DIGITAL IN/OUT** ..... 35
- Digital ATT** ..... 142, 267
- Digital Audio jacks ..... 35
- Digital connectors ..... 39
- Digital Filter ..... 193
- Digital I/O ..... 267
- Digital L, Digital R** ..... 142
- DIGITAL RGB** (jack) ..... 2, 35
- Digital sampling ..... 142
- Digital Unlock** ..... 240, 277
- Disk** (function) ..... 100
- Disk pages ..... 6
- Disk space ..... 65
- Disk Tools** ..... 242
- Disk types ..... 69
- Disk Utility** ..... 247
- Disks ..... 60
- Disp Type** ..... 163
- Dly** ..... 205, 209
- Double arrow boxes ..... 28, 52
- Drive Select** ..... 61
- Driver software ..... 260
- Drum mapping ..... 85
- DSP ..... 26
- Dump** ..... 257
- Dynamic voice allocation ..... 259
  
- E-660 Digital Equalizer ..... 267
- Edit Mode** ..... 150, 152
- Edit Step** ..... 157
- Emphasis** (resampling) ..... 208
- $\pm$ **Emphasis** (Digital Filter) ..... 194
- End** (Loop point) ..... 158
- End** (switch) ..... 147
- Enter** ..... 47
- Envelope** (TVA) ..... 124
- Envelope** (TVF) ..... 118, 121
- Envelope templates ..... 25, 125, 250
- Exc** ..... 90-93
- Exit** ..... 48
- EXIT** ..... 32
- EXT CTRL** ..... 2, 31
  
- F (display mode) ..... 167
- F=S** ..... 181
- F-buttons ..... 32
- Fade** (Time Stretch) ..... 197
- Fade\_H** ..... 114
- Fade\_L** ..... 113
- Fade Len** ..... 180
- Fan Control** ..... 239
- Fast Delete Mode** ..... 67, 246, 253, 277
- FD Format** ..... 248
- Fil** ..... see **MIDI Filter**
- File length ..... 60
- File list ..... 52
- Filter envelope ..... see **TVF**
- Filter Mode** (Digital Filter) ..... 193
- Filter Mode** (Partial TVF) ..... 116
- Fine** ..... 158
- Fine Tuning** (Partial) ..... 110
- Fine Tuning** (Patch) ..... 82
- Floppy disk drive ..... 33
- Floppy disks ..... 69-71
- Footswitch** ..... 32
- Formatting ..... 69
- Forward** (Loop) ..... 154
- Free** ..... 277
- Freq** ..... 139
- From, From To** ..... 179
- Front Panel ..... see ..... 30
- F.T** ..... 106, 205
- FTune** ..... see **Fine Tuning**
- Function through another function ..... 52
- Functions ..... 46
- Fwd+One** (Loop) ..... 154
- Fwd+R** (Loop) ..... 154
  
- G-Edit** ..... 207
- Get=** ..... 181
- Global** ..... 131
- GRAPHIC** ..... 34
- Graphic window ..... 161
  
- Hard disk ..... 33
- HD/MO File Sort** ..... 23, 248
- HD/MO Format** ..... 247
- HD/MO Park Heads** ..... 248
- HD/MO Rename** ..... 249
- HD/MO Restart** ..... 248
- HD/MO Volume Pg#** ..... 249
- HEAD AMP** ..... 32
- High Pass Filter ..... see **HPF**
- Hold** ..... 229
- HPF** (Digital Filter) ..... 193
- HPF** (TVF) ..... 116
  
- ID Numbers (SCSI) ..... 262
- Inc**(rement) ..... 43
- Index** ..... 34, 49

- INDIVIDUAL** outputs ..... 35, **37**
- Info** ..... 89
- Initial Volume** ..... 239
- Initialize** (Patch) ..... 101
- Initializing Performances ..... 223
- Initiator ..... 262
- INPUT** (jacks) ..... 32
- Input** (parameter) ..... 141-142
- Inputs ..... 35-37
- Insert** ..... 188
- Internal Free** ..... **63**, 215, 244
- JUMP** ..... 32
- Jump pages ..... 24, **50-51**, 271
- Key Follow** ..... 107-109
- Key Follow** (Partial LFO) ..... 128
- Key Follow** (Partial TVA) ..... 123-124
- Key Follow** (Partial TVF) ..... **117**, 120
- Key Follow** (Volume) ..... 122-124
- Key Pressure ..... see Polyphonic Aftertouch
- Key Range** ..... 85
- Key Sync** ..... 128
- Keyboard Fades ..... 217
- Keyboard Graphic ..... 86-87
- KeyOn Mode** ..... 156
- K.F** ..... see Key Follow
- KF Point** (Partial TVA) ..... 123
- KF Point** (Partial TVF) ..... 120
- Ky+/Ky-** ..... 111
- L** ..... 150
- L(MONO) and R ..... 32
- LCD ..... 31
- LCD Display** (parameter) ..... 242
- Legend (Loop) ..... 160
- Length Lock** ..... 159
- Lev** (Output level) ..... 214
- Level** ..... 15
- Level** (box) ..... 146
- Level** (Comp/Expand) ..... 195
- Level** (Digital Filter) ..... 193
- Level** (envelope) ..... **121**, 124
- Level** (trigger) ..... 143
- LFO** ..... 12, **127**
- LFO assignments ..... 129
- LFO Pitch Depth** ..... 97
- LFO Rate Ctrl** ..... 97
- Load** ..... 244
- Loading ..... 5, **60-62**
- Loading Volumes ..... 232
- Loop editing ..... 166
- Loop Field ..... 160
- Loop graphic ..... 160
- Loop matching ..... 169
- Loop mode** ..... 154
- Loop point parameters ..... 158
- Loop tuning ..... 158
- Loop-Smoothing Length** ..... 174
- Looping ..... 13, 17, **152**
- Looping in stereo ..... 171
- Looping tips ..... 161, 172
- Low Pass Filter ..... see **LPF**
- L.P** ..... 217
- LPF** (Digital Filter) ..... 193
- LPF** (TVF) ..... 116
- L.W** ..... 217
- L—PEAK—R** ..... 32
- Macintosh ..... 266
- Magneto-Optical (**MO**) drive ..... 61, 71, **261**
- Magnification ..... 157, 170
- Manual** (trigger) ..... 144
- MARK** ..... 34, 50-51
- Master Freq** ..... **240**, 267
- Master Tune** ..... 238
- Max** ..... 30
- Memory capacity ..... 55
- Memory, adding ..... 272
- Menus ..... 46
- MIDI** (Function) ..... 255
- MIDI** (jacks) ..... 3, 35, **36**
- MIDI** (Trigger) ..... 143
- MIDI Channels ..... 214
- MIDI Config** ..... 255
- MIDI Controllers ..... 93-98
- MIDI Filter** ..... 228
- MIDI IN** ..... 3, 35, **36**
- MIDI MESSAGE** ..... 34
- MIDI Monitor** ..... 231, **257**
- MIDI Note Number ..... 86
- MIDI OUT** ..... 35, **36**
- MIDI Program Change ..... see **Program Change**
- MIDI Response ..... 116
- MIDI Sample Dump Standard ..... 257, **268**
- MIDI THRU** ..... 35, **37**
- MIDI Velocity ..... 94, **231**
- MIDI Volume ..... 214
- Mixed Volume IDs ..... 234
- Mixing samples ..... 191
- Mod** ..... 229
- Mode** (sample) ..... 139
- Mode Change ..... 45
- Mode Menu ..... 45
- Modulation wheel ..... 94
- Module** ..... 259
- Monitor** ..... 145
- Mono** ..... 90-93
- Mono sampling ..... 139
- MONOCHROME** (jack) ..... 2, 35

- Monochrome ..... 40
- Mouse ..... 2, 40, 241, 274
- Mouse, Mickey ..... 57
- Multiplying Samples ..... 205-206
- Multisampling ..... 83-84
- Multitimbral ..... 212
- Munchkinization ..... 83
  
- N** (display mode) ..... 167
- N** ..... 150
- Naming disks ..... 75
- Naming files ..... 72, 75
- Naming samples ..... 138
- Naming volumes ..... 232
- Negative values ..... 47
- New Length** ..... 179
- Next** ..... 147
- NL** ..... 150
- Non-destructive editing ..... 153
- Non-Western music ..... 108
- Normalize** (Comp/Expand) ..... 196
- Normalize** ..... 145
- Normalizing** ..... 177
- Now working** ..... 62
- NR** ..... 150
- Numeric keypad ..... 42
  
- Oct Shift** ..... 81
- Omni Mode ..... 99, 215
- One-way** ..... 144
- OneShot** ..... 154
- Open Loop Sample Dumps ..... 269
- OPTICAL** ..... 39
- Option** ..... 251
- Orig Length** ..... 179
- Original key** ..... 139
- Output Assign** (Partial) ..... 109
- Output Assign** (Patch) ..... 78
- Outputs ..... 37
- Overwrite switch** ..... 254
  
- P** ..... 78
- Packing ..... 275
- Pages ..... 46
- Pan** ..... 214
- Panning** (Partial) ..... 109
- Panning** (Patch) ..... 79
- Parameters ..... 47
- Park heads ..... see **HD/MO Park Heads**
- Part** ..... 99
- Part Map** ..... 222
- Part numbers ..... 221
- Partial Level** ..... 109
- Partial Map** ..... 134
- Partials** ..... 11, 56, 103-135
  
- Patch Level** ..... 78
- Patch Map** ..... 102, 224
- Patch Priority** ..... 80
- Patch Split** ..... 217
- Patch to Patch (Convert Load)** ..... 251-253
- Patches** ..... 8, 57, 76-102
- Patchwork** ..... 182, 187
- PC ..... 266
- PEAK** ..... 32
- Pedal** (triggering) ..... 143
- PERFORM** (button) ..... 33
- Perform Only** ..... 227
- Perform/Volume** ..... 227
- Performance editing ..... 216
- Performance Map** ..... 225
- Performance Mode ..... 45
- Performance Resampling ..... 27, 149, 210
- Performances ..... 58, 212-223
- Phase Lock ..... see **P.L**
- PHONES** (jack) ..... 2, 32
- Phrase Sampling ..... 14
- Pitch change with constant length ..... 198-199
- Pitch Ctrl** ..... 96
- Pitch Depth** ..... 120
- Pitch Mod Depth** ..... 128
- Pitchbend** ..... 96
- P.L** (Phase Lock) ..... 230
- Play** ..... 212
- Playing Partials from MIDI ..... 104
- Please Rename** ..... 75
- Point** (Mode) ..... 163
- Poly** ..... 90-93
- Polyphonic Aftertouch ..... 94, 96, 229
- Positional crossfades ..... see **Keyboard Fades**
- POWER** (switch) ..... 1, 34
- Power ..... 36
- Pre-emphasis ..... 194
- Pre-trig** ..... 144
- Prev**(ious) ..... 144
- Priority (SCSI) ..... 263
- Priority** (Voices) ..... 80
- Prog** (MIDI Filter) ..... 229
- Program change ..... 27, 219, 224, 229, 236
- Program Number** ..... 78
- Punctuation ..... 74
  
- R** ..... 150
- R-880 Digital Reverb ..... 267
- Rackmounting ..... 30
- Range extension ..... 201
- RAS-770 ..... 272
- Rate** ..... 127
- Ratio** (Comp/Expand) ..... 195
- Ratio** (Time Stretch) ..... 197
- RC-100 ..... 41, 44, 241

- Ready** ..... 142, **144**  
**Real Time MSG** ..... 258  
**REC LEVEL** ..... 31  
Recording ..... 138  
**Recover** ..... 26, 175, **181**  
**Release** (Comp/Expand) ..... 195  
Release Loop ..... 159  
**Remaining** ..... 140  
Remote control ..... 41  
**R-End** ..... 156  
Renaming Partials ..... **93**, 101  
**Resampling** ..... **204**  
Resampling algorithms ..... 205  
Resampling tips ..... 209  
**Resampling TVA** ..... 207  
**Resampling TVF** ..... 207  
**RESET** ..... 43  
Resolution ..... **157**, 161  
**Resonance** (Digital Filter) ..... 193  
**Resonance** (TVF) ..... 118  
Restricted access ..... 130  
**Retry** ..... 147  
Retuning ..... 201  
**Rev** (Loop) ..... 154  
**Rev One** (Loop) ..... 154  
**Reversing** ..... 182  
**RGB** (jack) ..... 40  
Ring modulator ..... 205  
R-Loop ..... See Release Loop  
**R-Loop** (KeyOn Mode) ..... 156  
**R-Loop** (Loop point) ..... 159  
**R-Loop smoothing Length** ..... 134  
**RL<T<RE** ..... 181  
**Rnd** ..... 111  
  
S-50/S-550/S-330 ..... 251-253  
S-770 organization ..... 53-54  
S-buttons ..... 32  
Sample Dumps .... see MIDI Sample Dump Standard  
Sample editing ..... 19, **152**  
Sample Mix Table (SMT) ..... 110  
Sample rate conversion ..... 200-201  
Sample shifting ..... 94  
Samples ..... 13, **55**  
Sampling ..... 136-177  
**Sampling Execute** ..... 146  
**Sampling Over** ..... 148  
Sampling rate ..... 39  
Sampling time ..... 64  
**Save** ..... 245  
Save System (**Save SYS**) ..... 22, 250, **271**  
Saving ..... 65  
Saving Performances ..... 220  
Saving Volumes ..... 236  
Scales ..... 107-109  
**Scan** ..... 261  
  
Schwarzenegger, Arnold ..... 266  
Scrubbing ..... **167-169**, 185  
**SCSI** ..... 35, 43, 253, **260**  
SCSI chains ..... 264  
**SCSI Config** ..... 253  
SCSI connections ..... 260  
SCSI Device Scanning ..... 261  
SCSI disks ..... 71  
SCSI ID ..... 262  
SCSI Priority ..... 263  
SCSI Terminators ..... **262**, 265  
**Search** ..... 198  
Select Icon ..... 24, **51**  
Select Window ..... 51  
**Select/MIDI in** ..... 99, **221**  
**SENS** ..... 32  
Sequencer ..... 215  
Service ..... 275  
**Set** ..... 87  
**Set Mono** ..... 151  
**Set Stereo** ..... 152  
**Set Volume ID** ..... 233  
Setting MIDI channels ..... 214  
Setting outputs ..... 214  
**S<F<L** ..... 181  
Shared files ..... 56-59  
Signal-to-noise ratio ..... 30  
SIMMs ..... 272  
**Single** ..... 131  
Slots ..... 138  
Slots, number of ..... 55  
Slow display ..... 125  
**Smoothing** ..... 173  
**Smplng** ..... **148**, 250  
**SMT** ..... see Sample Mix Table  
**SMT Ctrl Sel** ..... 94-95  
**SMT Ctrl Sens** ..... 94-95  
**SMT Velocity Ctrl** ..... 110  
**Sort** ..... 28, **52**  
**SOUND** (button) ..... 33, **45**  
**Sound** (Menu) ..... 8  
**Sound** (Mode) ..... 45  
Sound effects ..... 85  
Sound Mode ..... 45  
**Sound Play** ..... 239  
**SOUND PLAY** (button) ..... 34  
**Source** (Dump) ..... 257  
**Source** (Resampling) ..... 204-205  
S/P DIF ..... 267  
**Split** ..... **83**, 86  
**Splits** (Performance) ..... 217  
**Start** ..... 144  
**Start** (KeyOn Mode) ..... 156  
**Start** (Loop point) ..... 155  
Startup Disk ..... 239  
**Status** ..... 257



- STEREO OUT** (jacks) ..... 2, **35**  
**STEREO** outputs ..... 37  
**Stereo Mix Level** (Partial) ..... 109  
**Stereo Mix Level** (Patch) ..... 79  
Stereo samples ..... 150  
Stereo sampling ..... 139  
Stereo synthesis ..... 111  
Stuttering effect ..... 90  
Subsidiary files ..... **56**, 57  
Suffixes ..... 74  
Sustain Loop ..... 156  
Sustain pedal ..... 229  
Switches ..... 48  
SyQuest drives ..... 61, 71, **260**, 263  
**SYSTEM** (button) ..... 33, **45**  
**System** (menu) ..... 238  
**System** (mode) ..... 45  
System Exclusive ..... 258  
System installation ..... 21  
**System PRM** ..... 238  
System software ..... 270
- Target** ..... 61  
**Templates** ..... 25, **125**, 250  
Terminal ..... 266  
Terminator ..... **262**, 265  
**Threshold** (Comp/Expand) ..... 194  
**Threshold** (triggering) ..... 143  
**Time** (envelope) ..... 120  
**Time** (Sampling) ..... 140  
**Time Stretch** ..... 196  
**Time Vel Sens** ..... 120  
Timed Loops ..... 160  
Title ..... 160  
**To** ..... 179  
**Tone to Partial** ..... 251  
Transpose limit ..... 106  
**Trigger** (MIDI) ..... 258  
**Trigger** (Monitor) ..... 258  
**Trigger** (Sampling) ..... 142  
Troubleshooting ..... 276  
**Truncate** ..... 178  
Truncating looped samples ..... 185  
Truncating stereo samples ..... 185  
**Tuning** ..... 106  
**Tuning** (Loop) ..... 158  
**TVA** (Time Variant Amplifier) ..... 12, **123**  
**TVA Ctrl** ..... 97  
**TVA Depth** ..... 97  
**TVA Mod Depth** ..... 129  
**TVF** (Time Variant Filter) ..... 11, **116**  
**TVF Ctrl** ..... 96  
**TVF Depth** ..... 97, **118**  
**TVF Mod Depth** ..... 129  
**Type** (split) ..... 90-93  
**Type** (trigger) ..... 143
- Underline cursor ..... 73  
Undo ..... see **Recover**  
**Unit Number** ..... 28, **255**  
**U.P** ..... 217  
Upgrades ..... 270  
**Util** ..... 247  
**U.W** ..... 217
- VALUE** ..... 32  
VCR ..... 40  
**Vel** (MIDI Filter) ..... 231  
**Vel-Hi** ..... 112-114  
**Vel-Low** ..... 112-114  
**Vel Sens** (Partial TVA) ..... 124  
**Vel Sens** (Partial TVF) ..... 118  
**Vel Curve** (Partial TVA) ..... 123  
**Vel Curve** (Partial TVF) ..... 119  
**Vel-Sens Offset** ..... 81  
Velocity Fading ..... 113  
Velocity Response ..... 119, **123**, 231  
Velocity Switching ..... 111  
Version 1.0 files ..... 23  
Version 2.0 software ..... 21-28  
Vibrato ..... see LFO  
Video display ..... 40  
Video output ..... 35  
Voice Limit ..... 29  
**Vol** (MIDI Filter) ..... 230  
**VOLUME** (knob) ..... **30**, 35  
Volume envelope ..... see TVA  
Volume ID ..... 27, 59, 62, 74, **233**, 235, 243  
Volume, MIDI ..... see MIDI Volume  
Volumes ..... 59, **232-237**
- W-30 ..... 253  
**Wait Trigger** ..... 258  
**Wave Draw** ..... 202  
**Wave Form** ..... 127  
**Wave Length** ..... 200  
Wave Memory ..... 55  
**Wave Memory Check** ..... 273  
**Wave Memory Full** ..... **64**, 141  
Waveform display ..... 161  
Wild Controller ..... 96  
Windows ..... 48  
Write protection ..... 69
- X** ..... 170  
**X-Zoom** ..... 157  
**Y** ..... 170, 203  
**Y-Zoom** ..... 157  
Zero-crossing ..... **161**, 166  
Zero-slope ..... 161

## Information

When you need repair service, call your local Roland Service Station or the authorized Roland distributor in your country as shown below.

### U. S. A.

**Roland Corporation U.S.**  
7200 Dominion Circle  
Los Angeles, CA. 90040-3696, U. S. A.  
TEL: (213) 685 5141

### CANADA

**Roland Canada Music Ltd. (Head Office)**  
5480 Parkwood Way  
Richmond B. C., V6V 2M4  
CANADA  
TEL: (604) 270 6626

**Roland Canada Music Ltd. (Montreal Office)**  
9425 Transcanadienne  
Service Rd. N., St Laurent,  
Quebec H4S 1V3, CANADA  
TEL: (514) 335 2009

**Roland Canada Music Ltd. (Toronto Office)**  
346 Watline Avenue,  
Mississauga, Ontario L4Z  
1X2, CANADA  
TEL: (416) 890 6488

### AUSTRALIA

**Roland Corporation Australia Pty. Ltd.**  
38 Campbell Avenue  
Dee Why West. NSW 2099  
AUSTRALIA  
TEL: (02) 982 8266

### NEW ZEALAND

**Roland Corporation (NZ) Ltd.**  
97 Mt. Eden Road, Mt. Eden,  
Auckland 3, NEW  
ZEALAND  
TEL: (09) 3098 715

### UNITED KINGDOM

**Roland (U.K.) Ltd.**  
Rye Close Ancells Business  
Park Fleet, Hampshire GU13  
8UY, UNITED KINGDOM  
TEL: (0252) 816181

### Roland (U.K.) Ltd.,

**Swansea Office**  
Atlantic Close, Swansea  
Enterprise Park, Swansea,  
West Glamorgan SA79FJ,  
UNITED KINGDOM  
TEL: (0792) 700 139

### IRELAND

**The Dublin Service Centre Audio Maintenance Limited**  
11 Brunswick Place Dublin 2  
Republic of Ireland  
TEL: (01) 677322

### ITALY

**Roland Italy S. p. A.**  
Viale delle Industrie 8 20020  
ARESE MILANO ITALY  
TEL: (02) 93581311

### SPAIN

**Roland Electronics de España, S. A.**  
Calle Bolivia 239 08020  
Barcelona, SPAIN  
TEL: (93) 308 1000

### GERMANY

**Roland Elektronische Musikinstrumente Handelsgesellschaft mbH.**  
Oststrasse 96, 22844  
Norderstedt, GERMANY  
TEL: (040) 52 60090

### FRANCE

**Guillard Musiques Roland**  
ZAC de Rosarge Les Echets  
01700  
MIRIBEL FRANCE  
TEL: (72) 26 5060

**Guillard Musiques Roland (Paris Office)**  
1923 rue Léon Geoffroy  
94400 VITRY-SUR-SEINE  
FRANCE  
TEL: (1) 4680 86 62

### BELGIUM/HOLLAND/LUXEMBOURG

**Roland Benelux N. V.**  
Houtstraat 1 B-2260 Oevel-  
Westerlo BELGIUM  
TEL: (014) 575811

### DENMARK

**Roland Scandinavia A/S**  
Langebrogade 6 Box 1937  
DK-1023 Copenhagen K.  
DENMARK  
TEL: 31 95 31 11

### SWEDEN

**Roland Scandinavia A/S**  
Danvik Center 28 A, 2 tr.  
S-131 30 Nacka SWEDEN  
TEL: (08) 702 0020

### NORWAY

**Roland Scandinavia**  
Avd. Kontor Norge  
Lilleakerveien 2 Postboks 95  
Lilleaker N-0216 Oslo 2  
NORWAY  
TEL: (02) 73 0074

### FINLAND

**Fazer Musik Inc.**  
Länsituulentie POB 169,  
SF-02101 Espoo FINLAND  
TEL: (00) 43 5011

### SWITZERLAND

**Roland (Switzerland) AG**  
Musitronic AG  
Gerberstrasse 5, CH-4410  
Liestal, SWITZERLAND  
TEL: (061) 921 1615

### AUSTRIA

**E. Dematte & Co.**  
Neu-Rum Siemens-Strasse 4  
A-6040 Innsbruck P.O.Box  
83  
AUSTRIA  
TEL: (0512) 26 44 260

### GREECE

**V. Dimitriadis & Co. Ltd.**  
20, Alexandras St. &  
Bouboulinas 54 St. 106 82  
Athens, GREECE  
TEL: (01) 8232415

### PORTUGAL

**Caius - Tecnologias Audio e Musica, Lda.**  
Rue de Catarina 131  
4000 Porto, PORTUGAL  
TEL: (02) 38 4456

### HUNGARY

**Intermusica Ltd.**  
Warehouse Area 'DEPO'  
Pf.83 H-2046 Torokbalint,  
Budapest HUNGARY  
TEL: (1) 1868905

### ISRAEL

**D.J.A. International Ltd.**  
Twin Towers, 33 Jabntinsky St.  
Room 211, Ramat Gan 52511  
ISRAEL  
TEL: (03) 751 8585

### CYPRUS

**Radex Sound Equipment Ltd.**  
17 Diagorou St., P.O.Box  
2046, Nicosia CYPRUS  
TEL: (2) 453 426  
(2) 466 423

### U.A.E

**Zak Electronics & Musical Instruments Co.**  
P.O. Box 8050  
DUBAI, U.A.E  
TEL: 360715

### KUWAIT

**Easa Husain Al-Yousifi**  
P.O. Box 126 Safat 13002  
KUWAIT  
TEL: 5719499

### LEBANON

**A. Chahine & Fils**  
P.O. Box 16-5857  
Beirut, LEBANON  
TEL: (01) 335799

### TURKEY

**Barkat Sanayi ve Ticaret**  
Siraselviler Cad. 86/6  
Taksim Istanbul, TURKEY  
TEL: (0212) 2499324

### EGYPT

**Al Fanny Trading Office**  
9, Ebn Hagar Ai Askalany  
Street, Ard El Golf,  
Heliopolis, Cairo, 11341  
EGYPT  
TEL: (02) 4171828  
(02) 4185531

### QATAR

**Badie Studio & Stores**  
P.O.Box 62,  
DOHA Qatar  
TEL: 423554

### SYRIA

**Technical Light & Sound Center**  
Khaled Ebn Al Walid St.  
P.O.Box 13520  
Damascus - Syria  
TEL: (11) 2235 384

### BAHRAIN

**Moon Stores**  
Bad Al Bahrain Road,  
P.O.Box 20077  
State of Bahrain  
TEL: 211 005

### REUNION

**FO - YAM Marcel**  
25 Rue Jules MermanZL  
Chaudron - BP79 97491  
Ste Clotilde REUNION  
TEL: 262 28 29 16

### BRAZIL

**Roland Brasil Ltda.**  
R. Coronel Octaviano da  
Silveira 203 05522-010  
Sao Paulo BRAZIL  
TEL: (11) 843 9377

### MEXICO

**Casa Veerkamp, s.a. de c.v.**  
Mesones No. 21 Col. Centro  
MEXICO D.F. 06080  
TEL: (905) 709 3716

**La Casa Wagner de Guadalajara s.a. de c.v.**  
Av. Corona No. 202 S.J.  
Guadalajara, Jalisco  
MEXICO C.P.44100  
TEL: (36) 13 1414

### VENEZUELA

**Musicland Digital C.A.**  
Av. Francisco de Miranda,  
Centro Parque de Cristal,  
Nivel C2 Local 20 Caracas  
VENEZUELA  
TEL: (2) 285 9218

### PANAMA

**Productos Superiores, S.A.**  
Apartado 655 - Panama 1  
REP. DE PANAMA  
TEL: 26 3322

### ARGENTINA

**Instrumentos Musicales S.A.**  
Florida 638  
(1005) Buenos Aires  
ARGENTINA  
TEL: (1) 394 4029

### HONG KONG

**Tom Lee Music Co., Ltd. Service Division**  
22-32 Pun Shan Street, Tsuen  
Wan, New Territories,  
HONG KONG  
TEL: 852 2 737 7688

### KOREA

**Cosmos Corporation Service Station**  
261 2nd Floor Nak-Won  
Arcade Jong-Ro ku, Seoul,  
KOREA  
TEL: (02) 742 8844

### SINGAPORE

**Swee Lee Company**  
BLOCK 231,  
Bain Street #03-23  
Bras Basah Complex,  
Singapore 0718  
TEL: 3367886

### PHILIPPINES

**G.A. Yupango & Co. Inc.**  
339 Gil J. Puyat Avenue  
Makati, Metro Manila 1200,  
PHILIPPINES  
TEL: (02) 817 0013

### THAILAND

**Theera Music Co., Ltd.**  
330 Verng Nakorn Kasem,  
Soi 2, Bangkok 10100,  
THAILAND  
TEL: (02) 2248821

### MALAYSIA

**Bentley Music SDN BHD**  
No.142, Jalan Bukit Bintang  
55100 Kuala Lumpur,  
MALAYSIA  
TEL: (03) 2443333

### INDONESIA

**PT CITRARAMA BELANTIKA**  
Kompleks Perkantoran Duta  
Merlin Blok E No.6—7  
Jl. Gajah Mada No.3—5,  
Jakarta 10130,  
INDONESIA  
TEL: (021) 3850073

### TAIWAN

**Siruba Enterprise (Taiwan) Co., LTD.**  
Room. 5, 9fl. No. 112 Chung  
Shan N.Road Sec.2 Taipei,  
TAIWAN, R.O.C.  
TEL: (02) 571 5860

### SOUTH AFRICA

**That Other Music Shop (PTY) Ltd.**  
11 Melle Street (Cnr Melle  
and Juta Street)  
Braamfontein 2001  
Republic of South Africa  
TEL: (011) 403 4105

### Paul Bothner (PTY) Ltd.

17 Werdmuller Centre  
Claremont 7700  
Republic of South Africa  
TEL: (021) 64 4030

---

# SCSI compatible devices for S-770/750

## S-770/750 に接続できる SCSI 機器

---

The following devices can be connected to the S - 770/750 by using the SCSI interface.

ローランドで、動作確認をおこなった機種として、次のものがあります。

---

In order to connect a SCSI device to the S - 770/750, you will need to have the appropriate SCSI cable. The SCSI connector on the S - 770/750 is the DB - 25 type. You should check the shape of the connector on your SCSI device and count the number of pins it has to make sure you obtain the right SCSI cable. Refer to the section " About SCSI " of the S - 770/750's owner's manual.

Note that you will not to use any SCSI driver software that may have been supplied with your SCSI device.

SCSI 機器と S - 770/750 を接続するには、SCSI ケーブルが必要です。S - 770/750 の SCSI コネクターは、D - SUB 25 ピンです。SCSI 機器を S - 770/750 に接続するには、その SCSI 機器の SCSI コネクターの形状とピン数をご確認の上、SCSI ケーブルをご用意いただくこととなります。SYS - 772 Ver2.0 の取扱説明書の「SCSI とは」をご覧ください。また、SCSI 機器に付属されている、SCSI ドライバーなどのソフトウェアは、使用する必要はありません。

The operation of the following products listed below have been checked by Roland.

下記のリストは、ローランドで動作確認をしたものです。

### ●CD - ROM drives

PLEXTOR CORPORATION (TEXEL)  
DM - 5024 (double speed/2 倍速)

APPLE COMPUTER, INC.  
AppleCD 300 (double speed/2 倍速)

TOSHIBA CORPORATION  
XM - 3300A (Japan only/日本国内のみ)  
XM - 3400A (Japan only/日本国内のみ)  
(double speed/2 倍速)

関東電子 (株) (LOGITEC)  
LCD - M500 (Japan only/日本国内のみ)  
(double speed/2 倍速)

CHINON (CHINON AMERICA, INC)  
CDX - 535 (USA only/USAのみ)  
(double speed/2 倍速)

ヤノ電器 (株)  
CD295C (Japan only/日本国内のみ)  
(double speed/2 倍速)

SONY CORPORATION (Hardware Manufacturer)  
CDU561 - 02 (double speed/2 倍速)

NEC Corporation (Hardware Manufacturer)  
CDR - 210 (double speed/2 倍速)  
CDR - 211 (double speed/2 倍速)  
CDR - 510 (triple speed/3 倍速)  
CDR - 511 (fourfold speed/4 倍速)

ROLAND CORPORATION  
CD - 5

### ●Magneto-Optical drives

〈5 inch〉

SONY CORPORATION  
RMO - S550

ROLAND CORPORATION  
MO - 7

Available removable disks/使用できるディスク  
Sony Corporation  
EDM - 1DA1 (512 Byte/Sector)  
Seiko/Epson Corporation  
EPM - C51 (512 Byte/Sector)

MAXTOR CORPORATION  
TAHITI - 2

Available removable disks/使用できるディスク  
MAXOPTIX Corporation  
1 Gigabyte (512 Byte/Sector)  
650 Megabyte (512 Byte/Sector)

KUBOTA CORPORATION  
TAHITI · 1000S (Japan only/日本国内のみ)

Available removable disks/使用できるディスク  
KUBOTA Corporation  
C1000 · 512 (512 Byte/Sector)  
C650 · 512 (512 Byte/Sector)

RICOH COMPANY, LTD.  
RS · 9200EX (Japan only/日本国内のみ)

Available removable disks/使用できるディスク  
RICOH Company, Ltd.  
ROD · 5064F (512 Byte/Sector)

〈3.5 inch〉

SONY CORPORATION \*  
RMO · S350  
RMO · S360

RICOH COMPANY, LTD. \*  
RS · 3100EX (Japan only/日本国内のみ)

MIDORI ELECTRONICS CO., LTD. \*  
OMC · 120 (Japan only/日本国内のみ)

ヤノ電器 (株) \*  
MO128C (Japan only/日本国内のみ)

\* In most cases, any magneto · optical disk of a capacity 128 MBytes single · sided can be used with 3.5 inch magneto · optical drive.

\* 3.5 inch の光磁気ディスク · ドライブでは、128 MByte single · sided のディスクであれば、基本的にすべて使用できます。

## ● Hard Disk drives

In most cases, any hard disk of a capacity less than 600 megabytes can be used with S · 770/750. Although you can use hard disks that are larger than 600 megabytes. So, for example, with an 800 megabyte disk, you would have 600 megabytes of usable, and 200 megabytes that must remain idle. You can also use removable · media hard disk drives ( SyQuest 44 megabytes and 88 megabytes disks) .

容量が 600 メガバイト以下のハード · ディスクであれば、基本的にすべて使用できます。600 メガバイトより容量の大きいハード · ディスクも使用できますが、使用できる容量は 600 メガバイトまでです。たとえば、800 メガバイトのハード · ディスクの場合、600 メガバイトまで使用でき、残りの 200 メガバイトは、一切使用できません。また、リムーバブル式のハード · ディスク (SyQuest タイプの 44 メガバイトと 88 メガバイト) も使用できます。

For Germany

## Bescheinigung des Herstellers/Importeurs

Hiermit wird bescheinigt, daß der/die/das

**Roland DIGITAL SAMPLER S-770**

(Gerät. Typ. Bezeichnung)

in Übereinstimmung mit den Bestimmungen der

**Amtsbl. Vfg 1046/1984**

(Amtsblattverfügung)

funk-entstört ist.

Der Deutschen Bundespost wurde das Inverkehrbringen dieses Gerätes angezeigt und die Berechtigung zur Überprüfung der Serie auf Einhaltung der Bestimmungen eingeräumt.

**Roland Corporation Osaka/Japan**

Name des Herstellers/Importeurs

For the USA

## RADIO AND TELEVISION INTERFERENCE

**WARNING** — This equipment has been verified to comply with the limits for a Class B computing device, pursuant to Subpart J, of Part 15, of FCC rules. Operation with non-certified or non-verified equipment is likely to result in interference to radio and TV reception.

The equipment described in this manual generates and uses radio frequency energy. If it is not installed and used properly, that is, in strict accordance with our instructions, it may cause interference with radio and television reception. This equipment has been tested and found to comply with the limits for a Class B computing device in accordance with the specifications in Subpart J, of Part 15, of FCC Rules. These rules are designed to provide reasonable protection against such a interference in a residential installation. However, there is no guarantee that the interference will not occur in a particular installation. If this equipment does cause interference to radio or television reception, which can be determined by turning the equipment on and off, the user is encouraged to try to correct the interference by the following measure:

- Disconnect other devices and their input/output cables one at a time. If the interference stops, it is caused by either the other device or its I/O cable. These devices usually require Roland designated shielded I/O cables. For Roland devices, you can obtain the proper shielded cable from your dealer. For non Roland devices, contact the manufacturer or dealer for assistance.
- If your equipment does cause interference to radio or television reception, you can try to correct the interference by using one or more of the following measures:
  - Turn the TV or radio antenna until the interference stops.
  - Move the equipment to one side or the other of the TV or radio.
  - Move the equipment farther away from the TV or radio.
  - Plug the equipment into an outlet that is on a different circuit than the TV or radio. (That is, make certain the equipment and the radio or television set are on circuits controlled by different circuit breakers or fuses.)
  - Consider installing a rooftop television antenna with coaxial cable lead-in between the antenna and TV. If necessary, you should consult your dealer or an experienced radio/television technician for additional suggestions. You may find helpful the following booklet prepared by the Federal Communications Commission: "How to Identify and Resolve Radio — TV Interference Problems."

This booklet is available from the U.S. Government Printing Office, Washington, D.C. 20402. Stock No. 004-000-00345-4

For Canada

### CLASS B

### NOTICE

This digital apparatus does not exceed the Class B limits for radio noise emissions set out in the Radio Interference Regulations of the Canadian Department of Communications.

### CLASSE B

### AVIS

Cet appareil numérique ne dépasse pas les limites de la classe B au niveau des émissions de bruits radioélectriques fixés dans le Règlement des signaux parasites par le ministère canadien des Communications.

**Roland®**

**26033398**

UPC

26033398



18961