

ELECTRIC IMPEDANCE OF THE SQUID GIANT AXON DURING ACTIVITY*

BY KENNETH S. COLE AND HOWARD J. CURTIS

(From the Department of Physiology, College of Physicians and Surgeons, Columbia University, New York, and the Marine Biological Laboratory, Woods Hole)

(Accepted for publication, January 11, 1939)

The permeability of a membrane to a penetrating substance is given quantitatively by the amount of the substance which crosses a unit area of the membrane in unit time under the action of a unit force. In simple cases of ionized substances both the amount of substance and the force acting may be expressed in electrical terms. Then the permeability may be ultimately converted into coulombs per second for a square centimeter and a potential difference of 1 volt, which is the conductance, in reciprocal ohms, for a square centimeter. Marine eggs have been measured before and after fertilization and a number of tissues have been measured during activity, but the attempts to interpret the observed conductance changes have not been particularly satisfactory. Since it is quite generally believed that the depolarization of a nerve fiber membrane, during excitation and propagation, involves an increased permeability to ions there have been many attempts to detect and to measure this change as an increase in the electrical conductivity. A decrease in the longitudinal low frequency impedance of frog sciatic nerve during activity was found by Lullies (1930) (also Cole and Curtis, 1936), and a similar change was found in the transverse impedance of the squid giant fiber (Curtis and Cole, 1938). In these cases the measuring current was also the stimulating current and it was not possible to analyze the changes satisfactorily. In *Nitella*, Blinks (1936) showed with direct current transients that on excitation the membrane impedance decreased under the cathode, but it was not possible to separate the change into resistance and capacity components.

* Aided by a grant from The Rockefeller Foundation.

Recently the transverse alternating current impedance of *Nitella* has been measured during the passage of an impulse which originated several centimeters away (Cole and Curtis, 1938 *b*). These measurements showed that the membrane capacity decreased 15 per cent or less while the membrane conductance increased to about 200 times its resting value. Also this conductance increase and the membrane electromotive force decrease occurred at nearly the same time, which was late in the rising phase of the monophasic action potential. Similar measurements have now been made on Young's giant nerve fiber preparation from the squid (Young, 1936). These were undertaken first, to determine whether or not a functional nerve propagates an impulse in a manner similar to *Nitella*, and second, because the microscopic structure of the squid axon corresponds considerably better than that of *Nitella* to the postulates upon which the measurements are interpreted.

The squid axon has about the same membrane capacity (Curtis and Cole, 1938) as other nerve fibers (Cole and Curtis, 1936) and *Nitella* (Curtis and Cole, 1937). The large diameter of the axon, 0.5 mm. or more, makes it particularly favorable material since, for a given membrane conductance change, the magnitude of the observed transverse impedance change is proportional to the fiber diameter. It is also relatively easy to obtain considerable lengths of the axon which can be kept functional for hours.

The experimental procedure and the technique of analysis are fundamentally the same as those used for *Nitella* during activity, although variations have been necessary or possible because of the relatively short time intervals involved. We will present and discuss here only observations made during the passage of an impulse which has been initiated at a distant point.

Material and Dissection

The Atlantic squid, *Loligo pealii*, was used at Woods Hole for these experiments. From early May until late June excellent animals were available, but later they were smaller, not so numerous, and did not live long in the aquarium. The measuring cell was designed for an axon diameter between 530μ and 580μ and this was usually to be found in squid having a mantle length between $10\frac{1}{2}$ and $11\frac{1}{4}$ inches. Slender animals were preferred because the axons were of nearly uniform diameter over their usable length.

It seemed fairly certain that body fluids had an injurious effect, so the mantle was removed from the rest of the animal under running sea water. It was slit along the ventral mid-line, and laid out flat. The preganglionic stellate and fin nerves were then cut on each side and the mantle freed from the rest of the body. The mantle was placed on a large glass absorption cell, cooled by circulating water and illuminated from underneath, and the hindmost stellar nerve dissected out. The nerve was freed at the stellate ganglion, ligated with silk thread, and then separated from the fin nerve and the mantle up to the point where it entered the muscle. It was again ligated and cut free. The small fibers were then teased away from the giant axon in sea water in a Petri dish. The two silk threads were held against the bottom by clips on opposite sides of the dish after the nerve had been stretched until the giant axon was nearly straight. Under a binocular dissecting microscope, the small fibers were all cut near one end with a sharp pointed double edged scalpel and then pulled slightly to one side and cut free where they looped around the giant axon. The axon has a number of small branches which must be cut at a short distance from it. These can often be pulled free without immediately killing the nerve, but degeneration will usually progress slowly from that point. The fibers which remained in good condition for considerable time were usually very turgid after dissection. A 3 cm. length of axon was necessary but it was usually possible to get 6 or 8 cm. in good condition.

After the axon was placed in the measuring cell, the sea water circulation was started, and preliminary measurements made. If the impedance, the threshold for excitation, and the impedance change on excitation became constant within an hour, measurements were started. If not, the fiber was discarded because experience showed that the impedance and impedance change would decrease and the threshold for excitation would increase more or less steadily until after 4 to 6 hours the fiber failed. Under favorable conditions, the axons would have quite constant electrical characteristics for 6 to 8 hours and one remained excitable for 36 hours.

Some experiments were made at room temperature, but the majority were between 2°C. and 4°C. where the conduction velocity was less, a higher bridge input and consequent greater sensitivity could be used, and the axon survival was better. When monophasic action potentials were desired, one end of the axon was dipped in iso-osmotic KCl for a few minutes.

Measuring Cell

The measuring cell, shown in Fig. 1, is very similar to that used for *Nitella*. The axon was placed in the trough, 570 μ wide and 560 μ deep, cut in the top of a sheet of Victron. The entire cell was mounted on a metal box which was maintained at constant temperature by circulating water. After the axon was in place, the cell was covered with a thin microscope cover glass and sea water circulation was started through the cell by a siphon. This maintained a slight negative pressure in the trough and so held the cover glass in place. The cell assembly was mounted on the bridge panel in an insulating shield to lessen temperature changes.

The stimulating electrodes, *a*, impedance electrodes, *b*, *b'*, and potential electrodes, *c*, *c'*, were all platinized platinum. The impedance electrodes should be wide to minimize electrode polarization corrections at low frequencies and the effect of the "fringing" of the current at the electrode edges, but narrow to include as short a length of the axon as possible. The electrode width of 570μ was a fairly satisfactory compromise. The polarization was considerable below 1 kc.,¹ but the duration of the impedance change was short enough to make the interpretation of lower frequency measurements difficult, and the time of transit of a given point of the impulse past the electrode region was about 0.1 millisecond which was too short for the bridge amplifier to follow faithfully. The electrode wells used for the resting squid axon (Curtis and Cole, 1938) were not tried because of the loss in sensitivity and difficulty of construction involved.

The potential electrodes, *c*, *c'*, were all 140μ wide. The "monophasic" potentials, *V*, were measured between the grounded impedance electrode, *b*, and the farther *c'* electrode on an inactive portion of the axon (see Fig. 9 *a*).

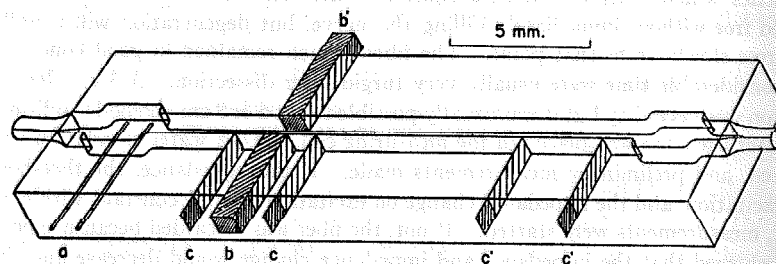

FIG. 1. Measuring cell for squid giant axon. The central trough is for the axon and the connections for circulating sea water are at each end. The axon is stimulated with electrodes, *a*, the transverse impedance measured between electrodes, *b*, *b'*, and the action potentials between various combinations of *b*, *c*, and *c'*.

On the basis of simple cable theory which has been discussed (*Nitella*²), the monophasic action potential is proportional to the potential difference across the membrane and its slope or first derivative is proportional to the current flow parallel to the fiber axis. The density of current flow across the membrane is then given by the second derivative. For *Nitella*, the first and second derivatives were usually calculated from the monophasic action potential, but this was not a particularly satisfactory procedure. The disadvantages were even greater with the squid axon. The oscillograph time scale was not linear and completely monophasic action potentials were seldom obtained, so the extra potential electrodes were added to record the approximate derivatives directly. As is shown on p. 663, the potential difference between electrodes *c*, *c'* (see Fig. 9 *b*) is approxi-

¹ Kilocycles per second.

² Cole, K. S., and Curtis, H. J., 1938-39, *J. Gen. Physiol.*, **22**, 58.

mately the first derivative,³ V_i , of the potential at the impedance electrodes. Also the potential difference between the mid-point of a high resistance across the electrodes c, c and the ground electrode b (see Fig. 9 *c*) gives the approximate second derivative,³ V_{ii} , at the same point.

Conduction velocities were measured by the separation between the V_i potential at electrodes c, c and that at c', c' when these were recorded on the same film. If there was an inactive end under one c' electrode, the V potentials between this electrode and each of the c electrodes, were used to determine the conduction velocity.

Electrical Apparatus

The ellipse and motion picture technique, as used for the *Nitella* experiments, gave complete information on each excitation and would have been ideal for these experiments if the short duration of the action had not made it completely impractical. The next best system considered was the "Lichtbandmethode" of Hozawa (1935), using the Schering bridge in which either the reactance or resistance component of an impedance change can be recorded independently of the other component. The objections to its use were primarily practical ones for, after it was recognized that the Wheatstone bridge could be used, it was obviously inadvisable to attempt to design, construct, and learn to operate a new bridge for the investigation of a phenomenon that was not known to exist. The alternating current Wheatstone bridge which was used and the method of making steady state impedance measurements with it have been described (Cole and Curtis, 1937). A schematic diagram of the equipment is shown in Fig. 2.

The strength of the bridge current was kept as low as possible because it was found that even relatively small currents can cause local changes in the portion of the axon between the impedance electrodes. By maintaining 50 to 100 mv. across the impedance electrodes for a number of minutes, the impedance change on excitation was diminished and only a partial recovery was possible. But if the axon was then moved along the trough so that a different section was between the electrodes, the impedance change was as large as ever. During a run, the voltage across the axon was not allowed to exceed 20 mv. and this was maintained for as short a time as possible.

As a result of the low input voltage requirement, an adequate sensitivity could be obtained only by the use of considerable detector amplification. An ordinary audio frequency bridge output amplifier was satisfactory for *Nitella*, which has a transverse characteristic frequency⁴ of 1 kc., but this did not go to high enough frequencies for the squid axon where the characteristic frequency is about 30 kc. The amplifier was first replaced by a conventional radio superheterodyne mixer, to convert the bridge output to 175 kc., and a transformer coupled amplifier tuned to this frequency. This arrangement introduced very serious distortion when the

³ $V_i = \partial V / \partial t$; $V_{ii} = \partial^2 V / \partial t^2$

⁴ The frequency at which the series reactance is a maximum (Cole, 1932).

amplifier was sharply tuned so that a bridge frequency as low as 20 kc. could be used. A balanced modulator was then substituted for the simple mixer and the amplifier tuning broadened as much as possible. A bridge frequency of 2 kc. could then be used and the distortion was greatly decreased.

A differential resistance-capacity coupled amplifier with degeneration in the common mode was used for the action potentials. The output of either this amplifier or the 175 kc. bridge amplifier could be switched to the vertical deflecting plates of the cathode ray oscillograph through a single stage untuned power amplifier.

The conversion of all bridge output frequencies to 175 kc. before they were impressed on the oscillograph as well as the short time intervals involved precluded

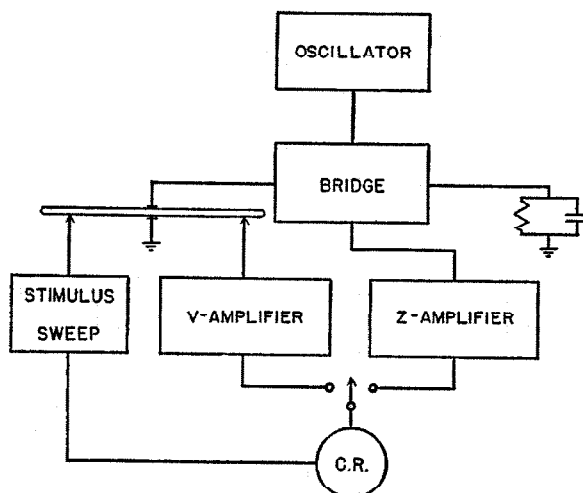

FIG. 2. Schematic diagram of the electrical equipment. The axon is at the left, and the balancing resistance and capacity at the right, of the bridge. The action potential and bridge amplifiers are represented by V-amplifier and Z-amplifier respectively and the cathode ray oscillograph by C. R.

the use of the *Nitella* motion picture and ellipse technique, but the use of a horizontal sweep circuit was convenient since the axon could be stimulated between one and ten times per second as was usually done. The stimulus was a short shock which was taken from the sweep circuit in such a manner that it was applied at the start of the sweep, and a shielded transformer was used in the stimulus circuit to reduce the shock artifact.

Procedure

Experimental.—After the axon was placed in the measuring cell and had become steady, the resting parallel resistance and capacity were measured at 9 frequencies

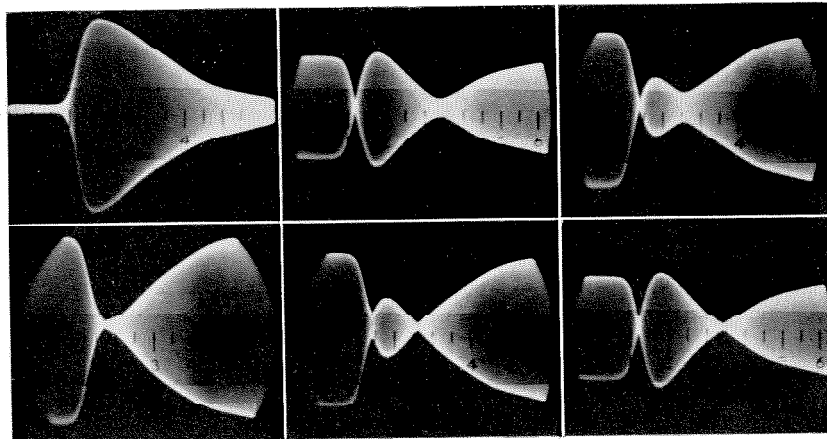

FIG. 3. Bridge output during the passage of an impulse with the bridge balanced for the impedance of the axon first at rest and then at various times during the action. Frequency 50 kc.; maximum change, 7 per cent.

from 2 kc. to 1000 kc. At one frequency, the bridge would then be balanced with the oscillograph which gave a narrow horizontal trace each sweep, when the stimulus was below threshold. After the threshold was reached, the bridge went off balance when the action came between the impedance electrodes, and the oscillograph line broadened into a band. Then as the axon recovered, the bridge returned to balance and the band narrowed down to the resting line again as shown in Fig. 4. The width of the band at any point is proportional to the magnitude of the change of impedance, but does not give any information as to the relative values of the resistance and capacity components of this change. The resistance and capacity of the known arm of the bridge were then altered so that, although the bridge is no longer balanced at rest, it would be balanced at some particular point during the activity as shown in Fig. 3. In this way the resistance and capacity were measured during the action at a series of ten or fifteen points along a scale on the face of the oscillograph which was calibrated in milliseconds.

The relation between the impedance change and the action potential was recorded photographically as shown in Fig. 4 (Cole and Curtis, 1938 *a*). The impedance change was first exposed for about ten sweeps, the oscillograph was then

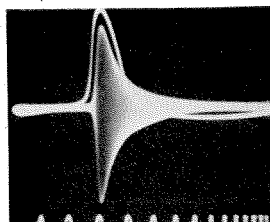

FIG. 4. Double exposure of the 2 per cent maximum bridge unbalance at 20 kc. and the monophasic action potential at one of the impedance electrodes. The time marks at the bottom are 1 millisecond apart.

switched from the bridge amplifier to action potential amplifier, the bridge oscillator turned off, and without change of the sweep circuit or stimulus, a second exposure of two or three sweeps of the action potential was made a second later on the same film. The resistance and capacity were also measured both at rest and at the time of the maximum impedance change.

These measurements during activity were made at frequencies of 5, 10, 20, 50, 100 kc. and sometimes 200 and 500 kc. Finally, another complete frequency run was taken on the axon at rest to show what changes had taken place during the experiment, and if these were too large the experiment was discarded. The conduction velocity and the amplification of the action potential amplifier were measured and a time record was made to calibrate the sweep circuit.

When the axon was removed from the cell at the end of the experiment it was carefully examined and the diameter measured at the point which was between the impedance electrodes. The cell was filled with sea water and resistance and capacity data were taken at low frequencies, to determine the electrode polarization, and at high frequencies, to measure the static capacity of the cell.

Analytical.—The data on parallel resistance and capacity, R_p and C_p , were corrected for the electrode polarization and static capacity of the cell (Cole and Curtis, 1937) and the series resistance and reactance, R_s and X_s , were calculated by

$$R_s = R_p / (1 + R_p^2 C_p^2 \omega^2); \quad X_s = R_p^2 C_p \omega / (1 + R_p^2 C_p^2 \omega^2)$$

The frequency impedance locus, which is the path followed when X_s is plotted against R_s , as the frequency of the measuring current is varied (Cole, 1928, 1932), was plotted for the resting fiber (Fig. 5). The properties of the resting axon have been calculated from the extensions of the Rayleigh equation which have been used for single cylindrical cells (Curtis and Cole, 1937, 1938; Cole and Curtis, 1938 *b*). The average membrane capacity at 1 kc. is $1.80 \mu\text{f./cm.}^2$ with an average phase angle of 71° . The average internal specific resistance is 71 ohms cm. or about 2.9 times that of sea water.

At each frequency, the value of R_s and X_s during activity may be plotted in the same manner and trace a path which is called the time impedance locus. The points of maximum change at five frequencies are shown in Fig. 5 and all of the 10 kc. points taken at different times during the action of another axon are shown on a larger scale in Fig. 6. If the only change during activity were a decrease of membrane resistance, then the time impedance locus at each frequency would be

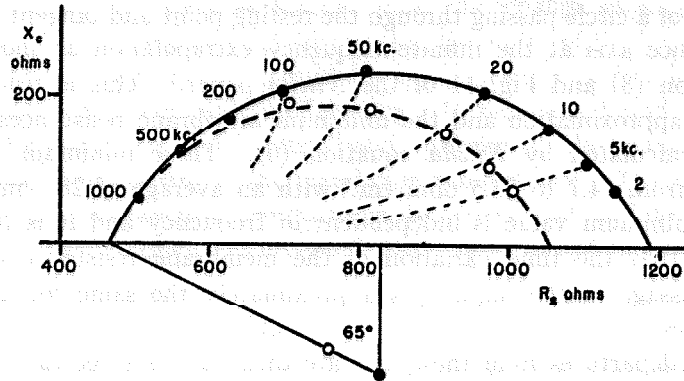

FIG. 5. Impedance loci of series resistance, R_s , vs. series reactance, X_s , in ohms. The solid circles which lie on the solid frequency locus are obtained from resting nerve at the indicated frequencies, and the open circles are the points of maximum change which lie on the heavy broken line representing the frequency locus. The light broken lines forming circular arcs are the theoretical time loci for a pure membrane resistance decrease at each of five frequencies.

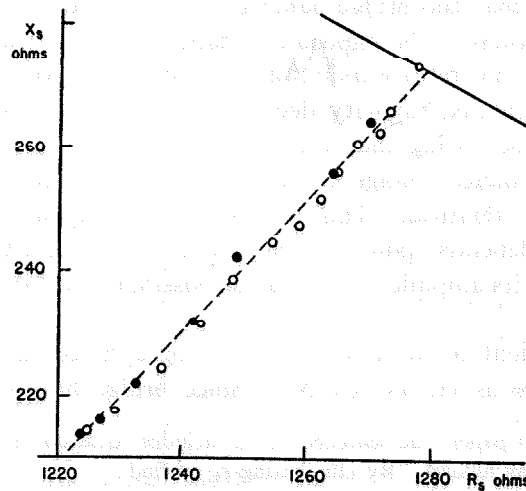

FIG. 6. Time impedance locus of series resistance, R_s , vs. series reactance, X_s , at 10 kc. during the passage of an impulse. The solid circles were taken during the impedance decrease on excitation and the open circles during the increase on recovery. The broken line represents part of a circular arc which is the theoretical locus for a pure membrane resistance change and the solid line is a portion of the resting frequency locus.

an arc of a circle passing through the resting point and tangent to the resistance axis at the infinite frequency extrapolation as shown in equation (8) and Fig. 11 of the *Nitella* paper.⁵ This is true as a rough approximation and the minimum membrane resistances have been calculated by *Nitella* equation (6). These minimum values range from 14.7 to 53.5 ohm cm.² with an average of 28 ohm cm.² This minimum value is independent of frequency and it is further found that the time variation of the membrane resistance during the passage of the impulse is approximately the same for all frequencies.

The departures from these arcs are then due to a decrease of the membrane capacity during activity, which can be calculated by *Nitella* equation (9). The capacity decrease in Fig. 5 depends upon the frequency and reaches a maximum of nearly 10 per cent at 50 kc. At the other extreme is the negligible capacity change which was found from the data in Fig. 6. The average capacity decrease for all experiments is about 2 per cent. It is usually found, as can be seen in Fig. 3 that the bridge balance is not the same on the rising and falling portions of the impedance change and this means that the time locus does not retrace its initial path during recovery. Because of this the calculated capacity decrease lags slightly behind the resistance decrease during the passage of the impulse. On the other hand the impedance change records made at different frequencies are practically identical. This means that the apparent capacity change either depends upon frequency or is an artifact introduced by the bridge and its amplifier. The latter possibility will be considered later (p. 661).

It is convenient to work with the oscillograph records of the impedance change as far as possible. Since bridge balance measure-

⁵ In the *Nitella* paper, the sentence which includes equation (8) is incorrect and should read as follows, "By eliminating r_4 we find

$$r^2 + x^2 - 2r_\infty r - [(f - r_\infty)^2 + x^2]/2x + r_\infty^2 = 0$$

which is the equation of a circle having its center at the point,

$$r_\infty, [(f - r_\infty)^2 + x^2]/2x$$

and the radius,

$$[(f - r_\infty)^2 + x^2]/2x."$$

ments during the impulse indicate that the change of membrane capacity is small, equation (4) shows that the width of the impedance band on the oscillograph should be approximately proportional to the change of membrane conductance. It has been found experimentally that both the "balance" and "unbalance" data give nearly the same time course for the membrane conductance. The average time of rise to maximum conductance is between 250 and 300 $\mu\text{sec.}$, but this value cannot be accepted until its accuracy has been established (see below).

Distortions and Corrections

The ideal measuring equipment would record accurately the properties of an infinitesimal length of axon, regardless of adjacent portions and independent of what happened the instant before. But in these experiments the impedance and the action potential have been measured over at least a half millimeter length of axon, while the responses of the bridge and the amplifiers may be expected to lag behind the phenomena.

Lines of current flow resulting from the action potential which would otherwise be confined to the sea water in the trough will enter and leave the impedance electrodes as the action passes them. This may alter the speed of propagation (Hodgkin, 1939) and modify other characteristics of the impulse in this region, but no attempt has been made to estimate the magnitude of these effects.

Impedance.—The effects of electrode length and current spread on the impedance measurements are the same as for the *Nitella* cell. If a perfectly sharp change of membrane conductance moved between the impedance electrodes, the observed change of impedance would be spread over the entire effective electrode length, including the region of current spread beyond the ends of the electrodes. As for the *Nitella* cell, this effect has been investigated by measuring the resistance as a cylindrical glass rod was moved along the trough with its end passing through the electrode region. The square cut end of the rod was then equivalent to the sharp transition from a non-conducting to a conducting fiber which corresponded to a sudden drop of membrane resistance.

The results of Fig. 7 show that although the actual electrode length was 570 μ , and 90 per cent of the change was confined to 1000 μ , the entire electrode region was over 1600 μ long. If the rod moved at 12 meters per second, the 90 per cent change would require 83 $\mu\text{sec.}$ and the whole over 130 $\mu\text{sec.}$ This is a considerable portion of the time of rise of the impedance change as observed on axons having this velocity and so must be considered.

For a steady state, the deflection of the oscillograph was proportional to the difference between the impedances of the known and unknown arms of the bridge, but the response to a rapid change of impedance must also be determined. After the bridge has been thrown off balance, the currents in the bridge, oscillator, and

detector circuits will change only as fast as the inductances, capacities, and resistances will permit, and the voltage appearing across the detector will be distorted. Rough calculations indicate that under ideal conditions this effect would have a time constant of no more than a few micro-seconds. And when bridge output voltage is applied to the modulator and amplifier further distortion may be expected for, so far as changes of amplitude are concerned, this system is equivalent to an audio frequency amplifier. The combined characteristics of the bridge, modulator, and amplifier have been determined by recording the response to a sudden unbalance of the bridge. The bridge was balanced with a high resist-

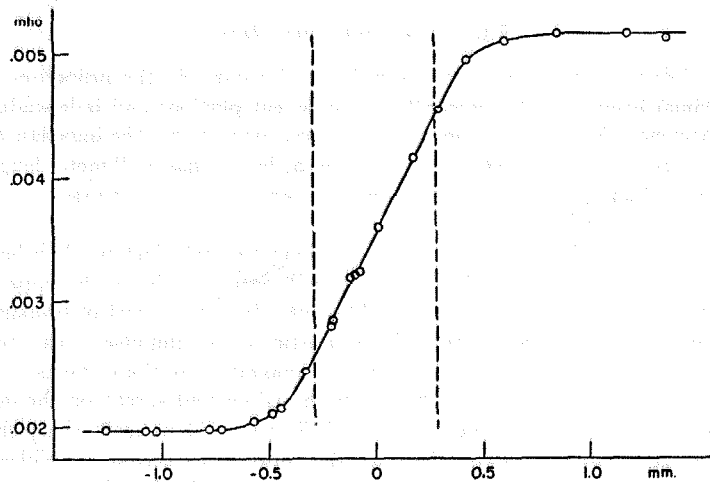

FIG. 7. Conductance of the measuring cell, with a glass rod in place of the squid axon. The rod is introduced between the electrodes and is moved to the right so its left end goes through the electrode region. The electrode boundaries are given by the broken lines and the abscissae are distances in millimeters between the left end of the rod and the center of the electrodes.

ance shunt on the known arm of the bridge. One circuit on a Lucas spring rheotome then started the oscillograph sweep and a millisecond later a second circuit removed the shunt and so threw the bridge off balance. The record shown in Fig. 8 *a* has a complicated form, which has not been satisfactorily explained, but it may be roughly approximated by an exponential having a time constant of 100 μ sec.

It would be difficult to obtain directly the oscillograph response to a sudden change of membrane conductance moving past the impedance electrodes with a velocity of 12 meters per second, but it has been calculated by combining the data

of Figs. 7 and 8 *a* in Duhamel's integral or the principle of superposition.^{6,7} With the response of the oscillograph to a known cause, it is theoretically possible to determine the cause of any other effect, but the practical difficulties are considerable and several methods for the correction of the experimental curves have been tried and found unsatisfactory. For example, the desired curve may be approximated by an exponential with a time constant of 0.125 millisecond and the data corrected by the subtangent method (*cf.* Lucas, 1912; Rushton, 1937) as has been done in Fig. 10. In general these corrections have shortened the apparent time of rise of the membrane conductance to 100 μ sec. or less, but have usually increased its maximum value by only about 10 per cent.

It should also be pointed out that the data obtained by balancing the bridge at different points of the impedance change are subject to the same distortions by the bridge, modulator, and amplifier. It is to be expected that there will be a phase alteration introduced during and for a short time after a rapid impedance change, and this would require false capacity and resistance changes for the apparent balance point. The magnitude of this effect has not been investigated in detail, and it is difficult to estimate how much of the apparent change of membrane capacity may be due to it.

Action Potentials.—A strictly monophasic action potential was never obtained probably due to some remaining activity of the distant end or a lack of uniformity of the axon in the region between the two electrodes. For this reason and because it is preferable to make as many of the measurements in the immediate neighborhood of the impedance electrodes as possible, the integral of the first derivative curve is more satisfactory. The first derivative curve is an approximation as is discussed on p. 664. The two portions of the rising phase of the monophasic action potential have an average time constant of about 110 μ sec. corresponding to a length of about 1.3 mm. This is very close to 1.25 mm., the half separation of the V_i electrodes. Thus we find by equation (9) that the recorded V_i curve should be more than 60 per cent wider at the half maximum than the actual V_i . If we now differentiate this curve to obtain V_u , we compute by equation (10) that the two maxima would be separated by 2.5 mm. or 210 μ sec. if the rising portion is a double exponential, whereas without distortion the reversal for this curve

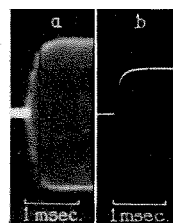

FIG. 8. (*a*) Response of the bridge and the bridge amplifier to a sudden unbalance at 20 kc. (*b*) Response of the action potential amplifier to a suddenly applied potential.

⁶ Webster, A. G., 1927, *Partial differential equations of mathematical physics*, Leipsic, Teubner, p. 172.

⁷ Bush, V., 1929, *Operational circuit analysis*, New York, John Wiley and Sons, p. 68.

should take place instantaneously. On the other hand, using the three electrode connection, the reversal time would be $175 \mu\text{sec.}$ and values of from 180 to $200 \mu\text{sec.}$ have been found. A simple method has not been found for applying corrections for the electrode separations, and no attempt has been made to construct any complete curves.

After the potential is on the electrodes, there is still the action potential amplifier distortion to consider. This also was determined with the spring rheotome which applied a known potential to input of the amplifier. The response curve shown in Fig. 8 *b*, is approximately an exponential with a time constant of $80 \mu\text{sec.}$ The monophasic action potential record of Fig. 10 has been corrected for this time constant by the subtangent method.

Theory

Membrane Conductance.—The output voltage of the bridge and the oscillograph deflection arc proportional to

$$Y = 2 \left| \frac{z - \bar{z}}{z + \bar{z}} \right|, \quad (1)$$

where \bar{z} is the impedance at balance and z is the impedance off balance. When the resting impedance is \bar{z} and the membrane conductance changes by an amount λ without change of membrane capacity, the impedance becomes by *Nitella* equation (7),

$$z = \frac{a\sigma\lambda r_\infty + z}{a\sigma\lambda + 1}, \quad (2)$$

where a is the fiber radius, σ is a complex constant involving \bar{z} , and r_∞ is the infinite frequency resistance. We then have, approximately,

$$Y = \frac{2\beta\lambda}{1 + \beta\lambda}, \quad (3)$$

where

$$\beta = \left| \frac{a\sigma(z - r_\infty)}{2z} \right|,$$

so if $\beta\lambda$ is small the oscillograph deflection is proportional to the change of membrane conductance. In practice, the maximum change of conductance λ_0 was determined from bridge balance measurements at rest and maximum change. If the oscillograph deflection at the maximum is Y_0 then

$$Y_0 = \frac{2\beta\lambda_0}{1 + \beta\lambda_0},$$

and when λ is calculated by

$$\lambda = Y\lambda_0/Y_0$$

the fractional error in this procedure is given by

$$\frac{Y\lambda_0/Y_0 - \lambda}{\lambda} = \frac{Y_0 - Y}{2 - Y_0} \quad (4)$$

The average value of Y_0 was about 8 per cent at low frequencies, so that the maximum error in the membrane conductance change was about 4 per cent for the smallest changes and became less nearer the maximum.

Action Potential Derivatives.—At a particular instant let the action potential at each point, x , along the axon be $V(x)$. The potential at a neighboring point, $x + \delta$, is then given by Taylor's expansion,

$$V(x + \delta) = V(x) + \delta \dot{V}(x) + \frac{\delta^2}{2!} \ddot{V}(x) + \frac{\delta^3}{3!} \dddot{V}(x) + \dots,$$

where \dot{V} , \ddot{V} , etc. are the first, second, etc. total derivatives with respect to the independent variable, x in this case. The difference in potential V_1 between two electrodes at a distance on either side of the point x (see Fig. 9 *b*) is

$$V_1 = V(x + \delta) - V(x - \delta) = 2\delta \dot{V}(x) + \frac{2\delta^3}{3!} \dddot{V}(x) + \dots \quad (5)$$

and if δ , \ddot{V} , and successive derivatives are sufficiently small,

$$V_1 = 2\delta \dot{V}(x) \quad (6)$$

Thus the extreme case of a diphasic potential with electrodes close together is proportional to the first derivative, \dot{V} , with respect to moving coordinates and also with respect to time at a fixed point, V_t , if the velocity is constant.

Similarly when the circuit of Fig. 9 *c* is used, the potential at the midpoint of the resistor connected between points $x + \delta$, and $x - \delta$ is

$$\frac{1}{2}[V(x + \delta) + V(x - \delta)]$$

and the potential difference between this point and the center point, x , is

$$V_2 = \frac{1}{2}[V(x + \delta) + V(x - \delta)] - V(x) = \frac{\delta^2}{2!} \ddot{V}(x) + \frac{\delta^4}{4!} \ddddot{V}(x) + \dots \quad (7)$$

which is proportional to $\ddot{V}(x)$ if δ , \ddot{V} , and successive derivatives are small, or

$$V_2 = \frac{\delta^2}{2!} \ddot{V}(x). \quad (8)$$

The question of how small δ must be depends of course upon $V(x)$ and we shall consider the errors which may be introduced in the rising phase. For purposes of calculation this part of $V(x)$ will be assumed to be made up of two identical exponentials symmetrically placed

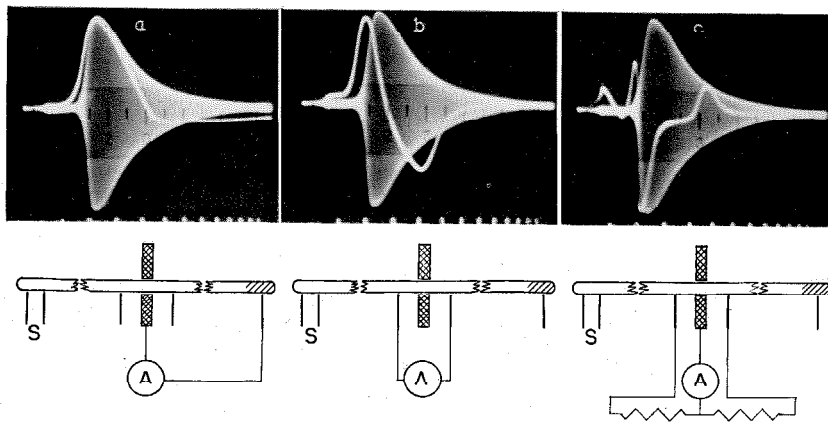

FIG. 9. Double exposures of the impedance change at 10 kc. on each with the action potential in each picture from the circuit shown below it. (a) is V , the monophasic potential, (b) is V_t , the first derivative or axial current, and (c) is V_{tt} , the second derivative or membrane current. The time marks at the bottom are 1 millisecond apart.

with respect to the half maximum point, which will be taken as the origin. Then on the upper half

$$V(x) = 1 - e^{-x/\lambda},$$

and on the lower

$$V(-x) = -(1 - e^{x/\lambda}),$$

where λ is the characteristic length. When $x > \delta$,

$$V(x + \delta) - V(x - \delta) = e^{-x/\lambda}(e^{\delta/\lambda} - e^{-\delta/\lambda}), \quad (9)$$

and if x is the point of half maximum of this potential,

$$e^{x/\lambda} = e^{\delta/\lambda} + 1.$$

If δ/λ is small the width of the true \dot{V} at half maximum is increased by δ , and when $\delta = \lambda$ the width is 62 per cent too large. Obtaining \dot{V} by direct differentiation of this approximate \dot{V} we find that the maximum occurs at $x = -\delta$ and the minimum at $x = \delta$ so that the peaks are separated by 2δ whereas there should be a discontinuity with reversal of sign at $x = 0$. A similar error is found in the value of \dot{V} measured directly from the three electrodes, the minimum being at the value of $x < \delta$ given by

$$\delta/\lambda = x/\lambda + \log_e \cosh x/\lambda \quad (10)$$

When δ/λ is small the separation of the peaks is 2δ but when $\delta = \lambda$ the separation is 1.49δ .

DISCUSSION AND CONCLUSIONS

The values for the capacity and phase angle of the membrane and the internal resistance of the resting axon given above are somewhat different from those which were found before (Curtis and Cole, 1938), but this is not particularly surprising. Although the material in the present work was in considerably better condition, the electrodes were short and the data were calculated on the assumption that end effects were negligible, and it was found for muscle that the measured phase angle was less for short electrodes than for long (Cole and Curtis, 1936). It has been assumed in calculations on transverse impedance measurements that the resting axon membrane is non-conducting. The value of 1000 ohm cm.² obtained by Cole and Hodgkin (1939), more than justifies that assumption. There are considerable differences between the values of the internal specific resistances which have been measured but we are not in a position to explain them.

Turning now to the impedance change during activity, it is first necessary to show that this is a real effect and not an artifact resulting from the stimulus or the action potential. The stimulus may be eliminated because the effect is entirely all-or-none. The bridge balance remains unchanged until the stimulus reaches threshold, and then the unbalance picture remains unaltered as the stimulus is further increased except that it moves forward with the action potential because the point of stimulation moves closer to the impedance elec-

trodes. Any possible effect due directly to the action potential is eliminated for several reasons. The only action potential which would be effective is that appearing across the impedance electrodes, which should be zero in a perfect axon. In practice this potential was always present, although it was small and did not come through the bridge amplifier. However, it was never the same in any two axons and yet the impedance change always had the same form. Most conclusive, however, is the fact that the amplitude of the unbalance picture was directly proportional to the bridge input voltage from the oscillator while the action potential was unaffected.

In spite of the shortcomings of the apparatus and the difficulty of correcting for them, the general nature and magnitude of the impedance change seems quite certain. The decrease of the extrapolated zero frequency resistance (Fig. 5) might be due to a change of either the volume of the axon or the resistance of the external medium, but these factors should alter the extrapolated infinite frequency resistance which is unchanged. The phase angle of the membrane is unchanged and the membrane capacity does not change alone because this would merely move each point along the resting curve. Consequently we must assume that there is a change of the membrane resistance which falls from a resting value of 1000 ohm cm.² to a minimum value which is probably 10 per cent and perhaps 20 per cent below the average uncorrected value of 28 ohm cm.². The 2 per cent decrease of membrane capacity is of quite a different order of magnitude, but even this value should not be taken too seriously because there are indications that the actual change may be somewhat less.

We may reason, as we did for *Nitella*, that the conductance is a measure of the ion permeable aspect of the membrane and we see that the maximum conductance is far from a complete permeability. And indeed the capacity, which represents the ion impermeable portion of the membrane, has not been encroached upon by more than 2 per cent. Thus if the change on excitation is uniform throughout the structure of the membrane it must be so delicate as to leave the capacity and phase angle nearly unchanged and conversely if there are drastic changes they must be confined to a small fraction of the membrane area. The time constant of the resting membrane is of

the order of 1 millisecond which is equivalent (*Nitella*)⁸ to a thousand ions per second crossing the membrane for each ion pair separated by the membrane, and the time constant of 0.03 millisecond at the maximum then gives a permeability of some thirty thousand ions per ion pair.

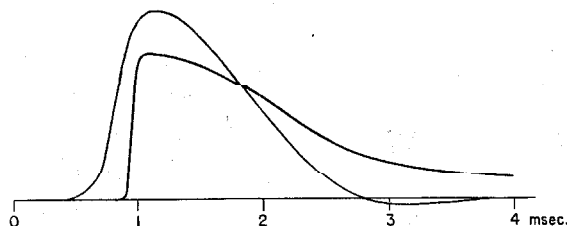

FIG. 10. Membrane conductance increase (heavy line) after approximate corrections for electrode length and bridge amplifier response and monophasic action potential (light line) obtained from the first derivative after approximate correction for action potential amplifier response.

The time course of the membrane conductance is best discussed in connection with the action potential, but before doing so we should submit some proof that the oscillograph sweep circuit, which gave the horizontal time scale, did not alter in the interval between the impedance and action potential exposures. To do this, the two have been taken simultaneously by applying the V_i potential, of Fig. 9 *b*, to the vertical plates and bridge output to the horizontal plates with the result shown in Fig. 11. It is here seen as in Fig. 9 *b*, that the potential rises to its maximum value before the bridge goes off balance. It is then clear that the conductance does not start to increase until the point of inflection on the V_i or membrane potential, curve, Fig. 9 *a*, which is the reversal point of the V_u or membrane current, curve, Fig. 9 *c*. The small "foot" at the start of the membrane conductance pictures is due in part to the spread of the measuring current beyond the impedance electrodes which gives a similar foot in Fig. 7, but it seems fairly certain that there is

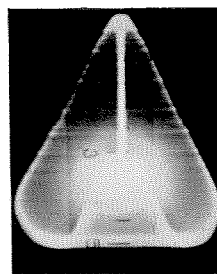

FIG. 11. The first derivative action potential, V_i , vertical, against the bridge unbalance at 20 kc., horizontal, during the passage of an impulse.

⁸ Cole, K. S., and Curtis, H. J., 1938-39, *J. Gen. Physiol.*, **22**, 51.

at least a measurable increase in conductance before the large and rapid increase takes place. The action potential corrections do not permit an accurate placement of this change, but it seems slightly to precede the reversal of the membrane current. This effect may be the impedance counterpart of the phenomenon preceding excitation at the cathode which has been observed by Katz (1937) and Hodgkin (1938).

The difficulties of determining the time of rise of the membrane conductance have already been discussed and the only conclusion to be made at present is that it is probably at least as short as 100 μ sec. and perhaps even shorter. In contrast to the *Nitella* results, it will be noticed that for the squid axon the recovery of the action potential is completed considerably before that of the membrane resistance, but it seems likely that when this difference can be explained the whole phenomenon of excitation and conduction will be fairly well understood.

It should be possible, at this point, to determine the time course of the membrane electromotive force, by *Nitella* equation (16), and so obtain a complete picture of the electrical behavior of the membrane during activity. These calculations on *Nitella* were found to be very sensitive to small errors, so it seems best to avoid this procedure until other means have been exhausted and better squid data are available.

It seems apparent, however, from the data now available that, as was found for *Nitella*, the foot of the monophasic action potential up to the point of inflection represents a purely passive discharge into the active region following. Up to this point, the axon acts like a communication cable and although the conditions for the breakdown are being approached the axon has not yet exhibited any biological characteristics. At the point of inflection, we have the increase of conductance and decrease of electromotive force which give rise to the constant velocity and all-or-none behavior so characteristic of the propagated disturbance in excitable tissues.

The similarity of the impedance changes in the activity of *Nitella* and the squid axon is so striking as to add further proof that the phenomena of excitation and conduction are fundamentally the same in these forms. Since the action potentials of these forms are com-

parable with those of other nerve fibers and the membrane capacities of many cells, including the *Nitella* and the squid, cat sciatic, and frog sciatic axons, are nearly the same (*cf.* Cole, 1939) we may assume for the present that there are impedance changes in other nerve fibers and that the mechanisms of excitation and propagation are all quite similar. In the future the impedance changes should be measured more accurately in *Nitella* and in squid and should be looked for in other forms, and the effects of various chemical and physical changes of environment should be investigated. There are a few preliminary observations on subthreshold phenomena and drug action but these are too incomplete to be discussed at the present time.

SUMMARY

Alternating current impedance measurements have been made over a wide frequency range on the giant axon from the stellar nerve of the squid, *Loligo pealii*, during the passage of a nerve impulse. The transverse impedance was measured between narrow electrodes on either side of the axon with a Wheatstone bridge having an amplifier and cathode ray oscillograph for detector. When the bridge was balanced, the resting axon gave a narrow line on the oscillograph screen as a sweep circuit moved the spot across. As an impulse passed between impedance electrodes after the axon had been stimulated at one end, the oscillograph line first broadened into a band, indicating a bridge unbalance, and then narrowed down to balance during recovery. From measurements made during the passage of the impulse and appropriate analysis, it was found that the membrane phase angle was unchanged, the membrane capacity decreased about 2 per cent, while the membrane conductance fell from a resting value of 1000 ohm cm.² to an average of 25 ohm cm.²

The onset of the resistance change occurs somewhat after the start of the monophasic action potential, but coincides quite closely with the point of inflection on the rising phase, where the membrane current reverses in direction, corresponding to a decrease in the membrane electromotive force. This E.M.F. and the conductance are closely associated properties of the membrane, and their sudden changes constitute, or are due to, the activity which is responsible for the all-or-none law and the initiation and propagation of the

nerve impulse. These results correspond to those previously found for *Nitella* and lead us to expect similar phenomena in other nerve fibers.

We wish to express our appreciation of the valuable assistance of Mr. J. M. Spencer in all parts of this work.

BIBLIOGRAPHY

- Blinks, L. R., 1936, *J. Gen. Physiol.*, **20**, 229.
Bush, V., 1929, Operational circuit analysis, New York, John Wiley and Sons.
Cole, K. S., 1928, *J. Gen. Physiol.*, **12**, 29; 1932, **15**, 641; 1939, *Tabulae Biologicae, Cellula*, in press.
Cole, K. S., and Curtis, H. J., 1936, Electric impedance of nerve and muscle, in Cold Spring Harbor symposia on quantitative biology, Cold Spring Harbor, Long Island Biological Association, **4**, 73. 1937, *Rev. Scient. Instr.*, **8**, 333. 1938a, *Nature*, **142**, 209. 1938b, *J. Gen. Physiol.*, **22**, 37.
Cole, K. S., and Hodgkin, A. L., 1939, *J. Gen. Physiol.*, **22**, 671.
Curtis, H. J., and Cole, K. S., 1937, *J. Gen. Physiol.*, **21**, 189; 1938, **21**, 757.
Hodgkin, A. L., 1938, *Proc. Roy. Soc. London, Series B*, **126**, 87. 1939, *J. Physiol.*, **94**, 560.
Hōzawa, S., 1935, *Z. Biol.*, **96**, 586.
Katz, B., 1937, *Proc. Roy. Soc. London, Series B*, **124**, 244.
Lucas, K., 1912, *J. Physiol.*, **44**, 225.
Lullies, H., 1930, *Arch. ges. Physiol.*, **18**, 215.
Rushton, W. A. H., 1937, *Proc. Roy. Soc. London, Series B*, **123**, 382.
Young, J. Z., 1936, Structure of nerve fibers and synapses in some invertebrates, in Cold Spring Harbor symposia on quantitative biology, Cold Spring Harbor, Long Island Biological Association, **4**, 1.
Webster, A. G., 1927, Partial differential equations of mathematical physics, Leipsic, Teubner.