

AD630587

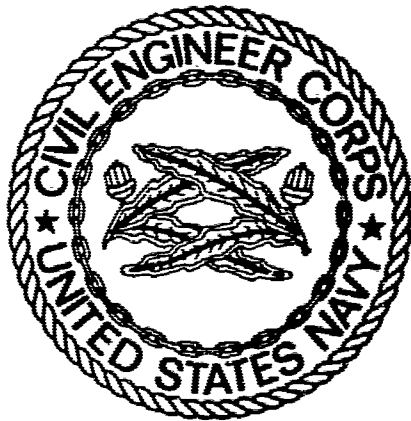

R 435

CURRENT-VOLTAGE CHARACTERISTICS
OF THIN-FILM DIODES



March 1966

CLEARINGHOUSE FOR FEDERAL SCIENTIFIC AND TECHNICAL INFORMATION			
Hardcopy	Microfiche		
\$ 2.00	\$ 0.50	40 pp	<i>ad</i>
ARCHIVE COPY			

Code 1

Distribution of this document is unlimited

U. S. NAVAL CIVIL ENGINEERING LABORATORY
PORT HUENEME, CALIFORNIA

CURRENT-VOLTAGE CHARACTERISTICS OF THIN-FILM DIODES

Technical Report R-435

Y-R011-01-01-049

by

R. D. Hitchcock

ABSTRACT

The current-voltage (I-V) characteristics of thin-film diodes were measured at 4.2°K, 77°K, and room temperature. Superconductive tunneling was achieved with a diode consisting of aluminum, aluminum oxide, and lead (Al/Al₂O₃/Pb). In the nonsuperconducting state the Al/Al₂O₃/Pb type of thin-film diode exhibited Zener breakdown between 1.5 and 3.5 volts. However, the Al/Al₂O₃/Pb diodes did not have reproducible I-V characteristics, and the nonsuperconducting Al/Al₂O₃/Pb diode could not be operated with AC voltage long enough to serve as a practical electronic device.

A thin-film diode consisting of aluminum, aluminum oxide, manganese, and lead exhibited power-law I-V characteristics at ambient temperatures, under 60-cycle excitation, and could be operated with a reproducible I-V characteristic for several hours. Bistable switching was achieved with a thin-film diode consisting of aluminum, aluminum oxide, lead, and aluminum; in this diode the short-circuit state was produced by a high-voltage pulse and the open-circuit state by a low-voltage pulse.

A theoretical analysis of the observed I-V characteristics is presented.

Distribution of this document is unlimited.

Copies available at the Clearinghouse (CFSTI) \$2.00
The Laboratory invites comment on this report, particularly on the
results obtained by those who have applied the information.

CONTENTS

	page
NOMENCLATURE	iv
INTRODUCTION	1
BACKGROUND	2
APPARATUS FOR CONSTRUCTION OF DIODES AND ATTAINMENT OF LOW TEMPERATURES	4
Vacuum Deposition System	4
Liquid-Helium Cryostat	4
CONSTRUCTION AND MEASUREMENT TECHNIQUES	5
Diode Construction	5
Measurement of Current-Voltage Characteristics	11
RESULTS	15
THEORETICAL DISCUSSION	27
CONCLUSIONS	31
GLOSSARY	32
REFERENCES	34

NOMENCLATURE

e	charge on the electron
h	Planck's constant
I	electrical current
I_n	electrical current in normal state
J	electrical current density
k	Boltzmann's constant
K_1	first-order modified Bessel function of the second kind
m	mass of the electron, grams
R_L	load resistance, ohms
s	film thickness, cm
T	absolute temperature, °K
T_c	superconductor transition temperature, °K
v	carrier drift velocity, cm/sec
V	voltage
V_i	input or supply voltage
Δ	half the superconductor energy gap
ΔV	change of output voltage
ϵ	dielectric constant of insulating film
μ_n	mobility of electrons
μ_p	mobility of holes
ϕ	electronic work function
τ	carrier lifetime, seconds

INTRODUCTION

One of the concerns of the Naval Shore Establishment is the housing of electronic systems under the water as well as on land, eventually at great depths in the open sea. In a high-pressure environment, it is possible to operate certain types of electronic components in a pressure-equalizing fluid; however, whether components are operated in a fluid at ambient pressure or in air at normal pressure, it is important that individual components occupy very little space. In the near future it may turn out that the need for extremely small electronic devices in deep-ocean systems is vital for the successful installation, operation, and maintenance of facilities mounted on the ocean bottom.

Since the advent of the transistor, electronic devices have been rapidly diminishing in size. At the present time entire electronic systems can be contained within a few cubic centimeters. The investigation, development, and production of these small systems come under the general heading of microelectronics, also known as subminiaturization.

Semiconductor devices, such as the bulk transistor and the Zener diode, can be constructed hundreds or thousands of times smaller than electron tubes. However, devices are now being used in microelectronic systems which are much smaller than and may eventually replace entirely the bulk semiconductor devices. The new devices utilize the electronic properties of thin metallic or semiconductor films. These films require a substrate thickness like that required for the mounting of bulk solid-state devices. However, packaging efficiency is markedly improved through the use of thin-film components, because thin films facilitate considerably the integration of components and interconnections. The use of thin films increases packaging density while simultaneously reducing the overall weight of the system.

Thin-film components which are used for capacitors and resistors are presently in the production stage. But as yet the more advanced functions performed by bulk transistors and diodes are not performed reliably enough by thin-film devices to allow their incorporation in mass-produced systems.

Programs to develop reliable thin-film electronic devices which can be mass produced and which will perform such functions as amplification, bistable switching, and voltage regulation are presently under way both in the government and in private industry. This report describes some of the characteristics of the thin-film diodes that have been studied at the Naval Civil Engineering Laboratory (NCEL). In particular the investigation at NCEL has involved the study of the current-voltage characteristics of thin-film diodes which consist of two vacuum-deposited metallic strips separated by a thin layer of nonmetallic material.

Originally, the aim of this work was the development of a superconductor detector of submillimeter radiation. It was thought that superconductive tunneling would make possible the quantum detection of radiation in the submillimeter band, because the superconducting energy gap approximates the photon energy of this radiation. However, it has turned out to be impossible to construct a stable superconductor diode with the equipment presently available at NCEL; consequently, a basic experiment could not be set up to determine whether a superconductor diode is affected by submillimeter radiation.

BACKGROUND

The basic electronic characteristic of a solid-state diode is the current-voltage, or I-V, plot. This plot expresses the dependence of current, through the diode, on the voltage, which is applied across the diode.

The I-V characteristics of three types of solid-state diodes are shown in Figure 1. Figure 1a is the I-V plot for the tunnel diode, which is a bulk-semiconductor device. Because of the negative resistance region between the two inflection points of the curve, the tunnel diode can be used to provide amplification and other important electronic functions.

Voltage amplification by a negative-resistance diode can be seen by constructing load lines with a slope slightly steeper than that between inflection points A and B in Figure 1a. A slight change of input voltage, V_i , shifts one load line into the other and causes a relatively large change in the voltage across the diode, ΔV .

Figure 1b is the I-V characteristic of a Zener diode, which is also a bulk-semiconductor device. Because of the breakdown region, exhibited by the nearly vertical part of the curve, the Zener diode is used as a voltage regulator.

The I-V plot of a superconductor thin-film diode¹ is given in Figure 1c. The pronounced "knee" of this I-V characteristic is the result of electron tunneling between two metallic films, both of which are in the superconducting state.* As yet, the superconductor diode is not used in prototype electronic circuits; however, Shapiro and Janus² have demonstrated that this type of diode can demodulate an AM signal at frequencies up to 65 MHz.

The thin-film metal/oxide/metal diode that operates at room temperature is at about the same stage of development as the superconductor thin-film diode. Reproducibility is a major problem in the development of both types of diodes. Operation of the room-temperature diode, however, is not encumbered as is the superconductor diode by the requirement for liquid helium.

*Over 20 metallic elements and a number of alloys exhibit superconductivity at temperatures between 0°K and 18.1°K.

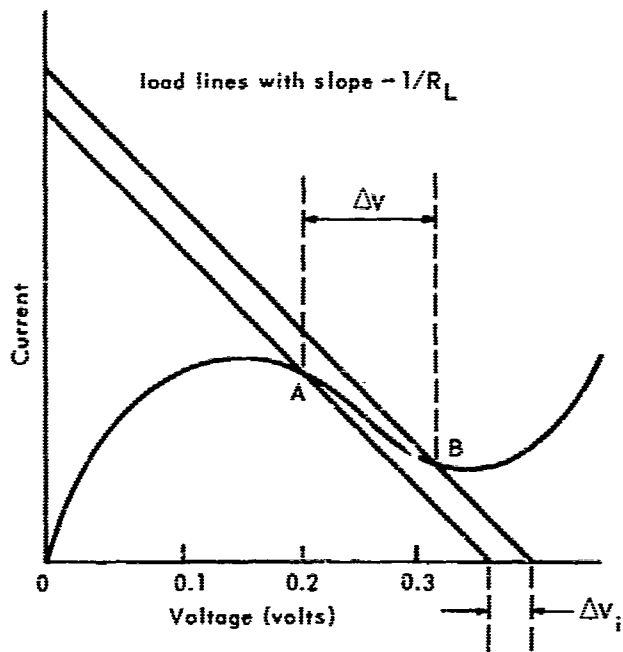

$$-I = V/R_L - V_i/R_L$$

$$\text{gain} = \Delta V / \Delta V_i$$

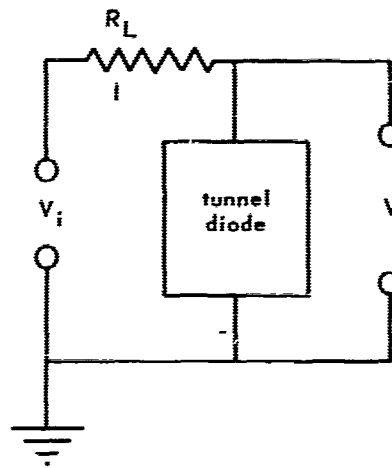

(a) Tunnel diode

A, B - Inflection points
 ΔV - Change of output voltage
 ΔV_i - Change of input voltage

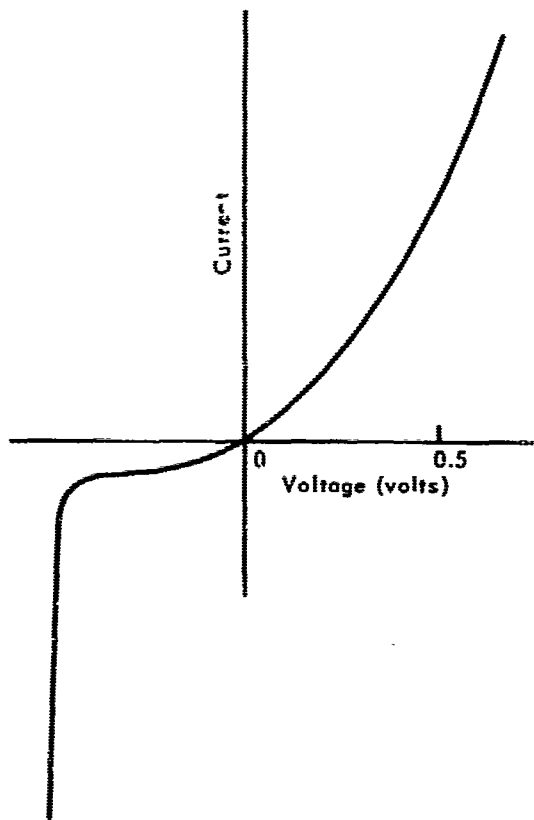

(b) Zener diode

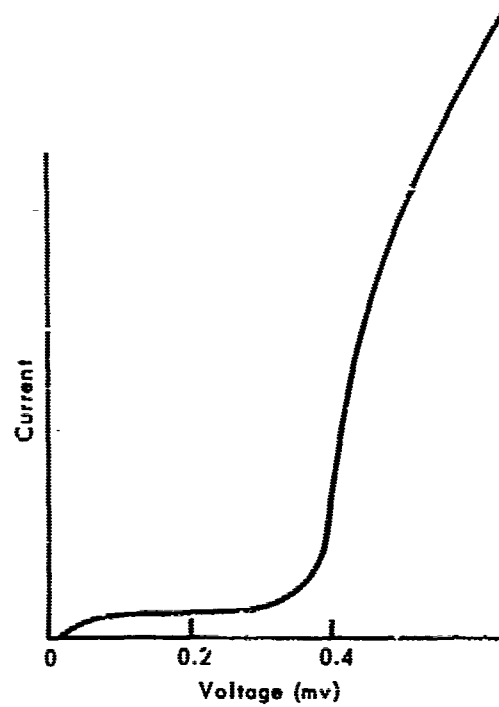

(c) Superconductor thin-film diode

Figure 1. I-V characteristics of solid-state diodes.

Hickmott^{3,4} has investigated room-temperature thin-film diodes and has obtained I-V characteristics which exhibit negative resistance. Bistable switching in thin-film diodes has also been observed by Hiatt and Hickmott.⁵

The I-V characteristics of superconductor thin-film diodes are fairly well explained by the theoretical electron spectrum of a superconductor.¹ Yet, in the case of thin-film diodes operating at room temperature, or at a cryogenic temperature but in the nonsuperconducting state, the I-V characteristics cannot always be explained. Some nonsuperconducting thin-film diodes exhibit I-V plots which appear to have a power-law dependence of current on voltage. Hickmott³ has suggested that an I-V curve showing square-dependence is the result of space-charge-limited current flow.⁶

APPARATUS FOR CONSTRUCTION OF DIODES AND ATTAINMENT OF LOW TEMPERATURES

Vacuum Deposition System

Vacuum deposition of thin-film diodes was performed in a system which uses a 2-inch oil diffusion pump. The deposition system is shown in Figure 2, and Figure 3 is a diagram of the system.

With the exception of the water-cooled baffle, which was constructed in the NCEL shops, the major components of the deposition system are commercial stock items. Two mechanical pumps are included in the system, one for evacuating the atmospheric pressure from the bell jar and the other for operating the diffusion pump. This arrangement permits the diffusion pump to remain on at all times during the venting of the bell jar and the setting up of a substrate for a new deposition.

Heater current for vaporizing metal from the filament is supplied by a 450-watt, 115-volt transformer with a 5-volt secondary winding. The deposition system also includes a high-voltage transformer to be used in the cleaning of substrates by ion bombardment. A potential between 2,000 and 5,000 volts can be produced between the pump plate and an electrode which enters the space in the bell jar to one side of the filament posts.

The length of time required to evacuate the bell jar down to 1 torr is about 5 minutes. About 15 more minutes are required to bring the vacuum to 10^{-4} torr. Reduction of the pressure to 5×10^{-5} torr requires more than 2 hours; however, this pressure cannot be maintained during deposition of metal onto a substrate.

Liquid-Helium Cryostat

In order to measure the I-V characteristics of superconductor diodes a liquid-helium cryostat was constructed. Figure 4 is a partial view of the cryostat, showing the stainless-steel dewar positioned between the pole pieces of an

electromagnet.* A diagram of the dewar is shown in Figure 5. The dewar was designed by the author and fabricated by a private firm which specializes in cryogenic hardware.

In addition to the dewar, the cryostat system includes a pumping system and a liquid-helium transfer tube. The pumping system uses a high-speed 4-inch oil-diffusion pump that is assisted by a mechanical pump with a free-air capacity of about 4.4 liters per second. The liquid-helium transfer tube is constructed of stainless steel and is equipped with a jacket which can be pumped down to around 10^{-5} torr. Without a vacuum-jacketed transfer line, it is not possible to transfer liquid helium from the storage vessel into the dewar.

Before the dewar can be used to hold liquid helium the vacuum jackets must be pumped down to about 10^{-3} torr; then a quantity (~1.5 liters) of liquid nitrogen must be delivered to the open storage jacket of the dewar. The normal boiling point of helium is 4.2°K , so that any residual air in the vacuum jackets is solidified, and heat conduction through the jackets is negligible. The main causes of heat flow to the helium vessel are radiation through the dewar neck and across the vacuum spaces and conduction down the neck.

About a half liter of liquid helium can be transferred into the dewar in 5 minutes. This time interval includes the time required to cool the helium vessel from room temperature to a point just below the boiling point of helium. After an 8-hour period, the superconductor level indicator,** just above the tail section of the dewar, still indicates immersion in liquid helium.

CONSTRUCTION AND MEASUREMENT TECHNIQUES

Diode Construction

Substrates for supporting vacuum-deposited thin films were prepared by cutting $1 \times 12 \times 25$ -mm glass plates from microscope slides. The glass plate was cleaned by soaking it in a detergent, washing it in distilled water, and finally, drying it with a tissue. For making connections to an external circuit, patches of pure indium metal were then spread onto the ends and sides of the substrate by means of a 2-mm-diameter soldering tip. A copper lead was indium-soldered to each of the four patches.

*A magnetic field can be used to switch a metal out of the superconducting state without changing the temperature.

**A thin film of lead, deposited on a glass substrate, was connected to an ohmmeter. Immersion of the lead film in liquid helium was indicated by the disappearance of resistance caused by the transition to the superconducting state.

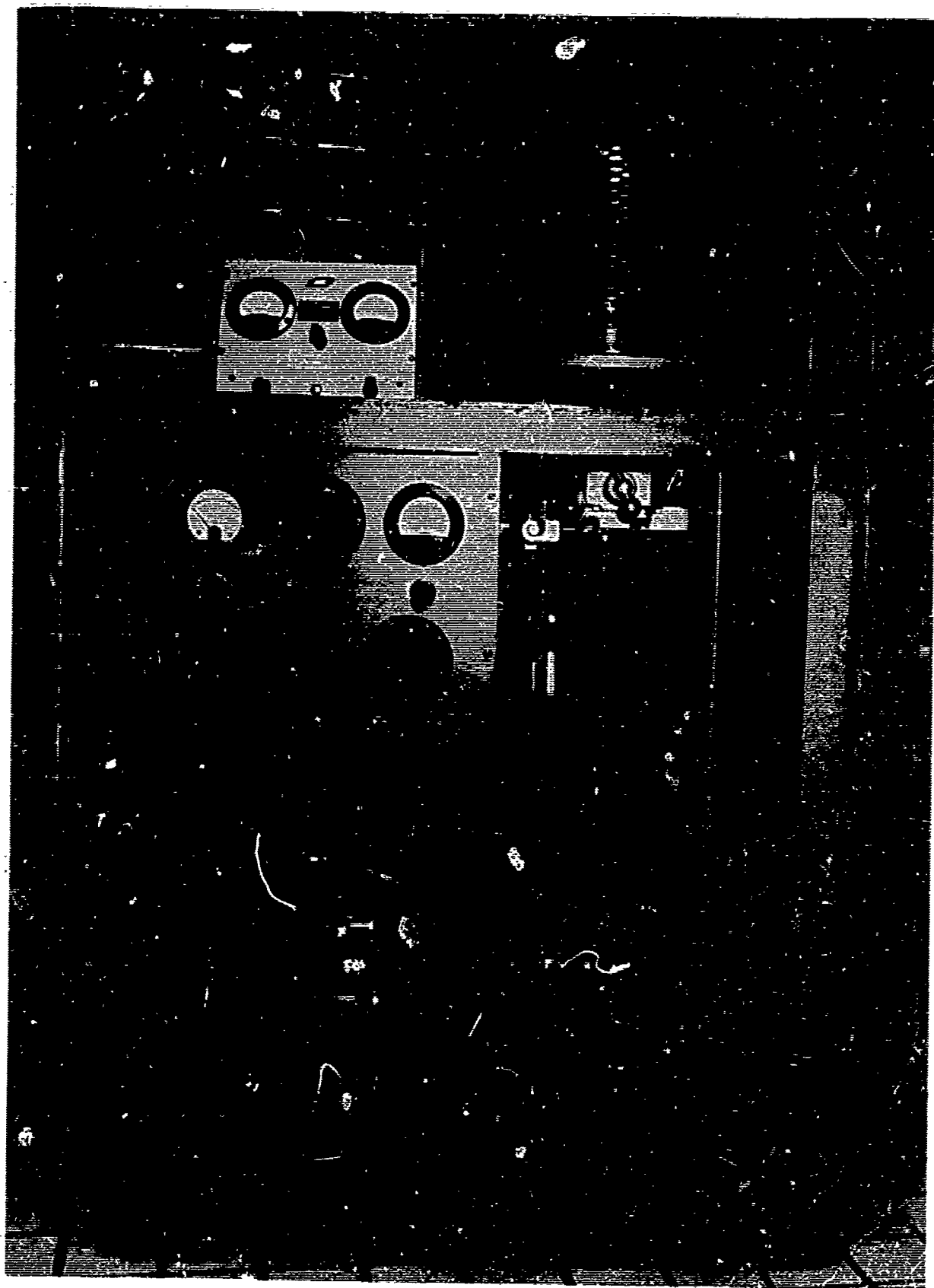

Figure 2. NCEL vacuum deposition system.

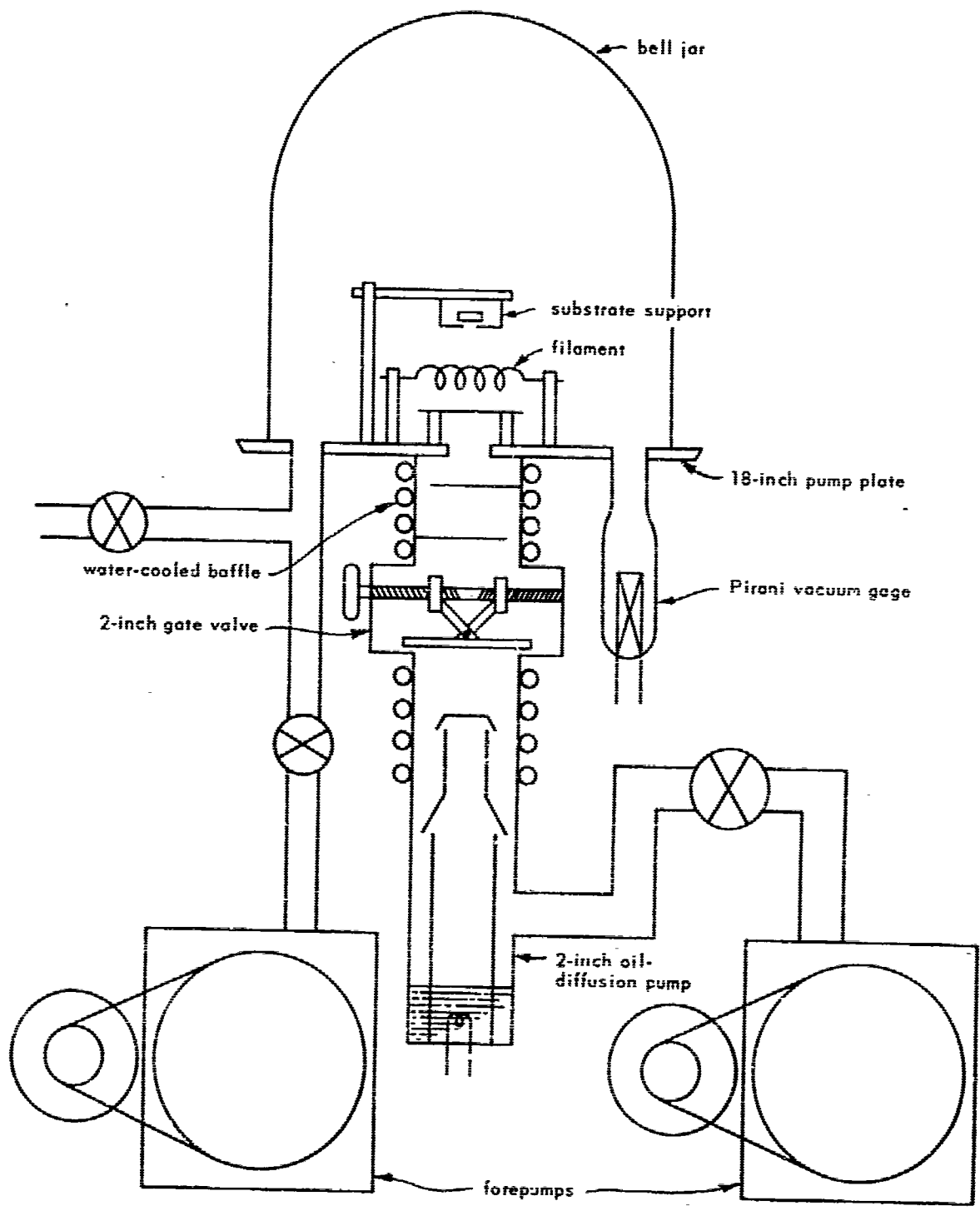

Figure 3. Diagram of NCEL vacuum deposition system.

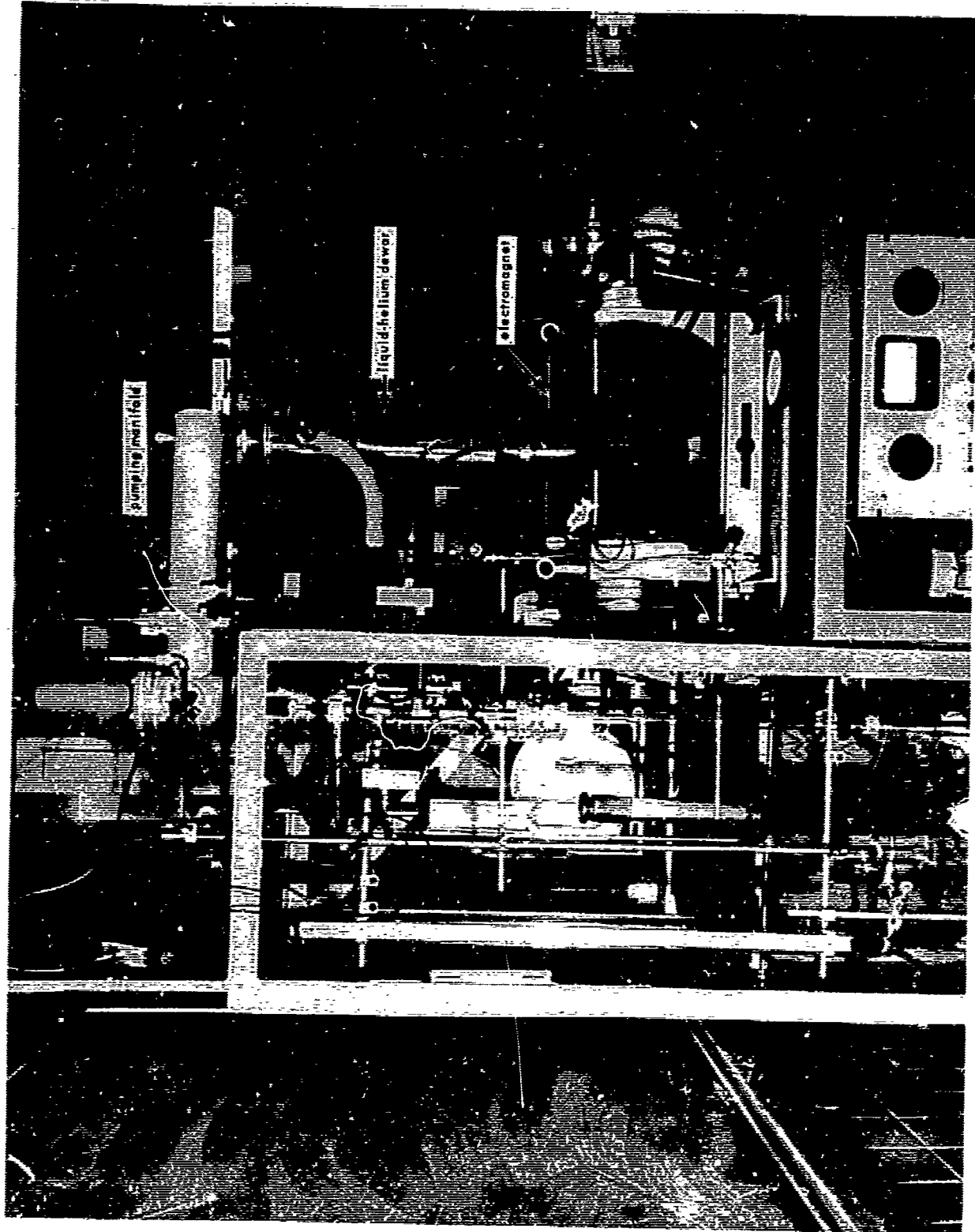

Figure 4. NCEM liquid-helium cryostat.

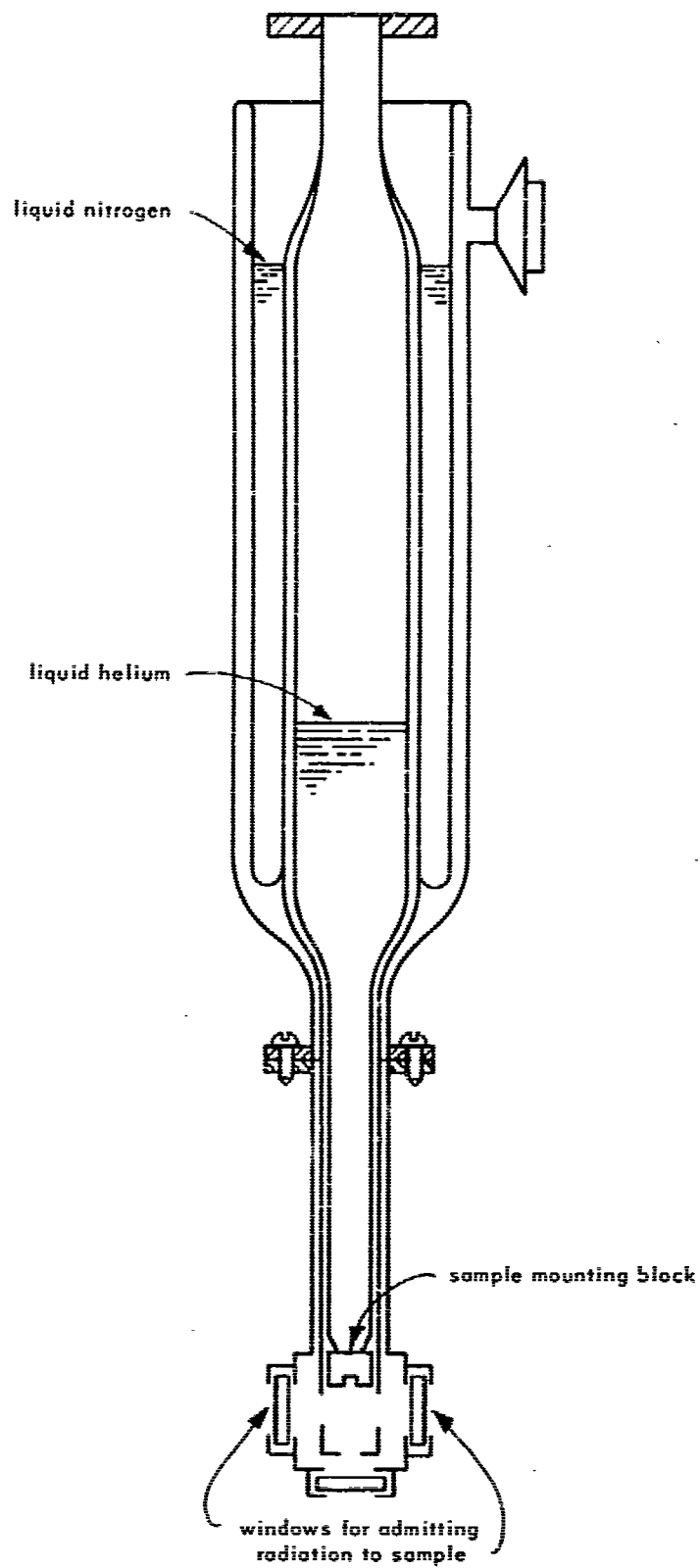

Figure 5. Diagram of NCEL liquid-helium dewar.

A conductive epoxy cement was used to make electrical connections to an external circuit. This technique, however, was not very satisfactory, because evidently the cement did not wet the glass enough to form a smooth, flat patch which gradually sloped into the glass surface. The contact angle between patch surface and glass surface was so high that the thin metal film frequently broke at the contact point and caused an open circuit.

Thin-film sandwiches, or diodes, were made first by depositing a 1-mm-wide strip of aluminum lengthwise onto the substrate, then by oxidizing the aluminum to form a thin insulating film of aluminum oxide, and finally by depositing a second 1-mm-wide strip of a metal, usually different from aluminum, across the oxidized strip, at right angles.

The following procedures were used in constructing an aluminum, aluminum oxide, and lead (Al/Al₂O₃/Pb) diode:

1. Aluminum.

- a. Filament: six-turn, 7-mm-diameter helix of 0.3-inch-diameter tungsten wrapped on a glass mandrel.
- b. Filament preparation: six pieces of 0.03-inch-diameter, 3/8-inch-long aluminum wire, each folded twice and clamped to the filament at the lowest point of each turn; aluminum pieces melted under vacuum of 10⁻⁴ torr to form beads.
- c. Mask: aluminum foil with 1 x 25-mm slot cut in center with razor blade; held to substrate by kinking leads around edges of mask.
- d. Mask position: 30 mm above filament.
- e. Filament current: 1 minute to bring filament to red heat and just begin appearance of film on substrate; 20 to 30 seconds at 20 amps to form opaque film.
- f. Pressure: 10⁻⁴ torr.
- g. Method of monitoring: direct observation through top of bell jar.

2. Aluminum oxide deposition.

- a. After aluminum film has cooled under vacuum for 10 minutes, bell jar is vented, and substrate is repositioned on mask; oxidation is conducted in air at atmospheric pressure and room temperature; oxidation time varies from 10 minutes to a little over 1 hour.

3. Lead deposition.

- a. Filament: three-turn basket of tantalum wire, 0.04-inch diameter; basket diameter slightly greater than 1/4 inch so that crucible is not held too tightly and does not cause shorting of turns.

- b. Crucible: 1/4-inch-diameter, 3/8-inch-long spectrographic graphite drilled with 3/16-inch-diameter, 1/4-inch-deep hole.
- c. Crucible preparation: filled with wad of lead consisting of folded piece of lead foil, 1/4 inch x 1-1/2 inch.
- d. Mask: same as for aluminum deposition.
- e. Mask position: 30 mm above crucible.
- f. Filament current: 40 amps, maximum.
- g. Deposition time: 1 minute to bring filament to red heat and just begin deposition; 20 seconds at 40 amps to form opaque film.
- h. Pressure: 10^{-4} torr.

Figure 6 shows a glass substrate, with indium patches and copper leads, before deposition of the metal strips. Figure 7 shows the substrate mounted on the pump plate and ready for deposition. Figure 8 is a completed Al/Al₂O₃/Pb diode mounted on a plug-in board.

Another kind of diode was constructed by vaporizing manganese powder from the same type of crucible as used for lead, and then by depositing the lead strip over the manganese strip to form a double layer. Deposition of the manganese film required a considerably longer time than the deposition of the lead. Film formation was not detectable by the eye for about 3 minutes at 40 amps, 2 or 3 minutes more were required to make the film very slightly opaque.

Measurement of Current-Voltage Characteristics

Plots of diode I-V characteristics were obtained by using either an X-Y pen recorder or an X-Y oscilloscope. Records of the oscilloscope traces were made with a polaroid camera.

Figure 9 is a schematic of the circuit used to obtain the I-V plots. A battery was used as the voltage source for the pen recorder; and a 12-volt transformer, connected directly to 115 volts, 60 cycles, was used for the oscilloscope.

The reason for the "cross" geometry of the thin-film diode, as seen in Figure 8, is to allow the voltage drop across the insulating barrier to be directly measured. If a measurement of the voltage were attempted across points A and B in Figure 9, the voltage would not only be increased by the drop across the thin-film path from A through the junction to B, but also the resulting I-V plot would probably not have the correct shape.

The room-temperature I-V characteristics were measured with the diode exposed to the atmosphere. Measurements at 77°K were performed with the plug-in board assembly (Figure 8) immersed in liquid nitrogen. To obtain the I-V plot for liquid-helium temperatures a smaller plug-in board was constructed and attached to the end of a long pyrex tube.

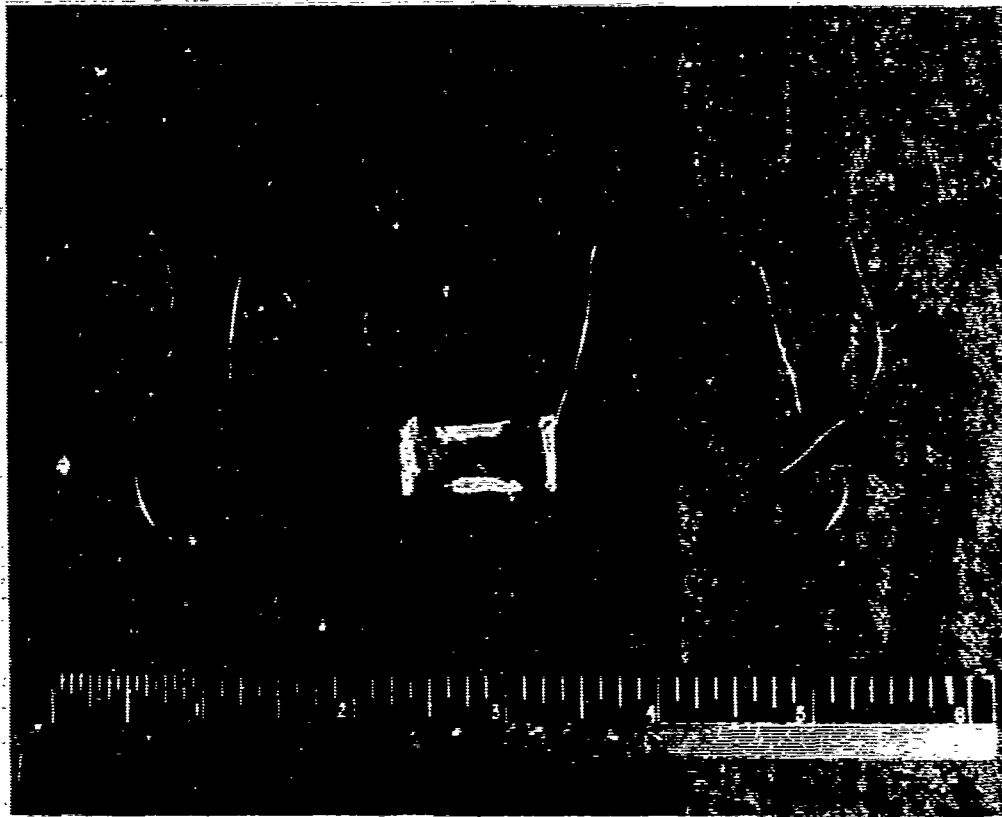

Figure 6. Glass substrate with indium patches and copper leads.

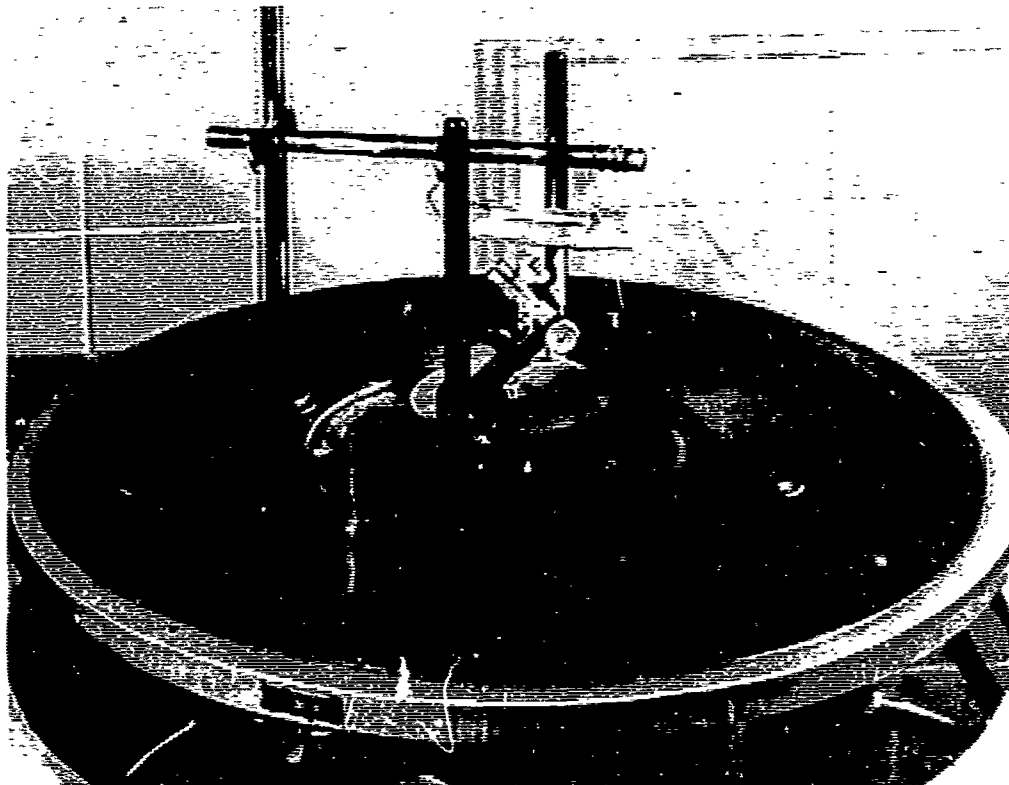

Figure 7. Glass substrate and aluminum deposition filament mounted on pump plate of NCEL vacuum deposition system.

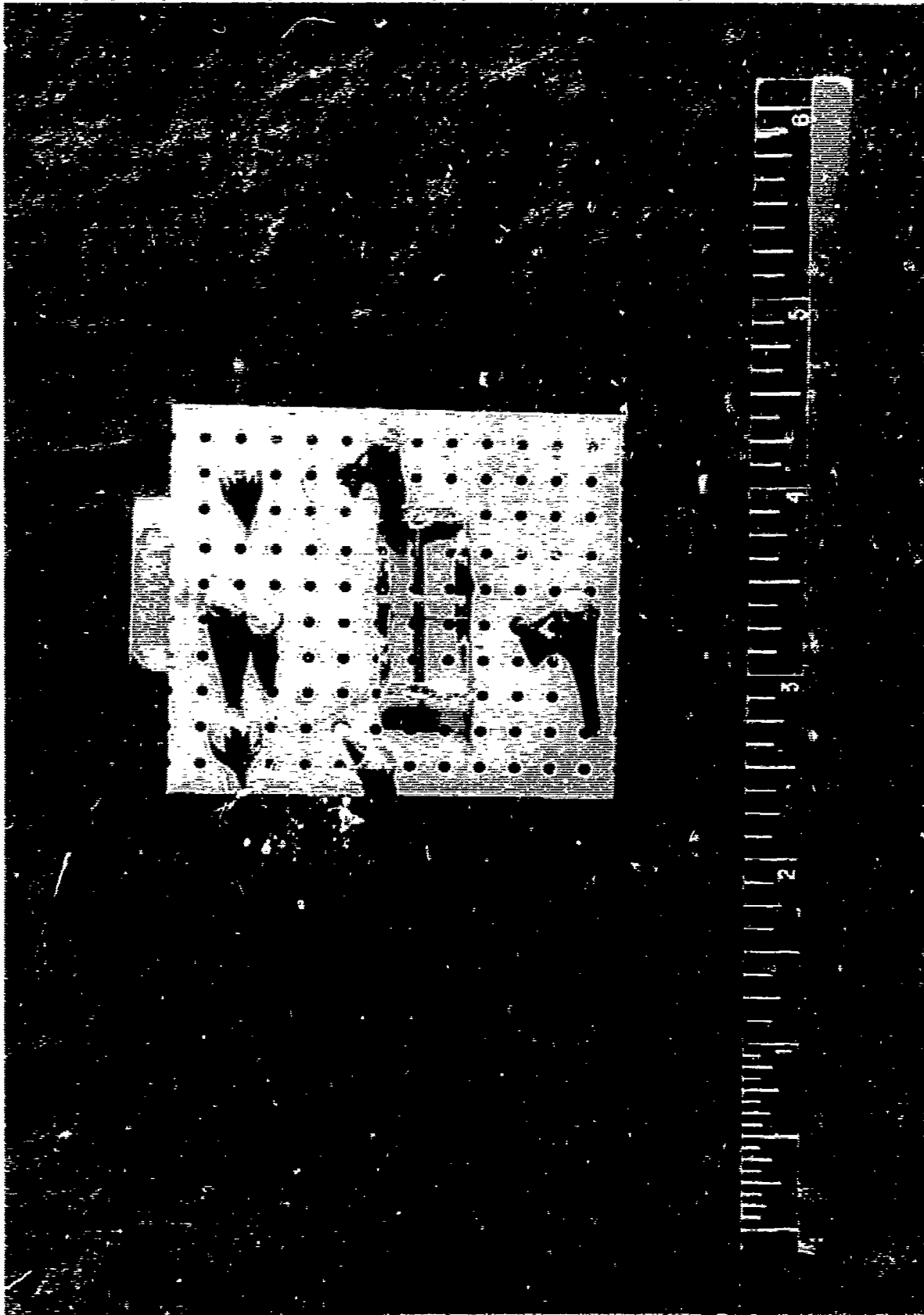

Figure 8. Thin-film diode assembly, consisting of Al/Al₂O₃/Pb sandwich mounted on plug-in board.

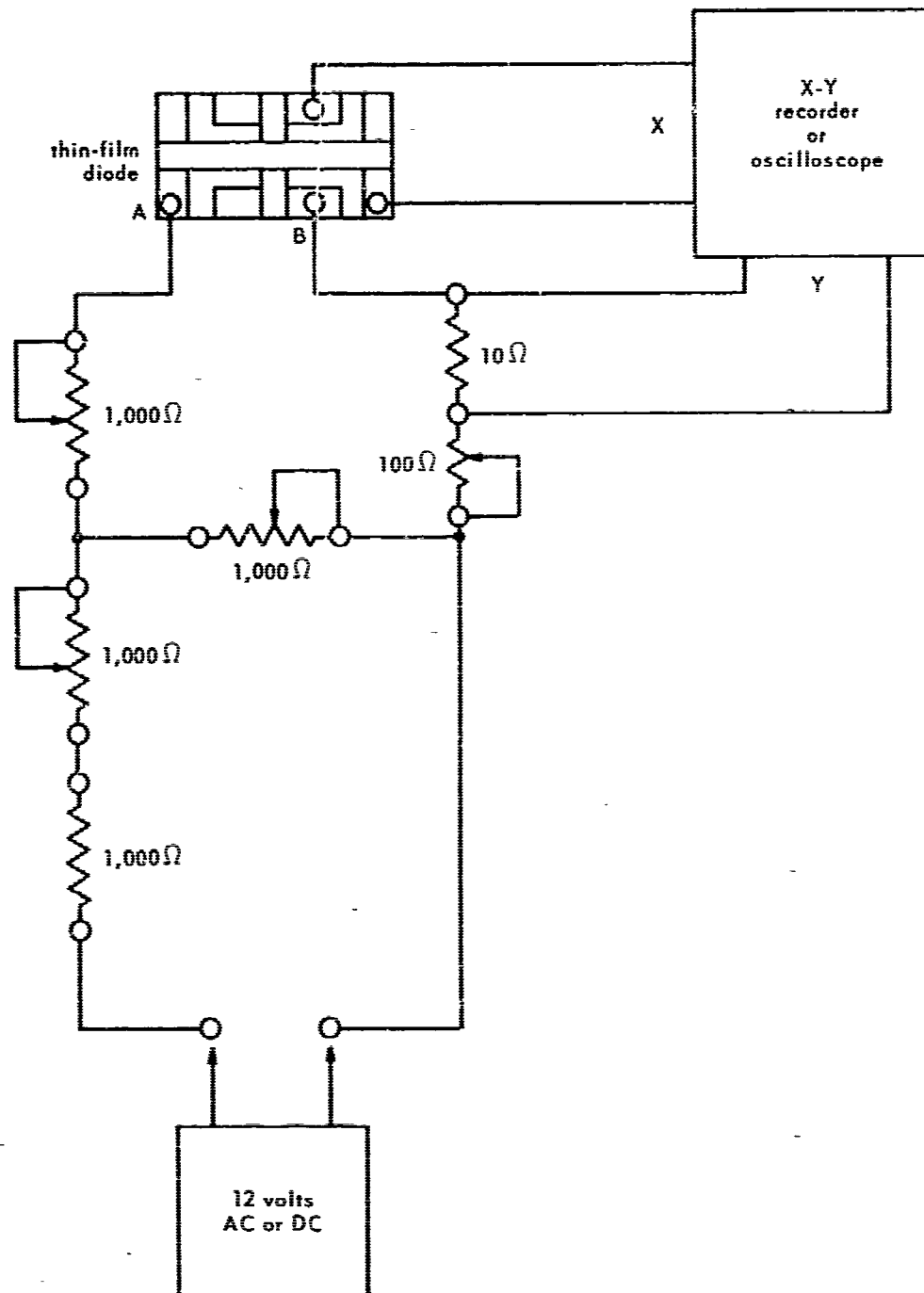

Figure 9. Circuit schematic for measuring I-V characteristics of diodes.

The glass-tube assembly permitted immersion of the thin-film diode into liquid helium through the top of the dewar. Thin German-silver wires, insulated from each other by small-diameter glass tubes, were threaded down the inside of the larger tube and connected to a transistor socket. This socket received the plug-in board which held the diode. The immersion device, with plug-in board attached, is shown in Figure 10.

RESULTS

Figure 11 consists of several I-V plots obtained by slowly increasing the DC voltage applied to different thin-film sandwich diodes. The diodes were operated at atmospheric pressure at temperatures ranging from 4.2°K to room temperature.

Curve a of Figure 11A is the I-V plot of an Al/Al₂O₃/Pb diode, as measured on an X-Y pen recorder, with the diode exposed to the air of the room. Curve b of Figure 11A is the I-V characteristic for this diode immersed in liquid helium at its normal boiling point (4.2°K). Of three different Al/Al₂O₃/Pb diodes with junction resistances ranging from 0.1 to 10³ ohms, the diode of Figure 11A was the only one which appeared to exhibit superconductive tunneling. Several other Al/Al₂O₃/Pb diodes were immersed in liquid helium, but their I-V plots could not be obtained because of film breakage. Oxidation of the aluminum strip of the diode in Figure 11A was made at atmospheric pressure and room temperature. Oxidation time was around 10 minutes.

Curve e of Figure 11B is the measured I-V plot for an Al/Al₂O₃/Pb diode in which the oxide film was obtained by exposing the aluminum strip to air for about 1 hour. During the recording of curve e of Figure 11B, the diode was immersed in liquid helium at a temperature close to 4.2°K; curve e was measured within a few minutes after the lead film was deposited.

Curve f of Figure 11B was obtained while the diode was immersed in liquid nitrogen at a temperature near 77°K. Curve g was recorded with the diode exposed to the atmosphere at a temperature around 300°K. Both curves f and g were measured several hours after deposition of the lead film.

I-V plots were recorded for the diode of Figure 11B at various times in between the measurement of curves e and g in an effort to correlate junction resistance, V/I, at a given voltage, with temperature. In general, for this particular diode, the magnitude of V/I, for a given voltage, increased on going from 4.2°K to 77°K, and then decreased at 300°K to a value below that for 4.2°K. Wide variations occurred in V/I for repeated measurements at a given temperature; and it was assumed that the dependence of V/I on temperature was masked by effects such as the development of metallic bridges through the oxide film or changes in junction area. Repeated determinations of the I-V plot for this diode finally caused the oxide layer to be permanently shorted.

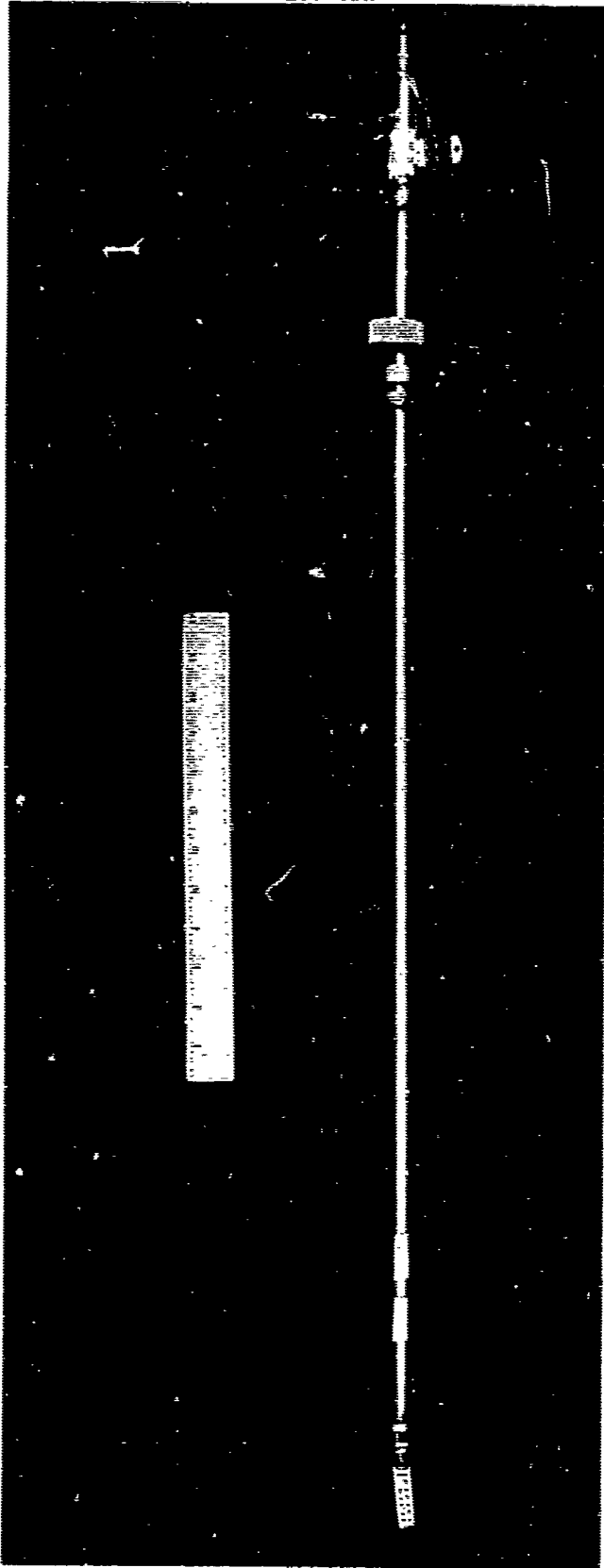

Figure 10. Immersion assembly for measurement of diode characteristics at liquid-helium temperatures.

The wide variation in I-V characteristics for a particular Al/Al₂O₃/Pb diode is illustrated in Figure 11C, in which curves i, j, and k were obtained with the diode exposed to the air and measured at room temperature; curve l was obtained with the diode immersed in liquid nitrogen at about 77°K. Immediately after curve k was recorded the I-V characteristic consisted of a vertical line, coincident with the I-axis; about 15 minutes later the I-V plot again assumed a shape similar to that of curve j. The aluminum oxide film in the diode of Figure 11C was formed by exposing the aluminum film to the air at room temperature for 1 hour.

Curve m of Figure 11D is the room-temperature I-V characteristic of another Al/Al₂O₃/Pb diode, in which, again, the oxide film was formed by exposing the aluminum film to the air at room temperature for 1 hour. Curve n of Figure 11D is the I-V plot for a commercially available Zener diode. Although curve m shows Zener-type breakdown, this particular characteristic of the thin-film diode could not be obtained after repeated I-V tracings on the X-Y recorder. After several determinations, the I-V plot for the experimental diode began to assume a more gradual curvature from low-current to high-current values, followed by hysteresis effects (different shape for decreasing voltage), negative resistance, and finally breakage of the lead film.

The I-V characteristic shown in curve p of Figure 11D is for the Al/Al₂O₃/Pb diode and was measured at the temperature of liquid nitrogen. The negative resistance appeared after repeated measurements of the I-V curve. Subsequent recordings of the curve for this diode still showed negative resistance, but the shape of the negative-resistance region was different each time.

Several of the Al/Al₂O₃/Pb diodes, such as those plotted in Figures 11B, 11D, and 11E, displayed Zener-type I-V characteristics. But after repeated I-V determinations, either the oxide layers of these diodes became permanently shorted or an open circuit occurred in one of the metal films close to the junction. Curve q of Figure 11E is the Zener-type I-V plot for an Al/Al₂O₃/Pb diode in which the aluminum film was oxidized in air for 70 minutes. Curve r of Figure 11E is for the same diode and shows that the breakdown process occurs for positive as well as negative voltage.

Figure 11F is an I-V plot for an Al/Al₂O₃/Pb diode in which the aluminum film was oxidized in air at room temperature for 1 hour. The negative resistance shown in Figure 11F could only be obtained during one recording of the I-V plot; none of several previous determinations of the I-V plot exhibited negative resistance. Immediately after this recording, the plot became linear and quite steep with a slope of around 1 ohm.

It was not possible to record the I-V plot of an Al/Al₂O₃/Pb diode by using 60-cycle AC voltage in place of the manually controlled DC voltage and by substituting an X-Y oscilloscope for the X-Y pen recorder. Attempts to obtain an AC measurement of the I-V plot for this type of diode invariably produced on the oscilloscope screen only a momentary image of a curve with a breakdown or negative-resistance region. After this transient image, the oscilloscope pattern became a slanted straight line.

With the assumption that some kind of metallic-bridging effect was taking place through the oxide layer, a number of aluminum, aluminum oxide, manganese, and lead (Al/Al₂O₃/Mn/Pb) diodes were constructed, and their I-V characteristics were observed by the AC technique. Manganese was chosen to be sandwiched between the aluminum oxide and lead films simply because it has a melting temperature almost four times greater than that of lead, and it was suspected that bridging might be caused by the lead melting during current flow through the junction. Mere substitution of a manganese film for the lead film produced only straight-line I-V plots; thus, it appeared that the breakdown and negative-resistance characteristics were connected with some intrinsic feature of the lead film.

Curve a of Figure 12 is the room-temperature I-V plot of an Al/Al₂O₃/Mn/Pb diode, obtained by the method of manually varied DC voltage; the aluminum film was oxidized in air for 10 minutes. Figure 13 is a photograph of the oscilloscope image of the room-temperature I-V plot of the same diode, driven by a 60-cycle AC voltage. All the Al/Al₂O₃/Mn/Pb diodes had AC-driven I-V characteristics similar to that of the plot of Figure 13, and these plots remained unchanged for many hours, as long, in fact, as the voltage peak-value was not advanced beyond about 6 volts. When the voltage was increased beyond this value the oscilloscope image became a vertical straight line (dead short). This shorted condition appeared to be permanent.

Another type of diode consisted of an aluminum film covered by an oxide film in the usual way, but across the oxide layer two films were deposited — a lead strip σ' about 45 degrees to the aluminum strip and an aluminum strip at about 135 degrees to the first aluminum strip (Al/Al₂O₃/Pb/Al). The three metallic strips formed a junction at the center of the substrate. Since each of the three films was isolated electrically, the device could be regarded as a triode. However, no triode effects were obtainable, and the device was investigated as a diode. During attempts to observe triode effects (for example, gain control through voltage control of lead film) the lead film broke near the junction, so that the diode voltage was measured between the aluminum films.

With the Al/Al₂O₃/Pb/Al diode at room temperature, it was discovered that bistable switching was possible. Initially the oscilloscope trace was a horizontal line of about 4 volts, peak to peak, which could be considered a "voltage" state. When the diode was subjected briefly to high voltage from a Tesla coil (~5,000 volts) the oscilloscope trace switched to a "current" state, manifested by a vertical line representing around 2 milliamps, peak to peak. When the voltage source was connected directly across the diode for a moment the diode switched back into the voltage state. Direct connection corresponded to an increase in peak voltage from about 2 volts to 6 volts.

The voltage and current states of the Al/Al₂O₃/Pb/Al diode could be produced repeatedly by the procedure described above. The current state was observed to remain unchanged for more than 12 hours. It was also found that this bistable switching could be accomplished by pressing the diode junction with a blunt object made of wood or glass.

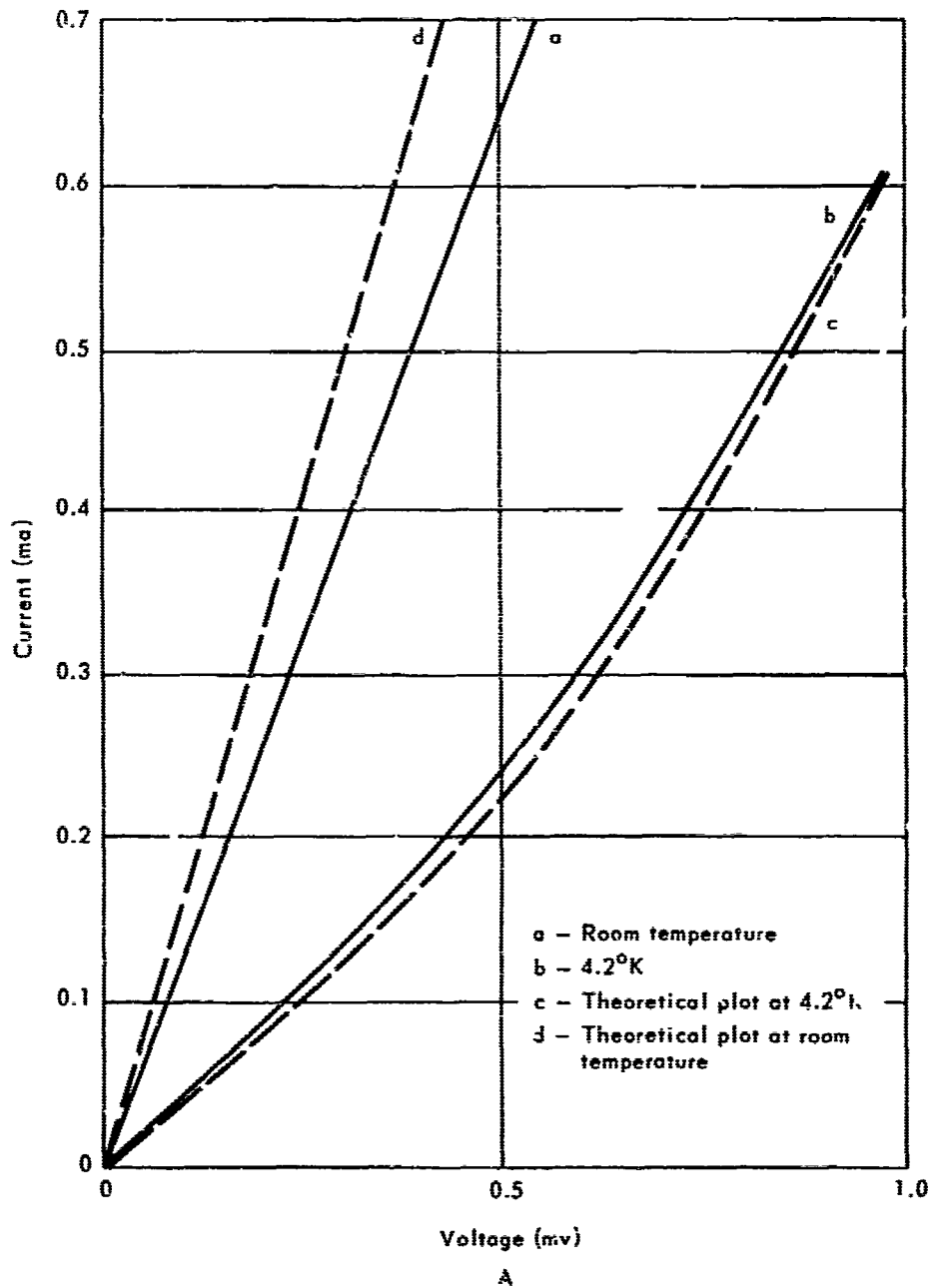

Figure 11. X-Y recorder plot of I-V characteristic of Al/Al₂O₃/Pb diodes.

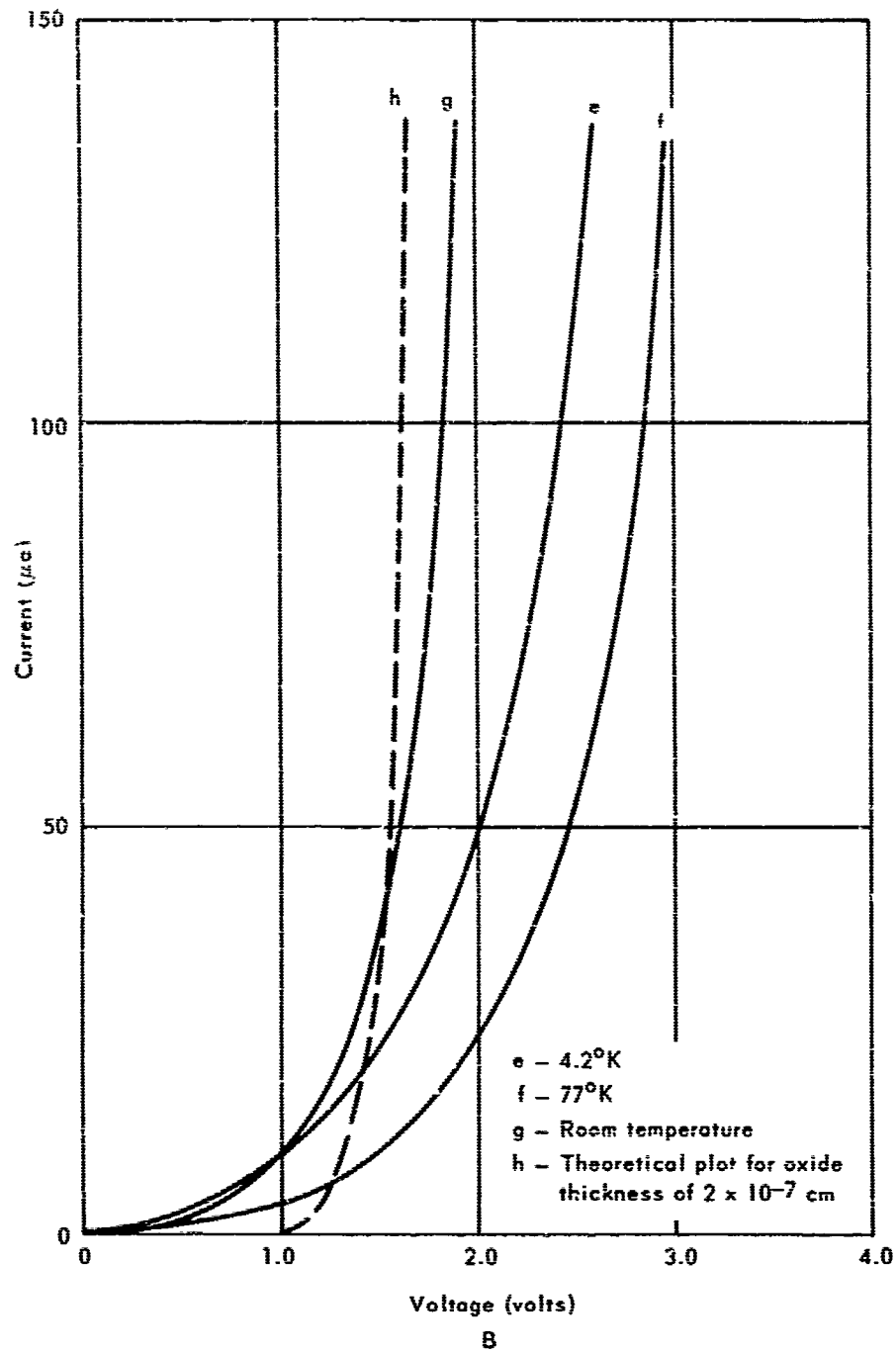

Figure 11. X-Y recorder plot of I-V characteristic of Al/Al₂O₃/Pb diodes.

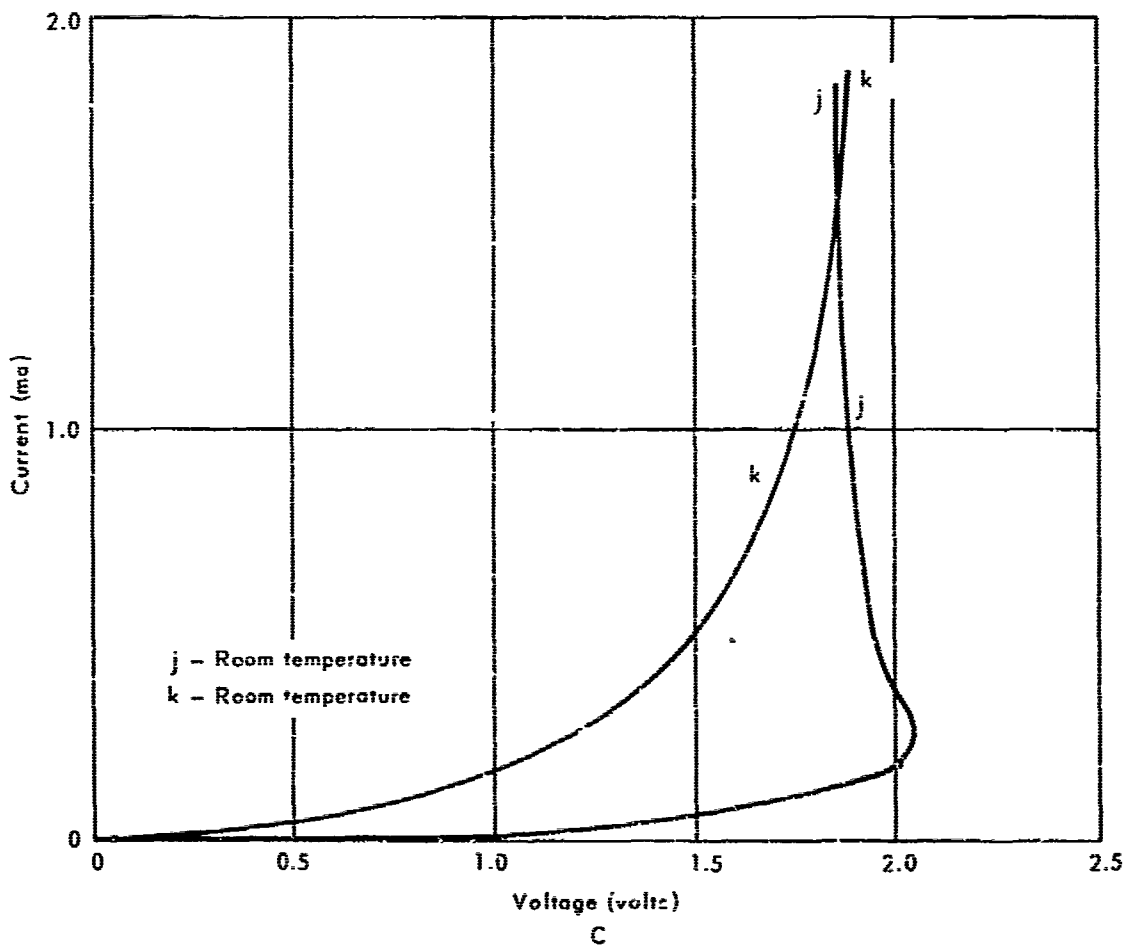
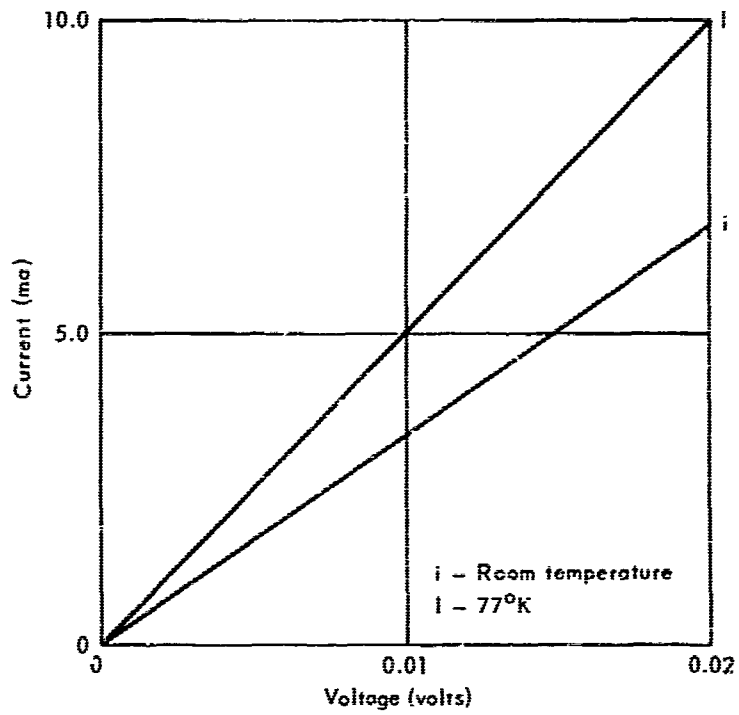

Figure 11. X-Y recorder plot of I-V characteristic of Al/Al₂O₃/Pb diodes.

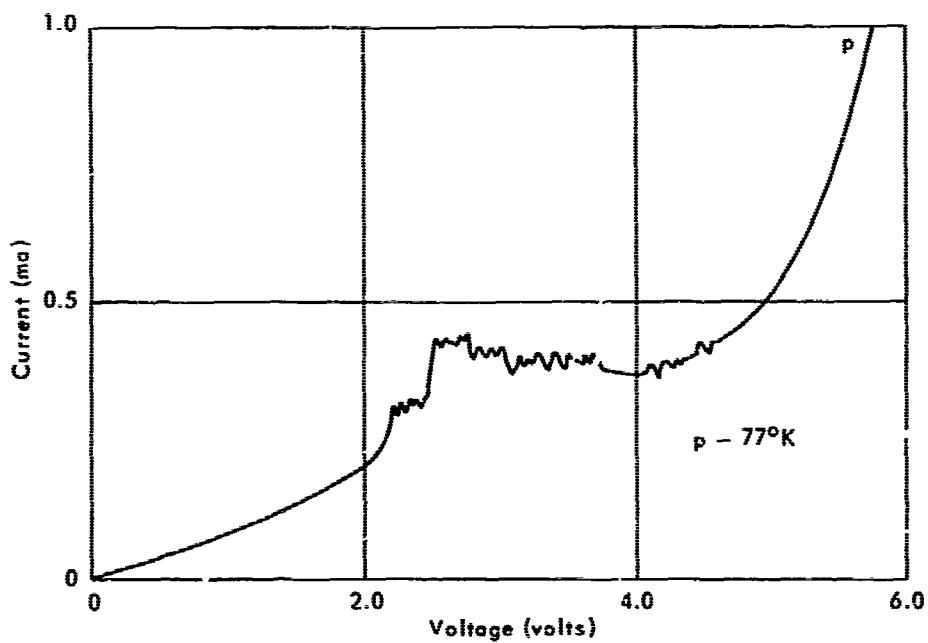
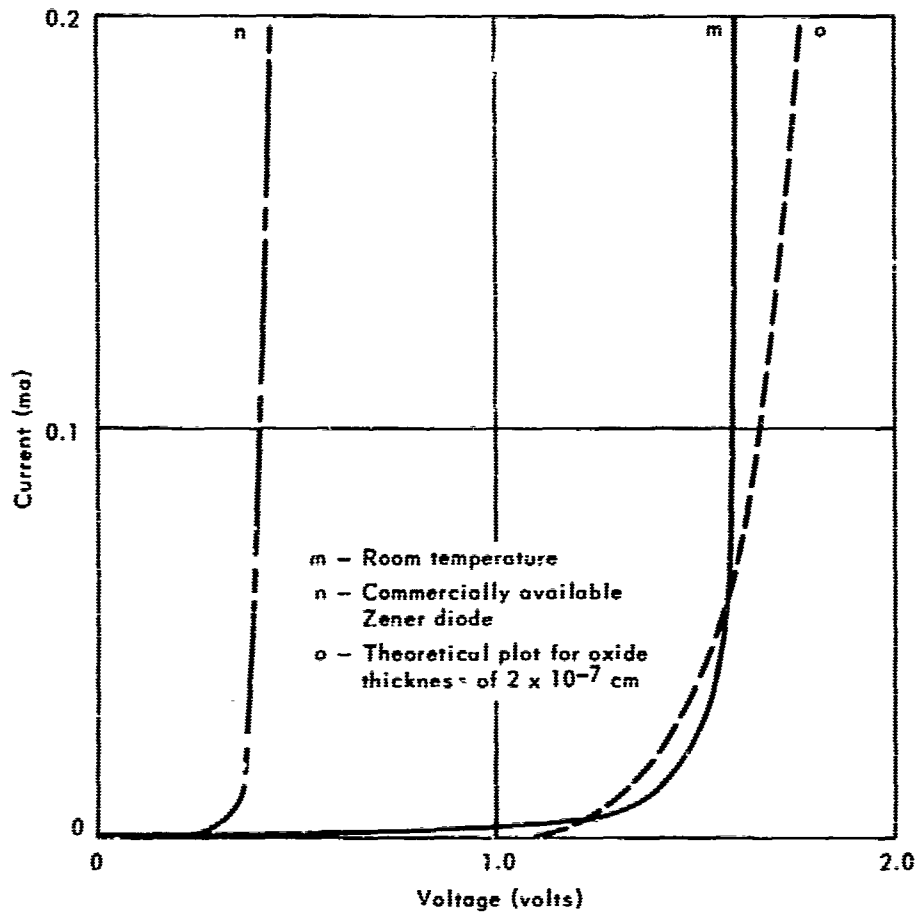

Figure 11. X-Y recorder plot of I-V characteristic of Al/Al₂O₃/Pb diodes.

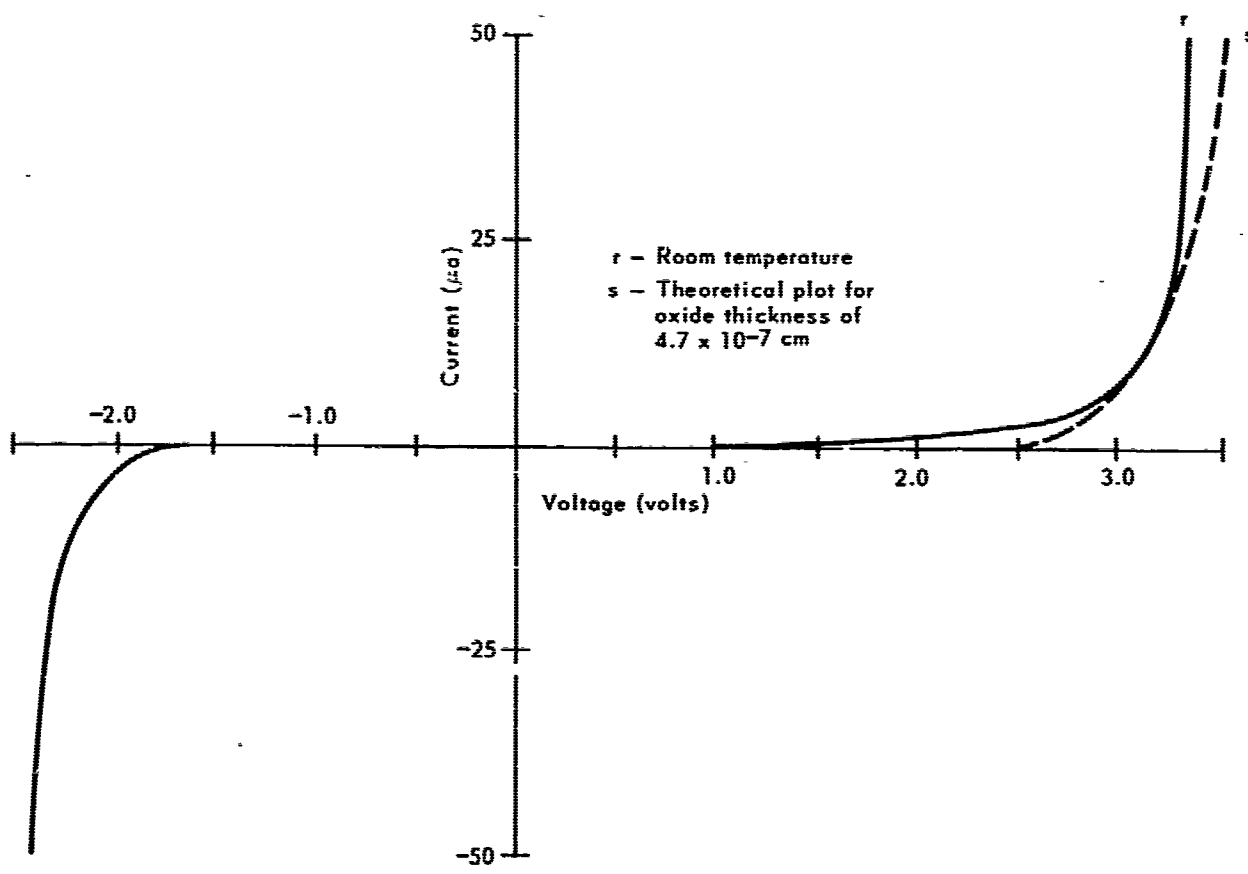
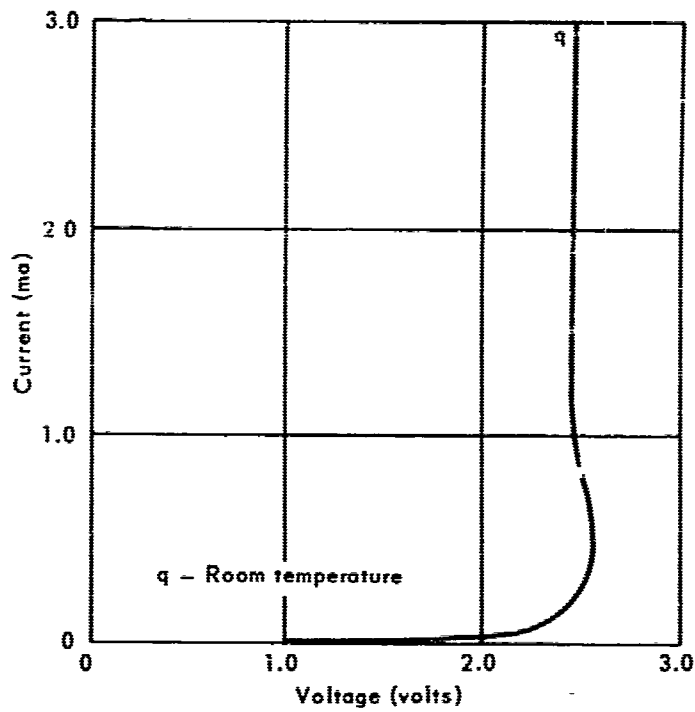

Figure 11. X-Y recorder plot of I-V characteristic of Al/Al₂O₃/Pb diodes.

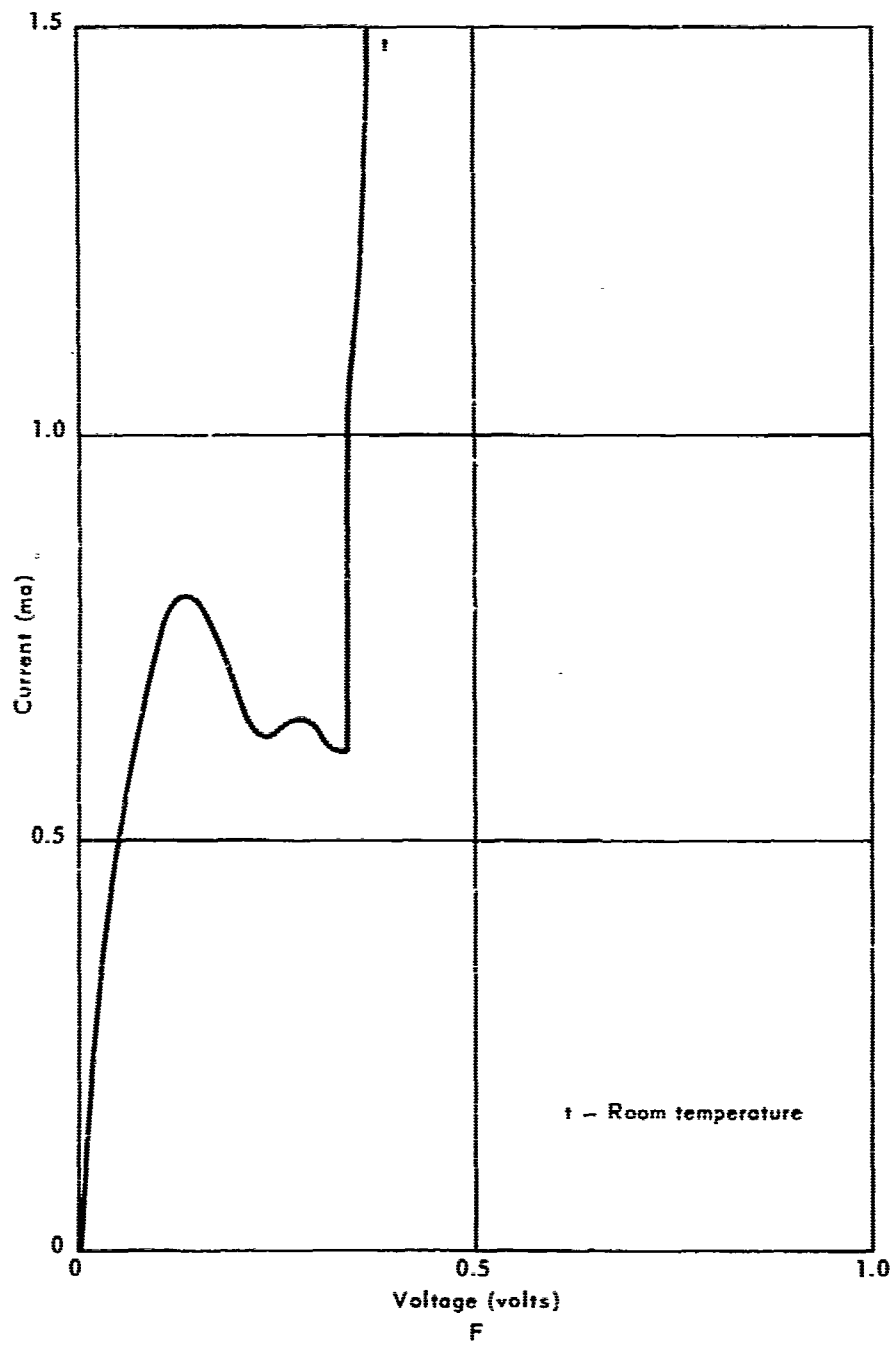

Figure 11. X-Y recorder plot of I-V characteristic of Al/Al₂O₃/Pb diodes.

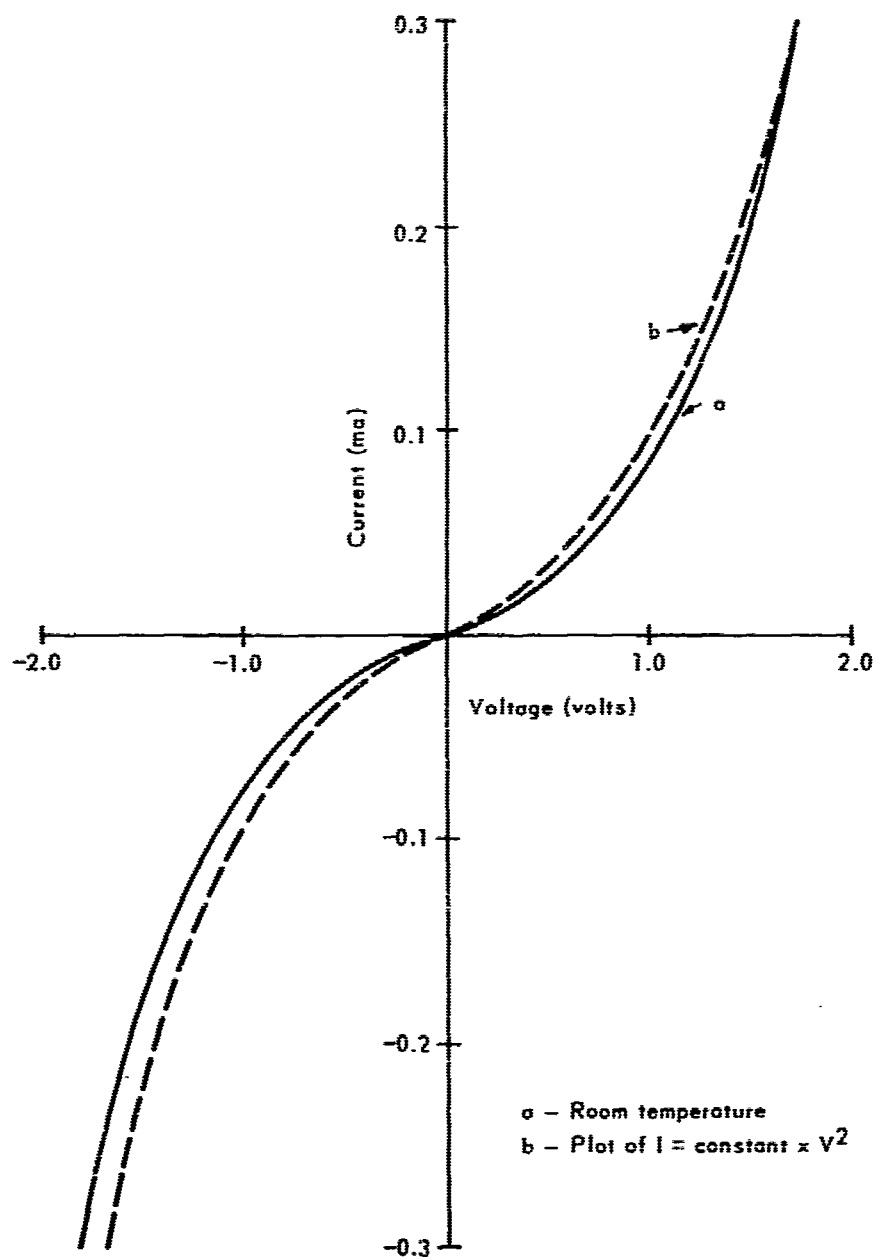

Figure 12. X-Y recorder plot of I-V characteristic of Al/Al₂O₃/Mn/Pb diodes.



Figure 13. Oscilloscope image of I-V characteristic of Al/Al₂O₃/Mn/Pb diode driven by 60-cycle AC voltage at room temperature.

It is not known how long the bistable-switching capability of this diode would have been retained because, in a different type of experiment, both films were broken. In the experiment that destroyed the diode a drop of water was placed on the diode junction, and the AC I-V trace was observed on the oscilloscope. Voltage breakdown such as shown in Figure 13 was manifested, accompanied by hysteresis; the pattern remained until the water drop evaporated, after which an open circuit occurred in each film near the junction.

The water-drop experiment was tried because of the discovery that breathing on a thin-film diode caused voltage-breakdown knees to appear in normally horizontal I-V oscilloscope patterns. Evidently moisture was the cause, since a blast of dry air or pure carbon dioxide did not produce these knees; also, organic liquids placed directly on the junction had no effect.

Thickness values for the aluminum and lead films were estimated from the AC resistance of the film, as measured with a conductivity bridge. The aluminum film on all of the diodes was about 1 x 20 mm and the lead strip about 1 x 9 mm. Usually the AC resistances of the aluminum and lead films (measured between the two indium patches) were around 2 ohms and 10 ohms, respectively. According to

Boettcher and Hass,⁷ the resistivity of aluminum films of a thickness greater than 3×10^{-6} cm is the same as that of bulk specimens. And according to Foster⁸ lead films greater than 6×10^{-7} cm in thickness have a resistivity equal to the bulk value. When bulk resistivity values were used and the film strips were assumed to have rectangular cross sections, the thickness values for the aluminum and lead films were estimated to be 3×10^{-5} cm and 2×10^{-5} cm, respectively.

THEORETICAL DISCUSSION

Theoretical analyses of the I-V characteristics of thin-film diodes have been carried out by Giaever and Megerle¹ and also by Holm.⁹ A comparison of the results of these analyses with the measured plots is made in this section in an attempt to explain the mechanisms responsible for the observed I-V characteristics.

Giaever and Megerle have utilized the results of the Bardeen-Cooper-Schrieffer theory¹⁰ of superconductivity to derive I as a function of V for the thin-film superconductor diode. The Giaever-Megerle derivation is based on the assumption that the insulating film presents a potential barrier to electrons and that current flow is the result of quantum-mechanical tunneling. For a diode with one metal in the superconducting state, and for values of V less than Δ/e , where Δ is half the superconducting energy gap and e is the charge on the electron, the following equation is deducible:

$$I = \frac{2I_n \Delta}{eV} \sum_{\lambda=1}^{\infty} (-1)^{\lambda+1} K_1 \left(\frac{\lambda e}{kT} \right) \sinh \left(\frac{\lambda eV}{kT} \right) \quad (1)$$

where I_n = diode current when both metals are in the normal (nonsuperconducting) state

k = Boltzmann's constant

K_1 = first-order modified Bessel function of the second kind

T = absolute temperature, °K

Equation 1 gives the ratio I/I_n , so that such parameters as the electronic work function of the metal or the thickness of the oxide layer are not required. For the theoretical treatment of room-temperature diodes, where the absolute value of the current is derived, these parameters must be included.

Curve c of Figure 11A is a plot of the sum of the first three terms of equation 1. T is taken to be 4.2°K, and the energy gap of lead at this temperature is taken to be 3.96×10^{-15} erg.*

Curve d of Figure 11A is a straight-line plot of I_n versus V, drawn with a slope which makes the theoretical plot, curve c, and the measured plot, curve b, coincide at V = 1 volt. Shifting the room-temperature I-V plot causes the theoretical I-V plot for T = 4.2°K to practically coincide at all points with the observed plot at 4.2°K; hence, superconductive tunneling must have been achieved for this diode. The disagreement between the linear plots a and d is evidently due to a change of junction resistance with time.

Attempts to find theoretical fits to the i-V plots of diodes in the normal-conducting state have yielded little success. Curve h of Figure 11B is the plot of an equation derived by Holm⁹ for electron flow over the potential barrier of an insulating film, that is, where the applied voltage is greater than the electronic work function of the metals:

$$J = \frac{e^2 V^2}{8\pi h \phi s} \exp \left[-\frac{8\pi s}{3heV} (2m)^{1/2} \phi^{3/2} \right] \frac{\text{electrons}}{\text{second-cm}^2} \quad (2)$$

where J = electrical current density, electrons/second-cm²

h = Planck's constant

ϕ = electronic work function, ergs

s = thickness of insulating film, cm

m = electronic mass, grams

Curve h in Figure 11B is plotted for $\phi = 1$ electron-volt (eV), $s = 2 \times 10^{-7}$ cm, and a junction area of 1 mm².

For voltages greater than 1.5 volts, it appears that, as predicted by equation 2, electron emission, and not avalanche breakdown, is taking place in the diode of Figure 11B. For voltages under 1.5 volts, equation 2 obviously does not apply. Attempts to fit low-voltage electron-tunneling equations produced curves which fit the observed plots only slightly better than curve h.⁹

* NCEL TN-496 of 5 August 1963 presents data obtained from the open literature which indicate that the energy gap of lead at 4.2°K is $4.0k T_c$, where T_c is the superconducting transition temperature for lead, namely, 7.2°K.

Because the measured curves of Figure 11B suggest a power-law dependence on voltage (that is, V^x), the mechanism of space-charge-limited current flow has been considered. According to Lampert⁶ the theory of space-charge-limited current leads to power-law equations in which the power of V is not greater than 3. The measured plots of Figure 11B are approximated more closely by 4th-degree equations in V ; but the main objection to the assumption of space-charge-limited current is that extremely small values of carrier mobility and lifetime are required to bring the coefficient of V^x even close to the measured coefficient. For example, Lampert has derived the following cubic equation in V for two-carrier space-charge-limited current flows:

$$J = 10^{-12} \frac{\epsilon \mu_n \mu_p \tau V^3}{s^5} \frac{\text{amps}}{\text{cm}^2} \quad (3)$$

where ϵ = dielectric constant of insulating film

μ_n = mobility of electrons

μ_p = mobility of holes

τ = carrier lifetime

Using representative values for the parameters, that is, $\epsilon \sim 10$, $\mu_n = \mu_p \sim 1,000 \text{ cm}^2/\text{volt-second}$, and $\tau \sim 10^{-6}$ second, we find

$$J \sim \frac{10^{-11} V^3}{s^5} \frac{\text{amps}}{\text{cm}^2}$$

Thus, for a thin-film diode, where $s \lesssim 10^{-6} \text{ cm}$, $J \gtrsim 10^{19} V^3 \text{ amps/cm}^2$, which, for $V \sim 1$ volt, is far beyond any reasonable value of current density.

Lampert has pointed out that one of the restrictions in the theory of space-charge-limited current is that diffusion currents can be neglected. In the case of thin-film diodes, it is probably not possible to neglect diffusion currents, and hence, even though carrier mobility in a thin film of aluminum oxide may be much smaller than mobilities representative of bulk insulators, space-charge-limited current cannot be used to explain the I-V characteristics.

Curve o of Figure 11D is a plot of equation 2 for $\phi = 1 \text{ eV}$, $s = 2 \times 10^{-7} \text{ cm}$, and junction area = 1 mm^2 . The rough agreement between observed and theoretical plots up to 1.6 volts indicates that between 1 and 1.6 volts cold-emission-type current flow may be taking place in the diode and that beyond 1.6 volts an avalanche process occurs. Unfortunately, the avalanche effect was not reproducible in this type of diode, even before the voltage was reached which caused complete breakdown and permanent shorting of the diode.

Curve s of Figure 11E is a plot of Equation 2 with, again, $\phi = 1$ eV and the junction area = 1 mm^2 , but s increased to 4.7×10^{-7} cm. It is also possible to obtain a rough fit of the observed plot, curve r of Figure 11E, by increasing ϕ to around 2 eV and decreasing s to about 3×10^{-7} cm. However, an insulator thickness of 3×10^{-7} cm seems somewhat low, and furthermore, a thickness of 4.7×10^{-7} cm is in good agreement with values measured elsewhere.¹¹ Although a work function of 2 eV is more reasonable than only 1 eV, the lower work function could probably be explained by the presence of impurities in the aluminum oxide.

Because rectification effects were not observed in these diodes, it is not likely that p-n junction current flow can explain any of the I-V characteristics shown in Figures 11 through 13. However, it is possible that a region between the oxide layer and the metal has n-type semiconducting properties, and this condition would explain the negative resistance exhibited by the curves of Figures 11D and 11F.¹² Negative resistance can be explained qualitatively when current flows between crystalline solids which have an energy gap in their electron spectra. However, rigorous derivation of an analytical expression for the I-V characteristic is a formidable mathematical problem.

No part of curve a of Figure 12 can be even roughly approximated by the cold-emission-type of current flow predicted by Equation 2. The only analytical expression which gives a reasonably good fit to curve a is

$$I = 10^{-4} V^2 \text{ amps} \quad (4)$$

as shown by curve b of Figure 12. According to Lampert,⁶ an equation of this form indicates one-carrier space-charge-limited current flow. As already mentioned, this theory assumes that diffusion currents can be neglected; but in a thin-film diode, where the distance between cathode and anode is a few tens of angstroms, this assumption is probably not valid.

The Lampert equation is

$$J = 10^{-13} \frac{\epsilon \mu_n V^2}{s^3} \quad (5)$$

and using the same parameter values as before, we find

$$J \sim 10^9 V^2 \text{ amps/cm}^2$$

For $V \sim 1$ volt, this result still gives an unreasonably large current density.

An additional reason for rejecting the space-charge-limited theory is that both equations 3 and 5 are based on the assumption that the carrier drift velocity, v , is proportional to the electric field: that is, $v = \mu V/s$. However, it is reported¹³ that for

values of the field beyond about 10^3 volts/cm, v is proportional to $(V/s)^{1/2}$. Thus, in a thin-film diode with an oxide thickness of about 10^{-6} cm, $V/s \sim 10^6$ volts/cm and Equations 2 and 5 probably do not apply.

Evidently, the impossibility of finding a single analytical expression which will fit the region of the I-V plot below the avalanche region is due to a combination of current-flow mechanisms taking place in the diode. By choosing certain nonsuperconducting tunneling equations, such as derived by Holm,⁹ multiplying them by suitable weighting factors, and finally, adding the results to the cold-emission Equation 2, it might be mathematically possible to obtain good fits to the observed I-V plots. This would mean that the work function of the metal or the barrier thickness or both vary from point to point over the surface of the junction.

CONCLUSIONS

1. This investigation has revealed that it is probably impossible to operate an Al/Al₂O₃/Pb diode at ambient temperatures with an I-V characteristic which would remain unchanged for more than a few hours. At ambient temperature, negative resistance in the Al/Al₂O₃/Pb diode could not be achieved with AC operation, so that not even an experimental amplifier or oscillator could be built to utilize this type of diode.
2. The Al/Al₂O₃/Mn/Pb diode can be operated with 60-cycle excitation and retain a given I-V characteristic for several hours, as long as a certain critical voltage, around 6 volts, is not exceeded. Thus, a combination of thin metallic films separated by an insulating layer can probably be found which could be operated as a voltage-regulator diode at ambient temperatures for an indefinite period.
3. A thin-film diode utilizing aluminum and aluminum oxide can probably be constructed which will operate as a bistable switch for an indefinite period at room temperature.
4. Construction of a stable superconductor diode will probably require a much faster pumping system than the one presently used in the NCEL deposition system. During deposition of metallic films, the pressure will probably have to be held below 10^{-6} torr. Furthermore, a more refined technique of forming the oxide film will have to be developed. Since moisture was observed to have a pronounced effect on junction resistance, oxidation should probably take place in a dry atmosphere at a reduced pressure. Cooling of the substrate by liquid nitrogen, during vacuum deposition, would also probably produce more stable diodes. Development of a technique for constructing a diode which displays a stable tunneling characteristic at liquid helium temperatures will make it possible to investigate the quantum detectivity of the superconductor diode in the submillimeter band.

GLOSSARY

avalanche breakdown	An electronic process characterized by an abrupt increase in current for a given value of voltage and manifested by a sharp "knee" in the I-V curve, with a nearly vertical slope at the breakdown voltage.
bistable switch	An electronic device, employing either solid-state or vacuum-tube components, which produces either of two physical states for an indefinite length of time.
cold emission	Current flow resulting from electrons passing through a potential barrier under the influence of a strong electric field.
energy gap	A range of energies which cannot be occupied by electrons in a particular solid; that is, all electrons must have energies above or below this region of energies. The width of the energy gap in semiconductors is a few electron volts.
hysteresis	The influence of the previous history or treatment of a body on its subsequent response to a given force or changed condition.
I-V characteristic	A graph which shows the dependence of current upon voltage applied across a given electronic device, usually a diode.
junction resistance	The section of the aluminum oxide film sandwiched between the two metal films.
load line	A straight line through the I-V curve which has a slope equal to the negative reciprocal of the load resistance. The slope of the load line is the coefficient of V in the mathematical equation relating I, V, R_L , and V_i .
negative resistance	That portion of the I-V curve which has a negative slope.
photon energy	The quantum energy of an electromagnetic wave equivalent to h (Planck's constant) multiplied by the wavelength of the radiation.
p-n junction	The boundary in a crystalline solid between a p-region and an n-region, where a p-region has an excess of positive charges (symbolized by "p") and an n-region, an excess of negative charges (symbolized by "n"). Another term for positive charges is "hole." The generic term for electrons and holes is "carrier"; and excess carriers are caused by impurities in the crystal.

power-law dependence of current upon voltage	An I-V curve described by $I = V^x$, where x is any number. For example, if $x = 2$, we have square dependence.
space-charge-limited current	The amount of current flowing in a diode is limited because of a charge (usually of electrons) which is present between the cathode and the anode. This space charge generates an electric field which opposes the current flow.
superconductivity	A property of certain metals and alloys characterized by passage of electrical current with zero resistance. Superconductivity usually takes place at temperatures below about 18°K.
torr	A pressure of 1 mm of mercury.
tunneling	A quantum mechanical process in which particles, for example, electrons, pass from one side of a potential barrier to the other without an increase in energy. In other words, the particle passes <u>through</u> the barrier — an impossibility in classical physics.
work function	Energy required for an electron to leave the surface of a metal.

REFERENCES

1. I. Giaever and K. Megerle. "Study of superconductors by electron tunneling," *Physical Review*, vol. 122, 1961, pp. 1101-1111.
2. S. Shapiro and A. R. Janus. "RF detection by electron tunneling between superconductors," VIII International Conference on Low Temperature Physics, London, Sept. 1962.
3. T. W. Hickmott. "Low frequency negative resistance in thin anodic oxide films," *Journal of Applied Physics*, vol. 33, 1962, pp. 2669-2682.
4. ———. "Impurity conduction and negative resistance in thin oxide films," *Journal of Applied Physics*, vol. 35, 1964, pp. 2118-2122.
5. W. R. Hiatt and T. W. Hickmott. "Bistable switching in Nb-Nb₂O₅ - metal diodes," *Applied Physics Letters*, Vol. 6, 1965, pp. 106-108.
6. M. A. Lampert. "Theory of two-carrier space-charge-limited current flow in solids," *R.C.A. Review*, vol. 20, 1959, pp. 682-701.
7. A. Boettcher and G. Hass. "Conductivity of evaporated aluminum layers," *Optik*, vol. 6, 1950, pp. 299-309 (in German).
8. M. G. Foster. "Conductivity of thin lead films," *Physical Review*, vol. 57, 1940, pp. 42-46.
9. R. Holm. "The electric tunnel effect across thin insulator films in contacts," *Journal of Applied Physics*, vol. 22, 1951, pp. 569-574.
10. J. Bardeen, L. N. Cooper, and J. R. Schrieffer. "Theory of superconductivity," *Physical Review*, vol. 108, 1957, pp. 1175-1204.
11. J. C. Fisher and I. Giaever. "Tunneling through thin insulating layers," *Journal of Applied Physics*, vol. 32, 1960, pp. 172-177.
12. V. B. Sandormirskii. "Volt-ampere characteristic in a semiconductor-dielectric-semiconductor system," *Fiz. Tverdogo Tela (USSR)*, vol. 6, 1964, pp. 326-327 (in Russian).
13. G. C. Dacey. "One-carrier current calculations," *Physical Review*, vol. 90, 1953, pp. 759-763.

Unclassified

Security Classification

DOCUMENT CONTROL DATA - R&D

(Security classification of title, body of abstract and indexing annotation must be entered when the overall report is classified)

1. ORIGINATING ACTIVITY <i>(Corporate author)</i>		2a. REPORT SECURITY CLASSIFICATION	
U. S. Naval Civil Engineering Laboratory Port Hueneme, California 93041		Unclassified	
		2b. GROUP	
3. REPORT TITLE			
CURRENT-VOLTAGE CHARACTERISTICS OF THIN-FILM DIODES			
4. DESCRIPTIVE NOTES <i>(Type of report and inclusive dates)</i>			
Not final March 1965 - June 1965			
5. AUTHOR(S) <i>(Last name, first name, initial)</i>			
Hitchcock, R. D.			
6. REPORT DATE		7a. TOTAL NO. OF PAGES	7b. NO. OF REFS
March 1966		37	13
8a. CONTRACT OR GRANT NO.		9a. ORIGINATOR'S REPORT NUMBER(S)	
b. PROJECT NO. Y-R011-01-01-049		TR-435	
c.		9b. OTHER REPORT NO(S) <i>(Any other numbers that may be assigned this report)</i>	
d.			
10. AVAILABILITY/LIMITATION NOTICES			
Distribution of this document is unlimited. Copies available at the Clearinghouse (CFSTI) \$2.00.			
11. SUPPLEMENTARY NOTES		12. SPONSORING MILITARY ACTIVITY	
		BUDOCKS	
13. ABSTRACT			
<p>The current-voltage (I-V) characteristics of thin-film diodes were measured at 4.2°K, 77°K, and room temperature. Superconductive tunneling was achieved with a diode consisting of aluminum, aluminum oxide, and lead (Al/Al₂O₃/Pb). In the non-superconducting state the Al/Al₂O₃/Pb type of thin-film diode exhibited Zener breakdown between 1.5 and 3.5 volts. However, the Al/Al₂O₃/Pb diodes did not have reproducible I-V characteristics, and the nonsuperconducting Al/Al₂O₃/Pb diode could not be operated with AC voltage long enough to serve as a practical electronic device.</p> <p>A thin-film diode consisting of aluminum, aluminum oxide, manganese, and lead exhibited power-law I-V characteristics at ambient temperatures, under 60-cycle excitation, and could be operated with a reproducible I-V characteristic for several hours. Bistable switching was achieved with a thin-film diode consisting of aluminum, aluminum oxide, lead, and aluminum; in this diode the short-circuit state was produced by a high-voltage pulse and the open-circuit state by a low-voltage pulse.</p> <p>A theoretical analysis of the observed I-V characteristics is presented.</p>			

14. KEY WORDS	LINK A		LINK B		LINK C	
	ROLE	WT	ROLE	WT	ROLE	WT
Diodes — thin-film Cryostat Vacuum deposition Superconductive tunneling Current-voltage characteristics Low-temperature physics						

INSTRUCTIONS

1. ORIGINATING ACTIVITY: Enter the name and address of the contractor, subcontractor, grantee, Department of Defense activity or other organization (*corporate author*) issuing the report.

2a. REPORT SECURITY CLASSIFICATION: Enter the overall security classification of the report. Indicate whether "Restricted Data" is included. Marking is to be in accordance with appropriate security regulations.

2b. GROUP: Automatic downgrading is specified in DoD Directive 5200.10 and Armed Forces Industrial Manual. Enter the group number. Also, when applicable, show that optional markings have been used for Group 3 and Group 4 as authorized.

3. REPORT TITLE: Enter the complete report title in all capital letters. Titles in all cases should be unclassified. If a meaningful title cannot be selected without classification, show title classification in all capitals in parenthesis immediately following the title.

4. DESCRIPTIVE NOTES: If appropriate, enter the type of report, e.g., interim, progress, summary, annual, or final. Give the inclusive dates when a specific reporting period is covered.

5. AUTHOR(S): Enter the name(s) of author(s) as shown on or in the report. Enter last name, first name, middle initial. If military, show rank and branch of service. The name of the principal author is an absolute minimum requirement.

6. REPORT DATE: Enter the date of the report as day, month, year, or month, year. If more than one date appears on the report, use date of publication.

7a. TOTAL NUMBER OF PAGES: The total page count should follow normal pagination procedures, i.e., enter the number of pages containing information.

7b. NUMBER OF REFERENCES: Enter the total number of references cited in the report.

8a. CONTRACT OR GRANT NUMBER: If appropriate, enter the applicable number of the contract or grant under which the report was written.

8b, 8c, & 8d. PROJECT NUMBER: Enter the appropriate military department identification, such as project number, subproject number, system numbers, task number, etc.

9a. ORIGINATOR'S REPORT NUMBER(S): Enter the official report number by which the document will be identified and controlled by the originating activity. This number must be unique to this report.

9b. OTHER REPORT NUMBER(S): If the report has been assigned any other report numbers (*either by the originator or by the sponsor*), also enter this number(s).

10. AVAILABILITY/LIMITATION NOTICES: Enter any limitations on further dissemination of the report, other than those

imposed by security classification, using standard statements such as:

- (1) "Qualified requesters may obtain copies of this report from DDC."
- (2) "Foreign announcement and dissemination of this report by DDC is not authorized."
- (3) "U. S. Government agencies may obtain copies of this report directly from DDC. Other qualified DDC users shall request through _____."
- (4) "U. S. military agencies may obtain copies of this report directly from DDC. Other qualified users shall request through _____."
- (5) "All distribution of this report is controlled. Qualified DDC users shall request through _____."

If the report has been furnished to the Office of Technical Services, Department of Commerce, for sale to the public, indicate this fact and enter the price, if known.

11. SUPPLEMENTARY NOTES: Use for additional explanatory notes.

12. SPONSORING MILITARY ACTIVITY: Enter the name of the departmental project office or laboratory sponsoring (*paying for*) the research and development. Include address.

13. ABSTRACT: Enter an abstract giving a brief and factual summary of the document indicative of the report, even though it may also appear elsewhere in the body of the technical report. If additional space is required, a continuation sheet shall be attached.

It is highly desirable that the abstract of classified reports be unclassified. Each paragraph of the abstract shall end with an indication of the military security classification of the information in the paragraph, represented as (TS), (S), (C), or (U).

There is no limitation on the length of the abstract. However, the suggested length is from 150 to 225 words.

14. KEY WORDS: Key words are technically meaningful terms or short phrases that characterize a report and may be used as index entries for cataloging the report. Key words must be selected so that no security classification is required. Identifiers, such as equipment model designation, trade name, military project code name, geographic location, may be used as key words but will be followed by an indication of technical context. The assignment of links, roles, and weights is optional.