



ONEM2M TECHNICAL REPORT

Document Number	TR-0001-V2.4.2
Document Name:	Use Cases Collection
Date:	2018-03-12
Abstract:	This oneM2M Technical Report includes a collection of use cases from various M2M industry segments. Use cases focus on the sequence of interactions among actors, and may include potential requirements.

This Specification is provided for future development work within oneM2M only. The Partners accept no liability for any use of this Specification.

The present document has not been subject to any approval process by the oneM2M Partners Type 1. Published oneM2M specifications and reports for implementation should be obtained via the oneM2M Partners' Publications Offices.

About oneM2M

The purpose and goal of oneM2M is to develop technical specifications which address the need for a common M2M Service Layer that can be readily embedded within various hardware and software, and relied upon to connect the myriad of devices in the field with M2M application servers worldwide.

More information about oneM2M may be found at: <http://www.oneM2M.org>

Copyright Notification

No part of this document may be reproduced, in an electronic retrieval system or otherwise, except as authorized by written permission.

The copyright and the foregoing restriction extend to reproduction in all media.

© 2018, oneM2M Partners Type 1 (ARIB, ATIS, CCSA, ETSI, TIA, TSDSI, TTA, TTC).

All rights reserved.

Notice of Disclaimer & Limitation of Liability

The information provided in this document is directed solely to professionals who have the appropriate degree of experience to understand and interpret its contents in accordance with generally accepted engineering or other professional standards and applicable regulations. No recommendation as to products or vendors is made or should be implied.

NO REPRESENTATION OR WARRANTY IS MADE THAT THE INFORMATION IS TECHNICALLY ACCURATE OR SUFFICIENT OR CONFORMS TO ANY STATUTE, GOVERNMENTAL RULE OR REGULATION, AND FURTHER, NO REPRESENTATION OR WARRANTY IS MADE OF MERCHANTABILITY OR FITNESS FOR ANY PARTICULAR PURPOSE OR AGAINST INFRINGEMENT OF INTELLECTUAL PROPERTY RIGHTS. NO oneM2M PARTNER TYPE 1 SHALL BE LIABLE, BEYOND THE AMOUNT OF ANY SUM RECEIVED IN PAYMENT BY THAT PARTNER FOR THIS DOCUMENT, WITH RESPECT TO ANY CLAIM, AND IN NO EVENT SHALL oneM2M BE LIABLE FOR LOST PROFITS OR OTHER INCIDENTAL OR CONSEQUENTIAL DAMAGES. oneM2M EXPRESSLY ADVISES ANY AND ALL USE OF OR RELIANCE UPON THIS INFORMATION PROVIDED IN THIS DOCUMENT IS AT THE RISK OF THE USER.

Contents

Contents.....	3
1 Scope.....	11
2 References.....	12
1.1 Normative references.....	12
1.2 Informative references.....	12
3 Abbreviations.....	13
4 Conventions.....	15
5 Energy Use Cases.....	16
5.1 Wide area, energy related measurement/control system for advanced transmission and distribution automation.....	16
5.1.1 Description.....	16
5.1.2 Source.....	16
5.1.3 Actors.....	16
5.1.4 Pre-conditions.....	17
5.1.5 Triggers.....	17
5.1.6 Normal Flow.....	17
5.1.7 Alternative Flow.....	19
5.1.8 Post-conditions.....	19
5.1.9 High Level Illustration.....	19
5.1.10 Potential Requirements.....	19
5.2 Analytics Use Case for M2M.....	20
5.2.1 Description.....	20
5.2.2 Source.....	22
5.2.3 Actors.....	22
5.2.4 Pre-conditions.....	22
5.2.5 Triggers.....	22
5.2.6 Normal Flow.....	22
5.2.7 Alternative Flow 1.....	23
5.2.8 Post-conditions.....	23
5.2.9 High Level Illustration.....	23
5.2.10 Potential requirements.....	25
5.3 Smart Meter Reading.....	25
5.3.1 Description.....	25
5.3.2 Source.....	25
5.3.3 Actors.....	25
5.3.4 Pre-conditions.....	26
5.3.5 Triggers.....	26
5.3.6 Normal Flow.....	26
5.3.7 Alternative Flow.....	29
5.3.8 Post-conditions.....	29
5.3.9 High Level Illustration.....	29
5.3.10 Potential Requirements.....	29
5.4 Environmental Monitoring of Remote Locations to Determine Hydropower.....	30
5.4.1 Description.....	30
5.4.2 Source.....	30
5.4.3 Actors.....	30
5.4.4 Pre-conditions.....	30
5.4.5 Triggers.....	31
5.4.6 Normal Flow.....	31
5.4.7 Alternative Flow.....	31
5.4.8 Post-conditions.....	32
5.4.9 High Level Illustration.....	32
5.4.10 Potential Requirements.....	32
5.5 Oil and Gas Pipeline Cellular/Satellite Gateway.....	32

5.5.1	Description	32
5.5.2	Source	32
5.5.3	Actors	33
5.5.4	Pre-conditions	33
5.5.5	Triggers	33
5.5.6	Normal Flow	33
5.5.7	Alternative Flow.....	34
5.5.8	Post-conditions.....	36
5.5.9	High Level Illustration	37
5.5.10	Potential Requirements	37
6	Enterprise Use Cases	39
6.1	Smart Building	39
6.1.1	Description	39
6.1.2	Source	39
6.1.3	Actors	39
6.1.4	Pre-conditions	39
6.1.5	Triggers	39
6.1.6	Normal Flow	40
6.1.7	Alternative Flow.....	41
6.1.8	Post-conditions.....	41
6.1.9	High Level Illustration	41
6.1.10	Potential Requirements	41
6.2	Use cases for Machine socialization	41
6.2.1	Description	41
6.2.2	Source	42
6.2.3	Actors	42
6.2.4	Pre-conditions	42
6.2.5	Triggers	42
6.2.6	Normal Flow	42
6.2.7	Alternative Flow.....	42
6.2.8	Post-conditions.....	42
6.2.9	High Level Illustration	43
6.2.10	Potential Requirements	43
7	Healthcare Use Cases	43
7.1	M2M Healthcare Gateway	43
7.1.1	Description	43
7.1.2	Source	43
7.1.3	Actors	44
7.1.4	Pre-conditions	44
7.1.5	Triggers	44
7.1.6	Normal Flow	45
7.1.7	Alternative Flow.....	46
7.1.8	Post-conditions.....	50
7.1.9	High Level Illustration	50
7.1.10	Potential Requirements	51
7.2	Use Case on Wellness Services	53
7.2.1	Description	53
7.2.2	Source	53
7.2.3	Actors	53
7.2.4	Pre-conditions	54
7.2.5	Triggers	54
7.2.6	Normal Flow	54
7.2.7	Alternative Flow.....	54
7.2.8	Post-conditions.....	55
7.2.9	High Level Illustration	55
7.2.10	Potential Requirements	55
7.3	Secure remote patient care and monitoring.....	56
7.3.1	Description	56
7.3.2	Source	58
7.3.3	Actors	58

7.3.4	Pre-conditions	58
7.3.5	Triggers	59
7.3.6	Normal Flow	59
7.3.7	Alternative Flow.....	60
7.3.8	Post-conditions.....	60
7.3.9	High Level Illustration	60
7.3.10	Potential requirements.....	60
8	Public Services Use Cases.....	61
8.1	Street Light Automation	61
8.1.1	Description	61
8.1.2	Source	62
8.1.3	Actors.....	62
8.1.4	Pre-conditions	62
8.1.5	Triggers	62
8.1.6	Normal Flow	62
8.1.7	Alternative Flow.....	65
8.1.8	Post-conditions.....	65
8.1.9	High Level Illustration	66
8.1.10	Potential Requirements	66
8.2	Use Case on Devices, Virtual Devices and Things.....	67
8.2.1	Description	67
8.2.2	Source	67
8.2.3	Actors.....	67
8.2.4	Pre-conditions	68
8.2.5	Triggers	68
8.2.6	Normal Flow	68
8.2.7	Alternative Flow.....	68
8.2.8	Post-conditions.....	68
8.2.9	High Level Illustration	68
8.2.10	Potential Requirements	68
8.3	Car/Bicycle Sharing Services	69
8.4	Smart Parking	69
8.5	Information Delivery service in the devastated area.....	69
8.5.1	Description	69
8.5.2	Source	69
8.5.3	Actors.....	69
8.5.4	Pre-conditions	70
8.5.5	Triggers	70
8.5.6	Normal Flow	70
8.5.7	Alternative Flow.....	71
8.5.8	Post-conditions.....	71
8.5.9	High Level Illustration	71
8.5.10	Potential Requirements	72
8.6	Holistic Service Provider	73
8.6.1	Description	73
8.6.2	Source	73
8.6.3	Actors.....	73
8.6.4	Pre-conditions	74
8.6.5	Triggers	74
8.6.6	Normal Flow	74
8.6.7	Alternative flow	75
8.6.8	Post-conditions.....	75
8.6.9	High Level Illustration	75
8.6.10	Potential requirements.....	75
9	Residential Use Cases	76
9.1	Home Energy Management	76
9.1.1	Description	76
9.1.2	Source.....	76
9.1.3	Actors.....	76
9.1.4	Pre-conditions	76

9.1.5	Triggers	77
9.1.6	Normal Flow	77
9.1.7	Alternative Flow.....	77
9.1.8	Post-conditions.....	77
9.1.9	High Level Illustration	78
9.1.10	Potential Requirements	78
9.2	Home Energy Management System (HEMS)	79
9.2.1	Description	79
9.2.2	Source	79
9.2.3	Actors	79
9.2.4	Pre-conditions	79
9.2.5	Triggers	79
9.2.6	Normal Flow	79
9.2.7	Alternative Flow.....	80
9.2.8	Post-conditions.....	80
9.2.9	High Level Illustration	80
9.2.10	Potential Requirements	80
9.3	Plug-In Electrical Charging Vehicles and power feed in home scenario	80
9.3.1	Description	80
9.3.2	Source	81
9.3.3	Actors	81
9.3.4	Pre-conditions	81
9.3.5	Triggers	81
9.3.6	Normal Flow	82
9.3.7	Alternative Flow.....	83
9.3.8	Post-conditions.....	83
9.3.9	High Level Illustration	83
9.3.10	Potential Requirements	84
9.4	Real-time Audio/Video Communication	84
9.4.1	Description	84
9.4.2	Source	85
9.4.3	Actors	85
9.4.4	Pre-conditions	85
9.4.5	Triggers	85
9.4.6	Normal Flow	85
9.4.7	Alternative Flow.....	85
9.4.8	Post-conditions.....	86
9.4.9	High Level Illustration	86
9.4.10	Potential Requirements	86
9.5	Event Triggered Task Execution Use Case.....	87
9.5.1	Description	87
9.5.2	Source	87
9.5.3	Actors	87
9.5.4	Pre-conditions	87
9.5.5	Triggers	87
9.5.6	Normal Flow	87
9.5.7	Alternative Flow.....	87
9.5.8	Post-conditions.....	88
9.5.9	High Level Illustration	88
9.5.10	Potential Requirements	88
9.6	Semantic Home Control.....	89
9.6.1	Description	89
9.6.2	Source	89
9.6.3	Actors	89
9.6.4	Pre-conditions	89
9.6.5	Triggers	89
9.6.6	Normal Flow	90
9.6.7	Alternative Flow.....	90
9.6.8	Post-conditions.....	90
9.6.9	High Level Illustration	90
9.6.10	Potential Requirements	90
9.7	Semantic Device Plug and Play	90

9.7.1	Description	90
9.7.2	Source	90
9.7.3	Actors	91
9.7.4	Pre-conditions	91
9.7.5	Triggers	91
9.7.6	Normal Flow	91
9.7.7	Alternative Flow.....	91
9.7.8	Post-conditions.....	91
9.7.9	High Level Illustration	91
9.7.10	Potential Requirements	91
9.8	Triggering in the Field Domain	91
10	Retail Use Cases	92
10.1	Vending Machines	92
10.1.1	Description	92
10.1.2	Source	92
10.1.3	Actors	92
10.1.4	Pre-conditions	92
10.1.5	Triggers	92
10.1.6	Normal Flow	92
10.1.7	Alternative Flow.....	92
10.1.8	Post-conditions.....	92
10.1.9	High Level Illustration	93
10.1.10	Potential Requirements	93
11	Transportation Use Cases.....	93
11.1	Vehicle Diagnostic & Maintenance Report	93
11.2	Use Case on Remote Maintenance Services	93
11.3	Traffic Accident Information Collection	93
11.4	Fleet Management Service using DTG (Digital Tachograph)	94
11.5	Use cases for Electronic Toll Collection (ETC) Service.....	94
11.6	Use cases for Taxi Advertisement service	94
11.7	Use Case on Vehicle Data Service.....	94
11.8	Smart Automatic Driving	94
11.9	Use Case on Vehicle Data Wipe Service	94
12	Other Use Cases	95
12.1	Extending the M2M Access Network using Satellites.....	95
12.1.1	Description	95
12.1.2	Source	95
12.1.3	Actors	95
12.1.4	Pre-conditions	95
12.1.5	Triggers	95
12.1.6	Normal Flow	96
12.1.7	Alternative Flow.....	96
12.1.8	Post-conditions.....	96
12.1.9	High Level Illustration	96
12.1.10	Potential Requirements	96
12.2	M2M Data Traffic Management by the Underlying Network Operator	97
12.2.1	Description	97
12.2.2	Source	97
12.2.3	Actors	97
12.2.4	Pre-conditions	97
12.2.5	Triggers	97
12.2.6	Normal Flow	97
12.2.7	Alternative Flow.....	99
12.2.8	Post-conditions.....	99
12.2.9	High Level Illustration	99
12.2.10	Potential Requirements	100
12.3	Optimized M2M interworking with mobile networks (Optimizing connectivity management parameters) .	100
12.3.1	Description	100
12.3.2	Source	101
12.3.3	Actors	101

12.3.4	Pre-conditions	101
12.3.5	Triggers	101
12.3.6	Normal Flow	102
12.3.7	Alternative Flow.....	102
12.3.8	Post-conditions.....	102
12.3.9	High Level Illustration	103
12.3.10	Potential Requirements	103
12.4	Optimized M2M interworking with mobile networks (Optimizing mobility management parameters)	103
12.4.1	Description	103
12.4.2	Source	104
12.4.3	Actors	104
12.4.4	Pre-conditions	105
12.4.5	Triggers	105
12.4.6	Normal Flow	105
12.4.7	Alternative Flow.....	106
12.4.8	Post-conditions.....	106
12.4.9	High Level Illustration	107
12.4.10	Potential Requirements	107
12.5	Sleepy Nodes	107
12.5.1	Description	107
12.5.2	Source	108
12.5.3	Actors	108
12.5.4	Pre-conditions	109
12.5.5	Triggers	109
12.5.6	Normal Flow	109
12.5.7	Alternative Flow.....	110
12.5.8	Post-conditions.....	110
12.5.9	High Level Illustration	110
12.5.10	Potential Requirements	110
12.6	Use Case on Collection of M2M System data	112
12.6.1	Description	112
12.6.2	Source	112
12.6.3	Actors	112
12.6.4	Pre-conditions	112
12.6.5	Triggers	112
12.6.6	Normal Flow	112
12.6.7	Alternative Flow.....	112
12.6.8	Post-conditions.....	112
12.6.9	High Level Illustration	113
12.6.10	Potential Requirements	114
12.7	Leveraging Broadcasting/ Multicasting Capabilities of Underlying Networks	114
12.7.1	Description	114
12.7.2	Source	115
12.7.3	Actors	115
12.7.4	Pre-conditions	115
12.7.5	Triggers	115
12.7.6	Normal Flow	115
12.7.7	Alternative Flow.....	116
12.7.8	Post-conditions.....	116
12.7.9	High Level Illustration	116
12.7.10	Potential Requirements	117
12.8	Leveraging Service Provisioning for Equipment with Built-in M2M Device	118
12.8.1	Description	118
12.8.2	Source	118
12.8.3	Actors	118
12.8.4	Pre-conditions	119
12.8.5	Triggers	119
12.8.6	Normal Flow	119
12.8.7	Alternative Flow.....	122
12.8.8	Post-conditions.....	122
12.8.9	High Level Illustration	122
12.8.10	Potential requirements.....	123

12.9	Semantics query for device discovery across M2M Service Providers	124
12.9.1	Description	124
12.9.2	Source	124
12.9.3	Actors	124
12.9.4	Pre-conditions	124
12.9.5	Triggers	124
12.9.6	Normal Flow	124
12.9.7	Alternative Flow.....	125
12.9.8	Post-conditions.....	125
12.9.9	High Level Illustration	125
12.9.10	Potential Requirements	125
12.10	Underlying network service activation and deactivation	126
12.10.1	Description	126
12.10.2	Source	127
12.10.3	Actors.....	127
12.10.4	Pre-conditions	127
12.10.5	Triggers	127
12.10.6	Normal Flow	127
12.10.7	Alternative Flow.....	127
12.10.8	Post-conditions.....	128
12.10.9	High Level Illustration	128
12.10.10	Potential requirements.....	128
12.11	An industrial use case for On-demand data collection for factories	128
12.12	Smart Irrigation System	129
12.12.1	Description	129
12.12.2	Source	129
12.12.3	Actors.....	129
12.12.4	Pre-conditions	129
12.12.5	Triggers	130
12.12.6	Normal Flow	130
12.12.7	Alternative flow	130
12.12.8	Post-conditions.....	130
12.12.9	High Level Illustration	130
12.12.10	Potential requirements.....	130
12.13	Group Registration Management	131
12.13.1	Description	131
12.13.2	Source	131
12.13.3	Actors.....	131
12.13.4	Pre-conditions	131
12.13.5	Triggers	131
12.13.6	Normal Flow	131
12.13.7	Alternative flow	133
12.13.8	Post-conditions.....	133
12.13.9	High Level Illustration	133
12.13.10	Potential requirements.....	133
12.14	Multicast using group	133
12.14.1	Description	133
12.14.2	Source	133
12.14.3	Actors.....	133
12.14.4	Pre-conditions	133
12.14.5	Triggers	133
12.14.6	Normal Flow	133
12.14.7	Alternative flow	134
12.14.8	Post-conditions	134
12.14.9	High Level Illustration	134
12.14.10	Potential requirements.....	134
12.15	Access control using group.....	134
12.15.1	Description	134
12.15.2	Source	134
12.15.3	Actors.....	135
12.15.4	Pre-conditions	135
12.15.5	Triggers	135

12.15.6	Normal Flow	135
12.15.7	Alternative flow	135
12.15.8	Post-conditions	135
12.15.9	High Level Illustration	136
12.15.10	Potential requirements.....	136
12.16	Personal data management mechanism based on user's privacy preference	136
12.16.1	Description	136
12.16.2	Source	136
12.16.3	Actors.....	136
12.16.4	Pre-conditions	137
12.16.5	Triggers	137
12.16.6	Normal Flow	137
12.16.7	Alternative flow	138
12.16.8	Post-conditions.....	138
12.16.9	High Level Illustration	138
12.16.10	Potential requirements.....	138
12.17	Quality of Sensor Data.....	139
12.17.1	Description	139
12.17.2	Source	139
12.17.3	Actors.....	139
12.17.4	Pre-conditions	140
12.17.5	Triggers	140
12.17.6	Normal Flow	140
12.17.7	Alternative flow	140
12.17.8	Post-conditions.....	140
12.17.9	High Level Illustration	140
12.17.10	Potential requirements.....	141
12.18	Agriculture monitoring drone system	141
12.18.1	Description	141
12.18.2	Source	142
12.18.3	Actors.....	142
12.18.4	Pre-conditions	142
12.18.5	Triggers	142
12.18.6	Normal Flow	142
12.18.7	Alternative Flow.....	142
12.18.8	Post-conditions.....	142
12.18.9	High Level Illustration	143
12.18.10	Potential requirements.....	143
12.19	Terms And Conditions Markup Language for Privacy Policy Manager	143
12.19.1	Description	143
12.19.2	Source	144
12.19.3	Actors.....	145
12.19.4	Pre-conditions	145
12.19.5	Triggers	145
12.19.6	Normal Flow	145
12.19.7	Alternative flow	145
12.19.8	Post-conditions.....	145
12.19.9	High Level Illustration	145
12.19.10	Potential requirements.....	146
History		146

1 Scope

The present document includes a collection of use cases from a variety of M2M industry segments (listed in table 1.1). Each use case may include a description, source, actors, pre-conditions, triggers, normal and alternative flow of sequence of interactions among actors and system, post-conditions, illustrations and potential requirements. The potential requirements provide an initial view of what oneM2M requirements could arise from the Use Case as seen by the contributor. These are intended to help the reader understand the use case's needs. These potential requirements may have been subsequently submitted by the contributor for consideration as candidate oneM2M requirements, which may or may not have been agreed as a oneM2M requirement (often after much editing). As such, there may not be a direct mapping from the potential requirements to agreed oneM2M requirements [i.15]

Table 1.1

Industry Segment	oneM2M Use Cases									
Agriculture	Smart Irrigation System	Use Case for Agricultural Drone								
Energy	Wide area Energy related measurement /control system for advanced transmission and distribution automation	Analytics for oneM2M	Smart Meter Reading	Environmental Monitoring for Hydro-Power Generation using Satellite M2M	Oil and Gas Pipeline Cellular /Satellite Gateway					
Enterprise	Smart building									
Healthcare	M2M Healthcare Gateway	Wellness services	Secure remote patient care and monitoring							
Industrial	On-demand data collection for factories	Quality of Sensor Data								
Public Services	Street Light Automation	Devices, Virtual devices and Things	Car/Bicycle Sharing Services	Smart parking	Information Delivery service in the devastated area	Holistic Service Provider				
Residential	Home Energy Management	Home Energy Management System	Plug-In Electrical Charging Vehicles and power feed in home scenario	Real-time Audio/Video Communication	Event Triggered Task Execution	Semantic Home Control	Semantic Device Plug and Play	Triggering in the field domain		
Retail	Vending Machines									
Transportation	Vehicle Diagnostic & Maintenance Report	Remote Maintenance services	Traffic Accident Information collection	Fleet management service using Digital Tachograph	Electronic Toll Collection Services	Taxi advertisement	Vehicle Data Services	Smart Automatic Driving	Vehicle Data Wipe Service	
Other	Extending the M2M Access Network using Satellites	M2M data traffic management by underlying network operator	Optimizing connectivity management parameters with mobile networks	Optimizing mobility management parameters with mobile networks	Sleepy nodes	Collection of M2M system data	Leveraging Broadcasting / Multicasting Capability of Underlying Networks	Service Provisioning for Equipment with Built-in Device	Semantics query for device discovery on Inter-M2M SP	Underlying network service activation and deactivation

Industry Segment	oneM2M Use Cases										
Other (Continued)	Group Registration Management	Multicast using group	Access control using group	Personal data management system based on user's privacy preference	Terms And Conditions Markup Language for Privacy Policy Manager						

2 References

1.1 Normative references

Normative references are not applicable in the present document.

1.2 Informative references

References are either specific (identified by date of publication and/or edition number or version number) or non-specific. For specific references, only the cited version applies. For non-specific references, the latest version of the referenced document (including any amendments) applies.

The following referenced documents are not necessary for the application of the present document but they assist the user with regard to a particular subject area.

[i.1] oneM2M Drafting Rules.

NOTE: Available at http://member.onem2m.org/Static_pages/Others/Rules_Pages/oneM2M-Drafting-Rules-V1_0.doc.

[i.2] ETSI TR 102 935 (V2.1.1): "Machine-to-Machine communications (M2M); Applicability of M2M architecture to Smart Grid Networks; Impact of Smart Grids on M2M platform".

[i.3] ETSI TS 102 689 (V1.1.1): "Machine-to-Machine communications (M2M); M2M service requirements".

[i.4] ETSI TR 102 732: "Machine-to-Machine Communications (M2M); Use Cases of M2M applications for eHealth".

[i.5] void [i.6] HGI-GD017-R3: "Use Cases and Architecture for a Home Energy Management Service".

[i.7] ISO/IEC 15118: "Road vehicles, vehicle to grid communication".

[i.8] Mandate 486: "Mandate for programming and standardisation addressed to the European Standardisation Bodies in the field of urban rail".

[i.9] DIN specification 70121: "Electromobility - Digital communication between a D.C. EV charging station and an electric vehicle for control of D.C. charging in the combined charging system".

[i.10] ETSI TR 102 638: "Intelligent Transport Systems (ITS); Vehicular Communications; Basic Set of Applications; Definitions".

[i.11] 3GPP TS 22.368: "Service requirements for Machine-Type Communications (MTC); Stage 1".

[i.12] 3GPP TS 23.682: "Architecture enhancements to facilitate communications with packet data networks and applications".

- [i.13] 3GPP TR 23.887: "Architectural Enhancements for Machine Type and other mobile data applications".
- [i.14] Communications Guidelines defined in Continua Health Alliance, The Continua Version 2012 Design Guidelines.
- [i.15] oneM2M TS-0002: "Requirements Technical Specification".
- [i.16] ETSI TS 103 383: "Smart Cards; Embedded UICC; Requirements Specification".
- [i.17] IEC 61850: "Communication networks and systems in substations".
- [i.18] oneM2M-TR-0013: "Home Domain Enablement Technical Report".
- [i.19] oneM2M TR-0018: "Industrial Domain Enablement Technical Report".
- [i.20] oneM2M TR-0016: "Authorization Architecture and Access Control Policy".
- [i.21] oneM2M TR-0026: "Vehicular Domain Enablement Technical Report".

3 Abbreviations

For the purposes of the present document, the following abbreviations apply:

A/C	Air Conditioner
ACL	Access Control List
AL	Authorization Level
AMC	Agriculture Monitoring administration Centre
AMI	Advanced Metering Infrastructure
AP	Applications Provider
API	Application Programming Interface
ARIB	Association of Radio Industries and Business
ARPU	Average Revenue per User
ATIS	Alliance for Telecommunications Industry Solutions
BMS	Building Management System
CCSA	China Communications Standards Association
CIS	Customer Information System
CL	Criticality Level
CMS	Cryptographic Message Syntax
CP	Care Provider
CPU	Central Processing Unit
DAP	Data Aggregation Point
DCS	Distributed Control System
DER	Distributed Energy Resources
DP	Device Provider
DR	Demand Response
DRX	Discontinuous reception
DSO	Distribution System Operator
DB	DataBase
DTG	Digital TachoGraph
DVR	Digital Video Recorder
EGW	Energy GateWay
EHR	Electronics Health Record
EP	Equipment Provider
EPBA	Equipment Provider Back-end Application

ETC	Electronic Toll Collection
ETSI	European Telecommunications Standards Institute
ETWS	Earthquake and Tsunami Warning System
EU	European Union
eUICC	Embedded Universal Integrated Circuit Card
EV	Electric Vehicle
EVC	Electric Vehicle Charging
EVCE	Electric Vehicle Charging Equipment
EVC-SP	Electric Vehicle Charging Service Provider
FAN	Field Area Network
FFS	For Further Study
GPS	Global Positioning System
HAMS	Home Automation Management System
HEM	Home Energy Management
HEMS	Home Energy Management System
HLR	High-Level Requirement
HMI	Human Machine Interface
HV	High Voltage
I/F	InterFace
IAC	Irrigation Administration Centre
ICCID	Integrated Circuit Card Identifier
IEC	International Electrotechnical Commission
IMSI	International Mobile Subscriber Identity
IP	Internet Protocol
ITS	Intelligent Transportation System
LAN	Local Area Network
LATAM	Latin American
LDR	Low Data Rate
MDMS	Meter Data Management System
MDM	Medical Device Manufacturer
MDN	Mobile Directory Number
MDMMS	Medical Device Monitoring & Management Service
MN	Middle Node
MNO	Mobile Network Operator
MSCN	M2M Service Capabilities Network
MSISDN	Mobile Station International Subscriber Directory Number
MSP	M2M Service Platform
MTC	Machine Type Communications
MV	Medium Voltage
M2M	Machine to Machine
NW	NetWork
PAN	Personal Area Network
PC	Personal Computer
PEV	Plug-in Electric Vehicle
PKCS	Public Key Cryptology Standards
PLC	Power Line Communications
PMU	Phase Measurement Unit
PPM	Privacy Policy Manager
QoS	Quality of Service
RL	Redaction LevelLeve
RTU	Remote Terminal Unit
SCADA	Supervisory Control And Data Acquisition
SDDTE	Small Data and Device Triggering Enhancements
SGCG	Smart Grid Coordination Group
SGIP	Smart Grid Interoperability Panel
SIM	Subscriber Identity Module
SLA	Service Level Agreement
SM	Smart Meter
SMS	Short Message Service
SN	Sleepy Node
SP	Service Provider
SW	SoftWare

T&C	Terms and Conditions
TSO	Transmission System Operator
TIA	Telecommunications Industry Association
TSDSI	Telecommunications Standards Development Society, India
TTA	Telecommunications Technology Association
TTC	Telecommunications Technology Committee
TV	TeleVision
UD	User Device
UE	User Equipment
UEPCOP	User Equipment Power Consumption OPTimizations
UIM	User Identity Module
USB	Universal Serial Bus
URI	Universal Resource Identifier
WAM	Wide Area Measurement
WAMS	Wide Area Measurement System
WAN	Wide Area Network
WCDMA	Wideband Code Division Multiple Access
WG	Wireless Gateway
WLAN	Wireless Local Area Network
3GPP	3rd Generation Partnership Project
TR	Technical Report
HV/MV	High Voltage/Medium Voltage
TS	Technical Specification
SG	Smart Grid
US	United States
MB	Mega Bytes
Wi-Fi	Wireless Fidelity
HIPAA	Health Insurance Portability and Accountability Act,
EU	European Union
HM	Holistic Management (Service Provider)
FO	Facility Operator
ICT	Information and Communication Technologies
TP	Third Party (facility ICT provider)
GW	Gateway
TC	Technical Comitee
CEN	European Committee for Standardization
DIN	Deutsche Industry Norm
AA, BB, CC	
ON	
ALU	
PEV-SP	
PEV-SW	
UC	

4 Conventions

The key words "Shall", "Shall not", "May", "Need not", "Should", "Should not" in this document are to be interpreted as described in the oneM2M Drafting Rules [i.1]

5 Energy Use Cases

5.1 Wide area, energy related measurement/control system for advanced transmission and distribution automation

5.1.1 Description

Background:

- Phase Measurement Units (PMUs, aka Synchrophasors) in power electrical systems, is a technology that provides a tool for power system operators and planners to measure the state of the electrical system and manage power quality.
- PMUs are positioned across the high voltage (HV) transmission and Medium voltage (MV) distribution network, operated by transmission and distribution system operators (TSO/DSO) respectively, typically in a substation where network node connections are made and the distribution of load is of importance.
- PMUs usually generate bulk statistical information transmitted hourly or daily or event based. They are capable of continuously monitoring the wide-area network status online, so continuous information streaming data will be available to control centers from hundreds of PMUs at once which requires a stable communication network with sufficient capacity and quality.
- The communications network that is used to collect, monitor and control electricity power systems (HV transmission and MV Distribution power systems) are usually owned by Electricity TSO/DSO and are very secure and reliable.
- PMUs are sampled from widely dispersed locations in the power system network and synchronized from the common time source of a global positioning system (GPS) radio clock. PMUs measure voltages and currents at diverse locations on a power grid and output accurately time-stamped voltage and current phasors, allowing for synchronized comparison of two quantities in real time. These comparisons can be used to assess system conditions.

Description:

- This use case shows the feasibility of High voltage /MV supervision through the interconnection of PMUs especially via mobile broadband communication networks. Thus not requiring any additional TSO/DSO internal network extensions especially in remote sites.
- Through analysis of PMU power state information collected in operator control centers (TSO/DSO), the TSO/DSO can send control information to PMUs, in the same mobile broadband communication network, to control the power flow in the power system.
- Transmission delay of less than a second for the transmission of PMU measurements in near real time to TSO/DSO in the case of control centers.
- Black-out causes propagates within minutes and sometimes only seconds through entire national and even international transport & distribution networks. So the transmission of control is critical in the range of less than seconds.

5.1.2 Source

oneM2M-REQ-2012-0030R07 Wide area Energy related measurement/control system for Advanced transmission and Distribution Automation.

NOTE: from ETSI TR 102 935 [i.2]

5.1.3 Actors

- Energy system operators:
 - Transmission System Operator (TSO) is responsible for operation, maintenance and development of the transmission network in its own control area and at interconnections with other control areas, long-term power system ability to meet the demand, and grid connection of the transmission grid users, including the DSOs.
 - Distribution System Operator (DSO) is responsible for operation, maintenance and development of its own distribution grid and where applicable at the connections with other grids, ensuring the long-term ability to meet the distribution demand, regional grid access and grid stability, integration of renewables at the distribution level and regional load balancing (if that is not done by the balance responsible party).

- Communication operator (s) provider of the access network (Telcos):
 - System operators and/or providers of service layer platform(s) which can provide services/common functionalities for applications that are independent of the underlying network(s).

5.1.4 Pre-conditions

Communication/connectivity networks (phase network) to collect the measurements from PMUs to centers.

5.1.5 Triggers

System conditions deducted from the analysis of collected data trigger a counter measure action for example to curtail or reduce power flow in a HV/MV transmission.

5.1.6 Normal Flow

Interactions between actors and system required for successful execution of the use case or scenario.

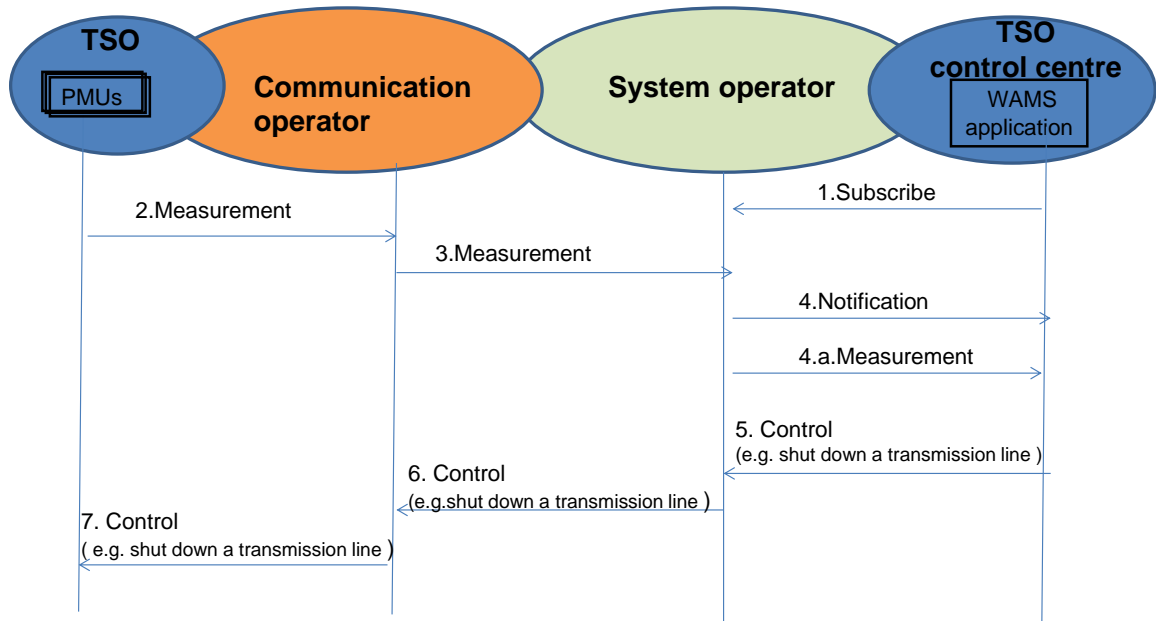

Figure 5-1 An example flow for the TSO scenario

An example flow for the TSO scenario:

1. WAMS application subscribes to PMU data which is owed by the Transmission System Operator .
2. Measurements requested are sent back through (service provider) Telco operator and System Operator to TSO center for the WAM application .
3. Measurements sent to the system operator are collected and can be stored by the operator.
4. Notification message is sent to WAMS application in TSO control center when the system operator receives the measurement. WAMS application/TSO control center can pull/push the data measurements.
5. Based on measurements collected, WAMS application/ TSO control center initiates a control command to shut down a transmission line under its controlled area.
6. The Control command is sent to system operator where an appropriate communication network is selected to send the control command.
7. Then control command is sent by system operator to the PMU under TSO controlled area to initiate the execution of the command e.g. the shutdown of a specific transmission line.

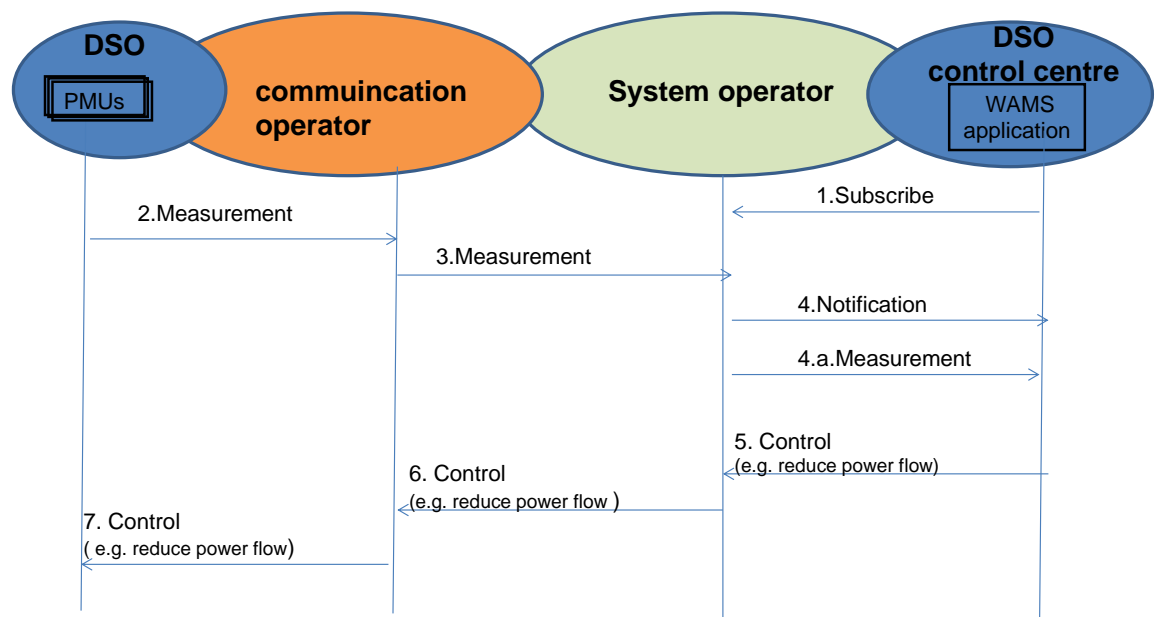

Figure 5-2 An example flow for DSO scenario

An example flow for DSO scenario:

1. WAMS application subscribes to the PMU data.
2. Measurements are sent through Telco operator.
3. Measurements sent to system operator where they are stored.
4. Notification sent to WAMS application in DSO control center when the measurements are received by system operator. WAMS application in DSO control center pulls the measurements.
5. Based on measurements collected WAMS application in DSO control center, initiates a control command to reduce flow in a particular region under its controlled area.
6. Control command sent to system operator where an appropriate communication network is selected to send the control command.
7. Then control command is sent to the PMU under DSO control to initiate the execution of the command e.g. the change of power flow.

5.1.7 Alternative Flow

None.

5.1.8 Post-conditions

Corrective or Restricted operation of power electrical network as a result of the preventive action because of the shut-down of (a part) power network.

5.1.9 High Level Illustration

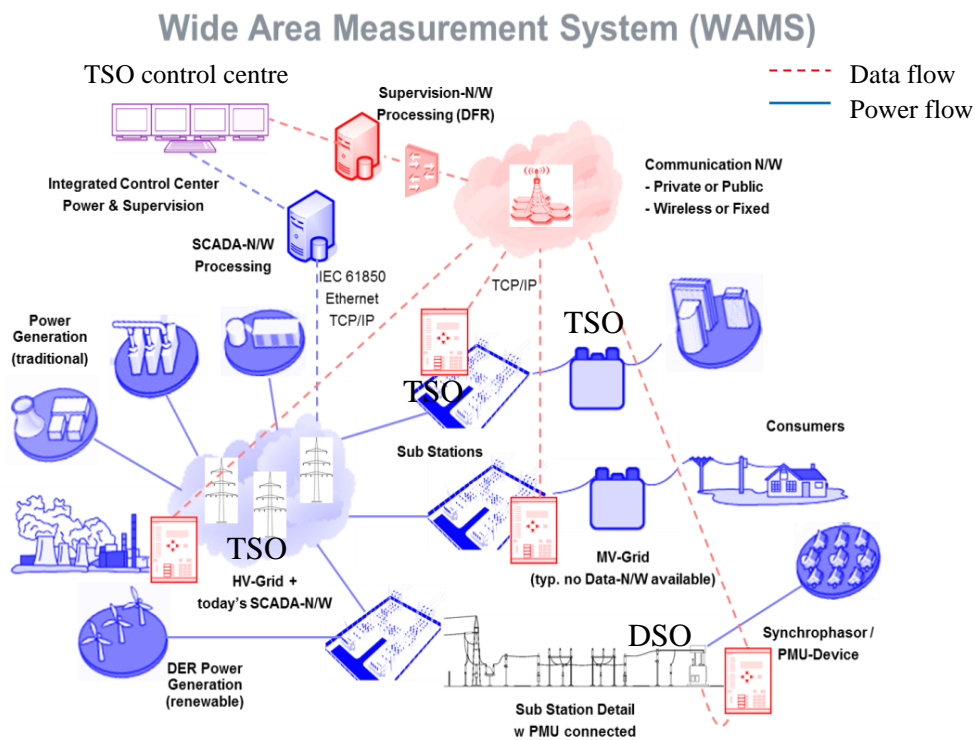

Figure 5-3 High Level Illustration of Wide Area Measurement System

5.1.10 Potential Requirements

Extracted from ETSI service requirements (TS 102 689 V1.1.1[i.3]) but suitable for this use case.

1. Data collection and reporting capability/function

The M2M System (e.g. be owned by System Operator) shall support the reporting from a specific M2M Device (e.g. PMU) or group of M2M Devices or group of M2M collectors in the way requested by the M2M Application (e.g. WAM) as listed below:

- a. a periodic reporting with the time period being defined by the M2M application;

- b. an on-demand reporting with two possible modes. One is an instantaneous collecting and reporting of data, the other one is a reporting of the data that were pre-recorded at the indicated specific time period;
- c. an event-based reporting e.g. transient fault.

NOTE: Specific time requirements FFS.

2. Remote control of M2M Devices

The M2M System shall support the capability for an Application to remotely control M2M Devices that support this capability; e.g. control power flow or shut down a regional power network to prevent a black-out event

3. Information collection & delivery to multiple applications

The M2M System shall support the ability for multiple M2M Applications (in this use case the WAM) to interact with multiple applications on the same M2M Devices (in this case can interact with many PMUs) simultaneously

4. Data store and share

The M2M System shall be able to store data to support the following requirements:

- a. Provide functionality to store and retrieve data.
- b. Establish storage policies for stored data (e.g. define maximum byte size of the stored data).
- c. Enable data sharing of stored data subjected to access control

5. Security requirements

- a. Authentication of M2M system with M2M devices/ /collectors.

The M2M system shall support mutual authentication with M2M Device or M2M Gateway/collector. For example mutual authentication may be requested between a service providers/operators and the entity requesting the service. The parties may choose the strength of authentication to ensure appropriate level of security.

- b. Authentication of applications on M2M devices with M2M applications on the network.

When there is a request for data access or for M2M Device/Gateway access, the M2M Device or M2M Gateway access, the application on M2M Device or M2M Gateway shall be able to mutually authenticate or M2M Applications on the Network from which the access request is received.

- c. Data integrity.

The M2M System shall be able to support verification of the integrity of the data exchanged.

- d. Prevention of abuse of network connection.

M2M security solution shall be able to prevent unauthorized use of the M2M Device/Gateway.

6. Privacy

The M2M System shall be able to protect confidentiality of collected information.

- a. Security credential and software upgrade at the Application level.
 - i. Where permitted by the security policy, M2M System shall be able to remotely provide the following features, at the Application level
 - ii. Secure updates of application security software and firmware of the M2M Device/Gateway.
 - iii. Secure updates of application security context (security keys and algorithms) of the M2M Device/Gateway.
- b. This functionality should be provided by a tamper-resistant Secured Environment (which may be an independent Security Element) in M2M Devices/Gateways supporting this functionality.

7. Continuous Connectivity

The M2M System shall support continuous connectivity, for M2M applications requesting the same M2M service on a regular and continuous basis. This continuous connectivity may be de-activated upon request of the Application or by an internal mechanism in the M2M system.

1 5.2 Analytics Use Case for M2M

2 5.2.1 Description

3 The term "analytics" is often used to describe complex algorithms applied to data which provide actionable
4 insights. Simpler algorithms may also provide actionable insights - here the term "compute" is used for them.

5 Both "analytics" and "compute" may be used similarly by an M2M System to provide benefits to M2M
6 applications. This use case uses a simple "compute" example to introduce the topic.
7 M2M application service providers may wish to use analytics for several purposes. There are many analytics
8 providers who may offer their libraries directly to application service providers. However there are situations
9 where application service providers may wish to apply analytics to their M2M data from devices before it is
10 delivered to the "back-end" of the application "in the cloud".

11
12 To satisfy M2M application service provider needs, a oneM2M system may offer compute/analytics
13 capabilities which may be internally or externally developed. Furthermore, these compute/analytics capabilities
14 may be geographically distributed. Benefits to M2M application service providers might include:

- 15 • Convenience - due to integration
- 16 • Simplicity - due to a cross-vertical standardized analytics interface
- 17 • Cost savings - due to resource minimization (of compute, storage, and/or network)
- 18 • Improved performance - due to offloading/edge computing

19
20 M2M service providers may also benefit by deploying distributed compute/analytics to optimize operations
21 such as regional management e.g. device/gateway software updates.

22 The use case described below assumes:

- 23 • millions of devices continuously report M2M data from devices at geographically diverse locations
- 24 • the M2M application is interested in receiving only certain sets of data based upon changes in
25 particular data elements.

26
27 Use of oneM2M computation and analytics for anomaly detection and filtering avoids the use of bandwidth
28 needed to transport unnecessary device data to the back-end of the M2M application. To enable the oneM2M
29 system to do this, the M2M application specifies:

- 30 1. Which device data (the baseline set) is needed to create a baseline (which is indicative of "normal"
31 operation).
- 32 2. The duration of the training period used to set a baseline.
- 33 3. The method to create/update the baseline.
- 34 4. Which device data (the trigger set) is to be compared to the baseline.
- 35 5. The method of comparison between the baseline set and the trigger set.
- 36 6. The variation of M2M data in comparison to the baseline used to trigger action.
- 37 7. Which data (the storage set) is to be stored in addition to the data used in the baseline.
- 38 8. Which data (the report set, which may include data from the baseline set, trigger set and the storage
39 set) which is to be reported to the M2M application upon trigger.
- 40 9. "Location directives" which expresses where the device data collection point, storage and
41 compute/analytics program and libraries should be located. (Distributed, possibly hierarchical
42 locations may be specified, and may be defined by max response time to devices, geographic
43 location, density of convergent device data flows, available compute/storage capacity, etc.).
- 44 10. "Lifecycle management directives" for compute/analytics program and libraries instances e.g. on
45 virtual machines.

46 The action by the oneM2M system in response to a trigger in this use case is to send the filtered report set to
47 the M2M application; however, other alternative actions are summarized below (which would require different
48 information from the M2M application).

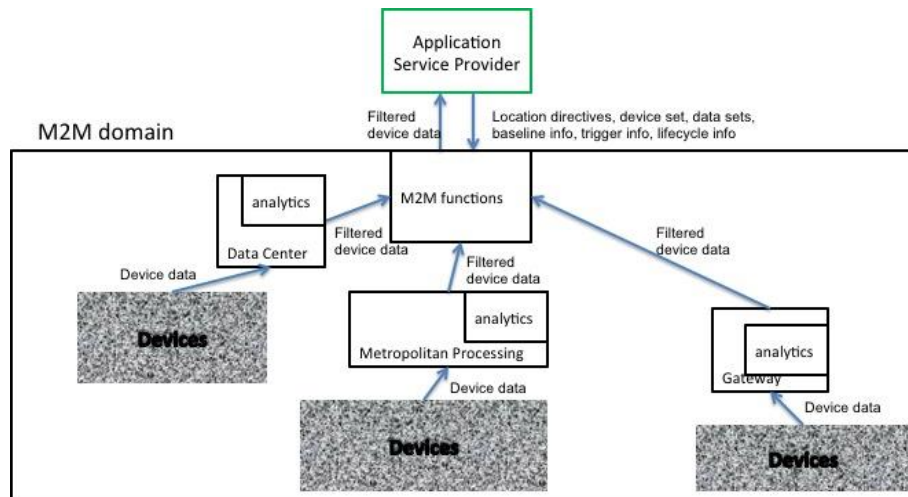

Figure 5-4 Analytics Use Case for M2M

Example of distributed, non-hierarchical location of analytics use case -- normal flow.
 A hierarchical version of this use case would locate different compute/analytics at different levels of a hierarchy.

5.2.2 Source

oneM2M-REQ-2013-0102R03 Analytics for oneM2M .

5.2.3 Actors

Devices - aim is to report what they sense.

Analytics library provider - aim is to provide analytics libraries to customers.

M2M application service provider - aim is to provide an M2M application to users.

5.2.4 Pre-conditions

Before an M2M system's compute/analytics may be used, the following steps are to be taken:

1. The M2M application service provider requests compute/analytics services from the oneM2M system. A request may include parameters required by analytics to perform computation and reporting, plus parameters required by the oneM2M system to locate and manage the lifecycle of the analytics computation instance (see clause 5.2.1).
2. The oneM2M system selects a source Analytics library provider for, and obtains the appropriate analytics library.
3. The oneM2M system provisions the appropriate analytics library at a location that meets the M2M application service provider's location directives.
4. The oneM2M system generates a program based upon the M2M application service provider's request.
5. The oneM2M system provisions the appropriate program based upon the M2M application service provider's request at the location(s) of step 3.
6. The oneM2M system starts collecting M2M data from devices and inputs them into the provisioned compute/analytics program for the duration of the baseline-training period. A baseline is established, which may include bounds for M2M data ranges, bounds for frequency of M2M data received, bounds for relative M2M data values to other M2M data values, etc.

5.2.5 Triggers

Triggering is described within clause 5.2.7.

5.2.6 Normal Flow

1. The devices provide M2M data to the oneM2M system.
2. The oneM2M system stores a set of M2M data (the storage set) from the devices.
3. The oneM2M system uses analytics to compare M2M data (the trigger set) from devices with the baseline.

4. The oneM2M system determines whether the variation between the M2M data set and the baseline exceeds the specified bounds of the trigger condition, if it does then the following action occurs:
5. The oneM2M system sends the requested M2M data (the report set), to the M2M application service provider.

5.2.7 Alternative Flow 1

The action to be taken by the oneM2M system following a trigger may be different than step 11 above. For example, the action may be to initiate conditional collection where for some duration or until some other trigger occurs.

- A. A current collection scheme of device data is modified e.g. more frequent updates, or
- B. A new collection scheme is initiated

Other alternative actions may include, but are not limited to:

- Initiating device/gateway diagnostics e.g. following a drop in the number of responding devices
- Sending control commands to devices
- Sending alerts to other oneM2M system services e.g. fraud detection
- Sending processed (e.g. cleansed, normalized, augmented) data to the application

5.2.8 Post-conditions

Not applicable.

5.2.9 High Level Illustration

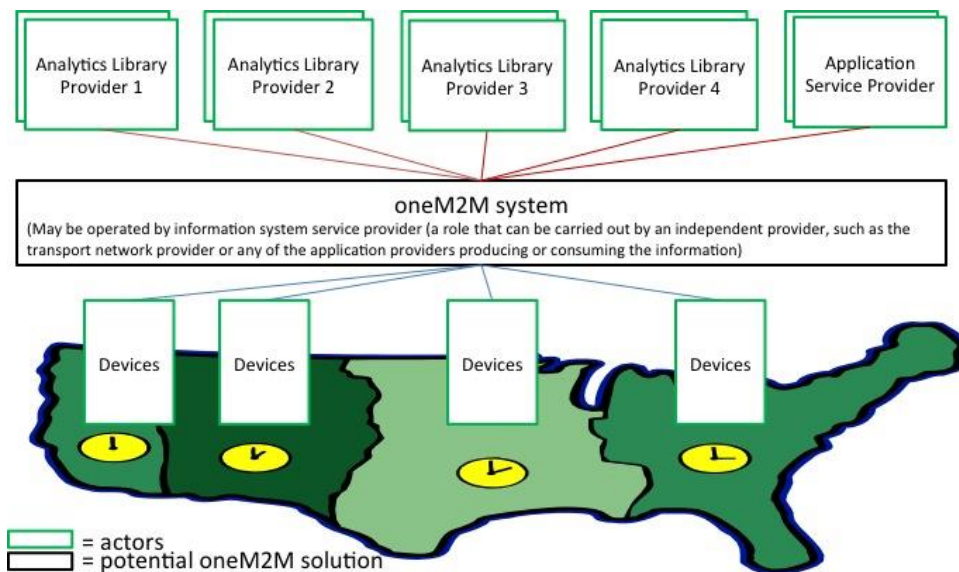

Figure 5-5 High level illustration of Analytics use case

Concrete Example Oil and Gas

The above description is of the abstracted use case; a more concrete example is as follows:

Oil and gas exploration, development, and production are important potential use cases for M2M. To stay competitive energy companies are continuously increasing the amount of data they collect from their field assets, and the sophistication of the processing they perform on that data. This data can literally originate anywhere on Earth, is transported to decision makers over limited bandwidths, and often must be reacted to on real-time time scales. An M2M system can prove very useful in its ability to perform analytics, data storage, and business intelligence tasks closer to the source of the data.

Oil and Gas companies employ some of the most sophisticated and largest deployments of sensors and actuators networks of any vertical market segment. These networks are highly distributed geographically, often spanning full continents and including thousands of miles of piping and networking links. Many of these

123 deployments (especially during the exploration phases) must reach very remote areas (hundreds of miles away
124 from the nearest high bandwidth Internet connection), yet provide the bandwidth, latency and reliability
125 required by the applications. These networks are typically mission critical, and sometimes life critical, so
126 robustness, security, and reliability are key to their architecture.

127 Oil and gas deployments involve a complex large-scale system of interacting subsystems. The associated
128 networks are responsible for the monitoring and automatic control of highly critical resources. The economic
129 and environmental consequences of events like well blowouts, pipeline ruptures, and spills into sensitive
130 ecosystems are very severe, and multiple layers of systems continuously monitor the plant to drive their
131 probability of occurrence toward zero. If any anomalies are detected, the system must react instantly to correct
132 the problem, or quickly bring the network into a global safe state. The anomalies could be attributable to many
133 different causes, including equipment failure, overloads, mismanagement, sabotage, etc. When an anomaly is
134 detected, the network must react on very fast timescales, probably requiring semi-autonomous techniques and
135 local computational resources. Local actions like stopping production, closing valves, etc. often ripple quickly
136 through the entire system (the system cannot just close a valve without coordinating with upstream and
137 downstream systems to adjust flows and insure all parameters stay within prescribed limits). Sophisticated
138 analytics at multiple levels aids the system in making these quick decisions, taking into account local
139 conditions, the global state of the network, and historical trends mined from archival big data. They may help
140 detect early signs of wear and malfunction before catastrophic events happen.

141 Security is critical to Oil and Gas networks. This includes data security to insure all data used to control and
142 monitor the network is authentic, private, and reaches its intended destination. Physical security of installations
143 like wells, pump stations, refineries, pipelines, and terminals is also important, as these could be threatened by
144 saboteurs and terrorists.

145 There are three broad phases to the Oil and Gas use case: Exploration, Drilling and Production. Information is
146 collected in the field by sensors, may be processed locally and used to control actuators, and is eventually
147 transported via the global internet to a headquarters for detailed analysis.

148 **Exploration**

149 During the exploration phase, where new fields are being discovered or surveyed, distributed process
150 techniques are invaluable to manage the vast quantities of data the survey crews generate, often in remote
151 locations not serviced by high bandwidth internet backbones. A single seismic survey dataset can exceed one
152 Petabyte in size. Backhauling this data to headquarters over the limited communications resources available in
153 remote areas is prohibitive (Transporting a petabyte over a 20Mb/s satellite link takes over 12 years), so
154 physical transport of storage media is currently used, adding many days of time lag to the exploration process.
155 Distributed computing can improve this situation. A compute node in the field is connected to the various
156 sensors and other field equipment used by the exploration geologists to collect the data. This node includes
157 local storage arrays, and powerful processor infrastructures to perform data compression, analysis, and
158 analytics on the data set, greatly reducing its size, and highlighting the most promising elements in the set to be
159 backhauled. This reduced data set is then moved to headquarters over limited bandwidth connections.

162 **Drilling**

163 When oil and gas fields are being developed, large quantities of data are generated by the drilling rigs and
164 offshore platforms. Tens of thousands of sensors monitor and record all conditions on the rig, and thousands of
165 additional sensors can be located downhole on the drill string, producing terabyte data sets. Distributed
166 compute nodes can unify all of these sensor systems, perform advanced real-time analytics on the data, and
167 relay the appropriate subset of the data over the field network to headquarters. Reliably collecting, storing and
168 transporting this data is essential, as the future performance of a well can be greatly influenced by the data
169 collected and the decisions made as it is being drilled.

170 A subset of the data collected (wellhead pressure, for example) is safety critical, and must be continuously
171 analysed for anomalies in real-time to insure the safety of the drilling operations. Because of the critical
172 latency requirements of these operations, they are not practical for the Cloud, and distributed computing
173 techniques are valuable to achieve the necessary performance.

175 **Production**

176 Once wells are producing, careful monitoring and control is essential to maximize the productivity of a field. A
177 field office may control and monitor a number of wells. A computing node at that office receives real-time
178 reports from all the monitoring sensors distributed across the field, and makes real-time decisions on how to
179 best adjust the production of each well. Some fields also include injection wells, and the computing node
180 closes the feedback loop between the injection rates and the recovery rates to optimize production. Some
181 analytics are performed in the local computing node, and all the parameters are stored locally and unlinked to
182 headquarters for more detailed analysis and archiving. Anomalies in sensor readings are instantly detected, and
183 appropriate reactions are quickly computed and relayed to the appropriate actuators.

184 The Pump Station shown also includes a computing node. It is responsible for monitoring and controlling the
185 pumps / compressors responsible for moving the product from the production field to the refinery or terminal
186 in a safe and efficient manner. Many sensors monitor the conditions of the pipelines, flows, pressures, and
187 security of the installation for anomalous conditions, and these are all processed by the local computing node.
188

189 **Conclusion**

190 The oneM2M Services Layer could offer “cloud-like” services to M2M Applications of computation/analytics
191 functions commonly used across verticals, where those functions are optimally placed near to the sources of
192 M2M data.

193 These services could include:

- 194 1. Advertisement of services to M2M Applications.
- 195 2. Acceptance of M2M Applications' directives over the “North-bound” interface.
- 196 3. Selection of where the requested computation/analytics functions are optimally placed.
- 197 4. Provisioning and maintenance of virtual machine and computation/analytics functions (provided by
198 oneM2M provider or 3rd party).
- 199 5. Redirection of M2M traffic to the virtual machine.
- 200 6. Delivery of virtual machine output to other virtual machines or directly to M2M Applications (e.g. of
201 filtered M2M data).

202 The M2M Applications and the M2M Service Provide may benefit from these services:

203 oneM2M Services Layer use of virtual machines on behalf of M2M Applications (e.g. to trigger new/modified
204 data collection or device diagnostics or low latency M2M Device control)

205 oneM2M Services Layer use of virtual machines on behalf of the oneM2M Service Provider (e.g. optimized
206 device management, fraud detection)

207 **5.2.10 Potential requirements**

- 208 1. The oneM2M system should be able to accept standardized inputs from M2M application providers which
209 request compute/analytics services.
- 210 2. Note that: Many Analytics APIs exist today, the most popular one being Google analytics service.
- 211 3. The oneM2M system should be able to select analytics libraries from Analytics library providers.
- 212 4. The oneM2M system should be able to locate and run instances of compute/analytics programs and
213 libraries at locations requested by M2M applications service providers.
- 214 5. The oneM2M system should be able to manage the lifecycle of instances of compute/analytics programs
215 and libraries.
- 216 6. The oneM2M system should be able to steer device data to inputs of instances of compute/analytics
217 programs.
- 218 7. The oneM2M system should be able to take operational and management action as a result of analytics
219 reports received.
- 220 8. The oneM2M system should specify supported compute/analytics triggers and actions.

222 **5.3 Smart Meter Reading**

223 **5.3.1 Description**

224 This clause provides selected Smart Meter Reading use cases.

225 **5.3.2 Source**

226 oneM2M-REQ-2013-0217R02 Smart Meter Reading Use Case .

227 **Note:** use case information extracted from SGIP/OpenSG.

228 REQ-2015-0563 pCR on smart meter reading.
229

230 **5.3.3 Actors**

- 231 • Smart Meters (SM), Data Aggregation Points (DAPs)
- 232 • Advanced Metering Infrastructure (AMI) Head-end
- 233 • Meter Data Management System (MDMS)

- Customer Information System (CIS)

5.3.4 Pre-conditions

Availability of meter data.
Smart Meters which are deployed in a block (e.g. same house, building, community, etc.) with the same behaviour based on default configuration or charging policy could be assigned as a group.

5.3.5 Triggers

Smart meter on-demand or bulk interval meter read request events

5.3.6 Normal Flow

Smart Grid Interoperability Panel (SGIP) (<http://www.sgip.org>) and OpenSG users group (<http://osgug.ucaiuug.org/default.aspx>) have been leading this effort in North America. An informative document has been submitted to OneM2M based on the SGIP activity. In general, a number of external organizations such as the SGIP or the SGCG (Smart Grid Coordination Group) in Europe have been working to define use cases for Smart Grid (SG). Portals such as the Smart Grid Information Clearing House (<http://www.sgiclearinghouse.org>) to assist with distributing information about smart grid initiatives in the US. The use-cases presented are derived in part from the above publicly available information. Figure 5.-6 shows the conceptual actors/data flow diagram based on a more detailed diagram developed by SG-Net. The more detailed diagram developed by SG-Net can be seen in the associated submission related to SGIP-based Smart Grid Use Cases. In Figure 5.-7 each element is an "actor" that is communicating with another actor using the shown data flows. As an example, consider "Smart Meter in the "Customer" quadrant (lower right). Smart Meter (SM) communicates with a number of other actors, such as a Data Aggregation Point (DAP) located in the AMI Network. The DAP can then transmit the aggregated data to the Utility Service Provider using the Wide Area Network. The meter reading information can reach the data center for the Utility Service Provider via the AMI Headend which can forward the information to the MDMS which can coordinate with the CIS to store/retrieve meter data and to determine customer billing information. In certain variations such as cellular-based smart metering systems, a DAP entity may be bypassed, or merely serve as a pass-through for the information flow between the utility data center and the smart meter.

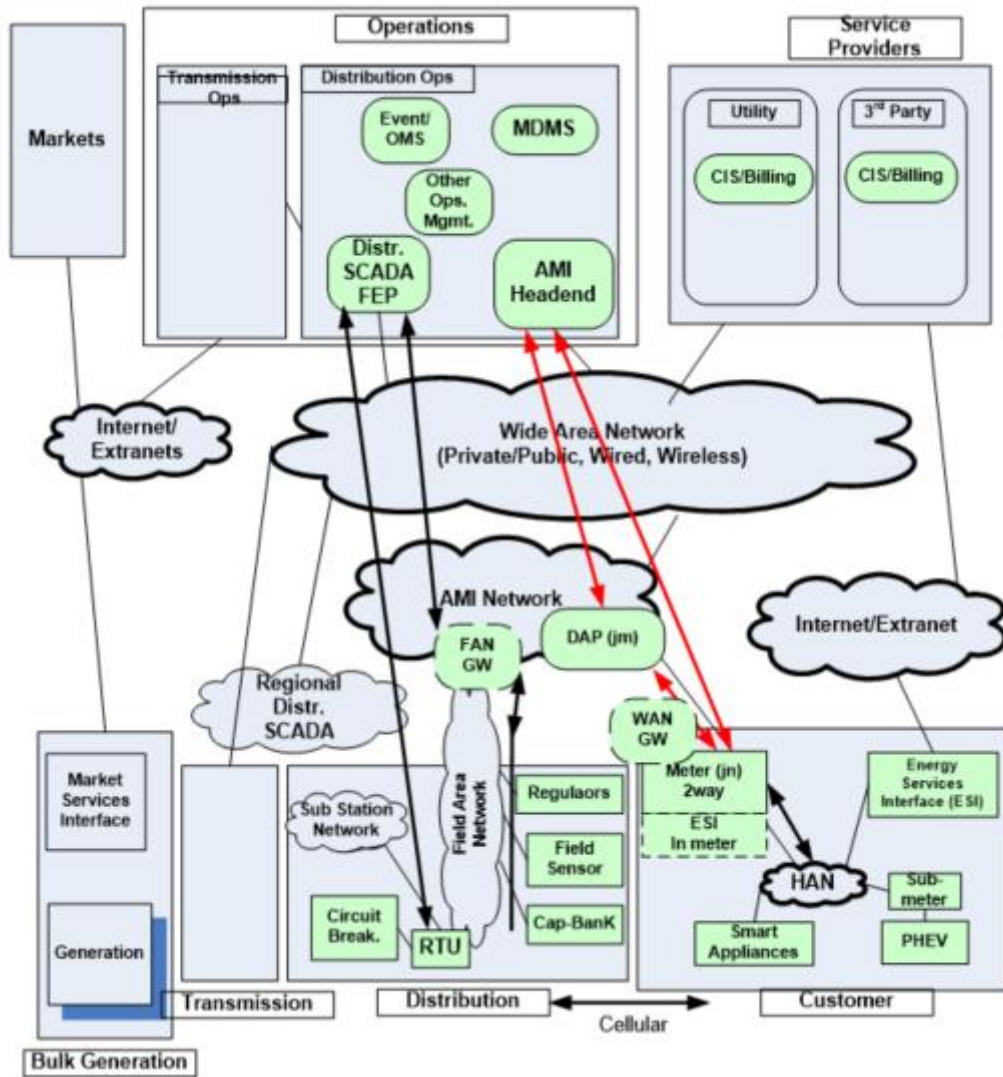

Figure 5-6 Conceptual Actors/Data Flow Diagram

264

265

266

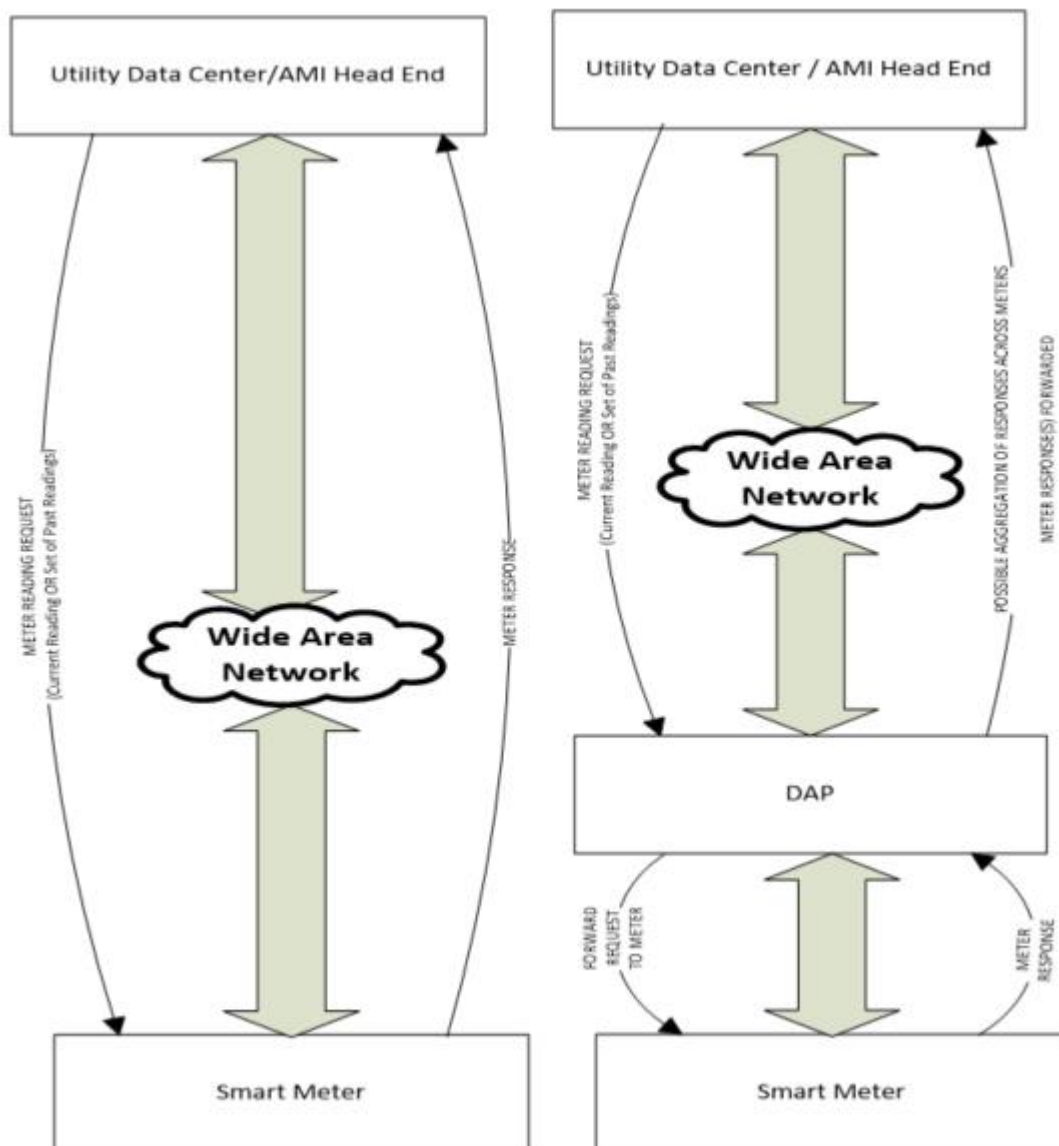

Figure 5-7 Typical Smart Meter Reading Flows A (on left) and B (on right)

Typically, a utility data center processing application communicates end-to-end via the AMI Headend with a smart meter data application at the edge. Figure 5-7 shows two possible flows A and B depending on whether there is a DAP entity along the path from the Utility Data Center / AMI Headend and the Smart Meter.

In flow A, the Utility Data Center / AMI Headend can make a request to the Smart Meter directly. Typically there may be 3 to 6 such requests per day (typically < 10 times per day). The request could indicate that the current meter reading is desired. Alternatively, multiple meter readings over a period of time such as for a few hours (e.g. from 2 p.m. to 8 p.m.) for a given day or across days could be requested. The Smart Meter completes the request and communicates it back to the Utility Data Center / AMI HeadEnd. Typical in such on-demand or bulk-interval read requests, a reasonably immediate response is desired of the order of a few seconds, so that there is not necessarily any significant delay tolerance allowed for the response. However, it is possible that, in current systems or in future systems, such requests could optionally carry a delay tolerance associated with the request depending on the urgency of the request. The size of the meter reading response can be of the order of a few tens to hundreds of bytes, and is also implementation dependent.

In flow B, the Utility Data Center / AMI Headend can make a request to the Smart Meter that can be received via the DAP. Typically there may be 3 to 6 such requests per day (typically < 10 times per day). The request could indicate that the current meter reading is desired or that multiple meter readings over a period of time are

288 desired. The Smart Meter completes the request and sends its response to the DAP. This response from the
289 Smart Meter to the DAP is typically desired in the order of 15 to 30 seconds, as suggested in the submitted
290 informative document related to SGIP-based Smart Grid Use Cases. However the actual delay in processing
291 can be implementation dependent across smart metering systems across the world. The size of the meter
292 reading response can be of the order of a few tens to hundreds of bytes, and is also implementation dependent.
293

294 In case that the Smart Meters belong to a group, there are two ways to distribute the request from the Utility
295 Data Center / AMI Headend to Smart Meters: the Utility Data Center / AMI Headend sends a request to DAP
296 then DAP distributes it to all Smart Meters, or the Utility Data Center / AMI Headend sends same requests to
297 all Smart Meters via DAP which acts as a router. There are several ways to submit the data from Smart Meters
298 to the Utility Data Center / AMI Headend: The DAP entity can buffer the data for some time, receive data from
299 many meters, and then submit the aggregated data across meters to the Utility Data Center / AMI Head End.
300 The duration for which the DAP may buffer data can be implementation dependent, and could last for several
301 seconds or minutes. In some variants, the DAP may serve merely as a router, so that it directly forwards the
302 smart meter response to the Utility Data Center / AMI HeadEnd without performing any aggregation tasks. In
303 further variants, the DAP entity could be merely a virtual processing entity and not a physical one, where such
304 a virtual entity could even potentially reside on the other side (not shown) of the wide area network associated
305 with the Utility Data Center / AMI Head End. For instance, the Utility Data Center / AMI Headend could send
306 a request to DAP for distributing it to all Smart Meters in a group, and if the DAP belongs to the third party,
307 the DAP shall serve as a router to directly forward the smart meter response to the Utility Data Center / AMI
308 HeadEnd without performing any aggregation tasks.
309

310 Summary

311 To summarize, meter reading requests could request a single meter reading or a set of meter readings. Such
312 requests may occur a few times (typically < 10) per day and can be of the order of a few tens of bytes. Meter
313 reading responses can be of the order of a few 10s to 100s of bytes typically. Meter reading responses are
314 typically expected in the order of a few seconds after reception of the request at the meter. Any delay tolerance
315 associated with such requests can be optional or implementation dependent. In some system variants, a DAP
316 entity may not exist at all so that the Utility Data Center / AMI Head End communicates directly with the
317 smart meter. In other end-to-end system variants, a DAP entity may serve as an intermediate processing or
318 forwarding entity between the Smart Meter and the Utility Data Center / AMI Head End. In such cases, the
319 DAP entity may be either a physical or virtual processing entity in the end-to-end system and can assist with
320 buffering and aggregating meter reading responses. The duration of buffering or aggregation at the DAP entity
321 can be implementation dependent and could be of the order of a few seconds or minutes typically.
322

323 5.3.7 Alternative Flow

324 None.

325 5.3.8 Post-conditions

326 None.

327 5.3.9 High Level Illustration

328 None.

329 5.3.10 Potential Requirements

- 330 1. The M2M System shall be able to provide identity verification between the M2M device and the
331 M2M server.
- 332 2. The M2M System shall be able to protect confidentiality of data (i.e. Smart Meter Response), even
333 when DAP is deployed by the third party.
334
335
336

337
338

339

340
341
342
343
344
345
346
347
348
349
350
351

352

353

354

355

356

357
358
359
360
361
362
363
364
365
366
367
368
369
370
371
372
373
374
375
376
377
378
379
380
381
382
383
384
385
386
387
388

5.4 Environmental Monitoring of Remote Locations to Determine Hydropower

5.4.1 Description

Monitoring environmental parameters and effects in remote locations is of increasing interest due to the rapidly changing Global Climate and the world in general. Parameters such as temperate, pressure, water levels, snow levels, seismic activity have significant effects on applications such as green energy (wind and hydro power), agriculture, weather forecasting and tsunami warnings. The demand for remote monitoring information (real time and historical) has been increasing over the past decade and expected to increase exponentially in the foreseeable future.

Environmental monitoring is a M2M application where satellite is the only communications alternative as no other infrastructure is generally in such remote localities. This case study attached presents one solutions where satellite communication is commonly used for environmental monitoring. This is Hydro power generation through snow/water monitoring.

This attached paper provides an overview of the solution and how satellite is used to support this requirement. The document also outlines why the solution requires M2M remote satellite communications.

5.4.2 Source

oneM2M-REQ-2013-0123R02 Use-case Hydro-Power Monitoring Satellite .

5.4.3 Actors

Energy companies.

5.4.4 Pre-conditions

Two main requirements exist for remote monitoring in Hydro Power Generation. Firstly, there needs to be monitoring of the flow and supply of water to generate the power itself. Secondly, there needs to be monitoring of the environmental impact the hydro-electricity has on surrounding ecosystems for the storage of water and resulting change in natural flow.

Flow and Supply of Water: Availability and supply of water is fundamental to hydro generated power and is very seasonal and related to the regional climate. In cold climates such as Canada and Norway, water is supplied by snow where reservoirs are located in high locations and catchment areas cover extensive mountain regions. Snow levels, melting periods and supplies are inconsistent throughout the year. Reservoirs and storage facilities are designed to take into account seasonal inconsistencies from mother nature. In more tropical areas such as Brazil, tropical downfalls in the wet seasonal periods are important for flow management and are also seasonal.

Regardless of region, accurate sensors are critical to monitor water flow and supply such as rain fall, snow levels, snow temperature, snow wetness, reservoirs levels and other seasonal parameters. These sensor readings are critical to ensure Hydro companies can accurately predicate and monitor power generation levels. Sensor readings need to be sent back in near real time to Hydro processing plants to maintain operations. The location for the sensors are in mountainous and hard to reach areas that experience harsh environmental factors, partially high water/snow falls. Power or communication infrastructure is generally not available; therefore reliable satellite communication is the only option.

Sensor data is sent back consistently at short interval rates generally every five minutes from a number of multiple sensors in each location. Monthly usages in the region of 5 MB-10MB per month are typical depending on the number of sensor registers to poll and the M2M SCADA (supervisory control and data acquisition) communication protocol used (e.g. Modbus or priority protocol protocols used such as Totalflow).

Environmental impact that hydro-electricity has on surrounding ecosystems: Hydro-Electricity has the potential to affect the local ecosystems upstream and downstream from the generating plants. Government and world regulations are in place to ensure these systems minimize the impact on the local environment. Close monitoring and reporting of the surrounding areas are also part of the monitoring solution. Factors such as soil salinity, water levels, fish stock levels and erosion are some parameters that could be potentially monitored to ensure regulation and adhered to. This type of data is not critical for the power generation, however is required historically for trend analysis. Near real time communications is require for these types of sensors.

Sensor data is sent back long consistently interval rates generally every 30 minutes to 1 hour from a number of multiple sensors in each location. Monthly usages in the region of 1 MB-2 MB per month are typical, depending on the number of sensor registers to poll and the M2M SCADA communication protocol used.

389
390
391
392
393
394
395
396
397
398
399
400
401
402
403
404
405
406
407
408
409
410
411
412
413
414
415
416
417
418
419
420
421
422
423
424
425
426
427
428
429
430
431
432
433
434
435
436
437
438
439
440
441
442

5.4.5 Triggers

Two triggers that initiate information being sent over this architecture.

- Constant polling; and
- Conditional polling.

Constant Polling: Sensor polling rates are set by the Hydro operator. This information is used at the host to provide real time data as well as historical for trending analysis. Polling rates depend on the rate of change in environmental changes or how often data is required to make decision on flow rates through the Pembroke. Rates could be every few minutes up to few hours, but rates are constant. This data is very important to determine power requirements for the satellite terminal. The more data the more power that is required.

Conditional Polling: Information can be sent from the RTU based on specified events, sharp rise in water levels, temperate and any specific data. This data must be fed back to the Hydro control (host) in the event critical controls need to be made on the Hydro station.

5.4.6 Normal Flow

Remote Sensor/Satellite Terminal Integration: Remote sensors are normally connected to a Remote Terminal Unit (RTUs) that condition the sensors values into registers that are transmitted (over satellite) to a host. The RTU polls (or changes register value in some circumstances) register values from Programmable Logic Controllers (PLCs) that are connected to the aforementioned sensors. The RTU will then use a M2M (SCADA) communication protocol to send the register values to the host. SCADA protocol are designed to be very compact, only sending the minimum require data to the host, thus why serial based communication is popular. Modbus, DNP3 (Distributed Network Protocol), IEC 61850 [i.7] (used in electrical substations) or other priority based communication protocols are used and are generally based around serial communication to keep traffic to a minimum. IP is starting to become more popular to support these SCADA protocols.

The host resides in a corporate network of the Hydro provider, which analyses and presents this data into meaning information to make decisions on. The host is normally a hydro-power monitoring application designed specifically by the hydro provider that is integrated with the remote monitoring sites and controls for the Hydro plant. The host normally has a very advanced Human Machine Interface (HMI) to process data to a human operator, and through this, the human operator monitors water flow and controls the amount of water flowing through the penstock to the turbine.

As mentioned, RTUs communicate via either serial (RS-232/485) or IP layer 2 M2M SCADA protocols.

Majority of modern based satellite communications systems support IP only layer two protocols and it is very common for RTUs to communicate via serial only. Terminals servers are usually placed in line between RTUs and satellite terminals where serial communication is required.

Satellite Service solution: L Band satellite service are the most popular used by Hydro plants in LATAM and North America. The L band satellite service operates over the L band frequency range (1,5 GHz to 1.,6 GHz). This band is unique as it is not attenuated by weather where other high frequency band solutions operate in. Remote terminals in this application must be able to operate in wet tropical and cold snow ranges.

The terminal normally provides a direct IP network connection to the customer corporate control network (backhaul) via secure IP VPNs or leased line. A backhaul satellite solution is sometimes used for increased reliability. The L band satellite network must offers geographical redundancy for downlink earth station and backhaul infrastructure.

Satellite Terminal Solution: The L band satellite terminal must operate with extremely low power, less than 1W idle and 20W transmit. Majority of power used by remote terminals is used during the idle state. Solar power designs are suitable for the most modern L band satellite terminals terminal to operate in remote locations.

Remote terminal management and control is essential for this remote application. The terminal must continually ensure the terminal is on-net. If the terminal seems to be unable to transmit (or receive), the terminal automatically must reboots and reconnects itself to the network (known as watchdog). This removes the requirement to send someone to reboot the terminal. Remote management is conducted via out of band signalling. Terminal status, manual reboot and remote firmware updates are also essential of the operation of the remote terminal.

5.4.7 Alternative Flow

None.

443 5.4.8 Post-conditions

444 None.

445 5.4.9 High Level Illustration

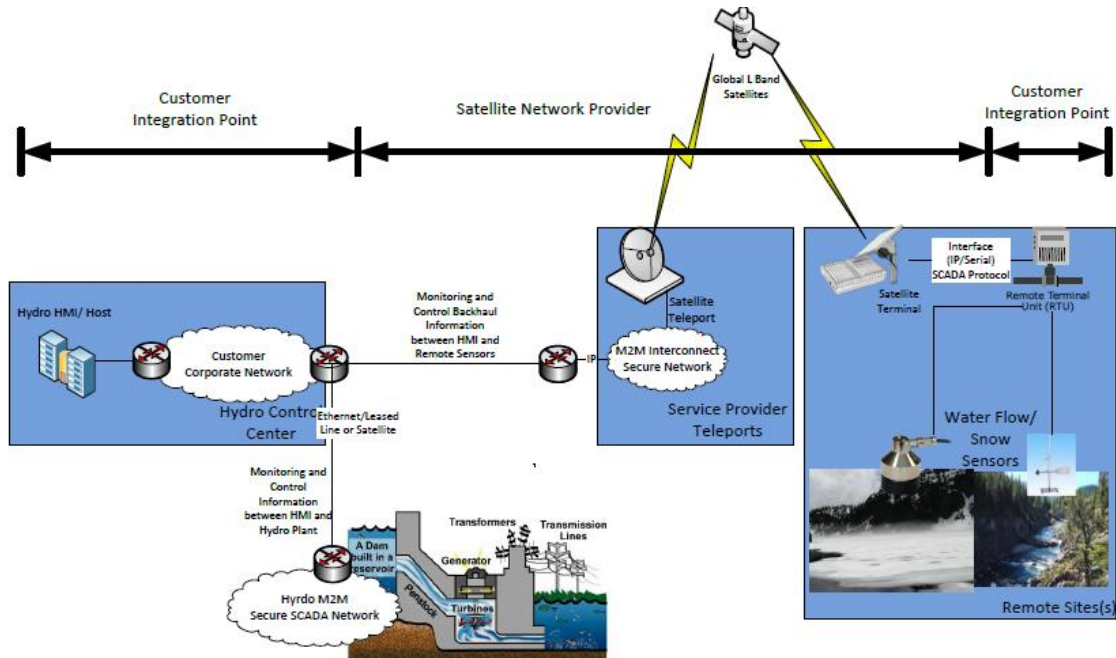

446

447

448

Figure 5-8 High Level Illustration of Environmental Monitoring for Hydro-Power Generation using Satellite M2M

449 5.4.10 Potential Requirements

450

451

452

453

454

455

456

457

458

1. The M2M System shall provide mechanisms for ensuring round trip communications of specified times from sensors to actuators.
2. The M2M System shall support power constrained devices.
3. The M2M System shall support an M2M Application's choice of communications transport characteristics e.g. Reliable or unreliable.
4. The M2M System shall support commonly used communications mechanisms for local area devices, e.g. RS-232/RS422.
5. The M2M System must provide communication availability to exceed 99.,5% (1.,83 days/year).

459 5.5 Oil and Gas Pipeline Cellular/Satellite Gateway

460 5.5.1 Description

461

462

463

464

465

466

467

468

This use case addresses a cellular gateway to transport oil and gas pipeline data to a backend server, to remotely monitor, manage and control devices equipped in the pipeline (e.g. meters, valves, etc.). Oil and gas companies can have meters are remote destinations that makes manual monitoring of the state of these meters as an expensive task to be pursued on a regular basis. Automated monitoring of oil and gas pipeline data can streamline the remote monitoring and management of these remote pipeline meters. When a fault is monitored on specific link of the pipeline network, it is necessary to open or shut the pipeline valve to block the link or to provide detour route. Also, when there is a necessity to change the quantity of oil and gas in pipeline, the valves should be damped through remote control.

469 5.5.2 Source

470

471

oneM2M-REQ-2013-0294R01 Oil and Gas Pipeline Cellular/Satellite Gateway.
 oneM2M-REQ-2013-0399 Additional Use Case for Oil and Gas

472

473 5.5.3 Actors

474 Oil and gas pipeline meters, valve controllers, cellular networks, backend servers, remote monitoring,
475 management and control software.

476 5.5.4 Pre-conditions

477 Cellular network connectivity, Satellite connectivity.

478 5.5.5 Triggers

479 New pipeline sensor data requiring transport to a backend server.
480 Network dynamic access constraint or network utilization constraints or prior network access policy
481 constraints or device energy minimization considerations can cause delay tolerant sensor data to be buffered
482 (and aggregated if needed) at the gateway and transmitted at a later time.
483 Processing of recent measurements can result in remote requests for additional or more frequent
484 measurements.
485 A firmware upgrade becomes available that needs to get pushed to the gateways.

486 5.5.6 Normal Flow

487 Sensor data related to oil/gas quantity and quality, pressure, load, temperature, and consumption data is
488 forwarded to backend server that is processed by a remote monitoring service associated with the oil and gas
489 pipeline. Pipeline sensors and pipeline cellular gateways can communicate with each other wirelessly (if
490 sensors and gateways are different nodes in the system). Pipeline cellular or satellite gateways can serve as
491 aggregation points. Sensor data may be locally forwarded until it reaches a gateway or directly transmitted to
492 the gateway depending on proximity of the sensor(s) to each gateway on the pipeline.
493

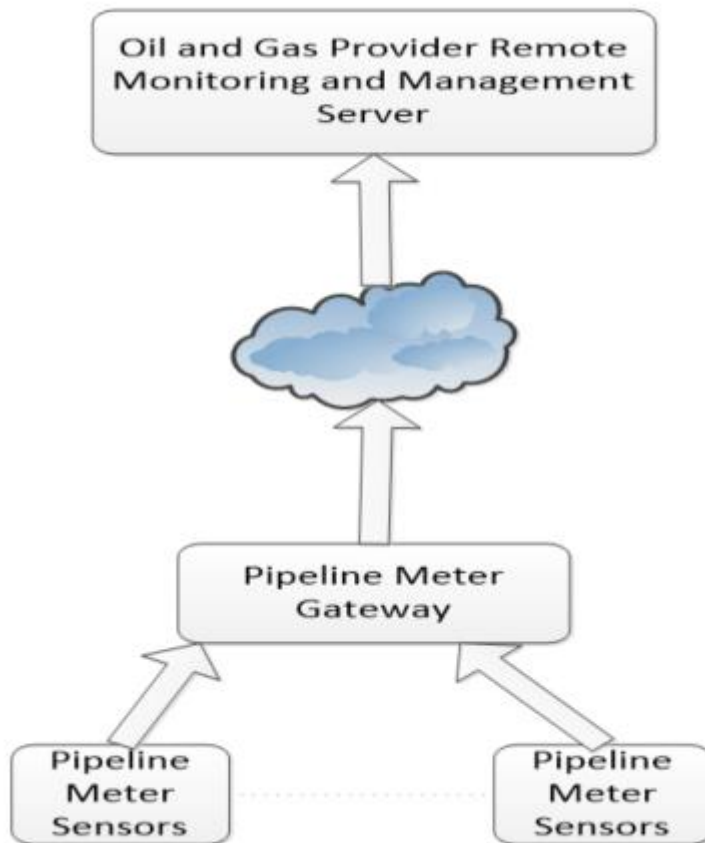

494

495
496
497
498
499
500
501

Figure 5-9 Flow - Oil and Gas Pipeline Gateway

5.5.7 Alternative Flow

Alternative Flow 1

Pipeline meter data can be stored, aggregated, and forwarded at an appropriate time based on network availability constraints or policy constraints or energy minimization constraints for the pipeline meter gateway. Transmission policies can be designed made to minimize network overhead.

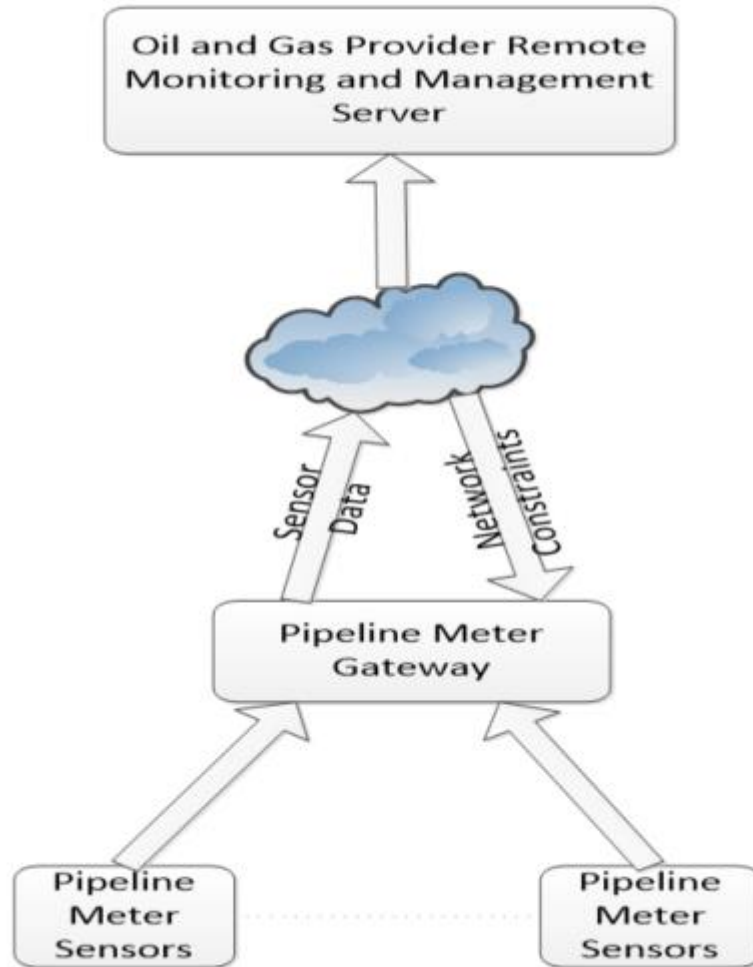

502
503
504
505
506
507
508
509
510
511
512

Figure 5-10 Alternative Flow 1 - Oil and Gas Pipeline gateway

Alternative Flow 2

Pipeline meter data can be processed by the remote monitoring and management service. If any anomalies are detected, additional measurements could be triggered, or more frequent measurements could be triggered, or measurements by additional sensors can be triggered by the remote service manager. Firmware upgrades can also be provided by the remote management service. Remote measurement requests are typically triggered or polled only as absolutely needed so as to avoid the overhead of unnecessary polling and network congestion using such schemes with Normal Flow or Alternative Flow 1 preferred for reporting sensor data.

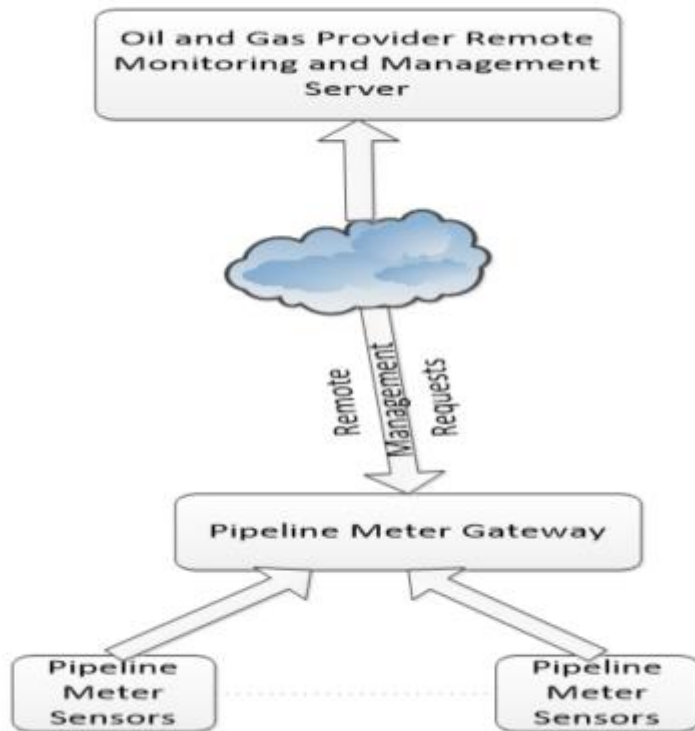

513
514
515
516
517
518
519
520

Figure 5-11 Alternative Flow 2 - Oil and Gas Pipeline gateway

Alternative Flow 3

Valve control data should be delivered in real-time. For this purpose, Pipeline Meter Gateway can be used to transport valve control data as well. The Gateway should be connected to and control the targeted valve controllers.

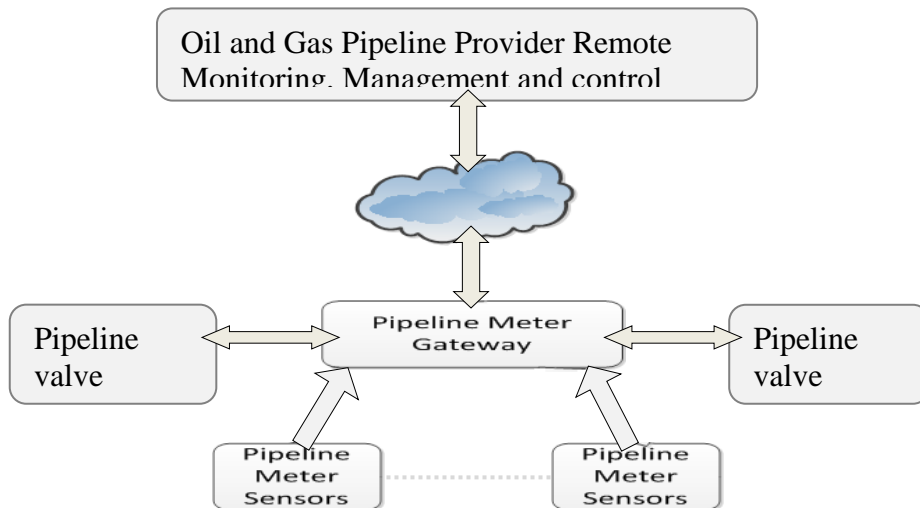

521

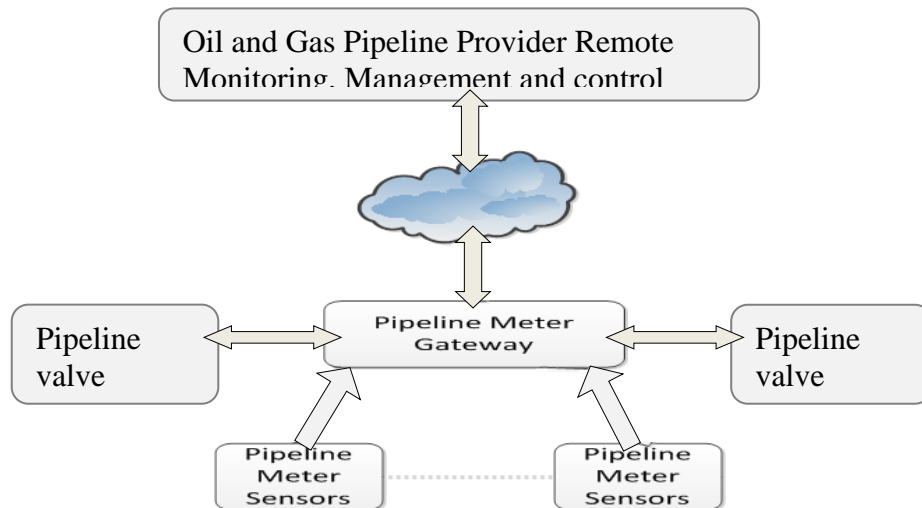

Figure 5-12 Alternative Flow 3 - Oil and Gas Pipeline gateway

5.5.8 Post-conditions

Sensor data is stored in a database associated with the backend server. Remote monitoring service verifies the status of the different pipeline meters.

1. Alternative Flow 1
Data is buffered and transmitted when the network or policy constraints or energy optimization constraints allow transmission of delay-tolerant pipeline sensor data.
2. Alternative Flow 2
More frequent or additional measurement request events can get triggered from the network based on processing of recent measurement data.
3. Alternative Flow 3
When a valve controller received errored information from the gateway, the valve controller should send a request of retransmission to the gateway.

5.5.9 High Level Illustration

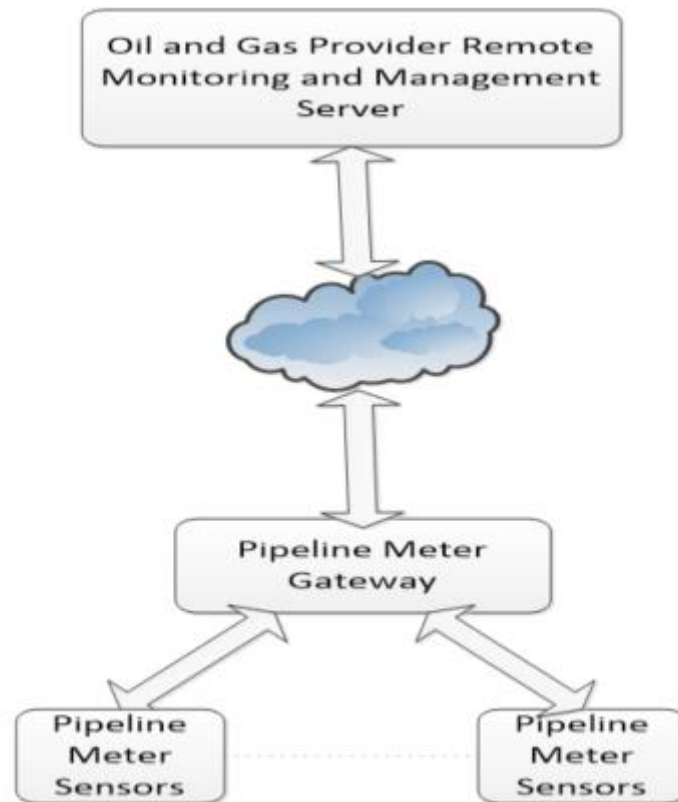

539

540

Figure 5-13 High Level Illustration - Oil and Gas Pipeline Gateway

541

542

5.5.10 Potential Requirements

543

Rationale

This use case sets out from the presence of a gateway between one or more oil and gas pipeline sensor(s) and a backend server. One gateway node may serve multiple pipeline sensors and data may be forwarded multi-hop until it reaches a gateway. Data mules can collect data and dump the information at a gateway for transportation. The ability to locally forward data wirelessly between nodes to a local aggregation point serving as a gateway may be desirable depending on the location of sensor nodes and gateway nodes. Even though the use case is assuming a cellular/satellite gateway, this restriction is not needed in general.

Resulting requirements:

1. The M2M system shall be capable of supporting gateway nodes that are capable of transporting sensor measurements to back end servers.
2. The M2M system shall be capable of supporting static or mobile peer forwarding nodes that are capable of transporting sensor measurements to a gateway node.

555

Rationale

Pipeline sensors can measure data at predetermined times. Pipeline sensors can also take measurements at random times or based on a request from a backend server to study the health of the pipeline. Therefore, new measurement data may become available at any time. When measurement data is available, the data can be processed locally to understand the criticality of the information. Based on the criticality/urgency of the information, the data can be transported over the network immediately or in a delay-tolerant manner. If an anomaly is detected with regard to the measured data, more frequent measurements may be taken locally or requested from the backend server, to continually assess the criticality of the situation. In case there is no new or relevant information, the system may choose not to transport unnecessary data to reduce network or reduce device energy usage.

Resulting requirements:

566

- 567
568
569
570
571
572
573
574
575
576
577
578
579
3. Whenever a pipeline sensor has measurement data available, it shall be possible for the sensor to send a request to the local pipeline gateway to transport new measurement data to the backend server.
 4. Whenever measurement data is available, it shall be possible for the pipeline sensor or a local processing node/gateway to process the information and assess the urgency or criticality of the information, and tag the data appropriately to be critical/urgent or delay-tolerant.
 5. Whenever measurement data is available that is determined to be critical/urgent, it shall be possible for the local gateway to send the information to a backend server as soon as possible (such as within a few 100s of ms). Delay-tolerant data shall be transported within the delay tolerance specified.
 6. Whenever measurement data is available that is determined to be not important, the system may choose to not transport the data to reduce network usage or to reduce device energy usage.
 7. More frequent measurements may be taken such as when one or more anomalies are detected in the system, which can result in more data and more frequent urgent transmissions in the system, depending on the criticality of the data.

580
581

Rationale

582 Local analytics service functions can be executed to process sensor information. A service function could
583 consist of evaluation rules based on sensor data, and decisions based on rules associated with the data. An
584 evaluation engine can process the rules to then decide whether/when to transmit data. Analytics processing can
585 also be done in a distributed manner, with additional processing on the backend server, or configurability of
586 the evaluation rules at the local gateway by the backend server.

587

Resulting requirements:

- 588
589
590
591
592
593
8. A local analytics service function can be executed on the local processing gateway based on evaluation rules associated with the measurement data, and decisions can be taken based on the processing.
 9. A distributed analytics service function can be executed in collaboration with a backend server, where additional processing of data can be performed at the backend server, or where the rules associated with local processing can be configurable by a backend server.

594

Rationale

595 Incoming requests from the pipeline sensor to the pipeline gateway may not result in immediate forwarding of
596 the data to the backend server if any of the following is applicable: Dynamically changing cellular network
597 availability (coverage); cellular network utilization constraints (policies); device energy consumption or
598 memory constraints. In one of the flows also the quality of the data to be transported (alert=high priority) was
599 relevant for determining when the connection needs to be triggered. Categorization of traffic such as
600 abnormal/urgent data such as a pipeline failure, versus normal traffic can be done at the gateway. Tagging and
601 processing such traffic differently based on application/network/device constraints can be done at the local
602 processing gateway. The system should allow a provisioning policy for handling categorized traffic at the local
603 processing gateway. In many cases, in oil and gas pipeline systems, it is desirable to avoid unnecessary polling
604 of the sensors and minimized network usage. Therefore it is desirable to enable the system to determine
605 policies for transmitting data such as a scheduled transmission versus an aggressive polling request based on
606 the urgency of information, or aggregating information based on delay tolerance, to best utilize network
607 resources.

608

Resulting requirements:

- 609
610
611
612
613
614
615
616
617
618
619
620
621
622
623
624
625
10. The local pipeline gateway needs to be capable to buffer incoming requests from the pipeline sensor for transporting data to the backend server and support forwarding them at a later time — which could potentially be a very long time in the order of hours, days or even more — depending on cellular network availability, cellular network utilization policies, device constraints.
 11. The local pipeline gateway needs to be capable to accept parameters with incoming requests from the pipeline sensor which define a delay tolerance for initiating the delivery of the sensor measurements or parameters for categorizing sensor measurements into different levels of priority/QoS.
 12. The local pipeline gateway needs to be cable of receiving policies which express cellular network utilization constraints and which shall govern the decision making in the gateway when initiating connectivity over cellular networks.
 13. The local pipeline gateway needs to be capable to trigger connections to the cellular network in line with the parameters given by the request to transport data and in line with configured policies regarding utilization of the cellular network.
 14. The local pipeline gateway shall have the ability to categorize the data based on the abnormality/urgency or delay tolerance of the data.
 15. The local pipeline gateway can be provisioned with policies to handle categorized traffic.

626

Rationale

627 The use case also describes a flow in which the backend server could initiate an action on the local pipeline
628 gateway. The action could include a request for a measurement, or a firmware upgrade push to the gateway, or

629 a change in the policies associated with data transportation. In particular, the ability to provide remote
630 firmware upgrades or remote provisioning of policies is particularly desirable for these pipeline gateways at
631 remote locations.

632 **Resulting requirements:**

633 16. The M2M system shall support transport of data from the backend server to the local pipeline gateway.

634 17. The M2M system shall support of triggering a cellular connection to the local pipeline gateway in case the
635 gateway supports such functionality.
636
637

638 6 Enterprise Use Cases

639 6.1 Smart Building

640 6.1.1 Description

641 Smart building is a M2M service that utilizes a collection of sensors, controllers, allerter, gateways deployed at
642 the correct places in the building combined with applications and server resides on the Internet to enable the
643 automatic management of the building with just limited human labour. Smart building system can greatly
644 reduce the cost involved in managing the building like energy consumption, labour cost. With the smart
645 building system, services like video monitor, light control, air-condition control and power supply can all be
646 managed at the control center. Some services can be triggered automatically to save the precious time in case
647 of fire, intruder, gas leak etc.

648 6.1.2 Source

649 oneM2M-REQ-2013-0122R04 Use Case Smart Building
650 .

651 6.1.3 Actors

652 **M2M Service Provider:** A company that provides M2M service including entities like gateway, platform and
653 enables the communication between them. The M2M Service Provider also exposes APIs for the development
654 of all kinds of applications. The gateway provided by the Service Provider can be used to connect to different
655 devices such as sensors, controllers.

656 **Control Centre:** The manage center of the building, all data collected by the sensor is reported to the Control
657 Centre and all commands are sent from the Control Centre. The Control Centre is in charge of the controlling
658 of the equipment deployed around the building.

659 **Smart Building Service Provider:** A company that provides smart building services. A Smart Building
660 Service Provider is a professional in the area. It is in charge of install the device all around the building, set up
661 the Control Centre and provide the application that is used to manage the Control Centre and necessary
662 training to workers in the Control Centre on how to manage the system. The Smart Building Service Provider
663 has a business contract with the M2M Service Provider in utilizing the communication, gateway, M2M
664 platform and APIs provided by the M2M Service Provider.

665 6.1.4 Pre-conditions

666 The Smart Building Service Provider establishes a business relationship with the M2M Service Provider in
667 using the gateway, M2M platform and APIs.

668 The Smart Building Service Provider installs all the sensors, controllers, allerter in and around the building and
669 sets up the Control Centre in the building with the application to run the system.

670 The Control Centre belongs to an estate management company and takes charge of several buildings all over
671 the city. The building in the use case is one of them.

672 6.1.5 Triggers

673 None.

6.1.6 Normal Flow

The light control of the building

The Control Centre needs to control the light in the building by different areas and different floors. The Control Centre also needs to switch on and off all the light in the building. For the management of the lights, the Smart Building Service Provider deployed one gateway in each floor to get connection with the lights in the same floor. Each floor of the building has at least 100 lights and the building has 50 floors above the ground and 5 floors under the ground and each light can be switched separately. The lights in every floor is connected with the gateway using local Wi-Finetwork, the gateway is connected with the M2M platform using paid 3GPP network, the Control Centre is connect with the M2M platform using fixed network. A patrolling worker with a mobile device can access to the gateway's local network to switch the lights. The illustration can be seen in figure 6.1.

In order to switch the light from the whole floor, instead of sending request from the Control Centre 100 times, the Control Centre creates a group on the gateway of each floor to include all the light on that floor. As a result, the Control Centre could switch the light of a whole floor just by sending one request to the group created on the gateway, the gateway fans out the request to each light to switch them off.

In order to switch the light of the building, instead of sending request from the Control Centre 5 5005500 times, the Control Centre could create a group on the M2M platform to include all the groups created on each gateway on each floor. In this way, the Control Centre simply send one request to the group on the M2M platform, the group fans out the request to the group on every gateway, the group on the gateway fans out the request to each lights to switch it.

The maintenance of the member of the group is the duty of a worker with a mobile device. Whenever a new light is installed, the worker adds the light to the group of the corresponding floor. Whenever a broken light is removed, the worker with the mobile device first searches the light from the group and removes the light from the group.

The Control Centre creates the group in the purpose of controlling the lights, so the group is configured to accept lights only in case the group may cause unexpected result on other devices introduced to the group by mistake. For example, if the type of the group is configured as "light", then "wash machine" cannot be a member of the group. Because the commands to wash machine is much more complicated. If a wash machine is added to the group of lights by mistake, it may cause unexpected behavior to the wash machine.

The add and remove of the members of the group of each floor is not necessary to be known to the Control Centre, but the Control Centre do know how to switch off the lights from the whole floor. In this way the Control Centre is exempt from the trivial task of maintaining each single light. However in the meantime, the administrator of the Control Centre can always make a list of all the lights and view their status from the Control Centre by retrieving from the group.

Intruder

With the deployment of smart building system, the number of patrollers is greatly reduced. For the security reason, a number of motion detector and cameras are installed all over the building.

The motion detector and the cameras are configured to work together. During the period when certain floor of the building is in safe mode, whenever the motion detector detects a moving object, the camera captures a picture of the moving object immediately. The picture is sent to the Control Centre for the inspector to verify if it is an intruder or an automated image recognition system. As a result of fast reaction, the motion detector must trigger the photo shot as soon as possible.

If the inspector sitting in the Control Centre finds that the object captured in the photo is a dog or a cat, he could just ignore the picture. If the figure caught in the picture is a stranger with some professional tools to break into a room. The inspector could send out a security team as soon as possible to the location based on the location reported from the motion detector.

Fire alarm

In case of an emergency, the residents of the building need to be evacuated immediately. All the devices related to a fire alarm need to be triggered almost at the same time. Whenever the fire sensor detects a fire in the building, a chain group of devices associated with the fire detection shall be turned on simultaneously such as the siren, the evacuation guide light, start the water pouring system, stop the elevator, cut off the electricity at certain areas, send message to the hospital, call the fireman, in a way not interrupting each other. Due to the possible latency and unavailability on the network to the Control Centre, the trigger of the devices on one floor is configured in the gateway.

If only one fire sensor in one room of the building detects a fire with a range less than one square meter, siren and water pouring system in the room would be switched on to alarm the resident to put out the fire. If lots of fire sensors all detect fire together with smoke sensors, temperature sensors reporting unusual situations, the whole fire alarm system will be triggered and all the residents in the building will be evacuated. If in the meantime of a fire alarm, the sensors detect that the temperature is below the threshold which means the fire is under control, the alarm can be cancelled automatically to all sirens and actuators to avoid the panic.

734 With the configuration on the gateway, the trigger of the devices can be very fast so that the damage caused by
735 the fire can be limited to its minimum.

736 **6.1.7 Alternative Flow**

737 None.

738 **6.1.8 Post-conditions**

739 None.

740 **6.1.9 High Level Illustration**

741

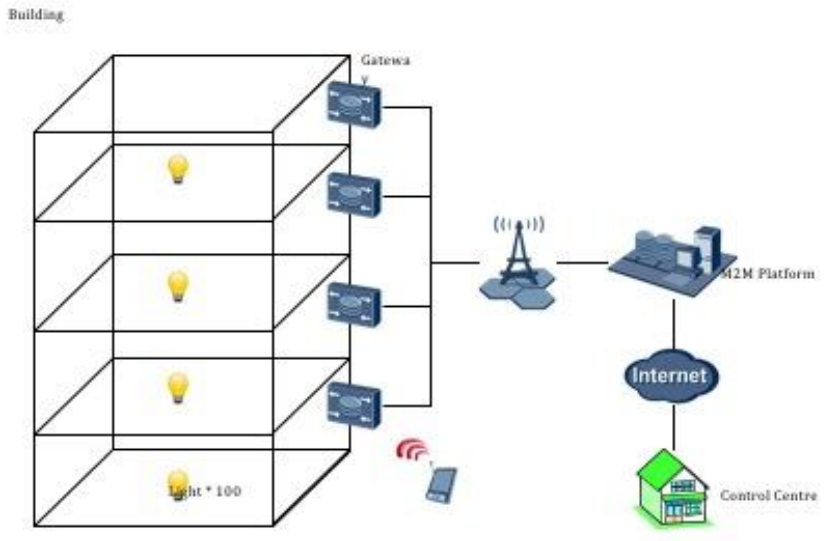

742

743 **Figure 6-1 Smart Building Scenario**

744

745 **6.1.10 Potential Requirements**

- 746
- 747 1. The M2M system shall support the action chain harmonize a series of actions among a group of between
 - 748 2. The M2M system shall harmonize a series of actions based on certain conditions that support the action
 - 749 3. The M2M system shall support the devices to report their locations.
 - 750 4. The M2M system shall support a mechanism to group a collection of devices together.
 - 751 5. The M2M system shall support that same operations can be dispatched to each device via group.
 - 752 6. The M2M system shall support the members' management in a group i.e. add, remove, retrieve and
 - 753 7. The M2M system shall support that the group can check if its member devices are of one type.
 - 754 8. The M2M system shall support the group to include another group as a member.
- 755
756
757

758 **6.2 Use cases for Machine socialization**

759

760 **6.2.1 Description**

761 A robot is designed to clean rooms in hotel. The task of the robot is to keep all rooms clean. If the hotel has
762 only one robot, it has to clean rooms one by one. If the hotel has two robots, they will complete the task more
763 efficiently if they cooperate with each other. If robot A has cleaned a room, it may inform the other robot that

764 this room has been cleaned, so robot B can move to another room for clean job. This implies that if multiple
765 robots share a same task, cooperation will improve the efficiency. As in the hotel scenario, the robots owner
766 may not tell the robots explicitly that there exists another robot with the same task. So, firstly, the robot must
767 have the capability to discover other robots and find out if they share the same task as itself. Secondly, a robot
768 must realize what kind information will affect other robots behaviour, and it must transmit messages in order
769 to share these information to other co-operators. For example, after a machine scan a room, it will find out the
770 clean status of that room (clean or dirty), when a robot is cleaning a room or after it is cleaned, it will change
771 the status of that room, the information will affect other robots' behaviour, because for any other robots it is
772 unnecessary to go to a room that is being cleaned or has been cleaned by another robot. Thirdly, a robot must
773 have the knowledge about the message interface of other robots. Only with this knowledge, it can send inform
774 or command to another robots.
775 A cloud robot service platform may play an important role in this hotel scenario. Because the platform may
776 help robots to discover each other, and the platform may initialize a powerful commander to optimize the job
777 with multiple robots.
778

779 6.2.2 Source

780 REQ-2015-0658R01.
781

782 6.2.3 Actors

- 783 • The clean robot is designed to keep all rooms clean. They may cooperate with each other directly or with the
784 help of cloud robot service platform.
- 785 • Cloud robot service platform can discover the underline cooperation between machines.
786

787 6.2.4 Pre-conditions

- 788 • Multi-robots share the same tasks or correlated tasks.
789

790 6.2.5 Triggers

- 791 1. A robot discover another robot with the same or correlated tasks.
792

793 6.2.6 Normal Flow

- 794 • A robot A is deployed in a hotel.
- 795 • Another robot B is deployed in a hotel.
- 796 • Robot A&B discover each other (the discovery is performed by themselves or aided by the cloud robot
797 service platform).
- 798 • Robot A share information to robot B and Robot B share information to Robot A.
- 799 • The cloud robot service platform help to optimize the task process and help the robots to cooperate with each
800 other.
801

802 6.2.7 Alternative Flow

803 None.
804

805 6.2.8 Post-conditions

806 None.

807

6.2.9 High Level Illustration

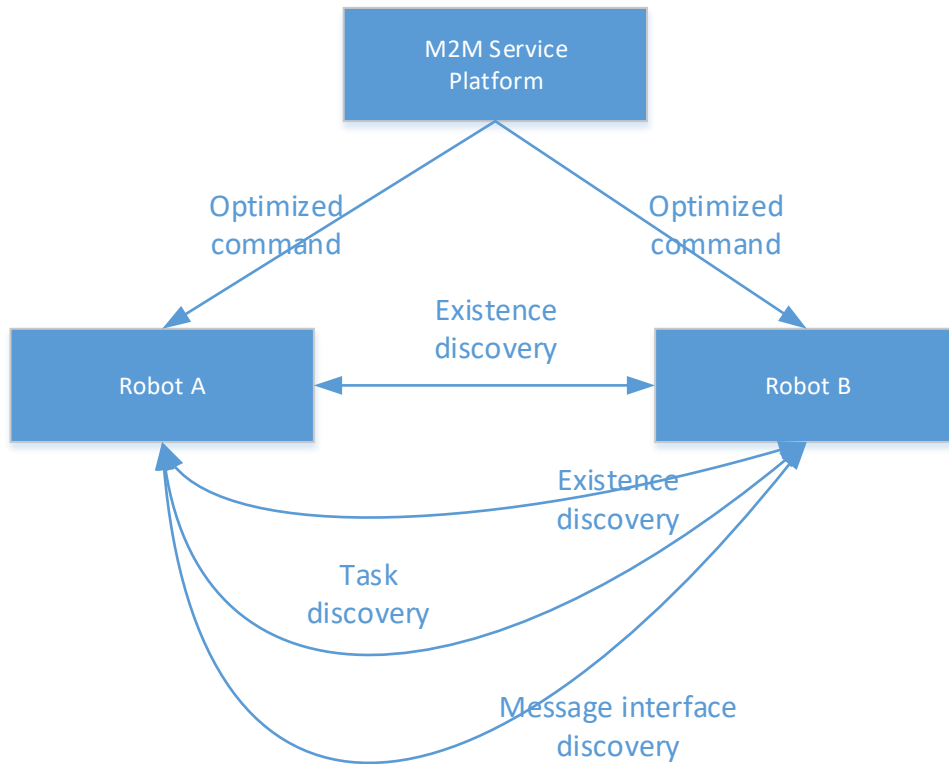

808

809

810

Figure 6-2 Machine Socialization

811

6.2.10 Potential Requirements

812

813

814

815

816

1. A M2M infrastructure shall be able to support the machine socialization functionalities, such as existence discovery, correlated task discovery, message interface discovery and process optimization for multiple machines with same tasks.

817

7 Healthcare Use Cases

818

7.1 M2M Healthcare Gateway

819

7.1.1 Description

820

821

822

823

824

825

This use case addresses a healthcare gateway to transport healthcare sensor data from a patient to a backend server and to also support bidirectional communications between a backend server via a gateway. The use case results in a set of potential requirements out of which some are specific to the fact that cellular connectivity is assumed between gateway and backend. Other than that, this use case is not restricted to cellular connectivity. This use case also addresses the situations where some of M2M System components are not available due to, for example, disaster.

826

7.1.2 Source

827

828

829

oneM2M-REQ-2012-0057R02 Use Case M2M Cellular Healthcare Gateway.
 oneM2M-REQ-2012-0208R01 Correction to M2M Healthcare Gateway Use Case.
 oneM2M-REQ-2013-0283R01 Addendum to M2M Healthcare Gateway Use Case.

oneM2M-REQ-2013-0185R03 Use case of peer communication.
oneM2M-REQ-2013-0356R01 Correction to M2M Healthcare Gateway Use Case.,

NOTE: Several scenarios also supported by guidelines [i.14] defined in Continua Health Alliance should be covered by this use case.

7.1.3 Actors

- Patients using healthcare sensors.
- Health-care gateways (also known as AHDs (Application Hosting Devices) in Continua Health Alliance terminology). Examples of healthcare gateways can include wall plugged devices with wired or wireless connectivity, or mobile devices such as smartphones.
- Operating healthcare service enterprise backend servers (equivalent to a WAN Device (Wide Area Network Device) in Continua Health Alliance terminology.)
- Health care providers, operating healthcare enterprise backend servers.
- Care givers and authorized users that could eventually access health sensor data .
- Wide Area Network operator.

7.1.4 Pre-conditions

- Operational healthcare sensor(s) that requires occasionally or periodically transport of sensor data to a backend server.
- A local healthcare gateway is available that can be used to transport data from the healthcare sensor to a backend server. It is open as regards who owns and/or operates this local gateway. Different scenarios shall be possible supported (patient, healthcare provider, care-giver, M2M service provider, wide area network operator).
- Network connectivity is available for transporting healthcare sensor data from the local gateway to the backend server.
- A backend server that is hosting applications to collect measurement data and makes it available to care-givers, healthcare-providers or the patient.

7.1.5 Triggers

The following triggers could initiate exchange of information according to the flows described further-below:

- Patient-initiated measurement request (Trigger A). In this case, the patient decides to take a measurement and triggers the processing in the system.
- Static configured policy at a healthcare gateway that requests patient to initiate measurement (Trigger B). This can be an explicit message from the gateway device to a patient device, or it could just an indicator on the gateway itself such as a pop-up message or an indicator light requesting measurement.
- Static configured policy at a healthcare gateway that directly requests sensor data without patient intervention (Trigger C). This can be used in conjunction or in lieu of Triggers A or B. Some sensor data may be measurable or accessible without patient intervention so that the gateway merely needs to communicate with one or more sensors to obtain the data.
- Patient monitoring app on healthcare service backend server that triggers generation of sensor data (Trigger D).
- Dynamic patient monitoring request from the healthcare service provider (Trigger E).
- Availability of new patient healthcare data at a healthcare gateway that requires transport to a backend server.
- Availability of new patient healthcare data at a backend server that requires sharing with authenticated users such as a nurse/doctor (healthcare provider) and a patient's relative (such as a child care-giver).
- Health care service provider needing to contact patient to take measurements.
- Analysis of healthcare patient sensor info or trends that triggers the need to take action on behalf of patient (for example determination of a deteriorating health condition).
- QoS-aware data buffering policy on the healthcare gateway.
- Network-aware and/or device-aware delay-tolerant data management policy on the healthcare gateway. Network dynamic access constraints or network utilization constraints or prior network access policy constraints or device energy minimization considerations can cause delay tolerant sensor data to be buffered (and aggregated if needed) at the gateway and transmitted at a later time.

- Failure in the components of the M2M System for the healthcare service. (e.g. functional failure in Wide Area Network, functional failure in Healthcare Service Backend Server).

The following clauses describe different flows that are possible in the m2m healthcare gateway system. For each flow, the events corresponding to the flow are high-lighted in the corresponding figure. Other events may be shown in a figure that are preserved to reflect the different types of processing that can occur in the system, with new events added in each subsequent figure to increase the complexity of the system. The high-level illustration 7.1.9 provides a comprehensive summary description of the overall system.

7.1.6 Normal Flow

A measurement of the healthcare sensor is initiated as shown in clause 7.-1. Patient can initiate the generation of sensor data such as taking a glucose meter measurement (Trigger A). The measurement may also be initiated based on some pre-defined schedule.

1. At the healthcare gateway (Trigger B or C).
2. The healthcare sensor data is forwarded to a backend server by a healthcare-gateway. If the data has a QoS indicator such as dynamic latency/bandwidth and/or delay tolerance, the gateway can determine whether to send the data immediately, or whether to buffer and send the data at a later time. Buffered data can be aggregated with past data or future data for a future aggregated transmission over the network. In wireless/cellular networks, aggregated transmissions can reduce the utilization of the network by requesting access to the network less frequently.
3. Measured data (or processed/interpreted versions of the data) that arrives at the healthcare service enterprise backend server may need to be forwarded to authorized subscribers — such as family care-giver or a nurse/doctor — via notifications. Subscriptions can be set up in advance, and configured at the backend server, so that when the data arrives, the subscribers can be notified. Filters can be associated with the subscriptions, so that only selective data or alert information can be sent to subscribers.

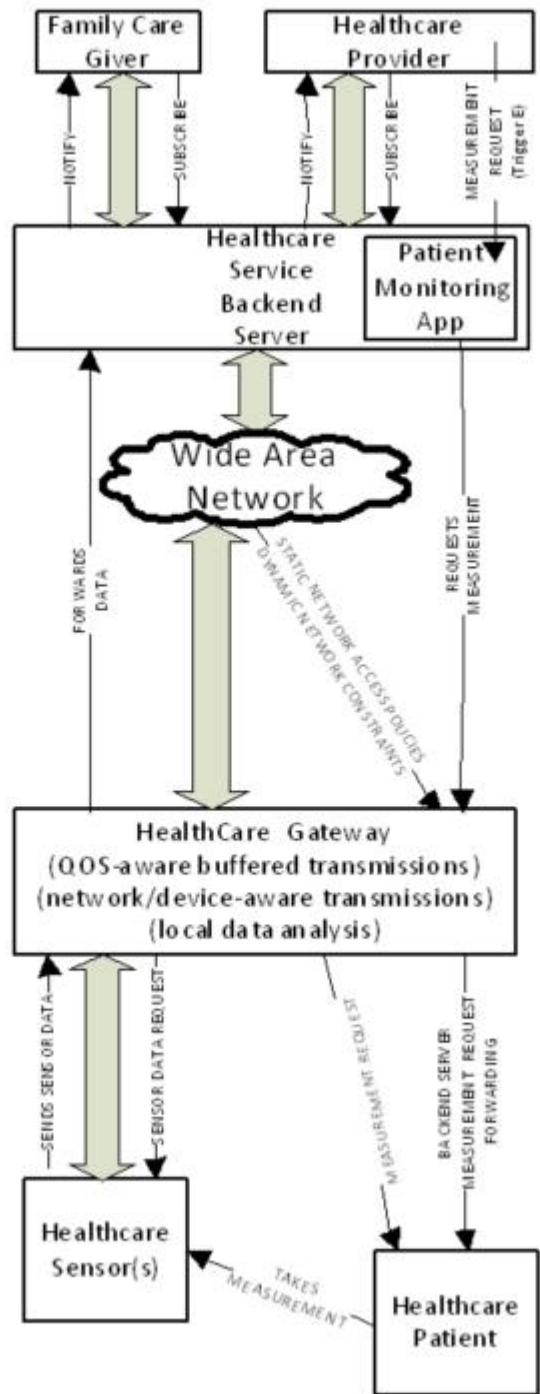

Figure 7-1 Healthcare Measurement Data Processing Flow

7.1.7 Alternative Flow

Alternative Flow 1 -Network/Device-aware transmissions

The flow in figure 7-2 depicts network/device-aware constraint processing in the system. This flow is the same as the regular flow with the following exceptions: The healthcare sensor data may need be stored on the gateway and forwarded at a future time based on one or more of the following factors:

- delay tolerances associated with the data.
- network policy constraints (efficiency, avoidance of peak loads, protection of spectrum).
- device constraints (energy consumption, data tariff).

921
922
923
924
925
926
927
928

• temporary lack of coverage of network connectivity.
Multiple measurements can be aggregated and transmitted together at a future time.
Measurements can be taken with or without patient intervention and sent to the healthcare gateway. As measured data arrives at the healthcare gateway, its QoS indicators such as dynamic latency/bandwidth and delay tolerance can be processed. Delay tolerant data can be buffered and aggregated with past and future delay-tolerant data, with network/device-aware constraints can be applied to determine an appropriate time to transmit the data.

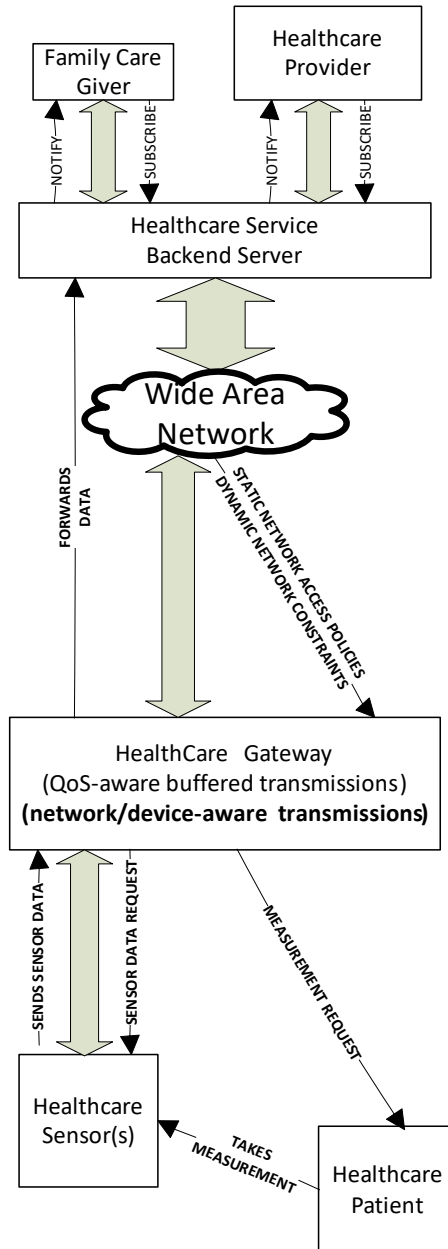

929

Figure 7-2 Network/Device-aware Flow

930

Alternative Flow 2 - Remote Monitoring

Figure 7-3 depicts the event flow for remote monitoring from the healthcare service enterprise backend server. The backend server may expect the patient to submit sensor data periodically or with a pre-defined schedule. In the absence of a typically expected sensor data event, the backend server can trigger an event to request the patient to take a measurement. In this case, the trigger (Trigger D) arrives over a wide-area-network from the patient monitoring app on the healthcare service backend server delivered to the healthcare gateway. The patient monitoring app could generate this request based on a statically configured policy to request measurements or due to some dynamic needs based on processing of previous patient data.

931
932
933
934
935
936
937
938
939
940

941
 942
 943
 944
 945
 946
 947
 948
 949
 950
 951
 952
 953
 954
 955

Optionally, the healthcare service provider may generate a measurement request (Trigger E) that can be received by the patient monitoring app on the backend server, which can subsequently submit a request over the wide area network for the patient monitoring request to the healthcare gateway. The healthcare gateway forwards the received request to the patient. In many cases, it is possible that a device associated with the patient, such as the healthcare cellular gateway, or a smartphone connected to the gateway, does not always have an active network connection, and that such a device may be asleep. In such a case, the measurement request can arrive with a wakeup trigger (such as using an SMS) (also called “shoulder tap” in Continua Health Alliance terminology) to the healthcare gateway, which can then establish connectivity with the backend server to determine the purpose for the trigger, and then subsequently process the patient measurement request. The patient subsequently takes the sensor measurement upon receiving the request. Alternatively, some sensor measurements could be taken without patient intervention. Measured sensor data is then received at the healthcare gateway, and subsequently transmitted based on processing the QoS/Network/Device-aware constraints for transmission.

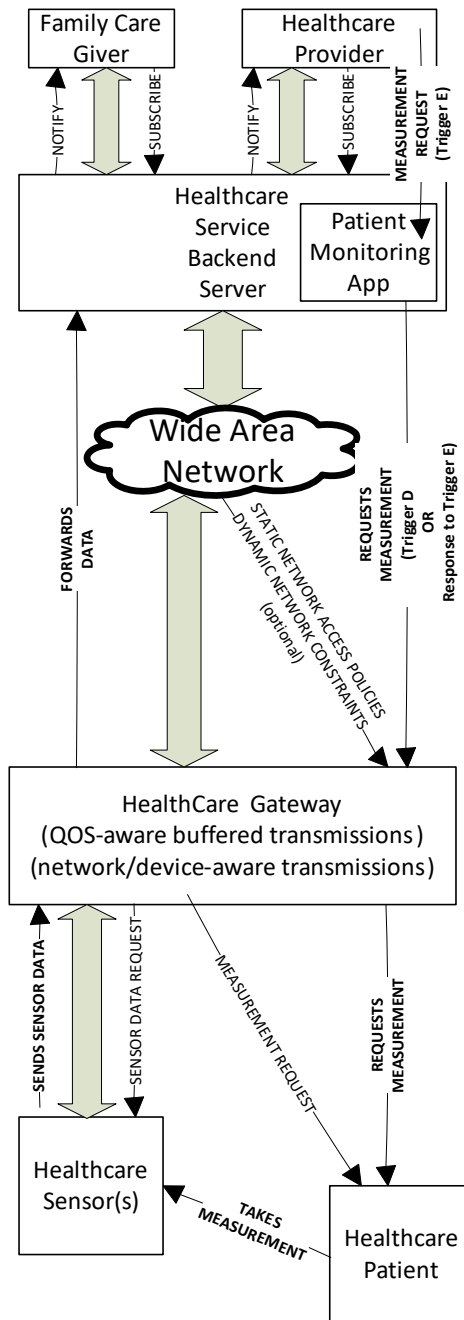

956
 957

Figure 7-3 Remote Monitoring Flow

958
 959
 960
 961
 962
 963
 964
 965

Alternative Flow 3 - Local Gateway Data Analysis

Figure 7.-4 illustrates a Local Gateway Data Analysis flow of events. The local gateway node can continuously process the data that it forwards. It can have smart algorithms to detect health anomalies associated with the patient. In case no anomalies are detected, the health sensor data may only be forwarded occasionally (see also alternative flow 1). In case an anomaly is detected, the local gateway needs to send an alert to the health care provider or the care-giver or to the patient if desired.

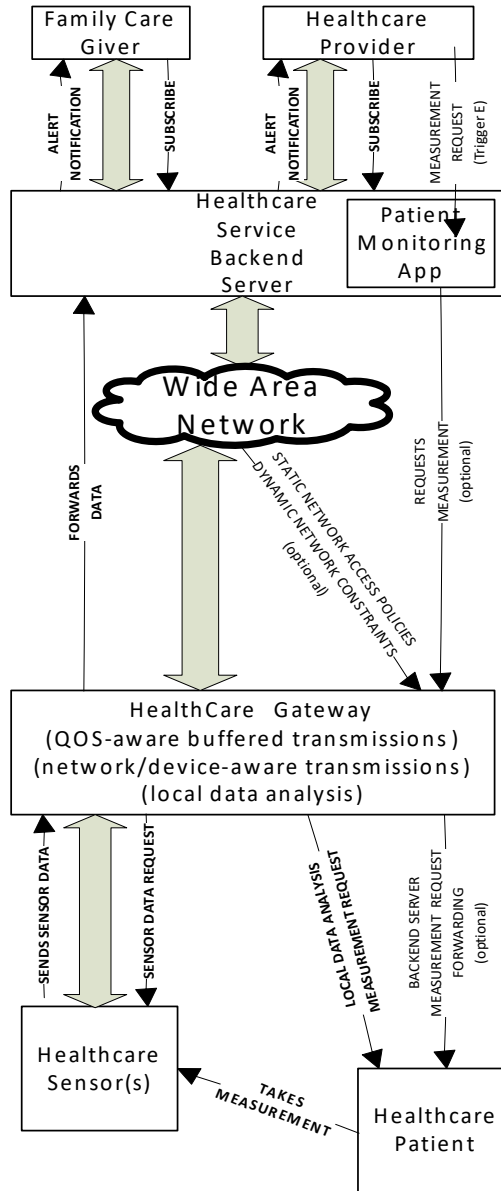

966

967

Figure 7-4 Local Gateway Data Analysis Flow

968

Alternative Flow 4 -- Partial Failure Case

Figure 7.-5 illustrates a partial system failure, i.e. the failure of Healthcare Service Backend Server and/or the failure of the connection between Healthcare Gateway and Wide Area Network. In this situation, nevertheless, components of the healthcare system that are not in failure should continue their normal operations. Examples of the "normal operation" are as follows:

970
 971
 972
 973
 974
 975
 976
 977
 978
 979

1. Reports from Healthcare sensor are received by and stored in Healthcare Gateway.
2. Notification from Healthcare Gateway (e.g. Measurement triggers) is forwarded to Patient.
3. If the messages transmitted between Healthcare Sensors and Healthcare Gateway were encrypted before the failure for the privacy of patients, that encryption should be maintained after the failure. (c.f. For maintaining the security mechanism in an isolated domain, a locally operable key management mechanism can be introduced).

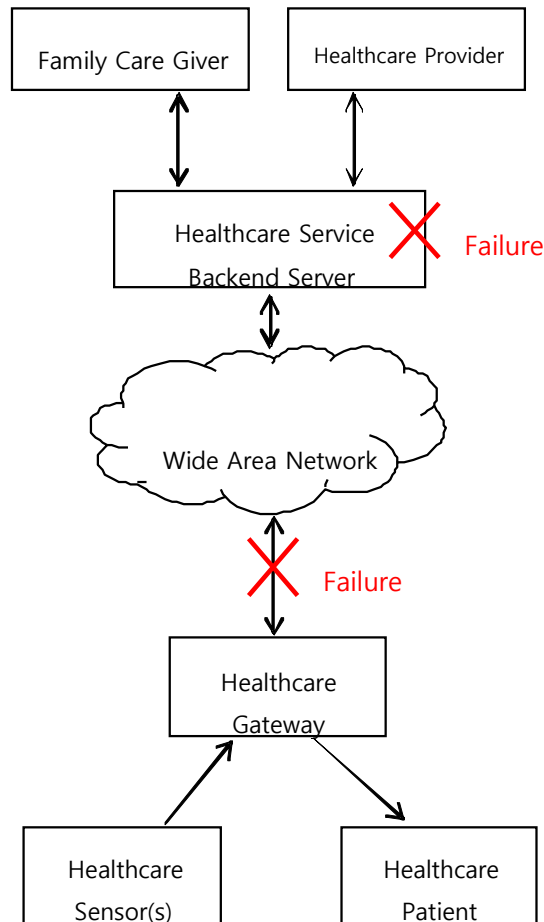

Figure 7-5 Example of failures in components of the M2M System for healthcare service

7.1.8 Post-conditions

1. Normal flow

Sensor data is stored in a database associated with the backend server. Healthcare provider and care-giver observe data to ascertain status of patient's health.

2. Alternative Flow 1

Data is buffered and transmitted when the network constraints or policy constraints or device energy minimization constraints allow the transmission of delay-tolerant data.

3. Alternative Flow 2

Patient takes measurement and sends data to backend server.

4. Alternative Flow 3

Local data analysis with indication of abnormal condition results in an alert message sent to the health care provider and optionally to the patient.

5. Alternative Flow 4

Components of the healthcare system that are not in failure continue their normal operations.

7.1.9 High Level Illustration

Figure 7.-6 summarizes the overall description of this use-case. All the flows and connectivity should be self-explanatory based on the discussions in the previous clauses.

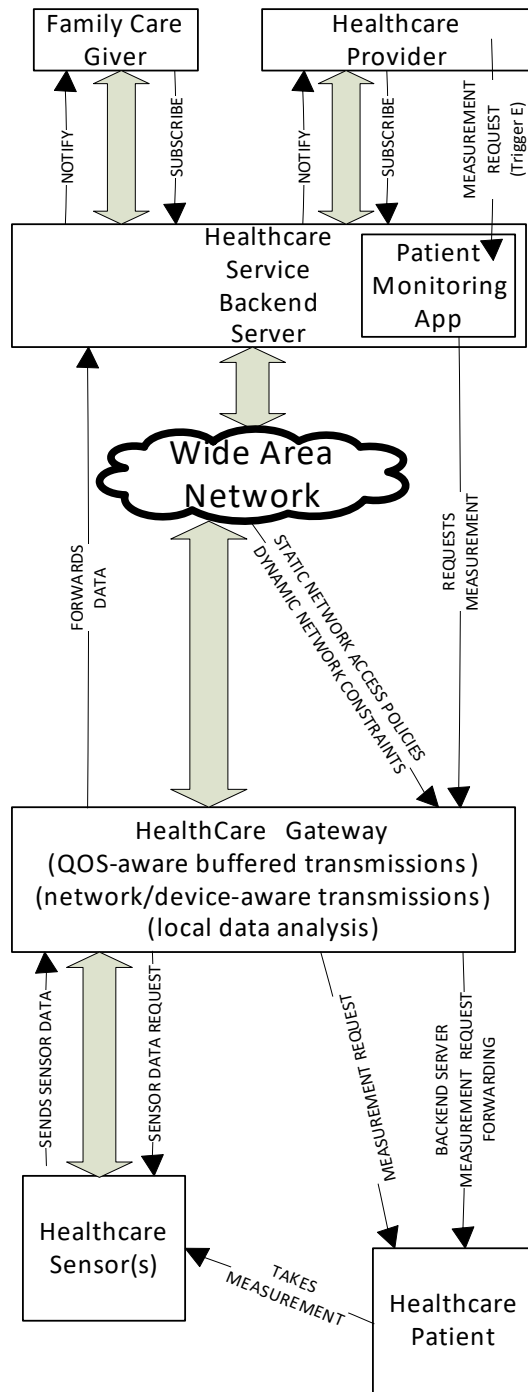

Figure 7-6 Healthcare Gateway High Level Illustration

7.1.10 Potential Requirements

Rationale

This use case sets out from the presence of a gateway between one or more healthcare sensor(s) and a backend server. Even though the use case is assuming a cellular gateway, this restriction is not needed in general.

Resulting requirement:

1. The M2M system shall be capable of supporting gateway nodes that are capable of transporting sensor measurements to back end servers.

Rationale

Sensors can measure patient data with or without patient initiation. Therefore, new measurement data may become available at any time.

Resulting requirement:

- 1018 2. Whenever a healthcare sensor has measurement data available, it shall be possible for the sensor to
1019 send a request to the local healthcare gateway to transport new measurement data to the backend
1020 server.
1021

1022 **Rationale**

1023 Incoming requests from the healthcare sensor to the healthcare gateway may not result in immediate
1024 forwarding of the data to the backend server if any of the following is applicable: Dynamically changing
1025 cellular network availability (coverage); cellular network utilization constraints (policies); device energy
1026 consumption or memory constraints or mobility, and data delay tolerance/QoS information. In some cases, the
1027 delay tolerance may be very low (implying requiring immediate transport) whereas in other cases, the delay
1028 tolerance can be significant. In some other variants where real-time delivery or near-real-time delivery is of
1029 interest, then real-time latency and bandwidth QoS requirements become significant. More than one healthcare
1030 sensor may provide data at the same time, so that the healthcare gateway will need to process one or more
1031 concurrent data streams. Event categories associated with the data to be transported (such as alert=high
1032 priority) can also be relevant for determining when the connection needs to be triggered.

1033 **Resulting requirements:**

- 1034 3. The local healthcare gateway needs to be capable to buffer incoming requests from the healthcare
1035 sensor for transporting data to the backend server and support forwarding them at a later time --
1036 which could potentially be a very long time in the order of hours, days or even more -- depending on
1037 cellular network availability, cellular network utilization policies, device constraints.
1038 4. The local healthcare gateway needs to be capable of accepting parameters with incoming requests
1039 from the healthcare sensor source which define a QoS policy for initiating the delivery of the sensor
1040 measurements or parameters for categorizing sensor measurements into different levels of
1041 priority/QoS.
1042 5. The local healthcare gateway needs to be able to concurrently process multiple streams of data from
1043 different sources with awareness for the stream processing requirements for each of the streams. The
1044 local healthcare gateway needs to address the QoS policy of one or more concurrent streams while
1045 taking into account network constraints such as available link performance and network cost. The
1046 local healthcare gateway needs to adapt to dynamic variations in the available link performance or
1047 network communication cost or network availability to deliver one or more data streams concurrently.
1048 6. The local healthcare gateway needs to be capable of receiving policies which express cellular network
1049 utilization constraints and which shall govern the decision making in the gateway when initiating
1050 connectivity over cellular networks.
1051 7. The local healthcare gateway needs to be capable to trigger connections to the cellular network in line
1052 with the parameters given by the request to transport data and in line with configured policies
1053 regarding utilization of the cellular network
1054

1055 **Rationale**

1056 A subscription and notification mechanism was described in this use case. Only authenticated and authorized
1057 users (e.g. care-giver, relatives, and doctors) shall be able to subscribe to healthcare sensor measurement data
1058 and get notifications and access to the measured data. These authenticated and authorized stakeholders are
1059 typically using applications that use the M2M system to access the measured data.

1060 **Resulting requirement:**

- 1061 8. The M2M system shall be capable of supporting a mechanism to allow applications (residing on the
1062 local gateway, on the backend server or on the sensor itself) to subscribe to data of interest and get
1063 notifications on changes or availability of that data.
1064 9. The M2M system needs to be able to allow access to data that is being transported or buffered only to
1065 authenticated and authorized applications
1066

1067 **Rationale**

1068 The use case also describes a flow in which the backend server could initiate an action on the local healthcare
1069 gateway.

1070 **Resulting requirements:**

- 1071 10. The M2M system shall support transport of data from the backend server to the cellular healthcare
1072 gateway.
1073 11. The M2M system shall support of triggering a cellular connection to the local healthcare gateway in
1074 case the gateway supports such functionality.

1075 **Rationale**

1076 Different subscribers may be interested in different information so that each subscriber may want to get
1077 notified only for events of interest to that subscriber

1078 **Resulting requirements:**

- 1079 12. Subscriber-specific filters can be set up at the healthcare service enterprise backend server so that each
1080 subscriber can be notified only when information/events relevant to the subscriber are available/occur.
1081

1082 **Rationale**

1083 The M2M healthcare gateway device can be without an active network connection because it is in a sleep
1084 mode of operation to save energy and/or because it is trying to save radio/network resources. A patient
1085 monitoring app may be desirous of communicating with the gateway device when the gateway device is in this
1086 sleep mode of operation.

1087 **Resulting requirements:**

- 1088 13. The M2M system shall be able to support a wakeup trigger (aka "shoulder-tap") mechanism (such as
1089 using SMS or alternate mechanisms) to wake up the gateway. The gateway can subsequently establish
1090 a network connection and query the enterprise backend server for additional information, and the
1091 enterprise backend server may then respond with adequate information to enable further processing of
1092 its request.
- 1093 14. When some of the components of M2M System are not available (e.g. WAN connection lost), the
1094 M2M System shall be able to support the normal operation of components of the M2M System that
1095 are available.
- 1096 15. When some of the components of M2M System are not available (e.g. WAN connection lost), the
1097 M2M System shall be able to support the confidentiality and the integrity of data between authorized
1098 components of the M2M System that are available.
1099

1100 7.2 Use Case on Wellness Services

1101 7.2.1 Description

1102 This use case introduces several services based on wellness data collected by wellness sensor devices via
1103 mobile device such as smartphones and tablets which is regarded as M2M gateway.
1104 Some wellness sensor devices are equipped with M2M area network module and measure individual wellness
1105 data. The mobile device connects to the wellness sensor devices by using the M2M area network technology,
1106 collecting and sending the wellness data to application server.
1107 It is important to consider that mobile device as M2M gateway has mobility. For instance, there are
1108 possibilities for a mobile device to simultaneously connect to many wearable wellness sensor devices, and to
1109 connect newly to wellness sensor devices which have never connected previously at the location of outside.
1110 This use case illustrates potential requirements from the use case of wellness services utilizing mobile device.

1111 7.2.2 Source

1112 oneM2M-REQ-2013-0167R03 Use Case on Wellness Services .

1113 7.2.3 Actors

- 1114 • M2M Device: wellness sensor device is blood pressure sensor, heart rate sensor and weight scale, for
1115 example. It can measure wellness data of users, may be multi-vendor, and equipped with several kind of
1116 communication protocol.
- 1117 • M2M Area Network: network which connects between M2M device and M2M gateway.
- 1118 • M2M Gateway: mobile device (e.g. a smart phone) which can receive wellness data from wellness sensor
1119 devices and communicate with application servers.
- 1120 • Mobile Network: network which has functions to communicate wellness data and control message between
1121 M2M gateway and M2M service platform.
- 1122 • M2M Service Platform: platform where management server is located and which is used by the Application
1123 Server to communicate with the M2M Gateway.
- 1124 • Management Server: server which manages the gateway such as mobile device, and controls its configuration
1125 such as installing/uninstalling applications.
- 1126 • Application Server: server which serves the wellness services such as indicating the graph of wellness data
1127 trend.

1128 Note: Definition of some words is in discussion. Therefore, the description of these actors may change.

7.2.4 Pre-conditions

- Wellness sensor devices are able to establish a connection to the mobile device in order to send wellness data to M2M Service Platform or Application Server.
- It is first time to associate the mobile device with the wellness sensor devices.

7.2.5 Triggers

New wellness sensor devices such as weight scale are detected by mobile device. User tries to associate the detected devices. Examples are below:

- User buys several kind of wearable wellness sensor devices such as blood pressure sensor, heart rate sensor. In order to start monitoring vital data using these sensors, User tries setting of these devices simultaneously. Note that please refer to ETSI TR 102 732 “Use cases of M2M applications for eHealth” [i.4]. (Normal Flow)
- User buys wellness sensor devices such as weight scale, and newly deploys them at User's house to check the wellness status daily. (Normal Flow).
- User goes to a fitness center to do exercise and checks the effect by utilizing equipment which is owned by fitness center and has never connected to User's mobile device. (Alternative Flow 1).

7.2.6 Normal Flow

Usually wellness sensor devices are bought by Users. These devices are deployed in User's house, or are worn with User.

1. The mobile device detects new wellness sensor devices and tries to connect to it under User's permission to connect (pairing between sensor device and mobile device).
2. The mobile device has established a connection to the wellness sensor device, and then the mobile device receives additional information of the wellness sensor device (e.g. type of device, service certificates of the device, required application software, etc.).
3. The mobile device is provided with the appropriate application software from the Management Server and is appropriately configured by the Management Server.
4. When the User measures the data by using wellness sensor device, the mobile device collects the data and sends it to the Application Server.

7.2.7 Alternative Flow

Alternative Flow 1

1. As indicated in the Normal Flow, usually the wellness service collects the data from wellness sensor devices which the User owns.
2. When the mobile device is brought outside, there is an opportunity to connect new wellness sensor devices (e.g. blood pressure which is set in fitness center).
3. The mobile device detects new wellness sensor devices and tries to connect to them under User's permission to connect.
4. The mobile device has established a connection to the wellness sensor device and then the mobile device receives additional information of the wellness sensor device (e.g. type of device, service certificates of the device, required application software, etc.).
5. The mobile device is provided with the appropriate application software and is appropriately configured by the Management Server.
6. When the User measures the data by using wellness sensor device, the mobile device collects the data and sends it to the Application Server.

Alternative Flow 2

1. The wellness service may be an optional subscriber service to be charged. The User subscribes it and creates an account on the Application Server.
2. When the User utilizes the wellness service, at first the User needs to activate the service on the Application Server.
3. When the mobile device detects wellness sensor devices, it requests the Management Server to provide appropriate application software with configuration to the mobile device.
4. The Management Server checks with the Application Server if the User has subscribed to the service and activated it or not.
5. And then, if the User is not subscribed to the service or has not activated it, the Management Server does not provide any application software.

Alternative Flow 3

After the User has collected the data, the User is able to disconnect the mobile device from the wellness sensor device and to de-activate the service.

1. If the User brings the mobile device out of the range of M2M Area Network, the mobile device disconnects the wellness sensor device automatically.
2. The User is also able to disconnect these devices by operating settings of the mobile device or by waiting for a while until the wellness sensor device disconnect by itself.
3. The User is also able to cancel the optional service. The User applies the cancellation to the Application Server. After the Application Server accepts the cancellation, the Management Server checks with the Application Server. The Management Server confirms the cancellation, it makes application software de-activate and/or remove from the mobile device.

7.2.8 Post-conditions

- Measured wellness data are stored in the M2M Service Platform or the Application Server.
- User is able to access to the Application Server and explore the graph of the wellness data trend.

7.2.9 High Level Illustration

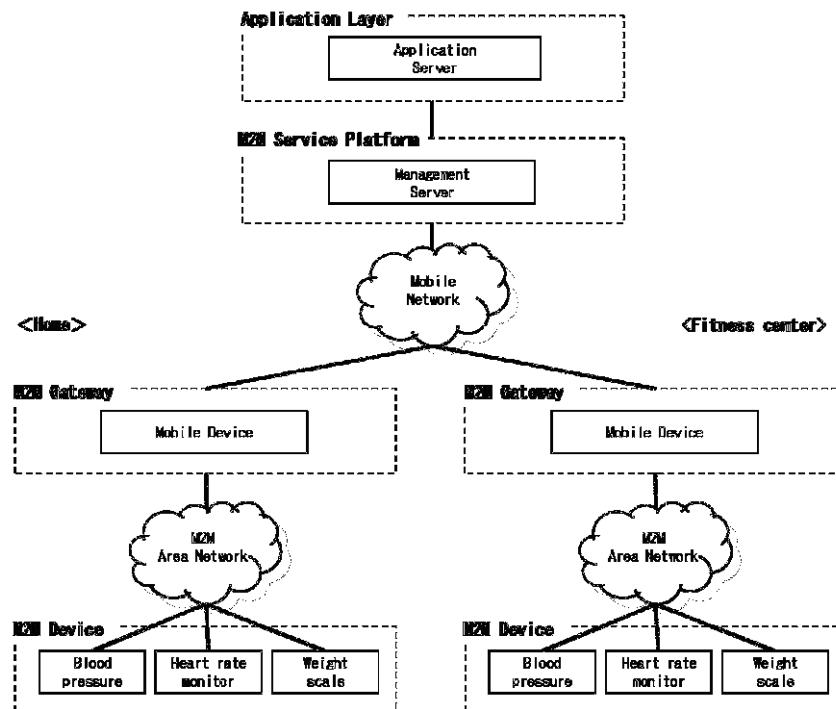

Figure 7-7 Wellness Service High Level Illustration

7.2.10 Potential Requirements

1. M2M Gateway SHALL be able to detect device that can be newly installed (paired with the M2M Gateway).
2. Upon detection of a new device the M2M Gateway SHALL be able to be provisioned by the M2M Service Platform with an appropriate configuration which is required to handle the detected device.
3. The M2M Service Platform SHALL be able to provide an authenticated and authorized application in the M2M Gateway with appropriate configuration data.

7.3 Secure remote patient care and monitoring

7.3.1 Description

E-health applications, that provide the capability for remote monitoring and care, eliminate the need for frequent office or home visits by care givers, provide great cost-saving and convenience as well as improvements. “Chronic disease management” and “aging independently” are among the most prominent use cases of remote patient monitoring applications. More details of the actors and their relationships for these use cases are mentioned in details in an ETSI document [i.4] and are not covered here. Instead this contribution provides an analysis of specific security issues pertaining to handling of electronic health records (EHR) to provide a set of requirements in the context of oneM2M requirement definition work.

Remote patient monitoring applications allow measurements from various medical and non-medical devices in the patient's environment to be read and analysed remotely. Alarming results can automatically trigger notifications for emergency responders, when life-threatening conditions arise. On the other hand, trigger notifications can be created for care givers or family members when less severe anomalies are detected. Dosage changes can also be administered based on remote commands, when needed.

In many cases, the know-how about the details of the underlying communications network and data management may be outsourced by the medical community to e-health application/ solution provider. The e-health solution provider may in turn refer to M2M service providers to provide services such as connectivity, device management. The M2M service provider may intend to deploy a service platform that serves a variety of M2M applications (other than e-health solution provider). To that end, the M2M service provider may seek to deploy optimizations on network utilization, device battery or user convenience features such as ability of using web services to reach application data from a generic web browser. The M2M service provider may try to provide uniform application programming interfaces (APIs) for all those solution providers to reach its service platform in a common way. From the standpoint of the M2M application, the application data layer rides on top a service layer provided by this service platform. By providing the service platform and its APIs, the M2M SP facilitates development and integration of applications with the data management and communication facilities that are common for all applications.

As part of providing connectivity services, the M2M service provider may also provide secure sessions for transfer of data for the solution providers that it serves. In many jurisdictions around the world, privacy of patient healthcare data is tightly regulated and breaches are penalized with hefty fines. This means the e-health application provider may not be able to directly rely on the security provided by the M2M service provider links/sessions and instead implement end to end security at application layer. This puts additional challenges on the M2M service platform, since it needs to provide its optimizations on encrypted data.

One particular issue with e-health is that not only the data is encrypted, but it may also contain data at different sensitivity levels, not all of which appropriate to each user. For instance in the US the Health Insurance Portability and Accountability Act (HIPAA) regulates the use and disclosure of protected health information. Different actors within a healthcare scenario may have different levels of authorizations for accessing the data within the health records, so the information system must take care to present the health data to each user according to the level of authorization for that user. A process, common to address this issue is redaction. This means that one starts with a document that originally includes data of all sensitivity levels and then removes any piece of information that has a higher sensitivity level than the pre-determined redaction level (RL). The end result is a redacted version of the initial document that can be presented to a person/entity that has the matching authorization level (AL). Persons with lower AL are not authorized to view this particular version of document. The redaction engine can produce multiple versions of the initial records, where each version corresponds to one redaction level (RL) including material at specific sensitivity level (and lower).

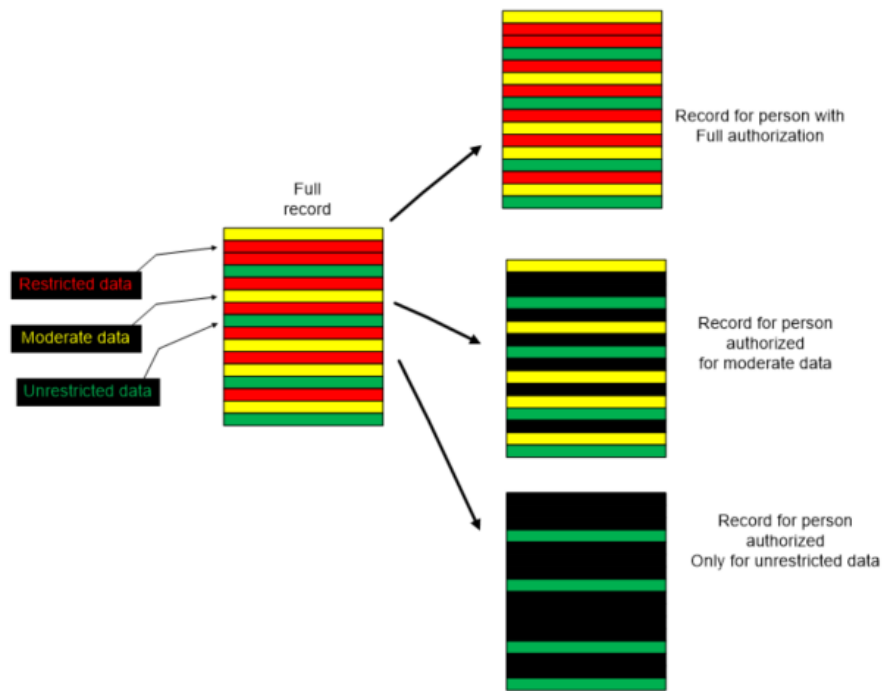

NOTE: Black color indicates a data field that is masked from an unauthorized user.

Figure 7-8 – An illustration of a process with 2 levels of redaction. Black colour indicates a data field that is masked from an unauthorized user.

Care must be taken to ensure that only authorized users have access to data. Therefore, the system must match the redaction level (RL) of data with the authorization level (AL) and present the proper version of the record for each actor.

The redaction engine may reside at a policy control server or at the application server operated by the M2M application service provider. The policy server may also hold policies on which users get which authorization level (AL), while an authorization server may be in charge of authenticating each user and assigning her the proper AL.

In a system relying on notifications based on prior subscriptions, data must be examined first to determine which subscribers should receive notifications and then only those subscribers should be capable to retrieve the data about which the notification is sent.

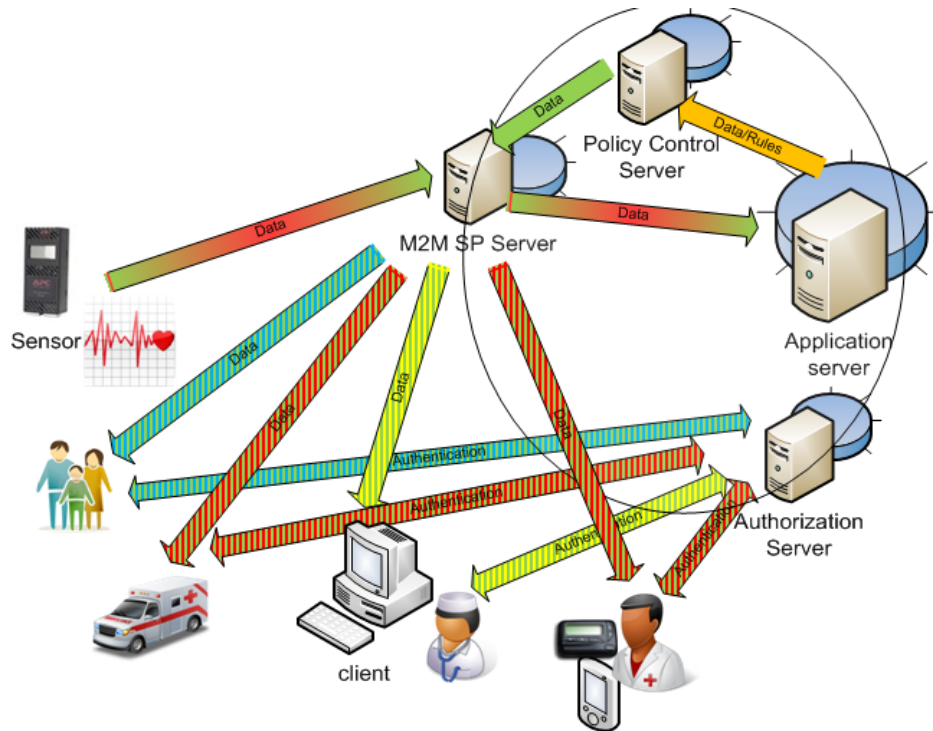

Figure 7-9 An e-Health application service capable of monitoring remote sensor devices and producing notifications and data to health care personnel based on their authorization level.

7.3.2 Source

oneM2M-REQ-2013-0227R02 e-Health application security use case .

7.3.3 Actors

- Patients using sensor (medical status measurement) devices.
- E-Health application service providers, providing sensor devices and operating remote patient monitoring, care and notification services.
- Care givers (e.g. nurses, doctors, homecare assistants, emergency responders) and other administrative users with authorization to access healthcare data (e.g. insurance providers, billing personnel). These entities are also referred to as “participants in the healthcare episode”.
- M2M service providers, network operators, providing connectivity services for the patients, e-health application providers and care givers.

7.3.4 Pre-conditions

- A categorization rule set, that is able to categorize various entries within a medical record according to the sensitivity levels and label them accordingly, must exist.
- A redaction engine that is able to examine the raw medical record and produce different versions of the record at different redaction levels (RL) with only data that is at or below a sensitivity level.
- A policy engine that is able to examine medical records and determine level of criticality (applicable to one of the flows described).
- A set of authorization policies that describe what authorization level (AL) is required to be able to access data at each redaction level (RL).
- An authorization engine/server that interacts with each user of the e-health application to verify their claimed AL, for example the server may perform an authentication function with the user.
- The e-health application server that is capable of interacting with the authorization server to check the AL of each user to determine the user's RL before serving data at the requested (or appropriate) RL to that user.

7.3.5 Triggers

- Creation of new measurement data by a remote medical device.
- Analysis of received measurement data at application servers, and determination of need for redaction, or creation of alarms and notifications, etc.
- Requests from participants in a health care episode (caregivers) for sensitive medical records.
- Arrival of new participants (new doctors, etc.) in the health care episode.

7.3.6 Normal Flow

In the main flow a remote medical device performs a measurement and sends it to an e-health application provider's (AP) application server, which in turn processes the data and notifies the appropriate actors regarding the condition of the patient.

The AP provides an application client to be installed on the device, and the application servers that interact with all the application clients. Both the application client and application server use the data management and communication facilities within the service layer exposed through the service layer APIs.

This flow could be as follows:

- The sensor on the medical device performs a measurement and reports it to the application client on the device.
- The application client (e.g. an e-health application) uses the service layer API to reach the service layer (provided by M2M service provider) within the device to transfer data to the application server. When application level data privacy is required, the application client on the device must encrypt the sensor data before passing the data to the service layer. Since the data must be kept private from service layer function, the encryption keys and engine used by the application client must be kept within a secure environment that is out of reach of the M2M service provider. This may require a set of secure APIs to reach the application's secure environment. It may however be more convenient that these APIs are bundled with the secure APIs used to reach keys/ environment that secures the service layer, so that each application only deals with one set of APIs.
- The service layer (provided by M2M service provider) passes the data from the device to the M2M service provider servers.
- The M2M service layer at the server side passes the data to the e-health application server.
- At this point, the application needs to prepare to notify any interested parties (caregivers) that have subscribed to receive notifications regarding the status or data received about a patient. However, when application data is encrypted and redaction is to be applied, more intelligence must be applied regarding who is authorized to receive a notification regarding status update. This may be done as follows:
 - After the e-health application server receives the data from M2M SP server, it decrypts the data, analyses and performs redactions based on application policies (possibly with help of policy servers). This produces multiple versions of the initial data (one at each redaction level). The application server then re-encrypts each redacted version. Each encrypted version needs to be tagged based on the redaction level (RL) it contains and possibly the authorization level (AL) it requires for viewing.
 - The application server passes the tagged data (multiple files) to the M2M service provider server (the service layer server).
 - The M2M SP server will then send a notification to each of the subscribers as long as their AL is at or above the level required to view any of the data just received. This means a separate authorization server may have initially performed an authorization of each user that requests to subscribe to data regarding each patient. The authorization would need to assess the identity of the user, her role and the claimed AL before registering the user for notifications. It is possible that the authorization server upon assertion of AL for each user provide the necessary decryption keys for receiving encrypted redacted data to the user's device. In that case, the device that the user is using needs to be authenticated based on a verifiable identity (an identity that is bound to a tamper-proof identity within the secured environment). Alternatively, the decryption keys may be present within the user devices (e.g. specific USB stick!) through other means. In either case a mechanism must exist to release decryption keys stored with an authenticated device's secure storage based on the user authorization and thus a binding of user and device authentications may be important.

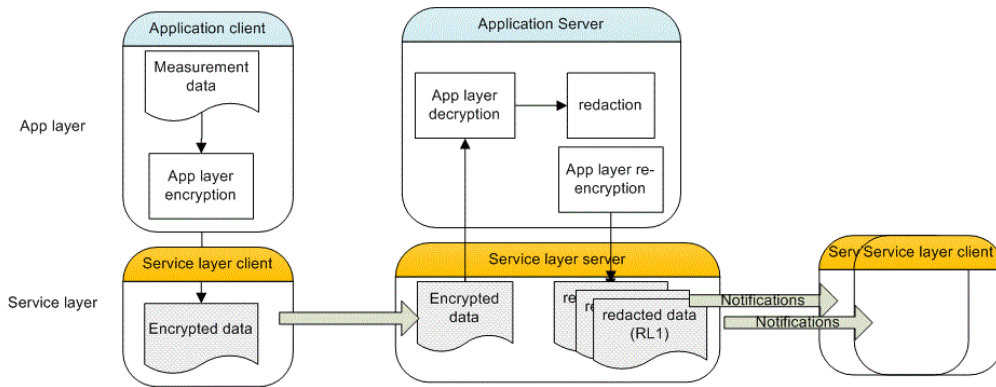

Figure 7-10 Dealing with Redaction in an M2M system separating Application layer and Service layer

NOTE: The Service layer functions are provided by M2M service provider, while application layer functions are provided by application provider.

7.3.7 Alternative Flow

Alternative Flow No 1

One alternative flow is when a user requests information regarding a patient without having previously subscribed for any notifications. The M2M SP server must first refer the user to the authorization server to assert the user's authorization level (AL) before serving the user with a response.

Alternative Flow No 2

One alternative flow is when a user requests to provide instruction commands regarding a patient to a remote device. The service must make sure that the user has the proper AL to issue the command.

Alternative Flow No 3

One alternative flow is when users are categorized not based on authorization levels but based on the level of their responsiveness. For instance, a life-critical event must cause the emergency responders to receive notifications and act very quickly, while a less critical event may only lead to a family member to be alerted. The subscription/ notification system should provide this level of granularity, i.e. information can be tagged based on criticality level. There must also be a policy engine that categorize the data based on its criticality level (CL).

7.3.8 Post-conditions

Normal flow

Multiple versions of patient record exist for multiple redaction levels at the M2M service provider servers. Each user can pull the version corresponding to her AL after she has been notified about presence of new data. The server can serve the data based on its RL tagging or AL tagging.

Alternative Flow No 3

Data is tagged with criticality level and served to each user according to their level of responsiveness.

7.3.9 High Level Illustration

Not provided.

7.3.10 Potential requirements

1. The M2M system shall support M2M applications with establishing a security context for protecting the privacy of application data from the underlying M2M service.

This means support of synchronous exchanges required by identification/ authentication/ or other security algorithms for establishment of security associations (keys, parameters, algorithms) for end-to-end encryption and integrity protection of data. Furthermore, any exchanges for establishing the M2M application security

1400 context can use the security context at underlying layers (e.g. M2M service layer) to protect the exchanges (as
1401 another layer of security), but the M2M application security context, once established, would be invisible to
1402 the M2M system.

- 1403
- 1404 2. The M2M system must support mechanisms for binding identities used at service layer and/or
1405 application layer to the tamper proof identities that are available within the device secured
1406 Environment.
- 1407

1408 Anchoring higher layer identities to a low level identity (e.g. identities that are protected at the hardware or
1409 firmware level) is needed to be able to securely verify claimed identities during device authentication
1410 processes at various levels. Also APIs providing lower layer identities to application layer for the purpose of
1411 binding application layer identities and lower layer identities.

- 1412
- 1413 3. M2M devices and M2M system shall support provisioning of application specific parameters and
1414 credentials prior and/or after field deployment, while preserving the privacy of provisioned material
1415 from M2M system if needed.
- 1416

1417 This means the M2M devices must support identities and credentials that are independent of the M2M system
1418 provider credentials and could be used for delivery of application specific parameters/credentials.

- 1419 4. When M2M application data security is independent of M2M system, the Secured Environment
1420 within devices or infrastructure entities shall provide separation between the secured environments for
1421 each application and the secured environment for M2M service layer.
- 1422 5. The secure environment described in requirement above shall provide both secure storage (for keys,
1423 sensitive material) and secure execution engine (for algorithms and protocols) for security functions
1424 for each application or service layer.
- 1425 6. The security functions provided by the Secured Environment should be exposed to both M2M service
1426 layer and M2M applications through a set of common APIs that allow use of Secured Environment of
1427 each of M2M service layer and M2M applications in a uniform fashion.
- 1428 7. The M2M service layer must be able to perform authorization before serving users with sensitive data.
- 1429 8. The authorization process should support more than two authorization levels and the service layer
1430 must be able to accommodate response/ notifications to the users based on their level of authorization.
- 1431 9. The M2M service layer must accommodate tagging of opaque application data for various purposes,
1432 such as urgency levels, authorization/redaction levels, etc.
- 1433 10. There must be a mechanism to allow the M2M application or service layer to bind user credentials/
1434 authorizations to device credentials, such that credentials within the device can be used for security
1435 purposes during or after a user is authenticated/ authorized.
- 1436 11. The M2M service layer must be able to accommodate delay requirements for the application based on
1437 the tagging applied to the application data. For instance, data that is marked critical must create
1438 notifications for first-level responders.
- 1439 12. Any software client, especially those performing security functions (e.g. authentication clients) must
1440 be integrity protected (signed) and verified after device power up/reset or before launch. Widely
1441 deployed standards such PKCS#7 or CMS should be used for code signing.
- 1442
- 1443
- 1444
- 1445

1446 8 Public Services Use Cases

1447 8.1 Street Light Automation

1448 8.1.1 Description

1449 Street Light Automation can be considered as part of the City Automation (ETSI classifier) vertical industry
1450 segment — and related to others e.g. Energy, Intelligent Transportation Systems, etc.

1451 Industry segment organizations/organisations: none known

1452 Industry segment standards: none known

1453 Deployed: with varying functionality, in multiple countries

1454

- 1455 Street Light Automation Goals
1456
 - Improve public safety

1457
 - Reduced energy consumption / CO2 emissions

1458
 - Reduce maintenance activity

1459

- 1460 Methods
- 1461
 - Sensing and control

1462
 - Communications

1463
 - Analytics

1464

1465 A street light automation service provider, provides services to control the luminosity of each street light
1466 dependent upon (resulting in 10 sub-use cases):

1467 Local (street level)

- 1468
 1. Light sensors

1469
 2. Power quality sensors

1470
 3. Proximity sensors (civilian or emergency vehicles, pedestrians)

1471 Street light automation service provider operation center

- 1472
 4. Policies (regulatory & contractual)

1473
 5. Ambient light analytics (sunrise/sunset, weather, moonlight, etc.)

1474
 6. Predictive analytics (lights parts of streets predicted to be used, etc.)

1475 Communications received from other service providers

- 1476
 7. Traffic light service (emergency vehicle priority)

1477
 8. Emergency services (vehicle routing, police action, etc.)

1478
 9. Road maintenance service (closures and/or diversions)

1479
 10. Electricity service (power overload)

1480 8.1.2 Source

1481 oneM2M-REQ-2012-0036R07 Proposed Use Case Street Light Automation .

1482 8.1.3 Actors

- 1483
 - Street light automation application service provider, has the aim is to adjust street light luminosity.

1484
 - Street light devices have the aim is to sense, report, execute local and remote policies, illuminate street.

1485
 - Traffic light application service provider, has the aim is to enhance their emergency vehicle service using
1486 street lighting.

1487
 - Emergency services application services provider, have the aim is to brightly illuminate police action areas
1488 and brightly illuminate planned path of emergency vehicles.

1489
 - Road maintenance application service provider, has the aim is to obtain extra street light signalling near
1490 closed roads.

1491
 - Electricity application service provider, has the aim is to have electricity consumers reduce their load when
1492 an overload is declared.

1493 8.1.4 Pre-conditions

1494 See sub-case flows.

1495 8.1.5 Triggers

1496 See sub-case flows.

1497 8.1.6 Normal Flow

1498 1. **Sub use case 1** - Local: Light sensors

1499 **Summary:** (no atomic action steps)

1500 **Trigger:** Detected light level moves below/above threshold

1501 **Action:** Increase/decrease luminosity in a set of street lights

1502 **Detailed flow** (no confirmation, etc. - actors in "quotes", system under study in italics)

- 1503
 - a) "Street lights" message the Street light system that street light sensors have detected light level
1504 movement below/above threshold.

1505
 - b) Street light system informs the "street light operation center" with the street light sensor
1506 information.

- c) "Street light operation center" messages the Street light system with a street light control message to increase/decrease luminosity according to "street light operation center" policy.
- d) Street light system messages the "street lights" with a street light control message to increase/decrease luminosity according to "street light operation center" policy.
- e) Optionally (normal case), if "street lights" receive a control command from the Street light system within some time, then, "street lights" increase/decrease luminosity in a set of street lights according to "street light operation center" policy.
- f) Optionally (alternative case), if "street lights" do not receive a control command from the Street light system within some time, then, "street lights" increase/decrease luminosity in a set of street lights, according to local policy.

Note that the terminology "policy" refers to a set of rules which may be dependent upon variables output from analytics algorithms.

2. Sub use case 2 - Local: Light sensors

Local: Power quality sensors

Summary: (no atomic action steps)

Trigger: Detected input voltage level moves above/below threshold

Action 1: Send alert message to electricity service provider

Action 2: Decrease/increase energy applied to a set of street lights

Detailed flow (no confirmation, etc. - actors in "quotes", system under study in italics)

- a) "Street lights" message the Street light system that street light power sensors have detected input voltage level movement above/below threshold.
- b) Street light system informs the "street light operation center" with the street light sensor information.
- c) "Street light operation center" messages the Street light system with an alert message to "electricity service provider" according to "street light operation center" policy.
- d) Street light system informs "electricity service provider" of alert message.
- e) "Street light operation center" messages the Street light system with a street light control message to increase/decrease luminosity according to "street light operation center" policy.
- f) Optionally (normal case), if "street lights" receive a control command from the Street light system within some time, then, "street lights" increase/decrease luminosity in a set of street lights according to "street light operation center" policy.
- g) Optionally (alternative case), if "street lights" do not receive a control command from the Street light system within some time, then, "street lights" increase/decrease luminosity in a set of street lights, according to local policy

3. Sub use case 3 - Local: proximity sensors (civilian or emergency vehicles, pedestrians)

Summary: (no atomic action steps)

Trigger: Civilian or emergency vehicle or pedestrian detected entering/leaving street section

Action: Increase/decrease luminosity in a set of street lights

Detailed flow (no confirmation, etc. - actors in "quotes", system under study in italics)

- a) "Street lights" message the Street light system that street light power sensors have detected civilian or emergency vehicle or pedestrian detected entering/leaving street section.
- b) Street light system informs the "street light operation center" with the street light sensor information.
- c) "Street light operation center" messages the Street light system with a control message to increase/decrease luminosity according to "street light operation center" policy.
- d) Street light system messages the "street lights" with a street light control message to increase/decrease luminosity according to "street light operation center" policy.
- e) Optionally (normal case), if "street lights" receive a control command from the Street light system within some time, then "street lights" increase/decrease luminosity in a set of street lights according to "street light operation center" policy.
- f) Optionally (alternative case), if "street lights" do not receive a control command from the Street light system within some time, then, "street lights" increase/decrease luminosity in a set of street lights, according to local policy.

4. Sub use case 4 - Operation Centre: Policies (regulatory & contractual)

Summary: (no atomic action steps)

Trigger: SLA non-conformity for low intensity imminent

Action: Increase luminosity in a set of street lights to keep within SLA

Detailed flow (no confirmation, etc. - actors in "quotes", system under study in italics)

- 1569 a) a) The “street light operation center” detects through analytics that an SLA regarding minimum street
1570 light intensity is in danger of not being met.
1571 b) b) “Street light operation center” messages the Street light system with a control message to increase
1572 luminosity according to “street light operation center” policy.
1573 c) c) Street light system messages the “street lights” with a street light control message to increase
1574 luminosity according to “street light operation center” policy.
1575

1576 5. **Sub use case 5** - Operation center: Ambient light analytics (sunrise/sunset, weather, moonlight)

1577 **Summary:** (no atomic action steps)

1578 **Trigger 5a:** A band of rain moves across an area of street lights

1579 **Action 5a:** Increase/decrease luminosity in a rolling set of street lights

1580 **Trigger 5b:** Sunrise/sunset is predicted to occur area in 30 minutes

1581 **Action 5b:** Decrease/increase luminosity in a rolling set of street lights

1582 **Detailed flow** (no confirmation, etc. - actors in “quotes”, system under study in italics)

- 1583 a) a) The “street light operation center” detects through analytics that (5a) a band of rain is moving
1584 across an area of street lights, or (5b) Sunrise/sunset is predicted to occur area in 30 minutes.
1585 b) b) “Street light operation center” messages the Street light system with a street light control message
1586 to increase/decrease luminosity according to “street light operation center” policy.
1587 c) c) The Street light system messages the “street lights” to increase/decrease luminosity in a set of
1588 street lights according to “street light operation center” policy.
1589

1590 6. **Sub use case 6** - Operation center: Predictive analytics (lights parts of streets predicted to be used)

1591 **Summary:** (no atomic action steps)

1592 **Precondition:** Vehicle paths are tracked via proximity sensors and a route model is generated

1593 **Trigger:** A vehicle enters a street section which has 85% probability of taking the next left turn

1594 **Action:** Increase luminosity on current street section ahead and also on street on next left

1595 **Detailed flow** (no confirmation, etc. - actors in “quotes”, system under study in italics)

- 1596 a) a) “Street lights” message the Street light system that street light power sensors have detected civilian
1597 or emergency vehicle entering street section.
1598 b) b) Street light system informs the “street light operation center” with the street light sensor
1599 information.
1600 c) c) “Street light operation center” messages the Street light system with a control message to
1601 increase/decrease luminosity according to “street light operation center” policy.
1602 d) d) Street light system messages the “street lights” with a street light control message to
1603 increase/decrease luminosity according to “street light operation center” policy.
1604

1605 7. **Sub use case 7** - From other service providers: Traffic light service input (emergency vehicle priority)

1606 **Summary:** (no atomic action steps)

1607 **Trigger:** An emergency vehicle is approaching a junction

1608 **Action:** Increase luminosity in street lights along streets leading away from junction

1609 **Detailed flow** (no confirmation, etc. - actors in “quotes”, system under study in italics)

- 1610 a) a) “Traffic light service provider” messages the Street light system that emergency vehicle
1611 approaching street junction from certain direction.
1612 b) b) Street light system informs the “street light operation center” with the street junction information.
1613 c) c) “Street light operation center” messages the Street light system with a control message to increase
1614 luminosity according to “street light operation center” policy.
1615 d) d) Street light system messages the “street lights” with a street light control message to increase
1616 luminosity according to “street light operation center” policy.
1617

1618 8. **Sub use case 8** - From other service providers: Emergency services input (vehicle routing, police action)

1619 **Summary:** (no atomic action steps)

1620 **Trigger 8a:** An emergency vehicle route becomes active

1621 **Action 8a:** Increase luminosity in street lights along vehicle route

1622 **Trigger 8b:** An area is declared as having an active police action

1623 **Action 8b:** Increase luminosity in street lights within police action area

1624 **Detailed flow** (no confirmation, etc. - actors in “quotes”, system under study in italics)

- 1625 a) a) “Emergency services provider” messages the Street light system that (8a) emergency vehicle street
1626 route is active, or (8b) an area is declared as having an active police action.
1627 b) b) Street light system informs the “street light operation center” with the street junction information.
1628 c) c) “Street light operation center” messages the Street light system with a control message to increase
1629 luminosity according to “street light operation center” policy.

- 1630 d. d) Street light system messages the “street lights” with a street light control message to increase
1631 luminosity according to “street light operation center” policy.
1632

1633 9. **Sub use case 9** - From other service providers: Road maintenance service input (closures and/or
1634 diversions)

1635 **Summary:** (no atomic action steps)

1636 **Trigger 9a:** A road is closed

1637 **Action 9a:** Program a changing luminosity pattern in street lights near to closed road

1638 **Trigger 9b:** A route diversion is activated

1639 **Action 9b:** Program a changing luminosity pattern in street lights along the streets of the diversion

1640 **Detailed flow** (no confirmation, etc. - actors in “quotes”, system under study in italics)

- 1641 a. a) “Road Maintenance service provider” messages the Street light system that (9a) a road is closed,
1642 or (9b) a route diversion is activated.
1643 b. b) Street light system informs the “street light operation center” with the road maintenance
1644 information.
1645 c. c) “Street light operation center” messages the Street light system with a control message to set lights
1646 to changing luminosity pattern according to “street light operation center” policy.
1647 d. d) Street light system messages the “street lights” with a street light control message to set lights to
1648 changing luminosity pattern according to “street light operation center” policy.
1649

1650 10. **Sub use case 10** - From other service providers: Electricity service input (power overload)

1651 **Summary:** (no atomic action steps)

1652 **Trigger:** A power overload situation is declared

1653 **Action:** Decrease luminosity in a set of street lights

1654 **Detailed flow** (no confirmation, etc. - actors in “quotes”, system under study in italics)

- 1655 a. a) “Electricity service provider” messages the Street light system that (9a) that an overload condition
1656 exists across some area.
1657 b. b) Street light system informs the “street light operation center” with the overload condition
1658 information.
1659 c. c) “Street light operation center” messages the Street light system with a control message to decrease
1660 luminosity according to “street light operation center” policy.
1661 d. d) Street light system messages the “street lights” with a street light control message to decrease
1662 luminosity according to “street light operation center” policy.
1663

1664 8.1.7 Alternative Flow

1665 In the case of loss of communications, street lights have local policies which they obey.

1666 8.1.8 Post-conditions

1667 Street light luminosity or luminosity pattern is adjusted as needed.

8.1.9 High Level Illustration

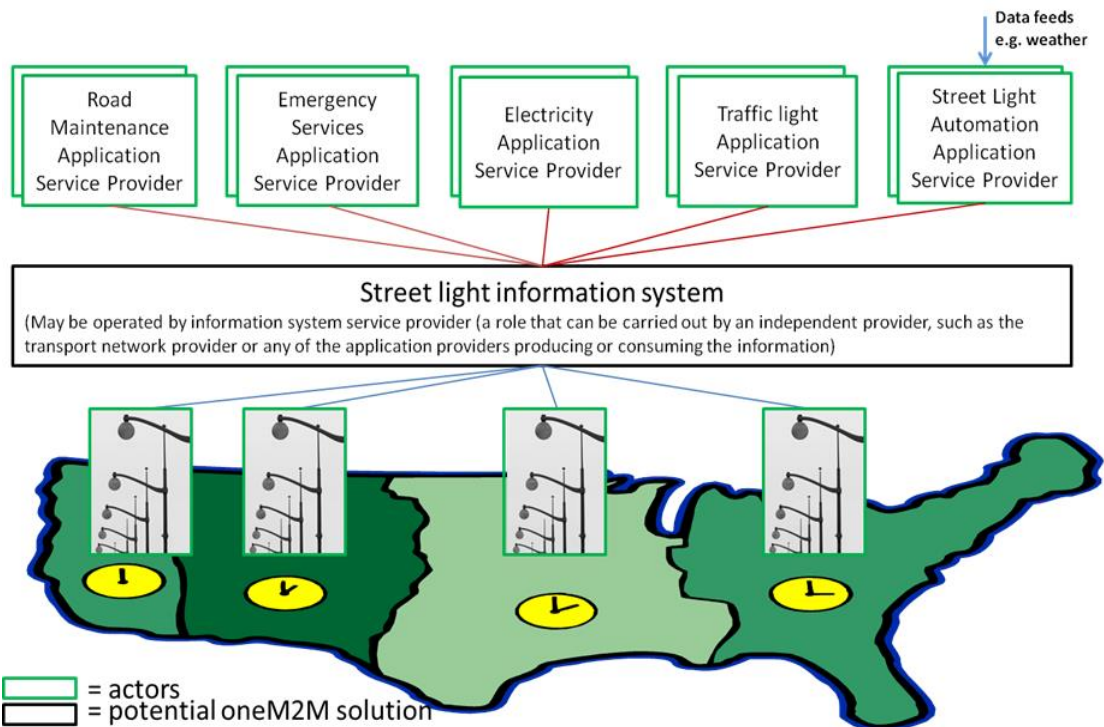

1669
1670

Figure 8-1 Street Light Automation High Level Illustration

1671
1672

8.1.10 Potential Requirements

1673

Generic (needed by two or more verticals or applications)

1674
1675
1676
1677
1678
1679
1680
1681
1682
1683
1684
1685
1686
1687
1688
1689
1690
1691
1692
1693
1694
1695
1696
1697
1698
1699
1700

1. The M2M solution shall support the ability to collect information from M2M devices.
2. The M2M solution shall support the ability to deliver collected information from M2M devices to M2M applications.
3. The M2M solution shall support control commands (for devices) from M2M applications.
4. The M2M solution shall support control commands for groups of M2M devices.
5. The M2M solution shall support the ability to receive device application software from M2M applications.
6. The M2M solution shall support the ability to deliver device application software to M2M devices.
7. The M2M solution shall provide mechanisms for information sharing, i.e. receiving information from M2M applications (information providing) to be consumed by other M2M applications (information consuming).
8. The M2M solution shall provide charging mechanisms for information sharing among M2M applications.
9. The M2M solution shall support the ability to provide an estimate of the time period from when a device sent a message to the M2M solution until when it responded with a message to the device.
10. The M2M solution shall provide security context (authentication, encryption, integrity protection) for secure connection between entities. The security context shall include mechanisms and techniques on how to setup a security connection , and where the security connection information is stored and how to establish the secure connection.
11. The M2M service layer shall provide security mechanisms to facilitate the end to end security of M2M applications.
12. The M2M service layer shall provide security mechanisms to avoid compromising the end to end security of M2M applications.

Specific (to this vertical/use case)

None

Note that the terminology:

- “Device application software” refers to application software that runs on a device including programs, patches, program data, configuration, etc.
- “M2M application” is any application that makes use of the M2M service layer - some form of prior agreement may be needed.

Security Considerations

- Attack vectors and example impacts:
 - By sending false reports of sensors to applications
 - Energy provider overdriving voltage
- By sending false control commands to devices
 - Blackout to obscure crime
- By blocking valid messages
 - Energy wastage

8.2 Use Case on Devices, Virtual Devices and Things

8.2.1 Description

The municipality of a Smart City operates an Application Service that monitors traffic flow and switches traffic lights depending on traffic. This “traffic application” controls the traffic lights and a couple of surveillance cameras to observe traffic flow.

The traffic application makes several of the surveillance cameras discoverable in the M2M System and potentially allows access to the data (the video streams) of these cameras. The surveillance cameras can be searched and discovered in the M2M System based on search criteria such as type (e.g. video camera for traffic) and other meta-data (e.g. location or activation state).

In addition to (physical) devices the traffic application publishes “virtual devices” that act similar to sensors and provide derived data such as: number of vehicles that passed during the last minute/hour, average speed of vehicles, etc.

Also these “virtual devices” can be searched and discovered in the M2M System based on type and other meta-data.

However, in contrast to the previous case (real devices) virtual devices only implemented as software and do not require a Connectivity Layer. They are data structures published by the traffic application.

The traffic application charges other applications to receive data from these virtual devices.

Finally, the traffic application also publishes “things” in the M2M System like roads and intersections. Other “things” the traffic application might publish are phased traffic lights (green wave).

“Things” are similar to “virtual devices” but have relations to other “things” (e.g. a section of a road lies between two intersections).

A “street”, published by the traffic application, provides information on the average speed of traffic, congestion level, etc. A “series of phased traffic lights” provides information about which traffic lights are in phase, the current minimal/maximal/optimal speed, etc.

The “traffic application” of the Smart City charges other applications to access data from its published “things”.

A second Application Service, a “logistics application” is operated by a company that manages a fleet of trucks to deliver goods all over the country. This “logistics application” provides an optimal route for each truck at any time.

One of the trucks is currently driving in the Smart City. The logistics application has a service level agreement with the traffic application of the Smart City.

The logistics application discovers all things (streets, intersections, etc.) that are relevant to calculate an optimal route for the truck, based on type and location. It uses the published data and is charged for the access to these data.

8.2.2 Source

oneM2M-REQ-2012-0073 Use Case on Devices - Virtual devices - Things .

8.2.3 Actors

- The municipality of a Smart City (Application Service Provider)
- The fleet management company (Application Service Provider)

1755 • The M2M Service provider (M2M Service provider)

1756 8.2.4 Pre-conditions

- 1757 • The municipality of a Smart City operates a “traffic application” that monitors traffic flow and switches
- 1758 traffic lights.
- 1759 • The fleet management company operates a “logistics application” that manages a fleet of trucks.
- 1760 • Both Applications are using the same M2M Service Capabilities Network (MSCN) operated by the M2M
- 1761 Service provider.
- 1762 • The traffic application allows the logistics application to access some of its Devices, Virtual devices and
- 1763 Things.

1764 8.2.5 Triggers

1765 None.

1766 8.2.6 Normal Flow

- 1767 • The traffic application creates Virtual devices (e.g. traffic sensors) and Things (e.g. streets, series of phased
- 1768 traffic lights, etc.) for use by other M2M applications in the MSCN of the M2M Service operator.
- 1769 • The traffic application publishes the semantic description (types, relations, and meta-data) of its Devices (e.g.
- 1770 cameras), Virtual devices and Things in the MSCN of the M2M Service operator. The traffic application
- 1771 restricts discoverability of its Virtual devices and Things to applications provided by business partners of
- 1772 the municipality of a Smart City.
- 1773 • The traffic application enables access to the data of some of its traffic cameras to all M2M applications, but
- 1774 access to the data of virtual devices and things is restricted to applications of business partners (e.g. the
- 1775 logistics application).
- 1776 • The logistics application searches the MSCN of the M2M Service operator for things and virtual devices in
- 1777 the vicinity of the truck. Based on the semantic search criteria (described by reference to a taxonomy or
- 1778 ontology) only the things and virtual devices that are useful for calculating the route of the truck are
- 1779 discovered.
- 1780 • The logistics application reads the data from relevant things and virtual devices and calculates the optimal
- 1781 route for the truck.
- 1782 • The logistics application is charged by the MSCN of the M2M Service operator for reading the data from
- 1783 things and virtual devices of the traffic application.
- 1784 • The traffic application is reimbursed for usage of its things and virtual devices.

1785 8.2.7 Alternative Flow

1786 None.

1787 8.2.8 Post-conditions

1788 None.

1789 8.2.9 High Level Illustration

1790 None.

1791 8.2.10 Potential Requirements

- 1792 1. The M2M System shall provide a capability to an Application shall be able to create Virtual Devices
- 1793 and Things in the M2M Service Capability Network.
- 1794 2. The M2M System shall provide a capability to an Application shall be able to publish semantic
- 1795 descriptions and meta-data (e.g. location) of its Devices, Virtual Devices and Things in the M2M
- 1796 Service Capability Network.
- 1797 3. The M2M System shall provide a capability to an Application to search for and discover Devices,
- 1798 Virtual Devices and Things in the M2M Service Capability Network based on their semantic
- 1799 descriptions and meta-data. The supported formats of semantic descriptions shall be described in the
- 1800 oneM2M standard.

- 1801 4. The M2M System shall provide a capability to an Application shall be able to control, via the M2M
1802 Service Capability Network, access to semantic descriptions and meta-data of its Devices, Virtual
1803 Devices and Things.
1804 5. The M2M System shall provide a capability to an Application shall be able to allow, via the M2M
1805 Service Capability Network, access to its Devices, Virtual Devices and Things to individual other
1806 applications.
1807

1808 8.3 Car/Bicycle Sharing Services

1809 -void -

1810 NOTE: This use case can be found in oneM2M TR-0026 [i.21]

1811 Source: oneM2M-REQ-2012-0132R01 Use Case: Car/Bicycle Sharing Services.

1814 8.4 Smart Parking

1815 -void -

1816 NOTE: This use case can be found in oneM2M TR-0026 [i.21]

1817 Source: oneM2M-REQ-2013-0169R03 Use Case Smart Parking
1818

1819 8.5 Information Delivery service in the devastated area

1820 8.5.1 Description

1821 Background

- 1822 • When a disaster occurs in the metro area, many victims require various kinds of information such as
1823 traffic, safety and evacuation area. However, it may be difficult to collect such information
1824 immediately and properly.

1826 Description

- 1827 • This is the use case of a M2M Service that transmits required information to the User Devices (UDs)
1828 of disaster victims immediately and automatically. Some of the information shall be maintained
1829 before a disaster happens.
- 1830 • UD connects to the Wireless Gateways (WGs). The WGs properly provide the UD with the
1831 information stored on its local DB to avoid the network congestion.
- 1832 • When Disaster Sensor detect a serious disaster, the Service Provider multicasts the latest information
1833 which the victims need such as traffic congestion, locations of closest hospitals and evacuation area.
1834 The UD receives and update the information automatically.
- 1835 • After the disaster happens, the Service Provider continues to update the information according to the
1836 situation of traffic, safety and evacuation area as well as the data from Disaster Sensors and
1837 Equipment for public information.

1838 8.5.2 Source

1839 oneM2M-REQ-2012-0074R09 Use Case: Information Delivery service in the devastated area.

1840 8.5.3 Actors

- 1841 • Service Provider has the aim to assist disaster victims by providing information to victims who have
1842 User Devices (UDs).
- 1843 • Disaster Sensor shall detect a disaster and send the disaster detection to the Service Provider.
- 1844 • Equipment shall send information to the Service Provider.
- 1845 • The UD shall receive the information from the Service Provider to support the disaster victim in
1846 emergency.
- 1847 • Wireless Gateway (WG) can send the information from the Service Provider to the UD by wireless
1848 connection (e.g. Wi-Fi, 3GPP) in an emergency.

1849

8.5.4 Pre-conditions

1850

1851

1852

1853

1854

1855

1856

1857

1858

1859

1860

1861

1862

1863

1864

- In times when disasters are not present (peace time), the Equipment collects information to be used for disaster situations (emergencies). The information is maintained in the DBs on the Service Provider's Disaster Information Network.
- The Service Provider shall have reliable, secure communication with the Disaster Sensor by checking the certificate issued by the Disaster Sensor.
- When receiving information regarding a disaster from the Service Provider, the WGs shall have the method to check if the information is reliable prior to distributing the information to UDs.
- UDs shall be able to receive the message from the Disaster Sensor by the other communication paths.
- The WG may be used for the other services for specific UDs in peace time. In case of emergency, every subscribed UDs should be able to receive the message from the Service Provider through the WG.
- Communication connections among UDs, WGs and Service Provider are established.
- When the network connectivity is available, the information on DB in the Service Provider-Disaster Information Network and local DBs in the WGs should be capable of being regularly synchronized and updated.

1865

8.5.5 Triggers

1866

The detection of a disaster (emergency) by the disaster sensor.

1867

8.5.6 Normal Flow

1868

1869

1870

Normal flow for collecting information during a disaster.

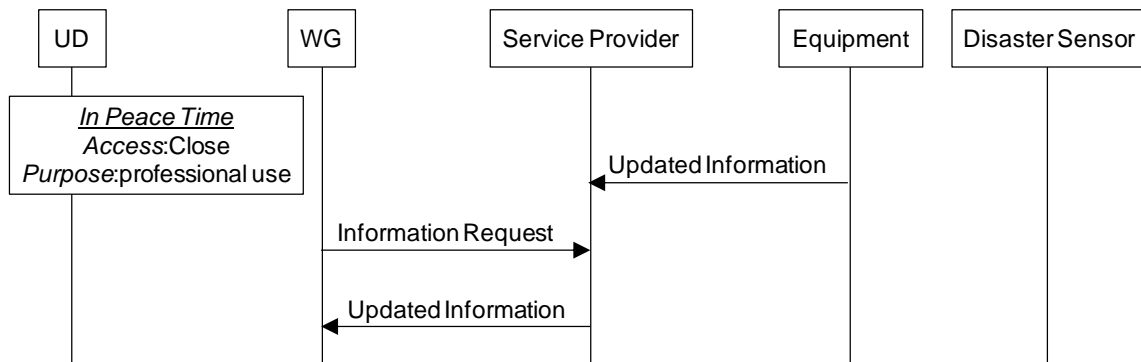

1871

1872

1873

1874

Figure 8-2 In Peace Time

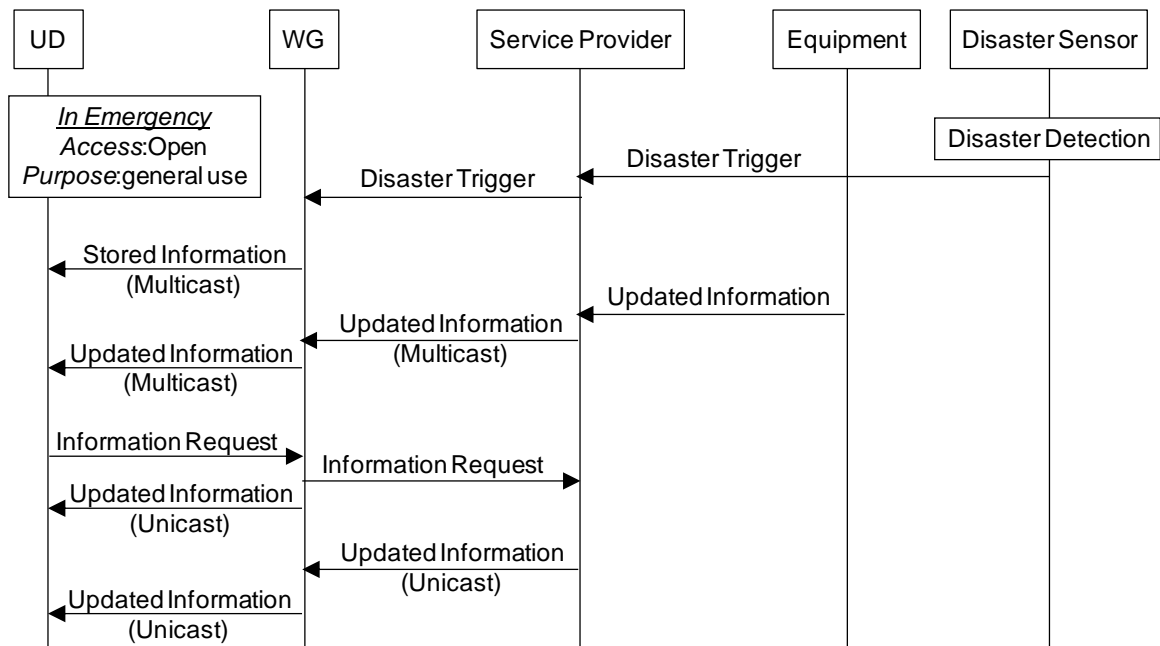

1875
1876

1877

Figure 8-3 In emergency

1878
1879
1880
1881
1882
1883
1884
1885
1886
1887

1. WGs request the updated information from the Service Provider in peace time repeatedly and stores the information in their local DBs.
2. Disaster Sensors send messages to start the processing flow of the information delivery service to the Service Provider if they detect the disaster trigger.
3. The Service Provider should be able to allow every UD to access to the Databases in the WGs and Service Provider's Disaster Information Network.
4. The Service Provider sends the latest information to UDs automatically. WGs can send the stored information on the local DB to the UDs in order to suppress the network congestion.

1888

8.5.7 Alternative Flow

1889
1890
1891

UDs can request their dedicated information from WGs. When the network connectivity between the WG and Service Provider is established, WGs can request from the Service Provider the dedicated information for the UDs (e.g. family safety and their refuge area, personal medical information).

1892

8.5.8 Post-conditions

1893

None.

1894

8.5.9 High Level Illustration

1895

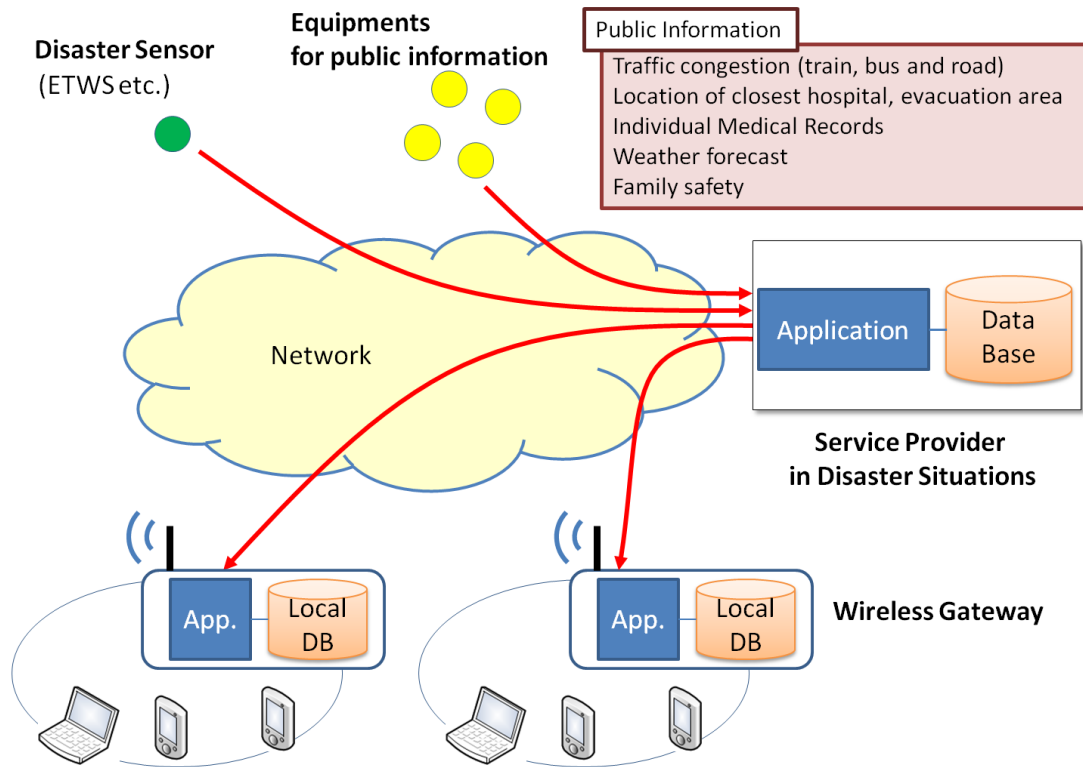

Figure 8-4 High Level System View

8.5.10 Potential Requirements

Table 8-1. Potential Requirements

Requirement ID	Classification	Requirement Text
HLR-088-a	Data reporting	The M2M System shall provide capabilities to Applications to update/synchronize Application specific databases between the Network Application and Gateway Application. Fulfilled by HLR-041.
HLR-087	Data reporting	The M2M System shall support transmission of Application specific data (e.g. tsunami and earthquake detection sensor data) from Devices and oneM2M external sources (e.g. ETWS data) to Applications in the Network. Fulfilled by HLR-046.
HLR-088-b	Data storage	A (wireless) Gateway shall be able to autonomously provide Devices that are attached via the LAN of the Gateway with trusted data that is locally stored in the Gateway. Trusted data and retrieval fulfilled by HLR-041 ACLs.
HLR-088-c	Data reporting	When the WAN connection between the Gateway and Service provider is not possible, the Gateway shall continue to provide data that is locally stored on the Gateway to authorized Devices.
HLR-089	Data reporting	A (wireless) Gateway shall be able to transmit data (e.g. disaster warnings) to M2M Devices that are connected to the Gateway and are authorized to receive the data. Fulfilled by HLR-010.
HLR-092-a	Security	A M2M Device that receives broadcast data from a (wireless) Gateway shall be able to verify that the (wireless) Gateway is

		authorized to broadcast the data (e.g. disaster warnings) and that the data is authentic. Fulfilled by HLR-185 and HLR-213.
HLR-092-b	Security	The M2M System shall provide capabilities to the Service Provider to enable/disable open access of M2M Devices to the Gateway. <ul style="list-style-type: none"> • If access of M2M Devices to the Gateway is open any M2M Device shall be allowed to receive data from the Gateway. • If access of M2M Devices to the Gateway is not open only authorized M2M Devices shall be allowed to receive data from the Gateway. Fulfilled by HLR-180, HLR-201

8.6 Holistic Service Provider

8.6.1 Description

In this use case a “Holistic Service Provider” provides M2M Application services for a large building, an industry facility, a sports complex, a public infrastructure, etc. In contrast to "normal" “normal” M2M Application service providers a Holistic Service Provider mainly aggregates and combines data from other M2M Application service providers of the facility, e.g. to provide analytics ore forecast services.

In this use case a Holistic Service Provider for a football stadium provides the optimal fill status of the water reservoir of the stadium, taking into account:

- Event calendar and occupancy patterns for the planned events
- Current weather conditions and forecast,
- Ticket sales,
- lawn irrigation with the target to enable a high level of rain water

The requirement for such a scenario is that M2M Application service providers can provide limited access to a subset of their M2M data to the Holistic Service Provider. In addition this needs to be done in a semi-automated way that requires minimal human involvement.

8.6.2 Source

REQ-2015-0527R01.

NOTE : This use case has been gathered from material of the EU FP7 Project CAMPUS 21 (<http://www.campus21-project.eu>), in particular from Deliverable 1.1 “Analysis of Existing Business Models and Procurement Schemes” (<http://www.campus21-project.eu/media/publicdeliverables/D1-1.pdf>).

8.6.3 Actors

- **Holistic Management Service Provider (HM)**: A company that provides holistic management services for energy, material and resource flows for any kinds of facilities. The actor provides the synergetic analytics over all data sources within different dimensions like time, space and context, and provides decision support for advanced facility control operations. This actor cooperates with the facility operator in order to provide holistic data management and control.
According to oneM2M terminology the **HM** is a M2M Application Service Provider.
- **Facility Operator (FO)**: A company that is in charge of the operation of facility. The main focus is the main facility's metering and control system (e.g. building automation systems) and therefore the operation of the facility in a cost- and energy-efficient manner. This actor will cooperate with third party facility services in order to enable holistic data integration. It is in charge of the business relations for all actors active within and for the facility.
According to oneM2M terminology the **FO** is a M2M Application Service Provider.

- **Third Party Facility ICT provider (TP):** A company which provides an additional sensor/ control/ metering system into the facility operated independently (installed permanently or temporarily, e.g. event ticketing system) from the main facility monitoring system. This actor might have a business relation with the facility operator, and enables access to its data.

According to oneM2M terminology the **TP** is a M2M Application Service Provider.

All the above mentioned actors provide oneM2M System compliant M2M Application services.

8.6.4 Pre-conditions

- In order to provide services the Holistic Management Service Provider (HM) needs to get access to M2M data of multiple, independent Third Party Facility ICT providers (TP) in near real time. He needs to prove legitimacy of his request to access these data by some authorization of the Facility Operator (FO)
- The Facility Operator has established a business relationship with the Holistic Management Service Provider
(FO ↔ HM)
- The Facility Operator has established business relationships with Third Party Facility ICT providers that provide:
 - The event calendar and ticket sales (TP for event management)
 - ticket sales solutions at the stadium
 - maintenance (temperature- and humidity control, irrigation) of the lawn of the stadium
 - maintenance (filling level, quality control, outflow- and inflow control) of the water reservoir of the stadium
(FO ↔ TP)
- Facility Operator, Holistic Management Service Provider and Third Party Facility ICT providers has established business relationships with the M2M Service Provider.
(FO, HM, TP ↔ M2M-SP)

Note, there is no business relationship between the Holistic Management Service Provider and Third Party Facility ICT providers.

8.6.5 Triggers

Not applicable

8.6.6 Normal Flow

1. Offline Step:
 - (a) The Holistic Management Service Provider (HM) requests the Facility Operator (FO) to provide him with data read-access to event calendar, ticketing information, lawn conditions and water reservoir conditions. These data are required with a certain quality/granularity (e.g. twice a day). Moreover actuation-access to the inflow of the water reservoir is requested
 - (b) The Facility Operator (FO) returns a list of IDs of Third Party Facility ICT providers (TP) whose Applications provide these data.
2. The Facility Operator (FO) provides the HM with an electronic token that certifies the FO's consent to allowing the HM's applications to access Third Party Facility ICT provider (TP) data.
This consent — and the token - is restricted to only:
 - The TPs and the data of these TPs that are required for the holistic service
 - The necessary quality/granularity of the data.
 The Facility Operator (FO) can at any time revoke his consent by invalidating the electronic token.
3. Based on list of IDs of TPs the M2M Application of the HM discovers relevant applications of the TPs.

- 1988 4. The M2M Application of the HM requests read / write access to the relevant data of the TPs
- 1989 applications. The electronic token provided by the FO is attached to this request to prove its
- 1990 legitimacy.
- 1991 5. Since the legitimacy of the data access request is proven through the electronic token the TP enables
- 1992 the data access to the HM with the necessary quality/granularity of the data.
- 1993

1994 8.6.7 Alternative flow

1995 Not applicable

1996 8.6.8 Post-conditions

1997 Not applicable

1998 8.6.9 High Level Illustration

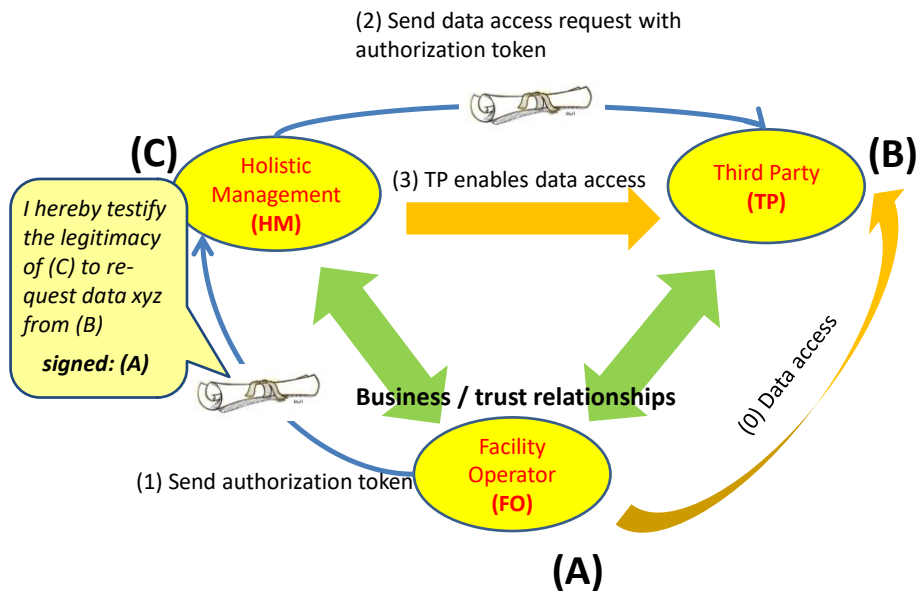

2000
2001
2002 **Figure 8-5 Holistic Service Provider High Level Illustration**

2003 8.6.10 Potential requirements

- 2005 1. When an M2M Application (A) has access (read and/or write) to application data of another M2M
- 2006 Application (B) then (A) shall be able to create an electronic means - e.g. a token - that certifies the
- 2007 consent of (A) that a third M2M Application (C) is authorized to access these data too.
- 2008 2. The M2M Application (A) shall be able to provide a third M2M Application (C) with this authorization
- 2009 token.
- 2010 3. The M2M Application (A) shall be able to restrict the consent expressed in the authorization token to
- 2011 specify:
 - 2012 • the authorized M2M Application (C);
 - 2013 • the data accessed from a specified M2M Application (B);
 - 2014 • the type of data access (read and/or write) and time when (how often) data can be accessed;

- 2015
- in case of subscription to the data the time granularity of providing data updates.
- 2016
- 2017
- 2018
- 2019
- 2020
- 2021
- 2022
- 2023
- 2024
4. An M2M Application (B) shall be able to receive a request to access its data from an M2M Application (C) together with an authorization token that certifies the consent of M2M Application (A) that (C) has been authorized by (A) to access these data.
 5. The M2M Application (A) that had issued the authorization token shall be able to revoke the authorization token.
 6. When an authorization token has been revoked, then any M2M Application (B) that had granted access to its data based on the presence of this authorization token shall receive notification by the M2M System that the authorization token has been revoked.

2025

9 Residential Use Cases

2026

9.1 Home Energy Management

2027

9.1.1 Description

2028 This use case is to manage energy consumption at home so that consumers can be aware of their daily home
2029 energy consumptions and able to control this consumption by remote actions on home appliances. Innovative
2030 services can be developed from the data (energy) collection and sent to either the consumers/ equipment or to
2031 Business-to-Business market.

2032 The use case focuses on a home Energy Gateway (EGW) that collects energy information from the electrical
2033 home network and communicates it to an M2M system for aggregating and processing of the data. Services
2034 can then be developed from the collected data.

2035 The EGW performs an initial treatment of the data received from various sources (sensors, context) as follows:

- 2036
- aggregating and processing the obtained information;:
 - sending some information to the remote M2M system e.g. sending alerts through the M2M system;
 - using some information locally for immediate activation of some actuators/appliances;
 - Is connected (wirelessly or via wireline) to home devices, including the home electrical meter, for information on global or individual consumption of the appliances ;
 - Providing displayable consumed energy-related information to the end-user/consumer terminals (PC, mobile phone, tablet, TV screen, etc.).
- 2037
- 2038
- 2039
- 2040
- 2041
- 2042
- 2043

See HGI-GD017-R3 (Use Cases and Architecture for a Home Energy Management Service [i.6].

2044

9.1.2 Source.

2045 oneM2M-REQ-2012-0058R03 Home Energy Management .

2046 NOTE From ETSI TR 102 935 [i.2].

2047

9.1.3 Actors

- 2048
- User: user of home appliance.
 - Communication operators: in charge of communicating the collected information via any protocol (e.g. ZigBee®, PLC, Bluetooth® 4.0, etc.) to EGW and from the EGW to the M2M system.
 - Energy gateway SP: in charge of collecting & transmitting securely energy information from appliances to the M2M system and receiving remote controls/commands from the M2M system.
 - System operators/providers of service layer platform(s): in charge of providing services/common functionalities for applications (e.g. HEM) that are independent of the underlying network(s); e.g. they are in charge of collecting the status information of home devices and controlling them via the energy gateway.
 - Application Service Provider: Provides Home Energy Management (HEM) Application for the user through the M2M system.
- 2049
- 2050
- 2051
- 2052
- 2053
- 2054
- 2055
- 2056
- 2057
- 2058

2059

9.1.4 Pre-conditions

2060 None.

2061 9.1.5 Triggers

2062 None.

2063 9.1.6 Normal Flow

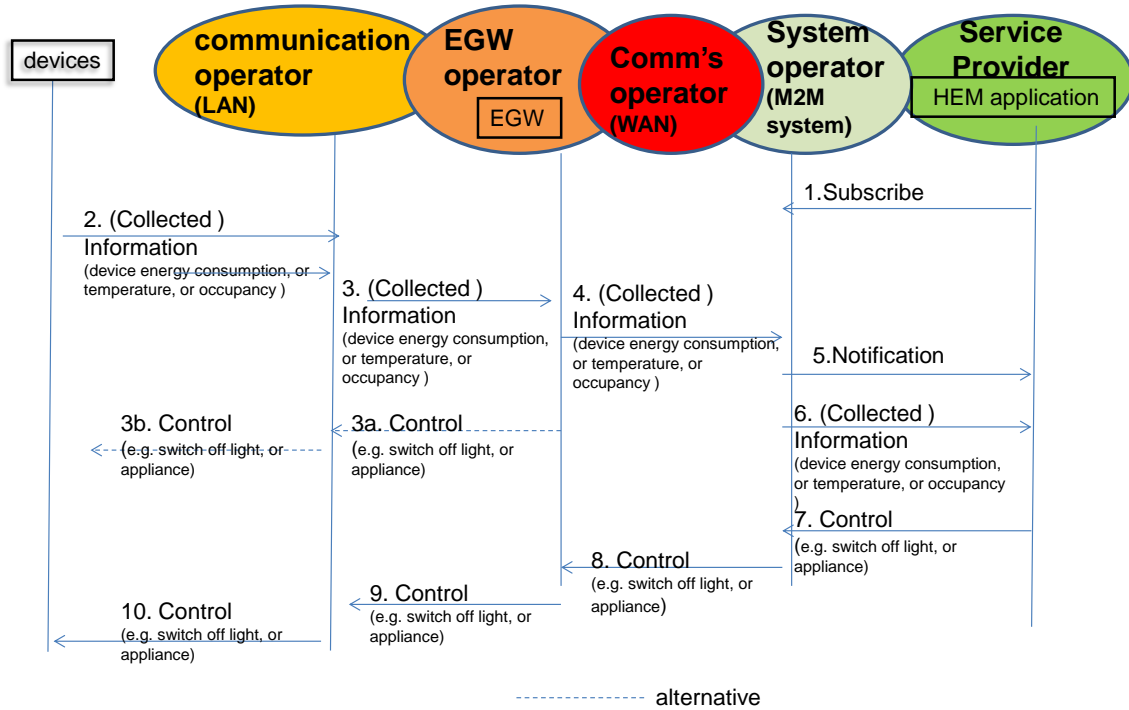

2065
2066 **Figure 9-1 Home Energy Management Normal Flow**

- 2067
- 2068 1. HEM application (M2M device) subscribe to System Operator/SP for information from home device(s).
 - 2069 2. Information from devices which could be M2M devices (smart meters, electric lightening, fridge, washing machine etc.) at home is collected by the Energy Gateway Operator (EGW) via communication network operator. . Information may include room, temperature, occupancy, energy consumption.
 - 2070 3. Collected information is stored in the EGW SP and may be processed at energy gateway. As a result, control message may be sent back to device from the energy GW depending on policies stored in the energy gateway.
 - 2071 4. Collected information may also be sent to system operator which contains the M2M service platform for storage via communication network.
 - 2072 5. Subscribed application (HEM) is notified information is available for processing. Its subscribe M2M operator can process the information before sending to HEM application depending on subscription profile.
 - 2073 6. HEM application reacts to the shared /collected information and can send control message (e.g. To switch a home device e.g. light /appliance or washing machine) via the system operator.
 - 2074 7. Control is propagated back through different operator to appropriate M2M device(s).
- 2075
2076
2077
2078
2079
2080
2081
2082
2083

2084 9.1.7 Alternative Flow

2085 None.

2086 9.1.8 Post-conditions

2087 None.

9.1.9 High Level Illustration

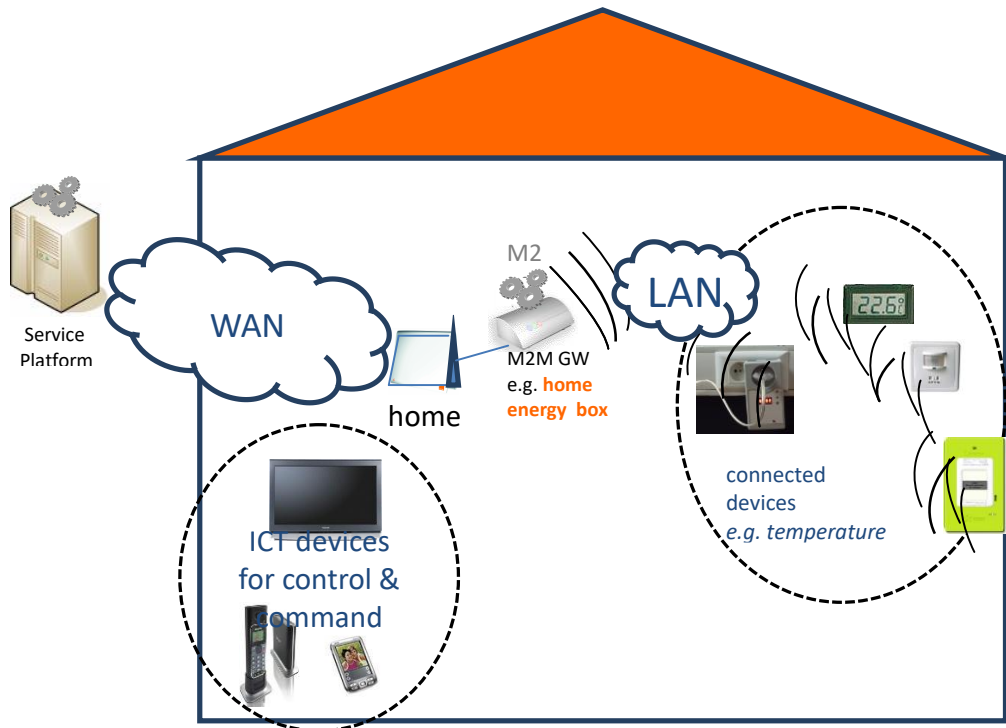

Figure 9-2 Home Energy Management System High Level Illustration

9.1.10 Potential Requirements

1. Similar to that of WAMS use case summarized as follows:
 - a. a) Data collection and reporting capability/function
 - b. b) Remote control of M2M Devices
 - c. c) Information collection & delivery to multiple applications
 - d. d) Data store and share
 - e. e) Authentication of M2M system with M2M devices/ /collectors
 - f. f) Authentication of M2M devices with M2M applications
 - g. g) Data integrity
 - h. h) Prevention of abuse of network connection
 - i. i) Privacy
 - j. j) Security credential and software upgrade at the Application level.
 - k. k) In addition the following requirements are needed:
 - l. l) The M2M system shall support a Gateway
 - m. m) The Gateway can be per home or per multiple homes e.g. a Gateway Concentrator
2. Configuration Management.
3. Pre provisioning of the M2M Devices and Gateways:
 - a. a) The M2M System shall support mechanisms to perform simple and scalable pre provisioning of M2M Devices/Gateways.
4. Management of multiple M2M Devices/Gateways:
 - a. a) The M2M Application e.g. the HEM application shall be able to interact with one or multiple M2M Devices/Gateways, e.g. for information collection, control, either directly or through using M2M Service Capabilities.
 - b. b) The HEM application shall be able to share anonymous data with energy partners to provide the consumer with special energy rates.
5. Support for subscribing to receive notification:
 - a. a) The M2M System shall support a mechanism for allowing applications to subscribe and being notified of changes.

- 2121 b. b) The M2M System operator shall be able to support subscription of the HEM application to
2122 subscribe.

2123 6. Support for optimizing notification:

2124 The M2M System shall be able to may support a mechanism for delaying notification of Connected Devices in
2125 the case of a congested communication network.

2126 7. Support for store and forward:

- 2127 a. a) The M2M System shall be able to support a mechanism to manage a remote access of information
2128 from other Connected Devices. When supported the M2M system shall be able to aggregate requests and
2129 delay to perform the request depending on a given delay and/or category e.g. the M2M application does
2130 not have to connect in real time with the devices.

2133 9.2 Home Energy Management System (HEMS)

2134 9.2.1 Description

2135 This use case introduces several services based on HEMS technologies.

2136 Home appliances from multiple vendors are connected to a LAN or PAN, and controlled by the gateway
2137 device.

2138 The gateway device aggregates functionalities of home appliances by getting their status and sending this to
2139 the management server.

2140 The gateway device is also upgradable to host newly released home appliance(s).

2141 The gateway device provides an API for remote control which takes privacy and authorization issues into
2142 account.

2143 9.2.2 Source

2144 oneM2M-REQ-2012-0072R05 Use Case Home Energy Management System (HEMS).

2146 9.2.3 Actors

- 2147 • User: user (owner) of the home appliances.
- 2148 • Home Appliance: appliances which may be from multiple vendors and are monitored and/or controlled
2149 energy consumption.
- 2150 • Gateway Device: a device installed in the user's home and receives remote control commands from the
2151 management server.
- 2152 • Management Server: the server which is in charge of collecting the status of appliances and controlling the
2153 appliances via the gateway device.
- 2154 • HEMS Application Server: the server which provides HEMS service for the user through the remote
2155 management server.

2156 9.2.4 Pre-conditions

- 2157 • WAN connectivity to the Gateway Device is installed.
- 2158 • Service contract is required, and authentication credentials for the Management Service are installed on the
2159 Gateway device.

2160 9.2.5 Triggers

2161 New Air Conditioner (for example) is installed.

2162 9.2.6 Normal Flow

- 2163 1. User operates the Gateway Device to identify newly installed Air Conditioner (A/C) on the LAN.
- 2164 2. The newly installed A/C is identified by the Gateway Device.
- 2165 3. The Gateway Device requests the Management Server to provide support software for the A/C.
- 2166 4. The support software is installed on the Gateway Device.
- 2167 5. The Gateway Device registers the functionalities of the A/C to the Management Server.
- 2168 6. The Management Server notifies the event of the installation of the A/C to the HEMS Application Server.
- 2169 7. The HEMS Application Server is reconfigured with the newly installed A/C.

8. The HEMS Application Server receives the latest status of all of the Home Appliances including the newly installed A/C from the Management Server.
9. The HEMS Application Server sends management command(s) to the Management Server to minimize energy consumption.

9.2.7 Alternative Flow

None.

9.2.8 Post-conditions

Energy consumption within the home is minimized by monitoring and controlling Home Appliances.

9.2.9 High Level Illustration

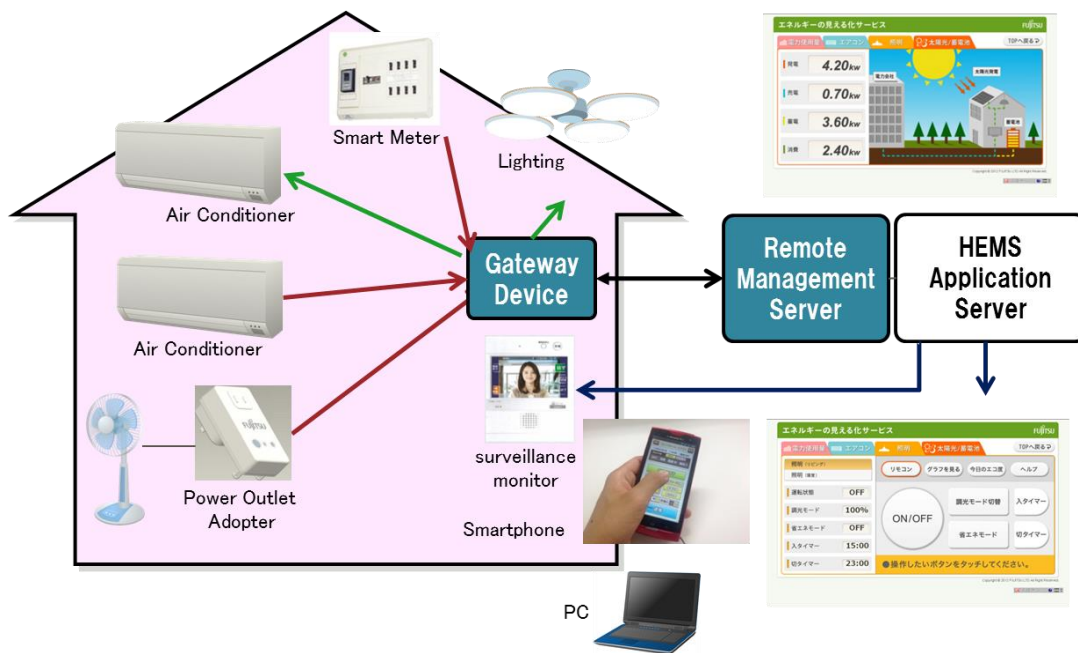

Figure 9-3 Home Energy Management System High Level Illustration

9.2.10 Potential Requirements

1. Gateway Device shall have the following requirements.
2. To detect the newly installed Home Appliance.
3. To be provided with appropriate pre provisioning configuration which is required to host the Home Appliances
4. To support Home Appliances from multiple vendors as an abstracted object model.
5. To allow control to be overridden of the Home Appliances by User's direct operation.

9.3 Plug-In Electrical Charging Vehicles and power feed in home scenario

9.3.1 Description

The aim of the Plug-In Electric Vehicle (PEV) Charging and Power feed use case is to show the interaction between the different actors that can be involved in the charging of Electric Vehicle in home scenario. The scenario includes engagement of various actors:

- Electricity-Network Service Provider (Electricity-N/W-SP).
- Dedicated Electric Vehicle Charging SP (EVC-SP) who takes care of special functions like the Demand Response (DR) enablement (cost effective PEV Charging and Power Feed).
- PEVService Provider (SP) in charge of functions related to PEV service and maintenance (providing a data connection for PEV health purposes such as managing Power Feed cycles, PEV software upgrading & remote fault analysis, etc.).
- PEV manufacturer in charge of replacing faulty parts for the PEV

PEV can be considered as a load and also as power storage (DER resource). In the latter case, a Power Feed from the PEV's battery into the Electricity-N/W is required.

The Electricity-N/W-SP is responsible for the residential homes (smart) metering. Depending on local laws, the metering for the (Electrical Vehicle Charging Equipment) EVCE may be independent and might be a physical part of the EVCE.

Depending on the PEV's brand, a parallel wired data connection may be included in the EVCE charging plug to enable the PEV's controller to access its agreed service and maintenance provider (PEV SP). In case of no wired connection (high data rate, e.g. Ethernet), a short reach link, e.g. via ZigBee® or even Bluetooth® may be established (medium data rate ~2 Mb/s). This connection will then be routed via the EVCE's mobile broadband link to the PEVSP's control center in parallel to the charging and power feed control data, which is routed to the EVC-SP's control center.

Related Standard activities:

- TC 69 committee: working on ISO/ IEC 15118 [i.7] parts 1-4, vehicle to grid communication; currently under development.
- EU standardisation Mandate 486 to CEN, CENELEC and ETSI (for further information refer to Mandate 486 [i.8]).
- Open 2G: using DIN specification 70121 [i.9] and ISO/ IEC 15118 [i.7].
- DIN specification 70121 [i.9] defines the requirements for the communications between the electric vehicle (EV) and the charging EVCE).

9.3.2 Source

oneM2M-REQ-2012-0059R02 Plug-In Electric Vehicle Charging (PEV).

NOTE: From ETSI TR 102 935 [i.2].

9.3.3 Actors

- Electricity Network service provider (Electricity N/W-SP/DSO) is responsible for the residential homes smart metering.
- Electricity vehicle charging service provider (EVC-SP) takes care of special functions like the Demand Response (DR) enablement (cost effective PEV Charging and Power Feed)
- PEV service provider (PEV SP) offering functions in conjunction with PEV service and maintenance (PEV health check and management such as management of power feed cycles, PEV software upgrading & remote fault analysis, etc.).
- Communication operator /provider provide the public wireless data service to PEV SP and EVC SP control centers.

9.3.4 Pre-conditions

Connection from PEV to EVCE through a wired EVCE plug (data communication) or wirelessly (ZigBee® or Bluetooth®) or any short range technology.

Public communication network from EVCE to PEV SP and EVCE SP control centers.

Public communication between EVCE metering and El. N/W SP.

9.3.5 Triggers

Control and pricing announcements from El. N/W SP to for example balance the power N/W.

Control and pricing trigger/initiate PEV being charged at a particular time with a specific power feed cycle that is appropriate for consumer (cheaper) and for El. N/W SP (balance power system).

PEV health management through PEV control link to EVCE.

e.g. PEV SP initiates health check when PEV is plugged into EVCE for charging; if there is a problem detected or a PEV part status is over a certain limit, this will trigger a corrective measure according to health check result (e.g. PEV SP place an order for a part replacement to PEV manufacturer, or SW upgrade, etc.).

2252
2253
2254
2255
2256
2257
2258
2259
2260

EVCE SP will control and manage EVCE through EVCE control link.

9.3.6 Normal Flow

An example flow to show the interaction between PEV SP (PEV health check), PEV manufacturer (PEV defect part replacement) and EVC SP (metering/charging):

- Red colour to refer to flow related to EVC charging application
- Green colour refer to flow related to PEV SP application
- Blue colour refer to flow related to PEV manufacturer application

2261

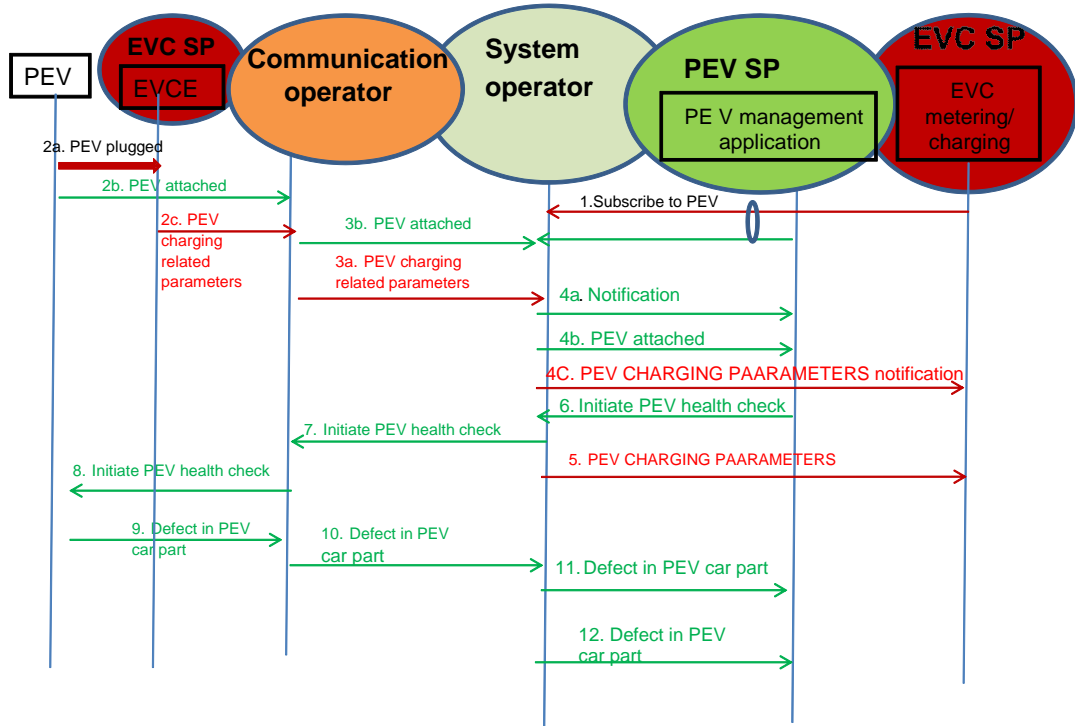

2262
2263
2264

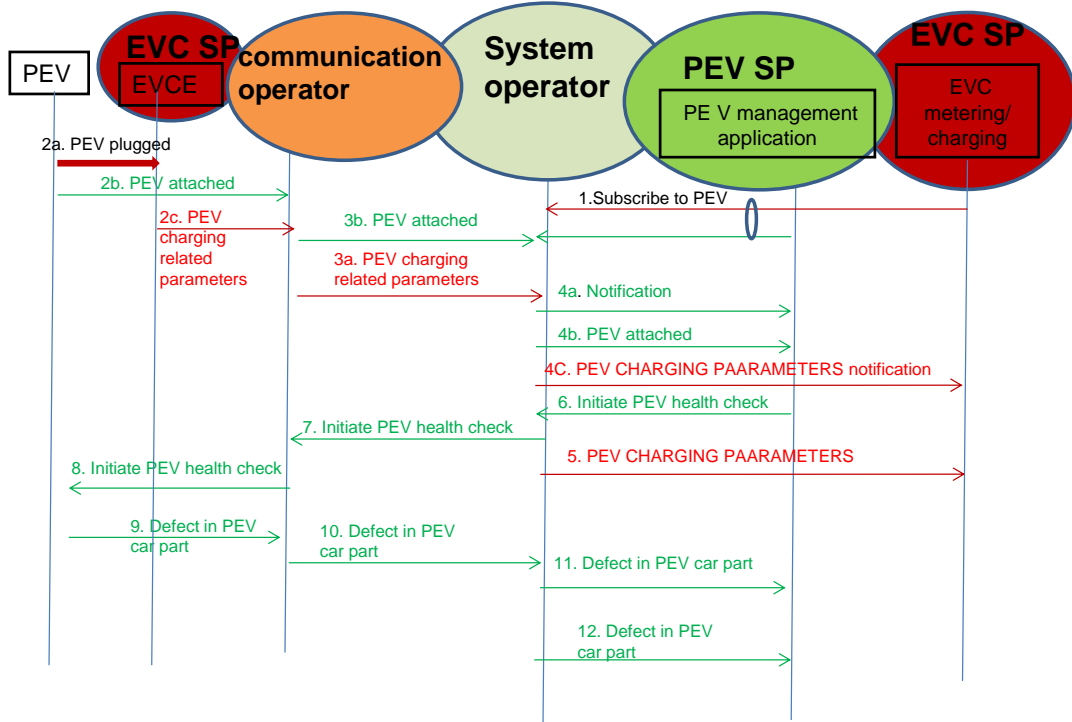

Figure 9-4 PEV Normal Flow

- 2265 1. PEV management application and EVC metering/charging application subscribe to information related to PEV.
- 2266 2.
- 2267 2a. PEV is plugged to EVCE.
- 2268 2b. PEV related information (e.g. PEV1) is sent to communication operator.
- 2269 2c. PEV charging related information (e.g. .charging period).
- 2270 3. Information sent in step 2 are sent to system operator which trigger the notification in step 4 .
- 2271 4. Notifications are sent to the subscribed applications.
- 2272 5. PEV charging parameters pulled/pushed to the EVC-SP.
- 2273 6. PEV management application sent an initiation of health check message to system operator .
- 2274 7. Initiation message is sent by system operator through communication operator to PEV to start the health check.
- 2275 8. A PEV part defect is detected and a message is sent to the system operator, which triggers the notification of
- 2276 the PEV SP.
- 2277 10. System operator is sent a defect Notification to PEV SP application of the car part.
- 2278 11. Which in turn send an order of the defected part to system operator.
- 2279 12. System operator sends the order to a PEV manufacturer
- 2280 .

2281 **9.3.7 Alternative Flow**

2282 None.

2283 **9.3.8 Post-conditions**

2284 None.

2285 **9.3.9 High Level Illustration**

2286

Plug-In Electric Vehicle (PEV) Charging & Power Feed

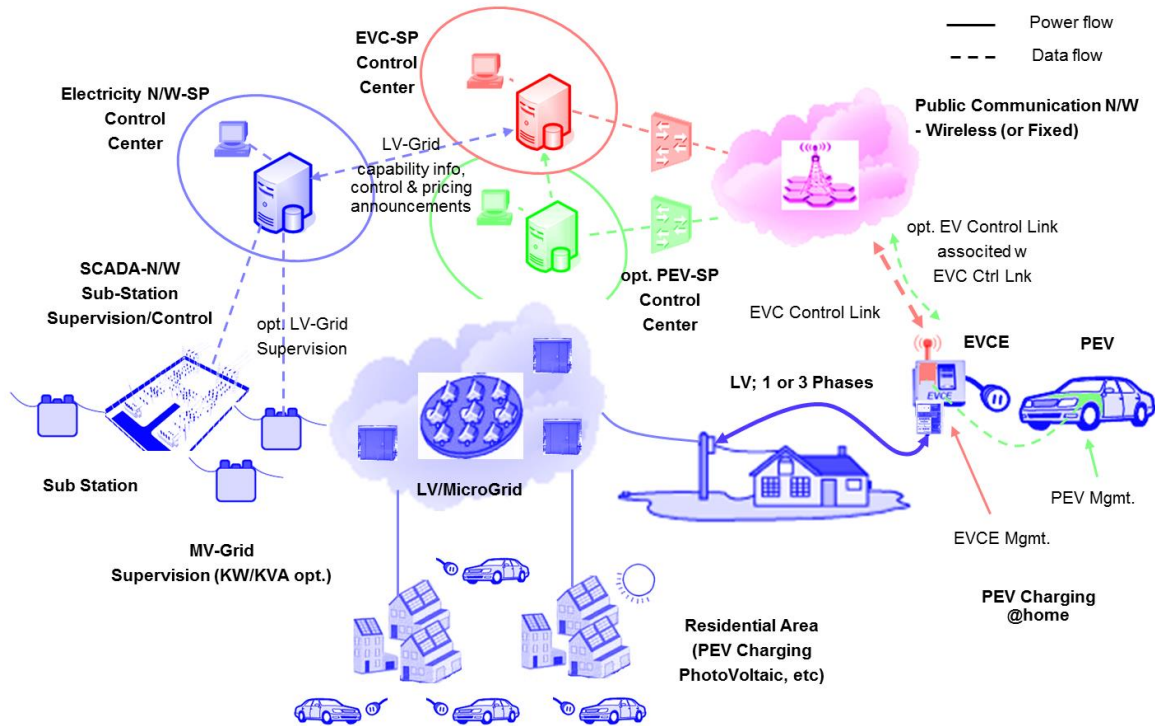

2287

2288

Figure 9-5 PEV Charging High Level Illustration

2289

2290

9.3.10 Potential Requirements

2291

1. Secure communication of the following transactions:

2292

- i. i) SW upgrade by PEV manufacturer,

2293

- ii. ii) Collecting PEV status info for health check will trigger control or command (e.g. order new part, trigger to do a car service) to another SP

2294

2295

- iii. iii) Collecting charging information (metering) from EVCE i.e. power feed cycle and time and charging period to the EVC-SP control center (the metering could be home owned smart meter or Utility owned)

2296

2297

- iv. iv) Collection metering info from EVCE (PEV considered as a load or resource), to Electric N/W provider for billing purposes. Controlling EVCE e.g. SW upgrade, part order

2299

- v. v) Pricing info from Electricity Network SP to EVC SP

2300

2301

- vi. vi) Fleet management control center to collect location information of PEV

2302

2. Potential requirements are similar to those of WAMS:

2303

- i. vii) Data collection and reporting capability/function including data delivery to multiple applications

2304

2305

- ii. viii) Remote control of M2M Devices

2306

- iii. ix) Data store and share

2307

- iv. x) Authentication of M2M system with M2M devices/ /collectors

2308

- v. xi) Authentication of M2M devices with M2M applications

2309

- vi. xii) Data integrity

2310

- vii. xiii) Prevention of abuse of network connection

2311

- viii. xiv) Privacy

2312

- ix. xv) Security credential and software upgrade at the Application level.

2313

2314

9.4 Real-time Audio/Video Communication

2315

9.4.1 Description

2316

So far, session control and Real-time audio/video communication are taken as basic capabilities in H2H telecom network. People may think that device does not need to listen or watch something from elsewhere except itself, thus there is no need for M2M system to support such kinds of human oriented capabilities, however, this is not the case. The following are some use cases in which session control for real-time audio/video communication is needed.

2317

2318

2319

2320

2321

2322

Use Case 1: Home Surveillance

2323

One person, when travelling far from home, would like to use the application installed on his/her cell phone or pad computer to monitor his/her house, via the cameras fixed inside or outside his/her house. In the case the person makes a call to the camera through his/her cell phone or pad computer requesting for image/video transmission, the camera can answer the call request and automatically start transmission of images/video captured by the camera.

2324

2325

2326

2327

2328

The camera may be able to initiate an audio/video call or send messages for alarm addressing to the cell phone of the person in the case there are abnormal images captured by the camera, e.g. the image changes or the camera are moved. The cameras can communicate with other M2M devices via wired or wireless network. The communication can be between the M2M application on the M2M device and the M2M application applied in a service center which provides home surveillance service to the users.

2329

2330

2331

2332

2333

In order to have a clearer look at the images captured by the cameras, some commands can be sent to the camera to adjust some parameters on the cameras, e.g. tilt, zoom in/out, adjust the focus, initiate recording, and so on. For easy and better control of the camera along with the video transmission, the commands can be transported within the same session as for video transmission. It is assumed that standalone session can be created to control the cameras as well.

2334

2335

2336

2337

2338

The cell phone can also start calling the camera automatically according to some predefined rules. For example, the cell phone calls the camera and records the audio/video information automatically every night while the owner is sleeping.

2339

2340

2341

2342

Use Case 2: Doorbell Controller

2343

One person, when he/she is away from home, his/her children or parents may forget to take the keys and lock them from entering into the house. After they push the door bell or door controller with cameras equipped, the

2344

2345 application installed on the door bell or door controller may initiate a video call to the person's person's cell
2346 phone in which it shows who are standing before the door, and once the user answers the call reaching his/her
2347 cell phone, the door will open.

2348 Also, when the motion detector equipped near the doorbell detects some abnormal movements near the door,
2349 the motion detector notifies the doorbell with a camera to start a call to the owner's owner's cell phone. When
2350 the owner answers the phone, he/she will be able to make sure if the movements are normal.

2351 **Use Case 3: Customized Home Service**

2352 One person, when he/she is away from home, he/her may use his/her mobile device to coordinate appointments
2353 using calendar application or to search information on internet. His/her mobile device also can trace its
2354 location using GPS. By collecting the information, his/her life pattern/context and interests can be analysed.

2355 Using well-analysed information, a service provider can provide user- customized home service with home
2356 appliances which have capability of showing video or playing audio like smart television or smart refrigerator.

2357 He/she may come back to home and turn on TV. Channels would be recommended based on analysed data of
2358 his/her preference. Then commercial advertisement on TV would be shown regarding of his/her interest and
2359 personal information.

2363 9.4.2 Source

2364 oneM2M-REQ-2013-0281R02 Use Case real time audio video communication .
2365 oneM2M-REQ-2013-0398R01 Use Case of Additional audio video
2366 .

2367 9.4.3 Actors

2368 • M2M Service Provider:

2369 A company that provides M2M service including one or more of the entities e.g. devices with camera,
2370 oneM2M platform and service center for surveillance and alarm reaction.

2371 • Service Centre:

2372 The service center provides home surveillance and other corresponding services, e.g. initiating an audio/video
2373 call to the host of the home in case there are intruders or initiating a multimedia conference call for
2374 consultation for a patient.
2375

2376 9.4.4 Pre-conditions

2377 Before the audio/video call could be set up, the following steps are to be taken:

- 2378 • The Devices are configured with the number/address to which an audio/video call can be initiated for
2379 alarm.
- 2380 • The oneM2M system allocates unique identifiers for the devices.
- 2381 • The devices need to be registered in the oneM2M system.

2382 9.4.5 Triggers

2383 None.

2384 9.4.6 Normal Flow

- 2385 1. The device registers in oneM2M system.
- 2386 2. When receiving request towards or from the device for an audio/video call, the oneM2M system
2387 authorizes if the originator is allowed to send the request.
- 2388 3. If it is allowed, the oneM2M system route the message accordingly and create a connection between the
2389 originator and the receiver for real-time audio and video transfer, and even commands for camera control.
- 2390 4. After the communication is completed, the oneM2M system releases the connection and resources.

2391 9.4.7 Alternative Flow

2392 None.

2393

9.4.8 Post-conditions

2394

None.

2395

Not applicable

2396

9.4.9 High Level Illustration

2397

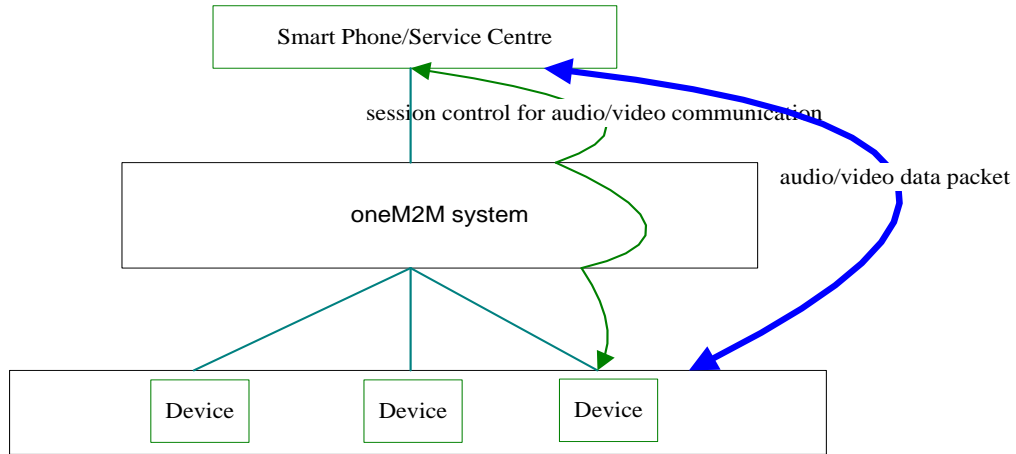

2398

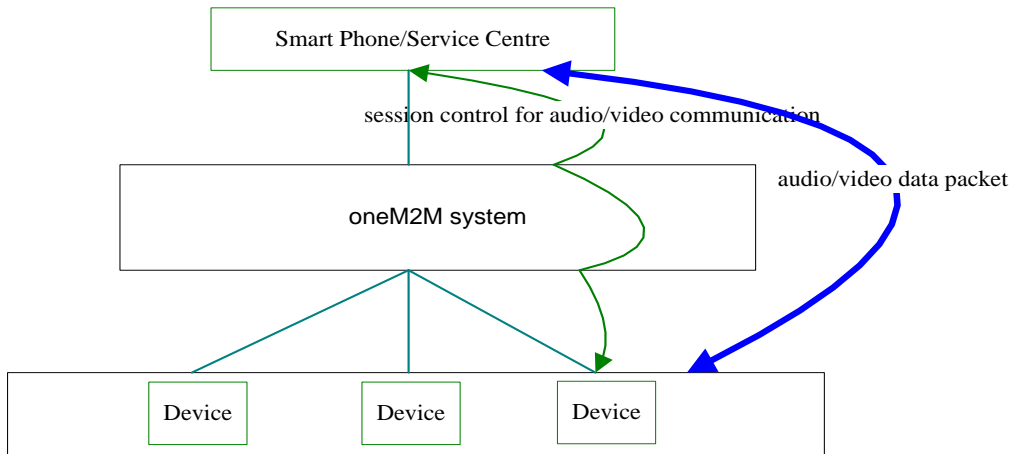

2399

Figure 9-6 High Level Illustration of Real-time Audio/Video Communication

2400

9.4.10 Potential Requirements

2401

1. The oneM2M system shall provide a capability to allocate unique identifiers to devices for identification and session routing in oneM2M system.
2. The oneM2M system shall support to establish and terminate real-time audio/video session between M2M applications.
3. The oneM2M system shall provide a capability for a device to be registered in the system.
4. The oneM2M system shall support authorization if a request to and from the device for real-time audio/video call establishment is allowed.
5. The oneM2M system shall provide a capability for routing a request for real-time audio/video call establishment from or to the device.
6. The oneM2M system shall provide a capability for media control (e.g. negotiation of transcoding, QoS) between the M2M applications for real-time audio/video data packet transmission.

2402

2403

2404

2405

2406

2407

2408

2409

2410

2411

2412

2413

9.5 Event Triggered Task Execution Use Case

9.5.1 Description

Gateway Device may be required to configure for executing some tasks which are triggered by pre-defined events.

9.5.2 Source

oneM2M-REQ-2013-0176R03 Event Triggered Task Exec Use Case .
REQ-2015-0596 Event Trigger Use Case Revise.

9.5.3 Actors

- Management Server,
- Gateway Device which has the characteristic both M2M Gateway (aggregate measured value) and M2M Device (accepting setting change)),
- Thermometer and Air Conditioner (M2M Device)),
- Data Storage Server,
- User

9.5.4 Pre-conditions

- Gateway Device is configured to work as the gateway for collecting data from some sensor devices installed at home network.
- Sensor Devices are configured to accept the management request from Gateway Device which requests reporting measured data on demand.

9.5.5 Triggers

- M2M System is going to configure Gateway Device for scheduling task execution for data collection from sensor devices.

9.5.6 Normal Flow

1. Management Server requests management on scheduling task settings of Gateway Device to fetch the current value of the thermometer, and report collected data from a thermometer (one of the Sensor Devices in this use case) every 30 minutes.
2. Gateway Device establishes the connection to the thermometer, and collects measured data.
3. Gateway Device reports the collected data to Data Storage Server.

9.5.7 Alternative Flow

Alternative Flow 1

1. (after step 2 in normal flow,) Gateway Device stores series of measured data associating with the source Sensor Device.
2. Management Server requests Gateway Device to report the log data which summarize series of measured data by Sensor Devices for one day.

Alternative Flow 2

1. Management Server configures the M2M Application on the Gateway Device to start monitoring energy consumption of Air Conditioner, when the device is turned on, and to stop monitoring when that is turned off.
2. M2M Application on the Gateway Device subscribes requests notification on the power status change of Air Conditioner.
3. When the user turned on the Air Conditioner, the Gateway Device is notified by event **notification** for the status change.
4. M2M Application on the Gateway Device starts monitoring the energy consumption of the Air Conditioner.
5. When User turned off the Air Conditioner, the M2M Application on the Gateway Device is notified the status change.

6. Gateway Device stops monitoring the energy consumption of the Air Conditioner.

Alternative Flow 3

1. Management Server configures the M2M Application on the Gateway Device to report the energy consumption when the total energy consumption exceeded over the 20kW per day.
2. M2M Application on the Gateway Device keeps collecting data about energy consumption from home electronics (i.e. Air Conditioner).
3. When the total energy consumption exceeded over the 20kW per day, the M2M Application on the Gateway sends notify the report to the Data Storage Server.

9.5.8 Post-conditions

Collected data is stored on the Data Storage Server for further use.

9.5.9 High Level Illustration

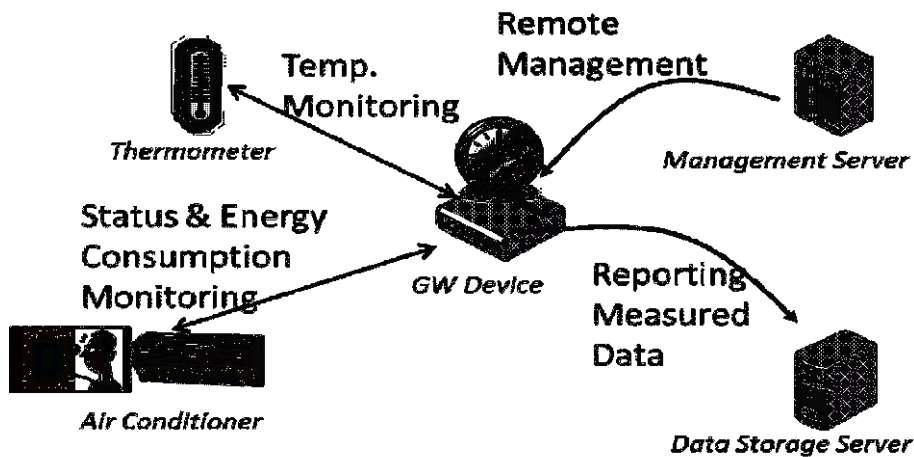
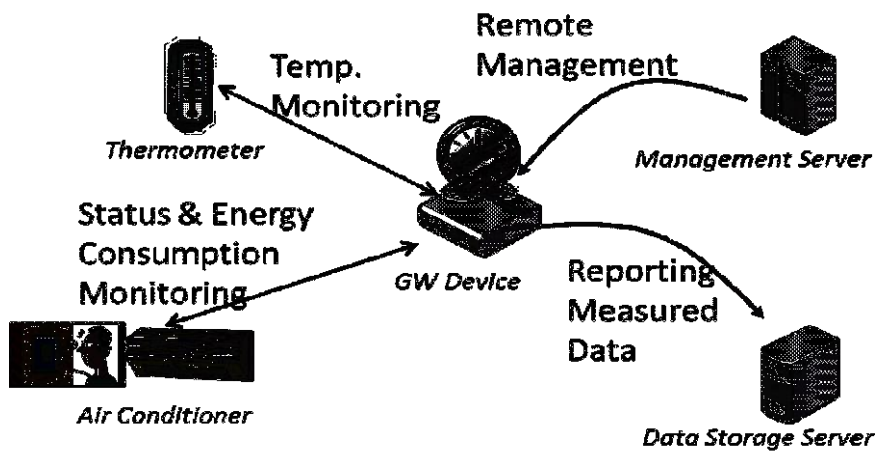

Figure 9-7 Event triggered Task Execution High Level Illustration

9.5.10 Potential Requirements

1. M2M System Shall support timer triggered data collection on M2M Gateway from M2M Device.
2. M2M System Shall support M2M Gateway which reports collection of data measured by M2M Device.
3. M2M System Shall support to start/stop monitoring measured data by M2M Device triggered by status change of M2M Device to be monitored.

- 2484 4. M2M System Shall support conditional report from M2M Gateway which reports measured data by
2485 M2M Device(s). The condition can be expressed as event notification message which is triggered by
2486 M2M Application which is monitoring threshold and/or size of value change.
2487

2488 9.6 Semantic Home Control

2489 9.6.1 Description

2490 This use case demonstrates co-operation between two independent M2M applications. The co-operation is
2491 made possible because one application can find the other application through semantic information about the
2492 application's resources. This semantic information is available in the M2M System.

2493 One application is a building management system (BMS) for a big apartment house. The BMS is operated by a
2494 building manager, e.g. the owner of the apartment house. BMS has knowledge about the blueprints of all the
2495 apartments in the house, e.g. it knows which heater is located in which room (heaters are assumed to be
2496 equipped with temperature sensors/actuators).

2497 The other application is a home energy management system (HEMS). It has been subscribed by the tenant of
2498 one of the apartments. HEMS controls the heaters of the apartment (among other purposes).

2499 Because HEMS can find the resources of BMS - e.g. the resource that represents the tenant's apartment and the
2500 heaters therein HEMS can configure itself automatically (and can adapt to changes over time) and does not
2501 require human configuration.

2502 Finding the right resources in the M2M System is made possible through semantic annotation of the resources

2503 9.6.2 Source

2504 oneM2M-MAS-2013-0020 Semantic use cases from ETSI Semantics TR .

2505 9.6.3 Actors

- 2506 • Building manager: is running a Building management system (BMS) for his apartment house.
- 2507 • Tenant of an apartment: has subscribed to a home energy management system (HEMS) for his apartment.
- 2508 • M2M service provider: is providing access to the M2M System for both applications, BMS and HEMS.
- 2509 • Building management system (BMS): is a M2M network application.
- 2510 • Home energy management system (HEMS): is a M2M network application.
- 2511

2512 9.6.4 Pre-conditions

2513 The Building management system (BMS) is an M2M application that contains all the information needed to
2514 manage a large apartment house. In particular it contains the construction details of the tenant's apartment,
2515 where the doors and windows are located, where the heaters are, their capacity, etc. The BMS is used for
2516 overall control of the building, but information relevant for individual apartments (e.g. control of the heaters,
2517 built-in sensors for windows and doors) can be made available to authorized tenants. In case of fire, the
2518 complete blueprint of the house can be made available to fire-fighters.

2519 In the M2M System the BMS makes its information available as M2M resources, similar to as if they were
2520 data transmitted by a device. E.g. the complete apartment, individual rooms, their heaters and windows could
2521 be represented as M2M resources.

2522 A new tenant is renting an apartment in the house. As he is moving in, he also subscribes to a general-purpose
2523 home energy management system (HEMS) that promised a very efficient heater control. E.g. the HEMS
2524 always uses the best available electricity tariff and the heating is turned off when windows are open.

2525 As part of the subscription, the HEMS is granted access to the respective resources used by the BMS in the
2526 M2M system. In particular, the building manager has permitted access of the tenant's HEMS to those resources
2527 of the BMS that are needed for energy management of the tenant's apartment (rooms, heaters, door-and
2528 window sensors, etc.). Other resources not needed for this task are not exposed to the HEMS.

2529 9.6.5 Triggers

2530 None.

9.6.6 Normal Flow

The newly subscribed HEMS will immediately start discovering new devices in the apartment. Once the BMS has granted access, the HEMS will discover the resources of the BMS that are related to the apartment. Using the semantic description of the devices the HEMS can immediately find out about the available rooms, heaters, temperature sensors, etc. With this knowledge it can configure itself without any human intervention. Since the BMS has configured its devices to be represented in the M2M System as abstract devices, the HEMS can use this information to immediately control the devices using the offered abstract command set. Consequently, HEMS does not have to understand the specifics (e.g. specific protocol) of a particular heater control. Later, the building manager installs a new device into the tenant's apartment which can help in efficient energy management. This new device is also managed by BMS. Using the selection rule of the HEMS service, the new device will get immediately available to the HEMS. The HEMS will discover the new device and will use it to control the apartment's energy consumption.

9.6.7 Alternative Flow

None.

9.6.8 Post-conditions

None.

9.6.9 High Level Illustration

None

9.6.10 Potential Requirements

1. The M2M System shall support a common (e.g. per vertical domain) semantic data model (e.g. represented by Ontology) available to M2M application.
2. The M2M System shall provide discovery capabilities that enable the discovery of M2M resources based on their semantic information, e.g. semantic categories and relationship among them. (e.g. all heaters and windows in a room; the room in which a window is located, etc.).
3. The M2M System shall provide representation and discovery functionality of real-world entities (rooms, windows) that are not necessarily physical devices.
4. The M2M system shall be able to map control commands issued towards an abstract device to the concrete commands of a specific device.

9.7 Semantic Device Plug and Play

9.7.1 Description

This use case applies with any verticals, below just take home automation as an example. The use case is about when a device is newly registered in a home, it will find its own character and its relationship with its neighbour devices and Things automatically based on semantic information within the M2M system without the interference of human being. For example, the house owner bought a lamp and a switch to the lamp for his house. Both the lamp and switch is enabled with wireless abilities to be able to communicate with the home automation gateway and other devices. The lamp is for the lobby and accordingly the switch is located near the entrance of the lobby. When the house owner has placed the lamp and the switch properly, a simple power-on would make the lamp and the switch work fine.

9.7.2 Source

oneM2M-MAS-2013-0020 Semantic use cases from ETSI Semantics TR .

2575

9.7.3 Actors

2576

- Home automation service provider: is providing home automation service by providing applications running on home automation devices such as gateway, lamp, switch, TV, air-condition, etc.

2577

- Home automation management system (HAMS): is a network application.

2578

- Device manufacturer: produces devices as M2M nodes.

2579

- M2M service provider: provides M2M service acts as a platform where all M2M nodes can register to.

2580

- House owner: is a consumer of the home automation service.

2581

2582

9.7.4 Pre-conditions

2583

The house owner has a contract with the home automation service provider for the home automation service.

2584

The home automation service provider has a business relationship with the M2M service provider and the

2585

device manufacturer. The home automation management system manages all the devices and their

2586

relationships registered in the house. Each device has its role and serves fixed services among all home devices.

2587

9.7.5 Triggers

2588

None.

2589

9.7.6 Normal Flow

2590

When the house owner buys new devices for his house, the newly bought devices will register to the M2M service provider and expose to the M2M SP its role and functionalities including their semantic descriptions.

2591

According to such information, the HAMS will compare the semantic description of the new device with the semantic description of the existing devices in the house and judge their relationships by semantic inference.

2592

Then the HAMS will help establish the relationship between the new device and the device in the home and

2593

the relationship is maintained in the M2M SP. For example the HAMS finds that the lamp is to be controlled

2594

by the switch, it may then bind the status of the switch to the action of the lamp. If the status of the switch is

2595

ON, an "ON" command will be sent to the lamp automatically.

2596

2597

2598

9.7.7 Alternative Flow

2599

None.

2600

9.7.8 Post-conditions

2601

None.

2602

9.7.9 High Level Illustration

2603

None.

2604

9.7.10 Potential Requirements

2605

1. The M2M System shall support a semantic data model that is at least common to the vertical industry in which a Thing is used to describe Things registered in the M2M System.

2606

2. The M2M entity shall be able to expose its semantic description to the M2M System.

2607

3. If a Thing is capable to expose semantic information to the M2M System the M2M System shall be able to use that information to represent the Thing.

2608

2609

4. The M2M System shall be able to describe the semantic relationship between Things.

2610

2611

2612

9.8 Triggering in the Field Domain

2613

- void -

2614

NOTE: This use case can be found in oneM2M TR-0013 [i.18].

2615

Source: REQ-2014-0447 Use case for Triggering in Field Domain

2616

2617

2618

2619 10 Retail Use Cases

2620 10.1 Vending Machines

2621 10.1.1 Description

2622 In some situations, vending machine providers need to limit the network access for vending machines based on
2623 their geographic location. The providers do NOT want the vending machine user to move the machine from
2624 the specified area to other locations (potentially for better sales), so that the providers can control the
2625 geographic distribution of their vending machines and make decisions based on data statistics and analysis (e.g.
2626 which are the best-selling areas? How many products are sold in specified areas during specified time? (and so
2627 on).

2628 10.1.2 Source

2629 REQ-2014-0466R05 Use case for vending machine .

2630 10.1.3 Actors

- 2631 • Vending machine, which can automatically sell products and report data information to the application
2632 platform through M2M service platform.
- 2633 • The M2M service platform, which can control the vending machine device and its access to the network .
- 2634 • Vending machine application platform, which can accept the data report from vending machine, monitor its
2635 status, and perform data analysis.

2636 10.1.4 Pre-conditions

2637 The location information of the Vending machine is provided to the M2M Service platform by the Underlying
2638 network.

2639 10.1.5 Triggers

- 2640 • Vending machine restarts and registers to M2M service platform.
- 2641 • Vending machine reports data information (e.g., each sale transaction or products selling information and so
2642 on).

2643 10.1.6 Normal Flow

- 2644 • The vending machine restarts and registers to M2M service platform.
- 2645 • The M2M service platform checks the geographic location policy. If current geographical location of the
2646 vending machine is in the permitted area, it allows the vending machine to register. Otherwise, it denies
2647 access.
- 2648 • After vending machine successfully registers, it reports data information (for example, the product selling
2649 information and the stock information) periodically or for each product sale to the vending machine
2650 application platform through M2M service platform.
- 2651 • The M2M service platform checks the geographic location policy. If the current geographic location of the
2652 vending machine is in the permitted area, it allows for the data report. Otherwise, it will be denied.
- 2653 • The vending machine application platform receives the data information report, records the information and
2654 performs data analysis.

2655 10.1.7 Alternative Flow

2656 None.

2657 10.1.8 Post-conditions

2658 None.

10.1.9 High Level Illustration

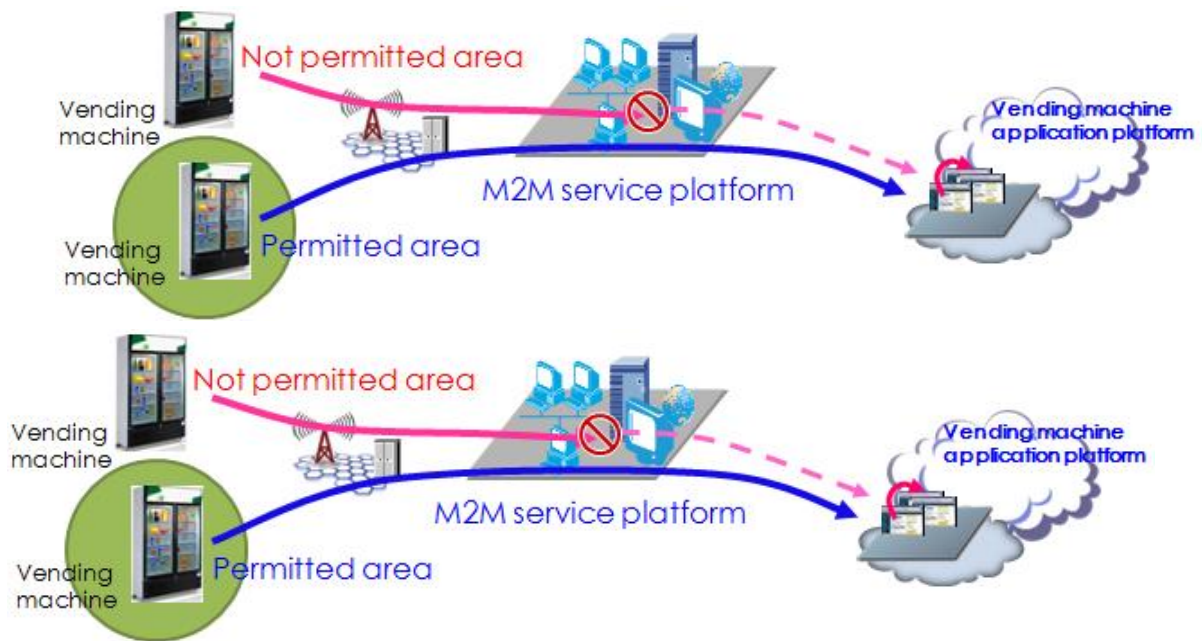

Figure 10-1 High level illustration of Vending Machines use case

10.1.10 Potential Requirements

1. The M2M service platform shall be able to support the geographic location-based network access policy. (see also requirement OSR-047).
2. The M2M service platform shall be able to support a geographical boundary within a network access policy. (see also requirement OSR-047).

11 Transportation Use Cases

11.1 Vehicle Diagnostic & Maintenance Report

- void -

NOTE: This use case can be found in oneM2M TR-0026 [i.21]

Source: oneM2M-REQ-2012-0067R03 Vehicle Stolen and Vehicle Diagnostics.

11.2 Use Case on Remote Maintenance Services

- void -

NOTE: This use case can be found in oneM2M TR-0026 **Error! Reference source not found.**

Source: oneM2M-REQ-2013-0188R06 Use Case Remote Maintenance .

11.3 Traffic Accident Information Collection

- void -

NOTE 1: This use case can be found in oneM2M TR-0026 [i.21] .

Source: oneM2M-REQ-2013-0264R05 Use Case Traffic Accident Information Collection.

2688 Note 2: From ETSI TR 102 638 [i.10].
2689

2690 11.4 Fleet Management Service using DTG (Digital Tachograph)

2691 - void -

2692 NOTE: This use case can be found in oneM2M TR-0026 [i.21].

2693 Source: oneM2M-REQ-2013-0219R01 Use case - Fleet management using DTG .
2694
2695

2696 11.5 Use cases for Electronic Toll Collection (ETC) Service

2697 - void -

2698 NOTE: This use case can be found in oneM2M TR-0026 [i.21]

2700 Sources:

2701 REQ-2014-0431R03 Use cases for Electronic Toll Collection (ETC) service .

2702 REQ-2014-0449R02 Use cases for Electronic Toll Collection (ETC) service .
2703
2704

2705 11.6 Use cases for Taxi Advertisement service

2706 - void —

2707 NOTE: This use case can be found in oneM2M TR-0026 [i.21]

2708 Source: REQ-2014-0467R02 Use case for taxi advertisement.
2709
2710

2711 11.7 Use Case on Vehicle Data Service

2712 - void -

2713 NOTE: This use case can be found in oneM2M TR-0026 [i.21]

2714 Source: REQ-2014-0472R06 Use Case on Vehicle Data Services .
2715
2716
2717
2718

2719 11.8 Smart Automatic Driving

2720 - void -

2721 NOTE: This use case can be found in oneM2M TR-0026 **Error! Reference source not found.**

2722 Source: REQ-2015-0554-Smart Automatic Driving.
2723
2724
2725

2726 11.9 Use Case on Vehicle Data Wipe Service

2727 - void —

2728 NOTE: This use case can be found in oneM2M TR-0026 [i.21]

2729 Source: REQ-2015-0589R04 Use case on vehicle data wipe service
2730
2731
2732

12 Other Use Cases

12.1 Extending the M2M Access Network using Satellites

12.1.1 Description

This Use Case demonstrates a scenario that extends the M2M access network using satellite communications. It serves to emphasize that satellite communication is a key component of the network domain to be incorporated in future requirements work at OneM2M on Smart Metering and other M2M use cases. In locations that are difficult to reach with fixed-line or cellular communications, a machine-to-machine (M2M) satellite solution extends terrestrial coverage and provides access to devices that require remote monitoring and control. Satellite-based communication networks provide communications that integrate seamlessly with any remote IP based application. Satellite networks offer IP connectivity, ubiquitous real time coverage, robust security, high availability compared to cellular networks. Satellite M2M solutions are also much more cost-effective than some years due to advances in satellite technology. Traditional satellite communications has had a stigma of being expensive and requiring large, power-hungry terminals too complex to integrate with applications. Modern satellite networking, however, provides competitive price solutions, ubiquitous coverage, and a high level of availability which compliment terrestrial networks. For this reason, it is important to consider satellite services for Supervisory Control and Data Acquisition (SCADA) applications, low data rate (LDR) solutions, and other remote, unmanned machine-to-machine (M2M) services.

12.1.2 Source

oneM2M-REQ-2012-0061R02 Use Case Smart Metering with Satellite Communications .

12.1.3 Actors

- Service Providers for M2M

12.1.4 Pre-conditions

The following additional functionalities or sub scenarios are explained in a high level format, to relate to electricity, gas, heating, and water.

1. Distribution Automation

Deploying satellite M2M services along power distribution lines, as a supporting link, allows electrical utility providers to connect to their data centers and extend their network reach to the boundaries of their entire service territory, improving decision-making and operational efficiencies. A single, two-way IP data connection provides automated monitoring and control of re-closers, switches, or other distribution devices — anywhere - enabling utility providers to maintain continuous surveillance and control of their distribution network for voltage fluctuations, outages and service demands.

2. Substation Connectivity

M2M Satellite communications provide services for electricity substations in locations that may be difficult to reach with fixed-line or cellular communications.

M2M Satellite communications contains the flexibility to cope with both low-volume high-frequency traffic and bursts of high-volume, low-frequency traffic. If a primary link breaks down, satellite communications can automatically provide backup communications at any substation.

3. Disaster Recovery

Business continuity is vital for utilities that provide essential services such as electricity, water and gas to millions of people as they need to be able to recover immediately from natural or manmade disasters. When a catastrophic event causes terrestrial networks to fail, utilities companies can rapidly deploy satellite terminals to provide an alternative communications path, enabling them to maintain communications, diagnose issues quickly, and run critical applications.

12.1.5 Triggers

The need to access M2M user devices (UDs) that may not be reachable with terrestrial and wireless networks.

2782

12.1.6 Normal Flow

2783

2784

2785

2786

2787

An example of a M2M communication using satellite service is Smart Metering (valves, electricity meter, gas meter, water meter, and heat meter). Smart Metering devices over a small area connect to aggregation points or Smart Meter Concentrators via a local, meshed wireless network. These aggregation points, or concentrators, collect usage data and distribute control data to and from consumers in a limited geographical area, transmitting it back to the utility's data center

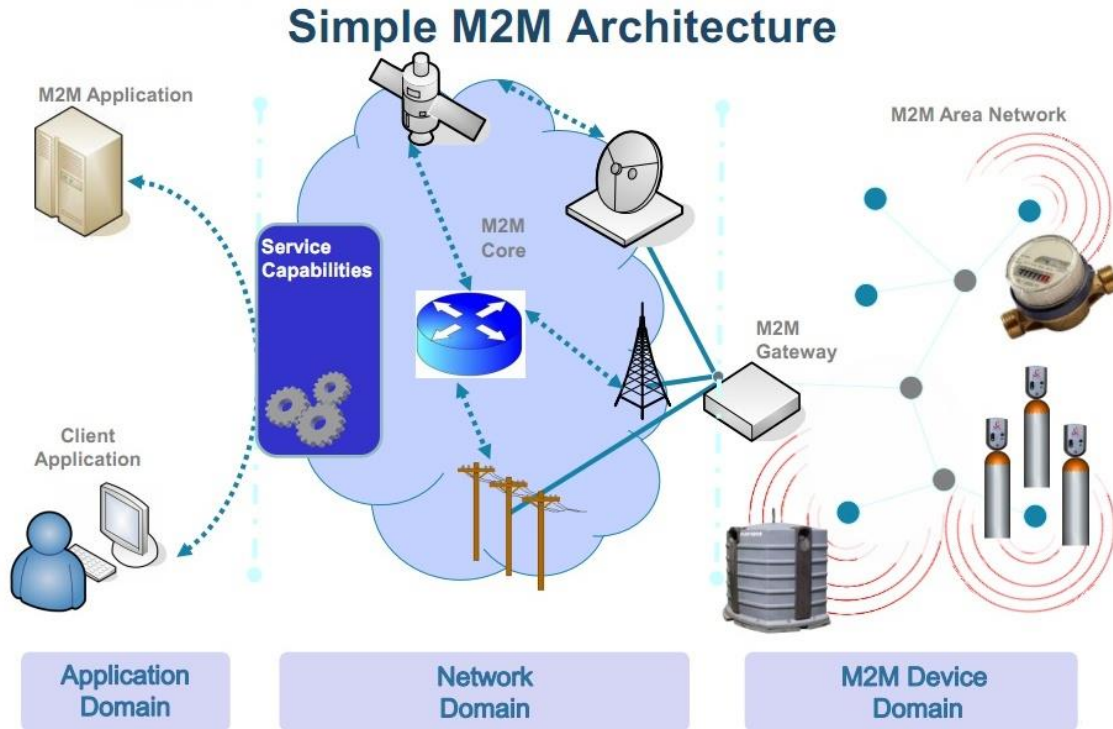

2788

(Figure 12-1).

2789

2790

2791

2792

2793

2794

The satellite connectivity backhauls Smart Meter data from a satellite antenna mounted on an Advanced Metering Infrastructure (AMI) concentrator to the utility's data center. Each AMI concentrator links to multiple smart meters via a local wireless network.

In this configuration example, satellite communications co-locate with the primary gateway communication to aggregate meter data at the gateway, extending the network reach across a utility's entire service.

2795

12.1.7 Alternative Flow

2796

None.

2797

12.1.8 Post-conditions

2798

None.

2799

12.1.9 High Level Illustration

2800

2801

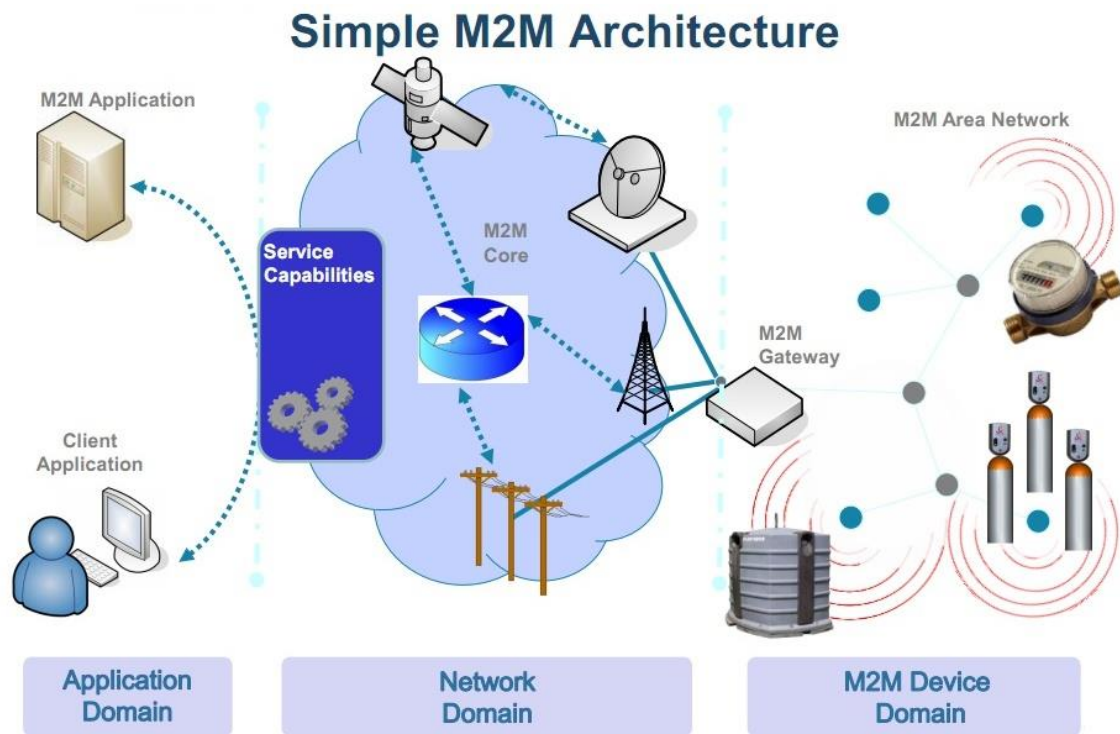

2802
2803 **Figure 12-1 Extended Smart Metering Configuration (source: ETSI)**

2804 12.1.10 Potential Requirements

- 2805 1. Satellite access shall be considered in all M2M network domain architectures.
- 2806
2807
2808

2809 12.2 M2M Data Traffic Management by the Underlying Network Operator

2810

2811 12.2.1 Description

2812 According to the data traffic condition, e.g. current traffic congestion status, in underlying networks, the
2813 underlying network operators (e.g. mobile network operators) would like to manage the M2M data traffic in
2814 their networks in conjunction with M2M service platform and/or M2M application server providers in order to
2815 avoid losing the M2M communication data packets in the networks.

2816 The M2M service platform and/or M2M application server providers will change their configuration such as
2817 data transmission interval or stop sending data over the underlying networks for some duration after receiving
2818 the notification from underlying networks.

2819 This use case illustrates handling of M2M data transmission based on the data traffic condition information of
2820 underlying network and interworking among the M2M service application server, M2M platform and the
2821 underlying network.

2822 12.2.2 Source

2823 oneM2M-REQ-2013-0175R03 Use Case on M2M data traffic management by underlying network operator.

2824

2825 12.2.3 Actors

- 2826 • The M2M application server providing data transmission control according to the data traffic condition of
2827 underlying network.

2828 The application server has functions to receive data traffic condition information from the M2M platforms
2829 and/or the underlying networks, and control M2M data transmissions according to the received
2830 information.

- 2831 • The M2M service platform providing data transmission control according to the data traffic condition
2832 information of underlying networks.
2833 The M2M service platform has functions to receive the data traffic condition information from the
2834 underlying networks, and/or control M2M data transmissions according to the information.
- 2835 • The underlying network providing the data traffic condition information.
2836 The underlying network has functions to send the data traffic condition information to M2M application
2837 servers, M2M service platforms, and/or M2M devices.
2838 The data traffic condition information includes required transmission interval, required maximum data
2839 rate, required maximum data volume, current traffic congestion status, congested network area
2840 information, etc.
- 2841 • The M2M device providing data transmission control according to the data traffic condition information.
2842 The M2M device to receive the data traffic condition information from the underlying networks or M2M
2843 service platforms, and control M2M data transmissions.

2844 12.2.4 Pre-conditions

2845 The underlying network monitors the status of the data traffic, analyse the status, define the traffic condition
2846 and provides the data traffic condition information to M2M application servers, M2M platforms and/or M2M
2847 devices.

2848 12.2.5 Triggers

2849 None.

2850 12.2.6 Normal Flow

2851 Normal Flow 1:

- 2852 1. The mobile network sends the data traffic condition information to the M2M service platform and/or
2853 M2M application server.
- 2854 2. After the M2M service application server receives the data traffic condition information from the
2855 underlying network in step1, and it controls M2M data transmission accordingly.
- 2856 3. After the M2M application service platform receives the data traffic condition information from the
2857 underlying network in step 1 via the M2M service platform, it and controls M2M data transmissions
2858 accordingly.
- 2859 4. The M2M service platform may send M2M data transmission configuration information to the M2M
2860 device.
- 2861 5. After the M2M device may receive M2M data transmission configuration information from the M2M
2862 service platform in step 4, it and may controls M2M data transmissions accordingly.
2863

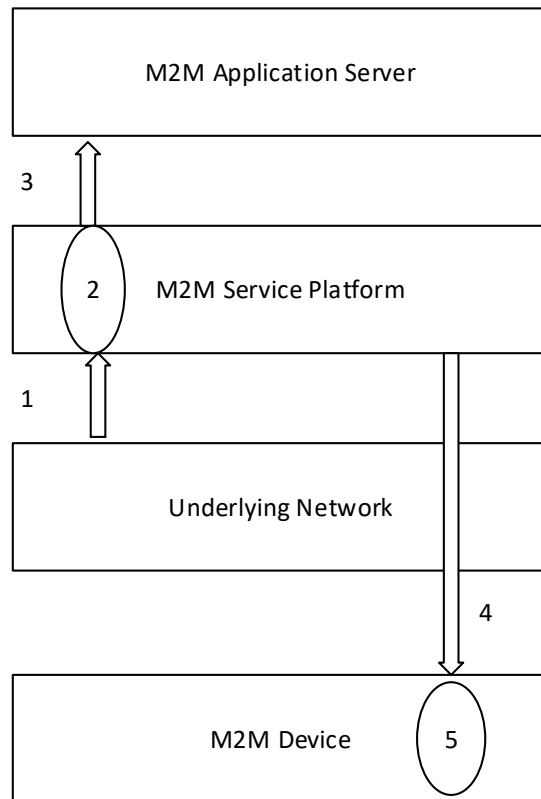
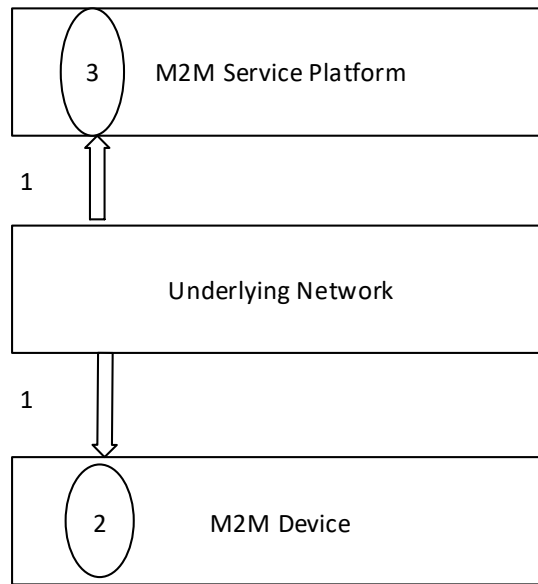

Figure 12-2: Normal Flow 1 of Data Traffic Management by Underlying Network Operator

Normal Flow 2:

1. The underlying mobile network sends the data traffic condition information to the M2M device as well as M2M service platform.
2. Upon receiving the information, the M2M device re-configures the application behaviour, e.g. the interval extension of communication, by M2M service layer capability. The re-configuration profile may be statically stored or can be overwritten by control from the M2M service platform.
3. Upon receiving the information, the M2M service platform controls M2M data transmission accordingly in cooperation with M2M service application server described in step 1 to step 3 in normal flow 1.



2879
2880 **Figure 12-3: Normal Flow 2 of Data Traffic Management by Underlying Network Operator**

2881 **12.2.7 Alternative Flow**

2882 None.

2883 **12.2.8 Post-conditions**

2884 None.

2885 **12.2.9 High Level Illustration**

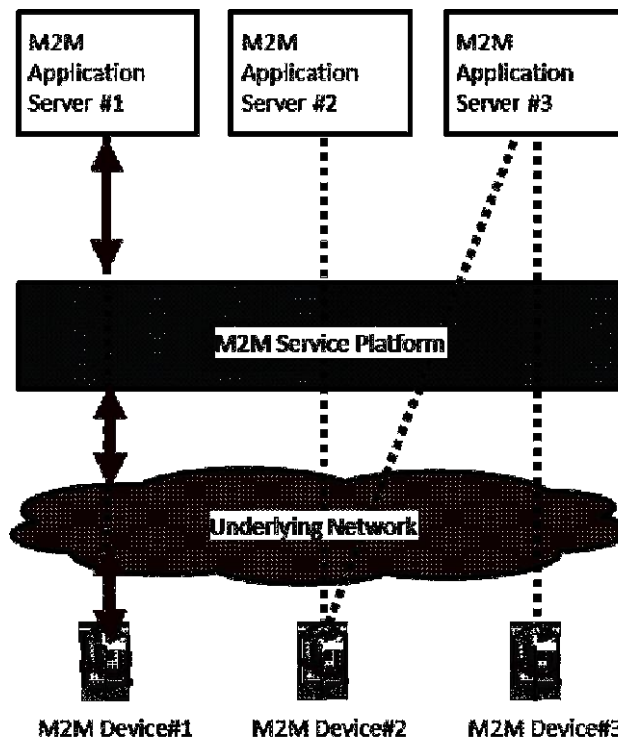

2886
2887 **Figure 12-4: High Level Illustration of Data Traffic Management by Underlying Network Operator**

2888

2889 12.2.10 Potential Requirements

- 2890 1. The M2M service platform SHALL be able to receive the data traffic condition information from the
2891 Underlying network and notify it to the M2M application server. The M2M application server
2892 SHALL be able to control M2M data transmission based on the Underlying Network data traffic
2893 condition.
2894 2. The M2M service platform MAY SHALL be able to control M2M data transmission based on the
2895 Underlying Network data traffic condition.
2896 3. The M2M device SHALL be able to control M2M data transmission based on the Underlying
2897 Network data traffic condition.
2898 4. The M2M device SHALL control M2M application behavior implemented on top of M2M service
2899 layer when the M2M device received notification regarding Underlying Network data traffic
2900 condition from the Underlying Network.
2901
2902

2903 12.3 Optimized M2M interworking with mobile networks 2904 (Optimizing connectivity management parameters)

2905 12.3.1 Description

2906 **Background on the use case and current state in 3GPP.**

2907 M2M Services, due to their nature (generally not involving human conversations), will most likely create much
2908 lower Average Revenue Per User (ARPU) to an Underlying mobile Network than ordinary Human-to-Human
2909 traffic.

2910 Since M2M services, and in particular the oneM2M standard, relies on Underlying Networks (often mobile
2911 networks) the success of M2M will inevitably depend on the fact that M2M traffic in the underlying network
2912 will compete with human-to-human traffic; both, technically (use of resources) and economically (ARPU).

2913 If M2M traffic in the Underlying Network would not be competitive with human-to-human traffic then a
2914 significant sector of M2M services - i.e. those with low ARPU - could not be realized.

2915 To enable economically feasible M2M business e.g. 3GPP seeks to reduce the costs - impact of traffic to the
2916 network and the consumption of radio resources - that M2M devices will create for their networks.

2917 E.g. already as early as in 2008 3GPP has created a first set of requirements on Machine Type
2918 Communications (MTC) in 3GPP TS 22.368 [i.11]. These were finally approved in 3GPP Rel-10 (2010).

2919 However, due to the (at the current point in time) low priority of M2M business for 3GPP Networks only
2920 limited work has been done in 3GPP architecture, radio- and protocol groups until now.

2921 E.g. only 2 out of 4 building blocks: MTCe-SDDTE (Small Data and Device Triggering Enhancements) and
2922 MTCe-UEPCOP (UE Power Consumption Optimizations) have been prioritized by SA2 to be handled in
2923 current 3GPP Rel-12.

2924 SA2 (architecture) normative work can be found in 3GPP TS 23.682 [i.12], the architecture study in TR
2925 3GPP TR 23.887 [i.13].

2926 It is likely that in a few years 3GPP Rel-12/13 networks will be in operation then M2M traffic will have a
2927 significant share in 3GPP networks. Therefore it is crucial that oneM2M expresses its needs and potential
2928 impact to 3GPP now.

2929 OneM2M, representing a high level of expertise in M2M business, needs to actively offer support to 3GPP and
2930 other Underlying Network technologies.

2931 **Overview of the use case**

2932 Many mobile data applications are characterized by transmission of small data packets. Frequent small data
2933 transmission may cause the network load by the mobile terminal changing frequently between idle and

2934 connected state, if the terminal returns to idle mode soon after the data transmission. On the other hand, when
2935 the mobile terminal is kept connected state unnecessarily (if normal operation involves only small data
2936 transmission), it has impact on mobile terminal power consumption and radio resources consumption.

2937 In order to reduce both, the control load related to the state transition and the consumption of radio resources,
2938 the mobile network (e.g. 3GPP) needs to adjust configuration parameters (the connect keep timer, the radio
2939 reception interval, etc.) based on the data transmission interval (frequent or infrequent) of the mobile terminal.

2940 It is important for a mobile network to be informed about a change of data transmission interval of a M2M
2941 device which is handled or monitored on service layer. However, such a change of data transmission interval is
2942 not easily detected by the mobile network.

2943 This use case illustrates detection of a change of data transmission interval on service layer and notification to
2944 the mobile network by interworking between the M2M service platform and the mobile network.

2945 12.3.2 Source

2946 oneM2M-REQ-2013-0231R02 Use Case on Mobile Network interworking-connectivity .

2947 12.3.3 Actors

- 2948 • An M2M Application, hosted on an application server, provides services for creating flood warnings by
2949 making use of (and communicating with) an M2M Device that is measuring water levels of a river:
 - 2950 ○ If the M2M Application detects that the water level becomes hazardous by the measurement data
2951 of the M2M device it sends a request to change the communication mode (normal->abnormal) to
2952 the M2M device (the water sensor), and sends current data transmission interval (frequent
2953 communication) of the M2M device to the M2M service platform.
 - 2954 ○ The data transmission interval includes interval level (normal or frequent), interval value (5 min,
2955 30 min, 1 h) etc.
- 2956 • The M2M service platform provided by the M2M service provider:
 - 2957 ○ The M2M service platform has functions to get the data transmission interval from the application
2958 server, analyse the information to detect the change of the transmission interval of the M2M
2959 device and send the current data transmission interval of the M2M device to the mobile network
2960 if any changes are discovered.
- 2961 • The mobile network provided by the mobile network operator:
 - 2962 ○ The mobile network has functions to get the current data transmission interval of the M2M device
2963 from the M2M service platform and inform the mobile network about it.
- 2964 • The M2M device:
 - 2965 ○ The M2M device (the water level sensor) has functions to collect the measurement data and send it
2966 the application server.
 - 2967 ○ The M2M device has two communication modes:
 - 2968 ▪ The normal communication mode (the water level is within a safe range): the data
2969 transmission interval is infrequent (e.g. once an hour).
 - 2970 ▪ The abnormal communication mode (the water level exceeds the normal range (hazards)):
2971 the data transmission interval is frequent (e.g. every minute).
 - 2972 ○ The M2M device has function to change into abnormal communication mode (the data
2973 transmission interval is frequent) by a request to change the communication mode (normal-
2974 >abnormal) from the application server.

2975 12.3.4 Pre-conditions

- 2976 • The water level of the river is safe. It means the data transmission interval of the M2M device (the sensor) is
2977 infrequent (the communication mode is normal).
- 2978 • The configuration parameters of the mobile network about the M2M device:
 - 2979 ○ The connection keep time: Short.

2980 12.3.5 Triggers

2981 The water level of the river changes to hazardous through heavy rain. It means the data transmission interval
2982 changes to frequent (the communication mode is abnormal) from normal (the communication mode is normal).

12.3.6 Normal Flow

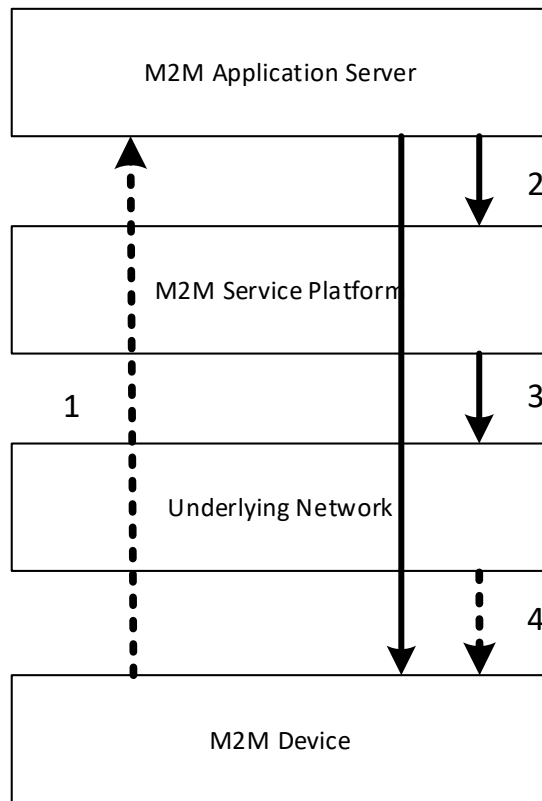

Figure 12-5 Normal Flow - Optimizing connectivity management parameters

1. The application server checks the measurement data from the M2M device (the water sensor).
2. If the application server detects that the water level becomes hazardous by the measurement data, sends a request to change the communication mode (normal->abnormal) to the M2M device (the water sensor), send current communication interval (frequent) of the M2M device to the M2M service platform.
3. The M2M service platform detects the change of the data transmission interval (infrequent->frequent) of the M2M device based on the current communication interval (frequent), and sends the current data transmission interval of the M2M device to the mobile network.
4. The mobile network adjusts configuration parameters of the mobile network about the M2M device based on the current data transmission interval of the M2M device if necessary.
E.g. the configuration parameters of a 3GPP network may include the connection keep time (e.g. the inactivity timer, the idle (dormant) timer), the radio reception interval (e.g. the DRX (discontinuous reception) timer) etc.

12.3.7 Alternative Flow

None.

12.3.8 Post-conditions

The configuration parameters of the mobile network about the M2M device.

- The connection keep time :Long

3006

12.3.9 High Level Illustration

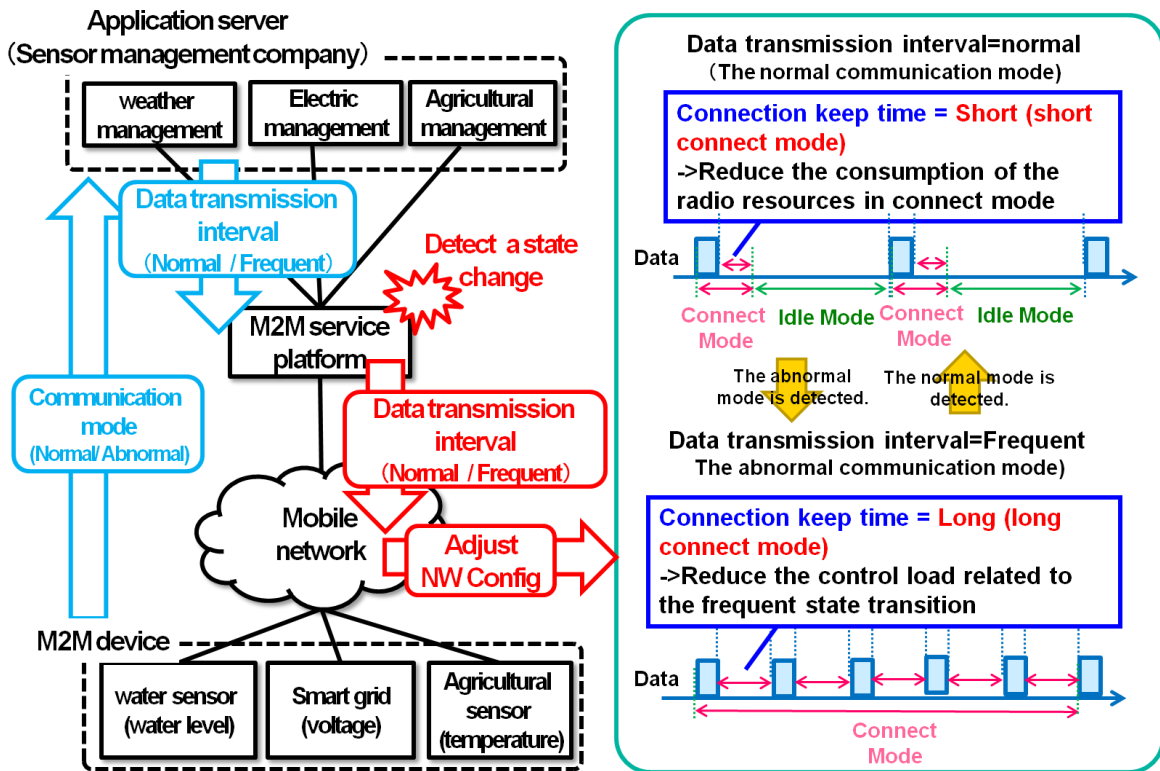

3007

3008

3009

3010

Figure 12-6 High Level Illustration - Optimizing connectivity management parameters

3011

12.3.10 Potential Requirements

3012

3013

3014

3015

3016

3017

3018

3019

3020

3021

3022

3023

3024

3025

- The M2M service platform SHALL be able to provide the Underlying Network with information related to M2M devices that allows optimizations in the Underlying Network with regard to M2M traffic:
 - An example of such useful information to a cellular network is the current (or change of the) set of data transmission scheduling descriptors including interval times (5min, 30 min, 1h), time ranges (10pm-6pm) etc. of the M2M Device .
 - How to utilize such information by the cellular network is the cellular operator implementation dependent and outside the scope of oneM2M.
- The M2M service platform MAY be able to compute the information with which the Underlying Network should be provided by analysing the information received from the M2M application before providing to the Underlying Network.
 NOTE: The interface to convey such information to the Underlying Network will depend on the type (e.g. 3GPP, 3GPP2, fixed) of the Underlying Network.

3026

12.4 Optimized M2M interworking with mobile networks (Optimizing mobility management parameters)

3027

3028

12.4.1 Description

3029

Background on the use case and current state in 3GPP.

3030 M2M Services, due to their nature (generally not involving human conversations), will most likely create much
3031 lower Average Revenue Per User (ARPU) to an Underlying mobile Network than ordinary Human-to-Human
3032 traffic.

3033 Since M2M services, and in particular the oneM2M standard, relies on Underlying Networks (often mobile
3034 networks) the success of M2M will inevitably depend on the fact that M2M traffic in the underlying network
3035 will compete with human-to-human traffic; both, technically (use of resources) and economically (ARPU).

3036 If M2M traffic in the Underlying Network would not be competitive with human-to-human traffic then a
3037 significant sector of M2M services - i.e. those with low ARPU - could not be realized.

3038 To enable economically feasible M2M business e.g. 3GPP seeks to reduce the costs - impact of traffic to the
3039 network and the consumption of radio resources - that M2M devices will create for their networks.

3040 E.g. already as early as in 2008 3GPP has created a first set of requirements on Machine Type
3041 Communications (MTC) in 3GPP TS 22.368 [i.11]. These were finally approved in 3GPP Rel-10 (2010).

3042 However, due to the (at the current point in time) low priority of M2M business for 3GPP Networks only
3043 limited work has been done in 3GPP architecture, radio- and protocol groups until now.

3044 E.g. only 2 out of 4 building blocks: MTCe-SDDTE (Small Data and Device Triggering Enhancements) and
3045 MTCe-UEPCOP (UE Power Consumption Optimizations) have been prioritized by SA2 to be handled in
3046 current 3GPP Rel-12.

3047 SA2 (architecture) normative work can be found in 3GPP TS 23.682 [i.12], the architecture study in 3GPP TR
3048 TR 23.887 [i.13].

3049 It is likely that when 3GPP Rel-12/13 networks will be in operation then M2M traffic will have a significant
3050 share in 3GPP networks. Therefore it is crucial that oneM2M expresses its needs and potential impact to 3GPP
3051 now.

3052 OneM2M, representing a high level of expertise in M2M business, needs to actively offer support to 3GPP and
3053 other Underlying Network technologies.

3054

3055 **Overview of the use case**

3056 For optimizing traffic handling it is important for a mobile network to know about the mobility characteristics
3057 (e.g. low mobility) of a M2M device to adjust configuration parameters (the traffic (paging) area, the location
3058 registration interval, etc.). Such mobility characteristics are not easily detected by the mobile network itself but
3059 depend on the M2M service and need to be provided by the service layer.

3060 Currently e.g. the assumption in 3GPP is that such mobility characteristics are relatively static and do not
3061 change for the device. However in reality one and the same device (e.g. device in a car) may at one time be
3062 stationary — low mobility characteristics when the car is parked — and at other times be mobile — high
3063 mobility characteristics when driving.

3064 Therefore it becomes important for the mobile network to be informed about mobility characteristics (and
3065 changes of it) of a M2M device. However such information can only be provided on service layer and not by
3066 the mobile network itself.

3067 This use case illustrates detection of a change of mobility characteristics on service layer (through the M2M
3068 Application) and notification (through the oneM2M Service Capabilities) to the mobile network by
3069 interworking between the M2M service platform and the mobile network.

3070

3071 12.4.2 Source

3072 oneM2M-REQ-2013-0137R02 Use Case on Mobile Network interworking-mobility .

3073 12.4.3 Actors

3074 • The application server providing an application for a fleet management company.

3075 The application server has functions to get the mobility related M2M information from the M2M device
3076 and send the current mobility characteristics based on the mobility related M2M information to the M2M
3077 service platform.

- 3078 • The M2M service platform provided by the M2M service provider.
3079 The M2M service platform has functions to get the current mobility characteristics from the application
3080 server, analyse the information to detect the change of the mobility characteristics of the M2M device
3081 based on the current mobility characteristics and send the current mobility characteristics of the M2M
3082 device to the mobile network if any changes are discovered.
3083 The mobility characteristics include mobility status (high mobility, low mobility, no mobility), direction
3084 and speed, etc.
- 3085 • The mobile (transport) network provided by the mobile network operator.
3086 The mobile network has functions to get the current mobility characteristics of the M2M device from the
3087 M2M service platform and adjust the configuration parameters of the mobile network about the M2M
3088 device based on the current mobility characteristics of the M2M device.
3089 The configuration parameters of the mobile network include the traffic (paging) area, the location
3090 registration interval, etc.
- 3091 • The M2M device.
3092 The M2M device has functions to collect the mobility related M2M information from sensors within the
3093 vehicle and send it to the application server.
3094 The mobility related M2M information includes engine on/off, navigation system on/off, and GPS data,
3095 etc.

3096 12.4.4 Pre-conditions

3097 An M2M Application, hosted on an application server, provides services for fleet management by making use
3098 of (and communicating with) an M2M Device that is mounted on a vehicle of the fleet.

- 3099 • The vehicle is running on the road. It means the mobility characteristics of the M2M device (the
3100 vehicle) is high mobility (the engine is on).
- 3101 • The configuration parameters of the mobile network about the M2M device:
 - 3102 ○ The traffic (paging) area: Wide.
 - 3103 ○ The location registration interval: Short.

3104 12.4.5 Triggers

3105 The vehicle stops at a parking lot. It means the mobility characteristics of the M2M device (the vehicle)
3106 changes from high mobility (the engine is on) to no mobility (the engine is off).

3107 12.4.6 Normal Flow

3108
3109

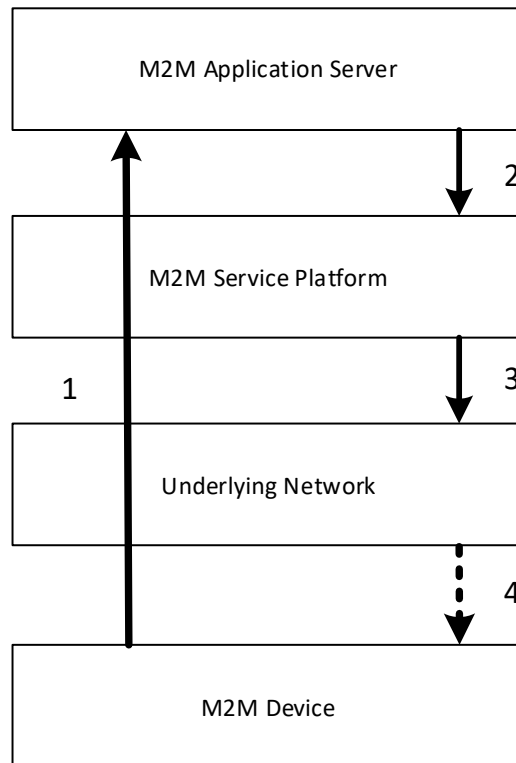

Figure 12-7 Normal Flow - Optimizing mobility management parameters

1. The M2M device collects the mobility related M2M information (the engine is off) from sensors within the vehicle and sends it to the application server.
2. The application server gets the mobility related M2M information of the M2M device (the vehicle) and sends the current mobility characteristics (high mobility) based on the mobility related M2M information to the M2M service platform.
3. The M2M service platform detects the change of the mobility characteristics (high mobility->no mobility) of the M2M device based on the current mobility characteristics (high mobility), and sends the current mobility characteristics of the M2M device to the mobile network.
4. The mobile network adjusts configuration parameters of the mobile network about the M2M device based on the current mobility characteristics of the M2M device if necessary:
 - The changed configuration parameters of the mobile network are the traffic area (Wide->Small), the location registration interval (Short->Long).
 - The mobile network may additionally need to adjust configuration parameters in the mobile M2M device.

12.4.7 Alternative Flow

None.

12.4.8 Post-conditions

The configuration parameters of the mobile network about the M2M device:

- The traffic (paging) area: Small.
- The location registration interval: Long

3134

12.4.9 High Level Illustration

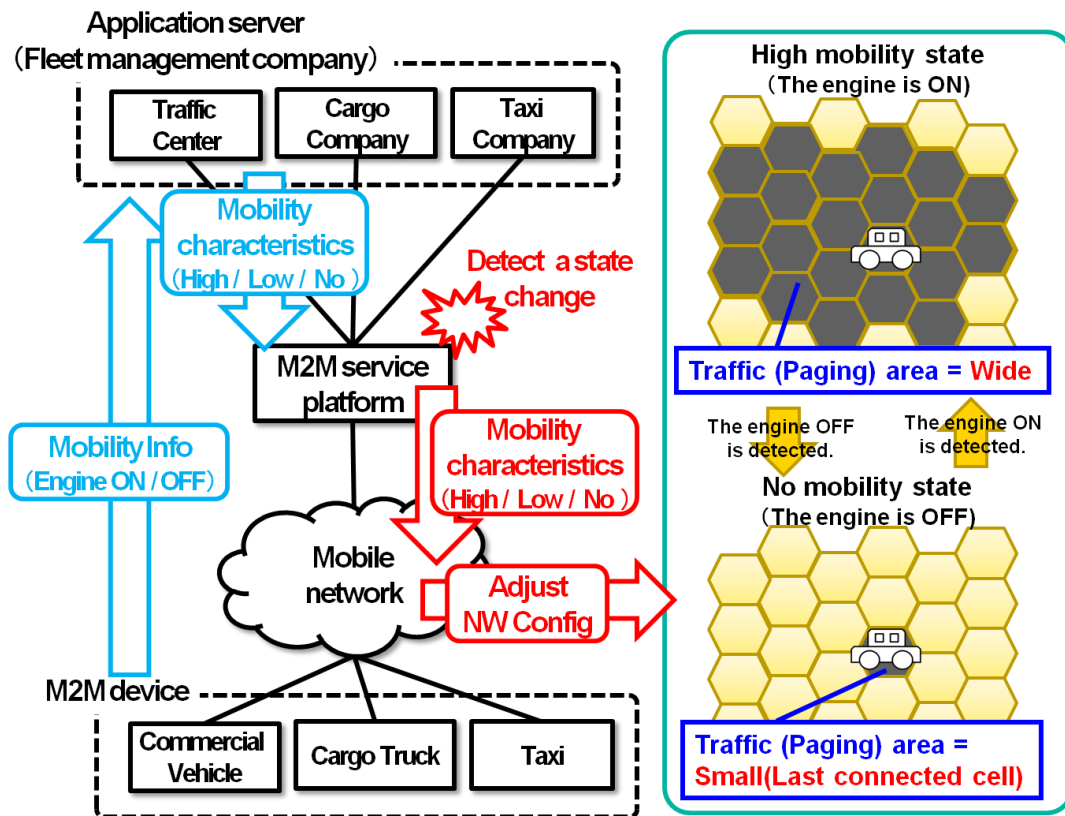

3135

3136

3137

Figure 12-8 High Level Illustration - Optimizing mobility management parameters

3138

3139

12.4.10 Potential Requirements

3140

3141

3142

3143

3144

3145

3146

3147

3148

3149

3150

3151

3152

3153

3154

1. The M2M service platform SHALL be able to provide the Underlying Network with information related to M2M devices that allows optimizations in the Underlying Network with regard to M2M traffic :
An example of such useful information to a cellular network is the current (or change) of the mobility characteristics include moving range (e.g. high mobility, low mobility, no mobility, or speed range), moving direction and moving speed, etc. of the M2M device.
2. How to utilize such information by the cellular network is the cellular operator implementation dependent and outside the scope of oneM2M.
3. The M2M service platform MAY be able to compute the information with which the Underlying Network should be provided by analysing the information received from the M2M application before providing to the Underlying Network.
NOTE: The interface to convey such information to the Underlying Network will depend on the type (e.g. 3GPP, 3GPP2, Fixed) of the Underlying Network.

3155

12.5 Sleepy Nodes

3156

12.5.1 Description

3157

3158

3159

Many e-Health applications involve the use of medical devices which may be connected to a monitoring service. The device user or the user's care providers may periodically need to observe measurements or interact with the device to optimize treatment.

3160 Communications capabilities with multiple entities may be required. For example, communications may be
3161 needed between the device and a service/application that collects and analyses the monitored information. In
3162 another application communications to allow some control over the device. In one such case the
3163 communications may be between the device and the user's care provider(s) and in another case the
3164 communication may be with the device manufacturer. Short range communications capability that operates
3165 through other devices such as Smartphone or home gateway is assumed to conserve battery life.
3166 One example of such a device is a diabetes management system that includes an insulin pump and a blood
3167 glucose monitor.
3168 An insulin pump is used to deliver the insulin. Two types of insulin are commonly used one is fast acting the
3169 other slow. The fast acting is usually administered in conjunction with a meal, while the slow acting is used
3170 throughout the day.
3171 When and how often the blood glucose level monitor needs to take a reading varies with the daily routine as
3172 well as the user's condition.
3173 The need to report the monitored information could vary from an instantaneous reading ordered by the user's
3174 care provider to a record of readings at varying intervals over different time periods.
3175 Usually, the monitored information is stored on the device for a period of time before being periodically
3176 downloaded. In some cases, the data is sent to a monitoring service, which may perform analysis of the
3177 information in preparation for reporting to the user's care providers.
3178 This device can automatically operate the above mentioned functions when needed. Programming of some of
3179 these functions can be varied depending on the condition of the user. Sometimes during a daily routine
3180 automated operation is preferred (e.g. while traveling or sleeping). Automation is more important for some
3181 device users, such as infants, which cannot operate the device manually.
3182 Occasionally, there may be a need to download new firmware to a device to correct a software problem or
3183 provide new programming.
3184 The proper functioning of the device is important to maintaining the user's health. The device needs to be
3185 operational when needed (i.e. reliable). Optimizing the devices battery life contributes to its reliable
3186 functioning. To maximize the life of the device's battery requires putting certain of its functions to sleep for
3187 different time intervals (i.e. sleep cycles) when not needed.
3188 Sleep mode device handling is a fundamental issue/requirement for the M2M system. Although there are
3189 several requirements in this domain, currently there is no use case clearly addressing this functionality.

3190 12.5.2 Source

3191 oneM2M-REQ-2013-0261R03 Sleepy Node Use Case .

3192 12.5.3 Actors

3193 • Sleepy Node (SN)

3194 A device that spends a large amount of its lifetime disconnected from the network, mainly to save power,
3195 or just because it is not capable of storing the energy required for its reliable operation. The device wake
3196 up may be based on a variety of methods including but not restricted to: local physical interrupts or
3197 triggers, alarms, notifications, etc.

3198 Sleepy node devices may own and host a set of resources that need to be made available to the other
3199 network participants as if it were a typical, always connected device. In some cases low-power, low-range
3200 communication technologies (e.g. ZigBee® or Bluetooth®) may be used to establish connections with
3201 relays or gateways capable of longer-range communication (e.g. the user's home Wi-Fi router or
3202 smartphone). In this use case several devices used for medical treatment (e.g. insulin pump and blood
3203 glucose monitor) embody sleepy node functionality.

3204 • Medical Device Monitoring & Management Service (MDMMS)

3205 This service periodically collects medical information from the user's monitoring device. Such a service
3206 usually provides analysis of the device information for use by medical professionals (e.g. user's care
3207 providers). This service can also initiate communication with the device (to send it a command, to re-
3208 program it, to update its firmware, etc.). Additional services could be provided to other actors through the
3209 collection and analysis of additional information such as device reachability, connection and
3210 synchronization requirements, battery status, etc.

3212 • Care Provider (CP)

3213 Care Providers refers to medical professionals responsible for evaluating and directing treatment for an
3214 illness or disease. In this use case the Care Providers are M2M Application Service Providers that interact
3215 with the user's medical device. The Care Providers require access to the data provided by the device as
3216 well as to applications and functions residing on the device.

- Medical Device Manufacturer (MDM)
The medical device manufacturer will occasionally require to access and control the device to, for example, download a firmware update or to re-program the device.

12.5.4 Pre-conditions

In this use case the user (e.g. patient) is assumed to be wearing a medical device that operates as a Sleepy Node. However, other similar use cases may involve a medical device that has been surgically implanted within the user, which places an even higher degree of emphasis on its power conservation characteristics. The device has been provisioned for communication using the oneM2M System and is capable of establishing a data connection for communicating with the MDMMS.

12.5.5 Triggers

A variety of triggers might be associated with the overall use case:

- Scheduled transfer of information from SN to MDMMS
- Command from MDMMS to SN (initiated by CP)
- Alarm condition at SN requiring interaction with MDMMS
- Update of SN firmware (by MDMMS or MDM)
- Status update or servicing of the SN (by CP, MDMMS or MDM)

To be noted: triggers for device wake up are different than the use case triggers and may be based on a variety of methods such as: local physical interrupts or triggers, alarms, notifications, etc. Communications between SN and the MDMMS may be triggered by either entity.

12.5.6 Normal Flow

A. Initial setup of SN to MDMMS communications

- 1) The device is first installed /powered up.
- 2) Network connectivity with the oneM2M System will be established.
- 3) Communications between SN and MDMMS are initiated by either entity, depending on individual requirements. Device, capability, service, subscription, user, etc. information is exchanged.
- 4) The SN and MDMMS may exchange SN specific information such (power cycles, allowable communication wake-up triggers, etc.).
- 5) The device may receive commands from the MDMMS.
- 6) The device completes any received commands and communicates status as appropriate.
- 7) The device returns to a sleep state.

B. SN to MDMMS transfer of information

- 8) The device wakes up from a sleep cycle. The wake up may occur based on any number of asynchronous events.
- 9) The device initiates communication with the MDMMS. Because the device has been in a sleep condition that does not support any network connectivity, it is possible that a data connection with the oneM2M System will need to be re-established.
- 10) Once a data connection is established, the device transfers its accumulated information payload to the MDMMS.
- 11) The device may receive commands from the MDMMS that are either sent directly during the established communication session or have been sent previously and stored in an intermediate node.
- 12) The device completes any received commands and communicates status as appropriate.
- 13) The device returns to a sleep state.

C. Command from MDMMS to SN

- 14) Care Provider initiates command to the device (e.g. change in insulin delivery rate) via MDMMS.
- 15) MDMMS may schedule delivery of the command based on any relevant scheduling information (such as service and application requirements, notification types, network congestion status, SN power cycle status, SN reachability, etc.). Several commands may be aggregated, ordered or queued and delivered to the SN or an intermediary node.
- 16) Command(s) are delivered by the intermediary node or MDMMS to the SN after its wake up.
- 17) The device completes any received commands and communicates status as appropriate.
- 18) The device returns to a sleep state.

D. Alarm condition at SN requiring interaction with MDMMS

- 19) The device wakes up outside of its sleep cycle due to an alarm condition (e.g. blood glucose levels below a predetermined threshold).

- 3273 2. 20)The device initiates communication with the MDMMS. Because the device has been in a sleep
3274 condition that does not support any network connectivity, it is possible that a data connection with the
3275 oneM2M System will need to be re-established.
3276 3. 21)Once a data connection is established, the device communicates the alarm condition to the
3277 MDMMS.
3278 4. 22)The device may receive commands from the MDMMS that are either sent directly during the
3279 established communication session or have been sent previously and stored in an intermediate node.
3280 5. 23)The device completes any received commands and communicates status as appropriate, but
3281 also maintains the communication session until the alarm condition is cleared or otherwise resolved.
3282 6. 24)The device returns to a sleep state.
- 3283 E. Update of SN firmware
3284 1. 25)MDMMS is notified by MDM that the device firmware must be updated.
3285 2. 26)MDMMS schedules the firmware update.
3286 3. 27)The device wakes up and receives a notification that firmware update is requested. This may
3287 require additional action by the user (e.g. plugging the device into a power source during the update
3288 process) and by the MDMMS to establish a communication channel between the MDM and the
3289 device to perform the data transfer and/or execute the update process.
3290 4. 28)The device returns to a sleep state.
- 3291 F. SN status update or servicing
3292 1. 29)Various SN status and/or parameters (battery status, reachability state, etc.) are requested via
3293 MDMMS .
3294 2. 30)MDMMS notifies the SN.
3295 3. 31)The device initiates communication with the MDMMS. Because the device has been in a sleep
3296 condition that does not support any network connectivity, it is possible that a data connection with the
3297 oneM2M System will need to be re-established.
3298 4. 32)Upon device wake up .
3299 G. The device returns to a sleep state

3300 12.5.7 Alternative Flow

3301 None.

3302 12.5.8 Post-conditions

3303 In most cases, the SN will resume sleep as detailed in the flow clause, but the state of wakefulness is
3304 determined by other factors such as device, application, service or subscription requirements.

3305 12.5.9 High Level Illustration

3306 None.

3307 12.5.10 Potential Requirements

3308 The following is a list of previously submitted requirements with impact on SN functionality, which is now re-
3309 submitted for consideration for this scenario.

3310 **Table 12-1**

Temporary requirement number.	Submitted requirement number	Initial submitter	Requirement
SNR-001	HLR-118	Telecom Italia	The M2M System may be aware of the reachability state of the Applications.
SNR-002	HLR-024	Telecom Italia	The M2M System shall be able to support a variety of different M2M Devices/Gateways types, e.g. active M2M Devices and sleeping M2M Devices, upgradable M2M Devices/Gateways and not upgradable M2M Devices/Gateways.
SNR-003	HLR-055	Telecom Italia	The M2M System should support time synchronization. M2M Devices and M2M Gateways may support time synchronization. The level of accuracy and of security for the time synchronization can be system specific.
SNR-004	HLR-114	Telecom Italia	The M2M System shall support testing the connectivity towards a selected set of Applications at regular intervals

			provided the Applications support the function.
SNR-005	HLR-095	Fujitsu	The M2M System shall be able to support a mechanism for delaying notification of Connected Devices in the case of a congested communication network.
SNR-006	HLR-096	Fujitsu	The M2M System shall be able to support a mechanism to manage a remote access of information from other Connected Devices. When supported the M2M system shall be able to aggregate requests to perform the request depending on a given delay and/or category e.g. the M2M application does not have to connect in real time with the devices.
SNR-007	HLR-097	Telecom Italia	The M2M System may support a mechanism for delaying notifying a Connected Objects.
SNR-008	HLR-098	Telecom Italia	The M2M System may support a mechanism to manage a remote access of information from Applications and shall be able to aggregate requests and delay to perform the request depending on a given delay and/or category.
SNR-009	HLR-115	Telecom Italia	The Applications and their resources operational status shall be monitorable.
SNR-010	HLR-161	Alcatel Lucent, Huawei	The M2M System shall be capable of retrieving information related to the environment (e.g. battery, memory, current time) of a M2M Gateway or Device

NOTE: The following lists capture agreed requirements related to Sleepy Node functionality

Requirements TS content related to Sleepy Node functionality

OSR-002

The M2M system shall support communication means that can accommodate devices with constrained computing (e.g. small CPU, memory, battery) or communication capabilities (e.g. 2G wireless modem, certain WLAN node) as well as rich computing (e.g. large CPU, memory) or communication (e.g. 3/4G wireless modem, wireline) capabilities.

OSR-013

The M2M System shall be aware of the delay tolerance acceptable by the M2M Application and shall schedule the communication accordingly or request the underlying network to do it, based on policies criteria.

OSR-015

The M2M system shall support different communication patterns including infrequent communications, small data transfer, large file transfer, streamed communication.

MGR-001

M2M System shall support management and configuration of resource constrained devices.

Other agreed requirements related to Sleepy Node functionality

(HLR-005)

The M2M System shall support M2M applications accessing the M2M system by means of a non-continuous connectivity.

(HLR-006)

The M2M System shall be able to manage communication towards a device which is not continuously reachable.

(HLR-047)

The M2M System shall be able to manage the scheduling of network access and of messaging.

(HLR-137)

The M2M System shall provide the capability to notify M2M Applications of the availability of, and changes to, available M2M Application/management data on the M2M Device/Gateway, including changes to the M2M Area Network.

12.6 Use Case on Collection of M2M System data

12.6.1 Description

M2M Service Providers have a need to provide the Application Service Providers with data and analysis related to the behavior of the M2M System as well as the service provider supplied components of the M2M System (e.g. Device Gateway) M2M Operators face two problems.

M2M Service Providers can utilize the methods of Big Data by collecting M2M System data for the behavior of the M2M System as well as data from M2M System components provided by the Service Provider.

In this scenario, the data is collected from M2M Gateways and Devices provided by the M2M Service Provider. The M2M System data that is collected from the M2M Devices and Gateways can be described as:

- M2M System Behavior
- Component Properties

M2M System Behavior: Data related to the operation of the M2M Applications within the M2M System. Types of data that is to be collected includes information related Messages transmittal and reception (e.g. bytes, response times, event time).

Component Properties: Data related to the Service Provider supplied components as the component is in use by the M2M System (e.g. location, speed of the component, other anonymous data).

With this data, the M2M Service Provide can provide:

1. Analysis of the data without knowledge of content of the Application's data.
2. Insights into the operation of the M2M Applications. For example, the M2M Service Provider can infer the "correct" state of the application or the network status changes, by the analysis of the data, and then trigger some kinds of optimization mechanisms.

12.6.2 Source

oneM2M-REQ-2013-0279R04 Collection of non-application data .

12.6.3 Actors

- Front-end data-collection equipment (e.g. M2M Devices and Gateways)
- Management Platform (e.g. M2M Service Provider's Platform)
- Monitor Center (e.g. M2M Application's Platform)
- M2M System Data Collection Center

12.6.4 Pre-conditions

None.

12.6.5 Triggers

- Time trigger: collecting data at a specific time
- Position trigger: collecting data when position changed
- Behavior trigger: collecting data when certain behavior happened

12.6.6 Normal Flow

1. The M2M Device and Gateway collects M2M System data.
2. Once a trigger is activated, the M2M Devices and Gateway sends the M2M System data to the M2M System Data Collection Center.

12.6.7 Alternative Flow

None.

12.6.8 Post-conditions

None.

12.6.9 High Level Illustration

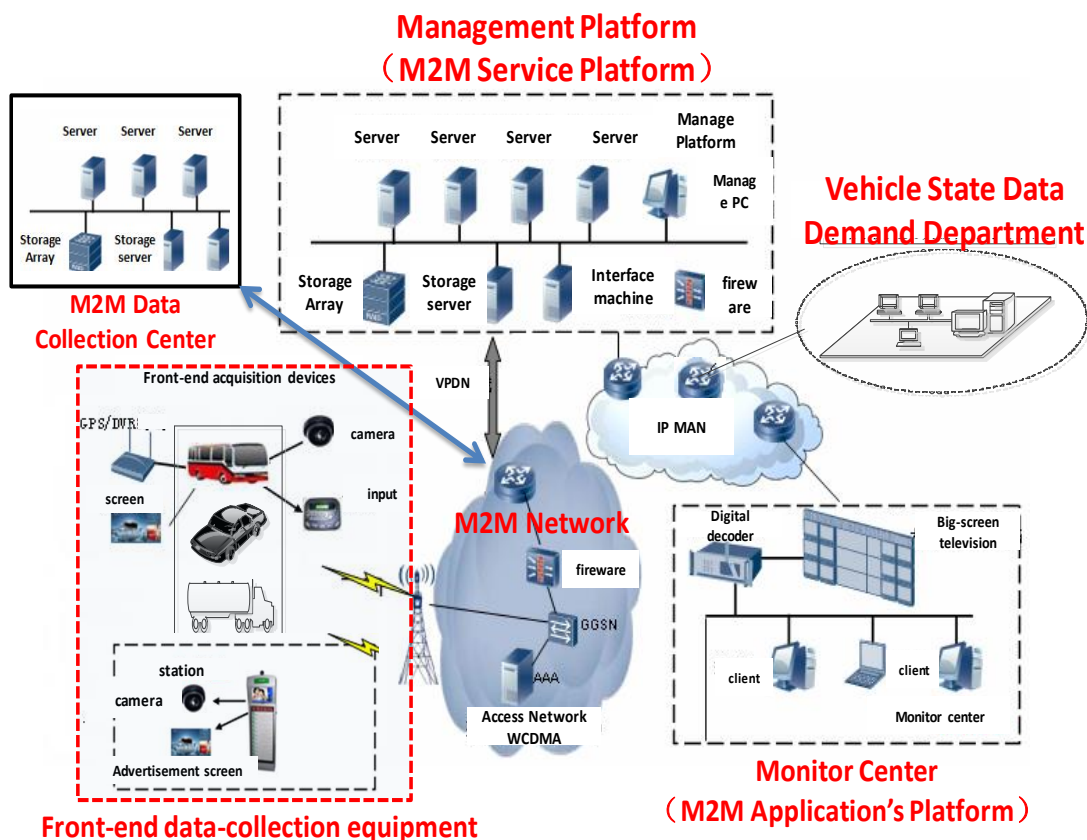

3387

3388

Figure 12-9 Vehicle Operation Management System

3389

3390

3391

3392

3393

3394

3395

3396

3397

3398

3399

3400

3401

3402

- Vehicle Operation Management System provide users a new telecommunications business with remote collection, transmission, storage, processing of the image and alarm signals.
- Front-End Data Collection Equipment include Front-End 3G camera, Electronic Station, Car DVR, costumed car GPS, WCDMA wireless routers and other equipment.
- Management Platform with business management function, include:
 - Forwarding, distribution, or storage of images
 - Linkage process of alarms
 - Management and maintenance of the vehicle status data
- Monitor Center: consists of TV wall, soft / hardware decoder, monitor software, etc.
- Vehicle State Data Demand Department: such as auto 4S shop, vehicle repair shop, vehicle management center, automobile and parts manufacturers, government regulatory platform, etc.
- M2M System Data Collection Center: use built-in data collectors resided in Network Equipment, M2M Platform, Costumed M2M Modules and Costumed M2M Terminal Devices to collect M2M System data.

12.6.10 Potential Requirements

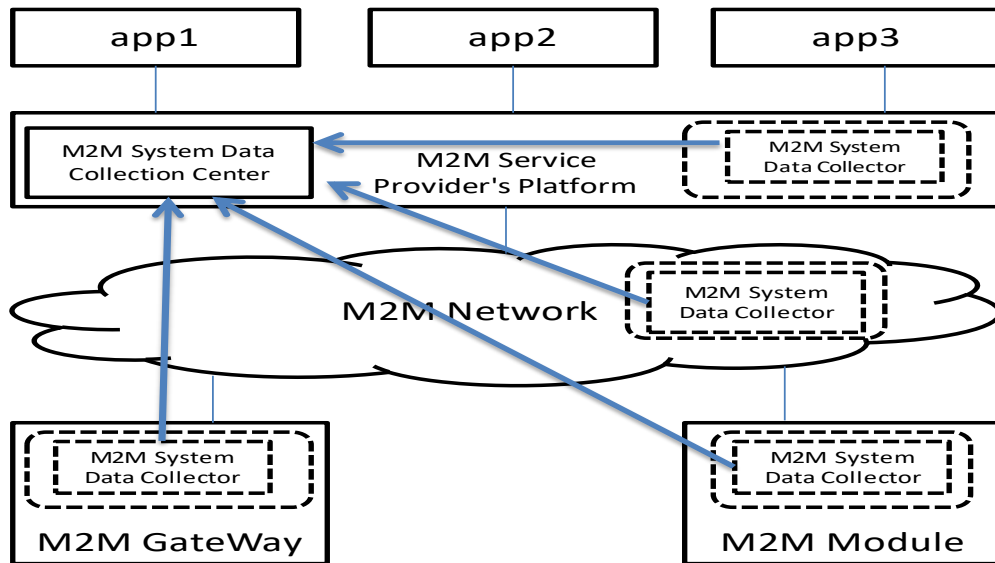

Figure 12-10 M2M System Data Collection Processing Flow

1. M2M System should support M2M System data collection.

Figure 12-10 depicts the M2M System data collector residing in:

- M2M Service Providers' Platform
- M2M Network Equipment
- M2M Devices and Gateways
- M2M Communication Module

12.7 Leveraging Broadcasting/ Multicasting Capabilities of Underlying Networks

12.7.1 Description

This use case illustrates that an automotive telematics (Application) service provider XYZ Ltd. alerts vehicles around where a traffic accident has just happened. The alerted vehicles could go slow or go another route to prevent a second accident and to avoid the expected traffic jam.

In this case, the automotive telematics service provider XYZ Ltd. takes advantage of broadcasting/multicasting capability of underlying communication networks. Some kinds of communication networks (in particular, a mobile communication network) have the capability to broadcast/multicast a message in specific areas.

Utilizing this capability, XYZ Ltd. can alert at once all the relevant vehicles within a specific region. This approach can avoid burst traffic in the communication network and provides a simple and cost-efficient way for XYZ Ltd. to implement this neighbourhood alerting mechanism.

Note 1: Ordinary unicast messaging mechanism is inadequate here. The alert messages shall be delivered in a timely manner to all the relevant vehicles within a specific region. XYZ Ltd. therefore needs to select the relevant vehicles that should receive the alert messages according to their current registered location. (It needs continuous location management of vehicles). Moreover the underlying communication network has to route large number of unicast messages with very short delay.

However it is hard for XYZ Ltd. to utilize broadcasting/multicasting functionality of underlying networks directly which can vary with kinds of communication networks (e.g. 3GPP, 3GPP2, WiMAX or Wi-Fi).

A oneM2M service provider ABC Corp. facilitates this interworking between XYZ Ltd. and a variety of communication network service providers (or operators). ABC Corp. exposes unified/standardized interfaces to utilize broadcasting (or multicasting) capability of communication networks. ABC Corp. authenticates the

3437 requester (=XYZ Ltd.), validates and authorizes the request, then calls the corresponding function of the
3438 appropriate communication networks.

3439 Note 2: There are many other scenarios in which broadcasting/multicasting capability of underlying
3440 communication networks provides significant benefit in a M2M system. For example:

- 3441 • Warning about a crime incident:
 - 3442 ○ - When a security firm detects a break-in at a house, it sets off all neighborhood burglar alarms
 - 3443 and alerts the M2M Application on the subscribed users' cellular phones around there.
- 3444 • Monitoring a water delivery system:
 - 3445 ○ - When a water-supply corporation detects a burst of a water pipe, it remotely shuts off the
 - 3446 water supply valves in that block, and alerts the M2M Application on the subscribed users'
 - 3447 cellular phones around there.

3448 The potential requirements in this contribution cover the above and all similar use cases, too.

3449 12.7.2 Source

3450 oneM2M-REQ-2013-0260R02 Leveraging Broadcasting - Multicasting Capability of Underlying Networks .

3451 12.7.3 Actors

- 3452 • The automotive telematics service provider: XYZ Ltd.
3453 It provides automotive telematics service as a M2M application.
 - 3454 • The oneM2M service provider: ABC Corp.
3455 It provides a common platform to support diverse M2M applications and services.
 - 3456 • The communication network service providers (or operators): AA Wireless, BB Telecom and CC Mobile.
3457 They operate communication networks.
3458 Some of them have the capability to broadcast/multicast a message in specific areas. The
3459 broadcasting/multicasting capability is available for external entities.
 - 3460 • The vehicles:
3461 They have communication capability as M2M devices, and have user interfaces (e.g. displays, audio
3462 speakers) or actuators to control driving.
- 3463 Note: roles are distinct from actors. For example, the oneM2M service provider role may be performed by any
3464 organization that meets the necessary standardization requirements, including MNOs.

3465 12.7.4 Pre-conditions

3466 The vehicles are able to communicate in one or more communication networks.

3467 12.7.5 Triggers

3468 The automotive telematics service provider XYZ Ltd. detects a traffic accident.
3469 How it detects the accident and captures details of the accident is out of scope of this use case.

3470 12.7.6 Normal Flow

- 3471 1. XYZ Ltd. estimates the location and impact of the accident to specify the area in which all the relevant
3472 vehicles should be alerted.
- 3473 2. XYZ Ltd. requests oneM2M service provider ABC Corp. to alert subscribed vehicles in the specified area.
 - 3474 • That request encapsulates the alert message (payload) and alert parameters (options).
 - 3475 ○ The request contains the payload to be delivered to vehicles. It can contain for example the
 - 3476 alert level (how serious and urgent), the location and time of the accident, and
 - 3477 directions to the driver (e.g. go slow or change routes).
 - 3478 ○ The request also defines targeted receivers of the message and specifies alert options. They
 - 3479 can contain for example the area to be covered, the type of devices to be alerted, the
 - 3480 option whether the alerting should be repeated, the repetition interval, and stopping
 - 3481 conditions.
- 3482 3. ABC Corp. receives the alert request from XYZ Ltd. It authenticates the requester (=XYZ Ltd.), validates
3483 and authorizes the request. When the request from XYZ Ltd. does not have alert parameters, ABC Corp.
3484 analyses the alert message to determine broadcast parameters. Then it chooses appropriate
3485 communication network service providers (or operators) to meet the alert request from XYZ Ltd.
- 3486 4. ABC Corp. requests AA Wireless and CC Mobile to broadcast the alert message in the specified area.
 - 3487 • That request encapsulates the alert message (payload) and broadcast parameters.

3488
3489
3490
3491
3492
3493
3494
3495
3496
3497
3498
3499

- The alert message is the payload to be delivered to vehicles. The contents are the same as from ABC Corp. but the format and encoding of the message may be different from AA Wireless and CC Mobile.
- The broadcast parameters define targeted receivers of the message and specify broadcast options. They can contain for example the area to be covered, the type of devices to be alerted, the option whether the broadcast should be repeated, the repetition interval, and stopping conditions. The format of the parameters can be different between AA Wireless and CC Mobile.

ABC Corp. may need to cover a part of the broadcasting functions for some communication network service providers. For example, if CC Mobile does not have the functionality to repeat broadcasting periodically, ABC Corp. repeatedly requests CC Mobile to broadcast the message, in order to meet the request from XYZ Corp.

3500

12.7.7 Alternative Flow

3501

None.

3502

12.7.8 Post-conditions

3503

The vehicles around where the traffic accident has just happened are properly alerted about the accident.

3504

12.7.9 High Level Illustration

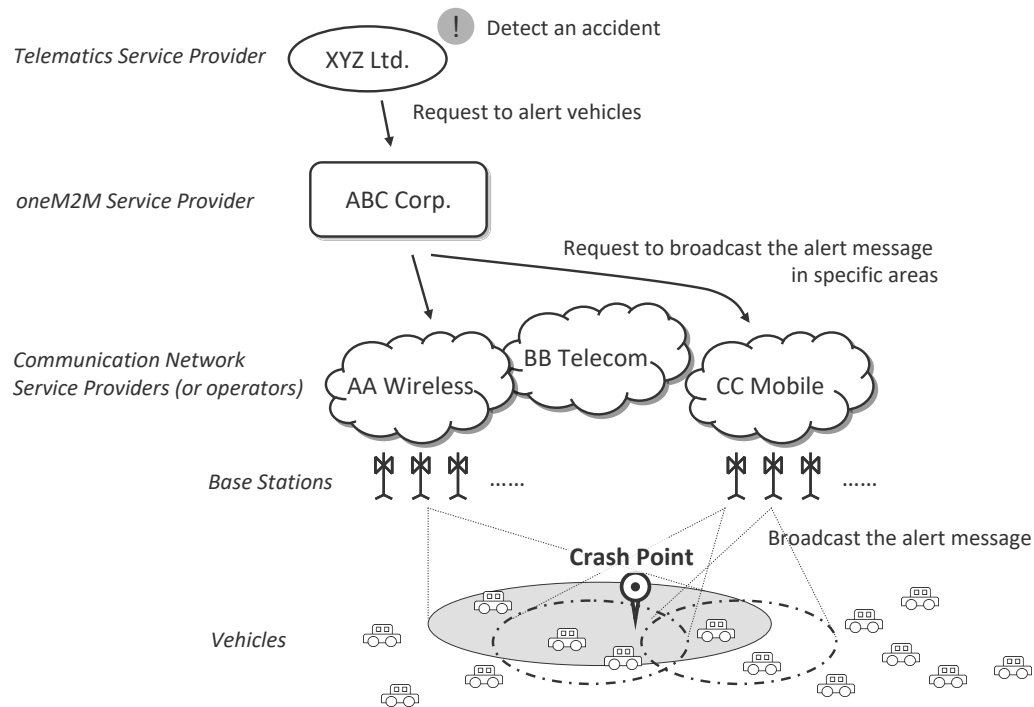

3505
3506

3507

Figure 12-11 High level illustration 1

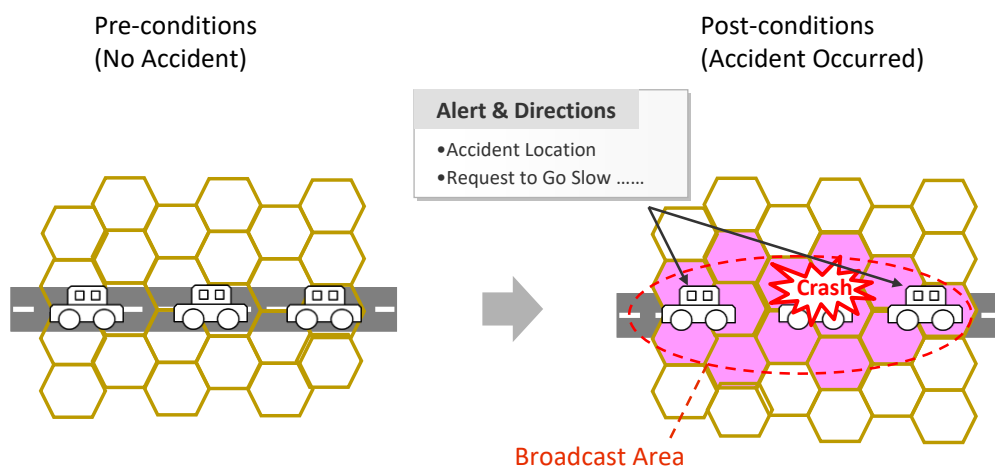

3508
3509
3510 **Figure 12-12 High Level Illustration 2**

3511 **12.7.10 Potential Requirements**

- 3512
3513
3514
3515
3516
3517
3518
3519
3520
3521
3522
3523
3524
3525
3526
3527
3528
3529
3530
3531
3532
3533
3534
3535
1. oneM2M System SHALL be able to leverage broadcasting and multicasting capability of Underlying Networks.
 2. oneM2M System SHALL enable a M2M Application to request to broadcast/multicast a message in specific geographic areas.
 - That request SHALL encapsulate the message (payload) from the M2M Application, relevant parameters (options) and optionally credentials for authentication and authorization.
 - The M2M System SHALL support that request to be independent of the types of the Underlying Networks.
 3. oneM2M System SHALL support mechanisms for Authentication, Authorization and Accounting of an M2M Application to request to broadcast/multicast a message.
 - oneM2M System SHALL authenticate the M2M Application.
 - oneM2M System SHALL validate and authorize the request.
 - oneM2M System SHALL support accounting on handling the request.
 4. oneM2M System SHALL be able to select appropriate underlying networks to broadcast/multicast a message in specified geographic areas according to capability/functionality of those networks.
 5. oneM2M System SHALL be able to receive information on broadcasting/multicasting capability/functionality of each underlying network.
 6. oneM2M System SHALL be able to indicate towards the Underlying Network that a message needs to be broadcasted/multicast and to determine its broadcast parameters (or multicast parameters), e.g. the area to be covered, the type of devices to be alerted, the option whether the broadcast should be repeated, the repetition interval, and stopping conditions.
 7. oneM2M System SHALL be able to analyse a message from a M2M Application to determine broadcast parameters.
 8. Interfaces to address the above requirements SHALL be standardized by oneM2M.

3536 Note: roles are distinct from actors. An actor may play one or more roles and the economic boundary
3537 conditions of a particular market will decide which role(s) will be played by a particular actor.
3538

12.8 Leveraging Service Provisioning for Equipment with Built-in M2M Device

12.8.1 Description

Some industrial equipment is so complicatedly designed that it is difficult for users themselves to maintain, such as construction engineering equipment, air compressor, large medical instrument and so on. Vehicles with online service can also be seen as one kind of such equipment. Therefore, equipment vendors build back-end applications to monitor and maintain them remotely. They also collect data from them for analysis in order to improve service level and product quality. The service provided by equipment providers is termed "equipment remote maintenance service".

Equipment providers can integrate remote communication unit into equipment directly. But often, they get M2M device from other providers, which mainly provide remote communication capability. They embed one M2M device into one equipment.

More and more equipment begin to use mobile network to communicate with the back-end application because of the convenience and low-cost of the current mobile network. In this case, SIM Card or UIM Card should be put into the M2M device. eUICC [i.16] can be one of the best choices.

This contribution mainly focuses on M2M service provisioning in the above case. M2M service consists of the service provided by M2M service platform and network service provided by the mobile network. Therefore, full M2M service provisioning consists of M2M service provisioning and network service provisioning. The former is to allow M2M device to talk with M2M service platform. The latter is to make M2M device access mobile network.

M2M service platform is operated by M2M Service Providers (M2M SP). With M2M SP's help, Equipment Providers do not need to manage mobile-network specific identifiers, such as IMSI, MSISDN or MDN. They just use Equipment ID / Equipment Name and Device ID / Device Name to identify equipment and device.

M2M Service Platform can hide the complexity of the underlying mobile network.

For devices managed by M2M Service platform, there are two kinds of M2M Service status. One is administrative status. The other is operational status. The former is to tell whether M2M Service has been allowed to be running by M2M SP for a device. "active" means it is allowed. "de-active" means it's not allowed. The latter is to tell whether M2M Service is available now for a device. "available" means it function correctly now. "unavailable" means it does not function correctly now. For example, if related IMSI has been deactivated by MNO, M2M Service operational status of the device is unavailable.

For network identifiers, Network Service administrative status is to tell whether network service has been allowed to be running for a network identifier by MNO. "active" means it is allowed. "de-active" means it is not allowed.

12.8.2 Source

oneM2M-REQ-2013-0171R03 M2M Service Provisioning for Equipment with Built-in M2M Device .

12.8.3 Actors

- Equipment Provider
Vendors who make equipment with built-in remote communication capability, sell and install equipment, and provide equipment remote maintenance service .
- Equipment User
Customers who use equipment.
- M2M Device Provider (M2M DP)
Vendors who make M2M Device with built-in remote communication capability and other M2M service capability .
- M2M Service Provider (M2M SP)
Service provider who provide M2M service which including network service.
- Mobile Network Operator (MNO)
Service provider who provide mobile network service.
- Equipment Provider Back-end Application (EPBA)
One kind of M2M Applications by which EPs can monitor, control, and collect data from their equipment. It is normally located in EP's office.
- M2M Service Platform (MSP)
Platform which is operated by M2M SP and provides M2M Service.

- Equipment
 - It is made by EP, which can do some specific work in some specific areas, such as concrete machinery, hoisting machinery and air compressor.
- M2M Device
 - Device embedded into equipment, which serves the function of communication between equipment and EPBA. It also talks with MSP to use M2M service.

12.8.4 Pre-conditions

Equipment User uses equipment remote maintenance service provided by EP.
 Equipment Provider uses M2M Service provided by M2M SP.
 M2M Service provided by M2M SP includes Network Service. That is to say, M2M service provider chooses which MNO's network to be used.

12.8.5 Triggers

None.

12.8.6 Normal Flow

Equipment's lifetime can be summarized as in figure 12.13

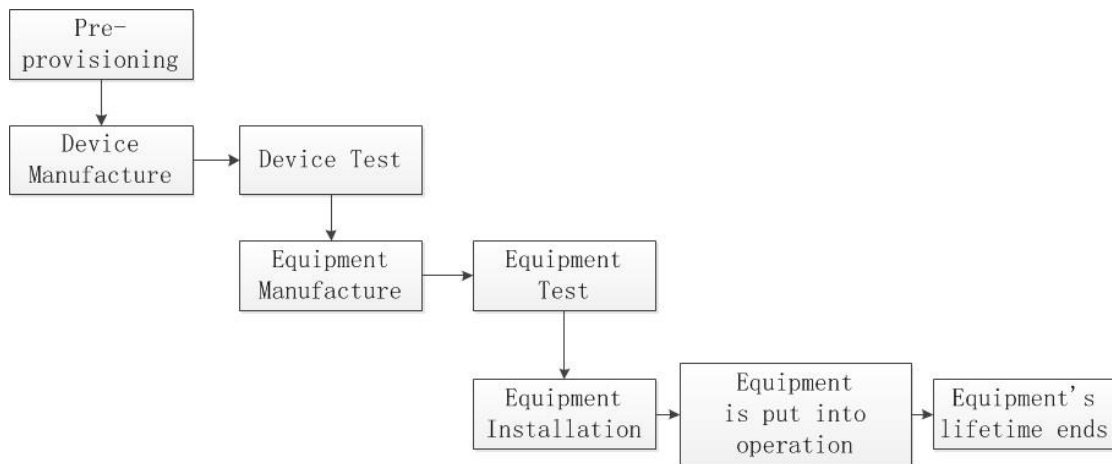

Figure 12-13 Equipment lifetime

M2M service provisioning for equipment with built-in M2M device mainly consists of the following scenarios:

- Pre-provisioning Scenario
- Manufacture and Test Scenario
- Installation Scenario
- EP Suspends / Resumes / Stops Equipment Remote Maintenance Service Scenario
- M2M SP Suspends / Resumes M2M Service Scenario
- MNO Suspends / Resumes Network Service Scenario
- Replacing-device Scenario

1. Pre-provisioning Scenario

At first, M2M SP prepares a batch of SIM/UIM cards from MNOs and registers the information of these cards in MSP, such as ICCID, IMSI and so on

2. Manufacture and Test Scenario

Device Manufacture Phase: M2M DP gets SIM/UIM card from M2M SP, and puts it into the module, and integrates the module into the device. Then, M2M DP configures the device ID parameter in device.

Device Test Phase: After that, M2M DP tests the device. Before and after the test, M2M DP or M2M SP sets M2M Service administrative status of specific ICCID as “active” or “de-active”, which allows MSP to talk with underlying mobile network to activate or deactivate the network service administrative status of the

3631
3632
3633
3634
3635
3636
3637
3638
3639

corresponding IMSI. In the test process, M2M Device reports its device ID and ICCID/IMSI to MSP. Thus, MSP knows such binding info.

Equipment Manufacture Phase: After that, EP gets the device and puts it into their equipment. Then, EP configures the equipment ID parameter in device.

Equipment Test Phase: EP also tests the equipment. Before and after the test, EP or M2M SP sets the M2M Service administrative status of specific device as “active” or “de-active”, which allows MSP to talk with underlying mobile network to activate or deactivate the network service administrative status of the corresponding IMSI. In the test process, Equipment reports its device ID and equipment ID to EPBA.

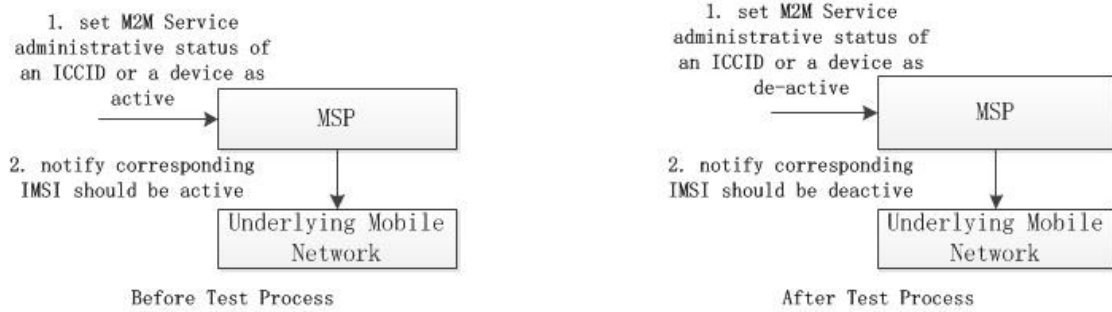

3640
3641

3642 **Figure 12-14. Manufacture and Test Scenario**

3643

3644 **3. Installation Scenario**

3645 Before the installation, EP sets equipment remote maintenance service of specific equipment as “active”, and
3646 it talks with MSP to set M2M service administrative status of the corresponding device as “active”, and
3647 which also allows MSP to notify underlying mobile network to set network service administrative status of the
3648 corresponding IMSI as “active”. Then, EP continues to install the equipment. After that, the equipment can be
3649 put into operation.

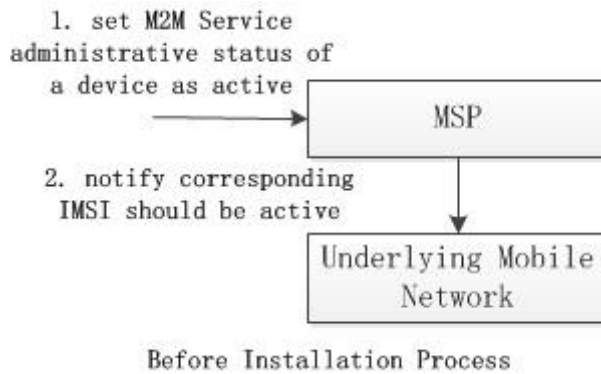

3650
3651

3652 **Figure 12-15. Installation Scenario**

3653

3654 **4. EP Suspends / Resumes / Stops Equipment Remote Maintenance Service Scenario**

3655 EP may suspend, resume, or stop equipment remote maintenance service of specific equipment.

3656 For suspending and resuming scenario, EP sets equipment remote maintenance service of specific equipment
3657 as “de--active” or “active”, which may trigger MSP to set M2M service administrative status of the
3658 corresponding device as “de-active” or “active”, and which also may trigger MSP to notify underlying
3659 mobile network to set network administrative status of the corresponding IMSI as “de-active” or “active”. But,
3660 in some cases, the above administrative statuses do not correlate together. It is up to different business model
3661 and management policy.

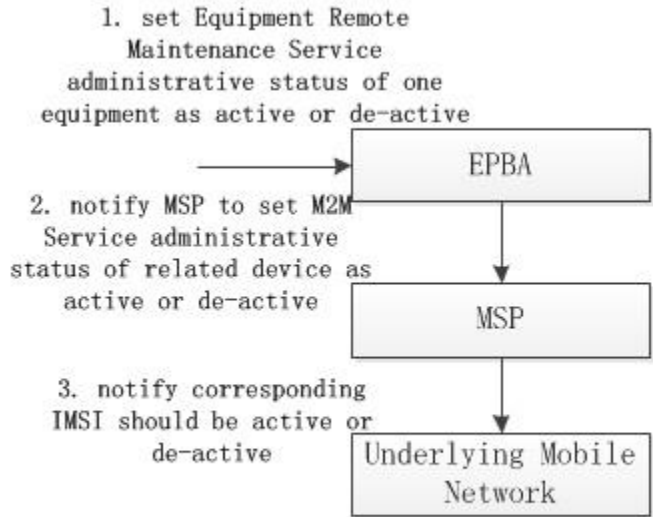

EP suspends or resumes Equipment Remote Maintenance Service

Figure 12-16 EP Suspends / Resumes / Stops Equipment Remote Maintenance Service Scenario

For stopping scenario, EP sets equipment remote maintenance service of specific equipment as “stopped”, which may trigger MSP to set M2M service administrative status of the corresponding device as “stopped”, and which also may trigger underlying mobile network to reclaim the corresponding IMSI.

5. M2M SP Suspends / Resumes M2M Service Scenario

M2M SP may suspend or resume M2M service of specific device, which may let MSP talk with underlying mobile network to deactivate or activate network service administrative status of the corresponding IMSI. After that, MSP should notify EPBA of such M2M service administrative status change of the device if EPBA has registered such notification, which allows EPBA to do some operations.

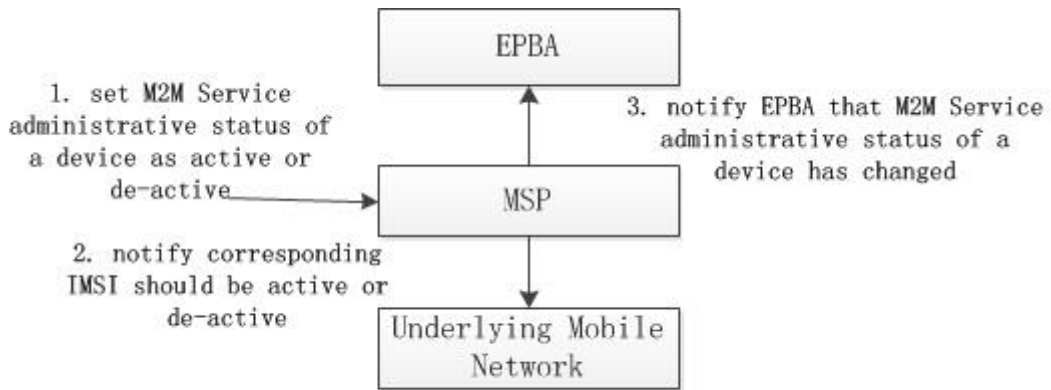

M2M SP Suspends / Resumes M2M Service Scenario

Figure 12-17 . SP Suspends / Resumes M2M Service Scenario

6. MNO Suspends / Resumes Network Service Scenario

MNO may suspend or resume network service of specific IMSI. If that happens, underlying mobile network may notify MSP the change of specific IMSI. Then, MSP may change the M2M service operational status of the corresponding device to “unavailable” or “available”. After that, MSP may also notify EPBA of the M2M service operational status change of the corresponding device if EPBA has registered such notification.

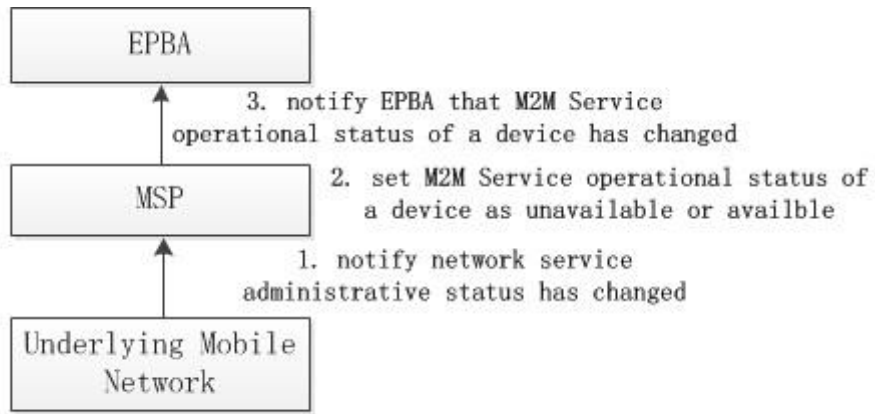

MNO Suspend / Resumes Network Service Scenario

3683
3684

Figure 12-18 MNO Suspend / Resumes Network Service Scenario

3685

3686

7. Replacing-device Scenario

In some cases, EP may decide to replace bad device with new one in the equipment.

EP sets equipment remote maintenance service of specific equipment as “replaced”, which triggers MSP set M2M service administrative status of the corresponding device as “stopped”, which also may trigger MSP to notify underlying mobile network to reclaim the corresponding IMSI.

The following procedure is the same as the Equipment Manufacture Phase in Manufacture and Test Scenario.

3687
3688
3689
3690
3691
3692
3693

12.8.7 Alternative Flow

None

3694
3695

12.8.8 Post-conditions

Not applicable

3696
3697
3698

12.8.9 High Level Illustration

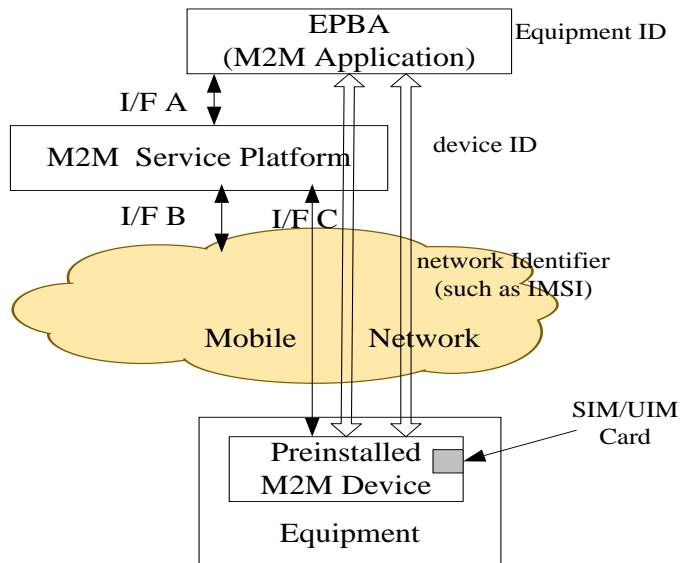

3700

3701 **Figure 12-19 High Level Illustration**

3702

3703 **Service Model**

3704 Equipment Provider provides equipment remote maintenance service to Equipment User. M2M SP provides
3705 M2M service to EP. MNO provides network service to M2M SP.
3706 Equipment remote maintenance service consists of M2M service which is provided by M2M SP and other
3707 service provided by EP.
3708 M2M service consists of network service which is provided by MNO and other service provided by M2M SP.
3709 M2M service operational status will be de-active if network service administrative status is de-active.
3710

3711 **Entity Model**

3712 EPBA uses equipment ID to identify specific equipment.
3713 EPBA and MSP uses device ID to identify specific device. MSP and underlying mobile network use network
3714 identifier such as IMSI, MSISDN, MDN or External id to identify specific user in its network.
3715 One equipment has only one M2M device in it at one time. EP can replace old M2M device in equipment with
3716 new one.
3717 One M2M device has only one SIM/UIM card in it.

3718 **12.8.10 Potential requirements**

- 3719 1. The M2M System shall identify and manage M2M Service status of devices.
3720

3721 NOTE 1: There are two kinds of M2M Service status. One is administrative status. The other is operational
3722 status. The former is to tell whether M2M Service has been allowed to be running by M2M SP for a
3723 device. “active” means is allowed. “de-active” means is not allowed. The latter is to tell whether M2M
3724 Service is available now for a device. “available” means it function correctly now. “unavailable” means it
3725 does not function correctly now. For example, if related IMSI has been deactivated by MNO, M2M
3726 Service operational status of the device is unavailable.
3727

- 3728 2. The M2M System should identify Network Service administrative status of device-related network
3729 identifiers such as IMSI, MSISDN, MDN, or External id.
3730

3731 NOTE2: Network Service administrative status is to tell whether network service has been allowed to be
3732 running for a network identifier by MNO. “active” means it is allowed. “de-active” means it is not allowed.
3733 The M2M System should support the correlation of service identifier of a device in service layer and
3734 related mobile network identifier such as IMSI, MSISDN, MDN, or External id in underlying network
3735 layer.
3736

3737 NOTE 3: Different MNOs may expose different kinds of network identifiers to the M2M System. It is up to
3738 MNO.
3739

- 3740 3. System should notify underlying mobile network that Network Service administrative status of related
3741 mobile network identifier should be changed when M2M Service administrative status of a device changes
3742 if underlying mobile network can receive such notification and has subscribed such notification.
3743
- 3744 4. The M2M System shall notify M2M Application when M2M Service administrative status of a device
3745 changes if M2M Application has subscribed such notification. The M2M System should notify M2M
3746 Application when M2M Service operational status of a device changes if M2M Application has subscribed
3747 such notification.
3748
- 3749 5. The M2M System should change M2M Service operational status of the corresponding device to available
3750 or unavailable when it receives the notification from the underlying mobile network that Network Service
3751 administrative status of a mobile network identifier has changed to active or de-active, if the underlying
3752 mobile network can send such notification to the M2M System.
3753
- 3754 6. The M2M System should support M2M Application to activate or de-activate M2M Service
administrative status of a device.

12.9 Semantics query for device discovery across M2M Service Providers

12.9.1 Description

This use case describes discovery of a device based on metadata of the device such as the type of device or its location. It is similar to the use case “Use Case on Devices, Virtual Devices and Things” in clause 8.2 however in the present use case the discovery may be extended to the domains of different M2M service providers.

12.9.2 Source

REQ-2014-0005R01 Semantics query for device discovery across M2M Service Providers .

12.9.3 Actors

- M2M Application Provider
The M2M Application Provider provides an application which can employ a device that has already been installed and is operated by a different M2M Application Provider. However, the M2M Application Provider does not have any information (ID, URI, etc.) that can identify the device, the M2M service provider and the M2M Application Provider which the device belongs to.
- M2M Service Provider 1
M2M Service Provider 1 is a service provider with whom the M2M Application Provider has a contractual relationship.
- M2M Service Provider 2
M2M Service Provider 2 is a service provider with whom the M2M Application Provider does not have a contractual relationship. The M2M Service Infrastructure of M2M Service Provider 1 can communicate with the M2M Service Infrastructure of M2M Service Provider 2 via an inter-provider interface.
- The device which M2M Application Provider wants to employ is connected to M2M Service Provider 2.

12.9.4 Pre-conditions

An M2M Device (e.g. a surveillance camera in a public space, a thermometer for agriculture in a field, etc.) has been installed and is operated in the domain of M2M Service Provider 2.
The M2M Application Provider has found the device in the real world (in the public space, the agriculture field, etc.) and wants to make use of the device within his application. The M2M Application Provider, however, does not have any information (ID, URI, etc.) that can identify the device. Further, the M2M Application Provider does not know which M2M Service Provider the device belongs to.
The M2M Application Provider has a contractual relationship with M2M Service Provider 1.
M2M Service Providers 1 and 2 have databases that contain information on their devices. The databases include location information (where each device is currently located) and the device type.

12.9.5 Triggers

Using a suitable interface (e.g. a web-page) of the M2M Application the M2M Application Provider creates a request for using the device. The request contains location information about the device and possibly a device type.

12.9.6 Normal Flow

0. The M2M Application launches a query within the domain of M2M Service Provider 1 to find and identify the device. The query is invoked with location information on the device and information on the device type.
1. The database of M2M Service Provider 1 is searched whether the requested device is connected to his domain or not.
2. If the requested device is connected to M2M Service Provider 1, M2M Service Provider 1 returns to the M2M Application the information to identify the device (ID, URI, etc.) and terms of use for the device.
3. If the requested device is not connected to M2M Service Provider 1 then M2M Service Provider 1 forwards the query to other M2M Service Providers to which M2M Service Provider 1 has an inter-provider system interface. Forwarding may depend on whether some criteria of the query are known to be supported / not supported by a certain Service Provider (e.g. if it is known that the devices of a Service

- 3803 Provider only operate in a certain geographical region and the query looks for a device in a different
 3804 region).
- 3805 4. The query is executed in the domains of the other M2M Service Providers.
- 3806 5. If the requested device is connected to M2M Service Provider 2 then M2M Service Provider 2 returns to
 3807 M2M Service Provider 1 the information to identify the device (ID, URI, etc.) and terms of use for the
 3808 device.
- 3809 6. M2M Service Provider 1 returns to M2M Application Provider the information to identify the device (ID,
 3810 URI, etc.) and terms of use.

3811 **12.9.7 Alternative Flow**

3812 None.

3813 **12.9.8 Post-conditions**

3814 M2M Application Provider can start to employ the device on the basis of the terms of use sent by M2M
 3815 Service Provider 1.

3816 **12.9.9 High Level Illustration**

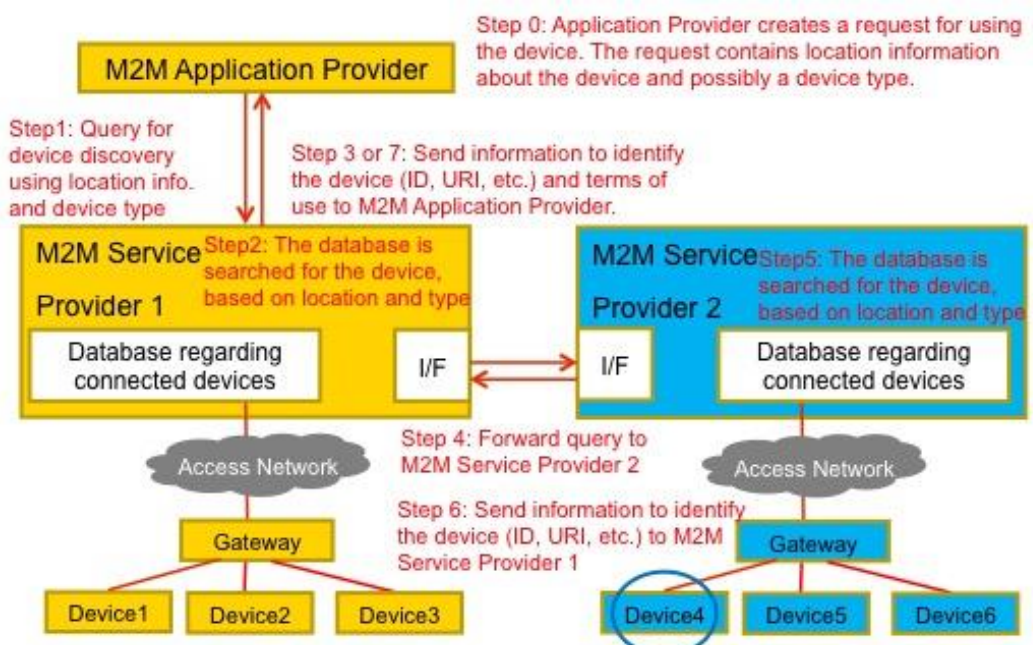

3817
 3818

3819 **Figure 12-20: High Level Illustration of Semantics discovery across M2M Service Providers**

3820 **12.9.10 Potential Requirements**

3821 The following requirements extend the requirement SMR-004 from clause 6.3.2 (Semantic Requirements) of
 3822 [i.15]:

3823 SMR-004: The M2M System shall provide capabilities to discover M2M Resources based on semantic
 3824 descriptions.

- 3825
- 3826
- 3827 1. The M2M System shall provide a capability to an M2M Application to search (semantic query) within
 3828 the domain of the application's M2M Service Provider to discover M2M Devices, Virtual Devices and
 3829 Things on the basis of their semantic descriptions and meta-data such as device location or a device
 3830 type.
- 3831 2. The M2M System shall provide a capability to a M2M Service Provider to automatically forward such
 3832 a semantic query via standardized inter-provider interfaces to the domains of other M2M Service
 3833 providers in order to extend the search to these domains.

3834 NOTE: : Based on Service Provider's policies forwarding can depend on whether some criteria of the query
3835 are known to be supported / not supported by a certain Service Provider (e.g. if it is known that the devices
3836 of a Service Provider only operate in a certain geographical region and the query looks for a device in a
3837 different region).
3838

3839 If M2M Devices, Virtual Devices and Things that match the criteria are found within the domain of a
3840 M2M Service Provider to which the semantic query had been forwarded then the search results may be
3841 returned via standardized inter-provider interfaces to the domain of the M2M Service Provider that had
3842 forwarded the query. The search result shall contain sufficient information to identify the device and the
3843 term of use for the device.
3844

- 3845 3. The M2M System shall provide the capability to return to the M2M Application that had issued the
3846 semantic query the results of the query from the M2M Service Provider's domain and from M2M
3847 Service Provider domains to which the query had been forwarded.
3848

3849 The supported formats for semantic queries shall be described in the oneM2M standard.
3850

3851 12.10 Underlying network service activation and deactivation

3852 12.10.1 Description

- 3853 • Background of the use case

3854 Currently, for flexible M2M service deployments and low network service subscription cost, some underlying
3855 network operators have developed their private network service activation and deactivation APIs and opened
3856 them to M2M application providers. The M2M systems may need to support reusing the network service
3857 activation and deactivation capability provided by underlying network via transforming these network APIs
3858 and opening for M2M applications.

- 3859 • Overview of the use case

3860 In the M2M device, a network service module (e.g. SIM card) will be embedded to support the network
3861 communication. For some potential requirements, the network service module need be activated or deactivated
3862 by remote or local M2M applications via M2M platform.

3863 In the context of this use case, an *active network service module* means that the network service module
3864 enables the M2M device to send / receive M2M traffic. An *inactive network service module* does not allow the
3865 M2M device to send / receive M2M traffic, however the service module, together with the M2M device, is
3866 capable to exchange signalling with M2M platform according to network operator's policy.

3867 The network entity of underlying network can activate/deactivate network service module according to
3868 network policy and network service activation/deactivation request.

3869 The following scenarios are given to show above requirements.

- 3870 • Factory acceptance test

3871 During the factory acceptance test of the M2M device, the network service module need be activated for M2M
3872 service testing. After the test, the network service module need be deactivated for saving the network
3873 subscription cost.

- 3874 • Starting usage

3875 When the M2M device are sold and the user starts to use it, the network service module need be activated to
3876 support the M2M service. The network service module may be activated via M2M platform by local M2M
3877 applications in the case that the local M2M applications detects the M2M device in use or by remote M2M
3878 applications in the case that the user requests the M2M application server to active the M2M device.

- 3879 • Abandon

3880 When the M2M device is abandoned by user, the network service of the M2M device need to be deactivated
3881 for reducing network service subscription cost. In this case, the network service module will be deactivated via
3882 M2M platform by remote M2M applications.

- 3883 • Lost

3884 When the M2M device is lost or stolen, the network service of the M2M device need be deactivated for
3885 reducing network service subscription cost. In this case, the network service module will be deactivated via
3886 M2M platform by remote M2M applications.

- 3887 • Abused

3888 When the M2M device is misused by user (e.g. used for certain forbidden services), the remote M2M
3889 application server intends to stop providing M2M service and deactivate the network service of target M2M
3890 device via M2M platform.
3891 Similarly, if a M2M device is used outside a specific geographic area in which the M2M device is supposed to
3892 operate (e.g. a vending machine is removed from its assigned place) then a location enabled M2M device may
3893 deactivate the network service module.

3894 12.10.2 Source

3895 REQ-2014-0446R02 Underlying network service activation and deactivation use case .

3896 12.10.3 Actors

- 3897 • Underlying network operator
- 3898 • M2M service provider
- 3899 • M2M Application server (operated by a M2M Application Service provider)
- 3900 • M2M platform (operated by the M2M service provider)
- 3901 • M2M device (containing a network service module)
- 3902 • Network service module (operated by the Underlying network operator)

3903 12.10.4 Pre-conditions

- 3904 • The mobile network operator opens the service interface, i.e. network API, for remote activation and
3905 deactivation of underlying network service.

3906 12.10.5 Triggers

3907 The following triggers could initiate exchange of information.

3908 **Trigger A:**

3909 The M2M application on M2M device initiates the activation request. In this case, the M2M device is in use,
3910 and the M2M application intends to activate / deactivate the network service of the corresponding M2M device
3911 via an M2M platform.

3912 (Note that even if the network service of the M2M device is deactivated, the M2M device may still be able
3913 to connect to target M2M platform according to the policy of network operator.)

3914 **Trigger B:**

3915 The M2M application server initiates the activation/deactivation request. In this case, the M2M application
3916 intends to activate / deactivate the network service of the target M2M device via M2M platform.

3917 12.10.6 Normal Flow

3918 **Trigger A:**

3919 When the M2M device is in first use, network service activation request will be triggered by local M2M
3920 application on M2M device (Trigger A).

- 3921 1. The M2M application on M2M device initiates the activation request to M2M platform.
- 3922 2. The M2M platform uses the network service activation API provided by the underlying network
3923 operator to active the network service module of the corresponding M2M device and feedback the
3924 activation information.

3925 **Trigger B:**

3926 When the user intends to reuse the M2M device, network service activation request will be triggered by remote
3927 M2M application, and when the M2M device is misused by users, network service deactivation request will be
3928 triggered by remote M2M application. (Trigger B).

- 3929 1. The M2M application server initiates the activation/deactivation request to M2M platform.
- 3930 2. The M2M platform uses the network service activation/deactivation API provided by the underlying
3931 network operator to activate/deactivate the network service module of target M2M device and
3932 feedback the activation/deactivation information to the M2M application server.

3933 12.10.7 Alternative Flow

3934 None.

12.10.8 Post-conditions

Trigger A:

The M2M device can send / receive M2M traffic if the network service module is activated successfully according to network activation request.

Trigger B:

The M2M device cannot send / receive M2M traffic but may be able to exchange signalling with M2M platform if the network service module is deactivated successfully according to network deactivation request.

12.10.9 High Level Illustration

Figure 12-21 and Figure 12-22 describe the normal flow of this use case for Trigger A and Trigger 2 from high level aspect.

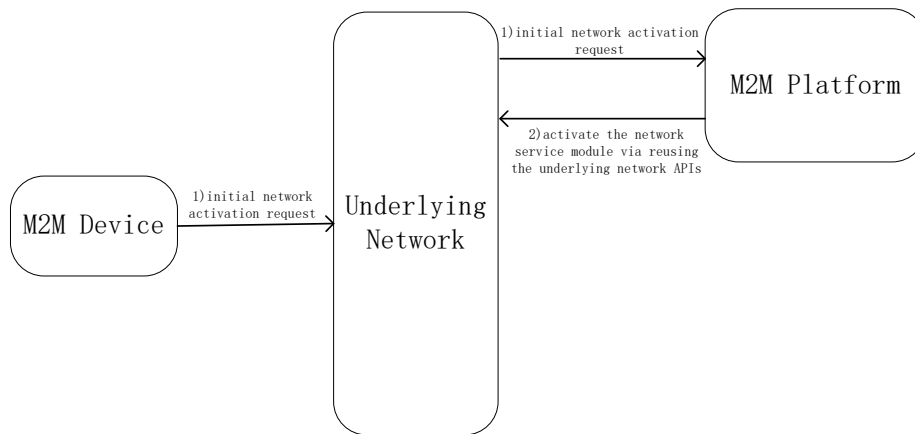

Figure 12-21: Normal flow description for Trigger A

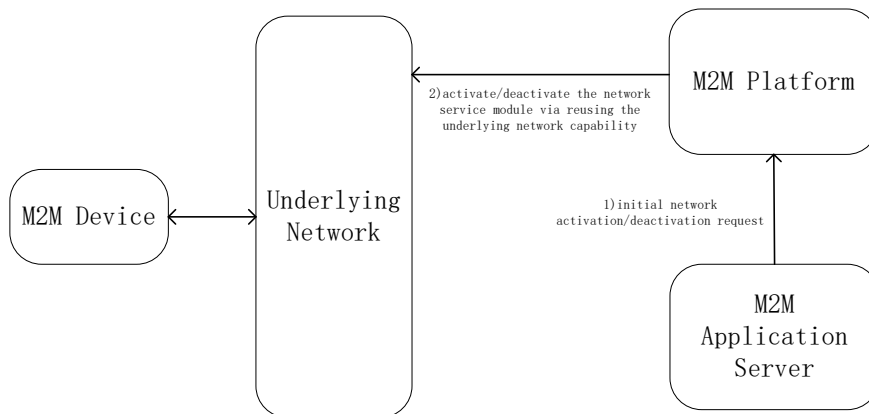

Figure 12-22: Normal flow description for Trigger B

12.10.10 Potential requirements

1. The M2M systems shall support the capability of reusing the network service activation and deactivation capability in underlying network via Mcn reference point.

12.11 An industrial use case for On-demand data collection for factories

- void -

Note: This use case can be found in oneM2M TR-0018 **Error! Reference source not found.**[i.19].

Source: REQ-2014-0487R03: A use case for industry: On-demand data collection for factories.

12.12 Smart Irrigation System

12.12.1 Description

The use case describes a smart irrigation system in which all the valves and sensors deployed around the farmland are centrally controlled and managed by Irrigation Administration Centre. The sensors include temperature, humidity, illumination and soil moisture level. The Irrigation Administration Centre collects data from those sensors and decides if it is time to irrigate the farmland. Because the soil condition and the plant are different depend on the area of the farmland. The timing of the irrigation may be different. According to the pre-configured policies, and the Irrigation Administration Centre decides which valves to open, which valves to close as well as how much the value opens to irrigate the farmland.

12.12.2 Source

REQ-2015-0528R03 Use case on transactions (Smart Irrigation System).

12.12.3 Actors

- Irrigation Administration Centre (IAC): The application that analyses the data collected by sensors and control the valves to irrigate the farmland.
- Smart Irrigation Service Provider: The Smart Irrigation Service Provider provides special sensors and valves to implement irrigation system. The Smart Irrigation Service Providers also own the database on the policies of how to irrigate certain plant based on the data collected by sensors. The Smart Irrigation Service Provider helps the customer of its system to deploy the irrigation system which includes the deployment of gateways, sensors and valves into the farmland. Prepare the channel and pipes to let the water flow to every corner of the farmland. The installation and configuration of the Irrigation Administration Centre. And make sure the system is working fine before the finishing of its service.
- M2M Service Provider: The M2M Service Provider provides M2M platform, M2M Gateway and standard ways to connect devices with each other. The Smart Irrigation Service Provider subscribes the service provided by M2M Service Provider to deploy its own service.
- Farmer: The customer that purchases the service from Smart Irrigation Service Provider. After the installation of the Smart Irrigation System, the farmer will no longer worry about the irrigation of its farmland.
- Sensors and Valves: Sensors and Valves deployed by Smart Irrigation Service Provider. The Valves are connected by channels or pipes. The sensors are scattered around the farmland include temperature sensor, humidity sensor, light sensor, soil moisture sensor.
- Channels and Pipes: Channels and pipes are jointly connected by valves from the source of the water to every corner of the farmland. Channels are half closed and may be overflowed if the water cannot be released in time. Pipes are closed and have standard pressure limit. If the downstream valve cannot be opened in time, may cause irregular pipe pressure which may result in fall of the junction valve or leak of water.
- M2M Gateway: M2M Gateways are deployed by M2M Service Provider to connect with sensors and valves around the farmland. M2M Gateway collects data from sensors and reports the data to M2M Platform. M2M Gateway also distribute control message from M2M Platform to valves.
- M2M Platform: M2M Platform is deployed by M2M Service Provider. It stores sensor data and valve conditions which are read or written by Irrigation Administration Centre application.

12.12.4 Pre-conditions

The subscription relationships between farmer, Smart Irrigation Service Provider, M2M Service Provider are carefully contracted.

Channels and Pipes are connected with valves from the source of water to every corner of the farmland.

Sensor are scattered around the farmland and connected with gateway and finally connected with the M2M Platform.

Irrigation Administration Centre is registered with M2M Platform and can successfully read or write sensor and valve state data.

To irrigate one part of the farmland, it may need to open several valves at the same time or in a certain order. If failed to do so, it may cause water overflow of the channel or irregular pressure of the water pipes. This may then result in unexpected irrigation or water leak.

12.12.5 Triggers

Based on the sensors data read by the Irrigation Administration Centre, the Irrigation Administration Centre decides to irrigate one part of the farmland.

12.12.6 Normal Flow

- 1) IAC read sensors data from M2M Platform of Area_A of the farmland.
- 2) IAC detects that according to current condition, Area_A needs to be irrigated half an hour later.
- 3) IAC detects that to irrigate Area_A, Valve_1, Valve_3 and Valve_7 need to be opened at the same time. Valve needs to be opened to 10%, Valve_3 needs to be opened to 50% and Valve_7 needs to be opened to 100%.
- 4) IAC then sends request to M2M Platform to indicate to switch the valves to corresponding percentage in half an hour.
- 5) Valve_1, Valve_3 and Valve_7 responded with success information immediately.
- 6) Valve_1, Valve_3 and Valve_7 adjusted its open percentage after half an hour. Irrigation starts.
- 7) IAC detects that according to current condition, the water in Area_A would be sufficient.
- 8) IAC then sends request to M2M Platform to indicate to switch the valves off in 5 min.
- 9) Valve_1, Valve_3 and Valve_7 responded with success information immediately.
- 10) Valve_1, Valve_3 and Valve_7 is shut off in 5 min. Irrigation stopped.

12.12.7 Alternative flow

The alternative flow is about the scenario that something error happened during the operation of the valves.

- 1) IAC read sensors data from M2M Platform of Area_A of the farmland.
- 2) IAC detects that according to current condition, Area_A needs to be irrigated half an hour later.
- 3) IAC detects that to irrigate Area_A, Valve_1, Valve_3 and Valve_7 need to be opened at the same time. Valve needs to be opened to 10%, Valve_3 needs to be opened to 50% and Valve_7 needs to be opened to 100%.
- 4) IAC then sends request to M2M Platform to indicate to switch the valves to corresponding percentage in half an hour.
- 5) Valve_1 and Valve_7 responded with success information immediately but Valve_3 responded with a failure.
- 6) IAC requests to Valve_1 and Valve_7 the cancellation of the operation.
- 7) Valve_1 and Valve_7 responded the success cancellation.
- 8) Irrigation failed, the IAC will try some time later again for the irrigation.

12.12.8 Post-conditions

None.

12.12.9 High Level Illustration

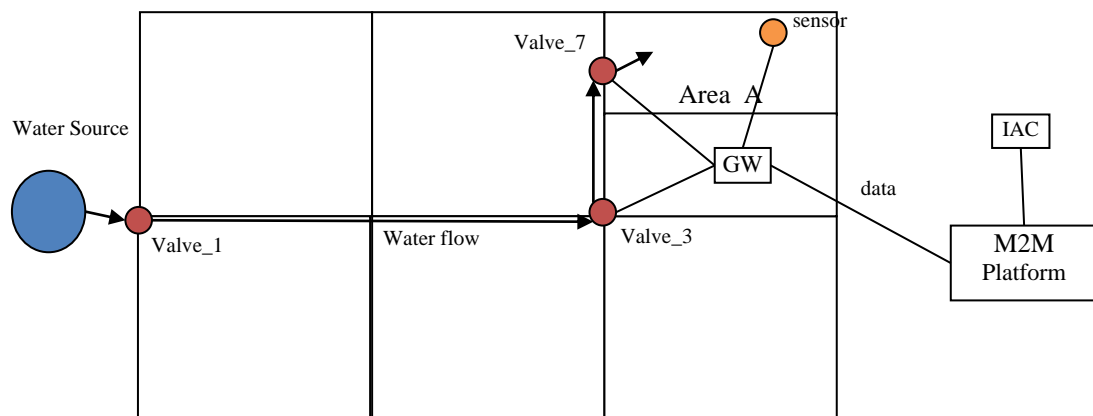

Figure 12-23 Smart Irrigation System

12.12.10 Potential requirements

1. The oneM2M system shall support distributed transactions to multiple devices or applications where the transaction includes the characteristics of atomicity, consistency, isolation and durability.

- 4047 2. The oneM2M system shall support the completion of distributed transactions to multiple devices or applications
4048 while maintaining the order of the operations and performing the transaction within a given time frame.

4049 12.13 Group Registration Management

4050 12.13.1 Description

4051 A user's smart phone hosts several workout tracking applications and several home automation applications.
4052 The workout tracking applications were provided with the user's gym membership. When in the gym, the
4053 workout applications are used to reserve and monitor the availability of workout equipment (e.g., treadmills)
4054 and track the user's workout performance. While at home, the workout tracking applications are used to track
4055 the user's workout performance.
4056 The home automation application are used to control smart devices in the home while the user is at home or on
4057 the road.
4058 When the user is at home, both the workout and home automation applications register with the user's home
4059 automation gateway so that they can communicate with smart devices and workout equipment in the home.
4060 While on the road, the home automation applications register with an M2M Server) that can be used to monitor
4061 and control devices in the home via the home automation gateway .. The workout applications also register
4062 with the M2M Server and take advantage of a location tracking service that the M2M Server offers. The
4063 location tracking service will be used by the workout application to detect when the host devices enters a gym.
4064 Upon entering the gym, the workout applications register with an M2M Gateway that is owned by the gym.
4065 The geographical availability of new services triggers the workout applications to search for a new service
4066 layer and a registration to a new service layer.

4067 12.13.2 Source

4068 REQ-2015-0561 Use case group registration.

4069 12.13.3 Actors

- 4070 • Workout Applications
- 4071 • Home Automation Applications (
- 4072 • Home Gateway
- 4073 • Gym Gateway
- 4074 • M2M Server

4075 12.13.4 Pre-conditions

4076 The Home GW is registered with the M2M Server .

4077 12.13.5 Triggers

4078 Location change.

4079 12.13.6 Normal Flow

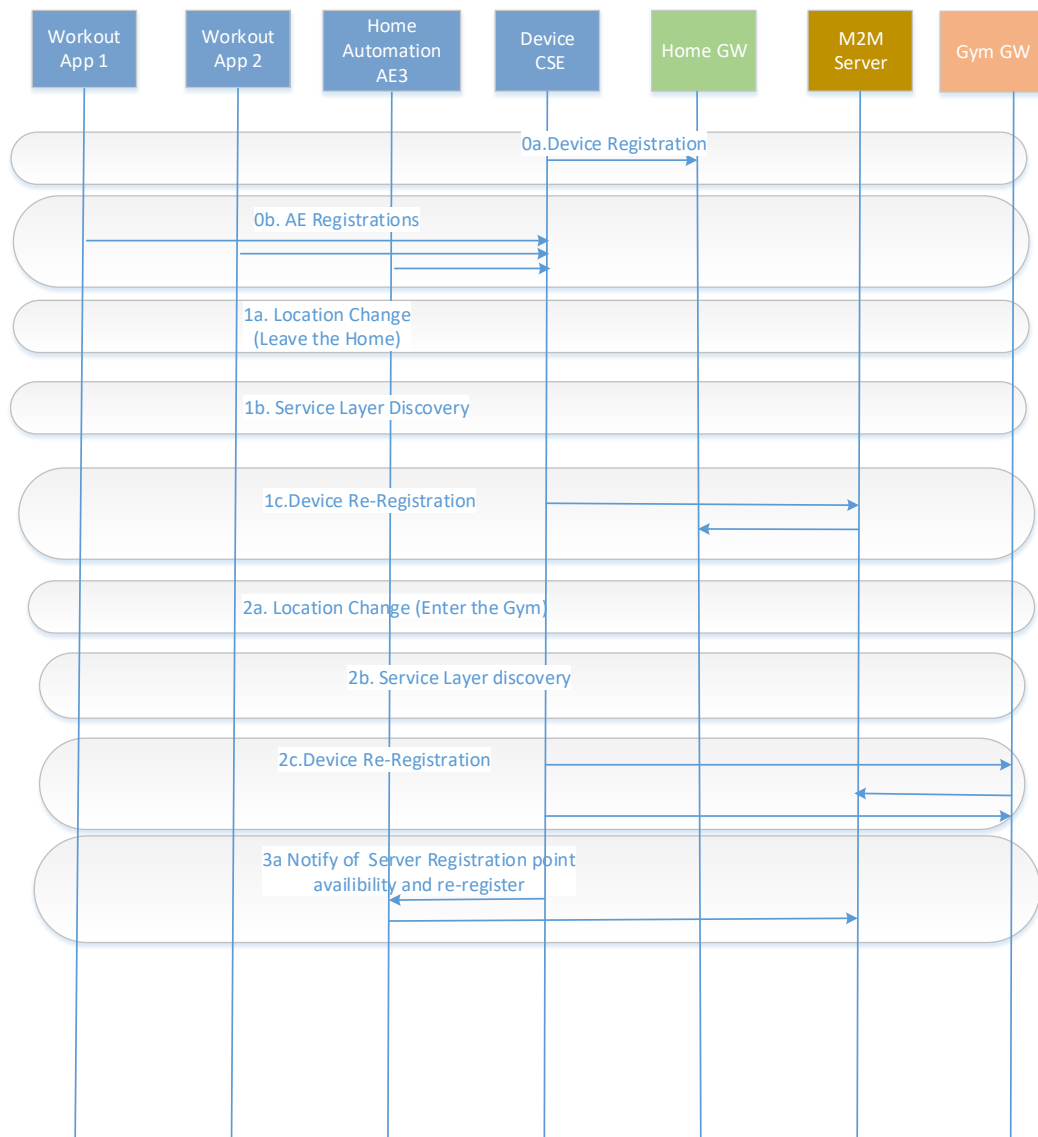

Figure 12-24 Group Registration Management

- 4081
4082
4083
4084
- 4085 0a. The Device is registered with the home GW (i.e. via Wi-Fi).
 - 4086 0b. The workout and home automation applications AEs are registered with the ASN-CSE
 - 4087 1a. The user leaves the home, thus losing its network connection to the Home Gateway .
 - 4088 1b. The device (smart phone) performs service discovery and determines that the M2M Server can be reached
 - 4089 (i.e. via cellular).
 - 4090 1c. The device registers with the M2M Server (i.e. via cellular).
 - 4091 2a. The user enters the gym.
 - 4092 2b. The device performs service layer discovery and determines the availability of the gym GW as registration
 - 4093 point. Alternatively M2M Server notifies the device of the new registration point available at the gym. The
 - 4094 cellular connection continues to be available.
 - 4095 2c. The device re-registers at Gym Gateway (e.g. via Wi-Fi___33)and announces the workout applications AE1
 - 4096 and AE2. The device does not announce applications which cannot be serviced by the gym gateway (e.g. home
 - 4097 automation AE3)
 - 4098 3. The device notifies the home automation application AE3 of the availability of the M2M Server as registration
 - 4099 point and AE3 re-registers directly with the M2M Server
 - 4100

12.13.7 Alternative flow

Depiction of alternative flows is not relevant.

12.13.8 Post-conditions

The workout applications (AE1 and AE2) are being serviced by the Gym Gateway via a Wi-Fi connection. The home automation applications (AE3) is now registered to the M2M Server via a cellular connection.

12.13.9 High Level Illustration

See high level flow.

12.13.10 Potential requirements

1. The oneM2M System shall provide the capability to notify a device hosting a group of applications that it should perform discovery when alternative registration points are available (e.g. via different underlying networks) based on the service requirements of each of the applications hosted.
2. The oneM2M System shall provide the capability to register applications in group or independently, based on their service requirements.

12.14 Multicast using group

12.14.1 Description

In the smart metering scenario, meters are reporting their collected data to the server in a predefined frequency. If it is decided to change the frequency, the server will have to change the policy to every meter by unicast manner. It is preferred that the system may utilize the broadcast or multicast mechanism to send out the configuration message to all the eligible devices at one time to save the network resources.

12.14.2 Source

REQ-2015-0557R01-Use Case multicast using group.

12.14.3 Actors

- Metering Company: The Company that provides metering service to collect metering data from all the meters deployed across the city.
- M2M SP Platform: The platform provided by the M2M Service Provider to collect metering data from all meters.
- Meter: The meter device that is equipped with a wireless or wired network capability that connects with the M2M SP Platform to report their metering data.

12.14.4 Pre-conditions

The Metering Company and M2M Service Provider has signed contract about delivering the M2M Service. The Metering Company deploys Meters with pre-configuration on the frequency of reporting the data. The Meters connect and register with the M2M SP Platform and periodically reports metering data.

12.14.5 Triggers

The Metering Company decided to change the report frequency.

12.14.6 Normal Flow

1. The Metering Company creates a group on the M2M SP Platform and include all the meters as group members.

2. After the successful creation of group, the Metering Company then sends a policy configuration message to all meters through the group.
3. The M2M SP Platform determines if the connection of the meters supports broadcast/ multicast.
4. The M2M SP Platform then makes the best use of the broadcast/ multicast mechanism to fan out configuration messages.
5. After the receiving of the policies, meters start to report the metering data using the new frequency.

12.14.7 Alternative flow

None.

12.14.8 Post-conditions

None

12.14.9 High Level Illustration

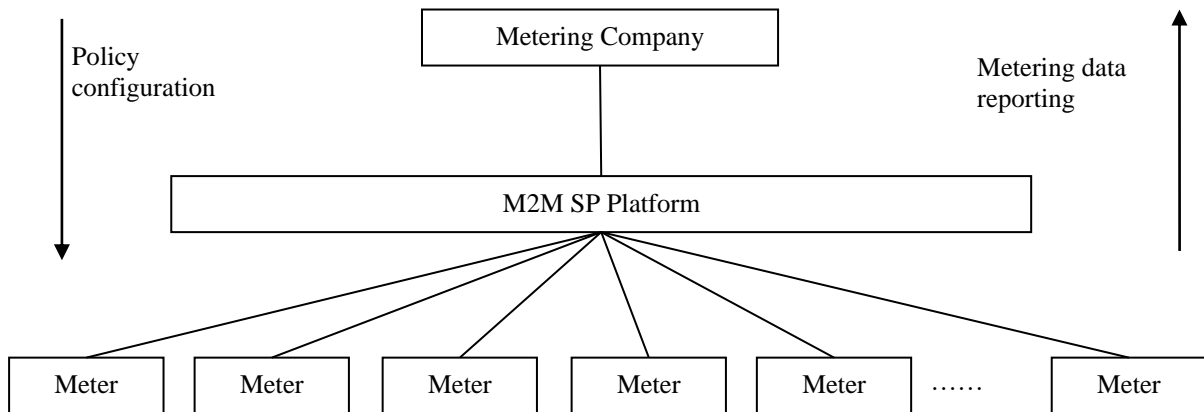

Figure 12-25 Multicast using group

12.14.10 Potential requirements

1. The oneM2M System shall be able to select an appropriate Underlying Network to broadcast or multicast data depending on the network's broadcast/multicast support and the connectivity supported by the targeted group of M2M Devices/Gateways.[OSR-052]
2. The M2M System shall be capable of collecting asynchronous responses pertaining to the broadcasted messages.

12.15 Access control using group

12.15.1 Description

The Parking Management System of the building is in charge of collecting the number of the available parking slot by the sensor that was set above each slot. The Parking Management System publishes the information on the M2M Platform for vehicles which is destined to the building to acquire. However, the information is only disclosed to vehicles that has proper access rights. The Parking Management System uses a group to organize the vehicles that has the correct access rights.

12.15.2 Source

REQ-2015-0556R01-Use Case access control using group.

12.15.3 Actors

- Parking Management System: The Parking Management System uses the M2M SP to host its parking slot reservation service. The Parking Management System reports the available number of parking slots to the M2M platform for vehicles to acquire.
- M2M SP: The M2M Service Provider provides M2M platform as well as the connection between the platform, vehicles and the Parking Management System.
- Vehicle: The Vehicle acquires the available parking slot number of the building and decides if to reserve one from the Parking Management System or choose another nearby parking area.

12.15.4 Pre-conditions

The Parking Management System, the M2M SP and the Vehicles have established business relationship with each other.
Some Vehicles has been authorized by the Parking Management System to read the available parking slot information while some others are not.
The Parking Management System created a group on the platform of the M2M SP to organize all the Vehicles that are authorized.

12.15.5 Triggers

One Vehicle attempts to acquire the available parking slot number from the platform.

12.15.6 Normal Flow

1. The Vehicle that is destined to the building acquires the available parking slot from the platform.
2. The platform inspects if the Vehicle is among the group that is authorized to retrieve such information.
3. The platform finds that the Vehicle is a member of the group.
4. The platform responds back the information to the Vehicle.

12.15.7 Alternative flow

1. The Vehicle that is destined to the building acquires the available parking slot from the platform.
2. The platform inspects if the Vehicle is among the group that is authorized to retrieve such information.
3. The platform finds that the Vehicle is not a member of the group.
4. The platform rejects the acquire attempt from the Vehicle.

12.15.8 Post-conditions

None

4195 12.15.9 High Level Illustration

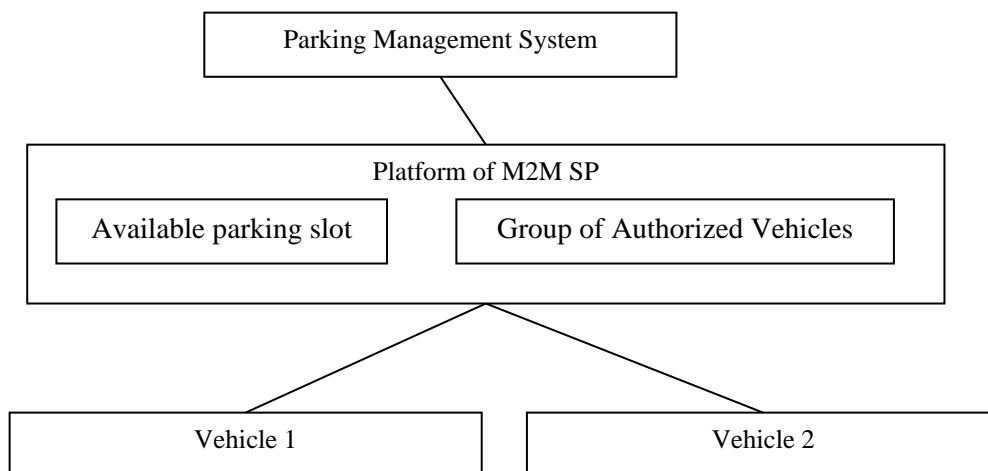

4196
4197

Figure 12-26 Access control using group

4198 12.15.10 Potential requirements

- 4199 1. The M2M System shall support grouping of M2M applications that have the same access control rights towards
4200 specific resources, so that access control can be performed by validating if the M2M application is a member
4201 of certain group.

4202

4203 12.16 Personal data management mechanism based on user's
4204 privacy preference

4205 12.16.1 Description

4206 Because the data collected by the M2M platforms may include personal information or sensitive information of
4207 data providers, the access to such data should be controlled appropriately. This use case shows the data
4208 management mechanism based on data provider's privacy preferences, which is developed as a PPM (Privacy
4209 Policy Manager). Because access from application service providers to the collected data at M2M service
4210 platform is controlled based on the privacy preferences that are configured by the data providers, unnecessary
4211 and unwanted access to the collected data is blocked appropriately.

4212 12.16.2 Source

4213 REQ-2015-0576-Use case of PPM.

4214 12.16.3 Actors

- 4215 • Front-end data-collection equipment (M2M devices): This actor collects various kinds of data and sends the
4216 data to a management platform. The collected data may include sensitive or privacy information of data
4217 providers.
- 4218 • Management platform (M2M Service Provider's Platform): The management platform stores the data
4219 collected by M2M devices. This also has authorization function that manages the access control to the
4220 stored data.
- 4221 • Data provider: A data provider is a user of services from application service providers. The user subscribes
4222 services, and the management platform starts to collect data related to the user and its services. In case
4223 that a service requires personal information of a user, such data are collected by the management platform.
4224 So the user becomes the data provider. The data that are provided by the data provider may include

sensitive or private information. The data provider can configure his/her privacy preference for the collected personal data. If the data provider would not like to permit the application service provider to collect or access specific kinds of data, the data provider can configure the privacy preference of the service to control the data collection or access. The management platform control the data collection from the M2M devices and the data access from the application service providers to the collected personal data based on the privacy preferences.

- PPM: A PPM function manages privacy preferences of the data providers. The data providers configure their privacy preferences while subscribing application services. The application service providers present the data providers which kinds of data are collected and used by the application service, and the data providers configure their privacy preferences to give access permissions to several kinds of collected data. Although an application service provider may use many kinds of data from a data provider, the data provider can permit the subset of listed data by configuring the privacy preference for its application service. A PPM function also has mechanism to record the usage of the collected data. When application service providers access to the collected data from data providers, its accesses are logged to the PPM. If the data providers would like to refer the past usage of their personal data, they can check it by accessing the PPM. The data provider can request the application service providers to delete the collected data based on the record of access log.
- Application service providers: This actor provides many kinds of services to service users. In case the application service providers use the data stored in the management platform, they access to the data via authorization function. Because this function provides access control to the data, the function asks a PPM and decides whether the application service provider has access permission to the accessing data or not.

12.16.4 Pre-conditions

None.

12.16.5 Triggers

- Service subscribing trigger: configuring privacy preference of data providers for each service
- Data collection trigger: collecting data at M2M modules
- Data access trigger: accessing collected data from application service providers
- Data usage reference trigger: referring usage of collected data from application service providers
- Data deletion trigger: requesting deletion of accessed and stored data in application service providers

12.16.6 Normal Flow

The following normal flow is described based on the High Level Illustration figure (clause 12.16.9).

- a) Configuration of privacy preference by data provider
 - 1) When a user starts to subscribe a service of application service provider, the user checks the privacy policy of service. The privacy policy explains what kinds of data will be accessed to provide the service. If the user permits the application service provider to access the collected data by M2M management platform, the user becomes the data provider.
 - 2) The data provider can select the kinds of data that the application service provider can use by using the PPM. If the data provider would not like to permit the application service provider to access specific kinds of data, the data provider can configure the privacy preference to enable this situation. In other words, because this access permission can be defined item by item, the data provider can restricts the access to the part of collected data.
- b) M2M data collection
 - 3) The M2M Service Provider's platform collects data related to the data providers by using M2M devices. In this phase, unwanted and unused data are not collected by configuring privacy preference in PPM appropriately.
- c) M2M data access from application service providers
 - 4) When application service providers access to the collected data in M2M Data, they access M2M Service Provider's Platform. The authorization function in the platform controls access to the

4273
4274

M2M Data based on the privacy preference stored in the PPM. The authorization function retrieves privacy preference to the target data from the PPM.

4275
4276
4277

5) If the access is permitted, the target data are transferred to the application service provider. If the access is not permitted, the authorization function responds to the application service provider with the notification of access denied with reasons.

4278

d) Traceability of personal data usage

4279
4280

6) When the application service providers access to the collected data in M2M Data, all the access and its result (access permitted, access denied) are recorded and stored at the PPM.

4281
4282
4283

7) If the data provider would like to check the status of data usage by application providers, the data provider access to the PPM. The data provider can recognize that which application provider accessed to what kinds of collected data.

4284
4285
4286

8) If the data provider would like to delete the collected data that were stored in the application service providers, the data provider can request the application service providers to delete the transferred data by specifying access record in the PPM.

4287

4288

12.16.7 Alternative flow

4289

None.

4290

12.16.8 Post-conditions

4291

None.

4292

12.16.9 High Level Illustration

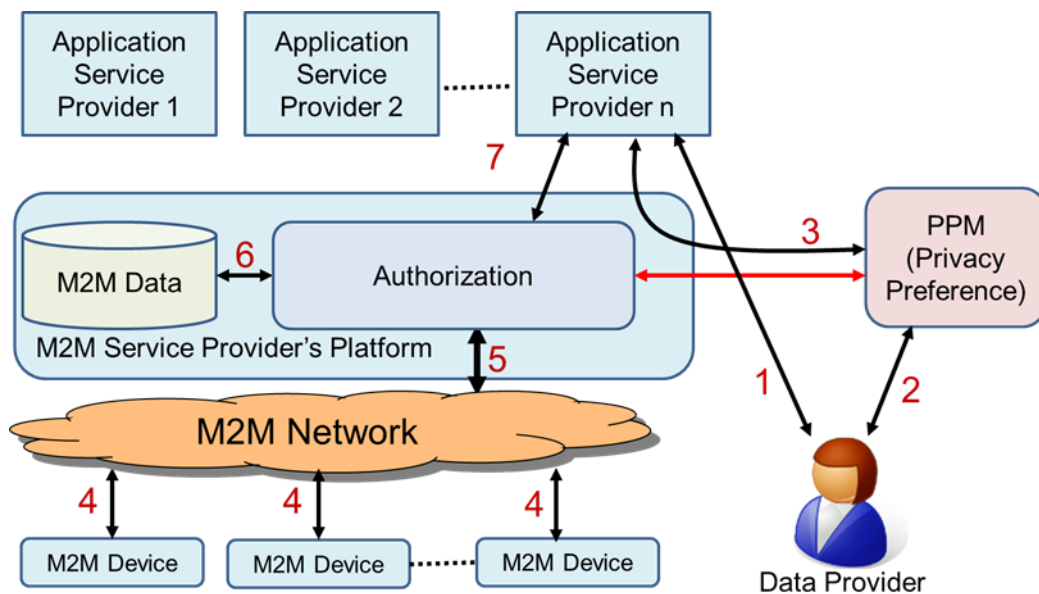

4293
4294

Figure 12-27 Overview of Personal Data Management mechanism using PPM

4296

12.16.10 Potential requirements

4297
4298
4299

1. The M2M system shall support the capability of managing the data collection and access to the collected data by using authorization mechanism to avoid unnecessary and unwanted personal information access based on the privacy preference defined by the data provider.

4300
4301

2. The M2M Service Provider's Platform system shall provide an interface that enables access control for personal data of a data provider by using access control policy defined by the data provider as privacy preference.

4302

4303 12.17 Quality of Sensor Data

4304 12.17.1 Description

4305 It is quite popular to transmit observation values of the sensor as a form of time series data in social
4306 infrastructure, i.e. factories, power plants, water systems, or railroad systems. In these handling of sensor
4307 values, observation value is transmitted with “quality bit”, which represents quality of data, i.e. the
4308 observation value is valid or not by reference to predefined normal operating condition of the sensor.
4309 The quality bit is used as a quality indicator of observation value of sensor. In other words, it is used as a basis
4310 for considering whether the value is usable or not, or how the value should be used.
4311 Consider an example case where water is stored in a tank and is conveyed by a pump. The water level of a tank
4312 is observed by a sensor, and data collection policy (named data catalogue) is utilized at oneM2M MN to
4313 transmit average of 2 observation values. The observation value is not adequate to be utilized when there is any
4314 abnormality in the electric power source of the sensor or in controller. The average value is not adequate to be
4315 utilized when one of observation values is not adequate. Therefore, information such as “the observation value
4316 of sensor of water level lacks quality” is added in order to make the application work as intended.

4317 12.17.2 Source

4318 REQ-2015-0599R03 Sensor Data Quality.

4319 12.17.3 Actors

- 4320 • Tank1: Tank stores water.
- 4321 • Pump1: Pump conveys water.
- 4322 • Water level sensor1: It observes water level of a tank1 and transmit the observation value d1 to
4323 PLC/DCS1 at fixed time intervals.
- 4324 • Electric power source of water level sensor1: It supplies electric power which is required for the water
4325 level sensor1 to work correctly.
- 4326 • PLC(Programmable Logic Controller)/DCS(Distributed Control System)1: PLC/DCS receives two
4327 observation values, i.e. water level of tank1 and status signal of electric power source of water level
4328 sensor1, and transmit a form of water level data d1 with a quality bit q1 at fixed time intervals. When
4329 the electric power source of water level sensor1 is abnormal or PLC/DCS1 itself has some
4330 abnormality, the water level observation value d1 is considered to be incorrect and the quality bit q1 is
4331 set to “not good
- 4332 • Tank2: Tank stores water.
- 4333 • Pump2: Pump conveys water.
- 4334 • Water level sensor2: It observes water level of tank2 and transmit the observation value d1 to
4335 PLC/DCS2 at fixed time intervals.
- 4336 • Electric power source of water level sensor2: It supplies electric power which is required for the water
4337 level sensor to work correctly.
- 4338 • PLC/DCS2: PLC/DCS receives two observation values, i.e. water level of tank2 and status signal of
4339 electric power source of water level sensor2, and transmit a form of water level data d2 with a quality
4340 bit q2 at fixed time intervals. When the electric power source of water level sensor2 is abnormal or
4341 PLC/DCS2 itself has some abnormality, the water level observation value d2 is considered to be
4342 incorrect and the quality bit q2 is set to “not good”.
- 4343 • oneM2M MN: oneM2M MN receives water level observation values d1 and its corresponding
4344 quality bit q1 from PLC/DCS1 as a form of time series data, receives water level observation value d2
4345 and its corresponding quality bit q2 from PLC/DCS2 as a form of time series data, calculates average
4346 value d3 as specified by data catalogue, and transmits the average value d3 and its quality bit q3 to
4347 oneM2M platform. When quality bit q1 or q2 is “not good”, the calculated average d3 is considered to
4348 be incorrect and quality bit q3 is set to “not good”.
- 4349 • oneM2M platform: oneM2M platform receives time series data and its corresponding quality bit from
4350 oneM2M MN and transmit them to Application.
- 4351 • oneM2M Application: oneM2M Application receives time series data and its corresponding quality
4352 bit, and performs user-defined procedure(s) referring quality bit value.
- 4353 • Real-time Ethernet: Real-time Ethernet connects PLC/DCS and oneM2M MN.

4354 • Underlying network: connects oneM2M MN and oneM2M platform.

4355 12.17.4 Pre-conditions

4356 Observation value of sensor is coupled with its quality bit and correspondence relation is defined.

4357 12.17.5 Triggers

4358 PLC/DCS receives observation value at fixed time intervals and receives status signal of electric power supply
4359 of the water volume sensor.

4360 12.17.6 Normal Flow

- 4361 1. When the electric power source of water level sensor1 is normal and PLC/DCS1 has no abnormality, the
4362 observation value d1 is considered to present correct water level and to be usable and PLC/DCS1 adds quality
4363 bit q1 “good” to the observation value d1. Otherwise, when the electric power source of water level sensor 1 is
4364 abnormal or PLC/DCS1 has some abnormality, the observation value d1 is considered to be incorrect and
4365 PLC/DCS1 adds quality bit q1 “not good” to the observation value d1. Similarly, PLC/DCS2 adds quality bit
4366 q2 “good” or “not good” to the observation value d2.
- 4367 2. oneM2M MN receives observation value d1 and its corresponding quality bit q1 from PLC/DCS1 as a
4368 form of time series data receives observation value d2 and its corresponding quality bit q2 from PLC/DCS2 as
4369 a form of time series data, calculates average value d3 as specified by data catalogue, and transmits the average
4370 value d3 and its quality bit q3 to oneM2M platform. When q1 or q2 is “not good”, the calculated average
4371 value d3 is considered to be incorrect and quality bit q3 is set to “not good”..”
- 4372 3. oneM2M platform receives time series data and its corresponding quality bit from oneM2M MN, and
4373 transmits them to oneM2M application.
- 4374 4. Application receives time series data and its corresponding quality bit from oneM2M platform and
4375 performs user-defined procedure(s) referring quality bit value. Usually, observation value with quality bit “not
4376 good” is not used to monitoring or controlling functions.

4377 12.17.7 Alternative flow

4378 None.

4379 12.17.8 Post-conditions

4380 None.

4381 12.17.9 High Level Illustration

4382

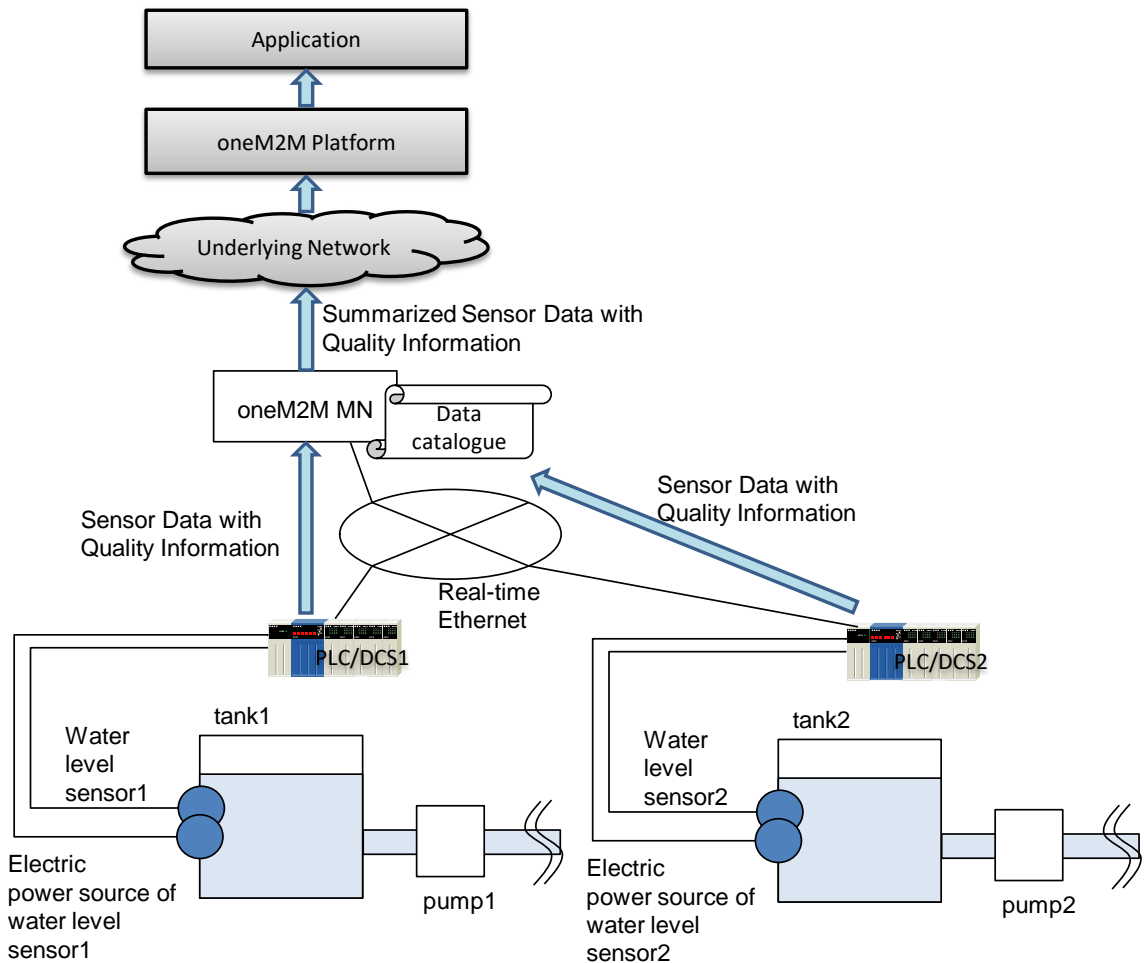

4383
4384
4385 **Figure 12-28 Quality of sensor data**

4386 **12.17.10 Potential requirements**

- 4387 1. The oneM2M system shall provide capability to manage data quality description of resource.
4388
4389
4390

4391 **12.18 Agriculture monitoring drone system**

4392 **12.18.1 Description**

4393 Drone was originally developed for military purpose for surveillance of enemy troops. However, the drone is
4394 now used in a wide variety area specifically in sport, logistic, media, industry, and agriculture area. Since
4395 drone can be equipped with GPS flight assistance, Sensor, Radar, and Camera, it can detect abnormal action
4396 when it fly over the farmland and report the data to the administration center. In addition, the drone can carry
4397 pesticides and spray over the crop to protect it from fungal infections.
4398 Drone collects the information regarding the condition of farmland and crop and send the monitoring data to
4399 the administration center. At agriculture administration center, the aggregated data can be analysed and the
4400 information used for smart faming solution e.g., knowing how much fertilizer needs to be used, detecting what
4401 harmful insects are living in the farmland.
4402 Drone is operated with battery power and after receiving command message from administration center, it
4403 follows the action described in the command message e.g., modifying monitoring region coverage, coming

4404 back to the battery charging station. If a series of command messages are not delivered to each drone because
4405 of communication loss or if the message is delivered well but it malfunctioned then the desired actions are not
4406 performed. In order to prevent this situation, service transaction mechanism was introduced in the M2M
4407 platform. This use case is based on service transaction and this additionally introduces policy-based transaction
4408 rescheduling mechanism.

4409 12.18.2 Source

4410 REQ-2015-0607R01 Use Case for Agricultural Drone.

4411 12.18.3 Actors

- 4412 • Drone, which can monitor the condition of farmland and crop and report data to the administration
4413 center through M2M platform. It also carry pesticides or fertilizer on the move to spray over the crop.
- 4414 • M2M Platform, which can manage the resources about drones and receive message from drone and
4415 deliver control message to the drone connected via access network.
- 4416 • Agriculture Monitoring administration Center (AMC), which receive the data from drones for
4417 monitoring farmland and crops and send the command message to each drone for desired action.

4418 12.18.4 Pre-conditions

4419 None.

4420 12.18.5 Triggers

4421 The battery level of one drone is low and needs to be recharged. In this situation, AMC sends the drone a
4422 command message which indicates the drone coming back. At the same time, AMC sends group of drones
4423 command messages which direct coverage modification about monitoring region.

4424 12.18.6 Normal Flow

- 4425 0) All Drone are registered with M2M Platform and AMC sends control messages to each drone for
4426 monitoring the farmland and crop.
- 4427 1) If one drone's battery level become low, AMC gets this information and waits for sending the control
4428 message which indicates the drone with low level battery should come back to the battery charging
4429 station. If one drone come back to the charging station and then the number of drone monitoring the
4430 farmland decrease. Thus each drone needs to update its monitoring coverage. To this end, AMC waits for
4431 sending each drone control messages which indicate modifying its monitoring coverage.
- 4432 2) Because a series of command message is important, AMC initiates transaction triggering mechanism and
4433 sends command message to drone 1~6.
- 4434 3) In this situation, drone 1~5 responded with success information, drone 3 has a problem and responded
4435 with failure information.
- 4436 4) Because transaction mechanism was initiated, AMC sends the roll-back message to drone 1~6 which
4437 enables each drones to cancel the received command message and return to the previous status.

4438 12.18.7 Alternative Flow

4439 The alternative flow is about the scenario represents policy-based rescheduling mechanism.

- 4440 0) AMC initiates transaction triggering mechanism and sends command message to drone 1~6.
- 4441 1) In this situation, drone 1~5 responded with success information, drone 3 has a problem and responded
4442 with failure information.
- 4443 2) Based on the responding message from drone 1~6, M2M platform triggers transaction rescheduling
4444 mechanism referring to the transaction policy.
- 4445 3) Transaction group is created for transaction rescheduling for example, drone 1~3 are grouped with A,
4446 drone 4~6 are grouped with B.
- 4447 4) In this case, if drone 3 fails again as the same in previous situation, only drone 1~3 in Group A would be
4448 affected by the cancellation of the operation.

4449 12.18.8 Post-conditions

4450 None.

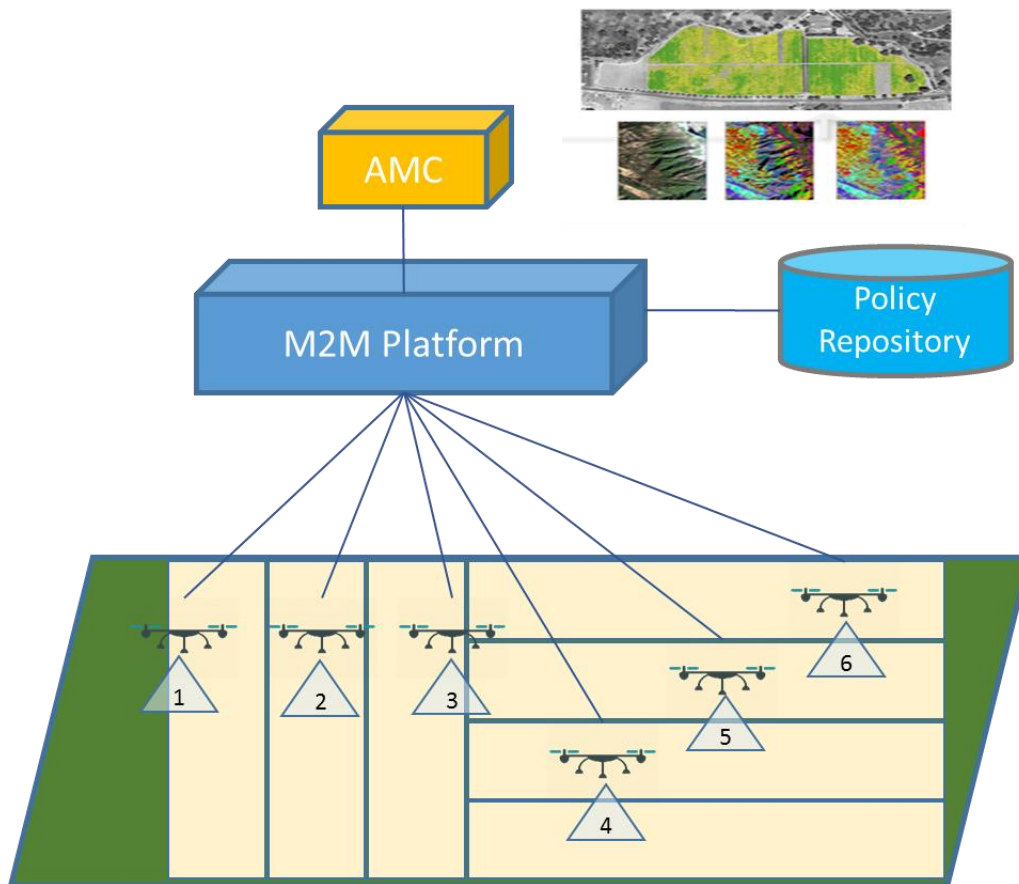

4452
4453

4454
4455

4456

Figure 12-29 Agriculture monitoring drone system

4457

4458 12.18.10 Potential requirements

- 4459 1. The oneM2M System shall support transaction management to multiple devices or applications providing policy
4460 based mechanism that should be invoked (e.g. keep status, re-schedule, rollback) depending on the outcome of
4461 the desired operation.

4462 12.19 Terms And Conditions Markup Language for Privacy Policy 4463 Manager

4464 12.19.1 Description

4465 Given different legal jurisdictions and individual preferences, there is a need to at least semi-automate the
4466 process for configuring privacy preferences and agreement to Terms and Conditions (T&C's). Otherwise the
4467 user (data subject) would have to agree multiple T&C's and each smart device and service would have to have
4468 a GUI that the user would have to access and configure to set their privacy preferences by hand. A better way
4469 forward would be to allow the profile owner configure a single set of profile'sprofile's (house, work, personal,
4470 parental, legal etc.) and as a new smart device or service is added:

- 4471 a) Where the terms and conditions fall within the parameters set in the user's profile, the device can be
4472 automatically authorized (with a notification to the user). If the T&C do not fall within the parameters
4473 set, only the differences (as a delta to the user's profile) are presented to the user for authorization with
4474 the exception of the parental/Legal profile which the user will not be able to override, only the profile
4475 owner (e.g. parent/Local government respectively) can override.
- 4476 b) The user's privacy settings from their profile can be automatically configured where relevant, with
4477 confirmation notification to the user. Where it is not possible to fully configure the relevant security
4478 controls the user is alerted and can manually decide.

4479
4480 To make this possible it is needed to convert Terms & Conditions and privacy settings in to a standard mark-up
4481 language that can be understood by smart devices and translated in to a human readable format. Another
4482 advantage of this mark-up language will allow standard translations of this mark-up language in to multiple
4483 human languages allowing new compliant devices to be rapidly brought to market in multiple countries.
4484 Customers can also shop for devices and services that meet their requirements, such a meeting their defined
4485 minimal level of data encryption, thus allow business to more easily market the high value features of their
4486 products to mass market customers.
4487

4488 Consider someone buying a prebuilt new home in the year 2025, the buyer will be looking at a home with
4489 integrated smart sensors, smart home appliances, each selected by builder or their subcontractor. Each of these
4490 will potentially have a separate set of terms and conditions, such as the Oven, fridge, washing machine,
4491 security motion sensor, fire alarm etc. just in an integrated kitchen alone. Currently as part of the legal
4492 information that the builder has to provide to a buyer certain paperwork, mainly focuses on legal liabilities
4493 governed by law which the buyer's solicitor will check on buyer behalf for any issues.
4494

4495 In 2025 the buyer will also have to go through potentially dozens of sets of T&C before purchasing the
4496 property, the buyer may also need to check this with their insurer (e.g. who can access alarm data) and
4497 Mortgage company as they could affect the value of the property (such as the issues with zero priced solar
4498 panels & roof leases in the UK, example of devices). In addition to the smart devices, which may be tied to
4499 specific service, selected by the builder such as electrical power and water, the builder may have selected other
4500 services such as Fire and security monitoring services that are pre-configured as part of the smart home.
4501 [The builder may have selected these as they provide free trials they can use to demonstrate the features, may
4502 be required to by law (Energy), their own backers (such as banks funding the development wanting
4503 fire/security monitoring to protect their investment), the smart device makers may offer a discounted price in
4504 return for connecting the service or the builder may be provided with financial incentives to "install" a service by
4505 a specific company. There will be business interest by service providers in getting builders to pre-select and
4506 configure their services on the grounds that inertia selling will convert a percentage of home buyers in to
4507 customers.
4508

4509 The home purchaser will have to read though all the terms and conditions*, decide which he agrees with, which
4510 he does not, then go through the process to disable each of the devices/services they do not accept the T&C
4511 for, add their own selected services before configuring the devices and services how they want. In theory as
4512 each of the devices and services is gathering data about the new owner, they should suspend their operation
4513 until the user has formally provided informed consent to the T&C in accordance to local laws.
4514

4515 This will require that smart devices and services do the following:

- 4516 • Announce their presence to the new owner.
- 4517 • Be able to display their terms and conditions directly to the user.
- 4518 • Have some way for the new owner to accept the terms and conditions.
- 4519 • Configure their preferences
- 4520 • Be able to receive a revocation of permissions command and delete user configuration to trigger the above
4521 steps.

4522 Another option would be for all machine to machine devices to be able to communicate this information to a
4523 user's selected control devices e.g. a Smart Phone.
4524

4525 12.19.2 Source

4526 REQ-2015-0619R02 Terms And Conditions Markup Language for Privacy Policy Manager.

12.19.3 Actors

Names are based on the current European Union (EU) data protection definitions.

- Data subject. The living individual about who the data is captured. May or may not be the data owner.
- Data owner. The individual who owns the data. E.g. the home owner. Can be the data processor or a separate entity. [But also need to account for Non EU companies who may believe they own the data].
- Data processor. The entity who processes the data on behalf of the data owner.

12.19.4 Pre-conditions

Not applicable

12.19.5 Triggers

Not applicable

12.19.6 Normal Flow

1. The profile owner configures a single set of profile's (house, work, personal, parental, legal, etc.)
2. A new smart device or service is added
3. Where the terms and conditions fall within the parameters set in the data subject's profile, the device can be automatically authorized (with a notification to the data subject).
4. If the T&C do not fall within the parameters set, only the differences (as a delta to the data subjects profile are presented to the data subjects for authorization.
5. The data subject will not be able to override the parental/legal profile. Only the profile owner (e.g. parent/local government respectively) can override.
6. The data subject's privacy settings from their profile can be automatically configured where relevant, with confirmation notification to the data subject.

12.19.7 Alternative flow

Where it is not possible to fully configure the relevant security controls the data subject is alerted and can manually decide.

12.19.8 Post-conditions

The data subject has given or refused informed consent for data capture for each oneM2M service based only on the deltas between each new service and the terms and conditions already accepted.

12.19.9 High Level Illustration

The concept of a Privacy Policy Manager (PPM), as described in oneM2M TR-0016 **Error! Reference source not found.** [i.20] is :

" "The PPM had been adapted to large scale HEMS (Home Energy Management System) as trial, and they had started evaluation of PPM effectiveness.

The PPM is based on the following two main concepts:

- *Based on "Privacy by Design", Inclusion in the architecture of a personal data distribution base.*
- *Based on "Privacy First", the provision of an "end users function" by which end users can manage their own personal data distribution according to their privacy preferences."*

An overview of the proposal is shown below (Data Provider is the equivalent of Data Subject in UE data protection legislation).

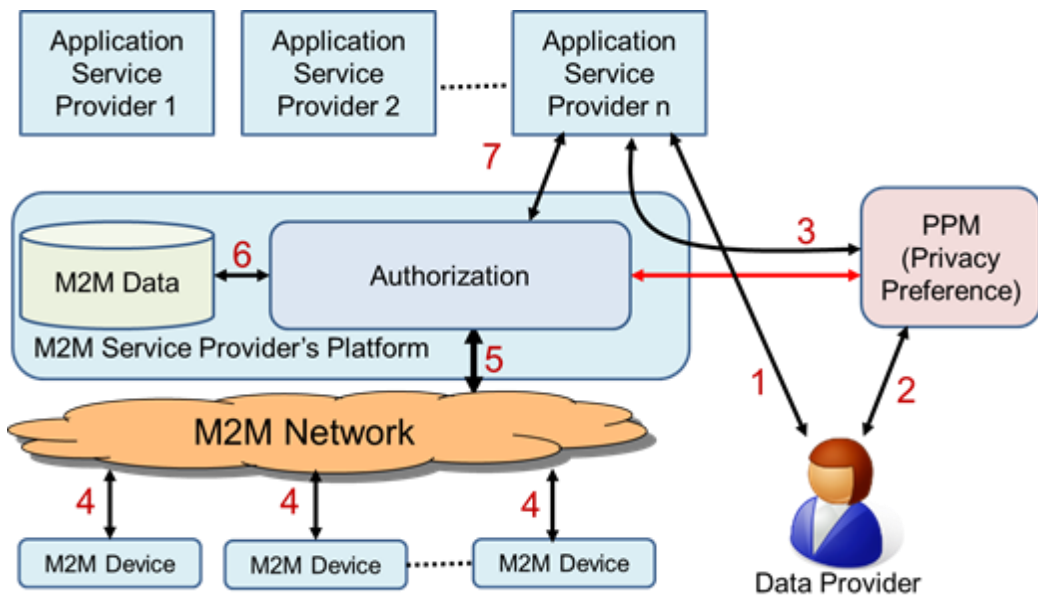

Figure 12-30 Terms And Conditions Markup Language for Privacy Policy Manager

12.19.10 Potential requirements

1. The oneM2M system shall store and process privacy preferences in an interoperable manner.
2. The oneM2M system shall support privacy profiles at various levels to care for conditions of legal requirements, manufacturers, and data subjects.
3. The oneM2M system shall be able to prioritize privacy profiles where there is a conflict between profiles (legal profile takes priority over data subject profile, for example).

History

Publication history		
V1.0.1	30-Jan-2015	Release 1 - Publication
V2.4.2	312-Mar-2018	Release 2A - Publication