

z/OS



Network File System Guide and Reference

Version 2 Release 3

Note

Before using this information and the product it supports, read the information in "Notices" on page 585.

This edition applies to Version 2 Release 3 of z/OS (5650-ZOS) and to all subsequent releases and modifications until otherwise indicated in new editions.

Last updated: July 17, 2017

© **Copyright IBM Corporation 1991, 2017.**

US Government Users Restricted Rights – Use, duplication or disclosure restricted by GSA ADP Schedule Contract with IBM Corp.

Contents

Figures ix

Tables xi

About this document xiii

Required product knowledge xiii
Where to find more information xiii
 Access to documents xiii
How to read syntax diagrams xiv
Related protocol specifications xvii
The z/OS Basic Skills Information Center xviii

How to send your comments to IBM xix

If you have a technical problem xix

Summary of changes xxi

Summary of changes for SC23-6883-02 xxi
Summary of changes for z/OS Version 2 Release 2
(V2R2) as updated December 2015 xxi
Summary of changes for SC23-6883-01 xxii
Summary of changes for SC23-6883-00 xxii

Part 1. Using z/OS Network File System. 1

Chapter 1. Introduction 3

Overview 3
z/OS UNIX files 4
 z/OS UNIX advantages. 4
 NFS protocol compliance 5
 Crossing between file systems–NFS server 5
z/OS conventional MVS data sets 5
 Mounting MVS data sets onto a client mount
 point 5
 Creating z/OS conventional MVS data sets 6
 Serializing and sharing data sets. 6
NFS version 2 and version 3 statelessness. 7
NFS version 4 state 7
Name space and file system management. 8
z/OS NFS File System Type Selection 9
 Specifying the path type prefix and the
 customer-configurable path resolution heuristic. 9
 Implicit prefix support restrictions 11
Server control files 13
 Attributes data set 13
 Exports data set 13
 Mount handle data set. 14
 Log data set 14
Tested clients for the z/OS NFS server 14
 NFS protocol attributes for the z/OS NFS server 15
 z/OS NFS server restrictions 15
Tested servers for the z/OS NFS client 16
 z/OS NFS client restrictions 17

WebNFS support 17
NFS versions with TCP/IP protocols 18
Internet Protocol version 6 19
User-specified port range support 20
Dynamic addressing 20
64-bit exploitation 21
Data transfer and conversion 21
 Native ASCII support 21
NFS Error Client Loop Detection Facility 21

Chapter 2. Creating z/OS conventional MVS data sets 23

Overriding data set creation attributes 23
Preparing to create an MVS file. 23
 Naming MVS files 24
Creating physical sequential files 24
Creating direct access files 25
Creating PDSs and PDSEs 26
 Creating a PDS or PDSE - mkdir dsntype(pds),
 dsntype(library) 26
 Removing a PDS or PDSE - rm, rmdir 26
 Accessing PDS or PDSE members 27
 Updating or extending a PDS or PDSE member
 Timing out while writing a PDS or PDSE
 member 27
 Wildcard copy to a PDS or PDSE 27
 Limitations of a PDS 28
 Concurrent writes to a PDSE 28
 ISPF extended statistics support for PDS or PDSE
 members 28
Creating VSAM files 28
Exploiting SAM striped files. 30
Exploiting large format data sets 30
Exploiting data sets on extended address volumes 30

Chapter 3. Using z/OS conventional MVS data sets 31

Special MVS considerations 31
 Selection of an MVS data storage format 31
 File size determination and time stamps. 32
 Ownership and permissions 32
 File reading and writing 33
 Case sensitivity–maplower, nomaplower. 34
 Selection of text or binary processing modes–text,
 binary 34
 MVS prefix support 36
 Number representation 36
 Partial record identification 37
 Access to migrated files–retrieve, noretrieve; wait,
 nowait 39
 Access to migrated system-managed data sets 39
 File handle refresh 40
Mapping between the workstation and MVS file
systems. 40
 File extension mapping 40

Mounting of MVS data sets onto a client mount point	41
Use of a PDS or PDSE as a directory	44
Use of multiple mount points	44
Data set serialization and sharing	45
NFS protocol	45
NFS file system attributes	45
Delegating management of a file's resources to an NFS client	46

Chapter 4. Using z/OS UNIX System

Services files	49
z/OS UNIX file system	49
POSIX compatibility	50
NFS protocol	51
Attributes specific to z/OS UNIX System Services	51
Synchronous write to a z/OS UNIX file for NFS version 2 protocol	51
Synchronous write to a z/OS UNIX file for NFS version 3 or 4 protocol.	51
Authorization checking when writing to a z/OS UNIX file	52
HFSPREFIX site attribute	52
Protecting your z/OS UNIX System Services files	52
Accessing z/OS UNIX files from a client	53
Mount examples.	53
z/OS UNIX data transfer and conversion	54
Data transfer under the NFS version 4 protocol	54
Text or binary processing - NFS version 2 and 3 protocols	54
Linking an MVS data set to a z/OS UNIX file system	55
Creating an external link	55
Displaying the contents on an external link.	56
Deleting an external link	56
Accessing symbolic links on z/OS NFS version 4.	56
UNIX look and feel.	58
NFS file system attributes	58
Displaying and modifying remote file system access control lists	58
Remote ACL management restrictions:	59

Chapter 5. z/OS NFS file locking and access control 61

Locking in NFS versions 2 and 3 (NFS server only)	61
Using Network Lock Manager (NLM) in NFS V2 and V3	61
Using Network Status Monitor (NSM) in NFS V2 and V3	62
Locking in NFS version 4.	63
Byte-range locking	63
Share reservations	63
Specifying a grace period for reclaiming locks.	63
Listing locks held for a file	64
Releasing locks held for a file	64

Chapter 6. Commands and examples for AIX and UNIX clients 65

Using commands on AIX.	65
Quick reference of AIX and UNIX commands	69

Accessing z/OS UNIX file systems and z/OS conventional MVS files	69
Mvslogin command examples	70
Mount command examples using an MVS prefix	72
Mount command example: overriding server default attributes without an MVS prefix	73
Displaying default and mount point attributes - showattr	74
Unmounting and logging out of z/OS	78
Disconnecting your mount point - umount	78
Ending your z/OS session - mvlogout	79

Chapter 7. Commands and examples for z/OS NFS clients 81

Using commands on the z/OS NFS client	81
Accessing z/OS	88
Mvslogin command examples	88
Mount command syntax and examples	89
Unmount command syntax and examples	98
Displaying client and server statistical information-nfsstat.	99
Displaying server mount information-showmount	104
Displaying default and mount point attributes-showattr	105
Ending your z/OS session - mvlogout.	107

Chapter 8. Initialization attributes for the z/OS NFS client. 109

Client attribute syntax	109
Datacaching attribute.	116
Mount processing parameters and installation parameters	118
NFS client translation support	119
z/OS NFS client with z/OS NFS server	119

Chapter 9. Initialization attributes for the z/OS NFS server 121

Attributes used for z/OS UNIX file access.	121
Multipliers	122
Duplicate attributes	122
Data set creation attributes syntax	122
Processing attributes syntax	127
Timeout attributes.	135
Retrieve attributes.	136
Mapped keyword processing attribute	136
Native ASCII processing attributes	137
Site attributes syntax	139

Part 2. Customization and Operations 159

Chapter 10. Customization. 161

Protecting your programs and files	161
Protecting the server control files.	161
Setting up the z/OS NFS authorization.	162
Protecting the file system on z/OS with the NFS V4 protocol	163

Protecting the file system on z/OS with the Security site attribute	166
Customizing installation security exits	172
Using UNIX style credentials for authentication	172
Converting data	173
Creating the conversion environment for Unicode Services	174
Collecting NFS usage data	175
Configuring the z/OS NFS client	176
Creating the PARMLIB statement for the client	176
Updating z/OS system data sets for the client	176
Allocating client log data sets	177
NFS Client with Multiple TCPIP stacks	177
Mounting remote file systems	178
Setting up reserved (privileged) ports	178
Configuring a secure z/OS NFS client	179
Configuring the z/OS NFS server	181
Attributes data set	181
Exports data set	182
Checklist data set	191
Mount handle data sets	192
Lock data sets	192
Converting data between ASCII and EBCDIC - NFS V2 and V3 only	193
Updating z/OS system data sets for the server	195
Allocating the z/OS NFS server log data sets	196
Side file data set	196
Modifying tcpip.ETC.RPC and etc/rpc	196
Setting up a user-specified port range	197
Configuring a secure z/OS NFS server	199
Using dynamic client IP addressing	202
Terminal ID based restricted MVSLOGIN	203
SERVAUTH based restricted MVSLOGIN	204
Data Labeling	206
Using multiple TCP/IP stacks	206
Installing the client enabling commands	209
Retrieving commands for AIX, Sun Solaris, and Linux	211
Porting the mvslogin, mvslogout, and showattr commands	213
Porting on different compilers and operating systems	214
NFS v4 protocol name mapping	217
Inbound owner/owner_group processing	218
Outbound owner and owner_group attributes processing	219
Domain processing in NFSv4 Name Mapping	220
Using the NFS Error Client Loop Detection Facility	220

Chapter 11. Network File System operation 223

Starting the z/OS NFS client	223
Stopping the z/OS NFS client	224
Starting component tracing for the z/OS NFS client	224
Starting the z/OS NFS server	227
Starting multiple servers	229
Stopping the z/OS NFS server	230
Starting the z/OS NFS NSM and z/OS NFS NLM	231
Starting component tracing for the z/OS NFS server	231

Entering operands of the modify command for the z/OS NFS server	235
Addds operand	238
bufferusage operand	238
bufhigh operand	238
Cbsniff operand	239
CONSOLEMSGs operand	240
DlyDTimeout operand	240
exportchk operand	240
Exportfs operand	241
Frees operand	241
Freeze operand	242
ID2NAME operand	242
List operand	243
Mapfile operand	244
racf_cache_reset operand	244
Release operand	245
smf operand	246
Status operand	246
Swapldb operand	246
Swapmhdb operand	247
Unmount operand	247
Unmntall operand	247
Unmthfs operand	247
Unmntmvs operand	248
v4delg operand	248
Entering operands of the modify command for diagnosis	248
chkloop operand	249
Debug operand	250
Flushlog operand	250
Listlock operand	250
Log operand	251
Smf operand	252
Sockhang operand	252
Switchlog operand	253
Version operand	253
Displaying NFS trace information	254

Chapter 12. Installation-wide exit routines for the z/OS NFS server . . . 255

Requirements for NFS	255
Sample link-edit JCL	256
Storage blocks of the server exits	256
Login installation-wide exit	257
Requirements of the login exit	259
Options of the login exit	259
Structure of the login exit message	259
Contents of the login exit parameter list	259
Login exit parameter list	260
Request codes to the login exit	260
Return codes from the login exit	261
System initialization routine of the login exit	261
Start of new user session routine of the login exit	261
User login request routine of the login exit	262
User logout request routine of the login exit	263
System termination routine of the login exit	263
File security installation-wide exit	263
Requirements of the file security exit	266
Structure of the file security exit message	266

Contents of the file security exit parameter list	266
File security exit parameter list	268
Request codes to the file security exit	268
Return codes from the file security exit	268
Validate allocate request routine of the file security exit	268
Validate write request routine of the file security exit	269
Validate read request routine of the file security exit	269
Return security permissions routine of the file security exit	270

Part 3. Performance Tuning 273

Chapter 13. Performance tuning in the NFS environment. 275

What is performance tuning?	275
How is performance characterized?	275
What is the NFS environment?	276
How to tune for performance	276
Impact of the NFS protocol on performance	278

Chapter 14. Optimizing the NFS environment. 281

Network performance tuning	281
NFS client system performance tuning	283
NFS server system performance tuning	284
z/OS constraints	285

Chapter 15. Evaluating z/OS NFS performance. 287

Evaluating throughput	287
Single process throughput	287
Multiple process throughput	288
Multiple client throughput	288
Evaluating NFS command response time	288
Evaluating CPU utilization	288
Collecting server usage data	289

Chapter 16. Tuning the z/OS NFS server 291

Data set creation attributes	291
Block size and record length	291
Record format	292
Data set organization and data set type	292
B37/D37/E37 ABEND handling	293
NFS server cache monitoring and reporting	293
Processing attributes	294
Character translation	294
File size determination	294
Data set timeout specification	296
Accessing migrated files	296
Asynchronous z/OS UNIX processing	297
Site attributes	297
Buffer usage and caching	297
Ordering out-of-sequence data	299
Storage considerations	301
Subtasking	302

Chapter 17. Tuning the z/OS NFS client 305

Caching	305
Dynamicsizeadj	306
Bufhigh	306
Biod	306
Readahead	306
syncwrite	306
Delaywrite	307
Vers	307
Wsize and rsize	307

Part 4. Diagnosis and Messages 309

Chapter 18. Diagnosis and reporting of problems 311

Correcting input errors	311
Using keywords to identify a problem	312
Component identification keyword	313
Release level keyword	313
Type-of-failure keyword	313
Service level keyword	315
Using z/OS component tracing	316
Component trace benefits	317
Using NFS component trace PARMLIB members CTINFS nm and CTINFC nm	317
Capturing NFS Server component trace information in an SVC dump	324
Capturing NFS Client component trace information in an SVC dump	324
Using a z/OS component trace external writer	325
Setting up a dump data set for abnormal ends	331
Searching the IBM database for APARs and PTFs	331
Contacting the IBM Support Center	332
Diagnostic aids	332
First failure data capture	332
Errors and messages	334
Debug trace data capture	334
NFS client hang problem analysis	335
Environmental checklist	336

Chapter 19. Network File System messages 339

Server messages	339
Client messages	407
Client/Server Shared Messages	428
Messages from the client platform (AIX)	440

Chapter 20. Return codes 445

Chapter 21. Reason codes. 455

Special reason codes (xx is 00-0F)	456
Reason codes from NFS Client or NFS Server modules (xx is 10-FF)	470
USS JR $cccc$ reason codes (0000-0FFF)	470
Global reason codes ($yyyy$ = 1000 - 3FFF)	474
Module specific reason codes ($yyyy$ = 4000 - 4FFF)	478

Part 5. Appendixes	481
Appendix A. File size value for MVS data sets	483
Storage of the file size value	483
System-managed PS, VSAM, and PDSE data sets	483
Migrated system-managed data sets	483
Non-system-managed, PDS, and direct data sets	484
How the file size value is generated	484
Using fastfilesize to avoid read-for-size	485
Using nofastfilesize	486
Appendix B. Time stamps for MVS data sets	487
Time stamps for system-managed VSAM and PS data sets	487
Time stamps for non-system-managed PS and DA data sets	487
Storage of time stamps	487
Client program requirements	488
Generating time stamps	488
Time stamps for non-system-managed VSAM data sets	488
Time stamps for PDSs and PDSEs	488
Setting time stamps	490
Appendix C. NFS server attributes	491
NFS file system attributes for MVS data sets	491
NFS file system attributes for z/OS UNIX file systems	492
NFS protocol attributes	493
Appendix D. NSM (statd) protocol	497
Using supported NSM (statd) procedures	497
Appendix E. NFS system server sample attribute table	499
Appendix F. Sample exports data set	525
Appendix G. Sample startup procedures	535
Sample z/OS NFS server startup procedures	535
Sample z/OS NFS client startup procedures	539
Appendix H. Retrieval of source code for client enabling commands	543
Appendix I. PCNFSD protocol	545
Accessing data with PCNFSD	545
Accessing z/OS UNIX files	545
Starting the PCNFSD server	545
Using supported PCNFSD protocols	546

Version 1 of the PCNFSD protocol	546
Version 2 of the PCNFSD protocol	546

Appendix J. SMF C and assembler header macros **549**

SMF C header macro GFSASSMF	549
SMF assembler header macro GFAUSMF	557

Appendix K. Capturing diagnostic information using z/OS NFS log data sets and from other components . . . **565**

Using log data sets	565
Server log data sets	565
Client log data sets	566
Debug trace data capture	567
z/OS NFS server debug trace capture	567
z/OS NFS server DEBUG trace types	568
z/OS NFS client debug trace capture	568
Related component trace capture	569
z/OS UNIX System Services activity trace	569
z/OS hierarchical file system (HFS) physical file system activity trace	570
z/OS TCP/IP activity trace	570
AIX client activity trace	571
SUN client activity trace	571
z/OS dump	571

Appendix L. GFSAMHDJ sample code for creating NFS mount handle data sets and lock data sets **573**

Appendix M. Setting up NFS functions with Kerberos Support **577**

Special considerations for Linux Clients	577
Windows recommendations and limitations	577
Setting up a Kerberos Key Distribution Center	578

Appendix N. Accessibility **581**

Accessibility features	581
Consult assistive technologies	581
Keyboard navigation of the user interface	581
Dotted decimal syntax diagrams	581

Notices **585**

Terms and conditions for product documentation	587
IBM Online Privacy Statement	588
Policy for unsupported hardware	588
Minimum supported hardware	588
Programming interface information	589
Trademarks	589

Glossary **591**

Index **601**

Figures

1. NFS client-server relationship	3	24. Modify /etc/services for mountd, mvsmount, pcnfsd, showattr, status, and nlockmgr	197
2. Examples of mounting MVS data sets on Windows, UNIX and Linux clients	44	25. Modify tcpip.profile for z/OS NFS server services	198
3. Example of mounting an HFS or zFS file from a UNIX client	50	26. Retrieving the client enabling commands for AIX, Sun Solaris, and Linux.	212
4. Displaying server attributes	75	27. Common source files	214
5. Displaying mount point attributes	77	28. Sample link-edit JCL for the NFS	256
6. Displaying mount point attributes, part 2	78	29. Determining which login checking routines are used	258
7. TSO MOUNT command syntax operands	90	30. Determining which file security checking routines are used	265
8. TSO UNMOUNT command syntax operands	98	31. Displaying NFS client rpc and NFS statistical information	279
9. Displaying NFS Server and Client NFSv3 statistical information	100	32. Sample network topology	282
10. Displaying NFS client rpc statistical information	101	33. Directory list comparison between DFSMS-managed and non-managed	295
11. Displaying NFS client NFS statistical information	102	34. Bufhigh utilization with percentsteal	298
12. Displaying all of the z/OS NFS Server (RPC, NFSv2, NFSv3, NFSv4) statistical information	103	35. Relationship between cachewindow and BIODs	300
13. Displaying NFS mounted file system information	103	36. Logicalcache utilization for cachewindows	300
14. Displaying NFS mounted file system information with secure(upd) (Versions 2 and 3 protocol only)	104	37. z/OS NFS server component trace PARMLIB member CTINFS00.	321
15. Displaying NFS mounted file system information with public mountpoint (Version 4 protocol only)	104	38. z/OS NFS client component trace PARMLIB member CTINFC00	323
16. Displaying attributes	106	39. CTRACE Display Parameters panel	327
17. Permission checking for the security(none) attribute	167	40. NFS Server Filtering Criteria	328
18. Permission checking for the security(exports) attribute	168	41. NFS Client Filtering Criteria	328
19. Permission checking for the security(saf) attribute	169	42. NFS system server sample attribute table	500
20. Permission checking for the security(safexp) attribute	170	43. Sample exports data set	525
21. Sample FILESYSTYPE parmlib statement	176	44. Sample z/OS NFS server startup procedures	536
22. Specifying the mount handle data set in the MVS NFS procedure	192	45. Sample z/OS NFS client startup procedures	540
23. Specifying the lock data set in the MVS NFS procedure.	193	46. Retrieving source code for client enabling commands	543
		47. SMF C header macro GFSASSMF	549
		48. SMF assembler header macro GFS AUSMF	557
		49. Sample code for creating mount handle data sets and lock data sets	573

Tables

1. Reference documents	xiii	47. Codes and fields for validate read request	269
2. Mount statements based on the IMPPREFIX setting	10	48. Codes and fields for return security permissions	270
3. View of NFS server capability	18	49. Network performance tuning symptom and action information	281
4. Breakdown of text and binary writes	34	50. NFS client system performance tuning symptom and action information	283
5. Examples of mounting MVS data sets from clients	42	51. z/OS constraints symptom and action information	285
6. NFS procedures	45	52. Default block sizes for RAMAC 3 or ESS 2105 DASD	292
7. Examples of the mount command for clients	53	53. Client installation parameters for tuning	305
8. Examples of the mvslogin command for clients	70	54. Mount parameters for performance and tuning	305
9. Examples of the showattr command for clients	74	55. z/OS NFS FMIDs and release names	312
10. Examples of the amount command for clients	79	56. Summary of type-of-failure keywords	313
11. Example of the mvslogout command for clients	79	57. NFS symptom data	333
12. Examples of the mvslogin command for clients	88	58. Dump content and storage areas	333
13. Attributes - z/OS NFS client	109	59. Diagnostic errors and messages	334
14. Client attributes.	109	60. Messages - client operating system, NFS server, and NFS client.	339
15. Mount processing parameters	118	61. NFS server z/OS operators console message format	339
16. Installation parameters	118	62. Message format for the NFS server log data set	340
17. z/OS NFS clients with non-z/OS based NFS servers	119	63. NFS client z/OS operators console message format	407
18. Attributes - z/OS NFS server	121	64. NFS client log data set message format	408
19. Data set creation attributes	122	65. Common variables.	408
20. Processing attributes	127	66. Message format for the NFS server or NFS client log data sets	428
21. The mapped keyword and existing keywords	136	67. Externalized return codes defined by the NFS version 2 protocol	445
22. File tagging with Unicode Services active	138	68. Externalized return codes defined by the NFS version 3 protocol	445
23. File tagging with Unicode Services not active	139	69. Externalized return codes defined by the NFS version 4 protocol	446
24. Site attributes	140	70. z/OS NFS Server: z/OS UNIX return codes mapped to NFS Version 2 return codes	448
25. Customizing NFS	161	71. z/OS NFS Server: z/OS UNIX return codes mapped to NFS Version 3 return codes	450
26. UID, GID, SGID permission checking with security site attribute	171	72. z/OS NFS Server: z/OS UNIX return codes mapped to NFS Version 4 return codes	452
27. z/OS server processing of a mount request	171	73. Special NFS reason codes	456
28. z/OS server processing of a file request	172	74. Special NFS reason codes where xx = 05	457
29. Shorthand for addresses with multiple zero bits	191	75. Parsing error (when reason code is 6E01xxxx)	466
30. Shorthand for addresses in mixed IPv4 and IPv6 environments	191	76. Parsing error (when reason code is from 6E0111yy to 6E0133yy.	467
31. Modifying tcpip.ETC.RPC and etc/rpc	196	77. RPC error (when reason code is 6E03xxxx)	468
32. Files in the prefix.NFSTARB data set to download to clients	210	78. NFS reason codes that match USS JRcccc reason codes (0000-0FFF).	470
33. List of installation-wide exits	255	79. NFS client global reason codes (1000 - 3FFF)	474
34. Format of login installation-wide exit routine parameter list	260	80. Reason codes for module GFSCVNAT (xx = 12)	478
35. Request codes to the login exit.	261	81. Reason codes for module GFSCVMNT (xx = 18)	479
36. Return codes from the login exit	261		
37. Codes and fields for system initialization	261		
38. Codes and fields for start of new user session	261		
39. Codes and fields for user login request	262		
40. Codes and fields for logout request	263		
41. Codes and fields for system termination	263		
42. Format of the parameter list for the file security installation-wide exit	267		
43. Request codes to the file security exit	268		
44. Return codes from the file security exit	268		
45. Codes and fields for validate allocate request	268		
46. Codes and fields for validate write request	269		

82.	Time stamp sources for PDS and PDSE members	489	86.	File system values to retrieve POSIX information	491
83.	Time stamp sources for PDS and PDSE data sets (directories)	489	87.	File system values to get static file system information	492
84.	File system values to get dynamic file system information	491	88.	File system values to retrieve POSIX information	492
85.	File system values to get static file system information	491	89.	NFS Version 4 Attributes.	493

About this document

This document provides users, system programmers, and operators with information about using, customizing, operating, tuning, and diagnosing the z/OS[®] Network File System (z/OS NFS).

For information about the accessibility features of z/OS, for users who have a physical disability, see Appendix N, “Accessibility,” on page 581.

Required product knowledge

To use this document effectively, you should be familiar with the IBM multiple virtual system (MVS) as a component of the z/OS operating system, the IBM Time Sharing Option (TSO), and their commands. In addition, you should be familiar with System Modification Program/Extended (SMP/E) and the basic concepts of the NFS protocol and networking (Transmission Control Protocol/Internet Protocol (TCP/IP)).

Where to find more information

Where necessary, this document references information in other documents, using the shortened version of the document title. For complete titles and order numbers of the documents for all products that are part of z/OS, see *z/OS Information Roadmap*.

Access to documents

Table 1 contains additional reference information.

Table 1. Reference documents

Title	Order Number
<i>AIX Commands Reference, Volume 1</i>	SC23-2537
<i>AIX Commands Reference, Volume 2</i>	SC23-2538
<i>AIX Commands Reference, Volume 3</i>	SC23-2539
<i>AIX Commands Reference, Volume 4</i>	SC23-2539
<i>AIX Commands Reference, Volume 5</i>	SC23-2639
<i>AIX General Concepts and Procedures for RISC System/6000</i>	GC23-2202
<i>Character Data Representation Architecture Overview</i>	GC09-2207
<i>Character Data Representation Architecture Reference and Registry</i>	SC09-2190
<i>SMP/E for z/OS Reference</i>	SA23-2276
<i>SMP/E for z/OS User's Guide</i>	SA23-2277
<i>z/OS and Software Products DVD Collection</i>	SK3T-4271
<i>z/OS Communications Server: IP Configuration Reference</i>	SC27-3651
<i>z/OS DFSMS Introduction</i>	SC23-6851
<i>z/OS DFSMS Macro Instructions for Data Sets</i>	SC23-6852
<i>z/OS Migration</i>	GA32-0889
<i>z/OS DFSMS Using the New Functions</i>	SC23-6857
<i>z/OS DFSMS Using Data Sets</i>	SC23-6855
<i>z/OS DFSMSdfp Advanced Services</i>	SC23-6861

Table 1. Reference documents (continued)

Title	Order Number
<i>z/OS DFSMSdfp Diagnosis</i>	SC23-6863
<i>z/OS DFSMSdfp Storage Administration</i>	SC23-6860
<i>z/OS DFSMSShsm Diagnosis</i>	GC52-1387
<i>z/OS Information Roadmap</i>	SA23-2299
<i>z/OS MVS Installation Exits</i>	SA23-1381
<i>z/OS MVS JCL Reference</i>	SA23-1385
<i>z/OS MVS Programming: Authorized Assembler Services Guide</i>	SA23-1371
<i>z/OS MVS Programming: Authorized Assembler Services Reference ALE-DYN</i>	SA23-1372
<i>z/OS MVS Programming: Authorized Assembler Services Reference EDT-IXG</i>	SA23-1373
<i>z/OS MVS Programming: Authorized Assembler Services Reference LLA-SDU</i>	SA23-1374
<i>z/OS MVS Programming: Authorized Assembler Services Reference SET-WTO</i>	SA23-1375
<i>z/OS MVS System Codes</i>	SA38-0665
<i>z/OS MVS Programming: Authorized Assembler Services Guide</i>	SA23-1371
<i>z/OS MVS System Management Facilities (SMF)</i>	SA38-0667
<i>z/OS MVS System Messages, Vol 1 (ABA-AOM)</i>	SA38-0668
<i>z/OS MVS System Messages, Vol 2 (ARC-ASA)</i>	SA38-0669
<i>z/OS MVS System Messages, Vol 3 (ASB-BPX)</i>	SA38-0670
<i>z/OS MVS System Messages, Vol 4 (CBD-DMO)</i>	SA38-0671
<i>z/OS MVS System Messages, Vol 5 (EDG-GFS)</i>	SA38-0672
<i>z/OS MVS System Messages, Vol 6 (GOS-IEA)</i>	SA38-0673
<i>z/OS MVS System Messages, Vol 7 (IEB-IEE)</i>	SA38-0674
<i>z/OS MVS System Messages, Vol 8 (IEF-IGD)</i>	SA38-0675
<i>z/OS MVS System Messages, Vol 9 (IGF-IWM)</i>	SA38-0676
<i>z/OS MVS System Messages, Vol 10 (IXC-IZP)</i>	SA38-0677
<i>z/OS Security Server RACF Security Administrator's Guide</i>	SA23-2289
<i>z/OS Security Server RACF System Programmer's Guide</i>	SA23-2287
<i>z/OS Security Server RACF Callable Services</i>	SA23-2293
<i>z/OS Integrated Security Services Network Authentication Service Administration</i>	SC23-6786
<i>z/OS Integrated Security Services Network Authentication Service Programming</i>	SC23-6787
<i>z/OS TSO/E User's Guide</i>	SA32-0971
<i>z/OS Unicode Services User's Guide and Reference</i>	SA38-0680
<i>z/OS UNIX System Services File System Interface Reference</i>	SA23-2285
<i>z/OS UNIX System Services Messages and Codes</i>	SA23-2284
<i>z/OS UNIX System Services Programming: Assembler Callable Services Reference</i>	SA23-2281
<i>z/OS UNIX System Services Programming Tools</i>	SA23-2282
<i>z/OS UNIX System Services Command Reference</i>	SA23-2280
<i>z/OS UNIX System Services User's Guide</i>	SA23-2279
<i>z/OS UNIX System Services Planning</i>	GA32-0884

How to read syntax diagrams

Throughout this library, diagrams are used to illustrate the programming syntax. Keyword parameters are parameters that follow the positional parameters. Unless otherwise stated, keyword parameters can be coded in any order. The following list tells you how to interpret the syntax diagrams:

- Read the diagrams from left-to-right, top-to-bottom, following the main path line. Each diagram begins on the left with double arrowheads and ends on the right with two arrowheads facing each other.



- If a diagram is longer than one line, each line to be continued ends with a single arrowhead and the next line begins with a single arrowhead.

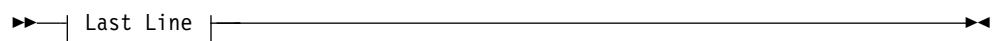
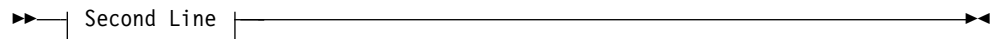

- Required keywords and values appear on the main path line. You must code required keywords and values.

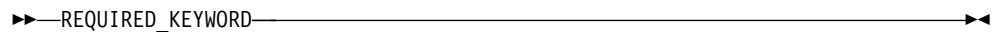

If several mutually exclusive required keywords or values exist, they are stacked vertically in alphanumeric order.

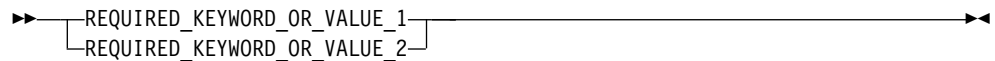

- Optional keywords and values appear below the main path line. You can choose not to code optional keywords and values.

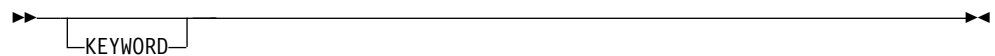

If several mutually exclusive optional keywords or values exist, they are stacked vertically in alphanumeric order below the main path line.



- An arrow returning to the left above a keyword or value on the main path line means that the keyword or value can be repeated. The comma means that each keyword or value must be separated from the next by a comma.



- An arrow returning to the left above a group of keywords or values means more than one can be selected, or a single one can be repeated.

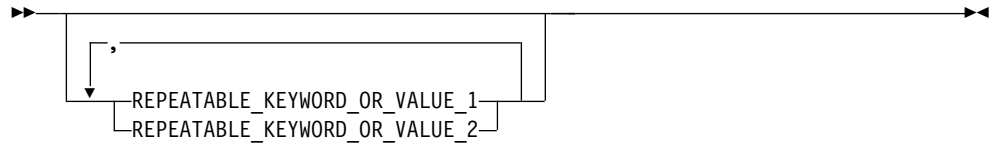

- A word in all upper case is a keyword or value you must spell exactly as shown. In this example, you must code **KEYWORD**.

▶▶—KEYWORD—▶▶

If a keyword or value can be abbreviated, the abbreviation is discussed in the text associated with the syntax diagram.

- If a diagram shows a character that is not alphanumeric (such as parentheses, periods, commas, and equal signs), you must code the character as part of the syntax. In this example, you must code **KEYWORD=(001,0.001)**.

▶▶—KEYWORD=(001,0.001)—▶▶

- If a diagram shows a blank space, you must code the blank space as part of the syntax. In this example, you must code **KEYWORD=(001 FIXED)**.

▶▶—KEYWORD=(001 FIXED)—▶▶

- Default keywords and values appear above the main path line. If you omit the keyword or value entirely, the default is used.



- A word in all lower case italics is a *variable*. Where you see a variable in the syntax, you must replace it with one of its allowable names or values, as defined in the text.

▶▶—*variable*—▶▶

- References to syntax notes appear as numbers enclosed in parentheses above the line. Do not code the parentheses or the number.

(1)
▶▶—KEYWORD—▶▶

Notes:

1 An example of a syntax note.

- Some diagrams contain *syntax fragments*, which serve to break up diagrams that are too long, too complex, or too repetitious. Syntax fragment names are in mixed case and are shown in the diagram and in the heading of the fragment. The fragment is placed below the main diagram.

▶▶ | Reference to Syntax Fragment | ▶▶

Syntax Fragment:

|—1ST_KEYWORD,2ND_KEYWORD,3RD_KEYWORD—|

Related protocol specifications

IBM is committed to industry standards. The internet protocol suite is still evolving through Requests for Comments (RFC). New protocols are being designed and implemented by researchers, and are brought to the attention of the internet community in the form of RFCs. Some of these are so useful that they become a recommended protocol. That is, all future implementations for TCP/IP are recommended to implement this particular function or protocol. These become the *de facto* standards on which the TCP/IP protocol suite is built.

The Network File System (NFS) is implemented as a set of RPC procedures that use External Data Representation (XDR) encoding to pass arguments between clients and servers. The NFS is based on the following RFCs.

Internet Protocol	RFC 791, J.B. Postel
NFS: Network File System Version 2 Protocol Specification	RFC 1094, Sun Microsystems, Incorporated
NFS: Network File System Version 3 Protocol Specification	RFC 1813, Sun Microsystems, Incorporated
NFS: Network File System Version 4 Protocol Specification	RFC 3530, Sun Microsystems, Incorporated
Open Group Technical Standard Protocols for Interworking: XNFS, Version 3W	Document Number: C702
RPC: Remote Procedure Call Protocol Specification Version 2	RFC 1057, Sun Microsystems Incorporated
RPC: Remote Procedure Call Protocol Specification Version 2	RFC 1831, R. Srinivasan
User Datagram Protocol	RFC 768, J.B. Postel
WebNFS Client Specification	RFC 2054, B. Callaghan
WebNFS Server Specification	RFC 2055, B. Callaghan
XDR: External Data Representation Standard	RFC 1014, Sun Microsystems, Incorporated
XDR: External Data Representation Standard	RFC 1832, R. Srinivasan
Generic Security Service Application Program Interface, Version 2	RFC 2078, J.Linn, OpenVision Technologies
RPCSEC_GSS Protocol Specification	RFC 2203, M. Eisler, A.Chiu, L. Ling
The Kerberos Version 5 GSS-API Mechanism	RFC 1964, J.Linn, OpenVision Technologies
The Kerberos Network Authentication Service (V5)	RFC 1510, J. Kohl, Digital Equipment Corporation, C. Neuman, ISI

For more information about Request for Comments (RFC), see The Internet Engineering Task Force (IETF) (www.ietf.org).

The z/OS Basic Skills Information Center

The z/OS Basic Skills Information Center is a Web-based information resource intended to help users learn the basic concepts of z/OS, the operating system that runs most of the IBM mainframe computers in use today. The Information Center is designed to introduce a new generation of Information Technology professionals to basic concepts and help them prepare for a career as a z/OS professional, such as a z/OS system programmer.

Specifically, the z/OS Basic Skills Information Center is intended to achieve the following objectives:

- Provide basic education and information about z/OS without charge
- Shorten the time it takes for people to become productive on the mainframe
- Make it easier for new people to learn z/OS.

To access the z/OS Basic Skills Information Center, open your Web browser to the following Web site, which is available to all users (no login required): z/OS Basic Skills in IBM Knowledge Center (www.ibm.com/support/knowledgecenter/zosbasics/com.ibm.zos.zbasics/homepage.html)

How to send your comments to IBM

We appreciate your input on this documentation. Please provide us with any feedback that you have, including comments on the clarity, accuracy, or completeness of the information.

Use one of the following methods to send your comments:

Important: If your comment regards a technical problem, see instead “If you have a technical problem.”

- Send an email to mhvrcfs@us.ibm.com.
- Send an email from the Contact z/OS web page (www.ibm.com/systems/z/os/zos/webqs.html).

Include the following information:

- Your name and address
- Your email address
- Your phone or fax number
- The publication title and order number:
 - z/OS Network File System Guide and Reference
 - SC23-6883-30
- The topic and page number or URL of the specific information to which your comment relates
- The text of your comment.

When you send comments to IBM®, you grant IBM a nonexclusive right to use or distribute the comments in any way appropriate without incurring any obligation to you.

IBM or any other organizations use the personal information that you supply to contact you only about the issues that you submit.

If you have a technical problem

Do not use the feedback methods that are listed for sending comments. Instead, take one or more of the following actions:

- Visit the IBM Support Portal (support.ibm.com).
- Contact your IBM service representative.
- Call IBM technical support.

Summary of changes

Changes have been made to this document.

This document contains terminology, maintenance, and editorial changes. Technical changes or additions to the text and illustrations are indicated by a vertical line to the left of each change.

Summary of changes for SC23-6883-02

- rsize site attribute has increased to 64KB in “Site attributes syntax” on page 139 and Appendix E, “NFS system server sample attribute table,” on page 499.
- wsize site attribute has increased to 64KB in “Site attributes syntax” on page 139 and Appendix E, “NFS system server sample attribute table,” on page 499.
- chkloop site attribute in “Site attributes syntax” on page 139, “Using the NFS Error Client Loop Detection Facility” on page 220, and “chkloop operand” on page 249.
- loopthreshold site attribute in “Site attributes syntax” on page 139, “Using the NFS Error Client Loop Detection Facility” on page 220, and Appendix E, “NFS system server sample attribute table,” on page 499.
- EXPORTCHK operand in “exportchk operand” on page 240 and Appendix E, “NFS system server sample attribute table,” on page 499.
- Updated GFSCPROC, as described in “Sample z/OS NFS client startup procedures” on page 539.
- The following messages have been added to Chapter 19, “Network File System messages,” on page 339:
 - GFSA1036E
 - GFSC507I
- The following messages have been changed in Chapter 19, “Network File System messages,” on page 339:
 - GFSA784I
 - GFSA930I
 - GFSA936I
 - GFSA939I
 - GFSA963E
 - GFSA1030E
 - GFSA1031I

Summary of changes for z/OS Version 2 Release 2 (V2R2) as updated December 2015

The following changes are made for z/OS V2R2 as updated December 2015.

New

- APAR OA47371, adds support for rpcsec_gss AES encryption
- Client attribute mtxtonly, described in Table 14 on page 109, Table 16 on page 118, Table 75 on page 466, and Table 79 on page 474 for BPXMTEXT support on NFS reason codes.
- New and modified reason codes described in Table 79 on page 474.

- Significant changes to “Special reason codes (xx is 00-0F)” on page 456, including new tables:
 - Table 74 on page 457
 - Table 77 on page 468
- The following messages have been added to Chapter 19, “Network File System messages,” on page 339:
 - GFSA939I (in “Server messages” on page 339)
 - GFSC507I (in “Client messages” on page 407)
- The following messages have been changed in “Server messages” on page 339:
 - GFSA930I
 - GFSA932I
 - GFSA936I
 - GFSA963E

Summary of changes for SC23-6883-01

Changes have been made to this document.

This document contains terminology, maintenance, and editorial changes. Technical changes or additions to the text and illustrations are indicated by a vertical line to the left of each change.

Summary of changes for SC23-6883-00

- The z/OS NFS Server has improved from AMODE31 or ILP32 to AMODE64 or LP64.
- The following messages have been added to Chapter 19, “Network File System messages,” on page 339:
 - GFSA572E
 - GFSA779I
 - GFSA780I
 - GFSN5034E
- The following messages have been changed in Chapter 19, “Network File System messages,” on page 339:
 - GFSA361I
 - GFSA362I
 - GFSA385I

Part 1. Using z/OS Network File System

Chapter 1. Introduction

This topic explains the Network File System's client-server relationship and introduces the IBM Network File System (z/OS NFS). When used to access z/OS UNIX System Services (z/OS UNIX) data, which conforms to portable operating system interface (POSIX) standards, it is similar to other UNIX/AIX Network File Systems.

Overview

A client is a computer or process that requests services on the network. A server is a computer or process that responds to a request for service from a client. A user accesses a service, which allows the use of data or other resources.

Figure 1 illustrates the client-server relationship. The upper right portion of the figure shows the z/OS NFS server. The lower right portion of the figure shows the z/OS NFS client. The left portion of the figure shows various NFS clients and servers which can interact with the z/OS NFS server and client. The center of the figure shows the Transmission Control Protocol/Internet Protocol (TCP/IP) network used to communicate between the clients and servers.

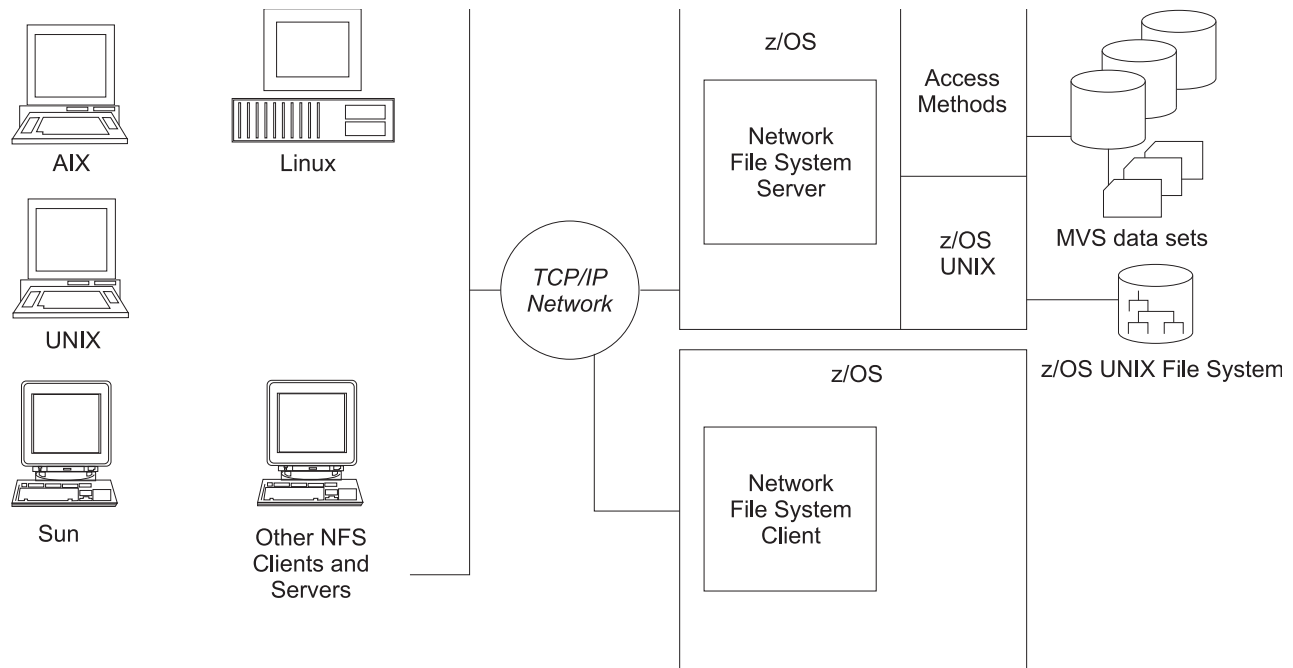

Figure 1. NFS client-server relationship

With the z/OS NFS server, you can remotely access MVS z/OS conventional data sets or z/OS UNIX files from workstations, personal computers, and other systems that run client software for the Sun NFS version 2, version 3, and version 4 protocols, and the WebNFS protocols over TCP/IP network.

The z/OS NFS server acts as an intermediary to read, write, create or delete z/OS UNIX files and multiple virtual storage (MVS™) data sets that are maintained on a z/OS host system. The remote MVS data sets or z/OS UNIX files are mounted

from the host processor to appear as local directories and files on the client system. This server makes the strengths of an z/OS host processor (storage management, high-performance disk storage, security, and centralized data) available to the client platforms.

With the z/OS NFS client, you can allow basic sequential access method (BSAM), queued sequential access method (QSAM), virtual storage access method (VSAM), and z/OS UNIX users and applications transparent access to data on systems that support the Sun NFS version 2 protocols, the Sun NFS version 3 protocols, and the Sun NFS version 4 protocols. The remote NFS Server can be a z/OS, UNIX, AIX®, or other system. The z/OS NFS client is implemented on z/OS UNIX and implements the client portion of the Sun NFS version 2 protocols, the Sun NFS version 3 protocols, and the Sun NFS version 4 protocols.

The NFS uses the communication services provided by TCP/IP, a suite of protocols that includes the remote procedure call (RPC) and External Data Representation (XDR) protocols. RPC allows a program on one machine to start a procedure on another machine, as if the procedure is local. XDR resolves the differences in data representation of different machines.

The NFS, then, can be used for file sharing between platforms and file serving (as a data repository).

If you use NFS as a file server, the z/OS UNIX file system might be a better choice than using z/OS conventional MVS data sets, because of its UNIX-based features.

z/OS UNIX files

The NFS server enables the client user remote access to z/OS UNIX files from a client workstation.

z/OS UNIX provides a hierarchical file system (HFS) for z/OS. The HFS file system is similar to a UNIX file system. All z/OS UNIX files reside in a directory, which in turn is a file in a higher level directory. The highest level directory is called the root directory.

When client users mount files from your server system, you can use a common HFS prefix to distinguish z/OS UNIX files from z/OS conventional MVS data sets or you can use an implied prefix. You see z/OS UNIX files in a standard UNIX format on your workstation, but the files are stored on a z/OS host system.

Using the NFS, the client can mount all or part of the z/OS UNIX file system and make it appear as part of your local file system. From there the client user can create, delete, read, write, and treat the host-located files as part of the workstation's own file system. For more information about z/OS UNIX see *z/OS UNIX System Services User's Guide*.

z/OS UNIX advantages

z/OS UNIX file system support provides these advantages over z/OS conventional MVS data sets:

- Support for hierarchical directories
- File names up to 255 characters in length
- Path names up to 1023 characters in length

- Mixed case names and special characters, except nulls and slash characters, in file and path names
- UNIX style access permission support
- Group and user ID support at a file level
- Ability to link z/OS conventional MVS data sets to a POSIX path name.

NFS protocol compliance

The z/OS Network File Systems provides full NFS protocol compliance for accessing the z/OS UNIX file system.

Crossing between file systems–NFS server

Crossing file systems means the NFS client can also potentially be a server, and remote and local mounted file systems can be freely mixed. This leads to some problems when a client travels down the directory tree of a remote file system and reaches the mount point on the server for another remote file system. Allowing the server to follow the second remote mount would require loop detection, server lookup, and user revalidation. When a client does a lookup on a directory on which the server has mounted a file system, the client sees the underlying directory instead of the mounted directory.

The NFS server does not support crossing file systems in NFS protocol versions 2 (NFSv2) and 3 (NFSv3) for either local or remote file systems. In NFS protocol version 4 (NFSv4) the z/OS NFS server does support crossing local file systems, but not remote file systems. For example, if a server has a file system called /usr and mounts another local file system on /usr/src, a client can also mount /usr, but the server will only see the mounted version of /usr/src with NFSv4. In NFSv2 and NFSv3, a client could perform remote mounts that match the server's mount points to maintain the server's view. In this example, the client would also have to mount /usr/src in addition to /usr, even if the mounts are from the same server.

z/OS conventional MVS data sets

Using NFS, you can access z/OS conventional MVS data sets from a client workstation, personal computer, or any client system using software for the NFS protocol.

In MVS, a file is called a data set. The NFS allows client users to mount z/OS conventional MVS data sets from their workstations. It presents the information to them in the form of a UNIX (or AIX) file, though the information is actually stored on an MVS-owned DASD.

The files for an operating system are organized into a file system. The UNIX environment use a file system that is a hierarchy of directories. z/OS conventional MVS, in contrast to z/OS UNIX, uses a non-hierarchical file system in which groups of data sets are referred to by specifying a high-level qualifier (HLQ).

The MVS HLQ can include the first (leftmost) qualifier of data sets, or the first and second qualifiers, or the first, second, and third qualifiers, and so on. For example, SMITH is the HLQ for the files named SMITH.TEST.DATA and SMITH.PROJ7.SCHED, while SMITH.TEST is the HLQ of SMITH.TEST.DATA and SMITH.TEST.DOCS.

Mounting MVS data sets onto a client mount point

To access an MVS file system from the client, client users use the **mount** command to create a temporary link (until unmounted) between specific MVS data sets and

their UNIX directory (preferably empty) or an unused logical drive on their workstations. The empty UNIX directory or logical drive is called a mount point.

Client users use an MVS HLQ in the **mount** command to specify which MVS data sets to mount at a mount point. The MVS data sets beginning with the specified HLQ appear as files under the mount point.

Client users can mount a fully-qualified PDS but not a fully-qualified PS data set. Only cataloged data sets are supported by the z/OS NFS server. Tape data sets and generation data sets are not supported.

Some client platforms support both TCP and the user datagram protocol (UDP). Users can choose either TCP or UDP to access the server. The default protocol option depends on the NFS client platform. For NFS version 4, some platforms do not support UDP.

Note: When directly mounting on a fully qualified data set name, the server must return the mount size as part of getting the attributes for the mount. This can slow down the completion of the **mount** command.

Clients using the NFS version 4 protocol must pass mount requests to the server using a series of **lookup** operations. Client users may still use the mount command, and the client must convert the mount command into the lookup operations.

Creating z/OS conventional MVS data sets

Client users can create MVS data sets from a client system using the NFS. The default data set creation attributes specified by the system administrator are used to create MVS data sets, unless the user overrides them. These attributes determine how the MVS data sets are structured and where they are stored. Client users can override the default data set creation and processing attributes for a mount point when issuing the **mount** command. In addition, you can override these attributes at file creation time.

Serializing and sharing data sets

The z/OS NFS server handles data set serialization and sharing differently, depending on the type of data set:

Physical sequential

The server ensures physical sequential data set read/write integrity by SVC 99 dynamic allocation with exclusive option whenever a physical sequential data set is opened for output. Otherwise, it allocates with share option.

Virtual storage access method (VSAM)

The server dynamically allocates a VSAM data set with share option and allows the VSAM access method to manage data sharing using the **shareoptions** specified during data set definition.

Partitioned data set extended (PDSE)

The server dynamically allocates a PDSE data set with share option and allows the PDSE functions to manage the serialization of the PDSE data set and its members.

Partitioned data set (PDS)

For read and write, the z/OS NFS server issues ENQ SHR on QNAME=SYSDSN and RNAME=data_set_name (through an SVC 99). For

write, the server issues an exclusive ENQ against QNAME=SPFEDIT and RNAME=data_set_name.member_name, in addition to the serialization of resources by SVC 99. For all MVS users who are allocating their data set with exclusive status, this provides write protection. It only provides read integrity for ISPF users.

NFS version 2 and version 3 statelessness

Under the NFS version 2 and version 3 protocols, the z/OS NFS server strives to be as *stateless* as possible; that is, it tries to work correctly without maintaining any state information about any of its clients. However, a failure of the server causes cached writes to be lost, some attributes to be reset, and file handles to become stale, or not valid.

With the NFS version 4 protocol, the z/OS NFS server maintains state information for some client operations, to prevent such losses.

NFS version 4 state

The NFS version 4 protocol introduces *state information* that allows clients and servers to keep track of certain resources.

NFS version 4 uses a value of *clientid* or *stateid* to represent the current state (instance) of client-held resources such as locks, opens, and host restarts. The client and server pass this state information between them on certain operations, allowing both to agree on the current instance of resources held by the client.

NFS version 4 includes new states for the following:

1. Client/Server restart instance
2. Open Share/Deny instance
3. Byte Range Locks instance
4. Client Delegation instance.

The NFS version 4 state that is passed between the client and server represents a single instance in a dynamically changing environment; it is incremented when a state is changed within a group of held resources (restart, open, or lock). Once state is established on the server, the client returns what it believes is the current state. The server compares the client state to the server state to detect stale and out of order requests.

The client uses the **setclientid** operation to notify the server of its intention to use a particular client identifier for subsequent requests that entail creating lock, share reservation, and delegation state on the server. Upon successful completion the server returns a shorthand *clientid*, which, if confirmed in a separate step, will be used in subsequent file locking and file open requests. Confirmation of the *clientid* must be done using the **setclientid_confirm** operation to return the *clientid* and *setclientid_confirm* values, as verifiers, to the server.

NFS version 2 and version 3 used the Network Status Monitor (NSM) protocol to determine if resources such as file open share or byte range locks were still in use by a remote client. NFS version 4 no longer uses NSM to communicate a client or server restart. NFS version 4 instead uses a current state on both the client and server, where the state is established and passed in subsequent NFS version 4 operations.

In NFS versions 2 and 3, a client or server issues an NSM **sm_notify** RPC procedure to notify the remote host of a restart. Server resources such as an exclusive byte range lock on a file might remain held until explicitly released by the client. If a client that holds a server resource is removed from the network for a long period without the server being notified, the server resource would be unavailable to other clients until timed out by the server.

NFS version 4 provides a protocol for the client to establish or reestablish state, and associates ownership of subsequent server *stateful* operations to previously established states. To resolve the absent client problem, the NFS version 4 client must routinely refresh the state within the server-specified lease time. Upon lease time-out, the server may release resources for the client and make them available to other applications.

- A client obtains the server-specified lease time-out attribute by issuing a **getattr** operation. **getattr** is not a stateful operation, thus it does not require prior state to be established. A **getattr** operation may precede a **setclientid** or **setclientid_confirm** operation.
- Refer to the NFS server's **leasetime** site attribute for setting and tuning lease time periods.

Name space and file system management

NFS versions 2 and 3 used the mount protocol to define the initial "mount point" and its associated file handle. File locking was done with the Network Lock Manager protocol. NFS version 4 uses a well-defined port as an anchor. This allows the hookup (no longer called "mount") to occur implicitly, because the concept of a "Root" file handle, in combination with the port, allows the equivalent of a mount to take place on the server side.

In NFS versions 2 and 3, a client application would request to mount a file system object; the NFS client would then issue a "mount" protocol operation to the server, providing usage attributes, and specifying a file system object that is exported by the server. This mount command would specify to the server the name of the object to be mounted. The server would then provide a handle to the client for use in accessing objects related to this mount point.

In NFS version 4, this mount protocol is no longer used. Instead, the server provides a name space to the objects that are exported by the server. Standard non-mount operations such as LOOKUP and READDIR are changed by the NFS version 4 protocol to accomplish this. These changes are transparent to the client application. The NFS Client translates the mount request into the proper NFS version 4 operations that accomplish this access.

In NFS versions 2 and 3, objects in the server file system are accessed by a filehandle. This filehandle is given to the client in response to a mount or lookup operation, and is provided by the client when attempting to access objects in that file system. The NFS version 4 protocol specifies a pair of operations, PUTROOTFH and PUTPUBFH, that allow the client to request a starting point in the exported (or public, respectively) file system.

The NFS version 4 protocol also uses a COMPOUND procedure in which many operations can be sent in a single request. For this purpose, a filehandle is known within the COMPOUND structure as one of two items: a "current filehandle" and/or a "saved filehandle". NFS Version 4 operation PUTFH allows the client to provide a previously returned (by operation GETFH) filehandle, and operations

SAVEFH and RESTOREFH allow the client to manipulate the current and saved file handles within the compound procedure. Further operations within the COMPOUND RPC will make use of the handles, once established by these "filehandle manipulation" operations. Refer to the NFS version 4 protocol (RFC3530) for usage of the current and saved file handles.

For NFS version 4, when the client receives a mount command from an application, the client translates the command into a PUTROOTFH operation followed by a series of LOOKUP operations. If this series of LOOKUPs deviates from a path that would lead to an exported object, the LOOKUP that starts this deviation will be rejected with NFSERR_NOENT.

The elimination of the mount/unmount operations from the NFS version 4 protocol means that the NFS client can not tell the NFS server when an application unmounts a file system. As a result, the NFS server keeps the file system mounted until the mount point times out. Therefore, those unmounted file systems will still appear in the mount list produced by a **Modify mvsnfs,LIST=MOUNTS** operator command.

z/OS NFS File System Type Selection

The z/OS NFS Server must distinguish between the two different file system types when processing mount requests and other requests that involve the specification of path names: z/OS UNIX file systems and MVS data sets. Prior to z/OS NFS V1R11 this was done via the specification of the special "hfs" prefix for z/OS UNIX file systems and the absence of the prefix for MVS data sets.

As of NFS V1R11, the z/OS NFS file system type management function has been expanded by adding an mvs prefix and a customer configurable path resolution heuristic. The new mvs prefix provides the capability to explicitly specify a prefix for identifying MVS data sets, as the hfs prefix does for z/OS Unix files. The new customer-configurable heuristic enables you to specify how to interpret absolute path names that do not have a prefix specified. By setting the heuristic to indicate that MVS data sets now require a prefix and z/OS Unix files do not, symbolic links in z/OS Unix mount paths can be supported.

Specifying the path type prefix and the customer-configurable path resolution heuristic

The following z/OS NFS server site attributes apply to all NFS path names and their resolution processing. This includes directories specified in the Exports list and the checklist in the Exports file, as well as mount and root lookup objects.

HFSPREFIX(*prefix*)

specifies the z/OS UNIX file system prefix to be appended to the front of z/OS UNIX file system path names for a mount path directory. The default value of the prefix is /hfs

MVSPREFIX(*prefix*)

specifies an MVS data set prefix to be appended to the front of MVS data set name for a mount path directory. The default value of the prefix is /mvs.

IMPPREFIX(*impprefix*)

specifies how to interpret a mount path that does not have a path type prefix, where *impprefix* is one of the following:

NONE

An explicit prefix must always be specified for an absolute path. Implicit prefix resolution is not valid in this case.

HFS If no explicit prefix is present, assume the path is a z/OS UNIX file system.

MVS If no explicit prefix is present, assume the path is an MVS data set. This is the default.

HFS, MVS

If no explicit prefix is present, first assume the path is a z/OS UNIX file system. If no matching z/OS UNIX file system can be found, assume that it is an MVS data set.

MVS, HFS

If no explicit prefix is present, first assume the path is an MVS data set. If no data set with a matching high-level qualifier can be found, assume that it is a z/OS UNIX file system.

Valid mount path specifications

This section shows valid mount path specifications for back-level (prior to V1R11), MVS prefix, and the MVS implicit prefix.

Back-level (prior to V1R11):

Note: An ellipsis (...) denotes that more similarly-specified items are possible.

- v2/v3,
 /hfs/[,procatrr] '/' after the prefix is required
 /hfs/abc[/def...][,procatrr]
 mvsdsn[(mbr)][,procatrr]
- v4
 /hfs[/][,procatrr]
 /hfs/abc[/def...][,procatrr]
 mvsdsn[(mbr)][,procatrr]

MVS prefix:

- v2/v3
 /mvs/mvsdsn[(mbr)][,procatrr]
- v4
 /mvs/mvsdsn[(mbr)][,procatrr]

MVS implicit prefix: Table 2 summarizes the interpretation of the mount statements based on the IMPPREFIX setting.

Table 2. Mount statements based on the IMPPREFIX setting

Mount\IMPPREFIX	MVS	HFS	MVS,HFS	HFS,MVS
v2/v3				
/abc[,procatrr]	MVS HLQ	z/OS UNIX dir	1. MVS HLQ if a data set exists 2. z/OS UNIX dir otherwise	1. z/OS UNIX dir if exists 2. MVS HLQ otherwise

Table 2. Mount statements based on the IMPPREFIX setting (continued)

Mount\IMPPREFIX	MVS	HFS	MVS,HFS	HFS,MVS
/abc[/def...][,procatrr]	Invalid	z/OS UNIX dir	1. MVS Invalid, so 2. z/OS UNIX dir	1. z/OS UNIX dir if exists, 2. Invalid otherwise
/a[b...][mbr][,procatrr]	MVS PDS with member 'mbr' if PDS exists; otherwise invalid	z/OS UNIX dir	1. MVS PDS with member 'mbr' if PDS exists 2. z/OS UNIX dir otherwise	1. z/OS UNIX dir if exists, 2. MVS PDS with member 'mbr' otherwise
v4				
/abc[,procatrr]	MVS HLQ	z/OS UNIX dir	1. MVS HLQ if a data set exists 2. z/OS UNIX dir otherwise	1. z/OS UNIX dir if exists 2. MVS HLQ otherwise
/abc/def[,procatrr]	MVS PDS with member 'def' if PDS exists; otherwise invalid	z/OS UNIX dir	1. MVS PDS with member 'def' if PDS exists; otherwise invalid, so 2. z/OS UNIX dir	1. z/OS UNIX dir if "/abc" exists, 2. MVS PDS with member 'def' if PDS exists; otherwise invalid
/abc/def/...[,procatrr]	Invalid	z/OS UNIX dir	1. MVS Invalid, so 2. z/OS UNIX dir	1. z/OS UNIX dir if "/abc" exists, 2. Invalid otherwise
/a[b...][mbr][,procatrr]	MVS PDS with member 'mbr' if PDS exists; otherwise invalid	z/OS UNIX dir	1. MVS PDS with member 'mbr' if PDS exists; otherwise invalid, so 2. z/OS UNIX dir otherwise	1. z/OS UNIX dir if exists, 2. MVS HLQ otherwise

Implicit prefix support restrictions

The following processing characteristics and restrictions must be considered when using the path name prefix processing support provided by the NFS Server Site Attributes:

1. When both path options are available based on the IMPPREFIX site attribute (when IMPPREFIX = mvs,hfs or hfs,mvs), only the existence or nonexistence of the first path name qualifier is used to determine whether the second option is tried. That is, if the first path qualifier exists, the second option is not attempted and the mount/lookup succeeds to the first path. However if the first path does NOT exist, the second option is tried.
2. Prior to V1R11, an MVS mount to an HLQ (for example, a.b.c) for which no data sets exist was considered valid and would mount to that HLQ, allowing the first data set to be created via NFS. As of V1R11, if the IMPPREFIX site attribute specifies mvs,hfs, NFS Version 4 mounts to such an HLQ fail on the MVS side and then attempt to mount z/OS UNIX node /a.b.c. If that z/OS

UNIX node does not exist, the mount fails. If this behavior is not desired, either an MVS prefix must be specified on the path or one of the other IMPPREFIX site attribute values must be specified.

3. For IMPPREFIX(HFS,MVS), if the object does not exist (neither z/OS UNIX nor MVS), it creates the mount point as a new MVS HLQ with no entries, just as an MVS mount does in prior releases.

Conversely, for IMPPREFIX(MVS, HFS), if the object does not exist (neither z/OS UNIX nor MVS), it tries MVS, then z/OS UNIX, then fail, just as a z/OS UNIX mount for a non-existent object did prior to V1R11.

Once NFS has switched to option 2, it cannot switch back to option 1.

4. For NFS Version 2 or Version 3 mount requests, NFS clients send the entire mount path to the NFS server as a single string. By contrast, for NFS Version 4 mount requests, NFS clients send a series of lookup requests (there is no mount request) to the NFS server for one path qualifier at a time. Consequently, the NFS server does not know whether additional path qualifiers follow. This can produce unexpected results.
5. If a mount request is issued as an NFS Version 2 or Version 3 mount request, the path is handled as a single string entity and is resolved by z/OS UNIX resolving the symbolic link to the z/OS UNIX /a directory, ignoring the IMPPREFIX setting. This is effectively no change from prior releases.

The same is true for NFS Version 4 mount requests if the symbolic link is the last name in the path and it is followed by some processing attributes.

Note: If the NFS client is z/OS there will always be at least one processing attribute, automatically added by the client identifying it as z/OS.

However, if the mount request is issued as an NFS Version 4 mount request and the symbolic link is not the last name in the path, or it is not followed by any processing attributes, then the symbolic link will be identified as such back to the NFS client. The client will then read the link data and reinitiate the path resolution. In this case, assuming the link is defined as an absolute path, then the path type resolution will come into play based on whether a prefix is included and based on the implicit prefix resolution heuristic.

Note: This can cause the symbolic link to resolve into MVS space, not just z/OS UNIX space.

6. The implicit prefix heuristic also applies to the exports file; that is, for export entries that do not include an explicit prefix, the IMPPREFIX() site attribute is used to determine the specified path. If both the HFS and the MVS options are specified, the export entry applies to both types of file systems, assuming that the specified entry exists in both file system spaces.
7. When the NFS Server restarts, it attempts to recover mount points recorded in the MHDB. If the HFS or MVS prefix and/or implicit prefix site attributes were changed before the restart, the new mount points will reflect the new HFS and MVS prefixes. Implicit prefix changes will have no effect.

NFS Version 4 mount points that were established without specifying the MVSMNT processing attribute were not recorded in the MHDB. The NFS Client will attempt to re-establish these mount points when it receives a stale file handle response from the NFS Server. However, the NFS Client has no knowledge of the changed prefix site attributes and will use the original mount name string in this attempt. This can result in the NFS Client not being able to reestablish the mount points.

Note: This statement only applies when the NFS server prefix site attributes are changed during the server restart. Otherwise, the NFS client should be able to re-establish the mount points.

8. If the IMPPPREFIX(NONE) Site Attribute is specified, **all** path names, including those in the exports file (if used), must be specified with a prefix.

Server control files

These special files are used by the z/OS system administrator to control the z/OS NFS server:

- Attributes data set
- Exports data set
- Mount handle data sets
- Log data sets

For information about customizing these control files, see “Configuring the z/OS NFS server” on page 181.

Attributes data set

The attributes data set contains the settings for the z/OS NFS server. There are three types of attributes stored in this data set:

Data set creation attributes

Used to define the structure of MVS data sets when creating a file (for z/OS conventional MVS data sets only).

File processing attributes

Used to control how files are accessed by the client.

Site attributes

Used to control z/OS NFS server resources.

The system administrator changes the default settings by editing the attributes data set and restarting the server. Client users can override the data set creation and file processing attributes at the command line. For z/OS conventional MVS data sets, the client user can specify the data set creation attributes when mounting, creating, or accessing files. The client user can override the file processing attributes when mounting, creating, or accessing files. However, some file processing attributes can only be overridden on a mount point basis.

Note: Many of the attributes are valid only for z/OS conventional MVS files, and not for z/OS UNIX files. “Attributes used for z/OS UNIX file access” on page 121 gives a complete list of attributes that are valid for z/OS UNIX.

Exports data set

The exports data set can control which client users can mount which MVS data sets. The entries in the exports data set specify which MVS high-level qualifiers or HFS directories can be mounted. The system administrator can use this data set to limit mounts to accredited clients only. It also controls which client users can mount all or part of the z/OS UNIX file system, based on the client machine's specified Internet Protocol (IP) address. To use the exports data set, the **security** site attribute must be set to either **safexp** or **exports** by the MVS system administrator.

In z/OS V1R8, the exports data set also provides the function previously provided by the checklist data set: specifying files or directories that are exempt from System Authorization Facility (SAF) checking even though **saf** or **safexp** is specified as the security option.

Mount handle data set

The z/OS NFS server maintains a list of the active mount points in a pair of files called the mount handle data sets on MVS also known as the mount handle database (MHDB). The two data sets are used alternately to automatically reestablish the client mount points when the server is started. If the file system is not available, the mount point is not reestablished and the mount failure is recorded in the log data set.

The z/OS NFS server does the cleanup activity during z/OS NFS server shutdown and daily at the cleanup time specified by the **restimeout** site attribute.

During cleanup time, the z/OS NFS server reads the list and checks all mount points against the retention period specified in the **restimeout** site attribute. If your mount points are idle longer than the retention period specified in the **restimeout** site attribute, they are removed. Only the active mount points are reconnected.

If a mount handle is removed by the cleanup activity, the client user might receive the "Stale NFS File Handle" message or some other appropriate message. If so, all the client user needs to do is unmount the stale mount point and mount it again.

NFS Version 4 mount points that were established without specifying the MVSMNT processing attribute are not recorded in the MHDB. However, for NFS Version 4 mount points without the MVSMNT processing attribute, the MHDB is updated with records at z/OS NFS server shutdown that are used solely for diagnostic purposes. At z/OS NFS server restart, the server reviews the diagnostic records and reports the reason why the mount points were not reestablished. This helps diagnose any problems that may occur during a failover.

Log data set

The log data sets store the messages for the z/OS NFS start-up procedures. This log can be used to identify the user's correctable errors or the user's problem errors. There are two logs that this information is stored in; the primary log and the secondary log. The primary log is used at start-up until it is filled and then overflows into the secondary log. When the secondary log is full, the primary log will then be overwritten with new error messages. The number of log records is dependent on the number of transactions that the server can handle.

The z/OS NFS server also records messages and diagnostic information in a z/OS component trace buffer, if one is specified. Component trace buffers can be used in addition to or instead of the log data sets. Using a component trace buffer can provide performance improvements over the log data sets. For details, see "Using z/OS component tracing" on page 316.

Tested clients for the z/OS NFS server

Tested clients for the z/OS NFS server, using the NFS version 2, version 3, and version 4 protocols, are:

- z/OS NFS Client
- Linux

- Red Hat EL 6
 - Intel x86_64
 - Linux on Power (ppc64)
 - Linux on z Systems (s390x)
- Suse SLES 11.4
 - Intel x86_64
 - Linux on Power (ppc64)
 - Linux on z Systems (s390x)
- AIX
 - 7.1
- Oracle Solaris version 10
 - Sparc
 - x86_64
- Windows
 - Windows 7 with OpenText NFS 14

Note:

1. Older versions of these clients are still supported under the NFS version 2, version 3, and version 4 protocols, but not all have been tested by IBM.
2. Other client platforms should work as well, since NFS is an industry standard protocol, but have not been tested by IBM.

NFS protocol attributes for the z/OS NFS server

The NFS protocol defines file attributes that NFS clients can read and set on NFS servers. In the NFS version 4 protocol, some file attributes are mandatory and others are recommended for servers to support. For a list of the NFS version 4 file attributes that the z/OS NFS server supports, see Appendix C, “NFS server attributes,” on page 491.

z/OS NFS server restrictions

As of the writing of this publication, use of the following functions must be restricted because they have not been successfully tested on the listed systems:

- AIX /7.1
 - NFSv4 mounts to MVS data sets must include a leading slash "/" before the HLQ.
- Linux
 - Red Hat EL 6
 - Cannot recover from FH_Expired after server restart or failover. Mount attribute mvsmnt should be used to work around this restriction.
 - Suse SLES 11.4
 - Cannot recover from FH_Expired after server restart or failover. Mount attribute mvsmnt should be used to work around this restriction.

Note: For NFS version 4 mounts to the z/OS NFS Server with conventional MVS datasets, it is recommended to use the "nordirplus" mount option from Linux NFS Clients.

- Windows

- Double quotes have to be used when OpenText NFS client mounts to the z/OS NFS server if the remote mount path doesn't exactly match the NFS exports.

Example 1: Export USS /u/user* or MVS A.B in export file.

Maestro GUI:

```
"\\server\hfs/u/user4"
"\\server\A.B.CD"
```

DOS/Shell:

```
nfs link mountdrive "\\server\hfs/u/user4\" /T /4 /A:u
nfs link mountdrive "\\server\A.B.CD\" /T /4 /A:u
```

Example 2: Use double quotes when mounting to the z/OS server with z/OS server attributes.

Maestro GUI:

```
"\\server\nfsexport,binary"
```

DOS/Shell:

```
nfs link mountdrive "\\server\nfsexport,binary\" /T /4 /A:u
```

Note: This is not intended to be an all-inclusive list of remote platform restrictions.

Tested servers for the z/OS NFS client

The z/OS NFS client supports servers that implement the server portion of the Sun NFS Version 2, Version 3, and Version 4 protocols:

- z/OS NFS Server
- Linux
 - Red Hat EL 6
 - Intel x86_64
 - Linux on Power (pppc64)
 - Linux on z Systems (s390x)
 - Suse SLES 11.4
 - Intel x86_64
 - Linux on Power (pppc64)
 - Linux on z Systems (s390x)
- AIX
 - 7.1
- Oracle Solaris version 10
 - Sparc
 - x86_64
- Windows
 - Windows 7 with OpenText NFS 14

Note:

1. Older versions of these servers are still supported under the NFS version 2, version 3, and version 4 protocols, but not all have been tested by IBM.
2. Other server platforms should work as well, since NFS is an industry standard protocol, but have not been tested by IBM.

A **mount** parameter **vers(x)**, where *x* is either 2, 3, or 4 is provided to make the z/OS NFS client communicate with the server at the specified protocol level. The z/OS NFS client also communicates at the highest protocol level that is supported by the server if no level is specified.

- If **no version** is specified and if the server supports:
 - Only the NFS version 2 protocol, then the z/OS NFS client will use the NFS version 2 protocol to communicate
 - The NFS version 2 and 3 protocols, then the z/OS NFS client will use the NFS version 3 protocol to communicate
 - The NFS version 2, 3 and 4 protocols, then the z/OS NFS client will use the NFS version 4 protocol to communicate.
- If **vers(2)** is specified, then use NFS version 2 protocol to communicate with the server.
- If **vers(3)** is specified, then use NFS version 3 protocol to communicate with the server. z/OS NFS client fails the mount command if the server does not support NFS version 3 protocol.
- If **vers(4)** is specified, then use NFS version 4 protocol to communicate with the server. z/OS NFS client fails the mount command if the server does not support NFS version 4 protocol.

z/OS NFS client restrictions

None.

WebNFS support

The z/OS NFS server supports the WebNFS protocol. WebNFS specification extends the semantics of NFS versions 2, 3 and 4 protocols to allow clients to obtain file handles without the mount protocols. The z/OS NFS server supports the public filehandle and multi-component lookup features as well as other additional requirements as described in RFC 2055. A keyword, **public**, is added for the system administrator to specify the public paths that the public file handle can access. A public path for z/OS conventional MVS data and a public path for HFS data can both be specified. When a lookup request comes in from an NFS client and an absolute path name is specified, it will be matched with the public paths to determine which public path it is trying to reference. If a relative path is specified and both HFS and MVS public paths are defined then the lookup request will be processed relative to the HFS public path.

The following are restrictions for the WebNFS support provided by the z/OS NFS server in this release.

Export Spanning Pathnames

Lookup requests that reference files or directories outside of the exported public path, will result in an error condition.

Native Path

Only canonical pathnames will be supported.

Canonical path

A canonical path is a hierarchically-related, slash-separated sequence of components, in the form: <directory>/<directory>/.../<name>.

Processing attributes

NFS version 2, version 3, and version 4 public MVS mount does not support attributes inheritance. Therefore server attributes specified with the mount command (such as `text`, `srv_ccsid()`, and `cln_ccsid()`) cannot be

inherited when subsequently working with MVS data under a mount point. The z/OS NFS server processes MVS data as binary.

For example, to work with a PDS member a.b.c(text_memb) in text processing mode it is necessary to do a public mount directly to the member:

```
mount -o vers=x,public zNFSserver:"/a.b.c/text_memb,text" client_mount_path
```

In this case, the text attribute specified on the mount command will be taken into account when processing the data.

NFS versions with TCP/IP protocols

Information for NFS version 3 and version 4 protocols with **proto=tcp** can be found on the mount man page on a UNIX client. The NFS client automatically selects the **proto=tcp** option, unless the end-user overrides the option. For example, you can enter this command:

```
unix$ mount -o vers=2,proto=udp mvshost1:smith /mnt
```

This example shows a specification of NFS version 2 with **udp** protocol, even though the client platform can handle the NFS version 4 and **tcp** protocol.

Users can issue the `rpcinfo -p <hostname>` to show all the RPC programs available on the server. For example:

```
$ rpcinfo -p mvshost1
```

Table 3 shows the information from this command.

Table 3. View of NFS server capability

program	vers	proto	port	service
100000	4	tcp	111	portmapper
100000	3	tcp	111	portmapper
100000	2	tcp	111	portmapper
100000	4	udp	111	portmapper
100000	3	udp	111	portmapper
100000	2	udp	111	portmapper
150001	1	udp	4954	pcnfsd
150001	2	udp	4954	pcnfsd
100024	1	udp	4955	status
100024	1	tcp	4944	status
100021	1	udp	4956	nlockmgr
100021	1	tcp	4945	nlockmgr
100021	3	tcp	4945	nlockmgr
100021	3	udp	4956	nlockmgr
100021	4	tcp	4945	nlockmgr
100021	4	udp	4956	nlockmgr
100003	2	tcp	2049	nfs
100003	2	udp	2049	nfs
100003	3	tcp	2049	nfs
100003	3	udp	2049	nfs
100003	4	tcp	2049	nfs
100059	2	udp	4953	
100059	2	tcp	4943	
100044	1	udp	4952	
100044	1	tcp	4942	
100005	1	udp	4951	mountd

Table 3. View of NFS server capability (continued)

program	vers	proto	port	service
100005	1	tcp	4941	mountd
100005	3	tcp	4941	mountd
100005	3	udp	4951	mountd

Users can issue `rpcinfo -s <hostname>` from Solaris clients to show a concise list of all the RPC programs available on the server.

Here is an example of output from `rpcinfo -s <hostname>` in an IPv4 environment:

program	version(s)	netid(s)	service	owner
100000	4,3,2	udp,tcp	rpcbind	superuser
150001	2,1	udp	pcnfsd	unknown
100024	1	tcp,udp	status	unknown
100021	4,3,1	tcp,udp	nlockmgr	unknown
100003	4,3,2	udp,tcp	nfs	unknown
100059	2	tcp,udp	showattr	unknown
100044	1	tcp,udp	mvmount	unknown
100005	3,1	tcp,udp	mountd	unknown

Here is an example of output from `rpcinfo -s <hostname>` in an IPv4/IPv6 environment:

program	version(s)	netid(s)	service	owner
100000	4,3,2	udp,udp6,tcp,tcp6	rpcbind	superuser
150001	2,1	udp6,udp	pcnfsd	unknown
100024	1	tcp6,tcp,udp6,udp	status	unknown
100021	4,3,1	tcp6,tcp,udp,udp6	nlockmgr	unknown
100003	4,3,2	udp6,udp,tcp6,tcp	nfs	unknown
100059	2	tcp6,tcp,udp6,udp	showattr	unknown
100044	1	tcp6,tcp,udp6,udp	mvmount	unknown
100005	3,1	tcp6,tcp,udp6,udp	mountd	unknown

Internet Protocol version 6

Internet Protocol version 6 (IPv6) expands the range of addresses that are available for internet communications. IPv6 extends address sizes from a 32-bit value to a 128-bit value, vastly expanding the number of globally unique addresses that can be assigned. Both the z/OS NFS Client and the z/OS NFS Server support the longer addresses of IPv6, as well as the 32-bit addresses of IPv4 and below. Your network infrastructure must be enabled to use IPv6; if the network does not support IPv6, z/OS NFS will use IPv4 instead.

The z/OS NFS server can use both IPv6 and IPv4 for all NFS protocols.

SMF records for the z/OS NFS server report client IP addresses for both IPv4 and IPv6, with separate address fields for each.

The z/OS Portmapper does not support IPv6. Therefore, when using IPv6 addresses, the z/OS server host must be configured with RPCBIND, not the Portmapper. RPCBIND supports both IPv6 and IPv4. As of z/OS V1R8, Portmapper should only be used for IPv4 only systems. Otherwise, RPCBIND should be used.

Mount handle database (MHDB) records may be affected in the following situation: The zOS NFS server is started in an IPv4 system. Subsequently a restart of the zOS NFS server in an IPv6 system. Then another restart of the zOS NFS server in an IPv4 system. This may cause the situation where IPv6 addresses

cannot be converted to IPv4 addresses. The MHDB may contain IPv6 addresses that cannot be referenced when running in IPv4 mode. Thus mounts will not be rebuilt properly.

User-specified port range support

The z/OS NFS server supports a user-specified range of ports. The z/OS NFS server allows users to specify port assignments for services **mountd**, **mvsmount**, **pcnfsd**, and **showattr**. Additional ports are also required by the server for locking functions. The port assignments for these services can be any port number (except for reserved port 2049 for the NFS program) but must be a contiguous port range for the z/OS NFS server to identify them. The user specified range of ports provides a flexible port range to accommodate programs such as a firewall that supports a range of ports for security purposes.

Users wanting a user-specified port range setup must change the `/etc/rpc` file for the z/OS NFS client and the `/etc/services` and `tcpip.profile` files for the z/OS NFS server. For more information, see “Setting up a user-specified port range” on page 197.

Dynamic addressing

Before z/OS V1R7, the z/OS NFS client and server were based on the static IP address model to handle all communications with other systems. However, many systems have migrated from the use of static IP addresses to the dynamic host configuration protocol (DHCP). Now, the z/OS NFS server accepts dynamic NFS client IP address changes and properly understands the source of the communication even if the sender's IP address has changed. Since not all customers' environments use dynamic IP addresses, NFS server site attributes have been added to specify whether the NFS server should use the dynamic IP algorithm (**dhcp**) or the current static IP algorithm (**nodhcp**). The default is **nodhcp**, to use the static IP algorithm.

To use dynamic IP addressing, the client must:

- Have a constant host name that the NFS server can identify it by.
- Dynamically update the authentication DNS (dynamic name server) with new IP addresses whenever they change.
- Maintain the TTL (time to live) value that the authentication DNS server specifies to any caching DNS server, based on the frequency with which system IP addresses might change.

If you are using the static IP algorithm (**nodhcp**) and there are changes to network addressing, the `exportfs` command will not rebuild the exports list correctly. See “TCP/IP” on page 336 for further details.

For more information, see “Using dynamic client IP addressing” on page 202.

The z/OS NFS Server continues to have a static IP address, based on the standard industry practice of assigning static IP addresses to servers.

64-bit exploitation

When writing to z/OS MVS data sets, the z/OS NFS Server has to buffer the RPC WRITE data so the buffered data logically appears sequential before the z/OS NFS Server call DFSMSdfp to write the blocks of data. To handle the large data sets and the random write from the NFS Clients, you can convert or port the z/OS NFS Server to AMODE64 (or LP64) to give it access to 64-bit Address Space (16 exabytes) for the logical data buffering and other control blocks management.

For z/OS V2R1, the meaning of the **bufhigh**, **logicalcache**, and **cachewindow** attributes have been changed to support the larger address space of AMODE64. See Table 24 on page 140 for more information on these attributes.

Data transfer and conversion

With the NFS version 4 protocol, text data and metadata are transferred between the server and client in the UTF-8 data format (ASCII text is not transferred directly). z/OS NFS conversion of UTF-8 text data and metadata requires setting up a conversion environment using the z/OS Unicode Services by creating a Unicode conversion image that defines conversion tables with UTF-8 [CCSID 1208].

With the NFS version 4 protocol, *stringprep* provides preparation of internationalized strings. Stringprep helps ensure that character string input and string comparisons work consistently and correctly for users of multilingual text. The z/OS NFS server supports the UTF-8 encoding and stringprep requirements in the NFS Version 4 protocol, using z/OS Unicode services to normalize inbound UTF-8 encoded strings when comparisons are needed.

The server site attributes **stringprep** and **nostringprep** let you enable or disable stringprep normalization. You can use this attribute to disable stringprep normalization if necessary, for example if needed for compatibility with existing client workaround utilities. See “Site attributes syntax” on page 139 for information on the **stringprep** attribute.

Native ASCII support

The z/OS NFS client and server support applications running on z/OS V1R2 (and higher) in a native ASCII environment. Applications can operate on files in either EBCDIC or ASCII format, as well as other data formats defined with a coded character set identifier (CCSID). Native ASCII support is provided with a mechanism called file tagging where the file is defined with a tag to identify the CCSID to use for data conversion. File tagging is defined in the appropriate z/OS UNIX System Services documents. The z/OS NFS client and server provide the necessary support to provide data conversion between different CCSIDs specified for the client and server. The z/OS NFS client **cln_ccsid** and **srv_ccsid** parameters are also supported by the z/OS NFS server to identify the CCSID to be used in the data conversion. See “Processing attributes syntax” on page 127 for more information about the **cln_ccsid** and **srv_ccsid** parameters.

NFS Error Client Loop Detection Facility

The z/OS NFS server contains NFS Error Client Loop Detection Facility which is capable of detecting certain loop situations, including mvlogin failures triggering access denied loops. The facility identifies remote client system(s) at fault triggering loops, and displays adequate exploitable GFS1036E console error messages.

NFS Error Client Loop Detection Facility is designed to detect loops of only NFS errors between NFS client(s) and the z/OS NFS server. Therefore, a loop arising because of RPC errors, CPU and I/O loops will not be detected by this facility.

NFS Error Client Loop Detection Facility includes: site attribute `chkloop(on | off)` to control the usage of this facility. See Table 24 on page 140 for information on the `chkloop(on | off)` attribute; two site attributes, `loopthreshold(n)` and `timethreshold(m)` for tuning the detection sensitivity of this facility. See Table 24 on page 140 for information on the `loopthreshold(n)` and the `timethreshold(m)` attributes; operand `CHKLOOP={ON | OFF | LOOP=x | TIME=y}` of MODIFY operator command to control and tune the detection sensitivity of this facility. See “Entering operands of the modify command for diagnosis” on page 248 Entering operands of the modify command for diagnosis on page 247 for information on the operand `CHKLOOP`.

Chapter 2. Creating z/OS conventional MVS data sets

This topic explains how to create the various types of data sets (files) that are supported by the z/OS NFS server.

The examples shown are from an AIX client platform perspective. Any examples for other platforms are so indicated.

Overriding data set creation attributes

When you create an MVS file, default file creation attributes are applied, unless you override them. The attributes are passed to the z/OS host.

Data set creation attributes are controlled in the following ways, in increasing order of priority.

- Default server data set creation attributes
- Default installation data set creation attributes, specified by the system administrator in the attributes data set
- DFSMS data class attributes
- Data set creation attributes specified in the **mount** (or **nfs link**) command
- Data set creation attributes specified in the **mkdir**, **vi** (edit), or **cp** (copy) commands (highest priority)

The z/OS NFS server does not support the following data class attributes.

- CI size of data component
- Number of volumes
- Percentage of CI or CA free space
- Retention period/Expiration date
- VSAM imbed index option
- VSAM replicate index option

Preparing to create an MVS file

When creating an MVS file, you should know whether to process the file in text or binary mode (see “Selection of text or binary processing modes—text, binary” on page 34) and what type of file to create.

The z/OS NFS server supports the following types of files.

- Physical sequential (PS) data sets, including basic format and extended format data sets but excluding compressed format data sets.
- Direct access (DA)
- Partitioned data sets (PDS)
- Partitioned data sets extended (PDSE)
- VSAM KSDS
- VSAM ESDS
- VSAM RRDS

Keyed access and relative record number access to files is not supported. GDG data sets are not supported.

Naming MVS files

The z/OS NFS server uses the comma (,) as a delimiter to a list of file attributes. Do not use a comma as a special character in file name. For example, you can enter this command:

```
$ vi "/u/smith/new,text"
```

This indicates to NFS that a file called *new* is being edited in the attribute text mode, not file *new,text*.

When naming z/OS conventional MVS files, you must follow the MVS file naming conventions, as described in *z/OS DFSMS Using Data Sets*.

For information about the z/OS UNIX System Services naming conventions, see Chapter 4, "Using z/OS UNIX System Services files," on page 49.

An MVS file name (or data set name) can consist of one or several simple names joined so that each represents a level of qualification. For example, the MVS file name DEPT58.SMITH.DATA3 is composed of three qualifiers.

The following characteristics apply to the MVS file name.

- Each qualifier consists of 1 to 8 alphanumeric characters, national characters (@, #, \$), or a hyphen (-)
- Each qualifier must start with an alphabetical or national character
- The period (.) separates simple names from each other
- Including all simple names and periods, the length of the MVS file name must not exceed 44 characters
- PDS and PDSE member names can be up to 8 characters long

For information about the MVS file system, see "Mapping between the workstation and MVS file systems" on page 40.

Restrictions on using alias names for MVS files

For non-VSAM files, alias names can be used interchangeably with the true file name except on remove (**rm** and **rmdir**) and rename (**mv**) requests. Renaming or removing an alias name results in an I/O error. This is due to an MVS restriction.

If the true name of an MVS file is renamed or removed and alias names have been defined for the file, MVS deletes the alias names during execution of the rename or remove request.

Creating physical sequential files

When creating a physical sequential (PS) file, specify the **dsorg(ps)** attribute (if it is not the default already) with the **mount** command or a file creation command, such as the **vi** UNIX (or AIX) command.

The physical sequential data set can only allocate on a single volume with the maximum size of 65535 tracks unless defined with a characteristic allowing increased sizes, such a Large Format. See *z/OS DFSMS Using Data Sets* for additional information on MVS file size limits.

To create a PS file, perform the following steps:

1. Create a local directory on your client to be used as a mount point. For example (with UNIX), enter this command:

```
$ mkdir /u/smith/mnt
```

2. Mount the MVS file system. For example, suppose your host is `mvshost1`, and you want to issue a mount on the high-level qualifier `smith`. You can enter this command:

```
# mount mvshost1:"smith,dsorg(ps)" /u/smith/mnt
```

If you do not specify any other attributes, the MVS site defaults are used. You can use the **showattr** command to display the site defaults.

3. You can use the **vi** UNIX command to create the new file.

```
$ vi /u/smith/mnt/new
```

When you save the file using **vi**, you have just created a new MVS PS file named `SMITH.NEW`.

You can get the same results by specifying **dsorg(ps)** in the file creation command rather than in the **mount** command.

```
# mount mvshost1:smith /u/smith/mnt
$ vi "/u/smith/mnt/new,dsorg(ps)"
```

Creating direct access files

The z/OS NFS supports sequential access to direct access (DA) files. When creating a DA file, specify the **dsorg(da)** attribute (if it is not the default already) with the **mount** command or a file creation command (such as the **vi** UNIX command).

The direct access data set can only allocate on a single volume with the maximum size of 65535 tracks unless defined with a characteristic allowing increased sizes, such a Large Format. See *z/OS DFSMS Using Data Sets* for additional information on MVS file size limits.

To create a DA file, perform the following steps:

1. Create a local directory on your client to be used as a mount point. For example (with UNIX), enter this command:

```
$ mkdir /u/smith/mnt
```

2. Mount the MVS file system. For example, suppose your host is `mvshost1`, and you want to issue a mount on the high-level qualifier `smith`. You can enter this command:

```
# mount mvshost1:"/mvs/smith,dsorg(da)" /u/smith/mnt
```

If you do not specify any other attributes, the multiple virtual system (MVS) site defaults are used. You can use the **showattr** command to display the site defaults.

3. Next, you can use the **vi** UNIX command to actually create the new file.

```
$ vi /u/smith/mnt/new
```

You have just created a new MVS DA file named `SMITH.NEW`.

You can get the same results by specifying **dsorg(da)** in the file creation command, rather than in the **mount** command.

```
# mount mvshost1:smith /u/smith/mnt
$ vi "/u/smith/mnt/new,dsorg(da)"
```

Creating PDSs and PDSEs

Partitioned data sets (PDS) and partitioned data sets extended (PDSE) can be used as directories, and their members are files within those directories. An illustration of the use of PDSs to act as directories is shown in Figure 2 on page 44. For general information on PDSs and PDSEs, see *z/OS DFSMS Using Data Sets*.

You cannot create new directories within a PDS or PDSE, due to the nature of these data structures. Updates or appends to a member name are not allowed.

The partitioned data set can only allocate on a single volume with the maximum size of 65535 tracks. See *z/OS DFSMS Using Data Sets* for additional information on MVS file size limits.

Creating a PDS or PDSE - `mkdir dsntype(pds), dsntype(library)`

To create a PDS or PDSE, perform the following steps:

1. Create a local directory on your client to be used as a mount point. For example (with UNIX), enter this command:

```
$ mkdir /u/smith/mnt
```
2. Mount the MVS file system (accessing files that begin with the high-level qualifier of smith).

```
# mount mvshost1:"smith,mgmtclas(normal)"  
/u/smith/mnt
```
3. If creating a PDSE, use the **mkdir** (make directory) UNIX command, specifying the **dsntype(library)** attribute to create a PDSE named `smith.data1ib`.

```
$ mkdir /u/smith/mnt/"data1ib,dsntype(library)"
```

If creating a PDS, use the **mkdir** (make directory) UNIX command, specifying the following **dsntype(pds)** attribute.

```
$ mkdir /u/smith/mnt/"data1ib,dsntype(pds),dir(20)"
```

Omitting `dsntype(pds)`: You can omit specifying the **dsntype(pds)** attribute if **pds** has been specified for the **dsntype** attribute either in your site attribute data set or in your mount point.

4. You can use the **vi** UNIX command to create a PDS or PDSE member named `smith.data1ib(member1)`.

```
$ vi "/u/smith/mnt/data1ib/member1,text"
```

Type your text, save it, and quit.

You have now created a PDS or PDSE member, which is processed in text processing mode. You can use the **cat** UNIX command to view the contents of your PDS or PDSE member.

Note: z/OS NFS server supports a maximum of 14,562 members in a PDS or PDSE data set. When a NFS read-directory request on a PDS or PDSE is processed, the z/OS NFS server will return up to 14,562 member names. Other requests, such as read and write, to individual members are not affected.

Removing a PDS or PDSE - `rm, rmdir`

To remove a PDS or PDSE, first make sure that the PDS or PDSE is empty. You can delete all members under the directory using the **rm** UNIX command. Then use

the **rmdir** (remove directory) UNIX command. This example removes the `data1ib` directory, and confirms its removal by a failed try to query it (**ls** is the UNIX list files command).

```
$ ls -F /u/smith/mnt/data1ib
data1* data2* data3*
$ rm /u/smith/mnt/data1ib/*
$ rmdir /u/smith/mnt/data1ib
$ ls -F /u/smith/mnt/data1ib
/u/smith/mnt/data1ib not found
```

Accessing PDS or PDSE members

There is more than one way to mount and access PDS and PDSE members. For example, you can display the existing PDS member `smith.source(bigblue)` by entering either of these command sequences.

```
$ mkdir /mnt
# mount hostname:"smith.source,text" /mnt
$ cat /mnt/bigblue
```

Or

```
$ mkdir /mnt
# mount hostname:"smith,text" /mnt
$ cat /mnt/source/bigblue
```

These two approaches are equivalent.

Updating or extending a PDS or PDSE member

The z/OS NFS server does not support updating or extending a PDS or PDSE member directly. To update or extend a PDS or PDSE member, a client program must follow these steps.

1. Copy the file to the client machine
2. Update or extend the copied version on the local system
3. Truncate the original MVS file to zero size by sending a SETATTR request with zero file size
4. Copy the updated version on the local host to MVS by writing request

Some client editors follow these steps, for example, the AIX and UNIX **vi** editor. Other editors do not follow these steps, for example, the z/OS UNIX **OEDIT** editor. In the latter case the user must save the updated version into a new file.

Timing out while writing a PDS or PDSE member

If you are writing to a PDS or PDSE member and a timeout occurs, the timeout causes the member to close. The remaining write requests appear to append to a PDS or PDSE member. The write request does not complete successfully and causes an I/O error. To avoid timing out, increase the time on the timeout setting.

Wildcard copy to a PDS or PDSE

To ensure that a wildcard copy of a PDS or PDSE is completed successfully, the PDS or PDSE member must be closed and dequeued (if necessary). For example, for the statement

```
$ cp smith.* /u/smith/mnt/data1ib
```

the wildcard copy will fail if any member inside of `smith.data1ib` is open.

Limitations of a PDS

The PDS support in NFS adheres to the conventions used in MVS. For example, you cannot have more than one member of a PDS open for output at a time. If you try to create, remove, rename, or write a member of a PDS while another member is open for output, you get a "Permission denied" message.

A PDS member stays open for the timeout period specified in the appropriate timeout processing attribute, or until you try to create or write to another member.

Concurrent writes to a PDSE

NFS does not support concurrent writes to a PDSE. If you are writing to one member of a PDSE, another NFS client cannot write to any other member in the same PDSE. However, you can use ISPF, or some other local z/OS application to edit, or write, a PDSE member while an NFS client is writing to a different member of the same PDSE.

Note: If you are running multiple NFS servers, for this discussion, the "other" NFS server should be considered to be "some other local z/OS application" because the NFS servers are not aware of each other.

ISPF extended statistics support for PDS or PDSE members

As of z/OS V2R1, the z/OS NFS Server supports processing extended ISPF statistics for PDS or PDSE members with more than 65535 lines (see *z/OS ISPF User's Guide Vol I* and *z/OS ISPF User's Guide Vol II*). The z/OS NFS Server always creates extended ISPF statistics when creating/writing a member.

Note:

1. Use of extended ISPF statistics requires more directory blocks than standard ISPF statistics for the same number of members in a PDS. So, if members of a PDS are being written, or created and in the process generates extended statistics, the directory may run out of directory blocks even though no new members are added. It is the customer's responsibility to ensure that the PDS is defined with adequate directory blocks.
2. When accessing a PDS or PDSE member which contains more than 65535 lines, but only has standard ISPF statistics, and the ISPF statistics do not have a value of 65535 for the number of lines in the member to indicate that the value is incorrect, the z/OS NFS Server CANNOT convert the ISPF statistics to extended statistics. This may lead to an incorrect filesize calculation.
3. Use the "TSO ISPCCONF" command to activate the display of extended ISPF statistics on ISPF panels. See *z/OS ISPF User's Guide Vol I* and *z/OS ISPF User's Guide Vol II* for details.
4. In releases prior to V2R1, the z/OS NFS Server will convert extended ISPF statistics to base statistics when writing to an existing PDS/E member, and will reset ISPF statistics when truncating a PDS/E member to a size of 0.

Creating VSAM files

The z/OS NFS supports three types of VSAM files: key-sequenced (KSDS), entry-sequenced (ESDS), and relative record (RRDS). However, keyed access and relative-number access to the files are not supported. Maximum file size supported for any VSAM file type is less than 4GB. VSAM files should not be defined as EXTENDED ADDRESSABILITY even though the file size may be less than 4GB. See *z/OS DFSMS Using Data Sets* for additional information on MVS file size limits.

If you plan to update a VSAM data set (for example, with the `vi` editor or with the `cp copy` command), the data set must have been defined with the `reuse` option. Trying to write back a VSAM data set that was not defined as reusable results in an "I/O error", "failure to open", or similar error message. If you create a VSAM file using the NFS, the reuse option is used by the server.

For more information on VSAM files, see *z/OS DFSMS Using Data Sets*.

In the following example for creating a VSAM KSDS file, the attributes indicate that:

- Spanned records are allowed
- Organization is key-sequenced
- Keys are 8 bytes long and start in position 0 of each record
- Average record size is 1024
- Maximum record size is 4096
- Space is allocated for 50 records with a secondary allocation of 10
- Cross-region and cross-system share options are provided
- The file is to be created on a volume named D80CAT

```
$ cp ksds.old "ksds.new2,spanned,dsorg(indexed),keys(8,0),
  recordsize(1K,4K),space(50,10),shareoptions(1,3),
  vol(D80CAT)"
```

In the following example for creating a VSAM ESDS file, the attributes indicate that:

- Spanned records are allowed
- Organization is entry-sequenced
- Average record size is 1024
- Maximum record size is 4096
- Space is allocated for 50 records with a secondary allocation of 10
- Cross-region and cross-system share options are provided
- The file is to be created on a volume named D80CAT

```
$ cp esds.old "esds.new3,spanned,dsorg(nonindexed),
  recordsize(1K,4K),space(50,10),shareoptions(1,3),
  vol(D80CAT)"
```

In the following example for creating a VSAM RRDS file, the attributes indicate that:

- Spanned records are not allowed
- Organization is relative record, numbered in ascending order
- Average record size is 1024
- Maximum record size is 1024
- Space is allocated for 50 records with a secondary allocation of 10
- Cross-region and cross-system share options are provided
- The file is to be created on a volume named D80CAT

```
$ cp rrrds.old "rrds.new4,nonspanned,dsorg(numbered),
  recordsize(1K,1K),space(50,10),shareoptions(1,3),
  vol(D80CAT)"
```

Exploiting SAM striped files

With SAM striping, data I/O is done in parallel to improve performance. For a file with 16 stripes, data is simultaneously processed on the first track of the allocated space in each of the 16 volumes. This allows for quick access to all the information.

The z/OS NFS server can support data set striping through the use of data class and storage class attributes that define extended format data sets. The z/OS NFS server can exploit the performance of extended format data sets by reading multiple blocks at a time when reading ahead.

For more information about striped files, see *z/OS DFSMS Using Data Sets*.

Exploiting large format data sets

Large format data sets are a type of physical sequential data set, other than extended format data sets, which can grow beyond a size limit of 65 535 tracks on each volume. That size limit applies to z/OS conventional (basic format) sequential data sets. Large format data sets can exploit the increased storage capacity of most hardware storage devices, and reduce the need for very large data sets to span multiple volumes.

To create a large format data set with z/OS NFS, specify a data class which has a dsntype value of *large*. The dsorg value must be *ps*, *psu*, or omitted.

For more information about large format data sets, see *z/OS DFSMS Using Data Sets*.

Exploiting data sets on extended address volumes

An extended address volume is a volume with more than 65 520 cylinders. NFS can read, write, and create VSAM data sets on extended address volumes.

For more information about data sets on extended address volumes, see *z/OS DFSMS Using Data Sets*.

Chapter 3. Using z/OS conventional MVS data sets

This topic explains what you need to know to use z/OS conventional MVS data sets on a client workstation. This topic discusses the following topics:

- Special MVS considerations
- Reading and writing MVS data sets
- Accessing MVS data sets
- Mapping between the workstation and MVS file systems.

In MVS, a file is called a data set, and the two terms are used interchangeably in this book. The z/OS NFS server presents information to you in the form of a UNIX (or AIX) file, though the information is actually stored on MVS-owned DASD in the form of an MVS data set.

Special MVS considerations

In addition to mapping between the workstation and the MVS file systems, the z/OS NFS server might be different from non-MVS NFS servers in other ways, including these differences:

- Selection of an MVS data storage format
- File size determination and time stamps
- Ownership and permissions
- Selecting MVS file systems versus z/OS UNIX file systems
- State
- File reading and writing
 - Random access to files
 - Cached data writing
- Case sensitivity—**maplower**, **nomaplower**
- Selection of text or binary processing modes—**text**, **binary**
 - Binary processing mode
 - Text processing mode
- Number representation
- Partial record identification
- Access to migrated files—**retrieve**, **noretrieve**; **wait**, **nowait**
- Access to system-managed migrated data sets
- File handle refresh
- File extension mapping

Selection of an MVS data storage format

The files you create with the z/OS NFS server are contained in MVS data sets. These MVS data sets are record-oriented and can be sequential, direct, VSAM, partitioned, and so forth. These MVS data sets are variable or fixed in record length. UNIX files, however, are byte-oriented and typically written or read at certain offsets in the file.

You can map non-MVS files to most types of MVS data set organizations. However, how the time stamps and file size value are handled depends on the

type of MVS data set used, and the file size processing can affect performance. See Appendix A, "File size value for MVS data sets," on page 483.

Direct reads with record format **recfm(fbs)** or **recfm(f)** can be fast. In some cases, the z/OS NFS server can determine the physical block addresses from the record offsets. The MVS sequential file organization with **recfm(fbs)** or **recfm(f)** on DASD allows for efficient updating or reading at any offset in the file. Other supported MVS access methods (for example, VSAM) can be used if required by a given application but, in general, the sequential file organization is the best choice for files that are used mainly by UNIX clients.

File size determination and time stamps

How the z/OS NFS server handles the file size value and time stamps depends on the type of MVS data set used and the attributes used to access the data set. See Appendix A, "File size value for MVS data sets," on page 483 and Appendix B, "Time stamps for MVS data sets," on page 487.

Ownership and permissions

The UNIX UID and GID file attributes are reset to their default state (UID=0 and GID=0) after a restart of the z/OS NFS server or an unmount of the file system. In some cases, this requires that a superuser on the client workstation reissue **chown** and **chgrp** commands to reset the UID and GID. These commands can be included in the same script used to mount the file system.

The permissions checking done by RACF®, a component of the Security Server for z/OS, or an equivalent security package, is transparent to you. Access to a data set is granted, provided that the server's exports list, the MVS security subsystem, and the customized installation security exit allow access to the data set. Which of these security systems are active depends on the security settings used at your installation. The UNIX file modes or permission bits are ignored by z/OS NFS server and authorization is done with the RACF or equivalent security package.

UNIX's UID, GID, and MODE attributes are not used by the z/OS NFS server for checking user access to z/OS conventional MVS data sets (see previous paragraph). UNIX's **chown**, **chgrp**, and **chmod** commands do not update z/OS RACF security policies and will not alter access to files. Do not use returned values to determine access rights. The z/OS NFS server supports the setting and obtaining of these attributes to minimize impact to client applications. For performance, validation of passed values is limited to the following checks for proper operations.

When a new MVS data set is created, the UID and GID are inherited from the NFS RPC, or from z/OS UNIX segment, or from the RPC Authentication, in the listed priority order.

CHOWN

Request is failed for a non-root user with EPERM if changing to a value other than yourself. The root user can make arbitrary changes to MVS data set ownership. Change to yourself is allowed for mount support.

CHGRP

No checking.

CHMOD

No checking, new value ignored, existing z/OS NFS server value is left unchanged, "success" is returned to the client.

File reading and writing

After the z/OS NFS server is started and you have mounted the MVS data set, you can use regular data access or creation commands from your workstation to access files that reside on MVS.

For example, suppose you accessed an MVS file named `prefix.file3` mounted on the local directory `/mnt`. This is how you could use the UNIX `cat` command (or a similar command) to display the file:

```
$ cat /mnt/file3
```

Suppose you accessed an MVS file named `prefix.file12` mounted on the local directory `/mnt`. This is how you could use the UNIX `vi` command (or a similar command) to edit the file.

```
$ vi /mnt/file12
```

Writing a file on MVS is straightforward. If the file already exists, the file's existing attributes are used; they are not modified during the write operation. For the priorities of attributes, see "Overriding data set creation attributes" on page 23.

Random access to files

If your application accesses the files at random offsets, there is a performance implication.

In the UNIX environment, a file is represented as a byte stream. That byte stream is accessible for reading and writing at any byte offset for any byte length. In the MVS environment, a file is represented as a collection of records. The record, rather than a single byte, is the smallest object that can be processed. Therefore, the z/OS NFS server has to convert the byte stream operations from NFS clients into standard access method operations on MVS.

To convert byte stream operations to MVS access method operations, the server has to determine which record in the MVS file contains the offset specified in the NFS read or write request. To determine this, the server reads, mapping byte offsets to records, from the last known location in the file until the record containing the requested byte offset is located. This mapping byte offsets to records process can have performance implications depending on the record size used.

For example, suppose a file on MVS contains 10,000 variable-length records with a maximum length of 80 bytes for any record. Suppose the first NFS request received tells the server to read 4,000 bytes starting at offset 10,000 bytes. Because the file has not been opened yet, the server would open the file and start reading at the first record, searching for the record that contains offset 10,000. Once it found the record, the server would process the request, which might involve reading more records to find enough bytes to satisfy the request.

Another complication involved in mapping byte offsets to records is the processing defined by the user to apply to a file. For example, if you specify text mode processing with end-of-line terminators, the perceived offset into a file from a given client changes.

Cached data writing

The z/OS NFS Server always caches writes if out-of-sequence data packets are received or if a physical block of data is partially filled. If the NFS Server is processing in the binary data mode, the writes will remain cached until one of the following occurs: `v4 CLOSE` occurs, the write timeout for a data set has been

reached or, if the logicalcache attribute is defined at less than 2GB, the number of cached packets exceeds the number specified in **cachewindow** . If the NFS Server is processing text data, the writes remain cached until v4 CLOSE occurs, or the write timeout for a data set occurs. If the logicalcache attribute is defined at less than 2GB and the number of cached packets exceeds the number specified in **cachewindow**, data processing ends with EIO error code.

The missing data is padded with binary zeroes and record delimiters so that cached writes for text processing are written in the MVS data set on DASD at the location specified in each cached data packet. In the case of cached data packets for binary processing, only binary zeroes will be used to pad the missing data written at the specified location on DASD. See Table 4.

Attention: It is recommended that the application and NFS client perform the writes in offset and length in multiple of 512 bytes in order to optimize the mapping byte offsets to records process described previously in this section and, therefore, reduce data flush time. On the other hand, for the NFS version 3 commit procedure, the z/OS server will only support committing the cached data when the data set is timed out. For the NFS version 4 commit operation, the z/OS Server will only support committing the cached data upon receiving the close operation.

Table 4. Breakdown of text and binary writes

Description	Binary	Text
Data is flushed to DASD when the	Number of cached packets exceeds the amount specified in cachewindow ¹ , or the file times out.	File times out. If the number of packets exceeds the amount specified in cachewindow ¹ , all new out of sequence packets will be dropped.
Padding	Binary zeros	Binary zeros
Record delimiters	There are no record delimiters. Therefore, there is no attempt to add end of line characters.	There can be record delimiters. Therefore, an end of line character is added to the end of the record.

Note:

1. **cachewindow** is taken into account when the logicalcache attribute is defined at less than 2GB

Case sensitivity–maplower, nomaplower

If the processing attribute **maplower** is specified, the MVS file name is mapped to the lower case when returned to the client and all client specified names are mapped to upper case. If the processing attribute **nomaplower** is specified in the attributes, all entries in the exports data set are case-sensitive. Therefore the client mount request must specify the MVS qualifier with the correct case to successfully match the exports data set entry.

Note: Unpredictable behavior can be expected if **maplower** is used with PDS/PDSe datasets containing mixed or lowercase members.

Selection of text or binary processing modes–text, binary

You can specify either **text** or **binary** processing mode when you access files. This processing mode does not describe the type of data in the original file, but rather, it specifies whether to convert between ASCII and EBCDIC when sending file contents between the z/OS host and the client workstation. See “Mount command syntax and examples” on page 89 for more information about text and binary processing of files using the z/OS NFS client.

Binary processing mode

The **binary** processing mode specifies to send and receive file contents between the z/OS host and the client in binary form, avoiding the ASCII/EBCDIC conversion required in text mode. This is faster than text mode. However, users on MVS cannot read the file, because the contents are not in EBCDIC. Therefore, use the binary processing mode to create or access a file only if the file is not intended to be shared with users on the z/OS host, or the file content is binary.

When fixed-length records are written in binary mode, the server pads the last record of the file with null characters if the last record is less than the fixed record length. These padding bytes are counted in the file size.

Text processing mode

With the **text** processing mode, when data is read, record boundaries are marked with the end-of-line terminators such as **lf** or **crlf**. These terminator characters have the same data representation as the data that is read (the CCSID of the data read in is the same as the CCSID of the appended end-of-line terminators). The data representation of the record formatted data is then changed to the client representation (client CCSID). If the client data representation is the same as the data representation of the data that is read, then there is no data translation.

When the record formatted data is received from the client for writing to the data set, its data representation is changed to the data representation of the data stored in that data set, with the converted end-of-line terminators used to recognize the record boundaries.

In text processing mode, the representation of data along with end-of-line terminators is changed between client representation (client CCSID) and data set representation. All data and end-of-line terminators are converted according to the active translation table. Therefore, if the data set contains a mixture of characters and binary data, binary data is converted as well. In text mode, be careful not to mix your text data (characters) with binary data. Also pay attention that end-of-line terminator conversion depends on the Unicode Conversion Technique - `convserv()` attribute.

For example:

- With `convserv(LRE)`, ASCII LF 0x0a is converted to EBCDIC NL 0x15 (Language Environment behavior)
- With `convserv(RE)`, ASCII LF 0x0a is converted to EBCDIC LF 0x25

NFS version 4 protocol (NFSv4) differs from NFSv2 and NFSv3 protocol in handling single to multiple byte conversion. Therefore, the technique-search-order specified in the `convserv()` attribute should consider the effects of the NFS protocol being used. See "Creating the conversion environment for Unicode Services" on page 174 for further details.

Using the lf line terminator: For an AIX or UNIX client, use **lf** as a line terminator when using **text** processing mode.

Selection of how blanks are handled—`blankstrip`, `noblankstrip`: When fixed-length records are written in **text** mode, records are padded with blanks if the record length is larger than a line, and if the **blankstrip** processing attribute is enabled. (When sending data from MVS, **blankstrip** strips trailing blanks. When sending data to MVS, **blankstrip** pads the records with blanks).

If you are writing data to a fixed record length MVS data set in text mode with blank stripping enabled, and the data contains blanks at the end of the line, an I/O error occurs. This is because the server is not able to return the blanks to the client when the file is read back.

If you get an error message when trying to create or access an MVS data set, see Chapter 19, “Network File System messages,” on page 339 for further explanation of the message.

Potential fixed/variable/undefined record length data set logical I/O errors: If you save a fixed/variable/undefined record length MVS data set in **text** mode with one or more lines exceeding the maximum record length, an I/O error occurs. For example, suppose an MVS data set has fixed-length records of 80 bytes. After you edit the file using the **vi** editor on your workstation, one of the file’s records is 83 bytes long (exceeding the fixed length by 3 bytes). When you save the file back to the server, the MVS data set may be either partially or totally destroyed, and the “I/O Error” message appears on your screen. While you are still in the editing session, save the edited file in an alternate local file. After you correct the local file so that no line exceeds 80 bytes, save it back into the MVS data set.

For example, suppose a variable-length MVS data set is defined with an LRECL of 132 bytes. The maximum effective record length of the data set is actually 128 bytes, because 4 bytes are reserved by DFSMS SAM to accommodate the record descriptor word (RDW). As a result, any line that is attempted to be written into this data set that exceeds this maximum effective record length will result in an I/O error.

For more information about I/O errors related to different MVS data set types, see *z/OS DFSMS Using Data Sets*.

MVS prefix support

New for V1R11, the MVS prefix support enables you to explicitly specify a prefix for identifying MVS data sets.

All path type resolution (checking) processing uses the presence or absence of a leading slash (/) to indicate whether the path is an absolute or relative path. If the slash is present, the first qualifier after the slash is compared against the MVS prefix to determine if it matches the prefix. If so, then the path type will be considered to be explicitly resolved via the prefix. If no match is found, or no slash was present, the implicit path type resolution heuristic is used. To avoid causing unnecessary customer impacts, the default settings cause the file system type resolution algorithm to give the same results as the resolution algorithm in previous releases.

For more detailed information, see “z/OS NFS File System Type Selection” on page 9.

Number representation

The **text** processing mode does not change the number representation format between the host and client. When you choose **text** as the processing mode, the NFS converts characters between ASCII format and EBCDIC format, and processes end-of-line terminators, but no other translation of user data occurs.

When you select **binary** as the processing mode, NFS stores your data unchanged. Therefore, regardless of the processing mode you choose, you cannot change numbers from one client workstation's format to another client workstation's format.

Partial record identification

The term *partial record* or *incomplete record* applies to both z/OS NFS server text and binary modes whenever processing data blocks in RPC WRITE operations for the legacy path.

For text mode, the z/OS NFS server finds and extracts a record from the byte data stream sent by a client by checking sequentially for end-of-line (EOL) delimiters. The scope of a record being defined as a text partial record is limited to an RPC WRITE size of a data block.

An RPC WRITE data block usually contains several text records. If the last or the only record in the first RPC WRITE data block (starting at offset=0 of the byte data stream) has no tail with EOL then it is a text partial record. The second sequential RPC WRITE data block (with the byte data stream offset = size of the first RPC WRITE data block) contains the tail of the partial record from the first RPC WRITE data block, and so on for further RPC WRITES.

RPC WRITES may come to the z/OS NFS server out-of-sequence, so there can be a lost RPC WRITE data block within the byte data stream and thus RPC WRITE data blocks cannot be chained together one-by-one by the z/OS NFS server. If an RPC WRITE data block is not the first one (offset not equal to 0) and the previous sequential RPC WRITE data block is lost, then the first record in this RPC WRITE data block may be incomplete as it has no beginning, just some tail bytes before EOL (or only EOL).

The z/OS NFS server treats a lost or absent RPC WRITE data block as containing a partial record by default.

For binary mode, there is no need to look for records or EOL in the byte data stream, but a lost or absent RPC WRITE data block leads to the same partial record problem (a very long record of the data stream size has data holes somewhere inside).

For both text and binary modes the z/OS NFS server counts the number of bytes of data stream arrived from a client and waits for a new RPC WRITE data block from the client for a specified writetimeout. After this writetimeout expiration, the z/OS NFS server flushes the record_structured cached data (raw data for binary mode) to disk, and closes/deallocates the data set. The z/OS NFS server fills in the "holes" caused by lost RPC WRITE data blocks with zeroes during data flushing. So if an RPC WRITE data block is truly lost (never retransmitted) to the z/OS NFS server, a closed data set will contain zeroes for that data portion that contains holes. The zeroes in a closed data set may be put by the z/OS NFS server at the end of a data set if the last record (referenced by the last data stream byte) is a partial record.

Also, data flushing may be initiated by the z/OS NFS server on RPC WRITE and COMMIT operations without the data set being closed or deallocated.

To indicate the cases of lost RPC WRITE data blocks or partial records, APAR OA16182 introduced special GFSA824W and GFSA825W messages that are issued to the console/log data sets after original writetimeout(n) expiration before data set closure/deallocation.

Symptoms of GFSA824W/GFSA825W messages

The GFSA824W message presents that at least one partial/lost record case has happened during the processing of a data set.

There is an explicit requirement for NFS users who use the z/OS NFS server text mode for data processing to end the byte data stream with an EOL delimiter for client applications writing to the z/OS NFS server. If a user's application does not comply with this requirement, it may provoke partial record conditions for the last RPC WRITE operation that corresponds to the end of data stream (even if all data from the client application was sent to the z/OS NFS server). If a user works with the z/OS NFS server in text mode and does not end its byte data stream with EOL, the GFSA824W/GFSA825W messages appear as a reaction on the last partial record case.

That partial/lost record case results in GFSA824W messages appearing and, subsequently, data set closure/deallocation problems. If a partial/lost record case happened in the beginning/middle of user data stream, the impact of data set closure/deallocation results is data corruption in the beginning/middle of a data set. The holes of the user data portion is filled in by zeroes by the z/OS NFS server.

If a partial/lost record case happened at the end of a user data stream (no EOL delimiter), the impact results in a prolonged timeout before data set closure/deallocation.

For data sets with F/FB record format, the last record in the data set is filled out with trailing zeroes. For example if a data set has RECFM=F,LRECL=40, but the last partial record is 20 bytes in the last RPC WRITE data block, the data set contains hex zeroes in the last physical partial record xxxxxxxxxxxxxxxxxxxx....., where '.' is a x'00' hex byte.

For data sets with V/VB/U record format, the last record in the data set is filled in with one trailing zero. For example if a data set has RECFM=V,LRECL=40, but the last partial record is 20 bytes in the last RPC WRITE data block, the data set contains one hex zero in the last physical partial record xxxxxxxxxxxxxxxxxxxx., where '.' is a x'00' hex byte.

The GFSA825W message presents that a data set is closed/deallocated after extended writetimeout with at least one partial/lost physical partial record.

If any late RPC WRITE operations with lost data portion are sent to the z/OS NFS server after the data set has been closed/deallocated, the data set will be re-opened, re-read and updated with the lost portion of data. But this late RPC WRITE should not alter the existing record structure in the data set. The shorter or longer record from the update against the existing data set records may cause logical errors in the z/OS NFS server that will be reported to a client as EIO(5) error code.

The z/OS NFS server supports correct recovery/extension of the last physical partial F/FB/V/VB/U record on disk during processing of further RPC WRITES from a client which contains the rest of the record.

The z/OS NFS server does not support the last physical partial record recovery for VS/VBS data sets.

To eliminate conditions reported by GFSA824W/GFSA825W messages, the user should adhere to the EOL requirement for text mode and tune the z/OS NFS server by setting the proper timeouts, that is, writetimeout(n) value must be greater than the maximum delay between WRITE operations in a slow client/network. Improper writetimeout settings may cause performance problems and data set closure/deallocation problems due to partial/lost record conditions.

Access to migrated files—retrieve, noretrieve; wait, nowait

Sometimes files on MVS are migrated to another storage level, such as a space-saving format on DASD or tape. If your file has been migrated and you try to access it, it might take a while for it to be recovered back into primary storage. The **retrieve** and **noretrieve** processing attributes control what happens when you try to access a migrated file.

There are three ways that the **retrieve** or **noretrieve** option is controlled.

1. Using the Default Retrieve Attribute

You can use the default retrieve processing attribute by not entering **retrieve** or **noretrieve** in your **mount** command or **file access** command.

2. Specifying **retrieve** with the **mount** command

You can issue the **mount** command, specifying **retrieve** or **noretrieve**. The attributes specified in the **mount** command override the attributes in the default attribute data set.

In this example, migrated files under the mount point are not retrieved. However, you can access files under the mount point which are not migrated.

```
$ mount mvshost1:"smith,noretrieve" /u/smith/mnt
```

Conversely, the next command causes the migrated files under the mount point to be retrieved when accessing the files.

```
$ mount mvshost1:"smith,retrieve" /u/smith/mnt
```

3. Specifying **retrieve** with a file access command

You can issue a file access command with the attribute **retrieve** or **noretrieve** specified. The attributes specification in the **file access** command overrides the attributes in the **mount** command and the server default attributes.

This command causes all files under the mount point /u/smith/mnt to be retrieved if they are migrated:

```
$ ls -l "/u/smith/mnt,retrieve"
```

This command, however, does not cause migrated files under the mount point /u/smith/mnt to be retrieved:

```
$ ls -l "/u/smith/mnt,noretrieve"
```

Access to migrated system-managed data sets

z/OS DFSMS allows access to data set attributes for migrated SMS-managed data sets, without having to recall the data set if the data set was migrated under DFSMS/MVS V1R3 or later. Supported data set types are SMS-managed PS, VSAM ESDS, VSAM KSDS, VSAM RRDS, PDS, and PDSE. Migrated PDS/PDSE members are not supported.

The z/OS NFS server is able to obtain the attributes of a supported SMS-managed migrated data set without recalling the data set. Attributes such as the time stamp

and file size are saved to DASD. Subsequent file size requests do not cause a recall of the supported SMS-managed migrated data set, thus improving performance. However, when the data set is modified outside the server by a non-NFS application (for example, by the TSO/E editor) before it was migrated, the stored file size could be incorrect. When the data set is accessed again by the server, a recall must be done to determine the correct file size.

When a request is made to remove any of the supported SMS-managed migrated data sets, the data set will be deleted without recall. For PDS and PDSE migrated data sets, the data set will be recalled in order to read its member information.

File handle refresh

File handles of mounted objects (directories or file systems) are saved on DASD in a mount handle data set and are automatically established again when the server restarts. However, file handles for the files within a mounted object are kept in virtual storage (memory) and they are lost if the server restarts. This may result in stale file handles for NFS version 2 and 3, or file handle expired in NFS version 4, and the clients may be required to request a new file handle by redoing the **lookup** on the file.

Mapping between the workstation and MVS file systems

In MVS, a file is called a data set, and the two terms are used interchangeably in this book. The z/OS NFS server presents information to you in the form of a UNIX (or AIX) file, though the information is actually stored on MVS-owned DASD in the form of an MVS data set.

The files for a computer system are organized into a file system. The UNIX environment uses a file system that is a hierarchy of directories. MVS, however, uses a non-hierarchical file system in which groups of data sets are referred to by specifying a high-level qualifier.

The MVS high-level qualifier can include the first (leftmost) qualifier of data sets, or the first and second qualifiers, or the first, second, and third qualifiers, and so on. For example, SMITH is the high-level qualifier for the files named SMITH.TEST.DATA and SMITH.PROJ7.SCHED, while SMITH.TEST is the high-level qualifier of SMITH.TEST.DATA and SMITH.TEST.DOCS.

File extension mapping

File extension mapping allows users to access members of z/OS conventional MVS PDS or PDSE data sets on the z/OS host that are mapped from client machine files that contain file extensions. File extension mapping also allows the selection of text or binary processing for members of z/OS conventional MVS data sets and z/OS UNIX files.

Each PDS or PDSE data set on the host can only be mapped with one unique file extension. For example: IBMUSER.TEXT(M1), IBMUSER.TEXT(M2) will map to m1.txt, m2.txt under directory ibmuser.text on the client machine. This capability allows client machine tools such as editors and compilers, to process host files remotely without modification. There are site and processing attributes and an operator command that are associated with the file extension mapping.

The rules for file extension mapping are contained in a data set called a *side file*. The side file consists of two sections: NFS.MAPPING and NFS.MAPPING.MAPPED.

Section NFS.MAPPING is used to define file extension mapping for z/OS conventional MVS PDS/PDSE data sets. The client user can specify the **fileextmap** attribute to turn the file extension mapping on and the **nofileextmap** attribute to turn the file extension mapping off. Section NFS.MAPPING.MAPPED is used to specify whether text or binary processing is performed for file extensions of z/OS conventional MVS data sets and z/OS UNIX files. The client user can specify the **mapped** attribute to specify when a mixed set of data types is to be processed. For z/OS conventional MVS data sets, the **maplower** and **nomaplower** attribute controls the mapping of lower case files names to upper case when accessing files on z/OS.

You can establish a default side file, with the default rules for file extension mapping, by specifying the **sidefile(dsname)** attribute in the attributes data set. A client user can also specify this attribute on a mount command to override the default side file name, as shown in the following example:

```
[C:\] mount z: mvshost1:"user1.pds,sidefile(hlq.nfs.mapping)"
```

The side file specified at the **mount** command will be searched first followed by the default side file. The system administrator can specify the maximum space available for side files using the site attribute **sfmax(n)**. The mapfile operand of the modify command can be used to have a side file read again and rebuilt without stopping and restarting the server or remounting of mount points. A sample mapping side file is provided as GFSAPMAP in the SYS1.NFSSAMP library. See "Entering operands of the modify command for the z/OS NFS server" on page 235, "Processing attributes syntax" on page 127, and "Site attributes syntax" on page 139 for more information.

Specifying the side file on an NFS version 4 **mount** command has the following effects:

- Loads the side file if it is not loaded
- Does not reload the side file if it was already loaded (does not change the current side file).

Note:

1. With NFS version 4, an **unmount** command does not unload the side file, because no UNMOUNT_RPC is sent to the z/OS NFS server.

Mounting of MVS data sets onto a client mount point

To access an MVS file system from the client, you use the **mount** command to create a temporary link between specific MVS data sets and a UNIX directory (preferably empty) or an unused logical drive. The UNIX directory or drive is called a mount point.

You use an MVS high-level qualifier in the mount command to specify which MVS data sets to mount onto a mount point. The MVS data sets beginning with the specified high-level qualifier appear as files under the mount point. See Figure 2 on page 44.

You can also perform a mount using a fully qualified partitioned data set name (PDS or PDSE) or an alias to a user catalog, but not the catalog name itself. Only cataloged data sets are supported by the z/OS NFS server, and tape data sets are not supported.

Data set organizations supported include:

- Physical sequential (PS)
- Direct access (DA)
- Partitioned data sets (PDS)
- Partitioned data sets extended (PDSE)
- VSAM KSDS
- VSAM ESDS
- VSAM RRDS
- SAM extended format data sets

Both SMS-managed and non-SMS-managed data sets are supported.

- NFS supports multivolume data sets.
- Generation data sets are not supported.

Note:

1. The filesize for the MVS z/OS conventional data set as a directory has a dummy size with a value of 8192.
2. For the NFS Version 3 CREATE procedure, the z/OS server does not harden the exclusive create verify token to disk.

Mount examples

Table 5 shows how to mount z/OS MVS data sets from various platforms.

Table 5. Examples of mounting MVS data sets from clients

Clients	Command Examples
UNIX/Linux	<pre>mount -o vers=n,sec=r,proto=x mvshost1:"MVSHLQ,procattr1,procattr2,..." /u/smith/mnt</pre> <p>Note: For NFS version 4 mounts to the z/OS NFS Server, it is recommended to use the "nordirplus" mount option from Linux NFS Clients.</p>
Linux Redhat EL 5 (NFS version 4)	<pre>mount -t nfs4 -o sec=r,proto=x mvshost1:MVSHLQ /u/smith/mnt</pre> <p>Note: For NFS version 4 mounts to the z/OS NFS Server, it is recommended to use the "nordirplus" mount option from Linux NFS Clients.</p>
Windows	<pre>nfs link z:"\\mvshost1\MVSHLQ,procattr1,procattr2,..." id pw</pre>
Any (UNIX, Linux, Windows), with explicit MVS prefix	<pre>mount ... mvshost1:"/mvs/MVSHLQ"...</pre>

In the examples:

Operand

Description

mvshost1

Specifies the name of the z/OS host.

/mvs

Assuming that MVSPREFIX(/mvs) is set in the site attribute file (this is the default), identifies this as an MVS mount. Note that this does not need to be **/mvs**. It only needs to match the MVSPREFIX value (case-insensitive).

MVSHLQ

Specifies the high-level qualifier of the MVS data set.

- procattr*
Specifies any valid processing attribute, such as text/binary or hfsbtimeout(n).
- /u/smith/mnt*
Specifies the local mount point.
- z:* Specifies the drive letter on the Windows system.
- id pw*
Specifies login id and password for pcnfsd.
- t nfs4*
Specifies NFS protocol version 4 for Linux (optional).
- o vers=n*
Specifies the NFS protocol version to be used (2 or 3 for Linux; 2, 3 or 4 for others) (optional).
- o sec=r*
Specifies RPCSEC_GSS security flavors, which is available only on the z/OS NFS version 4 server. Valid options are **sys**, **krb5**, **krb5i**, and **krb5p**.
- o proto=x*
Specifies the transport protocol for the NFS client to communicate with the NFS server. Valid options are **tcp** or **udp**. (Note for IPv6, some platforms use **proto=tcp6** instead of **tcp**)

Variants of the mount command

The name of the command that performs the mount operation varies for different client implementations. For example, the Windows implementation uses the **nfs link** command while most UNIX and Linux implementations use the **mount** command.

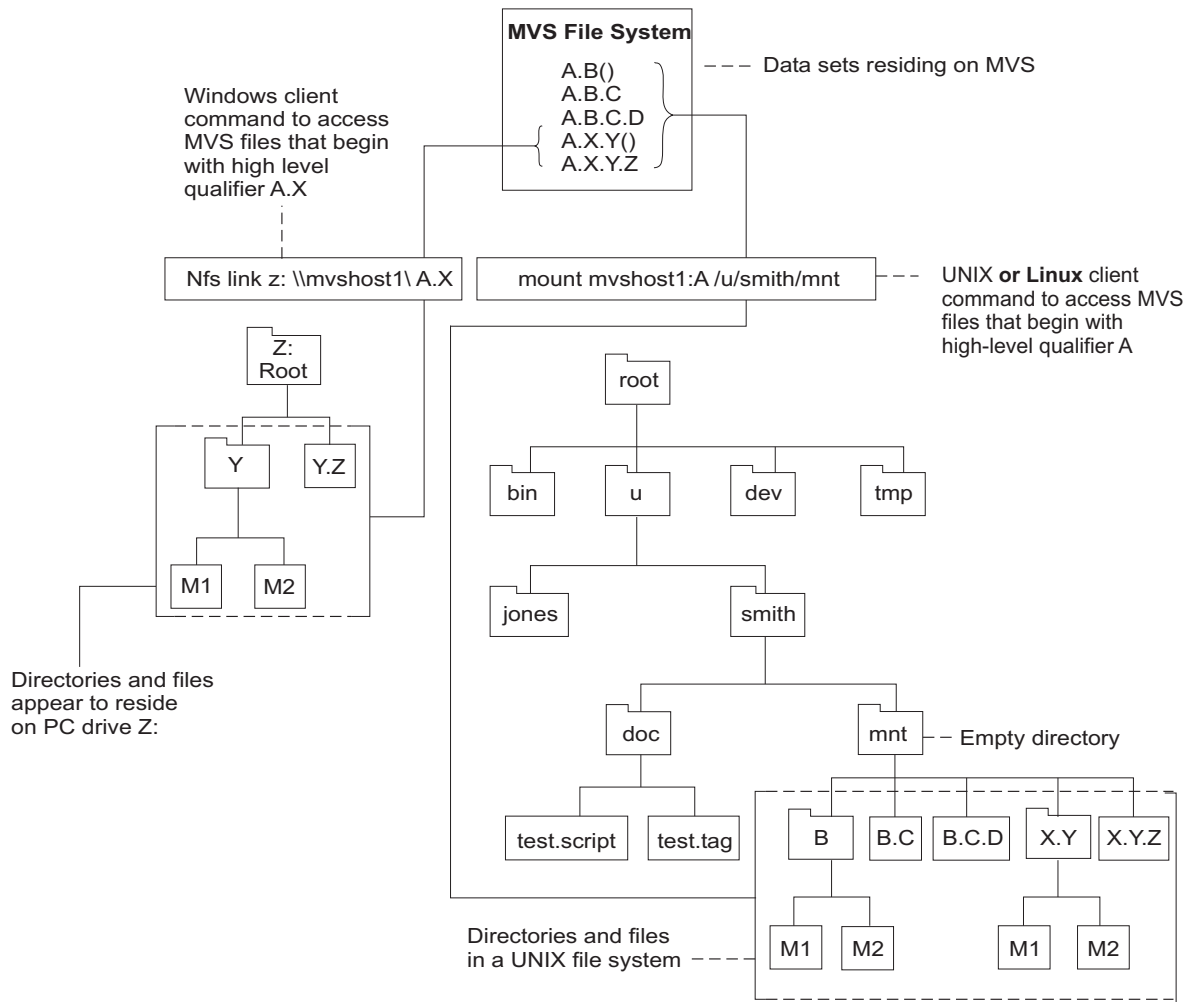

Figure 2. Examples of mounting MVS data sets on Windows, UNIX and Linux clients. The Windows client is mounting the MVS data sets which begin with the high-level qualifier “A.X”. The UNIX and Linux clients are mounting the MVS data sets which begin with the more inclusive high-level qualifier “A”. The parentheses indicate a PDSE containing the members M1 and M2. The PDSEs A.B() and A.X.Y() appear as directories, and their members appear as files within those directories.

Use of a PDS or PDSE as a directory

If the data sets specified include partitioned data sets, a second level of hierarchy is shown. This allows you to define one level of directories under the mount point. Thus, you can issue **mkdir** to create a directory (stored as a PDS or PDSE) and then create files (stored as members of a PDS or PDSE) within that directory.

This use of a PDSE is shown in Figure 2, which illustrates the mapping of file names between client file systems and the MVS file system resulting from a **mount** command.

Use of multiple mount points

You can arrange groups of data sets into several UNIX mount directories (or PC mount drives) by using MVS naming conventions to mount specific data sets at each mount point. For example, you could mount user1.project1 to get all data sets beginning with user1.project1 mounted at one point in the local file system, and you could mount user1.project2 at another point. This would create the effect of

two distinct directories (or drives), one containing the user1.project1.* data sets, and the other containing the user1.project2.* data sets.

Data set serialization and sharing

The z/OS NFS server handles data set serialization and sharing differently depending on the type of data set:

Physical sequential

The server insures the read/write integrity of a physical sequential data set by SVC 99 dynamic allocation with exclusive option whenever a physical sequential data set is opened for output; otherwise it is allocated with share option.

VSAM data set

The server dynamically allocates a VSAM data set with share option and allows the VSAM access method to manage data sharing using the SHAREOPTIONS specified during data set definition.

PDSE data set

The server dynamically allocates a PDSE data set with share options and allows the PDSE functions to manage the integrity of the PDSE data set and its members.

PDS data set

The server dynamically allocates a PDS data set with share option and surrounds the PDS and its members with exclusive ENQs against the QNAME=SPFEDIT and RNAME=data set name. This does not protect the PDS from other z/OS users who are attempting to access the PDS without performing ENQ against SPFEDIT similar to the z/OS NFS server.

NFS protocol

Table 6 illustrates that the NFS procedures are not all supported for z/OS conventional MVS data sets.

Table 6. NFS procedures

Procedure	Version 2 Protocol	Version 3 Protocol	Version 4 Protocol
link	no	no	no
mknod	N/A	no	no
readlink	no	no	no
readdirplus	N/A	no	no
setattr	yes	yes	yes
statfs	yes	N/A	N/A
symlink	no	no	no

Note: Setattr only supports filesize=0 truncation and UNIX permission is set to 777.

NFS file system attributes

The z/OS NFS server generates MVS-specific values for certain UNIX file system attributes. Table 84 on page 491, Table 85 on page 491, and Table 86 on page 491 illustrate the MVS values that the z/OS NFS server generates.

Delegating management of a file's resources to an NFS client

The NFS version 4 protocol enables an NFS Server to temporarily delegate management of a file's resources to an NFS Client. The key purpose of the delegation is to provide improved performance by eliminating communications with the NFS Server.

When a file's management is delegated to an NFS Client, all file access requests can be managed locally by the NFS Client while the file is delegated.

Use the following NFS Server Site Attributes to control the activation of the delegation function:

DELEGATION/NODELEGATION

specifies whether or not the NFS server allows NFS Version 4 protocol file management delegation to NFS clients. The default setting is NODELEGATION.

A new Modify operator command, V4DELG=ON/OFF can be used to dynamically turn on or off NFS Version 4 protocol file management delegation to NFS clients.

- When Modify operator command V4DELG=ON is specified, the server checks each client for a valid callback path. This will take some time. The server can only grant the delegation if a valid callback path exists between the server and the client.
- When Modify operator command V4DELG=OFF is specified, any existing delegations continue until they are recalled by the NFS server due to a conflicting request, or returned by the NFS client. However, no new delegations are started.

File delegation is at the NFS Server's discretion. When an NFS Client sends a file open request, the server determines whether to delegate the file or not. The NFS Client cannot assume that the file will be delegated.

When the client has not contacted the server for a lease time interval, the server can remove all delegations to the client.

If a local user or another client requests share reservations or access to the delegated file, the server will recall the delegated file.

The NFS Server may recall the delegation at any time. The NFS Client must then send any modified data buffers and attributes back to the server. It should also send any locally established file locks to the server so that those locks can be established on the NFS Server to maintain the Client's lock status over those files.

When the delegation is granted to the client, the result is as follows:

- Request for open Read share - Granted: Read delegation (READ Delegation)
- Request for open Write share - Granted: Read and Write delegation (Write Delegation)

When the file is closed, the delegation returns back to the server.

When another application on the z/OS system requires access to the delegated file, the system must notify the NFS Server that the delegation is being recalled. The server must then recall the file from the delegated NFS Client(s). Any modified data buffers and file attributes must be updated, and any necessary file locks must

be established before the recall can be completed. The NFS server initiates a delegation recall during the following circumstances:

- If the NFS server receives an NFS client access request for a file and this request is not compatible with existing client delegations for the file, then the existing delegations are recalled and access is granted to the interested clients in a non-delegated mode, on a normal file open priority order.
- If an NFS Client does not respond to a recall request within a reasonable amount of time, the delegation is treated as having been successfully recalled from the standpoint of any other delegation requests. At that point, any subsequent file access operation requests from this client will fail.
- When an NFS Client's lease expires, the z/OS NFS Server recalls any outstanding delegations as part of the lease expiration process.

Note:

1. Currently delegation is only supported for MVS data sets. zOS Unix file delegation is not provided.
2. Only the AUTH_UNIX RPC flavor is supported for delegation.
3. NFS V4 delegation reclaim after an NFS Client reboots (that is, Open claim type, CLAIM_DELEGATE_PREV) is not supported due to potential issues if the client reboots in close succession.

Chapter 4. Using z/OS UNIX System Services files

This topic explains what you need to know to access z/OS UNIX files from a client workstation.

- The z/OS UNIX file system
- POSIX compatibility
- Attributes specific to z/OS UNIX
- Protecting your z/OS UNIX files
- Accessing z/OS UNIX files from the client
- Linking an MVS data set to a hierarchical file system
- Selecting z/OS UNIX file systems versus MVS file systems
- UNIX look and feel
- Displaying and modifying remote file system access control lists

For detailed information about z/OS UNIX, see *z/OS UNIX System Services User's Guide*.

z/OS UNIX file system

z/OS UNIX provides a hierarchical file system (HFS) for z/OS. z/OS UNIX also provides the z/OS File System (zFS). An HFS or zFS file within z/OS UNIX is called a z/OS UNIX file. HFS and zFS files are organized in a hierarchy of files and directories in a tree structure. A directory can contain files or other sub-directories. The highest level directory is called the root directory. Figure 3 on page 50 shows an example of mounting an HFS or zFS directory from a UNIX client.

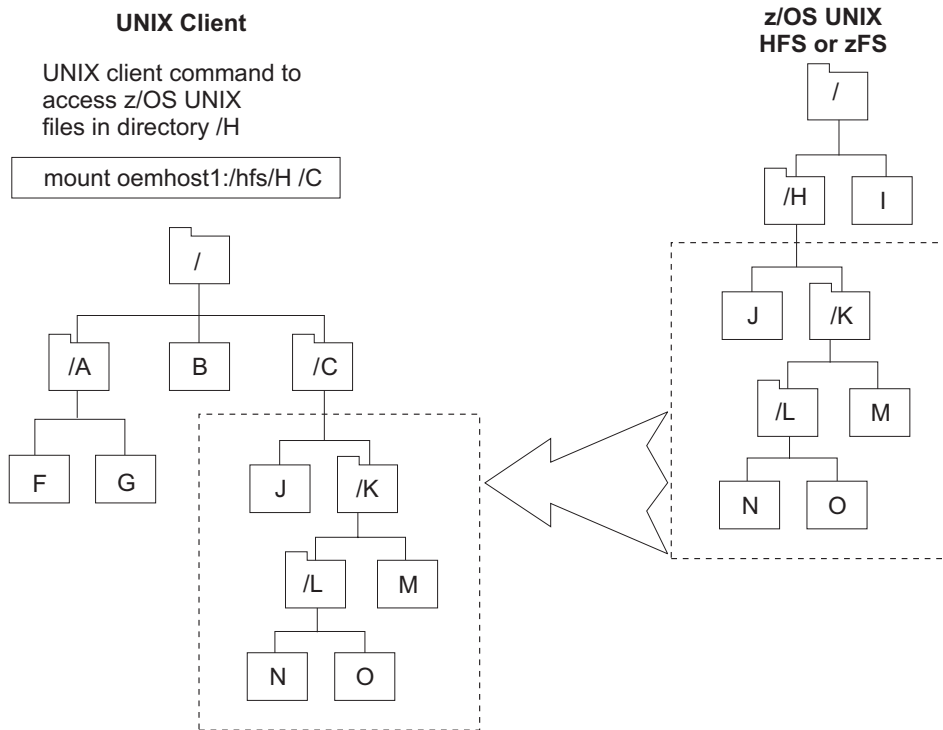

Figure 3. Example of mounting an HFS or zFS file from a UNIX client

A z/OS UNIX file system must be mounted by an MVS system operator using a TSO MOUNT command before that z/OS UNIX file system can be mounted by an NFS client through the z/OS NFS server. If a z/OS UNIX file system is mounted after the NFS client mount is already established, this file system's directory structure and contents will not be visible to the remote NFS Client until the NFS mount is unmounted and remounted or the z/OS NFS Server is restarted.

z/OS UNIX files are byte-oriented rather than record-oriented (unlike z/OS conventional MVS data sets). This data can be shared with TSO/E z/OS UNIX users in addition to NFS clients. All data written to a z/OS UNIX file can be read by all programs as soon as it is written. You can also copy data between z/OS UNIX files and MVS data sets using z/OS UNIX utilities like ISHELL.

POSIX compatibility

The NFS supports file access to the z/OS UNIX file system. z/OS UNIX supports a set of standards called the portable operating system interface (POSIX). See *z/OS UNIX System Services User's Guide* for more information about POSIX compliance. With z/OS UNIX, the NFS performs the following functions.

- Supports hierarchical directories
- Allows file names up to 255 characters in length
- Allows path names up to 1023 characters in length
- Supports mixed-case names and special characters, except nulls, slashes, and commas in file and path names
- Supports UNIX-style file access permissions
- Supports group ID and user ID at the file level
- Supports the full NFS protocol (including external links)
- Enables data sharing between clients and the z/OS UNIX

- Enables you to link z/OS conventional MVS data sets to a POSIX path name

This support incorporates the basic strengths of the z/OS system for both existing MVS data and applications and for new POSIX conforming data and applications.

NFS protocol

z/OS UNIX is compliant with all of the z/OS Network File Systems version 2, version 3 and version 4 protocols.

Attributes specific to z/OS UNIX System Services

The following attributes are specific to the z/OS UNIX:

Attribute	Description
alias	Optional site attribute to enable alias processing.
sync	Processing attribute for version 2 protocol only
hfsprefix	Site attribute
extlink	Attribute, see "Linking an MVS data set to a z/OS UNIX file system" on page 55

Note: These attributes are also explained in Chapter 9, "Initialization attributes for the z/OS NFS server," on page 121.

Synchronous write to a z/OS UNIX file for NFS version 2 protocol

Use the **sync** and **async** processing attributes to specify whether data received by a write request for a z/OS UNIX file object is committed to nonvolatile storage before the write response is returned to you.

If **sync** is specified for a z/OS UNIX file object, the data is written to z/OS UNIX and immediately committed to non-volatile storage.

For greater throughput, you can alternatively specify **async**. Your data is then committed to the disk some time after the write request is received from the NFS client. Your data is written to disk when the write timeout occurs, or if z/OS UNIX reclaims buffer cache storage.

The **sync** and **async** processing attributes only apply to z/OS UNIX data access. They are ignored for MVS data set access. A TSO/E z/OS UNIX user doesn't have to wait for the data to be committed to nonvolatile storage before accessing. z/OS UNIX maintains a central buffer cache and a TSO/E z/OS UNIX user can access the data as if it were in the file once it has been written by the z/OS NFS server.

Synchronous write to a z/OS UNIX file for NFS version 3 or 4 protocol

For the NFS version 3 WRITE procedure or NFS version 4 WRITE operation there is a processing argument **stable** and output parameter **commit** which specifies whether data received by a write request for a z/OS UNIX file object is committed to nonvolatile storage before the write response is returned to you.

If the *stable* processing argument is used during the write procedure, there are three modes when the write procedure writes to a file:

file_sync

The z/OS NFS server must commit all data written and all file system data to stable storage before returning commit results.

data_sync

The z/OS NFS server must commit all data written and sufficient metadata to enable retrieval of data, before it returns a reply to the client.

unstable

The z/OS NFS server may not commit any part of the data and metadata to stable storage, before returning a reply to the client. The data will be committed when a timeout occurs.

For the commit procedure, the z/OS server will support committing the entire data and metadata to stable storage.

Authorization checking when writing to a z/OS UNIX file

The z/OS Network File System server allows the owner of an z/OS UNIX file to write to the file regardless of the UNIX permission bits setting on the file.

HFSPREFIX site attribute

The HFS Prefix is not required, depending on the implicit prefix selection algorithm specified in the IMPPREFIX site attribute.

If the system administrator has not specified an implicit prefix selection, then to access z/OS UNIX files, you must know the HFS prefix defined by your system administrator (the default is /hfs). You can use the **showattr** command to display the HFS prefix defined for your location. You use this prefix in your mount command before the path name of the z/OS UNIX directories that you are mounting. The HFS prefix is used by the NFS server to distinguish z/OS UNIX directories from z/OS conventional MVS data sets, but the HFS prefix isn't part of the path name that you see. After you have entered the mount command, you access HFS files using the local mount point.

See “z/OS NFS File System Type Selection” on page 9 for more information on selecting NFS file system types.

Protecting your z/OS UNIX System Services files

As an z/OS UNIX user, you can control the read, write, and execute access to your files by other users in and outside of your group by setting the permission bits associated with the files.

To access z/OS UNIX files from the NFS, you must be defined as an z/OS UNIX user. The system programmer defines you as a z/OS UNIX user by assigning a z/OS UNIX user ID (UID) and a z/OS UNIX group ID (GID) to you. The UID and GID are numeric values associated with a TSO/E user ID. The values are set in the RACF user profile and group profile when you are authorized to use z/OS UNIX. The system uses the UID and GID to identify the files that you can access. Your specific UID value identifies you as a user of z/OS UNIX services. A GID value is a unique number assigned to a group of related users. These numbers appear in the RACF user profile. See *z/OS UNIX System Services Planning* for more information.

Accessing z/OS UNIX files from a client

Most of the commands that are used to access z/OS UNIX files are identical to the commands that are used to access z/OS conventional MVS data sets.

```
mvslgin
showattr
mount
umount
mvslgout
```

The only command that is changed for z/OS UNIX is the **mount** command.

Note: The syntax of these commands may vary between platforms; see the appropriate topic for examples specific to the platform you are using to access z/OS UNIX files.

If you are using AIX (or any other UNIX-based operating system) see Chapter 6, "Commands and examples for AIX and UNIX clients," on page 65.

Mount examples

Table 7 shows how to mount z/OS UNIX files from various platforms.

Table 7. Examples of the mount command for clients

Clients	Command Examples
AIX, UNIX/Linux, Solaris	<pre>mount -o vers=<i>n</i>,sec=<i>r</i>,proto=<i>x</i> mvshost1:"/hfs/smith" /u/smith/mnt</pre> <p>Note: For NFS version 4 mounts to the z/OS NFS Server, it is recommended to use the "nordirplus" mount option from Linux NFS Clients.</p>
Linux Redhat EL 5 (NFS version 4 only)	<pre>mount -t nfs4 -o sec=<i>r</i>,proto=<i>x</i> mvshost1:"/hfs/smith" /u/smith/mnt</pre> <p>Note: For NFS version 4 mounts to the z/OS NFS Server, it is recommended to use the "nordirplus" mount option from Linux NFS Clients.</p>
Windows	<pre>nfs link z: '\\mvshost1\hfs/smith' /n id pw nfs link z: "\\mvshost1\hfs/smith,procatr1,procatr2,...." /n id pw</pre>
Any (UNIX, Linux, Windows), with implicit prefix	<pre>mount mvshost1:/smith</pre>

In the examples:

Operand

Description

mvshost1

Specifies the name of the MVS host.

/hfs

Specifies the HFS prefix. Note that the HFS Prefix is not required, depending on the implicit prefix selection algorithm specified in the IMPPREFIX site attribute.

/smith

Specifies the HFS directory to be mounted.

/u/smith/mnt
Specifies the local mount point.

-t nfs4
Specifies NFS protocol version 4 for Linux (optional)

-o vers=n
Specifies the NFS protocol version to be used (2 or 3 for Linux; 2, 3, or 4 for others) (optional)

-o sec=r
Specifies RPCSEC_GSS security flavors, which are available only on the z/OS NFS version 4 server. Valid options are **sys**, **krb5**, **krb5i**, and **krb5p**.

-o proto=x
Specifies the transport protocol for the NFS client to communicate with the NFS server. Valid options are **tcp** or **udp**. (Note for IPv6, some platforms use *proto=tcp6* instead of *tcp*)

/n Specifies the NFS protocol version for Windows (2, 3, or 4) (optional)

id pw
Specifies login id and password for pcnfsd.

Note:

1. The */hfs* prefix value is used by the z/OS NFS server to determine if a file is a z/OS UNIX file, and does not appear in the path name of an HFS file once it is mounted.
2. The HFS prefix is not required, depending on the implicit prefix selection algorithm specified in the IMPPREFIX site attribute.

z/OS UNIX data transfer and conversion

With the NFS version 4 protocol, text data and metadata are transferred between the server and client in the UTF-8 data format (ASCII text is not transferred directly). z/OS NFS conversion of UTF-8 text data and metadata requires setting up a conversion environment using the z/OS Unicode Services by creating a Unicode conversion image that defines conversion tables with UTF-8 [CCSID 1208].

Data transfer under the NFS version 4 protocol

With the NFS version 4 protocol, text data and metadata are transferred between the server and client in the UTF-8 data format. With NFS version 4, ASCII text is not transferred directly.

Text or binary processing - NFS version 2 and 3 protocols

z/OS UNIX is a byte-oriented, hierarchical, EBCDIC file system. For the NFS version 2 and version 3 protocols, the z/OS NFS server provides ASCII to EBCDIC text translation. For these versions of NFS, if you are just using the mainframe as a repository for your workstation (ASCII) data, you should use the binary mode to speed processing. If you use text mode, data from your workstation is converted into EBCDIC when it is stored on the mainframe. Conversely, when the z/OS NFS server returns the data to your client system, it converts the data back into ASCII. The conversion can slow processing, but might be necessary if you are sharing data with other MVS users. All data is converted according to the active translation table. Therefore, if the data set contains a mixture of characters and binary data, binary data is converted as well. In text mode, then, be careful not to mix your text data (characters) with binary data.

In text mode, you can either use the OEMVS311 translation table or the replacement customized translation table to convert data between ASCII and EBCDIC. If you are using z/OS UNIX and text mode processing, specify the OEMVS311 translation table with the `xlat` processing attribute. The OEMVS311 table translates ASCII (ISO 8859-1) to and from EBCDIC (1047 - z/OS UNIX System Services). TCP/IP for MVS version 3.1 provides the OEMVS311 table. This table translates the UNIX line terminator (lf) to the z/OS UNIX line terminator (nl). See *z/OS Communications Server: IP Configuration Reference* for more information about creating and customizing your own translation tables.

This is an example of specifying the OEMVS311 translation table during a mount:

```
$ mount 1stc3mvs: "/hfs/usr/man/C,text,xlat(oemvs311)" /mnt
$ export MANPATH=/mnt
$ man more
```

In this example:

Operand

Description

1stc3mvs

Specifies the name of the z/OS host.

/hfs

Specifies the HFS prefix.

/urs/man/C

Specifies the HFS directory to be mounted.

text

Specifies that data be converted between ASCII and EBCDIC

xlat(oemvs311)

Specifies that the translation table named OEMVS311 is used to convert data between ASCII and EBCDIC.

/mnt

Specifies the local mount point.

man more

Obtains a Man Page description of the **more** command

Linking an MVS data set to a z/OS UNIX file system

This section explains how to access an MVS data set through a z/OS UNIX path name by using the external link command. It also explains how to display the contents of an external link and how to delete an external link.

Creating an external link

You can create an external link to an MVS data set, and then transparently access the MVS data set by referencing the external link. The external link simulates a UNIX-like hierarchical naming convention for z/OS conventional MVS data sets. This is done using the **ln** command, for example:

```
mount mvshost1:USER1 /mnt
mount mvshost1:/hfs/u/nfs /samples
ln -s USER1.MVSFILE /samples/linkfile,"extlink"
```

In this example a z/OS UNIX file object, */linkfile*, of the file type "extlink" is created containing the file name of the MVS data set USER1.MVSFILE to be accessed. The

source file must be mounted to a z/OS UNIX file system. The external link must reference an MVS data set. All future references to */samples/linkfile* access USER1.MVSFILE transparently.

In this example the file */usr/pub/myfile* is copied to the MVS data set USER1.MVSFILE that is contained in the external link */samples/linkfile*:

```
cp /usr/pub/myfile /samples/linkfile
```

Your installation should make sure that the appropriate security permissions have been obtained to access the MVS data set. You will receive "Permission Denied" message if the mount point */mnt* has not been established on USER1.

A mount point must be established before the external link is established. Otherwise, the error code ACCESS DENIED is returned. For physical sequential data sets, the high level qualifier of a data set must be established. For example, if you had a file called *smith.test.data* you can mount with *smith*, *smith.test*, or *smith.test.data* as your high level qualifier. For PDS and PDSE data sets, the fully qualified name must be established as a mount point. An example of a fully qualified name would be, *smith.test.data*.

Displaying the contents on an external link

You can display the contents of an external link by appending the "extlink" sequence to the external link path name. This permits the user to inspect the contents of the external link with the **ls -l** command.

This example shows how to display the attributes and contents of the external link */samples/linkfile*:

```
ls -l /samples/linkfile,"extlink"  
lrwxrwxrwx 1 user1 13 Jun 17 20:43 /samples/linkfile ->USER1.MVSFILE
```

This example shows how to display the attributes of the MVS target data set USER1.MVSFILE:

```
ls -l /samples/linkfile  
-rw-rw-rw- 1 root 2112 Sep 28 13:50 /samples/linkfile
```

Deleting an external link

The external link file object is deleted with the remove request:

```
rm /samples/linkfile,"extlink"  
rm /samples/linkfile
```

Either **rm** command results in the z/OS UNIX external link file object alone being removed. The target MVS data set is not affected.

Accessing symbolic links on z/OS NFS version 4

The issues associated with accessing symbolic links on z/OS NFS version 4 due to two file system types has been resolved in z/OS V1R11. This has been done with enhanced prefix support. See "z/OS NFS File System Type Selection" on page 9 for more information.

When using an Exports file (Security(EXPORTS) or Security(SAFEXP) mode), both the initial path containing the symbolic link and the target path must be exported. Otherwise, the mount will fail. This is necessary because in NFS v4, the initial mount emulation (lookup) processing proceeds until the symbolic link is found. If that is not exported, that initial mount processing will fail. Once the symbolic link

is discovered, the NFS client starts over with the mount emulation (lookup) processing using the target path name. If that path is not exported, then that mount processing will fail.

The NFS version 4 protocol (NFSv4) does not include a mount operation. Instead, mount requests are processed as a series of lookup operations starting from the root node. If the mount request includes a symbolic link in the path name, the fact that the node is a symbolic link is returned to the NFS Client. It is the client's responsibility to read the link to get the defined data path and then restart the lookup process starting from the root node, but using this defined data path. From the NFS Server's perspective, this is a brand new request. A side effect of this protocol defined processing sequence is that when using an Exports file, both the original path name and this symbolic link defined path name must be exported, as previously described.

By contrast, NFSv2 and NFSv3 use the Mount protocol for mount requests which sends the entire path name to the NFS Server in a single request. In this case, after that path name has been export checked, the path name is passed to z/OS UNIX System Services which resolves the entire path, including any symbolic link resolution, bypassing any separate export checking of the defined symbolic link path.

One exception to NFSv4 mount request processing that was described previously in this section is for the case when the symbolic link is the last qualifier in the path and it is followed by any processing attributes. In this case, the z/OS NFS server cannot follow the NFSv4 defined process because it would cause the processing attributes to get lost since non-z/OS NFS Clients do not understand the concept of z/OS NFS processing attributes and thus would not append them to the new lookup path. Therefore, if the z/OS NFS Server detects a lookup operation for a symbolic link which is followed by processing attributes, instead of returning the fact that this node is a symbolic link to the NFS Client, the z/OS NFS Server resolves the mount path in a similar manner to that used for NFSv2 and NFSv3 mount requests. The one difference between the NFSv4 and the NFSv2 and NFSv3 behavior is that NFSv4 performs export checking of the defined symbolic link path, while NFSv2 and NFSv3 do not.

In the event of a SYSPLEX failover where there is a need to get symlink based mounts to automatically (and transparently to the client user application) switch to a *different real path* when switching to a new NFS Server instance, the following procedure is recommended:

1. Execute on one NFS Client system at a time
 - a. Stop any running application (for example, SAP).
 - b. Unmount the file system.
 - c. Remove the 'mvsmnt' attribute from the mount statement.
 - d. Remount the file system.
2. Issue the z/OS NFS Server Operator UNMOUNT command to remove the symlink mounts from the MHDB
3. Stop and restart the z/OS NFS Server.

UNIX look and feel

Using the z/OS NFS with z/OS UNIX managed files provides UNIX client users with a transparent view of their data. The file attributes are maintained in the same way as is found on any UNIX system.

- Regular, directory, link, device, and FIFO file types
- User, group, and other read/write/execute access permissions
- UID and GID file ownership
- File size

To access z/OS UNIX files, it is necessary to be defined to RACF as an z/OS UNIX user. Some installations might prefer to provide users with unrestricted access to their z/OS UNIX data by specifying **security(none)** or **security(exports)** in the site attributes. With this setting, the client's user ID and group ID credentials are used for all file access authentication, and there is no requirement for the user to be defined to RACF or to perform the `mvslogin` command.

Note: For the **security(none)** and **security(exports)** options, the UID of the root (UID=0 from the workstation) is mapped to UID of NOBODY (UID=65534) by the z/OS NFS server. The implication is that the z/OS NFS server will use the mapped UID of 65534 for all z/OS UNIX file authorization checking. For example, file creation owner UID is set to 65534 in the z/OS UNIX file attribute.

NFS file system attributes

For z/OS UNIX files, see Table 87 on page 492 and Table 88 on page 492 for the file system values that are returned for NFS attributes.

Displaying and modifying remote file system access control lists

POSIX provides limited file security management granularity. File access security can only be controlled via the permission bits as specified for the user, group and other classes. Some UNIX platforms have introduced additional security granularity by adding access control list (ACL) support to provide security specification on an individual user and/or group basis. An ACL is simply a list that specifies which users and groups get access to a file with what type of permission. The precise characteristics of this ACL support are platform specific.

The NFS Version 4 protocol provides the ability to remotely manage ACLs by providing the ability to display and modify ACL values with the ACL attribute. The NFS v4 protocol has provided a very rich ACL definition with granularity beyond that provided by many platform ACL implementations. Therefore, it is necessary to map between the NFS ACL definition and the platform definition. The key is to ensure that in this mapping process, the mapping should err in the direction of more restricted access, not less. When the NFS server sets an ACL it must be set at least as secure as specified by the NFS request. When an NFS server sends an ACL to an NFS client, the client must not perceive the file as more secure than it really is. For details on the NFS version 4 ACL definition, see the NFS version 4 protocol.

For POSIX permission bits, and some flavors of ACLs, a single entry specifies whether permission is being granted or denied for the target user or group to access the file. By contrast, NFS version 4 ACLs have two types of ACLs: "Allow" and "Deny". An "Allow" indicates that the target user or group is being given the

specified permission to access the file while a “Deny” indicates that the target user or group is explicitly being denied the specified permission to access the file.

Further, the ordering of a POSIX ACE (access control entry - an entry in the ACL) differs from that of an NFS Version 4 ACE. POSIX has a defined ordering as follows: owner, supplemental users, owning group, supplemental groups, and other. This is a kernel maintained ordering and can not be changed by the user. NFS version 4 ACEs do not have a rigid order. It is defined by the order of the entries in the ACL as created by the user. If an ACL conflict arises because of differences between the two ordering algorithms, then the POSIX rules will apply, since the ACL access authority is determined by the underlying z/OS UNIX system, not by the z/OS NFS server.

NFS can display and modify remote file system access control lists, provided that the function is supported by the remote NFS server. This support is limited to z/OS UNIX access control lists, as described in *z/OS UNIX System Services Planning*, under Using Access Control Lists (ACLs). Access control list checking is controlled by the underlying file systems on the server systems, not by z/OS NFS server or client.

Remote ACL management restrictions:

Due to the differences in ACL implementations on the various platforms, the following restrictions must be applied when attempting to remotely manage ACLs to/from z/OS.

Note: At this time only the z/OS, AIX and Sun platforms are supported.

AIX restrictions

- AIX supports two kinds of ACLs: AIX ACLs and NFS ACLs. Only the NFS ACLs can be remotely managed from z/OS.
- The AIX Client requires a mount option on the mount command to enable ACLs on the mount:

```
mount -o vers=4,acl maxi:/nfs-authsys/user11_acltest2 /nfs-authsys/user11_acltest
```
- AIX only supports NFS ACLs on JFS2 extended attributes v2 file systems.

z/OS client restrictions

- Because z/OS Unix does not have a unique Base Mask ACL entry:
 - The z/OS NFS Client uses the Base Group ACL entry permission value for calculating the Mask ACL entries sent to NFS Servers.
 - The z/OS NFS Client fails 'get attribute' requests containing Mask ACL entries which do not match the Base Group ACL entry. The failure returns an ENODEV error.
 - Unlike Sun, the z/OS NFS Client set both the Group and Mask ACL entries when a 'chmod' is issued for a file/directory which has Extended ACLs. If only the Group or Mask ACL entry were changed, it would no longer be possible to display or change the ACLs for this object since the Group and Mask entries would be different.
- Because z/OS Unix does not have unique Default Base ACL entries:
 - The z/OS NFS Client uses the Access Base ACL entries for calculating the Default Base ACL entries sent to NFS Servers (that is, the Access and Default Base ACL entries will always match).

- The z/OS NFS Client fails get attribute requests containing Default Base ACL entries that do not match the Access Base ACL entries. The failure returns an ENODEV error.
- Because non-z/OS platforms do not have separate File and Directory Default ACLs:
 - The z/OS NFS Client uses the File Default ACL entries for the NFS Default ACL entries sent to non-z/OS NFS Servers. The entries are used as both File and Directory Defaults on the non-z/OS platforms.
The z/OS NFS Client checks any Dir Default ACL set requests to verify that they match the existing NFS Default ACL entries. If the two lists do not precisely match (same entries with same permissions), the set request fails with an ENODEV error. This requires that the File Default ACL entries must be set before the Directory Default ACL entries.
 - Ideally, Directory Default ACL entry set requests should not be issued in this case.
 - The z/OS NFS Client uses the NFS Default ACL entries sent by a non-z/OS Server for both File and Directory Default ACL get requests.
- The z/OS NFS Client supports the File and Directory Default ACL entries as unique entries when communicating with a z/OS NFS Server. There are no request order or permission value restrictions for this case.

z/OS server restrictions

- Because z/OS Unix does not have a unique Base Mask ACL entry:
 - The z/OS NFS Server uses the Base Group ACL entry permission value for calculating the Mask ACL entries sent to NFS Clients.
 - The z/OS NFS Server fails set attribute requests containing Mask ACL entries that do not match the Base Group ACL entry. The failure returns an NFS4ERR_ATTRNOTSUPP error.
- Because z/OS Unix does not have unique Default Base ACL entries:
 - The z/OS NFS Server uses the Access Base ACL entries for calculating the Default Base ACL entries sent to NFS Clients (that is, the Access and Default Base ACL entries will always match).
 - The z/OS NFS Server fails set attribute requests containing Default Base ACL entries that do not match the Access Base ACL entries. The failure returns an NFS4ERR_ATTRNOTSUPP error.
 - Since z/OS Unix only has Default Extended ACLs, Default Base ACLs are returned by the z/OS Server if Default Extended ACLs are also present.
- Because non-z/OS platforms do not have separate File and Directory Default ACLs:
 - The z/OS NFS Server uses the File Default ACL entries for the NFS Default ACL entries sent to non-z/OS NFS Clients. The entries are used as both File and Directory Defaults on the non-z/OS platforms.
The z/OS NFS Server checks all existing z/OS Unix Directory Default ACL entries to verify that they match the z/OS Unix File Default ACL entries. If the two lists do not precisely match (same entries with same permissions), the get request fails with an NFS4ERR_ATTRNOTSUPP error.
 - The z/OS NFS Server uses the NFS Default ACL entries sent by a non-z/OS Client to set both the File and Directory Default ACL entries.
- The z/OS NFS Server supports the File and Directory Default ACL entries as unique entries when communicating with a z/OS NFS Client. There are no ACL entry restrictions in this case.

Chapter 5. z/OS NFS file locking and access control

This topic provides an overview of the z/OS NFS locking and access control functions.

Locking in NFS versions 2 and 3 (NFS server only)

This topic provides an overview of the z/OS NFS locking and access control functions provided by the Network Lock Manager (z/OS NFS NLM) and the z/OS NFS Network Status Monitor (z/OS NFS NSM). It explains how they work together to provide file locking and access control capability over z/OS NFS. In addition, this topic also explains the following features:

- Monitored lock
- Non-monitored locks
- Locking files
- Locking records

In NFS versions 2 and 3, the locking of a file on the z/OS NFS server is managed by Network Lock Manager (NLM) and Network Status Monitor (NSM). NLM and NSM are integrated into the z/OS NFS server to facilitate the expanded locking and serialization functions. Separate procedures for starting and stopping NLM and NSM were replaced in z/OS V1R7 by the server site attribute `nlm | nonlm`, which specifies their startup along with the NFS server. This integration also coordinates the locking function with stale file handle processing; when a file handle becomes stale, not only will the code clean up the file related data as it does in prior releases, but it will also release any locks that remain held for that file.

Using Network Lock Manager (NLM) in NFS V2 and V3

In NFS version 2 and version 3, the z/OS NFS NLM allows a client on the host to lock range of bytes or an entire file on the z/OS NFS server. The two types of locks that the client host uses are monitored locks and non-monitored locks.

The z/OS NFS NLM supports only advisory locking. Advisory locking is when the operating system keeps track of which files have been locked by which process, but does not prevent a process from writing to a file that is locked by another process. This means that a process can ignore an advisory lock if the process has adequate permission.

Monitored locks

Monitored locks provide the client user with reliability. If the server host on which the monitored locks are established fails, the locks are reinstated when the server host recovers. The locks that are held by the client host are discarded by the z/OS NFS NLM on the server host if the client host fails before the locks are released. Monitored locks will only work correctly if both the server host and the client host are running NSM.

Non-monitored locks

Non-monitored locks are used on personal computer (PC) operating systems. Non-monitored locks provide the same functionality as the monitored locks with one exception. If the server host on which the locks are established, fails and

recovers, the locks will not be re-established. The client host is responsible for detecting a server host failure and re-establishing the locks. In addition, the client host informs the z/OS NFS NLM when it has rebooted so that the client host can discard all of the locks and file shares held for the client.

Specifying a grace period for reclaiming locks

You can specify a time limit, or grace period, for clients to reclaim NFS V4 or NLM locks and share reservations when the z/OS NFS server restarts after a failure. To set this time limit, use the **leasetime** site attribute. For details, see “Site attributes syntax” on page 139.

During the reclaim grace period after a z/OS NFS server restart, the grace period may be extended after an open or lock reclaim event. If the **leasetime** site attribute is greater than 1200 seconds (20 minutes), the grace period will not be extended at a reclaim event; if the **leasetimesite** attribute is less than 20 minutes, the grace period will be extended to one lease time after the reclaim event, up to but not exceeding 20 minutes after the z/OS NFS server completed its restart.

Note: In order for z/OS NFS client to reclaim locks from an AIX NFS server, AIX must be at Technology level 5 service pack 1 (5300-05-01).

Listing locks held for a file

To diagnose possible problems with conflicting locks, z/OS operators can issue a **listlock** command that displays all client programs and users which hold a lock on a file. The output messages include client and user id, the lock ranges held, and lock status. The **listlock** command can be used for MVS data sets, PDS or PDSE members, or z/OS UNIX files. For more information, see “Listlock operand” on page 250.

You can use the listlock command to find locking information in cases where a lock is unavailable and the blocker is managed by another NFS server address space running on the z/OS system. To determine the identity of the blocker in this case, the listlock command should be issued on the system which owns the lock.

Releasing locks held for a file

To release all locks for a file, z/OS operators can issue a **release** command that releases locks for z/OS UNIX files and MVS data sets or members. The command also forces the NFS server to release the file, and if the file is active, to close and deallocate it. For more information, see “Release operand” on page 245.

Note: The NLM protocol does not provide any means for NFS server to notify the NFS client that the locks were released. Thus, the client may proceed under the false assumption that it still has the locks. Therefore, the release command should only be used in extreme circumstances.

Using Network Status Monitor (NSM) in NFS V2 and V3

In NFS version 2 and version 3, the z/OS NFS NSM is a service that provides applications with information on the status of network host. Each z/OS NFS NSM keeps track of its own “state” and notifies any interested parties of a change in its state.

For correct operation of the z/OS NFS NSM, the client and the server hosts are required to monitor each other. When a lock request is issued by a process running on the client host, the NLM on the client host requests the NSM on the client host to monitor the server host. The client NLM then transmits the lock request to the z/OS NFS NLM on the server. On receipt of the lock request the z/OS NFS NLM

on the server host will request the z/OS NFS NSM on the server host to monitor the client host. In this way, each host is monitored by the NSM on the other host.

For compatibility with supported NFS clients, it is important that the TCPIP.DATA file "HOSTNAME" parameter represent the hostname exactly as it is returned by a DNS query (that is, it is case sensitive).

Locking in NFS version 4

With the NFS version 4 protocol, the support for file locking is part of the NFS protocol. The file locking support is structured so that an RPC callback mechanism is not required. This is a departure from the previous versions of the NFS file locking protocol, Network Lock Manager (NLM). The state associated with file locks is maintained at the server under a lease-based model. The server defines a single lease period for all states held by an NFS client. If the client does not renew its lease within the defined period, all state associated with the client's lease may be released by the server. The client may renew its lease with use of the RENEW operation or implicitly by use of other operations (primarily READ).

With the NFS version 4 protocol, a client user can choose to lock the entire file, or a byte range within a file. z/OS NFS client file locking requests can be managed with the `llock(Y|N)` parameter on the mount command or as an installation default.

z/OS NFS supports only advisory locking. Advisory locking is when the operating system keeps track of which files have been locked by which process, but does not prevent a process from writing to a file that is locked by another process. This means that a process can ignore an advisory lock if the process has adequate permission.

Byte-range locking

Byte-range locking is used to serialize activity to a range of bytes within a file. Byte-range locking is an advisory locking mechanism; that is, it does not prevent access to any application, but provides a mechanism for applications to communicate cooperatively through obtaining locks and querying if a lock is held.

Share reservations

Share reservations are a new concept in the NFS version 4 protocol and are different than byte-range locking. Share reservations provide a method for controlling access to a file. When an OPEN request is sent for a file, the requester can indicate the type of access that should be denied to other requesters attempting to access the same file, which is NONE, READ, WRITE or BOTH.

Share reservations have an advantage over byte-range locking in that they provide a mandatory locking interface; any application that attempts to OPEN a file that is already opened and locked by another application is denied access. However, in these cases, access to files (and application processing) may be slowed if files are not shared.

Specifying a grace period for reclaiming locks

You can specify a time limit, or grace period, for clients to hold an exclusive lock on a z/OS NFS server resource. This time limit, or lease time, determines how long a client can hold a lock against a conflicting lock request. Once the time limit is reached, if the client has not extended the lease time, the lock may be revoked, and

the lock will be revoked if NLM receives a conflicting request for the lock. This lease time also applies to the grace period that NFS clients have to reclaim NFS V4 locks and share reservations when the z/OS NFS server restarts after a failure. It also dictates the amount of time that a client ID can remain active on the server without communicating. To set this time limit, use the **leasetime** site attribute. For details, see “Site attributes syntax” on page 139.

During the reclaim grace period after a z/OS NFS server restart, the grace period may be extended after an open or lock reclaim event. If the **leasetime** site attribute is greater than 1200 seconds (20 minutes), the grace period will not be extended at a reclaim event; if the **leasetime** site attribute is less than 20 minutes, the grace period will be extended by one lease time after the reclaim event, up to but not exceeding 20 minutes after the z/OS NFS server completed its restart.

Note: For the z/OS NFS client to reclaim locks from an AIX NFS server, AIX must be at Technology level 5 service pack 1 (5300-05-01).

Listing locks held for a file

To diagnose possible problems with conflicting locks, z/OS operators can issue a **listlock** command that displays all client programs and users which hold a lock on a file. The output messages include client and user id, the lock ranges held, and lock status. The **listlock** command can be used for MVS data sets, PDS or PDSE members, or z/OS UNIX files. For more information, see “Listlock operand” on page 250.

You can use the listlock command to find locking information in cases where a lock is unavailable and the blocker is managed by another NFS server address space running on the z/OS system. To determine the identity of the blocker in this case, the listlock command should be issued on the system which owns the lock.

The listlock command also lists file delegations. For more information, see “Delegating management of a file's resources to an NFS client” on page 46.

Releasing locks held for a file

To release all locks for a file, z/OS operators can issue a **release** command that releases locks for z/OS UNIX files and MVS data sets or members. The command also forces the NFS server to release the file, and if the file is active, to close and deallocate it. For more information, see “Release operand” on page 245.

Chapter 6. Commands and examples for AIX and UNIX clients

This topic gives the syntax and examples of commands that AIX users need to know to access MVS data sets from a client. Some examples are also provided for UNIX and Sun Solaris environments. This topic shows how to perform the following tasks.

- Log on to z/OS from your client
- Access MVS data sets from your client
- Display default mount point attributes
- Query mount points
- Unmount MVS data sets from the client
- Log out of z/OS.

The **mount** and **umount** commands are operating system specific commands. They are not shipped with z/OS NFS. See your NFS client documentation for the exact syntax and usage.

Using commands on AIX

The **mvsllogin** command is used to log in to z/OS from your workstation. The mvsllogin command can be issued multiple times, and the last one overrides the previous one.

Note: When the z/OS NFS server site attributes hfssec, mvssec, or pubsec specify any of the Kerberos security flavors (krb5, krb5i, or krb5p):

- An MVS login is no longer required when using RPCSEC_GSS. The RACF authentication is done automatically based on your Kerberos principal.

The following is the mvsllogin command syntax.

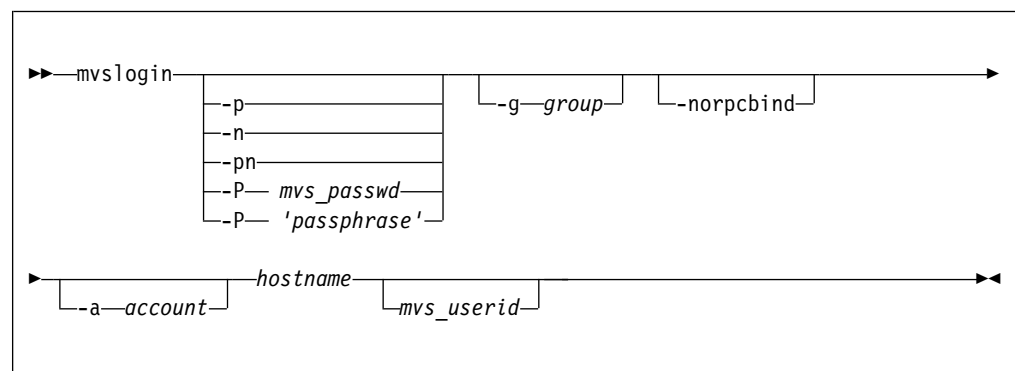

where

Operand

Description

- p Causes a prompt for your z/OS password. The password is passed to z/OS to validate the user logging in. Your security procedures determine whether you should use this parameter.

- n Causes a prompt for a new password.
 - pn Causes a prompt for the user's current password and then causes two prompts for the user's new password.
 - P *mvs_passwd*
No prompt for your z/OS password; just type your z/OS password after the -P. This enables you to automate your z/OS login.
 - P '*passphrase*'
No prompt for your z/OS password phrase, a text string of a minimum of 9 to 14 characters (depending on whether or not ICHPWX11 is installed) to a maximum of 100 characters. This enables you to automate your z/OS login. See *z/OS Security Server RACF Command Language Reference* for more information on the z/OS password phrase and its syntax rules.
 - g *group*
A group name string passed to z/OS for accounting purposes. The maximum length is 8 characters.
 - norpcbind
Specifies that mvlogin should not look for the RPCBIND protocol on the NFS server system. The default is that mvlogin will first look for the RPCBIND protocol. If that request fails, or times out, it will then look for the PORTMAPPER. If this keyword is used, mvlogin will immediately use the PORTMAPPER protocol. Using this keyword, when it is known that the NFS server system does not support RPCBIND, can improve the performance of mvlogin, because it does not look for RPCBIND first. This keyword has no effect if the client system is not enabled for IP version 6 (IPv6).
 - a *account*
An account string passed to z/OS for accounting purposes. The maximum length is 16 characters.
- hostname*
The name of the z/OS host (for example, mvshost1).
- mvs_userid*
A user ID that z/OS recognizes as valid. If you do not specify this parameter, your workstation user name is used. The z/OS NFS server does not support the use of an alias user ID or a mixed case user ID with the mvlogin command.

The **mount** command is used to make a connection between a mount point on your local file system and one or more files in the z/OS file system.

The following is the **mount** command syntax.

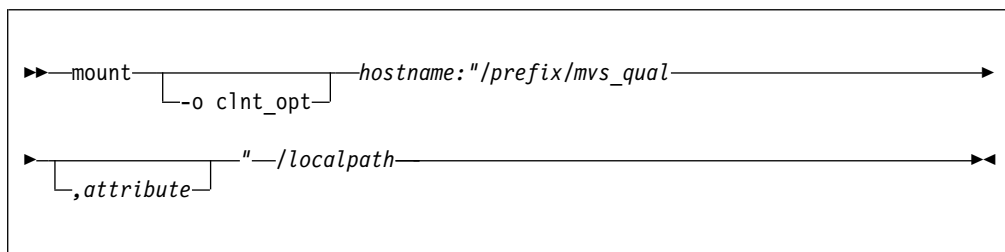

where

Operand

Description

-o *clnt_opt*

The client mount command options (such as `soft,timeo=20`). Refer to the documentation of your client operating system for a description of the options for your client environment.

hostname

The name of the z/OS host (for example, `mvshost1`).

/prefix

An optional explicit prefix for selecting the z/OS UNIX file system type (the `HFSPREFIX()` site attribute value), or for selecting the MVS file system type (the `MVSPREFIX()` site attribute value). If no prefix is specified, then the implicit prefix heuristic specified in the `IMPPREFIX` site attribute is used for determining the file system type.

mvs_qual

The path name of a z/OS UNIX directory or an MVS high-level qualifier for accessing z/OS MVS data sets.

attribute

A z/OS NFS server data set creation or file processing attribute (such as `text`). See Chapter 9, "Initialization attributes for the z/OS NFS server," on page 121. If you specify any attributes, make sure you enclose *mvs_qual* and the attributes in double quotation marks.

/localpath

The mount point on your client system (for example, `/u/smith/mnt`). This should be an empty directory.

The **showattr** command is used to display the default attributes or the attributes that have been set for a specific mount point. If you specify a mount point, **showattr** shows the attributes for the mount point, including the overriding values. For descriptions of the attributes, see Chapter 9, "Initialization attributes for the z/OS NFS server," on page 121.

The following is the **showattr** command syntax.

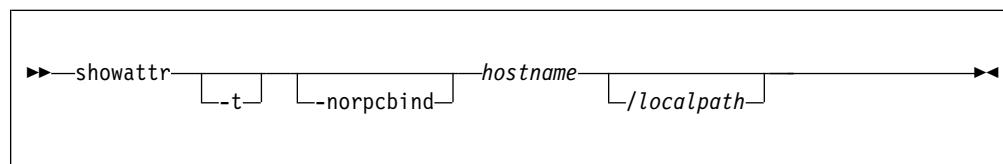

where

Operand

Description

-t Used to specify tersed output.

-norpcbind

Specifies that **showattr** should not look for the `RPCBIND` protocol on the NFS server system. The default is that **showattr** will first look for the `RPCBIND` protocol. If that request fails, or times out, it will then look for the `PORTMAPPER`. If this keyword is used, **showattr** will immediately use the `PORTMAPPER` protocol. Using this keyword, when it is known that the NFS server system does not support `RPCBIND`, can improve the performance of

showattr, because it does not look for RPCBIND first. This keyword has no effect if the client system is not enabled for IP version 6 (IPv6).

hostname

The name of the z/OS host (for example, mvshost1).

/localpath

The mount point on your client system (for example, /u/smith/mnt). This should be an empty directory.

The **umount** command is used to break the connection between the mount point on your client and the server. When you issue this client command, the file you were editing is released (written to DASD). You do not need to unmount after each session, unmount only when you no longer have a need to access the z/OS file system. Check the documentation for your client operating system to ensure that you enter the umount command correctly.

The following is the **umount** command syntax.



where

Operand

Description

/localpath

The mount point on your client system (for example, /u/smith/mnt). This should be an empty directory.

The **mvlogout** command is used to disconnect from the remote z/OS NFS server host. The mvlogout command is only required when the mvlogin command was used to begin the connection.

The following is the mvlogout command syntax.

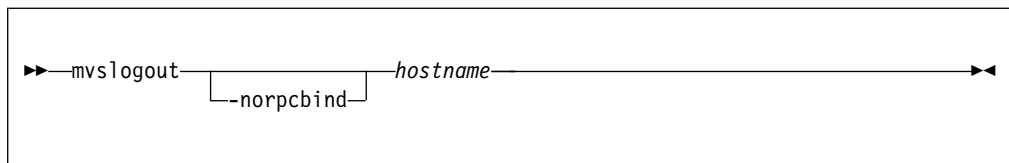

where

Operand

Description

-norpcbind

Specifies that mvlogout should not look for the RPCBIND protocol on the NFS server system. The default is that mvlogout will first look for the RPCBIND protocol. If that request fails, or times out, it will then look for the PORTMAPPER. If this keyword is used, mvlogout will immediately use the PORTMAPPER protocol. Using this keyword, when it is known that the NFS server system does not support RPCBIND, can improve the performance of

mvlogout, because it does not look for RPCBIND first. This keyword has no effect if the client system is not enabled for IP version 6 (IPv6).

hostname

The name of the z/OS host (for example, mvshost1).

Quick reference of AIX and UNIX commands

The following information is an example of a standard z/OS login and logout procedure for AIX.

```
# mvslogin mvshost1 smith
Password required
GFSA973I Enter MVS password: password
GFSA955I smith logged in ok.
# mount mvshost1:"/mvs/smith" /u/smith/mnt
mount: mvshost1:"/mvs/smith"
"/mvs/smith" was attached successfully.
# umount /u/smith/mnt
Unmounting '/u/smith/mnt' ...    successful
# mvlogout mvshost1
UID 200 logged out ok.
```

In this example:

Operand

Description

smith

Specifies a z/OS user ID and high level qualifier for MVS data sets.

mvshost1

Specifies the system name of the z/OS host.

/mvs/smith

Specifies the MVS prefix followed by the name of the high -level qualifier of the MVS data sets.

/u/smith/mnt

Specifies the name of the mount point.

GFSA $nnnt$

Messages starting with GFSA apply towards z/OS NFS requests. These messages are explained in Chapter 19, "Network File System messages," on page 339.

You can use the **mount** command with no parameters specified to list the mount points on your client system.

Accessing z/OS UNIX file systems and z/OS conventional MVS files

To access z/OS UNIX files or z/OS conventional MVS data sets, enter both the **mvslogin** command to log in to the z/OS host system and the **mount** command to mount the files or data sets to your local system. The **mvslogin** command is only required when accessing data on systems where the z/OS NFS server site security attribute is set to *saf* or *safexp*. Once the files or data sets are mounted to a local directory, you can read, write, create, delete, and treat the mounted files as part of your workstation's local file system. When you are finished with your work, use the **umount** and **mvlogout** commands to break the connection. The **mvlogout** command is only required when the **mvslogin** command was used to begin the connection.

z/OS UNIX file systems and MVS data sets are very different and require different management techniques. Prior to z/OS V1R11, the NFS server distinguished between the two by the fact that z/OS UNIX file system paths are prefixed with an hfs prefix value (/hfs/pathname) and MVS data sets are not. The hfs prefix is not actually part of the path name. It is only intended as a trigger to tell the z/OS NFS Server that the specified path is a z/OS UNIX path, not an MVS data set. Based on the presence, or absence, of a prefix, the NFS Server invokes its appropriate data management functions.

Starting in V1R11, the z/OS NFS file system type management function has been expanded by adding an mvs prefix and a customer-configurable path resolution heuristic. The new mvs prefix provides the capability for the customer to explicitly specify a prefix for identifying MVS data sets, like the hfs prefix does for z/OS Unix files. The customer-configurable heuristic allows the customer to specify how to interpret absolute path names that do not have a prefix specified.

Note: If the underlying z/OS UNIX file system structure should change due to the mount of a new HFS or zFS file system into the space accessible by an existing remote NFS Client mount, this change and new directory structure and contents will not be visible to the remote NFS Client until the NFS mount is unmounted and remounted or the z/OS NFS Server is restarted.

To access files on z/OS systems where the z/OS NFS server site security attribute is set to *saf*, *exports*, or *safexp*, you need a z/OS user ID and password, and authorization to access the files that you need. You can only establish one z/OS session for each z/OS user ID. If you do not already have a z/OS user ID, a z/OS password, and access authorization, request them from your z/OS system administrator.

Note: If you cannot use the *mvslogin*, *mvslogout*, or *showattr* commands, they might be installed incorrectly or in another directory. Ensure that your system administrator has made the executable code for these three commands available to your workstation and that you have been given the correct path name to find the commands. Also, make sure that your version of these commands matches the release of the z/OS NFS that you are using. Otherwise, the commands might not function properly.

Mvslogin command examples

Use the **mvslogin** command to log in to z/OS from your workstation. The *mvslogin* command can be issued multiple times and the last one overrides the previous ones. The *mvslogin* command is only required when accessing data on systems where the z/OS NFS server site *security* attribute is set to *saf* or *safexp*.

Table 8 shows examples of the *mvslogin* command where *mvshost1* is the name of the z/OS host and *smith* is the user's ID on z/OS.

Table 8. Examples of the mvslogin command for clients

Command Examples

```
mvslogin -p mvshost1 smith
```

```
mvslogin -P smithspw -g finance -a 5278 mvshost1 smith
```

```
mvslogin -P "Smith's password phrase" mvshost1 smith
```

```
mvslogin -n mvshost1 smith
```

```
mvslogin -pn -a 5278 mvshost1 smith
```

Table 8. Examples of the `mvlogin` command for clients (continued)

Command Examples

`mvlogin mvshost1`

`mvlogin mvshost1 smith`

In the example where the user enters `mvlogin mvshost1`, the current login client user ID is used as the z/OS user ID.

In the example where the user enters `mvlogin mvshost1 smith`, the system then prompts for Smith's z/OS password. If Smith logs in successfully, this message appears:

```
GFSA955I smith logged in ok.
```

Otherwise, an appropriate error message appears.

Note: Messages with the prefix of GFSA and GFSC apply to NFS requests. These messages are further explained in Chapter 19, “Network File System messages,” on page 339.

In the example where the user enters `mvlogin -P "Smith's password phrase" mvshost1 smith`, double-quotation marks are required around the password phrase because of the apostrophe within the phrase (smith's). Otherwise, only single-quotation marks are required around the password phrase. See *z/OS Security Server RACF Command Language Reference* for more information on syntax rules for password phrases.

When an z/OS UNIX UID or GID segment is defined with the user identification, an additional check is done to compare the z/OS UNIX UID or GID with the client UID or GID during the login processing. An informational message is returned when the server and the client UID or GID do not match. This informational message contains the z/OS UNIX UID and GID for the z/OS user identification.

Note: The authentication is considered successful even if the UID and GID do not match. The message is issued for the user's information only.

For the PCNFSD authentication request, the server UID and GID is returned to the client user if the UID and GID are defined. Otherwise, an arbitrary number is generated and returned to the client user.

“Permission denied” message

If you have successfully logged in and get the “Permission denied” message while trying to access data, that can be due to one of the following cases:

- An **mvlogout** command for the same z/OS host has been entered from the same client platform. See the description of **mvlogout** in “Using commands on the z/OS NFS client” on page 81 for details.
- Your z/OS user ID has been automatically logged out because the **logout** attribute value has been exceeded. This can happen when you leave the client idle for too long. Enter the **mvlogin** command again, and start your processes again. To find out how many seconds you can stay logged in while your client is idle, issue the **showattr** command and look at the **logout** attribute.
- Another `mvlogin` to the same z/OS host using the same z/OS ID has been entered from the same UID and the same client platform. If this is the case, retry your access.

- In multi-homed environments where a system has more than one network interface, the remote IP address specified in the mount command should match the remote IP address specified in the mvslogin and mvslogout. Note that a loopback IP address and the real IP address for the same system are considered separate IP addresses and therefore require the mount command and mvslogin/mvslogout to have matching IP addresses.
- The z/OS NFS server has been re-started. Enter the mvslogin command again, and start your processes again.

For more information, including additional causes of this message, see the explanation of the "Permission denied" message in "Messages from the client platform (AIX)" on page 440.

Note: Some clients give a somewhat different message such as "Access is Denied".

Mount command examples using an MVS prefix

Use the **mount** command to make a connection between a mount point on your local file system and one or more files in the z/OS file system.

```
# mount mvshost1:"/mvs/smith" /u/smith/mnt
```

In this example:

Operand

Description

mvshost1

Specifies the name of the host server.

/mvs

The MVS prefix.

/smith

Specifies the name of the high-level qualifier of the MVS data sets.

/u/smith/mnt

Specifies the name of the mount point (preferably an empty directory).

At the same time, you can specify attributes for the mount point, overriding the default attributes.

Overriding default attributes

To override the default attributes, specify different attributes with the **mount** command or in a file access or creation command (such as **vi** in AIX or UNIX).

There are two kinds of attributes that you can modify:

Data set creation attributes provide information about an MVS data set to the z/OS NFS server, such as:

- The type of data set
- How the data set is allocated

Note: Data set creation attributes do not apply to z/OS UNIX files.

Processing attributes provide information to the z/OS NFS server about how to handle the file. For example:

- How long the files remain open

- Whether the file contents are sent and received in text form, or in binary form to avoid ASCII/EBCDIC conversion

Use the **showattr** command to display the default data set creation and processing attributes. For descriptions of the attributes, see Chapter 9, “Initialization attributes for the z/OS NFS server,” on page 121.

Files are created and processed using the mount point attributes that were in effect when the files were last mounted. If your installation's default attributes have been changed (by way of the *exportfs* operand of the **modify** system operator command or restart of the server) and you want to apply these new default attributes, you can unmount and remount (using the **umount** and **mount** commands).

When you access the file with a data access or creation command, you can override some of the attributes that were set by a mount command or the server default settings.

Mount command example: overriding server default attributes without an MVS prefix

In this example, the **mount** command is used to modify two processing attributes, specifying **binary** (rather than **text**), and **readtimeout(30)** (rather than the server default **readtimeout** value):

```
# mount mvshost1:"smith,binary,readtimeout(30)" /u/smith/mnt
```

In this example:

Operand

Description

mvshost1

Specifies the name of the host server.

smith

Specifies the name of the high-level qualifier of the MVS data sets or z/OS UNIX directory (depending on the IMPPREFIX() site attribute setting).

binary

Specifies the processing mode for file contents sent between z/OS and the client (binary mode avoids ASCII/EBCDIC conversion).

readtimeout(30)

Specifies the amount of time (30 seconds) allowed since the last read access before the file is closed.

/u/smith/mnt

Specifies the name of the mount point (preferably an empty directory).

At the same time, you can specify the MVS prefix for the mount point.

Note: Starting with AIX 6.1, NFSv4 clients require that all remote mount points include a leading slash.

Getting authorization to access files

If the mount fails, check with your system administrator to ensure that you are authorized to access the MVS data sets or z/OS UNIX files and that the data sets or files are listed in the exports data set. The privilege level required to enter **mount** and **umount** commands varies among client operating system implementations. Many UNIX implementations limit these commands to the root

user or superuser mode. If the MVS system operator issues the *freeze=on* operand of the z/OS NFS server **modify** command, all new tries to mount an MVS or z/OS UNIX file system fail until the z/OS system operator issues the *freeze=off* operand. If the z/OS system operator issues the *freeze=onhfs* operand of the z/OS NFS server **modify** command, z/OS conventional MVS data sets can still be mounted, but all new tries to mount z/OS UNIX file systems fail until the system operator issues the *freeze=offhfs* operand.

Saving of mount points

Once the **mount** command is issued successfully and a mount point is established between a local directory and the MVS or z/OS UNIX file system, the mount point information is saved in the mount handle data set by the z/OS NFS server. This information is used to automatically reestablish active mount points when the server is started. When accessing z/OS conventional MVS data sets, a mount point is active if the last activity against this mount point is less than the **restimeout** attribute value set by the system administrator.

The **mount** command does not need to be reissued for the same mount point in further sessions unless the **umount** command has been used to disconnect the mount point or the mount point has been disconnected by the cleanup activity of the **restimeout** site attribute. For more information about the **restimeout** site attribute see Chapter 9, "Initialization attributes for the z/OS NFS server," on page 121.

Automatic timed logout - logout attribute

If there is no activity on the client within the period specified in the **logout** attribute of the attributes file, or the server stops, the connection between the server and the client workstation is logged out automatically. You must issue the **mvlogin** command again to get access to the z/OS files.

Displaying default and mount point attributes - showattr

Use the **showattr** command to display the default attributes or the attributes that have been set for a specific mount point. If you specify a mount point, **showattr** shows the attributes for the mount point, including the overriding values. For descriptions of the attributes, see Chapter 9, "Initialization attributes for the z/OS NFS server," on page 121.

If you omit the hostname, you must specify the */localpath*.

Table 9 shows examples of the **showattr** command for some clients.

Table 9. Examples of the showattr command for clients

Client Environments	Command Examples
AIX, UNIX	<code>showattr mvshost1 /u/smith/mnt</code>
z/OS	<code>showattr mvshost1 /u/smith/mnt</code>
Solaris	<code>showattr mvshost1 /u/smith/mnt</code>
Linux	<code>showattr mvshost1 /u/smith/mnt</code>

Make sure that your version of the **showattr** command matches the release of the z/OS NFS that you are using. Otherwise, the z/OS NFS server attributes do not display.

These examples show different ways you can use the **showattr** and **mount** commands.

Figure 4 shows a **showattr** command with just the host name (**mvshost1** in this example) specified. The attributes for the server are displayed.

```
# showattr mvshost1

GFSA988I Remote host does not have AF_INET6 interface.

FMID HDZ222N , last APAR OA47737, last changed module: GFSA4ULU
Compiled at May 19 2015 11:23:29

z/OS Network File System Server Data Set Creation Attributes:

lrecl(8196)          recfm(vb)          blksize(0)
space(100,10)       blks                dsorg(ps)
dir(27)             unit()             volume()
recordsize(512,4K)  keys(64,0)         nonspanned
shareoptions(1,3)  mgmtclas()         dsntype(pds)
norlse              dataclas()         storclas()

z/OS Network File System Server Processing Attributes:

binary              lf                  blankstrip
nofastfilesize      retrieve            maplower
mapleaddot          executebitoff      setownerroot
attrtimeout(120)    readtimeout(90)    writetimeout(30,120)
sync                nofileextmap       xlat()
srv_ccsid(1047)     cln_ccsid(819)     notag
convserv(lre)       nordrverf          sidefile()

z/OS Network File System Server Site Attributes:

mintimeout(1)       nomaxtimeout        logout(1800)
nfstasks(8,16,8,4,4)  restimeout(48,0)
hfsprefix(/hfs)      mvsprefix(/mvs)    impprefix(mvs)
bufhigh(32M, 80%)    readaheadmax(16K)  cachewindow(112)
percentsteal(20)     maxrdfsleft(32)    logicalcache(4096G)
smf(none,off)        nopcnfsd           security(safexp,safexp,safexp)
leadswitch          sfmtmax(0)         nochecklist
fn_delimiter(,)      readdirtimeout(30) hfsfbtimeout(60)
upcase               rec878             mintasks(4,8,4)
noremount            fileidsize(64)     denyrw
nonlm                nodhcp             nostringprep
leasetime(120)       nodelegation       DlyDTimeout(10)
setgid(posix)        nosymresolve       mvslogindelay(0)
nooemhsm             noalias
nfsv4domain*(tuc.stglabs.ibm.com)
public()             mvssec(sys,krb5,krb5i,krb5p)
hfssec(sys,krb5,krb5i,krb5p)  pubsec(sys,krb5,krb5i,krb5p)
id2name(callsaf)     consolemsgs(10)
```

Figure 4. Displaying server attributes

If you use the terse (-t) option, the attributes display like this:

```

# showattr -t mvshost1

GFSA988I Remote host does not have AF_INET6 interface.
lrecl(8196),recfm(vb),blksize(0),space(100,10),blks,dsorg(ps),dir(27),unit(),
volume(),recordsize(512,4K),keys(64,0),nonspanned,shareoptions(1,3),mgmtclas(),
dsntype(pds),norlse,dataclas(),storclas()
binary,lf,blankstrip,nofastfilesize,retrieve,maplower,mapleaddot,executebitoff,
setownerroot,attrtimeout(120),readtimeout(90),writetimeout(30,120),sync,
nofilexmap,xlat(),srv_ccsid(1047),cln_ccsid(819),notag,convserv(1re),nordrverf,
sidefile()
mintimeout(1),nomaxtimeout,logout(1800),nfstasks(8,16,8,4,4),restimeout(48,0),
hfsprefix(/hfs),mvsprefix(/mvs),impprefix(mvs),bufhigh(32M,80%),
readaheadmax(16K),cachewindow(112),percentsteal(20),maxrdforszleft(32),
logicalcache(4096G),smf(none,off),nopcnfsd,security(safexp,safexp,safexp),
leadswitch,sfmax(0),nochecklist,fn_delimiter(),readdirtimeout(30),
hfsfbtimeout(60),upcase,rec878,mintasks(4,8,4),noremount,fileidsize(64),denyrw,
nonlm,nodhcp,nostringprep,leasetime(120),nodelegation,DlyDTimeout(10),
setgid(posix),nosymresolve,mvslogindelay(0),noemhsm,noalias,
nfsv4domain*(tuc.stglabs.ibm.com),public(),mvssec(sys,krb5,krb5i,krb5p),
hfssec(sys,krb5,krb5i,krb5p),pubsec(sys,krb5,krb5i,krb5p),id2name(callsaf),
consolemsgs(10)

```

Figure 5 on page 77 illustrates the **showattr** command being used to display the attributes for the z/OS host named **mvshost1** as well as the mount point, **/u/smith/mnt**.

Figure 6 on page 78 also illustrates the specified options: a second **showattr** command, where the client user specifies **/u/smith/mnt** in addition to **mvshost1**. This shows the user's specified settings at that mount point, rather than the settings in the attributes data set.

```

# mount mvshost1:"smith,text,space(5,0),trks" /u/smith/mnt

# showattr mvshost1

GFSA988I Remote host does not have AF_INET6 interface.

FMID HDZ222N , last APAR OA47737, last changed module: GFS44ULU
Compiled at May 19 2015 11:23:29

z/OS Network File System Server Data Set Creation Attributes:

lrecl(8196)          recfm(vb)          blksize(0)
space(100,10)       blks                dsorg(ps)
dir(27)             unit()             volume()
recordsize(512,4K)  keys(64,0)         nonspanned
shareoptions(1,3)   mgmtclas()         dsntype(pds)
norlse              dataclas()         storclas()

z/OS Network File System Server Processing Attributes:

binary              lf                 blankstrip
nofastfilesize      retrieve           maplower
mapleaddot          executebitoff      setownerroot
attrtimeout(120)    readtimeout(90)   writetimeout(30,120)
sync                nofileextmap      xlat()
srv_ccsid(1047)     cln_ccsid(819)    notag
convserv(1re)       nordrverf         sidefile()

z/OS Network File System Server Site Attributes:

mintimeout(1)       nomaxtimeout       logout(1800)
nfstasks(8,16,8,4,4)  restimeout(48,0)  mvsprefix(/mvs)
hfsprefix(/hfs)      mvsprefix(/mvs)  impprefix(mvs)
bufhigh(32M, 80%)    readaheadmax(16K) cachewindow(112)
percentsteal(20)     maxrdfsleft(32)  logicalcache(4096G)
smf(none,off)        nopcnfsd          security(safexp,safexp,safexp)
leadswitch           sfmtmax(0)        nochecklist
fn_delimiter(,)      readdirtimeout(30) hfsfbtimeout(60)
upcase               rec878            mintasks(4,8,4)
noremount            fileidsz(64)      denyrw
nonlm                nodhccp           nostringprep
leasetime(120)       nodelegation      DlyDTimeout(10)
setgid(posix)        nosymresolve      mvslogindelay(0)
nooemhsm             noalias
nfsv4domain*(tuc.stglabs.ibm.com)
public()              mvssec(sys,krb5,krb5i,krb5p)
hfssec(sys,krb5,krb5i,krb5p)  pubsec(sys,krb5,krb5i,krb5p)
id2name(callsaf)     consolemsgs(10)

```

Figure 5. Displaying mount point attributes. The client user changed the space(100,10), blks, and binary attributes to space(5,0), trks, and text for the mount point /u/smith/mnt, and then specified that mount point in the second showattr command.

```

# showattr mvshost1 /u/smith/mnt

server = mvshost1, serverbuf = mvshost1
GFSA988I Remote host does not have AF_INET6 interface.

FMID HDZ222N , last APAR OA47737, last changed module: GFS44ULU
Compiled at May 19 2015 11:23:29

z/OS Network File System Server Data Set Creation Attributes:

lrecl(8196)          recfm(vb)          blksize(0)
space(5,0)          trks               dsorg(ps)
dir(27)             unit()            volume()
recordsize(512,4K)  keys(64,0)        nonspanned
shareoptions(1,3)  mgmtclas()        dsntype(pds)
norlse              dataclas()         storclas()

z/OS Network File System Server Processing Attributes:

text                lf                 blankstrip
nofastfilesize      retrieve           maplower
mapleaddot          executebitoff     setownerroot
attrtimeout(120)   readtimeout(90)  writetimeout(30,120)
sync                nofilextmap       xlat()
srv_ccsid(1047)    cln_ccsid(819)   notag
convserv(lre)      nordrverf        sidefile()

NFSv4 mount point; may be unmounted.

z/OS Network File System Server Site Attributes:

mintimeout(1)      nomaxtimeout      logout(1800)
nfstasks(8,16,8,4,4)  restimeout(48,0)
hfsprefix(/hfs)     mvsprefix(/mvs)  impprefix(mvs)
bufhigh(32M, 80%)   readaheadmax(16K)  cachewindow(112)
percentsteal(20)    maxrdforszleft(32)  logicalcache(4096G)
smf(none,off)       nopcnfsd          security(safexp,safexp,safexp)
leadswitch          sfmax(0)          nochecklist
fn_delimiter(,)     readdirtimeout(30)  hfsfbtimeout(60)
upcase              rec878            mintasks(4,8,4)
noremount           fileidsz(64)      denyrw
nonlm               nodhcp            nostringprep
leasetime(120)     nodelegation      DlyDTimeout(10)
setgid(posix)      nosymresolve      mvslogindelay(0)
nooemhsm           noalias
nfsv4domain*(tuc.stglabs.ibm.com)
public()            mvssec(sys,krb5,krb5i,krb5p)
hfssec(sys,krb5,krb5i,krb5p)  pubsec(sys,krb5,krb5i,krb5p)
id2name(callsaf)   consolemsgs(10)

```

Figure 6. Displaying mount point attributes, part 2. The client specified that mount point in the showattr command.

Unmounting and logging out of z/OS

This section describes the **umount** and **mvslogout** commands.

Disconnecting your mount point - umount

Use the **umount** command to break the connection between the mount point on your client and the server. When you issue this client command, the file you were editing is released (written to DASD). You do not need to unmount after each session, unmount only when you no longer have a need to access the MVS file

system. Check the documentation for your client operating system to ensure that you enter the `umount` command correctly.

Table 10 shows examples of the `umount` command for some clients.

Table 10. Examples of the `umount` command for clients

Client Environments	Umount Command Examples
AIX, UNIX	<code>umount /u/smith/mnt</code>
Solaris	<code>umount /u/smith/mnt</code>
Windows	<code>nfs unlink z:</code> (where <code>z:</code> is the NFS mounted drive)
Linux	<code>umount /u/smith/mnt</code>

In this example:

Operand

Description

`u/smith/mnt`

Specifies the mount point on the local file system.

`mvshost1`

Specifies the name of the z/OS host system.

For example, suppose that you want to unmount from the server, and the mount point on your workstation is named `/u/smith/mnt`. You could enter the **`umount`** command as follows:

```
# umount /u/smith/mnt
```

“No Such File or Directory” Message - The z/OS system operator can also unmount your workstation from the server. If this happens before you try to unmount, you get a “No such file or directory” error message.

Ending your z/OS session - `mvlogout`

Use the **`mvlogout`** command to disconnect from the z/OS host. The `mvlogout` command is only required when the **`mvlogin`** command was used to begin the connection.

An `mvlogout` to an z/OS user ID cancels a prior `mvlogin` to the same z/OS user ID from the same local host.

Your account is automatically logged out if it is inactive for the period of time specified in the **`logout`** site attribute.

Table 11 shows an example of the `mvlogout` command for some clients, in which the name of the z/OS host is `mvshost1`.

Table 11. Example of the `mvlogout` command for clients

Client Environments	Mvlogout Command Examples
AIX, UNIX	<code>mvlogout mvshost1</code>
Solaris	<code>mvlogout mvshost1</code>
Linux	<code>mvlogout mvshost1</code>

If you log out successfully, a message like this appears:
GFSA958I uid 215 logged out ok.

Chapter 7. Commands and examples for z/OS NFS clients

This topic gives the syntax and examples of commands that NFS users need to know to access AIX, UNIX, , and other remote files using the NFS client. This topic shows how to perform the following tasks.

- Log on to a remote z/OS system from the NFS client if the target server is a remote NFS server
- Access NFS files from the NFS client
- Display NFS client statistical data
- Query mount points
- Display default mount point attributes
- Mount and unmount remote file systems from the NFS client
- Log out of z/OS, if the target server was a remote NFS server

The command programs are intended to run in a shell environment and are not implemented as TSO/E commands, with the exception of **mount** and **unmount**.

The **mount** and **unmount** commands are not part of NFS. See *z/OS UNIX System Services Command Reference* for additional details. An example of the syntax and usage is shown here for your information. You can use the TSO HELP MOUNT and TSO HELP UNMOUNT commands to see the syntax that is applicable to your system.

For information about the NFS attributes, see Chapter 8, “Initialization attributes for the z/OS NFS client,” on page 109 and Chapter 9, “Initialization attributes for the z/OS NFS server,” on page 121.

Using commands on the z/OS NFS client

The following is a summary of the syntax for the commands described in this topic. See “Mount command syntax and examples” on page 89 and “Unmount command syntax and examples” on page 98 for information about the **mount** and **unmount** commands.

The **mvlogin** command is used to log in to z/OS from your workstation. The **mvlogin** command can be issued multiple times, and the last one overrides the previous one. The **mvlogin** command is required only when accessing data on systems where the z/OS NFS server site **security** attribute is set to *saf* or *safexp*.

Note: As of z/OS V1R11, **mvlogin** is no longer required for NFS v4 requests using RPCSEC_GSS authentication. Instead, for these requests, the z/OS NFS server will use the user's Kerberos identity associated with the request to establish the user's RACF identity/authority.

The following is the **mvlogin** command syntax.

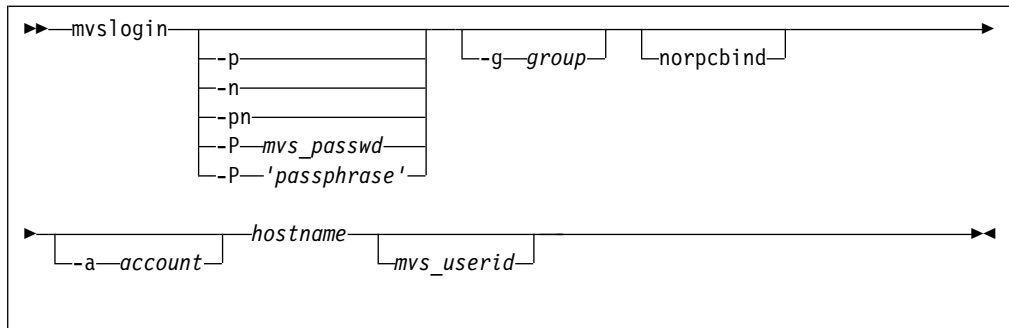

where

Operand

Description

- p** Causes a prompt for the user's z/OS password. The password is passed to z/OS to validate the user logging in. Your security procedures determine whether you should use this parameter.
- n** Causes a prompt for a new password.
- pn** Causes a prompt for the user's current password and then causes two prompts for the user's new password.
- P *mvs_passwd***
No prompt for your z/OS password; just type your z/OS password after the -P. This enables you to automate your MVS login.
- P '*passphrase*'**
No prompt for your z/OS password phrase, a text string of a minimum of 9 to 14 characters (depending on whether or not ICHPWX11 is installed) to a maximum of 100 characters. This enables you to automate your MVS login. See *z/OS Security Server RACF Command Language Reference* for more information on the z/OS password phrase and its syntax rules.
- g *group***
A group name string passed to z/OS for accounting purposes. The maximum length is 8 characters.
- norpcbind**
Specifies that mvslogin should not look for the RPCBIND protocol on the NFS server system. The default is that mvslogin will first look for the RPCBIND protocol. If that request fails, or times out, it will then look for the PORTMAPPER. If this keyword is used, mvslogin will immediately use the PORTMAPPER protocol. Using this keyword, when it is known that the NFS server system does not support RPCBIND, can improve the performance of mvslogin, because it does not look for RPCBIND first. This keyword has no effect if the client system is not enabled for IP version 6 (IPv6).
- a *account***
An account string passed to z/OS for accounting purposes. The maximum length is 16 characters.
- hostname***
The name of the z/OS host (for example, mvshost1). The default is the local host.

mvs_userid

A user ID that z/OS recognizes as valid. If you do not specify this parameter, your workstation user name is used. The NFS server does not support the use of an alias user ID or a mixed case user ID with the mvslogin command.

The **showattr** command is used to display the default attributes or the attributes that have been set for a specific mount point. If you specify a mount point, showattr shows the attributes for the mount point, including the overriding values. For descriptions of the attributes, see Chapter 9, "Initialization attributes for the z/OS NFS server," on page 121.

The following is the showattr command syntax.

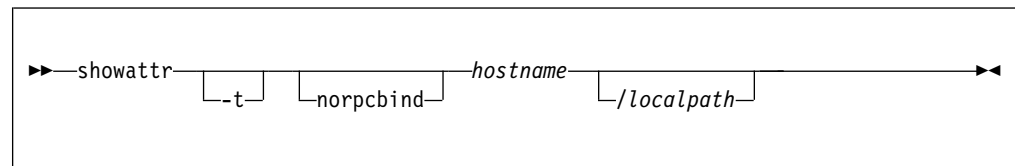

where

Operand

Description

-t Used to specify tersed output.

-norpcbind

Specifies that showattr should not look for the RPCBIND protocol on the NFS server system. The default is that showattr will first look for the RPCBIND protocol. If that request fails, or times out, it will then look for the PORTMAPPER. If this keyword is used, showattr will immediately use the PORTMAPPER protocol. Using this keyword, when it is known that the NFS server system does not support RPCBIND, can improve the performance of showattr, because it does not look for RPCBIND first. This keyword has no effect if the client system is not enabled for IP version 6 (IPv6).

hostname

The name of the z/OS host (for example, mvshost1). The default is the local host.

/localpath

The mount point on your client system (for example, /u/smith/mnt). This should be an empty directory.

The **nfsstat** command is used to display the NFS client and server statistical information, to reset the statistical information to zero, to display NFS mount point information, or to set the debug status.

The following is the nfsstat command syntax.

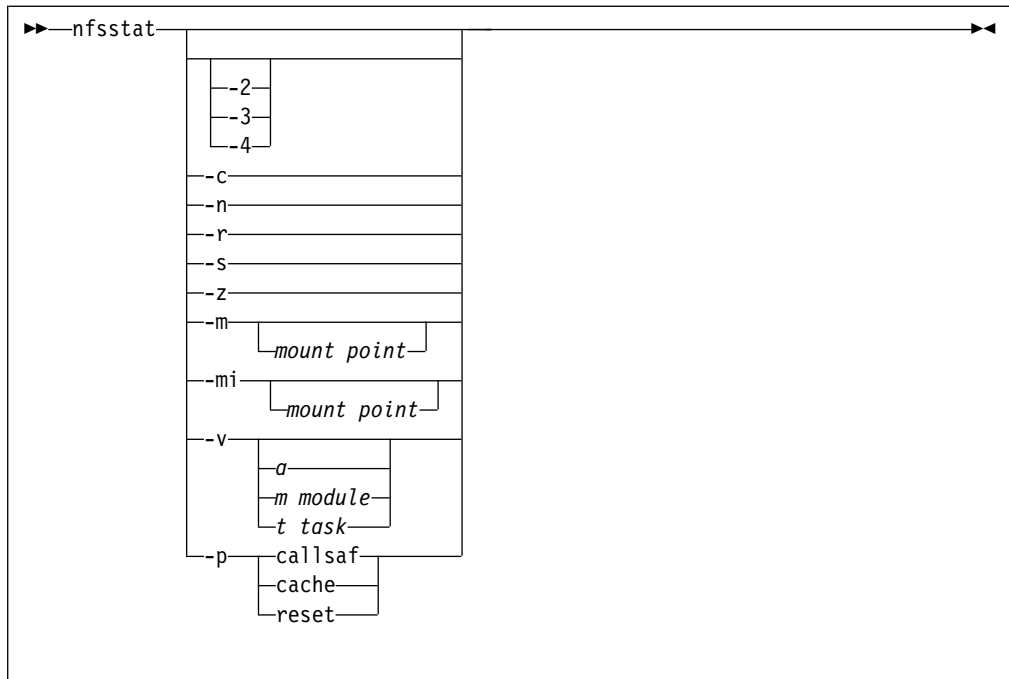

where

Operand

Description

- 2 Displays statistics for Version 2 of the z/OS NFS server and z/OS NFS client.
- 3 Displays statistics for Version 3 of the z/OS NFS server and z/OS NFS client.
- 4 Displays statistics for Version 4 of the z/OS NFS server and z/OS NFS client.
- c Displays both NFS and RPC statistics about the NFS client. This is the default option on the nfsstat command.
- n Displays NFS statistics about the NFS client and NFS servers.
 - To display the NFS statistics of only the client, use -cn
 - To display the NFS statistics of only the server(s), use -sn
- r Displays RPC statistics about the NFS client and NFS servers.
 - To display the RPC statistics of only the client, use -cr
 - To display the RPC statistics of only the server(s), use -sr
- s Displays statistics about the NFS servers.
- z Initializes statistics to zero for the NFS client and NFS servers. Used by root user only. This option can be combined with options -c, -n, and -r on the nfsstat command. When combined with these nfsstat options, each particular set of statistics is set to zero after the statistics are printed.
 - To only reset the client side statistics, use -cz
 - To reset the server(s) side statistics, use -sn
- m Displays the name of each NFS mounted file system.
- mi Displays the name of each NFS mounted file system and checks the server's IP address validity.

- m** *mount point*
Displays information for the NFS mounted file system on the specified mount point.
- mi** *mount point*
Displays information for the NFS mounted file system on the specified mount point and checks the server's IP address validity.
- v** Returns information about the latest APAR installed on the z/OS NFS client.
- v a**
Returns a list of all the modules in the z/OS NFS client with their current level information. At the end of the list is information about the latest APAR installed.
- v m** *module*
Returns information about the APAR level of the specified *module*.
- v t** *task*
Returns information about the APAR level of the specified *task*.
- p**
Stands for performance. -p requires one of three options (callsaf, cache or reset).
- p callsaf**
Client global flag that disables the client Uid/Gid Cache.
- p cache**
Client global flag that enables the client Uid/Gid Cache.
- p reset**
clears the client Uid/Gid Cache.

Any of the options specified previously in this section in the `nfsstat` command can be used in conjunction with each other to display the desired statistics. The following are some examples of such usage:

- To display the RPC and NFS statistics of the z/OS NFS client and the z/OS NFS server(s): `nfsstat` (that is, with no options, which is equivalent to `nfsstat -cs` or `-csr` or `-rn` or `-csr234`)
- To display the RPC statistics of the z/OS NFS client and the z/OS NFS server(s): `nfsstat -csr`
- To display the NFS version 2 statistics of the z/OS NFS client: `nfststat -c2`
- To display the NFS version 3 statistics of the z/OS NFS Client and the z/OS NFS server(s): `nfsstat -cs3`
- To display the NFS version 4 statistics of the z/OS NFS server(s): `nfsstat -s4`

Note: The examples listed previously in this section are not a complete list, but a sampling of the combinational usage of the `nfsstat` command's options. As stated previously, any of the `nfsstat` command's options can be combined with each other to achieve the desired level of filtering to display the desired statistics.

The **showmount** command is used to display the remote NFS server mount information. If you omit the options, the default option displays hostnames of all remote mounts from the *hostname* NFS server. If you omit the *hostname* parameter, then the local hostname is used.

The following is the `showmount` command syntax.

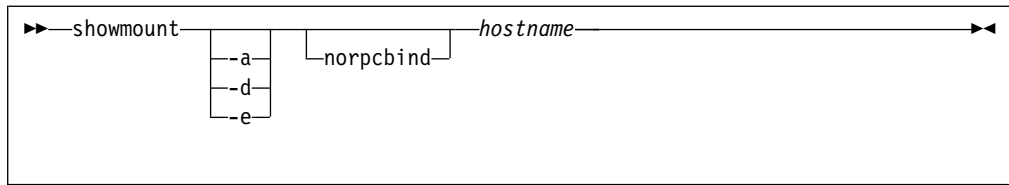

If you omit the options, the default option displays hostnames of all remote mounts from the *hostname* NFS server.

where

Operand

Description

- a Displays all mounts in the format *hostname:directory* from the *hostname* specified in the *showmount* command.
- d Displays only directory names of all mounts from the *hostname* specified in the *showmount* command.
- e Displays the list of exported directories from the *hostname* specified in the *showmount* command. Directory entries are shown as they appear in the exports data set.

Note that exported directory entries containing symbolic links are displayed with both the symbolic link path and resolved real path for NFSV4 mounts only (after the mount has been completed). NFSV3 mounted paths will display only the symbolic link path.

-norpcbind

Specifies that *showmount* should not look for the RPCBIND protocol on the NFS server system. The default is that *showmount* will first look for the RPCBIND protocol. If that request fails, or times out, it will then look for the PORTMAPPER. If this keyword is used, *showmount* will immediately use the PORTMAPPER protocol. Using this keyword, when it is known that the NFS server system does not support RPCBIND, can improve the performance of *showmount*, because it does not look for RPCBIND first. This keyword has no effect if the client system is not enabled for IP version 6 (IPv6).

hostname

The name of the NFS server host (for example, *mvshost1*). The default is the local host.

The **crnl2nl** command will remove the carriage-return and end-of-file mark (EOF) from the input file. No other conversions are performed. Either, or both the input and output file can be a local or remote file.

The following is the *crnl2nl* command syntax.

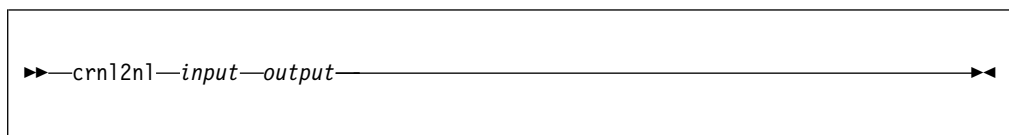

The data is assumed to be in EBCDIC format.

where

Operand

Description

input

Absolute path name of the input file to be converted.

output

Absolute path name of the output file.

The **nl2crnl** converts the line delimiter from MVS format to carriage-return newline (CRNL) format; the newline (NL) in the input file is converted to the carriage-return newline pairs (CR, NL). No other conversions are performed. Both input and/or output file can be local or remote file.

The following is the nl2crnl command syntax.

```

▶▶nl2crnl—input—output▶▶

```

where**Operand**

Description

input

Absolute path name of the input file to be converted.

output

Absolute path name of the output file.

Note:

1. The size of the write buffer is double the size of the read buffer.
2. The data is assumed to be in EBCDIC format.

The **mvlogout** command is used to disconnect from the remote z/OS NFS server host. The mvlogout command is only required when the mvlogin command was used to begin the connection.

The following is the mvlogout command syntax.

```

▶▶mvlogout—[norpcbind]—hostname▶▶

```

where**Operand**

Description

-norpcbind

Specifies that mvlogout should not look for the RPCBIND protocol on the NFS server system. The default is that mvlogout will first look for the RPCBIND protocol. If that request fails, or times out, it will then look for the PORTMAPPER. If this keyword is used, mvlogout will immediately use the

PORTMAPPER protocol. Using this keyword, when it is known that the NFS server system does not support RPCBIND, can improve the performance of `mvslogout`, because it does not look for RPCBIND first. This keyword has no effect if the client system is not enabled for IP version 6 (IPv6).

hostname

The name of the z/OS host (for example, `mvshost1`). The default is the local host.

Accessing z/OS

To access remote z/OS files, enter both the `mvslogin` command to log in to the NFS server's host system and the `mount` command to mount the files or data sets to your local system. The `mvslogin` command is only required when accessing data on systems where the NFS server site *security* attribute is set to `saf` or `safexp`. Once the files or data sets are mounted to a local mount point, you can read, write, create, delete and treat the mounted files as part of your local UNIX files. When you are finished with your work, use the `unmount` and `mvslogout` commands to break the connection. The `mvslogout` command is only required when the `mvslogin` command was used to begin the connection.

Note:

1. Issuing the `mount` and `unmount` commands, as well as creation of the mount point, must be performed by someone with superuser authority.
2. If the underlying z/OS UNIX file system structure should change due to the mount of a new HFS or zFS file system into the space accessible by an existing remote NFS Client mount, this change and new directory structure and contents will not be visible to the remote NFS Client until the NFS mount is unmounted and remounted or the z/OS NFS Server is restarted.

To access files on z/OS systems where the NFS server site *security* attribute is set to `saf` or `safexp`, you need a z/OS user ID and password, and authorization to access the files that you need. You can only establish one z/OS session for each z/OS user ID. If you do not already have an z/OS user ID, a z/OS password, and access authorization on the z/OS system from which you require NFS services, request them from your z/OS system administrator.

Note: If you cannot use the `mvslogin`, `mvslogout`, or `showattr` commands, they might be installed incorrectly. Ensure that your system administrator has made the executable code for these three commands available to your z/OS user ID and that you have been given the correct access authority to them.

Mvslogin command examples

Use the `mvslogin` command to log in to the remote z/OS system. The `mvslogin` command can be issued multiple times and the last one overrides the previous one. The `mvslogin` command is only required when accessing data on systems where the NFS server site *security* attribute is set to `saf` or `safexp`.

Table 12 shows examples of the `mvslogin` command where `mvshost1` is the name of the z/OS host and `smith` is the user's ID on z/OS.

Table 12. Examples of the mvslogin command for clients

Command Examples

```
mvslogin -p mvshost1 smith
```

```
mvslogin -P smithspw -g finance -a 5278 mvshost1 smith
```

Table 12. Examples of the `mvlogin` command for clients (continued)

Command Examples

```
mvlogin -P "Smith's password phrase" mvshost1 smith
```

```
mvlogin -n mvshost1 smith
```

```
mvlogin -pn -a 5278 mvshost1 smith
```

```
mvlogin mvshost1
```

```
mvlogin mvshost1 smith
```

In the example where the user enters `mvlogin mvshost1`, the current login client user ID is used as the z/OS user ID.

In the example where the user enters `mvlogin mvshost1 smith`, the system then prompts for Smith's z/OS password. If Smith logs in successfully, this message displays.

```
GFSA955I smith logged in ok.
```

Otherwise, an appropriate error message displays.

Note: Messages that start with GFSA and GFSC apply to NFS requests. See Chapter 19, "Network File System messages," on page 339.

"Permission denied" message

If you have successfully logged in and get the "Permission denied" message while trying to access data, that can be due to one of these cases:

- An `mvlogout` command for the same z/OS host has been entered from the same client platform. See `mvlogout` for details.
- Your z/OS user ID has been automatically logged out because the `logout` attribute value has been exceeded. This can happen when you leave the client idle for too long. Enter the `mvlogin` command again, and start your processes again. To find out how many seconds you can stay logged in while your client is idle, issue the `showattr` command and look at the `logout` attribute.
- Another `mvlogin` to the same z/OS host using the same z/OS ID has been entered from the same UID and the same client platform. If this is the case, retry your access.

Mount command syntax and examples

Use the TSO MOUNT command to make a connection between a mount point on your local file system and one or more files on a remote AIX, UNIX, , or other file system. The MOUNT command can only be used by a z/OS superuser.

Note: The same mount function can also be performed using the UNIX automount facility or `/etc/rc` shell scripts support. When the automount facility is used to manage remote NFS mount points, the NFS client user could experience ESTALE/EIO errors if the automounter unmounts the accessed mount point when the time limits specified by the automount DURATION and DELAY parameters have been exceeded. The automount default, DURATION=NOLIMIT, disables the DURATION timeout period. The DELAY for unmounting file systems should be longer than the time NFS clients are likely to keep NFS mounts to the files and directories active. For more information, see *z/OS UNIX System Services Command Reference*.

Figure 7 illustrates the syntax of the TSO MOUNT command. For more information about the **mount** command, see *z/OS UNIX System Services Command Reference*.

```
MOUNT FILESYSTEM(file_system_name)
      TYPE(NFS)
      MOUNTPOINT(local_mountpoint)
      MODE(RDWR|READ)
      PARM('hostname:"path_name,server_attributes", client_options')
      SETUID|NOSETUID
      TAG(TEXT,CCSID)
      WAIT|NOWAIT
```

Figure 7. TSO MOUNT command syntax operands

where

FILESYSTEM(*file_system_name*)

Specifies the name of the file system to be added to the file system hierarchy. This operand is required. The file system name specified must be unique among previously mounted file systems. It may be an arbitrary name up to 44 characters in length of a filesystem. You can enclose *file_system_name* in single quotes, but they are not required.

TYPE(*NFS*)

Specifies the type of file system that performs the logical mount request. The NFS parameter must be used.

MOUNTPOINT(*local_mountpoint*)

Specifies the path name of the mount point directory, the place within the file hierarchy where the file system is to be mounted. The *local_mountpoint* specifies the mount point path name. The name can be a relative path name or an absolute path name. The relative path name is relative to the current working directory of the TSO/E session (usually the home directory). Therefore, you should usually specify an absolute path name. A path name is case-sensitive, so enter it exactly as it is to appear. Enclose the path name in single quotes.

Note: The mount point must be a directory. Any files in that directory are inaccessible while the file system is mounted. Only one file system can be mounted to a mount point at any time.

MODE(*RDWR|READ*)

Specifies the type of access for which the file system is to be opened.

RDWR specifies that the file system is to be mounted for read and write access. *RDWR* is the default option.

READ specifies that the file system is to be mounted for read-only access.

PARM('hostname:"*path_name,server_attributes*", *client_attributes*')

Specifies the hostname of the remote NFS server, the path name of the UNIX file or MVS data set to be mounted, the server attributes, and the client attributes.

See Chapter 9, "Initialization attributes for the z/OS NFS server," on page 121 for descriptions of the server attributes, including the **mvsmnt** processing attribute to be used with mount commands using the NFS version 4 protocol. The "client_attributes" used on the PARM parameter are the same as the NFS client attributes, although some attributes cannot be used on the mount. See

Table 15 on page 118 for a list of the parameters that can be used to specify client attributes on the MOUNT command.

path_name and server attributes are delimited with double quotes. path_name and server attributes are not parsed for validity by the z/OS NFS client. path_name is defined as the characters between the first double quote and the first comma before the server attributes. server attributes is defined as the characters between the first comma after the path_name and the second double quote.

If the path_name has no colon and if no server attributes are specified then the double quotes can be omitted. Enclose the entire string in single quotes. path_name is defined as the characters between the colon after the hostname and the first comma before the client_attributes. Any syntax errors that occur after the colon and before the first comma can cause the mount to fail. If the automount facility is being used, the single quotes should not be specified.

SETUID|NOSETUID

See *z/OS UNIX System Services Command Reference* for details about **SETUID** and **NOSETUID**.

TAG(TEXT,CCSID)

See *z/OS UNIX System Services Command Reference* for details about the **TAG** keyword.

Note: When TAG is specified, **xlat(Y)** must not be specified; otherwise, mount will fail.

WAIT|NOWAIT

See *z/OS UNIX System Services Command Reference* for details on **WAIT** and **NOWAIT**.

Data conversion

The NFS client supports data conversion defined by the universal character encoding standard known as the Unicode Standard on V1R2 (and later) when reading data from a remote NFS server or writing data to a remote NFS server. The Unicode Standard offers character conversion as well as basic case conversion. Within character conversion, characters are converted from one coded character set identifier (CCSID) to another. CCSID information is obtained from the *cln_ccsid* and *srv_ccsid* parameters.

Only single byte to single byte data conversion is supported. For example, if a client file has a CCSID of 437 and a server file has a CCSID of 297, data conversion will occur between USA ASCII format (CCSID 437) and French EBCDIC format (CCSID 297). Single byte to multiple byte conversion (including double byte character set (DBCS)) is not supported and will result in NFS terminating with an error message. NFS version 4 protocol (NFSv4) differs from NFSv2 and NFSv3 protocol in handling single to multiple byte conversion. Therefore, the technique-search-order specified in the **convserv()** attribute should consider the effects of the NFS protocol being used. See "Creating the conversion environment for Unicode Services" on page 174 for further details.

The **cln_ccsid**, **srv_ccsid**, **xlat**, **tag/notag**, and **convserv** attributes identify whether data conversion is performed, and how data conversion is done. The **cln_ccsid**, **srv_ccsid**, **xlat**, **tag/notag**, and **convserv** attributes are supported by the z/OS NFS client installation parameter and TSO MOUNT command. The parameters on a TSO MOUNT command override the parameters specified as a NFS client installation parameter.

The `cln_ccsid` and `srv_ccsid` are always used to correctly display file names from a remote server. In the case of file names from a multi-byte conversion, the file names can even be viewed correctly by specifying the correct `cln_ccsid`, `srv_ccsid` and `xlat(n)` attribute. Note that in the case of `xlat(n)` there is no data conversion of a file's content - only the file names.

Sometimes, the source buffer (server file) may contain byte strings that do not represent a character in the source code page. These characters are referred to as "malformed characters" and cannot be converted to a valid target code point. These characters will be substituted during conversion processing in Unicode with the conversion table's "malformed character" substitution character.

BSAM, QSAM, and VSAM ESDS access to remote files

BSAM, QSAM, and VSAM ESDS applications can access files stored on remote NFS servers through the NFS client. This will allow existing MVS application programs access to data on other systems using BSAM, QSAM, and VSAM ESDS interfaces. The BSAM, QSAM, and VSAM ESDS access methods assume that all text files are EBCDIC. When using these access methods, the `delim` parameter indicates whether the remote files contain text or binary data. Text data consists of records that are separated by a delimiter. If the `delim` parameter is not binary, the EBCDIC text delimiter is used by the access methods when processing the remote files. The `delim` parameter is supported on the NFS client installation parameter and TSO MOUNT command.

Note: The z/OS NFS client can also access VSAM key-sequenced (KSDS) and relative record (RRDS) data sets.

All the remote file objects under the same mount point have the same `delim` value. The `delim` parameter cannot be set on a file basis under the mount point. The `delim` parameter in the TSO MOUNT command overrides the `delim` parameter specified in NFS client installation parameter. However, you can override the `delim` parameter on the TSO MOUNT command with the `filedata` parameter on a JCL DD statement, SVC 99, or TSO ALLOCATE command. The `filedata` parameter can be either **text** or **binary**.

For BSAM, QSAM, and VSAM ESDS applications accessing files stored on remote NFS servers, the NFS client provides data conversion when the `xlat=Y` parameter is specified. It uses the `cln_ccsid` and `srv_ccsid` settings. When `xlat=N`, the NFS client will not perform data conversion. The `filedata` parameter on a JCL DD statement is also used to specify if the data consists of text records separated by delimiters or if the data is binary and does not contain record delimiters. To avoid undesirable data conversions, care should be taken to insure the specification of the `xlat` and `delim` parameters are not in conflict with the data type specified by the `filedata` parameter on a JCL DD statement. The `filedata` and `delim` parameters only affect BSAM, QSAM, and VSAM ESDS data access and have no effect on the NFS client data conversion. The NFS client data conversion is only controlled by the `xlat` parameter. The significance of different `filedata` and `delim` combinations are described in the following information.

Note: In each case, ensure the NFS client `xlat=Y`, `cln_ccsid`, and `srv_ccsid` parameter settings are correct for the `filedata` and `delim` combination.

FILEDATA=TEXT, delim=notBINARY

Specifies that the data is to be accessed as text. The access method appends a record delimiter on output and expects delimiters on input. The delimiter used is that specified on the `delim` parameter.

FILEDATA=TEXT, delim=BINARY

Specifies that the data is to be accessed as text. The access method appends a record delimiter on output and expects delimiters on input. The delimiter used is the default of the EBCDIC new line character (x'15') since the *delim* parameter does not specify a valid text delimiter.

FILEDATA=BINARY, delim=notBINARY

Specifies that the data is to be accessed as binary. The access method does not append record delimiters on output, does not recognize record delimiters on input, and it treats all characters as data on input.

FILEDATA=BINARY, delim=BINARY

Specifies that the data is to be accessed as binary. The access method does not append record delimiters on output, does not recognize record delimiters on input, and it treats all characters as data on input.

FILEDATA=not specified, delim=specified

Means that the data is to be accessed according to the value specified in the *delim* parameter.

FILEDATA=not specified, delim=not specified

Means that the data is to be accessed as binary. The access method does not append record delimiters on output, does not recognize record delimiters on input, and it treats all characters as data on input.

The NFS client also provides UNIX authentication for security and provides the UNIX client's user ID (UID), group ID (GID), and a list of users GIDs to the remote NFS server for authorization checking. When the remote NFS server is the NFS server, the **mvslogin** command can be used to provide additional security checking through RACF authentication. MVS application programs which require access to data on remote systems may be required to perform an **mvslogin**.

For information on BSAM, QSAM, and VSAM ESDS applications access to z/OS UNIX or remote files and their restrictions, refer to *z/OS DFSMS Using Data Sets*.

Invoking the Mount command on the z/OS platform

Use the TSO MOUNT command to make a connection between a local mount point on the NFS client and an NFS server.

The Mount command can be invoked on the z/OS platform from different locations. Assume the following values are to be used for the mount point:

Value	Description	Explanation
NFS	file system type	indicates that this file system is to be mounted as an NFS file system
my nfs	file system	is the name of the file system to be mounted.
tcpj701:	server host name	is the NFS Server host name
nfstest	exported path	is the name of the directory to be mounted.
text,mvsmnt	server attributes	are the z/OS NFS Server mount attributes to be used for this mount point. Note: Other NFS servers, such as AIX, Linux, and SUN, do not have server attributes.
,soft,timeo(0),xlat(y)	client attributes	are the z/OS NFS Client attributes to be used for this mount point
/nfstest	mountpoint	is the directory in the local client file system where the file system is to be mounted.

The different styles of mount command are:

1. **From TSO.** The mount command can be issued from the TSO Ready prompt or from the ISPF TSO commands prompt. (This is the version of the command that is shown in the examples in "Additional mount command examples.")

```
mount type(NFS) filesystem(mynfs) mountpoint('/nfstest')
parm('tcpj701:"nfstest,text,mvsmnt",soft,timeo(100),xlat(y)')
```

2. **From the OMVS shell.** The mount command can also be invoked from within the OMVS shell or a shell script. This version of the command looks more like it would be when issued on other Unix platforms:

```
/usr/sbin/mount -tnfs -fmynfs -w0
-o'tcpj701:"nfstest,text,mvsmnt",soft,timeo(100),xlat(y)' /nfstest
```

3. **TSO command from OMVS shell.** The mount command can also be invoked as a TSO command from within the OMVS shell or a shell script. In this case, the command looks like the TSO version of the command:

```
tso -t "mount type(NFS) filesystem(mynfs) mountpoint('/nfstest')
parm('tcpj701:\'nfstest,text,mvsmnt\'",soft,timeo(100),xlat(y)'"
```

Note: The inner double quote must be entered with an escape character (\ "). If only a double quote is entered , the double quote will be stripped by the shell TSO command parser, causing the z/OS NFS server mount attributes to be misinterpreted as z/OS NFS client attributes, which will lead to unpredictable results.

Additional mount command examples

In this example, the **mount** command is used to mount a set of MVS files. The PARM operand contains the NFS server **text** processing attribute and requires the use of double quotes around the string **user,text**.

```
mount filesystem(nfs00) type(nfs) mountpoint('/u/nfsdir')
parm('stlmvs3:"user,text",soft,timeo(100)')
```

In this example:

Operand

Description

nfs00

Specifies the name of the file system to be added to the file system hierarchy.

nfs

Specifies the required file system type.

/u/nfsdir

Specifies the name of the mount point (preferably an empty directory).

stlmvs3

Specifies the name of the host NFS server.

user

Specifies the name of the high-level qualifier of the MVS files on the NFS server.

Note: Based on the implicit prefix heuristic specified with the IMPPREFIX() site attribute, you may need to specify the MVS path type prefix to identify the file system being mounted as an MVS data set path. For example:
parm('stlmvs3:"/mvs/user,text",soft,timeo(100)')

text

Specifies the processing attribute for the NFS server.

soft

Specifies the PARM operand option for the NFS client.

timeo(100)

Specifies the PARM operand option for the NFS client.

In this example, the mount command is used to mount a z/OS UNIX directory. The PARM operand contains the NFS server *binary* processing attribute and requires the use of double quotes around the string */hfs/u/user,binary*.

```
mount filesystem(nfs01) type(nfs) mountpoint('/u/nfsdir1')
parm('stlmvs3:/hfs/u/user,binary',soft')
```

In this example:

Operand

Description

nfs01

Specifies the name of the file system to be added to the file system hierarchy.

nfs

Specifies the required file system type.

/u/nfsdir1

Specifies the name of the mount point (preferably an empty directory).

stlmvs3

Specifies the name of the host NFS server.

/hfs/u/user

Specifies the name of the z/OS UNIX directory on the NFS server. The '/hfs' prefix is optional based on the implicit prefix selection setting.

binary

Specifies the processing attribute for the NFS server.

soft

Specifies the PARM operand option for the NFS client.

In this example, the mount command is used to mount an AIX home directory.

```
mount filesystem(nfs02) type(nfs) mountpoint('/u/nfsdir2')
parm('aix6000:/home/user,xlat(y)')
```

In this example:

Operand

Description

nfs02

Specifies the name of the file system to be added to the file system hierarchy.

nfs

Specifies the required file system type.

/u/nfsdir2

Specifies the name of the mount point (preferably an empty directory).

aix6000

Specifies the name of the host AIX NFS server.

/home/user

Specifies the name of the home directory on the AIX NFS server.

xlat(y)

Specifies the PARM operand option for the NFS client.

In this example, the mount command is used to mount an AIX home directory using the NFS version 4 protocol.

```
mount filesystem(nfs03) type(nfs) mountpoint('/u/nfsdir2')  
parm('aix6000:/home/user,xlat(y),vers(4)')
```

In this example:

Operand

Description

nfs03

Specifies the name of the file system to be added to the file system hierarchy.

nfs

Specifies the required file system type.

/u/nfsdir2

Specifies the name of the mount point (preferably an empty directory).

aix6000

Specifies the name of the host AIX NFS server.

/home/user

Specifies the name of the home directory on the AIX NFS server.

xlat(y)

Specifies the PARM operand option for the NFS client.

vers(4)

Specifies the version of NFS protocol that is being used.

In this example, the mount command is used to mount a Windows Share using the NFS version 4 protocol.

```
mount filesystem(nfs04) type(nfs) mountpoint('/u/nfsdir4')  
parm('windowshost:"D:/",xlat(y),vers(4)')
```

In this example:

Operand

Description

nfs04

Specifies the name of the file system to be added to the file system hierarchy.

nfs

Specifies the required file system type.

/u/nfsdir4

Specifies the name of the mount point (preferably an empty directory).

windowshost

Specifies the hostname of the Windows NFS server.

D:/

Specifies the name of the share on the Windows NFS server.

xlat(y)

Specifies the PARM operand option for the NFS client.

vers(4)

Specifies the version of NFS protocol that is being used.

Automount facility mount: In this example, the mount command in the automount policy file is used to do ASCII to EBCDIC conversion.

```

name *
type NFS
filesystem shared.<asis_name>
mode rdwr
duration 15
delay 10
parm mvshost<asis_name>",<convserv(LE)>",<xlat(Y)>
setuid no

```

In this example:

Operand

Description

type NFS

Identifies the automount file system type as NFS.

parm mvshost<asis_name>",<convserv(LE)>",<xlat(Y)>

Specifies the parameter information to be supplied to NFS. mvshost specifies the name of the NFS Server. /<asis_name> is the remote file system.

convserv(LE) is a z/OS NFS server option convserv to conversion technique.

The string should be enclosed in quotes. xlat(Y) is a z/OS NFS client option xlat to allow the client to perform ascii to ebcdic conversion. The string should not be enclosed in quotes.

For more information about the z/OS UNIX automount facility, including the other parameters in the automount policy, such as filesystem, mode, duration, delay, and setuid, see *z/OS UNIX System Services Planning* and *z/OS UNIX System Services Command Reference*.

Getting authorization to access files

If the mount fails, check with your system administrator to ensure that you are authorized to access the AIX or UNIX file system listed in the exports control file. The NFS client also provides UNIX authentication for security and provides the UNIX client's UID, GID, and a list of the GIDs from the UNIX client's groups to the remote NFS server for authorization checking. When the remote NFS server is the NFS server, the **mvlogin** command can be used to provide additional security checking through RACF authentication. The privilege level required to enter **mount** and **unmount** commands is superuser. When requesting service from the NFS server, if the z/OS system operator issues the *freeze=on* operand of the **modify** command, all new tries to mount a z/OS UNIX file system fail until the z/OS system operator issues the *freeze=off* operand. If the UNIX system operator issues the *freeze=onhfs* operand of the modify command, z/OS conventional MVS data sets can still be mounted, but all new tries to mount UNIX files fail until the system operator issues the *freeze=offhfs* operand.

Saving of mount points

Once the **mount** command is issued successfully and a mount point is established between a remote directory and the file system, the mount point information is not saved by the NFS client. The NFS client does not maintain mount persistence across restart. If UNIX or the NFS client is restarted, all prior session's mount point information is lost and all mount points must be reestablished.

Automatic timed logout - logout attribute

When using Network File System services from the NFS server, if there is no activity on the client within the period specified in the **logout** attribute of the attributes file, or if the server stops, the connection between the server and the client workstation is logged out automatically. You must issue the **mvlogin** command again to get access to the z/OS files.

Unmount command syntax and examples

This section describes the **umount** command.

Disconnecting your mount point - unmount

Use the **umount** command to break the connection between the mount point on your client and the server (that is, to unmount). You must have superuser authority to issue the unmount command.

Note: The same unmount function can also be performed using the UNIX **automount** facility. When the automount facility is used to manage remote NFS mount points, the NFS client user could experience ESTALE/EIO errors if the automounter unmounts the accessed mount point when the time limits specified by the automount *duration* and *delay* parameters have been exceeded. For additional information on the UNIX automount facility, see *z/OS UNIX System Services Planning* and *z/OS UNIX System Services Command Reference*.

Figure 8 illustrates the syntax of the TSO UNMOUNT command. For more information about the UNMOUNT command, see *z/OS UNIX System Services Command Reference*.

```
UNMOUNT FILESYSTEM(file_system_name)
NORMAL | DRAIN | IMMEDIATE | FORCE | RESET
```

Figure 8. TSO UNMOUNT command syntax operands

where

FILESYSTEM(*file_system_name*)

Specifies the name of the file system to be removed from the file system hierarchy. *file_system_name* specifies the *file_system_name* exactly as it was specified when the file system was originally mounted. You can enclose *file_system_name* in single quotes, but they are not required.

NORMAL | DRAIN | IMMEDIATE | FORCE | RESET

NORMAL: Specifies that if no user is accessing any of the files in the specified file system, the unmount request is processed. Otherwise, the system rejects the unmount request. **NORMAL** is the default option.

DRAIN: Specifies that the system is to wait until all uses of the file system have ended normally before the unmount request is processed or until another UNMOUNT command is issued.

Note: UNMOUNT can be specified with IMMEDIATE to override a previous unmount DRAIN request for a file system. If this is used in the foreground, your TSO/E session waits until the unmount request has completed. The attention request key (usually ATTN or PA1) will not end the command.

IMMEDIATE: Specifies that the system is to unmount the file system immediately. Any users accessing files in the specified system receive failing return codes. All data changes to files in the specified file system are saved. If the data changes to files cannot be saved, the unmount request fails.

Note: UNMOUNT of an NFS mount point (regardless of soft or hard mount option) with NORMAL, DRAIN, or IMMEDIATE may fail with the return code of EBUSY if the z/OS NFS client determines that there are ongoing NFS requests to the NFS server. The UNMOUNT receiving EBUSY can have the file system unmounted immediately with FORCE, at the risk of data loss.

FORCE: Specifies that the system is to unmount the file system immediately. Any users accessing files in the specified file system receive failing return codes. All data changes to files in the specified file are saved, if possible. If the data changes cannot be saved to the files, the unmount request continues and data is lost.

Note: You must issue an UNMOUNT IMMEDIATE request before issuing UNMOUNT FORCE. Otherwise, UNMOUNT FORCE fails.

RESET: A reset request stops a previous unmount DRAIN request.

The following example unmounts the file system NFSC_001 normally:

```
UNMOUNT FILESYSTEM('NFSC_001')
```

The following example forces an **unmount** of the file system NFSC_001. You must issue an UNMOUNT IMMEDIATE before you can issue an unmount *FORCE* command.

```
UNMOUNT FILESYSTEM('NFSC_001') IMMEDIATE  
UNMOUNT FILESYSTEM('NFSC_001') FORCE
```

If you receive a “No Such File or Directory” message, the z/OS system operator can also unmount your workstation from the server. If this happens before you try to unmount, you get a “No such file or directory” error message.

Displaying client and server statistical information—nfsstat

Use the **nfsstat** command to display the NFS client and server statistical information, to reset the statistical information to zero, to display NFS mount point information, or to set the debug status.

The following **nfsstat** command displays the NFS and RPC statistics for the NFS client:

```
nfsstat -c
```

The following **nfsstat** command resets the NFS and RPC statistics for the NFS server and client to zero. Only the root user may use this option:

```
nfsstat -z
```

You may also use this command as follows:

- To only reset the client side statistics, use **nfsstat -cz**
- To only reset the z/OS NFS server(s) side statistics, use **nfsstat -sz**

The following **nfsstat** command displays the RPC statistics of both the NFS Client and the NFS server(s):

```
nfsstat -r
```

You may also use this command as follows:

- To only display the client side RPC statistics, use **nfsstat -cr**
- To only display the server(s) side RPC statistics, use **nfsstat -sr**

The following **nfsstat** command displays the NFS statistics of both the NFS Client and the NFS server(s):

```
nfsstat -n
```

You may also use this command as follows:

- To display the NFS statistics of only the client, use `nfsstat -cn`
- To display the NFS statistics of only the server(s), use `nfsstat -sn`

To display NFS version-specific information, use the following values with an `nfsstat` command option:

- 2 NFS version 2
- 3 NFS version 3
- 4 NFS version 4

For example, to display the NFS version 3 statistics of the z/OS NFS Client and the z/OS NFS server(s), enter:

```
nfsstat -cs3
```

Figure 9 displays both z/OS NFS Server and Client NFSv3 statistics, assuming that the LPAR has one z/OS NFS Server (with the `StartUpProcedure` name of `MVSNFS`) and one z/OS NFS Client.

```
$ /usr/lpp/NFS/nfsstat -3
GFSC857I z/OS Network File System Server : (MVSNFS)

Server NFSv3:
calls          badcalls
20019          0
null           getattr      setattr      lookup      access
0             0% 0         0% 753        4% 9123       45% 2424      12%
readlink      read         write
208           1% 1058       5% 941        5% 488        2% 118        0%
symlink       mknod       remove      rmdir
312           1% 0          0% 1214       6% 119        0% 725        4%
link          readdir     readdirplus fsstat
412           2% 419        2% 0          0% 1508       7% 1          0%
pathconf      commit
1             0% 195        1%

GFSC857I z/OS Network File System Client :

Client NFSv3:
calls          badcalls
20035          0
null           getattr      setattr      lookup      access
0             0% 0         0% 754        4% 9124       45% 2427      12%
readlink      read         write
208           1% 1058       5% 948        5% 488        2% 118        0%
symlink       mknod       remove      rmdir
312           1% 0          0% 1214       6% 119        0% 725        4%
link          readdir     readdirplus fsstat
412           2% 419        2% 0          0% 1509       7% 2          0%
pathconf      commit
2             0% 196        1%
Unicode Support service is used.
```

Figure 9. Displaying NFS Server and Client NFSv3 statistical information

Figure 10 on page 101 shows the output from the `nfsstat` command using the `-r` option to display the remote procedure call (RPC) statistics for the NFS client.

```
USER1:/u/user1:> nfsstat -r
Client rpc:
calls          badcalls      retrans       timeout       qfull
107            0             0             0             0
lossconn
0
```

Unicode Support service is used.

Figure 10. Displaying NFS client rpc statistical information

In this example:

Operand

Description

calls

Specifies the total number of RPC calls sent.

badcalls

Specifies the total of RPC calls rejected by a server.

retrns

Specifies the number of times an RPC call had to be retransmitted.

timeout

Specifies the number of times an RPC call timed out.

qfull

specifies the number of times an RPC call had to be delayed due to insufficient resources.

lossconn

specifies the number of times an RPC call had to be retransmitted on a new TCPIP connection.

Figure 11 on page 102 shows the output from the **nfsstat** command using the **-nc** option to display the NFS statistics for the NFS client.

```

USER1:/u/user1:> nfsstat -nc

Client NFSv2:
calls          badcalls
71             0
null          getattr      setattr      root         lookup
0             0% 1         1% 0           0% 0         0% 68         96%
readlink      read         writecache   write        create
0             0% 0         0% 0           0% 0         0% 0         0%
remove        rename       link         symlink      mkdir
0             0% 0         0% 0           0% 0         0% 0         0%
rmdir         readdir     fsstat
0             0% 1         1% 1           1%

Client NFSv3:
calls          badcalls
10             0
null          getattr      setattr      lookup       access
0             0% 0         0% 0           0% 0         0% 0         0%
readlink      read         write        create       mkdir
0             0% 0         0% 0           0% 0         0% 0         0%
symlink       mknod       remove       rmdir       rename
0             0% 0         0% 0           0% 0         0% 0         0%
link          readdir     readdirplus  fsstat      fsinfo
0             0% 0         0% 5           50% 3         30% 1         10%
pathconf      commit
1             10% 0         0%

Client NFSv4:
calls          badcalls
18             0
null          access       close        commit       create
0             0% 2         5% 0           0% 0         0% 0         0%
deletpurge   delegreturn  getattr     getfh       link
0             0% 0         0% 9           21% 4         9% 0         0%
lock         lockt       locku       lookup      lookupp
0             0% 0         0% 0           0% 4         9% 0         0%
nverify      open        openattr    open_cfm    downgrade
2             5% 0         0% 0           0% 0         0% 0         0%
putfh        putpubfh    putrootfh   read        readdir
12           28% 0         0% 2           5% 0         0% 4         9%
readlink     remove      rename      renew       restorefh
0             0% 0         0% 0           0% 0         0% 0         0%
savefh       secinfo    setattr     setclid    clid_cfm
0             0% 0         0% 0           0% 2         5% 2         5%
verify       write      rlse_lockowner
0             0% 0         0% 0           0%

Unicode Support service is used.

```

Figure 11. Displaying NFS client NFS statistical information

In this example:

Operand

Description

calls

Specifies the total number of NFS calls sent.

badcalls

Specifies the total of NFS calls rejected by a server.

Figure 12 on page 103 shows the output from **nfsstat** command using the **-s** option to display ALL of the z/OS NFS Server (RPC, NFSv2, NFSv3, NFSv4) statistical information.

```

# /usr/lpp/NFS/nfsstat -s

GFSC857I z/OS Network File System Server : (MVSNFS)
Server RPC:
calls          badcalls      nullrecv      badlen         xdrcalls
69130          0              0              0              0
dupreqs
0

Server NFSv2:
calls          badcalls
26678          0
null           getattr       setattr       root           lookup
0              0% 3519         13% 264          1% 0            0% 9616         36%
readlink       read           writecache    write
208            1% 4148         15% 0             0% 3647         14% 487          2%
remove         rename         link           symlink        mkdir
1212           4% 724          3% 412           1% 312          1% 118          0%
rmdir          readdir        fsstat
119            0% 388          1% 1504          6%

Server NFSv3:
calls          badcalls
20019          0
null           getattr       setattr        lookup         access
0              0% 0            0% 753           4% 9123         45% 2424         12%
readlink       read           write          create
208            1% 1058         5% 941           5% 488          2% 118          0%
symlink        mknod         remove         rmdir          rename
312            1% 0            0% 1214          6% 119          0% 725          4%
link           readdir        readdirplus    fsstat         fsinfo
412            2% 419          2% 0             0% 1508         7% 1            0%
pathconf       commit
1              0% 195          1%

Server NFSv4:
calls          badcalls
22433          0
null           access        close          commit         create
0              0% 8109         8% 1039          1% 189          0% 430          0%
deleypurge     delegreturn   getattr        getfh          link
0              0% 0            0% 28423         30% 9559         10% 412          0%
lock           lockt         locku          lookup         lookupp
1028           1% 59           0% 1038          1% 7878         8% 145          0%
nverify        open          openattr       open_cfm       downgrade
2707           3% 1041         1% 0             0% 6            0% 0            0%
putfh          putpubfh      putrootfh      read           readdir
22843          24% 0            0% 1             0% 1138         1% 1686         2%
readlink       remove        rename         renew          restorefh
208            0% 1331         1% 724           1% 1            0% 1334         1%
savefh         secinfo       setattr        setclid        clid_cfm
2054           2% 0            0% 752           1% 1            0% 1            0%
verify         write         rlse_lockowner
0              0% 1180         1% 15            0%
cb_null        cb_compound   cb_getattr     cb_recall
0              0% 0            0% 0             0% 0            0%

```

Figure 12. Displaying all of the z/OS NFS Server (RPC, NFSv2, NFSv3, NFSv4) statistical information

Figure 13 shows the output from the nfsstat command using the -m option to display the server and path name of each NFS mounted file system.

```

# nfsstat -m

mvshost1:"/hfs/sj/sjpl" is mounted on /sj/sjpl/host1 filesystem NFS_MNT1
mvshost1:"/hfs/sj/sjpl2" is mounted on /sj/sjpl/host2 filesystem NFS_MNT2

```

Figure 13. Displaying NFS mounted file system information

Figure 14 shows the output from the `nfsstat` command using the `-m` option to display the server name, path name, and attributes of mount point `/mnt` using the version 3 protocol with `secure(udp)`.

```
# tso -t "mount type (NFS) filesystem(nfs1) mountpoint('/mnt') parm('mvshost1:/hfs/home/hain,secure(udp),vers(3)')"
mount type (NFS) filesystem(nfs1) mountpoint('/mnt') parm('mvshost1:/hfs/home/hain,secure(udp),vers(3)')

# nfsstat -m /mnt

server mvshost1
path /hfs/home/hain,secure(udp),vers(3)

hard      vers(3)      proto(udp)   secure(udp)
timeo(7)  retrans(3)  rpcbind(y)   accesschk(y)
delim(NA) xlat(n)     cln_ccsid(1047)  srv_ccsid(819)
convserv(LRE) stringprep(n) llock(y)
rsize(32768) wsize(32768) readahead(8) delaywrite(16)
acregmin(3)  acregmax(60) acdirmin(30)  acdirmax(60)
datacaching(y) attrcaching(y) retry(10)     dynamicresizeadj(y)
```

Figure 14. Displaying NFS mounted file system information with `secure(udp)` (Versions 2 and 3 protocol only)

Figure 15 shows the output from the `nfsstat` command using the `-m` option to display the server name, path name, and attributes of mount point `/mnt` using the version 4 protocol with a public mountpoint.

```
# tso -t "mount type(NFS) filesystem(nfs1) mountpoint('/mnt') parm('sjvm5151:/hfs/u/public,public')"
mount type(NFS) filesystem(nfs1) mountpoint('/mnt') parm('sjvm5151:/hfs/u/public,public')

# /usr/lpp/NFS/nfsstat -m /mnt
server sjvm5151
path /hfs/u/public,public

hard public vers(4)      proto(tcp)
timeo(7) retrans(3)  rpcbind(y)   accesschk(y)
delim(NA) xlat(n)     cln_ccsid(1047)  srv_ccsid(819)
convserv(LRE) stringprep(n) llock(n)     syncwrite(n)
rsize(32768) wsize(32768) readahead(8) delaywrite(16)
acregmin(3)  acregmax(60) acdirmin(30)  acdirmax(60)
datacaching(y) attrcaching(y) retry(10)     dynamicresizeadj(y)
```

Figure 15. Displaying NFS mounted file system information with public mountpoint (Version 4 protocol only)

Displaying server mount information—`showmount`

Use the `showmount` command to display the remote NFS server mount information. If you omit the options, the default option displays hostnames of all remote mounts from the hostname NFS server. If you omit the `hostname` parameter, then the local hostname is used.

The following `showmount` command displays all remote mounts in the format `hostname:directory` from the local hostname NFS server.

```
showmount -a
```

The following `showmount` command displays only the directory names of all the remote mounts from the local `hostname` NFS server.

```
showmount -d
```

The following example shows the output from the `showmount` command using the `-a` option to display all mounts in the format `hostname:directory` from the hostname `mvshost`.

```
# showmount -a mvshost
mvshost.sanjose.ibm.com:/IBMUSER
usera.sanjose.ibm.com:/USER2
```

The following example shows the output from the showmount command using the -d option to display only the directory names of all mounts from the hostname mvshost.

```
# showmount -d mvshost
/IBMUSER
/USER2
```

The following example shows the output from the showmount command with no option specified. To only display the hostnames of all remote mounts from the hostname mvshost.

```
# showmount mvshost
mvshost.sanjose.ibm.com
usera.sanjose.ibm.com
```

The following example shows the output from the showmount command using the -e option to display the exported directories from the hostname aix_server1.

```
USER1:/u/user1:>showmount -e aix_server1
Export list for host aix_server1:
/home/u/guest/test (everyone)
/usr/lpp/info      (everyone)
/tmp               (everyone)
```

The following example shows the output from the showmount command using the -e option to display the exported directories from the hostname mvshost. In this case, mvshost has the site attribute set to *security(none)*.

```
# showmount -e mvshost
No exported file systems for host MVSHOST
```

The following examples show the output from the showmount command using the -e option to display the exported directories from the hostname mvshost. In this case, mvshost has the site attribute set to *security(safexp)*.

```
# showmount -e mvshost
Export list for host MVSHOST:
/IBMUSER          user1
```

Displaying default and mount point attributes—showattr

Use the **showattr** command to display the default attributes or the attributes that have been set for a specific mount point of the z/OS NFS server. If you specify a mount point, showattr shows the attributes for the mount point, including the overriding values. For descriptions of the attributes, see Chapter 9, “Initialization attributes for the z/OS NFS server,” on page 121 and “Mount command syntax and examples” on page 89.

If you omit the *hostname*, you must specify the */localpath*.

The following is an example of the showattr command.

```
showattr mvshost1 /u/smith/mnt
```

Make sure that your version of the showattr command matches the release of NFS that you are using. Otherwise, the NFS server attributes will not display.

These examples show different ways you can use the showattr command.

Figure 16 shows a showattr command with just the hostname (mvshost1 in this example) specified. The attributes for the server are displayed.

```
# showattr mvshost1

GFSA988I Remote host does not have AF_INET6 interface.

FMID HDZ222N , last APAR OA47737, last changed module: GFSA4ULU
Compiled at May 19 2015 11:23:29

z/OS Network File System Server Data Set Creation Attributes:

lrecl(8196)          recfm(vb)          blksize(0)
space(100,10)       blks                dsorg(ps)
dir(27)             unit()             volume()
recordsize(512,4K)  keys(64,0)        nonspanned
shareoptions(1,3)  mgmtclas()        dsntype(pds)
norlse              dataclas()         storclas()

z/OS Network File System Server Processing Attributes:

binary              lf                 blankstrip
nofastfilesize     retrieve           maplower
mapleaddot         executebitoff     setownerroot
attrtimeout(120)  readtimeout(90)  writetimeout(30,120)
sync               nofileextmap     xlat()
srv_ccsid(1047)   cln_ccsid(819)   notag
convserv(lre)     nordrverf        sidefile()

z/OS Network File System Server Site Attributes:

mintimeout(1)      nomaxtimeout      logout(1800)
nfstasks(8,16,8,4,4)  restimeout(48,0)
hfsprefix(/hfs)     mvsprefix(/mvs)  impprefix(mvs)
bufhigh(32M, 80%)   readaheadmax(16K)  cachewindow(112)
percentsteal(20)    maxrdforszleft(32)  logicalcache(4096G)
smf(none,off)       nopcnfsd          security(safexp,safexp,safexp)
leadswitch          sfmax(0)          nochecklist
fn_delimiter(,)     readdirtimeout(30)  hfsfbtimeout(60)
upcase              rec878            mintasks(4,8,4)
noremount           fileidsize(64)    denyrw
nonlm               nodhcp            nostringprep
leasetime(120)     nodelegation      DlyDTimeout(10)
setgid(posix)       nosymresolve      mvslogindelay(0)
nooemhsm            noalias
nfsv4domain*(tuc.stglabs.ibm.com)
public()            mvssec(sys,krb5,krb5i,krb5p)
hfssec(sys,krb5,krb5i,krb5p)  pubsec(sys,krb5,krb5i,krb5p)
id2name(callsaf)   consolemsgs(10)
```

Figure 16. Displaying attributes

If you use the terse (-t) option, the following attributes display.

```
# showattr -t mvshost1

GFSA988I Remote host does not have AF_INET6 interface.
lrecl(8196),recfm(vb),blksize(0),space(100,10),blks,dsorg(ps),dir(27),unit(),
volume(),recordsize(512,4K),keys(64,0),nonspanned,shareoptions(1,3),mgmtclas(),
dsntype(pds),norlse,dataclas(),storclas()
binary,lf,blankstrip,nofastfilesize,retrieve,maplower,mapleaddot,executebitoff,
setownerroot,attrtimeout(120),readtimeout(90),writetimeout(30,120),sync,
nofilexmap,xlat(),srv_ccsid(1047),cIn_ccsid(819),notag,convserv(1re),nordrverf,
sidefile()
mintimeout(1),nomaxtimeout,logout(1800),nfstasks(8,16,8,4,4),restimeout(48,0),
hfsprefix(/hfs),mvsprefix(/mvs),impprefix(mvs),bufhigh(32M,80%),
readaheadmax(16K),cachewindow(112),percentsteal(20),maxrdforszleft(32),
logicalcache(4096G),smf(none,off),nopcnfsd,security(safexp,safexp,safexp),
leadswitch,sfmax(0),nochecklist,fn_delimiter(,),readdirtimeout(30),
hfsfbtimeout(60),upcase,rec878,mintasks(4,8,4),noremount,fileidsize(64),denyrw,
nonlm,nodhcp,nostringprep,leasetime(120),nodelegation,DlyDTimeout(10),
setgid(posix),nosymresolve,mvslogindelay(0),nooemhsm,noalias,
nfsv4domain*(tuc.stglabs.ibm.com),public(),mvssec(sys,krb5,krb5i,krb5p),
hfssec(sys,krb5,krb5i,krb5p),pubsec(sys,krb5,krb5i,krb5p),id2name(callsaf),
consolemsgs(10)
```

Ending your z/OS session - mvslogout

Use the **mvslogout** command to disconnect from the remote NFS server host. The **mvslogout** command is only required when the **mvslogin** command was used to begin the connection.

An **mvslogout** to an z/OS user ID cancels a prior **mvslogin** to the same z/OS user ID from the same local host.

Your account is automatically logged out if it is inactive for the period of time specified in the **logout** site attribute.

The following example disconnects the client from the remote NFS server machine, *mvshost1*.

```
mvslogout mvshost1
```

Chapter 8. Initialization attributes for the z/OS NFS client

This topic contains information about the attributes that are used by the z/OS NFS client. Note that running the z/OS NFS client with attributes from a z/OS NFS release later than the current z/OS NFS release may lead to unpredictable results.

Table 13 contains directive information about this topic's contents:

Table 13. Attributes - z/OS NFS client

Section	Page
"Client attribute syntax"	"Client attribute syntax"
"Datacaching attribute" on page 116	"Datacaching attribute" on page 116
"Mount processing parameters and installation parameters" on page 118	"Mount processing parameters and installation parameters" on page 118

Client attribute syntax

Client attributes are described in Table 14.

Table 14. Client attributes

Attribute	Description
accesschk(Y N)	Specifies whether the z/OS NFS client or NFS server is to check that the user has the requested access to the file or directory. If accesschk(Y) is specified, the z/OS NFS client performs the access check. If accesschk(N) is specified, the NFS server performs the access check. The accesschk attribute default value is: Y For mounts established with system authentication (sys) N For mounts established with RPCSEC_GSS authentication (krb5, krb5i, or krb5p)
acdirmax(<i>n</i>)	Specifies the maximum lifetime in seconds of cached directory attributes. The acdirmax attribute default value is <u>60</u> .
acdirmin(<i>n</i>)	Specifies the minimum lifetime in seconds of cached directory attributes. The acdirmin attribute default value is <u>30</u> .

Table 14. Client attributes (continued)

Attribute	Description
acregmax (<i>n</i>)	<p>Specifies the maximum lifetime in seconds of cached file attributes.</p> <p>The acregmax attribute default value is <u>60</u>.</p>
acregmin (<i>n</i>)	<p>Specifies the minimum lifetime in seconds of cached file attributes.</p> <p>The acregmin attribute default value is <u>3</u>.</p>
attrcaching (<u>Y N</u>)	<p>Specifies whether to process attributes and data caching.</p> <p>If attribute caching is in effect, the z/OS NFS client maintains cache consistency with the copy of the file on the NFS server by performing the consistency check with the cached file attributes. When a file's data is read, it remains valid on the z/OS NFS client until the attribute cache is timed out or negated. If attrcaching(N) is specified, it will automatically set datacaching(N).</p> <p>The attrcaching attribute default value is:</p> <p>Y For mounts established with system authentication (sys)</p> <p>N For mounts established with RPCSEC_GSS authentication (krb5, krb5i, or krb5p)</p> <p>Note: attrcaching is not supported for Kerberos mounts (for example, krb5, krb5i, or krb5p). It is only supported for system authentication (sys) mounts. Specifying attrcaching(Y) is ignored with RPCSEC_GSS mounts.</p>
biod (<i>n</i>)	<p>Specifies the number of asynchronous block input/output (I/O) daemons.</p> <p>The BIOD daemon runs on all NFS client systems. When a user on a client wants to read or write to a file on a server, the BIOD daemon sends this request to the server. The BIOD daemon is activated during system startup and runs continuously.</p> <p>The number of daemons is based on the load the client can handle. Six to 8 daemons can handle an average load. You must run at least 1 daemon for NFS to work.</p> <p>The valid range is 1 - 32.</p> <p>The biod attribute default value is <u>6</u>.</p>
bufhigh (<i>n</i>)	<p>Specifies the storage limit for data buffers for the NFS client.</p> <p>The valid range is 4 MB to 1 GB.</p> <p>The bufhigh attribute default is <u>128</u> MB.</p>

Table 14. Client attributes (continued)

Attribute	Description
cln_ccsid(x)	<p>Specifies the coded character set identifier (CCSID) for the local mounted file system.</p> <p>The cln_ccsid attribute default is 1047 (LATIN OPEN SYSTEM EBCDIC).</p>
convserv(technique)	<p>Specifies the conversion technique-search-order that Unicode Services use for specified srv_ccsid(x) and cln_ccsid(x) code pages. <i>Technique</i> consists of up to five technique-characters corresponding to the available techniques: R, E, C, L and M. See <i>z/OS Unicode Services User's Guide and Reference</i> for detailed descriptions on these conversion techniques.</p> <p>NFS version 4 protocol (NFSv4) differs from NFSv2 and NFSv3 protocol in handling single to multiple byte conversion. Therefore, the technique-search-order that is specified in the convserv() attribute should consider the effects of the NFS protocol being used. See "Creating the conversion environment for Unicode Services" on page 174 for further details.</p> <p>The convserv default is LRE.</p>
datacaching(Y N)	<p>Specifies whether to perform data caching.</p> <p>The datacaching attribute provides finer granularity in controlling whether file data should be cached by the z/OS NFS client. By caching the file data, all subsequent references to the cached data is done locally thus avoiding the network overhead. This has more significance when obtaining data from NFS server systems that do not use UNIX access permissions for security as there is a potential security exposure allowing unauthorized users to access file data.</p> <p>The datacaching attribute default value is:</p> <p>Y For mounts established with system authentication (sys)</p> <p>N For mounts established with RPCSEC_GSS authentication (krb5, krb5i, or krb5p)</p> <p>Note:</p> <ol style="list-style-type: none"> 1. datacaching is not supported for Kerberos mounts (for example, krb5, krb5i, or krb5p). It is only supported for system authentication (sys) mounts. Specifying datacaching(Y) is ignored with RPCSEC_GSS mounts. 2. During mount, datacaching is turned off when security negotiation was attempted such that security was negotiated from sys to any of the krb flavors. 3. rsize / wsize are ignored when datacaching is turned off. 4. If attrcaching(N) is specified, it will automatically set datacaching(N).
delaywrite(n)	<p>Specifies the maximum number of disk blocks for delay write.</p> <p>The valid range is 0 - 32. The delaywrite attribute default value is 16. The blocksize is 8192. This option is valid only when datacaching=Y.</p>

Table 14. Client attributes (continued)

Attribute	Description
delim (<u>na</u> binary nl cr lf crlf lfcr)	Specifies the line delimiter for record access to remote files through the basic sequential access method (BSAM), queued sequential access method (QSAM), and Virtual Storage Access Method (VSAM).
<u>na</u>	Not specified. This value applies when the delim attribute is omitted. Note that this value must not be specified on the delim attribute. na can be specified only by omitting the delim attribute from the parameter list.
binary	Specifies the data does not have record delimiters. The access method does not add a delimiter for each record on output and treats any delimiters on input as data.
The following text options can be specified:	
cr	Specifies that records are delimited by the EBCDIC carriage return character (x'0D').
crlf	Specifies that records are delimited by the EBCDIC carriage return character followed by the EBCDIC line feed character (x'0D25').
crnl	Specifies that records are delimited by the EBCDIC carriage return character followed by the EBCDIC new line character (x'0D15').
lf	Specifies that records are delimited by the EBCDIC line feed character (x'25').
lfcr	Specifies that records are delimited by the EBCDIC line feed character followed by the EBCDIC carriage return character (x'250D').
nl	Specifies that records are delimited by the EBCDIC new line character (x'15').
<hr/> disablella (<u>Y</u> <u>N</u>)	
Specifies the disabling or enabling of Lookup Look-Aside (LLA) caching.	
The enabling of LLA cache with disablella (N) provides better performance, but may cause data integrity issues in a Shared File System sysplex or a network environment if file objects are altered by more than one system in the sysplex or network.	
The disabling of LLA cache with disablella (Y) causes more LOOKUP requests from z/OS NFS client to z/OS NFS Server, thus affecting performance but guaranteeing data integrity. This is the recommended setting in a Shared File System sysplex environment or a network environment.	
See <i>z/OS UNIX System Services File System Interface Reference</i> for further details on the use of disablella .	
<hr/> dynamicsizeadj (<u>Y</u> <u>N</u>)	
Specifies whether to perform the packet size adjustment for remote procedure call (RPC).	
The dynamicsizeadj attribute default value is <u>Y</u> .	

Table 14. Client attributes (continued)

Attribute	Description
llock(Y N)	<p>Specifies whether file locking requests are managed on your local z/OS UNIX file system or remotely on the NFS Server.</p> <p>Y the local Byte Range Lock Manager (BRLM) manages the lock.</p> <p>N The z/OS NFS Client sends various NFS Version 4 locking operations to the remote NFS Server to manage the file lock requests. The z/OS NFS Client and other participating NFS Clients can perform Byte Range Locking on the remote files at the supported NFS Server.</p> <p>The llock attribute default value is N.</p> <p>Note: This attribute is valid only for the NFS Version 4 protocol. If the NFS mounted file system is NFS Version 2 or 3 or if the NFS Server does not support the NFS Version 4 Locking then /usr/lpp/NFS/nfsstat reports llock(y).</p>
mtxtonly	<p>Specifies the minimum configuration of the z/OS NFS Client that it only supports vfs_pfsctl for bpxmtext . The z/OS NFS Client uses very little virtual memory in the minimum configuration. This attribute can only be specified in BPXPRMxx parmlib member.</p>
nfsv4domain(NFSv4_default_domain)	<p>Specifies the default domain for the NFS v4 protocol (NFSv4) name mapping.</p> <p>The nfsv4domain attribute serves for redefinition of a name of this unique domain. In accordance with RFC3530 NFSv4 attributes "owner"and "owner_group"are transferred between the client and server in the form of "user_name@domain"and "group_name@domain". The client provides the mapping of names to ID's and vice versa. <i>NFSv4_default_domain</i> identifies the user/group name space with one to one correspondence between the names and their numeric identifiers (uid's and gid's).</p> <p>z/OS NFS Client will accept as valid a set of users and groups for default domain. The client treats other domains as having no valid translations. If the nfsv4domain attribute is not used, the client uses the system-defined domain. The <i>NFSv4_default_domain</i> is converted internally to lowercase.</p> <p>Note: If NFS4DOMAIN attribute is not specified, the z/OS NFS Server represents the system-defined domain was used by appending an asterisk (*) to "nfsv4domain*" in the "showattr" command output.</p> <p>For further details on NFSv4 name mapping, see "NFS v4 protocol name mapping" on page 217.</p>

Table 14. Client attributes (continued)

Attribute	Description
proto(tcp udp)	<p>Specifies the transport protocol for the NFS client to communicate with the NFS server. By default, the NFS client selects the proto and vers with the following priorities:</p> <ol style="list-style-type: none"> 1. proto(tcp) and vers(4) 2. proto(tcp) and vers(3) 3. proto(udp) and vers(3) 4. proto(tcp) and vers(2) 5. proto(udp) and vers(2) <p>Note:</p> <ol style="list-style-type: none"> 1. proto(udp) is functionally equivalent to secure(udp) 2. proto(udp) is mutually exclusive with the vers(4) parameter. proto(udp) is valid only for the NFS Version 2 and Version 3 protocols. 3. If proto(tcp) and secure(udp) are both in effect as mount parameters, proto(tcp) is ignored.
public	<p>Forces the use of the public file handle when connecting to the NFS server.</p> <p>This option is valid only during mount processing. The public keyword is valid only for the NFS version 4 protocol.</p>
readahead(<i>n</i>)	<p>Specifies the maximum number of disk blocks to read ahead.</p> <p>The block size is 8192 bytes. The valid range is 0 - 16.</p> <p>The readahead attribute default value is <u>1</u>.</p>
retrans(<i>n</i>)	<p>Specifies the number of times to retransmit the NFS remote procedure calls (RPC).</p> <p>The valid range is 0 - 1000.</p> <p>The retrans attribute default value is <u>3</u>.</p> <p>This option is valid only when soft and proto(udp) are specified.</p>
retry(<i>n</i>)	<p>Specifies the number of times to retry the mount operation.</p> <p>The valid range is 0 - 20,000.</p> <p>The retry attribute default value is <u>10</u>.</p> <p>This option is valid only during mount processing.</p>
rsize(<i>n</i>)	<p>Sets the read buffer size in <i>n</i> bytes.</p> <p>The valid range for <i>n</i> is 1 - 64 KB.</p> <p>For NFS NFSv2 mounts, the rsize attribute default value is <u>8192</u>.</p> <p>For NFSv3 or NFSv4 mounts, unless atrcaching / datacaching is set to no, the rsize attribute value is negotiated between the z/OS NFS client and the NFS server.</p> <p>The maximum read buffer size supported by the z/OS NFS client is 64 KB.</p>

Table 14. Client attributes (continued)

Attribute	Description
rpcbind(Y N)	<p>Specifies whether the target NFS server platform supports the RPCBIND protocol, so the NFS client will not have to attempt to use the RPCBIND protocol if that protocol is not supported. The default is rpcbind(Y), to indicate that RPCBIND is supported. If N is specified, the z/OS NFS Client will immediately use the PORTMAPPER protocol instead. This keyword has no effect if the client system is not enabled for IP version 6 (IPv6).</p> <p>The rpcbind default value is <u>Y</u>.</p>
secure(sys krb5 krb5i krb5p udp)	<p>Specifies the transport protocol for the NFS client to use to bind reserved (privileged) ports when communicating to the NFS server.</p> <p>Note:</p> <ol style="list-style-type: none"> 1. secure(sys) uses the system authentication. 2. secure(krb5) provides Kerberos V5 based integrity on the RPC credentials (but not data) and uses the RPCSEC_GSS service of <code>rpc_gss_svc_none</code>. secure(krb5) is valid only for the NFS Version 4 protocol. 3. secure(krb5i) provides Kerberos V5 based integrity on both the RPC credentials and data and uses the RPCSEC_GSS service of <code>rpc_gss_svc_integrity</code>. secure(krb5i) is valid only for the NFS Version 4 protocol. 4. secure(krb5p) provides Kerberos V5 based integrity and privacy on both the RPC credentials and data. It uses the RPCSEC_GSS service of <code>rpc_gss_svc_privacy</code>. secure(krb5p) is valid only for the NFS Version 4 protocol. 5. secure(udp) is functionally equivalent to proto(udp). 6. If secure(udp) is specified, proto(tcp) is ignored and the NFS client uses udp as the transport protocol to communicate with the NFS server. 7. secure(udp) is mutually exclusive with the vers(4) parameter. secure(udp) is valid only for the NFS Version 2 and Version 3 protocols. <p>During mount when <code>sys,krb5,krb5i</code>, or <code>krb5p</code> is specified in the secure keyword, the client does not attempt a security negotiation.</p>
soft hard	<p>Returns an error if the NFS server does not respond or continues to retry the NFS remote procedure call (RPC) until the NFS server responds.</p> <ul style="list-style-type: none"> • If hard is specified, the NFS remote procedure call (RPC) is retried until the NFS server responds. • If soft is specified, an error is returned if the NFS server does not respond. The maximum number of retries is specified with the retrans option. <p>This option is valid for all NFS RPCs under the mount point.</p>
srv_ccsid(x)	<p>Specifies the coded character set identifier (CCSID) for the remote mounted file system.</p> <p>The srv_ccsid attribute default value is <u>819</u> (ISO 8859-1 ASCII).</p>

Table 14. Client attributes (continued)

Attribute	Description
stringprep(Y N)	Specifies whether z/OS NFS Client is to enable or disable stringprep normalization. Stringprep normalization is the NFS version 4 globalization function for converting inbound strings to UTF-8 format. The stringprep attribute default value is <u>N</u> .
syncwrite(Y N)	Specifies whether the z/OS NFS Client sends implicit v4COMMIT or STABLE v4Write operation to NFS servers. If you specify N , the z/OS NFS Client does not send implicit v4COMMIT or STABLE v4Write operations to the NFS server. In this case, if an NFS server crashes and restarts, then all uncommitted data is lost. The syncwrite attribute default value is <u>Y</u> .
timeo(n)	Sets the remote procedure call (RPC) timeout to <i>n</i> tenths of a second. The timeo attribute default value is <u>7</u> .
vers(2 3 4)	Specifies the NFS protocol version that the client uses to communicate with the NFS server. If no version is specified, the z/OS NFS client communicates with the NFS server at the highest protocol level that is supported by the server.
wsiz(e)n	Sets the write buffer size to <i>n</i> bytes. The valid range for <i>n</i> is 1 - 64 KB. For NFSv2 mounts, the wsiz(e)n attribute default value is <u>8192</u> . For NFSv3 or NFSv4 mounts, unless attrcaching / datacaching is set to no , the wsiz(e)n attribute value is negotiated between the z/OS NFS client and the NFS server. The maximum write buffer size supported by the z/OS NFS client is 64 KB.
xlat(Y N)	If Y is specified, the data in all the files are text and the NFS client performs data conversion according to the cln_ccsid and srv_ccsid parameters. The xlat attribute default value is <u>N</u> and should be used for binary data.

Datacaching attribute

Security checking is done on the Network File System server to determine whether the requesting client user is authorized to access the data. On UNIX systems, this is done by validating the client's user ID and group ID against the file's permission codes. If the authorization checking is successful, the file data is returned to the z/OS NFS client system. Further authorization checking for subsequent access to the cached data or for other client users is done on the z/OS NFS client system.

For z/OS conventional MVS data set access through the z/OS NFS server, the user is required to present their z/OS credentials which are checked by the z/OS security system, such as RACF, before file data is returned. Since the z/OS system does not maintain UNIX style permission codes for MVS data sets, the z/OS NFS server returns a code indicating that anyone can access the file. This is done since passing any lesser access code to the client would result in the client user not being allowed to use the cached data which was already read. When the file data is cached on the z/OS NFS client system and another client user on this system attempts to access the same file data, the z/OS NFS client checks the returned permission codes to validate access. Since the z/OS NFS server has passed a code which allows anyone access to the file, all users on the client system can access the cached data without further restrictions. If data caching is turned off, no client caching takes place and each user must pass the server security check.

Based on the installation time out values, the file data cached by the client is flushed and further attempts to access the file data again requires passing server authorization.

The installation **datacaching** parameter can be set and it can be overridden for each mount point so that different mount points can be handled as required for the files under that mount point.

Note:

1. attrcaching and datacaching are not supported for Kerberos mounts (for example, krb5, krb5i, or krb5p). It is only supported for system authentication (sys) mounts.
2. datacaching is turned off whenever there is a security negotiation from sys to any of the krb flavors during mount.
3. If attrcaching(N) is specified, it will automatically set datacaching(N).

If the potential security exposure can not be tolerated for sensitive file data, the **datacaching** should not be used so that no file data is cached by the z/OS NFS client.

Mount processing parameters and installation parameters

Table 15 shows the client attributes that can be modified when used as parameters on the MOUNT command.

Table 15. Mount processing parameters

Mount processing parameters	
acdirmax(n)	public
accesschk(Y N)	readahead(n)
acdirmin(n)	retrans(n)
acregmax(n)	retry(n)
acregmin(n)	rpcbind(Y N)
attrcaching(Y N)	rsize(n)
cln_ccsid(n)	secure(krb5 krb5i krb5p udp)
convserv(UNICODE technique)	stringprep(Y N)
datacaching(Y N)	srv_ccsid(n)
delaywrite(n)	syncwrite(Y N)
delim (na binary nl cr lf crlf lfcr)	timeo(n)
dynamicsizeadj(Y N)	vers(2 3 4)
hard soft	wsize(n)
llock(Y N)	xlat(Y N)
proto(tcp udp)	

Table 16 shows installation parameters.

Table 16. Installation parameters

Installation parameters	
attrcaching(Y N)	dynamicsizeadj(Y N)
biod(n)	llock(Y N)
bufhigh(n)	mtxtonly
cln_ccsid(n)	readahead(n)
convserv(UNICODE technique)	rpcbind(Y N)
datacaching(Y N)	secure(krb5 krb5i krb5p udp)
delaywrite(n)	srv_ccsid(n)
delim (binary nl cr lf crlf lfcr)	stringprep(Y N)
disablella(Y N)	syncwrite(Y N)
	xlat(Y N)

The following conditions may cause the NFS client to fail its initialization:

- The NFS client is not started in a stand-alone colony address space.
- The NFS client is already started; multiple instances of the NFS client on a single z/OS system are not supported.
- Invalid parameter is specified in the installation parameters.
- If Unicode exists, then Unicode is used. If Unicode does not exist and Character Data Representation Architecture (CDRA) exists, then CDRA is used. If both Unicode and CDRA do not exist, then initialization fails.

A WTO message is issued to the operator console if the NFS client fails to initialize.

NFS client translation support

Table 17 contains NFS client attributes. See Table 22 on page 138 for more information about considerations for native ASCII environment support.

Table 17. z/OS NFS clients with non-z/OS based NFS servers

Client Attributes Specified	Mount Option	Read	Write
xlat(Y), cln_ccsid,srv_ccsid	No TAG specified	NFS client does translation	NFS client does translation
xlat(N)	TAG(TEXT,CCSID)	Logical file system does translation	Logical file system does translation
xlat(Y)	TAG(TEXT,CCSID)	Mount will fail	Mount will fail

Notes:

1. The logical file system will do translation when the **mount tag** option is specified. It will do translation based on the process tag (calling application) and file tag (if the file tag is not zeros or untagged). Otherwise, the system will do translation based on the process tag and **mount tag** for the CCSID information.
2. It is assumed that the user doing the mount knows the files being accessed from the remote non-z/OS file systems. So the CCSID needs to be set accordingly. Data written to the server will be stored in a specific CCSID format. To read it back correctly, the correct CCSID must be specified (for example, without it being translated with the wrong CCSID).

For more information about client mount options, see Chapter 6, "Commands and examples for AIX and UNIX clients," on page 65 and Chapter 7, "Commands and examples for z/OS NFS clients," on page 81.

z/OS NFS client with z/OS NFS server

Both the client and server operate as described in "NFS client translation support" and "NFS servers with non-z/OS based NFS clients" on page 138.

In order to avoid double translation, the mount to the server must specify the correct **cln_ccsid** (server option) and the client TSO MOUNT command should not have the **tag** option. The client mount option **xlat(N)** should be specified so that only the server will do translation (if needed) and return the data in the correct CCSID.

```
mount filesystem(NFS001) type(nfs) mountpoint('/u/nfsdir')
      parm('mvsnfs:"/hfs/u/user,text,cln_ccsid(2000)",xlat(N)')
      vi /u/nfsdir/file1
```

** Translation will be done by the server only based on file1's file tag and cln_ccsid of 2000.

In all other cases, double translation may occur as the server will do translation based on its file tag and **cln_ccsid** settings and the logical file system will do translation based on the process tag and the CCSID in the **mount tag** option. Caution must be used as double translation may result in the data becoming garbage.

Chapter 9. Initialization attributes for the z/OS NFS server

This topic contains information about the attributes that are used to manipulate files in the z/OS NFS server. Note that running the z/OS NFS server with attributes from a z/OS NFS release later than the current z/OS NFS release may lead to unpredictable results.

Table 18 contains directive information about this topic's contents.

Table 18. Attributes - z/OS NFS server

Section	Modification	Description	Page
"Data set creation attributes syntax" on page 122	Data set creation attributes can be modified by the client	Data set creation attributes provide information about an MVS file to the z/OS NFS server, such as the type of file, or how the file is allocated (for example, blocks, cylinders, or tracks)	"Data set creation attributes syntax" on page 122
"Processing attributes syntax" on page 127	Processing attributes can be modified by the client	Processing attributes provide information to the z/OS NFS server about how to handle the file, such as how long the files remain open, or whether the files are processed in text or binary format	"Processing attributes syntax" on page 127
"Site attributes syntax" on page 139	Site attributes can only be modified by the system administrator	Site attributes control the z/OS NFS server resources	"Site attributes syntax" on page 139

Attributes used for z/OS UNIX file access

These attributes are specific to the following z/OS UNIX file access.

- **alias**
- **hfs(prefix)**
- **hfsprefix(prefix)**
- **sync** and **async**
- **extlink**

These attributes are relevant to accessing the following z/OS UNIX files as well as z/OS conventional MVS data sets.

- **impprefix(opt1, opt2)**
- **restimeout** - Resource timeout
- **logout** - User log time out
- **security** - Security checking
- **text** - ASCII to EBCDIC data conversion and vice versa
- **binary** - No ASCII and EBCDIC
- **xlat** - Customized translation table

This attribute is relevant to accessing z/OS conventional MVS data sets.

- `mvsprefix(prefix)`

Multipliers

Instead of entering the entire numeric values for the attributes, you can use the multipliers K (1024), M (1024 × 1024), or G (1024 × 1024 × 1024). For example, entering 10M is the same as entering 10,485,760.

Duplicate attributes

Specifying an attribute several times on a line does not cause an error. The line is read from left to right, and the last of any duplicate attribute is used. For example:

```
$ vi "file,recfm(vb),recfm(fb)"
```

This results in a file created with a fixed-blocked format.

Data set creation attributes syntax

The data set creation attributes are used to define the structure of MVS data sets when creating a file. These attributes correspond to the data control block (DCB) or the job control language (JCL) parameters used to define an MVS data set when it is created. See *z/OS MVS JCL Reference* for more information about data set creation attributes.

The data set creation attributes do not apply for z/OS UNIX files.

Table 19 describes data set creation attributes. Defaults are underlined **in this format**. You can override these attributes by using the **mount** command or file creation command. For PDS and PDSE, members have the same attributes as the data set attributes, so the file creation attributes specified for members are ignored.

Table 19. Data set creation attributes

Data Set Creation Attribute	Description
<u>blks</u>	Specifies that disk space is allocated by blocks, except for VSAM data sets. See the space attribute in this table.
cyls	Specifies that disk space is allocated by cylinders.
recs	Specifies that disk space is allocated by records for VSAM data sets. The blks and recs attribute values are identical for VSAM data sets.
trks	Specifies that the disk space is allocated by tracks.

blksize(0 | quan)

Specifies the maximum length, in bytes, of a physical block on disk. The value of *quan* can range from **0** (the default value) to 32,760. If `blksize(0)` is specified, the system determines an optimal block size to use.

System determined block size is not supported by the system for Direct Access (DA) data sets. z/OS NFS Server uses the following formula to calculate the block size for a DA data set depending on the record format:

F		FB	blksize = lrecl
V		VB	blksize = lrecl + 4
VS		VBS	blksize = 6160

Table 19. Data set creation attributes (continued)

Data Set Creation Attribute	Description
dataclas (<i>class_name</i>)	<p>Specifies the data class associated with the file creation. The <i>class_name</i> must be defined to DFSMS before it can be used by the client. The system-managed storage automatic class selection (ACS) routine must also assign a storage class to the file being created. If a data class is not specified in the attribute file, dataclas() is displayed by the showattr client enabling command.</p> <p>For more information about data classes, see <i>z/OS DFSMSdfp Storage Administration</i>.</p>
dir (<u>27</u> <i>quan</i>)	<p>Specifies the number of 256-byte records needed in the directory of a PDS. Use the dir attribute with the mkdir command when you create a PDS.</p> <p>The value of <i>quan</i> can range from 1 to 16,777,215. The default value is <u>27</u>. The maximum number of PDS members is 14,562.</p>
dsntype (<i>library</i> <u>pds</u>)	<p>Specifies whether a PDSE or a PDS is to be created when the mkdir client command is used.</p> <p>The following options can be specified.</p> <p>library Specifies partitioned data set extended (PDSE)</p> <p>pds Specifies partitioned data set (PDS)</p> <p>You cannot create a PDS (or PDSE) within another PDS (or PDSE).</p> <p>For more information about creating a PDS or a PDSE, see <i>z/OS DFSMS Using Data Sets</i>.</p>
dsorg (<i>org</i>)	<p>Specifies the organization of a data set.</p> <p>The following <i>org</i> values can be specified.</p> <p>da Direct data set</p> <p>indexed VSAM KSDS data set</p> <p>nonindexed VSAM ESDS data set</p> <p>numbered VSAM RRDS data set</p> <p>ps Physical sequential (ps) data set</p> <p>The dsorg attribute is ignored for directory-oriented client commands.</p> <p>If you are using VSAM data sets in binary mode, then nonindexed is recommended.</p>

Table 19. Data set creation attributes (continued)

Data Set Creation Attribute	Description
keys (<i>len, off</i>)	<p>Specifies the length and offset of the keys for VSAM KSDS data sets. The keys attribute can only be specified when using dsorg(indexed).</p> <p>The <i>len</i> and <i>off</i> values are specified in bytes.</p> <p><i>len</i> Specifies a value between 1 and 255. The default value is <u>64</u>.</p> <p><i>off</i> Specifies a value between 0 and 32,760. The default value is <u>0</u>.</p> <p>When you create a VSAM KSDS data set, the records you are loading into it must be keyed-sequenced or the write fails. Each write of the data set is treated like a first load, and requires that the records being loaded are in ascending key sequence.</p>
lrecl (<u>8196</u> <i>quan</i>)	<p>The value of <i>quan</i> specifies a record length.</p> <ol style="list-style-type: none"> 1. Length, in bytes, for fixed-length records. 2. Maximum length, in bytes, for variable-length records. If the blksize attribute is specified, the value must be at least 4 bytes less than the blksize quantity. <p>The value of <i>quan</i> can range from 1 to 32,760. The default value is <u>8196</u>.</p>
mgmtclas (<i>mgmt_class_name</i>)	<p>Specifies the management class associated with the file creation. The <i>mgmt_class_name</i> must be defined to DFSMS/MVS before it can be used by the client. The system-managed storage automatic class selection (ACS) routine must also assign a storage class to the file being created. If a management class is not specified in the attribute file, mgmtclas() is displayed by the showattr client enabling command.</p> <p>For more information about management classes, see <i>z/OS DFSMSdfp Storage Administration</i>.</p>

Table 19. Data set creation attributes (continued)

Data Set Creation Attribute	Description
recfm (<i>cccc</i>)	<p>Specifies the format and characteristics of the records in the data set. The value of <i>cccc</i> can be 1 to 4 characters, in one of the following combinations.</p> <p>[f fb fs fbs] [a m]</p> <p>u [a m]</p> <p>[v vb vs vbs] [a m]</p> <p>The following are valid record format characters.</p> <p>a ANSI control codes</p> <p>b Blocked</p> <p>f Fixed-length records</p> <p>m Machine control codes</p> <p>s Spanned for variable records, standard format for fixed records</p> <p>u Undefined-length records</p> <p>v Variable-length records</p> <p>The recfm format characters v, f and u are mutually exclusive. The recfm format characters a and m are mutually exclusive. The format character s is not allowed for a PDS or PDSE.</p>
recordsize (<i>avg,max</i>)	<p>Specifies the average and maximum record size for VSAM data sets. The <i>avg</i> and <i>max</i> values are specified in bytes. They can each range from 1 to 32,760.</p> <p>The default values are 512 and 4K, respectively. These values must be equal for VSAM RRDS.</p>
rlse	<p>Specifies that unused space should be released from the data set the first time a new data set is closed. For slow clients with long pauses between writes, the rlse attribute causes space to be released from the primary extent prematurely. Any additional writes will cause secondary space to be allocated.</p>
<u>norlse</u>	<p>Specifies that unused space should not be released from the data set.</p>
shareoptions (<i>xreg,xsys</i>)	<p>Specifies the cross-region and cross-system share options for a VSAM data set.</p> <p>The value of <i>xreg</i> ranges from 1 to 4.</p> <p>The value of <i>xsys</i> is either 3 or 4.</p> <p>The default values are 1 and 3, respectively.</p> <p>For more information, see "Sharing VSAM Data Sets" in <i>z/OS DFSMS Using Data Sets</i></p>

Table 19. Data set creation attributes (continued)

Data Set Creation Attribute	Description
spanned	<p>This applies to VSAM data sets only. For spanned records of non-VSAM data sets, see the entry for the recfm attribute in this table.</p> <p>Specifies that VSAM KSDS or ESDS data sets can contain records that span control intervals (spanned records).</p>
nonspanned	<p>Specifies that data sets do not have spanned records.</p>
space (<i>prim</i> [, <i>aux</i>])	<p>Specifies the amount of primary and auxiliary space allocated for a new data set on a direct access volume.</p> <p>The value of <i>prim</i> is the number (from 0 to 16,777,215) of primary tracks, cylinders, or data blocks in the data set.</p> <p>The value of <i>aux</i> (optional) is the number (from 0 to 16,777,215) of additional tracks, cylinders, or blocks allocated if more space is needed.</p> <p>If the space attribute is not specified, the default is used. The default values are 100 and 10, respectively.</p>
storclas (<i>class_name</i>)	<p>Specifies the storage class associated with the file creation. The <i>class_name</i> must be defined to the DFSMS efore it can be used by the client. If a storage class is not specified in the attribute file, storclas() is displayed by the showattr client enabling command.</p> <p>For more information about storage classes, see <i>z/OS DFSMSdfp Storage Administration</i>.</p>
unit (<i>unit_name</i>)	<p>Specifies the unit on which to create a data set. The <i>unit_name</i> is a generic or symbolic name of a group of DASD devices. The <i>unit_name</i> must be specified as 3390 for extended format data sets. If a side file name is not specified in the attribute file, unit() is displayed by the showattr client enabling command.</p> <p>Note:</p> <ol style="list-style-type: none"> 1. You cannot create or access tape data sets on an z/OS host using the z/OS NFS server. 2. You cannot create extended format data sets with the z/OS NFS server, except using ACS routines.
vol (<i>volser</i>) or volume (<i>volser</i>)	<p>Specifies the name of the DASD volume to use to store the created data set. volume or vol is the keyword, and the value of <i>volser</i> represents the volume name. If a volume is not specified in the attribute file, volume() is displayed by the showattr client enabling command.</p> <p>If a data set is system-managed, as determined by the DFSMS automatic class selection (ACS) routines, you can omit this attribute.</p>

Processing attributes syntax

Processing attributes are used to control how files are accessed by the client.

Table 20 describes processing attributes. Defaults are underlined **in this format**. You can override the default processing attributes on the mount command or file processing commands.

Table 20. Processing attributes

Processing Attribute	Description
alias	Indicates that the exports file can contain exports with the "alias" keyword. An alias for an export will allow an NFS client, using NFS protocol version 4, to mount or navigate across the entire export path with a single lookup. If the mount using alias also contains the "mvsmnt" processing attribute, the mount will be recorded in the Mount Handle Database with the alias in the pathname, such that upon NFS server restart, the alias will be detected and the corresponding export entry to be reevaluated. The alias site attribute MUST be provided to use this feature.
<u>noalias</u>	Indicates that any alias keywords in the exports file will not be processed (though they may be interpreted for proper logic, they will not be retained for mount processing). This is the default. See Appendix F, "Sample exports data set," on page 525 for sample entries description.

attrtimeout(n)

The time (in seconds) that the data set remains allocated after a **lookup** or **getattr** server operation.

The default value of *n* is 120. The value of *n* can range from 1 to 32,767 (9 hours, 6 minutes, and 7 seconds).

Note:

1. The **attrtimeout** value is normally greater than the **readtimeout** or **writetimeout** values.
2. With NFS version 2 and version 3 protocols, the lookup operation searches for a file in the current directory. If it finds the file, **lookup** returns information on the file's attributes and a file handle pointing to the file. With NFS version 4, neither the file's attributes nor the file handle are returned. The file handle is saved by the server and used as an anchor for accessing the file.
3. When using the NFS version 4 protocol, the **attrtimeout** value should be set to a value less than or equal to the lease time. Otherwise, it is possible for performance problems to occur when attempting to access MVS data sets.
4. With NFS version 2 and version 3 protocols, the data set may be closed/deallocated before the timeout value has been reached if the data set has been requested by another application if the **delegation** site attribute or modify operator command V4DELG=on is specified.

noattrtimeout

The data set is not deallocated after a **lookup** or **getattr** operation.

For more information, see "Timeout attributes" on page 135.

Table 20. Processing attributes (continued)

Processing Attribute	Description
<u>binary</u>	Indicates that the data set is processed between the client and server using binary format and no data conversion occurs between ASCII and EBCDIC formats.
text	<p>Converts the contents in the data set between EBCDIC and ASCII formats. Use this format to share text data between clients and z/OS applications.</p> <p>In text mode, the following attributes apply only to z/OS MVS data sets:</p> <ul style="list-style-type: none"> • <u>blankstrip</u> and noblankstrip. (See the entry for <u>blankstrip</u> in this table.) • End-of-line terminators (cr, crlf, lf, lfcr, or noeol) are used to indicate the MVS logical record boundary. (See the entry for lf in this table. See “Text processing mode” on page 35 for rules of coding EOL terminators by the z/OS NFS server. See the xlat attribute in this table for customized EBCDIC-ASCII tables.)
<u>blankstrip</u>	<p>With text mode, strips trailing blanks from the end of each record of a fixed-length text file when the file is read. Trailing blanks pad the end of each file or record when a text file is written.</p>
noblankstrip	<p>Does not strip trailing blanks from the end of fixed-length records when a fixed-length text file is read. Does not pad records when writing a text file. The file must be of the correct size or an I/O error is reported to the client.</p> <p>For information about the text attribute, see the entry for <u>binary</u> in this table.</p> <p>This attribute does not apply to z/OS UNIX files.</p>
	<p>With text mode, use one of the following end-of-line specifiers.</p> <p>cr Carriage Return is the end-of-line terminator.</p> <p>crlf Carriage Return followed by Line Feed is the end-of-line terminator (standard DOS).</p> <p><u>lf</u> Line Feed is the end-of-line terminator (standard AIX or UNIX).</p> <p>lfcr Line Feed followed by Carriage Return is the end-of-line terminator.</p> <p>noeol No end-of-line terminator.</p> <p>For information about the text attribute, see the entry for <u>binary</u> in this table.</p> <p>This attribute does not apply to z/OS UNIX files.</p>
cln_ccsid(<i>n</i>)	<p>Specifies the coded character set identifier (CCSID) for the remote mounted file system (NFS client) when text is being translated.</p> <p>The default value of <i>n</i> is <u>819</u> (ISO 8859-1 ASCII).</p>

Table 20. Processing attributes (continued)

Processing Attribute	Description
convserv (<i>technique</i>)	<p>Specifies the conversion technique-search-order that Unicode Services will use for specified srv_ccsid(x) and cln_ccsid(x) code pages. <i>Technique</i> consists of up to five technique-characters corresponding to the available techniques: R, E, C, L and M. See <i>z/OS Unicode Services User's Guide and Reference</i> for detailed descriptions on these conversion techniques.</p> <p>NFS version 4 protocol (NFSv4) differs from NFSv2 and NFSv3 protocol in handling single to multiple byte conversion. Therefore, the technique-search-order specified in the convserv() attribute should consider the effects of the NFS protocol being used. See "Creating the conversion environment for Unicode Services" on page 174 for further details.</p> <p>The default value of <i>technique</i> is LRE.</p>
executebiton	<p>Sets the execute permission bits in user, group, and other (as reported with the ls AIX or UNIX command) for a mount point's files. Use when storing executable or shell scripts on the z/OS system.</p> <p>This option can only be overridden on a mount point basis — not at a command level.</p> <p>The executebiton attribute does not apply to z/OS UNIX files and can only be used with the mount command.</p>
executebitoff	<p>Does not set execute bits in user, group, and other for the mount point's files. This value is normally used in the site file.</p>
extlink	<p>Specifies the use of the external link command to create, process, and delete a symbolic link to an MVS data set.</p> <p>The extlink attribute is used with the following commands.</p> <p>ln -s Create a symbolic link to an MVS data set.</p> <p>ls -l Display the attributes and contents of the symbolic link.</p> <p>rm Delete the symbolic link.</p> <p>The extlink attribute only applies to z/OS UNIX file objects. If extlink is not specified then it is not displayed by the showattr client enabling command.</p>
fastfilesize	<p>Specifies to get the file size from SPF statistics, if it exists, for direct data sets, PDSs, and non-system-managed data sets.</p>
nofastfilesize	<p>Specifies to read the entire file or member to get the file size for direct data sets, PDSs, PDSEs, and non-system-managed data sets. Using the nofastfilesize attribute might cause a noticeable delay when first accessing very large data sets.</p> <p>These attributes apply to MVS data sets, but do not apply to z/OS UNIX files.</p> <p>For more information, see "Using fastfilesize to avoid read-for-size" on page 485.</p>

Table 20. Processing attributes (continued)

Processing Attribute	Description
fileextmap	Enables file extension mapping. The fileextmap attribute can be specified at the file command level for the client platforms that support passing of attributes. See "File extension mapping" on page 40 for related information.
nofileextmap	Disables file extension mapping.
mapleaddot	Enables mapping of a single leading "." from a client file name to a legal leading "\$" on z/OS. The mapleaddot attribute should normally be enabled for access by AIX and UNIX clients.
nomapleaddot	Disables mapping of a single leading "." from a client to a leading "\$" on z/OS. These attributes do not apply to z/OS UNIX files.
maplower	Enables mapping of lower case file names to upper case when accessing files on z/OS, and back to lower case when sending to the network. This option only affects file names (high-level qualifiers and user catalog aliases). When using this option, avoid file names that are unique on UNIX-type file systems only because of case-sensitivity (for example, File and file), as these types of file names are mapped to the same upper case name by the NFS Server (for example, FILE) and are treated as the same file. Note: This attribute does not apply to z/OS UNIX files. Note: Unpredictable behavior can be expected if maplower is used with PDS/PDSe datasets containing mixed or lowercase members.
nomaplower	Disables mapping of lower case file names to upper case and back to lower case when using files on z/OS; file names are processed as presented to the NFS Server and will preserve any lower case characters used. Note: This attribute does not apply to z/OS UNIX files.
mapped	The mapped attribute should be specified at the mount or site level when a mixed set of data types is to be processed under a single mount point. The determination of whether the data is to be processed as text or binary depends on the rules that are established in the specified side file. See "File extension mapping" on page 40 for related information. If a file extension is not mapped to text or to binary using the side files, then the data will be processed according to what has been specified at the mount or site level (binary or text). If binary or text is specified at the file command level, that overrides the mapped specification. If mapped is not specified then it is not displayed by the showattr client enabling command.

Table 20. Processing attributes (continued)

Processing Attribute	Description
mvsmnt	<p>It is highly recommended that the mvsmnt processing attribute be specified on all NFS Version 4 user mount commands issued to the z/OS NFS server for three reasons.</p>
	<ol style="list-style-type: none"> 1. In NFS Version 4, mount requests are passed to the server in the form of a PUTROOTFH operation followed by a sequence of lookup operations. The mvsmnt processing attribute indicates to the z/OS NFS server that the associated lookup operation is emulating a mount procedure and causes the z/OS NFS server to write the mount point to the mount handle database (MHDB), so the z/OS NFS server can automatically recover the mount point during a server restart. Without the specification of the mvsmnt attribute, the z/OS NFS server must rely on the mount being restored via the FHEXPIRED error mount recovery process between the server and client after the server restart.
	<p>Note: Some clients may not be able to recover from an FHEXPIRED error. See “Implicit prefix support restrictions” on page 11 for an important note about the recovery of mount points after z/OS NFS server restart when there has been a change to the prefix site attributes.</p>
	<ol style="list-style-type: none"> 2. If the mvsmnt, or any other, processing attribute is not specified, then saf checking may be disabled longer than desired due to the z/OS server's inability to detect the end of the mount and the beginning of other access requests. However, access is allowed only to information necessary for the completion of mount related processing, and any non-mount related operations are always processed with full SAF enforcement. This behavior is required to avoid requiring an mvlogin to be issued prior to mount processing. The EXPORT file may be used to restrict access to file systems, regardless of the specification of any processing attribute.
	<p>Note: The mvsmnt attribute must not be specified when mounting a path that contains a symbolic link whose underlying real path can change between z/OS NFS server instances, unless the alias feature is also used in the mount command, and the export entry includes the symlink as part of the exported path. Without the alias feature, the specification of the mvsmnt attribute will prevent the z/OS NFS server from recognizing the underlying real path change upon restart; with alias, the alias portion will be recorded as part of the Mount Handle Database record, and the corresponding export entry will be reevaluated with the updated symbolic link location.</p>
	<ol style="list-style-type: none"> 3. For any LOOKUPS that do not specify MVSMNT, any processing attributes that may have been provided will be merged with any that were in effect for the LOOKUP parent directory before applying to this LOOKUP.
	<p>For LOOKUPS that <i>do</i> specify MVSMNT, any other processing attributes provided will be merged with the site defaults before applying to this LOOKUP. MVSMNT cannot be specified for any LOOKUP where the parent directory was navigated to by a mount procedure or a result of an object that was already LOOKUP'ed with MVSMNT. This is to ensure that only a client system mount specifies MVSMNT.</p>
	<p>mvsmnt is not displayed by the showattr client enabling command.</p>

Table 20. Processing attributes (continued)

Processing Attribute	Description
overflow	<p>Specifies x37 detection support for PS/PDS MVS data sets for NFS Version 2, Version 3, and Version 4 WRITE operations. It allows ENOSPACE errors to be reported to the NFS Client in a timely manner and to avoid situations when the z/OS NFS Server closes a data set on timeout expiration basis with x37 abend which can not be propagated to the NFS Client. This option may also be activated on the MOUNT level. Default mode is no overflow detection, and is not displayed by the showattr client enabling command..</p> <p>Note: PDSE and VSAM data sets are not supported.</p>
nordrcache	<p>Specifies that the server should not stale the legacy (MVS z/OS conventional data) internal readdir cache if an addition is made to the directory. This causes the next READDIR operation to access the directory information from the Physical File System (PFS) rather than the internal readdir cache.</p> <p>The default value is nordrcache and is not displayed by the showattr client enabling command.</p> <p>The nordrcache attribute does not apply to z/OS UNIX files.</p> <p>When nordrcache is not specified, the addition of an entry to the legacy internal readdir cache will not be visible to the client until the next readdir cache timeout or a remove from that directory. When nordrcache is specified, the addition will be visible to the client by the subsequent READDIR, whether the readdir cache timeout has expired or not. This may impair performance because the directory list must be read from the Physical File System after any addition to the cached directory. When nordrcache is specified, if no changes are made to the internal readdir cache, the cache does remain available until the readdir cache timeout expires.</p>
nordrverf	<p>Specifies not to perform cookie verifier checking for the NFS version 3 readdir and readdirplus procedures, and the NFS version 4 readdir procedure.</p> <p>Note: nordrverf does not provide consistency in the listing of a directory's content and may cause duplicate or omit entries when the directory is changing during the listing.</p>
rdrverf	<p>Specifies to perform cookie verifier checking for the NFS version 3 readdir and readdirplus procedures, and the NFS version 4 readdir procedure.</p> <p>Note: rdrverf provides consistency in the listing of a directory content and, as a result, may impact performance.</p>
readtimeout(<i>n</i>)	<p>The readtimeout attribute specifies the amount of time in seconds before a data set is released after a read operation.</p> <p>The value of <i>n</i> can range from 1 to 32,767 (9 hours, 6 minutes, and 7 seconds). The default value of <i>n</i> is <u>90</u>. The server closes the file when the file times out.</p> <p>The readtimeout attribute does not apply to z/OS UNIX files.</p> <p>Note: When using the NFS version 4 protocol, the readtimeout value should be set to a value less than or equal to the lease time. Otherwise, it is possible for performance problems to occur when attempting to access MVS data sets.</p>
noreadtimeout	<p>Specifies the data set is not deallocated after a read operation.</p> <p>For more information, see "Timeout attributes" on page 135.</p>

Table 20. Processing attributes (continued)

Processing Attribute	Description
	<p>The z/OS NFS server uses DFSMSHsm to recall or delete migrated files. The action that the server takes against migrated files depends on which of the retrieve or noretrieve attributes is active.</p> <p>The retrieve and noretrieve attributes do not apply to z/OS UNIX files.</p>
retrieve	<p>When the retrieve attribute is active, the server will recall the migrated file if necessary, upon an NFS_LOOKUP request for the file, depending on the files status.</p> <p>The server may be able to obtain the migrated files attributes without recall (see "Retrieve attributes" on page 136 for additional information). If not, the recall operation is started by the server. The server waits for the recall operation to complete if the file resides on DASD. If the file does not reside on DASD, the server does not wait for the recall operation to complete and returns a "device not available" message. You can attempt accessing the file again later when the recall is complete.</p>
retrieve(wait)	<p>When the retrieve(wait) attribute is active, the server waits for the recall to finish.</p>
retrieve(nowait)	<p>When the retrieve(nowait) attribute is active, the server does not wait for the recall to finish, and immediately returns a "device not available" message. You can attempt accessing the file again later when the recall is complete.</p>
noretrieve	<p>When the noretrieve attribute is active, the server does not recall the file, and returns "device not available" upon an NFS_LOOKUP, NFS_READ, or NFS_CREATE request for a migrated data set.</p> <p>For more information, see "Retrieve attributes" on page 136.</p>
setownerroot	<p>Specifies that z/OS NFS server return root user authority as the owner of a z/OS MVS data set when the client is logged on as superuser. setownerroot does not grant root authority for a UID=0 user, instead see the mvlogin command or the root keyword in the exports file.</p> <p>The setownerroot attribute can only be used with the mount command and does not apply to z/OS UNIX files.</p>
setownernobody	<p>Specifies setting the user ID in a file's attributes to nobody (65534), for a superuser.</p>

Table 20. Processing attributes (continued)

Processing Attribute	Description
sidefile (<i>dsname</i>)	<p>Specifies the name of the data set that contains the rules for file extension mapping purposes. If a side file name is specified in the attributes data set, then it is used as the default side file for the NFS server. A user can also specify an additional side file name during a mount operation to be used along with the default. The mapping rules will first be searched in the side file specified during the mount command and then the default side file is searched. To allow file extension mapping, a side file name must be specified either as a default or in the mount command. The value of <i>dsname</i> is a fully-qualified MVS data set name without quotation marks. See “File extension mapping” on page 40 for related information.</p> <p>If a side file name is not specified in the attribute file or in the mount command, sidefile() is displayed by the showattr client enabling command.</p>
srv_ccsid (<i>n</i>)	<p>Specifies the coded character set identifier (CCSID) for the local mounted file system (NFS server) when a new file is being created.</p> <p>The srv_ccsid attribute has no effect on the translation of an existing file's data.</p> <p>The default value of <i>n</i> is <u>1047</u> (LATIN OPEN SYSTEM EBCDIC).</p> <p>If the srv_ccsid attribute is not specified, new z/OS UNIX files will continue to be created as untagged.</p>
sync	<p>Specifies that data transmitted with the write request should be committed to nonvolatile media (for example, DASD) by the server immediately when received.</p>
async	<p>The user can alternatively specify the async processing attribute to get improved performance. When this attribute is specified, the data will be committed asynchronously.</p> <p>The sync async attribute only applies to z/OS UNIX file objects and only for the NFS version 2 protocol.</p>
tag	<p>Specifies that the newly created files should receive a file tag.</p>
notag	<p>Specifies that the newly created files should not receive a file tag. The tag is set to 0x0000.</p> <p>See “Native ASCII processing attributes” on page 137 and Table 22 on page 138 for considerations when using the tag and notag processing attributes.</p>

Table 20. Processing attributes (continued)

Processing Attribute	Description
writetimeout(<i>n,o</i>)	<p>Specifies the amount of time <i>n</i>, in seconds, before a data set is released after a write operation and the amount of time <i>o</i>, in seconds, that the server will wait for data to arrive to complete a partial record before closing the data set.</p> <p>The value of <i>n</i> can range from 1 to 32,767 (9 hours, 6 minutes, and 7 seconds). The default value of <i>n</i> is <u>30</u>.</p> <p>The value of <i>o</i> can range from <i>n</i> to 255 * <i>n</i>. The default value of <i>o</i> is <u>120</u>.</p> <p>The server closes the file when the file times out. All cached buffers are forced to disk. Normally writetimeout values are kept short because write operations result in exclusive locking. However, for slow client machines with long pauses between writes, you should increase the writetimeout value.</p> <p>The server will use the <i>o</i> value to extend the writetimeout value for a data set processed in text or binary mode in the case of a partial record (no end-of-line terminator discovered in the record or RPC WRITE data was lost in the network) on a WRITE operation to delay file closing and wait for the record completion data to arrive, so that the server is able to correctly process the partial record.</p> <p>The writetimeout attribute does not apply to z/OS UNIX files.</p> <p>Note: When using the NFS version 4 protocol, the writetimeout value should be set to a value less than or equal to the lease time. Otherwise, it is possible for performance problems to occur when attempting to access MVS data sets.</p>
nowritetimeout	<p>Specifies that the data set is not deallocated after a write operation.</p> <p>For more information, see "Timeout attributes."</p>
xlat(<i>member_name</i>)	<p>Specifies how to override the installation default translation table during file processing. The <i>member_name</i> is the member name of the PDS or PDSE that contains the customized translation table.</p> <p>The system administrator defines this member name in the attribute data set, and PDS or PDSE in the startup procedure. The xlat attribute is ignored if specified on the command line.</p> <p>If a customized translation table is not specified in the attribute file or in the mount command, xlat() is displayed by the showattr client enabling command.</p>
znfsclient	<p>Specifies that the NFS client is a z/OS NFS client. The z/OS NFS server uses this attribute to customize its response to the NFS client.</p> <p>Note: Do not specify this attribute. This attribute is automatically appended to the processing attribute string by the z/OS NFS client when it detects that it is sending the mount request (or the last LOOKUP for an NFS version 4 mount) to a z/OS NFS Server. znfsclient is not displayed by the showattr client enabling command.</p>

Timeout attributes

The values of the following attributes depend on the settings of the associated site attributes:

attrtimeout, **readtimeout**, and **writetimeout** – These attributes must be within the ranges specified by the **maxtimeout** and **mintimeout** site attributes.

Note: When using the NFS version 4 protocol, these timeout values should be set to a value less than or equal to the lease time. Otherwise, it is possible for performance problems to occur when attempting to access MVS data sets.

noattrtimeout, **noreadtimeout** and **nowritetimeout** – These attributes are valid only when **nomaxtimeout** is specified in the site attributes.

There are three processing attributes which control when files are timed out: **attrtimeout**, **readtimeout**, and **writetimeout**. The server determines which of these timeouts are in effect based on the last file operation. Thus when an existing file is appended, the file cannot be accessed before it times out in the time specified for **writetimeout** and is released by the server, because write operations result in exclusive locking. Similarly, if a file is read, it is not released before it times out in the time specified for **readtimeout** seconds.

The **readtimeout** and **writetimeout** attributes do not apply to the MVS data set or member being opened by NFS version 4 OPEN operation because there is a stateful CLOSE operation that closes and releases the data set or member.

The **readdirtimeout** site attribute controls the internal **readdir** cache used by directory lookups of MVS z/OS conventional data sets to be timed out or discarded based on a customizable value. The default is 30 seconds.

Retrieve attributes

The server deletes the migrated file upon an NFS_REMOVE request for a file, regardless if the **retrieve** or the **noretrieve** attribute is active. Typically, an NFS_REMOVE request is preceded by an NFS_LOOKUP request. If the data set was migrated with DFSMS/MVS 1.2 or earlier, the retrieve attribute causes a recall because NFS_LOOKUP processing needs to open the data set and read for size. If the data set was migrated under DFSMS/MVS 1.3 and DFSMSshm 1.3, and is SMS managed, its attributes were saved on DASD; therefore it is not always necessary to recall the data set to read for size and the data set may be deleted without recall. If the **noretrieve** attribute is active, the NFS_LOOKUP can return a “device not available” message. If the client code decides to ignore the error and issue the NFS_REMOVE, the migrated file is then deleted.

The UNIX command **ls mvshost** does not issue requests for individual files under the **mvshost** directory. Migrated files under the **mvshost** directory are displayed, but are not recalled. However, the UNIX command **ls -l mvshost** issues NFS_LOOKUP requests for individual files under the **mvshost** directory.

Mapped keyword processing attribute

Table 21 contains mapped and existing keyword information.

Table 21. The mapped keyword and existing keywords

SFMAX	SIDEFIL(NAM)	MAPPED	ACTION
=0	X		Data processed using existing rules for binary/text
	I	Don't care	Server won't come up
	M		MOUNT will fail

Table 21. The mapped keyword and existing keywords (continued)

SFMAX	SIDFILE(NAME)	MAPPED	ACTION
1-2000	I + M	SET	File extension used in the MOUNT-specified side file and then the site-specified side file. If an extension is not found, the existing rules for binary/text will be used.
		NOT SET	Data processed using existing rules for binary/text
	I	SET	File extension used in the site-specified side file. If an extension is not found, the existing rules for binary/text will be used.
		NOT SET	Data processed using existing rules for binary/text
	X	Don't care	Data processed using existing rules for binary/text
	M	SET	File extension used in the mount-specified side file. If an extension is not found, the existing rules for binary/text will be used.
NOT SET		Data processed using existing rules for binary/text	

Legend:

I = side file specified in installation table

M = side file specified in mount command

X = no side file specified

Native ASCII processing attributes

The **cln_ccsid(n)** and **srv_ccsid(n)** attributes can be specified either as installation defaults or at mount time for more granularity between different mount points. Unless **srv_ccsid** is specified either as an installation default or at mount time, newly created files will not have any file tag set (that is, the file tag is all zeros). These two attributes affect translation only when text processing is involved and only when an existing file has a nonzero or a nonbinary file tag.

Special attention must be paid to the different server attributes specified. See Table 17 on page 119 and Table 22 on page 138.

Considerations for native ASCII environment support

For applications running on z/OS V1R2 (and higher), a native ASCII environment is provided for z/OS UNIX file processing.

In this environment, applications can operate on files in either EBCDIC or ASCII format as well as other data formats defined with a coded character set identifier (CCSID) without translation, provided the data is already defined and stored in the data format wanted.

For the z/OS NFS server to operate properly on z/OS UNIX files in this environment, consider the following important factors:

- Unicode Services must be installed and set up on the system to let the NFS server use it for text translation. With the NFS version 4 protocol, z/OS NFS conversion of UTF-8 text data and metadata requires setting up a conversion environment using the z/OS Unicode Services by creating a Unicode conversion image that defines conversion tables with UTF-8 [CCSID 1208].
- Two processing attributes, **cln_ccsid** and **srv_ccsid**, are available for the NFS server for translation purposes as well as for the creation of new files. The

srv_ccsid attribute determines the CCSID of newly created z/OS UNIX files. If **srv_ccsid** is not specified as an installation default or at mount time, then new files continue to be created as untagged, or with a tag of 0x0000 and the old translation method of using translation tables specified by the **xlat** keyword applies.

- Processing (read/write) of tagged files depends on the different server options specified.

NFS servers with non-z/OS based NFS clients

Table 22 contains NFS server options (file tagging with Unicode Services active).

Table 22. File tagging with Unicode Services active

Server Options Specified	File Tag	Read	Write	Create
text,notag ⁴	Untagged or Tag=0x0000 or Tag=0xFFFF	Translation using the current xlat tables	Translation using the current xlat tables	New file created with Tag=0x0000
text,notag	Yes	xlat using Src=FileTag and Tgt=cln_ccsid	xlat using Src=cln_ccsid and Tgt=FileTag	N/A (file exists)
text,cln_ccsid,srv_ccsid,notag ¹²	Untagged or Tag=0x0000 or Tag=0xFFFF	xlat using Src=srv_ccsid and Tgt=cln_ccsid	xlat using Src=cln_ccsid and Tgt=srv_ccsid	New file created with Tag=0
text,cln_ccsid,srv_ccsid,notag	Yes ³	xlat using Src=FileTag and Tgt=cln_ccsid	xlat using Src=cln_ccsid and Tgt=FileTag	N/A (file exists)
text,tag	Untagged or Tag=0x0000 or Tag=0xFFFF	xlat using Src=site attribute srv_ccsid and Tgt=cln_ccsid ¹⁰	xlat using Src=cln_ccsid and Tgt=site attribute srv_ccsid ¹⁰	New file created with Tag=srv_ccsid ²
text,tag	Yes ³	xlat using Src=FileTag and Tgt=cln_ccsid	xlat using Src=cln_ccsid and Tgt=FileTag	N/A (file exists)
binary,notag ⁶	Untagged or Tag=0x0000 or Tag=0xFFFF	No translation	No translation	New file created with Tag=0x0000
binary,notag	Yes ¹³	No translation	Fail operation	N/A (file exists)
binary,tag	Untagged or Tag=0x0000 or Tag=0xFFFF	No translation	No translation	If ccscid on mount, Tag=srv_ccsid else Tag=0xFFFF
binary,tag	Yes ¹³	No translation	If FileTag!=srv_ccsid fail op else no xlat	N/A (file exists)

Table 22. File tagging with Unicode Services active (continued)

Server Options Specified	File Tag	Read	Write	Create
<p>Notes:</p> <ol style="list-style-type: none"> Writing to a file that has a tag that is different from the <code>srv_ccsid</code> (regardless whether the file is empty or not) will result in the file tag overriding the specified <code>srv_ccsid</code> when text is specified. If <code>srv_ccsid</code> is specified (as an installation default or at mount), then the file is created with the <code>srv_ccsid</code> tag. Otherwise an untagged file is created. <code>xlat</code> is ignored when the file being accessed is tagged. <code>xlat</code> is optional. For untagged files, translation is done using default <code>xlat</code> tables, or custom <code>xlat</code> tables (if specified). There is no facility in the NFS server to change an existing file tag. This must be done outside the NFS server. Specifying the binary option overrides any <code>cln_ccsid</code> and <code>srv_ccsid</code> specified. All files created by the server when text and <code>srv_ccsid</code> are specified will also have the <code>TXTFLAG</code> set to <code>ON</code>. The NFS file tagging function assumes that Unicode Services is installed and activated on the system (available as of OS/390 V2.8). If Unicode Services is not activated, only the <code>NOTAG</code> option is valid <ol style="list-style-type: none"> If the <code>TAG</code> option is specified in the site attributes, the NFS server start-up will fail. If the <code>TAG</code> option is specified on the <code>mount</code> command, the mount will fail. File create and write are atomic operations. A file is created before it can be written. Thus, a file always already exists when it is written, and the attributes are used accordingly. For reading or writing untagged files when in text, <code>TAG</code> mode, NFS uses the default server <code>CCSID</code> from the site attribute file. Any <code>srv_ccsid</code> values specified on the mount command will be ignored for reading or writing files in this case. The mount <code>srv_ccsid</code> will still be used for file creation however. If <code>TAG</code> is specified in site attribute file, the site attribute <code>srv_ccsid</code> and <code>cln_ccsid</code> are always used for translating file names. If <code>TAG</code> is specified in site attribute file but Unicode Services is not active, the NFS server will shut down. If <code>NOTAG</code> is specified in the site attribute file, the site attribute <code>xlat(table)</code> is always used for translating file names. These <code>CCSIDs</code> must be specified on the mount. 				

Table 23 contains NFS server options (file tagging with Unicode Services not active).

Table 23. File tagging with Unicode Services not active

Server Options Specified	File Tag	Read	Write	Create
text,notag	Untagged or Tag=0x0000 or Tag=0xFFFF	Translation using the current <code>xlat</code> tables	Translation using the current <code>xlat</code> tables	New file created with Tag=0x0000
text	Yes	Translation using the current <code>xlat</code> tables	Fail operation	N/A (file exists)
binary,notag	Untagged or Tag=0x0000 or Tag=0xFFFF	No translation	No translation	New file created with Tag=0x0000
<p>Note: The <code>TAG</code> option is not valid if the Unicode Services are not active.</p> <p>To support the correct use of Unicode Services the <code>CONVSERV</code> processing attribute is added. The values of this attribute defines the technique search order, or how Unicode Services processes specified code pages. See "Creating the conversion environment for Unicode Services" on page 174 for descriptions of the values.</p> <p>The value of this attribute should exactly concur with the value of the technique search order, that was used during the current Unicode Image generation.</p>				

Site attributes syntax

You can use the site attributes to control z/OS NFS server resources.

Table 24 describes the site attributes. Defaults are underlined **in this format**. Some initial settings are shown, but the system administrator might have changed these settings, so use the **showattr** command to show the actual settings being used. The site attributes cannot be modified by client users.

Table 24. Site attributes

Site Attribute	Description
bufhigh (<i>xx</i> , <i>yy</i>)	<p>Specifies the below-the-2GB bar virtual storage limit for data buffers on z/OS NFS Server. When this maximum limit of allocated buffer storage is reached buffer reclamation is initiated (see the percentsteal attribute in this table).</p> <p><i>xx</i> the high water mark data buffer storage limit (in bytes, KB, or MB). The valid range is 1 to 2047 MB.</p> <p>The default storage limit (<i>xx</i>) is 32 MB.</p> <p>A higher storage limit (<i>xx</i>) means more caching, and potentially better read performance.</p> <p><i>yy</i> the watermark in percent of the storage limit (<i>xx</i>) for printing a data buffer utilization alert message. The valid values are 0 (which turns off the data buffer utilization reporting mechanism) and from 50 to 90. If no percentage (<i>yy</i>) value is specified, a default value of 80 percent is used. If an invalid value is specified for the percentage (<i>yy</i>), the default value is used.</p> <p>At z/OS Server startup, the actual value (<i>xx</i>) specified with bufhigh may be adjusted by the z/OS NFS Server internally depending on the available region size and other z/OS NFS Server memory requirements to enable the z/OS NFS Server to execute properly.</p> <p>Within limits, the bufhigh values can be changed while the z/OS NFS Server is running with the MODIFY operator command (see the bufhigh operand in "Entering operands of the modify command for the z/OS NFS server" on page 235).</p> <p>The bufhigh attribute does not apply to z/OS UNIX files.</p>
cachewindow (<i>n</i>)	<p>Specifies the window size used in logical I/O to buffer NFS Clients' RPC WRITES received out of order. The value of <i>n</i> is a number from 1 to 2048 (the default is 112). The cachewindow attribute does not apply to z/OS UNIX files. The cachewindow attribute is ignored if the server-adjusted logicalcache is greater than 2GB. The suggested value is some small multiple of the number of BIODs running on a client. The general rule in setting the <i>n</i> value of cachewindow(<i>n</i>) is</p> $n = ((\textit{num of BIOD} + 1) * (\textit{client_max_IO_buffer_size} / \textit{transfer_size}))$ <ul style="list-style-type: none"> <i>num of BIOD</i> is the number of blocked I/O daemons set by the client workstation. This value is usually set to defaults at the installation of the operating system or by your system administrator. <i>client_max_IO_buffer_size</i> is the amount of I/O data requested by the client (for example, client writes 8192 bytes of data to the remote file system). This value is determined by your application programs. <i>transfer_size</i> is the actual size of data being sent across the network (for example, the 8192 bytes of data can be broken down to 16 smaller packets of 512 bytes (16x512=8192)). This value is determined dynamically by your client workstation.

Table 24. Site attributes (continued)

Site Attribute	Description
checklist	When specified, the server bypasses saf checking (even when saf or safexp is specified) for the list of files and directories underneath mount points which either matches a mount point entry or is a child of a mount point entry specified on the dirsuf parameter in the exports data set. CHECKLIST is only valid if SAF checking is the security option for the particular data access; otherwise, it is ignored even if it is specified. See GFSAPEXP in NFSSAMP library for a sample exports data set.
nochecklist	When specified, the server operates as before and ignores the information that is specified on the dirsuf parameter in the exports data set.
chkloop (on off)	This attribute controls the usage of NFS error loop detection facility. z/OS NFS server is able to detect a loop situation, to identify the remote client system causing the loop and to issue an adequate exploitable warning console message GFSA1036. on NFS error loop detection facility is enabled for z/OS NFS server. off NFS error loop detection facility is disabled for z/OS NFS server. The default is off .
consolemsgs(n ALL)	Specifies the number of messages for NFS operator commands: LIST=MOUNTS, LIST=DSNAMES, LISTLOCK will print on console. Full output can be found in NFS log. Valid range of <i>n</i> is 10 to 100. Default value of <i>n</i> is <u>10</u> . If "ALL" option is specified, all messages will be printed on the console.
delegation	When specified, the server temporarily delegates management of a file's resources to an NFS client for NFS Version 4. When a file's management is delegated to an NFS client, all file access requests can be managed locally by the NFS client while the file is delegated.
nodelegation	When specified, the server does not delegate management of a file's resources to an NFS client for NFS Version 4.
denyrw	When specified, the server honors deny requests for file share reservations (the Windows Share_Deny value) from the NFS client. The deny requests may be specified on an NFS V4 Open operation or an NLM_share RPC.
nodenyrw	When specified, the server ignores deny requests from NFS clients (the Windows Share_Deny value), and treats the requests as if deny_none were specified.

Table 24. Site attributes (continued)

Site Attribute	Description
dhcp	When specified, the server accepts dynamic IP addresses for the NFS client, using the dynamic host configuration protocol (dhcp). The client system must have a static host name and must dynamically update the DNS server with their IP address changes.
<u>nodhcp</u>	When specified, the server supports only NFS clients that use a static IP address.
<hr/>	
DlyDTimeout(n)	<p>Specifies the minimum delay detection time value in sec before the delay detection mechanism observes a delay in an external call/function and prints message GFSA1030E on the console.</p> <p>Valid values are 0 and a range of 5 to 60 seconds. Any value of DlyDTimeout from 1 to 4 seconds is converted to 5 seconds. If DlyDTimeout is set to 0 the delay detection mechanism is turned off. The default value is 10 seconds.</p>
<hr/>	
fileidsize(n)	<p>Specifies how to control the handling of fileid sizes by the NFS server in NFS objects. Fileids may be recognized either as 32-bit or 64-bit addresses.</p> <p>Valid values are 32 and 64.</p> <p>The default value is fileidsize(64).</p> <p>Note: fileidsize(32) is applicable to NFS version 2/3/4 while fileidsize(64) is only applicable to NFS version 4.</p> <p>Client platforms often copy the returned NFS 64 bit object fileid to internal structure fields such as a UNIX inode. For instance UNIX system function stat/fstat returns a result in the structure stat, which has field st_ino defined as u_int32. Older 32-bit applications and operating systems may not support NFS fileids larger than 32 bits (that is, not zero high 32 bit word) resulting in 'value too large' errors or unexpected client behavior.</p>
<hr/>	

Table 24. Site attributes (continued)

Site Attribute	Description
----------------	-------------

fn_delimiter

Specifies a character 'c' to be used as a delimiter between the file name and the attributes that follow it. This capability allows those sites that have UNIX data sets containing commas to copy and store their data on the NFS server. The following example specifies the default delimiter as a semicolon:

```
fn_delimiter(;
```

So a user can process a file called 'comma,in-name' by entering:

```
vi "comma,in-name;text,lf"
```

Note:

1. If the comment symbol was set as ";" with the *altsym* keyword and the `fn_delimiter(;` attribute uses semicolon then the `fn_delimiter semicolon` will be treated as a delimiter between the file name and the attributes that follow, not as a comment symbol.

2. It is admissible to use the semicolon as the comment symbol after the right parenthesis if the *altseq* keyword is used.

3. The following example shows allowable multi-line syntax:

```
fn_delimiter \  
(;) ; the second semicolon is the comment symbol if altseq kwd is used
```

(;) must be located on one line.

A user can also include a default file name delimiter as a comma as follows:

```
fn_delimiter(,
```

fn_delimiter(,

The default file name delimiter is a comma.

hfs(prefix) or hfsprefix(prefix)

Specifies a z/OS UNIX file system *prefix* to be imbedded in the mount directory path name. The default value of the z/OS UNIX file system prefix is **/hfs**. Mount requests received by the z/OS NFS server beginning with the z/OS UNIX file system prefix value are identified as mount requests for z/OS UNIX. The z/OS UNIX file system prefix value is not part of the path name.

Note:

1. *hfsprefix* is preferred and should be used in future updates, but *hfs* is still accepted.
2. The z/OS UNIX file system must already be mounted locally by z/OS UNIX. Otherwise, the client mount request will fail.
3. The prefix value can only be 7 characters or less including the beginning "/"
4. The prefix value is case insensitive. It is always folded to upper case.

Table 24. Site attributes (continued)

Site Attribute	Description
hfsbtimeout(<i>n</i>)	<p>Specifies how to control the timeout of the z/OS UNIX vnode token used by the NFS server. The timeout value controls how long before <i>vnode tokens</i> saved in file blocks are released.</p> <p>The valid range is 1 to 32,767 seconds.</p> <ul style="list-style-type: none"> • The value of <i>n</i> can go as low as 1 second but to avoid the possibility of the client hanging (because of network delays). The value of <i>n</i> is not recommended to be lower than 5 second. • The value of <i>n</i> may need to be increased if the network is slow and the accessed directory has a lot of entries. <p>The hfsbtimeout attribute default value is 60 seconds.</p>
hfssec(<i>krb5,krb5i,krb5p,sys</i>)	<p>Specifies the acceptable network transmission levels of security which can be used as the authentication flavor on NFS version 4 requests for accesses to z/OS UNIX files. This attribute is only used when not overridden by authentication specifications in the exports file. Multiple values for this attribute can be specified using the comma as delimiter. The following are the supported values:</p> <p>krb5 Provides Kerberos V5 based integrity on the RPC credentials (but not data), when the RPC authentication flavor is RPCSEC_GSS and uses the RPCSEC_GSS service of <code>rpc_gss_svc_none</code>.</p> <p>krb5i Provides Kerberos V5 based integrity on both the RPC credentials and data, when the RPC authentication flavor is RPCSEC_GSS and uses the RPCSEC_GSS service of <code>rpc_gss_svc_integrity</code>.</p> <p>krb5p Provides Kerberos V5 based integrity and privacy on both the RPC credentials and data, when the RPC authentication flavor is RPCSEC_GSS. The RPCSEC_GSS service used here is <code>rpc_gss_svc_privacy</code>.</p> <p>sys Specifies that the AUTH_SYS authentication flavor can also be used to access this file system. Note that the AUTH_SYS authentication flavor does not provide any integrity or privacy protection.</p> <p>The hfssec attribute default is hfssec(sys,krb5,krb5i,krb5p).</p> <p>Note: File systems that require integrity or privacy protection over network transmissions of data should explicitly specify the desired settings. Do not rely on the default settings, because the default settings allow for RPC accesses using the AUTH_SYS authentication flavor, which does not provide any integrity or privacy protection.</p>
id2name(cache callsaf)	<p>Controls the usage of Uid/Gid cache for uid/gid numbers to/from owner/group names conversion. The caching of the most recently used pairs of (uid, owner) and (gid, group) reduces SAF calls.</p> <p>cache Uid/Gid Cache is enabled for z/OS NFS server.</p> <p>callsaf Uid/Gid Cache is disabled for z/OS NFS server and it calls SAF each time to do the conversion.</p> <p>This attribute affects only NFS version 4. The default is "callsaf".</p>

Table 24. Site attributes (continued)

Site Attribute	Description
impprefix (<i>impprefix</i>)	<p>Specifies how to interpret a mount path name that does not have a path type prefix, where <i>impprefix</i> is one of the following:</p> <p>NONE An explicit prefix must always be specified for an absolute path. Implicit prefix resolution is not valid in this case.</p> <p>HFS If no explicit prefix is present, assume the path is a z/OS UNIX file system.</p> <p>MVS If no explicit prefix is present, assume the path is an MVS high-level qualifier. This is the default.</p> <p>HFS, MVS If no explicit prefix is present, first assume the path is a z/OS UNIX file system. If no matching z/OS UNIX file system can be found, assume that it is an MVS high-level qualifier.</p> <p>MVS, HFS If no explicit prefix is present, first assume the path is an MVS high-level qualifier. If no matching high level qualifier can be found, assume that it is a z/OS UNIX file system.</p> <p>Note:</p> <ol style="list-style-type: none"> 1. For the "MVS,HFS" setting, MVS selection requires that at least one MVS data set exists in the system catalog with the specified High Level Qualifier (HLQ). 2. The "MVS" setting, results in equivalent implicit prefix processing to releases prior to V1R11; that is, z/OS UNIX requires a prefix and MVS does not. However, an MVS prefix can still be specified on path names. 3. Since NFS v4 mount processing is performed one qualifier at a time, when 2 options are specified, the object existence test for determining whether to move on to the second option is based on the first path name qualifier only. If it exists, then the first option is selected and that cannot change if a later qualifier is not found.
leadswitch	<p>Specifies that the server returns '/' as the first character in each export entry.</p>
noleadswitch	<p>Specifies that the server will not return '/' as the first character in each export entry.</p> <p>The leadswitch attribute is ignored for z/OS UNIX file objects.</p>

Table 24. Site attributes (continued)

Site Attribute	Description
leasetime(<i>n</i>)	<p>Specifies the length of time (the lease interval) in seconds that the z/OS NFS server allows clients to:</p> <ul style="list-style-type: none"> • Reclaim locks and share reservations following an NFS server restart. During this grace period, clients can reclaim locks on behalf of their users. • Remain active without communicating with the NFS server. If an NFS V4 client does not communicate with the z/OS NFS server for the length of the lease interval, its client id will expire. <p>The value of <i>n</i> can range from 5 to 3600. The specified value must be smaller than the value of the logout attribute, if logout is not set to zero. The default value is 120.</p> <p>Note: When using the NFS version 4 protocol, the leasetime value should be set to a value larger than or equal to the attrtimeout, writetimeout and readtimeout attributes. Otherwise, it is possible for performance problems to occur when attempting to access MVS data sets.</p>
logicalcache(<i>n</i>)	<p>Specifies the above-the-bar virtual storage for allocated logical cache buffers in the logical I/O processing. If <i>n</i> is greater than the available storage above-the-bar (implied by the MEMLIMIT parameter in the startup procedure) at startup, the z/OS NFS Server shuts down immediately.</p> <p>The value of <i>n</i> is an integer from 1 to 4096GB. The default value is 16M.</p> <p>The logicalcache attribute does not apply to z/OS UNIX files.</p> <p>At z/OS Server startup, the actual value (<i>n</i>) specified with logicalcache may be adjusted by the z/OS NFS Server internally depending on the available MEMLIMIT and other z/OS NFS Server memory requirements to enable the z/OS NFS Server to execute properly.</p> <ul style="list-style-type: none"> • If <i>n</i> is greater than the available storage above-the-bar after z/OS NFS Server starts its threads (which uses some memory above-the-bar due to the LE runtime THREADSTACK64 options), the Server shuts down immediately. • If <i>n</i> is less than the available storage above-the-bar after z/OS NFS Server starts its threads, then the server may increase the initial nn specification up to the smaller of 4096GB or one-half of the available storage if <i>n</i> is smaller than one-half of the available storage; or the server honors the specified nn if <i>n</i> is greater than one-half of the available storage (no expansion). • If the total number of threads in the nfsstasks attributes is X, then LE use X * 0.25MB for thread stacks (due to THREADSTACK64(256K) runtime option). If MEMLIMIT is 1024GB and there are 100 threads that initially use 25MB (100 * 0.25MB) and the logicalcache is 100MB, then the server may expand the logicalcache to 512GB.
logout(<i>n</i>)	<p>Specifies the time limit for inactivity in seconds for a given user on a client. The default value is 1800. When the limit is reached, the user is automatically logged out. The client user must enter the mvslogin command again to reestablish the client's z/OS session. This value should normally be the same as the value defined for TSO/E logout at your site. The value of <i>n</i> can range from 61 seconds to 20 megaseconds (approximately 243 days).</p>

Table 24. Site attributes (continued)

Site Attribute	Description
loopthreshold(n)	<p>This attribute specifies 'n' in decimal number of the number of NFS error repetitions required to trigger the loop detection process. That is, the Loop Detection Facility assumes a loop is in progress if the NFS error repetitions are greater than the loopthreshold value n.</p> <ul style="list-style-type: none"> • The minimum value for loopthreshold is 3. • The maximum value for loopthreshold is 99999. • Any value of loopthreshold less than 3 is converted to 3. • Any value of loopthreshold greater than 99999 is converted to 99999. <p>The default is 3.</p> <p>In a high performance environment, it may be necessary to set n to a higher value.</p>
maxrdforszleft(n)	<p>Specifies the number of physical block buffers left after determining a file's size. This operation is done for later server read requests to the same file. The buffers left are subject to trimming during a "buffer steal" operation. The value of n is an integer from 1 to 1024.</p> <p>The default value is <u>32</u>.</p>
maxtimeout(n)	<p>Specifies the maximum timeout allowed. This attribute and the mintimeout attribute define the range of values that client users can specify for attrtimeout, readtimeout, and writetimeout. The value of n is the number of seconds from 1 to 32,767 (9 hours, 6 minutes, and 7 seconds). This attribute does not affect the logout attribute.</p>
nomaxtimeout	<p>Allows client users to specify noattrtimeout, noreadtimeout, and nowritetimeout.</p>
memfree()	<p>Specifies unused memory threshold (in Megabytes). When free memory in any internal NFSS subpool is more than this value, the memory reclamation process is scheduled in order to avoid possible memory exhaustion.</p> <ul style="list-style-type: none"> • To disable automatic memory reclamation, the memfree attribute must not be specified. • The maximum value for memfree is 999 (MB). • The minimum value for memfree is 10 (MB). • If memfree is set to 0, internal memory management is turned off and every memory request (below 2GB) is translated to GETMAIN or FREEMAIN system calls. <p>This value should be chosen based on a particular workload/available job region size.</p> <p>If this attribute is used, a value of 20 is recommended unless the attribute is being tuned.</p> <p>For memory above 4GB the defined memfree value is multiplied by 4.</p>

Table 24. Site attributes (continued)

Site Attribute	Description
mintasks(<i>n,m,o</i>)	<p>Defines the minimum number of NFS tasks or threads allowed to run. Tasks may be terminated for reasons such as 80A or 878 ABENDs.</p> <p>n Specifies the minimum number of subtasks which handle the asynchronous I/O operations or short blocking operations. If the number of active 'short' tasks becomes less than <i>n</i> the shutdown process of the NFS server starts.</p> <p>m Specifies the minimum number of subtasks which handle z/OS UNIX file requests. If the number of active z/OS UNIX tasks becomes less than <i>m</i> the shutdown process of the NFS server starts.</p> <p>o Specifies the minimum number of subtasks which handle long blocking operations. If the number of active legacy long service tasks becomes less than <i>o</i> the shutdown process of the NFS server starts.</p> <p>If <i>n</i>, <i>m</i>, or <i>o</i> are greater than the corresponding values in nfstasks, they are assigned to half the nfstasks values. If <i>n</i>, <i>m</i>, or <i>o</i> are not specified, they are assigned default values of 4, 4 and 1, respectively.</p> <p>Valid range for <i>n</i> is from 4 to 99</p> <p>Valid range for <i>m</i> is from 4 to 100</p> <p>Valid range for <i>o</i> is less than or equal to 99</p> <p>Valid range for <i>n</i> + <i>o</i> is less than or equal to 100</p>
mintimeout(<i>n</i>)	<p>Specifies the minimum timeout. This attribute and maxtimeout define the range of values that can be specified for attrtimeout, readtimeout, and writetimeout. The value of <i>n</i> is the number of seconds from 1 to 32,767.</p> <p>The default value is <u>1</u>.</p>
mixcase/upcase	<p>Specifies messages display in mixed or upper case.</p> <p>Note: Starting with z/OS NFS V1R10, this attribute is ignored.</p>
mvslogindelay()	<p>Specifies the delay time value in seconds since z/OS NFS Server startup.</p> <p>To avoid an NFS client's cache invalidation due to access errors after z/OS NFS server startup, in SECURITY(SAF/SAFEXP) mode, the server maps the reply error NFS3ERR_ACCES/NFS4ERR_ACCES to NFS3ERR_JUKEBOX/NFS4ERR_DELAY on NFSv3 and NFSv4 RPC requests, until the mvslogin is received or the mvslogindelay expires. This allows an NFS client time to reissue an MVSlogin.</p> <ul style="list-style-type: none"> • The maximum value for mvslogindelay is 300 seconds. • The minimum value for mvslogindelay is 0 seconds. <p>The default value is 0 seconds (off). If mvslogindelay is set to 0 the error mapping is turned OFF.</p>
mvsprefix(<i>prefix</i>)	<p>Specifies an MVS data set prefix to be appended to the front of MVS data set name for a mount path directory. The default value of <i>prefix</i> is <u>mvs</u>.</p> <p>The mvs prefix enables you to explicitly specify a prefix for identifying MVS data sets, similar to the way in which the hfs prefix does for z/OS Unix files.</p>

Table 24. Site attributes (continued)

Site Attribute	Description
<i>mvssec(krb5,krb5i,krb5p,sys)</i>	Specifies the acceptable network transmission levels of security which can be used as the authentication flavor on NFS version 4 requests for accesses to MVS data sets. This attribute is only used when not overridden by authentication specifications in the exports file. Multiple values for this attribute can be specified using the comma as delimiter. The following are the supported values:.
krb5	Provides Kerberos V5 based integrity on the RPC credentials (but not data), when the RPC authentication flavor is RPCSEC_GSS and uses the RPCSEC_GSS service of <code>rpc_gss_svc_none</code> .
krb5i	Provides Kerberos V5 based integrity on both the RPC credentials and data, when the RPC authentication flavor is RPCSEC_GSS and uses the RPCSEC_GSS service of <code>rpc_gss_svc_integrity</code> .
krb5p	Provides Kerberos V5 based integrity and privacy on both the RPC credentials and data, when the RPC authentication flavor is RPCSEC_GSS. The RPCSEC_GSS service used here is <code>rpc_gss_svc_privacy</code> .
sys	Specifies that the AUTH_SYS authentication flavor can also be used to access this data set. Note that the AUTH_SYS authentication flavor does not provide any integrity or privacy protection.
	The mvssec attribute default is <i>mvssec(sys,krb5,krb5i,krb5p)</i> .
	Note: File systems that require integrity or privacy protection over network transmissions of data should explicitly specify the desired settings. Do not rely on the default settings, because the default settings allow for RPC accesses using the AUTH_SYS authentication flavor, which does not provide any integrity or privacy protection.

Table 24. Site attributes (continued)

Site Attribute	Description
nfstasks (<i>n,m,o,t,u</i>)	<p>Specifies the number of server processes to initiate on startup.</p> <p>If nfstasks(<i>n,m</i>) is specified, then the following is true.</p> <ul style="list-style-type: none"> • The value of <i>n</i> is the number of subtasks that handle the asynchronous input/output (I/O) operations or short blocking operations (the maximum number of concurrent NFS server requests) in the z/OS MVS data path. • The value of <i>m</i> is the number of subtasks that handle the long blocking operations (the maximum number of concurrent NFS server recall and z/OS UNIX requests). Increase this value if your server supports lots of active recall or z/OS UNIX clients. <p>Based on system resources available below the 16 Mb line, the maximum <i>n</i> value may not be achievable. The precise maximum value will be system configuration dependent. If an 80A or 878 Abend is experienced during NFS server startup, use a smaller value for <i>n</i>.</p> <p>If nfstasks(<i>n,m,o</i>) or nfstasks(<i>n,m,o,t,u</i>) is specified, then the following is true.</p> <ul style="list-style-type: none"> • The value of <i>n</i> is the number of subtasks that handle the asynchronous input/output (I/O) operations or short blocking operations (the maximum number of concurrent NFS server requests) in the z/OS MVS data path. • The value of <i>m</i> is the number of subtasks that handle z/OS UNIX requests. Increase this value if your server supports lots of active z/OS UNIX requests. • The value of <i>o</i> is the number of subtasks that handle the long blocking operations (the maximum number of concurrent NFS server recall requests). Increase this value if your server supports lots of active recall operations. • The value of <i>t</i> is the number of transport subtasks that handle TCP network requests. • The value of <i>u</i> is the number of transport subtasks that handle UDP network requests. <p>Based on system resources available below the 16 Mb line, the maximum <i>n + o</i> value may not be achievable. The precise maximum value will be system configuration dependent. If an 80A or 878 Abend is experienced during NFS server startup, use a smaller value for <i>n + o</i>.</p> <p>The following are valid value ranges for <i>n</i>, <i>m</i>, <i>o</i>, <i>t</i>, and <i>u</i>.</p> <ul style="list-style-type: none"> • Valid range for <i>n</i> is from 4 to 99. • Valid range for <i>m</i> is from 4 to 100. • Valid range for <i>o</i> is from 1 to 99. • Valid range for <i>n + o</i> is from 5 to 100 • Valid range for <i>t</i> is from 4 to 32. • Valid range for <i>u</i> is from 4 to 32. <p>The nfstasks attribute default is <u>nfstasks(8,16,8,4,4)</u>.</p>

Table 24. Site attributes (continued)

Site Attribute	Description
nfsv4domain (<i>NFSv4_default_domain</i>)	<p>specifies the default domain for the NFS v4 protocol (NFSv4) name mapping.</p> <p>The NFSV4DOMAIN attribute serves for redefinition of a name of this unique domain. In accordance with RFC3530 NFSv4 attributes "owner" and "owner_group" are transferred between the client and server in the form of "user_name@domain" and "group_name@domain". The server provides the mapping of names to ids and vice versa. <i>NFSv4_default_domain</i> identifies the user/group name space with one to one correspondence between the names and their numeric identifiers (uids and gids).</p> <p>z/OS NFS Server will accept as valid a set of users and groups for default domain. The server will treat other domains as having no valid translations. If the NFSV4DOMAIN attribute is not used, the server uses the system-defined domain. The <i>NFSv4_default_domain</i> will be converted internally to lower case.</p> <p>For further details on NFSv4 name mapping, see "NFS v4 protocol name mapping" on page 217.</p>
nlm	<p>Specifies that the initialization of the z/OS NFS server should include starting the NLM and NSM daemons.</p>
<u>nonlm</u>	<p>Specifies that the initialization of the z/OS NFS server should not include starting the NLM and NSM daemons. The system will run without lockd and statd. Specifying nonlm does not affect the availability of byte range locking and share reservation support for NFS version 4 protocol access.</p> <p>If nonlm is specified, the NLM may not be started after NFS has initialized. If NLM is desired, you must stop and restart NFS after specifying the nlm site attribute. The only way to stop NLM is to shut down the NFS server. It is no longer necessary to define the NLM and NSM startup procedures to a z/OS UNIX segment as UID(0) to RACF because the NLM and NSM startup procedures are no longer supported.</p> <p>Note:</p> <ol style="list-style-type: none"> 1. The lock data sets must always be allocated, even if nonlm is specified in the site attributes. 2. The old startup procedures for NLM and NSM are no longer shipped with z/OS; these procedures are obsolete and old copies from previous releases should not be used on z/OS V1R7 or later releases.
oemhsm	<p>When specified, indicates that a non-DFSMS HSM product is used to work with migrated data sets. z/OS NFS Server starts working with migrated data sets without checking for HSM availability. If no HSM is installed, a hang may result.</p>
<u>nooemhsm</u>	<p>When specified, the z/OS NFS Server checks whether the DFSMS HSM product is started when working with migrated data sets. If the DFSMS HSM product is not started, an error is returned.</p>
pcnfsd	<p>Specifies that z/OS NFS server is to start the PCNFSD server.</p>
<u>nopcnfsd</u>	<p>Specifies that z/OS NFS server is not to start the PCNFSD server.</p>

Table 24. Site attributes (continued)

Site Attribute	Description
percentsteal (<i>n</i>)	<p>Specifies the percent of data buffers that can be reclaimed for use when the bufhigh(<i>xx,yy</i>) limit has been reached. A higher value means a reclaim operation is frequently performed, and the cached data is significantly trimmed on each reclaim. This can result in poor read performance, because readahead buffers might be stolen. Lower values result in less frequent reclaim operations, and the cached data normal water mark is higher, meaning possibly better performance by reading from cached data.</p> <p>The value of <i>n</i> is an integer from 1 to 99.</p> <p>The percentsteal attribute default value is <u>20</u>.</p> <p>The percentsteal attribute does not apply to z/OS UNIX files.</p>
public (<i>legacy_path,hfs_path</i>)	<p>Specifies the legacy path (MVS z/OS conventional data) and HFS path (z/OS UNIX data) that is associated with the public file handle for WebNFS access. The first path, if specified, is the legacy path. The second path is the HFS path.</p> <p>If the first path is not present, a comma must precede the second path. If the public keyword is specified, then one of the paths must be specified. The public keyword must be specified after the hfsprefix(), mvsprefix(), and impprefix() keywords in the site attribute table. A lookup request with the public file handle determines which of the two paths is being referenced by the pathname that is specified. An absolute pathname will tell the server which of the paths is referenced by matching one of the paths specified. A lookup request with a relative pathname will be interpreted as a z/OS UNIX request if HFS is active (<i>hfs_path</i> has been provided); otherwise, it is treated as a MVS request.</p> <p>The public attribute default value is <u>no public path</u>.</p>

Table 24. Site attributes (continued)

Site Attribute	Description
pubsec (<i>krb5,krb5i,krb5p,sys</i>)	<p>Specifies the acceptable network transmission levels of security for accesses to public file systems which can be specified as the authentication flavor of the RPC request. This attribute is only used when not overridden by authentication specifications in the exports file. Multiple values for this attribute can be specified using the comma as delimiter. The following are the supported values:</p> <p>krb5 Provides Kerberos V5 based integrity on the RPC credentials (but not data), when the RPC authentication flavor is RPCSEC_GSS and uses the RPCSEC_GSS service of <code>rpc_gss_svc_none</code>.</p> <p>krb5i Provides Kerberos V5 based integrity on both the RPC credentials and data, when the RPC authentication flavor is RPCSEC_GSS and uses the RPCSEC_GSS service of <code>rpc_gss_svc_integrity</code>.</p> <p>krb5p Provides Kerberos V5 based integrity and privacy on both the RPC credentials and data, when the RPC authentication flavor is RPCSEC_GSS. The RPCSEC_GSS service used here is <code>rpc_gss_svc_privacy</code>.</p> <p>sys Specifies that the AUTH_SYS authentication flavor can also be used to access file systems. Note that the AUTH_SYS authentication flavor does not provide any integrity or privacy protection.</p> <p>The pubsec attribute default is pubsec(sys,krb5,krb5i,krb5p).</p> <p>Note: File systems that require integrity or privacy protection over network transmissions of data should explicitly specify the desired settings. Do not rely on the default settings, because the default settings allow for RPC accesses using the AUTH_SYS authentication flavor, which does not provide any integrity or privacy protection.</p>
readaheadmax (<i>n</i>)	<p>Specifies the number of bytes to be read to fill internal buffers during read processing to enhance satisfying read requests directly from cache. This reduces the amount of synchronous physical I/O performed for NFS read requests for sequential read file access. It also reduces context switching overhead on NFS read requests by allowing more read requests to be satisfied directly from cache.</p> <p>The value of <i>n</i> is an integer from 1 KB to 128 KB (normally 2 to 4 times the common block size used for file access, which is recommended at 8 KB for AIX file activity).</p> <p>The readaheadmax attribute default value is 16K. Specifying zero (0) will deactivate readahead.</p> <p>The readaheadmax attribute does not apply to z/OS UNIX files.</p>
readdirtimeout (<i>n</i>)	<p>Specifies the amount of time, in seconds, before the internal readdir cache that is used for MVS z/OS conventional data sets is timed out or discarded. The valid range is from 1 to 32,767 (9 hours, 6 minutes, and 7 seconds). The value of <i>n</i> can go as low as 1 second, but to avoid the possibility of <i>client hanging</i> (due to network delays and staled cache), <i>n</i> is not recommended to be lower than 5 seconds. The value of <i>n</i> may need to be increased if the network is slow and the accessed directory has a lot of entries.</p> <p>The readdirtimeout attribute default value is 30 seconds.</p>

Table 24. Site attributes (continued)

Site Attribute	Description
rec878	Specifies that the recovery processing of 878 and 80A ABENDs will be turned on, and affected tasks will attempt to recover.
norec878	Specifies that the recovery processing of 878 and 80A ABENDs will be turned off. That is, if this type of ABEND occurs, the server will shutdown without recovery. It should only be used for debug.
remount	When specified, the server processes NFS requests after the NFS Server is restarted even though the HFS file system was remounted with a new HFS file system number (USS device number) after its last usage. Use of the remount attribute causes the NFS Server to automatically access a remounted HFS file system even though it may have been changed prior to remounting. Any active client mounts are re-established.
noremount	When specified, the server fails NFS requests (with return value NFSERR_STALE) if the HFS file system was remounted with a new HFS file system number (USS device number) after its last usage.
The remount/noremount attributes apply only to HFS file systems.	
restimeout(<i>n,m</i>)	Specifies a retention period and a clock time for the removal of mount points and control blocks that have been inactive longer than the specified retention period.
n	Specifies the resource retention period for mounts and associated resources. If they have been inactive for more than <i>n</i> hours, they are removed. The valid range for <i>n</i> is 0 to 720 hours (30 days). The default is 48 hours. If <i>n</i> is set to 0, the z/OS NFS server does not remove any mount points or associated resources.
m	Specifies the time of day to do the cleanup for mounts and associated resources that have been inactive more than <i>n</i> hours. The time of day is specified as a 24 hour local time value. The valid range for <i>m</i> is 0 to 23. The default is 0 (that is, midnight). Because cleanup work slows down the server, set <i>m</i> so that cleanup work occurs when the server is lightly loaded. If a mount handle is removed by the cleanup activity, the user must do the umount and mount operations to access the mount point again. The resource cleanup is also done when the server is shutting down.

Table 24. Site attributes (continued)

Site Attribute	Description
security (<i>mvs[,hfs,public]</i>)	
	Specifies security options for MVS data sets, z/OS UNIX files, and data that is accessed using the public file handle.
<i>mvs</i>	Specifies the security option for MVS z/OS conventional data sets. The <i>mvs</i> parameter is a required parameter.
<i>hfs</i>	Specifies the security option for z/OS UNIX files. The <i>hfs</i> parameter is an optional parameter.
<i>public</i>	Specifies the security option for data that is accessed with the public file handle. The <i>public</i> parameter is an optional parameter.
	Note: When the optional parameters (<i>hfs</i> and <i>public</i>) are not specified, they are assigned the same security option as the first parameter.
	You can specify the following security options:
exports	Exports list checking. For z/OS UNIX files, checks UNIX permission bits. The UID is obtained from the client RPC request. No SAF checking.
none	Neither SAF checking nor exports list checking. For z/OS UNIX files, checks UNIX permission bits. The UID is obtained from the client RPC request.
saf	SAF checking. No exports checking. For z/OS UNIX files, checks UNIX permission bits. The UID is obtained from the z/OS UNIX segment using mvslogin . There is no transparent access across z/OS NFS server restart. An mvslogin is required
safexp	SAF checking and exports list checking. For z/OS UNIX files, checks UNIX permission bits. The UID is obtained from the z/OS UNIX segment using mvslogin . There is no transparent access across z/OS NFS server restart. An mvslogin is required
	The security attribute default is security(safexp,safexp, safexp) .

Table 24. Site attributes (continued)

Site Attribute	Description
setgid(POSIX ZOSUNIX)	<p>z/OS NFS Server uses POSIX rules in GID inheritance for new z/OS UNIX objects. If the S_ISGID bit of the parent directory is on, the new GID is set to the GID of the parent directory. Otherwise, it is set from the GID of the process. A new directory inherits the S_ISGID bit value of the parent directory.</p>
POSIX	<p>z/OS NFS Server uses POSIX rules in GID inheritance for new z/OS UNIX objects. If the S_ISGID bit of the parent directory is on, the new GID is set to the GID of the parent directory. Otherwise, it is set from the GID of the process. A new directory inherits the S_ISGID bit value of the parent directory.</p> <p>This is the default value.</p>
ZOSUNIX	<p>z/OS NFS Server provides compatibility with z/OS UNIX. When the RACF profile FILE.GROUPOWNER.SETGID in the UNIXPRIV class is set, z/OS NFS Server uses POSIX rules, as stated previously. Otherwise, a new GID is always set to the GID of the parent directory, and for a new directory, the S_ISGID bit is always set off.</p> <p>Note: Some NFS clients (such as, SUN and AIX) force GID setting after object creation and prevent compatibility with z/OS UNIX even though the setgid(ZOSUNIX) attribute is set.</p>
sfmax(<i>n</i>)	<p>Specifies the maximum size (in kilobytes) of allocated storage for all of the side files. The value of <i>n</i> is an integer from 0 to 2000. The default value is 0 and it signifies that no mapping is allowed on the NFS server. If sfmax is set to 0, specifying the sidefile keyword in the attributes data set will cause the server to shut down and specifying the sidefile keyword in any subsequent mount commands causes the mount to fail because mapping is not allowed on the NFS server. If the amount of storage specified cannot be obtained during server initialization then the server will shut down immediately.</p>

Table 24. Site attributes (continued)

Site Attribute	Description
smf (<i>level</i> [, <i>switch</i>])	<p>Specifies the level of SMF support and defines whether or not to start SMF record collection at the NFS server startup.</p> <p>The following <i>level</i> options can be specified:</p> <p>none No SMF records are to be produced.</p> <p>all All SMF NFS type 42 records are to be produced.</p> <p>userfile Both user session and file usage SMF records are to be produced.</p> <p>Alternately a list of levels (<i>subtype_list</i>) delimited by commas, can be specified. In this mode of specification, at least one of the subtype levels (user, file, audit) must be specified, and the remaining levels are optional.</p> <p>file Produces file usages SMF records (subtype 7).</p> <p>user Produces user session SMF records (subtype 8).</p> <p>audit Produces file creation, removal, and rename records (subtype 26).</p> <p>The following <i>switch</i> options can be specified:</p> <p>off Activation of SMF records collection can be done manually by issuing the modify command. The <i>switch</i> parameter is optional.</p> <p>on Activates SMF records collection at the NFS server startup.</p> <p>The full syntax of the smf attribute follows: smf(none all userfile <i>subtype_list</i>[,on off])</p> <p>An example of the smf attribute follows: smf(user,on)</p> <p>An example follows that shows the smf attribute when the value of <i>switch</i> is off: smf(user)</p>
stringprep	<p>Specifies that z/OS NFS server is to enable stringprep normalization. Stringprep normalization is the NFS version 4 globalization function for converting inbound strings to UTF-8 format.</p>
nostringprep	<p>Specifies that z/OS NFS server is to not enable stringprep normalization.</p>

Table 24. Site attributes (continued)

Site Attribute	Description
symresolve	<p>Specifies that the z/OS NFS server is to resolve a symbolic link (symlink) found in an EXPORT or CHECKLIST entry and add it to the in-memory EXPORT or CHECKLIST list. The new entry is created in memory only. This option only applies to NFSv4 LOOKUP in z/OS UNIX space when a symlink is found within an EXPORT entry.</p> <p>Note:</p> <ol style="list-style-type: none">1. Only absolute paths are supported; symlinks pointing to relative paths are not supported.2. If the path of a symlink is changed, an EXPORTFS command must be run to allow z/OS NFS Server to reinterpret the new symlink path at the next mount.3. For effects of using the showmount command, see "Using commands on the z/OS NFS client" on page 81.
nosymresolve	<p>Specifies that z/OS NFS server is not to resolve a symlink found in an EXPORT or CHECKLIST entry.</p>
timethreshold(n)	<p>This attribute specifies the maximal interval <i>n</i> in seconds between two subsequent NFS errors that belong to the loop. Exceeding of this interval will result in current loop closing. All data relating to the current loop will be discarded and new sequence of NFS errors will begin with the last NFS error.</p> <ul style="list-style-type: none">• The minimum value for timethreshold is 4 seconds.• The maximum value for timethreshold is 60 seconds.• Any value of timethreshold less than 4 seconds is converted to 4 seconds.• Any value of timethreshold greater than 60 seconds is converted to 60 seconds. <p>The default is 4 seconds.</p> <p>In high performance environment, it may be necessary to set <i>n</i> to a low value.</p>

Part 2. Customization and Operations

Chapter 10. Customization

This topic describes how to configure NFS and how to make it available to users. You can perform these tasks to customize NFS:

Table 25. Customizing NFS

Section	Page
"Protecting your programs and files"	"Protecting your programs and files"
"Converting data" on page 173	"Converting data" on page 173
"Creating the conversion environment for Unicode Services" on page 174	"Creating the conversion environment for Unicode Services" on page 174
"Using multiple TCP/IP stacks" on page 206	"Using multiple TCP/IP stacks" on page 206
"Collecting NFS usage data" on page 175	"Collecting NFS usage data" on page 175
"Configuring the z/OS NFS client" on page 176	"Configuring the z/OS NFS client" on page 176
"Configuring the z/OS NFS server" on page 181	"Configuring the z/OS NFS server" on page 181
"Installing the client enabling commands" on page 209	"Installing the client enabling commands" on page 209

Protecting your programs and files

This section describes security measures that you should take to protect your programs and files in preparation for customizing NFS. These security measures help you protect the server control files, the NFS server and client installations, and the MVS file system. You can customize the NFS security processing and use UNIX style credentials to verify the identity of a client system.

Protecting the server control files

You should protect the following server control data sets from unauthorized access with RACF, a component of the Security Server for z/OS.

- Attributes file (read by the server at initialization)
- Exports file (read by the server)
- Mount handle data set (read and updated by the server)
- Checklist data set (read by the server)
- Lock data sets (read and updated by the server)
- Kerberos configuration file (read by the server)

- Kerberos keytab (read by the server)

Setting up the z/OS NFS authorization

The following security measures should be addressed when you install the z/OS NFS server and client:

- All programs that come with the z/OS NFS server and client must reside in an APF-authorized program library.
- The z/OS NFS server and client must be defined to the resource access control facility (RACF) and assign the necessary level of authority. This is done by defining a RACF user ID with an OMVS segment for the z/OS NFS server and client. Because the z/OS NFS server and client are run as started tasks, it is also necessary to define an entry in the RACF-started procedures table which associates the z/OS NFS server and client startup procedure names with the previously defined user IDs. The z/OS NFS client is run as an LFS Colony address space started by USS. The ASNAME used to call the started procedure in BPXPRMxx SYS1.PARMLIB needs to have a RACF ID by the same name. For more information about coding and replacing the RACF-started procedure table, see *z/OS Security Server RACF Security Administrator's Guide* and *z/OS Security Server RACF System Programmer's Guide*.

The z/OS NFS server can now be set up with the **trusted** attribute as follows:

```
ADDUSER mvsnfs OMVS(UID(1000))
SETROPTS GENERIC(STARTED) (If not already active)
SETROPTS CLASSACT(STARTED) (If not already active)
RDEFINE STARTED mvsnfs.** STDATA(USER(mvsnfs) GROUP(sys1) TRUSTED(YES))
SETROPTS RACLIST(STARTED) REFRESH
```

Note: The UID of 1000 is chosen for illustrative purposes only and can be specified as any non-0 valid UID value.

The z/OS NFS client can now be set up with the **trusted** attribute as follows:

```
ADDUSER mvsnfsc OMVS(UID(0))
SETROPTS GENERIC(STARTED) (If not already active)
SETROPTS CLASSACT(STARTED) (If not already active)
RDEFINE STARTED mvsnfsc.** STDATA(USER(mvsnfsc) GROUP(sys1) TRUSTED(YES))
```

Note: It is necessary to define a z/OS UNIX segment for the z/OS NFS client in the RACF user profile. The z/OS NFS client requires UID 0 authority to operate. If UNIXPRIV SHARED.IDS is in effect, the SHARED keyword is necessary or else message IRR5274I will be returned by RACF.

With trusted authority, the NFS server can perform the following tasks:

- Reconstruct the mount points (from the active mount handle data set) upon startup
- Handle mount requests from client prior to user login
- Handle **ls** or **nfsdir** list commands prior to user login
- Be a trusted user during normal operation

For more information on using trusted authority, see *z/OS MVS Initialization and Tuning Reference*. A trusted started procedure or address space is treated as a z/OS UNIX superuser if a z/OS UNIX user identifier (UID) is assigned to it in the OMVS segment, even when the assigned UID is not 0.

During actual remote client file access, the z/OS NFS server first RACROUTEs the remote client's user ID to determine if the remote client is authorized to access the file system. If the remote client is authorized, the z/OS NFS server switches to its own user ID, which has trusted authority, to access the file system.

- The z/OS NFS client can be set up with the trusted attribute in the same way as the z/OS NFS Server.

For TCP/IP security information, see *z/OS Communications Server: IP Configuration Guide*.

For z/OS UNIX security information, see *z/OS UNIX System Services Planning*.

Protecting the file system on z/OS with the NFS V4 protocol

The NFS version 4 protocol improves on the NFS version 2 and 3 protocols with stronger authentication and network transmission protection for NFS data. The NFS V4 protections include encryption algorithms for data privacy, multiple protections per file, and the means to negotiate security as NFS clients explore the file system. The NFS V4 protocol provides these protections through the required RPCSEC_GSS security authentication flavor and the SECINFO operation.

The z/OS NFS server enforces these protections, for client RPC requests that use RPCSEC_GSS, through the site attributes **mvssec**, **hfssec**, and **pubsec**. These attributes provide the Kerberos V5 Security Mechanism (RFC1964) subset of the V4 protocol, at the file-system level. The z/OS NFS server also continues to support NFS V2 and V3, as well as V4 protocol requests with the protections provided by the **security** site attribute, as described in “Protecting the file system on z/OS with the Security site attribute” on page 166.

The export data set also contains a security keyword, **sec**, that specifies the Kerberos authentication level that clients must have to access individual files and data sets on the z/OS NFS server. That is, specific export entries can be further constrained with different authentication flavors by using this security keyword. For example, an important export entry can be protected with **krb5p** level set by the security keyword, while other exported entries in the file system can be accessed by all authentication levels which are specified by the **mvssec**, **hfssec** and **pubsec** site attributes. The authentication flavors specified by the **sec** keyword in the export entries should be a subset of the authentication flavors of site attributes **mvssec**, **hfssec** and **pubsec**. In other words, an authentication level is effective only if it is specified by the site attribute logically AND'ed with the security keyword. For this reason, if the **sec** keyword is not specified, meaning all flavors are on, the authentication level is defaulted to the site attribute **mvssec**, **hfssec** and **pubsec**. For more information on the export security **sec** keyword, see “Exports data set” on page 182.

The **mvssec**, **hfssec**, and **pubsec** attributes let you specify the default network security flavors, and order, that can be used by requests accessing MVS, z/OS UNIX, and public file systems, respectively. These attributes only apply when the RPCSEC_GSS security mechanism is being used for communicating with the NFS client. These site attributes apply to all NFS versions. If you protect a data set with any one of these transmission attributes, NFS V2/V3 requests will get responses of AUTH TOOWEAK unless 'sys' is listed as a valid authentication flavor. NFS V4 requests that do not comply with these protections will get WRONG SEC. For more information on these site attributes, see “Site attributes syntax” on page 139.

Note: Since z/OS NFS only supports RPCSEC_GSS security for NFS version 4, if one of the site attributes is set to require RPCSEC_GSS, then clients using NFS versions 2 and 3, which only support AUTH_SYS security, cannot access those file systems. On the other hand, if the attribute is specified at a mount point, then only that mount point will be affected.

To use the NFS V4 RPCSEC_GSS security flavors, the following changes to the security infrastructure are required:

- Kerberos services must be activated on the z/OS system where the NFS server is running. This activation includes the definition of Realms, Inter-Realm relationships, and the Kerberos Principal for the z/OS NFS server. For details on these definitions, see the *z/OS Integrated Security Services Network Authentication Service Administration*.
- The Kerberos principals on NFS clients need to be defined to RACF and assigned a RACF identity. In addition, for Linux clients a principal `nfs/hostname.domain` should be defined to RACF. This is because Linux Clients use this principal for mounts and some state operations. For further details on defining principals, see *z/OS Security Server RACF Security Administrator's Guide*.
- No UNIX style user ID checking will be performed. Clients will always be validated to check for authorization based on their GSS credentials.
- The z/OS NFS server must have READ access to the IRR.RUSERMAP resource in the FACILITY class.

Note: For more information on setting up the z/OS NFS server with RPCSEC_GSS security, see “Configuring a secure z/OS NFS server” on page 199.

The z/OS NFS client always uses the `mvsnfsc` kerberos principal during mount operation for a secure mount (`krb5`, `krb5i` or `krb5p`) regardless of the user's current principal identity.

For accesses to an already established secure (`krb5`, `krb5i`, `krb5p`) mount point, the NFS client uses the kerberos principal that was used by the user to obtain the kerberos ticket via the `kinit` command. This principal is used to establish security contexts with the server and the NFS data is exchanged on these contexts.

The effect of a principal switch in the same user session (where a user does a `kinit` with a different Kerberos principal) may not be reflected immediately in the client's communications on established secure mount points with the NFS server (not until the contexts created using the prior principal have expired).

GSS credential acquisition

GSS credentials enable the communicating applications to establish security contexts with each other. They can contain multiple cryptographic keys that are required for authentication and message encryption to be performed with different algorithms. The z/OS NFS server uses Kerberos V5 as its security mechanism for acquiring the GSS credentials. The z/OS NFS server initially acquires these credentials during server startup. The z/OS NFS server uses the credentials for accepting the security context requests from NFS clients, and the same credentials may be used for initiating security contexts during RPC callbacks. The Kerberos principal for the z/OS NFS server must be defined in the Kerberos key table identified by the `KRB5_KTNAME` environment variable.

Note: For more information on setting up the z/OS NFS server with RPCSEC_GSS security, see “Configuring a secure z/OS NFS server” on page 199.

The z/OS NFS server will attempt to acquire the GSS credentials for the maximum credential lifetime but the actual lifetime of credentials will depend on the lifetime of the underlying Ticket Granting Ticket of the Kerberos Security Server, and is not controlled or governed by the z/OS NFS server. On expiration of the server's GSS credentials, client requests will receive the RPCSEC_GSS documented errors and the client is expected to refresh the contexts and retry the requests.

Security context acceptance

A security context is a data structure that contains information about the cryptographic state of a program on the client communicating with the server, and is required for RPC message security services. NFS clients create security contexts with the z/OS NFS server as part of the RPCSEC_GSS protocol of data flow. The z/OS NFS server accepts security context requests subject to the following restrictions and recommendations:

1. The z/OS NFS server does not support channel bindings.
2. The z/OS NFS server never initiates any requests as an agent of NFS clients and therefore recommends that clients do not use credential delegation services while creating security contexts.
3. The z/OS NFS server does not support the Out Of Sequence Detection services of GSS API. It expects NFS clients to have the `seq_req_flag` parameter turned off on their calls to GSS API `gss_init_sec_context`.
4. The z/OS NFS server recommends that the clients do not use the Message Replay services of the GSS API. It expects NFS clients to have the `replay_det_req_flag` turned off on their calls to the GSS API `gss_init_sec_context`. Note that the z/OS NFS server's implementation of the RPCSEC protocol provides for the protection against replay attacks.
5. The z/OS NFS server does not allow clients to authenticate as anonymous principals.
6. The z/OS NFS server recommends that NFS clients use mutual authentication services during context creation. The z/OS NFS server will still honor context creation requests from NFS clients that are unable to, or choose not to, use mutual authentication services in the GSS-API. However, clients that would require RPC callbacks from the z/OS NFS server have to support accepting security contexts with mutual authentication, because the z/OS NFS server always initiates security contexts with mutual authentication services.

Security negotiation

The NFS version 4 protocol facilitates the use of multiple RPC authentication flavors. The z/OS NFS server supports the Kerberos V5 security mechanism and all the pseudo flavors of the Kerberos security mechanism using the cryptographic algorithms referred to in NFS V4 (RFC3530). To facilitate selection of a particular pseudo flavor, the z/OS NFS server supports security negotiation using the NFS V4 protocol's SECINFO operation. IBM strongly recommends that security negotiation be done by the NFS clients using the SECINFO operation with an RPC authentication flavor of RPCSEC_GSS with the `krb5i` or `krb5p` pseudo security flavors.

When responding to SECINFO for security negotiation (when multiple security flavors are present for a file system or file), the z/OS NFS server uses an order of preference that has RPCSEC_GSS as the most favored flavor followed by AUTH_SYS. For the authentication flavor of RPCSEC_GSS, the z/OS NFS server has `krb5`, `krb5i`, and `krb5p` as its listed pseudo flavors in descending order of preference. NFS clients are, however, free to choose from any one of the z/OS NFS server-supported security flavors for their NFS V4 requests.

NFS V4 clients that decide to use the AUTH_SYS flavor may still have to do an **mvlogin** like their V2/V3 counterparts, depending on the settings of the **security** site attribute.

Security Negotiation using the SECINFO operation is performed by the z/OS NFS Client in the following instances:

- During mount point establishment
- During NFS4ERR_WRONGSEC handling

Mount point establishment: When a security flavor is not specified for an NFS V4 mount, the z/OS NFS client queries the supported security flavors on the NFS server using the SECINFO operation. The z/OS NFS client chooses a security flavor returned by the server based on the following order of preference:

- sys** System Authentication
- krb5** Kerberos V5 security providing integrity protection on the RPC header
- krb5i** Kerberos V5 security providing integrity protection on the RPC header and the RPC data
- krb5p** Kerberos V5 security providing encryption protection on the RPC data and integrity protection on the RPC header

The chosen security flavor serves as the designated flavor for the NFS client for all future accesses to this mount point.

The following should be noted with regards to Security Negotiation during mount point establishment:

1. Security Negotiation during mount is not done when a security flavor is specified in the secure keyword.
2. During mount when datacaching is specified and a security negotiation was attempted, Datacaching is turned off.

NFS4ERR_WRONGSEC handling

NFS servers fail an NFS request with NFS4ERR_WRONGSEC if the security policy on the mount point at the server's end does not allow the authentication flavor with which the request was issued. After receiving this error, the z/OS NFS client negotiates security with the NFS server by issuing a SECINFO operation to query the server-supported security flavors. The z/OS NFS client chooses a security flavor from the server supported flavors based on the order of preference specified in "Mount point establishment" and retries the failing request with this newly-chosen security flavor. This security flavor serves as the designated security flavor for all future accesses to that mount point.

The following should be noted with regards to Security Negotiation during NFS4ERR_WRONGSEC handling:

1. On existing mount points and objects, the client only negotiates security when it is an upgrade to a more secure flavor. The order of flavors in the descending order of security that they provide is as follows:
 - krb5p
 - krb5i
 - krb5
 - sys
2. For existing files, Security Negotiation is not done when datacaching is on for that file.

Protecting the file system on z/OS with the Security site attribute

You can use the **security** site attribute, with the NFS V2, V3, and V4 protocols, to select the level of protection for different types of data access. A different

protection level can be specified for MVS data sets, HFS files, and data that is accessed using the public file handle. The attribute used to protect data access is the **security** attribute. The format of the keyword is **security(mvs[,hfs,public])**. The following are the security options: **exports**, **none**, **saf**, and **safexp**. See “Site attributes syntax” on page 139 for syntax rules.) The z/OS NFS server can be configured to handle security in the following ways:

- None
- Exports list checking
- System Authorization Facility (SAF) checking
- Customized installation security exit
- System Authorization Facility (SAF) checking with checklist processing (to bypass SAF for files and directories under selected mount points)
- A combination of these approaches

Note: The UNIX permission checking against the z/OS UNIX hierarchical file system might appear to be inconsistent if the definitions of UID, GID, and SGID are not consistent throughout the domain of the network.

Unrestricted data access—security(none)

If you do not want to restrict data access, you can use the **security(none)** attribute. Neither exports list checking nor SAF checking is done. Client users can access z/OS files without a z/OS user ID and without using the **mvlogin** command. They simply mount the z/OS file systems that they want to access and unmount when they are finished. For z/OS UNIX files, the UNIX permission bits are checked before access is granted to the client user. See Figure 17 and Table 26 on page 171 for information on permission checking.

Note: If UID or GID from the RPC request is zero, it will be mapped to 65534 (nobody) before the UNIX permission checking is performed.

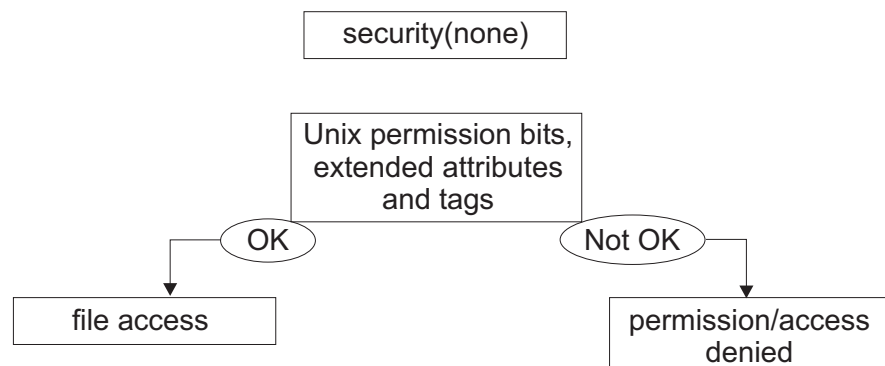

Figure 17. Permission checking for the security(none) attribute

Exports list checking—security(exports)

When you specify **security(exports)** in the attributes data set, the NFS server checks the client IP address against the exports list, which is generated from the exports data set, to determine whether or not a mount is to be granted. The NFS server also checks the requested directory (or high-level qualifier) to be mounted. For z/OS UNIX data, it also checks the UNIX permission bits before granting file access to a client user. See Figure 18 on page 168 and Table 26 on page 171 for information on permission checking.

Note: If UID or GID from the RPC request is zero, it will be mapped to 65534 (nobody) before the UNIX permission is performed.

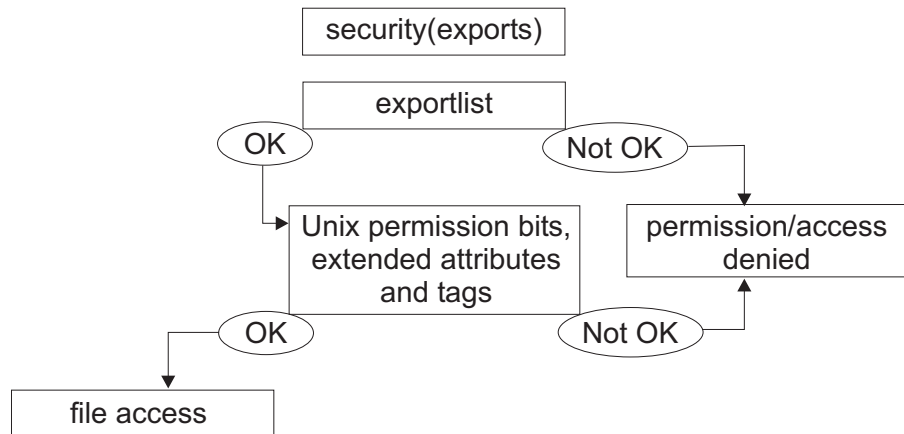

Figure 18. Permission checking for the *security(exports)* attribute

For more information about the *exports* data set, see “Exports data set” on page 182.

SAF checking—*security(saf)*

When you specify **security(saf)** in the attributes data set, the NFS server uses RACF or an equivalent product to control access to z/OS file systems. All RACF requests from the server are made through SAF. SAF directs control to RACF, or an equivalent security product, if it is active.

The server uses SAF to validate the z/OS user id and password supplied by the client user. It also uses SAF to validate that the client user is allowed to access z/OS data. A RACF user ID must be defined for each client user that requires access to the server.

For z/OS UNIX data, z/OS UNIX checks the UNIX permission bits, or ACLs, before granting file access to a client user. See Figure 19 on page 169 and Table 26 on page 171 for information on permission checking. For users accessing z/OS UNIX, their RACF user ID must have an z/OS UNIX segment defined in the RACF profile.

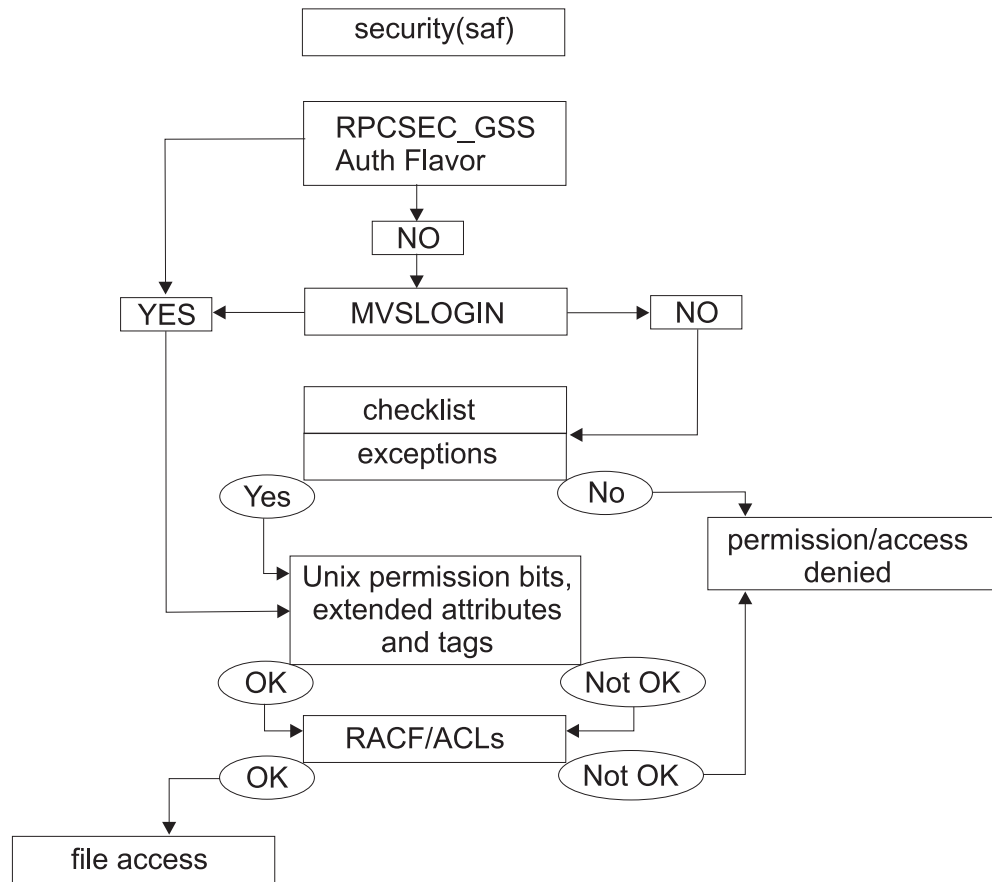

Figure 19. Permission checking for the security(saf) attribute

SAF and exports list checking—security(safexp)

When you specify **security(safexp)** in the attributes data set, the NFS server checks for both RACF authorization and exports list authorization before granting a client user access to z/OS data. For z/OS UNIX data, z/OS UNIX checks the UNIX permission bits, or ACLs, before granting file access to a client user. See Figure 20 on page 170 and Table 26 on page 171 for information on permission checking. This is the most restrictive means of limiting file system access. It requires client users to use the **mvsllogin** command.

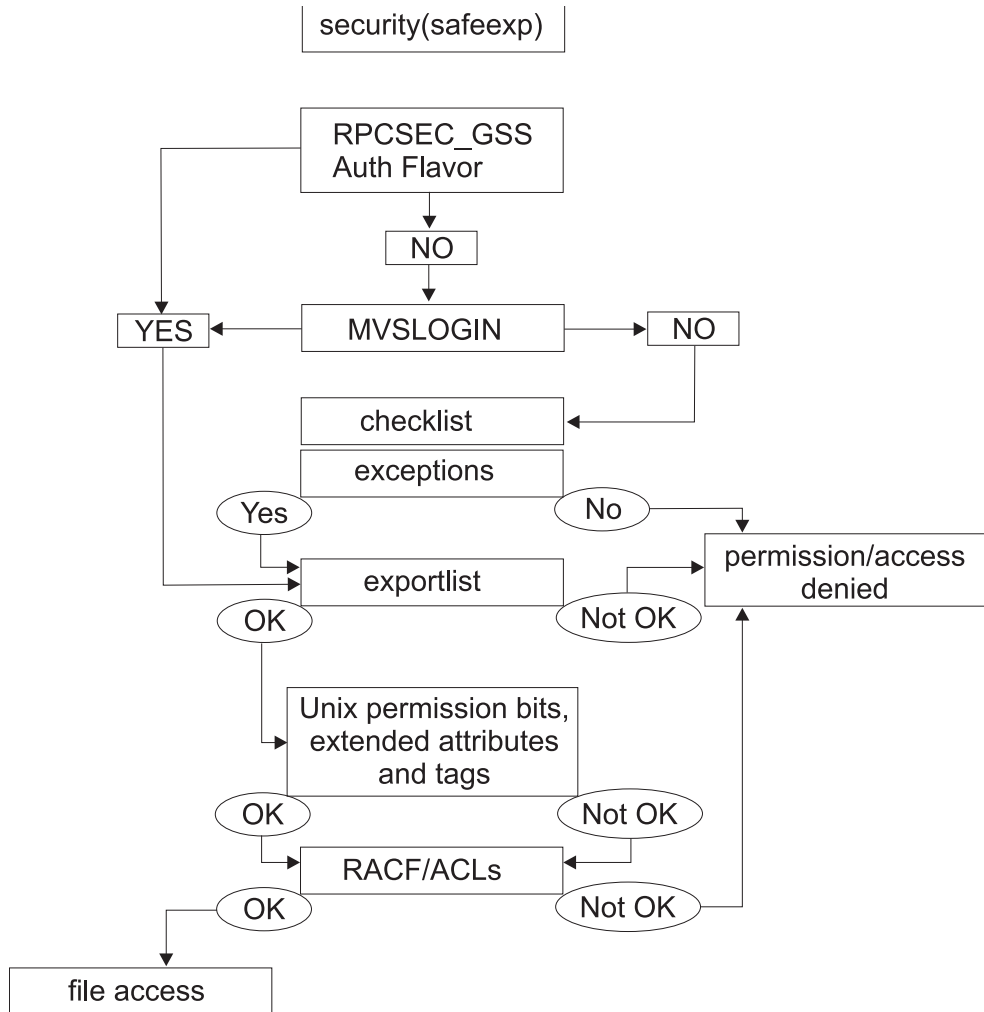

Figure 20. Permission checking for the security(safexp) attribute

For more information about the exports data set, see “Exports data set” on page 182.

SAF checking with checklist processing

When you specify **security(saf)** or **security(safexp)** with the **checklist** attribute, the NFS server performs SAF as described in “SAF and exports list checking–security(safexp)” on page 169. The only exception to this is that it will not check the files and directories that are underneath the mount points that either match the mount point or the children of the mount points that are specified in the exports data set using the **dirsuf** parameter. For more information, see “Exports data set” on page 182.

Table 26. UID, GID, SGID permission checking with security site attribute

Client			z/OS			Comments
uid	gid	sgids	uid	gid	sgid	
<i>uid_a</i>	<i>gid_a</i>	<i>sgid_b,...</i>	N/A	N/A	N/A	<p>When security(none) or security(exports) is used the z/OS NFS server checks the object owner uid, owner_group gid and its permission bits against the client uid (<i>uid_a</i>), gid (<i>gid_a</i>), and supplemental gids (<i>sgid_b,...</i>) in the RPC AUTH_SYS authentication.</p> <p>Advantages: Performance may be improved.</p> <p>Disadvantages:</p> <ol style="list-style-type: none"> 1. The RPC AUTH_SYS allows only a maximum of 16 supplemental gids. 2. Spoofing of client uids, gids, and sgids cannot be prevented. 3. The object in the underlying physical file system (zFS or HFS) could have extended ACL entries, but the z/OS NFS server does not check
<i>uid_a</i>	<i>gid_a</i>	<i>sgid_b,...</i>	<i>uid_A</i>	<i>gid_A</i>	<i>sgid_B,...</i>	<p>When security(saf) or security(safexp) is used the z/OS NFS server defers to the underlying physical file system (zFS or HFS) and RACF to check the object owner uid, owner_group gid, and its permission bits against the mapped Client-z/OS uid (<i>uid_A</i>), gid (<i>gid_A</i>), and supplemental gids (<i>sgid_B,...</i>) from RACF User's Definition</p> <p>Note:</p> <ol style="list-style-type: none"> 1. mvslogin establishes the mapped Client to z/OS <i>uid_A</i>, <i>gid_A</i>, <i>sgid_B,...</i> 2. The RPC AUTH_SYS authentication (<i>uid_a</i>) is used to find the mapped Client to z/OS segment (<i>uid_A</i>, <i>gid_A</i>, <i>sgid_B,...</i>). <p>Advantages:</p> <ol style="list-style-type: none"> 1. The RPC AUTH_SYS limitation of maximum 16 supplemental gids is eliminated because of the mapped Client to z/OS supplemental gids (<i>sgid_B,...</i>). 2. Spoofing of uid/gids/sgids is prevented by mvslogin 3. Exploits the underlying physical file system ACL support <p>Disadvantages: Performance may be impaired.</p>

File system export

A system administrator issues the **mount** command to an NFS server and makes a remote file system available to the user. The z/OS server keeps a list of file systems and associated access restrictions in an export file. It then compares incoming mount requests to the entries in the file. If a match is found in the export file and the client is authorized for access, then the file system is successfully mounted.

Table 27 shows server processing of a mount request.

Table 27. z/OS server processing of a mount request

Security Option	Export File	z/OS UNIX File	MVS Data Set
none	Not required	No checking exported	No checking exported
saf	Not required	No checking exported	No checking exported
exports	Required	Checking export file	Checking export file

Table 27. z/OS server processing of a mount request (continued)

Security Option	Export File	z/OS UNIX File	MVS Data Set
safexp	Required	Checking export file	Checking export file

Note: MVSLOGIN is not required for NFS mount request.

Authorization of file operations

After the file system is mounted, the user performs the normal file operations on the NFS-mounted remote file system. z/OS NFS server adds the z/OS SAF checking in addition to the UNIX file permissions check.

Note: MVS z/OS conventional data sets do not support UNIX permission bits in the file attribute structure. By disabling the SAF security, there is no authorization checking for file operation to MVS z/OS conventional data set. The UNIX permission bits checking is still performed for z/OS UNIX file operations when the SAF security is disabled.

Table 28 shows server processing of a file request.

Table 28. z/OS server processing of a file request

Security Option	MVSLOGIN	z/OS UNIX File	MVS Data Set
none	Not required	Check file permission bits	No checking
saf	Required***	SAF check***	SAF check***
exports	Not required	Check file permission bits	No checking
safexp	Required***	SAF check***	SAF check***

Note:

1. z/OS UNIX segment must be defined for z/OS file operation. (***)This does not apply when checklist requirements are satisfied.)
2. If the file system is mounted with an RPCSEC_GSS authentication flavor, no MVSLOGIN is required.

Customizing installation security exits

You can write installation-wide exits or replaceable modules that customize Network File System security processing, by using product-sensitive programming interfaces provided by the server. Depending on how you code the exit, client users could be required to use the **mvslogin** command even for the **security(none)** and **security(exports)** attributes.

For more information about customizing your installation's security exits see "Login installation-wide exit" on page 257 and "File security installation-wide exit" on page 263.

Using UNIX style credentials for authentication

Authentication is the process of verifying the identity of a client system. This ensures that one client system cannot masquerade as another client system (perhaps with a different set of privileges). Client systems are identified by a set of credentials and authenticated with verification information passed in messages sent to server systems. There are several different conventions for exchanging authentication information in the NFS protocol, including these credentials:

- Null

- UNIX style
- RPCSEC_GSS style
- Other, user written

The z/OS NFS server supports the System Authentication flavor of the RPC protocol that employs the UNIX style credentials for all supported NFS protocol versions. For the NFS version 4 protocol, the z/OS NFS server also supports the RPCSEC_GSS authentication flavor, which employs GSS credentials. For its RPCSEC_GSS authentication support, the z/OS NFS server only supports the Kerberos V5 security mechanism.

The z/OS NFS client utilizes z/OS UNIX-socket-enabled RPCs to communicate with remote z/OS NFS servers over a TCP/IP network. The credential includes the user ID (UID), group ID (GID), and a list of GIDs to which the user belongs. z/OS NFS supports all GID groups specified in the GID group list, which extends support beyond the 16 GID group restriction of the UNIX style AUTH_SYS authentication flavor. As of V1R11 the z/OS NFS Client also supports the RPCSEC_GSS authentication flavor.

Converting data

The z/OS NFS client supports data conversion defined by the universal character encoding standard known as the Unicode Standard on z/OS V1R2 (and later) when reading data from a remote NFS server or writing data to a remote z/OS NFS server. The Unicode Standard offers character conversion as well as basic case conversion. Within character conversion, characters are converted from one coded character set identifier (CCSID) to another. CCSID information is obtained from the **cln_ccsid** and **srv_ccsid** parameters.

Only single byte to single byte data conversion is supported. For example, if a client file has a CCSID of 437 and a server file has a CCSID of 297, data conversion will occur between USA ASCII format (CCSID 437) and French EBCDIC format (CCSID 297). Single byte to multiple byte conversion (including double byte character set (DBCS)) is not supported and will result in NFS terminating with an error message. NFS version 4 protocol (NFSv4) differs from NFSv2 and NFSv3 protocol in handling single to multiple byte conversion. Therefore, the technique-search-order specified in the **convserv()** attribute should consider the effects of the NFS protocol being used. See "Creating the conversion environment for Unicode Services" on page 174 for further details.

The **cln_ccsid**, **srv_ccsid**, **xlat**, **tag/notag**, and **convserv** attributes identify whether data conversion is performed, and how data conversion is done. These parameters are supported by the z/OS NFS client installation parameter and TSO MOUNT command. The parameters on a TSO MOUNT command override the parameters specified as a z/OS NFS client installation parameter.

The **cln_ccsid** and **srv_ccsid** are always used to correctly display file names from a remote server. In the case of file names from a multi-byte conversion, the file names can even be viewed correctly by specifying the correct **cln_ccsid**, **srv_ccsid** and **xlat(n)** attribute. Note that in the case of **xlat(n)** there is no data conversion of a file's content - only the file names.

Creating the conversion environment for Unicode Services

The z/OS client or server uses Unicode Services to support data conversion on files in either EBCDIC or ASCII formats as well as other data formats that are defined with a CCSID. No setup is needed to begin using Unicode Services. As of Version 1 Release 7, z/OS ships with Unicode Services ready to use. See *z/OS Unicode Services User's Guide and Reference* for more information.

With the NFS version 4 protocol (NFSv4), metadata are transferred between the server and client in the UTF-8 data format (ASCII text is not transferred directly). The CCSID used by Unicode Services for UTF-8 is 1208.

The **convserv** attribute defines how data conversion is performed between CCSIDs by specifying the conversion technique-search-order which Unicode Services will use for specified `srv_ccsid(x)` and `cln_ccsid(x)` code pages. Technique consists of up to five technique-characters corresponding to the available techniques (R, E, C, L and M) used to define the technique search order for Unicode Services to process the specified code pages.

The technique-characters, with description, are defined as follows. See *z/OS Unicode Services User's Guide and Reference* for more information.

R Roundtrip conversion

Roundtrip conversions between two CCSIDs assure that all characters making the "roundtrip" arrive as they were originally.

E Enforced Subset conversion

Enforced Subset conversions map only those characters from one CCSID to another that have a corresponding character in the second CCSID. All other characters are replaced by a substitution character.

C Customized conversion

Customized conversions use conversion tables that have been created to address some special requirements.

L Language Environment-Behavior conversion

Language Environment-Behavior conversions use tables that map characters like the *iconv()* function of the Language Environment Runtime library.

M Modified Language Environment-Behavior conversion

Modified Language Environment-Behavior conversions use tables that map characters like the *iconv()* function of the Language Environment Runtime library does for converters ending with "C" (for example IBM-932C).

For mixed data format conversion, it is advisable to use more than one technique-character as one of the sub-conversions might exist only in round-trip mode and one only in enforced-subset. In the case of NFSv4, a technique-search-order of `convserv(RE)` or `convserv(ER)` would be required. In contrast, in the case of NFSv2 or NFSv3, `convserv(R)` would be sufficient for the data conversion.

The **convserv** attribute uses a default value of "LRE" which is recommended to provide correct translation of EBCDIC-newline to ASCII and back.

Collecting NFS usage data

The z/OS NFS client does not produce any System Management Facilities (SMF) records. However, it does provide the accounting information to z/OS UNIX for SMF recording. z/OS in turn provides the SMF recording services for all physical file systems (PFSs).

The z/OS NFS server does not produce z/OS UNIX SMF records. However, z/OS UNIX provides the SMF recording services for all physical file systems (PFSs).

You can use the SMF records that the z/OS NFS server produces to keep track of how MVS z/OS conventional data sets are accessed, and how long each Network File System user session lasts. The z/OS NFS server writes the following SMF records:

Record type-42 subtype 7

This record, written when a file times out, provides the Network File System file usage statistics.

Record type-42 subtype 8

This record, written when a client user logs out of NFS, provides the Network File System user session statistics.

Record type-42 subtype 26

This record, written when a client creates, removes, or renames the file objects on the NFS mounted file system, provides the NFS Client's information, the type of operation (create, remove, rename) and object descriptive information (depending on file system type: MVS or z/OS Unix). For z/OS Unix objects, the file system name, USS device number, object name, FID, and parent FID information are saved. If the pathname of an object is desired, it is recommended to enable SMF recording for USS Type 92 and RACF Type 80 records in order to derive this information. For MVS objects, the volume name, full data set name, and member name (if appropriate) are saved.

For records containing Internet Protocol (IP) Version 6 addresses, the z/OS NFS server writes a specific type of SMF record. This record type is indicated by a version number of **2** in the smf42psv record field. In these records, the IP address field (smf42cip) is expanded to hold the larger IP V6 address values. For details on these record fields, see Appendix J, "SMF C and assembler header macros," on page 549.

You can control the SMF data collection in the following ways:

- You can use the **smf** site attribute, described in "Site attributes syntax" on page 139, to determine which, if any, SMF statistics are to be collected.
- You can use the **smf=on** or **smf=off** operand of the **modify** command. See "Smf operand" on page 252 for a description of this command, which turns SMF data collection on and off.
- You can generate an SMF report. Use the SMF report sample routine, GFSAPSMF, that can be found in the NFSSAMP library.
- You can use the SMF C and Assembler header macros. See Appendix J, "SMF C and assembler header macros," on page 549 for copies of the C header macro, GFSASSMF, and the Assembler header macro GFS AUSMF. Both header macros contain the mapping for SMF records and can be found in the NFSMAC library.
- Check the SMF setting in the system in SYS1.PARMLIB(SMFPRMnn) for the SMF record type and subtype, where nn is determined by IEASYSmm and the

operator command (SET SMF=nn). The Network File System uses the SMF type 42 record, subtypes 7 and 8. You specify **SMF=nn** so the system picks the member of SMFPRM with suffix nn.

You can display the SMF settings with the **d smf,0** operator command.

The SMF write macro, SMFWTM, is used to write the SMF records to the SMF data set. When the server starts, the SMF option is disabled. Therefore, the operator needs to explicitly enable the SMF collection.

For more information about SMF see *z/OS MVS System Management Facilities (SMF)*.

Configuring the z/OS NFS client

This section describes the tasks you can perform to configure the z/OS NFS client. These tasks include creating the PARMLIB statement and updating z/OS system data sets for the client. This section also includes information about allocating client log data sets and mounting remote file systems.

Creating the PARMLIB statement for the client

During z/OS UNIX file system initialization, the z/OS NFS client is started and run in the logical file system (LFS) colony address space. The filesystype parmlib statement for the z/OS NFS client must be present in the SYS1.PARMLIB(BPXPRMxx) parmlib member in order to start the z/OS NFS client. For more information about z/OS UNIX file system reference see *z/OS UNIX System Services File System Interface Reference*.

Updating z/OS system data sets for the client

To accommodate the z/OS NFS client you must update z/OS system data sets PARMLIB, PROCLIB, and the DD statement.

PARMLIB updates

Add the data set defined in the GFSCPROC STEPLIB containing the z/OS NFS client library to the system's APF authorization list (IEAAPFxx). A sample cataloged procedure named GFSCPROC is provided as a member of the sample library NFSSAMP, see "Sample z/OS NFS client startup procedures" on page 539.

Add the FILESYSTYPE parmlib statement shown in Figure 21 to the z/OS UNIX parmlib member (BPXPRMxx):

```
FILESYSTYPE
  TYPE(NFS)
  ENTRYPOINT(GFSCINIT)
  ASNAME(proc_name)
  PARM('installation parms')
```

Figure 21. Sample FILESYSTYPE parmlib statement

The name in the TYPE operand must be NFS, otherwise the utility program nfsstat fails.

The operand ENTRYPOINT(GFSCINIT) specifies the entry point for the z/OS NFS client initialization.

The operand PARM('installation parms') specifies the installation parameters for the z/OS NFS client. See Table 16 on page 118 in "Mount processing parameters and installation parameters" on page 118 for a list of valid installation parameters.

The operand ASNAME(proc_name) specifies the procedure name in SYS1.PROCLIB that is used by z/OS UNIX to start the address space in which the z/OS NFS client is initialized.

If you do not want z/OS NFS Client colony address space to be started under JES (which is the default), you can change this by including the SUB=MSTR parameter with the ASNAME keyword:

```
ASNAME(proc_name, 'SUB=MSTR')
```

The z/OS NFS Client colony address space runs outside of JES control and does not have to be stopped if JES has to be stopped, which facilitates planned shutdowns of individual systems in a sysplex that has shared file systems. For more information about starting colony address space outside of JES, see *z/OS UNIX System Services Planning*.

Note: The proc_name is also used for the name of the address space.

For data integrity and data isolation among different PFSs, the z/OS NFS client is required to start in a separate and standalone colony address space. To start the NFS client in a separate and standalone colony address space, a unique proc_name must be used.

PROCLIB updates

Add the procedure name, *proc_name*, specified in the ASNAME(*proc_name*) operand to the system PROCLIB.

A sample cataloged procedure named GFSCPROC is provided as a member of the sample library NFSSAMP, see "Sample z/OS NFS client startup procedures" on page 539.

Modify the MVSNFSC procedure and place it in your system PROCLIB. Add the DD statements:

```
NFSCMSG1 as the DD for the primary log data set  
NFSCMSG2 as the DD for the secondary log data set
```

Allocating client log data sets

For information about allocating the z/OS NFS client primary and secondary log data sets, see Appendix K, "Capturing diagnostic information using z/OS NFS log data sets and from other components," on page 565.

NFS Client with Multiple TCPIP stacks

In order for the NFS client to bind to multiple TCPIP stacks, a single rpcbnd/portmap should be used. The rpcbnd/portmap procs should not use affinity to bind to a specific TCPIP stack. Also, the system should use a single resolver for all stacks on the system. If you require transport affinity with the NFS Client, see the section "Using specific transports under CINETS" in *z/OS UNIX System Services Planning* for information on using PARM=TP(TPNAME) on the EXEC statement that starts BPXVCLNY in the colony address space procedure.

Note: Multiple instances of the NFS Client are not supported.

Mounting remote file systems

In order to make a connection between a mount point on your local z/OS UNIX file system and one or more files on a remote MVS, AIX, UNIX, z/OS, or other file system, any z/OS UNIX mount method may be used, including:

- z/OS UNIX automount facility
- /etc/rc shell scripts support
- z/OS UNIX shell mount command
- SO MOUNT
- BPXPMRxx MOUNT statement

The remote file system can be mounted only after the z/OS UNIX file system, z/OS NFS client, and TCP/IP initializations are complete. The mount can only be performed by a z/OS UNIX superuser (uid=0). For more information about the TSO MOUNT command, when used with the z/OS NFS client, see “Mount command syntax and examples” on page 89.

When using the automount facility of z/OS UNIX System Services, the remote file system is mounted on its first data access attempt if it is not already mounted.

When the automount facility is used to manage remote NFS mount points, the z/OS NFS user could experience ESTALE/EIO errors if the automounter unmounts the accessed mount point when the time limits specified by the automount duration and delay parameters have been exceeded. The automount default, DURATION=NOLIMIT, disables the DURATION timeout period. The DELAY for unmounting file systems should be longer than the time z/OS NFS clients are likely to keep z/OS NFS mounts to the files and directories active. For more information about the z/OS UNIX automount facility, see *z/OS UNIX System Services Planning* and *z/OS UNIX System Services Command Reference*.

The remote file system must be mounted on the z/OS UNIX file system prior to any reference being made to the remote data. Once mounted, the remote file system can be treated as an extension of the local z/OS UNIX file system.

Note: If the Memory Mapping service (mmap) is used for a NFS file, requests for this file are sent to the NFS Server using UID(0). The NFS Server must be set up to allow UID(0) requests to be accepted as UID(0) and not convert the UID(0) to the userid *nobody*. See the <root> parm on the -access option of the Exports dataset in “Exports data set” on page 182

Setting up reserved (privileged) ports

The z/OS NFS client uses a reserved (privileged) port to prevent the NFS server from rejecting a client request. The z/OS client attempts to use reserved port 1023 and if that port is not available, the z/OS client will subtract one from 1023 until a reserve port is available. If no reserve ports are available, the z/OS client will issue error message GFSC724E.

The amount of reserved ports the z/OS client can use is based on the client attribute biod. The amount of reserved ports can be calculated from the following formula:

$$\text{reserved ports} = 8 + (\text{\#biod} * 4)$$

The privileged ports should be reserved in the tcpip.profile file using the PORTRANGE statement. The default biod(6) and 8 additional ports correspond to

32 privileged ports that can be used by the z/OS client. For biod(6), the tcpip.profile file should include the following PORTRANGE statement:

```
PORTRANGE 991 32 UDP MVSNFSC
PORTRANGE 991 32 TCP MVSNFSC
```

This allows ports 991 through 1023 to be used by the z/OS client. Note that MVSNFSC is the default z/OS NFS client start-up procedure. Please specify the correct z/OS NFS client start-up procedure if it is different than the default.

When specifying secure(udp) or proto(udp), the z/OS client uses the privileged UDP ports to communicate with the NFS servers. When specifying proto(tcp) the z/OS client uses the privileged TCP ports to communicate the MOUNT RPC or UNMOUNT RPC with the NFS server. However, the z/OS client uses the ephemeral TCP ports to communicate NFS RPC with the NFS server. As a result, the z/OS client does not work with NFS servers that require all source TCP ports to be privileged.

Configuring a secure z/OS NFS client

In order for the z/OS NFS client to support the RPCSEC_GSS authentication flavor using the Kerberos V5 Security Mechanism, the following should be done. We are assuming that a properly configured KDC is already setup in your environment. If a KDC is not already configured, see Appendix M, “Setting up NFS functions with Kerberos Support,” on page 577. This document assumes you will be using a KDC provided by “Security Server and Integrated Security Services” (RACF) provided by IBM but are not specific to a KDC provided by IBM. As of z/OS V2R3, ensure that ICSF is started and complete initialization prior to starting the z/OS NFS Client on the system. ICSF will need to be running for the duration of use of all Kerberos functions. See *z/OS Integrated Security Services Network Authentication Service Administration*. The following steps need to be run on the system that contains the KDC unless otherwise noted:

1. Add the client principal "mvsnfsc" to the Kerberos database on the KDC with a defined password. This principal should not use randkey as the password. For example, for the z/OS NDBM type or SUN KDC, issue the command "addprinc mvsnfsc" in the kadmin interface, then enter the desired password at the prompt. For the z/OS SAF type KDC, the password can be defined in the "PASSWORD" field of the RACF "adduser" or "altuser" commands. Please remember this password; it will be needed in step 3. Refer to “Setting up a Kerberos Key Distribution Center” on page 578 for more information.
2. Map the principal "mvsnfsc" in lower case to the z/OS NFS client RACF user. For example:

```
ALTUSER mvsnfsc KERB(KERBNAME('mvsnfsc'))
```

If the SAF KDC is configured on the same system as the z/OS NFS client then a PASSWORD must be set:

```
ADDUSER mvsnfsc OWNER(owner) OMVS(UID(0))
ALTUSER mvsnfsc PASSWORD(password) NOEXPIRED KERB(KERBNAME('mvsnfsc'))
PASSWORD USER(mvsnfsc) NOINTERVAL
```

Note:

- a. We expect that the z/OS NFS client's ID has already been defined to RACF. If it has not been configured, please see “Setting up the z/OS NFS authorization” on page 162.
- b. If a SAF KDC is NOT being used, create a principal 'mvsnfsc' according to your vendor's KDC documentation.

- c. The NFS Client requires that the Kerberos segment use KERBNAME 'mvsnfsc' and it must be in lowercase.
 - d. Including PASSWORD option "NOINTERVAL" prevents the password from expiring.
3. Regardless of which KDC is used, the system administrator must add the principal "mvsnfsc" into the keytab from the omvs shell. If /etc/skrb/krb5.keytab does not exist, create a new one. Failure to do so will caused the principals "key version" to be incremented causing preciously created keytabs to become absolute. For example:

```
IBMUSER:/ :> keytab add mvsnfsc -p password -k /etc/skrb/krb5.keytab -v 1
```

Note:

- a. The "password" in step 3 must match the "password" entered in step 2, when the principal was added to the KDC Kerberos database. This principal "mvsnfsc" is used to perform NFSv4 mounts for all users.
 - b. The key version used to create the keytab must be the same key version as in the RACF database. The "-v" option of the keytab command is used to specify the key version when adding a principal to a keytab. Issue the following RACF command to see the current key version: "LU mvsnfsc NORACF KERB" Or from a non SAF or NDBM KDC from kadmin interface issue: "getprinc mvsnfsc"
 - c. The password used with the "keytab" command is case sensitive. If mixed case password support is not in effect you must enter the password in uppercase.
 - d. SFTP, or Secure copy the new keytab to the z/OS NFS Client and place in "/etc/skrb/krb5.keytab".
 - e. To gain access to a secure mount point, all users should perform a "kinit" to acquire their Kerberos credentials.
4. The z/OS NFS client requires the Kerberos configuration file "krb5.conf" be configured to match your sites Kerberos environment.

Sample /etc/skrb/krb5.conf file to be put on the z/OS NFS client system:

```
[libdefaults]
default_realm = KRB390.IBM.COM
kdc_default_options = 0x40000010
use_dns_lookup = 0
default_tkt_enctypes = aes256-cts-hmac-sha1-96,aes128-cts-hmac-sha1-96,
des3-cbc-sha1,des-hmac-sha1,des-cbc-md5,des-cbc-md4,des-cbc-crc
default_tgs_enctypes = aes256-cts-hmac-sha1-96,aes128-cts-hmac-sha1-96,
des3-cbc-sha1,des-hmac-sha1,des-cbc-md5,des-cbc-md4,des-cbc-crc

[realms]
KRB390.IBM.COM = {
kdc = dcesec4.krb390.ibm.com:88
kpasswd_server = dcesec4.krb390.ibm.com:464
admin_server = dcesec4.krb390.ibm.com:749
}
KRB2000.IBM.COM = {
kdc = sstone1.krb2000.ibm.com:88
admin_server = sstone1.krb2000.ibm.com:749
}

[domain_realm]
.krb390.ibm.com = KRB390.IBM.COM
.krb2000.ibm.com = KRB2000.IBM.COM
```

Supported etypes:

```
ENCTYPE_DES_CBC_CRC
ENCTYPE_DES_CBC_MD4
ENCTYPE_DES_CBC_MD5
ENCTYPE_DES_HMAC_SHA1
ENCTYPE_DES3_CBC_SHA1
ENCTYPE_AES128_CTS_HMAC_SHA1_96
ENCTYPE_AES256_CTS_HMAC_SHA1_96
```

5. Most issues with kerberos are related to invalid keytabs. Once the keytab has been placed on the zNFS client's LPAR in `"/etc/skrb/krb5.keytab"`, verify that the keytab is valid by issuing the following command:

```
kinit -k mvsnfsc
```

- a. This command should complete with out errors and you should not be prompted for a password.
- b. If this command fails, the keytab is invalid or the Kerberos configuration is incorrect.

Configuring the z/OS NFS server

This section describes the tasks you can perform to configure the z/OS NFS server. These tasks include allocating and modifying data sets, allocating mount handle, lock, side file, and z/OS NFS server log data sets, modifying `tcpip.ETC.RPC`, and updating z/OS system data sets for the server. This section also includes information about the data conversion between EBCDIC and ASCII.

Attributes data set

To allocate and modify the attributes data set, perform the following tasks:

1. Allocate a fixed-block partitioned data set or a fixed-block sequential data set with a record length of 80.
2. Copy the sample member `GFSAPATT` from the `prefix.NFSSAMP` data set into the allocated attributes data set.
3. Modify the attributes to suit your installation. Appendix E, "NFS system server sample attribute table," on page 499 shows the sample attributes data set. You can specify three sets of attributes within the attributes data set.
 - Data set creation attributes
 - Processing attributes
 - Site attributes.

Note:

1. Client users can override the processing and data set creation attributes (for their own sessions), but not the site attributes.
2. The attributes data set specified on the `NFSATTR DD` statement of the `mvsnfsc` startup procedure is read during server startup processing. Further changes to this data set do not take effect until the server is restarted. Also, whenever any attributes are changed, all the previous existing mount points have to be unmounted and mounted again (using the `umount` and `mount` client commands) if you want the mount points to pick up the new attributes.

Specify this attributes data set for the `NFSATTR DD` statement in the `MVSNFSC` cataloged procedure.

Coding attribute statements

Here are guidelines for coding attribute statements:

- You can continue a line in the attributes data set by placing a “\” or “+” at the end of the line.
- A “#” anywhere in the data set indicates a comment that extends to the end of the line (unless the **altsym** keyword is used in the **start** command or the server startup procedure; if **altsym** is used, a “;” indicates a comment but with one exception: If the `fn_delimiter(;` attribute uses a semicolon, the `fn_delimiter` semicolon is treated as a delimiter between the file name and the attributes that follow, not as a comment symbol).
- If you specify more than one attribute on a line, separate the attributes with a comma and a space.

Exports data set

To allocate and modify the exports data set, perform the following tasks.

1. Allocate a fixed block partitioned data set or a fixed block sequential data set with record length of 80.
2. Copy the sample member GFSAPEXP from the *prefix.NFSSAMP* data set into the allocated data set.
3. Modify the sample exports data set to suit your installation. Appendix F, “Sample exports data set,” on page 525 shows the sample exports data set.
4. Specify this exports data set for the EXPORTS DD statement in the MVS NFS cataloged procedure.

The exports data set contains entries for directories that can be exported to clients. It is used by the server to determine which data sets' high-level qualifiers or z/OS UNIX directories can be mounted by a client in a read or write mode.

Note: You cannot specify exporting a “parent directory” or a subdirectory of an exported directory. For example, if you specify DIR1 in the exports data set, DIR1 and all its subdirectories are exported. You cannot specify any subdirectories under DIR1 in the exports data set.

When the modified exports data set takes effect

The exports data set specified in the exports DD statement of the MVS NFS startup procedure is read during server startup processing. Changes to this file do not take effect for new mount points until the **exportfs** operand of the **modify** command is completed or the server is restarted. The changes will also be immediately enforced at z/OS NFS server startup or **exportfs** operand time regardless of the state of any pre-existing mount points. For **exportfs** operand with 'symresolve' attribute effects for the **showmount** command, see “Using commands on the z/OS NFS client” on page 81. Note that any pre-existing mount points continue to exist even if they have been removed from the exports data set. However, any security changes apply immediately.

When the **exportfs** operand of the **modify** command is issued, any errors found in the file are sent to the system log, the entire exports list is not refreshed, and processing continues.

When the server is started, if any errors are found in the file, they are sent to the system log, and the server stops once the entire exports data set has been read.

Directory statement

Use the directory statements in the exports data set to limit access of directories to specified client workstations.

- Entries can be up to 4096 characters long. Directory names for MVS data sets must follow z/OS naming conventions.
- Lines can be continued by placing a backslash (\) or a plus sign (+) at the end of the line.
- A “#” anywhere in the data set indicates a comment that extends to the end of the line (unless the **altsym** keyword is used in the **start** command or the server startup procedure; if the altsym keyword is used, the “;” indicates a comment).
- Spaces cannot be used in the keywords.
- A vertical bar (|) acts as a separator character between multiple list entries such as client ids or network security values. Before z/OS V1R8, the separators were colon (:) characters . Since client ids can include colons as part of their IPv6 addresses, the separator characters are changed to prevent ambiguity. Any colon separator characters must be changed to vertical bars in exports files that are used with z/OS V1R8.
- The parameters to the right of directory are optional. Except for **ro** and **rw**, the parameters can be combined. If they are combined, only the first parameter is preceded by “-”. For example:

```
user1.test -access=rs60001|sun1|sun2,ro
```

Note: Prefix site attributes apply to the exports file. Either the **hfsprefix** or **mvsprefix** can be specified as part of the directory name. If no prefix is specified, then the implicit prefix algorithm applies. If both implicit options are specified, the export entry can apply to both z/OS UNIX file systems and MVS data sets. The existence check is applied to the mount request, not to the export entry itself.

An entry for a directory is specified, as follows:

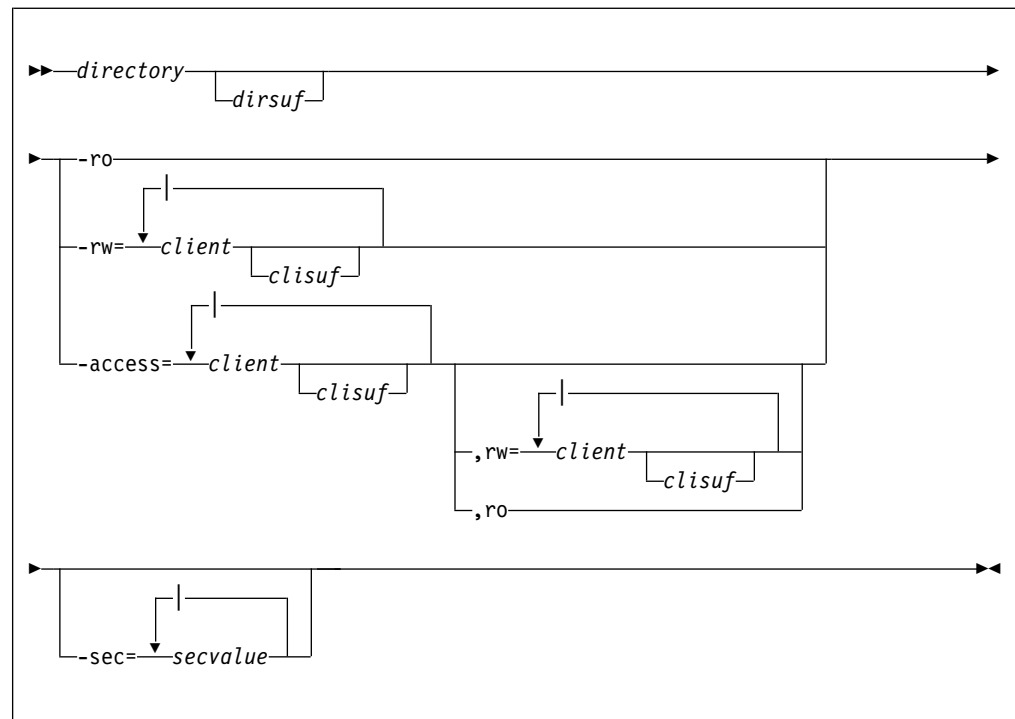

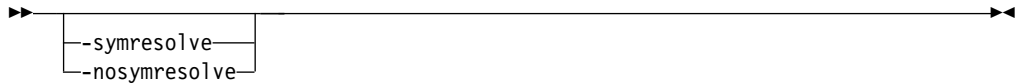

where

directory

For MVS data sets, the MVS high-level qualifier, partitioned data set name, or alias to a user catalog; the name must conform to MVS data set naming conventions. The name may be preceded by the MVS prefix.

For z/OS UNIX file systems, the entire UNIX directory path name, starting from the root. The name may be preceded by the HFS prefix.

If no prefix is specified, the implicit prefix algorithm is used for determining which file system type this entry applies to. If both implicit options are active, and are valid for this entry, then the entry will be assumed to apply to both file system types. No existence check is performed to refine the file system type selection to a single option.

For both MVS data sets and z/OS UNIX directories, wildcard symbols can be used to create regular expressions, and MVS system symbols can also be used to create regular expressions for MVS data sets.

dirsuf

Suffix for a directory to be exempt from SAF checking, even though SAF or SAFEXP is specified as the security option. This parameter emulates an entry in the NFS checklist data set prior to z/OS V1R8. Prior to z/OS V1R8, the Checklist used a one-to-one correspondence policy, that is, one checklist entry should generate one real path that was to be exempted from SAF checking. In z/OS V1R8 and later, the former checklist one-to-one correspondence policy remains unchanged; MVS system symbols and wildcard symbols must not be used in a directory if *dirsuf* is used together with a directory. The suffix is ignored if the **checklist** site attribute is not specified, or the **security** site attribute is not set to SAF or SAFEXP. The directory suffix can have the following values:

blank

If the **security** site attribute is set to SAF or SAFEXP, SAF checking is performed for this directory and its sub-directories.

<nosaf>

If the **security** site attribute is set to SAF or SAFEXP, SAF checking is not performed for this directory and its sub-directories. This value emulates the checklist function prior to z/OS V1R8.

<sub-directory list,nosaf>

If the **security** site attribute is set to SAF or SAFEXP, SAF checking is performed for this directory. However, for the specified *sub_directory_list*, and its sub-directories, SAF checking is not performed.

sub-directory list

A list of sub-directories separated by commas, and optionally client host lists.

sub-directory [**,hosts=client_list**]

sub-directory

Name of a sub-directory to which the **nosaf** function is to be applied. The directory name is appended to the front of each

sub-directory name to generate to full name of the directory item for which no SAF checking is to be performed.

A sub-directory entry can also refer to a specific member of an MVS PDS or PDSE for which no SAF checking is to be performed: *sub_directory(member)*.

client_list

List of client host names to which the **nosaf** function is to be applied. If no *client_list* is specified, then the function applies to all clients.

Note: The *hosts=client_list* specification in the directory suffix expands the checklist functionality beyond that available in prior releases. This parameter allows you to limit the checklist applicability to a subset of hosts, only those specified in the *client_list*.

-ro

Export the directory as read only. If not specified, the directory is exported as read/write.

-rw=client[clisuf][|client...]

The directory is exported as read/write to specified *clients*, and read-only to everyone else. Use a vertical bar (|) to separate client names. *Client* names may be specified as shown in “Client id specification” on page 189.

-access=client[clisuf][|client...][[,rw=client[|client...]] | [,ro]]

Gives access only to *clients* listed. *Client* names may be specified as shown in “Client id specification” on page 189.

If neither **rw** nor **ro** is specified for the **-access** parameter, then the clients listed have read/write access and the rest of the clients have no access.

If the **rw** parameter is specified for the **-access** parameter, the associated clients have read/write access to the directory, and the clients specified in the **access** list but not in the **rw** list have read-only access.

If the **ro** parameter is specified for the **-access** parameter, the clients in the **access** list have read-only access to the directory, and the rest of the clients have no access.

Use a vertical bar (|) to separate client names.

client

Name of the client to which the specification applies. *Client* names may be specified as shown in “Client id specification” on page 189.

clisuf

The client suffix can be specified to give root access to the root user of the specified client. The client suffix can have the following values:

blank

If no MVSLOGIN has been done, the id of root users from the client system are converted to id=**nobody** (-2) before access permissions are checked. This means that there is a good chance that root users will be denied access to the directory while other users from that client have access.

<root>

If no MVSLOGIN has been done, root users from the client system are given root access to this directory and its subdirectories (that is, the user is treated as a trusted user).

-sec=secvalue

Specifies the acceptable level of network transmission security access that a client's RPC request must provide. If a client attempts to access an object in the directory using a network security level that is not specified on the **sec** parameter, the access is denied.

krb5

Provides Kerberos V5 based integrity on the RPC credentials (but not data), when the RPC authentication flavor is RPCSEC_GSS. It uses the RPCSEC_GSS service of `rpc_gss_svc_none`.

krb5i

Provides Kerberos V5 based integrity on both the RPC credentials and data, when the RPC authentication flavor is RPCSEC_GSS. It uses the RPCSEC_GSS service of `rpc_gss_svc_integrity`.

krb5p

Provides Kerberos V5 based integrity and privacy on both the RPC credentials and data, when the RPC authentication flavor is RPCSEC_GSS. The RPCSEC_GSS service used here is `rpc_gss_svc_privacy`.

sys

Specifies that the AUTH_SYS authentication flavor can also be used to access this file system. Note that the AUTH_SYS authentication flavor does not provide any integrity or privacy protection.

Use a vertical bar (|) to separate security levels.

If the **sec** parameter is provided, it further restricts the network transmission protection of specific export entries, in the domain of the file system wide network transmission protection, which is controlled by the **mvsec**, **hfsec**, or **pubsec** site attributes. When this parameter is not specified, the allowed security levels are governed by the **mvsec**, **hfsec**, and **pubsec** site attributes.

Note: If no options are specified, the default value allows any client to mount the given directory with read/write access.

-symresolve

The symbolic link (symlink) in the directory path is resolved at time of z/OS NFS Client access to the directory. New Export entry is created in memory with a real directory path.

Note:

1. Only absolute paths are supported; symlinks pointing to relative paths are not supported.
2. If the path of a symlink is changed, an EXPORTFS command must be run to allow z/OS NFS Server to re-interpret the new symlink path at the next mount.
3. For effects of using the **showmount** command, see "Using commands on the z/OS NFS client" on page 81

-nosymresolve

The symlink in the directory path is not resolved.

Note: `-symresolve` and `-nosymresolve` are optional. If not specified, the server default attribute value is used.

Examples of entries in an exports data set: Following are examples of entries in an exports data set.

Examples of specifying directories: The following are examples of specifying directories for z/OS UNIX files:

```

/u                # If the IMPPREFIX( ) site attribute is set to HFS, this entry
                  # will be interpreted to refer to z/OS UNIX directory /u.
                  # If the IMPPREFIX( ) site attribute is set to MVS, this entry
                  # will be interpreted to refer to MVS high-level qualifier 'u'.
                  # If the IMPPREFIX( ) site attribute is set to HFS,MVS or MVS,HFS,
                  # this entry will be interpreted to refer to both.
/hfs/u            # If the SECURITY Site Attribute is set to SAF or SAFEXP,
                  # SAF checking is performed for /hfs/u and its subdirectories.
/hfs/u<nosaf>     # If the SECURITY Site Attribute is set to SAF or SAFEXP, NO
                  # SAF checking is performed for /hfs/u and its subdirectories.
/hfs/u<vrr,nosaf> # If the SECURITY Site Attribute is set to SAF or SAFEXP, SAF
                  # checking will be performed for /hfs/u, but NO SAF checking
                  # will be done for /hfs/u/vrr and its subdirectories.
/hfs/u<vrr,/vrs,nosaf> # If the SECURITY Site Attribute is set to SAF or SAFEXP,
                  # SAF checking will be performed for /hfs/u, but NO SAF checking
                  # will be done for /hfs/u/vrr, /hfs/u/vrs and their
                  # subdirectories.
/hfs/u<vrr,hosts=host1,host2,vndrcvs,nosaf> # if the SECURITY Site Attribute ist
                  # set to SAF or SAFEXP, SAF checking will be performed for
                  # /hfs/u,and for client hosts other than host1 and host2 for
                  # /hfs/u/vrr. NO SAF checking will be done for hosts host1 and
                  # host2 for /hfs/u/vrr or for any host for /hfs/u/vndrcvs.
                  # The same applies to subdirectories of vndrcvr and vndrcvs.
/hfs/u/symlink_ent -symresolve # z/OS NFS server will resolve 'symlink_ent'
                  # and create a temporary in-memory export entry when an
                  # NFS Client issues NFSv4_LOOKUP for this path.
                  #
/hfs/u/symlink1_ent <nosaf> -access=fslab008,symresolve # z/OS NFS server will
                  # resolve 'symlink_ent' and create a temporary in-memory export
                  # entry when an NFS Client issues NFSv4_LOOKUP for this path.
                  # Temporary in-memory CHKLIST entry for the resolved path is
                  # also created.

```

The following are examples of specifying directories for MVS data sets:

```

/mvs/a.b          # If the SECURITY Site Attribute is set to SAF or SAFEXP, SAF
                  # checking is performed for a.b and its lower level qualifiers.
/mvs/a.b<nosaf>   # If the SECURITY Site Attribute is set to SAF or SAFEXP
                  # NO SAF checking is performed.
a.b<nosaf>        # If the SECURITY Site Attribute is set to SAF or SAFEXP,
                  # NO SAF checking is performed for a.b and its lower level
                  # qualifiers.
a.b<c.d,nosaf>    # If the SECURITY Site Attribute is set to SAF or SAFEXP, SAF
                  # checking will be performed for a.b and a.b.c, but NO SAF
                  # checking will be done for a.b.c.d and its lower level
                  # qualifiers.
a.b<c.d(membl),nosaf> # If the SECURITY Site Attribute is set to SAF or SAFEXP,
                  # SAF checking will be performed for a.b, a.b.c, and a.b.c.d
                  # and all its members, except NO SAF checking will be done for
                  # a.b.c.d(membl).
a.b<c.e,c.d(membl),nosaf> # If the SECURITY Site Attribute is set to SAF or SAFEXP,
                  # SAF checking will be performed for a.b, a.b.c, and a.b.c.d and
                  # all its members, except NO SAF checking will be done for
                  # a.b.c.e and a.b.c.d(membl).
A.b<c.e,c.d(member1),hosts=host1,nosaf> # If the SECURITY Site Attribute is set to
                  # SAF or SAFEXP, SAF checking will be performed for a.b, a.b.c
                  # and a.b.c.d and all its members, except NO SAF checking will
                  # be done for a.b.c.e or for host1 for a.b.c.d(member1).

```

Examples of specifying access parameters: Following are examples of specifying access values in an exports data set.

```

/mvs/mvsnfs      -ro,sec=krb5          # give read-only access
                                     # to all clients with RPCSEC_GSS
                                     # security specified
                                     #
theresa.text     # give read/write
                                     # access to all clients
                                     #
robert.mixds     -rw=fsrs001|fslab004|fslab007 #
                                     # give read/write access
                                     # to the clients named
                                     # fsrs001, fslab004 and
                                     # fslab007, and give
                                     # read-only access to
                                     # all other clients
                                     #
/hfs/newproductdirectory -rw=johnson # give read/write access to
                                     # this z/OS UNIX directory to the
                                     # client named johnson;
                                     # give read-only access to
                                     # all others
                                     #
barbara.pds      -access=fsrs001|fslab007 #
                                     # give read/write access
                                     # only to clients named
                                     # fsrs001and fslab007
                                     #
daniel.pds2      -access=fslab004,ro    # give read-only access
                                     # only to the client
                                     # named fslab004
                                     #
virginia.vsam    -access=fslab004|fslab007,rw=fslab004 #
                                     # give read-only
                                     # access only to the
                                     # client named fslab007,
                                     # and give read/write
                                     # access to fslab004.
                                     #
/hfs/u           -sec=krb5|krb5i|krb5p  # client must use krb5, krb5i or
                                     # krb5p authentication levels to
                                     # access server, provided that
                                     # hfssec also allows these
                                     # authentication levels.

```

Note:

1. If your installation cannot use the “#” as a comment delimiter, see “Starting the z/OS NFS server” on page 227.
2. The keywords **ro** and **rw** are mutually exclusive.
3. The ability to write (that is, **rw** specified or **access** specified without other parameters) implies read access also.
4. If **access** and **rw** are specified together, the client names in the **rw** list are logically or'ed with the **access** list to determine the total list of clients with read access.
5. Multiple lines can be used in the exports data set for a given directory to merge the **access** list and the **rw** list. However, similar clauses (for example, an access followed by an access) completely replace any previous specification. If **ro** is specified for a data set on one line and a further line specifies **rw** for that data set, the **rw** undoes the **ro** specified earlier. Similarly, a line with null options completely undoes all previous specifications for that directory, giving read/write access to all clients.

6. It is not appropriate to have the same data set or z/OS UNIX directory defined more than once in the exports data set. If for any reason this is the case, only the last definition in the exports data set is valid.
7. If a directory entry is specified without a prefix, the IMPPPREFIX() site attribute specifies both options, and there is nothing in the directory name syntax that explicitly limits it to one or the other of the two file system types, then the directory entry is exported for both file system types.

Client id specification

There are several options for specifying the client hostname in the exports data. Some options apply only when NODHCP is specified in the site attributes file and others apply regardless of the DHCP mode. The client specification options are as follows.

Single hostname

This is the most common format and the one supported in releases before z/OS V1R8. In this format the client is specified by a hostname recognized by the DNS resolver. This name must be unique and unchanging for the duration of the NFS connections. A client suffix may be specified with this format.

Netgroup name

Name of a netgroup defined in the local /etc/netgroup file. The group entry in the file lists the hosts who are members of the group. Only the host part of each netgroup member is considered for checking for membership. Empty host parts, or those containing a single dash (-) are ignored. Netgroup names must be preceded by an at-sign (@), for example @group. A client suffix may not be specified with this format.

Single IP address

A client may be specified by an IPv4 or IPv6 address. Invalid IPv4 or IPv6 address specifications are ignored. If the NFS server starts in IPv4 mode and an IPv6 address is specified, it is ignored. If the NFS Server starts in IPv6 mode and an IPv4 address is specified, the address is translated to an IPv4-mapped address (which is standard IPv4 address handling in IPv6 networks). This option is only valid in NODHCP mode. In DHCP mode such client specifications are ignored. A client suffix may be specified with this format.

IP networks

Directories can also be exported to all hosts on an IPv4 or IPv6 network or subnetwork simultaneously. For IPv4 networks, specify an IP address and netmask pair as address/netmask where the netmask can be specified in dotted-decimal format, or as a contiguous mask length. For example, either '/255.255.252.0' or '/22' appended to the network base address will result in identical subnetworks with 10 bits of hostname. IPv4 addresses and mask lengths are checked for format and range, and ignored if invalid. A range from 1 to 31 is assumed.

For IPv6 networks, this is done by specifying IPv6 address/prefix-length. For example, the node address 12AB:0:0:CD30:123:4567:89AB:CDEF and its subnet number 12AB:0:0:CD30::/60 can be abbreviated as 12AB:0:0:CD30:123:4567:89AB:CDEF/60. IPv6 addresses and prefix-length are checked for format and range, and ignored if invalid. A range from 1 to 127 is assumed.

If the NFS server starts in IPv4 mode and an IPv6 address is specified, it is ignored. If the NFS Server starts in IPv6 mode and an IPv4 address is specified, the address is translated to an IPv4-mapped address (standard IPv4 address handling in IPv6 networks).

This option is only valid in NODHCP mode. In DHCP mode, IP network entries are ignored. A client suffix may not be specified with this format.

Netgroup definitions: Since z/OS does not support the NIS environment, z/OS NFS can only support netgroups defined in the local `/etc/netgroup` file. z/OS NFS assumes the same file record length restriction as for the NIS environment (that is, a maximum size of 1024 bytes). A netgroup cannot have a client id list longer than 1024 characters. z/OS NFS assumes the same wildcard character ('*' and '?') restrictions as the NIS environment (that is, no wildcard character specification as part of a netgroup name, nor as part of client host names specified in a netgroup file).

z/OS NFS also assumes that the local netgroup file contains netgroup information without the NIS "+" token. In other words, the local netgroup file does not contain any LOCAL netgroup information and all network netgroup information put into the file from the NIS data base without the NIS "+" token. Any "+" tokens encountered are ignored.

Here is an example of some sample local netgroup files:

```
# /etc/netgroup local file.
#
LocalAdmins (,root,)
NetAdmins (sonne,user1,) (sonne,user2,) LocalAdmins
Gateways (rechner1,,) (rechner7,,)
```

Here is another example:

```
# /etc/netgroup local file.
# shown one netgroup, it must contain no more than 1024 chars.

cnet2331 (bart.foobar.net,,cnet2331.foobar.net) \
        (lisa.foobar.net,,cnet2331.foobar.net) \
        (dead.foobar.net,,cnet2331.foobar.net)
```

Wildcard characters: In DHCP mode, client host names may contain the wildcard characters '*' and '?'. Wildcard characters '*' and '?' cannot be specified in netgroup names, nor as part of client host names specified in a netgroup file. These characters can be used to make exports files more compact; for example, *.cs.foo.edu matches all hosts in the domain cs.foo.edu. However, these wildcard characters do not match the dots in a domain name, so that example does not include hosts such as a.b.cs.foo.edu.

When wildcard characters are used, the domain name is mandatory because the NFS server cannot check wildcard host names with DNS or rely on any default domain name definitions.

When wildcard characters are used, client suffix specification is not permitted.

IP address representation: Text representations of IP addresses must conform to the industry standard defined in RFC-2373, IP Version 6 Addressing Architecture. IPv4 addresses and masks must be written in the standard IPv4 dotted-decimal form:

```
ddd.ddd.ddd.ddd
```

where ddd is a one-to-three digit decimal number between 0 and 255.

IPv6 addresses must be written in the standard IPv6 form:

```
x:x:x:x:x:x:x
```

where the x characters are the hexadecimal value of the eight 16-bit pieces of the address. For example:

```
FEDC:BA98:7654:3210:FEDC:BA98:7654:3210
1080:0:0:0:8:800:200C:417A
```

Due to some methods of allocating IPv6 addresses, it is common for addresses to contain long strings of zero bits. To simplify writing addresses containing zero bits, you can use a special syntax to compress the zeros. You can use two colons (::) to indicate multiple groups of 16-bits of zeros. The double colons (::) can only appear once in an address. They can also be used to compress the leading and/or trailing zeros in an address. For example, the following shorthand addresses can be used:

Table 29. Shorthand for addresses with multiple zero bits

Address	Shorthand	Description
1080:0:0:0:8:800:200C:417A	1080::8:800:200C:417A	Unicast address
FF01:0:0:0:0:0:101	FF01::101	Multicast address
0:0:0:0:0:0:0:1	::1	Loopback address
0:0:0:0:0:0:0:0	::	Unspecified address

An alternative form that is sometimes more convenient in a mixed environment of IPv4 and IPv6 nodes is x:x:x:x:x:d.d.d.d, where the x characters are the hexadecimal values of the six high-order 16-bit pieces of the address, and the d characters are the decimal values of the four low-order 8-bit pieces of the address (standard IPv4 representation). Some examples follow:

Table 30. Shorthand for addresses in mixed IPv4 and IPv6 environments

Address	Compressed Form	Description
0:0:0:0:0:13.1.68.3	::13.1.68.3	IPv4-compatible addresses
0:0:0:0:0:FFFF:129.144.52.38	::FFFF:129.144.52.38	IPv4-mapped addresses

Address Prefix Representation: The text representation of IPv6 address prefixes is similar to that of IPv4 addresses prefixes. They are written in CIDR notation. An IPv6 address prefix is represented by the notation: Ipv6-address/prefix-length.

Abbreviation: a node address and its subnet address can be abbreviated, as in the following example:

Node address

```
12AB:0:0:CD30:123:4567:89AB:CDEF
```

Its subnet number

```
12AB:0:0:CD30::/60
```

Abbreviation

```
12AB:0:0:CD30:123:4567:89AB:CDEF/60
```

Checklist data set

In z/OS V1R8, the function of the z/OS NFS checklist data set was merged into the exports data set. If you used a checklist data set in previous releases, use the **dirsuf** parameter to specify its contents in the exports data set. See “Directory statement” on page 182 for details. With this merger, the checklist information can be refreshed dynamically using the **exportfs** operand of the **modify mvsnfs** command, instead of requiring a restart of the NFS server.

Mount handle data sets

The mount handle data sets are used to record active mounts during server operation and allow clients to stay mounted when the server is shut down and restarted. The Network File System alternates between two data sets to record this information; only one data set is used at a time, and it is switched at either shutdown or at resource cleanup timeout.

To create the mount handle data sets, perform the following tasks:

1. Allocate two empty VSAM KSDS data sets with the following attributes:
 - Starting with offset 0, the first 16 bytes in the record are the prime key field.
 - The maximum record length of the mount handle data set is 2000 bytes, and the average record length is 1700 bytes.

```
DEFINE CLUSTER (NAME(mount_handle_data_set_name) -
               VOL(vsam_volume_name) -
               CYL(1 1) -
               INDEXED -
               REUSE -
               KEYS(16 0) -
               SHAREOPTIONS(1 3) -
               RECSZ(1700 2000))
```

See Appendix L, “GFSAMHDJ sample code for creating NFS mount handle data sets and lock data sets,” on page 573 for sample JCL showing how to create the mount handle data sets.

2. Specify these two data sets to the FHDBASE DD statement and FHDBASE2 DD statement in the MVS NFS procedure (see Figure 22).
3. The server switches data sets after resource cleanup has run.
4. Resource cleanup is done at Network File System shutdown and resource cleanup timeout.

Figure 22 shows how to specify the mount handle data set on the FHDBASE DD statement and FHDBASE2 DD statement on the MVS NFS procedure.

```
/**      FHDBASE AND FHDBASE2 ARE
/**      THE MOUNT HANDLE DATA SETS.
/**      THEY NEED TO BE PREALLOCATED
/**      AS EMPTY VSAM KSDS DATA SETS.
/**      THEY WILL BE USED ALTERNATELY.
/**      SAMPLE JCL CAN BE FOUND IN HLQ.NFSSAMP(GFSAMHDJ).
/**
//FHDBASE DD  DISP=SHR,DSN=MVS NFS.FHDBASE
//FHDBASE2 DD DISP=SHR,DSN=MVS NFS.FHDBASE2
```

Figure 22. Specifying the mount handle data set in the MVS NFS procedure

Lock data sets

Lock data sets are VSAM key-sequenced data sets that record the client host IP address and, for NFS V4, the client identification as well as the client host name. Following a server outage, the z/OS NFS server reads the new lock data sets during initialization to determine which clients can reclaim locks. The z/OS Network File System alternates between two data sets to record this information; only one data set is used at a time, and it is switched at shutdown, at resource cleanup timeout, and at the end of the grace period at server startup.

Note: The lock data sets must always be allocated, even if **nonlm** is specified in the site attributes.

To create the lock data sets, perform the following tasks:

1. Allocate two empty VSAM KSDS data sets, on separate DASD volumes to reduce the possibility that a single failure would result in the loss of both data sets. Allocate them with the following attributes:

- Starting with offset 0, the first eight bytes in the record are the prime key field.
- The maximum record length of the lock data set is 2000 bytes, and the average record length is 1700 bytes.

```
DEFINE CLUSTER (NAME(lock_data_set_name) -  
                VOL(vsam_volume_name) -  
                CYL(1 1) -  
                INDEXED -  
                REUSE -  
                KEYS(8 0) -  
                SHAREOPTIONS(1 3) -  
                RECSZ(1700 2000))
```

See Appendix L, “GFSAMHDJ sample code for creating NFS mount handle data sets and lock data sets,” on page 573 for sample JCL showing how to create the lock data sets.

2. Specify these two data sets to the LDBASE DD statement and LDBASE2 DD statement in the MVS NFS procedure (see Figure 23).
3. The server switches data sets after resource cleanup has run.
4. Resource cleanup is done at Network File System shutdown, resource cleanup timeout, and at the end of the grace period at server startup.

Figure 23 shows how to specify the lock data set on the LDBASE DD statement and LDBASE2 DD statement on the MVS NFS procedure.

```
/**      LDBASE AND LDBASE2 ARE  
/**      THE LOCK DATA SETS.  
/**      THEY NEED TO BE PREALLOCATED  
/**      AS EMPTY VSAM KSDS DATA SETS.  
/**      THEY WILL BE USED ALTERNATELY.  
/**      SAMPLE JCL CAN BE FOUND IN HLQ.NFSSAMP(GFSAMHDJ).  
/**  
//LDBASE DD  DISP=SHR,DSN=MVS NFS.LDBASE  
//LDBASE2 DD DISP=SHR,DSN=MVS NFS.LDBASE2
```

Figure 23. Specifying the lock data set in the MVS NFS procedure

Converting data between ASCII and EBCDIC - NFS V2 and V3 only

With the NFS version 2 and 3 protocols, data and metadata is converted between EBCDIC and ASCII as well as other data formats defined with a coded character set identifier (CCSID). No double byte character set (DBCS) or multiple byte character set (MBCS) forms of data or metadata are converted.

Customizing the translation table

You can customize the translation table for NFS using the processing attribute **xlat(member_name)**. The parameter (**member_name**) is the member name of a PDS or PDSE containing the customized translation table. This attribute can be specified either in the mount operation or in the attribute file. It can be specified on a file operation but is ignored, only the mount or the xlat value takes effect.

If the processing attribute, **xlat**, is not specified in the attribute file, the NFS internal translation table is used as the installation default translation table. When

the **xlat(member_name)** processing attribute is specified in the attribute file, this customized translation table becomes the installation default translation table. The NFS internal translation table is derived from EBCDIC code page 0037 and ISO 8859-(ASCII). RPC arguments, such as filenames, are always translated by the installation default translation table. Data shipped with RPCs are translated by the mount specified translation table, if any. Otherwise, they are also translated by the installation default translation table.

A mount request with processing attribute, **xlat**, specified overrides the installation default translation table.

When accessing z/OS UNIX files, you must specify the OEMVS311 translation table or your customized translation table either in the mount request or in the default attributes. The OEMVS311 table translates ASCII (ISO 8859-1) to and from EBCDIC (1047 - z/OS UNIX). TCP/IP for MVS version 3.1 provides the OEMVS311 table. This table translates the UNIX line terminator (**lf**) to the z/OS UNIX line terminator (**nl**).

See *z/OS Communications Server: IP Configuration Reference* for more information about creating and customizing your own translation tables.

Enabling the xlat processing attribute

A DD statement, NFSXLAT, is required in the Network File System startup procedure to enable the **xlat(member_name)** processing attribute:

```
//NFSXLAT          DD          DSN=data_set_name,DSP=SHR
```

where

data_set_name

Specifies the name of a PDS or PDSE whose member contains the customized translation table.

A PDS or PDSE, *data_set_name*, is created by the CONXLAT utility whose member contains the customized translation table.

Note:

1. See *z/OS Communications Server: IP Configuration Reference*, "Using Translation Tables," for more information about creating and customizing your own translation tables.
2. You can edit or modify the translation table from your own or from a member in the tcpip.SEZATCPX data set and then use CONVXLAT utility to convert the source table into binary format. The CONVXLAT utility can take a PDS or PDSE as input, and its output data set can be physical sequential, PDS or PDSE.
3. The Network File System only supports PDS and PDSE. A sequential data set must be copied to either a PDS or PDSE member.
4. The Network File System does not support the translation for multiple-byte character sets.
5. Sample steps for creating the xlat member:
 - a. Run the TCPIP CONVXLAT utility to create a physical sequential (PS) data set with DSORG=PS, RECFM=F, LRECL=256, BLKSIZE=256;
"convxlat" 'tcpip.sezaticpx(standard)' 'hlq.xlat.output'

- b. Allocate a PDS data set with DSORG=PO, RECFM=F, LRECL=256, BLKSIZE=256; copy the CONVXLAT output data set as a member in the PDS data set
- c. Allocate the xlat member in the z/OS NFS startup procedure.

Updating z/OS system data sets for the server

Update the following z/OS system data sets to accommodate the z/OS NFS server:

- PARMLIB updates

Add the data set defined in the GFSAPROC STEPLIB containing the z/OS NFS server library to the system's APF authorization list (IEAAPFxx). A sample cataloged procedure named GFSAPROC is provided as a member of the sample library NFSSAMP, see "Sample z/OS NFS server startup procedures" on page 535.

- PROCLIB updates

A sample cataloged procedure named GFSAPROC is provided as a member of the sample library NFSSAMP, see "Sample z/OS NFS server startup procedures" on page 535. Modify the MVSNFS procedure and place it in your system PROCLIB. Add the DD statements:

```
EXPORTS as the DD for the exports data set
NFSATTR as the DD for the attributes data set
FHDBASE and FHDBASE2 as the DD for the mount handle data set
NFSXLAT as the DD to enable the xlat processing attribute
NFSLOG1 as the DD for the primary log data set
NFSLOG2 as the DD for the secondary log data set
SYSxDUMP as the DD for the SYSxDUMP data set ('x' = U or M)
LDBASE and LDBASE2 as the DD for the lock data sets
```

- REGION updates

The REGION specifies the total size of usable virtual storage below-the-bar of an address space.

- If REGION is zero (give the address space ALL the available virtual storage below the bar), MEMLIMIT is assigned no limit.

The sample z/OS NFS Server startup procedure GFSAPROC has REGION=0M.

- If REGION is non-zero, the MEMLIMIT value takes effect. If the MEMLIMIT is not specified the z/OS NFS Server may not complete startup and shutdown immediately.

- MEMLIMIT updates

The MEMLIMIT specifies the total size of usable virtual storage above-the-bar of an address space. It can come from the following:

- IEFUSI system exit
- SMFPRMxx MEMLIMIT parameter
- SETSMF command
- MEMLIMIT keyword in the JOB and EXEC JCL (that is, z/OS NFS Server startup procedure). It is worthwhile to update the sample startup procedure GFSAPROC with an example of a non-zero REGION size and MEMLIMIT.

The following is an example of REGION and MEMLIMIT use in the startup procedure GFSAPROC.

```
//*****
//*
//* The REGION specifies the virtual memory below the bar (2GB) @P0AA
//* while the MEMLIMIT specifies the memory above the bar. @P0AA
//* If REGION=0M then MEMLIMIT=NOLIMIT (default), or @P0AA
//* optionally specify the MEMLIMIT. @P0AA
```

```

      /* If REGION=xxxM then specify MEMLIMIT=yyyG rather than      @P0AA
      /*   taking some default value.                               @P0AA
      /* The z/OS Network File System Server will not start if     @P0AA
      /*   MEMLIMIT=0M or if it is too small.                       @P0AA
      /*
      /*MVSNFSS EXEC PGM=GFSAMAIN,                                  @LG2C
      /*   PARM='&PARMS',
      /*   TIME=1440,                                             @P0AM
      /*   REGION=0M
      /*   REGION=0M,MEMLIMIT=yyyG                                @P0AA
      /*   REGION=xxxM,MEMLIMIT=yyyG                             @P0AA
      /*   REGION=xxxM,MEMLIMIT=yyyM                             @P0AA
      /*

```

Allocating the z/OS NFS server log data sets

For information about allocating the z/OS NFS server primary and secondary log data sets, see Appendix K, “Capturing diagnostic information using z/OS NFS log data sets and from other components,” on page 565.

Side file data set

A side file data set is allocated as a fully-qualified MVS data set name.

- Record format of FB 80 is required.
- Data set organization of Physical Sequential is required.
- The name must follow the naming convention:

"USERID.MLQ.NFS.MAPPING"

where:

USERID

can be any valid userid.

MLQ

is optional; if present, may be any valid MVS qualifiers

NFS.MAPPING

are required low-level qualifiers

The last two qualifiers of the data set name must be NFS.MAPPING .

A sample side file, GFSAPMAP, is provided in the SYS1.NFSSAMP library. For information about side files, see “File extension mapping” on page 40, “Processing attributes syntax” on page 127, “Site attributes syntax” on page 139, and Appendix E, “NFS system server sample attribute table,” on page 499.

Modifying tcpip.ETC.RPC and etc/rpc

Add the entries in Table 31 to the tcpip.ETC.RPC and etc/rpc files for the services provided by the z/OS NFS server:

Table 31. Modifying tcpip.ETC.RPC and etc/rpc

Service	Number	Alias	Description
nfsd	100003	nfs nfsprog	# Network File System daemon
mountd	100005	mount showmount	# Mount daemon
nlockmgr	100021	nlm nfs_lockd	# Network Lock Manager
status	100024	nsm nfs_statd	# Network Status Monitor
mvs mount	100044	nfs_mvsmnt	# MVS mount daemon (for mvlogin, mvlogout)

Table 31. Modifying *tcpip.ETC.RPC* and *etc/rpc* (continued)

Service	Number	Alias	Description
showattr	100059	nfs_showattr	# showattr daemon
pcnfsd	150001	nfs_pcnfs	# pcnfs daemon

Setting up a user-specified port range

The */etc/services* file must define the port number entries for services **mountd**, **mvsmount**, **pcnfsd**, **showattr**, network status monitor (**status**), and network lock manager (**nlockmgr**) of the z/OS NFS server. Figure 24 outlines the port numbers for these services, with contiguous port numbers 2043-2049 as examples.

```
# NFS server
#
# Port 2049 must be used for nfsd.
#
# Consecutive port numbers must be assigned for the NFS status,
# nlockmgr, mountd, mvsmount, showattr, and pcnfsd services.
# The example belows uses ports 2043-2048.
#
# When the NFS callback function is being used the services
# nfsscb_b and nfsscb_e should reserve 100 consecutive ports.
# The example below uses port 10300 for the beginning port
# and port 10399 as the ending port.
# For additional information see the Network File System Guide
# and Reference manual.
#
Service      port/protocol  Alias      Description
status      2043/tcp      nfs_statd  # NFS State daemon (NSM)
status      2043/udp      nfs_statd  # NFS State daemon (NSM)
nlockmgr    2044/tcp      nfs_lockd  # NFS Lock daemon (NLM)
nlockmgr    2044/udp      nfs_lockd  # NFS Lock daemon (NLM)
mountd      2045/tcp      mount      # NFS mount daemon
mountd      2045/udp      mount      # NFS mount daemon
mvsmount    2046/tcp      nfs_mvsmnt # NFS mvsmount daemon
mvsmount    2046/udp      nfs_mvsmnt # NFS mvsmount daemon
showattr    2047/tcp      nfs_showattr # NFS showattr daemon
showattr    2047/udp      nfs_showattr # NFS showattr daemon
pcnfsd      2048/udp      nfs_pcnfs  # NFS pcnfsd daemon
pcnfsd      2048/tcp      nfs_pcnfs  # NFS pcnfsd daemon
nfsd        2049/tcp      nfs        # NFS server daemon
nfsd        2049/udp      nfs        # NFS server daemon
nfsd        2049/udp      nfs        # - do not change

#
# NFS Callback function port range
#
nfsscb_b    10300/tcp      # NFSS callback port begin
nfsscb_e    10399/tcp      # NFSS callback port end
nfsscb_b    10300/udp      # NFSS callback port begin
nfsscb_e    10399/udp      # NFSS callback port end
```

Figure 24. Modify */etc/services* for *mountd*, *mvsmount*, *pcnfsd*, *showattr*, *status*, and *nlockmgr*

The user specified range of ports provides a flexible port range to accommodate programs such as a firewall that supports a range of ports for security purposes between the NFS Client and the NFS Server. Firewall security honors a limited port range so the NFS server has to allow the user to specify a few server ports in */etc/services* to narrow the port ranges used for programs **mountd**, **mvsmount**, **pcnfsd** and **showattr**.

The `tcpip.profile` file must define the port range entries for services `nfsd`, `mountd`, `mvsmount`, `pcnfsd`, `showattr`, `status`, and `nlockmgr` of the z/OS NFS server. Figure 25 outlines the port ranges for these seven services with contiguous port numbers 2043-2049 as examples, starting with port 2043 for the network status monitor.

```

PORTRANGE 2043 7 UDP mvsnfs ; Reserved for startup JCL,
                                ; mvsnfs
PORTRANGE 2043 7 TCP mvsnfs ; Reserved for startup JCL,
                                ; mvsnfs
PORTRANGE 10300 100 UDP mvsnfs ; Reserved for startup JCL,
                                ; mvsnfs
PORTRANGE 10300 100 TCP mvsnfs ; Reserved for startup JCL,
                                ; mvsnfs

```

Figure 25. Modify `tcpip.profile` for z/OS NFS server services

Note: Check the z/OS USS BPXPRMxx parmlib member for `INADDRANYPORT` and `INADDRANYCOUNT`. Their range cannot include the z/OS NFS server port ranges for the server to initialize. See *z/OS Communications Server: IP Configuration Guide* for more details.

If the z/OS NFS server is started in the TCP/IP Autolog section, then the `NOAUTOLOG` parameter should be specified on the `PORTRANGE` statement, unless there will always be listeners/sockets on all ports defined in the statement. For additional information, refer to the section on `AUTOLOG` in *z/OS Communications Server: IP Configuration Reference*.

Add the following two lines in `/etc/rpc` on the client side to see `mvsmount` and `showattr` information:

```

mvsmount      100044  mvsmount
showattr      100059  showattr

```

The query result from the client side will show the following messages:

```

# rpcinfo -p hostname
  program  vers  proto  port  service
  100000   2    tcp    111   portmapper
  100000   2    udp    111   portmapper
  100024   1    udp    2043  status
  100024   1    tcp    2043  status
  100021   1    udp    2044  nlockmgr
  100021   1    tcp    2044  nlockmgr
  100021   3    tcp    2044  nlockmgr
  100021   3    udp    2044  nlockmgr
  100021   4    tcp    2044  nlockmgr
  100021   4    udp    2044  nlockmgr
  100005   1    udp    2045  mountd
  100005   1    tcp    2045  mountd
  100005   3    udp    2045  mountd
  100005   3    tcp    2045  mountd
  100044   1    udp    2046  mvsmount
  100044   1    tcp    2046  mvsmount
  100059   2    udp    2047  showattr
  100059   2    tcp    2047  showattr
  150001   1    udp    2048  pcnfsd
  150001   2    udp    2048  pcnfsd
  150001   1    tcp    2048  pcnfsd
  150001   2    tcp    2048  pcnfsd
  100003   2    udp    2049  nfs
  100003   2    tcp    2049  nfs

```

100003	3	udp	2049	nfs
100003	3	tcp	2049	nfs
100003	4	tcp	2049	nfs

Configuring a secure z/OS NFS server

In order for the z/OS NFS version 4 server to be able to provide RPCSEC_GSS security authentication flavors such as krb5, krb5i and krb5p, the z/OS NFS server must be configured to communicate with the Kerberos facilities. To do so, complete the following steps.

We are assuming that a properly configured KDC is already setup in your environment. If a KDC is not already configured please see Appendix M, “Setting up NFS functions with Kerberos Support,” on page 577. This section is split up into two parts to include specific examples using a KDC provided by “Security Server and Integrated Security Services” (RACF) provided by IBM and generic examples for non RACF KDC’s. These steps assume that Resource Access Control Facility (RACF) is available in the system. If you have a different but equivalent external security manager, please refer to its product documentation for instructions. As of z/OS V2R3, ensure that ICSF is started and complete initialization prior to starting the z/OS NFS Server on the system. ICSF will need to be running for the duration of use of all Kerberos functions. See *z/OS Integrated Security Services Network Authentication Service Administration*. A domain name server (DNS) resolver should also be available to the z/OS system in order to enable the security feature. Otherwise message GFSA735I is shown during startup of the secure z/OS NFS server. Since there are many options to set up a DNS resolver, such as /etc/resolv.conf or GLOBAL TCPIPDATA, specific examples are not given here. For more information on setting up a DNS resolver, see *z/OS Communications Server: IP Configuration Guide*.

1. The Kerberos key distribution center (KDC) must be running, and must contain the z/OS NFS server’s principal before the secure z/OS NFS server starts. If the KDC is not set up correctly, whether the z/OS NFS server can start depends on the hfssec, mvssec, and pubsec attribute settings. If any of these three attributes also contains the sys security flavor in addition to any of the Kerberos flavors, the z/OS NFS server is started with message GFSA737I and functions with the sys security flavor only. On the other hand, if none of the hfssec, mvssec, or pubsec attributes contains the sys security flavor and the KDC is not available, the message GFSA736E is shown and z/OS NFS server does not start. The KDC can be running on z/OS, either on the same host as the z/OS NFS server itself or remotely from the z/OS NFS server. It can also be a KDC running on other platforms, for example, a SUN Solaris system or any other platform.

For a brief description on how to setup a z/OS KDC, see “Setting up a Kerberos Key Distribution Center” on page 578, or refer to *z/OS Integrated Security Services Network Authentication Service Administration* for more advanced details. For setting up other platforms’ KDCs, refer to the specific platform’s documentation.

2. Define local realm and default policy. For example, issue the following TSO command:

```
RDEFINE REALM KERBDFLT KERB(KERBNAME(KRB390.IBM.COM) PASSWORD(password))
```

Note: “KRB390.IBM.COM” should match the Kerberos REALM of the KDC.

3. Define IRR.RUSERMAP and grant READ authority to all system users, issuing TSO commands:

```
RDEFINE FACILITY IRR.RUSERMAP UACC(READ) SETROPTS RACLIST (FACILITY)
REFRESH PERMIT IRR.RUSERMAP CLASS(FACILITY) ID(mvsnfs) ACCESS(READ)
SETROPTS CLASSACT (FACILITY)
```

Note: If “mvsnfs” is the RACFID of the z/OS NFS server. It is recommended that you add this path in the z/OS UNIX /.profile:

```
"PATH=/usr/lpp/skrb/bin:$PATH"
```

and export the "PATH."

4. Add a kerberos segment to the RACF user ids for the z/OS NFS server.

Issue the TSO command:

```
ALTUSER mvsnfs
KERB(KERBNAME(nfs/hostname.domain))
```

If the SAF KDC is configured on the same system as the z/OS NFS sever then a PASSWORD must be set:

```
ALTUSER mvsnfs PASSWORD(password) NOEXPIRED
KERB(KERBNAME(nfs/hostname.domain))
PASSWORD USER(mvsnfs)NOINTERVAL
```

If the Kerberos segment is not defined correctly to RACF, the following error message appears on the server when an NFS client tries to mount to z/OS NFS server with Kerberos.

```
GFS728E SAF APPLICATION USER MAPPING FAILED WITH SAF RETURN CODE 8,
RACF RETURN CODE 8, AND RACF REASON CODE 16
```

Note:

- a. We expect that the z/OS NFS server's ID was already defined to RACF. If it has not been configured please see “Setting up the z/OS NFS authorization” on page 162.
 - b. If a SAF KDC is NOT being used, create a principal "nfs/hostname.domain" according to your vendor's KDC documentation.
 - c. The ALTUSER command converts the password to upper case if the MIXEDCASE SETROPTS option is not set. If MIXEDCASE is not set, you must ensure that the upper case value is used when you request an initial ticket. The principal name is not converted to upper case and the realm name is not included. You must change the password for the user in order to create the Kerberos secret key.
 - d. The Kerbname must be the fully qualified hostname and domain. For example *hostname.domain* could be "host1.ibm.com"
 - e. Including PASSWORD option “NOINTERVAL” prevents the password from expiring.
5. The z/OS NFS server requires the Kerberos configuration file “krb5.conf” be configured to match your sites Kerberos environment.

Sample /etc/skrb/krb5.conf file to be put on the z/OS NFS server host:

```
[libdefaults]
default_realm = KRB390.IBM.COM
kdc_default_options = 0x40000010
use_dns_lookup = 0
default_tkt_enctypes = aes256-cts-hmac-sha1-96,aes128-cts-hmac-sha1-96,
des3-cbc-sha1,des-hmac-sha1,des-cbc-md5,des-cbc-md4,des-cbc-crc
default_tgs_enctypes = aes256-cts-hmac-sha1-96,aes128-cts-hmac-sha1-96,
des3-cbc-sha1,des-hmac-sha1,des-cbc-md5,des-cbc-md4,des-cbc-crc

[realms]
KRB390.IBM.COM = {
```

```

kdc = dcesec4.krb390.ibm.com:88
kpasswd_server = dcesec4.krb390.ibm.com:464
admin_server = dcesec4.krb390.ibm.com:749
}
KRB2000.IBM.COM = {
kdc = sstone1.krb2000.ibm.com:88
admin_server = sstone1.krb2000.ibm.com:749
}

```

```

[domain_realm]
.krb390.ibm.com = KRB390.IBM.COM
.krb2000.ibm.com = KRB2000.IBM.COM

```

Supported etypes:

```

ENCTYPE_DES_CBC_CRC
ENCTYPE_DES_CBC_MD4
ENCTYPE_DES_CBC_MD5
ENCTYPE_DES_HMAC_SHA1
ENCTYPE_DES3_CBC_SHA1
ENCTYPE_AES128_CTS_HMAC_SHA1_96
ENCTYPE_AES256_CTS_HMAC_SHA1_96

```

6. Generate the keytab from the KDC and put it in /etc/skrb of the z/OS NFS server unless otherwise defined. For more detailed examples of generating keytabs see "Setting up a Kerberos Key Distribution Center" on page 578 or in *z/OS Integrated Security Services Network Authentication Service Administration*.

From the omvs shell, the system administrator must add the principal "nfs/hostname.domain" into the keytab. If /etc/skrb/krb5.keytab does not exist, create a new one. For example for a SAF or NDBM KDC

```

IBMUSER:/ :> keytab add nfs/hostname.domain -p password -k /etc/skrb/krb5.keytab -v 1

```

For example for a Unix KDC in kadmin:

```

Kadmin: ktadd -k /etc/krb5/krb5.keytab nfs/hostname.domain

```

Note:

- a. The "password" in this step must match the "password" entered in step 4, when the principal was added to the SAF KDC Kerberos database. This principal is used to authenticate the z/OS NFS Sertver to the KDC.
 - b. The key version used to create the keytab must be the same key version as in the racf database. The "-v" option of the keytab command is used to specify the key version when adding a principal to a keytab. Issue the following RACF command to see the current key version:

```

LU mvsnfs NORACF KERB

```
 - c. The password used with the "keytab" command is case sensitive. If mixed case password support is not in effect you must enter the password in uppercase
7. For systems with multiple TCPIP stacks you must create the keytab with principals for each stack. If a stack is part of a different REALM then keys will need to be added to the keytab from each KDC. Cross REALM trusts must also be created.

```

IBMUSER:/:>klist -k
Key table: /etc/skrb/krb5.keytab
Principal: nfs/host1.domain.com@KRB390.IBM.COM
Key version: 4
Principal: nfs/host2.domain.com@KRB390.IBM.COM
Key version: 4
Principal: nfs/host3.domain.com@KRB2000.IBM.COM
Key version: 2

```

8. For Systems having TCP/IP stacks with multiple IP addresses (IPv4/IPv6), their DNS entries must map all of the IP addresses to the default host name for their associated stack.

9. If there is any multi-realm setup in the environment, the z/OS NFS server needs to have the foreign principals mapped to a RACF ID.

For example: To map a foreign principal "fprinc" in "KRB2000.IBM.COM" to RACF ID "fprealm2", issue the TSO commands:

```
ADDUSER (fprealm2) OWNER(owner) OMVS(UID(102))
ALTUSER fprealm2 PASSWORD(password) NOEXPIRED
PASSWORD USER(fprealm2) NOINTERVAL
RDEFINE KERBLINK /.../KRB2000.IBM.COM/fprealm2 APPLDATA('fprealm2')
```

To map the entire foreign realm (every principal in the trusted foreign realm) to a RACF user, issue the TSO command:

```
RDEFINE KERBLINK /.../KRB2000.IBM.COM/ APPLDATA('fprealm2')
```

Note: the /.../ and trailing slash are required. "KRB2000.IBM.COM" is the foreign realm.

10. Start the z/OS NFS server. If set up is correct, the following message should be shown:

```
GFSA730I NETWORK FILE SYSTEM SERVER KERBEROS INITIALIZATION SUCCESSFUL
```

11. Most issues with kerberos are related to invalid keytabs. Once the keytab has been placed on the zNFS server's LPAR in "/etc/skrb/krb5.keytab", verify that the keytab is valid by issuing the following command:

```
kinit -k nfs/hostname.domain
```

- a. This command should complete with out errors and you should **not** be prompted for a password.
- b. If you have multiple stacks, This command should be performed for each principal in the keytab.
- c. If this command fails, the keytab is invalid or the Kerberos configuration is incorrect.

Note:

1. These are the minimal requirements to set up a secure z/OS NFS server in order for it to communicate with Kerberos facilities. For more advanced configurations, please see *z/OS Integrated Security Services Network Authentication Service Administration*.
2. If z/OS NFS server is configured to use a KDC that resides on a remote host, the local KDC procedure (for example, skrbkdc) on the same host as the z/OS NFS server should not be started.

Using dynamic client IP addressing

By default, the z/OS NFS server expects to communicate with clients based on a static client IP address. The server can also use the dynamic host configuration protocol (DHCP) to accept dynamic client IP address changes. To use dynamic client IP addressing, specify the **dhcp** server site attribute. The default attribute, **nodhcp**, tells the server to use the static IP algorithm.

To use dynamic IP addressing, the client must:

- Have a constant host name that the NFS server can identify it by.
- Dynamically update the authentication DNS (dynamic name server) with new IP addresses whenever they change.

- Maintain the TTL (time to live) value that the authentication DNS server specifies to any caching DNS server, based on the frequency with which system IP addresses might change. The larger the TTL value, the greater the possibility that the caching DNS server will have obsolete information. If dynamic addressing is used, the TTL value should be small, ideally zero, but a small value defeats the benefit of caching, so a compromise must be set with the understanding that cached values can become obsolete during the TTL interval and report incorrect information to querying systems like the NFS server.

Regardless of the **dhcp/nodhcp** attribute value, the z/OS NFS server itself continues to have a static IP address.

Terminal ID based restricted MVSLOGIN

When the z/OS NFS Server is used in SECURITY (**saf** or **safexp**) mode, it is necessary for users on NFS clients to issue an NFS Client Enabling Utility MVSLOGIN command from the NFS client system before they can access any files on the NFS Server. Normally, assuming the user has a valid z/OS userid and password, this is not a problem and will successfully provide the user with access to the z/OS system through NFS. However, with the appropriate RACF configuration specifications, the z/OS NFS server also provides the ability to restrict MVSLOGINS based on an NFS client's IP address.

In order to support this capability, the z/OS NFS server transforms an NFS client's IP address into an 8-byte character string, which is then used as the Terminal ID (*termid*) for that NFS Client. Each decimal number of the IP address is transformed into two hex digits. For example:

IP address
is transformed into

12.15.16.32
0C0F1020

9.157.161.12
099DA10C

To use this capability, the z/OS system administrator must:

1. Activate the RACF class TERMINAL. This is done with the RACF command:
SETROPTS CLASSACT(TERMINAL) RACLIST(TERMINAL)
2. Define the proper resource in the TERMINAL class. This is done with the RACF command:
RDEFINE TERMINAL *termid* UACC(NONE)

where *termid* is the terminal Id as generated by the z/OS NFS server using the algorithm cited previously in this section.

Assume a *termid* value of 099DA10C is specified, then NFS client with IP address 9.157.161.12 cannot successfully execute the MVSLOGIN NFS Client Enabling Utility for users, which have NONE access for the *termid* class.

3. Refresh the RACF class TERMINAL. This is done with the RACF command:
SETROPTS RACLIST(TERMINAL) REFRESH
4. Grant permission to some users (for example, USER4 and USER5) from the NFS client with IP address 9.157.161.12 to successfully execute the MVSLOGIN NFS Client Enabling Utility. This is done with the RACF command:
PERMIT 099DA10C CLASS(TERMINAL) ID(USER4 USER5) ACCESS(ALTER)
SETROPTS RACLIST(TERMINAL) REFRESH

For more details on the RACF configuration specifications, see *z/OS Security Server RACF Security Administrator's Guide*.

This feature is supported by z/OS NFS only for IPv4 IP addresses in **saf** or **safexp** SECURITY mode, and only in NODHCP mode. The z/OS NFS Server does not support this capability for IPv6 IP addresses (because an IPv6 IP address is too large for this mapping algorithm), or in DHCP mode (because IP addresses change dynamically in DHCP mode).

Note: This feature is also supported with RPCSEC_GSS authentication. However, since mvslogin is no longer required with RPCSEC_GSS, the RACF authentication is done automatically based on the Kerberos segment of the RACF ID.

SERVAUTH based restricted MVSLOGIN

The z/OS NFS server relies on the z/OS Communications Server (CS) and RACF to protect several resources and to restrict access from a network, subnetwork, or particular IP address in the network. Using NETACCESS statements in a TCPIP profile, z/OS CS can map networks, subnetworks, and IP addresses to RACF resource names in the SERVAUTH class (see *z/OS Communications Server: IP Configuration Guide*). Users that are not permitted access to a particular RACF resource are not allowed to execute MVSLOGIN from the corresponding network, subnetwork, or IP address.

User access to MVS data sets through the z/OS NFS Server can be protected/permitted restricted to/from some network, subnetwork, or IP address (see *z/OS Security Server RACF Security Administrator's Guide*).

To use this capability, the z/OS system administrator must:

1. Add the NETACCESS section in your TCPIP profile if it does not exist, and modify the NETACCESS section in your TCPIP profile to prevent/permit users from/to accessing a given network, subnetwork, or host.

NETACCESS examples:

```
NETACCESS    INBOUND    OUTBOUND ; check both ways
              192.168.0.55 255.255.255.255 SUN1      ; specific UNIX host
              192.168.0.56/32 MVSNFS      ; the z/OS NFS server Requires
                                      ; matching "PERMIT" to grant access
              192.168.0.0/16  CORPNET    ; Net address
              192.168.113.19/32 HOST1     ; Specific host address
              192.168.113.0   255.255.255.0  SUBNET1   ; Subnet address
              192.168.192.0/24 SUBNET1    ; Subnet address
              Fe80::6:2900:1dc:21bc/128 HOST2 ; IPv6 specific host address
              2001:0DB8:/16   GLBL       ; IPv6 global network
              DEFAULTHOME    HOME       ; Required local zone
              DEFAULT 0      DEFZONE    ;Optional Default security zone
ENDNETACCESS
```

2. Define and activate a RACF profile for each resource specified in the SERVAUTH class via the NETACCESS statement. Issue the following RACF commands (see *z/OS Security Server RACF Security Administrator's Guide*):

```
RDEFINE SERVAUTH (EZB.NETACCESS.SYSTEM1.TCPIPRX.MVSNFS)
RDEFINE SERVAUTH (EZB.NETACCESS.SYSTEM1.TCPIPRX.SUN1)
RDEFINE SERVAUTH (EZB.NETACCESS.SYSTEM1.TCPIPRX.HOME)
RDEFINE SERVAUTH (EZB.NETACCESS.SYSTEM1.TCPIPRX.DEFZONE)
SETROPTS CLASSACT(SERVAUTH) REFRESH RACLIST(SERVAUTH)
```

where SYSTEM1 is the *sysname*, TCPIPSJ is the *tcpname*, and MVSNFS is the *saf_resname* as described later in this section.

The corresponding RACF profile name has the following format (see *z/OS Communications Server: IP Configuration Reference*):

```
EZB.NETACCESS.sysname.tcpname.saf_resname
```

where

EZB.NETACCESS

is constant.

sysname

is the value of the MVS &SYSNAME. system symbol.

tcpname

is the name of the procedure used to start the TCP stack.

saf_resname

is 8-character value from the NETACCESS section.

An asterisk is allowed as *sysname* and *tcpname*. For example:

```
EZB.NETACCESS.*.*.CORPNET  
EZB.NETACCESS.*.*.SUBNET1
```

3. To allow an NFS client to create connections with the z/OS NFS Server, socket activity for the NFS Server and the Port mapper, (or RPCBIND) must be permitted with the following RACF commands:

```
PERMIT EZB.NETACCESS.SYSTEM1.TCPIPRX.MVSNFS ACCESS(ALTER) CLASS(SERVAUTH) ID(IBMUSER)  
PERMIT EZB.NETACCESS.SYSTEM1.TCPIPRX.SUN1 ACCESS(ALTER) CLASS(SERVAUTH) ID(IBMUSER)  
PERMIT EZB.NETACCESS.SYSTEM1.TCPIPRX.HOME ACCESS(ALTER) CLASS(SERVAUTH) ID(IBMUSER)  
PERMIT EZB.NETACCESS.SYSTEM1.TCPIPRX.DEFZONE ACCESS(NONE) CLASS(SERVAUTH) ID(IBMUSER)
```

In this example, assuming IBMUSER is the owning ID of both NFS Server and RPCBIND, it is needed to grant ALTER access to IBMUSER.

4. To allow an NFS client to access the z/OS NFS Server with specific RACF ID (for example, USER3), issue the following RACF PERMIT commands:

```
PERMIT EZB.NETACCESS.SYSTEM1.TCPIPRX.MVSNFS ACCESS(ALTER) CLASS(SERVAUTH) ID(USER3)  
PERMIT EZB.NETACCESS.SYSTEM1.TCPIPRX.SUN1 ACCESS(ALTER) CLASS(SERVAUTH) ID(USER3)  
PERMIT EZB.NETACCESS.SYSTEM1.TCPIPRX.HONME ACCESS(ALTER) CLASS(SERVAUTH) ID(USER3)  
PERMIT EZB.NETACCESS.SYSTEM1.TCPIPRX.DEFZONE ACCESS(ALTER) CLASS(SERVAUTH) ID(USER3)  
SETROPTS CLASSACT(SERVAUTH) REFRESH RACLIST(SERVAUTH)
```

NFS client SUN1 (192.168.0.55) can now execute MVSLOGIN with RACF ID USER3, but not other RACF users.

5. To prevent an NFS client to access the z/OS NFS Server with specific RACF ID (for example, USER3), issue the following RACF PERMIT commands:

```
PERMIT EZB.NETACCESS.SYSTEM1.TCPIPRX.DEFZONE ACCESS(NONE) CLASS(SERVAUTH) ID(USER3)  
PERMIT EZB.NETACCESS.SYSTEM1.TCPIPRX.DEFZONE ACCESS(ALTER) CLASS(SERVAUTH) ID(USER5)  
SETROPTS CLASSACT(SERVAUTH) REFRESH RACLIST(SERVAUTH)
```

NFS client SUN1 (192.168.0.55) can now execute MVSLOGIN with RACF ID USER5, but not USER3 and other RACF users.

By using conditional PERMIT commands, the system administrator can restrict access to a data set profile (for instance 'USER2.*') for USER5. The RACF will permit the access only if USER5 executes MVSLOGIN from SUBNET1 (IP address 192.168.113.19).

```
PERMIT 'USER2.*' ID(USER5) ACCESS(ALTER)  
WHEN(SERVAUTH(EZB.NETACCESS.*.*.SUBNET1))
```

For more information, see *z/OS Security Server RACF Command Language Reference*.

Note:

1. The z/OS NFS server supports this capability only in **saf** or **safexp** SECURITY mode.
2. SERVAUTH supports both IPv4 and IPv6 modes.
3. To change between TERMID and SERVAUTH will require user configuration changes to switch between TERMINAL class security specification and SERVAUTH class specification, respectively.
4. This feature is also supported with RPCSEC_GSS authentication. However, since mvslogin is no longer required with RPCSEC_GSS, the RACF authentication is done automatically based on the Kerberos segment of the RACF ID.

Data Labeling

The z/OS NFS server supports the RACF Data Labeling option MLNAMES (also known as name-hiding). For more details on this option, see *z/OS Security Server RACF Security Administrator's Guide*.

This option is activated by RACF command:

```
SETOPTS MLNAMES
```

and is deactivated by RACF command:

```
SETOPTS NOMLNAMES
```

When this option is active MVS data set names will be hidden from NFS users who do not have at least READ access to the data sets. Therefore, it may change the contents of an MVS data set index list produced by the **ls -l** command.

Note:

1. The z/OS NFS server supports this option only in **saf** or **safexp** SECURITY mode.
2. This function only applies to MVS data set access, not to z/OS Unix file access.
3. The name-hiding function can degrade system performance because it requires authorization checks for every object for which a non-SPECIAL user attempts to list the name.

Using multiple TCP/IP stacks

Configuring multiple NFS servers with multiple TCP/IP stacks

The following tasks should be performed to set up the NFS servers for multiple TCP/IP stacks:

- Invocation
- Example procedure to start a NFS server in a multiple server environment
- User interactions
- Errors
- Messages and codes

An NFS server can exploit the ability of the z/OS Communication Server to configure up to eight TCP/IP stacks simultaneously. Each TCP/IP stack can support only one NFS server. All NFS servers have their own IP-address and work independently of each other with each connecting to a specific transport provider. Each NFS server will use its own unique set of data sets for mount handle database, error log, and startup procedures.

The client works with any NFS server as an independent host. At startup, the client selects an NFS server using the servers IP-address or HOST-NAME on the mount parameter. On shutdown of one of the NFS servers, all the clients connected to that server will be forced to make new connections with another NFS server and to repeat the startup procedures such as mvslogins and mount connections.

Multiple NFS server support provides an environment on z/OS where applications can have system flexibility by running a NFS server on each LPAR of one z/OS system. This lets you, for example, have a production and test NFS server run on one z/OS system. The use of multiple NFS servers also provides the ability to define separate security-schemes, to separate workload on different NFS servers, and use separate attribute definitions.

The z/OS NFS Server is a generic server (refer to the section entitled "Generic server versus server with affinity for a specific transport provider" in *z/OS Communications Server: IP Configuration Guide*). The z/OS NFS Server relies on another generic server that is the z/OS PORTMAP or z/OS RPCBIND. When configuring a z/OS NFS Server as a generic server, the z/OS PORTMAP or z/OS RPCBIND should be configured as a generic server. When configuring z/OS NFS Servers as multiple servers with transport affinity, multiple z/OS PORTMAP or z/OS RPCBIND should be configured with transport affinity. Mixing generic servers along with servers with transport affinity is not recommended and could lead to undesirable results.

Invocation: To run multiple NFS servers on one z/OS system, it is necessary to have a corresponding number of active TCP/IP stacks each with their own portmapper or rpcbind. A properly configured BPXPRMxx with CINET is required. The NFS server and TCP/IP startup procedures for each TCP/IP stack should have different names.

Example CINET configuration in BPXPRMxx to start an NFS server in a multiple server environment:

```
FILESYSSTYPE TYPE(CINET) ENTRYPOINT(BPXTCINT)
  NETWORK TYPE(CINET)
    DOMAINNAME(AF_INET)
    DOMAINNUMBER(2)
    MAXSOCKETS(64000)
    INADDRANYPORT(4901)
    INADDRANYCOUNT(100)
  NETWORK TYPE(CINET)
    DOMAINNAME(AF_INET6) /* activate IPv6 */
    DOMAINNUMBER(19)
SUBFILESYSSTYPE TYPE(CINET) NAME(TCPIPRX) ENTRYPOINT(EZBPFINI) DEFAULT
SUBFILESYSSTYPE TYPE(CINET) NAME(TCPIPRY) ENTRYPOINT(EZBPFINI)
```

Each NFS server startup procedure needs to have the following change:

1. Add the envar parameter with the `_BPXK_SETIBMOPT_TRANSPORT` environment variable to point to the TCP/IP startup procedure.
2. SYSTCPD DD statement to point to its TCP/IP stack profile. See the example in "Example procedure to start an NFS server in a multiple server environment."

Example procedure to start an NFS server in a multiple server environment: The following contains a sample procedure to start an NFS server in a multiple server environment.

```
| //MVS NFS PROC SYSNFS=SYS1, @LG2C
| // PARS=' /INFO', @LG2C
| // * SYSLE=SYS1, @LG2C
| // TCP/IP=TCP/IP.OS390R10,
```

```

//          NFSPRFX=MVSNFS                                @LG2C
//MVSNFSS EXEC PGM=GFSAMAIN,                              @LG2C
//*
//* Use LE ENVAR runtime option to set the environment variable
//* _BPXK_SETIBMOPT_TRANSPORT with a specific TCPIP/IP stack affinity.
//* TCPIPRTX is the StartUp Procedure of the selected TCIP/IP stack
//*
//          PARM=(' ENVAR("_BPXK_SETIBMOPT_TRANSPORT=TCPIPRTX")',
//          '&PARMS'),
//          TIME=1440,                                     @P0AM
//          REGION=0M
//*
//*      Define dataset name of selected TCP/IP stack.
//SYSTCPD DD DISP=SHR,DSN=&TCPIP..TCPIP.DATA(TCPDATA)
//STEPLIB DD DISP=SHR,DSN=&SYSNFS..NFSLIBE
//SYSPRINT DD SYSOUT=*
//*
//*SYSDUMP DD DISP=SHR,DSN=&NFSPRFX..SYSDUMP
//OUTPUT DD SYSOUT=*
//SYSERR DD SYSOUT=*
//*
//*      Define dataset names which will be used by current NFS server
//NFSLOG1 DD DISP=SHR,DSN=&NFSPRFX..TCPIPRTX.LOG11
//NFSLOG2 DD DISP=SHR,DSN=&NFSPRFX..TCPIPRTX.LOG21
//NFSATTR DD DISP=SHR,DSN=&NFSPRFX..CNTL(NFSATTRV)
//EXPORTS DD DISP=SHR,DSN=&NFSPRFX..CNTL(EXPORT1)
//FHDBASE DD DISP=SHR,DSN=&NFSPRFX..TCPIPRTX.FHDBASE
//FHDBASE2 DD DISP=SHR,DSN=&NFSPRFX..TCPIPRTX.FHDBASE2
//LDBASE DD DISP=SHR,DSN=&NFSPRFX..TCPIPRTX.LDBASE
//LDBASE2 DD DISP=SHR,DSN=&NFSPRFX..TCPIPRTX.LDBASE2

```

User interactions: For more information about configuring multiple TCP/IP stacks, see *z/OS UNIX System Services Planning* and *z/OS Communications Server: IP Configuration Reference*.

Console operators will need to distinguish between different NFS server console messages received from multiple NFS servers on one z/OS system.

System administrators can use the new support to define separate security-schemes, separate workload on different NFS servers, and use separate attribute definitions.

Errors: Existing NFS Server console messages display the start procedure name for a specific NFS server.

Messages and codes: Each NFS Server console message displays the NFS server start procedure as in the following example:

```
GFS320I(procname) NETWORK FILE SYSTEM SERVER INITIALIZATION FAILED: text
```

Where (*procname*) is the name of the NFS server start procedure.

Configuring a single NFS server with multiple TCP/IP stacks

You can perform the following tasks to set up an NFS server for multiple TCP/IP stacks:

- Invocation
- Example procedure to start a NFS server in a multiple server environment
- User interactions
- Errors
- Messages and codes

An NFS server can exploit the ability of the z/OS Communication Server to configure up to eight TCP/IP stacks simultaneously. An NFS server can interact with multiple TCP/IP stacks. A single NFS server will use the IP addresses associated with each stack.

The client works with any NFS server as an independent host. At startup, the client selects an NFS server using the server's IP address or HOST-NAME on the mount parameter. On shutdown of the NFS server, all the clients connected to that server will be forced to make new connections with another NFS server and to repeat the startup procedures, such as `mvslogin` and mount connections.

Invocation: To run a single NFS server with multiple TCP/IP stacks on one z/OS system, properly configure `BPXPRMxx` with `CINET` and a single `rpcbind` or `portmapper` for all stacks.

Note: The `envar` parameter should not be used when configuring a single NFS server with multiple stacks.

Example CINET configuration in BPXPRMxx to start a single NFS server in a multi stack environment:

```
FILESYSTYPE TYPE(CINET) ENTRYPPOINT(BPXTCINT)
NETWORK TYPE(CINET)
    DOMAINNAME(AF_INET)
    DOMAINNUMBER(2)
    MAXSOCKETS(64000)
    INADDRANYPORT(4901)
    INADDRANYCOUNT(100)
NETWORK TYPE(CINET)
    DOMAINNAME(AF_INET6) /* activate IPv6 */
    DOMAINNUMBER(19)
SUBFILESYSTYPE TYPE(CINET) NAME(TCPIPRX) ENTRYPPOINT(EZBPFINI) DEFAULT
SUBFILESYSTYPE TYPE(CINET) NAME(TCPIPRY) ENTRYPPOINT(EZBPFINI)
```

User interactions: For more information about configuring multiple TCP/IP stacks, see *z/OS UNIX System Services Planning* and *z/OS Communications Server: IP Configuration Reference*.

Errors: Existing NFS Server console messages display the start procedure name for a specific NFS server.

Messages and codes: Each NFS Server console message displays the NFS server start procedure as in the following example.

```
GFS320I(procname) NETWORK FILE SYSTEM SERVER INITIALIZATION FAILED: text
```

Where (*procname*) is the name of the NFS server start procedure.

Installing the client enabling commands

This section describes the tasks you must perform to install and port the client enabling commands. These tasks include retrieving commands for AIX and Sun Solaris. This section also includes information about porting the **`mvslogin`**, **`mvslogout`**, and **`showattr`** commands and dealing with different compilers and operating systems.

To enable client users to access the z/OS system and to display system attributes, you must install the **`mvslogin`**, **`mvslogout`**, and **`showattr`** commands on the client workstations. For some client machines, you might need to modify the code to port these commands so they run on your client machine. See "Porting the `mvslogin`,

`mvlogout`, and `showattr` commands” on page 213. Before you install the commands, make sure that TCP/IP and File Transfer Protocol (FTP) are running both on z/OS and on the client.

Note: The z/OS NFS client utilities, including `mvlogin`, `mvlogout`, and `showattr`, are installed when the z/OS NFS client and TCP/IP are installed. The target library NFSCUTIL is a DDDEF to an existing z/OS UNIX directory (/usr/lpp/NFS/IBM) and will contain the client commands for the z/OS NFS client after installation. There is no need to port the z/OS NFS client utilities as you would for the remote NFS clients which use the z/OS NFS server.

Follow these installation procedures:

1. Delete any previous versions of the `mvlogin`, `showattr`, and `mvlogout` commands and their source code from your client workstation.
2. Retrieve the `mvlogin`, `mvlogout`, and `showattr` commands (in tarbin file format for AIX or UNIX, or in source code format for any other platform) from the `prefix.NFSTARB` data set, where `prefix` is an installation-specified variable. Use FTP with a binary transfer to send the tarbin or executable files to a client workstation for UNIX or AIX (no character conversion should be made). Use FTP with text transfer to send the source code of the three commands to a client workstation for any platform.
3. Use the tar utility to extract the files only if the client uses AIX or UNIX.
4. Compile the source code only if it is not in executable code format. (You might need to modify the code for your specific client machine.)
5. Make executable code versions of the commands available to all clients.

Recommendation: We recommend placing these commands on a LAN server (possibly in /usr/local/bin) that is available to many workstations, rather than installing them on each client workstation.

Table 32 is a list of all files stored in `prefix.NFSTARB` data set related to the server's client commands (`mvlogin`, `mvlogout`, and `showattr`):

Table 32. Files in the `prefix.NFSTARB` data set to download to clients

File Name	Download as:	Description	Client Environment
<code>prefix.NFSTARB(GFSAWAIX)</code>	client.tarbin (or any name)	Binary file	AIX, UNIX
Source Code for Commands			
<code>prefix.NFSTARB(GFSAWMNT)</code>	gfsawmnt.h	C header files	All ¹
<code>prefix.NFSTARB(GFSAWSHO)</code>	gfsawsho.h		
<code>prefix.NFSTARB(GFSAWRP6)</code>	gfsawrp6.h		
<code>prefix.NFSTARB(GFSAWRS6)</code>	gfsawrs6.h		
<code>prefix.NFSTARB(GFSAWAXD)</code>	gfsawaxd.c	C modules	All ¹
<code>prefix.NFSTARB(GFSAWLIN)</code>	gfsawlin.c		
<code>prefix.NFSTARB(GFSAWLOU)</code>	gfsawlou.c		
<code>prefix.NFSTARB(GFSAWMOU)</code>	gfsawmou.c		
<code>prefix.NFSTARB(GFSAWSHA)</code>	gfsawsha.c		
<code>prefix.NFSTARB(GFSAWJCL)</code>	makefile	All ¹	

Note:

1. For AIX or UNIX, you do not need to download every individual file if you download the GFSAWAIX file.

The following sample client screens show how to retrieve and create the `mvlogin`, `mvlogout`, and `showattr` client commands for the following platforms.

- AIX, Sun Solaris, and Linux; see page “Retrieving commands for AIX, Sun Solaris, and Linux.”

Appendix H, “Retrieval of source code for client enabling commands,” on page 543 shows how to retrieve the necessary source code to install the client commands on any platform except for an AIX or UNIX workstation.

Retrieving commands for AIX, Sun Solaris, and Linux

Figure 26 on page 212 shows how to retrieve the necessary files to install the client commands on workstations with AIX, Sun Solaris, or Linux. Use the “Make” section that is appropriate for your platform and omit the others. Use MVSHOST1 as the name of the z/OS host, and smith is a z/OS user ID.

Note: The compiler name can be changed to match the installed compiler name.

```

$ ftp mvshost1
Connected to mvshost1
220-FTPSERVE at MVSHOST1, 01:44:24 on 6/02/07
220 Connection closes if idle for more than 5 minutes.
Name (mvshost1:w42dept): smith
<Press ENTER key>
331 Send password please.
Password: password
230 smith is logged on.
ftp> bin
200 Representation type is IMAGE.
ftp> get 'prefix.nfstarb(gfsawaix)' client.tarbin
200 Port request OK.
125 Sending data set PREFIX.NFSTARB(GFSAWAIX)
250 Transfer completed successfully.
local: client.tarbin remote: 'prefix.nfstarb(gfsawaix)'
213504 bytes received in 2.4 seconds (87 Kbytes/s)
ftp> quit
221 Quit command received. Goodbye. $
$ mkdir mvsnfs.client
$ cd mvsnfs.client
$ tar -xvf ../client.tarbin
tar: record size = 20 blocks
x ./makefile, 8234 bytes, 17 tape blocks
x ./gfsawaxd.c, 13474 bytes, 27 tape blocks
:
:
$
$ touch *.*

```

(Following are Make sections for each supported platform - use the appropriate one

```

SUN:
$ make sun
gcc -D SUN -D _UTILS -D SOLARIS -lnsl -lsocket -o showattr gfsawsha.c gfsawaxd.c
gcc -D SUN -D _UTILS -D SOLARIS -lnsl -lsocket -o mvslogin gfsawlin.c gfsawmou.c
gcc -D SUN -D _UTILS -D SOLARIS -lnsl -lsocket -o mvslogout gfsawmou.c gfsawlou.c

```

Sun binaries for NFS Tools are made

```

LINUX:
make linux
gcc -D LINUX -D _UTILS -o showattr gfsawsha.c gfsawaxd.c
gcc -D LINUX -D _UTILS -o mvslogin gfsawlin.c gfsawmou.c
gcc -D LINUX -D _UTILS -o mvslogout gfsawmou.c gfsawlou.c

```

Linux binaries for NFS Tools are made

```

AIX:
$ make aix
gcc -D AIX -D _UTILS -D AIX_RT -o showattr gfsawsha.c gfsawaxd.c
gcc -D AIX -D _UTILS -D AIX_RT -o mvslogin gfsawlin.c gfsawmou.c
gcc -D AIX -D _UTILS -D AIX_RT -o mvslogout gfsawmou.c gfsawlou.c

```

AIX binaries for NFS Tools are made

```

$ ./mvslogin mvshost1 smith
(MVSNFS must be operational. Password Required on host side.)
GFS988I Remote host does not have AF_INET6 interface.
GFS973A Enter MVS password: password
GFS955I smith logged in ok.
$

```

Figure 26. Retrieving the client enabling commands for AIX, Sun Solaris, and Linux

After retrieving the files of client enabling source code for the AIX or UNIX environment, follow these steps as shown in Figure 26 to create the executable commands:

1. To make sure the source files have the current date. Some platforms do not have correct time stamps and cause make files to fail; issue the following command.
2. To create the executable commands **mvslogin**, **mvslogout**, and **showattr**, issue one of these commands for the environment that IBM supports.

make aix

Creates executables for AIX.

make sun

Creates executables for Sun.

make linux

Creates executables for Linux.

The IBM-supplied makefile for the NFS client enabling commands provides the following keywords to enable the use of 64-bit addressing on various platforms:

make aix64

Creates 64-bit executables for AIX.

make sun64

Creates 64-bit executables for Sun.

make linux64

Creates 64-bit executables for Linux.

Porting the **mvslogin**, **mvslogout**, and **showattr** commands

The z/OS NFS server supports any client machine that has an NFS client software package implemented according to the Sun NFS protocol. See “Tested clients for the z/OS NFS server” on page 14 for a list of supported platforms.

Note: NFS supports the authentication procedures of PCNFSD Version 1 and Version 2 protocols. If a PC client supports PCNFSD and keeps the UID and GID to each mount point base, you do not need to port the **mvslogin** command. See Appendix I, “PCNFSD protocol,” on page 545 for details on PCNFSD support.

To port the **mvslogin**, **mvslogout**, and **showattr** commands successfully, you should understand the following:

- C language - The source code for these commands is written in C.
- System calls for your client machine's operating system - For example, the FAT file system under DOS only allows up to eight characters for file names, and up to three characters for file name extensions. AIX and UNIX do not have this restriction. Therefore, while **mvslogout** is a valid file name in an AIX or UNIX environment, it is too long to be a valid file name in a FAT file system under DOS.

As another example, the way that you get mount information varies for different platforms. The **mount** command is in the following (or similar) format:

```
mount <server>:<remote file system> <local mount point>
```

The minimum information for porting the client enabling commands is:

1. Server name
2. Remote file system (high-level qualifier)
3. Local Mount point
4. UID and GID

The system calls to get the information for porting the client enabling commands are platform-dependent. If you cannot find the information in the following types of documents for the platform, you must call the support telephone number for the platform and ask to speak with their NFS development department:

- Operating system development toolkit
- TCP/IP development toolkit
- NFS development toolkit
- The source code for **mvslogin**, **mvslogout**, and **showattr**.
For example, **mvslogin** tells the server the z/OS user id and its associated client UID number. This client UID number is expected to be passed to the server for all further client requests to the NFS. If the client user does not specify the z/OS user id and password on the **mvslogin** command, the z/OS login ID is taken from the login ID on the workstation with no password assumed. If authentication for this default login ID from the workstation fails, then **mvslogin** prompts the user to enter the z/OS login password.

Figure 27 shows the common source files for the **mvslogin**, **mvslogout**, and **showattr** commands on all platforms:

Five .c files

gfsawaxd.c

XDR encode and decode routines for attributes service.

gfsawlin.c

Main program to generate **mvslogin** command.

gfsawlou.c

Main program to generate **mvslogout** command.

gfsawmou.c

XDR protocol definitions for **mvslogin** and **mvslogout**.

gfsawsha.c

Main program to generate **showattr** command **mvslogout**.

Four .h files

gfsawmnt.h

Protocol definitions for **mvslogin** and **mvslogout**.

gfsawsho.h

Attribute definition and procedures.

gfsawrp6.h

IPv6 RPC library definitions.

gfsawrs6.h

IPv6 RPC support functions.

One makefile

Figure 27. Common source files

Porting on different compilers and operating systems

Procedures for porting vary for different C compilers and operating systems. Differences can occur during compiling, linking, and run time.

Compiling

The following items might vary for your client machine's operating system:

- Different set of compilation flags
There are different sets of compilation flags based on compilers or operating systems. For example:
 - AIX (on System p) has the unique flags `_BSD`, `_SUN`, and `BSD_INCLUDES`.
 - DOS compilers have different compiler models, which require the corresponding compiler flag (for example, `-AL` and `-AS`).
- Include files in different directories
Because the include files can be installed differently based on the operating systems and their toolkits, the include files could be in different directories.
- Include file has a different name
Include files for the same or similar functions could have the same or similar file names. For example, DOS uses the file name “string.h”, and the other platforms use “strings.h”.
- System variables in different include files
The system variables are usually in different include files, based on the operating systems. For example, to access the mount table some AIX and UNIX clients use `mntent.h`.
- System variables have different names
The variables related to operating systems could have different variable names. For example; some AIX and UNIX clients use `getuid` to get the real UID.
- System variables have different structure
The structures related to operating systems could be different. For example, DOS FAT file systems have file name length restrictions which cause them to have a different directory structure from AIX or UNIX.
- System variables not supported
Some system variables are supported by one operating system but not another.
- Sequence of include files
Some include files are based on the precedence of another include file. The prerequisite include file has to come before the other include files. For example, some Programming Libraries offer `types.h` which is based on C compiler `sys/types.h`. Therefore, `#include <sys/types.h>` should be before `#include <types.h>`.
- Mount information varies depending on the client operating system
The information about mount points provided by vendors of the client operating systems and client TCP/IP products varies and might not always be complete. To find the mount information:
 1. Search through the documentation (for example, the TCP/IP development toolkit and the installation and administration guides).
 2. If you cannot find the mount information in the documentation, contact the vendor that offers the TCP/IP development toolkit.
- 32-bit mode and 64-bit mode
IBM supports the compilation of the client enabling commands in 32-bit mode and in 64-bit mode on AIX, Sun, and Linux.
IBM has tested the client enabling commands in 32-bit mode and 64-bit mode on both 32-bit and 64-bit capable systems using the standard gcc (GNU Compiler collection) 4.0.x compiler command for Linux, gcc 3.4.x compiler command for Sun, and gcc 4.0.x compiler command for AIX. Compiler support has been expanded to include Sun Studio 11 for Solaris 10 and XLC v11 for AIX.

The IBM-supplied makefile for the NFS client enabling commands also provides the following keywords to override some of the default values:

CC Allows the default compiler used by the makefile for the target platform to be overridden with a different compiler name. For example, “make cc=gcc sun” builds the utilities for the SUN Solaris platform using the gcc compiler.

CFLAGS

Allows the default compiler options to be used for the target platform to be overridden with a different set of compiler options. The options string must be placed in double quotes, because the string can include any characters, including blanks.

Note:

1. IBM cannot test all possible compiler/option combinations. Any compilation or execution failures experienced when the default compiler/option values are overridden are the customer’s responsibility to resolve.
2. The required system run-time libraries for 64-bit support must be available on the platform.

Linking

After linking the programs together, check for attention messages and error messages. The following items might vary for your client machine's operating system:

- Different set of linker/loader flags
Some programs require a different set of linker/loader flags.
- Library files in a different directory
The library files required to complete the linkage could be in a different directory.
- Library files have different names
Depending on how the client machines' operating systems are installed, the library files might have different names.
- Different libraries required
The system variables could be in different libraries for the different operating systems.
- Compiler is not compatible with the system toolkit
Some operating systems support multiple versions of C compilers. Some C compilers, however, might not match the various system toolkits.
- Different library model required
The library models have to match with the compilation time.
- System variables not supported
Some system variables are supported during compile time but not supported by the link time.

Running commands

After the compilation and linkage are successful, run the command to see if the result is as expected. If not, figure out the difference of the result or failure. The difference or failure can be in the following areas:

- Definition of the standard C variables is different
The definition of the standard C variables could be different for the different operating systems or compilers. Some special handling might be required. For example:

- **int** is 2 bytes long for DOS but it is 4 bytes long for the z/OS NFS, AIX, and Sun.
- **tab** has a different value, causing the spacing of the output to be different.
- Definition of function calls is slightly different

Although a given function is supported, it might work slightly differently. For example, the “mount table” has a different format in AIX from Sun Solaris.
- Library functions might have a defect

Some functions in the C libraries do not function as the documentation describes. You might report the problems or write your own functions to replace them.

NFS v4 protocol name mapping

Using NFS v4 protocol (NFSv4) name mapping, a user can map owner and group names on a single DNS domain (INET environment) or on multiple DNS domains (CINET environment) to z/OS USS uid and gid numeric values.

nfsv4domain(*NFSv4_default_domain*) specifies the "pseudo" NFSv4 domain for the NFSv4 name mapping. The "pseudo" NFSv4 domain allows various NFSv4 Clients from various network domains to seamlessly access the server provided that these NFSv4 Clients are also configured with the same "domain,"

Advantages: NFSv2 and NFSv3 protocol has been limited to the use of the UNIX-centric user identification mechanism of numeric user id (uid and gid). However, for NFS to move beyond the limits of large work groups, the NFS v4 protocol changed the user identification to be string based. It provides:

- The owner and group names to be administered on a DNS domain basis
- Flexibility (support of multiple internal naming schemes).

NFSv4 Name Mapping requires:

- The same owner and group names to be defined on both the server and client.
- The owner and group names must be defined to RACF with appropriate uid and gid values on z/OS.
- **nfsv4domain**(*NFSv4_default_domain*) attribute should be appropriately set. When **nfsv4domain** is omitted, the participating NFSv4 Client's domain must match one of the Server's network domain for the proper NFSv4 name mapping.

Name resolution is not supported through any global name server such as LDAP.

The NFS client and NFS server can have their own local representation of owner and owner_group attributes that is used for local storage or presentation to the end user. Owner and owner_group attributes are transferred between the NFSv4 client and server in the form of "user@dns_domain". To provide a greater degree of compatibility with NFSv2 and NFSv3, which identified users and groups by 32-bit unsigned uids and gids, the owner and group strings that consist of decimal numeric values can be given a special interpretation by clients and servers.

Examples of owner, owner_group attributes syntax:

- vndrcvr@storage.tucson.ibm.com
- sys@storage.tucson.ibm.com
- 100 (numeric string "100").

z/OS NFS server has supported NFSv4 since V1R7. z/OS NFS server V1R7, V1R8, V1R9 only support the limited interpretation (i.e. only numeric strings). z/OS NFS

server V1R10 added full name@domain strings. The inability of z/OS NFS server prior to V1R10 to interpret the owner and owner_group attributes caused problems with NFSv4 root support (See z/OS NFS APAR OA22311).

- z/OS NFS server has supported <root> suffix in Export List since z/OS NFS server V1R8
- Root support widely uses the functions (chown, chgrp) demanding full name@domain strings.

The z/OS NFS server performs the following:

- Mapping inbound owner/owner_group attributes to local representation
Usage of RPC uid and gid as local representation in case of unsuccessful interpretation.
- Mapping local representation to outbound owner/owner_group attributes
Usage of z/OS NFS server uid and gid cache in case of the absence of the local representation in the RACF database.
- Mapping owner and group names to a single DNS domain or multiple DNS domains

Inbound owner/owner_group processing

Inbound owner/owner_group attributes may be present in:

- CREATE, NVERIFY, OPEN, SETATTR, VERIFY NFSv4 operations
- Access Control List NFSv4 (ACL) attribute.

Owner/owner_group attributes can be in the form of:

- "user@dns_domain" strings
- Special strings, like anonymous user/group strings or superuser strings
- Numeric string (for example, "100").

There are special strings representation:

- Client anonymous user
- Client superuser.

owner attribute for anonymous user consists of: String "nobody" with the at sign "@" and the domain

owner_group attribute for anonymous user consists of: String "nobody" with the at sign "@" and the domain

owner attribute for client superuser consists of: String "root" with the at sign "@" and the domain

owner_group attribute for client superuser can be anyone.

The z/OS NFS server uses the implicit interpretation on the base of hardcoded strings "nobody" and "root" (without the reference to RACF database) to designate a client anonymous user and client superuser, except for owner_group attribute for client superuser.

The z/OS NFS server stores anonymous uid and gid:

- At z/OS NFS server start up, the RACF database is queried for user with "nobody" name

- If that user is found in the RACF database, its RACF uid and gid are used
- Otherwise 65534 (not '-2') is used.

z/OS NFS server maps:

- Anonymous owner string to RACF uid of "nobody"
- Anonymous owner_group string to RACF gid of "nobody"
- Superuser owner string to 0
- Superuser owner_group string in the standard way (using z/OS NFS server internal cache and RACF database). z/OS NFS server does not use default name for superuser group name.

The subsequent processing of UID=0:

- If the z/OS NFS server is in EXPORTS mode and EXPORT list entry includes <root> suffix, UID keeps the value
- Otherwise, UID maps to the stored RACF UID of "nobody"

Outbound owner and owner_group attributes processing

Outbound owner and owner_group attributes may be present in:

- GETATTR, REaddir NFSv4 operations

Owner and owner_group attributes can be sent to the client in the form of:

- "user@dns_domain" strings
- Special strings like anonymous user/group strings and superuser strings
- Numeric string (for example, "100")

Translation of UID, GID to owner and owner_group attributes uses (in the following order):

1. Internal z/OS NFS server cache of UIDs, GIDs
2. RACF database

For invalid translation z/OS NFS server uses numeric string representation for outbound owner and owner_group attributes.

Special strings "nobody" and "root" generation :

- If UID is equal to the stored uid of "nobody", z/OS NFS server maps it to anonymous owner string using the default "nobody" name.
- If GID is equal to the stored gid of "nobody", z/OS NFS server maps it to anonymous owner_group string using the same default "nobody" name.
- If UID is equal to 0, z/OS NFS server maps it to superuser owner string using default "root" name.
- If GID is equal to 0, z/OS NFS server maps it from RACF cache and derives the group name from the RACF database.

z/OS NFS server uses internal z/OS NFS server uid and gid cache and RACF database to find user/group names and their UIDs/GIDs.

During mapping inbound owner and owner_group attributes to numeric identifiers:

- The z/OS NFS server gets UID by user name from the RACF database.
- The z/OS NFS server gets GID by group name from the RACF database.

During mapping numeric identifiers to outbound owner and owner_group attributes:

- The z/OS NFS server searches for the numeric identifier (UID or GID) in internal z/OS NFS server cache.
- If the numeric identifier is found in z/OS NFS server cache then there is no reason to obtain it from the RACF database (invalid translation uses numeric string representation).
- Otherwise the z/OS NFS server attempts to obtain a name by numeric identifier from the RACF database.
- If the name is not found in the RACF database, the z/OS NFS server puts numeric identifier into internal z/OS NFS server cache and uses the numeric string representation.

Domain processing in NFSv4 Name Mapping

The domain portion of the owner or owner_group attribute refers to a DNS domain name. For example,

user@us.ibm.com

For inbound mapping, the z/OS NFS server validates the domain portion of the owner or owner_group attribute .

- The z/OS NFS server identifies the domain to be used to verify the domain portion of owner/group strings coming from the client. It does so as follows:
If the **nfsv4domain** attribute was set, the z/OS NFS server uses it as its domain for NFSv4 name mapping; otherwise, the z/OS NFS server gets the domain from the TCP/IP stack which connects with the client; if the z/OS NFS server cannot get the domain from TCP/IP stack, it uses the default server domain. The z/OS NFS server compares this domain with the domain portion of the owner/group string that the server has received from the client.
- If the domain portion of owner/group string is not valid, z/OS NFS server attempts to derive UID and GID from the RPC packet.

For outbound mapping z/OS NFS server puts the domain portion to the owner or owner_group attribute

- For an invalid translation, z/OS NFS server uses numeric string representation for outbound owner and owner_group attributes (without domain).

Users can override the DNS domain(s) with the z/OS NFS server or z/OS NFS client attribute **nfsv4domain(NFSv4_default_domain)**.

Using the NFS Error Client Loop Detection Facility

The NFS Error Client Loop Detection Facility is used to detect a loop situation, to identify the remote system causing the loop and to issue series of GFSA1036E console error messages. If z/OS NFS server starts without an explicit site attribute **CHKLOOP** or this attribute is specified as **CHKLOOP(OFF)**, the NFS Error Client Loop Detection Facility will not be available. To make it available, either enter the MODIFY command with **CHKLOOP=ON** operand or start z/OS NFS server with **CHKLOOP(ON)** specified in the site attribute file.

To tune the NFS Error Client Loop Detection Facility, specify the two site attributes **loopthreshold(n)** and **timethreshold(m)** before z/OS NFS server starts. See “Site attributes syntax” on page 139 for information on the **loopthreshold(n)** and the **timethreshold(m)** attributes. If the z/OS NFS server is started with NFS Error

| Client Loop Detection Facility disabled, execute the **MODIFY** command with
| **CHKLOOP=LOOP=n** operand to set value 'n' of loopthreshold(x) attribute or
| execute command with **CHKLOOP=TIME=m** to set value 'm' of timethreshold(x)
| attribute. See "Entering operands of the modify command for diagnosis" on page
| 248 for information on the operand **CHKLOOP** of **MODIFY** operator command.

| Once NFS Error Client Loop Detection Facility is enabled it cannot be tuned, i.e. to
| change the values of the loopthreshold(n) and timethreshold(m) attributes the NFS
| Error Client Loop Detection Facility must be disabled. The final message of the
| **MODIFY** command **CHKLOOP=ON** operand:

| GFS796I (MVS NFS) CHKLOOP=ON, Loop=x, Time=y - changeable only if CHKLOOP
| is OFF: completed successfully.

| In order to tune the Loop=x and Time=y values, the user must disable the NFS
| Error Client Loop Detection Facility. To disable NFS Error Client Loop Detection
| Facility user must enter the **MODIFY** command with **CHKLOOP=OFF** operand.

Chapter 11. Network File System operation

This topic describes how to start and stop the z/OS Network File System, and describes the operands of the MVS **modify** and **display** commands that are related to the z/OS NFS server. The operands for collecting diagnostic information are also described.

Starting the z/OS NFS client

If you want to use the z/OS NFS client, do the following:

- Define the z/OS client as a file system in the z/OS UNIX BPXPRMxx member of SYS1.PARMLIB. Start the z/OS UNIX address space, which will cause the BPXPRMxx member to be used. As part of the z/OS UNIX startup, the z/OS NFS client will be started in an z/OS UNIX colony address space. Wait until this message appears before proceeding:

```
BPXI004I OMVS INITIALIZATION COMPLETE
```

See *z/OS UNIX System Services Planning* for more information.

- Ensure that TCP/IP and PORTMAP are active.

During z/OS UNIX file system initialization, the z/OS NFS client is started and run in the z/OS UNIX colony address space. The FILESYSTYPE parmlib statement for the z/OS NFS client must be present in the SYS1.PARMLIB(BPXPRMxx) parmlib member in order to start the z/OS NFS client. BPXPRMxx can specify optional component trace options for the NFS client, as shown in “Using NFS component trace PARMLIB members CTINFSnn and CTINFCnn” on page 317. For more information on z/OS UNIX file system, see *z/OS UNIX System Services File System Interface Reference*.

If the z/OS NFS client fails to initialize, a write to operator (WTO) message is issued to the operator console. The following conditions can cause z/OS NFS client initialization to fail.

- The z/OS NFS client is not started in a standalone colony address space.
- The z/OS NFS client is already started. Multiple instances of the z/OS NFS client on a single z/OS system is not supported.
- Using a security product that is downlevel, the z/OS NFS client requires RACF 2.2 or later.
- An incorrect parameter is specified in the installation parameters.
- Unicode services is not installed or is not active.

When the z/OS NFS client initializes, messages like these example messages are displayed on the operator's console.

```
$HASP373 NFSCR    STARTED
BPXI004I OMVS INITIALIZATION COMPLETE
GFSC700I z/OS NETWORK FILE SYSTEM CLIENT
(HDZ222N) started. HDZ222N, GFSCMAIN, Jun 14 2014 15:29:05.
```

If the z/OS NFS client is stopped, canceled, or for any other reason terminates, z/OS UNIX issues the following message:

```
BPXF032D FILESYSTYPE type TERMINATED. REPLY 'R' WHEN READY TO RESTART.
REPLY 'I' TO IGNORE
```

To restart the z/OS NFS client, specify 'R' in reply to the message. Replying with 'T' will cause z/OS UNIX to ignore the termination of the z/OS NFS client. If 'T' was replied and you still wish to restart the z/OS NFS client, use the SET command as follows. If z/OS UNIX has been initialized but the z/OS NFS client is not active, issue a SETOMVS RESET=(xx) command to the BPXPRMxx member of SYS1.PARMLIB that defines the z/OS NFS file system. z/OS UNIX will then start the z/OS NFS client.

Stopping the z/OS NFS client

The z/OS NFS client is started when the z/OS UNIX file system is initialized and is persistent until z/OS UNIX is stopped. To stop the z/OS NFS client gracefully the system operator can use the modify operator command **omvs,stoppfs** specifying the NFS client, as follows:

```
f omvs,stoppfs=NFS
```

If this command fails to gracefully shut down the z/OS NFS client, the operator can force an abnormal termination using the operator command **cancel** with the z/OS NFS client address space name; for example:

```
cancel mvsnfsc
```

It is imperative and necessary to stop the z/OS NFS client gracefully so it can save its important data (RPC transaction ID) for the subsequent restart.

Attention: The destruction of the z/OS NFS client address space can cause unpredictable abnormal z/OS UNIX address space behavior. If a z/OS UNIX process tries to access the NFS client data during its address space destruction, then an OC4 protection exception in the z/OS UNIX BPXVCLNY load module can occur.

To bring down the NFS client during shutdown, follow these steps:

1. Stop the NFS client. It runs in a colony address space; to terminate it, enter either of the following:
 - f omvs,stoppfs=nfs
 - CANCEL <nfsv> (if STOPPFS did not work)
2. Stop TCPIP, because it is a registered blocker of OMVS SHUTDOWN.
3. Terminate z/OS UNIX System Services

```
f omvs,shutdown
```

Starting component tracing for the z/OS NFS client

To start recording diagnostic information for the z/OS NFS client in z/OS component trace buffers, follow these steps:

1. Decide on the trace options to use. These can be in a CTINFCnn member of SYS1.PARMLIB to be specified on the TRACE CT command, or individual options to be specified when prompted in response to the TRACE CT command. Note that if TRACEOPTS OFF is used, no other TRACEOPTS value can be specified. See *z/OS MVS Initialization and Tuning Reference* for further information.
2. From the master console or another console with master authority, issue the TRACE CT command as follows:

```
▶▶—TRACE CT[,ON] [,—bufsize—],COMP=—mvsnfsc—  
└─,parm=CTINFCnn—▶▶
```

where

bufsize

Specifies the buffer size in kilobytes or megabytes (for example, 1500K, 2M, or 500M). The valid size range is 600K-600M.

mvsnfsc

Specifies the name of the procedure in your system PROCLIB used to start up the client.

parm=CTINFCnn

Specifies that diagnostic information for the NFS client be recorded in z/OS component trace buffers using trace options specified in member *CTINFCnn* of SYS1.PARMLIB. To use the default trace options for the z/OS NFS client, specify *parm=CTINFC00* for the default SYS1.PARMLIB member CTINFC00.

If you do not specify a *CTINFCnn* PARMLIB member on the CTRACE CT command, the following message will prompt you to enter trace operands:

```
* id ITT006A SPECIFY OPERAND(S) FOR TRACE CT COMMAND.
```

In response to the message, reply with the identification number *id* from the message, an external writer program if any to receive the records, and a trace option or options to use from the list shown later in this section. Here is the response syntax:

```
▶▶R(eply)—id—OPTIONS=—(name,name...)—  
└─,WTR=—procname—  
└─DISCONNECT—  
  
▶▶,CONT  
└─,END—▶▶
```

where:

id Specifies the identification number from the ITT006A message.

name,name...

Specifies a trace option or options for tracing NFS client records. The possible options are:

Buffer

Buffer management (BUFNODE)

CB_Mgmt

Control Block Management (creation, initialization, modification, deletion).

Detail

Detailed Trace Record. This is used for low level debug.

Dispatch

Unit of work is dispatched from a queue to resume processing.

Entry

Entry into a function

Exit

Exit from a function.

FFDC

First Failure Data Capture. This option is on by default and cannot be turned off.

General

General Trace Record.

Lock_Release

Control block lock release

Lock_Request

Control block lock requests

Lock_Resume

Control block lock request resumes after lock request either succeeds or fails.

Msg

Existing NFS Trace Error, Warning and Informational Records. This option is on by default and cannot be turned off.

Network

Network communication related trace.

NFS_Request

Request sent to NFS server.

NFS_Return

Return from NFS request.

Resume

Unit of work resumed due to availability of resource (for example, latch acquired).

Schedule

Unit of work is scheduled onto another queue (for example, ipcqueue of this or another task, array queue.).

Suspend

Unit of work must suspend due to unavailability of resource (for example, waiting for a latch).

Trap

For use in special temporary trap code created to aid in the analysis of a problem.

USS_Request

Request issued to z/OS UNIX System Services.

USS_Return

Returned from z/OS UNIX System Services request.

In addition to these basic options, you can also enter the following shorthand values to specify multiple record types:

All

All record types.

Call

Entry and Exit record types.

Lock

Lock_Request, Lock_Result, and Lock_Release record types.

NFS

NFS_Request and NFS_Return record types.

Task_Flow

Suspend, Resume, Schedule, and Dispatch record types.

USS

USS_Request and USS_Return record types.

Note:

1. An option can be turned off by preceding the option value with a minus sign (for example, OPTIONS=(-GENERAL)).
2. Options are processed from left to right, first processing all values to turn on options and then processing all values to turn off options. Thus all options except Network can be turned on with the following specification: OPTIONS=(ALL, -NETWORK).
3. If an option value of -ALL is specified, only the minimum set of options remains active (FFDC and MSG).

WTR=*procname* | DISCONNECT

Connects or disconnects the component trace external writer and the trace. *procname* identifies the name of the member that contains the source JCL that invokes the external writer. The member can be a SYS1.PROCLIB cataloged procedure or a job. The *procname* in the WTR parameter must match the *procname* in a previous TRACE CT,WTRSTART command.

WTR=DISCONNECT disconnects the writer and the trace. The component continues tracing and placing the trace records in the address-space buffer, but stops passing trace records to the external writer.

You must also specify a TRACE CT,WTRSTART or TRACE CT,WTRSTOP command to start or stop the writer.

CONT or END

Specifies that the reply continues on another line. The system reissues the same prompting message. You then can continue the reply. You can repeat any parameters on the continuation line, except END. Repeated parameters are strung together. They do not overlay each other. You must specify END to complete the response. END identifies the end of the REPLY.

Starting the z/OS NFS server

Make sure that z/OS UNIX is customized to be able to start automatically during IPL.

If you want to use the z/OS NFS server, TCP/IP and PORTMAP need to be started and active on your system. Then, start the z/OS NFS server.

You might also need to start up NAMESRV to map machine names into their corresponding Internet addresses. If you use the dynamic host configuration protocol (DHCP), NAMESRV is required.

Note:

1. PORTMAP is synonymous with portmapper, which is a program provided by z/OS Communications Server that maps registered server programs to port

numbers. NAMESRV is the cataloged procedure of the Domain Name Server which is provided by Communications Server that maps a host name to an internet address or an internet address to a host name. See *z/OS Communications Server: IP Configuration Guide* and *z/OS Communications Server: IP Configuration Reference* for information on configuring PORTMAP, starting PORTMAP, configuring the Domain Name Server, and starting NAMESRV automatically with z/OS Communications Server.

2. The z/OS Portmapper does not support IPv6. Therefore, when using IPv6 addresses, the z/OS server host must be configured with RPCBIND, not the Portmapper. RPCBIND supports both IPv6 and IPv4. As of z/OS V1R8, Portmapper should only be used for IPv4 only systems. Otherwise, RPCBIND should be used.

The z/OS NFS server does not support file persistence. That is, when the server is restarted, files cannot be accessed using old file handles.

To start the z/OS NFS server, enter the **start** command from a console. Enter the command as follows:

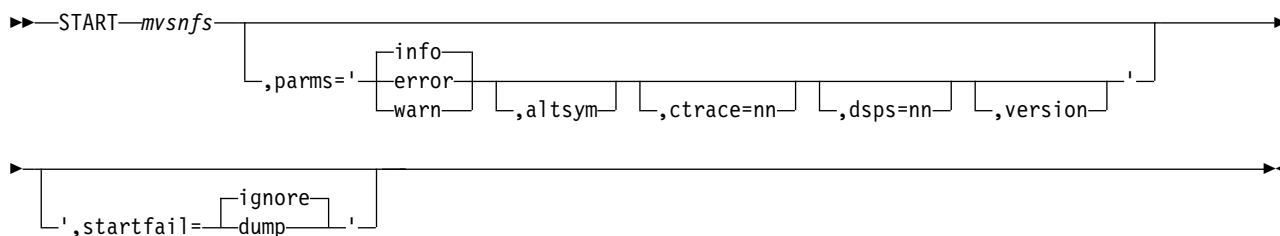

where

mvsnfs

Specifies the name of the procedure in your system PROCLIB used to start up the server.

info

The first parameter specifies the level for diagnostic messages (the default is info).

altsym

If *altsym* is specified in the second parameter, the semicolon (;) is used as the comment symbol in the attributes (with one exception: If the *fn_delimiter*(;) attribute uses a semicolon, the *fn_delimiter* semicolon is treated as a delimiter between the file name and the attributes that follow, not as a comment symbol) and exports data sets. Otherwise, the pound sign (#) is used as the comment symbol.

For example, suppose you have some data sets with a high-level qualifier of #USER05, and you want client users to be able to read them. First, you would modify the exports data set and attributes data set by using ';' as the comment symbol rather than '#'. Next you would specify #user05 -ro as an entry in the exports data set. Finally, you would specify the **altsym** parameter when you enter the **start** command.

ctrace=nn

Specifies that diagnostic information for the NFS server be recorded in z/OS component trace buffers, using trace options specified in member CTINFSnn of SYS1.PARMLIB. To use the default trace options for the z/OS NFS server,

specify **ctrace=00** for the default SYS1.PARMLIB member CTINFS00. If the **ctrace** operand is not specified, then the default SYS1.PARMLIB member CTINFS00 is used.

dsp=nn

Specifies the size of the data space to be allocated for the NFS component trace buffers, where *nn* equals the number of megabytes to be allocated for each trace buffer. NFS uses 3 trace buffers in rotation. The value of *nn* can be between 10 and 600. If a value outside this range is specified, it will be adjusted accordingly. The default value is 10 (representing 10 MB).

version

Causes the server to place a GFSA947I message on behalf of each module in the server into the server log and component trace, at startup. Similar to using the **MODIFY mvsnfs, version=all** operator command.

startfail

Specifies the action the z/OS Network File System Server should take if it encounters a terminating error during startup, or later during execution which did not otherwise create a dump.

- **ignore:** No special action is taken. The z/OS Network File System server proceeds with termination as it has done prior to z/OS NFS V1R11. This is the default setting if the parameter is not specified.
- **dump:** For terminating errors, an SVC dump is created before terminating, if no dump was otherwise created.

Note: No dump is produced if the z/OS Network File System server is stopped by the operator stop request. A dump is generated if the z/OS Network File System server shuts down because of a TCP/IP termination.

These parameters override the parameter settings in the server startup procedure.

When you enter **start**, the following console message appears; if you installed HDZ222N, then this FMID is displayed in the GFS348I message text.

```
GFS348I z/OS NETWORK FILE SYSTEM SERVER  
(HDZ222N, HDZ222N) STARTED.
```

Starting multiple servers

More than one z/OS NFS server on a single z/OS system can be started, but each must be at the same release level. If a server is running, attempts to start another release level of the server on the same system will fail.

Note: The NFS server and NFS client can be at different release levels on the same system; there is no requirement for server and client release levels to match.

Within a sysplex, different levels of NFS servers and clients on different systems can exist. However, each running NFS server will require its own unique set of data sets for mount handle database, lock data set, error log, and startup procedures. A configuration can include a high availability scenario wherein the NFS server is moved from one system to another reusing the same datasets; however, at no time are two NFS servers accessing the datasets at once. Byte-range locking and file share reservations are not communicated across systems within the sysplex. Therefore, in sysplex environments where byte range locking and share reservations are required for accessing MVS data sets with NFS, IBM recommends that only one NFS server be started.

Stopping the z/OS NFS server

When shutting down your system, follow these sequential steps.

1. Stop the z/OS NFS server
2. Shut down the TCP/IP server
3. Shut down z/OS UNIX if it is running

Use the **stop** command to shut down the z/OS NFS server. All current input/output (I/O) operations are completed and all OPEN data sets are closed. The z/OS NFS Server synchronizes or flushes any unwritten data to the MVS data sets or PDS/PDSE members. It writes null-data to represent the missing data that the Client did not write along with any partially received data. This command can be entered at any time. Enter the command as follows, where *mvsnfs* is the name of the procedure in your system PROCLIB used to start up the server.

```
➤➤ STOP mvsnfs ➤➤
```

You can also shut down the server by entering the **modify** command.

```
➤➤ MODIFY mvsnfs,stop ➤➤
  F
```

The operator's console displays messages like the following:

```
GFS329I SERVER SHUTDOWN IN PROGRESS.
GFS814I (MVS NFS) Begin synchronizing 1 opened data sets or members.
GFS828I (MVS NFS) Synchronize offset 0x0000000000000000 for 2 write blocks of IBMUSER.PS2.
GFS330I SERVER SHUTDOWN COMPLETE.
$HASP395 MVS NFS ENDED
```

The synchronization processing may take quite some time if a large amount of data must be written to disk. If the NFS Server must be stopped immediately or if the synchronization process must be aborted, the modify SHUTDOWN operator command can be entered *after* the STOP command. However, note that *all unwritten data will be dropped and discarded*. The z/OS NFS Server will display the list of *incomplete* MVS data sets or PDS/PDSE data sets and member names that must be rewritten after the z/OS NFS Server is restarted.

```
➤➤ MODIFY mvsnfs,SHUTDOWN ➤➤
  F
```

The operator's console displays messages like the following:

```
GFS329I (MVS NFS) SERVER SHUTDOWN IN PROGRESS.
GFS814I (MVS NFS) Begin synchronizing 3 opened data sets or members.
GFS828I (MVS NFS) Synchronize offset 0x0000000000000000 for 2 write blocks of IBMUSER.PS2.
F mvsnfs,SHUTDOWN
GFS831E (MVS NFS) Abort synchronizing IBMUSER.PS2.
```

```
GFSA831E (MVS NFS) Abort synchronizing IBMUSER.RRDSBIN.
GFSA831E (MVS NFS) Abort synchronizing IBMUSER.PDSE(PDSETEXT).
GFSA330I (MVS NFS) SERVER SHUTDOWN COMPLETE.
$HASP395 MVS NFS ENDED
```

The modify SHUTDOWN operator command can be issued at any time. It can replace the STOP command or the modify STOP operator command *without* the synchronization processing. *All unwritten data will be dropped or discarded.*

The operator's console displays messages like the following:

```
F mvs nfs, SHUTDOWN
GFSA329I (MVS NFS) SERVER SHUTDOWN IN PROGRESS.
GFSA814I (MVS NFS) Abort synchronizing 3 opened data sets or members.
GFSA831E (MVS NFS) Abort synchronizing IBMUSER.PS2.
GFSA831E (MVS NFS) Abort synchronizing IBMUSER.RRDSBIN.
GFSA831E (MVS NFS) Abort synchronizing IBMUSER.PDSE(PDSETEXT).
GFSA330I (MVS NFS) SERVER SHUTDOWN COMPLETE.
$HASP395 MVS NFS ENDED
```

The z/OS NFS Server allows only the modify SHUTDOWN operator command after either the STOP command or the modify STOP operator command is entered. All other modify operator commands (except SHUTDOWN) are disallowed after STOP is issued.

As a last resort, you can cancel the server by entering the **cancel** command.

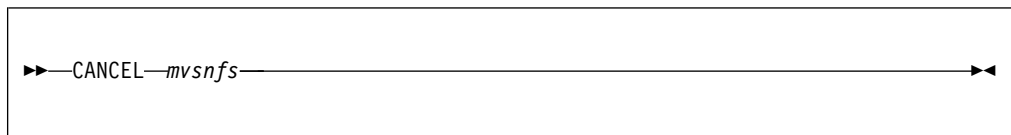

Starting the z/OS NFS NSM and z/OS NFS NLM

If you want to use the z/OS NFS Network Status Monitor (z/OS NFS NSM) and the z/OS NFS Network Lock Manager (z/OS NFS NLM), you must specify the NLM site attribute for the z/OS NFS server. See Table 24 on page 140 for details. If you specify the NLM site attribute, NLM and NSM will start when the NFS server is started, and will stop when the NFS server is stopped. The attribute's default value, NONLM, specifies that the NFS server will run without NLM or NSM.

After a z/OS NFS server restart, the z/OS NFS server sends an SM_NOTIFY request to each NFS client that supports NLM. The NFS client should reclaim locks as soon as it receives the SM_NOTIFY request.

Starting component tracing for the z/OS NFS server

To start recording diagnostic information for the z/OS NFS server in z/OS component trace buffers, follow these steps:

1. Decide on the trace options to use. These can be in a CTINFS nn member of SYS1.PARMLIB to be specified on the TRACE CT command, or individual options to be specified when prompted in response to the TRACE CT command. Note that if TRACEOPTS OFF is used, no other TRACEOPTS value can be specified. See *z/OS MVS Initialization and Tuning Reference* for further information.
2. From the master console or another console with master authority, issue the TRACE CT command as follows:

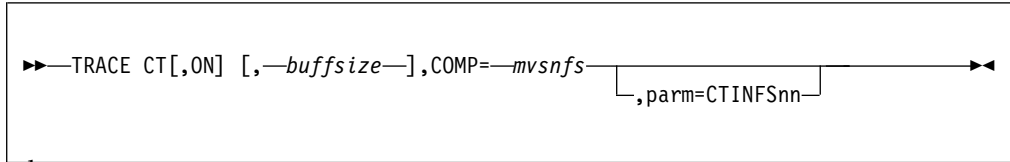

where

buffer-size

Specifies the buffer size in kilobytes or megabytes (for example, 1500K, 2M, or 500M). The valid size range is 600K-600M.

mvsnfs

Specifies the name of the procedure in your system PROCLIB used to start up the server.

parm=CTINFSnn

Specifies that diagnostic information for the NFS server be recorded in z/OS component trace buffers using trace options specified in member *CTINFSnn* of SYS1.PARMLIB. To use the default trace options for the z/OS NFS server, specify *parm=CTINFS00* for the default SYS1.PARMLIB member CTINFS00.

If you do not specify a *CTINFSnn* PARMLIB member on the CTRACE CT command, the following message will prompt you to enter trace operands:

```
* id ITT006A SPECIFY OPERAND(S) FOR TRACE CT COMMAND.
```

In response to the message, reply with the identification number *id* from the message, an external writer program if any to receive the records, and a trace option or options to use from the list shown later in this section. Here is the response syntax:

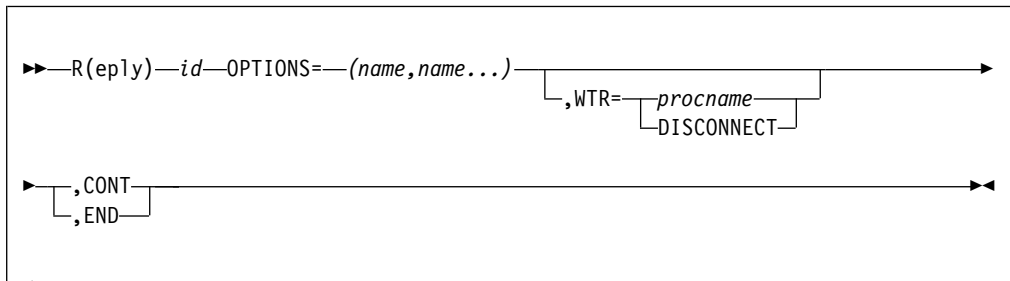

where:

id Specifies the identification number from the ITT006A message.

name,name...

Specifies a trace option or options for tracing NFS server records. The possible options are:

Buffer

Buffer Management (that is, BUFNODE)

CB_Mgmt

Control Block Management (creation, initialization, modification, deletion).

Detail

Detailed Trace Record. This is used for low level debug.

DFP_request

Call to MVS data set system function.

DFP_return

Return from MVS data set system function.

Dispatch

NFS Client worker thread posts results back to Cross memory thread.

Entry

Entry into a function

Error

Existing NFS Trace Error Record. This option is on by default and cannot be turned off.

Exit

Exit from a function.

FFDC

First Failure Data Capture. This option is on by default and cannot be turned off.

General

General Trace Record.

Info

Existing NFS Trace Info Record.

Lock_Release

Control Block Lock Release

Lock_Request

Control Block Lock Requests

Lock_Resume

Control block lock request resumes after lock request either succeeds or fails.

Network

Network communication related trace.

Resume

Cross memory thread receives result from NFS Client worker thread and resumes processing, or NFS worker thread receives work for processing

Schedule

Cross memory thread sends work to NFS Client worker thread and continues processing in parallel.

Suspend

Cross memory thread sends work to NFS Client worker thread and waits for result, or NFS worker thread waits for work.

Trap

For use in special temporary trap code created to aid in the analysis of a problem.

USS_request

Request issued to z/OS UNIX System Services.

USS_return

Returned from z/OS UNIX System Services request.

Warning

Existing NFS Trace Warning Record.

In addition to these basic options, you can also enter the following shorthand values to specify multiple record types:

All

All existing NFS trace records.

Call

Entry and Exit record types.

Debug1

FFDC, Entry and Exit record types.

Debug2

FFDC, Entry, Exit and Network record types.

Debug4

FFDC, Entry, Exit, Network, Suspend, Resume, Schedule, Dispatch and General record types.

Debug9

All existing NFS trace records (equal to **All**).

Lock

Lock_Req, Lock_Result and Lock_Release record types

MVS

DFP_Request and DFP_Return record types.

NFS

NFS_Req and NFS_Rtn record types.

Task_Flow

Suspend, Resume, Schedule and Dispatch record types.

USS

USS_Request and USS_Return record types.

Note:

1. An option can be turned off by preceding the option value with a minus sign (for example, `OPTIONS=(-GENERAL)`).
2. Options are processed from left to right, first processing all values to turn on options and then processing all values to turn off options. Thus all options except Network can be turned on with the following options specification: `OPTIONS=(ALL, -NETWORK)`. If an options value of " `-ALL`" is specified, the options revert back to a minimum trace state.
3. A minimum trace state has been defined, which will be the default initial trace state and will also be the trace state that takes effect if "all" trace states are turned off. In this "MIN" state, ERROR and FFDC record tracing will remain active. They cannot be deactivated. Neither MIN nor -MIN can be specified in the OPTIONS list.

WTR=*procname* | DISCONNECT

Connects or disconnects the component trace external writer and the trace. *procname* identifies the name of the member that contains the source JCL that invokes the external writer. The member can be a SYS1.PROCLIB cataloged procedure or a job. The *procname* in the WTR parameter must match the *procname* in a previous TRACE CT,WTRSTART command.

WTR=DISCONNECT disconnects the writer and the trace. The component continues tracing and placing the trace records in the address-space buffer, but stops passing trace records to the external writer.

You must also specify a TRACE CT,WTRSTART or TRACE CT,WTRSTOP command to start or stop the writer.

CONT or END

Specifies that the reply continues on another line. The system reissues the same prompting message. You then can continue the reply. You can repeat any parameters on the continuation line, except END. Repeated parameters are strung together. They do not overlay each other. You must specify END to complete the response. END identifies the end of the REPLY.

Note: It is no longer necessary to use the **flushctr** option on the Modify command to flush the last buffer being filled to the component trace before the external writer is stopped or before a dump is taken. This function is now done automatically when the Component Trace external writer is stopped.

Entering operands of the modify command for the z/OS NFS server

Besides the **start** and **stop** commands, you can enter the **modify** command at the console with three operands shown in the summary of the modify command later in this section. All operands must be preceded by either **MODIFY** *mvsnfs*, or **F** *mvsnfs*, where *mvsnfs* is the name of the procedure in your system PROCLIB used to start the server.

Each message is sent to a component trace buffer, or to the console or the data set that is pointed to by the NFSLOG1 and NFSLOG2 DD statements, or to any combination of those destinations. NFSLOG1 and NFSLOG2 are DD statements in the startup procedure of the z/OS NFS server. These z/OS NFS server DD statements specify data sets where all the messages for debugging or trace are stored during the processing of the z/OS NFS server.

All data set names entered from the console must be fully-qualified and without quotation marks.

This is a summary of the modify command with the relevant operands:

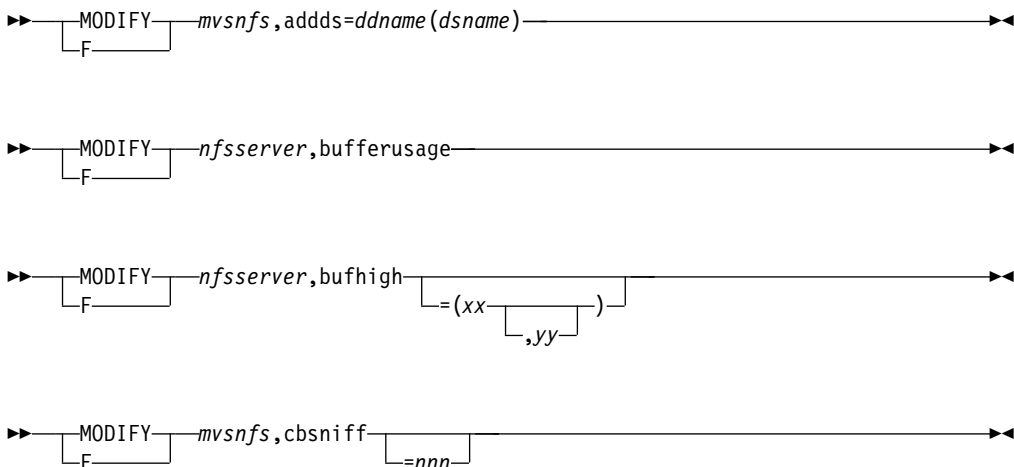

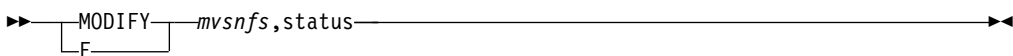
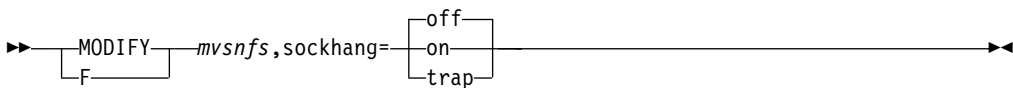
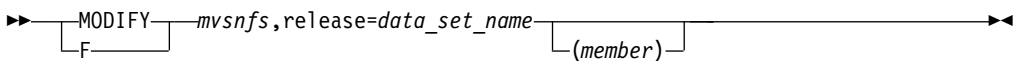
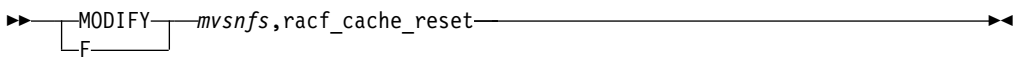
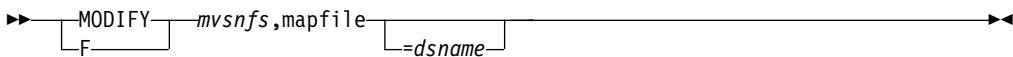
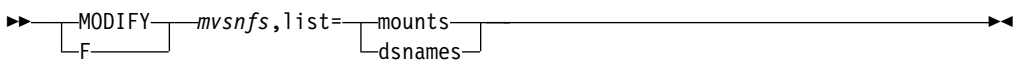
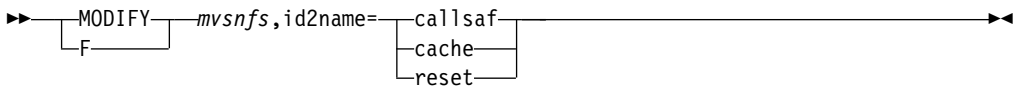
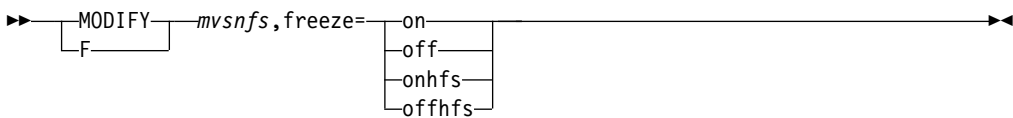
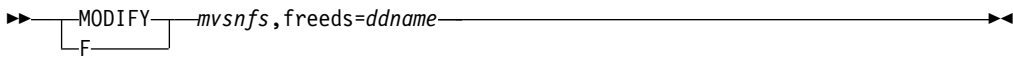
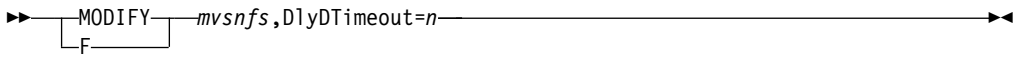
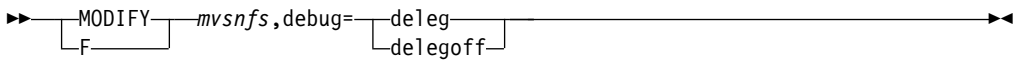
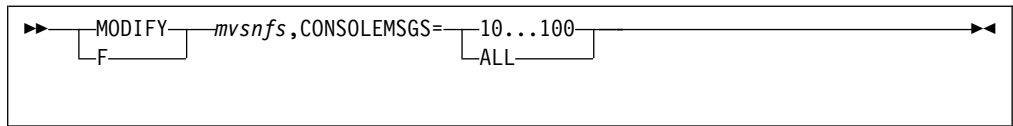

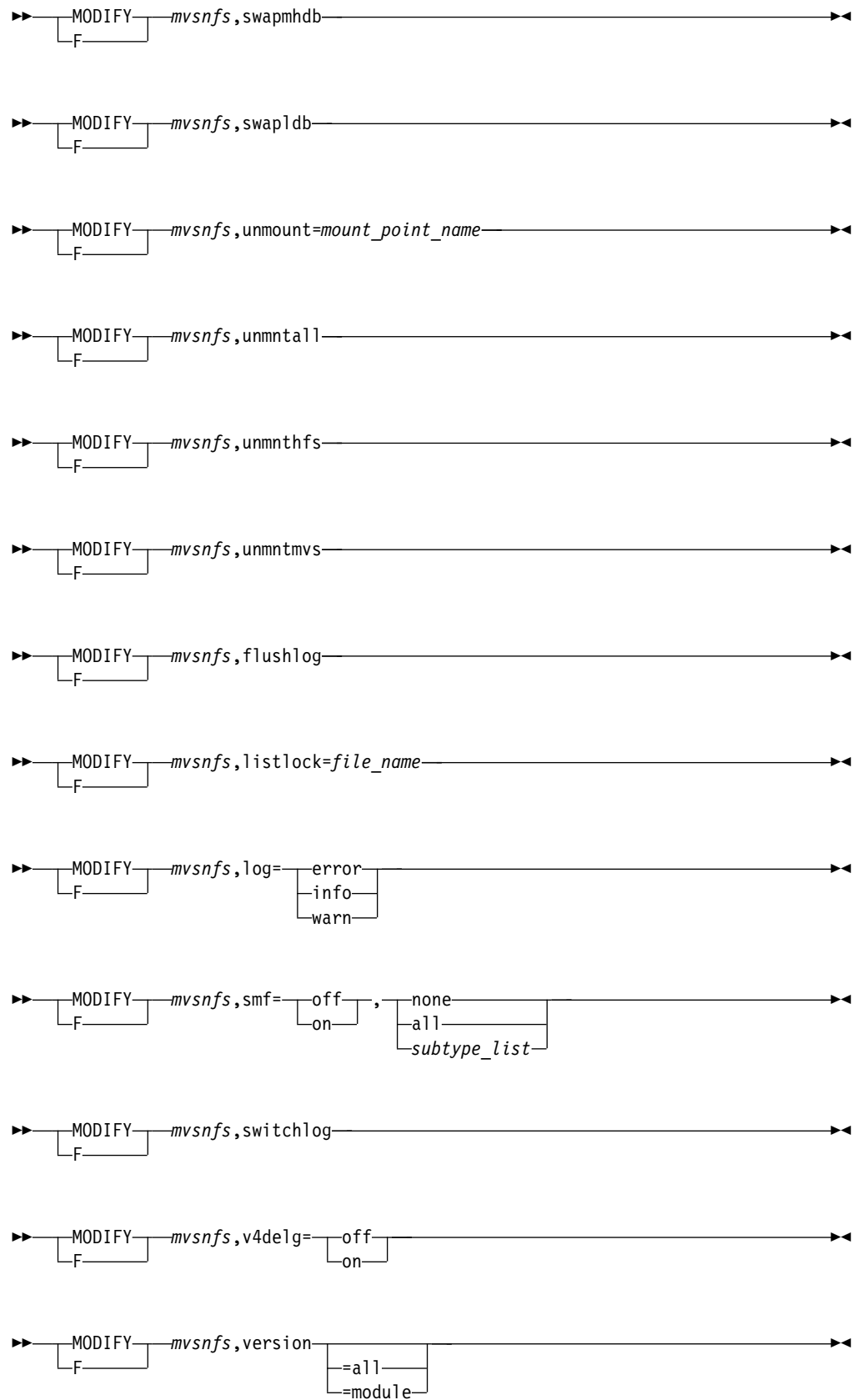

Adds operand

This operand is used to specify a replacement for one of the NFS control data sets. This applies to either the lock data sets or the mount handle data base data sets. When the z/OS NFS server determines that one of the control data sets has become unusable, it will write a warning message to the operator console requesting that the broken data set be replaced. Rename or delete the broken data set, allocate a new data set with the original name, and issue the MODIFY Adds command to enable the new data set. If the ddname does not match one of the valid control data set ddnames that has been freed, an error message is written. If the system programmer chooses not to replace the broken data set, the server will continue processing with the remaining data set. If a different data set name is used, the corresponding data set name in the NFS server startup procedure must be changed. Enter the operand as follows:

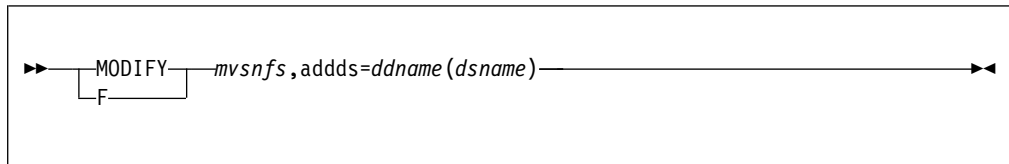

where

ddname

is the ddname of the NFS server control data set that is to be replaced. The valid ddnames are: FHDBASE, FHDBASE2, LDBASE, LDBASE2.

dsname

is the name of the lock data set or mount handle data set to be enabled for use by the z/OS NFS server.

Note: The current NFS server control data set must be freed with the **MODIFY Freeds** command before the **MODIFY Adds** command can be issued against it.

bufferusage operand

This operand reports the current data buffer utilization (in Mbytes). The **bufferusage** operand does not apply to z/OS UNIX files. Enter the operand as follows:

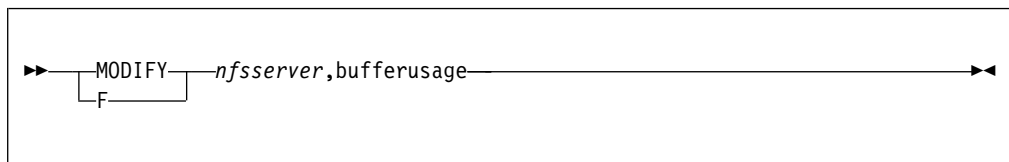

bufhigh operand

This operand specifies the below-the-bar virtual storage limit for data buffers for the NFS server. The **bufhigh** operand does not apply to z/OS UNIX files. Enter the operand as follows:

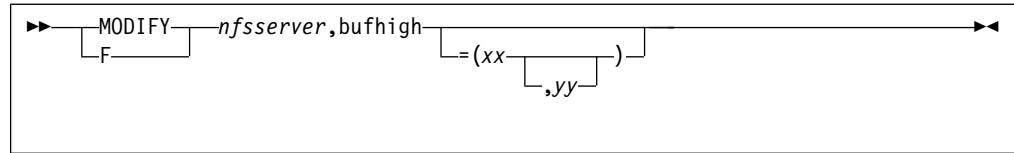

where

bufhigh=xx

the storage limit (in bytes). The valid range is 1 byte to 2047 MB. The new value MUST not be less than the current value of *xx*. If the specified value is less than the current value, the command will fail and error message GFSA386E is displayed. The upper boundary of the value is limited to 2GB and depends on the amount of free space below 2GB in the job region. If the specified value is more than the amount of free space below 2GB in the job region then the command will fail and error message GFSA386E is displayed. If the new value is omitted in the command the current *xx* value is not changed.

bufhigh=yy

the watermark in percent of the storage limit (*xx*) for printing a data buffer utilization alert message. The new value must be within the range 50 to 90, or 0 (zero to switch off the buffer cache monitoring and reporting mechanism).

If there is a command syntax error or an invalid value specified, an error message is printed and the actual values are unchanged. Otherwise, the values specified become the actual values and are printed to the console.

To check the current values being used for the *bufhigh* server attribute the following command is used:

```
MODIFY nfsserver,bufhigh
```

Cbsniff operand

This operand is used to periodically look (sniff) for a z/OS NFS Server control block chain breakage associated with z/OS UNIX file systems. The sniffer inspects the z/OS UNIX mount control blocks, checking for allocation and linked-list consistency, and creates a dump if it detects a problem (the z/OS NFS Server continues to run after the dump is taken). Enter the operand as follows:

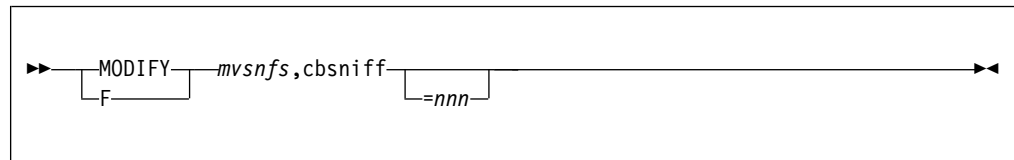

where

nnn

is a value of 0 or a number of seconds from 2 to 86400 (24 hours) specifying the time interval at which the sniffer is to run. If the specified value is larger than the maximum in this range, it is set to 86400. If it is 1, it is set to 2 (to prevent the sniffer from running too often). If it is negative, it is set to 0.

If the sniffer value is set to 0, the sniffer is turned off; otherwise it will be run immediately and then set to the timer period (in seconds) as specified.

If Cbsniff is issued without the equals sign ('='), the sniffer runs one time without altering the period of the sniffer (even if it is off at the time). If it does not identify a problem, any timer period is started anew.

If the sniffer identifies a problem, it generates an SDUMP and turns itself off (no further sniffers unless turned on explicitly).

The sniffer default is 0. It must be explicitly started every time the z/OS NFS Server is started or restarted, including for a SYSPLEX failover, or after the sniffer has triggered and created a dump.

CONSOLEMSGs operand

This operand specifies the number of messages for NFS operator commands: LIST=MOUNTS, LIST=DSNAMES, LISTLOCK will print on the console. It does not impact on console output of other NFS operator commands including VERSION=ALL. Enter the operand as follows:

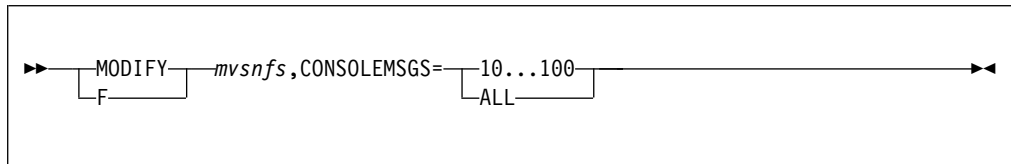

You can specify between 10 and 100 message lines to print on the console. The ALL option specifies that all NFS server messages are printed on the console.

DlyDTimeout operand

This command sets the minimum delay detection time value in sec before the delay detection mechanism observes a delay in an external call/function and prints message GFSA1030E on the console. Enter the operand as follows:

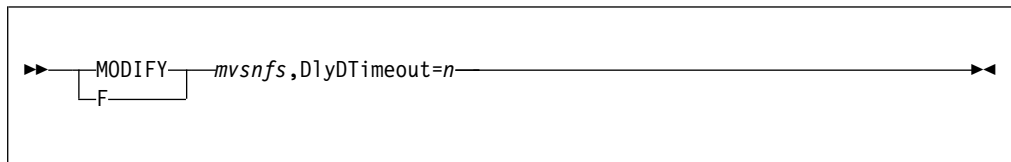

Valid values are 0 and a range of 5 to 60 seconds. Any value of DlyDTimeout from 1 to 4 seconds is converted to 5 seconds. If DlyDTimeout is set to 0 the delay detection mechanism is turned off. The Default value is 10 seconds.

exportchk operand

Checks the Exports file about export and checklist values without rebuilding the new export list.

Enter the operand as follows:

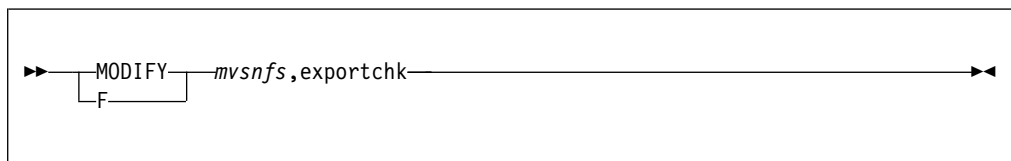

Exportfs operand

This operand causes the exports data set to be re-read and the internal exports list to be rebuilt without stopping and restarting the server. Checklist data specified on the **dirsurf** parameter in the exports data set is included in the update. This operand can be run at any time. Any changes in the **sec** keyword of the export list will be **immediately** enforced at server startup or EXPORTFS time, regardless of the state of any preexisting mount points. If client IP addresses have been changed and the z/OS NFS server is running in NODHCP mode, the exportfs command will **not** rebuild the exports list correctly.

If an exported path contains symbolic link(s), the 'symresolve' attribute is in effect and an NFS Client accesses this path using NFSv4, then the resolved path for this directory entry is added as a temporary in-memory export entry. If the 'f mvsnfs,exportfs' command is issued, the in-memory export list is rebuilt and all temporary export entries are removed. This has the same effect as a z/OS NFS server restart, unless there are active mounts. If there are active mounts then the result of the exportfs command is to not remove those temporary export entries. This has the same effect as a mount being restored via the FHEXPIRED error mount recovery process between the z/OS NFS server and NFS client after a z/OS NFS server restart.

Enter the operand as follows:

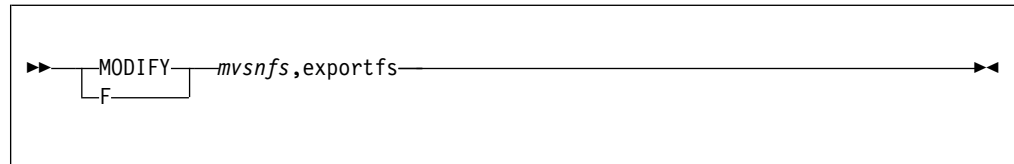

Frees operand

This operand is used to free one of the NFS control data sets so it can be replaced. This applies to either the lock data sets or the mount handle data base data sets. Enter the operand as follows.

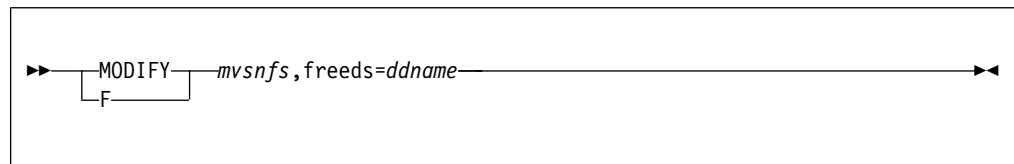

where

ddname

is the ddname of the NFS server control data set that is to be freed. The valid ddnames are: FHDBASE, FHDBASE2, LDBASE, LDBASE2.

Note:

1. Only the currently inactive data set of the mount handle data base, or lock data base, pair can be freed. Therefore, if the active data set is the one to be freed, it is necessary to first swap the data set pair. This can be done with a `swapmhdb`, or `swaplodb`, command. This command swaps the active and inactive data sets in the database. Once this is done, it is then possible to free the previously active (now inactive) data set.

- The freed data set must be renamed or deleted before a new data set of the same name can be allocated.

Freeze operand

This operand suspends or resumes processing of user mount requests. For the NFS V4 protocol, this operand also suspends or resumes processing of lookup operations from the NFS server into z/OS UNIX file systems or MVS data sets. You can enter the *freeze=on* command at any time for maintenance purposes. Enter the operand as follows:

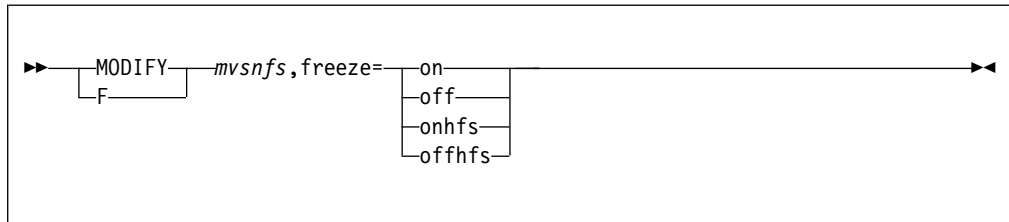

- If you select **on**, these messages appear.

```

GFS A901I Mounts Processing Suspended.
GFS A771I z/OS UNIX mounts suspended
  
```

Future mount requests by client users are refused for both z/OS UNIX file systems and z/OS conventional MVS data sets and the message "Permission Denied" displays on their monitors. After issuing a *freeze=off* operand, mount processing resumes for both z/OS UNIX file systems and z/OS conventional MVS data sets, and these messages appear.

```

GFS A902I Mounts Processing Resumed.
GFS A772I z/OS UNIX mounts resumed.
  
```

Client users can again mount z/OS directories as normal.

- If you select **onhfs**, future mount requests by client users for z/OS UNIX file systems are refused.
- If you select **offhfs**, mount processing resumes for z/OS UNIX file systems.

ID2NAME operand

This operand is to set the value of the site attribute ID2NAME, which controls NFS version 4 name mapping Uid/Gid caching for performance improvement. Enter the operand as follows:

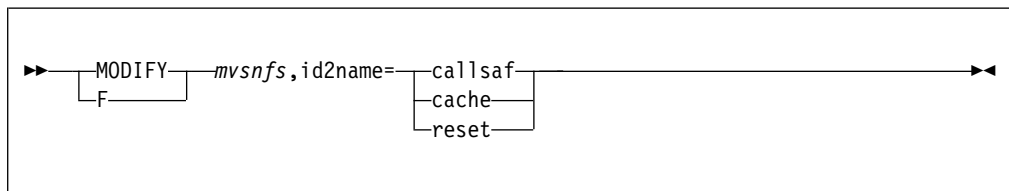

where

callsaf

disables the server Uid/Gid Caching. The default value is **callsaf**.

cache

enables the server Uid/Gid Caching instead of calling SAF for each Uid/Gid query.

reset

clears the server Uid/Gid Cache.

To find out the current state of server Uid/Gid Cache customer should use SHOWATTR utility.

List operand

This operand displays a list of either the mount points or the MVS data sets that are currently active in the Network File System. This command can be entered at any time for maintenance or diagnostic purposes. The path name output of an z/OS UNIX file object might require multiple console messages. Enter the operand as follows:

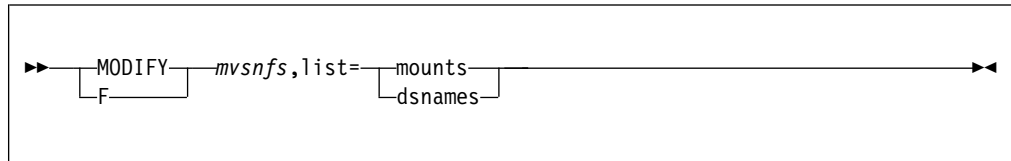

The **mounts** option returns a list of all mount points currently active in the system for NFSv2, NFSv3, and NFSv4 protocols. The list of active mount point names and their associated *current use counts* (NFSv2 and NFSv3 only) are displayed, along with the list of clients which have active mounts to the mount point. If available, a client's hostname is displayed; if not, the client's IP address is displayed. For example, in the following list entry, the mount point /HFS/U/BLUE has a current use count of 3, indicating that three clients are currently accessing it. The hostnames of the two of the clients are displayed, but the third client's hostname is unavailable, so its IP address is displayed instead.

```
GFSA910I /HFS/U/BLUE ACTIVE =3 hostname1 hostname2 9.1.22.73
```

Note: Because there could be a large number of mounts or hosts for a single mount, NFS limits the console display of this message to a maximum of approximately 10 lines of the response. The entire response is recorded in the NFS log data set. Message GFSA907I is displayed on the console if not all of the information is shown.

The list of clients is always less than or equal to the current use count that is displayed on the ACTIVE parameter; if the number of clients is less than the current use count, then one or more of the clients have multiple active mounts to the mount point.

Current use counts indicate how many mount requests have been made without an unmount request for the same mount point regardless to which local directory the mount is attached. For example, suppose the high-level qualifier JOHN is mounted to the same local directory 12 times without any unmount. ACTIVE =12 is shown. Now, suppose the high-level qualifier JOAN has been mounted to 15 different local directories but 5 of them have been unmounted. ACTIVE =10 is shown, as in the following example:

```
GFSA910I JOHN ACTIVE =12.  
...  
GFSA910I JOAN ACTIVE =10.  
...
```

With the NFS version 4 protocol, the current active mounts are reflected for the **mvsmnt** and **nomvsmnt** processing attributes, NFSv4 HFS mounts issued from non

z/OS NFS clients (such as AIX, Oracle and Linux) will not be reflected if no z/OS NFS server attributes are specified. In order for such mounts to be reflected, at least one z/OS NFS server attribute must be explicitly specified. If an NFSv4 HFS mount request includes a symbolic link in the path name and the request fails with NFSERR_NOENT error (No such file or directory), the result may be an erroneous NOMVSMNT display for LIST=MOUNTS. This can result when the MVS HLQ matches the z/OS UNIX file system prefix.

The current MVS MNT parameter reflects only mounts specified with the mvs mnt processing attribute, as in the following example:

```
GFS A910I MIKE MVS MNT.
```

The current NOMVSMNT parameter reflects only mounts specified without the mvs mnt processing attribute, as in the following example:

```
GFS A910I BILL NOMVSMNT.
```

The **dsnames** option returns a list of all data sets that are currently active. Currently active means that the data set is either in use or has been opened for accessing but has not been closed due to timeout even though the file is not in use. A list of data sets and data set members such as these display.

```
GFS A912I CHRIS.TEST.
GFS A912I SMITH.PAYROLL(JULY).
GFS A912I /HFS/U/PAYROLL.
```

z/OS UNIX file names are truncated after 126 characters.

Mapfile operand

This operand causes the side files data to be read again and rebuilt without stopping and restarting the server or remounting of mount points. Enter the operand as follows:

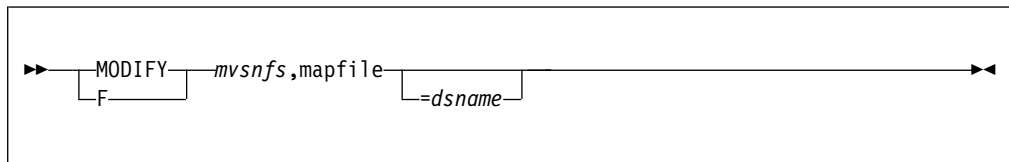

where

mapfile

refreshes all side files specified either from the sidefile site attribute (from NFSATTR DD statement) or previously specified by any mount command.

mapfile=dsname

refreshes only side file *dsname*.

racf_cache_reset operand

This operand erases all UIDs and GIDs from the NFS RACF cache. Note that if you issue this operand during z/OS NFS server shutdown, the command is rejected with GFS A949I (ECMDER) console error message. Enter the operand as follows:

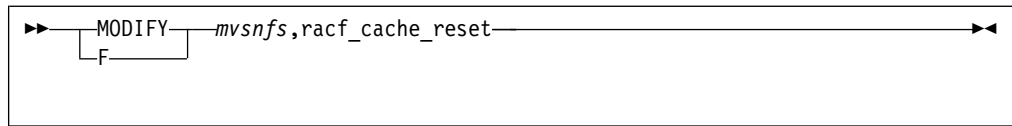

Release operand

This operand forces the Network File System to close and deallocate the MVS data set or PDS/PDSE member specified. Any locks which exist will also be released and any waiting locks for the data set or member will be cancelled. Any waiting byte range lock requests (for the specified data set) will be purged. File share reservations will also be released.

For a z/OS UNIX file, any locks held will be released and any waiting locks will be canceled. File names specified with a prefix must be specified in single quotes with the prefix (/hfs or /mvs) followed by the z/OS UNIX path name or the MVS data set name, respectively. Note that the currently active prefix settings apply for determining whether a z/OS UNIX file or an MVS data set is specified. The command syntax is as follows.

Attention: The NFS and NLM protocols do not provide any means for the NFS server to notify the NFS client that the file (or MVS data set) and associated locks have been released. Use of the RELEASE command can lead to data corruption because the NFS client will be unaware of the fact that its file and locks are no longer held. This command should only be used as a last resort when it is not possible to release the file any other way.

NFS v4 Delegation: The Release operand initiates the recall of any delegations associated with the file. This is done asynchronously. The release command completes immediately, not waiting for the recall to complete. If an NFS client has a write delegation, it is the client's responsibility to properly recover from the stale file error received when the client attempts to write back any modified buffers. Enter the operand as follows:

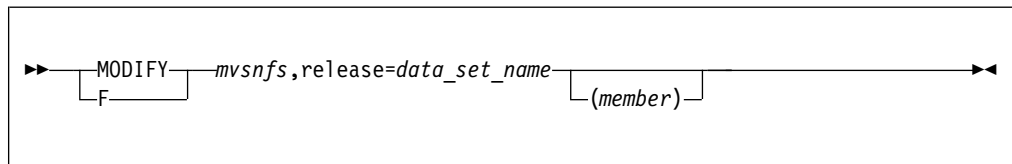

where

data_set_name

is the name of an MVS data set or a z/OS UNIX file. If *data_set_name* references a PDS or a PDSE data set and does not include the member name, a syntax error will result.

For z/OS UNIX file names, specify the release operand as follows:

f mvsnfs, release='/hfs/u/jones' (hfs path specified in quotes)

For MVS data sets, specify the release operand as follows:

f mvsnfs, release=data_set_name (MVS data set name not specified in quotes)

- If the object you specify is active, you receive a message as follows.

GFS914I data.set.name(member) DEALLOCATED.

- If the object you specify is not active, you receive a message as follows.
GFSA915I data.set.name(member) NOT ALLOCATED.

smf operand

This operand enables changing the smf site attribute settings for the SMF Record Type 42 without requiring a Server Restart. Enter the operand as follows:

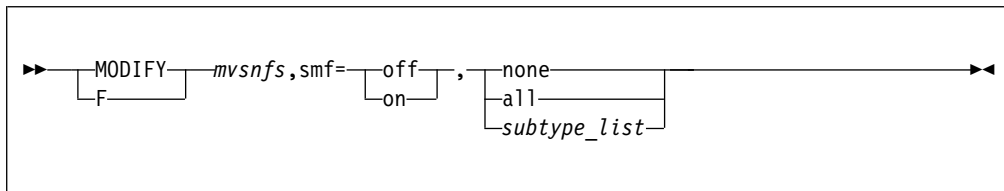

Status operand

This operand displays the status of the server's active subtasks. You can enter this command for diagnosis purposes at any time that the server is running. Enter the operand as follows:

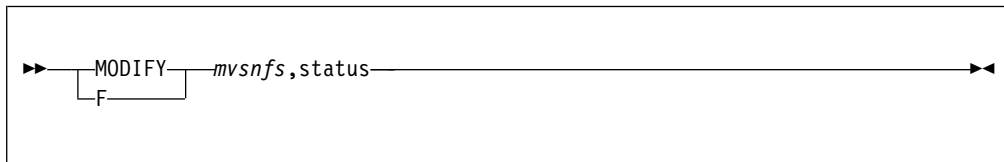

This is a sample message listing.

```

GFSA900I MOUNT PROCESSING ACTIVE.
GFSA751I SMF PROCESSING SUSPENDED FOR USER LOGOUT.
GFSA753I SMF PROCESSING SUSPENDED FOR FILE TIMEOUT.
GFSA781I mvsnfs SAF PROCESSING ENABLED.
GFSA903I TASK 5C580 TCB 8D1888 PROGRAM = GFSALEGT =
NFSTSK02
GFSA903I TASK 5C7A0 TCB 8D10C8 PROGRAM = GFSALEGT =
NFSTSK01
GFSA903I TASK 5C9C0 TCB 8D1378 PROGRAM = GFSALEGT =
NFSTSK00
GFSA903I TASK 5CE00 TCB 8D1378 PROGRAM = GFSAXPRT =
TRANSPORT
  
```

Swapldb operand

This operand is used to swap the active and inactive lock data base data sets. Once this is done, it is then possible to free the previously active (now inactive) lock data base data set. Enter the operand as follows:

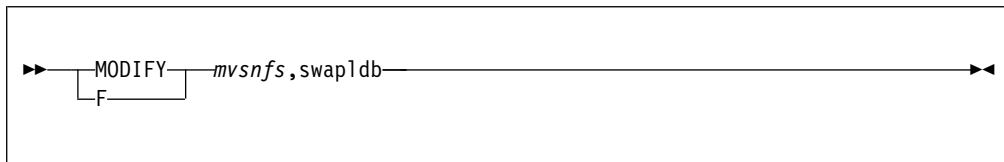

Swapmhdb operand

This operand is used to swap the active and inactive mount handle data base data sets. Once this is done, it is then possible to free the previously active (now inactive) mount handle data base data set. Enter the operand as follows:

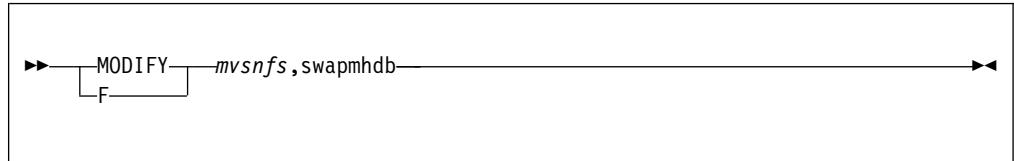

Unmount operand

This operand unmounts a mount point that is currently active. The path name for a z/OS UNIX file object cannot exceed 126 bytes. File names specified with a prefix must be specified in single quotes with the prefix (/hfs or /mvs) followed by the z/OS UNIX path name or the MVS data set name, respectively. For example: F mvsnfs, unmount='/HFS/u/jones'. Note that the currently active prefix settings apply for determining whether a z/OS UNIX file or an MVS data set is specified. Enter the operand as follows:

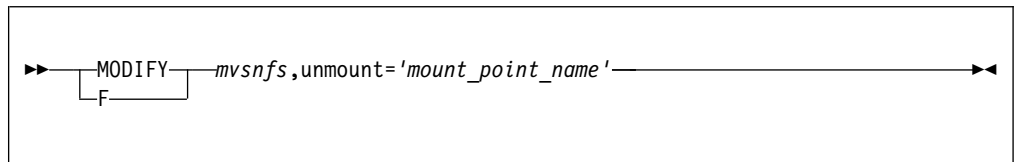

- If the mount point is active, the server responds.
GFS916I mount_point UNMOUNTED.
- If the mount point you specify does not exist when you enter the command, the server displays messages similar to the following messages.
GFS917I SMITH NOT MOUNTED.
GFS917I /HFS/U/JONES NOT MOUNTED.

Once the mount point is removed, client users are unable to access this mount point, and they get the "Stale NFS File Handle" message. Client users have to enter the **umount** command to end the stale file handle problem.

Unmntall operand

This operand causes the server to immediately unmount all mount points without stopping and restarting the NFS server. Enter the operand as follows:

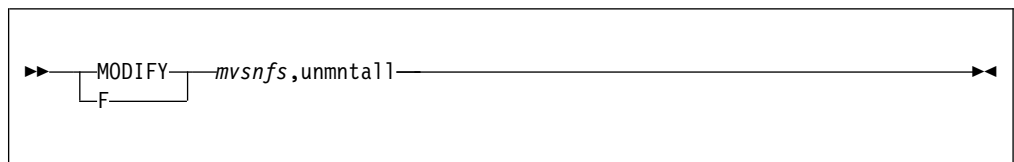

Unmntnfs operand

This operand causes the server to immediately unmount all z/OS UNIX mount points without stopping and restarting the NFS server. Enter the operand as follows:

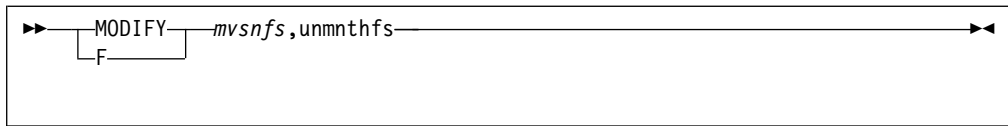

Unmntmvs operand

This operand causes the server to immediately unmount all MVS data set mount points without stopping and restarting the NFS server. Enter the operand as follows:

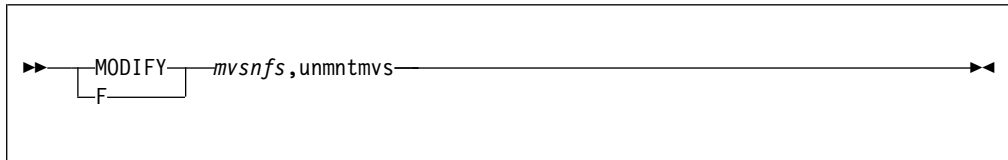

v4delg operand

When the z/OS NFS server starts up, `v4delg` is set to off. Set `v4delg` to on if you want to enable NFS v4 MVS data set access delegation. The `v4delg` operand is used to resume or suspend delegation. This operand has two parameters, ON and OFF. Enter the operand as follows:

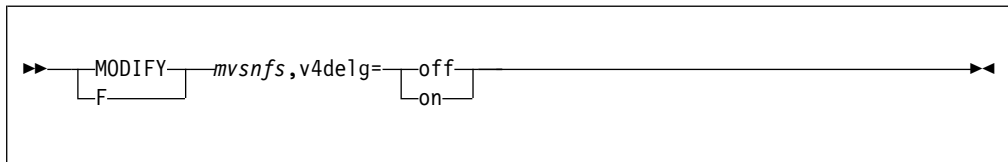

where

v4delg=on

enables NFS v4 MVS data set access delegation.

v4delg=off

disables NFS v4 MVS data set access delegation.

Entering operands of the modify command for diagnosis

These operands of the `modify` command can help you to collect data for diagnosing problems.

Note: All operands must be preceded with either:

`MODIFY mvsnfs,`

or

`F mvsnfs,`

where

`mvsnfs`

Specifies the name of the procedure in your system PROCLIB used to start up the server.

Each message is sent to the console, the component trace, or the data set that is pointed to by the NFSLOG1 or NFSLOG2 DD statements, or a combination of those destinations.

chkloop operand

This operand is to set the value of the site attribute `CHKLOOP`, which enables/disables NFS Error Client Loop Detection Facility and sets the values of the site attributes `LOOPTHRESHOLD(x)` and `TIMETHRESHOLD(y)`. Enter the operand as follows:

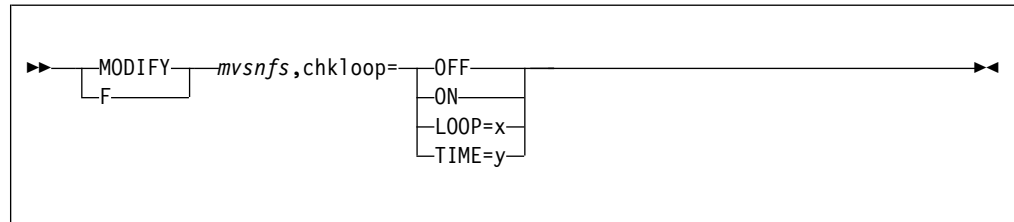

where

OFF

disables the NFS Error Client Loop Detection Facility. The default value is **OFF**.

ON enables the NFS Error Client Loop Detection Facility.

LOOP=x

sets the loop threshold value x (decimal number of loop repetitions), permissible value is $2 < x < 10000$. The default value is 3. The number of NFS error repetitions considered as a loop if the loop counter exceeds the loop threshold value.

TIME=y

sets the time threshold value y (decimal number of seconds), permissible value is $3 < x < 61$. The default value is 4. In this case, we assume the loop has stopped if the interval in seconds between the last error and the current error exceeds the time threshold value. Thus, current loop count is cleared or reset.

The loop threshold value and the time threshold value may only be set if NFS Error Client Loop Detection Facility is disabled. Otherwise the message:

```
GFS A386E (MVS NFS) Command error: wrong syntax.
```

is displayed.

The output of `MODIFY` command with `CHKLOOP=ON` operand contains the descriptive text which warns about it:

```
GFS A796I (MVS NFS) CHKLOOP=ON, Loop=x, Time=y -
changeable only if CHKLOOP is OFF: completed successfully.
```

If the loop threshold value or the time threshold value receives invalid input values then the messages:

```
GFS A386E (MVS NFS) Command error: invalid or omitted value.
GFS A386E (MVS NFS) Command error: the second argument is out of range.
```

are displayed.

Debug operand

This operand provides the ability to turn on extra debug controls to capture special diagnostics for specific functional areas in the z/OS NFS Server. Use this operand only when requested by IBM Support. Enter the operand as follows:

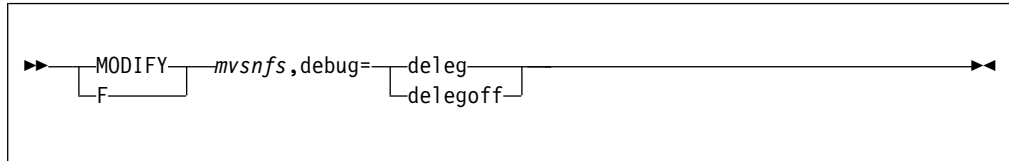

where

deleg

monitors the z/OS NFS Server NFS v4 delegation functions for the occurrence of various errors. If any of these errors are detected, a dump is generated to capture the associated NFS trace data before it is lost.

delegoff

turns off the special z/OS NFS Server NFS v4 delegation function monitoring. The writing of NFS trace records is not changed.

The default setting is for all of the debug controls to be off.

Flushlog operand

flushlog is an operator command that lets you flush the NFS message log to disk. This command enables a TSO/E user to browse all the log records that have been written by the NFS. Enter the operand as follows.

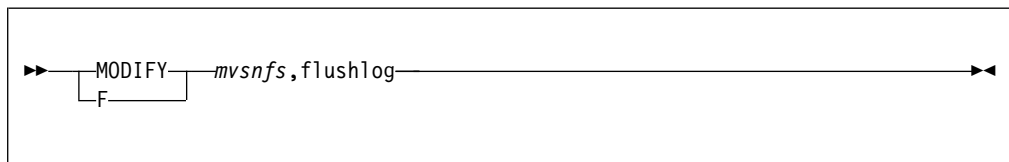

Listlock operand

This operand lists client NFS processes that hold locks, share reservations or delegations for a specified file on the z/OS Network File System server. The list of lock holders can be used to diagnose problems with locking, share reservation or delegation conflicts. The listlock operand lets you specify an MVS data set, PDS or PDSE member, or z/OS UNIX file, and writes a message (GFSA791I or GFSA792I) for each unique userid and client host pair that holds locks, share reservations or delegations for it. Note that the currently active prefix settings apply for determining whether a z/OS UNIX file or an MVS data set is specified. The general command syntax is as follows:

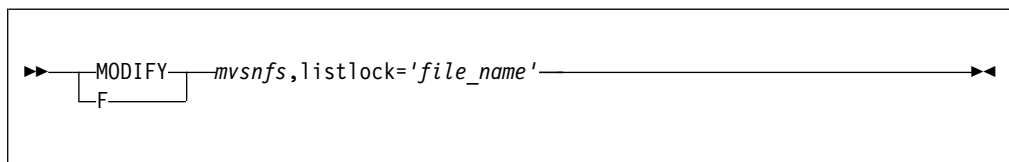

where

file_name

is the name of an MVS data set, z/OS UNIX file, PDS member, or PDSE member. File names specified with a prefix must be specified in single quotes with the prefix (/hfs or /mvs) followed by the z/OS UNIX path name or the MVS data set name, respectively. For example, if the HFS(/hfs) site attribute was specified, LISTLOCK='/hfs/u/user' will indicate the z/OS UNIX file /u/user.

- For an MVS data set, PDS member, or PDSE member:
 - If *file_name* references a z/OS conventional MVS data set for the first time, message GFS A921I is issued.
 - If *file_name* references a PDS or a PDSE data set (that does not include the member name), GFS A918I is issued.
 - If *file_name* references an invalid member name of a PDS or a PDSE data set, GFS A919I is issued.
 - If *file_name* is found and there are no locks, share reservations or delegations to list, message GFS A793I is issued.
 - When an NFS client closes a file, delegation is returned to the NFS Server. Assuming there is no local user access request, the delegation is kept by the NFS Server, and not returned to MVS. In this case, message GFS A790I is issued.
- For a z/OS UNIX file, if there are no locks to list, message GFS A793I is issued.
- If the specified file does not have any locks, message GFS A793I is issued to report that no locks exist.
- Since the lock information may only be reported to the server log data set or component trace buffer, and not back to the console, message GFS A794I is issued to indicate that the listlock function completed successfully.
- Response messages are sent to the console if there are 10 or fewer locks to be reported. Otherwise, the response messages are only sent to the NFS log data set.
- Before reading the output of this command, you need to flush the log using the flushlog operand.

Log operand

Use the **log** operand to set the level of NFS logging messages to be collected. Enter the operand as follows:

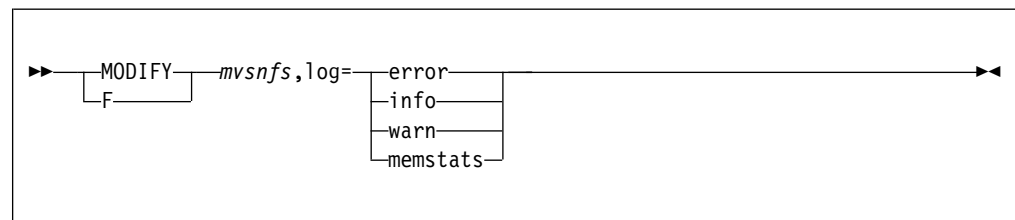

where

log=error

collects only error messages.

log=info

collects error, attention, and informational messages.

log=warn

Collects error message and attention messages.

log=memstats

requests the NFS Server to write memory usage statistics to the NFS Log.

The diagnostic message level can also be set in the execution statement of the NFS startup procedure. For more information, see Appendix K, "Capturing diagnostic information using z/OS NFS log data sets and from other components," on page 565.

Smf operand

When the z/OS NFS server starts up, *smf* is set to off. You need to set *smf* to on if you want to collect the SMF records. The Network File System suspends writing SMF records when it detects an SMF error. The *smf* operand is used to resume or suspend the collection of SMF data. This operand has two parameters, ON and OFF. Enter the operand as follows.

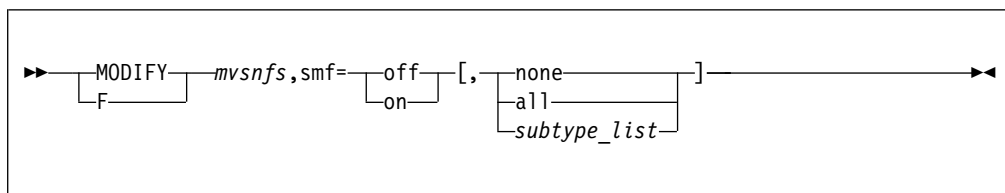

where

smf=on

resumes the collection of SMF records.

smf=off

suspends the collection of SMF records.

smf=none

no SMF records are to be produced.

smf=all

all SMF NFS type 42 records are to be produced.

smf=subtype_list

a list of levels that are delimited by commas. At least one of the levels (user | file | audit) must be specified for a list, and the remaining levels are optional.

Where:

- file: Produces file usages SMF records (subtype 7).
- user: Produces user session SMF records (subtype 8).
- audit: Produces file creation, removal, and rename records (subtype 26).

Sockhang operand

When the z/OS NFS server starts up, *sockhang* is set to off. Set *sockhang* to on if you want the z/OS NFS server to create a dump if it detects a potential socket hang condition. This optimizes the ability to detect the situation and capture the necessary diagnostic trace data before the trace data is lost. Set *sockhang* to trap if you want z/OS NFS server to create a dump if it detects a potential ambiguity in the RPC request.

When *sockhang* is set to on or trap, tracing levels Network, MVS (DFP_request and DFP_return), and Task_Flow (Dispatch, Resume, Schedule, and Suspend) are set on to ensure that the necessary diagnostic data is collected when a socket hang is first detected. When *sockhang* is subsequently set to off, tracing levels Network, MVS,

and Task_Flow are reset to off; any previous settings of Network, MVS, and Task_Flow before *sockhang* was turned on must be re-set as needed. Detail level tracing provides the ideal setting to further isolate the source of a socket hang condition or an RPC request ambiguity, but with a greater effect on system performance. Enter the operand as follows:

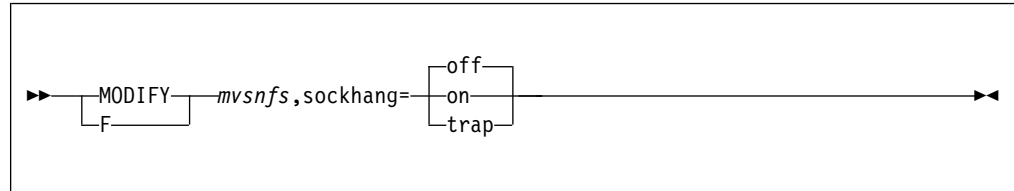

where

sockhang=off

does **not** create a dump if a socket hang or an RPC request ambiguity is detected. Both `sockhang=on` and `sockhang=trap` are turned off.

sockhang=on

creates a dump if a socket hang is detected. `sockhang=trap` can be set in parallel.

sockhang=trap

creates a dump if an RPC request ambiguity is detected. `sockhang=on` can be set in parallel.

Switchlog operand

When the log data set being used to collect z/OS NFS server debug trace record becomes full or unusable, you can use **switchlog** to switch the trace recording to another log data set. Enter the operand as follows.

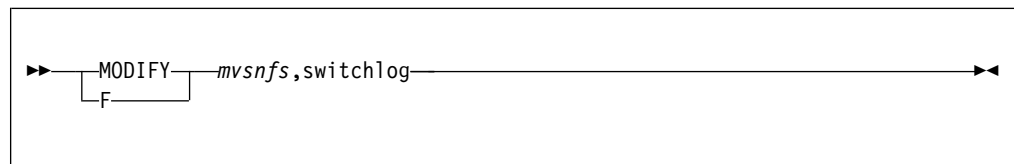

where

switchlog

switches the z/OS NFS server debug trace recording from the current log data set to the next log data set. Prior to the switch, the in-storage debug trace information is flushed to disk and the current log data set is closed. Message GFSA930I is issued to report the log switch, including the previous and new log data set DD names, and debug trace recording continues in the next log data set.

Version operand

To aid in diagnostics, the *version* operand identifies the precise release and maintenance levels of the z/OS NFS server modules, including the latest APAR installed. Enter the operand as follows.

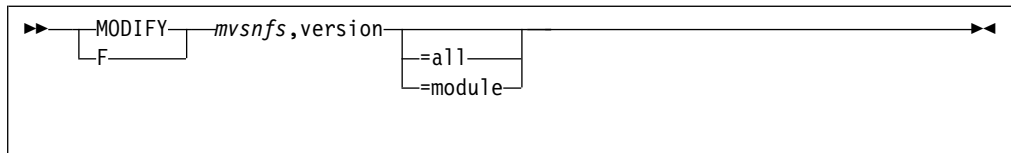

where

version

returns information about the release level of the z/OS NFS server and the latest APAR installed on the server.

version=all

returns a list of all the modules in the z/OS NFS server with their current level information. At the end of the list is information about the latest APAR installed.

version=module

returns information about the APAR level of the specified module.

Displaying NFS trace information

NFS component trace status and active options can be displayed by using the MVS **DISPLAY TRACE, COMP= mvsnfs** command for the NFS server or the **DISPLAY TRACE, COMP= mvsnfsc** command for the NFS client. For more information on the DISPLAY TRACE command, refer to *z/OS MVS System Commands*.

Chapter 12. Installation-wide exit routines for the z/OS NFS server

This topic helps you write installation-wide exits or replaceable modules that customize NFS processing. It contains product-sensitive programming interfaces that are provided by the server.

If there is no customization made to the installation-wide exit routines, we recommend that you remove them for better performance.

Requirements for NFS

Table 33 summarizes the installation-wide exit routines that are provided by the NFS.

Table 33. List of installation-wide exits

Source Module Name	Load Module Name	Parameter List Mapping Macro	Description
GFS AUXL	GFS AUXL	GFS AU LOG GFS AU DSA	Login security exit
GFS AUXF	GFS AUXF	GFS AU SEC GFS AU DSA	File security exit

GFS AU DSA is a sample skeleton for a user storage block.

The installation-wide exit routines are shipped with the NFS and they contain the dummy skeleton code. The source modules reside in the prefix.NFSSAMP data set and the macros reside in prefix.NFSMAC data set. (The value of prefix depends on the installation.) Before modifying or replacing these exits, you should review the functions and processing of these exit routines carefully. These are basic requirements for all the NFS exit routines:

- Exit routines must reside in an authorized program library and be accessible by the z/OS LOAD macro. NFS and installation-wide exit routines receive control in problem state key 8. Installation-wide exits are run as an APF-authorized task, because the Network File System is APF-authorized. As with any APF-authorized program, your exits should not be link-edited with APF-authorization. Only the main task, NFS, should have that link edit attribute.
- Exit routines must be link-edited with AMODE(31).
The installation-wide exit routines are entered in AMODE(31) and can reside above or below the 16M line depending on the requirements of the installation-wide exits themselves.
- Exit routines must be reentrant.
- Exit routines must follow the standard z/OS register save and restore convention. The standard z/OS registers convention is:
 - Register 1 contains the address of the exit parameter list.
 - Register 13 contains the address of the caller's save area.
 - Register 14 contains the caller's return address.
 - Register 15 contains the address of the entry point for this exit routine. The server does not use return codes stored in register 15, but includes a parameter in the parameter list for exits that supply return codes.

Note:

1. Address parameters have null value (0) if the related data does not exist.
2. The length of each field can be found in the macros shipped. Field length can be changed in the future.

Sample link-edit JCL

Use the sample JCL shown in Figure 28 to assemble and link-edit the GFS AUXL and GFS AUXF load modules:

```
//jobname JOB (job_and_user_accounting_information)
//EXITASM PROC M=
//ASM EXEC PGM=ASMA90,
// PARM='RENT'
//SYSPRINT DD SYSOUT=*
//SYSIN DD DISP=SHR,DSN=source_library_name(&M)
//SYSLIB DD DISP=SHR,DSN=SYS1.MACLIB
// DD DISP=SHR,DSN=source_macro_library_name
//SYSLIN DD DISP=SHR,DSN=obj_library_name(&M)
//SYSUT1 DD UNIT=SYSDA,
// SPACE=(32000,(30,30))
//PEND
// EXEC EXITASM,M=GFS AUXL
// EXEC EXITASM,M=GFS AUXF
//stepname EXEC PGM=HEWL,
// PARM='MAP,LIST,RENT,REUS'
//SYSPRINT DD SYSOUT=A
//SYSUT1 DD DSN=&SYSUT1,UNIT=SYSDA,SPACE=(CYL,(1,1))
//SYSLMOD DD DSN=apf_library_name,DISP=OLD
//USER DD DSN=obj_library_name,DISP=SHR
//SYSLIN DD *
INCLUDE USER(GFS AUXL)
MODE AMODE(31)
ENTRY GFS AUXL
NAME GFS AUXL(R)
INCLUDE USER(GFS AUXF)
MODE AMODE(31)
ENTRY GFS AUXF
NAME GFS AUXF(R)
/*
```

Figure 28. Sample link-edit JCL for the NFS. This example uses High Level Assembler. To use Assembler H, replace ASMA90 on the EXEC statement with IEV90. The rest of the JCL would be the same.

Storage blocks of the server exits

This section discusses how to use storage blocks of the NFS installation-wide exits.

Global exit block (GXB)

The GXB is obtained once during system initialization by the server login exit. The exit returns a word to the server. This word is referred to as 'the address of the GXB', but the system initialization exit might store any value in the word. The address of the GXB is returned to the server in the parameter list and passed back to the installation-wide exits in each subsequent call. This block contains user installation-wide exit data that is needed to communicate with the server.

The GXB can contain an area to save the user data needed for all sessions. The usage of this block is determined by the exit. Access to the Global Exit Block must be controlled by the user-written installation-wide exits to ensure that updates are serialized and do not interfere with each other. This block is shared with the file

security Installation-Wide Exit. The format of the GXB is entirely controlled by the login and file security installation-wide exits.

User exit block (UXB)

During a *Start of New User Session* request or a *User Login Request* or an *RPCSEC_GSS User Session Request* (see the Note that follows), the exit can obtain a User Exit Block. The exit returns a word to the server. This word is referred to as 'the address of the UXB', but the system initialization exit might store any value in the word. The address of the UXB is returned to the server in the parameter list (depends on which request comes first), and is passed back to the installation-wide exits on each subsequent call related to this combination of machine and user IDs.

Note: An RPCSEC_GSS User Session is the first RPCSEC_GSS request coming into the NFS from a unique combination of the user as identified by the user's Kerberos Principal and the Internet address.

The UXB can contain an area to save the user data needed for this session. The usage of this block is determined by the exit. The exit is responsible for obtaining, and freeing access to these storage areas. This block is used by the login installation-wide exit and file security installation-wide exit. The format of the UXB is entirely controlled by the login and file security installation-wide exits.

Login installation-wide exit

The exit routine can invoke a customized authorization facility. The server mainline code can be set to perform Security Authorization Facility (SAF) checking, by specifying the **security** attribute in the attributes table.

If **security(saf)** or **security(safexp)** is specified in the attributes table and the exit routines exist, these exit routines get control first, and then SAF security checking gets control. If the exit routines fail the request, the entire request fails. If the exit routines process the request successfully, then the request is processed by the SAF checking. Similarly, if the SAF checking fails the request, the entire request fails.

If neither **security(saf)** nor **security(safexp)** is specified in the attributes table and the exit routine exists, this exit routine determines whether the request is successful or fails.

Figure 29 on page 258 shows the logic flow that determines which login checking routines are used.

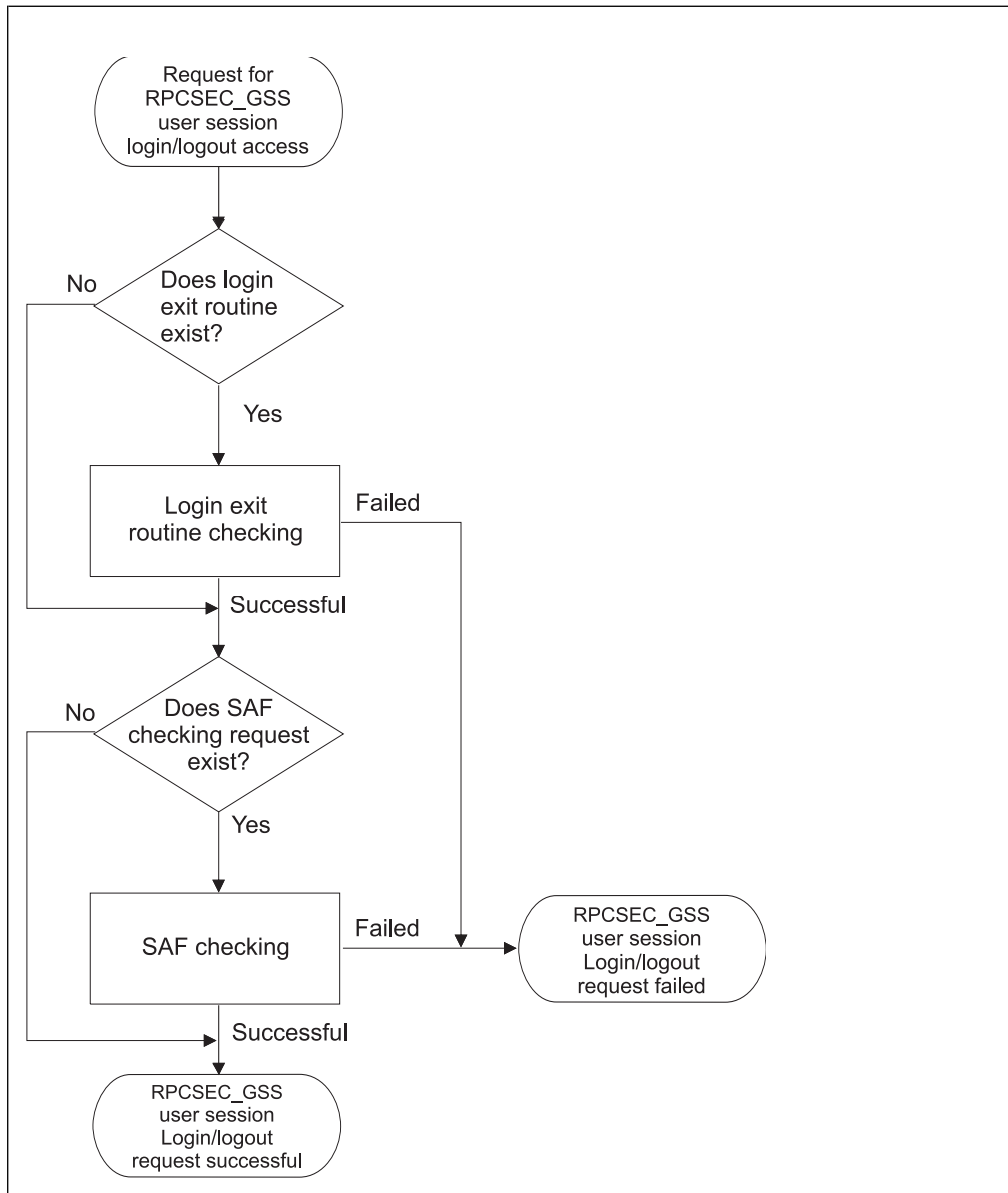

Figure 29. Determining which login checking routines are used

The login installation-wide exit has a parameter list which is passed from the server to the installation-wide exit. The login installation-wide exit can be invoked for any of the following conditions:

System initialization

Performed once during the initialization of the server and allows a Global Exit Block to be obtained. The GXB address is always returned to the installation-wide exits (see GXB in “Requirements of the login exit” on page 259). If this request fails, both the login installation-wide exit and the file security installation-wide exit are marked as non-existent.

New user session

Performed when a unique combination of UNIX UID and Internet address is detected. The exit might obtain a User Exit Block for use by later calls if the UXB does not exist.

Login Performs user verification when a client tries to use either an **mvslogin** command or a PCNFSD request or an RPCSEC_GSS user session request

(see “User exit block (UXB)” on page 257). The exit might obtain a User Exit Block for use by later calls if the UXB does not exist.

Logout

Performs cleanup when a client tries to use the **mvslogout** command or a timeout occurs. Timeout is the value specified in the logout attribute in the attributes table. On a logout, the UXB is released. Logout can also be initiated by the login request. For RPCSEC_GSS request, logout is only initiated when a timeout occurs since mvslogin/mvslogout is no longer required.

System termination

Occurs once during the termination of the server, and causes the Global Exit Block to be freed.

Requirements of the login exit

Besides the requirements stated in “Requirements for NFS” on page 255, the login installation-wide exit routine must be link-edited with the name of GFSAUXL.

Options of the login exit

The login installation-wide exit routine can perform these functions:

- Obtain a Global Exit Block (GXB)
- Obtain a User Exit Block (UXB)

If the User Exit Block already exists, its address is passed to the installation-wide exit routine; otherwise, 0 is passed. The installation-wide exit routine can accept or reject the request. If the request is accepted and the User Exit Block does not exist, you can allocate the User Exit Block and return the address in the LEDSXS parameter list.

Structure of the login exit message

The message supplied by the login exit is sent to the NFS server log data set and component trace, if activated. The message has the label name LEDSDX and consists of these two fields:

LEDSXCNT

1 byte message length, excluding the NULL character (X'00').

LEDSXMGS

81 byte NULL character string. The installation-wide exit can fill in this message field with the message ended by one or more bytes of X'00'.

If the format of the message is incorrect, both the login installation-wide exit and the file security installation-wide exit are marked as nonexistent, and a message (GFSA990I or GFSA991E) is sent to the z/OS NFS server log data set and to the console.

Contents of the login exit parameter list

The parameter list is mapped by macro and DSECT GFSAULOG. Table 34 on page 260 describes the contents of each field.

For configurations that use Internet Protocol Version 4, the client IP address is in field LEDSIA. If your configuration uses IPv6, refer to field LEDSIA6 for the client IP address. When an IPv6 address is provided in LEDSIA6, LEDSIA takes a value of -1.

If the **dhcp** site attribute is specified for the NFS server to use dynamic client IP addresses, the contents of the client IP address field will be correct when the exit parameter list request is processed. However, the exit must not have any dependency on the persistence of the IP address value beyond the duration of the individual request. That IP address can change between requests.

Table 34. Format of login installation-wide exit routine parameter list

Field Name	Description	Contents
LEDSRQ	Request code	System request code set by the server before calling this installation-wide exit, for these conditions: 4 System initialization 8 System termination 12 Start of new user Session 16 User login request 20 Logout has been requested
LEDSRC	Return code	Codes generated and returned by the calls.
LEDSM	Client machine name	Character string ended by single byte containing X'00'.
LEDSIA	Client IP address	Number (32-bit Internet address). Contains -1 (X'0xFFFFFFFF) if an IPv6 address is provided in the LEDSIA6 field.'
LEDSU	UNIX Client user ID number	Number
LEDSG	UNIX Client group ID number	Number
LEDSMU	z/OS user ID	Character string padded with a blank at the end of the user ID, conforming to z/OS standards.
LEDSMG	z/OS group name	Character string padded with a blank at the end of the group name, conforming to z/OS standards.
LEDSXS	Address of UXB	Size and content are installation-dependent, generated at the start of a new user session or a user login request.
LEDSXG	Address of GXB	Size and content are installation-dependent, generated at system initialization.
LEDSXD	Message supplied by this exit routine	Message structure (see "Structure of the login exit message" on page 259).
LEDSVERS	z/OS version number	Number (0x17 for z/OS V1R7)
LEDSIA6	Client IP address	Number (128-bit Internet address, for Internet Protocol V6 users)

Note: Character strings are in upper-case EBCDIC.

Login exit parameter list

This section describes how the Global Exit Block (GXB) or User Exit Block (UXB) is constructed and used between the login installation-wide exit and the NFS. A request code is set by the server before each call to this installation-wide exit routine. The installation-wide exit routine provides a return code for each event.

Request codes to the login exit

Table 35 on page 261 shows the login installation-wide exit request codes and their meanings:

Table 35. Request codes to the login exit

Code	Meaning
4 (X'04')	System initialization
8 (X'08')	System termination
12 (X'0C')	Start of new user session
16 (X'10')	User login request
20 (X'14')	User logout request

IBM might add new request codes in a future level of the server. To provide for this, consider making your exit set a return code 0 if it does not recognize the request code.

Return codes from the login exit

Table 36 shows the login installation-wide exit routine return codes and their meanings:

Table 36. Return codes from the login exit

Code	Meaning
0 (X'00')	Request successful
4 (X'04')	Request unsuccessful

System initialization routine of the login exit

The system initialization routine is called each time the server address space starts, and can acquire and initialize the GXB. Table 37 shows the codes and fields that are used for this routine:

Table 37. Codes and fields for system initialization

When Invoked	Field Name	Description	Contents
On entry	LEDSRQ	Request code	4
On exit	LEDSXD	Exit-supplied error message	Message Structure
On exit	LEDSRC	Return code	0 Initialization successful 4 Stop the NFS.
On exit	LEDSXG	Global Exit Block	Address

Start of new user session routine of the login exit

The start of new user session routine is called when a new client machine-user combination is recognized by the server. The exit might acquire and initialize a UXB. This is needed only for system authentication, not for RPCSEC_GSS authentication. Table 38 shows the codes and fields that are used for this routine:

Table 38. Codes and fields for start of new user session

When Invoked	Field Name	Description	Contents
On entry	LEDSRQ	Request code	12
On entry	LEDSM	Client machine name	EBCDIC character string
On entry	LEDSIA	Client IP address	Number
On entry	LEDSU	UNIX Client User ID	Number
		number	

Table 38. Codes and fields for start of new user session (continued)

When Invoked	Field Name	Description	Contents
On entry	LEDSG	UNIX Client Group ID number	Number
On entry	LEDSXS	User Exit Block	0
On entry	LEDSXG	Global Exit Block	Value
On entry	LEDSIA6	Client IP address	Number (128-bit Internet address, for Internet Protocol V6 users)
On exit	LEDSXD	Exit-supplied error message	Message Structure
On exit	LEDSRC	Return code	0 New session established 4 New session not established
On exit	LEDSXS	User Exit Block	Value, if return code in LEDSRC is 0

User login request routine of the login exit

This routine is called when the **mvlogin** command or PCNFSD request or RPCSEC_GSS user session request is used. The installation security system should be called to determine if the user is properly authorized. Table 39 shows the codes and fields:

Table 39. Codes and fields for user login request

When Invoked	Field Name	Description	Contents
On entry	LEDSRQ	Request code	16
On entry	LEDSM	Client machine name	Character string
On entry	LEDSIA	Client IP address	Number
On entry	LEDSU	UNIX Client User ID number	Number
On entry	LEDSG	UNIX Client Group ID number	Number
On entry	LEDSMU	z/OS User ID	Character string
On entry	LEDSMG	z/OS Group Name	Character string
On entry	LEDSXS	User Exit Block	Address or 0
On entry	LEDSXG	Global Exit Block	Address
On entry	LEDSIA6	Client IP address	Number (128-bit Internet address, for Internet Protocol V6 users)
On exit	LEDSXD	Exit-supplied error message	Message Structure
On exit	LEDSRC	Return code	0 Login successful 4 Login failed
On exit	LEDSXS	User Exit Block	Value

User logout request routine of the login exit

This routine is used at logout to return the User Exit Block storage obtained at the start of the session and to perform any related logout processing. The codes and fields used are shown in Table 40.

Table 40. Codes and fields for logout request

When Invoked	Field Name	Description	Contents
On entry	LEDSRQ	Request code	20
On entry	LEDSM	Client machine name	Character string
On entry	LEDSIA	Client IP address	Number
On entry	LEDSU	UNIX Client User ID number	Number
On entry	LEDSG	UNIX Client Group ID number	Number
On entry	LEDSMU	z/OS User ID	Character string
On entry	LEDSMG	z/OS Group Name	Character string
On entry	LEDSXS	User Exit Block	Address or 0
On entry	LEDSXG	Global Exit Block	Address
On entry	LEDSIA6	Client IP address	Number (128-bit Internet address, for Internet Protocol V6 users)
On exit	LEDSXD	Exit-supplied error message	Message Structure
On exit	LEDSRC	Return code	0 Logout successful
On exit	LEDSXS	User Exit Block	0 UXB is released

System termination routine of the login exit

This routine is used at server termination to release the GXB storage. All users are automatically logged off. The codes and fields used are shown in Table 41.

Table 41. Codes and fields for system termination

When Invoked	Field Name	Description	Contents
On entry	LEDSRQ	Request code	8
On entry	LEDSXG	Global Exit Block	Address
On exit	LEDSXD	Exit-supplied error message	Message Structure
On exit	LEDSRC	Return code	0 Exit termination successful
On exit	LEDSXG	Global Exit Block	0 GXB is released

File security installation-wide exit

The file security installation-wide exit routine verifies that a user is authorized to access a data set or data set member with the access mode requested. If the request from allocation, write, read, or access does not have permissions set up, then the exit routine gets control.

This exit applies only to MVS data set access, not to z/OS UNIX file access.

The permissions set up by the file security exit can be overridden by the SAF checking. If the exits allow access and there is no SAF checking, the permissions remain in effect until logout. The server does not call again for the same access before logout. The server gets the access mode or permissions before any of the other three types of calls.

If **security(saf)** or **security(safexp)** is specified in the attributes table and the exit routine exists, this exit routine gets control first, and then SAF security checking gets control. If the exit routines fail the request, the entire request fails. If the exit routines process the request successfully, then the request is processed by the SAF checking. Similarly, if the SAF checking fails the request, the entire request fails. If the SAF checking is successful, the file permissions from the SAF checking are set up for the request.

If neither **security(saf)** nor **security(safexp)** is specified in the attributes table and the exit routine exists, this exit routine determines the permissions.

Figure 30 on page 265 shows the logic flow determining which file security checking routines are used.

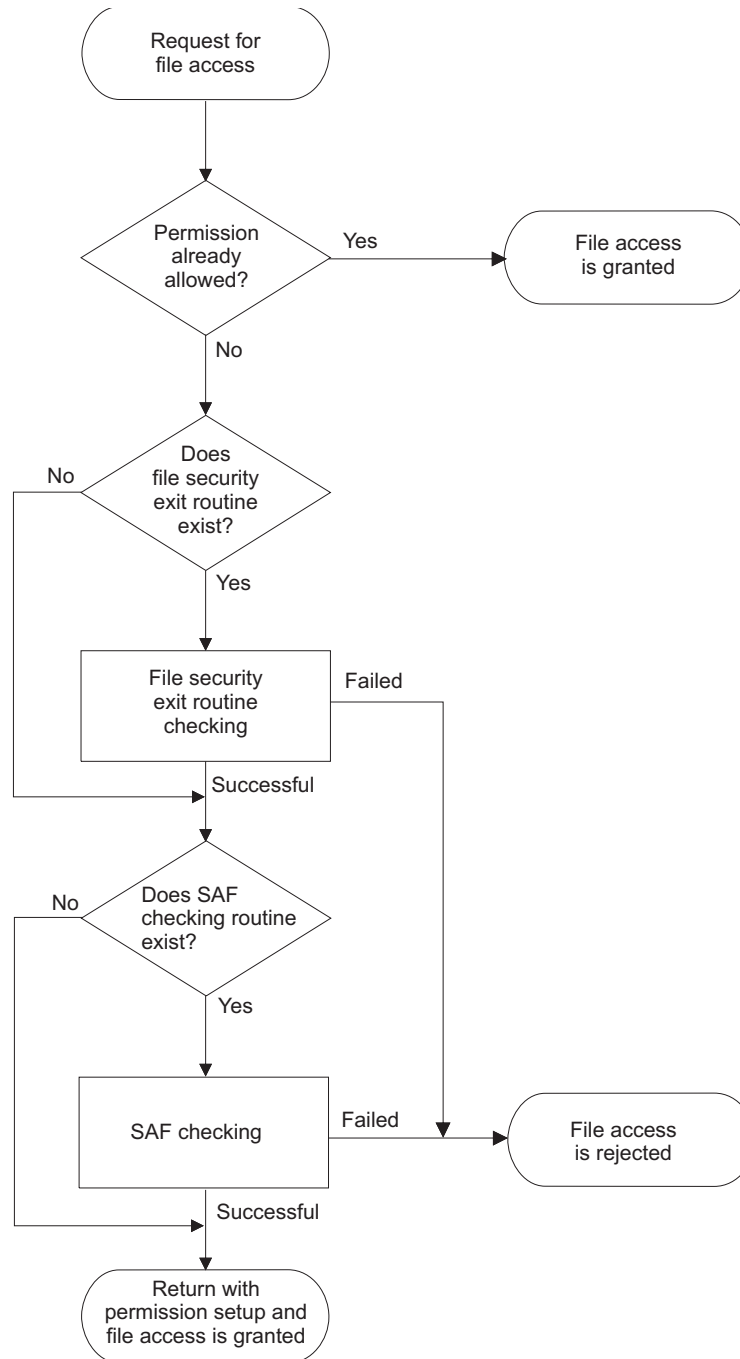

Figure 30. Determining which file security checking routines are used

The file security installation-wide exit uses the parameter list which is used by the server installation-wide exit. This exit is called for at these times.

Data Set Allocation

When a client user creates, renames, or deletes a data set.

Data Set Write

When a client user first writes to an MVS data set or data set member.

Data Set Read

When a logged in user tries to first read from an MVS data set or data set member.

Getting Access Mode or Permissions

This function is called first to set up permission for the read, write, create, delete, or rename data set request. The server needs to obtain the access mode or the permissions that a user has for a data set. This function is only called when SAF is not being used.

The following show access modes and what they permit.

Allocate

Read, write, create, delete, or rename the data set.

Write Read or write the data set

Read Read the data set

A return code is set by the installation-wide exit indicating whether the request is allowed. The file security installation-wide exit is not called at server startup or shutdown.

Requirements of the file security exit

Besides “Requirements for NFS” on page 255, the following requirements must be fulfilled.

- The file security installation exit must be link-edited with the name of GFSAXUF.
- The login exit must exist (GFSAXUL).
- If the GXB or UXB are to be used, the login exit must obtain them.
- The UXB and GXB are shared with the login installation-wide exit.

Structure of the file security exit message

The message supplied by the file security exit is sent to the NFS server log data set and component trace, if activated. The message has the label name FEDSXD and consists of the following two fields.

FEDSXCNT

1 byte message length, excluding the NULL character (X'00').

FEDSXMGS

81 byte NULL character string. The installation-wide exit can fill in this message field with an error message ended by one or more bytes of X'00'.

If the format of the message is incorrect, the file security installation-wide exit is marked as nonexistent, and a message (GFSAX90I or GFSAX91E) is sent to the NFS server log data set and to the console, and to component trace if activated.

Contents of the file security exit parameter list

The file security installation-wide exit parameter list is mapped by macro and DSECT GFSAXUSEC. Table 42 on page 267 describes each field.

For configurations that use Internet Protocol Version 4, the client IP address is in field FEDSIA. If your configuration uses IP version 6, refer to field FEDSIA6 for the client IP address. When an IPv6 address is provided in FEDSIA6, FEDSIA takes a value of -1.

If the **dhcp** site attribute is specified for the NFS server to use dynamic client IP addresses, the contents of the client IP address field will be correct when the exit parameter list request is processed. However, the exit must not have any

dependency on the persistence of the IP address value beyond the duration of the individual request. That IP address can change between requests.

Table 42. Format of the parameter list for the file security installation-wide exit

Field Name	Description	Contents
FEDSRQ	Request code	System request code set by the server before each call to this exit for these conditions. 4 Validate allocate request 8 Validate write request 12 Validate read request 16 Return the current settings of the security permissions
FEDSRC	Return code	Codes are generated and returned by the exit routine.
FEDSM	Client system name	Character string ended by a single byte containing X'00'.
FEDSIA	Client IP address	Number (32-bit Internet address). Contains -1 (X'0xFFFFFFFF) if an IPv6 address is provided in the FEDSIA6 field.'
FEDSU	Client user ID number	Number
FEDSG	Client group ID number	Number
FEDSMU	z/OS user ID	Character string padded with a blank at the end of the user ID, conforming to z/OS standards.
FEDSDN	MVS data set name	Character string ended by a single byte containing X'00'. This conforms to z/OS standards.
FEDSMN	MVS data set member name	Character string ended by a single byte containing X'00'. This conforms to z/OS standards.
FEDSXS	Address of UXB	Size and contents are installation dependent. Generated at the start of a user session or user login by the <i>login</i> exit routine.
FEDSXG	Address of GXB	Size and content are installation dependent. Generated at server initialization by the <i>login</i> exit routine.
FEDSTYPE	File Type	Address of fullword integer defining the data set organization: 0 Not used 1 Sequential 2 Partitioned 3 Direct 4 Reserved 5 VSAM (if unable to classify further) 6 VSAM ESDS 7 VSAM RRDS 8 VSAM KSDS 9 Reserved 10 Reserved
FEDSRPM	UNIX Permissions	UNIX file modes of type mode_t as defined by POSIX.
FEDSXD	Message supplied by this exit routine	Address of the message structure (see "Structure of the file security exit message" on page 266).
FEDSVERS	z/OS version number	Number (0x17 for z/OS V1R7)

Table 42. Format of the parameter list for the file security installation-wide exit (continued)

Field Name	Description	Contents
FEDSIA6	Client IP address	Number (128-bit Internet address, for Internet Protocol version 6 users)

Note: Character strings are in upper-case EBCDIC.

File security exit parameter list

These sections each describe how the data in the parameter list is used by the server and the file security installation-wide exit routine. A request code is set by the server before each call to this installation-wide exit routine.

Each topic describes an event, for which some fields are set on entry. The file security installation-wide exit provides a return code for each event.

Request codes to the file security exit

Table 43 shows the request codes to the file security installation-wide exit:

Table 43. Request codes to the file security exit

Code	Meaning
4 (X'04')	Validate allocate request
8 (X'08')	Validate write request
12 (X'0C')	Validate read request
16 (X'10')	Return the current settings of the security permissions

Return codes from the file security exit

Table 44 shows the request codes returned by the file security installation-wide exit:

Table 44. Return codes from the file security exit

Code	Meaning
0 (X'00')	Request successful
4 (X'04')	Request unsuccessful

Validate allocate request routine of the file security exit

This routine is called when a user allocates, renames, or deletes a data set or data set member. The codes and fields used are shown in Table 45.

Table 45. Codes and fields for validate allocate request

When Invoked	Field Name	Description	Contents
On entry	FEDSRQ	Request code	4
On entry	FEDSM	Client machine name	Character string
On entry	FEDSIA	Client IP address	Number
On entry	FEDSU	Client user ID number	Number
On entry	FEDSG	Client group ID number	Number
On entry	FEDSMU	z/OS user ID	Character string
On entry	FEDSDN	MVS data set name	Character string
On entry	FEDSMN	MVS data set member name	Character string

Table 45. Codes and fields for validate allocate request (continued)

When Invoked	Field Name	Description	Contents
On entry	FEDSXS	User Exit Block	Address
On entry	FEDSXG	Global Exit Block	Address
On entry	FEDSTYPE	File type	Number
On entry	FEDSIA6	Client IP address	Number (128-bit Internet address, for Internet Protocol version 6 users)
On exit	FEDSXD	Exit-supplied error message	Message Structure
On exit	FEDSRC	Return code	0 Access allowed 4 Access denied

Validate write request routine of the file security exit

This routine is called when a user writes to an MVS data set or data set member. The codes and fields used are shown in Table 46.

Table 46. Codes and fields for validate write request

When Invoked	Field Name	Description	Contents
On entry	FEDSRQ	Request code	8
On entry	FEDSM	Client machine name	Character string
On entry	FEDSIA	Client IP address	Number
On entry	FEDSU	Client User ID number	Number
On entry	FEDSG	Client Group ID number	Number
On entry	FEDSMU	z/OS user ID	Character string
On entry	FEDSDN	MVS data set name	Character string
On entry	FEDSMN	MVS data set member name	Character string
On entry	FEDSXS	User Exit Block	Address
On entry	FEDSXG	Global Exit Block	Address
On entry	FEDSTYPE	File type	Number
On entry	FEDSIA6	Client IP address	Number (128-bit Internet address, for Internet Protocol version 6 users)
On exit	FEDSXD	Exit-supplied error message	Message Structure
On exit	FEDSRC	Return code	0 Access allowed 4 Access denied

Validate read request routine of the file security exit

This routine is called when a user reads from an MVS data set or data set member. The codes and fields used are shown in Table 47.

Table 47. Codes and fields for validate read request

When Invoked	Field Name	Description	Contents
On entry	FEDSRQ	Request code	12
On entry	FEDSM	Client machine name	Character string

Table 47. Codes and fields for validate read request (continued)

When Invoked	Field Name	Description	Contents
On entry	FEDSIA	Client IP address	Number
On entry	FEDSU	Client user ID number	Number
On entry	FEDSG	Client group ID number	Number
On entry	FEDSMU	z/OS user ID	Character string
On entry	FEDSDN	MVS data set name	Character string
On entry	FEDSMN	MVS data set member name	Character string
On entry	FEDSXS	User Exit Block	Address
On entry	FEDSXG	Global Exit Block	Address
On entry	FEDSTYPE	File type	Number
On entry	FEDSIA6	Client IP address	Number (128-bit Internet address, for Internet Protocol version 6 users)
On exit	FEDSXD	Exit-supplied error message	Message Structure
On exit	FEDSRC	Return code	0 Access allowed 4 Access denied

Return security permissions routine of the file security exit

This routine is called to query a data set access mode or permission. The codes and fields used are shown in Table 48.

Table 48. Codes and fields for return security permissions

When Invoked	Field Name	Description	Contents
On entry	FEDSRQ	Request code	16
On entry	FEDSM	Client machine name	Character string
On entry	FEDSIA	Client IP address	Number
On entry	FEDSU	Client user ID number	Number
On entry	FEDSG	Client group ID number	Number
On entry	FEDSMU	z/OS user ID	Character string
On entry	FEDSDN	MVS data set name	Character string
On entry	FEDSMN	MVS data set member name	Character string
On entry	FEDSXS	User Exit Block	Address
On entry	FEDSXG	Global Exit Block	Address
On entry	FEDSTYPE	File type	Number
On entry	FEDSIA6	Client IP address	Number (128-bit Internet address, for Internet Protocol version 6 users)
On exit	FEDSXD	Exit-supplied error message	Message Structure
On exit	FEDSRC	Return code	0 Exit processing successful 4 Exit failed

Table 48. Codes and fields for return security permissions (continued)

When Invoked	Field Name	Description	Contents
On exit	FEDSRPM	New permissions in mode_t format	UNIX file modes of type mode_t as defined by POSIX

Part 3. Performance Tuning

Chapter 13. Performance tuning in the NFS environment

This topic explains performance tuning within the context of the NFS client-server environment. It provides guidelines on the performance expectation of the underlying hardware and software products on which an NFS client-server implementation is dependent. These guidelines specifically note the limitations to performance tuning and describe processes to tune z/OS NFS.

What is performance tuning?

In general, performance tuning improves the price to performance ratio for a system or set of services by reallocating the available computing, network, or storage resources. The reallocation of these resources not only improves the performance for a particular load of work, but also accommodates an increase in the amount of work to be performed with minimal acquisition of additional resources. The information acquired from performance tuning can also be an important basis for long range capacity planning.

The following might be some possible reasons to do performance tuning.

- Access more data over existing networks
- Improve response time for particular applications or groups of users
- Better utilize the available storage capacity
- Minimize cost for additional services or functional capability

How is performance characterized?

Performance is the manner in which a process, system, processor, network, or device behaves for a particular load or unit of work. To measure, or quantify, performance, we monitor the length of time for a unit of work to complete. If units of work are being shared, we monitor the amount of time waiting for a resource to be available to perform a unit of work. A unit of work is a specific activity or action that we expect a process, system, processor, network, or device to perform. This could be something as granular as an I/O request, sending or receiving a buffer of data over a network, or processing an NFS request. We are frequently interested in the performance of a particular set of work activities which we will refer to as a load of work, or workload.

When a particular workload has been identified for performance measurement, we can determine the performance metrics, or units of measurement, that are relevant to that workload. Some examples of the following performance metrics that might be used in reference to performance tuning for z/OS NFS are:

Performance metric	Description.
throughput	Number of units of work completed per unit of time.
response time	Elapsed time necessary to complete a unit of work.
CPU time	Amount of time the processor spends executing instructions.
instructions per byte	Total number of CPU instructions to process data divided by the number of bytes of data processed.
aggregate throughput	Sum of the throughput measurements for multiple processes.
NFS operations per second (NFSops)	Number of NFS requests processed by an NFS server divided by the total time in seconds to process the requests.

Measuring performance metrics can be as simple as using your watch to time the execution of a particular command or as complex as using specialized hardware and software tools to monitor and extract a diversity of performance metrics. Chapter 15, “Evaluating z/OS NFS performance,” on page 287 will address some methods that can be used to evaluate the performance of z/OS NFS. The method selected will depend on the complexity of the workload and the monitoring tools available at your installation.

What is the NFS environment?

The NFS environment includes the NFS client system(s), the mix of networks available, the NFS server system(s), and the manner in which they are configured. While this guide is intended for z/OS NFS, it is important to know the performance limitations within the NFS environment to determine the necessity of tuning z/OS NFS.

NFS client systems range from single user desktop personal computers to large scale processors with many users. These NFS client systems typically support multiple applications as well. Clearly, the NFS client system resources will be shared between its users and/or applications. These resources include available physical storage, memory, processing capability, and network access. The NFS client is one application, with a possibility for many users, that must share the memory, processing, and network resources in exchange for providing access to additional physical storage on other systems. The degree to which the NFS client application must share such resources will affect performance for NFS client users and applications.

The NFS server system, like the NFS client system, must share resources with other users and applications. NFS server application performance will be affected by the amount of contention over system resources and by the priority established for the NFS server application. The overall performance of an NFS server is also influenced by the number of NFS clients for which it provides services.

The network(s) over which NFS clients access NFS servers also affect overall performance in the NFS environment. Such networks can be homogenous, consisting of a single network medium, or heterogeneous, consisting of a mix of network mediums. Each network medium type has an expected maximum capacity, or *bandwidth*. For instance, the capacity of a Fast Ethernet Ring network may be 16 megabits per second (Mbps) or 4 Mbps, and the capacity of a Fiber Distributed Data Interface (FDDI) network is 100 Mbps. When different network mediums are combined in a more complex network environment, the capacity for a fixed route over the network is limited by the network segment with the smallest capacity. For example, a route over a network consisting of both 4 and 16 Mbps Token Rings and a FDDI backbone will have a maximum capacity equivalent to that of the Token Ring, or 4 Mbps. When bridges, routers, and gateways are included in a network configuration, their capacity must also be considered. Such devices must also be considered when tuning performance in a network environment, particularly if a device does not support increased network buffer sizes.

How to tune for performance

Given the complexity of the NFS environment, it is important to establish a methodology for tuning performance. The following steps provide a guideline that highlights particular areas relevant to the NFS environment. Implementing the guideline may involve more than one person or support organization.

Identify Performance Requirements: Before you begin performance tuning in general, and particularly z/OS NFS, determine those areas where performance is unsatisfactory. This is a good time to establish more precise performance requirements. As users and application requirements are identified, it can be advantageous to rank or group them according to their requirements.

Know the NFS Environment: In the previous section, the NFS environment was discussed. It is very important to fully understand the performance of the existing NFS environment, particularly that of the network. Such analysis can eliminate unnecessary tuning of the NFS client and server systems.

Establish Performance Objectives: Once the performance requirements and the NFS environment are known, you are in a position to define and prioritize your performance objectives. The performance objectives should be specified in a manner that is quantifiable and measurable. Keep in mind that you will need an executable workload or test scenario to evaluate the effectiveness of your performance tuning.

Define Workloads and Test Scenarios: You may already have workloads or test scenarios depending on how requirements and/or objectives were defined. However, these may be unwieldy or impractical to use for your performance tuning purposes. Therefore, it is advantageous to spend some time initially to define some simplified test cases that can be executed in a repeatable fashion and with as much control as is feasible. Simple test cases are also useful in diagnosing performance problems, particularly to locate an area within the NFS environment that may be impacting performance.

Select Monitoring Tools: While you may only be interested in the performance of z/OS NFS, you will find it useful to have access and familiarity with a variety of performance hardware and software monitoring tools. Not only will such knowledge assist you in collecting data to evaluate performance, but it will also help you to identify areas that may be impacting the performance of z/OS NFS. Minimally, a set of monitoring tools must be identified to collect the data upon which performance tuning decisions will be made and to determine the effectiveness of tuning.

Collect Performance Data: At this point you should be ready to begin collecting performance data. Initial measurements will be the starting point, or *baseline*, that will be used to evaluate the effect of your tuning. Since there can be a significant variation in network and system performance, it is prudent to repeat a performance measurement to establish the degree of variation inherent in the measurement. Doing this will provide a sense of whether or not future tuning is really affecting performance or simply normal variation.

While it may be convenient to collect performance data when systems and networks are idle, this is probably not practical. However, it is useful to collect data during peak and low activity periods. If user or application requirements are related to a specific time period, or sensitive to other system and network activity, data should be collected for these periods of time, as well. Remember that redistributing the workload may be the most cost effective approach to performance tuning.

Evaluate Performance Data: This may seem like an obvious step. However, keep in mind that the NFS environment may be quite complex. The more complex the NFS environment and your test cases are, the more data there will be to evaluate. You may also have both client and server data to evaluate as well as network data.

As you begin evaluating performance data you have collected, look for areas or opportunities where performance could be improved. Before attempting to tune z/OS NFS, you should determine if performance is primarily impacted by the NFS server system, the NFS client system, or the network itself. In fact, you may determine that additional data must be collected prior to any performance tuning. You may also discover evidence that configurations and parameter settings within the evaluation environment are not optimal.

The output of this step is a list of changes that you believe will positively affect performance. As you make this list, identify the impact or cost associated with a change. It is also useful to identify any resources that are heavily utilized or that have contending requirements. This will help you to prioritize and ultimately select the changes you will make or recommend.

Tune Your NFS Environment: Make one change from your list of possible tuning changes at a time. Measure and evaluate the effect of that change before making any other changes. Pay particular attention to any impact on heavily utilized resources that may have been previously identified in addition to newly exposed resources that now appear to be impacted. Since performance tuning typically involves a trade off in resource utilization, make sure you have not inadvertently caused a performance problem elsewhere. Also, before deciding to implement a change, consider whether any observed changes are due to the tuning change you've made or simply a result of normal measurement variation. Repeat this step as necessary.

Impact of the NFS protocol on performance

Command response time is of particular importance to NFS client users. The longer a user waits for the results of a particular command, the more important this will become. The nature of transparent access with the NFS protocol results in users not necessarily being aware of the impact on performance caused by the network and the NFS server system.

Also, while users are generally knowledgeable of the commands supported by the NFS client operating system, they may have no knowledge of the NFS commands, or procedures, that are executed as a result of one simple user command. In fact, one user command typically results in execution of multiple NFS commands.

Another impact on command response time is the NFS protocol itself; version 2 and version 3 of the NFS protocol are intended to be as stateless as possible. This means that a stateless server operates correctly without maintaining any protocol state information for its clients. A stateless protocol was originally selected to minimize the probability of data losses due to a server crash. In NFS version 4, some state information is introduced into the protocol (for example, the open/close, lock, and setclientid operations).

For NFS version 2 and version 3 protocols, the stateless nature of the NFS server places the responsibility of keeping track of NFS commands on the NFS client. To do this NFS client implementations generally wait a period of time for a response to a particular NFS command. If a response is not received within this period of time, the NFS client will retransmit the NFS command. This process is repeated for a fixed number of times or until a response is received.

NFS servers and clients have typical methods of queuing requests and responses as part of the underlying protocol layers. When these queues are full, incoming requests or responses are dropped. The NFS client and server do not know when

responses or requests are dropped. Both rely on the stateless protocol whereby the client will eventually retransmit the NFS request again. Under these conditions the NFS client is waiting for a response that will never be received. Clearly, waiting to retransmit an NFS command, particularly multiple times, will negatively affect the response time for the initial user command.

To determine whether or not NFS client users are being impacted by the situation previously described, most NFS client implementations provide a **nfsstat** command to monitor NFS statistics. Figure 31 shows the output from the **nfsstat -c** command.

```

USER1:/u/user1:>nfsstat -c

Client rpc:
Connection oriented
calls      badcalls  badxids  timeouts  newcreds  badverfs  timers
0          0         0        0         0         0         0
nomem     cantconn  interrupts
0          0         0

Connectionless
calls      badcalls  retrans  badxids  timeouts  newcreds  badverfs
0          0         0        0        0         0         0
timers    nomem     cantsend
0          0         0

Client nfs:
calls      badcalls  clgets   cltoomany
0          0         0        0

Version 2: (0 calls)
null      getattr  setattr  root      lookup    readlink  read
0 0%     0 0%    0 0%     0 0%     0 0%    0 0%    0 0%
wrcache  write    create    remove    rename    link      symlink
0 0%     0 0%    0 0%     0 0%     0 0%    0 0%    0 0%
mkdir    rmdir    readdir   statfs
0 0%     0 0%    0 0%     0 0%

Version 3: (0 calls)
null      getattr  setattr  lookup    access    readlink  read
0 0%     0 0%    0 0%     0 0%     0 0%    0 0%    0 0%
write    create    mkdir    symlink    mknod    remove    rmdir
0 0%     0 0%    0 0%     0 0%     0 0%    0 0%    0 0%
rename   link      readdir   readdir+  fsstat    fsinfo    pathconf
0 0%     0 0%    0 0%     0 0%     0 0%    0 0%    0 0%
commit
0 0%

Version 4: (0 calls)
null      getattr  setattr  lookup    access    readlink  read
0 0%     0 0%    0 0%     0 0%     0 0%    0 0%    0 0%
write    create    mkdir    symlink    mknod    remove    rmdir
0 0%     0 0%    0 0%     0 0%     0 0%    0 0%    0 0%
rename   link      readdir   statfs    finfo     commit    open
0 0%     0 0%    0 0%     0 0%     0 0%    0 0%    0 0%
confirm  downgrade close     lock      locku     lockt     setclid
0 0%     0 0%    0 0%     0 0%     0 0%    0 0%    0 0%
renew    clid_cfm secinfo  release_lo replicate
0 0%     0 0%    0 0%     0 0%     0 0%

```

Figure 31. Displaying NFS client rpc and NFS statistical information

When using the **nfsstat** command, users should be aware that results are cumulative. These statistics may be reset with the **-z** option of the **nfsstat** command. Also, the **nfsstat-c** command provides statistics for all NFS client activity, which makes it possible to access files on more than one NFS server. When using this command to query the NFS client statistics for z/OS NFS, make sure that all NFS client access is for z/OS NFS only.

The **nfsstat-c** command provides two types of statistics, *client rpc* and *client nfs*. The *client rpc* statistics provide an indication of NFS performance from the perspective

of that particular NFS client. In general, if the *timeout* value is more than 0.2% of the total number of *rpc* calls, then some performance tuning is necessary.

If the *timeout* value is essentially equivalent to the *retrans* value, the NFS client is waiting on the NFS server. While you can increase the *timeout* option of the **mount** command to reduce the number of retransmissions, this will not improve the perceived responsiveness of the NFS server.

The *badcall* and *badxid* statistics are generated when information is lost or dropped somewhere between the NFS client and the NFS server. This can happen when processes are interrupted and are not necessarily indicative of a performance problem unless they are disproportionately high or persist. On the NFS client system the **netstat -s** command provides additional statistics that may be useful in tuning at the network level. For the z/OS NFS, the z/OS TCP/IP netstat command provides information that may be useful for tuning as well.

The client NFS statistics provide a distribution of the NFS procedure calls made by users and applications on that particular NFS client. For a typical NFS client you will probably see a larger percentage of *getattr* and *lookup* calls. These calls are made whenever an NFS file is initially accessed. Directory listing is a common user activity that will generate these NFS calls.

The write and read statistics can also provide insight into the manner of NFS access on an NFS client, such as read or write biases. If the percentage of read and write NFS calls is higher than the percentage of *getattr* and *lookup* NFS calls, the client is probably accessing relatively large files as opposed to accessing many smaller files. Conversely, if the percentage of *getattr* and *lookup* NFS calls is higher than the percentage of read and write NFS calls, you might want to investigate whether users are querying directories or accessing relatively small files. In the latter case you might further determine if such files should be stored on an NFS server or the NFS client system.

Chapter 14. Optimizing the NFS environment

This topic explores areas that may impact the overall performance within an NFS environment. The focus will be on various network and NFS client and server system parameters which may affect NFS performance. Specific product documentation should be consulted for additional detail.

Network performance tuning

Table 49 contains network performance tuning information.

Table 49. Network performance tuning symptom and action information

Symptom	Action
Data transfer rates significantly less than network capacity	<p>ACTION 1: <i>Know your network topology</i> - “What is the NFS environment?” on page 276 briefly introduces the role of the network in the NFS environment. Clearly, transferring data over congested networks results in poor performance. Therefore, when a performance problem is encountered in the NFS environment, it is useful to determine whether or not the network is the source of the problem prior to investigating other alternatives. While there are products specifically designed to monitor and report on network activity, knowing your particular network topology may be sufficient for initial tuning.</p> <p>Figure 32 on page 282 shows a simple network topology with two 100 Mbps Fast Ethernet Rings connected to a Gbps Fast Ethernet backbone network. In this example, access from NFS client A, on a 100 Mbps Fast Ethernet Ring, to NFS server B, directly connected to the Gbps Fast Ethernet backbone, would be as limited by network bandwidth as access to NFS server A. On the other hand, access from NFS client B, directly connected to the Gbps Fast Ethernet backbone, would be limited by the load on the Gbps Fast Ethernet network and the capacity of NFS server B.</p>

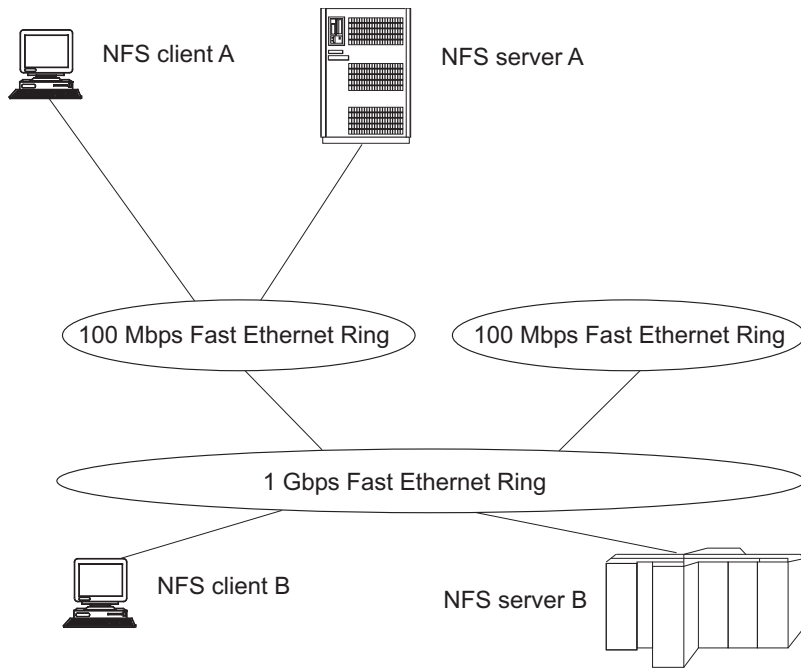

Figure 32. Sample network topology

Factors to consider in addition to the theoretical capacity of a network configuration

There are other factors to consider in addition to the theoretical capacity of a network configuration. For instance, there are differences in the capability of network adaptors and network controllers. Overall network performance can also be influenced by the devices connecting network segments or subnets, particularly in terms of packet size limits and UDP checksum processing. While it may initially appear that there is no network constraint, there may be a device, adaptor, or network segment that is not performing at expected levels.

With this type of investigation, you may already have discovered that your primary constraint is a congested network. If so, you may elect to pursue such alternatives as:

- Increasing network bandwidth
- Changing network topology
- Scheduling applications during low system usage
- Modifying applications to reduce data transfer

ACTION 2: *Monitor network activity* - It may be necessary to monitor network activity over a period of time to determine what is causing a performance problem. In addition to whatever monitoring your network administrator may be able to provide, the `netstat -s` command, available on many NFS client platforms, may provide some insight as well. This command reports such statistics as bad checksums, dropped fragments, non-forwardable packets, various time-outs, and socket buffer overflows. In some cases, it may be necessary to use a network analyzer to determine exactly what is being sent over a network segment. While it can be difficult to analyze congested networks, network analyzers occasionally capture evidence that may indicate a problem with the NFS client or server system.

NFS client system performance tuning

Table 50 contains NFS client system performance tuning symptom and action information.

Table 50. NFS client system performance tuning symptom and action information

Symptom	Action
Excessive NFS retransmissions	A high number of NFS retransmissions can be detected with the <code>nfsstat -c</code> command. See section “Impact of the NFS protocol on performance” on page 278 for more information. A general rule of thumb is that the number of retransmissions should not be more than 2% of the total calls. Use <code>traceroute hostname</code> command to trace the route that IP packets take to a network host. This helps isolate where the bottleneck may occur.

Symptom	Action
	<p>ACTION 1: <i>Increase network queue length</i> - If the <code>nfsstat -c</code> command shows evidence of bad calls in addition to timeouts, or the <code>netstat -s</code> indicates that packets or fragments are being dropped, increasing the network queue length may be advisable. Occasionally, a network analyzer will detect that the server has responded to an NFS request before the client retransmits the request. This indicates that the network queue on the NFS client system was full and the response was dropped.</p> <p>ACTION 2: <i>Increase maximum transmission unit</i> - The <code>nfsstat -in</code> command will display the maximum transmission unit (MTU) for each network interface active on the NFS client system. The MTU can be reset with the <code>ifconfig</code> command. This command is available on most UNIX NFS clients. For the z/OS NFS client, MTU can be reset in the TCP/IP profile. Increasing the MTU can improve overall performance and alleviate excessive IP fragmentation. However, with heterogeneous networks the MTU should not be set larger than the smallest acceptable MTU over the entire network route. For instance, when the network consists of a mix of Token Rings and Ethernets, the MTU is typically set at 1492 that is less than the 1500 MTU for an Ethernet and a 2000 MTU for Token Ring. Changing the network topology may allow you to increase the NFS client system MTU.</p> <p>ACTION 3: <i>Change socket buffer size</i> - Changing the buffer size is another way to tune the NFS client system. The AIX <code>no -a</code> command will display the current settings, in particular the <code>udp_sendspace</code> and <code>udp_recvspace</code>. The AIX <code>no -o udp_sendspace=32768</code> and <code>no -o udp_recvspace=32768</code> commands can be used to reset the <code>udp_sendspace</code> and <code>udp_recvspace</code>, respectively. For the z/OS NFS client, the <code>udpsendbfrsize</code> and <code>udprecvbfrsize</code> in the TCP/IP profile should be set respectively. The recommended value for Sun NFS V3 protocol is 65536. When processing with TCP protocol, it may be necessary to modify the <code>tcpseendbfrsize</code> and <code>tcprecvbfrsize</code>.</p> <p>ACTION 4: <i>Increase number of BIODs</i> - If data on an NFS server is typically accessed sequentially, or if there are many users on an NFS client system, it may be advantageous to increase the number of block I/O daemons (BIODs). This increases the NFS client processor utilization and should be weighed against other processor requirements on a multiple user system. If access is typically at random offsets within a file or file sizes are very small, you may even consider decreasing the number of BIODs. It should also be noted that some NFS client implementations honor BIODs differently to provide read or write bias.</p> <p>ACTION 5: <i>Increase timeout parameters</i> - If you have determined that NFS retransmissions are not caused by dropped NFS responses, you may consider increasing the timeout value. <i>This should be one of the last alternatives you select since this can have adverse effects.</i> If information is lost or dropped between the NFS client and the NFS server, increasing the timeout value can make performance worse. In this case the client would wait longer to decide to resend a request. In a heavily used NFS environment, increasing the timeout value also increases the likelihood that internal client or server buffers will become stagnant or stolen to service other network requests. You would probably only want to attempt this if you have strong evidence, probably from a network analyzer, that the NFS server is sending responses <i>after</i> the NFS client retransmits requests. The timeout values can be reset with the <code>mount</code> command.</p>

NFS server system performance tuning

Regardless of whatever network and NFS client system tuning is done, some level of tuning or resource balancing should be addressed on the z/OS NFS server system. Typically, these systems have tuning and capacity planning procedures in place along with a high level of experience. Consequently, this section will be limited to a surface level discussion of the resource components to be considered when tuning the NFS server system.

z/OS constraints

Table 51 contains z/OS constraints information. These actions should be weighed against any increase in z/OS storage they may require.

Table 51. z/OS constraints symptom and action information

Symptom	Action
High CPU utilization with low aggregate throughput	<p>ACTION 1: <i>Increase z/OS TCP/IP send and receive buffers</i> - There are other applications besides z/OS NFS which are dependent on the z/OS TCP/IP application. Some applications have different tuning requirements. The default values for udpsendbfrsize (or tcpsendbfrsize) and udp udprcvbrfsize (or tcprcvbrfsize) is 16 KB. It may be useful to increase these parameters up to 64 KB for better throughput with large files.</p> <p>ACTION 2: <i>Increase z/OS TCP/IP UDP queue</i> - Another area to consider is the z/OS TCP/IP UDP queue. As discussed in section "NFS client system performance tuning" on page 283, NFS responses are dropped when network adaptor queues are full. A similar situation occurs when the UDP queue of z/OS TCP/IP is full; in this case incoming NFS requests are dropped. The noudpqueueulimit keyword in the assortedparms section of the TCP/IP profile data set can be specified to enable the z/OS TCP/IP server to accept incoming UDP datagrams. Without specifying this keyword, the default queue length of 30 may not be sufficient.</p> <p>ACTION 3: <i>Modify NFS and TCP/IP dispatching priorities</i> - It is recommended that the z/OS NFS procedure have a relative dispatching priority less than that of TCP/IP. This is important because the MVS mean time to wait dispatching priorities are adjusted based on increased I/O activity. Since TCP/IP has higher network I/O than z/OS NFS, the TCP/IP dispatching priority is lowered. Assigning fixed dispatching priorities, with TCP/IP dispatched at a higher relative value than the z/OS NFS, can ensure this situation.</p> <p>ACTION 4: <i>Select transport protocols</i> - z/OS NFS supports TCP and UDP as transport protocols for the server, for both NFS Version 2 and Version 3 protocols. For the Version 4 protocol, NFS supports only TCP as a transport protocol. UDP is primarily used for its efficiency on high bandwidth, low latency networks, such as LANS. TCP is used for its efficiency on low bandwidth, high latency networks, such as WANS.</p>
Constrained throughput with low CPU utilization	<p>ACTION 1: - See "Subtasking" on page 302.</p>

Table 51. z/OS constraints symptom and action information (continued)

Symptom	Action
High DASD utilization and NFS command response time	<p>ACTION 1: <i>Evaluate placement of z/OS catalog data sets</i> - The performance of z/OS NFS will be impacted when serving files located on heavily utilized storage devices or devices behind congested storage controllers. Before deciding whether or not to move data or upgrade storage systems, make sure system catalogs are not on heavily utilized devices. Many of the NFS commands that are executed for z/OS conventional MVS data sets involve catalog access. In fact, listing directories, one of the most commonly executed commands on NFS client systems, accounts for a significant portion of the NFS get attribute and lookup commands. Such commands not only cause the z/OS catalog to be accessed but might also cause the entire file to be read depending on:</p> <ul style="list-style-type: none"> • z/OS NFS processing options • Prior access by z/OS NFS • Whether or not files are DFSMS-managed <p>ACTION 2: <i>DFSMS-managed data accessed from the network</i> - Files that are primarily accessed by way of z/OS NFS should be DFSMS-managed for improved performance. The z/OS NFS maintains file attributes for DFSMS-managed data sets when the z/OS NFS nofastfilesize processing option is specified. The nofastfilesize processing option provides exact file size determination rather than approximating file size as with the fastfilesize processing option. DFSMS management also provides improvements in terms of better storage utilization and specification of service levels.</p> <p>ACTION 3: <i>Evaluate placement of data accessed from the network</i> - While deciding whether or not to access DFSMS-managed files using z/OS NFS, consider also the placement of such files. Files with critical performance requirements should be placed on the appropriate devices by using the storage class parameters. If reallocation is necessary, you might also consider allocating sequential access method striped data sets for larger files or a z/OS UNIX file for smaller files. If you elect to maintain data set organization, you may choose to reblock the data set to a more optimal block size, such as half track blocking. You may even determine for some files that the best alternative is to store the files locally on the NFS client system.</p>

Chapter 15. Evaluating z/OS NFS performance

This topic assists both NFS client users and NFS server system administrators in evaluating the performance of z/OS NFS. Test methods are provided to assist in collecting performance data for evaluation. The appropriateness and usage of these test cases and methods depend on the following conditions:

- Workload requirements to be evaluated
- Level of expertise of the evaluator
- Monitoring tools available

Evaluating throughput

Throughput refers to the rate at which data is transferred between the NFS client and server systems. Establishing throughput baselines for the Client-Server environments of interest will assist in determining any benefits achieved from tuning. Baselines and measurement techniques are also useful in diagnosing performance problems.

As discussed in “How is performance characterized?” on page 275, a set of work activities or workloads should be identified for measurement. For throughput the type of workload selected should reflect the type of NFS read and write access expected by typical users or specific applications. Consider the following points:

- Average file size or range of file sizes
- Sequential or random access
- Data set types and organizations to be accessed
- Requirements for ASCII/EBCDIC translation

Single process throughput

The easiest place to begin evaluating NFS read and write throughput is on a single client and a single process basis. While measuring in a controlled and isolated laboratory situation is advantageous, it may not be practical. Measuring the actual environment of interest can provide more meaningful information as well as establishing a methodology for monitoring performance in the future. Under such uncontrollable situations, it is important to determine range and normal variation in measurements with particular attention to peak and non-peak periods of activity.

Once the NFS environment has been selected for measurement, some simple techniques can be used to initially evaluate NFS read and write throughput. One of the easiest methods is to use commands available on the NFS client system, such as **copy** or **cp**, to generate NFS reads and writes. Copy commands along with **date**, **time**, or **timex** commands can be used to determine the elapsed time for the copy. Throughput can be readily calculated from the elapsed time and the size of the file.

Some additional considerations when measuring NFS throughput are the effects of graphical user interfaces (GUI), any overhead associated with opening files, and I/O to and from local physical storage. Measuring with and without a GUI will show the effect on NFS throughput caused by the GUI. Using a network analyzer can assist with isolating the time spent opening files from the time spent executing NFS reads or writes. Techniques such as copying to `/dev/null` can eliminate local physical I/O for NFS reads. For more complex requirements such as reading and

writing at random offsets, you may use an existing application to provide such access or write a program to execute NFS procedure calls at random offsets within a file. Program generated NFS procedure calls can also be useful when available local physical storage is insufficient for the file sizes to be measured.

Multiple process throughput

For NFS client systems with multiple users or applications you may want to determine aggregate throughput on a multiple process basis. If throughput on a single process basis has achieved the network capacity, then multiple process throughput will be limited by the same network capacity as well as any NFS client system limitations. A simple method for evaluating multiple process throughput is to simply execute multiple single process measurements simultaneously.

Multiple client throughput

Evaluating multiple client throughput requires the ability to propagate the measurement workload over more than one NFS client system, preferably the same type of system. Such measurements are more complex in that they require controlled execution and collection of results from multiple systems. Depending on your network configuration, remotely executing your single process workload on multiple systems is a relatively simple method to use to initially evaluate multiple client aggregate throughput.

Evaluating NFS command response time

A user is probably more interested in the response time for typical user commands, such as listing a directory, making or removing a directory, and creating or removing a file. However, when such commands are executed for NFS mounted file systems, the NFS command response times become a factor in user command response time. The transparent nature of the NFS protocol allows a user to define a set of commands as a measurement workload with a minimum amount of effort.

For those desiring more detail on NFS command response time, there are public domain programs as well as industry standard benchmarks. Both of these options require more experience on the part of the user and may have limitations on their usage. Such programs are typically written for the UNIX environment and may not support all NFS client and server systems.

Evaluating CPU utilization

Evaluating CPU utilization on an MVS system can be quite complex, particularly for a production system. The activity on such systems is already generally monitored and z/OS NFS is simply one more application to be monitored. High level monitoring can be accomplished from the Display Active (DA) display of the System Display and Search Facility (SDSF). This display provides an overview of the total activity on the system. Of particular importance are the CPU usage and relative dispatching priorities of TCP/IP and z/OS NFS. Monitoring tools such as the Resource Measurement Facility (RMF™) Monitor I and Monitor II can provide more detail on the performance characteristics of the MVS system.

Collecting server usage data

You can use the SMF records that z/OS NFS produces to keep track of how files are accessed and how long each NFS user session lasts. The following SMF records can be produced:

SMF record	Description
Record type 42 subtype 7	This record, written when a file times out, provides file usage statistics.
Record type 42 subtype 8	This record, written when a client user logs out of the z/OS NFS, provides user session statistics.
Record type 42 subtype 26	This record, written when a client creates, removes, or renames the file objects on the NFS mounted file system, provides the NFS Client's information

Chapter 16. Tuning the z/OS NFS server

Previous topics discussed performance tuning from a total system perspective. This topic discusses performance tuning at the z/OS NFS server level. In particular, this topic focuses on the z/OS NFS data set creation, processing, and site attributes.

Data set creation attributes

When creating new MVS data sets, the allocation parameters are the most readily accessible means for the end user to influence the performance of z/OS NFS server. They are also not well known outside of the z/OS user community. This is primarily due to the fact that MVS has a record oriented data structure and most NFS client systems have a byte oriented data structure. This section looks at how a variety of allocation parameters affect performance.

Block size and record length

Block size (BLKSIZE) specifies the maximum length, in bytes, of a physical block of storage in MVS. If BLKSIZE(0) is specified, the system will determine the optimal block size based on the maximum record length (LRECL) and the physical characteristics of the disk, or approximately half of a physical track. Half track blocking is optimal in that it reduces the amount of wasted storage on the disk. If BLKSIZE(0) is specified for Direct Access (DA) data sets, the system does not determine the block size. z/OS NFS Server uses a formula to calculate the block size; see **blksize(0 | quan)** in “Data set creation attributes syntax” on page 122.

The BLKSIZE is also important to the performance of the z/OS NFS, which performs physical I/O on a block basis. While half track blocking is generally optimal, for z/OS NFS server you should be aware of the relationship between the block size, the file record length, the network packet size and the NFS client **mount** write and read buffer sizes, *wsiz*e and *rsiz*e.

A network packet size will be negotiated between the NFS client and the NFS server when the NFS **mount** is processed. In general, the NFS server will determine the packet size for write operations, and the NFS client will determine the packet size for read operations. For z/OS NFS, this packet size is 8192 bytes, when processing with Sun NFS V2 protocol. For several NFS client implementations the default packet size is 8192. However, there are some implementations with a 4096 byte maximum packet size. The maximum packet size is 65536 bytes when processing with Sun NFS V3 protocol, and larger with the V4 protocol. However, z/OS NFS supports a maximum packet size of 32768 bytes for both the NFS V3 and V4 protocols.

The packet size can also be automatically reset to a smaller value when a constraint is detected. Such a reduction in packet size causes an increase in the number of NFS requests for the server to process the same amount of data. This increases the load on the server and may or may not have been the initial constraint causing the packet size reduction. This can have an adverse effect on z/OS NFS server performance, particularly when processing write requests.

Regardless of the packet size, the z/OS NFS server must reassemble the packets, possibly arriving out of sequence, into records. The z/OS NFS server buffers (see “Ordering out-of-sequence data” on page 299) and orders these packets until a

block of data can be written to disk. Write requests, especially those for large files, are processed more efficiently when the likelihood of packets spanning records and blocks is reduced.

When the z/OS NFS server is processing read requests, the physical I/O is again on a block basis. Consequently, read throughput is improved by increasing the block size up to half track blocking.

If files are allocated with a default block size (BLKSIZE=0) on RAMAC 3 or Enterprise Storage Server (ESS™) 2105 DASD with 3390-3 format, the actual block sizes will probably vary between 24 and 27 KB, depending on the specified record length and record format. Table 52 shows the actual allocation block sizes for physical sequential data sets allocated on a RAMAC 3 or ESS 2105 DASD with a variety of record lengths and with both fixed and variable length records.

Table 52. Default block sizes for RAMAC 3 or ESS 2105 DASD

Record Format	Record Length (bytes)	Block Size (bytes)
FB	80	27,920
FB	1024	27,648
FB	4096	24,576
FB	8192	24,576
VB	84	27,998
VB	1028	27,648
VB	4100	27,998
VB	8196	27,998

Record format

Record format (RECFM) specifies the format and characteristics of the records in the data set. This section will be limited to a discussion of the performance considerations associated with fixed and variable length records.

There seems to be a natural affinity toward allocating MVS data sets with variable length records from the perspective of a byte oriented NFS client operating system. Such allocations enhance the feeling of transparent access and eliminate requirements to determine a fixed record length. However, the placement of incoming packets into records of varying lengths is more complex than placing packets into records with fixed lengths. Consequently, write performance for z/OS NFS is generally more efficient when MVS data sets are allocated with fixed length records. Record formats are specified with the RECFM data set creation attribute.

Data set organization and data set type

Data set organization (DSORG) specifies the organization of an MVS data set. The z/OS NFS data set organization attribute can be physical sequential (ps), direct access (da), or VSAM. z/OS NFS server supports three types of VSAM files: key-sequenced (KSDS), entry-sequenced (ESDS), and relative record (RRDS). However, keyed access and relative-number access are not supported by the NFS protocol.

The DSORG attribute is ignored for directory-oriented NFS client commands. The data set type (DSNTYPE) specifies whether a PDSE or PDS is to be created when the z/OS NFS receives a **mkdir** command from the NFS client. A PDSE is created

when library is specified, and a PDS is created when PDS is specified. You cannot create another PDS (or PDSE) within a PDS (or PDSE).

Another MVS data set type is extended (EXT), which identifies an extended format data set. With z/OS NFS, these DFSMS-managed data sets are allocated based on specification of a data class (DATACLAS). An appropriate data class must have been defined on the MVS system for an extended format data set to be allocated. One of the values specified when creating an MVS data class is the volume count which determines the number of stripes allocated for an extended format data set. If automatic class selection (ACS) routines have been written to allocate extended format data sets based on such criteria as naming conventions, it would not be necessary to specify a DATACLAS to allocate an extended format data set through the z/OS NFS server.

The hierarchical file system (HFS) and z File System (zFS) are other data set types. They must be DFSMS-managed and be mounted within the z/OS UNIX subsystem. While an HFS or zFS file cannot be allocated using z/OS NFS, they can be accessed through the z/OS NFS server.

Data set organizations and data set types are generally selected based on user and application requirements. However, performance should be considered as one of these requirements. An important factor to consider when evaluating performance is the size of the files to be accessed. For smaller file sizes, we can differentiate between the overhead costs associated with creating or opening a file for output. As the file size increases, this impact becomes less of a factor in the transfer rates.

B37/D37/E37 ABEND handling

The z/OS NFS server has no control over available space for a data set on disk and cannot automatically extend to the available space on the disk. During writing to disk from the z/OS server, x37 Abends can occur more readily when data sets are created with small SPACE primary and secondary allocation units. For the z/OS server to avoid possible x37 Abends, data sets should be allocated with primary and secondary SPACE allocation units to fit the largest byte data stream from an NFS client. Due to asynchronous write between the z/OS NFS server and the NFS client, the NFS client may not get a no-space-on-disk error as a result of an x37 Abend on the z/OS server side if the z/OS server has to flush cached data and close/deallocate a data set at a time other than a write or commit request, such as after writetimeout expiration. For small data set allocations, there is a risk to lose data and get a no-space-on-disk error postponed due to z/OS server data caching.

NFS server cache monitoring and reporting

The NFS Server issues a message to indicate an MVS data buffer shortage each time the server's threshold limit is reached, and when the threshold is overcome. This message implies that some of the current requests may fail. This threshold is governed by the server site attributes that specify the storage limit (in bytes) for the buffers (**bufhigh** attribute) and a percentage of **bufhigh** storage limit before BUFHIGH watermark is reached (the **percentsteal** attribute). See "Buffer usage and caching" on page 297 for more information.

To mitigate this situation, a buffer alert limit can also be specified with the z/OS NFS server **bufhigh** site attribute, or the MODIFY operation command **bufhigh** operand. When an alert limit is set and that value is reached, message GFSA383I is written to the console reporting the current rounded usage percentage of the maximum allowed data buffer pool size value (**bufhigh**). While the data buffer

usage remains above the alert limit, a new message will be written to the console every 30 seconds reporting the current usage value.

If the buffer usage drops below the alert limit, message GFSA384I is written to the console to report that the buffer shortage situation has been mitigated.

System Automation can be configured to monitor these warning messages and inform the application administrators on the remote NFS clients to react accordingly and possibly throttle the incoming workload before the z/OS NFS server reaches a critical "out of memory" situation.

Processing attributes

Processing attributes are used to control how files are accessed from the NFS client system. Default values can be specified when the server is started. These defaulted values can be overridden at the NFS **mount** level or at the individual command level. The processing attributes, like the data set creation attributes, can affect the performance of the Network File System (NFS). This section will be limited to those processing attributes which have the most influence on performance.

Character translation

The processing attributes that specify whether or not data conversion occurs between ASCII and EBCDIC formats may have the most influence on the performance of z/OS NFS. The binary attribute, which specifies no data conversion, is the most efficient manner in which to access data by way of z/OS NFS. However, data conversion may be a requirement, particularly when data is shared with z/OS users or applications. Under such circumstances the text processing attribute would be specified instead of the binary processing attribute. The actual impact associated with data conversion will depend on the data to be converted.

In text processing mode for MVS data sets, end-of-line (EOL) terminators are inserted into the data at the end of each record to preserve the record format when data is viewed from the z/OS NFS client. However, text mode processing invokes an implicit ASCII to EBCDIC translation, which is not needed for a z/OS to z/OS mount. If, during text mode processing, this implicit data conversion (ASCII to or from EBCDIC translation with UNICODE and XLAT) is disabled using the `srv_ccsid(1047)` and `cln_ccsid(1047)` processing attributes on the mount command then the EOL terminators are converted (including EOL terminators such as LF, CR, NL) to an internal representation of the MVS data on the z/OS NFS server. The z/OS NFS server will use the EOL internal representation as record boundaries when writing to a data set. During reading of data from an MVS data set, the insertion of EOL terminators (in the internal representation on the z/OS NFS server) is used to create record boundaries. The data with EOL terminators are then converted to the external representation before replying to a client.

File size determination

The attributes discussed previously have primarily affected data transfer rates. Whether or not to determine the exact file size in bytes has more of an effect on user command response time. This is because the file size in bytes is one of the file attributes obtained by an NFS **Get Attribute** procedure. The NFS **Get Attribute** procedure is executed for every user command accessing an NFS mounted file system.

z/OS NFS provides processing attributes to specify estimated file size determination, `fastfilesize`, or exact file size determination, `nofastfilesize`. The accuracy of the file size with `fastfilesize` processing is best for binary processing of data sets with fixed length records. For other situations, or when exact file size is a requirement, the `nofastfilesize` processing attribute MUST be specified if NFSv2 or NFSv3 protocol is used. `Fastfilesize` attribute can be used for all read/write/append situations if NFSv4 protocol is used, although approximate file size still may be reported by the `ls -l` command in this case.

When the `nofastfilesize` processing attribute is specified, there are performance factors to consider. The most important factor is that file size in bytes is maintained by z/OS NFS for DFSMS-managed data sets with many data set organizations.

Figure 33 compares the differences in response time between the z/OS NFS attribute support for DFSMS-managed data sets and the case when attributes are not cached for non-SMS managed data sets. In this example, all data sets were members of a PDSE data set allocated with a variable block record format. The `ls -l` command was executed with the z/OS NFS `nofastfilesize` and `binary` processing attributes.

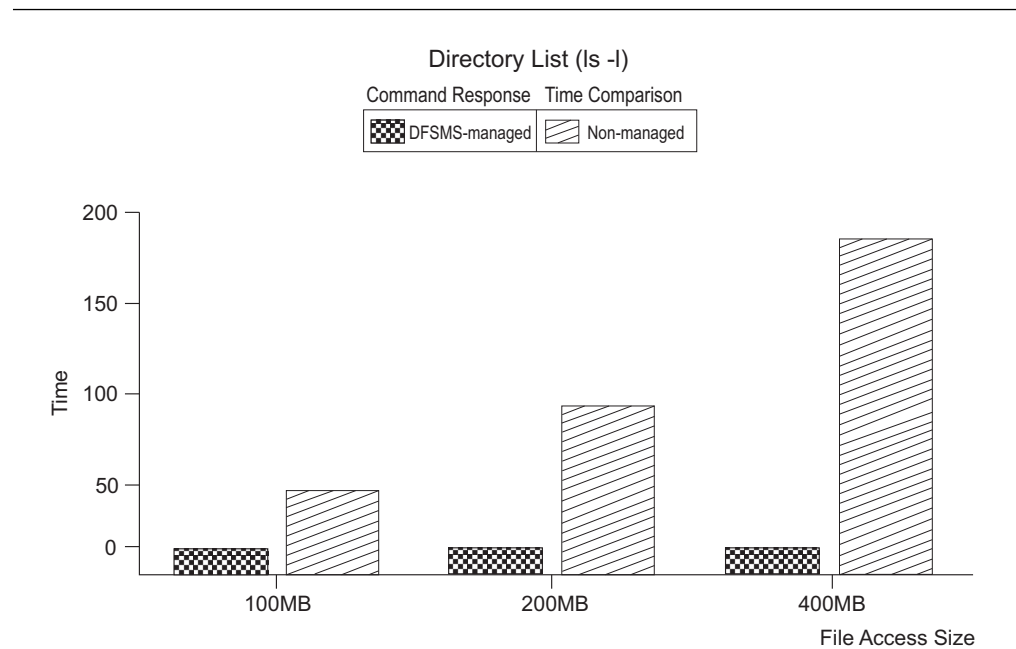

Figure 33. Directory list comparison between DFSMS-managed and non-managed

Data sets processed with the `nofastfilesize` attribute that are not DFSMS-managed will need to be read entirely to determine the exact file size in bytes when initially accessed by way of z/OS NFS. z/OS NFS will cache this information until the data set is modified (see section “Buffer usage and caching” on page 297) or the attribute time value has expired. The larger the file is, the greater the impact to command response time is. Figure 33 shows how the response time for a directory list command can be impacted when the file has to be read to determine the exact file size in bytes.

Maintaining the file size attribute by z/OS NFS also affects read throughput when accessing larger DFSMS-managed data sets with the `nofastfilesize` processing attribute. In the `nofastfilesize` case, reading the entire file to determine byte file size

is not necessary. The impact on the end-to-end response time for the read is lessened by reducing the response time for the initial access to obtain file attributes.

Data set timeout specification

There are three timeout processing attributes that specify when z/OS NFS will release a data set following certain NFS operations. The **readtimeout** and **writetimeout** processing attributes specify how long z/OS NFS will wait after respective read and write operations before releasing a data set. The **attrtimeout** processing attribute specifies how long a data set will remain allocated after an NFS **Get Attribute** or **Lookup** operation. When accessing data sets that are not DFSMS-managed with the **nofastfilesize** processing attribute, it may be advantageous to increase the **attrtimeout** value so that z/OS NFS caches data set attributes for a longer period of time. However, all three processing timeout attributes must be within the range of the **maxtimeout** and **mintimeout** site attributes.

Note:

1. When using the NFS version 4 protocol, these timeout values should be set to a value less than or equal to the lease time. Otherwise, it is possible for performance problems to occur when attempting to access MVS data sets.
2. With NFS version 2 and version 3 protocols, the data set may be closed/deallocated before the timeout value has been reached if the data set has been requested by another application if the **delegation** site attribute or modify operator command **V4DELG=on** is specified.

Accessing migrated files

While migrating less frequently accessed data sets to tape improves MVS storage utilization, retrieving migrated data sets can impact the performance of z/OS NFS. z/OS NFS provides three processing attributes to specify how migrated data sets are to be handled by the server: **retrieve(wait)**, **retrieve(nowait)**, and **noretrieve**.

The **retrieve(wait)** attribute instructs the server to wait for a migrated data set to be recalled to a direct access storage device. The NFS client user or application process will not receive a response from z/OS NFS until the data set has been recalled. If the migrated file is relatively large, or migrated to tape, this can cause the NFS client to retransmit the request. The NFS client will retransmit the request a fixed number of times as specified by the **retrans** parameter of the **mount** command. If the recall of a migrated data set takes longer than the product of the **timeo** value on the **mount** command and one plus the **retrans** value for the **mount**, **timeo * (retrans +1)**, the initial command will most likely need to be executed again. Using the default values for the AIX **mount** command of seven-tenths of a second for **timeo** and three attempts for **retrans**, a recall would need to take less than 3 seconds. An alternative approach is to use the **retrieve(nowait)** processing attribute.

The **retrieve(nowait)** attribute instructs the server to recall a migrated data set and immediately return a "device not available" message to the client without waiting for the recall to complete. With this option, users attempting to access the file can continue to use their session for other activity rather than waiting an indeterminate time for the recall of a file. They can attempt to access the file again after allowing some period of time for the recall to have completed.

If it is critical to the user that a file be recalled before further work can continue, the **retrieve(wait)** processing attribute can be specified more selectively as part of the NFS client user command syntax along with the file name. While doing this provides the user more control over command execution, the user command may still timeout and have to be executed again.

Specifying the **retrieve(wait)** processing attribute as the system default may also impact the availability of z/OS NFS subtasks to process such requests. The last parameter of the **nfstasks** site attribute determines the number of z/OS NFS subtasks available to process such recall operations. See “Subtasking” on page 302 for more information about the **nfstasks** site attribute.

Another method of avoiding the unnecessary recall of migrated data sets is to specify the **noretrieve** processing attribute. With the **noretrieve** attribute, the server does not recall a migrated data set and a "device not available" message is returned to the client. This processing attribute is particularly useful when listing a directory with unknown contents.

Asynchronous z/OS UNIX processing

z/OS NFS with Sun NFS V2 protocol provides two processing attributes that only apply to z/OS UNIX processing. The **sync** attribute specifies that z/OS UNIX write requests should be committed to nonvolatile media (for instance, DASD) when received by the server. Some performance improvement can be obtained with the alternative **async** processing attribute. This type of processing causes z/OS UNIX write requests to be cached at a level within the z/OS UNIX architecture prior to the physical I/O. For more information about z/OS UNIX tuning, see “Ordering out-of-sequence data” on page 299 and “Subtasking” on page 302.

The **async** and **sync** attributes specified in the control file are ignored when z/OS NFS server is communicating with Sun NFS V3 and V4 protocols. The processing attribute is determined in the client application implementation. Asynchronous write is also recommended for faster throughput.

Site attributes

The site attributes control z/OS NFS resources. Tuning of these parameters should be done with caution. They are only specified at the start of the z/OS NFS server and cannot be modified by client users. This section is limited to those attributes which more directly affect performance.

Buffer usage and caching

The **bufhigh** attribute specifies the below-the-bar virtual storage limits (in bytes) of allocated buffers (see Figure 34 on page 298). When the **bufhigh** storage limit has been reached, a percentage of the buffers will be reclaimed, and the amount of reclamation is determined by the **percentsteal** attribute. z/OS NFS uses this buffer area to cache MVS data set information, thereby satisfying requests more efficiently.

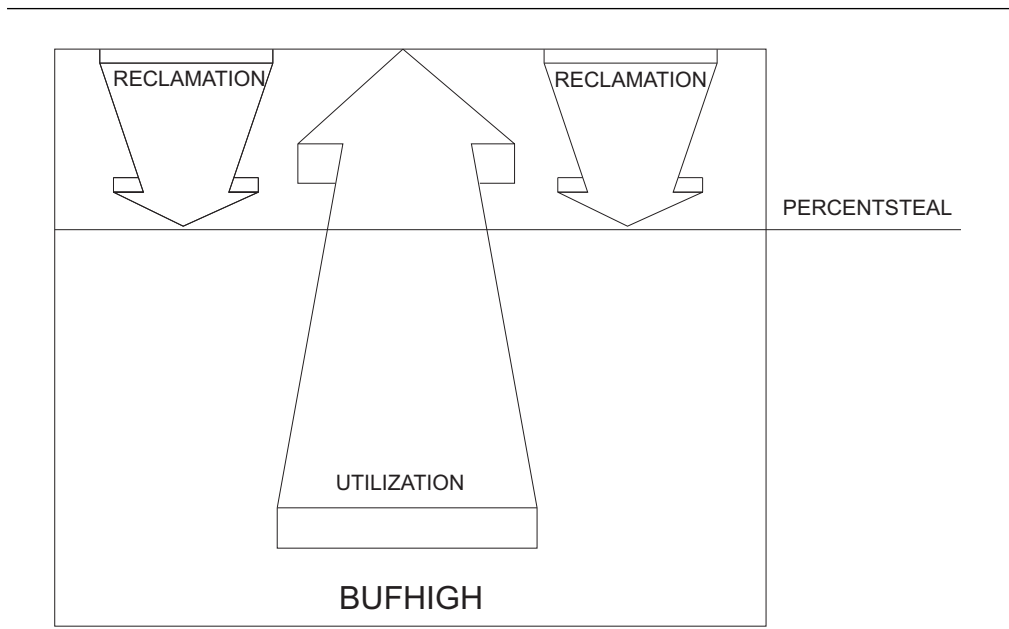

Figure 34. Bufhigh utilization with percentsteal

The NFS Server issues the message GFS363I to indicate an MVS data buffer shortage each time the server's threshold limit is reached, and message GFS364I when the threshold is overcome. These messages imply that some of the current requests may fail with an "out of memory" error. This threshold is governed by two values set by the bufhigh server site attributes: the storage limit (in bytes, Kbytes, or Mbytes) of data buffers and the water mark (in percent) of the storage limit. There are additional console messages generated to pre-warn of the impending buffer shortage, before the critical threshold is actually reached. The benefit of these warning messages is that System Automation can be configured to act upon these 'Buffer Shortage' warning messages to inform the application administrators on the remote NFS client to react accordingly and possibly throttle the incoming workload.

There are two additional site attributes, **readaheadmax** and **maxrdforszleft**, that also affect buffer usage. The **readaheadmax** attribute specifies the number of bytes to be read to fill the internal buffers so that additional read requests for that file may be satisfied directly from cache. The **maxrdforszleft** site attribute defines the number of physical block buffers to cache after determining a file's size (see section "File size determination" on page 294). This information is cached to satisfy any subsequent read requests for the same file.

Keep in mind also that some information will be cached on a file handle basis, in other words, for every file accessed within the timeout periods. Tuning of the **bufhigh**, **readaheadmax**, and **percentsteal** values should be determined based on the following conditions:

- Number of files to be accessed
- Available region
- Amount of data to cache per file

The **bufhigh**, **readaheadmax**, and **percentsteal** attributes do not apply to z/OS UNIX processing.

For example, suppose that, on average, 1,000 physical sequential (DSORG=PS) files allocated on 3390 Model 3 DASD are accessed within the same timeout period

through the z/OS NFS server. Further, assume that we would like two blocks of a file cached internally to satisfy read requests. If we assume an average block size of 25 KB (see “NFS client system performance tuning” on page 283 for more detail), we would need at least 50 MB of storage for internal buffers. With a 20 percent value for **percentsteal**, a 64 MB value for **bufhigh** would probably be more reasonable. For this example, a reasonable value for the **readaheadmax** attribute is the file block size, or 25 KB. The **readaheadmax** value should not be less than twice the maximum record length of files accessed by way of the z/OS NFS server.

Ordering out-of-sequence data

While the previous section primarily addressed satisfying read requests from cache, this section discusses the caching used by z/OS NFS to satisfy write requests. z/OS NFS provides two site attributes for this purpose: **cachewindow** and **logicalcache**. As with all site attributes, **cachewindow** and **logicalcache** can be modified only at server startup.

The **cachewindow** attribute specifies the window size, in terms of number of packets, used in logical I/O to buffer client block writes received out of sequence. Figure 35 on page 300 shows how out of order packets are buffered in a cache window until a block of data can be physically written to storage. Since out of sequence packets are an inevitability, a certain amount of buffering is necessary.

In a congested network environment, the nature of the underlying protocols should be taken into consideration when tuning the **cachewindow** attribute. Under such circumstances, NFS, UDP, and IP requests are more likely to timeout. When this situation is detected within the underlying protocols, the packet size can be reduced automatically. The packet size is generally halved until the server and client systems are balanced. The minimum packet size that can be negotiated is 512 bytes. Accessing the z/OS NFS server in such an environment can result in the default 8 KB read and write buffers being reduced to 512 bytes, or 16 packets instead of one packet. Under these circumstances the recommended value for **cachewindow** is 16 times the number of BIODs.

Another factor to consider in tuning the **cachewindow** attribute relates to the relationship between packet size, data set record length, and block size. If the packet size is typically greater than or equal to the data set block size, there is less of a need to buffer the packets. On the other hand, if the packet size is smaller than the block size and/or record length, a larger **cachewindow** value will be required to buffer the packets until a block I/O is executed.

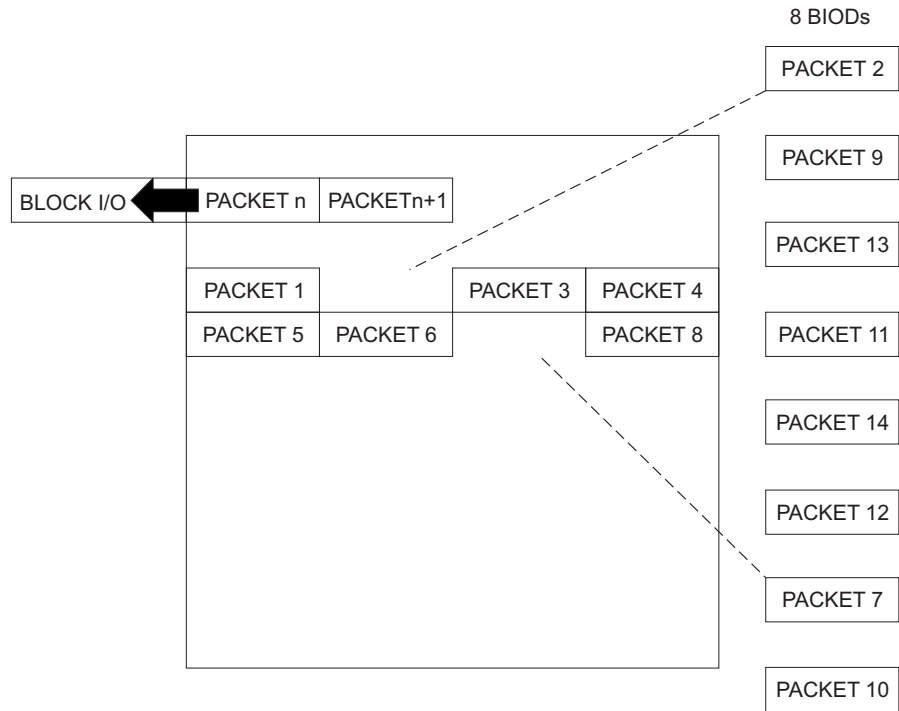

Figure 35. Relationship between cachewindow and BIODs

The **logicalcache** site attribute specifies the size (in bytes) of allocated buffers for all the cache windows combined (see Figure 36). The number of cache windows in use will depend on the number of file handles accessed within a given timeout period.

LOGICALCACHE

CACHEWINDOW			CACHEWINDOW		
PACKET	PACKET	PACKET	PACKET	PACKET	PACKET
PACKET		PACKET	PACKET	PACKET	
	PACKET	PACKET	PACKET		PACKET
PACKET				PACKET	
CACHEWINDOW			CACHEWINDOW		
PACKET	PACKET	PACKET	PACKET	PACKET	PACKET
PACKET	PACKET		PACKET		PACKET
	PACKET	PACKET	PACKET	PACKET	PACKET
	PACKET		PACKET		

Figure 36. Logicalcache utilization for cachewindows

Tuning of the **logicalcache** and **cachewindow** values should be determined based on the following conditions:

- Number of files accessed for write
- Available region
- Typical packet size
- Data set block size
- Number of client Biods

The **cachewindow** and **logicalcache** attributes do not apply to z/OS UNIX processing.

For example, suppose you have AIX NFS client workstations on a lightly loaded network, with the default value of six Biods, writing to physical sequential MVS data sets allocated with 8 KB fixed length records. Further, assume that these files were allocated on 3390 Model 3 DASD with a 24 KB block size and that the network packet size is 8 KB. Then, a value of 12, twice the number of NFS client Biods, for **cachewindow** means that an out of sequence packet could be internally buffered within a 96 KB or four block range. If a packet is received outside this range, z/OS NFS must read data from storage in order to write the packet at the correct offset into the data set. z/OS NFS detects and ignores duplicate requests.

A value of 12 for **cachewindow** and a network packet size of 8 KB in our example results in a 96 KB buffer requirement per client actively writing to MVS data sets through z/OS NFS. A 5 MB value for **logicalcache** is sufficient to satisfy sustained write requests from 50 NFS client workstations at the same time.

Storage considerations

To avoid storage shortages, consider the following conditions:

- If a region size is specified, the **bufhigh** value should not be more than 90 percent of the region size. (The more **bufhigh**; the better performance.) With **bufhigh(4M)** and the existing NFS core size, the minimum region size is 25M.
- If a region size is equal to 0, **bufhigh** value is limited by the supported virtual memory size on the installation. Region size can be set up as large as the size of the local page data sets.
- REGION updates

The REGION specifies the total size of usable virtual storage below-the-bar of an address space.

- If REGION is zero (give the address space ALL the available virtual storage below the bar) , MEMLIMIT is assigned no limit.

The sample z/OS NFS Server startup procedure GFSAPROC has REGION=0M.

- If REGION is non-zero, the MEMLIMIT value takes effect. If the MEMLIMIT is not specified the z/OS NFS Server may not complete startup and shutdown immediately.

- MEMLIMIT updates

The MEMLIMIT specifies the total size of usable virtual storage above-the-bar of an address space. It can come from the following:

- IEFUSI system exit
- SMFPRMxx MEMLIMIT parameter
- SETSMF command
- MEMLIMIT keyword in the JOB and EXEC JCL (that is, z/OS NFS Server startup procedure). It is worthwhile to update the sample startup procedure GFSAPROC with an example of a non-zero REGION size and MEMLIMIT.

The System Programmer should also consider if the other jobs on the installation use virtual memory.

Subtasking

The **nfstasks(n,m,o,t,u)** site attribute specifies the number of server threads (subtasks) to initiate on startup, where:

- n** is the number of threads started to handle asynchronous operations (z/OS MVS data set access) and short duration synchronous operations (SAF calls).
- m** is the number of threads which handle z/OS UNIX requests. Increase this value if your server requires many parallel z/OS UNIX accesses.
- o** is the number of threads that handle longer duration synchronous operations (concurrent NFS server recall requests.) Increase this value if your server supports lots of active recall operations.
- t** is the number of transport threads dedicated to receiving TCP requests. If a large number of concurrent TCP requests are expected and the *n,m* values have already been increased to handle the expected request processing workload but the requests still seem to be taking excessively long to complete, then this value should be increased to relieve any possible bottleneck in the request receive processing.
- u** is the number transport threads dedicated to receiving UDP requests. If a large number of concurrent UDP requests are expected and the *n,m* values have already been increased to handle the expected request processing workload but the requests still seem to be taking excessively long to complete then this value should be increased to relieve any possible bottleneck in the request receive processing.

If **nfstasks(n,m)** is specified, then the valid value range for *n* is from 4 to 99 and for *m* is from 4 to 100. The sum of *n* and *m* must be less than or equal to 100. If **nfstasks(n,m,o)** is specified, then the valid value range for *n* is less than or equal to 99 and for *m* is less than or equal to 100. The valid value range for *o* is less than or equal to 99. The sum of *m* plus *o* must be less than or equal to 100.

The absolute and relative value of *n* and *m* should be tuned for the expected system usage. If z/OS MVS data sets will be accessed, primarily, then *n* should be relatively high. If z/OS UNIX files will be accessed, primarily, then *m* should be relatively high. The absolute value of these will influence the amount of system resources consumed (higher values will make more system resources available to process NFS requests).

Based on system resources available below the 16 Mb line, the maximum *n* value may not be achievable. The precise maximum value will be system configuration dependent. If an 80A or 878 Abend is experienced during NFS server startup, use a smaller value for *n*.

When **nfstasks(n,m)** is specified, *m* represents both the processes for z/OS UNIX as well as the long duration synchronous operations. It is better to use the **nfstasks(n,m,o)** format to have better granularity of control and have the ability to specify a higher number of z/OS UNIX processes to handle more z/OS UNIX operations.

Based on system resources available below the 16 Mb line, the maximum $n + o$ value may not be achievable. The precise maximum value will be system configuration dependent. If an 80A or 878 Abend is experienced during NFS server startup, use a smaller value for $n + o$.

Chapter 17. Tuning the z/OS NFS client

This topic discusses performance tuning at the z/OS NFS client level. Performance of the z/OS NFS client is affected by the following installation parameters that can be tuned (see Table 53). The default value of each parameter is specified in parentheses.

Table 53. Client installation parameters for tuning

Parameter (value)
attrcaching (Y)
biod (6)
bufhigh (32)
datacaching (Y)
delaywrite (16)
dynamicsizeadj (Y)
readahead (8)
syncwrite (N)

Most of the installation parameters that are specified in member BPXPRMxx in SYS1.PARMLIB can be overridden for a mount point by using the **mount** command. The exceptions to this are **biod** and **bufhigh**, which require restarting z/OS UNIX.

Table 54 shows mount parameters that affect performance and that can be tuned. The default values are specified in parentheses.

Table 54. Mount parameters for performance and tuning

Parameter (value)
attrcaching (Y)
datacaching (Y)
delaywrite (16)
readahead (8)
rsize (8192 for NFSV2) (For NFSV3 or NFSV4 - negotiated between the z/OS NFS client and the NFS server)
syncwrite (N)
wsizer (8192 for NFSV2) (For NFSV3 or NFSV4 - negotiated between the z/OS NFS client and the NFS server)
vers (4)

Caching

Caching of file attributes (**attrcaching=y**) and data (**datacaching=y**) are recommended for performance. By caching the file data, all subsequent references to the cached data is done locally, avoiding the network overhead. Further authorization checking for subsequent access to the cached data or for other client users is done on the z/OS NFS client system. With attribute caching, z/OS NFS client will perform consistency checks to maintain valid cached data.

Note: attrcaching and datacaching are not supported for Kerberos mounts (for example, krb5, krb5i, or krb5p). They are only supported for system authentication (sys) mounts.

Dynamicsizeadj

The **dynamicsizeadj** parameter specifies the capability to have the packet size adjusted automatically when the remote procedure call (RPC) timeout has occurred.

For example, consider the situation where the negotiated size of the read buffer for an NFSv3 mount is 32K. If the RPC READ with a 32 K bytes request times out:

- The RPC request times out.
- The client cuts the size in half and sends the RPC READ with a 16 K request.
- The RPC request times out again.
- The client cuts the size in half and sends the RPC READ with a 8 K request.

Note: This process continues until the minimum size is reached.

Bufhigh

The **bufhigh** parameter specifies the maximum size in megabytes of allocated buffers for caching. z/OS NFS client uses this buffer area to cache file data, thereby satisfying requests efficiently.

When a client system is suffering high CPU utilization and low throughput, increase the **bufhigh** storage size. Increasing the **bufhigh** storage size by twice the default value (within available region) may improve system performance. Also, if the client system is processing mostly large files, it is good to increase the **bufhigh** storage size. Any changes to the **bufhigh** parameter require restarting z/OS UNIX.

Biod

The z/OS NFS client uses block I/O daemons (BIOD) to perform asynchronous read or write when **datacaching** is enabled. The **biod** parameter specifies the number of asynchronous block I/O daemons to use. If there are a lot of users on the NFS client system, it may be advantageous to increase the number of BIODs. The maximum number of BIODs should never exceed two times the number of client system processors. This will avoid excessive TCB switching. Tuning of this parameter should be done with caution. Any change to the **biod** parameter requires restarting z/OS UNIX.

Readahead

With caching enabled, read requests may be satisfied from cache. The **readahead** parameter specifies the maximum number of disk blocks to read ahead. Thus, additional read requests for the file may be satisfied directly from cache. When application is anticipating mostly sequential reads, increase the readahead to the maximum. If application is mostly processing random reads, use the default or a minimal readahead value.

syncwrite

The **syncwrite** parameter specifies whether the z/OS NFS client sends implicit v4COMMIT or STABLE v4WRITE requests to an NFS server. Setting **syncwrite(n)** may improve the performance of writing large files.

Delaywrite

With caching enabled, write requests may be cached. The **delaywrite** parameter specifies the maximum number of disk blocks to cache. The z/OS NFS client will issue the WRITE RPC whenever the system load is low or if the cache data are in sequence. **delaywrite** increases WRITE performance by overlapping the disk I/O. This performance increase is most apparent with many small writes or with many random writes. When there is a high volume of write requests, set the **delaywrite** parameter to the maximum value(32). If there is a low volume of write requests, set the **delaywrite** to the default (16).

Vers

The **vers** parameter does not have to be specified unless you would like to override the default. The z/OS NFS client will communicate at the highest protocol level supported by the server, by default. Verify the protocol level for tuning of read or write buffer size (**wsiz**, **rsiz**). Use `nfsstat -m /mountpoint` command and look for **vers(n)** in the report or use `rpcinfo -p servername` command and look for "100003 4 TCP 2049 nfs" in the report.

Wsize and rsiz

wsiz and **rsiz** specify the buffer size to use for read and write request. For NFS Version 2 protocol, **rsiz** and **wsiz** are 1 to 8192 bytes.

For the NFS server with Version 3 (or later) protocol, **rsiz** and **wsiz** are negotiated between the z/OS NFS client and the NFS server. The maximum buffer size that is supported in z/OS NFS client system is 64 KB. The negotiated read and write buffer size will be the smaller value of either the buffer size supported by the NFS server, or z/OS NFS client's **rsiz**/**wsiz** parameters value.

The z/OS NFS client system will reduce the read or write buffer size when there is constraint on the storage resource.

When using NFS Version 3 (or later) protocol the system normally determines the optimal buffer values. However, if the number of retransmissions or the number of time-out from **nfsstat** report is high, reduce the write buffer size (**wsiz**) to 8 KB to avoid retransmission of large 32 KB data.

Part 4. Diagnosis and Messages

Chapter 18. Diagnosis and reporting of problems

This topic is intended to help you diagnose NFS problems and use keywords to describe the NFS program failures.

Before you begin diagnostic procedures, verify that the suspected problem is not a result of failure caused by:

- z/OS Communication Server's TCP/IP (Transmission Control Protocol/Internet Protocol)
- Broken clients (for example, sending incorrect file handles or ignoring the server's error return code)
- The network (for example, packets not arriving at the server, clients not receiving replies, or a gateway going down)
- The result of user input error.

For failures caused by z/OS Communication Server's TCP/IP, see *z/OS Communications Server: IP Diagnosis Guide* to diagnose the problem.

Correcting input errors

For a user input error, use this procedure to assist in correcting the error:

1. Look up the command and its attributes (or parameters), the attributes in the attributes data set, and the entries in the exports data set in this book or the appropriate client machine command documentation.
2. Examine the attributes (or parameters) specified by each command, specified in the attributes data set, and the DIRECTORY entries specified in the exports data set to verify that they are specified correctly. Check the z/OS NFS server log data set, the z/OS NFS client log data set, or both log data sets to find the error message if applicable.
3. If you find a user input error, reenter the command or restart the server after you correct the error.
4. If all attributes (or parameters) and directory statements appear to be specified correctly, you should use this topic to build a set of keywords that describe the error, and then contact IBM for help.

After determining that the suspected failure is neither a z/OS TCP/IP program error nor a user error, you need to develop a set of keywords that describe the program failure. A keyword is an agreed-upon word or abbreviation used to describe a single aspect of a program failure.

After you have selected a set of keywords, use the set to search IBMLink/Service to determine whether an authorized program analysis report (APAR) has already been recorded for the failure. The IBMLink/Service online database contains information about the resolution of APARs. If a program failure is identified in these databases with the same set of keywords, the search yields a description of the problem and usually a fix. If the failure is not known, use the keywords to describe the failure when you contact IBM for help, which is the final step before an APAR is generated. For more information about these services see *z/OS DFSMSdfp Diagnosis*.

Using keywords to identify a problem

In general, when you contact IBM, you are asked to identify the problem with a full set of keywords. A full set of keywords for the NFS identifies these specific keywords:

- Component identification keyword
- Release level keyword
- Type-of-failure keyword
- Service level keyword

This example displays a full set of keywords:

```
5695DF121 R1VS MSGGFSA865I UW12345
```

Note:

1. 5695DF121 - Signifies the component identification keyword.
2. R1VS - R1VS is the release level keyword for the z/OS NFS server, FMID HDZ11VS. R1VC is the release level keyword for the z/OS NFS client, FMID HDZ11VC. See Table 55 for a list of the z/OS NFS FMIDs and their corresponding releases.
3. MSGGFSA865I - MSGGFSA is the type-of-failure keyword prefix for the z/OS NFS server. MSGGFSC is the type-of-failure keyword prefix for the z/OS NFS client.
4. UW12345 - Service level keyword.

Table 55. z/OS NFS FMIDs and release names

FMID	z/OS Release
HDZ11VS	Release 7 NFS server
HDZ11VC	Release 7 NFS client
HDZ118N	Release 8 NFS client and server
HDZ119N	Release 9 NFS client and server
HDZ1AN0	Release 10 NFS client and server
HDZ1B1N	Release 11 NFS client and server
HDZ1C1N	Release 12 NFS client and server
HDZ1D1N	Release 13 NFS client and server
HDZ221N	Version 2 Release 1 NFS client and server
HDZ222N	Version 2 Release 2 NFS client and server

These sections explain individual keywords and their relation to the full set of keywords used to describe a NFS program failure.

A search in IBMLink/Service using the first keyword, the NFS component identifier, alone would detect all reported problems for the entire program product. Each keyword added to the search argument makes the search more specific, thereby reducing the number of problem descriptions to be considered. Sometimes you can find a correction for a problem without using the full set of keywords. Each keyword after the first is optional.

Component identification keyword

The component identification number is the first keyword in a set. You should use this keyword whenever the Network File System is suspected of being the failing component. The component identification keyword should be used with at least one other keyword to search IBMLink/Service. Used alone, it produces a full listing of APARs against the Network File System.

1. The component identification number for the Network File System is 5695DF121.
2. Go to “Release level keyword.”

Release level keyword

Using this keyword to identify the release level of the Network File System is optional in the IBMLink/Service search argument. However, it is required when you submit an APAR.

1. Issue the MODIFY mvsnfs VERSION command, as shown in “Version operand” on page 253.
2. In output message GFSA944I, find the release level, as shown by *R1xx* in the following example:
GFSA944I z/OS Network File System Server release R1xx
3. See “Type-of-failure keyword.”

Type-of-failure keyword

To identify the type of failure that occurred, select the one keyword from Table 56 which best describes the problem. Then follow the specific instructions for that keyword. If you are not certain which of two keywords to use for the type of failure, use the one that appears first in the list.

Table 56. Summary of type-of-failure keywords

Keyword	Type of Failure	Page
ABENDxxx	Network File System ends abnormally because of a system-detected error	“ABENDxxx”
MSGGFS hnnnt	Error indicated by a system message	“MSGGFS hnnnt ” on page 314
WAIT	The program does not seem to be doing anything	“WAIT” on page 314
LOOP	The program is doing something repetitively	“LOOP” on page 314
INCORROUT	Output from the program is incorrect or missing	“INCORROUT” on page 314
DOC SCnnnnnnnn	Documentation is incorrect or incomplete	“DOC SCnnnnnnnn” on page 315
PERFM	Performance of the program is degraded	“PERFM” on page 315

ABENDxxx

Use this procedure when Network File System ends abnormally.

In this step, you build a type-of-failure keyword:

1. Replace the *xxx* part of the **abendxxx** keyword with the abend code from either the SYSLOG message or the abend dump. For example, if the abend code is 0C4, the ABENDxxx keyword is ABEND0C4.

2. To continue, see “Service level keyword” on page 315 to identify the service level of Network File System.

MSGGFS $hnnnt$

Use this procedure for any of these conditions:

- Network File System message indicates an unexpected error detected.
- Message is not issued under conditions that should cause it to be issued.
- Message is issued under conditions that should not cause it to be issued.

In this step, you build a type-of-failure keyword.

1. For the $hnnnt$ portion of the MSGGFS $hnnnt$ keyword replace the h with an **A** if the message prefix was GFSA or with a **C** if the message prefix was GFSC. Replace the nnn with the message number and replace the t with the type code. For example, if the message is GFSA865I, the MSGGFS $hnnnt$ keyword is MSGGFSA865I.
2. To continue, see “Service level keyword” on page 315 to identify the service level of the Network File System.

WAIT

Use this procedure when Network File System suspends activity while waiting for some condition to be satisfied without issuing a message to tell why it is waiting.

In this step, you build a type-of-failure keyword:

1. If a Network File System task was in a WAIT, use the *wait* keyword.
5695DF121 Rccc WAIT
2. To continue, see “Service level keyword” on page 315 to identify the service level of the Network File System.

LOOP

Use this procedure when some part of the program repeats endlessly.

In this step, you build a type-of-failure keyword.

1. If a Network File System task was in a LOOP, use the *loop* keyword.
2. If a message repeats endlessly, use the MSGGFS $hnnnt$ keyword at the same time with the LOOP keyword. For the $hnnnt$ portion of the MSGGFS $hnnnt$ keyword replace the h with an **A** if the message prefix was GFSA or with a **C** if the message prefix was GFSC. Replace the nnn with the message number and replace the t with the type code.
5695DF121 Rccc LOOP MSGGFS $hnnnt$
3. To continue, see “Service level keyword” on page 315 to identify the service level of the Network File System.

INCORROUT

Do not use *incorROUT* if another keyword applies. Use this procedure only for these conditions:

- Output was expected but not received (missing).
- Output is different from expected (incorrect).

In this step, you build a type-of-failure keyword.

1. Use the *incorROUT* keyword.
2. If the output is in the form of an incorrect message, also use the type-of-failure keyword MSGGFS $hnnnt$. For the $hnnnt$ portion of the MSGGFS $hnnnt$ keyword

replace the *h* with an *A* if the message prefix was GFSA or with a *C* if the message prefix was GFSC. Replace the *mmn* with the message number and replace the *t* with the type code.

```
5695DF121 Rccc INCORROUT MSGGFShnnt
```

3. To continue, see “Service level keyword” to identify the service level of the Network File System.

DOC SCnnnnnnnn

Use this procedure when a program problem appears to be caused by incorrect or missing information in the Network File System documentation. If the documentation error is minor (for example, incorrect punctuation or a misspelled word), you do not need to build a keyword string to describe it. Instead, submit a Reader’s Comment Form from the back of the book.

If the error is serious, and of general concern to other users, continue with this procedure.

In this step, you build a type-of-failure keyword, which includes a document order number. No other keywords are needed:

1. Place the order number of the document after the DOC keyword, omitting the hyphens. If the suffix is one digit, precede it with a zero. For example, the keyword for a document with order number SC26-7029-01 would be DOC SC26702901.
2. Locate the page in the document at which the error occurs, and prepare a description of the problem. If you submit an APAR, you must include this information in the error description.
3. To continue, see “Service level keyword” to identify the service level of the Network File System.

PERFM

Performance problems can be related to system tuning. Use this procedure when the performance problem cannot be corrected by system tuning and performance is below stated expectations.

In this step, you build a type-of-failure keyword.

1. Use the *perfm* keyword.
5695DF121 Rccc PERFM
2. To continue, see “Service level keyword” to identify the service level of the Network File System.

Service level keyword

Use this keyword to identify the service level of the module that failed. The service level is defined as the most current fix applied to the module.

1. Issue the MODIFY mvsnfs VERSION=module command, as shown in “Version operand” on page 253.
2. In output message GFSA945I, find the service level of the module, as shown by *service_level* in the following example:
GFSA945I modulename service_level compile_date/time
3. Specify the service level keyword.

For example, if the service level of the failure related module is UW12345, you would specify UW12345 as the service level keyword.

```
5695DF121 Rccc MSGGFSA865I UW12345
```

You now have all the necessary information for an effective search of known problems in IBMLink/Service. Refer to "Contacting the IBM Support Center" on page 332 or "Searching the IBM database for APARs and PTFs" on page 331.

Using z/OS component tracing

To improve the recording and tracing of NFS diagnostic information, you can use component trace services. After activating component tracing and recreating the problem, the diagnostic information in the trace buffers can then be captured in a z/OS SVC dump or written to a DASD or tape data set and then viewed using the IPCS CTRACE command. Use of component trace services offers other advantages over using the server's log data sets, including performance improvements and virtual storage constraint relief.

To activate component tracing of NFS information, an operator can issue a TRACE CT command specifying the procedure name of the z/OS NFS server or client with individual trace options or a member of SYS1.PARMLIB that contains the trace options. The operator can choose different PARMLIB members (if they were previously created) by specifying CTRACE=*nm* on a START mvsnfs command, where *nm* is the suffix of a CTINFS*nm* PARMLIB member. When CTRACE=*nm* is not specified, the default PARMLIB member, CTINFS00, is used to initialize CTRACE for the server. If the specified PARMLIB member is absent or incorrect, CTRACE is activated with the default options in effect (CTRACE buffer size of 10M and FFDC,ERROR trace options). For details on these commands and their NFS trace options, see Chapter 11, "Network File System operation," on page 223. For details on the member of SYS1.PARMLIB, see "Using NFS component trace PARMLIB members CTINFS*nm* and CTINFC*nm*" on page 317.

z/OS V2R2 NFS introduces CTRACE version 2 record to support 64-bit NFS control block pointers. z/OS NFS CTRACE version 2 record is incompatible with z/OS NFS CTRACE formatter of the lower z/OS releases. If it is necessary to format z/OS NFS CTRACE version 2 record in the lower-release z/OS IPCS, consult "Making Load Libraries Available to IPCS" in *z/OS MVS IPCS Customization* with the load library containing z/OS V2R2 CTRACE formatter load modules.

One way to achieve this:

1. In the shared disk array, create a data set with the same attributes as z/OS V2R2 SYS1.SIEAMIGE with a name (for example, *hlq.SIEAMIGE*).
2. Copy z/OS V2R2 NFS CTRACE formatter load modules GFSNEFIL, GFSNEFMT and GFSNELOC from z/OS V2R2 SYS1.SIEAMIGE to *hlq.SIEAMIGE*.
3. On the lower z/OS release system, attach this data set to the current TSO session by issuing TSOLIB ACT DSNAME(*hlq.SIEAMIGE*) at the TSO READY prompt.

This allows z/OS V2R1 or previous release systems to format z/OS NFS CTRACE version 2 records captured on z/OS V2R2 or above.

Starting in V2R2, NFS CTRACE performance can be improved with certain CTRACE options, including the "ALL" option. With this change, the data space with CTRACE buffers is created with the user protection key.

The requirement is that data space with user protection key should be created with SCOPE=SINGLE parameter to be referenced only by the owning address space.

Because the NFS data space is created with SCOPE=SINGLE, if it is needed to view the NFS component trace via IPCS in ACTIVE mode, it is necessary to execute the following set of RACF commands:

```
rdefine FACILITY BLSACTV.ADDRSPAC UACC(none)
rdefine FACILITY BLSACTV.SYSTEM UACC(none)
permit BLSACTV.ADDRSPAC CLASS(FACILITY) ID(userID) ACCESS(READ)
permit BLSACTV.SYSTEM CLASS(FACILITY) ID(userID) ACCESS(READ)
SETROPTS RACLIST(FACILITY)
```

The following sections describe how to use NFS component tracing in diagnosis procedures. Further information on using the IPCS CTRACE command can be found in *z/OS MVS IPCS Commands*. Additional information regarding the MVS DISPLAY, TRACE, and DUMP commands may be found in *z/OS MVS System Commands*.

When you use component tracing, NFS diagnosis information continues to be recorded in the NFS server log data sets, at the level specified on a MODIFY *mvsnfs*, LOG=*xxx* operator command. IBM recommends that you adjust the level of logging to avoid duplicating diagnostic records and to maximize the performance benefits of using component trace buffers.

If additional NFS diagnosis information is required using the log data sets for the z/OS NFS server, see Appendix K, “Capturing diagnostic information using z/OS NFS log data sets and from other components,” on page 565 for further details.

Component trace benefits

Component trace support offers the following benefits over the NFS log data sets:

- For virtual storage constraint relief, trace buffers are stored to a z/OS data space. In a multi-server implementation, each server or client has its own data space initialized at startup.
- Performance is improved because in-memory tracing can now be activated without the overhead of I/O.
- The optional use of an external writer data set may extend the amount of trace data collected when accompanied with a z/OS dump.
- For performance, the I/O overhead of writing to a data set is performed under the started external writer address space. Removing the I/O path provides a more responsive NFS error log daemon.
- Use of the IPCS MERGE command provides the ability to merge an NFS server or client component trace with those of other NFS or clients servers and related z/OS products such as TCPIP and UNIX System Services to obtain a single image of system activity.
- Performance is improved over the previous NFS server and client tracing methodology with the ability to enable only those trace events of interest. Previously, the amount of tracing was cumulative.

Using NFS component trace PARMLIB members CTINFS nn and CTINFC nn

CTINFS00 and CTINFC00 members of SYS1.PARMLIB provide default component trace values for the z/OS NFS server and z/OS NFS client, respectively. These members are used automatically when the z/OS NFS application (the server or the client) is started. You can create and use additional copies of the member with different trace option values, placing them in SYS1.PARMLIB using the naming convention CTINFS nn /CTINFC nn .

Component tracing is active from the NFS application's start with trace options defined in the CTINFS nn /CTINFC nn PARMLIB member, where $nn=00$ is the default. If the specified PARMLIB member is incorrect or absent, component tracing functions in minimum state (MIN) with a minimum set of trace options (FFDC and ERROR for the server, FFDC and MSG for the client). The operator can change trace options individually on the TRACE CT command, or can specify the name of a CTINFS nn /CTINFC nn PARMLIB member containing the desired trace options. Using a PARMLIB member on the TRACE CT command can help minimize operator intervention and avoid syntax or keystroke errors. The syntax and options for a z/OS NFS application component trace are shown in "Starting component tracing for the z/OS NFS server" on page 231 and in "Starting component tracing for the z/OS NFS client" on page 224.

If the NFS client is started by z/OS UNIX (specified in the BPXPRM xx parmlib member), you can designate a component trace parmlib member with options to be used at startup. Use the CTRACE= nn parameter, as shown in the following example:

```
FILESTYPE TYPE(NFS) ENTRYPPOINT(GFSCINIT) ASNAME(mvsnfsc)
PARM(' INITD,CTRACE=nn')
```

where:

mvsnfsc

is the name of the z/OS NFS procedure to be started.

nn

is the suffix of a CTINFC nn PARMLIB member.

CTRACE

must appear as the first or second parameter after INITD, in capital letters, separated by commas without blank spaces. If CTRACE= nn is not specified, the default PARMLIB member, CTINFC00, is used to initialize CTRACE for the client.

The component trace options specified on the CTINF xnn member control the component trace. These trace options can be overridden by a subsequent TRACE CT command if necessary, for example if a problem arises requiring a different set of trace options.

Note: The minimum trace options remain in effect after the TRACE CT,OFF,COMP=*startup_name* operator command, so tracing never stops while the server or the client is active.

The parmlib member used at NFS application's startup specifies the size of the trace buffers to be used. Three buffers of that size are created and used cyclically. If no value is specified, or no parmlib member is found at startup, or syntax error is encountered while processing the parmlib member, and the dsps startup parameter is also not specified (for the server only), a default buffer size of 10 MB is used. The buffer size may be set in the range of 600KB to 600MB. The maximum value of 600MB was chosen because the total size of the three buffers must stay below 2 GB.

Note: The z/OS NFS applications do not support changing the buffer size after startup.

If no parmlib member is found at z/OS NFS application startup, or it does not contain a tracing Options specification, the trace options default to the MIN options setting (FFDC and ERROR for the server, FFDC and MSG for the client).

The CTINFxn parmlib member contains the following parameters:

ON/OFF

specifies whether trace is turned on or off.

OPTIONS

specifies the trace options that are to be applied.

BUFSIZE(nnnnK | nnnnM)

specifies the size, in kilobytes (K) or megabytes (M), of one trace buffer. A valid range is from 600K to 600M.

WTRSTART(membername){WRAP | NOWRAP}

identifies a member containing source JCL for a started task that the system uses to start the component trace external writer and to open the data sets that the writer uses. You must also specify the WTR parameter.

WRAP or NOWRAP

If you specify WRAP, when the system reaches the end of the data set or group of data sets, it writes over the oldest data at the start of the data set or the start of the first data set. If you specify NOWRAP, the system stops writing to the data set or sets when the data set or sets are full.

If the WTRSTART parameter on the CTnccxx parmlib member or TRACE CT command specifies NOWRAP, the system uses the primary and secondary extents of the data set or sets. If the WTRSTART parameter specifies WRAP or omits the parameter, the system uses only the primary extent or extents.

Default: WRAP.

WTR(membername | DISCONNECT)

connects or disconnects the component trace external writer and the trace. The member name identifies the member that contains the source JCL that invokes the external writer. The membername in the WTR parameter must match the membername in the WTRSTART parameter.

WTR(DISCONNECT) disconnects the writer and the trace. The component continues tracing and placing the trace records in the address-space buffer, but stops passing trace records to the external writer.

You must also specify a WTRSTART or WTRSTOP parameter to start or stop the writer.

Default trace options required by the Health Checker (HC)

The objective of the IBM Health Checker for z/OS is to identify potential problems before they impact your availability or, in worst cases, cause outages. It checks the current active z/OS and sysplex settings and definitions for a system and compares the values to those suggested by IBM or defined by you. For more details, see *IBM Health Checker for z/OS User's Guide*. The Health Checker checks whether NFS Component Trace starts with options, defined in the appropriate CTINFSnn /CTINFCnn parmlib member, other than the default options. Starting NFS CTRACE with other options can result in performance degradation.

If the Health Checker detects a mismatch, the application startup name is listed in message IEAH844I in the HEALTH CHECKER's SDSF panel. Note that this message does not mean that the IBM Health Checker for z/OS has found problems that you need to report to IBM! The IBM Health Checker for z/OS output

messages simply inform you of potential problems so that you can take action on your installation. To adjust the set of trace options in accordance with HC requirements you can do the following:

1. Correct a set of trace options in the CTINF xnn parmlib member
2. Switch off trace activity by the operator command:

```
TRACE CT,OFF,COMP=startup_name
```

Note: Trace system stays working in MIN state.

3. Switch on tracing by operator command:

```
TRACE CT,ON,COMP=startup_name, PARM=CTINF $xnn$ 
```

The default trace options should be set in a strictly defined order. The syntax of the OPTIONS parameter in the parmlib member allows defining trace options, as follows:

- As a string enclosed in quotes. For example:

```
OPTIONS('INFO,WARNING,ERROR ,FFDC')
```
- A set of strings placed in one line. For example:

```
OPTIONS('INFO', 'WARNING', 'ERROR', 'FFDC')
```
- A set of strings in consecutive line order. For example:

```
OPTIONS(  
    'INFO'  
    , 'WARNING'  
    , 'ERROR'  
    , 'FFDC'  
)
```

CTINFS00 member of SYS1.PARMLIB

Figure 37 on page 321 shows a copy of the CTINFS00 member of SYS1.PARMLIB that NFS provides for tracing the z/OS NFS server. This file is used for setting the initial startup trace settings.

The z/OS NFS server default trace options are defined as:

```
INFO,WARNING,ERROR,FFDC
```

You can change a set of trace options for debug purposes.

```

/* ===== */
/*
/* $MAC(CTINFS00) COMP(5694DF121) @P01C*/
/*
/* Z/OS Network File System Server.
/* Sample CTRACE options.
/*
/* COPYRIGHT:
/*PROPRIETARY V3 STATEMENT
/*Licensed Materials - Property of IBM
/*"Restricted Materials of IBM"
/*5650-ZOS @P03C*/
/*COPYRIGHT IBM Corp. 2004, 2013 @LE7C*/
/*END PROPRIETARY V3 STATEMENT
/*
/*
/* ----- */
/*
/* CHANGE ACTIVITY:
/*
/* $L77=NFS,HDZ11VS,040507,IBSMVB: Convert To CTrace @L77A*/
/* $L77=NFS,HDZ11VS,041210,IBSKYL: Add FFDC @L777A*/
/* $P01=KAJ0199,HDZ11VS,041216,SJPLMB: Restore PID to 5694-A01 @P01A*/
/* $P02=K9N0156,HDZ119N,060912,SJPLMB: Add BUFSIZE option @P02A*/
/*----- Release V2R1 ----- @P03A*/
/* $P03=KEN0148,HDZ221N,20110912,SJPLMB: @P03A*/
/* 1. Change Copyright to "IBM Corp." before date(s). @P03A*/
/* 2. Changed product id from "5694-A01" to "5650-ZOS". @P03A*/
/* 3. Removed '(C)' from copyright statements. @P03A*/
/* $LE7= NFS,HDZ221N,20120228,SJPLMB: @LE7A*/
/* 1. Changed Copyright from 2012 to 2013. @LE7A*/
/* $P04=SM00306,HDZ221N,20120806,IBSKVV: @P04A*/
/* 1. Add DEFOPS option of CTRACE DEFINE macro @P04A*/
/*
/* ----- */
/*
/* DEFAULT CTINFS00 MEMBER
/* ===== */
/*
TRACEOPTS
/* ----- */
/* Optionally start external writer in this file (use both
/* WTRSTART and WTR with same wtr_procedure)
/* ----- */
/* WTRSTART(wtr_procedure)
/* WTRSTART(CTWTR)
/* ----- */
/* ON OR OFF: PICK 1
/* ----- */
/* ON
/* BUFSIZE(10M) /* @P04C */
/* OFF
/* Note. When defining OFF do not use OPTIONS parameter. @P04A */
/* ----- */
/* WTR(CTWTR)
/* ----- */
/* OPTIONS: NAMES OF FUNCTIONS TO BE TRACED.
/* DEFAULT OPTIONS ARE: @P04A */
/* 'INFO' @P04A */
/* , 'WARNING' @P04A */
/* , 'ERROR' @P04A */
/* , 'FFDC' @P04A */
/* The order of Default Options cannot be changed! @P04A */
/* ----- */
/* OPTIONS(
/* 'INFO'
/* , 'WARNING'
/* , 'ERROR'
/* , 'FFDC'
/* )
/*

```

CTINFC00 member of SYS1.PARMLIB

Figure 38 on page 323 shows a copy of the CTINFC00 member of SYS1.PARMLIB that NFS provides for tracing the z/OS NFS client. This file is used for setting the initial startup trace settings.

The z/OS NFS client default trace options are defined as:

MSG,FFDC

```

/* ===== */
/*                                          */
/* $MAC(CTINFC00) COMP(5694DF121)          @L84A */
/*                                          */
/* Z/OS Network File System Client.        */
/* Sample CTRACE options.                  */
/*                                          */
/* COPYRIGHT:                              */
/*PROPRIETARY V3 STATEMENT                  */
/*Licensed Materials - Property of IBM     */
/*"Restricted Materials of IBM"            */
/*5650-ZOS                                  @P02C*/
/*COPYRIGHT IBM Corp. 2004, 2013          @LE7C*/
/*END PROPRIETARY V3 STATEMENT            */
/*                                          */
/* ----- */
/*                                          */
/* CHANGE ACTIVITY:                         */
/*                                          */
/* $L84=NFS,HDZ118N,051031,IBSKVV: Convert To CTrace @L84A*/
/* $P01=K9N0156,HDZ119N,060912,SJPLMB: Change BUFSIZE to 10M @P01A*/
/*----- Release V2R1 ----- @P02A*/
/* $P02=KEN0148,HDZ221N,20110912,SJPLMB: @P02A*/
/*     1. Change Copyright to "IBM Corp." before date(s). @P02A*/
/*     2. Changed product id from "5694-A01" to "5650-ZOS". @P02A*/
/*     3. Removed '(C)' from copyright statements. @P02A*/
/* $LE7= _NFS_,HDZ221N,20120228,SJPLMB: @LE7A*/
/*     1. Changed Copyright from 2012 to 2013. @LE7A*/
/* $P03=SM00306,HDZ221N,20120806,IBSKVV: @P03A*/
/*     1. Add DEFOPS option of CTRACE DEFINE macro @P03A*/
/*                                          */
/* ----- */
/* DEFAULT CTINFC00 MEMBER                  */
/* ===== */
/*
TRACEOPTS
/* ----- */
/*   Optionally start external writer in this file (use both */
/*   WTRSTART and WTR with same wtr_procedure)                */
/* ----- */
/*           WTRSTART(wtr_procedure)                          */
/*           WTRSTART(CTWTR)                                  */
/* ----- */
/*   ON OR OFF: PICK 1                                        */
/* ----- */
/*           ON                                               */
/*           BUFSIZE(10M)                                     */
/*           OFF                                              */
/* Note. When defining OFF do not use OPTIONS parameter. @P03A */
/* ----- */
/*           WTR(CTWTR)                                       */
/* ----- */
/*   OPTIONS: NAMES OF FUNCTIONS TO BE TRACED.                */
/*   DEFAULT OPTIONS ARE: @P03A */
/*           'MSG' @P03A */
/*           ', 'FFDC' @P03A */
/* The order of Default Options cannot be changed!            */
/* ----- */
/*           OPTIONS(                                         */
/*               'MSG' @P03C */
/*               ', 'FFDC' @P03C */
/*           ) @P03C */
/*

```

Figure 38. z/OS NFS client component trace PARMLIB member CTINFC00

Capturing NFS Server component trace information in an SVC dump

You can use component tracing to gather information for diagnosis when recreating prior problems related to the z/OS NFS server. To do so, follow these steps:

1. Have an operator issue a TRACE CT command, as described in “Starting component tracing for the z/OS NFS server” on page 231. Specify individual trace options on the command, or OPTIONS=All to include all trace types.
2. Recreate the reported problem. After the problem is recreated, disable tracing with the following command at the operator console:

```
TRACE CT,OFF,COMP=MVSNFS
```

which will convert the NFS server to MIN state of tracing.

3. Create an MVS dump

To create a dump of the an NFS server address space and associated data space, enter the following command at the operator console:

```
DUMP COMM=(any dump description title you choose)
```

In response to operator message *nn IEE094D SPECIFY OPERAND(S) FOR DUMP COMMAND, reply with:

```
R nn, JOBNAME=(MVSNFS),DSPNAME=('mvsnfs'.NFSCTRDS),CONT  
R nn,SDATA=(LPA,CSA,ALLNUC,GRSQ,LSQA,SWA,PSA,SQA,TRT,RGN,SUM)
```

To include NFS component trace records in an SVC dump, specify the associated data space name *mvsnfs*.NFSCTRDS on the MVS DUMP command. The value of *mvsnfs* represents the server's procedure name.

You can now use the IPCS command CTRACE COMP(MVSNFS) FULL to look at the trace records, where the default data set has been set to a captured dump data set. NFS provides both IPCS exits and format tables to facilitate this activity.

Capturing NFS Client component trace information in an SVC dump

You can use component tracing to gather information for diagnosis when recreating prior problems related to the z/OS NFS client. To do so, follow these steps:

1. Have an operator issue a TRACE CT command, as described in “Starting component tracing for the z/OS NFS client” on page 224. Specify individual trace options on the command, or OPTIONS=All to include all trace types.
2. Recreate the reported problem. After the problem is recreated, disable tracing with the following command at the operator console:

```
TRACE CT,OFF,COMP=MVSNFSC
```

which will convert the NFS server to MIN state of tracing.

3. Create an MVS dump

To create a dump of the an NFS client address space and associated data space, enter the following command at the operator console:

```
DUMP COMM=(any dump description title you choose)
```

In response to operator message *nn IEE094D SPECIFY OPERAND(S) FOR DUMP COMMAND, reply with:

```
R nn,JOBNAME=(MVSNFSC),DSPNAME=('MVSNFSC'.NFSCTRDS),CONT  
R nn,SDATA=(LPA,CSA,ALLNUC,GRSQ,LSQA,SWA,PSA,SQA,TRT,RGN,SUM)
```

To include NFS component trace records in an SVC dump, specify the associated data space name 'MVSNFSC'.NFSCTRDS on the MVS DUMP command. The value of MVSNFSC represents the client's procedure name.

You can now use the IPCS command CTRACE COMP(MVSNFSC) FULL to look at the trace records, where the default data set has been set to a captured dump data set. NFS provides both IPCS exits and format tables to facilitate this activity.

Using a z/OS component trace external writer

z/OS Component Trace (CT) supports an external writer which can be used to write trace records to a DASD or tape data set in real time. That is, as NFS generates trace records those records can be placed on DASD or tape.

Activating a CT External Writer for a program is a two-step process. These steps can be done in either order, but the external writer will not start writing out trace records until they have both been done.

Step 1. Telling MVS to start a CT external writer

Before a CT external writer can start there must be a procedure in SYS1.PROCLIB that tells how to invoke the writer. An example of a CT external writer procedure that can be placed in SYS1.PROCLIB(CTWTR) is:

```
//CTWTR PROC  
//IEFPROC EXEC PGM=ITTTTCWR  
//TRCOUT01 DD DSN=IBMUSER.CT1,DISP=NEW
```

If you are tracing in a multi-server or sysplex environment, the data set names on TRCOUTnn DD statements must be unique throughout the sysplex. An ENQUEUE error results if the data set names are not unique. *z/OS MVS Diagnosis: Tools and Service Aids* has a discussion about creating external writer procedures.

An example of values to use in allocating IBMUSER.CT1 is:

DATA SET NAME: IBMUSER.CT1

VOLUME SERIAL	====> USRPAK	(BLANK FOR AUTHORIZED DEFAULT
GENERIC UNIT	====>	(GENERIC GROUP NAME OR UNIT
SPACE UNITS	====> CYLS	(BLKS, TRKS, OR CYLS)
PRIMARY QUANTITY	====> 3	(IN ABOVE UNITS)
SECONDARY QUANTITY	====> 5	(IN ABOVE UNITS)
DIRECTORY BLOCKS	====> 0	(ZERO FOR SEQUENTIAL DATA SET)
RECORD FORMAT	====> VB	
RECORD LENGTH	====> 23472	
BLOCK SIZE	====> 23476	
EXPIRATION DATE	====>	(YY/MM/DD, YYYY/MM/DD)

To start a CT external writer, enter the following command at the operator console:
TRACE CT,WTRSTART=CTWTR

When you see the following message, the CT external writer is now ready:
ITT110I INITIALIZATION OF CTRACE WRITER CTWTR COMPLETE.

Step 2. Telling NFS to connect to a CT external writer and start sending records

To have the NFS server start sending trace records to the CT external writer, enter the following command at the operator console:

```
TRACE CT,ON,COMP=MVSNFS
```

To have the NFS client start sending trace records to the CT external writer, enter the following command at the operator console:

```
TRACE CT,ON,COMP=MVSNFSC
```

In response to operator message *nn ITT006A SPECIFY OPERAND(S) FOR TRACE CT COMMAND reply with:

```
R nn,WTR=CTWTR,OPTIONS=(value(,value)),END
```

NFS will now start sending its trace records to the CT external writer, which in turn will start writing them to IBMUSER.CT1. A description of NFS trace option values (FFDC, Entry, Exit, etc.) is listed under “Starting component tracing for the z/OS NFS server” on page 231.

Using IPCS to view records from an external writer

Before you can use IPCS to look at trace records captured by a CT external writer, the remaining trace buffers must be queued to the external writer and the writer must be stopped in order to place an end-of-file record at the end of the data set.

For the z/OS NFS server, to stop NFS tracing issue the command:

```
TRACE CT,OFF,COMP=MVSNFS
```

For the z/OS NFS client, to stop NFS tracing and flush the remaining buffer to the external writer, issue the command:

```
TRACE CT,OFF,COMP=MVSNFSC
```

You can stop the writer when control is received back from the flush command. Issue the following command to stop the writer and make the data set available to IPCS:

```
TRACE CT,WTRSTOP=CTWTR
```

You can now use the IPCS CTRACE command CTRACE COMP(MVSNFSC) FULL to look at the trace records, where the default data set has been set to IBMUSER.CT1.

When writing NFS trace records from more than one NFS server or client into separate component trace data sets, allocate each data set on a separate volume for improved performance. Use the IPCS COPYTRC command to merge records from multiple component trace data sets into one data set. Each component trace data set may represent one NFS server or one NFS client in the NFS multi-server or z/OS sysplex implementations. See *z/OS MVS IPCS Commands* for additional information.

Filtering NFS ctrace records in IPCS

The z/OS NFS Ctrace function allows you to restrict the trace records to be processed by IPCS and displayed on the trace screen. Use the CTRACE DISPLAY PARAMETERS panel, shown in Figure 39 on page 327, to do so.

Use the Component field to specify whether you want trace records for the NFS server or NFS client. Specify the name of the server or client as it appears in your start procedure. The example shown in Figure 39 uses MVSNFSC as the name of the NFS client.

Use the Options field to specify any of the following:

- Nothing, in which case all records will be processed and displayed.
- A specific list of record types to be processed and displayed. In this case, you can use shorthand record specifications (for example, CALL, TASK_FLOW), as well as the full-length record type names. All other record types will be filtered out and not displayed. Any invalid option values are ignored. If no valid options are specified, no trace records are displayed. Figure 39 shows an example of selecting only the BUFFER and USS (that is, USS_REQUEST and USS_RETURN) record types.
- The value "PANEL" to display a filtering criteria panel, which provides another method of specifying options. If the Component field specifies the name of the NFS server, then the NFS Server Filtering Criteria panel (shown in Figure 40 on page 328) is displayed. If the Component field specifies the name of the NFS client, then the NFS Client Filtering Criteria panel (shown in Figure 41 on page 328) is displayed.

```

----- CTRACE DISPLAY PARAMETERS -----
COMMAND ==>

System      ==>          (System name or blank)
Component   ==> MVSNFSC (Component name (required))
Subnames    ==>

GMT/LOCAL   ==> G          (G or L, GMT is default)
Start time  ==>          (mm/dd/yy, hh:mm:ss.dddddd or
Stop time   ==>          mm/dd/yy, hh.mm.ss.dddddd)
Limit       ==> 0          Exception ==>
Report type ==> FULL      (SHort, SUmmary, Full, Tally)
User exit   ==>          (Exit program name)
Override source ==>
Options     ==> USS,BUFFER

To enter/verify required values, type any character
Entry IDs ==>  Jobnames ==>  ASIDs ==>  OPTIONS ==>  SUBS ==>

CTRACE COMP(MVSNFSC) FULL OPTIONS((REQ,BUF))

ENTER = update CTRACE definition.  END/PF3 = return to previous panel.
S = start CTRACE.  R = reset all fields.

```

Figure 39. CTRACE Display Parameters panel

If you specify the NFS server name in the Components field and PANEL in the Options field, then the NFS Server Filtering Criteria panel is displayed:

```

----- NFS Server Filtering Criteria -----
COMMAND ==>
----- options -----
- FFDC          | SCHEDULE      | - INFO         | USS_REQUEST   | - LOCK_REQUEST
- ENTRY         | - DISPATCH    | - WARNING      | USS_RETURN    | - LOCK_RESUME
- EXIT          | - CB_MGMT     | - ERROR        | DFP_REQUEST   | - LOCK_RELEASE
- SUSPEND       | - NETWORK     | - DETAIL       | DFP_RETURN    |
- RESUME        | - GENERAL     | - TRAP         | BUFFER        |
----- super options -----
- CALL (ENTRY+EXIT) | - DEBUG1 (FFDC+ENTRY+EXIT)
- TASK_FLOW (SUSPEND+RESUME+SCHEDULE+DISPATCH) | - DEBUG2 (DEBUG1+NETWORK)
- LOCK (LOCK_REQUEST+LOCK_RESUME+LOCK_RELEASE) | - DEBUG4 (DEBUG2+TASK_FLOW+
- USS (USS_REQUEST+USS_RETURN) | GENERAL)
- MVS (DFP_REQUEST+DFP_RETURN)
----- secondary filtering criteria -----
MODNAME => _____ TASKNAME => _____ FUNCNAME => _____
PREQBLK => _____ REQID => _____ OPERATION => _____
-----
Batch processing => _ (Y/N)
-----
ENTER = update Filtering Criteria definition.
END/PF3 = return to previous panel. S = start. R = reset all fields.

```

Figure 40. NFS Server Filtering Criteria

If you specify the NFS client name in the Components field and PANEL in the Options field, then the NFS Client Filtering Criteria panel is displayed:

```

----- NFS Client Filtering Criteria ---- ENTER NEW VALUES
COMMAND ==>
-----
O P T I O N S | S U P E R O P T I O N S
-----
- FFDC          | - NFS_REQUEST | - CB_MGMT     | - CALL (ENTRY, EXIT)
- ENTRY         | - NFS_RETURN  | - BUFFER      | - TASK_FLOW (SUSPEND, RESUME,
- EXIT          | - USS_REQUEST | - NETWORK     | SCHEDULE, DISPATCH)
- SUSPEND       | - USS_RETURN  | - GENERAL     | - USS (USS_REQUEST, USS_RETURN)
- RESUME        | - LOCK_REQUEST | - DETAIL      | - NFS (NFS_REQUEST, NFS_RETURN)
- SCHEDULE      | - LOCK_RESUME | - TRAP        | - LOCK (LOCK_REQUEST,
- DISPATCH      | - LOCK_RELEASE | - MSG         | LOCK_RESUME, LOCK_RELEASE)
-----
MODNAME => _____ PID => _____ FUNCNAME => _____
PREQBLK => _____ REQID => _____ VNOP => _____
RNODE => _____ DIRRNODE => _____ MNTINFO => _____
-----
Buffer Filtering Criteria
BNPTR => _____ BNFLAG => _____ BNUM => _____
-----
Batch processing => N (Y/N)
-----
ENTER = update Filtering Criteria definition.
END/PF3 = return to previous panel. S = start. R = reset all fields.

```

Figure 41. NFS Client Filtering Criteria

Any combination of record types can be selected on the Options and Superoptions sections of the Filtering Criteria menus by putting an X or other character before the desired option. Within those record types, further selection filtering can be done based on the following criteria (on either Filtering Criteria panel):

FUNCNAME

1 to 16 character name of a specific z/OS NFS server or client function for which trace records are to be displayed. This will limit the display to only trace records issued from within the selected function.

Note: Because function names are mixed case, but this parameter can not be specified in mixed case in all instances, the filter function will match the names regardless of case. For example, FUNC1 will match func1, Func1, FUNC1, and so on.

If the specified name ends in an asterisk, all function names starting with the specified string will be considered a match and will be selected. For example, FUN* will match FUNC1, function2, Funny, and so on. If the asterisk is the only character specified for FUNCNAME, all function names will be considered a match. The asterisk can be specified only on the right end of the string or as the only character in the string. No other wildcard variations are supported.

MODNAME

1 to 8 character name of the z/OS NFS server or client module for which trace records are to be displayed. This will limit the display to only trace records issued from within the selected load module.

PREQBLK

1 to 8 hexadecimal digit number representing the address of a specific request block for which trace records are to be displayed. Note that request blocks are reused.

REQID

1 to 8 hexadecimal digit number representing a specific request for which trace records are to be displayed.

The following fields apply only to the NFS Server Filtering Criteria panel (Figure 40 on page 328):

OPERATION

Four-byte, 8-character, hexadecimal representation of the NFS V2 or V3 request, or V4 operation, for which trace records are to be displayed. For example, 0xFFFFFFFF60.

TASKNAME

1 to 8 character name of the z/OS NFS server task for which trace records are to be displayed. This will limit the display to only trace records issued from within the selected task.

The following fields apply only to the NFS Client Filtering Criteria panel (Figure 41 on page 328):

DIRRNODE

1 to 8 hexadecimal digit number representing the address of a specific parent directory rnode associated with the trace records to be displayed.

MNTINFO

1 to 8 hexadecimal digit number representing the address of a specific mount info block associated with the trace records to be displayed.

PID

1 to 8 hexadecimal digit number representing the process id of the z/OS NFS client process for which trace records are to be displayed.

RNODE

1 to 8 hexadecimal digit number representing the address of a specific rnode associated with the trace records to be displayed.

VNOP

1 to 8 character name of the vnode/vfs operation (for example, vn_rdwr) for which trace records are to be displayed. Only a single vnode/vfs operation name can be specified.

Buffer record types

For BUFFER record types on the client filtering panel, several additional selection criteria are available. These criteria are ignored if no buffer records are selected.

BNNUM

1 to 16 hexadecimal digit number representing a specific buffer associated with the BUFFER trace records that are to be displayed.

BNFLAG

3 bit flag field associated with the BUFFER trace records that are to be displayed. This value is treated as a mask for identifying buffers whose selected bits are on.

BNPTR

1 to 8 hexadecimal digit number representing the address of a specific 8K buffer associated with the BUFFER trace records that are to be displayed.

Note:

1. If multiple criteria are specified, records matching any of the record type options and all of the other specified criteria are considered to be a match and are selected.
2. Any of these secondary options can be specified on the IPCS Ctrace Display Parameters panel OPTIONS list if one of the Filtering Criteria panels is not being used.

Processing Traces in Batch Mode: You can process traces in batch mode by running IPCS under the TSO/E terminal monitor program (TMP) in a batch job. Since it can take a long time to process all of the trace records in a large trace file, use of batch mode for filtering the records and producing a readable output file can be helpful by not tying up the debugger's TSO session the entire time. This section discusses only the batch mode features specifically applicable to NFS traces. For general information on the use of batch mode, see *z/OS MVS IPCS User's Guide*.

The trace analysis can be submitted from the NFS Filtering Criteria panel by specifying "Y" in the "Batch Processing" field on the menu.

When batch processing is selected from the NFS Filtering Criteria panel, that panel will be followed by an IPCS Batch Job Parameters panel, with contents similar to this example:

```

GFSNBTP1----- IPCS Batch Job Parameters -----
COMMAND ==>

Job statement information

//IBMUSER# JOB ,NOTIFY=&SYSUID,
//  MSGCLASS=H,MSGLEVEL=(1,1),REGION=2M,CLASS=A
//*
//*
IPCSDDIR => SYS1.IPCS.DIR
DUMPDSN  => 'VNDRCVQ.CT.NFSC'
COMP     => MVSNFSC
STEPLIB
//STEPLIB DD DSN=SYS1.LINKLIB,DISP=SHR
//*
IPCSPRNT
//IPCSPRNT DD SYSOUT=*
//*
Start time ==> 02/23/07,12:00:00.000000 (mm/dd/yy, hh:mm:ss.dddddd or
Stop time  ==> 02/24/07,12:00:00.000000 mm/dd/yy, hh.mm.ss.dddddd)

Edit generated JOB ? ==> N (Y/N)

After update press ENTER or END/PF3.

```

The information from this panel is used together with a skeleton file for building the JCL to be submitted for the batch job. If desired, you can edit the JCL before it is submitted. This is done by specifying "Y" on the "Edit generated JOB ?" line. The default for this option is N. Once the JCL has been edited, you can submit the job by issuing the SUBMIT command on the editor command line.

Setting up a dump data set for abnormal ends

Normally, the Network File System ESTAE issues a SVC dump when failure occurs. However, if ESTAE is not able to do this, z/OS takes over and issues the appropriate dump you coded in your DD statement. This is an example of setting up a DUMP data set:

```
//SYSDUMP DD DISP=SHR,DSN=MVSDFS.SYSDUMP
```

File attributes of this DUMP data set should be set up like this:

Organization	PS
Record Format	FB
Record Length	4160
Block Size	4160

Searching the IBM database for APARs and PTFs

If your installation has access to the interactive online database program, IBMLink/ServiceLink, you can use IBMLink/ServiceLink to perform these tasks:

1. Search and browse for an existing APAR that is similar to your problem. Use the full set of keywords that is developed from the diagnostic procedures. Use only the keywords that are described in this book. Make sure that keywords are spelled exactly as they are described in this book.
2. If an APAR exists, search to see if a program temporary fix (PTF) is available.
3. If a PTF is available, order the PTF.
4. If an APAR does not exist, you can create an Electronic Technical Response (ETR) problem report to receive assistance from a z/OS NFS service representative. See "Contacting the IBM Support Center" on page 332 for the type of information you will need.

Contacting the IBM Support Center

If your installation does not have access to IBMLink/ServiceLink, z/OS NFS also provides telephone support. Within the U.S.A. and Puerto Rico, call the following number and request assistance for the z/OS NFS feature by specifying the program number 5695DF121 and release level keyword.

IBM Support Center
1-800-237-5511
Monday through Friday, 8 a.m.-5 p.m. (excluding national holidays)

Outside of the U.S.A. and Puerto Rico, contact your local IBM representative.

When contacting IBM, be prepared to supply the following information:

- Your customer number
- Release level
- Current[®] service level (from the APAR list)
- Keyword set or sets used to search in IBMLink/Service

You will be asked to describe the Network File System server and client machine environment. The IBM support representative might request the following relevant information.

- A minimum set of input commands on the client machine or z/OS operator console that reproduces the error.
- A copy of the minimum output from the client machine or z/OS operator console necessary to illustrate the failure.
- A copy of the z/OS NFS server log data set, the z/OS NFS client log data set, or both log data sets created by the input commands provided to recreate the error.
- Storage dump (if for an abnormal end).
- Linkedit map (if for abnormal end).
- Other supporting material, such as trace file printout from a network analyzer.
- For DOC *z/OS Network File System Guide and Reference* failures, include the revision number and page(s) containing the error, and a description of the problem it caused.
- A copy of the attributes data set.
- A copy of the exports data set.
- A copy of the Network File System startup procedure.

Submitting Documentation on Tape: If the IBM service representative requests you submit documentation on tape, please write it to a standard label tape and include a hard copy of the DCB information for each data set along with the JCL used to create the tape.

Diagnostic aids

A description of first failure data capture, including SVC dump characteristics, dump contents, and errors and messages, is provided with the NFS as a major diagnostic aid.

First failure data capture

Network File System RAS characteristics are improved by the capture of diagnostic service data. Error records are written to SYS1.LOGREC and dumps are requested to SYS1.DUMPnn (these are in addition to the existing server trace).

Component-specific information is provided in the SYS1.LOGREC entry and in the dump for the generation of RETAIN search symptom strings.

Symptom data

Table 57 lists the component-specific symptom data placed in the System Diagnostic Work Area (SDWA).

Table 57. NFS symptom data

SDWA Field	Meaning	RETAIN Key
SDWAMODN	Active load module name	RIDS/
SDWACSCT	Active CSECT name	RIDS/
SDWAMDAT	Active CSECT assembly date	VALU/C
SDWAMVRS	Active CSECT service level	VALU/C
SDWAREXN	Recovery routine module name	RIDS/
SDWARRL	Recovery routine label name	FLDS/
SDWACID	Component identifier	PIDS/
SDWACIDB	Base component identifier	PIDS/
SDWASC	Active server function name	RIDS/

SVC dump

The Network File System SVC dumps have these characteristics:

Dump title: The dump title contains the component name, component identifier, release level, abend code, reason code, and the name of the ESTAE module requesting the dump. If available, the name of the failing module and the offset within the module are included.

Dump content: Table 58 shows the dump options and areas of storage that are included in the dump request:

Table 58. Dump content and storage areas

Dump Options	Storage Areas
SUMDUMP	Suspend summary dump
RGN	Server private area storage; programs and subpools
TRT	z/OS trace table
GRSQ	GRS ENQ control blocks
IO	I/O data areas
ALLPSA	All Prefixed Storage Areas
DFA	Data Facility Area
DFVT	Data Facility Vector Table
NFSSVT	Network File System Vector Table

Eye-catchers: Each CSECT within each server load module is identified by the CSECT name, the compile date, and the FMID or APAR level. Each function within a CSECT is identified by its variable length name.

Dump suppression

z/OS Dump Analysis and Elimination (DAE) is supported by providing sufficient information for DAE to uniquely identify the dump and by setting the VRADAE key in the Variable Recording Area (VRA) of the SDWA.

Data capture suppression

SYS1.LOGREC entries and SVC dumps are not requested for these abend codes:

X'0F3'
X'806'
X'A03'
X'x13'
X'x22' (except X'122')
X'x37'
X'x3E'

Invocation

A server ESTAE instance is entered whenever any server task ends abnormally. It is the ESTAE's responsibility to ensure that adequate and correct diagnostics are captured.

Errors and messages

Table 59 illustrates the diagnostic errors and messages GFSA470I and GFSA471I.

Message GFSA470I is written if the SVC dump request fails. The message contains the error reason code from the SDUMP service.

Secondary ESTAE routines detect failures during the execution of the primary server ESTAE. If ESTAE processing is unable to complete, message GFSA471I is issued, and the server task is allowed to stop. The message contains the last abend code detected by the secondary ESTAE routines.

Table 59. Diagnostic errors and messages

Message	Explanation
GFSA470I	NETWORK FILE SYSTEM SVC DUMP REQUEST FAILED. REASON = hh
GFSA471I	NETWORK FILE SYSTEM ESTAE EXIT UNABLE TO COMPLETE PROCESSING. ABEND = X'xxx'

Debug trace data capture

The z/OS Network File System uses trace facilities to record debug trace diagnostic information when a problem requires additional diagnostic information beyond diagnostic messages. Assuming that debug trace diagnostics were not activated at the time of the original failure, the problem must be recreated a second time and the NFS debug trace facilities turned on to capture the diagnostic information. The server provides debug trace diagnostic information from two separate trace facilities. The z/OS Network File System client provides debug trace diagnostic information from one trace facility.

The z/OS NFS server records z/OS NFS debug trace diagnostic information to the z/OS component trace buffer or to the server log data sets. z/OS NFS error and informational messages are also recorded to the z/OS component trace buffer or to the server log data sets. Only ERROR, WARN and INFO go into the log data set, depending on the server startup job setting. This setting may be ERROR, WARN (which includes ERROR), or INFO (which includes all three and is the default). All others are NOT written to the log, but all may be written in the component trace buffer. When recording debug trace diagnostic information, IBM recommends that you set the component trace parameter according to performance tastes; "ALL" will cause the server to run more slowly and the defaults (ERROR + WARN + INFO + FFDC) will run faster. To record z/OS NFS server debug trace diagnostic

information in the z/OS component trace buffer, see “Using z/OS component tracing” on page 316. To record z/OS NFS server debug trace diagnostic information in the log data sets, see “z/OS NFS server debug trace capture” on page 567.

The z/OS NFS client records z/OS NFS debug trace diagnostic information to the z/OS component trace buffer. z/OS NFS client error, informational, and warning messages are also recorded to the client log data sets. To record z/OS NFS client debug trace diagnostic information in the z/OS component trace buffer, see “Using z/OS component tracing” on page 316. To record z/OS NFS client error, informational, and warning messages in the log data sets, see “z/OS NFS client debug trace capture” on page 568.

NFS client hang problem analysis

NFS client hang situations can arise from many different causes. Detailed analysis of the situation is required to determine the source. Some of the possible causes could be:

- Slow server or underlying file system response
- Server failure
- Network failure
- Socket hang
- Concurrent updates to a data set by users and applications via NFS protocol and non-NFS protocol methods
- NFS client - z/OS NFS server loop due to NFS errors.

When a client hang occurs, the general UNIX netstat (or TSO netstat or z/OS shell onetstat) command can be used to determine whether this could be a socket hang problem. If the netstat command is issued on the failing client system and it shows that a very large number of TCP sockets are in CLOSEWAIT state with the destination IP address of the z/OS NFS server, it indicates that sockets are probably hung (z/OS NFS server may not accept new TCPIP connections). In this case, it is very probable that the diagnostic trace data recorded by the z/OS NFS Server is already lost by the time that the hang is recognized at the client. The only thing that can be done to resolve the immediate situation is to restart the z/OS NFS server.

Once the z/OS NFS server is restarted, it is recommended that the **MODIFY sockhang** command is used to help capture the necessary diagnostic data before it is lost the next time that this situation occurs. This command tells the server to monitor the server's sockets for potential hang conditions and to create a dump when a hang is suspected so that the diagnostic trace data can be captured before it is lost. For details on the **MODIFY sockhang** command, see “Entering operands of the modify command for diagnosis” on page 248.

z/OS NFS client users can also experience a hang when trying to update a data set concurrently on an NFS mount point that was mounted with the text processing attribute and the attrcaching(y) parameter while the same data set is also being updated by users and applications via mechanisms outside of the NFS protocol. To avoid this hang situation, the following is recommended:

1. If possible, avoid simultaneous concurrent updates to a data set by users and applications through NFS protocol and non-NFS protocol methods.
2. Otherwise, establish the corresponding NFS mount point with the attrcaching(n) parameter or the binary processing attribute.

When a client hang occurs, try to use NFS Error Client Loop Detection Facility to detect loop. See “NFS Error Client Loop Detection Facility” on page 21 for information on NFS Error Client Loop Detection Facility.

For other possible causes of a client hang, standard problem analysis techniques should be used.

Environmental checklist

This environmental checklist covers useful information that is recommended prior to the initializing the NFS server.

Dispatching Priority

Ensure that z/OS NFS has lower dispatching priority than TCP/IP. Also ensure that TCP/IP has a lower dispatching priority than VTAM®.

TCP/IP

Ensure that the MTU (Packet Size) is set to the lowest MTU when in a heterogeneous network. For example, if the network is comprised of:

Ethernet 802.3 (MTU=1492)
Ethernet Version 2 IEEE (MTU=1500)
token ring (MTU=2000)
FDDI (MTU=4000)
CTC (MTU=65527)
CLAW (MTU=4096)

In this example, the lowest MTU is set to 1492 to reduce packet fragmentation. The MTU setting is defined in the TCP/IP profile.

If there are changes to network addressing and the z/OS NFS server is running in NODHCP mode, the following sequence must be performed to correctly process the changes within the NFS server:

1. Unmount all client mounts
2. Clear the mount handle database (MHDB)
3. Stop the z/OS NFS server
4. Make the necessary changes in the network
5. Restart the z/OS NFS server.

NFS

Verify that NFS is fully initialized.

- RPCBIND or Portmapper is up. The z/OS Portmapper does not support IPv6. Therefore, when using IPv6 addresses, the z/OS server host must be configured with RPCBIND, not the Portmapper. RPCBIND supports both IPv6 and IPv4. As of z/OS V1R8, Portmapper should only be used for IPv4 only systems. Otherwise, RPCBIND should be used.

Note: If a hostname is defined with a primary IPv6 address, and a secondary IPv4 address, the z/OS NFS Client will use the IPv6 address for accessing the host. The z/OS NFS Client will only select the IPv4 address if instructed to do so with the "rpcbind(n)" attribute. Because the z/OS Portmapper does not support IPv6, the z/OS server host must be configured with RPCBIND, not the Portmapper.

- NFS has obtained port 2049 for NFS program such as *rcpinfo -p <hostname>*.

- NFS has z/OS UNIX SEGMENT with UID=1000 defined. The NFS server must also be marked Trusted.

Note: The UID of 1000 is chosen for illustrative purposes only and can be specified as any non-0 valid UID value.

For more information, see “Configuring the z/OS NFS server” on page 181 and “Configuring the z/OS NFS client” on page 176.

Useful Utilities

The following utilities are available on client machines to help diagnose simple network connection problems:

- *rcpinfo -p <hostname>* to determine if RPCBIND or Portmapper (port 111), NFS (port 2049) are initialized with the appropriate port.
- *ping* to confirm that there is a live TCP/IP connection between client/server machines.
- *tracert* *<hostname>* to determine how packets are being routed from client to server.
- *iptrace* (AIX) or *snoop* (Solaris) are useful packet tracing utilities used to debug inbound and outbound packets between client and server. For example, during a mount request, using *iptrace* or *snoop* will show whether the client transmitted the mount request, the server has received the request, or the server is still processing the request.

Chapter 19. Network File System messages

This topic lists messages from the NFS server, the NFS client, and the client operating system.

Table 60 lists the contents of this topic.

Table 60. Messages - client operating system, NFS server, and NFS client

Section	Page
"Server messages"	"Server messages"
"Client messages" on page 407	"Client messages" on page 407
"Client/Server Shared Messages" on page 428	"Client/Server Shared Messages" on page 428
"Messages from the client platform (AIX)" on page 440	"Messages from the client platform (AIX)" on page 440

Server messages

This is a listing of the messages generated by the NFS server. Each message description gives an explanation and recommended actions where applicable. The system substitutes data for any part of a message shown here in *italics*.

Messages appear on the z/OS operator's console in the same format as this example: **GFSA348I z/OS NETWORK FILE SYSTEM SERVER (HDZ222N,OA35630) STARTED.**

Table 61 shows the message format on the NFS server operators console:

Table 61. NFS server z/OS operators console message format

Value	Description
GFSA	The component identifier for the NFS server
348	A unique message number
I	The message type: <ul style="list-style-type: none"> A Action; the user must perform a specific action. E Eventual action; the user must perform an action when time is available. I Informational; no user action is required. W Warning; a user action may need to be performed.
z/OS NETWORK FILE SYSTEM SERVER (HDZ222N,OA35630) STARTED.	The message text

Messages appear in the NFS server log data set in the same format as this example: **19:25:14 GFSA348I (I) GFSAMAIN ANMAI 02 NFS_INIT: z/OS NETWORK FILE SYSTEM SERVER (HDZ222N,OA35630) STARTED.**

Table 62 shows the message format for the NFS server log data set:

Table 62. Message format for the NFS server log data set

Value	Description
19:25:14	The time stamp (<i>hours:minutes:seconds</i>)
GFS3	The component identifier for the NFS server
348	A unique message number
I	The message type: A Action; the user must perform a specific action. E Eventual action; the user must perform an action when time is available. I Informational; no user action is required. W Warning; a user action may need to be performed.
(I)	The message level: E (error), W (attention), or I (informational). The system programmer can use the message level to determine which type of messages are shown by specifying log=error, log=warn, or log=info.
GFS3MAIN ANMAI 02 NFS_INIT:	Programming support information
z/OS NETWORK FILE SYSTEM SERVER (HDZ222N,OA35630) STARTED.	The message text

The messages are listed in numerical order (the time stamp, message level, and programming support information are not shown).

1. A value of *h_digits* is a hexadecimal number, and *d_digits* is a decimal number. A value of *text* or *dsname* is variable text (such as a data set name).
2. Messages GFS300I through GFS319I are intended for IBM support personnel when they are performing diagnosis. They do not indicate a problem with NFS but do provide statistics on NFS processing. As such, an extensive number of GFS300I through GFS319I messages may be issued.
3. For messages written to the console, the name of the start procedure is substituted for *procname*.

GFS300I - GFS319I

Explanation: These messages are intended for IBM support personnel when they are performing diagnosis. They do not indicate a problem with NFS but do provide statistics on NFS processing. As such, an extensive number of GFS300I through GFS319I messages may be issued.

System action: NFS continues processing.

Operator response: None.

System programmer response: Turn debugging off.

**GFS320I (procname) NETWORK FILE SYSTEM
SERVER INITIALIZATION FAILED:
*text***

Explanation: In the message text:

procname

The name of the start procedure.

text The value of *text* can be any of these messages:

- VIRTUAL STORAGE IS UNAVAILABLE
- MAPPING SIDE FILE NOT FOUND
- MAPPING SIDE FILE HAS INVALID SYNTAX OR FORMAT

- ERROR OPENING/READING MAPPING SIDE FILE
- SIDE FILE SPECIFIED BUT MAPPING IS DIS-ALLOWED BY INSTALLATION
- TASK IS NOT APF AUTHORIZED
- DFP LEVEL MUST BE DFSMS 1.2 OR HIGHER
- SERVER ALREADY STARTED

System action: The NFS server startup ends.

Operator response: Notify the system programmer.

System programmer response: The system programmer response follows:

- If it is a virtual storage problem, increase the region size.
- If it is an APF-authorization problem, APF authorize all libraries in the STEPLIB DD statement.
- If the mapping side file is not found, make sure that the name specified in the attribute data set is correct and the file exists.
- If the mapping side file has invalid syntax, check the part GFSAPMAP in SYS1.NFSSAMP library for mapping side file rules. Refer to the server log data sets for message GFSA432I, which identifies the record number containing the syntax error. If GFSA432I is not issued, check that the last two qualifiers of the side file data set name are NFS.MAPPING.
- If an error occurs during the opening of the side file, check to make sure that the side file is not migrated and that it is readable.
- If **sfmax=0**, then the side file cannot be specified in the attribute data set.
- If you are using a down-level release of DFSMSdfp, restart the NFS server after installing DFSMSdfp 1.2 or a later release.
- If the same start procedure is used with the same TCP/IP stack name, use a different name for either the start procedure or the TCP/IP stack name.

GFSA321I (procname) NETWORK FILE SYSTEM SERVER INITIALIZATION FAILED: z/OS UNIX ADDRESS SPACE HAS NOT BEEN STARTED.

Explanation: The Network File System server was not able to establish successful communications with the UNIX address space.

In the message text:

procname

The name of the start procedure.

System action: The NFS server startup ends.

Operator response: Before starting the NFS server, both the UNIX and the TCP/IP address spaces must have been successfully started.

GFSA322I (procname) z/OS UNIX V_REG FAILED: RV=1, RC=h_digit1, RSN=h_digit2.

Explanation: The NFS server failed to register.

In the message text:

procname

The name of the start procedure.

System action: The NFS server ends.

Operator response: Contact the system programmer.

System programmer response: The values of *h_digit1* and *h_digit2* are the return code and reason code from the z/OS UNIX V_REG callable service. See *z/OS UNIX System Services File System Interface Reference* for more information about return code and reason codes.

GFSA323I (procname) z/OS UNIX FID=fid1 for path pathname is different from MHDB FID=fid2; unable to restore mount handle for client clienthostname.

Explanation: The internal FileID *fid1* returned by z/OS UNIX for path name *pathname* is different from the fileID *fid2* indicated in the MHDB record for the same path name. This can be due to a filesystem presented by z/OS UNIX having reordered its inode numbers when moving from one z/OS release level to another, or unmounting a filesystem and mounting a different filesystem to the same z/OS UNIX pathname while the NFS server was not running.

In the message text:

procname

The name of the start procedure.

fid1 The file handle in another z/OS mount handle data base.

pathname

The pathname of the mount object.

fid2 The file handle in the current z/OS mount handle data base.

clienthostname

The client host name, or IP address, that mounted the object.

System action: NFS continues processing.

Operator response: Contact the system programmer.

System programmer response: Any clients mounted to the affected mount points must have those mount points remounted.

GFSA324I (procname) MVS FHDB records from FMID fmid are not tolerated in this release; mount point pathname for client clienthostname must be remounted.

Explanation: The Filehandle Database from FMID *fmid*

GFS326E • GFS331E (procname)

contains mount records for MVS data sets that cannot be used in the current release. FHDB records that cannot be used will be listed to the console with one or more GFS324I messages. If multiple GFS324I messages are issued to the console, message GFS907I may be issued to indicate that additional GFS324I messages are in the NFS log, if the logging level permits.

In the message text:

procname

The name of the start procedure.

fmid The FMID of the server that generated the FHDB records being processed.

pathname

The pathname of the mount object.

clienthostname

The client host name, or IP address, that mounted the object.

System action: NFS continues processing.

Operator response: Contact the system programmer.

System programmer response: Any clients mounted to the affected mount points must have those mount points remounted.

GFS326E NETWORK FILE SYSTEM SERVER INITIALIZATION FAILED: CANNOT BIND *text1* PORT *d_digit* FOR PROGRAM *text2* return code=*h_digit1* reason code=*h_digit2* .

Explanation: The NFS server was not able to bind port *d_digit* of port type *text1* for program name *text2*, and failed with return code *h_digit1* and reason code *h_digit2*. For definitions of the return code and reason code values, see *z/OS UNIX System Services Messages and Codes*.

System action: The NFS server ends.

Operator response: Notify your system programmer.

System programmer response: The possible failing reasons can be:

- The port *d_digit* is not available. Program *text2* is either specified in */etc/services* with a duplicate port *text1*, or is reserved in the range of the NFS server defined in *TCPIP.PROFILE* but port *text1* does not match program *text2* in */etc/services*.
- The port *d_digit* is in use. Issue *'/bin/netstat -P d_digit'* on the *z/OS UNIX* shell to find out the status of port *d_digit*. Correct the situation and retry.

GFS328I (procname) NO SWAP REQUEST FOR NETWORK FILE SYSTEM SERVER FAILED.

Explanation: The *z/OS* NO SWAP request for NFS failed.

In the message text:

procname

The name of the start procedure.

System action: NFS server ends.

Operator response: Contact the system programmer.

System programmer response: Try to restart the NFS server. If the failure appears to be an NFS error, contact the IBM Support Center. Have available a symptom string and a copy of the *z/OS* console log.

GFS329I (procname) SERVER SHUTDOWN IN PROGRESS.

Explanation: Shutdown procedures have started.

In the message text:

procname

The name of the start procedure.

System action: The shutdown of the NFS server continues.

GFS330I (procname) SERVER SHUTDOWN COMPLETE.

Explanation: The NFS server and its associated subtasks ends.

In the message text:

procname

The name of the start procedure.

System action: NFS ends.

GFS331E (procname) RECALL FAILED FOR MIGRATED DATA SET *dsname*.

Explanation: DFSMSHsm was unable to recall a data set, *dsname*, because the data movement program, DFSMSDss, detected during a restore that the migrated data set had internal errors.

In the message text:

procname

The name of the start procedure.

System action: NFS processing continues.

Operator response: Notify the system programmer for recovery actions.

System programmer response: The data set *dsname* had an internal error when it was migrated and cannot be recalled. See the DFSMSHsm message ARC0075E for

appropriate recovery actions.

GFSA332I (procname) ERRlogdata() - invalid length
digit1 from text1 text2.

Explanation: The ERRlog function is called with a data length *digit1* greater than the allowed maximum of 2048 bytes. The call was from function *text2* in module *text1*.

System action: The trace record is skipped and NFS processing continues.

Operator response: Contact the system programmer.

System programmer response: Provide this information to IBM Support.

GFSA333I (procname) z/OS NETWORK FILE
SYSTEM SERVER *fmid* IS NOT
STARTED BY A START COMMAND.

Explanation: The system programmer tried to start the NFS server with a command other than **start**.

In the message text:

procname

The name of the start procedure.

fmid The FMID of the NFS server; for example, null or (HDZ222N).

System action: NFS stops.

System programmer response: Start the NFS server by issuing a **start** command.

GFSA334E (procname) MOUNT HANDLE
DATABASE CANNOT BE READ.

Explanation: The NFS server attempted to read the mount handle database but could not do so. This might occur because the mount handle database could not be opened or because it contained a record with an incorrect length. If migration coexistence APAR OA11612 is installed, pre-HDZ11TS mount handle databases are not supported.

In the message text:

procname

The name of the start procedure.

System action: The NFS Server ends.

Operator response: Contact the system programmer.

System programmer response: If the mount handle database could not be opened, check that the record length of the mount handle database is 1600 for HDZ11TS and 2000 for HDZ11US and later releases. If the record length of the mount handle database is correct, then rebuild the mount handle database. If migration coexistence APAR OA11612 is installed and a pre-HDZ11TS mount handle database is being used, then rebuild the mount handle database.

GFSA335E (procname) MOUNT HANDLE DATA
SET CANNOT BE WRITTEN,
EXPECTING LEN *d_digits1* REAL LEN
d_digits2*, VSAM R15(DEC) *d_digits3
REASON CODE(DEC) *d_digits4* LAST
OP(DEC) *d_digits5*.

Explanation: The NFS server attempted to write a mount record to the mount handle database but could not do so. The length of the mount record is *d_digits1* bytes, but only *d_digits2* bytes were written. The failing information in writing the virtual storage access method (VSAM) key-sequenced data set (KSDS) mount handle database is the decimal return code *d_digits3*, the decimal error code or reason code *d_digits4*, and the code for the last operation *d_digits5*.

In the message text:

procname

The name of the start procedure.

System action: System processing continues but in a degraded mode. Additional mounts or unmounts might fail in writing the record to the mount handle data set.

Operator response: Contact the system programmer.

System programmer response: The mount handle data sets have probably become unusable and need to be either cleared or restored to some previous level, and then the server has to be restarted. The information for the mount point was not saved in the mount handle data set. Clients might have to unmount and mount these mounted directories when the server is restarted.

GFSA336E (procname) MOUNT HANDLE DATA
SET CANNOT BE OPENED, VSAM
R15(DEC) *d_digits1* REASON
CODE(DEC) *d_digits2* LAST OP(DEC)
***d_digits3*.**

Explanation: During a resource timeout, the NFS server tried to open the mount handle data set for writing but could not do so. The failing information in **fopen** for the VSAM KSDS mount handle data set is the decimal return code *d_digits1*, the decimal error code or reason code *d_digits2*, and the code for the last operation *d_digits3*.

In the message text:

procname

The name of the start procedure.

System action: NFS stops.

Operator response: Contact the system programmer.

System programmer response: The mount handle data sets probably were created with incorrect attributes.

GFS337E (*procname*) Network File System Server CTRACE initialization failed because macro *text1* had return code=*digit1*, reason code=*digit2*. Diagnostic information is being recorded in error log data sets only.

Explanation: The Network File System server was not able to obtain services needed for NFS component tracing. This message is received during the Network File System server initialization or resulting from a TRACE CT,ON,COMP=MVSNFS command.

In the message text:

procname

The name of the start procedure.

Text1 Name of system service call which failed.

Digit1 Return code returned from the service.

Digit2 Reason code returned from the service.

System action: The Network File System server continues. Debug trace messages, if any, will be recorded to the error log data sets only.

Operator response: Notify the system programmer.

System programmer response: Return and reason codes for system services such as DSPSERV, ALESERV and CTRACE are documented in *z/OS MVS Programming: Assembler Services Reference ABE-HSP* and *z/OS MVS Programming: Authorized Assembler Services Reference ALE-DYN*. Restart the NFS server to enable NFS component tracing after correcting the error or contact IBM support.

GFS339I (*procname*) Network File System *text1* RESTRICTION FOR DATA SET *text2*; ACCESS BLOCKED TO *text3* DATA SETS.

Explanation: NFS encountered a data set (*text2*) which is a type of data set that is not supported at the NFS release level.

In the message text:

procname

The name of the start procedure.

Text1 NFS release level.

Text2 Name of the unsupported data set.

Text3 Type of data set.

System action: NFS processing terminates.

Operator response: Notify the system operator.

System programmer response: Remove the data set and retry NFS.

GFS340I (*procname*) Mvslogin is replacing userid *text1* with userid *text2* for client UID: *d_digits*, IP: *text3*

Explanation: During MVSLOGIN, the existing MVS userid, *text1*, having RACF authorization has been replaced with the new MVS userid, *text2*, having RACF authorization for the client with UNIX UID *d_digits* on the host system with IP address *text3*.

In the message text:

procname

The name of the start procedure.

Text1 The existing MVS userid.

Text2 The new MVS userid.

d_digits

UNIX user identification (UID).

Text3 IP address of the host system.

System action: NFS processing continues with the new MVS userid authority.

Operator response: None.

System programmer response: None.

GFS344I (*procname*) MOUNT HANDLE DATABASE CANNOT BE READ.

Explanation: The NFS server attempted to read the mount handle database but could not do so. This might occur because the mount handle database contained a record with an incorrect length or incorrect contents.

In the message text:

procname

The name of the start procedure.

System action: System processing continues but in a degraded mode. Some or all the directories have not been remounted.

Operator response: Contact the system programmer.

System programmer response: If the mount handle database contains a record with an incorrect length or incorrect contents, then rebuild the mount handle data sets.

GFS345E VSAM DATA SET IS NOT REUSABLE.

Explanation: At least one VSAM data set (FHDBASE, FHDBASE2, LDBASE, or LDBASE2 DD statements in the z/OS NFS Server job) is not defined with the REUSE option.

System action: NFS server processing stops.

Operator response: Contact the system programmer.

System programmer response: Recreate the appropriate VSAM data sets using IDCAMS with the REUSE option, and restart the NFS server.

GFSA346I *time_stamp.*

Explanation: Displays the current time stamp. This message is issued when the NFSLOG switches.

GFSA347I **ERROR RETURNED TO CLIENT: RC =**
d_digits text.

Explanation: The error code *d_digits* was returned to the client.

In the message text:

text The value of *text* is the meaning of the error code.

System action: NFS processing continues.

GFSA348I (procname) z/OS NETWORK FILE
SYSTEM SERVER (*fmid, apar*) STARTED.

Explanation: The NFS is initialized and ready to accept **modify** commands from the operator console.

In the message text:

procname
The name of the start procedure.

fmid The FMID of the NFS server; for example, null or (HDZ222N).

apar The last APAR installed on the NFS server. If this is the base NFS server for the release and no APARs have been installed for this release yet, then this value is the same as the *fmid*.

System action: NFS continues processing.

GFSA349I **UNEXPECTED ERROR DETECTED:**
d_digits text.

Explanation: The NFS server encountered a condition that indicates continued processing might produce undesirable results.

In the message text:

text The value of *text* is additional debugging information for programming support personnel.

System action: NFS either shuts down or stops the request and continues processing, depending on where the error was detected.

System programmer response: Contact your programming support personnel.

GFSA352E **Lock Data Set *dsname* for the**
DDNAME=*ddname* failed op *opname*
with rc=*rtncode*

Explanation: An attempt to read, write, or modify the lock data set has failed. This messages identifies the data set, the operation, and the failure code.

In the message text:

dsname
The name of the failing LDB data set.

ddname
The ddname of the failing data set.

opname
The name of the operation that failed.

rtncode
The failure code from the operation.

System action: This lock data set will not be used. NFS continues, using the other lock data set. If both lock data sets have failed, lock information will not be recorded and reclaim permissions on the next NFS restart may be inaccurate.

Operator response: Notify the system programmer.

System programmer response: The lock data set has probably been corrupted. Plan to delete the data set and reallocate it.

GFSA360I *text.*

Explanation: This message displays memory management statistics, *text*.

System action: NFS continues processing.

GFSA361I (procname) NETWORK FILE SYSTEM
SERVER SHORT OF STORAGE.

Explanation: This message displays on the operator console when a shortage of virtual storage is detected.

In the message text:

procname
The name of the start procedure.

System action: NFS processing continues. The storage constraint might be relieved when some storage is freed up later on.

Operator response: If this message is displayed repeatedly within a short period of time, stop or cancel the z/OS NFS server and notify the system programmer.

System programmer response: Take one or more of the following actions before restarting the NFS server.

- Increase the region size (REGION) for the step or started task.
- Decrease the value specified for the **bufhigh** attribute of the attributes data set.
- Increase the memory limitation (MEMLIMIT) for the step or started task.
- Decrease the value specified for the **logicalcache** attribute of the attributes data set.

GFS362I (procname) • GFS368I

GFS362I (procname) *text1* SIZE WILL NOT ACCOMMODATE *text2* SPECIFICATIONS.

Explanation: The value of the system parameter *text1* can not accommodate the value of the site attribute *text2*.

In the message text:

procname

The name of the start procedure.

text1 The name of the system parameter (REGION or MEMLIMIT)

text2 The name of the site attribute of the attributes data set (**bufhigh** or **logicalcache**).

System action: z/OS NFS Server ends.

System programmer response: Take one or more of the following actions before restarting the z/OS NFS server.

If the system parameter printed is REGION

- Increase the region size (REGION) for the step or started task.
- Decrease the value specified for the **bufhigh** attribute of the attributes data set.

If the system parameter printed is MEMLIMIT

- Increase the memory limitation (MEMLIMIT) for the step or started task.
- Decrease the value specified for the **logicalcache** attribute of the attributes data set.

GFS363I (procname) NETWORK FILE SYSTEM SERVER IS SHORT OF BUFFERS.

Explanation: NFS has no memory blocks in the buffer area limited by the **bufhigh** attribute for data buffers.

In the message text:

procname

The name of the start procedure.

System action: None

Operator response: Notify the system programmer.

System programmer response: Increase the **bufhigh** value in the NFS attribute profile.

GFS364I (procname) Not enough storage below 16Mb for requested number of Legacy Tasks.

Explanation: The size of available storage is not enough for the requested number of legacy Tasks.

In the message text:

procname

The name of the start procedure.

System action: The NFS server is shut down.

Operator response: Notify the system programmer.

System programmer response: Reduce the number of legacy tasks in the site attribute data set, using the **nfstasks** attribute.

GFS365I Routine *text1*() for *text2* failed return code= *digit1* errno=*digit2* errno2=*digit3*.

Explanation: Function call *text1* failed for data set *text2* with return code *digit1*. The *digit2* and *x_digit3* values specify the errno and errno2 error codes. For explanations of these codes, see *z/OS UNIX System Services Messages and Codes*.

System action: The current NFS request will fail. Otherwise, NFS processing continues.

Operator response: Contact the system programmer.

System programmer response: Keep the existing z/OS NFS Server traces and contact IBM Support.

GFS366I Routine *text1*() for data set *text2* failed, return code= *digit1*.

Explanation: Function call *text1* failed for data set *text2* with return code *digit1*.

System action: The current NFS request will fail. Otherwise, NFS processing continues.

Operator response: Contact the system programmer.

System programmer response: Keep the existing z/OS NFS Server traces and contact IBM Support.

GFS367I No correct label, NFS.MAPPING and NFS.MAPPING.MAPPED

Explanation: The current mapping side file does not contain labels: NFS.MAPPING or NFS.MAPPING.MAPPED. See "File extension mapping" on page 40 in *z/OS Network File System Guide and Reference* for details on the use of these labels in the mapping side file.

System action: The current mount request will fail. Otherwise, NFS processing continues.

Operator response: Contact the system programmer.

System programmer response: Check and correct the current mapping side file.

GFS368I Catalog locate for *text1* failed because file is migrated.

Explanation: The *text1* data set is not available because it is migrated.

System action: The current request will fail. Otherwise, NFS processing continues.

Operator response: Contact the system programmer.

System programmer response: Recall the migrated data set. Then retry the request.

GFSA369I **Catalog locate for *text1* failed because file does not exist in catalog.**

Explanation: The *text1* data set is not available because it is migrated.

System action: The current request will fail. Otherwise, NFS processing continues.

Operator response: Contact the system programmer.

System programmer response: Either create the requested data set, or change the request to specify a different data set.

GFSA370I **Catalog locate for *text1* failed with return code = *digit1*.**

Explanation: The *text1* data set is not available. The Catalog Locate function (SVC 26) failed with return code *digit1*. See the Catalog Services documentation for details on the return code.

System action: The current request will fail. Otherwise, NFS processing continues.

Operator response: Contact the system programmer.

System programmer response: Either correct the data set access problem, or change the request to specify a different data set.

GFSA371I **The *text1* Mapping Side File name is missing an entry for string *text2*.**

Explanation: The mapping side file named *text1* does not have an entry for *text2*.

System action: The current mount request will fail. Otherwise, NFS processing continues.

Operator response: Contact the system programmer.

System programmer response: Check and correct the mapping side file and retry the mount request.

GFSA372I **Invalid *text1* dataset, LRECL = *digit1* and BLKSIZE = *digit2*, expected LRECL = 256 and BLKSIZE = multiple of 256.**

Explanation: The *text1* data set has an invalid format. The Logical Record Length and/or Block Size are not the required values. The LRECL must be 256 and the BLKSIZE must be a multiple of 256.

System action: The current request will fail. Otherwise, NFS processing continues.

Operator response: Contact the system programmer.

System programmer response: Create an data set with the required format and retry the request.

GFSA375I **Operation *text1* failed expected length=*digit1* real length=*digit2* VSAM R15(dec)=*digit3* Reason code(dec)=*digit4* RBA(dec)=*digit5* Last op(dec)=*digit6* errno=*digit7* errno2=*digit8* .**

Explanation: During shutdown, the NFS Server encountered an error trying to perform operation *text1* on the Mount Handle Data Base. The cited VSAM error codes were received.

System action: The failing Mount Handle Data Base record is ignored. NFS Shutdown processing continues.

Operator response: Contact the system programmer.

System programmer response: Analyze the cited VSAM error codes and take the appropriate corrective action. If necessary, contact IBM Support.

GFSA376I **Operation *text1* failed VSAM R15(dec)=*digit1* Reason code(dec)=*digit2* RBA(dec)=*digit3* Last op(dec)=*digit4* .**

Explanation: . During UNMOUNT request processing, the NFS Server encountered an error trying to perform operation *text1* on the Mount Handle Data Base. The cited VSAM error codes were received

System action: The Mount Handle Data Base record is not removed. Otherwise, NFS processing continues.

Operator response: Contact the system programmer.

System programmer response: Analyze the cited VSAM error codes and take the appropriate corrective action. If necessary, contact IBM Support.

GFSA377I **Operation *text1* failed expected length=*digit1* real length=*digit2* VSAM R15(dec)=*digit3* Reason code(dec)=*digit4* RBA(dec)=*digit5* Last op(dec)=*digit6* .**

Explanation: During timeout processing, the NFS Server encountered an error trying to perform operation *text1* on the Mount Handle Data Base. The cited VSAM error codes were received.

System action: The Mount Handle Data Base record is ignored and NFS processing continues.

Operator response: Contact the system programmer.

System programmer response: Analyze the cited VSAM error codes and take the appropriate corrective action. If necessary, contact IBM Support.

GFSA378I **Routine *text1* *text1*failed errno=*digit1* errno2=*digit2* .**

Explanation: System Function call *text1* failed for data set *text2* with errno=*digit1*, errno2=*digit2*.

System action: The current NFS request will fail. Otherwise, NFS processing continues.

GFSA379I • GFSA385I (procname)

Operator response: Contact the system programmer.

System programmer response: Analyze the cited VSAM error codes and take the appropriate corrective action. If necessary, contact IBM Support.

GFSA379I MAPPING SIDE FILE NOT FOUND .

Explanation: The Mapping Side File could not be read. The preceding GFSA368I, GFSA369I, or GFSA370I message should provide more details on the reason for the failure.

System action: The current mount request will fail. Otherwise, NFS processing continues.

Operator response: Contact the system programmer.

System programmer response: Take the specified action for the associated message.

GFSA380I MAPPING SIDE FILE HAS INVALID SYNTAX OR FORMAT .

Explanation: The current Mapping Side file contains a syntax or format error. See preceding messages for more details.

System action: The current mount request will fail. Otherwise, NFS processing continues.

Operator response: Contact the system programmer.

System programmer response: Check the Mapping Side File for any errors and correct them.

GFSA381I ERROR OPENING/READING MAPPING SIDE FILE.

Explanation: An error was encountered attempting to open/read the Mapping Side File.

System action: The current mount request will fail. Otherwise, NFS processing continues.

Operator response: Contact the system programmer.

System programmer response: Check the Mapping Side File for any data set errors and correct them. If necessary, contact IBM Support.

GFSA382I STORAGE LIMIT REACHED LOADING MAPPING SIDE FILE.

Explanation: The NFS server ran out of memory attempting to read the mapping side file.

System action: The current mount request will fail. Otherwise, NFS processing attempts to continue. It may not be possible to continue due to the out-of-memory situation.

Operator response: Contact the system programmer.

System programmer response: Keep the existing z/OS NFS server traces and contact IBM Support.

GFSA383I (mvsnfs) Network File System Server data buffer utilization has reached *yyy*% of *xxxxxx* MB.

Explanation: Buffer utilization has reached the alerting threshold of bufhigh z/OS NFS Server processing attribute. The message prints current data buffer usage in percent of the limit from z/OS NFS Server bufhigh attribute (*yyy* value) and a value of the limit in Mbytes (*xxxxxx* value).

mvsnfs the Network File System Server start up procedure name

yyy the percent of MVS data buffers used in reference to the limit specified by *xxxxxx*.

xxxxxx the maximum MVS internal data buffer pool size (value of attribute bufhigh)

System action: None.

Operator response: None.

System programmer response: Inform the application administrators on the remote NFS client to possibly decrease the incoming workload or change z/OS NFS Server Bufhigh or Percentsteal attributes.

GFSA384I (mvsnfs) Resource shortage for Network File System Server data buffers has been relieved.

Explanation: Data buffer utilization decreased from a high value to the value below the alerting threshold of the Bufhigh z/OS NFS Server processing attribute

mvsnfs the Network File System Server start up procedure name

System action: None.

Operator response: None.

System programmer response: None.

GFSA385I (procname) Current memory utilization is *text*

Explanation: This message is printed in response to the MODIFY BUFFERUSAGE command, or to accompany the GFSA361I message. The message prints current MVS data buffer storage allocation.

text is one of the following:

REGION = *d_digits1* MB, Used= *d_digits2* MB;
BufHigh = *d_digits3* MB, Used= *d_digits4* MB;
MEMLIMIT = *d_digits5* MB, Used= *d_digits6* MB;
LogicalCache = *d_digits7* MB, Used= *d_digits8* MB;

procname

The name of the start procedure.

d_digits1

The total size of usable virtual storage below-the-bar of an address space in MB.

d_digits2
The used virtual storage below-the-bar of an address space in MB.

d_digits3
The below-the-bar virtual storage limit for data buffers on z/OS NFS Server in MB.

d_digits4
The used below-the-bar virtual storage limit for data buffers on z/OS NFS Server in MB.

d_digits5
The total size of usable virtual storage above-the-bar of an address space in MB.

d_digits6
The used virtual storage above-the-bar of an address space in MB.

d_digits7
The above-the-bar virtual storage for allocated logical cache buffers in the logical I/O processing in MB.

d_digits8
The used above-the-bar virtual storage for allocated logical cache buffers in the logical I/O processing in MB.

System action: None.

Operator response: None.

System programmer response: None.

GFSA386E (*mvsnfs*) **Command error: ERROR DESCRIPTION.**

Explanation: There is an error in the command. It can be a command syntax error or an invalid value specified.

ERROR DESCRIPTION can be one of the following:

- "wrong syntax"
- "the first argument is out of range"
- "the second argument is out of range"
- "invalid or omitted value"

mvsnfs the Network File System Server start up procedure name

System action: None.

Operator response: None.

System programmer response: Use correct command syntax and valid values.

GFSA387I (*mvsnfs*) **The current attribute settings for bufhigh are (XX Mb, YY %).**

Explanation: A response to the successful completion of the **MODIFY nfserver, bufhigh** and **MODIFY nfserver, bufhigh=(xx,yy)** commands. This message

displays actual z/OS NFS Server Bufhigh attribute values.

mvsnfs the Network File System Server start up procedure name

XX the current Bufhigh data buffer pool size in megabytes.

YY the Bufhigh alert percentage.

System action: None.

Operator response: None.

System programmer response: None.

GFSA400I **INVALID RECFM SPECIFICATION** (*text*).

Explanation: The value of *text* is the incorrect record format that was specified in the attributes data set.

System action: NFS stops.

System programmer response: Correct the attributes data set.

GFSA401I (procname) CANNOT OPEN THE ATTRIBUTE DATA SET.

Explanation: The server was unable to open the attributes data set defined in the JCL for DDNAME NFSATTR. The DD statement might be missing or the data set name might be incorrect.

In the message text:

procname

The name of the start procedure.

System action: NFS stops.

Operator response: Notify the system programmer.

System programmer response: Correct the JCL for DDNAME NFSATTR.

GFSA402I (procname) READ FAILED FOR THE ATTRIBUTE DATA SET.

Explanation: An error occurred while NFS was processing the attribute data set. This message follows other messages that describe the error in greater detail. The attributes data set is defined in the JCL for DDNAME NFSATTR.

In the message text:

procname

The name of the start procedure.

System action: NFS stops.

Operator response: Notify the system programmer.

System programmer response: Correct the attributes data set.

GFSA403I (procname) • GFSA412I

Note: When the NFS attribute data set is created, the *num off* option in ISPF should also be used. The sequence number is not allowed in the NFS attributes data set.

GFSA403I (procname) PARSE FAILED IN LINE
d_digits text.

Explanation: The parsing of line number *d_digits* in the attribute data set failed.

In the message text:

procname

The name of the start procedure.

text

The value of *text* is the actual line from the attributes data set that contains the failure.

This message follows other messages that describe the error in greater detail.

System action: NFS stops.

System programmer response: Correct the attributes data set.

GFSA404I UNEXPECTED END OF STRING ON
END OF PARSE IN LINE *d_digits.*

Explanation: A comma is missing between attributes on line number *d_digits* of the attributes data set.

System action: NFS stops.

System programmer response: Correct the attributes data set.

GFSA405I PARSE FAILED FOR ATTRIBUTE
FIELD - ILLEGAL KEYWORD IN LINE
d_digits.

Explanation: The keyword specified in line number *d_digits* of the attribute data set is not a valid attribute keyword.

System action: NFS stops.

System programmer response: Correct the attributes data set.

GFSA406I MISSING LEFT PARENTHESIS IN
LINE *d_digits.*

Explanation: An attribute specified on line number *d_digits* of the attributes data set is missing a left parenthesis.

System action: NFS stops.

System programmer response: Correct the attributes data set.

GFSA407I MISSING RIGHT PARENTHESIS IN
LINE *d_digits.*

Explanation: An attribute specified on line number *d_digits* of the attributes data set is missing a right parenthesis.

System action: NFS stops.

System programmer response: Correct the attributes data set.

GFSA408I PARSE FAILED ON NUMBER FIELD
IN LINE *d_digits.*

Explanation: An attribute with a negative number was specified on line number *d_digits* of the attributes data set.

System action: NFS stops.

System programmer response: Correct the attributes data set.

GFSA409I INVALID DSORG SPECIFICATION IN
LINE *d_digits.*

Explanation: The data set organization specified in the **dsorg** attribute on line number *d_digits* of the attributes data set is incorrect or is not supported by NFS.

System action: NFS stops.

System programmer response: Correct the attributes data set.

GFSA411I INVALID VOL SPECIFICATION IN
LINE *d_digits.*

Explanation: The volume specified in the **vol** (volume) attribute on line number *d_digits* of the attributes data set is incorrect.

System action: NFS stops.

System programmer response: Correct the attributes data set.

GFSA412I INVALID UNIT SPECIFICATION IN
LINE *d_digits.*

Explanation: The unit specified in the unit attribute on line number *d_digits* of the attributes data set is incorrect.

System action: NFS stops.

System programmer response: Correct the attributes data set.

GFSA413I THE ATTRIBUTE VALUE *d_digits1* IS NOT IN THE RANGE OF *d_digits2* TO *d_digits3*.

Explanation: The value of *d_digits1*, specified in one of the attributes of the attributes data set, must be between the minimum value, *d_digits2*, and the maximum value, *d_digits3*, for this attribute. Message GFSA403I follows this message.

System action: NFS stops.

System programmer response: See message GFSA403I to determine the attribute in error, and then correct the attributes data set.

GFSA414I THE ATTRIBUTE VALUE *d_digits1* EXCEEDS THE MAXIMUM TIMEOUT VALUE OF *d_digits2*.

Explanation: In the message text:

d_digits1

The value of *d_digits1*, specified in one of the attributes of the attributes data set, must be less than or equal to *d_digits2*.

d_digits2

The value of *d_digits2* is the maximum value allowed for the attribute.

Message GFSA403I follows this message.

System action: NFS stops.

System programmer response: See message GFSA403I to determine the attribute in error, and then correct the attributes data set.

GFSA415I THE ATTRIBUTE TIME OUT VALUE *d_digits1* IS LESS THAN THE MINIMUM TIME OUT VALUE *d_digits2*.

Explanation: The value of *d_digits1*, specified in the **attrtimeout** attribute in the attributes data set, must be greater than or equal to the value *d_digits2*, which is specified in the **mintimeout** attribute of the attributes data set.

System action: NFS stops.

System programmer response: Correct the attributes data set.

GFSA416I THE READ TIME OUT VALUE *d_digits1* IS LESS THAN THE MINIMUM TIME OUT VALUE *d_digits2*.

Explanation: The value of *d_digits1*, specified in the **readtimeout** attribute of the attributes data set, must be greater than or equal to the value *d_digits2*, which was specified in the **mintimeout** attribute of the attributes data set.

System action: NFS stops.

System programmer response: Correct the attributes data set.

GFSA417I THE WRITE TIME OUT VALUE *d_digits1* IS LESS THAN THE MINIMUM TIME OUT VALUE *d_digits2*.

Explanation: The value of *d_digits1*, specified in the **writetimeout** attribute of the attributes data set, must be greater than or equal to the value *d_digits2*, which was specified in the **mintimeout** attribute of the attributes data set.

System action: NFS stops.

System programmer response: Correct the attributes data set.

GFSA418I THE ATTRIBUTE TIME OUT VALUE *d_digits1* IS GREATER THAN THE MAXIMUM TIME OUT VALUE *d_digits2*.

Explanation: The value of *d_digits1*, specified in the **attrtimeout** attribute of the attributes data set, must be less than or equal to the value *d_digits2*, which was specified in the **maxtimeout** attribute of the attributes data set.

System action: NFS stops.

System programmer response: Correct the attributes data set.

GFSA419I THE READ TIME OUT VALUE *d_digits1* IS GREATER THAN THE MAXIMUM TIME OUT VALUE *d_digits2*.

Explanation: The value of *d_digits1*, specified in the **readtimeout** attribute of the attributes data set, must be less than or equal to the value *d_digits2*, which was specified in the **maxtimeout** attribute of the attributes data set.

System action: NFS stops.

System programmer response: Correct the attributes data set.

GFSA420I THE WRITE TIME OUT VALUE *d_digits1* IS GREATER THAN THE MAXIMUM TIME OUT VALUE *d_digits2*.

Explanation: The value of *d_digits1*, specified in the **writetimeout** attribute of the attributes data set, must be less than or equal to the value *d_digits2*, which was specified in the **maxtimeout** attribute of the attributes data set.

System action: NFS stops.

System programmer response: Correct the attributes data set.

GFS421I THE NOATTRTIMEOUT ATTRIBUTE WAS SPECIFIED BUT THE MAXTIMEOUT VALUE WAS SET TO *d_digits*.

Explanation: The **noattrtimeout** attribute means that the data set is not to be deallocated following a **lookup** or **getattr** operation. The **maxtimeout** attribute specifies the maximum timeout value allowed for any of the timeout attributes. The value of *d_digits* was specified as the **maxtimeout** value, in seconds, that the data set is to remain allocated. These attributes are in conflict. The **noattrtimeout** and **maxtimeout** attributes are specified in the attributes data set.

System action: NFS stops.

System programmer response: If you want to use the **noattrtimeout** attribute, specify the **nomaxtimeout** attribute in the attributes data set. Correct the attributes data set.

GFS422I THE NOREADTIMEOUT ATTRIBUTE WAS SPECIFIED BUT THE MAXTIMEOUT VALUE WAS SET TO *d_digits*.

Explanation: The **noreadtimeout** attribute means that the data set is not to be deallocated following a read operation. The **maxtimeout** attribute specifies the maximum timeout value allowed for any of the timeout attributes. The value of *d_digits* was specified as the value of the **maxtimeout** attribute, in seconds, that the data set is to remain allocated. These attributes are in conflict. The **noreadtimeout** and **maxtimeout** attributes are specified in the attributes data set.

System action: NFS stops.

System programmer response: If you want to use the **noreadtimeout** attribute, specify the **nomaxtimeout** attribute in the attributes data set. Correct the attributes data set.

GFS423I THE NOWRITETIMEOUT ATTRIBUTE WAS SPECIFIED BUT THE MAXTIMEOUT VALUE WAS SET TO *d_digits*.

Explanation: The **nowritetimeout** attribute means that the data set is not to be deallocated following a write operation. The **maxtimeout** attribute specifies the maximum timeout value allowed for any of the timeout attributes. The value of *d_digits* was specified as the value of the **maxtimeout** attribute, in seconds, that the data set is to remain allocated. These attributes are in conflict. The **nowritetimeout** and **maxtimeout** attributes are specified in the attributes data set.

System action: NFS stops.

System programmer response: If you want to use the **nowritetimeout** attribute, specify the **nomaxtimeout** attribute in the attributes data set. Correct the attributes data set.

GFS424I MINIMUM TIME OUT VALUE, *d_digits1*, IS GREATER THAN THE MAXIMUM TIME OUT VALUE, *d_digits2*.

Explanation: The value of *d_digits1*, specified in the **mintimeout** attribute of the attributes data set is greater than the value *d_digits2*, specified in the **maxtimeout** attribute of the attributes data set.

System action: NFS stops.

System programmer response: Correct the attributes data set.

GFS425I INVALID SPECIFICATION RECFM(*text*).

Explanation: One of the characters in the value of *text* specified in the **recfm** data set creation attribute of the attributes data set is incorrect.

System action: The NFS stops.

System programmer response: Correct the attributes data set.

GFS426I INVALID RECFM(*text*) - MUST SPECIFY U, F, OR V.

Explanation: One of the characters in the value of *text* specified in the **recfm** data set creation attribute of the attributes data set must define whether the record is fixed length (F), variable length (V), or undefined (U).

System action: NFS stops.

System programmer response: Correct the attributes data set.

GFS429I INVALID DSNTYPE SPECIFICATION IN LINE *d_digits*.

Explanation: The data set type specified in the **dsntype** attribute on line number *d_digits* of the attributes data set is incorrect.

System action: NFS stops.

System programmer response: Correct the attributes data set.

GFS430I INVALID *SMS_keyword* SPECIFICATION IN LINE *d_digits*.

Explanation: The SMS keyword *SMS_keyword* is syntactically incorrect on line number *d_digits*. See system-managed storage documentation for

DATACLAS, MGMTCLAS, and STORCLAS naming conventions.

System action: NFS startup ends if the keyword was specified as a site attribute. If the incorrect SMS keyword was specified by a client as a mount parameter or in a command, the line number is set to zero and an I/O error is returned to the client.

System programmer response: Correct the site attributes file, if applicable.

GFS431I INVALID OPTION SPECIFICATION IN LINE *d_digits*.

Explanation: The option specified in the value on line number *d_digits_* of the attributes data set is incorrect.

System action: The current NFS request fails. Otherwise, NFS processing continues.

Operator response: Contact the system programmer.

System programmer response: Correct the site attributes file, if applicable.

GFS432I Incorrect text in MAPPING SIDE FILE entry *digit1*

Explanation: A syntax error was detected processing record *digit1* in the current mapping side file.

System action: The current mount request will fail. Otherwise, NFS processing continues. If the syntax error was detected during z/OS NFS Server initialization, z/OS NFS Server initialization will fail.

Operator response: Contact the system programmer.

System programmer response: Correct any errors in the record and then reissue the mount request or restart the z/OS NFS Server.

GFS433 Pathname parse error *text1*

Explanation: During startup processing, the NFS server detected an invalid z/OS UNIX File System name (*text1*) in the Mount Handle Data Base. The file system either no longer exists, or was modified locally while the NFS Server was down.

System action: The specified Mount Handle Data Base entry will be skipped and NFS processing continues.

Operator response: Contact the system programmer.

System programmer response: If the file system no longer exists or was modified while the NFS server was down, ignore this message. If no changes were made and there are no other explanations for this error, keep the existing z/OS NFS server traces and contact IBM Support.

GFS434I (procname) NFSTASKS(*value*) is set to the default value, NFSTASKS(*default_values*).

Explanation: In the message text:

procname The name of the start procedure.
value Value specified on NFSTASKS keyword
default_values Current default values for NFSTASKS keyword

Only one value was specified for the NFSTASKS keyword, but a minimum of two values is required. NFS has set NFSTASKS to its current set of default values. See the description of the *nfstasks* site attribute in Table 24 on page 140 for a listing of the current defaults.

System action: NFS processing continues.

GFS435E For *attrname* Site Attribute, Sum of N_SUBTASKS (*n_value*) and *parmname* (*mo_value*) must be less than or equal to *max_value*.

Explanation:

attrname MINTASKS or NFSTASKS
n_value value specified for N_SUBTASKS
parmname M_SUBTASKS or O_SUBTASKS
mo_value value specified for M_SUBTASKS or O_SUBTASKS
max_value Maximum allowed sum

The sum of the value specified for N_SUBTASKS *n_value* plus the value specified for M_SUBTASKS or O_SUBTASKS *mo_value* is greater than the allowed amount *max_value*. See the descriptions of the *mintasks* or *nfstasks* site attributes and their *n*, *m*, and *o* values in Table 24 on page 140 for more information.

System action: NFS processing stops.

System programmer response: Correct the values.

GFS436I INVALID SIDEFILE SPECIFICATION IN LINE *linenum*

Explanation: A data set name was not specified in the *sidefile* attribute.

System action: NFS server startup ends.

System programmer response: Correct the problem and make the necessary changes in the attributes data set.

GFS4371 INVALID PUBLIC SPECIFICATION IN LINE *d_digits*

Explanation: Parsing of the **public** keyword resulted in an error for one of the following reasons:

- **public** keyword specification is syntactically incorrect
- No public path names have been specified
- The path name specified is not valid
- The HFS public path name does not match the HFS prefix

System action: NFS server startup ends.

Operator response: Correct the problem and make the necessary changes in the attributes data set.

GFS438I EXPORT SPANNING PATHNAMES NOT SUPPORTED

Explanation: The export-spanning path names support for a multicomponent **lookup** request is not supported.

System action: The request fails. NFS processing continues.

User response: Construct a different path name in which the path is not spanned.

GFS439I z/OS UNIX PUBLIC PATHNAME SPECIFIED BUT z/OS UNIX IS NOT ENABLED

Explanation: A z/OS UNIX public path name was specified for the **public** keyword but **nohfs** was also specified, which disables z/OS UNIX processing.

System action: NFS server startup ends.

Operator response: Correct the problem and make the necessary changes in the installation table.

GFS440I INVALID SECURITY SPECIFICATION IN *d_digits*

Explanation: Parsing of the **security** keyword resulted in an error for one of the following reasons.

- Missing first parameter
- First parameter not valid

System action: NFS server startup ends.

Operator response: Correct the problem and make the necessary changes in the attributes data set.

GFS441E (*procname*) Invalid leasetime value. It must be smaller than logout value.

Explanation: The specified Network File System lock lease time value is larger than the logout timeout value. The leasetime value must be smaller than the logout timeout value.

System action: The Network File System server

initialization fails and the server terminates.

Operator response: None.

System programmer response: Check and correct the relationship between the leasetime and logout values specified in the Site Attribute File.

GFS442I SIDE FILE SPECIFIED BUT MAPPING IS DIS-ALLOWED BY INSTALLATION.

Explanation: A Mapping Side File was specified on a Mount command but mapping is disallowed by the NFS server site attribute settings.

System action: The current mount request will fail. Otherwise, NFS processing continues.

Operator response: Contact the system programmer.

System programmer response: Either change the NFS site attribute settings or remove the Mapping Side File specification from the Mount request.

GFS443I Missing parameter in MODULE INFO entry.

Explanation: During startup processing, the NFS server detected incorrect internal module statistics.

System action: NFS processing continues.

Operator response: Contact the system programmer.

System programmer response: Keep the existing z/OS NFS server traces and contact IBM Support.

GFS444E Invalid IMPPREFIX specification in line *d_digit*.

Explanation: The IMPPREFIX site attribute specified on line *d_digit* in the site attribute file contains an invalid value.

System action: The Network File System server initialization fails and the server terminates.

Operator response: Contact the system programmer.

System programmer response: Check and correct the IMPPREFIX value specified in the Site Attribute File and then restart the NFS server.

GFS445E Site Attribute IMPPREFIX(NONE) is set. Required path prefix is missing in the path name: *text*.

Explanation: The IMPPREFIX site attribute indicates that all path names must be specified with an explicit hfs or mvs prefix, but this path name was specified without a prefix. The path type (z/OS UNIX or MVS) cannot be determined. In the message text:

- *text* - The path name string that is in error.

System action: The request fails. NFS processing continues.

Operator response: Contact the system programmer.

System programmer response: Change the IMPPREFIX value specified in the Site Attribute file, or add an explicit prefix to the path name.

GFSA446E Invalid path name: *text*.

Explanation: The specified path name is not valid. Possible causes for this error include the following:

- The name does not start with a prefix and the path name contains invalid characters for the path type determined from the implicit path type heuristic specified in the IMPPREFIX site attribute.
- The name was determined to be an MVS data set name, either due to the presence of an MVS prefix or based on the implicit path type heuristic specified in the IMPPREFIX site attribute, but the name is too long for a valid MVS data set name.

In the message text:

- *text* - The path name string that is in error.

System action: The request fails. NFS processing continues.

Operator response: Contact the system programmer.

System programmer response: Either correct the name, change the IMPPREFIX value specified in the Site Attribute file, or add an explicit prefix to the path name.

GFSA450I CREATED TASK(*h_digits*) - *text1* - *text2*.

Explanation: The NFS is creating the number of tasks requested in the **nfstasks** attribute of the attributes data set. This message displays for each task created.

In the message text:

h_digits

The value of *h_digits* is the TCB address.

text1 The value of *text1* is the task name.

text2 The value of *text2* is the module name.

System action: NFS processing continues.

GFSA451I DELETING TASK(*h_digits*) - *text*.

Explanation: The NFS is deleting a task. This is in response to the **stop** operand of the **modify** command. This message is displayed for each task deleted.

In the message text:

h_digits

The value of *h_digits* is the TCB address.

text The value of *text* is the module name.

System action: NFS shutdown continues.

GFSA452I SUBTASK TERMINATED: *h_digits*.

Explanation: NFS is stopping a task. This is in response to the **stop** operand of the **modify** command. This message is displayed for each ended task.

In the message text:

h_digits

The value of *h_digits* is the task control block (TCB) address.

System action: NFS shutdown continues.

GFSA453E (procname) NETWORK FILE SYSTEM SERVER LOST TASK *tasktype*. NOW AVAILABLE: *nn1* LEGACY TASKS, *mm1* HFS TASKS, *oo1* LONG SERVICE TASKS. LEGACY TASKS SHUTDOWN LIMIT IS < *nn2*. HFS TASKS SHUTDOWN LIMIT IS < *mm2*. LONG SERVICE TASKS SHUTDOWN LIMIT IS < *oo2*.

Explanation: This message means that one *tasktype* task was detached due to an ABEND 878. If the count of the available tasks of one type is less than the shutdown limit for the task, the NFS server restarts the suspended tasks.

In the message text:

procname

The name of the start procedure.

tasktype

This value indicates the type of tasks: "legacy", "HFS", or "Long service" tasks.

nn1

This value indicates the number of available legacy tasks (for z/OS conventional MVS data sets).

mm1

This value indicates the number of HFS tasks.

oo1

This value indicates the number of long service tasks.

nn2

This value indicates the limit of legacy tasks (for z/OS conventional MVS data sets).

mm2

This value indicates the limit of HFS tasks.

oo2

This value indicates the limit of long service tasks.

System action: The task ends. The NFS server restarts the suspended tasks.

User response: None

GFSA454I (procname) *taskname* TASK HAS BEEN RECOVERED AFTER 878 ABEND. ALL TASKS WILL BE STARTED NOW

Explanation: The NFS task had an ABEND 878 (80A)

GFSA455E • GFSA462E (procname)

and then was recovered. The NFS server is ready to restart task processing.

In the message text:

procname

The name of the start procedure.

taskname

Specifies the name of the NFS task that had the ABEND 878 (80A).

System action: NFS server restarts task processing.

User response: None

GFSA455E (procname)Connection failed from TCPIP, shutting down. Errno(digit1) errno2(digit2).

Explanation: The Network File System was unable to connect to TCPIP The attempted connection returned error code *digit1* and reason code *digit2*.

System action: The Network File System server initialization fails and the server terminates.

Operator response: None.

System programmer response: Check the return and reason codes. If these indicate a system configuration error, correct it. Otherwise, submit this error to IBM Support.

GFSA456E (procname) Socket creation failed, errno(digit1) errno2(digit2).

Explanation: The Network File System was unable to create a communication socket. The attempted connection returned error code *digit1* and reason code *digit2*.

System action: The Network File System server initialization fails and the server terminates.

Operator response: None.

System programmer response: Check the return and reason codes. If these indicate a system configuration error, correct it. Otherwise, submit this error to IBM Support.

GFSA459E (procname) ioctl: cannot set socket to blocking/non-blocking mode, errno(digit1) errno2(digit2).

Explanation: The Network File System was unable to set the required socket blocking mode. The z/OS UNIX ioctl function returned error code *digit1* and reason code *digit2*. See z/OS XL C/C++ Runtime Library Reference for details on the ioctl function.

System action: The request require this mode fails.

Operator response: None.

System programmer response: Check the return and

reason codes. If these indicate a system configuration error, correct it. Otherwise, submit this error to IBM Support.

GFSA460E (procname) send/sendto request failed, errno(digit1) errno2(digit2).

Explanation: The Network File System server was unable to send a request to unregister functions in the portmapper before registering this new instance of the server. z/OS UNIX returned error code *digit1* and reason code *digit2*.

System action: The Network File System server initialization fails and the server terminates.

Operator response: None.

System programmer response: Check the return and reason codes. If these indicate a system configuration error, correct it. Otherwise, submit this error to IBM Support.

GFSA461E (procname) Min *d_digits* subtask threshold is reached.

Explanation: The number of NFS Server subtasks has reached the minimum value.

In the message text:

procname

The name of the start procedure.

System action: NFS stops.

Operator response: Contact the system programmer.

System programmer response: Check mintasks and nfstasks in the NFS server attribute data set, and reduce this number if possible.

User response: None

GFSA462E (procname) MVS delegation disabled. Return code=0xh_digit1.

Explanation: An error occurred when the NFS Server was registering ENF 51 to Listen For System Events. Return code, *h_digit*, is documented for the ENFREQ in z/OS MVS Authorized Assembler Services Reference. The capability of delegation for MVS data set is disabled.

System action: The Network File System server continues processing

Operator response: Contact the system programmer.

System programmer response: Correct the problem if it is possible; otherwise, keep the existing z/OS NFS server traces and contact IBM Support Center.

User response: None

GFS463E (procname) MVS delegation disabled due to short of storage.

Explanation: There is not enough memory to support NFS version 4 file management delegation. The capability of delegation for MVS data set is disabled.

System action: The Network File System server continues processing

Operator response: None.

System programmer response: None.

User response: None

GFS464I (procname) MVS delegation was disabled.

Explanation: NFS version 4 file management delegation for MVS data sets is disabled by the Modify operator subcommand, V4DELG=OFF.

System action: The Network File System server continues processing

Operator response: None.

System programmer response: None.

User response: None

GFS465I (procname) MVS delegation was enabled.

Explanation: NFS v4 MVS data set delegation has been enabled by the operator subcommand, V4DELG=ON.

System action: The Network File System server continues processing

Operator response: None.

System programmer response: None.

User response: None

**GFS469I (procname) taskname(tcbaddr)
ABEND=abendcode,REASON=reasoncode**

Explanation: A subtask (thread or TCB) of the z/OS NFS server abnormally terminates when the Recovery Termination Manager (RTM) does not allow the ESTAEX exit to retry.

In the message text:

procname

The name of the Network File System Server startup procedure.

taskname

Eight-character name of the z/OS NFS server task that terminated.

tcbaddr

Address of the TCB corresponding to the task that terminated.

abendcode

Abend code indicating the type of abend.

reasoncode

Reason code (if any) associated with this abend.

System action: NFS Server processing terminates.

Operator response: Contact the system programmer.

System programmer response: If the NFS server was not terminated as part of a deliberate operator action, then collect the dumps and the NFS Server Joblog data sets prior to contacting the IBM Support Center. The z/OS NFS Server ESTAEX exit does not internally generate a dump for the system abend code of x22, x37, x3E, 806, A03.

For these Abend codes the SLIP command is required to capture the necessary dump.

User response: None

**GFS470I (procname) NETWORK FILE SYSTEM
SERVER SVC DUMP REQUEST
FAILED. REASON=reason_code.**

Explanation: A request to write a z/OS SVC dump failed.

In the message text:

procname

The name of the start procedure.

reason_code

The value of *reason_code* is a hexadecimal number indicating the reason that z/OS was unable to write the dump. See the description of the **sdump** macro in *z/OS MVS Programming: Authorized Assembler Services Reference LLA-SDU* for the meaning of the reason code.

System action: ABEND processing continues.

Operator response: If the dump could not be written due to an operational procedure and a dump is necessary to diagnose the failure, correct the procedure.

System programmer response: If the failure appears to be due to an NFS error, contact the IBM Support Center. Have available a symptom string and a copy of the z/OS console log.

**GFS471I (procname) NETWORK FILE SYSTEM
SERVER ESTAE EXIT UNABLE TO
COMPLETE PROCESSING.
ABEND=abend_code.**

Explanation: The NFS ESTAE exit routine that ended abnormally and is unable to complete processing.

In the message text:

procname

The name of the start procedure.

GFSA472I (procname) • GFSA477E

abend_code

The *abend_code* value is set to the last abend code encountered by a secondary instance of the ESTAE exit routine.

System action: ESTAE processing is stopped. The NFS address space might end also.

Operator response: Restart the NFS address space. Notify network users of the failure.

System programmer response: Contact the IBM Support Center. Have available a symptom string, the related SYS1.LOGREC entries, any related SDUMPs, and the NFS error trace log.

GFSA472I (procname) 878 ABEND HANDLING FOR TASK *taskname* IN PROCESS. ALL TASKS STOPPED. PLEASE WAIT FOR RECOVERY.

Explanation: The NFS task had an ABEND 878 (80A), and the recovery procedure is in process.

In the message text:

procname

The name of the start procedure.

taskname

Specifies the name of the NFS task that had the ABEND 878 (80A).

System action: The NFS server is in recovery processing and all normal processing is suspended.

User response: None

GFSA473E (procname) No connection yet between z/OS UNIX and TCPIP. Waiting for connection. *errno(rtncode) errno2(rsncode)*.

Explanation: The Network File System was unable to connect to TCP/IP. The attempted connection returned error code *rtncode* and reason code *rsncode*.

In the message text:

procname

The name of the start procedure.

System action: NFS processing waits for TCP/IP connection to be established.

Operator response: Contact the system programmer.

System programmer response: Check the error and reason codes. If these indicate a TCP/IP system configuration error, correct it. Otherwise, submit this error to IBM TCP/IP Support.

User response: None

GFSA474E (procname) No connection yet from z/OS Portmapper. Waiting for connection. *errno(errcode) errno2(rsncode)*.

Explanation: The Network File System was unable to connect to the TCP/IP Portmapper/RPCBIND. The attempted connection returned error code *errcode* and reason code *rsncode*.

System action: NFS processing waits for the TCP/IP Portmapper/RPCBIND connection to be established.

Operator response: Contact the system programmer.

System programmer response: Check the error and reason codes. If these indicate a TCP/IP Portmapper/RPCBIND system configuration error, correct it. Otherwise, submit this error to IBM TCP/IP Support.

Programmer response: None

GFSA475E (procname) cannot connect host(*ipaddr*) *hostname* UNIX & TCPIP. port(*port1 port2*) *errno(errcode) errno2(rsncode)*.

Explanation: The Network File System was unable to connect to client host. *ipaddr* is the client host IP address. *hostname* is the client hostname if hostname exists. The attempted connection from port, *port1*, to client host port, *port2*, returned error code *errcode* and reason code *rsncode*.

System action: The request continues without the ability to callback to the client host. NFS processing continues.

Operator response: Contact the system programmer.

System programmer response: Check the error and reason codes. If these indicate a TCP/IP system configuration error, correct it. Otherwise, submit this error to IBM TCP/IP Support.

Programmer response: None

GFSA477E System Call *callname* failed, return value *h_digit1*, return code *h_digit2*, reason code *h_digit3*.

Explanation: A system call failed during server startup. In the message text:

callname

the name of the system call that failed.

h_digit1

the return value returned by the system call.

h_digit2

the return code returned by the system call.

h_digit3

the reason code returned by the system call.

System action: The Network File System server terminates.

Operator response: If no dump was taken, set STARTFAIL=DUMP in the startup procedure and re-attempt; a dump will be taken if the problem persists.

System programmer response: Contact the system programmer.

GFS478E pthread_create`taskname` failed, return value `h_digit1`, return code `h_digit2`, reason code `h_digit3`.

Explanation: Creation of a server thread failed. In the message text:

taskname

the name of the server task thread that was not created.

h_digit1

the return value returned by pthread_create.

h_digit2

the return code returned by pthread_create.

h_digit3

the reason code returned by pthread_create.

System action: The Network File System server terminates.

Operator response: If no dump was taken, set STARTFAIL=DUMP in the startup procedure and re-attempt; a dump will be taken if the problem persists.

System programmer response: Contact the system programmer.

GFS480I REQUEST FAILED BECAUSE OF ERRORS ENCOUNTERED IN THE CONVERSION SERVICES, RC=`d_digits1`, RSN=`d_digits2`.

Explanation: The request received an error condition from the conversion services while data was being translated.

System action: The request failed. NFS processing continues.

User response: See *z/OS Unicode Services User's Guide and Reference* for information about the error encountered, and correct the problem if possible.

GFS481I REQUEST FAILED BECAUSE TEXT CONVERSION RESULTED IN THE LENGTHS OF INPUT AND OUTPUT STRINGS BEING DIFFERENT.

Explanation: The request failed because the translation of the text string resulted in a different length. Translations that involve length changes (such as SBCS to MBCS) are not currently supported.

System action: The request failed. NFS processing continues.

User response: Make the necessary changes so that text string translations do not result in different lengths.

GFS482I REQUEST FAILED BECAUSE TRANSLATION OF TEXT IS NOT POSSIBLE.

Explanation: An operation is being requested for a file that is tagged with a valid coded character set identifier (CCSID), but the user has not specified a `cln_ccsid` value to be used for translation, and the `xlat()` keyword is also specified.

System action: The request failed. NFS processing continues.

User response: Either specify a `cln_ccsid` value for translation or remove the specification `xlat()` keyword.

GFS483E TAG OPTION IS SPECIFIED BUT CONVERSION SERVICES IS NOT ACTIVE.

Explanation: Conversion Services must be active if TAG is specified in the site attribute data set or mount command.

System action: Network File System Server startup ends if TAG is specified in the site attribute data set, or mount point is ignored during MHDB processing, or mount command is rejected.

Operator response: Notify the system programmer.

System programmer response: Either change from TAG to NOTAG in site attribute data set (or mount command) or activate Conversion Services.

GFS483I WRITE REQUEST FAILED BECAUSE BINARY DATA CANNOT BE WRITTEN TO A FILE WITH PURE TEXT DATA.

Explanation: A write request has the **binary** option specified explicitly, and the file being written to has pure text data.

System action: The request failed. NFS processing continues.

User response: Either remove the **binary** option or change the file tag that is associated with the file to show that the file has mixed data.

GFS484E TECHNIQUE VALUE OF CONVSERV OPTION IS INVALID.

Explanation: The technique specified for CONVSERV(technique) in the attributes data set or mount command is incorrect. It can consist of up to five characters corresponding to the five available

GFSA485I (procname) • GFSA507I

techniques: R, E, C, L and M.

System action: Network File System Server startup ends if CONVSERV(technique) is specified in the attributes data set, or the mount command is rejected.

Operator response: Notify the system programmer.

System programmer response: Update the values for CONVSERV(technique).

GFSA485I (procname) CONVERSION SERVICES ARE NOT ACTIVE DURING NETWORK FILE SYSTEM SERVER STARTUP.

Explanation: During startup, the NFS Server detected that Conversion Services were not available.

In the message text:

procname

The name of the start procedure.

System action: NFS server processing continues without the availability of Conversion Services.

Operator response: Notify the system programmer.

System programmer response: If data conversion is required, Conversion Services must be available to NFS. See *z/OS Unicode Services User's Guide and Reference* for more information.

GFSA486I (procname) CONVERSION SERVICES ARE ACTIVE AND WILL BE USED BY NETWORK FILE SYSTEM SERVER.

Explanation: During RPC MOUNT processing, the NFS Server detected that Conversion Services were available.

In the message text:

procname

The name of the start procedure.

System action: NFS server processing continues.

GFSA487E (procname) During startup, Network File System Server encountered problems with Conversion Services: Service returned RC = *rtncode*, RSN = *rsncode*.

Explanation: During Network File System server startup, it encountered problems with the Conversion Services. The conversion service failed.

In the message text:

procname

The name of the start procedure.

rtncode

The return code from conversion services.

rsncode

The reason code from conversion services.

System action: NFS server processing continues.

System programmer response: The conversion services problem must be resolved before the conversion services can be used by the NFS server.

GFSA501I REQUEST HEADER ALLOCATION FAILED.

Explanation: An operation to allocate virtual memory for a request header was tried but was unsuccessful.

System action: The request is stopped. NFS processing continues.

System programmer response: Increase the size of the step region.

GFSA502I REQUEST HEADER DATA BLOCK ALLOCATION FAILED.

Explanation: An operation to allocate virtual memory for a request header data block was tried but was unsuccessful.

System action: The request is stopped. NFS processing continues.

System programmer response: Increase the size of the step region.

GFSA507I (*procname*) Alias for active mount to *alias* from host *hostname* has been *state*; *action*.

Explanation: An export alias that has been established has been removed, or an export alias that has been removed has been restored.

In the message text:

procname

The name of the start procedure.

alias

The name of the mounted alias.

hostname

The host that has mounted the alias.

state

Removed, or restored.

action

If state is removed, the action that must be taken to restore the alias.

System action: NFS processing continues, in a possibly degraded mode. Any active mounts to that alias will be inaccessible, unless and until it is restored.

Operator response: Correct the exports file, and perform the action specified in *action*.

System programmer response: None.

GFSA508I (*procname*) **Alias: *aliasname* ignored, reason.**

Explanation: An alias in the exports file will not be created, for the reason given. This message will be generated even if the alias site attribute is not specified.

In the message text:

procname

The name of the start procedure.

aliasname

The name of the specified alias in the exports file.

reason The reason that the alias is not created

System action: NFS processing continues.

Operator response: Correct the exports file.

System programmer response: None.

GFSA509I (*procname*) **Noalias attribute is specified. Alias entries will not be created.**

Explanation: An alias in the exports file is present, but either the alias site attribute was not specified, or the noalias site attribute was specified.

In the message text:

procname

The name of the start procedure.

System action: NFS server processing continues.

Operator response: If export aliases are desired, specify the **alias** site attribute.

System programmer response: None.

GFSA510I **EXPORTS: CAN'T READ /etc/netgroup FILE. NETGROUP *name* HAS BEEN IGNORED.**

Explanation: The netgroup name *name* in the exports data set has been ignored because NFS cannot read the local netgroup file. See messages GFSA878I and GFSA879I for more information.

In the message text:

name The netgroup name.

System action: NFS processing continues.

Operator response: Contact the system programmer.

System programmer response: Check for validity of the specified netgroup file. Correct the name contents of the local netgroup file.

Programmer response: None.

GFSA511I **EXPORTS: FILE /etc/netgroup CONTAINS EMPTY NETGROUP (*text*).**

Explanation: The netgroup name *text* in the exports data set has no data in the local netgroup file.

In the message text:

text The netgroup name.

System action: NFS processing continues.

Operator response: Contact the system programmer.

System programmer response: Correct the local netgroup file.

Programmer response: None.

GFSA512I **EXPORTS: CIRCULAR GROUP NAME REFERENCE DETECTED IN /etc/netgroup FILE DURING NETGROUP *text1* PARSING. NETGROUP *text2* HAS BEEN IGNORED.**

Explanation: The netgroup named *text2* in the exports data set has been ignored because NFS detected a circular group name reference when it parsed the nested netgroup named *text1*. NFS checks for cycles which can happen if, for example, a netgroup named @name1 includes a netgroup named @name2 which in turn includes a netgroup named @name1.

In the message text:

text1 The name of the netgroup that is the cause of the cycle.

text2 The starting netgroup name.

System action: NFS processing continues.

Operator response: Contact the system programmer.

System programmer response: Correct the local netgroup file.

Programmer response: None.

GFSA513I **EXPORTS: SYNTAX ERROR IN /etc/netgroup FILE IN NETGROUP (*text1*) . NETGROUP (*text2*) HAS BEEN IGNORED.**

Explanation: The netgroup named *text2* in the exports data set has been ignored because NFS detected a syntax error when parsing the nested netgroup named *text1*. NFS checks syntax for the starting group and all nested subgroups.

In the message text:

text1 The name of the netgroup with incorrect syntax.

text2 The starting netgroup name.

System action: NFS processing continues.

GFSA514I • GFSA518A

Operator response: Contact the system programmer.

System programmer response: Correct the local netgroup file.

Programmer response: None.

GFSA514I EXPORTS: NETGROUP (*text*) PARSING ALREADY FAILED, NETGROUP HAS BEEN IGNORED.

Explanation: The netgroup named *text* in the exports data set has been previously parsed unsuccessfully. See messages GFSA512I and GFSA513I for more information.

In the message text:

text The name of the netgroup.

System action: NFS processing continues.

Operator response: Contact the system programmer.

System programmer response: Correct the local netgroup file.

Programmer response: None.

GFSA515I EXPORTS: NETGROUP (*text*) NOT FOUND IN /etc/netgroup FILE AND HAS BEEN IGNORED.

Explanation: The netgroup named *text* in the exports data set has been ignored because NFS did not find a netgroup with this name in the local netgroup file.

In the message text:

text The name of the netgroup.

System action: NFS processing continues.

Operator response: Contact the system programmer.

System programmer response: Correct the local netgroup file.

Programmer response: None.

GFSA516I EXPORTS: NETWORK FILE SYSTEM SERVER IS IPV4-NODE, IPV6 *text1* (*text2*) HAS BEEN IGNORED.

Explanation: The network template or IP address specified in *text2* has IPv6 format whereas the NFS Server runs as an IPv4 node. The network template or IP address is ignored.

In the message text:

text1 The item that is in IPv6 format: *network template* or *address*.

text2 The value of the network template or IP address.

System action: NFS processing continues.

Operator response: Contact the system programmer.

System programmer response: Correct the exports data set.

Programmer response: None.

GFSA517I EXPORTS: DHCP IS *text1*, *text2* (*text3*) HAS BEEN IGNORED.

Explanation: If the NFS server runs with NODHCP support (DHCP is OFF), it ignores any hostname with wild cards in the exports data set. If the NFS server runs with DHCP support (DHCP is ON) it ignores any network templates or IP addresses in the exports data set.

In the message text:

text1 The DHCP value: *ON* or *OFF*.

text2 The type of item that has been ignored: *network template*, *hostname with wildcards*, or *IP address*.

text3 The value of the network template or hostname template (hostnames with wildcards), or IP address.

System action: NFS processing continues.

Operator response: Contact the system programmer.

System programmer response: Correct the exports data set.

Programmer response: None.

GFSA518A CHECKLIST: WRONG *text1* (*text2*), CHECK LIST HAS NOT BEEN CREATED.

Explanation: NFS detected a syntax error when parsing a directory suffix or full directory name. A full directory name is formed by concatenation of string1, which is before the directory suffix, with string2 which is a subdirectory in the directory suffix. For example: string1 <string2,nosaf>. String2 may be empty, for example: string1 <nosaf>.

In the message text:

text1 The type of item where the syntax error was found:

- *directory suffix*
- *directory name*
- *name* – in this case, the name or its parent directory or subdirectory are already specified in the exports data set.

text2 The value of the directory suffix or full directory name.

System action: The Network File System server initialization fails and the server terminates.

Operator response: Contact the system programmer.

System programmer response: Correct the exports data set.

Programmer response: None.

GFSA519I (*procname*) **Nochecklist attribute is specified. Checklist entries will not be created.**

Explanation: Checklist entries are in the exports data set, but the nochecklist attribute is set in the NFS server site attributes and as a result, checklist entries were not created.

A single message appears only if there is at least one checklist entry in the exports data set.

In the message text:

procname

The name of the start procedure

System action: The Network File System server continues processing.

Operator response: Restart the NFS server with the **checklist** attribute if needed.

System programmer response: None.

Programmer response: None.

GFSA520I **Operation** *text1* **for** *text2* **type** *digit1* **failed** *digit2*.

Explanation: The NFS server detected an error *digit2* on *text1* operation for DDname *text2*, open mode *digit1*.

System action: The current NFS request will fail. Otherwise, NFS processing continues.

Operator response: Contact the system programmer.

System programmer response: Keep the existing z/OS NFS server traces and contact IBM Support.

GFSA521I **Operation** *text1* **for** *text2* **failed** *digit1*.

Explanation: The NFS server detected an error *digit1* on *text1* operation for DDname *text2*.

System action: The current NFS request will fail. Otherwise, NFS processing continues.

Operator response: Contact the system programmer.

System programmer response: Keep the existing z/OS NFS server traces and contact IBM Support.

GFSA522I **Operation** *text1* **for** *text2* **failed** *digit1* **reason** *digit2*.

Explanation: The NFS server detected an error *digit1*, reason code *digit2* on *text1* operation for data set name *text2*, open mode *digit1*.

System action: The current NFS request will fail. Otherwise, NFS processing continues.

Operator response: Contact the system programmer.

System programmer response: Keep the existing z/OS NFS server traces and contact IBM Support.

GFSA523I **Operation** *text1* **for** *text2* **type** *digit1* **return** *codedigit2* **reason** *codedigit3*.

Explanation: The NFS server detected an error *digit2*, reason code *digit3* on *text1* operation for DDname *text2*.

System action: The current NFS request will fail. Otherwise, NFS processing continues.

Operator response: Contact the system programmer.

System programmer response: Keep the existing z/OS NFS server traces and contact IBM Support.

GFSA524I **VSIO** *text1* **failed** *digit1* **for** **branch** *digit2*.

Explanation: The NFS server detected an error *digit1* on I/O phase *digit2* for DDname *text1*.

System action: The current NFS request will fail. Otherwise, NFS processing continues.

Operator response: Contact the system programmer.

System programmer response: Keep the existing z/OS NFS server traces and contact IBM Support.

GFSA525I **VSIO** *text1* **failed** *digit1*/*digit2* **for** **branch** *digit3* **VSAM** **supplied** **codes:** *digit4*,*digit5*.

Explanation: The NFS server detected an error *digit1*, return code *digit2* on I/O phase *digit3* for DDname *text1* for a VSAM data set.

System action: The current NFS request will fail. Otherwise, NFS processing continues.

Operator response: Contact the system programmer.

System programmer response: Keep the existing z/OS NFS server traces and contact IBM Support.

GFSA526I **VSIO** *text1* **busy** *digit1* **for** **branch** *digit2*.

Explanation: The NFS server detected an error *digit1* on I/O phase *digit2* for DDname *text1*.

System action: The current NFS request will fail. Otherwise, NFS processing continues.

Operator response: Contact the system programmer.

System programmer response: Keep the existing z/OS NFS server traces and contact IBM Support.

GFSA527I **VSIO** **for** *text1* **VSAM** **message:** *text2*.

Explanation: The NFS server detected an error *text2* for DD name *text1*.

System action: The current NFS request will fail.

GFSA550I • GFSA559I (procname)

Otherwise, NFS processing continues.

Operator response: Contact the system programmer.

System programmer response: Keep the existing z/OS NFS server traces and contact IBM Support.

GFSA550I (procname) IPtext is active.

Explanation: The Network File System server found the IP level (text) of V6 or V4, with the TCPIP Stack active. The server will use that stack for all its communications.

System action: The Network File System server continues.

Operator response: None.

System programmer response: None.

GFSA554I Routine text1 () failed, errno(digit1) errno2(digit2).

Explanation: Function call text1() failed with an errno value of digit1 and an errno2 value of digit2.

System action: The current NFS request will fail. Otherwise, NFS processing continues.

Operator response: Contact the system programmer.

System programmer response: Keep the existing z/OS NFS server traces and contact IBM Support.

GFSA555I Connection failed between z/OS UNIX and TCPIP errno(digit1) errno2(digit2), shutting down.

Explanation: Connection between the NFS Server and TCPIP failed with an errno value of digit1 and an errno2 value of digit2. For definitions of the errno and errno2 values, see z/OS UNIX System Services Messages and Codes.

System action: The current NFS request will fail. Otherwise, NFS processing continues.

Operator response: Contact the system programmer.

System programmer response: Check the errno and errno2 value definitions in z/OS UNIX System Services Messages and Codes for any possible corrective action that can be taken and proceed accordingly. Keep the existing z/OS NFS server traces and contact IBM Support.

GFSA556I getaddrinfo() failed, error(digit1): text1.

Explanation: Call to function getaddrinfo() failed with an errno value of digit1, as described in text1.

System action: The NFS server processing continues.

Operator response: Contact the system programmer.

System programmer response: Check the errno value

definition in z/OS UNIX System Services Messages and Codes for any possible corrective action that can be taken and proceed accordingly. Keep the existing z/OS NFS server traces and contact IBM Support.

GFSA557I Routine text1 () failed, errno(digit1) - text2.

Explanation: Call to function text1 failed with an errno value of digit1 due to text2.

System action: The current NFS request will fail. Otherwise, NFS processing continues.

Operator response: Contact the system programmer.

System programmer response: Check the errno value definition in z/OS UNIX System Services Messages and Codes for any possible corrective action that can be taken and proceed accordingly. Keep the existing z/OS NFS server traces and contact IBM Support.

GFSA558I (procname) UNABLE TO CREATE IPC QUEUE.

Explanation: An operation to allocate virtual memory for an interprocess communication (IPC) queue was tried but was unsuccessful.

In the message text:

procname

The name of the start procedure.

System action: NFS stops.

Operator response: Notify your system programmer.

System programmer response: Increase the size of the step region.

GFSA559I (procname) CANNOT CREATE UDP SERVICE.

Explanation: User datagram protocol (UDP) service transport could not be created, or you started TCP/IP before UNIX initialization was complete.

In the message text:

procname

The name of the start procedure.

System action: NFS stops.

Operator response: Check your z/OS TCP/IP setup or notify your system programmer. Before starting TCP/IP, make sure that UNIX initialization is complete, and that the TCP/IP UNIX connection is established.

System programmer response: Check your z/OS TCP/IP setup. Also check the UNIX BPXPRMxx parmlib member, specifically MAXFILEPROC, MAXSOCKETS, INADDRANYPORT, and INADDRANYCOUNT. INADDRANYPORT and INADDRANYCOUNT must be specified, but their range cannot include 2049, for the server to initialize.

See *z/OS MVS Initialization and Tuning Guide* for more details.

GFSA563I **Operation *text1* for socket(*digit1*) failed, errno(*digit2*) errno2(*digit3*).**

Explanation: The operation identified by *text1* failed with an errno value of *digit1* and an errno2 value of *digit3*.

System action: The current NFS request will fail. Otherwise, NFS processing continues.

Operator response: Contact the system programmer.

System programmer response: Check the errno and errno2 value definitions in *z/OS UNIX System Services Messages and Codes* for any possible corrective action that can be taken and proceed accordingly. Keep the existing z/OS NFS server traces and contact IBM Support.

GFSA564I **Socket(*digit1*) invalid fragment length. Expected size (*digit2*), real size(*digit3*).**

Explanation: A request was received for the socket(*digit1*). The length for the fragment should be *digit2* but (*digit3*) bytes of data were received

System action: The current NFS request will fail. Otherwise, NFS processing continues.

Operator response: Contact the system programmer.

System programmer response: Keep the existing z/OS NFS Server traces and contact IBM Support.

GFSA565I **The registration (xid=*digit1*) to the PORTMAPPER failed.**

Explanation: The NFS Server PORTMAPPER registration request with xid=*digit1* failed to register NFS information in the PORTMAPPER.

System action: The NFS Server will shut down.

Operator response: Contact the system programmer.

System programmer response: Check the NFS server job log and NFS Log data set for an explanation. If none is found, keep the existing z/OS NFS Server traces and contact IBM Support.

GFSA566I (procname) CANNOT ACCEPT NEW TCP CLIENT CONNECTION — MAXIMUM NUMBER OF SOCKETS HAS REACHED

Explanation: When an NFS TCP client attempts to connect to the NFS server, the server cannot accept the connection because the maximum number of sockets is reached.

In the message text:

procname

The name of the start procedure.

System action: The connection request fails. NFS processing continues.

Operator response: Increase the value of **maxsockets** for the AF_INET domain in the BPXPRMxx parmlib member so that client TCP connections can be accepted by the NFS server. See *z/OS UNIX System Services Planning* for more information.

GFSA567I **Client host changed IP address *x* to *y* when in NODHCP mode.**

Explanation: The NFS Server detected that an NFS Client's host IP address *x* has been changed to *y*, but the NFS Server was started with NODHCP mode.

The message will only be issued when the IP address is changed from the original value to a new setting for a given client host unless the IP address is changed back to the original value. For example, for a change from IP1 to IP2 to IP3, the change from IP to IP3 will not generate a message. However, if the IP address is changed from IP1 to IP2, BACK to IP1, and THEN to IP3, a message will be generated for both the IP1 to IP2 change and for the following IP1 to IP3 change because the change back to IP1 restores the original value, resetting the message blocking condition.

System action: The current NFS request will fail. Otherwise, NFS processing continues.

Operator response: Contact the system programmer.

System programmer response: Either change to DHCP mode or correct the NFS Client's IP address.

GFSA571E **DNS does not return domain name for TCPIP stack hostname: *hostname***

Explanation: z/OS NFS server requested full host name (*hostname.domain*) from DNS, but received only host name without domain name. In the message text: *hostname* is the DNS response to z/OS NFS server request.

System action: z/OS NFS server processing continues. The current client's request will fail.

System programmer response: Correct the DNS configuration. Ensure the DNS resolver is active. If the DNS resolver is not active, restart DNS and then the z/OS NFS server.

GFSA572E **(procname) Hostname *hostname* does not contain domain name, function = *funcname()***

Explanation: After initialization, the z/OS NFS server did not receive the domain name of the host name from DNS which is needed to perform NFSv4 mounts. In the absence of a domain name, subsequent NFSv4

GFSA595I • GFSA667I

mounts will be rejected with GFSA571E message. In the message text:

hostname

The host name for which the z/OS NFS server was unable to get a domain name.

funcname()

The name of the function that did not return the domain name.

System action: z/OS NFS server processing continues.

System programmer response: This message has two system programmer responses.

1. If it is preceded by GFSA556I console message, then the z/OS NFS server cannot get a domain name because of inoperable DNS. If customer intends to use NFSv4 protocol operations, ensure the DNS resolver is active. If not active, restart DNS and then the z/OS NFS server.
2. In the absence of GFSA556I console message, correct the DNS data content. This content should reflect the correct domain names. Restart the z/OS NFS server.

GFSA595I Time Zone Delta is *digit1* hours, *digit2* minutes.

Explanation: During startup the z/OS NFS Server set its Time Zone as *digit1* hours *digit2* minutes. The NFS Server prints to the log the MVS system time zone value that was specified in the SYS1.PARMLIB(CLOCKxx) member at system IPL.

System action: z/OS NFS server initialization continues.

Operator response: None.

System programmer response: None.

GFSA596I BUFHIGH is set up : *digit1*.

Explanation: During startup NFS Server sets the BUFHIGH value as *digit1*.

System action: NFS processing continues.

Operator response: None.

System programmer response: None.

GFSA598I Network File System is SHORT of BUFFERS. BUFHIGH is too small for current workload.

Explanation: The NFS server detected that the BUFHIGH Attribute value is too small for the current workload.

System action: NFS processing continues. However, server performance may be somewhat degraded because of not being able to keep file data cached.

Operator response: Contact the system programmer.

System programmer response: Increase the BUFHIGH value in the NFS Server Site Attribute file and restart the Server.

GFSA660I Incorrect build info event was received.

Explanation: The NFS server detected an error in the load module statistics during startup.

System action: NFS processing continues.

Operator response: Contact the system programmer.

System programmer response: Check that the latest NFS Server maintenance install completed successfully. Keep the existing z/OS NFS Server traces and contact IBM Support.

Programmer response: None.

GFSA665I *text1* failed.

Explanation: XDR type *text1* decoding of a request, or XDR type *text1* encoding of a response, failed due to invalid data.

System action: The current NFS request will fail. Otherwise, NFS processing continues.

Operator response: Contact the system programmer.

System programmer response: Keep the existing z/OS NFS Server traces and contact IBM Support.

Programmer response: None.

GFSA666I *text1* encoding error.

Explanation: XDR type *text1* encoding of a response failed due to invalid data.

System action: The current NFS request will fail. Otherwise, NFS processing continues.

Operator response: Contact the system programmer.

System programmer response: Keep the existing z/OS NFS Server traces and contact IBM Support.

Programmer response: None.

GFSA667I Program *digit1* Version(*digit2*) Procedure(*digit3*) not supported.

Explanation: The NFS server received a request for Program *digit1*, Version *digit2*, Procedure *digit3*. This combination is not supported by NFS. The request is rejected.

System action: The current NFS request will fail. Otherwise, NFS processing continues.

Operator response: Contact the system programmer.

System programmer response: Investigate and correct the source of this request. If necessary, keep the existing z/OS NFS Server traces and contact IBM Support.

Programmer response: None.

GFSA668I *text1* Version(*digit1*) Procedure(*digit2*) not supported.

Explanation: The NFS server received a request for the *text1* Protocol, Version *digit1*, Procedure *digit2*. This combination is not supported by NFS. The request is rejected.

System action: The current NFS request will fail. Otherwise, NFS processing continues.

Operator response: Contact the system programmer.

System programmer response: Investigate and correct the source of this request. If necessary, keep the existing z/OS NFS Server traces and contact IBM Support.

Programmer response: None.

GFSA669I XDR operation *text1* (*digit1*) failed.

Explanation: XDR decoding of request *text1* (operation : *digit1*), or XDR encoding of response request *text1* (operation : *digit1*), failed due to invalid data.

System action: The current NFS request will fail. Otherwise, NFS processing continues.

Operator response: Contact the system programmer.

System programmer response: Keep the existing z/OS NFS Server traces and contact IBM Support.

Programmer response: None.

GFSA670I Tag=*digit1* xdr_status=*digit2* or minor=*digit3* or numops=*digit4* failed.

Explanation: XDR decoding of NFS version 4 request tag, minor version or the number of operations in the compound request failed due to invalid data. The tag pointer is *digit1*, XDR status value is *digit2*, minor version is *digit3* and number of operations is *digit4*.

System action: The current NFS request will fail. Otherwise, NFS processing continues.

Operator response: Contact the system programmer.

System programmer response: Keep the existing z/OS NFS Server traces and contact IBM Support.

Programmer response: None.

GFSA671I Minor version *digit1* not zero.

Explanation: The NFS server received an NFS version 4 protocol compound request for a minor version other than version 0. The z/OS NFS Server supports only minor version 0 at this time.

System action: The current NFS request will fail. Otherwise, NFS processing continues.

Operator response: Contact the system programmer.

System programmer response: Investigate and correct the source of the request. If necessary, keep the existing z/OS NFS Server traces and contact IBM Support.

Programmer response: None.

GFSA672I Illegal operation code *digit1*.

Explanation: The NFS server received an NFS version 4 protocol compound request containing an invalid operation code: *digit1*. This operation code is not supported by the protocol.

System action: As defined in the NFS version 4 protocol, the z/OS NFS server will attempt to process all of the operations before to one in error. At that point the compound request will fail and no further operations in the request will be processed. Otherwise, NFS processing continues.

Operator response: Contact the system programmer.

System programmer response: Investigate and correct the source of the request. If necessary, keep the existing z/OS NFS Server traces and contact IBM Support.

Programmer response: None.

GFSA673I *text1* (*digit1*) staled GLOBAL(*digit2*) STATEID(*digit3*).

Explanation: The NFS server received an NFS version 4 protocol request. XDR decoding of the request *text1*(operation : *digit1*) has detected that the request is attempting to use a stale Stateid (the base value is *digit3*). The current NFS Server Stateid base value is *digit2*.

System action: The current NFS request will fail. Otherwise, NFS processing continues.

Operator response: Contact the system programmer.

System programmer response: None. No action should be required. According to the NFS version 4 protocol, the NFS client is supposed to automatically recover from this error situation.

Programmer response: None.

GFSA674I Not supported operation code(*digit1*) type(*digit2*).

Explanation: The NFS server received an NFS version 4 protocol compound request containing an invalid operation code: *digit1*, type: *digit1*. This operation code is not supported.

System action: The current NFS request will fail. Otherwise, NFS processing continues.

Operator response: Contact the system programmer.

System programmer response: Keep the existing z/OS NFS Server traces and contact IBM Support.

Programmer response: None.

GFS A675I Bad file handle length *digit1*.

Explanation: NFS Server received an NFS version 4 protocol compound request containing a PUTFH operation with an invalid file handle length: *digit1*.

System action: The current NFS request will fail. Otherwise, NFS processing continues.

Operator response: Contact the system programmer.

System programmer response: Keep the existing z/OS NFS Server traces and contact IBM Support.

Programmer response: None.

GFS A677I *text1* decoding error.

Explanation: The NFS server detected an XDR error decoding *text1* for a received request.

System action: The current NFS request will fail. Otherwise, NFS processing continues.

Operator response: Contact the system programmer.

System programmer response: Keep the existing z/OS NFS Server traces and contact IBM Support.

Programmer response: None.

GFS A678I Character conversion error.

Explanation: The NFS server detected a character conversion error while processing a request.

System action: The current NFS request will fail. Otherwise, NFS processing continues.

Operator response: Contact the system programmer.

System programmer response: Keep the existing z/OS NFS Server traces and contact IBM Support.

Programmer response: None.

GFS A679I *text1 (digit1)* Version(*digit2*) not equal to 1.

Explanation: The NFS server received a request for protocol *text1* (Program number = *digit1*), version *digit2*. The z/OS NFS Server only supports version 1 of this protocol.

System action: The current NFS request will fail. Otherwise, NFS processing continues.

Operator response: Contact the system programmer.

System programmer response: Investigate and correct the source of the request. If necessary, keep the existing z/OS NFS Server traces and contact IBM Support.

Programmer response: None.

GFS A680I *text1* decoding error, *errno(digit1)* *errno2(x_digit2)*.

Explanation: The NFS server detected an error attempting to decode a *text1*. It received the following error codes: *errno=digit1*, *errno2=x_digit2*. See the z/OS UNIX System Services Messages and Codes for definitions of the *errno/errno2* values.

System action: The current NFS request will fail. Otherwise, NFS processing continues.

Operator response: Contact the system programmer.

System programmer response: Keep the existing z/OS NFS Server traces and contact IBM Support.

Programmer response: None.

GFS A681I XDR of attribute *text1* failed, status *digit1*.

Explanation: While processing an NFS version 4 protocol response, XDR encoding/decoding of Attribute number *text1* (Owner or Owner Group) failed. The XDR error status is *digit1*.

System action: The current NFS request will fail. Otherwise, NFS processing continues.

Operator response: Contact the system programmer.

System programmer response: Keep the existing z/OS NFS Server traces and contact IBM Support.

Programmer response: None.

GFS A682I XDR of attribute mask failed, status(*digit1*) or length(*digit2*) wrong.

Explanation: While processing an NFS version 4 protocol response, XDR encoding of the Supported Attribute mask failed. Either the XDR received an error status (*digit1*) or the mask length (*digit2*) is invalid (length < 1 or length > 2).

System action: The current NFS request will fail. Otherwise, NFS processing continues.

Operator response: Contact the system programmer.

System programmer response: Keep the existing z/OS NFS Server traces and contact IBM Support.

Programmer response: None.

GFS A683I XDR length=*digit1* supported bitmap_attr=*digit2* failed.

Explanation: While processing an NFS version 4 protocol response, XDR encoding of the Supported Attribute mask experienced an error. XDR of either the mask length (*digit1*) or the mask (*digit2*) failed.

System action: The current NFS request will fail. Otherwise, NFS processing continues.

Operator response: Contact the system programmer.

System programmer response: Keep the existing z/OS NFS Server traces and contact IBM Support.

Programmer response: None.

GFSA684I XDR setclientid() failed xdr_status=*digit1* v4_status=*digit2*.

Explanation: While processing an NFS version 4 protocol SetClientId operation response, XDR encoding of the response experienced an error. The XDR status is *digit1* and the NFS version 4 status is *digit2*.

System action: The current NFS request will fail. Otherwise, NFS processing continues.

Operator response: Contact the system programmer.

System programmer response: Keep the existing z/OS NFS Server traces and contact IBM Support.

Programmer response: None.

GFSA685I Client requested invalid READ attribute in bitmap_attr=*digit1*.

Explanation: The NFS server received an NFS version 4 protocol request. The request attempted to read unsupported attributes. The request attribute bitmap is *digit1*.

System action: The current NFS request will fail. Otherwise, NFS processing continues.

Operator response: Contact the system programmer.

System programmer response: Keep the existing z/OS NFS Server traces and contact IBM Support.

Programmer response: None.

GFSA686I Mount(*digit1*) Version(*digit2*) not 1 or 3.

Explanation: The NFS server received a Mount Protocol (program number *digit1*) Version (*digit2*) request. Only versions 1 and 3 of the Mount protocol are supported by the z/OS NFS server.

System action: The current NFS request will fail. Otherwise, NFS processing continues.

Operator response: Contact the system programmer.

System programmer response: Investigate and correct the source of the request. If necessary, keep the existing z/OS NFS Server traces and contact IBM Support.

Programmer response: None.

GFSA687I *text1* Version(*digit1*) not supported.

Explanation: The NFS server received a *text1* Protocol Version (*digit1*) request. This Protocol/Version combination is not supported by the z/OS NFS Server.

System action: The current NFS request will fail.

Otherwise, NFS processing continues.

Operator response: Contact the system programmer.

System programmer response: Investigate and correct the source of the request. If necessary, keep the existing z/OS NFS Server traces and contact IBM Support.

Programmer response: None.

**GFSA727E NETWORK FILE SYSTEM SERVER
KERBEROS DLL LOAD FAILED:
*d_digits***

Explanation: Dynamic Linked Library loading of the Kerberos runtime environment has failed during the NFS server startup. This message is created when NFS is configured to require Kerberos (such that system authentication (authsys) is not allowed).

In the message text:

d_digits

The value of errno after the call to the krb5_dll_load API.

System action: NFS server processing ends.

Operator response: Contact the system programmer.

System programmer response: Refer to *z/OS Integrated Security Services Network Authentication Service Programming* for more information about this failure.

**GFSA728E (procname) SAF APPLICATION USER
MAPPING FAILED WITH SAF
RETURN CODE *d_digits1*, RACF
RETURN CODE *d_digits2*, and RACF
REASON CODE *d_digits3*.**

Explanation: NFS encountered a problem in determining the RACF user ID associated with the NFS Client's Kerberos Principal.

In the message text:

d_digits1

The value of *d_digits1* is the SAF return code.

d_digits2

The value of *d_digits2* is the RACF return code.

d_digits3

The value of *d_digits3* is the RACF reason code.

System action: The NFS Client's request is failed with an RPC reply status of MSG_ACCEPTED and an accepted status of SYSTEM_ERR.

Operator response: Ensure that the NFS client principal is defined to RACF. Refer to *R_usermap* information in *z/OS Security Server RACF Callable Services* for a full explanation of the SAF Return code, RACF return code and RACF reason code.

System programmer response: Refer to *R_usermap* information in *z/OS Security Server RACF Callable*

GFSA729E (procname) • GFSA733I

Services for a full explanation of the SAF Return code, RACF return code and RACF reason code.

GFSA729E (procname) USERNAME *text1* NOT FOUND IN SAF DATABASE

Explanation: NFS encountered a problem in determining the z/OS UNIX uid/gid for this RACF user.

In the message text:

procname

The name of the start procedure.

text1 The RACF User ID for which the z/OS UNIX uid/gid could not be obtained.

System action: The NFS Client's request is failed with an RPC reply status of MSG_ACCEPTED and an accepted status of SYSTEM_ERR.

Operator response: Ensure that the NFS Client Principal is correctly defined.

GFSA730I (procname) NETWORK FILE SYSTEM SERVER KERBEROS INITIALIZATION SUCCESSFUL

Explanation: The NFS server's Kerberos initialization was successful.

In the message text:

procname

The name of the start procedure.

System action: NFS server processing continues.

GFSA731I NETWORK FILE SYSTEM SERVER COULD NOT LOAD KERBEROS DLL: *d_digits*

Explanation: Dynamic Linked Library loading of the Kerberos runtime environment could not be completed during the NFS server startup. This message is issued when NFS is configured to also allow system authentication (AUTH_SYS).

If only AUTH_SYS authentication is specified as a site attribute (sys) then this message is issued to the NFS server log only (and not to the console). If AUTH_SYS authentication (sys) and any kerberos flavors (KRB5 or KRB5I or KRB5P) are specified as site attributes then this message is issued to the console as well as the NFS server log.

In the message text:

d_digits

The value of the errno after the call to the krb5_dll_load API.

System action: NFS processing continues such that only requests with system authentication (sys) will be supported.

Operator response: Contact the system programmer.

System programmer response: Refer to *z/OS Integrated Security Services Network Authentication Service Programming* for more information.

GFSA732E NETWORK FILE SYSTEM SERVER KERBEROS CONTEXT CREATION FAILED: *d_digits*

Explanation: The creation of a Kerberos Context and its initialization with default values obtained from the Kerberos configuration file during the server startup has failed.

In the message text:

d_digits

The value of the Kerberos error code after the call to the API krb5_init_context().

System action: The NFS server is brought down.

Operator response: Contact the system programmer.

System programmer response: Refer to *z/OS Integrated Security Services Network Authentication Service Programming* for more information about this failure.

GFSA733I NETWORK FILE SYSTEM SERVER COULD NOT CREATE KERBEROS CONTEXT: *d_digits*

Explanation: The creation of a Kerberos Context and its initialization with default values obtained from the Kerberos configuration file during the server startup could not be completed.

If only AUTH_SYS authentication is specified as a site attribute (sys) then this message is issued to the NFS server log only (and not to the console). If AUTH_SYS authentication (sys) and any kerberos flavors (KRB5 or KRB5I or KRB5P) are specified as site attributes then this message is issued to the console as well as the NFS server log.

In the message text:

d_digits

The value of the Kerberos error code after the call to the API krb5_init_context().

System action: NFS processing continues such that only requests with system authentication (sys) will be supported.

Operator response: Contact the system programmer.

System programmer response: Refer to *z/OS Integrated Security Services Network Authentication Service Programming* for more information.

**GFSA734E NETWORK FILE SYSTEM SERVER
CREDENTIAL CACHE
MANAGEMENT FAILED IN ROUTINE
procName(), KERBEROS RETURN
CODE(krbRc) GSS MAJOR
STATUS(majorStat) GSS MINOR
STATUS(minorStat)**

Explanation: There was a failure in the NFS server's Kerberos credential cache management. This message is issued when NFS is configured to require Kerberos (that is, system authentication (AUTH_SYS) is not allowed).

In the message text:

procName

The name of the failing API. For details, refer to *z/OS Integrated Security Services Network Authentication Service Programming*.

krbRc The error code returned by the Kerberos Security Mechanism. For details, refer to *z/OS Integrated Security Services Network Authentication Service Administration*.

majorStat

The major status returned by the Generic Security Services. For details, refer to *z/OS Integrated Security Services Network Authentication Service Administration*.

minorStat

The minor status returned by the Generic Security Services. For details, refer to *z/OS Integrated Security Services Network Authentication Service Administration*.

System action: NFS server processing ends.

Operator response: Contact the system programmer.

System programmer response: Refer to *z/OS Integrated Security Services Network Authentication Service Programming* for more information about this failure.

**GFSA735I NETWORK FILE SYSTEM SERVER
COULD NOT SETUP CREDENTIAL
CACHE MANAGEMENT IN ROUTINE
procName(), KERBEROS RETURN
CODE(krbRc) GSS MAJOR
STATUS(majorStat) GSS MINOR
STATUS(minorStat)**

Explanation: There was a failure in the NFS server's Kerberos credential cache management. This message is issued when NFS is configured to also allow system authentication (AUTH_SYS).

If only AUTH_SYS authentication is specified as a site attribute (sys) then this message is issued to the NFS server log only (and not to the console). If AUTH_SYS authentication (sys) and any kerberos flavors (KRB5 or KRB5I or KRB5P) are specified as site attributes then

this message is issued to the console as well as the NFS server log.

In the message text:

procName

The name of the failing API. For details, refer to *z/OS Integrated Security Services Network Authentication Service Programming*.

krbRc The error code returned by the Kerberos Security Mechanism. For details, refer to *z/OS Integrated Security Services Network Authentication Service Administration*.

majorStat

The major status returned by the Generic Security Services. For details, refer to *z/OS Integrated Security Services Network Authentication Service Administration*.

minorStat

The minor status returned by the Generic Security Services. For details, refer to *z/OS Integrated Security Services Network Authentication Service Administration*.

System action: NFS server processing continues such that only requests with system authentication(sys) will be supported.

Operator response: Contact the system programmer.

System programmer response: Refer to *z/OS Integrated Security Services Network Authentication Service Programming* for more information about this failure.

**GFSA736E NETWORK FILE SYSTEM SERVER
KERBEROS TICKET ACQUISITION
FAILED IN ROUTINE procName(),
KERBEROS RETURN CODE(krbRc)**

Explanation: There was a failure in the NFS server's acquisition of Kerberos Ticket. This message is issued when NFS is configured to require Kerberos (that is, system authentication (AUTH_SYS) is not allowed).

In the message text:

procName

The name of the failing API. For details, refer to *z/OS Integrated Security Services Network Authentication Service Programming*.

krbRc The error code returned by the Kerberos Security Mechanism. For details, refer to *z/OS Integrated Security Services Network Authentication Service Administration*.

System action: NFS server processing ends.

Operator response: Contact the system programmer.

System programmer response: Refer to *z/OS Integrated Security Services Network Authentication Service Programming* for more information about this failure.

**GFSA737I NETWORK FILE SYSTEM SERVER
COULD NOT GET KERBEROS TICKET
IN ROUTINE *procName()*, KERBEROS
RETURN CODE(*krbRc*)**

Explanation: There was a failure in the NFS server's acquisition of Kerberos Ticket. This message is issued when NFS is configured to also allow system authentication (AUTH_SYS).

If only AUTH_SYS authentication is specified as a site attribute (sys) then this message is issued to the NFS server log only (and not to the console). If AUTH_SYS authentication (sys) and any kerberos flavors (KRB5 or KRB5I or KRB5P) are specified as site attributes then this message is issued to the console as well as the NFS server log.

In the message text:

procName

The name of the failing API. For details, refer to *z/OS Integrated Security Services Network Authentication Service Programming*.

krbRc The error code returned by the Kerberos Security Mechanism. For details, refer to *z/OS Integrated Security Services Network Authentication Service Administration*.

System action: NFS server processing continues such that only requests with system authentication (sys) will be supported.

Operator response: Contact the system programmer.

System programmer response: Refer to *z/OS Integrated Security Services Network Authentication Service Programming* for more information about this failure.

**GFSA738E NETWORK FILE SYSTEM SERVER
GSS CREDENTIAL ACQUISITION
FAILED IN ROUTINE *procName()*, GSS
MAJOR STATUS(*majorStat*) GSS
MINOR STATUS(*minorStat*)**

Explanation: There was a failure in the NFS server's acquisition of GSS credentials. This message is issued when NFS is configured to require Kerberos (that is, system authentication (AUTH_SYS) is not allowed).

In the message text:

procName

The name of the failing API. For details, refer to *z/OS Integrated Security Services Network Authentication Service Programming*.

majorStat

The major status returned by the Generic Security Services. For details, refer to *z/OS Integrated Security Services Network Authentication Service Administration*.

minorStat

The minor status returned by the Generic

Security Services. For details, refer to *z/OS Integrated Security Services Network Authentication Service Administration*.

System action: NFS server processing ends.

Operator response: Contact the system programmer.

System programmer response: Refer to *z/OS Integrated Security Services Network Authentication Service Programming* for more information about this failure.

**GFSA739I NETWORK FILE SYSTEM SERVER
COULD NOT ACQUIRE GSS
CREDENTIALS IN ROUTINE
procName(), GSS MAJOR
STATUS(*majorStat*) GSS MINOR
STATUS(*minorStat*)**

Explanation: There was a failure in the NFS server's acquisition of GSS credentials. This message is issued when NFS is configured to also allow system authentication (AUTH_SYS).

If only AUTH_SYS authentication is specified as a site attribute (sys) then this message is issued to the NFS server log only (and not to the console). If AUTH_SYS authentication (sys) and any kerberos flavors (KRB5 or KRB5I or KRB5P) are specified as site attributes then this message is issued to the console as well as the NFS server log.

In the message text:

procName

The name of the failing API. For details, refer to *z/OS Integrated Security Services Network Authentication Service Programming*.

majorStat

The major status returned by the Generic Security Services. For details, refer to *z/OS Integrated Security Services Network Authentication Service Administration*.

minorStat

The minor status returned by the Generic Security Services. For details, refer to *z/OS Integrated Security Services Network Authentication Service Administration*.

System action: NFS server processing continues such that only requests with system authentication (sys) will be supported.

Operator response: Contact the system programmer.

System programmer response: Refer to *z/OS Integrated Security Services Network Authentication Service Programming* for more information about this failure.

GFSA740W (procname) Routine *rtn()* could not retrieve the stack names, *errno(errno)* *errno2(errno2)*.

Explanation: This message is issued when *w_ioctl* fails to retrieve the stack names. In the message text:

rtn Name of the failing routine.

errno *errno* set by the failing routine.

errno2 *errno2* set by the failing routine.

System action: NFS processing continues with the limitation that only the TCP/IP stack of the local host will be processing the RPCSEC requests.

Operator response: None

System programmer response: Ensure that the TCP/IP stacks are configured correctly.

Programmer response: None

GFSA741W (procname) Configured TCP Stacks(*d_digit1*) is more than the number allowed(*d_digit2*).

Explanation: This message is issued when the maximum number of TCP/IP stacks configured on a single NFS server is greater than the maximum allowed. In the message text:

d_digit1 Number of TCP/IP stacks that are currently configured.

d_digit2 Maximum number of stacks allowed on a single NFS server.

System action: NFS processing continues with the limitation that only the number of stacks represented by *d_digit2* will be supported.

Operator response: Contact the system programmer.

System programmer response: Ensure that only up to the *d_digit2* TCP/IP stacks are configured to the NFS server.

Programmer response: None

GFSA742W (procname) Could not get *hostname* for *stackname*, return value(*h_digit1*), return code(*h_digit2*), reason code(*h_digit3*).

Explanation: The message is issued when the *hostname* can not be retrieved for a TCP/IP stack. In the message text:

stackname The name of TCP/IP stack for which the *hostname* could not be retrieved.

h_digit1 The returned value returned by BPX1PCT.

h_digit2 The return code returned by BPX1PCT.

h_digit3 The reason code returned by BPX1PCT.

For details on *rv,rc,rsnc*, refer to *z/OS UNIX System Services Programming: Assembler Callable Services Reference*.

System action: NFS processing continues with the limitation that RPCSEC_GSS requests will not be processed for the failing TCP/IP stack identified by the *stackname* in this message.

Operator response: None

System programmer response: Check the TCPIP/stack configuration for the stack identified by the *stackname*.

Programmer response: None

GFSA743W (procname) Could not get GSS credentials for host *hostname*: Routine *rtn()* returned Major Status(*h_digit1*) Minor Status(*h_digit2*).

Explanation: This message is issued when the NFS server's attempt to acquire the GSS credential failed. In the message text:

hostName The name of the host for which GSS credentials could not be acquired.

rtn The name of the GSS API that failed.

h_digit1 The major status returned by the failing GSS API.

h_digit2 The minor status returned by the failing GSS API.

Note: For details on the failing GSS API, Major Status and Minor Status, refer to *z/OS Integrated Security Services Network Authentication Service Programming*.

System action: NFS processing continues with the limitation that RPCSEC_GSS requests will not be processed for the failing host identified by the *hostName* in this message.

Operator response: None

System programmer response: Check the GSS/Kerberos configurations.

Programmer response: None

GFSA744E(procname) • GFSA754I (procname)

GFSA744E(procname) Routine *text* () could not retrieve the TCP stack names, Return Value(*dec_value*) Return Code(*HEX_value1*) Reason Code(*HEX_value2*).

Explanation: This message specifies that the z/OS NFS Server cannot determine TCP stack names at start up. If only some stack names are found, the z/OS NFS Server start up will proceed, but only with the resolved stacks.

In the message text:

procname

The startup procedure name of z/OS NFS Server.

text

The name of the z/OS USS function (BPX1PCT) that returned the error.

dec_value

The decimal Return Value from the function.

HEX_value1

The hex value of Return Code from the function.

HEX_value2

The hex value of Reason Code from the function.

System action: The z/OS NFS Server shuts down.

Operator response: Contact the system programmer.

System programmer response: Correct the TCP stacks configuration and restart the z/OS NFS Server.

Programmer response: None

GFSA750I (procname) SMF PROCESSING ACTIVE FOR USER LOGOUT.

Explanation: SMF processing is active for user logout records. This message displays in response to the **status** operand of the **modify** command.

In the message text:

procname

The name of the start procedure.

System action: NFS server processing continues.

GFSA751I (procname) SMF PROCESSING SUSPENDED FOR USER LOGOUT.

Explanation: The system-managed facility (SMF) processing is suspended for user logout records. This message displays in response to the **status** operand of the **modify** command or after a nonzero return code from SMF. See message GFSA754I for the SMF return code.

In the message text:

procname

The name of the start procedure.

System action: NFS server processing continues without generating any user or file SMF records.

Operator response: Resume SMF recording by entering a **modify** command that specifies **smf=on**.

GFSA752I (procname) SMF PROCESSING ACTIVE FOR FILE TIMEOUT.

Explanation: The system-managed facility (SMF) processing is active for file timeout records. This message displays in response to the **status** operand on the **modify** command.

In the message text:

procname

The name of the start procedure.

System action: NFS server processing continues.

GFSA753I (procname) SMF PROCESSING SUSPENDED FOR FILE TIMEOUT.

Explanation: The system-managed facility (SMF) processing is suspended for file timeout records. This message displays in response to the **status** operand of the **modify** command or after a nonzero return code from SMF. See message GFSA754I for the SMF return code.

In the message text:

procname

The name of the start procedure.

System action: NFS server processing continues without generating any user or file SMF records.

Operator response: Resume SMF recording by entering the **modify** command that specifies **smf=on**.

GFSA754I (procname) UNEXPECTED RETURN CODE *d_digits* RECEIVED FROM SMF WHILE WRITING RECORD TYPE 42 SUBTYPE [7|8].

Explanation: The NFS server received a nonzero return code, *d_digits*, while processing a file timeout (subtype 7) or user logout (subtype 8) record.

In the message text:

procname

The name of the start procedure.

System action: NFS processing continues. No more SMF records of the same type and subtype are generated until the NFS address space is restarted or the **smf=on** operand of the **modify** command is entered.

Operator response: Notify your system programmer.

System programmer response: See *z/OS MVS System Management Facilities (SMF)* for information about the return code. Correct the problem, and have the operator enter a **modify** command that specifies **smf=on**.

GFSA770I z/OS UNIX REGISTRATION SUCCESSFUL.

Explanation: A connection with z/OS UNIX was established.

System action: NFS processing continues.

GFSA771I (procname) z/OS UNIX MOUNTS SUSPENDED.

Explanation: z/OS UNIX mount processing is suspended by the **freeze=onhfs** operand of the **modify** command. This message displays in response to either the **freeze=onhfs** operand or the **status** operand of the **modify** command. Any additional z/OS UNIX mount requests from the network are ignored. The existing mounts are unaffected.

In the message text:

procname

The name of the start procedure.

System action: NFS processing continues.

GFSA772I (procname) z/OS UNIX MOUNTS RESUMED.

Explanation: Mount requests to the z/OS UNIX file system have been enabled. This message displays in response to a console **modify** command.

In the message text:

procname

The name of the start procedure.

System action: NFS processing continues.

GFSA776I z/OS UNIX CANNOT RESOLVE PATH NAME *text*.

Explanation: There was a failure to resolve the path name with UNIX when initializing from the mount handle data sets. The z/OS UNIX file system was removed or renamed. If the user attempts to access a file object under this mount point, the NFS error response NFSERR_STALE is returned.

System action: NFS processing continues.

GFSA777I z/OS UNIX SERVICE REQUESTER DOES NOT HAVE SECURITY PRIVILEGE.

Explanation: The client user must be defined to Resource Access Control Facility (RACF) as a user of

z/OS UNIX to access z/OS UNIX file objects.

System action: The request is stopped. NFS processing continues.

System programmer response: Check the System Authorization Facility (SAF) security product user profiles.

GFSA779I An inode was found that exceeds the fileidsize(32) size limit; there is more information in the Network File System Log.

Explanation: An inode was found that exceeds the fileidsize(32) size limit.

System action: NFS continues processing.

System programmer response: Use the NFS server site attribute fileidsize(64).

GFSA780I *operation from hostname of nodename in filesystem fsname has inode=xnodeid server response*

Explanation: In the message text:

operation

Is one of the following:

- LOOKUP
- READDIR
- PUTFH
- OPEN
- OPEN/CREATE

hostname

The DNS-returned name of the host issuing the operation, or the IP address if the DNS name is not present.

nodename

The name of the object (node) within the filesystem.

fsname The name of the MVS dataset containing the file system.

nodeid The value of the nodeID that is out of range.

server response

Is one of the following:

- "hiding entry" (READDIR or LOOKUP)
- "failing operation" (PUTFH or OPEN)
- "removing node and failing operation" (OPEN/CREATE)

System action: NFS continues processing.

System programmer response: Use the NFS server site attribute fileidsize(64).

GFSA782I (procname) NO ACTIVE z/OS UNIX MOUNT POINTS.

Explanation: This message is in response to the **list=mounts** operand of the **modify** command and shows that no z/OS UNIX clients are connected to NFS. See message GFSA910I for the types of active mounts displayed.

In the message text:

procname

The name of the start procedure.

System action: NFS processing continues.

GFSA784I *procname* **RPC z/OS UNIX ERROR VNODE_OP** *text1* **RC:** *number1*: *text2* **RSN:** *number 2* *number3* **filesystem name:** *text3* **FID:** *fid* **hostname/IPaddress:** *hostname*.

Explanation: NFS encountered a problem on an interface call to z/OS UNIX. The error was encountered during processing of a *text1* remote procedure call (RPC).

In the message text:

procname

Network File System Server startup procedure name

text1 The value of *text1* data is the function called when failure occurred.

number1

The value of *number1* is the return code.

text2 The value of *text2* text is the English description of the return code.

number2 number3

The combination of *number2* *number3* represents the reason code as returned by z/OS UNIX.

text3 The name of zFS/HFS partition or VSAM/PDSE data set.

fid The FID of the object.

hostname

The Host name or IP address of NFS Client.

System action: NFS processing continues.

System programmer response: See z/OS UNIX documentation for a full explanation of z/OS UNIX reason codes (for example, *z/OS UNIX System Services Messages and Codes*).

GFSA786I MULTI-COMPONENT LOOKUP REQUEST FOR PATHNAME *text* **CANNOT BE RESOLVED.**

Explanation: The multi-component **lookup** request for the path name failed. Possible reasons follow:

- Symbolic links cannot be embedded in a multi-component path name because it is not supported at this time. See “Accessing symbolic links on z/OS NFS version 4” on page 56 for details on NFS version protocol use.
- Either the specified path name specified is not supported, or access is not allowed.
- A public path is not set up on this server.

System action: The request fails. NFS processing continues.

User response: Construct a different **lookup** request with a valid path name.

GFSA787I z/OS UNIX PATHNAME SPECIFIED, BUT NOHFS SPECIFIED IN THE ATTRIBUTE DATA SET.

Explanation: A z/OS UNIX path name was specified but **nohfs** was also specified in the attributes data set, which disables z/OS UNIX processing.

System action: Network File System Server request fails.

User response: Either change the attributes data set to activate z/OS UNIX processing and restart the NFS server, or change the path name.

GFSA788I z/OS UNIX OPERATION *unixop* **FAILED WITH RETURN CODE** *number*, **NFS client IP address** *IPv6addr* **hostname** *hostname*.

Explanation: z/OS UNIX operation *unixop* failed with return code *rc* for NFS client *IPv6addr* and hostname *hostname*.

In the message text:

unixop The z/OS UNIX operation that failed.

number The return code.

IPv6addr

The NFS client address in the form of 0:FFFF:a.b.c.d

hostname

The hostname and domain name of the NFS client host.

System action: NFS processing continues.

System programmer response: See z/OS UNIX documentation (for example, *z/OS UNIX System Services Messages and Codes*) for a full explanation of z/OS UNIX reason codes.

**GFSA790I (procname) NETWORK FILE SYSTEM
SERVER holds delegation= *access*.**

Explanation: This message displays the fact that the NFS server holds access type delegation for the file requested in the LISTLOCKS operator command. This does not necessarily mean that the NFS v4 delegation is currently granted to a remote NFS Client.

access indicates the delegation access type:

- R - Read
- RW - Read/Write

System action: The Network File System server continues processing.

Operator response: None.

System programmer response: None.

User response: None

**GFSA791I (procname) Owner (serverid clientid userid
processid) offset=hex1 len=hex2
lockacc=mode status=status**

Explanation: This message displays a byte range lock owner for the file requested in the LISTLOCKS operator command. Message GFSA791I will be returned for each lock. The lock owner is identified by *serverid*, *clientid*, *userid*, and *processid*. The lock is for offset *hex1* and length *hex2*. The lock access *mode* (share/exclusive) and the current lock *status* (waiting/granted) are also displayed.

System action: The Network File System server continues.

Operator response: None.

System programmer response: None.

**GFSA792I (procname) Owner (serverid clientid userid
processid) access=access deny=deny
delegation= *delg_access***

Explanation: This message displays a lock share holder for the file requested in the LISTLOCKS operator command. Message GFSA792I will be returned for each share holder. The share owner is identified by *serverid*, *clientid*, *userid*, and *processid*. The lock access mode *access*, deny mode *deny*, and delegation mode *delg_access* are displayed.

access indicates the access type:

- R - Read
- W - Write
- RW - Read/Write

deny indicates the deny type:

- DN - Deny None
- DW - Deny Write
- DR - Deny Read

- DRW - Deny Read/Write

delg_access

indicates the delegation access type:

- NO - None
- R - Read
- RW - Read/Write

System action: The Network File System server continues processing.

Operator response: None.

System programmer response: None.

GFSA793I (procname) text does not have Locks.

Explanation: This message is returned from the LISTLOCKS operator command for the specified file *text*, if the file does not have any locks or shares.

System action: The Network File System server continues.

Operator response: None.

System programmer response: None.

**GFSA794I (procname) LISTLOCK for text found
count shares/locks. Command was
completed successfully.**

Explanation: This message indicates that processing of the LISTLOCKS operator command for the specified file *text* has been completed. *count* is the number of shares and/or locks that were found and were listed with messages GFSA791I (for byte range locks) or GFSA792I (for shares).

System action: The NFS server continues.

Operator response: None.

System programmer response: None.

**GFSA796I (procname) cmdstr: completed
successfully.**

Explanation: The modify command has completed without error and there are no other messages associated with the command.

- *procname* - Network File System Server start up procedure name
- *cmdstr* - the text of the command issued

System action: None.

Operator response: None.

System programmer response: None.

GFSA797I (*procname*) **Command *cmdstr* is obsolete. Instead, use the TRACE CT operator command to capture the desired diagnostics.**

Explanation: The a modify command has been issued to change the NFS server logging to a level that is no longer supported.

- *procname* - Network File System Server start up procedure name
- *cmdstr* - the text of the command issued

System action: None.

Operator response: None.

System programmer response: Issue the appropriate Component Trace commands to capture debug trace information.

GFSA801I **MOUNT FAILED:** *text*

Explanation: The value of *text* can be any of these messages.

- FILE MAPPING ENABLED BUT NO SIDE FILE SPECIFIED
- STORAGE LIMIT REACHED LOADING MAPPING SIDE FILE
- MAPPING SIDE FILE NOT FOUND
- ERROR OPENING/READING MAPPING SIDE FILE
- MAPPING SIDE FILE HAS INVALID SYNTAX OR FORMAT
- SIDE FILE SPECIFIED BUT MAPPING IS DIS-ALLOWED BY INSTALLATION

User response: Take one of these actions depending on the value of *text*:

- Specify a side file if **fileextmap** is ON.
- Fix the problem with mapping the side file.
- Ask the system administrator to change the **sfmax** value, and then reissue the **mount** command.

GFSA802E **REMOUNT FAILED — PHYSICAL FILE SYSTEM CHANGED. PATH: *pathname* PREV: *datasetname* CURRENT: *datasetname***

Explanation: During a restart of the NFS server, the rebuild of the mount point recorded in the mount handle database failed. The failure occurred because the physical file system for the mount point was changed by a TSO UNMOUNT command because the mount point was originally mounted.

System action: NFS server processing continues.

GFSA803I **Mounting to a remote file system not allowed.**

Explanation: The z/OS NFS server received a request to access a cross-system mount point. Crossing into local and remote file systems is not supported by the z/OS NFS Server for NFS protocol versions 2 and 3,

and remote file systems for the NFS protocol version 4.

System action: The current NFS request fails. Otherwise, NFS processing continues.

Operator response: Contact the system programmer.

System programmer response: Investigate and correct the source of the request. If necessary, keep the existing z/OS NFS server traces and contact IBM Support.

GFSA804I **Mounting on a file not allowed.**

Explanation: The NFS server received a Mount request to mount on a file. File Systems can only be mounted on directories, not on files.

System action: The current NFS request fails. Otherwise, NFS processing continues.

Operator response: Contact the system programmer.

System programmer response: Investigate and correct the source of the request. If necessary, keep the existing z/OS NFS server traces and contact IBM Support.

GFSA805E (*procname*) *client_host_or_ip_address* **attempts to mount to *pathname* for file system *file_system_name_new*. However, there are *number* client(s) already mounted to this path with file system *file_system_name*.**

Explanation: An attempt to nfs mount to *pathname* for a file system *file_system_name_new* from a particular client *client_host_or_ip_address* failed because at least one mount point remained on the server side for that *pathname* mount path but for a different file system *file_system_name*. Usually this happens when nested file systems underneath the mount path have changed (attached or detached) during server processing.

System action: NFS continues processing.

Operator response: Perform the following recovery actions:

- Check all existing mount points on the server side with the following:
F *procname*,LIST=MOUNTS
- Find all of the clients using the same mount path */pathname*
- Prevent any client from mounting to z/OS UNIX file systems with the F *procname*,FREEZE=ONHFS operator command
- Inform the system administrator about the file system change and about the possibility of performing unmount on clients for */pathname* on behalf of new mount from *client_host_or_ip_address*
- After clients unmount the mount points, verify again that there are no other clients accessing the */pathname* with the F *procname*,LIST=MOUNTS operator command

- If no other client is accessing the */pathname* but the Server still shows them in F *procname*,LIST=MOUNTS report, use F *procname*,UNMOUNT='/hfs/ *pathname*' to remove any information on the server side about obsolete mount points
- Enable clients to mount to z/OS UNIX file systems with F *procname*,FREEZE=OFFHFS

System programmer response: Contact clients to inform them about the file system change situation during new mount processing and a need to unmount the mount points on all clients.

GFSA806I **Mount removed from *text* server instance, Reason: *rsnstr*, Client: *host*, Mount path: *mpath*, Filesystem: *fsname*, mountFH: *fhandle***

Explanation: A mount for server *text* was dropped. At z/OS NFS server shutdown, the message is issued and the mount path is written into the MHDB along with the reason string *rsnstr*. At next z/OS NFS startup, the reason string in the MHDB is detected and the message issued. By contrast, at resource timeout the message is issued, but no MHDB record is written in the swapped MHDB data set. In the message text:

<i>text</i>	"current" or "prior". The text "prior" is only seen at z/OS NFS server startup from MHDB diagnostic records. All other instances of this message see "current".
<i>rsnstr</i>	The reason for the mount to be dropped is one of the following: <ul style="list-style-type: none"> • "Mount Block current count is 0" • "No MVS File Block found" • "No Mount Usage Block found" • "NFS version 4 non-recorded mount" • "Mount Usage Block marked for deletion" • "Mount Usage Block has usage count of 0" • "Mount timed out" • "Mount has no hostname" • "Mount record has no hostname" • "Mount MVS File Block locate reasoncode=<i>fbrc</i>" where <i>fbrc</i> is an internal reason code
<i>host</i>	the host name of the mount being dropped
<i>mpath</i>	the path name of the mount being dropped
<i>fsname</i>	the USS filesystem name for the mount pathname, or "MVS" for an MVS mount
<i>fhandle</i>	hex representation of the mount filehandle, so the mount keys can be correlated to dependent filehandles getting dropped errors

Note: If "No Mount Usage Block found" is the reason string *rsnstr*, then the host and *fhandle* values can be ignored.

System action: NFS continues processing.

Operator response: None, unless an NFS client mount is lost. In that case, collect NFS Server log data sets and notify the system programmer.

System programmer response: None, unless an NFS client mount is lost. In that case, collect NFS Server log data sets and contact the IBM Support Center.

GFSA811I **CANNOT FLUSH PARTIAL RECORDS FOR DATA SET *text1(text2)*: FB *h_digits*.**

Explanation: There was not enough memory to allocate the storage that is required to flush partial records to the data set at data set close time. The partial record was discarded.

System action: The data set is closed. NFS processing continues.

System programmer response: Increase the size of the step region. The data set might be incomplete.

GFSA812I **FLUSH FAILED: RC *d_digits1* OFFSET *d_digits2* WAS DROPPED FOR DATA SET *text1(text2)*.**

Explanation: When NFS attempted to flush cached data at data set close time, the error *d_digits1* was detected. The data at offset *d_digits2* was discarded. This error message follows more specific error messages.

System action: The data set is closed. NFS processing continues.

System programmer response: See the message preceding this message to determine the correct action. The data set might be incomplete. See Table 67 on page 445 for a description of the return code *d_digits1*.

GFSA813I **REMOVE/RENAME FAILED: RC *h_digits* DSN *text1(text2)*.**

Explanation: The error *h_digits* was detected during an attempt to remove or rename member *text2* of PDS *text1*.

System action: The current NFS request fails. Otherwise, NFS processing continues.

Operator response: Contact the system programmer.

System programmer response: The value of *h_digits* is the return code from the z/OS DFSMS STOW macro. See z/OS DFSMS Macro Instructions for Data Sets for the explanation of STOW return codes.

GFSA814I (*procname*) Action **synchronizing *d_digit* opened data sets or members.**

Explanation: The message indicates the number of data sets or PDS/PDSE members with buffered data that is to be synchronized (written) to disk or to be dropped (discarded).

In the message text:

procname

The name of the z/OS NFS Server start procedure.

action One of the following:

Begin If the STOP command is issued.

Abort If the modify SHUTDOWN operator command is issued.

d_digit The number of opened data sets or PDS/PDSE members.

System action: The z/OS NFS Server begins its termination processing with either synchronizing the write buffers (STOP command) or discarding the write buffers (modify SHUTDOWN command).

Operator response: If z/OS NFS Server takes a long time to synchronize the write buffers for many data sets or PDS/PDSE members, and there is an immediate need to stop the Server by aborting the synchronization processing, contact the system or application programmer for the modify SHUTDOWN operator command that can be entered after issuing the STOP command.

Note: The modify SHUTDOWN command causes any unwritten data to be discarded and lost.

System programmer response: None.

GFSA815I **RENAME FAILED: RC *h_digits1* OLDDSN *text1* VOL *text2* UNIT *h_digits2* NEWDSN *text3*.**

Explanation: The error *h_digits1* was detected during an attempt to rename the non-VSAM data set *text1* to *text3*. The value of *text2* is disk volume serial number. The value of *h_digits2* is the disk device type code.

System action: NFS processing continues.

System programmer response: The value of *h_digits1* is a composite of one or more error return codes that the system encountered when trying to rename the data set. You can decode the hexadecimal digits using the following list.

Renaming a data set requires three steps:

1. Uncatalog the old data set name,
2. Rename the data set in the disk VTOC, and
3. Catalog the new data set name.

Should an error occur in either of the last two steps, the prior step or steps are undone to preserve the old data set name.

Find the step that failed by matching the value in byte zero of the return code with one of the values under the heading **Byte 0** in the following list. Byte three contains the return code from the first failing DFP service (uncatalog/catalog or DADSM rename). If more errors occur during an attempt to recatalog or rename the data set back to the old name, the return codes are placed in bytes one and two respectively.

Byte 0 Meaning/other bytes

- | | |
|-----------|---|
| 00 | Error uncataloging old data set name. Byte 3: Uncatalog return code. |
| 01 | Error renaming the data set. Byte 1: Recatalog return code for old data set name. Byte 3: DADSM rename return code. |
| 02 | Error cataloging new data set name. Byte 1: Recatalog return code for old data set name. Byte 2: DADSM rename return code for old data set name. Byte 3: Catalog return code for new data set name. |

Catalog and DADSM rename return codes are documented in *z/OS DFSMSdfp Advanced Services*.

Message IEC614I is written for DADSM rename errors and contains more diagnostic codes. These codes are documented in *z/OS DFSMSdfp Diagnosis*.

GFSA816I **HOST NAME OF IP ADDRESS (*d_digits*) WAS NOT FOUND BY TCP/IP.**

Explanation: The client host name of IP address *d_digits* is not defined in either the TCP/IP domain name server or the TCP/IP site table.

System action: NFS processing continues. The dotted IP address is used as the host name.

System programmer response: Insert this client host's entry into either the TCP/IP domain name server or the TCP/IP site table.

GFSA817I *text1* **REQUEST NOT VALID ON ALIAS NAME *text2*.**

Explanation: The value of *text1* can be remove or rename. The value of *text2* is an MVS access method services alias name of a file that also has a true name. Remove (**rm** or **rmdir**) and rename (**mv**) requests cannot be run using an alias name. The true file name is required.

System action: The request is stopped. An I/O error indication is returned to the client. NFS processing continues.

System programmer response: Inform the client user of this error.

User response: Provide the true name of the file in the request.

GFSA818I (procname) EXPORTS: NO VALID HOST NAMES IN *text* LIST.

Explanation: None of the client host names in the read/write or access list is defined to the network (see *text*).

In the message text:

procname

The name of the start procedure.

System action: The NFS does not export the associated directory if the result is a null access list. If the result is a null read/write list, the directory is exported with read-only access.

System programmer response: Correct the host names in the exports data set or have the host names defined to the network.

GFSA819I DATA SET *text1* CREATION USING DATA CLASS = *text2*.

Explanation: Data set *text1* is being allocated using the attributes in data class *text2*.

System action: NFS processing continues.

GFSA820I CATALOG ERROR OCCURRED WHILE [RETRIEVING | UPDATING] CATALOG INFORMATION FOR *text*. RETURN CODE IS *d_digits1*, REASON CODE IS *cc-d_digits2*.

Explanation: The catalog management module IGG0CLcc returned the return code *d_digits1* and reason code *d_digits2* as the result of a catalog error or an exception condition. The value of *text* is the name of the data set against which the retrieve or update operation was performed.

System action: NFS processing continues.

System programmer response: See message IDC3009I in *z/OS MVS System Messages, Vol 6 (GOS-IEA)* for specific return code and reason code information.

GFSA821I ERROR OCCURRED WHILE UPDATING THE FORMAT 1 DSCB FOR *text1* ON *text2*. FUNCTION CODE IS *d_digits1*, RETURN CODE IS *d_digits2*, REASON CODE IS *d_digits3*.

Explanation: In the message text:

text1 The value of *text1* is the name of the data set.

text2 The value of *text2* is the serial number of the volume on which the data set resides.

The function code can be one of the following codes:

- 2 Deserializing the unit control block (UCB)
- 4 Deserializing the direct access storage device (DASD) volume
- 12 Searching for the UCB
- 16 Serializing the DASD volume
- 20 Reading the data set control block (DSCB)
- 24 Writing the DSCB

System action: NFS processing continues.

System programmer response: See the following manuals for specific return code and reason code information:

- 2 *z/OS MVS Programming: Authorized Assembler Services Reference SET-WTO*, macro UCBPIN
- 4 *z/OS MVS Programming: Authorized Assembler Services Reference ALE-DYN*, macro DEQ
- 12 *z/OS MVS Programming: Authorized Assembler Services Reference SET-WTO*, macro UCLOOK
- 16 *z/OS MVS Programming: Authorized Assembler Services Reference LLA-SDU*, macro RESERVE
- 20 *z/OS DFSMSdfp Advanced Services*, return codes from CVAFDIR
- 24 *z/OS DFSMSdfp Advanced Services*, return codes from CVAFDIR

GFSA822I (*procname*) UNABLE TO PERFORM FILE MAPPING BECAUSE NO SIDE FILE SPECIFIED OR LOADED

Explanation: File mapping cannot be performed because a side file was not specified either as a default or at the mount point.

In the message text:

procname

The name of the start procedure.

System action: The operation fails.

System programmer response: Specify a side file in the attributes data set.

User response: Specify a side file in the **mount** command.

GFSA823I (*procname*) PUBLIC PATH CANNOT BE ESTABLISHED.

Explanation: The public path name(s) specified in the **public** keyword cannot be established during server

GFSA824W (procname) • GFSA828I (procname)

startup. This could be because the path is not exported or because it does not exist.

In the message text:

procname

The name of the start procedure.

System action: NFS server startup ends.

Operator response: Make sure that the public path name exists and is exported if export list checking is enabled. Correct the problem and restart the server.

GFSA824W (procname) NETWORK FILE SYSTEM CLIENT *ipaddr (clientname)* DID NOT SEND COMPLETE RECORDS FOR OFFSET (*offset*) FOR DATA SET *dsname* WITHIN *seconds* SECONDS.

Explanation: During MVS z/OS conventional data set timeout for the data set *dsname* in TEXT mode, the NFS server detected incomplete records sent by the NFS client *ipaddr(clientname)* that were not processed in the required time (*seconds*) of the timeout value that was extended.

In the message text:

procname

The name of the start procedure.

ipaddr The client IP address

clientname

Client name

offset Offset into record

dsname

Name of data set

seconds

Time in seconds

System action: NFS server continues processing without closing the detected data set. NFS server waits for an extended period for the NFS client to send the needed data to complete the records.

Operator response: Contact the user.

User response: Check the network and end-user end-user application on the client side. It is possible that the client terminated or an application is hung or has terminated. Restart the application or re-boot the client workstation to continue processing the data set.

GFSA825W (procname) DATA SET *dsname* CLOSED WITH PARTIAL RECORDS.

Explanation: Data set *dsname* was closed with partial records during 1) MVS z/OS conventional data set timeout processing, 2) NFSv4 close processing, or 3) z/OS NFS server shutdown.

In the message text:

procname

The name of the start procedure.

dsname

Name of data set

System action: z/OS NFS server closes the data set and continues processing.

Operator response: Contact the user.

User response: Check the data integrity of the data set. Check the network and user application on the client side. It is possible 1) the client did not send the necessary data packets to complete the partial record within the z/OS NFS server extended timeout wait, or before the NFSv4 RPC close had arrived or before the z/OS NFS server shutdown, 2) the client terminated or an application is hung or has terminated, or 3) the client needs to be rebooted or the application needs to be restarted to continue processing the data set if the z/OS NFS server has not shutdown yet. For more information about partial records, see "Partial record identification" on page 37 and "Symptoms of GFSA824W/GFSA825W messages" on page 38.

GFSA827I Control block (*text1*) allocation failed.

Explanation: An operation to allocate virtual storage for control block *text1* was attempted but was unsuccessful.

In the message text:

text1 The name of the control block.

System action: The current NFS request fails. Otherwise, NFS processing continues.

Operator response: Contact the system programmer.

System programmer response: Increase the size of the step region.

GFSA828I (procname) Synchronize offset *h_digit* for *d_digit* write blocks of *dsn/mem* .

Explanation: The message indicates the synchronization progress of the data set or PDS/PDSE member. The synchronization processing includes writing null-data to represent the missing data that the Client did not write, and writing the buffered data that was received from the Client.

It is possible that the subsequent GFSA828I message for the same *dsn/mem* may show the increasing offset but the number of the buffered logical write blocks is not decreased because z/OS NFS Server is writing null-data.

In the message text:

procname

The name of the z/OS NFS Server start procedure.

h_digit 16-digit hexadecimal offset from the last written logical block.

d_digit Number of buffered RPC logical write blocks to be written.

dsn/mem

The data set or PDS/PDSE data set and member name.

System action: The z/OS NFS Server continues the synchronization processing and it may display the GFSA828I message again at one-minute interval to indicate the progress.

Operator response: If the z/OS NFS Server takes a long time to synchronize the write buffers for many data sets or PDS/PDSE members, and there is an immediate need to stop the Server by aborting the synchronization processing, consult with the System or Application Programmer for the **modify SHUTDOWN** operator command that can be entered after issuing the STOP command.

Note: The **modify SHUTDOWN** command causes any unwritten data to be discarded and lost.

System programmer response: None.

GFSA829I REQUEST *h_digits* INVALID CREDENTIALS FLAVOR *d_digits*.

Explanation: An incorrect credentials type was received from the client. This is probably a client software error. NFS supports UNIX and nonauthentication styles.

In the message text:

h_digits

The value of *h_digits* is the request block address.

System action: The request is stopped. NFS processing continues.

System programmer response: Inform the client user that the credentials used are not valid.

GFSA831E (procname) Abort synchronizing *dsn/mem*

Explanation: The message indicates the data set or PDS/PDSE member with partial or incomplete data because the z/OS NFS Server is about to stop, the Client does not finish writing, and the buffered write data are dropped (not written to disk) due to the **modify SHUTDOWN** operator command.

In the message text:

procname

The name of the z/OS NFS Server start procedure.

dsn/mem

The data set or PDS/PDSE data set and member name.

System action: The z/OS NFS Server continues discarding the write buffers associated with the *dsn/mem* (**modify SHUTDOWN** command).

Operator response: Provide the *dsn/mem* to the System or Application Programmer to rewrite the *dsn/mem* upon starting the z/OS NFS Server.

System programmer response: Rewrite the *dsn/mem* upon starting the z/OS NFS Server.

GFSA832I REQUEST *h_digits* INVALID MEMBERNAME FOR *text*.

Explanation: In the message text:

text The value of *text* is the member name of a partitioned data set (PDS) that was specified as a file name by the NFS client user. The file name specified was incorrect or was not found in the PDS.

h_digits

The value of *h_digits* is the request block address.

System action: The request is stopped. NFS processing continues.

System programmer response: Inform the client user of this error.

User response: Correct the error and resubmit the request.

GFSA833I REQUEST *h_digits* PARSE FAILED FOR *text*.

Explanation: In the message text:

text The value of *text* is the member name of a partitioned data set (PDS) or a data set name that was specified as a file name by the NFS client user. The file name specified was incorrect, was not found in the PDS, or was an incorrect or nonexistent data set.

h_digits

The value of *h_digits* is the request block address.

System action: The request is stopped. NFS processing continues.

System programmer response: Inform the client user of this error.

User response: Correct the error and resubmit the request.

GFSA834I Control block *text1* insertion failed *digit1*.

Explanation: The NFS server cannot insert *text1* control block (at location *digit1*) into the control block collection.

In the message text:

text1 The name of the control block.

digit1 The location of the control block.

System action: The current NFS request fails. Otherwise, NFS processing continues.

Operator response: Contact the system programmer.

System programmer response: Keep the existing z/OS NFS Server traces and contact IBM Support.

GFSA840I DYNAMIC ALLOCATION FAILED WITH RETURN CODE *h_digits* FOR DATA SET *text(dsname)*.

Explanation: A dynamic file allocation error occurred.

In the message text:

h_digits The value of *h_digits* is the dynamic allocation return code.

dsname The value of *dsname* is the data set name.

text The value of *text* is the member name, if any.

System action: The request is stopped. NFS processing continues.

System programmer response: This message is preceded by either message GFSA853I or GFSA854I. See the programmer response for the message that precedes this message to determine the appropriate action.

GFSA841I REaddir: *text1* (*digit1* bytes) too small, at least *digit2* bytes needed.

Explanation: The NFS server received a ReadDir request. The NFS Client specified buffer/dircount (*text1*) is too small (*digit1* bytes). It should be at least *digit2* bytes.

In the message text:

text The client-specified buffer/dircount.

digit1 The size of the client-specified buffer/dircount.

digit2 The required minimum size of the client-specified buffer/dircount.

System action: The current NFS request fails. Otherwise, NFS processing continues.

Operator response: Contact the system programmer.

System programmer response: Keep the existing

z/OS NFS Server traces and contact IBM Support.

GFSA842I *dsname1* UNSUPPORTED DSORG *dsname2*.

Explanation: NFS does not support data set organization of data set *dsname1*. The value of *dsname2* can be ISAM or UNKNOWN.

System action: The request is stopped. NFS processing continues.

System programmer response: Inform the client user of this error.

GFSA843I CREATE FAILED FOR *dsname*.

Explanation: An error occurred while the NFS was trying to create the data set *dsname*. This message follows other messages that describe the error in greater detail.

System action: The request is stopped. NFS processing continues.

System programmer response: See the messages preceding this message to determine the appropriate response.

GFSA846I Cannot locate Host Block from *text1* = *digit1*.

Explanation: NFS Server cannot locate the Client Host control block from the *text1* control block (pointer to *text1* = *digit1*).

System action: The current NFS request fails. Otherwise, NFS processing continues.

Operator response: Contact the system programmer.

System programmer response: Keep the existing z/OS NFS Server traces and contact IBM Support.

GFSA847I IDCAMS ERROR: *text*.

Explanation: The value of *text* is an access method services error message.

System action: The request is stopped. NFS processing continues.

System programmer response: See z/OS MVS System Messages for more information about the access method services error message.

GFSA848I PDS *text* IS NOT EMPTY.

Explanation: The NFS client user issued a **rmdir** (remove directory) AIX or UNIX command to remove a partitioned data set (PDS) that was not empty. The NFS version 2 protocol specification requires the directory (PDS) to be empty before it is removed. This is an NFS client user error.

In the message text:

text The value of *text* is the name of the PDS.

System action: The request is stopped. An error is returned to the client. NFS processing continues.

System programmer response: Inform the NFS client user of this error.

User response: Remove all files in the directory, and then resubmit the **rmdir** request.

**GFSA849I New and old files are not members
(*text1*) of the same PDS (*text2*).**

Explanation: Rename is not allowed for a member of a partitioned data set (PDS) when the target name is not in the same PDS. This is an NFS client user error.

In the message text:

text1 The member names of the files.

text2 The name of the PDS.

System action: The current NFS request fails. Otherwise, NFS processing continues.

Operator response: Contact the system programmer.

System programmer response: Inform the NFS client user of this error.

User response: Check the file name used. Correct it and try again.

**GFSA850I READDIR: Server Cookie Verifier NOT
SAME, Current Cookie Verifier: *digit1*
Saved Cookie Verifier: *digit2*.**

Explanation: NFS Server received a ReadDir continuation request. The target directory changed since the previous request was processed. Therefore, the Readdir continuation request cannot be processed.

In the message text:

digit1 The current cookie verifier.

digit2 The saved cookie verifier.

System action: The current NFS request fails. Otherwise, NFS processing continues.

Operator response: Contact the system programmer.

System programmer response: None. The client should automatically recover from this error. Keep the existing z/OS NFS Server traces and contact IBM Support if the client does not recover.

**GFSA851I READDIR: Bad Cookie, Server Cookie
Verifier: *digit1*, Client Cookie: *digit2*.**

Explanation: NFS Server received a ReadDir continuation request. The Cookie verifier sent back to the Server by the Client does not match the Cookie Verifier saved by the Server.

In the message text:

digit1 The server cookie verifier.

digit2 The client cookie.

System action: The current NFS request fails. Otherwise, NFS processing continues.

Operator response: Contact the system programmer.

System programmer response: Keep the existing z/OS NFS Server traces and contact IBM Support.

**GFSA853I DYNAMIC ALLOCATION: INPUT
VALIDATION ROUTINE REJECTED
ALLOCATION.**

Explanation: Dynamic allocation failed when issued by the installation input validation routine. Installation configuration errors probably occurred.

System action: The request is stopped. NFS processing continues.

System programmer response: See the z/OS *MVS Installation Exits* for more information about the Input Validation routine.

**GFSA854I DYNAMIC ALLOCATION: RC=*d_digits*
ERROR=*h_digits1* INFO=*h_digits2* : *text*.**

Explanation: Dynamic allocation failed with return code *d_digits*, error reason code *h_digits1*, and information reason code *h_digits2*.

In the message text:

text The value of *text* is a description of the interrupted dynamic allocation request.

System action: The request is stopped. NFS processing continues.

System programmer response: See z/OS *MVS Programming: Authorized Assembler Services Guide* for more information about these codes.

**GFSA858I OPEN FAILED RC *d_digits* FOR DATA
SET *dsname1*(*dsname2*).**

Explanation: An error occurred during an attempt to open the data set.

In the message text:

dsname1

The value of *dsname1* is the data set name.

dsname2

The value of *dsname2* is the member name, if any.

d_digits

The value of *d_digits* is the return code.

System action: The request is stopped. NFS processing continues.

GFSA859I • GFSA866I (procname)

System programmer response: If this error was not caused by an out-of-memory condition, contact your programming support personnel. See Table 67 on page 445 for a description of the return code *d_digits*.

GFSA859I READ FAILED RC *d_digits* FOR DATA SET *dsname1(dsname2)*.

Explanation: An error occurred during an attempt to read the data set.

In the message text:

dsname1
The value of *dsname1* is the data set name.

dsname2
The value of *dsname2* is the member name, if any.

d_digits
The value of *d_digits* is the return code.

System action: The request is stopped. NFS processing continues.

System programmer response: If this error was not caused by an out-of-memory condition, contact your programming support personnel. See Table 67 on page 445 for a description of the return code *d_digits*.

GFSA860I WRITE FAILED RC *d_digits* FOR DATA SET *dsname1(dsname2)*.

Explanation: An error occurred during an attempt to write the data set.

In the message text:

dsname1
The value of *dsname1* is the data set name.

dsname2
The value of *dsname2* is the member name, if any.

d_digits
The value of *d_digits* is the return code.

System action: The request is stopped. NFS processing continues.

System programmer response: If this error was not caused by an out-of-memory condition, contact your programming support personnel. See Table 67 on page 445 for a description of the return code *d_digits*.

GFSA862I CATALOG (*text*) COULD NOT BE LOCATED.

Explanation: The user catalog named *text* that contains the entry for an index, could not be located. The catalog does not exist or is not mounted. If it does not exist, the entry in the master catalog might be incorrect.

System action: NFS processing continues.

System programmer response: Investigate why the catalog could not be found and take corrective action.

GFSA863I READDIR ON ROOT IS NOT ALLOWED.

Explanation: The user attempted to list the contents of the master catalog.

System action: The request is stopped. NFS processing continues.

GFSA864I (procname) CANNOT OPEN THE EXPORTS DATA SET.

Explanation: The server was unable to open the exports data set defined in the job control language (JCL) for DDNAME EXPORTS. The DD statement might be missing or the data set name might be incorrect.

In the message text:

procname
The name of the start procedure.

System action: NFS stops.

Operator response: Notify your system programmer.

System programmer response: Correct the JCL for DDNAME EXPORTS.

GFSA865I (procname) EXPORTS: UNEXPECTED OPTION (*text*)-- SHUTDOWN SCHEDULED.

Explanation: The option information provided in the *text* data is incorrect. This error could occur as a result of unexpected blanks, incorrect syntax, or mutually exclusive options (for example, both **ro** and **rw**).

In the message text:

procname
The name of the start procedure.

System action: Checking of the exports data set continues, but the shutdown of NFS occurs at its completion.

System programmer response: Correct the exports data set and restart NFS.

GFSA866I (procname) EXPORTS: DIRECTORY *dsname* WAS NOT EXPORTED.

Explanation: An error was encountered that was severe enough to prevent the data set or index named *dsname* from being exported. This message follows a more specific error message that is issued to the console only, to the z/OS NFS Server log only, or to both the console and the z/OS NFS Server log depending on the severity of the error in the exports data set.

In the message text:

procname

The name of the start procedure.

System action: NFS processing continues or terminates depending on the severity of the error in the exports data set and the phase the z/OS NFS Server is processing.

System programmer response: Correct the exports data set.

GFSA867I (procname) EXPORTS: *dsname1* CANNOT BE EXPORTED BECAUSE *dsname2* ALREADY IS.

Explanation: The data set or index named in *dsname1* is a parent directory or a subdirectory of the data set or index named in *dsname2* that is already exported.

In the message text:

procname

The name of the start procedure.

System action: NFS processing continues.

System programmer response: Correct the exports data set.

GFSA868I (procname) EXPORTS: WRONG *text1* (*text2*) HAS BEEN IGNORED.

Explanation: The network template, hostname template, or IP address specified by *text2* was incorrect.

In the message text:

procname

The name of the start procedure.

text1 The type of item that has been ignored: *network template, hostname template, or IP address.*

text2 The value of the network template, hostname template, or IP address.

System action: NFS processing continues.

Operator response: Contact the system programmer.

System programmer response: Correct the exports data set.

Programmer response: None.

GFSA869I (procname) EXPORTS: UNKNOWN HOST (*text*) HAS BEEN IGNORED.

Explanation: NFS cannot create the HOSTCACHE control block for the client host, specified by *text*. The reason is that the client host with hostname (*text*) is not defined to the network; NFS received a hostname client suffix syntax error.

In the message text:

procname

The name of the start procedure.

text The host name or IP address.

System action: NFS processing continues.

Operator response: Contact the system programmer.

System programmer response: Correct the host name in the exports data set or have this host name defined to the network.

Programmer response: None.

GFSA871I REQUEST *h_digits* HAS MISMATCHED UID: CRED = *d_digits1* ARGS = *d_digits2*.

Explanation: The value of *h_digits* is a block created for the logon or logout request. The value of *d_digits1* represents the credential user ID number. The value of *d_digits2* represents the client user ID number. The user ID numbers do not match, and this is considered a security failure.

System action: The client logon or logout request is stopped. NFS processing continues.

System programmer response: This is an NFS client application problem. If the NFS client application is offered by IBM, inform the IBM Support Center. If the NFS client application is offered by the programming support personnel, contact your programming support personnel.

GFSA872E No RACF support for *mvlogin* request of userid from client UID: *uid* on host: *hostname*

Explanation: The mvlogin request failed because RACF does not support a password change from the current password to new password phrase or from current password phrase to new password.

System action: The NFS server fails the request.

Operator response: None.

System programmer response: Retry the mvlogin command by subscribing to the RACF Password and Passphrase syntax rules as specified in the z/OS Security Server RACROUTE Macro Reference.

GFSA876I I/O ERROR ON DSN = *text1*(*text2*) SENSE *h_digits1* IOBCSW *h_digits2* *h_digits3*. ACCESS METHOD RC = *h_digits4* ACCESS METHOD RSN = *h_digits5*

Explanation: The physical I/O layer tried to check some previous operation in the data set and the check failed.

In the message text:

text1 The value of *text1* is the data set name.
text2 The value of *text2* is the member name, if any.

h_digits1
 The value of *h_digits1* is the sense bytes 0 and 1 from the device.

h_digits2
 The value of *h_digits2* is the first 3 bytes of the channel status word from the device.

h_digits3
 The value of *h_digits3* is the last 4 bytes of the channel status word from the device.

h_digits4
 The value of *h_digits4* is the access method return code.

h_digits5
 The value of *h_digits5* is the access method reason code.

System action: The request is stopped. NFS processing continues.

System programmer response: See the appropriate device documentation for more information on the sense bytes and channel status word.

GFS A877I R0=*h_digits1* R1=*h_digits2: text* ACCESS METHOD RC = *h_digits3* ACCESS METHOD RSN = *h_digits4*

Explanation: A SYNAD error was detected during a physical I/O operation.

In the message text:

h_digits1
 The value of *h_digits1* is the contents of register 0.

h_digits2
 The value of *h_digits2* is the contents of register 1.

text
 The value of *text* is the message returned from the SYNAD analysis function macro.

h_digits3
 The value of *h_digits3* is the access method return code.

h_digits4
 The value of *h_digits4* is the access method reason code.

System action: The request is stopped. If the error detected is a B37, D37, or E37 abend, NFS restores the file size to the last known file size before the SYNAD error. NFS processing continues.

System programmer response: A data management message should have displayed on the console. See *z/OS MVS System Messages, Vol 1 (ABA-AOM)* through *z/OS MVS System Messages, Vol 9 (IGF-IWM)* for a

description of the return code to determine the corrective action.

GFS A878I (procname) EXPORTS: CANNOT OPEN THE NETGROUP FILE /etc/netgroup . Error=(*digit1,x_digit2*)

Explanation: NFS cannot open the local netgroup file. The *digit1* and *x_digit2* values specify the errno and errno2 error codes. See *z/OS UNIX System Services Messages and Codes* for details on these error codes.

System action: NFS processing continues.

Operator response: Contact the system programmer.

System programmer response: Check for validity of the specified netgroup file.

Programmer response: None.

GFS A879I (procname) EXPORTS: PROBLEMS ENCOUNTERED PARSING THE NETGROUP FILE /etc/netgroup . GROUP (*text1*) IS EXPERIENCING THE PROBLEM.

Explanation: NFS was not able to parse the local netgroup file. The problem occurred while parsing Group *text1*.

In the message text:

procname
 The name of the start procedure.

System action: NFS processing continues.

Operator response: Contact the system programmer.

System programmer response: Correct the contents of the netgroup file.

Programmer response: None.

GFS A881I FUB: *fub1addr* UNABLE TO ACCESS FILE *dsname(member)* OWNED BY FUB *fub2addr*.

Explanation: A user tried to access a data set that is already locked by NFS for writing by another user. The data set has not been released yet.

In the message text:

fub1addr
 is the address of the file usage block (FUB) attempting to access the file.

dsname
 is the data set name.

member
 is the member name, if any.

fub2addr
 is the address of the file usage block (FUB) that currently has the file allocated.

System action: The request is stopped. A Not Owner error message is returned to the user. NFS processing continues.

System programmer response: If queried by the user, the Not Owner error message, as it relates to NFS, is described in "Messages from the client platform (AIX)" on page 440.

GFSA882I (*procname*) **The tape dataset *dsname* is not supported.**

Explanation: Access to a dataset that is not supported by z/OS NFS Server.

In the message text:

procname

is the name of the start procedure.

dsname

is the name of the dataset that is not supported.

System action: The request is stopped. NFS processing continues.

Operator response: Inform the Client user of this error.

System programmer response: None.

GFSA883I Record *digit1* size *digit2* is too short: minimum = *digit3* DSN *text1(text2)*.

Explanation: The NFS server detected that a record in a data set is too short – less than the minimum required size.

In the message text:

digit1 The record of the data set that is too short.

text1 The data set name.

text2 The member name, if any.

digit2 The current size of the record.

digit3 The minimum required size of the record.

System action: The current NFS request fails. Otherwise, NFS processing continues.

Operator response: Contact the system programmer.

System programmer response: Keep the existing z/OS NFS Server traces and contact IBM Support.

Programmer response: None.

GFSA886I UNABLE TO WRITE RECNO *d_digits* TO *text1(text2)* DUE TO PREVIOUS ERROR.

Explanation: An error was previously detected which prevents writing to a data set.

System action: The request is stopped. NFS processing continues.

System programmer response: If the previous error cannot be determined, contact your programming support personnel.

GFSA892W The file *filename* is opened by host *hostname* and has not been used or closed for over *secs* seconds.

Explanation: A client process on host *hostname* opened file *filename* and has not addressed it for the indicated time. Other client processes may be blocked from using this file.

Note: This message is initially generated after 5 minutes (or 16 server lease times, whichever is less) of nonuse of the file. The message is reissued in intervals that double the prior interval, up to a maximum of one hour between messages, and continues until the file is used or released.

System action: NFS processing continues.

Operator response: Determine whether the client or client process has hung or terminated without proper cleanup and, if so, issue the operator RELEASE command to free the file.

System programmer response: None.

GFSA895I REQUEST *h_digits* - FILE *text* NOT ALLOCATED.

Explanation: NFS did not have the data set *text* open during a request to close the file. The file name might have been specified incorrectly, or the timeout might have already occurred for this data set, causing the server to close the data set.

In the message text:

h_digits

The request block address.

text The data set name.

System action: The system ends the request. Return code X'131' is passed back to the user. The system processing continues for NFS.

GFSA896I REQUEST *h_digits1* - FILE BLOCK *h_digits2* ASSOCIATED WITH FILE *text* NOT IN USE BY CREDENTIALS *h_digits3*.

Explanation: The request to close file *text* was received, but the file was not opened by the client. A file can be closed only by the same client that opened the file.

In the message text:

GFSA897I • GFSA903I (procname)

h_digits1

The value of *h_digits1* is the request block address.

h_digits2

The value of *h_digits2* is the file block address.

h_digits3

The value of *h_digits3* is the credentials block address.

System action: The request is stopped. Return code 132 is passed back to the client. NFS processing continues.

GFSA897I Record *d_digits1* size *d_digits2* is too long; maximum = *d_digits3* DSN = *text1(text2)*.

Explanation: The NFS server detected that the record *d_digit1* of data set *text1(text2)* is too long (its size = *d_digits2*). Its size should be at most *d_digits3*.

System action: The current NFS request fails. Otherwise, NFS processing continues.

Operator response: Contact the system programmer.

System programmer response: Keep the existing z/OS NFS server traces and contact IBM Support.

Programmer response:

1. Check whether z/OS NFS Server text processing mode is appropriate.
2. Check the target data set characteristics.
3. Check that there is no line in the remote source file being written to the target data set that is longer than the effective record length allowed for the data set type.

GFSA898I EOL SEQUENCE MISMATCH FOR DATA SET *text1(text2)*.

Explanation: The NFS server processed data in TEXT mode. The end-of-line terminator was not found in the same place as the previous end-of-line terminator for an offset that is being rewritten by the client. This is an NFS client error.

System action: The request is stopped. NFS processing continues.

User response: Make sure that the record you are writing is the same size as the record you are replacing.

GFSA899I BLANKSTRIP MODE: TRAILING BLANK(S) IN RECORD *d_digits* IS NOT ALLOWED DSN = *text1(text2)*.

Explanation: Writing data in text mode with blank stripping enabled and blanks at the end of the line to a data set with fixed-length records is not allowed.

System action: The request is stopped. NFS processing continues.

GFSA900I (procname) MOUNT PROCESSING ACTIVE.

Explanation: Mounts can be issued from the network. This message displays in response to the **status** operand of the **modify** command.

In the message text:

procname

The name of the start procedure.

System action: NFS processing continues.

GFSA901I (procname) MOUNT PROCESSING SUSPENDED.

Explanation: Mount processing was suspended by the **freeze=on** operand of the **modify** command. This message displays in response to either the **freeze=on** operand or the **status** operand of the **modify** command. Any additional mount requests from the network are ignored. Existing mounts are unaffected.

In the message text:

procname

The name of the start procedure.

System action: NFS processing continues.

GFSA902I (procname) MOUNT PROCESSING RESUMED.

Explanation: Mount processing has been resumed by the **freeze=off** operand of the **modify** command. Any additional mount requests from the network are honored. Existing mounts are unaffected.

In the message text:

procname

The name of the start procedure.

System action: NFS processing continues.

GFSA903I (procname) TASK *h_digits1* TCB *h_digits2* PROGRAM = *text1 = text2*.

Explanation: This is in response to the **status** operand of the **modify** command.

In the message text:

procname

The name of the start procedure.

h_digits1

The value of *h_digits1* is the task queue address.

h_digits2

The value of *h_digits3* is the task control block address.

text1 The value of *text1* is the program name.

text2 The value of *text2* is the specific task name.

System action: NFS processing continues.

GFSA904I (procname) z/OS UNIX MOUNT PROCESSING ACTIVE.

Explanation: Mounts can be issued from the network. This message displays in response to the **status** operand of the **modify** command.

In the message text:

procname

The name of the start procedure.

System action: NFS processing continues.

GFSA905I (procname) Current CTRACE buffer is flushed and switch made to the next buffer.

Explanation: In response to the FLUSHCTR operator command the Network File System Component Trace function flushed the remaining trace buffers to the component trace external writer and switched to the next available buffer.

System action: The Network File System server continues.

Operator response: None.

System programmer response: None.

GFSA907I THERE IS MORE INFORMATION IN THE Network File System LOG.

Explanation: Due to the potential impact on the console, not all of the information associated with the previous message was reported on the console. The remaining lines will only be placed in the NFS Log. This message is displayed on the console to indicate that not all the information has been displayed on the console and more information is available in the NFS Log.

System action: The Network File System server continues.

Operator response: None.

System programmer response: None.

GFSA908I (procname) z/OS UNIX PROCESSING DISABLED.

Explanation: z/OS UNIX file system processing is suspended. This message displays in response to the **status** operand of the **modify** command.

In the message text:

procname

The name of the start procedure.

System action: NFS processing continues.

GFSA909E (procname) UNMOUNT COMMAND FAILED: MOUNT POINT STILL IN USE

Explanation: This message is in response to the **unmount** operand of the **modify** command. The unmount processing fails because the file system is still in use. The user can retry the **unmount** command later after there is no reference to the file system.

In the message text:

procname

The name of the start procedure.

System action: The system ends the request. The system processing continues for NFS.

GFSA910I (procname) path users = d_digits : client_list

Explanation: This message is in response to the **list=mounts** operand of the **modify** command and shows the mounted file path, the number of active users (*d_digits*) mounted to that path, and the host names (*client_list*) mounted to that path. The active users are displayed for NFSv2 and NFSv3 (ACTIVE), and the active mounts for NFSv4 with **mvsmnt** (MVSMNT) and without **mvsmnt** (NOMVSMNT). The active number might not be accurate if a client has crashed without unmounting the path.

Note: A maximum of approximately ten lines are displayed on the console. However, all the hosts are displayed in the NFS Log message.

In the message text:

procname

The name of the start procedure.

path

The path name of the mounted file.

users

Indicates the active user by protocol type:

ACTIVE

NFSv2 and NFSv3

MVSMNT

NFSv4 with **mvsmnt** attribute

NOMVSMNT

NFSv4 without **mvsmnt** attribute

d_digits

The number of active users for ACTIVE only; the number of active users is not listed for MVSMNT and NOMVSMNT.

client_list

The hostnames mounted for the path.

Note: NFSv4 HFS mounts issued from non-z/OS NFS clients (such as AIX, Oracle, and Linux) will not be reflected if no z/OS NFS server attributes are specified. In order for such mounts to be reflected, at least one z/OS NFS server attribute must be explicitly specified.

GFSA911I (procname) • GFSA916I (procname)

System action: NFS processing continues.

Operator response: None.

System programmer response: None.

Programmer response: None.

GFSA911I (procname) *path(member) users = d_digits : client_list*

Explanation: This message is in response to the **list=mounts** operand of the **modify** command and shows the mounted file space (path and member), the number of active users (*d_digits*) mounted to that path/member, and the host names (*client_list*) mounted to that path/member. The active users are displayed for NFSv2 and NFSv3 (ACTIVE), and the active mounts for NFSv4 with mvsmnt (MVSMNT) and without mvsmnt (NOMVSMNT). The active number might not be accurate if a client has crashed without unmounting the path/member.

This message is generated when the mount point is an MVS PDS or PDSE member.

Note: Only the first ten hosts are displayed on the console message for a given mount point. However, all the hosts are displayed in the NFS Log message. In the message text:

procname

The name of the start procedure.

path(member)

The path name of the mounted file.

users Indicates the active user by protocol type:

ACTIVE

NFSv2 and NFSv3

MVSMNT

NFSv4 with mvsmnt attribute

NOMVSMNT

NFSv4 without mvsmnt attribute

d_digits

The number of active users for ACTIVE only; the number of active users is not listed for MVSMNT and NOMVSMNT.

client_list

The hostnames mounted for the path.

Note: If an NFSv4 HFS mount request includes a symbolic link in the path name and the request fails with NFSERR_NOENT error (No such file or directory), the result may be an erroneous NOMVSMNT display for LIST=MOUNTS. This can result when the MVS HLQ matches the z/OS UNIX file system prefix.

System action: NFS processing continues.

Operator response: None.

System programmer response: None.

Programmer response: None.

GFSA912I (procname) *dsname.*

Explanation: The data set name *dsname* appears in response to a **list=dsnames** operand of the **modify** command and shows a currently active data set.

In the message text:

procname

The name of the start procedure.

System action: NFS processing continues.

GFSA913I (procname) *text1(text2).*

Explanation: The PDS member appears in response to the **list=dsnames** operand of the **modify** command and shows a currently active data set.

In the message text:

procname

The name of the start procedure.

System action: NFS processing continues.

GFSA914I (procname) *dsname DEALLOCATED.*

Explanation: The data set name *dsname* appears in response to a **release=dsname(member)** operand of the **modify** command after successful deallocation.

In the message text:

procname

The name of the start procedure.

System action: NFS processing continues.

GFSA915I (procname) *dsname NOT ALLOCATED.*

Explanation: The data set name *dsname* appears in response to the **release=dsname(member)** operand of the **modify** command if the data set or member specified to be released was not found.

In the message text:

procname

The name of the start procedure.

System action: NFS processing continues.

GFSA916I (procname) *dsname UNMOUNTED.*

Explanation: The data set name *dsname* appears in response to an **unmount** (data set or member) operand of the **modify** command after a successful unmount.

In the message text:

procname

The name of the start procedure.

System action: NFS processing continues.

GFSA917I (procname) *dsname* NOT MOUNTED.

Explanation: The data set name *dsname* appears in response to the **unmount** (data set or member) operand of the **modify** command if the data set or member specified to be unmounted was not found in the current mount list.

In the message text:

procname

The name of the start procedure.

System action: NFS processing continues.

GFSA918I (procname) *dsname text1* IS NOT A VALID NAME.

Explanation: The *text1* specified in the **release**, the **listlock**, or the **unmount** operand of the **modify** command is not a valid name.

- For the **release** operand, only a valid MVS data set name is allowed.
- For the **listlock** operand, only a valid MVS data set name or a UNIX file name is allowed.
- For the **unmount** operand, only a valid MVS data set name or a UNIX directory is allowed.

In the message text:

procname

The name of the start procedure.

System action: NFS processing continues.

Operator response: Specify the command again with a valid data set name.

GFSA919I (procname) *text* IS NOT A VALID MEMBER NAME.

Explanation: The member name *text* specified in the **release**, the **listlock** or the **unmount** operand of the **modify** command is not a valid MVS member name.

In the message text:

procname

The name of the start procedure.

System action: NFS processing continues.

Operator response: Specify the command again with a valid member name.

GFSA920I (procname) NO ACTIVE MOUNT POINTS.

Explanation: This message is in response to the **list=mounts** operand of the **modify** command and shows that there are no clients connected to the NFS. See message GFSA911I for the types of active mounts displayed.

In the message text:

procname

The name of the start procedure.

System action: NFS processing continues.

GFSA921I (procname) NO ACTIVE DATA SETS.

Explanation: This message is in response to the **list=dsnames** or the **listlock** operand of the **modify** command and shows that there are no clients actively accessing data sets.

In the message text:

procname

The name of the start procedure.

System action: NFS processing continues.

GFSA922I (procname) VERIFY: (*dsname*) IS NOT A VSAM DATA SET.

Explanation: This message is in response to the **verify** operand of the **modify** command and shows that the data set name *dsname* specified is not a Virtual Storage Access Method (VSAM) data set.

In the message text:

procname

The name of the start procedure.

dsname

The value of *dsname* specifies the data set name.

System action: The system ends the request. The system processing continues for the NFS.

GFSA923I (procname) VERIFY SUCCESSFUL FOR (*dsname*).

Explanation: This message is in response to the **verify** operand of the **modify** command. It shows that the verify was successful for the VSAM data set.

In the message text:

procname

The name of the start procedure.

dsname

The value of *dsname* specifies the data set name.

System action: The system processing continues for NFS.

GFSA924I (procname) VERIFY FAILED WITH RC = *d_digits* FOR (*dsname*).

Explanation: This message is in response to the **verify** operand of the **modify** command. It shows that the **verify** operand failed with a return code for the data set. Message GFSA847I follows this message in the log data set.

GFSA925I (procname) • GFSA932I (procname)

In the message text:

procname

The name of the start procedure.

d_digits

The value of *d_digits* is the return code.

dsname

The value of *dsname* is the data set name.

System action: The system ends the request. The system processing continues for NFS.

GFSA925I (procname) ERROR WAS DETECTED IN THE EXPORTS FILE. EXPORT LIST NOT REBUILT.

Explanation: This is the response from the **exportfs** operand of the **modify** command, indicating that one or more errors were detected in the exports data set (for example, the exports data set cannot be opened).

In the message text:

procname

The name of the start procedure.

System action: NFS processing continues. The existing exports list is not changed.

Operator response: Notify your system programmer.

System programmer response: Review previous console error messages for detailed information about the specific error in the exports data set.

GFSA927I (procname) MODIFY EXPORTS COMMAND IGNORED - THE EXPORTS FILE IS NOT BEING USED FOR SECURITY CHECKING.

Explanation: This is the reply from the **exportfs** operand of the **modify** command, indicating that the command was ignored because the site attribute for security requested that no exports file checking be done.

In the message text:

procname

The name of the start procedure.

System action: NFS processing continues with the security options unchanged.

GFSA929I MODIFY MAPFILE COMMAND IGNORED - MAPPED SIDE FILES ARE NOT BEING USED.

Explanation: This is the reply from the **mapfile** operand of the **modify** command, indicating that the command was ignored because mapped processing attribute was not specified in the site attribute file (NFSATTR) or any **mount** command.

System action: NFS processing continues with the side files data unchanged.

GFSA930I (procname) LOG DATA SET IS SWITCHED FROM *text1* TO *text2*.

Explanation: A “no space” or an I/O error condition is detected when writing to the log data set. NFS logging is now switched to the other log data set.

In the message text:

procname

The name of the start procedure.

text1 The value of *text1* is the name of the switched-from log data set.

text2 The value of *text2* is the name of the switched-to log data set.

System action: NFS processing continues.

Operator response: If requested by the installation, back up the switched-from log data set at this point. The switched-from data set is reused when the switched-to log data set is also filled.

System programmer response: Consider allocating larger NFS server log data sets for future NFS usage. Note that the last data buffer is lost when the log is switched.

GFSA93II (procname) NETWORK FILE SYSTEM SERVER LOGGING IS TERMINATED.

Explanation: The NFS logging is ended. This can be caused by a “no space” condition of the log data set.

In the message text:

procname

The name of the start procedure.

System action: NFS processing continues.

System programmer response: Allocate a larger log data set for future NFS usage.

GFSA932I (procname) LOG DATA SET *text* IS FLUSHED.

Explanation: The data buffer of the active log data set is flushed to disk.

In the message text:

procname

The name of the start procedure.

text The name of the log data set.

System action: NFS processing continues.

GFSA933I (procname) LOG DATA SET IS RE-INITIALIZED.

Explanation: The log data set is reinitialized.

In the message text:

procname

The name of the start procedure.

System action: NFS processing continues.

GFSA934I (procname) NFSLOG1 OR NFSLOG2 DD STATEMENTS NOT DEFINED.

Explanation: Either the NFSLOG1 and NFSLOG2 DD statements are not coded in the NFS startup cataloged procedure or the log data sets have incorrect data set characteristics.

In the message text:

procname

The name of the start procedure.

System action: The server stops.

System programmer response: Code the NFSLOG1 and NFSLOG2 DD statements with attributes as described in "Using log data sets" on page 565 and allocate the associated log data sets.

GFSA935I (procname) SWITCHED-TO LOG IN ERROR. NETWORK FILE SYSTEM SERVER LOGGING CONTINUED ON DD: *text*.

Explanation: An operator issued a **switchlog** command, but an open error is detected in the new log data set. NFS logging is continued in the original log data set.

In the message text:

procname

The name of the start procedure.

text The value of *text* is the data definition associated with the original log data set.

System action: NFS processing continues.

Operator response: Fix the inactive log data set.

GFSA936I (procname) NETWORK FILE SYSTEM SERVER LOG *text* SET TO FORCELOG.

Explanation: The NFS server log was closed to force all log data to disk immediately.

In the message text:

procname

The name of the start procedure.

text The name of the log data set.

System action: NFS continues.

GFSA937E MODIFY MAPFILE COMMAND – ERROR IN SIDEFILE DATA SET – – SIDEFILE IS NOT REFRESHED.

Explanation: This message is the response from the **mapfile** operand of the **modify** command, indicating that one or more errors were detected in the side files data set (for example, the side files data set cannot be opened due to insufficient storage).

System action: NFS processing continues. The existing side files data in storage is not changed.

Operator response: Notify your system programmer.

System programmer response: Review previous error messages for detailed information as to the specific error in the side files data set.

GFSA938I SIDE FILE WAS NOT LOADED BEFORE.

Explanation: This message is the response from the **mapfile** of the **modify** command, indicating that the command was ignored because the side file was not loaded.

System action: NFS processing continues with the side files data unchanged.

GFSA939I (*procname*) LOG dataset *dataset name* is being used.

Explanation: The informational console message indicates the name of the starting log data set.

In the message text:

procname

The name of the start procedure.

dataset name

The name of the starting log data set.

System action: NFSS continues processing.

Operator response: None.

System programmer response: None.

Programmer response: None.

GFSA942I UNMNTXXX: MODIFY COMMAND IGNORED – MOUNT POINT *mount_point* IS IN USE BY USER *user_name*

Explanation: This message is the response from the **unmntxxx** operand of the **modify** command, indicating that *mount_point* was ignored because the mount point is in use by another user, *user_name*.

System action: The NFS server processing continues.

Operator response: Reenter the same operand of the **modify** command and try again later.

GFSA943E (procname) • GFSA949I

GFSA943E (procname) EXPORTS: UNEXPECTED OPTION (text) WAS DETECTED IN THE EXPORTS FILE.

Explanation: The option information provided in *text* is incorrect. This error could occur as a result of unexpected blanks, incorrect syntax, or mutually exclusive options (for example, both **ro** and **rw**). This message might occur after performing the EXPORTFS command.

In the message text:

procname

The name of the start procedure.

System action: The NFS server continues processing.

Operator response: Reenter the same operand of the **modify** command.

GFSA944I (procname) text1 Network File System Server release text2 last APAR text3 last changed module: text4 compiled at text5

Explanation: This message is reported by the Network File System server in response to the MODIFY mvsnfs,VERSION operator command. It reports the current maintenance level of the server.

In the message text:

Text1 System level (z/OS, for example).

Text2 Network File System server release level.

Text3 Last APAR maintenance version of Network File System server.

Text4 Name of one module installed by the last maintenance level.

Text5 Compilation date/time of the module.

System action: The Network File System server continues.

Operator response: None.

System programmer response: None.

GFSA945I (procname) text1 | text2 | text3

Explanation: This message is reported by the Network File System server in response to the operator command MODIFY mvsnfs,VERSION=ALL or MODIFY mvsnfs,VERSION=MODULE. Message GFSA945I is generated for each module.

In the message text:

Text1 Module name.

Text2 APAR maintenance level of the module.

Text3 Compile date/time of the module.

System action: The Network File System server continues.

Operator response: None.

System programmer response: None.

GFSA946I (procname) Total modules: digit

Explanation: This message is returned by the Network File System server in response to the MODIFY mvsnfs,VERSION=ALL operator command after message GFSA945I lists the information on all the modules. This message reports the total module count *digit*.

System action: The Network File System server continues.

Operator response: None.

System programmer response: None.

GFSA947I (procname) text1 | text2 | text3

Explanation: This message is reported by the Network File System server during initialization if debug tracing is turned on. Message GFSA947I is generated for each module.

In the message text:

Text1 Module name.

Text2 APAR maintenance level of the module.

Text3 Compile date/time of the module.

System action: The Network File System server continues.

Operator response: None.

System programmer response: None.

GFSA948I (procname) Non-existent module: text1

Explanation: This message is returned by the Network File System server in response to the MODIFY mvsnfs,VERSION=*text1* operator command, indicating that the module name specified as *text1* does not exist.

System action: The Network File System server continues.

Operator response: None.

System programmer response: None.

GFSA949I (procname) COMMAND text NOT VALID.

Explanation: The modify operator command *text* or the operand *text* is not valid, or the operator command *text* was issued after issuing the STOP operator command.

In the message text:

procname

The name of the z/OS NFS Server start procedure.

text

The operator command or the operand of the operator command

System action: z/OS NFS Server processing continues.

Operator response: If the STOP command is not issued yet, reenter the correct operator command or the operand of the modify command with the correct syntax.

If the STOP command is already issued, but the z/OS NFS Server takes a long time to synchronize the write buffers for many data sets or PDS/PDSE members, and there is an immediate need to stop the Server by aborting the synchronization processing, consult with the System or Application Programmer for the modify SHUTDOWN operator command that can be entered after issuing the STOP command.

Note: The modify SHUTDOWN command causes any unwritten data to be discarded and lost.

System programmer response: None.

GFSA950I Unknown flag '-character'

Explanation: The character *character* specified in the **mvlogin**, **mvlogout**, or **showattr** command is not a valid option. A usage message might follow this message.

User response: See *z/OS Network File System Guide and Reference* for a description of the valid options used with the command.

GFSA951I text : can't find name for uid d_digits.

Explanation: There was an error reading information for the user ID *d_digits* from the etc/passwd file.

User response: Correct the etc/passwd file and retry the command.

GFSA952I Retyped password does not match

Explanation: The password entered when message GFSA975I displayed does not match the password entered when message GFSA974A displayed.

User response: Restart the **mvlogin** command sequence.

GFSA953A Password change required by host.

Explanation: The multiple virtual system (MVS) password for the user ID passed to the host expired. A new password is required. Message GFSA974A follows this message.

GFSA954I Host text1 returned status code d_digits: text2

Explanation: A non-zero status was detected during **mvlogin** processing. Host *text1* returned status code *d_digits* and message *text2* to the client.

The value of *d_digits* and its associated *text2* message can be any of the following:

<i>d_digits</i>	<i>text2</i>
1	There is no <i>text2</i> message associated with this status code. This status code returns when any error is detected during RACF processing.
129	The new password phrase cannot be set when specifying a password, nor can a new password be set when specifying a password phrase. Try again.
130	The site attribute settings on the z/OS NFS Server being communicated with indicate that mvlogin is not required. It is therefore not being processed.
131	The site attribute settings on the z/OS NFS Server being communicated with indicate that mvlogout is not required. It is therefore not being processed.
132	User is logged in, this request is ignored.
878	Memory temporary not available. Try again later.

User response: Restart the **mvlogin** command sequence with valid user ID and password when appropriate.

GFSA955I text logged in ok.

Explanation: The MVS user ID *text* was logged in without any errors.

GFSA956I usage: text[-p][-n][-pn] [-P password] [-g group][-norpcbind][-a account] hostname [mvs_username]

Explanation: This message provides usage information for the **text** command.

User response: Enter the command using the correct syntax.

GFSA957I Host text1 returned error d_digits: text2

Explanation: An error was detected during **mvlogout** processing. Host *text1* returned error code *d_digits* and message *text2* to the client.

User response: Notify your system programmer.

GFSA958I **uid *text* logged out ok.**

Explanation: The user ID *text* logged out successfully.

GFSA959I **usage: *text* [-norpcbind] hostname**

Explanation: This message provides usage information for the *text* command.

User response: Enter the command using the correct syntax.

GFSA960I ***text1*: host "*text2*" unknown.**

Explanation: The host *text2*, specified in the command *text1*, is not known to the network.

User response: Correct the host name specified and retry the command.

GFSA962E **Unable to create CLNT handle. rc = *d_digit1*, rsn = *hex_digit1*.**

Explanation: The NFS client was unable to create a handle for communicating with the NFS server. The request failed with return code *d_digit1* and reason code *hex_digit1*.

System action: The Network File System Client request fails.

Operator response: None.

System programmer response: Verify that the network connection to the NFS Server is operational and that the NFS Server is functional.

GFSA963E **Call to remote Network File System Server failed. RV=*retv* RC=*retc* RSN=*rsnc* *additional text*.**

Explanation: The Remote Procedure Call from the utility program to the Network File System Server failed. The request failed with return value (*retv*), return code (*retc*) and reason code (*rsnc*) along with the additional message.

System action: The Network File System Client request fails.

Operator response: None.

System programmer response: Verify that the network connection to the NFS Server is operational and that the NFS Server is functional.

User response: See *z/OS UNIX System Services Messages and Codes* for a description of the reason code *rsnc* or see Table 73 on page 456.

Note that if the high-order byte of the reason code contains X'6E', it means that utility runs under a non-z/OS platform, points to the error location inside of the source code and is information for the development team. If the utility runs under USS, then

the reason code is the USS reason code for the *errno* specified in the message. See *z/OS UNIX System Services Messages and Codes* for more information.

GFSA964I ***text*: Error: cannot determine server.**

Explanation: The *text* command found the mount path, but the server name was not returned by the local operating system service that keeps mount point information.

User response: Correct the mount point table and retry the command.

GFSA965I ***text1*: Error: *text2* mounted from server *text3*, not *text4*.**

Explanation: The wrong host name was specified for the *text1* command. *text2* is mounted from server *text3* instead of server *text4*.

User response: Specify the command again with the correct host name.

GFSA966I ***text*: Error: unknown return from usage routine.**

Explanation: The usage routine used for the **text** command returned an unknown error code.

User response: Contact your programming support personnel.

GFSA967I **Host Error: *text*.**

Explanation: The host returned an error and the message *text*. The error might be due to either of these causes:

- A porting failure occurred for the **showattr** command.
- The NFS is not compatible with the **showattr** command on the client.

User response: Contact your programming support personnel.

GFSA969I **Error: Can't open *text* for read.**

Explanation: The file *text* could not be opened to read the mount path.

User response: Correct the file and reissue the command.

GFSA970I **Error: Directory *text* not mounted.**

Explanation: The directory *text* was not mounted. The **showattr** command cannot show the attributes for this directory.

User response: Mount the directory and reissue the command.

GFSA971I **Error: filesystem *text* is local.**

Explanation: The file system *text* is not an NFS file system. The **showattr** command is for NFS file systems only.

User response: Reissue the command for an NFS file system.

GFSA972I **usage: *text1* [-t] [-norpcbind] hostname [*text2*]**

Explanation: This message provides usage information for the *text1* command.

In the message text:

text2 The value of *text2* is the operating-system-dependent mount-point format.

GFSA973A **Enter MVS password:**

Explanation: The NFS requires a password for the user.

User response: If a user ID was specified in the **mvlogin** command, enter the password for that user ID. If no user ID was specified, the name from `etc/passwd` for the user ID that issued the **mvlogin** command was passed to the NFS. Enter the password for this user.

GFSA974A **Enter new MVS password:**

Explanation: The password for the user ID passed to NFS has expired.

User response: Enter a new password.

GFSA975A **Retype new MVS password:**

Explanation: The system requires the new password to be entered twice for verification.

User response: Reenter the new password.

GFSA976I *text1: text2*

Explanation: The command *text1* received an error when trying to create a client transport handle using the **clnt_call** TCP/IP remote procedure call.

In the message text:

text1 The value of *text2* is the message produced by the **clnt_perror** TCP/IP procedure.

User response: Contact your system administrator.

GFSA977I *text:*

Explanation: The command *text* received an error when trying to create a client transport handle using the **clnt_call** TCP/IP remote procedure call (RPC). This message is followed by the message produced by the

clnt_perror TCP/IP procedure.

User response: Contact the system administrator.

GFSA978I *text* logged in ok. Mismatch in uid/gid: z/OS UNIX uid is *digit_1*, gid is *digit_2*, client uid is *digit_3*, gid is *digit_4*

Explanation: The z/OS UNIX user ID or group ID does not match the client machine user ID or group ID. The authentication is successful and the message is for information only.

GFSA979E **Unable to create UDP socket rc = *d_digit1*.**

Explanation: The NFS client was unable to create a UDP protocol socket for communicating with the NFS server. The request failed with return code *d_digit1*.

System action: The Network File System Client request fails.

Operator response: None.

System programmer response: Verify that the network connection to the NFS Server is operational and that the NFS Server is functional.

GFSA980E **Unable to get the program's port.**

Explanation: The NFS client was unable to find the port for communicating with the NFS server.

System action: The Network File System Client request fails.

Operator response: None.

System programmer response: Verify that the network connection to the NFS Server is operational and that the NFS Server is functional.

GFSA981I **Unable to establish TCP connection rc = *d_digit1*. Trying UDP ...**

Explanation: The NFS client was unable to establish a TCP protocol connection to the NFS server. The request failed with return code *d_digit1*.

System action: The Network File System Client attempts to create a UDP protocol connection.

Operator response: None.

System programmer response: None.

GFSA982E **The program *d_digit1* is not registered on *string*.**

Explanation: The requested program *d_digit1* is not registered on host *string*.

System action: The Network File System Client request fails.

GFSA983E • GFSA991E (procname)

Operator response: None.

System programmer response: Verify that the network connection to the NFS Server is operational and that the NFS Server is functional.

GFSA983E Remote host does not have AF_INET interface.

Explanation: The remote host does not support the desired IP interface.

System action: The Network File System Client request fails.

Operator response: None.

System programmer response: Verify that the requested IP version is operational.

GFSA984E Error in authunix_create.

Explanation: The Network File System Client was unable to create an Auth_sys security connection to the NFS server.

System action: The Network File System Client request fails.

Operator response: None.

System programmer response: Verify that the system is properly configured.

GFSA985E Cannot get local host name

Explanation: The Network File System client utility was unable to determine the NFS Server host name for the specified mount point.

System action: The Network File System Client utility request fails.

Operator response: None.

System programmer response: None.

GFSA986I The z/OS Network File System client utility was unable to get the attribute information for the specified mount point.

Explanation: The Network File System client utility was unable to determine the NFS Server host name for the specified mount point.

System action: The Network File System Client utility request fails.

Operator response: None.

System programmer response: None.

GFSA987I Directory *string* is not a supported Network File System type of directory.

Explanation: The specified directory path *string* is not a Network File System mounted directory.

System action: The Network File System Client request fails.

User response: Correct the directory path specification.

GFSA988I Remote host does not have AF_INET6 interface.

Explanation: The remote host does not support the desired IP interface string.

System action: The Network File System Client switches to using AF_INET (Internet Protocol version 4) and continues request processing.

Operator response: None.

System programmer response: Verify that the requested IP version is operational.

GFSA990I *text*

Explanation: The LOGON or FILE SECURITY user exit routine returned the message *text* to the NFS server.

System action: The Network File System server processing continues.

User response: No action required.

GFSA991E (procname) MESSAGE FORMAT FROM USER EXIT ROUTINE(S) IS INCORRECT. USER *text* EXIT ROUTINE(S) HAS(HAVE) ENDED.

Explanation: The *test* exit routine returned a message with an incorrect length.

In the message text:

procname

The name of the start procedure.

text The value of *text* can be either LOGON AND FILE SECURITY or FILE SECURITY.

System action: The NFS server processing continues without the user exit routines.

Operator response: Record the operator console message and notify the NFS system programmer.

System programmer response: Correct the user exit routines, relink the user exit routines, and restart the NFS server.

GFSA996E (procname) INSTALLATION DEFAULT TRANSLATION TABLE CANNOT BE INITIALIZED.

Explanation: The NFS ends because one of these conditions happens during NFS startup:

- The NFSXLAT DD statement is not coded in the NFS startup catalog procedure, and the *xlat* processing attribute is specified.
- The translation table data set defined in the NFSXLAT DD statement is not a PDS or PDSE.
- The translation table specified in the translation table data set cannot be found.
- The translation table contained in the translation table data set is in an incorrect format.

In the message text:

procname

The name of the start procedure.

System action: NFS processing stops.

System programmer response: Take the following actions before restarting the NFS:

- Code the NFSXLAT DD statement in the NFS startup catalog procedure correctly.
- Allocate the translation table data set defined in the NFSXLAT DD statement.
- Make sure that the translation table in the translation table data set exists.
- Make sure the translation table specified in the translation table data set is in the correct format.

GFSA997I ERROR IN READING TRANSLATION TABLE, *text*.

Explanation: The NFS tried to read the translation table, *text*, during the mount but was unsuccessful. The value of *text* is the name of the member that contains the translation table. The reason might be one of these causes:

- The NFSXLAT DD statement is not coded in the NFS startup catalog procedure.
- The NFSXLAT DD statement is not coded correctly in the NFS startup catalog procedure.
- The translation table data set defined in the NFSXLAT DD statement is not a PDS or PDSE.
- The translation table specified in the translation table data set cannot be found.
- The format of the translation table contained in the translation table data set is not valid.

System action: NFS processing stops.

User response: This error occurs during the mount operation. Contact your system programmer for the correct member name for the translation table.

GFSA998I TRANSLATION TABLE *text* IS LOADED.

Explanation: The NFS loaded the translation table, *text*, successfully.

System action: NFS processing continues.

GFSA999I Error during rebuild of translation table, *text1*.

Explanation: During NFS server startup, the server detected an error during rebuild of translation table, *text1*.

System action: The NFS skips restoring the current MHDB record and continues processing.

Operator response: Contact the system programmer.

System programmer response: Keep the existing z/OS NFS server traces and contact IBM Support.

Programmer response: None.

GFSA1000E (procname) Invalid DD name specified in the *text* command.

Explanation: This message is issued when an operator enters an unacceptable (invalid) DD name in the ADDDS or FREEDS command.

text The name of the operator command used.

System action: The system ignores the command.

Operator response: Reenter the command with the correct DD name.

System programmer response: None

Programmer response: None

GFSA1001I (procname) Use any of the DD names: *text1, text2, text3, text4*.

Explanation: This message is issued when an operator enters an unacceptable (invalid) DD name in the ADDDS or FREEDS command. It follows message GFSA1000E.

text1 - text4

The list of valid MHDB and LDB DD names.

System action: The system ignores the command.

Operator response: Reenter the command with the correct DD name.

System programmer response: None

Programmer response: None

GFSA1002I (procname) • GFSA1007E (procname)

GFSA1002I (procname) DDNAME=*text* is already freed.

Explanation: This message is issued when an operator issues a FREEDS command for a DD name that is already freed.

text The DD name for which the request was issued.

System action: The system ignores the command.

Operator response: None

System programmer response: None

Programmer response: None

GFSA1003E (procname) Unable to perform FREEDS command. The data set *text1* for the DDNAME=*text2* is busy.

Explanation: This message is issued when an operator issues a FREEDS command for a DD name for which the associated data set is in use.

text1 The name of the data set associated with the DD name.

text2 The DD name for which the request was issued.

System action: The system ignores the command.

Operator response: Retry the command later.

System programmer response: None

Programmer response: None

GFSA1004I (procname) The data set *text1* for the DDNAME=*text2* is deallocated.

Explanation: This message is issued when an operator issues a FREEDS command and the command completes successfully.

text1 The name of the data set associated with the DD name.

text2 The DD name for which the request was issued.

System action: The system successfully deallocated the data set associated with the specified DD name.

Operator response: None

System programmer response: None

Programmer response: None

GFSA1005E (procname) Unable to *text1* the data set *text2* for DDNAME=*text3*. Operation return code *digit1*, error code *digit2*, info code *digit3*.

Explanation: This message is issued when a file system error occurs when the system tries to

allocate/deallocate the data set for the specified DD name in response to an ADDDS or FREEDS operator command.

text1 The name of the operator command used.

text2 The name of the data set associated with the DD name.

text3 The DD name for which the request was issued.

digit1 The return code from the MVS Dynamic Allocation function.

digit2 The error code from the MVS Dynamic Allocation function.

digit3 The information code from the MVS Dynamic Allocation function.

System action: The system ignores the operator command.

Operator response: Contact the system programmer

System programmer response: Check the characteristics of the data set and correct as appropriate. See *z/OS MVS Programming: Authorized Assembler Services Guide* for a description of the return codes, error codes, and reason codes returned by the MVS Dynamic Allocation function.

Programmer response: None

GFSA1006W (procname) *text1* switching is suspended because one of the data sets is unusable. To resume switching, repair/replace the unusable data set.

Explanation: This message is issued when one of the MHDB, or LDB, data sets is unusable and the system tries to switch between the two data sets during a cleanup operation.

text1 is either "MHDB" or "LDB" depending on which database is experiencing the problem.

System action: The system suspends cleanup operations for the database. It continues writing new records to the remaining data set.

Operator response: Contact the system programmer

System programmer response: Allocate a new, or repaired, data set for the database.

Programmer response: None

GFSA1007E (procname) The data set *text1* for the DDNAME=*text2* is not allocated because it does not have the correct characteristics.

Explanation: This message is issued when an operator issues an ADDDS command but the specified data set does not have the correct characteristics.

text1 The name of the specified data set.
text2 The DD name for which the request was issued.

System action: The command is ignored.

Operator response: Contact the system programmer

System programmer response: Reissue the ADDDS command specifying a data set with the correct characteristics.

Programmer response: None

GFSA1008E (procname) *text1* is not a valid data set specification or MVS data set name. Use the format DDNAME(DSNAME).

Explanation: This message is issued when an operator issues an ADDDS command with an incorrect command format or data set name specification.

text1 The data set specification used in the command.

System action: The command is ignored.

Operator response: Reissue the ADDDS command using the correct format and MVS data set name specification rules.

System programmer response: None

Programmer response: None

GFSA1009E (procname) Unable to perform the ADDDS command. The DDNAME=*text1* is not freed.

Explanation: This message is issued when an operator issues an ADDDS command but a data set is still allocated to the specified DD name.

text1 The DD name for which the request was issued.

System action: The command is ignored.

Operator response: Use the FREEDS command to break the current allocation (association) for the DD name and then reissue the ADDDS command.

System programmer response: None

Programmer response: None

GFSA1010E (procname) The specified data set *text1* cannot be allocated because it is already in use.

Explanation: This message is issued when an operator issues an ADDDS command but the specified data set is already in use for the other MHDB/LDB data set.

text1 The name of the specified data set.

System action: The command is ignored.

Operator response: Reissue the ADDDS command specifying a different data set.

System programmer response: None

Programmer response: None

GFSA1011I (procname) The data set *text1* is successfully allocated for the DDNAME=*text2*.

Explanation: This message is issued when the operator issued ADDDS command completed successfully.

text1 The name of the specified data set.

text2 The DD name for which the request was issued.

System action: The system successfully created the new allocation (association) between the DD name and the provided data set.

Operator response: None

System programmer response: None

Programmer response: None

GFSA1012W (procname) The *text1* will not be refreshed because one of the data sets is unusable.

Explanation: This message is issued when one of the MHDB, or LDB, data sets is unusable and the system tries to swap between the two data sets either during a regular resource time-out or during a server shutdown operation.

System action: The server did not refresh the MHDB, or LDB state (that is, swap the data sets).

Operator response: Contact System Programmer

System programmer response: Correct the problem with the unusable data set. The cause for the problem should have been reported at the original time when the problem was detected by the server.

Programmer response: None

GFSA1013E (procname) The *cmdname* command cannot be executed because at least one *dsname* data set is deallocated or corrupted.

Explanation: This message is issued when the operator issued a SWAPMHDB or SWAPLDB command when both data sets of the database are not available. One, or both, of the data sets is either deallocated or corrupted.

cmdname

is either SWAPMHDB or SWAPLDB, depending on which swap command was issued.

GFSA1014I (procname) • GFSA1018E (procname)

dsname is either MHDB or LDB, depending on which swap command was issued.

System action: The command is ignored.

Operator response: Allocate the missing data sets with the ADDDS command. Then, repeat the SWAPMHDB command if necessary.

System programmer response: None

Programmer response: None

GFSA1014I (procname) *text* data sets swapping is launched.

Explanation: This message is issued when the operator issued the SWAPMHDB or SWAPLDB command. It indicates that the system has started the swapping process, which includes a cleanup procedure.

text1 is either "MHDB" or "LDB" depending on which data sets were swapped.

System action: The swap process has started. Message GFSA1015I is generated when it has completed.

Operator response: None

System programmer response: None

Programmer response: None

GFSA1015I (procname) *text1* is swapped. The current data set is *text2*.

Explanation: This message is issued when the operator issued the SWAPMHDB or SWAPLDB command. It follows message GFSA1014I and indicates that the system has completed the swapping process successfully.

text1 is either "MHDB" or "LDB" depending on which data sets were swapped.

text2 This is the name of the currently active data set.

System action: The swap command was completed.

Operator response: None

System programmer response: None

Programmer response: None

GFSA1016E (procname) Switching *dstype* was denied due to an internal request error=*h_digit1*.

Explanation: An operator attempt to switch datasets failed. In the message text:

dstype either "MHDB" (Mount Handle Database) or "LDB" (Locking Database).

h_digit1 the error code detected by the server.

System action: NFS processing continues.

Operator response: Check the status of the NFS server MHDB or LDB datasets, then repeat the action. If the problem persists, force a memory dump of the server.

System programmer response: None

Programmer response: None

GFSA1017E (procname) *dstype* data set *dsname* for the DDNAME=*ddname* cannot be opened, VSAM rc=*errcode* rsn=*rsncode* LastOp=*opname*.

Explanation: This message is issued when the NFS server attempts to open the LDB or MHDB data set, but is unable to do so. This message identifies the data set type, the data set, return, and reason codes and the code of the last operation. In the message text:

dstype is either "MHDB" or "LDB" depending on which data set was being opened.

dsname This is the name of the data set that was being opened.

ddname This is the ddname of the data set that was being opened.

errcode VSAM error code

rsncode VSAM reason code

opname Last VSAM operation executed

See the VSAM publications for more details on the meaning of the VSAM codes.

System action: The data set was not opened and was flagged as unusable by the NFS server.

Operator response: Contact System Programmer

System programmer response: Check the data set characteristics to confirm that they match the required characteristics for the NFS database. Deallocate and reallocate a new or repaired data set with the proper characteristics.

Programmer response: None

GFSA1018E (procname) *dstype* data set *dsname* for the DDNAME=*ddname* does not have the proper characteristics: VSAM=*dsorg1 type=type1 (expect type2) KeyOff=keyoff1 (expect 0) KeySize=keysize1 (Expect keysize2) RecSize=recsize1 (Expect recsize2)*.

Explanation: This message is issued when the NFS server checks the LDB or MHDB data set characteristics before using the data set and discovers an error. This message identifies the data set type, the data set, the

found characteristics, and the expected characteristics. In the message text:

dstype is either "MHDB" or "LDB" depending on which data set was being opened.

dsname
This is the name of the data set that was being opened.

ddname
This is the ddname of the data set that was being opened.

dsorg1 VSAM data set organization

type1 VSAM data set type

type2 Required VSAM data set type

keyoff1
VSAM key offset in the data set

keysize1
VSAM key size in the data set

keysize2
Required VSAM key size

recsize1
VSAM data set record size

recsize2
Required VSAM data set record size

System action: The data set was rejected and was flagged as unusable by the NFS server.

Operator response: Contact System Programmer

System programmer response: Check the data set characteristics to confirm that they match the required characteristics for the NFS database. Deallocate and reallocate a new or repaired data set with the proper characteristics.

Programmer response: None

GFSA1019E (procname) The routine *text* for data set *dsname* failed due to input/output error.

Explanation: The call made to routine *text* failed for data set *dsname* due to an input/output error occurring. In the message text:

procname
The name of the start procedure.

text The routine called.

dsname
The name of the data set that failed the call to routine *text*.

System action: The current z/OS NFS request fails. Otherwise, z/OS NFS processing continues.

Operator response: Contact System Programmer

System programmer response: Keep the existing z/OS NFS server traces and contact IBM Support.

Programmer response: None

GFSA1030E (procname) Network File System Server subtask is waiting for a reply from the resource (FileSystemTypeName) FID: *fid* hostname/IP address of *hostname*

Explanation: One of the NFS worker tasks has been waiting for a reply longer than specified by DelayDetectionTimeout parameter.

- *procname* - Network File System Server startup procedure name
- *resource* - The z/OS UNIX file system or MVS data set name
- *FileSystemTypeName* - The name of the type of the file system (HFS or MVS)
- *fid* - The FID of the zFS/HFS object
- *hostname* - The host name or IP address of the NFS Client

System action: None.

Operator response: None.

System programmer response: If needed, collect the dump/trace regarding the type of file system that is being waited.

GFSA1031I (procname) Network File System Server subtask was waiting for reply a from the resource (FileSystemTypeName) was completed after *n* seconds FID: *fid* hostname/IP address of *hostname*

Explanation: This message is issued if the message GFSA1030E has been previously issued.

procname
Network File System Server startup procedure name

resource The z/OS UNIX file system or MVS data set name

FileSystemTypeName
The name of the type of the file system (HFS or MVS)

n the amount of time, in seconds, the Network File System Server waited for reply

fid The FID of the zFS/HFS object

hostname
The host name or IP address of the NFS Client

System action: None.

Operator response: None.

System programmer response: None.

GFSA1032E (*procname*) **The Delay Detection timeout value must be 5 - 60 seconds**

Explanation: An incorrect value for the Delay Detection timeout was specified in the MODIFY *mvsnfs*,DDTIMEOUT=*x* operator command.

- *procname* - Network File System Server startup procedure name

System action: None.

Operator response: Specify the correct value for the Delay Detection timeout.

System programmer response: None.

GFSA1033E (*procname*) **There are many delays detected. There is more information in Network File System Log.**

Explanation: There are more than five delays detected. The information about the new delays is printed in the Network File System Log.

- *procname* - Network File System Server startup procedure name

System action: None.

Operator response: None.

System programmer response: If needed, collect the dump/trace regarding the type of file system being waited upon.

GFSA1034E (MVS NFS) **The value of *text* site attribute of the Network File System Server is out of range. The value of *text* site attribute has been set to *d_digit*.**

Explanation: The value of *text* z/OS NFS Server site attribute specified is out of range. The value of the *text* z/OS NFS Server site attributes is set to *d_digit*.

System action: z/OS NFS server processing continues.

Operator response: None.

System programmer response: The value of *text* may be adjusted in the attribute data set and the z/OS NFS server restarted.

GFSA1036E (*procname*) **Remote user with *uid=uid*, *gid=gid* from *hostname/IPaddr* failed with NFS_Error *objectname* - *d_digit1* times within the last *d_digit2* seconds.**
loopstatus .

Explanation: The warning console message indicates that z/OS NFS Server detects a loop situation and the remote system causing the loop. The message informs about the status of detected loop.

The message is issued after 4 seconds of loop detection, repeated at 64 seconds (~ 1 min), and subsequently at 256 seconds (~ 4 minutes).

The message will stop repeating if the remote user performs "mvslogin" or if the repeatedly failed access is stopped.

In the message text:

procname
Network File System Server startup procedure name

uid z/OS UNIX user ID that represents the client machine user ID to z/OS NFS Server side

gid z/OS UNIX group ID that represents the client machine group ID to z/OS NFS Server side

hostname/IPaddr
client host name. If the host name is not known, then the IP address is displayed. If the IP address is not known, then "UNKNOWN" is displayed

NFS_error
NFS error name, see "Server messages" on page 339 for error code information

objectname
information about file system name under attack by the loop. For HFS path, information may contain:
FSYS=UNKNOWN - if file system is not available
FSYS=fsname - if file system is available

or
information about data set name and member name under attack by the loop. For MVS path, information may contain:

DSN=UNKNOWN - if dsname not available

DSN=dsname - if membername not available

DSN=dsname(member) - if both names are available

d_digit1 the number of repetitions of the NFS errors sequence

d_digit2 the number of seconds since the beginning of the loop

loopstatus
Text string describe the status of the current loop, can be one of the following text:

The loop is in progress.

Loop is cleared due to loop stopped.

Loop is cleared due to no FH and/or operation.

Loop is cleared due to RPC Transmission error.

Loop is reset due to switching to other FH.

| Loop is reset due to loop stopped.
 | Loop is reset due to lack of table entries.
 | Loop is reset due to error or operation
 | mismatch.

| 'Loop is cleared' means there was an event that is NOT
 | associated with any NFS error, which leads to the
 | conclusion that the current loop has stopped. The
 | current loop data were cleared.

| 'Loop is reset' means there was an event that is
 | associated with new NFS error, which leads to the
 | conclusion that the current loop has stopped. The
 | current loop data were cleared and new error sequence
 | started from this new NFS error.

| **System action:** z/OS NFS server processing continues.

| **Operator response:** One of the following:

- | • Provide dump.
- | • Contact the IBM Support Center.

| **System programmer response:** None.

| **Programmer response:** None.

GFSA1040I (*procname*) **RPCBIND/PORTMAPPER**
registration is in progress.

Explanation: The z/OS NFS Server has not yet completed its registration with TCP/IP RPCBIND/PORTMAPPER. This may indicate that

RPCBIND/PORTMAPPER is not Active. Until this registration has completed, NFS Clients will not be able to get information about TCP/IP port numbers of z/OS NFS Server registered programs.

In the message text:

- *procname* - Network File System Server startup procedure name

System action: z/OS NFS server processing continues.

Operator response: Check whether TCP/IP RPCBIND/PORTMAPPER has been started. If it has not, start it.

System programmer response: None.

GFSA1041I (*procname*) **RPCBIND/PORTMAPPER**
registration complete.

Explanation: The z/OS NFS Server has completed its registration with TCP/IP RPCBIND/PORTMAPPER. NFS Clients can now get information about TCP/IP port numbers of z/OS NFS Server registered programs.

In the message text:

- *procname* - Network File System Server startup procedure name

System action: z/OS NFS server processing continues.

Operator response: None.

System programmer response: None.

Client messages

This section is a listing of the messages that the NFS client generates. A message, explanation, and recommended action are supplied where applicable. Data is substituted for any part of a message shown here in *italics*.

Messages that appear on the z/OS operator's console for the NFS client will be in the following example format: **GFSC700I z/OS NETWORK FILE SYSTEM CLIENT (HDZ222N) started. HDZ222N, GFSCMAIN, Jun 14 2014 15:29:05.**

Table 63 shows the message format on the NFS client operators console.

Table 63. NFS client z/OS operators console message format

Value	Description
GFSC	Component identifier for the NFS client
700	A unique message number
I	Message type:
A	Action; the user must perform a specific action.
E	Eventual action; the user must perform an action when time is available.
I	Informational; no user action is required.
z/OS NETWORK FILE SYSTEM CLIENT (HDZ222N) STARTED	Message text

Messages appear in the NFS client log data set in the same format as in the following example:

12:34:18 GFSC100E (E) CCXDR 11 XDR_DISP: RPC REQUEST (7F638E30) FAILED, RETURN VALUE -1 RETURN CODE 00000467 REASON CODE 5 (TIMED OUT)

Table 64 shows the message format in the NFS client log data set.

Table 64. NFS client log data set message format

Value	Description
12:34:18	The time stamp (<i>hours:minutes:seconds</i>)
GFSC	Component identifier for the NFS client
100	A unique message number
E	Message type: A Action; the user must perform a specific action. E Eventual action; the user must perform an action when time is available. I Informational; no user action is required.
(E)	The message level: E (error), W (warning), or I (informational)
CCXDR 11	'CCXDR' is the last 5 characters of CSECT name. '11' is the message sequence within the function.
XDR_DISP	The first 8 characters of the function name
RPC REQUEST (7F638E30) FAILED, RETURN VALUE -1 RETURN CODE 00000467 REASON CODE 5 (TIMED OUT)	Message text

The messages are listed in numerical order (the time stamp, message level, and programming support information are not shown).

Note: Messages GFSC098I and GFSC099I are intended for IBM support personnel to use when they are performing diagnosis. They do not indicate a problem with NFS, but do provide statistics on NFS processing. As such, an extensive number of GFSC098I and GFSC099I messages may be issued.

Table 65 shows common variables in the message text.

Table 65. Common variables

Variable	Meaning
<i>retv</i>	Decimal return value
<i>retc</i>	Decimal return code
<i>rsnc</i>	Decimal reason code
<i>returncd</i>	8-digit hexadecimal return code – see Chapter 20, “Return codes,” on page 445
<i>reasoncd</i>	8-digit hexadecimal reason code – see Chapter 21, “Reason codes,” on page 455

Table 65. Common variables (continued)

Variable	Meaning
<i>h_digit</i>	8-digit hexadecimal address
<i>d_digit</i>	Decimal digits
<i>dsname</i>	Data set name
<i>text</i>	Place holder for long text of different lengths

GFSC098I

Explanation: This message is intended for IBM support personnel when they are performing diagnosis. They do not indicate a problem with NFS but do provide statistics on NFS processing. As such, an extensive number of GFSC098I messages may be issued.

System action: NFS continues processing.

Operator response: None.

System programmer response: Turn debugging off.

GFSC099I

Explanation: This message is intended for IBM support personnel when they are performing diagnosis. They do not indicate a problem with NFS but do provide statistics on NFS processing. As such, an extensive number of GFSC099I messages may be issued.

System action: NFS continues processing.

Operator response: None.

System programmer response: Turn debugging off.

GFSC100E RPC REQUEST FAILED, RETURN VALUE -1 RETURN CODE *returncdh* REASON CODE *rsnch* (*text*)

Explanation: A remote procedure call (RPC) request failed.

In the message text:

rsnc The reason code, *rsnc*, (hexadecimal) is the return code returned from TCP/IP.

text The value of *text* is the failure reason.

returncd
For the explanation of return code *returncd*; see *z/OS UNIX System Services Messages and Codes*.

System action: The client processing continues.

User response: See the return code *returncd* in *z/OS UNIX System Services Messages and Codes* and reason code *rsnc* in *z/OS UNIX System Services Messages and Codes*.

GFSC101E *release* NETWORK FILE SYSTEM CLIENT REQUEST FAILED, *release* UNIX RETURN CODE *returncd* NETWORK FILE SYSTEM SERVER RETURN CODE *retc* (*text3*)

Explanation: The NFS server failed the request from the client.

In the message text:

release system release (z/OS)

retc The return code, *retc*, (hexadecimal) is returned from the NFS server.

text3 The value of *text* is the failure reason for the request.

returncd
For the explanation of return code *returncd* (hexadecimal), see *z/OS UNIX System Services Messages and Codes*.

System action: The client processing continues.

User response: See the return code *returncd* in *z/OS UNIX System Services Messages and Codes* and the return code *retc* in the *Network File System Protocol Specification, RFC 1094* documentation.

GFSC102E RPC REQUEST FAILED, RETURN VALUE -1 RETURN CODE *returncdh* REASON CODE *rsnc*

Explanation: A remote procedure call (RPC) request failed.

In the message text:

rsnc The reason code, *rsnc*, is the return code returned from TCP/IP.

returncd
The explanation of return code *returncd* is in *z/OS UNIX System Services Messages and Codes*.

System action: The client processing continues.

User response: See the return code *returncd* in *z/OS UNIX System Services Messages and Codes* and the reason code *rsnc* in the TCP/IP message document.

GFSC103E *release* NETWORK FILE SYSTEM SERVER REQUEST FAILED, *release* UNIX RETURN CODE *returncdh* NETWORK FILE SYSTEM SERVER

RETURN CODE *retc*

Explanation: The NFS server failed the request from the client.

In the message text:

release system release (z/OS)

retc The return code, *retc*, is returned from the NFS server.

returncd

For the explanation of return code *returncd* see *z/OS UNIX System Services Messages and Codes*.

System action: The client processing continues.

User response: See the return code *returncd* in *z/OS UNIX System Services Messages and Codes* and the return code *retc* in the *Network File System Protocol Specification, RFC 1094* documentation.

**GFSC105E READ FAILED, RETURN VALUE -1
RETURN CODE *returncd* REASON
CODE *reasoncd*.**

Explanation: The system detected an error, *returncd*, while reading a block of data from a remote file.

System action: The read operation ends. NFS client processing continues.

User response: See *z/OS UNIX System Services Messages and Codes* for a description of the return code *returncd* and the reason code *reasoncd* to determine corrective action.

**GFSC106E WRITE FAILED, RETURN VALUE -1
RETURN CODE *returncd* REASON
CODE *reasoncd*.**

Explanation: The system detected an error, *returncd*, while writing a block of data to a remote file.

System action: The write operation ends. NFS client processing continues. The remote file might not be complete.

User response: See *z/OS UNIX System Services Messages and Codes* for a description of the return code *returncd* and the reason code *reasoncd* to determine corrective action.

**GFSC107E FLUSH FAILED, RETURN VALUE -1
RETURN CODE *returncd* REASON
CODE *reasoncd*.**

Explanation: The system detected an error, *returncd*, while flushing cached data to a remote file during close processing.

System action: The write operation ends. NFS client processing continues. The remote file might not be complete.

User response: See *z/OS UNIX System Services*

Messages and Codes for a description of the return code *returncd* and the reason code *reasoncd* to determine corrective action.

**GFSC110E *text* FAILED, RETURN VALUE -1
RETURN CODE *returncd* REASON
CODE *reasoncd***

Explanation: The NFS client has detected an error in the function *text*.

System action: The request ended. NFS client processing continues.

System programmer response: Collect the detail trace diagnostics from the client and from the server.

User response: See *z/OS UNIX System Services Messages and Codes* for a description of the return code *returncd* and the reason code *reasoncd* to determine corrective action.

**GFSC200E VFS_MOUNT FAILED, RETURN
VALUE -1 RETURN CODE *returncd*
REASON CODE *reasoncd*.**

Explanation: The **mount** command failed because of error *returncd*.

System action: The **mount** command ended abnormally. NFS client processing continues.

User response: See *z/OS UNIX System Services Messages and Codes* for a description of the return code, *returncd* and the reason code *reasoncd* to determine the corrective action, and reissue the **mount** command.

**GFSC201E z/OS NETWORK FILE SYSTEM
CLIENT DOES NOT SUPPORT
SYNCHRONOUS MOUNT REQUEST.**

Explanation: The NFS client supports only an asynchronous mount.

System action: The **mount** command ended with an error. NFS client processing continues.

User response: Reissue the **mount** command with the **asynchronous** option.

**GFSC202E A FILE SYSTEM WITH THE SAME
NAME IS ALREADY MOUNTED.**

Explanation: The system cannot mount on an existing mount point.

System action: The **mount** command ended with an error. No mount point was established. NFS client processing continues.

User response: Reissue the **mount** command with a different mount point.

GFSC203E PARSING MOUNT OPTION FAILED, RETURN VALUE -1 RETURN CODE *returncd* REASON CODE *reasoncd* OPTION='text'.

Explanation: The mount option *text* was incorrectly specified.

System action: The **mount** command ended with an error. No mount point is established. NFS client processing continues.

User response: See *z/OS UNIX System Services Messages and Codes* for a description of the return code *returncd* and see Table 75 on page 466 for more details of the reason code *reasoncd*. Correct the mount option, and reissue the **mount** command.

GFSC204E VFS_UMOUNT FAILED, RETURN VALUE -1 RETURN CODE *returncd* REASON CODE *reasoncd*.

Explanation: The **umount** or **unmount** command failed.

System action: The **umount** or **unmount** command ended with an error. The mount point might still exist. NFS client processing continues.

User response: See *z/OS UNIX System Services Messages and Codes* for a description of the return code *returncd* and the reason code *reasoncd* to determine the corrective action. Correct it and reissue the **unmount** command.

GFSC205E VFS_STATFS FAILED, RETURN VALUE -1 RETURN CODE *returncd* REASON CODE *reasoncd*.

Explanation: The VFS_STATFS operation failed. The system detected an error, *returncd*, while trying to get the status of a remote file system.

System action: The VFS_STATFS operation ended with an error. NFS client processing continues.

User response: See *z/OS UNIX System Services Messages and Codes* for a description of the return code *returncd* and the reason code *reasoncd* to determine the corrective action.

GFSC206E VFS_SYNC FAILED, RETURN VALUE -1 RETURN CODE *returncd* REASON CODE *reasoncd*.

Explanation: The VFS_SYNC operation failed. The system detected an error, *returncd* while flushing cached data of remote files.

System action: The VFS_SYNC operation ended with an error. The remote files might not be complete. NFS client processing continues.

User response: See *z/OS UNIX System Services*

Messages and Codes for a description of the return code *returncd* and the reason code *reasoncd* to determine the corrective action.

GFSC207E VFS_RECOVER FAILED, RETURN VALUE -1 RETURN CODE *returncd* REASON CODE *reasoncd*.

Explanation: The VFS_RECOVER operation failed. The system detected an error, *returncd*, while trying to recover from a previous abend.

System action: The VFS_RECOVER operation ended with an error. NFS client processing continues.

User response: See *z/OS UNIX System Services Messages and Codes* for a description of the return code *returncd* and the reason code *reasoncd* to determine the corrective action. If the error occurs and the program is not in error, see the messages in the client log data sets for more information. Search problem-reporting databases for a fix for the problem. If no fix exists, contact the IBM Support Center. Provide all the printed output and copies of output data sets related to the problem.

GFSC208E VFS_PFSCTL FAILED, RETURN VALUE -1 RETURN CODE *returncd* REASON CODE *reasoncd*.

Explanation: The VFS_PFSCTL operation failed.

System action: The VFS_PFSCTL operation ended with an error. NFS client processing continues.

User response: See *z/OS UNIX System Services Messages and Codes* for a description of the return code *returncd* and the reason code *reasoncd* to determine the corrective action. If the error occurs and the program is not in error, look at the messages in the client log data sets for more information. Search problem-reporting databases for a fix for the problem. If no fix exists, contact the IBM Support Center. Provide all the printed output and copies of output data sets related to the problem.

GFSC209E THE IP ADDRESS OF REMOTE HOST NAME, *hostname*, COULD NOT BE RESOLVED.

Explanation: The VFS_MOUNT operation failed. The mount processing failed when it tried to resolve the remote host name, *hostname*, to a dotted IP address.

System action: The **mount** command ended with an error. NFS client processing continues.

User response: Correct the remote host name, or use the dotted IP address of the remote host, and reissue the **mount** command.

GFSC210E NFS SERVER *hostname* DOES NOT SUPPORT NFS VERSION 3 PROTOCOL WHILE 'VERS(3)' WAS SPECIFIED

Explanation: The VFS_MOUNT operation failed. The mount processing failed because the server does not support NFS version 3 protocol, which the user requested with the **mount** parameter **vers(3)**.

System action: The **mount** command ended with an error. NFS client processing continues.

User response: Verify that the server actually does not support NFS version 3 protocol. Remove **vers(3)** from the **mount** parameter, and reissue the **mount** command.

GFSC211E NFS SERVER *hostname* DOES NOT SUPPORT 'AUTH_SYS' AUTHENTICATION.

Explanation: The VFS_MOUNT operation failed. The **mount** processing failed because the server does not do AUTH_SYS authentication. z/OS does not support other authentication, such as Kerberos.

System action: The **mount** command ended with an error.

User response: Verify that the server actually does not support AUTH_SYS authentication. Notify the server system administrator.

GFSC212E MOUNT FAILED BECAUSE OF CONVERSION SERVICE CONNECTION FAILURE CCSID *ccsid* RETURN CODE *returncd* REASON CODE *reasoncd*

Explanation: Coded character set identifiers (CCSID) specified in the **mount** command are not supported by the conversion service.

System action: The **mount** command ended abnormally. NFS client processing continues.

System programmer response: Check the availability of the specified CCSIDs.

User response: See *z/OS UNIX System Services Messages and Codes* for more information about the return code *returncd*, and the reason code *reasoncd* to determine corrective action.

GFSC213E REQUEST (*requestid*) : THE NFS SERVER *hostname* DOES NOT SUPPORT THE SPECIFIED 'VERS' AND/OR 'PROTO'.

Explanation: The **mount** request *requestid* failed because the user-specified **vers** and **proto** was not supported by the NFS server on *hostname*.

System action: The **mount** command ended with an

error. NFS client continues processing.

User response: Either let the NFS client choose the compatible **vers** and **proto**, or determine the NFS server capabilities (by **orpcinfo**) and reissue the **mount** command with the correct **vers** or **proto**.

GFSC214E REQUEST (*requestid*): THE NFS SERVER *hostname* DOES NOT HAVE NFS REGISTERED ON PORT 2049

Explanation: The request *requestid* failed because the NFS server on *hostname* did not register or use port 2049.

System action: The operation ended with an error. NFS client continues processing.

User response: Use **orpcinfo** to verify the server and correct the server.

GFSC216E THE NETWORK FILE SYSTEM SERVER *hostname* IS NOT COMPATIBLE WITH THE SPECIFIED 'PUBLIC' AND 'VERS' OPTIONS.

Explanation: z/OS NFS Client only supports the public mount keyword for NFS Servers that support NFS Version 4. It is possible that the *hostname* does not support NFS Version 4, or the mount command has the restrictive **vers** (version version) keyword.

System action: The mount command ended with an error. No mount point is established. z/OS NFS Client processing continues.

Operator response: None

System programmer response: Reissue the mount command without the public option.

Programmer response: None

GFSC217E MOUNTING TO FILE SYSTEM SERVER *hostname* FAILS WITH CLIENTID_INUSE FROM *ip_address*.

Explanation: The NFS Server, *hostname*, denies z/OS NFS Client NFS V4 mount request because there is another NFS Client at *ip_address* with the same identification (*clientid*). z/OS NFS Client generates its NFS V4 identification as "client@domain#server".

System action: The mount command ended with an error. No mount point is established. z/OS NFS Client processing continues.

Operator response: None

System programmer response: Check and correct the z/OS host name and domain name, or check and correct the other system (at *ip_address*) host name and domain name.

Programmer response: None

GFSC218E THE NETWORK FILE SYSTEM SERVER *servername* IS NOT COMPATIBLE WITH THE SPECIFIED 'RPCBIND(N)' OPTION

Explanation: The identified NFS Server seems to only have an IPv6 address, but the `rpcbind(n)` option was specified. This option causes the z/OS NFS Client to send a PORTMAP Protocol request that is not compatible with Internet Protocol Version 6 (IPv6 IPv6).

servername

Name of the NFS Server to which this situation applies.

System action: The `mount` command ended with an error.

Operator response: None.

System programmer response: Remove the `rpcbind(n)` option from the mount command and reissue the mount command.

Programmer response: None.

GFSC219E ATTEMPTING TO ESTABLISH THE MOUNT PATH *pathname* AT THE NETWORK FILE SYSTEM SERVER *hostname*, BUT DETECTING A SYMBOLIC LINK LOOP AT *symlink*.

Explanation: NFS Client detects a symbolic link loop because it encounters the same *symlink* again when it attempts to establish an NFS Version 4 mount point. See "Accessing symbolic links on z/OS NFS version 4" on page 56 for details on NFS version protocol use.

System action: The mount operation fails. NFS Client processing continues.

Operator response: Verify the *pathname* with the NFS Server system administrator and reissue the mount command with the proper path name.

System programmer response: None.

Programmer response: None.

GFSC220E ATTEMPTING TO ESTABLISH THE MOUNT PATH *pathname* AT THE NETWORK FILE SYSTEM SERVER *hostname*, BUT THE OBJECT *objectname* IS NEITHER A DIRECTORY NOR A SYMBOLIC LINK.

Explanation: Only directories or symbolic links are allowed in the mount *pathname*. See "Accessing symbolic links on z/OS NFS version 4" on page 56 for details on NFS version protocol use.

System action: The mount operation fails. NFS Client processing continues.

Operator response: Verify the *pathname* with the NFS Server system administrator and reissue the mount

command with the proper path name.

System programmer response: None.

Programmer response: None.

GFSC221I MOUNT PARAMETER LLOCK(N) IS IGNORED FOR NETWORK FILE SYSTEM PROTOCOL VERSION *version*.

Explanation: Local locking is always in effect for mounts to NFS protocol versions 2 and 3. Parameter `llock(n)` is ignored.

In the message text:

version

The NFS protocol version specified in the mount command.

System action: The attribute is ignored and NFS Client processing continues.

Operator response: None.

System programmer response: None.

Programmer response: If the mount command is in a script, correct it for future use.

GFSC222E MOUNT FAILED BECAUSE THE NFS CLIENT DOES NOT SUPPORT MULTIBYTE DATA CONVERSION BETWEEN CCSID(*ccsid1*) AND CCSID(*ccsid2*).

Explanation: The z/OS NFS Client does not support multi-byte character conversion. One of the character conversion set IDs (*ccsid*) specifies such a conversion.

In the message text:

ccsid1

The character conversion set ID for the client.

ccsid2

The character conversion set ID for the server.

System action: The mount specifying the *ccsids* is rejected by the z/OS NFS client.

Operator response: None.

System programmer response: None.

Programmer response: If the mount command is in a script, correct it for future use.

GFSC275E GSS API *rtn()* FAILED, USER IDENTIFIER *uid* GSS MAJOR STATUS *majstat* GSS MINOR STATUS *minstat*

Explanation: An RPCSEC_GSS request failed because of a failure returned by the GSS API referenced in the message. In the message text:

rtn The name of the GSS API that failed.

uid The user identifier of the user for whom this request was issued.

majstat The major status returned by the failing API.

minstat
The minor status returned by the failing API.

System action: The NFS client retries this request once and fails the request if the retry also fails.

Operator response: Contact the system programmer.

System programmer response: Check the reported major status and minor status values in *z/OS Integrated Security Services Network Authentication Service Administration* and take the specified actions.

GFSC276E GSS API gss_import_name() FAILED FOR SERVER, HOSTNAME *host* GSS MAJOR STATUS *majstat* GSS MINOR STATUS *minstat*

Explanation: An RPCSEC_GSS request failed to import the hostname of its target NFS server because of a failure returned by the GSS API `gss_import_name()`.

In the message text:

host The DNS hostname of the NFS server to which this request is being directed.

majstat The major status returned by the failing API.

minstat
The minor status returned by the failing API.

System action: The NFS client retries this request once and fails the request if the retry also fails.

Operator response: Contact the system programmer.

System programmer response: Check the reported major status and minor status values in *z/OS Integrated Security Services Network Authentication Service Administration* and take the specified actions.

GFSC277E GSS API gss_init_sec_context() FAILED, SERVER HOSTNAME *host* USER IDENTIFIER *uid* GSS MAJOR STATUS *majstat* GSS MINOR STATUS *minstat*

Explanation: An RPCSEC_GSS request failed to create a security context because of a failure returned by the GSS API `gss_init_sec_context()`.

In the message text:

host The DNS hostname of the NFS server with which this context was being created.

uid The user identifier of the user for whom this request was issued.

majstat The major status returned by `gss_init_sec_context()`.

minstat
The minor status returned by `gss_init_sec_context()`.

System action: The NFS client retries this request once and fails the request if the retry also fails.

Operator response: Contact the system programmer.

System programmer response: Check the reported major status and minor status values in *z/OS Integrated Security Services Network Authentication Service Administration* and take the specified actions.

GFSC278E KERBEROS CREDENTIALS EXPIRED FOR USER NAME *user* USER IDENTIFIER *uid*

Explanation: An RPCSEC_GSS request failed to acquire the GSS credentials for the user identified in the message because the Kerberos credentials for the user don't exist. This can happen if the Kerberos credentials for the user have expired or the user has not done a "kinit".

In the message text:

user The RACF user name of the user for whom the credentials were being obtained.

uid The user identifier of the user for whom the credentials were being obtained.

System action: The NFS client fails all requests issued by this user.

Operator response: None.

System programmer response: None.

Programmer response: The user needs to issue a "kinit" and retry the request.

GFSC279E GSS API gss_unwrap() FAILED, USER IDENTIFIER *uid* GSS MAJOR STATUS *majstat* GSS MINOR STATUS *minstat*

Explanation: An RPCSEC_GSS request using the krb5p flavor, failed to decrypt the encrypted response from the NFS server because of a failure returned by the GSS API `gss_unwrap()`.

In the message text:

uid The user identifier of the user for whom this request was issued.

majstat The major status returned by `gss_unwrap()`.

minstat
The minor status returned by `gss_unwrap()`.

System action: The NFS client retries this request once and fails the request if the retry also fails.

Operator response: Contact the system programmer.

System programmer response: Check the reported major status and minor status values in *z/OS Integrated*

Security Services Network Authentication Service Administration and take the specified actions.

**GFSC280E NETWORK FILE SYSTEM CLIENT
COULD NOT GET GSS CREDENTIALS
FOR THE USER IDENTIFIER *uid* : GSS
API *rtn()* FAILED WITH GSS MAJOR
STATUS *majstat* GSS MINOR STATUS
*minstat***

Explanation: The NFS client could not get GSS credentials for the user identified in the message because of a failure returned by the GSS API referenced in the message.

In the message text:

uid The user identifier of the user for whom this request was issued.

rtn The name of the GSS API that failed.

majstat The major status returned by the failing API.

minstat
The minor status returned by the failing API.

System action: On experiencing this failure for a regular user the NFS client retries this request once and it fails the request if the retry also fails.

Operator response: Contact the system programmer.

System programmer response: Check the reported major status and minor status values in *z/OS Integrated Security Services Network Authentication Service Administration* and take the specified actions.

**GFSC281E NETWORK FILE SYSTEM CLIENT
COULD NOT LOAD THE KERBEROS
DLL:RETURN CODE *rc***

Explanation: The NFS client could not dynamically load the Kerberos runtime library because of a failure returned by the API `krb5_dll_load()`. In the message text:

rc The error code returned by `krb5_dll_load()`.

System action: RPCSEC_GSS activity is not supported by NFS client.

Operator response: Contact the system programmer.

System programmer response: Refer to the documentation on `krb5_dll_load()` in *z/OS Integrated Security Services Network Authentication Service Programming* and take the specified actions.

**GFSC282E NETWORK FILE SYSTEM CLIENT
COULD NOT CREATE KERBEROS
CONTEXT:RETURN CODE *rc***

Explanation: The NFS client could not create a Kerberos Context because of a failure returned by the API `krb5_init_context()`. In the message text:

rc The error code returned by `krb5_init_context()`.

System action: RPCSEC_GSS activity is not supported by NFS client.

Operator response: Contact the system programmer.

System programmer response: Refer to the documentation on `krb5_init_context()` in *z/OS Integrated Security Services Network Authentication Service Programming* and take the specified actions.

**GFSC283E NETWORK FILE SYSTEM CLIENT
COULD NOT FIND KERBEROS
CREDENTIAL CACHE FOR THE USER
IDENTIFIER *uid* : USS API *rtn()*
FAILED WITH RETURN CODE *majstat*
REASON CODE *minstat***

Explanation: The NFS client could not find the user's Kerberos credential cache in the directory `/var/skrb/creds` because of a failure the message. In the message text:

uid The user identifier of the user for whom this request was issued.

rtn The name of the USS API that failed.

majstat The return code returned by the failing API.

minstat
The reason code returned by the failing API.

System action: The NFS client fails RPCSEC_GSS requests issued by the user identified in the message.

Operator response: Contact the system programmer.

System programmer response: Ensure that the user has done "kinit" and check the reported Return Code and Reason Code values in the *z/OS UNIX System Services Messages and Codes guide, SA22-7807* and take the specified actions.

**GFSC284I NETWORK FILE SYSTEM CLIENT
COULD NOT GET GSS CREDENTIALS
FOR THE NFS CLIENT: GSS API *rtn()*
FAILED WITH GSS MAJOR STATUS
majstat GSS MINOR STATUS *minstat***

Explanation: The NFS client could not get GSS credentials for its Kerberos Principal; `mvsnfsc` because of a failure returned by the GSS API referenced in the message. In the message text:

rtn The name of the GSS API that failed.

majstat The major status returned by the failing API.

minstat
The minor status returned by the failing API.

System action: On experiencing this failure RPCSEC_GSS activity is not supported by the NFS client for any user.

Operator response: Contact the system programmer.

System programmer response: Check the reported major status and minor status values in *z/OS Integrated Security Services Network Authentication Service Administration* and take the specified actions.

GFSC300E MISSING LEFT PARENTHESIS IN *text* KEYWORD.

Explanation: The specified keyword, *text*, is missing a left parenthesis.

System action: NFS client processing stops if the error occurs in the NFS client installation parameter. The **mount** command failed if the error is in the **mount** parameter.

Operator response: Record the z/OS operator console message and notify the system programmer.

System programmer response: If the error is in the **mount** parameter, correct the parameter and reissue the **mount** command. If the error occurs in the NFS client installation parameter, correct the parameter, stop z/OS UNIX, and restart z/OS UNIX.

GFSC301E PARSE FAILED ON NUMERIC FIELD FOR *text* KEYWORD.

Explanation: The specified keyword, *text*, contains alphabetic data in a numeric field.

System action: NFS client processing stops if the error is in the NFS client installation parameter. The **mount** command failed if the error is in the **mount** parameter.

Operator response: Record the z/OS operator console message and notify the system programmer.

System programmer response: If the error is in the **mount** parameter, correct the parameter and reissue the **mount** command. If the error occurs in the NFS client installation parameter, correct the parameter, stop z/OS UNIX, and restart z/OS UNIX.

GFSC302E MISSING RIGHT PARENTHESIS IN *text* KEYWORD.

Explanation: The specified keyword, *text*, is missing a right parenthesis.

System action: NFS client processing stops if the error is in the NFS client installation parameter. The **mount** command failed if the error is in the **mount** parameter.

Operator response: Record the z/OS operator console message and notify the system programmer.

System programmer response: If the error is in the **mount** parameter, correct the parameter and reissue the **mount** command. If the error occurs in the NFS client installation parameter, correct the parameter, stop z/OS UNIX, and restart z/OS UNIX.

GFSC303E THE SPECIFIED VALUE *d_digit1* IS NOT IN THE RANGE OF *d_digit2* TO *d_digit3* FOR *text* KEYWORD.

Explanation: The value *d_digit1* specified in the keyword *text* must be between the minimum value, *d_digit2*, and the maximum value, *d_digit3*.

System action: NFS client processing stops if the error is in the NFS client installation parameter. The **mount** command failed if the error is in the **mount** parameter.

Operator response: Record the z/OS operator console message and notify the system programmer.

System programmer response: If the error is in the **mount** parameter, correct the parameter and reissue the **mount** command. If the error occurs in the NFS client installation parameter, correct the parameter, stop z/OS UNIX, and restart z/OS UNIX.

GFSC304E PARSE FAILED ON ALPHABETIC FIELD FOR *text* KEYWORD.

Explanation: The specified keyword, *text*, contains numeric data for an alphabetic field.

System action: NFS client processing stops if the error is in the NFS client installation parameter. The **mount** command failed if the error is in the **mount** parameter.

Operator response: Record the z/OS operator console message and notify the system programmer.

System programmer response: If the error is in the **mount** parameter, correct the parameter and reissue the **mount** command. If the error occurs in the NFS client installation parameter, correct the parameter, stop z/OS UNIX, and restart z/OS UNIX.

GFSC305E INCORRECT OPTION *text1* SPECIFIED FOR *text2* KEYWORD, VALID OPTION IS Y OR N.

Explanation: An incorrect option, *text1*, was specified for the keyword *text2*.

System action: NFS client processing stops if the error is in the NFS client installation parameter. The **mount** command failed if the error is in the **mount** parameter.

Operator response: Record the z/OS operator console message and notify the system programmer.

System programmer response: If the error is in the **mount** parameter, correct the option for the keyword *text2* and reissue the **mount** command. If the error occurs in the NFS client installation parameter, correct the option for the keyword *text2*, stop z/OS UNIX, and restart z/OS UNIX.

GFSC307E *text* IS AN INCORRECT KEYWORD FOR MOUNT PARAMETER.

Explanation: The value of *text* can be specified only as an installation parameter.

System action: The **mount** command failed.

System programmer response: Correct the **mount** parameter keyword *text*.

GFSC308E XLAT(Y) CANNOT BE SPECIFIED AS A MOUNT PARAMETER WHEN TAG OPTION IS ALSO SPECIFIED.

Explanation: The **mount** request with the *requestid* code failed because the user specified both the **xlat(Y)** and the **tag** options together. This is not allowed.

System action: The **mount** command ended with an error. NFS client continues processing.

User response: Either specify **xlat(Y)** to have the NFS client do text translation based on the **cln_ccsid** and **srv_ccsid** values, or specify the **tag** option with the correct coded character set identifier (CCSID) to have the translation done by the logical file system (LFS) based on the CCSID in the **tag** option.

GFSC309E UNKNOWN KEYWORD ENCOUNTERED AROUND POSITION *d_digit*.

Explanation: The keyword specified in position *d_digit* is not a valid keyword.

System action: NFS client processing stops if the error is in the NFS client installation parameter. The **mount** command failed if the error is in the **mount** parameter.

Operator response: Record the z/OS operator console message and notify the system programmer.

System programmer response: If the error is in the **mount** parameter, correct the keyword and reissue the **mount** command. If the error occurs in the NFS client installation parameter, correct the keyword, stop z/OS UNIX, and restart z/OS UNIX.

GFSC310I READAHEAD AND DELAYWRITE OPTIONS WILL BE IGNORED AS DATACACHING IS OFF.

Explanation: The keywords **readahead** and **delaywrite** are ignored because **datacaching** has been set to OFF.

System action: NFS client processing continues.

Operator response: Record the z/OS operator console message and notify the system programmer.

System programmer response: Check the parameters to make sure that **datacaching** should be OFF.

GFSC311I CLN_CCSID AND SRV_CCSID WILL BE IGNORED AS XLAT OPTION IS OFF.

Explanation: The keywords **cln_ccsid** and **srv_ccsid** are ignored because **xlat** has been set to OFF.

System action: NFS client processing continues.

Operator response: Record the z/OS operator console message and notify the system programmer.

System programmer response: Check the parameters to make sure that **xlat** should be OFF.

GFSC312I ACREGMIN, ACREGMAX, ACDIRMIN, AND ACDIRMAX OPTIONS WILL BE IGNORED AS ATTRCACHING IS OFF.

Explanation: The keywords **acregmin**, **acregmax**, **acdirmin**, and **acdirmax** are ignored because **attrcaching** has been set to OFF.

System action: NFS client processing continues.

Operator response: Record the z/OS operator console message and notify the system programmer.

System programmer response: Check the parameters to make sure that **attrcaching** should be OFF.

GFSC313I RETRANS OPTION WILL BE IGNORED AS HARD OPTION IS ON.

Explanation: The keyword **retrans** is ignored because **hard** has been set to ON.

System action: NFS client processing continues.

Operator response: Record the z/OS operator console message and notify the system programmer.

System programmer response: Check the parameters to make sure that **hard** should be ON.

GFSC315E ERROR ENCOUNTERED WHILE PARSING MOUNT PATH, REASON CODE *reasoncd*.

Explanation: The specified mount path is not correct.

System action: The **mount** command failed.

Operator response: Record the z/OS operator console message and notify the system programmer.

System programmer response: See *z/OS UNIX System Services Messages and Codes* for a description of the reason code *reasoncd*. Correct the mount path and reissue the **mount** command.

GFSC317E ERROR ENCOUNTERED WHILE PARSING HOSTNAME, REASON CODE *reasoncd*.

Explanation: The specified host name is not correct.

System action: The **mount** command failed.

Operator response: Record the z/OS operator console message and notify the system programmer.

System programmer response: See *z/OS UNIX System Services Messages and Codes* for a description of the reason code *reasoncd*. Correct the mount path and reissue the **mount** command.

GFSC318E READ FAILED FOR NETWORK FILE SYSTEM CLIENT MOUNT PARAMETERS.

Explanation: An error occurred while the NFS client was processing the **mount** parameters. This message follows other messages, GFSC3xxE, that describe the error in more detail.

System action: The **mount** command failed.

System programmer response: Correct the **mount** parameter options, and reissue the **mount** command.

GFSC319E *text* **IS AN INCORRECT KEYWORD FOR NETWORK FILE SYSTEM CLIENT INSTALLATION PARAMETER.**

Explanation: The value of *text* can be specified only as a **mount** parameter.

System action: The NFS client processing stops.

Operator response: Record the z/OS operator console message and notify the system programmer.

System programmer response: Correct the NFS client installation parameter, stop z/OS UNIX, and restart z/OS UNIX.

GFSC320E INCORRECT OPTION *text* **SPECIFIED FOR DELIM KEYWORD, VALID OPTION IS BINARY, CR, CRLF, CRNL, LF, LFCR, OR NL.**

Explanation: An incorrect option, *text*, has been specified for the keyword **delim**.

System action: NFS client processing stops if the error is in the NFS client installation parameter. The **mount** command failed if the error is in the **mount** parameter.

Operator response: Record the z/OS operator console message and notify the system programmer.

System programmer response: If the error is in the **mount** parameter, correct the option for the keyword **delim** and reissue the **mount** command. If the error occurs in the NFS client installation parameter, correct

the option for the keyword **delim**, stop z/OS UNIX, and restart z/OS UNIX.

GFSC500I CLIENT LOG DATA SET, *text*, **FLUSHED.**

Explanation: The data buffer of the active client log data set, *text*, was flushed to disk.

In the message text:

text The value of *text* is the associated data set name of the active client log data set.

System action: NFS client processing continues.

GFSC501I CLIENT LOG DATA SET *text* **RE-INITIALIZED.**

Explanation: The error log data set is reinitialized.

In the message text:

text The value of *text* is the associated data set name of the active log data set.

System action: NFS client processing continues.

GFSC502E CANNOT OPEN CLIENT LOG DATA SET, *text1*, *text2*.

Explanation: The NFS client failed to open the client log data set.

In the message text:

text1 The value of *text1* is the data definition (DD) associated with the client log data set that cannot be opened.

text2 The value of *text2* is the failure reason of the C function, **fopen**.

System action: NFS client processing stops.

Operator response: Record the z/OS operator console message and notify the system programmer.

System programmer response: Fix the client log data set and reply to the z/OS UNIX message to restart the NFS client.

GFSC503E CLIENT LOGGING ENDED.

Explanation: The NFS client failed to manipulate the client log data set. See the previous operator console message for the failure reason.

System action: NFS client processing continues.

Operator response: Record the z/OS operator console message and notify the system programmer.

System programmer response: Fix the client log data set, stop the NFS client, and reply to the z/OS UNIX message to restart the NFS client.

GFSC504I CLIENT LOG DATA SET SWITCHED TO *text*.

Explanation: A no space or an I/O error condition was detected while the system was writing to the client log data set. NFS client logging switched to the other log data set, *text*.

System action: NFS client processing continues.

GFSC505E MISSING DD STATEMENT OR INCORRECT DATA SET ORGANIZATION FOR LOG DATA SET.

Explanation: The error log data set has either an incorrect data set organization or a missing data definition (DD) statement.

System action: NFS client processing stops if the error occurred during initialization. NFS client processing continues with client logging ended if the error occurred after initialization.

Operator response: Record the z/OS operator console message and notify the system programmer.

System programmer response: Correct the data definition statement or data set organization for the error log data set, stop the NFS client, and reply to the z/OS UNIX message to restart the NFS client.

GFSC506E *text1* FAILED FOR *text2*, *text3*.

Explanation: The NFS client failed to manipulate the client log data set, *text2*. The value of *text3* is the failure reason for the C function *text1*.

System action: NFS client processing continues.

Operator response: Record the z/OS operator console message and notify the system programmer.

System programmer response: Fix the client log data set, stop the NFS client, and reply to the z/OS UNIX message to restart the NFS client.

GFSC507I LOG dataset *dataset name* is being used.

Explanation: The informational console message indicates the name of the starting log data set.

In the message text:

dataset name

The name of the starting log data set.

System action: NFS client processing continues.

Operator response: None.

System programmer response: None.

Programmer response: None.

GFSC510E NETWORK FILE SYSTEM CLIENT CTRACE INITIALIZATION FAILED BECAUSE MACRO *function* HAD RETURN CODE=*rc* REASON CODE=*rsn*.

Explanation: NFS client CTRACE initialization failed to create the data space or to register to the component trace services. The specified macro ended with a nonzero return code. Explanations of the return and reason codes from the specified macro can be found in *z/OS MVS Programming: Authorized Assembler Services Reference ALE-DYN*.

In the message text:

procname

The name of the start procedure.

function

The name of the macro with a nonzero return code.

rc

The value of the return code.

rsn

The value of the reason code.

System action: NFS processing continues.

Operator response: Contact the system programmer.

System programmer response: Check the reported return/reason codes and take the specified actions.

Programmer response: None.

GFSC700I z/OS NETWORK FILE SYSTEM CLIENT (*fmid*) STARTED *apar*, *module*, *date*, *time*.

Explanation: The NFS client is initialized and ready to process NFS requests.

In the message text:

fmid

The FMID of the NFS client; for example, (HDZ222N).

apar

The last APAR installed on the NFS client. If this is the base NFS server for the release and no APARs have been installed for this release yet, then this value is the same as the *fmid*.

module

The last module compiled and installed on the NFS client.

date

The compile date of the last module compiled and installed on the NFS Client.

time

The compile date of the last module compiled and installed on the NFS Client.

System action: NFS client processing continues.

**GFSC701I z/OS NETWORK FILE SYSTEM
CLIENT SHUTDOWN IN PROGRESS.**

Explanation: NFS client shutdown processing has started.

System action: NFS client shutdown processing continues.

**GFSC702I z/OS NETWORK FILE SYSTEM
CLIENT SHUTDOWN complete.**

Explanation: The NFS client has completed shutdown processing.

System action: The NFS client and its associated subtasks have ended.

**GFSC703E z/OS NETWORK FILE SYSTEM
CLIENT INITIALIZATION FAILED:
text.**

Explanation: The value of *text* can be any of the following:

- CLIENT IS ALREADY STARTED
- DOWN LEVEL SECURITY PRODUCT
- INSUFFICIENT REGION
- INSUFFICIENT MEMLIMIT
- TASK IS NOT APF AUTHORIZED
- INCORRECT INSTALLATION PARAMETERS
- DEFAULT LOCAL HOST NAME OR LOCAL DOMAIN NOT FOUND
- NOT STARTED IN A STANDALONE COLONY ADDRESS SPACE
- ESTAEX INITIALIZATION FAILED
- ATTACH GFSCRPCD FAILED

System action: This NFS client initialization ends.

Operator response: Record the z/OS operator console message and notify the system programmer.

System programmer response: The system programmer response follows:

- If NFS Client is already started, then a prior NFS client session has not ended. UNIX end processing should have ended the NFS client colony address space. Collect installation parameters, memory dumps, and NFS client log data sets, and contact the IBM Support Center.

Use the **force** command to end the NFS client colony address space and then restart UNIX

- If Resource Access Control Facility (RACF) is down level, then check to determine the required RACF level.
- If the NFS client was not able to allocate the necessary storage, then do either or both of the following:
 - Increase the REGION size for the client procedure

- Decrease the value specified for the bufhigh attribute of the FILESYSTYPE parameter in the BPXPRMxxx parmlib member.
- If insufficient MEMLIMIT - the virtual storage above-the-bar, then specify the MEMLIMIT or raise the existing MEMLIMIT, or specify REGION=0M in the z/OS Client startup procedure.

The 64-bit z/OS NFS Client requires a minimum 1G memory above-the-bar for every biod. Given the default "biod(6)" the z/OS NFS Client would need 6 GB virtual memory above-the bar.
- If it is an APF-authorization problem, then APF authorize all libraries in the STEPLIB DD statement.
- If incorrect installation parameters, then check previous console messages prefixed with GFSC. Correct the parameter in BPXPRMxx parmlib member, stop z/OS UNIX, and restart z/OS UNIX.
- If no local host name or no local domain name, then see *z/OS UNIX System Services Planning* and *z/OS Communications Server: IP Configuration Guide* with regards to z/OS Network Configuration to take the corrective action.
- If NFS Client was not started in a stand-alone Colony Address Space, then check BPXPRMxx parmlib member to ensure that there is only one ASNAME associated with z/OS NFS Client.
- If Abend Recovery (ESTAEX) Initialization failed, or ATTACHing the load module GFSCRPCD failed, then collect installation parameters, memory dumps, and NFS client log data sets, and contact the IBM Support Center.

**GFSC708E z/OS NETWORK FILE SYSTEM
CLIENT INITIALIZATION FAILED:
CONVERSION SERVICE IS NOT
INSTALLED OR NOT AVAILABLE.
RETURN CODE *retc*, REASON CODE
rsnc.**

Explanation: Both the Unicode and character data representation architecture (CDRA) initialization requests failed.

System action: NFS client startup ends.

Operator response: Record the z/OS operator console message and notify the system programmer.

System programmer response: See *z/OS MVS System Messages, Vol 2 (ARC-ASA)* for a description of the return code *retc* and reason code *rsnc* to determine the corrective action.

**GFSC711E z/OS NETWORK FILE SYSTEM
CLIENT INITIALIZATION FAILED:
function_API UNIX KERNEL SERVICE
FAILED, RETURN CODE *retc* REASON
CODE *rsnc*.**

Explanation: The NFS client detected an error during

the second phase of initialization processing.

The z/OS UNIX KERNEL *function_API* could be one of the following:

- BPX4SDD()
- BPX4PCT(PC#TDNames)
- v_reg()
- osi_kmsgget()

See *z/OS UNIX System Services Programming: Assembler Callable Services Reference* for BPX4SDD() and BPX4PCT().

See *z/OS UNIX System Services Messages and Codes* for v_reg() and osi_kmsgget().

See *z/OS UNIX System Services File System Interface Reference* for a description of the return code *retc* and reason code *rsnc*.

System action: The NFS client ends.

Operator response: Collect any dumps and NFS client log data sets and notify the system programmer.

System programmer response: Collect installation parameters, memory dumps, and NFS client log data sets, and contact the IBM Support Center.

GFSC712E z/OS NETWORK FILE SYSTEM CLIENT INITIALIZATION FAILED: SOCKET CALL *function_API* FAILED, RETURN CODE *retc*.

Explanation: The NFS client has detected an error (*returncd*) during initialization processing. This error might be caused by z/OS UNIX and a TCP/IP connection failure.

The z/OS UNIX KERNEL *function_API* could be one of the following:

- BPX4HST()
- __iphost()
- __ipDomainName()

See *z/OS UNIX System Services Programming: Assembler Callable Services Reference* for BPX4HST().

See *z/OS UNIX System Services Messages and Codes* for __iphost() and __ipDomainName().

See *z/OS UNIX System Services File System Interface Reference* for a description of the return code *retc*.

System action: NFS client ends.

Operator response: Collect any dumps and NFS client log data sets and notify the system programmer.

System programmer response: Collect installation parameters, memory dumps, and NFS client log data sets, and contact the IBM Support Center.

GFSC713E z/OS NETWORK FILE SYSTEM CLIENT *daemon* TERMINATED RV(*rtnval*, *rtncode*, *rsncode*)

Explanation: The NFS client has detected an error. The *daemon* daemon has ended with a return value of *rtnval*, return code of *rtncode*, and reason code of *rsncode*.

System action: The NFS client is terminated.

Operator response: Collect any dumps and NFS client log data sets and notify the system programmer.

System programmer response: Collect installation parameters, dumps, and NFS client log data sets, and contact the IBM Support Center.

GFSC714E z/OS NETWORK FILE SYSTEM CLIENT SVC DUMP FAILED RC=*returncd* RSNC=*reasoncd*

Explanation: A request to write an MVS SVC dump failed. See the description of the **sdump** macro in *z/OS MVS Programming: Authorized Assembler Services Reference LLA-SDU* for the meaning of return code *returncd* and reason code *reasoncd*.

System action: NFS client ends.

Operator response: Collect the MVS console log and NFS client log data sets, and notify the system programmer.

System programmer response: Collect installation parameters, dumps, and NFS client log data sets, and contact the IBM Support Center.

GFSC715E z/OS NETWORK FILE SYSTEM CLIENT *daemon* ESTAE EXIT FAILED *abendcd* RSN=*reasoncd*

Explanation: The NFS client recovery exit detected a recursive abend.

In the message text:

daemon

is the name of the NFS client daemon that experienced this failure.

abendcd

is the last abend code encountered by a secondary instance of the ESTAE exit routine.

reasoncd

is the abend reason code.

System action: The ESTAE processing stops and the NFS client terminates.

Operator response: Collect any dumps, the z/OS console log, and NFS client log data sets, and notify the system programmer.

System programmer response: Collect installation parameters, dumps, the z/OS console log, and NFS

client log data sets, and contact the IBM Support Center.

GFSC716I z/OS NETWORK FILE SYSTEM
CLIENT *daemon* RESTARTED.

Explanation: The NFS client detected that asynchronous daemon text *daemon* was stopped and restarted it.

System action: The NFS client daemon has restarted. NFS Client processing continues.

Operator response: None.

System programmer response: None.

GFSC717E z/OS NETWORK FILE SYSTEM
CLIENT *daemon* ABNORMALLY
TERMINATED *abendcd* RSN=*reasoncd*

Explanation: The NFS client daemon *daemon* abended. In the message text:

daemon

is the name of the NFS client daemon that experienced this failure.

abendcd

is the abend code encountered by the daemon.

reasoncd

is the abend reason code.

System action: The NFS client terminates.

Operator response: Collect any dumps, the z/OS console log, and NFS client log data sets and notify the system programmer.

System programmer response: Collect installation parameters, dumps, the z/OS console log and NFS client log data sets, and contact the IBM Support Center.

GFSC718E z/OS NETWORK FILE SYSTEM
CLIENT *daemon* UNABLE TO RETRY

Explanation: The NFS client daemon *daemon* abend recovery exit was unable to retry. The NFS client terminates.

System action: The NFS client terminates.

Operator response: Collect any dumps, the z/OS console log, and NFS client log data sets and notify the system programmer.

System programmer response: Collect installation parameters, dumps, the z/OS console log and NFS client log data sets, and contact the IBM Support Center.

GFSC721E UNABLE TO SETUP ERROR
RECOVERY (ESTAE), RETURN CODE
returncd.

Explanation: The NFS client daemon or thread failed to setup error recovery. See *z/OS MVS Programming: Authorized Assembler Services Reference EDT-IXG* for information about the **estae** macro return code *returncd*.

System action: If the error occurred in the daemon, the NFS client has initiated shutdown processing. If the error occurred in the thread, the associated operation ends and the NFS client processing continues.

Operator response: Collect any dumps, the z/OS console log, and NFS client log data sets, and notify the system programmer.

System programmer response: If the program is not in error, see the messages in the client log data sets for more information. Search problem-reporting databases for a fix for the problem. If no fix exists, contact the IBM Support Center. Provide all the printed output and copies of output data sets related to the problem.

GFSC722E A SOCKET COULD NOT BE
CREATED, RETURN VALUE -1
RETURN CODE *returncd* REASON
CODE *reasoncd*.

Explanation: The NFS client daemon or thread processing failed to create a socket for network communications.

System action: If the error occurred in the daemon, the NFS client has initiated shutdown processing. If the error occurred in the thread, the associated operation ends and the NFS client processing continues.

Operator response: Collect any dumps, the z/OS console log, and NFS client log data sets, and notify the system programmer.

System programmer response: See *z/OS UNIX System Services Messages and Codes* for a description of return code *returncd* and reason code *reasoncd* to determine the corrective action. If the program is not in error, see the messages in the client log data sets for more information. Search problem-reporting databases for a fix for the problem. If no fix exists, contact the IBM Support Center. Provide all the printed output and copies of output data sets related to the problem.

GFSC723E z/OS NETWORK FILE SYSTEM
CLIENT ABEND @ *module+offset*.

Explanation: The NFS client encountered a programming error. An SVC dump was issued to capture the diagnostic information.

System action: The NFS client has initiated shutdown processing.

System programmer response: Look at the messages in the client log data sets for more information. Search

problem-reporting databases for a fix for the problem. If no fix exists, contact the IBM Support Center. Provide all the printed output and copies of output data sets related to the problem

GFSC724E UNABLE TO BIND A RESERVED PORT TO SOCKET *socketnum* RETURN VALUE -1 RETURN CODE *returncd* REASON CODE *reasoncd*.

Explanation: z/OS client failed to obtain a reserved port for socket *socketnum* for network communications.

System action: If the error occurred during z/OS client initialization, it the z/OS client has initiated shutdown processing. If the error occurred in the thread (owing to recent tcpip.profile change and z/OS client/Server restart), the associated operation ends and the NFS client processing continues.

System programmer response: Check that the tcpip.profile file has defined reserved (privileged) ports for the z/OS client. See *z/OS UNIX System Services Messages and Codes* for a description of return code *returncd* and reason code *reasoncd* to determine the corrective action. If the program is not in error, look at the messages in the client log data sets for more information. Search problem-reporting databases for a fix for the problem. If no fix exists, contact the IBM Support Center. Provide all the printed output and copies of the output data sets related to the problem.

GFSC725E SOCKET, *socketnum*, COULD NOT BE CLOSED, RETURN VALUE -1 RETURN CODE *returncd* REASON CODE *reasoncd*.

Explanation: While closing a socket *socketnum*, the system detected an error *returncd* was detected.

System action: The NFS client continues processing.

System programmer response: See *z/OS UNIX System Services Messages and Codes* for a description of return code *returncd* and reason code *reasoncd* to determine the corrective action. If the program is not in error, look at the messages in the client log data sets for more information. Search problem-reporting databases for a correction for the error. If no fix exists, contact the IBM Support Center. Provide all the printed output and copies of output data sets related to the problem.

GFSC726E THE PORTMAPPER OF THE SERVER *hostname* DOES NOT RESPOND TO PMAP_GETMAPS

Explanation: The **mount** request with code *requestid* failed because the user specified **proto(tcp)** and the *hostname* did not publish its registered remote program port for the remote procedure call (RPC).

System action: The **mount** command ended with an error. NFS client continues processing.

User response: Verify that the server does not respond

to **orpcinfo**. Reissue the **mount** command without **proto(tcp)**.

GFSC727W THE PORTMAPPER OF THE SERVER *hostname* DOES NOT RESPOND TO PMAP_GETMAPS. ATTEMPTING UDP RPC WITH NFS VERSION *d_digit* PROTOCOL.

Explanation: The NFS client warns the user who mounts to *hostname* that the host might not have its portmapper running; the NFS client uses the user datagram protocol (UDP) remote procedure call (RPC). A UDP RPC is attempted with the NFS protocol.

System action: The **mount** command might or might not succeed. NFS client continues processing.

User response: Verify that the server does not respond to the code **orpcinfo**. If the **mount** command subsequently fails, then the host likely does not have the NFS server.

GFSC728E UNABLE TO CONNECT SOCKET=*socketno* PORT=*portno1* WITH THE SERVER *hostname* PORT=*portno2*

Explanation: The NFS client uses TCP/IP to connect socket *socketno* with port *portno1* to the server *hostname* with port *portno2*; however, the connect system call failed.

System action: The operation ended with an error. The NFS client processing continues.

User response: Verify that the NFS server on *hostname* is available and running. Verify that the TCP/IP subsystem on z/OS is available and running. If the **mount** command subsequently fails, then the host likely does not have the NFS server.

GFSC729W z/OS NFS CLIENT IS UNABLE TO RESERVE *d_digit* SOCKETS, CURRENT MAXFILEPROC IS *d_digit*

Explanation: The maximum number of socket descriptors that a process can have open concurrently has been exceeded. Increase the MAXFILEPROC parameter value in the BPXPRMxx member to bypass this problem. See *z/OS UNIX System Services Planning* for more information about specifying the MAXFILEPROC value.

System action: The operation ended with an error. The NFS client processing continues.

System programmer response: Increase the MAXFILEPROC parameter value in the BPXPRMxx member to bypass the problem.

GFSC734I NETWORK FILE SYSTEM NO LONGER SUPPORTS THE STOP COMMAND. PLEASE ISSUE: F OMVS,STOPPFS=NFS.

Explanation: Operator entered STOP MVSNFSC command to stop NFS Client. This command is no longer supported.

System action: The NFS client processing continues.

Operator response: Issue 'F OMVS,STOPPFS=NFS' command to stop the NFS Client.

System programmer response: None.

Programmer response: None.

GFSC735W NETWORK FILE SYSTEM CLIENT IS UNABLE TO USE STRINGPREP CONVERSION SERVICES.

Explanation: Calling the Unicode Service CUNLSTRP (stringprep) for the three stringprep profiles of CUNSTCSP (case sensitive), CUNSTCIS (case insensitive), and CUNSTMX1 (case mixed) failed.

System action: The z/OS NFS Client processing continues without the Unicode Stringprep Services for NFS V4 requests.

Operator response: None

System programmer response: Check and correct the Unicode Service Configuration. The z/OS NFS Client must be stopped and restarted after correcting the Unicode Stringprep so that it can pick up the new Unicode Configuration.

Programmer response: None

GFSC737W Found numconfig TCPIP Stacks, but the maximum number of supported TCPIP Stacks is maxstacks.

Explanation: The z/OS NFS client found that the local z/OS installation has *numconfig* CINET TCP/IP Stacks, but it is greater than the maximum number of supported CINET TCP/IP Stacks of *maxstacks*. The network communication is fine. However, the NFS Version4 name-to-uid/gid mapping (and vice versa) may not be correct.

System action: The NFS client processing continues but it uses the default local domain name of the default CINET TCP/IP Stack for any communication on the TCP/IP Stack that is greater than *maxstacks*.

Operator response: Collect any dumps and NFS client log data sets and notify the system programmer.

System programmer response: See *z/OS UNIX System Services Planning* and *z/OS Communications Server: IP Configuration Guide* with regards to z/OS Network Configuration to take the corrective action.

GFSC738W z/OS NETWORK FILE SYSTEM CLIENT uses the default domain name local_domain.

Explanation: Due to the preceding error messages, the z/OS NFS client uses the default local domain name under CINET for the NFS Version4 name-to-uid/gid mapping (and vice versa).

System action: The NFS client processing continues but it uses the default local domain name of the default CINET TCP/IP Stack.

Operator response: Collect any dumps and NFS client log data sets and notify the system programmer.

System programmer response: See *z/OS UNIX System Services Planning* and *z/OS Communications Server: IP Configuration Guide* with regards to z/OS Network Configuration to take the corrective action.

GFSC739E z/OS UNIX service BPX4PCT(PC#DirGetHost) for TCPIP Stack StackName failed, return code retc reason code rsnc.

Explanation: z/OS NFS client is unable to retrieve the local z/OS TCP/IP *StackName* from the established network connection. See *z/OS UNIX System Services Messages and Codes* for a description of the return code *retc* and reason code *rsnc*.

System action: The NFS client processing continues but it uses the default local domain name of the default CINET TCP/IP Stack. The NFS Version4 name-to-uid/gid mapping (and vice-versa) may not be correct.

Operator response: Collect any dumps and NFS client log data sets and notify the system programmer.

System programmer response: See *z/OS UNIX System Services Planning* and *z/OS Communications Server: IP Configuration Guide* with regards to z/OS Network Configuration to take the corrective action.

GFSC740E z/OS UNIX service GETADDRINFO() for HOST hostname failed, return code retc reason code rsnc.

Explanation: The z/OS NFS client is unable to resolve the given *hostname* to the fully qualified host name or an IP address.

System action: The NFS client processing continues but it uses the default local domain name of the default CINET TCP/IP Stack. The NFS Version4 name-to-uid/gid mapping (and vice versa) may not be correct.

Operator response: Collect any dumps and NFS client log data sets and notify the system programmer.

System programmer response: See *z/OS UNIX System Services Planning* and *z/OS Communications Server: IP*

Configuration Guide with regards to z/OS Network Configuration to take the corrective action.

GFSC741E **z/OS UNIX service**
w_ioctl(IOCC_GETSTACKS) for socket
socketnum failed, return code retc reason
code rsnrc.

Explanation: The z/OS NFS client is unable to find the local CINET TCP/IP Stack associated with the locally connected TCP/IP socket.

System action: The NFS client processing continues but it uses the default local domain name of the default CINET TCP/IP Stack. The NFS Version4 name-to-uid/gid mapping (and vice versa) may not be correct.

Operator response: Collect any dumps and NFS client log data sets and notify the system programmer.

System programmer response: See *z/OS UNIX System Services Planning* and *z/OS Communications Server: IP Configuration Guide* with regards to z/OS Network Configuration to take the corrective action.

GFSC742W **Socket socketnum has affinity to**
numstack Stacks

Explanation: The z/OS NFS client found that there is more than one local CINET TCP/IP stack with affinity to a locally connected TCP/IP socket.

System action: The NFS client processing continues but it uses the default local domain name of the default CINET TCP/IP Stack. The NFS Version4 name-to-uid/gid mapping (and vice versa) may not be correct.

Operator response: Collect any dumps and NFS client log data sets and notify the system programmer.

System programmer response: See *z/OS UNIX System Services Planning* and *z/OS Communications Server: IP Configuration Guide* with regards to z/OS Network Configuration to take the corrective action.

GFSC743E **Unable to add TCPIP Stack StackName.**
The default domain name is used.

Explanation: The z/OS NFS client is unable to find information about the recently activated TCPIP stack *StackName*.

System action: The NFS client processing continues but it uses the default local domain name of the default CINET TCP/IP Stack. The NFS Version4 name-to-uid/gid mapping (and vice versa) may not be correct.

Operator response: Collect any dumps and NFS client log data sets and notify the system programmer.

System programmer response: See *z/OS UNIX System Services Planning* and *z/OS Communications Server: IP*

Configuration Guide with regards to z/OS Network Configuration to take the corrective action.

GFSC840I **usage: text [-a] [-d] [-e] [-norpcbind]**
[host]

Explanation: This is the usage for the **showmount** command. The value of *text* is the command as entered by the user. The valid options follow:

- a** Display all mounts in the format
hostname:directory from host NFS server
- d** Display only directory names of all mounts
 from host NFS server
- e** Display the list of exported directories from
 host NFS server

GFSC841E **Unknown host text**

Explanation: The user entered incorrect host address information, *text*.

System action: The system stops processing the command.

User response: Correct the syntax and reissue the command.

GFSC842E **Cannot resolve local host name**

Explanation: The local host name was not found.

System action: The system stops processing the command.

User response: Contact the system administrator to check the TCP/IP configuration.

GFSC843E **Unknown flag '-character'**

Explanation: An incorrect option, '-character', was specified.

System action: The system stops processing the command.

User response: Correct the syntax and reissue the command.

GFSC845I **usage: text input output**

Explanation: This is the usage for the **crnl2nl** and **nl2crnl** commands.

In the message text:

text The value of *text* is the command as entered by the user.

The valid parameters follow:

input Absolute path name of the input file to be converted.

output Absolute path name of the output file.

GFSC846E Cannot open input file, *text1*:*text2*

Explanation: The system cannot open the input file, *text1*.

In the message text:

text1 The value of *text1* is the input path name entered by the user.

text2 The value of *text2* is the failure information returned during an attempt to open the input file.

System action: The system stops processing the command.

User response: Check the input file, *text1*.

GFSC847E Cannot open output file, *text1*:*text2*

Explanation: The system cannot open output file, *text1*.

In the message text:

text1 The value of *text1* is the output path name entered by the user.

text2 The value of *text2* is the failure information returned during an attempt to open the output file.

System action: The system stops processing the command.

User response: Check the output file, *text1*.

GFSC848E Cannot read input file, *text1*: *text2*

Explanation: The system cannot read the input file, *text1*.

In the message text:

text1 The value of *text1* is the input path name entered by the user.

text2 The value of *text2* is the failure information returned during an attempt to read the input file.

System action: The system stops processing the command.

User response: Check the input file, *text1*.

GFSC849E Cannot write output file, *text1*: *text2*

Explanation: The system cannot write to the output file, *text1*.

In the message text:

text1 The value of *text1* is the output path name entered by the user.

text2 The value of *text2* is the failure information returned during an attempt to write to the output file.

System action: The system stops processing the command.

User response: Check the output file, *text1*.

GFSC850E Input path name cannot be equal to output path name.

Explanation: The input path name cannot be the same as the output path name.

System action: The system stops processing the command.

User response: Correct the syntax and reissue the command.

GFSC854I usage: *text* [-crnzmi <mount point>]

Explanation: This is the usage for the `nfsstat` command.

In the message text:

text The value of *text* is the command entered by the user.

The valid parameters follow:

- c** Display both NFS and remote procedure call (RPC) statistics about the NFS client.
- n** Display NFS statistics about the NFS client.
- r** Display remote procedure call (RPC) statistics about the NFS client.
- z** Initializes statistics to zero. This option is for use by the root user only and can be combined with any of the preceding options. Zero a particular set of statistics after printing them.
- m** Display the name of each NFS-mounted file system.
- mi** Displays the name of each NFS-mounted file system and checks server's IP address validity (compare current server's IP address and IP address established at mount time).

-m mount point

Display information about the NFS-mounted file system on the specified mount point.

-mi mount point

Displays information for the NFS-mounted file system on the specified mount point and checks server's IP address validity (compare current server's IP address and IP address established at mount time)

GFSC855E **Must be a root user to issue 'character' flag**

Explanation: The option 'character' can be issued only with the root authority.

System action: The system stops processing the command.

User response: Contact your system administrator to issue this command.

GFSC856E **z/OS Network File System Client command, text, failed, return value -1 return code returned reason code reasoncd**

Explanation: The command *text* failed.

System action: The system stops processing the command.

User response: See *z/OS UNIX System Services Messages and Codes* for a description of the return code *returned*. See Table 75 on page 466 for more information about the reason code *reasoncd*.

GFSC857I **z/OS Network File System type:status**

Explanation: The header message before the statistics sections

type Client or Server

status One of the following:

- "not available"
- "no statistics"
- The server startup procedure

System action: None.

Operator response: If the status is "not available" verify whether the Client or Server is started. If the status is "no statistics" then it is possible that the Client or the Server is about to be terminated.

System programmer response: If the status is "not available" verify whether the Client or Server is started, and start the appropriate service.

GFSC858E **Directory text not mounted.**

Explanation: The directory *text* was not mounted.

System action: The system stops processing the command.

User response: Issue `nfsstat -m` to view the list of active mount points. If the mount point does not exist, contact the system administrator to mount the directory.

GFSC859E **Incomplete command.**

Explanation: The entered command is incomplete. The request of module's version (-v option) should be completed with the module name or 'a' for all modules.

System action: The system stops processing the command.

User response: Check the input command. Specify version details

GFSC860W **Name Resolver indicates the Server=servername is at ipaddr [, ipaddr]**

Explanation: The Name Resolver indicates that the ip address *ipaddr* for NFS server *servername* has been changed. In the message text:

servername

The name of NFS server.

ipaddr The new IP address of the NFS server.

System action: The system continues processing the command.

User response: Check the existing mounts related to this NFS server. Remount if needed.

GFSC869E **Call to remote NFS Server failed. ERRP = rpc_retvalue uss_retcode uss_rsnocode**

Explanation: The NFS Client showmount utility encountered a failure attempting to send a request to the NFS Server. In the message text:

rpc_retvalue

The return value returned by RPC `clnt_call()`.

uss_retcode

The return code returned by RPC `clnt_call()`.

uss_rsnocode

The reason code returned by RPC `clnt_call()`.

System action: The showmount utility fails the request.

System programmer response: Check the reported `rpc_retvalue` in *z/OS TCP/IP Programmer's Reference*, and `uss_retcode` and `uss_rsnocode` in *z/OS UNIX System Services Messages and Codes* and take the specified actions.

User response: Check network availability.

GFSC870E **The Network File System mount path mntpath is being function shipped.**

Explanation: The mount point indicated by the *mntpath* is being function shipped to another LPAR that owns the mount point. The z/OS NFS Client of the current LPAR cannot obtain information for display by the `nfsstat` utility.

System action: The nfsstat utility fails the request for the specified mntpath.

System programmer response: Remount (unmount

and mount) the mount point.

User response: Ensure that the nfsstat utility is used on the LPAR that owns the mount point.

Client/Server Shared Messages

This is a listing of the messages generated by the NFS server or NFS client. Each message description gives an explanation and recommended actions where applicable. The system substitutes data for any part of a message shown here in *italics*.

Messages appear in the NFS server or NFS client log data sets in the same format as this example: **GFSN5001E Both z/OS Unix ACL and Mode pointers are NULL. Nothing converted.**

Table 66 shows the message format for the NFS server or NFS client log data sets:

Table 66. Message format for the NFS server or NFS client log data sets

Text	Description
GFSN	Component identifier for Client/Server Shared Messages
5001	A unique message number
E	The message level: E (error), W (attention), or I (informational). The system programmer can use the message level to determine which type of messages are shown by specifying log=error, log=warn, or log=info.
Both z/OS Unix ACL and Mode pointers are NULL. Nothing converted.	The message text

The messages are listed in numerical order (the time stamp, message level, and programming support information are not shown).

1. A value of *h_digits* is a hexadecimal number, and *d_digits* is a decimal number. A value of *text* or *dsname* is variable text (such as a data set name).
2. For messages written to the console, the name of the start procedure is substituted for *procname*.

GFSN5001E Both z/OS Unix ACL and Mode pointers are NULL. Nothing converted.

Explanation: The z/OS NFS Client, or the z/OS NFS Server, called the z/OS UNIX to NFS ACL conversion function, but did not pass the location of any ACL, or permission mode bit, values to be converted.

System action: No ACLs are converted from z/OS UNIX to NFS ACLs. The request fails and normal processing continues.

Operator response: None.

System programmer response: Capture a trace of the situation and report it to the IBM Support Center.

Programmer response: None.

GFSN5002E Invalid z/OS UNIX ACL header: *h_digit1* ACE count: *d_digit*.

Explanation: The z/OS NFS Client, or the z/OS NFS Server, called the z/OS UNIX to NFS ACL conversion function, but an invalid z/OS UNIX ACL header control block was received. This is the result of a program logic error.

In the message text:

h_digit1

The contents of the control block for IBM support personnel analysis.

d_digit The number of USS ACL entries to be converted.

System action: No ACLs are converted from z/OS UNIX to NFS ACLs. The request fails and normal processing continues.

Operator response: None.

System programmer response: Capture a trace of the situation and report it to the IBM Support Center.

Programmer response: None.

GFSN5003E Unsupported Network File System ACL Who Type. Supported Values are: OWNER, GROUP, EVERYONE, User, Group. ACE: *d_digit*, WType: *h_digit1*, WId: *h_digit2*, AType: *h_digit3*, AFlag: *h_digit4*, AMask: *h_digit5*.

Explanation: The z/OS NFS Client, or the z/OS NFS Server, called the z/OS UNIX to, or from, NFS ACL conversion function. In the process of merging the z/OS UNIX ACLs into the existing NFS ACLs, an NFS ACL entry with an unsupported WHO type was encountered. The ACLs cannot be converted and the request is terminated.

If this message occurs on the z/OS NFS Server, it means that a remote NFS Client is attempting to set ACL entries with WHO types which are not supported by z/OS UNIX.

If this message occurs on the z/OS NFS Client, it means that the z/OS NFS Client is attempting to manage ACLs for a remote NFS Server and the NFS ACL contains entries which specify unsupported WHO types.

z/OS NFS only supports the following WHO types:

OWNER@

specifies the owner of the file or directory

GROUP@

specifies the group of the owner of the file or directory

EVERYONE@

specifies the base Other permissions for the file or directory

user@domain

specifies an explicit user identifier

group@domain

specifies an explicit user group identifier

In the message text: (primarily intended for IBM support personnel use):

d_digit

0-origin index of the NFS ACL entry containing the error.

h_digit1

hexadecimal value of the NFS ACL who type. (1-owner, 2-user, 3-owner group, 4-user group, 8-everyone)

h_digit2

hexadecimal value of the user, or group, id.

h_digit3

hexadecimal value of the NFS ACL type field (see RFC3530).

h_digit4

hexadecimal value of the NFS ACL flag field (see RFC3530).

h_digit5

hexadecimal value of the NFS ACL mask field (see RFC3530).

System action: The request fails and normal processing continues.

Operator response: None.

System programmer response: None.

Programmer response: Check the remote system NFS ACL values and update them to comply with the z/OS NFS ACL management restrictions. See "Displaying and modifying remote file system access control lists" on page 58 for more information.

GFSN5004E Directory Default ACL delete is not allowed. This is only allowed for z/OS Network File System Client/Server connections.

Explanation: A z/OS NFS Client Directory Default ACL delete request was attempted but the remote NFS Server is not a z/OS system. Directory Default requests are only supported when the remote NFS Server is the z/OS NFS Server. Otherwise, Default ACLs must be managed using File Default ACL requests. Most non-z/OS platforms only have a single set of Default ACLs, not separate File and Directory Default ACLs. Therefore, z/OS NFS ACL management support uses the File Default ACL requests to manage the NFS Default ACLs. To avoid potential confusion, or even errors due to duplicate requests, Directory Default ACL requests are not supported.

System action: The request fails and normal processing continues.

Operator response: None.

System programmer response: None.

Programmer response: Use the z/OS UNIX File Default ACL management requests, not the z/OS UNIX Directory Default ACL requests.

GFSN5005E z/OS Unix Directory Default ACL entry does not match existing Network File System Default ACL entry.

Explanation: The z/OS NFS ACL conversion service encountered a UNIX System Services Directory Default ACL entry which does not match the existing NFS Default ACL entry. Management of mismatched

Directory and File Default ACLs is only supported between the z/OS NFS Client and the z/OS NFS Server. The conversion request cannot be processed.

On the z/OS NFS Server this could occur when the z/OS UNIX File and Directory Default ACL entries do not match. z/OS NFS does not support remote management of such ACLs.

On the z/OS NFS Client this can occur when the Directory Default does not match the remote system's existing Default ACLs. Most non-z/OS platforms only have a single set of Default ACLs, not separate File and Directory Default ACLs. Therefore, z/OS NFS ACL management support uses the File Default ACL requests to manage the NFS Default ACLs. To avoid potential errors, in this scheme, Directory Default ACL requests are not supported.

System action: The request fails and normal processing continues.

Operator response: None.

System programmer response: None.

Programmer response: Non-z/OS NFS Clients can not be used to manage z/OS UNIX directory Default ACLs when the File and Directory Defaults do not match. Either change them via local requests so that they match, or manage them locally. For managing non-z/OS NFS Default ACLs from the z/OS NFS Client, use z/OS UNIX System Services File Default ACL management requests.

GFSN5006E Directory Default and File Default ACLs do not match. This is only allowed for z/OS Network File System Client/Server connections.

Explanation: The z/OS UNIX System Services Directory Default and File Default ACLs for this object do not match. Management of mismatched Directory and File Default ACLs is only supported between the z/OS NFS Client and the z/OS NFS Server. For other NFS Client/Server combinations, the z/OS Directory and File Defaults must match and z/OS File Default requests should be used for managing non-z/OS NFS ACLs. The conversion request cannot be processed.

On the z/OS NFS Server this could occur when the z/OS UNIX File and Directory Default ACL entries do not match. z/OS NFS does not support remote management of such ACLs.

On the z/OS NFS Client this can occur when the Directory Default does not match the remote system's existing Default ACLs. Most non-z/OS platforms only have a single set of Default ACLs, not separate File and Directory Default ACLs. Therefore, z/OS NFS ACL management support uses the File Default ACL requests to manage the NFS Default ACLs. To avoid potential errors, in this scheme, Directory Default ACL requests are not supported.

System action: The request fails and normal processing continues.

Operator response: None.

System programmer response: None.

Programmer response: Non-z/OS NFS Clients can not be used to manage z/OS UNIX directory Default ACLs when the File and Directory Defaults do not match. Either change them via local requests so that they match, or manage them locally. For managing non-z/OS NFS Default ACLs from the z/OS NFS Client, use z/OS UNIX System Services File Default ACL management requests.

GFSN5007E z/OS UNIX to Network File System ACL conversion error. USS ACL Type: *h_digit1* ObjType: *d_digit* RsnCode: *h_digit2*.

Explanation: The z/OS UNIX to NFS ACL conversion function experienced an error. See the previous z/OS NFS error messages for details.

In the message text:

h_digit1 The z/OS UNIX ACL type (1-Access, 2-File Default, 3-Dir Default)

d_digit The object type (1-file, 2-directory)

h_digit2 The error reason code. This is intended for IBM support personnel use only.

System action: No ACLs are converted from z/OS UNIX System Services to NFS ACLs. The request fails and normal processing continues.

Operator response: None.

System programmer response: None.

Programmer response: See the previous z/OS NFS ACL conversion error message to identify the actual error that occurred.

GFSN5008E Invalid Network File System ACL header: (*h_digit1*)->*h_digit2*.

Explanation: The z/OS NFS Client, or the z/OS NFS Server, called the NFS to z/OS UNIX ACL conversion function, but an error was detected in the NFS ACL header control block. This is the result of a program logic error.

In the message text:

h_digit1 A pointer to the control block for IBM support personnel analysis.

h_digit2 The contents of the NFS ACL control block header for IBM support personnel analysis.

System action: No ACLs are converted from NFS to z/OS UNIX ACLs. The request fails and normal processing continues.

Operator response: None.

System programmer response: Capture a trace of the situation and report it to the IBM Support Center.

Programmer response: None.

GFSN5009E Invalid Mask ACL. First Mask: *h_digit0*.
ACE: *d_digit*, **WType:** *h_digit1*, **WId:** *h_digit2*, **AType:** *h_digit3*, **AFlag:** *h_digit4*, **AMask:** *h_digit5*.

Explanation: The z/OS NFS Client, or the z/OS NFS Server, called the NFS to z/OS UNIX ACL conversion function. All of the NFS Mask ACL entries must have the same Mask (permission) value. The function encountered an NFS ACL entry with a different Mask value. The ACLs cannot be converted and the request is terminated.

If this message occurs on the z/OS NFS Server, it means that a remote NFS Client is attempting to set ACL entries with Mask ACL entries with different Mask (permission) values. This is not supported by z/OS UNIX.

If this message occurs on the z/OS NFS Client, it means that the z/OS NFS Client is attempting to manage ACLs for a remote NFS Server and the remote NFS ACL contains Mask ACL entries with different Mask (permission) values. This is not supported by z/OS UNIX.

In the message text: (primarily intended for IBM support personnel use)

h_digit0

The hexadecimal value of the first NFS Mask ACL mask (permission) value.

d_digit The 0-origin index of the NFS ACL entry containing the error.

h_digit1

The hexadecimal value of the NFS ACL who type. (1-owner, 2-user, 3-owner group, 4-user group, 8-everyone)

h_digit2

The hexadecimal value of the user, or group, id.

h_digit3

The hexadecimal value of the NFS ACL type field (see RFC3530).

h_digit4

The hexadecimal value of the NFS ACL flag field (see RFC3530).

h_digit5

The hexadecimal value of the NFS ACL mask field (see RFC3530).

System action: The request fails and normal processing continues.

Operator response: None.

System programmer response: None.

Programmer response: Check the remote system NFS ACL entries and update them to comply with the z/OS NFS ACL management restrictions. See "Displaying and modifying remote file system access control lists" on page 58 for more information.

GFSN5010E Base Group Mask and Deny ACL mismatch: Group Mask: *h_digit0*. **Deny ACE:** *d_digit*, **WType:** *h_digit1*, **WId:** *h_digit2*, **AType:** *h_digit3*, **AFlag:** *h_digit4*, **AMask:** *h_digit5*.

Explanation: The z/OS NFS Client, or the z/OS NFS Server, called the NFS to z/OS UNIX ACL conversion function. z/OS UNIX does not support storing a Mask ACL entry. Therefore, z/OS NFS dynamically computes the Mask ACL permission value from the Base Group Deny permissions. This requires that the Base Group Mask and Deny permissions must match. The function encountered an NFS Deny ACL entry whose Mask (permission) value does not match the Base Group Mask value. Mismatched values can not be supported by z/OS NFS. The ACLs cannot be converted and the request is terminated.

If this message occurs on the z/OS NFS Server, it means that a remote NFS Client is attempting to set ACL entries with mismatched NFS Base Group Mask and Deny ACL Mask (permission) values. This is not supported by z/OS UNIX.

If this message occurs on the z/OS NFS Client, it means that the z/OS NFS Client is attempting to manage ACLs for a remote NFS Server and the remote NFS ACL contains mismatched NFS Base Group Mask and Deny ACL Mask (permission) values. This is not supported by z/OS UNIX.

In the message text: (primarily intended for IBM support personnel use)

h_digit0

The hexadecimal value of the NFS Base Group Mask ACL entry mask field.

d_digit The 0-origin index of the NFS Base Group Deny ACL entry containing the error.

h_digit1

The 0-origin index of the NFS Base Group Deny ACL entry containing the error.

h_digit2

The hexadecimal value of the user, or group, id.

h_digit3

The hexadecimal value of the NFS ACL type field (see RFC3530).

h_digit4

The hexadecimal value of the NFS ACL flag field (see RFC3530).

h_digit5

The hexadecimal value of the NFS ACL mask field (see RFC3530).

System action: The request fails and normal processing continues.

Operator response: None.

System programmer response: None.

Programmer response: Check the remote system NFS ACL entries and update them to comply with the z/OS NFS ACL management restrictions. See "Displaying and modifying remote file system access control lists" on page 58 for more information.

GFSN5011E Access and Default Base ACL mismatch.
BMask: *h_digit0*. **MaskACE:** *yn*. **ACE:** *d_digit*, **WType:** *h_digit1*, **WId:** *h_digit2*, **AType:** *h_digit3*, **AFlag:** *h_digit4*, **AMask:** *h_digit5*.

Explanation: The z/OS NFS Client, or the z/OS NFS Server, called the NFS to z/OS UNIX ACL conversion function. z/OS UNIX does not support storing separate Access and Default Base ACLs. Therefore, z/OS NFS uses the Access Base ACLs for both. The function encountered a mismatch between an NFS Access Base ACL entry and the NFS Default Base ACL entry. Mismatched values can not be supported by z/OS NFS. The ACLs cannot be converted and the request is terminated.

If this message occurs on the z/OS NFS Server, it means that a remote NFS Client is attempting to set ACL entries with different NFS Access Base and NFS Default Base ACL values. This is not supported by z/OS NFS.

If this message occurs on the z/OS NFS Client, it means that the z/OS NFS Client is attempting to manage ACLs for a remote NFS Server and the remote NFS ACL contains entries which have different NFS Access Base and NFS Default Base ACL values. This is not supported by z/OS NFS.

In the message text: (primarily intended for IBM support personnel use)

h_digit0

The hexadecimal value of the first (Access or Default) NFS Base ACL entry mask field.

yn 'Y' - yes, this is a Mask entry. 'N' - no, this is not a Mask ACE (It is an Allow or Deny entry).

d_digit The 0-origin index of the mismatched NFS Base ACL entry.

h_digit1

The hexadecimal value of the NFS ACL who type. (1-owner, 2-user, 3-owner group, 4-user group, 8-everyone).

h_digit2

The hexadecimal value of the user, or group, id.

h_digit3

The hexadecimal value of the NFS ACL type field (see RFC3530).

h_digit4

The hexadecimal value of the NFS ACL flag field (see RFC3530).

h_digit5

The hexadecimal value of the NFS ACL mask field (see RFC3530).

System action: The request fails and normal processing continues.

Operator response: None.

System programmer response: None.

Programmer response: Check the remote system NFS ACL entries and update them to comply with the z/OS NFS ACL management restrictions. See "Displaying and modifying remote file system access control lists" on page 58 for more information.

GFSN5012E Invalid Mask ACL. **BMask:** *h_digit0*. **ACE:** *d_digit*, **WType:** *h_digit1*, **WId:** *h_digit2*, **AType:** *h_digit3*, **AFlag:** *h_digit4*, **AMask:** *h_digit5* **RsnCode:** *h_digit6*.

Explanation: The z/OS NFS Client, or the z/OS NFS Server, called the NFS to z/OS UNIX ACL conversion function. All of the NFS Mask ACL entries must have the same Mask (permission) value. The function encountered a user or user group NFS ACL entry with a different Mask value. The ACLs cannot be converted and the request is terminated.

If this message occurs on the z/OS NFS Server, it means that a remote NFS Client is attempting to set ACL entries with Mask ACL entries with different Mask (permission) values. This is not supported by z/OS UNIX.

If this message occurs on the z/OS NFS Client, it means that the z/OS NFS Client is attempting to manage ACLs for a remote NFS Server and the remote NFS ACL contains Mask ACL entries with different Mask (permission) values. This is not supported by z/OS UNIX.

In the message text: (primarily intended for IBM support personnel use)

h_digit0

The hexadecimal value of the NFS Base Group ACL entry mask field.

d_digit The 0-origin index of the user or user group NFS ACL entry containing the error.

h_digit1 The hexadecimal value of the NFS ACL who type. (2-user, 4-user group)

h_digit2 The hexadecimal value of the user, or group, id.

h_digit3 The hexadecimal value of the NFS ACL type field (see RFC3530).

h_digit4 The hexadecimal value of the NFS ACL flag field (see RFC3530).

h_digit5 The hexadecimal value of the NFS ACL mask field (see RFC3530).

h_digit6 The error reason code. This is intended for IBM support personnel use only.

System action: The request fails and normal processing continues.

Operator response: None.

System programmer response: None.

Programmer response: Check the remote system NFS ACL entries and update them to comply with the z/OS NFS ACL management restrictions. See "Displaying and modifying remote file system access control lists" on page 58 for more information.

GFSN5013E Unsupported Network File System ACL Type. Supported ACL Types: Allow or Deny. ACE: *d_digit*, WType: *h_digit1*, WId: *h_digit2*, AType: *h_digit3*, AFlag: *h_digit4*, AMask: *h_digit5*.

Explanation: The z/OS NFS Client, or the z/OS NFS Server, called the NFS to z/OS UNIX ACL conversion function. The function encountered an NFS ACL entry with an unsupported ACL Type. z/OS NFS only supports Allow and Deny NFS ACL Types. The ACLs cannot be converted and the request is terminated.

If this message occurs on the z/OS NFS Server, it means that a remote NFS Client is attempting to set ACL entries with an NFS ACL Type which is not supported by z/OS NFS.

If this message occurs on the z/OS NFS Client, it means that the z/OS NFS Client is attempting to manage ACLs for a remote NFS Server and the remote NFS ACL contains entries which specify an NFS ACL Type which is not supported by z/OS NFS.

In the message text: (primarily intended for IBM support personnel use)

d_digit The 0-origin index of the NFS ACL entry containing the error.

h_digit1 The hexadecimal value of the NFS ACL who type. (1-owner, 2-user, 3-owner group, 4-user group, 8-everyone)

h_digit2 The hexadecimal value of the user, or group, id.

h_digit3 The hexadecimal value of the NFS ACL type field (see RFC3530).

h_digit4 The hexadecimal value of the NFS ACL flag field (see RFC3530).

h_digit5 The hexadecimal value of the NFS ACL mask field (see RFC3530).

System action: The request fails and normal processing continues.

Operator response: None.

System programmer response: None.

Programmer response: Check the remote system NFS ACL entries and update them to comply with the z/OS NFS ACL management restrictions. See "Displaying and modifying remote file system access control lists" on page 58 for more information.

GFSN5014E Unsupported Network File System ACL Mask. Supported Mask values: *h_digit0*. ACE: *d_digit*, WType: *h_digit1*, WId: *h_digit2*, AType: *h_digit3*, AFlag: *h_digit4*, AMask: *h_digit5*.

Explanation: The z/OS NFS Client, or the z/OS NFS Server, called the NFS to z/OS UNIX ACL conversion function. The function encountered an NFS ACL entry with an unsupported Mask (permission) value. Only the supported (*h_digit0*) bits can be processed. The ACLs cannot be converted and the request is terminated.

If this message occurs on the z/OS NFS Server, it means that a remote NFS Client is attempting to set ACL entries with an NFS ACL Mask value which is not supported by z/OS UNIX.

If this message occurs on the z/OS NFS Client, it means that the z/OS NFS Client is attempting to manage ACLs for a remote NFS Server and the remote NFS ACL contains entries which specify an NFS ACL Mask value which is not supported by z/OS UNIX.

In the message text: (primarily intended for IBM support personnel use)

h_digit0

The hexadecimal value of supported NFS ACL entry mask field bits (see RFC3530).

d_digit The 0-origin index of the NFS ACL entry containing the error.

h_digit1

The hexadecimal value of the NFS ACL who type. (1-owner, 2-user, 3-owner group, 4-user group, 8-everyone)

h_digit2

The hexadecimal value of the user, or group, id.

h_digit3

The hexadecimal value of the NFS ACL type field (see RFC3530).

h_digit4

The hexadecimal value of the NFS ACL flag field (see RFC3530).

h_digit5

The hexadecimal value of the NFS ACL mask field (see RFC3530).

System action: The request fails and normal processing continues.

Operator response: None.

System programmer response: None.

Programmer response: Check the remote system NFS ACL entries and update them to comply with the z/OS NFS ACL management restrictions. See "Displaying and modifying remote file system access control lists" on page 58 for more information.

GFSN5015E Unsupported Network File System ACL Mask. Required Allow Mask values:
h_digit0. **ACE:** *d_digit*, **WType:** *h_digit1*,
WId: *h_digit2*, **AType:** *h_digit3*, **AFlag:**
h_digit4, **AMask:** *h_digit5*.

Explanation: The z/OS NFS Client, or the z/OS NFS Server, called the NFS to z/OS UNIX ACL conversion function. z/OS UNIX does not support all NFS Allow permission values. To accommodate this, some NFS Allow Mask ACL entry mask (permission) values (*h_digit0*) are required. Otherwise the Allow Mask entry can not be supported. The function encountered an NFS Allow Mask ACL entry in which the required mask (permission) bits were not all specified. The ACLs cannot be converted and the request is terminated.

If this message occurs on the z/OS NFS Server, it means that a remote NFS Client is attempting to set ACL entries with an NFS Allow Mask ACL entry in which not all the required mask bits are specified. This is not supported by z/OS NFS.

If this message occurs on the z/OS NFS Client, it means that the z/OS NFS Client is attempting to

manage ACLs for a remote NFS Server and the remote NFS ACL contains entries with an NFS Allow Mask ACL entry in which not all the required mask bits are specified. This is not supported by z/OS NFS.

In the message text: (primarily intended for IBM support personnel use)

h_digit0

The hexadecimal value of the required NFS Allow Mask ACL entry mask field bits.

d_digit The 0-origin index of the NFS ACL entry containing the error.

h_digit1

The hexadecimal value of the NFS ACL who type. (1-owner, 2-user, 3-owner group, 4-user group, 8-everyone)

h_digit2

The hexadecimal value of the user, or group, id.

h_digit3

The hexadecimal value of the NFS ACL type field (see RFC3530).

h_digit4

The hexadecimal value of the NFS ACL flag field (see RFC3530).

h_digit5

The hexadecimal value of the NFS ACL mask field (see RFC3530).

System action: The request fails and normal processing continues.

Operator response: None.

System programmer response: None.

Programmer response: Check the remote system NFS ACL entries and update them to comply with the z/OS NFS ACL management restrictions. See "Displaying and modifying remote file system access control lists" on page 58 for more information.

GFSN5016E Unsupported Network File System ACL Allow Read Permissions. Required values are: *h_digit0*. **ACE:** *d_digit*, **WType:**
h_digit1, **WId:** *h_digit2*, **AType:** *h_digit3*,
AFlag: *h_digit4*, **AMask:** *h_digit5*.

Explanation: The z/OS NFS Client, or the z/OS NFS Server, called the NFS to z/OS UNIX ACL conversion function. z/OS UNIX does not support all NFS Allow read permission values. To accommodate this, read permission requires specific (*h_digit0*) NFS Allow ACL entry mask (permission) values. Otherwise, the NFS Allow ACL entry can not be supported. The function encountered an NFS Allow ACL entry in which the required mask (permission) bits were not all specified. The ACLs cannot be converted and the request is terminated.

If this message occurs on the z/OS NFS Server, it means that a remote NFS Client is attempting to set ACL entries with an unsupported combination of NFS Allow ACL read mask (permission) bits. This is not supported by z/OS NFS.

If this message occurs on the z/OS NFS Client, it means that the z/OS NFS Client is attempting to manage ACLs for a remote NFS Server and the remote NFS ACL contains entries with an unsupported combination of NFS Allow ACL read mask (permission) bits. This is not supported by z/OS NFS.

In the message text: (primarily intended for IBM support personnel use)

h_digit0

The hexadecimal value of the required NFS Allow ACL entry read mask field bits.

d_digit The 0-origin index of the NFS ACL entry containing the error.

h_digit1

The hexadecimal value of the NFS ACL who type. (1-owner, 2-user, 3-owner group, 4-user group, 8-everyone)

h_digit2

The hexadecimal value of the user, or group, id.

h_digit3

The hexadecimal value of the NFS ACL type field (see RFC3530).

h_digit4

The hexadecimal value of the NFS ACL flag field (see RFC3530).

h_digit5

The hexadecimal value of the NFS ACL mask field (see RFC3530).

System action: The request fails and normal processing continues.

Operator response: None.

System programmer response: None.

Programmer response: Check the remote system NFS ACL entries and update them to comply with the z/OS NFS ACL management restrictions. See "Displaying and modifying remote file system access control lists" on page 58 for more information.

GFSN5017E Unsupported Network File System ACL Allow Write Permissions. Required values are: *h_digit0*. **ACE:** *d_digit*, **WType:** *h_digit1*, **WId:** *h_digit2*, **AType:** *h_digit3*, **AFlag:** *h_digit4*, **AMask:** *h_digit5*.

Explanation: The z/OS NFS Client, or the z/OS NFS Server, called the NFS to z/OS UNIX ACL conversion function. z/OS UNIX does not support all NFS Allow write permission values. To accommodate this, write

permission requires specific (*h_digit0*) NFS Allow ACL entry mask (permission) values. Otherwise, the NFS Allow ACL entry can not be supported. The function encountered an NFS Allow ACL entry in which the required mask (permission) bits were not all specified. The ACLs cannot be converted and the request is terminated.

If this message occurs on the z/OS NFS Server, it means that a remote NFS Client is attempting to set ACL entries with an unsupported combination of NFS Allow ACL write mask (permission) bits. This is not supported by z/OS NFS.

If this message occurs on the z/OS NFS Client, it means that the z/OS NFS Client is attempting to manage ACLs for a remote NFS Server and the remote NFS ACL contains entries with an unsupported combination of NFS Allow ACL write mask (permission) bits. This is not supported by z/OS NFS.

In the message text: (primarily intended for IBM support personnel use)

h_digit0

The hexadecimal value of the required NFS Allow ACL entry write mask field bits.

d_digit The 0-origin index of the NFS ACL entry containing the error.

h_digit1

The hexadecimal value of the NFS ACL who type. (1-owner, 2-user, 3-owner group, 4-user group, 8-everyone)

h_digit2

The hexadecimal value of the user, or group, id.

h_digit3

The hexadecimal value of the NFS ACL type field (see RFC3530).

h_digit4

The hexadecimal value of the NFS ACL flag field (see RFC3530).

h_digit5

The hexadecimal value of the NFS ACL mask field (see RFC3530).

System action: The request fails and normal processing continues.

Operator response: None.

System programmer response: None.

Programmer response: Check the remote system NFS ACL entries and update them to comply with the z/OS NFS ACL management restrictions. See "Displaying and modifying remote file system access control lists" on page 58 for more information.

GFSN5018E Unsupported Network File System ACL Allow Execute Permissions. Required values are: *h_digit0*. **ACE:** *d_digit*, **WType:** *h_digit1*, **WId:** *h_digit2*, **AType:** *h_digit3*, **AFlag:** *h_digit4*, **AMask:** *h_digit5*.

Explanation: The z/OS NFS Client, or the z/OS NFS Server, called the NFS to z/OS UNIX ACL conversion function. z/OS UNIX does not support all NFS Allow execute permission values. To accommodate this, execute permission requires specific (*h_digit0*) NFS Allow ACL entry mask (permission) values. Otherwise, the NFS Allow ACL entry can not be supported. The function encountered an NFS Allow ACL entry in which the required mask (permission) bits were not all specified. The ACLs cannot be converted and the request is terminated.

If this message occurs on the z/OS NFS Server, it means that a remote NFS Client is attempting to set ACL entries with an unsupported combination of NFS Allow ACL execute mask (permission) bits. This is not supported by z/OS NFS.

If this message occurs on the z/OS NFS Client, it means that the z/OS NFS Client is attempting to manage ACLs for a remote NFS Server and the remote NFS ACL contains entries with an unsupported combination of NFS Allow ACL execute mask (permission) bits. This is not supported by z/OS NFS.

In the message text: (primarily intended for IBM support personnel use)

h_digit0

The hexadecimal value of the required NFS Allow ACL entry execute mask field bits.

d_digit The 0-origin index of the NFS ACL entry containing the error.

h_digit1

The hexadecimal value of the NFS ACL who type. (1-owner, 2-user, 3-owner group, 4-user group, 8-everyone)

h_digit2

The hexadecimal value of the user, or group, id.

h_digit3

The hexadecimal value of the NFS ACL type field (see RFC3530).

h_digit4

The hexadecimal value of the NFS ACL flag field (see RFC3530).

h_digit5

The hexadecimal value of the NFS ACL mask field (see RFC3530).

System action: The request fails and normal processing continues.

Operator response: None.

System programmer response: None.

Programmer response: Check the remote system NFS ACL entries and update them to comply with the z/OS NFS ACL management restrictions. See "Displaying and modifying remote file system access control lists" on page 58 for more information.

GFSN5019E z/OS UNIX ACL Max size exceeded.

Max: *d_digit1* **NFS ACE:** *d_digit2*.

Explanation: z/OS UNIX does not support ACLs with more than *d_digit1* entries. The NFS to z/OS UNIX ACL conversion function received an ACL conversion request which will exceed this limit even though NFS Mask, Allow and Deny ACL entries for a given userid are combined into a single z/OS UNIX ACL entry. The ACLs cannot be converted and the request is terminated.

In the message text:

d_digit The maximum number of z/OS UNIX ACL entries supported for an object.

d_digit2

The 0-origin index of the NFS ACL entry being processed that will cause this limit to be exceeded.

System action: The request fails and normal processing continues.

Operator response: None.

System programmer response: None.

Programmer response: Reduce the size of the NFS ACL list for the object.

GFSN5020E Network File System to z/OS UNIX ACL conversion error. USS ACL Type: *h_digit1* **Mode:** *h_digit2* **ObjType:** *d_digit1* **USS Cnt:** *d_digit2* **RsnCode:** *h_digit3*.

Explanation: The NFS to z/OS UNIX ACL conversion function experienced an error. See the previous z/OS NFS error messages for details.

In the message text:

h_digit1

Identifies the z/OS UNIX ACL type (1-Access, 2-File Default, 3-Dir Default)

h_digit2

The hexadecimal value of the z/OS UNIX permission mode bits.

d_digit1

Identifies the object type (1-file, 2-directory).

d_digit2

The number of z/OS UNIX ACL entries created before the error was encountered.

h_digit3

The error reason code. This is intended for IBM support personnel use only.

System action: The request fails and normal processing continues.

Operator response: None.

System programmer response: None.

Programmer response: See the previous z/OS NFS ACL conversion error message to identify the actual error which occurred.

GFSN5025E Temporary buffer overflow.

Explanation: NFS detected an error building the load module statistics during startup.

System action: NFS will shut down.

Operator response: Contact the system programmer.

System programmer response: Check that the latest NFS maintenance install completed successfully. Keep the existing z/OS NFS traces and contact IBM Support.

Programmer response: None.

GFSN5026E (procname) Module module is inconsistent between Network File System load modules loadmod1(fmid1, apar1, compdate1, comptime1) and loadmod2(fmid2, apar2, compdate2, comptime2).

Explanation: During the Network File System initialization a module was found to be at different maintenance levels in two load modules.

In the message text:

module The module that is at inconsistent maintenance levels.

loadmod1 The name of the first load module containing the module in error.

fmid1 The release level of the module in load module *loadmod1*.

apar1 The APAR maintenance version of the module in load module *loadmod1*.

compdate1 The compile date of the module in load module *loadmod1*.

comptime1 The compile time of the module in load module *loadmod1*.

loadmod2 The name of the second load module containing the module in error.

fmid2 The release level of the module in load module *loadmod2*.

apar2 The APAR maintenance version of the module in load module *loadmod2*.

compdate2 The compile date of the module in load module *loadmod2*.

comptime2 The compile time of the module in load module *loadmod2*.

System action: The Network File System terminates.

Operator response: Contact the system programmer.

System programmer response: Verify that the last maintenance was installed correctly by SMP/E. When a maintenance update is installed for a module SMP/E should install it in all load modules.

Programmer response: None.

GFSN5027E (procname) Module module release rel1 in loadmod is incompatible with Network File System release rel2.

Explanation: During the Network File System initialization a module was found in a task which is at an incompatible release level.

In the message text:

module The module that is in error.

rel1 The release level of the module in error.

loadmod The task load module in which the module in error was found.

rel2 The Network File System release level.

System action: The Network File System terminates.

Operator response: Contact the system programmer.

System programmer response: Verify that the last maintenance was installed correctly by SMP/E. When a maintenance update is installed for a module SMP/E should install it in all load modules.

Programmer response: None.

GFSN5028E Last MODULE INFO not found for text1.

Explanation: NFS detected an error building the load module statistics during startup. The maintenance level statistics were not found for module *text1*.

System action: NFS processing continues.

Operator response: Contact the system programmer.

System programmer response: Check that the latest NFS maintenance install completed successfully. Keep the existing z/OS NFS traces and contact IBM Support.

Programmer response: None.

GFSN5030E REQUESTED MEMORY NOT AVAILABLE.

Explanation: An operation to allocate virtual memory was tried but was unsuccessful. If this condition persists, the cause might be either of these problems.

- The value specified in the **region** parameter is too small.
- The value specified in the **bufhigh** attribute is too large.

System action: The request is stopped. The NFS server processing continues.

GFSN5032I (*procname*) NFS does not support *item*

Explanation: The described item was found in the site attributes, exports file, or an operator command, which is not supported in this release.

In the message text:

procname

The name of the start procedure.

item

The item that was detected.

System action: NFS processing continues. The item is ignored.

Operator response: Check that the current NFS release supports the intended item. It may be that the attribute or exports file was updated in anticipation of a release upgrade that has not yet been performed, or a release rollback occurred with an item indicated in these files that is not supported in the lower release, or in a shared environment with a mixture of releases.

System programmer response: None.

Programmer response: None.

GFSN5034E (*procname*) An attempt to send trace data to the External Writer failed. RC = *retcode*, RSN = *rsncode rsntext*

Explanation: The interface to the CTrace External Writer has returned an error to the invoking function.

In the message text:

procname

The name of the start procedure.

retcode

The return code from the CTrace External Writer.

rsncode

The additional reason code from the CTrace External Writer

rsntext

An explanation of the reason code returned:
 No connection to an active external writer.
 Storage could not be obtained.
 Unable to schedule an SRB to process this request.

TBWC has already been reused by the application.

The caller is holding locks.

The input token was not valid.

The seq number is the same as a previous write request.

TBWC is not valid.

Unknown error.

System action: The CTrace record is not written and may be lost.

Operator response: None.

System programmer response: Verify that the CTrace External Writer is properly configured. If no obvious problems are found, contact IBM support.

Programmer response: None.

GFSN5035E UNKNOWN OPTION=*option*

Explanation: The operator entered an invalid CTRACE option that was not recognized by NFS.

In the message text:

option

A CTRACE option that was not recognized by NFS.

System action: The invalid option is ignored.

Operator response: Repeat the TRACE CT command with the invalid option corrected.

System programmer response: None.

Programmer response: None.

GFSN5036E (*procname*) CTRACE DEFINE ERROR, RC = *h_digit0*, RSN = *h_digit1*, Start/Stop routine RC = *h_digit2*, RSN = *h_digit3*. Specified parmlib member name = *text1*. *text2*
Default parameters are in effect, trace activities are in MIN state.

Explanation: An error was detected during z/OS NFS client or z/OS NFS server registration of the Component trace services.

In the message text:

procname

The name of the start procedure.

h_digit0

The return code from the CTRACE DEFINE macro.

h_digit1

The reason code from the CTRACE DEFINE macro.

h_digit2 The return code from the start/stop exit.

h_digit3 The reason code from the start/stop exit.

text1 The member name of the CTINFxyy parmlib.

text2 May be one of the following:

- Start/Stop routine version conflict.
- The specified parmlib member was not found.
- A syntax error in the specified parmlib member.
- See Network File System Guide and Reference

System action: NFS continues processing with Component trace activities for z/OS NFS server or z/OS NFS client in MIN state (FFDC and ERROR for z/OS NFS server and FFDC and MSG for z/OS NFS client) with default parameters (BUFSIZE = 10M).

Operator response: Contact the system programmer.

System programmer response: Correct the error according to the return code and reason code. See the description of the CTRACE DEFINE macro in *z/OS MVS Programming: Authorized Assembler Services Reference ALE-DYN* for further details.

GFSN5037E (*procname*) **NFS CTRACE SRB failed.**
RETCODE =h_digit1, start/stop routine
RC = h_digit2, abend code = h_digit3,
reason code = h_digit4. CTRACE
command is ignored.

Explanation: NFS CTRACE SRB of the start/stop routine, was not scheduled or did not completed successfully.

In the message text:

procname
The name of the start procedure.

h_digit1
The hexadecimal value of the return code produced by the SRB.

h_digit2
The hexadecimal value of the return code produced by the NFS CTRACE start/stop routine.

h_digit3
The abend code or X'FFFFFFFF' if there is no meaningful value.

h_digit4
The reason code associated with the abend code.

System action: Transaction requested via TRACE CT operator command was not executed. NFS processing continues.

Operator response: Contact the system programmer.

System programmer response: The value of h_digit1 is a return code of IEAMSCHD macro. h_digit2, h_digit3 and h_digit4 are the values of SYNCHCOMADDR, SYNCHCODEADDR and SYNCHRSNADDR of IEAMSCHD macro respectively. See *z/OS MVS Programming: Authorized Assembler Services Reference EDT-IXG* for explanation of IEAMSCHD return codes.

GFSN5038E (*procname*) **MVS System Call** *service failed, return code retc.*

Explanation: Calling MVS System service failed with return code *retc*.

The service can be:

IEAVAPE
allocate Pause Element

IEAVPSE
PAUSE

IEAVRLS
RELEASE a PAUSE element

The possible return code are documented in *z/OS MVS Programming: Authorized Assembler Services Reference*.

System action: The Network File System server terminates.

Operator response: Contact the system programmer.

System programmer response: Collect failure documentation and contact IBM Support Center.

User response: None

GFSN9999E **Network File System [Server | Client]**
CTRACE: Module=module,
Function=function, Line=line. message text.

Explanation: The z/OS NFS server, or client, detected an error building a Component Trace (CTRACE) record.

System action: The z/OS NFS server, or client, will continue to function. The erroneous Component Trace (CTRACE) record will be ignored.

Operator response: Contact the system programmer.

System programmer response: Save the issued message text and report it to the IBM Support Center.

Messages from the client platform (AIX)

This section provides a list of messages from the client operating system, in response to NFS reply results (messages without message numbers). These messages are platform dependent.

Note: The message text is from an AIX system.

Cross device link

Explanation:

1. An attempt has been made to rename a member of a partitioned data set (PDS) or partitioned data set extended (PDSE), but the target file is not a member of the same PDS or PDSE.
2. An attempt has been made to rename a non-PDS or non-PDSE file, but the target file is a member of a PDS or PDSE.

User response: Try a copy and remove operation, instead of a rename operation.

Directory Not Empty

Explanation: An attempt was made to remove a PDS or PDSE with members.

User response: Delete all members before trying to remove a PDS or PDSE.

File exists

Explanation: An attempt was made to rename a PDS or PDSE, but the target file already exists.

User response: Delete the target file before renaming the PDS or PDSE. This is not required for a regular file or for a PDS or PDSE member.

File Name Too Long

Explanation: The file name is not a valid z/OS data set or member name.

User response: File names must follow the z/OS naming conventions. See *z/OS DFSMS Using Data Sets* for data set naming conventions.

Invalid

Explanation:

1. The specified parameters were incorrect.
2. The creation of a virtual storage access method (VSAM) data set failed.

User response: Respecify the correct parameters, or contact the system programmer to determine the VSAM data set failure on the NFS server.

I/O Error (with possible system programmer response)

Explanation:

1. An unexpected error from catalog management occurred.
2. Dynamic allocation failed during an action other than a read or write.
3. A file could not be opened during an action other than a read or write.
4. An error occurred during the reading of a PDS or PDSE directory.
5. No space is available in the task input/output table (TIOT).
6. The TIOT resource is unavailable.
7. The system is unable to release enough resources.
8. Insufficient units are available.
9. The server could not get enough memory to perform this function.

System programmer response: For explanation number 9, stop the server and change the region field in the job control language (JCL) before restarting, or modify parameters in the attributes file. For the other explanations, perform the appropriate action.

I/O Error (with possible user response)

Explanation:

1. An attempt was made to nest PDSs or PDSEs.
2. The maximum number of file allocations was exceeded.
3. The file is being written in text mode, the new write request offset is determined to fall within the end-of-line (EOL) sequence (**lf**, **cr**, **crlf**, **lfcr**) of a previous line, and the new data does not contain the correct EOL characters.
4. The file is being written in text mode, with a nonzero EOL (**lf**, **cr**, **lfcr**, **crlf**). The number of bytes of data in the written line is larger than the maximum record size of the file.
5. The file is being written in text mode, with fixed records, a nonzero EOL, and **blankstrip** not set (no padding blanks on write), and the number of bytes of data in the written line is less than or greater than the record size of the file.
6. The file is being written in text mode, with fixed records and **blankstrip** set, and the line of written data contains trailing blanks as part of the data.
7. When a file containing a 0 length line is written to z/OS as **recfm(u)** in text mode, a write error occurs.

8. An access method services alias name was specified in a remove (**rm** or **rmdir**) or rename (**mv**) request.
9. An "s" was specified in the **recfm** data set creation attribute for a PDS or PDSE.
10. If you try to append data to a member of a PDS or PDSE, an I/O error occurs.
11. An incorrect attribute was specified in the command.

User response: Perform the appropriate action.

Is a directory

Explanation: A nondirectory operation has been tried on a PDS or PDSE.

User response: Use directory operations on the data set.

NFS server *name* not responding still trying

Explanation: Long delays occurred between operations.

User response: Possible user responses follow:

- The server might need extra time to service client requests. Wait until the message "NFS server *name* ok" appears.
- Determine if the network traffic is heavy and overloaded. Try to isolate the path where the client workstation communicates with the server machine.
- Determine if the client workstation transmits the same requests over and over. Commands such as **nfsstat -c** on AIX or UNIX platforms show the number of client retransmissions (**retrans**) as well as the number of **badcalls** and **badxid**. When the values of **badcalls** and **badxid** are high, the client machine usually has bad retransmissions. High retransmissions might be caused by an overloaded network or a slow server.
- If the network is overloaded, contact the network administrator.
- If the server is slow, determine if the client workstation tends to transmit requests out of sequence or incompletely, and you are performing I/O to a file in text mode. If the request is incomplete, the client might not send the remainder of the request until a later time. In this case, increase the value of the server's **cachewindow** attribute. The **cachewindow** buffers store out of sequence and incomplete requests from clients. The general rule in setting the *n* value of **cachewindow(*n*)** is

$$n = ((\textit{num of BIOD} + 1) * (\textit{client_max_IO_buffer_size}/\textit{transfer_size}))$$

In the formula:

num of BIOD

Is the number of blocked I/O daemons set by the client workstation. This value is usually set to defaults at the installation of the operating system or by the system administrator.

client_max_IO_buffer_size

Is the amount of I/O data that is requested by the client (for example, the client writes 8192 bytes of data to the remote file system). This value is determined by the application programs.

transfer_size

Is the actual size of data being sent across the network (for example, the 8192 bytes of data can be broken down into 16 smaller packets of 512 bytes (16x512=8192)). This value is determined dynamically by the client workstation.

- If your client workstation tends to send duplicate transmissions for the same request too often, thus increasing the workload on the server, you might want to decrease the client's retransmission rate and increase the request timeout. In the **mount** command, you can specify these values:

```
mount -o retrans=3,timeout=30 IO_buffer_size
```

In the command:

retrans

Is the number of retransmissions allowed before a timeout. The default value is vendor specific, ranging from 3 to 5.

timeout

Is the timeout value in tenths of a second. **timeout=30** means 3 seconds. The default value is vendor specific, ranging from 5 to 11.

If the reply is not received by the client within the timeout period, a minor timeout occurred for this request. The timeout period is doubled, and the request is resent. The process is repeated until the retransmission count specified by **retrans** is reached; if no reply is received, a major timeout occurred.

No such device

Explanation:

1. The file resides on an off-line device
2. The file was migrated to another storage level. Whether the file is being recalled depends on the **retrieve** attribute

User response: For Step 1, contact the system operator or system programmer.

For Step 2, try the request again later, if the **retrieve** attribute is enabled. If not, try the request again, with the **retrieve** attribute enabled.

No space left on device

Explanation:

1. The file exceeded the space that was allocated for it.
2. The PDS or PDSE exceeded the space that was allocated for it.
3. The PDS directory exceeded the space that was allocated for it.

User response:

1. For explanation 1, save the file into a larger file, and then rename it to the old name, if necessary.
2. For explanation 2, create a larger PDS or PDSE and store the member there. Then copy the members of the old PDS or PDSE to the new PDS or PDSE. Rename the new PDS or PDSE, if necessary.
3. For explanation 3, create a new PDS with a larger directory (use the **dir** attribute). Store the member in the new PDS. Then copy the members from the old PDS to the new PDS and rename them, if necessary.

No such file or directory

Explanation: A **locate** command failed for this file. The file is not cataloged, or the system operator might have unmounted the file before you issued the **umount** command.

User response: Check the spelling. If the spelling is correct, contact the system administrator.

Not a directory

Explanation: A directory operation was made on a file that is not a PDS or PDSE.

User response: Use nondirectory operations on the file.

Not Owner

Explanation:

1. File has not timed out yet.
2. File is open. Another client (maybe even the same client) has the file open for writing.
3. The client tried to change the mode in a **nfsattr** NFS procedure call.

User response: Possible user responses follow:

- For explanation 1, follow the steps in waiting and retrying that are described under the "Permission denied" message,
- For explanation 3, do not try to change the mode.

Permission denied

Explanation:

1. The file is not in use but has not timed out yet (occurs most often when writing to PDS or PDSE members without **writetimeout** expiring between saving members).
2. The file is in use by a z/OS user or another client.
3. Dynamic allocation—authorized function requested by an unauthorized user. The error codes from dynamic allocation are printed to the log data set.
4. The Resource Access Control Facility (RACF) is not active.
5. Dynamic allocation—The request was denied by the operator (dsname allocation). The error codes from dynamic allocation are printed to the log data set.
6. Dynamic allocation—The installation validation routine denied this request. The error codes from dynamic allocation are printed to the log data set.
7. You are not authorized for this request.
8. The system operator suspended mount request processing (only if this message appears following a mount attempt).
9. The file/prefix is not exported to the client (only if this message appears following a mount attempt).
10. IDCAMS failed during a rename or remove procedure. Usually this happens because the file is in use. The output from IDCAMS is printed to the log data set.
11. With OS/2, you might get a "SYS0055 Access denied" message if the **noretrieve** attribute is set and a **dir** command is done against a mounted file system containing migrated files.

User response: For explanation 1, to determine if this is the problem, check the timeout values (**attrtimeout**, **readtimeout**, **writetimeout**). Retry the request after the shortest timeout expires. If the request still fails, retry the request after the next shortest timeout expires. If the request still fails, retry after the longest timeout expires. If the request still fails, this is not the problem.

For explanations 2 and 10, retry the request later.

For explanations 3, 4, 5, 6, and 9, notify the system programmer.

For explanation 7, enter the **mvslogin** command again and retry the request. If the request still fails, notify your system programmer.

For explanation 8, notify your system operator or system programmer.

For explanation 11, specify the **retrieve** attribute in the **mount** command, or the system administrator can make that the default.

Read Only File System

Explanation: One of these NFS procedures was tried on a read-only file system: **link**, **write**, **rename**, **remove**, **mkdir**, or **create**.

User response: See the documentation on the exports data set to see how a file system is designated read only (see *z/OS Network File System Guide and Reference*). The exports data set needs to be changed, or you are using it incorrectly.

Stale NFS File Handle

Explanation: A file handle is used by the client and server sides of the NFS to specify a particular file or prefix. A stale file handle occurs when the name is no longer valid, possibly due to one of the these conditions:

1. The file or prefix was removed by the system operator.
2. The server was stopped and restarted. This affects files and members below mount points.

User response: For case 1, unmount and remount the file system or prefix.

For case 2, if SAF, or if SAFEXP security is being used, reenter the **mvsllogin** command and retry the request as follows:

1. Change the directory back to the mount point, using the **cd** command
2. Verify the NFS mount point is still accessible using the **df** command
3. Re-navigate to the desired object (MVS data set or member or z/OS UNIX objects)
4. Re-issue the command with the desired object.

Weak Authorization

Explanation: The authorization data in the remote procedure call (RPC) message was not valid. This is a client side error.

User response: UNIX style authorization is required.

value too large

Explanation: The NFS version 4 protocol defines 64-bit file ids which may be returned to the client application as a 64-bit value. Client applications may receive err79 "Value too large" when using 32-bit system calls such as UNIX `stat()` against remote NFS version 4 server objects.

User response: Change your application to use 64-bit system calls such as UNIX `stat64()` to prevent err79 messages in client applications when using NFS version 4.

Chapter 20. Return codes

Table 67 lists the externalized return codes that are defined by the NFS version 2 protocol.

Table 67. Externalized return codes defined by the NFS version 2 protocol

Return Value	Return Code	Description
NFS_OK	0	Requests completed successfully and the results are valid.
NFSERR_PERM	1	Not owner. The operation was not allowed because: 1. The caller does not have correct ownership (not a privileged user as root). 2. The caller is not the owner of the target of the operation. 3. The server requires the use of a privileged port (an available reserved port of 1023 or lower).
NFSERR_NOENT	2	No such file or directory. The file or directory specified does not exist.
NFSERR_IO	5	A hard error occurred when the operation was in progress. For example, this could be a disk error.
NFSERR_NXIO	6	No such device or address.
NFSERR_ACCESS	13	Permission denied. The caller does not have the correct permission to perform the requested operation.
NFSERR_EXIST	17	File exists. The file specified already exists.
NFSERR_NODEV	19	No such device.
NFSERR_NOTDIR	20	Not a directory. The caller specified a non-directory in a directory operation.
NFSERR_ISDIR	21	Is a directory. The caller specified a directory in a non-directory operation.
NFSERR_EINVAL	22	An argument was passed to the z/OS NFS server that was not valid.
NFSERR_FBIG	27	File too large. The operation caused a file to grow beyond the server's limit.
NFSERR_NOSPC	28	No space left on device. The operation caused the server's file system to reach its limit.
NFSERR_ROFS	30	Read-only file system. Write tried on a read-only file system.
NFSERR_NAMETOOLONG	63	File name too long. The file name in an operation was too long.
NFSERR_NOTEMPTY	66	Directory not empty. Tried to remove a directory that was not empty.
NFSERR_DQUOT	69	Disk quota exceeded. The client's disk quota on the server has been exceeded.
NFSERR_STALE	70	The file handle given in the arguments was not valid. That is, the file referred to by that file handle no longer exists, or access to it has been revoked.

Table 68 lists the externalized return codes that are defined by the NFS version 3 protocol.

Table 68. Externalized return codes defined by the NFS version 3 protocol

Return Value	Return Code	Description
NFS_OK	0	Requests completed successfully and the results are valid.
NFS3ERR_PERM	1	Not owner. The caller does not have correct ownership to perform the requested operation.

Table 68. Externalized return codes defined by the NFS version 3 protocol (continued)

Return Value	Return Code	Description
NFS3ERR_NOENT	2	No such file or directory. The file or directory specified does not exist.
NFS3ERR_IO	5	A hard error occurred when the operation was in progress. For example, this could be a disk error.
NFS3ERR_NXIO	6	No such device or address.
NFS3ERR_ACCESS	13	Permission denied. The caller does not have the correct permission to perform the requested operation.
NFS3ERR_EXIST	17	File exists. The file specified already exists.
NFS3ERR_XDEV	18	Attempt to do an operation across the file system.
NFS3ERR_NODEV	19	No such device.
NFS3ERR_NOTDIR	20	Not a directory. The caller specified a non-directory in a directory operation.
NFS3ERR_ISDIR	21	Is a directory. The caller specified a directory in a non-directory operation.
NFS3ERR_INVALID	22	An argument was passed to the z/OS NFS server that was not valid.
NFS3ERR_FBIG	27	File too large. The operation caused a file to grow beyond the server's limit.
NFS3ERR_NOSPC	28	No space left on device. The operation caused the server's file system to reach its limit.
NFS3ERR_ROFS	30	Read-only file system. Write tried on a read-only file system.
NFS3ERR_MLINK	31	Too many links.
NFS3ERR_NAMETOOLONG	63	File name too long. The file name in an operation was too long.
NFS3ERR_NOTEMPTY	66	Directory not empty. Tried to remove a directory that was not empty.
NFS3ERR_DQUOT	69	Disk quota exceeded. The client's disk quota on the server has been exceeded.
NFS3ERR_STALE	70	The file handle given in the arguments was not valid. That is, the file referred to by that file handle no longer exists, or access to it has been revoked.
NFS3ERR_BADHANDLE	10001	File handle is not valid.
NFS3ERR_NOT_SYNC	10002	Synchronization mismatch on SETATTR.
NFS3ERR_BAD_COOKIE	10003	READDIR and READDIRPLUS cookie is stale.
NFS3ERR_NOTSUPP	10004	Operation is not supported.
NFS3ERR_TOOSMALL	10005	Buffer or request is too small.
NFS3ERR_SERVERFAULT	10006	Server abandons the request.
NFS3ERR_BADTYPE	10007	Type of an object is not supported.
NFS3ERR_JUKEBOX	10008	Request was initiated, but not completed.

Table 69 lists the externalized return codes that are defined by the NFS version 4 protocol.

Table 69. Externalized return codes defined by the NFS version 4 protocol

Return Value	Return Code	Description
NFS4_OK	0	Requests completed successfully and the results are valid.
NFS4ERR_PERM	1	Not owner. The caller does not have correct ownership to perform the requested operation.
NFS4ERR_NOENT	2	No such file or directory. The file or directory specified does not exist.

Table 69. Externalized return codes defined by the NFS version 4 protocol (continued)

Return Value	Return Code	Description
NFS4ERR_IO	5	A hard error occurred when the operation was in progress. For example, this could be a disk error.
NFS4ERR_NXIO	6	No such device or address.
NFS4ERR_ACCESS	13	Permission denied. The caller does not have the correct permission to perform the requested operation.
NFS4ERR_EXIST	17	File exists. The file specified already exists.
NFS4ERR_XDEV	18	Attempt to do an operation across the file system.
	19	Not used/reserved.
NFS4ERR_NOTDIR	20	Not a directory. The caller specified a non-directory in a directory operation.
NFS4ERR_ISDIR	21	Is a directory. The caller specified a directory in a non-directory operation.
NFS4ERR_INVALID	22	An argument was passed to the NFS server that was not valid.
NFS4ERR_FBIG	27	File too large. The operation caused a file to grow beyond the server's limit.
NFS4ERR_NOSPC	28	No space left on device. The operation caused the server's file system to reach its limit.
NFS4ERR_ROFS	30	Read-only file system. Write tried on a read-only file system.
NFS4ERR_MLINK	31	Too many hard links.
NFS4ERR_NAMETOOLONG	63	File name too long. The file name in an operation was too long.
NFS4ERR_NOTEMPTY	66	Directory not empty. Tried to remove a directory that was not empty.
NFS4ERR_DQUOT	69	Disk quota exceeded. The client's disk quota on the server has been exceeded.
NFS4ERR_STALE	70	The file handle given in the arguments was not valid. That is, the file referred to by that file handle no longer exists, or access to it has been revoked.
NFS4ERR_BADHANDLE	10001	File handle is not valid.
NFS4ERR_BAD_COOKIE	10003	READDIR and READDIRPLUS cookie is stale.
NFS4ERR_NOTSUPP	10004	Operation is not supported.
NFS4ERR_TOOSMALL	10005	Buffer or request is too small.
NFS4ERR_SERVERFAULT	10006	Server abandons the request.
NFS4ERR_BADTYPE	10007	Type of an object is not supported.
NFS4ERR_DELAY	10008	Request was initiated, but not completed. File was busy; retry.
NFS4ERR_SAME	10009	Request was initiated, but attributes are the same.
NFS4ERR_DENIED	10010	Lock was unavailable.
NFS4ERR_EXPIRED	10011	Lock release expired.
NFS4ERR_LOCKED	10012	I/O failure due to lock.
NFS4ERR_GRACE	10013	In grace period.
NFS4ERR_FHEXPIRED	10014	File handle expired.
NFS4ERR_SHARE_DENIED	10015	Share reserve denied.
NFS4ERR_WRONGSEC	10016	Wrong security level.
NFS4ERR_CLID_INUSE	10017	Client id in use.
NFS4ERR_RESOURCE	10018	Resource exhaustion.
NFS4ERR_MOVED	10019	Filesystem relocated.
NFS4ERR_NOFILEHANDLE	10020	Current file handle is not set.
NFS4ERR_MINOR_VERS_MISMATCH	10021	Minor version not supported.
NFS4ERR_STALE_CLIENTID	10022	Server has rebooted.

Table 69. Externalized return codes defined by the NFS version 4 protocol (continued)

Return Value	Return Code	Description
NFS4ERR_STALE_STATEID	10023	Server has rebooted.
NFS4ERR_OLD_STATEID	10024	State is not in synch.
NFS4ERR_BAD_STATEID	10025	Incorrect state id.
NFS4ERR_BAD_SEQID	10026	Request is out of sequence.
NFS4ERR_NOT_SAME	10027	Verify - attributes not the same.
NFS4ERR_LOCK_RANGE	10028	Lock range not supported.
NFS4ERR_SYMLINK	10029	Should be file/directory.
NFS4ERR_RESTOREFH	10030	No saved file handle.
NFS4ERR_LEASE_MOVED	10031	Some file system moved.
NFS4ERR_ATTRNOTSUPP	10032	Recommended attribute not supported.
NFS4ERR_NO_GRACE	10033	Reclaim attempt was not within the grace period.
NFS4ERR_RECLAIM_BAD	10034	Reclaim error occurred at server.
NFS4ERR_RECLAIM_CONFLICT	10035	Conflict occurred on reclaim.
NFS4ERR_BADXDR	10036	XDR decode failed.
NFS4ERR_LOCKS_HELD	10037	File locks held at CLOSE.
NFS4ERR_OPENMODE	10038	Conflict in OPEN and I/O.
NFS4ERR_BAD_OWNER	10039	Owner translation was not correct.
NFS4ERR_BADCHAR	10040	utf-8 character was not supported.
NFS4ERR_BADNAME	10041	Name is not supported.
NFS4ERR_BAD_RANGE	10042	Lock range was not supported.
NFS4ERR_LOCK_NOTSUPP	10043	No atomic upgrade or downgrade.
NFS4ERR_OP_ILLEGAL	10044	Operation was undefined.
NFS4ERR_DEADLOCK	10045	Deadlock occurred in file locking.
NFS4ERR_FILE_OPEN	10046	An open file blocked the operation.
NFS4ERR_ADMIN_REVOKED	10047	The lock owner's state was revoked.
NFS4ERR_CB_PATH_DOWN	10048	The callback path was down.

Table 70 lists the z/OS UNIX return codes and their equivalent NFS Version 2 server return codes.

Table 70. z/OS NFS Server: z/OS UNIX return codes mapped to NFS Version 2 return codes

OMVS Codes	Dec	Hex	NFS V2 Codes (NFSERR_)	Dec	Hex	Description
EACCES	111	006F	ACCES	13	000D	Permission denied
EAGAIN	112	0070	IO	5	0005	Resource is temporarily unavailable
EBUSY	114	0072	IO	5	0005	Resource is busy
EDEADLK	116	0074	IO	5	0005	A resource deadlock is avoided
EEXIST	117	0075	EXIST	17	0011	The file exists
EFAULT	118	0076	IO	5	0005	The address is incorrect

Table 70. z/OS NFS Server: z/OS UNIX return codes mapped to NFS Version 2 return codes (continued)

OMVS Codes	Dec	Hex	NFS V2 Codes (NFSERR_)	Dec	Hex	Description
EFBIG	119	0077	FBIG	27	001B	The file is too large
EINVAL	121	0079	IO	5	0005	The parameter is incorrect
EIO	122	007A	IO	5	0005	An I/O error occurred
EISDIR	123	007B	ISDIR	21	0015	The file specified is a directory
EMFILE	124	007C	IO	5	0005	Too many files are open for this directory
EMLINK	125	007D	IO	5	0005	Too many links occurred
ENAMETOOLONG	126	007E	NAMETOOLONG	63	003F	The file name is too long
ENFILE	127	007F	IO	5	0005	Too many files are open
ENODEV	128	0080	NODEV	19	0013	No such device exists
ENOENT	129	0081	NOENT	2	0002	No such file, directory or IPC member exists
ENOMEM	132	0084	IO	5	0005	Not enough space is available
ENOSPC	133	0085	NOSPC	28	001C	No space is left on device
ENOTDIR	135	0087	NOTDIR	20	0014	Not a directory
ENOTEMPTY	136	0088	NOTEMPTY	66	0042	Directory is not empty
ENXIO	138	008A	NXIO	6	0006	No such device or address exists
EPERM	139	008B	IO	5	0005	The operation is not permitted
EROFS	141	008D	ROFS	30	001E	The specified file system is read only
EXDEV	144	0090	XDEV	18	0012	A link to a file on another file system was attempted
E2BIG	145	0091	IO	5	0005	The parameter list is too long
ELOOP	146	0092	IO	5	0005	A loop is encountered in symbolic links
EILSEQ	147	0093	IO	5	0005	The byte sequence is illegal

Table 70. z/OS NFS Server: z/OS UNIX return codes mapped to NFS Version 2 return codes (continued)

OMVS Codes	Dec	Hex	NFS V2 Codes (NFSERR_)	Dec	Hex	Description
EMVSERR	157	009D	IO	5	0005	MVS environmental or internal error
EMVSPARM	158	009E	IO	5	0005	Bad parameters were passed to the service
EMVSPFSFILE	159	009F	IO	5	0005	z/OS UNIX encountered a permanent file error
EMVSPFSPERM	162	00A2	IO	5	0005	z/OS UNIX encountered a system error
EMVSSAFEXTRERR	163	00A3	IO	5	0005	SAF/RACF extract error
EMVSSAF2ERR	164	00A4	IO	5	0005	SAF/RACF error
EDQUOT	1133	046D	DQUOT	69	0045	Disk quota exceeded
ESTALE	1134	046E	STALE	70	0046	Stale NFS file handle
EREMOTE	1135	046F	IO	5	0005	Too many levels of remote in path

Table 71 lists the z/OS UNIX return codes and their equivalent NFS Version 3 server return codes.

Table 71. z/OS NFS Server: z/OS UNIX return codes mapped to NFS Version 3 return codes

OMVS Codes	Dec	Hex	NFS V3 Codes (NFS3ERR_)	Dec	Hex	Description
EACCES	111	006F	ACCES	13	000D	Permission denied
EAGAIN	112	0070	JUKEBOX	10008	2718	Resource is temporarily unavailable
EBUSY	114	0072	JUKEBOX	10008	2718	Resource is busy
EDEADLK	116	0074	DEADLOCK	10045	273D	A resource deadlock is avoided
EEXIST	117	0075	EXIST	17	0011	The file exists
EFAULT	118	0076	SERVERFAULT	10006	2716	The address is incorrect
EFBIG	119	0077	FBIG	27	001B	The file is too large
EINVAL	121	0079	INVAL	22	0016	The parameter is incorrect
EIO	122	007A	IO	5	0005	An I/O error occurred

Table 71. z/OS NFS Server: z/OS UNIX return codes mapped to NFS Version 3 return codes (continued)

OMVS Codes	Dec	Hex	NFS V3 Codes (NFS3ERR_)	Dec	Hex	Description
EISDIR	123	007B	ISDIR	21	0015	The file specified is a directory
EMFILE	124	007C	JUKEBOX	10008	2718	Too many files are open for this directory
EMLINK	125	007D	MLINK	31	001F	Too many links occurred
ENAMETOOLONG	126	007E	NAMETOOLONG	63	003F	The file name is too long
ENFILE	127	007F	DQUOT	69	0045	Too many files are open
ENODEV	128	0080	NODEV	19	0013	No such device exists
ENOENT	129	0081	NOENT	2	0002	No such file, directory or IPC member exists
ENOMEM	132	0084	JUKEBOX	10008	2718	Not enough space is available
ENOSPC	133	0085	NOSPC	28	001C	No space is left on device
ENOTDIR	135	0087	NOTDIR	20	0014	Not a directory
ENOTEMPTY	136	0088	NOTEMPTY	66	0042	Directory is not empty
ENXIO	138	008A	NXIO	6	0006	No such device or address exists
EPERM	139	008B	PERM	1	0001	The operation is not permitted
EROFS	141	008D	ROFS	30	001E	The specified file system is read only
EXDEV	144	0090	XDEV	18	0012	A link to a file on another file system was attempted
E2BIG	145	0091	SERVERFAULT	10006	2716	The parameter list is too long
ELOOP	146	0092	IO	5	0005	A loop is encountered in symbolic links
EMVSERR	157	009D	SERVERFAULT	10006	2716	MVS environmental or internal error
EMVSPARM	158	009E	SERVERFAULT	10006	2716	Bad parameters were passed to the service

Table 71. z/OS NFS Server: z/OS UNIX return codes mapped to NFS Version 3 return codes (continued)

OMVS Codes	Dec	Hex	NFS V3 Codes (NFS3ERR_)	Dec	Hex	Description
EMVSPFSFILE	159	009F	IO	5	0005	z/OS UNIX encountered a permanent file error
EMVSPFSPERM	162	00A2	IO	5	0005	z/OS UNIX encountered a system error
EMVSSAFEXTRERR	163	00A3	IO	5	0005	SAF/RACF extract error
EMVSSAF2ERR	164	00A4	IO	5	0005	SAF/RACF error
EDQUOT	1133	046D	DQUOT	69	0045	Disk quota exceeded
ESTALE	1134	046E	STALE	70	0046	Stale NFS file handle
EREMOTE	1135	046F	REMOTE	71	0077	Too many levels of remote in path

Table 72 lists the z/OS UNIX return codes and their equivalent NFS Version 4 server return codes.

Table 72. z/OS NFS Server: z/OS UNIX return codes mapped to NFS Version 4 return codes

OMVS Codes	Dec	Hex	NFS V4 Codes (NFS4ERR_)	Dec	Hex	Description
EACCES	111	006F	ACCES	13	000D	Permission denied
EAGAIN	112	0070	DELAY	10008	2718	Resource is temporarily unavailable
EBUSY	114	0072	DELAY	10008	2718	Resource is busy
EDEADLK	116	0074	DEADLOCK	10045	273D	A resource deadlock is avoided
EEXIST	117	0075	EXIST	17	0011	The file exists
EFAULT	118	0076	SERVERFAULT	10006	2716	The address is incorrect
EFBIG	119	0077	FBIG	27	001B	The file is too large
EINVAL	121	0079	INVAL	22	0016	The parameter is incorrect
EIO	122	007A	IO	5	0005	An I/O error occurred
EISDIR	123	007B	ISDIR	21	0015	The file specified is a directory
EMFILE	124	007C	DQUOT	69	0045	Too many files are open for this directory

Table 72. z/OS NFS Server: z/OS UNIX return codes mapped to NFS Version 4 return codes (continued)

OMVS Codes	Dec	Hex	NFS V4 Codes (NFS4ERR_)	Dec	Hex	Description
EMLINK	125	007D	MLINK	31	001F	Too many links occurred
ENAMETOOLONG	126	007E	NAMETOOLONG	63	003F	The file name is too long
ENFILE	127	007F	DQUOT	69	0045	Too many files are open
ENODEV	128	0080	NXIO	6	0006	No such device exists
ENOENT	129	0081	NOENT	2	0002	No such file, directory or IPC member exists
ENOMEM	132	0084	DELAY	10008	2718	Not enough space is available
ENOSPC	133	0085	NOSPC	28	001C	No space is left on device
ENOTDIR	135	0087	NOTDIR	20	0014	Not a directory
ENOTEMPTY	136	0088	NOTEMPTY	66	0042	Directory is not empty
ENXIO	138	008A	NXIO	6	0006	No such device or address exists
EPERM	139	008B	PERM	1	0001	The operation is not permitted
EROFS	141	008D	ROFS	30	001E	The specified file system is read only
EXDEV	144	0090	XDEV	18	0012	A link to a file on another file system was attempted
E2BIG	145	0091	SERVERFAULT	10006	2716	The parameter list is too long
ELOOP	146	0092	IO	5	0005	A loop is encountered in symbolic links
EMVSERR	157	009D	SERVERFAULT	10006	2716	MVS environmental or internal error
EMVSPARM	158	009E	SERVERFAULT	10006	2716	Bad parameters were passed to the service
EMVSPFSFILE	159	009F	IO	5	0005	z/OS UNIX encountered a permanent file error
EMVSPFSPERM	162	00A2	IO	5	0005	z/OS UNIX encountered a system error

Table 72. z/OS NFS Server: z/OS UNIX return codes mapped to NFS Version 4 return codes (continued)

OMVS Codes	Dec	Hex	NFS V4 Codes (NFS4ERR_)	Dec	Hex	Description
EMVSSAFEXTRERR	163	00A3	IO	5	0005	SAF/RACF extract error
EMVSSAF2ERR	164	00A4	IO	5	0005	SAF/RACF error
EMVSNORTL	167	00A7	IO	5	0005	Access to z/OS UNIX version of C RTL denied
EDQUOT	1133	046D	DQUOT	69	0045	Disk quota exceeded
ESTALE	1134	046E	STALE	70	0046	Stale NFS file handle

Chapter 21. Reason codes

This topic lists reason codes that are returned by the z/OS Network File System server and the z/OS Network File System client.

Network File System reason codes are generic eight-digit hexadecimal codes that provide an indication of the problem location. They appear in the format **6nxyyyyy**, where:

6D Indicates NFS Client and Server Common Shared modules (that is, GFSNxxxx; for example, GFSNETRC).

6E Indicates NFS Client modules (that is, GFSCxxxx).

6F Indicates NFS Server modules (that is, GFSAxxxx).

xx Is a two-digit hexadecimal number with one of the following values:

00 - 0F

Have special meaning. This range applies only to the z/OS NFS Client reason codes. See "Special reason codes (xx is 00-0F)" on page 456.

10 - 3F

Identifies the NFS client module where the reason code was generated.

40 - FF

Identifies the NFS server module where the reason code was generated.

yyyy

Is a four-digit hexadecimal number with one of the following values:

0000 - 7FFF

NFS reason codes.

0000 - 0FFF

Reason codes that match USS JRxxx reason codes. See "Reason codes from NFS Client or NFS Server modules (xx is 10-FF)" on page 470.

1000 - 3FFF

Global reason codes that have the same meaning independent of module id. See "Global reason codes (yyyy = 1000 - 3FFF)" on page 474.

4000 - 4FFF

Module specific reason codes. A given value has different meanings depending on the module id. See "Module specific reason codes (yyyy = 4000 - 4FFF)" on page 478.

5000 - 70FF

Reserved

7100 - 73FF

Reason codes that match TCPIP JRxxx reason codes. See *z/OS UNIX System Services Messages and Codes*.

8000 - FFFF

The line number of the location in the code where the error occurred. This line number is intended for IBM Service use only.

Special reason codes (xx is 00-0F)

Reason codes whose *xx* part is in the range 00 through 0F have special meanings. Table 73 contains the rest of the reason code information that is presented in client messages, including the return codes *retc*. Note that Table 74 on page 457 contains the codes where *xx*=05.

Table 73. Special NFS reason codes

<i>xx</i>	Error type	<i>yyyy</i>	Description
01	Parsing error		See Table 75 on page 466 and Table 76 on page 467.
02	TCP/IP common error	0001	clntudp_create() failed
02	TCP/IP common error	0002	Server NFS port is not 2049
02	TCP/IP common error	0003	authunix_create() failed
02	TCP/IP common error	0004	clnt_control() timeout failed
02	TCP/IP common error	0005	clnt_control() total timeout failed
02	TCP/IP common error	0006	clnttcp_create() failed
02	TCP/IP common error	0007	clntudp_bufcreate() failed
02	RPCSEC_GSS error	0008	RPCSEC_GSS request failed. <i>Probable cause:</i> This failure can happen because of the following reasons: <ol style="list-style-type: none"> 1. The Kerberos Dynamic Load Library could not be loaded by the NFS client. 2. The kerberos context could not be created by the NFS client. 3. The GSS credentials for the NFS client's Kerberos Principal could not be obtained. <i>Action:</i> Check your Kerberos configurations, fix any configuration issues identified, restart the NFS client and retry the operation. Contact the system programmer if the problem persists.
02	TCP/IP common error	<i>inum</i>	clnt_call() timeout (<i>retc</i> =0467h, ETIMEDOUT) <i>Action:</i> Increase the value of the <i>timeo</i> client attribute on the mount command.
02	TCP/IP common error	<i>inum</i>	clnt_call() EINTR (<i>retc</i> =0078h, EINTR)
03	RPC error	<i>rsnc</i>	See Table 77 on page 468.
04	TCP/IP error	<i>yyyy</i>	Authentication error - authunix_create() failed
05	NFS reason codes	<i>yyyy</i>	See Table 74 on page 457.
0C	System abend without SDWA	0sss	sss - System abend code
0D	User abend without SDWA	0uuu	uuu - User abend code
0E	System abend	0sss	sss - System abend code
0F	NFS abend	0uuu	uuu - User abend code

Table 74 on page 457 contains the rest of the reason code information that is presented in client messages, including the return codes *retc*.

Table 74. Special NFS reason codes where xx = 05

yyyy	Name	Description
0000	NFS_OK	NFS_OK.
0001	NFSERR_PERM	Not owner (operation not permitted). An attempt was made to perform an operation limited to Processes with appropriate privileges or to the owner of a file or other resource. Action: Ensure that uid and gid are correct.
0002	NFSERR_NOENT	No such file or directory A component of a specified path name does not exist, or the path name is an empty string. Action: Ensure that the file or directory exists.
0005	NFSERR_IO	I/O error. Some physical input or output error occurred. Action: Ensure that correct data is written.
0006	NFSERR_NXIO	No such device or address. Input or output on a special file refers to a device that does not exist, or makes a request beyond the capabilities of the device. It may also occur when, for example, a tape drive is not online. Action: Ensure that the mount address is correct.
000D	NFSERR_ACCES	Permission denied. An attempt was made to access a file in a way that is forbidden by its file access permissions. Action: Verify that the correct access authority is being requested.
0011	NFSERR_EXIST	File/dir exists. An existing file/dir was mentioned in an inappropriate context; for example, as a new link name in the link function. Action: Try to use another file/dir name.
0012	NFSERR_XDEV	Cross-device link. A hard link to a file on another file system was attempted. Action: Ensure that the link is correct.
0013	NFSERR_NODEV	No such device. An attempt was made to apply an inappropriate function to a device; for example, trying to read a write-only device such as printer. Action: Ensure that the command parameters are correct.

Table 74. Special NFS reason codes where xx = 05 (continued)

yyyy	Name	Description
0014	NFSERR_NOTDIR	<p>Not a directory.</p> <p>A component of the specified path name exists, but it is not a directory, when a directory was expected.</p> <p>Action: Ensure that the specified path name is correct.</p>
0015	NFSERR_ISDIR	<p>Is a directory.</p> <p>A component of the specified path name exists, but it is a directory, when a non-directory object was expected.</p> <p>Action: Ensure that the specified path name is correct.</p>
0016	NFSERR_INVALID	<p>Invalid arguments.</p> <p>Some invalid argument was supplied, source had an invalid superblock or a remount was attempted, while source was not already mounted on target.</p> <p>Action: Ensure that the arguments are correct. If remount is used, determine that the mount command was made.</p>
001B	NFSERR_FBIG	<p>File too large.</p> <p>The size of a file would exceed the maximum file size of implementation or offset maximum that is established in the corresponding file description.</p> <p>Action: Operate with files that satisfy maximum file size requirement and use offsets that satisfy maximum offset requirement.</p>
001C	NFSERR_NOSPC	<p>No space left on device.</p> <p>During the write function on a regular file or when extending a directory, there is no free space left on the device.</p> <p>Action: Use another directory or device for store file or clear hash/garbage (be sure that these data are useless).</p>
001E	NFSERR_ROFS	<p>Read-only file system.</p> <p>An attempt was made to modify a file or directory on a file system that is read only.</p> <p>Action: Ensure that you have sufficient privileges.</p>
001F	NFSERR_MLINK	<p>Too many links.</p> <p>An attempt was made to have the link count of a single file exceed (LINK_MAX).</p>
003F	NFSERR_NAMETOOLONG	<p>File name is too long.</p> <p>The length of a path name exceeds (PATH_MAX), or a path name component is longer than (NAME_MAX) and (_POSIX_NO_TRUNC) was in effect for that file.</p> <p>Action: Use names that correspond with file name requirements.</p>

Table 74. Special NFS reason codes where xx = 05 (continued)

yyyy	Name	Description
0042	NFSERR_NOTEMPTY	<p>Directory is not empty.</p> <p>A directory with entries other than dot and dot-dot was supplied when an empty directory was expected.</p> <p>Action: Ensure that the directory is empty.</p>
0045	NFSERR_DQUOT	<p>Disk quota exceeded.</p> <p>The user's quota of disk blocks or user's quota of inodes was exhausted.</p> <p>Action: Ensure that free space is available on the disk.</p>
0046	NFSERR_STALE	<p>File handle is stale.</p> <p>An attempt was made to access a remote object (on an NFS file system) which is now unavailable as referenced by the file descriptor. This may indicate the object was deleted on the NFS server or some other catastrophic event occurred.</p> <p>Action: Ensure that object was not deleted on the NFS server.</p>
0047	NFSERR_REMOTE	<p>Too many levels of remote in path.</p> <p>Server made attempt to handle an NFS request by generating a request to another NFS server, which is not allowed.</p> <p>Action: Establish another nested mount point.</p>
0063	NFSERR_WFLUSH	<p>The server write cache that is used in NFSv2 WRITECACHE RPC call got flushed to disk.</p>
2711	NFSERR_BADHANDLE	<p>Illegal NFS filehandle.</p> <p>The filehandle failed internal consistency check.</p> <p>Action: Consult NFS Client system administrator.</p>
2712	NFSERR_NOT_SYNC	<p>Update synchronization mismatch was detected during a SETATTR operation.</p> <p>Action: Usually the NFS Client retries or recovers. However, it may percolate the error and fail the request; then retry the operation.</p> <p>Consult NFS Server Administrator if the issue persists.</p>
2713	NFSERR_BAD_COOKIE	<p>REaddir or REaddirplus cookie is stale, possible cause is that the directory contents keep changing.</p> <p>Action: Usually the NFS Client retries or recovers. However, it may percolate the error and fail the request; then, retry the operation.</p> <p>Consult NFS Server Administrator if the issue persists.</p>
2714	NFSERR_NOTSUPP	<p>Operation not supported.</p> <p>An attempt was made to use a function or operation that is not available in this implementation.</p> <p>Action: Consult NFS Client system administrator.</p>

Table 74. Special NFS reason codes where xx = 05 (continued)

yyyy	Name	Description
2715	NFSERR_TOOSMALL	<p>Buffer too small.</p> <p>Insufficient buffer resources were available in the system to perform the operation.</p> <p>Action: Usually NFS Client retries or recovers. However it may percolate the error and fail the request; then retry the operation.</p> <p>Consult NFS Server Administrator if the issue persists.</p>
2716	NFSERR_SERVERFAULT	<p>An error occurred on the server that does not map to any of the legal NFS version 3 or 4 protocol error values. The client usually translates this to EIO.</p> <p>Action: Consult NFS Server Administrator if the issue persists.</p>
2717	NFSERR_BADTYPE	<p>An attempt was made to create an object of a type that is not supported by the server.</p> <p>Action: Check the command or the API creating object at NFS server, or check the server capability.</p>
2718	NFSERR_DELAY	<p>The server received the request, but was not able to complete it in a timely fashion.</p> <p>Action: No action required (This is a temporary condition and later calls to the same routine may complete normally).</p>
2719	NFSERR_SAME	<p>This error is returned by the NVERIFY operation to signify that the attributes compared were the same as provided in the client request.</p> <p>Action: Usually NFS Client retries or recovers. However, it may percolate the error and fail the request; then, retry the operation.</p> <p>Consult NFS Server Administrator if the issue persists.</p>
271A	NFSERR_DENIED	<p>An attempt to lock a file is denied. Since this may be a temporary condition, the client is encouraged to retry the lock request until the lock is accepted.</p> <p>Action: Usually NFS Client retries or recovers. However, it may percolate the error and fail the request; then, retry the operation.</p> <p>Consult NFS Server Administrator if the issue persists.</p>
271B	NFSERR_EXPIRED	<p>A lease has expired that is being used in the current operation.</p> <p>Action: Usually NFS Client retries or recovers. However, it may percolate the error and fail the request; then, retry the operation.</p> <p>Consult NFS Server Administrator if the issue persists.</p>
271C	NFSERR_LOCKED	<p>A read/write operation was attempted on a locked file.</p> <p>Action: Retry the operation later.</p>

Table 74. Special NFS reason codes where xx = 05 (continued)

yyyy	Name	Description
271D	NFSERR_GRACE	<p>NFS Server is in grace period.</p> <p>The server is in its recovery or grace period and does not accept new OPEN file operations.</p> <p>Action: Usually NFS Client retries or recovers. However, it may percolate the error and fail the request; then, retry the operation.</p> <p>Consult NFS Server Administrator if the issue persists.</p>
271E	NFSERR_FHEXPIRED	<p>The file handle that is provided is volatile and has expired at the server.</p> <p>Action: Try to remount.</p>
271F	NFSERR_SHARE_DENIED	<p>An attempt to OPEN a file with a share reservation has failed because of a share conflict. For example: OPEN to read while there is another remote user OPEN the same file to write and deny other readers.</p> <p>Action: Retry the operation later.</p>
2720	NFSERR_WRONGSEC	<p>The security mechanism being used by the client for the operation does not match the server's security policy. The client should change the security mechanism being used and retry the operation.</p> <p>Action: Usually NFS Client retries or recovers. However, it may percolate the error and fail the request; then, retry the operation.</p> <p>Consult NFS Server Administrator if the issue persists.</p>
2721	NFSERR_CLID_INUSE	<p>The SETCLIENTID operation has found that a client ID is already in use by another client. The error is similar to 2 hosts having the same IP address.</p> <p>Action: Consult NFS Server system administrator.</p>
2722	NFSERR_RESOURCE	<p>Requested resource, such as a lock or a process, is temporarily unavailable.</p> <p>Action: Retry the operation. (This is a temporary condition and later calls to the same routine may complete normally.)</p>
2723	NFSERR_MOVED	<p>File system moved.</p> <p>The file system that contains the current file handle object is not present at the server. It may have been relocated, migrated to another server or may have never been present. The client may obtain the new file system location by obtaining the 'fs_locations' attribute for the current file handle.</p> <p>Action: Usually NFS Client retries or recovers. However, it may percolate the error and fail the request; then, retry the operation.</p> <p>Consult NFS Server Administrator if the issue persists.</p>

Table 74. Special NFS reason codes where xx = 05 (continued)

yyyy	Name	Description
2724	NFSERR_NOFILEHANDLE	<p>No file handle.</p> <p>The logical current file handle value (or, in the case of RESTOREFH, the saved file handle value) has not been set properly. This may be a result of a malformed COMPOUND operation (that is, no PUTFH or PUTROOTFH before an operation that requires the current file handle be set).</p> <p>Action: Consult NFS Client system administrator.</p>
2725	NFSERR_MINOR_VERS_MISMATCH	<p>Minor version is not supported.</p> <p>The server has received a request that specifies an unsupported minor version. The server must return a COMPOUND4res with a zero length operations result array.</p> <p>Action: Usually NFS Client retries or recovers. However, it may percolate the error and fail the request; then, retry the operation.</p> <p>Consult NFS Server Administrator if the issue persists.</p>
2726	NFSERR_STALE_CLIENTID	<p>Server has rebooted, or Client failed to renew lease.</p> <p>A clientid not recognized by the server was used in a locking or SETCLIENTID_CONFIRM request.</p> <p>Action: Usually NFS Client retries or recovers. However, it may percolate the error and fail the request; then, retry the operation.</p> <p>Consult NFS Server Administrator if the issue persists.</p>
2727	NFSERR_STALE_STATEID	<p>Server has rebooted, or Client failed to renew lease.</p> <p>A stateid generated by an earlier server instance was used in READ or WRITE.</p> <p>Action: Usually NFS Client retries or recovers. However, it may percolate the error and fail the request; then, retry the operation.</p> <p>Consult NFS Server Administrator if the issue persists.</p>
2728	NFSERR_OLD_STATEID	<p>State is out of sync because of Server rebooted or Client failed to renew lease in a timely fashion.</p> <p>A stateid that designates the locking state for a lockowner-file at an earlier time was used.</p> <p>Action: Usually NFS Client retries or recovers. However, it may percolate the error and fail the request; then, retry the operation.</p> <p>Consult NFS Server Administrator if the issue persists.</p>

Table 74. Special NFS reason codes where xx = 05 (continued)

yyyy	Name	Description
2729	NFSERR_BAD_STATEID	<p>Incorrect stateid.</p> <p>A stateid generated by the current server instance, but which does not designate any locking state (either current or superseded) for current lockowner-file pair, was used.</p> <p>Action: Usually NFS Client retries or recovers. However, it may percolate the error and fail the request; then, retry the operation.</p> <p>Consult NFS Server Administrator if the issue persists.</p>
272A	NFSERR_BAD_SEQID	<p>SeqId is out of sync.</p> <p>The sequence number in a locking request is neither the next expected number or the last number processed.</p> <p>Action: Usually NFS Client retries or recovers. However, it may percolate the error and fail the request; then, retry the operation.</p> <p>Consult NFS Server Administrator if the issue persists.</p>
272B	NFSERR_NOT_SAME	<p>Verify - attributes not same.</p> <p>This error is returned by the VERIFY operation to signify that the attributes compared were not the same as provided in the client's request.</p> <p>Action: Usually NFS Client retries or recovers. However, it may percolate the error and fail the request; then, retry the operation.</p> <p>Consult NFS Server Administrator if the issue persists.</p>
272C	NFSERR_LOCK_RANGE	<p>Lock range not supported.</p> <p>A lock request is operating on a sub-range of a current lock for the lock owner and the server does not support this type of request.</p> <p>Action: Consult NFS Server system administrator.</p>
272D	NFSERR_SYMLINK	<p>Object is a symbolic link instead of file/directory.</p> <p>The current file handle provided for a LOOKUP is not a directory but a symbolic link. Also used if the final component of the OPEN path is a symbolic link.</p> <p>Action: Ensure that the specified path name is correct.</p>
272E	NFSERR_RESTOREFH	<p>No saved file handle for RESTOREFH.</p> <p>The RESTOREFH operation does not have a saved file handle (identified by SAVEFH) to operate upon.</p> <p>Action: Consult NFS Client system administrator.</p>
272F	NFSERR_LEASE_MOVED	<p>A lease being renewed is associated with a file system that has been migrated to a new server.</p> <p>Action: No action required.</p>

Table 74. Special NFS reason codes where xx = 05 (continued)

yyyy	Name	Description
2730	NFSERR_ATTRNOTSUPP	<p>Recommended attributes not supported.</p> <p>An attribute that is specified is not supported by the server. Does not apply to the GETATTR operation.</p> <p>Action: No action required.</p>
2731	NFSERR_NO_GRACE	<p>Reclaim outside of grace period.</p> <p>A reclaim of client state was attempted in circumstances in which the server cannot guarantee that conflicting state has not been provided to another client. This can occur because the reclaim has been done outside of the grace period of the server, after the client has done a RECLAIM_COMPLETE operation, or because previous operations have created a situation in which the server is not able to determine that a reclaim-interfering edge condition does not exist.</p> <p>Action: Lengthen the NFS Server grace period so that the NFS Client can adequately reclaim OPEN states after NFS Server rebooted.</p>
2732	NFSERR_RECLAIM_BAD	<p>The reclaim that is provided by the client does not match any of the server's state consistency checks and is bad.</p> <p>Action: Consult NFS Client system administrator.</p>
2733	NFSERR_RECLAIM_CONFLICT	<p>Reclaim conflicts with an already-granted OPEN state.</p> <p>The reclaim that is provided by the client has encountered a conflict and cannot be provided. Potentially indicates a misbehaving client.</p> <p>Action: Consult NFS Client system administrator.</p>
2734	NFSERR_BADXDR	<p>XDR decode failure.</p> <p>The server encountered an XDR decoding error while processing an operation.</p> <p>Action: Consult NFS Client system administrator.</p>
2735	NFSERR_LOCKS_HELD	<p>Locks held at close.</p> <p>A CLOSE was attempted and file locks would exist after the CLOSE.</p> <p>Action: Usually NFS Client retries or recovers. However, it may percolate the error and fail the request; then, retry the operation.</p> <p>Consult NFS Server Administrator if the issue persists.</p>
2736	NFSERR_OPENMODE	<p>Conflict in OPEN versus READ or WRITE.</p> <p>The client attempted a READ, WRITE, LOCK or SETATTR operation not sanctioned by the stateid passed (for example, writing to a file opened only for read).</p> <p>Action: Check the program at NFS Client side.</p>

Table 74. Special NFS reason codes where xx = 05 (continued)

yyyy	Name	Description
2737	NFSERR_BADOWNER	<p>Unable to translate owner@domain to UID, or group@domain to GID and vice versa.</p> <p>An owner, owner_group, or ACL attribute value cannot be translated to local representation.</p> <p>Action: Ensure that z/OS RACF is properly setup to convert name@domain to UID or GID and vice versa.</p>
2738	NFSERR_BADCHAR	<p>UTF-8 character not supported.</p> <p>A UTF-8 string contains a character that is not supported by the server in the context in which it being used.</p> <p>Action: Use correct character encoding symbols.</p>
2739	NFSERR_BADNAME	<p>Name not supported.</p> <p>A name string in a request consists of valid UTF-8 characters supported by the server but the name is not supported by the server as a valid name for current operation.</p> <p>Action: Provide valid name that is supported by the server.</p>
273A	NFSERR_BAD_RANGE	<p>Lock range not supported.</p> <p>The range for a LOCK, LOCKT, or LOCKU operation is not appropriate to the allowable range of offsets for the server.</p> <p>Action: Check the program on NFS Client side, or check NFS Server capability.</p>
273B	NFSERR_LOCK_NOTSUPP	<p>Server does not support atomic upgrade or downgrade of locks.</p> <p>Action: Check the program on NFS Client side, or check NFS Server capability.</p>
273C	NFSERR_OP_ILLEGAL	<p>Undefined operation.</p> <p>An illegal operation value has been specified in the 'argop' field of a COMPOUND or CB_COMPOUND procedure.</p> <p>Action: Consult NFS Client system administrator.</p>
273D	NFSERR_DEADLOCK	<p>File locking deadlock.</p> <p>An attempt was made to lock a system resource that would have resulted in a deadlock situation.</p> <p>Action: Check the program on the NFS Client side.</p>
273E	NFSERR_FILE_OPEN	<p>Open file prevents current operation.</p> <p>The operation cannot be successfully processed because a file involved in the operation is currently open.</p> <p>Action: Ensure that the appropriate file is not opened. Then, retry the operation.</p>

Table 74. Special NFS reason codes where xx = 05 (continued)

yyyy	Name	Description
273F	NFSERR_ADMIN_REVOKED	Lockowner state revoked. Due to administrator intervention, the lock owner's record locks, share reservations, and delegations have been revoked by the server. Action: Consult NFS Server system administrator.
2740	NFSERR_CB_PATH_DOWN	The Delegation callback path between Server and Client is not operational. Action: Usually NFS Client retries or recovers. However, it may percolate the error and fail the request; then, retry the operation. Consult NFS Server Administrator if the issue persists.

You can use Table 75 for initial translation of the reason code *reasoncd* information that is presented in client messages related to parsing errors.

Table 75. Parsing error (when reason code is 6E01xxxx)

Last 4 hex digits of reason code	Description
7xxx	Unknown keyword
11yy	Host name
12yy	Path name
13yy	Keyword acdirmax
14yy	Keyword acdirmin
15yy	Keyword acregmax
16yy	Keyword acregmin
17yy	Keyword cln_ccsid
18yy	Keyword srv_ccsid
19yy	Keyword hard
1Ayy	Keyword soft
1Byy	Keyword retrans
1Cyy	Keyword timeo
1Dyy	Keyword wsize
1Eyy	Keyword rsize
1Fyy	Keyword retry
21yy	Keyword biod
22yy	Keyword bufhigh
23yy	Keyword delaywrite
24yy	Keyword readahead
25yy	Keyword attrcaching
26yy	Keyword datacaching
27yy	Keyword dynamicsizeadj
28yy	Keyword delim

Table 75. Parsing error (when reason code is 6E01xxx) (continued)

Last 4 hex digits of reason code	Description
29yy	Keyword xlat
2Ayy	Keyword vers
2Byy	Keyword proto
2Cyy	Keyword disablella
2Dyy	Keyword tcpsok
2Eyy	Keyword tag
2Fyy	Keyword convserv
30yy	Keyword secure
31yy	Keyword rpcbind
32yy	Keyword accesschk
33yy	Keyword public
34yy	Keyword stringprep
35yy	Keyword nfsv4domain
36yy	Keyword llock
37yy	Keyword syncwrite
38yy	Keyword mtxtonly

Notes:

xxx

The beginning hexadecimal position of the **mount** parameter of the bad keyword or syntax error (for example, an extra parenthesis). Position starts at 1 from the beginning of the host name.

yy See Table 76 for more details.

You can use Table 76 for any additional translation of the reason code information presented in client messages related to parsing errors.

Table 76. Parsing error (when reason code is from 6E0111yy to 6E0133yy)

Last 2 hex digits of reason code	Description
01	Null host name or null path name
02	Blank detected
03	Incorrect member name in the path name
04	Missing double quotation mark
05	No member name found
06	Missing left parenthesis
07	Incorrect number
08	Number is larger than 2 GB
09	Incorrect multiplier; must be K, M, or G
0A	Missing right parenthesis
0B	The specified number is not within the allowable range
0C	Incorrect keyword parameter value
0D	Mutually exclusive keyword/option

Table 76. Parsing error (when reason code is from 6E0111yy to 6E0133yy (continued))

Last 2 hex digits of reason code	Description
0E	Keyword is not allowed in the mount option
0F	Keyword is not allowed in the installation parameter

Table 77 summarizes the reason codes 6E03xxxx.

Table 77. RPC error (when reason code is 6E03xxxx)

Last 4 digits of reason code	Description	retv	Action/Comment
0001	RPC_CANTENCODEARGS		Can't encode RPC arguments. Action: Contact the IBM Support Center.
0002	RPC_CANTDECODERES		Can't decode RPC results Action: Contact the IBM Support Center. Provide the TCPIP packet trace and utility's output.
0003	RPC_CANTSEND		Can't send RPC data due to <i>readable-text</i> from <i>errno</i> of the send() or sendto() API. Action: Do the following: <ol style="list-style-type: none"> 1. Ensure that the remote site z/OS NFS server is on and available. Use ping and rpcinfo utilities against hostname. If there is an error, call your network support personnel. 2. Retry the utility. 3. If the error recurs, search problem reporting databases for a fix for the problem. If no fix exists, contact the IBM Support Center. Provide the TCPIP packet trace.
0004	RPC_CANTRECV		Can't send RPC data due to <i>readable-text</i> from <i>errno</i> of the recv() or recvfrom() API. Action: Do the following: <ol style="list-style-type: none"> 1. Ensure that the remote site z/OS NFS server is on and available. Use ping and rpcinfo utilities against hostname. If there is an error, call your network support personnel. 2. Retry the utility. 3. If the error recurs, search problem reporting databases for a fix for the problem. If no fix exists, contact the IBM Support Center. Provide the TCPIP packet trace.
0005	RPC_TIMEDOUT		RPC call timed out. Action: Ensure that the remote site is on and available. Use ping and rpcinfo utilities against hostname. If there is an error, call your network support personnel. Retry the utility.

Table 77. RPC error (when reason code is 6E03xxxx) (continued)

Last 4 digits of reason code	Description	retv	Action/Comment
0006	RPC_VERSMISMATCH		<p>RPC versions are not compatible.</p> <p>Action: Do the following:</p> <ol style="list-style-type: none"> 1. Ensure that the remote site is on and available. Use ping and rpcinfo utilities against hostname. If there is an error, call your network support personnel. 2. Retry the utility. 3. If the error recurs, search problem reporting databases for a fix for the problem. If no fix exists, contact the IBM Support Center. Provide the TCPIP packet trace and output of rpcinfo.
0007	RPC_AUTHERROR	1 AUTH_BADCRED	<p>Remote site cannot validate credentials.</p> <p>Action: Check network status. Retry the utility. If the error recurs contact the IBM Support Center. Provide the TCPIP packet trace.</p>
		2 AUTH_REJECTEDCRED	<p>Remote site requires a new session.</p> <p>Action: Reopen session. Retry the utility. If the error recurs contact the IBM Support Center. Provide the TCPIP packet trace.</p>
		3. AUTH_BADVER	<p>Invalid verifier.</p> <p>Action: Check network functioning. Retry the utility. If the error recurs contact the IBM Support Center. Provide the TCPIP packet trace.</p>
		4. AUTH_REJECTEDVERF	<p>Verifier expired or was replayed.</p> <p>Action: Verify your system/network settings. Retry the utility with correct values. If the error recurs contact the IBM Support Center. Provide the TCPIP packet trace.</p>
		5. AUTH_TOOWEAK	<p>Rejected due to security reason.</p> <p>Action: Verify your security settings. Retry the utility with correct credentials. If the error recurs contact the IBM Support Center. Provide the TCPIP packet trace.</p>
		6. AUTH_INVALIDRESP	<p>Invalid response verifier.</p> <p>Action: Check network status. Retry the utility. If the error recurs contact the IBM Support Center. Provide the TCPIP packet trace.</p>
		7. AUTH_FAILED	<p>AUTH call failed due to unexpected error.</p> <p>Action: Verify the system status. Retry the utility. If the error recurs contact the IBM Support Center. Provide the TCPIP packet trace.</p>
0008	RPC_PROGUNAVAIL		<p>RPC program is not available.</p> <p>Action: Do the following:</p> <ol style="list-style-type: none"> 1. Ensure that the remote site is on and available. Use ping and rpcinfo utilities against hostname. If there is an error, call your network support personnel. 2. Retry the utility. 3. If the error recurs, search problem reporting databases for a fix for the problem. If no fix exists, contact the IBM Support Center. Provide the TCPIP packet trace and output of rpcinfo.

Table 77. RPC error (when reason code is 6E03xxxx) (continued)

Last 4 digits of reason code	Description	retv	Action/Comment
0009	RPC_PROGVERSMISMATCH		<p>RPC program version mismatched.</p> <p>Action: Do the following:</p> <ol style="list-style-type: none"> 1. Ensure that the remote site is on and available. Use ping and rpcinfo utilities against host name. If there is an error, call your network support personnel. 2. Retry the utility. 3. If the error recurs, search problem reporting databases for a fix for the problem. If no fix exists, contact the IBM Support Center. Provide the TCPIP packet trace and output of rpcinfo.
0010	RPC_PROCUNAVAIL		<p>RPC procedure is unavailable.</p> <p>Action: Do the following:</p> <ol style="list-style-type: none"> 1. Ensure that the remote site is on and available. Use ping and rpcinfo utilities against hostname. If there is an error, call your network support personnel. 2. Retry the utility. 3. If the error recurs, search problem reporting databases for a fix for the problem. If no fix exists, contact the IBM Support Center. Provide the TCPIP packet trace and output of rpcinfo.
0011	RPC_CANTDECODEARGS		<p>Remote RPC can't decode arguments.</p> <p>Action: Contact the IBM Support Center. Provide the TCPIP packet trace and utility's output.</p>
0012	RPC_SYSTEMERROR		<p>Remote RPC meets some system error.</p> <p>Action: Contact the IBM Support Center. Provide the TCPIP packet trace and utility's output.</p>

Reason codes from NFS Client or NFS Server modules (xx is 10-FF)

Reason codes with an xx value in the range 10 to FF are issued by NFS Client or NFS Server modules. The xx value indicates which module issued the reason code.

USS JRcccc reason codes (0000-0FFF)

A yyyy value in the range 0000 to 0FFF indicates that the reason code matches one of the USS JRcccc reason codes described in *z/OS UNIX System Services Messages and Codes*. These reason codes can potentially appear for any NFS Client or NFS Server module.

Table 78 lists the NFS reason codes that have a yyyy value in the range 0000 to 0FFF.

Table 78. NFS reason codes that match USS JRcccc reason codes (0000-0FFF)

yyyy	Name	Description
0000	JROK	<p>The return code value describes the error.</p> <p>Action: Refer to the return code for information on the error.</p>

Table 78. NFS reason codes that match USS JRcccc reason codes (0000-0FFF) (continued)

yyyy	Name	Description
001D	JREstaeErr	The ESTAE macro failed. Action: Consult your IBM service representative.
0026	JRKernel Ready	The system is not in a ready state. Action: Retry after OMVS has been allowed to complete initialization.
002E	JRFilesysNotThere	The file system named does not exist. Action: The file system specified on the service could not be found.
003D	JRDirNotFound	A directory in the pathname was not found. Action: One of the directories specified was not found. Verify that the name specified is spelled correctly.
0051	JRInvalidName	<ul style="list-style-type: none"> • An incorrect parameter (such as, file system name or remote object name) has been specified. • No name is specified when it is mandatory. • The requested object was removed / renamed / migrated / etc. Action: Reissue the request specifying an object name that is acceptable at both Client and Server.
0058	JRLskOffsetIsInvalid	The offset given for lseek service is incorrect. Action: The final cursor value on an lseek call cannot be a negative number. <ul style="list-style-type: none"> • The offset must be nonnegative if the Reference_point specified <Set>. • If specified <Current>, then the sum of the input offset and the current cursor value must be nonnegative. • If specified <End>, then the sum of the input offset and the cursor value of the end of the file must be nonnegative.
006B	JRBuffTooSmall	The buffer for return information is too small. Action: The length of the buffer specified on the service was not large enough to contain the data to be returned.
0078	JRPathNotDir	The pathname does not specify a directory. Action: The service requested requires a directory, but the pathname passed is not for a directory.
007A	JRDirInUse	The requested directory is in use. Action: Retry the operation at a later time.
0083	JRKernelDown	The kernel has ended during this service. OpenMVS ended during this service. Action: Restart OpenMVS, then reissue the failing service.
0090	JRNotForDir	The system cannot perform the requested function on a directory. Action: The problem could be: <ul style="list-style-type: none"> • The file descriptor specified refers to a directory opened with opendir() service, and the request is not valid such a file descriptor. Reissue the request specifying a non-directory file descriptor. • The file specified is a directory, and the request is not valid for such object. Reissue the request specifying a non-directory file.

Table 78. NFS reason codes that match USS JRcccc reason codes (0000-0FFF) (continued)

yyyy	Name	Description
00A9	JRInvalidParms	<p>Possible causes:</p> <ul style="list-style-type: none"> • NFSv2 does not support REaddirPlus RPC. • NFSv4 Server does not support some REaddir attributes. • getfacl or setfacl is supported only on NFSv4 mounted filesystems. • getfacl or setfacl calls vn_ioctl without the ACL buffer. • An attempt to establish a hard link on a file that is about to be removed. • Byte-range lock (vn_lockctl) is supported only on NFSv4 mounted filesystems. <p>Action:</p> <ul style="list-style-type: none"> • For REaddir issues, z/OS UNIX System Service should recover and retry without REaddirPlus. • Ensure that getfacl or setfacl operates on NFSv4 mounted filesystems. • Ensure that byte-range lock operates on NFSv4 mounted filesystems; or use "llock(y)" (local lock).
00AB	JRFsUnmountInProgress	<p>An unmount service is already in progress.</p> <p>Action: The file system named is being unmounted.</p>
00B4	JRQuiesced	<p>There was a previous quiesce request.</p> <p>Action: The file system required for the current function has been quiesced. After the file system has been unquiesced, retry this service.</p>
00B6	JRPfsSuspend	<p>The PFS is waiting to restart.</p> <p>Action: If there is a WTOR prompt on the operator console, the PFS will be restarted when the reply is issued.</p> <p>Otherwise, the PFS will be restarted by its own procedures.</p> <p>Close and re-open the socket or file descriptor and retry the request again after the PFS is active.</p> <p>This value may also be returned if there is a configuration problem and the address space is not connected to the proper PFS.</p>
00B7	JRPfsAbend	<p>The physical file system abended.</p> <p>Action: The file system owning the file abended on the last request. Report this to support personnel. Try the request again, or try it with a file on another system.</p>
0115	JRBufLenInvalid	<p>The length of the buffer is less than or equal to zero or it is less than a minimum length.</p> <p>Probable cause: The buffer length specified for this request was a negative number, zero, or less than a minimum length.</p> <p>Action: Retry the request specifying a valid buffer length parameter.</p>
011A	JRInvalidSymLinkLen	<p>The content of the symbolic link is NULL or empty.</p> <p>Action: Ensure the specified symbolic link contains a valid path name.</p>
011C	JRFileNotOpen	<p>The file is not opened.</p> <p>Action: Reissue the request specifying an open file descriptor.</p>

Table 78. NFS reason codes that match USS JRcccc reason codes (0000-0FFF) (continued)

yyyy	Name	Description
0130	JRSigDuringWait	A signal occurred during a wait. Action: While the service was waiting, a signal was received to interrupt it.
018F	JRQuiescing	The call did not complete. The file system is unmounting. Action: The requested function cannot be performed while an unmount is in progress for a file system. Retry when the file system is mounted again.
01AB	JRFsInUse	The requested file system is still in use. Action: A normal unmount was requested for the file system. There is at least one process still using the file system, so the request to unmount cannot be honored.
0211	JRTimeOut	The time for the service to wait has expired. Action: While the process was waiting for signals or a condition to occur, the wait time specified expired.
0296	JRTcpNotActive	No AF_INET socket provider is active. Action: Start the AF_INET socket provider you specified in parmllib and retry this socket request.
029E	JRInvalidVlok	The supplied VLock structure is not valid. The vl_lockertok for VL_UNLOCK or VL_UNREGLOCKER is invalid. Action: Check the program on NFS Client side, and/or consult NFS Client System Administrator.
0350	JRAsynchMount	The request to mount a file system will complete asynchronously. The system rejects all vnode (file) operations against the file system. Action: Use w_getmntent to determine when the mount completes. Retry the operation once the file system is mounted.
0351	JRPfsOpNotSupported	The vn_ioctl command code is not supported. Action: Ensure that z/OS NFS supports the operation.
0352	JRPfsOpNotPermitted	Not authorized to perform this pfsctl operation. Action: The request must be made by an authorized user.
03A5	JROWaitSetupErr	An error occurred while attempting OsiWait setup Action: Contact your IBM service representative.
03BD	JRFsUnAuthClnt	Server returns a list of RPC authentication that NFS Client is unable to support Action: Consult the NFS Server system administrator.
03CA	JROutOfMountEntries	Unable to find the internal Mount Info data structure associated with the unmounted file system. Action: Consult your IBM service representative.
0421	JRFileInUse	Unable to remove a file or unmount because file is in use. Action: Retry the operation at a later time.

Table 78. NFS reason codes that match USS JRcccc reason codes (0000-0FFF) (continued)

yyyy	Name	Description
0469	JRInvalidOption	The option specified is not supported. Action: Reissue the request with a supported option.
04B3	JRInRecovery	A required file system is being recovered. Action: Retry the operation later.

Global reason codes (yyyy = 1000 - 3FFF)

A *yyyy* value in the range 1000 to 3FFF indicates that the reason code is a global reason code, whose meaning is the same regardless of which NFS module issued it.

Table 79 shows the *yyyy* values that can be issued by any NFS client module:

Table 79. NFS client global reason codes (1000 - 3FFF)

yyyy	Name	Description
1001	JRNfs_FileidChanged	NFSC recovering FHEXPIRED but the lookup object has a different fileid than before. It is possible that during the NFSS interruption, the "old" object is removed and a "new" object is created with the same name, but the fileid is different. NFSC treats it as ESTALE. Action: The operation fails. Try to traverse backward to the parent directory, or to check the object existence, and reissue the operation.
1002	JRNfs_StaleObject	NFSC recovering NFS4ERR_FHEXPIRED but the object seems stale or fails its consistency check. It is possible that the intermediate directory at the Server is removed during NFSS interruption. Action: The operation fails. Try to traverse backward to the parent directory, or to check the object existence, and reissue the operation.
1003	JRNfs_MntRetry	Exhausting the retry count while attempting to contact the specified NFS Server. Action: The mount command fails. Verify the NFS Server availability and reissue the mount command with a larger "retry" value.
1004	JRNfs_PermissionBits	The Object Permission Mode bits deny the operation. Action: The operation fails. Verify the Object Permission Mode bits (RWX), obtain the proper authority (Owner, Group, Others), and reissue the operation.
1005	JRNfs_SymLinkLoop	NFSv4 Mount Emulation encounters an already-resolved symbolic link. A loop of symbolic links is detected. Action: The mount operation fails. Issue "showmount -e <server>" and verify the mount pathname against the list of export paths. Correct the mount path name or consult the NFS server system administrator.
1006	JRNfs_MntObjNotDirSymlnk	NFSv4 Mount Emulation encounters an object that is neither a directory nor a symbolic link. Action: The mount operation fails. Ensure every component of the mount path name is either a symbolic link or a directory.

Table 79. NFS client global reason codes (1000 - 3FFF) (continued)

yyyy	Name	Description
1007	JRNfs_RpcsecNotSupported	<p>An RPCSEC_GSS request failed because of one of the following reasons:</p> <ol style="list-style-type: none"> 1. The Kerberos context could not be created by the NFS client. 2. The GSS credentials for the NFS client's Kerberos Principal could not be obtained. <p>Action: The operation fails.</p> <p>Check your Kerberos configurations, fix any configuration issues identified, restart the NFS client and retry the operation.</p> <p>Contact the system programmer if the problem persists.</p>
1008	JRNfs_RpcsecCryptographicFailure	<p>An RPCSEC_GSS request failed because either the cryptographic generation or cryptographic verification of the request failed.</p> <p>Action: The operation may be retried once and if the retry fails, the operation is failed.</p> <p>Check the Kerberos configurations at the client and the server.</p> <p>Contact the system programmer if the problem persists.</p>
1009	JRNfs_RpcsecKinitNeeded	<p>An RPCSEC_GSS request failed because the user's Kerberos Credentials have expired.</p> <p>Action: The operation is retried once and if the retry fails, the operation is failed.</p> <p>Reacquire the Kerberos credentials by issuing a "kinit" and retry the operation.</p> <p>Contact the system programmer if the problem persists.</p>
100A	JRNfs_HostNotFound	<p>Name Resolver is unable to resolve the given host name to an IP address.</p> <p>Action: The command fails.</p> <ul style="list-style-type: none"> • Try nslookup to ensure the given host name can be resolved into an IP address by the Name Resolver. • If nslookup fails, contact the responsible network administrator to correct the Name Resolver configuration or the Name Server. • If nslookup works, ensure SYSTCPD DDname in the StartUp Procedure or Jobname DOES NOT alter the Name Resolver search order or search path. <p>It is possible to remove SYSTCPD DDname so the Name Resolver search order for the successful nslookup applies to z/OS NFS. Changing the z/OS NFS StartUp Procedure requires restarting the z/OS NFS component.</p>
100B	JRNfs_NotTimeouted	<p>The z/OS NFS component has found that no actions are required due to requested resource is not timed out yet.</p> <p>The requester has not waited long enough, or a request has been processed that updated the timeout value.</p> <p>Action: The request fails. Wait until the timeout is expired.</p>

Table 79. NFS client global reason codes (1000 - 3FFF) (continued)

yyyy	Name	Description
100C	JRNfs_Inconsistency	<p>The z/OS NFS loadlib contains inconsistent modules.</p> <p>Modules of different versions are used in loadlib.</p> <p>Action: Correct loadlib and restart z/OS NFS.</p>
100D	JRNfs_UnicodeFail	<p>The Unicode Conversion Service fails on translation.</p> <p>Code page IDs (ccsid) in z/OS NFS parameters (specified as "clnccsid()" or "srvccsid()") could not be used in Unicode Conversion Service to correctly translate between ccsids, or UFT-8.</p> <p>Action: Set up proper ccsids, and retry.</p>
100E	JRNfs_NoLocalHost	<p>The z/OS NFS failed to retrieve its own local host name.</p> <p>There is a possible error in the z/OS TCPIP configuration file (HOSTname keyword).</p> <p>Action: Ensure that the resolver configuration file is correct and restart z/OS NFS Client.</p>
100F	JRNfs_NoLocalDomain	<p>The z/OS NFS failed to retrieve its own local domain name.</p> <p>Action: Correct the z/OS network configuration and restart z/OS NFS.</p>
1010	JRNfs_PortmapUnsupp	<p>The z/OS NFS component cannot use PORTMAP RPC protocol on a true IPv6 network.</p> <p>The remote side of a TCPIP address isn't type IPv4 or IPv4mapped_IPv6, or rpcbind(n) option is specified.</p> <p>Action: Remove 'rpcbind(n)' or use IPv4 addressing.</p>
1011	JRNfs_InvalidFileMode	<p>The specified file mode is not supported by the z/OS NFS component.</p> <p>Action: Consult the system administrator to ensure use of proper parameters.</p>
1012	JRNfs_ServerNotActive	<p>No active NFS server was found on the remote side. NFS server on remote side is not operational.</p> <p>Action: Wait for the NFS Server availability, and retry.</p>

Table 79. NFS client global reason codes (1000 - 3FFF) (continued)

yyyy	Name	Description
1013	JRNfs_Wrongsec	<p>The request failed because the RPC authentication flavor with which the request was issued was not allowed by the security policy being enforced at the server's name space and a security negotiation either could not be done for this request or a security negotiation was attempted for this request, but it failed.</p> <p>The security negotiation may not have been done for this request for one of the following reasons:</p> <ol style="list-style-type: none"> 1. This failure was encountered during a mount, where a security flavor was specified in the "secure" keyword in the mount parameters. 2. This failure happened on an existing file or directory that had datacaching enabled. <p>The security negotiation may have failed for this request for one of the following reasons:</p> <ol style="list-style-type: none"> 1. The security policy on the server name space does not support any of the following security flavors: sys krb5 krb5i krb5p 2. There was a change in the server security policy whereby it was downgraded from a more secure security flavor to a less secure security flavor. Note: The flavors are listed as follows, in descending order of the level of protection that they provide: krb5p krb5i krb5 sys <p>Action: Ensure the following.</p> <ol style="list-style-type: none"> 1. If this failure is encountered during a Mount, do one of the following: <ul style="list-style-type: none"> • Do not specify a security flavor in the "secure" keyword to facilitate the client to dynamically negotiate the security policy with the server. • If a security flavor must be specified in the "secure" keyword, ensure that the specified flavor conforms to the security policy at the server's name space. 2. If this failure was encountered on an existing file or directory that had datacaching enabled, then to recover from this failure, datacaching would have to be disabled on that object by mounting with datacaching(n). 3. The NFS server being communicated with must support at least one of the following security flavors: sys krb5 krb5i krb5p 4. To get around a security policy downgrade on the server name space for an existing mount point, the mount point must be unmounted and remounted and the request must be retried.

Table 79. NFS client global reason codes (1000 - 3FFF) (continued)

yyyy	Name	Description
1014	JRNfs_UnicodeMBCv	Unicode Conversion Service detects multi-byte data conversion specified by "clnccsid"/"srvccsid". Incorrect "clntccsid" or "srvccsid" causes multi-byte to single-byte (or vice versa) data conversion that severely affects "offset" and "length" in read/write. Action: Set up ccsids to proper value and retry.
1015	JRNfs_SoftMntTimeout	The request on the "soft" mount point with proto=udp fails because the server does not respond in a timely fashion. Probable cause: The server is overloaded or unresponsive, or the timeout and the retrans settings are too small for UDP retransmission. Action: Consider "hard" mount with proto=tcp, or consider lengthening the timeout and/or retrans settings.
1016	JRNfs_SoftMntNoNetwork	The request on the "soft" mount point fails because there is no network connection to the Server. Probable cause: There is no network connection to the server, or the server is terminated. Action: Consider "hard" mount with proto=tcp, or retry after verifying that there is a network connection to the responsive server.
1017	JRNfs_bpxmtext_only	z/OS NFS Client was minimally configured with "mtxonly" for "bpxmtext" and its vfs_pfsctl. It does not support other vfs/vn_ops. Action: Consider restarting z/OS NFS Client in its full configuration mode by: <ul style="list-style-type: none"> • Stopping the NFS Client. • Removing "mtxonly" from BPXPRMxx parmlib. • Restarting PFS via SETOMVS or SET OMVS.

Module specific reason codes (yyyy = 4000 - 4FFF)

A yyyy value in the range 4000 to 4FFF indicates that the reason code is a module specific reason code, whose meaning can vary, depending on which NFS module issued it.

Table 80 shows the yyyy values that can occur when the xx value is 12 (module GFSCVNAT) and their meanings:

Table 80. Reason codes for module GFSCVNAT (xx = 12)

yyyy	Name	Description
4001	JRNfsInvalidTimeAttr	Versions 2 and 3 of the NFS Protocol do not support second time values larger than $2^{31}-1$. The request attempted to set an atime and/or mtime value larger than $2^{31}-1$ Action: Reissue the request with the correct parameter.

Table 80. Reason codes for module GFSCVNAT (xx = 12) (continued)

yyyy	Name	Description
4002	JRNfsInvalidAttr	The request attempted to set one or more of the following attributes, which are not supported by the NFS Protocol: audit (at_auditchg) ctime (at_ctimechg) reftime (at_reftimechg) file format (at_filefmtchg) general attribute flags (at_setgen) Action: Reissue the request with the correct parameter.
4003	JRNfsInvalidSetIdAttr	The request attempted to set the character set id (at_charsetidchg) attribute, which is not supported by the NFS Protocol. Action: Reissue the request with the correct parameter.

Table 81 shows the *yyyy* values that can occur when the *xx* value is 18 (module GFSCVMNT) and their meanings:

Table 81. Reason codes for module GFSCVMNT (xx = 18)

yyyy	Name	Description
4001	JRNfsSyncMountNotSupp	NFS mount requests must be asynchronous. The mt_synchonly option is not supported. The unsupported option may be the result of a chmount request issued against a function shipped NFS mounted file system. Action: Reissue the request with the correct parameter.
4002	JRNfsRemountNotSupp	An NFS mount request specified the mt_remount. NFS does not support this option. Action: Reissue the request with the correct parameter.

Part 5. Appendixes

Appendix A. File size value for MVS data sets

Many NFS procedures (such as `nfs_lookup` and `nfs_getattr`) in the NFS protocol require the file size to be returned. This Topic explains some performance and accuracy considerations in obtaining the file size value for MVS data sets. For z/OS UNIX files, the file size is directly available from the underlying file system because it is saved as part of the file metadata.

The meaning of the file size value that is returned by the NFS and how fast the file size is returned depends on the following conditions:

- Whether you use text or binary processing mode
- The type of MVS data set being accessed
- If the data set is system-managed
- If `fastfilesize` processing is used

Storage of the file size value

How the file size value is stored affects how quickly files are accessed and depends on the type of MVS data set used.

System-managed PS, VSAM, and PDSE data sets

Text and binary file size are saved on non-volatile storage (DASD) for quick access and maintained by the server for these data set types:

- Physical sequential (including striped)
- VSAM ESDS
- VSAM KSDS
- VSAM RRDS
- PDSE members

These data sets must be SMS managed. When the NFS accesses a data set for the first time, it performs a read-for-size to get the text or binary file size and stores this value on DASD. Subsequent file size requests from clients do not cause the server to read for size, thus improving performance. However, when the data set is modified outside the server by a non-NFS application (for example, by the TSO/E editor), the stored file size could be incorrect. When the data set is accessed again by the server, read-for size must be done to determine the correct file size.

For file size limitations, see sections “Creating physical sequential files” on page 24, “Creating direct access files” on page 25, and “Creating PDSs and PDSEs” on page 26.

Migrated system-managed data sets

z/OS DFSMS allows data set attribute accessibility for SMS managed data sets, without having to recall the data set if the data set is migrated under DFSMS/MVS V1R3 or later. Supported data set types are SMS managed PS, VSAM ESDS, VSAM KSDS, VSAM RRDS, PDS, and PDSE. Migrated PDS/PDSE members are not supported.

The z/OS NFS server is able to obtain the attributes of a supported SMS managed migrated data set without recalling the data set. Attributes such as the record format and file size are saved to DASD. Subsequent file size requests do not cause a recall of the supported SMS managed migrated data set, thus improving performance. However, when the data set is modified outside the server by a non-Network File System application (for example, by the TSO/E editor) before it was migrated, the stored file size could be incorrect. When the data set is accessed again by the server, a recall must be done to determine the correct file size.

Non-system-managed, PDS, and direct data sets

The file size value for non-system-managed data sets, PDS members, and direct (DA) data sets is cached in virtual storage until timeout but not written to DASD. Therefore, for these types of MVS data sets, the file size value is regenerated after the file is closed or after the server is restarted.

How the file size value is generated

When a file is first accessed (for example with `ls -l` or `dir`), usually the entire file is read to determine its size, except for `recfm(f)` or `recfm(fbs)` where the binary size can be computed without reading the file. If the file is a system-managed PS, VSAM, or PDSE member, both binary and text file sizes are stored on DASD, so that subsequent file size requests do not require the file to be read.

Binary file size can be quickly generated by using `recfm(f)` or `recfm(fbs)` to specify a fixed-length record format for the MVS data set. With this format type, the server pads the last logical record with binary zeros in binary mode processing, because MVS always expects complete logical records. If the application tolerates these zeros, using `recfm(f)` or `recfm(fbs)` allows the binary size to be computed quickly because the number of bytes can be computed from the number of blocks, which is stored by MVS.

If you need the exact file size and are using binary mode processing, map it to a variable-format, sequential data set on DASD so that the NFS does not need to pad a partially filled last MVS logical record to a record boundary.

For reading small files or the beginning of files, the read-for-size might not add any processing time. As the file is being read for size, the beginning of the file is stored in the buffers set aside by the `maxrdforszleft` site attribute, until the buffers are full. When the application reads the beginning of the file, this read is fast because it reads directly from the buffer.

MVS stores the number of blocks (rather than the number of bytes) in an MVS file. For most files, therefore, without reading the entire file, the NFS can only give an estimate of the number of bytes in the file, not the exact number of bytes in the file. Even when the server could get the exact byte count without reading the file, the file size could change depending on the file's processing attributes.

For example, selecting `text` mode processing introduces end-of-line terminators such as `lf`, `CrLf`, or `\n` into the file, thus changing the perceived size of the file. As another example, suppose you select text mode processing with blank stripping enabled on a fixed-length record format file. That causes the server to remove trailing blanks from each record, again changing the perceived size of the file. In these examples, when you first request a file, the server must read the entire file to determine its exact size in bytes.

Using **fastfilesize** to avoid read-for-size

If you can use an approximate file size for a PDS, PDSE, DA, or non-system-managed data set, you can specify the **fastfilesize** attribute to improve performance. With this attribute, the server estimates the size without opening and reading the entire file.

PDS members

For PDS members, the **fastfilesize** attribute gets the file size from the ISPF statistics, if they exist. Otherwise, the NFS Server estimates a filesize based on members' TTR locations from the PDS directory. That filesize is larger than the real member size. The NFS Server will return true size(0) detection for empty members.

PDSE members

For PDSE members, the **fastfilesize** attribute gets the file size from the ISPF statistics, if they exist. If the ISPF statistics do not exist, it gets the file size from the attribute extension in the AX cell, if it exists and is valid. If neither is available, the NFS Server has to perform read-for-size to get the non-zero filesize.

Warning: A file size of zero (0) may result in unpredictable behavior from client applications when the PDS/PDSE member actually contains data. Therefore, it is recommended to provide ISPF statistics for the PDS/PDSE members, or to use **nofastfilesize**.

DA data sets

For direct access (DA) data sets, an approximate file size is calculated based on the device characteristics, the number of disk tracks in use, and the block size of the data set.

VSAM

For non-system-managed VSAM data sets, the estimated size using **fastfilesize** is zero. Therefore, such commands as **cat** or **vi** will usually not show any data. In some instances, if the NFS server already has the actual file size cached, data may be shown. Once the cache times out, however, the size is lost and the commands do not show any data.

The **fastfilesize** attribute speeds up data set access by calculating approximate file sizes during data set access. Use this only when you are browsing through files (using the **ls** UNIX command for example) because some commands (such as **cp** or **copy**) might not work correctly if **fastfilesize** is set. When reading or modifying a data set, the **nofastfilesize** attribute must be used to ensure accurate results. The exception is NFSv4 protocol. If NFSv4 protocol is used the **fastfilesize** attribute can be used in all read/write/append cases.

For SMS-managed Extended Format data sets, the **fastfilesize** estimated file size is calculated based on the DFSMS DCBE and DSCB control blocks. It is set to the maximum of the following two values:

- The DFSMS estimated number of blocks in the data set (DCBESIZE) multiplied by the block size
- The estimated number of bytes within all of the data set's DASD tracks with data.

Using nofastfilesize

When you use the default, **nofastfilesize** attribute, the NFS reads the entire file or member to get the file size. It stores the file size value in cache until timeout. If the server's default has been changed to **fastfilesize**, you can still use the **nofastfilesize** attribute to override it.

```
$ ls -l "filename,nofastfilesize"
```

Using this attribute might cause a delay when first accessing very large data sets.

Note: When directly mounting on a fully qualified data set name and **nofastfilesize** is specified, the server must return the mount size as part of getting the attributes for the mount. This can slow down the completion of the mount command.

Appendix B. Time stamps for MVS data sets

This topic explains how to obtain time stamps for MVS data sets. For z/OS UNIX files, the time stamp is directly available from the underlying file system because it is saved as part of the file metadata.

UNIX file attributes define the following time stamps:

atime The last time the file was accessed (read).

mtime The last time the file was modified (write).

ctime The last time the file status was changed (chmod).

The NFS handles time stamps differently for these types of data sets:

- System-managed PS data sets and system-managed VSAM data sets
- Direct data sets and non-system-managed PS data sets
- Non-system-managed VSAM data sets
- PDS and PDSE members

The z/OS NFS server treats all MVS data sets as belonging to the same file system (having the same file system id). Since not all attributes are supported for all DFSMSdftp access methods, but the NFS protocols track attribute support at the file system level, the z/OS NFS server reports to the client that **atime** and **mtime** are supported for all MVS data sets. The z/OS NFS server will generate values as described in this topic.

The **metatime** attribute, which is new in NFS version 4, is not supported by any DFSMSdftp access method, nor by the z/OS NFS server. The new NFS version 4 **change** attribute will be based on **mtime** values as described in this topic.

Time stamps for system-managed VSAM and PS data sets

For system-managed PS data sets and system-managed VSAM data sets, **atime** and **mtime** are fully maintained, and the **ctime** value is set to the **mtime** value.

Time stamps for non-system-managed PS and DA data sets

For non-system-managed physical sequential (PS) and direct access (DA) data sets, consider the following conditions:

- How time stamps are stored.
- The requirements of your workstation programs.
- The type of multiple virtual system (MVS) data set used to store the file.

Storage of time stamps

For non-system-managed physical sequential (PS) and direct access (DA) data sets, the Network File System temporarily stores the time stamps in virtual storage, but not on direct access storage device (DASD). These cached attributes are purged when the file times out and closes or when the server is restarted. When the file is accessed again, the time stamps are regenerated.

Client program requirements

Some workstation-based utilities (such as **make**) rely on date and time stamps to determine whether to recompile. For example, **make** checks the update time of the object file with the source file and recompiles if the source has been updated. Before storing these types of files using the MVS server, examine them to ensure that these attributes are unimportant. In an environment which relies on such utilities, use system-managed PS data sets.

Generating time stamps

This is how NFS generates **atime**, **mtime** and **ctime** values for non-system-managed PS and DA data sets from the MVS dates:

atime = **mtime** = **ctime** = *reference_date* + *time_increment*

If the *reference_date* value is zero (that is, the file has not yet been referenced):

atime = **mtime** = **ctime** = *creation_date* + *time_increment*

The *time_increment* value is either the server local time or 23:59 hours. If *reference_date* value or *creation_date* value is equal to the server local date, the server local time is added. Otherwise, a fixed value of 23 hours and 59 minutes is added.

Time stamps for non-system-managed VSAM data sets

The time stamps for these types of data sets are set to the current time.

Time stamps for PDSs and PDSEs

An MVS PDS or PDSE data set can act as a UNIX directory, when mounted by an NFS client to the z/OS NFS server. Members of the PDS or PDSE data sets are files within the UNIX directory. When the client accesses the directory, UNIX-format file time stamps are expected for each file on the client side. File time stamps in UNIX format are part of the attributes required by the NFS protocol for NFS client/server communication.

Based on the NFS protocol, the z/OS NFS server generates the following UNIX time stamps to send to the client:

atime

the time when the file data was last accessed

mtime

the time when the file data was last modified

ctime

the time when the attributes of the file were last changed.

The z/OS NFS server converts MVS time stamps to UNIX time stamps (and vice versa) to match NFS protocol requirements. The server uses the following main time stamp sources to generate UNIX time stamps for MVS z/OS conventional (legacy) file systems:

- DSCB (data set control block)
- Master Catalog data set attribute extension (AX) cell
- PDSE member attribute extension (AX) cell
- ISPF member statistics
- TOD (current *time_of_day* on the server side).

Time stamp generation depends on the NFS operation (such as read, write, or setattr) and the type of data set.

TOD is used to set up current times in internal NFS control blocks if needed.

For PDS or PDSE member create/update access with ISPF, some specific additional statistics for the member are maintained by ISPF. They include the creation date and the last modification date and time. The server supports ISPF statistics for compatibility with TSO/ISPF. The server always creates ISPF statistics for new PDS/PDSE members created by NFS clients. For existing PDS/PDSE member updates by the client, the server creates/updates the member ISPF statistics.

The following tables summarize the time stamp sources for NFS operations when obtaining file attributes for PDS (SMS-managed and non SMS-managed) and PDSE data sets and members.

Table 82. Time stamp sources for PDS and PDSE members

Time stamp sources for members (files)				
Data set type	ISPF statistics	atime	mtime	ctime
PDS (note 1)	Available	ISPF_ modification_ date + ISPF_ modification_ time	ISPF_ modification_ date + ISPF_ modification_ time	ctime = mtime
	Not available	DSCB_ reference_date + time_increment	DSCB_ reference_date + time_increment	ctime = mtime
PDSE (note 2)	Available (not used for time generation)	PDSE AX cell	PDSE AX cell	ctime = mtime

Note:

1. MVS does not maintain time stamps for members of a PDS, only for the PDS data set. MVS creation and reference dates are maintained in the DSCB control block.

The UNIX time stamps for PDS members are generated from the DSCB creation and reference dates of the PDS data set containing the members, if the time stamps cannot be generated from the member's ISPF statistics.

2. MVS maintains the PDSE member create/change time stamp (mtime) in the PDSE AX cell. The Server uses a FileAccessMethodService (FAMS) call to retrieve/save the member attributes (containing time stamps) from/to the PDSE AX cell.

For a PDSE data set/member, the server generates the UNIX time stamps obtained from the Catalog AX cell/PDSE AX cell. The server supports PDSE member's ISPF statistics just for compatibility with ISPF but does not return them to the client.

Table 83. Time stamp sources for PDS and PDSE data sets (directories)

Time stamp sources for data sets (directories)			
Data set type	atime	mtime	ctime
PDS (non-SMS)	DSCB_ reference_ date + time_ increment	DSCB_ reference_ date + time_ increment	ctime = mtime

Table 83. Time stamp sources for PDS and PDSE data sets (directories) (continued)

Time stamp sources for data sets (directories)			
Data set type	atime	mtime	ctime
PDS (SMS)	catalog AX cell	catalog AX cell	ctime = mtime
PDSE (SMS)	catalog AX cell	catalog AX cell	ctime = mtime

In Table 82 on page 489 and Table 83 on page 489, *time_increment* is either the server local TOD or 23:59 hours. If *reference_date* or *creation_date* is equal to the server local date, the server local TOD is added. Otherwise, a fixed value of 23 hours and 59 minutes is added. If the *reference_date* value is zero (that is, the file has not yet been referenced) then **atime** = **mtime** = **ctime** = *creation_date* + *time_increment*.

MVS maintains PDSE/SMS-managed PDS atime, mtime time stamps in the Catalog AX cell. The Server uses an SVC26 call to retrieve/save the data set attributes (containing time stamps) from/to the Catalog AX cell.

The server keeps all file time stamps current in internal control blocks in readiness to return time stamps when servicing NFS requests issued from NFS clients. The server updates the time stamp sources (in the DSCB, member ISPF statistics, or attribute extension cells) from internal control blocks only during close file operations depending on file timeout expiration values (attrtimeout, readtimeout, writetimeout) as described in section 'Timeout attributes'.

Setting time stamps

NFS clients can issue SETATTR requests to set **atime** and **mtime** for a system-managed PS or VSAM data set. For PDSE members, setting **mtime** is allowed, but setting **atime** is not supported. PDSE member **mtime** is also maintained by PDSE access methods, so it is modified when a TSO/E user modifies the PDSE member.

Appendix C. NFS server attributes

This topic lists NFS server attributes and how they are supported on the z/OS NFS server.

NFS file system attributes for MVS data sets

The z/OS NFS server generates MVS-specific values for certain UNIX file system attributes. Table 84, Table 85, and Table 86 illustrate the MVS values that the z/OS NFS server generates.

Table 84. File system values to get dynamic file system information

Value	Description	z/OS Conventional MVS Value
tbytes	Total size, in bytes, of the file system	10000000000
fbytes	Amount of free space, in bytes, in the file system	8000000000
abytes	Amount of space, in bytes, available to the user identified by the authentication in the RPC	80000000
tfiles	Total number of file slots in the file system	200000
ffiles	Number of free file slots in the file system	20000
afiles	Number of free file slots that is available to the user corresponding to the authentication information in the RPC	2000
invarsec	Number in seconds for which the file system is not expected to change	0

Table 85. File system values to get static file system information

Value	Description	z/OS Conventional MVS Value
rtmax	Maximum number in bytes for the read request supported by the server	65536 (64KB)
rtpref	Preferred size of the read request	32768 (32KB)
rtmult	Suggested multiple for the size read request	4096
wtmax	Maximum size of a write request supported by the server	65536 (64KB)
wtpref	Preferred size of the write request	32768 (32KB)
wtmult	Suggested multiple for the size of a write request	4096
dtpref	Preferred size of the readdir request	8192
maxfilesize	Maximum size of a file on the system	2 ** 63 - 1
time_delta	File time using setattr	(0,1000000)
Properties:	FSF_LINK	1
	FSF_SYMLINK	0
	FSF_HOMOGENEOUS	1
	FSF_CANSETTIME	1

Table 86. File system values to retrieve POSIX information

Value	Description	z/OS Conventional MVS Value
linkmax	Maximum number of hard links	1
name_max	Maximum length of a component file name (file name + attributes)	255

Table 86. File system values to retrieve POSIX information (continued)

Value	Description	z/OS Conventional MVS Value
no_trunc	Server will reject any name that is longer than the name_max	True
chown_restricted	Change either the owner or the group associated with the data set	True
case_insensitive	Server does not distinguish the case when interpreting file names	True
case_preserving	If True, the server file system will preserve the case of a name during a create, mkdir, mknod, symlink, rename, or link	False

NFS file system attributes for z/OS UNIX file systems

For z/OS UNIX files, Table 87 and Table 88 show the file system values that are returned for NFS attributes.

Note: Static UNIX values are for general reference only and may change. Actual values are provided by UNIX System Services or an underlying physical file system such as zFS, TFS, HFS, or NFS client. Refer to these products for current values.

Table 87. File system values to get static file system information

Value	Description	UNIX value
rtmax	Maximum number in bytes for the read request supported by the server	65536 (64KB)
rtpref	Preferred size of the read request	32768 (32KB)
rtmult	Suggested multiple for the size read request	4096
wtmax	Maximum size of a write request supported by the server	65536 (64KB)
wtpref	Preferred size of the write request	32768 (32K)
wtmult	Suggested multiple for the size of a write request	4096
dtpref	Preferred size of the readdir request	8192

Table 88. File system values to retrieve POSIX information

Value	Description	UNIX Value
linkmax	Maximum number of hard links	2 ** 31
name_max	Maximum length of a component file name (file name + attributes)	255
no_trunc	Server will reject any name that is longer than the name_max	True
chown_restricted	Change either the owner or the group associated with the data set	False
case_insensitive	Server does not distinguish the case when interpreting file names	False
case_preserving	If True, the server file system will preserve the case of a name during a create, mkdir, mknod, symlink, rename, or link	True

NFS protocol attributes

Table 89 provides general reference information about the z/OS NFS server's support of NFS protocol attributes. To determine which attributes are communicated between the client and server for the version of the NFS protocol that you are using, see the corresponding RFC at The Internet Engineering Task Force (IETF) (www.ietf.org):

- NFS protocol version 2: RFC 1094
- NFS protocol version 3: RFC 1813
- NFS protocol version 4: RFC 3530.

Table 89. NFS Version 4 Attributes

Num	Attribute Name	Supp_attr value (Note 1, 5)	Comments (Note 2)
1	type	1	File object type (File, Directory, Link, etc.) (Note 5) UNIX value: at_mode, NFALL_B MVS value: NFS generated
2	fh_expire_type	1	Indicates a file handle is persistent or volatile across server restarts. (Note 5) UNIX value: NFSV4 fh4_volatile_any MVS value: NFSV4 fh4_volatile_any
3	change	1	Server generated value which is updated when an NFS object attribute or content changes. UNIX value: at_ctime64, at_ctimemsec MVS value: NFS server generated (Notes 4, 5)
4	size	1	Object size in bytes. UNIX value: at_size or 512 if an empty directory (Note 5) MVS value: (Note 3)
5	link_support	1	Objects file system supports hard links (Note 5) UNIX value: fs_nfsprop.fs_fsf_link MVS value: 0 (not supported)
6	symlink_support	1	Objects file system supports symbolic links (Note 5) UNIX value: fs_nfsprop.fs_fsf_symlink MVS value: 0 (not supported)
7	named_attr	1	Object has named attributes (Note 5) UNIX value: 0 (not supported) MVS value: 0 (not supported)
8	fsid	1	Unique file system id (Note 5) UNIX value: at_dev MVS value: (Note 8)
9	unique_handles	1	Distinct file handles are guaranteed to represent different objects. UNIX value: 0 MVS value: 0
10	lease_time	1	Duration of lease in seconds. UNIX value: NFS server site attribute. MVS value: NFS server site attribute
11	rdattr_error	1	Readattr error during getattr operation. UNIX value: error enum MVS value: error enum
12	ACL	UNIX: 1 MVS: 0	Object's associated access control list UNIX value: Object's ACL values MVS value: undefined
13	aclsupport	1	Types of ACLs supported by the server UNIX value: 1 MVS value: 0
14	archive	0	Object has been archived since last modification. UNIX value: undefined MVS value: undefined
15	cansetime	1	Server is able to change times as specified in a setattr UNIX value: fs_nfsprop.fs_fsf_CanSetTime MVS value: 1
16	case_insensitive	1	Server file name comparisons are case insensitive. (Note 5) UNIX value: pcfgcaseinsensitive MVS value: 1
17	case_preserving	1	Filename case is persevered on this file system. UNIX value: pcfgcaseonpreserving MVS value: 0
18	chown_restricted	1	Changes to file owner or group requires privileged user. (Note 5) UNIX value: 0 MVS value: 1
19	filehandle	1	Objects associated file handle. (Note 5) UNIX value: NFS server generated MVS value: NFS server generated
20	fileid	1	A number uniquely identifying the file on this file system. (Notes 5, 7) UNIX value: BPXYATTR.AttrFid MVS value: NFS server generated
21	files_avail	1	Available file slots. (Note 5) UNIX value: fs_favail MVS value: 2,000

Table 89. NFS Version 4 Attributes (continued)

Num	Attribute Name	Supp_attr value (Note 1, 5)	Comments (Note 2)
22	files_free	1	Free file slots. (Note 5) UNIX value: fs_ffree MVS value: 20,000
23	files_total	1	Total file slots. (Note 5) UNIX value: fs_files MVS value: 200,000
24	fs_locations	0	Alternate locations where this file system may be found. UNIX value: undefined MVS value: undefined
25	hidden	0	Hidden file with respect to the Windows API. UNIX value: undefined MVS value: undefined
26	homogeneous	1	file system attributes are the same for all objects within the file system. UNIX value: fs_nfsprop.fs_fs_homogeneous MVS value: 1
27	maxfilesize	1	Maximum file size. (Notes 3, 5) UNIX value: fs_maxfilesize MVS value: see notes.
28	maxlink	1	Maximum number of links for this object. (Note 5) UNIX value: pcfglinkmax MVS value: 1
29	maxname	1	Maximum filename size for this object. (Note 5) UNIX value: pcfgnamemax MVS value: 256
30	maxread	1	Maximum read size for this object. (Note 5) UNIX value: 65536 MVS value: 65536
31	maxwrite	1	Maximum write size for this object. (Note 5) UNIX value: 65536 MVS value: 65536
32	mimetype	0	MIME body type/subtype for this object. UNIX value: undefined MVS value: undefined
33	mode	1	Support of UNIX-style mode and permission bits. (Note 5) UNIX value: at_mode MVS value: 666 or 777
34	no_trunc	1	Return error rather than truncate the filename if name is greater than <i>maxname</i> . UNIX value: pcfgnotrunc MVS value: 1
35	numlinks	1	Number of hard links to this object. (Note 5) UNIX value: at_nlink MVS value: file = 1, directory = 2
36	owner	1	The owner's string name. (Note 9) UNIX value: undefined. MVS value: undefined..
37	owner_group	1	The owner's group string name. (Note 9) UNIX value: undefined. MVS value: undefined.
38	quota_avail_hard	0	Server rejects a write request and provides the additional disk space that can be allocated to this file or directory. UNIX value: undefined. MVS value: undefined.
39	quota_avail_soft	0	Server reasonably warns on a write request and provides the additional disk space that can be allocated to this file or directory. UNIX value: undefined. MVS value: undefined.
40	quota_used	0	Amount of disk space used by this file or directory. UNIX value: undefined. MVS value: undefined.
41	rawdev	UNIX: 1 MVS: 0	Raw USS device identifier (UNIX device major/minor node information). UNIX value: at_major, at_minor MVS value: undefined.
42	space_avail	1	Disk space available to this user. (Notes 3, 5) UNIX value: fs_freespace, fs_blocksize MVS value: 80,000,000
43	space_free	1	Filesystem free disk space. (Notes 3, 6) UNIX value: fs_freespace, fs_blocksize MVS value: 8,000,000,000
44	space_total	1	Filesystem total disk space. (Notes 3, 5) UNIX value: fs_usedspace, fs_blocksize MVS value: 10,000,000,000
45	space_used	1	Allocated bytes for this file object. (Notes 3, 6) UNIX value: at_blocksh, at_blocks, at_blksize MVS value: see notes.
46	system	0	System file with respect to the Windows API. UNIX value: undefined. MVS value: undefined.
47	time_access	1	Last read access satisfied by server for this object. (Notes 4, 5, 6) UNIX value: at_atime64 MVS value: see notes.

Table 89. NFS Version 4 Attributes (continued)

Num	Attribute Name	Supp_attr value (Note 1, 5)	Comments (Note 2)
48	time_access_set	1	Setattr operation to set the time of last access for this object. (Notes 4, 5, 6) UNIX value: at_atimechg, at_atimeTOD MVS value: support is limited, see notes.
49	time_backup	0	Last backup time for this object. UNIX value: undefined. MVS value: undefined.
50	time_create	UNIX: 1 MVS: 0	Object time of creation. (Notes 4, 6) UNIX value: at_createtime64 MVS value: undefined.
51	time_delta	1	Smallest useful server time granularity. (Notes 4, 5) UNIX value: fs_time_delta_sec, fs_time_delta_ns MVS value: 1 second.
52	time_metadata	UNIX: 1 MVS: 0	Time of last meta-data modification to the object. (Note 4) UNIX value: at_ctime64,at_ctimemsec MVS value: undefined.
53	time_modify	1	Time of last modification to the object. (Notes 4, 6) UNIX value: at_mtime64 MVS value: see notes.
54	time_modify_set	1	Setattr operation to set the time of last modification for this object. (Notes 4, 5, 6) UNIX value: at_mtimechg, at_mtimeTOD MVS value: see notes.
55	mounted_on_fileid	UNIX: 1 MVS: 0	Like <i>fileid</i> , but if the target filehandle is a file system root the <i>fileid</i> of the underlying file system directory is returned. UNIX value: undefined. MVS value: same as <i>fileid</i> .

Note:

1. Column indicates z/OS NFS server V4 **supp_attr** attribute setting, where 0 = no support, 1 = supported values. The NFS V4 **supp_attr** is a bitmap of attributes requested, returned, or being set in an NFS client request.
2. UNIX value may contain the UNIX system provided macro and field name. For additional information on UNIX values see *z/OS UNIX System Services File System Interface Reference*.
3. See *z/OS DFSMS Using Data Sets* for additional information on MVS file size limits. See Appendix A, "File size value for MVS data sets," on page 483 and sections "Creating physical sequential files" on page 24, "Creating direct access files" on page 25, and "Creating PDSs and PDSEs" on page 26 for additional information on file sizes.
4. For z/OS conventional MVS data sets refer to handling of time stamps in Appendix B, "Time stamps for MVS data sets," on page 487.
5. The constant or generated values are being provided by the NFS server for performance or correct operation.
6. For z/OS conventional MVS data sets, values represent those in the data set control block DSCB, Catalog locate, PDSE directory, HSM MIC cell, and SMS DATACLASS.
7. The *fileid* of z/OS conventional MVS data sets is generated from data set name and member name using **crc32** checksum algorithms.
8. Returned by z/OS UNIX System Services as a result of the NFS server registration request **v_reg()** during server initialization.
9. The z/OS NFS server supports name@domain owner and owner_group strings in this release. These strings are the string name of the owner of file system object and the string name of the group ownership of file system object. The strings are returned and accepted for setattr, verify, nverify, open, create, getattr, and readdir.

Appendix D. NSM (statd) protocol

The NSM (statd) protocol defines network status monitor (NSM) functions for NFS. In z/OS V1R7, the network status monitor, along with the network lock manager (NLM) was integrated into the z/OS NFS address space to improve performance and other functions. This integration changed the statd protocol implementations on the z/OS NFS server.

Using supported NSM (statd) procedures

The NSM protocol defines six RPC procedures which implement the network status manager. With the integration of NSM into the NFS server address space, procedures 0 through 5 act as null procedures and return no results if invoked externally. Procedure 6, however, is fully implemented. The procedures are as follows:

Procedure 0: do nothing

Procedure 0 (NULL) does nothing

Procedure 1: SM_STAT

Dummy call, always return STAT_FAIL

Procedure 2: SM_MON

Monitor a client host

Procedure 3: SM_UNMON

Unmonitor a client host

Procedure 4: SM_UNMON_ALL

Unmonitor all client hosts

Procedure 5: SM_SIMU_CRASH

Simulate a crash

Procedure 6: SM_NOTIFY

NFS server notifies clients that server is restarting, so clients need to reclaim any locks they previously had on server files. This procedure is fully implemented by the z/OS NFS server.

Note: NSM is only active if the NFS server is started with the NLM attribute set, not with NONLM.

For compatibility with supported NFS clients, it is important that the TCPIP.DATA file "HOSTNAME" parameter represent the hostname exactly as it is returned by a DNS query (that is, it is case sensitive).

Appendix E. NFS system server sample attribute table

You can use the contents of the Figure 42 on page 500 attribute table file as a NFS server sample. The attributes table can be found as GFSAPATT in the NFSSAMP library.

```

#####
#
# Z/OS Network File System Server Sample Attribute Table @L6C #
#
# PROPRIETARY STATEMENT=
# LICENSED MATERIALS - PROPERTY OF IBM
# THIS MODULE IS "RESTRICTED MATERIALS OF IBM"
# 5650-ZOS @017C #
# COPYRIGHT IBM CORPORATION 1991, 2012 @017C #
# SEE IBM COPYRIGHT INSTRUCTIONS
# END PROPRIETARY STATEMENT
# Copyright IBM Corp. 1991, 2011 @P0GC #
# Copyright SUN Microsystems, Inc &
# Electronic Data Systems Corp. 1988, 1989
#
#####
#
# change activities:
# 1. 5/10/91 - Release it for MVS/DFP V3
# 2. 1/30/92 - Updates for VSCR
# 3. 8/06/92 - Change mintimeout default
# 4. 8/31/92 - Add PCNFSD
# 5. 9/20/92 - R2 updates
# $L3X=NFS,HDZ11NP,931230,SJPLJST: Change NFSTASKS default and @L3XA#
# add XLAT keyword @L3XA#
# $L3L=KA90033,HDZ11NP,940405,SJPLJST: Add RESTIMEOUT keyword @L3LA#
#
# $L33=NFS,HDZ11NP,940613,SJPLTEM: Add SMF keyword @L33A#
# $01=OW12199,HDZ11NP,950323,SJPLTEM: Add HFS keyword @01A#
# $P1=KA00045,HDZ11SP,960111,SJPLTEM: Updates for DFSMS 1.3 @P1A#
# $P2=KA00107,HDZ11SM,960415,SJPLTEM: Remove MODEL attribute @P2A#
# $L59=NFS,HDZ11TS,970226,SJPLBPF: File Ext. Support @L59A#
# $P3=KAB0033,HDZ11TS,970701,SJPLPKL: Add # comment char after @P3A#
# xlat keyword @P3A#
# $P4=KAB0114,HDZ11TS,971030,SJPLTEM: Chg DFSMS/MVS->OS/390 @P4A#
# $L53=NFS,HDZ11TS,971031,SJPLBPF: WebNFS Support @L53A#
# $P5=KAB0379,HDZ11TS,980512,SJPLBPF: Default changes @P5A#
# $L5D=NFS,HDZ11TS,980821,SJPLBPF: NC Support OW34846=@L5DA#
# $L5X=NFS,HDZ11TS,980820,SJPLTEM: Filename delimiter OW34846=@L5XA#
# $LA1=OW38745,HDZ11TS,981209,SJPLRMS: nfstasks(n,m,o) @LA1A#
# $02=OW40268,HDZ11TS,990727,SJPLRMS: Comment out nfstasks flag @02A#
# $03=OW42036,HDZ11TS,991213,SJPLBPF: New readdirtimeout keyword @03A#
# $04=OW43829,HDZ11TS,000410,SJPLBPF: Lower readdirtimeout limit @04A#
# $LA7=OW46949,HDZ11TS,000921,IBSKEK: TEXT/BINARY on a single @LA7A#
# mount point @LA7A#
# $P6=KAD0016,HDZ11TS,001106,SJPLBPF: Allow up to 100 hfs tasks @P6A#
# $05=OW48939,HDZ11TS,010415,SJPLJST: rddr cookie verifier @05A#
# $LC1=OW49104,HDZ11TS,010115,IBSNIV: File Tagging Support @LC1A#
# $06=OW51358,HDZ11TS,010921,IBSPIV : New hfsfbtimeout keyword @06A#
# $07=OW54351,HDZ11TS,020422,IBSKVV : New upcase and @07A#
# mixcase keywords @07A#
# $08=OW55830,HDZ11TS,020819,IBSKVV :SMF activate at NFSS startup @08A#
# $L6=NFS,HDZ11US,030405,SJPLMB: Changed OS/390 to Z/OS @L6A#
# $L66=NFS,HDZ11US,030303,IBSMVB: NFSS 878 abend handling @L66A#
# $LCE=OW55734,HDZ11TS,020701,IBSNIV: File Tagging Support @LCEA#
# $L74=NFS,HDZ11VS,031015,SJPLJST: NFS ver 4 protocol support @L74A#
# $09=OA03523,HDZ11TS,030515,IBSVKR: Extend RETRIEVE attr to HFS @09A#
# $0A=OA05684,HDZ11TS,031208,IBSNIV: New remount/noremount keyword@0AA#
# $L76=NFS,HDZ11VS,040119,IBSDYP: NFS Server DHCP Support @L76A#
# $L74=NFS,HDZ11VS,040322,SJPLSLH: Added MVMNT PProcessing Attr @L74BA#
# $L74=NFS,HDZ11VS,040805,SJPLMB: Added DENYRW/NODENYRW Attrs @L74MA#
# $L7E=NFS,HDZ11VS,041214,SJPLMB: @L7EA#
# Legal Rqmt: Change "OPEN EDITION" to "z/OS UNIX" @L7EA#
# $P07=KAJ0262,HDZ11VS,050204,SJPLMB: @P07A#
# 1. Add missing comment delimiters @P07A#
# 2. Move MVMNT to Processing Attributes Section @P07A#
# 2. Remove nohfs option. It is no longer supported. @P07A#

```

Figure 42. NFS system server sample attribute table

```

# $0B=0A08867,HDZ11US,040929,IBSKYL: Correct typo for @L66A @0BA#
# $P08=KAJ0243,HDZ11VS,050331,SJPLSCA: 64bit fileid support @P08A#
# $0C=0A12850,HDZ118N,050811,SJPLSLH: MVMNT and SAF text added @0CA#
# $0D=0A14044,HDZ118N,051208,IBSNIV: Correct nfstasks(n, ,o) @0DA#
# $L74=NFS,HDZ11VS,041020,SJPLKU: @L74AA#
# Added mvssec(),hfssec() and pubsec(). @L74AA#
# $L81=NFS,HDZ118N,050908,IBSDYP: Exports file netgroup support @L81A#
# $L82=NFS,HDZ118N,050808,SJPLJFA: Stringprep Support @L82A#
# $0E=0A12994,HDZ118N,060106,SJPLRAS: @0EA#
# Added nordrcache @0EA#
# $P09=K9N0086,HDZ119N,060807,SJPLMB: @P09A#
# 1. Added NFS v4 attr/read/write timeout vs lease @P09A#
# time restriction note. @P09A#
# $P0A=K9N0099,HDZ119N,060823,SJPLMB: @P0AA#
# 1. Changed nfstasks note wording slightly. @P0AA#
# $P0B=K9N0317,HDZ1AN0,070315,SJPLRAS: @P0BA#
# 1. Changed comment for SETOWNERNOBODY attribute. @P0BA#
# $0F=0A20232,HDZ1AN0,070321,IBSNIV: @0FA#
# 1. New second parameter of writetimeout attribute added@0FA#
# $LAG=NFS,HDZ119N,070410,IBSDYP: @LAGA#
# 1. Added NFSv4domain attribute for NFSv4 name mapping @LAGA#
# $P0C=KN00022,HDZ1AN0,070615,IBSDYP: @P0CA#
# 1. Changed comment for NFSV4DOMAIN attribute. @P0CA#
# $P0D=KN00025,HDZ1AN0,070704,SJPLJST: # TCP/UDP tasks spec @P0DA#
# $LAH=NFS,HDZ1AN0,070831,SJPLMB: @LAHA#
# 1. Added ZNFSCClient attribute for z/OS NFS Client @LAHA#
# $P0E=KN00144,HDZ1AN0,071024,IBSDYP: multi-domain support for @P0EA#
# NFSv4 name mapping @P0EA#
#----- Release V1r11 -----@LCQC#
# $LBB=NFS,HDZ1B1N,080404,SJPLMB: @LBBA#
# 1. Added MVSPREFIX and IMPPREFIX site attributes for @LBBA#
# the extended path prefix support. @LBBA#
# $LBK= NFS,HDZ1B1N,080414,IBSVAE: @LBKA#
# 1. Delay Detection @LBKA#
# $P0F=KBN0052,HDZ1B1N,080814,IBSVAE: @P0FA#
# 1. Correct wording in description of DlyDTimeout @P0FA#
# $LBC= NFS,HDZ1B1N,080818,SJPLJST: @LBCA#
# 1. Add DELEGATION/NODELEGATION Site Attributes @LBCA#
# $010=0A24375,HDZ1B1N,080605,IBSVKR: @010A#
# 1. h3_rddr enhancement @010A#
#----- Release V1r12 -----@LCQA#
# $LCQ= NFS,HDZ1C1N,090420,IBSAYG: @LCQA#
# 1. Cache monitoring & reporting - Bufhigh attribute @LCQA#
# now contains 2 values. @LCQA#
# $LCO= NFS,HDZ1C1N,090407,IBSVKR : @LCOA#
# 1. Add new operands in the site attribute: SMF @LCOA#
# $011=0A29577,HDZ1C1N,090720,SJPLMM: @011A#
# 1. Change MAXWINDOW from 256 to 2048 so zNFSS can @011A#
# cache up to 64MB out_of_sequence 32KB_rpc_write. @011A#
# $012=0A27743,HDZ1C1N,090522,IBSVKR: @012A#
# 1. New site attribute for GID inheritance @012A#
# $013=0A24594,HDZ1C1N,080521,IBSNIV: @013A#
# 1. The overflow attribute support. @013A#
# $014=0A31051,HDZ1C1N,091111,IBSNIV: @014A#
# 1. AE for 0A24594: Add pound sign to fiche flag. @014A#
# $015=0A30333,HDZ1C1N,091221,IBSSAN: @015A#
# 1. Changed comment for NFSV4DOMAIN attribute. @015A#
#----- Release V1r13 -----@P0GA#
# $P0G=KCN0160,HDZ1D1N,100325,SJPLRAS: @P0GA#
# 1. bufhigh - restore Server may adjust initial value on @P0GA#
# startup. And change default to 32M from 64M @P0GA#
# $P0H=KCN0164,HDZ1D1N,100402,SJPLRAS: @P0HA#
# 1. bufhigh - restore comment delimiter in front of fiche @P0HA#

```

```

# $POI=KCN0145,HDZ1D1N,100407,SJPLRAS: @P0IA#
# - General Comment Cleanup @P0IA#
# 1. Comment update: nfstasks attribute @P0IA#
# 2. Comment update: mintasks attribute @P0IA#
# 3. Fix Prolog comment @P0IA#
# 4. Comment update: MVSMNT @P0IA#
# 5. Comment update: Added commented out sidefile(dsname) @P0IA#
# 6. Convert lowercase BUFHIGH to bufhigh @P0IA#
# 7. Comment update: RECFM - change "S" to "M" @P0IA#
# $016=OA31545,HDZ1D1N,100311,IBSNIV: @016A#
# 1. The overflow attribute support for V4. @016A#
# (included in R1.12 roll-up APAR OA32835) @016A#
#----- Release V2r1 -----@017A#
# $017=OA34879,HDZ221N,20111123,IBSNIV: @017A#
# 1. The BLKSIZE for direct access data set. @017A#
# $018=OA35630,HDZ221N,20110216,IBSVAE: @018A#
# 1. symresolve/nosymresolve support. @018A#
# $019=OA36971,HDZ221N,20110701,IBSVKR: @019A#
# 1. New site attribute: mvslogindelay @019A#
# $LEP=_NFS_,HDZ221N,20110926,SJPLHPN: @LEPA#
# 1. Update LOGICALCACHE, BUFHIGH, CACHEWINDOW comments @LEPA#
# with regards to LP64 and the z/OS NFS Server ability @LEPA#
# to utilize the virtual memory above 2GB BAR to @LEPA#
# buffer the logical read/write data to MVS data sets. @LEPA#
# $POJ=KEN0151,HDZ221N,20111012,IBSDYP: @P0JA#
# 1. Move OVERFLOW to Processing Attributes Section. @P0JA#
# $POK=KEN0169,HDZ221N,20111014,IBSDYP: @P0KA#
# 1. Move OVERFLOW to Processing Attributes Section (PTM @P0KA#
# KEN0151 concerned only PUB updates). @P0KA#
# $POL=KEN0196,HDZ221N,20111214,SJPLTB: @P0LA#
# 1. Add default value for logicalcache @P0LA#
# $LE7=_NFS_,HDZ221N,20120228,SJPLMB: @LE7A#
# 1. Changed Copyright from 2012 to 2013. @LE7A#
# $020=OA37904,HDZ221N,20120103,IBSDYP: @01AA#
# 1. Add comment to mvsmnt attribute to explain the effects @01AA#
# when a processing attribute is not specified. @01AA#
# $POM=SM01485,HDZ221N,20130311,SJPLHPN: @P0MA#
# 1. Correct the percentsteal comments. @P0MA#
# $PON=SM01491,HDZ221N,20130311,SJPLHPN: @P0NA#
# 1. Correct the Proprietary stmt. @P0NA#
#----- Release V2R2 -----@LFD1A#
# $LFD1=SM01523,HDZ222N,20130404,IBSDYP: @LFD1A#
# 1. Showattr should display z/OS NFSS default network @LFD1A#
# domain if NFSV4DOMAIN attribute is not specified. @LFD1A#
# $LFC=SM01541,HDZ222N,20130705,IBSDYP: @LFCA#
# 1. Added id2name(cache|callsaf) attribute to control @LFCA#
# Uid/Gid Cache for id to/from name conversion. @LFCA#
# $LFD=SM01533,HDZ222N,20130410,IBSVKR: @LFD4A#
# 1. Remove restriction of 10 lines on console @LFD4A#
# $01B=OA43352,HDZ222N,20130923,IBSVAE: @01BA#
# 1. oemhsm/noemhsm support. @01BA#
# $LFS=SM02141,HDZ222N,20140106,SJPLSLH: @LFSA#
# 1. alias/noalias support @LFSA#
# $01C=OA44119,HDZ222N,20140205,IBSVKR: @01CA#
# 1. New site attribute: memfree @01CA#
# $P00=SM02164,HDZ222N,20140618,IBSDYP: @P00A#
# 1. Add to MAPLOWER attribute section the description of @P00A#
# special case of the MVS mount failure. @P00A#
# $01D=OA47848,HDZ222N,20150603,SJPLSLH: @01DA#
# 1. Site attribute: sync/async @01DA#
# #
#####

```

```

#
# This is a prototype site defaults attribute file for the
# Z/OS Network File System Server Sample Attribute Table @L6C
#
# '#' character starts a comment. Comments can appear anywhere.
# White space is ignored when parsing the file.

# Default values are illustrated in the examples in this file

#
# Keywords are not case sensitive. 'BLKS' is the same as 'blks' is
# the same as 'Blks'.

# All time values are in seconds.

#####
# The following are known as data set creation attributes. #
#####

# SPACE specifies the amount of primary and secondary space allocated
# for a new data set. The syntax is:
#
#     SPACE(PRIMARY,SECONDARY)
#
# The secondary field is optional (if omitted, the default is taken).
#
# Dimension of allocation is BLKS, TRKS, or CYLS
# RECS is a synonym for BLKS.

space(100,10), blks
# RLSE specifies that unused space should be released from the data
# set the first time that a new data set is closed. For slow clients,
# with long pauses between writes, the RLSE attribute will cause space
# to be released from the primary extent prematurely. Subsequent
# writes will cause secondary space to be allocated.

norlse

# The record format, or RECFM, defines part of the layout of a data
# set: how the records are physically layed out on disk.
#
# Valid RECFM characters are:
#
#     V - Variable Length Records (LRECL defines maximum size of
#         any record)
#     F - Fixed Length Records (LRECL defines the actual length of
#         all records)
#     U - Undefined Length Records
#
# modified by:
#
#     B - Records are Blocked (BLKSIZE defines the size of the block)
#     S - Spanned for variable length records
#         Standard format for fixed length records
#     M - Machine Control Codes
#     A - ANSI Control Codes
#
# "A" and "M" are mutually exclusive @P0IC
# "V", "F", and "U" are mutually exclusive
# "S" is not allowed for DSNTYPE(PDS) and DSNTYPE(LIBRARY)
# (refer to DSNTYPE later in this section.)
#
# The BLKSIZE is the size, in bytes, of a physical block on disk.
# BLKSIZE(0) allows the system to choose an optimized block size.

```

```

# The system does not determine a block size for Direct Access    @017A
# (DA) data sets. z/OS NFS Server uses the following formula      @017A
# to calculate the block size for a DA data set depending on     @017A
# the record format:                                           @017A
#                                                                 @017A
# F | FB  blksize = lrecl                                       @017A
# V | VB  blksize = lrecl + 4                                   @017A
# VS | VBS blksize = 6160                                       @017A
#                                                                 @017A
# LRECL defines the size, in bytes, of a logical record in the data set.

recfm(vb), blksize(0), lrecl(8196)

# The data set organization can be one of:
#
#      PS          - Physical Sequential
#      DA          - Direct Access
#      INDEXED     - VSAM KSDS data set
#      NONINDEXED  - VSAM ESDS data set
#      NUMBERED    - VSAM RRDS data set
#
# PS is a good organization for NFS usage, and NONINDEXED is the
# corresponding good VSAM data set for NFS (e.g. with AIX client in
# BINARY mode) usage.

dsorg(ps)

# DSNTYPE specifies whether a PDS or a PDSE is to be created when
# the make directory workstation command is issued.
#
# Valid DSNTYPES are:
#
#      PDS        - Create a Partitioned Data Set.
#      LIBRARY    - Create a Partitioned Data Set Extended.

dsntype(pds)

# Number of Directory blocks for PDS allocation

dir(27)

# The MGMTCLAS specifies the management class associated with the
# file creation.
#
# The syntax is:
#
#   mgmtclas(mgmt_class_name)

# The VOLUME (or VOL) attribute enables you to specify the volume
# on which to create the specified data set.
#
# The syntax is:
#
#   volume(volser)

# The UNIT attribute enables you to specify the unit on which to
# create the specified data set.
#
# The syntax is:
#
#   unit(unit_name)

# The following attributes are used to control VSAM data set
# creation. They are used only if the DSORG parameter defines
# the data set to be type INDEXED, NONINDEXED or NUMBERED.
#

```

```

# Refer to appropriate IBM MVS documentation for a more
# complete description of these and other data set creation
# attributes.

# The KEYS(LENGTH,OFFSET) attribute enables you to define the key
# length and offset for a VSAM INDEXED (KSDS) data set. It is used
# only if DSORG is INDEXED.
#
# Valid range for LENGTH is from 1 to 255.
# Valid range for OFFSET is from 0 to 32760.

keys(64,0)

# The RECORDSIZE(AVERAGE,MAXIMUM) attribute enables a user to define
# the average and maximum record sizes for a VSAM data set.
# These two values must be equal for NUMBERED (RRDS) data sets.
#
# Valid range is from 1 to 32760.

recordsize(512,4K)

# The SPANNED and NONSPANNED attributes define whether VSAM
# records will span control intervals. This option does not affect
# non-VSAM variable length record data sets. Use the 'S' option
# with the RECFM attribute for non-VSAM data sets.

nonspanned

# The SHAREOPTIONS attribute defines the cross region and cross
# system file sharing allowed for a VSAM data set.
# Valid range for each argument is from 1 to 4.

shareoptions(1,3)

#####
# The following are known as processing attributes. #
#####

# There are three timeout types: attributes, reads and writes.
# The various timeout values are used by the system to determine
# when to close and deallocate an inactive data set after the last
# "attribute", "read", or "write" operation.
# The WRITETIMEOUT is usually kept short, because WRITE
# operations result in exclusive locking, and you'll want to release
# the data set. For slow clients, with long pauses between writes,
# you'll want to increase the WRITETIMEOUT value.
#
# Valid range is from "m" to "n"; where "m" is the argument of
# MINTIMEOUT(m) and "n" is the argument of MAXTIMEOUT(n), unless
# NOMAXTIMEOUT is specified. In that case, "n" is 32767.
#
# xxxxTIMEOUT(n) indicates to deallocate the data set n seconds after
# the "xxxx" operation;
# NOxxxxTIMEOUT indicates not to deallocate the data set after
# the "xxxx" operation;
# Where "xxxx" can be "ATTR", "READ", or "WRITE".
#
# e.g. WRITETIMEOUT(1) indicates to deallocate the data set 1 second
# after a write.
# NOWRITETIMEOUT indicates not to deallocate the data set after
# a write.
# READTIMEOUT(90) indicates to deallocate the data set 90 seconds
# after a read if no further activity against it.
#
# NOTE: When using the NFS version 4 protocol, these timeout @P09A
# values should be set to a value less than or equal to @P09A

```

```

#         the lease time. Otherwise, it is possible for           @P09A
#         performance problems to occur when attempting to access @P09A
#         MVS data sets.                                         @P09A
# Also, WRITETIMEOUT(n,o) for a data set can be specified.     @0FA
# In this case, "o" indicates the number of seconds that NFS    @0FA
# Server will wait for data to arrive to complete a partial    @0FA
# record before closing the data set.                            @0FA
# Valid range for "o" is from "n" to "255 * n".                @0FA
# The default value for "o" is "4 * n", if not specified.      @0FA
# It is preferable to set it as a multiple of "n", otherwise it @0FA
# will be rounded down to the nearest multiple of "n".         @0FA

attrtimeout(120), readtimeout(90), writetimeout(30,120)        # @0FC

# Processing may be TEXT or BINARY
#
# BINARY is good for using MVS as a disk farm for PCs and AIX machines
# and offers better performance.
#
# TEXT should be specified if it is necessary to share data sets
# containing textual data with other MVS applications.

binary

#                                                                 @LA7A
# MAPPED should be specified when a mixed set of data types are @LA7A
# to be processed on a single mount point. The determination    @LA7A
# of whether the data is to be processed as text or binary     @LA7A
# depends on the rules established in the specified side file.  @LA7A
# If a file extension cannot be mapped to text or binary, then @LA7A
# the data will be processed according to what has been specified @LA7A
# as binary or text at the mount level, and finally, the site  @LA7A
# level. If binary or text is specified at the file level,    @LA7A
# the specification overrides the MAPPED specification.        @LA7A
#                                                                 @LA7A
# The syntax is:                                               @LA7A
#                                                                 @LA7A
# mapped                                                         # @LA7A
#                                                                 @LA7A

# The end of line terminators are:
#
#         CR, CRLF, LF, LFCR, or NOEOL.
#
# They define the conversion of records to end-of-line terminators in
# TEXT mode.
# LF should be used for AIX clients;
# CRLF should be used for PC clients.
# (set through client mounts appropriately). When TEXT mode is
# specified, LF is the default.

LF

# BLANKSTRIP or NOBLANKSTRIP affects the processing of trailing
# blanks when reading and writing to Fixed Record data sets with
# text processing enabled.

blankstrip

# The MAPLEADDOT attribute turns on mapping of a file name starting
# with a leading "." from a client to a legal leading "$" for a
# MVS data set name. NOMAPLEADDOT turns off this mapping.

mapleaddot

```



```

# The MAPLOWER attribute tells the server to map file names to
# uppercase when received from the client in an NFS request and
# to translate from uppercase to lowercase when returned to the client.
# Keywords are not case sensitive and are unaffected by this option.
#
# The NOMAPLOWER attribute tells the server NOT to do any translation.
# i.e. the server is neither to map uppercase when received from
# the client nor to translate to lowercase when returned to the client.
# All the entries in the EXPORTS file are case sensitive.
# The client MOUNT request must specify the MVS qualifier with
# the correct case to successfully match the EXPORTS file entry.
#

```

maplower

```

# RETRIEVE tells the server to recall a migrated data set on read/write
# access. NORETRIEVE will force the return of "Device not available"
# error for migrated files.
# RETRIEVE can be coded in the following ways:
# RETRIEVE          - nowait for recall.           @09C
# RETRIEVE(WAIT)   - wait for recall.
# RETRIEVE(NOWAIT) - nowait for recall.
# For a quiesced HFS file system:                 @09A
# RETRIEVE(WAIT) will suspend a request until the file system @09A
# will be unquiesced.                             @09A
# Others value will force the return of IO error. @09A
# RETRIEVE is the default

```

retrieve

```

# The FASTFILESIZE attribute tells the server to calculate approximate
# file sizes from available catalog information and disk geometries.
# This approximate size may cause problems with client applications
# since the size is probably inaccurate. The NOFASTFILESIZE may
# result in decreased performance because the server may read a data
# set, applying the defined processing attributes, to determine the
# exact size of the data set as viewed by an NFS client.

```

nofastfilesize

```

# The SETOWNERROOT keyword tells the server to set the user ID in the
# attributes returned to a client for a specified file to 'root' when
# the client is logged on as superuser. SETOWNERNOBODY tells the
# server to set the user ID in the attributes to 'nobody' (65534).@P0BC

```

setownerroot

```

# You can have the execute bit for plain files on or off by mount
# point. Turn this option on if you plan to store executables
# or shell scripts on the MVS system on a mount by mount basis.
# It should probably always be off in the site file.
#
# EXECUTEBITON will turn on the execute bits (user, group
# and other) for a mount point's files.

```

executebitoff

```

# If the installation intends to customize the translation table, @L3XA
# a new DD card, NFSXLAT, is required in the NFSS startup proc. @L3XA
# @L3XA
# //NFSXLAT DD DSN=dataset_name,DSP=SHR @L3XA
# @L3XA
# Where dataset_name is the name of PDS or PDSE whose @L3XA
# members are the translation tables. @L3XA
# @L3XA
# The XLAT(member) keyword tells the server which member @L3XA
# the server is to use as the installation default translation @L3XA

```

```

# table. 'member' is the name of a translation table which      @L3XA
# resides in a PDS or PDSE dataset.                             @L3XA
#                                                               @L3XA
# The syntax is:                                              @L3XA
#                                                               @L3XA
# xlat(member)                                                # @P3C

# The 'overflow' processing attribute for MVS data path turns on @P0KM
# x37 detection support for PS/PDS MVS data sets for NFS v2/v3/v4 @P0KM
# WRITE operations. It allows ENOSPACE errors to be reported to @P0KM
# NFS Client in a timely manner and to avoid situations         @P0KM
# when the z/OS NFS Server closes a data set on timeout expiration@P0KM
# basis with x37 abend which can not be propagated to the NFS   @P0KM
# Client. This option may also be activated on the MOUNT level. @P0KM
# Default mode is no overflow detection.                        @P0KM
# Note: 1. PDSE and VSAM data sets are not supported.          @P0KM
#                                                               @P0KM
# overflow                                                    # @P0KM

# FILEEXTMAP or NOFILEEXTMAP affects the file extension mapping @L59A
# capability. FILEEXTMAP turns on file extension mapping and    @L59A
# NOFILEEXTMAP turns it off. This option can be specified at   @L59A
# the file command level. The default is NOFILEEXTMAP.         @L59A

nofileextmap                                                  # @L59A

# SIDEFILE(dsname) specifies the name of the data set that     @L59A
# contains the rules for file extension mapping purposes.       @L59A
# If a side file name is specified in the attributes data set   @L59A
# then it is the default side file for this NFS server.        @L59A
# A user can also specify another side file name during a MOUNT @L59A
# operation to be used along with the default. The mapping rules @L59A
# will first be searched in the side file specified during MOUNT @L59A
# and then in the default. To allow file extension mapping a    @L59A
# side file name must be specified either as a default or in the @L59A
# MOUNT command. dsname is a fully-qualified MVS data set name @L59A
# without quotation marks. SIDEFILE is only specifiable at the @L59A
# MOUNT level. See GFSAPMAP for sample mapping side file and   @L59A
# syntax.                                                       @L59A

# sidefile(dsname)                                            # @P0IA

# TAG specifies the newly created files should receive a file tag.@LCEA
# NOTAG specifies the newly created file should be untagged.   @LCEA
# The default is NOTAG.                                        @LCEA

notag                                                         # @LCEA

# CLN_CC SID(n) specifies the Coded Character Set Identifier(CCSID)@LC1A
# for the remote mounted file system (NFS client) when text is @LC1A
# being translated.                                           @LC1A
# The default (if specified) is 819 (ISO 8859-1 ASCII).        @LC1A

c1n_ccsid(819)                                              # @LCEC

# SRV_CC SID(n) specifies the Coded Character Set Identifier(CCSID)@LC1A
# for the local file system (Z/OS NFS Server) when              @L6C
# a new file is being created.                                 @LC1A
# The default (if specified) is 1047 (Latin Open System EBCDIC). @LC1A

srv_ccsid(1047)                                             # @LCEC

# CONVSERV(technique) - 'technique' specifies technique-search-order
# which Unicode Service will use for specified srv_ccsid(n) and @LCEA
# c1n_ccsid(n) code pages.                                     @LCEA

```

```

# 'technique' consists of up 5 technique-characters corresponding @LCEA
# to the 5 available techniques: R, E, C, L and M. @LCEA
# The default is CONVSERV(LRE). @LCEA

    convserv(LRE) # @LCEA

# MVSMT specifies that in NFS version 4, a lookup will be @P07M
# treated as if a mount procedure were given for the LOOKUP @P07M
# result object. @P07M
# @P07M
# For any LOOKUPS that do not specify MVSMT, any Processing @P07M
# Attributes that may have been provided will be merged @P07M
# with any that were in effect for the LOOKUP parent directory. @P07M
# @P07M
# For LOOKUPS that *DO* specify MVSMT, any other Processing @P07M
# Attributes provided will be merged with the site defaults. @P07M
# MVSMT cannot be specified for any LOOKUP where the parent @P07M
# directory was navigated to by an mount procedure or a result @P07M
# of an object that was already LOOKUP'ed with MVSMT. This @P07M
# is to ensure that only a client system mount specifies MVSMT. @P07M
# If the MVSMT, or any other, processing attribute is not @P07M
# specified, then SAF checking may be disabled longer than @P07M
# desired due to the z/OS NFS server not being able to detect @P07M
# the end of the mount and the beginning of other access @P07M
# requests. However, access is only allowed to information @P07M
# necessary for the completion of mount related processing. @P07M
# This behavior is required to avoid requiring an mvslogin to @P07M
# be issued prior to mount processing. The EXPORT file may @P07M
# be used to restrict access to file systems, regardless of the @P07M
# specification of any processing attribute. @P07M
#
# MVSMT is not to be specified as a site default attribute. @P07M
# There is no default. MVSMT should not be specified in the @P0IA
# attributes data set. The mvsmt attribute should only be @P0IA
# specified on NFS Version 4 mount commands. @P0IA
# @P0IA
# NORDRCACHE specifies that the server should not @00EA
# stale the Legacy (MVS conventional data) directory cache if an @00EA
# addition is made to the directory. This causes the next @00EA
# READDIR operation to access the directory @00EA
# information from the Physical File System (PFS) rather than the @00EA
# directory cache. @00EA
# @00EA
# The NORDRCACHE attribute does not apply to z/OS UNIX files. @00EA
# @00EA
# NOTE: When NORDRCACHE is not specified, the addition of an entry @00EA
# to the LEGACY directory cache will not be visible to client @00EA
# until the next readdir cache timeout or a remove from that @00EA
# directory. @00EA
# When NORDRCACHE is specified, the addition will be visible to @00EA
# the client by the subsequent READDIR whether the readdir @00EA
# cache timeout has expired or not. This may impact @00EA
# performance because the directory list must be read from the @00EA
# Physical File System after any addition to the directory. @00EA
# @00EA
# The syntax is: @00EA
# @00EA
# NORDRCACHE # @00EA

# The RDRVERF attribute tells the server to do cookie verifier @00EA
# checking for NFS version 3 readdir and readdirplus requests, @00EA
# and for NFS version 4 readdir requests. @00EA
# NOTE: RDRVERF provides consistency in the listing of a @010A
# directory's content and as a result may impact performance. @010A
# @00EA
# The NORDRVERF attribute tells the server not to do cookie @00EA
# verifier checking for NFS version 3 readdir and readdirplus @00EA
# requests, and for NFS version 4 readdir requests. @00EA
# NOTE: NORDRVERF does not provide consistency in the listing of @010A

```

```

# a directory's content and may cause duplicate or omit entries @010A
# when the directory is changing during the listing. @010A
# The default is NORDRVERF. @0EA

nordrverf # @0EA

# ZNFSCIENT specifies that the NFS Client is z/OS. @LAHA
# @LAHA
# This value is used for compatibility purposes only. For @LAHA
# example, z/OS Unix System Services has separate File and @LAHA
# Directory Default Access Control Lists (ACLs). Other platforms @LAHA
# a common Default ACL which is used for both. This flag @LAHA
# allows the z/OS NFS Server to customize its response to the @LAHA
# NFS Client accordingly. @LAHA
# @LAHA
# NOTE: This value should never be specified by the customer. @LAHA
# this attribute is automatically appended to the processing @LAHA
# attribute string by the z/OS NFS Client when it detects that @LAHA
# it is sending the mount request (or the last LOOKUP for an @LAHA
# NFS version 4 mount) to a z/OS NFS Server. @LAHA
# If this attribute is specified on a non-z/OS Client Mount @LAHA
# request, some requests may not function properly. @LAHA
# @LAHA
# ZNFSCIENT DO NOT SPECIFY! The attribute is listed here for @LAHA
# documentation purposes only. @LAHA

#####
# The following are known as site attributes. #
#####
# The following are attributes specifiable ONLY in the site
# file (this file).
#
# Some of these values control internal structures and processing
# within the NFS server. Tuning of these values to improve performance
# should be done incrementally and tested.

# SECURITY attribute control the level of security checking.
# The format of the security keyword is security(mvs,hfs,public) @L5DA
# where: @L5DA
# mvs - security option for mvs data access @L5DA
# hfs - security option for HFS data access @L5DA
# public - security option for data access with the public @L5DA
# filehandle @L5DA
# The first positional parameter is required and the other two @L5DA
# are optional. When the optional parameters are not specified @L5DA
# they are assigned the same security as the first parameter. @L5DA
# Four options can be chosen from. They are:
# NONE - No security checking is performed.
# SAF - SAF checking is performed in line.
# EXPORTS - EXPORTS file is used to check security.
# SAFEXP - Both SAF and EXPORTS file checks are performed.
#
#
# Defaults are SAFEXP for all data accesses. @L5DA

security(safexp,safexp,safexp) # @L5DC

# PCNFSD tells the server to start PCNFS server.
# NOPCNFSD tells the server not to start PCNFS server.
# If not specified PCNFSD, default is NOPCNFSD.

nopcnfsd

# LEADSWITCH tells the server to return '/' as the first character

```

```

#           in each export entry.
# NOLEADSWITCH tells the server not to return '/' as the first character
#           in each export entry.
# If not specified NOLEADSWITCH, default is LEADSWITCH.

leadswitch

# MINTIMEOUT and MAXTIMEOUT set allowable values for
# ATTRTIMEOUT, READTIMEOUT, and WRITETIMEOUT. Specify NOMAXTIMEOUT
# to allow NOATTRTIMEOUT, NOREADTIMEOUT and NOWRITETIMEOUT specification
# by clients.
#
# Valid range is from 1 to 32767.

mintimeout(1)
nomaxtimeout

# The logout time is the time limit on inactivity for a given user
# on a machine. When the limit is reached, the user is automatically
# logged out. The user must then do another "mvslogin" to restart
# the session. The time value is specified in seconds.
#
# You would probably want to set LOGOUT to the TSO timeout value that
# is defined at your site.
#
# MAXTIMEOUT does not affect the LOGOUT site attribute.
#

logout(1800)           # 30 minutes (30 * 60)

# The readdirtimeout is a new timeout attribute to control the      @03A
# timeout of the readdir cache used by MVS conventional data        @03A
# sets. The timeout value controls how long before the readdir     @03A
# results saved in cache are discarded.                             @03A
#                                                                    @03A
# Valid range is from 1 to 32,767 seconds.                          @04C
#                                                                    @03A
# n can go as low as 1 second but to avoid the possibility of      @04C
# client hanging (because of network delays and staled cache),     @04C
# n is not recommended to be lower than 5 seconds.                 @04A
# n may need to be increased if the network is slow and the        @03A
# accessed directory has a lot of entries.                          @03A
# The default readdirtimeout is 30 seconds.                         @03A

readdirtimeout(30)           # @03A

# The NFSTASKS(n,m,o,t,u)                                         @P0DC
# defines the number of NFS tasks (or threads) to spawn.          @P0DC
#                                                                    @LA1A
# If NFSTASKS(n,m) is specified, then the following is true:     @LA1A
#                                                                    @LA1A
# 'n' is the number of subtasks which handle the asynchronous I/O @L3BC
# operations or short blocking operations (the maximum number of  @LA1C
# concurrent NFSS requests) in the z/OS MVS data path.             @P0IC
# 'm' is the number of subtasks which handle the long blocking     @L3BC
# operations (the maximum number of concurrent NFSS recall and    @L3BC
# HFS requests.). Increase this value if your server supports     @L3BC
# many active recall operations or HFS clients.                   @P0IC
#                                                                    @P0IC
# Valid range for 'n' is from 4 to 99.                             @P0IC
# Valid range for 'm' is from 4 to 100.                           @P0IC
# The sum of 'n' plus 'm' must be less than or equal to 100.      @0DC
#                                                                    @0DA
# NOTE: Based on system resources available below the 16Mb line,  @0DA
# the maximum 'n' value may not be achievable. The                @0DA

```

```

#       precise maximum value will be system configuration      @0DA
#       dependent. If an 878 or 80A Abend is experienced during @P0AC
#       NFSS startup, use a smaller value for 'n'.              @P0AC
#
# If NFSTASKS(n,m,o) or NFSTASKS(n,m,o,t,u) is specified,      @P0DC
# then the following is true:                                    @P0DA
#                                                                 @LA1A
# 'n' is the number of subtasks which handle the asynchronous I/O @LA1A
# operations or short blocking operations (the maximum number of @LA1A
# concurrent NFSS requests) in the MVS data path.                @P0IC
# 'm' is the number of subtasks which handle HFS requests.       @LA1A
# Increase this value if your server supports lots of active    @LA1A
# HFS clients.                                                  @LA1A
# 'o' is the number of subtasks which handle the long blocking  @LA1A
# operations (the maximum number of concurrent NFSS recall     @LA1A
# requests) in the z/OS MVS data path.                           @P0GC
# Increase this value if your server supports many active recall @P0IC
# operations.                                                  @P0IC
# 't' is the number of transport subtasks which handle TCP      @P0DA
# network requests.                                             @P0DA
# 'u' is the number of transport subtasks which handle UDP      @P0DA
# network requests.                                             @P0DA
#
# Valid range for 'n' is from 4 to 99.                          @P0IC
# Valid range for 'm' is from 4 to 100.                         @P0IC
# Valid range for 'o' is from 1 to 99.                          @0DC
# Valid range for 't' is from 4 to 32.                          @P0DA
# Valid range for 'u' is from 4 to 32.                          @P0DA
# The sum of 'n' plus 'o' must be less than or equal to 100.    @0DC
#                                                                 @0DA
# NOTE: Based on system resources available below the 16Mb line, @0DA
# the maximum 'n' + 'o' value may not be achievable. The       @0DA
# precise maximum value will be system configuration           @0DA
# dependent. If an 878 or 80A Abend is experienced during     @P0AC
# NFSS startup, use a smaller value for 'n' + 'o'.             @P0AC

nfstasks(8,16,8,4,4)                                           # @P0DC

#                                                                 @L66A
# The MINTASKS(n,m,o) defines the minimum number of NFS tasks  @L66A
# or threads) allowed to run. Tasks may be terminated for reasons @L66A
# such as 878 or 80A abends.                                     @L66A
#
# Note: Options t and u in NFSTASKS(n,m,o,t,u) do not have     @P0DA
# MINTASKS counterparts because MINTASKS only applies to       @P0DA
# the request processing tasks, not the transport tasks.       @P0DA
#
# 'n' is the minimum number of subtasks which handle           @L66A
# the asynchronous I/O operations or short blocking             @L66A
# operations. If the number of active 'short' tasks becomes    @L66A
# less than 'n' the shutdown process of NFS server will start. @L66A
# 'm' is the minimum number of subtasks which handle HFS       @L66A
# requests. If the number of active HFS tasks becomes less    @L66A
# than 'm' the shutdown process of NFS server will start.     @L66A
# 'o' is the minimum number of subtasks which handle long      @L66A
# blocking operations. If the number of active legacy long    @L66A
# service tasks becomes less than 'o' the shutdown process    @L66A
# of NFS server will start.                                     @L66A
# If 'n','m' or 'o' are greater than the corresponding values  @L66A
# in NFSTASKS, they are assigned to half of the NFSTASKS value. @P0IC
# If 'n','m' or 'o' are not specified they are assigned default @P0IC
# values of 4,4,1 respectively.                                 @P0IC
# Valid range for 'n' is from 4 to 99.                          @P0IC
# Valid range for 'm' is from 4 to 100.                         @P0IC
# Valid range for 'o' is from 1 to 99.                          @0DC
# The sum of 'n' plus 'o' must be less than or equal to 100.    @0DC
#                                                                 @0DA

```

```

# NOTE: Based on system resources available below the 16Mb line, @0DA
# the maximum 'n' + 'o' value may not be achievable. The @0DA
# precise maximum value will be system configuration @0DA
# dependent. If an 878 or 80A Abend is experienced during @P0AC
# NFSS startup, use a smaller value for 'n' + 'o'. @P0AC

mintasks(4,8,4) # @L66A

# The RESTIMEOUT(n,m) defines resource cleanup timer. @L3LA
# 'n' is the resource retention period for mounts and
# associated resources which will be removed if the mounts
# have been inactive more than 'n' number of hours. @L3LA
# 'm' is the time of day to do the cleanup work
# for mounts and associated resources which
# have been inactive more than 'n' number of hours.
# The time of day is specified as a 24 hour local time value
# The starting time is at least 24 hours from NFSS start-up.
# @L3LA
# NFSS will appear slow during this cleanup activity. @L3LA
# Cleanup will be executed under main task, thus preventing
# any additional work from executing. @L3LA
# The value of RESTIMEOUT should be set to a value @L3LA
# such that this cleanup activity will occur while @L3LA
# NFSS is lightly loaded. @L3LA
# @L3LA
# Valid range for 'n' is from 1 to 720. @L3LA
# If n is set to 0, NFSS will not remove any mount points. @L3LA
# Note: NFSS keeps all the information for the @L3LA
# inactive mount points, thus creating long chains @L3LA
# to be searched. @L3LA
# @L3LA
# Valid range for 'm' is from 0 to 23. @L3LA

restimeout(48,0) # @L3LA

# The CACHEWINDOW attribute limits the number of windows to be used
# for each data set in caching client block writes which are received
# out of order.
# The size of each window is determined by the packet size.
# The suggested value is some small multiple of
# the number of BIODs running on an NFS client.
#
# If the "adjusted" LOGICALCACHE is larger than 2GB then the @LEPA
# specified CACHEWINDOW value is ignored. @LEPA
# Valid range is from 1 to 2048. @011C
#

cachewindow(112) # @P5C

# The HFSPREFIX (or HFS) attribute specifies a z/OS UNIX file @LBBC
# system prefix to be imbedded in the mount directory path name. @LBBC
# The default value of the z/OS UNIX file system prefix is /hfs. @LBBC
# Mount requests received by the Network File System beginning @LBBC
# with this prefix value are identified as mount requests for @LBBC
# z/OS UNIX. The prefix value is not part of the path name. @LBBC
# @01A
# Note: The file system must be mounted locally by z/OS UNIX. @LBBC
# Otherwise, the client mount fails. @LBBC
# hfsprefix(prefix) or hfs(prefix) @LBBC

hfsprefix(/hfs) # @LBBC

# The MVSPREFIX attribute specifies an MVS data set prefix @LBBA
# to be imbedded in the mount directory path name. @LBBA
# The default value of the MVS data set prefix is /mvs. @LBBA
# Mount requests received by the Network File System beginning @LBBA

```

```

# with this prefix value are identified as mount requests for @LBBA
# MVS data sets. The prefix value is not part of the path name. @LBBA
# @LBBA
# mvsprefix(prefix) @LBBA

mvsprefix(/mvs) # @LBBA

# The IMPPREFIX attribute specifies how mount directory path @LBBA
# names which do not have either an HFSPREFIX or an MVSPREFIX @LBBA
# are to be interpreted. If no prefix is present in the path @LBBA
# name, the path is to be interpreted according to the IMPPREFIX @LBBA
# setting: @LBBA
# HFS - assume it is a z/OS UNIX file system. @LBBA
# MVS - assume it is an MVS data set. @LBBA
# HFS,MVS - try z/OS UNIX file system first. If that fails @LBBA
# or is not found, try MVS data set. @LBBA
# MVS,HFS - try MVS data set first. If that fails or is not @LBBA
# found, try z/OS UNIX file system. @LBBA
# The default value is MVS, which matches pre-z/OS V1R11 @LBBA
# functionality. @LBBA
# @LBBA
# Note: For the MVS,HFS setting, the MVS data set must exist @LBBA
# if the path is referring to an MVS data set. Prior to @LBBA
# this attribute being added, it was not necessary for the @LBBA
# data set to pre-exist. However, now, if it does not @LBBA
# exist, the 2nd option (HFS) will be used. @LBBA

impprefix(mvs) # @LBBA

# fileidsize site attribute: @P08C
# @P08C
# The fileidsize attribute tells NFS how to handle the size @P08C
# of fileids. Fileids can be recognized either as 32-bit @P08C
# values or 64-bit values. @P08C
# @P08C
# Client platforms often copy the returned NFS object fileid to @P08C
# client internal structure fields such as a UNIX inode. Older @P08C
# 32-bit applications and operating systems may not support NFS @P08C
# fileids larger than 32 bits resulting in value too large errors @P08C
# or unexpected client behaviors. @P08C
# @P08C
# IBM recommends upgrading older applications and operating @P08C
# systems to an environment which supports the latest supported @P08C
# NFS Protocol Version offering the largest supported fileidsize. @P08C
# If upgrading your environment is not possible, the fileidsize @P08C
# may be set to a lower value to support older applications if @P08C
# accessed data can be properly recovered or refreshed. @P08C
# @P08C
# Valid values are 32 or 64. @P08C
# @P08C
# NFS Version 2 maximum value in effect is (32) bits @P08C
# NFS Version 3 maximum value in effect is (32) bits @P08C
# NFS Version 4 maximum value in effect is (64) bits @P08C
# @P08C
# If NFS Version 2 or Version 3 is in effect, the maximum value @P08C
# of 32 is used. When the specified fileidsize value @P08C
# is larger than the maximum value for the NFS Version in effect, @P08C
# the proper maximum value will be used for generating @P08C
# the NFS fileid attribute. @P08C
# @P08C
# Warning: @P08C
# @P08C
# The fileidsize site attribute should be set to the maximum @P08C
# value to generate the maximum size in unique ids for NFS @P08C
# objects within a file system. Setting the value lower than @P08C
# the allowed maximum (e.g. NFS Version 4) may result in the @P08C

```



```

# same NFS fileid to be returned to the client for          @P08C
# different server objects. As a result, reducing the      @P08C
# fileidsize site attribute for client                     @P08C
# compatibility may result in data corruption.            @P08C
#                                                         @P08C
# The default is fileidsize(64)                           @P08C

fileidsize(64)                                           # @P08C

# The LOGICALCACHE attribute sets the high water mark for all the
# cache windows combined(in bytes).
# The LOGICALCACHE attribute denotes the memory above 2GB BAR @LEPA
# and it is related to the system MEMLIMIT.              @LEPA
# *) The z/OS Server will terminate if the specified LOGICALCACHE @LEPA
# is LARGER THAN the usable memory of the system MEMLIMIT. @LEPA
# *) The z/OS Server may adjust the LOGICALCACHE to take @LEPA
# advantage of the large usable memory of the system MEMLIMIT @LEPA
# | = MIN( 4096G, 1/2 of available memory above 2GB ) ". @LEPA
# *) The modify operator BUFFERUSAGE command reports the @LEPA
# "adjusted" LOGICALCACHE.                               @LEPA
#                                                         @LEPA
# Valid range is from 1 to 4096G.                        @LEPC
# The default value is 16MB                               @P0LA

logicalcache(4G)                                         # @LEPC

# BUFHIGH(XX,YY)                                         @LCQC
# The BUFHIGH attribute sets the high water mark (in bytes) @LCQC
# of data buffers ( below 2GB BAR )                     @LEPC
# before a buffer reclamation takes place                @LEPC
# (it's the first parameter XX) and the watermark in percent of @LCQC
# XX for printing a data buffer utilization alert message @LCQC
# (it's the second parameter YY).                       @LCQC
# A higher number of XX means more caching and probably better @LCQC
# read performance.                                     @LCQC
# (If XX is larger than the available storage            @LEPC
# in the extended private area (implied by the REGION parameter @LCQC
# coded in your PROC) at startup, the NFS server will @LCQC
# shutdown immediately.)                                @LCQC
#                                                         @LCQC
# At z/OS Server startup, the actual value (xx) specified with @P0GA
# bufhigh may be adjusted by the z/OS NFS Server internally @P0GA
# depending on the available region size and other z/OS NFS @P0GA
# Server memory requirements to enable the z/OS NFS Server to @P0GA
# execute properly.                                     @P0GA
#                                                         @P0GA
# The valid value of YY is from 50 to 90 percents or 0(zero) @LCQC
# to turn off the data buffer utilization reporting mechanism. @LCQC
# Any invalid value of YY is converted to 80 percent.    @LCQC
# The default value of YY is 80 percent.                 @LCQC
# If Bufhigh contains only the first parameter (comma and YY are @LCQC
# omitted) the default value of YY is used.              @LCQC

bufhigh(32M,80)                                         # @P0IC

# On reaching the BUFHIGH high water mark, a percentage of buffers
# is reclaimed for reuse. This is the PERCENTSTEAL. A higher value
# means a reclaim operation is frequently performed, and that
# the cached buffers will be significantly trimmed on each reclaim.
# This can result in a poor read performance, because readahead
# buffers may be stolen.
# Lower values result in less frequent reclaim operations, and the
# cached buffers are not significantly trimmed on each reclaim.
#

```

```

# Valid range is from 1 to 99.

percentsteal(20)

# The READAHEADMAX value defines the maximum read ahead (in bytes)
# during read processing.
# This reduces the amount of synchronous physical I/O required for
# NFS read requests in sequential processing. It also reduces context
# switching overhead on NFS read requests by allowing more read
# requests to be satisfied directly from the main task.
#
# The number is usually set to 2 to 4 times the common block size
# used for file access (which is recommended at 8K for AIX file
# activity).
#
# Valid range is from 1 to 128K

readaheadmax(16K)

# The MAXRDFORSZLEFT attribute defines the number of physical block
# buffers to be remained after a read-for-size operation.
# These buffers are remained to satisfy potential subsequent
# NFS read requests against the same file.
# The buffers remained are subject to trimming during buffer
# steal operations.
#
# Valid range is from 1 to 1024.

maxrdforszleft(32)

# SMF(level,switch) attribute controls the level of smf support @08A
# and defines whether to start SMF records collection @08A
# at the NFSS startup or not. @08A
# The following 'level' options are available: @LCOC
# NONE - No smf records are to be produced. @08A
# ALL - All smf records are to be produced. @LCOA
# USERFILE - Both user session and file usage smf records are @LCOM
# to be produced. @LCOM
# List of levels that are delimited by commas, can be specified. @LCOA
# At least one of the levels: ( USER | FILE | AUDIT ) @LCOA
# must be specified for a list, and the remaining levels @LCOA
# are optional. Where: @LCOA
# USER - User session smf records are to be produced. @08A
# FILE - File usage smf records are to be produced. @08A
# AUDIT- File creation, file removing and file renaming @LCOA
# smf records are to be produced. @LCOA
# Default level is NONE. @LCOC
# Switch has two options: @08A
# ON - activates SMF records collection at the NFSS @08A
# startup @08A
# OFF - activation of SMF records collection can be done @08A
# manually by issuing the operator command MODIFY. @08A
# Switch is optional parameter. Its default value is OFF. @08A
# @08A
# The syntax of the SMF attribute is @08A
# SMF(NONE|ALL|USERFILE|subtype_list,ON|OFF) @LCOC
# where subtype_list is list of 1 - 3 levels:(USER|FILE|AUDIT) @LCOA
# separated by commas. @LCOA
# For example, @08A
# SMF(USER,ON) @08A
# SMF(AUDIT,FILE,OFF) @LCOA
# You can use the short form of the SMF attribute: @08A
# SMF(level) @08A
# In that case the value of the switch is OFF @08A
smf(none,off) # @08A

```

```

# SFMAX(n) where n specifies the maximum size (in kilobytes) of @L59A
# allocated storage to hold all of the side files. n is an @L59A
# integer from 0 to 2000 (2MB). The default value is 0 and it @L59A
# also signifies that no mapping is allowed on this NFS server. @L59A
# If SFMAX=0, the specification of sidefile in the attributes @L59A
# data set will cause the server to shut down and the @L59A
# specification of sidefile in any subsequent MOUNT commands will @L59A
# cause the mount to fail as mapping is not allowed on this NFS @L59A
# server. If the amount of storage specified can not be obtained @L59A
# during server initialization then the server will shut down @L59A
# immediately. @L59A
# @L59A
# The default is SFMAX(0). @L59A

sfmax(0) # @L59A

# PUBLIC(legacy_path,hfs_path) specifies the legacy path @L53A
# (MVS conventional data) and/or HFS path that is associated with @L53A
# the public file handle for WebNFS access. The first path, if @L53A
# specified, is the legacy path. The second path is the HFS @L53A
# path. MVS and HFS prefix values are optional on these path @LBBC
# name values since they are positional and thus self-defining. @LBBA
# However, if a prefix is specified, it must match the active @LBBA
# prefix value to be recognized as such. Otherwise, it will @LBBA
# be assumed to be a qualifier in the path name. The PUBLIC @LBBA
# keyword must be specified after the HFSPREFIX (or HFS) and @LBBA
# MVSPREFIX keywords in this site attribute table. @LBBA
# If the first path is not there, a comma must precede @LBBC
# the second path. If the PUBLIC keyword is specified then one @L53A
# of the paths must be specified. @LBBC
# A LOOKUP request with the public file handle will determine @L53A
# which of the two paths it is referring to by the pathname that @L53A
# it comes in with. An absolute pathname will tell the server @L53A
# which of the paths it is referring to by a match on one of the @L53A
# paths specified. A LOOKUP request with a relative pathname @L53A
# will be taken to be an HFS request if HFS is active (i.e. an @L53A
# hfs_path has been provided); otherwise, it is treated as a @L53A
# legacy request. @L53A
# @L53A
# The default is no PUBLIC paths. @L53A

# CHECKLIST refers to the data set pointed to by the EXPORTS DD @L81C
# in the startup procedure to be scanned. The data set may contain @L81C
# a list of CHKLIST entries which should match a subsequent @L81C
# mount point or be the parent of a subsequent mount point to @L5DA
# allow SAF checking to be bypassed for everything underneath @L5DA
# that mount point. CHECKLIST is only valid if SAF checking is @L5DA
# the security option for the particular data access; otherwise, @L5DA
# it is ignored even if specified. See GFSAPEXP in NFSSAMP @L81C
# library for sample CHKLIST entries description. @L81C
# NOCHECKLIST will cause the server not to look at the CHKLIST @L81C
# information in the EXPORTS data set even if it is there. This @L81C
# is the default. @L81C

nochecklist # @L5DA

# FN_DELIMITER specifies a character to be used instead of a @L5XA
# comma to delimit the file name from the accompanying attributes. @L5XA
# This will allow those sites which have UNIX data sets containing @L5XA
# commas to copy and store their data on the Z/OS NFS Server. @L6C
# @L5XA
# An example of this would be: @L5XA
# The attribute data set contains fn_delimiter(;) @L5XA
# this changes the default delimiter character from a comma @L5XA
# to a semicolon. @L5XA
# @L5XA

```

```

# so instead entering ... vi "data_set_name;text,lf" @L5XA
# @L5XA
# you would enter.....vi "comma,in-name;text,lf" @L5XA
# @L5XA
# This is a new SITE attribute and it's default is a comma @L5XA
# @L5XA
fn_delimiter(,) # @L5XA

# The hfsbtimeout is a new timeout attribute to control the @06A
# timeout of the HFS vnode token used by NFS server. @06A
# The timeout value controls how long before vnode tokens @06A
# saved in file blocks are released. @06A
# @06A
# Valid range is from 1 to 32,767 seconds. @06A
# @06A
# n can go as low as 1 second but to avoid the possibility of @06A
# client hanging (because of network delays), @06A
# n is not recommended to be lower than 5 seconds. @06A
# n may need to be increased if the network is slow and the @06A
# accessed directory has a lot of entries. @06A
# The default hfsbtimeout is 60 seconds. @06A
# @06A
hfsbtimeout(60) # @06A

# The UPCASE attribute will convert the messages to uppercase. @07A
# The MIXCASE attribute will display the messages without @07A
# any modification (as they are). @07A
# The default is upcase. @07A
# @07A
upcase # @07A

# NOREC878 specifies that recovery processing of 878 or 80A @L66A
# abends will be turned OFF. That is, if this type of abend @L66A
# occurs, server will shutdown without recovery. @L66A
# It can be used for Debug only. @L66A
# REC878 specifies that recovery processing of 878 or 80A @L66A
# abends will be turned ON, and affected tasks will attempt to @L66A
# recover. @L66A
# This is default value. @L66A
rec878 # @L66A

# NLM tells the server to start Lockd/Statd. @L74A
# NONLM tells the server not to start Lockd/Statd. @L74A
# If not specified NLM, default is NONLM. @L74A

nonlm # @L74A

# DELEGATION tells the server to enable delegation support. @LBCA
# NODELEGATION tells the server not to enable delegation support. @LBCA
# If neither is specified, the default is NODELEGATION. @LBCA

# nodelegation # @LBCA

# Stringprep Support:
# Stringprep is a standard by which similar characters are @L82A
# mapped to a common character to improve string compares. NFS @L82A
# calls Z/OS Conversion Services stringprep services when @L82A
# receiving network strings such as filenames. @L82A
# STRINGPREP tells the server to invoke Stringprep support. @L82A
# NOSTRINGPREP tells the server to disable Stringprep support. @L82A
# Default: @L82A
# For compatibility with NFS version 4 support in Z/OS V1R7 @L82A
# stringprep is disabled by default: NOSTRINGPREP @L82A
# @L82A
# stringprep # @L82A

```

```

# nostringprep # @L82A

nostringprep # @L82A

# Leasetime(n) specifies the lease time for NFSv4 access. The @L74A
# lease time is the length of time for which a client is @L74A
# irrevocably granted a lock. At the end of a lease period the @L74A
# lock may be revoked if the lease has not been extended. @L74A
# The lock must be revoked if a conflicting lock has been @L74A
# granted after the lease interval. The lease time is also @L74A
# used to specify the grace period duration. The grace period @L74A
# is the length of time provided for NFSv4 and NLM clients to @L74A
# reclaim locks following a server crash and restart. @L74A
# @L74A
# n is from 5 seconds to 300 seconds. @L74A
# The default value is 120 seconds. @L74A
# n must be smaller than logout value if logout is not 0. @L74A
# @L74A
# NOTE: When using the NFS version 4 protocol, the lease time @P09A
# value should be set to a value larger than or equal to @P09A
# the attr/read/write timeout values. Otherwise, it is @P09A
# possible for performance problems to occur when @P09A
# attempting to access MVS data sets. @P09A

leasetime(120) # @L74A

# The REMOUNT attribute enables the NFS Server to process NFS @0AA
# requests after the NFS Server is restarted even though the HFS @0AA
# file system was remounted with a new HFS file system number @0AA
# (device number) after its last usage. @0AA
# Use of the REMOUNT attribute causes the NFS Server to @0AA
# automatically access a remounted HFS file system even though it @0AA
# may have been changed prior to remounting. @0AA
# Any active client mounts are reestablished. @0AA
# The NOREMOUNT attribute enables the NFS Server to fail NFS @0AA
# requests (with return value NFSERR_STALE) if the HFS file system @0AA
# was remounted with a new HFS file system number (device number) @0AA
# after its last usage. @0AA
# The default is NOREMOUNT. @0AA
# This site attribute applies only to HFS file systems. @0AA
# @0AA
noremount # @0AA

# DHCP specifies that NFS Clients using Dynamic IP addresses @L76A
# are supported. To function properly, this support requires @L76A
# that the Clients have static Host Names and that they @L76A
# dynamically update the DNS server with their IP address @L76A
# changes. @L76A
# NODHCP specifies that only NFS Clients using Static IP @L76A
# addresses are supported. @L76A
# The default is NODHCP. @L76A
# @L76A
nodhcp # @L76A

# DENYRW specifies that the NFS Version 4 OPEN operation, @L74M5A
# and the NLM Protocol NLM_Share procedure, should support @L74M5A
# the Windows Share_Deny value. @L74M5A
# NODENYRW specifies that the NFS Version 4 OPEN operation, @L74M5A
# and the NLM Protocol NLM_Share procedure, should ignore @L74M5A
# the Windows Share_Deny value for z/OS UNIX file systems (the @L7EC
# value will be treated as if DENY_NONE was specified). @L74M5A
# The default is DENYRW. @L74M5A
# @P07C
DENYRW # @P07C

# mvssec( , , , ) specifies the permissible network @L74AA
# transmission security for MVS data. @L74AA

```

```

# The valid flavors are krb5,krb5i,krb5p,sys. All or none of @L74AA
# them can be specified. @L74AA
# The default value is to allow all pseudo flavors for MVS @L74AA
# Data sets. @L74AA
# If mvssec is specified, then only the specified flavors @L74AA
# will be allowed for MVS Data sets. @L74AA
# @L74AA
mvssec(krb5,krb5i,krb5p,sys) # @L74AA

# hfssec( , , , ) specifies the permissible network @L74AA
# transmission security for HFS data. @L74AA
# The valid flavors are krb5,krb5i,krb5p,sys. All or none of @L74AA
# them can be specified. @L74AA
# The default value is to allow all pseudo flavors for MVS @L74AA
# Data sets. @L74AA
# If hfssec is specified, then only the specified flavors @L74AA
# will be allowed for HFS Data sets. @L74AA
# @L74AA
hfssec(krb5,krb5i,krb5p,sys) # @L74AA

# pubsec( , , , ) specifies the permissible network @L74AA
# transmission security for PUBLIC data. @L74AA
# The valid flavors are krb5,krb5i,krb5p,sys. All or none of @L74AA
# them can be specified. @L74AA
# The default value is to allow all pseudo flavors for MVS @L74AA
# Data sets. @L74AA
# If pubsec is specified, then only the specified flavors @L74AA
# will be allowed for PUBLIC Data sets. @L74AA
# @L74AA
pubsec(krb5,krb5i,krb5p,sys) # @L74AA

# NFSV4DOMAIN(NFSv4_default_domain) specifies the "pseudo" NFSv4 @015A
# domain for the NFS v4 protocol (NFSv4) name mapping. The @015A
# "pseudo" NFSv4 domain allows various NFSv4 Clients from various @015A
# network domain to seamlessly access the server provided that @015A
# these NFSv4 Clients are also configured with the same @015A
# "NFSv4_default_domain". @015A
# When the NFSV4DOMAIN is omitted, the participating NFSv4 @015A
# Clients' domain must match the Server's network domain for @015A
# the proper NFS V4 protocol name mapping. @015A
# NFSV4DOMAIN(NFSv4_default_domain) # @LAGA

#DlyDTimeout(10) Specifies the minimum Delay Detection time value @LBKA
# in sec before the Delay Detection mechanism observes a delay in @LBKA
# an external call/function and prints message GFSA1030W on @LBKA
# console. @LBKA
# The maximum value for DlyDTimeout is 60 seconds. @LBKA
# The minimum value for DlyDTimeout is 5 seconds. @LBKA
# Any value of DlyDtimeout from 1 to 4 seconds is @P0FC
# converted to 5 seconds. @LBKA
# The Default value is 10 seconds. @LBKA
# If DlyDTimeout is set to 0 the DelayDetection mechanism @LBKA
# is turned OFF @LBKA
# DlyDTimeout(10) # @LBKA

# setgid(POSIX | ZOSUNIX) attribute controls GID inheritance for @012A
# new UNIX objects. @012A

```

```

# POSIX - z/OS NFS server @012A
# uses POSIX rules in GID inheritance for new z/OS UNIX objects. @012A
# If the S_ISGID bit of the parent directory is on, @012A
# then the new GID is set to the GID of the parent directory. @012A
# Otherwise, it is set from the GID of the process. @012A
# A new directory inherits the S_ISGID bit value @012A
# of the parent directory. @012A
# ZOSUNIX - z/OS NFS server @012A
# provides the compatibility with z/OS UNIX. @012A
# When the RACF profile FILE.GROUPOWNER.SETGID in the UNIXPRIV @012A
# class is set, z/OS NFS server @012A
# uses POSIX rules, as stated above. Otherwise, a @012A
# new GID is always set to the GID of the parent directory, @012A
# and for a new directory, the S_ISGID bit is always set off. @012A
# NOTE: Some NFS clients (e.g. SUN, AIX) force GID setting after @012A
# object creation and prevent compatibility with @012A
# z/OS UNIX even though the setgid(ZOSUNIX) attribute is set. @012A
# @012A
# The default is POSIX. @012A
  setgid(POSIX) # @012A

# SYMRESOLVE specifies that the server will resolve a symlink @018A
# found in EXPORT or CHECKLIST entries. @018A
# The new EXPORT or CHECKLIST entries are created in memory only @018A
# This option is only for NFSv4 LOOKUP in HFS space when @018A
# a symlink is found within an export entry. @018A
# The default is NOSYMRESOLVE. @018A

# nosymresolve # @018A

#mvslogindelay() Specifies the delay time value in seconds since @019A
# z/OS NFS Server startup. To avoid an NFS client's cache @019A
# invalidation due to access errors after z/OS NFS server startup, @019A
# in SECURITY(SAF/SAFEXP) mode, the server maps the reply error @019A
# NFSERR_ACCES to NFSERR_DELAY on NFS v3 or NFS v4 RPCs, until @019A
# the mvslogin is received or the mvslogindelay expires. @019A
# This allows an NFS client time to reissue an mvslogin. @019A
# The maximum value for mvslogindelay is 300 seconds. @019A
# The minimum value for mvslogindelay is 0 seconds. @019A
# The Default value is 0 seconds (off). @019A
# If mvslogindelay is set to 0 the error mapping is turned OFF. @019A
#mvslogindelay(0) # @019A
#
# id2name(cache | callsaf) attribute controls the usage of Uid/Gid@LFCA
# Cache for uid/gid numbers to/from owner/group names conversion. @LFCA
# z/OS NFS server calls SAF to get owner/group name by uid/gid @LFCA
# number or to get uid/gid number by owner/group name to do such @LFCA
# conversion. The caching of the most recently used pairs of @LFCA
# (uid, owner) and (gid, group) reduce the SAF calls. @LFCA
# cache - Uid/Gid Cache is enabled for z/OS NFS server. @LFCA
# callsaf - Uid/Gid Cache is disabled for z/OS NFS server and it @LFCA
# calls SAF each time to do the conversion. @LFCA
# The default is "callsaf". @LFCA
  id2name(callsaf) # @LFCA

```

```

#consolemsgs(10..100 | ALL) @LFD4A
# Specifies the number of messages for NFS operator commands: @LFD4A
# LIST=MOUNTS, LIST=DSNAMES, LISTLOCK @LFD4A
# will print on console. Full output can be found in NFS log. @LFD4A
# Min value is 10. Max value is 100. Default value is 10. @LFD4A
# If "ALL" option is specified all messages will be printed @LFD4A
# on console. @LFD4A
#consolemsgs(10) @LFD4A

#@01CA
# OEMHSM specifies that non-DFSMSHsm is used to work with @01BA
# migrated datasets. @01BA
# NOOEMHSM specifies that the DFSMSHsm is used to work with @01BA
# migrated datasets. @01BA
# If OEMHSM is set then z/OS NFS Server starts working with @01BA
# migrated dataset without checking for HSM availability. It @01BA
# could lead to a hang of the worker task if HSM is not @01BA
# available. @01BA
# If NOOEMHSM is set then z/OS NFS Server checks whether DFSMSHsm @01BA
# is started. If DFSMSHsm is not started then an error is @01BA
# returned. @01BA
# The default is NOOEMHSM. @01BA
# nooemhsm # @01BA

#
# ALIAS refers to the data set pointed to by the EXPORTS DD @LFSA
# in the startup procedure to be scanned. Export entries in @LFSA
# the exports dataset may have an ALIAS keyword, which indicates @LFSA
# that the exported pathname can be replaced by a single path @LFSA
# component. See GFSAPEXP in NFSSAMP library for sample CHKLIST @LFSA
# entries description. @LFSA
# NOALIAS will cause the server not to look at the ALIAS @LFSA
# information in the EXPORTS data set even if it is there. This @LFSA
# is the default. @LFSA

noalias

#memfree() Specifies unused memory threshold (in Megabytes). @01CA
# When free memory in any internal NFSS subpool is more than this @01CA
# value, the memory reclamation process is scheduled in order @01CA
# to avoid possible memory exhaustion. @01CA
# - To disable automatic memory reclamation, the memfree @01CA
# attribute must not be specified. @01CA
# - The maximum value for memfree is 999 (MB). @01CA
# - The minimum value for memfree is 10 (MB). @01CA
# - If memfree is set to 0, internal memory management is turned @01CA
# off and every memory request (below 2GB) is translated @01CA
# to GETMAIN or FREEMAIN system calls. @01CA
# This value should be chosen based on a particular @01CA
# workload/available job region size. @01CA
# If this attribute is used, a value of 20 is recommended @01CA
# unless the attribute is being tuned. @01CA
# For memory above 4GB the defined memfree value is multiplied 4. @01CA
#memfree(20)

#sync - Specifies that data transmitted with the write request @01DA
# should be committed to nonvolatile media (for example, DASD) by @01DA
# the server immediately when received. @01DA
#async - The user can alternatively specify the async processing @01DA
# attribute to get improved performance. When this attribute is @01DA
# specified, the data will be committed asynchronously. @01DA
#The sync|async attribute only applies to z/OS UNIX file objects @01DA
# and only for the NFS version 2 protocol. Sync is the default. @01DA
#sync #@01DA

```



```

#chkloop(on | off) attribute controls the usage of NFS error
#loop detection facility.
#z/OS NFS server is able to detect a loop situation, to identify
#the remote client system causing the loop and to issue an
#adequate exploitable warning console message GFSA1036.
#on - NFS error loop detection facility is enabled for z/OS
#   NFS server.
#off - NFS error loop detection facility is disabled for z/OS
#   NFS server.
#The default is "off".
#
chkloop(off)
#
#loopthreshold(n) attribute specifies the decimal number 'n' of
#the NFS error repetitions required to trigger the loop
#detection process. I.e. we assume that there is a loop if
#the NFS error repetitions are greater than loopthreshold value.
#The minimum value for loopthreshold is 3.
#The maximum value for loopthreshold is 99999.
#Any value of loopthreshold less than 3 is converted to 3.
#Any value of loopthreshold more than 99999 is converted to 99999.
#The default value is 3.
#Note: in high-performance environment, it is common to set
#loopthreshold to a higher value
#
loopthreshold(3)
#
#timethreshold(n) attribute specifies the maximal interval 'n'
#in seconds between two subsequent NFS errors associated to
#a loop. Exceeding of this interval will result in current
#loop closing. All data related to the current loop will be
#discarded and new sequence of NFS errors will begin with the
#last NFS error.
#The minimum value for timethreshold is 4 seconds.
#The maximum value for timethreshold is 60 seconds.
#Any value of timethreshold less than 4 seconds is converted to
#4 seconds.
#Any value of timethreshold more than 60 seconds is converted to
#60 seconds.
#The default value is 4 seconds.
#Note: in high-performance environment, it is common to set
#timethreshold to a low value
timethreshold(4)

```

Appendix F. Sample exports data set

Figure 43 contains an example exports data set. The exports data set can be found as GFSAPEXP in the NFSSAMP library.

```
#####  
#  
# z/OS Network File System Server Sample EXPORTS #  
#  
# COPYRIGHT: @P05A #  
#PROPRIETARY V3 STATEMENT @P05C #  
#Licensed Materials - Property of IBM #  
#"Restricted Materials of IBM" @P05C #  
#5650-ZOS @P02C #  
#Copyright IBM Corp. 1991,2015 @LFSC #  
#END PROPRIETARY V3 STATEMENT @P05C #  
# Copyright SUN Microsystems, Inc & @03C #  
# Electronic Data Systems Corp. 1988, 1989 #  
#  
# change history #  
# $L3L=KA90033,HDZ11NP,940117,SJPLHYC: Updates for DFSMS 1.2 @L3LA #  
# $P01=KA00045,HDZ11SP,960111,SJPLTEM: Updates for DFSMS 1.3 @P01A #  
# $P02=KAB0114,HDZ11TS,971030,SJPLTEM: Chg DFSMS/MVS->OS/390 @P02A #  
# $L6=NFS,HDZ11US,030405,SJPLMB: Chg OS/390 to z/OS @L6A #  
# $LC9=OW55830,HDZ11TS,030128,IBSVVT: Updates for wildcard @LC9A #  
# and MVS system symbols @LC9A #  
# support @LC9A #  
# $01=OA10174,HDZ11US,050121,IBSVKR: Comments for wildcard @01A #  
# $L74=NFS,HDZ11VS,051101,SJPLKC: Added sec keyword options @L74AA#  
# $L81=NFS,HDZ118N,050908,IBSDYP: Exports file netgroup @L81A #  
# support @L81A #  
# $02=OA14882,HDZ118N,060119,SJPMTM: Delete @L74AC comment @02A #  
# from userid3.nfs.ps line @02A #  
# $03=OA22311,HDZ1AN0,071011,IBSDYP: Root support for non @03A #  
# owner in EXPORTS mode @03A #  
# $P04=KN00180,HDZ1AN0,071206,IBSDYP: NFS v4 Root support @P04A #  
# $004=OA29077,HDZ1C1N,090518,IBSDYP: @004A #  
# 1. Symbolics and wildcards do not work in the @004A #  
# checklist entries @004A #  
#-----Release V2R1 -----@005A #  
# $005=OA35630,HDZ221N,20110223,IBSVAE: @005A #  
# 1. -symresolve/-nosymresolve export options are added @005A #  
# $P05=KEN0221,HDZ221N,20120228,SJPLMB: @P05A #  
# 1. Update obsolete Copyright statement. @P05A #  
#-----Release V2R2 -----@LFSA #  
# $LFS=SM02141,HDZ222N,20140106,SJPLSLH: @LFSA #  
# 1. Export now has alias keyword @LFSA #  
# $P06=SM02164,HDZ222N,20140618,IBSDYP: @P06A #  
# 1. Describe the impact of MAPLOWER attribute on the @P06A #  
# case of the exported HLQ. @P06A #  
#  
#####
```

Figure 43. Sample exports data set

```

# @(#)exports.cnt1 3.2 89/04/20 SMI EDS
#
# This file contains EXPORT and CHKLIST entries. @L81A
# This file is used for processing EXPORT entries when Server @L81A
# security option is set to EXPORT/SAFEXP, and CHKLIST entries @L81A
# when Server security option is SAF/SAFEXP modes. @L81A
# i.e. being in security(SAFEXP) mode both EXPORT and CHKLIST @L81A
# entries (directory suffixes) are to be processed. @L81A
# This file is not used for SECURITY(NONE). @L81A
#
# This data set contains entries for directories that may be
# exported to Network File System Clients. It is used by the
# server to determine which data sets and prefixes may be
# accessed by a client, and to write protect data sets on the
# server provided that the SECURITY site attribute is set
# to either SECURITY(EXPORTS) or SECURITY(SAFEXP). This file @L81C
# is not used for SECURITY(NONE). @L81C
#
# This data set contains also suffixes of directories that are @L81A
# to be exempt from SAF checking even though SAF or SAFEXP is @L81A
# specified as the security option. The directory suffixes are @L81A
# only used when SAF or SAFEXP is specified for the particular @L81A
# data type (i.e. MVS data, HFS data, data accessed using the @L81A
# public file handle) AND CHECKLIST option is specified as the @L81A
# site attribute. The directory suffixes specified here forms @L81A
# file/directory names which HAVE TO MATCH a subsequent mount @L81A
# point OR be the parent of a subsequent mount point to allow @L81A
# SAF checking to be bypassed for everything underneath that @L81A
# mount point. @L81A
# @005A
# This data set also defines how a symlink in the directory @005A
# path is resolved at the time of a NFS Client access to the @005A
# directory. @005A
#
# The mvsnfs.cnt1(exports) data set is read during server startup
# processing. Subsequent changes to this data set will not take
# effect until the server is restarted or the EXPORTFS command
# is issued. However, changes to the data set do NOT affect the
# mounts processed before the server was restarted or before
# EXPORTFS was issued.
#
# The EXPORTCHK NFS operator command checks the Exports file @LGA3A
# without rebuilding the current export list. Error Diagnosis of @LGA3A
# EXPORTCHK and EXPORTFS is identical. @LGA3A

```

```

# Errors found in the file are sent to the system log, and the server
# continues processing for minor errors such as undefined host
# names. Termination is brought about if the EXPORTS data set
# cannot be read or if a syntax error exists. (In the case of the
# EXPORTFS command, these errors will cause the command to be
# ignored and processing will continue with the original exports
# file in effect.)
#
# Statement Syntax
#
# Entries can be up to 4096 characters long. Lines can be continued
# by placing a '+' or '\' at the end of the line. A '#' anywhere in the
# data set indicates a comment that extends to the end of the line.
#
# Wildcard symbols support @LC9A
# @LC9A
# The following wildcard symbols can be used to create regular @LC9A
# expressions within directories in the EXPORTS file. @004C
# @LC9A
# Symbol Explanation @LC9A
# @LC9A
# * Represents any length sequence (can be zero) of any @LC9A
# valid characters. @LC9A
# @LC9A
# Example /u/ab* matches /u/abcde or /u/abfg @LC9A
# IBMUSER.HO*.NAME matches IBMUSER.HOME.NAME or @LC9A
# IBMUSER.HOLD.NAME @LC9A
# @LC9A
# ? Represents any (but only one) valid character. @LC9A
# @LC9A
# Example /u/user? matches /u/user1 or /u/user2 @LC9A
# but not /u/user12 @LC9A
# @LC9A
# [.-.] or @LC9A
# [...] Is used to specify one symbol from the region of @LC9A
# characters. @LC9A
# Characters are regulated in EBCDIC alphabetical order. @LC9A
# Open bracket, [, has to be hex value x'AD' @01A
# Close bracket, ], has to be hex value x'BD' @01A
#
# NOTE: Hex values x'AD' and x'BD' may represent @01A
# different characters depending on the @01A
# code page defined for your installation @01A
# @LC9A
# Example 1: /u/[a-c]de matches /u/ade or /u/bde or /u/cde @01C
# /u/[abd]fg matches /u/bfg or /u/dfg @LC9A
# but not /u/cfg @LC9A
# Example 2: Given the set of similar resource names @01A
#
# /user/abcdef1 /user/abddef1 @01A
#
# /user/abcdef2 /user/abedef2 @01A
#
# /user/abcdef3 /user/abfdef3 @01A
#
# /user/abcdef4 @01A
#

```

```

# with wildcard symbols support it is possible to export all
# of these names by only one row in the EXPORTS file:
#
#   /user/ab[c-f]def?
#
# Be aware that with this line other datasets, for example
# /user/abfdef4, are also exported.
#
# MVS system symbols support
#
# The NFS server supports both types of MVS system symbols:
# static and dynamic.
# System-defined static system symbols already have their names
# defined to the system.
# An installation defines a default list of symbols that can be
# adjusted by the system administrator.
#
# Some examples of static MVS system symbols are:
# &SYSCLONE, &SYSNAME, &SYSPLEX, &SYSR1.
# Actual values for static symbols are constant for a running
# system.
#
# In contrast, dynamic MVS system symbols can change their
# values at any time.
# The NFS server will substitute the actual values for the
# the dynamic symbols at NFS start up and on the EXPORTFS
# or EXPORTCHK NFS operator command.
# These values will be fixed in the NFS exports list until
# the next EXPORTFS command execution even if the value of any
# dynamic symbol changes.
# Some examples of dynamic MVS system symbols are:
# &SYMMDD, &DATE, &SHHMMSS, &YR4.
#
# When used in the EXPORTS file, MVS system symbols
# (static or dynamic) should be preceded by an "&" sign and
# closed with a ".".
# Also it should not be empty (i.e. "&." is not allowed).
# The name of the MVS system symbol should not exceed 80
# characters.
#
#   Examples           /u/&&SYSNAME.
#                       IBMUSER.&&DATE..REPORT
#
# Limitations on the usage of Wildcard symbols and MVS system
# symbols in directories are described under directory_suffix.
#
# The first keyword occurrence on a line is delineated with a
# dash. Subsequent keyword occurrences on the same line must not
# have the dash but must be separated with a comma from the
# keyword that precedes it.
# No spaces may appear between the keywords; however, leading
# blanks are ignored in new or continuation lines.
#
# Entries for a directory are specified by a line of the following
# syntax:
#
#   directory   -ro
#   directory directory_suffix -ro

```

```

# directory -rw=clients
# directory directory_suffix -rw=clients
# directory -access=clients
# directory directory_suffix -access=clients
# directory_suffix
# directory -sec=sys|krb5|krb5i|krb5p
# directory -symresolve|-nosymresolve (optional)
#
# where:
#
# directory = Prefix or file name
# directory_suffix = <nosaf>
#                   <hosts=clients,nosaf>
#                   <hosts=list_of_items,nosaf>
#       where item is prefix or file name with optional client
#       list:
#                   hfs_subdir_or_mvs_prefix
#                   hfs_subdir_or_mvs_prefix,hosts=clients
#
#       Clients in the "hosts=" option may be specified as
#       hostname or IP address.
#       Only hosts from the list can have access to the mounted
#       data in SAF or SAFEXP mode without MVSLOGIN.
#       If the directory_suffix is used together with a directory
#       wildcard symbols and MVS system symbols within a
#       directory must not be used because the checklist entry
#       provides for the exact data path to be excluded from
#       SAF checking.
#
# -ro      = Export the directory as read only. If not specified,
#           the directory is exported read/write to every one.
#
# -rw      = Directory exported read/write to specified clients,
#           and read only to everyone else. Separate clients
#           specs by '|' (vertical bar).
#
# -access  = Give access only to clients listed. Separate client
#           specs by '|' (vertical bar). This can be further
#           qualified with the "ro" keyword or with an "rw"
#           list.
#
# -sec     = Specifies the Kerberos authentication level that
#           clients must have to access individual files and
#           data sets on the z/OS NFS server.
#
# -alias   = Specifies the single path component that can
#           replace the entire export pathname at mount time.
#           The attribute "alias" must be specified in the
#           default attributes. Restrictions:
#           - Alias cannot be for an MVS mount path. Therefore
#             the export entry cannot contain an MVS prefix,
#             and if no prefix is given, the default imprefix
#             attribute cannot be MVS only.
#           - Alias name must conform to USS directory naming
#             conventions:
#             - between 1 and 255 characters
#             - no directory separator '/'
#
#

```

```

# -symresolve = The symlink in the directory path is resolved
#               at time of an NFS Client access to the
#               directory. A new Export entry is created in
#               memory with the real directory path.
# -nosymresolve = The symlink in the directory path is not
#                 resolved.
#
# The keywords "ro" and "rw" are mutually exclusive.
# The keywords "ro" and "rw" are mutually exclusive.
# The symresolve option is only for NFSv4 LOOKUP in zOS UNIX
# space when a symlink is found within an export entry.
# -symresolve and -nosymresolve are optional. If not specified,
# the server default attribute value is used.
#
# Directory suffix examples.
# 1. Example showing bypass of the SAF checking of multiple
#    sub-directories for the SAME directory.
# Given that the directory tree and the exports list are as
# follows:
# Directory tree:           Exports:
# /user1/.                 /hfs/user1<docs,test/release2,nosaf>
#   temp
#   docs.
#   /guides
#   test/.
#       release1
#       release2
#
# SAF checking will be bypassed for mount point and everything
# underneath that mount point, i.e. users do not need to do
# MVSLOGIN for the files/directories underneath the mount point:
# /hfs/user1/docs
# /hfs/user1/docs/guides
# /hfs/user1/test/release2
#
# SAF checking will be enforced for mount point:
# /hfs/user1
# /hfs/user1/temp
# /hfs/user1/test/release1
#
# 2. Example for SAFEXP and SAF security.
# Given that security of SAFEXP or SAF is specified and the
# exports list is as follows:
# Exports:
# WEBNFS.PDS <hosts=client1|client2,nosaf>
# USER1hosts=<PUBLIC,NOSAF>
# /hfs/user1 <tmp,hosts=client1|client2,NOSAF>
# /hfs/u/public<nosaf>
# /hfs/bin
#
# For SAF security only exports entries with NOSAF option will
# be taken into consideration. Such entries will be used only to
# bypass SAF checking and to limit access to the mount point
# with the list of hosts.
#
# The following mount requests for SAFEXP security will fail
# because it is not in the exports list:
#   WEBNFS
#   /hfs/u
#

```



```

# The following mount requests for SAFEXP and SAF security will
# succeed and SAF checking will be bypassed for mount point and
# everything underneath that mount point (i.e. users do not need
# to do MVSLOGIN to access mount point and everything underneath
# that mount point):
#   WEBNFS.PDS
#   USER1.PUBLIC.PDS
#   /hfs/user1/tmp/dir1
#   /hfs/u/public
# But access to WEBNFS.PDS and /hfs/user1/tmp/dir1 will be
# allowed only for client1 and client2 and will require the use
# of MVSLOGIN by users on all other hosts.
# Access to USER1.PUBLIC.PDS, /hfs/u/public will not be limited
# (will be possible for any hosts).
#
# The following mount requests for SAFEXP security will succeed
# but SAF checking will be enforced:
#   USER1.SOMEPPDS
#   /hfs/user1
#   /hfs/bin
# Access to the mount point will be possible for any hosts.
#
# The following mount requests for SAF security will succeed
# (no exports checking) but SAF checking will be enforced:
#   WEBNFS
#   USER1.SOMEPPDS
#   /hfs/u
#   /hfs/bin
#   /hfs/dir_which_is_absent_in_exports_list_but_exist
# Access to the mount point will be possible for any hosts.
#
# 3. Example showing usage of a directory suffix with nothing
#   before it.
# Given that security of SAFEXP or SAF is specified and the
# exports list and the PUBLIC z/OS NFS site attribute are as
# follows:
# Exports:
# <WEBNFS.PDS,hosts=client1|client2,nosaf>
# </hfs/user1/tmp,hosts=client1|client2,NOSAF>
# <nosaf>
# <hosts=client1|client2,nosaf>
# PUBLIC:
# PUBLIC(WEBNFS.PDS,/hfs/user1/tmp)
#
# SAF checking will be bypassed for PUBLIC mount points and
# everything underneath these PUBLIC mount points:
# WEBNFS.PDS
# /hfs/user1/tmp
# But access to WEBNFS.PDS and /hfs/user1/tmp will be allowed
# only for client1 and client2 and will require the use of
# MVSLOGIN by users on all other hosts.
#
# The entries of the exports list will be ignored but will cause
# syntax error:
# <nosaf>
# <hosts=client1|client2,nosaf>
#
# Client suffix can be used to give the root user of the client
# root access to the exported directory.

```

```

# Client root user will have full root support on NFSv2, NFSv3,
# NFSv4 mounted directory.
# Client suffix only applies to Security EXPORTS mode. It is
# ignored in SAF and SAFEXP Security modes.
#
# Clients in the client list must be separated with '|' and may
# contain a client suffix. Client suffix can be used to give the
# root user of the client root access to the exported directory.
# Client suffix only applies to Security EXPORTS mode. It is
# ignored in SAF and SAFEXP Security modes.
# Client suffix has syntax:
#
# <root>
#
# Client and its suffix combines as:
#
# client<root>  NFSS will honor client UID = 0 (trusted user).
#               NFSS will give client's user with UID=0
#               (trusted user) superuser access on the directory
#               while other users on that client will get normal
#               access to the directory the same as if the
#               client suffix (i.e. <root> ) was not specified
#               for that client.
#
# Clients in the client list can be specified in a number of ways
# (depending on DHCP z/OS NFS site attribute):
#
# single hostname
#       You may specify a hostname regardless of DHCP Z/OS
#       NFS site attribute. It may be specified without the
#       domain part.
#       You may specify client suffix. Example:
#       host1<root>
#       host1.cs.foo.edu<root>
#
# netgroup name
#       Netgroup name (from the local /etc/netgroup file)
#       may be given as @groupname. You may specify a
#       netgroup name regardless of DHCP z/OS NFS site
#       attribute.
#       You may NOT specify client suffix (i.e. <root>)
#       with netgroup name.
#
# single IP address
#       You may specify a client by an IPv4 or IPv6 address.
#       If DHCP z/OS NFS site attribute is "dhcp" such
#       clients will be ignored. If NFS Server starts up in
#       IPv4 mode all clients specified with IPv6 addresses
#       will be ignored. If NFSS starts up in IPv6 mode all

```

```

#           IPv4 addresses of clients will be translated to
#           IPv4-mapped addresses.
#           You may specify client suffix (i.e. <root>).
#
# IP network template
#           You can export directory to all hosts on an IPv4
#           and IPv6 (sub-) network simultaneously. If DHCP
#           attribute is "dhcp" such IP network template will
#           be ignored.
#           You may NOT specify client suffix (i.e. <root>).
#           For IPv4, a network template is specified by an
#           IPv4 address and netmask pair as address/netmask
#           where a netmask must be specified in dotted-decimal
#           format, or as a contiguous mask length (for example,
#           either '/255.255.252.0' or '/22' appended to the
#           network base address result in identical subnetworks
#           with 10 bits of host). If NFS Server starts up in
#           IPv6 mode IPv4 network template will be converted
#           to a template based on IPv4-mapped addresses.
#           For IPv6, a network template is specified by an
#           ipv6-address/prefix-length (for example, the node
#           address 12AB:0:0:CD30:123:4567:89AB:CDEF and its
#           subnet number 12AB:0:0:CD30::/60 can be abbreviated
#           as 12AB:0:0:CD30:123:4567:89AB:CDEF/60). If NFS
#           Server starts up in IPv4 mode IPv6 network template
#           will be ignored.
#
# hostname template
#           Machine names may contain the wildcard characters
#           '*' and '?'. This can be used to make the exports
#           file more compact; for instance, *.cs.foo.edu
#           matches all hosts in the domain cs.foo.edu. However,
#           these wildcard characters do not match the dots in
#           a domain name, so the above pattern does not include
#           hosts such as a.b.cs.foo.edu.
#           For hostname template the domain part is mandatory.
#           If DHCP z/OS NFS site attribute is "nodhcp" such
#           entries will be ignored.
#           You may NOT specify client suffix (i.e. <root>).
#
# If no options are specified, the default value
# allows any client read/write access to the given directory.
#
#

```

```

# If 'maplower' is specified in the default attributes, the
# entries with explicit or implicit MVS prefix
# are translated to upper case. High level qualifiers
# specified in the client mount request are translated to
# upper case.
#
# If 'nomaplower' is specified in the default attributes,
# attention must be given to the case of entries. High level
# qualifiers specified in the client mount request are not
# translated to upper case.
mvsnfs -ro
userid0.mixds -rw=fsrs001|fslab004<root>|9.43.249.211|\
          9.43.249.206<root>|fe80::204:acff:fee4:b7b6|\
          fe80::a00:20ff:feb9:4a65<root>|fssun??.cs.foo.edu|\
          *.de.foo.net|10.20.324.151/255.255.255.240|\
          10.33.324.151/28|fe80::b04:ac20:feff:a776/121|@hpnetgrp
userid1<nfs,nosaf> -rw=fsrs001
userid2.nfs.pds <nosaf> -access=fsrs001|fssun03<root>
userid3.nfs.ps -sec=krb5|krb5i|krb5p|sys
userid4.nfs.another.pds -access=fslab004
/hfs/u/newproducts -access=fsrs001,ro
/hfs/u/symlink_ent -symrersolve
/hfs/u/symlink1_ent <nosaf> -access=fslab008,symresolve

/hfs/u/dir1/dir2/mountdir -alias=mountalias

```

Appendix G. Sample startup procedures

The following text contains sample startup procedures that you can use to start the z/OS NFS server and client.

Note: All data sets specified in startup procedures should be cataloged and not migrated. Although both the following sample startup procedures include the SYSTCPD DD statement, SYSTCPD is not required for either the NFS server or the NFS client, unless a custom configuration is required for NFS. To see how the configuration is determined when the SYSTCPD DD card is not specified in the NFS startup procedures, see the documented search order for the resolver configuration files in the section "Search orders used in the z/OS UNIX environment" in *z/OS Communications Server: IP Configuration Guide*.

Sample z/OS NFS server startup procedures

Figure 44 on page 536 contains a sample MVS NFS z/OS NFS server startup procedure. This procedure can be found as GFSAPROC in the NFSSAMP library.

```

//MVS NFS PROC SYSNFS=SYS1, @LG2C
// PARS='INFO', @LG2C
//* @LG2A
//* The above slash '/' is the delimiter between @LG2A
//* o) optionally specified Language Environment runtime options @LG2A
//* (which MUST be specified BEFORE the slash), and @LG2A
//* o) z/OS NFS Server options @LG2A
//* (which MUST be specified AFTER the slash). @LG2A
//* @LG2A
//* SYSLE=SYS1, @LG2C
//* TCPIP=TCPIP, @LG2M
// NFSRFX=MVS NFS @LG2C
//*****
//* z/OS Network File System Server Start Up Procedure (HDZ223N) @LG2C
//*
//*PROPRIETARY V3 STATEMENT
//*LICENSED MATERIALS - PROPERTY OF IBM
//*"RESTRICTED MATERIALS OF IBM"
//*5650-ZOS @LE0C
//*COPYRIGHT IBM Corp. 1989, 2017 @LG2C
//*END PROPRIETARY V3 STATEMENT
//*
//*****
//*
//* CHANGE HISTORY
//*
//* $01=0Y55396,HDP3FS1,920616,SJPLHYC : ENHANCED ERROR LOG @01A
//* $L12=NFS,JDZ1170,920925,SJPLHYC : ADD SYSMDUMP DD @L12A
//* $L3L=KA90033,HDZ11NP,940117,SJPLHYC: MODIFY FOR DFSMS 1.2 @L3LA
//* $L3G=NFS,HDZ11NP,940420,SJPLJST : ADD NFSXLAT DD @L3GA
//* $P1=KA901XX,HDZ11NP,940805,SJPLJST : CHANGE &SYS1 @P1A
//* $P2=KA00045,HDZ11SM,960111,SJPLTEM : MODIFY FOR DFSMS 1.3 @P02A
//* $P3=KA00093,HDZ11SM,960327,SJPLTEM : ADD HDZ11SM STEPLIB @P03A
//* $P4=KA00101,HDZ11SM,960410,SJPLTEM : SWITCH TO HDZ11SM @P04A
//* $P5=KAB0114,HDZ11TS,971030,SJPLTEM : CHG DFSMS/MVS->OS/390 @P05A
//* $P6=KAB0316,HDZ11TS,980325,SJPLBPF : ADD CHKLIST DD @P06A
//* $L6=NFS,HDZ11US,030405,SJPLMB : CHG OS/390 TO Z/OS @L6A
//* $L65=NFS,HDZ11US,030214,IBSKVV: UPGRADE TO SP4 MACRO @L65A
//* $L781=NFS,HDZ11VS,041207,SJPLMB : CHANGE NFSLIB TO NFSLIBE @L781A
//* $L74=NFS,HDZ11VS,050308,SJPLSLH : ADD LOCKING DB DD DEF @L74FA
//* $P07=KAJ0355,HDZ11VS,050414,SJPLMB: UPDATE TO HDZ11VS @P07A
//* $L80=NFS,HDZ118N,050512,SJPLMB: UPDATE RELEASE TO HDZ118N @L80A
//* $L81=NFS,HDZ118N,050908,IBSDYP: REMOVE CHKLIST DD CARD @L81A
//* $L90=NFS,HDZ119N,060131,SJPLMB: UPDATE RELEASE TO HDZ119N @L90A
//* $LA0=NFS,HDZ1AN0,070110,SJPLMB: UPDATE RELEASE TO HDZ1AN0 @LA0A
//* $P08=KN00140,HDZ1AN0,071022,SJPLMB: REMOVE SYSTCPD @P08A
//*----- RELEASE VIR11 -----
//* $LB0= NFS,HDZ1B1N,080208,SJPLMB: UPDATE REL TO HDZ1B1N @LB0A
//* $002=0A25770,HDZ1B1N,080709,SJPLMTM: @002A
//* 1. REMOVE TCPIP PARM FROM PROC STMT @002A
//*----- RELEASE VIR12 -----
//* $LC0= NFS,HDZ1C1N,090118,SJPLMB: @LC0A
//* 1. UPDATE REL TO HDZ1C1N. @LC0A
//*----- RELEASE VIR13 -----
//* $LD0= NFS,HDZ1D1N,100302,SJPLMB: @LD0A
//* 1. UPDATE REL TO HDZ1D1N. @LD0A
//*----- Release V2R1 -----
//* $LE0= NFS,HDZ221N,20101211,SJPLMB: @LE0A
//* 1. Changed product id from "5694-A01" to "5650-ZOS". @LE0A

```

Figure 44. Sample z/OS NFS server startup procedures

```

/**      2. Update constants for release HDZ221N.                @LE0A
/** $P09=KEN0148,HDZ221N,20110912,SJPLMB:                      @P09A
/**      1. Change Copyright to "IBM Corp." before date(s).    @P09A
/** $P0A=KEN0173,HDZ221N,20111031,SJPLHPN:                    @P0AA
/**      1. Add MEMLIMIT for virtual memory above the bar.     @P0AA
/**      2. Remove NFSSNAP DD.                                  @P0AA
/** $LE7= _NFS_,HDZ221N,20120228,SJPLMB:                      @LE7A
/**      1. Changed Copyright from 2012 to 2013.              @LE7A
/**----- Release V2R2 -----                                @LF0A
/** $LF0= _NFS_,HDZ222N,20120310,SJPLMB:                      @LF0A
/**      1. Update constants for release (HDZ222N).            @LF0A
/**----- Release V2R3 -----                                @LG2A
/** $LG2=W138100,HDZ223N,20161027,SJPLHPN:                    @LG2A
/**      1. Update constants for release (HDZ223N).            @LG2A
/**
/**-----
/**
/** The REGION specifies the virtual memory below the bar (2GB) @P0AA
/** while the MEMLIMIT specifies the memory above the bar.    @P0AA
/** If REGION=0M then MEMLIMIT=NOLIMIT (default), or          @P0AA
/** optionally specify the MEMLIMIT.                          @P0AA
/** If REGION=xxxM then specify MEMLIMIT=yyyG rather than     @P0AA
/** taking some default value.                                 @P0AA
/** The z/OS Network File System Server will not start if    @P0AA
/** MEMLIMIT=0M or if it is too small.                        @P0AA
/**
/**MVSNFSS EXEC PGM=GFSAMAIN,                                  @LG2C
/**      PARM='&PARMS',
/**      TIME=1440,                                           @P0AM
/**      REGION=0M
/**      REGION=0M,MEMLIMIT=yyyG                               @P0AA
/**      REGION=xxxM,MEMLIMIT=yyyG                             @P0AA
/**      REGION=xxxM,MEMLIMIT=yyyM                             @P0AA
/**
/** The SYSTCPD explicitly identifies the data set to be      @P0AC
/** used to obtain the parameters defined by TCPIP.DATA       @P08A
/** when NO GLOBALTCPIPDATA statement is configured.         @P08A
/** See the "IP Configuration Guide" for information on      @P0AC
/** the TCPIP.DATA search order.                              @P08A
/** The data set can be any sequential data set or a member  @P08A
/** of a partitioned data set (PDS).                          @P08A
/** &TCPIP..TCPIP.DATA is the TCP/IP DATA file.             @P0AC
/**                                                           @002A
/** NOTE: The TCPIP parameter on the PROC statement is       @002A
/** required when using the SYSTCPD DD statement.            @002A
/**                                                           @002A
/**SYSTCPD DD DISP=SHR,DSN=&TCPIP..TCPIP.DATA(TCPDATA)      @P08C
/**
/** STEPLIB consists of NFSLIBE and Language Environment     @P0AC
/** libraries.                                                @P0AA
/** Change the names as appropriate for your installation.    @P0AM
/** Note: Each of these libraries MUST be APF-authorized and @P0AC
/** the matching Language Environment release is required.    @P0AC
/** The SYSLE parameter on the PROC statement is              @LG2A
/** required when using the &SYSLE..SCEERUNx.                @LG2A
/**
/** &SYSNFS..NFSLIBE is the z/OS Network File System Server  @P0AC
/** target library.
/** &SYSLE..SCEERUN2 is the Language Environment Runtime     @P0AA
/** for z/OS Network File System Server AMODE64.             @P0AA

```

```

/** &SYSLE..SCEERUN is the Language Environment Runtime Library. @P0AC
/**
//STEPLIB DD DISP=SHR,DSN=&SYSNFS..NFSLIBE @L781C
/** DD DISP=SHR,DSN=&SYSLE..SCEERUN2 @LG2C
/** DD DISP=SHR,DSN=&SYSLE..SCEERUN @LG2C
/**
/** The NFSLOG1 and NFSLOG2 DD'S define the LOG data sets @P0AC
/** The two LOG data sets must be pre-allocated @P0AC
/** as sequential files. @01A
/** The DCB will be set to (VB,LRECL=137,BLKSIZE=6144) once @P0AC
/** MVS NFS is started, regardless of the allocation DCB. @P0AC
/** We recommend SPACE=(CYL,(2,5),RLSE) @P0AC
/**
//NFSLOG1 DD DISP=SHR,DSN=&NFSPRFX..LOG1 @01A
//NFSLOG2 DD DISP=SHR,DSN=&NFSPRFX..LOG2 @01A
/**
/** &NFSPRFX..CNTL is a FB LRECL 80 data set (PDS or PDSE). @L3LC
/** Sample NFSATTR can be found in &NFSPRFX.NFSSAMP(GFSAPATT). @P0AC
/** Sample EXPORTS can be found in &NFSPRFX.NFSSAMP(GFSAPEXP). @P0AC
/** Note: As of Z/OS V1R8, the EXPORTS file is composed of @L81A
/** both EXPORT and CHKLIST entries. @L81A
/**
//NFSATTR DD DISP=SHR,DSN=&NFSPRFX..CNTL(NFSATTR)
//EXPORTS DD DISP=SHR,DSN=&NFSPRFX..CNTL(EXPORTS)
/**
/** The FHDBASE and FHDBASE2 are @L3LC
/** the MOUNT FILE HANDLE DATABASES. @L3LC
/** They must be pre-allocated as empty VSAM KSDS data sets. @P0AC
/** They will be used alternately. @L3LC
/** Sample JCL can be found in &NFSPRFX.NFSSAMP(GFSAMHDJ). @L3GC
/**
//FHDBASE DD DISP=SHR,DSN=&NFSPRFX..FHDBASE @L3LC
//FHDBASE2 DD DISP=SHR,DSN=&NFSPRFX..FHDBASE2 @L3LA
/**
/** The LDBASE and LDBASE2 are the LOCKING DATABASES. @L74FA
/** They must be pre-allocated as empty VSAM KSDS data sets. @P0AC
/** They will be used alternately. @L74FA
/** Sample JCL can be found in &NFSPRFX.NFSSAMP(GFSAMHDJ). @L74FA
/**
//LDBASE DD DISP=SHR,DSN=&NFSPRFX..LDBASE @L74FA
//LDBASE2 DD DISP=SHR,DSN=&NFSPRFX..LDBASE2 @L74FA
/**
/** If the Installation intends to customize the translation @L3GA
/** table, a new DD card, NFSXLAT, is required in the PROC. @L3GA
/** The translation table data set must be pre-allocated @P0AC
/** as PDS or PDSE data set. The format of the data set must @P0AC
/** conform to the translation table format supported by @P0AC
/** Z/OS TCP/IP. @P0AC
/**
/**NFSXLAT DD DISP=SHR,DSN=&NFSPRFX..XLAT @L3GA
/** @LG2A
/** z/OS Language Environment "stdin" (SYSIN DD) @LG2A
/** @LG2A
//SYSIN DD DUMMY @LG2M
/** @LG2A
/** z/OS Language Environment "stdout" (SYSPRINT DD) and @LG2A
/** z/OS Language Environment "stderr" (SYSOUT DD). @LG2A
/** @LG2A
/** o) It is possible to use SYSOUT=*, or DUMMY, or @LG2A

```



```

|      /* pre-allocated data sets.                                @LG2A
|      /* o) The pre-allocated data set for SYSPRINT DD should have @LG2A
|      /* these DCB attributes RECFM=VB,LRECL=1028,BLKSIZE=6144    @LG2A
|      /* o) The pre-allocated data set for SYSOUT DD should have   @LG2A
|      /* these DCB attributes RECFM=VB,LRECL=137,BLKSIZE=6144    @LG2A
|      /*                                                            @LG2A
|      /*SYSPRINT DD SYSOUT=*                                       @LG2A
|      /*OUTPUT DD SYSOUT=*                                         @LG2A
|      /*SYSOUT DD SYSOUT=*                                         @LG2A
|      /*                                                            @LG2A
|      /**SYSPRINT DD DUMMY                                          @LG2A
|      /**OUTPUT DD DUMMY                                           @LG2A
|      /**SYSOUT DD DUMMY                                           @LG2A
|      /*                                                            @LG2A
|      /**SYSPRINT DD DISP=SHR,DSN=&NFSPRFX..STDOUT                 @LG2C
|      /**OUTPUT DD DISP=SHR,DSN=&NFSPRFX..STDOUT                   @LG2C
|      /**SYSOUT DD DISP=SHR,DSN=&NFSPRFX..STDERR                   @LG2C
|      /*                                                            @LG2A
|      /* Dump data sets.                                           @LG2A
|      /*                                                            @LG2A
|      /* Specify a pre-allocated CEEDUMP data set when requested   @LG2A
|      /* by IBM Support personnel, otherwise use DUMMY.           @LG2A
|      /*                                                            @LG2A
|      /*CEEDUMP DD DUMMY                                           @LG2M
|      /**CEEDUMP DD DISP=SHR,DSN=&NFSPRFX..CEEDUMP                 @LG2M
|      /*                                                            @LG2A
|      /* Specify a pre-allocated SYSMDUMP data set when requested  @LG2A
|      /* by IBM Support personnel, otherwise use DUMMY.           @LG2A
|      /*                                                            @LG2A
|      /*SYSMDUMP DD DUMMY                                          @LG2A
|      /**SYSMDUMP DD DISP=SHR,DSN=&NFSPRFX..SYSMDUMP               @LG2C

```

Sample z/OS NFS client startup procedures

Figure 45 on page 540 contains a sample MVSNFSC z/OS NFS client startup procedure. This procedure can be found as GFSCPROC in the NFSSAMP library.

```

//MVSNFSC PROC SYSNFS=SYS1,                                @004C
//*          TCPIP=TCPIP,                                    @004C
//*          SYSLE=SYS1,                                    @004A
//*          NFSRFX=MVSCINT                                  @004A
//*****
//*
//* z/OS Network File System Client Start Up Procedure (HDZ223N) @LG2C
//*
//*PROPRIETARY V3 STATEMENT
//*LICENSED MATERIALS - PROPERTY OF IBM
//*"RESTRICTED MATERIALS OF IBM"
//*5650-ZOS                                                @LE0C*
//*COPYRIGHT IBM Corp. 1989, 2017                          @LG2C*
//*END PROPRIETARY V3 STATEMENT
//*
//*****
//*
//* CHANGE HISTORY
//*
//* $L41=NFS,HDZ11SE,960120,SJPLJST: NFS Client support
//* $KAB0020=NFS,HDZ11TC,970425,SJPLPKL: Update FMID
//* $OW52984=NFS,HDZ11TC,020322,IBSPIV:
//* 1. replace DD with SYSOUT=* (SYSPRINT, SYSOUT, SYSERR and
//*          OUTPUT) to use DSN specification
//* 2. add SYSIN and CEEDUMP DD's to reduce LE activity
//* $L6=NFS,HDZ11UC,030405,SJPLMB: Change OS/390 to Z/OS
//* $L781=NFS,HDZ11VC,041207,SJPLMB : Change NFSLIB to NFSLIB@L781A*
//* $P01=KAJ0356,HDZ11VC,050414,SJPLMB : Changed to HDZ11VC @P01A*
//* $L80=NFS,HDZ118N,050512,SJPLMB: Update release to HDZ118N @L80A*
//* $L90=NFS,HDZ119N,060201,SJPLMB: Update release to HDZ119N @L90A*
//* $LA0=NFS,HDZ1AN0,070110,SJPLMB: Update release to HDZ1AN0 @LA0A*
//* $P02=KN00140,HDZ1AN0,071022,SJPLMB: REMOVE SYSTCPD @P02A*
//*----- Release VIR11 -----@LB0A*
//* $LB0= NFS_,HDZ1B1N,080208,SJPLMB: UPDATE REL TO HDZ1B1N @LB0A*
//* $002=0A25770,HDZ1AN0,080709,SJPLMTM: @002A*
//* 1. REMOVE TCPIP PARM FROM PROC STMT @002A*
//*----- Release VIR12 -----@LC0A*
//* $LC0= NFS_,HDZ1C1N,090118,SJPLMB: @LC0A*
//* 1. UPDATE REL TO HDZ1C1N. @LC0A*
//*----- Release VIR13 -----@LD0A*
//* $LD0= NFS_,HDZ1D1N,100302,SJPLMB: @LD0A*
//* 1. UPDATE REL TO HDZ1D1N. @LD0A*
//*----- Release V2R1 ----- @LE0A*
//* $LE0= NFS_,HDZ221N,20101211,SJPLMB: @LE0A*
//* 1. Changed product id from "5694-A01" to "5650-ZOS". @LE0A*
//* 2. Update constants for release HDZ221N. @LE0A*
//* $P03=KEN0148,HDZ221N,20110912,SJPLMB: @P03A*
//* 1. Change Copyright to "IBM Corp." before date(s). @P03A*
//* $LE7= NFS_,HDZ221N,20120228,SJPLMB: @LE7A*
//* 1. Changed Copyright from 2012 to 2013. @LE7A*
//*----- Release V2R2 ----- @LF0A*
//* $LF0= NFS_,HDZ222N,20120310,SJPLMB: @LF0A*
//* 1. Update constants for release (HDZ222N). @LF0A*
//* $P04=SM02773,HDZ222N,20140814,SJPLHPN: @P04A*
//* 1. Add MEMLIMIT for virtual memory above the bar. @P04A*
//*----- Release V2R3 ----- @LG2A*
//* $003=0A48811,HDZ223N,20150831,SJPLSLH: @003A*
//* 1. Add warning: data sets should be cataloged and @003A*
//*          not migrated @003A*
//* $004=0A51445,HDZ223N,20161018,SJPLHPN: @004A*

```

Figure 45. Sample z/OS NFS client startup procedures

```

/**      1. Remove the unused SYSERR; SYSPRINT is sufficient. @004A*
/**      2. LE stderr is SYSOUT, separated from stdout. @004A*
/**      ## SDI via STG Defect 138100. @004A*
/** $LG2=W138100,HDZ223N,20161027,SJPLHPN: @LG2A*
/**      1. Update constants for release (HDZ223N). @LG2A*
/**
/*******
/**
/** The REGION specifies the virtual memory below the bar (2GB) @P04A
/** while the MEMLIMIT specifies the memory above the bar. @P04A
/** If REGION=0M then MEMLIMIT=NOLIMIT (default), or @P04A
/** optionally specify the MEMLIMIT. @P04A
/** If REGION=xxxM then specify MEMLIMIT=yyyG rather than @P04A
/** taking some default value. @P04A
/** The z/OS Network File System Client will not start if @P04A
/** MEMLIMIT=0M or if it is too small ( 1GB for each @P04A
/** specified "biod"; since the default is "biod(6)" @P04A
/** then the mimimum MEMLIMIT is 6G ). @P04A
/**
/**MVSCCLNT EXEC PGM=BPXVCLNY,
/**      TIME=1440, @P04M
/**      REGION=0M @P04C
/**      REGION=0M,MEMLIMIT=yyyG @P04A
/**      REGION=xxxM,MEMLIMIT=yyyG @P04A
/**
/** Note1: All data sets specified in this procedure should be @004C
/** ===== cataloged and not migrated. @004C
/**
/** &TCPIP..TCPIP.DATA IS TCP/IP DATA FILE
/**
/** SYSTCPD EXPLICITLY IDENTIFIES WHICH DATA SET IS TO BE @P02A
/** USED TO OBTAIN THE PARAMETERS DEFINED BY TCPIP.DATA @P02A
/** WHEN NO GLOBALTCPIPDATA STATEMENT IS CONFIGURED. @P02A
/** SEE THE IP CONFIGURATION GUIDE FOR INFORMATION ON @P02A
/** THE TCPIP.DATA SEARCH ORDER. @P02A
/** THE DATA SET CAN BE ANY SEQUENTIAL DATA SET OR A MEMBER @P02A
/** OF A PARTITIONED DATA SET (PDS). @P02A
/** @002A
/** Note2: The TCPIP parameter on the PROC statement is @004C
/** ===== required when using the SYSTCPD DD statement. @004C
/** @002A
/**SYSTCPD DD DISP=SHR,DSN=&TCPIP..TCPIP.DATA(TCPDATA) @P02C
/**
/** STEPLIB consists of NFSLIBE and Language Environment @P04M
/** libraries. @P04M
/** *) &SYSNFS..NFSLIBE is z/OS Network File System Client @P04M
/** target library. @P04M
/** *) &SYSLE..SCEERUN2 is Language Environment AMODE64 runtime @P04A
/** library. @P04A
/** *) &SYSLE..SCEERUN is Language Environment runtime library. @P04M
/** Change the names as appropriate for your installation. @004M
/** Note3: Each of these libraries must be APF-authorized. @P04C
/** ===== The SYSLE parameter on the PROC statement is @004A
/** required when using the &SYSLE..SCEERUNx. @004A
/**
/**STEPLIB DD DISP=SHR,DSN=&SYSNFS..NFSLIBE @L781C
/** DD DISP=SHR,DSN=&SYSLE..SCEERUN2 @004C
/** DD DISP=SHR,DSN=&SYSLE..SCEERUN @004C
/** @004A
/** z/OS Language Enviroment "stdin" (SYSIN DD) @004A

```

```

|      /*                                     @004A
|      //SYSIN      DD DUMMY                                     @004M
|      /*                                               @004A
|      /* z/OS Language Enviroment "stdout" (SYSPRINT DD) and @004A
|      /* z/OS Language Enviroment "stderr" (SYSOUT DD).      @004A
|      /*                                               @004A
|      /* o) If z/OS NFS Client is started with JES then it is @004A
|      /* possible to use SYSOUT=*, or DUMMY, or               @004A
|      /* pre-allocated data sets.                             @004A
|      /* o) If z/OS NFS Client is started without JES ( SUB=MSTR @004A
|      /* in BPXPRMxx ) then specify pre-allocated data sets @004A
|      /* or DUMMY.                                           @004A
|      /* o) The pre-allocated data set for SYSPRINT DD should have @004A
|      /* these DCB attributes RECFM=VB,LRECL=1028,BLKSIZE=6144 @004A
|      /* o) The pre-allocated data set for SYSOUT DD should have @004A
|      /* these DCB attributes RECFM=VB,LRECL=137,BLKSIZE=6144 @004A
|      /*                                               @004A
|      //SYSPRINT DD SYSOUT=*                                  @004A
|      //OUTPUT DD SYSOUT=*                                   @004A
|      //SYSOUT DD SYSOUT=*                                  @004A
|      /*                                               @004A
|      /**SYSPRINT DD DUMMY                                   @004A
|      /**OUTPUT DD DUMMY                                    @004A
|      /**SYSOUT DD DUMMY                                    @004A
|      /*                                               @004A
|      /**SYSPRINT DD DISP=SHR,DSN=&NFSPRFX..STDOUT          @004C
|      /**OUTPUT DD DISP=SHR,DSN=&NFSPRFX..STDOUT           @004C
|      /**SYSOUT DD DISP=SHR,DSN=&NFSPRFX..STDERR           @004C
|      /*                                               *
|      /* NFSCMSG1 AND NFSCMSG2 DD'S ARE                      *
|      /* THE TWO CLIENT LOG DATA SETS NEED TO BE PRE-ALLOCATED *
|      /* AS SEQUENTIAL FILES.                                *
|      /* THE DCB WILL BE SET TO (VB,LRECL=137,BLKSIZE=6144) *
|      /* ONCE MVSLCNT IS STARTED, REGARDLESS OF THE ALLOCATION DCB. *
|      /* INITIALLY, WE RECOMMEND SPACE=(CYL,(2,5),RLSE)     *
|      /*                                               *
|      //NFSCMSG1 DD DISP=SHR,DSN=&NFSPRFX..LOG1
|      //NFSCMSG2 DD DISP=SHR,DSN=&NFSPRFX..LOG2
|      /*                                               @004A
|      /* Dump data sets.                                     @004A
|      /*                                               @004A
|      /* Specify a pre-allocated CEEDUMP data set when requested @004A
|      /* by IBM Support personnel, otherwise use DUMMY.      @004A
|      /*                                               @004A
|      //CEEDUMP DD DUMMY                                     @004M
|      /*CEEDUMP DD DISP=SHR,DSN=&NFSPRFX..CEEDUMP          @004M
|      /*                                               @004A
|      /* Specify a pre-allocated SYSMDUMP data set when requested @004A
|      /* by IBM Support personnel, otherwise use DUMMY.     @004A
|      /*                                               @004A
|      //SYSMDUMP DD DUMMY                                   @004A
|      /**SYSMDUMP DD DISP=SHR,DSN=&NFSPRFX..SYSMDUMP       @004C

```

Appendix H. Retrieval of source code for client enabling commands

Figure 46 shows how you can retrieve the necessary source code to install the client enabling commands on any platform except an AIX, UNIX, or z/OS client. See “Installing the client enabling commands” on page 209 for information on retrieving the necessary source code to install the client enabling commands on AIX or UNIX workstation. The z/OS NFS client source code is installed when the z/OS NFS client and TCP/IP are installed. In this example, **mvshost1** is the name of the z/OS host and **smith** is a z/OS user ID:

```
C> md client          (to create a directory to contain clientcode)
C> cd client
C> ftp mvshost1
Connected to mvshost1
220-FTPSERVE at MVSHOST1, 01:44:24 on 12/02/07
220 Connection closes if idle for more than 5 minutes.
Name (mvshost1:nobody): smith
<Press ENTER key>
331 Send password please.
Password: password

230 smith is logged on.
ftp> get 'mvsnfs.nfstarb(gfsawaxd)' gfsawaxd.c
200 Port request OK.
125 Sending data set MVS NFS.NFSTARB(GFSAWAXD)
250 Transfer completed successfully.
local: gfsawaxd.c remote: 'mvsnfs.nfstarb(gfsawaxd)'
19516 bytes received in 0.14 seconds (139.4 Kbytes/s)
ftp> get 'mvsnfs.nfstarb(gfsawclt)' gfsawclt.c
200 Port request OK.
125 Sending data set MVS NFS.NFSTARB(GFSAWCLT)
250 Transfer completed successfully.
local: gfsawclt.c remote: 'mvsnfs.nfstarb(gfsawclt)'
17584 bytes received in 0.19 seconds (92.36 Kbytes/s)
ftp> get 'mvsnfs.nfstarb(gfsawlin)' gfsawlin.c
200 Port request OK.
125 Sending data set MVS NFS.NFSTARB(GFSAWLIN)
250 Transfer completed successfully.
local: gfsawlin.c remote: 'mvsnfs.nfstarb(gfsawlin)'
52808 bytes received in 0.25 seconds (211.23 Kbytes/s)
ftp> get 'mvsnfs.nfstarb(gfsawlou)' gfsawlou.c
200 Port request OK.
125 Sending data set MVS NFS.NFSTARB(GFSAWLOU)
250 Transfer completed successfully.
local: gfsawlou.c remote: 'mvsnfs.nfstarb(gfsawlou)'
22468 bytes received in 0.14 seconds (160.49 Kbytes/s)
ftp> get 'mvsnfs.nfstarb(gfsawmcl)' gfsawmcl.c
200 Port request OK.
125 Sending data set MVS NFS.NFSTARB(GFSAWMCL)
250 Transfer completed successfully.
```

Figure 46. Retrieving source code for client enabling commands

```

local: gfsawmcl.c remote: 'mvsnfs.nfstarb(gfsawmcl)'
17302 bytes received in 0.12 seconds (144.18 Kbytes/s)
ftp> get 'mvsnfs.nfstarb(gfsawmou)' gfsawmou.c
200 Port request OK.
125 Sending data set MVS NFS.NFSTARB(GFSAWMOU)
250 Transfer completed successfully.
local: gfsawmou.c remote: 'mvsnfs.nfstarb(gfsawmou)'
29110 bytes received in 0.17 seconds (171.24 Kbytes/s)
ftp> get 'mvsnfs.nfstrab(gfsawrp6)' gfsawrp6.h
200 Port request OK.
125 Sending data set MVS NFS.NFSTARB(GFSAWRP6)
250 Transfer completed successfully.
local: gfsawrp6.h remote: 'mvsnfs.nfstarb(gfsawrp6)'
27880 bytes received in 0.16 seconds (174.25 Kbytes/s)
ftp> get 'mvsnfs.nfstrab(gfsawrs6)' gfsawrs6.h
200 Port request OK.
125 Sending data set MVS NFS.NFSTARB(GFSAWRS6)
250 Transfer completed successfully.
local: gfsawrs6.h remote: 'mvsnfs.nfstarb(gfsawrs6)'
204262 bytes received in 0.94 seconds (216.84 Kbytes/s)
ftp> get 'mvsnfs.nfstarb(gfsawsha)' gfsawsha.c
200 Port request OK.
125 Sending data set MVS NFS.NFSTARB(GFSAWSHA)
250 Transfer completed successfully.
local: gfsawsha.c remote: 'mvsnfs.nfstarb(gfsawsha)'
141122 bytes received in 0.61 seconds (230.97 Kbytes/s)
ftp> get 'mvsnfs.nfstarb(gfsawmnt)' gfsawmnt.h
200 Port request OK.
125 Sending data set MVS NFS.NFSTARB(GFSAWMNT)
250 Transfer completed successfully.
local: gfsawmnt.h remote: 'mvsnfs.nfstarb(gfsawmnt)'
10414 bytes received in 0.09 seconds (115.71 Kbytes/s)
ftp> get 'mvsnfs.nfstarb(gfsawsho)' gfsawsho.h
200 Port request OK.
125 Sending data set MVS NFS.NFSTARB(GFSAWSHO)
250 Transfer completed successfully.
local: gfsawsho.h remote: 'mvsnfs.nfstarb(gfsawsho)'
7052 bytes received in 0.07 seconds (100.74 Kbytes/s)
(Note: Make sure that the tabs key in the gfsawjcl makefile will not
be translated into a space key for the following step.)
ftp> get 'mvsnfs.nfstarb(gfsawjcl)' makefile
200 Port request OK.
125 Sending data set MVS NFS.NFSTARB(GFSAWJCL)
250 Transfer completed successfully.
local: makefile remote: 'mvsnfs.nfstarb(gfsawjcl)'
8364 bytes received in 0.07 seconds (119.49 Kbytes/s)
ftp> quit
221 Quit command received. Goodbye.
C>
C> (Port commands source code to be compiled in your client
workstation.)
C> (Set up the path to the "client" directory for the users to use
the executable code of mvslogin, mvslogout,
and showattr commands.)
C> mvslogin mvshost1 smith (MVS NFS must be operational
Password required on host side.)
GFS A973A Enter MVS password:
GFS A955I smith logged in ok.
C>

```

Appendix I. PCNFSD protocol

The PCNFSD protocol enables clients to access z/OS files without issuing the **mvslogin** command. Check with your workstation administrator to see if your clients have PCNFSD support.

Accessing data with PCNFSD

NFS creates a unique UID and GID for each client, and the UIDs and GIDs are consistent within a session. For example, the server might return the UID and GID set (100,100) for one user, and (101,100) for the next user.

If the client maintains the UID and GID for the mount point base, you should use the PCNFSD requests rather than the **mvslogin** client enabling command. However, if the client does not maintain the UID and GID for the mount point base, you should use the **mvslogin** client enabling commands rather than PCNFSD requests.

If you issue the **mount** command, which issues a PCNFSD request (as it is implemented on some platforms), to do the authentication, you should not use the **mvslogin** client enabling command.

If the client's z/OS user ID, which was authenticated by a PCNFSD request issued by a **mount** command, is logged off by the server due to timeout or server restart, then the client needs to issue the **umount** and **mount** commands to log on again.

See Part 1, "Using z/OS Network File System," on page 1 for information about how clients use PCNFSD.

Accessing z/OS UNIX files

For z/OS UNIX file access, the user must first have a TSO/E user ID defined to RACF with a z/OS UNIX segment defining the UID and GID. When the PCNFSD authenticate request is received, the Network File System uses the UID and GID associated with the user's RACF profile z/OS UNIX segment, to return in the client's UID and GID credentials. It is recommended that the RACF installation preserve a unique network UID and GID that each user is associated with throughout the network. If there is no z/OS UNIX segment for a user, the client's UID and GID credentials are assigned as presented in the following paragraphs.

If **security(saf)** or **security(safexp)** is specified in the site attributes and the client user does not have a valid z/OS UNIX segment, a system assigned UID and GID is returned in the client user credentials.

If **security(none)** or **security(exports)** is specified in the site attributes, a system assigned UID and GID is returned in the client user credentials.

Starting the PCNFSD server

Specify **pcnfsd** or **nopcnfsd** in the attributes data set to control whether to start the PCNFSD server.

Using supported PCNFSD protocols

You can use either version 1 or 2 of the PCNFSD protocol with the Network File System.

Version 1 of the PCNFSD protocol

The PCNFSD Version 1 protocol is specified in *Developer's Specification Protocols for X/Open PC Interworking (PC) NFS*. The z/OS Network File System supports procedures 0 and 1 of the version 1 PCNFSD protocol.

Procedure 0: do nothing

Procedure 0 (NULL) does nothing.

Procedure 1: perform user authentication

The input parameters for this procedure are the z/OS user ID and password. The output parameters are the return code, UID and GID. If the z/OS user ID and password are verified successfully (return code=0), the corresponding UID and GID values are returned.

Return codes	
The caller receives one of these return codes:	<ul style="list-style-type: none">• Return code = 0 - Authentication successful• Return code = 2 - Authentication failed

Version 2 of the PCNFSD protocol

z/OS NFS supports procedures 0, 1, 12, and 13 of the PCNFSD Version 2 protocol.

Procedure 0: do nothing

Procedure 0 (NULL) does nothing.

Procedure 1: give descriptions

Procedure 1 describes how the NFS supports each procedure of the PCNFSD version 2 Protocol.

The input parameters are the version information and comments from the client platform. The NFS ignores the information in the input parameters.

The output parameters are the version information, comments, number of procedures in the PCNFSD version 2 protocol, and a list of descriptions about how the NFS supports each procedure in this PCNFSD version 2 protocol.

Values	
There are three values to represent how the server supports the procedures:	<ul style="list-style-type: none">• -1 - The procedure is not supported• 100 - The procedure gets quick service from the server• 2000 - The procedure takes more time to complete the service from the server

Procedure 12: perform mapping

Procedure 12 performs mapping the UID to user name, GID to group name, or group name to GID depending on the request identifier.

If the mapping is successful, the procedure returns successfully. If the names (or IDs) do not exist, or the caller does not have permission to do the mapping, the procedure returns an error.

Procedure 13: perform user authentication

The input parameters are local host name, encoded user name, encoded password, and comments from the requestor. NFS ignores the local host name and comments from the requestor, and decodes the user name and password in the input parameters. NFS does authentication based on the user name and password.

The output parameters are:

Return codes	
There are only two possible return codes that can be sent back to the caller:	<ul style="list-style-type: none">• Return code = 0 - Authentication successful• Return code = 2 - Authentication failed
UID and GID	If user name and password are verified successfully (return code = 0), the corresponding UID and GID values are returned.
Number of alternate GIDs	Because NFS does not support alternate GIDs, this field is set to zero.
Pointer to a list of the alternate GIDs	Because NFS does not support alternate GIDs, this field is set to zero.
Logon Home Directory	Because NFS does not support logon home directory, this field is zero.
Default umask	Because NFS does not support default umask, this field is set to zero.
Comments sent to the requestor	If the return code is 2, this comment field contains the reason why the request failed.

Appendix J. SMF C and assembler header macros

The following text contains copies of the SMF C and Assembler header macros for your reference. The SMF C header macro is GFSASSMF and the Assembler header macro is GFSASM. Both header macros can be found in the SYS1.NFSMAC library.

SMF C header macro GFSASSMF

Figure 47 contains information about the SMF C header macro GFSASSMF. The GFSASSMF macro can be found in the SYS1.NFSMAC macro library.

```

/*****/ 00050000
/* */ 00100000
/* $MAC(GFSASSMF) COMP(5695DF121): NFSS XI */ 00150000
/* */ 00200000
/* MACRO NAME: GFSASSMF.H (SMF.H) */ 00250000
/* */ 00300000
/* DESCRIPTION: Contains C Language Mapping of SMF type 42 */ 00350000
/* and the subtype 7, 8 and 26 records. @LCOC */ 00400000
/* */ 00450000
/* STATUS: Version 1 Release 1 */ 00500000
/* */ 00550000
/* COPYRIGHT: */ 00600000
/*PROPRIETARY V3 STATEMENT */ 00650000
/*LICENSED MATERIALS - PROPERTY OF IBM */ 00700000
/*"RESTRICTED MATERIALS OF IBM" */ 00750000
/*5694-A01 */ 00800000
/*COPYRIGHT 1996,2010 IBM CORP. @LCOC */ 00850000
/*END PROPRIETARY V3 STATEMENT */ 00900000
/* */ 00950000
/* FUNCTION: This header file contains the mapping for SMF */ 01000000
/* records in the following format: */ 01050000
/* */ 01100000
/* ----- */ 01150000
/* | Type 42 Header | */ 01200000
/* ----- */ 01250000
/* | Subtype 7 or 8 or 26 Header | @LCOC */ 01300000
/* ----- */ 01350000
/* | Product Section | */ 01400000
/* ----- */ 01450000
/* | Subtype 7 or 8 or 26 Data | @LCOC */ 01500000
/* ----- */ 01550000
/* | Client Section | */ 01600000
/* ----- */ 01650000
/* */ 01700000
/* Note: 1) To obtain address of the subtype 7,8 or 26 header @LCOC */ 01750000
/* add SMF42LEN to the address of the type 42 header */ 01800000
/* 2) To obtain the address of the product section */ 01850000
/* add SMF420PS to the address of the type 42 header */ 01900000

```

Figure 47. SMF C header macro GFSASSMF

```

/*      3) a) To obtain the address of the subtype 7 data portion */ 01950000
/*          add SMF42NFO to the address of the type 42 header */ 02000000
/*      b) To obtain the address of the subtype 8 data portion */ 02050000
/*          add SMF42NUO to the address of the type 42 header */ 02100000
/*      c) To obtain the address of the subtype 26 data @LCOA*/ 02116600
/*          add SMF42ADO to the address of the type 42 header */ 02133300
/*      4) a) To obtain the address of the subtype 7 client */ 02150000
/*            section add SMF42FLO to the address of the */ 02200000
/*            current subtype 7 data portion. There can be more */ 02250000
/*            than one subtype 7 record in a type 42 record. */ 02300000
/*            There will always be a subtype 7 and client pair. */ 02350000
/*      b) To obtain the address of the subtype 8 client */ 02400000
/*            section add SMF42UCO to the address of the */ 02450000
/*            type 42 header. */ 02500000
/*      c) To obtain the address of the subtype 26 client @LCOA*/ 02508300
/*            section add SMF42ALO to the address of the */ 02522200
/*            type 42 header. */ 02536100
/*            */ 02550000
/*            */ 02600000
/*            */ 02650000
/* NOTES: */ 02700000
/* DEPENDENCIES: All changes made to this macro must be */ 02750000
/*                reflected in GFSASMF. If any of the header */ 02800000
/*                sections change, they will also have to be */ 02850000
/*                reflected in IGWSMF */ 02900000
/*            */ 02950000
/* MODULE TYPE: C header/include file */ 03000000
/* PROCESSOR: IBM ADC/370 compiler */ 03050000
/* LIBRARY: NFSLB */ 03100000
/* CC OPTIONS: None. */ 03150000
/* ATTRIBUTES: None. */ 03200000
/*            */ 03250000
/* LINKAGE: #include "GFSASsmf.h" */ 03300000
/*            */ 03350000
/*            */ 03400000
/* EXTERNAL REFERENCES: (external to this header file) */ 03450000
/* DATA AREAS: None */ 03500000
/* INCLUDE FILES: None */ 03550000
/*            */ 03600000
/* TYPEDEFS DEFINED: */ 03650000
/*     smf42 */ 03700000
/*     smf427h */ 03750000
/*     smf428h */ 03750000

```

```

/*      smf4226h                                @LCOA */ 03775000
/*      smf42prd                                */ 03800000
/*      smf42s7                                 */ 03850000
/*      smf42cs                                 */ 03900000
/*      smf42s8                                 */ 03950000
/*      smf42s26                                @LCOA */ 03975000
/*
/* STRUCTs DEFINED:                             */ 04000000
/*   None                                       */ 04050000
/*                                             */ 04100000
/*                                             */ 04150000
/* MACROs DEFINED:                             */ 04200000
/*   None                                       */ 04250000
/*                                             */ 04300000
/* CHANGE ACTIVITY:                             */ 04350000
/* $L33=NFS,HDZ11NP,940425,SJPLTEM: New macro for DFSMS 1.2/NFSS@L33A*/ 04400000
/* $P1=KA90085,HDZ11NP,940623,SJPLTEM: Add File sys & type values@P1A*/ 04450000
/* $P2=KA90127,HDZ11NP,940726,SJPLTEM: Remove HFS block counters @P2A*/ 04500000
/*                                             Convert to 2 name lengths @P2A*/ 04550000
/* $P3=KA90166,HDZ11NP,940825,SJPLTEM: Add hfs pathname support @P3A*/ 04600000
/* $P4=KA90179,HDZ11NP,940909,SJPLTEM: Define HFS SMF42FSN & FDN @P4A*/ 04650000
/* $LA5=NFS,HDZ11TS,000521,SJPLJST: AIO C Compiler V2.6 support @LA5A*/ 04700000
/* $L75=NFS,HDZ11VS,031209,IBSVKR: IPv6 support @L75A*/ 04750000
/* $O1=0A10174,HDZ11US,050311,IBSGYG: for IGWSMF compatibility as@O1A*/ 04800000
/*                                             IGWSMF contains SMF42 header@O1A*/ 04850000
/* $LCO= _NFS_,HDZ1C1N,090407,IBSIPI :         @LCOA*/ 04866600
/*   1. Add SMF type 42 subtype 26 recording    @LCOA*/ 04883200
/* $P05=KCN0097,HDZ1C1N,091103,IBSVKR:        @P05A*/ 04888800
/*   1. Delete SMF42ATN field (New Data Set Type) @P05A*/ 04894400
/******
/*-----*/
/* Header for SMF record type 42 as in IGWSMF */ /*@01C*/
/*-----*/
typedef _Packed struct smf42 {
short int smf42rc1; /* Record Length */ 05200000
short int smf42sgd; /* Segment Descriptor (RDW) -- 0 if record is not spanned */ 05300000
unsigned char smf42flg; /* System indicator flags */ 05350000
char smf42rty; /* Record type: 42 (X'2A') */ 05400000
int smf42tme; /* Time in hundredths of a second */ 05450000
unsigned char smf42dte[4]; /* Date record written (by SMF) */ 05500000
unsigned char smf42sid[4]; /* System identification (by SMF) */ 05550000
unsigned char smf42ssi[4]; /* Subsystem Id */ 05600000
short int smf42sty; /* Record subtype */ 05650000
short int smf42nt; /* Number of triplets (optional) */ 05700000
short int _filler1; /* Reserved (optional) */ 05750000
/*-----*/
/* Product section triplet */ 05800000
/*-----*/
int smf42ops; /* Offset to product section */ 05850000
short int smf42lps; /* Length of product section */ 05900000
short int smf42nps; /* Number of product sections */ 05950000
06000000
06050000
06100000
06150000
06200000
06250000

```

```

/*-----*/
/* Header must end on word boundary */
/*-----*/
/* unsigned char smf42end; 1st data section triplet */
} SMF42;

/* Values for field "smf42flg"
#define smf42fsi 0x80 /* When set=subsystem id follows system id
#define smf42fsu 0x40 /* When set = subtypes are used
#define smf42fxa 0x04 /* When set = MVS/XA (SMF enters)
#define smf42fs2 0x02 /* When set = VS2 (SMF enters)
#define smf42fs1 0x01 /* When set = VS1 (SMF enters)

#define smf42_len 0x28

/*-----*/
/* SMF42 subtype 7 header section
/* (file timeout statistics)
/*-----*/

typedef struct smf427h {
    int smf42nfo; /*Offset NFSS file timeout stats section */
    short int smf42nfl; /*Length NFSS file timeout stats section */
    short int smf42nfn; /*Number NFSS file timeout stats section */
} SMF427H;

/*-----*/
/* SMF42 subtype 8 header section
/* (user logout statistics )
/*-----*/

typedef struct smf428h {
    int smf42nuo; /* Offset NFSS user session stats section */
    short int smf42nul; /* Length NFSS user session stats section */
    short int smf42nun; /* Number NFSS user session stats section */
} SMF428H;

/*-----*/
/* SMF42 subtype 26 header section
/* (delete/rename/create statistics)
/*-----*/

typedef struct smf4226h {
    int smf42ado; /* Offset NFSS audit stats section
    short int smf42adl; /* Length NFSS audit stats section
    short int smf42adn; /* Number NFSS audit stats section
} SMF4226H;

/*-----*/
/* Product Section
/*-----*/

typedef struct smf42prd {
    char smf42pd1[8]; /* Product Level

```

```

char          smf42pdn[10]; /* Product Name          */ 08650000
char          smf42psv; /* Subtype Version Number @L75A*/ 08700000
char          filler[21]; /* Reserved          @L75C*/ 08750000
} SMF42PRD;
08800000
08850000
08900000
/*----- */ 08950000
/* SMF type 42 subtype 7 file timeout Statistics */ 09000000
/*----- */ 09050000
09100000
typedef _Packed struct smf42s7 { /*@P2C*/ 09150000
int          smf42flo; /*Offset to client identification section.*/ 09200000
short int    smf42fl1; /*Length of client identification section.*/ 09250000
char         smf42ffs; /* File system type indicator.          */ 09300000
/* 01 = z/OS UNIX          @LCOC*/ 09350000
/* 02 = MVS                @P1A*/ 09400000
char         smf42fty; /* File type as defined in NFS protocol. */ 09450000
/* 0 = Non-file           @P1A*/ 09500000
/* 1 = Regular file       @P1A*/ 09550000
/* 2 = Directory          @P1A*/ 09600000
/* 3 = Block special device @P1A*/ 09650000
/* 4 = Character special device @P1A*/ 09700000
/* 5 = Symbolic link      @P1A*/ 09750000
char         smf42ftm; /* MVS data set type.          */ 09800000
/* 0 = unknown MVS file type @P1A*/ 09850000
/* 1 = Sequential (BSAM) file @P1A*/ 09900000
/* 2 = Partitioned (BPAM) @P1A*/ 09950000
/* 3 = Direct Access file @P1A*/ 10000000
/* 4 = ISAM is not supported @P1A*/ 10050000
/* 5 = Virtual Sequential Access @P1A*/ 10100000
/* 6 = VSAM Entry Sequenced @P1A*/ 10150000
/* 7 = VSAM Relative Record @P1A*/ 10200000
/* 8 = VSAM Keyed access @P1A*/ 10250000
/* 9 = dummy index level file block @P1A*/ 10300000
/* 10 = z/OS UNIX file type @LCOC*/ 10350000
char         s7fill1[3]; /* Reserved          */ 10400000
int          smf42fsn; /*File Serial Number,z/OS UNIX INODE@LCOC*/ 10450000
int          smf42fdn; /*Unique device number, z/OS UNIX @LCOC*/ 10500000
/* file system number @LCOC*/ 10550000
int          smf42fir; /* Number of I/O blocks read.          */ 10600000
int          smf42fiw; /* Number of I/O blocks written.        */ 10650000
int          s7fill2; /* Reserved          */ 10700000
u_int64     smf42fbr; /* Number of bytes read from file. @LA5C*/ 10750000
u_int64     smf42fbw; /* Number of bytes written to file. @LA5C*/ 10800000
short int    smf42fnl; /* Length of file name.          */ 10850000
char         s7fill3[6]; /* Reserved - Dword boudary @P2A*/ 10900000

```

```

/*-----*/
/* This is followed by the file name. It is */
/* a 256 byte character string. 5L75C*/
/* @L75D*/
/* See the S7RECV0 and S7RECV2 types below. @L75C*/
/* @L75D*/
/*-----*/
} SMF42S7;
10950000
11000000
11050000
11100000
11150000
11200000
11250000
11300000
11350000
11400000
11450000
/*-----*/
/* Client Identification Section. Version 0 @L75C*/
/*-----*/
typedef struct smf42cs0 { /*@L75C*/
char smf42cri[8]; /* RACF user ID. */
char smf42crg[8]; /* RACF group name. */
char smf42can[8]; /* Account Number. */
int smf42cui; /* User ID at client host (UNIX style)*/
int smf42cgi; /* Group ID at client host (UNIX style)*/
int smf42cip; /* IP address of client host. */
short int smf42chl; /* Length of client host name */
char smf42chn[256]; /* Client host name. @L75C*/
} SMF42CS0; /*@L75C*/
11500000
11550000
11600000
11650000
11700000
11750000
11800000
11850000
11900000
11950000
12000000
12050000
12100000
12150000
12200000
12250000
/*-----*/
/* Client Identification Section. Version 2 @L75A*/
/*-----*/
typedef struct smf42cs2 { /*@L75A*/
char smf42cri[8]; /* RACF user ID. @L75A*/
char smf42crg[8]; /* RACF group name. @L75A*/
char smf42can[8]; /* Account Number. @L75A*/
int smf42cui; /* User ID at client host @L75A*/
int smf42cgi; /* Group ID at client host @L75A*/
char smf42cip[16]; /* IPv6 address of client host. @L75A*/
short int smf42chl; /* Length of client host name @L75A*/
char smf42chn[256]; /* Client host name. @L75A*/
} SMF42CS2; /*@L75A*/
12450000
12500000
12550000
12600000
12650000
12700000
12750000
12800000
12850000
12900000
12950000
13000000
13050000
/*-----*/
/* SMF type 42 subtype 8 user session completion Statistics */
/*-----*/
typedef struct smf42s8 {
int smf42uco; /* Offset client identification section */
short int smf42ucl; /* Length client identification section */
short int smf42res2; /* Reserved. */
u_int64 smf42ust; /* Session start time (in STCK format)@LA5C*/
u_int64 smf42uet; /* Session end time (in STCK format)@LA5C*/
int smf42uel; /* Session elapsed time (milliseconds) */
u_long smf42unr; /* Number of RPC requests processed in
/* this session */
int smf42ute; /* Total elapsed time of all RPC
/* requests processes in this session. */
int smf42uat; /* Total active time of all RPC
/* requests processes in this session. */
13100000
13150000
13200000
13250000
13300000
13350000
13400000
13450000
13500000
13550000
13600000
13650000
13700000
13750000
13800000
13850000

```



```

u_int64      smf42urn; /*Number of bytes read in from the)@LA5C*/ 13900000
/* network in this session */ 13950000
u_int64      smf42uwn; /*Number of bytes written out to the@LA5C*/ 14000000
/* network in this session */ 14050000
u_int64      smf42urf; /*Number of bytes read from files on@LA5C*/ 14100000
/* this session */ 14150000
u_int64      smf42uwf; /*Number of bytes written to files in@LA5C*/ 14200000
/* this session */ 14250000
14300000
} SMF42S8; 14350000
14350700
/*-----*/ 14351400
/* SMF type 42 subtype 26 delete/rename/create Statistics @LCOA*/ 14352100
/*-----*/ 14352800
14353500
typedef _Packed struct smf42s26 /*@LCOA*/ 14354100
{ 14354700
int          smf42alo; /*Offset to client ident section */ 14355300
short int    smf42all; /*Length of client ident section */ 14355900
char         smf42aov; /*NFS protocol version (2,3 or 4)*/ 14356700
char         smf42aop; /*NFS operation/procedure number */ 14357500
char         smf42afs; /* File system type */ 14358500
/* 01 = UNIX */ 14358600
/* 02 = MVS */ 14358700
char         s26fill1[3]; 14359100
union 14359800
{ 14360500
struct 14361200
{ 14361900
char         smf42atm; /* Data Set type */ 14362600
/* 0 = unknown MVS file type */ 14363300
/* 1 = Sequential (BSAM) file */ 14364000
/* 2 = Partitioned (BPAM) file */ 14364700
/* 3 = Direct Access file */ 14365400
/* 4 = ISAM is not supported */ 14366100
/* 5 = Virtual Sequential Access*/ 14366800
/* 6 = VSAM Entry Sequenced */ 14367500
/* 7 = VSAM Relative Record */ 14368200
/* 8 = VSAM Keyed access */ 14368900
/* 9 = dummy index level file block*/ 14369600
char         s26fill2; 14370300
char         smf42avl[6]; /* Volume name 6 chars */ 14371000
int          smf42anl; /* Data set name length*/ 14371700
/*@P05D*/ 14372600
char         s26fill3[2]; /*@P05C*/ 14373500
char         smf42avn[6]; /* New Volume name 6 chars */ 14374500
int          smf42ann; /* New Data set name length*/ 14375200
} mvs; 14375900
14376600
struct 14377300
{ 14378000
char         smf42aty; /* File object type */ 14378700
/* 1 = Directory */ 14379400
/* 2 = Character special file*/ 14380100
/* 3 = Regular file */ 14380800
/* 4 = Named pipe (FIFO) file*/ 14381500
/* 5 = Symbolic link */ 14382200
/* 6 = Block special file */ 14382900
/* 7 = Socket file */ 14383600

```

```

char      s26fill4[3];                               14385000
int       smf42asd; /* File system device number */   14385700
int       smf42asl; /* File system name length */     14386400
char      smf42asn[44]; /* File system name 1-44 chars */ 14387100
/* it is not NULL terminated */                      14387800
int       smf42afi; /* File inode attribute */        14388500
char      smf42afa[16]; /* File auditid attribute */   14389200
int       smf42adi; /* Directory inode attribute */    14389900
char      smf42ada[16]; /* Directory auditid attribute */ 14390600
int       smf42af1; /* File name length */            14391300
int       smf42ani; /* New directory inode */         14392000
char      smf42ana[16]; /* New directory audited */   14392700
int       smf42afn; /* New File name length */        14393400
} unix;                                             14394100
} s26a;                                             14394800
char smf42anm[1]; /* File name (1-255 chars) */      14395500
/* and New file name, if exist */                  14396200
/* It are not NULL terminated */                   14396900
} SMF42S26;                                       14397600
                                                    14398300
/*****/ 14400000
/* the following typedefs are used internally to construct and @P2A*/ 14450000
/* free SMF type 42 subtype 7 data chaining elements. @P2A*/ 14500000
/* elements. @P2A*/ 14550000
/* @P2A*/ 14600000
                                                    14650000
#define SMF_SHORT_FNAME 256 /* short file name <= 256 */ 14700000
#define SMF_LONG_FNAME 1023 /* long file name > 256 */ 14750000
#define SMF_MAX_RECLEN 32390 /* maximum SMF record length */ 14800000
/* Length of file usage stat., plus short file name, plus client data*/ 14850000
#define SMF_SHORT_DATALEN \
  (sizeof(SMF42S7)+SMF_SHORT_FNAME+(GLOBAL->flags.IPV6 ? /*@L75C*/\ 14950000
  sizeof(SMF42CS2) : sizeof(SMF42CS0))) /*@L75A*/ 15000000
#define SMF_LONG_DATALEN \
  (sizeof(SMF42S7)+SMF_LONG_FNAME+(GLOBAL->flags.IPV6 ? /*@L75C*/\ 15100000
  sizeof(SMF42CS2) : sizeof(SMF42CS0))) /*@L75A*/ 15150000
                                                    15200000
/* S7ELEM is gotten whenever a file times out, to collect statistics 15250000
on the file. It is then chained to the list from NFSGLOBAL, and 15300000
the chain is processed later to write SMF dataset usage record 15350000
subtype 7. This is done for files with file name <= 256. */ 15400000
typedef _Packed struct s7elem { /* element to be chained@P2A*/ 15450000
_Packed struct s7elem *next; /* next element in list @P2A*/ 15500000
char *filler; /* account for C forcing@P2A*/ 15550000
/* doubleword alignment @P2A*/ 15600000
SMF42S7 smf42s7; /* data portion @P2A*/ 15650000
char smfilen[SMF_SHORT_FNAME]; /* 256 byte file name @P2A*/ 15700000
SMF42CS2 smf42cs; /* client section V2 @L75C*/ 15750000
} S7ELEM; /* @P2A*/ 15800000
                                                    15850000
/* SMF file usage record. Version 0 @L75C*/ 15900000
typedef _Packed struct s7recV0 { /* type 42 subtype 7 @L75C*/ 15950000
SMF42 smf42; /* type 42 header @P2A*/ 16000000
SMF427H smf427h; /* subtype 7 header @P2A*/ 16050000
SMF42PRD smf42prd; /* product section @P2A*/ 16100000
SMF42S7 smf42s7; /* data portion @P2A*/ 16150000
char smfilen[SMF_SHORT_FNAME]; /* 256 byte path name @P2A*/ 16200000
SMF42CS0 smf42cs0; /* client section @L75C*/ 16250000
} S7RECV0; /* @L75C*/ 16300000
                                                    16350000

```

```

/* SMF file usage record. Version 2                                     @L75A*/ 16400000
typedef _Packed struct s7recV2 { /* type 42 subtype 7 @L75A*/ 16450000
    SMF42 smf42; /* type 42 header @L75A*/ 16500000
    SMF427H smf427h; /* subtype 7 header @L75A*/ 16550000
    SMF42PRD smf42prd; /* product section @L75A*/ 16600000
    SMF42S7 smf42s7; /* data portion @L75A*/ 16650000
    char smfilen[SMF_SHORT_FNAME]; /* 256 byte path name@L75A*/ 16700000
    SMF42CS2 smf42cs2; /* client section @L75A*/ 16750000
} S7RECV2; /* @L75A*/ 16800000
16850000

/* SMF user session statistics record - subtype 8. Version 0 @L75C*/ 16900000
typedef _Packed struct s8recV0 { /* type 42 subtype 8 @L75C*/ 16950000
    SMF42 smf42; /* type 42 header @P2A*/ 17000000
    SMF428H smf428h; /* subtype 8 header @P2A*/ 17050000
    SMF42PRD smf42prd; /* product section @P2A*/ 17100000
    SMF42S8 smf42s8; /* data portion @P2A*/ 17150000
    SMF42CS0 smf42cs0; /* client section @L75C*/ 17200000
} S8RECV0; /*@L75C*/ 17250000
17300000

/* SMF user session statistics record - subtype 8. Version 2 @L75A*/ 17350000
typedef _Packed struct s8recV2 { /* type 42 subtype 8 @L75A*/ 17400000
    SMF42 smf42; /* type 42 header @L75A*/ 17450000
    SMF428H smf428h; /* subtype 8 header @L75A*/ 17500000
    SMF42PRD smf42prd; /* product section @L75A*/ 17550000
    SMF42S8 smf42s8; /* data portion @L75A*/ 17600000
    SMF42CS2 smf42cs2; /* client section @L75A*/ 17650000
} S8RECV2; /*@L75A*/ 17700000
17750000

/* SMF delete/rename record /*@LCOA*/ 17800000
typedef _Packed struct s26recV2 /* type 42 subtype 26 @LCOA*/ 17833300
{ /* @LCOA*/ 17866600
    SMF42 smf42; /* type 42 header @LCOA*/ 17900000
    SMF4226H smf4226h; /* subtype 26 header @LCOA*/ 17950000
    SMF42PRD smf42prd; /* product section @LCOA*/ 18000000
    SMF42S26 smf42s26; /* data portion @LCOA*/ 18050000
    SMF42CS2 smf42cs2; /* client section @LCOA*/ 18100000
} S26RECV2; /*@LCOA*/ 18150000
18200000

```

SMF assembler header macro GFS AUSMF

Figure 48 contains information about the SMF Assembler header macro GFS AUSMF. The GFS AUSMF macro can be found in the SYS1.NFSMAC library.

```

/******/ 00050000
/*/ 00100000
**/ $MAC(GFS AUSMF) COMP(5695DF121): NFSS XI /*/ 00150000
**/ /*/ 00200000
**/ MACRO NAME: GFS AUSMF.ASM /*/ 00250000
**/ /*/ 00300000
**/ DESCRIPTION: Contains ASM Language Mapping of SMF type 42 /*/ 00350000
**/ and the subtype 7, 8 and 26 records. @LCOC /*/ 00400000
**/ /*/ 00450000
**/ STATUS: z/OS V2R1 NFS Server @LE7C*/ 00500000
**/ /*/ 00550000
**/ COPYRIGHT: /*/ 00600000
**/ PROPRIETARY V3 STATEMENT /*/ 00650000
**/ LICENSED MATERIALS - PROPERTY OF IBM /*/ 00700000
**/ "RESTRICTED MATERIALS OF IBM" /*/ 00750000
**/ *5650-ZOS @P06C*/ 00800000
**/ COPYRIGHT IBM Corp. 1996, 2013 @LE7C*/ 00850000
**/ END PROPRIETARY V3 STATEMENT /*/ 00900000
**/ /*/ 00950000

```

Figure 48. SMF assembler header macro GFS AUSMF

```

/** FUNCTION: Contains ASM Language Mapping of SMF type 42          */ 01000000
/**      subtypes 7, 8 and 26 records in the following          @LCOC */ 01050000
/**      format:                                               */ 01100000
/**                                                             2@02D */ 01150000
/**      -----                                               */ 01200000
/**      | Subtype 7 or 8 or 26 Header                          | @LCOC */ 01250000
/**      -----                                               */ 01300000
/**      | Product Section                                      |      */ 01350000
/**      -----                                               */ 01400000
/**      | Subtype 7 or 8 or 26 Data                            | @LCOC */ 01450000
/**      -----                                               */ 01500000
/**      | Client Section                                       |      */ 01550000
/**      -----                                               */ 01600000
/**                                                             */ 01650000
/** Note: 1) To obtain address of the subtype 7,8 or 26 header @LCOC*/ 01700000
/**      add SMF42LEN to the address of the type 42 header      */ 01750000
/**      2) To obtain the address of the product section         */ 01800000
/**      add SMF420PS to the address of the type 42 header      */ 01850000
/**      3) a) To obtain the address of the subtype 7 data portion */ 01900000
/**      add SMF42NFO to the address of the type 42 header      */ 01950000
/**      b) To obtain the address of the subtype 8 data portion */ 02000000
/**      add SMF42NUO to the address of the type 42 header      */ 02050000
/**      c) To obtain the address of the subtype 26 data @LCOA*/ 02066600
/**      add SMF42ADO to the addr of the type 42 header @LCOA*/ 02083300
/**      4) a) To obtain the address of the subtype 7 client     */ 02100000
/**      section add SMF42FLO to the address of the              */ 02150000
/**      current subtype 7 data portion. There can be more      */ 02200000
/**      than one subtype 7 record in a type 42 record.         */ 02250000
/**      There will always be a subtype 7 and client pair.     */ 02300000
/**      b) To obtain the address of the subtype 8 client       */ 02350000
/**      section add SMF42UCO to the address of the              */ 02400000
/**      type 42 header.                                         */ 02450000
/**      c) To obtain the address of the subtype 26 client @LCOA*/ 02458300
/**      section add SMF42ALO to the address of the @LCOA*/ 02472200
/**      type 42 header.                                         @LCOA*/ 02486100
/**                                                             */ 02500000
/**                                                             */ 02550000
/** NOTES:                                                       */ 02600000
/** DEPENDENCIES: All changes made to this macro must be       */ 02650000
/**      reflected in GFSASSMF. @02C*/ 02700000
/**      All changes made into IGWSMF SMF42 header @02A*/ 02750000
/**      should be reflected in GFSASSMF @02A*/ 02800000
/** USAGE: To get SMF42 header definitions if needed @02A*/ 02850000
/**      IGWSMF should be used and precede GFSASSMF: @02A*/ 02900000
/**      IGWSMF | GFSASSMF covers the both @02A*/ 02950000
/**      GFSASSMF | macros definitions @02A*/ 03000000
/**                                                             */ 03050000
/** MACRO:                                                       */ 03100000
/** PROCESSOR: High Level Assembler                             */ 03150000
/** LIBRARY: NFSLB                                             */ 03200000
/** ATTRIBUTES: Include                                       */ 03250000
/**                                                             */ 03300000
/**                                                             */ 03350000
/** EXTERNAL REFERENCES: (external to this header file)        */ 03400000
/** DATA AREAS: None                                          */ 03450000
/** CONTROL BLOCKS: None                                       */ 03500000
/** MACROS: None                                               */ 03550000
/**                                                             */ 03600000
/** CHANGE ACTIVITY:                                           */ 03650000
/**                                                             */ 03700000

```

```

*/*$L33=NFS,HDZ11NP,940310,SJPLTEM: New macro for DFSMS 1.2/NFSS@L33A*/ 03750000
*/*$P1=KA90085,HDZ11NP,940623,SJPLTEM: Add File sys & type values@P1A*/ 03800000
*/*$P2=KA90127,HDZ11NP,940726,SJPLTEM: Remove HFS block counters @P2A*/ 03850000
*/*$P3=KA90179,HDZ11NP,940909,SJPLTEM: Define HFS SMF42FSN & FDN @P3A*/ 03900000
*/*$L75=NFS,HDZ11VS,031209,IBSVKR: IPv6 support @L75A*/ 03950000
*/*$O1=OA08867,HDZ11US,040712,IBSVKR: Add Sybtype Version Number @O1A*/ 04000000
*/*$O2=OA10174,HDZ11US,050311,IBSGYG: for IGWSMF compatibility as@O2A*/ 04050000
*/* IGWSMF contains SMF42 header@O2A*/ 04100000
*/*$O3=OA15050,HDZ118N,060130,SJPLMTM: Remove SMF42PSV reserved @O3A*/ 04112500
*/* field added from IPv6 @O3A*/ 04125000
*/* integration (@L75). @O3A*/ 04137500
*/*$LCO=__NFS__,HDZ1C1N,090407,IBSIPI : @LCOA*/ 04141600
*/* 1. Add SMF type 42 subtype 26 recording @LCOA*/ 04145700
*/*$P04=KCN0097,HDZ1C1N,091103,IBSVKR: @P04A*/ 04147100
*/* 1. Delete SMF42ATN field (New Data Set Type) @P04A*/ 04148500
*/*$O04=OA33868,HDZ1D1N,100730,IBSVKR: @O04A*/ 04149000
*/* 1. Fix syntax errors @O04A*/ 04149500
*/*$P05=KDN0062,HDZ1D1N,100924,IBSVKR: @P05A*/ 04149600
*/* 1. Add comment to define 0 value of SMF42ATY @P05A*/ 04149700
*/*----- Release V2R1 ----- @P06A*/ 04158000
*/*$P06=KEN0146,HDZ221N,20110911,SJPLMB: @P06A*/ 04166300
*/* 1. Change Copyright to "IBM Corp." before date(s). @P06A*/ 04174600
*/* 2. Changed product id from "5694-A01" to "5650-Z0S". @P06A*/ 04178700
*/*$LE7=__NFS__,HDZ221N,20120228,SJPLMB: @LE7A*/ 04180100
*/* 1. Changed Copyright from 2012 to 2013. @LE7A*/ 04181500
*/*$O05=OA41861,HDZ221N,20130507,IBSVKR: @O05A*/ 04181900
*/* 1. Avoid duplicate some fields with IGWSMF @O05A*/ 04182300
*/* */ 04182900
*/*****/ 04191200
MACRO 04200000
GFSUSMF &Subtype @O05C 04250990
.*Values for &Subtype must be enclosed parentheses unless only one@O05A 04251980
LCLA &I Index to each substring value @O05A 04252970
LCLB &Subtypes(26) Switch to map each subtype @O05A 04253960
.* After the LCLB all bits are logically zero. @O05A 04254950
AIF ('&Subtype' EQ '').GotParms @O05A 04255940
.STLoop ANOP Loop to examine subtypes @O05A 04256930
&I SETA &I+1 Increment to first or next number @O05A 04257920
AIF (&I GT N'&Subtype').GotParms Go if no more numbers@O05A 04258910
AIF ('&Subtype(&I)' EQ '').E3 Go if null value @O05A 04259900
AIF (T'&Subtype(&I) NE 'N').E4 Go if not numeric @O05A 04260890
AIF (&Subtype(&I) NE 7 AND &Subtype(&I) NE 8 AND *04261880
&Subtype(&I) NE 26).E5 Go if invalid subtype@O05A 04262870
&Num SETA &Subtype(&I) @O05A 04263860
&Subtypes(&Num) SETB 1 Ensure mapping of this subtype @O05A 04264850
AGO .STLoop @O05A 04265840
.E3 MNOTE 4,'Null record subtype ignored in GFSUSMF' @O05A 04266830
AGO .STLoop @O05A 04267820
.E4 MNOTE 4,'&Subtype(&I) must be numeric in GFSUSMF' @O05A 04268810
AGO .STLoop @O05A 04269800
.E5 MNOTE 4,'Invalid record type &Subtype(&I) specified and ignore*04270790
d' @O05A 04271780
AGO .STLoop @O05A 04272770
.GotParms ANOP @O05A 04273760
.* The &Subtypes array has bits to tell which subtypes to map. @O05A 04274750
.* The default is for all of them to be zero. @O05A 04275740
* 04300000
* 04350000
***** 04400000
* Header for SMF record type 42 should be used from IGWSMF @O2C 04450000

```

```

***** 04500000
* 04550000
* 04600000
* SMF42 header definition is deleted from GFSASMF. For reference@02A 04650000
* the SMF42 header contains the following fields : @02A 04700000
* 04750000
*SMF42 DSECT 56@02D 04800000
*SMF42BAS DS 0D SMF42BAS is the basing expr. 04850000
*SMF42RCL DS H Record Length 04900000
*SMF42SGD DS H Segment Descriptor (RDW) -- 0 if record is 04950000
** not spanned 05000000
*SMF42FLG DS 0BL1 System indicator flags 05050000
*SMF42FSI EQU X'80' When set=subsystem id follows system id 05100000
*SMF42FSU EQU X'40' When set = subtypes are used 05150000
*SMF42FXA EQU X'04' When set = MVS/XA (SMF enters) 05200000
*SMF42FS2 EQU X'02' When set = VS2 (SMF enters) 05250000
*SMF42FS1 EQU X'01' When set = VS1 (SMF enters) 05300000
* ORG SMF42FLG+X'0000001' 05350000
*SMF42RTY DS X Record type: 42 (X'2A') 05400000
*SMF42TME DS FL4 Time in hundredths of a second when record 05450000
* was moved to SMF buffer 05500000
*SMF42DTE DS CL4 Date record written (by SMF) 05550000
*SMF42SID DS CL4 System identification (by SMF) 05600000
*SMF42SSI DS CL4 Subsystem Id 05650000
*SMF42STY DS HL2 Record subtype 05700000
*SMF42NT DS HL2 Number of triplets (optional) 05750000
* DS HL2 Reserved (optional) 05800000
** 05850000
***** 05900000
* Product section triplet * 05950000
***** 06000000
** 06050000
*SMF420PS DS FL4 Offset to product section 06100000
*SMF42LPS DS HL2 Length of product section 06150000
*SMF42NPS DS HL2 Number of product sections 06200000
** 06250000
***** 06300000
* Header must end on word boundary * 06350000
***** 06400000
** 06450000
*SMF42END DS 0F 1st data section triplet 06500000
*SMF42LEN EQU *-SMF42 06550000
** 06600000
** 06650000
***** 06700000
* Product Section * 06750000
***** 06800000
** 2@03D 06850000
*SMF42PRD DSECT 07000000
*SMF42PDL DS CL8 Product Level 07050000
*SMF42PDN DS CL10 Product Name 07100000
*SMF42PSV DS CL1 Subtype Version Number @01A 07150000
* DS CL21 Reserved @01C 07200000
** 07250000
***** 07300000
* Product section must end on word boundary * 07350000
***** 07400000
** 07450000
*SMF42PEN DS 0F 07500000
*SMF42PLN EQU *-SMF42PRD Length of product section 07550000
** 07600000
** end of header deletion 56@02D 07650000

```

```

***** 07700000
* SMF42 subtype 7 header section * 07750000
* (file timeout statistics) * 07800000
***** 07850000
* 07900000
SMF427H DSECT 07950000
SMF42NFO DS F Offset to NFSS file timeout stats section 08000000
SMF42NFL DS H Length of NFSS file timeout stats section 08050000
SMF42NFN DS H Number of NFSS file timeout stats section 08100000
SMF427HE EQU *-SMF427H Length of subtype 7 header 08150000
* 08200000
* 08250000
***** 08300000
* SMF42 subtype 8 header section * 08350000
* (user logout statistics ) * 08400000
***** 08450000
* 08500000
SMF428H DSECT 08550000
SMF42NUO DS F Offset to NFSS user session stats section 08600000
SMF42NUL DS H Length of NFSS user session stats section 08650000
SMF42NUN DS H Number of NFSS user session stats section 08700000
SMF428HE EQU *-SMF428H Length of subtype 8 header 08750000
* 08800000
* 08850000
***** 08853800
* SMF42 subtype 26 header section @LCOA * 08857600
* audit (delete/rename/create) statistics @LCOA * 08861400
***** 08865200
* 08869000
SMF4226H DSECT 08872800
SMF42ADO DS F Offset to NFSS audit stats section @LCOA 08876600
SMF42ADL DS H Length to NFSS audit stats section @LCOA 08880400
SMF42ADN DS H Number to NFSS audit stats section @LCOA 08884200
SMF4226L EQU *-SMF4226H Length of subtype 26 header @004C 08888000
* 08891800
* 08895600
AIF (NOT &Subtypes(7) AND '&Subtype' NE ').SKIP_07 @005A 08897600
***** 08900000
* SMF type 42 subtype 7 file timeout Statistics * 08950000
* (file timeout statistics) * 09000000
***** 09050000
* 09100000
SMF42S7 DSECT 09150000
AIF ('&Subtype' EQ ').01d07A Go if called the old way @005A 09157000
SMF42FLOff DS F Offset to client identification section @005A 09164000
SMF42FLLI DS H Length of client identification section @005A 09171000
SMF42FFST DS X File system type indicator @005A 09178000
AGO .End07A @005A 09185000
.01d07A ANOP @005A 09192000
SMF42FLO DS F Offset to client identification section 09200000
SMF42FLL DS H Length of client identification section 09250000
SMF42FFS DS X File system type indicator 09300000
.End07A ANOP @005A 09320000
* 09350000
* 09400000
SMF42FTY DS X File type as defined in NFS protocol 09450000
* 09500000
* 09550000
* 09600000
* 09650000
01 = z/OS UNIX @LCOC
02 = MVS @PIA
00 = Non-file @PIA
01 = Regular file @PIA
02 = Directory @PIA
03 = Block special device @PIA

```

```

*           04 = Character special device      @PIA  09700000
*           05 = Symbolic link                 @PIA  09750000
SMF42FTM DS   X           MVS data set type    09800000
*           0 = unknown MVS file type         @PIA  09850000
*           1 = Sequential (BSAM) file        @PIA  09900000
*           2 = Partitioned (BPAM)           @PIA  09950000
*           3 = Direct Access file           @PIA  10000000
*           4 = ISAM is not supported         @PIA  10050000
*           5 = Virtual Sequential Access     @PIA  10100000
*           6 = VSAM Entry Sequenced         @PIA  10150000
*           7 = VSAM Relative Record         @PIA  10200000
*           8 = VSAM Keyed access            @PIA  10250000
*           9 = dummy index level file block @PIA  10300000
*          10 = z/OS UNIX file type           @LCOC  10350000
          DS   XL3       Reserved              10400000
SMF42FSN DS   F           File Serial Number, z/OS UNIX INODE @LCOC  10450000
          AIF ('&Subtype' EQ '').01d07B Go if called the old way @005A  10457000
SMF42FDNZ DS   F           Unique device number z/OS UNIX FSYS @005A  10464000
SMF42FIRN DS   F           Number of I/O blocks read             @005A  10471000
SMF42FIWN DS   F           Number of I/O blocks written          @005A  10478000
          AGO .End07B                                         @005A  10485000
          .01d07B ANOP                                         @005A  10492000
SMF42FDN DS   F           Unique device number z/OS UNIX FSYS @LCOC  10500000
SMF42FIR DS   F           Number of I/O blocks read             10550000
SMF42FIW DS   F           Number of I/O blocks written          10600000
          .End07B ANOP                                         @005A  10620000
          DS   F           Reserved              10650000
SMF42FBR DS   D           Number of bytes read from file        10700000
SMF42FBW DS   D           Number of bytes written to file       10750000
          AIF ('&Subtype' EQ '').01d07C Go if called the old way @005A  10757000
SMF42FNLen DS   H           Length of file name                 @005A  10764000
SMF42FCLB DS   0D          C370 ends structure on dblword boundry @005A  10771000
SMF42FFName DS   0D          File name                           @005A  10778000
          AGO .End07C                                         @005A  10785000
          .01d07C ANOP                                         @005A  10792000
SMF42FNL DS   H           Length of file name                   10800000
SMF42FCL DS   0D          C370 ends structure on doubleword boundry 10850000
SMF42FFN DS   0D          File name                             @P2C   10900000
          .End07C ANOP                                         @005A  10920000
*
* The file name is either a 256 byte character string, or a    10950000
* 1023 byte character string. SMF42FNL will contain the length 11000000
*
*
* Start of Client Section                                     11050000
* SMF42F7E EQU *-SMF42S7 Length of subtype 7 data section     11100000
*
* SMFSNAME EQU 256 Short file name                             11150000
SMFLNAME EQU 1023 Long file name                              11200000
.SKIP_07 ANOP                                               @005A  11250000
*
*
* Client Identification Section. Version 0                    @L75C*  11300000
*****
* SMF42CS0 DSECT                                             @L75C   11350000
SMF42CRI DS   CL8       RACF user ID                          11600000
SMF42CRG DS   CL8       RACF group name                      11650000
SMF42CAN DS   CL8       Account Number                      11700000
SMF42CUI DS   F         User ID at client host (UNIX style) 11750000

```



```

SMF42CGI DS F Group ID at client host (UNIX style) 11950000
SMF42CIP DS F IP address of client host 12000000
SMF42CHL DS H Length of client host name 12050000
SMF42CHN DS CL256 Client host name @L75C 12100000
SMF42CSE EQU *-SMF42CS0 Length of Client Section Version 0 @P05C 12150000
* 12200000
* 12250000
*****
* Client Identification Section. Version 2 @L75A* 12300000
***** 12350000
***** 12400000
* 12450000
SMF42CS2 DSECT @L75A 12500000
S2F42CRI DS CL8 RACF user ID @L75A 12550000
S2F42CRG DS CL8 RACF group name @L75A 12600000
S2F42CAN DS CL8 Account Number @L75A 12650000
S2F42CUI DS F User ID at client host @L75A 12700000
S2F42CGI DS F Group ID at client host @L75A 12750000
S2F42CIP DS CL16 IPv6 address of client host @L75A 12800000
S2F42CHL DS H Length of client host name @L75A 12850000
S2F42CHN DS CL256 Client host name @L75A 12900000
S2F42CSE EQU *-SMF42CS2 Length of Client Section Version 2 @L75A 12950000
* 13000000
* 13050000
AIF (NOT &Subtypes(8) AND '&Subtype' NE '').SKIP_08 @005A 13070000
***** 13100000
* SMF type 42 subtype 8 user session completion Statistics * 13150000
* (user logout statistics ) * 13200000
***** 13250000
* 13300000
SMF42S8 DSECT 13350000
SMF42UCO DS F Offset to client identification section 13400000
SMF42UCL DS H Length of client identification section 13450000
DS H Reserved 13500000
SMF42UST DS D Session start time (in STCK format) 13550000
SMF42UET DS D Session end time (in STCK format) 13600000
SMF42UEL DS F Session elapsed time (in milliseconds) 13650000
SMF42UNR DS F Number of RPC requests processed in this 13700000
* session 13750000
SMF42UTE DS F Total elapsed time of all RPC requests 13800000
* processes in this session 13850000
SMF42UAT DS F Total active time of all RPC requests 13900000
* processes in this session 13950000
SMF42URN DS D Number of bytes read in from the network in 14000000
* this session 14050000
SMF42UWN DS D Number of bytes written out to the network 14100000
* in this session. */ 14150000
SMF42URF DS D Number of bytes read from files on this 14200000
* session */ 14250000
SMF42UWF DS D Number of bytes written to files in this 14300000
* session 14350000
SMF42UCS DS 0F Start of Client Section 14400000
SMF42S8E EQU *-SMF42S8 Length of subtype 8 data section 14450000
.SKIP_08 ANOP @005A 14450400
* 14450800
AIF (NOT &Subtypes(26) AND '&Subtype' NE '').SKIP_26 @005A 14451200
***** 14451600
* SMF type 42 subtype 26 create/delete/rename Statistics @LCOA * 14452400
***** 14453200
* 14454000
SMF42S26 DSECT @LCOA 14454800

```

SMF42ALO	DS	F	Offset to client identification section	@LCOA	14455600
SMF42ALL	DS	H	Length of client identification section	@LCOA	14456400
SMF42A0V	DS	X	NFS protocol version (2,3 or 4)	@LCOA	14457100
SMF42A0P	DS	X	NFS operation/procedure number	@LCOA	14457800
SMF42AFS	DS	X	File system type z/OS UNIX = 1, MVS = 2	@LCOA	14458500
	DS	XL3	Reserved	@LCOA	14459300
*				@LCOA	14459600
* Legacy MVS audit data *				@LCOA	14460400
*				@LCOA	14461200
SMF42ATM	DS	X	Data Set type	@LCOA	14462000
*			0 = unknown MVS file type	@LCOA	14462800
*			1 = Sequential (BSAM) file	@LCOA	14463600
*			2 = Partitioned (BPAM)file	@LCOA	14464400
*			3 = Direct Access file	@LCOA	14465200
*			4 = ISAM is not supported	@LCOA	14466000
*			5 = Virtual Sequential Access	@LCOA	14466800
*			6 = VSAM Entry Sequenced	@LCOA	14467600
*			7 = VSAM Relative Record	@LCOA	14468400
*			8 = VSAM Keyed access	@LCOA	14469200
*			9 = dummy index level file block	@LCOA	14470000
	DS	X	Reserved	@LCOA	14470800
SMF42AVL	DS	CL6	Volume name 6 chars	@LCOA	14471600
SMF42ANL	DS	F	Data set name length	@LCOA	14472400
**				@004C	14473400
	DS	XL2	Reserved	@P04C	14474400
SMF42AVN	DS	CL6	New Volume name 6 chars	@LCOA	14475600
SMF42ANN	DS	F	New Data set name length	@LCOA	14476400
*				@LCOA	14477200
* z/OS UNIX audit data *				@LCOA	14478000
*				@LCOA	14478800
	ORG	SMF42ATM		@LCOA	14479600
SMF42ATY	DS	X	File object type	@LCOA	14480400
*			0 = Unknown file type	@P05A	14480500
*			1 = Directory	@LCOA	14480600
*			2 = Character special file	@LCOA	14480700
*			3 = Regular file	@LCOA	14480800
*			4 = Named pipe (FIFO) file	@LCOA	14480900
*			5 = Symbolic link	@LCOA	14481000
*			6 = Block special file	@LCOA	14481100
*			7 = Socket file	@LCOA	14481200
	DS	XL3	Reserved	@LCOA	14481300
SMF42ASD	DS	F	File system device number	@LCOA	14482000
SMF42ASL	DS	F	File system name length	@LCOA	14482800
SMF42ASN	DS	CL44	File system name 1-44 chars	@LCOA	14483600
SMF42AFI	DS	F	File inode attribute	@LCOA	14484400
SMF42AFA	DS	CL16	File audited attribute	@LCOA	14485200
SMF42ADI	DS	F	Directory inode attribute	@LCOA	14486000
SMF42ADA	DS	CL16	Directory audited attribute	@LCOA	14486800
SMF42AFL	DS	F	File name length	@LCOA	14487600
*				@LCOA	14488400
SMF42ANI	DS	F	New directory inode attribute	@LCOA	14489200
SMF42ANA	DS	CL16	New directory audited attribute	@LCOA	14490000
SMF42AFN	DS	F	New file name length	@LCOA	14490800
*				@LCOA	14491600
SMF42ANM	DS	CL1	File name and New File name, if exist	@LCOA	14492400
*			It is not NULL terminated	@LCOA	14493200
SMF4226E	EQU	*-SMF42S26	Length of subtype 26 data section	@LCOA	14494000
.SKIP_26	ANOP			@005A	14497000
	MEND				14500000

Appendix K. Capturing diagnostic information using z/OS NFS log data sets and from other components

This topic describes how to use the z/OS NFS log data sets and how to capture diagnostic information for other components including z/OS UNIX, TCP/IP, and AIX.

Using log data sets

This section describes how to use log data sets for the z/OS NFS server and client.

Server log data sets

The z/OS Network File System server records diagnostic information (messages) in the z/OS NFS server log data sets specified in the NFSLOG1 and NFSLOG2 DD statements of the server's startup procedure.

The z/OS NFS server also records messages and debug trace information in a z/OS component trace buffer if specified. Using a component trace buffer can provide performance improvements compared to the log data sets. For details, see "Using z/OS component tracing" on page 316.

z/OS NFS Server Startup parameter "LOGSTART" specifies which log data set is the primary log data set. For example, LOGSTART=1 indicates that the data set associated with NFSLOG1 DD statement as the primary dataset and the other data set for NFSLOG2 as the secondary.

Similarly, LOGSTART=2 indicates the data set associated with the NFSLOG2 DD statement as the primary. LOGSTART=ALT (default value) indicates that the oldest log data set used as the starting primary error log data set, so that most recent error log data is always available.

When the server is started, both the primary and secondary logs are opened for reading to determine the older log data set, then either the primary or secondary log is re-opened for writing based on the "LOGSTART" parameter. As a result of this processing, the existing contents of the selected log data set is destroyed. To preserve the contents of the logs from the previous server instance, the logs must be copied prior to the start of the server. If either the NFSLOG1 or NFSLOG2 DDNAME is not specified in the NFS server startup procedure or if an error occurs when attempting to open the data sets, NFS Server initialization will fail.

The primary log is used first. When the primary log is full, the logging is automatically switched or toggled to the secondary log and a console message is displayed. The last log buffer is lost when the switch takes place. When the secondary log is also full, the logging is switched back to the primary log and the original primary log content is cleared before writing to the log is started.

The number of log records depends on the log level setting and the number of transactions that the server handles. Adjust the space allocation of your z/OS NFS server log data sets according to your installation experience to avoid frequent log switching.

Setting up the z/OS NFS server log data set

Here is an example of setting up the z/OS NFS server log data sets:

```
//NFSLOG1 DD DISP=SHR,DSN=MVSNFS.PROCESS.LOG1
//NFSLOG2 DD DISP=SHR,DSN=MVSNFS.PROCESS.LOG2
```

File attributes of the z/OS NFS server log data sets can be set up like this:

```
Organization PS
Record Format VB
Record Length 137
Block Size 6144
```

See Chapter 11, “Network File System operation,” on page 223 and “Log operand” on page 251 to find out how to set the level of messages to be stored in this data set. The default message level is “info” which means that all error, attention, and informational messages are collected and stored in the z/OS NFS server log data set. Reading the message(s) in the z/OS NFS server log data set can help you identify the user correctable error or the problem error which you can report to IBM. See “Server messages” on page 339 for an explanation of the format of the messages that appear in the z/OS NFS server log data sets.

This example shows how to identify a sample problem by reading the z/OS NFS server log data set. This example shows a z/OS NFS server log data set with the message level set as “info” (informational):

```
20:25:16 GFS305I (I) GFSAMAIN ACOPR 01 OPRPARSE: RECEIVED
COMMAND: EXPORTFS , LENGTH = 9
20:25:16 GFS865I (E) GFSAMAIN ANEXP 03 DOPTION: EXPORTS:
UNEXPECTED OPTION (PO)--EXPORTS FILE UNUSABLE.
20:25:16 GFS866I (E) GFSAMAIN ANEXP 07 EXPORTAL: EXPORTS:
DIRECTORY (TCP) WAS NOT EXPORTED.
20:25:16 GFS925I (E) GFSAMAIN AXOPE 02 OPR_EXPO: ERROR WAS
DETECTED IN THE EXPORTS FILE. EXPORT LIST NOT REBUILT
20:25:34 GFS305I (I) GFSAMAIN ACOPR 01 OPRPARSE: RECEIVED
COMMAND: FLUSHLOG , LENGTH = 9
:
```

The message GFS865I in the example is an error message (indicated by the message level E).

```
20:25:16 GFS865I (E) GFSAMAIN ANEXP 03 DOPTION: EXPORTS:
UNEXPECTED OPTION (PO)--EXPORTS FILE UNUSABLE.
```

The message text indicates that the option “PO” specified in the DIRECTORY statement in the exports data set is not a valid option. You could correct this error by changing “PO” to “RO” and restarting the server.

Client log data sets

The z/OS Network File System client records diagnostic information (messages and debug trace information) in the z/OS NFS client log data sets specified in the NFSCMSG1 and NFSCMSG2 DD statements of the client's startup procedure.

z/OS NFS Client uses the oldest error log data set as the primary error log data set, so that most recent error log data is always available. When the primary log is full, the logging is automatically switched or toggled to the secondary log and a console message is displayed. The last log buffer is lost when the switch takes place. When the secondary log is also full, the logging is switched back to the primary log and the original primary log content is overwritten.

The number of log records depends on the log level setting and the number of transactions that the client handles. Adjust the space allocation of your z/OS NFS client log data sets according to your installation experience to avoid frequent log switching.

Setting up the z/OS NFS client log data sets

Here is an example of setting up the z/OS NFS client log data sets:

```
//NFSCMSG1 DD DISP=SHR,DSN=MVSNFS.CLIENT.LOG1
//NFSCMSG2 DD DISP=SHR,DSN=MVSNFS.CLIENT.LOG2
```

File attributes of the z/OS NFS client log data sets can be set up like this:

Organization	PS
Record Format	VB
Record Length	137
Block Size	6144

Reading the message(s) in the z/OS NFS client log data set can help you identify the user correctable error or the problem error which you can report to IBM. See “Client messages” on page 407 for an explanation of the format of the messages that appear in the z/OS NFS client log data sets.

The message GFSC313I in the example is an informational message (indicated by the message level I).

```
13:00:19 GFSC313I (I) CPARS 04 P_CHECK :
      RETRANS OPTION WILL BE IGNORED AS HARD OPTION IS ON.
```

The message text indicates that the keyword, *retrans*, will be ignored because *hard* has been set on. The system programmer should check the mount parameters to make sure that *hard* should be on.

Debug trace data capture

The z/OS Network File System uses trace facilities to record debug trace diagnostic information when a problem requires additional diagnostic information beyond diagnostic messages. Assuming that debug trace diagnostics were not activated at the time of the original failure, the problem must be recreated a second time and the NFS debug trace facilities turned on to capture the diagnostic information. The server provides debug trace diagnostic information from one trace facility. The z/OS Network File System client provides debug trace diagnostic information from one trace facility.

z/OS NFS server debug trace capture

The z/OS NFS server records z/OS NFS debug trace diagnostic information to the z/OS component trace buffer. z/OS NFS error and informational messages are also recorded to the z/OS component trace buffer or to the server log data sets. When recording debug trace diagnostic information, IBM recommends that the z/OS component trace buffer be used to minimize the performance impact of collecting these extra diagnostics. To record z/OS NFS server debug trace diagnostic information in the z/OS component trace buffer, see “Using z/OS component tracing” on page 316.

To record z/OS NFS server debug trace diagnostic information in the CTRACE buffer, use the MODIFY operator command with the LOG=*msgtype* trace option. To start NFS server debug trace recording from the console, enter:

```
MODIFY mvsnfs,LOG=msgtype
```

where *mvsnfs* is the name of the z/OS NFS procedure in the PROCLIB and *msgtype* is ERROR, WARN, or INFO.

The trace records are buffered in storage. The current buffers must be flushed to disk and then the log data sets must be swapped. After swapping, the desired log data set must be copied to disk before it is overwritten by toggling back to the previous log data set by the automatic toggle mechanism.

To flush the remaining z/OS NFS buffers to disk, enter the following console command:

```
MODIFY mvsnfs,FLUSHLOG
```

where *mvsnfs* is the name of the z/OS NFS procedure in the PROCLIB.

This command enables a TSO/E user to browse all the log records that have been written by the Network File System.

To swap z/OS NFS server debug trace recording to the next log data set from the USS command line, issue:

```
MODIFY mvsnfs,SWITCHLOG
```

where *mvsnfs* is the name of the z/OS NFS procedure in the PROCLIB.

To end z/OS NFS Server debug trace recording, enter the following console command:

```
MODIFY mvsnfs,LOG=INFO
```

where *mvsnfs* is the name of the z/OS NFS procedure in the PROCLIB.

To clear (reset) the server log data sets, enter the following console command:

```
MODIFY mvsnfs,INITLOG
```

where *mvsnfs* is the name of the NFS procedure in the PROCLIB.

z/OS NFS server DEBUG trace types

The z/OS NFS server has various trace types which control the amount of trace diagnostic information recorded.

ERROR

Only writes error messages to the log data set. Some informational messages are also written to the console. See Chapter 19, "Network File System messages," on page 339 for details.

WARN

Writes both error and warning messages to the NFS server log data set. Some informational messages are also written to the console. See Chapter 19, "Network File System messages," on page 339 for details.

INFO

Writes error, warning and informational messages to the NFS server log data set. Some informational messages are also written to the console. See Chapter 19, "Network File System messages," on page 339 for details.

z/OS NFS client debug trace capture

The z/OS NFS client records z/OS NFS client debug trace diagnostic information to the z/OS component trace buffer. z/OS NFS client error and informational messages are also recorded to the client log data sets. z/OS NFS Client log data set

tracing is on by default and cannot be disabled. For additional information on z/OS NFS client component tracing, see “Using z/OS component tracing” on page 316.

The `nfsstat` UNIX shell command can be used to manage the error and informational message recording to the client log data sets. Superuser authority is required to issue this command. There is no console command control capability for the client log data sets.

In order to see all error and informational messages, the current buffers must be flushed to disk.

To flush the remaining data in the z/OS NFS client buffers to disk, enter:

```
/usr/lpp/NFS/nfsstat -d f
```

Other `nfsstat` command options are available to swap the current client log data set and clear the contents of the client log data sets:

To swap z/OS NFS client error and informational message recording to the next log data set, issue:

```
/usr/lpp/NFS/nfsstat -d s
```

To clear (reset) the client log data sets from the USS command line, issue:

```
/usr/lpp/NFS/nfsstat -d c
```

Related component trace capture

The z/OS Network File System trace diagnostic information is used in parallel to other z/OS component trace diagnostic information to better understand the system activity for a problem encountered. Depending on the problem, trace diagnostic information may be needed from the z/OS components z/OS UNIX, HFS, or TCP/IP, and for an AIX client or SUN client. In addition, a z/OS dump may be required.

z/OS UNIX System Services activity trace

z/OS UNIX System Services (z/OS UNIX) diagnostic information is normally maintained in a set of cyclical buffers in memory. However, it can also be recorded to a file with a component trace. When it is maintained in memory, a dump must be taken to capture the diagnostic information for debugging purposes.

- To start the z/OS UNIX CTRACE from the console, enter:

```
TRACE CT,4M,COMP=SYSOMVS  
R nn,OPTIONS=(ALL),JOBNAME=(NFS_server),END
```

If you use the `JOBNAME` keyword on the statement, note that z/OS UNIX uses that parameter for `USERID`, not for job name. Specify the `userid`, not the `jobname`, for this parameter.

- Reproduce the problem in a system with minimal activity.
- Collect dump using console dump (see “z/OS dump” on page 571)
- To turn z/OS UNIX CTRACE off, issue the following console command:

```
TRACE CT,OFF,COMP=SYSOMVS
```

z/OS hierarchical file system (HFS) physical file system activity trace

HFS physical file system diagnostic information is normally maintained in a set of cyclical buffers in memory. However, it can also be recorded to a file with a component trace. When it is maintained in memory, a dump must be taken to capture the diagnostic information for debugging purposes.

- To start the HFS CTRACE from the console, enter:

```
TRACE CT,8M,COMP=SYSSMS  
R nn,JOBNAME=(OMVS),OPTIONS=(ENTRY,EXIT,EXITA,SPECIAL,CB,RRTN,COMP=(PFS)),END
```
- Reproduce the problem in a system with minimal activity.
- Collect dump using console dump (see “z/OS dump” on page 571)
- To turn HFS CTRACE off, issue the following console command:

```
TRACE CT,OFF,COMP=SYSSMS
```

z/OS TCP/IP activity trace

The TCP/IP CTRACE and Packet Trace are normally maintained in a set of cyclical buffers in memory. However, they can also be recorded to a file with a component trace. When they are maintained in memory, a dump must be taken to capture the diagnostic information for debugging purposes.

- To start the TCP/IP CTRACE from the console, enter:

```
TRACE CT,ON,COMP=SYSTCPIP,SUB=(tcpipprocname)  
R XX,JOBNAME=(nfsprocname,tcpipprocname)  
R XX,OPTIONS=(ENGINE,PFS,SOCKET,INTERNET,TCP,UDP,IOCTL),END
```
- To start the TCP/IP packet trace from the console, enter:

```
TRACE CT,ON,COMP=SYSTCPDA,SUB=(tcpipprocname)  
V TCPIP,tcpipprocname,PKTTRACE,ON,ABBREV=152,IP=xx.xx.xx.xx
```

In this example, *xx.xx.xx.xx* is the client_IP_address.

- Reproduce the problem in a system with minimal activity.
- To collect a dump of the TCPIP address space, issue the following console command:

```
DUMP COMM=('text')  
R xx,JOBNAME=(tcpipprocname,nfsprocname),  
SDATA=(ALLNUC,PSA,GRSQ,SUM,CSA,LPA,LSQA,RGN,SWA,SQA,TRT),END
```

See “z/OS dump” on page 571.

- To turn TCP/IP CTRACE off, issue the following console command:

```
TRACE CT,OFF,COMP=SYSTCPIP,SUB=(tcpipprocname)  
V TCPIP,tcpipprocname,PKT,OFF,IP=xx.xx.xx.xx
```
- To stop the TCPIP Packet trace, issue the following console command:

```
TRACE CT,OFF,COMP=SYSTCPDA,SUB=(tcpipprocname)
```

Note: The first step to collecting traces is to ensure that the *bufsize* in SYS1.PARMLIB member CTIEZB00 is set to at least 8 MB, which is the default value. It may need to be set higher depending on the amount of trace diagnostic information desired, but 8 MB should be used as a minimum. Using the maximum buffer size of 1024 MB, you will be sure that the maximum amount of contiguous trace diagnostic information is captured. A minimum of 256 MB buffer size is recommended.

TCP/IP will need to be restarted for the change in buffer size to take affect. The trace diagnostic information will be captured using a z/OS dump command. Be

aware that this method may result in lost trace diagnostic information as the possibility of wrapping is high. The dump command should be issued soon after the problem occurs.

AIX client activity trace

The AIX IP trace contains a trace of the IP activity from the AIX client:

```
rm /tmp/ibmsupt
```

Note: Make sure that there is enough space under /tmp for the IP-traces.

Systems with high TCP/IP activity may use up to 20 MB per minute.

snap -gkitn (takes 2-3 minutes and collects all necessary AIX diagnostic information).

- To start the AIX IP trace, issue the following AIX command:

```
startsrc -s iptrace -a "-s -d -b  
/tmp/ibmsupt/testcase/iptrc.bin"
```

```
cd /tmp/ibmsupt/testcase  
script cmd_log (puts all keyboard actions to file cmd_log in current directory)  
Ping -c 5 (z/OS NFS server) showmount -e  
cd to NFS mounted z/OS filessystem  
cp /etc/filesystems /tmp/ibmsupt/testcase/filesystems.out  
mount
```

- Reproduce the problem in a system with minimal activity.
- To stop the AIX IP Trace, issue the following AIX command:
stopsrc -s iptrace
- To format the Trace Report, issue the following AIX command:
ipreport -rns /tmp/ibmsupt/testcase/iptrc.bin > /tmp/ibmsupt/testcase/iptrc.out

Note: The formatted version of the trace will be approximately five times as large as the binary version.

- To stop script recording, issue the following console command:
CTRL-D
- To generate snap.pax.Z file in /tmp/ibmsupt directory, issue the following console command:
snap -c
- Send snap.pax.Z file to NFS service personnel.

SUN client activity trace

The SUN snoop trace contains a trace of the IP activity from the SUN client.

- To start the SUN snoop trace, issue the following SUN command:
snoop -o my.trace myclient myserver
- To stop the SUN snoop Trace, issue the following SUN command:
CTRL-C
- To format Trace Report, issue the following SUN command:
snoop -i my.trace -v >my.trace.report

z/OS dump

A z/OS memory dump contains the current state of the machine. The actual contents of the dump will depend on the address spaces and data spaces selected. The dump will also include any component traces running at the time the dump is

taken. IBM generally recommends taking a synchronous dump instead of an asynchronous dump. A synchronous dump ensures that the memory contents do not change between the time the dump request is made and the time the dump is actually taken on the machine.

To collect a console dump of NFS server, NFS client, z/OS UNIX, and TCPIP, issue the following console command:

```
DUMP COMM=(description)
```

```
R nn,JOBNAME=(OMVS,TCPPROC,NFSSPROC,NFSCPROC,jobname*),CONT
```

```
R nn,DSPNAME=('OMVS'.*,'tcpproc'.*),CONT
```

```
R nn, SDATA=(PSA,SQA,LSQA,RGN,TRT,LPA,CSA,GRSQ,SUM,ALLNUC),CONT
```

Appendix L. GFSAMHDJ sample code for creating NFS mount handle data sets and lock data sets

The following sample code (GFSAMHDJ member of SYS1.SAMLIB) shows how to allocate mount handle data sets, copy previous mount handle data sets to the new size needed for the current release, and how to allocate lock data sets.

```
//MVSNFSA JOB ,
//  MSGCLASS=A,MSGLEVEL=(1,1),TIME=30,REGION=12M,CLASS=A
//*
//* FOR MOUNT HANDLE DATABASE DEFINITION, USE:
//* KEYS(16 0) -
//* FOR LOCKING DATABASE DEFINITION, USE
//* KEYS(8 0) -
//*
//*****
//*
//* CREATE A VSAM KSDS DATASET FOR THE MOUNT HANDLE DATABASE
//*
//* THIS STEP IS ONLY REQUIRED IF THE OLD MOUNT HANDLE DATASETS
//* DO NOT HAVE THE SAME RECORD SIZE DEFINITIONS AS THE CURRENT
//* DEFINITIONS OR NO MOUNT HANDLE DATASETS EXIST.
//*
//* REPLACE THE FOLLOWING FIELDS BELOW:
//*
//* MVSNFS.FHDBASE WITH DESIRE MOUNT HANDLE DATASET 1 NAME
//* xxxxxx WITH VOLUME SERIAL FOR ALLOCATION
//*
//*
//*****
//DEFINE1 EXEC PGM=IDCAMS,REGION=512K,COND=(EVEN)
//SYSPRINT DD SYSOUT=*
//SYSIN DD *
DEFINE CLUSTER ( NAME(MVSNFS.FHDBASE) -
                VOL(xxxxxx) -
                CYL (1 1) -
                INDEXED -
                REUSE -
                KEYS(16 0) -
                SHAREOPTIONS(1 3) -
                RECSZ(1700 2000) )
LISTC ENT(MVSNFS.FHDBASE) ALL
/*
```

Figure 49. Sample code for creating mount handle data sets and lock data sets

```

//*****
//*
//*
//* CREATE THE SECOND VSAM KSDS FOR THE MOUNT HANDLE DATABASE
//* ON A DIFFERENT VOLUME
//*
//* THIS STEP IS ONLY REQUIRED IF THE OLD MOUNT HANDLE DATASETS
//* DO NOT HAVE THE SAME RECORD SIZE DEFINITIONS AS THE CURRENT
//* DEFINITIONS OR NO MOUNT HANDLE DATASETS EXIST.
//*
//* REPLACE THE FOLLOWING FIELDS BELOW:
//*
//* MVS NFS.FHDBASE2 WITH DESIRE MOUNT HANDLE DATASET 2 NAME
//* yyyyyy WITH VOLUME SERIAL FOR ALLOCATION
//*
//*****
//DEFINE2 EXEC PGM=IDCAMS,REGION=512K,COND=(EVEN)
//SYSPRINT DD SYSOUT=*
//SYSIN DD *
DEFINE CLUSTER ( NAME(MVS NFS.FHDBASE2) -
VOL(yyyyyy) -
CYL (1 1) -
INDEXED -
REUSE -
KEYS(16 0) -
SHAREOPTIONS(1 3) -
RECSZ(1700 2000) )
LISTC ENT(MVS NFS.FHDBASE2) ALL
/*
//*****
//*
//* @01A
//* COPY OLD SMALLER RECORD SIZE MOUNT HANDLE DATABASES TO THE
//* NEW LARGER RECORD SIZE MOUNT HANDLE DATABASES
//* REQUIRED AS OF Z/OS NFS 1.7
//*
//* THIS STEP IS ONLY REQUIRED IF THE OLD MOUNT HANDLE DATASETS
//* DO NOT HAVE THE SAME RECORD SIZE DEFINITIONS AS THE CURRENT
//* DEFINITIONS.
//*
//* REPLACE THE FOLLOWING FIELDS BELOW:
//*
//* MVS NFS1.FHDBASE WITH OLD MOUNT HANDLE DATASET 1 NAME
//* MVS NFS1.FHDBASE2 WITH OLD MOUNT HANDLE DATASET 2 NAME
//* MVS NFS.FHDBASE WITH NEW MOUNT HANDLE DATASET 1 NAME
//* MVS NFS.FHDBASE2 WITH NEW MOUNT HANDLE DATASET 2 NAME
//*
//*****
//IDCAMS1 EXEC PGM=IDCAMS,COND=(EVEN)
//SYSPRINT DD SYSOUT=*
//OLDFHDB1 DD DSN=MVS NFS1.FHDBASE,DISP=SHR
//OLDFHDB2 DD DSN=MVS NFS1.FHDBASE,DISP=SHR
//NEWFHDB1 DD DSN=MVS NFS.FHDBASE,DISP=SHR
//NEWFHDB2 DD DSN=MVS NFS.FHDBASE,DISP=SHR
//SYSIN DD *
REPRO INFILE(OLDFHDB1) OUTFILE(NEWFHDB1) REUSE
REPRO INFILE(OLDFHDB2) OUTFILE(NEWFHDB2) REUSE
/*

```

```

//*****
//*
//*                                     @01A
//* CREATE A VSAM KSDS DATASET FOR THE LOCKING DATABASE
//*
//* THE LOCK DATA SETS MUST ALWAYS BE ALLOCATED EVEN IF NONLM
//* IS SPECIFIED IN THE SITE ATTRIBUTES.
//*
//* REPLACE THE FOLLOWING FIELDS BELOW:
//*
//*     MVSNFS.LDBASE    WITH DESIRE LOCK DATASET 1 NAME
//*     xxxxxx          WITH VOLUME SERIAL FOR ALLOCATION
//*
//*
//*****
//DEFINE3 EXEC PGM=IDCAMS,REGION=512K,COND=(EVEN)
//SYSPRINT DD  SYSOUT=*
//SYSIN DD *
DEFINE CLUSTER ( NAME(MVSNFS.LDBASE) -
                VOL(xxxxxx) -
                CYL (1 1) -
                INDEXED -
                REUSE -
                KEYS(8 0) -
                SHAREOPTIONS(1 3) -
                RECSZ(1700 2000) )
LISTC ENT(MVSNFS.LDBASE) ALL
/*
//*****
//*
//*                                     @01A
//* CREATE THE SECOND VSAM KSDS FOR THE LOCKING DATABASE
//* ON A DIFFERENT VOLUME
//*
//* THE LOCK DATA SETS MUST ALWAYS BE ALLOCATED EVEN IF NONLM
//* IS SPECIFIED IN THE SITE ATTRIBUTES.
//*
//* REPLACE THE FOLLOWING FIELDS BELOW:
//*
//*     MVSNFS.LDBASE2  WITH DESIRE LOCK DATASET 2 NAME
//*     yyyyyy          WITH VOLUME SERIAL FOR ALLOCATION
//*
//*
//*****
//DEFINE4 EXEC PGM=IDCAMS,REGION=512K
//SYSPRINT DD  SYSOUT=*
//SYSIN DD *
DEFINE CLUSTER ( NAME(MVSNFS.LDBASE2) -
                VOL(yyyyyy) -
                CYL (1 1) -
                INDEXED -
                REUSE -
                KEYS(8 0) -
                SHAREOPTIONS(1 3) -
                RECSZ(1700 2000) )
LISTC ENT(MVSNFS.LDBASE2) ALL
/*
//*

```

Appendix M. Setting up NFS functions with Kerberos Support

The topic gives step-by-step instructions on how to set up Kerberos security for certain NFS functions. The following functions are included:

- “Special considerations for Linux Clients”
- “Windows recommendations and limitations”
- “Setting up a Kerberos Key Distribution Center” on page 578

Special considerations for Linux Clients

- By default `rpc.gssd` on linux nfs clients will use the "machine credential" `nfs/hostname.domain` in the keytab for user with (uid = 0) at mount time and for file access. This requires that a RACF ID be created with a kerb segment matching the linux "machine credential". If the Linux's NFS principal is not defined to RACF, z/OS NFS server will reject the mount requests. That is,

```
AU 1nxfsc1 OWNER(IBMUSER) OMVS(UID(87654321))
ALU 1nxfsc1 NOPASSWORD KERB(KERBNAME(nfs/hostname.domain))
```

Note: Regular users must obtain credentials with "kinit" before being able to access the mount points.

- The default behavior described in the previous bullet can be changed so that the root user (uid = 0) is treated like a normal user and must perform a "kinit" before being able to mount and access the mount point.

On Redhat EL 6 and Suse SLES 11 and later systems, you need to pass the "-n" option to `rpc.gssd`, as follows:

1. Edit `/etc/sysconfig/nfs`
2. Uncomment/set `RPCGSSDARGS="-n"`
3. Restart `rpc.gssd`

- `Kdestroy` will not destroy the context in the Linux kernel. This behavior will change once kernel keyring support is completed.

Windows recommendations and limitations

For Windows users, it is recommended to use Connectivity Kerberos or MIT Leash Kerberos Ticket Manager with OpenText Maestro NFS client. For more information on OpenText NFS Maestro client and the configurations of the Kerberos on Windows platform, see the OpenText NFS Maestro User's Guide. If the z/OS NFS server security site attribute is set to SAF or SAFEXP, the only supported authentication level on Windows platform is `authsys`. `RPCSEC_GSS` authentication levels, such as `krb5`, `krb5i`, and `krb5p`, are not supported because OpenText NFS Maestro 10 and higher requires NIS/NIS+ or LDAP with Kerberos instead of PCNFSD, which serves as the `mvslogin` tool for Windows platform. This restriction has been lifted with the addition of `mvslogin` elimination with `RPC_SECGSS` mounts in z/OS NFS V1R11.

Setting up a Kerberos Key Distribution Center

In order to start a z/OS NFS server with Kerberos authentication features, a Kerberos Key Distribution Center must be ready before the z/OS NFS server starts. This section lists the basic steps involved in setting up the z/OS KDC which will be compatible with the z/OS NFS server environment. For more advanced configurations and detailed explanations of the setup steps and the reasoning behind, please refer to *z/OS Integrated Security Services Network Authentication Service Administration*. For other platforms' KDC setups, please consult your vendor specific documentation.

These steps assume that Resource Access Control Facility (RACF) is available in the system. If you have a different but equivalent external security manager, please refer to the documentation of the product for instructions.

1. As of z/OS V2R3, ICSF is required for all Kerberos functions (KDC, application servers, application clients, commands and utilities) and must remain active for the duration of the application. See *z/OS Integrated Security Services Network Authentication Service Administration*.
2. Copy the SKRKBKDC started task procedure from EUVFSAM to SYS1.PROCLIB. The SYS1.PROCLIB(SKRKBKDC) should look like the following:

```

//*****
//*
//* Procedure for starting the Kerberos SKRKBKDC started task
//* Specify PARMS='-kdc' to enable the Kerberos KDC services.
//* Specify PARMS='-nokdc' to disable the Kerberos KDC services.
//*
//*****
//SKRKBKDC PROC REGSIZE=256M,OUTCLASS='A',PARMS='-kdc'
//-----
//GO EXEC PGM=EUVFSKDC,REGION=&REGSIZE,TIME=1440,
// PARM=('ENVAR("LANG=En_US.IBM-1047"),TERM(DUMP) / &PARMS X
// 1>DD:STDOUT 2>DD:STDERR')
//STDOUT DD SYSOUT=&OUTCLASS,DCB=LRECL=250,
// FREE=END,SPIN=UNALLOC
//STDERR DD SYSOUT=&OUTCLASS,DCB=LRECL=250,
// FREE=END,SPIN=UNALLOC
//SYSOUT DD SYSOUT=&OUTCLASS,
// FREE=END,SPIN=UNALLOC
//CEEDUMP DD SYSOUT=&OUTCLASS,
// FREE=END,SPIN=UNALLOC

```

3. Copy the sample Kerberos configuration file in z/OS UNIX from /usr/lpp/skrb/examples/krb5.conf to /etc/skrb/krb5.conf. The permission bits of this file should allow only the administrator to modify it but everyone else to be able to read.

```

;-----;
; Sample Kerberos configuration file ;
; ; ;
; Copy this file to /etc/skrb/krb5.conf and then tailor it for ;
; your Kerberos configuration ;
; ; ;
; Do not enable DES3 encryption unless all of the systems in the ;
; realm have DES3 support. In order to use DES3 encryption for ;
; tickets, you must set the SKDC_TKT_ENCTYPES environment variable ;
; in /etc/skrb/home/kdc/envar. ;
;-----;
```

```

[libdefaults]
default_realm = KRB390.IBM.COM
kdc_default_options = 0x40000010
use_dns_lookup = 0
; Default encryption types if DES3 is not supported

```



```

default_tkt_enctypes = aes256-cts-hmac-sha1-96,aes128-cts-hmac-sha1-96,
des3-cbc-sha1,des-hmac-sha1,des-cbc-md5,des-cbc-md4,des-cbc-crc
default_tgs_enctypes = aes256-cts-hmac-sha1-96,aes128-cts-hmac-sha1-96,
des3-cbc-sha1,des-hmac-sha1,des-cbc-md5,des-cbc-md4,des-cbc-crc

```

```

[realms]
KRB390.IBM.COM = {
kdc = dcesec4.krb390.ibm.com:88
kpasswd_server = dcesec4.krb390.ibm.com:464
admin_server = dcesec4.krb390.ibm.com:749
}
KRB2000.IBM.COM = {
kdc = sstone1.krb2000.ibm.com:88
admin_server = sstone1.krb2000.ibm.com:749
}

```

```

[domain_realm]
.krb390.ibm.com = KRB390.IBM.COM
.krb2000.ibm.com = KRB2000.IBM.COM

```

4. Copy the environment variable definitions from /usr/lpp/skrb/examples/skrbkdc.envar to /etc/skrb/home/kdc/envar. Depending on which type of KDC is being set up, the environment variable SKDC_DATABASE should be set to SAF or NDBM accordingly (default is set to SAF registry type KDC). The file permissions should allow only the administrator to read and update.
5. Add the path "PATH=/usr/lpp/skrb/bin:\$PATH" in the z/OS UNIX to the user's ".profile" and export the "PATH".
6. Issue the following RACF commands (entering each command on a single line). If needed, consult *z/OS Integrated Security Services Network Authentication Service Administration* for explanations.

```

RDEFINE FACILITY IRR.RUSERMAP UACC(read)
SETROPTS RACLIST(FACILITY) REFRESH
AU skrbkdc DFLTGRP(sys1) NOPASSWORD OMVS(UID(0) PROGRAM('/bin/sh')
HOME('/etc/skrb/home/kdc'))
RDEFINE REALM KERBDFLT KERB(KERBNAME(KRB390.IBM.COM)
PASSWORD(password) MINTKTLFE(15) DEFTKTLFE(36000)
MAXTKTLFE(86400))

```

Note: KERBNAME(KRB390.IBM.COM) should be changed to match your Kerberos Realm.

7. For SAF registry KDC, continue with the following steps. For NDBM registry KDC, skip to step 8 on page 580.
 - a. Issue the following RACF commands, entering each command on a single line:

```

SETROPTS CLASSACT(app1) RACLIST(app1)
RDEFINE APPL SKRBKDC UACC(read)
SETROPTS CLASSACT(ptktdata) RACLIST(ptktdata)
RDEFINE PTKTDATA SKRBKDC UACC(none) SSIGNON(keymasked(3734343237343131))
SETROPTS RACLIST(app1 ptktdata) REFRESH
SETROPTS GENERIC(started)
RDEFINE STARTED SKRBKDC.** STDATA(user(skrbkdc))
RDEFINE STARTED SKRBWTR.** STDATA(user(skrbkdc))
SETROPTS RACLIST(started) REFRESH
AU KADMIN DFLTGRP(sys1) PASSWORD(password)KERB(KERBNAME(kadmin/admin))
ALU KADMIN PASSWORD(password) NOEXPIRED
PASSWORD KADMIN NOINTERVAL
AU CHANGEPW DFLTGRP(sys1) PASSWORD(password)
KERB(kerbname(kadmin/changepw))
ALU CHANGEPW PASSWORD(password) NOEXPIRED
PASSWORD CHANGEPW NOINTERVAL

```

- b. For multiple Kerberos realms environment, create ticket-granting tickets with RACF commands:

```

RDEFINE REALM /.../KRB390.IBM.COM/KRBTGT/KRB2000.IBM.COM
        KERB(PASSWORD(password))
RDEFINE REALM /.../KRB2000.IBM.COM/KRBTGT/KRB390.IBM.COM
        KERB(PASSWORD(password))

```

Note:

- 1) KRB390.IBM.COM is the local realm. Change to match the realm of your KDC.
- 2) KRB2000.IBM.COM is the remote realm, Change to match the name of the remote realm.
- c. Add Kerberos segments to existing user definitions. These Kerberos segments serve as the Kerberos principals in the Kerberos database.
To add a RACF userid, issue RACF command, for example:
AU (userid1) OWNER (IBMUSER) OMVS(UID(101))
To define Kerberos segment to this user definition, issue RACF command:
ALTUSER userid1 PASSWORD(password) NOEXPIRED
KERB(KERBNAME(userid1))
- d. Start the skrbkdc task.
- e. Continue to step 9 to complete KDC setup.
8. For NDBM registry type KDC, follow these steps.
 - a. To create initial registry database files, issue z/OS UNIX command:
kdb5_ndbm create

IBMUSER and IBMUSER/admin user principals are now created with initial password of IBMUSER.

- b. Copy sample KDC configuration file from /usr/lpp/skrb/examples/kdc.conf to /etc/skrb/home/kdc/kdc.conf and set the values inside as needed or leave them to default values.
- c. Copy the sample administration access control file from /usr/lpp/skrb/examples/kadm5.acl to /etc/skrb/home/kdc/kadm5.acl. The administrator can choose to customize it or leave it as default.
- d. Start the skrbkdc task.
- e. Create NFS principal for the z/OS NFS server using the kadmin interface in z/OS UNIX.
To enter the kadmin interface, issue z/OS UNIX command:
kadmin -p IBMUSER/admin -w IBMUSER
To create NFS principal, enter:
kadmin> addprinc nfs/host.domain
- f. For multiple Kerberos realm environment, create ticket-granting tickets in kadmin interface:
kadmin> addprinc krbtgt/KRB390.IBM.COM@KRB2000.IBM.COM
kadmin> addprinc krbtgt/KRB2000.IBM.COM@KRB390.IBM.COM

Note: The passwords specified for these two principals should be the same.

- g. Add Kerberos principals into the Kerberos database through the kadmin interface:
kadmin> addprinc user1
kadmin> addprinc user2
9. See “Configuring a secure z/OS NFS server” on page 199 and “Configuring a secure z/OS NFS client” on page 179.

Appendix N. Accessibility

Accessible publications for this product are offered through IBM Knowledge Center (www.ibm.com/support/knowledgecenter/SSLTBW/welcome).

If you experience difficulty with the accessibility of any z/OS information, send a detailed message to the Contact z/OS web page (www.ibm.com/systems/z/os/zos/webqs.html) or use the following mailing address.

IBM Corporation
Attention: MHVRCFS Reader Comments
Department H6MA, Building 707
2455 South Road
Poughkeepsie, NY 12601-5400
United States

Accessibility features

Accessibility features help users who have physical disabilities such as restricted mobility or limited vision use software products successfully. The accessibility features in z/OS can help users do the following tasks:

- Run assistive technology such as screen readers and screen magnifier software.
- Operate specific or equivalent features by using the keyboard.
- Customize display attributes such as color, contrast, and font size.

Consult assistive technologies

Assistive technology products such as screen readers function with the user interfaces found in z/OS. Consult the product information for the specific assistive technology product that is used to access z/OS interfaces.

Keyboard navigation of the user interface

You can access z/OS user interfaces with TSO/E or ISPF. The following information describes how to use TSO/E and ISPF, including the use of keyboard shortcuts and function keys (PF keys). Each guide includes the default settings for the PF keys.

- *z/OS TSO/E Primer*
- *z/OS TSO/E User's Guide*
- *z/OS ISPF User's Guide Vol I*

Dotted decimal syntax diagrams

Syntax diagrams are provided in dotted decimal format for users who access IBM Knowledge Center with a screen reader. In dotted decimal format, each syntax element is written on a separate line. If two or more syntax elements are always present together (or always absent together), they can appear on the same line because they are considered a single compound syntax element.

Each line starts with a dotted decimal number; for example, 3 or 3.1 or 3.1.1. To hear these numbers correctly, make sure that the screen reader is set to read out

punctuation. All the syntax elements that have the same dotted decimal number (for example, all the syntax elements that have the number 3.1) are mutually exclusive alternatives. If you hear the lines 3.1 USERID and 3.1 SYSTEMID, your syntax can include either USERID or SYSTEMID, but not both.

The dotted decimal numbering level denotes the level of nesting. For example, if a syntax element with dotted decimal number 3 is followed by a series of syntax elements with dotted decimal number 3.1, all the syntax elements numbered 3.1 are subordinate to the syntax element numbered 3.

Certain words and symbols are used next to the dotted decimal numbers to add information about the syntax elements. Occasionally, these words and symbols might occur at the beginning of the element itself. For ease of identification, if the word or symbol is a part of the syntax element, it is preceded by the backslash (\) character. The * symbol is placed next to a dotted decimal number to indicate that the syntax element repeats. For example, syntax element *FILE with dotted decimal number 3 is given the format 3 * FILE. Format 3* FILE indicates that syntax element FILE repeats. Format 3* * FILE indicates that syntax element * FILE repeats.

Characters such as commas, which are used to separate a string of syntax elements, are shown in the syntax just before the items they separate. These characters can appear on the same line as each item, or on a separate line with the same dotted decimal number as the relevant items. The line can also show another symbol to provide information about the syntax elements. For example, the lines 5.1*, 5.1 LASTRUN, and 5.1 DELETE mean that if you use more than one of the LASTRUN and DELETE syntax elements, the elements must be separated by a comma. If no separator is given, assume that you use a blank to separate each syntax element.

If a syntax element is preceded by the % symbol, it indicates a reference that is defined elsewhere. The string that follows the % symbol is the name of a syntax fragment rather than a literal. For example, the line 2.1 %OP1 means that you must refer to separate syntax fragment OP1.

The following symbols are used next to the dotted decimal numbers.

? indicates an optional syntax element

The question mark (?) symbol indicates an optional syntax element. A dotted decimal number followed by the question mark symbol (?) indicates that all the syntax elements with a corresponding dotted decimal number, and any subordinate syntax elements, are optional. If there is only one syntax element with a dotted decimal number, the ? symbol is displayed on the same line as the syntax element, (for example 5? NOTIFY). If there is more than one syntax element with a dotted decimal number, the ? symbol is displayed on a line by itself, followed by the syntax elements that are optional. For example, if you hear the lines 5 ?, 5 NOTIFY, and 5 UPDATE, you know that the syntax elements NOTIFY and UPDATE are optional. That is, you can choose one or none of them. The ? symbol is equivalent to a bypass line in a railroad diagram.

! indicates a default syntax element

The exclamation mark (!) symbol indicates a default syntax element. A dotted decimal number followed by the ! symbol and a syntax element indicate that the syntax element is the default option for all syntax elements that share the same dotted decimal number. Only one of the syntax elements that share the dotted decimal number can specify the ! symbol. For example, if you hear the lines 2? FILE, 2.1! (KEEP), and 2.1 (DELETE), you know that (KEEP) is the

default option for the FILE keyword. In the example, if you include the FILE keyword, but do not specify an option, the default option KEEP is applied. A default option also applies to the next higher dotted decimal number. In this example, if the FILE keyword is omitted, the default FILE(KEEP) is used. However, if you hear the lines 2? FILE, 2.1, 2.1.1! (KEEP), and 2.1.1 (DELETE), the default option KEEP applies only to the next higher dotted decimal number, 2.1 (which does not have an associated keyword), and does not apply to 2? FILE. Nothing is used if the keyword FILE is omitted.

*** indicates an optional syntax element that is repeatable**

The asterisk or glyph (*) symbol indicates a syntax element that can be repeated zero or more times. A dotted decimal number followed by the * symbol indicates that this syntax element can be used zero or more times; that is, it is optional and can be repeated. For example, if you hear the line 5.1* data area, you know that you can include one data area, more than one data area, or no data area. If you hear the lines 3* , 3 HOST, 3 STATE, you know that you can include HOST, STATE, both together, or nothing.

Notes:

1. If a dotted decimal number has an asterisk (*) next to it and there is only one item with that dotted decimal number, you can repeat that same item more than once.
2. If a dotted decimal number has an asterisk next to it and several items have that dotted decimal number, you can use more than one item from the list, but you cannot use the items more than once each. In the previous example, you can write HOST STATE, but you cannot write HOST HOST.
3. The * symbol is equivalent to a loopback line in a railroad syntax diagram.

+ indicates a syntax element that must be included

The plus (+) symbol indicates a syntax element that must be included at least once. A dotted decimal number followed by the + symbol indicates that the syntax element must be included one or more times. That is, it must be included at least once and can be repeated. For example, if you hear the line 6.1+ data area, you must include at least one data area. If you hear the lines 2+, 2 HOST, and 2 STATE, you know that you must include HOST, STATE, or both. Similar to the * symbol, the + symbol can repeat a particular item if it is the only item with that dotted decimal number. The + symbol, like the * symbol, is equivalent to a loopback line in a railroad syntax diagram.

Notices

This information was developed for products and services that are offered in the USA or elsewhere.

IBM may not offer the products, services, or features discussed in this document in other countries. Consult your local IBM representative for information on the products and services currently available in your area. Any reference to an IBM product, program, or service is not intended to state or imply that only that IBM product, program, or service may be used. Any functionally equivalent product, program, or service that does not infringe any IBM intellectual property right may be used instead. However, it is the user's responsibility to evaluate and verify the operation of any non-IBM product, program, or service.

IBM may have patents or pending patent applications covering subject matter described in this document. The furnishing of this document does not grant you any license to these patents. You can send license inquiries, in writing, to:

*IBM Director of Licensing
IBM Corporation
North Castle Drive, MD-NC119
Armonk, NY 10504-1785
United States of America*

For license inquiries regarding double-byte character set (DBCS) information, contact the IBM Intellectual Property Department in your country or send inquiries, in writing, to:

*Intellectual Property Licensing
Legal and Intellectual Property Law
IBM Japan Ltd.
19-21, Nihonbashi-Hakozakicho, Chuo-ku
Tokyo 103-8510, Japan*

The following paragraph does not apply to the United Kingdom or any other country where such provisions are inconsistent with local law:

INTERNATIONAL BUSINESS MACHINES CORPORATION PROVIDES THIS PUBLICATION "AS IS" WITHOUT WARRANTY OF ANY KIND, EITHER EXPRESS OR IMPLIED, INCLUDING, BUT NOT LIMITED TO, THE IMPLIED WARRANTIES OF NON-INFRINGEMENT, MERCHANTABILITY OR FITNESS FOR A PARTICULAR PURPOSE. Some states do not allow disclaimer of express or implied warranties in certain transactions, therefore, this statement may not apply to you.

This information could include technical inaccuracies or typographical errors. Changes are periodically made to the information herein; these changes will be incorporated in new editions of the publication. IBM may make improvements and/or changes in the product(s) and/or the program(s) described in this publication at any time without notice.

This information could include missing, incorrect, or broken hyperlinks. Hyperlinks are maintained in only the HTML plug-in output for the Knowledge Centers. Use of hyperlinks in other output formats of this information is at your own risk.

Any references in this information to non-IBM websites are provided for convenience only and do not in any manner serve as an endorsement of those websites. The materials at those websites are not part of the materials for this IBM product and use of those websites is at your own risk.

IBM may use or distribute any of the information you supply in any way it believes appropriate without incurring any obligation to you.

Licensees of this program who wish to have information about it for the purpose of enabling: (i) the exchange of information between independently created programs and other programs (including this one) and (ii) the mutual use of the information which has been exchanged, should contact:

*IBM Corporation
Site Counsel
2455 South Road
Poughkeepsie, NY 12601-5400
USA*

Such information may be available, subject to appropriate terms and conditions, including in some cases, payment of a fee.

The licensed program described in this document and all licensed material available for it are provided by IBM under terms of the IBM Customer Agreement, IBM International Program License Agreement or any equivalent agreement between us.

Any performance data contained herein was determined in a controlled environment. Therefore, the results obtained in other operating environments may vary significantly. Some measurements may have been made on development-level systems and there is no guarantee that these measurements will be the same on generally available systems. Furthermore, some measurements may have been estimated through extrapolation. Actual results may vary. Users of this document should verify the applicable data for their specific environment.

Information concerning non-IBM products was obtained from the suppliers of those products, their published announcements or other publicly available sources. IBM has not tested those products and cannot confirm the accuracy of performance, compatibility or any other claims related to non-IBM products. Questions on the capabilities of non-IBM products should be addressed to the suppliers of those products.

All statements regarding IBM's future direction or intent are subject to change or withdrawal without notice, and represent goals and objectives only.

This information contains examples of data and reports used in daily business operations. To illustrate them as completely as possible, the examples include the names of individuals, companies, brands, and products. All of these names are fictitious and any similarity to the names and addresses used by an actual business enterprise is entirely coincidental.

COPYRIGHT LICENSE:

This information contains sample application programs in source language, which illustrate programming techniques on various operating platforms. You may copy, modify, and distribute these sample programs in any form without payment to IBM, for the purposes of developing, using, marketing or distributing application programs conforming to the application programming interface for the operating platform for which the sample programs are written. These examples have not been thoroughly tested under all conditions. IBM, therefore, cannot guarantee or imply reliability, serviceability, or function of these programs. The sample programs are provided "AS IS", without warranty of any kind. IBM shall not be liable for any damages arising out of your use of the sample programs.

Terms and conditions for product documentation

Permissions for the use of these publications are granted subject to the following terms and conditions.

Applicability

These terms and conditions are in addition to any terms of use for the IBM website.

Personal use

You may reproduce these publications for your personal, noncommercial use provided that all proprietary notices are preserved. You may not distribute, display or make derivative work of these publications, or any portion thereof, without the express consent of IBM.

Commercial use

You may reproduce, distribute and display these publications solely within your enterprise provided that all proprietary notices are preserved. You may not make derivative works of these publications, or reproduce, distribute or display these publications or any portion thereof outside your enterprise, without the express consent of IBM.

Rights

Except as expressly granted in this permission, no other permissions, licenses or rights are granted, either express or implied, to the publications or any information, data, software or other intellectual property contained therein.

IBM reserves the right to withdraw the permissions granted herein whenever, in its discretion, the use of the publications is detrimental to its interest or, as determined by IBM, the above instructions are not being properly followed.

You may not download, export or re-export this information except in full compliance with all applicable laws and regulations, including all United States export laws and regulations.

IBM MAKES NO GUARANTEE ABOUT THE CONTENT OF THESE PUBLICATIONS. THE PUBLICATIONS ARE PROVIDED "AS-IS" AND WITHOUT WARRANTY OF ANY KIND, EITHER EXPRESSED OR IMPLIED, INCLUDING BUT NOT LIMITED TO IMPLIED WARRANTIES OF MERCHANTABILITY,

IBM Online Privacy Statement

IBM Software products, including software as a service solutions, (“Software Offerings”) may use cookies or other technologies to collect product usage information, to help improve the end user experience, to tailor interactions with the end user, or for other purposes. In many cases no personally identifiable information is collected by the Software Offerings. Some of our Software Offerings can help enable you to collect personally identifiable information. If this Software Offering uses cookies to collect personally identifiable information, specific information about this offering’s use of cookies is set forth below.

Depending upon the configurations deployed, this Software Offering may use session cookies that collect each user’s name, email address, phone number, or other personally identifiable information for purposes of enhanced user usability and single sign-on configuration. These cookies can be disabled, but disabling them will also eliminate the functionality they enable.

If the configurations deployed for this Software Offering provide you as customer the ability to collect personally identifiable information from end users via cookies and other technologies, you should seek your own legal advice about any laws applicable to such data collection, including any requirements for notice and consent.

For more information about the use of various technologies, including cookies, for these purposes, see IBM’s Privacy Policy at ibm.com/privacy and IBM’s Online Privacy Statement at ibm.com/privacy/details in the section entitled “Cookies, Web Beacons and Other Technologies,” and the “IBM Software Products and Software-as-a-Service Privacy Statement” at ibm.com/software/info/product-privacy.

Policy for unsupported hardware

Various z/OS elements, such as DFSMS, JES2, JES3, and MVS, contain code that supports specific hardware servers or devices. In some cases, this device-related element support remains in the product even after the hardware devices pass their announced End of Service date. z/OS may continue to service element code; however, it will not provide service related to unsupported hardware devices. Software problems related to these devices will not be accepted for service, and current service activity will cease if a problem is determined to be associated with out-of-support devices. In such cases, fixes will not be issued.

Minimum supported hardware

The minimum supported hardware for z/OS releases identified in z/OS announcements can subsequently change when service for particular servers or devices is withdrawn. Likewise, the levels of other software products supported on a particular release of z/OS are subject to the service support lifecycle of those products. Therefore, z/OS and its product publications (for example, panels, samples, messages, and product documentation) can include references to hardware and software that is no longer supported.

- For information about software support lifecycle, see: IBM Lifecycle Support for z/OS (www.ibm.com/software/support/systemsz/lifecycle)

- For information about currently-supported IBM hardware, contact your IBM representative.

Programming interface information

This document documents intended Programming Interfaces that allow the customer to write programs to obtain the services of z/OS NFS.

Trademarks

IBM, the IBM logo, and ibm.com[®] are trademarks or registered trademarks of International Business Machines Corporation in the United States, other countries, or both. If these and other IBM trademarked terms are marked on their first occurrence in this information with a trademark symbol ([®] or [™]), these symbols indicate U.S. registered or common law trademarks owned by IBM at the time this information was published. Such trademarks may also be registered or common law trademarks in other countries. A current list of IBM trademarks is available on the Web at Copyright and Trademark information (www.ibm.com/legal/copytrade.shtml).

Java and all Java-based trademarks are trademarks of Sun Microsystems, Inc. in the United States, other countries, or both.

Microsoft, Windows, Windows NT, and the Windows logo are trademarks of Microsoft Corporation in the United States, other countries, or both.

Linux is a trademark of Linus Torvalds in the United States, other countries, or both.

UNIX is a registered trademark of The Open Group in the United States and other countries.

Other company, product, and service names, which may be trademarks or service marks of others.

Glossary

This glossary includes terms and definitions for Network File System (NFS).

The following cross-references are used in this glossary:

1. *See* refers the reader from a term to a preferred synonym, or from an acronym or abbreviation to the defined full form.
2. *See also* refers the reader to a related or contrasting term.

To view glossaries for other IBM products, see IBM Glossary of Computing Terms (www.ibm.com/software/globalization/terminology).

A

access method

A technique for moving data between main storage and input/output devices.

access permission

A group of designations that determine the users who can access a particular file and how the users can access the file.

ACS See automatic class selection.

address

A unique code or identifier for a register, device, workstation, system, or storage location.

address space

The range of addresses available to a computer program or process. Address space can refer to physical storage, virtual storage, or both.

alias An alternative name for an integrated catalog facility (ICF) user catalog, a file that is not a Virtual Storage Access Method (VSAM) file, or a member of a partitioned data set (PDS) or a partitioned data set extended (PDSE). Also refers to an alternative name for an exported path in the NFS exports file.

alias entry

The correlation of an alias with the physical entry name of a user catalog or a data set that is not a Virtual Storage Access Method (VSAM) data set or an export path in the exports list.

allocation

The process of temporarily connecting a program to a data set, file, or device.

American Standard Code for Information Interchange (ASCII)

A standard code used for information exchange among data processing systems, data communication systems, and associated equipment. ASCII uses a coded character set consisting of 7-bit coded characters. See also Extended Binary Coded Decimal Interchange Code.

APAR See authorized program analysis report.

APF See authorized program facility.

API See application programming interface.

application programming interface (API)

An interface that allows an application program that is written in a high-level language to use specific data or functions of the operating system or another program.

ASCII See American Standard Code for Information Interchange. See also Extended Binary Coded Decimal Interchange Code.

automatic class selection (ACS)

A mechanism for assigning storage management subsystem (SMS) classes and storage groups to data sets. The storage administrator is responsible for establishing ACS routines appropriate for an installation's storage requirements.

automatic class selection routine (ACS routine)

A procedural set of automatic class selection (ACS) language statements. Based on a set of input variables, the ACS routine generates, for a data set, the name of a predefined storage management subsystem (SMS) class or a list of names of predefined storage groups.

authorized program analysis report (APAR)

A request for correction of a defect in a current release of an IBM-supplied program.

authorized program facility (APF)

In a z/OS environment, a facility that

permits the identification of programs that are authorized to use restricted functions.

B

basic sequential access method (BSAM)

An access method for storing or retrieving data blocks in a continuous sequence, using either a sequential access or a direct access device.

BIOD The caching daemon that caches directory lookups and file data when remote files are accessed from the host.

block A string of data elements recorded, processed, or transmitted as a unit. The elements can be characters, words, or physical records.

BSAM

See basic sequential access method.

C

CCSID

See coded character set identifier.

CDRA

See Character Data Representation Architecture.

Character Data Representation Architecture (CDRA)

An IBM architecture that defines a set of identifiers, resources, services, and conventions to achieve consistent representation, processing, and interchange of graphic character data in heterogeneous environments.

client A software program or computer that requests services from a server. See also server, host.

client/server

Pertaining to the model of interaction in distributed data processing in which a program on one computer sends a request to a program on another computer and awaits a response. The requesting program is called a client; the answering program is called a server.

coded character set identifier (CCSID)

A 16-bit number that includes a specific set of encoding scheme identifiers, character set identifiers, code page identifiers, and other information that uniquely identifies the coded graphic-character representation.

credential

Detailed information, acquired during authentication, that describes the user, any group associations, and other security-related identity attributes. Credentials can be used to perform a multitude of services, such as authorization, auditing, and delegation. For example, the sign-on information (user ID and password) for a user are credentials that allow the user to access an account.

current directory

See working directory.

D

daemon

A program that runs unattended to perform continuous or periodic functions, such as network control.

DASD

See direct access storage device.

DASD volume

A direct access storage device (DASD) space identified by a common label and accessed by a set of related addresses. See also primary storage.

data control block (DCB)

A control block used by access method routines in storing and retrieving data.

Data Encryption Standard (DES)

A cryptographic algorithm designed to encrypt and decrypt data using a private key.

data set

The major unit of data storage and retrieval, consisting of a collection of data in one of several prescribed arrangements and described by control information to which the system has access. See also file.

data set control block (DSCB)

A control block in the volume table of contents (VTOC) that describes data sets.

data set organization (DSORG)

The type of arrangement of data in a data set, such as sequential organization or partitioned organization.

DBCS See double-byte character set.

DCB See data control block.

DES See Data Encryption Standard.

DES authentication

A type of encryption algorithm that requires a client to send credentials (name, conversation key, window key, and a time stamp) to the server. The server then returns a verifier to the client. Data Encryption Standard (DES) credentials are sometimes called secure credentials because they are based on a sender's ability to encrypt data using a common time reference; a randomly generated key is required to encrypt a common reference time that is then used to create a conversation key.

DFSMS (Data Facility Storage Management Subsystem)

An operating environment that helps automate and centralize the management of storage. To manage storage, the storage management subsystem (SMS) provides the storage administrator with control over data class, storage class, management class, storage group, and automatic class selection (ACS) routine definitions.

DFSMSdfp

A DFSMS functional component and a base element of z/OS that provides functions for storage management, data management, device management, and distributed data access.

direct access

A file access method allowing reading and writing of records in an arbitrary order.

direct access storage device (DASD)

A device that allows storage to be directly accessed, such as a disk drive.

direct data set

A data set that has records in random order on a direct access volume. Each record is stored or retrieved according to its actual address or its address relative to the beginning of the data set. See also sequential data set.

directory

In UNIX, a file that maps the names of other directories and files to their locations.

double-byte character set (DBCS)

A set of characters in which each character is represented by two bytes.

These character sets are commonly used by national languages, such as Japanese and Chinese, that have more symbols than can be represented by a single byte.

DSCB See data set control block.

E**EBCDIC**

See Extended Binary Coded Decimal Interchange Code. See also American Standard Code for Information Interchange.

entry-sequenced data set (ESDS)

A data set whose records are loaded without respect to their contents, and whose relative byte addresses cannot change. Records are retrieved and stored by addressed access, and new records are added at the end of the data set.

ESDS See entry-sequenced data set.

exports data set

In z/OS, an MVS file on the server containing entries for directories that can be exported to Network File System (NFS) clients. It is used by the server to determine which MVS files and prefixes can be mounted by a client, and to write-protect MVS files on the server.

Extended Binary Coded Decimal Interchange Code (EBCDIC)

A coded character set of 256 8-bit characters developed for the representation of textual data. See also American Standard Code for Information Interchange.

External Data Representation (XDR)

A standard developed by Sun Microsystems, Incorporated to represent data in machine-independent format. Because XDR is a vendor-independent method for representing the data, new computer architectures can be integrated into the network without requiring the updating of translation routines.

F

file A collection of related data that is stored and retrieved by an assigned name. See also data set.

file handle

A number that is used by the client and

server sides of the Network File System (NFS) to specify a particular file or prefix.

file system

The collection of files and file management structures on a physical or logical mass storage device, such as a diskette or minidisk.

File Transfer Protocol (FTP)

In the Internet suite of protocols, an application layer protocol that uses TCP and Telnet services to transfer bulk-data files between machines or hosts.

FMID See function modification identifier.

FTP See File Transfer Protocol.

function modification identifier (FMID)

With SMP/E, a code that identifies the release levels of a program product.

G

gateway

A device or program used to connect networks or systems with different network architectures.

GID See group ID.

group With respect to partitioned data sets (PDSs), a member and the member's aliases that exist in a PDS or partitioned data set extended (PDSE), or in an unloaded PDSE.

A collection of users who can share access authorities for protected resources.

group ID (GID)

In the UNIX operating system, an integer that uniquely identifies each group of users to the operating system.

H

handle

A character string that represents an object, and is used to retrieve the object.

HFS data set

See hierarchical file system data set.

hierarchical file system data set (HFS data set)

A data set that contains a particular type of file system that is compliant with the Portable Operating System Interface (POSIX). An HFS data set is a collection of files and directories organized in a

hierarchical structure that can be accessed using z/OS UNIX System Services (z/OS UNIX).

host

A computer that is connected to a network and provides an access point to that network. The host can be a client, a server, or both a client and server simultaneously. See also server, client.

I

IDCAMS

An IBM program that is used to process access method services commands. It can be invoked as a job or jobstep, from a TSO terminal or from within a user's application program.

Interactive System Productivity Facility (ISPF)

An IBM licensed program that serves as a full-screen editor and dialog manager. Used for writing application programs, it provides a means of generating standard screen panels and interactive dialogs between the application programmer and terminal user. See also Time Sharing Option.

Internet

The worldwide collection of interconnected networks that use the Internet suite of protocols and permit public access.

Internet Protocol (IP)

A protocol that routes data through a network or interconnected networks. This protocol acts as an intermediary between the higher protocol layers and the physical network. See also Transmission Control Protocol.

interprocess communication (IPC)

The process by which programs send messages to each other. Sockets, semaphores, signals, and internal message queues are common methods of interprocess communication.

IP See Internet Protocol. See also Transmission Control Protocol.

IPC See interprocess communication.

J

JCL See job control language.

job control language (JCL)

A command language that identifies a job to an operating system and describes the job's requirements.

K**key-sequenced data set (KSDS)**

A VSAM file or data set whose records are loaded in key sequence and controlled by an index.

KSDS See key-sequenced data set.

L**library**

A partitioned data set or a series of concatenated partitioned data sets. See also partitioned data set extended.

local host

The computer to which a user's terminal is directly connected.

M**management class**

A user-defined schedule for moving objects from one storage class to the next. Management class describes the retention and class transition characteristics for a group of objects in a storage hierarchy.

master catalog

A key-sequenced data set (KSDS) or file with an index containing extensive data set and volume information that the Virtual Storage Access Method (VSAM) requires to locate data sets or files, allocate and deallocate storage space, verify the authorization of a program or operator to gain access to a data set or file, and accumulate usage statistics for data sets or files.

maximum transmission unit (MTU)

The largest possible unit of data that can be sent on a given physical medium in a single frame. For example, the maximum transmission unit for Ethernet is 1500 bytes.

MBCS See multibyte character set. See also double-byte character set, single-byte character set, Unicode.

mount To place a data medium in a position to operate.

mount handle data set

In z/OS, a data set used to store the file handles of Network File System (NFS) mount points.

mount point

A directory established in a workstation or a server local directory that is used during the transparent accessing of a remote file.

In Linux operating systems and in UNIX operating systems such as AIX, the directory at which a file system is mounted and under which other file systems may be mounted.

MTU See maximum transmission unit.

multibyte character set (MBCS)

A character set that represents single characters with more than a single byte. See also double-byte character set, single-byte character set, Unicode.

Multiple Virtual Storage (MVS)

An IBM operating system that accesses multiple address spaces in virtual storage.

MVS See Multiple Virtual Storage.

N**network**

In data communication, a configuration in which two or more locations are physically connected for the purpose of exchanging data.

Network Lock Manager (NLM)

A service used by Network File System (NFS) when using version 2 or 3 of the NFS protocol that allows a client on the host to lock a range of bytes or an entire file on the NFS server.

Network Status Manager (NSM)

A service used by Network File System (NFS) when using version 2 or 3 of the NFS protocol to determine whether resources, such as file open share or byte range locks, are still in use by a remote client.

NLM See Network Lock Manager.

NSM See Network Status Manager.

null credential

A type of credential that is usually associated with diskless workstations. Because there is no repository of

information that is local to the workstation, it is not possible to obtain identifying information.

O

object A directory or file.

P

partitioned data set (PDS)

A data set on direct access storage that is divided into partitions, called members, each of which can contain a program, part of a program, or data. See also sequential data set.

partitioned data set extended (PDSE)

A system-managed data set that contains an indexed directory and members that are similar to the directory and members of partitioned data sets (PDSs). See also library.

PDS See partitioned data set. See also sequential data set.

PDS directory

A set of records in a partitioned data set (PDS) that is used to relate member names to their locations within the data set.

PDSE See partitioned data set extended. See also library.

permission code

A 3-digit octal code or a nine-letter alphabetic code that indicates the access permission for a UNIX file. The access permissions are read, write, and execute.

permission field

One of the 3-character fields within the permissions column of a UNIX directory listing. The permission field indicates the read, write, and run permissions for the file or directory owner and for the group. It is used by file systems to control access.

PFS See physical file system.

physical file system (PFS)

The part of the operating system that handles the actual storage and manipulation of data on a storage medium.

port An end point for communication between applications, generally referring to a logical connection. A port provides

queues for sending and receiving data. Each port has a port number for identification.

Portable Operating System Interface (POSIX)

An IEEE family of standards designed to provide portability between operating systems that are based on UNIX. POSIX describes a wide spectrum of operating-system components ranging from C language and shell interfaces to system administration

Portmapper

A program that maps client programs to the port numbers of server programs. A portmapper is used with remote procedure call (RPC) programs. Portmapper does not support IPv6. RPCBIND is required for IPv6. See also RPCBIND.

port number

The part of a socket address that identifies a port within a host.

POSIX

See Portable Operating System Interface.

primary storage

A direct access storage device (DASD) volume available to users for data allocation. The volumes in primary storage are called primary volumes.

primary volume

A volume managed by DFSMSHsm containing data sets that are directly accessible to the user. See also primary storage.

program temporary fix (PTF)

For Z products, a fix that is tested by IBM and is made available to all customers.

protocol

A set of rules controlling the communication and transfer of data between two or more devices or systems in a communication network.

PTF See program temporary fix.

Q

QSAM

See queued sequential access method.

queued sequential access method (QSAM)

An access method for storing and retrieving logical records in a continuous sequence. Input data blocks awaiting

processing or output data blocks awaiting transfer to auxiliary storage are queued on the system to minimize delays in I/O operations.

R

RACF See Resource Access Control Facility.

relative record data set (RRDS)

A type of Virtual Storage Access Method (VSAM) data set whose records have fixed or variable lengths, and are accessed by relative record number.

Remote Procedure Call (RPC)

A protocol that allows a program on a client computer to run a program on a server.

Resource Access Control Facility (RACF)

An IBM licensed program that provides access control by identifying users to the system; verifying users of the system; authorizing access to protected resources; logging unauthorized attempts to enter the system; and logging accesses to protected resources.

Resource Measurement Facility (RMF)

A feature of z/OS that measures selected areas of system activity and presents the data collected in the format of printed reports, System Management Facility (SMF) records, or display reports.

RMF See Resource Measurement Facility.

root The UNIX definition for a directory that is the base for all other directories.

The user name for the system user with the most authority.

root user

A system user who operates without restrictions. A root user has the special rights and privileges needed to perform administrative tasks.

RPC See Remote Procedure Call.

RPCBIND

A program that maps client programs to the port numbers of server programs. RPCBIND is used with remote procedure call (RPC) programs. RPCBIND is required for IPv6. See also Portmapper.

RRDS See relative record data set.

S

SAF See System Authorization Facility.

SDSF See System Display and Search Facility.

sequential file

A type of MVS file that has its records stored and retrieved according to their physical order within the file. It must be on a direct access volume.

sequential data set

A data set whose records are organized on the basis of their successive physical positions, such as on magnetic tape. See also partitioned data set, direct data set.

server A software program or a computer that provides services to other software programs or other computers. See also host, client.

sharing

Using a file on a remote system. Sharing is performed by mounting the remote file system and then reading or writing files in that remote system.

single-byte character set (SBCS)

A coded character set in which each character is represented by a 1-byte code. A 1-byte code point allows representation of up to 256 characters. See also double-byte character set.

SMF See System Management Facilities.

SMP/E

See SMP/E for z/OS.

SMP/E for z/OS

An IBM licensed program used to install software and software changes on z/OS systems.

SMS See storage management subsystem (SMS).

stale file handle

A file handle for a file or prefix that is no longer valid.

stateless

Having no record of previous interactions. A stateless server processes requests based solely on information provided with the request itself, and not based on memory from earlier requests.

storage management subsystem (SMS)

Software that automates as much as possible the management of physical storage by centralizing control,

automating tasks, and providing interactive controls for system administrators.

superuser

See root user.

System Management Facilities (SMF)

A component of z/OS that collects and records a variety of system and job-related information.

System Authorization Facility (SAF)

An MVS interface with which programs can communicate with an external security manager, such as RACF.

System Display and Search Facility (SDSF)

An IBM-licensed program that provides a menu-driven full-screen interface that is used to obtain detailed information about jobs and resources in a system.

system-managed storage

Storage managed by the storage management subsystem (SMS). System-managed storage attempts to deliver required services for availability, performance, space, and security to applications.

T

TCP/IP

See Transmission Control Protocol/Internet Protocol.

Time Sharing Option (TSO)

A base element of the z/OS operating system with which users can interactively work with the system. See also Interactive System Productivity Facility.

Time Sharing Option Extensions (TSO/E)

A licensed program that is based on Time Sharing Option (TSO). With TSO/E, MVS users can interactively share computer time and resources.

Transmission Control Protocol (TCP)

A communication protocol used in the Internet and in any network that follows the Internet Engineering Task Force (IETF) standards for internetwork protocol. TCP provides a reliable host-to-host protocol in packet-switched communication networks and in interconnected systems of such networks. See also Internet Protocol.

Transmission Control Protocol/Internet Protocol (TCP/IP)

An industry-standard, nonproprietary set of communication protocols that provides reliable end-to-end connections between applications over interconnected networks of different types.

TSO See Time Sharing Option. See also Interactive System Productivity Facility.

TSO/E See Time Sharing Option Extensions.

U

UDP See User Datagram Protocol.

UID See user identification.

Unicode

A character encoding standard that supports the interchange, processing, and display of text that is written in the common languages around the world, plus some classical and historical texts. The Unicode standard has a 16-bit character set defined by ISO 10646.

UNIX A highly portable operating system that features multiprogramming in a multiuser environment. The UNIX operating system was originally developed for use on minicomputers, but was adapted for mainframes and microcomputers. The AIX operating system is IBM's implementation of the UNIX operating system.

UNIX authentication

The process of identifying a client process, which requires that the client process send credentials to the server.

user catalog

An optional catalog used in the same way as the master catalog and pointed to by the master catalog. Employing a user catalog lessens the contention for the master catalog and facilitates volume portability.

User Datagram Protocol (UDP)

An Internet protocol that provides unreliable, connectionless datagram service. It enables an application program on one machine or process to send a datagram to an application program on another machine or process.

user ID

See user identification.

user identification (user ID)

The name used to associate the user profile with a user when a user signs on to a system.

V**Virtual Storage Access Method (VSAM)**

An access method for direct or sequential processing of fixed-length and variable-length records on disk devices. The records in a VSAM data set or file can be organized in logical sequence by a key field (key sequence), in the physical sequence in which they are written on the data set or file (entry sequence), or by relative-record number.

volume

A discrete unit of storage on disk, tape or other data recording medium that supports some form of identifier and parameter list, such as a volume label or input/output control.

VSAM

See Virtual Storage Access Method.

W**working directory**

The active directory. When a file name is specified without a directory, the current directory is searched.

X

XDR See External Data Representation.

Z

zFS See z/OS file system.

z/OS An operating system for the IBM z Series product line that uses 64-bit real storage.

z/OS file system (zFS)

A type of file system that resides in a Virtual Storage Access Method (VSAM) linear data set (LDS).

Index

Special characters

/etc/rpc file, client setup 20
/etc/services and tcpip.profile files,
server setup 20

Numerics

0C4 ABEND 313
0C4 protection exception 224
64-bit exploitation 21
80A ABEND 148
878 ABEND 148

A

ABEND

80A 148
878 148
X'0F3' 334
X'806' 334
X'A03' 334
X'x13' 334
X'x22' 334
X'x37' 334
X'x3E' 334

ABEND0C4 313

ABENDxxx keyword 313

abytes value 491

access to remote files

for BSAM applications 92
for QSAM applications 92
for VSAM ESDS applications 92

accesschk client attribute 109, 118

accessibility 581

contact IBM 581
features 581

accessing MVS data sets

command syntax for AIX 65
command syntax for DFSMS 81

accessing MVS files 75

changing attributes 72
end-of-line terminators 35
getting authorization 73, 97
mount command 72, 89
mvslogin command 88
overriding server default
attributes 73
showattr command 105

accessing z/OS UNIX System
Services 53

acdirmax client attribute 109, 118

acdirmin client attribute 109

acregmax client attribute 110

acregmin client attribute 110

ACS (automatic class selection)
routine 126, 293

active data sets, displaying 243

activity trace

for HFS 570
for TCP/IP 570

activity trace (*continued*)

for z/OS UNIX 569

adds operand 238

afiles value 491

AIX

client activity trace 571

command reference 69

command syntax 65

downloading client commands 211

gcc 4.0.x compiler command 215

make command for 213

mvslogout command for clients 79

NFS client 65

showattr command for clients 74

umount command for clients 79

vi command 72

XLC v11 215

alias names

for MVS files 24

alias processing attribute 127

allocated buffers

logical I/O processing 146

allocated storage

side file 156

allocating

attributes data set 181

exports data set 182

lock data sets 192

mount handle data sets 192

altsym keyword 181, 183

American National Standard Code for
Information Interchange (ASCII) 34, 54

ASCII to EBCDIC conversion 128

Assembler header macro, reference 557

assignments, port 20

assistive technologies 581

assortedparms 285

async processing attribute 51, 134, 297

asynchronous block input/output (I/O)

daemon (BIOD) 110

atime 487, 490

attention messages

collecting 249

attrcaching attribute

tuning client with 305

attrcaching client attribute 110

tuning client with 305

attribute caching

specifying 110

attribute statement syntax 181

attributes

accesschk client attribute 109, 118

acdirmax client attribute 109, 118

acdirmin client attribute 109

acregmax client attribute 110

acregmin client attribute 110

alias processing attribute 127

async processing attribute 51, 134,
297

attrcaching client attribute 110

attrtimeout 147

attributes (*continued*)

attrtimeout processing attribute 127

binary processing attribute 128, 294

biod client attribute 110

blankstrip processing attribute 35,
128

blks data set creation attribute 122

blksize data set creation attribute 122

buffhigh client attribute 110, 140

changing 72

cln_ccsid client attribute 111

cln_ccsid processing attribute

native ASCII environment 137

specifying 128

convserv client attribute 111, 129

cyls data set creation attribute 122

data set creation 72

datacaching client attribute 111

dataclas data set creation

attribute 123

delaywrite client attribute 111

delim client attribute 112

dir data set creation attribute 123

dsntype data set creation attribute

for PDS 26

for PDSE 26

syntax 123

dsorg data set creation attribute 123

for direct access (DA) file 25

for partitioned data set (PDS) 292

for physical sequential (PS)

file 24

partitioned data set extended

(PDSE) 292

dynamicsizeadj client attribute 112

executebitoff processing attribute 129

executebiton processing attribute 129

extlink processing attribute 51, 129

fastfilesize processing attribute 129

filexmap processing attribute 40,
130

for z/OS UNIX System Services 121

hard client attribute 115

hfs site attribute 51

keys data set creation attribute 124

llock client attribute 113

logout site attribute 71, 146

lrecl data set creation attribute 124

mapleaddot processing attribute 130

maplower processing attribute 31,
34, 130

mapped processing attribute 130

maxtimeout 147

mgmtclas data set creation

attribute 124

mintimeout 147, 148

mtxtonly client attribute 113

MVSMNT processing attribute 131

nfstasks site attribute 150, 297, 302

nfsv4domain client attribute 113

NFSV4DOMAIN site attribute 151

- attributes (*continued*)
 - noalias processing attribute 127
 - noattrtimeout processing attribute 127
 - noblankstrip processing attribute 128
 - nofastfilesize processing attribute 129
 - nofilexmap processing attribute 40, 130
 - nomapleaddot processing attribute 130
 - nomaplower processing attribute 31, 34, 130
 - nomaxtimeout 147
 - nordrache processing attribute 132
 - nordrverf processing attribute 132
 - noreadtimeout 147
 - noreadtimeout processing attribute 132
 - noretrieve process attribute 297
 - noretrieve processing attribute 39, 133, 296
 - norlse data set creation attribute 125
 - notag processing attribute 134
 - nowritetimeout processing attribute 135, 147
 - processing 72, 127
 - proto client attribute 114
 - public client attribute 114
 - rdrverf processing attribute 132
 - readahead client attribute 114
 - readtimeout 148
 - readtimeout processing attribute 132
 - recfm data set creation attribute 125
 - recordsize data set creation attribute 125
 - recs data set creation attribute 122
 - restimeout 74
 - retrans client attribute 114
 - retrieve process attribute 297
 - retrieve processing attribute 39, 133, 296
 - retrieve(wait) 297
 - retry client attribute 114
 - rlse data set creation attribute 125
 - rpcbind client attribute 115
 - rszie client attribute 114
 - saf 70
 - safexp 70
 - secure client attribute 115
 - security 70, 257
 - security site attribute 13
 - security(exports) 167, 172
 - security(none) 172
 - security(saf) 168, 545
 - security(safexp) 169, 170, 545
 - setownernobody processing attribute 133
 - setownerroot processing attribute 133
 - shareoptions data set creation attribute 125
 - side file processing attribute 134
 - sidefile processing attribute 40
 - site 139
 - soft client attribute 115
 - space data set creation attribute 126

- attributes (*continued*)
 - spanned data set creation attribute 126
 - srv_ccsid processing attribute
 - native ASCII environment 137
 - specifying 134
 - storclas data set creation attribute 126
 - sync processing attribute 51, 134, 297
 - tag processing attribute 134
 - text processing attribute 128, 294
 - trks data set creation attribute 122
 - trusted 162
 - unit data set creation attribute 126
 - vol data set creation attribute 126
 - writetimeout 148
 - writetimeout processing attribute 135
 - xlat 193, 194
 - xlat processing attribute 135
 - z/OS UNIX 51, 297
 - znfsclient processing attribute 135
- attributes data set
 - allocating 181
 - changing 181
 - GFSAPATT sample member 181
 - modifying 181
- attributes, data set 13
- attrtimeout processing attribute 127, 135, 296
- attrtimeout site attribute 147, 148
- authentication error 89
 - restart processing 71
- authentication, protocols 172
- authority, trusted 162
- authorization checking for z/OS UNIX files 52
- Authorized Program Analysis Report (APAR) 311
- authorizing file operations 172
- authsys (system authentication) security 166
- automatic class selection (ACS) routine 126, 293
- automatic logout, recovering 74, 97
- automount facility 89, 178

B

- badcall statistic 280
- badxid statistic 280
- binary files 35
- binary processing attribute 128
- binary processing mode 35
- biod (block input/output (I/O) daemon) 306
- biod client attribute 110
- blanks
 - handling of 35
 - trailing 128
- blankstrip processing attribute 35, 128
- blks data set creation attribute 122
- BLKSIZE (block size) 291
- blksize data set creation attribute 122
- block input/output (I/O) daemon (BIOD) 110, 140, 284, 299, 301, 306
 - tuning client with 305
- block size (BLKSIZE) 291

- BPXVCLNY load module 224
- BSAM (basic sequential access method)
 - access to remote files 4, 92
 - line delimiter for record access 112
- buffer client block writes
 - out of order 140
- buffer size
 - write buffer 116
- buffers
 - caching 297
 - number of physical block buffers 147
 - reclaimed
 - percentage of 152
 - usage of 297
- bufferusage operand 238
- bufhigh attribute
 - buffer reclamation 299
 - displaying value of 106
 - logicalcache value 146
 - percentsteal value 152
 - storage considerations 301
- bufhigh client attribute 110
 - specifying 140
 - tuning client with 305, 306
- bufhigh operand 238
- byte-range locking 63

C

- C header macro, reference 549
- cached buffers, disk 135
- cached data
 - reading 152
 - writing 33
- cached directory attributes 109
- cachewindow site attribute
 - displaying value of 106
 - for write requests 299, 301
 - modified only at server startup 299, 301
 - specifying 140
- cancel command 231
- cancel mvsnfsc command 224
- carriage-return newline (CRNL) 87
- case_insensitive value 491, 492
- case_preserving value 491, 492
- cat command 26, 27, 33, 35
- cataloged data sets 6, 41
- cbsniff operand 239
- changing
 - attributes 72, 73, 89
 - attributes data set 181
 - mount handle data sets 247
 - your MVS password 88
 - your z/OS password 70
- Character Data Representation Architecture (CDRA)
 - for data conversion 91, 173
- checking UNIX permission bits 155
- checklist data set 191
- checklist site attribute 141, 170
- chkloop operand 249
- chkloop site attribute 141
- chmod command 32
- chown_restricted value 491, 492
- client
 - inactive time limit 146

- client (*continued*)
 - storage limit 140
- client activity trace
 - for AIX 571
 - for SUN 571
- client attributes
 - accesschk 109, 118
 - acdirmax 109, 118
 - acdirmin 109
 - acregmax 110
 - acregmin 110
 - attrcaching 110
 - biod 110
 - bufhigh 110, 140
 - cln_ccsid 111
 - convserv 111, 129
 - datacaching 111
 - delaywrite 111
 - delim 112
 - disablella 112
 - dynamicsizeadj 112
 - hard 115
 - llock 113
 - mtxtonly 113
 - nfsv4domain 113
 - proto 114
 - public 114
 - readahead 114
 - retrans 114
 - retry 114
 - rpcbind 115
 - rsize 114
 - secure 115
 - soft 115
 - srv_ccsid 115
 - stringprep 116
 - syncwrite 116
 - syntax 109
 - timeo 116
 - vers 116
 - wsize 116
 - xlat 116
- client commands
 - installing 209
- client hanging 153
- client id
 - specifying in exports data set 189
- client log data set
 - setting up 565
- client nfs 279
- client program requirements 488
- client rpc 279
- client-server relationship
 - overview of 3
- client, z/OS NFS
 - stopping 224
- client/server, user specified port range
 - support 20
- cln_ccsid client attribute 111
- cln_ccsid processing attribute
 - native ASCII environment 137
 - specifying 128
- closing a data set 244, 245
- coded character set identifier (CCSID)
 - for data conversion 91, 173
 - for native ASCII environment support 137
- coded character set identifier (CCSID) (*continued*)
 - for native ASCII support 21
 - in mount tag option 119
 - specifying for local mounted file system 111, 134
 - specifying for remote mounted file system 115
- collecting
 - diagnostic messages 249
 - usage statistics 175
- command
 - cancel 231
 - cancel mvsnfs 224
 - cat 26, 27, 33, 35
 - chmod 32
 - copy 28, 287
 - cp 23, 287
 - crnl2nl 86
 - date 287
 - f omvs,stoppps=NFS 224
 - for mount operation 43
 - force 224
 - ln 55
 - ls 27
 - ls (UNIX) 129, 485
 - make 212
 - make example 543
 - mkdir 23, 26, 27, 44, 292
 - modify 73, 182, 235
 - more 55
 - mount 5, 23, 39, 41, 66, 72, 73, 76, 81, 89, 171, 279, 291, 294, 296
 - example 72
 - mvslgin 65, 70, 81, 88, 259
 - mvslgin (client) 209
 - mvslgout 68, 70, 79, 87, 107, 259
 - mvslgout (client) 209
 - net use 23
 - netstat -s 280, 282
 - nfsstat 83, 99, 279, 284
 - nl2crnl 87
 - rm 26, 56
 - rm (UNIX) 129
 - rmdir 26, 27
 - showattr 24, 25, 52, 67, 70, 74, 75, 83, 89, 105
 - showattr (client) 209
 - showmount 85, 104
 - start 183, 229
 - stop 229
 - time 287
 - timex 287
 - touch 212
 - TSO ALLOCATE 92
 - TSO HELP MOUNT 81
 - TSO HELP UNMOUNT 81
 - TSO MOUNT 91, 92, 173
 - umount 68, 78
 - unmount 81, 98
- command syntax
 - AIX user 65
 - for AIX client 65
 - for DFSMS 81
 - for NFS clients 81
 - for UNIX client 65
- comment symbol 228
- comments from the requestor 547
- commit procedure
 - cached data writing 33
- compatibility
 - POSIX 50
- component identification keyword 313
- component trace
 - command for starting on z/OS NFS client 224
 - command for starting on z/OS NFS server 231
- concurrent write, PDSE 28
- configuring
 - attributes data set 181
 - NFS 161
- configuring the server
 - attributes data set 182
 - exports data set 182
 - mount handle data sets 182
- CONSOLEMSG operand 240
- consolemsg site attribute
 - specifying 141
- contact
 - z/OS 581
- contiguous port range 20
- control files 13
- control timeout, HFS vnode token 144
- controlling access to data sets 182
- convserv client attribute 111, 129
- convserv processing attribute
 - values 174
 - customized conversion 174
 - enforced subset conversion 174
 - Language Environment-Behavior conversion 174
 - Modified Language Environment-Behavior conversion 174
 - roundtrip conversion 174
- CONVXLAT utility 194
- cookie verifier checking 132
- copy command
 - creating VSAM files with 28
- cp command 23
- creating external link 55
- creating VSAM files 28
- creating z/OS conventional MVS data sets 6
- credentials, UNIX-style 173
- crnl2nl command
 - syntax for DFSMS 86
- ctime 487
- CTINFC00 member of
 - SYS1.PARMLIB 322
- CTINFS00 member of
 - SYS1.PARMLIB 320
- ctrace
 - operand of the START mvsnfs command 228
- customized conversion 174
- customizing
 - exit routines 255
 - NFS 161
 - translation table 193
- cyls data set creation attribute 122

D

- DASD volume
 - for data set creation 126
- data access/creation commands 33
- data class
 - specifying 123
- data conversion
 - parameters used 173
 - Unicode Standard 91
 - xlat client attribute 116
- data labeling (RACF option)
 - z/OS NFS server support for 206
- data set
 - attributes 6, 13
 - binary format 128
 - cataloged 6
 - cataloged, organizations supported 41
 - checklist 191
 - creation attributes 122
 - definition 5, 40
 - DSNTYPE 292
 - DSORG 292
 - exports data set 13
 - MVS 268
 - organization 123
 - organization (DSORG) 292
 - readdirtimeout site attribute 153
 - record format and characteristics 125
 - release unused space 125
 - released after a read 132
 - released after a write 135
 - rules for file extension mapping 134
 - serialization 45
 - share options (VSAM) 125
 - side file 40
 - spanned data set creation attribute (VSAM) 126
 - structure 122
 - text format 128
 - timeout specification 296
 - type (DSNTYPE) 292
 - unit to create on 126
 - volume for 126
- data set creation attributes
 - blks 122
 - blksize 122
 - cyls 122
 - dataclas 123
 - dir 123
 - dsntype 123
 - dsorg 123
 - keys 124
 - lrecl 124
 - mgmtclas 124
 - norlse 125
 - recfm 125
 - recordsize 125
 - recs 122
 - rlse 125
 - shareoptions 125
 - space 126
 - spanned 126
 - storclas 126
 - trks 122
 - unit 126
 - vol 126
- data transmitted, write request 134
- data types, mixed set 130
- databufferpoolsize 285
- datacaching attribute 116
- datacaching client attribute 111
 - tuning client with 305
- DATACLAS 293
- dataclas data set creation attribute 123
- DCB (data control block)
 - parameters 122
- deallocating a data set 245
- debug operand 250
- debugging
 - collecting messages for 249
- default attributes
 - displaying 75
- default attributes, overriding 72, 89
- defaults
 - displaying 75
- defaults, displaying 105
- delay detection timeout 142
- delay write
 - maximum number of disk blocks for 111
- delaywrite client attribute 111
 - tuning client with 305
- delaywrite mount parameter
 - tuning client with 307
- delegation site attribute 141
- delegation/nodelegation 46
- deleting
 - entries from mount handle data sets 247
 - migrated files 133
- delim client attribute 112
- denyrw site attribute 141
- development toolkits 214, 215
- DFSMS
 - command syntax for 81
- DFSMSHsm
 - recall or delete migrated files 133
- dhcp site attribute 142
- diagnosis
 - diagnostic aids 332
 - modify command for 249
 - of problems 311
 - reporting problems 311
 - using keywords 311
 - using RETAIN 332
- diagnostic errors
 - messages for 334
- dir data set creation attribute 123
- direct (DA) data sets
 - file size value for 484
- direct access (DA) data set
 - attribute for creating 123
- direct access (DA) data sets
 - supported by z/OS NFS server 23
 - time stamps for 487
 - using fastfilesize for 485
- direct access (DA) files
 - creating 25
- directory
 - client commands 123
- directory statement
 - in the exports data set 182
- disablella client attribute 112
- disconnecting a mount point 78, 98
- disk blocks
 - maximum number for delay write 111
 - read ahead 114
- dispatching priority 285
- displaying
 - client statistical information 99
 - default and mount point attributes 75, 105
 - default attributes 75, 106
 - mount point attributes 74
 - mount points and active data sets 243
 - number of messages for NFS operator commands 240, 242
 - remote server mount information 104
 - site and mount point attributes 24
 - status of active subtasks 246
- displaying attributes 75
- DlyDtimeout site attribute 142
- DOC SCnnnnnnnn keyword 315
- Domain Name Server 227
- double byte character set (DBCS) 193
 - for data conversion 91
- downloading
 - commands to the client 209
 - NFSTARB files 209
 - source code to the client 543
- DSNTYPE (data set type) 292
- dsntype data set creation attribute
 - for PDS 26
 - for PDSE 26
 - syntax 123
- DSORG (data set organization) 292
- dsorg data set creation attribute 123
- dsorg(ps) attribute
 - for physical sequential (PS) file 24
- dspms
 - operand of the START mvsnfs command 229
- dtpref value 491, 492
- Dump Analysis and Elimination (DAE) 333
- dump data set, abnormal end 331
- dynamic IP addresses for clients 142
- dynamic IP addressing 20
 - server configuration 202
- dynamicsizeadj client attribute 112
 - tuning client with 305
- dynamicsizeadj mount parameter 306

E

- EBCDIC code page 0037 193
- EBCDIC to ASCII conversion 128
- Electronic Technical Response (ETR) 331
- encoded password 547
- encoded user name 547
- end-of-file mark (EOF) 86
- end-of-line specifiers 35, 128
- end-of-line terminators 35
- ending your z/OS session 79, 107
- enforced subset conversion 174
- Enterprise Storage Server (ESS) 292
- entry-sequenced data set (ESDS) 92

entry-sequenced data set (ESDS)
(continued)
 creating VSAM files 28
 supported by z/OS NFS server 23
 Error Client Loop Detection Facility 220
 error messages
 collecting 249
 ESDS (entry-sequenced data set) 92
 ESS 2105 DASD 292
 executebitoff processing attribute 129
 executebiton processing attribute 129
 exit routines
 customizing 255
 export entry, return first character 145
 export spanning pathnames 17
 exportchk operand 240
 exportfs operand 73, 241
 exporting a file system 171
 exports data set 13
 exports list and SAF checking 167, 169
 extended address volumes
 data sets on 30
 extended binary-coded decimal
 interchange code (EBCDIC) 34, 54
 extended format data sets, exploiting 30
 External Data Representation (XDR) 4
 external link 55
 externalized return codes
 NFS version 2 protocol 445, 448
 NFS version 3 protocol 445
 NFS version 4 protocol 446
 extlink processing attribute 51, 129

F

fastfilesize 285, 295
 fastfilesize processing attribute 129, 485
 FAT file system 213
 fbytes value 491
 ffiles value 491
 file attributes, NFS version 4
 protocol 491
 file creation
 attributes 122
 data class 123
 management class 124
 storage class 126
 file extension mapping 40
 side file 40
 file name
 mapping between lower and upper
 case 130
 file naming conventions
 for MVS files 24
 file processing
 overriding default translation
 table 135
 file security exit
 GFSAUSEC 266
 parameter list 266
 purpose 263
 request code 268
 return codes 268
 file size
 determination of 32, 483
 number of physical block buffers 147
 file system 5, 40

file system attributes for MVS 45
 file system size 58
 file tag
 for new files 134
 File Transfer Protocol (FTP) 209
 fileextmap processing attribute 40, 130
 fileidsite attribute 142
 files
 file tag for 134
 locking 61
 saving fixed-length MVS file 36
 source for client enabling
 commands 214
 filesystemtype parmlib statement 176
 filtering NFS ctrace records in IPCS 326
 fixed-blocked file format 122
 flushlog operand 250
 FMIDs for z/OS NFS 312
 fn_delimiter site attribute 143
 force command 224
 freed operand 241
 freeze operand 242
 freeze=off operand 73
 freeze=offhfs operand 73
 freeze=on operand 73
 freeze=onhfs operand 73
 FSF_CANSETTIME, properties 491
 FSF_HOMOGENEOUS, properties 491
 FSF_LINK, properties 491
 FSF_SYMLINK, properties 491
 fsinfo, static file system 491, 492
 fsstat, dynamic file system 491

G

Get Attribute
 data set timeout specification 296
 file size determination 294
 getattr call 280
 getattr operation
 data set timeout specification 127
 GFSA1000E (procname) 401
 GFSA1001I (procname) 401
 GFSA1002I (procname) 402
 GFSA1003E (procname) 402
 GFSA1004I (procname) 402
 GFSA1005E (procname) 402
 GFSA1006W (procname) 402
 GFSA1007E (procname) 402
 GFSA1008E (procname) 403
 GFSA1009E (procname) 403
 GFSA1010E (procname) 403
 GFSA1011I (procname) 403
 GFSA1012W (procname) 403
 GFSA1013E (procname) 403
 GFSA1014I (procname) 404
 GFSA1015I (procname) 404
 GFSA1016E (procname) 404
 GFSA1017E (procname) 404
 GFSA1018E (procname) 404
 GFSA1019E (procname) 405
 GFSA1030E 405
 GFSA1031I 405
 GFSA1032E 406
 GFSA1033E 406
 GFSA1034E 406
 GFSA1036E 406
 GFSA1040I 407
 GFSA1041I 407
 GFSA300I - GFSA319I 340
 GFSA320I (procname) 340
 GFSA321I (procname) 341
 GFSA322I (procname) 341
 GFSA323I (procname) 341
 GFSA324I (procname) 341
 GFSA326E 342
 GFSA328I (procname) 342
 GFSA329I (procname) 342
 GFSA330I (procname) 342
 GFSA331E (procname) 342
 GFSA332I (procname) 343
 GFSA333I (procname) 343
 GFSA334E (procname) 343
 GFSA335E (procname) 343
 GFSA336E (procname) 343
 GFSA337E 344
 GFSA339I 344
 GFSA340I 344
 GFSA344I (procname) 344
 GFSA345E 344
 GFSA346I 345
 GFSA347I 345
 GFSA348I (procname) 345
 GFSA349I 345
 GFSA352E 345
 GFSA360I 345
 GFSA361I (procname) 345
 GFSA362I (procname) 346
 GFSA363I (procname) 346
 GFSA364I (procname) 346
 GFSA365I 346
 GFSA366I 346
 GFSA367I 346
 GFSA368I 346
 GFSA369I 347
 GFSA370I 347
 GFSA371I 347
 GFSA372I 347
 GFSA375I 347
 GFSA376I 347
 GFSA377I 347
 GFSA378I 347
 GFSA379I 348
 GFSA380I 348
 GFSA381I 348
 GFSA382I 348
 GFSA383I 348
 GFSA384I 348
 GFSA385I (procname) 348
 GFSA386E 349
 GFSA387I 349
 GFSA400I 349
 GFSA401I (procname) 349
 GFSA402I (procname) 349
 GFSA403I (procname) 350
 GFSA404I 350
 GFSA405I 350
 GFSA406I 350
 GFSA407I 350
 GFSA408I 350
 GFSA409I 350
 GFSA411I 350
 GFSA412I 350
 GFSA413I 351

GFSA414I	351	GFSA509I	361	GFSA735I	371
GFSA415I	351	GFSA510I	361	GFSA736E	371
GFSA416I	351	GFSA511I	361	GFSA737I	372
GFSA417I	351	GFSA512I	361	GFSA738E	372
GFSA418I	351	GFSA513I	361	GFSA739I	372
GFSA419I	351	GFSA514I	362	GFSA740W (procname)	373
GFSA420I	351	GFSA515I	362	GFSA741W (procname)	373
GFSA421I	352	GFSA516I	362	GFSA742W (procname)	373
GFSA422I	352	GFSA517I	362	GFSA743W (procname)	373
GFSA423I	352	GFSA518A	362	GFSA744E(procname)	374
GFSA424I	352	GFSA519I	363	GFSA750I (procname)	374
GFSA425I	352	GFSA520I	363	GFSA751I (procname)	374
GFSA426I	352	GFSA521I	363	GFSA752I (procname)	374
GFSA429I	352	GFSA522I	363	GFSA753I (procname)	374
GFSA430I	352	GFSA523I	363	GFSA754I (procname)	374
GFSA431I	353	GFSA524I	363	GFSA770I	375
GFSA432I	353	GFSA525I	363	GFSA771I (procname)	375
GFSA433	353	GFSA526I	363	GFSA772I (procname)	375
GFSA434I (procname)	353	GFSA527I	363	GFSA776I	375
GFSA435E	353	GFSA550I	364	GFSA777I	375
GFSA436I	353	GFSA554I	364	GFSA779I	375
GFSA437I	354	GFSA555I	364	GFSA780I	375
GFSA438I	354	GFSA556I	364	GFSA782I (procname)	376
GFSA439I	354	GFSA557I	364	GFSA784I	376
GFSA440I	354	GFSA558I (procname)	364	GFSA786I	376
GFSA441E	354	GFSA559I (procname)	364	GFSA787I	376
GFSA442I	354	GFSA563I	365	GFSA788I	376
GFSA443I	354	GFSA564I	365	GFSA790I (procname)	377
GFSA444E	354	GFSA565I	365	GFSA791I	377
GFSA445E	354	GFSA566I (procname)	365	GFSA792I	377
GFSA446E	355	GFSA567I	365	GFSA793I	377
GFSA450I	355	GFSA571E	365	GFSA794I	377
GFSA451I	355	GFSA572E	365	GFSA796I	377
GFSA452I	355	GFSA595I	366	GFSA797I	378
GFSA453E (procname)	355	GFSA596I	366	GFSA801I	378
GFSA454I (procname)	355	GFSA598I	366	GFSA802E	378
GFSA455E	356	GFSA660I	366	GFSA803I	378
GFSA456E	356	GFSA665I	366	GFSA804I	378
GFSA459E	356	GFSA666I	366	GFSA805E	378
GFSA460E	356	GFSA667I	366	GFSA806I	379
GFSA461E (procname)	356	GFSA668I	367	GFSA811I	379
GFSA462E (procname)	356	GFSA669I	367	GFSA812I	379
GFSA463E (procname)	357	GFSA670I	367	GFSA813I	379
GFSA464I (procname)	357	GFSA671I	367	GFSA814I	380
GFSA465I (procname)	357	GFSA672I	367	GFSA815I	380
GFSA469I (procname)	357	GFSA673I	367	GFSA816I	380
GFSA470I (procname)	357	GFSA674I	367	GFSA817I	380
GFSA471I (procname)	357	GFSA675I	368	GFSA818I (procname)	381
GFSA472I (procname)	358	GFSA677I	368	GFSA819I	381
GFSA473E (procname)	358	GFSA678I	368	GFSA820I	381
GFSA474E (procname)	358	GFSA679I	368	GFSA821I	381
GFSA475E (procname)	358	GFSA680I	368	GFSA822I	381
GFSA477E	358	GFSA681I	368	GFSA823I (procname)	381
GFSA478E	359	GFSA682I	368	GFSA824W (procname)	382
GFSA480I	359	GFSA683I	368	GFSA825W (procname)	382
GFSA481I	359	GFSA684I	369	GFSA827I	382
GFSA482I	359	GFSA685I	369	GFSA828I (procname)	382
GFSA483E	359	GFSA686I	369	GFSA829I	383
GFSA483I	359	GFSA687I	369	GFSA831E (procname)	383
GFSA484E	359	GFSA727E	369	GFSA832I	383
GFSA485I (procname)	360	GFSA728E (procname)	369	GFSA833I	383
GFSA486I (procname)	360	GFSA729E (procname)	370	GFSA834I	384
GFSA487E (procname)	360	GFSA730I (procname)	370	GFSA840I	384
GFSA501I	360	GFSA731I	370	GFSA841I	384
GFSA502I	360	GFSA732E	370	GFSA842I	384
GFSA507I	360	GFSA733I	370	GFSA843I	384
GFSA508I	361	GFSA734E	371	GFSA846I	384

GFSA847I	384	GFSA936I (procname)	395	GFSC101E	409
GFSA848I	384	GFSA937E	395	GFSC102E	409
GFSA849I	385	GFSA938I	395	GFSC103E	409
GFSA850I	385	GFSA939I	395	GFSC105E	410
GFSA851I	385	GFSA942I	395	GFSC106E	410
GFSA853I	385	GFSA943E (procname)	396	GFSC107E	410
GFSA854I	385	GFSA944I	396	GFSC110E	410
GFSA858I	385	GFSA945I	396	GFSC200E	410
GFSA859I	386	GFSA946I	396	GFSC201E	410
GFSA860I	386	GFSA947I	396	GFSC202E	410
GFSA862I	386	GFSA948I	396	GFSC203E	411
GFSA863I	386	GFSA949I	396	GFSC204E	411
GFSA864I (procname)	386	GFSA950I	397	GFSC205E	411
GFSA865I (procname)	386	GFSA951I	397	GFSC206E	411
GFSA866I (procname)	386	GFSA952I	397	GFSC207E	411
GFSA867I (procname)	387	GFSA953A	397	GFSC208E	411
GFSA868I (procname)	387	GFSA954I	397	GFSC209E	411
GFSA869I (procname)	387	GFSA955I	397	GFSC210E	412
GFSA871I	387	GFSA956I	397	GFSC211E	412
GFSA872E	387	GFSA957I	397	GFSC212E	412
GFSA876I	387	GFSA958I	398	GFSC213E	412
GFSA877I	388	GFSA959I	398	GFSC214E	412
GFSA878I (procname)	388	GFSA960I	398	GFSC216E	412
GFSA879I (procname)	388	GFSA962E	398	GFSC217E	412
GFSA881I	388	GFSA963E	398	GFSC218E	413
GFSA882I	389	GFSA964I	398	GFSC219E	413
GFSA883I	389	GFSA965I	398	GFSC220E	413
GFSA886I	389	GFSA966I	398	GFSC221I	413
GFSA892W	389	GFSA967I	398	GFSC222E	413
GFSA895I	389	GFSA969I	398	GFSC275E	413
GFSA896I	389	GFSA970I	398	GFSC276E	414
GFSA897I	390	GFSA971I	399	GFSC277E	414
GFSA898I	390	GFSA972I	399	GFSC278E	414
GFSA899I	390	GFSA973A	399	GFSC279E	414
GFSA900I (procname)	390	GFSA974A	399	GFSC280E	415
GFSA901I (procname)	390	GFSA975A	399	GFSC281E	415
GFSA902I (procname)	390	GFSA976I	399	GFSC282E	415
GFSA903I (procname)	390	GFSA977I	399	GFSC283E	415
GFSA904I (procname)	391	GFSA978I	399	GFSC284I	415
GFSA905I	391	GFSA979E	399	GFSC300E	416
GFSA907I	391	GFSA980E	399	GFSC301E	416
GFSA908I (procname)	391	GFSA981I	399	GFSC302E	416
GFSA909E (procname)	391	GFSA982E	399	GFSC303E	416
GFSA910I (procname)	391	GFSA983E	400	GFSC304E	416
GFSA911I (procname)	392	GFSA984E	400	GFSC305E	416
GFSA912I (procname)	392	GFSA985E	400	GFSC307E	417
GFSA913I (procname)	392	GFSA986I	400	GFSC308E	417
GFSA914I (procname)	392	GFSA987I	400	GFSC309E	417
GFSA915I (procname)	392	GFSA988I	400	GFSC310I	417
GFSA916I (procname)	392	GFSA990I	400	GFSC311I	417
GFSA917I (procname)	393	GFSA991E (procname)	400	GFSC312I	417
GFSA918I (procname)	393	GFSA996E (procname)	401	GFSC313I	417
GFSA919I (procname)	393	GFSA997I	401	GFSC315E	417
GFSA920I (procname)	393	GFSA998I	401	GFSC317E	418
GFSA921I (procname)	393	GFSA999I	401	GFSC318E	418
GFSA922I (procname)	393	GFSA PATT sample member	499	GFSC319E	418
GFSA923I (procname)	393	GFSA PROC		GFSC320E	418
GFSA924I (procname)	393	in NFSSAMP library	535	GFSC500I	418
GFSA925I (procname)	394	GFSA SSMF macro	549	GFSC501I	418
GFSA927I (procname)	394	GFSA UD SA user storage block	255	GFSC502E	418
GFSA929I	394	GFSA U LOG		GFSC503E	418
GFSA930I (procname)	394	for login exit parameter list	259	GFSC504I	419
GFSA931I (procname)	394	GFSA USEC	266	GFSC505E	419
GFSA932I (procname)	394	GFSA US MF macro	557	GFSC506E	419
GFSA933I (procname)	395	GFSC098I	409	GFSC507I	419
GFSA934I (procname)	395	GFSC099I	409	GFSC510E	419
GFSA935I (procname)	395	GFSC100E	409	GFSC700I	419

GFSC701I 420
 GFSC702I 420
 GFSC703E 420
 GFSC708E 420
 GFSC711E 420
 GFSC712E 421
 GFSC713E 421
 GFSC714E 421
 GFSC715E 421
 GFSC716I 422
 GFSC717E 422
 GFSC718E 422
 GFSC721E 422
 GFSC722E 422
 GFSC723E 422
 GFSC724E 423
 GFSC725E 423
 GFSC726E 423
 GFSC727W 423
 GFSC728E 423
 GFSC729W 423
 GFSC734I 424
 GFSC735W 424
 GFSC737W 424
 GFSC738W 424
 GFSC739E 424
 GFSC740E 424
 GFSC741E 425
 GFSC742W 425
 GFSC743E 425
 GFSC840I 425
 GFSC841E 425
 GFSC842E 425
 GFSC843E 425
 GFSC845I 425
 GFSC846E 426
 GFSC847E 426
 GFSC848E 426
 GFSC849E 426
 GFSC850E 426
 GFSC854I 426
 GFSC855E 427
 GFSC856E 427
 GFSC857I 427
 GFSC858E 427
 GFSC859E 427
 GFSC860W 427
 GFSC869E 427
 GFSC870E 427
 GFSCPROC
 in NFSSAMP library 539
 GFSN5001E 428
 GFSN5002E 428
 GFSN5003E 429
 GFSN5004E 429
 GFSN5005E 429
 GFSN5006E 430
 GFSN5007E 430
 GFSN5008E 430
 GFSN5009E 431
 GFSN5010E 431
 GFSN5011E 432
 GFSN5012E 432
 GFSN5013E 433
 GFSN5014E 433
 GFSN5015E 434
 GFSN5016E 434

GFSN5017E 435
 GFSN5018E 436
 GFSN5019E 436
 GFSN5020E 436
 GFSN5025E 437
 GFSN5026E 437
 GFSN5027E 437
 GFSN5028E 437
 GFSN5030E 438
 GFSN5032I 438
 GFSN5034E 438
 GFSN5035E 438
 GFSN5036E 438
 GFSN5037E 439
 GFSN5038E (procname) 439
 GFSN9999E 439
 GID
 mapping to group name 546
 global exit block (GXB) 263
 Global Exit Block (GXB) 256, 260
 grace period for reclaiming locks 62, 63
 granting access to data sets 182
 group name
 mapping to GID 546
 group number (GID) 32, 52

H

hard client attribute 115
 Health Checker (HC) 319
 HFS
 activity trace 570
 hfs site attribute 51, 52
 hfsfbtimeout site attribute 144
 hfsprefix site attribute 143
 HFSPREFIX site attribute 9
 hfssec site attribute 144
 hierarchical file system (HFS) 4, 49, 55,
 56, 137, 293, 302
 high-level qualifier (HLQ)
 for MVS data sets 5
 mapping to workstation file
 system 40
 hostname
 mvslogin command 88

I

IBMLink/Service
 diagnosis using 311
 ID2NAME operand 242
 id2name site attribute
 specifying 144
 implicit prefix support
 restrictions 11
 impprefix site attribute 145
 IMPPREFIX site attribute 9
 inactive time limit 146
 incorrout keyword 314
 increase network bandwidth 282
 informational messages
 collecting 249
 input errors 311
 installation default settings,
 overriding 72
 installation exits 172

installation parameters 118
 installing
 mvslogin (client) command 209
 mvslogin command 543
 mvslogout (client) command 209
 mvslogout command 543
 showattr (client) command 209
 showattr command 543
 Internet Protocol (IP) address 13
 dynamic 20, 142, 202
 internet protocol version 6
 SMF records for 175
 invarsec value 491
 IPCS
 using to view NFS ctrace records 326

iptrace utility 337
 ISHELL utility 50
 ISO 8859-(ASCII) 193
 ISPF extended statistics support
 PDS members 28
 PDSE members 28

J

job control language (JCL) 122

K

Kerberos
 authentication
 in the exports data set 186
 NFS V4 protocol 163
 on hfssec site attribute 144
 Kerberos V5 based integrity 186
 key distribution center 578
 NFS client
 RACF requirements 164
 support for Linux 577
 windows recommendations 577
 key-sequenced data set (KSDS)
 creating VSAM files 28
 supported by z/OS NFS server 23
 keyboard
 navigation 581
 PF keys 581
 shortcut keys 581
 keys
 for VSAM KSDS data set
 length and offset 124
 keys data set creation attribute 124
 keyword
 altsym 183
 for diagnosis 311
 KSDS (key-sequenced data set) 92

L

Language Environment-Behavior
 conversion 174
 large format data sets
 accessing 30
 leadswitch site attribute 145
 leasetime for locks 62, 63
 leasetime site attribute 146
 lf end-of-line specifier 35
 limitations, PDS 28

- limiting access to data sets 182
- line delimiter for record access 112
- link request 45
- linkmax value 491, 492
- Linux
 - client/server definitions with
 - Kerberos support 577
 - command for mount operation 43
 - downloading client commands 211
 - gcc 4.0.x compiler command 215
 - make command for 213
 - mount command example 42
 - mvslogout command for clients 79
 - NFS client
 - RACF requirements 164
 - Red Hat Enterprise 577
 - showattr command for clients 74
 - umount command for clients 79
- list operand 243
- listing lock holders for a file 62, 64, 250
- listlock operand 62, 64, 250
- llock client attribute 113
- ln command 55
- local host name 547
- local mounted file system
 - specifying CCSID for 111, 134
- localpath 66
- lock data sets 192
- lock holders
 - listing 62, 64, 250
- lock time limit 62, 63
- lock time, control 146
- lockd protocol 497
- locking and access control 61
- log data set
 - how used 14
 - NFS client
 - setting up 567
 - NFS server
 - setting up 566
 - NFSLOG1 235, 249
 - NFSLOG2 235, 249
 - setting up 565
- log operand 251
- logical file system (LFS) 176
- logical I/O processing
 - buffer client block writes 140
 - cache windows 146
- logicalcache site attribute 146
 - displaying value of 106
 - for write requests 299, 301
 - modified only at server startup 299, 301
 - storage considerations 301
- login exit
 - GFSALOG 259
 - parameter list 259
- login exit routine 257
- logout
 - forced logout 257
- logout attribute, maxtimeout site attribute 147
- logout site attribute
 - displaying value of 106
 - purpose of 146
 - when exceeded 71
- logout, recovering from automatic 74, 97

- lookup 280
- lookup lookaside (LLA) caching
 - enabling or disabling 112
- lookup operation
 - data set timeout specification 127
- Lookup operation
 - data set timeout specification 296
- lookup request 17, 152
- loop keyword 314
- loopthreshold site attribute 147
- low system usage 282
- lower case file name
 - mapping to upper case 130
- lrecl data set creation attribute 124
- ls (UNIX) command 129, 485
- ls command 27

M

- mainframe
 - education xviii
- make command
 - for AIX 213
 - for Linux 213
 - for Sun 213
- make command example 543
- management class
 - file creation 124
- mapfile operand 244
- mapleaddot processing attribute 130
- maplower processing attribute 31, 34, 130
- mapped keyword processing
 - attribute 136
- mapped processing attribute 130
- mapping
 - between lower and upper case file names 130
 - file extensions 134
 - GID to group name 546
 - group name to GID 546
 - return codes 448
 - UID to user name, 546
- maxfilesize value 491
- maximum size
 - allocated buffers 146
- maximum transmission unit (MTU) 284
- maxrdforszleft site attribute 147, 298
 - displaying value of 106
- maxtimeout site attribute 147, 148, 296
 - displaying value of 106
- memfree site attribute 147
- message log data set
 - setting up 565
- messages
 - for diagnostic errors 334
- messages, client platform (AIX)
 - Cross device link 440
 - Directory Not Empty 440
 - File exists 440
 - File Name Too Long 440
 - I/O Error (with possible system programmer response) 440
 - I/O Error (with possible user response) 440
 - Invalid 440
 - Is a directory 441
- messages, client platform (AIX)
 - (continued)
 - NFS server name not responding still trying 441
 - No space left on device 442
 - No such device 441
 - No such file or directory 442
 - Not a directory 442
 - Not Owner 442
 - Permission denied 442
 - Read Only File System 443
 - Stale NFS File Handle 443
 - value too large 443
 - Weak Authorization 443
- messages, display in mixed/upper case 148
- mgmtclas data set creation attribute 124
- migrated files
 - recall or delete 133
- mintasks site attribute 148
- mintimeout site attribute 147, 148, 296
 - displaying value of 106
- mixcase site attribute 148
- mixed case, message display 148
- mixed set of data types 130
- mkdir command 23, 26, 44, 292
 - for UNIX 26
- mknod request 45
- MLNAMES (RACF option)
 - z/OS NFS server support for 206
- Modified Language Environment-Behavior conversion 174
- modify command 73, 175, 182, 235
- modify command, operands of 229
- modifying
 - attributes data set 181
 - mount handle data sets 247
- modifying file attributes 72, 89
- monitored locks 61
- more command 55
- mount command 5, 23, 39, 41, 73, 81, 89, 171, 279, 291, 294, 296
 - changing site and mount point attributes 72
 - creating a physical sequential (PS) file with 24
 - overriding default attributes 72
 - syntax on AIX 66
 - z/OS examples 93
- mount emulation if NFS V4 131
- mount handle data set 14, 192
- mount operation
 - number of times to retry 114
- mount point 122, 141
 - changing attributes 73
 - command 44
 - creating a mount point for a PDS 27
 - definition 41
 - disconnecting 78, 98
 - displaying attributes of 74
 - multiple 44
 - retention period for 154
 - showattr command 74
- mount point, access 27
- mount point, definition 5
- mount points, saving 74, 97
- mount processing parameters 118

- mount requests 143, 145, 148
- mount tag option 119
 - CCSID in 119
- MSGGFSHnnnt keyword 314
- mtime 487, 490
- MTU (Packet Size) 336
- mtxonly client attribute 113
- multiple byte character set (MBCS) 193
- multiple data set creation attributes,
 - specifying 122
- multiple NFS servers 229
- MVS
 - password and user ID 88
- MVS files
 - attributes 109, 121
 - changing attributes 72
 - creating 23
 - direct access files 25
 - PDSs and PDSEs 26
 - end-of-line terminators 35
 - mount command 72, 89
 - mvslogin command 88
 - mvslogout command 79, 107
 - naming 24
 - overriding creation attributes 23
 - physical sequential 24
 - restrictions on using alias names 24
 - saving 36
 - selecting format 31
 - showattr command 74, 105
 - umount command 78
 - unmount command 98
- MVS programs 44
- mvslogin command 146
 - authentication errors 88
 - examples of 70
 - exports list checking 167
 - installing 209
 - restricting
 - based on SERVAUTH 204
 - based on terminal ID 203
 - security attribute 81
 - SERVAUTH based restrictions 204
 - syntax for clients 88
 - syntax for DFSMS 81
 - syntax on AIX 65
 - terminal ID based restrictions 203
 - to access MVS data sets 70
 - to access remote z/OS files 88
 - to access z/OS UNIX files 70
- mvslogindelay site attribute 148
- mvslogout command 70, 79
 - installing 209
 - syntax for DFSMS 87
 - syntax on AIX 68
 - to end access to remote z/OS files 88
- MVSMNT processing attribute 131
- mvsprefix site attribute 148
- MVSPREFIX site attribute 9
- mvssec site attribute 149

N

- name_max value 491, 492
- name-hiding (RACF option)
 - z/OS NFS server support for 206
- namesrv 227

- naming conventions
 - for MVS files 24
- native ASCII environment support 137
- native ASCII NFS client support 119
- native ASCII support 21
- native path 17
- navigation
 - keyboard 581
- netgroups
 - specifying in the exports data set 190
- netstat -s command
 - for tuning NFS 280
 - monitoring network activity
 - with 282
- Network File System (NFS)
 - overview of 3
- Network Lock Manager (NLM) 61
- Network Status Monitor (NSM) 62
- newline (NL) 87
- NFS
 - configuring 161
 - customizing 161
- NFS client
 - commands for 81
 - native ASCII environment
 - support 119
 - non-z/OS based 119
 - operating 223
 - starting 223
 - stopping 224
 - storage limit 140
 - tested 14
 - translation support 119
- NFS Error Client Loop Detection Facility 21
- nfs link command 23
- NFS protocol attributes
 - z/OS NFS server support for 493
- NFS server
 - non-z/OS based NFS clients 138
- NFS server attributes 491
- NFS version 2 protocol
 - externalized return codes 445
 - mapping to externalized return codes 448
- NFS version 3 protocol
 - externalized return codes 445
 - return codes 450
- NFS version 4 file attributes 491
- NFS version 4 protocol
 - attributes for NFS server 15
 - externalized return codes 446
 - return codes 452
 - tested clients for z/OS NFS server 14
- NFSC_001 99
- NFSCTRDS data space 324, 325
- NFSLOG1 log data set 235, 249
- NFSLOG2 log data set 235, 249
- NFSSAMP library
 - GFSAPROC in 535
 - GFSCPROC in 539
 - sample startup procedures 535, 539
- nfsstat command 99
 - nfsstat -c 279, 284
 - nfsstat -in 284
 - nfsstat -s 284
 - nfsstat -z 279

- nfsstat command (*continued*)
 - syntax for DFSMS 83
- nfsstat mount parameter 307
- NFSTARB files
 - downloading 209
- nfstasks site attribute 150, 297, 302
 - displaying value of 106
- nfsv4domain client attribute 113
- NFSV4DOMAIN site attribute 151
- nl2crnl command
 - syntax for DFSMS 87
- nlm site attribute 151
- no_trunc value 491, 492
- noalias processing attribute 127
- noattrtimeout processing attribute 127
- noattrtimeout site attribute 147
- noblankstrip processing attribute 128
- nochecklist site attribute 141
- nodelegation site attribute 141
- nodenyrw site attribute 141
- nodhcp site attribute 142
- nofastfilesize 285, 295
- nofastfilesize processing attribute 129, 296, 486
- nofilextmap processing attribute 40, 130
- noleadswitch site attribute 145
- nomapleaddot processing attribute 130
- nomaplower processing attribute 31, 34, 130
- nomaxtimeout site attribute 147
- non-monitored lock 61
- non-monitored locks 61
- nonlm site attribute 151
- nonspanned data set creation
 - attribute 126
- nooemhsm site attribute 151
- nopcnfsd site attribute 151
- nopublic site attribute 152
- nordrache processing attribute 132
- nordrverf processing attribute 132
- noreadtimeout processing attribute 132
- noreadtimeout site attribute 147
- norec878 site attribute 154
- noremount site attribute 154
- noretrieve process attribute 297
- noretrieve processing attribute 39, 133, 296
- norlse data set creation attribute 125
- normalization, stringprep
 - enabling 157
- nostringprep site attribute 157
- nosymresolve site attribute 158
- notag processing attribute 134
- noudpqueuelimit 285
- nowritetimeout processing attribute 135, 147
- nowritetimeout site attribute 147
- number of physical block buffers 147
- number representation 36

O

- obtaining an MVS password 70, 88
- OEDIT editor, UNIX 27
- oemhsm site attribute 151
- OEMVS311 translation table 55, 194

- omvs stoppfs command 224
- operands of the MODIFY command 229
- operating the client
 - starting 223
 - stopping 224
- operating the NFS NSM, NLM 231
- operating the server
 - starting 227
 - stopping 230
- ordering out-of-sequence data 299
- out of order
 - buffer client block writes 140
- overflow site attribute 132
- overriding default attributes 72, 89
- overriding default translation table 135
- overview
 - of Network File System (NFS) 3

P

- packet size adjustment
 - for remote procedure call (RPC) 112
- partial record identification 37
- partitioned data set (PDS)
 - attribute for creating 123
 - CONXLAT utility 194
 - creating 26
 - directory records 123
 - dsorg 292
 - extending 27
 - file extension mapping 40
 - file size value for 484
 - limitations of 28
 - members 27
 - removing 26
 - serializing and sharing data sets 6
 - supported by z/OS NFS server 23
 - time stamps for 488, 490
 - timing out while writing 27
 - updating 27
 - using as a directory 44
 - using fastfilesize for 485
 - wildcard copy restriction 27
- partitioned data set extended (PDSE)
 - attribute for creating 123
 - concurrent write 28
 - CONXLAT utility 194
 - creating 26
 - dsorg 292
 - extending 27
 - file extension mapping 40
 - members 27
 - removing 26
 - serializing and sharing data sets 6
 - time stamps for 488, 490
 - timing out while writing 27
 - updating 27
 - using as a directory 44
 - using fastfilesize for 485
 - wildcard copy restriction 27
- password
 - for MVS 88
- password (MVS) 168
- password (z/OS) 70
- pathconf, retrieve POSIX
 - information 491, 492

- PCNFSD
 - accessing data with 545
 - authentication 161, 545
 - authentication request 71
 - version 1 protocol 546
 - version 2 protocol 546
- pcnfsd site attribute 151
- PDS members
 - ISPF extended statistics support
 - for 28
- PDSE members
 - ISPF extended statistics support
 - for 28
- percentsteal site attribute 152
 - buffer reclamation 299
 - displaying value of 106
- perfm keyword 315
- perform mapping 546
- permission bits, checking UNIX 155
- permission denied message 71, 89
- permissions
 - security 263
- physical block
 - maximum length 122
- physical block buffers
 - number of 147
- physical sequential (PS) data sets
 - time stamps for 487
- physical sequential (PS) files
 - supported by z/OS NFS server 23
- physical sequential data sets
 - serializing and sharing data sets 6
- physical sequential files
 - creating 24
- ping utility 337
- planning for installation
 - security measures 161
- port assignments 20
- port range, user specified 197
- portable operating system interface (POSIX) 3, 50
- porting commands for clients 213
- portmap 227
 - required for starting NFS client 223
- portmapper 18, 336
- Portmapper
 - configured as generic server 207
 - configured with transport
 - affinity 207
 - rcpinfo utility for 337
 - use only for IPv4 228, 336
- procedure 13, user authentication 547
- process attribute
 - noretrieve 297
 - retrieve 297
- processing attribute
 - alias 127
 - async 134
 - attrtimeout 127
 - binary 128
 - blankstrip 128
 - cln_ccsid 128
 - native ASCII environment 137
 - executebitoff 129
 - executebiton 129
 - extlink 129
 - fastfilesize 129

- processing attribute (*continued*)
 - fileextmap 40, 130
 - mapleaddot 130
 - maplower 31, 34, 130
 - mapped 130
 - MVSMNT 131
 - noalias 127
 - noattrtimeout 127
 - noblankstrip 128
 - nofastfilesize 129
 - nofileextmap 40, 130
 - nomapleaddot 130
 - nomaplower 31, 34, 130
 - nordrcache 132
 - nordrverf 132
 - noreadtimeout 132
 - noretrieve 39, 133, 296
 - notag 134
 - nowritetimeout 135, 147
 - rdrverf 132
 - readtimeout 132
 - retrieve 39, 133, 296
 - setownernobody 133
 - setownerroot 133
 - side file 134
 - sidefile 40
 - srv_ccsid
 - native ASCII environment 137
 - specifying 134
 - sync 134
 - tag 134
 - text 128
 - writetimeout 135
 - xlat 135
 - zfsclient 135
- processing attributes 127, 136
 - overflow 132
- PROCLIB updates 177
- protecting the file system
 - with NFS V4 security 163
 - with the security site attribute 166
- protecting your programs and files 161
- protecting your z/OS UNIX System
 - Services files 52
- proto attribute 18
- proto client attribute 114
- protocol attributes
 - z/OS NFS server support for 493
- PTFs, APARs, search 331
- public client attribute 114
- public file handle 152, 155
 - forcing use of 114
- public keyword 17
- public site attribute 152
- pubsec site attribute 153

Q

- QSAM (queued sequential access method)
 - access to remote files 4, 92
 - line delimiter for record access 112
- qualifiers
 - high-level 5, 40

R

RACF (Resource Access Control Facility)
 data labeling option 206
 MLNAMES option 206
 name-hiding option 206
 ownership and permissions 32
 protecting server control files 161
 protecting z/OS UNIX files 52
 SAF checking 168
racf_cache_reset operand 244
RACROUTE
 authorizing remote client 162
RAMAC3 292
random access to files 33
rcpinfo utility 336, 337
rdrverf processing attribute 132
read ahead
 maximum disk blocks 114
read buffer size
 specifying 114
read statistic 280
readahead buffers 152
readahead client attribute 114
 tuning client with 305
readahead mount parameter 306
readaheadmax site attribute 153, 299
 displaying value of 106
readdirplus request 45, 100, 103
readdirtimeout site attribute 153
reading out of cached data 152
readlink request 45
readtimeout processing attribute 132,
 135, 296
readtimeout site attribute 148
reason codes 455
rec878 site attribute 154
recalling migrated files 133
recfm data set creation attribute 125
record access
 line delimiter for 112
record boundaries 35
record format (RECFM) 292
record length (LRECL) 291
record type-42 (subtype 7, subtype
 8) 175
records
 locking 61
recordsize data set creation attribute 125
recs data set creation attribute 122
reduce data transfer 282
reference
 Assembler header macro 557
 C header macro 549
relative record 28
relative record data set (RRDS)
 creating VSAM files 28
 supported by z/OS NFS server 23
release level keyword 313
release operand 245
releases and FMIDs 312
releasing locks 62, 64, 245
remote file system access control lists 58
remote mount function 73
remote mounted file system
 specifying CCSID for 115, 116
remote procedure call (RPC) 4, 100, 224
 maximum number of retries 115

remote procedure call (RPC) (*continued*)
 number of times to retransmit 114
 packet size adjustment for 112
 timeout for 116
remount site attribute 154
remove request 56
removing entries from mount handle data
 sets 247
request code
 file security exit 268
 login exit 268
Resource Access Control Facility (RACF)
 data labeling option 206
 MLNAMES option 206
 name-hiding option 206
 ownership and permissions 32
 protecting server control files 161
 protecting z/OS UNIX files 52
 SAF checking 168
Resource Measurement Facility
 (RMF) 288
restart processing 89
restarting the z/OS NFS client 223
restimeout attribute 74
restimeout site attribute 14, 154
restricting access to data sets 182
restrictions 15, 17
resuming mount processing 242
RETAIN
 search symptom strings 332
retrans client attribute 114
retrieve attributes 136
retrieve process attribute 297
retrieve processing attribute 39, 133, 296
retrieve(nowait) 296
retrieve(wait) 296
retrieve(wait) attribute 297
retrieving client commands 211
retry client attribute 114
return codes
 externalized
 NFS version 2 protocol 445
 NFS version 3 protocol 445
 NFS version 4 protocol 446
 file security exit 268
 login exit 268
 mapping 448
 NFS version 3 protocol 450
 NFS version 4 protocol 452
reuse option
 creating VSAM files 28
RFC 2055 17
rlse data set creation attribute 125
rm (UNIX) command 129
rm command 26, 56
rmdir command 26, 27
root directory 4, 49
roundtrip conversion 174
RPCBIND
 configured as generic server 207
 configured with transport
 affinity 207
 rcpinfo utility for 337
 required for IPv6 228, 336
rpcbnd client attribute 115
RRDS (relative record data set) 92
rsize 291

rsize client attribute 114
rsize mount parameter 307
rtmax value 491, 492
rtmult value 491, 492
rtpref value 491, 492

S

saf attribute 70
saf checking, bypass 141
safexp attribute 70
SAM striped files 30
samples
 exports data set 525
 startup procedures for z/OS NFS
 client 539
 startup procedures z/OS NFS
 server 535
saving MVS files 36
saving of mount points 74, 97
sdump service 334
secure client attribute 115
security 167
security and z/OS UNIX System
 Services 52
security attribute 70, 257
 affect on mvsllogin command 81
Security Authorization Facility
 (SAF) 257, 302
security exit 266
security measures
 planning for 161
security options, none, saf, safexp,
 exports 155
security site attribute 155
security, user specified port range
 support 20
security(exports) attribute 172
security(none) attribute 172
security(saf) attribute 170, 545
security(safexp) attribute 545
security(safexp) attributes 170
sending comments to IBM xix
separation character in exports data
 set 183
sequential access method striped data
 sets 285
sequential byte stream 35
SERVAUTH
 restricting mvsllogin by 204
server
 z/OS NFS
 control files 13
 creating z/OS conventional MVS
 data sets 6
server attributes 121
 alias processing attribute 127
 async processing attribute 51, 134
 attrtimeout processing attribute 127
 binary processing attribute 128
 blankstrip processing attribute 128
 blks data set creation attribute 122
 blksize data set creation attribute 122
 cln_ccsid processing attribute
 native ASCII environment 137
 specifying 128
 cyls data set creation attribute 122

- server attributes (*continued*)
 - dataclas data set creation attribute 123
 - dir data set creation attribute 123
 - dsntype data set creation attribute
 - for PDS 26
 - for PDSE 26
 - syntax 123
 - dsorg data set creation attribute 123
 - executebitoff processing attribute 129
 - executebiton processing attribute 129
 - extlink processing attribute 51, 129
 - fastfilesize processing attribute 129
 - fileextmap processing attribute 40, 130
 - hfs site attribute 51
 - keys data set creation attribute 124
 - lrecl data set creation attribute 124
 - mapleaddot processing attribute 130
 - maplower processing attribute 31, 34, 130
 - mapped processing attribute 130
 - mgmtclas data set creation attribute 124
 - MVSMNT processing attribute 131
 - noalias processing attribute 127
 - noattrtimeout processing attribute 127
 - noblankstrip processing attribute 128
 - nofastfilesize processing attribute 129
 - nofileextmap processing attribute 40, 130
 - nomapleaddot processing attribute 130
 - nomaplower processing attribute 31, 34, 130
 - nordrverf processing attribute 132
 - nordrverf processing attribute 132
 - noreadtimeout processing attribute 132
 - noretrieve processing attribute 39, 133, 296
 - norlse data set creation attribute 125
 - notag processing attribute 134
 - nowritetimeout processing attribute 135, 147
 - rdrverf processing attribute 132
 - readtimeout processing attribute 132
 - recfm data set creation attribute 125
 - recordsize data set creation attribute 125
 - recs data set creation attribute 122
 - retrieve processing attribute 39, 133, 296
 - rlse data set creation attribute 125
 - setownernobody processing attribute 133
 - setownerroot processing attribute 133
 - shareoptions data set creation attribute 125
 - side file processing attribute 134
 - sidefile processing attribute 40
 - space data set creation attribute 126
 - spanned data set creation attribute 126
 - server attributes (*continued*)
 - srv_ccsid processing attribute
 - native ASCII environment 137
 - specifying 134
 - storclas data set creation attribute 126
 - sync processing attribute 51, 134
 - tag processing attribute 134
 - text processing attribute 128
 - trks data set creation attribute 122
 - unit data set creation attribute 126
 - vol data set creation attribute 126
 - writetimeout processing attribute 135
 - xlat processing attribute 135
 - zfsclient processing attribute 135
 - server log data set
 - setting up 565
 - server messages 339
 - server processes
 - start number 150
 - server, bypasses saf checking 141
 - server, HFS vnode token 144
 - server, return first character '/' 145
 - server/client, user specified port range support 20
 - service level keyword 315
 - setattr request 45
 - setgid site attribute 156
 - setownernobody processing attribute 133
 - setownerroot processing attribute 133
 - setting time stamps 490
 - setup files, user specified port range support 20
 - sfmax site attribute 156
 - share options, cross-region and cross-system 125
 - share reservations 63
 - shareoptions
 - managing VSAM data sets with 6
 - shareoptions data set creation attribute 125
 - shell environment 81
 - shortcut keys 581
 - showattr command 25, 52, 70, 74, 89, 105
 - installing 209
 - syntax for DFSMS 83
 - syntax on AIX 67
 - terse option 75
 - to see logout value 71
 - showmount command 104
 - syntax for DFSMS 85
 - shutdown of the client 224
 - shutdown of the server 229
 - SHUTDOWN operand 230
 - side file
 - allocated storage 156
 - side file data set
 - for file extension mapping 40
 - side file processing attribute 134
 - side files
 - forces 244
 - sidefile processing attribute 40
 - site attribute
 - attrtimeout 147, 148
 - bufhigh 146
- site attribute (*continued*)
 - cachewindow 140
 - checklist 141, 170
 - chkloop 141
 - consolemsgs 141
 - delegation 141
 - denyrw 141
 - dhcp 142
 - DlyDtimeout 142
 - fileidsize 142
 - fn_delimiter 143
 - hfsbftimeout 144
 - hfsprefix 143
 - HFSPREFIX 9
 - hfssec 144
 - id2name 144
 - impprefix 145
 - IMPPREFIX 9
 - leadswitch 145
 - leasetime 146
 - logicalcache 146
 - logout 146
 - loophreshold 147
 - maxrdfsleft 147
 - maxtimeout 147, 148
 - memfree 147
 - mintasks 148
 - mintimeout 147, 148
 - mixcase 148
 - mvslogindelay 148
 - mvsprefix 148
 - MVSPREFIX 9
 - mvssec 149
 - nfstasks 150, 297, 302
 - NFSV4DOMAIN 151
 - nlm 151
 - noattrtimeout 147
 - nochecklist 141
 - nodelegation 141
 - nodenyrw 141
 - nodhcp 142
 - noleadswitch 145
 - nomaxtimeout 147
 - nopcnfsd 151
 - nopublic site 152
 - noreadtimeout 147
 - norec878 154
 - noremount 154
 - nostringprep 157
 - nosymresolve 158
 - oemhsm 151
 - pcnfsd 151
 - percentsteal 152
 - public site 152
 - pubsec 153
 - readaheadmax 153
 - readdirtimeout 153
 - readtimeout 148
 - rec878 154
 - remount 154
 - restimeout 154
 - security 155
 - setgid 156
 - sfmax 156
 - smf 157
 - stringprep 157
 - symresolve 158

- site attribute (*continued*)
 - timethreshold 158
 - upcase 148
 - writetimeout 147, 148
- site attributes 139, 140, 297
- SMF (System Management Facilities) 175
- smf operand 246, 252
- smf site attribute 157
- smfwtm macro 176
- snoop trace for SUN client 571
- snoop utility 337
- socket hang
 - specifying dump for 252
- sockhang operand 252
- soft client attribute 115
- Solaris
 - mvslogout command for clients 79
 - showattr command for clients 74
 - umount command for clients 79
- source code
 - downloading to the client 543
- space data set creation attribute 126
- space, unused 125
- spanned data set creation attribute 126
- specifying
 - NFS attributes 181
 - the exports data set 182
- srv_ccsid client attribute 115
- srv_ccsid processing attribute
 - native ASCII environment 137
 - specifying 134
- stale NFS file handle 247
- start command 183, 229
- start number
 - server processes 150
- start PCNFSD server 151
- startfail
 - operand of the START mvsnfs command 229
- starting
 - NFS client 223
- starting an MVS session 88
- starting the NFS NSM, NLM 231
- starting the server 227
- startup procedures for z/OS NFS client
 - in NFSSAMP library 539
 - samples 539
- startup procedures for z/OS NFS server
 - in NFSSAMP library 535
- statd protocol 497
- state 7
- statelessness 7
- statfs request 45
- statistics, SMF 175
- status operand 246
- stop command 229
- stop operand 230
- stopping the client 224
- stopping the server 230
- storage block 256, 266
- storage block sample, GFSAUDSA 255
- storage class
 - for file creation 126
- storage considerations 301
- storage limit
 - NFS client 140
- storclas data set creation attribute 126
- stringprep
 - definition 21
 - site attribute 157
- stringprep client attribute 116
- striped files, SAM 30
- subtype 7, record type-42 175
- subtype 8, record type-42 175
- summary of changes xxi, xxii
- Sun
 - downloading client commands 211
 - gcc 3.4.x compiler command 215
 - make command for 213
 - Sun Studio 11 for Solaris 10 215
- SUN
 - client activity trace 571
 - snoop trace 571
- suspending mount processing 242
- swapldb operand 246
- swapmhdb operand 247
- switchlog operand 253
- symbolic link
 - symlink procedure 45
- symresolve
 - site attribute 158
- sync processing attribute 51, 134, 297
- synchronous write to z/OS UNIX file 51
- syncwrite client attribute 116, 306
 - tuning client with 305
- SYSERR DD statement 565
- sysplex
 - multiple NFS servers in 229
- SYSTCPD DD statement
 - not required 535
- system authentication (authsys)
 - security 166
- System Authorization Facility (SAF) 167, 168, 169, 170, 172
- System Display and Search Facility (SDSF) 288
- System Management Facilities (SMF) 175
- system toolkits 215, 216

T

- tag processing attribute 134
- tar utility 210
- tbytes value 491
- TCP/IP
 - activity trace 570
- TCP/IP tuning 285
- tcpip.ETC.RPC, modifying 196
- tcpip.profile and /etc/services files,
 - server setup 20
- tcprcvbrfsz 285
- tcprecvbfrsize 284
- tcpsendbfrsize 285
- terminal ID
 - restricting mvslogin by 203
- terse option
 - showattr command 75, 106
- tested NFS clients 14
- text mode
 - blankstrip processing attribute 128
 - end-of-line specifiers 128
 - noblankstrip processing attribute 128
- text processing attribute 128
- text processing mode 35
- text processing, z/OS UNIX System Services 54
- tfiles value 491
- time stamps 487
- time_delta value 491
- time, data set released after a write 135
- timeo client attribute 116
- timeo value 296
- timeout 73
 - maximum 147
 - minimum 148
- timeout attributes 135
- timeout option 279
- timeout, control 144
- timethreshold site attribute 158
- to end access to MVS data sets 70
- toolkits
 - development 215
 - system 215, 216
- toolkits, development 214
- touch command
 - for AIX 212
 - for UNIX 212
- trace
 - client activity trace 571
 - collecting messages for 249
 - HFS activity trace 570
 - SUN snoop 571
 - TCP/IP activity trace 570
 - z/OS UNIX activity trace 569
- TRACE CT command
 - for z/OS NFS client 224
 - for z/OS NFS server 231
- traceroute utility 337
- trailing blanks 128
- translation table
 - customized 135
 - for z/OS UNIX 194
- translation table, for z/OS UNIX System Services 54
- translation tables 193
- Transmission Control Protocol/Internet Protocol (TCP/IP) 3, 227, 336
- transport protocol
 - specifying 115
- trks data set creation attribute 122
- trusted attribute 162
- TSO ALLOCATE command 92
- TSO HELP MOUNT command 81
- TSO HELP UNMOUNT command 81
- TSO MOUNT 92
- TSO MOUNT command 91, 173

U

- UDP checksum processing 282
- udprcvbrfsz 285
- udprecvbfrsize 284
- udpsendbfrsize 285
- UID
 - mapping to user name 546
- umount command
 - syntax on AIX 68
- Unicode 118

- Unicode Services
 - creating conversion environment
 - for 174
 - required for text translation 137
- Unicode Standard
 - for data conversion 91, 173
- unit data set creation attribute 126
- UNIX
 - command for mount operation 43
 - command reference 69
 - file name delimiter 143
 - mkdir command 26
 - mount command example 42
 - mvslogout command for clients 79
 - NFS client 65
 - permission bits, checking 167
 - showattr command for clients 74
 - umount command for clients 79
 - vi command 72
- UNIX permission bits, checking 155
- UNIX-style credentials 173
- unmntall operand 247
- unmntnfs operand 247
- unmntmvs operand 248
- unmount (immediate, force) 99
- unmount all mount points 247
- unmount command 81, 98
- unmount HFS mount points 247
- unmount legacy mount points 248
- unmount operand 247
- upcase site attribute 148
- updating your MVS password 88
- updating your z/OS password 70
- upper case file name
 - mapping to lower case 130
- upper case, message display 148
- usage statistics, collecting 175
- user authentication, procedure 13 547
- user exit block (UXB) 257
- User Exit Block (UXB) 260
- user group (UIG) 71
- user interface
 - ISPF 581
 - TSO/E 581
- user number (UID) 32, 52, 58, 71
- user specified port range, set up 197
- user storage block, login exit 256
- user-specified port range support 20
- UTF-8 data format 21, 54

V

- v4delg operand 248
- validation of MVS passwords and user IDs 168
- Variable Recording Area (VRA) 333
- vers client attribute 116
- vers mount parameter
 - tuning client with 307
- version operand 253
- vi command
 - creating a physical sequential (PS) file
 - with 24
 - creating PDS or PDSE member
 - with 26
 - editing files with 33

- vi editor
 - creating VSAM files with 28
- vnode tokens 144
- vol data set creation attribute 126
- volume
 - for data set creation 126
- VSAM (virtual storage access method)
 - access to remote files 4, 92
 - line delimiter for record access 112
 - serializing and sharing data sets 6
- VSAM data sets
 - creating VSAM files 29
 - keys for KSDS data set 124
 - record size 125
 - serializing and sharing data sets 6
 - supported by z/OS NFS server 23
 - time stamps for 487, 488
 - using fastfilesize for 485
- VSAM KSDS data set
 - attribute for creating 123
- VSAM RRDS data set
 - attribute for creating 123
- VTAM 336

W

- wait keyword 314
- WebNFS support 17
- wildcard characters
 - specifying in the exports data set 190
- wildcard copy restriction 27
- window size 140
- Windows
 - command for mount operation 43
 - mount command example 42
 - umount command for clients 79
- write operation
 - writing a file on MVS 33
- write request, nonvolatile media 134
- write statistic 280
- writetimeout processing attribute 135, 296
- writetimeout site attribute 147, 148
- writing
 - fixed-length records 35
 - text data files 35
- wsize 291
- wsize client attribute 116
- wsize mount parameter 307
- wtmax value 491, 492
- wtmult value 491, 492
- wtpref value 491, 492

X

- X'0F3' ABEND 334
- X'806' ABEND 334
- X'A03' ABEND 334
- X'x13' ABEND 334
- X'x22' ABEND 334
- X'x37' ABEND 334
- X'x3E' ABEND 334
- XDR (External Data Representation) 4
- xlat attribute 193, 194
- xlat client attribute 116
- xlat processing attribute 135

Z

- z File System (zFS) 293
- z/OS
 - password and user ID 70
 - showattr command for clients 74
- z/OS Basic Skills information center xviii
- z/OS DFSMS
 - command syntax for 81
- z/OS File System (zFS) 49
- z/OS NFS client
 - operating 223
 - overview of 3
 - sample startup procedures 539
 - starting 223
- z/OS NFS server
 - overview of 3
 - restricting mvslogin to 203, 204
 - sample startup procedures 535
- z/OS UNIX
 - activity trace 569
- z/OS UNIX attributes 51
- z/OS UNIX file system 49
- z/OS UNIX segment 545
- z/OS UNIX System Services
 - accessing 53
 - delete external link 56
 - display external link 56
 - external link to MVS 55
 - mount command 53
 - overview of 3
 - security 52
- zdfsclient processing attribute 135



Product Number: 5650-ZOS

Printed in USA

SC23-6883-30

