



20th Anniversary

SARASOTA
FILM FESTIVAL

April 13-22 2018

FILM GUIDE

#SFFXX

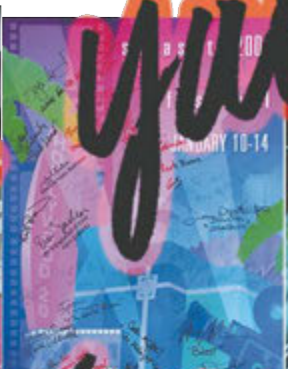
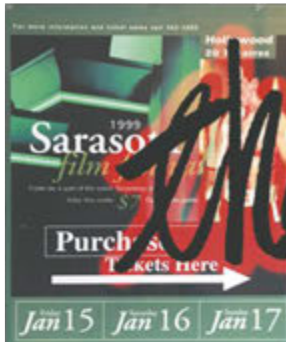

Thank you for 20 years of film!

SFF 2018 FILM GUIDE

TABLE OF CONTENTS

4

FESTIVAL INFORMATION

Tickets & Packages
Membership
Board of Directors & Staff

Message from the Board President
332 Coconut

10

SPONSORS

18

EVENTS

Opening Night Film & Party
Hollywood Nights
Riverview Awards Show
THROUGH THE TUNNEL
FACEing MENTAL ILLNESS
A LEAGUE OF THEIR OWN
20th Anniversary Party
In Conversation With...

Closing Night Films
Chill Under the Stars
Sensory-Friendly Screening
20-Hour Film Contest Screening
Moonlight Movies

28

COMMUNITY & PARTNERSHIPS

YouthFEST
Year-Round Education
Through Women's Eyes

33

FILMS & FOCUSES

Centerpiece Films
Spotlight Films
Florida on Film
Screenwriters Colony
Sidebars
SFF Special Awards

Bands to see at SFF
Juries
Narrative Feature Competition
Documentary Competition
Indie Visions Competition

66

SHORT FILMS

Shorts Programs
Through Womens Eyes
Shorts Before Features
Short Film Competitions

80

SCHEDULE GRID

92

INDEX



General Information

HOW TO BUY TICKETS

ONLINE: www.SarasotaFilmFestival.com
*service fees apply

PHONE: (941) 366-6200 or (866) 575-FILM *service fees apply

SFF BOX OFFICE & MERCHANDISE

Lobby of Regal Hollywood 11 Cinemas
1993 Main St. Sarasota, FL 34236

BOX OFFICE HOURS

Open exclusively to Members
March 24-25 12:00 PM - 7:00 PM

Open to the Public

March 26 - April 13 12:00 PM - 7:00 PM
(Closed April 1)

April 14 & 15 9:00 AM - 9:00 PM

April 16-20 11:00 AM - 9:00 PM

April 21 & 22 9:00 AM - 8:00 PM

WILL CALL

Tickets may be picked up at the Box Office.

REFUNDS AND EXCHANGES

There are no refunds or exchanges.

STANDBY FILMS

Many of our films sell out well before the Festival, but often there are seats available on the day of the screening. These available seats are released on a first-come, first-serve basis to our Standby Line at the Welcome Tent. Please arrive early (we suggest at least one hour before the show starts) to secure a place in line. The Welcome Tent only accepts cash.

VENUES

REGAL HOLLYWOOD 11 CINEMAS 1993 MAIN ST. SARASOTA, FL 34236

-FILM SCREENINGS FEATURING RENOVATED LUXURY SEATING. HOME OF AUDITORIUMS 3 THROUGH 7, AND THE "CITYSIDE" AUDITORIUM

ART OVATION HOTEL 1255 N. PALM AVE. SARASOTA, FL 34236

-FILM SCREENINGS IN ARTFULLY INSPIRED SETTING, SPECIAL RECEPTIONS AND EVENTS

FLORIDA STUDIO THEATRE 1241 N. PALM AVE. SARASOTA, FL 34236

-A BEAUTIFUL INTIMATE SETTING FOR OUR CONVERSATION SERIES

SARASOTA OPERA HOUSE 61 N. PINEAPPLE AVE. SARASOTA FL 34236

-HOST TO OUR OPENING AND CLOSING NIGHT FILMS

INDIVIDUAL TICKET PRICES

Regular Films

\$15 // \$11 Members

Florida Students & Educators

with valid school ID (Box Office only)
\$10

Centerpiece & Spotlight Films

\$20 // \$17 Members

Matinee Screenings (regular films showing before 5:00 PM Monday through Friday)

\$11 // \$9 Members

youthFEST

FREE for ages 12 and younger—see page 30

TICKET PACKAGES

Ten Pack: 10 regular film screening tickets
\$140 // \$130 members (Limit one per person.)

Spotlight Pack: Four Spotlight or Centerpiece film tickets
\$75 // \$65 members

Matinee Pack: Five matinee tickets
\$50 // \$40 members

Student Passport: Four regular film tickets
\$30 with valid school ID (Box Office only)

THROUGH WOMEN'S EYES FILM FESTIVAL

(TWE) More about TWE on p. 28.

One-Day Pass : \$65

Two-Day Pass: \$120

TWE Reception: \$75

Benefits of Membership

Your membership with the Sarasota Film Festival is an easy, affordable, tax-deductible way to support our mission to celebrate the art of filmmaking and the contribution of filmmakers, as well as support our year-round education and outreach programs.

SFF Members have perspectives and tastes as wide and varied as the communities in which we live. Members share a passion for film and a commitment to supporting filmmakers whose stories inform and transform us.

ASSOCIATE MEMBERSHIP \$60 / \$110 Dual

- Exclusive discounts on film and event tickets
- Discount on SFF merchandise
- Access to a dedicated Box Office Member Line
- Digital Film Guide access before the general public
- Access to purchase Festival tickets before Box Office opens to the general public
- Invitations to year-round events, such as members-only screenings, educational events, receptions, and more!
- Year-round discounts at some of SFF's partner businesses and organizations (see list on website)

PRODUCER MEMBERSHIP \$160 / \$300 Dual

(Limited to 150 Producer Memberships)
All Associate Member Benefits, PLUS:

- Priority seating (entry before the general public) to all regular, Spotlight, and Centerpiece films

MOGUL MEMBERSHIP \$250 / \$480 Dual

(Limited to 70 Mogul Memberships)
All Producer Member Benefits, PLUS:

- Access to one-on-one film selection with a Festival Programmer during Member Days
- One Gold ticket to Opening Night Film

DIRECTOR MEMBERSHIP \$500/\$950 Dual

(Limited to 40 Director Memberships)
All Producer Member Benefits, PLUS:

- Access to the SFF Filmmaker Lounge
- One VIP ticket to the Opening Night Film
- One VIP ticket to the Closing Night Film & Awards Presentation
- Access to one-on-one film selection with a Festival Programmer during Member Days

CINEPHILE PASS \$1,200

(Limited to 30 Cinephiles in total)
All Director Member Benefits, PLUS:

- Ticketless access to all Festival film screenings

CINEPHILE ELITE PASS \$1,500

(Limited to 30 Cinephiles in total)

All Cinephile Pass Benefits, PLUS:

- Ticketless access to SFF Kick-Off Party
- One VIP ticket to Opening Night Party
- One VIP ticket to 20th Anniversary Celebration
- One VIP ticket to Chill Under the Stars

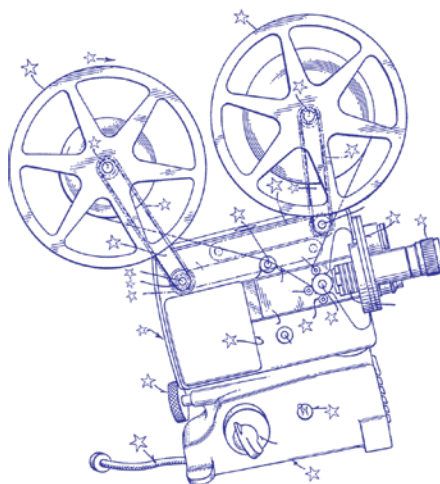

Memberships valid 12 months. Ticket discounts apply only to one Festival season. Dual memberships are available to individuals who share a home address. For more information about Membership, call (941) 366-6200 or email members@sarasotafilmfestival.com

BOARD OF DIRECTORS

Executive Committee of Board of Directors

Mark Famiglio, Chairman and President
Sharyn Weiner, Vice President

General Board of Directors

Ed Koplos	Wanda Rayle-Libby
Ann Logan	Wes Roberts
Kelly Martella	Alan Wallack
Lina Catalfamo Plath	

Honorary Board of Directors

Charles Clapsaddle	Michael Klauber
Jeanne Corcoran	Philip Mancini
Linda DesMarais	Hon. Charles E. Williams

Advisory Board of Directors

Steve Buscemi	Edward Norton
Peter Calamaras	Joe Pantoliano
Martha Coolidge	Steven Schachter
Bryan Cranston	Fred Schneider
Geena Davis	Jonathan Silverman
Jon Favreau	Patti Smith
Rory Kennedy	Michael Stipe
Barbara Kopple	Stanley Tucci
Robert Lange	Steven Tyler
William H. Macy	Victoria Varela
David McGough	Paula Wagner
Robert Molnar	Charles Winkler
Elisabeth Moss	

STAFF

Harrison Bender *Programmer*
Albert Betit *Spreadsheet Wizard*
Greg Bortnichak *Program Operations Director*
Megan Bradley *Guest Services Manager*
Chase Causey *Programming Intern*
Clare Anne Darragh *Partner, Frank PR*
Andrea Davis *Call Center Manager*
Bess Donoghue *Junior Publicist, Frank PR*
Joaquin de la Puente *Projection Manager*
Andrew Ensign *Box Office Manager*
James Faller *Projection Manager*
Caley Fagerstrom *Shorts Programmer*
Mark Famiglio *President & Chairman*
Candice Fortin *Marketing & Development*
Micaela Fox *Programming Intern*
Peter Halter *Technical Director*
Bob Giovanelli *Theater Manager*
Kami Hughes *Events Coordinator*
Nellie Killian *Programmer-at-Large*
Ed Koplos *Membership Coordinator*
Chuck Madden *Office Receptionist*
Mia Martin *Office Receptionist*
Erin Murphy *Associate Festival Director*
Michael Murphy *Festival Manager*
Michael Murphy Sr. *Call Center Manager*
Joe Neumaier *Creative Producer*
Lina Catalfamo Plath *Partner, Frank PR*
Paul Ratner *Education Director*
Petra Ratner *Marketing & Events Manager*
Jared Rendon *Graphics Intern*
Aimee Schaefer *Projection Manager*
Sue Szylin *Print Traffic Coordinator*
Alan Wallack *Sponsor Relations Coordinator*
Kat Wyatt *Volunteer Coordinator*
Priscilla Wyatt *Creative Services Coordinator*



Dear Friends,

This is the 20th Anniversary of the Sarasota Film Festival. This year we are showing 90 features, 131 shorts, and have curated six sidebars of interest to our community. We have more events programmed into a 10 day festival than we could have ever dreamed of.

In the beginning, the Sarasota Film Festival was a three-day festival. Over the last 20 years, we have grown to become a 10 day festival and one of the largest regional festivals in the country. We have hosted celebrities and luminaries from around the world, never losing sight of our mission to support the independent film community.

We also serve as a platform for many local human services and arts groups. Every year, we partner with a number of local charities such as the *Harvey Milk Festival*, *Nathan Benderson Park*, and *Embracing Our Differences*, just to name a few. We are especially appreciative of our local sponsors, many of whom have been with us during the entire 20 years of our existence.

By 2006, SFF was experiencing success of epic proportion. Our educational programming was (and still is) among the most outstanding on the festival circuit. Our educational program will expand this year with the introduction of the *20 Hour Film Contest*. As in our past festivals, we continue to provide programming of, by, and for students within the Sarasota-Manatee region.

In 2008, we were not immune to the financial crisis, as our community was in the virtual epicenter of the collapse. We rebuilt slowly and thoughtfully throughout 2009 and became increasingly efficient in our operation. At the same time, we doubled down on our focus: independent filmmakers.

Over the last several years, we have expanded our reach as we proceed into the next decade of operation in our growing city. We pledge to keep up with the changing media landscape of serialized content, virtual reality, augmented reality, and any other mode of expression that our extraordinary filmmakers continue to submit to us.

I thank all of our sponsors, our entire Board of Directors, our brilliant staff, and, of course, our viewing audience. It is with enormous pride, pleasure, and relief that we present the 2018 Sarasota Film Festival.

Twenty years and counting,
Mark P. Famiglio



CHAIRMAN AND PRESIDENT
SARASOTA FILM FESTIVAL
A 501(C)(3) EDUCATIONAL INSTITUTION





332 Coconut

After many wonderful years in the current Sarasota Film Festival offices it's high time for an upgrade.

Starting this summer 332 Coconut Avenue will begin its transition into a modern, mixed-use space.





Welcome to our neighborhood

In addition to our new campus, there will be 36 residential units where you can experience a down to earth, non high-rise luxury existence within moments of every important cultural event within the city, and the beaches beyond – more than most can hope for.

Located in the heart of the Rosemary District, 332 Coconut offers nearly 10,000 sf of business & retail spaces along with spacious, private residences; 18 two bedroom and 18 one bedroom +den with access to world class amenities.

Join us, on the ground, within walking distance of everything meaningful in our tranquil downtown setting.

Contact us: Info@332coconut.com



TITLE SPONSORS

The Sarasota Film Festival is thankful for all of its 2018 sponsors, without whom the Festival could not continue its mission to celebrate the art of filmmaking and the contribution of filmmakers by hosting an international film festival and developing yearlong programs for the economic, educational, and cultural benefit of our community.

LEGACY TITLE SPONSORS



AMICUS FOUNDATION INC.

For more than ten years, the Amicus Foundation has been a proud Title sponsor of the Sarasota Film Festival. Congratulations on the growth over the past decade and best wishes for continued success!



The Famiglio Family is a proud supporter of many regional and national charities. Having supported the Festival since its inception, the Family is enormously proud of the Festival's growth and stature within the independent film community.



The Experience Happens Here. When you join us at Regal theaters, you can sit back and relax knowing you'll enjoy a one-of-a-kind movie experience. From crystal-clear, all digital projections to custom-built sound systems and stunning 3D, our theaters will immerse you in the movies!

INAUGURAL TITLE SPONSORS



Art Ovation Hotel offers something unique to Sarasota, inspired and designed to engage the city's thriving arts scene. With on-site art installations, performances, and workshops, our guests are invited to interact and be part of an experience. Never static, always evolving, creativity is encouraged.

PRESENTING SPONSORS



Enjoy being here? Rent an apartment at Sarasota's newest urban apartment community – seasonal and furnished units are available. Just a stone's throw from the artistic and cultural delights of Sarasota's downtown. Immaculate clubhouse, pool, and fitness center. www.CitySideSRQ.com or 941-787-3333



GATES Construction is an industry leader providing construction management, design/build, and general contracting services. Our diverse portfolio of commercial, healthcare, educational, clubhouse, multi-family, religious, and hospitality showcases numerous landmarks successfully constructed over the past quarter of a century.



MAJOR MEDIA SPONSORS



ABC7—Your Suncoast News—We're Here for You! ABC7 is your source for local coverage in Sarasota and Manatee Counties. Get all the local information you need on ABC7 and MySuncoast.com – on air and on all your digital devices!



10NEWS WTSP is celebrating more than 50 years of serving Tampa Bay and Sarasota. We are your home for CBS, delivering your favorite shows, sports, and CBS News.



METV, a place where you can learn something new everyday, is committed to collaborating with all entities to produce award-winning programs and Public Service Announcements that are focused on education, enrichment, cultural information, and



Comcast NBCUniversal Corporation (Nasdaq: CMCSA) is a global media and technology company with two primary businesses, Comcast Cable and NBCUniversal. Comcast Cable is one of the nation's largest video, high-speed Internet, phone, and home-security providers to residential customers under the XFINITY brand and also provides these services to businesses.



Founded in 1925, the *Herald Tribune* Media Group's mission is to be the most trusted and valued source of news and information in the market we serve. SHT is a valued partner in SFF's education programs.



iHeartmedia reaches a quarter billion listeners across the country every month, engaging communities with live local radio stations like ours here on the Suncoast. On air, online, or using the iHeartradio app, tune in to your favorite Suncoast stations today: 103.9 KISS FM, 107.9 WSRZ, 92.1 CTQ, Z105, and Newsradio 1320AM.



Sarasota Magazine is delighted to welcome you to the 2018 Sarasota Film Festival. The Film Festival is undoubtedly one of the highlights of the season, and we are proud to be their longtime partner.



Founded in 1957, *Sarasota Scene* is the community's longest running city publication, connecting the affluent and socially sophisticated through engaging and inspiring editorial.



SarasotaOUT.com's mission is to empower the LGBTQ+ community in Sarasota by providing business listings, events, articles, and blogs that will spotlight our people, places, and things!



WSNN, the Suncoast News Network, is the only locally owned television station in the market, where Sarasota, Manatee and Charlotte County viewers turn for breaking news, wall-to-wall severe weather coverage and local sports. WSNN is available to viewers throughout the Suncoast on Comcast, Spectrum, Frontier, Dish Network and over the air on channel 39.



SRQ Media Group publishes *SRQ: Live Local: Sarasota | Bradenton*, the monthly regional magazine influencing 60,000+ affluent, multi-generational residents and visitors in Sarasota, Bradenton, and the Gulf Coast Keys. Named "Best Overall Magazine" four years by Florida Magazine Association- 2008, 2009, 2010 and 2013.



WUSF Public Media's mission is to provide meaningful and relevant content that enhances our community's quality of life. As the only comprehensive public media organization in the area, we are able to deliver a unique blend of news (NPR) & information, jazz on WUSF 89.7 FM & Classical Music on WSMR 89.1 FM, as well as our Digital platform on www.WUSF.org and our Free WUSF Mobile app available for download on all mobile devices.

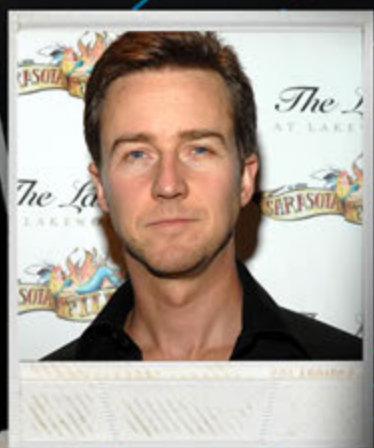

Celebrity

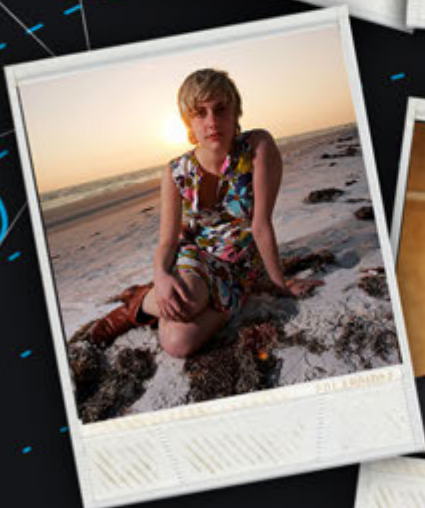
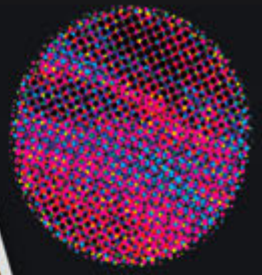

Scrapbook

MAJOR SUPPORTING SPONSORS



Founded in 1979, Richard's has 17 locations in Florida and is known as a leader in the vitamin and supplement industry. Stores offer an inspiring shopping experience to those seeking optimal health, well-being, and purpose. The Sarasota-based chain was named Best Independent Retailer in the Nation by *Vitamin Retail Magazine*.



Formerly known as Audio Images, the studio was first opened in 1992 and has been running ever since. Set in an unassuming warehouse, you will find a warm, cozy space filled with beautiful handmade wooden diffusers and a mix of boutique and vintage recording gear. Book a tour today and check out this hidden gem. Tours are complimentary and by appointment only.



DSDG Architects, is an award winning firm for everything Architecture. Mark Sultana and his team of design professionals are here to listen to your needs and understand what you would like to have designed.



The Aloft is Sarasota's newest and sassiest hotel located in the heart of downtown, just a block from Main Street and the Sarasota Bay front. Stay and play at our hip new hotel or stop by to have a drink at the WXYZ Bar.



Amazing live sound, state-of-the-art lighting, custom staging, runway and DJ services. From concept to completion, we can facilitate all your event needs. With our professional equipment and collaborative creative design, we turn your vision into a successful reality.



Full Moon Promotions founder Tim Mitten engages the community, supports local initiatives and most of all entertains. Over the last seven years FMP has created unique events that attract a wide demographic and has raised tens of thousands for local charities.



Situated adjacent to the beautiful Sarasota Bay, the Hotel Indigo Sarasota is an award-winning property in downtown Sarasota. Our boutique-style atmosphere and tropical décor has become the hotel of choice for Sarasota Film Festival attendees.



Group Z Signs is a small collective of creative souls, placing the utmost importance on honesty, integrity, and an unwavering commitment to quality. Our custom print work is nothing short of excellent. Visit our Ringling shop for all your printing needs.



The Jewish Federation of Sarasota-Manatee strives to build a strong community and better life for Jews at home, in Israel, and throughout the world.



Providing businesses with solutions to streamline processes and increase productivity. We are committed to helping our clients adopt the right technology solution to solve their business challenges.

WALLACK
FAMILY FUND

Atelier MEDIA

IL PANIFICIO

SUPPORTING SPONSORS

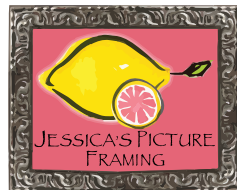
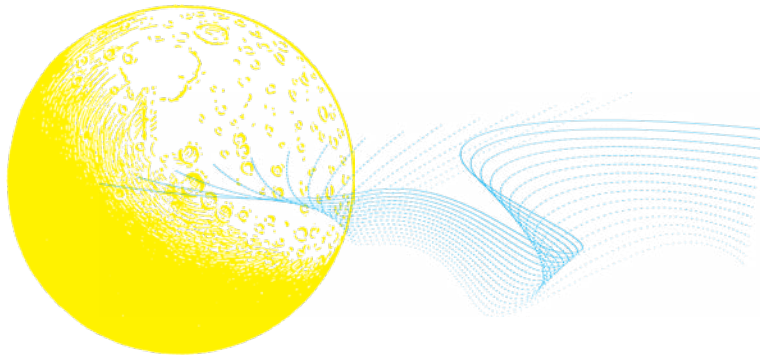

MEDIA SPONSORS

SPONSORS



SEE FILM GUIDE

FRIENDS OF THE FESTIVAL



SARASOTA FILM FESTIVAL.COM

PARTNERING ORGANIZATIONS



SPONSORS

SFF FILM GUIDE

GRANTING ORGANIZATIONS



SARASOTA FILM FESTIVAL.COM

OPENING NIGHT

EVENTS



SEE FILM GUIDE

OPENING NIGHT FILM

Sarasota Opera House

61 N. Pineapple Ave.
Sarasota FL 34236

FRIDAY, APRIL 13

6:30 PM RED CARPET

7:30 PM FILM

COMEDY

DIRECTOR: ERIC STOLTZ

PRODUCER: SANDY STERN

CAST: OLIVIA HOLT,
SKYLER GISONDO, KRISTIN
CHENOWETH, BRUCE DERN

USA / 101 MINUTES

FILM TICKETS

VIP: \$60 / MEMBERS: \$48

GOLD: \$40 / MEMBERS: \$35

SILVER: \$30 / MEMBERS: \$25

CLASS RANK

Academia, suburbia, romance, and politics face off in this wry, smart, and warm comedy directed by Eric Stoltz (MASK, PULP FICTION, CHICAGO HOPE and MADAM SECRETARY). Faced with unexpected road blocks en route to their next steps in life, two New Jersey high school outsiders, Veronica Krauss (Olivia Holt) and Bernard Flannigan (Skyler Gisondo), team up to fight the system from within – and scheme their way to their dreams. Veronica is a straight-A, Type-A personality, like her affectionate TV producer mom (Kristin Chenoweth), and is aiming to go to Yale; Bernard is running for a seat on the local board of education and fighting minor neighborhood offenses, all while caring for his young-at-heart widowed grandfather (Bruce Dern) and balancing social awkwardness with social responsibility. Together, Veronica and Bernard have the right stuff to achieve their goals. But as college, and Bernard's grass-roots campaign, come into focus, will the kids be blinded by love and ambition?

Director Eric Stoltz will be in attendance.

SARASOTA FILM FESTIVAL.COM

OPENING NIGHT PARTY

SFFXX *Block Party*

Friday, April 13

9:00-12:00 AM

**Selby Five Points Park
61 N. Pineapple Ave.
Downtown Sarasota**

**Three ways to
purchase tickets:**
Visit the Box Office,
SarasotaFilmFestival.com,
or call 941.366.6200

General Admission
\$25 // \$20 for members

VIP Admission
\$150 // \$120 for members
Includes complimentary Tito's
Vodka cocktails, Stella Artois and
hors d'oeuvres

VIP Private Cabana
\$1,000
Includes complimentary bottle
service and VIP experience
for up to six people

THANK YOU
SPONSORS:

CHILLOUNGE NIGHT
FURNITURE RENTALS

BEVERAGE
SPONSORS:



SarasotaOUT.com
Your LGBTQ+ Resource!



Tito's



Handmade
VODKA
AUSTIN ★ TEXAS

HOLLYWOOD NIGHTS

HOLLYWOOD NIGHTS

Regal Hollywood 11 Cinemas
1993 Main St.
Sarasota, FL 34236

SUNDAY, APRIL 15

PROGRAM 1

5:15 PM RED CARPET

5:45 PM FILM

PROGRAM 2

7:00 PM RED CARPET

7:30 PM FILM

TICKETS

STUDENT: \$5
(18 and under)

ADULT: \$10

The culmination of student participation in SFF Education programs is showcased at Hollywood Nights. Complete with a lively red carpet, this event features screenings from local up-and-coming filmmakers, ages 8 to 18. Students have an opportunity to premiere their films in a theatrical setting while competing for awards.

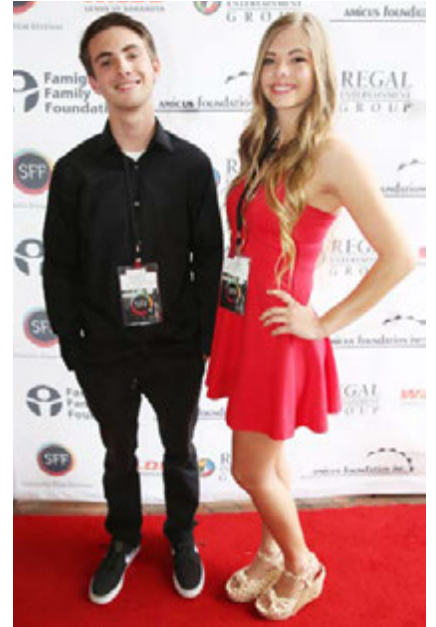

RIVERVIEW AWARDS SHOW

RIVERVIEW IB ACADEMY AWARDS SHOWCASE

Art Ovation Hotel Ballroom
1255 N. Palm Ave.
Sarasota, FL 34236

WEDNESDAY, APRIL 18

PROGRAM 1

6:30 PM RED CARPET

7:00 PM AWARDS

TICKETS

STUDENT: \$5
(18 and under)

ADULT: \$10

Riverview High School IB Academy Awards and Showcase is an event established to showcase films produced by the IB Film Program students and is the culmination of their work. This black tie event and awards show honors the students' film production process, builds community awareness to the art and education of film, and celebrates the students' thesis films in an Academy Awards®-style setting.



COMMUNITY SCREENINGS

THROUGH THE TUNNEL:

In 1969, Lincoln Memorial High School, the only high school for black children in Manatee County, was closed due to the official end of segregation. Fourteen years after Brown vs. The Topeka Board of Education had been



decided, integration was finally implemented in the Manatee County school system. Instead of going to high school in their neighborhoods, black children were required to attend one of three nearby white schools in the county.

THROUGH THE TUNNEL is a story of how ordinary people were figured out how to live with that change. Coach Eddie Shannon and Henry Lawrence talk about that first year of integration and how it went. They also remember the school that's gone, Lincoln High, with a feeling of ardent love and reverence, which has endured for over forty years since the day its doors were forever closed.

Featuring bonus footage celebrating the 10th Anniversary of THROUGH THE TUNNEL. Discussion and Reception to follow.

10-YEAR ANNIVERSARY SCREENING

THROUGH THE TUNNEL

Art Ovation Hotel Ballroom
1255 N. Palm Ave.
Sarasota, FL 34236

TUESDAY, APRIL 14

6:30 PM RED CARPET

7:00 PM FILM

TICKETS

ADULT: \$15

STUDENT: \$10

FACEing MENTAL ILLNESS:

THE ART OF ACCEPTANCE traces the course of a yearlong project conducted in Sarasota, Florida

that was aimed at reducing bias against individuals with mental illness, eliminating the stigma associated with a mental health diagnosis, and building a more supportive, inclusive community. As participants create artwork exploring their illnesses and share their stories of challenge and recovery in weekly newspaper articles, we see residents coalesce in support of an isolated and misunderstood population and take up the cause of acceptance and advocacy as their own.



Discussion to follow the screening with Project leader Carrie Seidman and participants of the project. All project participants will receive an invitation and a free ticket to the red carpet premiere.

WORLD PREMIERE FACEING MENTAL ILLNESS

Art Ovation Ballroom
1255 N. Palm Ave
Sarasota, FL 34236

SUNDAY APRIL 15

5:30 PM RED CARPET

6:00 PM FILM

TICKETS

ADULT: \$15

STUDENT: \$10

OUT OF THIS WORLD

20th ANNIVERSARY PARTY

Friday, April 20

8:00 PM-Midnight

Art Ovation Hotel Ballroom
1255 N. Palm Ave.
Downtown Sarasota

General Admission

\$40 Advance // \$60 Door

Includes two complimentary drinks (Stella Artois,
Stella Cidre or signature cocktails)

VIP Admission

\$120 Advance // \$150 Door

Includes access to VIP Sunset Soiree on the rooftop
of Art Ovation, with cocktails and hors d'oeuvres

Three ways to purchase tickets:

Visit the Box Office, SarasotaFilmFestival.com,
or call 941.366.6200

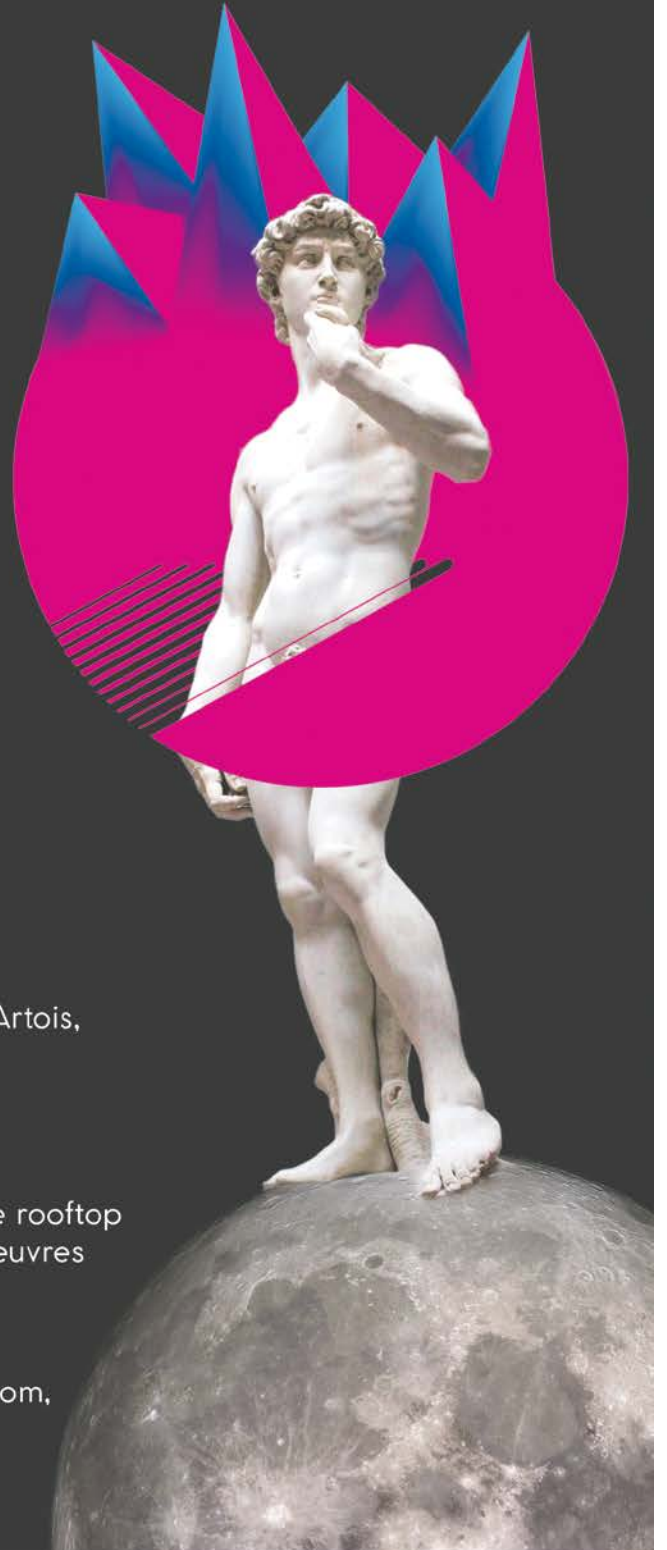

THANK YOU
SPONSORS:



WAGNER  REALTY
Bringing People Home Since 1939



LOVE MEANS ZERO

At eighty-six, famed tennis coach Nick Bollettieri is a living legend. At his academy near Bradenton, Florida, he raised a generation of champions: Courier, Seles, Agassi, and many more. No other coach has matched his success, his dominance, or his fame. His greatness, though, came at a price. Eight marriages, financial upheaval, and a dramatic break with his surrogate son and cherished student, Andre Agassi. **LOVE MEANS ZERO** tells the story of this celebrated yet controversial coach, and explores the cost of his all-consuming drive for greatness.

Director Jason Kohn and Coach Nick Bollettieri will be in attendance.

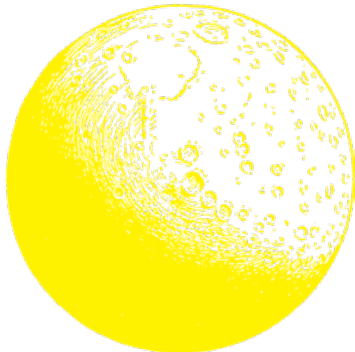

CLOSING DAY FILM SARASOTA OPERA HOUSE

61 N. Pineapple Ave.
Sarasota, FL 34236

SATURDAY, APRIL 21
1:30 PM RED CARPET
2:00 PM FILM

DOCUMENTARY

DIRECTOR: JASON KOHN

PRODUCERS: JASON KOHN,
JILL MAZURSKY, DAVID
STYNE, AMANDA BRANSON
GILL, ANNE WHITE

USA / 89 MIN

FILM TICKETS

\$25 / MEMBERS: \$20

STUDENTS: \$10

CLOSING NIGHT

EVENTS



SEE FILM GUIDE

CLOSING NIGHT FILM

SARASOTA OPERA HOUSE

61 N. Pineapple Ave.

Sarasota, FL 34236

SATURDAY, APRIL 21

5:00 PM RED CARPET

6:00 PM AWARDS & FILM

DOCUMENTARY

DIRECTOR: RORY KENNEDY

PRODUCER: MARK BAILEY,
RORY KENNEDY

USA / 90 MIN

FILM TICKETS

VIP: \$60 / MEMBERS: \$48

GOLD: \$40 / MEMBERS: \$35

SILVER: \$30 / MEMBERS: \$25

ATTIRE: COCKTAIL

ABOVE AND BEYOND: NASA'S JOURNEY TO TOMORROW

As NASA celebrates its 60th anniversary, Discovery Network shines a spotlight on the historic institution taking us to the moon, to the surface of Mars, to the outer edge of our solar system and beyond. Directed, produced, and narrated by Academy Award®-nominated and Emmy®-winning Rory Kennedy, ABOVE AND BEYOND: NASA'S JOURNEY TO TOMORROW, examines the extraordinary ways NASA has changed not only our vision of the universe, but also our planet, and ourselves. But more than a moving portrait of NASA's many accomplishments in space, the film also sheds light on the agency's lesser-known area of focus—the vital role NASA has played in measuring the health of our home planet. However far NASA may travel, its gaze has always returned to Earth—monitoring our seas and skies, our ice and sands—in an ongoing struggle to meet today's great challenge—protecting our planet.

Director Rory Kennedy and Producer Mark Bailey will be in attendance.

GATES
CONSTRUCTION

SARASOTA FILM FESTIVAL.COM

24



CLOSING NIGHT PARTY

Chill UNDER THE Stars

Presented in partnership with: **chillounge@night**[®]
The ultimate outdoor lounge party

Saturday, April 21

6:00-11:30 PM

**Selby Five Points Park
61 N. Pineapple Ave.
Downtown Sarasota**

Three ways to

purchase tickets:

Visit the Box Office,
SarasotaFilmFestival.com, or
call 941.366.6200

Selby Five Points Park will transform into the ultimate outdoor lounge. Brazilian Samba Parade - a unique fashion show - live bands and more

General Admission

\$30 Advance // \$40 Door

VIP Admission

\$120 Advance // \$150 Door

Limited reserved seating
options available

THANK YOU SPONSORS:



IN CONVERSATION WITH

Hosted at the elegant and intimate Florida Studio Theatre, the In Conversation With series features in-depth interviews with iconic Hollywood faces led by a member of the national press. Join us for a unique opportunity to learn from and experience the contemporary architects of cinema first-hand.

EVENTS

ERIC STOLTZ



Florida Studio Theatre
Saturday, April 14
12:00 PM

Eric Stoltz has been one of his generation's most versatile actors since debuting in the 1980s, bringing an independent spirit to his performances as well as his work as a

director and producer. He'll discuss a career that's included Quentin Tarantino, Chekhov on Broadway, CBS's hit MADAM SECRETARY, and his award-winning feature CLASS RANK, the 2018 SFF Opening Night film.

VIRGINIA MADSEN



Florida Studio Theatre
Saturday, April 21
1:00 PM

Virginia Madsen discusses an entrancing Hollywood career that has included an Oscar nomination for SIDEWAYS, exquisite characters, her collaborations with some

of America's great filmmakers, and her role in 1985.

STEVE GUTTENBERG



Florida Studio Theatre
Saturday, April 21
11:00 AM

Steve Guttenberg has gone from DINER to blockbuster comedies, sci-fi, mysteries, dramas, and the genre-

twisting CHASING THE BLUES. He'll talk about the full buffet of a long career.

RORY KENNEDY



Florida Studio Theatre
Saturday, April 21
3:00 PM

Join Academy Award-nominated director, producer, and philanthropist Rory Kennedy for an up-close-and-personal discussion about her celebrated career in

documentary filmmaking and her continued commitment to social, political, and civic issues.

TICKETS \$35 // \$30 MEMBERS

SFF FILM GUIDE

SARASOTA FILM FESTIVAL.COM

SENSORY FRIENDLY SCREENING



The eighth annual Sensory Friendly Screening is thoughtfully designed for those with cognitive and developmental disabilities. The theatre lights will be turned up and the sound turned down, inviting audience members to enjoy a positive, stress-free matinee at the movies. We also provide gluten-free cookies for all attendees.

LU OVER THE WALL

Kai is a young musician who moves from Tokyo to a small fishing village with his family. When his friends invite him to join their band on Merfolk Island, their music inspires Lu, a mermaid girl, to dance with them. But when an incident causes a rift between Lu and the rest of the village, what is Kai to do? **LU OVER THE WALL** is a visually dazzling story of how music and friendship can overcome fear and prejudice.

This film is dubbed in English.

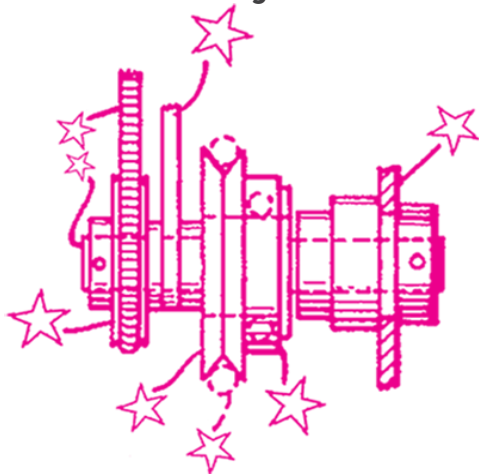

SENSORY-FRIENDLY SCREENING

Regal Hollywood 11 Cinemas

1993 Main St.
Sarasota, FL 34236

SATURDAY, APRIL 14
12:00 PM

SUNDAY, APRIL 22
11:00 AM

NARRATIVE

DIRECTOR: MASA AKI YUASA

PRODUCER: KOJI YAMAMOTO

CAST: CHRISTINE MARIA CABANOS,
MICHAEL SINTERNIKLAAS,
STEPHANIE SHEH

JAPAN / 112 MIN

TICKETS

FREE FOR ALL AGES

THROUGH WOMENS EYES



The following ticket packages will be sold only by TWE and may be purchased online at: www.throughwomenseyes.com

RECEPTION TICKET \$75

BENEFACTOR \$700

Four Two-day Day Passes for TWE films on April 14 and 15
Four Reception Tickets

PATRON \$350

Two Two-day Day Passes for TWE films on April 14 and 15
Two Reception Tickets

DONOR \$200

One Two-day Day Pass for TWE films on April 1 and 2
One Reception Ticket

The following tickets will be sold only by SFF by phone, in the box office, and online at sarasotafilmfestival.com

Reception Ticket – \$75
TWE One-Day Pass – \$65
TWE Two-Day Pass – \$120
Individual Tickets – \$15
Student & Educator Tickets – \$10 each

19TH ANNUAL THROUGH WOMENS EYES INTERNATIONAL FILM FESTIVAL

Celebrating 19 years of offering fabulous films written, directed and/or produced by women, Through Women's Eyes welcomes you!

TWE partners with the Sarasota Film Festival in presenting the best of current domestic and international, narrative and documentary, short and feature-length independent films.

In addition to seeing the best in women's film production, watching TWE films means supporting women and communities around the world. One hundred percent of funds raised by TWE goes toward the non-partisan United States National Committee for UN Women.

UN Women provides financial and technical assistance to innovative programs that end violence against women, promote economic independence and prosperity for women, and foster gender equality.

TWE also partners with Women Make Movies, a New York-based non-profit media arts organization, which encourages women to enter the world of filmmaking and shine a light on important international women's issues.

For more information about TWE, special pricing on ticket packages, and our fantastic films, go to www.throughwomenseyes.com.

The Gulf Coast Chapter of USNC for UN Women, Sarasota/Bradenton, invites you to join our efforts at empowering women. Learn more about our programs at www.unwomen-usnc.org/gccaboutus.

THROUGH WOMENS EYES

THANKS TO OUR SPONSORS



End Discrimination Against Women

Become a CEDAW city

Join the campaign for full gender equity - make SARASOTA a CEDAW city!
Contact UN Women-USNC Gulf Coast Chapter
www.unwomen-usnc.org/cccedaw



SATURDAY, APRIL 14

10:00 AM | WELCOME REMARKS | HALF THE PICTURE (95 min)

12:05 PM | SHORTS (75 min)
TREK FOR MANDELA
WE ARE DREAMERS

2:00 PM | ON HER SHOULDERS (96 min)

4:15 PM | SHORTS (54 min)
BUTTERCUP
TWENTY MINUTES
THE AFGHAN GIRL
THE GREAT WALL OF VICKY LYNN
THE PHOTOGRAPH

5:00-7:30 PM | FILMMAKERS RECEPTION

7:30 PM | RBG (97 min)

SUNDAY, APRIL 15

10:00 AM | CRACKING ACES: A WOMAN'S PLACE AT THE TABLE (65 min)

11:30 AM | SHORTS (76 min)
A DIVIDED ROAD
NIVEO
ONCE ALWAYS
PEARLS
SURVIVING INTERNATIONAL BOULEVARD

11:30 PM | I AM REBECCA and SISTERS (75 min)

3:00 PM | SHORTS (72 min)
PUSHING NIGHT AWAY
THREE AUGUST DAYS
12:58 PM
SUNDOGS
SHE
FAMILIES TOGETHER/FAMILIAS UNIDAS

6:45 PM | AUGUST IN BERLIN (88 min)

FESTIVAL FUN FOR FAMILIES



youthFEST



FILMS & FAMILIES

The Sarasota Film Festival is committed to educating and inspiring a future generation of filmgoers and filmmakers. During the Festival, our programming team screens the latest and greatest in kid-friendly independent films from all over the world for the youthFEST.

Each year as part of the larger Festival, SFF Education presents youthFEST: a family-friendly slate of films free for kids ages 12 and under.

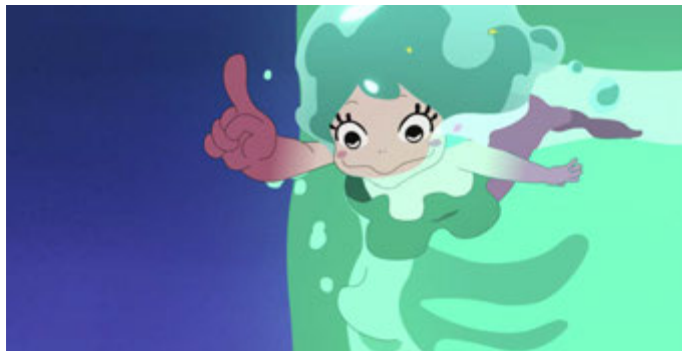

Sat 4/14 12:00 PM & Sun 4/22 11:00 AM
(see page 27 for description)

YOUTHFEST SHORTS: ALL AGES (P. 74)
YOUTHFEST SHORTS: AGES 8+ (P. 75)

HOLLYWOOD NIGHTS

The heart of the youth education programs during the Festival is our Young Filmmaker Showcase. We celebrate the accomplishments of young filmmakers under 18 by giving them the opportunity to have their work seen at a 10-day major international film festival. Students, families, and the general public are invited to attend a Hollywood-style premiere of the student films, complete with a red carpet and an awards ceremony.

See pg. 20 for details.

20 HOUR FILM CONTEST

Can you make a film in 20 hours? The 2018 Sarasota Film Festival gives aspiring filmmakers a great opportunity not only to make a short film during the festival but also have it play on the big screen in front of a live audience. Participants create a five-minute short film based on given elements and chosen themes, having just 20 hours to film and 20 hours to edit. The finished films will be shown and a winner selected **SUNDAY, APRIL 22 at 10:00 AM** at the Regal Cinemas Hollywood 11.

Contact education@sarasotafilmfestival.com for information on how to participate.

KIDS VIP TRIPS

Kids VIP Trips are a mainstay at the Festival. These trips provide film-screening field trips free of charge on school days to the Regal Hollywood 11 Cinemas for more than 2,000 area students. This program is in partnership with Embracing Our Differences, a local nonprofit that focuses on diversity and the arts in our community.



YEAR-ROUND EDUCATIONAL PROGRAMS



The mission of the Education Department is to inspire, educate, and entertain students by promoting creativity, collaboration, and community involvement.

Beyond our annual Festival, The SFF Sarasota Film Festival Education Department offers a number of scholastic programs. Applying the State of Florida Educational standards, students from elementary school through college participate in programming designed to encourage thoughtful citizenship and creativity through film literacy.

Operating both in and out of local classrooms, our department has reached over 17,000 students through filmmaking, film review, screenwriting, and movie screening programs.

CLASSROOM CRITIC

We believe it is important that students learn how to "read" films just as they learn to read books. The Classroom Critic program offers an in-class curriculum that centers on developing critical-thinking skills in film review and screenwriting. The new program this year includes an introduction to film language and key filmmaking tactics, using age-appropriate film clips from a variety of sources in American and international film history.

JUNIOR JURY

By being on the Junior Jury, high school students learn about film analysis, cultural and media literacy, and critical review. The program is highly competitive, with participants chosen based upon the applications and personal statement responses.

Junior Jurors meet with the professional SFF Jury to learn the process of critically reviewing the efficacy and artistic value of submitted films as well as to get insights about careers in the film industry.

GENDER IN MEDIA

In this partnership with the Geena Davis Institute on Gender in Media, young boys and girls learn to evaluate the ways gender roles are portrayed in TV and film. These lesson plans help students to be conscious media consumers as they learn about gender representations and stereotypes in the media and the world around them.

SPECIAL SCREENING AND PRESENTATION:

PROFILE in Screenlife

SUNDAY, APRIL 22

1:00 PM

Regal Hollywood 11 Cinemas

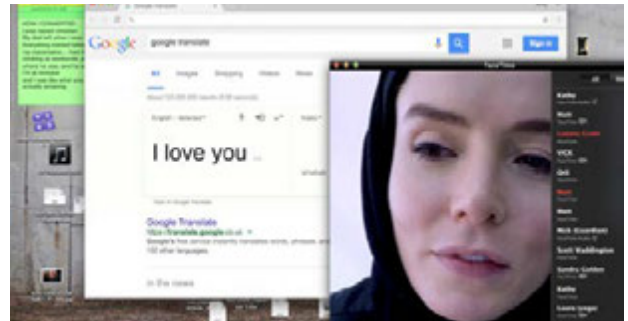

In this program, students will learn a new cutting-edge film language called "screenlife" where all action takes place on computer and phone screens. The program also includes the screening of the new thriller PROFILE, shot in the screenlife format, and an opportunity to participate in a film contest where the winners get development deals with a well-established production company.

PROFILE tells the story of a London journalist who plays the dangerous game of baiting an ISIS recruiter through social media and Skype. Based on a true story. Directed by Timur Bekmambetov (WANTED, NIGHT WATCH), the film won the Audience Award at the 2018 Berlin Film Festival.

FOR STUDENTS 16 AND OVER.
CONTAINS MINIMAL OFFENSIVE LANGUAGE.

MOONLIGHT MOVIES

COMMUNITY



Join SFF and our generous sponsors for FREE, public movies outside at our beautiful Sarasota County beaches and parks! All films begin at sunset, unless a specific time is indicated. Bring your own chairs and blankets. Be sure to follow our Facebook page for any important time changes or weather updates. See you under the stars!

SFF FILM GUIDE

APRIL 18 A LEAGUE OF THEIR OWN

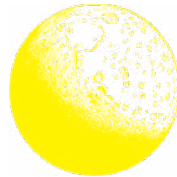

The Moonlight Movie on the Bayfront scheduled Wednesday, April 18th sets the stage for a night of fun and festivities, education and inspiration.

Come watch the classic, A LEAGUE OF THEIR OWN, at sunset on the historic greens at the Sarasota Lawn Bowling Club, with a waterfront backdrop and nostalgic fare. This special community event centers on progressive women in sport and is host to the legendary Rockford Peaches and members of the film's original cast.

Join Megan Cavanaugh ("Marla Hooch") and Tracy Reiner ("Betty Spaghetti"), daughter of director, Penny Marshall, and hear first-hand accounts of how the movie was made. Bring your family and a picnic and grab a spot on the grass while our celebrity women share stories that have never been told.

Come celebrate the 25th anniversary of A LEAGUE OF THEIR OWN with these dynamic, wise women on a mission to influence and **inspire the next generation.**

SARASOTA FILM FESTIVAL.COM



SFF FOCUS: SPORTS IN CINEMA

Since the earliest days of media, sports were among the most iconic events captured on film. Sports are a hallmark of our culture that celebrate human achievement, community and grit. Films that document achievements in sports history bring a rich narrative and context to greater social trends. We invite you to join us and our community partners in conversations around films that revitalize events in sports history and touch upon wider themes.

- KILLER BEES
- LOVE MEANS ZERO
- DAUGHTERS OF THE SEXUAL REVOLUTION:
The Untold story of the Dallas Cowboys cheerleaders
- A LEAGUE OF THEIR OWN

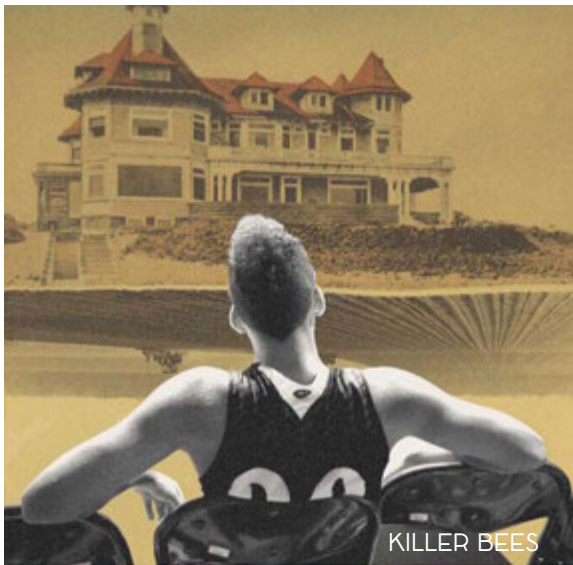

KILLER BEES



DAUGHTERS OF THE SEXUAL REVOLUTION

KILLER BEES tells the story of a championship high school basketball team that is the source of tradition and hope for a tiny African-American community living in the midst of the Hamptons, one of America's wealthiest areas. The film is produced by the basketball legend Shaquille O'Neill. An NBA player will visit local schools and youth organizations as part of the program.

SFF FOCUS: ENVIRONMENT, SCIENCE, AND SUSTAINABILITY

Now more than ever, we must employ visionary thinking to ensure the sustainability of our communities and our planet. SFF is proud to focus this year on urgent issues and solutions pertaining to the protection of our natural resources, diverse ecology, and green urban spaces.



RODENTS OF UNUSUAL SIZE

- LIVING IN THE FUTURE'S PAST
- EXPERIMENTAL CITY
- RODENTS OF UNUSUAL SIZE
- ABOVE AND BEYOND: NASA'S JOURNEY TO TOMORROW



FEAST OF MAN

SFF FOCUS: WOMEN'S COMEDIC VOICES

While often overlooked and underrepresented, women's comedic voices have served to break down social barriers and advance gender equality in immeasurable ways—especially in recent years. SFF wishes to honor the contributions of women comedic filmmakers, and is proud to present the standout selections below from a landmark year for women in Hollywood.

- LONG DUMB ROAD
- BIRDS WITHOUT FEATHERS
- WILD NIGHTS WITH EMILY
- CLARA'S GHOST
- FEAST OF MAN



MINDING THE GAP

SFF FOCUS: REDEFINING MANHOOD

In a time when gender issues are front and center in the public imagination, we wish to celebrate the contributions of conscientious filmmakers whose work raises essential questions about masculine identities, and urges conversation about ways to redefine manhood that address the sea-changes of recent years in our gendered society.

- MINDING THE GAP
- 1985
- THE RIDER
- WON'T YOU BE MY NEIGHBOR?

SFF FOCUS: MUSINGS ON MUSICIANS

Music is often the unseen force that makes a good film great; the relationship between music and movies is both dynamic and essential. This year, SFF is thrilled to present a collection of documentary and narrative selections that spotlight music and musicians' stories in cinema.

- TOUR WITHOUT END
- A TUBA TO CUBA
- THE TRANSCENDENTS
- GRACE JONES: BLOODLIGHT AND BAM!
- MILFORD GRAVES FULL MANTIS
- CHASING THE BLUES
- THE KING
- MATANGI / MAYA / M.I.A.
- HEARTS BEAT LOUD
- LU OVER THE WALL



A TUBA TO CUBA



HEART BEATS LOUD

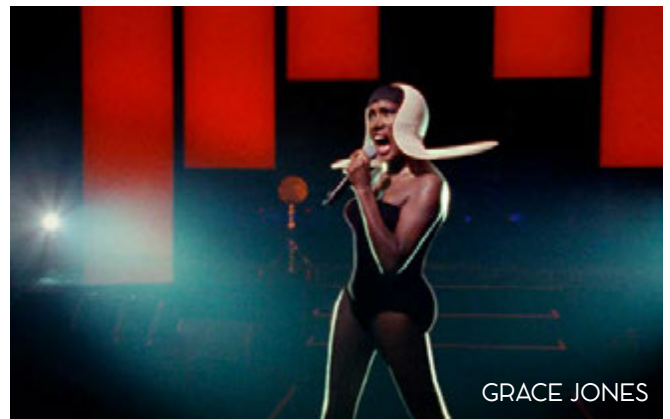

GRACE JONES



CHASING THE BLUES



NARRATIVE

Director: Yen Tan
Producers: Hutch, Ash
Christian
Cast: Cory Michael Smith,
Virginia Madsen, Michael
Chiklis, Jamie Chung, Aidan
Langford

USA/ 85 Min

FRIDAY, APRIL 20

5:00 PM

Regal Hollywood 11 Cinemas

SUNDAY, APRIL 22

2:30 PM

Regal Hollywood 11 Cinemas

1985

Based on Yen Tan's lauded short film by the same name, *1985* follows Adrian (Cory Michael Smith, *GOTHAM*), a closeted gay man, as he comes home for Christmas during the early years of the AIDS crisis. While there, he has difficulty revealing a terrible truth to his friends and conservative parents (played by Emmy Award® winning actor Michael Chiklis and Academy Award® nominated actress Virginia Madsen).



EIGHTH GRADE

Thirteen-year-old Kayla is like most adolescents: she's confident, she's cool, she's selfless. Well, at least that's how she presents herself on her YouTube channel (to an audience of zero). In reality, she is anxious, lonely, and confused. But Kayla is nonetheless determined to face her last week of middle school as confidently as she hosts her show. Comedian and YouTube sensation Bo Burnham's extraordinary first feature, *EIGHTH GRADE*, is a heartwarming, awkward portrait of being a young teenager in 21st-century America.

Director Bo Burnham in attendance.

NARRATIVE

Director: Bo Burnham
 Producers: Scott Rudin,
 Eli Bush, Lila Yacoub,
 Christopher Storer
 Cast: Josh Hamilton, Elsie
 Fisher, Emily Robinson

USA/ 94 Min

TUESDAY, APRIL 17
5:00 PM

Art Ovation Hotel
 1255 N. Palm Ave
 Sarasota, FL 34236

WEDNESDAY, APRIL 18
8:00 PM

Regal Hollywood 11 Cinemas

NARRATIVE

Director: Brett Haley
 Producers: Houston King, Sam Bisbee, Sam Slater
 Cast: Nick Offerman, Kiersey Clemons, Ted Danson, Sasha Lane, Blythe Danner, Toni Collette

USA/ 96 Min

SATURDAY, APRIL 14

7:00 PM

Regal Hollywood 11 Cinemas

SUNDAY, APRIL 22

5:00 PM

Regal Hollywood 11 Cinemas



HEARTS BEAT LOUD

Frank, a single dad, is a middle-aged Brooklyn hipster whose record shop is failing and whose music career never quite got off the ground. His daughter, Sam, is about to leave for college in California, and their frequent musical jam sessions are about to end. When Frank puts one of their songs online, it becomes an unexpected hit, and Frank begins to dream of a musical career together.

NARRATIVE

Director: Silas Howard
 Producers: Jim Parsons, Todd Spiewak, Eric Norsoph, Paul Bernon, Rachel Song
 Cast: Claire Danes, Jim Parsons, Octavia Spencer, Priyanka Chopra, Ann Dowd, Amy Landecker

USA/ 92 Min

TUESDAY, APRIL 17

7:45 PM

Art Ovation Hotel
 1255 N. Palm Ave
 Sarasota, FL 34236



A KID LIKE JAKE

When married couple Alex (Claire Danes) and Greg's (Jim Parsons) four-year-old son begins to stand out from the rest of his male classmates, his interest in princesses and traditionally feminine toys draws the attention of the principal who believes it may be something more than surface level. With the help of a preschool counselor (Octavia Spencer), Jake's parents must learn to adapt in order to continue raising their son in the best way possible.



THE KING

Elvis Presley is the undisputed King of Rock 'n' Roll, and his story is the stuff of American legend: a meteoric rise to fame, a life of excess, and an ignominious end. In a 1963 Rolls Royce originally owned by Elvis himself, **THE KING** takes a road tour of America visiting the cities that played major roles in Elvis' life, and muses about the historical significance of Elvis Presley's now archetypal story.

DOCUMENTARY

Director: Eugene Jarecki
 Producers: Christopher St. John, David Kuhn, Christopher Frierson, Georgina Hill
 Cast: Alec Baldwin, Ethan Hawke, Emmylou Harris, Ashton Kutcher

USA, Germany, France/ 109 Min

MONDAY, APRIL 16
6:00 PM

Art Ovation Hotel
 1255 N. Palm Ave
 Sarasota, FL 34236

SATURDAY, APRIL 21
1:30 PM

Regal Hollywood 11 Cinemas



LEAN ON PETE

At 15 years old, Charley is mostly alone in the world... until he meets Lean On Pete, a race-horse past his prime and due to be sold off to meet a grisly end. The two come together when Charley meets Del, a horse trainer who allows the boy to help manage his horses, of which Pete is one. When Charley learns of Pete's fate he decides it's time for them to make a break for it—but don't expect a Disney ending.

NARRATIVE

Director: Andrew Haigh
 Producer: Tristan Goligher
 Cast: Charlie Plummer, Chloë Sevigny, Steve Buscemi, Travis Fimmel

USA/ 119 Min

FRIDAY, APRIL 20
7:00 PM

Art Ovation Hotel
 1255 N. Palm Ave
 Sarasota, FL 34236

SPOTLIGHT FILMS

FILMS

SEE FILM GUIDE

SARASOTA FILM FESTIVAL.COM

40

NARRATIVE

Director: Hannah Fidell
Producers: Hannah Fidell,
JJ Ingram, Jonathan Duffy,
Kelly Williams
Cast: Tony Revolori, Jason
Mantzoukas, Taissa Farmiga,
Grace Gummer, Casey Wilson,
Ciara Bravo, Pamela Reed,
Ron Livingston

USA/ 90 Min

SATURDAY, APRIL 21

4:00 PM

Art Ovation Hotel
1255 N. Palm Ave
Sarasota, FL 34236

SUNDAY, APRIL 22

5:15 PM

Regal Hollywood 11 Cinemas

DOCUMENTARY

Director: Ali Weinstein
Producer: Caitlin Durlak

Canada/ 89 Min

SATURDAY, APRIL 14

12:00 PM

Art Ovation Hotel
1255 N. Palm Ave
Sarasota, FL 34236



THE LONG DUMB ROAD

Nathan, a budding photographer played by Tony Revolori (*GRAND BUDAPEST HOTEL*), is en route to his freshman year at art school when his car breaks down in Texas. Richard (Jason Mantzoukas), a local mechanic, offers to fix his car for a quid-pro-quo deal to jump in the passenger seat and escape his tyrannical boss. Along their journey, this odd couple tests their luck at love, attempts reconciliation with old flames, picks fights they cannot win, and navigates the murky waters of a fleeting friendship amidst a generational divide.



MERMAIDS

The allure of mermaids as a mythic creature has long been a phenomenon that excites and influences people of many cultures. The ancient myth has influenced five women in particular. *MERMAIDS* follows these modern sirens who steep themselves in mermaid subculture, including a few people from unlikely places like New York City, to nearby locales such as Weeki Wachee, Florida.

Preceded by TOM NODDY



A MURDER IN MANSFIELD

Academy Award® winner Barbara Kopple returns to the Sarasota Film Festival with a searing documentary about a domestic homicide in Mansfield, Ohio in 1989. Collier Boyle (now Collier Landry) was just 11 years old when his father, John, killed his mother, Noreen, with a blunt object. Two decades later, the now adult Collier returns to Mansfield to confront his past and his jailed father, who still claims his innocence.

DOCUMENTARY

Director: Barbara Kopple
Producers: Barbara Kopple, David Cassidy, Ray Nowosielski

USA/ 87 Min

THURSDAY, APRIL 19

8:00 PM

Regal Hollywood 11 Cinemas

FRIDAY, APRIL 20

2:45 PM

Regal Hollywood 11 Cinemas

FLORIDA PREMIERE



ON CHESIL BEACH

Young marriage, innocence, and complicated emotions collide in this adaptation of the novel by Ian McEwan (ATONEMENT). In 1962 England, Florence (Saoirse Ronan) and Edward's (Billy Howle) story is told in flashbacks: he's an Oxford academic; she's an aspiring violinist. Their families rush the couple into a union neither is ready for. On their honeymoon, they must confront old-world social mores and the burgeoning sexual revolution.

NARRATIVE

Director: Dominic Cooke
Producers: Elizabeth Karlsen, Stephen Woolley
Cast: Saoirse Ronan, Billy Howle, Anne-Marie Duff, Adrian Scarborough, Emily Watson, Samuel West

UK/ 110 Min

SUNDAY, APRIL 15

7:15 PM

Regal Hollywood 11 Cinemas

SATURDAY, APRIL 21

10:30 AM

Regal Hollywood 11 Cinemas

NARRATIVE

Director: Chloé Zhao
Producers: Chloé Zhao, Bert Hamelinck, Sacha Ben Harroche, Mollye Asher
Cast: Brady Jandreau, Lilly Jandreau, Tim Jandreau, Lane Scott, Cat Clifford

USA/ 103 Min

SUNDAY, APRIL 22

2:00 PM

Art Ovation Hotel
1255 N. Palm Ave
Sarasota, FL 34236



THE RIDER

A young rodeo cowboy struggles to get back in the saddle after a bone-crushing fall. The nonprofessional actors of this moody yet majestic film served as the inspiration for a script that loosely mirrors their real lives. Director Chloé Zhao's docufiction approach to filmmaking gently explores a story that's as much about the heavy weight of middle-American masculinity as it is about a young man's desperate attempt to follow his dream, even if it may one day claim his life.

NARRATIVE

Director: Madeleine Olnek
Producers: Casper Andreas, Max Rifkind-Barron, Anna Margarita Albelo
Cast: Molly Shannon, Amy Seimetz, Susan Ziegler, Brett Gellman, Jackie Monahan, Kevin Seal

USA/ 84 Min

SUNDAY, APRIL 15

1:45 PM

Regal Hollywood 11 Cinemas

SUNDAY, APRIL 22

8:00 PM

Regal Hollywood 11 Cinemas



WILD NIGHTS WITH EMILY

With the title taken from her raciest poem, *WILD NIGHTS WITH EMILY* sheds new light on the life of famously reclusive poet Emily Dickinson, revealing her hidden romance with her sister-in-law, and the irreverent side of Dickinson that the world at large never saw. Exploring the fierce rivalry between her brother's wife and his mistress—who published Dickinson's poems after her death—the film is also about the struggle to bring to life the work of one of history's most gifted poets.



DOCUMENTARY

Director: Morgan Neville
 Producer: Caryn Capotosto

USA/ 94 Min

**SUNDAY, APRIL 22
 4:45 PM**

Art Ovation Hotel
 1255 N. Palm Ave
 Sarasota, FL 34236

WON'T YOU BE MY NEIGHBOR?

For nearly 33 years, Fred Rogers provided entertainment and emotional security to children all around the world. In a world filled with political division and social media alienation, Mr. Rogers still shines as an example of warmth and comfort. *WON'T YOU BE MY NEIGHBOR?* is a sentimental tribute to a man who kept his private life close to his chest, and who influenced multiple generations of children.

OUR VISION IS...

a Vibrant
JEWISH COMMUNITY

You are the Jewish Community.
 This is Your Federation.

Together,
 we do extraordinary things.



The Jewish Federation
 OF SARASOTA-MANATEE

KLINGENSTEIN JEWISH CENTER
 580 McIntosh Road • Sarasota, FL 34232
941.371.4546 • jfedsrq.org

.COM/JFEDSRQ

WAGNER REALTY

Tim Mitten - Realtor®
Your Florida Real Estate Concierge!

CONGRATULATIONS SARASOTA FILM FESTIVAL
 ON YOUR **20TH** ANNIVERSARY!

WE ARE DELIGHTED TO HAVE OUR REALTOR, TIM MITTEN ON THEIR COORDINATING COMMITTEE.

THANK YOU! - FOR PRODUCING THIS SPECTACULAR EVENT!

Wagner Realty - Florida Real Estate
 proudly serving our community for 75+ years!

www.WagnerRealty.com
 941•727•2800

75+ YEARS
WAGNER REALTY
 ESTABLISHED IN 1949

FLORIDA ON FILM

FILMS



SEE FILM GUIDE

The Sarasota Film Festival is proud to continue our support of Sarasota and Florida filmmakers showcasing their work to audiences from national and international markets. This year, we feature 15 independent narrative, documentary, and animated films. Join us in celebrating our community's passion for cinema!

SHORTS

50 WORDS

BARELY THERE

THE DOLLMAKER

EXTINGUISHED

FULL CIRCLE

LADY PLUM

SARASOTA ORCHESTRA:

A WEEK IN THE LIFE

SHED

DOWNPOUR

FIX HISTORY



FEATURES

A FRENCHMAN IN FLORIDA

MERMAIDS

THE GREAT FLIP-OFF

LIFE AND NOTHING MORE

The Screenwriters Colony was founded in 2002 to provide a select group of emerging screenwriters with time, space, and freedom from the pressures of their daily lives to develop their work, engage with peers, and receive guidance from industry professionals. Since its inception, more than 40 emerging writers and 65 industry mentors have participated in the Colony's writers-in-residence program. The Sarasota Film Festival is pleased to welcome Roberto Bentivegna from the Screenwriters Colony to the Festival this season.



Roberto Bentivegna grew up in Milan and London, attending Emerson College in Boston before pursuing an MFA at Columbia University. Roberto has been awarded the Carla Kuhn fellowship, the Hollywood Foreign Press Award, the Alfred P. Sloan Screenwriting award and the Faculty Selects for "A Day in March". He was a finalist in the Academy's Nicholl Fellowship.

Roberto was awarded residencies at Yaddo, the Nantucket Screenwriters Colony, and was a fellow in the Italian Government's Apulia Film program.

His screenplays include SHELLA for acclaimed photographer Albert Watson; THE EEL starring Sam Rockwell and Jon Bernthal, SPIRIT HOUSE for Film Nation; MAY WE BE FORGIVEN for Cuzon/Artificial Eye to be directed by Simon Curtis; THE DISAPPEARANCE OF A QUIET MAN for producers Chris Coen and Alan Moloney; A HARD DAY for Sidney Kimmel Entertainment and Ivanhoe Productions.

SARASOTA FILM FESTIVAL.COM

Spotlights are native here.

Stay on top of the all the action of the 20th Annual Sarasota Film Festival with the Herald-Tribune.

The Herald-Tribune is proud to sponsor the Sarasota Film Festival and support artistic endeavors of our community.



IN PRINT | ONLINE | MOBILE

For advertising, call 941-361-4000
For subscriptions, call 941-365-6060

SFF SPECIAL AWARDS

THE FOLLOWING AWARDS ARE PRESENTED TO DESERVING FILMS AND THEIR FILMMAKERS AT OUR CLOSING NIGHT FILM, PG 24.



TERRY PORTER VISIONARY AWARD

Terry Porter was a legend in Sarasota film circles, holding court from behind the counter at the incredible Video Renaissance. Terry's passion for cinema shone through to his clients, his friends, and our entire community. Never afraid to take on challenging films of all stripes, Terry had an eye for the underdog, and for all things strange, new, and wonderful.

In honor of Terry's work as a tireless advocate for emerging voices and cinematic expressions, and for his tremendous friendship with the Sarasota Film Festival, we are proud to present the 8th Annual Terry Porter Visionary Award this year, sponsored by the Huisking Foundation.



INDEPENDENT VISIONS COMPETITION

Our annual Independent Visions competition celebrates the best emerging American filmmakers, whose bold, innovative films push the boundaries of conventional filmmaking (p. 54). The award recipients will receive a distribution deal from Factory 25.

FACTORY²⁵

FACTORY 25 is a Brooklyn-based independent-film distribution company launched in 2009. Factory 25 is a home for conceptually provocative narratives and documentaries, whose mission is to expose the world to under-the-radar programs, films, music, and other curiosities. Recent titles include MA, UNCLE KENT 2, STINKING HEAVEN, SUN DON'T SHINE, THE COLOR WHEEL, and CHRISTMAS, AGAIN.

WE ARE PROUD TO AWARD DESERVING WINNERS IN THE FOLLOWING ADDITIONAL CATEGORIES:

DOCUMENTARY FEATURE

NARRATIVE SHORT FILM

NARRATIVE FEATURE

AUDIENCE FAVORITE

ANIMATED SHORT FILM

SPECIAL JURY PRIZES

DOCUMENTARY SHORT FILM

OPENING NIGHT BLOCK PARTY (P. 19)



SERATONES

Get Gone, the debut album by Shreveport, Louisiana natives SERATONES, makes a strong case that this little-known corner of the country is musically fertile ground. Serving up a combination of Southern musicality, garage rock ferocity, and general badassery, Seratones create music that the band calls “an expression of freedom that’s all about waking people up,” and defies definition. The pure emotion of soul (singer A.J. Haynes found her voice in a Baptist Church at the age of 6), the grit and energy of punk, and the swagger of swing and blues coalesce into an experience that can only be described as... Seratones.

TANGINA STONE

Combining elements of soul, rock, electronic and r&b, TANGINA STONE has been championed by The FADER, Pigeons & Planes, CBC Radio Canada, Noisy, among others, as a universal breath of fresh air. Her debut album,

Elevate (2017), featuring Nelly Furtado and Liana Banks, peaked at #27 on the iTunes Top 200 R&B albums chart and at #44 on Apple Music Japan. Her music can be heard in nationally syndicated television shows on VH1 and TV One, and at her acclaimed performances around the globe.

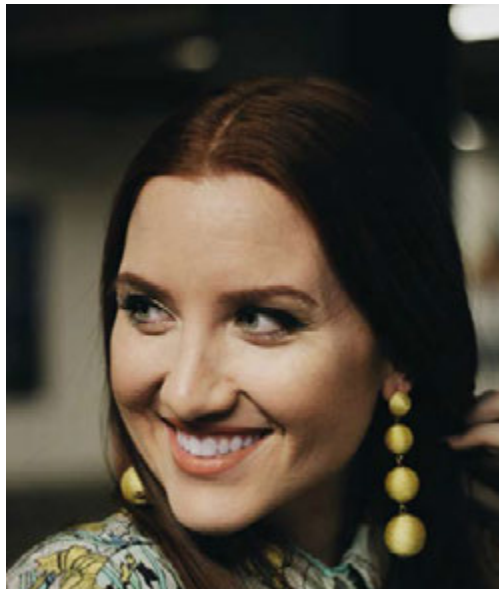
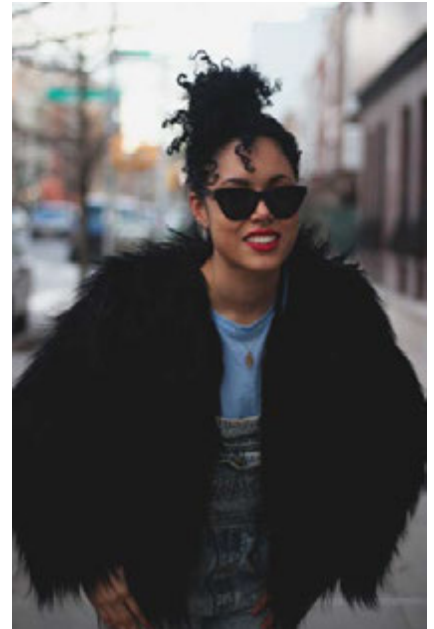

DJ WHITNEY

DJ WHITNEY Bibeau kicked off her musical career as on-air host with Source Life Radio, where she would ultimately become the station’s first female DJ. Perfecting her craft by curating sounds at venues all over NYC, in addition to working with major companies like Reebok and BMW, Whitney is the official DJ for singer and songwriter Tangina Stone. She has dedicated her career to empowering women and girls interested in breaking into the male-dominated world of deejaying and music production.

OUT OF THIS WORLD 20TH ANNIVERSARY CELEBRATION (P. 22)

PYLON REENACTMENT SOCIETY

PYLON is considered to be one of the most influential bands of the Athens, GA, alternative rock boom in the late 1970’s and early 1980’s along with The B-52’s and R.E.M. Fronted by Vanessa Briscoe (now Briscoe Hay), whose inimitable vocal textures and phrasing defined the band’s sound for most listeners, Pylon’s music draws from the deepest pockets of post-punk and No Wave to create a compulsively danceable sound that is as cerebral as it is visceral. They toured with Gang of Four, U2, Mission of Burma, REM, and Talking Heads, until their celebrated history coming to an abrupt end in 2009 with the death of iconic guitarist Randy Bewley, reincarnating in reverence under the moniker Pylon Reenactment Society.



JURIES

FILMS

SFF FILM GUIDE



AUTUMN BAILEY-FORD

A 9-year native of Atlanta with York, Pennsylvania origins, Autumn Bailey-Ford is an entertainment executive specializing in independent film production and distribution. As the founder of Autumn Bailey Entertainment, she has worked on over three dozen independent film projects as a producer and has assisted numerous filmmakers in securing film distribution for their projects. She is producing several film and television projects, with over 30 films under her belt both on the small and big screens. She is also a member of the Producer Guild of America.



MARK BAILEY

Mark Bailey is an Emmy-nominated writer and producer who has made a variety of award-winning documentaries. Bailey's films have been broadcast on HBO, Lifetime Television, National Geographic and PBS. Most recently, Bailey completed ABOVE AND BEYOND: NASA'S JOURNEY TO TOMORROW, a feature documentary examining the ways NASA has changed not only our vision of the universe, but also our planet, and ourselves. Premiering at the Sarasota Film Festival, the film will broadcast on the Discovery Channel in October of this year. Some of Bailey's other films include the Emmy Award-winning GHOSTS OF ABU GHRAIB, the five-part series PANDEMIC: FACING AIDS, for which Bailey was also nominated for a Primetime Emmy, and AMERICAN HOLLOW, nominated for an Emmy Award and an Independent Spirit Award.



ORSON CUMMINGS

Orson Cummings is half of the Brothers Cummings Film team along with his brother, Benjamin Cummings. They recently completed the film KILLER BEES, about the Bridgehampton High School Boys Basketball team, produced by Shaquille O'Neal. The Brothers Cummings Film team wrote and directed the feature, BLOOD IN THE WATER, a psychological thriller starring Willa Holland, now on Netflix and NINE OUT OF TEN (aka Blue Blood), a Noir starring Roy Scheider. Orson lives and works out of Southampton, NY and New York City.



DAVID EDELSTEIN

David Edelstein is the chief movie critic for New York Magazine (and its culture site, Vulture) and NPR's Fresh Air, as well as a commentator on film and television for CBS Sunday Morning. For ten years, he was film critic for Slate, and before that The New York Post and The Village Voice. His writing has also appeared in the New York Times, Vanity Fair, and Rolling Stone. A frequent guest host on Turner Classic Movies, he has presented two four-Friday spotlight programs on Francois Truffaut (2014) and Orson Welles (2015). He is the co-author, with producer Christine Vachon, of the L.A. Times bestselling book on independent filmmaking, *Shooting to Kill*. He lives in Brooklyn, NY.



MATT GRADY

Matt Grady is the founder of Factory 25, an independent film distribution company launched in 2009, a home for conceptually provocative narratives and documentaries. Grady was recently named "One of the Most Influential People in Brooklyn Culture," and has been called "One of the most important curatorial voices of new, independent American films." His mission is to expose the world to under-the-radar programs, films, music, and other curiosities. Recent titles include ALL THIS PANIC, SUN DON'T SHINE, THE COLOR WHEEL and CHRISTMAS, AGAIN. Grady also produced four feature films including Nathan Silver's THE GREAT PRETENDER, Onur Tukel's APPLESAUCE and SUMMER OF BLOOD. (imdb.com)



PATRICK HARRISON

Patrick Harrison joined the Academy of Motion Pictures Arts and Sciences as Director, New York Programs and Membership in 2001. He is responsible for the creation and implementation of all Academy programs on the East Coast including Monday Nights with Oscar® film series, the Spotlight on Crafts film series, Academy Tributes, educational outreach and the Oscar® Night New York celebrations. Patrick has served on a number of festival juries including the Hamptons International Film Festival, Sarasota Film Festival, and the Martha's Vineyard Film Festival. Before joining the Academy, Patrick served as Manager of Awards and Special Events for Miramax Films working on all awards campaigns including award nominees and winners GOOD WILL HUNTING and CHOCOLAT.

SARASOTA FILM FESTIVAL.COM



DEL JACOBS

Del Jacobs is an author and educator, serving as Director of Film & Media Studies at State College of Florida: Manatee-Sarasota and as part-time faculty at Ringling College. His background includes film production, promotion and exhibition, frequently tied together with critical research in published articles and books including *Interrogating the Image: Movies and The World of Film and Television*. A resident of Sarasota since 1976, Jacobs was owner and operator of Full Moon Productions, a local documentary film production and exhibition service that showcased issue-oriented non-fiction films. He currently serves on the Sarasota Film Commissioner's Advisory Board, and has worked closely with the Sarasota Film Festival in Educational Outreach since its inception.



PENNY LANE

Penny Lane is a Sundance award-winning filmmaker who was admitted to the Academy of Motion Picture Arts and Sciences in 2017. Lane has been making innovative nonfiction films for over a decade, including three feature-length documentaries: *OUR NIXON* (2013) premiered at Rotterdam, went on to SXSW, won the Ken Burns Award for "Best of the Festival" at Ann Arbor, and was Closing Night Film at New Directors/New Films; *NUTS!* (2016) premiered at Sundance where it won a Special Jury Award for Editing; and *THE PAIN OF OTHERS* (2018) which recently premiered at Rotterdam. She was named "Most Badass!" at the Iowa City Documentary Film Festival in 2009 and one of *Filmmaker Magazine's* "25 New Faces of Independent Film" in 2012.



PENELOPE ANN MILLER

Penelope Ann Miller is an acclaimed and diverse actor, who has stood the test of time, working in every medium and genre, with some of the most legendary actors and directors of all time. Most recently she took on the role of Elizabeth Turner in the controversial true story of Nat Turner's 1831 slave rebellion, *THE BIRTH OF A NATION*, which won rave reviews and The Grand Jury and Audience Awards at the 2016 Sundance Film Festival. Among her many accolades, Miller received a special jury award for Best Performance at the Hollywood Film Festival Awards for her role in the independent feature *RHAPSODY IN BLOOM*. She was named Star of Tomorrow by The Motion Picture Bookers Club, Most Promising Actress by The Chicago Film Critics Association, and received a Tony Award nomination for her portrayal of 'Emily' in Broadway's Tony-winning revival of *OUR TOWN*. (imdb.com)



TATIANA SIEGEL

Tatiana Siegel has worked with *The Hollywood Reporter* from 2003 and was promoted senior film writer in 2014. Ms. Siegel also offered showbiz analysis on the weekly TV series *Starz The Hollywood Reporter*. Before returning to THR, she covered the film business for *Variety* from 2007-12. Additionally, Ms. Siegel has appeared on ABC's *Good Morning America*, NPR's *All Things Considered*, CNN, CNBC, Fox News, MTV and E! as an industry expert. Before entering the Hollywood fray, she worked as an editor and reporter for several publications including the *New York Daily News*, the *Providence Phoenix* and the *Boston Globe*. Ms. Siegel also has written extensively as a freelancer for *USA Today*, *Emmy Magazine*, the *San Francisco Chronicle* and *The Nation*.



MELISSA SILVERSTEIN

Melissa Silverstein is the founder and publisher of *Women and Hollywood*, one of the most respected sites for issues related to women and entertainment. *Women and Hollywood* educates, advocates, and agitates for gender diversity in Hollywood and the global film industry. In 2013, she published the first book from *Women and Hollywood*, *In Her Voice: Women Directors Talk Directing, a compilation of over 40 interviews*. She is the Artistic Director and co-founder of the *Athena Film Festival* at Barnard College in NYC. She has written for *The Washington Post*, *NY Times*, *The Guardian*, *Forbes*, *More Magazine* and has been featured on CNN, the BBC as well as in *Newsweek*, *Salon*, *Chicago Tribune*, *Washington Post* and *NY Times*.



CHARLES WILLIAMS

Judge Charles E. Williams is a Circuit Court Judge in the 12th Judicial Circuit, a recipient of the Sarasota County NAACP 2014 Public Service Award, and the Sarasota County Branch NAACP's 2014 Lifetime Achievement Award. He is the recipient of the C.L. McKaig Award in recognition of his tireless dedication to promoting the ideals of equality, justice, and professionalism. Judge Williams also writes, directs, and produces documentary films. His film, *THE ENDURING BEAUTY OF MEMORY* was shown at SFF in 2014, and won the Best Documentary award at the 2014 Movieville Film Festival. In 2015 he was involved in the production of the film *NEWTOWN AT 100: A GLIMPSE THROUGH OUR EYES*, filmed by students from Booker High School, and received the Poitier Family Award for promoting diversity in film.



CLARA'S GHOST

Thursday, April 19, 9:00 PM, Auditorium 4
Friday, April 20, 5:30 PM, Auditorium 5

Director: Bridey Elliot
Producers: Sarah Winshall, Rachel Nederveld
Cast: Paula Niedert Elliott, Chris Elliott, Abby Elliott, Bridey Elliott, Haley Joel Osment, Isidora Goreshter
USA/ 93 Min

Former tween actors and twenty-something sisters Julie and Riley return home to visit their parents, washed-up actor Ted and non-famous Clara. Spurred on by copious amounts of alcohol and drinking rituals, the family trades increasingly sharp barbs, all while Clara deals with a possible ghost that only she can see. As her efforts to communicate with the spirit intensify, so does her erratic behavior, to the point where she may become a threat to her family and herself.



DON'T LEAVE HOME

Saturday, April 14, 8:00 PM, Auditorium 7
Friday, April 20, 9:45 PM, Auditorium 7

Director: Michael Tully
Producers: George Rush, Ryan Zacarias, Wally Hall, Jeff Allard, Tristan Lynch, Aoife O'Sullivan
Cast: Anna Margaret Hollyman, Lalor Roddy, Helena Bereen, David McSavage, Karrie Cox
USA, Ireland/ 86 Min

Sarasota Film Festival alum Michael Tully (PING PONG SUMMER, SEPTIEN) finally returns to SFF with his newest: a syncopated horror film set in Ireland. An American artist's obsession with an urban legend leads her to an investigation of the story's origins at the crumbling Irish estate of a reclusive painter. This film comes to the festival straight from its stint as an official selection from SXSW.



I AM NOT A WITCH

Thursday, April 19, 3:00 PM, Auditorium 5
Friday, April 20, 5:45 PM, Auditorium 4

Director: Rungano Nyoni
Producers: Emily Morgan, Juliette Grandmont
Cast: Margaret Mulubwa, Henry S.B. Phiri, Nancy Mulilo, Margaret Sipaneia, John Tembo
UK, France, Zambia, Germany/ 93 Min

Nine-year-old Shula, accused of witchcraft, is sentenced to live in a camp with other "witches." Tethered to spindles by long white ribbons, the women are told they will be turned into goats if they cut them and attempt to flee. Shula is then paraded around nearby towns by the camp manager, expected to use her powers for his gain. Inspired by real witch camps, director Rungano Nyoni spins a surrealist tale of social critique and feminist allegory.

In Nyanja and English with English subtitles



MADELINE'S MADELINE

Thursday, April 19, 5:15 PM, Auditorium 5
Saturday, April 21, 4:45 PM, Auditorium 6

Director: Josephine Decker
Producers: Krista Parris, Elizabeth Rao
Cast: Helena Howard, Molly Parker, Miranda July, Okwui Okpokwasili, Felipe Bonilla, Lisa Tharps
USA/ 94 Min

Growing up ain't easy. In fact, it can be absurdly hard. So why not embrace the absurdity? Madeline is a go-getter and is shooting to the top of her drama class. Like most girls her age, she has her differences with her mother, but as she gets closer and closer to her drama teacher (who is about to become a mother herself) things begin to get complicated. The lines between the real and the imagined grow increasingly less defined, and the drama both onstage and off begin to meld into that kind of all-consuming absurdity that is anything but funny.



THE QUEEN OF FEAR

Thursday, April 19, 7:45 PM, Auditorium 7
 Friday, April 20, 2:30 PM, Auditorium 7

Directors: Valeria Bertuccelli, Fabiana Tiscornia
 Producers: Santiago Gallelli, Benjamin Domenech, Matias Roveda
 Cast: Valeria Bertuccelli, Diego Velázquez, Gabriel Eduardo Goity, Darío Grandinetti
 Argentina, Denmark/ 107 Min

Robertina is an immensely famous theatre actress, and sure, drama goes with the territory. Split between meandering artistic experiments in a seemingly never-ending stream of fruitless rehearsals, and ridiculous encounters with her melodramatic home-help staff, Robertina's mounting anxiety is reaching a breaking point. When she learns that her best friend is dying of cancer, however, she must force herself to slow down and reconnect with the things that give her life true meaning.

In Spanish with English subtitles



THE SEEN AND THE UNSEEN

Thursday, April 19, 12:15 PM, Auditorium 4
 Friday, April 20, 12:15 PM, Auditorium 7

Director: Kamila Andini
 Producers: Kamila Andini, Ifa Isfansyah, Gita Fara
 Cast: Ni Kadek Thaly Titi Kasih, Ida Bagus Putu Radithya Mahijasena, Ayu Laksmi, I Ketut Rina, Happy Salma, Gusti Ayu Raka
 Indonesia, Netherlands, Australia, Qatar/ 86 Min

A fantastical fable that follows twin brother and sister Tantra and Tantri. Tantra develops a brain tumor and slowly loses his senses. Tantri must now mourn the loss of the sibling that she was so close to all her life. At night, the grieving ten-year-old Tantri keeps waking up from a nightmare and seeing her brother. They begin visitations on an otherworldly plane, dancing under the moonlight and playing in symbolic language which, for Tantri, is an emotional catharsis that lends magic and hope to her unavoidable grief.

In Balinese and Indonesian with English Subtitles



SUPPORT THE GIRLS

Thursday, April 19, 3:30 PM, Auditorium 6
 Friday, April 20, 8:30 PM, Auditorium 6

Director: Andrew Bujalski
 Producers: Houston King and Sam Slater
 Cast: Regina Hall, Haley Lu Richardson, Shayna McHayle, James LeGros, Dylan Gelula, AJ Michalka, Brooklyn Decker, Lea DeLaria, Jana Kramer, John Elvis
 USA/ 93 Min

Andrew Bujalski returns to the Sarasota Film Festival straight from SXSW with his newest, SUPPORT THE GIRLS. Follow a day in the life of "breastaurant" manager Lisa (Regina Hall) as she tries to keep her professional and personal lives from being pulled apart at both ends. Though she strives to stay positive and maintain a good attitude, she knows she can't do it alone, and finds strength and support from her female friends in a time of need.



Shore is vacation everyday. A full lifestyle brand that adds a philosophy on high quality to the Shore experience and fresh new American cuisine. Locally sourced ingredients, grown and sewn cotton, Shore is your all American brand.



Shop with us.
 Dine with us.

465 John Ringling Blvd
 Sarasota, FL 34236
 941-388-3535

shorebrand.com



DAUGHTERS OF THE SEXUAL REVOLUTION: THE UNTOLD STORY OF THE DALLAS COWBOY CHEERLEADERS

Friday, April 20, 8:15 PM, Auditorium 4
 Sunday, April 22, 11:00 AM, Art Ovation

Director: Dana Adam Shapiro
 Producers: Will Staeger, Greg Stern, Michael Antinoro, Randy Manis, Carra Greenberg, Stacey Reiss, Dana Adam Shapiro
 USA/ 80 Min

Director Dana Adam Shapiro (MURDERBALL) returns to Sarasota with his new film, which tells the story of Suzanne Mitchell, the matriarch of the cheerleaders, and how their sisterhood became a sensation during the forefront of the Sexual Revolution, permanently changing the way we see football and America as a whole.



GENERATION WEALTH

Thursday, April 19, 5:45 PM, Auditorium 6
 Saturday, April 21, 8:30 PM, Auditorium 7

Director: Lauren Greenfield
 Producers: Lauren Greenfield, Frank Evers, Wallis Annenberg
 USA/ 106 Min

Photographer/filmmaker Lauren Greenfield (QUEEN OF VERSAILLES) offers an introspective look back at her work exploring the haves and have-nots and the ever-increasing gap between. Greenfield turns the camera on herself as well as her subjects, making this a personal essay about what it is to have wealth, and why she feels compelled to explore it. Behind-the-scenes footage of some of her most famous images gives new perspective, and emotional interviews humanize her larger-than-life subjects.



GENESIS 2.0

Thursday, April 19, 2:45 PM, Auditorium 4
 Saturday, April 21, 1:15 PM, Auditorium 7

Directors: Christian Frei, Maxim Arbugaev
 Producer: Christian Frei
 Switzerland/ 113 Min

The Siberian republic of Yakutia is home to an unusual band of hunters: not looking for live game, but for prehistoric woolly mammoths that are now appearing as the permafrost thaws. One tusk can be sold for tens of thousands of dollars, a veritable fortune in this region, but the risks in retrieving them in this unforgiving climate can be deadly. On the other side of the world, scientists are looking to the future, to the possibilities of cloning and reviving this long-dead creature, and pondering the costs of "playing God."

In Yakut, Russian, English and Korean with English subtitles



HALE COUNTY THIS MORNING, THIS EVENING

Wednesday, April 18, 7:30 PM, Auditorium 5
 Friday, April 20, 5:15 PM, Cityside Auditorium 8

Director: RaMell Ross
 Producers: RaMell Ross, Joslyn Barnes, Su Kim
 USA/ 76 Min

An impressionistic portrait of the Historic South, HALE COUNTY, reflects stark reality in the visual language of a dreamscape. Focusing on intimate moments within an Alabama black community, this film is as much a meditation on race, identity, and America as it is an act of transcending the physical spaces that fill the screen. Winner of this year's Documentary Special Jury Award for Creative Vision at Sundance.



MINDING THE GAP

Friday, April 20, 2:00 PM, Auditorium 6
 Sunday, April 22, 3:00 PM, Auditorium 7

Director: Bing Liu
 Producers: Diane Quon, Bing Liu
 USA/ 98 Min

First-time filmmaker Bing Liu returns home to Rockland, Illinois, in the heart of Rust Belt America, to reconnect with his friends Zack and Keire. Though they've been skateboarding since childhood, they're now getting older, and new developments have arisen that will force them to confront themselves and each other. This extraordinary documentary vividly explores the trials and tribulations of youth and what it means to become an adult. Winner of the 2018 Special Jury Award for Breakthrough Filmmaking.



OF FATHERS AND SONS

Thursday, April 19, 1:00 PM, Auditorium 7
 Saturday, April 21, 11:00 AM, Auditorium 4

Director: Talal Derki
 Producers: Ansgar Frerich, Eva Kemme, Tobias N. Siebert, Hans Robert Eisenhauer
 Germany, Syria, Lebanon, Qatar/ 98 Min

Syrian filmmaker Talal Derki returns to his homeland to study a pro-jihadist radical Islamist family, seeing how they live, work, and love over the course of two years. OF FATHERS AND SONS focuses on the father, the general of an offshoot of al-Qaeda, Abu Osama, and his sons, Osama and Ayman, as he grooms them to become jihadists. Winner of the World Cinema Documentary Grand Jury Prize at the 2018 Sundance Film Festival.

In Arabic with English Subtitles



THE SENTENCE

Friday, April 20, 7:30 PM, Auditorium 7
 Sunday, April 22, 12:30 PM, Auditorium 3

Director: Rudy Valdez
 Producers: Sam Bisbee, Jackie Kelman Bisbee
 USA/ 84 Min

Once upon a time, Cindy was in love with a man involved with drug trafficking. That chapter ended abruptly with murder. Six years later, Cindy is happily married and a proud mother of three. A knock on the door heralds a seismic shift—to prison for a minimum sentence of 15 years under the "Girlfriend Law." The Sundance Audience Award winner, THE SENTENCE tells Cindy's remarkable story of motherhood despite unimaginable odds, and maintaining hope at all costs.

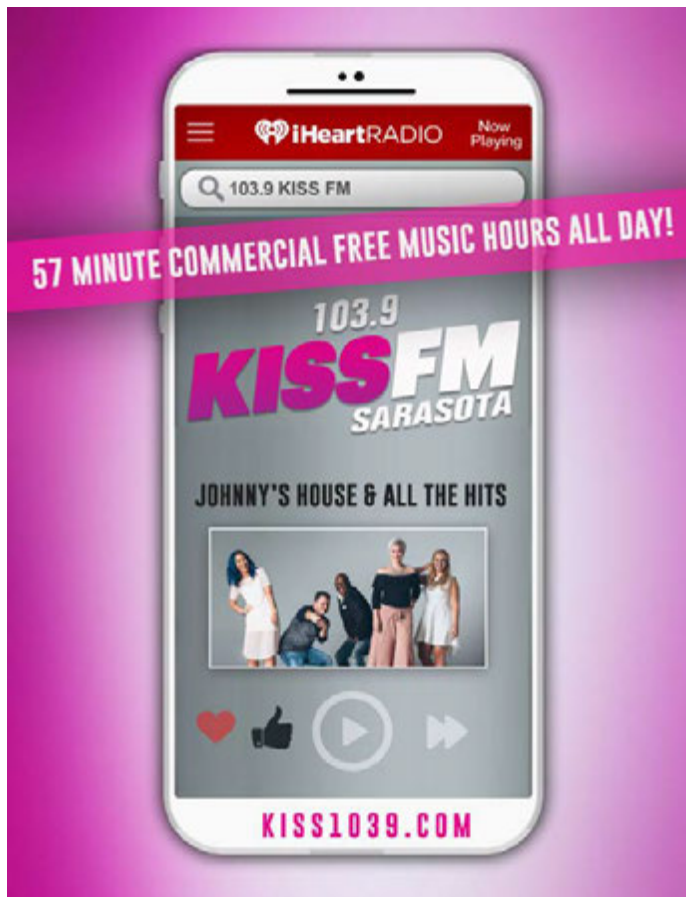



BIRDS WITHOUT FEATHERS

Thursday, April 19, 9:30 PM, Auditorium 3
 Sunday, April 22, 3:45 PM, Cityside Auditorium 8

Director: Wendy McColm
 Producers: Wendy McColm, Brian Robertson
 Cast: Wendy McColm, Lenae Day, Alex Stasko, William Gabriel Grier, Sara Estefanos, Jeff Goldbloom, Cooper Oz
 USA/ 84 Min

BIRDS WITHOUT FEATHERS has been described as “Fellini meets Solondz meets Lynch set in the California and Nevada deserts.” We tend to agree. In BIRDS WITHOUT FEATHERS, six idiosyncratic, forlorn individuals (including a wannabe Instagram star and a Russian cowboy obsessed with Jeff Goldblum) try their best to find love for themselves to no avail. Their lives all intertwine in the hopes of connecting, but ultimately create a world of smoke and mirrors. Winner of the Slamdance Spirit Award in 2018.

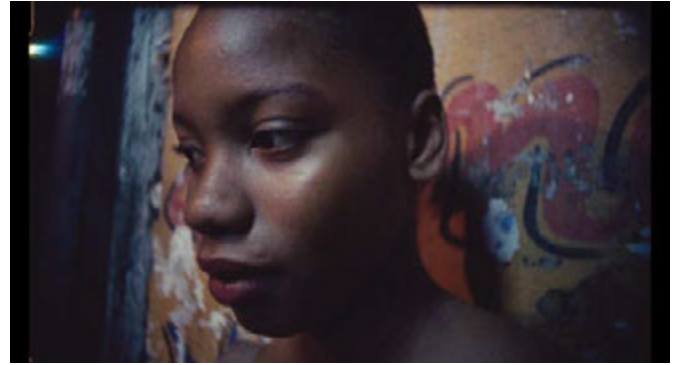

BLACK MOTHER

Wednesday, April 18, 5:30 PM, Auditorium 3
 Thursday, April 19, 2:30 PM, Auditorium 3

Director: Khalik Allah
 Producers: Khalik Allah, Leah Gibling
 USA/ 77 Min

Photographer and filmmaker Khalik Allah (FIELD NIGGAS) returns to Sarasota with another singular work of portraiture, this time capturing the spirit of his mother’s home country, Jamaica. Allah’s approach—intimate and open to the sights and sounds of street life—allows for a rich montage of the experiences of contemporary Jamaican life, creating an empathic synchronicity with a multivalent culture, attuned to the rhythms of everyone he encounters, whether they are preachers or prostitutes.



A FEAST OF MAN

Friday, April 20, 6:00 PM, Auditorium 3
 Sunday, April 22, 5:30 PM, Cityside Auditorium 8

Director: Caroline Golum
 Producers: John W. Yost
 Cast: Laurence Bond, Marleigh Dunlap, Zach Fleming, Jennifer Golum, Lloyd Kaufman, Frank Mosley
 USA/ 82 Min

“My dearest friends, in order to inherit my vast fortune, you must each agree to consume my corpse. You have 48 hours to decide.” And so begins Caroline Golum’s debut feature film. Like a twisted take on BREWSTER’S MILLIONS, A FEAST OF MAN explores how far five quirky, wealthy people will go to inherit their friends’ fortune. Will they commit the ultimate taboo, or will they all be left starving?



LIFE AND NOTHING MORE (LA VIDA Y NADA MÁS)

Thursday, April 19, 6:00 PM, Auditorium 4
 Saturday, April 21, 2:00 PM, Auditorium 6

Director: Antonio Méndez Esparza
 Producer: Pedro Hernández Santos
 Cast: Andrew Bleechington, Regina Williams, Robert Williams
 Spain, USA/ 114 Min

Regina Williams is a single mother who yearns for more from her life than just being a mother. Her teenage son, Andrew, also longs for something more, but is forced to take on added responsibility at home. As Regina and Andrew both feel increasingly withdrawn, something happens that compels both of them to address the predicaments they face and voids they seek to fill. Winner of the John Cassavetes Award at the 2018 Film Independent Spirit Awards.



MAISON DU BONHEUR

Friday, April 20, 12:00 PM, Auditorium 3
 Saturday, April 21, 6:00 PM, Auditorium 3

Director: Sofia Bohdanowicz
 Producers: Sofia Bohdanowicz, Calvin Thomas
 Canada/ 88 Min

Congratulations! You have been invited to travel to Paris and stay in the historic and chic neighborhood of Montmartre in the home of a native astrologer. The only caveat is that you two have never met and you have no idea what you're getting into. Will it be a "House of Happiness" after all?

Preceded by FLORES

In French with English subtitles



MILFORD GRAVES FULL MANTIS

Friday, April 20, 3:00 PM, Auditorium 3
 Saturday, April 21, 7:45 PM, Auditorium 4

Directors: Jake Meginsky, Neil Young
 Producer: Jake Meginsky
 USA/ 94 Min

Milford Graves is best known as an American jazz drummer who many argue is the single most influential figure in the development and continuing evolution of avant-garde music. He is credited with liberating percussion of its timekeeping role—even reconceptualizing time altogether. This 84-year-old polymath is anything but ordinary, and shows no signs of slowing down. Entering his world is akin to entering an entirely different dimension—to which this strikingly adventurous documentary by debut filmmaker Jake Meginsky grants full passage.

Preceded by KCLOC



NOTES ON AN APPEARANCE

Thursday, April 19, 12:00 PM, Auditorium 3
 Saturday, April 21, 3:30 PM, Auditorium 3

Director: Ricky D'Ambrose
 Producer: Graham Swon
 Cast: Keith Poulson, Tallie Medel, Bingham Bryant, Madeleine James
 USA/ 78 Min

In Ricky D'Ambrose's minimalistic debut feature, David, a young scholar in New York City, suddenly goes missing. His known whereabouts are scattered amongst auxiliary information: postcards, notes, letters, diary entries, boarding passes, etc. As his friends Todd and Madeleine search for him through these tiny windows of information, we learn more and more about the nefarious nature of his focus of study, provocative philosopher Stephen Taubes.

Preceded by IN SEARCH OF INDIGO



TOUR WITHOUT END

Friday, April 20, 8:00 PM, Auditorium 3
 Sunday, April 22, 2:45 PM, Cityside Auditorium 8

Director: Laura Parnes
 Producer: Laura Parnes
 Cast: Lizzi Bougatsos, Jim Fletcher, Kate Valk
 USA/ 92 Min

TOUR WITHOUT END is artist Laura Parnes' open invitation to enter the colorful and conscientious world of American independent rock musicians of the '90's and early aughts who sought (and still seek) to fuse musical expression with political action, formal experimentation, and other dialectically rigorous endeavors. The result is strikingly unique—a documentary and narrative hybrid comedy that utilizes the subjects of TOUR as non-actors playing themselves in this lighthearted exploration of identity, representation, and the arts. WORLD PREMIERE featuring Kate Valk (The Wooster Group), Lizzi Bougatsos (Gang Gang Dance), Johanna Fateman (Le Tigre), Kathleen Hanna (Julie Ruin, Bikini Kill), among others.

WORLD PREMIERE



ALL YOU CAN EAT BUDDHA

Monday, April 16, 6:00 PM, Auditorium 5

Director: Ian Lagarde
Producers: Gabrielle Tougas-Fr chet
Cast: Sylvio Arrizola, Ludovic Berthillot, Alexander Guerrero
Canada, Cuba/ 85 Min

Things are all well at the Palacio resort in the Caribbean. The sun is shining, the people are happy, and the food is plentiful. That is, until Mike arrives and disrupts everything. His intense magnetism, enormous appetite, and growing reputation as a miracle-worker attracts an idiosyncratic bunch, including a salsa teacher and a talking octopus. But as rations dwindle, the weather gets worse, and a change in administration threatens the integrity of the Palacio, Mike and his cohorts will have to figure something, anything, out.

In French with English Subtitles



AMERICAN ANIMALS

Saturday, April 14, 3:30 PM, Auditorium 5
Wednesday, April 18, 3:30 PM, Auditorium 6

Director: Bart Layton
Producers: Derrin Schlesinger, Katherine Butler, Dimitri Doganis, Mary Jane Skalski
Cast: Evan Peters, Barry Keoghan, Blake Jenner, Jared Abrahamson, Ann Dowd, Udo Kier
USA, UK/ 116 Min

This is the true story of four young Kentucky gentlemen who attempt a multimillion-dollar book heist from their college library. After successfully making away with priceless texts, the youngsters soon realize that life doesn't always play out like the movies. The anxiety over being apprehended takes hold and builds with each passing moment, dogging each of the boys with all-consuming totality. Told in part by the actual perpetrators of the crime, AMERICAN ANIMALS is a historic thriller with the stamina of a hungry lion.



AUGUST IN BERLIN

Sunday, April 15, 6:45 PM, Auditorium 3
Monday, April 16, 2:00 PM, Auditorium 6

Director: Becky Smith
Producer: Olivia Charamsa
Cast: Max von Pufendorf, Mariah Katharina Friedrich
Germany/ 88 Min

The chance meeting of a German man and a Canadian woman in a Berlin cafe unravels their carefully constructed lives. Two strangers get to know one another over a nonstop conversation all over the city. AUGUST IN BERLIN is a romance between two intellectuals, a beautiful and unique look at how we bond with a special someone.

In English and German with English subtitles



BIKINI MOON

Saturday, April 14, 12:45 PM, Auditorium 3
Monday, April 16, 4:00 PM, Auditorium 6

Director: Milcho Manchevski
Producers: Anja Wedell, Munire Armstrong
Cast: Condola Rashad, Sarah Goldberg, Will Janowitz, Sathya Sridharan
USA/ 102 Min

Bikini is a fascinating specimen, especially if you're shooting a documentary without a plan. She is so many things wrapped into one goldmine of a subject: a wise woman, a feral child, an unfettered free spirit, a war veteran, a sexually adventurous master manipulator... Bikini is the very embodiment of enigma. She presents prospects so enticing for an exploitative filmmaker that, despite the obvious risks of entering her world, she proves irresistible for all in her orbit, often with life-altering consequences.

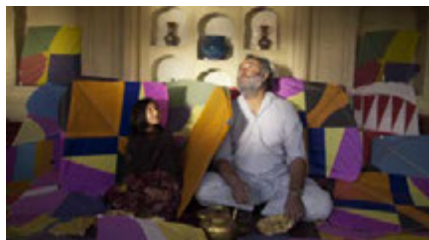

BLACK KITE

Sunday, April 22, 10:00 AM, Auditorium 5
Sunday, April 22, 12:15 PM, Auditorium 5

Director: Tarique Qayumi
Producers: Tajana Prka
Cast: Hadji Gul, Leena Alam, Hamid Noorzay, Masoud Fanayee, Hadi Delsoz, Sin Mim Alavi, Zahra Nasim, Kaka Nabi, Sameer Nasim
Afghanistan, Canada/ 87 Min

Arian grew up with a passion for kites, but fate and a rapidly changing Afghanistan are continuing roadblocks to his lifelong love. As Afghanistan becomes wartorn and extremists take over, kites become illegal—and later Arian will risk everything to share his personal symbol of freedom with his daughter. An engaging story beautifully shot with historical footage and animation to round out the narrative, this film truly shows the unintended consequences Afghanistan's race toward modernization.

In Dari with English subtitles



CAN HITLER HAPPEN HERE?

Saturday, April 21, 9:45 PM, Auditorium 3
Sunday, April 22, 8:30 PM, Cityside Auditorium 8

Director: Saskia Rifkin
Producers: Jay Cannold, Saskia Rifkin
Cast: Laura Esterman, John Pirkis, Sean Cullen
USA/ 75 Min

Meet Miriam—a 74-year-old New Yorker living her life on her own terms. Miriam is an artist, an unabashed eccentric, and the last lady in New York City to keep up with the Joneses. Unfortunately for Miriam, the Joneses are keeping up on her. When their passive-aggressive snobbery goes too far, and Miriam suspects a plot to evict her from her apartment, she does not sit by idly. CAN HITLER HAPPEN HERE? is a comic and often provocative homage to the individualist spirit and indomitable powers of an active imagination.



CHASING THE BLUES

Friday, April 20, 7:45 PM, Auditorium 5
Saturday, April 21, 4:15 PM, Auditorium 7

Director: Scott Smith
Producers: JJ Ingram, Aria Razza, De Cooper
Cast: Grant Rosenmeyer, Ronald L. Conner, Chelsea Tavares, John Lovitz, Steve Guttenberg, Anna Maria Horsford
USA/ 90 Min

Record collector Alan Thomas (Grant Rosenmeyer, *THE ROYAL TENENBAUMS*) is head over heels when he discovers that an ultra-rare blues record is just within his reach, in the hands of an older woman (Anna Maria Horsford, *AMEN*). However, he's not the only one going after the record, and when he and his rival (Ronald Conner) are thrown in jail, they're faced with a more fearsome adversary.

Preceded by **DEATH METAL GRANDMA**

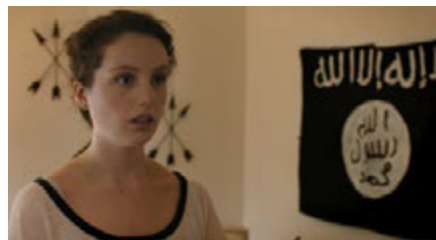

DELENDA

Thursday, April 19, 6:45 PM, Auditorium 3
Saturday, April 21, 1:00 PM, Auditorium 3

Director: Ralph Moffettone
Producers: Ralph Moffettone
Cast: Adelind Horan, Yael Shavitt, Vasile Flutur, Arin MacLaine, Michael Romeo Ruocco, Ralph Moffettone, Jonathan Tindle, Molly Deacon, Cristina Lucas, Caroline Aimetti
USA/ 106 Min

New York City has just suffered another terrorist attack, and the young professionals of the outer boroughs have rallied together in solidarity—for a little while, at least. Old feuds flare up between colleagues, kindness to strangers is quickly superseded by impatience, and overarching stereotypes prevail as quickly as they were suspended. It's a media frenzy: their insatiable hunger for fresh content and the competition to keep upping the ante help some to get rich, and others to get radicalized.

WORLD PREMIERE

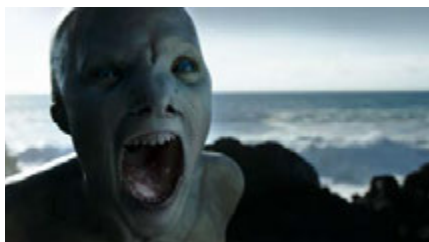

COLD SKIN

Tuesday, April 17, 8:15 PM, Auditorium 6

Director: Xavier Gens
Producers: Denise O'Dell, Mark Albela, Orlando Pedregosa, Denis Pedregosa
Cast: Ray Stevenson, David Oakes, Aura Garrido
Spain, France/ 106 Min

The year is 1914, and a young meteorologist named Friend has just arrived on a barren island to find the only other person in his midst is a cantankerous lighthouse keeper who reeks of madness and secrets. After an inexplicable night visitation, Friend is forced to take up with the lighthouse keeper and his strange pet, only to discover it's high time to reconsider everything he thought he knew about nature, people, and the nature of personhood.

WORLD PREMIERE



DIMINUENDO

Friday, April 20, 5:45 PM, Auditorium 6

Director: Adrian Stewart
Producers: Sarah Goldberger, Kevin Alexander Heard, Jenifer Ellis, Jeffrey Coghlan
Cast: Richard Hatch, Chloe Dykstra, Leah Cairns, Gigi Edgley, Walter Koenig, Peter James Smith, Yan Nikita Guo, Rebecca Gray
USA/ 105 Min

In his final performance, 'Battlestar: Galactica' star Richard Hatch plays has-been filmmaker and human shipwreck, Haskell Edwards. Once a renowned director, Haskell has wallowed in a haze of drug and alcohol abuse for nine years, since witnessing the suicide of his one true love, iconic actress Cello Shea. When a cutting edge tech-company approaches Haskell to direct a film about Cello's life, he is stunned to meet the actress who will portray her... an incredibly life-like robot called a LifeDoll. Number 8 mimics. She doesn't think. She doesn't reason. She doesn't understand. Which doesn't stop Haskell from becoming obsessed with this machine that is nothing more than a programmed doppelgänger. ... or is it?

WORLD PREMIERE



COME SUNDAY

Saturday, April 14, 3:00 PM, Art Ovation

Director: Joshua Marston
Producers: Ira Glass, James D. Stern, Alissa Shipp, Julie Goldstein
Cast: Chiwetel Ejiofor, Danny Glover, Condola Rashad, Jason Segel, Lakeith Stanfield, Martin Sheen
USA/ 106 min Min

Bishop Carlton Pearson used to be your everyday evangelical superstar. He had a following of millions of people who would worship with him as congregants of his Higher Dimensions Church. But after the suicide of a beloved family member, he soon comes to a realization that places him at odds with not only his church, but the people in his life that he loves the most.

Bishop Carlton Pearson in attendance.



EN EL SÉPTIMO DÍA (ON THE SEVENTH DAY)

Tuesday, April 17, 8:00 PM, Auditorium 5
Saturday, April 21, 2:15 PM, Cityside Auditorium 8

Director: Jim McKay
Producers: Alex Bach, Lindsey Cordero, Caroline Kaplan, Jim McKay, Michael Stipe
Cast: Fernando Cardona, Gilberto Jimenez, Abel Perez
USA/ 92 Min

Jim McKay's first film in twelve years, *EN EL SÉPTIMO DÍA* follows a Mexican immigrant in Brooklyn trying to establish himself in America. He works long hours six days a week, but on the seventh day, Sunday, he enjoys a day of rest on the soccer fields of Brooklyn. A refreshing take on the challenges and sacrifices made by recent immigrants trying to gain a foothold in America.

In Spanish with English subtitles



FIRST REFORMED

Wednesday, April 18, 8:15 PM, Auditorium 6
Saturday, April 21, 8:45 PM, Auditorium 6

Director: Paul Schrader
Producers: Chirstine Vachon, David Hinojosa, Gary Hamilton, Ying Ye, Jack Binder, Frank Murray
Cast: Ethan Hawke, Amanda Seyfried, Cedric Kyles, Victoria Hill, Philip Ettinger
USA/ 113 Min

Director Paul Schrader (screenwriter for TAXI DRIVER and RAGING BULL, director of AMERICAN GIGOLO) brings his newest film FIRST REFORMED to Sarasota by way of the Venice Film Festival. A deeply personal film, FIRST REFORMED tells the story of an emotionally tortured pastor (Ethan Hawke) of a small church in upstate New York. Still recovering from the death of his son, he has a deeply troubling encounter with an despondent parishioner and his wife (Amanda Seyfried) that leaves him questioning his role as a man of god in a dying world.



LET THE SUNSHINE IN (UN BEAU SOLEIL INTÉRIEUR)

Sunday, April 15, 4:00 PM, Auditorium 6
Wednesday, April 18, 6:15 PM, Auditorium 7

Director: Claire Denis
Producer: Olivier Delbos
Cast: Juliette Binoche, Xavier Beauvois, Philippe Katerine, Josiane Balasko, Sandrine Dumas
France, Belgium/ 94 Min

French master Claire Denis makes a disarming turn with her latest film. Juliette Binoche stars as Isabelle, a middle-aged Parisian artist looking for love. Very loosely based on Roland Barthes's A LOVER'S DISCOURSE, Denis moves elliptically with Isabelle from affair to rendezvous to flirtation, creating the rare romantic comedy that takes seriously the mysteries and frustrations of romantic love while never shying away from a well-observed joke.

In French with English subtitles



A FRENCHMAN IN FLORIDA

Thursday, April 19, 8:45 PM, Art Ovation

Director: Dante Rhev
Producer: Vincent Dale
Cast: Jules Pélissier, Léa Boulch, Summer Hill Seven, Brian Lee, Gauthier Battoue, Laure Lochet, Marie Colomb, and Folco Marchi
France, USA/ 88 Min

Two young girls have disappeared, and Sarasota detectives have a hunch that the mysterious Frenchman who has locked himself in a cheap motel bathroom has something to do with it. The only problem is that he won't say a word, let alone leave the bathroom. That is, until the detectives find a charismatic young translator who wins his trust and begins to extract his story little by little as the clock ticks away with each precious second the girls remain missing.

Preceded by KATIA

In English and French with English subtitles



MAKTUB

Wednesday, April 18, 5:45 PM, Auditorium 6
Thursday, April 19, 4:45 PM, Art Ovation
Hotel

Director: Oded Raz
Producers: Roni Abramowsky
Cast: Guy Amir, Hanan Savyon, Gal Amitai
Israel/ 100 Min

It's GOODFELLAS meets PAY IT FORWARD in this redemptive comedy from Israel. When two mobsters, Steve and Chuma, narrowly escape a terrorist bombing, they decide to eschew their life of crime and become "guardian angels." As the mobsters begin answering prayers that people write in notes and leave in the cracks of the Wailing Wall, they realize their unorthodox methods are turning some heads and making a few enemies along the way.

In Hebrew with English subtitles

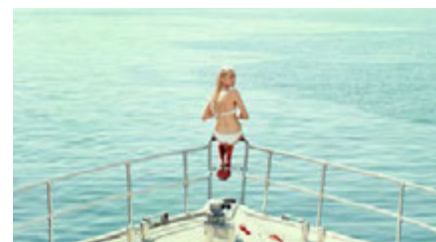

HOLIDAY

Wednesday, April 18, 8:30 PM, Auditorium 7

Director: Isabella Eklöf
Producers: David B. Sprensen
Cast: Victoria Carmen Sonne, Lai Yde, Thijs Romer
Denmark, Netherlands, Sweden/ 93 Min

Beauty and violence abound in this tale of a gangster's girlfriend and the lavish new life she finds herself in. On vacation on the Turkish Riviera, Sascha quickly learns that this glamorous existence comes at a high cost, and that her boyfriend Michael can and will do anything to get what he wants: total dominance over others. A chance meeting with a Dutch yacht owner has Sascha toying with the two men, and playing a very dangerous game.

In Danish and English with English subtitles

Explicit content



SANTA INOCENCIA

Sunday, April 15, 9:00 PM, Auditorium 3
Tuesday, April 17, 8:30 PM, Auditorium 3

Director: Meritxell Campos Olivé
Producers: Meritxell Campos Olivé
Cast: Natalia Agati, Chiara Catalano, Vincenzo D'Alfonso, Mario Fommei, Francesco Lepore, Andreina Orlando, Luisa Ricci, Mirko Russo, Luana Selvetella
Germany, Italy, Switzerland/ 83 Min

Little young "Saint Innocence" is preserved in wax and would love a visit! Legend has it that although her body has been dead for 300 years, her sense of humor is alive and well (but a bit dry)—winking at a lucky tourist every so often. Join her in spirit for a joyful jaunt through the Italian countryside with eight jocular hosts who are all but mute, yet speak volumes.

Preceded by TITAN

In Italian with English subtitles



SHELTER

Thursday, April 19, 6:45 PM, Art Ovation

Director: Eran Riklis
Producers: Eran Riklis, Bettina Brokemper, Antoine de Clermont-Tonnerre, Michael Eckelt
Cast: Neta Riskin, Golshifteh Farahani, Yehuda Almagor
Israel/ 93 Min

SHELTER is not your average spy movie. Naomi, a Mossad agent, is tasked with a new identity and heads to protect Mona, a Lebanese informant who is being hidden in Hamburg while she recovers from plastic surgery. However, things are not all that they seem when Naomi learns a dark truth about Mona. But in the time they spend together, they form an unlikely connection that may contradict their motives, their beliefs, and their mission.

In English and Hebrew with English subtitles

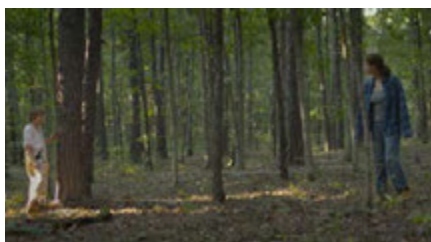

TATTERDEMALION

Sunday, April 15, 7:00 PM, Cityside Auditorium 8

Monday, April 16, 6:30 PM, Auditorium 4

Director: Ramaa Mosley
Producers: Gina Resnick, Ramaa Mosley, Tim Macy, Sarah Johnson, Cameron Gray
Cast: Leven Rambin, Jim Parrack, Taylor John Smith, Toni Johnson, Kip Collins, Landon Edwards
USA/ 100 Min

Fern, an Army veteran, returns home to the Ozarks to find an abandoned young boy in the woods. As any compassionate person would do, she takes the boy in as her own to ensure his safety and wellbeing. Gradually, the boy's behavior grows more and more suspect, especially in light of the local legend of the Tatterdemalion. Nonetheless, Cecil isn't your average boy—his secrecy and instinctive knowledge seems years beyond his age, and it is beginning to drive Fern mad...



TINKER

Sunday, April 15, 11:45 AM, Auditorium 4
Tuesday, April 17, 3:15 PM, Auditorium 5

Director: Sonny Mahrler
Producers: Tom Bhramayana
Cast: Clayne Crawford, Christian Kane, Wilmer Calderon, Colt Crawford, Randy Smith
USA/ 97 Min

Grady never much fancied the idea of fatherhood. He preferred to remain unentangled so he could devote his undivided attention to his unique hobby: completing the work of Nikola Tesla's free-energy experiments. It's a bit of a family affair after all, as his father was involved with covert government projects to unlock the power of Tesla's confiscated designs. Such is life, however, that fate would intervene to give Grady no choice but to become the guardian of a gifted and curious six-year-old, who just can't seem to mind his own business.

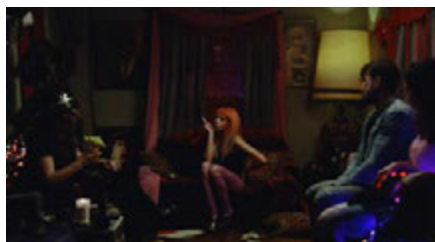

THE TRANSCENDENTS

Wednesday, April 18, 7:45 PM, Auditorium 3
Saturday, April 21, 1:45 PM, Auditorium 5

Director: Derek Ahonen
Producers: Melinda Prisco
Cast: Rob Franco, Savannah Welch, Kathy Valentine, William Leroy, Ben Reno
USA/ 106 Min

Roger is in search of the ultimate indie-rock band, The Transcendents. What he finds is less than transcendent: a group of bandmates who wish to do anything but play music, a host of unpleasant memories jogged by the dysfunction of the Rock 'n' Roll lifestyle, and more questions than answers in search of his own existential fulfillment. Set in the Wonderland of America's underground Do-It-Yourself music scene, THE TRANSCENDENTS is a Rock 'n' Roll fairytale that straddles the line between the absurd and the all too real.

Preceded by DOWNPOUR

WORLD PREMIERE



VIRGINIA, MINNESOTA

Saturday, April 14, 6:15 PM, Auditorium 5
Sunday, April 15, 7:45 PM, Auditorium 5

Director: Daniel Stine
Producers: Mike Stine, Helen Stine, Daniel Stine
Cast: Aurora Perrineau, Rachel Hendrix, Susan Walters, Julia Keefe, Jessica Meisel, Daniel Stine, Eyas Younis, Carl Palmer, Aaron Hill
USA/ 104 Min

Addison and Lyle have not seen each other in ages, and maybe that was for the best considering the tumult of their past growing up together in a home for troubled girls. Nonetheless, an unexpected reunion revives a friendship that is steeped in adventure and discovery, and the two spare no time in "borrowing" a car and tearing off into the sunset towards the home they grew up in together courting unforeseen antics and epiphanies at every turn.

Preceded by SUSANNE AND THE MAN



VIRUS TROPICAL

Sunday, April 15, 9:00 PM, Auditorium 6
Tuesday, April 17, 8:45 PM, Auditorium 4

Director: Santiago Caicedo
Producers: Carolina Barrera, Santiago Caicedo
Cast: Alejandra Borrero, Diego León Hoyos, María Cecilia Sánchez, Camila Valenzuela
Colombia/ 100 Min

VIRUS TROPICAL is the animated history of Paola's coming of age, told from the moment of her conception. The story takes place in Columbia, and is steeped in Latin-American gendered experience. Paola is the youngest of three daughters to a priest and psychic, and equally divided between the worlds of moral tradition and devil-may-care whimsy. VIRUS TROPICAL is not only a universally relatable parable about self-definition, it is also a frank and sensitive exploration of sexuality in Latin American culture.

Preceded by LOVE ON THE BALCONY

NARRATIVE FILMS

FILMS



WE THE ANIMALS

Monday, April 16, 3:30 PM, Auditorium 5

Director: Jeremiah Zagar
Producers: Dan Kitrosser, Jeremiah Zagar
Cast: Raul Castillo, Sheila Vand, Evan Rosado, Isaiah Kristian, Josiah Gabriel
USA/ 90 Min

Manny, Joel, and Jonah are three inseparable brothers living a lower-middle-class life with their mother and father. But as they get older, their parents fight, and the boys quickly have to fend for themselves. Manny and Joel take after their father, but Jonah, the youngest, is still soft at heart and desperately want to escape the new reality he finds himself in. Based on the Justin Torres novel, *WE THE ANIMALS* won the Next Innovator Award at the Sundance Film Festival in 2018.



WHITE RABBIT

Saturday, April 21, 9:00 PM, Cityside Auditorium 8

Sunday, April 22, 6:00 PM, Auditorium 3

Director: Daryl Wein
Producers: Daryl Wein, Vivian Bang
Cast: Vivian Bang, Nana Ghana, Nico Evers-Swindel, Tracy Hazas, Elizabeth Sung, Michelle Sui
USA/ 82 Min

Sophia makes unusual performance art: smashing her face into piles of food, staging guerrilla performances in drugstores, supermarkets, and street corners while sporting a white jumpsuit and a blonde wig. She tells her mother, "It's not art that people can buy." She soon meets Victoria, a photographer with similar views on being "hyphen Americans" and women of color, and feelings develop that may not be reciprocated.

Preceded by REAL ARTISTS



ZAMA

Tuesday, April 17, 5:15 PM, Auditorium 6

Director: Lucrecia Martel
Producers: Vânia Catani, Benjamin Doménech, Santiago Gallelli, Matias Roveda,
Cast: Daniel Giménez Cacho, Lola Dueñas, Matheus Nachtergaele
Argentina/ 115 Min

Lucrecia Martel's newest film is a historical period piece of Kafka-esque proportions. Set in the 18th century based on the novel by Antonio di Benedetto, Spanish officer Don Diego de Zama yearns for a new position in the new world. As he awaits a transfer letter from the king, de Zama's patience and sanity begin to quickly run out. *ZAMA* was the Argentine submission for Best Foreign Language Film in the 90th Academy Awards®.

In Spanish with English subtitles

SEE FILM GUIDE

SARASOTA FILM FESTIVAL.COM



306 HOLLYWOOD

Saturday, April 14, 1:15 PM, Auditorium 7
Wednesday, April 18, 1:30 PM, Auditorium 7

Director: Elan Bogarin, Jonathan Bogarin
 Producers: Elan Bogarin, Jonathan Bogarin, Judit Stalter
 USA, Hungary/ 101 Min

A pair of shoes. A toothbrush. Bank statements. What do these items have in common? When you die, the things you leave behind tell a story about you. In **306 HOLLYWOOD**, siblings and filmmakers Elan and Jonathan Bogarin explore their recently departed grandmother's story as told through her belongings, correspondence, and other personal items in this unique, magical-realist documentary.

Preceded by CATSKILLS



ANTONIO LOPEZ 1970: SEX FASHION & DISCO

Sunday, April 15, 11:00 AM, Auditorium 5
Tuesday, April 17, 5:00 PM, Auditorium 7

Director: James Crump
 Producers: James Crump, Ronnie Sassoon
 USA/ 110 Min

A time capsule of 1970s fashion, this film delves into the decade through visionary eyes of fashion illustrator Antonio Lopez. A bisexual Puerto Rican raised in the Bronx, Lopez shaped the '70s into an era of glamour and flamboyant style. Based in Paris and New York, he was known to have an outlandish and colorful social sphere, which influenced his work in a unique way and vaulted him to the forefront of his industry.

Preceded By WHILE I YET LIVE



ASK THE SEXPERT

Sunday, April 15, 6:45 PM, Auditorium 6
Wednesday, April 18, 5:00 PM, Auditorium 4

Director: Vaishali Sinha
 Producers: Vaishali Sinha, Mridu Chadra
 USA/ 95 Min

Mahinder Watsa is a 92-year-old OBGYN with a wildly popular sex advice column in Mumbai. Watsa dispenses advice daily on matters ranging from the mundane to the risqué with a no-nonsense approach that readers find refreshing and illuminating in a country that provides little if any sexual education in schools. His conviction that talking openly about pleasure and consent is vital for achieving gender-equality in India flies in the face of his conservative detractors, who would like nothing more than for his column to disappear.

Preceded by HEARTBREAK FACTORY

In English and Hindi with English Subtitles

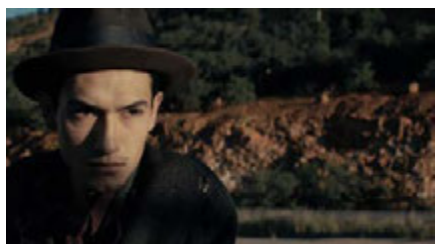

BISBEE '17

Wednesday, April 18, 2:30 PM, Auditorium 4
Saturday, April 21, 8:15 PM, Auditorium 5

Director: Robert Greene
 Producers: Douglas Tirola, Susan Bedusa, Bennett Elliott
 USA/ 118 Min

The old mining town of Bisbee, Arizona is haunted by the ghosts of its past, figuratively and literally. Bisbee was the site of a brutal deportation of 1,200 striking miners, most of them immigrants, who were left to die in the desert. Filmed during the centennial of this shocking but mostly forgotten event, **BISBEE '17** follows residents and descendants as they reenact the deportation. For some, the reenactment dredges up painful personal history; for others, it shifts their worldview.



CHEF FLYNN

Friday, April 20, 1:45 PM, Auditorium 4
Sunday, April 22, 12:00 PM, Auditorium 4

Director: Cameron Yates
 Producer: Laura Coxson
 USA/ 88 Min

With a bedroom-based kitchen lab at age 10, an elaborate supper club at age 12, and stints in top New York, Los Angeles, and European restaurants before age 16, Flynn McGarry is a remarkable rising star in the culinary world. Flynn's mother, Meg McGarry, herself an artist, thoroughly documented his childhood forays into gastronomy, and **CHEF FLYNN** mixes these home movies with five years' worth of documentary footage by director Cameron Yates.

Preceded by I HEART NY

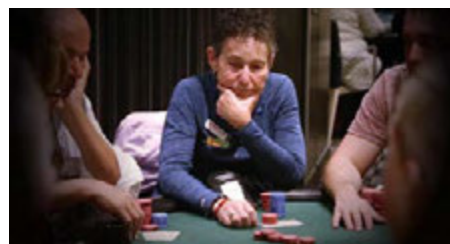

CRACKING ACES: A WOMAN'S PLACE AT THE TABLE

Sunday, April 15, 10:00 AM, Auditorium 6
Monday, April 16, 5:45 PM, Auditorium 7

Director: H. James Gilmore
 Producers: Tracy Halcomb
 USA/ 65 Min

CRACKING ACES tells the fascinating story of the pioneering women who broke through the glass ceiling of professional poker, challenging stereotypes and battling a hostile environment where women were often abused, insulted, and sexually harassed. In the last decade, the Internet—and the anonymity that it provides—has been a factor in opening up the game of poker to more and more women.



CRIME + PUNISHMENT

Sunday, April 15, 1:00 PM, Auditorium 6
Friday, April 20, 11:15 AM, Auditorium 6

Director: Stephen Maing
 Producers: Stephen Maing, Ross Tuttle,
 Eric Daniel Metzgar
 USA/ 111 Min

CRIME + PUNISHMENT follows the NYPD12, a group of New York Police Department officers determined to expose the department's illegal quotas practice, where officers are penalized if they do not reach a certain number of arrests and summonses per month. Through hidden-camera footage, firsthand accounts, and personal testimonies by the officers and the young minorities who have been overwhelmingly targeted, CRIME + PUNISHMENT is a historic document on corruption in law enforcement.

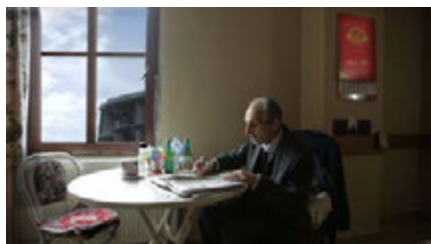

DISTANT CONSTELLATION

Saturday, April 14, 3:15 PM, Auditorium 4
Tuesday, April 17, 4:00 PM, Auditorium 4

Director: Shevaun Mizrahi
 Producers: Deniz Buga, Shelly Grizim
 USA, Turkey, Netherlands/ 91 Min

Shevaun Mizrahi's newest film DISTANT CONSTELLATIONS is an elliptical look at life in a Turkish nursing home. Life there is cyclical, sometimes to the point of absurdity, but it speaks to the existential beauty of growing old through the minutiae of living, and the wisdom of experience. This film won the Special Mention—Filmmakers of the Present Award at Locarno in 2017.

Preceded by ROADSIDE ATTRACTIONS

In Turkish, English and French with English subtitles

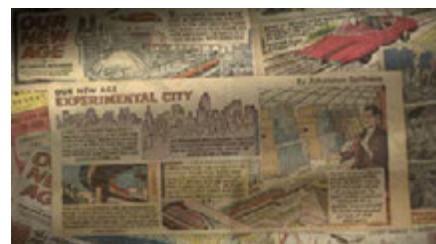

THE EXPERIMENTAL CITY

Saturday, April 21, 4:30 PM, Auditorium 5
Sunday, April 22, 8:15 PM, Auditorium 5

Director: Chad Freidrichs
 Producers: Chad Freidrichs, Jaime Freidrichs, Brian Woodman
 USA/ 96 Min

Imagine if urban infrastructure was reimagined to operate like a living organism that existed on what it produced and produced everything it needed to exist. During the 1960s and '70s the federal government funded a committee of leading inventors, scientists, architects, and futurists who devised comprehensive plans to achieve just that. If this sounds like something out of a '60s sci-fi comic strip, that's because the leader of the initiative, Dr. Athelstan Spilhaus, was also the comic artist for The Boston Globe who popularized this Jetsonesque vision for the future.



FATHER'S KINGDOM

Sunday, April 15, 2:00 PM, Auditorium 4
Thursday, April 19, 3:15 PM, Auditorium 7

Director: Lenny Feinberg
 Producers: Claire Chandler, Nancy Cutler,
 Lenny Feinberg, Chris Foster, Kevin Koltz
 USA/ 94 Min

Father Divine's immeasurable impact on the Civil Rights movement is oft overlooked by historians. He preached a message of unity, tolerance, and unconditional love, and was able to provide life-giving services and supplies to underrepresented communities via his worldwide network of disciples. His legacy continues amongst a small contingency of faithful outside of Philadelphia. In fact, they still call him God, and speak to him on a daily basis, despite his being dead for half a century.



FREEDOM FOR THE WOLF

Wednesday, April 18, 2:45 PM, Auditorium 5
Thursday, April 19, 8:30 PM, Auditorium 6

Director: Rupert Russell
 Producers: Patrick Hamm, Camilla Hall
 Germany/ 109 Min

Democracy is in crisis. Political leaders all across the globe are abusing their powers. Economic equality is dissolving as the rich become richer, and the poor become angrier. The first film to provide a global scale to the political upheaval that the Trump election resulted in, it follows common people fighting against the system, such as subversive comedians in India, a rapper in Tunisia, and young students in Hong Kong.

Preceded by FIGHT FOR THE FIRST

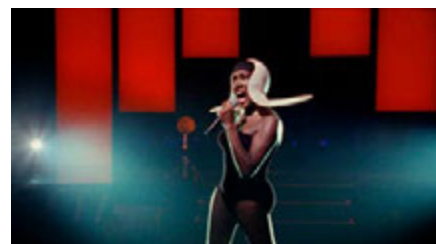

GRACE JONES: BLOODLIGHT AND BAMI

Saturday, April 14, 4:15 PM, Auditorium 7
Tuesday, April 17, 7:30 PM, Auditorium 7

Director: Sophie Fiennes
 Producers: Katie Holly, Sophie Fiennes,
 Beverly Jones, Shani Hinton
 UK, Ireland/ 115 Min

Director Sophie Fiennes returns to SFF with a brand new documentary on Grace Jones, the Jamaican born model, singer, and New Wave icon. But she's much more than the Bond girl from A VIEW TO A KILL. "Bloodlight" refers to the red recording light in a recording studio. "Bami" refers to bread--thus, art and life. Shot over 10 years, GRACE JONES: BLOODLIGHT AND BAMI explores the artists life and persona onstage and off.



THE GREAT FLIP-OFF

Sunday, April 15, 12:00 PM, Art Ovation

Director: Dafna Yachin
Producers: Dafna Yachin
USA/ 102 Min

Dafne Yachin's THE GREAT FLIP-OFF follows bareback riding families in the shadow of the decline of the Circus industry. Hailing from Italy, Mexico, Hungary, France, and beyond, they've all come to discuss the joys, the heartbreak, and the future of working in an industry with uncertain future after the closure of Ringling Bros. and Barnum and Bailey Circus after nearly 150 years.

WORLD PREMIERE



HALF THE PICTURE

Saturday, April 14, 10:05 AM, Auditorium 4
Monday, April 16, 6:45 PM, Auditorium 6

Director: Amy Adrion
Producers: Amy Adrion, David Harris
USA/ 94 Min

HALF THE PICTURE examines the dismal number of women directors working in Hollywood, and the challenges women filmmakers face: sexual harassment, sexism, male and societal discomfort with female leadership, and the added barrier of racial discrimination. Such successful women directors as Ava DuVernay, Lena Dunham, Jill Soloway, and Rosanna Arquette talk about their career paths, struggles, inspirations, and hopes for the future.



KILLER BEES

Thursday, April 19, 5:30 PM, Auditorium 7
Saturday, April 21, 11:45 AM, Auditorium 6

Director: Ben Cummings, Orson Cummings
Producers: Ben Cummings, Orson Cummings, Larry Gagolian, Eric S. Lane, Hilary McHone, Shaquille O'Neal
USA/ 85 Min

KILLER BEES explores the history of a famed high school basketball team in a community that's finding itself increasingly sidelined. Bridgehampton High may be tiny, but its championship team, preparing to defend their state title, is a symbol of hope for an African American community fighting gentrification and extreme income inequality in the midst of the Hamptons, one of the country's wealthiest communities.



LA FLOR DE LA VIDA

Sunday, April 15, 2:15 PM, Auditorium 7
Thursday, April 19, 12:45 PM, Auditorium 5

Director: Adriana Loeff, Claudia Abend
Producers: Adriana Loeff, Claudia Abend
Uruguay/ 86 Min

What is love? We meet a colorful group of candid individuals and their better halves who shed some light on the matter—some reflecting fondly on a love life shaped by many passionate encounters, others tied inextricably to a life partner of many decades. And then we meet Aldo and Gabriella, who, in the twilight of their lives, have chosen to split amicably. This is a story not just about romance but also about letting go, and the love that perseveres despite irreconcilable differences.

In Spanish with English subtitles

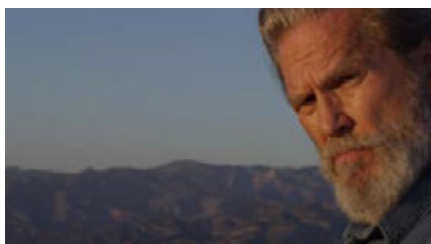

LIVING IN THE FUTURE'S PAST

Saturday, April 21, 11:30 AM, Auditorium 5
Sunday, April 22, 5:45 PM, Auditorium 7

Director: Susan Kucera
Producers: Jeff Bridges
USA/ 84 Min

Academy Award® winner Jeff Bridges presents this meditation on humanity's relationship to the natural world: questioning who we are, how we think, and how it all relates to the environmental challenges we now face. Bridges, alongside prominent scientists and authors, weaves evolution, emergence, entropy, dark ecology, and what some are calling the end of nature, into a story that helps us understand our place on Earth.



LOTS OF KIDS, A MONKEY AND A CASTLE (MUCHOS HIJOS, UN MONO Y UN CASTILLO)

Saturday, April 14, 12:30 PM, Auditorium 5
Wednesday, April 18, 5:15 PM, Auditorium 5

Director: Gustavo Salmerón
Producer: Gustavo Salmerón
Spain/ 95 Min

One could say that Gustavo Salmerón's debut film, LOTS OF KIDS, A MONKEY AND A CASTLE, is "just a home movie," but that would be ignoring the real star of the show: his mother, Julita. This matriarch has had three dreams in life: she wants lots of kids, a monkey, and a castle. And as the living definition of "living larger than life," it's fitting that all of her dreams come true. But for how long?

In Spanish with English subtitles



MATANGI / MAYA / M.I.A.

Monday, April 16, 8:15 PM, Auditorium 7

Director: Stephen Lovridge
Producers: Lori Cheattle, Andrew Goldman, Paul Mezey
Sri Lanka, UK, USA/ 93 Min

An autobiographical look at the life and career of London-born M.I.A. (Mathangi "Maya" Arulpragasam) as told through the lens of filmmaker Stephen Lovridge. Covering her early years to her pop stardom, it's an honest portrayal of a modern artist and what helped make her who she is today. During the course of a decade, Lovridge sorted through over 700 hours of footage, much of it taken by Arulpragasam herself, and only a longtime friend and former classmate could put together such a personal portrayal.



MAYNARD

Monday, April 16, 7:30 PM, Auditorium 3
Friday, April 20, 11:30 AM, Auditorium 4

Director: Sam Pollard
Producers: Wendy Eley Jackson, Maynard Jackson III, Dolly Turner, Daphne McWilliams, Winsome Sinclair, Donald Jarmond, Autumn Bailey-Ford, Karl Carter
USA/ 99 Min

Called by some the Obama before Obama, Maynard Jackson Jr. achieved an unprecedented success in 1973: he became the first black mayor of the Capital of the South, Atlanta. This documentary follows Maynard's life and challenges as he fought to make Atlanta a country leader. The father of Affirmative Action, he represented a much needed change in the political atmosphere of the South away from exclusion and bigotry, toward that of acceptance and progress.



OLD DOG

Saturday, April 14, 6:30 PM, Auditorium 3
Sunday, April 15, 11:30 AM, Auditorium 7

Director: Sally Rowe
Producers: Sally Rowe, Benjamin Breen, Regina Sobel, Alan Oxman, Roland Rojas
USA/ 79 Min

Paul Sorenson, a farmer in New Zealand, has spent the last several decades developing more intuitive training techniques for sheep dogs. He's spending his last few years before retirement teaching the next generation of shepherds these methods. Reflecting on the turmoil of his early life, and the difficult choices he made in pursuit of his love for dogs, Paul opens up and reveals his secrets and wisdom about dogs and life.

Preceded by GIVE UP THE GHOST

WORLD PREMIERE

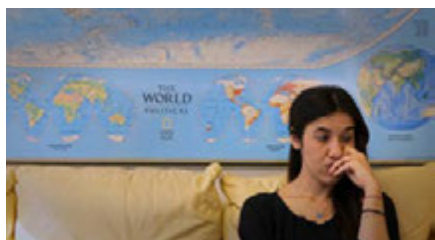

ON HER SHOULDERS

Saturday, April 14, 2:00 PM, Auditorium 4
Tuesday, April 17, 2:30 PM, Auditorium 7

Director: Alexandria Bombach
Producers: Hayley Pappas, Brock Williams
USA, Greece, Canada, Germany/ 96 Min

Nadia Murad is a human-rights activist from Iraq and a Yazidi, a Kurdish religious minority, captured by ISIS in August 2014. Since escaping in 2017, Nadia has emerged as the international voice for her people. Nominated for the 2016 Nobel Peace Prize, she was named the first UN Goodwill Ambassador for Human Trafficking in September 2016. ON HER SHOULDERS won the Directing Award: U.S. Documentary at the 2018 Sundance Film Festival.

In English, Kurmanji and Arabic with English subtitles

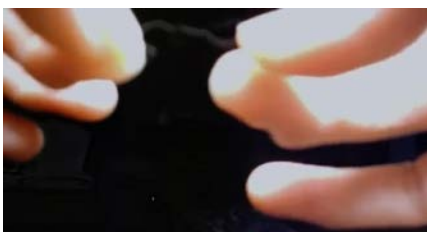

THE PAIN OF OTHERS

Friday, April 20, 9:30 PM, Cityside Auditorium 8
Saturday, April 21, 8:00 PM, Auditorium 3

Director: Penny Lane
Producer: Gabriel Sedgwick
USA/ 71 Min

According to the CDC, Morgellons disease is an "unexplained dermatopathy" not caused by infection or parasites. It predominantly affects middle-aged white women who all report the same symptoms: memory loss, bizarre lapses in time, a sensation of something crawling beneath their skin, and worm-like filaments emerging from rashes or sores. The medical community dismisses Morgellons disease as a symptom of mental illness. In this found footage documentary, you'll meet those afflicted with Morgellons, see their proof, and witness a community whose only hope for cure is sharing their stories and home-remedies online.

US PREMIERE

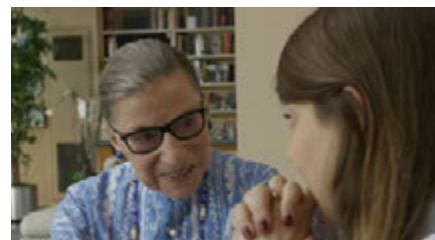

RBG

Saturday, April 14, 7:30 PM, Auditorium 3
Tuesday, April 17, 5:30 PM, Auditorium 5

Director: Betsy West and Julie Cohen
Producers: Betsy West and Julie Cohen
USA/ 97 Min

U.S. Supreme Court Justice Ruth Bader Ginsburg has followed a life path that is fascinating and unique, leading to her becoming, at age 84, an extraordinary legal legend and a feminist "pop culture icon." The film explores the life of "the notorious RBG" from an early age, through college and law school and meeting the love of her life, on to her family and career, culminating with her years at the Supreme Court.



RODENTS OF UNUSUAL SIZE

Saturday, April 21, 4:15 PM, Auditorium 4
Sunday, April 22, 2:15 PM, Auditorium 4

Director: Quinn Costello, Chris Metzler & Jeff Springer
 Producers: Chris Metzler, Quinn Costello & Jeff Springer
 USA/ 71 Min

Narrated by THE WIRE'S Wendell Pierce, the devastation from hurricanes and oil spills has led the population of coastal Louisiana to become very familiar with nature's dark side. But now, there's a new threat: a massive, invasive species of rodent with orange teeth from South America that is destroying the ecosystem—and repopulating faster than they can be killed—called the nutria. Thomas Gonzalez leads a team of bounty hunters to fight against the destructive rodents.



SISTERS

Sunday, April 15, 1:30 PM, Auditorium 3
Monday, April 16, 1:00 PM, Auditorium 7

Director: Justyna Tafel
 Producers: Monika Soba_ska
 Poland, Afghanistan/ 75 Min

Three brave and inspiring sisters shine a light upon the dark and bright sides of the life of women in Afghanistan. Traditional mentality forbids them to work, study, leave the house without their husband or a relative, enjoy entertainment, or even visit a doctor. But they still have their resistance strategies and they fight for independence.

Preceded by I AM REBECCA

WORLD PREMIERE

In English, Farsi and Dari with English subtitles



THAT SUMMER

Sunday, April 15, 5:00 PM, Auditorium 3
Friday, April 20, 11:00 AM, Auditorium 5

Director: Göran Hugo Olsson
 Producers: Joslyn Barnes, Nejma Beard
 Sweden, Denmark, United States/ 80 Min

Thought to be lost for decades, THAT SUMMER is a remarkable film project spearheaded by artist Peter Beard and his friend Lee Radziwill, about her eccentric aunt and cousin, "Big Edie" and "Little Edie" Beale, best known from GREY GARDENS, the 1975 Maysles brothers documentary that peeked inside their bohemian Hamptons estate of the same name. The film is a curated look at the creative community on 1970s Montauk, Long Island, and features appearances from the filmmakers themselves, as well as fashionable artists Edith Ewing Bouvier Beale, Edith Bouvier Beale, and Andy Warhol.



THREE IDENTICAL STRANGERS

Tuesday, April 17, 6:15 PM, Auditorium 4
Sunday, April 22, 7:45 PM, Auditorium 7

Director: Tim Wardle
 Producers: Becky Read
 USA/ 100 Min

The wild tale of Bobby Shafan, Eddy Galland, and David Kellman—three identical triplets separated at birth and brought together by chance in their early 20s—provides definitive proof that truth can be much stranger than fiction. Director Tim Wardle proves to be a master storyteller, bringing the audience along as the story to careens from an eccentric look at the reunited triplets taking 1980s New York by storm, to an evocative portrait of family, friendship, and mental illness, to an investigation of the sinister conspiracy at the root of the triplets' separation.



A TUBA TO CUBA

Saturday, April 21, 1:30 PM, Art Ovation

Director: T.G. Herrington, Danny Clinch
 Producers: Nicelle Herrington, Han Soto
 USA, Cuba/ 84 Min

New Orleans's famed Preservation Hall Jazz Band traces their musical roots from the city of jazz down to Cuba, in search of the indigenous music that gave rise to jazz. The band finds deep cultural connections in dark, shared histories of slavery as well as modern reflections of their own city in Cuba's hardships and struggles. Encounters with iconic Cuban musicians spark spontaneous and beautiful musical interludes in living rooms and in the streets, culminating in one last raucous performance before the band returns home, inspired, to work on their new album.

SHORTS 1 - NARRATIVE COMPETITION

99 Min | Thursday, April 19, 12:30 PM - Auditorium 6 | Friday, April 20, 2:15 PM - Cityside Auditorium 8

SHORT FILMS

SEE FILM GUIDE



CHILDREN LEAVE AT DAWN

Director: Manon Coubia
France/ 23 Min

An unexpected meeting with her estranged son forces Macha to confront her fears before he becomes a mountain infantryman in the French military.

In French with English subtitles



COPA-LOCA

Director: Christos Massalas
Greece/ 14 Min

This is the story of Copa-Loqa, an abandoned Greek summer resort. Paulina is the girl at the heart of Copa-Loqa. Everyone cares for her and she cares about everyone—in every possible way.

In Greek with English Subtitles



FOR NONNA ANNA

Director: Luis De Filippis
Canada/ 13 Min

A trans girl has to care for her Italian grandmother. She assumes that her Nonna disapproves of her—but instead discovers a tender bond in their shared vulnerability.

In French and English with English subtitles



LUNCH TIME

Director: Alireza Ghasemi
Iran/ 15 Min

A 16-year-old girl arrives at a hospital to identify the body of her mother but must first convince the staff to let her into the morgue.

In Persian with English subtitles



OSTOJA WILL MOVE YOUR PIANO

Director: Sandra Mitrovic
Serbia/ 15 Min

Today is a day when Ostoja, a legendary piano mover from Belgrade, gets a special delivery.

In Serbian with English subtitles



THE PRESIDENT'S VISIT

Director: Cyril Aris
Lebanon, Qatar, USA/ 19 Min

When a small coastal town of fishermen learns about the President's secret visit to its local soap shop, they embark in an everlasting struggle at cleaning up and maintaining the perfect image of their town.

In Arabic with English subtitles

SHORTS 2 - DOCUMENTARY COMPETITION

97 min | Friday, April 20, 11:45 AM - Cityside Auditorium 8 | Saturday, April 21, 10:15 AM - Auditorium 3

SARASOTA FILM FESTIVAL.COM



THE EARTH IS HUMMING

Director: Garrett Bradley
USA, Japan/ 14 Min

Japan has been preparing for a magnitude 7 earthquake predicted to hit Tokyo within the next 30 years.

In Japanese with English subtitles



MOTHER'S DAY

Director: Elizabeth Lo, R.J. Lozada
USA/ 9 Min

An annual bus service that takes children to visit their mothers in prison explores the impact of mass incarceration on a generation of youth.



NUUCA

Director: Michelle Latimer
USA, Canada/ 13 Min

An evocative meditation on Indigenous women's integral connection to the land and the ways in which the extractive industry's rape of the earth is directly linked to the violence perpetrated against Indigenous women and girls.



SAND MEN

Director: Tal Amiran
UK/ 14 Min

With their families in Romania depending on them, three men try to survive by creating sand sculptures on London's streets.



THE TERRORIST HUNTER

Director: Ann Shin
USA, Canada/ 33 Min

Rita Katz, a controversial spy, is lauded by some for her work fighting terrorism, and criticized by others who say she creates terrorist plots where none exist. THE TERRORIST HUNTER explores how fear and terror play out in our society.



VOLTE

Director: Monika Kotecka, Karolina Poryza
Poland/ 14 Min

Twelve-year-old Zuzia has been training to vault for two years and has an extraordinary role topping the acrobatic pyramid. During practice sessions it becomes apparent that she has lost some of her grace and lightness.

In Polish with English subtitles

SHORTS 3 - ANIMATED COMPETITION

86 min | Thursday, April 19, 4:45 PM - Auditorium 3 | Friday, April 20, 7:15 PM - Cityside Auditorium 8



AGUA VIVA

Director: Alexa Lim Haas
USA/ 7 Min

A Chinese manicurist in Miami attempts to describe feelings she doesn't have the words for.



THE ALLIGATOR HUNTER

Director: Kyle V James, Mallori Taylor, Michael Bourne
USA/ 4 Min

After losing his wife in a traumatic attack, an elderly hunter seeks revenge on the culprit: a massive albino alligator.



BARTLEBY

Director: Laura Naylor, Kristen Kee
USA/ 11 Min

An unassuming Wall Street lawyer finds himself beset by a new employee, Bartleby, who refuses to work—in an ongoing act of passive refusal, he simply “prefers not to.” A quiet, dogged battle of wills ensues in this stop-motion reimagining of a Melville classic.

In Swedish with English subtitles



THE BURDEN

Director: Niki Lindroth von Bahr
Sweden/ 14 Min

A dark musical enacted in a modern market place. The employees of the various commercial venues deal with boredom and existential anxiety by performing cheerful musical turns.

In Swedish with English subtitles



THE DRIVER IS RED

Director: Randall Christopher
USA/ 15 Min

Set in 1960 Argentina, this true-crime documentary follows the story of secret agent Zvi Aharoni as he hunted down one of the highest-ranking Nazi war criminals on the run.

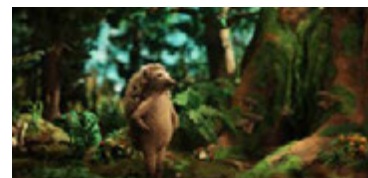

HEDGEHOG'S HOME

Director: Eva Cvijanovi_
Canada, Croatia/ 10 Min

In a lush and lively forest lives a hedgehog. He is respected and envied by the other animals. However, Hedgehog's unwavering devotion to his home annoys a quartet of insatiable beasts.

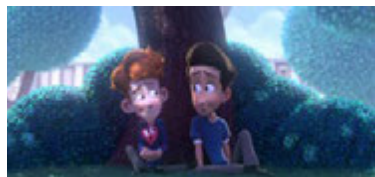

IN A HEARTBEAT

Director: Beth David, Esteban Bravo
USA/ 4 Min

A closeted boy runs the risk of being outed by his own heart after it pops out of his chest to chase down the boy of his dreams.



NEGATIVE SPACE

Director: Max Porter, Ru Kuwahata
France/ 6 Min

My dad taught me how to pack.

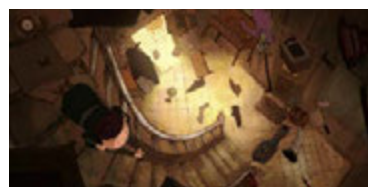

WEEKENDS

Director: Trevor Jimenez
USA/ 15 Min

The story of a young boy shuffling between the homes of his recently divorced parents. Surreal, dream-like moments mix with the domestic realities of a broken family in this hand-animated film set in 1980s Toronto.

SHORTS 4 - NARRATIVE 1

100 min | Saturday, April 14, 1:00 PM - Cityside Auditorium 8 | Tuesday, April 17, 3:45 PM - Auditorium 3

SHORT FILMS



ARIA

Director: Myrsini Aristidou
Cyprus, France/ 13 Min

Aria is waiting for a driving lesson with her father. When he arrives, it is not to go for a drive; instead he confides in her the care of a young Chinese immigrant who speaks neither Greek nor English.

In Greek with English Subtitles



BEAST

Director: Leonora Lonsdale
UK/ 19 Min

When Alice's mother, Grace, tells her that her father's a "beast," Alice begins to question who or what she really is.



LOCKDOWN

Director: Max Sokoloff
USA/ 15 Min

When a high school misfit is taken hostage by a classmate with a gun, he must find common ground with the shooter in order to survive the perilous standoff.



OKSIJAN

Director: Edward Watts
UK/ 19 Min

The incredible true story of a seven-year-old Afghan boy's fight to survive as he is smuggled to the UK in the back of a refrigerated lorry.



POLA

Director: Edyta Remba_a
Poland/ 20 Min

Eleven-year-old Pola will do anything to keep her mother with her family at home.



THE THINGS YOU THINK I'M THINKING

Director: Sherren Lee
Canada/ 14 Min

Canada A black male burn-survivor and amputee goes on a date with a regularly-abled man.

SEE FILM GUIDE

SHORTS 5 - NARRATIVE 2

87 min | Monday, April 16, 5:00 PM - Auditorium 3 | Wednesday, April 18, 3:45 PM - Auditorium 7

SARASOTA FILM FESTIVAL.COM



EASY AS...

Director: Andrea Niada
UK/ 16 Min

Two very English gentlemen sit in a very English living room attempting to find something that is universally easy. Flowing port wine and mounting frustration lead to a most un-English conclusion.



GLORIA TALKS FUNNY

Director: Kendall Goldberg
USA/ 18 Min

When struggling voice actress Gloria discovers her agent failed to tell her that her claim-to-fame cartoon is being remade, she sets her sights on reprising her role as the famous BioBoy.



LONG TERM DELIVERY

Director: Jake Honig
USA/ 16 Min

A short comedy about a secret division of the United States Postal Service.



SHERRY

Director: Mary Gulino
USA/ 11 Min

Sherry is the wallflower office manager of a dance studio, who finally acts on her dream of leading a class of her own.

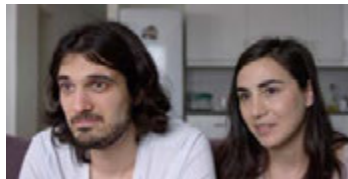

WELCOME HOME

Director: Armita Keyani
Norway/ 16 Min

Set in the north of Norway, an Iranian refugee couple invites two Jehovah's Witnesses in when they knock on their door.

In Norwegian, English and Farsi with English subtitles

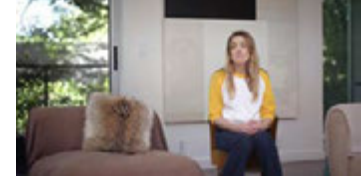

MAUDE

Director: Anna Margaret Hollyman
USA/ 10 Min

Teeny thought it was just another routine babysitting job—until she's shocked to meet the client. As the day goes on, Teeny decides to become the woman she had no idea she always wanted to be... until she gets caught.

SHORTS 6 - NARRATIVE 3

89 min | Saturday, April 14, 6:45 PM - Cityside Auditorium 8 | Sunday, April 15, 10:45 AM - Auditorium 8



BIRTHRIGHT

Director: Mauritz Solberg, Daniel Schwarz
Norway/ 21 Min

What if you had to acquire a license to become a parent?

In Norwegian and English with English subtitles

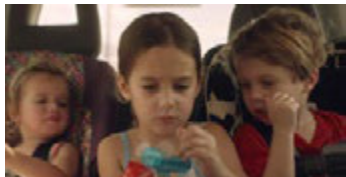

CAROLINE

Director: Logan George, Celine Held
USA/ 12 Min

When plans fall through, a six-year-old is faced with a big responsibility on a hot Texas day.



EVE

Director: Susan Bay-Nimoy
USA/ 22 Min

EVE exposes a 74-year-old woman's journey through grief, sexual passion, and renewal.



MOTHER, MOTHER

Director: Robert Machoian, Rodrigo Ojeda-Beck
USA/ 16 Min

A mother sneaks off in the middle of the night.

WORLD PREMIERE



THE VIEW FROM UP HERE

Director: Marco Calvani
USA, France/ 18 Min

Claire and Lila live in the same building, but they hardly know each other. Until today, when Claire decides to pay a visit to Lila, a refugee from Syria, and to ask for something that will definitely put at risk the cohabitation.



*Southwest Florida's
Premier Recording Studio*

burntorangesoundstudio.com | 941.751.2570 | 6003 28th St E B, Bradenton, FL 34203

SHORTS 7 - DOCUMENTARY 1

91 min | Tuesday, April 17, 6:00 PM - Auditorium 3 | Wednesday, April 18, 3:15 PM Auditorium 3

SHORT FILMS



63 BOYCOTT

Director: Gordon Quinn
USA/ 31 Min

'63 BOYCOTT connects the forgotten story of one of the largest northern civil rights demonstrations in 1963 to contemporary issues around race, education, and youth activism.



GAVIN GRIMM VS.

Director: Nadia Hallgren
USA/ 19 Min

In 2016, transgender teen Gavin Grimm sued his local school board after its members refused to let him use the bathroom of his choice. He was ready to take his case all the way to the Supreme Court—and then the election happened.



MONUMENT | MONUMENTO

Director: Laura Gabbert
USA/ 12 Min

At Friendship Park, a unique meeting place along the U.S.–Mexico border, family members and loved ones from both countries can see and speak to each other through a meshed fence, but they cannot touch.



SECOND ASSAULT

Director: Amy Rosner, Jillian Corsie
USA/ 19 Min

In 2005, Jillian was sexually assaulted on her college campus. After reporting it, she experienced a life-altering encounter with the police. Twelve years later, she embarks on a journey to confront the system that failed her.

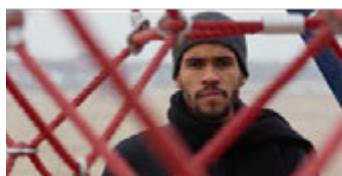

WORLD IS ROUND SO THAT NOBODY CAN HIDE IN THE CORNERS, THE - PART I: REFUGE

Director: Leandro Goddinho
Germany/ 10 Min

The journey of an African gay refugee seeking asylum in Germany.

In Arabic with English subtitles

SFF FILM GUIDE

SHORTS 8 - DOCUMENTARY 2

91 min | Sunday, April 15, 1:15 PM - Cityside Auditorium 8 | Monday, April 16, 8:30 PM - Auditorium 5



MR. CONNOLLY HAS ALS

Director: Dan Habib
USA/ 32 Min

A high school principal is embraced by his community as he continues to lead the school, despite rapidly losing his ability to walk and speak due to the debilitating effects of Amyotrophic Lateral Sclerosis (ALS).



MY PAINTBRUSH BITES

Director: Joel Pincosy, Co-director Joe Egender
USA/ 16 Min

A man battling reclusion and a racehorse on the brink of death save each other in unexpected ways.



NELLIE BLY MAKES THE NEWS

Director: Penny Lane
USA/ 23 Min

Nellie Bly was a legendary journalist who changed the game for women in reporting before women even had the right to vote.



ODE TO JOY

Director: Michael Koshkin
USA/ 12 Min

The elderly residents of a Houston retirement home make the best of their remaining days by playing in a kazoo band.



VIEW FROM THE WINDOW, A

Director: Azar Kafaei, Chris Filippone
USA/ 8 Min

An immersive glimpse of a school day through the eyes of deaf children.

SARASOTA FILM FESTIVAL.COM

70

SHORTS 9 - MIDNIGHT SHORTS

85 min | Saturday, April 14, 10:00 PM - Auditorium 3 | Monday, April 16, 10:00 PM - Auditorium 3

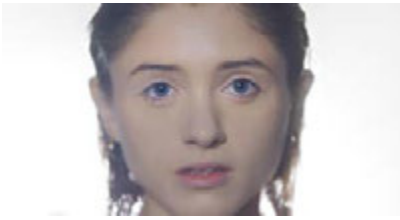

AFTER HER

Director: Aly Migliori
USA/ 15 Min

A wayward teenage girl goes missing and her friend is haunted by her disappearance. An atmospheric sci-fi about first love.



CREEPER

Director: Drew Macdonald
Australia/ 12 Min

After a night out, a young woman is unknowingly followed into her home by her "ride-share" driver—resulting in a dangerous game of cat and mouse that explores the lengths people will go to connect in the modern world.



FATHER

Director: Chris Keller
UK/ 10 Min

A young boy lives with his mother who is not terribly interested in giving him the attention he needs. There is also a father figure, but unfortunately for the boy, he is much worse.



FIX HISTORY

Director: Mitchell Zemil
USA/ 4 Min

A feral woman discovers of a strange, mysterious energy lying in the woods. Drawn to it magnetically, her attempts to embrace this power become a struggle not to be engulfed by it.

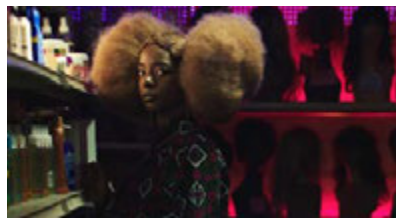

HAIR WOLF

Director: Mariama Diallo
USA/ 12 Min

At a black hair salon in gentrifying Brooklyn, the local residents fend off a strange new monster: white women intent on sucking the lifeblood from black culture.

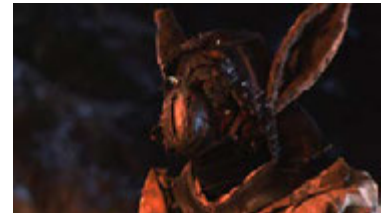

SPIRITUS LEPUS

Director: Kristofer Kiggs Carlsson
Sweden/ 20 Min

Hidden amongst the mythical undergrowth in a grimy operation room, six Rabbit Humanoid Surgeons haphazardly fight to save the life of a damaged soul.

WORLD PREMIERE



MOTHER FUCKER

Director: Nicholas Payne Santos
USA/ 6 Min

Charles is deeply in debt and desperate to save his kidnapped dog.

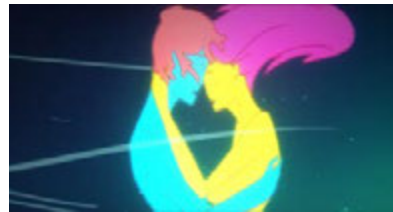

THE NIGHT I DANCE WITH DEATH

Director: Vincent Gibaud
France/ 6 Min

Unable to engage at a party, Jack consumes a psychedelic drug allowing him to shed his worry and enjoy the moment. But soon Jack must confront an anxiety he just cannot escape.

In French with English subtitles

SHORTS 10 - NYU SHORTS

84 min | Saturday, April 14, 4:30 PM - Cityside Auditorium 8 | Monday, April 16, 2:45 PM - Auditorium 3

SHORT FILMS

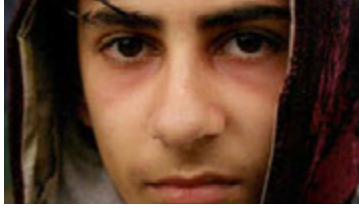

AAMIR

Director: Vika Evdokimenko
UK, USA/ 16 Min

Thirteen-year-old Aamir is stranded alone in the largest unofficial refugee camp in Europe. When he is befriended by Katlyn, a thinly stretched volunteer, she becomes Aamir's last hope for salvation.

In English and Kurtish with English subtitles



AMENITIES

Director: Jack Kendrick
USA/ 7 Min

A contractor taking measurements of a client's house has an unusual intimate encounter.

WORLD PREMIERE



AQUACULTURE

Director: Artemis Shaw
USA/ 12 Min

The employees of a cult-like biotech start-up test their product on themselves.

WORLD PREMIERE

SEE FILM GUIDE



ARNIE JOHNSTONE & THE VULVA TREE

Director: Jesse Swenson
USA/ 11 Min

A family man objects to the presence of an obscene tree in his upstanding neighborhood.



BURN BRIDGE

Director: Rhys Marc Jones
UK, USA/ 16 Min

Closeted teenager Harry has fallen for Jamie, his closest friend in their homophobic friendship group. When Lucy arrives on the scene, Harry must contend for Jamie's attention, bringing his true feelings closer to light.



HOUSEPLANTS

Director: Prashanth Kamalakanthan
USA/ 9 Min

As a couple moves in together, full of hope and worry, their day is unexpectedly interrupted by the ghosts of former relationships.

SARASOTA FILM FESTIVAL.COM



LIFE AFTER

Director: Ria Tobaccowala
USA/ 13 Min

While packing up her daughter's apartment, a single mother discovers startling details about her only child, which challenge her ability to process a recent loss.

SHORTS 11 - FLORIDA SHOWCASE

87 min | Sunday, April 15, 3:00 PM - Art Ovation | Saturday, April 21, 11:00 AM - Art Ovation

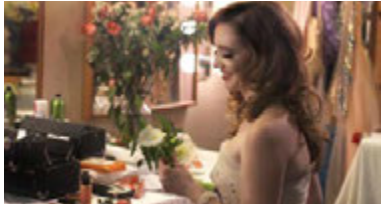

50 WORDS

Director: Mark Palmer
USA/ 28 Min

A newly single actress desperate for ways to meet men rewrites her bio in the theater program as a personal ad and suddenly finds herself swamped with admirers.

WORLD PREMIERE



BARELY THERE

Director: Hannah Lee
USA/ 3 Min

A baby polar bear searches for his missing mother, while a force much colder than the frozen tundra searches for him.



DOLLMAKER, THE

Director: Al Lougher
USA/ 10 Min

A grieving mother latches on to a magical surrogate for her lost child. But small miracles come with big consequences.



EXTINGUISHED

Director: Ashley Anderson, Jacob Mann
USA/ 4 Min

In a world where flames represent love, it's easy to get your heart burned.



FULL CIRCLE

Director: Raymond Knudsen
USA/ 8 Min

An accomplished NFL wide receiver looks beyond the football field in hopes to change the lives of the people from his poor hometown of Pahokee, Florida.



LADY PLUM

Director: Grayson Goga
USA/ 8 Min

Sylvia, a young mother who once showed promise as a competitive swimmer, overcomes her dark past in order to secure a future with her daughter, Plum.



SARASOTA ORCHESTRA:

A WEEK IN THE LIFE

Director: Austin McKinley
USA/ 12 Min

Follow the production team of the Sarasota Orchestra as they show you what it takes to wrangle a professional traveling orchestra through a week of concerts.

WORLD PREMIERE



SHED

Director: Andy McEntire, Matt Burch
USA/ 13 Min

A woman struggles to find a deeper purpose within the grind of marriage and motherhood.

SHORTS 12 - YOUTHFEST (ALL AGES)

60 min | Saturday, April 14, 11:00 AM - Cityside Auditorium 8 | Sunday, April 22, 12:45 PM - Cityside Auditorium 8

SHORT FILMS

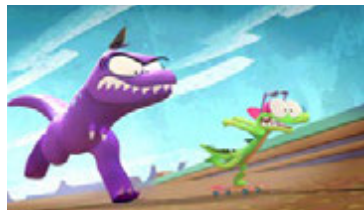

ALLISK8R

Director: Anna Prado
USA/ 2 Min

A plucky little skater gator makes an epic escape from the tyrannical dino law.

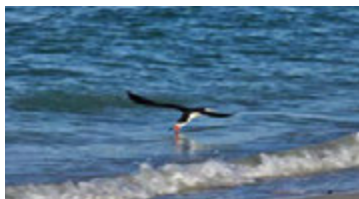

BLACK SKIMMERS OF LIDO BEACH

Director: Darryl Saffer
USA/ 14 Min

Black skimmers have nested along Florida shores for centuries. The challenges they face have shown their resilience and adaptability. But now they face the ultimate test.



ELIZABETH SEES

Director: Val Magarian
Canada/ 8 Min

A blind woman, with just a small dot of vision, must reconstruct the world around her, piece by piece. Before her sight is entirely gone, she must find a way to see it all.

SEE FILM GUIDE



PETS 4D!

Director: Jon Binkowski
USA/ 19 Min

Rescue Animals become "Rescue Heroes"!

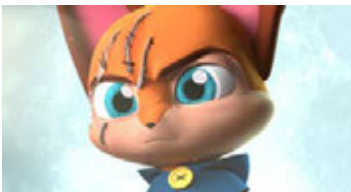

PLUSH ASSASSIN

Director: Anca Mihai
USA/ 2 Min

In a little girl's room, a plush fox fights against the villainous cat in order to protect all toys.



THE REFLECTION IN ME

Director: Marc Colagiovanni
USA/ 4 Min

A heartwarming family film sharing themes of love, acceptance, and having a positive self-image.

SARASOTA FILM FESTIVAL.COM



STARLIGHT

Director: Tyler Thompson
USA/ 5 Min

An old man who lights the stars of the sky has lost his motivation, and an unknowing little boy may be his only remaining source of light.



UNDISCOVERED

Director: Sara Litzenberger
USA/ 3 Min

Sasquatch has always remained elusive in photos—but not for the reasons we think.



THE WISHING CRANES

Director: Ellen Arnold, Kaiya Telle, Thomas Anderholm
USA/ 3 Min

When an orphaned paper boy fails to spend time with his light-hearted younger sister, she makes a wish by folding his papers into a thousand cranes that magically come to life and fly away.

SHORTS 13 - YOUTHFEST (8+)

60 Min | Sunday, April 15, 3:45 PM - Cityside Auditorium 8 | Saturday, April 21, 6:30 PM - Cityside Auditorium 8



INTREPID

Director: Alexa Tuttle
USA/ 17 Min

In an effort to make her senior trials unforgettable, a brilliant and overly ambitious witch named Hazel attempts to steal the ancient book of Merlin from her magical school's enchanted library!



MOUNTAIN OF SGAANA, THE

Director: Christopher Auchter
Canada/ 10 Min

A magical tale of a young man who is stolen away to the spirit world—and of the young woman who rescues him.



NORA

Director: Mo Davoudian, Farzad Varahramyan
USA/ 13 Min

The last of a secret element was stolen from the old city. A pair of hot-shot pilots are sent to retrieve it but they are forced into becoming the unwilling heroes once the secret of the element is revealed to them.



TOM IN COUCHLAND

Director: James Just
USA/ 2 Min

Tom is sucked into his couch and must battle crazy creatures in search of his remote.



TREE HOUSE TIME MACHINE

Director: Alan Ritchson
USA/ 13 Min

An eager 12-year-old boy and his friends race to secretly travel back in time in the hopes of unraveling the mystery surrounding his mother's untimely death before the rightful owner of the machine realizes it's gone missing.



WHAT LIVES UNDER THE BED

Director: Joey Daniel
USA/ 20 Min

A timid young boy goes on the adventure of lifetime after catching the monster that lives in his closet.

SHORTS 14 - THROUGH WOMENS EYES 1

75 min | Saturday, April 14, 12:05 PM - Auditorium 4 | Tuesday, April 17, 1:00 PM - Auditorium 3

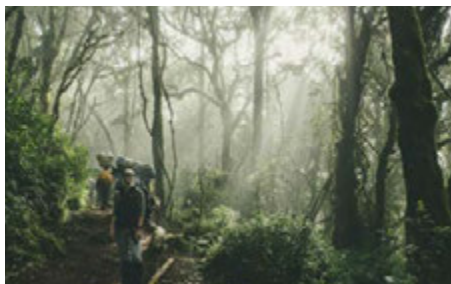

TREK FOR MANDELA

Director: Cecile Raubenheimer
South Africa, USA/ 35 Min

An inexperienced climber attempts to conquer Mount Kilimanjaro to raise awareness for challenges young African girls face.



WE ARE DREAMERS

Director: Mele Mason
USA/ 40 Min

Dreamers give voice to their hopes, dreams, and fears.

SHORTS 15 - THROUGH WOMENS EYES 2

60 Min | Saturday, April 14, 4:15 PM - Auditorium 3 | Monday, April 16, 2:15 PM - Auditorium 4

SHORT FILMS



THE AFGHAN GIRL

Director: Iben Ravn
Denmark, Greece/ 11 Min

How reality can be altered through a camera's lens.

In Greek with English Subtitles

WORLD PREMIERE



BUTTERCUP

Director: Megan Brotherton
USA/ 12 Min

Maggie is dealing with the aftermath of her mother's death when her old friend Janie unexpectedly swoops in to help her process her grief.



THE GREAT WALL OF VICKY LYNN

Director: Yu Ying Chien
USA/ 15 Min

For Vicky Lynn, there are three rules—Rule No.1: No dance club; Rule No.2: No dance club; Rule No 3: No dance club.

SFF FILM GUIDE



THE PHOTOGRAPH

Director: Fazila Amiri
Canada/ 12 Min

A young Afghan bride arrives in Toronto and searches for the husband she's never met.

In Farsi and English with English subtitles

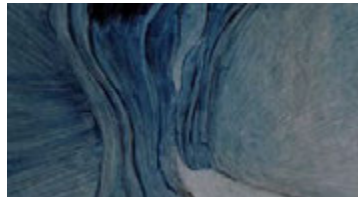

SHADOW

Director: Lei Lei
China/ 6 Min

An account of the injuries inflicted on a girl after she was followed and sexually harassed.

In Chinese and English with English subtitles



TWENTY MINUTES

Director: Oisín Byrne
UK/ 5 Min

A first-person survivor account of the emotional impact of sexual assault that is based on the victim impact statement of Emily Doe in the Stanford rape case.

SHORTS 16 - THROUGH WOMENS EYES 3

74 Min | Sunday, April 15, 11:30 AM - Auditorium 3 | Monday, April 16, 12:30 PM - Auditorium 3

SARASOTA FILM FESTIVAL.COM

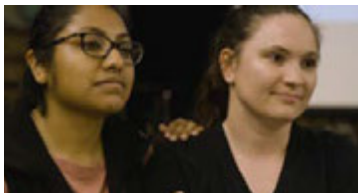

A DIVIDED ROAD

Director: Débora Silva
USA/ 9 Min

Shortly after the 2016 election, two young women decided to provide free legal aid to people living in the country without permission.



NÍVEO

Director: Noelia Crispin
Perú/ 12 Min

Two adolescents share an unexpected encounter that will change the path of their sexual lives.

In Spanish with English subtitles



ONCE ALWAYS

Director: Susanne Boeing
Germany/ 21 Min

Only when a young mother fears her child is in danger is she able to take the first step away from codependency with her own alcoholic mother.

In German with English subtitles



PEARLS

Director: Shelley Thompson
Canada/ 9 Min

Don, a transgender teen, leaves her Nova Scotia farm home for "the city," in the face of her father's scorn and her mother's support.



SURVIVING INTERNATIONAL BOULEVARD

Director: Sian Taylor Gowan
USA/ 22 Min

The complex reality of domestic child sex trafficking viewed through the experiences of two Oakland, California women.

PAID FOR IN PART BY SARASOTA COUNTY TOURISM DEVELOPMENT TAX REVENUES

SHORTS 17 - THROUGH WOMENS EYES 4

79 Min | Sunday, April 15, 3:15 PM - Auditorium 3 | Tuesday, April 17, 3:00 PM - Auditorium 6

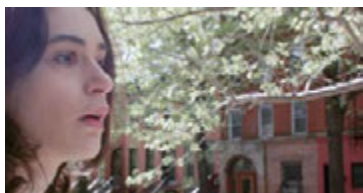

12:58 PM

Director: Kate Phelan
USA/ 5 Min

Mom's locked out of the house and her child is asleep upstairs. How quickly can Mom save the day?



PUSHING NIGHT AWAY

Director: Jade Hørem Aksnes
Norway/ 22 Min

An extended conversation about death and dying, past and future between Eddie, who plans to commit suicide, and Kate, a cancer patient who is fighting to keep herself alive.

In Norwegian with English subtitles



FAMILIES TOGETHER

Director: Karen Arango
USA/ 6 Min

The stories and ambitions of a range of Latin American women and families living in the Sarasota area. A 2Gen program of UnidosNow in partnership with the Community Foundation of Sarasota County.

In Spanish with English subtitles



SHE

Director: Philip Jamal Rachid
United Arab Emirates/ 10 Min

Portraits of seven women, each defining—through her experiences and accomplishments—her role in light of her own and her society's expectations.



SUNDOGS

Director: Elizabeth Chatelain
USA/ 16 Min

Two struggling transplants to North Dakota's booming oilfields—a single mother and her four-year-old daughter—seen over the course of a cold night.



THREE AUGUST DAYS

Director: Madli Lääne
Estonia/ 20 Min

In the midst of the political upheaval of the early 1990s, an Estonian girl and a Russian boy reach across cultural lines to unite over a shared experience.

In Estonian and Russian with English subtitles

A large graphic with a black background and colorful, abstract patterns of dots and lines. A globe is visible on the right side. The SFF logo is in the top right corner.

To Our Amazing Volunteers,

The success of the Sarasota Film Festival would not be possible without your dedication. We thank you for continued support over these past two decades!

Sincerely,
SFF Staff
& Board of Directors

THANK YOU

SFF

SARASOTA FILM FESTIVAL.COM



CATSKILLS

Director: Ben Kitnick
USA/ 7 Min

Now a fraction of what it once was, the Catskills was a bustling community in the 1950s. Eighty-six-year-old dancer Jackie Horner reflects on the region that has defined her life.



THE COFFIN CLUB

Director: Briar March
New Zealand/ 4 Min

A group of rebellious, creative Kiwi seniors give death the finger, one crazy coffin at a time.



DEATH METAL GRANDMA

Director: Leah Galant
USA/ 13 Min

Ninety-seven-year-old Holocaust survivor Igne Ginsberg makes a final attempt at being recognized as a death metal singer by auditioning for AMERICA'S GOT TALENT.



DOWNPOUR

Director: Tony Ahedo
USA/ 9 Min

During a hurricane, two brothers welcome a stranger in need into their home, but the stranger may be more dangerous than the storm outside.



FIGHT FOR THE FIRST

Director: Sharon Liese
USA/ 20 Min

Follow the young journalists-in-training at the world's oldest journalism school as they fight for their constitutional right to report the truth amidst a growing distrust for the press throughout the nation.



GIVE UP THE GHOST

Director: Marian Mathias
USA/ 13 Min

Floyd has worked his whole life. One day, while out on a new job, he discovers something that alters his way of thinking.

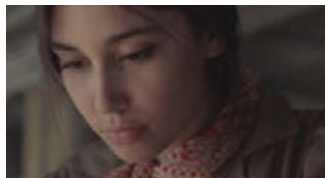

THE HEARTBREAK FACTORY

Director: So Young Shelly Yo
USA/ 12 Min

Ava, a fiery worker, is determined to mend all the broken hearts of the world. If you have ever turned away a love in your life, this movie is for you.



I AM REBECCA

Director: Kate McCaslin, Eve Doherty
UK/ 33 Min

An examination of the American Dream through the life and struggles of Rebecca Mabior, a mother, a nurse, and a refugee, now living in the Midwest.

In English and Dinka with English subtitles



I HEART NY

Director: Andre Andreev
USA/ 5 Min

A short film about Milton Glaser, the creator of the infamous I Heart NY symbol and his struggle to find love for the city in a trying time.

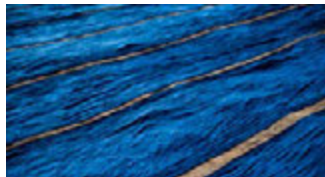

IN SEARCH OF INDIGO

Director: Shaktiraj Singh Jadeja
India/ 18 Min

Once the center of India's culture, the natural form of the color indigo has slowly been disappearing. Tracing the life of indigo through its makers, people have begun rejuvenating its practice to discover the color in its pure form.

In Hindi, Gujarati and English with English subtitles



KATIA

Director: Naida Joanides
USA/ 23 Min

Three women reveal their darkest secrets as they plot revenge against the man who harmed one of their own.

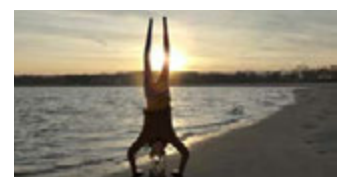

KCLOC

Director: Ninaad Kulkarni
USA/ 94 Min

What does time mean to you?

SHORTS BEFORE FEATURES

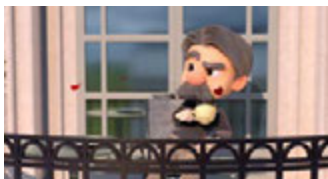

LOVE ON THE BALCONY

Director: Joshua Hyunwoo Jun, Kun Yu Ng
USA/ 4 Min

A crotchety old man does what he can to ruin his oppressively lovey-dovey neighbors.



REAL ARTISTS

Director: Cameo Wood
USA/ 12 Min

In the near future, a young animator is offered what should be her dream job. But when she discovers the truth of the modern "creative" process, she must make a hard choice about her passion for film.



ROADSIDE ATTRACTION

Director: Ivete Lucas, Patrick Bresnan
USA/ 9 Min

Palm Beach International Airport's newest snowbird has become one of the fastest-growing roadside attractions in the United States.



SUSANNE AND THE MAN

Director: Milena Govich
USA/ 7 Min

Susanne endeavors to find her own voice and rhythm when she is in a meeting with the king of mansplaining.



TITAN

Director: Trent Gidaro
USA/ 17 Min

A woman in a glass house hypnotizes herself by piecing together fragments of literature. Images in her mind begin to appear.



TOM NODDY

Director: Charles Poekel
USA/ 13 Min

Pioneer soap bubble entertainer Tom Noddy has taken his act around the world for over thirty years, conjuring fleeting beauty as he tries to stay true to himself and his art.



WHILE I YET LIVE

Director: Maris Curran
USA/ 15 Min

Five acclaimed African American quilters from Gee's Bend, Alabama, talk about love, religion, and the fight for civil rights as they continue the tradition of quilting that originally brought them together.

WORLD PREMIERE

Aloft
HOTELS

CELEBRATE
YOUR STYLE

AT ALOFT SARASOTA

Stay & play at our hip new hotel, located in the heart of downtown and steps from the waterfront. Enjoy the vibrant social scene with live music and specialty cocktails at W XYZ® bar, fast & free WiFi and more. Official host hotel for the Sarasota Film Festival Jury. Call 941 870 0900 or visit aloftsarasota.com

Aloft Sarasota
1401 Ringling Boulevard
Sarasota, FL 34236



spg*
Starwood
Preferred
Guest

©2017 Starwood Hotels & Resorts Worldwide, Inc. All Rights Reserved. For full terms and conditions, visit aloftsarasota.com.

SATURDAY, APRIL 14

SCHEDULE GRID

SEE FILM GUIDE

SARASOTA FILM FESTIVAL.COM

	Auditorium 3	Auditorium 4	Auditorium 5	Auditorium 6	Auditorium 7	Auditorium 8	Art Ovation	Events
10:00 AM		HALF THE PICTURE 94 Min 10:05 AM						
11:00 AM						SHORTS 12 YOUTHFEST ALL AGES 58 Min 11:00 AM		
12:00 PM		SHORTS 14 TWE 1 75 Min 12:05 PM	LOTS OF KIDS, A MONKEY AND A CASTLE & COFFIN CLUB 95 Min 12:30 PM	LU OVER THE WALL 112 Min 12:00 PM			MERMAIDS & TOMNODDY 92 Min 12:00 PM	IN CONVERSATION WITH ERIC STOLTZ 60 Min , 12:00 PM FST
1:00 PM	BIKINI MOON 102 Min 12:45 PM				306 HOLLYWOOD & CATSKILLS 101 Min 1:15 PM	SHORTS 4 NARRATIVE 1 100 Min 1:00 PM		
2:00 PM		ON HER SHOULDERS 96 Min 2:00 PM		TBD				
3:00 PM	DISTANT CONSTELLATION & ROADSIDE ATTRACTION 91 Min 3:15 PM		AMERICAN ANIMALS 116 Min 3:30 PM	2:30 PM			COME SUNDAY 106 Min 3:00 PM	
4:00 PM		SHORTS 15 TWE 2 60 Min 4:15 PM			GRACE JONES: BLOODLIGHT AND BAMI 115 Min 4:15 PM	SHORTS 10 NYU @ SFF 84 Min 4:30 PM		TWE RECEPTION 150 Min 5:00 PM Art Center Sarasota
5:00 PM		TBD						
6:00 PM	OLD DOG & GIVE UP THE GHOST 79 Min 6:30 PM	6:45 PM	VIRGINIA, MINNESOTA & SUSANNE AND THE MAN 104 Min 6:15 PM	HEARTS BEAT LOUD 96 Min 7:00 PM		SHORTS 6 NARRATIVE 3 89 Min 6:45 PM	THROUGH THE TUNNEL film + discussion 90 Min Red Carpet: 6:00 PM Film: 7:00 PM	
7:00 PM		RBG 97 Min 8:00 PM			DON'T LEAVE HOME 86 Min 8:00 PM			
8:00 PM			LEAVE NO TRACE 108 Min 8:45 PM					
9:00 PM						TBD 9:00 PM		
10:00 PM	SHORTS 9 MIDNIGHT SHORTS 85 Min 10:00 PM							
11:00 PM								

SPECIAL EVENT: IN CONVERSATION WITH ERIC STOLTZ
FLORIDA STUDIO THEATRE 12:00 PM (SEE P. 26)

NARRATIVE	DOCUMENTARY	youthFEST	EVENTS	SHORTS
DOCUMENTARY COMPETITION	TWE	TBA	COMMUNITY SCREENINGS	
NARRATIVE COMPETITION	INDIE VISIONS		SPOTLIGHT	

Schedule Subject To Change
Check our website or box office
for the latest details and additions

SUNDAY, APRIL 15

	Auditorium 3	Auditorium 4	Auditorium 5	Auditorium 6	Auditorium 7	Auditorium 8	Art Ovation
10:00 AM				CRACKING ACES: A WOMAN'S PLACE AT THE TABLE 65 Min 10:00 AM			
11:00 AM			ANTONIO LOPEZ 1970: SEX FASHION & DISCO & WHILE I YET LIVE			SHORTS 6 NARRATIVE 3 89 Min 10:45 AM	
12:00 PM	SHORTS 16 TWE 3 73 Min 11:30 AM	TINKER 97 Min 11:45 AM	110 Min 11:00 AM		OLD DOG & GIVE UP THE GHOST 79 Min 11:30 AM		GREAT FLIP-OFF 102 Min 12:00 PM
1:00 PM				CRIME + PUNISHMENT 111 Min 1:00 PM		SHORTS 8 DOCUMENTARY 2 91 Min 1:15 PM	
2:00 PM	I AM REBECCA & SISTERS 75 Min 1:30 PM	FATHER'S KINGDOM 92 Min 2:00 PM	WILD NIGHTS WITH EMILY 84 Min 1:45 PM		LA FLOR DE LA VIDA 86 Min 2:15 PM		
3:00 PM	SHORTS 17 TWE 4 79 Min 3:15 PM						SHORTS 11 FLORIDA SHOWCASE 87 Min 3:00 PM
4:00 PM		TBD	TBD	LET THE SUNSHINE IN 94 Min 4:00 PM		SHORTS 13: YOUTHFEST AGES 8+ PROGRAM 75 Min 3:45 PM	
5:00 PM	THAT SUMMER 80 Min 5:00 PM	4:30 PM	4:15 PM				
6:00 PM					HOLLYWOOD NIGHTS ONE 60 Min 5:45 PM		FACEing MENTAL ILLNESS film + discussion 90 Min 6:00 PM
7:00 PM	AUGUST IN BERLIN 88 Min 6:45 PM	ON CHESIL BEACH 110 Min 7:15 PM		ASK THE SXPERT & THE HEARTBREAK FACTORY 104 Min 6:45 PM		TATTERDEMALION 100 Min 7:00 PM	
8:00 PM			VIRGINIA, MINESOTA & SUSANNE AND THE MAN 104 Min 7:45 PM		HOLLYWOOD NIGHTS TWO 90 Min 7:30 PM		
9:00 PM	SANTA INOCENCIA & TITAN 86 Min 9:00 PM			VIRUS TROPICAL 97 Min 9:00 PM			
10:00 PM							

SCHEDULE GRID

SFF FILM GUIDE

SARASOTA FILM FESTIVAL.COM

NARRATIVE **DOCUMENTARY** **youthFEST** **EVENTS** **SHORTS**
DOCUMENTARY COMPETITION **TWE** **TBA** **COMMUNITY SCREENINGS**
NARRATIVE COMPETITION **INDIE VISIONS** **SPOTLIGHT**

MONDAY, APRIL 16

SCHEDULE GRID

SFF FILM GUIDE

SARASOTA FILM FESTIVAL.COM

	Auditorium 3	Auditorium 4	Auditorium 5	Auditorium 6	Auditorium 7	Art Ovation
12:00 PM						
	SHORTS 16 TWE 3					
1:00 PM	73 Min 11:30 AM				I AM REBECCA & SISTERS	
					75 Min 1:00 PM	
2:00 PM				AUGUST IN BERLIN		
		SHORTS 15 TWE 2		88 Min 2:00 PM		
3:00 PM	SHORTS 10 NYU@SFF	60 Min 2:15 PM				
	90 Min 2:45 PM		WE THE ANIMALS			
4:00 PM			90 Min 3:30 PM	BIKINI MOON		
				102 Min 4:00 PM		
5:00 PM	SHORTS 5: NARRATIVE 2 PROGRAM					
6:00 PM	97 Min 5:00 PM		ALL YOU CAN EAT BUDDHA		CRACKING ACES: A WOMAN'S PLACE AT THE TABLE	THE KING
		TATTERDEMALION	85 Min 6:00 PM	HALF THE PICTURE	65 Min 5:45 PM	109 Min 6:00 PM
7:00 PM		100 Min 6:30 PM		94 Min 6:45 PM		
	MAYNARD					
8:00 PM	99 Min 7:30 PM				MATANGI/MAYA /M.I.A.	
			SHORTS 8 DOCUMENTARY 2		95 Min 8:15 PM	
9:00 PM		WHEN JEFF TRIED TO SAVE THE WORLD	91 Min 8:30 PM			
		94 Min 9:00 PM				
10:00 PM	SHORTS 9 MIDNIGHT SHORTS					
	85 Min 10:00 PM					
11:00 PM						

NARRATIVE

DOCUMENTARY

youthFEST

EVENTS

SHORTS

DOCUMENTARY COMPETITION

TWE

TBA

COMMUNITY SCREENINGS

NARRATIVE COMPETITION

INDIE VISIONS

SPOTLIGHT

Schedule Subject To Change
Check our website or box office
for the latest details and additions

TUESDAY, APRIL 17

	Auditorium 3	Auditorium 4	Auditorium 5	Auditorium 6	Auditorium 7	Art Ovation			
1:00 PM	SHORTS 14 TWE 1 75 Min 1:00 PM								
2:00 PM									
3:00 PM						ON HER SHOULDERS			
4:00 PM	SHORTS 4 NARRATIVE 1 100 Min 3:45 PM	DISTANT CONSTELLATION & ROADSIDE ATTRACTION 91 Min 4:00 PM	TINKER 97 Min 3:15 PM	SHORTS 17 TWE 4 79 Min 3:00 PM	96 Min 2:30 PM				
5:00 PM									
6:00 PM									
7:00 PM	SHORTS 7 DOCUMENTARY 1 98 Min 6:00 PM	THREE IDENTICAL STRANGERS 100 Min 6:15 PM	RBG 97 Min 5:30 PM	ZAMA 115 Min 5:15 PM	ANTONIO LOPEZ 1970: SEX FASHION & DISCO & WHILE I YET LIVE 110 Min 5:00 PM	EIGHTH GRADE 92 Min 5:00 PM			
8:00 PM									
9:00 PM									
10:00 PM	SANTA INOCENCIA & TITAN 83 Min 8:30 PM	VIRUS TROPICAL & LOVE ON THE BALCONY 97 Min 8:45 PM	EN EL SÉPTIMO DIA (ON THE SEVENTH DAY) 92 Min 8:00 PM	COLD SKIN 108 Min 8:15 PM	GRACE JONES: BLOODLIGHT AND BAM!	A KID LIKE JAKE 92 Min 7:45 PM			

SCHEDULE GRID

SFF FILM GUIDE

SARASOTA FILM FESTIVAL.COM

NARRATIVE **DOCUMENTARY** **youthFEST** **EVENTS** **SHORTS**

DOCUMENTARY COMPETITION **TWE** **TBA** **COMMUNITY SCREENINGS**

NARRATIVE COMPETITION **INDIE VISIONS** **SPOTLIGHT**

WEDNESDAY, APRIL 18

SCHEDULE GRID

SEE FILM GUIDE

	Auditorium 3	Auditorium 4	Auditorium 5	Auditorium 6	Auditorium 7	Art Ovation	Events
1:00 PM							
					306 HOLLYWOOD & CATSKILLS		
2:00 PM					101 Min 1:30 PM		
		BISBEE '17					
3:00 PM		118 Min 2:30 PM	FREEDOM FOR THE WOLF & FIGHT FOR THE FIRST		AMERICAN ANIMALS		
	SHORTS 7 DOCUMENTARY 1			116 Min 3:00 PM			
4:00 PM	98 Min 3:15 PM		109 Min 2:45 PM			SHORTS 5 NARRATIVE 2	
						97 Min 3:45 PM	
5:00 PM		ASK THE SEXPERT & THE HEARTBREAK FACTORY					
	BLACK MOTHER		LOTS OF KIDS, A MONKEY AND A CASTLE & COFFIN CLUB				
6:00 PM	77 Min 5:30 PM	104 Min 5:00 PM		MAKTUB			
				100 Min 5:45 PM			
7:00 PM					LET THE SUNSHINE IN	RIVERVIEW IB ACADEMY AWARDS SHOWCASE	
					94 Min 6:15 PM	120 Min 6:30 PM	
8:00 PM	THE TRANSCENDENTS & DOWNPOUR	EIGHTH GRADE	HALE COUNTY THIS MORNING, THIS EVENING				MOONLIGHT MOVIE: A LEAGUE OF THEIR OWN FREE!
	106 Min 7:45 PM	92 Min 8:00 PM	76 Min 7:30 PM				
9:00 PM				FIRST REFORMED			128 Min 7:45 PM Sarasota Lawn Bowling Club
				113 Min 8:15 PM	HOLIDAY		
					90 Min 8:30 PM		
10:00 PM							

SARASOTA FILM FESTIVAL.COM

NARRATIVE
DOCUMENTARY
youthFEST
EVENTS
SHORTS

DOCUMENTARY COMPETITION
TWE
TBA
COMMUNITY SCREENINGS

NARRATIVE COMPETITION
INDIE VISIONS
SPOTLIGHT

Schedule Subject To Change
Check our website or box office
for the latest details and additions

THURSDAY, APRIL 19

	Auditorium 3	Auditorium 4	Auditorium 5	Auditorium 6	Auditorium 7	Art Ovation	Events
12:00 PM	NOTES ON AN APPEARANCE & IN SEARCH OF INDIGO 78 Min 12:00 PM	THE SEEN AND THE UNSEEN 86 Min 12:15 PM	LA FLOR DE LA VIDA 86 Min 12:45 PM	SHORTS 1 NARRATIVE COMPETITION 99 Min 12:30 PM	OF FATHERS AND SONS 99 Min 1:00 PM		
1:00 PM							
2:00 PM	BLACK MOTHER 77 Min 2:30 PM	GENESIS 2.0 113 Min 2:45 PM	I AM NOT A WITCH 93 Min 3:00 PM	SUPPORT THE GIRLS 93 Min 3:30 PM	FATHER'S KINGDOM 94 Min 3:15 PM		
3:00 PM							
4:00 PM							
5:00 PM	SHORTS 3 ANIMATED COMPETITION 86 Min 4:45 PM	LIFE & NOTHING MORE 114 Min 6:00 PM	MADELINE'S MADELINE 94 Min 5:15 PM	GENERATION WEALTH 106 Min 5:45 PM	KILLER BEES 85 Min 5:30 PM	MAKTUB 100 Min 4:45 PM	
6:00 PM							
7:00 PM	DELENDA 106 Min 6:45 PM					SHELTER 93 Min 6:45 PM	
8:00 PM							
9:00 PM		CLARA'S GHOST 93 Min 9:00 PM	A MURDER IN MANSFIELD 87 Min 8:00 PM	FREEDOM FOR THE WOLF & FIGHT FOR THE FIRST 109 Min 8:30 PM	THE QUEEN OF FEAR 107 Min 7:45 PM	A FRENCHMAN IN FLORIDA & KATIA 88 Min 8:45 PM	
10:00 PM	BIRDS WITHOUT FEATHERS 83 Min 9:30 PM						

SCHEDULE GRID

SFF FILM GUIDE

SARASOTA FILM FESTIVAL.COM

NARRATIVE

DOCUMENTARY

youthFEST

EVENTS

SHORTS

DOCUMENTARY COMPETITION

TWE

TBA

COMMUNITY SCREENINGS

NARRATIVE COMPETITION

INDIE VISIONS

SPOTLIGHT

FRIDAY, APRIL 20

SCHEDULE GRID

SEE FILM GUIDE

SARASOTA FILM FESTIVAL.COM

	Auditorium 3	Auditorium 4	Auditorium 5	Auditorium 6	Auditorium 7	Auditorium 8	Events
11:00 AM			THAT SUMMER 80 Min 11:00 AM	CRIME + PUNISHMENT 111 Min 11:15 AM			
12:00 PM	MAISON DU BONHEUR &- FLORES 88 Min 12:00 PM	MAYNARD 99 Min 11:30 AM			THE SEEN AND THE UNSEEN 86 Min 12:15 PM	SHORTS 2 DOCUMENTARY COMPETITION 97 Min 11:45 AM	
1:00 PM							
2:00 PM		CHEF FLYNN &- I HEART NY 88 Min 1:45 PM	A MURDER IN MANSFIELD 87 Min 2:45 PM	MINDING THE GAP 98 Min 2:00 PM	THE QUEEN OF FEAR 107 Min 2:30 PM	SHORTS 1 NARRATIVE COMPETITION 99 Min 2:15 PM	
3:00 PM	MILFORD GRAVES FULL MANTIS &- KCLOC 94 Min 3:00 PM						
4:00 PM							
5:00 PM					1985 83 Min 5:00 PM	HALE COUNTY THIS MORNING, THIS EVENING 76 Min 5:15 PM	
6:00 PM	A FEAST OF MAN 82 Min 6:00 PM	I AM NOT A WITCH 93 Min 5:45 PM	CLARA'S GHOST 93 Min 5:30 PM	DIMINUENDO 109 Min 5:45 PM			SUNSET SOIREE 120 Min 6:00 PM Art Ovation
7:00 PM							
8:00 PM	TOUR WITHOUT END 92 Min 8:00 PM	DAUGHTERS OF THE SEXUAL REVOLUTION 80 Min 8:15 PM	CHASING THE BLUES &- DEATH METAL GRANDMA 90 Min 7:45 PM	SUPPORT THE GIRLS 97 Min 8:30 PM	THE SENTENCE 84 Min 7:30 PM	SHORTS 3 ANIMATED COMPETITION 86 Min 7:15 PM	OUT OF THIS WORLD: 20TH ANNIVERSARY PARTY 240 Min 8:00 PM Art Ovation
9:00 PM							
10:00 PM					DONT LEAVE HOME 86 Min 9:45 PM	THE PAIN OF OTHERS 71 Min 9:30 PM	
11:00 PM							
12:00 AM							

SPECIAL EVENT: THE 20TH ANNIVERSARY "OUT OF THIS WORLD" PARTY
ART OVATION HOTEL AT 8:00 PM (SEE P. 22)

NARRATIVE	DOCUMENTARY	youthFEST	EVENTS	SHORTS
DOCUMENTARY COMPETITION		TWE	TBA	COMMUNITY SCREENINGS
NARRATIVE COMPETITION		INDIE VISIONS		SPOTLIGHT

Schedule Subject To Change
Check our website or box office
for the latest details and additions

SATURDAY, APRIL 21

	Auditorium 3	Auditorium 4	Auditorium 5	Auditorium 6	Auditorium 7	Auditorium 8	Art Ovation	Opera House	Events
10:00 AM	SHORTS 2 DOCUMENTARY COMPETITION				ON CHESIL BEACH				
11:00 AM	97 Min 10:15 AM	OF FATHERS SONS 99 Min 11:00 AM	LIVING IN THE FUTURE'S PAST 84 Min 11:30 AM	KILLER BEES 85 Min 11:45 AM	110 Min 10:30 AM		SHORTS 11 FLORIDA SHOWCASE 87 Min 11:00 AM		CONVERSAITON W/ STEVE GUTTENBERG 60 Min, 11:00 AM FST
12:00 PM									
1:00 PM	DELENDA 106 Min 1:00 PM	THE KING 109 Min 1:30 PM	THE TRANSCENDENTS & DOWNPOUR 106 Min 1:45 PM		GENESIS 2.0 113 Min 1:15 PM		A TUBA TO CUBA 84 Min 1:30 PM		CONVERSAITON W/ VIRGINIA MADSEN 60 Min, 1:00 PM FST
2:00 PM				LIFE AND NOTHING MORE 114 Min 2:00 PM		EN EL SÉPTIMO DIA (ON THE SEVENTH DAY) 92 Min 2:15 PM		CLOSING DAY FILM LOVE MEANS ZERO 89 Min 2:00 PM	
3:00 PM									CONVERSAITON W/ RORY KENNEDY 60 Min, 3:00 PM FST
4:00 PM	NOTES ON AN APPEARANCE & IN SEARCH OF INDIGO 78 Min 4:00 PM	RODENTS OF UNUSUAL SIZE 71 Min 4:15 PM	THE EXPERIMENTAL CITY 96 Min 4:30 PM	MADELINE'S MADELINE 94 Min 4:45 PM	CHASING THE BLUES & DEATH METAL GRANDMA 90 Min 4:15 PM		THE LONG DUMB ROAD 90 Min 4:00 PM		
5:00 PM								CLOSING NIGHT AWARDS AND FILM	
6:00 PM	MAISON DU BONHEUR 88 Min 6:00 PM	MILFORD GRAVES FULL MANTIS & KCLOC 94 Min 7:45 PM						ABOVE AND BEYOND: NASA'S JOURNEY TO TOMORROW 90 Min Red Carpet: 5:00 PM Awards: 6:00 PM Film: 6:45 PM	CLOSING NIGHT PARTY: CHILL UNDER THE STARS 360 Min 6:00 PM Five Points Park
7:00 PM						SHORTS 13: YOUTHFEST AGES 8+ PROGRAM 75 Min 6:30 PM			
8:00 PM	THE PAIN OF OTHERS 71 Min 8:00 PM		BISBEE '17 118 Min 8:15 PM	FIRST REFORMED 113 Min 8:45 PM	GENERATION WEALTH 106 Min 8:30 PM				
9:00 PM						WHITE RABBIT & REAL ARTISTS 83 Min 9:00 PM			
10:00 PM	CAN HITLER HAPPEN HERE? 75 Min 9:45 PM								
11:00 PM									
12:00 AM									

SCHEDULE GRID

SFF FILM GUIDE

SARASOTA FILM FESTIVAL.COM

SPECIAL EVENTS

IN CONVERSATION WITH ... AT FLORIDA STUDIO THEATRE (SEE P. 26)
-STEVE GUTTENBERG 11:00 AM
-VIRGINIA MADSEN 1:00 PM
-RORY KENNEDY 3:00 PM

CHILL UNDER THE STARS CLOSING NIGHT PARTY (SEE P. 25)
FIVE POINTS PARK 6:00-11:30 PM

NARRATIVE DOCUMENTARY youthFEST EVENTS SHORTS
DOCUMENTARY COMPETITION TWE TBA COMMUNITY SCREENINGS
NARRATIVE COMPETITION INDIE VISIONS SPOTLIGHT

SUNDAY, APRIL 22

SCHEDULE GRID

SFF FILM GUIDE

	Auditorium 3	Auditorium 4	Auditorium 5	Auditorium 6	Auditorium 7	Auditorium 8	Art Ovation	Events
10:00 AM			BLACK KITE (MEMBERS ONLY)	20 HOUR FILM CONTEST SCREENING				
		TRAFFICKED IN PARADISE 25 Min 10:30 AM	82 Min 10:00 AM					
11:00 AM				120 Min 10:15 AM	Sensory Friendly Screening: LU OVER THE WALL		DAUGHTERS OF THE SEXUAL REVOLUTION	ENVIRONMENT & SUSTAINABILITY 60 Min, 11:00 AM FST
12:00 PM		CHEF FLYNN & I HEART NY	BLACK KITE		112 Min 11:00 AM		80 Min 11:00 AM	MUSINGS ON MUSICIANS 60 Min, 12:00 PM FST
	THE SENTENCE	88 Min 12:00 PM	82 Min 12:15 PM			SHORTS 12: YOUTHFEST ALL AGES 58min 12:45 PM		REDEFINING MANHOOD 60 Min, 1:00 PM FST
1:00 PM	85 Min 12:30 PM			PROFILE				
				FREE STUDENT SCREENING				
2:00 PM		RODENTS OF UNUSUAL SIZE		104 Min 1:00 PM			THE RIDER	
		71 Min 2:15 PM	1985			TOUR WITHOUT END	103 Min 2:00 PM	
3:00 PM			85 Min 2:30 PM		MINDING THE GAP	92 Min 2:45 PM		
	BIRDS WITHOUT FEATHERS				98 Min 3:00 PM			
4:00 PM	83 Min 3:45 PM			TBD				
				4:00 PM			WON'T YOU BE MY NEIGHBOR?	
5:00 PM		THE LONG DUMB ROAD	HEARTS BEAT LOUD			A FEAST OF MAN	94 Min 4:45 PM	
		90 Min 5:15 PM	96 Min 5:00 PM		LIVING IN THE FUTURE'S PAST	82 Min 5:00 PM		
6:00 PM	WHITE RABBIT & REAL ARTISTS				84 Min 5:45 PM			
	83 Min 6:00 PM			TBD			LEAN ON PETE	
7:00 PM				7:00 PM			120 Min 7:00 PM	
8:00 PM		WILD NIGHTS WITH EMILY	THE EXPERIMENTAL CITY		THREE IDENTICAL STRANGERS	7:30 PM		
		84 Min 8:00 PM	96 Min 8:15 AM		100 Min 7:45 PM			
9:00 PM	CAN HITLER HAPPEN HERE?							
	75 Min 8:30 PM							

SARASOTA FILM FESTIVAL.COM

NARRATIVE

DOCUMENTARY

youthFEST

EVENTS

SHORTS

DOCUMENTARY COMPETITION

TWE

TBA

COMMUNITY SCREENINGS

NARRATIVE COMPETITION

INDIE VISIONS

SPOTLIGHT



Frame your
scene
at CitySide.

- Bike Share Program*
- Fitness Center & Yoga Studio*
- New Concrete Construction*
- Resort Style Pool*
- Pet Park with Off-leash Area*
- Concierge Services*



Our premier studios, one & two bedroom apartments offer **unparalleled amenities in an unrivaled downtown location.**

700 Coconut Avenue | Sarasota, FL 34236 | 941-702-2928 | CitySideSRQ.com



LJ Event Production, LLC.

From concept to completion, we can facilitate all your events Big or Small! With our state-of-the-art equipment & collaborative creative design, we turn your vision into a successful reality!

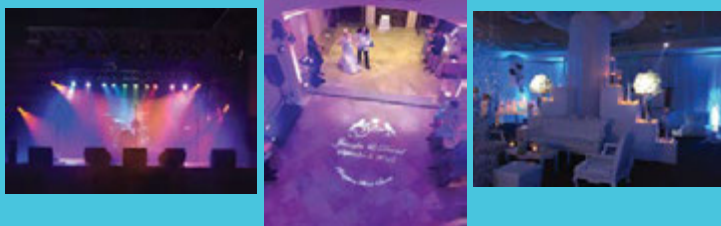

For event/booking needs, please contact us at (941) 315-6906 or Info@LJEventProduction.com

"We proudly support the Sarasota Film Festival!"

go OUT

...and support your local LGBTQ+ businesses and events!

SarasotaOUT.com
Your LGBTQ+ Resource!

Silverspot Cinema



7 One One Palm



Pelican Isle Yacht Club



GATES CONSTRUCTION

Florida's Premier Builder

Over the years we have had the honor of building many of Florida's landmarks from commercial and healthcare to the places that we work and the schools that our children and grandchildren attend. We sincerely thank our many repeat clients, associates and team members for helping to make **GATES Construction Florida's top choice in builders.**



Sarasota | 941.538.7998

Bonita Springs | 239.593.3777

www.GATESinc.com

Golisano Children's Hospital of SWFL Skanska GATES JV



Hampton Inn & Suites

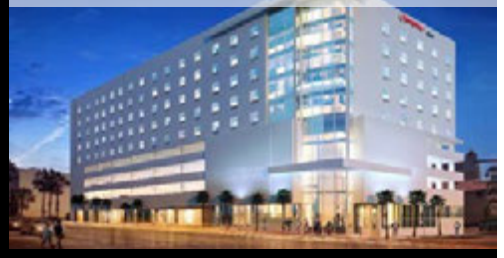

All Seasons Assisted Living Facility





ARCHITECTS

www.DSDGINC.com 941.955.5645 AA 0003661

Heirloom Quality

- Chests
- Trunks
- Humidors
- Custom Requests
- Custom Furniture
- Wood Floor Inlays



Handmade in Sarasota, FL



www.terryschests.com

Call Terry Downes: 941.812.5237



**A Healthy, Balanced Life
Starts at Richard's**

**NATURAL & SPECIALTY FOODS
VITAMINS • GIFTS • CARDS • BOOKS**

Locally Owned Since 1979



*“You're still a star
I whisper to myself
as I take my probiotic*

Solutions for your health and well being

- Beauty
- Skin
- Nails
- Heart Health
- Weight Management
- Brain Health
- Immune Support
- Energy
- Inflammation
- Digestion
- Joint Pain
- Stress
- Aging
- Allergies
- Fitness

BRADENTON • SARASOTA • OSPREY • VENICE • NORTH PORT • ENGLEWOOD • PORT CHARLOTTE



**www.RichardsFoodporium.com
17 Locations in Southwest Florida**

1985.....	36	COME SUNDAY.....	57
12:58 PM.....	77	COPA-LOCA.....	66
20 HOUR FILM CONTEST SCREENING.....	31	CRACKING ACES: A WOMAN'S PLACE AT THE TABLE.....	61
306 HOLLYWOOD.....	61	CREEPER.....	71
50 WORDS.....	73	CRIME + PUNISHMENT.....	62
63 BOYCOTT.....	70	DAUGHTERS OF THE SEXUAL REVOLUTION: THE UNTOLD STORY OF THE DALLAS COWBOY CHEERLEADERS.....	52
AAMIR.....	72	DEATH METAL GRANDMA.....	78
ABOVE AND BEYOND: NASA'S JOURNEY TO TOMORROW.....	24	DELENDÁ.....	57
THE AFGHAN GIRL.....	76	DIMINUENDO.....	57
AFTER HER.....	71	DISTANT CONSTELLATION.....	62
AGUA VIVA.....	67	DIVIDED ROAD, A.....	76
ALL YOU CAN EAT BUDDHA.....	56	DOLLMAKER, THE.....	73
ALLIGATOR HUNTER, THE.....	67	DON'T LEAVE HOME.....	50
ALLISK8R.....	74	DOWNPOUR.....	78
AMENITIES.....	72	DRIVER IS RED, THE.....	67
AMERICAN ANIMALS.....	56	EARTH IS HUMMING, THE.....	66
ANTONIO LOPEZ 1970: SEX FASHION & DISCO.....	61	EASY AS... ..	68
AQUACULTURE.....	72	EIGHTH GRADE.....	37
ARIA.....	68	ELIZABETH SEES.....	74
ARNIE JOHNSTONE & THE VULVA TREE.....	72	EN EL SÉPTIMO DÍA (ON THE SEVENTH DAY). ..	57
ASK THE SEXPERT.....	61	EVE.....	69
AUGUST IN BERLIN.....	56	EXPERIMENTAL CITY, THE.....	62
BARELY THERE.....	73	EXTINGUISHED.....	73
BARTLEBY.....	67	FACEING MENTAL ILLNESS.....	21
BEAST.....	68	FAMILIES TOGETHER.....	77
BIKINI MOON.....	56	FATHER.....	71
BIRDS WITHOUT FEATHERS.....	54	FATHER'S KINGDOM.....	62
BIRTHRIGHT.....	69	FEAST OF MAN, A.....	54
BISBEE '17.....	61	FIGHT FOR THE FIRST.....	78
BLACK KITE.....	56	FIRST REFORMED.....	58
BLACK MOTHER.....	54	FIX HISTORY.....	71
BLACK SKIMMERS OF LIDO BEACH.....	74	FOR NONNA ANNA.....	66
BURDEN, THE.....	67	FREEDOM FOR THE WOLF.....	62
BURN BRIDGE.....	72	FRENCHMAN IN FLORIDA, A.....	58
BUTTERCUP.....	76	FULL CIRCLE.....	73
CAN HITLER HAPPEN HERE?.....	56	GAVIN GRIMM VS.	70
CAROLINE.....	69	GENERATION WEALTH.....	52
CATSKILLS.....	78	GENESIS 2.0.....	52
CHASING THE BLUES.....	57	GIVE UP THE GHOST.....	78
CHEF FLYNN.....	61	GLORIA TALKS FUNNY.....	68
CHILDREN LEAVE AT DAWN.....	66	GRACE JONES: BLOODLIGHT AND BAMI.....	62
CLARA'S GHOST.....	50	GREAT FLIP-OFF, THE.....	63
CLASS RANK.....	18	GREAT WALL OF VICKY LYNN, THE.....	76
COFFIN CLUB, THE.....	78	HAIR WOLF.....	71
COLD SKIN.....	57		

HALE COUNTY THIS MORNING, THIS EVENING.....	52	MINDING THE GAP.....	53
HALF THE PICTURE.....	63	MONUMENT MONUMENTO.....	70
HEARTBREAK FACTORY, THE.....	78	MOTHER FUCKER.....	71
HEARTS BEAT LOUD.....	38	MOTHER, MOTHER.....	69
HEDGEHOG'S HOME.....	67	MOTHER'S DAY.....	66
HOLIDAY.....	58	MOUNTAIN OF SGAANA, THE.....	75
HOLLYWOOD NIGHTS 1 (GRADES 1 TO 5).....	20	MR. CONNOLLY HAS ALS.....	70
HOLLYWOOD NIGHTS 2 (GRADES 6 TO 12).....	20	MURDER IN MANSFIELD, A.....	41
HOUSEPLANTS.....	72	MY PAINTBRUSH BITES.....	70
I AM NOT A WITCH.....	50	NEGATIVE SPACE.....	67
I AM REBECCA.....	78	NELLIE BLY MAKES THE NEWS.....	70
I HEART NY.....	78	NIGHT I DANCE WITH DEATH, THE.....	71
IN A HEARTBEAT.....	67	NÍVEO.....	76
IN SEARCH OF INDIGO.....	78	NORA.....	75
INTREPID.....	75	NOTES ON AN APPEARANCE.....	55
KATIA.....	78	NUUCA.....	68
KCLOC.....	78	ODE TO JOY.....	70
KID LIKE JAKE, A.....	38	OF FATHERS AND SONS.....	53
KILLER BEES.....	63	OKSIJAN.....	68
KING, THE.....	39	OLD DOG.....	64
LA FLOR DE LA VIDA.....	63	ON CHESIL BEACH.....	41
LADY PLUM.....	73	ON HER SHOULDERS.....	64
LEAN ON PETE.....	39	ONCE ALWAYS.....	76
LET THE SUNSHINE IN (UN BEAU SOLEIL INTÉRIEUR).....	58	OSTOJA WILL MOVE YOUR PIANO.....	66
LIFE AFTER.....	72	PAIN OF OTHERS, THE.....	64
LIFE AND NOTHING MORE (LA VIDA Y NADA MÁS).....	54	PEARLS.....	76
LIVING IN THE FUTURE'S PAST.....	63	PETS 4D!.....	74
LOCKDOWN.....	68	PHOTOGRAPH, THE.....	76
LONG DUMB ROAD, THE.....	40	PLUSH ASSASSIN.....	74
LONG TERM DELIVERY.....	68	POLA.....	68
LOTS OF KIDS, A MONKEY AND A CASTLE (MUCHOS HIJOS, UN MONO Y UN CASTILLO).....	63	PRESIDENT'S VISIT, THE.....	66
LOVE MEANS ZERO.....	23	PUSHING NIGHT AWAY.....	77
LOVE ON THE BALCONY.....	79	QUEEN OF FEAR, THE.....	51
LU OVER THE WALL.....	27	RBG.....	64
LUNCH TIME.....	66	REAL ARTISTS.....	79
MADELINE'S MADELINE.....	50	REFLECTION IN ME, THE.....	74
MAISON DU BONHEUR.....	55	RIDER, THE.....	42
MAKTUB.....	58	RIVERVIEW IB AWARDS SHOWCASE.....	20
MATANGI / MAYA / M.I.A.....	64	ROADSIDE ATTRACTION.....	79
MAUDE.....	68	RODENTS OF UNUSUAL SIZE.....	65
MAYNARD.....	64	SAND MEN.....	66
MEMBERS SCREENING.....	56	SANTA INOCENCIA.....	58
MERMAIDS.....	40	SARASOTA ORCHESTRA: A WEEK IN THE LIFE.....	73
MILFORD GRAVES FULL MANTIS.....	55	SECOND ASSAULT.....	70
		SEEN AND THE UNSEEN, THE.....	51
		SENTENCE, THE.....	53
		SHADOW.....	76
		STARLIGHT.....	74

SHE	77
SHED	73
SHELTER	59
SHERRY	68
SISTERS	65
SPIRITUS LEPUS	71
SUNDOGS	77
SUPPORT THE GIRLS	51
SURVIVING INTERNATIONAL BOULEVARD	76
SUSANNE AND THE MAN	79
TATTERDEMALION	59
TERRORIST HUNTER, THE	66
THAT SUMMER	65
THINGS YOU THINK I'M THINKING, THE	68
THREE AUGUST DAYS	77
THREE IDENTICAL STRANGERS	65
THROUGH THE TUNNEL	21
TINKER	59
TITAN	79
TOM IN COUCLAND	75
TOMNODDY	79
TOUR WITHOUT END	55
TRANSCENDENTS, THE	59
TREE HOUSE TIME MACHINE	75
TREK FOR MANDELA	75
TUBA TO CUBA, A	65
TWE RECEPTION	28
TWENTY MINUTES	76
UNDISCOVERED	74
VIEW FROM THE WINDOW, A	70
VIEW FROM UP HERE, THE	69
VIRGINIA, MINNESOTA	59
VIRUS TROPICAL	59
VOLTE	66
WE ARE DREAMERS	75
WE THE ANIMALS	60
WEEKENDS	67
WELCOME HOME	68
WHAT LIVES UNDER THE BED	75
WHILE I YET LIVE	79
WHITE RABBIT	60
WILD NIGHTS WITH EMILY	42
WISHING CRANES, THE	74
WON'T YOU BE MY NEIGHBOR?	43
THE WORLD IS ROUND SO THAT NOBODY CAN HIDE IN THE CORNERS - PART I: REFUGE	70
ZAMA	60

MY NOTES



ACTION!

THE DEFINITIVE ART HOTEL IS TAKING CENTER STAGE IN DOWNTOWN SARASOTA.

COME DABBLE IN A CREATIVE CANVAS OF CURATED EXPERIENCES...

FROM INSPIRED DINING AND COCKTAILS AT OUR RESTAURANT AND LOUNGES
TO VISITING ART INSTALLATIONS AND EVENTS IN OUR GALLERIES.

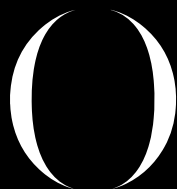

ART OVATION
HOTEL

1255 North Palm Avenue

ArtOvationHotel.com

941.316.0808



We love
bringing people together
through the power of
great storytelling.



The more you visit, the more you earn.
Join for FREE at MyRegal.com

