

THE
ANALYSIS & REPRODUCTION
OF
TEXTILE FABRICS.

By ALDRED F. BARKER,
*Head Master, Textile Department, Bradford Technical
College.*
Honorary Associate of the Yorkshire College, Leeds.

BEING A REASONABLE EXPLANATION OF THE NECESSARY
CALCULATIONS AND PROCESSES INVOLVED IN ANALYSING,
EFFECTING THE REQUIRED CHANGES, AND REPRODUCING
ALL THE PRINCIPAL TYPES OF WOVEN TEXTURES, FROM
THE RAW MATERIALS TO THE FINISHED CLOTH; WITH AN
APPENDIX UPON

“THE COST OF CLOTHS.”

MANCHESTER:
MARSDEN & Co., “TEXTILE MERCURY” OFFICE, CARR STREET.

BRADFORD:
THE AUTHOR, BRADFORD TECHNICAL COLLEGE.

1894.

MARSDEN AND CO., LTD., PRINTERS, MANCHESTER.

PREFACE.

In the following pages the analysis and reproduction of woven fabrics is dealt with at some length, two primary objects having been held in view throughout—the first, to write a systematic treatise on the subject for the student or the uninitiated to read through and study as they would any other text book; the second, to produce a work which the mill manager will find useful for reference, and in furtherance of this idea an index has been added.

Now, although much of the matter here given has already appeared in one form or another in the various textile journals, or in the works appertaining to the textile trades already published, yet I believe the following pages will come as a revelation to some.

Most designers and manufacturers are thoroughly conversant with the various difficulties involved in textile manufacturing, and the knowledge of a difficulty is half the battle; but the great majority of manufacturers overcome their difficulties in a very haphazard manner.

Sometimes they adopt a reasonable method, but very often the correctness of their method depends upon some rule of which they have little or no comprehension.

Now, a man who bases his calculations for, say hundreds or thousands of pieces, upon a rule which may

be wrong, is, to say the least, indiscreet, save he first prove the rule to be correct either by its application in a small way or by the reasonableness of the method.

In some cases, notably mechanics, it is hardly possible for the operative to thoroughly comprehend all formulæ involved, but I hope the following pages will prove to the manufacturer, designer, and student of the textile trades, that the "why" and "wherefore" of the various textile calculations and processes may be readily realised by systematic research, along with the exercise of a certain amount of common sense.

My experience as a teacher of some years' standing has shown me most clearly that no better advice can be given to those engaged in the textile trades than—"take nothing for granted, and never use a rule until you are thoroughly assured of the reasonableness thereof."

Upon this basis the present treatise is written.

I can hardly expect, however, to please everyone. My greatest difficulty has been in deciding what was really essential and what could well be omitted, since in order to bring much information into small compass, I have been desirous of curtailing as much as is compatible with efficient treatment. Owing to this, some sections of the work are rather brief, but in compensation for this reference is given to the published works treating upon the subject. Thus, in dealing with Designing in its various forms, I have frequently referred to the works of Professor Beaumont, of the Yorkshire College, Leeds, and have, of course, drawn upon the information obtained as a student at the Yorkshire College; and, again, in dealing with the science of Cloth Construction,

I have been more or less inspired by the previous work of Mr. T. R. Ashenurst, of Bradford. Notwithstanding this, however, I think the following pages will bear the most rigid scrutiny on the score of originality, being, in fact, partially a review of the experience gained by constant intercourse with practical men during the past six years.

My thanks are due to Mr. F. Bradbury and the students of the Shipley Technical Schools for advice and valuable assistance in working out the various calculations, they having thus rendered my task much easier and certainly more perfect; to Mr. L. Bentley, for practical particulars respecting the "double plush loom"; to many others who, in some cases without realising it, have given me most interesting material to work upon; and, finally, my thanks are due to Messrs. Marsden and Co. for the care they have exercised in editing and seeing the work through the press, and particularly with respect to the production of the blocks, with which they have spared no pains.

Shipley, 1893.

A. F. B.

ERRATA.

PAGE 42.—CLASS II. WEFT RIB MAKES:—Fig. 15 should be printed as here given, warp straight, weft bending.

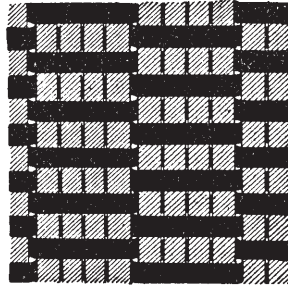

PAGE 27.—THE TAKE-UP IN TWISTING YARNS:—Figure 6 shows the twist, but by reference to p. 25, Fig. 5, it will be realised that here A only = $\frac{1}{2}$ a turn; consequently for the take-up in twisting 40 sk. woollen the calculation will stand:—

$$24^2 + 60^2 = C^2, \text{ or,}$$

$$576 + 3600 = 4176 = C^2, \text{ or, } C = \sqrt{4176} = 64.6.$$

The 24^2 is the twist A, since with 12 turns A will only = $\frac{1}{2}$ part of an inch. Similarly with the 12 sk. woollen and 40's worsted the calculation will stand:—

$$24^2 + (60 + 135)^2 = C^2, \text{ or,}$$

$$24^2 + 42^2 = C^2, \text{ or,}$$

$$2340 = C^2 \text{ and } C = \sqrt{2340} = 48.3.$$

The percentage allowance will be:—

As 60 : 64 : : 100 : x = about 7 per cent. allowance for both yarns in the first example.

As 42 : 48.3 : : 100 : x = 15 per cent. allowance for the 40's yarn in the last example.

CONTENTS.

INTRODUCTION.

CHAPTER I.—YARNS.

Raw Materials—Construction—Tests, etc.—Lists.

CHAPTER II.—CALCULATIONS, ETC., RELATING TO YARNS.

The Counts of Yarns—Testing a given Count—Yarn Reeling—Scales and Weights—Obtaining the Counts of Yarns taken from Cloths—Change in Denomination of Counts—The Count of Two-fold Yarns—The Cost of Two- and Many-fold Yarns—The Twist in Yarns—Testing the Twist—The relative number of Turns—The Take-up in Twisting—Colour—Twist Yarns—Yarn Examination.

CHAPTER III.—WEAVE ANALYSIS.

Two Methods—General Consideration—Instruments required.

Single Cloths.—Construction—Ordinary Makes—Weft-rib Makes—Warp-rib Makes—The Sateens.

Fancy Combinations—Stripes—Checks—Wefting Capacity—Fancy Twills.

Backed Cloths—*Double Cloths.*—Tieing or Stitching—Colour Pattern.

CHAPTER IV.—DRAFTING AND CALCULATIONS RELATING THERETO.

Method of Drafting—Calculations for Gears—Fancy Drafts—Pegging Plan—Calculations for Fancy Drafts—Casting-out—Crammed Stripes—The Arrangement and Number of Shafts in Weaving Backed and Double Cloths.

CHAPTER V.—FIGURED FABRICS.

Figure Analysis—The Reversing of Figures—Warp and Weft Weave Figures—Matelasses—Sateen Distribution of Spots—Weft Spot Figures—Extra Warp and Weft—Swivels—Lappets—Double Cloth Figures—Tie-up of Harness.

CHAPTER VI.—GAUZE AND LENO FABRICS.

Ordinary Gauze Fabrics.—Structure of Simple Gauze—Arrangement of Simple Gauze or Leno Loom—The Elementary Analysis—The Introduction of Thick Threads—Combination of Gauze with other Interlacings—Points to Note—Drafting or Douping—Complete Analysis.

Figured Gauze Fabrics.—Procedure in Analysis—Double Gauzes—Weft Figures upon Gauze Grounds—Gauze Harness—Mock Leno.

CHAPTER VII.—PILE FABRICS.

Classes of Pile Fabrics.

Weft Piles.—Structure—Difficulties in Analysis—Double Pile Fabrics—Piles produced in Finishing.

Warp Piles.—Structure—Figured Piles—Procedure in Analysis—Brussels Carpets—Tapestries—Axminster Pile—Turkish Towels—Double Plush Loom.

CHAPTER VIII.—SETTS AND THE SETTING OF CLOTHS.

Methods of Indicating the Sett—To find the Sett—Selection of Reed—Size of Twill or Repeat.

The Setting of Cloths.—Influences to consider—Diameters of Yarns—The Weave—Classification of Weave—Cloths Woven on the Square—Weft-rib Cloths—Warp-rib Cloths—Difficulties in Applying the Principles—Changes in Counts and Sett.

CHAPTER IX.—CALCULATIONS RELATING TO THE WEIGHTS OF CLOTHS.

Ordinary Warp and Weft Calculations.

Complicated Calculations for: Coloured Warps and Wefts—Cloths with Yarns of two or more Counts—Backed and Double Cloths—Crammed Stripes—Other Necessary Calculations.

Changing the Weights of Cloths.—Changing by the Counts—By the Ends—The Correct Method—Change of Weight in relation to Diameter—Change in both Weight and Weave.

CHAPTER X.—THE WEIGHTS OF FINISHED CLOTH.

Modifying Influences—Loss of Oil—Loss of Fibre—Effects of Shrinkage—Influence of Heat—Estimation of Loss in Weight

CLOTHS IN THE GREY AND FINISHED STATES CONTRASTED :
(1) Sett in the Loom—(2) Width in Loom—(3) Picks per
inch Woven—(4) Length of Warp—(5) Counts of both
Warp and Weft in the Grey—(6) Weight per yard Finished
—(7) Weight per yard Calculated.

APPENDIX I.—THE COST OF CLOTHS.

APPENDIX II.—FABRICS DIFFICULT TO ANALYSE.

APPENDIX III.—THE SELECTION OF DESIGN PAPER.

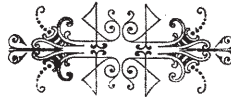

INTRODUCTION.



ALTHOUGH the subject of "Pattern Analysis," rightly considered, can only lay claim to a secondary place in the designer's curriculum, yet its importance is very apparent. The pioneers of artistic textile design may use what invectives they like against the wholesale copying or re-adaptation of French and German design, and rightly so ; but in another sphere, skill in analysis is so useful an adjunct that the designer can ill afford to ignore its importance. Nowadays, when fashion necessitates such frequent changes in style of pattern, in material, in design, the manufacturer requires his designer to have the most comprehensive knowledge possible, and this can only be acquired by the study of the work of others along with his own—not necessarily to copy therefrom, but rather to use this as the starting-point from which to traverse the yet vast field of original textile design. There is the difficulty, however, constantly cropping up of designers merely re-adapting designs—that is, applying designs effective in rich materials to lower goods, the rendering of the design being, of course, very inferior. This tendency

can only be counteracted by our technical schools demonstrating that each type of cloth requires specific treatment, which treatment (properly carried out) will give results vastly superior to any mere adaptation. At the same time, it will be well to remember that, if a sufficiently large number of true textile designers can be sent forth, there will not be the necessity for this re-adaptation, at present so largely carried on.

Having thus justified the claim of pattern analysis to the full and due consideration of all textile designers, it will be well to glance over the subject before attacking each section in detail. Let us suppose, then, that the designer has before him a pattern which he is required to exactly reproduce. How will he proceed? Probably his first consideration will be the nature of the raw material of which the cloth is built up: Is it of one material throughout, or is it composed of two—say a cotton warp and a wool weft? Then would follow a more minute inspection of the yarn: Is it woollen or worsted yarn, or a knicker or looped yarn? Of what counts are the respective yarns, and what about the colours—are they easily obtainable, or will there be some difficulty in “hitting off” the right shade? These are but minor considerations; but, nevertheless, all are important points, as those can testify who undertake such work. For example, using a white yarn instead of a tinted one may prove disastrous; and many other matters of detail are of equal importance. Then follows the consideration of the “make,” “weave,” or “figure,” the setting and the wefting, with all

calculations relating thereto, changing the weights of pieces ; and, lastly, the calculations for take-up in finishing, both in length and breadth, upon which depends to some extent the weight of the finished cloth. Hence it is desirable that the designer should thoroughly understand all the principles here involved.

All these points are discussed at some length in the following pages ; and, in order to render the treatment of practical service, whenever possible the deductions are tabulated for easy reference.

CHAPTER I.

YARNS.

Materials.—The materials most commonly met with in yarns are as follows:—1. The animal fibres: wool, mohair, cashmere, silk, etc. 2. The vegetable fibres: cotton, jute, flax, china grass, etc. 3. The mineral fibres, which are altogether of minor importance. There is another class, largely formed of the first two here given—viz., the re-manufactured materials: noil, mungo, shoddy, flocks, etc.; but since these partake of different characteristics, according to their components, no better tests can be given than in the lists appended. List I. indicates the various raw materials, with the practical means of distinguishing one from the other.

Construction.—Of great importance to the resultant cloth is the way in which the fibres in a yarn are bound together or spun. For example, between the true worsted (as typically represented by mohair or English yarn) and the mule-spun yarn (as typically represented by the woollen) there is a vast amount of difference, even should the same raw material be employed in both cases. The same difference is possible in cotton and even in silk yarns, though not in such a marked degree; therefore, with the idea of aiding the

LIST I.—TEXTILE MATERIALS.

MATERIAL.	GENERAL APPEARANCE.	MICROSCOPIC APPEARANCE.	HANDLE.	BURNING.	ACID OR OTHER TEST.
Wool	Varies from a light and downy to a stringy, hairy nature.	Overlapping scale like structure most marked.	Soft and plastic, oily.....	Burns with some difficulty and emits a disagreeable odour. Bead formed of burnt matter.	Turns yellow in nitric acid. Dissolves readily in cold concentrated caustic soda. Turns black when boiled with a solution of lead oxide in caustic soda. Boil in a solution of a dye such as indigo extract in the presence of a little sulphuric acid—wool will be dyed—vegetable fibres will be left white—silk tinted. Ditto.
Mohair	Long and lustrous	Scales not so prominent as in wool, more glossy.	Soft and silky	Ditto	Ditto.
Silk	Varies from a dull, non-lustrous, fibrous mass in the cocoon state, to a bright lustrous mass.	Glass rod like structure; two fibres glued together to form one.	Very elastic and strong, soft and silky.	Ditto	Turns yellow with nitric acid. Not so easily affected by caustic soda as wool. Easily dyed in a cold solution of a dye like magenta—wool left much lighter—cotton almost colourless.
Cotton	A white, downy, fibrous mass...	Flattened, twisted tube with striations.....	Soft, but of a harsher nature than wool.	Burns, with a flash, leaving no bead.	Steeped in dilute acid and then dried—the fibre falls to powder. Soluble in a solution of copper hydrate in ammonia. Coloured yellow with sulphuric acid and iodine.
Flax or Linen Fibre	Lustrous, snowy white fibres ...	Red like structure, showing fibrils.	Less elastic than cotton, soft.	Ditto	Ditto. Coloured blue on treatment with sulphuric acid and iodine. Distinguished from cotton by action of caustic soda.
Jute.....	Stiff and lustrous	Ditto.....	Distinguished from flax by being coloured dark brown under influence of sulphuric acid and iodine solution.
Re-Manufactured— (a) Noh, etc.	Like wool, only short and lumpy	Like wool.	Soft	Like wool	Same as wool.
(b) Mungo Merinos, etc.	Like wool, only very short	Examination reveals components and broken and damaged wool fibres.	Varied according to composition, but generally handles "dead."	According to presence or absence of cotton oil, etc.	Wool and cotton tests.

Fold-out rotated 90° to fit on page.

LIST II.—YARNS.

YARN.	MATERIAL.	STRUCTURE.	APPEARANCE.	STRENGTH.	ELASTICITY.	COUNTS SPUN TO	RELATIVE DIAMETERS.
WORSTED— (a) Botany	Finest Merino Wools...	Fibres parallel, but a full-bodied yarn.	Like fine woollen, fairly lustrous.	Varies considerably, but usually strong.	Very elastic	100's	Deduct from sq. rt. of yds. per lb. 10 per cent. for diameter.
(b) Cross-bred...	Cross between Lincoln and Merino.	Fibres parallel	Hairy, fairly lustrous.	Strong	Varies, but most will mill well.	40's	Ditto, 10 per cent.
(c) Mohair, etc.	Hair from Angora Goat	Fibres parallel	Hairy, but very lustrous.	Very strong as a rule.	Elastic	50's	Ditto, 10 per cent.
WOOLLEN	Various kinds of fine and medium wool.	Fibres mixed up	Bulky, uneven	In the yarn state not usually as strong as worsted.	Very elastic as a rule.	60sk.	Ditto, 16 per cent.
COTTON	Cotton	Fibres parallel as a rule, sometimes like woollen.	Solid and inelastic, sometimes lustrous	Strong as a rule ...	Not to be compared with wool.	300's	Ditto, 8 per cent.
SILK— (a) Orgazine...	Thread from cocoon ...	Continuous fibres twisted together.	Rather opaque, twisted.	Very strong	Elastic	200's	"
(b) Tram	Ditto	Fibres parallel, little twist.	Very lustrous	Strong	Elastic	"	"
(c) Spun	Carded Silk	More bulky than other fibres not so parallel.	Fairly lustrous, but somewhat opaque.	Very strong	Elastic	100's	"
MERINO, ETC. ...	Re-manufactured	Woollen structure ...	Uneven and short fibred as a rule.	Very deficient	Little or none	40sk.	Deduct from sq. rt. of yds. per lb. 16 per cent. per diameter.

In this list the counts spun to are only very approximate, since if price is no object much higher numbers than those given may be obtained.

Machine makers take 2/48's botany and single 32's cross-bred as standard counts in worsted.

Fold-out rotated 90° to fit on page.

analyst in selecting the type of yarn requisite, List II. is appended.

The student is strongly recommended to use this list while handling the various materials or yarns, since by so doing he will mentally record the principal features here noted, and consequently will rapidly become capable of judging yarns by handling and appearance alone. It is, of course, impossible to record here every type of yarn; but if the appended list be used in this way it will prove all that is desirable.

For further particulars readers are referred to Hummel's "Dyeing of Textile Fabrics," Bowman's "Structure of the Wool Fibre" and "Structure of the Cotton Fibre," and M'Laren's "Spinning Woollen and Worsted."

CHAPTER II.

CALCULATIONS RELATING TO YARNS.

The Counts of Yarns.—The many methods in vogue of counting yarns are bewildering. Simplicity can only be obtained by reducing all systems to the common basis of yards per lb., and the tendency in this direction is now so marked that a universal system of counting may be expected in the near future. The following are only the principal methods; others are in use, but their inexpediency precludes their notice in the short treatment here adopted, and the list may be found useful for reference.—

LIST III.—METHODS OF COUNTING YARNS.

Type of Yarn.	Basis of Counts.	Yards per Hank.
Woollen :—		
Leeds	1,536 yds. = 6 lb.	256
Galashiels	300 yds. = 24 oz.	200
West of England..	320 yds. = 16 oz.	320
Worsted	560 yds. = 1 lb.	560
Cotton	840 yds. = 1 lb.	840
Silk, Spun	840 yds. = 1 lb.	840
Linen	300 yds. = 1 lb.	300 yds. per "lea."

In each of the above cases the hanks per lb. indicate the counts; in reality, therefore, the yards per lb. indicate the

counts. Thus the defect of a certain number of yards per lb. meaning one count in one system and other counts in other systems is very apparent.

Testing a Given Count.—The simplest method of testing a given count is as follows :—

RULE.—Reel as many yards as there hanks per lb. in the count to be tested, and weigh against 12·5 grains for worsted, 8·33 for cotton, and 27·34 for woollens (Yorkshire skein). The reason for this is as follows :—There are 7,000 grains in 1lb. avoirdupois. Now, 1 yard of 1's worsted would weigh $7,000 \div 560 = 12\frac{1}{2}$ grains, and 10 yards of 10's worsted, 20 yards of 20's, etc., should weigh exactly the same. A similar reasoning applies to the other systems of counting yarns.

Yarn Reel.—There are many forms of reel in the market—from the simplest to quite complicated construction. Although the more complicated ones possess certain advantages which should not be ignored, the simple reels, as a rule, will prove sufficient for all that is necessary. Figure 1 is a useful reel made by Messrs. Goodbrand and Holland, consisting of a holder for the yarn to be tested, a guide to distribute the yarn on the reel, and a reel 1 or $1\frac{1}{2}$ yards in circumference, with a dial plate indicating the number of revolutions. For further details reference may be made to the catalogue of Messrs. Goodbrand and Holland, of Manchester.

Another method of testing the counts of yarn is by means of a quadrant so adjusted that by placing a given number of yards upon it, the pointer shows the counts. If the analyst is always engaged on one type of work this may save time ; but, as a rule, it will be found better to realise exactly each step throughout the calculation. Other yarn-testing machines

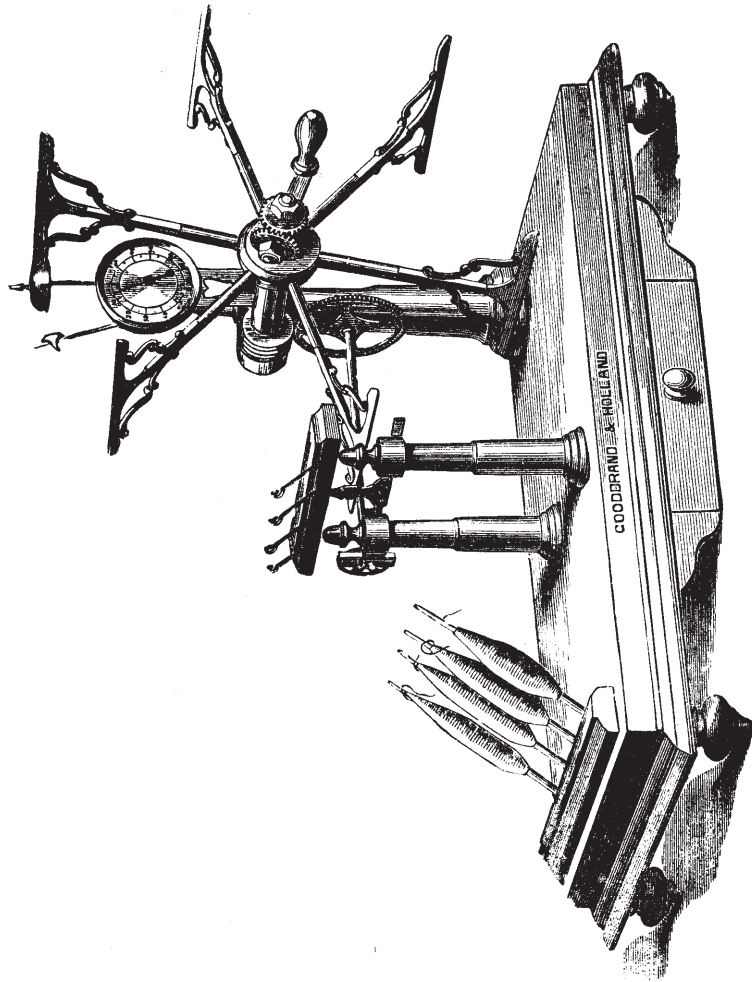

FIG. 1.

there are, which, however, are not of sufficient importance to obtain notice here.

Scales and Weights.—In the factory very crude scales will often be found—upon which the carder, comber, or spinner depends. This, however, is not as it should be and every day sees the introduction of more perfect systems into our factories ; and the manufacturer who is alive to his own interests will provide for his workpeople all that is necessary for conducting accurate tests, for he is then justified in expecting accurate results. Scales may be purchased of most opticians at prices varying from 2s. 6d. to £10 and upwards. Neither of these extremes is necessary or perhaps desirable. A good, substantial pair may be purchased for about £1 which should be quite accurate enough for all ordinary purposes, yet not so finely adjusted but that they will stand a little rough usage. Weights may be obtained in boxes at various prices. The analyst should be provided with the following grain weights :—50, 20, 20, 10, 5, 2, 2, 1, '5, '2, '2, '1, '05, '02, '02, '01 ; and he should be careful to lift them about with the tweezers supplied, since handling is very liable to affect their accuracy.

Obtaining the Counts of Yarn from the Cloth.—The foregoing particulars only apply to testing the counts of a yarn before weaving. To test yarn taken from a cloth is a more difficult matter. Let us suppose that it is desired to obtain the counts of yarns used in making a cloth of which we have a pattern 4in. by 4in. Then proceed thus :—

1. Examine the cloth carefully to ascertain if the warp is all one count and if the weft is all one count.
2. Obtain as great a length as convenient of each of the yarns present in the cloth.

3. Weigh this carefully to the hundredth part of a grain.
4. Divide the weight thus obtained into 7,000 grains, and multiply the yards of yarn weighed by this last quotient, and the result will be yards per lb., from which the counts may be readily deduced.

EXAMPLE.—1. An examination of the pattern reveals that it is a cross-bred serge.

2. From this 24 threads of warp and 24 picks of weft are taken, thus obtaining 2 yards of each.

3. Each is found to weigh 3·15 grains.

4. $7,000 \div 3\cdot15 = 2,222 \times 2 = 4,444$ yards per lb. $\div 560$ = nearly 8's counts worsted.

The accuracy of this calculation might be tested by making out the weight per square yard of the piece, taking the count to be 8's, and comparing this with the weight per square yard obtained by weighing the 4 square inches of cloth previous to pulling in pieces. (See page 39).

A more direct and simpler method of obtaining the count is as follows :—

RULE.—Divide the weight of the yarn weighed into 12·5 grains for worsted, 27·34 for woollen, and 8·33 for cotton, etc., and multiply the yards weighed by this quotient.

EXAMPLE.—In the foregoing calculation 2 yards weigh 3·15 grains, therefore $3\cdot15 \div 12\cdot5 = 4$ nearly, and 4×2 yards = 8's, the count.

The results obtained thus are likely to be slightly inaccurate owing to the bending of the warp and weft threads, there being rather more than the length cut (4 inches in the above example). This, however, is compensated for, as a rule, by the weight the yarn loses in the finishing processes; and, even were this not so, with care the result should be sufficiently accurate for all practical purposes.

Another method of estimating the counts of the yarn is to



compare it with known counts. The accompanying sketch shows how, by taking a number of threads of a known count and twisting them with a varying number of threads of the unknown count until the two, twisted, appear to make a similar thread, the counts of the yarn may be obtained. Practice enables the analyst to estimate the counts with great accuracy by such comparison in the case of low and medium numbers; but in the higher numbers some more certain method is necessary.

A combination of the two methods may also prove useful. Thus: judge as nearly as possible the counts of the yarn—say 20's; reel 20 yards and weigh against 8.33 grains, if for cotton. If it weighs more (say 9.5), the counts are less in the proportion

$$\text{As } 9.5 : 8.33 :: 20 : x = \text{the true counts.}$$

If it weighs less (say 7.5), the counts are a higher number, in the proportion

$$\text{As } 7.5 : 8.33 :: 20 : x = \text{the true counts.}$$

Although grain weights are invariably employed for fine tests in dealing with yarns and cloths, in the works the ordinary avoirdupois weights are more frequently met with, the method of testing being this: Since there are 256 drams in 1 lb., and 560 yards per hank of worsted, therefore 1 yard of 1's will weigh $\frac{256}{560}$ drams, or about $\frac{3}{7}$ dram, but this would evidently be too short a length and too small a weight to favour any degree of accuracy, therefore a convenient

practical part of the hank—say 70 yards ($1/8$ of the hank)—should be taken, then proceed as follows:—

$$\frac{256 \text{ drams}}{8} = \text{the weight of 70 yds. of 1's,}$$

therefore $\frac{256 \text{ drams}}{8 \times 20's} = \text{the weight of 70 yds. of 20's,}$

and, consequently, putting the desired counts in the place of the 20's, the drams that 70 yards should weigh will be obtained; and should the sample, being tested, weigh more or less, the counts will be less or more in direct proportion, as explained further on.

WORSTED SPINNERS use what is termed a “gauge point,” obtained as follows:—

Taking 70 yards as a convenient number to reel:—

$$\frac{256 \times 70}{560} = 32 \text{ drams or 2 oz. weight of 70 yards of 1's.}$$

Consequently the counts of any given yard, divided into this, will give the drams which 70 yards should weigh.

EXAMPLE.—Find the correct weight of 70 yards of $2/16$'s yarn (= 8's).

$$32 \div 8 = 4 \text{ drams.}$$

This may be readily proved, for if 70 yards = 4 drams, 560 yds. = 32 drams, and $256 \div 32 = 8$ hanks per lb., or 8's counts.

Of course there is no need to reel 70 yards; 80 yards (or $1/7$ of 560), or 140 or 280 yards, will do equally well.

In the case of COTTON AND SPUN SILK YARNS proceed in the same manner, reeling a convenient practical part of the 840 yards—say 84 yards = $1/10$ th of 840; then

$$\frac{256 \times 84}{840} = 25\frac{1}{2} \text{ drams weight of 84 yards of 1's.}$$

Consequently any counts divided into $25\frac{1}{2}$ gives the weight of 84 yards.

EXAMPLE.— $25\frac{1}{2} \div 20 = 1\frac{1}{4}$ drams weight of 84 yards of 2/40's or 20's.

This may be proved thus: 84 yds. = $1\frac{1}{4}$ drams, 840 yds. = $12\frac{1}{2}$ drams, and $256 \div 12\frac{1}{2} = 20$ hanks per lb., or 20's counts.

In the WOOLLEN TRADE the skein always equals the yards per dram; thus 20 sk. = 20 yds. per dram, 30 sk. = 30 yds. per dram.

Changing the Denomination.—From what has already been given, it will be evident that counts are used simply as a means of accurately estimating the thickness or size of yarns in relation to weight; and it will also be evident that in reality the yards to which 1lb. of the material is drawn is used as the measure. For instance, as shown in Figure 2, in (1) 1lb. of material is drawn out to 560 yards = 1's counts; in (2) 1lb. of material is drawn out to 1,120 yards = 2's counts; consequently, 1 yard of 1's is double the weight of 1 yard of 2's, or weight is inversely to counts.

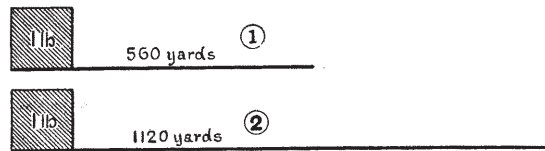

FIG. 2.

Upon these lines the manufacturer bases the calculations for his cloths. But from the particulars already given it will be evident that a 20's yarn in worsted counts is a very different yarn to a 20's yarn in cotton or other counts; consequently, the designer cannot estimate the relative thicknesses of any two such threads until they are in the same denomination—*i.e.*, both stated in either worsted or cotton counts. Remem-

bering that counts are really based upon yards per lb., the rule for this will be as follows:—

TO CHANGE THE COUNTS IN ANY GIVEN SYSTEM TO EQUIVALENT COUNTS IN ANY OTHER SYSTEM.

RULE.—Ascertain the yards per lb. in the counts to be changed and divide by the yards per hank in the system into which the required change is to be made.

EXAMPLE.—Change a 20's worsted into woollen counts.

$$\begin{aligned} 20 \times 560 &= 11,200 \text{ yards per lb.} \\ 11,200 \div 256 &= 43\frac{3}{4} \text{ woollen counts.} \end{aligned}$$

EXAMPLE.—Change a 60/2 silk into worsted counts.

$$\frac{60 \times 3}{2} = \frac{180}{2} = 90 \text{ 's worsted.}$$

[NOTE.—560 is to 840 as 2 : 3, therefore 2 and 3 are used in the above calculation instead of 560 and 840.]

The Counts of Two-fold Yarns.—The usual practice in two-folding yarns is to twist two or more threads of like counts together, thereby obtaining a stronger, evenner, and usually a heavier thread. The actual counts in this case will be just half the stated counts—*i.e.*, two-fold 40's yarn (written 2/40's) equals in weight single 20's. (*Exception*—2/60's silk, written 60/2 = 60's.)

In twisting together yarns varying in thickness, and consequently counts, they must all first be brought to one denomination—*i.e.*, worsted, woollen, or cotton, as required, and then the resultant count will be obtained as follows:—

RULE.—Multiply the two counts together, add the two counts together, and divide one by the other for the answer.

EXAMPLE.—What is the resultant count of 20's twisted with 40's?

$$\frac{20 \times 40}{20 + 40} = \frac{800}{60} = 13\frac{1}{3} \text{ counts.}$$

The following is the reason for this method of procedure :—
 40lb. of 20's is equal in length to 20lb. of 40's; therefore
 the resultant yarn will be composed in the proportion of
 20lb. of 40's yarn to 40lb. of 20's yarn. Now, the length of
 20lb. of 40's and 40lb. of 20's will be the same—*i.e.*, 20×40
 $= 800$ hanks; therefore the sum, simplified, is—if 800 hanks
 weigh 60lb., what are the counts? and the answer is $800 \div 60$
 $= 13\frac{1}{3}$ hanks per lb.

Another method of arriving at the same result is to divide
 one of the counts—preferably the highest—by itself, and by
 each of the others, and the result thus obtained divided into
 these counts will be the answer, thus :—

$$\begin{array}{r} 40 \div 40 = 1 \\ 40 \div 20 = 2 \\ \hline 40 \div \quad 3 = 13\frac{1}{3} \text{ counts.} \end{array}$$

In this case also the reason is very apparent : the 40 hanks
 equal 1lb. being taken as the length; thus, 2lb. of 20's is
 requisite to give the same length, and 40 hanks weighing
 3lb. = $13\frac{1}{3}$ hanks per lb.

In the case of three or more threads twisted together,
 proceeding by the first rule, the resultant counts of two must
 be first ascertained, and then of this and the third thread,
 and so on.

EXAMPLE.—What is the resultant counts of 20's, 40's, and
 80's?

$$\frac{20 \times 40}{20 + 40} = 13\frac{1}{3} \text{ resultant counts of first two threads.}$$

$$\frac{13\frac{1}{3} \times 80}{13\frac{1}{3} + 80} = 11\frac{5}{7} \text{ resultant counts of three threads.}$$

By the second method, however, the result may be much
 more easily obtained—

$$\begin{array}{l} 80 \div 80 = 1 \\ 50 \div 40 = 2 \\ 30 \div 20 = 4 \\ \hline 80 \div 7 = 11\frac{2}{7} \text{ counts.} \end{array}$$

Another case in which it may be necessary to apply the above principles is as follows :—

EXAMPLE.—What thread twisted with a 40's yarn will give $13\frac{1}{3}$ counts. Then,

$$\frac{40 \times 13\frac{1}{3}}{40 - 13\frac{1}{3}} = 20\text{'s counts.}$$

This may be reasoned out as follows :—40lb. of $13\frac{1}{3}$ counts (= $13\frac{1}{3}$ lb. of 40's counts) is taken for the length—*i.e.*, $533\frac{1}{3}$ hanks, weighing 40lb.; but of this 40lb., $13\frac{1}{3}$ lb. represents the 40's or given count, so the remainder or component is $533\frac{1}{3}$ hanks, weighing ($40 - 13\frac{1}{3}$ lb.) = $26\frac{2}{3}$ lb. = 20's counts.

N.B.—Note that in the above no denomination is given—the calculations apply equally to all denominations; but all the threads twisted together must be reduced to the same denomination before the calculation is made.

The Cost of Two and Many Fold Yarns.—

If the prices of the yarns combined are given it will evidently be an easy matter to calculate the cost of the folded yarn, since the above calculation gives the relative weight of each yarn in the combination. An example will best demonstrate this.

EXAMPLE.—Calculate the cost of a yarn composed of 20's yarn at 2/- and 40's yarn at 3/- :

$$\begin{array}{l} 40 \div 40 = 1\text{lb. at } 3/- = 3/- \\ 40 \div 20 = 2\text{lb. at } 2/- = 4/- \\ \hline \end{array}$$

Equals 3lb., costing 7/- = 2/4 per lb.
Counts of yarn = $13\frac{1}{3}$, costing 2/4 per lb.

A more difficult calculation is as follows :—Required the price per lb. of a three-fold twist yarn, made as follows :—One thread of 44's worsted at 3/8 per lb., one thread of 36's spun silk at 17/- per lb., and one thread of 36 sk. (Yorkshire) at 2/6 per lb. ; allowing 17½% for twisting-up in worsted and 15% for twisting-up in silk.

Evidently the first thing to be done is to bring all the counts to one denomination ; so first reduce the silk and worsted to woollen counts, thus :—

$$44 \text{ s worsted} = \frac{44 \times 560}{256} = 96\frac{1}{4} \text{ sk. woollen counts.}$$

$$36 \text{ s silk} = \frac{36 \times 840}{256} = 118\frac{1}{8} \text{ woollen counts.}$$

Now the weight for any given length must be obtained : let the given length be 118½ hanks, and proceed on the principles already laid down, thus :—

	lb. oz. dr.	
$118\frac{1}{8} \div 96\frac{1}{4} = \frac{118\frac{1}{8}}{96\frac{1}{4}} + \frac{17\frac{1}{2}}{100} \text{ (for \%)} = 1 \quad 7 \quad 14\frac{1}{4}$		of worsted.
$118\frac{1}{8} \div 118\frac{1}{8} = 1 + \frac{15}{100} \text{ (for \%)} = 1 \quad 2 \quad 6\frac{3}{8}$		of silk.
$118\frac{1}{8} \div 36 = \frac{118\frac{1}{8}}{36} = 3 \quad 4 \quad 8$		of woollen.
$118\frac{1}{8} \text{ hanks}$		$5 \quad 14 \quad 12\frac{3}{8}$

From this the counts may be readily obtained, for 118½ hanks = 118½ × 256 ÷ 1,516 drams = about 20 yards per dram, or 20 sk.

The cost per lb. will now readily be ascertained as follows :—

lb. oz. dr.	d.
1 7 14 $\frac{1}{4}$ at 3/8 per lb.	$\frac{382}{256} \times \frac{44}{1} = 65\frac{2}{3}\frac{1}{2}$
1 2 6 $\frac{2}{5}$ at 17/- per lb.	$\frac{294}{255} \times \frac{204}{1} = 234\frac{9}{12}$
3 4 8 at 2/6 per lb.	$\frac{840}{256} \times \frac{30}{1} = 98\frac{14}{12}$
5 14 12 $\frac{3}{8}$ costing	398 $\frac{11}{12}$

$(398\frac{3}{8} \div 1,516) \times 256 = 5/8$ per lb. for 3-fold yarn.

To test the correctness of this answer reduce all to worsted counts, and proceed as follows :—

	lb. oz. dr.
Silk = $54 \div 54 + \frac{15}{100}$	= 1 2 6 $\frac{2}{5}$
Woollen = $54 \div 16\frac{2}{3}$	= 3 4 8
Worsted = $54 \div 44 + \frac{17\frac{1}{2}}{100}$	= 1 7 14 $\frac{1}{4}$
54 hanks	= 5 14 12 $\frac{3}{8}$

or—

30,240 yards \div 1,516 drams = 20 yards per dram, or 20 sk. woollen ;
 and $\frac{20 \times 256}{560} = 9\frac{1}{7}$ counts in worsted.

For the price proceed as follows :—

	lb. oz. dr.	d.
Silk	1 2 6 $\frac{2}{5}$ at 17/-	= 234 $\frac{9}{12}$
Woollen	3 4 1 at 2/6	= 98 $\frac{14}{12}$
Worsted.....	1 7 14 $\frac{1}{4}$ at 3/8	= 65 $\frac{2}{3}\frac{1}{2}$
	5 14 12 $\frac{3}{8}$, costs	398 $\frac{11}{12}$

or about $5/7\frac{1}{2}$ per lb., thus proving the previous answer.

The Twist in Yarns.—Although “twist” should rightly have been dealt with under the heading of “Construction,” in Chapter I., yet of such importance is this matter that it well merits separate and full consideration.

The handle of a cloth, for example, may be varied almost infinitely by varying the amount of twist in the yarns employed. Most yarns may be made to handle very harsh by an undue amount of twist. This, under exceptional circumstances may be desirable; but, as a rule, only the number of turns necessary to secure the firm adhesion of the individual fibres should be introduced, while in the case of weft and other soft yarns the rule usually is to put in as little twist as possible—that is to say, just sufficient to allow the shuttle to lay the weft nicely in the shed.

RULE.—In the case of cotton, the twist is usually decided by multiplying the square root of the counts by 3.75 for warp and by 3.25 for weft.

A natural enquiry now will be—To what extent is this rule applicable to worsted and woollen yarns?

The benefit of having a universal standard for the more ordinary yarns is very apparent, but all hope of attaining such must immediately vanish when the nature of the wools most commonly in use is considered. The elasticity and rigidity of many of the long-stapled wools, the softness and flexibility of the best botany, with all the conceivable intermediate stages, present an insurmountable barrier, so that at the best only approximate results must be looked for. In List IV. the average results of a number of experiments are given, the accuracy of the deductions being ensured by previously reeling the yarns in order to test the counts.

Interesting experiments in this matter are recorded by Dr. F. H. Bowman in his "Structure of the Wool Fibre." Thus, lists are given headed by the yarn and turns per inch desired, with the wool from which the yarn is spun, followed by various tests. The following list has been drawn up to

LIST IV.

Yarn.	Counts.	Average turns per inch.
1 Woollen ...	18 sk. (two-fold)	14
2 Cross-bred.	2/16's	5.5
3 " "	2/24's	4.6
4 Botany.....	2/8's	8.1 (ex. twist)
5 "	2/16's	8.1
6 "	2/30's	11
7 "	2/40's	18
8 "	2/50's	15
2 "	2/56's	17.4

obtain, if possible, something upon which to base the turns per inch in yarns, the desired twist being taken from Dr. Bowman's list:—

LIST V.

Raw Material.	Counts.	Desired turns per inch.	Sq. rt. of counts x 3.75 for warp, and 3.25 for weft.
Irish and Leicester Botany	24's	8.5	15.9
" " "	36's	12	19.5
Leicester Botany	50's	17.22	22.7
Botany Merino	80's	18.71	28.9
Irish and Leicester Botany	2/30's	11	14.2
Leicester Botany	2/40's	12.2	16.5
" "	2/50's	15.3	18.75
Botany Merino	2/70's	23.3	22
" "	2/80's	28.8	23.6

An examination of this list confirms at once the previous remarks respecting variations in twist. In the two-fold yarns, for example, it will be noticed that in the coarser yarns the desired twist is less than the square root of the

counts $\times 3.75$, while in the case of the botany merino wool the number of turns exceeds the square root of the counts $\times 3.75$. On turning to single yarns, in a still less degree is the rule for twist applicable—the turns per inch being much less than the square root of the counts $\times 3.25$. The single yarns here given would probably be spun for weft or for twisting. Thus we should expect single warp yarns to approach nearer the theoretical number of turns than do the examples given.

Testing the Twist.—With these particulars, the analyst should be able to judge the amount of twist desirable for either warp or weft to give the requisite handle to the resultant cloth. If, however, he desires to obtain the exact number of turns present in the yarn under examination, he

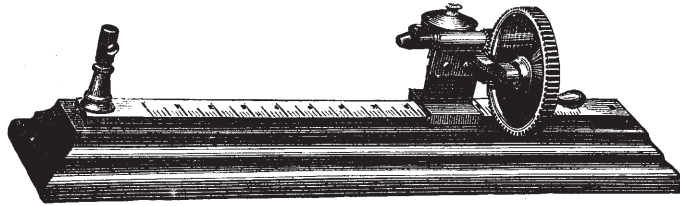

FIG. 3.

should employ the little machine shown in Figure 3, which is so constructed that the twist from any number of inches may be obtained. One end of the yarn is clasped in the stationary pillar; the moving pillar with winder is then run upon the rest (which is graduated in inches) to the desired length of the yarn to be tested, is clamped down, and the free end of the yarn clasped by the screw provided. Upon revolving the wheel shown the twist is taken out, while

a graduated disc shows the number of turns made by the handle. Upon examining the yarn and finding all the twist taken out, the number is read off the disc, and this, divided by the number of inches tested, gives the turns per inch.

EXAMPLE.—Six inches of two-fold yarn was stretched between the two pillars, and the wheel was revolved 36 times before careful examination showed all the twist to be taken out of the two-fold thread; then $36 \div 6 = 6$ turns per inch.

Note should be made that, while it is advisable to test a fair length of yarn, if too long a length is tested some difficulty may be experienced in judging when all the twist has been extracted; particularly is this the case with single yarns.

The Relative Number of Turns per Inch.—

As will be gathered from the preceding remarks, the relative amount of twist in yarns is well worth consideration. For example, suppose it is known that 2/40's yarn, with 12 turns per inch, gives the required handle to a cloth, and for some reason or other the designer wishes to use a 2/60's yarn: What amount of twist should the 2/60's have to give the same handle?

RULE.—The twist in yarn varies as the square root of the counts (the diameter)—inversely.

EXAMPLE.—A 2/32's gives the desired effect with 12 turns per inch in. What number of turns per inch should a 2/50's have?

$$\text{As } \sqrt{16} : \sqrt{25} :: 12 : x = 15 \text{ turns per inch.}$$

Or, by squaring all the terms—

$$\text{As } 16 : 25 :: 12^2 : x^2 = 15 \text{ turns per inch.}$$

The reason for this is well shown in Figures 4 and 5. In Figure 4 the diameter of the yarn increases in

multiple proportion—*i.e.*, B is twice the diameter of A, and C twice B; while the dotted lines show that the same number of turns per inch are inserted throughout. The variation of the angle of the twist is apparent. Compare, for example, c and A, where the difference is the greatest.

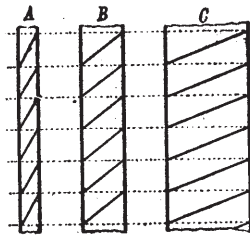

FIG. 4.



FIG. 5.

In Figure 5 is demonstrated the fact that the twist varies as the diameter—*i.e.*, as the square root of the counts. Here B is double the diameter of A; but the dotted lines show that, to keep the same inclination in the twist, B must have only half the number of turns that A has, thus proving that the variations must be as the square root of the counts,—*inversely*.

The Take-up in Twisting Yarns.—This, although a matter of detail, should be considered and reduced to rule by every manufacturer who desires to make his cloth to exact weight. The following question may be put:—If two threads (each 40's count) are twisted together, what will be the resultant counts? Or, if a 40's and a 20's yarn are twisted together, what will be the resultant counts?

In the first instance the answer will be 2/40's, and in the last

$$\begin{array}{r} 40 \div 40 = 1 \\ 40 \div 20 = 2 \\ \hline 40 \div 3 = 13\frac{1}{3} \text{ counts.} \end{array}$$

But actually neither of these answers will be correct, since in twisting a certain amount of contraction of the threads takes place, owing to the bending which yarns so combined are subject to; consequently a slightly heavier yarn—*i.e.* a smaller number in the counts—will result.

The question then is: Can this contraction during twisting be estimated? And, although there are difficulties in the way—such as variation in the materials, some fibres giving a softer, fuller yarn than others—still, the following particulars may prove of some service:—

All twist yarns may be classed under two heads:

1. Those in which both component threads bend equally out of the straight line. 2. Those in which one component bends while the other remains straight. Brief consideration shows that in the first class there will be the same take-up in each yarn, while in the second class all the take-up will be in one yarn.

Now, since the diameter of any given yarn is readily ascertainable, and since the amount of twist introduced is known, the triangle A, B, C (Figure 6) may be constructed,

in which A equals the twist and B the diameter of the yarn, and from these two the hypotenuse c may be ascertained.

Again, it will be evident that, relatively, A = the length of two-fold yarn produced by the thread or threads of length c; therefore the difference between A and c will give the take-up.

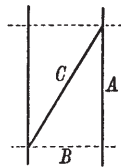

FIG. 6.

Now, owing to the fact that A, c, B is a right-angled triangle, $A^2 + B^2 = c^2$, and substituting the turns per inch and diameter of the yarn for A and B—supposing, in the first place, each of the yarns to be 40 sk. woollen and the turns per inch 12—then we have:—

$$12^2 + 60^2 = c^2 \\ 144 + 3,600 = c^2 \text{ or } \sqrt{3,744} = c,$$

or $c = 61$, or 61 yards of each yarn will be required to yield 60 yards of two-fold yarn.

Applying the same principle in the second case, with a thick yarn 12 sk. woollen and a fine yarn of 40's worsted, then—

$$12^2 + (60 + 135)^2 = c^2, \text{ or} \\ 12^2 + 42^2 = c^2, \text{ or} \\ 1,908 = c^2 \therefore \sqrt{1,908} = c = 43.7$$

—that is, for every 42 yards of yarn, 43.7 of the finer yarn must be calculated for, or an allowance of 1.7, while the thick thread yields length for length.

For the percentage allowance:—

As 60 : 61 :: 100 : x = nearly 2% for the woollen yarn,
 As 42 : 43.7 :: 100 : x = about 4% for the 40's worsted in the
 last example.

These are the theoretical conditions, and the manufacturer will do well to endeavour to bring his practical results as far as possible to bare facts ; or he should, at the very least, institute some means of recording the practical results obtained.

Colour.—Colour effects in yarns may be divided into five classes:—

- (a) Solid colours.
- (b) Mixtures.
- (c) Flaked or slubbed yarns.
- (d) Ordinary twists.
- (e) Fancy twists.

In matching off solid colours little difficulty will be experienced ; but the colour to be matched should always, if

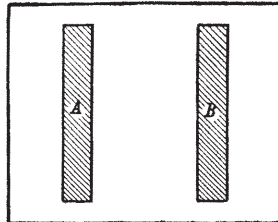

FIG. 7.

possible, be separated from its surroundings, since its tone may be altogether different in the cloth and out of the cloth. This may be effected at times by cutting two holes in a piece of cardboard (as shown in Figure 7) at such a distance that upon placing the cardboard upon the pattern supplied

for analysis one colour appears at A and another at B. This method, however, is not so effective as might be supposed in matching colours from cloth, as the cloth to be matched should be held up to the light and judged by looking over; but at times it will prove very useful. The "tintometer" has of late been much thought of as an advance in the right direction in the matching of colours. The idea is simply to match colours by slips of coloured glass, suitably graded and numbered; but since it is a fact that the nature of the raw material in textile fabrics influences very considerably the colour employed, it is apparent that its application is very limited.

Mixtures may be more difficult to deal with, especially if compounded of several shades. Microscopic examination will reveal the several colour-constituents; but matching under these conditions is practically impossible, so that judgment and experience are here most essential.

In order to match practically any desired mixture, a pair of hand cards (as shown in Figure 8) should be at hand, along with a well graded set of dyed wools (or, preferably, botany tops or drawings), so that a selection may be made of the colours supposed to be present in the combination, and the mixture effect obtained in a few minutes. This is a much handier method than running a small batch through a carder, although perhaps this latter procedure is more certain.

Flaked and slubbed yarns simply consist of an ordinary thread with a round or elongated lump (usually of a distinct colour and material), which is formed towards the end of the carding operation. Careful note should be made of both the colours and materials.

Of great use to the textile designer are twists composed of two, three, or even four colours. Two-folds are used most

extensively ; but three-fold in both plain and fancy twist may be introduced with effect at times. The attention of the analyst should always be given to this point when analysing goods where colour plays a prominent part ; as, for example, in Scotch tweeds, for in such goods the most careful toning

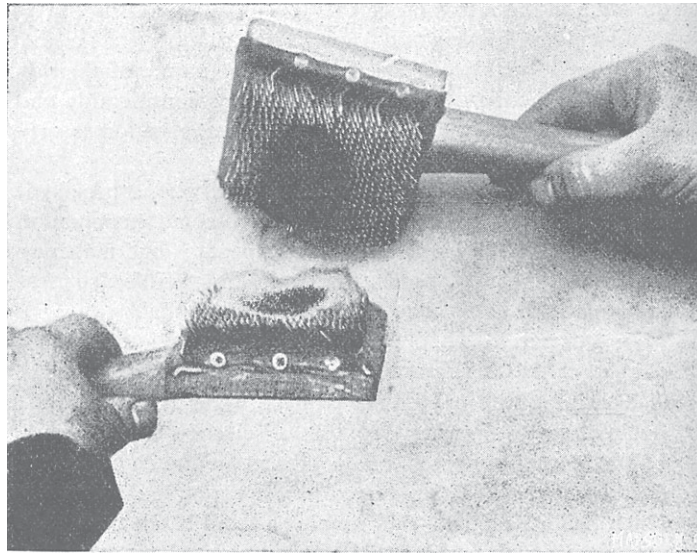

FIG. 8.

of colours is often effected by twisting coloured threads of varying thickness together, thus obtaining an effect not otherwise producible.

Fancy yarns are made in such variety that a minute analysis is usually necessary. The principle of most, however,

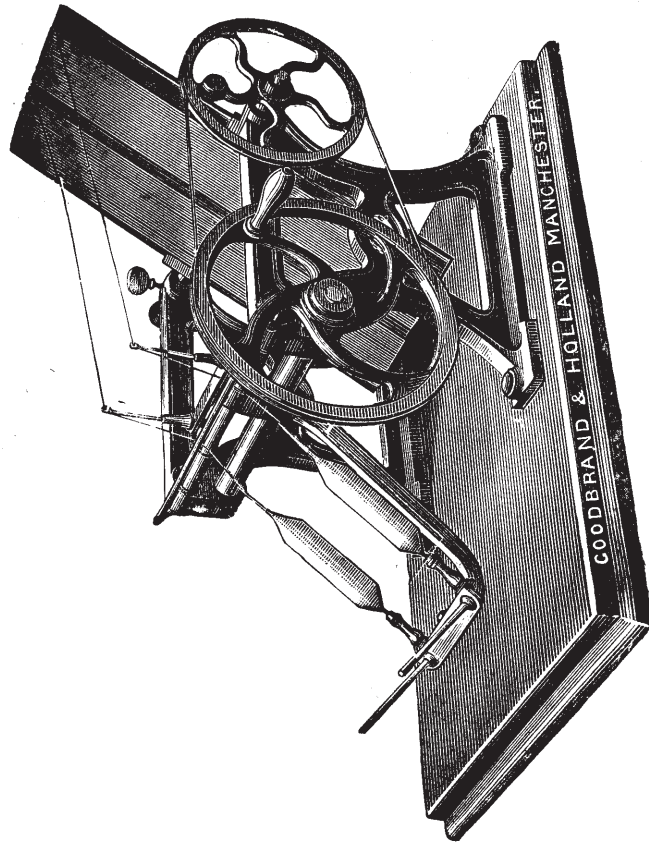

FIG. 9.

is simply holding one thread tight and twisting the other round it, and then reversing the yarns—thus continually reversing the colours.

Yarn Examination.—A useful machine for examining yarns is given in Figure 9. It simply consists of mechanism for evenly distributing any yarns—either for comparison or examination as to evenness, etc.—upon a black, grey, or white card, which, if required, will also act as a reel.

CHAPTER III.

WEAVE ANALYSIS.

Since any further calculations than those already dealt with will relate definitely to the cloths that happen to be under consideration, the next step will be to obtain the weave, or order of interlacing of the warp and weft threads, since, as will be shown later, this may prove of great service in the subsequent analysis—such as in determining the threads and picks per inch.

Two Methods.—Practically there are two methods of determining the make or weave of any given cloth, viz., by analysis and by synthesis. By the former method is implied pulling a cloth to pieces, thread from thread, pick from pick; and by the latter, building a cloth up according to the principles of interlacing, which experience enables the designer to detect in the cloth that it is desired to reproduce.

The second method is quite out of the reach of the uninitiated. They must fulfil the laborious task of following every end and pick throughout the cloth, whereas the experienced analyst would pull a thread or pick out to confirm his surmise respecting the make, and proceed at once to build up his cloth. More often than not the experienced judge the make of a cloth from the appearance alone: thus the fallacy of would-be analysts

simply pulling cloths to pieces is fully demonstrated. Of infinitely greater service is the experience gained by experiment with the various principles of textile design.

General Consideration.—Let the reader now suppose there is before him a pattern which it is desired to reproduce, and of which nothing is known. Then the first consideration will be—is it a single, a backed, or a double cloth? This, as a rule, can readily be decided by pulling out a few threads and picks, and observing whether any of them keep to one side of the fabric or not. If one series, say of threads, form the face, and another series of threads the back, while the picks interweave both face and back, then the fabric is backed with warp, and it will be necessary to find not only the face weave but also the backing ties. Weft might be used as backing instead of warp, when there would be two series of weft threads, or picks as they are termed, and one of warp, and the interweaving of each must be obtained as in the case of warp backing. Should there be both backing warp and weft, then the fabric will usually be a double cloth, in which case three points must be decided: firstly, the face weave; secondly, the back weave; and, thirdly, the system of tying the back cloth to the face. Having decided by brief examination under which heading the pattern to be analysed comes, the analyst should proceed in the manner laid down in the following pages.

Instruments Required.—It would be no difficult matter to draw up a list of instruments serviceable to the analyst costing pounds; but instruments will never make a successful analyst; therefore, the following should prove all that are necessary.

The first necessary is a piece-glass, *i.e.*, a magnifying glass of the form shown in Figure 10, which will cost from 1s. up to 10s., or even more. The glass should possess fair magnifying power, and in order to ensure this in purchasing, the glasses presented for examination should be compared with one of known excellence, or at least with others which the vendor shows. In order to ensure a good light on the fabric during analysis the supports (S) should be cut away as far as is compatible with strength. The measure (M) is made in three forms as

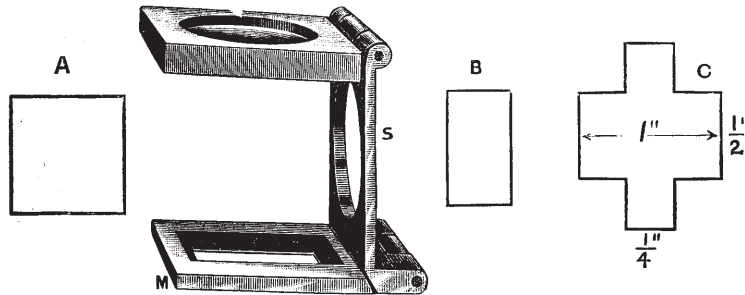

FIG. 10.

shown in A, B, and C, A being the square form, either 2, 1, or $\frac{1}{2}$ an inch; and B the oblong, usually made $\frac{1}{2} \times \frac{1}{4}$ or $1 \times \frac{1}{2}$, and C the combined form. For generally examining the weave of a texture a 2×2 glass will be best; for counting the ends and picks per inch in coarse goods, the 1×1 glass is the best; while for finer goods the $\frac{1}{2} \times \frac{1}{4}$ is the best. There is no necessity, however, for three glasses; if the reader doubts which is most suited to his work he should purchase the $1 \times \frac{1}{2}$, this size being very serviceable.

In order to examine with precision the interlacing of the threads, two needles fixed in wood handles should either be made or procured from some instrument maker, the usual charge being 2d. each. Corks should be fitted on the needles when not in work, to prevent damage to the points, and also to prevent accidents.

A pair of curved or straight scissors, a sharp knife, and a pair of tweezers to catch hold of any required thread, along with white cardboard upon which to firmly hold the pattern, design paper, drawing pins, black and white thread, pencils of two or three colours, and gum, complete the outfit.

SINGLE CLOTHS.

Construction.—As the name implies, single cloths are those in which only one series of warp and one series of weft threads are interlaced. The solid weave effects coming under this head may be divided into three distinctive classes :—

CLASS 1.—Ordinary weaves: Plain, hopsack, twill, etc.; which are usually woven on the square, *i.e.*, an equal number of threads and picks per inch, and in which warp and weft bend equally.

CLASS 2.—Weft Rib Makes: Usually woven with a finer weft than warp, and, consequently, more picks; and in which warp lies straight and weft does all the bending.

CLASS 3.—Warp Rib Makes: Usually woven with slightly finer warp than weft and with a greater number of threads per inch; in which the warp does all the bending, while the weft lies straight.

Under one or other of these headings all solid weaves will come, and the analyst will simplify his work by first

finding out which class the pattern under consideration is of. The analysis of one of the simpler makes of cloth shall first be fully described, and the variations for the other cloths noted later.

As already pointed out, it may not be at all necessary to pull the pattern in pieces, a very effective way of obtaining the weave being to place an ordinary piece-glass on the face of the cloth, when probably the make or makes (should it be a fancy) will be recognised; or, in the case of ordinary cotton, the threads may even be followed throughout the repeat space. In analysing woollens and rough-surface cloths, singeing often renders the make clearer, to effect which the pattern should be held over a gas jet till all the fibre is charred, and then scraped over with a sharp knife, care being taken not to injure the thread structure of the cloth. Under any circumstances, however, it is advisable to pull out a few threads or picks to test the accuracy of the observation.

Ordinary Makes.—Since in this class warp and weft interweave in the same or nearly the same order, either warp or weft may be pulled out. But here arises a fresh difficulty—which is warp, and which is weft? The following extract from an article on analysis, by Mr. E. A. Posselt, of the Philadelphia Textile School, will prove of some assistance here :—

If the sample submitted for “picking-out” contains a part of the selvage, the latter will readily indicate warp from filling, for the selvage threads always run in the direction of the warp.

If the threads in one system are “harder” twisted than in the other, the hard-twisted threads are generally the warp system.

If the sample submitted for analysis has what is technically known as a “face-finish” (kersey, beaver, doeskin, broadcloth, etc.), the direction of the nap indicates the warp.

The "counts" of yarn used in each system will often assist in ascertaining which is the warp and which is the filling, for in most instances the yarn used for warp is of a finer number than the filling.

If the fabric has cotton yarn for one system of threads and woollen for the other (as in union fabrics), the cotton yarn is generally the warp yarn.

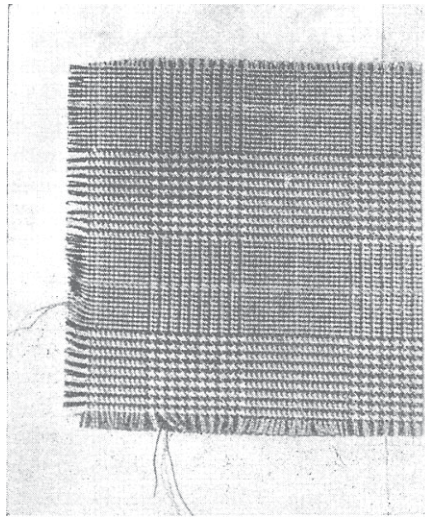

FIG. II.

If in the sample submitted for analysis the one system of threads is found to have been sized or starched and the other not, the former is the warp.

If the sample contains "reed-marks" (or imperfections known to the weaver as being caused by the warp system) such imperfections readily characterise the respective systems of threads.

Another guide for distinguishing the warp from the filling is found in the "style" of the respective fabrics submitted for "pick-

ing-out." In fabrics having a striped character, or check effects in which the one direction of the lines is prominent compared with the others, the direction of the stripes, or the prominent lines in the check, indicate the warp system.

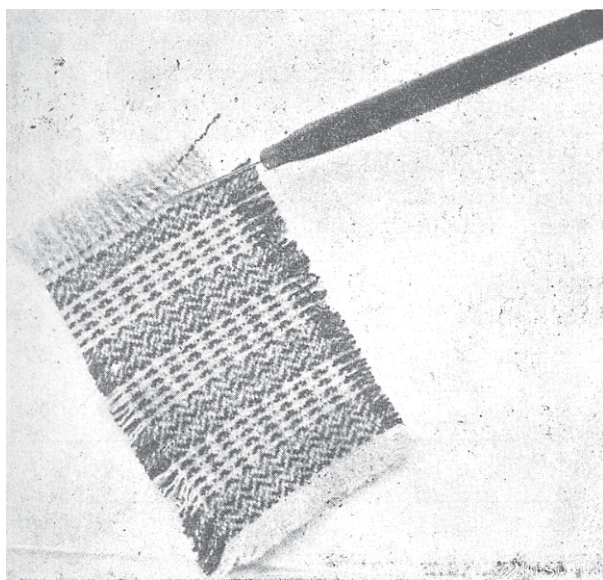

FIG. 12.

In fabrics composed of two systems of filling (face filling and backing) and one system of warp, the heavy and soft-spun filling, known as the "backing," indicates itself and thus the warp systems of threads.

Having decided which is the warp and which is the weft, the analyst should proceed as follows:—First, pull out a few picks, so that any thread may be pulled out at pleasure; second, pull out a few threads, so that any

pick may be pulled out at pleasure. The cloth will now be in the condition shown in Figure 11.

Now, placing the pattern upon a white ground if dark or black, or a black ground if light or white, with the needles endeavour to separate a pick from its neighbour, but still let it remain interlacing with the warp as shown in Figure 12, when the order of interlacing may possibly be transferred to design paper by examining with the naked eye, or the magnifying glass may be placed over and the interlacing read off to an assistant. Another system, employed by some analysts, is to prick out on paper the rises, as shown in Figure 13—which is a sectional representation of 2 and 2 twill—and obtain the weave by subsequently transferring the pricks

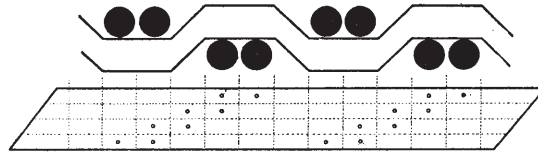

FIG. 13.

to design paper. This method, however, is only suited to coarse fabrics. Having obtained the interlacing of pick 1, liberate it from the warp and proceed in a similar way with picks 2, 3, 4, etc., etc., always commencing at the same thread. If the analyst is well grounded in the principles of design, after two or three picks have been extracted he will probably be able to complete the weave.

The curvature of warp and weft may also be of some service in obtaining the weave.

Figure 14 is a micro-photographic reproduction of a thread and pick taken out of a two-and-two twill cloth, as shown in Design I. Notice first that the curves are equal, this being a necessary condition where each

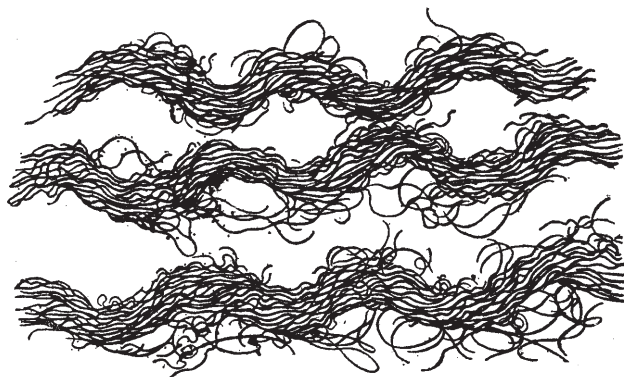
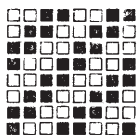

FIG. 14.

thread is up and down an equal number of times; and, secondly, that the deflections in warp and weft coincide, thus proving that, whatever the weave is, equal quantities of warp and weft are on the surface.



DESIGN I.

The above particulars will prove all that is necessary for the analysis of hopsacks, twills, and most of the ordinary small weave effects. There are two points, however, respecting twills that should be specially noted. Firstly,

that in the case of so-called ordinary twills a slight difficulty may arise, since, although all should run at an angle of 45 degrees, yet a very considerable variation in this respect is observable, owing to the insertion of rather more picks per inch than threads, or *vice versa*. Secondly, that a change in the sett of a cloth will make any twill broader or narrower as the case may be; consequently in copying say a three-and-three twill in a more open sett, a two-and-two twill would probably be employed. This point is dealt with at length further on.

Class 2: Weft Rib Makes.—In this class are included all those fabrics in which the warp lies straight and the weft bends round it. Design II. is a typical weft

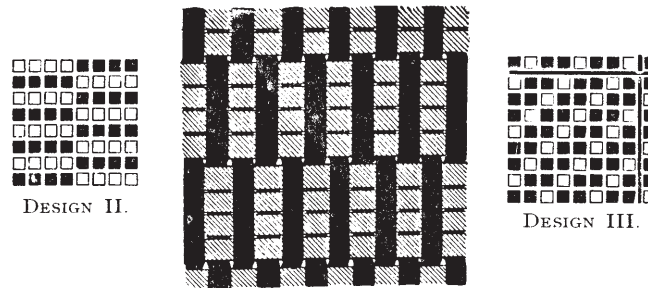

FIG. 15.

rib, of which Figure 15 is a flat view, under favourable circumstances the warp being quite straight and the weft doing all the bending, thus forming a prominent rib running with the warp. Design III. is the two-and-one or cashmere twill, of which a micro-photographic reproduction of actual threads is given in Figure 16. It is

noticed at once that the thick warp thread 1 is comparatively straight, and that the fine weft 2 practically does all the bending. The fact that the threads and picks are not up and down for an equal number of picks

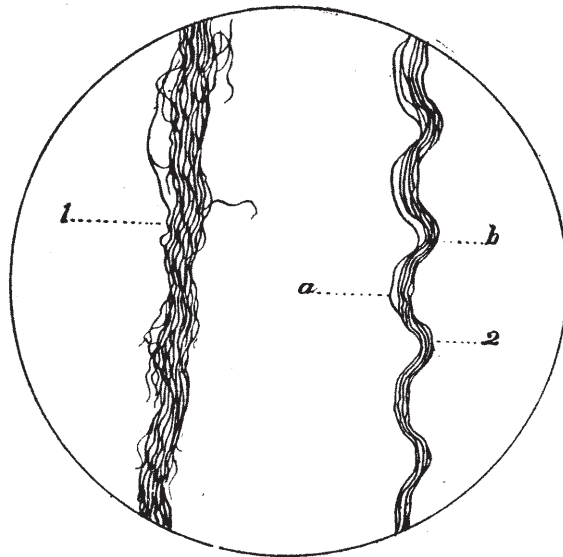

FIG. 16.

and threads is also clearly indicated by the wave of the pick here represented, (a) indicating the pick floating over two threads and (b) where it is down for one. It is very evident, then, that if there is any doubt as to whether the ribs or twills in a pattern are of the same breadth, a careful examination of the curvature of a pick will solve the question. In this class of goods it

will usually be found expedient to dissect the pattern by extracting the picks in preference to threads.

Class 3: Warp Rib Makes.—The only difference between these and the preceding class is that the

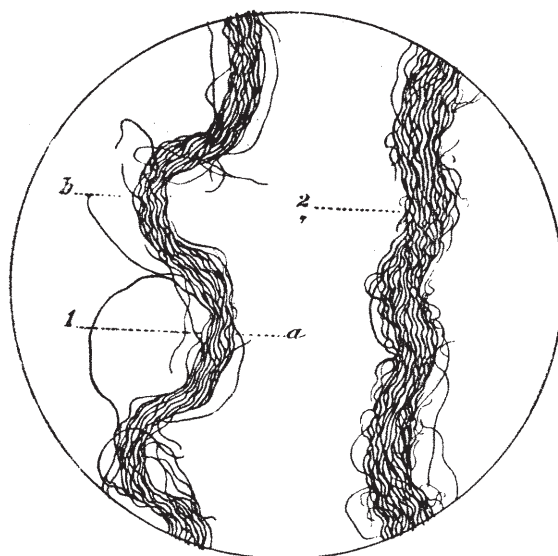

FIG. 17.

warp bends while the weft lies straight, thus forming ribs which run with the weft. Figure 17 shows this clearly, (1) being the warp thread, and (2) the weft pick. Design IV., of which Figure 18 is a flat view, is a typical warp rib, but Design V. was employed in the cloth from which the thread and pick shown in Figure 17 were taken, this being practically a 12-end corkscrew weave,

(a) indicating the thread up for 7 picks, and (b) down for 5 picks. In this case the structure will be most easily arrived at by carefully pulling out the threads. Should the weft be single yarn, however, it may be impossible to decide how many individual picks the warp floats over or under, each pick becoming merged with its neighbour. Under these circumstances it may be necessary to extract a few picks; in fact it is always advisable to do so, for it must be remembered that *it is not upon one circumstance alone that the structure of any cloth will be decided*, but by the combination of circumstances, which practice alone will enable the analyst to combine in one harmonious whole.

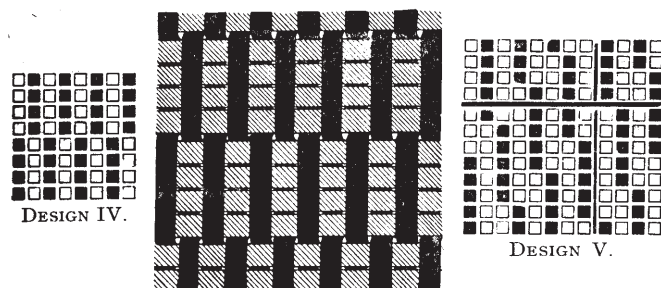

FIG. 18.

Sateens.—The sateens and sateen derivatives are a type of design which has representatives in all three classes, but the sateen twill may be recognised at once by its fine appearance and upright or horizontal angle, while the derivatives may usually be recognised by noting the principal weave feature along with its repeat; for example, the twilled hopsack is remarkably like

ordinary hopsack, but when the relative positions of each flush of two by two are noticed, the sateen distribution is at once apparent. An instance in which the observance of curvature of warp and weft is of much use is when, say, the eight-end sateen weave has been employed, and it is doubtful whether a dot has been added to the pure sateen or not; if the pure sateen has been employed the curvature of warp and weft will be similar. If a dot has been added, however, the curvature of warp and weft will be very different.

FANCY COMBINATIONS.

Having discussed the means of arriving at the weaves of the simpler cloths, attention must now be turned to combinations of the foregoing, such as in stripes, checks, etc.

Stripes.—These are easily treated, the weaves of each section being analysed separately, and then combined in the best manner. Thus, for example, the weaves of such a stripe as that represented in Figure 19

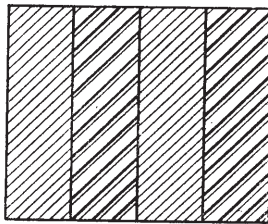

FIG. 19.

may be taken from the surface by means of a piece-glass. Suppose they are respectively Designs I. and VI., then there is usually no need to examine the exact way

in which they are combined in the cloth, which would only be waste of time, for they may be equally well combined on design paper irrespective of the cloth.

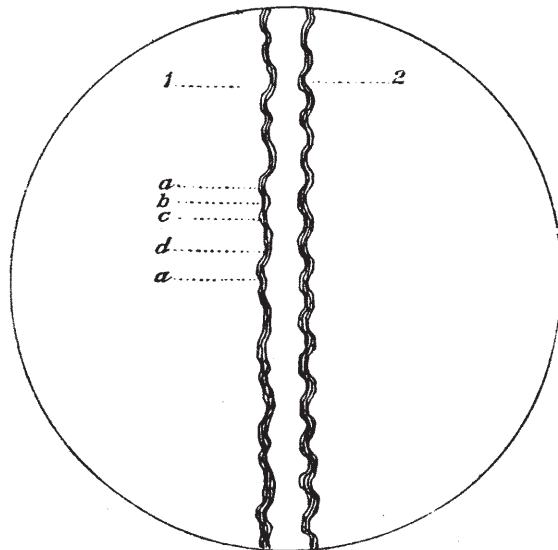
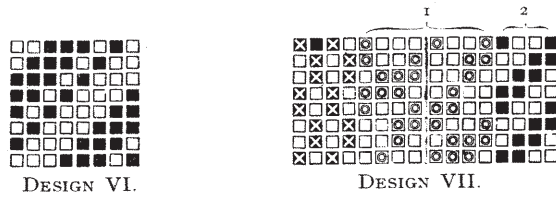

FIG. 20.

In Figure 20 are given two threads out of a cloth

which is a stripe composed of the weaves given in Design VII. Thread 1 has been taken out of section 1 on the design, being Mayo or Campbell twill, $a =$ two down, $b = 1$ up, and $c =$ two down, and $d =$ three up. Thread 2 is taken from section 2 of the design, being two-and-two twill or rib. Of course a weft pick would

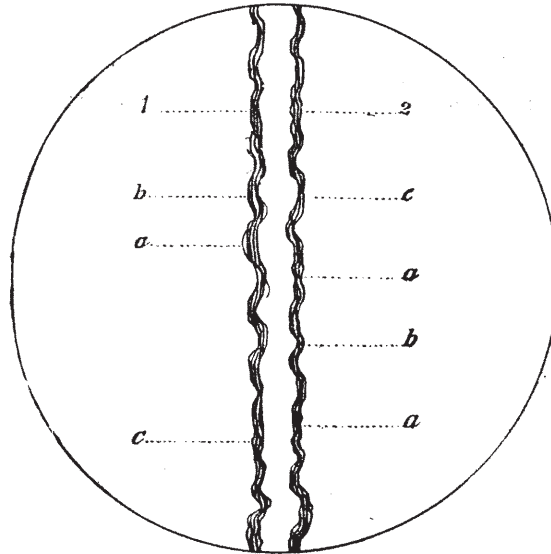
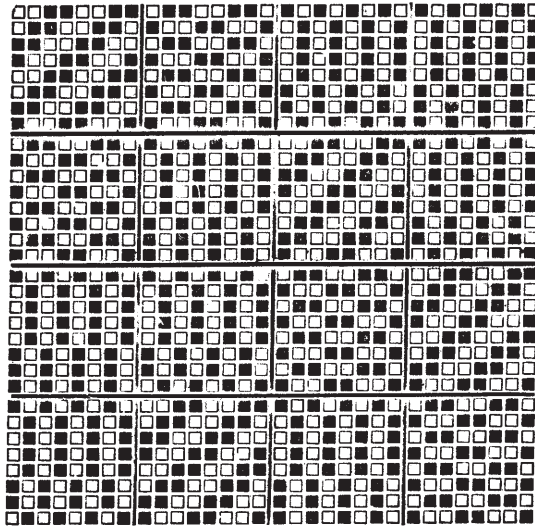

FIG. 21.

show alternately sections of each weave, and consequently might be of use in indicating the width of stripes each weave occupies.

Checks.—These may be treated in very much the same manner as stripes, the weaves being taken off each

section of the pattern and combined as efficiently as possible. For example, in Figure 21 a thread and pick taken from a fancy check are given. The construction is demonstrated in Design VIII. and Figure 22, which, it will be seen, is composed of warp and weft ribs and two-



DESIGN VIII.

and-two twill; a careful inspection of the curvature these threads reveals the respective components. In the thread 1 and the pick 2, a = warp rib, b = two-and-two twill, and c = weft rib. Thus, again, it is evident that the minute inspection of each individual thread and pick may be of some service in determining the order of interlacing. In extensive checks, however, such as that shown in Figure 22, after finding the component

weaves the difficulty occurs of allotting the approximate space to each. In effecting this it may be expedient to chalk out the repeat of the pattern on the cloth—the chalk may readily be beaten off—and then to count the number of repeats of each weave. For example, in section *b* of Figure 22 there are 4 repeats of the two-and-two twill; therefore $4 \times 4 = 16$ threads in section *b* and so with the other weaves.

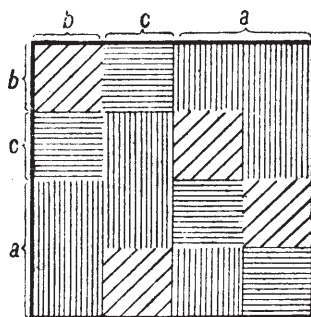
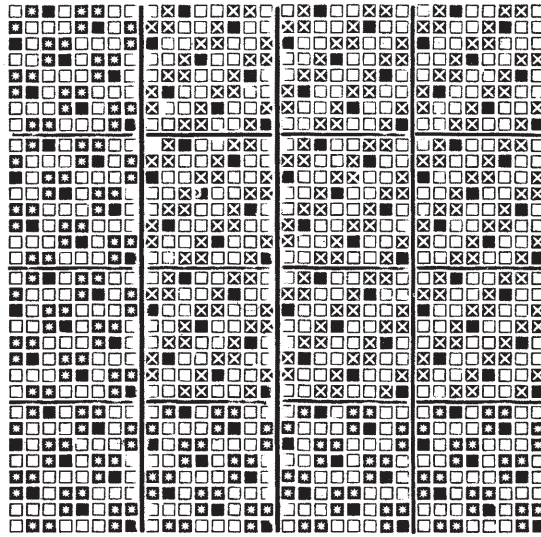

FIG. 22.

A useful point to observe in analysing sateen combinations is the use often made of the sateen as a groundwork or basis. Thus the check given in Design IX. is based entirely upon the eight-end sateen as indicated by the solid type.

Wefting Capacity.—In analysing for reproduction combination designs, particularly stripes, the following question will arise—Have all the weaves combined equal wefting capacity, and will all the warp weave well of one beam, *i.e.*, will the take-up of the warp in each section of the design be similar? The wefting capacity of any weave evidently depends upon its relationship to ordinary

weft and warp rib structure, and a thorough consideration of the foregoing remarks on these typical structures, with some few experiments, will at once demonstrate the principles involved. It will be well to note, however, that since the relating bending of warp and weft is in proportion to the cubes of their diameters, there must be some modify-



DESIGN IX.

ing influence which changes this relationship, since with the same warp and weft a considerable difference in the bending of ends and picks is observable. This modifying influence is the weave; and the reason is very apparent, for Design II. is nothing but plain weave with four threads working together—equivalent to a thread four times the area of the weft—consequently the weft

bends. Design IV., on the other hand, is but plain weave with four picks in a shed; consequently the finer warp bends, and so forth with many other weaves. The take-up of the warp in weaving will depend entirely upon the curvature of the warp, and is explained under the head of "Finishing," further on.

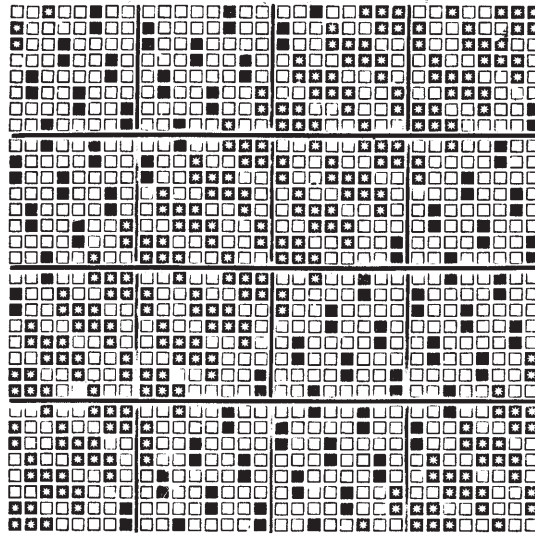

DESIGN X.

Fancy Twills.—Another type of combinations, at times of more intricate construction than the foregoing, are the so-called "fancy twills." It would be a difficult matter to draw a definite line between these and ordinary twills, since the latter are at times very extensive; but if the term "combination twill" be substituted for "fancy

twill" its meaning is very apparent. In Design X. a typical example of a combination twill is given, consisting of the combination of eight-end sateen and Mayo or Campbell, forming a twill running at an angle of 45°, provided equal quantities of warp and weft be used. Design XI. is an example of an upright combination twill,

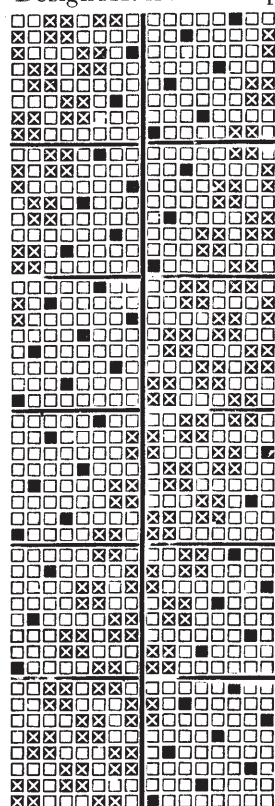

DESIGN XI.

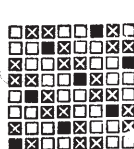

DESIGN XII.

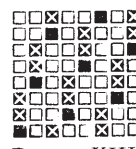

DESIGN XIII.

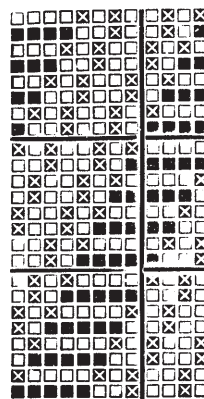

DESIGN XIV.

consisting wholly of eight-end sateen and twilled hopsack. In analysing such cloths as these, the use of the knowledge obtained by experimenting with the various makes is most effectively demonstrated. For example, the eight-end sateen possesses the peculiarity of forming an upright twill in one direction but an ordinary twill in the other, as shown in Designs XII. and XIII. Now a glance at Designs X. and XI. will show that they are what we termed "sateen twills." In the first instance the ordinary twill effect of the eight-end sateen has been made the basis of the combination, while in the latter case the upright effect has been utilised for the same purpose. Most of the sateens may be treated in this manner, thus supplying very effective bases for combination effects.

Since all twills are simply diagonal stripes, most of the remarks made with reference to stripes are equally applicable here. Particular note should, however, be made of the method of combining the weaves employed, and also of the number of ends each weave occupies, which point may often be decided by the curvature of the threads and picks, as already explained. The repetition of the various weaves in any given combination should also be noted as a means of finding the extent of the full combination.

As a rule it will be found that the weaves combined have a very low "least common multiple," and more often than not the most extensive weave present will give the L. C. M. Thus, if any 12-end make be made the principal feature in a twill, the other makes will probably repeat upon 2, 3, 4 and 6 ends, since each of these repeats an exact number of times in one repeat of the 12-end make. Under these circumstances the extent of

each weave in the design will regulate the repetition of the full effect. This, however, may not be the case if a figure is introduced: the figure must be counted as a weave, and repetition will be on the L. C. M. of the ends or picks occupied by the figure and each weave in the combination. Thus, if a figure is upon 16 ends and is run in combination with 3, 4, and 12-end weaves, then the L. C. M. of 16, 3, 4, and 12=48 threads and picks, and however extensive the twill may be made it must be upon some number of which 48 is a measure.

Another point regarding fancy twills to which attention should be directed is that, in such combinations as that given in Design XIV., a common practice is to make the fabric of woollen or worsted yarns, except every other pick, which is mohair; thus a lustrous twill is developed on a worsted or woollen ground.

BACKED CLOTHS.

Attention must now be directed to fabrics backed with warp or weft for the purpose of obtaining extra weight, warmth, and handle. In the first case we shall have two series of warp threads and one series of weft; and, in the latter case, one series of warp threads, and two series of weft threads. The following procedure should be adopted in analysing these cloths:—

- (1) Ascertain whether backed with warp or weft.
- (2) Ascertain the relative proportions of face and backing threads or picks, and counts of the same.
- (3) Ascertain the face weave as a single cloth.
- (4) Ascertain the backing ties.

To decide whether a piece is backed with warp or weft

may be rather a difficult matter if there is no list on the pattern submitted for analysis, and the only means of deciding will be the quality of the extra material. If it is a good quality—say a two-fold yarn—the backing has probably been warp, while if the material is single and short it has probably been weft, since it would not have the strength necessary for weaving as warp. Backing warp is nearly always finer than backing weft.

In ascertaining the relative quantities of backing yarns the safest method is to clean a $\frac{1}{2}$ -inch piece and separate carefully the threads from the picks, classifying them as backing and face according to thickness, colour, material, or position in the cloth. The relative numbers will thus be ascertained with certainty.

Possibly the question may arise—Which is the most economical—warp or weft backing? With a poor material, evidently weft backing; but with a good material, warp backing, since, although there will be the trouble of beaming and fixing the backing warp independently of the face warp, yet in the case of a one-and-one backing the cloth will be woven in about half the time, and there will be no extra weaving expense.

No further reference to the third item in the above procedure is really requisite, since generally a portion of the backing may be taken off, leaving the face intact; but the fourth may profitably be considered more fully. In tying the backing to the face, of course, under any circumstances the conditions of perfect tying must, if possible, be observed, whether warp or weft be employed. In Figure 23 is shown an interesting fact concerning the backing of the two-and-two twill: (1) is a thread taken from the face, weaving

as already indicated two-and-two twill, *a* indicating two up and *b* two down; (2) is the backing thread, *c* indicating the tie. It will at once be observed that *a* and *c* always come into relatively the same position,

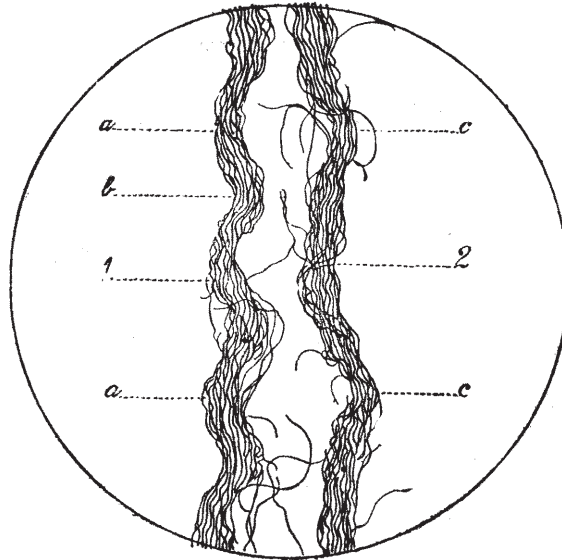
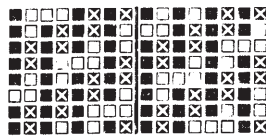

FIG. 23.

a being repeated twice to *c* once. This leads us at once to decide that the backing is tied to the face in eight-end sateen order, since, as shown in Design XV., this sateen ties on every other twill. An example of a weft-back plan is given in Design XVI.

It need scarcely be noted that it is almost impossible to analyse these cloths successfully without a complete

theoretical knowledge of the underlying principles, and some practical experience. For example, in addition to the foregoing difficulties, it is found in practice that, at times, such a small matter as the method of tying has



DESIGN XV.

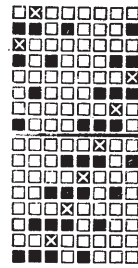

DESIGN XVI.

quite a remarkable influence on the resultant cloth, a slight variation in the position materially influencing the result.

DOUBLE CLOTHS.

The principles governing the construction of these are very similar to those governing backed cloths, the only difference being that there is a distinct back cloth formed. The analyst should proceed as follows:—

- (1) Find the face weave or design.
- (2) Find the back weave or design.
- (3) Find the relative quantities of face warp and weft to the backing warp and weft, along with the counts of yarn, and
- (4) Find the method of tying, whether with warp or weft, and the system of distribution.

With reference to this latter proceeding Figure 24 demonstrates a very useful point. Here (1) is a thread taken from the face of a cloth made as follows:—

Warp.

2 threads 2/30's worsted; 1 thread 18 sk. woollen,
12's reed 6's.

Weft.

Same as warp: 72 picks per inch.

(2) represents a thread taken from the plain back, of
18 sk. woollen. It will at once be observed that, owing

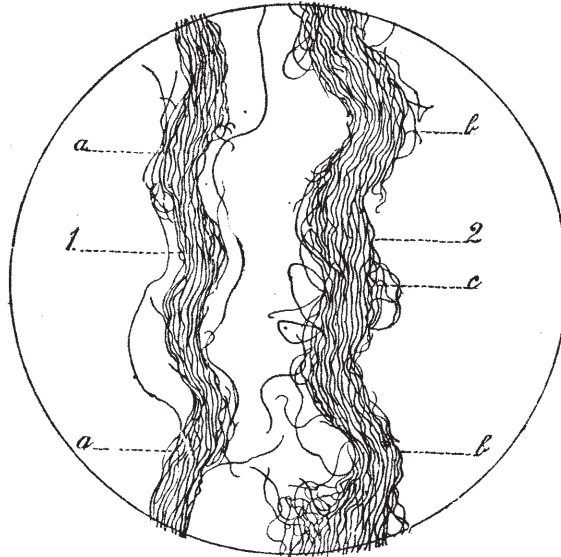
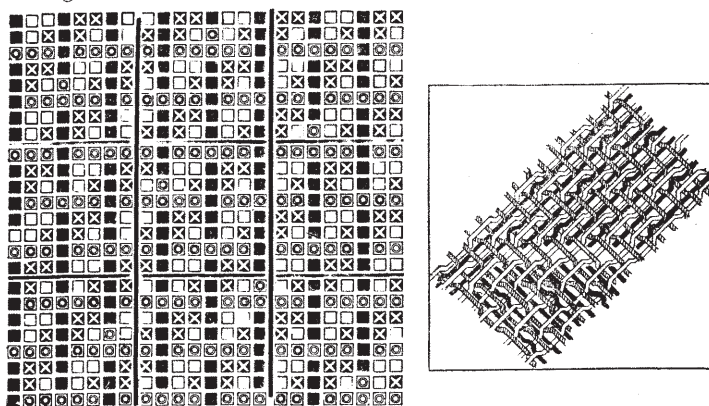

FIG. 24.

to the face being as fine again as the back cloth, the
curves of the two-and-two twill coincide with the plain.
Further, it is evident from an examination of the curve
of the backing thread that the back cloth has been tied

to the face by means of the backing warp, b indicating this tie, which is a much more marked curve than is c , where no such tie has taken place. In this way the system of tying may be ascertained, since if a backing thread rises over a face pick the curvature of the backing thread will show the tie; while if the backing weft rises over a face thread the curvature of the



DESIGN XVII.

FIG. 23A.

backing picks will show the tie. Design XVII. is the plan employed.

The Tying of Backed and Double Cloths.—

The principle upon which backed cloths are tied will readily be realised by careful examination of Figure 23A, in which both the warp and weft systems of tying are illustrated.

The chief points to attend to are the following:—
First, whether warp or weft ties, all ties should be

effected in such a manner that there is nothing perceptible upon the face of the cloth ; second, endeavours should be directed towards placing a tie upon every thread and every pick ; third, in the case of double cloths the finer material, whether warp or weft, should as a rule be selected for tying purposes.

The first point is well demonstrated in Figure 23A, a careful examination of which shows that the backing warp tie is effected between *two floating face warp threads*, while the backing weft tie is effected between *two floating face weft picks*.

The second point will be duly attended to if the ties are arranged in sateen order. In Figure 23A the eight-end sateen distribution is employed, since the face readily admits of this. If, however, a two of face to one of back scheme of arrangement, or any other arrangement, be adopted, the difficulties will be greater, and often cannot be entirely overcome. Note should be made that in a warp-backed cloth the backing threads should if possible rise over every face pick ; while in a weft-backed cloth a backing pick should, if possible, rise over every face thread. In the case of double cloths precisely the same principles apply, according to the system of tying adopted.

This leads up to the third point—the selection of the material to tie with. In the case of backed cloths there is no choice here, but in the case of double cloths either warp or weft tying, as just noted, may be used. Evidently, if the face weave gives no advantage to either system, the finer material, usually the warp, should be employed, but if the face weave favours the weft then it may be advisable to tie by the weft. For example, in a

three-and-one weft twill face cloth there is evidently no perfect tying place for a warp tie, but for a weft tie the conditions could hardly be more favourable; therefore a weft tie should undoubtedly be employed. At times it may be advisable to use both the warp and weft systems of tying, but this will be of rare occurrence. In this, as with textile designing throughout, the analyst should work upon the basis that "that which is not best is wrong."

In the case of figured double cloths tying is usually effected by an interchange of the back and face cloths, as shown in Figure 37, further on.

Obtaining the Coloured Pattern.—In most of the foregoing cloths there will be no difficulty in reading off the colour plans of both warp and weft, if such there be, by placing the piece-glass upon the pattern prepared for analysis, as shown in Figures 11 and 12; but care-

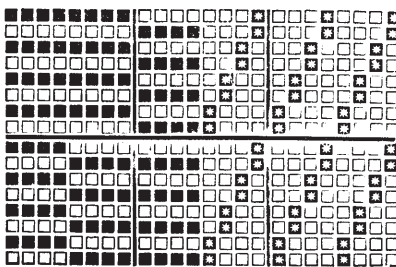

DESIGN XVIII.

lessness will readily lead astray. For instance, if Design XVIII. is employed with the following colouring—

2 threads light drab	4 threads lavender
4 " lavender	2 " green
2 " green	9 " lavender
1 " blue	—
9 " lavender	36 ends in repeat
1 " white	
2 " drab	

then, since the design is on 24 threads and the colour repeat on 36, a pattern extending over 72 ends (the L. C. M. of 36 and 24) will result, and carelessness might lead the analyst to suppose that the colour repeat was upon 72 ends, since the weave effects here combined tend to support this illusion. Care is also very necessary in obtaining the colourings in backed and double cloths. For further particulars refer to Chapter V.

CHAPTER IV.

DRAFTING.

Our treatise would not be complete without some allusion to the important matter of drafting, since by this means the number of shafts necessary to produce many patterns may be considerably reduced, and thus the use of a higher capacity dobby or jacquard be avoided. As an example take Design XIX. ; this extends over 48 threads, but it will not be necessary to use 48 shafts for its production, since a brief examination will show that certain threads are always up together and down together throughout the repeat, and consequently may be drawn into one shaft.

Method of Drafting.—Carefully examine each succeeding thread in the design. All the threads rising and falling on similar picks may be drawn on one shaft.

EXAMPLE.—As shown in Figure 25, Design XIX. may be drafted on to 8 shafts, since each shaft has 6 threads drawn upon it. For example, threads 1 and 6 are up and down together with the same picks, therefore one shaft will work both threads exactly as required, and similarly with the others. In order to thoroughly compare the working of any two threads, narrow slits should be cut in two pieces of paper, as shown in Figure 26,

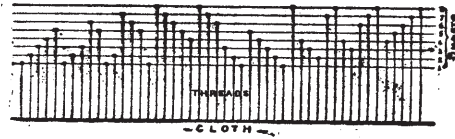
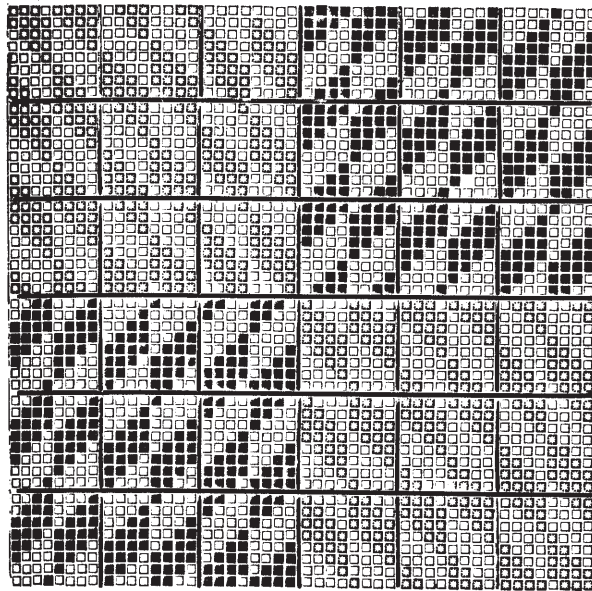
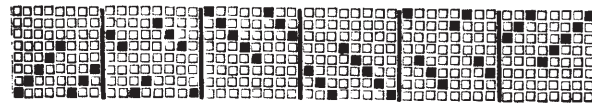

FIG. 25.



DESIGN XIX.



DRAFT FOR DESIGN XIX.

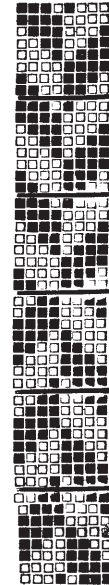

PEGGING PLAN FOR DESIGN XIX.

and these being placed over the respective threads enable the analyst to make a most thorough comparison.

Two methods of indicating the draft of Design XIX. are given, either of which may be used, but as a rule the draft is made out on point paper, since it is less trouble than the system shown in Figure 25.

Pegging Plan.—This, as a rule, will be the plan upon which any small number of shafts are worked to produce a large repeat in the cloth. It will consist of every kind of thread in the given pattern. For example, in Design XIX. there are only 8 kinds of threads, which 8 shafts can conveniently work; thus each shaft must be worked *according to the requirements of the threads drawn upon it*. Examination of Design XIX. with its draft and pegging plan will demonstrate all that is necessary respecting this matter.

Calculations for Mails per inch on each shaft in Plain and Fancy Drafts.—Another matter every designer should thoroughly understand is the arrangement of the mails on each shaft employed in any draft, be it fancy or plain. Take a simple illustration: A piece is woven 64 ends per inch on eight shafts; how many mails per inch will be required on each shaft for a straight draft? Evidently eight, since $64 \text{ threads per inch} \div 8 \text{ shafts} = 8 \text{ mails per inch on each shaft}$.

To find the mails per inch per shaft straight draft:—

RULE.—Divide the ends per inch by the number of shafts, and the number thus obtained is the number of mails per inch required on each shaft.

In the case of fine setts in two and three-shaft weaves it is sometimes found expedient to use double the number

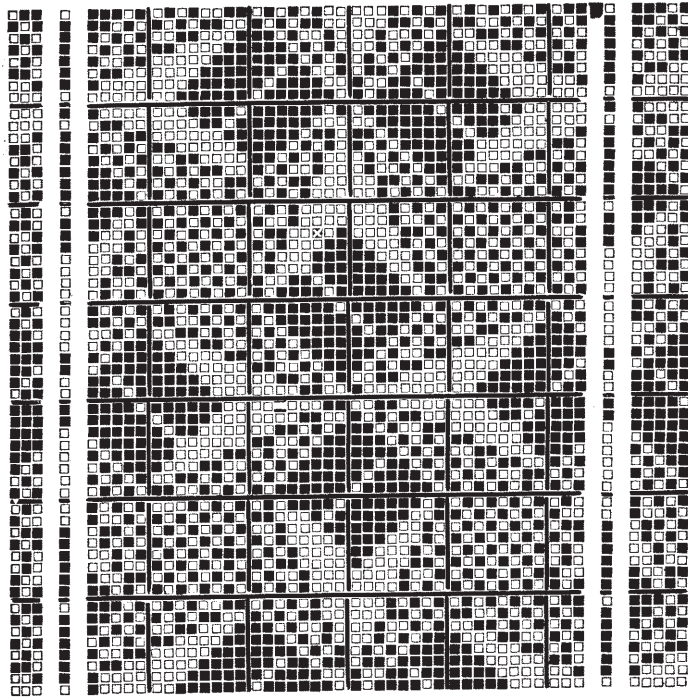

FIG. 26.

of shafts, and consequently only half the number of ends on each shaft that there would be if only two or three shafts were employed instead of four or six. In this case two shafts are usually linked together and so worked by the same tappet.

Fancy Drafts.—In the case of fancy drafts, the same principle applies, but there is rather more complication.

To find the mails per inch per shaft for fancy drafts :—

RULE.—Divide the number of ends per inch by the number of ends in the draft (thus obtaining the number of times the draft repeats in one inch), and multiply by the number of ends drawn on each shaft in the draft.

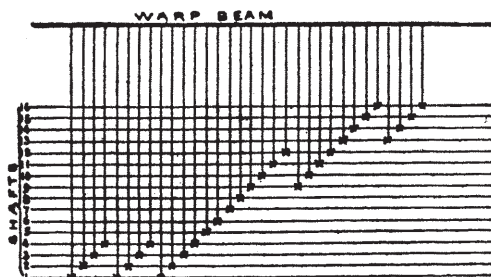

FIG. 24A.

EXAMPLE I.—The draft given in Figure 25 extends over 48 ends; thus, with 96 threads per inch,

$$96 \div 48 = 2 \text{ repeats of the draft per inch, and}$$

$$2 \times 6 = 12 \text{ mails per inch for shafts } 1 - 8 = 8 \times 12 = 96,$$

$$96 \text{ mails per inch for the sett.}$$

EXAMPLE II.—Draft given in Fig. 24A extends over 32 threads; thus, with 64 threads per inch,

$$\begin{array}{l}
 64 \div 32 = 2 \text{ repeats of the draft per inch, and} \\
 2 \times 3 = 6 \text{ mails per inch for shafts 1 to 4} = 4 \times 6 = 24 \text{ mails.} \\
 2 \times 1 = 2 \quad \quad \quad \text{,,} \quad \quad \quad 5 \text{ to } 8 = 4 \times 2 = 8 \quad \text{,,} \\
 2 \times 2 = 4 \quad \quad \quad \text{,,} \quad \quad \quad 9 \text{ to } 16 = 8 \times 4 = 32 \quad \text{,,}
 \end{array}$$

Thus the gears give 64 mails per inch.

In this case the system largely employed in America for indicating the draft is shown.

The same rule applies under all circumstances whether the draft be a fraction of the ends per inch or not, but in the case of awkward fractions the repeats of the draft in the width of the piece may be obtained, and thus the mails per shaft for the required width calculated. Design XIX. is a particularly good example of the use of drafting, since not only may 48 threads be worked by 8 shafts, but each shaft requires exactly the same number of mails per inch. This is a matter to which attention should always be directed.

Casting-out is frequently resorted to as a means whereby a sett of gears arranged for a given pattern may be re-adapted to another pattern, thus saving the expense of procuring a fresh sett. Casting-out is accomplished in two ways, with two distinct objects: (*a*) for the reduction of the sett or ends per inch; (*b*) for weaving a design repeating on a different number of ends.

EXAMPLE.—A sett of 8 shafts are arranged to give 64 threads per inch, therefore

$$64 \div 8 = 8 \text{ mails per inch per shaft.}$$

(*a*) TO REDUCE THE SETT.—Cast out every other gait, *i.e.*, draw threads upon 4 mails per inch per shaft only, leaving the others free; thus

$$8 \text{ shafts} \times 4 = 32 \text{ threads per inch.}$$

If a less reduction is required, draw in six and cast out two gaits per inch per shaft, thus

$$8 \text{ shafts} \times 6 = 48 \text{ threads per inch,}$$

and so on. In casting-out on the jacquard to reduce the sett it is usual to cast out uprights, since while casting-out in the harness leaves the full figuring capacity of the jacquard, yet the threads will be so extended in the reed, and the wear *caused by the empty harness working with the full* will be so great that, unless really necessary, this system should not be resorted to.

EXAMPLE.—A 400 jacquard with 100 ends per inch = a 4 inch pattern.

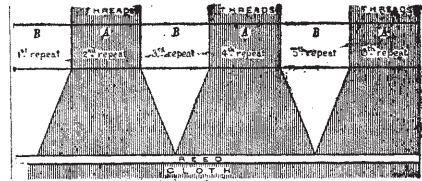

FIG. 25A.

To cast out in the harness to 50 ends per inch may then be effected as shown in Figure 25A by drawing-in 4 inches or one repeat of the mails (A) and missing 4 inches or one repeat B. The sley will then place the threads in their correct position in the cloth, but it will be realised that there is considerable friction on the threads, while the wear of the harness in sections B B will be considerable, since it will work similarly to sections A A, which are forming the figure, and, since there are no threads through the mails in B B, the oscillation is liable to be very great.

(b) FOR WEAVING A DESIGN REPEATING ON A DIFFERENT NUMBER OF ENDS.—Take the example already given, viz., 8 shafts, 8 mails per inch = 64 threads per inch. Then to weave a 7-shaft plan one shaft may be cast off, for a 6-shaft plan two shafts may be cast off, and so on. Under these circumstances, however, the ends per inch will be reduced in direct proportion; thus, for 7 shafts the ends per inch will be—

As 8 : 7 :: 64 : 56 ends per inch,

and for the 6 shafts—

As 8 : 6 :: 64 : 48 ends per inch, and so on.

The same principle obtains in the jacquard, uprights taking the place of shafts. Thus, to weave a 300 plan upon a 400 jacquard 100 uprights must be cast out, and so on. The sett will, of course, be reduced in this proportion, for if 400 uprights give 100 ends per inch, then—

As 400 : 300 :: 100 : 75 ends per inch.

This system also may result in the threads being slightly drawn across if the uprights are all cast out together instead of say one row out of every four; but since the uprights *are* cast out the empty harness may remain stationary and thus obviate the wear resulting from working empty harness.

Inversely, to obtain a given sett in a jacquard, uprights may be cast out in proportion as required, since, taking the foregoing as an example, to reduce from 100 ends per inch to 75 ends per inch will be

As 100 : 75 :: 400 : 300 uprights to be employed.

With these particulars the designer should be able to overcome any difficulties arising, even should the conditions be more complicated.

Crammed Stripes.—Still more intricate calculations relate to the mails per inch for crammed stripes, such as for the examples given in the weight calculations, Chapter IX. Under these circumstances two or more distinct setts of healds will be employed, one sett to weave the ground, and the other the figure or crammed stripe. Then—

(a) The number of shafts in each sett will depend upon the respective weaves.

EXAMPLE.—For a plain ground with an eight-end sateen crammed stripe, two or four shafts for the ground and eight for the stripe will be required.

(b) The absence of mails on the ground shafts, and the presence of mails on the stripe shafts, must be arranged for according to the extent of the figure.

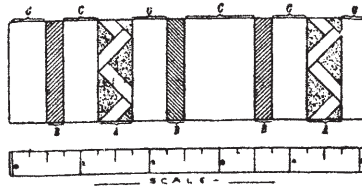

FIG. 27.

EXAMPLE.—In the stripe given in Figure 27, the extent is three inches, and since there are three separate effects, A, B, and C, there will be three setts of shafts required to reproduce the pattern. Suppose, then, 4 shafts are required for the ground (C), 8 for the two narrow stripes (B B), and 24 for the broad figured stripe (A), and that there are 48 threads per inch in the ground and 96 ends per inch in the pattern, then, to draw out the particulars for the various shafts, proceed as follows:—

1st, select a suitable reed, say 24 dents per inch.

2nd, allot the required dents to each portion of the pattern, thus—

$\frac{1}{2}$ inch	cotton	= 24	ends 2	in a dent	= 12	dents.
$\frac{1}{4}$ "	silk	= 24	" 4	" "	= 6	dents.
$\frac{3}{8}$ "	cotton	= 24	" 2	" "	= 12	dents.
$\frac{1}{2}$ "	silk	= 48	" 4	" "	= 12	dents.
$\frac{3}{8}$ "	cotton	= 24	" 2	" "	= 12	dents.
$\frac{1}{4}$ "	silk	= 24	" 4	" "	= 6	dents.
$\frac{1}{2}$ "	cotton	= 24	" 2	" "	= 12	dents.

3 inches with 72 dents.
Equals 24 dents per inch.

The setting-out of the pattern may now be accomplished, as shown in Figure 28. First, lightly rule in

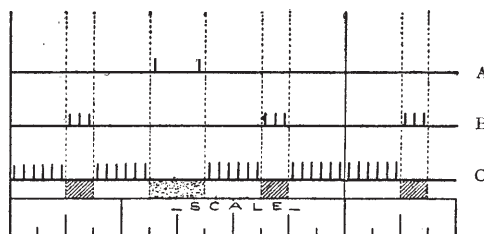

FIG. 28.

the desired stripe to scale as required, indicating the respective sections or setts of healds by the letters A, B, and C. Then—

A=48	threads per $\frac{1}{2}$ inch	on 24 shafts	= 2	mails per shaft	per pattern.
B=48	" "	$\frac{1}{2}$ " 8	" = 6	" "	"
C=96	" "	2 " 4	" = 24	" "	"

The best method of graphically representing this for the heald maker is given here.

There are two methods of arranging the gears for crammed stripes—viz., by specially constructing healds,

or by calculating the average number of mails per inch per shaft, and constructing the gears on the ordinary method. The latter procedure is of course the simpler, but it is only applicable when the crammed stripes are narrow, since, in the case of broad crammed stripes, if the healds are of ordinary construction, there is necessarily much drawing across.

The Arrangement and Number of the Shafts in Weaving Double Cloth.—There are three factors which influence the number of backing shafts in this case: (1) The backing weave, (2) the system of tying adopted, and (3) the manner in which such tying is effected.

For example, a double cloth may have a plain back, but be tied in the 8-end sateen order, when eight backing shafts will be required if a backing thread rises over a face pick, but only two backing shafts if a face thread passes under a backing pick. In this latter case, of course, eight face shafts will be required.

The position of the backing shafts is of some importance, since it undoubtedly affects the weaving. They may be placed in three positions—viz., in the front; at the back; or mingled with the face shafts. If they are placed at the back there is little liability of the face stitching, but the backing will certainly tend to stitch; while if the backing shafts are in the front there is little fear of the back stitching, but the face threads are worked at a disadvantage. If the back and face shafts are mixed there is the advantage of a straight draft, but complication in the pegging plan ensues. As a rule, however, it will be better to place the backing shafts in

the front, since the back of a piece is usually required soft, while the face is required crisp; consequently, the backing warp must be slackest and will be most liable to stretch; therefore these slack threads should be placed on shafts as near the front as possible. Under other circumstances, however, other conditions may be required. For example, if on one series of shafts only a few threads are drawn these shafts may conveniently be placed at the back, for then they will be in the best position for being removed should the remaining shafts only be required.

CHAPTER V.

FIGURED FABRICS.

Figure Analysis.—In analysing figured textiles for precise reproduction the unit or repeat of the figure must be first ascertained. Should a full repeat, or more than a repeat, of the pattern be obtainable, several methods may be adopted. A simple plan, frequently resorted to by professional analysts, is to pin the pattern on cardboard and prick with a needle round its edge, thus obtaining a representation in outline of the figure. The repeat must then be enclosed in a square or oblong, and this be divided into squares representing 8, 16, or 24 threads and picks, as required. Figure 29 illustrates

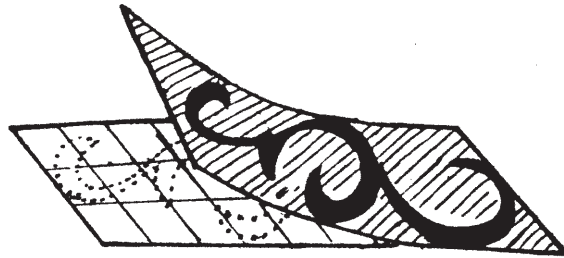

FIG. 29.

this system. Another method is to paste the cloth upon cardboard and divide it into spaces by wrapping threads round it, equidistant from each other, as shown in Figure 30. Each of these squares may then be taken

to represent 8, 12, 16, or 24 threads and picks, as required. Thus, taking each square to represent 24 threads and picks, $24 \times 12 = 288$ ends and picks for the full repeat of the design. The figure is then transferred in outline to the design paper, blocked in with some transparent colour, and then the desired weaves placed upon figure and ground respectively. A useful means for dividing the repeat of any figure into any desired number of squares is shown in Figure 31. By ruling a paper similar to this, and doubling until the repeat of the pattern is divided into the required number of divisions, any figure may be squared out as desired. In Figure 31 there are 25 divisions; thus,

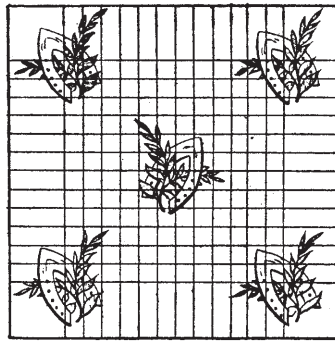

FIG. 30.

dividing any given figure according to this, if each division is taken to mean eight threads or picks, $25 \times 8 = 200$ threads or picks for repeat of the pattern; if 16 threads or picks, then $25 \times 16 = 400$ ends. For a 288 jacquard, only 18 divisions should be employed; thus, $288 \div 18 = 16$ threads or picks to each division, and so

78

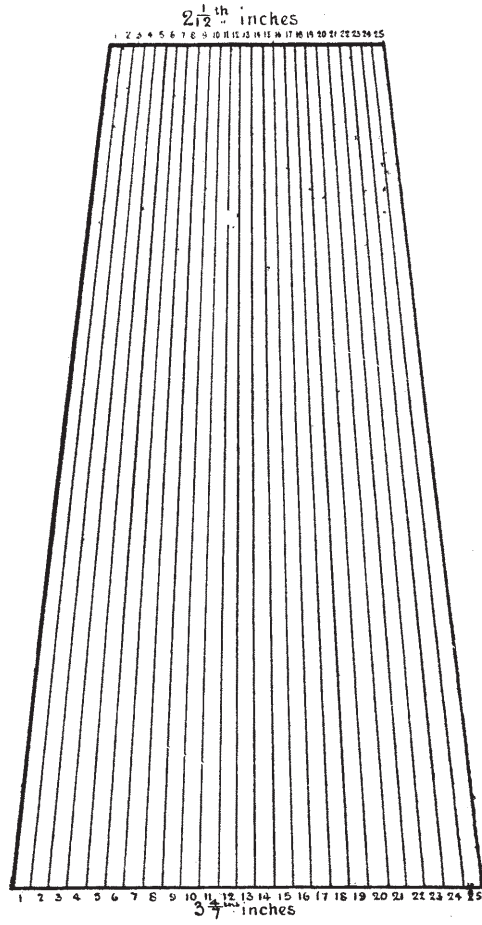

FIG. 31.

on. The lines should be ruled from the space likely to be occupied by the smallest figure to that occupied by the largest figure. Thus, in Figure 31 the divisions were drawn to $\frac{1}{2}$ of an inch; thus $\frac{25}{12} = 2\frac{1}{12}$ inches to $\frac{25}{7} = 3\frac{4}{7}$ inches; but, in drawing up a diagram for actual use, this latter space should be doubled—*i.e.*, $\frac{50}{7} = 7\frac{1}{7}$ inches, when it will include all save abnormal figures.

Other modifications of the above principles are in use, according to the fancy of the particular analyst. Nevertheless, whatever system be adopted, it should be remembered that what is required is simply the division of one repeat of the figure into squares or oblongs, each representing a certain number of threads and picks on the design paper.

When only a portion of a pattern is obtainable the difficulties are greater, since no further advance can be made unless there is sufficient of the figure to decide the method of arrangement adopted, and even then the analyst can often go no further unless he possess considerable artistic culture.

The Reversing of Figures.—A very prevalent system of figure arrangement is shown in Figure 30—termed the “drop reverse,” since each succeeding figure drops or moves further down the cloth, and is also turned over or inclined in the opposite direction, thus giving variety to the design. Two difficulties occur in arranging any given figure thus: firstly, in turning the figure over to obtain precise reproduction; secondly, in spacing out the ground between the two figures in such a way that

even distribution is obtained, or the figures are equidistant from each other. The first difficulty is soon overcome with practice, since—whether it is an ordinary figure spaced out, as here shown, or a point-paper figure—the spaces serve as a perfect guide, the only modification being that inclination in the given figure to the right has its counterpart to the left in the reversed figure, and so on. The second difficulty is not so readily surmounted as the first. Under ordinary circumstances, the safest way to space out the two figures is to find the centre of the figure and reverse by this, when (as a rule) the figures will be found equidistant from each other. This method is particularly applicable to point-paper figures.

At times, however, this system will not act, when the only thing to be done is to find the number of threads or units of space both figures occupy; deduct this from the full number of ends, and then divide the ends that are over into two lots coming between each figure. Thus, suppose a figure occupying 96 ends is to be reversed and arranged upon 288 ends, then :—

$$\begin{aligned} 96 + 96 &= 192 \text{ ends occupied by two figures.} \\ 288 - 192 &= 96 \text{ ends to distribute between the figures.} \\ 96 \div 2 &= 48 \text{ ends of ground between each figure.} \end{aligned}$$

For the distribution weft way proceed in like manner.

Design XX. admirably illustrates the reversing of a given figure, since it consists solely of one figure reversed four times. Wherever possible in textile designing this mechanical precision should be obtained.

Warp and Weft Weave Figures.—This class of figured textiles is very extensive, embracing fabrics designed for ulsterings, mantle cloths, dress fabrics, table covers, etc.

PROCEDURE.—Design XXI. is a small example demonstrating the principle of constructing or reconstructing these figures, the usual method being as follows:— Having decided upon the extent and form of the figure,

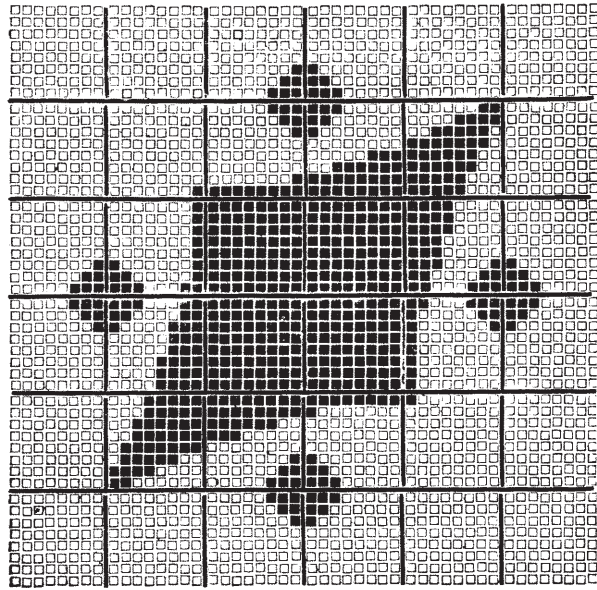

DESIGN XX.

pencil the required form in red or blue—any transparent colour will do—on the design paper, as indicated in Figure 32. Now put the ground weave upon the white part of the design paper and the figure weave on the coloured part, *having previously found the best relative positions of the two weaves.*

This is very simple, and the only difficulties to be overcome in analysing such cloths are:—

1. The various weaves combined.
2. The extent of figure.

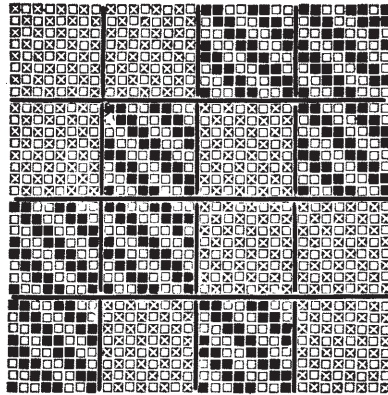

DESIGN XXI.

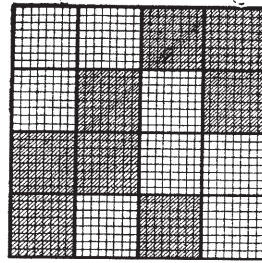

FIG. 32.

The first difficulty has previously been dealt with under the headings “Stripes, Checks, Twills, etc.,” the principle of finding the weave being exactly the same in each case. Having found the weave, the extent of figure may be readily ascertained by placing the piece-



FIG. 33.

glass on the face of the fabric and counting the number of repeats of the figuring weave in the figure. Thus, for example, in Design XXI. there are four repeats of the two-and-two twill, and $4 \times 4 = 16$ threads—the extent of

pattern in the thickest part. A sectional view, from which a similar demonstration may be made, is given in Figure 33. Thus the curvature of the threads and picks may be of aid in clearing up both the above-mentioned difficulties.

Matelasses.—These are a type of texture forming a distinct class in themselves, which should, at least, be briefly noted. In their simplest form they consist of a cotton warp interwoven in weft flush weaves with mohair weft. This type will come under the heading of weft weave figures, and may be analysed as such. In their second and more complicated form, however, they are very different. They then consist of a firm ground cloth, usually formed by interweaving cotton warp with wool weft; while a mohair pick, introduced after each ground pick, floats on the surface and is tied down to form the figure. A design for this type of structure is shown in Design XXII., in which A=figure, and B=part of the design fully developed.

There is also a similar type of warp matelasse which now and again is further complicated by the introduction of a floating woollen pick for the back of the texture, while sometimes a wadding pick is inserted to throw up the figure in relief.

In analysing these goods, since the figure is the important point, this should be first obtained by a detailed examination of both face and back of the texture; after this the backing or ground weaves, etc., may be ascertained and fitted to the face weave in the best possible manner. Here, also, as a rule, there will be no need to work exactly from the pattern.

Weft Spot Figures.—A type of weft spot likely to be attributed to an extra weft is largely found in scarf or tie patterns. As a rule, there is no extra weft; but the ordinary weft is introduced so aptly that the variety of

DESIGN XXII.

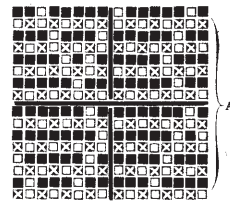
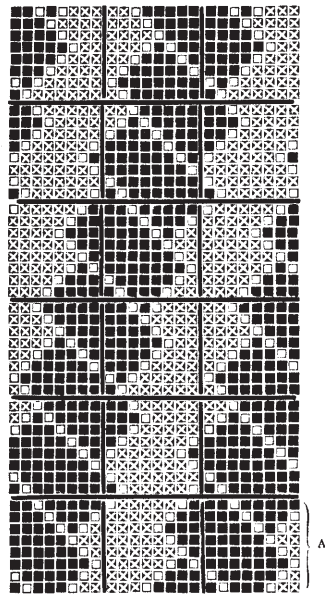

B :
FULLY DEVELOPED.

coloured spots, or the variety of colours in each spot figure, is quite delusive. Figure 34A illustrates this method of weft spotting, in which the ground is formed by a fine silk warp very closely set, so that the weft is entirely hidden. Then the weft will be red for section R, blue for section B, yellow for section Y, and olive

for section O, with the result that the spot figures formed by these wefts present such a variety of colours that the introduction in stripes is entirely hidden.

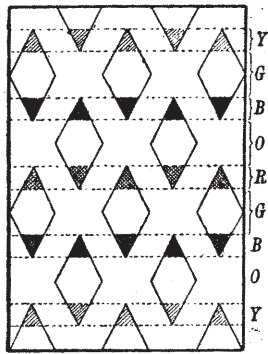

34A.

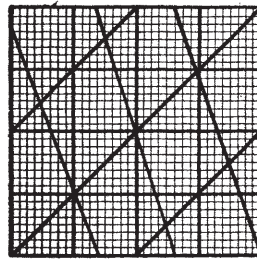

34B.

The Sateen Distribution of Spots.—A prevalent system of distributing the smaller type of spot figures is in sateen order. The advantage is a perfectly regular distribution, while the disadvantage is the repetition of the unit or figure 4, 5, 6, 7, or 8 times.

The *5-end sateen* is a favourite for figures that all lean one way or have no inclination; but if a figure is to be distributed and inclined first in one direction and then in the other the repeat will be twenty figures, since five figures would consist of three leaning in one direction and two in another.

The *6-end sateen* is an irregular, and so may easily be detected.

The *7-end sateen* has the same disadvantages as the five.

The disadvantage of the 8-end sateen is the large reduction in the figuring capacity of the dobby or jacquard.



FIG. 34.

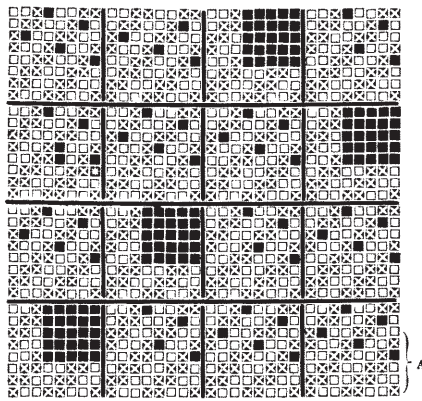

DESIGN XXIII.

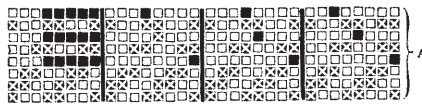

DESIGN XXIII A : FULLY DEVELOPED.



FIG. 35.

The method of distributing spots in sateen order either on design paper or on ordinary paper is shown in Figure 34B,* in which the 8-end sateen positions are

* Fully demonstrated in the Journal of the Yorkshire College Textile Society.

obtained and then are connected by diagonal lines, which thus divide the full repeat into the required number of spaces.

Experiment in floral design with diagonal effects will frequently demonstrate the analogy with the sateen.

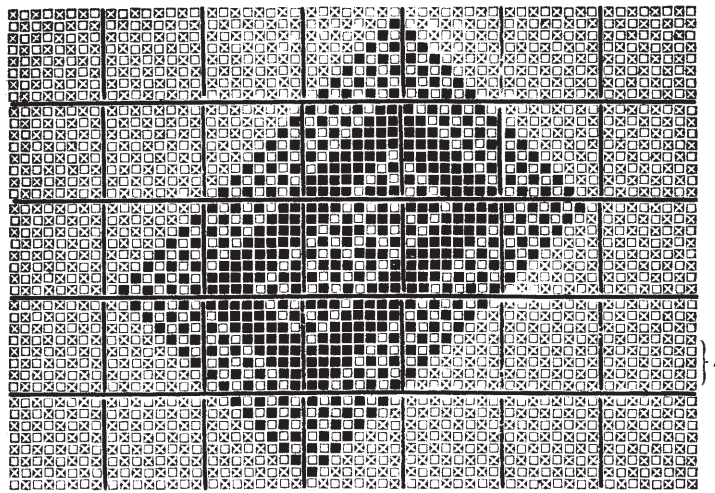

DESIGN XXIV.

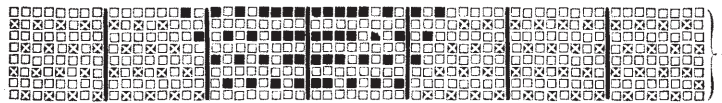

DESIGN XXIV. FULLY DEVELOPED.

Extra Warp and Weft Figures.—Fabrics figured on either of these principles may be divided into two classes, viz. :—

1. Those in which the extra material simply flushes on the surface as a spot figure (as shown in Figure 34 and

Design XXIII.) and is tied on the back when not flushing on the face.

2. Those in which the extra material flushes as a weave on the surface of the fabric and is tied on the back when not flushing on the surface ; or, if the fabric is required for very light goods, it is allowed to flush on the back and is cut off in the finishing process, being thus distinguished from swivel work. This type is illustrated in Design XXIV. and Figure 35.

The analysis of the first class is evidently very simple, the only points requiring attention being, firstly, the extent of flush, which may readily be ascertained by counting the repeats of ground weave, as previously explained ; and, secondly, the ties binding the extra weft or warp to the back of the ground fabric, a thorough comprehension of the principles of tying doing away with all difficulties in this case, as before.

The analysis of the second class is, of course, much more difficult, for the extra weft or warp may interweave with the ground threads in any and every order. For example, it is no extraordinary thing to find leaves and flowers developed most beautifully by means of the extra weft interweaving with the ground warp, or *vice-versâ*. Under these circumstances the method of development should be carefully examined and the figure be carefully sketched on design paper and developed as nearly as possible according to the original, irrespective of minute examination by the piece-glass—though, of course, this may be occasionally used to confirm the surmise of the analyst. The extent of the figure may often be decided, as previously indicated, by

the number of repeats of the ground weave ; while the ties, should any be required, must be inserted strictly according to the principle indicated on pages 60 and 61.

In this type of effect the question as to whether a material is an extra or not is likely to arise, since, along with the various systems of arranging the warp and weft in solid cloths, extra material is at times combined. This question may be decided by noticing whether the threads or picks in question interweave with the ground material at the back or are simply tied to it. In the former case there is no extra material, in the latter case there evidently is.

List VI. indicates the capabilities for floral, etc., development furnished by the various principles of introducing extra warp or weft.

LIST VI.

	ORDER OF WARPING OR WEFTING.	POSSIBLE COLOURS.	TYPE OF CLOTH.
1	1 to ground (black) 1 to figure (red).....	Black and red	Dress goods Waistcoatings, etc.
2	1 ground 1 figure (red) 1 figure (green)	Black, red, and green...	Waistcoatings, etc. Figured silks, etc.
3	1 ground 1 figure (red) 1 figure (green) 1 figure (blue).....	Black, red, green, and blue	Waistcoatings, etc. Figured silks
4	1 ground 1 figure (red) 1 ground 1 figure (green)	Black, red, and green...	Dress goods, shawls, etc.

Extra warps are often varied in colour, on the principle already demonstrated with reference to weft spots on page 85; in fact, this is certainly one of the most prevalent methods of employing extra weft or warp.

Swivel Spots.—Spots or figures introduced by means of swivels may be readily detected, since, although the extra material crosses the warp at right angles, each spot will be formed by a single thread passing backwards and forwards as though it had been put in by a needle. These goods are woven in the loom wrong side up.

Lappets.—This style of effect, although somewhat like the swivel spotting, may be readily distinguished from it, as the threads acted upon by the needles will be found occupying an important position throughout the pattern; they are never absent from the face, but simply form a figure by binding into the ground cloth.

DOUBLE CLOTH FIGURES.

A means of figuring largely adopted in almost every branch of the weaving industry is that obtained by weaving two plain cloths together and allowing them to change places for the figure. The simplest method of effecting this is shown in Design XXV., a useful set for a mantle woollen cloth figured on this principle being

Warp.

1 thread 30 sk. black, 1 thread 30 sk. white,
12's reed 4's.

Weft.

1 pick 30 sk. white, 1 pick 30 sk. black,
48 picks per inch.

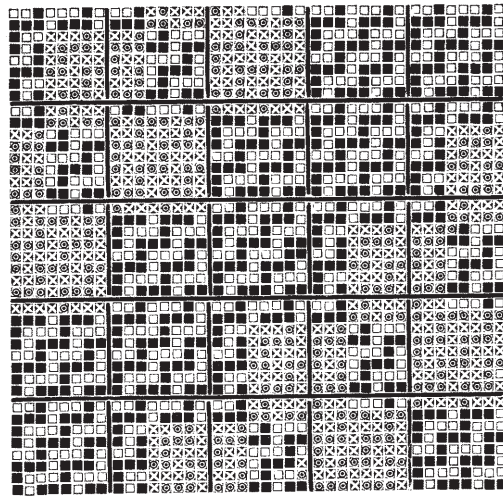

DESIGN XXV.

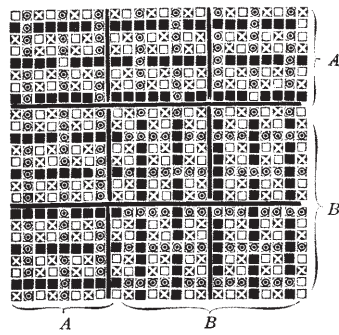

DESIGN XXVII.

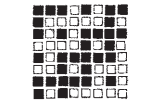

DESIGN XXVI.



FIG 36.

A fabric made to the above particulars with Design XXV. would consist entirely of a black and white cloth, which would simply change positions from back to face and *vice-versâ* for the figuring, thus obtaining the designation "figured reversibles." By means of Design XXVI. a double two-and-two twill cloth (a sectional view of which is given in Figure 36) is produced, while Design XXVII. produces a small figured double plain cloth, one cloth being as coarse again as the other. Other systems there are which it is impossible to note, since not the construction but the means of analysis is here to be considered.

Method of Analysis.—It is evident, then, that in their ordinary form these cloths may be analysed, so far as weave is concerned, as ordinary double cloths. To find the extent of figure is a rather more difficult task. The curvature of the threads may often prove of service; but perhaps the best method is to count the repeats of the weaves used, these being first found. It must, however, be remembered that in analysing these or any other cloths a knowledge of the principles of cloth construction is half the battle. For the study of this type of texture there is no better work than "Colour in Woven Design," by Prof. R. Beaumont.

Tie-up of the Harness for Special Figures.
—Irrespective of the sett, extent of pattern, etc.—which the analyst should be able to deal with by means of the particulars already given in this and the preceding chapters—the question may arise, in analysing such fabrics as table-covers, hangings, etc.: What kind of harness tie-up has been employed?

Take Figure 37 as an example. This is simply what is termed a "turn-over pattern," half the figure (*a*) representing the repeat so far as the jacquard itself is concerned; *a*¹ being an exact reproduction of *a* turned over.

The method of accomplishing this is shown in Figure 38, a 104 (13 rows of 8) jacquard being

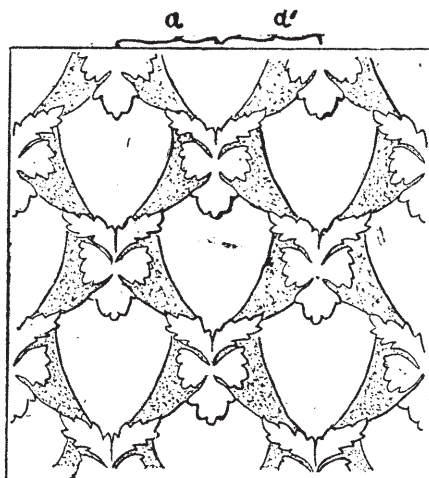

FIG. 37.

taken, to render the principle as apparent as possible. Eight hooks—*i.e.*, one row of eight—are taken for the lists on either side, as shown, while the remaining 12 rows—*i.e.*, 96 hooks—are taken for the figure. Thus hooks 1 to 12 have their first harness ends from the left-hand side of the lower cumber-board (*c*¹); but in their second repeat are worked in exactly the opposite

direction—viz., 12, 11, 10, etc.—thus turning over the pattern.

Figure 39 shows a pattern requiring a more intricate tie-up than Figure 38. In this case the border simply

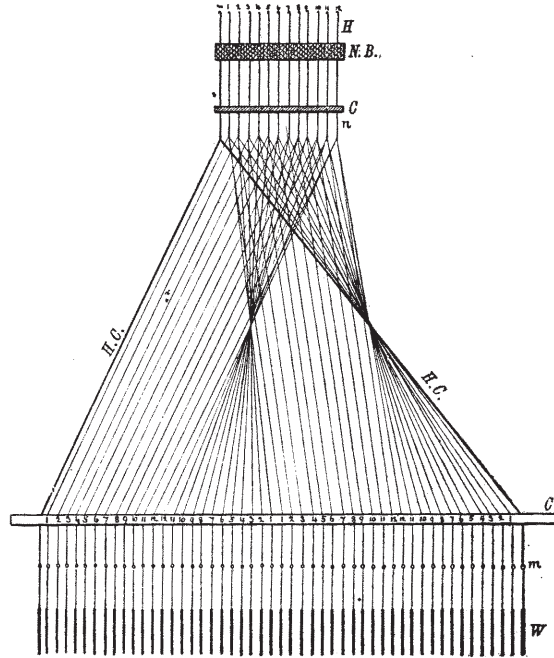

FIG. 38.

consists of parts *a* and *b* turned over, on the principles already demonstrated. There are more ways than one of treating this pattern, but the following treatment will demonstrate all that is necessary:—Let section *a*=48

threads—*i.e.*, 48 uprights; let section $b=144$ threads—*i.e.*, 144 uprights; the border on both sides of the cloth will then be produced from these 192 uprights, on the same principle as the lists are formed on in Figure 38, the uprights for section a having 8 harness cords to each neck-band, the uprights for section b having 4 harness cords to each neck-band. If the machine is a 400, there are still 192 hooks which may be taken to work a figure for the centre of the fabric, while

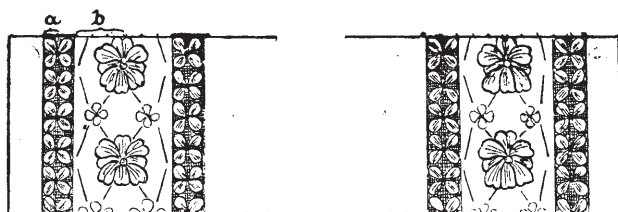
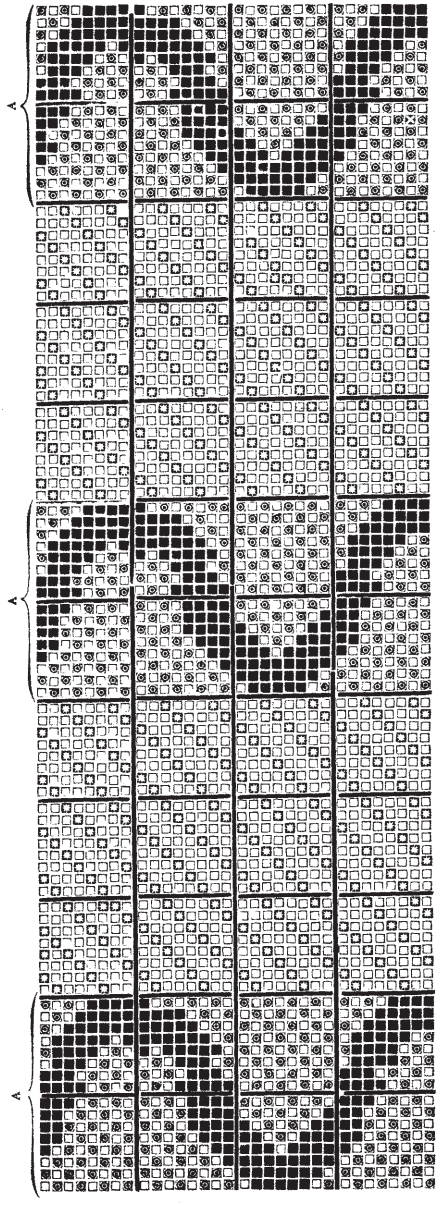

FIG. 39.

the remaining 16 hooks—8 on one edge of the machine and 8 on the other edge—will be taken to form the list or edge to the fabric on their respective sides.

Design XXVIII. illustrates the production of striped patterns by the use of harness and shafts combined. Section a represents some figure which repeats, say, upon 192 ends, thus requiring a full 192 jacquard for production. Harness cords are then taken from the neck-bands to the lower cumber-board *in those sections only where the figure is required*; thus between each repeat in the harness will be a blank space. Opposing these blank spaces, however, the four shafts required for the three-and-one twill present the necessary mails for working section b . By this means it is evident that the figuring



DESIGN XXVIII.

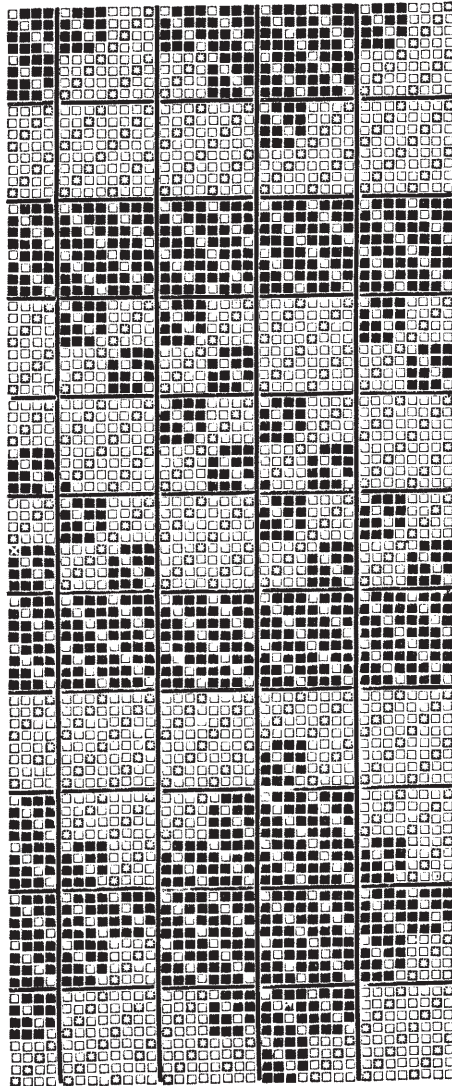

Design XXIX.

capacity of the jacquard may frequently be more than doubled.

Design XXIX. illustrates the production of a diaper type of figure by means of pressure harness. In this case four threads are drawn through each harness mail, and since the harness forms the figure, as under ordinary circumstances, it will be four times the ordinary size, but

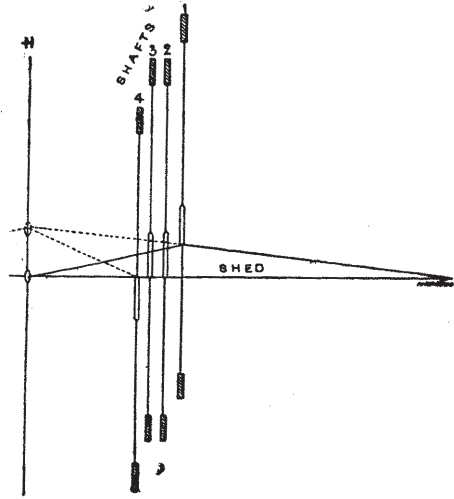

FIG. 40.

somewhat coarser in outline than is usually the case, being in blocks of four, as shown. In front of the harness are fixed four shafts, as shown in Figure 40, and the four threads coming through the harness mail are separated in these shafts, thus being rendered, to a certain extent, independent of one another.

The object of these four shafts is to work upon the fabric throughout three-and-one twill or sateen; thus, if a harness cord is lifted to form warp ground, the shafts work the four threads which are just raised three-and-one warp twill, while the threads passing through the mails on the harness cords which are depressed to form the weft figure are at the same time worked three-and-one weft twill. To effect this the mails upon the shafts are of such a size that the shed can be formed through them; two remain for each shed in the centre position, thus having no action whatever upon the threads drawn upon them. One is raised, thus working the weft figure three-and-one weft twill; and one is depressed, thus working the ground three-and-one warp twill. Of course, the picks need not be worked in blocks of four; but the threads can only be worked thus, since four pass through the same harness mail. The patterns mostly produced on this system are those known as reversibles—*i.e.*, one side is exactly the reverse of the other. The various sateen weaves are most frequently employed.

In what is termed a “split harness” it is only possible to interweave the weft figure in twill or sateen order, there being no means of depressing any threads *lifted* by the harness. Of course, this method throws less strain on the warp than the pressure harness.

The analyst will gain a fair idea of the possibilities of the various systems of mounting from the foregoing particulars, and will probably be able to class any patterns brought under his notice.

CHAPTER VI.

GAUZE FABRICS.

The analysis of gauze patterns in some respects is much easier than the analysis of ordinary cloths, since with an ordinary piece-glass it is usually quite an easy matter to follow each individual thread throughout the repeat. This, as will be seen directly, is not the most difficult part of the work to be done. It is the drawing-out of the weaving particulars, and the reduction of the pattern into the least possible number of shafts, that call forth all the energies of even the experienced analyst.

For convenience the subject will be treated under two heads, "Ordinary Gauze Fabrics" and "Figured Gauze Fabrics."

ORDINARY GAUZE FABRICS.

This class includes all those patterns in which ordinary warp or weft figuring is absent, the beauty of the patterns thus depending on the delicacy of the lace-like effect obtained by the varied orders of grouping.

Structure of Simple Gauzes.—The simplest possible example of gauze is given in Figure 41, by means of which the system of indicating gauze on point paper may be briefly described. The threads marked *s s* are termed the stationary or standard threads—*i.e.*, the threads round which the crossing thread works. These are the threads which the analyst first searches for, since the whole pattern literally revolves round

them. The threads marked *c c* are termed the crossing threads, and the essential feature of gauze is that these threads may be lifted at either side of the stationary

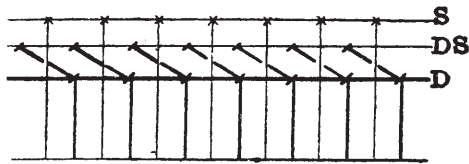
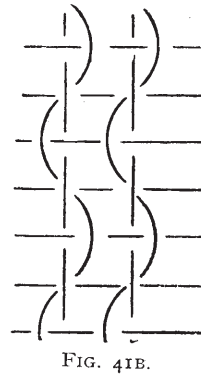
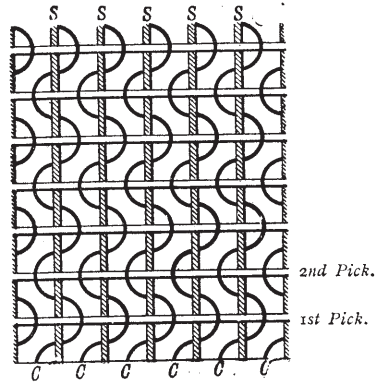
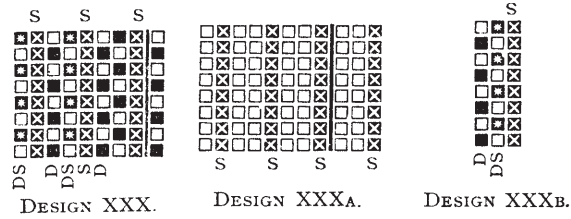

threads—on one side by the doup, on the other by the

doup shaft, which consequently works in conjunction with the doup. It is evident, then, that to each pair of threads three shafts must be allotted—viz., doup, D; stationary, S; doup shaft, D S, as indicated in Design XXX. Figure 41B represents what is termed “leno.”

Arrangement of Simple Gauze or Leno Loom.

—In Figures 42 and 43 the simplest possible method for producing gauze is shown, which will serve as an excellent introduction to the more complicated mechanisms.

Figure 42 shows the construction of the “doup,”

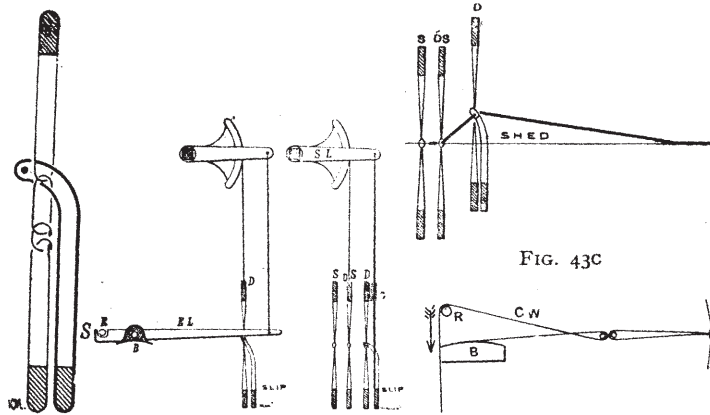

FIG. 42. FIG. 43A. FIG. 43B. FIG. 43C.

from which it will be gathered that the thread is not actually drawn upon the shaft, but through the “slip,” which, although lifted by the shaft, is to a certain extent independent.

In Figure 43, sketch B, the general arrangement of the shafts is shown, with the half-moon for lifting

the doup shaft D S, which is placed immediately behind the doup in order to form a clear shed. Upon the same rod as the half-moon are two levers (S L), from which two belts pass through guides (G) upon the doup to the slip, so that upon the doup shaft being lifted the slip also is raised, thus taking all the strain off the crossing warp in the act of crossing.

In sketch A the connection of levers for the doup is shown, from which it is evident that upon the half-moon lifting the doup it also lifts the easing lever E L, and

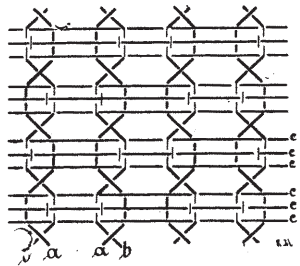

FIG. 44

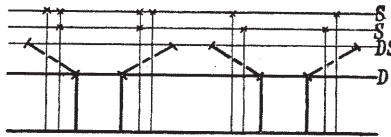
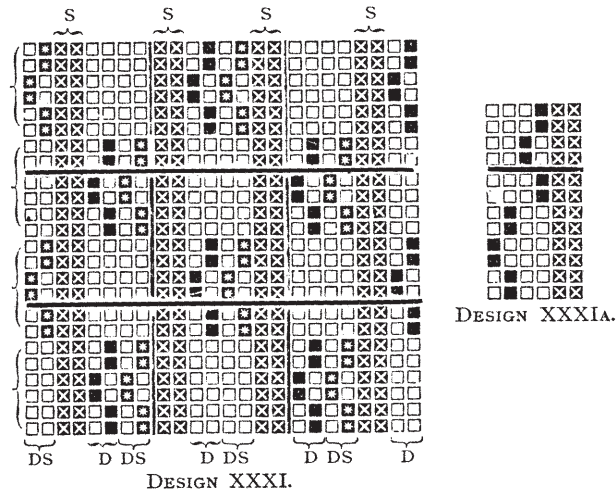

FIG. 44A.

since the crossing warp goes over the rod R it is thus eased. The reason for this easing will be realised on referring to sketch C, where it is evident that upon the doup lifting, as shown, the threads must be eased or they would break, since they are held down by the doup shaft.

Sketch D shows rather more clearly the action of the easing rod, the crossing warp C W going over this, while the stationary threads go directly over the back rest of the loom to the healds.

In all gauzes of this style it will be evident that equal bending of (crossing and stationary) warp must take place if all the warp is brought off one beam.



Elementary Analysis.—The analyst, then, should proceed as follows :—1. Search for the stationary threads, and, having found these, indicate them in red pencil on point paper, as shown in Design XXXA, *taking care to leave a sufficient number of spaces for the doup and doup shaft.* 2. It will usually be found that the crossing threads divide the picks into distinct groups. This grouping should be indicated by brackets, as shown in Design XXXI.

3. Having indicated these particulars, each thread must now be followed throughout the repeat, *marking for rises*, as shown in Design XXX. In following the crossing thread throughout any gauze pattern, it is observed that it first

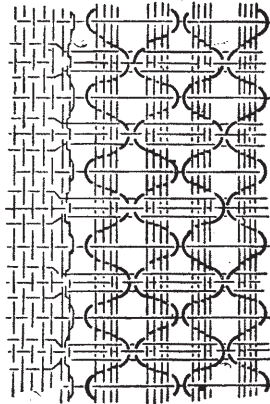

FIG. 45.

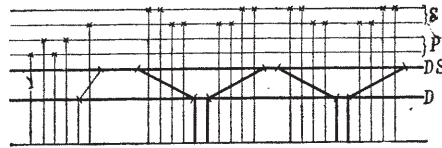

FIG. 45A.

rises on one side of the stationaries and then on the other, thus—taking the doup to lift on the right-hand side and the doup shaft on the left—the doup only in Figure 41 will be raised for the first pick, the doup shaft only for the second, and so on, the stationary thread being bound to the weft by the crossing thread alone.

In effects similar to this—simple as they apparently

are—there are difficulties often occurring, some of which may be illustrated by Figure 44, which is the gauze ground taken from a figured fabric. The first question which arises here is—Which are the stationary threads? It is quite allowable for either *a* or *b* to be taken as such; but if *a* (which, in reality, represents two threads) be examined they will be found to be bound to the weft only by the crossing threads *b*, therefore fulfilling the same conditions as indicated in Figure 41. Threads *a* may therefore be taken as the stationary, and the analysis carried out as above, Design XXXI. being the point-paper design, which should be compared with Figure 44, remembering that *a* and *b* each equal two threads, which will be split in the figure to form plain, etc.; picks *c c c* also equal two picks, each likewise split in the figure into two separate picks (see page 108).

The Introduction of Thick Threads.—The introduction of thick threads may sometimes prove confusing to the analyst, so he should remember that thick threads conform to the same laws as thin ones. For example, in Figure 45, if the thin threads edging the stripes be examined it will be found that they work precisely the same as the thick threads, therefore an extra doup for them is not needed.

Combination of Gauze with other Interlacings.—Another type of effect to which attention should be briefly directed is that illustrated in Figure 46. Here we have a combination of gauze, twill, and plain in stripe form. It is evident that in this case ordinary shafts will be required for the twill and plain, while the full complement of doup, doup shafts, and stationaries

will be required for the gauze stripe, as shown in Figure 46A. This means specially-constructed healds, which, of course, implies extra expense; while, at the same time, it should be noted that, once constructed,

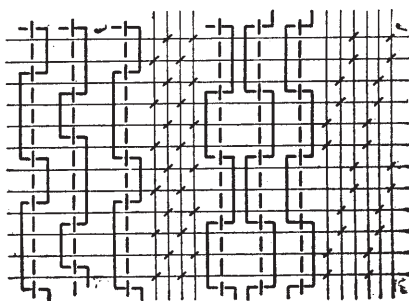

FIG. 46.

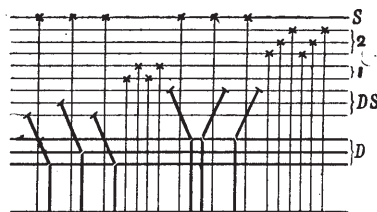

FIG. 46A.

the healds will only produce that particular width of stripe. For the principles of indicating the special construction of the healds refer to pages 72 and 73.

Points to Note.—In analysing any type of gauze effect there are two laws which may be of great service to the analyst. They are, firstly, in order to produce a clear, precise crossing, the crossing threads must go over the pick preceding and succeeding such crossing; and,

secondly, in order to comply with the above law, all picks and threads must be grouped together in varying numbers, according to the weaves employed, along with the gauze.

Drafting or Douping.—Having shown the method of transferring gauze effects on to design paper, attention must now be directed to the drafting, or “douping” as it is termed. Figure 41A indicates the draft for Figure 41, and Design XXXB the pegging plan, in which it will be observed that the only difference from Design XXX. is the relative position of doup and doup shaft, it being a custom in practice to place these together, so that a clear shed is formed, while the threads they really represent—or, rather, the positions they represent—are separated by the stationary threads.

The draft and pegging plan for Figure 44 are given in Figure 44A and Design XXXIA, in which it will be noticed that (should the figure be drafted as indicated on page 106) two douns will be required; while should threads *a* be taken as crossing threads there will be only one doup required. The fact that this is a ground effect for a figure accounts for this, which will serve well as an introduction to that important matter, the reduction of the number of douns. This represents the simplest case in which reduction is possible. It will at once be realised that this is simply what is termed a point draft, one doup under these conditions working the crossing thread on *opposite sides* of each group of stationaries. The analyst then should carefully examine the pattern before him with the idea of grouping those threads together *which work alike or exactly opposite*. The drafting for Figures 45 and 46 are shown in Figures 45A and 46A respectively.

A case in which extensive gauze patterns may actually be woven with one doup only is illustrated in Figure 47. A careful examination of this effect will show that, should the doup lift the crossing threads on the right-hand side of the stationaries, it must be lifted every other pick to form the plain weave; while the shafts lifting on the left-hand side of the stationaries form the gauze crossings, *if required*. Should the positions be reversed there will be no reduction in the doup shafts, but a considerable increase in the number of doups required. Note should

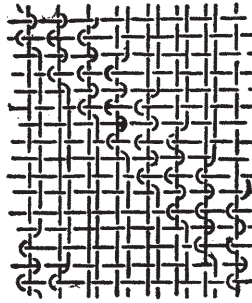

FIG. 47.

also be made that crossing in such cases may be prevented in two ways: first, by working the crossing thread by, say, doup only; or, secondly, by lifting the stationary thread when the doup shaft rises.

Complete Analysis.—To summarise our remarks as follows will conclude this section of our treatment. In analysing gauze fabrics proceed as follows:—

1. Indicate clearly on design paper the number of

threads required for the plain or twill, etc., stripes, should there be any, and for the doup, doup shaft, and stationary positions, as already explained.

2. Group all the threads and picks as they appear grouped in the pattern by means of brackets on the the design paper, as shown in Design XXX. and XXXI.

3. Obtain the full design by following each thread throughout the repeat by means of the piece-glass.

4. Examine to see what reduction can be made in the number of doups or ordinary shafts, should any be employed, and make out the draft, douping, easing, and pegging plan accordingly.

FIGURED GAUZES.

A thorough comprehension of the foregoing principles renders the task of analysing figured gauzes a compara-

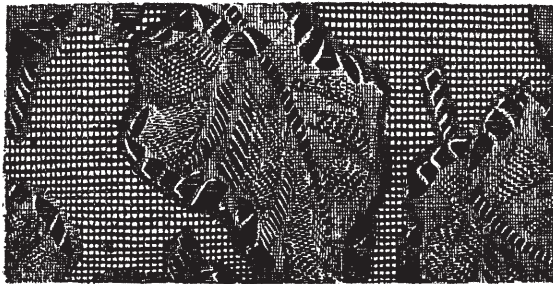

FIG. 48.

tively simple one. Take such an example as that represented in Figure 48. Intricate it undoubtedly looks, but if the analyst for the moment throws aside all

consideration of the combination of ordinary figure and gauze, and carefully examines each as separate and distinct patterns, and, having done this, proceeds to systematically combine them, then his task is much simplified.

Procedure in Analysis.—In all cases where gauze and figuring are combined the following procedure should be adopted :—

1. Find the gauze pattern by careful analysis, and divide the full sheet of design paper as required for the full figure into stationary, doup, and doup shaft threads, clearly indicating each, and insert the gauze weave.
2. Analyse the warp and weft flush figures as if it were an ordinary cloth.
3. Carefully put this figure upon the stationary threads and either the doup or doup shaft threads—not both.

It follows from the above that a gauze pattern will always occupy more threads than picks on the design paper should an equal number of threads and picks per inch be present in the cloth ; but by representing both doup and doup shaft by one line on the design paper and two kinds of marks, the ordinary design paper may be employed. The analysis of Figure 48 may now be given as an example for reference.

EXAMPLE :—

1. Brief examination of the gauze ground shows that it is constructed as indicated in Figure 49.
2. An examination of the figure reveals that it is composed of warp and weft flush, as indicated in

Design XXXII., with plain weave between these flushes and the gauze ground. This figure must then be sketched out in full and developed on design paper.

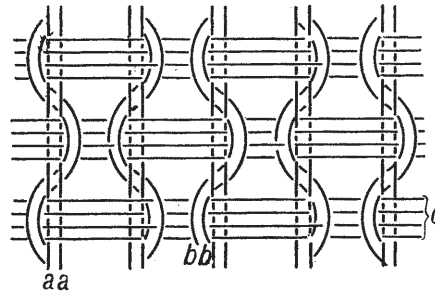
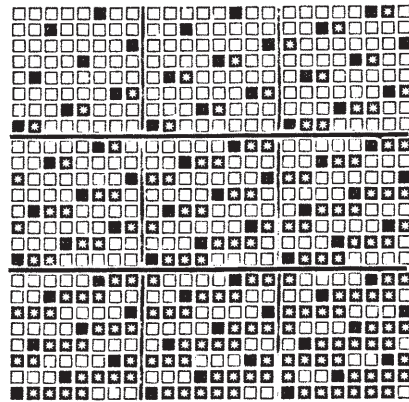
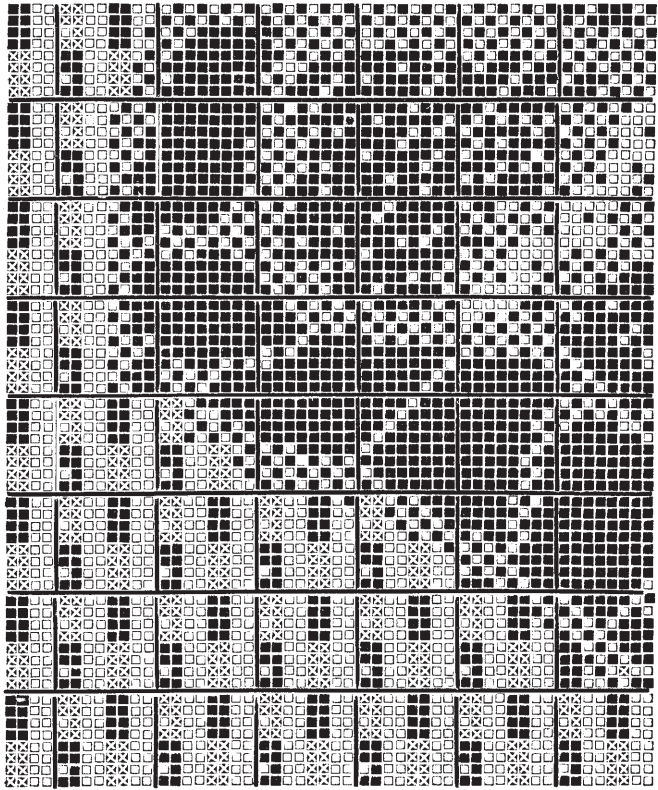

FIG. 49.



DESIGN XXXII.

3. Having ascertained the number of threads and picks that the figure occupies, take the same number



DESIGN XXXIII.

of picks and threads, and, as shown in Design XXXIII., represent both doup and doup shaft on one line in different type, joining the gauze ground up to the plain on the principles previously indicated.

It will be observed that in Design XXXIII. (which on the extended system would occupy 96 threads and 64 picks), 64 picks and 64 threads are in reality represented, the doups, occupying a third of the thread spaces, are simply *positions*, not actual threads, represented by any place in the cloth. To keep any given figured square on the design paper, the type must be selected according to the relative number of threads and picks.

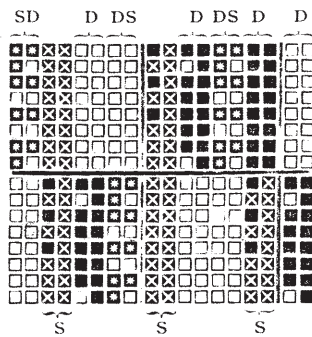

DESIGN XXXIV.

Double Gauzes.—A type of gauze effect liable to prove very confusing is that which may be best described as a double-weft gauze, the construction of which is indicated in Design XXXIV. and Figures 50 and 51. Here the idea is to use weft of two colours, thus obtaining the effect of an extra weft without any flushing at the back of the fabric. The gauze used in designs of this

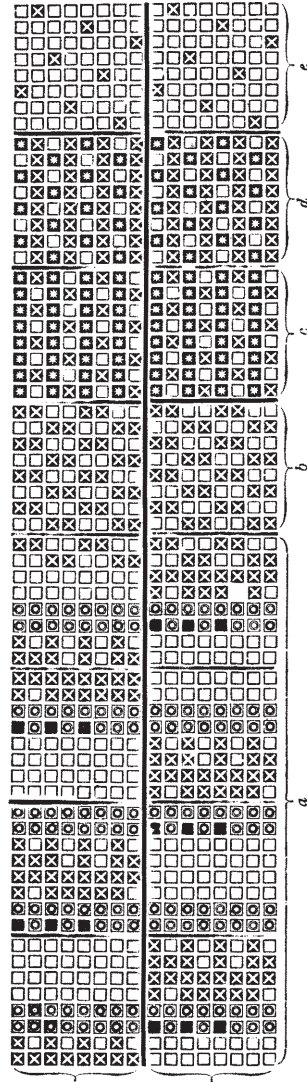

DESIGN XXXV



FIG. 51



FIG. 50.

kind is usually formed as indicated in Design XXXIV., which brings the dark odd picks to the surface, thus entirely covering the even numbered picks. Thinking out the effect of such a construction as this is well-nigh impossible; but if rough sketches are made of the cloth, as shown in Figures 50 and 51, then the effect may be rendered very apparent. For example, Figure 50 represents the working of the crossing or doup threads, while Figure 51 represents the working of the two stationary threads, thus:—*a, a, a, a* dark odd picks thrown into the surface of the fabric; *b, b, b, b* light even picks, covered by the peculiar arrangement of crossing and stationary threads, S1 and S2 stationary threads, doups 1 and 2 the crossing threads, and *c* the crossing of stationary and doup threads. In Design XXXV. the possibilities of this scheme of construction are shown, warp and weft to be as follows:—

Warp.

All fine black silk.

Weft.

1 pick grey, 1 pick white silk.

Then section *a* will be grey gauze, *b* will appear as plain cloth, *c* as pure white, *d* as pure grey, and *e* as black. Thus most elaborate figures may be designed on this scheme of construction, which may nevertheless be analysed with comparative ease according to the foregoing particulars.

Extra Weft Figures upon Gauze Grounds.

—Of the many methods of figuring with gauze in unison with other orders of interweaving none give more beautiful results than the type shown in Figure 52, in

which the figure is formed by an extra weft thrown upon a very fine gauze ground, the extra material being carefully cut off at the back.



FIG. 52.

So far as analysis is concerned, the perusal of the foregoing particulars will render it very simple, the gauze structure being first ascertained and put upon the design paper, ruled to the required particulars, and then the figure painted on by reference to the ground texture.

For example: In this case there are 48 threads per

inch, 36 ground picks, and 36 figuring picks; therefore the paper to give the figure on the square will be 48×72 or 4×6 .

Thus in this case 8×12 paper, as shown in the appendix, may be employed to keep the figure on the square; but if there are more threads than picks, or *vice-versâ*, the proportion must be varied accordingly.

Gauze Harness.—Although it is not within the scope of this treatise to consider and explain the various gauze harnesses, yet without some indication of the difficulties involved the treatise would be incomplete. The difficulties in mounting a gauze harness may be understood by referring to Figure 43, which fully illustrates the necessities for plain gauze, and may therefore be taken as an indication of the arrangement necessary for figured gauze:

1. In sketch B the arrangement of the shafts is shown, and in a harness a similar arrangement or allotment must be made—viz., the hooks and harness cords must be divided into doups, doup shafts or harness cords working in unison with the doup, and stationary or standards.
2. In sketch B is also shown the method of working the doup shafts along with the slip on the doup, which must have a counterpart in harness mounting. Thus, as shown in Figure 53, upon the harness cords D S lifting the slip is also lifted by means of the cord A, thus relieving the crossing threads of the weight of the slip.
3. In sketch C the necessity for easing when the doup

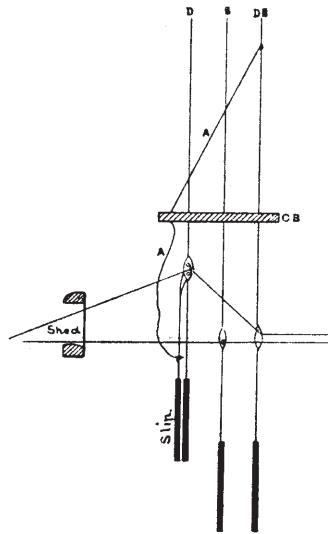

FIG. 53.

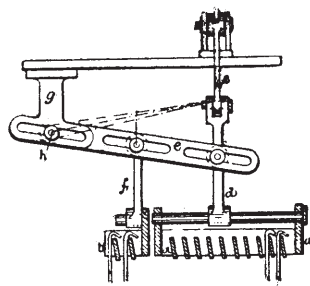

FIG. 54.

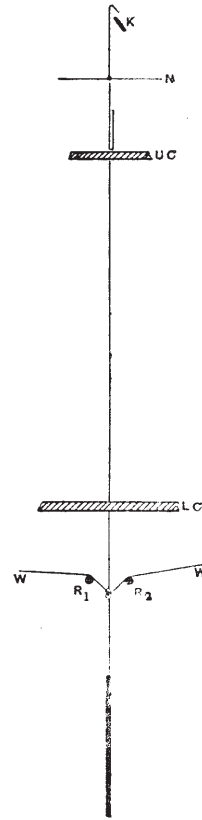

FIG. 55.

lifts, is shown; while sketch A shows the means of effecting this, the amount of easing being regulated by the relative lengths of the arms of lever E L.

The latest and best method of effecting this in a gauze harness is shown in Figures 54 and 55, being a recent patent of Messrs. Devoge and Co. Here, to work the pattern, 10 rows of hooks are employed; but, since the first two rows are the doups, the figuring capacity is equal to an eight-rowed machine. Two extra rows (*b*) are placed upon a separate block or grid for the easing, which is effected by raising them, as will be realised from Figure 53. The great difficulties which this arrangement overcomes are—firstly, the easing is readily arranged to take place at the correct time, *i.e.*, to commence just before the doups lift; and, secondly, the extent of the easing may be regulated according to requirements by the position of the connecting link *f* on the lever *e*. As shown, the link *f* connects the grid *b* nearer the fulcrum *h* of the lever *e* than is the connection for the grid; thus hooks *b* are lifted a less distance in this proportion. Where shafts are employed for easing the principle is exactly the same as in the Jacquard.

Mock Leno.—There are several methods of producing gauze or leno effects without the use of a doup, which call for brief comment.

The simplest method is by skipping dents and arranging the interweaving of the neighbouring threads in such a manner that they will be grouped together. The principle of effecting this is shown in Design XXXVI., in which it will be seen that all threads *a*, *b*, and *c* are grouped together by picks flushing over them, while the

other picks interweave plain. To produce the best possible result it is necessary that the threads thus grouped should be placed 3, 5, and 7 ends in a dent

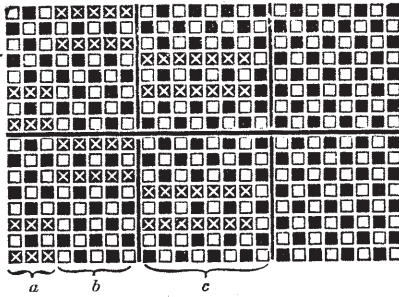

DESIGN XXXVI.

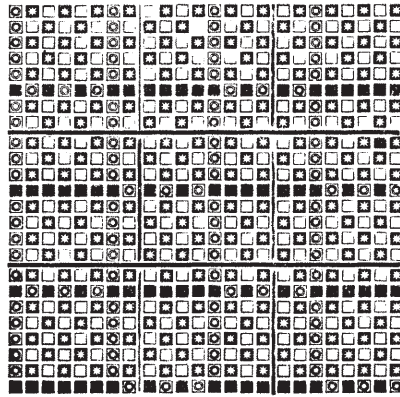

DESIGN XXXVII.

respectively, so that it may be necessary to draw a dent here and there in the reed.

This is the principle upon which all “mock gauzes” are constructed, but there is a modification of this system, introduced, we believe, by the late Prof. John Beaumont, at the Yorkshire College.

Design XXXVII. illustrates the type of structure, the ground being plain throughout. The threads marked in solid type are usually worsted if the ground is silk, or mohair if the ground is woollen. It will be observed

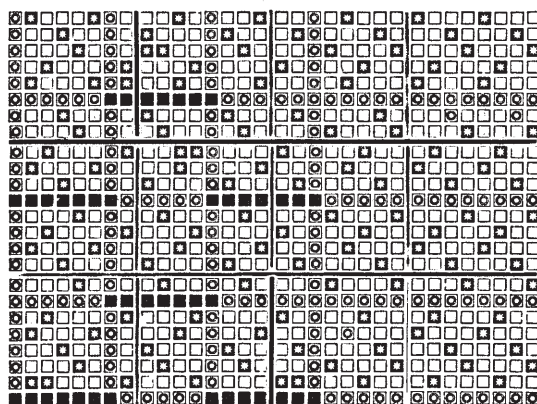

DESIGN XXXVIII.

that they interweave only with their picks, the picks drawing the threads to a certain extent out of the straight line, producing a kind of gauze appearance on plain ground.

A more marked gauze effect is produced by Design XXXVIII., in which the fine warp is cotton, but the threads marked in solid type are thick mohair. The weft is woollen and consequently shrinks very considerably,

and, drawing the mohair pick (solid type) with it, also draws the mohair threads out of the straight line to the right or left according to the float of the mohair weft, as shown in Figure 56, which is a Yorkshire College

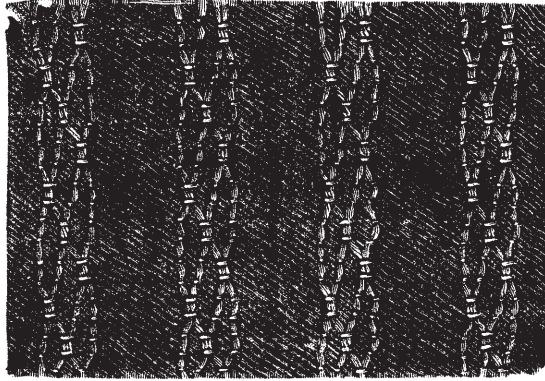

FIG. 56.

pattern. In analysing any patterns of a gauze type of structure the analyst should be very certain that one of the above systems has not been employed before he arranges for the douping, etc.

CHAPTER VII.

PILE FABRICS.

A lengthy consideration of the construction and analysis of these fabrics is hardly within the scope of a short treatise, so that only the principal structures will be touched upon, and the best system of analysis indicated as briefly as possible.

Formerly there was little difficulty in defining plushes ; to-day there is such a multitude of specially-constructed cloths, partaking more or less of the appearance of pile fabrics, that any rigid definition is impossible. The main feature of these cloths—viz., ends or loops standing straight out of the body of the cloth, however, renders recognition, as a rule, easy, while the extraction of a few threads or picks speedily clears up all doubt.

Classes of Piles.—There are two distinct classes of pile fabrics—viz., those in which the pile is formed by

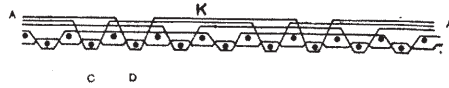

FIG. 57.

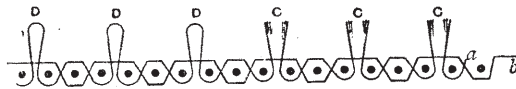

FIG. 58.

the weft, and those in which the pile is formed by the warp, as instanced in Figures 57 and 58. Weft piles may usually be distinguished from warp piles by the

pile in the latter being bound in across the piece in rows, while even distribution obtains in most weft piles, unless corduroys or imitation warp pile fabrics be attempted. Weft piles may be first considered.

WEFT PILES.

Structure.—The construction of these cloths is, in reality, very simple, since no pile is formed in the loom, the cloth being woven as an ordinary piece, as shown in Figure 57. After leaving the loom all the picks which

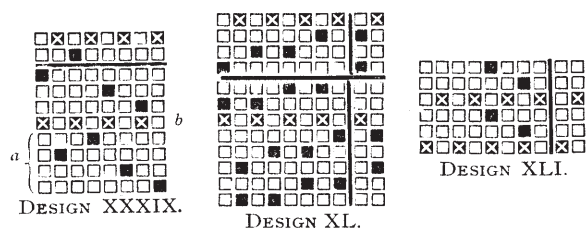

flush—for example, *a*—are cut with a knife *b*; thus the two ends will stand up from the *c* and *d* binding thread. The point-paper plan for this is given in Design XXXIX., in which there are four pile picks *a* to one ground pick *b*; and since the pile picks are only bound once in every 8, 10, or 12 ends, as the case may be, a large number of picks per inch are required to hold the pile firmly. A firmer binding is that shown in Design XL., in which the pile weft interlaces for three threads with the warp. A corduroy type of effect is given by Design XLI., and the reason is very apparent. If the binding of the pile picks be examined it will at once be seen that they all bind in a line up the piece; thus, when cut, they all

project from one portion of the piece, forming a distinct rib.

Difficulties in Analysis.—The difficulties in analysing such cloths will not appear great when it is remembered that these cloths are woven like ordinary pieces. There is one point, however, which must not be overlooked: it is, that in designs similar to Nos. XXXIX., XL., and XLI. the pile picks will not occupy so much space in the cloth as represented on paper. For example: In Design XXXIX. the four pile picks will altogether make one plain pick, as shown in Figure 57, and may be regarded as such in the cloth. In determining the number of pile picks between each ground pick, then this fact must be remembered. Although the interlacing of these cloths is usually comparatively simple, the fineness often renders actual analysis very difficult when the make must be estimated, and the correctness of the estimation will depend upon the knowledge and practical experience of the analyst.

Double-Pile Fabrics.—A recent innovation in the manufacture of these goods—the Richter patent—provides for the cutting of the weft float, as required, in the loom by means of thin knives passing between the reeds in the going part. The process is very simple, being as follows:—When, say, 7 threads are depressed to allow the weft pick to flush, the knife between the centre threads of the 7 is depressed, and thus the weft passes over it and is cut by it, when the reed drives the pick home (see *Textile Manufacturer*, January and March, 1893). One great advantage of this arrangement is that a double plush—*i.e.*, a fabric with pile at both sides—

may be readily obtained by allowing the picks to flush both at the back and at the face of the cloth and cutting the flushes by knives as indicated. A plan for this type of structure is given in Design XLII., in which crosses=ground weft, the star type=the weft float for the back of

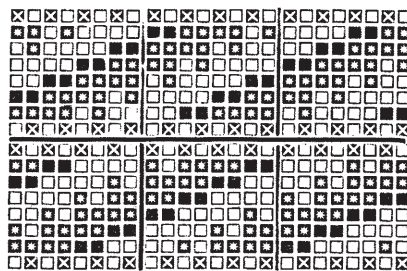

DESIGN XLII.

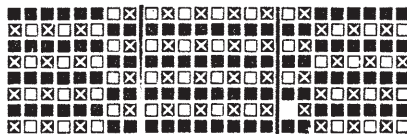

DESIGN XLIII

the piece and the binding, and the solid type=the threads between which the weft is cut. Quite elaborate figures may be woven thus, either single or double; but, under any circumstances, the fabrics should be analysed as intimated above, since the pile is formed by the healds or harness giving the requisite float to the pile pick, the knives simply being worked to cut the flushes.

Piles Produced in Finishing.—Another type of weft pile is formed in the finishing process. A plan similar to Design XLIII. is employed with a cotton warp,

and mohair weft ; the result being that structural shrinkage takes place weft-way, resulting in the long unshrinking float of mohair being thrown up as a curl. The analysis is, of course, effected in a manner similar to the previous examples.

WARP PILES.

Structure.—The structure and analysis of warp pile goods is somewhat more complex than the above. In Figure 58, for example, there is evidently some arrangement for forming the loop, while in Figure 59 there is



FIG. 59.

evidently still more complication. These loops are usually produced by means of wires inserted in a shed specially provided for them, for it is evident that only the pile threads must pass over the wire. Thus, in designing for these fabrics, the point paper must be classed into ground and pile threads and picks and wires. Design XLIV. is the point-paper plan for Figure 58, the solid type representing the ordinary picks and the crosses the wires, while *a* are pile threads and *b* ground threads. In developing these effects the analyst must remember that while a wire occupies the space of a pick on design paper, it really occupies no space in the fabric. With these particulars ordinary piles may readily be analysed, this being usually effected by examining the back of the fabric with a piece-glass; but the more intricately figured fabrics call for further explanation.

Figured Piles.—The simplest method of figuring these goods is by means of cut and uncut or looped pile, as illustrated in Figures 58 and 58A, *d* being the looped and *c* the cut pile. The advantages of figuring in this manner are:—Firstly, that only one pile warp beam is required, each end taking-up alike, while the figure produced is very distinct, as

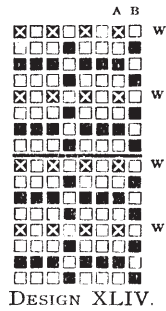

instanced in Figure 58A, which exaggerates very little the variation between the looped *d* and the cut *c*. Another effective method of figuring is that illustrated in Figures 60 and 60A, in which case the pile warp is composed of two colours, say red and tan, arranged end-and-end. Under these conditions either red or tan figures may be formed by bringing every other end over the wires as required; but should only one pile warp beam be used, every thread must be over the wires the same number of times. Should these conditions not be requisite, however, four distinct effects may be produced—viz., red pile, cut and uncut, and tan pile, cut and uncut.

Another system of figuring with pile is by means of

F



FIG. 58A.

different heights of wires, as shown in Figure 59, in which, when the shed for *a* is formed, a broad wire is inserted, while at *b* a narrow wire is inserted. This system of figuring is often employed with a flat or sateen ground, as instanced in Figure 61, in which *a* is the sateen ground, *b* the short loop, and *c* the long loop or cut pile, under which conditions every pile thread in the repeat must have a separate bobbin or beam.

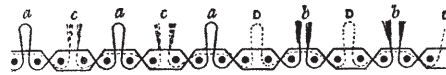

FIG. 60.

A point meriting full consideration is the binding of the pile thread into the ground. Should an ordinary straight pile be required, the pile thread should be down for both the preceding and succeeding picks, thus when cut or



FIG. 61.

looped projecting straight out of the cloth, as shown in Figure 58. If, however, the astrakan type of structure is required this order of interweaving is not necessary or

perchance desirable, for, as shown in Figure 62, by floating the pile thread before cutting, a longer length of pile to curl is obtained.



FIG. 62.

Procedure in Analysis.—1. In analysing any figures similar to those given, the figure must be ascertained by one of the systems already given (p. 76).

2. Examine the warping plan carefully to ascertain the relative number of pile threads to ground threads.

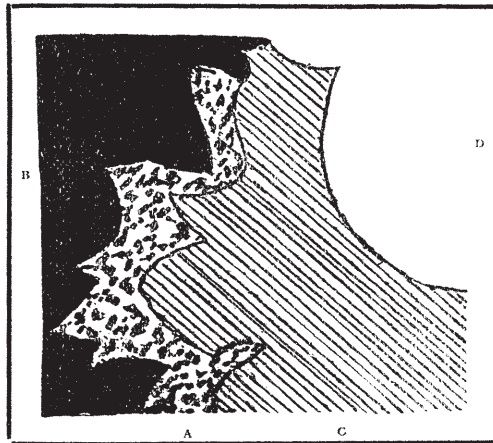

FIG. 60A.

3. By extracting weft picks and noticing the looping the proportion of picks to wires will be ascertained.

4. Having selected the design paper in accordance with the relative number of pile and ground threads, and

picks and wires, indicate clearly upon this paper the ground and pile threads and the ground picks and wires.

5. The interweaving of the ground warp with the ground weft must now be put on.

6. The rising of the pile warp over wires (marking for rises) should now be put on.

7. The interweaving of the pile warp or warps with the ground weft should finally be ascertained, the curvature of the pile threads forming an excellent guide in this respect.

EXAMPLE.—1. Figure 60A is obtained by pricking round the figure as explained in Chapter V.

2. Examination of the warping plan reveals
 - 1 thread cotton (for ground),
 - 1 .. tan mohair (for pile),
 - 1 .. cotton (for ground),
 - 1 .. red mohair (for pile).

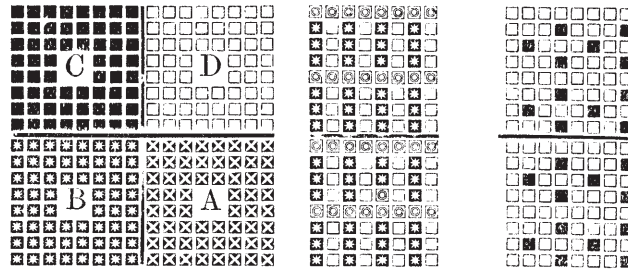

DESIGN XLV. SKETCH. DESIGN XLVA DESIGN XLVB.

3. Careful examination reveals that there are three ground picks to each insertion of wires.

4. The proportion for the design paper is obtained as follows :—

32 pile threads + 32 ground threads per inch = 64 threads per inch.
 48 ground picks + 16 loop wires + 16 cutting wires = 80 picks and
 wires per inch.

Thus design paper $64 \times 80 = 8 \times 10$ will be selected, and the sections allotted to pile and ground threads and picks and wires indicated by means of coloured chalks, as shown in Designs XLVA and XLVc.

5. The ground weave—*i.e.*, the interweaving of the

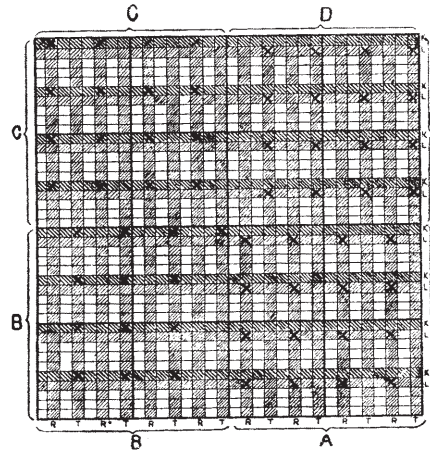

DESIGN XLVc.

ground threads and picks—may now be put on to the design paper, as shown in Design XLVB.

6. The rising of the pile threads over the wires must now be put on, since the figure effect depends upon this. Design XLV. sketch and XLVc illustrates this.

Section A is to be red looped,
 Section B .. tan cut,
 Section C .. red cut,
 Section D .. tan looped.

In order to effect the looping and cutting, two wires must be introduced between every three ground picks—one for looping and the other for cutting. L is the looping wire, so in weaving sections A and B the red threads only in section A are brought over it, but nothing else; while in weaving sections C, D the tan threads only in section D are brought over it. L is the cutting wire, so in weaving sections A and B the tan threads only in section B rise over it; while in weaving sections C, D the red threads only in section C rise over it.

7. The interweaving of the pile warp—firstly, for binding the pile, and, secondly, for binding the pile

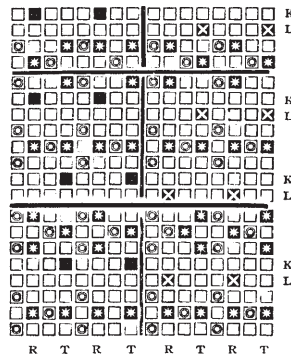

DESIGN XLVI.

threads not forming pile—may now be inserted, as shown briefly in Design XLVI., in which

- Circles=ground threads.
- Stars=interweaving of pile threads.
- Crosses=looping wires.
- Solids=cutting wires.

The above procedure will usually be found decidedly

the clearest and best, although in some cases a change in the order here given may be advisable.

In the case of a figured pile, should only ordinary design paper be at hand the figure may be sketched out upon this and then may be put on to the cutting design sheet, missing picks for the wires as required. By this means, however, the figure will be considerably distorted on the cutting sheet. Again, by dividing the design paper into spaces elongated warp and weft way, according to the proportions found in the fabric under treatment, and regarding these as squares, the figure may fairly easily be sketched in the elongated form. To obtain the correct design paper is, however, decidedly the safest.

Figure 60 is a sectional representation of plush made to the foregoing particulars.

Brussels Carpets.—These are produced by applying the extra warp principle to a pile structure. Thus in what is termed a three-frame the order of warping would be :—

- 1 thread cotton (for ground),
- 1 .. green worsted,
- 1 .. red worsted,
- 1 .. yellow worsted,
- 1 .. cotton (for ground).

The three coloured yarns really occupy only one line in the woven fabric, thus each colour is taken over the wires as required for the figure; while the other two colours in the meantime form the elastic body of the fabric. A four-frame would have four coloured pile threads to each ground thread, and so on.

Note that the proportion of pile threads to ground

threads gives the frame. The principles of changing the colours of, say, a two-frame carpet to give the appearance of a three or four-frame carpet are identical with the principles of changing the colours in extra warp and weft effects (Chapter V.)

Tapestries.—A type of figured pile likely to be mistaken for the above is that known as “tapestry carpet,” in which the figure is printed upon the warp in a considerably elongated form to allow for the take-up in weaving.

Axminster Pile.—Another type of much greater beauty is the Axminster carpet, in which the pile is put in from bobbins in front of the loom, the bobbins being arranged in the colours required to give the pattern, in many cases a very large number of colours being employed with telling effect.

Turkish Towels.—This type of material, although a true looped pile, is not the result of wiring, but simply of slack warp threads, the threads specially slackened being placed on a separate beam to form the loop. The unevenness of the loop serves as an excellent means of detection.

The Double Plush Loom.—Although somewhat wide of the object of this treatise, the production of two plush pieces at one and the same time, face to face, is of so much interest and importance from the economic point of view that no apology is necessary for its brief consideration here.

Figure 63 is a view of the loom mostly in use in

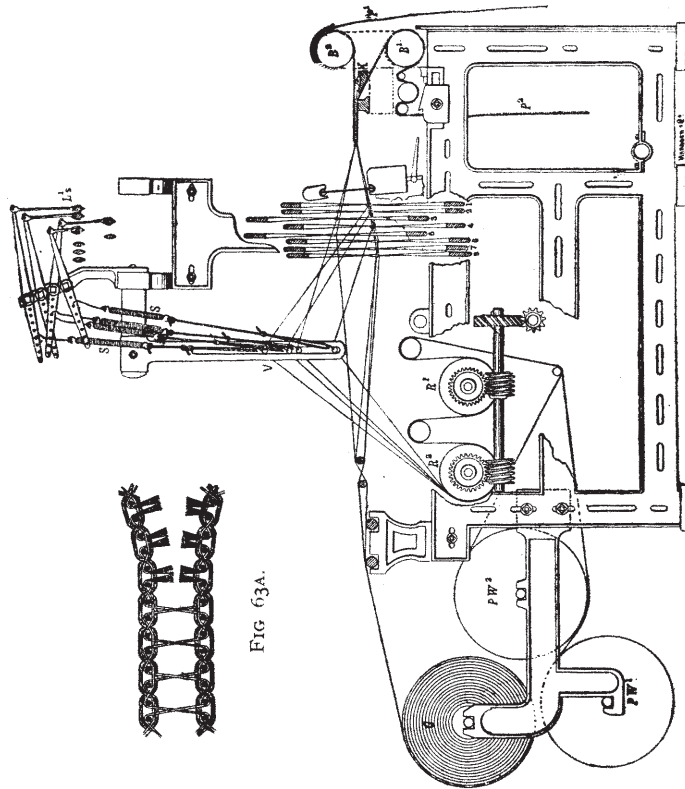
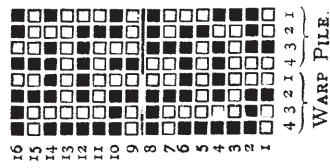

Fig. 63.



Fig. 63A.



WARP PILE.

Yorkshire, showing in section the arrangement of ground and pile warps, also the course of the two cloths P^1 , P^2 , around pin rollers B^1 , B^2 , after being severed by the knife K . The pile warp, dressed upon two beams $P W^1$, $P W^2$, for convenience, is conducted round the feed rollers R^1 , R^2 , through the ground warp to the four vibrating rods V and divided into four portions—one portion going over each rod. These rods are actuated by the levers L , through the springs and bands S , so that each one rises and falls with the heald through which its pile is drawn, and thus the pile is kept at one uniform tension throughout the stroke of the healds. The healds are worked as shown in plan Figure 63B by means of a Woodcroft tappet, thus producing two separate cloths, each with two picks in a shed and pile interweaving and passing from one to the other, as shown in section Figure 63A. The knife K (Figure 63) travels across between the two pieces and severs the pile every four picks, so that a very small portion of the cloth advances while the knife rests, otherwise the knife would force and tear out the pile and greatly damage the cloth.

CHAPTER VIII.

SETS AND THE SETTING OF CLOTHS.

Attention must now be directed to the methods of indicating the number of ends and picks, *i.e.*, warp and weft threads, in a piece, since these particulars, in conjunction with the counts of the yarn, indicate the weight of the resultant cloth.

The ends in a piece are indicated in such a number of ways that in order to render our remarks clear the simplest method shall first be considered, and the more intricate ones explained by means of this.

Methods of Indicating the Sett.—Evidently the simplest method will be to state always the threads per inch, since the width of the piece is usually stated in inches; thus the sett multiplied by the width gives the number of ends in the warp.

The “*Stockport* system” is similar to this, only the number of dents or splits in the reed is indicated along with the number of ends through each.

EXAMPLE.—A 12’s reed 4’s = 12 reeds per inch, with 4 threads through each = 48 threads per inch.

For the actual weaving operation, this latter method is perhaps preferable, but in all calculations for cloth the number of ends per inch forms a much more convenient standard.

The other important systems are as follows:—

The “*Bradford* system,” based upon the number of beers (40 ends) in 36 inches.

The "*Blackburn* system," based upon the number of beers (20 splits) in 45 inches.

The "*Manchester* system," based upon the dents in 35 inches; but the ends per inch is the now universal system in Lancashire.

The "*Scotch* system," based upon the dents in 37 inches.

The "*Leeds* system," based upon the number of porties (38 ends) in 9 inches ($\frac{1}{4}$ yard).

To shew clearly the different meaning of a certain sett, say 40's, in each of the above, the following list is given:—

40's sett in ends per inch	=	40 ends per inch.
40's Bradford	..	= $44\frac{1}{3}$..
40's Blackburn	..	= $17\frac{2}{3}$ splits per inch.
40's Manchester	..	= $1\frac{1}{8}$..
40's Scotch	..	= $1\frac{3}{7}$..
40's Leeds	..	= $169\frac{8}{9}$ ends per inch.

In all the following calculations, ends per inch and picks per inch will be adopted throughout, since this is simplest and most easily comprehended.

To Find the Sett.—There cannot be any fixed method for finding the sett of a cloth, since the conditions are so varied that a system which may answer admirably in one case may be of no use whatever in another. Of course the simplest method, if possible, is to count the number of ends in $\frac{1}{4}$, $\frac{1}{2}$, or 1 inch, by means of a piece-glass; but this can only be effected in analysing coarse and bare cloths, since in the finer makes the threads and picks become so merged into one another that it is practically impossible to count the number in even a quarter of an inch, although singeing may help to

some extent. The system most useful and most in vogue is to place the piece-glass on the piece, and count the repeats of the weave in the space covered.

EXAMPLE.—In Figure 64, a half inch measure encloses 4 complete twills. Should the weave be the $2\frac{1}{2}$ twill, the

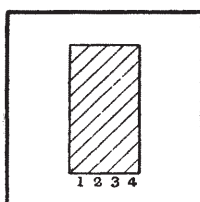

FIG. 64.

thread per inch will be $4 \times 4 \times 2 = 32$; if the $2\frac{2}{3}$ twill, $4 \times 6 \times 2 = 48$ threads per inch. And in like manner the threads or picks per inch in any weave may be calculated.

A system very similar to the above is to pull a thread or pick out of the piece and count the number of curves (= the repeats of weave) in $\frac{1}{4}$, $\frac{1}{2}$, or 1 inch.

EXAMPLE.—In Figure 16 (page 43) each curve in the pick 2 equals three threads, since the weave is the $2\frac{1}{2}$ twill; in Figure 17 (page 44) each curve in the thread 1 equals 12 picks.

Thus, under these circumstances, the curves in the weft indicate the threads per inch, and the curves in the warp the picks per inch.

Either of the above systems will be useful in analysing such fancy combinations as indicated in Design VIII., a thread and pick from which are given in Figure 21.

Having found the weave the sett may readily be obtained by direct proportion.

EXAMPLE.—If a fancy check, occupying on design paper 40 ends, repeats $1\frac{1}{2}$ times in one inch, what is the sett?

As 1 : $1\frac{1}{2}$:: 40 : 60 ends per inch.

If the design does not repeat once in the inch, say $\frac{3}{4}$ of a repeat to the inch, then—

As 1 : $\frac{3}{4}$:: 40 : 30 ends per inch.

Should the analyst fail to obtain the sett of a cloth by any of the foregoing methods, one other may be resorted to, and that is pulling the ends or picks out of, say $\frac{1}{2}$ or 1 inch of cloth, and counting them in this manner.

Selection of Reed.—Having found the ends per inch the question occurs—what reed shall be used and number of ends per dent will prove most efficient? Experience only can decide this, since, although a coarse reed might be selected which *would weave* the piece, still a much better result will usually be obtained by the use of a fine reed, for, within reason, the finer the reed the better. This is particularly so in the case of cotton warps, but designers are warned against applying the experience gained with cotton warps to wool warps, a large deduction owing to the increased bulk and nature of the threads, and the finish imparted being usually necessary. For example, a botany worsted cloth, woven as follows:—

Warp.

All 2/36's grey,
12's reed 6's,

Weft.

All single 18's grey,
72 picks per inch,

will, when finished, shew no reediness, still less will a woollen.

On the other hand a cotton warp dress fabric made a follows:—

Warp.

All 2/100's cotton,
20's reed 6's.

Wef.

All 36's botany or mohair,
120 picks per inch,

will prove very unsatisfactory. Whatever is done in the loom to counteract the reediness, the threads will not take their correct or best position, and altogether an unsightly piece results.

If the warp is now sleyed 60's reed 2's, quite a different cloth results: the reed marks go, the fine warp ground asserts itself, and the piece is, compared with the previous one, beautifully covered.

Of course a 60's reed is rather fine, but if the depth be reduced as low as possible it should stand all necessary strain.

In the case of all cotton goods novel styles are produced by skipping dents, drawing reeds, *i.e.*, extracting a reed here and there as required, etc., etc., as already mentioned under the heading "Mock Gauzes." In these cases the reed must be selected that coincides best with the required particulars; common sense only will serve as a guide here.

The Size of Twill or Repeat.—Another matter which should be noted is the relative size of twill.

EXAMPLE.—A $\frac{4}{4}$ twill in a 16's reed 4's sett = $\frac{8}{84} = \frac{1}{8}$ of an inch.

Should the sett be reduced to 32 ends per inch, for example, to obtain a similar twill the repeat should be reduced in like manner, in this case the $\frac{2}{3}$ twill being used, since $32 \div 8 = 4$ ends in repeat for a twill $\frac{1}{4}$ of an inch, or

As $64 : 32 :: 8 : 4$ threads in desired twill.

THE SETTING OF CLOTHS.

Since the analyst will often be required to build cloths in various ways from the knowledge obtained in pulling them in pieces, a brief consideration of the principles of setting fabrics may be of much use in this treatise. This question is one of such wide scope that we can only touch upon the principal features, leaving the reader to carry out the ideas to their full limits.

Influences to Consider.—There are three modifying influences to consider in setting cloths. Firstly, the characteristics of the yarns to be employed; secondly, the diameter of the yarn; and thirdly, the weave or weaves.

Respecting the characteristics of the yarns employed, little further need be said after the particulars given in Chapter II., but, in the following pages the other two influences are briefly explained.

Diameters of Yarns.—These may be ascertained by finding the yards per pound in the counts under consideration and extracting the square root. A deduction from this of 16 per cent. for woollen, 10 per cent. for worsted, and 8 per cent. in the case of cotton and silk yarns, will give the most approximate results.

EXAMPLE.—A 40's worsted yarn gives the following result:—

$$40 \times 560 = 22,400 \text{ yards per lb., and}$$

$$\sqrt{22,400} = 149.666 \approx 150 - 10\% = 135 \text{ diameter, i.e., } \frac{1}{35} \text{ part of an inch.}$$

Another method of ascertaining the diameters of yarns is to cut a space out of a piece of cardboard, as shewn in Figure 65, exactly 1 inch, and wrap the yarn round

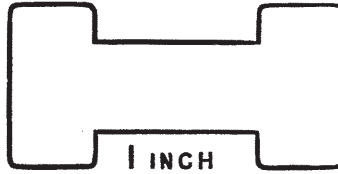

FIG. 65.

this, laying each wrap close to its predecessor. The diameter of the yarn is thus obtained, and, further than this, it is possible to work as it were backwards and obtain, very approximately, the counts of the yarn.

From the foregoing it is evident that the square root of any counts, *not the counts*, is in direct proportion to the diameter, so that should it be desired to find the diameter of one yarn from another, direct proportion may be employed, using the square root of the counts (or, what amounts to the same thing, squaring the whole equation.)

EXAMPLE.—If a 40's yarn has a diameter of 135, what is the diameter of a 20's yarn?

$$\text{As } \sqrt{40} : \sqrt{20} :: 135 : 95 \text{ diameter of 20's, i.e., as } \sqrt{40 \times 560} :$$

$$\sqrt{20 \times 560} :: 135 : 95 \text{ diameter of 20's, or}$$

$$\text{As } 40 : 20 :: 135^2 : x^2 = 95 \text{ diameter of 20's worsted.}$$

These rules apply to every system of counting yarns, but it should be remembered that the results obtained

are only approximate : they may be affected in some degree by material or structure, and many other influences. Still, the designer need not fear making these the basis of his calculations, and introducing such slight modifications as experience and reason suggest.

The Weave.—In considering the influence of weave on the sett of a cloth two questions at once present themselves—firstly, is the diameter of yarn modified at all in weaving? and secondly, in any given weave is it possible to ascertain the precise influence of the bending of warp and weft on the sett? Respecting the diameters of yarns the only further remark called for is that common sense is a most necessary adjunct in the application of the rules respecting the diameters of yarns ; particularly is this so in the case of woollen yarns.

Class of material, soft or hard twist, old or new spun yarns are a few of the most notable modifying influences, but notwithstanding this, the diameters of yarns as given may within reason be made the basis of all calculations or setts.

Classification of Weave.—The influence of weave upon the relative bending of the warp and weft and consequently upon the sett, is most remarkable, and here, as in the case of the diameters, experience is most necessary, although it is now a recognised fact that this matter may be dealt with on scientific principles.

All cloths, as previously shewn, may be classed under one of three heads, viz., cloths woven on the square ; weft rib cloths, in which the warp lies straight and the weft does all the bending ; and warp-rib cloths, in which the weft lies straight and the warp does all the bending.

The influence of the weave on the sett in each of these cases must now be considered.

CLOTHS WOVEN ON THE SQUARE.—In cloths woven on the square, *i.e.*, an equal number of threads and picks—if warp and weft are approximately the same counts, as is usually the case, the threads and picks will do an equal amount of bending, as represented in Figure 66. Now a glance at this diagram shews that

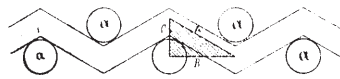

FIG. 66.



FIG. 66A.

the warp threads *a a* are separated from each other by the picks, so that taking both warp and weft to have a diameter of, say $\frac{1}{80}$ th of an inch (*i.e.*, 80 threads can be laid side by side in one inch), only 40 threads can be used, since there will be 40 intersections or units of space occupied by the weft.

The following rule may be made the basis for ascertaining the approximate sett required for any weave.

RULE.—(1st) Ascertain the number of units (*i.e.*, threads and intersections) the given plan contains.

(2nd) Divide the number of units as obtained in (1) into the diameter of the yarn to be used, thus obtaining the number of repeats of the plan in one inch.

(3rd) Multiply (2) by the threads in the given plan, thus obtaining the threads per inch.

EXAMPLE.—Required the ends per inch to use with the 3-and-3 twill (Figure 67.) Counts of warp and weft:—

32's worsteds = $\frac{1}{120}$ th of an inch diameter.

- (1) 6 threads + 2 intersections give 8 units in one repeat of 3-and-3 twill.
- (2) 120 (diameter of thread) $\div 8 = 15$ repeats of 3-and-3 twill in one inch.
- (3) $15 \times 6 = 90$ ends per inch to use, the other 30 units of space being occupied by weft intersections.

This is a very simple method, and gives fairly approximate results, but in some classes of goods, particularly lustre dress fabrics, greater accuracy is necessary. Mr. T. R. Ashenhurst was the first to point out that the essential condition for the most lustrous effect is that the weft shall make with the warp an angle of 60° , and in the appendix of his work entitled "Textile Calculations and the Structure of Fabrics," shows his application of this theory. The following deductions, however, differ from his to some extent :—

Taking Figure 66 again as our example, observe in the first place that although the threads are undoubtedly distant from one another by the full diameter of the weft yarn, yet *horizontally* they are not distant from each other the full diameter of the weft. Now proceed as follows :—

- 1st. Draw the line A running with the centre of the weft.
- 2nd. Draw the line B connecting the lowest positions of the lines A.
- 3rd. Draw the perpendicular C connecting the highest position of A with the base B, thus completing the triangle A, B, C.

Then the best angle of weft with warp, *i.e.*, A C, is one of 60° , and the sett must be selected to give this result. To obtain this it is evident that the necessary length of A B, *i.e.*, the base of the triangle, must be ascertained, since this will represent the space required for each thread, plus the intersection, thus giving the sett.

The length of B may be deduced as follows:—The perpendicular C is half the diameter of both warp and weft, *i.e.*, it equals the diameter of either warp or weft, which for simplicity may be taken as 1 inch. Now, since the angle A C is one of 60° and C B a right angle, therefore angle A B is 30° , and the triangle A B C is evidently half an equilateral triangle, as shewn in Figure 66A, and consequently the side A, the hypotenuse, is exactly twice the length of C, which is taken at 1 inch, thus $A = 2$ inches. From this data proceed as follows to obtain the length of B. Since the angle B C is a right angle, the following formula is correct:—

$$B^2 + C^2 = A^2 \text{ (Euclid 47 prop., Book I.)}$$

Now inserting the known figures given above.

$$B^2 + 1^2 = 2^2 \text{ or } B^2 + 1 = 4.$$

Therefore $B^2 = 4 - 1 = 3$, and $B = \sqrt{3} = 1.732$.

That is, if the fractional diameter of the yarn = C, then the space occupied by a thread and intersection = $C \times 1.732$.

EXAMPLE 1.—A $2/40$'s yarn has a diameter of $\frac{1}{35}$. Find the number of ends per inch for plain.

Then $\frac{1}{35} \times 1.732 = 95 \div 1.732 = 55$ triangles, or 55 threads per inch in the finished cloth.

Should the previous rule be adhered to, $95 \div 2 = 47\frac{1}{2}$ ends per inch only would be employed, so that there is evidently a considerable difference in the case of the plain weave.

Another example may be taken to show the application to other weaves.

EXAMPLE 2.—A 32's worsted = $\frac{1}{120}$ th part of an inch in diameter. Find the number of ends per inch to use with the 3-and-3 twill.

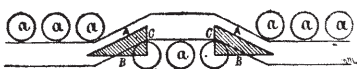

FIG. 67.

As shewn in Figure 67, in the 3-and-3 twill, there are 2 triangles + 4 diameters of the yarn.

Therefore $4 + (2 \times 1.732) = 7.464$ units of space in the repeat of the weave, and $\frac{1}{120} \times 7.464 = 120 \div 7.464 = 16$ repeats of twill, and 16×6 (threads in repeat of weave) = 96 ends per inch in the finished cloth.

Here owing to the few intersections, there is not such a marked difference between this and the result previously obtained, as in the case of plain weave.

WEFT-RIB CLOTHS.—Weft-rib cloths must be treated in a different manner to the foregoing. As shewn in

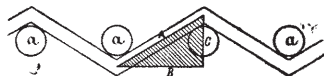

FIG. 68.

Figure 68 the warp lies straight and the weft does all the bending. Therefore, the weft picks may lie close to one another, while each group of threads will be separated by at least the diameter of the weft.

EXAMPLE.—In plain cloth, the picks per inch to use will be, with a 2/40's yarn with $\frac{1}{95}$ th part of an inch diameter, 95, while the threads per inch will be

$95 \div 2 = 47$, provided the angle of 60° is omitted from the calculation. If the angle of 60° be taken into account, then the altitude of the triangle formed, as shewn in Figure 68—the diameter of both warp and weft, thus the threads per inch will be—

$$\left(\frac{1}{95} + \frac{1}{95}\right) \times 1.732 = 47 \div 1.732 = 27 \text{ threads per inch and } 95 \text{ picks per inch.}$$

Now these are theoretical conditions, since the warp and weft would at least bend equally during weaving, being the same counts, but a thick warp and thin weft would fulfil these conditions.

EXAMPLE.—In a French cashmere made as follows ;—

<i>Warp.</i>	<i>Weft.</i>
All 56's Botany.	All 92's Botany.
64 threads per inch.	Picks according to quality.

Taking the the warp threads to be quite straight, the following result is obtained. Since 56's botany has a diameter of $\frac{1}{168}$ th part of an inch and 92's botany $\frac{1}{205}$ th part of an inch, the altitude of the triangle will be—

$$\frac{1}{168} + \frac{1}{205} = \frac{1}{89} \text{ and } \frac{1}{89} \times 1.732 = 89 \div 1.732 = \frac{1}{52} \text{ of an inch for base of triangle.}$$

Then, since the repeat of the cashmere twill contains

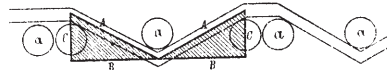

FIG. 68.

two triangles and one thread, as shown in Figure 68—

$$\left(\frac{1}{52} \times \frac{1}{2}\right) + \frac{1}{168} = \frac{1}{26} + \frac{1}{168} = \frac{159 + 26}{4134} = \frac{185}{4134} = \frac{1}{22} \text{ of an inch}$$

for each repeat of twill, and since each twill contain three threads, $22 \times 3 = 66$ threads per inch.

This is supposing the warp to lie quite straight, which it does not, as will be seen on referring to the micro-photograph of a thread and pick from a cashmere cloth given in Figure 16, consequently it may be taken for granted that a few threads should be added to the above for this deflection in the warp. Now, if the warp and weft did an equal amount of bending, the following would be the result :—

$(\frac{1}{159} + \frac{1}{205}) \div 2 = \frac{1}{178}$ and $\frac{1}{178} \times 1.732 = 178 \div 1.732 = \frac{1}{102}$ of an inch for base of triangle, and $\frac{1}{102} + \frac{1}{102} + \frac{1}{59} = \frac{1}{51} + \frac{1}{59} = \frac{51+59}{51 \times 59} = \frac{110}{3009} =$ about $\frac{1}{30}$ and $39 \times 3 = 117$ ends per inch.

This latter result is very far from correct, while the former is practically correct, for the practical sett given, *i.e.*, 64 threads per inch, is for the loom, while the 66—70 ends found by calculation is for the finished state, so that they practically coincide. The following is a clear statement of all the results for this cloth :—

Ends per inch ascertained by adding diameters together	-	89
Ends per inch ascertained by equal bending of warp and weft and angle of 60°	- - - - -	117
Ends per inch ascertained by warp straight, weft bending, and angle of 60°	- - - - -	66
Ends per inch used in practice in loom	- - - - -	64

It is evident, then, that a strict adherence to the principles laid down gives results that practice fully confirms.

WARP-RIB CLOTHS. — The treatment of warp-rib cloths will be exactly the reverse of weft-rib cloths, so there is practically no need to exemplify them here, since our space is somewhat limited.

Difficulties in Applying the Foregoing Principles.—A type of fabric very difficult to deal with is

the Bradford plain lustre goods, previously mentioned, thus coming under none of the foregoing treatments.

These fabrics are usually woven with a fine cotton warp and comparatively thick mohair weft, which should thus give a warp rib type of structure, *i.e.*, the finer material should bend; and in the loom it actually does, but during finishing the warp is pulled quite straight and the weft then doing all the bending produces a weft rib type of structure.

For which cloth, then, should the calculation be made, the cloth as woven or the cloth as finished? Neither calculation will give the desired result, simply because the cloth being woven on the square (to keep the figures square) has not sufficient warp in for a warp rib, while the threads are also much too close together to produce the structure shewn in Figure 68 should the necessary picks have been put in. A compromise therefore takes place between warp and weft. The warp becomes straight, in finishing, but in so doing flattens out the weft upon itself, bending it to the right angle at the same time. A suitable sett for plain lustre goods, from which the above deductions may be made, is as follows:—

Warp

All 2/90's cotton.
33's reed 2's, or
66's reeds 1's.

Weft.

All 36's mohair.
70 picks per inch.

Respecting the setting of woollens, unless unshrinkable goods are required, an open sett should be employed, particularly if the yarn is woolly and thus liable to

choke the shed. Under these circumstances the milling-up of the piece may be depended upon, and thus the required width obtained in the finishing. With linen and other solid yarns it is desirable to weave them as close in the loom as possible, since shrinkage by bending of warp and weft *only* ensues.

It will thus be evident that although certain principles obtain in the setting of all kinds of cloths, still common sense is a most necessary adjunct.

CHANGES IN COUNTS AND SETTS.

There are two simple yet important calculations which are likely to occur frequently, and which should be fully comprehended. They may be exemplified by the following examples:—

EXAMPLE 1.—A cloth is woven with a 2/40's warp, 72 ends per inch, and yields the required structure. What counts will be required to preserve the same balance of structure with 80 threads per inch?

EXAMPLE 2.—A cloth is woven with a 2/40's warp, 72 ends per inch, and yields the required structure. What number of ends per inch will be required to preserve the same balance of structure with 2/50's warp.

Example 1 may be reasoned out as follows:—There are two lots of threads given, therefore the change in counts will at first sight be as 72 : 80. Since with more threads a finer yarn, *i.e.*, a higher count, is required. But since the diameter of the yarn must change in proportion to the addition or subtraction of threads, and since the $\sqrt{\quad}$ of the counts = the diameter, the sum will be—

$$\text{As } 72 : 80 :: \sqrt{2/40\text{'s}} : \sqrt{x}, \text{ or}$$

$$\text{As } 72^2 : 80^2 :: 2/40\text{'s} : x = 25\text{'s or } 2/50\text{'s counts required.}$$

Similarly in the second case the number of threads will be regulated by the diameters, therefore

As $\sqrt{2/40}$'s : $\sqrt{2/50}$'s :: 72 : x , or

As $\sqrt{2/40}$'s : $\sqrt{2/50}$'s :: 72^2 : $x^2 = 80$ ends per inch.

The above two calculations may then be worked by the following general rule:—

RULE.—Place the proportions as for a rule of three sum, and work by the $\sqrt{\quad}$ of counts or the threads squared.

The foregoing remarks and rule are equally applicable to calculations for weft.

CHAPTER IX.

CALCULATIONS RELATING TO THE WEIGHTS OF CLOTHS.

Having indicated as clearly as possible the various methods of finding the counts of yarn and sett of any cloth, two very important matters have still to be fully dealt with, viz., the weight of the various yarns employed in any given cloth, and the weight of the same cloth finished. This question has been treated by other writers at some length, and we should be tempted to be very brief but for the fact that it has usually been treated under one heading instead of under the two indicated above. As those engaged in the trade are aware, the weight of cloth in the loom and the weight in the finished state vary considerably; thus, in the present chapter, calculations relating to cloths as woven are dealt with, and in the succeeding chapter the calculations dealing with the relationship of greasy and finished cloths.

ORDINARY WARP AND WEFT CALCULATIONS.

The simplest form in which a question may occur under this heading is that in which, having a cloth made to given particulars, the weight of warp and weft is required.

EXAMPLE.—A cloth is made of $2/40$'s worsted for warp, and 20 's single worsted for weft. Sett 64 threads

per inch in loom, 64 picks per inch, 34 inches wide, 50 yards of cloth from 56 yards of warp. Find the weight of the cloth. This question evidently involves the finding of the weight of both warp and weft, which two together give the weight of the cloth.

RULE 1.—To find the weight of warp :—

(1st) Ascertain length of material in the warp, *i.e.*, threads per inch \times inches wide = threads in warp; \times length of warp in yards = the length of material in the warp.

(2nd) The length of material in the warp divided by the yards in 1 lb. of such material gives the total weight of warp in 1 lb.

In the above example

$$(1) 64 \times 34 \times 56 = 121,856 \text{ yards of material in piece.}$$

$$560 \times 20 = 11,200 \text{ yards in 1 lb. of material.}$$

Therefore $121,856 \div 11,200 = 10 \text{ lb. } 14 \text{ oz. } \frac{17}{8} \text{ dr.}$ of warp in piece.

RULE 2.—To find weight of weft :—

(1st) Ascertain the length of the material in the piece by multiplying the picks per inch by the width in inches and by the length of the cloth.

(2nd) The length of material thus obtained, divided by the yards in 1 lb. of such material, gives the total weight of weft in lb.

In the above example

$$(1) 64 \times 34 \times 50 = 108,800 \text{ yards of weft in cloth.}$$

$$(2) 560 \times 20 = 11,200 \text{ yards per lb.}$$

Therefore $108,800 \div 11,200 = 9 \text{ lb. } 11 \text{ oz.}$, diam. $6\frac{1}{2}$ of weft in piece. Then $10 \text{ lb. } 14 \text{ oz.} + 9 \text{ lb. } 11 \text{ oz.} = 20 \text{ lb. } 9 \text{ oz.}$ weight of 50 yards of cloth, and $20 \text{ lb. } 9 \text{ oz. } 8 \text{ diam.} \div 50 = 6\frac{2}{3} \text{ oz.}$ per yard of cloth.

It will be well for the analyst, wherever possible, to work upon the basis of a square yard, since the weights for all the various widths may be obtained by direct proportion, while at the same time it forms a useful standard for comparisons.

In the above rules prominence is given to the reason for the procedure rather than to the shortest possible statement, since we cannot impress too strongly the advantage of working by reason rather than by rule. Two points in the above, however, need further explanation. In the first place, the reason for the weft rule is not as clear as it might be, since there is an apparent mixing-up of yards and inches, which to the uninitiated is very confusing. If the sum be thought out as follows, the reason for the abbreviation will be evident:—

64 picks per inch \times the width will give the inches of weft in one inch of cloth, and therefore the yards in 1 yard of cloth for $64 \times 36 = 2,176$ inches in the inch, and $2,176 \div 36 =$ yards in the inch $= 60\frac{2}{3} \times 36 = 2,176$ yards per yard, from which it is very evident that by dividing 36 in one case and multiplying in another may be dispensed with altogether; thus the abbreviated rule above is obtained.

The other matter to which attention was directed is the fact that, although the warp calculation is for 56 yards, the weft is only 50 yards, since 56 yards of warp are assumed to yield only 50 yards of cloth; therefore weft will only be required for 50 yards. Since this is fully dealt with in Chapter X. there is no need to go further into the matter here.

Having indicated the principles, the simplest method of stating the calculations for both warp and weft may now be given:—

$$\text{Warp} = \frac{64 \times 34 \times 56}{560 \times 20} = 10 \text{ lb. } 14 \text{ oz. weight of warp.}$$

$$\text{Weft} = \frac{64 \times 34 \times 50}{560 \times 20} = 9 \text{ lb. } 11 \text{ oz. weight of weft.}$$

And the two together give 20 lb. 9 oz. weight of 50 yards of cloth.

A calculation simpler in principle than the above cannot well be imagined, but the basis of all subsequent warp and weft calculations is present, and this being so, its thorough comprehension is most necessary.

COMPLICATED CALCULATIONS.

Attention may now be directed to calculations for more complicated warps, two modifications on the above practically including all possible warp calculations.

Coloured Warp Calculation.—The first modification of the foregoing is the introduction of coloured threads or picks in either stripe or check form, under which circumstances the weight of each coloured yarn must be obtained.

RULE 3.—To find the weights of the various colours of yarn in a given warp:—

- (1st) Find the number of ends of each colour in the warp, *i.e.*, divide the threads in the warp by the threads in one repeat of the colouring, thus obtaining the number of repeats of the pattern across the piece, and this, multiplied by the ends of each colour in the pattern, gives the number of ends of each colour in the warp.
- (2nd) Multiply the ends of each colour by their length, *i.e.*, the length of the warp, and divide by

the yards per lb. according to the counts of the yarn.

EXAMPLE.—Find the weight of each colour of yarn in the following:—

Warp.

8 threads 2/40's black.
 2 threads 2/40's black and white twist.
 4 threads 2/40's black.
 2 threads 2/40's black and orange twist.
 16's reeds 4's.

16 threads in repeat of pattern.

Weft.

All 20's black, 64 picks per inch.

Sett 34 inches wide, warp to be 56 yards long, to yield 50 yards of cloth.

- (1) $64 \times 34 = 2,176$ threads in warp.
 $2,176 \div 16 = 136$ repeats of colour pattern.
 $136 \times 12 = 1,632$ threads of black in the warp.
 $136 \times 2 = 272$ threads of black and white twist in the warp.
 $136 \times 2 = 272$ threads of black and orange twist in the warp.

2,176 ends in warp.

- (2) $\frac{1,632 \times 56}{20 \times 560} = 8 \text{ lb. } 2\frac{1}{2} \text{ oz.}$ weight of black yarn.

$$\frac{272 \times 56}{20 \times 560} = 1 \text{ lb. } 5\frac{3}{4} \text{ oz.}$$
 weight of black and white yarn.

$$\frac{272 \times 56}{20 \times 560} = 1 \text{ lb. } 5\frac{3}{4} \text{ oz.}$$
 weight of black and orange yarn.

10 lb. 14 oz. total weight of warp.

For the weft $\frac{64 \times 34 \times 50}{20 \times 56} = 9 \text{ lb. } 11 \text{ oz.}$ of weft.

The same method of working may be adopted whatever the order of colouring may be, but it is usually advisable to work out the calculations as for a solid to compare with the total weights of the various colours. The same principles may also be readily applied to weft colourings.

Cloths with Yarns of Two or more Counts.

—The second complication in warp calculation is the not unfrequent system of using yarns of two or more counts in the same warp. Two methods of finding the weight of the warp under these circumstances present themselves:—

Firstly, the average counts of the two or more yarns may be found, and the weight calculated for the average counts on the ordinary system.

Secondly, should the order of warping, etc., be very complicated, the system employed for finding the weights of various colours may be adapted to these conditions.

BACKED AND DOUBLE CLOTHS.—The cloths most easily dealt with under the first conditions are backed and double cloths, in which the warping plan seldom exceeds three or four threads.

EXAMPLE.—A warp is composed of alternate ends of 2/40's and 2/30's worsted, sett 120 ends per inch. Find the weight if made 60 inches wide, 60 yards long.

RULE 4.—To find the average counts. Find the resultant counts of the 2, 3, or 4 ends combined, and then multiply by 2, 3, or 4, according to the number of ends given.

In the above example

$$\frac{15 \times 20}{15 + 20} = 8\frac{2}{3}, \text{ and } 8\frac{2}{3} \times 2 = 17\frac{1}{3}, \text{ the average counts; and}$$

$$\frac{120 \times 60 \times 60}{17\frac{1}{3} \times 560} = 45 \text{ lb. total weight of warp.}$$

Or, by taking each count separately:—

$$\frac{60 \times 60 \times 60}{20 \times 560} = 19 \text{ lb. } 4 \text{ oz. } 9\frac{1}{2} \text{ dr. fine warp (2/40's).}$$

$$\frac{60 \times 60 \times 60}{15 \times 560} = 25 \text{ lb. } 11 \text{ oz. } 6\frac{1}{2} \text{ dr. thick warp (2/30's).}$$

$$\text{Total weight } \underline{\quad 45 \quad 0 \quad 0}$$

CRAMMED STRIPES.—A large number of fancy dress fabrics, usually included under the heading “crammed stripes,” require distinct treatment under the second heading given above, since whether they are true crammed stripes, or only those in which two distinct materials are employed, the treatment of each material separately is much to be preferred.

The method of finding the weight of the latter class of goods—viz., those in which two distinct materials are employed—is very easy, as the following example will demonstrate:—

Warp.

12	threads	2/50's	salmon	worsted.
12	„	2/50's	white	worsted.
12	„	2/50's	green.	
12	„	2/50's	white.	
12	„	40/2	blue	silk.
12	„	2/50's	white	worsted.
12	„	2/50's	green	worsted.
12	„	2/50's	white.	
<hr/>				
96	threads	in pattern.		
		12's	reed	4's.

Weft.

Same as warp, 48 picks per inch.

Piece to be woven 48 inches wide in loom, 60 yards long. Then 48 threads per inch \div 96 threads in pattern = $\frac{1}{2}$ pattern per inch, or 1 pattern = 2 inches.

Therefore, $48 \div 2 = 24$ patterns in piece, and

$$\begin{array}{r} \frac{48 \times 24 \times 60}{25 \times 560} = 4 \text{ lb. } 15 \text{ oz. } 0 \text{ dr. white worsted.} \\ \frac{12 \times 24 \times 60}{25 \times 563} = 1 \text{ lb. } 3 \text{ oz. } 12 \text{ dr. of salmon worsted.} \\ \frac{24 \times 24 \times 60}{25 \times 560} = 2 \text{ lb. } 7 \text{ oz. } 8 \text{ dr. of green worsted.} \\ \frac{12 \times 24 \times 60}{40 \times 840} = 0 \text{ lb. } 8 \text{ oz. } 4 \text{ dr. of blue silk.} \end{array}$$

Total 9 2 8

The weight of the weft yarns will be exactly the same, minus the take-up in the weaving of the warp (page 185).

The above is not a true "crammed stripe," since a true cram has more threads in one portion than in another, as instanced in the following:—

Warp.

40	threads of mohair,	4	in a reed =	10	reeds.
20	"	cotton, 2	"	= 10	"
12	"	mohair, 4	"	= 3	"
40	"	cotton, 2	"	= 20	"
12	"	mohair, 4	"	= 3	"
20	"	cotton, 2	"	= 10	"

Reeds in pattern..... 56
14's reeds per inch.

Piece to be woven 56 inches wide. Now it is very evident that here also the extent of pattern must first be found, so if the number of reeds occupied by the

pattern be ascertained, this, divided into the reeds across piece, will give the required answer, *i.e.* :—

$$56 \times 14 = 784 \text{ reeds across the piece,}$$

$$\text{And } 784 \div 56 = 14 \text{ patterns across the piece.}$$

Then 14×16 splits of mohair $\times 4$ threads

$$\text{in a split} = 896 \text{ ends of mohair.}$$

14×40 splits of cotton $\times 2$ threads in a split = 1,120 ends of cotton.

$$\text{Total number of ends in warp} \dots\dots\dots 2,016$$

Having the counts of mohair and cotton with the length of warp, etc., the weight of cloth may now readily be found as previously shewn.

OTHER NECESSARY CALCULATIONS.

There are many other forms in which warp and weft calculations may occur, but the following formula will prove all that is necessary :—

Let C = counts, W = width in loom, L = length, N = number of ends or picks per inch, and P = weight in pounds;

$$\text{Then } \frac{N \times W \times L}{C \times 560} = P, \text{ or } N \times W \times L = P \times C \times 560 \text{ for}$$

Worsted, 256 for Woollen, 840 for Cotton, or 300 for Linen.

Now this is a complete equation; consequently, if one of the terms be missing, the sum worked out will give that term—*i.e.*, the number which will complete the equation, so that all the following questions are here involved :—

(1) To find the counts when ends or picks per inch, width, length, and weight are given :—

$$\frac{N \times W \times L}{P \times 560} = \text{counts in worsted.}$$

- (2) To find the length when ends or picks per inch, width, weight, and counts are given :—

$$\frac{N \times W}{P \times C \times 840} = \text{length, if yarn is cotton or silk.}$$

- (3) To find the width when ends per inch, length, counts, and weight are given :—s

$$\frac{N \times L}{P \times C \times 256} = \text{width for a given weight of woollen yarn.}$$

- (4) To find the ends per inch when width, length, counts, and weight are given :—

$$\frac{W \times L}{P \times C \times 200} = \left. \begin{array}{l} \text{ends per inch if the counts of yarn are} \\ \text{Galashiels system.} \end{array} \right\}$$

With these formulæ not only should the analyst be able to work out any calculations which are likely to occur, but he should also be able to reason the matter out on reference to the particulars already given.

As already intimated, the above systems, although answering all requirements when dealing with cloths in the loom, require certain modifications in application to the cloth in the finished state. These modifications are considered fully in Chapter X.

CHANGING THE WEIGHTS OF CLOTHS.

There are three ways in which the weights of cloths may be changed, viz., by change of counts, by changing the number of ends and picks per inch, or by a combination of both these methods. The latter method is undoubtedly the correct one, but since all three methods may be useful to the analyst for modifying cloths in weight, each shall be briefly considered.

Changing by Counts.—Since counts in reality equal weights, a direct change of counts of yarn in a cloth necessarily implies a direct change of weight, inversely.

EXAMPLE.—If a cloth woven with a 20's yarn = 1 lb. per yard, a cloth woven with a 10's yarn will weigh 2 lb. per yard, or as 20 is to 10 *inversely*.

This is exceedingly simple, and at first sight would appear all-sufficing. Such, however, is not the case, since although it is true that the weight is changed in the right proportion, it is also true that the diameter of the yarn is increased, while no deduction from the ends per inch has been made; consequently, if the first cloth is a perfect one, the second cannot be perfect, and *vice-versâ*.

Changing by the Ends.—Again, the required change in weight may be made by the ends per inch, 80 ends giving double the weight of 40 ends per inch, and so on. But the same objection must be raised to this as was raised to the change by counts. If one cloth is perfect the other cannot be; thus for the true method we turn to the third method, in which both counts and ends are changed, and the same perfection of structure thus retained.

The Correct Method.—Increase or decrease the diameter (square root of the counts) of the yarn in direct proportion, and the threads per inch in the same proportion, thus preserving the correct balance of structure. An example will, perhaps, render the demonstration of the underlying principles more easy.

EXAMPLE.—A cloth is made to the following particulars:—

Warp.
All 36's worsted.
64 threads per inch.

Weft.
All 36's worsted.
64 picks per inch.

And a cloth $\frac{1}{8}$ heavier is required; then, evidently, $\frac{8}{7}$ must be made into $\frac{7}{6}$, or the weight must be increased as 6 : 7. Then,

As 7 : 6 :: $\sqrt{36} : \sqrt{x} = 26$ counts required for increase weight; or
As $7^2 : 6^2 :: 36 : 26$ counts required,

since the sett of a cloth must always be varied according to the square root of the counts, or diameter of the yarns employed.

As $\sqrt{36} : \sqrt{26} :: 64 : 55$ threads per inch; or
As 7 : 6 :: 64 : 55 threads per inch.

In the first calculation for the counts it should be observed that the counts are *increased* in weight by the change as 7 : 6, since a smaller number gives a heavier count; the change of as 6 : 7 would be a decrease in weight of $\frac{1}{7}$ th, *i.e.*, $\frac{7}{7}$ would be changed into $\frac{6}{7}$, therefore the proportion for the counts must always be taken inversely.

In the latter calculation for the threads for an increased weight, the threads must be reduced; while for a decrease in weight the threads must be increased in number, thus being exactly the opposite to what would be expected.

This is a very important matter as relating to setts, counts, and weight, and should be fully comprehended by the designer and analyst; so the treatment following is

inserted in the hope that its study will quite clear up this difficulty, which only too frequently is attacked in a very unsatisfactory manner, with, of course, an unsatisfactory result.

The Change of Area (*i.e.*, weight) in Relation to Diameter.—In the above calculations it will be seen—

- (1) That the desired addition in the case of the counts is made not to the area or weight, but to the diameter: thus, the *diameter* is increased $\frac{1}{8}$. The question then arises, What is the increase in the actual weight or *area* of the yarn?
- (2) The threads are decreased, evidently to compensate for the surplus addition to the counts, in increasing by the diameter of the yarn, instead of by the area. The question here, then, is, In what proportion must this decrease be made?
- (3) Having worked the calculation out according to the principles laid down, there still remains to be demonstrated that this correct change in weight is coincident with the change required to retain the correct balance of structure.

Before attacking each of the above sections in detail, consider the following simple example:—

Warp.
All* 40's yarn.
40 threads per inch.

Weft.
All 40's yarn.
40 picks per inch.

* The yarn denomination is not necessary in any of these calculations.

If a cloth is required four times the weight; then the simplest method is to change directly by the counts, thus :—

As $4 : 1 :: 40 : 10$, the required counts.

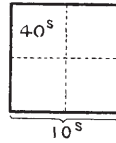

FIG. 69

Now, Figure 69 shews this to be true; but according to the correct method the change would be :—

As $4^2 : 1^2 :: 40 : 2\frac{1}{2}$, the correct counts required.

But $2\frac{1}{2}$ counts would give a cloth four times the required weight, as given by 10 counts; so this weight must be decreased four times by decreasing the number of threads :—

As $4 : 1 :: 40 : 10$ threads per inch;

and this is precisely the change necessary for the increase in the thickness or diameter of the yarn to maintain a correctly balanced cloth, viz. :—

As $\sqrt{40} : \sqrt{2\frac{1}{2}} :: 40 : 10$ threads per inch; or

As $40 : 2\frac{1}{2} :: 40^2 : x^2 = 10$ threads per inch.

That this is correct the following calculations shew :—

$$\frac{40 \times 30 \times 60}{40 \times 560} = 3\frac{3}{4} \text{ lb.} \times 4 = 12\frac{3}{4} \text{ lb.}$$

For cloth 30 inches wide and 60 yards long,

$$\frac{10 \times 30 \times 60}{2\frac{1}{2} \times 560} = 12\frac{3}{4} \text{ lb.}$$

A detailed consideration of this example will clear up many points, or at least prove the correctness of the

rule, but the principles here involved are as yet submerged, and will be best approached by the headings just given.

- (1) What is the increase in area for a given increase in diameter?

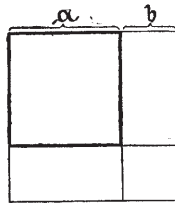

FIG. 70.

In Figure 70 let (a) = the diameter of a yarn as shown, then (a^2) = the area. Now, an addition (b) to the diameter of the yarn will give an increased area of

$$(a \times b) + (b \times b) + (a \times b) = 2(a \times b) + b^2.$$

Thus it is evident at a glance that an increase in diameter gives a very much greater increase in area.

EXAMPLE 1.—Let $a = 2$, then area of the primary yarn = $a^2 = 2 \times 2 = 4$.

Let $b = 1$, then increase in diameter = $2 + 1 = 3$.

But according to the above formula, the increase in the area =

$$2(a \times b) + b^2 = 2(2 \times 1) + 1 = 4 + 1 = 5 \text{ increase in area.}$$

That is to say that the increased area (or weight) is $\frac{5}{4}$ th of the original, or the weight is more than doubled, while the diameter is only increased one-half.

EXAMPLE 2.—It is required to add $\frac{1}{6}$ th to the diameter of a yarn: what will be the increase in area or weight?

As shown in Figure 71, the yarn = $\frac{6}{8}$, and it is required to add $\frac{1}{8}$ to the diameter. The increased diameter = $\frac{7}{8}$, or, if y = the counts,

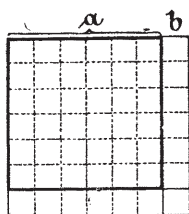

FIG. 71

As $7 : 6 :: \sqrt{y} : \sqrt{x}$, since counts are inversely to weight ;
and $\sqrt{\quad}$ of counts = the diameter of a yarn.

The area of the primary yarn = $6^2 = 36$, so the increase of $\frac{1}{8}$ would give an increased area or weight of $\frac{1}{8}$; but applying the formula

$$2(a \times b) + b^2 = 2(6 \times 1) + 1^2, \text{ the increase in area} = \frac{13}{8}.$$

From this it is very evident that while an addition of $\frac{1}{8}$ of the primary yarn would give an increased weight of $\frac{1}{8}$, yet upon increasing the *diameter* $\frac{1}{8}$, or in direct proportion to the required weight, the additional weight obtained is $\frac{13}{8}$, or rather more than double the weight required.

(2) It follows from both the above calculations that when a given increase or decrease in weight is required, a change, in the required proportion, of the diameter of a yarn will give about double the desired change.

In Example 2, for instance, suppose an increased weight of $\frac{1}{8}$ th is required, then, changing the diameter $\frac{1}{8}$ (according to the rule given), gives, as shewn in

Figure 71, an increased area or weight of $\frac{49}{36}$ against the $\frac{36}{36}$, representing an increased weight of $\frac{1}{6}$ upon the primary yarn; or to put it in a way which will be readily realised by a reference to the diagram, $\frac{49}{36}$ equal an increased weight of $\frac{1}{6}$ th upon the primary yarn, but the actual addition to the weight is $\frac{13}{36}$, so that the number of ends must be reduced in the proportion of, as 49 : 42, or as 7 : 6, or exactly as given in the rule.

(3) The fact that the correct change in weight is coincident with the change required to retain the correct balance of structure, will be realised from the above.

On reference to the example given to demonstrate the rule upon page 168, the sum is stated

As $7 : 6 :: \sqrt{36} : \sqrt{x} = 26$, the counts required.

This, as already shown, gives an increased weight of, as 6 : 7, and since, as already demonstrated, an increase in the diameter of a yarn necessitates an exactly proportionate decrease in the threads, it is very evident that the perfection of structure is retained.

CHANGE IN BOTH WEIGHT AND WEAVE.

A still more difficult question, depending upon the foregoing, may occur as follows:—

EXAMPLE.—A cloth is woven in a $\frac{2}{2}$ twill weave theoretically perfect, *i.e.*, with 76 threads and picks per inch of 2/50's yarn, and a piece is required in the $\frac{4}{4}$ twill, giving an increased weight of $\frac{1}{5}$ th. Then

As $6^2 : 5^2 :: 25 : x = 17\frac{1}{3}$ counts required, and

As $6 : 5 :: 76 : x = \begin{cases} 63\frac{1}{3} \text{ threads per inch required for the cloth} \\ \frac{1}{5} \text{th heavier according to the foregoing rule.} \end{cases}$

For the $\frac{4}{4}$ twill, however, a further change is necessary, according to the relative number of intersections in the respective weaves. Now, 8 threads of $\frac{2}{2}$ twill occupy 10.928^* diameters, while 8 threads of $\frac{4}{4}$ twill only occupy 9.464 diameters; therefore, to change from the $\frac{2}{2}$ to the $\frac{4}{4}$ twill,

$$(63.3 \text{ ends} \div 8) \times 10.928 = 86.462;$$

and $86.462 \div 9.464^* = 9.136$ repeats of the $\frac{4}{4}$ twill $\times 8 = 73.091$ threads per inch. This step may be considerably shortened, since

$$\frac{63\frac{1}{3} \times 10.928 \times 8}{8 \times 9.464} \text{ practically} =$$

As $9.464 : 10.928 :: 63.3 : 73.091$ threads per inch for the $\frac{4}{4}$ twill. But this is an increase of weight in the proportion as $63 : 73$; therefore, the weight must be reduced in this proportion—

$$\text{As } 63.3^2 : 73.1^2 :: 17.3 : x = 23 \text{ counts.}$$

$$\text{As } 63.3 : 73.1 :: 73.1 : x = 84 \text{ threads per inch.}$$

Therefore, a cloth made of $\frac{2}{46}$'s yarn with 84 threads per inch, is $\frac{1}{3}$ th heavier than a cloth made with the same yarns 76 threads per inch, while the perfection of structure is preserved in changing from the $\frac{2}{2}$ to the $\frac{4}{4}$ twill. That this is true may be proved by, firstly, showing that a 23's yarn with a $\frac{4}{4}$ twill requires 84 threads per inch; and, secondly, by showing that this latter cloth is $\frac{1}{3}$ heavier than the former, thus:

A 23's worsted = $\frac{1}{102}$ diameter; therefore, $(102 \div 9.464) \times 8 =$ about 85 threads per inch, the slight difference being due to fractions in the complicated work above.

For the weight calculation, taking a square yard (36 in. \times 36 in.) in each case—

* The 10.928 and 9.464 here given are obtained from the Theoretical Condition of Cloth Structure on pages 149-154.

$$\frac{76 \text{ ends} \times 36 \text{ in.} \times 1 \text{ yard}}{25 \text{ counts} \times 560 \text{ yds. per hank}} = \left\{ \begin{array}{l} 50 \text{ drs. per square yard for} \\ \text{primary cloth.} \end{array} \right.$$

$$\frac{84 \text{ ends} \times 36 \text{ in.} \times 1 \text{ yard}}{23 \text{ counts} \times 560 \text{ yds. per hank}} = \left\{ \begin{array}{l} 60 \text{ drs. per square yard for} \\ \text{cloth } \frac{1}{3} \text{ heavier.} \end{array} \right.$$

And since $\frac{1}{3}$ of 50 drams = 10, it is very evident that the cloth $\frac{1}{3}$ heavier should weigh 60 drams, thus proving the method of working to be correct. The definite rule may be obtained from the above intricate calculations by grouping together all the proportions relating respectively to threads and counts as follows:—

For the counts:—

$$\left. \begin{array}{l} \text{As } 9.464 : 10.928 \\ \text{As } 6 : 5 \end{array} \right\} :: \sqrt{25} : x = 23 \text{ counts ; or}$$

$$\left. \begin{array}{l} \text{As } 6^2 : 5^2 \\ \text{As } 9.464^2 : 10.928^2 \end{array} \right\} :: \sqrt{25} : x = 23 \text{ counts.}$$

For the threads:—

$$\left. \begin{array}{l} \text{As } 6 : 5 \\ \text{As } 9.464 : 10.928 \end{array} \right\} :: 76 : x = 84 \text{ threads.}$$

$$\left. \begin{array}{l} \text{As } 9.464 : 10.928 \end{array} \right\}$$

The rule then will be as follows:—

RULE.—*For the counts* increase or decrease the diameter of the yarn in direct proportion to the weight and also in proportion to the relative change required for the new weave.

For the ends increase or decrease (inversely) in direct proportion to the weight and to the necessary change in the ends *squared*.

In decreasing the weight the same principles apply: in a decrease of $\frac{1}{3}$ th the proportion will be—

As 5 : 4 or $\frac{4}{5}$ will become $\frac{4}{3}$ and so on throughout.

The analyst should most certainly reason out all important calculations, as here shewn, and not depend upon rules until the principles are thoroughly grasped.

CHAPTER X.

THE WEIGHTS OF FINISHED CLOTH.

In the absence of recorded results the relationship between cloth as woven and as finished is usually omitted in all text books, and although the following results are more or less incomplete they are given as a means of stimulating research in this direction, and also with the idea of laying down the lines upon which the results of such research should be recorded.

Modifying Influences.—It is a comparatively easy matter to calculate the weight of a cloth as woven, but it is quite another matter to estimate the weight per yard when finished. Of course cloths vary very much in this respect according to the material of which they are composed: thus in cloths made of wool the chief causes of variation are loss of oil in scouring, loss of fibre in milling, increase of weight per yard owing to contraction in length, which contraction may be varied, within certain limits, at will; and lastly, in the flocking or milling of fibres milled into some woollen cloths. In the case of cotton, linen, china grass, etc., the above influences are *nil*, since the material possesses little or no shrinking properties, the only modifying influence being the bending of warp or weft, or both, in the operation of weaving and the filling put into cotton, etc., goods in finishing. In the case of silk fabrics variation is likely to occur, according to the state of the yarn when woven. If it

has been boiled-off little loss is likely to occur with the light scour usually given these fabrics, but if there is any considerable amount of "gum" left on the fibre considerable loss may be expected.

Those engaged in these trades, however, will do well to study the following particulars, applied more particularly to the woollen and worsted trades, since they thereby materially extend their field of vision :—

The Loss of Oil.—The loss of oil, etc., in scouring must first be considered. Practically, all yarns containing wool are spun with oil; thus, when a yarn is delivered to a certain count it remains so only as long as the oil remains in it; therefore it will evidently be advantageous to ascertain the probable loss in scouring, by reeling say 100 yards of the yarn, accurately weighing, scouring with soap at about 96°F., drying, and leaving, say a couple of days, to regain the natural moisture, and weighing again to estimate the loss.

A series of such experiments are shown in List 7.

A curious point is here revealed, viz., that a marked difference frequently occurs in the weight of the same yarn weighed at different times. These weights have been very carefully tested, and may be taken as an indication of what actually occurs in practice, the weather materially influencing the weight of the wool, or more correctly the amount of moisture in the wool. Another point that should be carefully noted is the heat at which the yarn is scoured. This should not exceed 96°F., and guesswork will not do. (A pocket thermometer may be purchased for about 1s., which will answer every require-

LIST VII.

YARN.	Counts.	No. of yards reeled.	Greasy Weight, in grains.	Average greasy weight.	Average scoured weight, in grains.	Loss per lb.
1 Grey Botany	2/15's	100	166.5, 166.4, 166.89, 167.02	166.95	158.99	333.71 grains
2 Grey Botany	18's	100	54.3, 53.92, 54.14, 54.25	54.15	51.2	404.6 "
3 Brown Botany	20's	100	51.05, 51.64, 51.77, 51.85	51.58	49.45	289.06 "
4 Claret Botany	2/50's	100	34.2, 34.1, 34.17, 34.22	34.17	31.25	598.18 "
5 White Botany	40's	100	---	27.05	24.72	861.76 "
6 Dark Brown Cross-bred	2/16's	100	153.05, 151.42, 151.84, 151.8	152.03	148.3	172.3 "
7 Black	2/24's	100	---	97.57	92.82	340.67 "
8 Blue English	30's	100	40.20, 41.92, 42.02, 42.07	41.55	40.87	114.51 "
9 White Woollen	36 sk.	100	---	73.15	67.15	574.16 "

ment for exact work and should always be used to test the heat of the bath).

No further particulars will here be serviceable, simply because the conditions will vary so much according to the quality of the material. The analyst should carefully take a test on the lines here laid down for each yarn with which he has to deal, and this, with the following particulars, should enable him to fairly accurately estimate the loss in finishing the yarn as cloth.

The Loss of Fibre.—Having estimated the loss due to the extraction of oil, etc., in scouring, the loss of fibre in scouring and more particularly in milling and those processes comprehended under the term “finishing” must be estimated. This is a much more difficult task than estimating the loss in oil, since yarns are subject to quite as great variation in this respect; and further, it is not possible to test even in a general way the loss likely to occur, previous to putting the cloth into work. Against this, however, must be placed the fact that cloths can be varied in weight per yard to a very great extent by milling-up either in length or breadth, or both, as required, and also by tentering, crabbing, etc.; but there are limits to the modifying influences of these operations, and these limits must be thoroughly comprehended if accurate results are to be obtained.

Effects of Shrinkage.—Firstly, then, a thorough comprehension of the influence upon the weight of a cloth of shrinkage, warp and weft way, is necessary. Now cloths being sold by the weight per yard, any and

every width, it is evident that contraction in width has no influence on the desired weight whatever, certain standard widths being recognised in the various trades, these being obtained very accurately by the milling and tentering. Under the subsequent heading of "Width in the Loom" this matter is fully dealt with.

Contraction in length, however, has a direct influence on the weight of the piece. For example, if a cloth 40 yards long weighs 1lb. to the yard, the whole cloth weighs 40lb. If this is milled up to 20 yards, supposing there is no loss in milling, the piece will still weigh 40lb., *i.e.*, 2lb. to the yard, or

As 20 : 40 :: 1lb. : 2lb. per yard.

So that the contraction in length directly influences weight. This, however, in one sense, is not true, since the more a piece is milled, the greater may be the loss in fibre, which is particularly so in the case of woollens. This loss of fibre can only be estimated by experience, but since a manufacturer rarely puts material into a cloth to mill out, the foregoing deductions will give an accurate idea of what may be expected.

The Influence of Heat.—Another influence to be carefully noted is the heat employed in the various finishing operations. For example, it is found that in finishing woollen and worsted cloths, if the heat rises above 100°F. a loss in weight occurs, probably due to some of the wool being dissolved. Much heat is also developed at times in the milling machine, so that it is evident these matters should be carefully watched and noted down.

Estimation of Loss in Weight.—A long experience with woollen and worsted goods in various forms, *i.e.*, as unions, dress-face goods, serges, coatings, meltons, etc., is summed up in the following :—

For ordinary goods allow about $\frac{1}{4}$ th on the calculation weight.

For example, if a cloth in the grey weighs 80lb., in the finished state it should weigh 64lb.

For face goods allow about $\frac{1}{4}$ th on the calculation weight, *i.e.*, a cloth in the grey weighing 80lb., when finished should weigh 60lb.

These weights will, of course, vary slightly, according to the yarns, etc., employed, so that the matter cannot be thus summarily dismissed. The above must be taken as a general rule, but the details should be further considered.

CLOTHS IN THE GREY AND FINISHED STATES CONTRASTED.

Suppose the analyst has dissected a cloth on the lines laid down, has found the counts of warp and weft, threads and picks, per inch, and weight per yard of the finished cloth, then the following points must be successively decided :—

- (1) Sett in the loom.
- (2) Width in the loom.
- (3) Picks per inch woven.
- (4) Length of warp.
- (5) Counts of both warp and weft in the grey.
- (6) Weight per yard finished.

Each of these points must be dealt with in detail, and then to render thorough comprehension easy an example shall be fully considered.

The Sett in the Loom.—This to the unexperienced may prove a difficulty, and in fact will be to any one a matter of estimation, since cloths, as already intimated, may be varied considerably in width during finishing, and variation in width will directly influence the threads per inch.

EXAMPLE.—If a cloth 32 inches wide has 64 threads per inch, and when finished measures 30 inches, then

As 30 : 32 :: 64 : 68 picks per inch in finished cloth.

Inversely, then, a cloth having 68 picks per inch as analysed, will have been sett 64 threads per inch in the loom 32 inches wide, to finish to 30 inches. In estimating the sett in the loom, then, the shrinkage in width in finishing must be taken into account, and the sett based accordingly.

Width in Loom.—If the setts finished and in the loom are known, the width may be deduced by direct proportion. Taking the finished threads per inch to be 68, and the threads per inch in the loom to be 64, then any desirable finished width may be taken, say 30 inches, and the width in loom decided by the relative number of threads finished and in the loom as follows :—

As 64 : 68 :: 30 : 32 inches wide in the loom.

When it becomes necessary to *estimate* the shrinkage in width from the reed width to the finished width, two points must be carefully considered :—

- (1) The material of which the weft is composed.
- (2) The manner in which it is bound into the cloth :—

(1) Fibres, such as cotton, linen, etc., which possess no shrinking properties, tend to keep the cloths into which they are woven out at the full reed width, while wool yarns under almost any circumstances tend to contract the piece in width. Even in wools, however, there is considerable variety. A case in point is as follows:— A cotton warp leno piece, very open sett, was woven with mohair weft; the same warp was woven with botany weft, about the same counts. In the loom the width was 27 inches, the mohair in the grey was 25 inches and finished 20 inches, the botany in the grey was 20 inches, and finished 17 inches wide, there thus being a difference of 5 inches in the grey and 3 inches in the finished cloth.

(2) The extent of contraction in width is most materially influenced by the bending, upon the same principle that certain weaves take up more warp than others. Plain weave, for instance, is the weave above all others which tends to contract the piece in width during weaving, the influence of the tightly held warp being exerted in bending the weft, and thus rendering every individual weft pick shorter, and consequently the piece narrow. On the other hand, the warp corkscrew type of structure tends to keep the piece to the full reed width during weaving, but seems, in wool pieces, to afford the means of shrinking during the finishing processes.

This is probably due to the greater freedom allowed the fibres in the weft; in fact recent research proves most conclusively that in dealing with wool yarns the freedom of the fibres, by whatever means effected,

has a most marked influence on the resultant cloth. For example, a large number of turns per inch in the yarn, or close setting in the loom, all tend to diminish the amount of "finish" the piece will take.

Now, laying aside all extraordinary effects, in the case of all-wool or cotton warp and wool weft fabrics, an allowance of about 10 per cent. will prove a safe basis to calculate upon. Thus a piece for 38 inches wide should be woven about 42 inches wide in the loom.

In the case of cotton and other unshrinkable cloths, the calculations for the take-up in warp explained in the following pages should prove a very safe basis, but note should be made of the fact that to some extent the width of the finished piece may be influenced by the strain put upon the cloth *warp way* in finishing; what is gained in length is lost in width.

(3) PICKS PER INCH WOVEN.—Finding the picks per inch as woven is very similar to finding the threads per inch in the loom, both depending upon shrinkage in finishing. The shrinkage warp way is varied very considerably, but allowing 9 per cent. (a fair average allowance) for contraction in length, then 68 picks per inch finished will give—

As 109:100 :: 68:62 picks per inch woven.

In other words, the picks per inch will vary in direct proportion to the length of the finished and greasy cloths respectively. Note should be here made that the overlooker usually puts fewer picks in than, say, 62, since a 61 wheel will give 62, owing to the contraction of the warp after weaving.

(4) THE LENGTH OF WARP.—This is a most important matter, and one to which, so far, little attention has been directed. In its simplest form the question may be put as follows:—

EXAMPLE.—A warp 100 yards long is put into the loom: what length of cloth will come out?

There are two matters here involved—firstly, what allowance is necessary for twisting in and finishing a piece, a portion of the warp being usually left in the healds, by which the succeeding warp is tied in? Secondly, what will the warp take up in weaving?

The first matter will be influenced by the tier-in and starter of the loom, and can only be estimated when the time comes, but an allowance of $1\frac{1}{2}$ yards under ordinary circumstances should be ample.

The second matter is one of much importance, since it affects not only the calculation which we are considering, but also calculations relating to allowances for backing and figuring warps. The take-up in the case of single cloths must first be considered, and reference to Figures 66 to 68 will render this easy of demonstration. Figure 66 is a plain cloth, which if constructed perfectly will give an equal curvature in both warp and weft; and since the warp threads change for every pick, it is evident that the take-up in the case of plain weave will be more than in the case of twills, etc. Now, as already demonstrated, the angle of curvature of warp or weft should be 120° , and the triangle as shown will have relatively 1 for altitude, 2 for hypotenuse, and 1.732 for the base; consequently any line drawn straight through the low or high centres of the warp and weft threads and

picks, represented by the bases of all triangles similar to ABC, will represent the length of cloth, while hypotenuses A will represent the length of warp to give the forenamed length of cloth, or, 1.732 yards of cloth will require 2 yards of warp, there being a take-up of .268 yards in 2 yards, and this expressed as a fraction is about $\frac{1}{4}$ th, so that for a perfect plain cloth, finished strictly to the theoretical conditions laid down, 100 yards of warp will yield about $87\frac{1}{2}$ yards of cloth, or

$$\text{As } 2 : 1.732 :: 100 : 87\frac{1}{2} \text{ yards.}$$

With the two-and-two twill there will be less take-up, since there are relatively fewer intersections.

The calculation for for take-up in this case will be—

$$\begin{aligned} 2 \text{ threads} + 2 (1.732) \text{ intersections} &= 5.464 \text{ yards of cloth from} \\ 2 \text{ threads} + 2 (2) \text{ intersections} &= 6 \text{ yards of warp,} \\ \text{the take-up being } .536 \text{ in six yards, or about } \frac{1}{11}. \end{aligned}$$

Another important calculation is that for the 8-end sateen, which is as follows:—

$$\begin{aligned} 6 \text{ threads} + 2 (1.732) \text{ intersections} &= 9.464 \text{ yards of cloth from} \\ \text{warp,} \\ 6 \text{ threads} + 2 (2) \text{ intersections} &= 10 \text{ yards of cloth from warp,} \\ \text{the take-up being } .536 \text{ in 10 yards, or about } \frac{1}{10} \text{th take-up.} \end{aligned}$$

In weft-rib cloths the warp being almost straight the yield of cloth will be almost length for length, *i.e.*, 100 yards of warp will yield almost 100 yards of cloth.

In the case of warp-rib cloths, the weft being straight throws all the bending upon the warp; but if the cloth is constructed strictly according to the principles laid down the calculations for take-up will be precisely similar to the calculations for take-up in ordinary cloths, since the diameter of the yarn, or the altitude of the triangle, does not affect the result in the slightest, the

take-up being relative to the base and hypotenuse of the triangle formed. Note should, however, be made of the fact that size of the weft, picks per inch, shrinkage of the wool, and weighing of the warp-beam all influence the take-up in some degree. For example, if a worsted warp for a broad piece of cloth is received in two balls, and in beaming is not sleyed end and end, one ball is almost certain to be more heavily weighted than the other, with the result that the difference in length of each section in the case of long warps may actually be yards. In weaving striped patterns of intricate construction, such as crammed stripes, or any single cloths in which weaves are combined in stripe-form, the above principles are a good indication of what may be expected, and the need for an extra beam must be judged accordingly. Many weaves, however, of slightly different wefting capacities may be woven from the same beam, if the warp is good; but, of course, all the strain will go upon the threads weaving with the most intersections: thus the extent of the various weave stripes may influence the use or otherwise of extra beam.

Again, an extra beam may be required in order to throw up a crammed stripe or to prevent tying marks by the means afforded of working the special warps slack by very lightly weighting, *i.e.*, weighting just to get a fairly clean shed.

A method employed at times with success for these and backed cloths is to beam certain sections of the warp slacker than the other sections. The use of an extra beam may by these means be avoided, but its application is very limited.

In dealing with backed and double cloths, the same principles apply, with certain modifications. For instance, working out, on the lines already laid down, a two-and-two twill-face cloth with 8-end sateen back, the following result is obtained.

EXAMPLE.—70 yards of face warp — $\frac{1}{11} = 63.64$ yards of cloth. $64 \text{ yards} + \frac{1}{20} (= 3) = 67$ yards of backing warp to yield 63.64 yards of cloth.

The take-up in the case of double cloths will be a compound of the single and backed cloths, the take-up in both face and backed cloth being first calculated and then the take-up for ties, whether in warp or weft.

In the case of wool cloths an additional take-up occurs in the finishing, varying from 5 to 10 per cent., but this per centage may as a rule be varied at will according to requirements.

It is quite possible that practical men may offer some objections to the above system, but since careful consideration tends to show most emphatically that these theoretical results coincide with the best results obtained in practice, it must at once be admitted that there is something in these theories, and that they are worthy of the best attention.

5.—COUNTS OF BOTH WARP AND WEFT IN THE GREY.—The counts of yarn in any given cloth may readily be ascertained, as already shewn, by weighing as long a length as may be conveniently obtained, very accurately, *i.e.*, at least to the tenth part of a grain, and preferably to the hundredth part of a grain. The result obtained, however, may not represent the true counts, since two

important modifying influences have had full play, these being, respectively, the contraction of the thread in weaving, and the loss in oil, or fibre, etc., in finishing. It is at once seen, then, that the accuracy of the estimate—for it will be an estimate—will depend upon the accuracy with which the above-named influences are gauged. Now, a few moments' consideration will shew that these influences counterbalance each other to a greater or less extent, since contraction in length increases the counts of the yarn, while the loss of oil, fibre, etc., decreases the counts of the yarn.

Again, note should be made that wool yarns are subjected to two contractions, the first being due to the curving of the thread or pick in weaving, and the second to the actual shrinkage of the wool or interlocking of the fibres. The influence of the curvature of the thread may readily be counteracted in measuring off the length to weigh, as described: the contraction of the fibres, however, cannot be counteracted, but must be placed against the loss due to extraction of oil, fibres, etc. A rough estimate may at once be made from the weight of the finished yarn by allowing shrinkage of fibre and loss of oil to counteract each other, and taking the nearest suitable count to the one given by the ascertained weight.

6.—WEIGHT PER YARD FINISHED.—Having obtained the counts of warp and weft in the grease, sett, and picks per inch, width of cloth in the loom, and the length of warp, the full calculation for the cloth may readily be worked out, as already shewn in Chapter IX.

Then the question arises, having the calculated weight, what will be the actual weight per yard finished?

LJST VIII.

Make of Cloth.	Length of warp.	Grey length of cloth.	Finished length of cloth.	Reed width.	Grey width.	Finished width.	Weight per yard, finished.	Weaving Particulars.
(1) Lawn Tennis Cloth...	90 yds.	82½ yds.	79½ yds.	32½ in.	31 in.	(28 to) (29 in.)	5½ to 6 oz.	(Warp = 2/40's worsted, 26's weft, 64 threads per inch, 64 picks per inch.)
(2) 13 Shaft Corkscrew...	70 yds.	58 yds.	56½ yds.	63 in.	61 in.	58 in.	(15 to) (16 oz.)	(Warp = 2/48's worsted, 27's weft, 88 threads per inch, 104 picks per inch.)

The difficulties in getting at this will vary considerably, being easily surmounted in the case of cotton, linen, etc., cloths, but being very difficult to gauge in the case of wool cloths.

Take, for instance, the two examples supplied in List VIII. :—

EXAMPLE I. :—

$$\frac{90 \times 64 \times 32\frac{1}{2}}{560 \times 20} = 16\frac{5}{7} \text{ lb. of warp.}$$

$$\frac{82\frac{1}{2} \times 64 \times 32\frac{1}{2}}{560 \times 26} = 11\frac{1}{14} \text{ lb. of weft.}$$

And $28\frac{1}{2} \div 79\frac{1}{2} = 5 \text{ oz. } 13 \text{ dr.}$ per yard, or rather above the finished weight.

EXAMPLE II. :—

$$\frac{88 \times 63 \times 70}{560 \times 24} = 28 \text{ lb. } 14 \text{ oz. of warp.}$$

$$\frac{104 \times 58 \times 63}{560 \times 27} = 25 \text{ lb. } 2 \text{ oz. } 2 \text{ dr. of weft.}$$

Total 54 lb. 0 oz. 2 dr.

And $54 \text{ lb.} \div 56 = 15 \text{ oz. } 5 \text{ dr.}$ per yard.

In both these cases the loss in weight is less than the allowance of $\frac{1}{5}$ noted on page 181, for :—

$28\frac{1}{2} \text{ lb.} - \frac{1}{5} = \text{about } 22\frac{3}{4} \text{ lb.}$ and $22\frac{3}{4} \div 79\frac{1}{2} \text{ yards} = \text{about } 4 \text{ oz. } 10 \text{ dr.}$ per yard for Example I., and

$54 \text{ lb.} - \frac{1}{5} = \text{about } 43 \text{ lb. } 3 \text{ oz.}$ and $43\frac{3}{4} \text{ lb.} \div 56\frac{1}{2} \text{ yards} = 12 \text{ oz. } 4 \text{ dr.}$ per yard for Example II.

Both these cloths, however, have, comparatively speaking, no finish put on, and therefore may be taken as representing the least possible loss in dealing with wool goods, while in the case of low woollens the actual loss may possibly exceed the $\frac{1}{4}$ th or $\frac{1}{5}$ th allowance; but since the contraction will be more, the variation in weight will be about the same. Note should also be made that

while the weight per yard finished does not indicate a loss of $\frac{1}{3}$, still such a loss may have occurred *on the whole piece*, the contraction of the warp counteracting the loss, taken yard by yard. It is very evident, then, after estimating the loss in weight and the contraction in length, that the weight per yard in the finished state may be calculated with a fair amount of certainty as regards woollen, and perhaps with more certainty as regards cotton, etc., cloths, although in these latter the amount of sizing put in (often 200 or 300 per cent.) may render the estimation of the amount of pure fibre, a very difficult task. But it will be gathered from the foregoing that almost every type of cloth will vary in this respect; consequently it is of the utmost importance that every manufacturer should carefully record the results he obtains in manufacturing.

List VIII. shows a convenient system of recording such results, which the manufacturer will do well to study and further develop by recording all the cloths coming under his supervision.

In order to further assist in the recording of such results the author has specially designed a pattern book for entering-up all such necessary particulars. (See advertisement page.)

WEIGHT PER YARD CALCULATED.

A useful method of arriving at the weight of a finished sample of cloth submitted for analysis is to weigh a given number of square inches, and from this ascertain

the weight by direct proportion of 1 square yard of cloth or 1 yard of cloth the required width.

EXAMPLE :—

- (1) By carefully weighing 2×2 inches (*i.e.*, 4 square inches) of a linen cloth = 7.5 grains.
- (2) $36 \times 36 = 1,296$ square inches in 1 square yard of cloth.
- (3) As 4 : 1,296 :: 7.5 : 88 drams or 5.5 oz. per square yard.

In order to test the accuracy of this calculation, the counts of warp and weft may be found by carefully weighing, and, with the ends and picks per inch, will give the weight per yard, as follows:—

- (1) 32 inches of warp = .7 grains = 30's counts linen.
56 inches of weft = .7 grains = $51\frac{1}{2}$'s counts linen.
- (2) By examination there are found present 48 ends per inch and 64 picks per inch.

$$(3) \text{ Warp} = \frac{48 \times 36 \times 1}{300 \times 30} \times 16 = 3.2 \text{ oz. per yard of warp.}$$

$$\frac{64 \times 36 \times 1}{300 \times 51\frac{1}{2}} \times 16 = 2.3 \text{ oz. per yard of weft.}$$

5.5 oz. per square yard of cloth.

Again, in order to test the accuracy of the calculation, or to find the counts of the warp and weft yarns, instead of weighing separately the warp and weft threads as above, the proportion of threads and picks in the 2×2 inches, and the proportionate weight of the threads and picks, will readily solve the question.

Thus, for the warp, since the relative number of threads and picks is 48 and 64, then—

$$\text{As } 112 : 48 :: 7.5 : y = \text{weight of warp in } 2 \times 2 \text{ inches if counts are same as weft.}$$

But by accurately balancing warp threads with weft

picks it is found that 16 threads balance 28 picks, or the warp is heavier in this proportion, therefore

$$\text{As } (16+28) : 28 :: y : x, \text{ or as } 11 : 7 :: y : x.$$

This will evidently be better stated as follows :—

$$\left. \begin{array}{l} \text{As } 112 : 48 \\ \text{As } 11 : 7 \end{array} \right\} :: 7.5 : x \times 2 = 4.1 \text{ grains of warp in } 2 \times 2 \text{ inches.}$$

For the weft the calculation will be—

$$\left. \begin{array}{l} \text{As } 112 : 64 \\ \text{As } 11 : 4 \end{array} \right\} :: 7.5 : x \times 2 = 3.2 \text{ grains of weft in } 2 \times 2 \text{ inches.}$$

Now, as shown in Chapter II., 1 yard of 1's counts of linen weighs $23\frac{1}{3}$ grains, 20 yards of 20's the same, and so on, since $7,000 \div 300 = 23\frac{1}{3}$ grains; consequently if the lengths of warp and weft are found for the above weights the counts will be readily ascertained. Thus—

$$48 \times 2 \times 2 = 192 \text{ inches } \div 36 = 5\frac{1}{3} \text{ yards of warp, weighing } 4.1 \text{ grains.}$$

$$64 \times 2 \times 2 = 256 \text{ inches } \div 36 = 7\frac{1}{3} \text{ yards of weft, weighing } 3.2 \text{ grains.}$$

Therefore for the counts :—

$$(23\frac{1}{3} \div 4.1) \times 5\frac{1}{3} = 30 \text{'s counts of warp, and}$$

$$(23\frac{1}{3} \div 3.2) \times 7\frac{1}{3} = 51\frac{1}{2} \text{ counts of weft,}$$

or by a rather more complicated method :—

$$\frac{(7,000 \div 4.1) \times 5\frac{1}{3}}{300} = 30 \text{'s counts of warp.}$$

$$\frac{(7,000 \div 3.2) \times 7\frac{1}{3}}{300} = 51\frac{1}{2} \text{ counts of weft.}$$

Having obtained these counts, the weight of the cloth per square yard or the required width may readily be obtained.

This method might readily be condensed into a rule, but the analyst will find it infinitely better to construct his own rule from a thorough comprehension of the principles involved.

List IX. is given as a means of estimating the difference in count of any yarn in the finished and unfinished state, *i.e.*, in the cloth and in the yarn state.

LIST IX.

Material of which Yarn is composed.	Counts in Grease.	Weave Employed.	Counts in Finished Cloth
Woollen	18 sk.	Twill	19 sk.
Cross-bred	2/16's	Fancy twill	8 $\frac{1}{2}$'s
Cross-bred	2/24's	Sateen	12 $\frac{3}{4}$'s
Botany	2/56's	Fancy twill	27's
Cotton	2/90's	Twill	45's
Silk	30/2	Fancy weave	31's

APPENDIX I.

THE COST OF CLOTHS.

Although the subject of "Pattern Analysis," as treated here, is complete, some few remarks on the cost of cloths and the various modifying influences may not be out of place.

Now, from the particulars already given it will be no difficult matter to estimate the amount of yarn necessary for the production of any given pattern. This, however, is the simplest part of the work; other equally important matters must be estimated before the cost of the cloth can be ascertained with any degree of accuracy.

A writer in the "Textile Manufacturer" sums up the various influences on cost as follows:—

- (1) VALUE OF MATERIALS.
- (2) WAGES PAID FOR—
 - (a) Weaving.
 - (b) Preparing for Weaving: *i.e.*, Winding, Beaming, Slashing, Looming, and Tackling, or Jobbing.
 - (c) Selling, Examining, and Sundry Work: *i.e.*, Wages of Office and Warehouse hands, Engineer, and Labourer.

(3) WORKING EXPENSES—

- (a) Depreciation.
- (b) Interest on Loan Capital, Bank Commission, etc.
- (c) Sundry Repairs of Buildings, Machinery, Renewals of Machinery, Clothing, etc.
- (d) Rates, Insurance, and similar charges.
- (e) Fuel, Lighting, and Water.
- (f) Carriage of Yarn, etc., to, and Cloth from, the Mill.

The writer of the above has in mind the cotton trade, which is organised in a very different way from the woollen, worsted, and silk trades, where, to a large extent, specialties obtain; but it is, nevertheless, a most useful summary of the most necessary considerations, with which every manufacturer, designer, or analyst should be more or less acquainted.

Upon this matter in its extended form, as indicated here, it is not our intention to dwell, but rather to give as briefly as possible the lines upon which the cost of cloths, as going into the warehouse, are based, leaving the further development of the matter to the particular manufacturer concerned.

PRICES OF YARN.

The prices of yarn are so liable to variation, and the price up to date can be so readily obtained, if required, that there is really no advantage to be gained by inserting here lengthy lists, but the following particulars will at least afford the opportunity of experiment upon the cost of the various cloths:—

WORSTED YARNS (60's QUALITY BOTANY).

Colour.	Up to 30's.		Up to 36's.		Up to 2/32's.		2/40's.	2/48's.	2/56's.			
	s.	d.	s.	d.	s.	d.	s.	d.	s.	d.		
In the Grey ..	2	4½	2	5½	2	6	2	8	2	10	3	0
Black	2	7	2	8	2	8	2	10	3	0	3	2
Steels	2	9	2	10	2	10	3	0	3	2	3	4
Other mixtures	2	11	3	0	3	0	3	2	3	4	3	6
Twists, etc. ..	3	1	3	2	3	2	3	4	3	6	3	8
Woaded #.....	3	3	3	4	3	4	3	6	3	8	3	10

WORSTED YARNS (40's QUALITY CROSS-BRED).

Type of Yarn.	Up to 16's.	32's	36's.	2/12's.	2 2 s.	2/32's.	2/36's.	2/40's.
In the Grey or natural state	17½d.	18d.	19d.	18d.	18½d.	18¾d.	19¼d.	19¾d.
Black, Steels, & other Mixtures	18. 10½d.	2s.	2s. 1d.	1s. 11d.	2s. 0d.	2s. 1d.	2s. 2d.	2s. 3d.

Twists, 1d. per lb. more than mixtures, etc.
 Woaded Shades, 3d. extra.
 Double combed, for fine tweeds, coatings, etc., 2d. extra.

COTTON YARNS FOR WORSTED AND WOOLLEN TRADES.

Type of yarn.	20's.	24's.	30's.	2/20's.	2/40's.	2/60's.	2/80's.	2/100's.
Better class ..	9½	9¾	10¼	—	12	14d.	17d.	22d.
Ordinary class	8¾	8¾	9¾	8¾	10½	—	—	—

(SEE OVER.)

In the foregoing single yarns, an addition has been made of $\frac{1}{4}$ to $\frac{3}{4}$ lb. for sizing.

For black dyeing $2\frac{3}{4}$ d. per lb. should be added.

For other colours $4\frac{1}{2}$ d. per lb.

THE COST OF WOOLLEN YARNS.

Owing to the fact that almost every producer of woollen cloths spins his own yarns, there is no end to the variety of types. There is little exaggeration in saying the woollen yarns may be bought at any price from under 6d. per lb. to 3s. or even more per lb., according to the materials combined and the counts spun to. Perhaps the best method of assisting the analyst to arrive at the cost of any given yarn will be to give an example, which may be modified according to requirements.

THE COST OF 12 SKEIN (TWO-FOLD 24 SKEIN) WOOLLEN WARP.

(a) PRICE OF MATERIALS.

		s. d.
6 lb. wool, at 1s. 3d. (scoured)	=	7 6
6 " mungo, at 8d.	=	4 0
8 " cotton, at 6d.	=	4 0
<hr style="width: 20%; margin-left: 0;"/>		
20 lb. -5 per cent. for waste = 19 lb.	=	15 6 = { 10d., price of the blend per lb.

(b) COST OF PRODUCTION.

2s. per watern (6 lb.)	=	4d. per lb. for carding (condensing to 12 sk.)
1s. 2d. " "	=	2 $\frac{3}{4}$ d. " " spinning (to 24 sk.)
6d. " "	=	1d. " " twisting

$7\frac{1}{2}$ d. = $7\frac{1}{2}$ d. per lb., cost of production.

Thus, 12 skein (two-fold 24 skein) woollen warp costs 1s. $5\frac{1}{2}$ d. per lb.

THE COST OF 12 SKEIN (SINGLE) WOOLLEN WEFT.

(a) PRICE OF MATERIALS.

	s.	d.
4 lb. of botany noil, at 1s. 2d.	4	8
12 " mungo, at 4d.	4	0
4 " cotton, at 6d.	2	0

20 lb. — 10 per cent. = 18 lb. at 10 8 = 7d. per lb.

(b) COST OF PRODUCTION.

9d. per wartern (6 lb.) = 1½d. per lb. for carding (condensing to 6sk.)
 9d. " " " = 1½d. " " spinning

3d. per lb., cost of production.

Thus, 12 skein (single) woollen weft costs 10½d. per lb.

The chief points to note in the above are (1) the predominance of wool and cotton in the warp yarn calculation to spin to the 24 skein, as against a large proportion of mungo in the weft calculation to spin only to 12 skein; (2) owing to the poorer material in the weft there is more waste; (3) the extra prices for condensing and spinning in the case of the warp yarn.

Note should be made that the wool is calculated upon the cost scoured: thus, the wool here given might be taken at 7½d. greasy, and, losing 8 lb. in 16 lb. in yolk, etc., thus costs just double.

SILK YARNS.

Type of Yarn.	Counts.	Price.	Counts.	Price.	Counts.	Price.
Tussur Silk, for Seals, Plushes, etc. }	2/17's	6s.	2/35's	8s.	2/48's	9s.
Spun Silk for Dress Goods, etc. }	2/30's	9s.	2/60's	10s.	2/80's	Not much used; roughly, about 15s.
Organzine (R a w) Warp Silk) }	—	35s. per lb.	—	—	—	—
Tram (Raw Weft) Silk)	—	33s. per lb.	—	—	—	—

PREPARATION FOR THE LOOM.

Evidently the first additional expense to the actual cost of the materials will be incurred in preparing a warp for the loom, *i.e.*, in winding, warping, sizing, dressing, twisting-in, looming, and slewing.

Winding.—This is necessitated by the anxiety of the manufacturer to deal with the pure yarn alone; the difficulty of estimating the tare, should the yarn be purchased upon cops or paper tubes, and the difficulty of estimating and returning the tare if spun upon bobbins, resulting in most manufacturers buying in the hank and winding for themselves, the cost being reckoned at $\frac{1}{2}$ d. to 1d. per lb. There has been a tendency of late to spin or twist upon bobbins of stable weight, thus rendering the estimation of yarn more stable; but there is still the difficulty in returning the tare.

Yarns may usually be obtained in the form required from the spinner; but the foregoing considerations tend to render every manufacturer his own winder for weft yarns. In both the ordinary cotton and worsted trades the warp yarns are purchased in the warp form at no additional expense, while in some cases they may also be obtained warped, sized, and beamed on to the manufacturer's own beam, at a slightly increased expense.

Warping.—This is effected in so many different ways that it is practically impossible to estimate the cost save to given particulars. The various methods may be summed up as follows:—

- (1) Warping of solid colours, usually effected by the spinner.

- (2) Two or more warps made by the spinner, but dressed by the manufacturer to pattern.
- (3) Warps made by the manufacturer to pattern upon one of the many machines used in the trade.

Evidently the type of warp will decide the cost.

Sizing or Slashing varies very considerably in the wool and cotton trades. In the former trade animal size only is put on according to the roughness or tenderness of the warp to make the yarn weave well, being extracted in the finishing process: in the latter case size is put on not only to facilitate weaving, but also to weight the cloth. Thus the percentage of size to cloth may be taken as follows:—

For a light size	10	per cent.
For a medium size ..	50	„
For a heavy size	200	„

According to the price and weight of the various ingredients used in the composition of the size, and the percentage, will the cost, then, be estimated.

Dressing.—This is often effected along with the warping and sizing, on machines specially constructed for the work. With warps received in the “ball form,” however, dressing and beaming imply extra labour.

Twisting-in, Looming, and Sleying.—Having sized, dressed, and beamed the warp, it must now be drawn through the mails in the shafts or harness.

There are two methods of effecting this—firstly, by twisting or tying-in the fresh warp to the end of a previous warp, left in the mails with this idea; secondly,

by arranging the shafts or harness in a convenient manner for drawing the threads through their respective mails, and drawing-in the threads.

The prices for twisting or tieing-in will be less than the prices for drawing-in, since a good man may twist in about 2,000 threads, or tie-in about 1,000 threads per hour. In straight draft he will probably draw-in under 1,000 threads per hour, and with fancy drafts fewer, in accordance with the complication of the draft.

The price for twisting or tieing-in is based upon so much per 1,000 ends for say an ordinary yarn. Thus, taking 20's or 30's worsted, the ordinary price is from 5d. to 6d. per 1,000 for twisting-in ordinary solid colours. Variation from this occurs in twisting-in coloured patterns, or yarns of a different counts. Thus the following gives an idea of the ratio :—

Twisting-in a 1,000 ends 30's twist	=	5½d. to 6d.
„ 1,000 „ coloured pattern	=	6d. to 6½d.
„ 1,000 „ 40's	=	5d. to 6d.

Tieing-in should be charged more than twisting-in, owing to decreased speed; but varying prices are charged according to the district.

The cost of drawing-in is also reckoned upon a similar basis, but there is considerable variation, according to the simplicity or otherwise of the draft. Thus, while 9d. per 1,000 is paid for straight gait for 4 shafts, about 1s. 1½d. per 1,000 would be paid for a fancy draft, say 16 shafts.

Twisting-in in the loom, 1d. per 1,000 addition to the above.

Sleying is generally included in payment for twisting-in; or, separately, 4d. per 1,000 ends ordinary, 9d. per 1,000 ends, 1 in a reed.

COST OF WEAVING.

If there is variation in the foregoing items, still more will there be cause for variation in the cost of weaving. The following are the principal modifying influences:—

- (1) Breadth of Loom, or reed space.
- (2) Number of looms attended to by one weaver.
- (3) Speed of looms.
- (4) Type of loom, whether plain or box, and also whether tappet, dobby, or jacquard loom.
- (5) Type of work.
- (6) District in which cloth is to be woven.

Of course all these depend more or less upon one another, but some idea of the complexity of the question may be gained from the perusal of the above.

Payment is made in the several great centres of the weaving industry in many ways: thus, while the worsted trade follows the Lancashire system, based upon the price per pick per $\frac{1}{4}$ in. to the standard given below, the woollen trade has a system of its own, based upon the price per string of 10 feet. Again, when dealing with fancies, it is well-nigh impossible to fix any definite price; and particularly is this so in the case of fancy woollen and worsted fabrics.

The following particulars will give an idea of the cost of weaving in the various districts:—

Lancashire Cotton Trade.—The standard is an ordinarily-made loom, 45 inches reed space, measured from the fork grate on the one side to the back board on

the other, weaving cloth as follows:—Width: 39, 40, or 41 inches. Reed: 60 reed, two ends in one dent, or 60 ends per inch. Picks: 15 picks per $\frac{1}{4}$ inch, with $1\frac{1}{2}$ per cent. for contraction. Length: 100 yards of 36 inches, measured on the counter. Twist: 28's, or any finer number. Weft: 31's to 100's, both inclusive. Price: 30d., or 2d. per pick.

Deductions or additions are made for variations in reed width, reeds, picks, type of yarn, weave, and splits.

Worsted Trade.—Here the variation is very considerable, as already intimated, but the following particulars give an idea of the cost:—

Broad plain loom	6 $\frac{1}{2}$ d. to 7d. per $\frac{1}{4}$ picks, 70 yards
Broad box loom	1s. to 1s. 3d. " "
Narrow plain loom	1 $\frac{3}{4}$ d. to 2d. " "
Narrow circular box loom	2 $\frac{1}{4}$ d. to 2 $\frac{3}{4}$ d. " "

Again, there is in vogue a system of paying by the weight per yard, thus:—

- (1) For 80 yards worsted warp, 18 to 24 oz., say 7d. per $\frac{1}{4}$ picks. Thus, in a piece with 60 picks per inch = $60 \div 4 \times 7 = 8s. 9d.$ per piece.
- (2) For 80 yards worsted warp, 10 oz. to 14 oz., 6d. per pick. Thus, in a piece with 60 picks per inch = $60 \div 4 \times 6 = 7s. 6d.$ per piece.

The number of looms attended to by one weaver varies from one to two, according to the work.

Woollen Trade.—In the woollen districts, owing to the great variety of work—viz., cotton warps, worsted warps, woollen warps, with all possible variety in weft—the prices vary very considerably, but the cost is usually

calculated by the string of 10 feet. The looms employed may be divided into two classes, broad and narrow, the following giving an idea of the price lists:—

Broad plain loom	6d. to 7d. per string
Broad box loom	7d. to 9d. „
Narrow (Dandy) plain loom	2d. to 3d. „
Narrow (Dandy) circular box loom..	3d. „

The number of looms attended to by one weaver varies from one to two, according to the work.

The Cost of Finishing Textile Fabrics.—The cost of finishing any given piece of cloth will depend upon the processes to which it must be submitted. The following are the possible operations:—Perching, burling and mending, scouring, milling in the stocks or on the machine, dyeing, bleaching, crabbing, steaming, singeing, lustring, raising or brushing, cropping, tentering, cuttling and pressing, calendering. The expense will depend entirely upon which of the above operations the piece is submitted to. The following list for wool goods gives an idea of the expense of dyeing and a light finish. If milling, etc., operations are needed the expense will be greater.

WOOL GOODS LIST.

Type of cloth.	Weight.	Woaded blacks.	Common colours.	Fine colours.
Wool twill (66 yds.)	42 lb.	12/-	16/-	20/-
Wool twill (66 yds.)	20 lb.	6/-	7/6	11/-

If less than 200 yards to a shade, 3s. per shade extra. Excess of length, width, or weight charged extra in proportion.

The operations to which silk, cotton, linen, etc., goods are submitted will depend entirely upon the type of cloth, colour, and kind of finish required.

An example of the cost of production in each case will probably demonstrate all that is further desirable in a treatise of this type.

EXAMPLE I.—Find the cost of a cotton cloth made to the following particulars: 60's/60's, 73/59; that is:—

Warp,

All 60's cotton.

73 reed.

Weft.

All 60's cotton.

14.75 picks per $\frac{1}{4}$ inch.

Add 30 ends for selvage to warp.

Warp $45\frac{3}{4}$ inches in reed, $148\frac{1}{2}$ yards long; then:—

$$\frac{(73 \times 45\frac{3}{4} + 30) \times 148\frac{1}{2}}{840 \times 60} = 9.93 \text{ lb. of warp,}$$

And

$$\frac{45\frac{3}{4} \times 59 \times 148\frac{1}{2}^*}{840 \times 60} = 7.96 \text{ lb.}$$

Thus:—

	£	s.	d.
9.93 lb. of warp at 10s. per lb.	0	8	4
7.96 lb. of weft, at 10s. ,,	0	6	8
Cost of yarn	£0	15	0
Cost of yarn	0	15	0
9 $\frac{3}{4}$ lb. of warp sizing, at $\frac{1}{4}$ d. per lb.	0	0	2 $\frac{1}{2}$
Twisting-in 3,342 ends, at 6d. per 1,000..	0	1	8
Cost of weaving 1 $\frac{1}{2}$, at 2d. per pick	0	3	9
Finishing 148 yards, at	0	3	0
Total cost of production	£1	3	7 $\frac{1}{2}$

Or about 2d. per yard.

* No allowance is made here for contraction of the warp in weaving; thus unless the plan gave a weft rib structure, less than 148 yards of cloth would result from 148 yards of warp, as shown in the succeeding examples.

EXAMPLE II.—Find the cost of a worsted cloth made to the following particulars :—

Warp.

All 2/40's botany.
16's reeds 4's.

Weft.

All 26's botany.
64 picks per inch.

Length of warp, 70 yards; reed width, $32\frac{1}{2}$ inches; grey length of cloth, $64\frac{1}{2}$ yards; finished length of cloth, $61\frac{1}{2}$ yards. Then :—

$$\frac{64 \times 32\frac{1}{2} \times 70}{20 \times 560} = 13 \text{ lb. of warp,}$$

And

$$\frac{64 \times 32\frac{1}{2} \times 64\frac{1}{2}}{26 \times 560} = 9\frac{1}{10} \text{ lb. of weft.}$$

Then :—

	<i>£</i>	<i>s.</i>	<i>d.</i>
13 lb. of warp, at 2s. 8d.	1	14	8
$9\frac{1}{10}$ lb. of weft, at 2s. 6d.	1	2	9
Warping	0	0	6
Sizing and dressing	0	1	1
Twisting-in or looming	0	1	0
Weaving, at 2d. per $\frac{1}{4}$ pick	0	2	8
Total cost of cloth.....	£3	2	8

An addition might be made to the above particulars, as follows :—

	<i>s.</i>	<i>d.</i>
Warping	0	6
Sizing and dressing.....	1	1
Twisting-in or looming	1	0
Weaving, at 2d. per $\frac{1}{4}$ pick	2	8
General expenses.....	2	0
Expense upon loom.....	1	3
	8	6

Or three times the weaving expenses, to cover everything save cost of material and finishing. Thus:—

$$2s. 8d. \times 3 = 8s.$$

In addition to this there is the expense of "finishing," which varies considerably. A piece to be dyed, for example, will cost more than a piece simply to be finished; and a piece to be milled will take more time, and consequently will be more expensive, than a piece simply finished.

In this example an addition of 3s. 6d. for cost of finishing may be made; thus:—

	£	s.	d.
Cost of cloth	3	2	8
Finishing	0	3	6
	£3 6 2		

And $61\frac{1}{2}$ yards costing £3 6s. 2d. = 1s. 1d. per yard.

In order to further demonstrate the practical application of the principles demonstrated in this book, a rather more complicated cloth may be taken, and the calculations based upon the principles laid down as follows:—

EXAMPLE III.—Detailed examination of the finished cloth reveals the following construction:—

Warp.

1 thread equal to 17's = $2/34$'s botany (for face).
 1 " " 11's = $2/22$'s " (for back).
 134 ends per inch.

Weft.

All equal to 17's, or $2/34$'s botany.
 66 picks per inch.

The plan is Design XV., page 58.

This is the cloth as placed on the market ; so before the cost of the cloth can be decided, the counts of both warp and weft as woven, and the ends and picks per inch, must be ascertained upon the principles laid down. Here are also involved the woven and finished widths, and the calculations for length of warp, length of piece in the grey, and length of cloth finished.

(1) FIND THE COUNTS OF BOTH WARP AND WEFT IN THE GREY.—Thus, taking List IX., No. 4, as a guide :—

As 27 : 28 :: 17 . 18's, or 2/36's for face warp and weft.
As 27 : 28 :: 11 : 12's, or 2/24's for back warp.

(2) FIND THE SETT AS WOVEN.—Thus, according to the calculation on page 186 for $2-\frac{2}{2}$ twill, the take-up will be $\frac{1}{11}$ th, or generally estimated 10 per cent. ; thus, if the cloth is taken as a narrow width, from 28 to 29 inches, then :-

As 100 : 110 :: 29 :: $32\frac{1}{2}$ inches in reed.

And

As $32\frac{1}{2}$: 29 :: 134 : 120 ends per inch woven.

That is, to 60 face threads and 60 backing threads per inch.

(3) FIND THE LENGTH OF WARP FOR $43\frac{1}{2}$ YARDS OF CLOTH.—The allowance here will be best made for the face cloth, which interweaves $2-\frac{2}{2}$ twill, giving a take-up of $\frac{1}{11}$ th. Thus :—

$43\frac{1}{2}$ yards + $\frac{1}{11}$ for take-up + 2 yards for waste in tyeing-in,
etc. = 50 yards of face warp.

The length of backing warp to interweave 8-end sateen with the weft will be $\frac{1}{30}$ (page 186) added to the finished cloth ; thus :—

$43\frac{1}{2} + \frac{1}{20}$ for take-up + 2 yards for waste = 48 yards of backing warp.

$$(4) \text{ WEIGHT OF FACE WARP} = \frac{60 \times 32\frac{1}{2} \times 50}{560 \times 18} = 9\frac{3}{4} \text{ lb.}$$

$$(5) \text{ WEIGHT OF BACKING WARP} = \frac{60 \times 32\frac{1}{2} \times 48}{560 \times 12} = 14 \text{ lb.}$$

$$(6) \text{ WEIGHT OF WEFT} = \frac{105 \times 60 \times 48 \times 32\frac{1}{2}}{100 \times 18 \times 560} = 9\frac{3}{4} \text{ lb.}$$

The $\frac{105}{100}$ in this calculation is the allowance for waste in weft. The 60 is the picks per inch as woven, found by the relative lengths of the cloth finished and warp in loom; thus:—

As 48 : $43\frac{1}{2}$:: 60 : 60 picks per inch, as woven.

Having obtained these particulars, the weight per yard will be:—

$$\begin{array}{r} 9\frac{3}{4} \text{ lb. of face warp.} \\ 14 \text{ lb. of backing warp.} \\ 9\frac{3}{4} \text{ lb. of weft.} \\ \hline 32\frac{1}{2} \text{ lb. total.} \end{array}$$

And deducting $\frac{1}{8}$ th for weight lost by loss of oil, fibre, etc., and $\frac{1}{2}$ lb. for warp left in gears, less weft it should have had, etc., thus:—

$$(32\frac{1}{2} \text{ lb.} - \frac{1}{8}) - \frac{1}{2} \text{ lb.} = 27\frac{1}{2} \text{ lb.}$$

And $43\frac{1}{2}$ yards of cloth weighing $27\frac{1}{2}$ lb. = about 10 oz. per yard.

This is, if anything, too light, but in wool goods, within reason, the weight may be increased by milling-up to a greater extent in length, and, if necessary, tentering out in width.

(7) THE COST OF THIS CLOTH MAY BE CALCULATED ON THE FOLLOWING BASIS:—

	£	s.	d.
(1) $9\frac{3}{4}$ lb. of 2/36's face warp at 3s.	1	7	9
(2) 14 lb. of 2/24's back warp at 2s. 9d. . .	1	18	6
(3) $9\frac{3}{4}$ lb. of 2/36's weft, at 3s.	1	7	9
(4) Warping (warps made by spinners at above rates)			—
(5) Sizing and dressing	0	2	6
(6) Twisting-in, 4,000, at 6d. per 1,000 ..	0	2	0
(7) Weaving, at 7d. per $\frac{1}{4}$ pick, or $3\frac{1}{2}$ d. for this as a split-up	0	3	$1\frac{1}{2}$
(8) Finishing	0	5	0

Total cost for $43\frac{1}{2}$ yards..... £5 6 $7\frac{1}{2}$

Thus, £5 6s. $7\frac{1}{2}$ d. \div $43\frac{1}{2}$ yards = 2s. $5\frac{1}{2}$ d. per yard.

There are several matters in the above that should be thoroughly considered. For example, if a cut or warp can be put in, say 560 yards, to yield 10 pieces, about 50 yards a piece, the cost of warping, dressing, and twisting-in or looming, may be considerably reduced.

Again, the yarn is taken as mixture throughout, which will be more expensive than weaving in the grey and piece-dyeing, or even slubbing or hank-dyeing; and, again, a finisher or dyer will make a considerable reduction upon a number of pieces, since they would all be practically one trouble.

EXAMPLE IV.—Find the cost of a woollen cloth made to the following particulars:—

Warp.

All 20 skein woollen.
12's reed 3's.

Weft.

All 18 skein woollen.
36 picks per inch.

Length of warp, 80 yards; reed width, 34 inches, to finish to 28 inches; grey length of cloth, 72 yards (10 per cent. upon 80 yards); finished length of cloth, 66 yards (8 per cent. upon 72 yards, or 18 per cent. upon 80 yards).

$$\frac{36 \times 34 \times 80}{20 \times 256} = 19\frac{1}{8} \text{ lb. of warp.}$$

$$\frac{36 \times 34 \times 72}{18 \times 256} = 19 \text{ lb. of warp.}$$

The following may then be taken as a general estimate of the cost of production:—

	£	s.	d.
19 $\frac{1}{8}$ lb. of warp, at 2s. 3d. per lb.	2	3	0
19 lb. of weft, at 2s.	1	18	0
Warping, 1 at 1s. 6d.	0	1	6
Sizing and dressing, 1 at 2s. 6d.	0	2	6
Twisting-in or looming, 1,300, at 9d. per 1,000	0	1	0
Weaving, 24 strings, at 3d. per string ..	0	6	0
Burling, mending, etc.	0	3	0
Scouring and milling	0	2	6
Finishing proper	0	3	0

Total cost of cloth..... £5 0 6

And 66 yards, costing £5 os. 6d. = 1s. 6 $\frac{1}{4}$ d. per yard.

The above expenses are calculated as though the piece were woven as a “split-up,” *i.e.*, in a broad loom, alongside another which will be separated from it, or “split-up” during the finishing.

No allowance for general and loom expenses is made in the above calculations.

From the four examples given a fair idea of the method of calculating the cost of cloths may be obtained; but, as already shown, in the fancy trade there are so many influences modifying the cost that any standard price is impossible, though a little common

sense should render the ascertainment of the approximate cost, comparatively speaking, easy.

One or two cases where expense in production may be reduced may be further noted.

Suppose a designer has submitted to him a dozen fancy patterns, and is required to produce say 60 yards of cloth to each pattern: then he should examine the patterns carefully to see whether any of the warps are alike. If so, there will be no need to re-set the creel in warping, while the quantity of each kind of yarn (both warp and weft) may be ordered in larger batches, and thus probably obtained at a less price.

Again, it may possibly happen that two of the pieces have different warps, but the same weft, under which conditions the two pieces may be woven side by side in a "split-up."

Then, extra expense might be caused by the "stitching," *i.e.*, the threads floating either on the back or face of the cloth, instead of interweaving. Certain weaves are specially liable to this, so the designer who has his wits about him may either produce the same piece perfect by a different arrangement, or by a modification of the weave, thus facilitating the work, and consequently reducing the expense; and, lastly, as already pointed out, it is quite possible to produce the same size twill or other weave by a modification of weave and sett in combination.

These are only a few of the points, but they are sufficient to show that the man who would approach perfection in his work must, indeed, have his eyes open, and be on the alert to seize every advantage.

APPENDIX II.

FABRICS DIFFICULT TO ANALYSE.

There are two classes of fabrics in analysing which something more than care and application are necessary. These are respectively the Meltons or hard-milled cloths; and the fine-sett fabrics, usually silk, with hundreds of ends to the inch, of such fine yarn that judgment and experience only can solve the construction.

HARD-MILLED CLOTHS.

The Melton cloth is the typical representative of this class, but there are many others, such as beavers, doe-skins, tweeds, etc.

Taking, however, the Melton as an example will practically include all the others.

Upon endeavouring to extract a few threads or picks it is found that there are practically no threads or picks intact, they having been "burst" during milling, so that altogether a felt type of structure is obtained.

Now the experience of the analyst becomes of great service. He must use his judgment to an extent hardly dreamed of by those engaged in the other branches of the textile trades, since the successful construction of a Melton requires judgment in the selection of material, in the spinning, in the twisting, in the weave structure, and in the finishing, and without detailed consideration of all these points failure is almost certain.

Selection of Material.—Although all the processes through which the wool will have to pass will influence very considerably the milling of the resultant cloth, it is very certain that unless a wool capable of milling well is selected, whatever is done in the subsequent processes will be more or less in vain. Both the curves, serrations, and physical structure of the wool influence its shrinkage, so that some wools such as Saxony, Silesian, or any of the finer botany wools should be selected, perhaps excepting Cape wool, which is rather deficient in milling property.

Spinning.—In spinning, a typical woollen thread should be aimed at, and in order to facilitate this the material should be condensed as fine as possible, so that upon the mule there will be little drafting, and consequently few straight fibres in the thread.

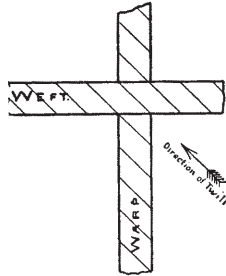
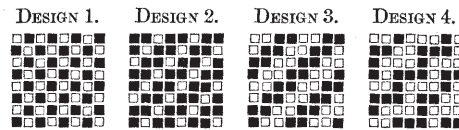

DIAGRAM A.

Twisting is one of the most important matters for consideration. To begin with, note should be made that the milling property on any given thread will decrease according to the twist inserted; thus, yarns for Meltons

must be twisted as slack as is compatible with fair weaving qualities. An equally important matter is the direction of the warp and weft twist. As will be realised from Diagram A, if the yarns are twisted in opposite directions, upon coming together in the loom the twists do not coincide, as invariably stated in text books, since it is the *back* of the weft pick which rests upon the *top* of the warp threads. Thus, for these goods, warp and weft should be twisted in the *same direction*; thus the weft will bed well into the warp, improving to a very considerable extent the milling capabilities.

Weave Structure.—There are a great variety of weaves suitable for producing the Melton, but, of course, the selection must be made according to the type of



Melton that may be required. Thus, Designs 1 and 2 are frequently used for the production of what is termed the "cotton-warp Melton," which is a low type of dress fabric; while for the really heavy Melton overcoating, some such weave as Design 4, which is really a double cloth, should be employed. Again, if the weave effect be not obliterated, the piece is considered faulty, so that if Design 2 or Design 3 be selected, the twill should be in the same direction as the twist in the warp and weft, indicated by the arrow in Diagram A. As demonstrated previously, the cloth must be sett and woven very open in the loom to ensure efficient milling.

Finishing.—During finishing the Melton must be subjected to rather severe treatment, both in the stocks and in the machine, the former tending to burst the fibre, and the latter to mill-up the cloth both in length and width.

In the heavier Meltons the operation of stiffening is performed, simply consisting of running the piece through a mixture of soap and flour, and then cracking the compound by the addition of hard water. Washing-off is finally effected in hard water, and the usual operations follow.

If, then, the analyst is required to reproduce a Melton, the above briefly indicated points must be attended to and allowed for in all calculations. The difficulties are great, but common sense, with very little practice, will soon teach what may be expected.

Cross-band and Open-band Effects.—Some very effective patterns are produced by means of cross-band and open-band yarns, *i.e.*, yarns twisted to the left

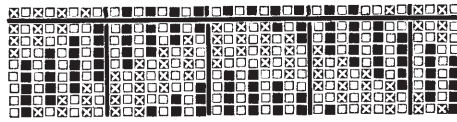

and to the right hand respectively. In the design given, if the warp is made

1 thread cross-band,
1 „ open-band,

the result is that, although the piece may be woven in the grey and dyed black, yet on examination after finish-

ing, there is seen to be developed a decided twill, as it were, of dark and light black.

The difficulty in producing these goods is that, owing to the warp being all of one colour, the weaver will piece-up cross-band with open-band, and open-band with cross-band yarn. In order to avoid this, one of the yarns, either the cross-band or the open-band, should be stained.

FINE-SETT FABRICS.

A short acquaintance with silks reveals that very frequently extremely fine yarns and setts are employed, which it is impossible to accurately count, and therefore the extent of the flushes, weaves, etc., cannot be ascertained. Under these circumstances, depending upon past experience, a sett must be supposed, say 250 ends per inch, and a suitable counts taken, say 160's spun silk = $160 \times 840 = 134,400$ yards per lb. Then, with compasses, the various weave flushes may be measured, and the extent of the flush calculated.

EXAMPLE.—By measurement the weft flush in a weave is found to be $\frac{1}{3}$ th of an inch; what number of ends is the weft flushing over?

$$250 \text{ ends per inch} \div \frac{1}{3} = 10 \text{ ends,}$$

And so on with any flushes.

APPENDIX III.

THE SELECTION OF DESIGN PAPER.

In reading through the text of this work reference will frequently be found to variously squared design paper, a few samples of which are here given :—

No. 289 is the ordinary 8×8 design paper, most frequently employed, owing to the fact that the great majority of cloths are woven on the square upon jacquards, in which the needles are arranged in rows of eight.

No. 408 is another 8×8 paper, with a ground weave already on, which may or may not prove useful. It is larger, and consequently better to work upon than No. 289.

No. 141 is the 12×12 paper, used in designs for a 600 jacquard, in which the needles are arranged twelve in a row.

No. 5 is divided into 8×4 , and thus will be suitable for end and end warp or weft backed cloths, and extra warp or weft figured cloths, thus allowing the figure to be sketched on the square.

No. 294 is an 8×12 paper, suitable for two-and-one backing, or figured cloths.

No. 293 is an 8×11 paper, often suitable for gauze work.

No. 342 is a 10×10 paper, largely used in the pro-

duction of Brussels carpets. Nos. 294 and 44 may also prove what is needed in special cases for figured plushes.

These are just a few examples from the catalogue of Mr. R. C. Mounteney, Byard Lane, Nottingham, to whom, for further information, the reader is referred.

If the correct size of design paper is not at hand, the ordinary 8×8 paper may be re-divided into the required numbers, say 8×11 , and the figure sketched out of the square upon it, as shown in the accompanying figure and design.

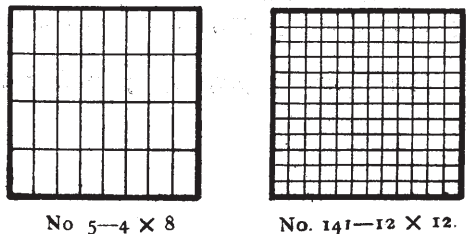
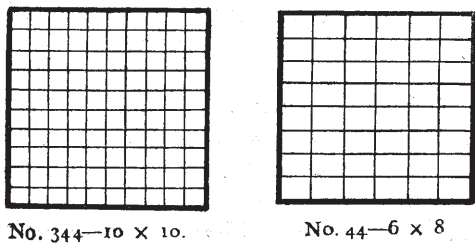
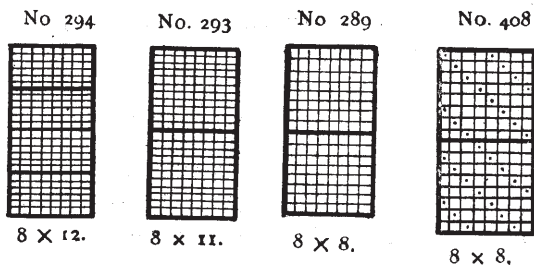

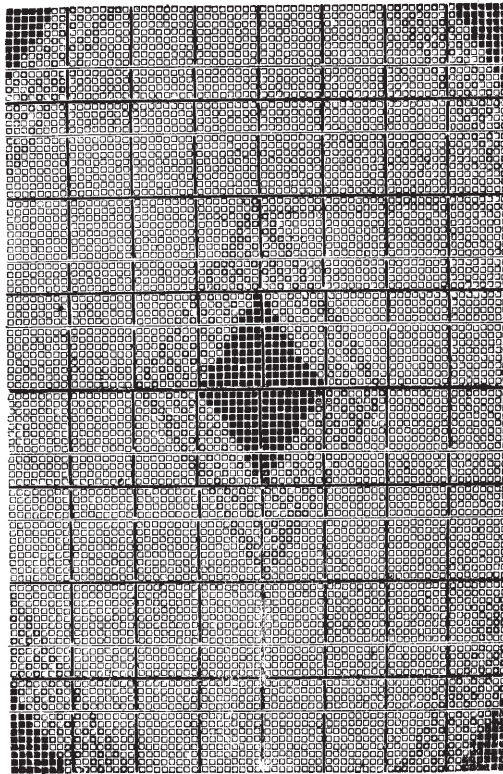
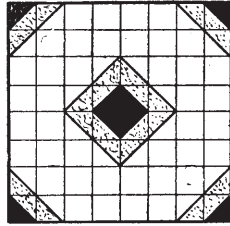

AVOIRDUPOIS WEIGHT.

16 drams.....	=	1 oz.
16 oz.	=	1 lb.
†14 lb.	=	1 stone.
4 quarters (112 lb.)....	=	1 hundredweight.
20 hundredweight.....	=	1 ton.

† Very frequently 16 lb. is calculated to the stone, although the practice is not to be commended.

GRAIN WEIGHT TABLE.

27·343 grains..	=	1 dram avoirdupois.
437·5 ,, ..	=	1 oz.
7,000 ,, ..	=	1 lb.