

Fig. 441.

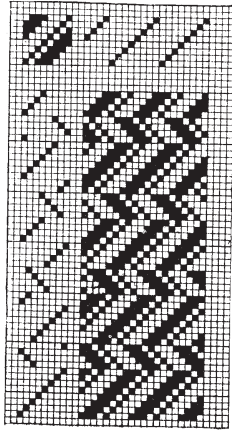

Fig. 442.

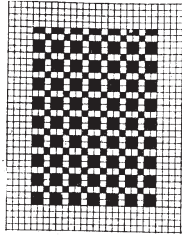

Fig. 445.

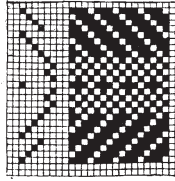

Fig. 446.

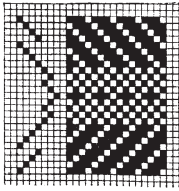

Fig. 448a.

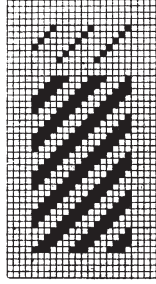

Fig. 448b.

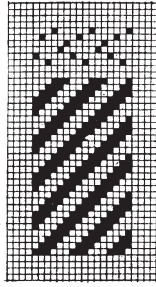

Fig. 443.

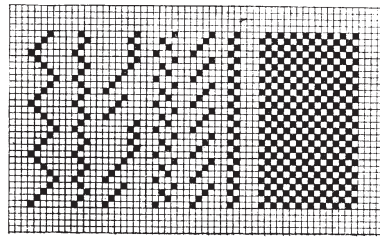

Fig. 444.

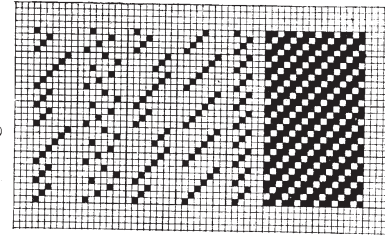

Fig. 447a.

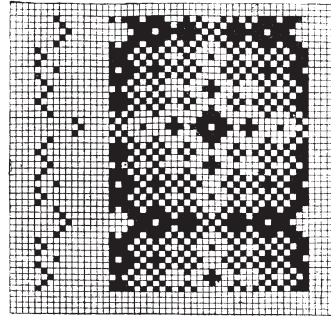

Fig. 447b.

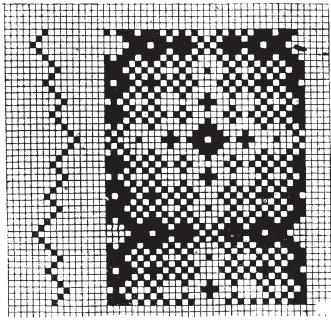

Fig. 449a.

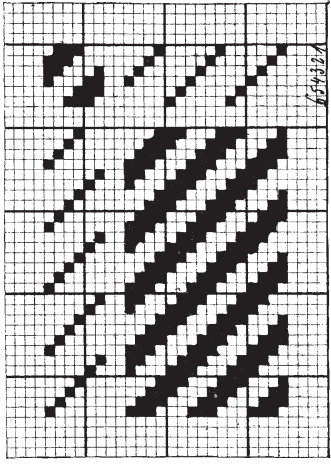

Fig. 449b.

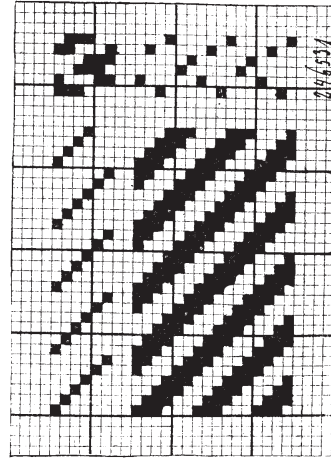

Fig. 452a.

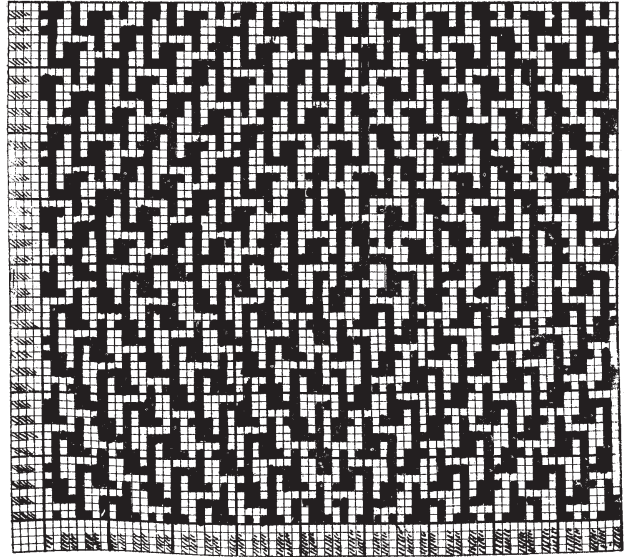

Fig. 452b.

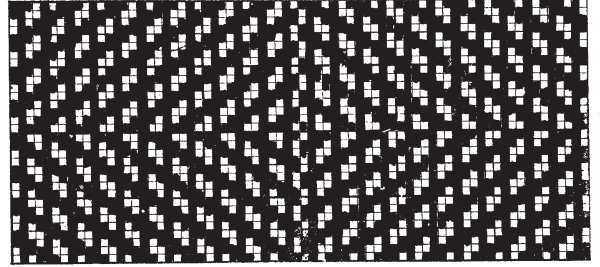

Fig. 452c.

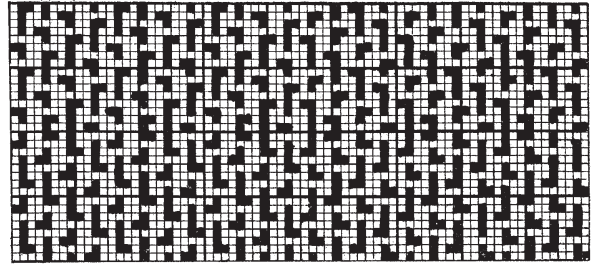

Fig. 450.

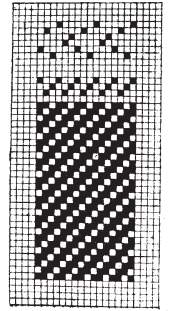
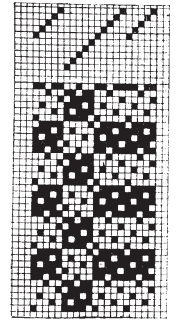

Fig. 451.



Tafel 31.  
Fig. 452d—465.

Fig. 452d.

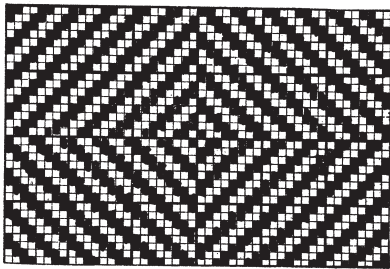

Fig. 452e.

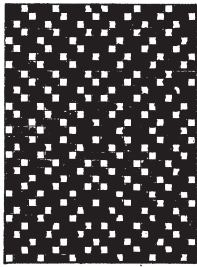

Fig. 452f.

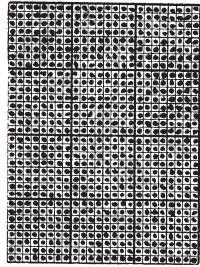

Fig. 452g.

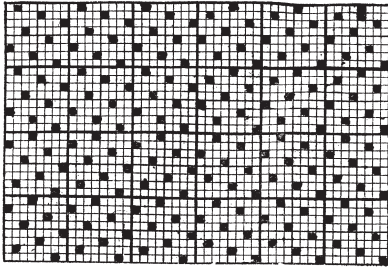

Fig. 453a.

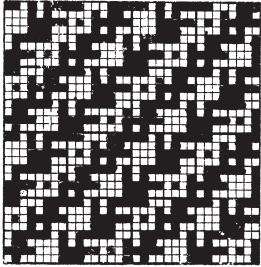

Fig. 453b.



Fig. 453c.

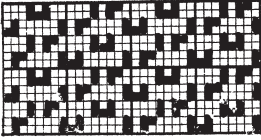

Fig. 453d.

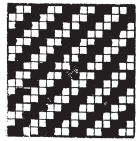

Fig. 453e.

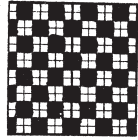

Fig. 453f.

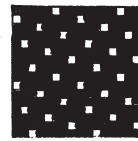

Fig. 453g.

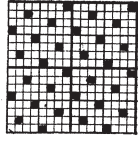

Fig. 454.

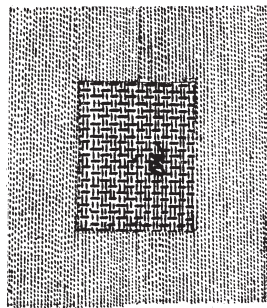

Fig. 456.

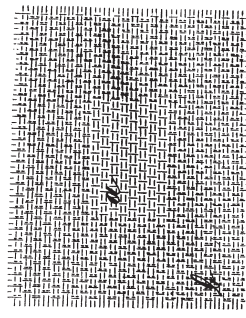

Fig. 455.

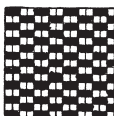

Fig. 458a—458b.

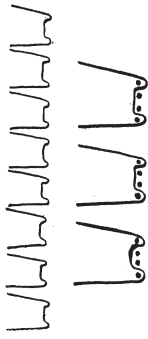

Fig. 459.



Fig. 465.

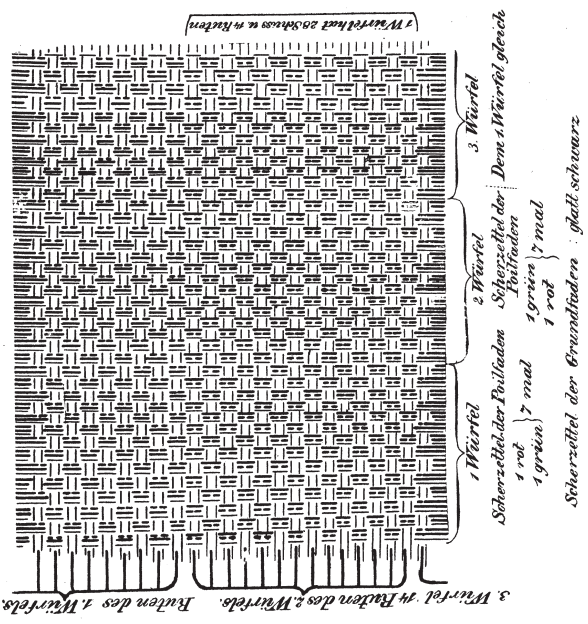

Fig. 457.

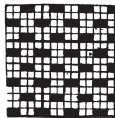

Fig. 462.

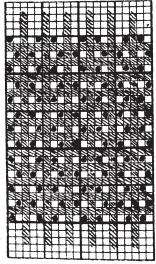

Fig. 460.



Fig. 463.

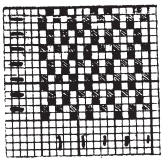

Fig. 461.



Fig. 466.

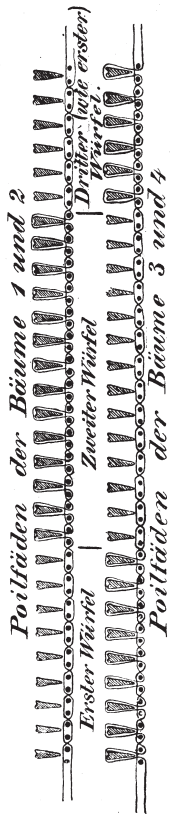

Fig. 470.

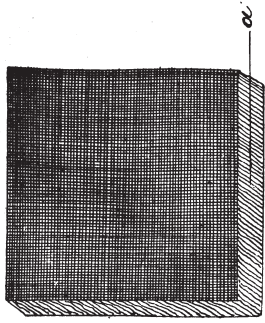

Fig. 471.

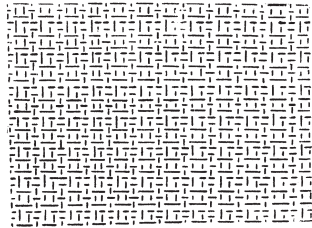

Fig. 474.

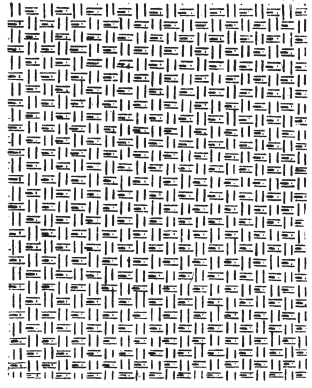
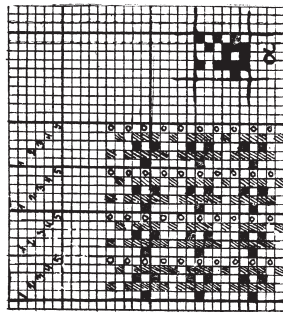

Fig. 473.



- = Mohairfäden
- = Grundfäden d. unter. Ware
- ▨ = Grundfäden d. oberen Ware
- α = Schlingpatrone

Fig. 472.

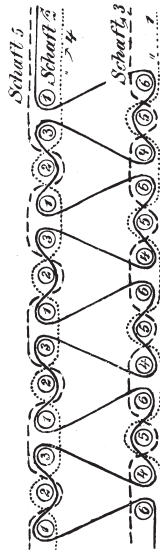

Fig. 475.

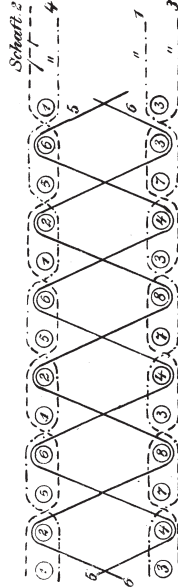

Fig. 467.

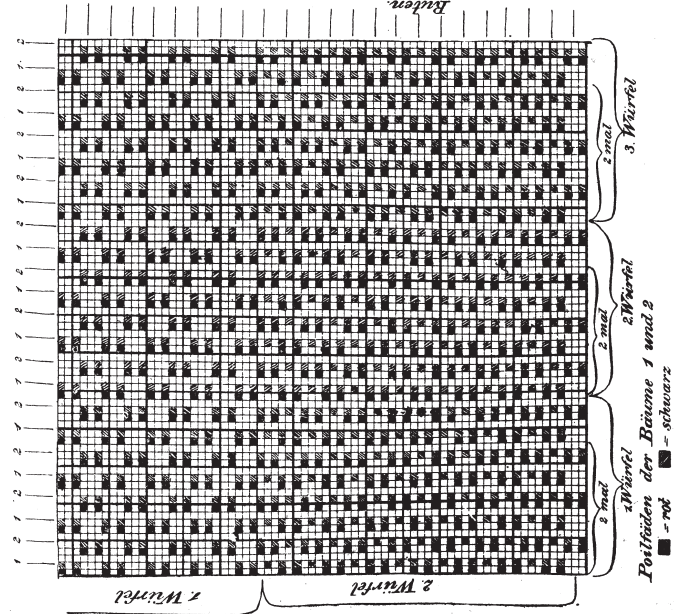

Fig. 468.

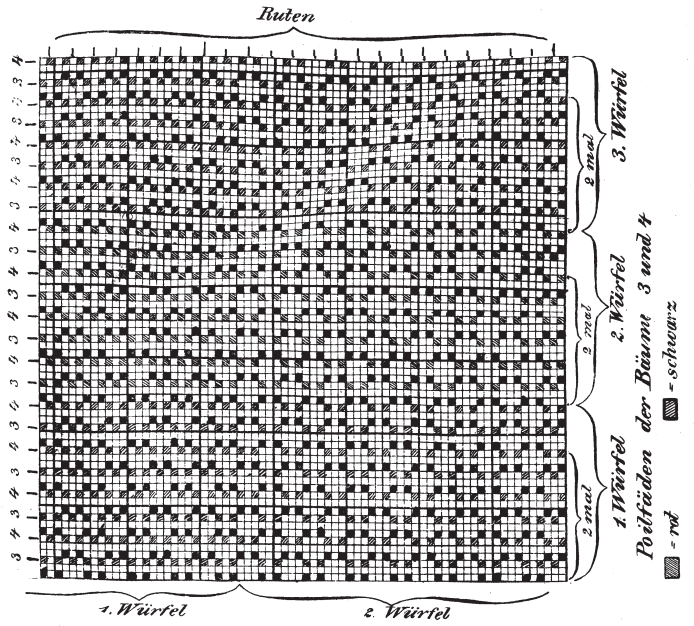

Fig. 469.

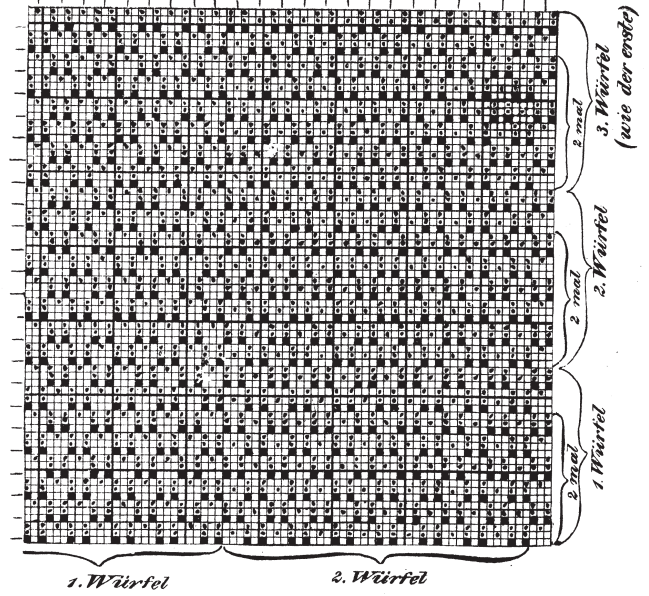

Fig. 476.

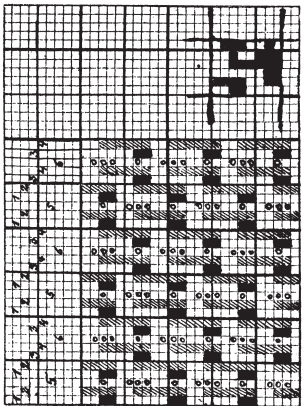

Fig. 477.

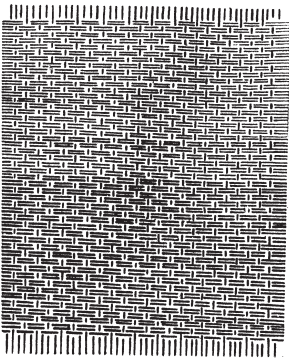
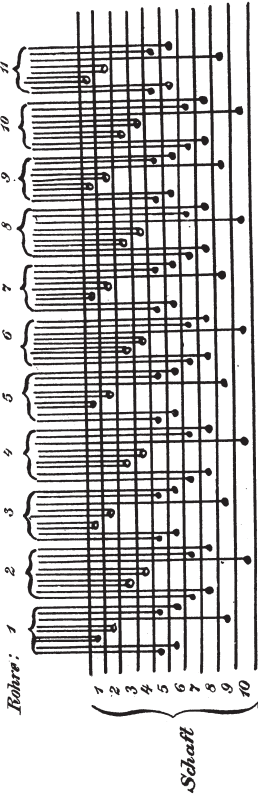

Fig. 478.



Schaff 1-4 Deckketten.  
5-8 Grundketten.  
9-10 Polkette.

Oberer Ware.  
Schaff 2, 4, 6, 8.  
Untere Ware.  
Schaff 1, 3, 5, 7.

Fig. 479.

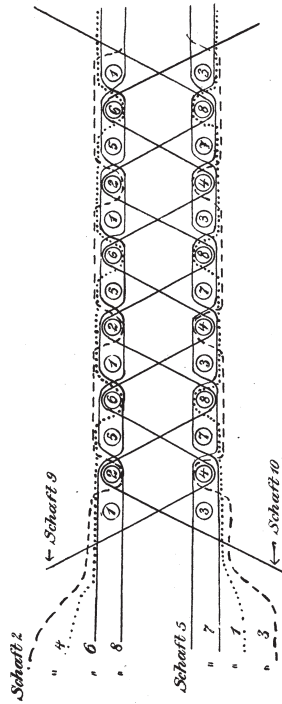

Fig. 480.

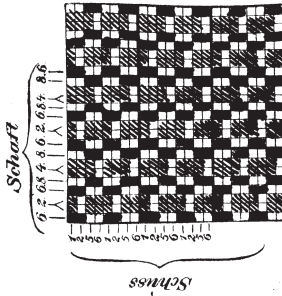

Fig. 481.

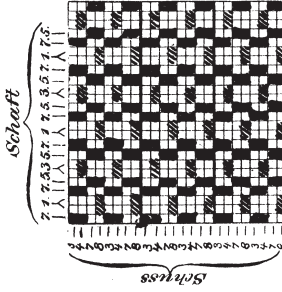

Fig. 482.

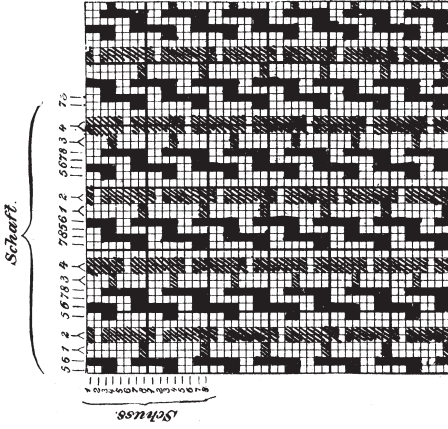

Fig. 485.

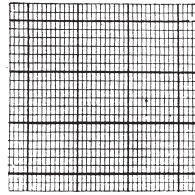

Fig. 486.

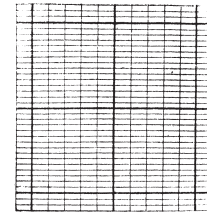

Fig. 487.

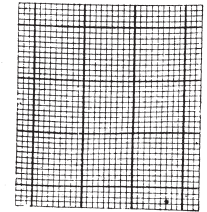

Fig. 488.

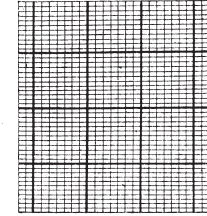

Fig. 483.

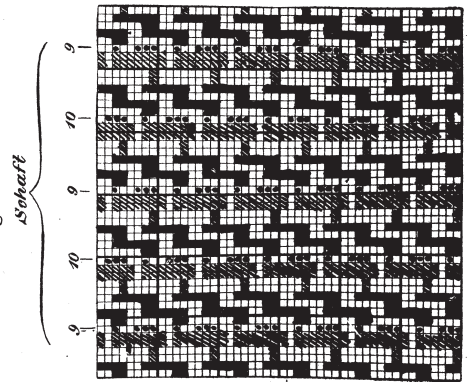

Fig. 484.



Fig. 489.

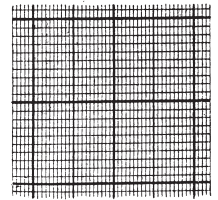

Fig. 490.

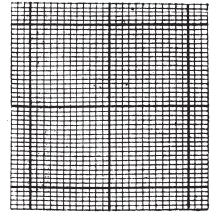

Fig. 491a.

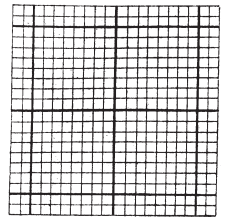

Fig. 491.

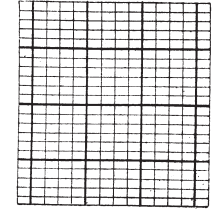

Fig. 492.

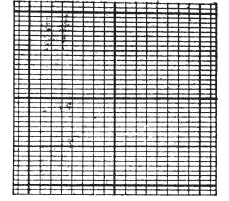

Fig. 493.

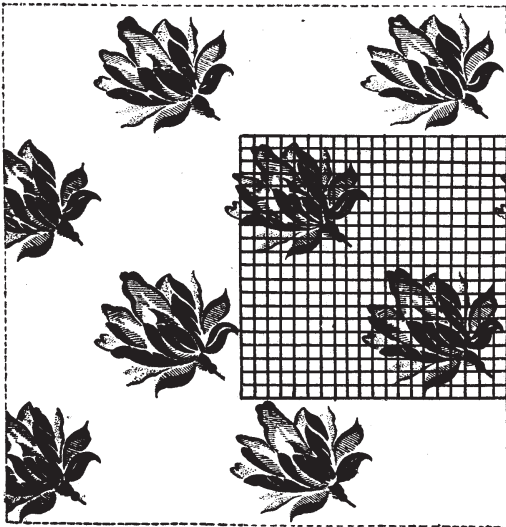

Fig. 495.



Fig. 494.

Fig. 496.

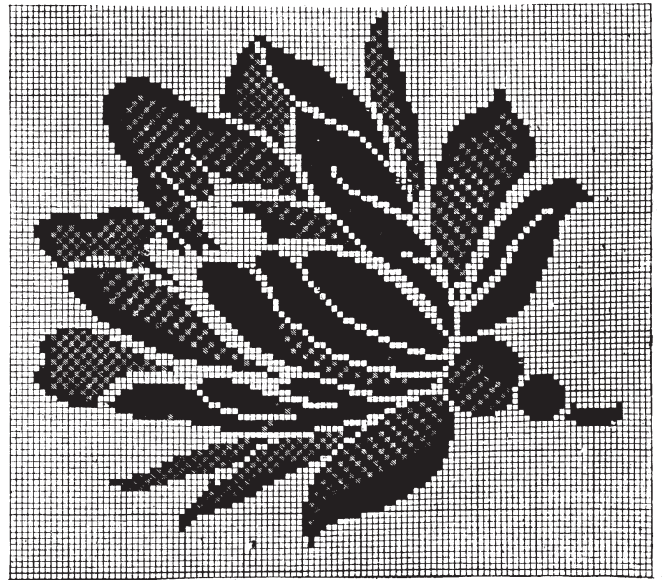

Fig. 498.

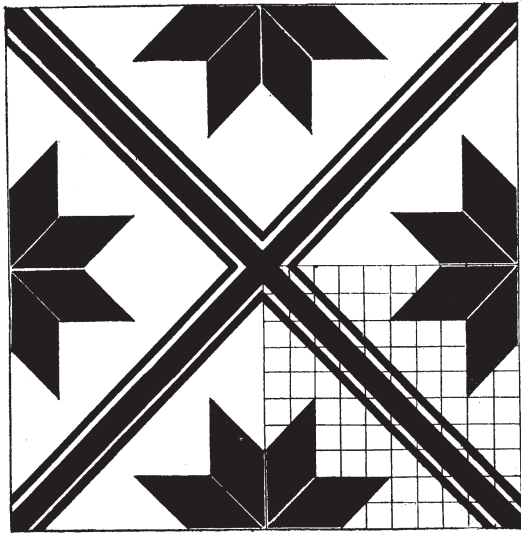

Fig. 499.

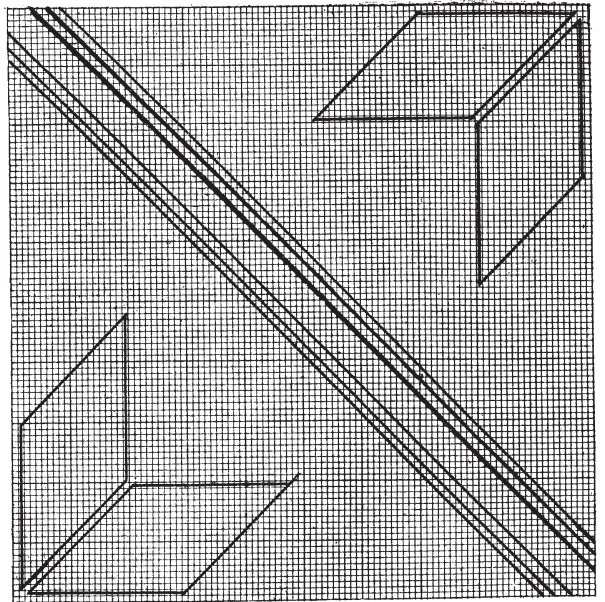

Fig. 497.



Tafel 36.  
Fig. 500—505.

Fig. 501.

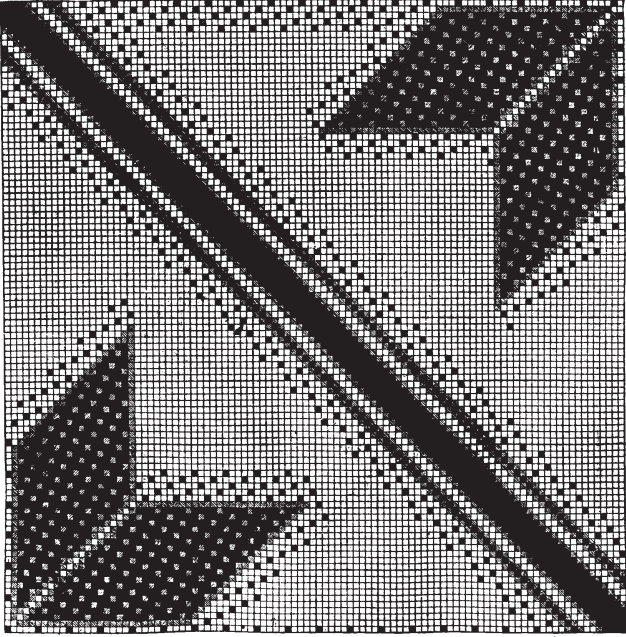

Fig. 500.

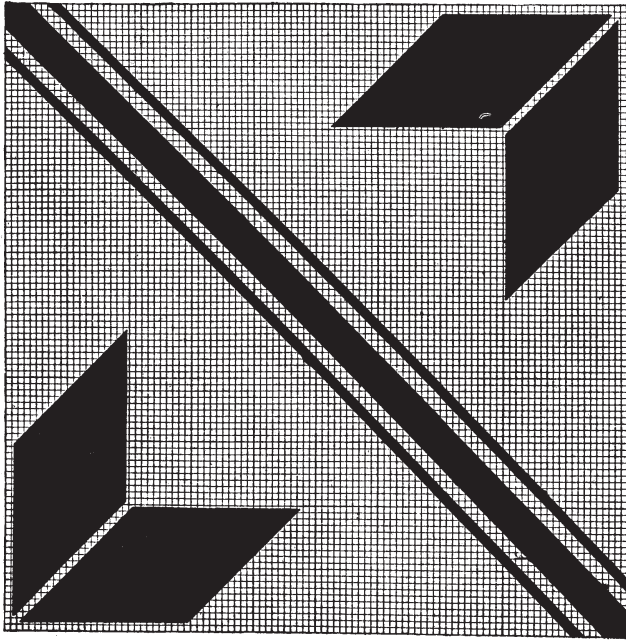

Fig. 502.

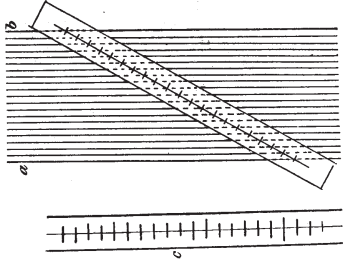

Fig. 503.

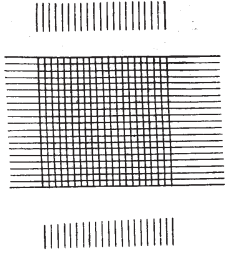

Fig. 504b.

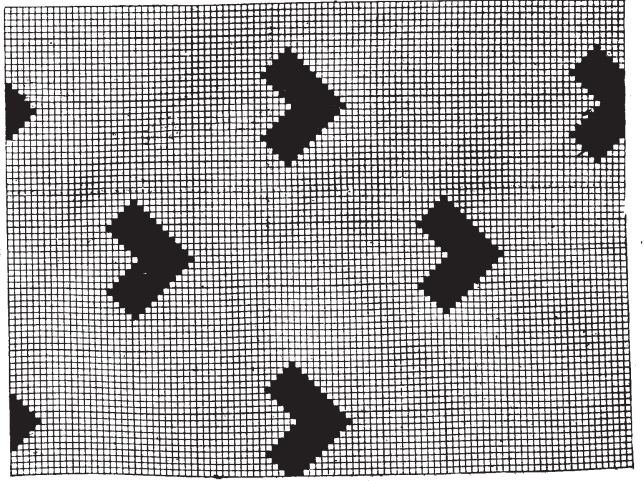

Fig. 504a.

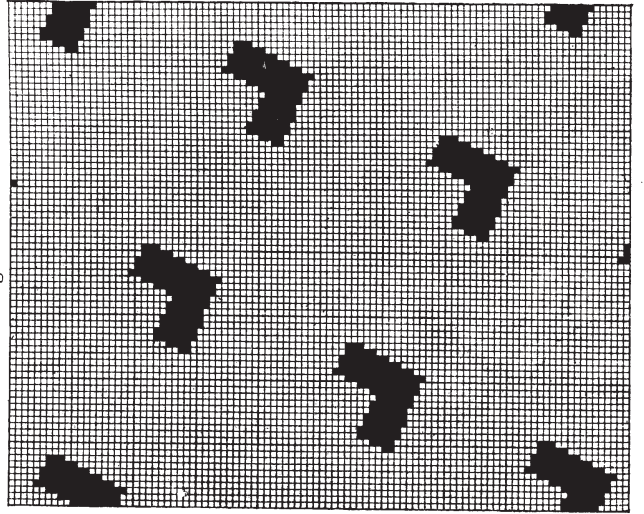
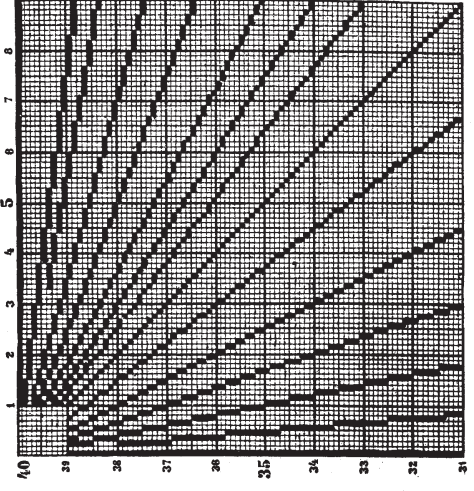

Fig. 505.



Tafel 37.  
Fig. 506—510, 513.

Fig. 508.

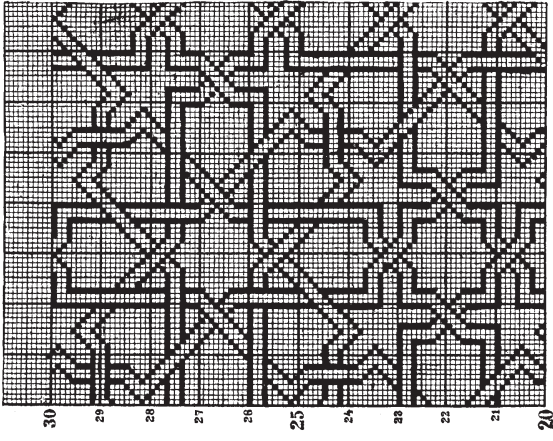

Fig. 507.

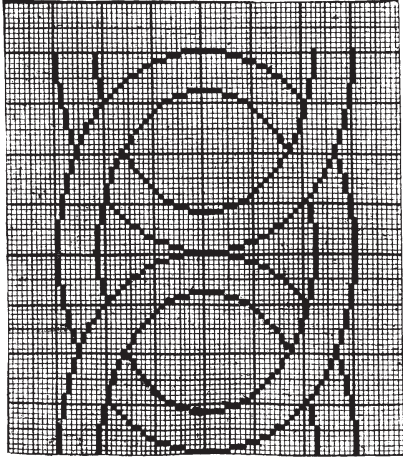

Fig. 506.

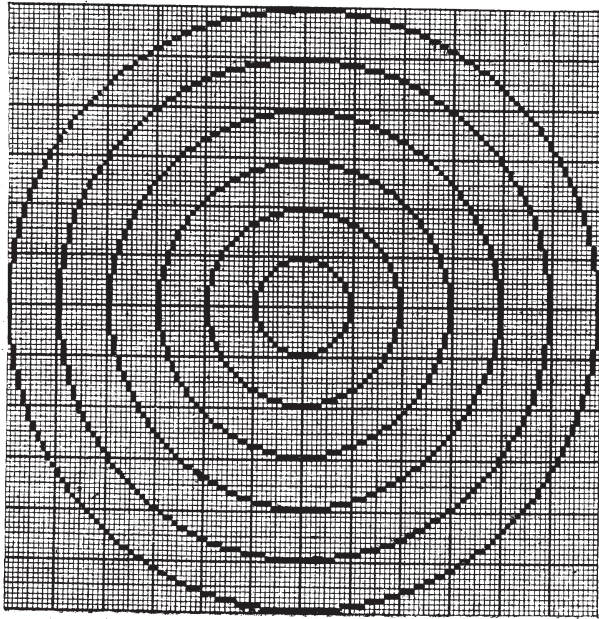

Fig. 509.

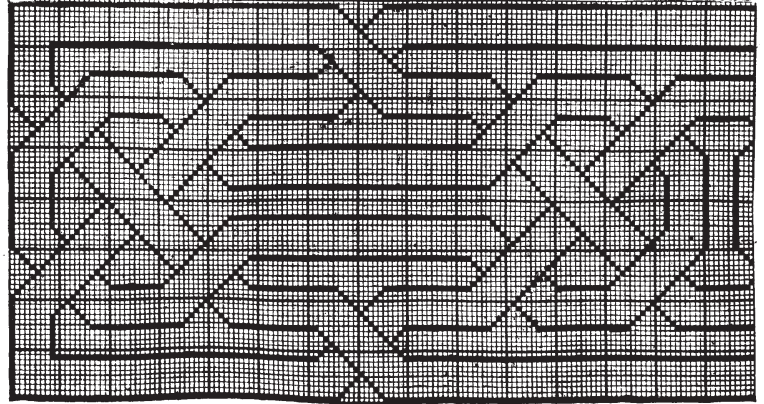

Fig. 513.

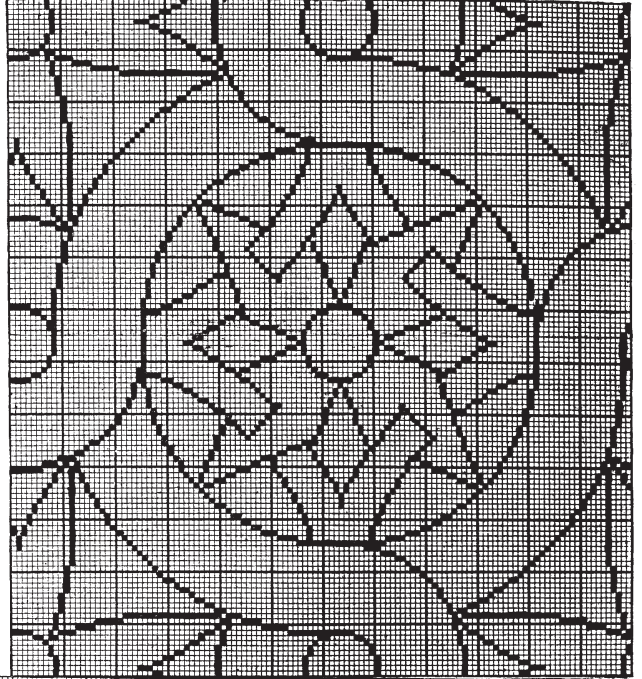
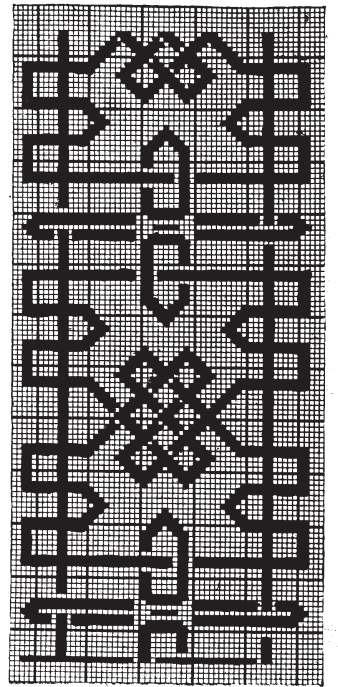

Fig. 510.





**Tafel 38.**

Fig. 511, 512, 514—519, 522, 523.

Fig. 519.

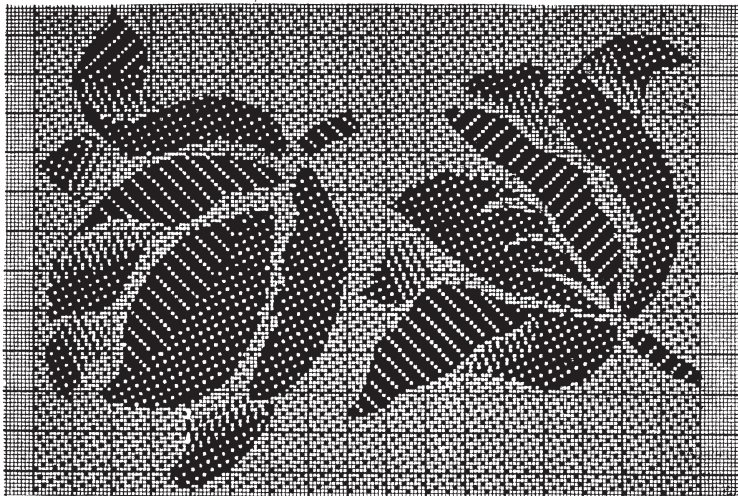

Fig. 518.

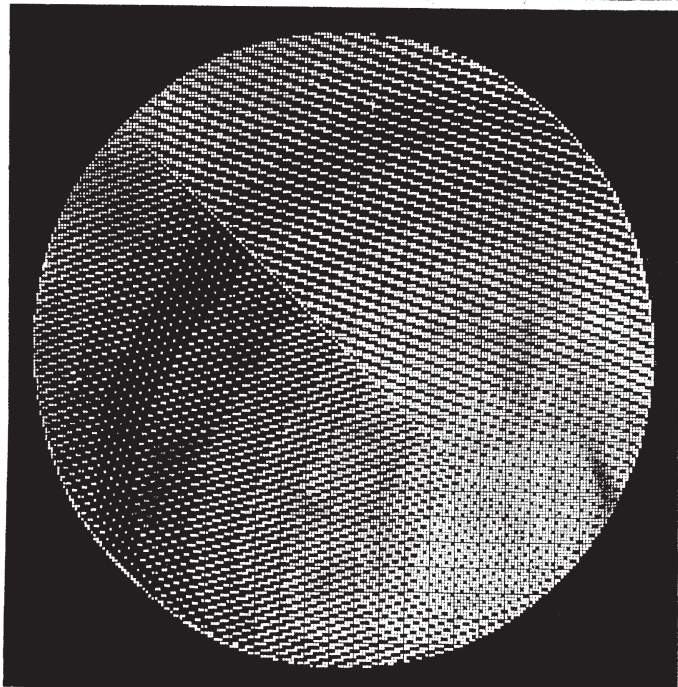

Fig. 511.

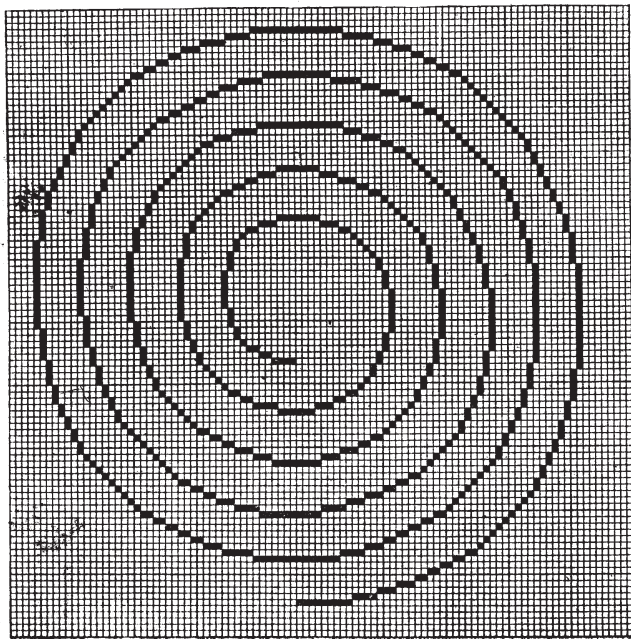

Fig. 516.

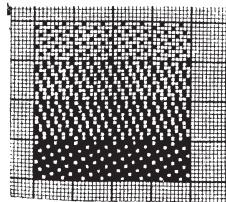

Fig. 517.

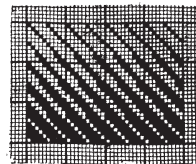

Fig. 515.

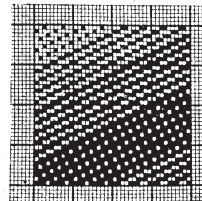

Fig. 514.

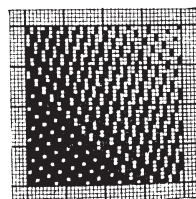

Fig. 512.

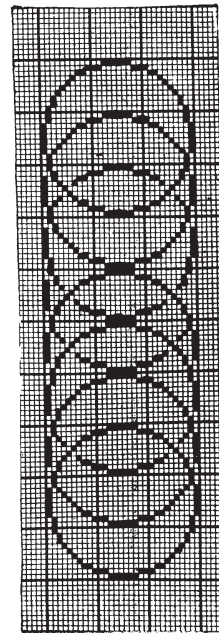

Fig. 522.

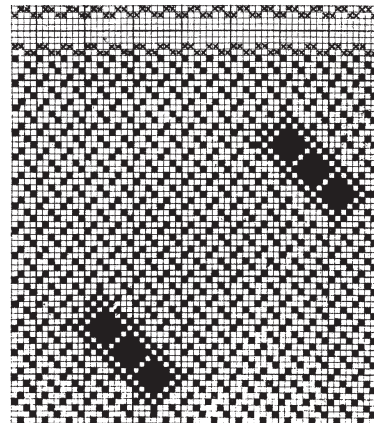

Fig. 523.

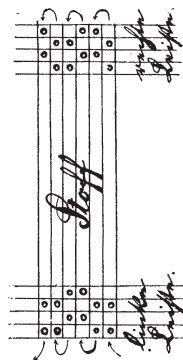

Fig. 520.

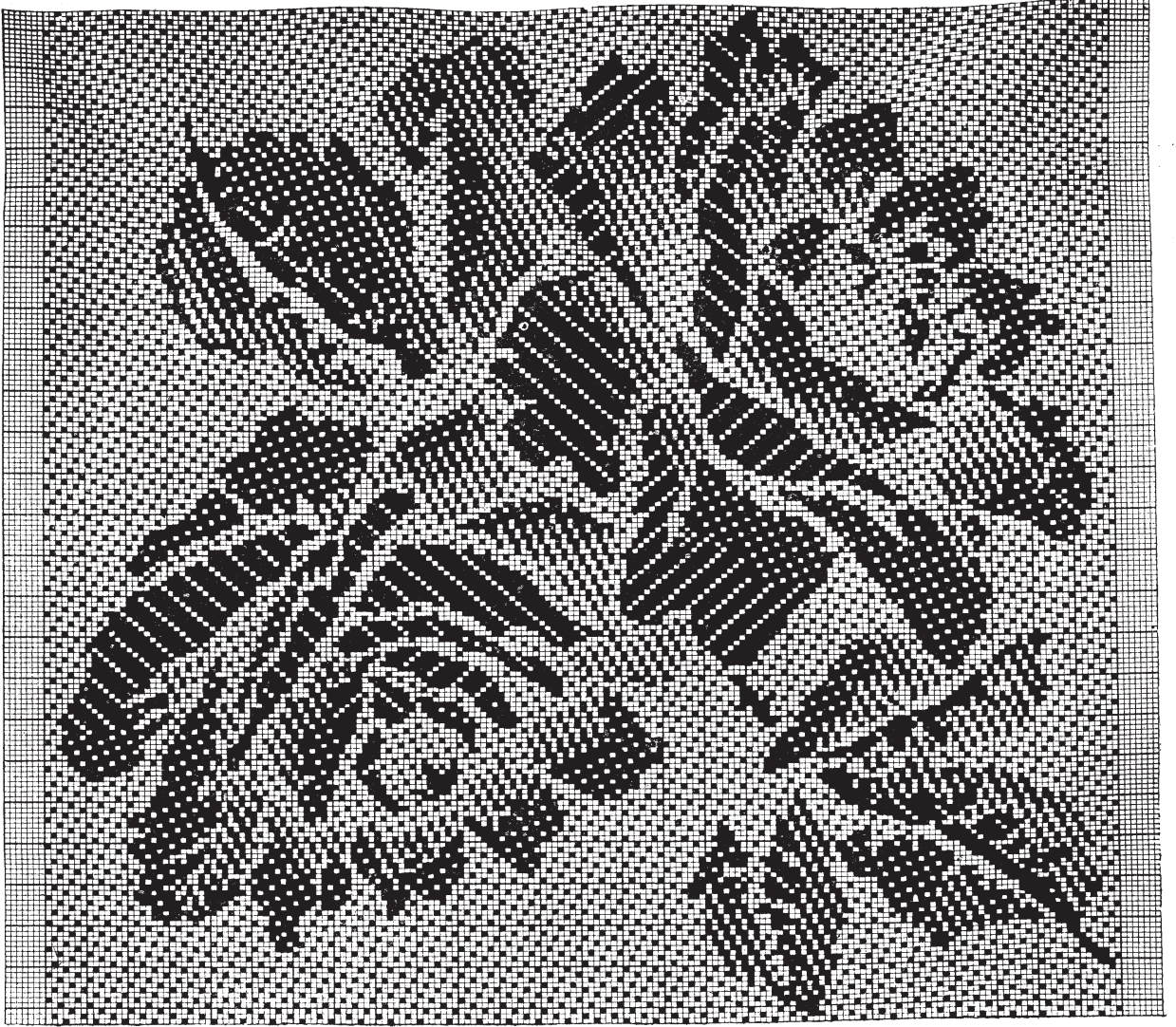

Fig. 524.

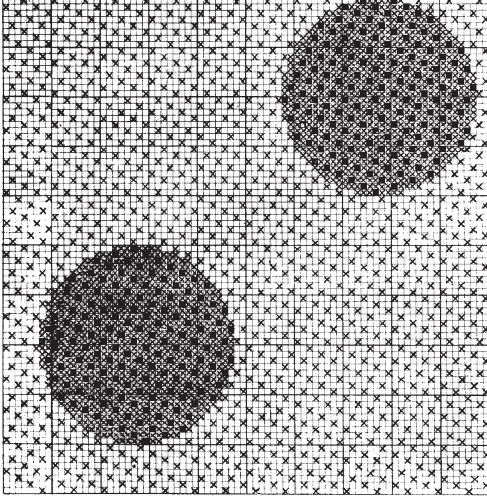
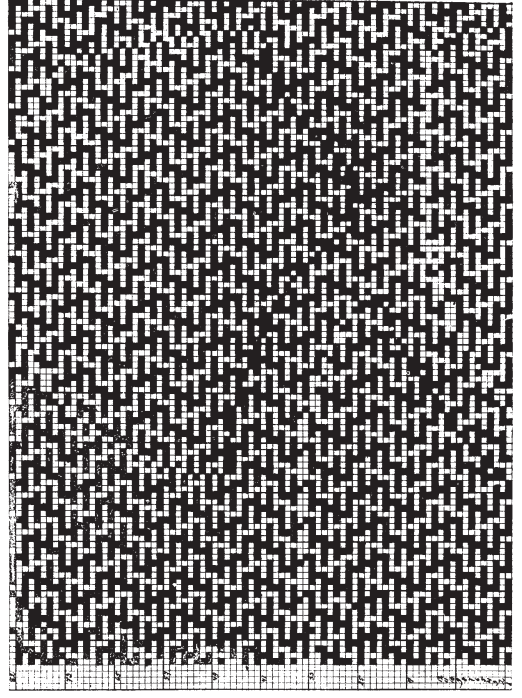

Fig. 525.



Tafel 40.  
Fig. 521.



Tafel 41.

Fig. 526—534, 536, 537.

Fig. 527.

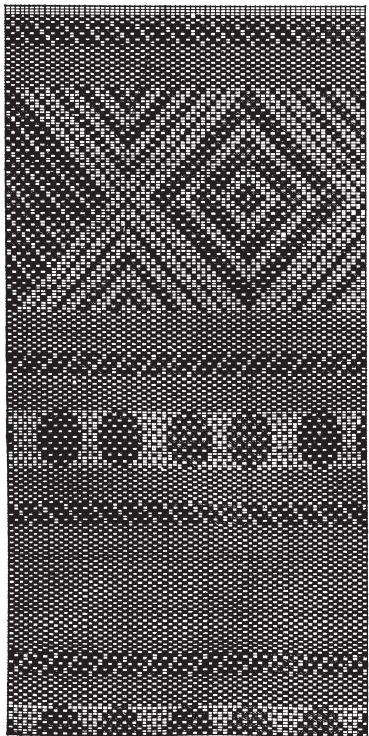

Fig. 526.

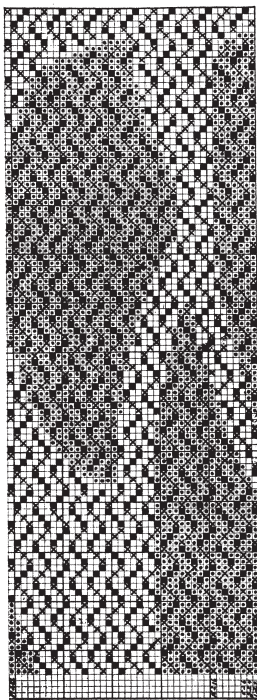

Fig. 531.

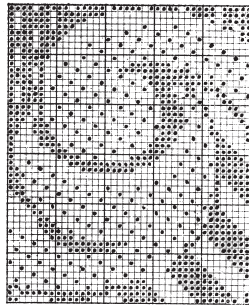

Fig. 528.

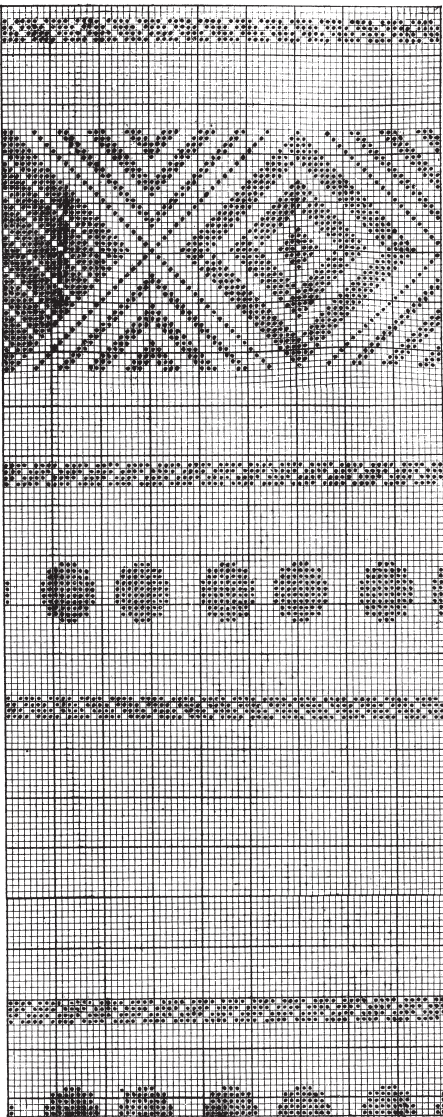

Fig. 529.

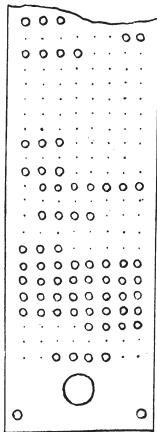

Fig. 532.

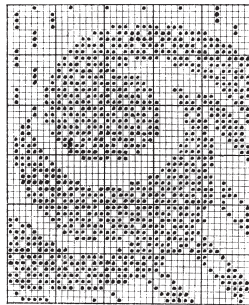

Fig. 534.

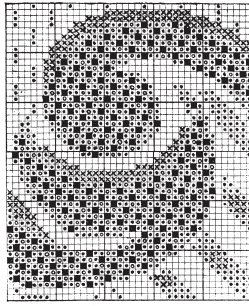

Fig. 533.

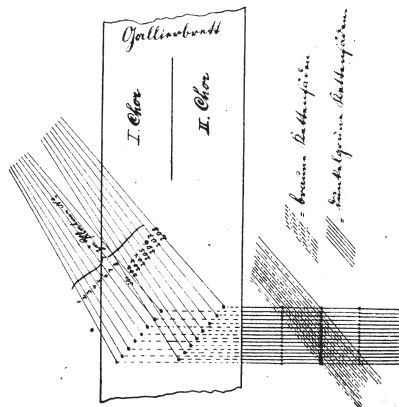

Fig. 537.

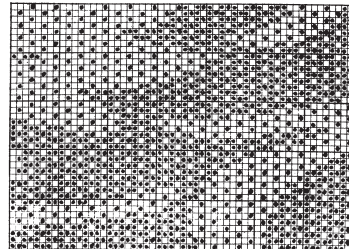

Fig. 536.

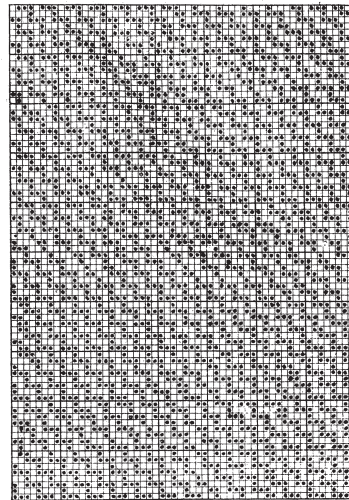
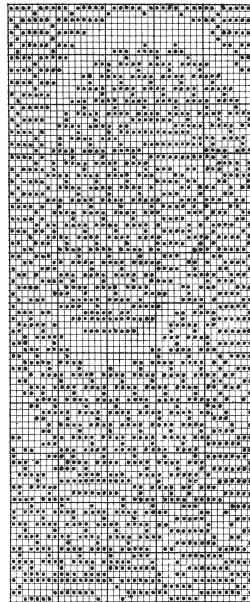

Fig. 530.



Tafel 42.

Fig. 535, 538—547, 551, 552.

Fig. 543 u. 544.

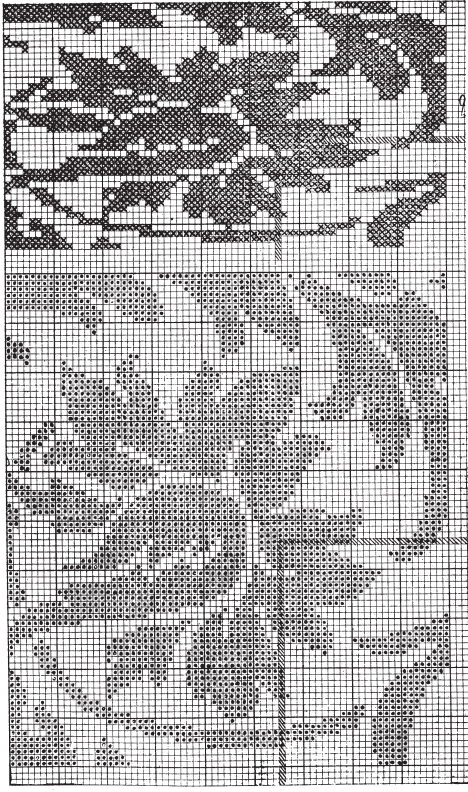

Fig. 545.

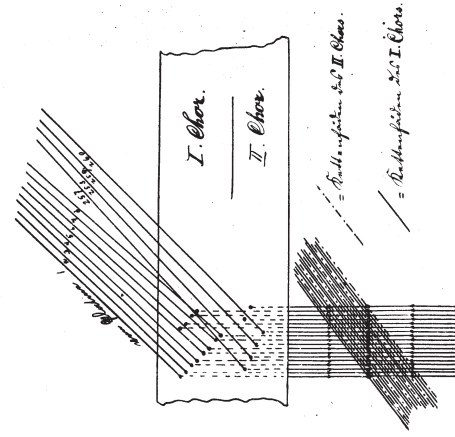

Fig. 535.

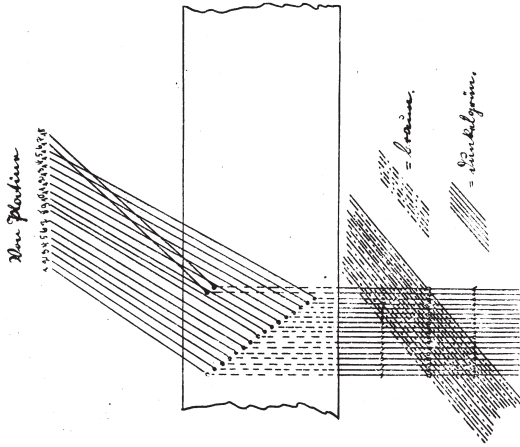

Fig. 538.

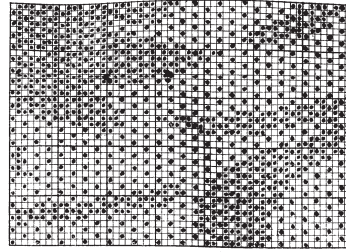

Fig. 540.

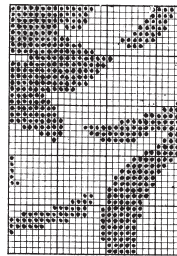

Fig. 551.

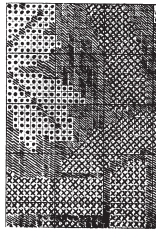

Fig. 542.

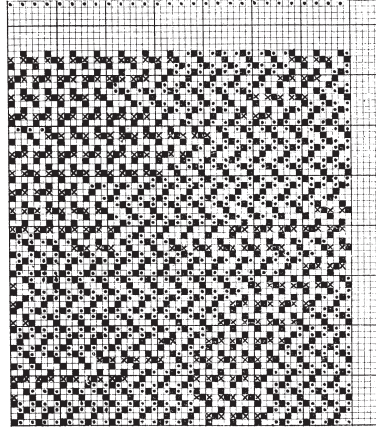

Fig. 547.

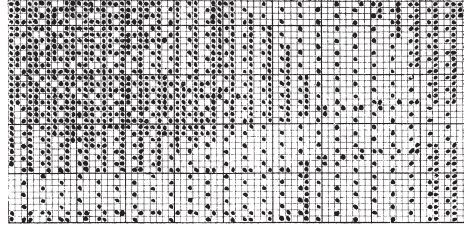

Fig. 546.

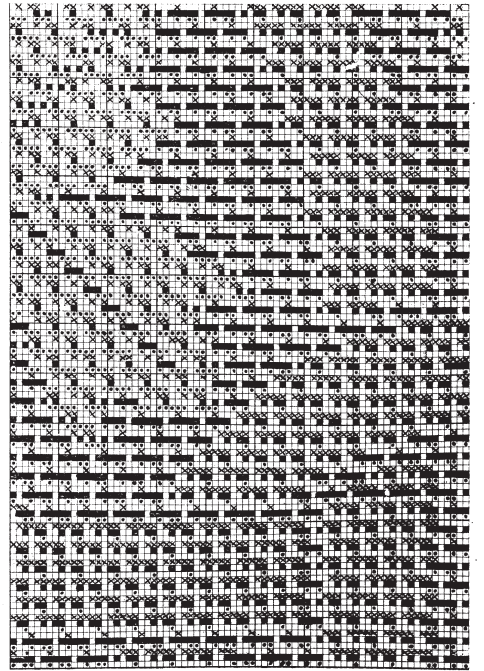

Fig. 541.

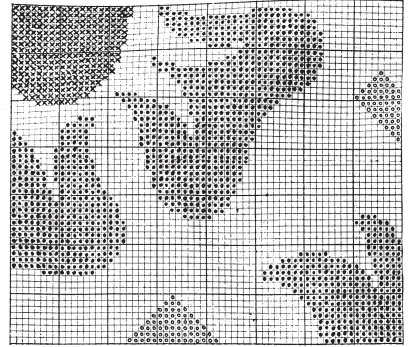

Fig. 539.

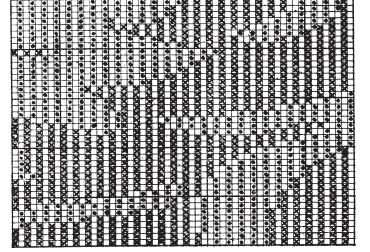
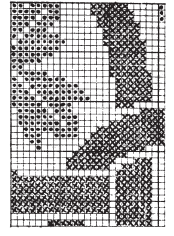

Fig. 552.



Tafel 43.  
Fig. 548—550, 553—565.

Fig. 548.

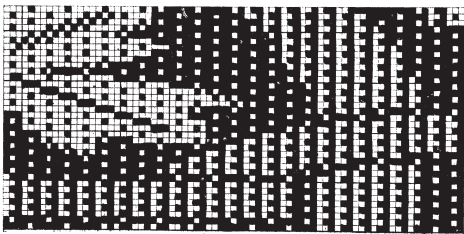

Fig. 549.

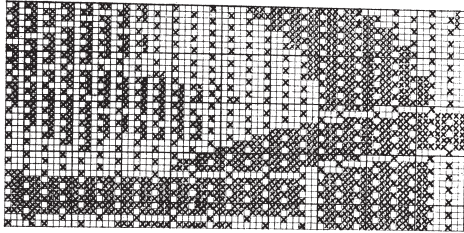

Fig. 555.

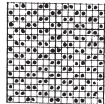

Fig. 556.

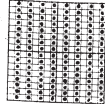

Fig. 561.

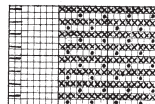

Fig. 562.

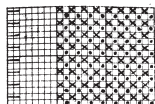

Fig. 553.

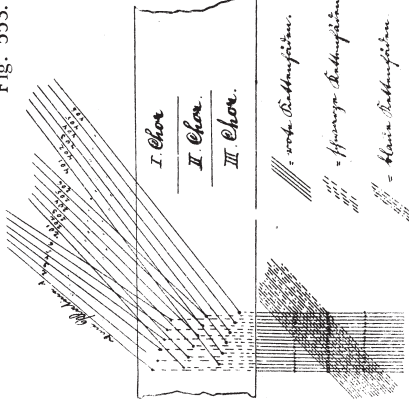

Fig. 563.

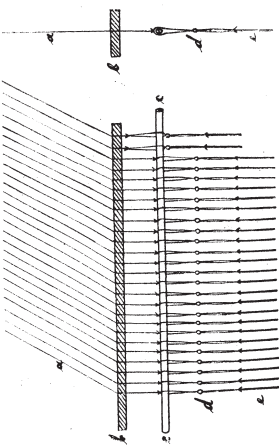

Fig. 560.

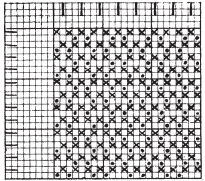

Fig. 558.



Fig. 557.

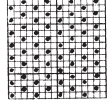

Fig. 559.



Fig. 564.

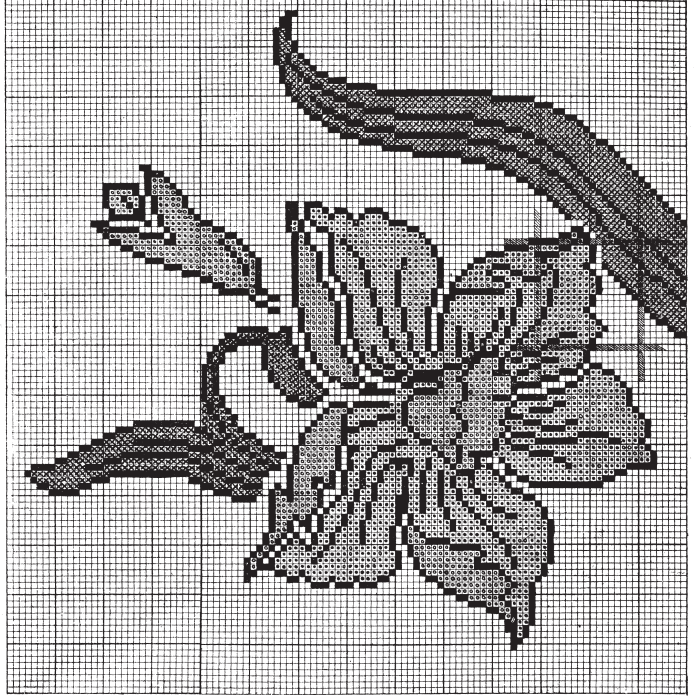

Fig. 565.

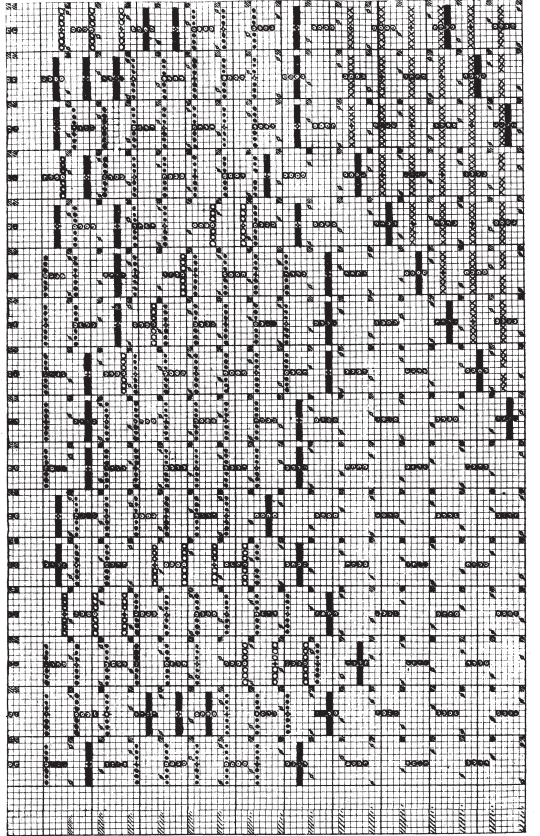

Fig. 550.

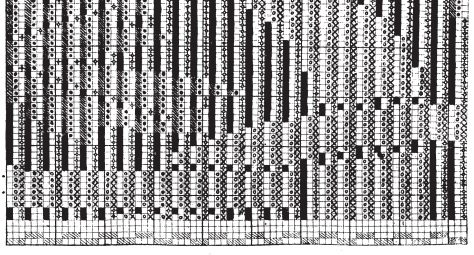

Fig. 566.

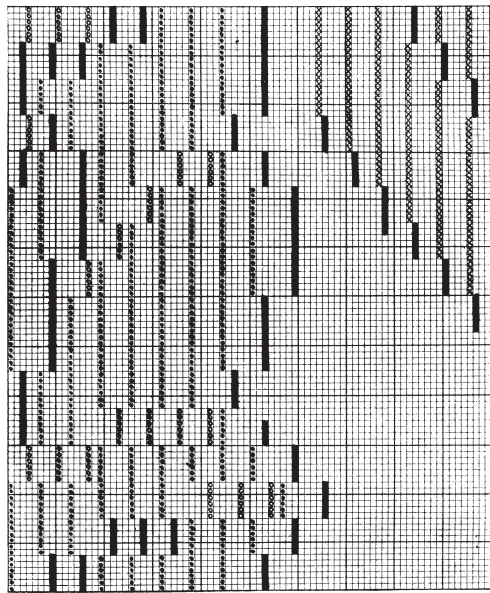

Fig. 567.

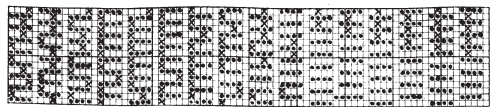

Fig. 568.

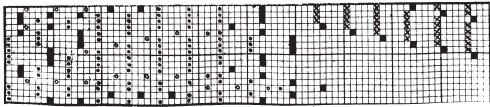

Fig. 569.

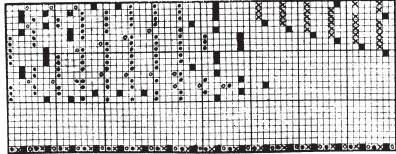

Fig. 569 a.

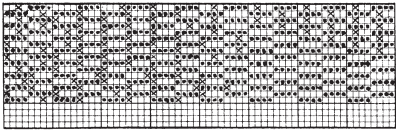
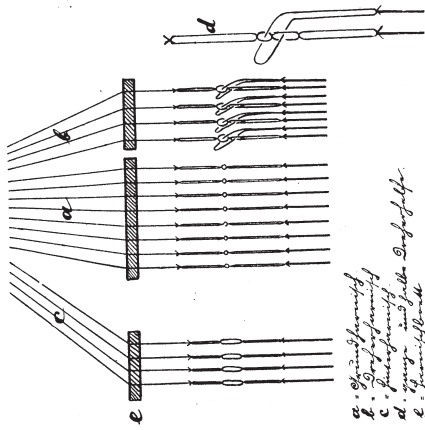

Fig. 572.



a = Drahtbaum  
b = Drahtbaum  
c = Drahtbaum  
d = Drahtbaum  
e = Drahtbaum

Fig. 570.

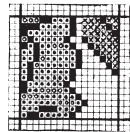

Fig. 580.

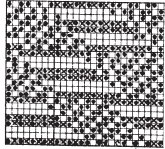

Fig. 574.

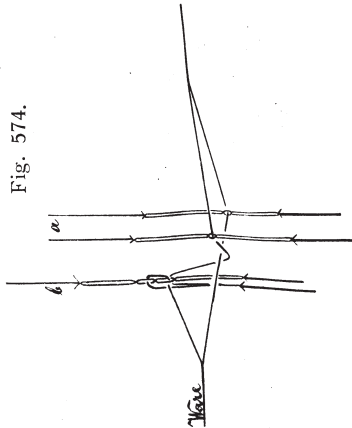

Fig. 577.

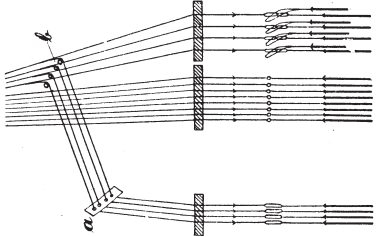

Fig. 575.

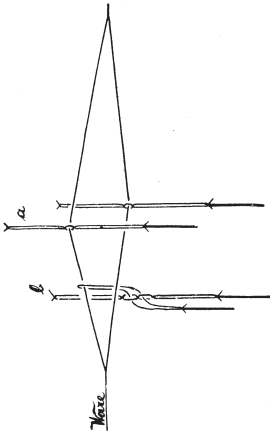
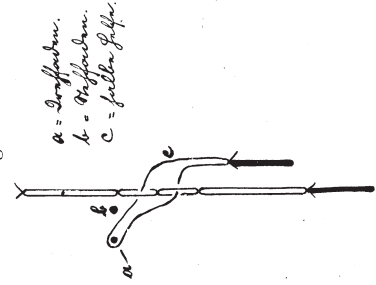

Fig. 573.



a = Drahtbaum  
b = Drahtbaum  
c = Drahtbaum

Fig. 576.

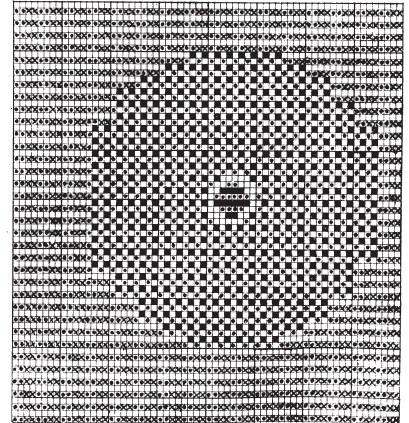

Fig. 571.

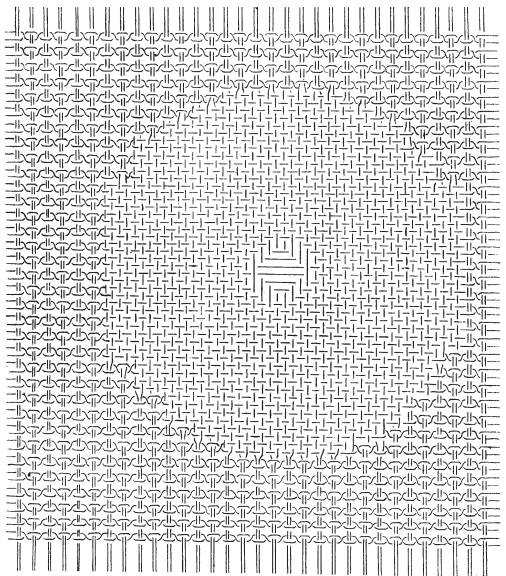

Fig. 578.

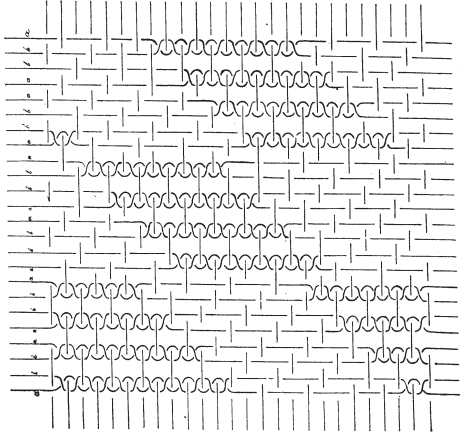

Fig. 579.

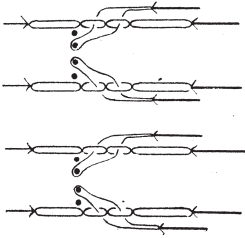

Fig. 582.

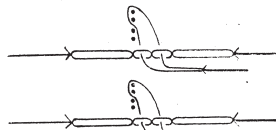

Fig. 581.

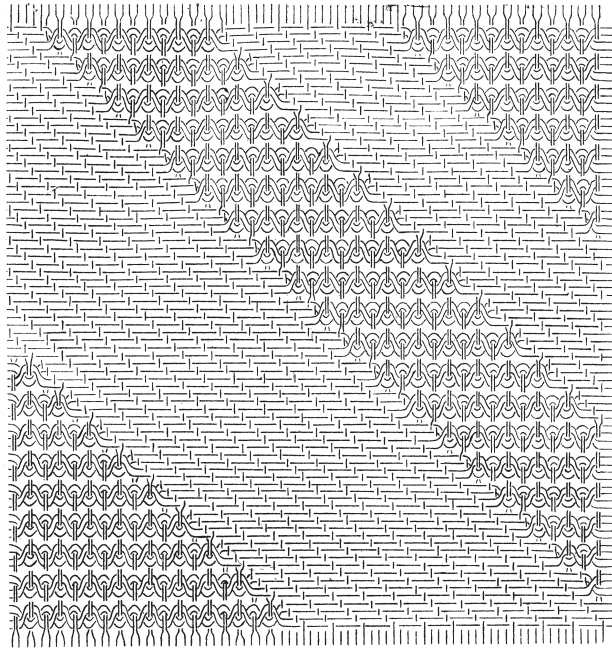

Fig. 583.

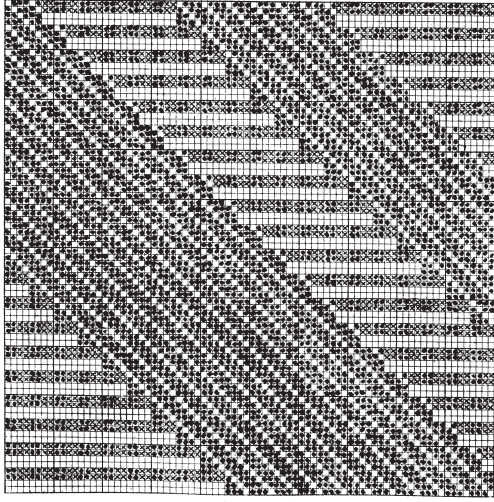

Fig. 586.



Fig. 587.



Fig. 588.

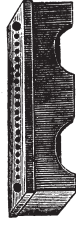

Fig. 589.

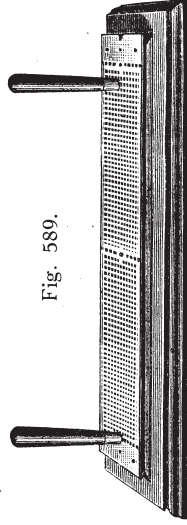

Fig. 584.

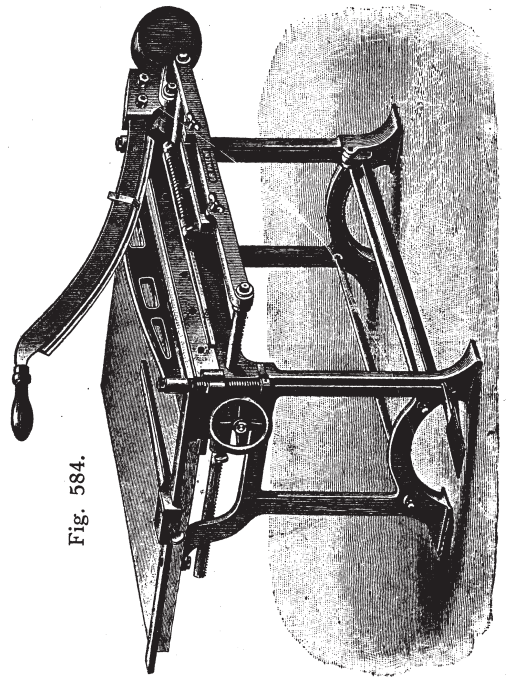

Fig. 585.

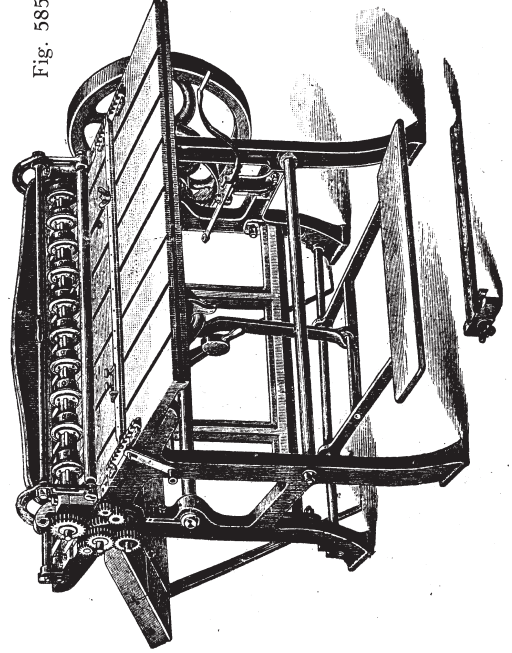

Fig. 590.

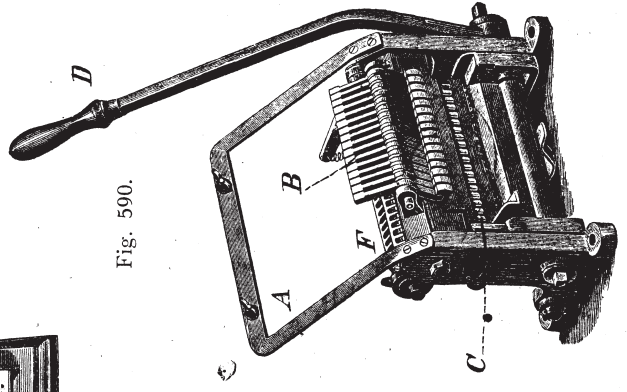



Fig. 594.

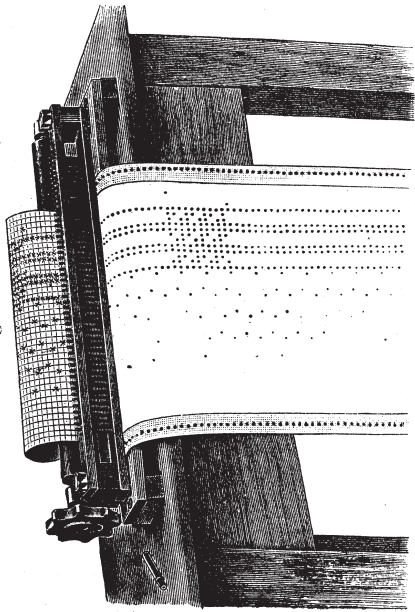

Fig. 595.

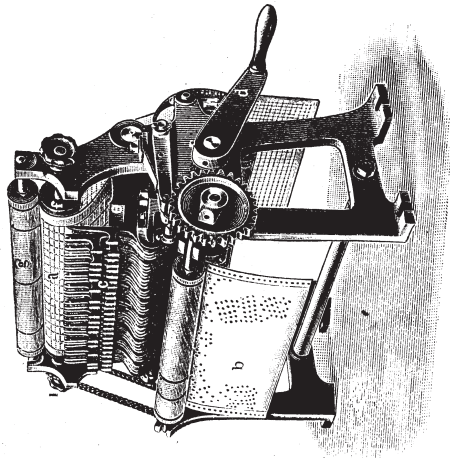

Fig. 597.

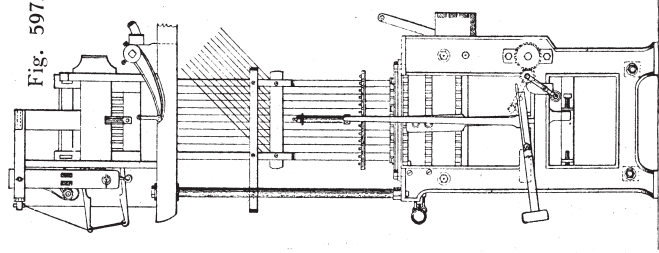

Fig. 598.

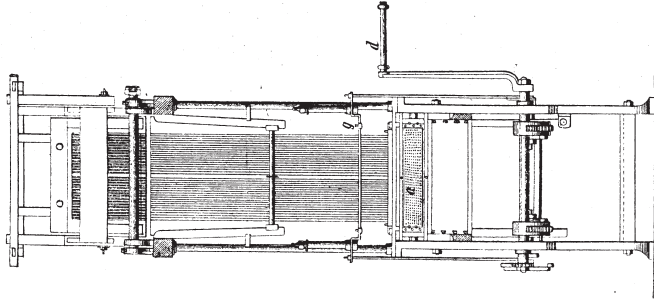

Fig. 591.

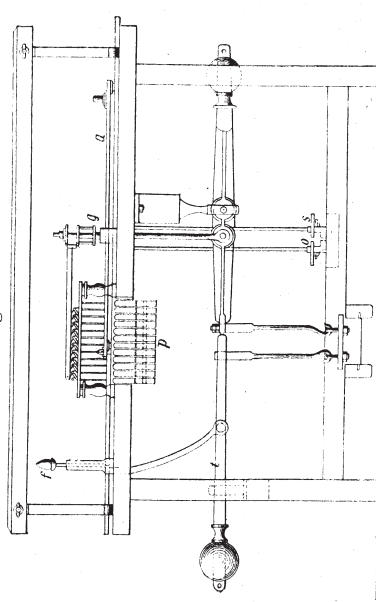

Fig. 593.

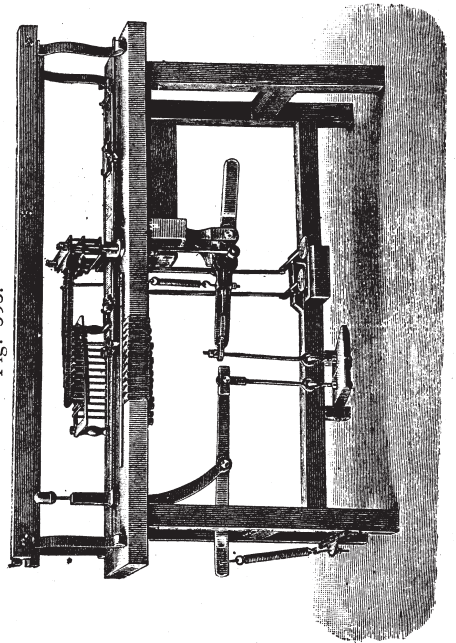

Fig. 592.

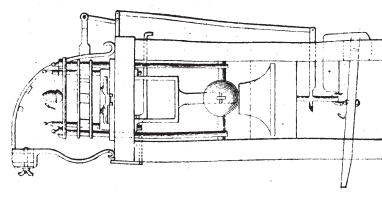

Fig. 596.

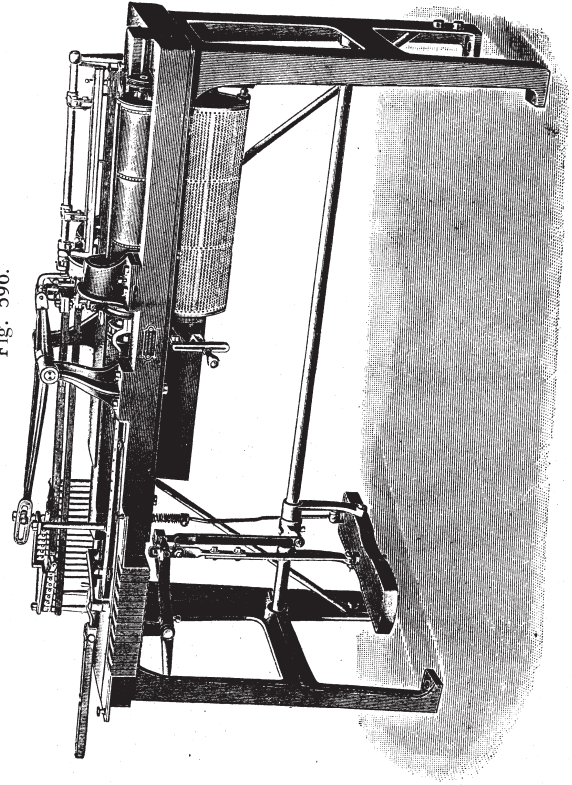

Fig. 599.



Fig. 600.



Fig. 601.

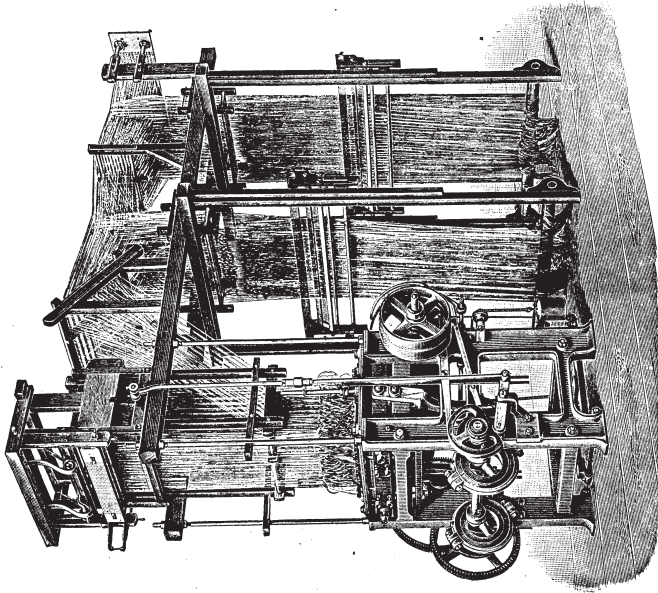

Fig. 602.

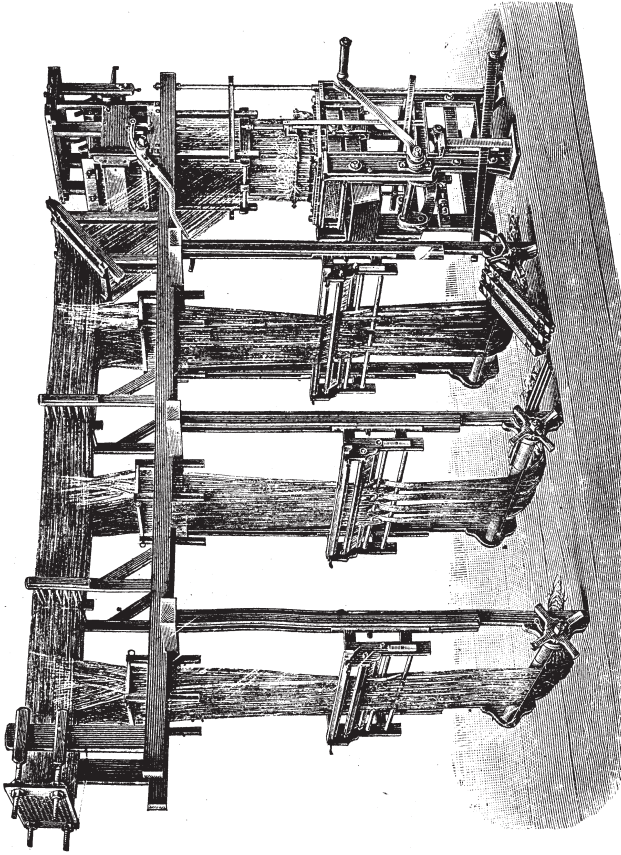

Fig. 603.

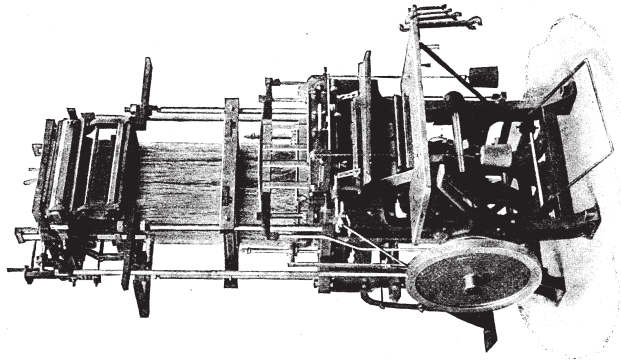

Fig. 604 a.

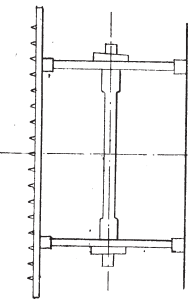

Fig. 604 b.

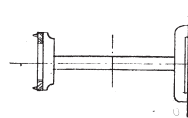

Fig. 604 c.



Fig. 605.

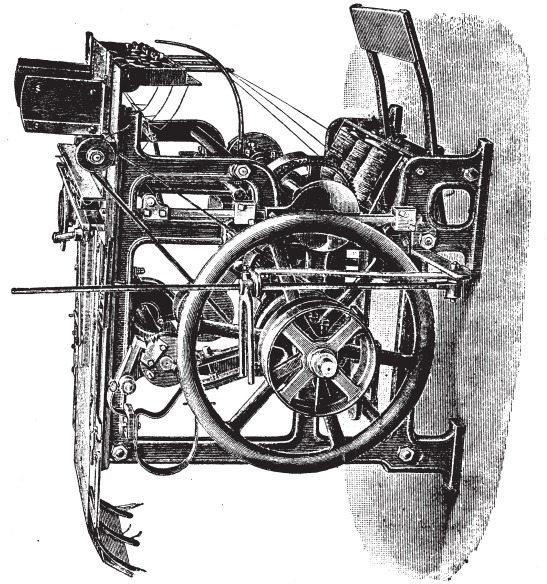

Fig. 606.

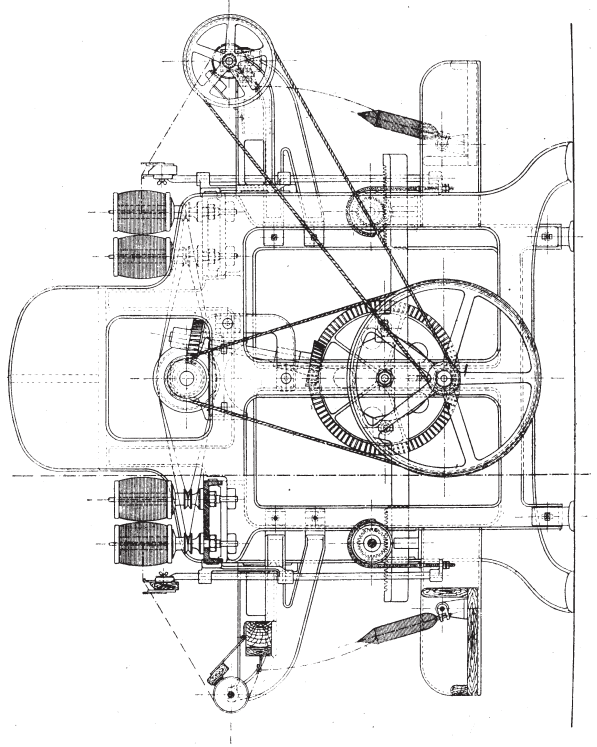

Fig. 608.

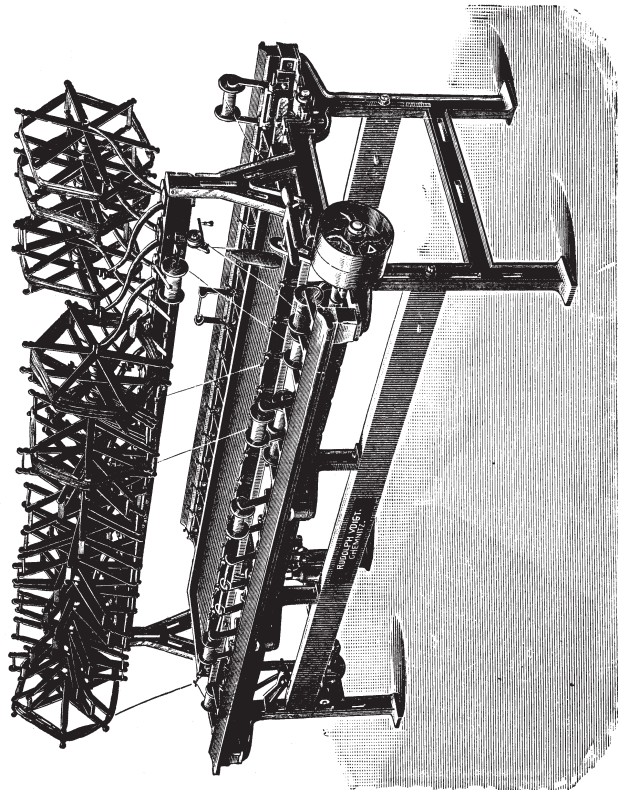

Fig. 607 a.

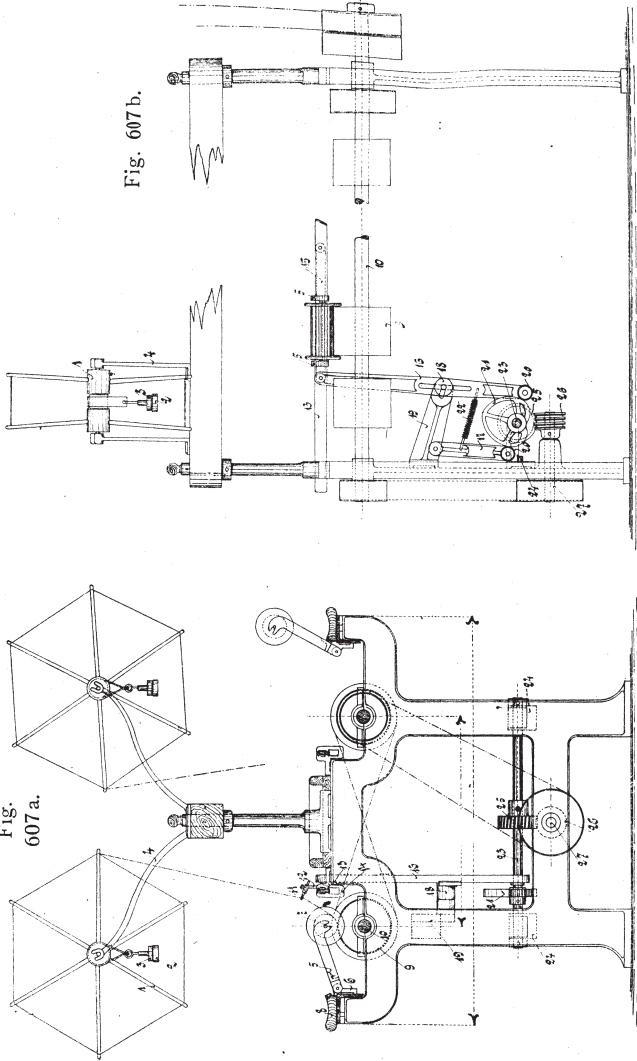

Fig. 607 b.

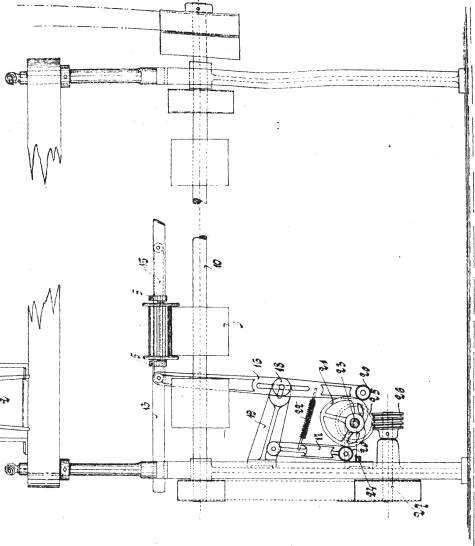

Fig. 610.

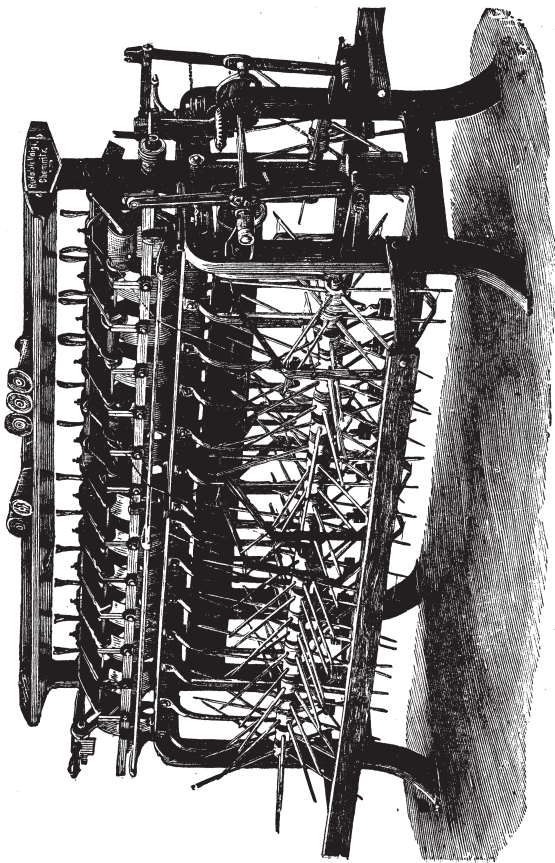

Fig. 609 a.

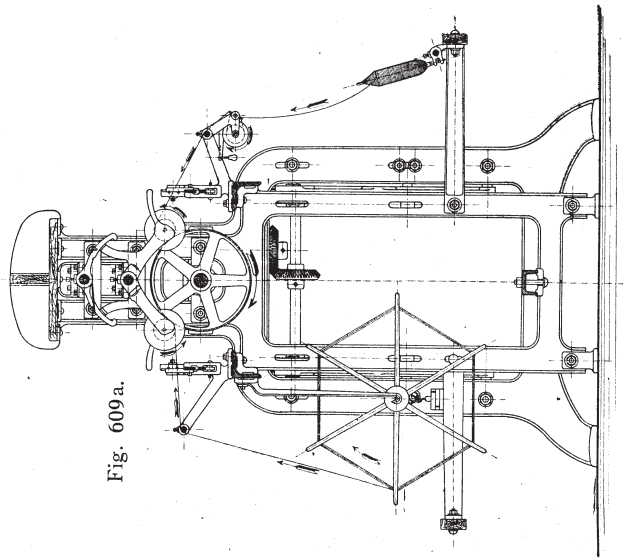
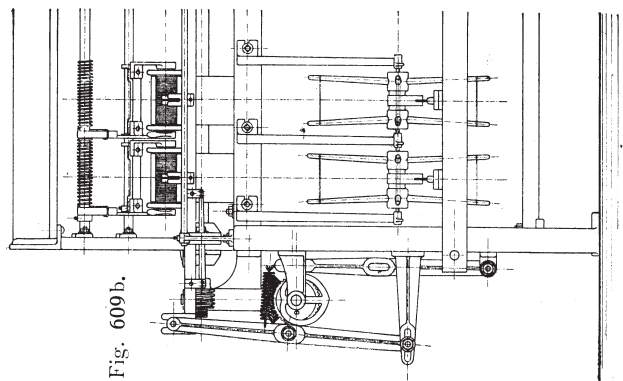

Fig. 609 b.



Tafel 49.  
Fig. 612-614b, 616, 617.

Fig. 612.

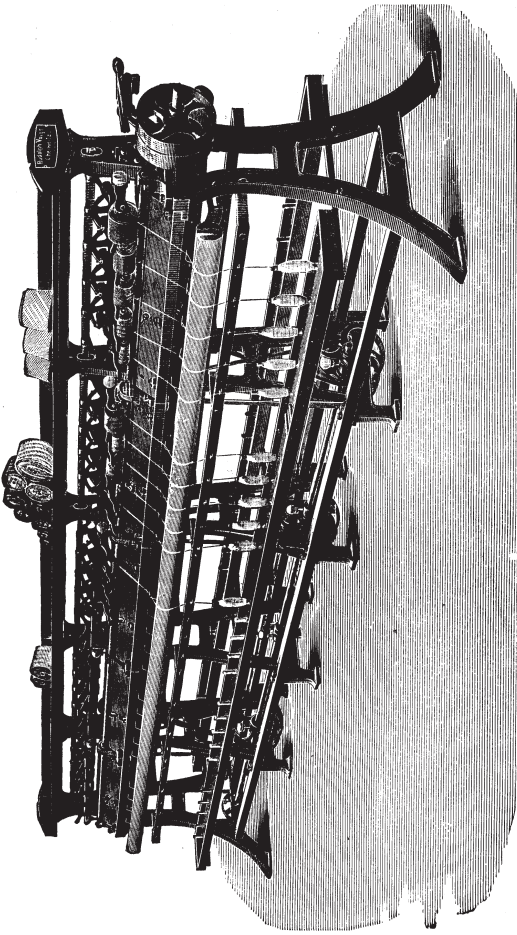

Fig. 614a.

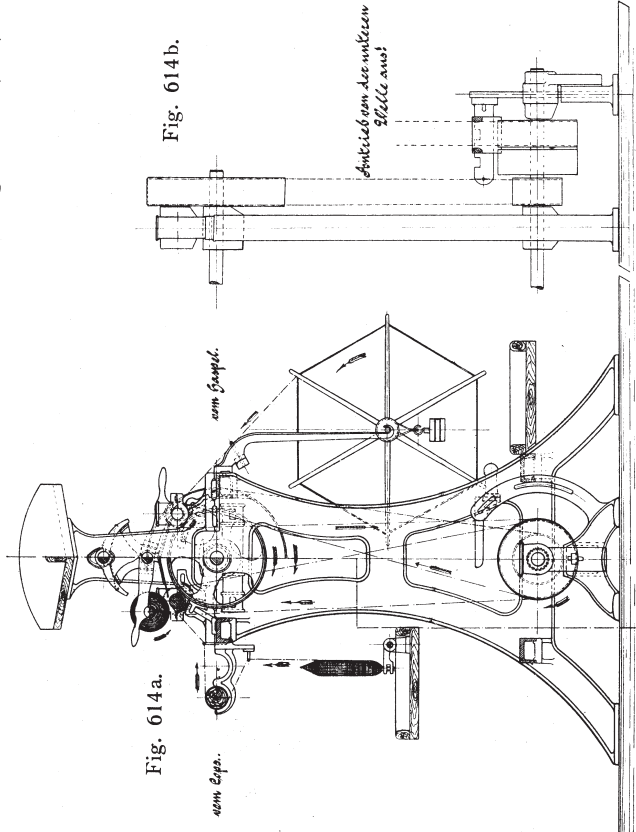

Fig. 614b.

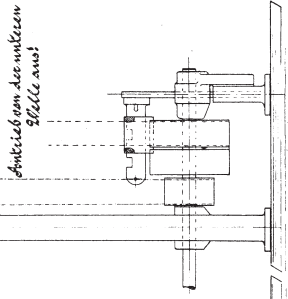

Fig. 616.

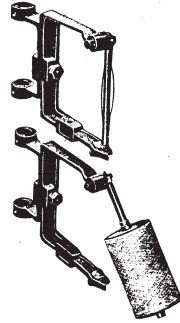

Fig. 617.

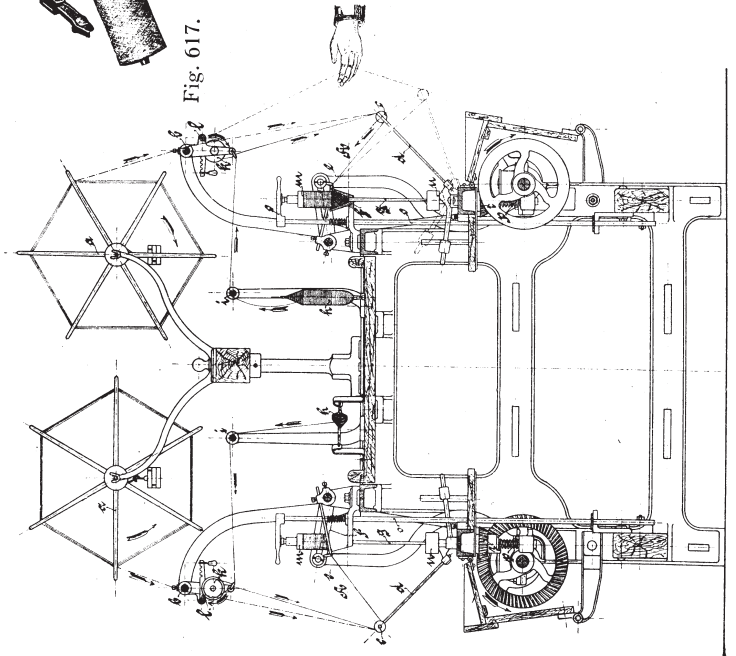

Fig. 613a.

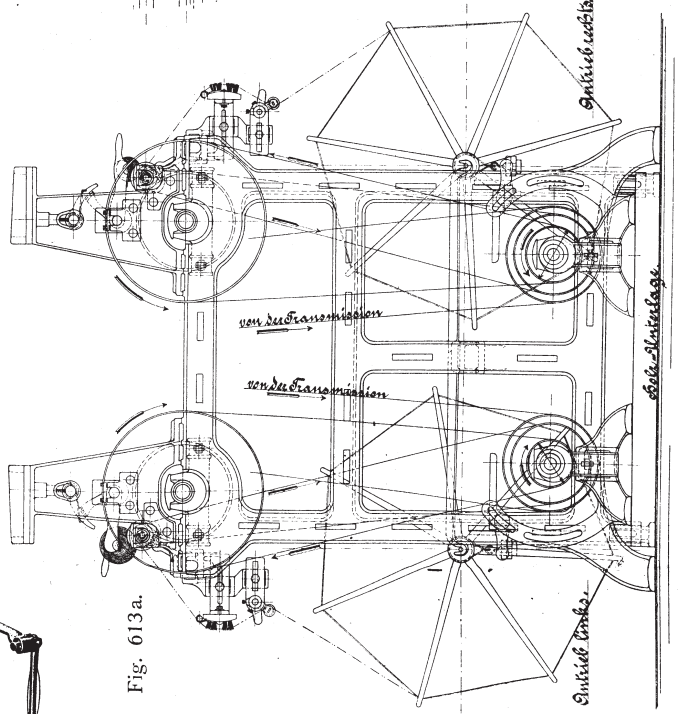

Fig. 613b.

