



Hand
W*eaving*

HAND WEAVING

A Publication
for
Beginning Weavers
on the
4-harness Foot Treadle Loom

Published By

Cedar Lakes

Arts and Crafts Center
Division of Vocational Education
Ripley, West Virginia

* * *

In Cooperation With
The Sears Roebuck Foundation
Philadelphia, Pennsylvania

ACKNOWLEDGMENT

The original analysis of this manual was completed with the able assistance of a committee of master craftsmen in Hand Weaving in New Hampshire and other New England states.

This manual on the 4-harness, Foot Treadle Loom has been prepared to meet two major objectives: (1) to help the beginner in Hand Weaving who does not have the services of a teacher available, and (2) to assist the teacher of Hand Weaving in organizing his class instruction.

It is hoped that the materials presented will enable the beginner in Hand Weaving to develop skills that will provide the incentive to become a craftsman. If it brings him additional income or a pleasurable use of leisure time, then the analysis has been useful.

In revising this book, we have tried to keep in mind the way we teach in West Virginia, realizing each area may differ in detail and in teaching methods, although the ultimate result should be the same.

This revision has been reviewed by Miss Lucy Quarrier, Weaving Instructor, Charleston, West Virginia. Constructive criticism was given by Mr. Rupert Peters of the Penland School of Handicrafts, Penland, North Carolina. Mr. Ronald B. Thomas, Consultant in Vocational Education, revised this publication and completed all illustrations. Hand Weaving is published by Cedar Lakes Arts and Crafts Center and the West Virginia Board of Education, Division of Vocational Education, Department of Education, Charleston, West Virginia.

We are grateful to the Sears Roebuck Foundation for their assistance with this publication on Hand Weaving.

Sherrill D. McMillen, Director
Vocational Education

Revised March 1, 1960

TABLE OF CONTENTS

<u>Chapter</u>	<u>Page</u>
	ACKNOWLEDGMENT II
One	EQUIPMENT USED IN HAND LOOM WEAVING 1
Two	USING THE OUTLINE 3
Three	MAKING A WARP 5
	I. Making a Warp for a Plain Warp Beam 5
	A. Figuring Required Yardage in Warp 5
	B. Buying Yarn 7
	C. Making the Warp 7
	D. Counting Warp Threads 8
	E. Placing Lease in the Warp 9
	F. Taking the Warp off Warping Frame 11
	G. Second Method 11
Four	SETTING-UP OR DRESSING THE LOOM 13
	I. Beaming the Warp on a Plain Warp Beam, Using a Raddle 13
	A. Removing Harnesses and Beater from Loom 13
	B. Placing Warp Beam Stick in Loops of Warp 14
	C. Placing Shed or Lease Sticks in Warp 14
	D. Tying Ends of Shed or Lease Sticks 15
	E. Tying Warp Beam Stick to Warp Beam 15
	F. Placing Raddle or Spacer on Back Beam 15
	G. Spacing Warp in Raddle 16
	H. Winding Warp on Warp Beam 16
	I. Replacing Beater and Harnesses 17
	II. Beaming the Warp on a Plain Warp Beam, Using a Reed 17
	A. Placing Lease Sticks in Warp 17
	B. Threading the Warp Through the Reed 18
	C. Placing Warp Stick in Warp 18
	D. Tying Warp Stick to Beam 18
	E. Moving the Cross from the Front of the Reed to the Back of the Reed 18
	F. Tying the New Lease Sticks Together 21
	G. Winding Warp on the Beam 21
	III. Beaming the Warp on a Sectional Warp Beam 21
	A. Preparing the Warp 22
	B. Placing Spools on Spool Rack 22

<u>Chapter</u>	<u>Page</u>
C. Threading the Thread Guide	22
D. Winding on the Warp	24
IV. Setting Up Looms -- Tying Up Counterbalanced Loom -- Hanging the Harnesses (Temporarily)	25
A. Tying Harnesses in Place Temporarily	26
B. Hanging the Small Rollers	26
C. Hanging Harnesses	27
V. Setting Up Looms -- Tying Up Counterbalanced Loom -- Tying Harnesses to the Lamms	28
A. Attaching each Lamm to Corresponding Harness	28
VI. Setting Up Looms -- Tying Up a Jack Type or Rising Shed Loom	29
VII. Reading the Pattern or Draft	29
A. Method of Notation	29
VIII. Threading the Heddles from Pattern	32
A. Preparing Harnesses for Threading	32
B. Placing Heddles on the Harnesses	33
C. Threading the Heddles	34
IX. Drawing-In or Sleying	36
A. Preparing for Sleying	36
B. Propping Beater or Batten in Position	37
C. Measuring the Reed	37
D. Sleying the Warp	37
X. Tying-In to Apron	38
A. Unrolling Apron and Bringing Over Breast Beam	38
B. Cutting Slots in Apron	39
C. Tying-In Warp Ends to Apron	39
D. Adjusting Tension of All Warp Threads of Apron	40
XI. Tying-Up the Treadles	41
A. Reading the Tie-up Draft	41
B. Reading the Tie-up Draft from Right to Left	42
C. Tying the Treadles	44
Five WEAVING	48
I. Preparing the Weft	48
A. Making Bobbin or Quill for Boat Shuttle	48
B. Winding Bobbin for Boat Shuttle	48
C. Threading Boat Shuttle	49
D. Winding Flat Shuttle	50

<u>Chapter</u>	<u>Page</u>
II. Weaving the Fabric	50
A. Making a Heading	50
B. Checking Threading	52
C. Correcting Mistakes	52
D. Placing Extra Thread in Warp on a Plain Warp Beam	54
E. Weaving Twill Pattern	55
III. Hemstitching	57
A. Preparing to Hemstitch	57
B. Hemstitching after Weaving One to Two Inches	58
IV. Changing Bobbins	59
A. Changing Bobbins	59
V. Winding Web on Cloth Beam	59
A. Winding Web on Cloth Beam	59
VI. Using Two Shuttles on a Twill Weave	60
A. Using Two Shuttles on a Twill Weave	60
VII. Removing Fabric From the Loom	61
A. Hemstitching End	61
B. Overcasting End	63
C. Cutting Warp	63
D. Taking Fabric Off Cloth Beam	64
E. Stitching Raw Ends of Fabric	64
VIII. Finishing Or Processing the Fabric	64
A. Washing the Fabric	64
B. Drying the Fabric	66
C. Pressing the Fabric	66
 <u>Appendix</u>	
One GENERAL INFORMATION	67
Two MATERIALS FOR FABRICS	69
REFERENCES FOR ADDITIONAL READING	71

LIST OF ILLUSTRATIONS

	<u>Page</u>
Miss Lucy Quarrier, Weaving Instructor, assisting a beginner in preparing the loom for weaving	3
Warping Board	6
Handling the Warp	10
A beginning weaver with the help of instructors completing the preparation for weaving	12
Warping With a Reed	19
Spool Rack	20
Thread Guide	20
Knots Used by Weavers	23
Sectional Warp Beam and Tying Warp to Sectional Beam or Apron	25
Tie-up for Counterbalanced Loom	27
Jack Type Loom	30
Twill Draft for 4-harness Twill	31
Heddle Frame or Harnesses	32
Counterbalanced or Sinking Shed Loom, 4-harness, 6-treadle Tie- up Draft	41
Jack Type or Rising Shed Loom Tie-Up Draft	42
Knots for Treadle Tie-up	43
Tie-up Draft for 4-treadle Loom	43
Using the Boat Shuttle in Weaving	45
Boat and Flat Shuttles	47
"C" Clamp and Bobbin for Boat Shuttle	47
Beautiful fabrics are the rewards of a Craftman's Efforts	65

Chapter One

EQUIPMENT USED IN HAND LOOM WEAVING

A 4-harness, 6-treadle, 36-inch loom had been selected for teaching purposes in this outline. This type of loom is a practical one for the beginner and the advanced weaver. For ease in treadling, a loom should have at least 2 more treadles than it has harnesses. When purchasing a loom more people select one with treadles attached at the back, because of ease in operation. A 36-inch loom is recommended because it is more versatile than a narrow loom. Any width fabric up to and including 36 inches can be woven on it. The reed should be a 15 dent one, as it is the one most often used. Some weavers use string heddles but most looms come equipped with steel ones, so they are described in this paper.

A "Jack type" loom is recommended for teaching purposes and for home use. On a "Jack type" loom the harnesses rise to form a shed. Some of the looms now on the market operate this way. Old hand looms are usually counter-balanced, that is, the harnesses are hung in pairs over rollers and sink and rise to form a shed. Tie-ups for both types of looms are explained in the outline.

Large and small looms are usually equipped with plain warp beams. Sectional warp beams can be purchased with large looms and we recommend coarse threads. Steel beams for ready warped spools can also be purchased for some large and small looms. This outline covers warping on plain and sectional beams.

When a loom is purchased the following equipment is usually included in the purchase price:

1. Reed - 15 dent
2. Heddles - steel wire or aluminum, number varies with the width of the loom (at least 30 per inch)
3. Shuttles - flat, usually 2
4. Lease sticks - 2 or more
5. Beam sticks - 2 or more
6. Cords or chains for tie-ups
7. Threading or drawing-in hook
8. Thread guide - if sectional warp beam is purchased.

The following equipment must be bought separately:

1. Bobbin winder
2. Spool rack - if a sectional warp beam is used
3. Boat shuttles - at least 2
4. Bobbins - can be made of wrapping paper.
5. Spools for sectional warping - at least 60 all the same size
6. Skein reel - the same type that is used by knitters
7. Graph paper - 10 squares to the inch
8. Warping board or wheel - be sure pegs on warping board are large enough not to bend when winding warp
9. Raddle

10. Pins - dressmaking type
11. Large-eyed blunt needle
12. Scissors
13. Tape measure
14. Rag rug shuttles - 2 or more

If much weaving is planned, the following items will prove useful:

1. Steel beam for ready warped spools
2. Tensioner for sectional warp beam or tension box
3. Extra lease sticks and steel heddles
4. Extra reeds - 10 dent and 12 dent are most often used
5. Carpet warp or plain string

Chapter Two

USING THE OUTLINE

The step-by-step procedure for setting up a 4-harness, 6-treadle loom and weaving and finishing one project has been written in outline form. It has been divided into two columns, the left column containing the operational steps, the right column containing the explanation or reasons for the steps. Alphabetical order of operations and information correspond, in most instances.

Beginners should read the outline in its entirety with the loom in front of them, locating the parts of the loom named in each step. When the names of the parts are familiar to the weaver, the warp can be put on the loom.

Warping is the most difficult operation in the whole process of weaving. No one is a real weaver unless he can make a warp and put it on the loom. Handle the warp with care, do not hurry because speed comes with practice. When the warp is on the loom, carry out the steps as outlined to complete the threading of the loom.

Project Covered In This Outline

All the steps necessary to weave a piece of twill 16 inches wide and 3 yards long are explained in the outline. The warp selected is Perle #5 in one color with 15 warp threads per inch, threaded one to a dent in a 15 dent reed. There are 240 threads in the entire warp. Perle #5 has been selected because



MISS LUCY QUARRIER, weaving instructor, assisting a beginner in preparing the loom for Weaving.

it is a yarn easy to handle and gives a satisfactory finish. A 4-harness twill, one of the basic patterns in weaving, has been selected for a beginner's project. About 1/2 pound of Perle #5 will be needed for the warp and 1/2 pound of either Perle #5 or Perle #3 for the weft. For the weft use Perle #5, or Perle #3 or linen floss in several colors and weave in stripes. The finished piece may be used for table mats and a runner.

Books

At the end of this outline, you will find "References For Additional Reading" which may be used as reference for patterns, weaves and textiles after the first project has been finished. If possible, study these at a library before purchasing any. Select the one or ones which seem to fill your needs.

Illustrations

The various illustrations will help to clarify operations and equipment.

NOTE: This manual does not cover the whole subject of weaving. It is merely an introduction to the craft. If the beginner follows this outline and completes the project described, he will be able to use the material on weaving in local libraries with greater ease.

Chapter Three

MAKING A WARP

1. Making a Warp for a Plain Warp Beam

The threads which run the length of a woven material are called the warp. The first step in a weaving project is the selection and making of the warp. A material woven of heavy yarns will have fewer threads per inch than one made of fine yarns.

For this project Perle #5, which is a heavy mercerized cotton thread, has been selected for the warp and the warp will have 15 threads to the inch. The number of warp threads per inch is called the sley of the warp. This warp will be made 3 3/4 yards long. An allowance of 3/4 of a yard has been made for waste.

The method of making a warp for a sectional warp beam differs from that for a plain beam and is covered in another section of this bulletin.

<u>Operation</u>	<u>Information</u>
A. <u>Figuring required yardage in warp</u>	A. <u>Figuring required yardage in warp</u>
1. Determine length of warp (in this case 3 3/4 yards).	1. It was decided that a twill pattern would be woven, the width of the material to be 16 inches and sleyed one thread to a dent. The following method is used to determine the number of threads in the warp.
2. Determine width of material (16 inches).	
3. Decide number of threads per dent (one per dent in a 15 dent reed).	3. A dent in a reed is the slot or cut through which thread is drawn. A 15 dent reed means 15 slots to one inch.
4. Multiply width of material (16 inches) by dents used per inch, (15 in this instance). Allow for drawing-in in weaving (about one inch). Finished piece would be 15 inches.	4. This determines the number of threads required in the warp. (In this case, 16 X 15 = 240 threads in the warp).
	5. This method of determining number of threads in warp is used regardless of the pattern used or width of material required.

WARPING BOARD

WARPING BOARD
With Dimensions

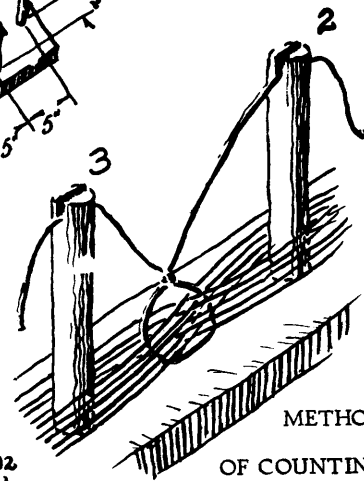
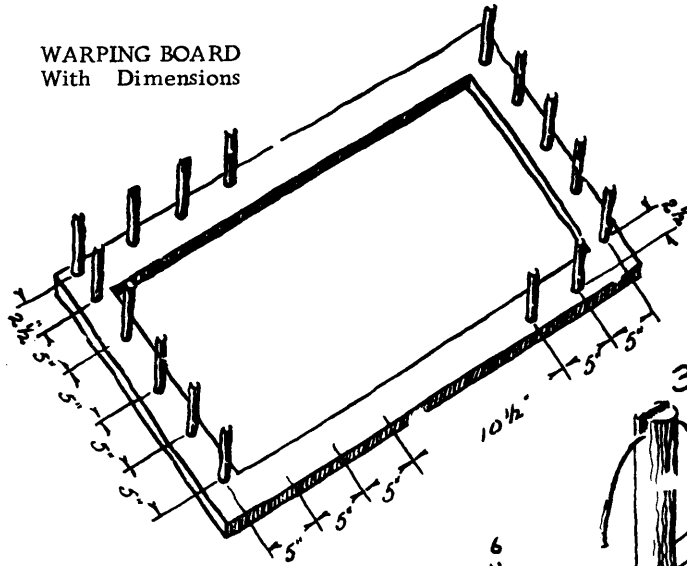

METHOD
OF COUNTING
WARP THREADS

CROSS

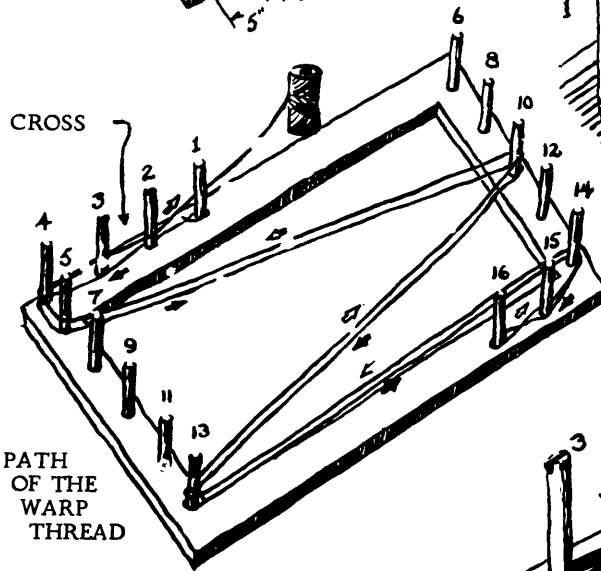

PATH
OF THE
WARP
THREAD

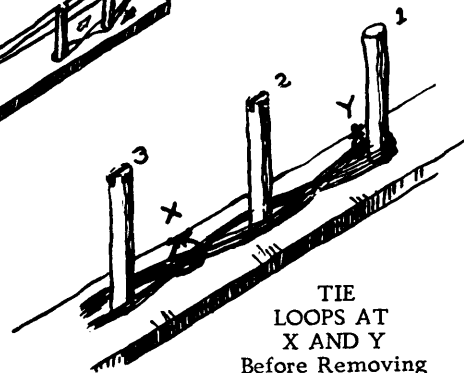

TIE
LOOPS AT
X AND Y
Before Removing
Warp From Board

Operation

7. Determine total yards required in warp by multiplying total number of warp threads by length of warp desired.

B. Buying yarn

C. Making the warp

2. Place yarn on skein winder so that it may be either wound into a ball or directly onto warping frame.
3. Place balls or spools of yarn in a container or on a spool rack.
4. Examine illustrations of warping frame on page 6.

Information

6. A warping frame is usually one yard wide. (See illustration.)
7. The total yardage required is approximately 960 yards. In this case, multiply 240 (warp threads) by $3 \frac{3}{4}$ yards (the length desired or approximately 4 yards).

B. Buying yarn

1. Most manufacturers' price lists indicate the yardage per pound of their products.
2. In estimating the yardage needed for the filler, allow a little more than $\frac{2}{3}$ the amount required for the warp. (The warp, in this case, is about 2000 yards.)
3. The weaver, knowing his total yardage, is now ready to purchase yarn by the pound.
4. It is advisable to buy at one time enough yarn to complete the project. Manufacturers do not guarantee to match colors of dye lots and it may be impossible to match material purchased at different times.

C. Making the warp

1. The yarn bought from the manufacturer will be either in spools or in skeins.
2. The yarn bought in a skein will require a skein winder.
3. A container or support should be used which will allow the yarn to unwind freely. The container will keep yarn free of dust and dirt.
4. The pegs are numbered. This numbering will assist in winding on frame so that the necessary crosses will be made in the warp.

Operation

8. Make large loop in end of yarn and place on peg #1 of frame.
9. Carry yarn over peg #2; under #3; over #4; down and under #5; across, over and under #10; across, over and under #13; over and under #14; under #15; over and under #16; over #15 under and over #14; across, under and over #13; across, under and over #10; across, under #5; up and over #4 and #3; under #2; over and under #1; over #2; and repeat until 20 threads have been warped.

D. Counting warp threads

1. Place a colored thread or cord about 24 inches long through one side of cross from front to back.
2. Bring colored cord from back through other half of cross to the front.
3. Twist (do not tie) the ends of the cord together and draw tight against the cross.
4. Place ends of cord in slot in end of peg #2, and other end of cord in slot in peg #3.

Information

5. A warp without crosses cannot be used. Be sure at all times to have perfect crosses, as the fabric woven is no better than its warp.
6. The frame illustrated will make a warp up to 10 yards in length.
7. The directions presented here will give the weaver a warp $3 \frac{3}{4}$ yards in length.
9. The threads must be wound with as little tension as possible, neither loose nor tight. Two or four threads may be carried at a time after the first warp.

D. Counting warp threads

1. It will be found helpful to have some means of counting warp threads in a simple, easy way after 20 threads have been warped.
3. It is desirable to have slots cut in pegs #2 and #3 as this will simplify the placing of cords for counting. Cords twisted together, are easy to remove from the warp after it has been completed.

Operation

5. Remove cords from slots after each group of 20 threads have been warped. Twist together and draw tight against that group of warp threads, and return cords to the slots in pegs.

E. Placing lease in the warp

1. Cut four colored cords about 36" long.
2. Cut 2 cords about 6" long.
3. Place one long cord through loop formed at peg #1.
4. Tie ends of cord together forming a large loop.
5. Place second cord through one side of cross from front to back (between 1 and 2).
6. Bring cord from back, through other half of cross to the front.
7. Tie ends of cord together forming a large loop. (See illustration.)
8. Place the third long cord in the cross formed between pegs 2 and 3, in the same manner as for the first cross.
9. Place fourth long cord through loops formed at peg #16.
10. Tie ends together to form a large loop.

Information

5. The groups of warp threads may be easily counted when the colored cords are removed from slots and pulled taut. Five groups indicate 100 threads have been warped.

E. Placing lease in the warp

1. The total number of warp threads (in this case, 240) having been warped, it is advisable to take warp off the warping frame immediately to prevent unnecessary stretching.
2. It may be impossible to complete the warping at one time. In such case, it is advisable to take the warp off the warping frame, at any multiple of 20 threads.
4. The cords are tied to form large loops so that when the warp is placed on the loom, it may be spread to its proper width.

HANDLING THE WARP

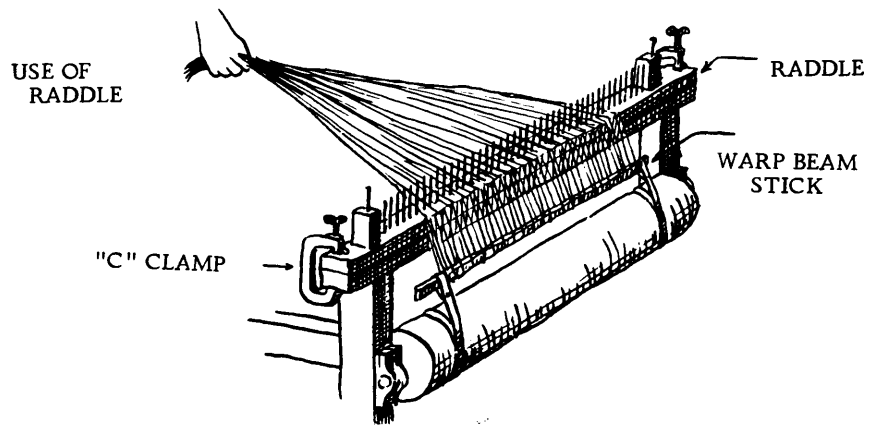
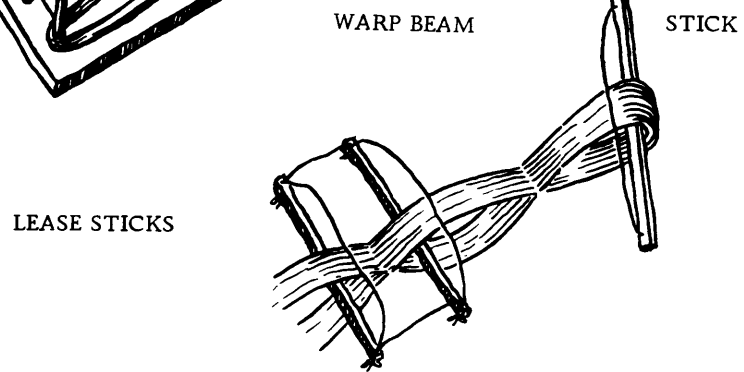
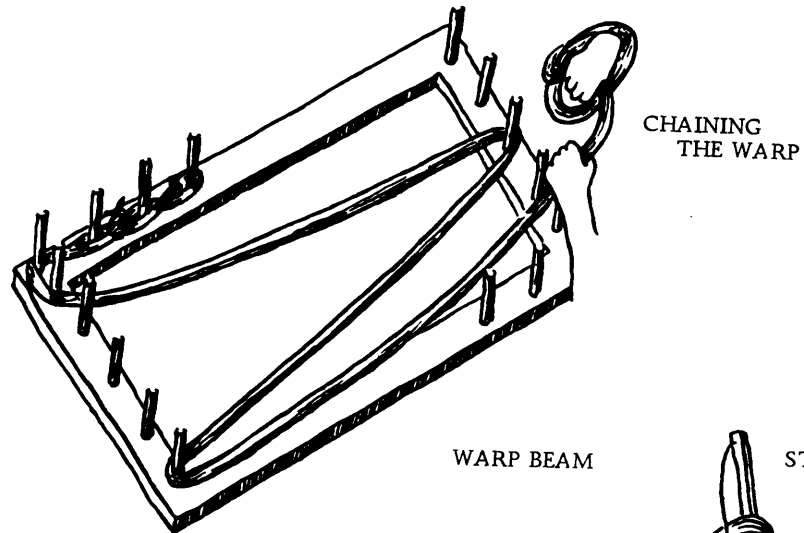

Operation

11. Use short cord, twist around entire warp about 30" from peg #1, pull tight and tie securely.
12. Tie second short cord around warp about 30" from end of warp at peg #16.
13. In a long warp, short cords should be tied around it tightly about every yard and a half.
14. Remove colored cord used for counting.

F. Taking the warp off warping frame

1. Grasp the warp at peg #16 with the right hand and remove from peg.
2. Grasp warp about 12" from end with left hand.
3. Use right hand as a crochet hook, and chain the warp to within 30" of peg #1.
4. Tie a cord through the last loop formed and fasten to short end of warp.

G. Second Method

1. Instead of chaining, tie warp with short threads in bow knots about each yard.
2. Begin at peg #16 and remove from warping board dropping it directly into a paper bag.

Information

11. This cord is tied around warp about 30" from peg #1. It must be securely tied to assist free movement of lease sticks when warp is placed on loom.
12. This tie keeps warp together and assists in ease of handling.
14. This cord is of no further use and is better out of the warp.

F. Taking the warp off warping frame

4. This tie prevents chain from unravelling and simplifies placing chained warp on loom.
5. This warp if not used immediately should be stored in paper bag, indicating the length, number of threads and material used.

G. Second Method

2. This method helps prevent any slipping of warp. Remove these ties one at a time as warp is rolled on.

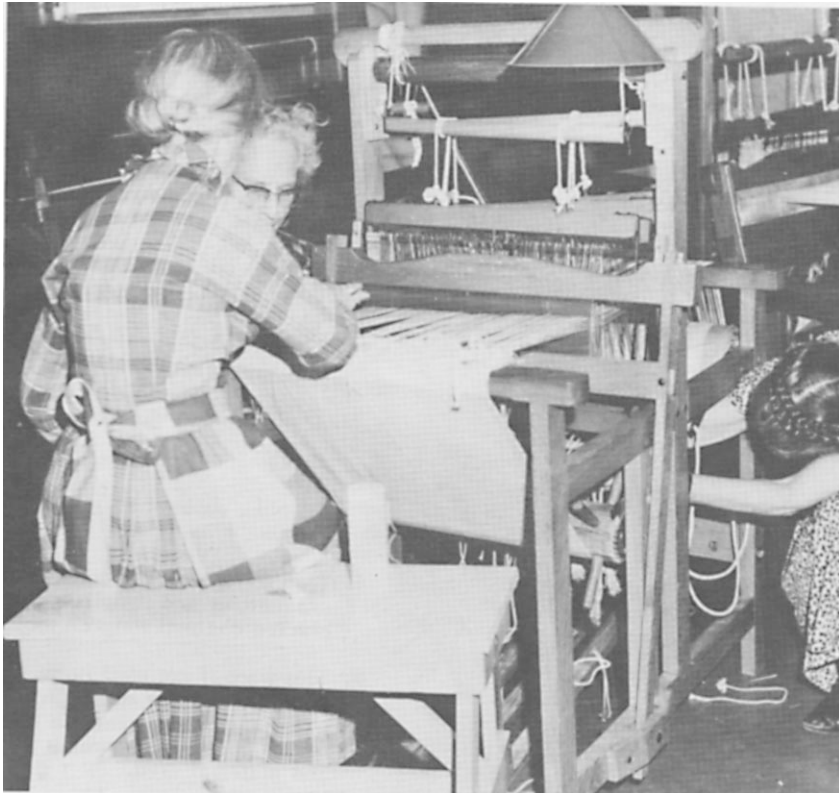

A beginning weaver with the help of instructors completing the preparation for weaving.

Chapter Four

SETTING-UP OR DRESSING THE LOOM

I. Beaming the Warp on a Plain Warp Beam, Using a Raddle

All woven fabrics are composed of two sets of threads. Those running the length of the material are the warp threads and must be fastened on a more or less rigid frame. The 4-harness loom is such a frame. Attached to the back of the loom is a smooth solid roller or plain warp beam. All of the warp threads are wound on this beam in the first step of weaving. To illustrate this project a warp 16 inches wide and 3 3/4 yards long will be put on the loom. There will be 15 threads to the inch or 240 threads in the entire warp. The process of putting the warp on the beam, called "beaming the warp," is explained in the following section of the outline. It is divided into sections: I. Using a Raddle; II. Using a Reed; III. Using a Sectional Warp Beam.

<u>Operation</u>	<u>Information</u>
A. <u>Removing harnesses and beater from loom</u>	A. <u>Removing harnesses and beater from loom</u>
1. Remove beater from loom.	1. The removal of beater gives freer access over breast beam and rear beam to the warp beam. If this is difficult, remove only top of beater and reed.
2. Observe how harnesses are fastened.	2. Harnesses must be replaced in same way so it is important to know how they are fastened in loom.
3. Remove harnesses, by unfastening cord or chain.	3. This makes it easier to add heddles to the required number for width and pattern used.
4. Number each harness as removed, the front harness being #1.	4. The term "beaming" is commonly used for the process of winding the warp thread onto warp beam, a large roller placed in back of loom.
5. Place beater and harnesses to one side until warp is on loom.	5. The step of beaming is a very important one in preparatory work. Careless beaming may be cause for serious trouble all through actual weaving.
6. Remove front breast beam if a large loom.	6. It is easier on the back.

Operation

B. Placing warp beam stick in loops of warp

1. Place chained warp on table. First lease stick takes place of Peg #2. Second of Peg #3.
2. Slide warp beam stick or rod through end loops of warp.
3. Secure warp beam stick in place with a cord passed through holes in each end of stick or rod, and over warp.
4. Draw cord taut and tie.

C. Placing shed or lease sticks in warp

1. Place a lease stick through the first cross already marked in the warp by a string or cord.
2. Run a cord through hole in one end of lease stick, fasten end.
3. Draw cord over outside of warp through hole in other end of stick.
4. Draw taut and secure cord firmly.

Information

B. Placing warp beam stick in loops of warp

1. It is more convenient to work on flat surface, as a table.
2. The warp beam stick is a heavy, smooth, flat stick or rod with hole in each end.
- 3a. The passing of a cord through holes in end of warp beam stick and over warp removes all danger of losing any warp threads.
- 3b. A good fabric cannot be woven on a poor warp, so this is an important procedure.
4. A cord tied at each end of stick prevents warp from coming off.

C. Placing shed or lease sticks in warp

- 1a. First cross is marked by a cord or colored string.
- 1b. Lease stick is smooth, flat, wooden stick, long as the loom's width, with hole in each end.
- 2a. It is impossible to part the warp properly on the loom if lease is lost.
- 2b. Lease sticks are put in warp to take the place of pegs #2 and #3 on board to keep the cross. In illustration on page 6 called "the cross" pegs #2 and #3 hold the cross.
3. Strings used for marking have now been replaced by sticks and warp beam rod.
4. The crosses must be properly made and kept there to insure orderly threading, a clean shed, and good weaving.

Operation

5. Place second lease stick in second cross of warp.
6. Secure this lease stick as directed for first stick.
7. Remove cords or strings originally placed in warp.

D. Tying ends of shed or lease sticks

1. Use cord or string to tie ends of lease sticks together.

2. Leave 2 to 4 inches between the sticks.

E. Tying warp beam stick to warp beam

1. Spread end loops of warp to full width on warp beam stick.
2. Bring warp rod over back beam towards the front of the loom. Secure warp to beam by cords or tapes which are fastened to beam.

F. Placing raddle or spacer on back beam

Information

D. Tying ends of shed or lease sticks

- 1a. Lease sticks are tied together so that they will slide in unison along the warp.
- 1b. Very strong cord or string should be used.
- 1c. It should be fastened firmly so cross cannot be lost, thus ruining warp.
- 1d. It is advisable on a long warp to secure a cross at both ends of warp, in case one cross is lost, the other can be used.

E. Tying warp beam stick to warp beam

1. The center of warp must be in center of beam, so it will wind in center of loom.
- 2a. The warp must be as evenly distributed as possible on warp rod.
- 2b. Most warp beams have holes through which cords are run, thus extending the length of warp, and allowing utilization of more warp material.
- 2c. Some warp beams have a groove, in which the warp beam stick is laid to hold warp secure.

F. Placing raddle or spacer on back beam

Operation

1. Slide raddle under warp, allowing warp to lie in raddle.
2. Attach raddle, with teeth in upright position, to back beam by means of "C" clamps. See illustration on page 10.
3. If more convenient tie raddle firmly to tall uprights of loom. Tie again to top cross piece of loom. Have raddle at eye level.

G. Spacing warp in raddle

1. Spread warp evenly to its full width in raddle.

H. Winding warp on warp beam

1. Hold warp at tension in front of loom, while another person turns crank handle on the warp beam with slow even motion, holding warp at as even a tension as possible.

Information

1. Raddle, shaped like large course wooden or metal comb, is used for proper spacing and placing of warp. The best raddles have metal nails with small heads instead of wooden dowels. These should be spaced 4 per inch.
2. Clamps will hold raddle firmly to back beam.

G. Spacing warp in raddle

- 1a. The raddle assists in even distribution of warp threads.
- 1b. The spacing in raddle or warp spreader, must be as even as possible. Warp threads must be spread in the same order as they appear on the lease sticks.

H. Winding warp on warp beam

- 1a. An assistant is needed for this operation.
- 1b. This process also is called "beaming the warp" or "turning on the warp."
- 1c. The winding device or handle is at right side of loom.
- 1d. Tension must be even for entire length of warp.
- 1e. Ratchet device prevents turning handle wrong way.
- 1f. Pegs or a friction device may be used if no ratchet device is available to hold beam and prevent unwinding of warp on beam.
- 1g. The warp now begins to wind evenly on beam.

Operation

2. Wind wrapping paper, corrugated paper (the kind with plain paper on one side only) or laths on beam, or a combination of the first two, with the warp.
3. Continue winding warp and paper.
4. Keep lease sticks gliding through warp to its entire length.
5. Wind warp on beam until the free ends of the warp are just long enough to go through the eyes of the heddles and hang down about six inches when harnesses are in place.

I. Replacing beater and harnesses

1. Replace harnesses in original positions.
2. Replace beater in original position. Do not put in reed or top of beater.

II. Beaming the Warp on a Plain Warp Beam, Using a Reed

When a raddle is not available it is possible to put the warp on a plain warp beam using a coarse reed instead of the raddle. For this process a 15 dent reed will serve.

A. Placing lease sticks in warp

Information

- 2a. Laths wound with warp on beam or paper wound on beam prevents warp threads from piling up or sinking into each other.
- 2b. Paper helps to maintain a level warp at all times so that loose warp threads are avoided.
- 3a. Three complete turns of paper and one of corrugated paper is a good rule.
- 3b. The slacking or stretching of warp should be avoided by careful turning of beam.
- 4a. Two people make beaming an easier job; one to hold the warp and guide the lease sticks, the other to do the turning of the crank handle and beaming.
- 4b. A gentle beating or shaking of warp by the hand if lease sticks bind in warp will permit free motion of the sticks.
- 4c. Do not pull lease sticks while other person is winding. It causes loose and tight threads in warp.

I. Replacing beater and harnesses

2. The shuttle race should be toward the front of loom if loom is equipped with one.

A. Placing lease sticks in warp

Operation

1. Place shed or lease sticks in the warp.
 - a. Follow the instructions on pages 14 and 15, C, 1-7.
2. Space warp on lease sticks. Place short loop of warp towards threading. Place reed in front of the loops. Work on a table or between table and back of a chair.

B. Threading the warp through the reed

1. Find center of reed and measure to the right of center 1/2 the width of the warp.
2. Thread the first loop of warp through the reed at this point.
3. Skip a dent and thread the next loop through the reed.
4. Work from right to left.
5. Repeat until each loop is threaded through reed.

C. Placing warp stick in warp

1. Run a warp stick or rod through the loops of warp threads as they are drawn through the reed.
2. Place reed in beater.

D. Tying warp stick to beam

1. Tie the warp stick to the warp beam in the manner described on page 15, E, 1-2.
2. Roll on warp as described in "Beaming Warp Using Raddle."

E. Moving the cross from the front of the reed to the back of the reed

Information

1. This is the section under beam-with a raddle.
2. The warp on the lease sticks should be spread out until it measures 16 inches.

B. Threading the warp through the reed

1. One-half the width is 8 inches in this project, as the warp is 16 inches wide.
2. The hook that came with the loom should be used.
4. A left-handed worker may prefer to start 8 inches from the left of the center and then work from left to right.
5. Loops should be threaded through the reed in the same order as they appear on the lease sticks.

C. Placing warp stick in warp

1. The loops should be picked up in the same order as they come through the reed, otherwise the warp will not go on the loom correctly.

D. Tying warp stick to beam

E. Moving the cross from the front of the reed to the back of the reed

WARPING WITH A REED

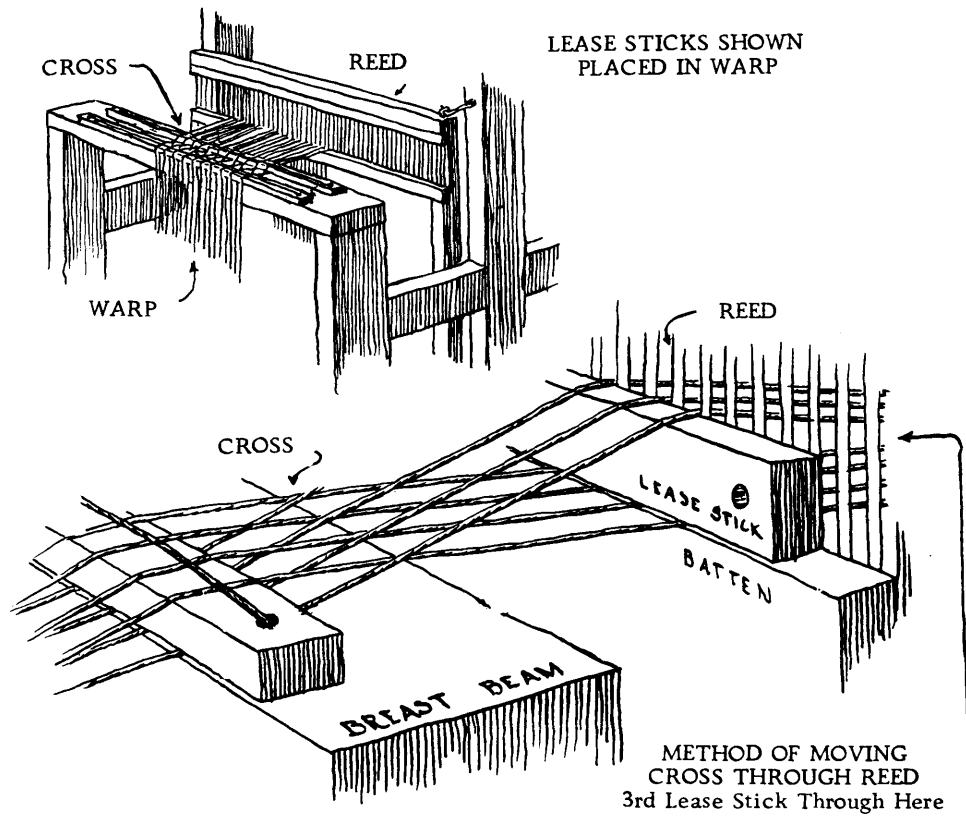

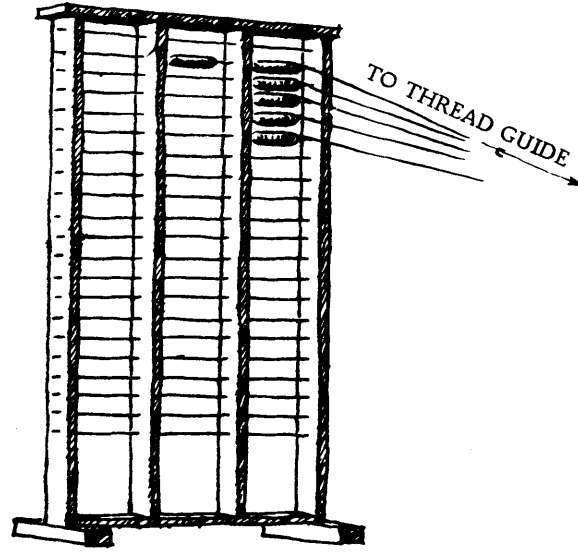

SPOOL RACK

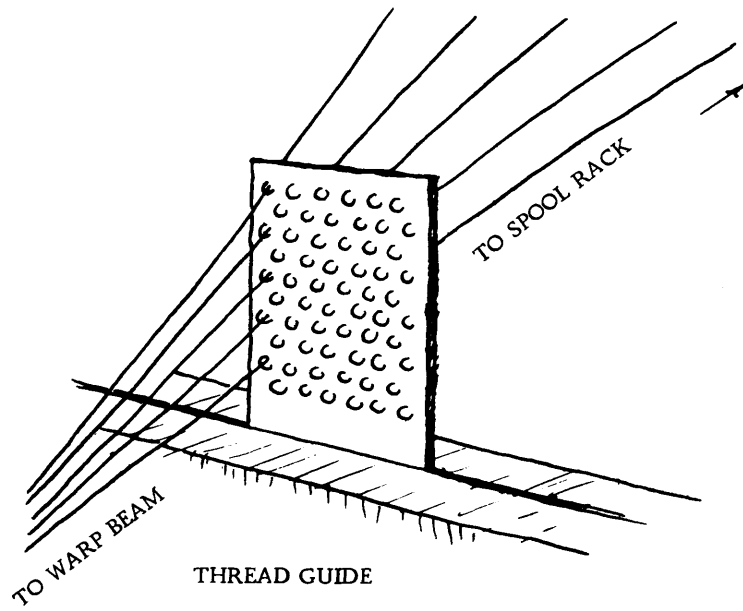

THREAD GUIDE

Operation

1. Hold all the warp at a tension at the front of the reed.
2. Turn the first lease stick on edge against the reed.
3. Run another lease stick through the opening that appears in the warp behind the reed. Replace cord to keep stick in place.
4. Remove the first lease stick from the front of the reed.
5. Repeat the above 4 steps with the second lease stick.

F. Tying the new lease sticks together

1. Tie as described before.

G. Winding warp on the beam

1. Hold the warp at the front of the loom by the short cord tied tightly around the warp.
2. Continue winding the warp on the beam until the free ends are just long enough to go through the eyes of the heddles and hang down about 6 inches when the harnesses are in place.
3. Cut loops in front of reed. Beat gently with palm of hand so warp will slide easily.

Information

F. Tying the new lease sticks together

1. The same method as described on pages 14 and 15, 2-7 should be used.

G. Winding warp on the beam

1. A description of this operation will be found on pages 16 and 17, H, - 1-4.
3. The complete warp cannot be wound on the beam until the loops have been cut and the reed removed.

III. Beaming the Warp on a Sectional Warp Beam

Only large looms can be equipped with sectional beams, and when buying a loom it is necessary to specify a sectional warp beam. Warping a sectional beam is a simpler process than warping a plain beam. The warp is put on a sectional beam from spools and 2 inches of width are warped at a time. Sectional warping is recommended for long warps of coarse threads.

A sectional warp beam is 1 yard in circumference and is divided by pegs into 2 inch sections for the entire width of the beam. (See illustration of the sectional warp beam.) A cord or tape with a loop in the free end is attached to the beam in each 2 inch section. The warp threads are tied to these tapes or cords.

Operation

A. Preparing the warp

1. Multiply the number of warp threads per inch by two to determine the number of spools to be used.
2. Wind enough warp on each spool to warp all the sections needed for the width of the warp.

B. Placing spools on spool rack

1. Pull out wires of spool rack and slide on spools, having all of the spools turn in the same direction.
2. Place filled spool rack 5 or 6 feet from the back of the loom.

C. Threading the thread guide

1. Place thread guide in the slit in top of back beam.
2. Thread the warp through the guide, one thread to one hole.
 - a. Start with the top spool on the left of the spool rack and the top hole at the left of the guide.

Information

A. Preparing the warp

1. A spool rack holding at least 60 spools, a supply of spools, a thread guide and a bobbin winder are needed to warp a sectional warp beam.
- 2a. The number of threads per inch is 15 in this project so the number of spools is 30.
- 2b. This project is 16 inches wide so 8 sections will be warped. The warp is 3 3/4 yards long. Each spool should be wound with 8 X 3 3/4 yards or 30 yards. So 30 spools will be wound. Each with 30 yards of warp.
- 2c. It is not necessary to have the exact amount on the spools but it is necessary to have at least 30 yards on each spool. Any warp left on the spools after warping can be wound on bobbins and used for weft.

B. Placing spools on spool rack

1. Illustration of spool rack shows method. (Page 20.)

C. Threading the thread guide

1. The thread guide is a rectangular piece of metal a little more than 2 inches wide with at least 60 holes punched in it. (See page 20.)
- 2a. The guide is used to keep the warp threads in order as they are wound on the beam. All looms with sectional beams should have a slit in the back beam.

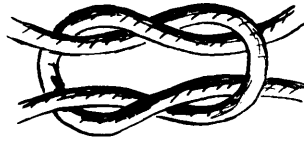

SQUARE KNOT

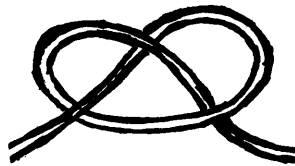

OVERHAND KNOT

LAMMS



TREADLES

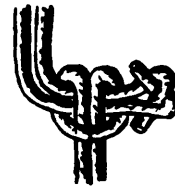
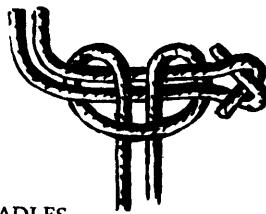

SNITCH KNOT
after M. Atwater

Operation

- b. Work from top to bottom on the spool rack and on the thread guide.

D. Winding on the warp

1. Move the guide over the first section to be warped.
2. Pick up the cord or tape in first section to be warped.
3. Pull all the warp ends through the loop for about 6 inches and tie.
4. Turn the warp beam to wind on the warp.
 - a. Count the turns.
 - b. Wind on the correct yardage.
5. Before threads are cut in each section put paper tape or masking tape over and under threads so they will not tangle when threading. Place well back from tie and remove after threading.
6. Cut all the warp ends at the $3\frac{3}{4}$ yard mark.
7. Tie the ends of the warp wound on the beam around a peg in the beam.
8. Move the guide over the next section to be warped.
9. Tie the warp ends to the tape.
10. Repeat 4, 5, 6, and 7 above.

Information

- 2b. The warp threads should not be crossed or tangled since this will make it difficult to wind warp on the beam.

D. Winding on the warp

1. Start with an end section if the entire width is to be used. If only a part of the beam is to be used, use center sections.
3. Use the tie illustrated for tying to the apron.
4. Turn for 3 complete turns plus $\frac{3}{4}$ turn for waste for this piece. One turn equals one yard.
6. Cut the whole strand at one time, but do not drop the cut ends.
7. Use a half hitch or the same tie as used for tying the warp ends to the tapes. Use the pegs which divide the filled section from the sections that will not be used. When tying the next section, tie to the peg on the same side as the first one.
10. Be sure the tension is the same on all sections.

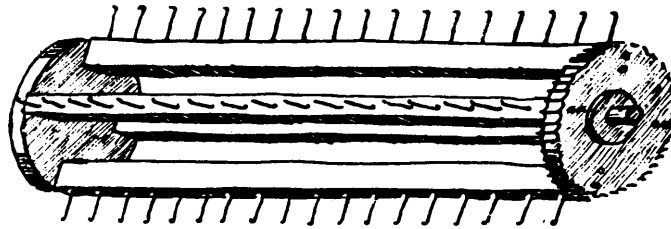

SECTIONAL WARP BEAM

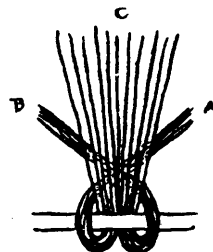
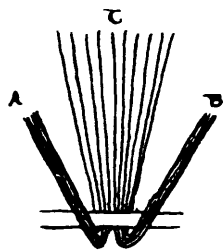

Cross "A" and "B"
Behind "C"

Bring "A" and "B"
To Front of "C"
Tie Bow Knot

To tie warp to sectional beam or apron

Operation

11. Repeat until all the sections are warped.

Information

11. Work eight sections for this project.

IV. Setting Up Looms - Tying Up Counterbalanced Loom - Hanging the Harnesses (Temporarily)

The old fashioned looms and some of the new ones are counterbalanced. The harnesses are hung in pairs over rollers which are suspended from the top cross beam of the loom. The following directions will outline the steps for hanging the harnesses.

Operation

A. Tying harnesses in place temporarily

1. Run a heavy cord under top piece of all the harnesses.
2. Take cord over top of cross beam of loom.
3. Tie the ends together so that the bottom bar of the harnesses is at the same level as the breast beam.

B. Hanging the small rollers

1. Cut 2 cords 2 yards long.
 - a. Double them.
 - b. Attach to the ends of one of the small rollers.
2. Cut 2 more cords 2 yards.
 - a. Tie ends together to form loops. Use over-hand knot. Put two ends together and tie single knot.
 - b. Attach to ends of other small roller.
3. Attach small rollers to large roller.

Information

A. Tying harnesses in place temporarily

1. A cord at each end of the harnesses is recommended for tying securely.

B. Hanging the small rollers

- 1a. A heavy linen cord is best because it stretches very little.
- 1b. A venetian blind cord is satisfactory. At least 60 yards will be needed for the entire tie-up.
- 1c. Doubled end may be attached by putting loop through hole in metal piece at end of rollers and running free ends through the loop and pulling tight.
2. One end of loop should be put under roller. To attach it put the other end through the first loop and pull tight.
3. The large roller is usually in place on the loom.

Operation

- a. Take long double cords up around and over large roller at the top of the loom, from back to front.
 - b. Attach to cords of other small roller. Use snitch knot. (See Illustration.)
4. Adjust snitch knot so that the small rollers hang halfway between the large roller and the top of the harnesses.

C. Hanging harnesses

1. Cut 4 long cords.
 - a. Double all cords.
 - b. Attach to each of 2 of the harnesses.
2. Cut 4 more long cords the same length.
 - a. Form loops by tying ends together, using overhand knot.
 - b. Attach to each end of other harnesses.
3. Hang harnesses from the small rollers.
 - a. Take the long double cords of harness #4 up around and over the small roller nearest the back of the loom (1 1/2 turns).
 - b. Attach to the looped cords on harness #3, using a snitch knot.

Information

4. The snitch knot should be adjusted by using single knot in the doubled cord and sliding the looped cord either up or down until the proper length has been reached. Re-tie doubled cord having the knot straight across.
5. It is necessary to tie rollers when in proper position so they will stay in place while the tie-up is completed. Use any extra cord for this.

C. Hanging harnesses

- 1a. The length of cords should be more than twice the distance between the top of the harnesses and the small rollers.
- 1b. The same method should be used to attach cords to small rollers, on harness #1 and #2, counting from front of loom.
- 2a. These are harnesses #3 and #4 counting from the front of the loom.
- 2b. The same method of attaching cords should be used as for small rollers.

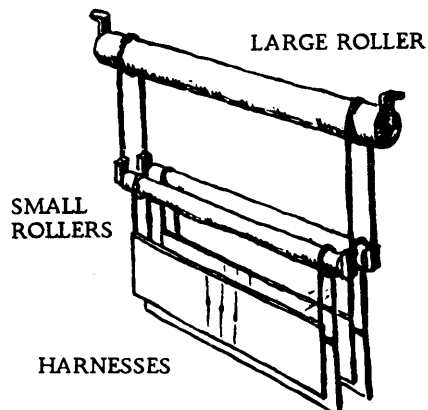

Operation

- c. Repeat process with harnesses #2 and #1.
- 4. Adjust cords so that the harnesses will hang in the correct position.
- 5. Tie harnesses together while tying the harnesses to the lamms.

Information

- 4. The correct position may be found by running a long piece of string through the eye of a heddle and taking the ends over the back beam and tying to the apron. If the string is in a straight horizontal line the harnesses are in the correct position.

V. Setting Up Looms -- Tying up Counterbalanced Loom -- Tying Harnesses to the Lamms

The harnesses are not tied directly to the treadles but are first tied to the lamms which are long pieces of wood running across the loom under the harnesses. One end is free and the other is attached to the uprights of the loom. Each lamm has a screw eye or hole in the top directly under a screw eye attached to the bottom of a harness.

Operation

- A. Attaching each lamm to corresponding harness
 - 1. Cut 8 cords whose length is a little more than twice the distance between the lamms and the bottom of the harnesses.
 - 2. Double 4 of the cords and attach to the screw eye in the bottom of the harnesses. (See Illustration.)
 - 3. Form loops with the other 4 by tying ends together with an overhand knot and attach to the screw eyes in the top of the lamms. (See Illustration.)
 - 4. Fasten the looped cords from the lamms to the double cords on the harness directly above the lamm.
 - 5. Adjust the knot so that the free ends of the lamms are slightly higher than the fixed ends.

Information

- A. Attaching each lamm to corresponding harness
 - 4. The snitch knot should be used because it is easily adjusted and never binds.
 - 5. The tie-up is the same no matter how many harnesses are involved.

VI. Setting Up Looms -- Tying Up A Jack Type or Rising Shed Loom

Most of the Jack type looms now on the market have two sets of lamms, and the manufacturers all arrange it so the harness frames rise when the foot treadle is depressed, but each manufacturer goes about this in a different way. And while there is a drawing given of one type of Jack loom, it is not the only type that works well. So far as we know, all of these looms come set up with the exception of the treadles and there is really no need to go into the methods by which manufacturers reach the same effect. The method of tying up the treadles for a jack type loom is given in XI. B. Read this carefully if your treadles are not already tied or if they are not tied as you like them.

Operation

Information

- A. 1. Most of these looms come already tied or chained in the proper way, but if not, directions are sent with the loom.
2. Keep in mind that in a jack type loom the harnesses only rise. They do not ever sink. For this reason all four harnesses when at rest have the heddle eyes just a little below the lowest part of the reed. In that way, when part of the heddles are raised to form a shed, the tension on the upper set of threads and the lower set is about the same.
3. The main advantage of the rising shed loom is that certain patterns call for an odd number of heddle frames to be lifted at a time. This is not true of many patterns, but is very desirable in some. It is harder to keep an even shed on a counterbalanced loom when this is called for. A jack type loom does it without difficulty.

VII. Reading The Pattern or Draft

A pattern or draft is a picture showing the order of threading the warp through the heddles so that a certain pattern may be woven. There are several methods of writing a draft. The one given here is the most common one used in the United States. Every potential weaver should learn to read a pattern.

Operation

Information

A. Method of notation

A. Method of notation

JACK TYPE LOOM

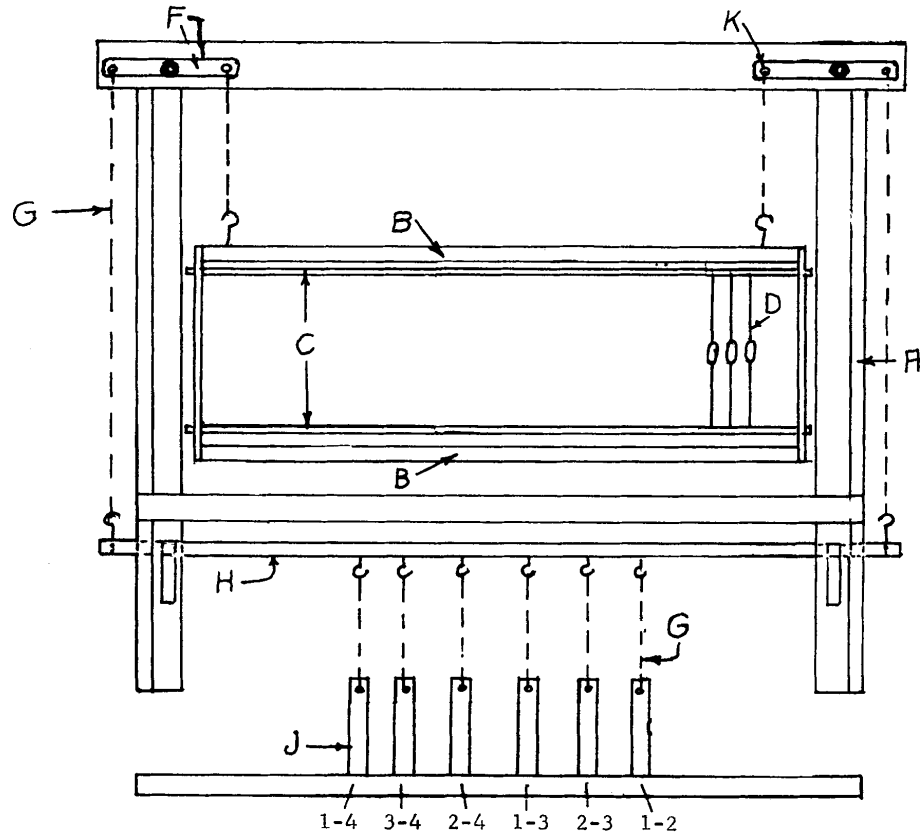

- | | |
|-------------------------------|------------------------|
| A - LOOM INNER FRAME | G - CHAINS OR CORDS |
| B - HARNESS FRAME | H - LAMMS |
| C - HEDDLE SUPPORT ROD | J - TREADLES |
| D - HEDDLES | K - ROLLER BOLT OR PIN |
| F - JACKS FOR RAISING HARNESS | |

Operation

2. Read the draft from right to left starting with the first marked square on the right.

Information

1. The patterns or drafts are written on graph or squared paper. The paper usually has 10 squares to the inch.
2. The draft of a 4-harness twill looks like this:

ILLUSTRATION OF TWILL DRAFT

Repeat of Pattern						Harness
X				X		4
	X				X	3
		X				2
			X			1

Begin

3. The numbered horizontal rows represent the harnesses. Row #1 is harness #1 which is the harness nearest the front of the loom.
4. The marked squares represent the warp threads.
5. The loom is threaded from right to left.
6. The draft should always be read from right to left starting with the first marked square on the right.
7. The first marked square on the draft of the 4-harness twill appears on row #1 and means that the first warp thread would go through the eye of the first heddle on harness #1.
8. The second marked square appears on row #2 and means that the second warp thread would go through the eye of the first heddle on harness #2.
9. The third marked square means that the third warp thread would go through the eye of the first heddle on harness #3.

Operation

Information

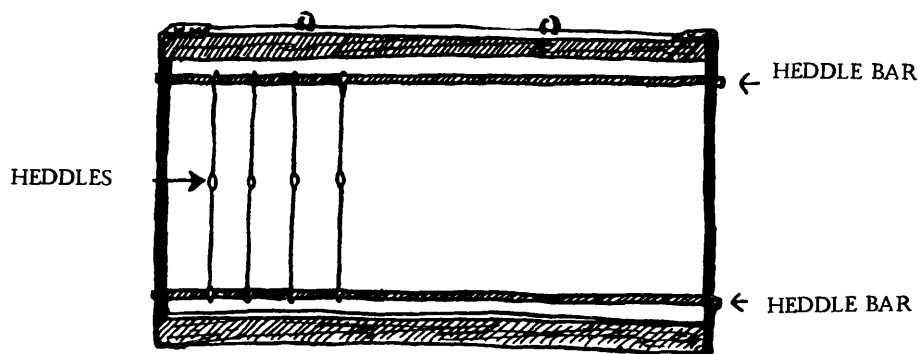

HEDDLE FRAME
OR HARNESS

10. The fourth warp thread would go through the eye of the first heddle on harness #4.
11. The fifth warp thread would go through the eye of the second heddle on harness #1, since this pattern must be repeated for all the warp threads.
12. The sixth warp thread would go through the second heddle on harness #2, and so forth until all the warp threads are through the eyes of the heddles.

VIII. Threading The Heddles From Pattern

Threading the heddles is a simple operation once a weaver has learned to read a pattern. It is important to thread the heddles in the proper order because mistakes in threading will disfigure finished fabric.

Operation

Information

A. Preparing harnesses for threading

A. Preparing harnesses for threading

1. Determine the number of heddles needed on each harness, by dividing total number of warp threads by number of threads in one repeat of the pattern.

- 1a. Each harness must have enough heddles to carry the warp.
- 1b. The total warp threads (240) must be divided by the number of threads in one repeat (4), giving total number of repeats in width of fabric (60 repeats).

Operation

2. Count the threads on each harness in one repeat of the pattern.
3. Multiply the answer found in 1b. by number of threads on each harness.
5. Lease sticks are between back beam of loom and heddles. Tie firmly in place or use two long strong sticks from back beam through harnesses to front of loom. Tie in place and rest lease sticks near harnesses. Tie firmly.

B. Placing heddles on the harnesses

1. Undo the catch of each heddle bar at one end of the harness only.
2. Slip the heddles on the bars.
3. Refasten the catches when the correct number of heddles has been placed on each harness.
4. If there are too many heddles on a harness, remove two heddles and place one beside one heddle bar and one beside the other and parallel to it. Slip the extra heddles off the bar and onto the two heddles in groups of six to twenty at a time, then tie them in place and store till needed.
5. Replace the harnesses in the loom when the harnesses have the correct number of heddles on them.

Information

2. A twill weave, in one repeat, has one thread on each harness.
3. The number of repeats multiplied by the number of threads in one repeat on harness #1 equals 60 X 1, or 60 threads on harness #1. Since in a twill weave there is only one thread to a harness in a repeat, each of the four harnesses holds 60 threads.
4. Each thread requires one heddle so there must be 60 heddles on each harness.

B. Placing heddles on the harnesses

2. The tops of the heddles should be placed on the bar in the same order as the bottoms.
5. Section on tie-up of looms gives description of this operation.

Operation

C. Threading the heddles

1. Take a position at the right side of the loom, facing right hand ends of harnesses.
2. Push all the heddles away from weaver to the left of all the harnesses.
4. Bring toward weaver the first heddle on first harness to be threaded.
5. Pick up the warp thread in the cross nearest the weaver with right hand. On sectional warp beam select first thread in warp.
6. Cut the end of the loop, if not already done. Select the nearest of the 2 cut ends.
7. Bring this thread to rear of the harnesses.
8. Insert the thread through the eye of #1 heddle on #1 harness. Use threading hook if preferred.
9. Pull thread through about 12 inches.
10. Bring toward weaver, the first heddle on next harness.

Information

C. Threading the heddles

2. Heddles may be moved out of the way to give space to handle yarn and to thread each heddle.
- 3a. This position is best if threading is done by one person only.
- 3b. This position enables weaver to reach warp thread, and heddle without moving.
- 3c. In some looms it is more comfortable to sit in front of loom with front feet of stool or chair inside framework of loom. Lease sticks tied close to heddle frames. Use low stool or lift or lower heddle frames till heddle eye in center of heddle is at eye level.
5. The first right hand section should be untied and enough yarn unwound to bring up over back beam, through eyes of heddles, plus 8 inches to tie.
9. It is necessary to draw threads far enough through heddles so threads will not slip out and thus lose the threading.
10. This thread may have to be cut depending on the number of threads that had been carried

Operation

11. Pick up the next thread in the cross.
12. Bring thread to rear of harnesses.
13. Insert the thread through #1 heddle on #2 harness.
14. Pull thread through about 12 inches.
15. Bring toward weaver, the first heddle on the next harness.
16. Select the next warp thread in cross.
17. Bring thread to rear of harness.
18. Insert the warp thread through #1 heddle on #3 harness.
19. Repeat 14 above.
20. Bring toward weaver, the first heddle on the next harness.
21. Select the next warp thread in cross.
22. Bring thread to rear of harness.
23. Insert the warp thread through #1 heddle in #4 harness.
24. Bring toward the weaver the second heddle of first harness.
25. Repeat selection of threads, and threading of heddles in same order as was done with the first group of heddles; that is, thread #2 heddle, on #1 harness; #2 heddle, #2 harness; #2 heddle, #3 harness; and #2 heddle, #4 harness. Continue operations until 16 or 20 warp threads have been threaded.

Information

together when making the warp. Loops are cut only as needed, so that threads cannot drop out of cross.

Note: Section 5 and 6 under operations, do not apply when using sectional warp beam.

21. Each heddle is brought toward the weaver for ease in threading.
- 25a. The warp ends must be threaded in the order in which they lie on the warp beam or through the lease sticks.
- 25b. It is important to check the threading after 16 or 20 heddles are threaded, to be certain that the threads follow in their proper order, according to the pattern of the draft.

Operation

Information

- 25c. A tie is made of all threaded warp ends, to prevent the threads from falling out of the heddles after making certain that threads are in proper order. This is a safety measure. Checking and tying should be done with every 16 or 20 threads as the threading proceeds.
26. Tie the ends of these threads together in a loop if correct. This makes it easy to untie later.
- a. Repeat operations until all warp threads are threaded in the heddles.
 - b. Check the threading to see that heddles are threaded in the correct order.

IX. Drawing-In or Sleying

The process of drawing the warp threads through the reed is called drawing-in or sleying. In the batten or beater is a long metal strip called the reed in which vertical slits are cut; these slits are called dents. Reeds are classified by the number of dents per inch. A 15 dent reed is one with 15 dents per inch and if threaded with one warp thread to a dent with a medium coarse yarn like Perle #5, would have 15 warp threads per inch. A finer yarn than Perle #5 would be threaded two threads to a dent and would have 30 threads per inch. The purpose of the reed is to space the warp threads evenly and to hold them in place while weaving.

Operation

Information

A. Preparing for sleying

A. Preparing for sleying

- 1. Stand or sit on weaving stool in front of loom.
- 1a. The weaver chooses the most comfortable position. It is important for the weaver to stand at front center so that he can move all threaded heddles to their natural position in their respective harnesses. The best position of the heddles is one in which they are spread evenly through the warp width, in the center of the loom.
 - 1b. The threading of the warp through the reed is called drawing-in or sleying.

Operation

2. Gather up all groups of tied warp ends.
3. Shake warp gently to carry the heddles to the center section of the harnesses.
4. Drop the tied ends so that they hang between the reed and the harness.

B. Propping beater or batten in position

1. Place two heavy sticks from front breast beam through harnesses to back beam. Tie firmly with waste thread. Place reed flat on sticks between heddle frames and breast beam. Tie to sticks.

C. Measuring the reed

1. Locate the center of the reed.
2. Measure to the right of center $\frac{1}{2}$ the width of the warp and mark, in this instance, 8 inches.

D. Sleying the warp

1. Take the first group of tied threads at right of loom, and bring over top of reed.
2. Hold loosely in left hand.
3. Untie the loop.
4. Shake gently to separate threads.

Information

- 1c. The slots in the reed are called dents.
- 1d. Replace breast beam of loom. (See page 19.)

B. Propping beater or batten in position

C. Measuring the reed

1. The center is measured from each end of the reed.
- 2a. It is necessary that warp be in center of loom for an evenly balanced loom and better quality fabric.
- 2b. The measuring is done to locate first dent to be sleyed so that warp is balanced in center of reed. Sticks should be placed far enough apart to allow room to thread through dents. In this case, 15 inches or more apart.

D. Sleying the warp

Operation

5. Insert draw-in hook from lower to upper side of reed and through the first dent to be sleyed.
6. Hook the first thread that was threaded through #1 heddle of #1 harness, and draw through the reed, letting thread hang below reed.
7. Insert draw-in hook in next dent, working toward the center.
8. Hook the next thread and repeat until the first group of threads is drawn in or sleyed.
9. Tie the first group of threads with a loop so there is no danger of threads being pulled out of reed.
10. Repeat these operations with each group of tied threads, until all warp threads are sleyed.
11. Check sleaying to be certain no dent has been skipped or double threaded.
12. Remove sticks and place reed in beater. Put on top of beater. If entire beater has been removed, replace it first.

X. Tying-In To Apron

Attached to the cloth beam is a canvas apron or a cord. A rod or stick runs through the large hem at free end of apron. The warp threads are tied to this stick holding the warp threads at a tension. As weaving progresses, the apron and the woven fabric are wound onto the cloth beam. Tying the warp to the apron is the last step in dressing the loom.

Operation

- A. Unrolling apron and bringing over breast beam

Information

6. The threads should be hooked in the order in which they were threaded in the heddles, so that there will be no crossed threads between the harnesses and the reed. Crossed threads will not weave in and will show later as an error in woven material.

Information

- A. Unrolling apron and bringing over breast beam

Operation

1. Release the catch on the cloth beam so beam will roll freely.
2. Take free end of apron and carry over the breast beam from front to back of loom.

B. Cutting slots in apron

1. Remove rod from hem of apron.
2. Use pinking scissors for cutting slots at right angles to position of rod when in place, cutting through hem of apron.
3. Cut slots 1 1/2 inches long, 2 inches apart, beginning 1 inch from selvage of apron.
4. Replace rod in hem dropping alternate pieces of cut cloth.

C. Tying-in warp ends to apron

1. Pick up one group of tied warp threads in center of warp.
2. Untie knot at end of group of warp threads.

Information

1. The apron is usually a medium weight cotton duck, which is permanently fastened to the cloth beam roller in the front of the loom.
2. The apron is usually fastened to the roller with carpet tacks when the loom is purchased.
3. The apron extends the full width of the roller and is long enough, when brought over the breast beam, to hang freely 6 to 12 inches.
4. The free end of the apron is finished with a one or two-inch hem in which a round metal rod or heavy stick, the width of the apron, is inserted.
5. The rod is part of the equipment furnished with the loom.

B. Cutting slots in apron

- 3a. A large number of slots permits tying warp threads into many small groups of a few threads rather than a few groups consisting of a large number of threads.
- 3b. This simplifies drawing together the warp when beginning to weave.

C. Tying-in warp ends to apron

1. It is advisable to begin with center group of warp threads for better balance.

Operation

3. Run finger through strands to comb out.
 4. Divide threads into 2 equal parts, holding one part in each hand.
 5. Push one strand of threads through center slot of apron and hold on under side.
 6. Push other strand of threads through same slot and hold with other hand.
 7. Bring one strand to the left and other to the right on either side of main strand.
 8. Keep the tension on all threads as nearly the same as possible.
 9. Bring each strand up on either side to top, and tie in bow.
 10. Pick up alternate groups of threads on each side of center group and proceed to tie-in apron as directed for center group of threads until complete warp has been tied-in to apron, using a separate slot for each group of threads.
 11. Tie all groups at the same tension.
- D. Adjusting tension of all warp threads of apron
1. Tighten warp. Test the tension of complete warp after tie-in is completed.

Information

4. Threads are divided equally so that they may be crossed over the rod or sticks in apron and tied.
 7. The strand should be equally divided to help maintain balance and an even tension.
 - 9a. It is important to make only a bow, without first tying a single knot, for ease in opening bow to adjust tension.
 - 9b. Tension must be maintained equally throughout warp.
 10. Alternate groups of threads should be tied in from center to maintain an even balance of the warp.
 - 11a. It is advisable to have the last tie on left and right edges slightly wider than width of warp. This will help to keep the starting edge of the finished weave from too much draw-in as the shuttle is thrown.
 - 11b. The narrowing of the warp as it is being woven, is called "Draw-in."
- D. Adjusting tension of all warp threads of apron
1. The testing should be done with flat of hand on top of warp.

Operation

2. Readjust tension of groups of threads where needed.
3. Re-tie all groups of threads that are loose or too tight.
4. Continue readjustment until all warp threads are at as even tension as possible.

Information

2. It is advisable to untie one group at a time so that entire warp does not become slack.
- 3a. A group of loose warp threads makes a loosely woven streak throughout the length of the fabric.
- 3b. A group of tight warp threads will also disfigure the fabric.
4. Any time spent on readjusting the ties is time well spent.

XI. Tying-Up The Treadles

The treadles on the "Jack type" loom and on the counterbalanced loom are tied directly to the lamms under the harnesses. When the treadles are depressed, the harnesses rise on a "Jack type" loom; on a counterbalanced loom, the harnesses sink. This action separates the warp threads into an upper group of threads and a lower group of threads. The space between these two groups of threads is called the shed. The shuttle, carrying the weft thread, passes through the shed. For a 4-harness twill, the treadles are tied to move two harnesses together at a time.

Operation

A. Reading the tie-up draft

Information

A. Reading the tie-up draft

1. A draft for the treadle tie-up usually accompanies the pattern draft and is usually labeled for "a rising shed" or "a sinking shed."
2. This is the 4-harness, 6-treadle tie-up for the counterbalanced or sinking shed loom.

3. Lamms

X	X	X				4
	X		X	X		3
		X		X	X	2
X			X		X	1

Treadles 6 5 4 3 2 1

4. The numbered vertical rows represent the lamms. Row #1 is lamm #1 which is the lamm nearest the front of the loom.

Operation

B. Reading the tie-up draft from right to left

1. Read the tie-up draft from right to left.

Information

5. The numbered horizontal rows represent the treadles. Row #1 is treadle #1 counting from the first treadle on the right.
6. The marked squares represent the lamms which are to be tied to the treadle.

B. Reading the tie-up draft from right to left

1. The treadles are numbered from right to left.
2. The two treadles at the right and the two at the left are the pattern treadles and the only ones used in a twill weave.
3. The two treadles marked 3 and 4 are the tabby treadles. When treadled alternately, they raise and lower alternate threads and make a plain over and under weave.
4. This tie-up runs as follows:
Lamms #1 and #2 are tied to treadle #1;
Lamms #2 and #3 are tied to treadle #2;
Lamms #3 and #4 are tied to treadle #5;
Lamms #1 and #4 are tied to treadle #6;
Lamms #2 and #4 are tied to tabby treadle 4;
Lamms #1 and #3 are tied to tabby treadle 3.
5. This tie-up draft for a Jack type loom or "rising shed" loom is given below.

			0	0	0	4
0		0			0	3
0	0		0			2
	0	0		0		1
Treadles	6	5	4	3	2	1

Operation

Information

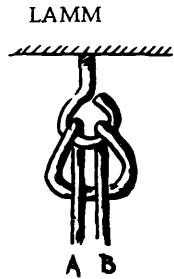

"A" AND "B" ARE LONG LOOSE ENDS WHICH EXTEND TO TREADLE

TIE "A" AND "B" TO "C" WITH SNITCH KNOT

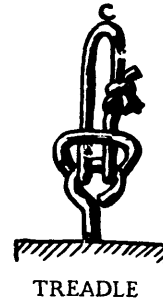

6. This draft is read in the same way as the sinking shed draft.
7. The only difference between the two drafts is that the squares marked in the rising shed draft are the ones that are unmarked in the sinking shed draft.
8. The 4-harness loom which has only 4 treadles requires each treadle to be tied to one lamm. This makes it necessary to use two treadles to move two harnesses.
9. This is the draft for a 4-treadle loom.

				Lamms
X				4
	X			3
		X		2
			X	1

Treadles 4 3 2 1

10. Treadles #1 and #2 have to be used to obtain the first shed for a 4-harness twill on a

Operation

C. Tying the Treadles

1. Cut 12 cords which when doubled and fastened through the screw eyes in the lamms will reach the treadles.
2. Attach one cord to each of the lamms to be tied to treadle #1.
3. Repeat with other cords on the other lamms.
5. Tie the ends of each cord together using the overhand knot.

Information

sinking shed loom. Treadles #2 and #3 depressed give the second shed. Treadles #3 and #4 depressed give the third shed and treadles #4 and #1 depressed give the fourth shed. For plain weave use treadles #1 and #3 and for the second plain weave use treadles #2 and #4.

C. Tying the Treadles

1. Looms in most cases come equipped with 4 screw eyes attached to the treadles and with 4 screw eyes to the lamms.
2. The cord should be attached to the screw eye directly over treadle #1 to lamms #1 and #2, counting from front of loom, on a counterbalanced loom; lamms #3 and #4 on a jack loom.
3. On a counterbalanced loom:
Lamms #1 and #2
for treadle #1;
Lamms #2 and #3
for treadle #2;
Lamms #3 and #4
for treadle #5;
Lamms #1 and #4
for treadle #6;
Lamms #2 and #4
for tabby #4;
Lamms #1 and #3
for tabby #3.
4. On a Jack type loom:
Lamms #3 and #4
for treadle #1;
Lamms #1 and #4
for treadle #2;
Lamms #1 and #2
for treadle #5;
Lamms #2 and #3
for treadle #6;
Lamms #1 and #3
for tabby #4;
Lamms #2 and #4
for tabby #3.

Operation

6. Attach these cords to the screw eyes in the treadles directly under the cords from the lamms.
7. Tie the cords from the lamms to the cords from the treadles using the snitch knot.
8. Pull up the treadles until they are high enough to raise or lower the harnesses for a good shed and will not touch floor when depressed.

Information

6. For illustration of method of attaching, see page 43.
7. For illustration of snitch knot, see page 23.
 - a. This knot is used because it is easily adjusted and does not bind.
8. A good shed allows plenty of room for the shuttle between the upper and lower groups of warp threads.
9. Knots should be adjusted until there is a good shed.

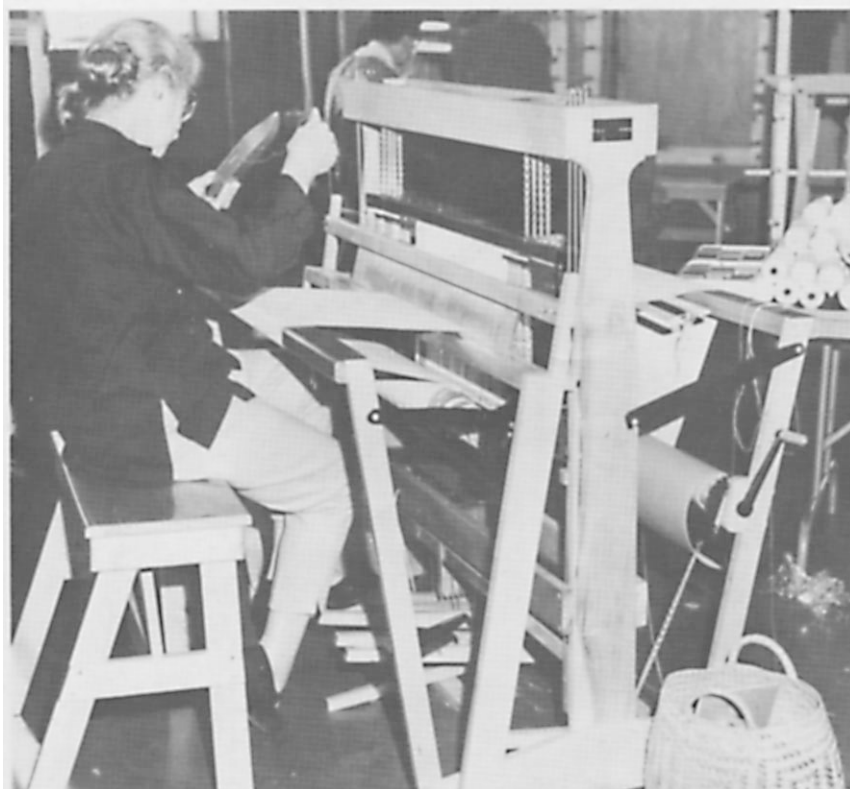

Using the boat shuttle in Weaving.

Operation

10. Tie both knots on each treadle at the same tension.
11. Tie all the ties on the treadles so that all the harnesses may be raised or lowered to the same level.

Information

10. The harnesses will move unevenly if the tension is not the same on both ties and shed will not be clear for shuttle to pass through.
11. It may become necessary later on while weaving to readjust these ties.
12. This tie-up is the standard one for the majority of patterns woven on a 4-harness loom.

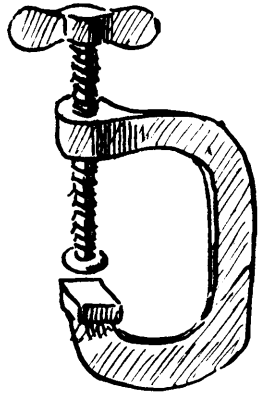

"C" CLAMP

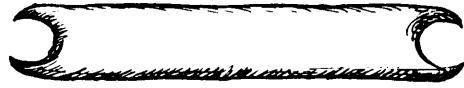

FLAT SHUTTLE



BOAT SHUTTLE

MAKING BOBBIN



FOR BOAT SHUTTLE

WINDING BOBBIN
FOR BOAT SHUTTLE

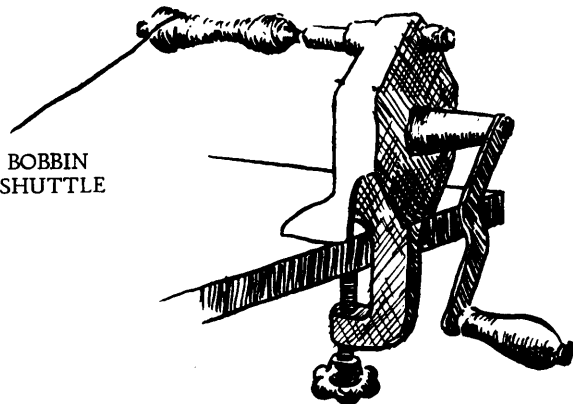

Chapter Five

WEAVING

I. Preparing the Weft

Operation

A. Making bobbin or quill for boat shuttle

1. Cut a piece of paper 6 inches long by 3 1/2 inches wide.
2. Round the corners.
3. Wind paper lengthwise around a small lead pencil to secure correct diameter.

B. Winding bobbin for boat shuttle

1. Fasten skein reel to table.
2. Place skein of yarn on skein reel.
3. Fasten bobbin winder near skein reel on table.
4. Take loose end of yarn on skein reel and fasten to paper bobbin with single knot.

Information

A. Making bobbin or quill for boat shuttle

1. Heavy brown wrapping paper makes good bobbins.
2. The corners of the paper will not protrude and winding is easier.
3. Paper is wound lengthwise to give a longer bobbin for holding larger supply of yarn.
4. Bobbin must turn freely in shuttle.
5. It is advisable to cut several bobbin papers for future use, as most weavers find it desirable to wind several bobbins at one time.

B. Winding bobbin for boat shuttle

1. Skein reel holds hank of yarn as it is unwound and transferred to bobbins. The skein reel is similar to that used by knitters.
- 1b. Yarn is often supplied on cones or spools and can be wound directly onto bobbins.
3. It is advisable to have skein reel and bobbin winder near each other so that both may be easily reached.

Operation

5. Place paper bobbin on bobbin winder.
6. Turn handle of bobbin with right hand, winding yarn on bobbin.
7. Hold yarn with left hand, guiding thread back and forth on bobbin at even tension, building up each end first.
8. Fill center on bobbin.
9. Turn winder until bobbin is full.
10. Break thread and remove bobbin from winder after bobbin is filled.

C. Threading boat shuttle

1. Unfasten rod or wire from shuttle.
2. Place a bobbin, wound with weft yarn, on the wire or rod.
3. Replace rod in shuttle so that thread unwinds from underside of bobbin.

Information

5. Bobbin should be pushed onto shaft of winder until it will turn with shaft, when the winder is operated.
- 7a. The ends of bobbin should be built up first to enable weaver to put more yardage on bobbin and prevent yarn from sliding off ends.
- 7b. The yarn should not be carried too close to ends of bobbin as thread may slip off ends.
9. The bobbin should not be overloaded as it must turn freely when placed in shuttle.

C. Threading boat shuttle

- 1a. The make of boat shuttle will determine whether the wire or rod may be hinged at one end while the other end is held by a small catch. To place bobbin in the shuttle, the rod must be pulled out at one end.
- 1b. Another type of shuttle has the rod held in place by a compression spring which is concealed in one end of the shuttle. To remove this rod, push the rod against the spring and withdraw completely from shuttle.
2. It is easier to weave with boat shuttles than with flat shuttles.
3. It is advisable to have a number of shuttles on hand in case the weaver desires to use several colors of material in the weft.

Operation

4. Thread end of yarn through slot or hole in the side of the boat shuttle.
5. Pull about 12 inches of yarn through slot.

D. Winding flat shuttle

1. Place yarn in skein reel as is done to wind bobbin.
2. Take loose end of yarn in right hand and flat shuttle in left hand.
3. Make loop in end of yarn and slip over one prong at end of shuttle to hold yarn in place.
4. Wind yarn lengthwise and over end through the notches in shuttle until full.
5. Break yarn when shuttle is full.
6. Fill several shuttles so that they will be ready when needed.

II. Weaving the Fabric

Throwing the shuttle from right to left and from left to right through the shed is the most pleasant operation in handweaving; it is also the simplest. Rhythm and speed come with practice. While weaving is more thrilling than setting up the loom, a real craftsman must be able to do both.

A. Making a heading

1. Use a flat shuttle wound with twine or waste yarn or heavy cord.
2. Hold flat shuttle in the right hand and unwind yarn one complete turn.
3. Push down tabby treadle 3.

Information

D. Winding flat shuttle

- 1a. Flat shuttle should be at least 1 inch longer than width of warp placed on the loom.
- 1b. Illustration of flat shuttle shown on page 47.
4. The shuttle should not be filled so heavily that it will not pass freely through the shed.

A. Making a heading

1. A heading is woven before starting the pattern in order to pull together the groups of threads tied to the apron.
2. The scrap yarn is suggested so that good weft yarns will not be wasted.
3. The heading is always made with tabby treadles.

Operation

4. Pass shuttle through the shed from right to left, taking end of shuttle into left hand.
5. Draw shuttle completely through the shed with the left hand.
6. Allow the first thread through the warp to extend from the right side for a few inches.
7. Grasp center of beater in the right hand.
8. Pull beater toward weaver pressing the weft toward the end of the warp as far as it will go. Use a sharp beating motion.
9. Push down treadle 4, after removing foot from treadle 3.
10. Return beater to original position near the harnesses.
11. Grasp shuttle with left hand, unwind enough yarn to go across the warp.
12. Pass shuttle through the shed from left to right.
13. Grasp end of shuttle with the right hand, and draw through the shed.
14. Grasp center of beater with the left hand.
15. Change foot to treadle 3.
16. Beat. Return beater to original position as you push foot down. This should be one motion.
17. Repeat operations 4 through 16 until all the warp threads are evenly spaced.

Information

4. Thread should lie softly in shed. Do not pull tight.
7. The beating should be done with the shed closed. Simply lift foot and beat.
8. The force of the beat depends on the type of material being woven. A heavy material takes a heavy beat, a light material a light beat.
9. An even beat must be used throughout the weaving.
18. The warp threads will draw together after 1 or 2 inches of heading.

Operation

B. Checking threading

2. Study the heading carefully for any mistakes in threading the reed or heddles.
3. Mistakes in threading the heddles can usually be corrected without taking the entire group of threads out of the heddles. Mistakes in the reed must be corrected from mistake to nearest border.

C. Correcting mistakes

1. Rethread the reed from this mistake out to the edge of the warp, first taking out the heading by reversing the order of the treadling.
2. Do the same as above.
3. Untie the group of warp threads in which the crossed threads appear and pull them out of the heading.
 - a. Straighten them out and rethread through the reed.
 - b. Attach to the apron by winding around a pin fastened in the apron.
4. Follow threads back to the heddles and pull out the thread that is incorrectly threaded.

Information

B. Checking threading

1. It is possible to detect most mistakes in threading the heddles and in sleying the reed after an inch or two of tabby has been woven. All mistakes should be corrected before weaving the pattern.
2. The weft should go alternately over and under one warp thread at a time and the warp threads should be evenly spaced.

C. Correcting mistakes (Read this column first)

1. A thick stripe the length of the heading indicates that more than one thread has been threaded through a dent.
2. A thin stripe indicates that a dent has been skipped.
3. It usually means that the threads are crossed between the heddles and the reed if a whole group of warp threads do not tabby.
4. A mistake in threading the heddles is indicated if three threads do not tabby or if there are two flats together.

Operation

- a. Add a string heddle to the correct harness at the correct place on the harness.
- b. Make a string heddle.
5. Cut a piece of string a little longer than twice the distance between the heddle bars.
6. Take one end under the bottom heddle bar of the correct harness.
7. Draw up both ends.
8. Tie a square knot at the level of the bottom of the eyes of the other heddles.
9. Tie another square knot at the level of the top of the eyes of the other heddles.
10. Take one end up and over the top heddle bar and tie very firmly to the other end.
 - a. Thread the warp end through the string heddle and through the correct dent in the reed and fasten around a pin in the apron.
11. Pull up the slack in the loose thread and wind the extra warp around a pin fastened to the apron.
12. Correct tabby mistakes by the following method:
 - a. Pull out one of the threads and leave at the back of the loom.
 - b. Thread it through the heddle and through the correct dent in the reed, resleying the reed if necessary.

Information

10. The string heddle must be held taut. The knots must be tied accurately or a clean shed will be impossible.
11. A loose thread in the warp may also prevent the warp from tabbying.
12. Other causes for the warp not tabbying:
 - 12a. Two threads through one heddle.
 - 12b. Reasons for heddle without a thread:
 1. The warp has fallen out of heddle.

Operation

- c. Rethread the heddles from the skipped heddle to the end of the warp or,
- d. Add a new warp thread on a sectional warp beam by taking a warp thread from a spool, over the back beam, through the skipped heddle and the reed. Wind around a pin fastened in the heading. Fasten the other end by winding back and forth between two pegs of the warp beam. This winding must then be moved every time the warp is rolled forward.

D. Placing extra thread in warp on a plain warp beam

1. Secure an empty spool similar to a linen thread spool.
2. Measure a warp thread the length of the warp used on the loom.
3. Tie the end of the thread to the spool.
4. Wind all of warp thread evenly on spool.
5. Fasten end of thread so it will not come off spool.
6. Allow spool to hang over back beam of loom where thread is to be replaced. Wrap spool once around back beam to secure proper tension.

Information

2. A heddle has been skipped. If pattern is correct, a skipped heddle will not affect the weaving.

D. Placing extra thread in warp on a plain warp beam

4. This winding is done by hand.
5. The fastening must be easily removed when additional warp is required from the spool. A pin is a good way to hold warp from unwinding.
- 6a. An extra weight may have to be fastened to spool so that thread will have same tension as rest of warp.
- 6b. The spool must at all times hang freely from back beam to maintain proper tension.

Operation

7. Take off enough warp to thread loom.
8. Pass warp thread through skipped heddle.
9. Make the correction, then continue with the next operation.
10. Re-tie the sections which are causing the irregularities. It may be necessary to unweave the heading first.
11. Finish the heading by cutting the heavy weft yarn at the edge of the fabric after all mistakes have been corrected.
12. Some mistakes in threading do not show up until first twill pattern is woven. Check after starting pattern. Above directions may be used to correct such mistakes.

E. Weaving twill pattern

2. Use a boat shuttle already prepared with bobbin wound with weft.
3. Grasp shuttle in the right hand.
4. Pull enough thread from the bobbin so that when the shuttle is passed through the shed, the

Information

7. The reed will have to be re-sleyed from the correction to the nearest edge if the mistake was found after the loom was completely threaded.
10. The heading should form a straight line across the warp, if it shows bumps or depressions the bunches of warp threads were not tied to the apron at an even tension.

E. Weaving twill pattern

1. The directions for treadling are usually given with the pattern draft. For a twill, treadle #1, #2, #5, #6 in order throughout the length of the fabric. The twill also may be woven by treadling #6, #5, #2, #1 in order. Do not change the order because the direction of the twill will change.

Operation

end of the thread remains at the right edge and hangs free about 1 1/2 inches.

5. Push down treadle #1 to open the shed.
6. Throw the shuttle through the shed from right to left, having the flat side of the shuttle as close to the reed as possible. Hole in shuttle through which thread is drawn is always towards the weaver.
7. Catch the shuttle with the left hand allowing the weft to lie loosely in the shed and have 1 1/2 inches of weft hanging free at the right side of the warp.
8. Grasp center of beater with the right hand.
9. Move foot from treadle #1. Draw beater sharply toward weaver, beating weft as far as it will go.
10. Place foot on treadle #2 and push down.
11. Return beater to original position near the harnesses.
12. Turn into the shed at the right the 1 1/2 inch of weft which was left free at the edge.
13. Throw shuttle from left to right with left hand.
14. Catch shuttle with right hand.
15. Grasp center of beater with left hand. Take foot off treadle #2.
16. Pull beater sharply toward weaver, pushing second weft thread against the first weft thread.

Information

7. The weft should not be pulled too tightly or the edges of the material will be pulled in and the edge warp threads are liable to break.
9. The beat depends on the type of material being woven. A light weight fabric takes a light beat and a heavy fabric takes a heavy beat.
12. The ends of weft should never be allowed to hang loose at the edges, always turn them into the next shed.
16. An even beat, one with the same pressure, must be used throughout the weaving so that the cloth will be of uniform weight.

Operation

17. Push down treadle #5.
18. Return beater.
19. Throw shuttle.
20. Remove foot to close shed.
Beat.
21. Push down treadle #6.
22. Return beater.
23. Throw shuttle.
24. Repeat operations beginning again with treadle #1, until the fabric is complete.

III. Hemstitching

A. Preparing to hemstitch

Information

17. The rhythm of weaving is as follows: treadle, return beater, throw shuttle, close shed by removing foot, beat, change treadle, return beater, again throw shuttle and continue in that order.
24. The edges of the fabric must not be handled.
25. The weft is too loose if the edges show loops. If the edges are drawn in, the weft is too tight. Test this with beater in forward position. If edges are drawn in more than 2 dents of edge of cloth, it is too tight.
26. Mistakes in weaving should be taken out by unweaving. (Treadling in reverse order.)

A. Preparing to hemstitch

1. Before beginning to weave the weaver must decide whether to finish the end of the fabric with a plain hem or with hemstitching.
2. If the weaver decides to finish the end by hemstitching, this operation is easiest done on the loom, and is described here.
3. For this, 4 pieces of cardboard 1 inch longer than the width of the warp and 3/4 inch wide will be required.

Operation

4. Push down tabby treadle 3.
5. Insert one piece of cardboard in shed.
6. Draw beater forward and press cardboard against heading.
7. Push down tabby treadle 4 and return beater to original position.
8. Insert second piece of cardboard in shed.
9. Draw beater forward and press cardboard toward the heading.
10. Remove foot from treadle and return beater to original position.

B. Hemstitching after Weaving One to Two Inches

1. Thread needle with length of weft which was left, at the start of the weaving for hemstitching.
2. Remove carefully both cardboards from shed.
3. Hold needle in right hand.
4. Guide needle over 4 or 6 threads, then under these threads.
5. Bring needle up and pull thread tight, drawing warp threads together.
6. Pass needle upwards through the opening made between

Information

4. For hemstitching on loom, use cardboard in shed. It also provides for a fringe if that is desired.
5. If more than one piece of material is to be woven, insert 4 pieces of cardboard between sections of fabric. This allows fringe on each piece.

B. Hemstitching after Weaving One to Two Inches

- 1a. The hemstitching is done after 1 or 2 inches of weft have been woven.
- 1b. The needle must have eye large enough for weight of yarn used.
2. The cardboards used should have smooth edges for ease in withdrawals from shed.

Operation

the 4th and 5th warp threads (about 1/8 inch from end of weft) and pull up tightly.

7. Pass needle over and under next 4 warp threads and repeat until all warp threads have been hemstitched.
8. Continue weaving as before after hemstitching.

IV. Changing bobbins

A. Changing bobbins

1. Weave weft as far as it will go in the shed.
2. Pull end up through the warp.
3. Thread shuttle with a new bobbin.
4. Throw the shuttle through the shed to finish the row.
5. Allow ends of the new and old weft to overlap under 8 to 14 warp threads.
6. Bring ends up through the warp.
7. Cut off the ends after weaving 4 or 5 more rows.
8. Where it shows, make the joining near selvage edge.

V. Winding Web on Cloth Beam

A. Winding web on cloth beam

1. Unlatch ratchet on cloth beam, loosening tension gently.

Information

A. Changing bobbins

7. The ends of the weft disappear into the fabric.

A. Winding web on cloth beam

1. It is necessary to wind the web onto the cloth beam when woven fabric or web gets so close to the reed that it is no longer possible to get a good shed.
2. The warp threads may snap if the tension is released too suddenly. Looms vary as to how far to weave before rolling up. All beginners have a

Operation

3. Release ratchet on the warp beam.
4. Unwind from the warp beam, warp equal in length to the length of the woven fabric.
5. Use cranking lever on the cloth beam to wind the woven fabric on it until the last weft thread is several inches from the breast beam or in a position so that it may be beaten.
6. Be sure to maintain the same tension as the piece had originally. Test by patting warp with fingers.
7. Adjust both beams to secure original tension if necessary and maintain fabric in position for beating.
8. Proceed with throwing the shuttle.
9. Wind fabric on the cloth beam whenever necessary. Best results are obtained by rolling up frequently.

VI. Using Two Shuttles on a Twill Weave

A. Using two shuttles on a twill weave

3. Thread two shuttles with weft yarn.

Information

tendency to weave too far before rolling up. This leaves loose and tight places in finished fabric.

A. Using two shuttles on a twill weave

1. A weaver may find that in weaving a twill pattern one or two warp threads at either edge may not weave into the cloth. Usually this does not matter greatly. If it does, rethread end thread or begin at different part of pattern.
2. It is possible to pick up these edge threads by using two shuttles thrown alternately through the weave.

Operation

Information

4. Push down treadle #1.
5. Throw shuttle #1 from left to right through the shed.
6. Beat.
7. Push down treadle #2.
8. Return beater.
9. Throw shuttle #2 from right to left through the shed.
10. Beat.
11. Push down treadle #5.
12. Return beater.
13. Throw shuttle #1 from right to left.
14. Beat.
15. Push down treadle #6.
16. Throw shuttle #2 from left to right.
17. Beat.
18. Push down treadle #1.
19. Return beater.
20. Continue operations using shuttles alternately until fabric is complete.
21. There are hundreds of variations of the twill weave. Try working out some of these. It will be a thrilling experience.

VII. Removing Fabric From The Loom

When the end of the warp is so close to the back of the heddles that it is impossible to get a good shed, it is time to remove the fabric from the loom. Weavers usually sew the end of the material before taking it from the loom. This is done to prevent unravelling when the cloth is washed and pressed.

Operation

Information

A. Hemstitching end

A. Hemstitching end

Operation

1. Unwind 2 yards of weft from shuttle.
2. Cut thread.
3. Thread yarn through eye of heavy needle similar to darning needle.
4. Hold needle in right hand.
5. Guide needle over 4 or 6 threads then under these threads.
6. Bring needle up and pull thread tight, drawing warp threads together.
7. Pass needle upwards through fabric through the opening made between the 4th and 5th warp threads (about 1/8 inch from end of weft) and pull tightly.
8. Pass needle over and under next 4 warp threads and repeat until all warp threads have been hemstitched.
9. Hemstitch the edges of table mats as they are woven. If the piece on the loom is planned for luncheon mats, do the following:
 - a. Weave heading.
 - b. Put in 2 pieces of a 3/4 inch wide cardboard in the next shed.
 - c. Weave 1 or 2 inches of pattern.
 - d. Pull out the cardboards and hemstitch the edge.
 - e. Finish weaving the mat.
 - f. Hemstitch edge.

Information

1. Hemstitching is used as a finish when a fringed end is desired.
2. Hemstitching should be started at left edge as the last throw of the shuttle was from right to left.

Operation

- g. Put in 2 pieces of a 3/4 inch cardboard in the next shed.
- h. Change the shed.
- i. Put 2 more pieces of 3/4 inch cardboard in the next shed.
- j. Weave 1 or 2 inches of pattern.
- k. Pull out cardboards.
- l. Hemstitch edge.
- m. Repeat process for each mat.

B. Overcasting end

- 1. Unwind from the bobbin, yarn equal to twice the width of the fabric.
- 2. Cut the thread from the bobbin.
- 3. Thread yarn through the eye of a heavy needle.
- 4. Start sewing on the left side.
- 5. Take stitches at an angle.
- 6. Take the thread over 3 warp threads, down between the 3rd and 4th warp threads, under 2 warp threads, up through the web about 3 weft threads from the edge.
- 7. Repeat for width of fabric.

C. Cutting warp

- 1. Take tension off warp by unfastening ratchet on warp beam.
- 2. Cut through complete warp about 1 inch beyond end of weaving.

Information

B. Overcasting end

- 1. The last shot of weft should end on the left side of the fabric.
- 6. The thread should not be pulled tight.
- 7. This finish is used when a turned hem is planned for the final edge of the piece.

C. Cutting warp

- 1. The removal of tension causes material to go slack.
- 2. Scissors should be used for cutting.
- 3. The warp will not fall out of reed or heddles if slack when cut.

Operation

D. Taking fabric off cloth beam

1. Release 2 ratchets on cloth beam.
2. Begin rolling free end of fabric onto tube.
3. Continue unwinding fabric from cloth beam on tube or board until all of woven material has been removed from beam.
4. Cut through the warp near apron to remove the fabric from the loom.

E. Stitching raw ends of fabric

1. Use sewing machine, with ordinary cotton thread and stitch two or three times across each end of the fabric, if it has not been previously hemstitched.
2. Roll fabric on tube, for ease in handling and protection of finished fabric when stitching is complete.

VIII. Finishing or Processing the Fabric

The finishing processes will depend on the materials used in the weaving. A cotton fabric may need pressing only. A woolen or linen fabric should be washed, dried and pressed.

Operation

A. Washing the fabric

1. Washing machine may be used for linen if machine is in good condition. Fabric is used alone in machine and washing time is very short. Use a mild soap.

Information

4. The warp may be tied in groups in front of reed, ready to be retied to apron.

D. Taking fabric off cloth beam

1. The ratchets are released so cloth beam will turn freely for unwinding of material.
2. The cardboard tube should be slightly longer than width of fabric.
3. A tube or a flat board with rounded edges may be used. It is important to avoid creases when the fabric is removed from loom.
4. In rugs where tied fringe is to be used untie knots on apron. This saves warp.

E. Stitching raw ends of fabric

1. It is advisable to stitch three or four rows across each end to prevent unravelling in finishing.
2. The rows of machine stitching should be within 1/2 inch of each end.

Information

A. Washing the fabric



Beautiful fabrics are the rewards of a Craftsman's efforts.

Operation

2. Use good quality, mild soap flakes.
3. Use lukewarm water for wool. Very hot water for linen.

Information

2. Plenty of suds and sufficient water should be used.
3. Most materials will shrink more in the warp than in the weft when washed.

Operation

4. Use hands to squeeze water thoroughly through fabric, until material is free from dust and sizing if washed by hand.
5. Squeeze out excess water.
6. Rinse in lukewarm water until all soapsuds have been completely removed.

B. Drying the fabric

1. For wool hang so that fabric has good circulation of air for quick drying. An old-fashioned curtain stretcher may be used.
2. Dry fabric naturally.
3. For linen roll without creases in white cloth while still very wet, cover tightly with heavy paper and let stand overnight.

C. Pressing the fabric

1. Use dampened press cloth when pressing wool.
2. Use iron of moderate temperature when pressing wool. Steam iron may be used. For suiting, some prefer sending it to dry cleaners to be steam pressed. Cleaners usually charge by yard for this and they can keep the threads straight by this method.
3. Use hot iron for linen and press until dry.
4. Roll fabric on tubing when pressing is complete.

Information

5. Fabric should not be twisted or wrung when removing excess water.

B. Drying the fabric

1. Fabric should not be creased sharply while drying.
- 2a. A sharp crease cannot be removed after material has been allowed to dry in this condition.
- 2b. Clothespins should not be used.
- 2c. Fabric should not be hung near heat.
3. This removes all sizing from linen.

C. Pressing the fabric

1. The use of press cloth prevents iron marks on fabric.
- 2a. Temperature of iron will be governed by material being pressed.
- 2b. The fabric should not be stretched unduly in process of ironing.
3. Linens must be very damp for pressing.
4. The use of tubing prevents creasing of fabric.

Appendix One

GENERAL INFORMATION

I. Broken threads and knots

A. Warp threads

A broken warp thread is mended by tying a new, long piece of warp to the broken warp at the back of the loom. Use a bow knot. Bring the new piece forward through the correct heddle and the reed, attach to the woven material by winding around a pin in the cloth. After the thread is woven in enough to hold it firmly, remove the pin and darn the end into the web following the pattern. Cut off the end. At the end of the piece or when thread at back becomes short untie bow knot, tie ends together and pull through heddle eye and reed to front of loom and pin down. This is cut apart if it is done at the end of piece. If this is not possible, draw warp end forward as given above and darn in as before.

B. Weft threads

Knot in the weft should never be woven in. Break the thread at the knot if it cannot be untied. Overlap the ends under a few warp threads bring to the surface, weave a few shots then cut the ends.

C. Loose warp thread

This may appear as the weaving progresses. If it does, wind the slack around a pin in the web, weave an inch or two, cut the thread close to the web and darn it in. If near the beginning or end of one piece, leave pin in place and later draw loose thread to end or beginning of piece and cut off.

II. Sample book

A sample book of completed weaving should be kept. Write down the setting, the pattern, the kind of warp and weft; and if possible, the time required to weave the piece. Also, keep a record of the cost and the amount of material used. All this will be helpful in recalling weaving completed.

III. Experiment

Try different treadlings with each threading. Try different weights of weft and different colors.

IV. Mistakes

Slight mistakes and unevenness in weaving are acceptable, but never be careless.

V. Tension

The tension on the warp should not be too great. It will raise the harnesses and the bottom threads will not lie flat on the shuttle race.

When leaving the loom, release the tension on the warp by unfastening the cloth beam ratchet. This prevents broken threads later on.

VI. Shrinkage

The material on the loom will shrink in width as it is woven. The wider the piece, the greater the shrinkage. There will also be some shrinkage in length on the loom. When the piece is washed, it will shrink some more, and the greatest amount of shrinkage will be in the length. Allow for this when putting the warp on the loom. Linen shrinks the least of any natural material and wool shrinks the most.

Appendix Two

MATERIALS FOR FABRICS

I. Warps

A. Cotton

1. Egyptian cotton 24/3 set at 30 threads per inch is an easy material to warp and to weave. It is a good warp for beginners.
2. Perle cotton #20 set at 30, 32, or 34 threads to the inch is easy to handle and comes in good colors, also Perle #10 set at 24 threads per inch, #5 at 15 threads.
3. Carpet warp set at 12 threads per inch for tabby weave but for pattern weave set at 15.
4. Cotton 20/2 set at 30 threads makes a fine material.

B. Linen

1. 40/3 should be set at 30 threads per inch.
2. #14 singles at the same setting. Single linens are usually set closer than the twisted ones. Beginners do not try single linens for warp.
3. Warp linens may be used for wefts but wefts cannot be used for warp as the yarn cannot stand the tension. The best effects are to use 2-ply linens for warp and singles for weft with fine threads.

C. Wool

1. Shetland yarn set at 15 threads. Do not use for suiting.
2. Germantown should be set at 10 threads.
3. 15/2 yarn, sometimes called Fabri, is set at 30 threads for heavy fabrics and at 24 for lighter materials. This is an easy warp to handle. Weaving wool is slightly heavier but good. Set 20 or 24 per inch.
4. Homespun and tweeds used for warps are rather hard to handle. These yarns should be set at 15 to 20 threads to the inch depending on their fineness.
5. Tightly twisted yarns make the easiest warps to handle.
6. Beat wool very lightly.

D. Silk warp

Spun silk at 30 ends per inch is easy to handle.

E. Rayon

This is a fair warp since it will not stretch and is slippery. Some textured rayon makes good warp but is not fast color in some climates.

F. Nylon

Strong but a little different to use. Experiment with sample first.

II. Wefts

1. Cotton: Almost any cotton may be used for weft. Tabby yarns are usually the same as the warp or of the same weight.
2. Linen: Singles and twisted linens and linen floss are used with linen warp. They are also used with cotton warp.
3. Wool: Almost any wool can be used on a wool warp. It can also be used on linen and cotton warps.
4. Silk: Strand and tussah are the most commonly used.
5. Rayons: They can be used as warps or wefts with cotton, linen, or wool or silk warps.
6. Nylon: See above.

REFERENCES FOR ADDITIONAL READING

- Black, Mary E., THE NEW KEY TO WEAVING, Milwaukee, Wisc., The Bruce Publishing Company. 1957. \$12.00.
- Thorpe, Heather G., A HANDWEAVER'S WORKBOOK, New York 1, N. Y., The Macmillan Company, 1956, when issued cost \$3.95.
- Beriau, Oscar, "HOME WEAVING", Quebec, Canada, Minestire De L' Agriculture. 1941. (Be sure to get the English Translation.)

SECOND GROUP

- Each has good points. Try borrowing first from public library. If they do not have it ask if they can borrow from another library.
- Atwater, Mary Meigs, THE SHUTTLE-CRAFT BOOK OF AMERICAN HANDWEAVING, New York 1, New York, The Macmillan Company. Revised 1951. \$7.50.
- Davison, Marguerite P., A HANDWEAVER'S PATTERN BOOK, Swarthmore, Pa., Swarthmore Looms. Revised reprint 1951. \$7.50.
- Frey, Berta, DESIGNING AND DRAFTING FOR HANDWEAVERS, New York, N. Y., The Macmillan Company. 1958. \$6.95.
- Niher, Evelyn, FOUR HARNESS HUCK, Evelyn Niher, 225 South Main Street, New Canaan, Conn. 1953. \$2.50 (paper bound).
- Overman, Ruth & Smith, Lula, CONTEMPORARY HANDWEAVING, Ames, Iowa, The Iowa State College Press. 1955. \$7.50.
- Watson, William. TEXTILE DESIGN AND COLOUR, Printed in Great Britain by Bell and Bain, Ltd., Glasgow. 1954 Sixth Edition. 50/. (50/ means 50 shillings.) May be purchased from Longman's, Green and Company, Inc., 55 Fifth Avenue, New York 3, N. Y. (This book is only of interest to the advanced weavers.) \$5.00.
- Worst, Edward F., FOOT POWER LOOM WEAVING, Milwaukee, Wisc., The Bruce Publishing Company. 1953-1956. \$7.50. (3rd Edition.)
- Worst, Edward F., HOW TO WEAVE LINENS, Milwaukee, Wisc., The Bruce Publishing Company. Copyright 1926. (2nd Edition 1953-1956.) \$5.50.

BULLETINS

- Lily Mills Company, Practical Weaving Suggestions, Shelby, N. C., Published quarterly. \$1.00 per year.
- Handweaver and Craftsman, 246 Fifth Avenue, New York 1, New York, Mary Alice Smith, Editor and Publisher. \$4.00 per year. Published quarterly.
- Loom Music, \$5.00 per year for ten issues, Co-Editors: Mrs. R. B. Sandin, University of Alberta, Edmonton, Alberta, Canada; Mrs. E. M. Henderson, 20 Ritz Apartments, Winnipeg, Manitoba, Canada.

NOTES