

which may be obtained in colour and weave effects by varying the form of the stripe. The corresponding arrangements, similarly lettered, are given in Fig. 204, different weave marks being used to represent the different sections. Pattern S

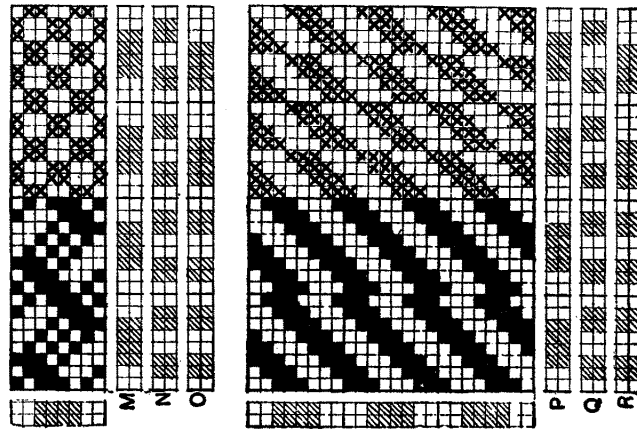

Fig. 202.

shows the simplest form of stripe, and consists of two sections which are equal in size. The colouring is 2-and-2 in warp and weft, and the weaves given in S, Fig. 204,

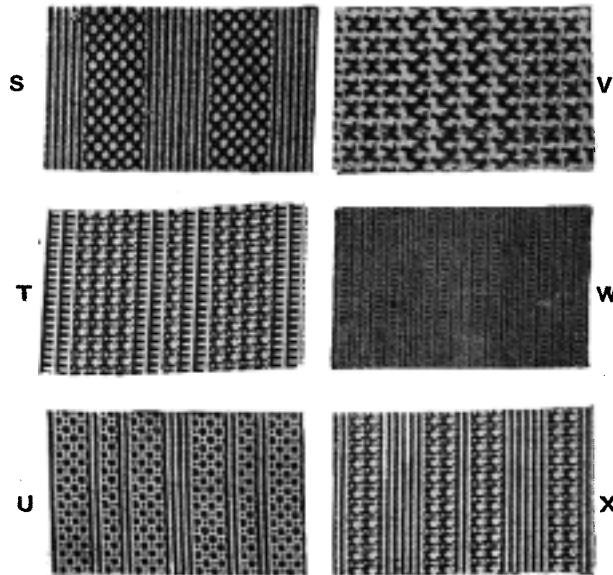

Fig. 203.

are arranged 32 threads of each alternately. Pattern T, which is coloured 4-and-4 in the warp and 2-and-2 in the weft, shows a simple modification, in which one section is bisected by a narrow stripe of the same pattern as the other section. The 8-shaft

and 4-shaft weaves, given in T, Fig. 204, alternate with each other, as regards the number of ends, in the order of 32, 16, 8, 16. Pattern U is coloured 2-and-2 in warp

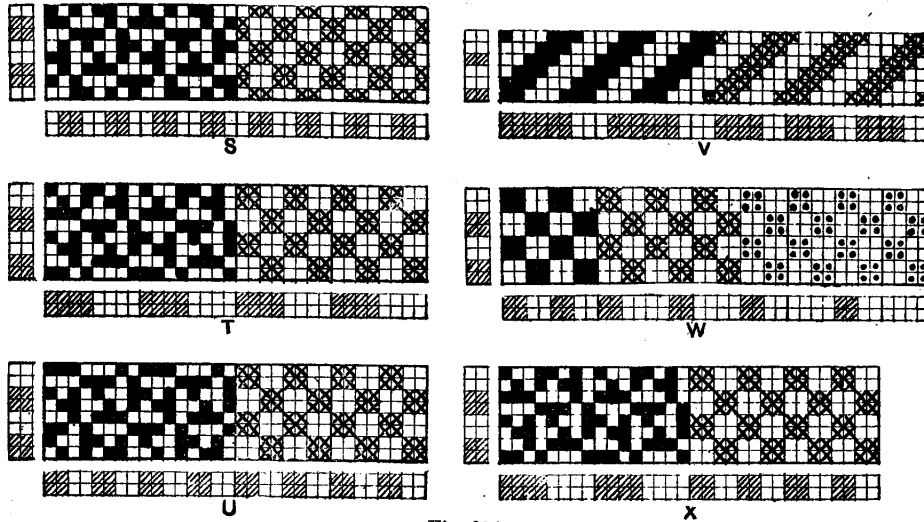

Fig. 204.

and weft, and shows a further modification which repeats on the same number of ends as pattern T, the first weave in U, Fig. 204, alternating with the second in the

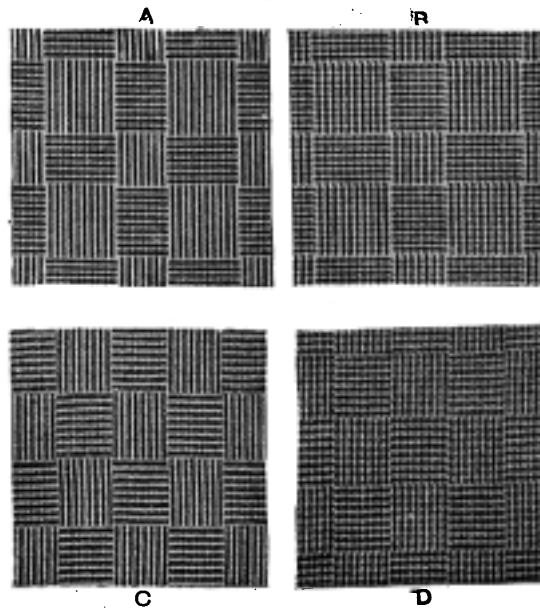

Fig. 205.

order of 16, 16, 16, 8, 8, 8, ends. Pattern V shows a stripe consisting of two sections which are unequal in size. The weave is 3-and-3 twill throughout, and the wefting

plan 1 dark, 2 light ; while the warp is arranged 6 dark, 3 light for 36 ends, and 4 dark, 2 light for 18 ends. Pattern W is 2-and-2 hopsack weave throughout, wefted in 2-and-2 order, and warped in four sections as follows :—2 dark, 2 light for 16 ends ; 2 dark, 4 light for 24 ends ; 2 dark, 6 light for 16 ends ; and 2 dark, 4 light for 24 ends. In pattern X the wefting plan is 2-and-2, and a compound warping order is combined with the stripe weave given at X in Fig. 204, as follows :—

1st weave in	4	dark,	4	light	colouring,	for	16	ends.
2nd	2	„	2	„	„	8	„	„
1st	4	„	4	„	„	16	„	„
2nd	2	„	2	„	„	24	„	„

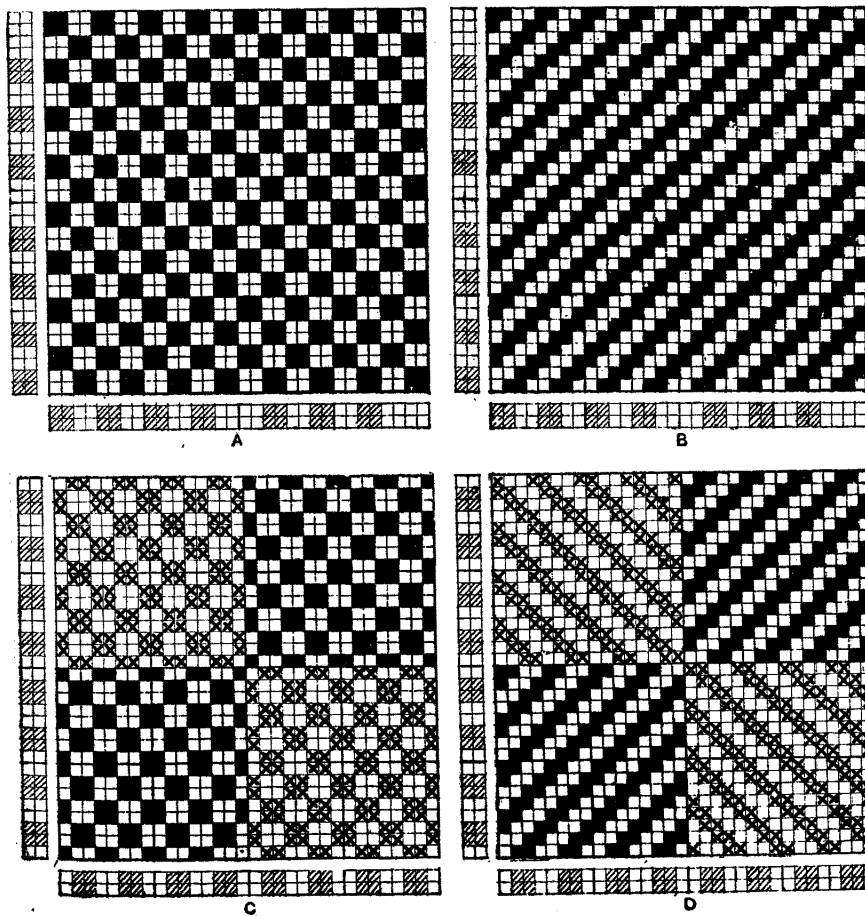

Fig. 206.

CHECK COLOUR AND WEAVE EFFECTS

Changing the Relative Position of the Weave and Colouring.—The fabrics represented at A, B, C, and D in Fig. 205 illustrate the method of producing check effects in one weave and one order of colouring, by varying the position of one in relation

to the other. In A and C, each section consists of 2-and-2 hopsack weave, and 2-and-2 warping and wefting ; and in B and D of 2-and-2 twill weave, and the same order

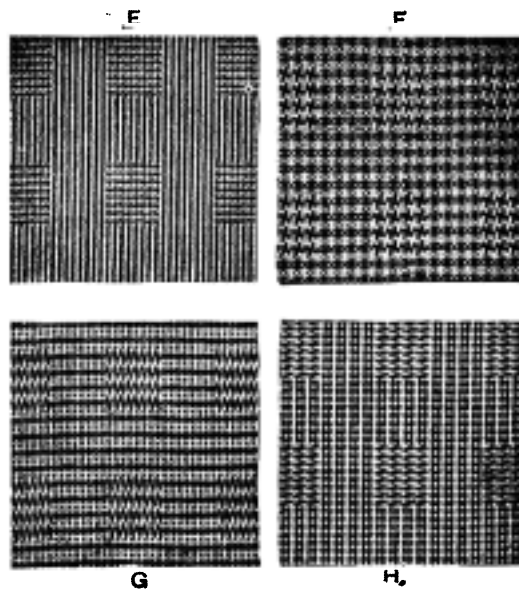

Fig. 207.

of warping and wefting. The corresponding plans, similarly lettered, are given in Fig. 206 ; and it will be noted in A and B that while the weaves are continuous, the

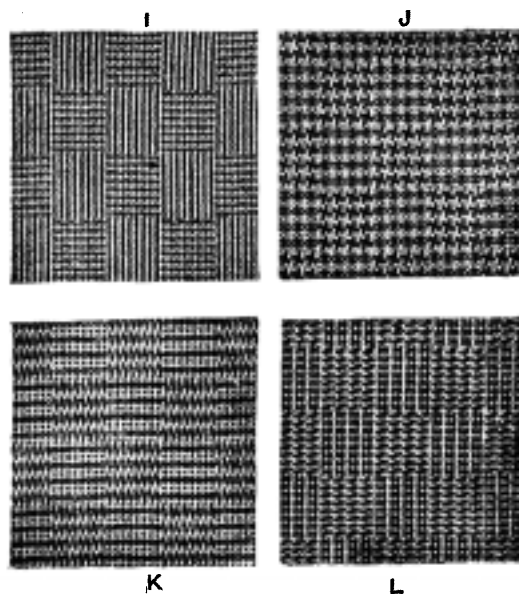

Fig. 208.

2-and-2 order of colouring is broken, a 4 of light occurring at each change of the effect. Thus, although the weave and colouring in every section are the same, the change

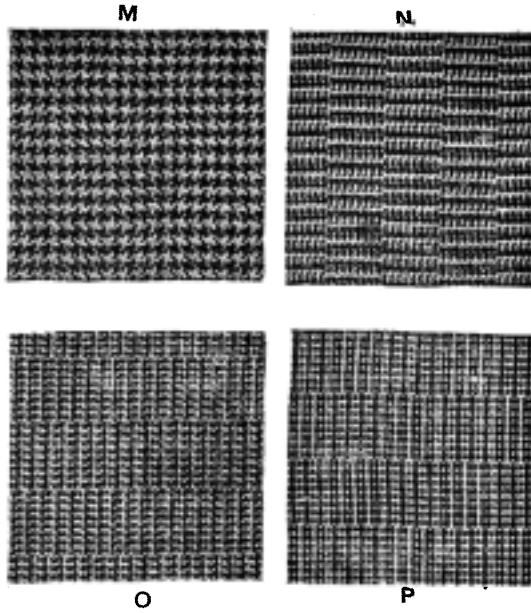

Fig. 209.

of footing in the colouring causes the relative positions to be changed, and alternate

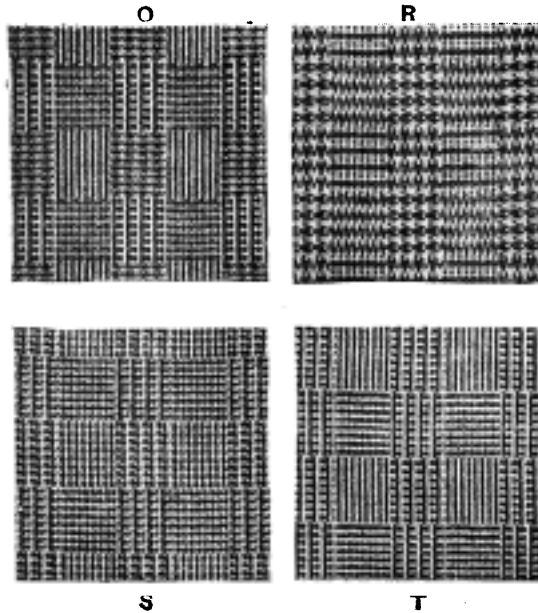

Fig. 210.

sections of vertical and horizontal lines result. Plans C and D produce similar styles, but in this case the order of colouring is continuous, the change of footing being obtained by making a break in the weave at each change of effect.

An analysis of the four plans in Fig. 206 will show that each requires 4 healds; but the first method, illustrated by A and B, is more convenient and more economical than the second. Thus, while A and B can be produced in a regular draft by means of tappets, C and D require a special draft and (on account of the large number of

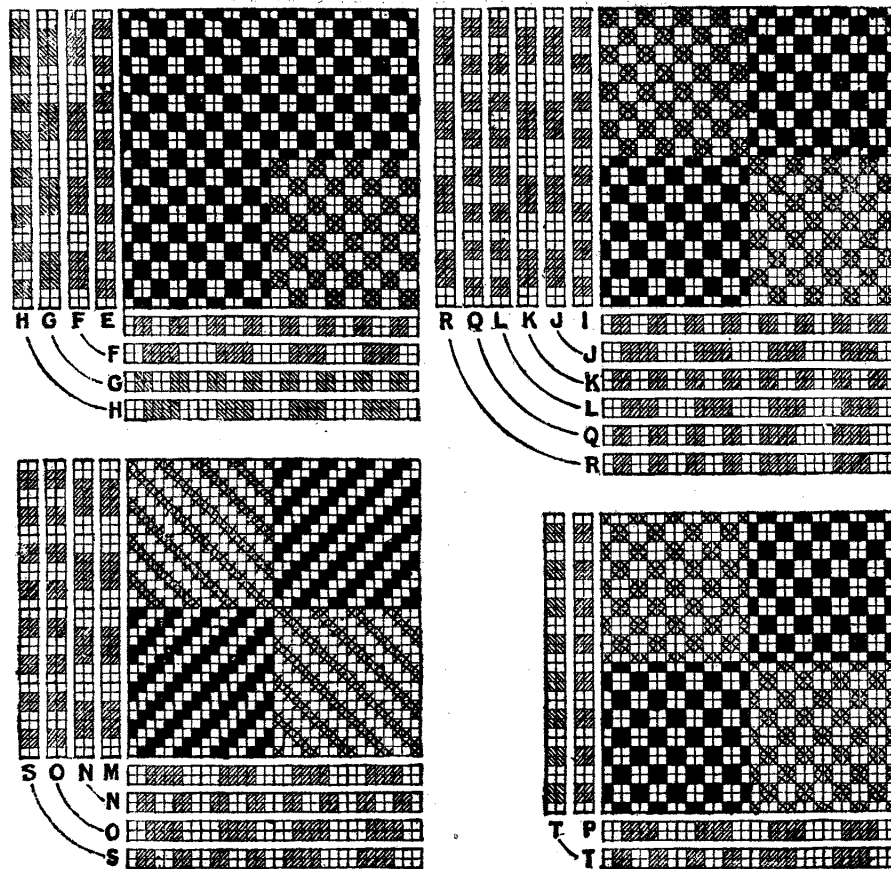

Fig. 211.

picks in the repeat) a dobby shedding motion. The boxing plan in the first method is more complex, but this does not materially affect the question, since a check motion is required in either case.

Additional examples of check patterns, in each of which the change of effect is due to changing the footing of the weave in relation to a continuous order of colouring are given at E to P in Figs. 207, 208, and 209. Also, examples are given at Q to T in Fig. 210, which show the appearance of these weaves when the warping is a compound of two different orders, and the wefting is simple. The corresponding plans

for producing all the examples are given in Fig. 211, each order of warping being lettered and linked with a similarly lettered order of wefting which, in conjunction with the accompanying design, will produce the pattern that is lettered to coincide. Thus patterns E, F, G, and H in Fig. 207; I, J, K, and L in Fig. 208; and P in Fig. 209, result from different modifications of the 2-and-2 hopsack weave, in the various combinations of 2-and-2 and 4-and-4 warping and wefting; while M, N, and O in Fig. 209 result in the same manner, from the 2-and-2 twill weave reversed in sections. The order of warping for the examples in Fig. 210 is a compound of 2-and-2 and 4-and-4 colouring; Q and T resulting from the modified 2-and-2

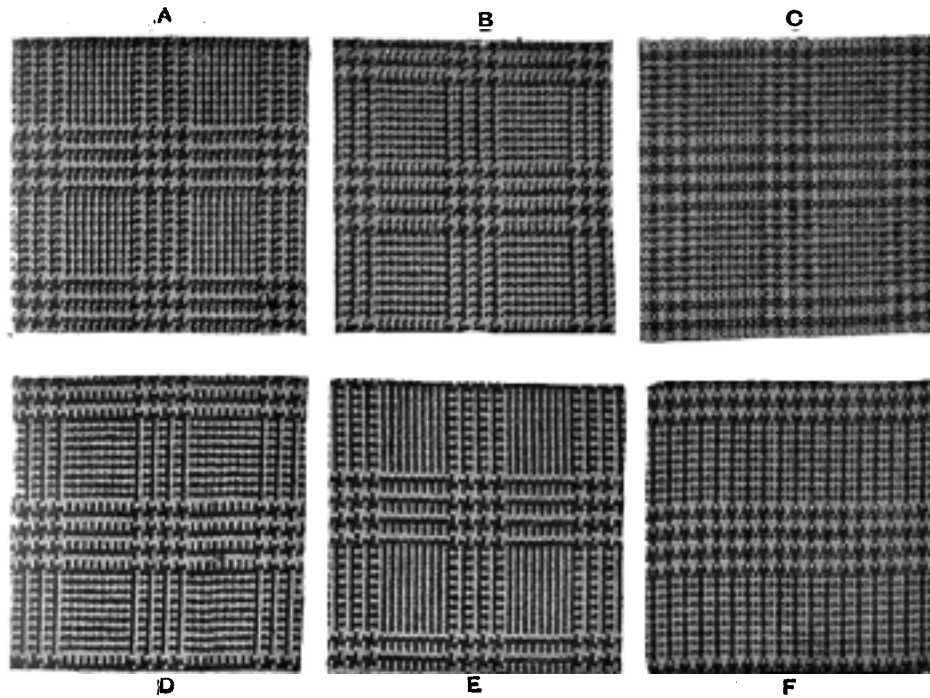

Fig. 212.

hopsack weave in 2-and-2 wefting, and R in 4-and-4 wefting; while in F the reversed 2-and-2 twill weave is wefted 2-and-2.

In addition to the foregoing styles check designs are produced in each of the following combinations:—

- | | | | | | | |
|----|------------|--------|----------|----------|----------|----------|
| 1. | Simple | weave, | compound | warping, | compound | wefting. |
| 2. | Stripe | „ | simple | „ | „ | „ |
| 3. | „ | „ | compound | „ | „ | „ |
| 4. | Cross-over | „ | „ | „ | simple | „ |
| 5. | „ | „ | „ | „ | compound | „ |
| 6. | Check | „ | simple | „ | simple | „ |
| 7. | „ | „ | compound | „ | „ | „ |
| 8. | „ | „ | simple | „ | compound | „ |
| 9. | „ | „ | compound | „ | „ | „ |

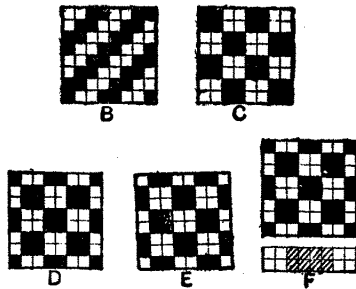
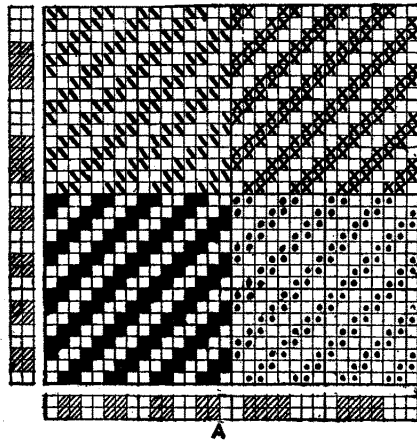

Fig. 213.

Simple Weave, Compound Warping, and Compound Wefting.—This combination is illustrated by the patterns A to E, Fig. 212, and the corresponding plans, similarly lettered, in Fig. 213. The order of warping and wefting for the five examples is the same—viz., a compound of 2 dark, 2 light, and 4 dark, 4 light colourings, as shown along the bottom and up the side of plan A. In A and B the weave is 2-and-2 twill throughout, the difference between them being due to the weave being commenced in different positions. In the same manner, the difference between C, D, and E in Fig. 212 is due to the 2-and-2 hopsack weave being commenced in different positions, as shown at C, D, and E in Fig. 213.

It will be noted that each check pattern in Fig. 212 is composed of four effects, the reason for which will be evident if the order of colouring be compared with the weave, which in A, Fig. 213, is indicated in different marks to correspond with the four sections. In the section marked in full squares, the

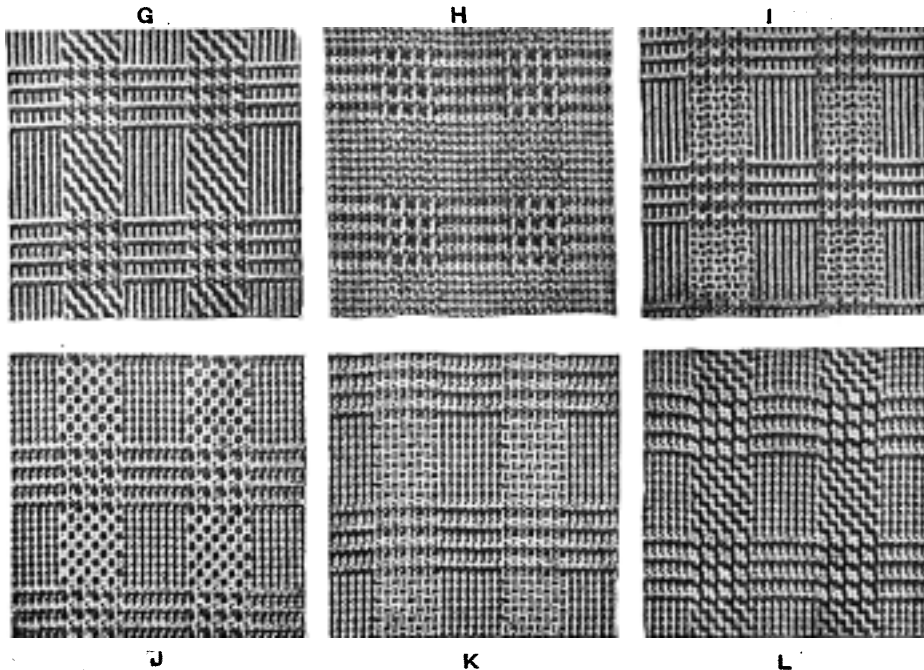
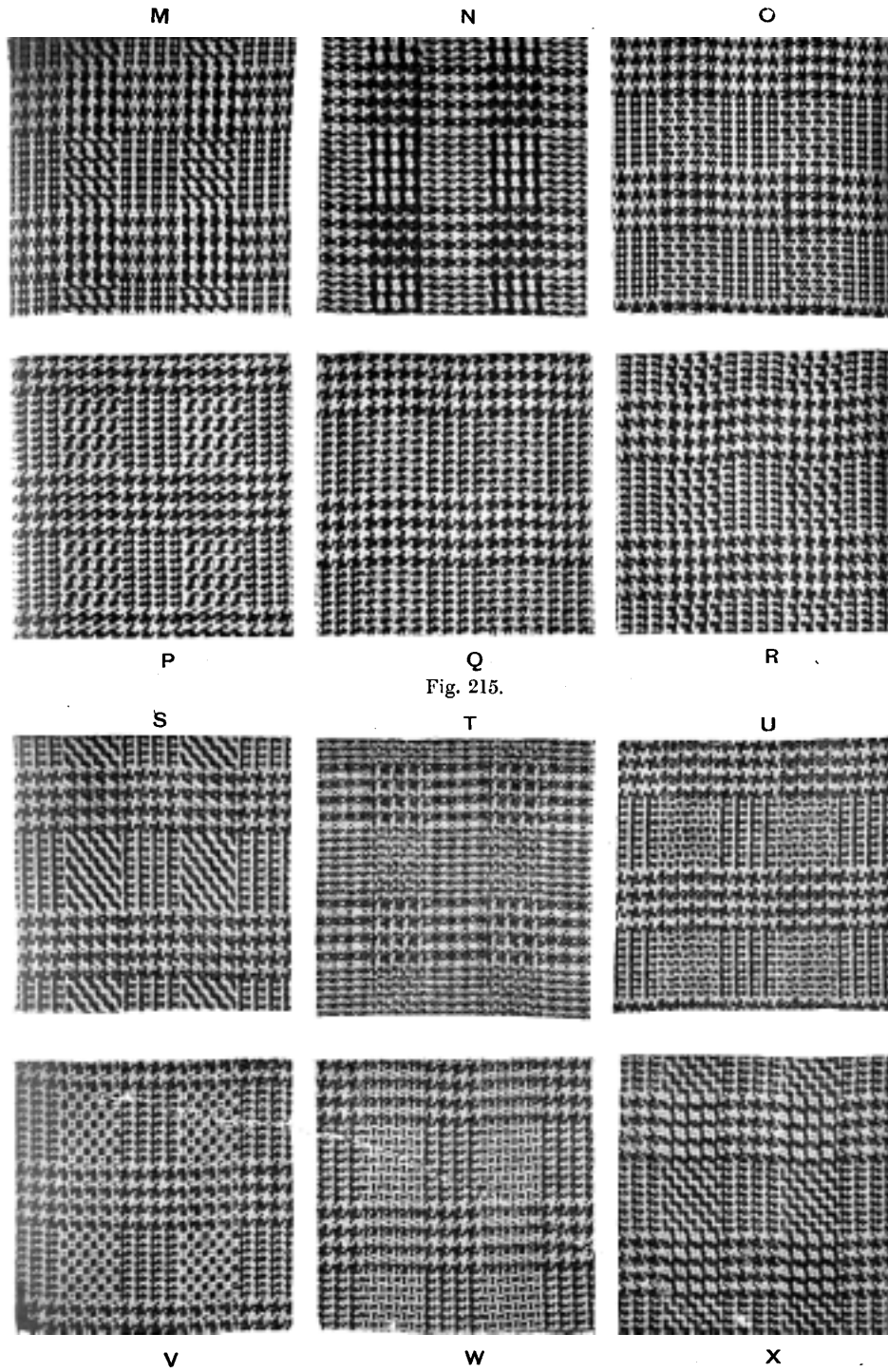

Fig. 214.



2-and-2 order of warping is crossed with 2-and-2 wefting, and in that marked in crosses, the 4-and-4 warping order with 4-and-4 wefting. Where the weave is indicated by diagonal marks, the 2-and-2 warping is crossed with 4-and-4 wefting, and where the dots are inserted, the 4-and-4 warping with 2-and-2 wefting. The best effects usually result in the sections where the warping and wefting orders are

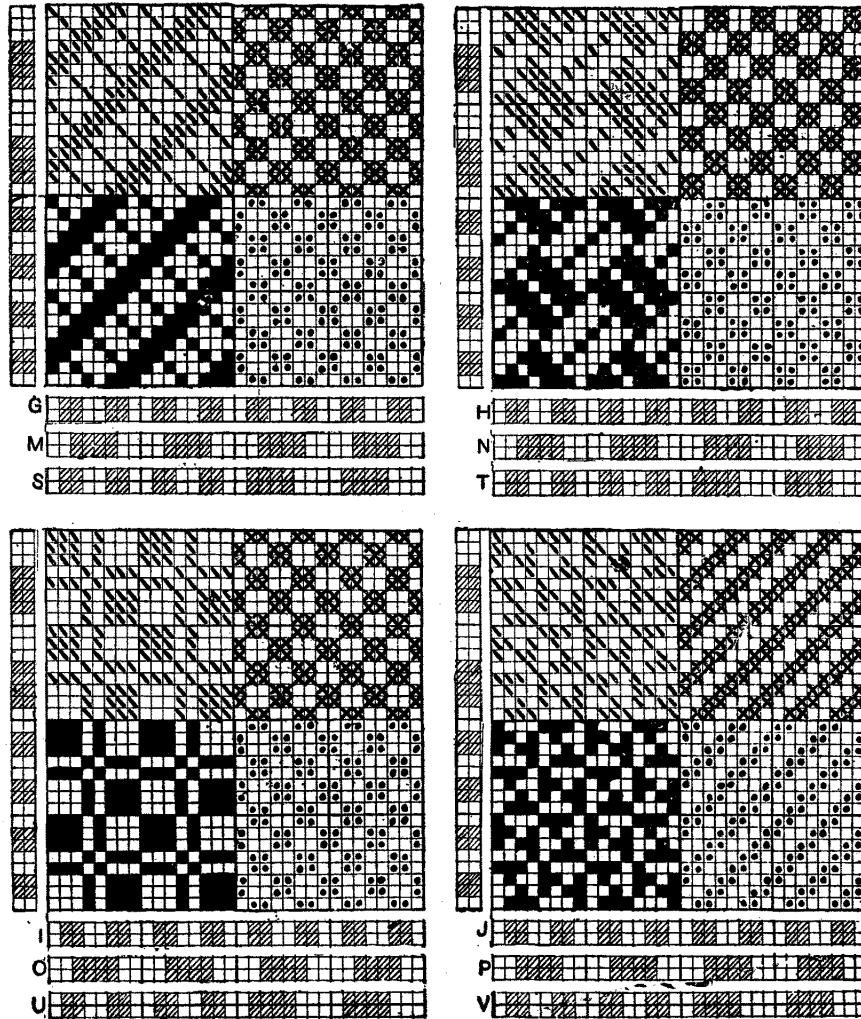

Fig. 217.

the same—viz., in the examples where the warping and wefting are both 2-and-2, or both 4-and-4. The cross effects produced where one order of colouring is crossed with another, while not so good, usually give sufficient variety to make the patterns interesting. In the same manner that the pattern consists of four effects when the warping and wefting plans are compounds of two simple orders, nine effects result from compounds of three-colour schemes, and sixteen effects

when the arrangement is a compound of four-colour schemes, because each warping order is crossed with all the wefting orders.

Pattern F in Fig. 212 is introduced to show the style of crossover effect which

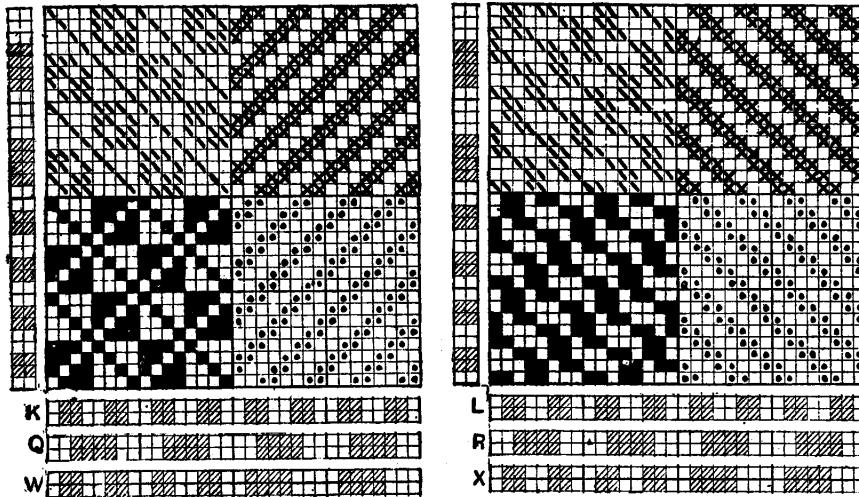

Fig. 217A.

results when a simple weave and a compound order of wefting are employed in conjunction with a simple order of warping. The corresponding weave is given at F in Fig. 213, the order of warping being 4 dark, 4 light, as shown along the bottom, while the order of wefting is the same as that indicated at the side of plan A.

Stripe Weave and Compound Wefting with Simple and Compound Warpings.— The patterns lettered from G to L in Fig. 214 and from M to R in Fig. 215, illustrate a combination in which a stripe weave is employed in conjunction with a simple order of warping, and a compound order of wefting; while those lettered from S to X in Fig. 216 show a combination, in which the weave is in stripe form, and both the orders of warping and wefting are compound. The arrangements for producing all the examples are grouped in Figs. 217 and 217A, and a letter is placed alongside each order of warping which, in conjunction with the design above and the compound

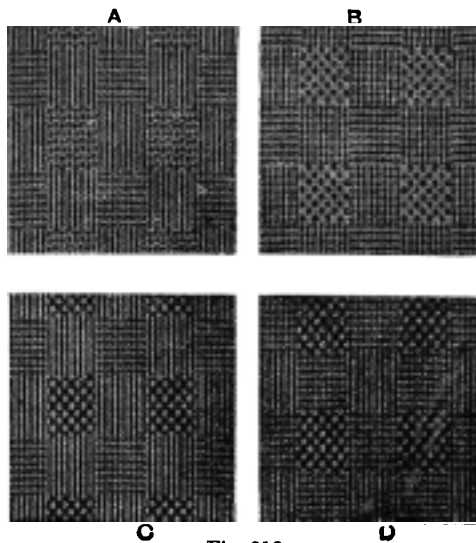

Fig. 218.

order of wefting, will produce the pattern that is lettered to coincide. The six patterns in each of Figs. 214, 215, and 216 are thus respectively produced by the six designs given in Figs. 217 and 217A, the difference between the figures

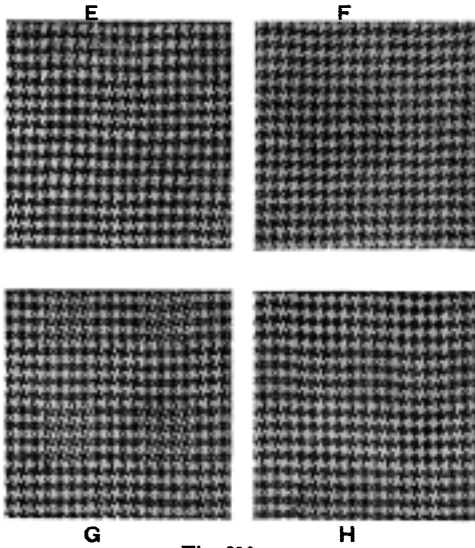

Fig. 219.

being due to three different warping orders being employed. The order of wefting in every case is a compound of a 2 dark, 2 light, and a 4 dark, 4

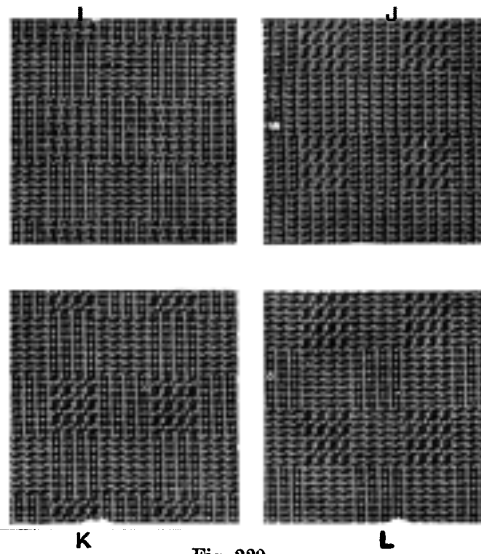

Fig. 220.

light order. In Fig. 214 the order of warping is 2-and-2; in Fig. 215 4-and-4; and in Fig. 216 is in the same compound order as the weft. Each design in Figs. 217 and 217A is a stripe composed of two weaves, but in order that

it may be readily noted how the four effects of which each pattern consists are formed, a different kind of mark is used for each section. In G to L the 2-and-2 order of warping, and in M to R the 4-and-4 order of warping,

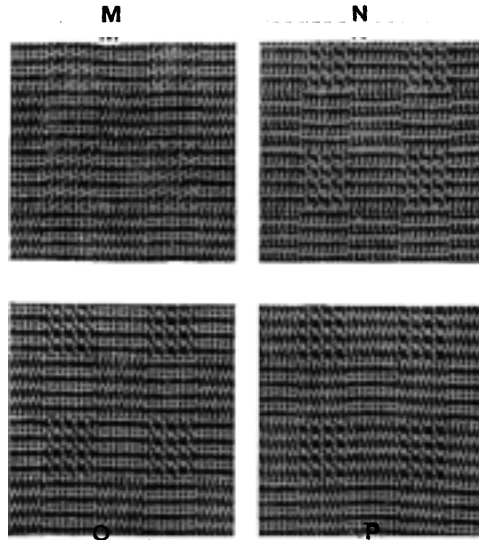

Fig. 221.

are crossed with 2-and-2 wefting—in the first weave—where the full squares are inserted, and—in the second weave—where dots are used ; and with 4-and-4 wefting

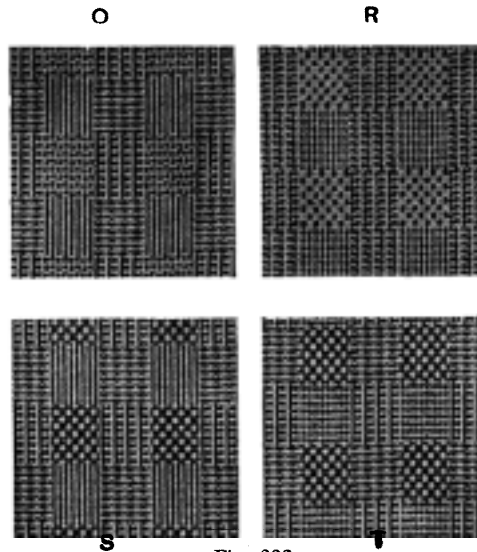

Fig. 222.

—in the first weave—where diagonal marks are used, and—in the second weave—where indicated by crosses. In S to X the 2-and-2 warping order—in the first weave—is crossed with 2-and-2 wefting where indicated by full squares, and with

4-and-4 wefting where indicated by diagonal marks; while the 4-and-4 warping order—in the second weave—is crossed with 2-and-2 wefting where the dots are inserted, and with 4-and-4 wefting where the crosses are employed.

Cross-over Weave and Compound Warping with Simple, and Compound Weftings.—These combinations respectively produce similar effects to those which result from the preceding combinations, but no illustrations are given, since their appearance can be noted by turning the patterns in Figs. 214, 215, and 216 round 90° ; while, in the same way, the method of construction can be observed by turning the plans in Figs. 217 and 217A round to the same angle. In examining the patterns, however, it is necessary to take into consideration that the effects have been made rather longer than wide, as is usually the case with check styles, and therefore when turned round appear flat. The chief point of difference is that in the previous method the weaves are arranged to form stripes lengthwise of the

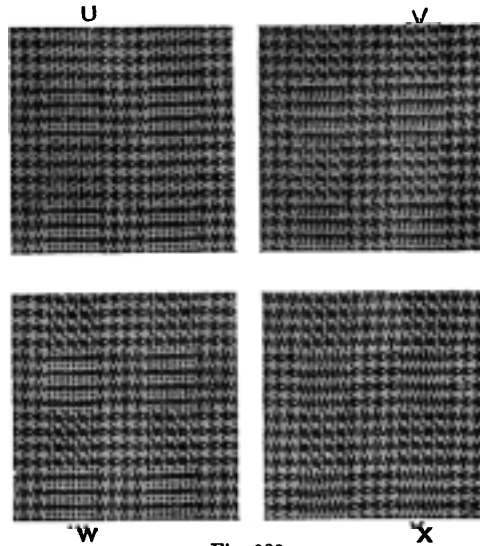

Fig. 223.

cloth, and in this method to form stripes across the cloth. The former type of design necessitates the use of a special method of drafting, and of two or more sets of healds; but the pegging plan repeats on a small number of picks. In the latter, on the other hand, the draft is straight over, and one set of healds only is necessary for the two or more weaves; but the pegging-plan is on a large number of picks.

Check Weave and Simple Wefting with Simple, and Compound Warpings.—The construction of check colour-and-weave effects, by combining a check weave with a simple order of warping and a simple order of wefting, is illustrated by the patterns A to P in Figs. 218, 219, 220, and 221; and with a compound order of warping and a simple order wefting, by Q to X in Figs. 222, and 223. The four designs given in Fig. 224 correspond with the four patterns in each figure; while for each design there are six different colour combinations, as indicated along the bottom and up the side. Each order of warping is lettered and linked with a similarly lettered order of wefting, which, in conjunction with the accompanying design, will produce the

pattern which is lettered to coincide. Thus, in A to D, Fig. 218, the four designs are warped and wefted 2-and-2, and in E to H, Fig. 219, 4-and-4. In I to L, Fig. 220, the warping is 4-and-4, and the wefting 2-and-2; while in M to P, Fig. 221, the warping is 2-and-2, and the wefting 4-and-4. In Q to T, Fig. 222, the warping is compound of a 2-and-2 and a 4-and-4 order, crossed with 2-and-2 wefting; and in U to X, Fig. 223, the same order of warping is crossed with 4-and-4 wefting.

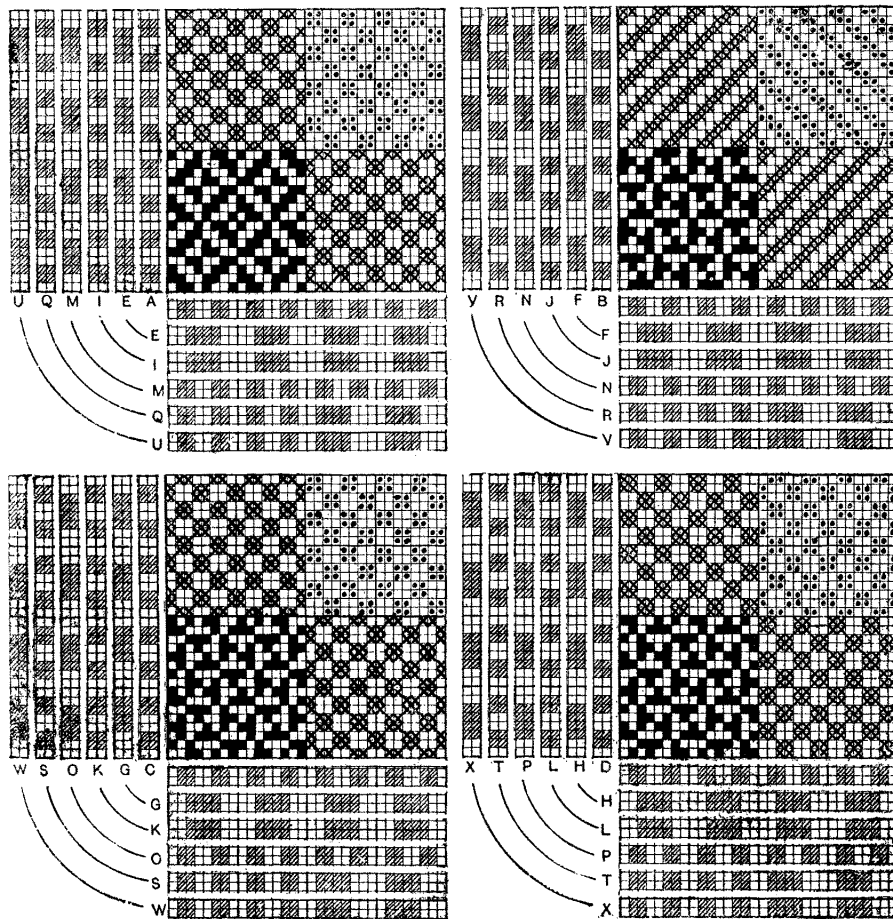

Fig. 224.

As previously stated, in arranging weaves in check form, the most important factor to note is that on the surface no long warp floats occur at the horizontal junctions, and no long weft floats at the vertical junctions. Considerable care is frequently necessary in getting the weaves in satisfactory relation to each other, at the same time that the desired colour-and-weave pattern is secured.

The patterns represented at M, N, O, and P in Fig. 225 result from the check combination of two weaves, one of which completely surrounds the other, as shown in the corresponding plans given in Fig. 226. In each example the order of wefting

is 4-and-4, while in M and O the order of warping is 4-and-4, and in N and P a compound of a 2-and-2 and a 4-and-4 order. The effects produced by the form of check design, indicated in Fig. 226, are usually stiffer and less interesting than those which result from check designs composed of three or four weaves. A considerable improvement may, however, be effected in them by introducing a bright coloured overcheck which occupies the bulk of the space; and in the pattern O in Fig. 225, such an overcheck is represented.

The foregoing colour- and -weave patterns illustrate standard styles, and the numerous examples that are given will, by examination and comparison, make clear how a very large variety of

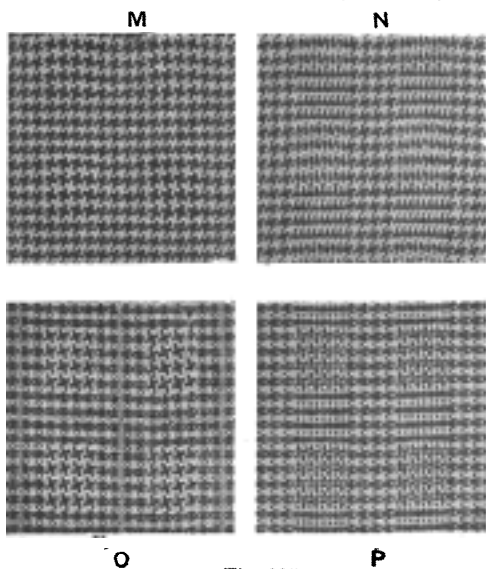

Fig. 225.

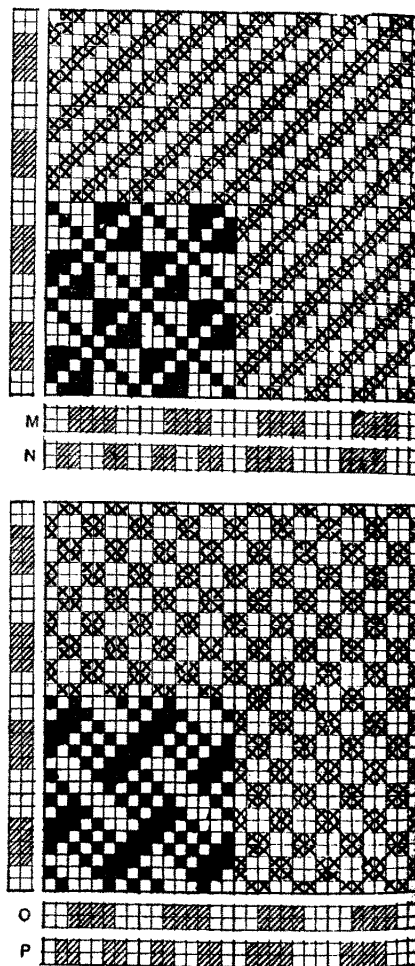

Fig. 226.

effects can be produced by the combination in different ways of a comparatively few units.

CHAPTER XIII

SPECIAL COLOUR AND WEAVE EFFECTS

Colouring of Rib and Corkscrew Weaves—Application of Special Weaves to Simple Orders of Colouring—Construction and Analysis of Special Effects—Combinations of Special Weaves and Special Yarns.

Colouring of Rib and Corkscrew Weaves.—Ordinary warp rib weaves, such as are illustrated at A to F in Fig. 3 (p. 5), and such special rib weaves as those shown at A, B, and C in Fig. 99 (p. 92), naturally lend themselves to a 1-and-1 order of colouring in the warp. Straight and waved horizontal lines in alternate colours are respectively produced by the two classes of weaves. In the same manner, a 1-and-1 order of colouring in the weft is suitable for similar weft rib weaves, by which vertical lines in alternate colours are formed. A regular rib weave may also be coloured in sections in the manner illustrated by the design S in Fig. 75 (p. 74), in which the order in the warp is 1 dark, 1 light for 16 threads, and 1 light, 1 dark for 16 threads; the arrangement producing a small check effect in different colours, as previously described.

The warp cord designs, shown at F and G in Fig. 99 (p. 92), will produce solid vertical lines in alternate colours by arranging the ends—6 dark, 6 light, and the picks 1 dark, 1 light; while the Bedford cord designs, given in Fig. 101 (p. 95) will yield similar effects if the ends are arranged in sections in different colours, and a 2-and-2 order of wefting is employed. A special arrangement of coloured threads may be applied to such designs as that shown at H in Fig. 99, which, for instance, may be coloured in the warp in the order of 6 dark; 3 light; 1 dark, 1 light for 6 threads; 3 dark; 6 light; and in the weft in the order of 1 dark, 1 light. The effect will be a stripe of 6 ends warp cord—solid dark; 3 ends weft rib—solid light; 6 ends warp rib—dark and light lines alternately; 3 ends weft rib—solid dark; and 6 ends warp cord—solid light. Check combinations of warp and weft rib weaves, an example of which is given at K in Fig. 117 (p. 109), may be coloured 1-and-1 in both warp and weft, and an effect in four colours is produced by employing colours in the weft that are different from the warp colours.

Ordinary warp and weft corkscrews, which are illustrated in Fig. 98 (p. 91), are appropriately coloured in 1-and-1 order in warp and weft respectively; twill lines being produced alternately in two colours in this case. Further, such designs as L and P in Fig. 99 (p. 92) are particularly suitable for 1-and-1 warp colouring, in the same manner that the design N in Fig. 99 may be very aptly coloured 1-and-1 in the weft. In most cases, particularly in warp effects—a special order of colouring can be used in conjunction with solid colouring. Thus, a warp corkscrew weave may be coloured 1-and-1 and solid alternately, so as to produce a stripe design.

Fig. 227 represents a corkscrew fabric, in which twill lines are produced alternately in two colours, and the example also illustrates the combination of an ordinary with a special corkscrew effect. In the cloth the ordinary corkscrew weave appears like an ordinary twill, and the special effect like a broken twill.

A broken twill appearance can be produced in the corkscrew structure in two ways: (1) By modifying the corkscrew weave and using a 1-and-1 order of colouring

throughout. (2) By modifying the 1-and-1 order of colouring and using an ordinary corkscrew weave throughout. For example, at A in Fig. 228 a 9-thread broken twill

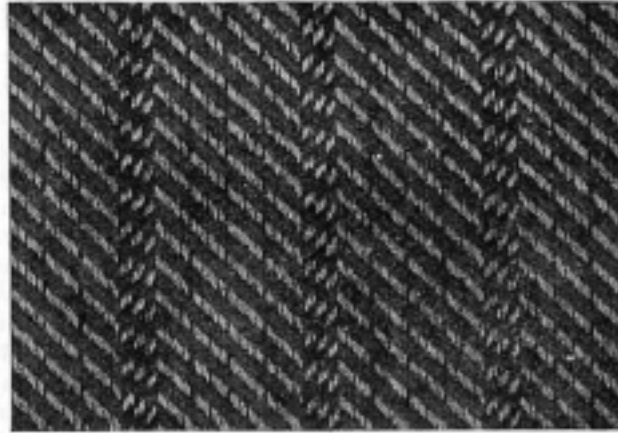

Fig. 227.

weave is indicated, while B shows the weave modified on the warp corkscrew principle to fit a 1-and-1 order of colouring, the different marks representing different colours, C in Fig. 228, on the other hand, shows a continuous 9-thread corkscrew weave in

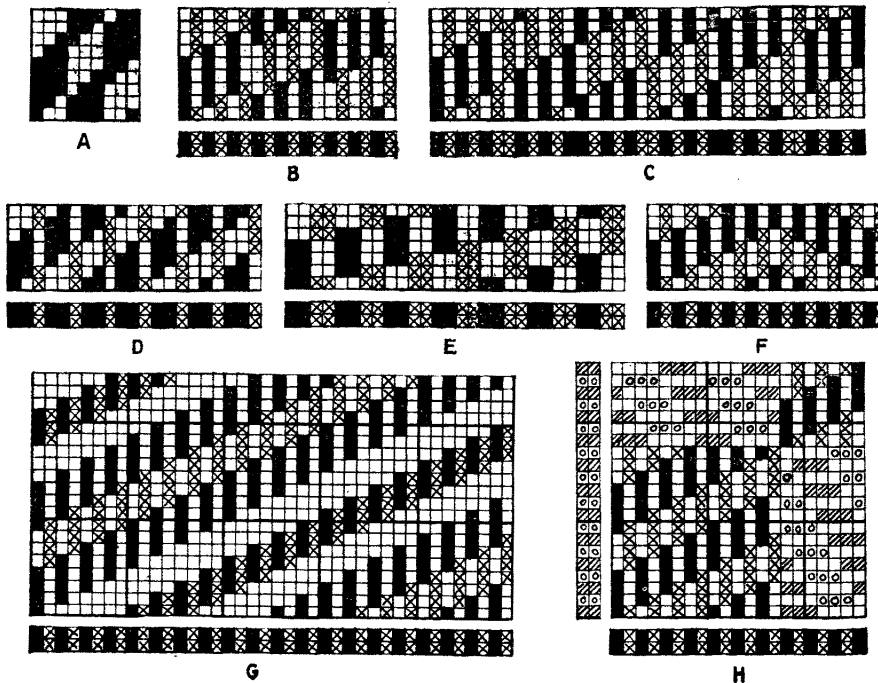

Fig. 228.

which a similar broken effect is produced by colouring the warp in the order of 1 dark, 1 light for six threads, and 1 light, 1 dark for six threads, as indicated along the bottom of the design. The usual close setting of the ends in the corkscrew weave will cause both B and C to appear similar to the motive weave A—assuming that the latter is woven in—say, dark warp and light weft.

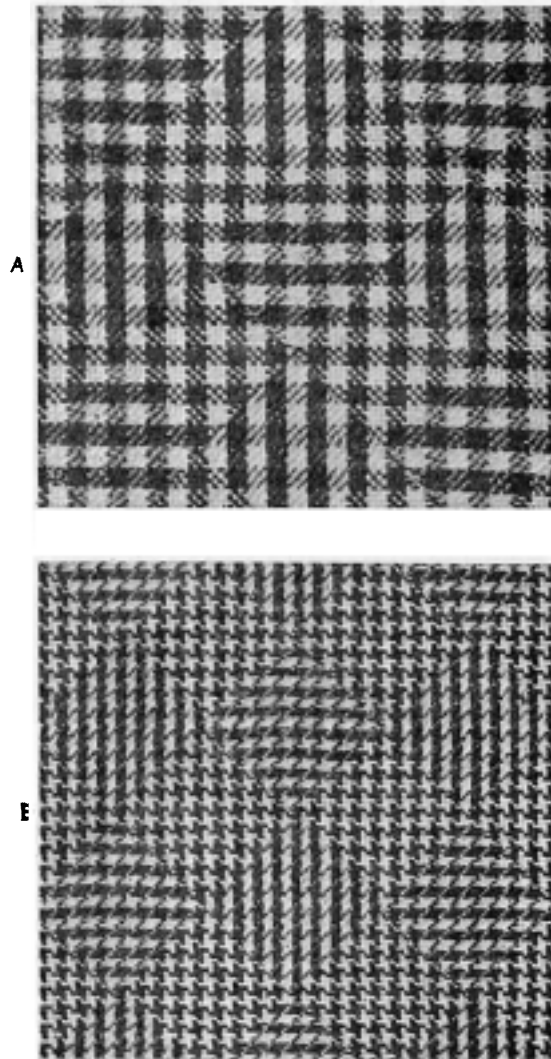

Fig. 229.

Three modifications of a warp corkscrew, which may be specially coloured and used in combination with an ordinary weave of the same class, are given at D, E, and F in Fig. 228. At D the weave is arranged to coincide with a 2-and-1 order of colouring, and at E with a 2-and-2 order, while F produces a waved effect in 1-and-1 colouring.

G in Fig. 228 shows a form of corkscrew weave which, in 1-and-1 colouring in the warp and solid colouring in the weft, produces differently coloured twill lines of warp, brings up the weft as a third effect, and also produces a twill line in which the warp colours are intermingled.

The design H in Fig. 228 is a check combination of warp and weft corkscrew weaves, which if woven in two colours of warp and two different colours of weft, as indicated along the bottom and at the side respectively, will produce an effect in four colours. The example repeats upon an odd number of threads, therefore, if the order of colouring is arranged 1-and-1 throughout, the colours in certain sections will change positions in succeeding repeats. As a rule, in a combination of warp and weft corkscrew weaves, the warp-face weave forms the bulk of the design. The sections of the design H may be repeated any required number of times.

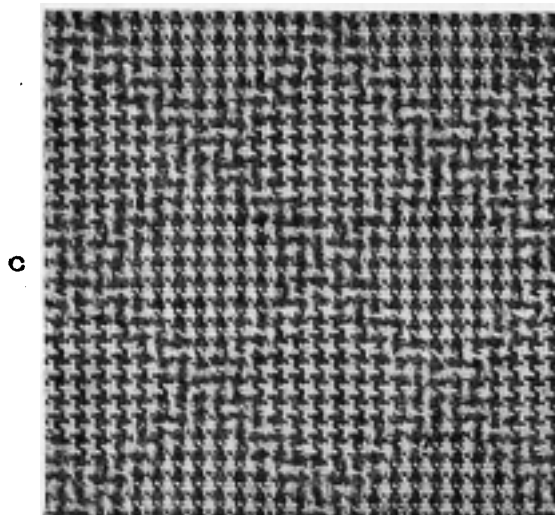

Fig. 229A.

Application of Special Weaves to Simple Orders of Colouring.—Special effects are most readily produced by using special weaves in combination with simple orders of warping and wefting. The fabrics represented in Figs. 229 and 229A illustrate a variation from the usual form of check colour-and-weave effect, which is particularly suitable for costume fabrics, cloakings, etc. The corresponding designs, which are shown in Figs. 230 and 231, are constructed on diamond bases, the spaces in the former consisting of 2-and-2 hopsack, 3-and-1 warp twill, and 3-and-1 weft twill weaves, and in the latter of 2-and-2 hopsack in two positions, and 3-and-3 twill. Both A and B in Fig. 229 result from the design shown in Fig. 230, the former being coloured 8-and-8, and the latter 4-and-4, as indicated at the side and along the bottom. C in Fig. 229A results from the design given in Fig. 231, which is coloured 4-and-4. Thus, by comparison A and B show how difference of effect is produced in the same design by changing the colouring, and B and C in the same colouring by changing the design. The given plans, however, are only about half the size necessary for producing the effects, but they illustrate how the weaves should be arranged in relation to each other, and to the colouring, so as to obtain a uniform pattern. Thus, it will be noted that (1) the centre of each diamond space coincides

with a central position of the colouring; (2) no long floats occur at the junctions of the weaves; (3) each weave is so combined with the colouring as to produce the required effect. The designs also illustrate two methods of arranging weaves in diamond form; Fig. 230 being composed solely of equal diamond spaces, while in Fig. 231 one weave (3-and-3 twill) forms interlacing lines, which enclose the diamond spaces.

The patterns D and E in Fig. 232, and the corresponding designs given in Fig. 233 show how special effects may be obtained in 1-and-1 warping and wefting. It has

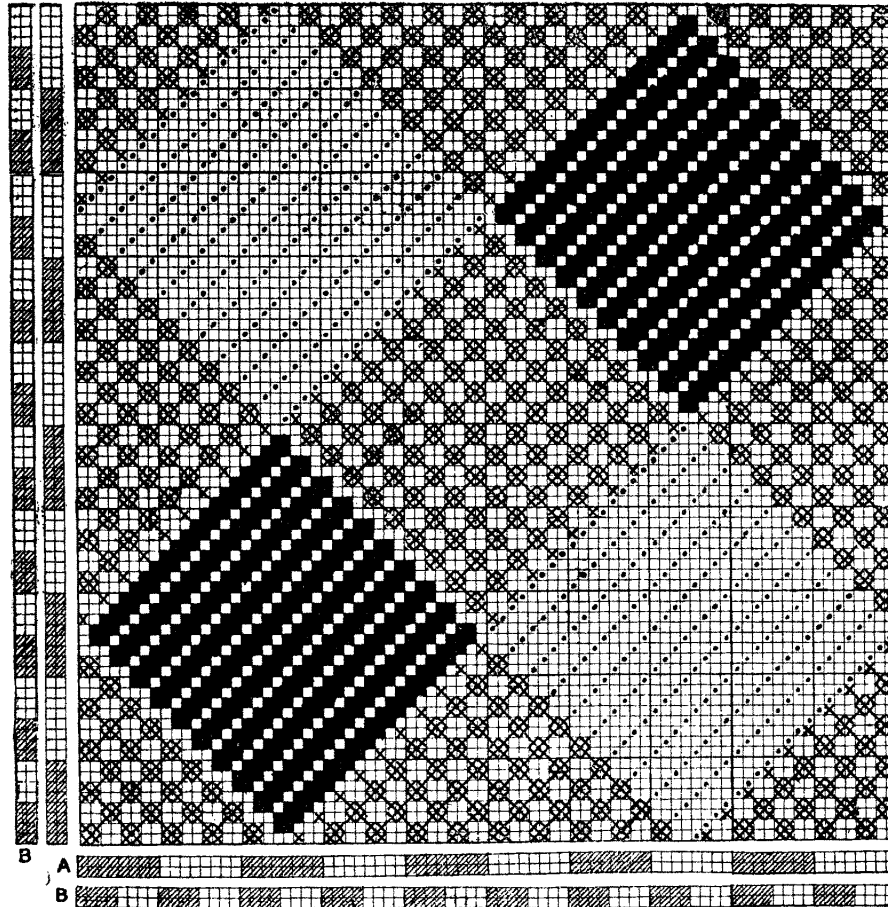

Fig. 230.

previously been noted that in this order of colouring both the 2-and-2 and the 2-and-1 twill will produce step patterns. The floats in the design D, Fig. 233, partake of both these weaves, and the result, shown at D in Fig. 232, is an irregular combination of step patterns, which gives the cloth a crêpy appearance. Additional variety is obtained in the example by the introduction of an overcheck.

The effect shown at E in Fig. 232 chiefly consists of the single-thread vertical hairline produced in the plain weave, which, however, is broken irregularly by the

introduction of weft floats, as shown at E in Fig. 233. Where the weft floats occur the lines of colour follow the direction of the weft with the result that the vertical

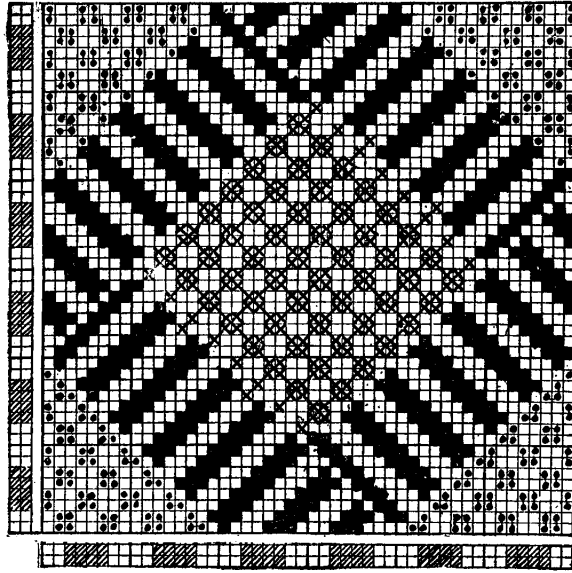

Fig. 231.

lines are broken in irregular order, and an intermingled effect is obtained. In this pattern, also, an overcheck is introduced.

The fabric represented in the lower portion of Fig. 234 illustrates a method of

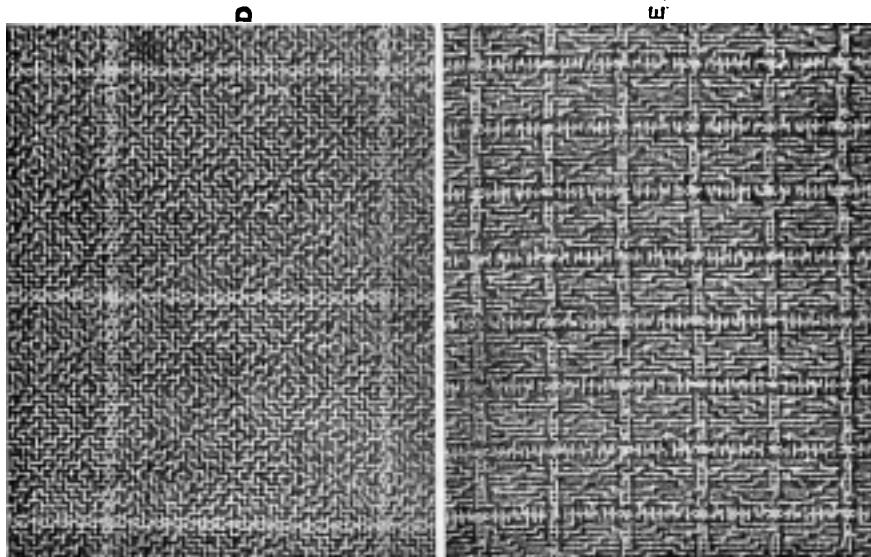
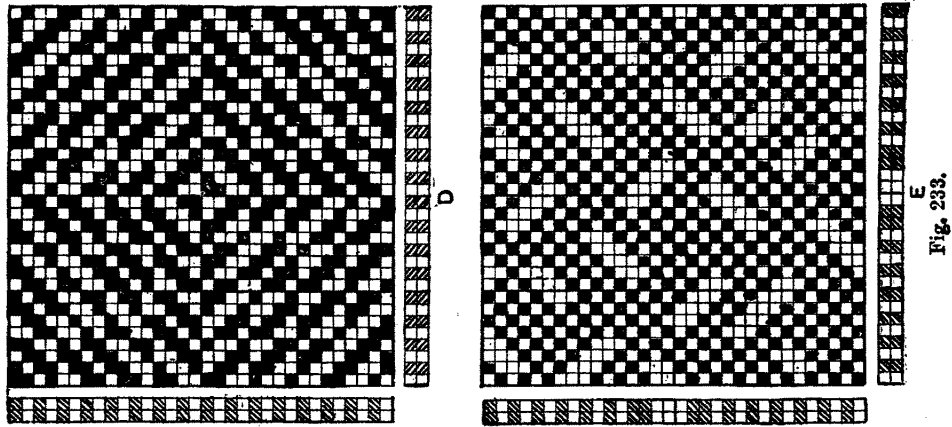

Fig. 232.

producing figured styles in one weave, and one order of colouring, by varying the position of the former in relation to the latter. Plain weave is used for both figure



and ground, while the 1-and-1 order of colouring is continuous, but the weave is arranged to produce a horizontal hairline effect where the figure occurs, and a vertical

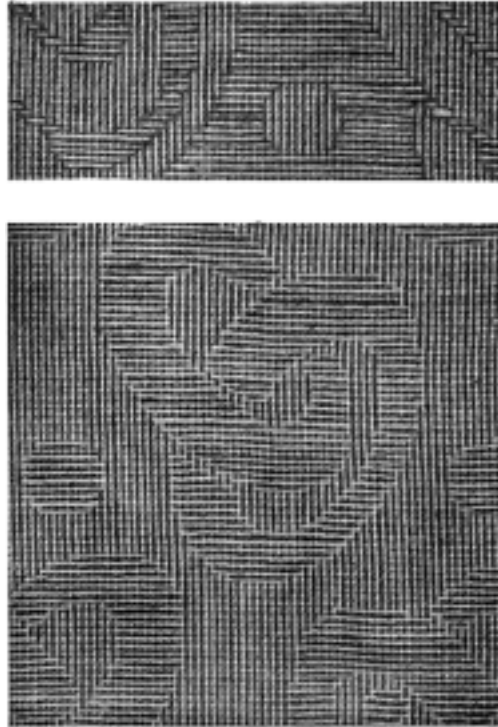

Fig. 234.

hairline effect in the ground. The underside of the cloth is exactly the opposite, as shown in the upper portion of Fig. 234, the figure being formed in vertical and the

ground in horizontal hairline. A portion of the corresponding design is given in Fig. 235, the different positions of the weave being represented by different marks, which, as in former examples, indicate warp float. Where the figure and ground join there is necessarily a float of two, either of weft or warp; and it is upon the proper arrange-

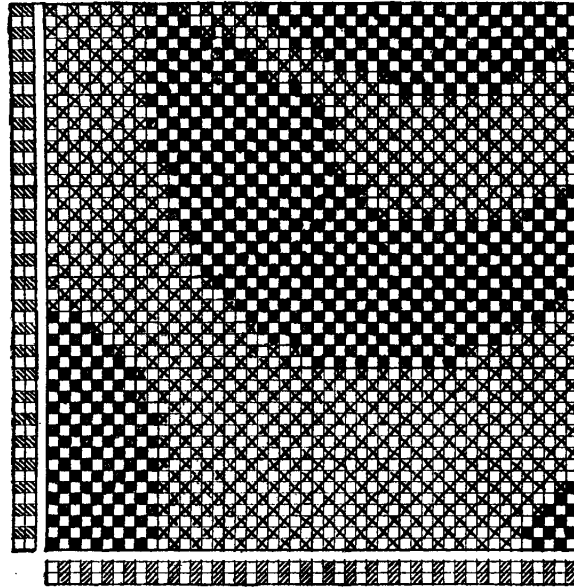

Fig. 235.

ment of these floats that the clearness of the outline of the figure depends. One of the colours—and usually, the lighter of the two is the more suitable—should form a fine line separating the figure from the ground, otherwise the form will be indefinite.

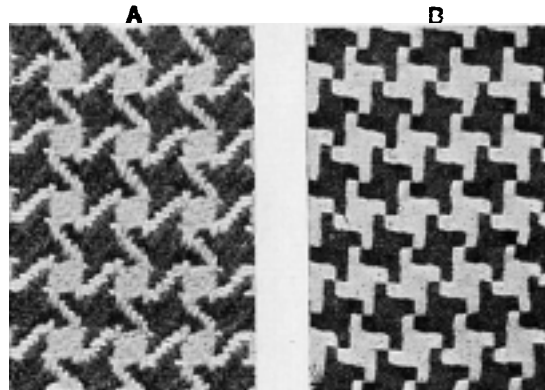

Fig. 236.

Assuming that the figure is required to be outlined in the lighter shade, as in the example, the following should be observed in marking the edge of the figure:—Where the floats of two are alongside each other they should be in weft float on the light picks, and in warp float on the dark picks; while, where the floats of two

are one above the other, they should be in warp float on the light ends, and in weft float on the dark ends. In the case of outlining the figure in the darker shade, the conditions will be exactly the opposite.

Construction and Analysis of Special Effects.—The fabrics represented at A and B in Fig. 236 illustrate a special class of small figured effects produced in simple orders of colouring. A shows a diamond form (the corresponding point-paper sketch of which is given at A in Fig. 237), which results from applying the reversed 3-and-3 twill weave to a 6-and-6 order of colouring, as shown at C in Fig. 237. It is only to a limited extent, however, that modified simple weaves can be used in producing a special style of pattern, whereas by constructing special weaves there is almost

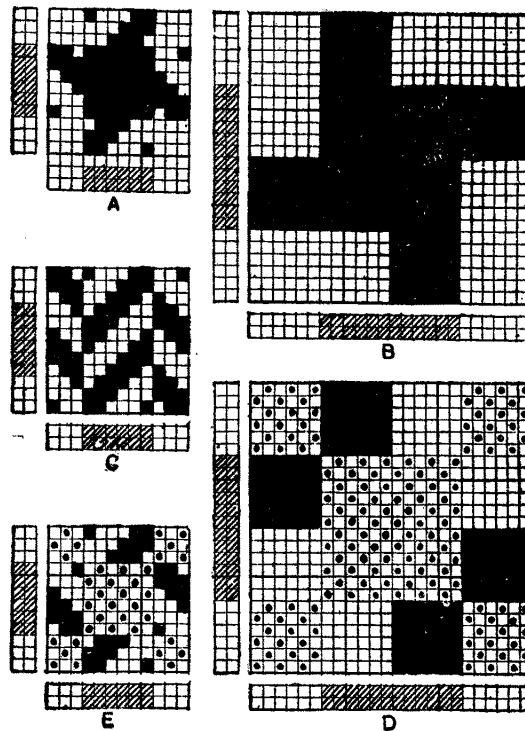

Fig. 237.

unlimited scope for the production of small figure effects. Example B in Fig. 236, and the corresponding sketch B and plan D in Fig. 237, illustrate the principle. In this system advantage is taken of the fact that where a colour of warp is intersected by the same colour of weft, that colour will appear on the surface whatever the weave is, which enables plain or other firm weave to be employed at these places in order to give the cloth the necessary strength. Where a colour intersects another colour, either may be made to appear on the surface, in forming the required pattern, by arranging the warp and weft floats to correspond. Thus in pattern B, which is arranged 12 black, 12 white, where black ends interweave with black picks, and white ends with white picks, plain weave is employed, as shown by the dots in D.

Fig. 237. Where the design is required to show black on white picks the black ends are raised, and where white on black picks the white ends are raised, as shown by the solid marks in D. Where the design is required to show black on white ends the black weft is floated, and where white on black ends the white weft is floated, as indicated by the blank squares.

E in Fig. 237 shows the application of the principle illustrated in D to the plan C—i.e., the 3-and-3 twill is replaced by plain weave where black crosses black, and white crosses white. E thus contains more intersections than C, and may be used to produce the pattern A, Fig. 236, in a cloth in which greater firmness is required.

A convenient method of procedure in sketching an effect, and in indicating the weave on design paper, is illustrated in Fig. 238. The arrangement of the threads

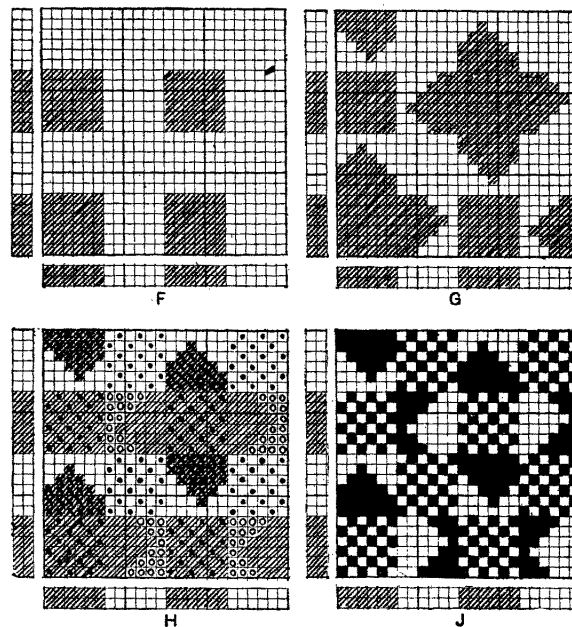

Fig. 238.

is 6 dark, 6 light, and the repeat of the pattern extends over two repeats of the colour plan. Assuming that a dark figure on a light ground is required, the first stage, as shown at F, consists of marking the squares faintly where dark ends and dark picks intersect, as at these places the pattern must be dark. Second, as shown at G, marks are added, in accordance with the desired effect, above and below, and at both sides of one or more of the shaded sections in F. In the third stage, shown at H, the required weave is obtained as follows—the weave marks indicating warp float: (a) Plain (or other simple weave) is inserted where each colour intersects its own colour, as shown by the dots; (b) the light picks are followed horizontally, and where there are figuring marks on dark ends weave marks are inserted, as shown by the crosses; (c) the light ends are followed vertically, and where there are blanks on dark picks weave marks are inserted, as indicated by the circles. At J the weave is represented in one kind of mark, and the chief point to note is that marks, where

dark ends and light picks intersect, produce a similar effect to blanks where light ends and dark picks intersect, and *vice versa*.

The system is not limited to the production of detached figures, as by suitably

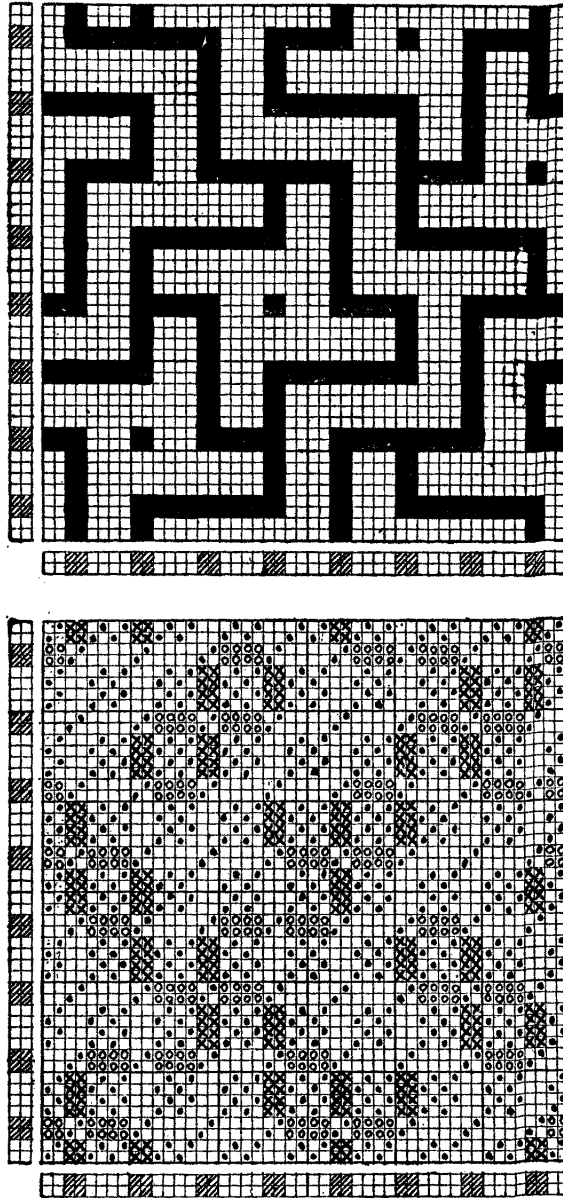

Fig. 239.

floating the threads of one colour entirely over those of another colour, many interesting effects, consisting of interlacing lines, can be obtained. The point-paper sketch in the upper portion of Fig. 239 is an example arranged on a 2 dark, 4 light

order of colouring. The corresponding design is given in the lower portion of the figure, the plain weave, where each colour intersects its own colour, being indicated by the dots, the lifts of the dark ends on the light picks by the crosses, and of the light ends on the dark picks by the circles. Large effects of this character may be readily produced in healds by special drafting; thus, 20 shafts are required for the effect given in Fig. 239. Also different materials, one of which is more costly than the other, may be economically combined—as, for example, in Fig. 239 the dark shade may be in silk or wool, and the light shade in cotton.

Combinations of Special Weaves and Special Yarns.—A special colour and weave style is represented in Fig. 240, in which yarns of different materials and different thicknesses are combined, a pattern in white silk and thick dark worsted being formed on a ground composed of fine light cotton threads. The arrangement in warp and weft is indicated along the bottom and at the side of the corresponding

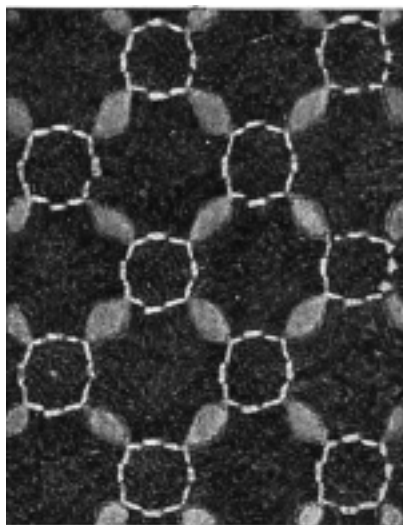

Fig. 240.

plans in Fig. 241; the solid marks representing the white silk, the shaded squares the dark worsted, and the blanks the light cotton threads. The point-paper sketch in the upper portion of Fig. 241 represents the appearance of the effect, but it does not give a correct idea of how it will be necessary for the threads to interweave, because the structure causes considerable distortion of the thick dark threads to take place. An examination of the actual weave given in the lower portion of Fig. 241 will show that where the worsted ends intersect with the worsted picks, in alternate sections the weave is 2-and-2 twill surrounded by a 4-and-4 order of interweaving with the silk threads, while in the other sections the weave is plain with the silk threads floating on the back. The 2-and-2 twill weave is sufficiently loose to enable the thick threads to approach each other readily, and they therefore group together at these places, and are retained firmly in position by the 4-and-4 stitching of the silk threads. Where the weave is plain, however, the intersections are too frequent for the thick threads, which therefore spread out, there being no obstacle to their distortion, since on every side of the plain interweaving the float is absolutely

loose. The fine cotton ends and picks interweave with each other, and with the silk threads in plain order, but the spreading out of the thick threads partly conceals them, and gives an oval shape to the rectangular space occupied by the fine threads.

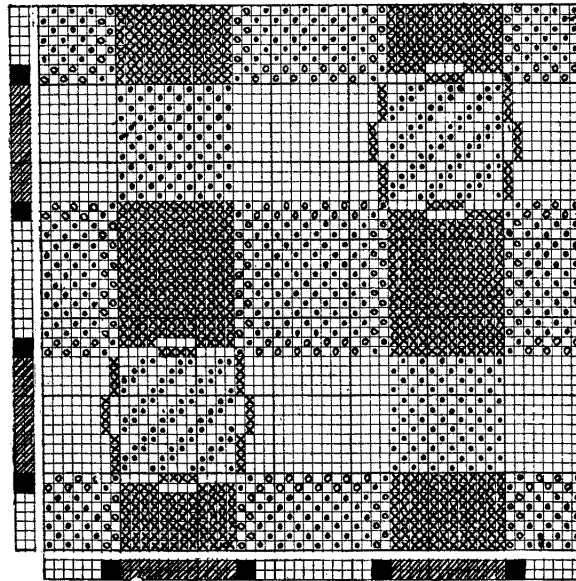
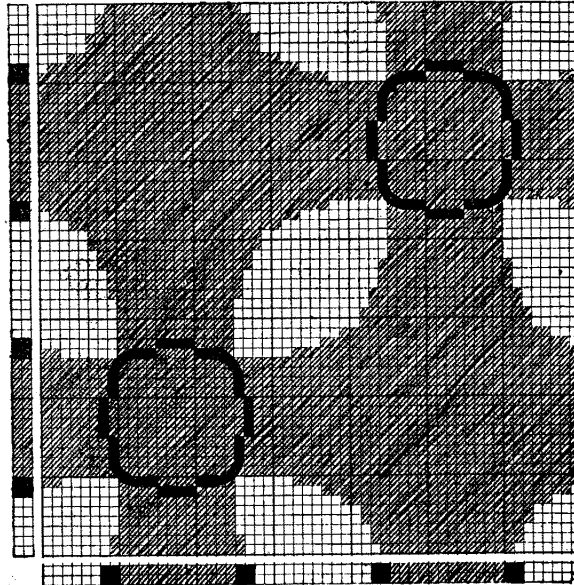

Fig. 241

The pattern shown in Fig. 242 illustrates another method of giving interest to a special style, as in this case not only are yarns of different materials and different counts combined, but alternate sections of the fabric are crammed. This is repre-

sented by the different sizes of squares in the corresponding plan given in Fig. 243. The arrangement in warp and weft is 8 threads pink silk, 4 threads thick hard-twisted worsted, 8 threads white silk, and 4 threads thick hard-twisted worsted; 8 threads of silk occupying the same space as 4 worsted threads. It will be seen in

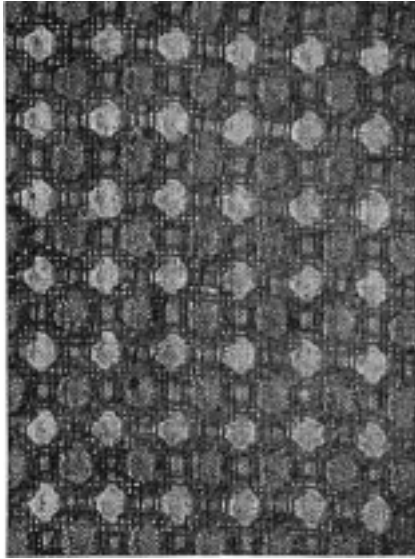

Fig. 242.

Fig. 243 that the weave is plain where the silk ends and the silk picks intersect, and also where the worsted ends and worsted picks intersect. The silk ends

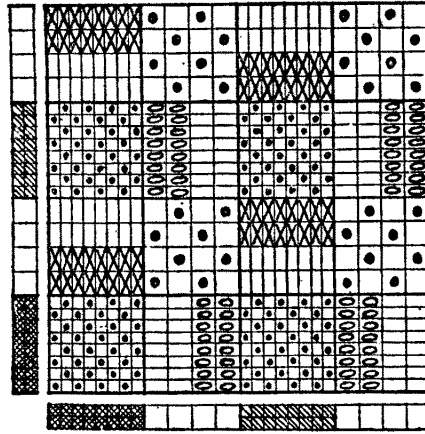

Fig. 243.

are raised over the two worsted picks that precede and follow alternate intersecting places of the silk threads, while the silk picks float at each side over two worsted ends. Alternate pink and white silk spots are thus formed which the distortion of the worsted threads causes to appear round in the cloth.

CHAPTER XIV

JACQUARD MACHINES AND HARNESSES

Ordinary Jacquard Machines—The Single-Lift Jacquard—The Centre-Shed Jacquard—The Double-Lift, Single-Cylinder Jacquard—The Double-Lift, Double-Cylinder Jacquard—The Open-Shed Jacquard—Sizes of Jacquards and Cards—Ordinary Harness Ties—Harness Drawing-in, Card-Cutting, and Card-Lacing. *Jacquard, Harness, and Design Calculations*—Sett of the Harness—Number of Harness Cords to Each Hook—Casting-out in Jacquards—Size of Repeat—Methods of Modifying the Repeat in a Lay-over Tie—Counts of Design Paper—Summary of Calculations—Irregularly Dented Jacquard Designs. *Special Harness Ties*—Centre or Point-Ties—Mixed Ties—Ties for Bordered Fabrics—Cross-Border Jacquard Arrangements.

A JACQUARD shedding motion is necessary in weaving designs that are beyond the scope of dobby shedding. It is also frequently found convenient and economical to use a jacquard for dobby designs in pattern range weaving, and when rather short lengths of cloth are required in complicated drafts. A great advantage of the Jacquard system of shedding is that the draft of the warp threads is very simple and

does not (as a general rule) require altering when the design is changed; but the principal features are the facility with which large and intricate designs can be woven and the comparatively small space that is occupied by the machine and harness.

The machines may be classified as: (a) *Ordinary jacquards*, of which there are five principal types—viz., single-lift; centre-shed; double-lift, single-cylinder; double-lift, double-cylinder; and open-shed. (b) *Special jacquards*, which include cross-border machines, gauze and leno jacquards, split-harnesses and jacquards, pressure harnesses, twilling, twin, double-cloth, and quilt jacquards. The special machines are described and illustrated along with the particular classes of cloths for which they are used in the accompanying book entitled "Advanced Textile Design." Of the ordinary machines the difference in type makes practically no difference to the textile designer; but the principle of action of one or more types should be thoroughly understood in order that the meaning of the terms "ties," "setts," "repeats," etc., may be properly comprehended.

ORDINARY JACQUARD MACHINES

The Single-Lift Jacquard.—A jacquard machine may be conveniently divided into three sections—viz. (a) the engine; (b) the harness; and (c) the mechanisms which connect the engine with the loom. The engine contains the parts by which the warp threads are selected in forming the design as the cloth is woven. In the single-lift jacquard the horizontal needles A (see Fig. 244) are each connected to a vertical hook B by forming a loop or a half bend round the latter, and are supported towards one end by a needle-board C, through which they project about half an inch. The rear end of each needle, which is formed into a narrow loop through which a vertical pin is passed, receives support from a horizontal wire D, and is pressed against by a spiral spring E contained in a spring-box F. In order to prevent a hook B from turning sideways the lower end is made double, and is passed through a narrow slit in a grate G with the bent end resting on a spindle H when the hook is out of action. The arrangement of eight needles in each short row, as shown in Fig. 244, is very common, but in some machines there are four, and in others ten, twelve, or sixteen needles in each short row according to the size of the jacquard. As many short rows of needles and hooks are placed side by side in long rows as will give the required size of machine. It is a general rule to connect the needles and hooks in the order shown in Fig. 244, the top needle being connected to the hook nearest to, and the bottom needle to the hook farthest from the cylinder K. The same number of inclined lifting knives I are carried in an iron frame or griffe J as there are hooks B in a short row. A 4-sided card-cylinder K, over which the pattern cards L pass, contains on each surface a hole opposite the end of each needle. Each face of the cylinder is provided with two adjustable pegs which fit into holes cut in the cards.

The cards L are composed of stiff paper, and are perforated according to the design; in an ordinary machine a separate card is required for each pick of weft, and the cards which form the complete repeat of a design are laced together with twine at the sides and in the middle; then the last card is joined to the first so that an endless chain is formed. The pitch of the needles, the springs in the spring-box, and the holes in the needle-board, card-cylinder, and cards is exactly the same.

In one method of suspending a "set" of cards in proper position in relation to the cylinder, a wire, which is about $1\frac{1}{2}$ inches longer than a card, is tied at intervals of twelve or more cards to the twine with which the cards are laced together.

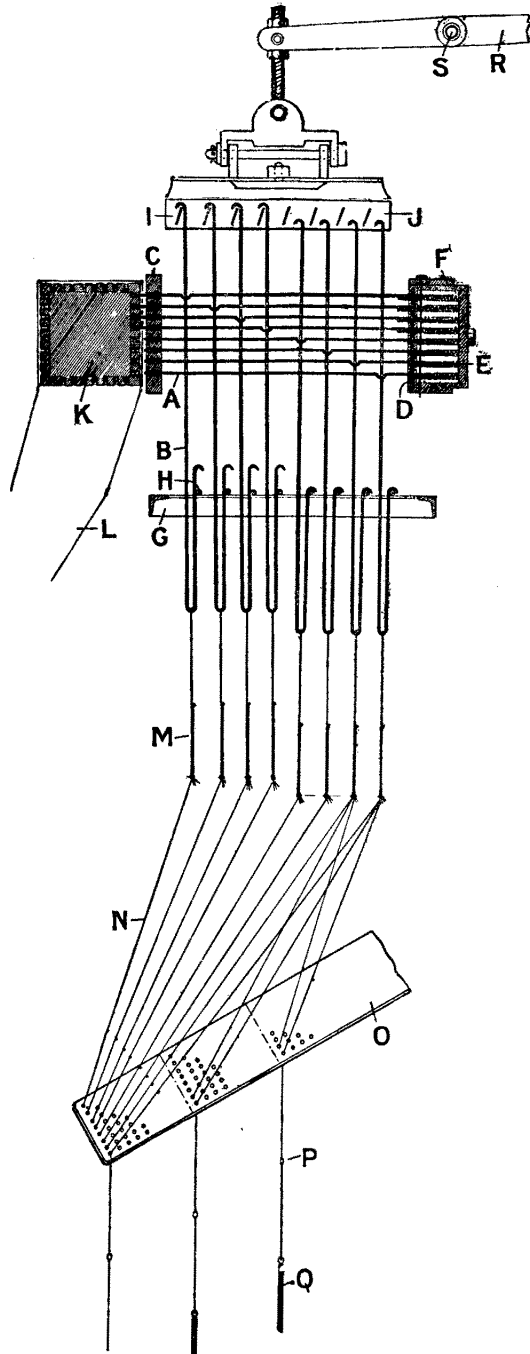

Fig. 244.

By means of the wires the cards hang from a frame or "cradle" which consists of two parallel iron bars that are rather further apart than the width of the cards, and the latter pass over supporting rollers. When long sets of cards are not used—say below 200 in a set—the cradle may consist of a curved tin channel in which the cards rest, the wires then being dispensed with.

The harness consists of neck or tail cords M that are suspended from the hooks B; harness cords N, which are connected to the tail cords and passed separately through holes in a comber-board O; mails P; and lingoes or weights Q. The number of harness cords, mails, and lingoes, connected to each neck-cord M, varies according to the "tie" and "sett" of the harness. The cord that connects a mail with a lingoe is double, and is termed the "lower coupling," while that which is connected to the top of a mail is also double to where a knot is indicated, and is termed the "upper coupling," the part above the knot being termed the mounting thread." By means of the lingoes Q, the warp threads, cords, and hooks are returned to their original position after they have been raised.

The purpose of the comber-board O (sometimes termed hole-board) is to keep the harness

cords in position and to determine the number of cords per unit space. There are three forms of comber-boards in use—viz. (1) A “harness reed,” which is similar to a coarse weaving reed except that the end pieces are broad and flat. This reed is supported horizontally in the loom, and stout cords, which are secured in holes bored in the end pieces, are laid on its upper surface at right angles to the reed wires, so that small holes are formed for the reception of the harness cords. (2) A solid wood comber-board in which the holes are pierced in rows. (3) A wood comber-board which is built up in sections, each section consisting of strips of wood from 1 to 3 or more inches broad which are held together in a grooved frame. The sections are pierced with holes in rows as in a solid board, and an advantage of the arrangement is that the outer strips, which wear out more rapidly than those in the centre, can be economically renewed. It is also possible to increase the width of the harness somewhat by inserting thin strips of wood between the sections, but this cannot be carried very far without disturbing the level of the mail eyes. The comber-board is adjustably supported at each end by means of a slotted bracket fixed to the loom frame, and it is placed from nine to twelve inches above the mails.

To a crank or eccentric, fixed to the end of the driving shaft of the loom, a long vertical rod is connected, and the upper end of the rod is attached to the end of a lever R, Fig. 244, which is fulcrumed at S. Each revolution of the crank shaft, by means of the eccentric, connecting rod, and lever R, imparts a rising and falling motion to the griffe J and the lifting knives I. By means of another eccentric on the crank shaft, and connecting rods and levers, the card cylinder is caused, at each pick, to move against and away from the ends of the needles A. (In hand-loom weaving the parts which operate the card cylinder are contained within the engine). On its outward movement the cylinder, at one corner, engages with a catch or “sneck” by which it is turned one-fourth of a revolution, so that a fresh card is presented at each pick to the needles.

Circular holes are punched in each card to correspond with the warp threads that are required up, and the method of action is as follows:—At each pick a card is pressed against the needles A at the time that the lifting knives I are in the lowest position. Where the card is not perforated (as represented opposite the four bottom needles in Fig. 244) the holes in the cylinder are covered and the needles and the corresponding hooks are pressed back, so that the bent upper ends of the latter are moved away from the path of the lifting knives I. Where there are holes in the card (as represented opposite the four top needles in Fig. 244), the needles enter the cylinder and the hooks remain vertical so that they are caught by the ascending knives I and are raised. In Fig. 244 the griffe J is shown partly raised in order that it will be readily seen which hooks are engaged by the lifting knives and which are left down. The card cylinder K continues to press against the needles until the hooks are securely held by the knives; it then moves outward, when the hooks that have been pressed back are returned to their normal position by the action of the springs E. The knives are inclined in order that in descending they will not damage the heads of the hooks, and they fall a sufficient distance to place them with the upper edges quite clear of the bent portion of the hooks. Each lifted hook raises as many warp threads as there are harness cords connected to the corresponding neck-cord. Warp threads are moved from the bottom of the shed to the top and back again, or twice the depth of the shed at every pick; and on account of the great distance traversed by the threads and the consequent strain put upon them, and the

absence of counterpoise in the machine, the single-lift jacquard is not suitable for high speeds. It is, however, particularly serviceable in weaving certain classes of gauze fabrics, and is also employed to some extent in the manufacture of complex cloths in which for other reasons quick running cannot be attained.

The Centre-Shed Jacquard.—In the centre-shed jacquard the arrangement of the hooks, needles, neck-cords, harness-cords, and card cylinder is the same as in

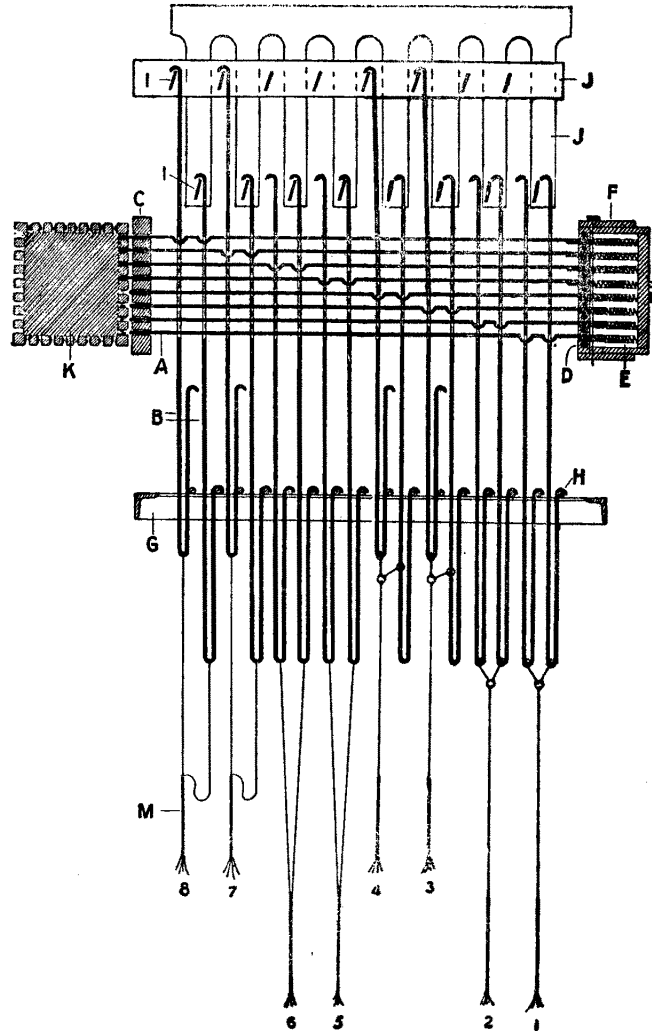

Fig. 245.

the single-lift machine, but there are both a rising and a falling griffe. The warp threads, when at rest, are in the centre of the shed; where there are holes in the cards the corresponding hooks are raised to the top through the action of the rising griffe, while the remaining hooks are lowered to the bottom by means of the descending griffe. The threads move only half the distance that they move in single-lift

jacquard shedding, and the rising shed is balanced by the falling shed, but as every thread is in motion a detrimental swinging movement is set up in the harness if a speed much greater than that of the single-lift is attempted. The centre-shed principle is found useful, however, in weaving certain classes of heavy cloths, for which a slow-running loom is required.

The Double-Lift, Single-Cylinder Jacquard.—The principle of arrangement of a double-lift, single-cylinder jacquard is illustrated in Fig. 245, in which corresponding parts are lettered the same as in Fig. 244. Each needle A is connected to two consecutive hooks B, and from each pair of hooks one neck-cord M is suspended. There are two griffes J, and two sets of lifting knives I which are operated in alternate order, one griffe and its knives rising while the others are descending. One set of lifting knives acts upon the odd hooks, and the other set upon the even hooks; therefore, to correspond with a hole in a card, a neck-cord may be raised by either hook of a pair according to which set of knives is raised after the press of the card. The griffes J are operated by a double-throw crank fixed to the end of the low shaft of the loom, a separate connecting rod and top lever being employed for each griffe. The card cylinder K, which is operated from the driving shaft as in the single-lift machine, is pressed against the needles when one griffe is at the top and the other at the bottom—that is, at the time that hooks which have been raised on the preceding pick are held by the knives I at the top. What takes place will be understood from an examination of Fig. 245, in which it is assumed that the needles 1, 2, 5, and 6, (counting from the bottom) have been pressed back by the previous card, the corresponding neck-cords thus being left down, while the needles 1, 2, 3, and 4 are shown pressed back by the card that is in action; or, what is the same thing, a lift of the neck-cords 3, 4, 7, and 8 has to be followed by a lift of the neck-cords 5, 6, 7, and 8. As the top set of knives descends, and lowers the hooks that have been raised, the bottom set rises and lifts the hooks required up on the next pick, so that the neck-cords (or warp threads) which are required up on two consecutive picks—*e.g.*, the neck-cords 7 and 8—are lowered half way by the descending knives, and are then carried back to the top by the ascending knives. Thus, the threads that have to be raised on several picks in succession, after being raised to the top of the shed for the first pick, simply move from the top to the centre, and back again to the top, as many times as desired, a semi-open shed being formed.

In Fig. 245 the hooks which govern the neck-cords 5 and 6 have been left down on the preceding pick, and are shown in position for being raised by the knives at the bottom. The neck-cords 3 and 4, which are shown raised, have to be down on the next pick, therefore the corresponding needles are pressed back in order that the hooks at the bottom will be away from the path of the lower set of knives. In pressing back the bottom hooks, however, it is necessary for the corresponding hooks 3 and 4, which are held by the knives at the top, to be bent back, which puts extra strain on the needles. The strain is reduced by making the hooks long and flexible, and in some cases the double lower portion of the hooks is made gradually narrower towards the bottom end so as to allow of a slight backward movement in the slits of the grid G. It will be found useful to reason out how the hooks are raised in forming different weaves; thus, in plain weave half the hooks are never raised, whereas in 2-and-2 warp rib they are lifted equally.

Two methods of connecting the hooks in pairs to the neck-cords are illustrated in Fig. 245. Each neck-cord numbered 5, 6, 7, and 8 is shown connected by a

separate cord from each hook of a pair, the disadvantages of which are that the alternate slackening and tightening of the cords causes strain, and one cord may break while the other continues in action and produce an unobserved defect in the cloth. Each neck-cord numbered 1, 2, 3, and 4 in Fig. 245 is connected to a pair of hooks by means of a single cord and a wire link. If the single cord breaks the warp thread is immediately put out of action and the consequent defect in the cloth is readily seen.

The chief advantages of the double-lift motion, as compared with the single lift, are :—(a) Less power is required, because descending threads balance those that are being raised ; (b) greater speed can be obtained, because the shed is formed in less time since rising and falling threads move simultaneously ; (c) heavier lifts can be woven, and there is less strain on the warp so that weaker yarns can be used, as a portion of the warp only moves one-half the depth of the shed ; (d) a better “ covered ” cloth can be produced on account of the shed being partly open at the time of beating up. In obtaining a high speed the chief disadvantages are that a great amount of work is put on the cylinder, which has to act at every pick, and there is more wear and tear of cards, needles, hooks, and cords.

The Double-Lift, Double-Cylinder Jacquard.—This machine is similar in most respects to the double-lift single-cylinder machine, but as each cylinder has to operate only half as quickly as the loom, a higher speed can be obtained if other conditions are suitable for quick running. The card cylinders are operated alternately, and the odd and even cards are laced in separate sets. In one type of machine each cylinder acts upon a separate set of needles, and there are two needles and two hooks to each neck-cord, the machine really consisting of the principal parts of two single-lift engines in one frame ; one set of cards must be laced forwards, and the other set backwards (see Fig. 250). In another type of machine the two cylinders operate against the opposite ends of one set of needles, the springs and spring box being dispensed with. In this case both sets of cards are laced in the same direction, but one set is turned inside out. Double-cylinder machines have the disadvantages that the storing of the cards is not so convenient, greater care is required in placing the cards on the cylinder, and the cards are liable to get out of proper rotation. A “ stop ” motion may be applied by means of which the cards (acting through two special needles and hooks and suitable connections to the starting lever of the loom) automatically cause the loom to stop if they do not follow each other in proper order.

The Open-Shed Jacquard.—A good type of open-shed machine is constructed on the double-lift single-cylinder principle. A series of fixed dwelling knives is provided, and each link that connects two hooks of a pair together is extended upward at one side through the grate, forms a loop round a hook, and is bent at the top to form a hook that rests on a dwelling knife when required up for successive picks. The machine is more complex but it has been successfully used in weaving warp face figured cloths right side up.

Recent Modifications of Jacquards.—These have been directed mainly to the simplification and improvement of details in order to secure saving of aisle space, more light and headroom, less wear and tear, and greater certainty of action. The double-throw crank, connecting rods, top levers, and upper gantry of double-lifts, are replaced by a drive from the crank-shaft. In one method spur wheels, through levers and a vertical rod, convey motion to the griffes, while in another

method a chain drive operates a counter-shaft on the gantry from which connections are made for working the griffes and the card cylinder. The card cylinder may be rotated positively either by means of a separate chain drive, or a vertical shaft drive, through a peg and star wheel device. A patent "ease-eye" needle, which is made with double wearing surface in the eye, enables any hook to be quickly taken out and replaced, while any needle can be easily removed without disturbing its hook and cord. Woven harness necks have replaced sewn necks, and special non-twist thread is used for linen harnesses and rustless steel for the mail eyes. Wire mail harnesses with hardened inserted eyes are attached to flat lingoos by steel links, and knots above the comber-board may be avoided. The holes in the comber-board are smoothed and counter-sunk top and bottom.

Sizes of Jacquards and Cards.—Standard British machines range in size from 100 to 600, and occasionally 900 hooks (in double-lift machines two hooks are counted as one) which are arranged as shown in the following list:—

100 size, with 26 rows of 4 hooks per row	= 104 hooks.
200 " " 26 " " 8 " " "	= 208 "
300 " " 38 " " 8 " " "	= 304 "
400 " " 51 " " 8 " " "	= 408 "
500 " " 51 " " 10 " " "	= 510 "
600 " " 51 " " 12 " " "	= 612 "
900 " " 77 " " 12 " " "	= 924 "

The 300, 400, and 600 sizes are in most general use, and very frequently a large machine is obtained by placing two or more smaller machines side by side over the loom—*e.g.*, a 600-size by combining two 304-hook machines; a 1,200-size by combining two 608-hook machines; and an 1,800-size from three 608-hook machines. The number of hooks given in the last column of the foregoing list indicates the figuring capacity of the respective machines—that is, the number of warp threads that can be operated independently of each other if all the hooks are tied up. In the sizes ranging from 408 to 924 hooks, however, one row of hooks is intended to be employed in operating the selvage threads of the cloth, but at each side there is a part row of hooks—in line with the positions occupied by the pegs in the card cylinder—which, if necessary, can be used for the purpose. In the 304-hook machine these extra hooks (six at each side) are mostly employed as selvage hooks. Either all or a portion of the total hooks in a machine may be tied up, but generally, the number that is employed should be a multiple of several smaller numbers, as this gives facilities in producing designs which repeat upon one-half, one-third, etc., the number of hooks, and ground weaves which repeat upon different numbers of threads.

Continental machines are chiefly of two types—the Vincenzi and the Verdol—both of which are finer in pitch than standard British pitch. The Vincenzi type is arranged with 16 needles and hooks in each short row, and is generally made in sizes of 440, 880, 1,320, and 1,760 hooks. The Verdol machine is made with 16 hooks in each short row and 8 needles, but the needles are arranged alternately—two rows corresponding to one row of hooks. The machines are made in multiples of 112 hooks, common sizes being 448, 896, 1,344, and 1,792 hooks. In the Vincenzi machine the cards act upon the needles in the same manner as in British machines, and a separate card is used for each pick. The Verdol type, however, is different, as the cards, which are in the form of an endless sheet of paper, act upon the needles indirectly.

The cards (fully perforated) for different sizes of machines are illustrated in

Figs. 246 and 247. A, B, and C in Fig. 246 represent 304, 408, and 612—British

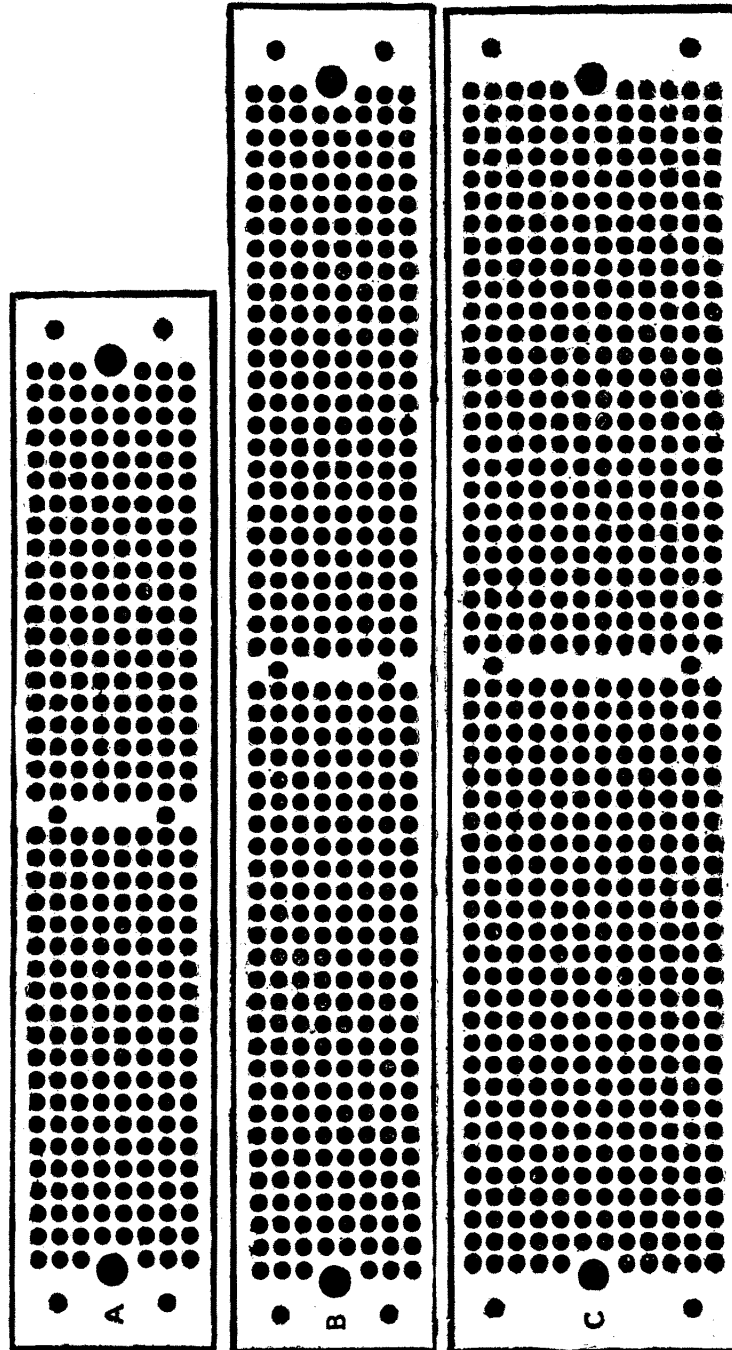

Fig. 246.

sizes, which are respectively $12\frac{3}{4}$ ins. \times $2\frac{3}{8}$ ins., $16\frac{1}{4}$ ins. \times $2\frac{3}{8}$ ins., and $16\frac{1}{4}$ ins. \times $3\frac{1}{8}$ ins. in length and breadth. D in Fig. 247 shows the 1,320—Vincenzi size, which is

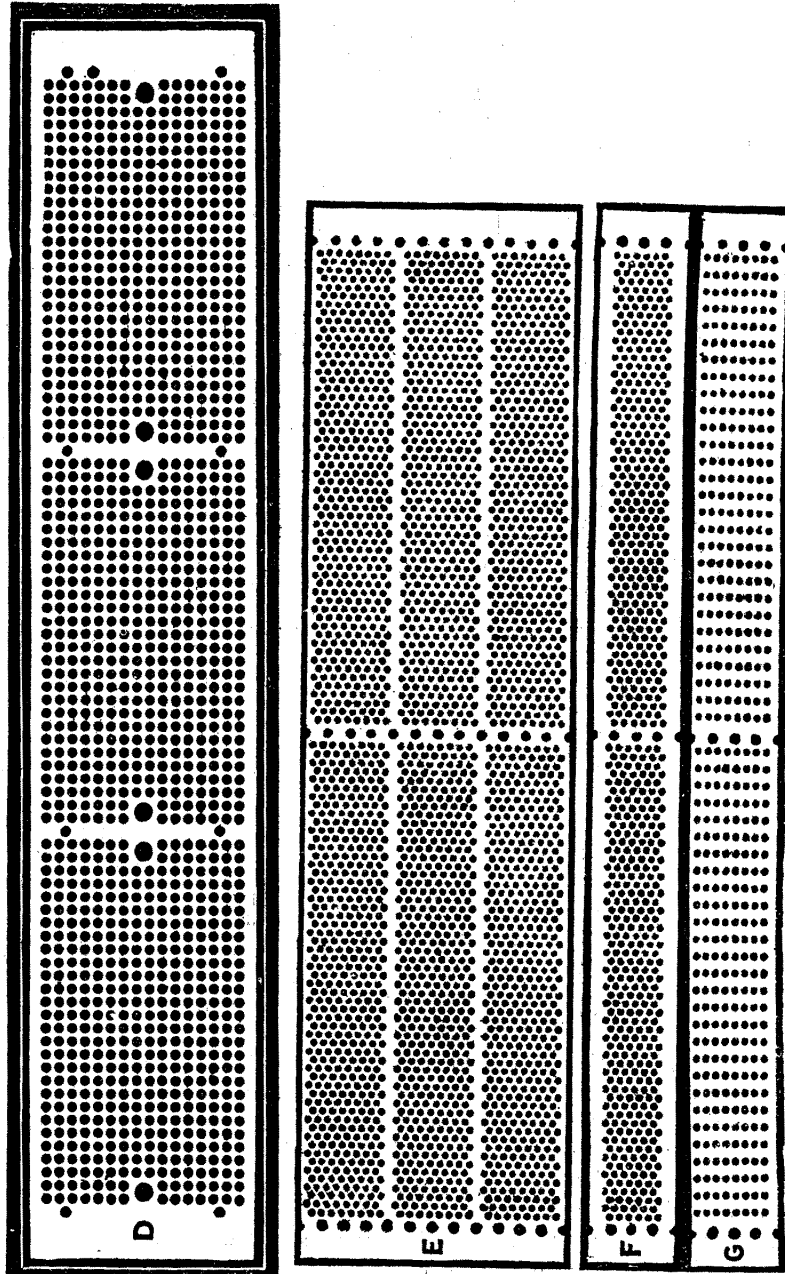

Fig. 247.

$14\frac{7}{8}$ ins. long \times $2\frac{3}{8}$ ins. broad. E in Fig. 247 represents the equivalent of there Verdol cards of 896 size, each of which occupies the space of $12\frac{3}{8}$ ins. \times $1\frac{1}{8}$ ins.

F and G both show the comparative size of one Verdol 896-card, and these examples demonstrate two methods that are adopted of reducing the capacity of a Verdol machine. F shows the capacity of 896 hooks reduced to 672, by reducing each row of 8 to 6; and G to 448 hooks by employing only the alternate rows of 8.

In further comparison of the difference in pitch of British and Continental machines—in an ordinary British machine there are approximately 14 needles per square inch, whereas there are 40 needles per square inch in the Vincenzi, and 80 in the Verdol. In weaving large designs in very fine silk fabrics a fine pitch is a necessity

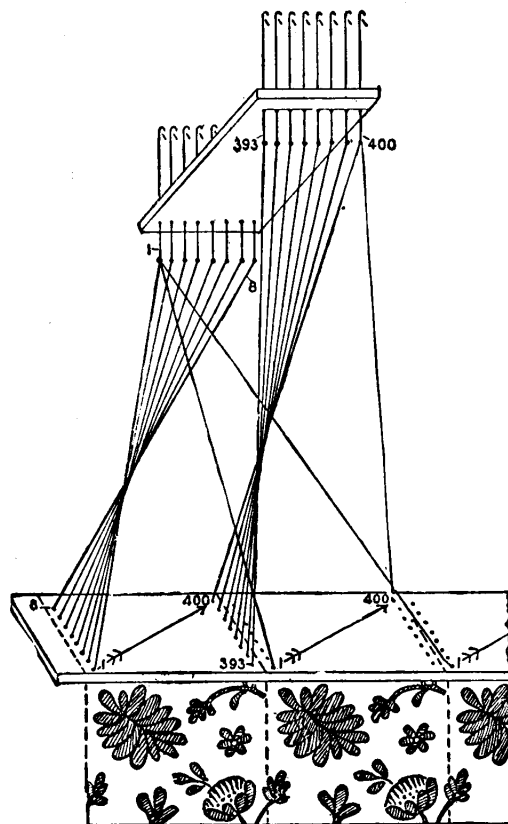

Fig. 248.

in order that the machine will be contained in reasonable compass. Several British jacquard makers now make machines of exactly the same sizes and fineness of pitch as the Vincenzi, which have been largely adopted. In fine pitch machines it is particularly necessary for card paper to be used which will be affected as little as possible by changes in atmospheric conditions. An advantage of the Verdol machine—in addition to its comparatively small size—is in the light weight of the paper, and its corresponding cheapness.

With the exception of the Verdol type shown at E, F, and G the cards illustrated in Figs. 246 and 247 show how the hooks and needles are arranged in the machines, and will make clear the meaning of the terms “short row,” and “long row,” as applied to the needles, hooks and harness cords. In looking at a fully-punched card the holes (with the exception of the peg and lace holes) represent the tops of the

hooks, and the ends of the needles; or, in other words, each hole represents the connection of a needle to a hook (or a pair of hooks in a double-lift single-cylinder jacquard). Further, a card represents one pick, or one horizontal space of the design paper, and each hole (or position where a hole may be punched) a small square of a horizontal space; and each small square also indicates where an end and a pick intersect. A card is perforated and left blank in the order indicated by the painting of the design; if certain marks, or the blanks, represent warp up, a hole is cut to correspond with each small square thus indicated (as shown in Fig. 250).

Ordinary Harness Ties.—A jacquard may be placed in relation to the loom with the card cylinder at the right or left side, or at the back or front. If the cylinder is

at one side the long rows of hooks are at right angles to the length of the comber-board, therefore the harness cords are crossed with each other in passing from the neck-cords to the holes in the comber-board. This arrangement, which is illustrated in Fig. 248, is termed a London, crossed, or quarter-twist tie. If, however, the card cylinder is at the back or front of the loom, the long rows of hooks are parallel with the length of the comber-board, so that the harness cords are not crossed. This tie is illustrated in Fig. 249, and the term Norwich or straight tie is applied to the arrangement.

In tying up a harness the first hook in the row nearest the head of the cylinder (the "sneck" or "catch" side, which is invariably on the right when facing the cylinder) is taken as the first hook in the machine. The other hooks in the same row follow in consecutive order from 2 to 8, as indicated by the numbers in Figs. 248 and 249; then the hooks 9 and 16 are the first and last in the second row; the hooks 17 and 24, the first and last in the third row, and so on. If the jacquard contains as many hooks as there are figuring threads in the full width of the cloth, as, for instance, in certain classes of carpet jacquards, only one harness cord is connected to each hook, and the tie is termed a "single" tie. The most commonly used arrangement, however, is the "lay-over" or "repeating" tie, which is illustrated in Figs. 248 and 249, and is also represented in the lower portion of Fig. 244. In this tie, commencing with the first hook (or neck-cord) of the machine, the first harness cord is connected to it, the second harness cord to the second hook, the third to the third, and so on in succession until each hook has one harness cord connected to it. This gives one "division" or "repeat" of the harness, which occupies a certain width of the comber-board and contains as many harness cords as there are hooks tied up. The process is then repeated—commencing with the first hook, and a second harness cord is successively connected to each, a second division of the harness being thus formed in the comber-board. Again the process is repeated (and again and again if necessary) until the required width of the harness in the comber-board is obtained.

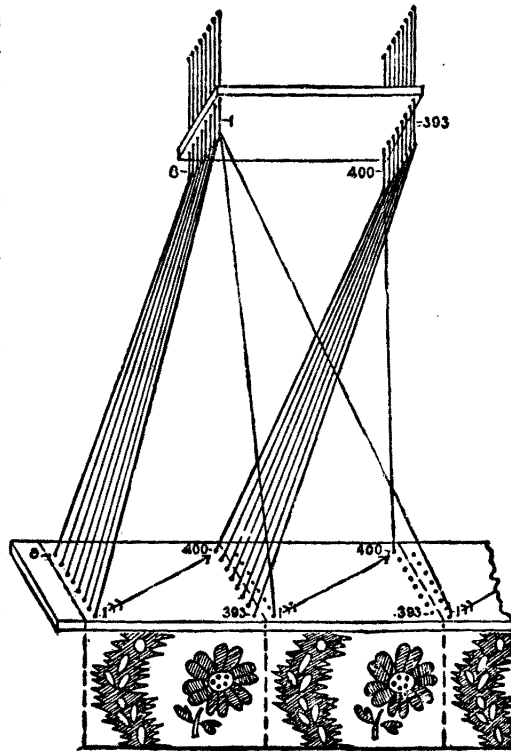

Fig. 249.

In Figs. 244, 248, and 249 the divisions of the comber-board are clearly indicated, and it will be readily understood, that as in each division the harness cords are

attached in exactly the same order to the hooks (or neck-cords), the figure formed by the first division will be formed just the same by the second division, and then again by the third division. That is, the design will be "repeated" across the width of the cloth by the repetition of the tie, in the manner illustrated by the sectional designs below the comber-boards in Figs. 248 and 249. In the lay-over tie the number of hooks tied up gives the maximum number of threads in the repeat in width of a design; by casting out (see page 219) designs may be woven which repeat upon a less number, while any division of the number of threads may be employed.

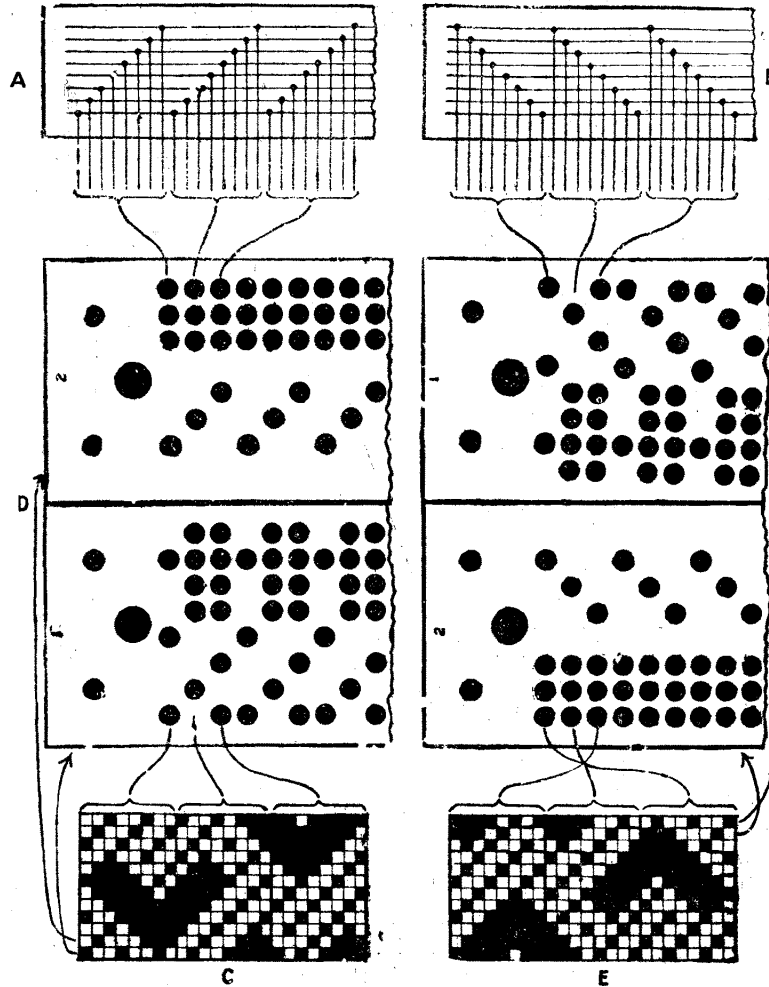

Fig. 250.

Harness Drawing in, Card Cutting, and Card Lacing.—The warp threads may be drawn through the harness mails in the order shown at A in Fig. 250, or as indicated at B. In the former method the first thread in a design (at the left as viewed from the front of the loom) is drawn upon a harness cord at the front of the comber-board, and if the card cylinder is at the back of the loom (which is most common) the

needle that controls the first thread is at the bottom of the first short row. In the latter method, under similar conditions, the first thread is drawn upon a harness cord at the back of the comber-board, and the needle which controls it is at the top of the first short row.

The construction of a design is not affected by the way in which the threads are drawn in, but a difference is made in the card-cutting. This is illustrated in Fig. 250 in which C shows a small design, and D sections of two cards which are cut to correspond with the first and second horizontal spaces, or picks of C—assuming that the harness draft A is employed and that the marks of the design indicate warp up. The design is placed in front of the card-cutter in the position that it has been constructed and as it is required to appear in the cloth. The bottom horizontal space corresponds with the first card, and the card-cutter follows it from left to right, each series of spaces between the thick lines of the paper coinciding with a short row of the card. If the draft indicated at B in Fig. 250 be employed, the design is turned one-half round, as shown at E. The first horizontal space is then at the top, and the first card is cut from it by reading from right to left. Thus, F shows sections of cards cut from the two top horizontal spaces of E. One method of drawing in and card-cutting is employed in certain districts, and the other method in other districts—*e.g.*, in Yorkshire the first method is common, and in Lancashire the second method. As to which is the better method is a matter of opinion, but the first method has an advantage in the respect that it corresponds with ordinary heald drafting.

Confusion sometimes arises when cards are transferred from one district to another, but cards cut for one draft can be used for the other simply by turning the set inside out. It will be seen that the cards shown at D in Fig. 250, when turned over, are exactly like those given at F. If, in the same factory, some of the jacquards have the cylinder at the back of the loom and others at the front, draft A should be used for one arrangement and draft B for the other, otherwise the cards will require to be laced “forwards” in one case, and “backwards” in the other case. A uniform system of card-lacing can be employed by using the two systems of drafting to correspond with the two positions of the cylinders, the cards being turned inside out in changing from one to the other.

The cards are numbered at the end where the cutting is commenced to correspond with the numbers of the horizontal spaces of the design, and they are laced together with the numbers arranged in consecutive order. Generally the numbers follow each other from one upward in the direction shown at D in Fig. 250, which is termed “lacing forwards.” Sometimes, however, as for instance in order to reverse the direction of a twill-ground weave, they follow each other in the opposite direction as shown at F, which is termed “lacing backwards.” As a rule the numbered ends of the cards are placed at the right (when facing the cylinder) or “sneck” side of the cylinder, and if the cards are laced forwards they rotate in order from the first to the last, whereas if they are laced backwards they rotate from the last to the first. An exception to this occurs when two cylinders are employed at opposite sides of the jacquard.

JACQUARD, HARNESS, AND DESIGN CALCULATIONS

Sett of the Harness.—The number of harness mails per unit space is decided by the rate at which the rows of holes are formed in the comber-board, and the number of holes in each row. Usually there are as many holes in each row of the comber-

board as there are hooks in each short row of the jacquard. Thus, in an 8-row machine there are 8 holes in each row, and in wooden comber-boards in coarse setts, the holes may be pierced as indicated at G in Fig. 251, whereas in medium setts, in order to give as much space as possible between the holes, they are arranged alternately, as shown at H. In a 12-row machine the rows are 12 holes deep arranged alternately. In very fine sett harnesses, however, in order that there will be sufficient space between the rows, each row in the comber-board mostly contains twice as many holes as there are hooks in a short row of the jacquard. The arrangement for an 8-row machine is then as shown at K in Fig. 251, and in tying up the harness the cords from the first row of hooks are passed through the odd holes, and

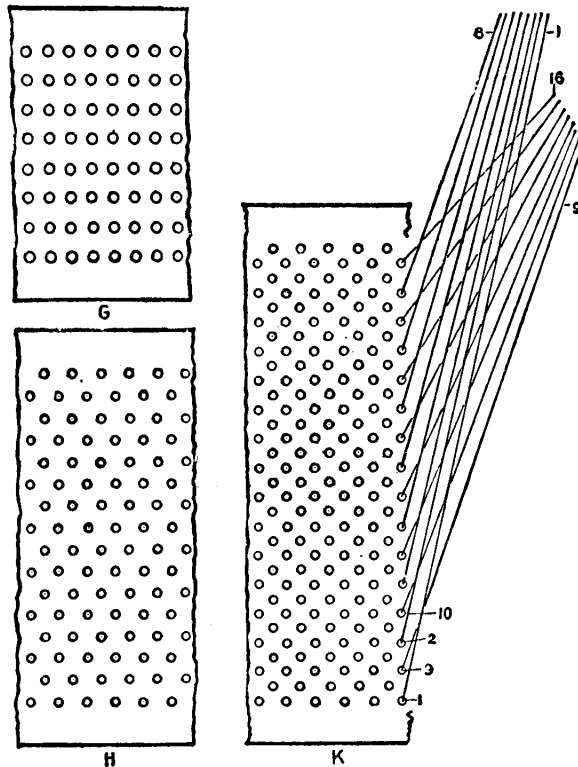

Fig. 251.

from the second row through the even holes, as represented on the right of K. The warp threads are drawn through the harness mails in corresponding order—threads 1 to 8 on the odd mails in succession, and threads 9 to 16 on the even mails, and so on.

Sometimes, for special purposes, as for instance in weaving broad crammed stripes, the comber-board is pierced at different rates to conform with the sett and width of the respective sections of the warp threads. Such an arrangement, however, is seldom necessary. For instance, a warp might be dented in the reed in the order of 200 threads, 4 per split, and 200 threads, 2 per split, but a uniform distribution of the harness cords in the

comber-board would cause no difficulty in weaving, because the cords yield (much more readily than in healds) to the draw of the reed.

The number of harness cords per inch is equal to the number of rows per inch multiplied by the number of holes per row. For example, if 72 harness cords per inch are required—in an 8-row machine there will be $72 \div 8 = 9$ rows of holes per inch, and in a 12-row machine— $72 \div 12 = 6$ rows per inch.

Number of Harness Cords to each Hook.—In a lay-over or repeating tie the number of hooks tied up, and the width and sett of the harness, determine the number of harness cords to each hook. For instance, assuming that 400 hooks are tied up, 50 inches wide in the harness, with 96 harness cords per inch—the total number of

harness cords in the full width = $50 \times 96 = 4,800$; and $4,800$ cords \div 400 hooks = 12 harness cords to each hook. That is, the harness will be in 12 divisions, and will produce 12 repeats of a design that is constructed upon 400 threads. As a further illustration, let it be assumed that 304 hooks are tied up, 40 inches wide, with 72 harness cords per inch. In this case there will be $40 \times 72 = 2,880$ cords, and $2,880 \div 304 = 9$ divisions + 144 cords. It is customary to tie one-half of the cords that are in addition to the full divisions at one side of the jacquard, and the other half at the other side, and the following arrangement will therefore be suitable :

Hooks 233 to 304	=	72 harness cords.	
„ 1 to 304×9 repeats	=	2,736	„ „
„ 1 to 72	=	72	„ „
		2,880	„ „

Thus, 144 hooks will be tied up with 10 cords per hook and 160 hooks ($304-144$) with 9 cords per hook. In the foregoing, no provision is made for the selvages, but assuming that 4 hooks are employed for the purpose, and that 24 cords are tied up at each side, each selvage hook will have $(24 + 24) \div 4$ hooks = 12 cords attached to it.

Casting-out in Jacquards.—Casting-out consists of leaving empty a portion of the mails in each repeat of the harness, and of allowing the corresponding needles, hooks, and harness cords in the machine to remain idle. The warp threads should occupy the same width in the harness as in the reed ; the sett of a harness, however, is fixed when it is tied up, whereas the sett of the warp in the reed is changed according to requirements (except that it should not be finer than the sett of the harness). Casting-out may therefore be defined as a process by which a jacquard is adapted, without retying, to suit conditions that are different from those for which the harness was constructed. For instance, if a harness is tied up to 400 hooks, with 96 harness cords per inch, the conditions are perfectly suited to weaving designs repeating upon 400 threads with 96 threads per inch. It may, however, be found necessary to use the machine—(a) in weaving designs that repeat upon a less number of threads than 400 ; and (b) in weaving cloths with less than 96 threads per inch. These are the two chief purposes of casting-out ; but, in addition, the process is employed to some extent in producing special effects in a straight repeating tie.

It is possible to weave designs that repeat upon any number of threads less than the number of hooks tied up, but it is obviously impracticable to employ a higher number. Very small designs can be repeated across the cards a number of times—e.g., in a 400 -tie, a design repeating upon 64 threads can be carried across the cards five times, with a remainder of 80 hooks cast out, or six times with 16 hooks cast out. The examples C and D, or E and F, in Fig. 250 illustrate the method in which a small design is repeated across the cards. Casting out 80 hooks, in a jacquard in which 400 hooks are tied up, leaves only 320 hooks in use, and under these conditions the machine is limited to designs which repeat upon 320 threads, or a number which is a measure of 320 .

It is important to note that the sett of the harness is reduced in ratio to the proportionate number of hooks that are cast out ; and the sett of the warp in the reed should be the same (or very nearly the same) as the reduced sett of the harness. By means of the following formula, which is of general application, an unknown factor can be readily found :—The sett of the harness : the sett of the warp in the reed :

the number of hooks tied up : the number of hooks employed, or the number of threads in the design.

Two problems arise in weaving designs that repeat upon a less number of threads than the number of hooks tied up : (1) To find the sett of warp to suit a given sett of harness. (2) To find the sett of harness to suit a given sett of warp. In illustration of both problems let it be assumed that it is desired to weave a design repeating upon 320 threads in a 400-tie. (1) Taking the sett of the harness as 90 cords per inch, the sett of the warp should be :—

$$400 : 320 :: 90 : 72 \text{ threads per inch.}$$

(2) Taking the sett of the warp as 80 per inch, the sett of the harness should be :—

$$320 : 400 :: 80 : 100 \text{ cords per inch.}$$

That is, in each case the sett of the harness should be finer than that of the warp in the proportion of the number of hooks tied up to the number of threads in the design.

When it is desired to weave a cloth with fewer threads per inch in the reed than there are harness cords per inch, it is necessary to find the number of threads in the repeat of the design relative to the number of hooks tied up. For example, assuming that a warp with 64 threads per inch in the reed, has to be woven in a 304-tie, with 80 harness cords per inch, the number of threads in the repeat of the design will be :—

$$80 : 64 :: 304 : 243 \text{ threads.}$$

In this case however, a more convenient number is 240 threads, then the number of hooks cast out = $304 - 240 = 64$.

In some special cases the hooks are cast out in long rows, which, as regards the card cutting, reduces the number of hooks in each short row—*e.g.*, if two long rows are cast out, a 12-rowed machine is reduced to 10 rows, and an 8-rowed machine to 6 rows. Most frequently, however, the casting out is done in short rows, and if a considerable number of rows are cast out, they should be distributed as regularly as possible across the card. Also, a definite system should be employed in selecting the rows, otherwise when a cast out is changed, it may be necessary to fill up mails at one place at the same time that threads are broken out at another place. Fig. 252 illustrates a principle upon which the cast out rows may be selected. A represents one long row of a 304-card, which is in two halves, each consisting of 19 rows, and it will be understood that each black circle corresponds to a short row of eight. For a cast out of 32 hooks the 1st and 19th rows in each half are cast out, as shown at B. To increase the cast out to one of 48 hooks, the 10th row in each half is added, as indicated at C. For a cast-out of 80 hooks the 7th and 13th rows in each half are also added, as shown at D ; to which the 4th and 16th rows in each half are added for a cast out of 112 hooks, as shown at E. This is further increased to a cast out of 144 hooks by adding the 6th and 14th rows in each half, as represented at F.

It will be seen that when the cast out is increased it is only necessary to break out the additional number of ends in each division of the harness ; and in the same way, when the cast out is reduced, it is only necessary to fill in the required number of mails. Also as both halves of the card are exactly alike, the cutting of small designs is simplified, as they can be readily carried across the card without being extended to more than one repeat.

Another important point to note in selecting the rows to be cast out is to arrange them, if possible, in such a manner that they are in the same order when counted from

either end of the card. This has been kept in view in selecting the rows for the cast outs shown at B to F in Fig. 252. For example, from whichever side of cast out E the rows are counted, the numbers are 1, 4, 7, 10, 13, 16, 19, in each half. The advantage of this arrangement is that the cards will fit on the cast out when turned round, which, in certain of the most common arrangements of figures, enables the cards for the second half of the design to be repeated from the cards which are cut from the first half, thus saving time both in the designing and card cutting. Such an arrangement cannot be made in the 408 and 612-hook machines, because one side of the cards contains 26 rows and the other side 25 rows, but the machines can now be obtained in a modified form in which there are 25 rows in each half.

When only a given size and sett of jacquard is available for producing a design, it sometimes occurs that the proper number of ends for the repeat, obtained by calculation, is different from the number of ends in one or more repeats of the design. For example, assuming that a 66 sett warp is required to be woven in a 76 sett 304 jacquard, the correct number of ends for the repeat =

$$76 : 66 :: 304 : 264 \text{ ends}$$

and the correct cast out =

$$304 - 264 = 40 \text{ hooks.}$$

In practice, the number of ends (264) for the repeat can be varied from about 256 to 272, but a large design, repeating on, say, 288 ends, or one repeating on, say, 240 ends, will require to be modified in size to suit the size of repeat which can be obtained in the given jacquard. Small designs may also require to be modified in size, as, for example, a design repeating on 48 ends may be altered to repeat on $(264 \div 6 \text{ repeats}) = 44$ ends, or $(260 \div 5 \text{ repeats}) = 52$ ends. When, however, it is impossible for the repeat of a small design to be altered in size, the warp may be kept straight between the harness and the reed by casting out in the following manner:—

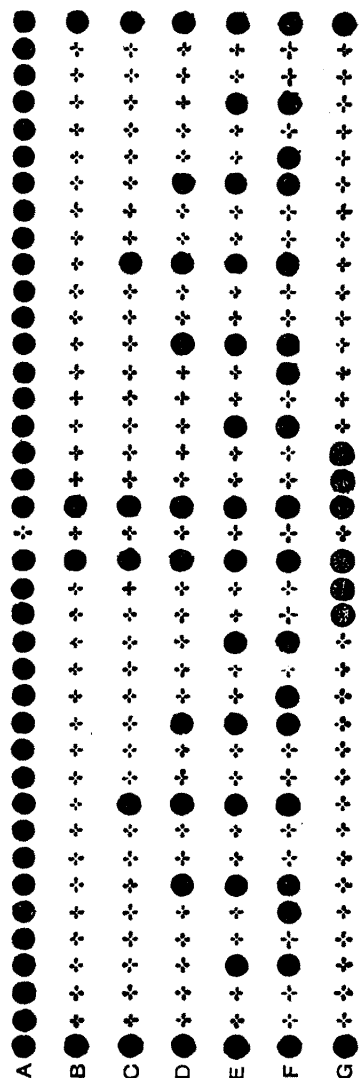

Fig. 252.

Assuming that the calculation number of ends for the repeat is 264, and that the design repeats on 48 ends, the design is carried out on a larger number of ends than the calculation number. Thus, in this case, by repeating the design six times, the size of the repeat = 288 ends, which in the 304 jacquard gives a cast out of 16 hooks, or two rows for the card cutting. The number of harness mails (16) which are cast

out in every division of the harness is then too little by $(288 - 264) = 24$ mails; but as the design repeats on 48 ends only, it is possible, without injury to the weaving, and without causing a break in the pattern, to cast out a block of 48 harness mails in addition to the 16 mails in any division of the harness. The number of times it will be necessary to cast out in blocks of 48 may be found as follows—

Assuming that the warp contains 3,200 ends, the number of divisions which the warp requires to occupy in the harness =

$$\begin{array}{r} 3,200 \div 264 = 12 \text{ divisions and } 32 \text{ ends.} \\ \hline 12 \text{ divisions} \times 24 \text{ mails cast out too little} \\ \hline 48 \text{ mails in each block.} \end{array} = 6 \text{ times.}$$

It is necessary to assort the 6 places regularly across the 12 divisions which the warp occupies; therefore, in this case, the odd divisions may be cast out 16, and the even divisions $16 + 48 = 64$ mails. The plan of the cast-out card is shown at G, Fig. 252, the shaded circles indicating a convenient position for the 48 mails or 6 rows which are cast out or filled in according to requirements. It will be understood that the cards for weaving the design must be cut as though the harness was cast out only on the first and last rows.

Size of Repeat.—Cloths contract in weaving and also in most cases in finishing, hence in the finished state a fabric contains more threads per unit space than are inserted in the loom. A jacquard design requires to be constructed in accordance with the finished conditions of the cloth for which it is intended, and if a cloth, when finished, contains 60 picks and 80 ends per inch, a design 8 ins. long by 5 ins. wide will repeat upon $60 \times 8 = 480$ picks or cards, and $80 \times 5 = 400$ ends.

The length of repeat that can be obtained in a jacquard is generally considered to be unrestricted, but in practice there is a limit to the number of pattern cards that can be conveniently suspended and made to work satisfactorily in a machine. Very long sets of pattern cards can by special arrangements be employed but in practically all cases if a certain limit is exceeded the productiveness of the loom is liable to be affected. Also it should be taken into account that the cost of a design is about in proportion to the number of cards that are required, and for this reason many special jacquard arrangements have been devised chiefly with the idea of saving cards. In ordinary jacquards, however, a separate card is required for each pick, and if it be assumed that the maximum number that can be conveniently used in a given machine is—say 2,000, the designer should endeavour to restrict his designs accordingly. Thus, in this case, in designing for a cloth with 100 picks per inch, the length of the repeat should not exceed 20 inches, and for a cloth containing 160 picks per inch, $12\frac{1}{2}$ inches; any less length of repeat, of course, being readily obtained.

The width of repeat that can be woven in an ordinary jacquard and tie is much more restricted than the length, as in the loom it cannot (in ordinary circumstances) exceed the space occupied by one division of the harness in the comber-board. The number of hooks tied up, the sett of the harness, and the contraction of the cloth, are the governing factors. For example, assuming that a cloth contracts 10 per cent. from the reed width to the finished width—a 400 tie with 80 harness cords per inch will give: $(400 \div 80) - 10 \text{ per cent.} = 4\frac{1}{2}$ ins. width of repeat in the finished cloth. The result is not affected if a cloth is woven with fewer threads per inch in the reed than the number of harness cords per inch, because the hooks require to be cast out

to correspond with the difference in the setts. Thus, if a cloth is woven in the foregoing tie with 60 ends per inch in the reed, there will be

$$80 : 60 :: 400 : 300 \text{ hooks employed,}$$

and $(300 \div 60) - 10 \text{ per cent.} = 4\frac{1}{2} \text{ ins. width of repeat as before.}$

Methods of Modifying the Repeat in a Lay-over Tie.—Although, in a general way

it is true that the figure produced in one division of a lay-over tie will be produced exactly the same in each succeeding division, and that the width of the repeat is correspondingly limited, yet it is possible by means of special methods of drawing in and casting out to modify the size of the repeat and to obtain special effects. For instance, when the sett of the warp is not more than half the sett of the harness, the following method of casting out may be employed in order to double the size of the repeat of the jacquard. Assuming that it is required to weave a warp with 54 ends per inch in a 304-tie with 114 mails per inch, the number of mails in each division which require to be filled in =

$$114 \text{ mails} : 54 \text{ ends} :: 304 : 144 ;$$

and the number of mails cast out in each division of the harness =

$$304 - 144 = 160.$$

Instead, however, of throwing 160 hooks entirely out of action, 288 hooks may be employed for figuring by making the design on $144 \times 2 = 288$ ends (which for the card cutting gives a cast out of $304 - 288 = 16$ ends), and by arranging the rows in the harness as follows: The first and last rows of hooks are cast out

in every division of the harness; in alternate divisions of the harness half of the remaining rows, say the even rows, are cast out, and the odd rows are filled in; then in the other divisions the odd rows are cast out, and the even rows are filled in. One repeat of the figure will thus extend across two divisions of the harness. In order to cut the cards conveniently from the design, it is necessary



Fig. 253.

to cut the sheet of point-paper into longitudinal strips, and to arrange a strip from the second half of the design alternately with a strip from the first half.

This method may be employed in various ways in the production of special effects in an ordinary machine. For example, the figured skirting fabric, represented in Fig. 253, was produced in an ordinary 304-jacquard by using the odd rows of hooks for the figure and the even rows for the ground. Where the border figure appears the even rows were cast out, while in the ground of the fabric the odd rows were cast out. The sett of the warp was half of that of the harness. In designing such a style the chief points to note are that the position of each part of the ornament on the point paper corresponds with the hooks which are available for its production, and that the warping plan coincides with the width and form of the border which can be obtained.



Fig. 254.

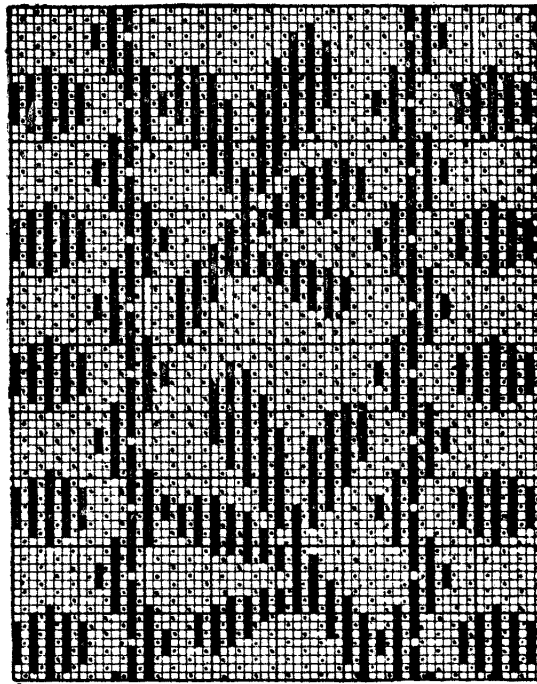

Fig. 255.

Another method of producing a novel effect by casting out in a special order is illustrated by the pattern represented in Fig. 254. In this case an ordinary ground figure, running transversely from selvage to selvage, is broken at intervals of two or more repeats by a separate and distinct longitudinal stripe in which the figure is produced by means of extra warp. The fabric was woven with 70 ends per inch, in an ordinary 384-tie with 84 harness mails per inch. The calculation number of ends in the repeat of the design therefore = 84 mails : 70 ends :: 384 hooks : 320

ends; and the cast out = $384 - 320 = 64$ ends. The horizontal ground figure was designed upon 320 ends, and the extra warp stripe upon 64 ends, the complete design thus occupying 384 ends for the card cutting. The point-paper plan of the extra warp stripe is shown in Fig. 255. Where the ground figure was required to run continuously for two or more repeats, the hooks, which were employed for the



Fig. 256.

extra warp effect, were cast out; but where the extra warp figure was introduced the mails for it were filled in, and a corresponding number of ground mails cast out.

Further, in figuring with two colours of warp arranged 1-and-1 in the harness it is possible by casting out an odd number of mails to obtain a repeat of figure which is apparently double the width of the repeat of the jacquard. For example, if one harness mail of a 304-tie be cast out, the number of ends in the repeat of the point-

paper plan = 303, and, as the 1-and-1 warping plan repeats on two ends, the design in the cloth will repeat on a number of ends which is common to 303 and 2—viz., 606. The ends of the first colour will be on the odd mails in one division, and on the even mails in the next division of the harness, and correspondingly the ends of the second colour will be on the even mails and then on the odd mails. The result of such an arrangement will be understood from an examination of the design shown in Fig. 256, only half the repeat of which needs to be painted out on the design paper. The two colours of warp, in which the figure is intended to be developed, will replace each other in succeeding divisions of the harness, hence the repeat of the design in the cloth will be on twice as many ends as the point-paper plan. A

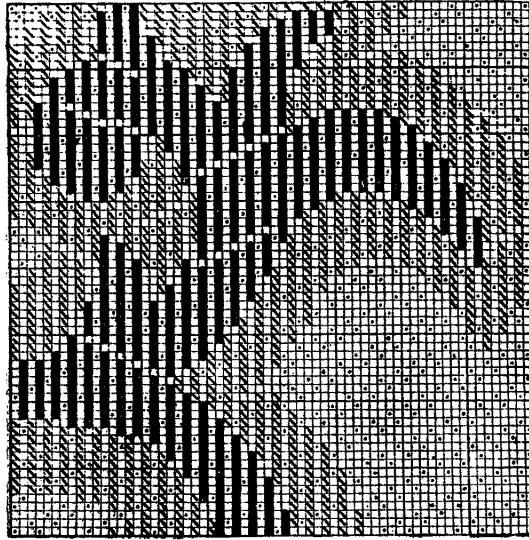

Fig. 257.

point-paper section of the design is shown at Fig. 257, which illustrates the end-and-end arrangement of the figure. The following are suitable weaving particulars :—

Warp.

1 thread 2/40's mercerised cotton, maroon.
 1 „ 2/40's „ „ gold.
 84 threads per inch.

Weft.

All 16's black cotton.
 76 picks per inch.

Counts of Design Paper.—Design paper is divided by thick lines usually into square blocks, each of which is subdivided into horizontal and vertical spaces. Each horizontal space corresponds to a pick of weft, and each vertical space to a warp thread and a hook of the jacquard. For convenience in the point-paper designing and card cutting the vertical ruling of the paper is arranged to coincide with the arrangement of the jacquard hooks—that is, each large square is divided vertically into as many spaces as there are hooks in a short row of the jacquard. Thus, in the

design paper used for an 8-row machine there are 8 vertical spaces between each pair of thick lines, and for a 12-row jacquard, 12 spaces, so that in each case the number of vertical spaces between the vertical thick lines corresponds to one row of the card. In order to facilitate the drafting (or draughting) of figure designs the number of horizontal spaces in each large square requires to be in the same proportion to the number of vertical spaces as the picks are to the ends per unit space in the finished cloth. Since, however, the number of vertical spaces is fixed by the

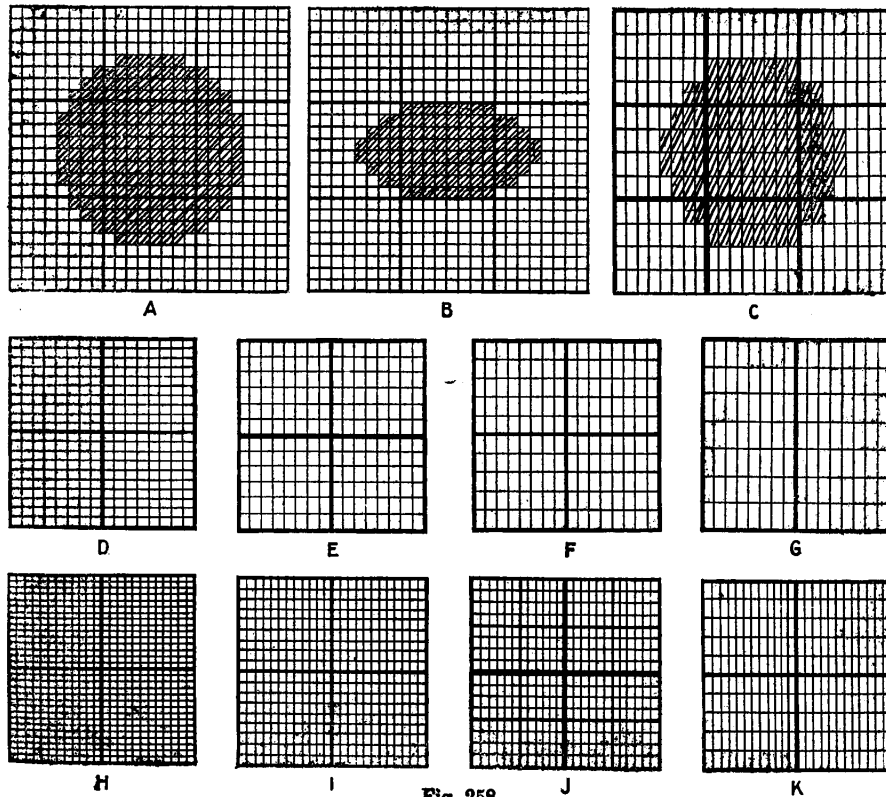

Fig. 258.

arrangement of the hooks in the jacquard, it is necessary for the number of horizontal spaces in each square to be varied according to the ratio of picks to ends in the cloth. Design paper can be purchased to suit practically any conditions, and in Fig. 258 a number of different rulings are illustrated. A and B represent 8×8 design paper which is used in designing for cloths in which the ends and picks per unit space are equal, while C shows 8×4 paper which is suitable for a cloth which contains twice as many ends as picks per unit space. The first number of the count of the paper indicates the vertical ruling.

In order to illustrate the necessity of using properly ruled paper a small spot is indicated at A, B, and C in Fig. 258; and, assuming that the spot is required to be one-quarter inch in diameter in a cloth containing 64 ends and 64 picks per inch, it will extend over 16 ends and 16 picks, as shown at A. If, however, the same size

of spot is required in a cloth containing 64 ends and 32 picks per inch, it will extend over 16 ends and 8 picks, as indicated at B, in which, however, the 8×8 paper shows the spot entirely out of proportion. On the other hand, by using paper that is ruled 8×4 to suit the ratio of 64 ends to 32 picks per inch in the cloth the spot is in proper proportion, as shown at C.

The proper counts of design paper to suit any given particulars of cloth (finished) may be found from the formula :

Ends per inch : Picks per inch :: Vertical spaces : Horizontal spaces.

The examples D to G in Fig. 258 are suitable for 8-row jacquards, and respectively show 8×10 , 8×6 , 8×5 , and $8 \times 3\frac{1}{2}$ papers ; while H to K are suitable for



Fig. 259.

12-row machines and are ruled respectively— 12×15 , 12×9 , 12×8 , and 12×5 . D and H are in proper ratio, for instance, for a cloth with 80 ends and 100 picks per inch ; E and I for a cloth with 96 ends and 72 picks ; F and J for 88 ends and 56 picks ; and C and K for 144 ends and 62 picks. In some cases 12-row paper is ruled with a line in the centre which is intermediate in thickness, as shown at J. It is generally near enough for practical purposes to take the nearest number for the horizontal spaces, but sometimes the paper is specially ruled to include a fraction. Thus at G the horizontal thick lines are twice as far apart as the vertical thick lines, and the paper is equivalent to 16×7 , or $8 \times 3\frac{1}{2}$.

Summary of Calculations.—In the following, which is chiefly a summary of the foregoing in a practical form, the calculations that are involved in designing, and the conditions to be observed are illustrated.

Assuming that the design represented in Fig. 259 (in which the lines indicate exactly one repeat) is required to be woven in a cloth that counts, when finished, 126 ends and 96 picks per inch, and has shrunk 8 per cent. from the reed width to the finished width, while the ground weave repeats upon 20 ends and 12 picks—the particulars may be ascertained as follows :—

- (a) Number of ends and picks (or cards) in one repeat of the design.
- (b) Number of ends per inch in the reed.
- (c) Suitable capacity of jacquard and sett of harness to produce the design exact in size.
- (d) Counts of design paper.

(a) The repeat is $1\frac{7}{8}$ ins. in width and $3\frac{3}{8}$ ins. in length. The number of ends in the repeat— $126 \times 1\frac{7}{8} = 236$, which, in order to fit with the ground weave, must be modified to 240 ends.

The number of picks in the repeat— $96 \times 3\frac{3}{8} = 324$.

(b) The number of ends per inch in the reed— $126 - 8$ per cent. = 116.

(c) A suitable standard capacity of jacquard is an 8-row 304-tie which will require to be cast out : $304 - 240 = 64$ hooks.

The sett of the harness requires to be finer than the sett of the warp, because 304 harness cords have to occupy the same width in the comber-board as 240 ends in the reed, and the proportion is therefore—

$$240 \text{ ends} : 304 \text{ hooks} :: 116 \text{ ends per inch} : 146 \text{ harness cords per inch.}$$

(d) The count of the design paper—

$$126 \text{ ends} : 96 \text{ picks} = 8 \times 6.$$

The example may be used in further illustration of practical conditions, by assuming that the design shown in Fig. 259 is required to be woven in the same cloth as before, but in a 304-jacquard, which is tied up with 128 harness cords per inch. In this case the number of ends in the repeat of the design will be less than 304 in the proportion of 128 (the harness sett) to 116 (the reed sett). The number of ends is therefore—

$$128 : 116 :: 304 : 276,$$

which it is necessary to modify to 280 to coincide with the repeat of the ground weave. This causes the repeat in width of the design to be increased from the preceding by 40 ends, and a corresponding increase in length should be made in order that the design will be in the same proportion as the original. The number of picks will therefore be—

$$240 : 280 :: 324 : 378,$$

which, to fit with the 12 picks in the repeat of the ground weave, should be modified to 372 or 384 picks.

Irregularly Dented Jacquard Designs.—In designing figured crammed stripes, extra warp figures, etc., a suitable capacity of jacquard may be decided upon from the number of threads in the repeat of a pattern, but such calculations as the following are involved in maintaining an even balance between the harness and the reed. The calculations vary in different circumstances, but usually the factors to consider are the number of ends and splits in the repeat, and the setts of the reed and the harness.

1. With a given order of denting and a given sett of reed, to find the sett of the harness.

2. With a given order of denting and a given sett of harness to find the sett of the reed.

3. With a given sett of reed and a given sett of harness, to find the amount of cram or number of extra threads which may be introduced.

By dividing one side into the other an unknown factor can be obtained from the formulae :—

$$\frac{\text{Hooks tied up in jacquard} \times \text{splits per inch in reed}}{\text{Mails per inch in harness} \times \text{splits in repeat of design}}$$

In illustration, a stripe fabric is represented in Fig. 260, which is dented as follows :—

36 ends—narrow figure stripe—	4 ends per split	= 9 splits.
12 „ warp twill	6 „ „ „	= 2 „
208 „ broad figure stripe	4 „ „ „	= 52 „
12 „ warp twill	6 „ „ „	= 2 „
36 „ narrow figure stripe	4 „ „ „	= 9 „
96 „ ground	2 „ „ „	= 48 „
400 ends.		122 splits.

The design repeats upon 400 ends, so that a 400-hook jacquard is suitable.

1. Assuming that the reed contains 30 splits per inch, and the sett of the harness is required—

$$\frac{\text{Hooks tied up} \times \text{splits per inch in reed}}{\text{Splits in repeat of design}} = \frac{400 \times 30}{122} = 98 \text{ mails per inch.}$$

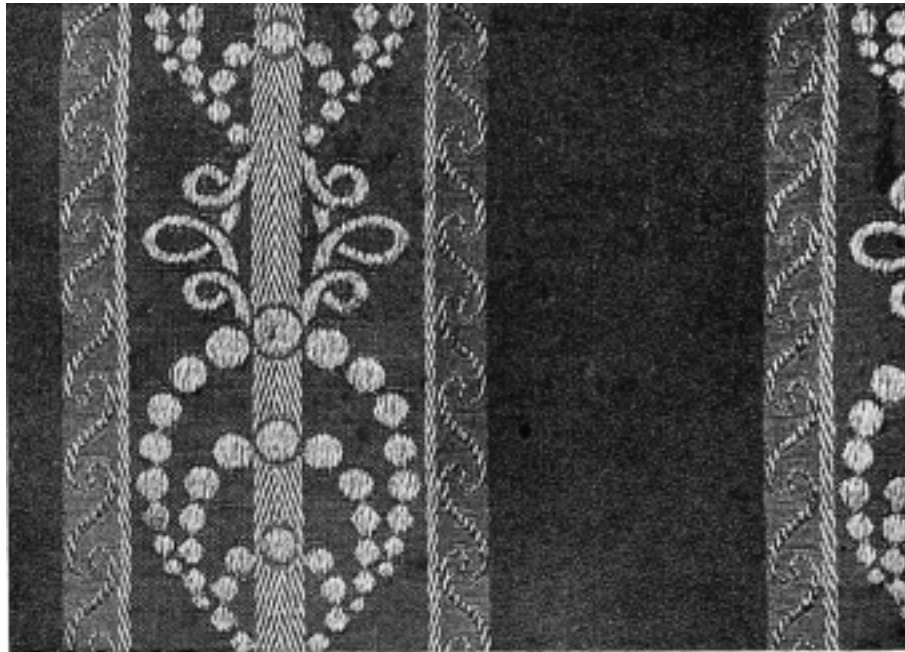

Fig. 260.

2. Assuming that the sett of the harness is 98 mails per inch and the sett of the reed is required—

$$\frac{\text{Mails per inch in harness} \times \text{splits in repeat of stripe}}{\text{Hooks tied up}} = \frac{98 \times 122}{400} = 30 \text{ splits per inch.}$$

3. Assuming that the sett of the harness is 98 mails per inch, and the reed has

30 splits per inch, the amount of cram, or number of extra ends, may be obtained by first finding the number of splits in the width of one repeat of the harness—

$$\frac{\text{Hooks tied up} \times \text{splits per inch in reed}}{\text{Mails per inch in harness}} = \frac{400 \times 30}{98} = 122 \text{ splits in repeat.}$$

Taking the ground to be 2 ends per split, the number of ends that may be added to form the cram = 400 hooks - (122 splits \times 2) = 156, which may be distributed as required. Thus the number of splits which may be arranged 4 per split = (156 \div 2 ends added per split) = 78; 5 per split = (156 \div 3 ends added per split) = 52; 6 per split = (156 \div 4 ends added per split) = 39; while a combination of 4's and 5's, or 4's and 6's, etc., may be employed, so long as not more than 156 ends are added, and the total number of splits does not exceed 122.

A smaller amount of cram than 156 ends may be introduced by casting out a number of hooks to correspond, as is shown in the following example, which is a modification of that given in Fig. 260 :—

12 ends, 6 per split	=	2 splits—	8 ends added.
88 „ 4 „	=	22 „ — 44 „ „	
24 „ 4 „	=	6 „ — 12 „ „	
88 „ 4 „	=	22 „ — 44 „ „	
12 „ 6 „	=	2 „ — 8 „ „	
136 „ 2 „	=	68 „	
360 „		122 „	116 „ „

The number of ends is reduced to 360, and in a 400-tie 40 hooks will therefore require to be cast out. The foregoing formulæ, however, apply exactly the same, the total splits in the repeat of the design, and not the total ends, being taken into account in relation to the number of hooks tied up. Thus, with 30 splits per inch in the reed, the sett of the harness will be—

$$\frac{400 \text{ hooks} \times 30 \text{ splits per inch}}{122 \text{ splits in repeat}} = 98 \text{ mails per inch as before.}$$

It may be assumed for the purpose of illustration, that the latter stripe has to be woven in a 384-tie with 40 splits per inch in the reed, in which case the sett of the harness will require to be—

$$\frac{384 \text{ hooks} \times 40 \text{ splits per inch}}{122 \text{ splits in repeat}} = 126 \text{ mails per inch.}$$

SPECIAL HARNESS TIES

From an examination of Figs. 248 and 249 (pp. 214 and 215) it will be readily understood that the harness cords do not necessarily require to be passed through the holes in the comber-board in the same order that they are connected to the hooks (or neckcords), but that they may be passed from one to the other in different orders according to requirements. That is, in tying up a harness various orders of “drafting” the cords may be employed (in the same manner that in dobby weaving the warp threads may be drawn in different orders through the healds) for the purpose

of enabling special forms of designs to be woven economically. The principal variations from the ordinary lay-over tie are :—(1) centre or point ties ; (2) mixed ties ; (3) ties for bordered fabrics ; (4) sectional ties (see “Advanced Textile Design”). Two or more of the systems may be used in combination.

Centre or Point Ties.—This class of tie is the simplest modification of the ordinary straight tie, and is the same in principle as point-drafting in healds (p. 52). The object of the arrangement is to enable bi-symmetrical designs to be woven which repeat upon twice as many ends as there are hooks in the jacquard. The cost of painting out and card cutting is comparatively small, as the full design is obtained from one-half of the width of the repeat. Fig. 261 illustrates the principle in reference

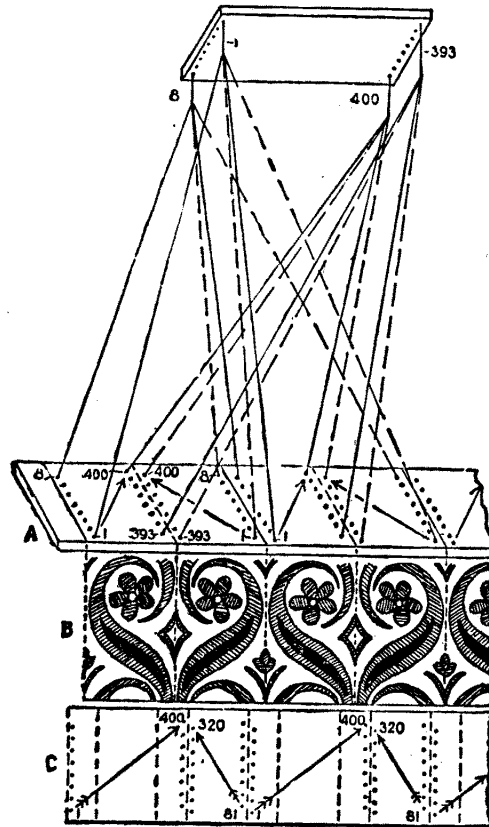

Fig. 261.

to a 400-hook jacquard ; the harness cords are tied up consecutively from the first to the last hook, and then in reverse order from the last to the first hook. The cords which are tied in reverse order are indicated by dotted lines. The figure formed in the first half of the tie is reproduced in the second half but turned the opposite way in the manner illustrated by the sketch B below the comber-board A in Fig. 261. The fabric represented in Fig. 260 and the sketch given in Fig. 329 also illustrate the form of centre tie designs. Although a 400-centre tie will produce a design repeating upon 800 ends, it is customary to leave out one end where the tie reverses, in order to avoid having two consecutive ends working alike. The actual full repeat is therefore 798 ends produced from a plan painted out upon 400 ends. The reversing of the tie also reverses the direction of twill and other ground weaves, and in some cases more than one thread is left out in order to prevent the formation of long floats where the ground weave is turned.

One repeat of a centre tie may extend the full width of the harness and cloth (in which case only two cords are connected to each hook) or the tie may be repeated two or more times across the width, as shown in Fig. 261. The arrangement of the cords, illustrated in Fig. 261, is suitable when the short rows of hooks are parallel with the short rows of holes in the comber-board (the Norwich system), but it is necessary in drawing in the warp to draw from front to back in one half of the tie, and from back to front in the other half. When, however, the short rows of

hooks are at right angles to the short rows in the comber-board (the London tie—see Fig. 248, p. 214) it is quite convenient to connect the first hook to the front hole and the last hook to the back hole of the comber-board in both halves of the tie, which enables the ends to be drawn in in the same order throughout the full width of the harness.

In the case of designs which turn over vertically as well as horizontally (illustrations of the type are given in Figs. 264, 308, and 315), it is only necessary to paint out and cut the cards from one-fourth of the complete repeat. The figure is turned over horizontally by means of the harness tie (as previously explained), and vertically by causing the cards to turn first towards the machine and then in reverse order away from the machine. In one method of accomplishing this, the last but one of the cards that form the half repeat in length, is perforated so that a special hook is raised. This, by releasing a weighted cord, causes the upper catch of the card cylinder to be made inoperative and the lower catch to be put into action, and *vice versa*.

Mixed Ties.—This class of tie is used in various ways; one useful arrangement consisting of a modification of a point tie that is employed for designs which, although

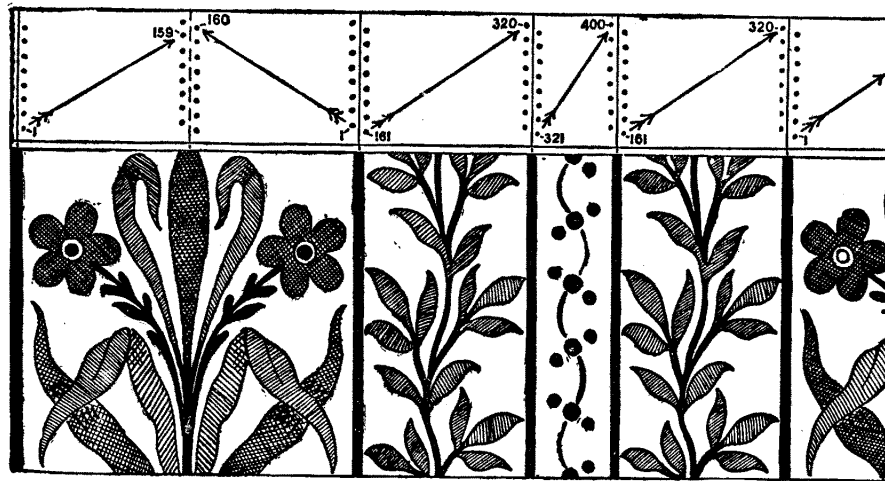

Fig. 262.

partly pointed, are required to be less stiff and formal than the pure bi-symmetrical patterns. Thus, a modification of the tie shown at A in Fig. 261 might be arranged with—say, 40 cords on each side of the middle positions tied to separate hooks, which would enable one side of each centre to be designed differently from the other side. The arrangement of the tie would then be 1 to 400, 320—81, as indicated at C in Fig. 261, a design repeating upon 640 ends being obtained from a plan painted out upon 400 ends.

A mixed system of tie-up is employed for the purpose of enabling a certain portion of figure to be introduced more or less frequently than another portion, and the stripe design represented in Fig. 254 might be thus woven. The principle is illustrated by the sketch shown in the lower portion of Fig. 262, and the tie (for a 400-hook jacquard) in the upper portion. The complete design repeats upon 719

ends (allowing for casting-out one end in the centre of the bi-symmetrical stripe), and results from a plan painted out upon 400 ends.

Ties for Bordered Fabrics.—In a bordered fabric the figure at one or both sides of the cloth is different from that formed in the centre. If the ornament in neither border nor centre is repeated, which is generally the case in the better qualities of table cloths, quilts, etc., an ordinary single, a pointed, or a mixed-pointed tie may be employed. Many cloths are made, however, in which the central figure is repeated a number of times, but, as a rule, only one repeat of the border figure is made at each side. The following list comprises the principal ties for cloths, with or without repeating centres, and with a similar border at each side; the order of tying is given, assuming that a 400-hook jacquard is employed, and that one half of the hooks are employed for the borders and the other half for the centre.

Left Border Tie	Centre Tie	Right Border Tie
Straight Hooks 1-200	Straight Hooks 201-400	Straight Hooks 1-200
Straight Hooks 1-200	Straight Hooks 201-400	Turned-over Hooks 200-1
Straight Hooks 1-200	Pointed Hooks 201-400 and 400-201	Straight Hooks 1-200
Straight Hooks 1-200	Pointed Hooks 201-400 and 400-201	Turned-over Hooks 200-1
Pointed Hooks 1-200 and 200-1	Straight Hooks 201-400	Pointed Hooks 1-200 and 200-1
Pointed Hooks 1-200 and 200-1	Pointed Hooks 201-400 and 400-201	Pointed Hooks 1-200 and 200-1

Any proportionate number of the available hooks may be employed for the border and centre—*e.g.*, one-third for the border and two-thirds for the centre—while a mixed order of tying may be introduced. Very frequently considerable ingenuity is necessary in adapting a design and the tie to suit the size of jacquard that is available.

The form of design and the tie illustrated in Fig. 263 corresponds with the second example in the foregoing list. The border figure is turned over, and the centre is repeated four times, and in order that the different sections may be more readily distinguished the lines which represent the centre harness cards are shown dotted. The complete design will be formed by painting out one border and one repeat of the centre each upon 200 ends.

Fig. 264 corresponds with the last example in the foregoing list in which both the border and the centre are pointed. In this case a square is represented in which a central repeating figure is surrounded by a border figure, and the latter by a narrow unfigured portion. Usually the unfigured portion is woven in a twill or sateen weave, and in the tie indicated in the upper portion of Fig. 264 the hooks 1-8 (of the 26 row

side) are set aside for the purpose. 200 hooks are used for the borders, and the same number for the centre, and if a plain or other selvage is also required the hooks that are in line with the peg-holes may be utilised.

Cross Border Jacquard Arrangements.—Different methods are employed in weaving cross-border fabrics in which the figure is repeated several times, with the idea of using as few cards as possible. The complete square, shown in Fig. 264, contains, both vertically and horizontally, two repeats of the border and four repeats of the central figure. The repetition and arrangement of the different sections of the design, horizontally, is due to the special harness tie that is employed. A

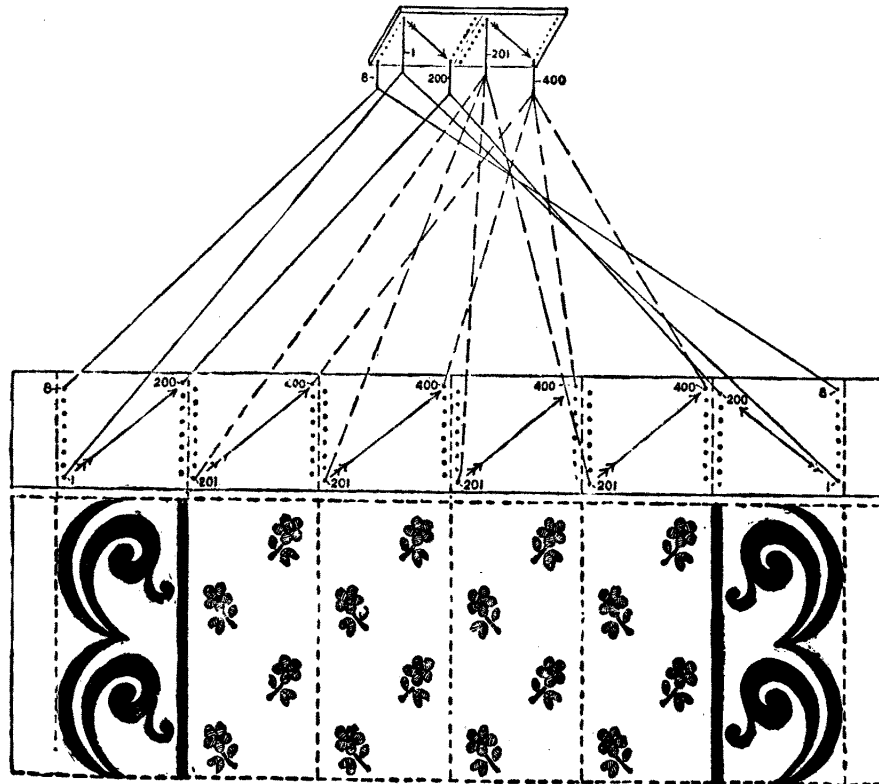

Fig. 263.

similar repetition and arrangement can be obtained vertically by employing two sets of cards, which are brought into action in turn. One set forms the corner and the cross-border figures, and the horizontal unfigured portions, and the other set the side-border and central figures. All the cards require to be cut to operate the selvages and the unfigured portion at the sides.

The complete square shown in Fig. 264 might be woven by cutting as many cross-border cards as will weave the portion indicated by the arrow A, and as many centre cards as will produce the portion represented by the arrow C. The two sets of cards are then brought into operation in turn as follows:—First—the border cards turning towards the machine, as indicated by the arrow A, and then away from

the machine until the border figure is completed, as indicated by the arrow B. Second—the centre cards turning alternately towards and away from the machine, as indicated by the arrows C and D respectively, for four repeats. Third—the border cards turning towards the machine to weave the figure portion, as indicated by the arrow E, and then away from the machine, as represented by the arrow F. The

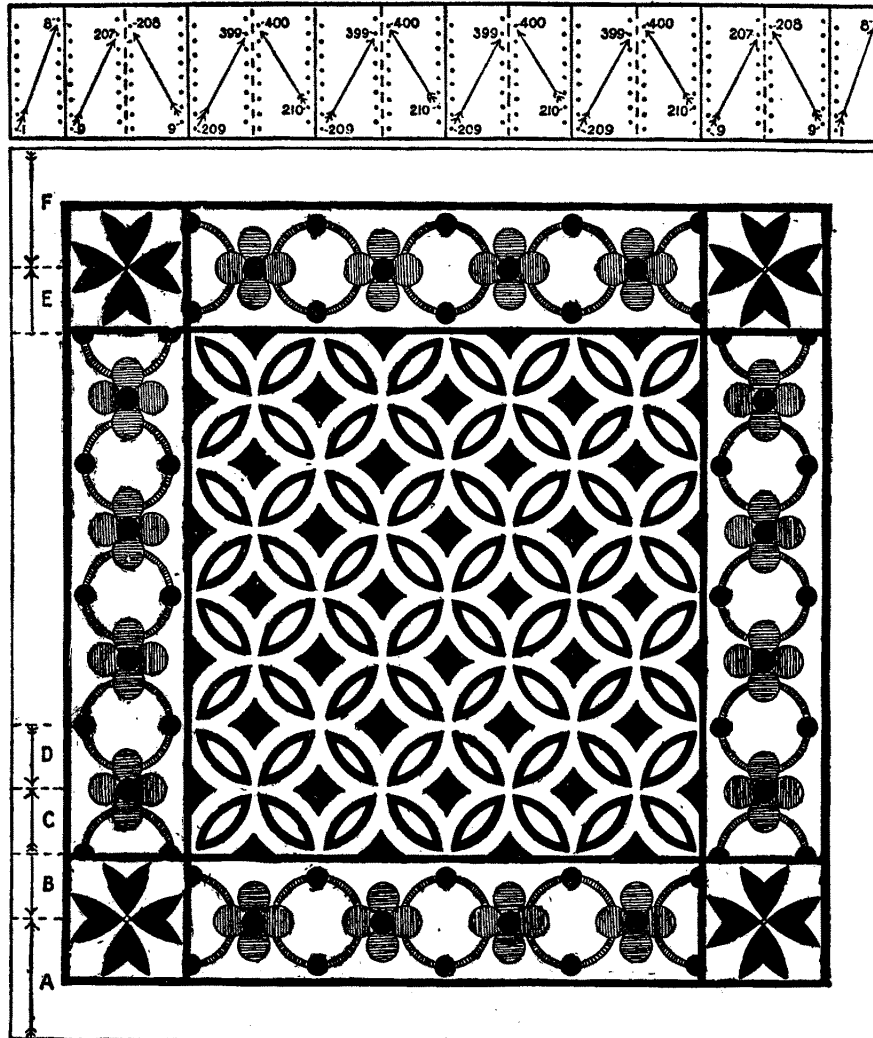

Fig. 264.

border cards are then retained in operation, while the first border of the next square is woven.

In some cases an ordinary form of jacquard is employed and the cards are changed by hand, but this method is convenient only when the changes have to be made at long intervals. An ordinary double-lift, double-cylinder jacquard may be

modified in such a manner that it can be used as two separate single-lift machines, provision thus being made for each set of cards to be placed on a separate cylinder. A short vertical rod, which is permanently connected to the crank on the driving shaft of the loom, is attached first to the rod from one griffe and then to the rod from the other griffe, according to which cylinder is required to be operated. The two cylinders are linked together in a special way so that one is made inoperative at the time that the other is put into action. The change from one set of cards to the other is made more quickly than by the hand method ; but as the machine is single-lift the speed of the loom is limited.

Special forms of cross-border jacquards are made on the double-lift, single-cylinder principle, but an extra cylinder is provided upon which the border cards are placed. The centre cards act on the needles and hooks in the ordinary manner, while the border cards, either by means of a series of supplementary needles which are connected to the ordinary needles, or through the medium of specially shaped hooks, produce the same result as if they had been placed upon the other cylinder. The border cards are laced together in the same way as the centre cards, but they require to be turned inside out.

CHAPTER XV

JACQUARD FIGURED FABRICS—POINT-PAPER DESIGNING

Construction of Point-paper Designs—Process of Drafting a Sketch Design—Drafting Designs from Woven Fabrics. *Development of Figures*—Prevention of Long Floats—Bold and Flat Development—Development of Large Figures—Warp and Weft Figuring—Figure Shading—Shaded Weave Bases—Double Shading—Shaded Development of Figures. *Insertion of Ground Weaves*—Printed Ground Weaves—Joining of Figure and Ground—Crépe Ground Weaves—Stencilling Ground Weaves. Correct and Incorrect Design Drafting.

CONSTRUCTION OF POINT-PAPER DESIGNS

THE construction of jacquard designs includes the preparation of a draft or card-cutting plan upon squared paper, which, if an ordinary jacquard machine is used, shows the complete working of every thread in the repeat. The point-paper design may be constructed from an original sketch, or from a woven sample of which the design is required to be reproduced. In either case the process generally involves an enlargement of the motive design, the degree of increase in size varying, in the same pitch of design paper, according to the fineness in sett of the cloth.

It is first necessary to ascertain the proper counts of the design paper and the most convenient number of ends and picks, or vertical and horizontal spaces of the design paper, upon which to draft the design, as previously described (pp. 217 to 231). It is shown in the calculations that the number of ends and picks, found by multiplying the ends and picks per inch respectively in the finished cloth by the width and length in inches of the repeat, may require to be modified to suit the sett and capacity of the jacquard and the repeat of the ground weave. That is, it is necessary to either select a jacquard which will give the width of repeat of the design, or to construct the

design upon a number of ends that is suitable for a given jacquard. The formula :--

$$\frac{\text{hooks in jacquard} \times \text{sett of warp in reed}}{\text{sett of harness}} =$$

the number of ends upon which the design should be made in order that the warp will be perfectly straight between the harness and the reed. In practice, however, the calculated number is not rigidly adhered to, as it is found that it can be varied, within limits, to suit the conditions of manufacture with practically no deteriorating



Fig. 265.

effect upon the weaving of the warp. It is a good method to decide upon a number of ends for a repeat which is a multiple of several smaller numbers, and to use this number for cloths which vary slightly in fineness. For example, a 72 sett warp is perfectly straight between the harness and the reed when woven in a 76 sett 304-tie jacquard with the design repeating on 288 ends; and designs repeating upon 288 ends, or a measure of 288, can be woven in the machine in cloths which vary in sett from 70 to 74. Again, with the same sett of harness, 240 is the calculation number for a 60-sett warp, which may be employed for cloths varying in sett from 58 to 62. The limits given are frequently exceeded in practice. This principle of working.

in addition to avoiding the necessity of filling up mails or breaking out ends when slight changes in the sett of the warp in the reed are made, which would be required if the cast out were also changed, enables the same design to be applied to the different setts without re-making.

After the number of ends and picks required for one repeat of the design have been decided upon, the point-paper work may be divided into the following processes: (1) An enlarged outline of the figure is drawn in pencil or chalk on the point-paper; (2) the figure is painted in with colour which is strong yet transparent; (3) the necessary weaves for the suitable development or binding of the figure are inserted in a second colour; (4) the ground weave is painted in. The work is frequently very tedious and occupies a large amount of time, and considerable skill and experience are required in reproducing a motive design to the best advantage. Much of

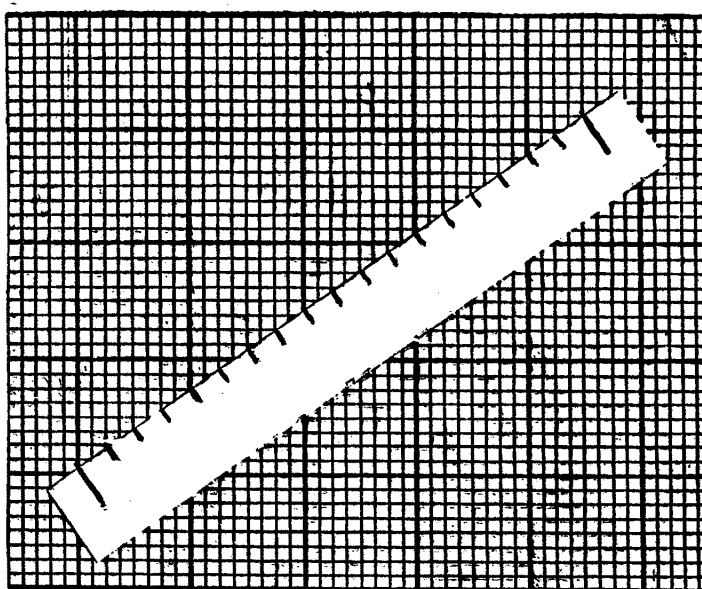

Fig. 266.

the work, however, is almost mechanical, and ingenious methods have been adopted to reduce the amount of time and labour involved.

Process of Drafting a Sketch Design.—Previous to drawing the outline of the figure it is necessary to prepare one repeat of the motive design so that it can be enlarged exactly to the required scale. Fig. 265 illustrates the method of procedure in drafting a sketch design. It is assumed that the repeat is upon 288 ends and 352 picks, and the design paper is 8×8 . One exact repeat is indicated by ruling vertical and horizontal lines which respectively pass through similar parts of the figure. If the sketch has been correctly constructed, these lines are at right angles to each other. The repeat is then divided into small spaces, each of which represents a certain number of ends and picks in the cloth and of small squares on the point-paper. Any number of threads may be represented by each small space, but usually a sketch is ruled so that each space corresponds to one, two, or more of the large squares of the design paper. In designing for medium and low-sett cloths, it is very convenient

to so rule the sketch that the lines correspond with the thick lines of the design paper. With the same rate of ruling for fine-sett cloths, however, the spaces in the sketch are so small that they are difficult to follow and for cloths which count over 80 threads per inch the method illustrated in Fig. 265 will be found useful. The repeat of the sketch is so divided that each space represents 2×2 large squares, or 16 ends and 16 picks in this case. The repeat in width is thus divided into 18 spaces of 16 ends each to correspond with the repeat of 288 ends, and in length into 22 spaces of 16 picks each to correspond with the repeat of 352 picks.

Very frequently a scale is employed in dividing a repeat into the required number of parts, but as shown in Fig. 266 design paper can be readily used for the purpose. The width of the repeat is indicated on a narrow strip of paper; this is placed on

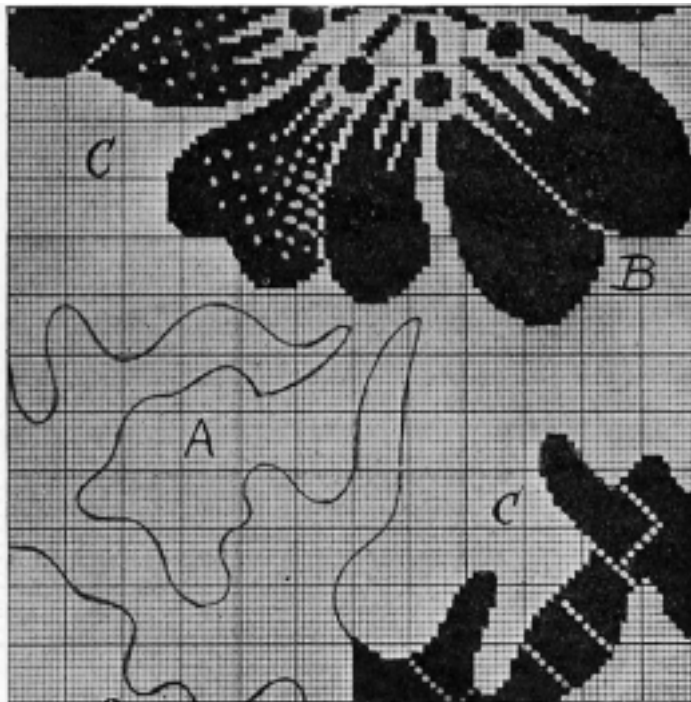

Fig. 267.

point-paper and moved to such an angle that it covers a number of small squares which is a multiple of the number of divisions required. The strip of paper is then marked at the proper intervals where its edge intersects the vertical lines on the point-paper. Fig. 266 shows the width of the repeat of Fig. 265 divided into 18 parts; the strip of paper is shown angled, so that the repeat covers 36 vertical spaces of the design paper, and the paper is marked where its edge intersects the alternate vertical lines of the design paper. Afterwards the strip is placed along the bottom and top of the sketch to which the marks are transferred to indicate the positions for drawing the vertical lines. The same method of procedure is employed in dividing the repeat horizontally.

The different stages of drafting a figure are illustrated in Fig. 267, which corre-

ponds with the bottom left-hand corner of Fig. 265. The portion A in Fig. 267 shows how the outline is copied from the sketch to the scale of 16 ends and 16 picks to each space in Fig. 265. The process of drawing the outline is very much facilitated by indicating distinctive lines at regular intervals in ruling the sketch, and by ruling lines at corresponding distances apart on the design paper. Thus, in Fig. 265 alternate lines are thicker than the others, while in Fig. 267 lines are lightly indicated, to correspond with the thicker lines, upon the last space of every fourth square. The distinctive lines enable corresponding portions of the figure in the sketch and point-paper to be readily found and retained.

The second stage of working, which is illustrated at B in Fig. 267, consists of painting in the small squares along the outline, and then filling in the figure solid



Fig 268.

with a wash of transparent colour. The parts lettered C illustrate the third stage in which the long floats are stopped and the figure developed by inserting marks in various orders in a colour that is in contrast with the first colour. Vermilion is chiefly used in painting in the figure, and blue for the binding weaves.

Drafting Designs from Woven Fabrics.—Woven patterns are employed in two ways by the designer. In some instances the design is required to be reproduced exact in every respect to the original and in a similar cloth; in other cases the patterns are only intended to serve as indications, the designs being modified and adapted to suit cloths which, perhaps, have very little resemblance to the original textures. In the former case it is essential that—(1) A suitable jacquard be employed to get the same size of repeat; (2) an exact copy of the form be obtained on the point paper; (3) the weaves in the figure and ground respectively of the pattern are correctly analysed and reproduced in the new design.

The second method of using woven patterns is much more common than the first, and it is probably due to such a large variety of effects being now required for a comparatively short length of cloth that the system has recently attained such prominence. The patterns are purchased by manufacturers and merchants from firms who make a speciality of collecting the latest productions, and when a range of designs is required in a given cloth a number of suitable samples are selected to be reproduced. Only a portion of the ornament in a cloth may be used, and sometimes a portion from one sample is combined with a portion from another. From the manufacturer's point of view the question as to whether such a system should or should not be employed simply resolves itself into one of economy and expediency. The time which would otherwise be occupied in sketching new figures is saved, while

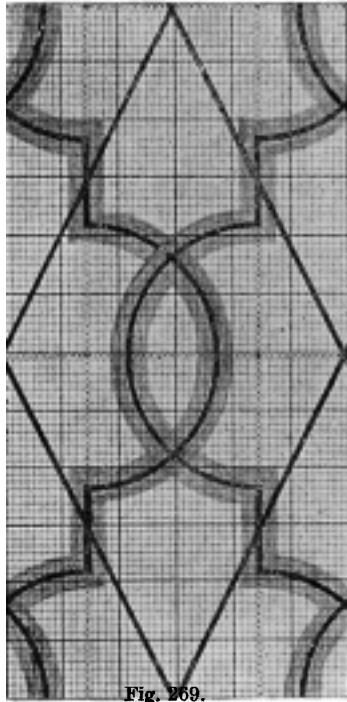

Fig. 269.



Fig. 270

a larger variety of effects can usually be obtained in any given range than when the designer's creative skill solely is relied upon. Further, the advantage to the designer of seeing and studying the various combinations of forms, colours, and materials observable in these patterns, cannot be over-estimated.

The character of the cloth in which a design is reproduced is an important factor in deciding how much resemblance there is between the new design and the original. The new cloth may be composed of different materials; it may be necessary to increase or decrease the amount of detail in drawing the outline of the figure on the point-paper; also various weave changes may be required in the figure and ground in order to adapt the design to the new texture. The result is that frequently an effect is produced in which the original design cannot be recognised.

In a range of motive designs the repeats may vary extremely in size, but they require to be modified to the size which can be obtained in the machine in which they have to be woven. It should be kept in mind that the number of ends and picks per inch to the scale of which the figure is drawn upon the point paper is not necessarily the same as that of the cloth for which the effect is intended, but that it varies according to the difference in size between the repeat of the indication and that which the jacquard will give. As an illustration, let it be assumed that designs repeating on 5 in., 3 in., and 2 in. respectively are required to be reproduced in a cloth with 96 ends and 64 picks per inch, and that 360 ends have been decided upon for the repeat. The design on 5 in. will require to be worked out at the rate of $360 \div 5 = 72$ ends per inch and $(64 \times \frac{72}{64}) = 48$ picks per inch; that on 3 in. at the rate of $360 \div 3 = 120$ ends and $(64 \times \frac{120}{64}) = 80$ picks per inch; that on 2 in. should be arranged on half the repeat and be worked out at the rate of $180 \div 2 = 90$ ends and $(64 \times \frac{90}{64}) = 60$ picks per inch.

Designs which are entirely geometrical in form, such as that shown in Fig. 268, can be reproduced from woven patterns directly on to the point-paper with the aid of compasses and ruler. The positions of the base lines and centres can be obtained by calculation after the number of threads in the repeat have been determined; also the number of squares to allot on the point paper for any portion of the figure can be found by measuring and calculating from the number of ends and picks per inch to which the design is

being worked out. Fig. 269 illustrates, in a very reduced form, the method of drawing the base lines directly upon design paper from the pattern represented in Fig. 268. After these have been indicated it is only necessary to clothe the lines with the calculated size of float.

In drafting woven designs that are not geometrical in form it is necessary to divide one repeat into small spaces in the same manner as in drafting a sketch design. Different methods of accomplishing this are employed, one of which consists of first making a sketch of the figure. A copy is readily made upon transparent tracing paper if the figure can be seen through it. If tracing paper is impracticable the method illustrated in Fig. 270 may be employed. The sample of cloth is pinned or

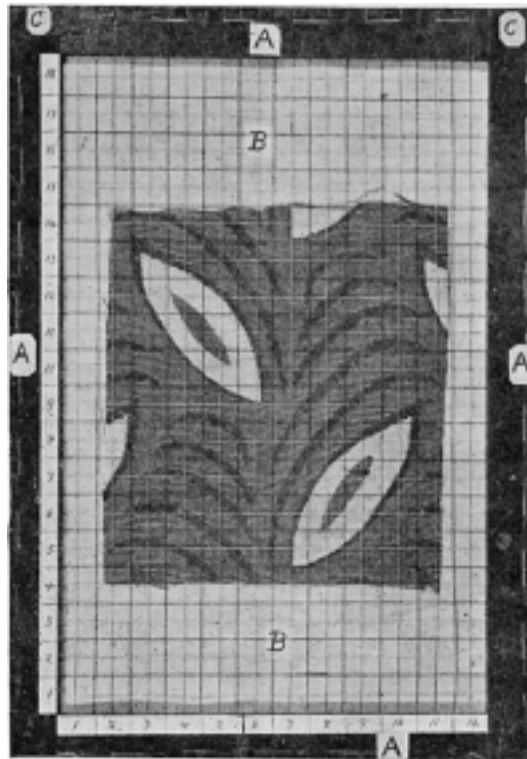

Fig. 271.

pasted, at two opposite edges, on to a sheet of plain paper, and the outline of the figure is pricked round with a fine needle. By placing a piece of carbon paper between the cloth and the sheet of paper, with the carbon side downwards (it is better to use paper



Fig. 272.

which is carbonised on one side only) the outline of the figure is shown in small black dots. A pen or pencil is then drawn through the dots to complete the sketch, as shown in the bottom left-hand corner of Fig. 270. Rather more than one repeat should be made, in order that two lines parallel with the weft and two parallel with the warp may be drawn which pass through similar parts of the figure and enclose one complete repeat. This is then divided up by drawing other lines, at regular distances apart, in the manner previously described in reference to a sketch design. It is frequently found that

the warp and weft threads are not exactly at right angles to each other, as the finishing processes have a tendency to distort the cloth, and for this reason care should be taken in dividing up the repeat to have the two series of lines parallel with the warp and weft threads respectively, or the figure will not join up correctly at the sides and at the top and bottom of the sheet of point-paper. In drawing the outline on the point-paper the shape of the figure should be observed in the cloth as well as in the sketch.

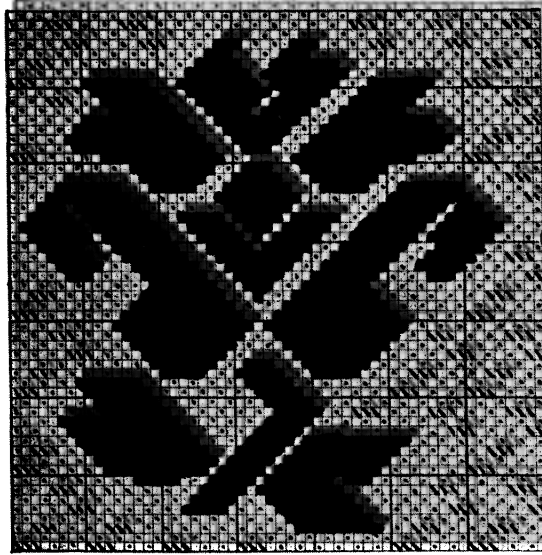

Fig. 273.

The construction of a sketch from a woven pattern is chiefly useful when changes in the design have to be made, and when the sketch has to be submitted for approval. If the method is used solely for the purpose of enabling a repeat to be squared out, it is really a waste of time, as other methods may be employed in which the design is made directly from the cloth. In one method, which, however, is not a very good one, a repeat of the design is squared out by drawing lines on the face of the cloth with coloured chalks. In

another method the pattern is placed on a sheet of cardboard round which threads are wound, vertically and horizontally, at intervals of about a quarter of an inch. By notching the edges of the cardboard, or inserting pins at regular distances

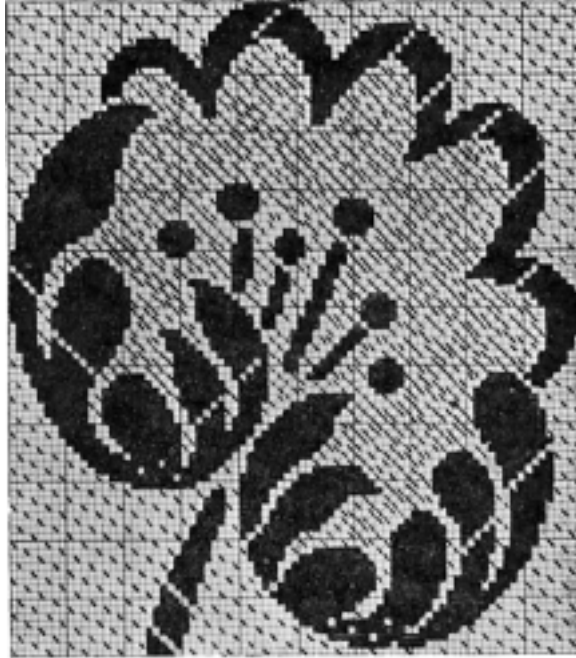

Fig. 274.

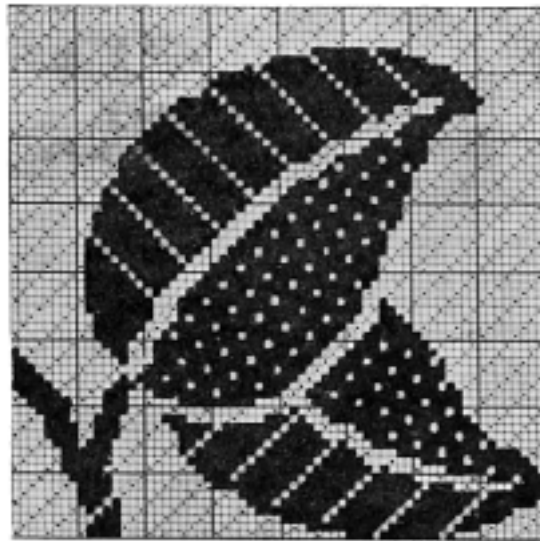

Fig. 275.

along the edges, the threads are evenly distributed over the surface of the cloth, so that the design is divided into spaces that are equal in size.

A very quick method of squaring out woven designs by means of threads is illustrated in Fig. 271. An apparatus is used that consists of a wood frame A, which is nicked at regular intervals along the outer edges with a fine saw. Threads are passed vertically and horizontally along the under side of the frame, in such a manner that its interior is divided into small squares. The frame A rests on a flat board B, and is hinged to the latter at C, so that the opposite end of A can be raised while the pattern is placed on the board. The frame is then dropped so that the



Fig. 276.

threads rest lightly on the cloth until the latter has been drawn with a needle into such a position that the picks are parallel with the horizontal threads of the frame, and the ends parallel with the vertical threads, after which the frame is pressed down and secured with a small catch. No difficulty is found in squaring out patterns which are distorted, as the pressure of the threads retains the cloth in any position into which it has been pulled before the frame is pressed down.

The threads are wound at fixed, equal distances apart, so that the surface of the cloth is divided into equal spaces. Taking the spaces to be $\frac{1}{4}$ in. square, which is a convenient distance apart of the threads, the number of squares of the point paper,

which each division of the pattern represents, may be found as follows:—Assuming that a design has to be worked out at the rate of 64 ends and picks per inch, each division represents 16 squares on the point-paper; if at the rate of 78 per inch, each division represents $19\frac{1}{2}$, or 19 and 20 squares alternately on the point paper. Again, assuming that the pattern shown in Fig. 271 has to be made upon 288 ends and 384 picks—the repeat occupies 16 divisions in width, and rather over 18 divisions in length, therefore each division will represent $288 \div 16 = 18$ ends, and $384 \div 18 = 21$ picks, with six over, which may be allotted to the portion of figure which exceeds

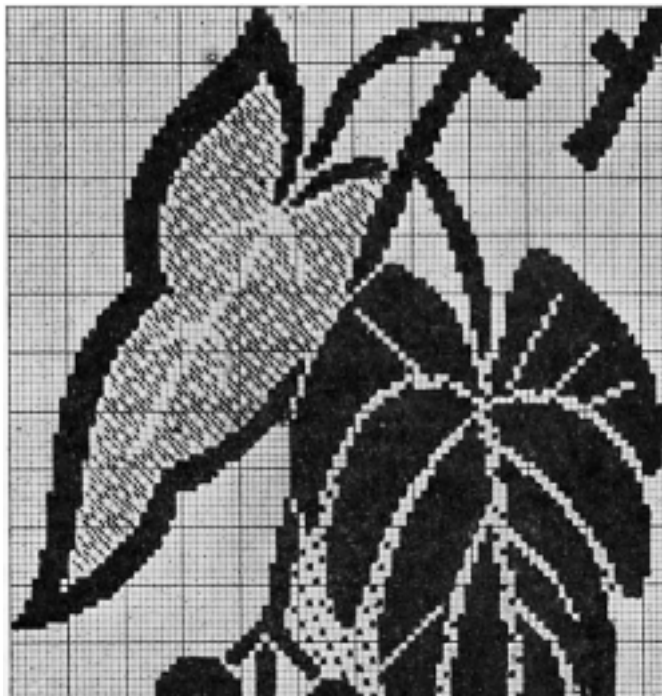

Fig. 277.

the 18 divisions. A figure is drawn on the design paper much more readily if the threads are passed across the frame in alternate colours, the design paper being then ruled, at the required intervals, with alternate colours of pencil to correspond.

DEVELOPMENT OF FIGURES

After a figure has been correctly painted in with transparent colour the next process is, usually, to insert suitable weaves upon it. The weaves should be selected with the following objects in view:—(1) To produce a good texture—that is, a texture in which the threads are interwoven to such a degree that they are not liable to slip or fray when the fabric is subjected to strain and friction during wear. (2) To develop the figure in such a manner that the form is shown to the best advantage in the finished cloth.

Prevention of Long Floats.—In some designs, of which an example is given in Fig. 272, the form breaks up the mass of the figure to such a degree that no weave is

required to be inserted either for stopping the floats of yarn or for developing the effect. This condition occurs particularly when lustrous yarns are employed in forming small figures, which, if broken up too much, appear less bold and effective. Fig. 273 shows the point-paper design of a portion of Fig. 272. The example illustrates the necessity of painting in the squares in odd numbers on the edge of a figure when plain ground, or a ground based upon plain weave, is employed, in order to ensure perfect joining of the ground weave with the figure.

When boldness of effect is required in large figures very frequently binding marks are inserted only where the floats on the face or back of the fabric will other-



Fig. 278.

wise be too long. Such a method of development is illustrated by the sectional plan given in Fig. 274, which represents a weft figure surrounded by warp sateen ground. The example also illustrates how an open figure may be made to appear massive by inserting in the interior a weave—in this case a crêpe—which contrasts well with the ground weave.

Bold and Flat Development.—In some massive styles the form can be effectively developed by inserting a large twill or sateen weave regularly over the surface of the figure, the former being employed when a lustrous and bold appearance is required, and the latter in producing a flat and less prominent effect. Fig. 275 shows how both

twill and sateen weaves may be employed in developing the same figure, the effect in this case being to bring out the twilled portion of each leaf more prominently and with a brighter appearance than the other portion.

Another method of developing leaves, which is similar in principle to the fore-



Fig. 279.

going, is shown in Fig. 276. In this example one of each pair of leaves is brought up massive and bold, while the other appears much less prominent at the same time that its massive appearance is retained. As shown in the corresponding sectional plan, given in Fig. 277, the form of the bold leaf is developed by simply bringing up the

veins in warp flush with a few additional binding places inserted to stop the floats which are too long. The other leaf is developed in fairly bold weft flush along the outer edges, and the interior is filled in with a four-thread weft sateen, except where the veins are shown in warp flush. This plan also shows the correct method of developing the fine lines which form the veins and stems. It is important that these show up distinctly at the same time that they do not detract from the prominence of the main feature of the design, which in this case, is formed by the leaves.

Development of Large Figures.—The pattern shown in Fig. 278 illustrates how a large number of weaves may be employed in developing a massive figure. The contrast in the appearance and the variation in the light and shade of the different weaves give interest to the effect, and assist in showing up the parts of the form clearly. A point-paper section of the main feature of the design is given in Fig. 279.

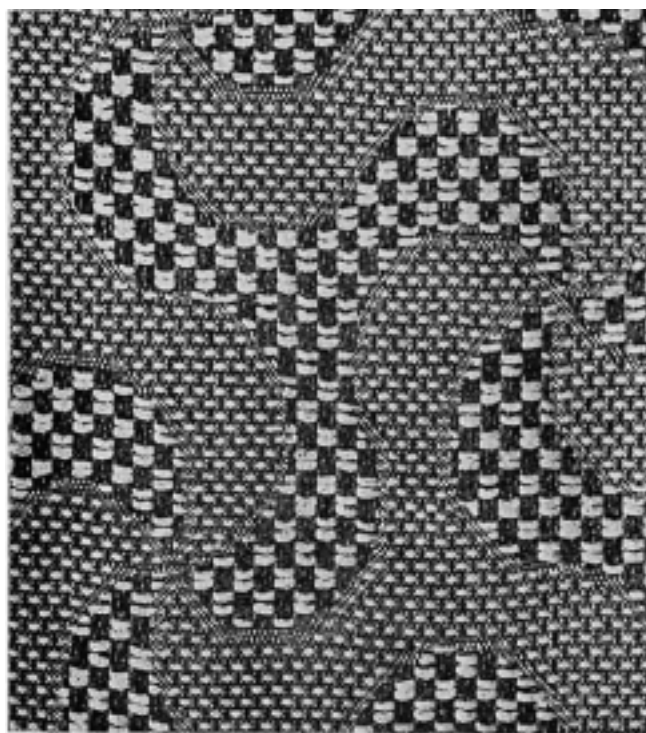

Fig. 280.

Such a combination of weaves in one figure is specially suitable for fabrics composed of cotton warp and silk or mohair weft, which, if woven with plain ground, should be set with from 60 to 80 ends and picks per inch.

The design shown in Fig. 280 is in decided contrast to the preceding example as here only one weave is employed in developing the figure. Such a weave can only be suitably applied to a massive style, in which considerable latitude may be taken in following the outline. A point-paper section of the design is given in Fig. 281, and it will be observed that, in order to prevent long floats and to show up the figure more distinctly, a few threads of plain separate the figure

weave from the ground weave. The example also illustrates a method of employing an expensive material in an economical manner. The following are suitable weaving particulars :—

Warp.

All 2/40's ordinary cotton, shade 1.
72 threads per inch.

Weft.

1 pick 30's ordinary cotton, shade 1.
2 picks 2/40's mercerised cotton or silk, shade 2.
1 pick 30's ordinary cotton, shade 1.
72 picks per inch.

Shade two is brought up prominently in the figure, and, in the 4-thread imitation gauze weave ground, it is arranged to fall on the picks where there is a 4-float of

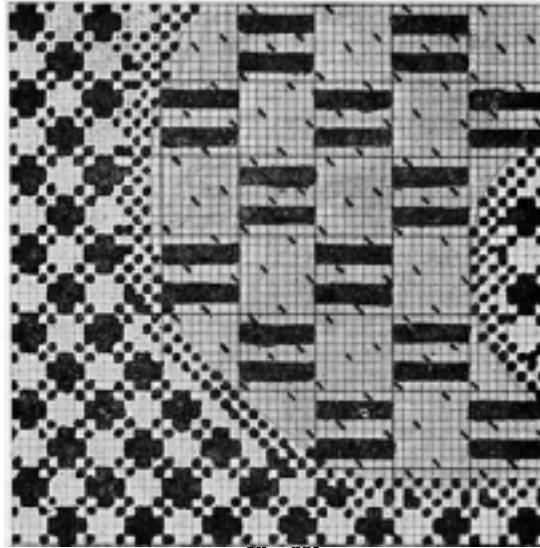

Fig. 281.

weft on the face. The ground of the fabric is therefore covered with minute spots of mercerised cotton or silk weft, and is in contrast with the figured portion, which is composed of larger spots of the same material.

Warp and Weft Figuring.—The development of a figure in both warp and weft float is illustrated in Fig. 282. This method is chiefly applicable to cloths in which there is a contrast between the colours of warp and weft, and when the two series of threads are brought about equally to the surface in the ground of the fabric. A point-paper draft of a portion of Fig. 282 is given in Fig. 283. In drafting a figure formed in warp and weft float, the outline may be drawn in the ordinary way, then the weft figure is indicated in one colour, say red, and the warp figure in a second colour, say blue. The long flushes in the weft figure are then stopped by inserting blue marks, and in the warp figure are then stopped by inserting red marks. The colour which is used for the ground weave will usually be the same as that used for the weft figure, and in that case the warp figure should be marked round with red to separate it from

the warp floats in the ground. The card cutting particulars will then be cut blanks and blue. In Fig. 283 both the warp and weft figure is surrounded by plain



Fig. 282.

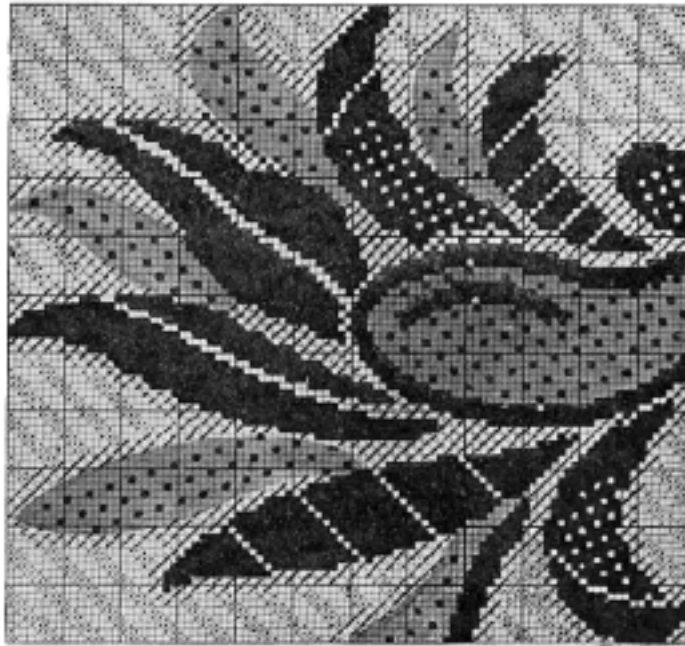

Fig. 283.

weave, which joins with the 3-and-3 twill ground and assists in showing the figure distinctly.

Figure Shading.—The shaded development of figures enables different degrees of light and shade to be obtained in a graduated form, so that a flower or leaf can be represented in a somewhat natural manner. In Fig. 299 the petals of a rose are shown shaded, while in Fig. 284 portions of a leaf are shaded so as to form a subdued but pleasing contrast with the parts that are developed in bold floats. The principle is applied most successfully to fine silk, cotton, linen, and worsted textures in which the yarns are smooth and even.

Shaded Weave Bases.—The most common forms of shading are produced by using a twill or sateen weave as the base and varying the floats of weft and warp, as shown in Figs. 285 and 286. For instance, a 6-thread twill basis enables five



Fig. 284.

changes to be made—viz., 1-and-5, 2-and-4, 3-and-3, 4-and-2, and 5-and-1, as shown at A in Fig. 285. The space to be shaded, in this case 36 ends, is divided into five sections, and the 1-and-5 twill is marked in, as shown by the crosses. The first section is left as it is, one mark is added in the 2nd section, two marks in the 3rd, three marks in the 4th, and four marks in the 5th, with the result that the warp float is gradually reduced, and the weft float correspondingly increased, and 5 degrees of light and shade are produced.

In the method shown at A in Fig. 285, the warp and weft are brought about equally to the surface of the cloth, hence both series of threads should be of good quality. B illustrates a shaded weave, based upon six threads, which is suitable

for shading a cloth in which, taking the marks to indicate weft, the weft is better material than the warp. There is less variation in light and shade, however, than in the former method. The 1-and-5 twill, indicated by the crosses, is changed to the 1-and-2, 2-and-1, 5-and-1, and 11-and-1 twills in succeeding sections. The last weave is suitable to use in forming the edge of a figure when a prominent outline is required, as represented in Fig. 284.

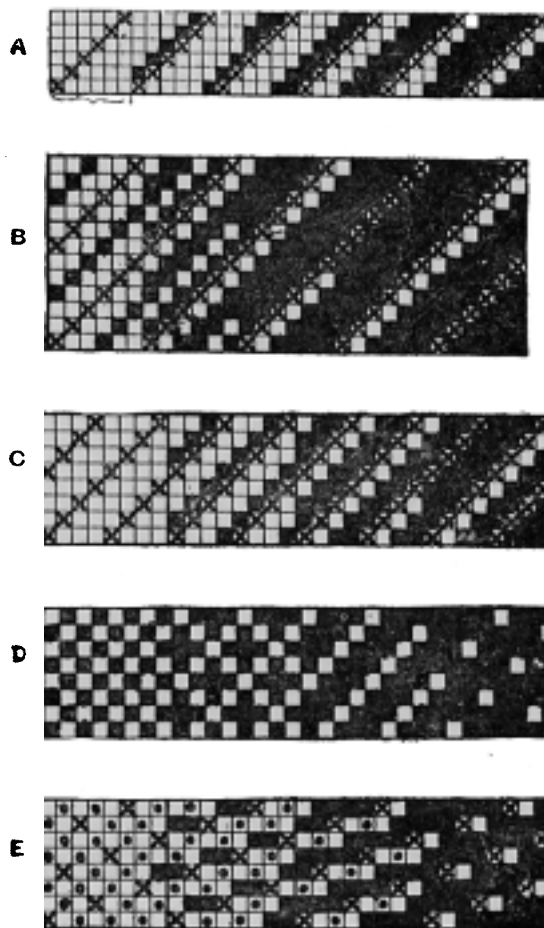

Fig. 285.

C in Fig. 285 shows, in the first three sections, how a 4-thread twill may be changed from warp to weft surface, and, in the 4th section, to 7-and-1 twill.

In the form of shading shown at D in Fig. 285, the floats on the face are arranged to fit with plain ground. This method is suitable for fabrics in which only one yarn is required on the face, as, for example, when silk or lustre worsted weft is employed in forming the figure, and a fine cotton warp is used. The end section shows how the 4-thread twill may be changed to the 8-thread sateen.

E in Fig. 285 illustrates the principle of shading the 8-thread sateen to fit with plain ground. The figure may be either weft or warp surface, according to whether the marks are missed or cut. The 10-thread sateen may be shaded in a similar manner.

F and G in Fig. 286 show two methods of shading the 8-thread sateen weave, each of which gives seven degrees of light and shade. The sateen base weave is indicated by the crosses; in F the marks are added at the top, and in G at the side

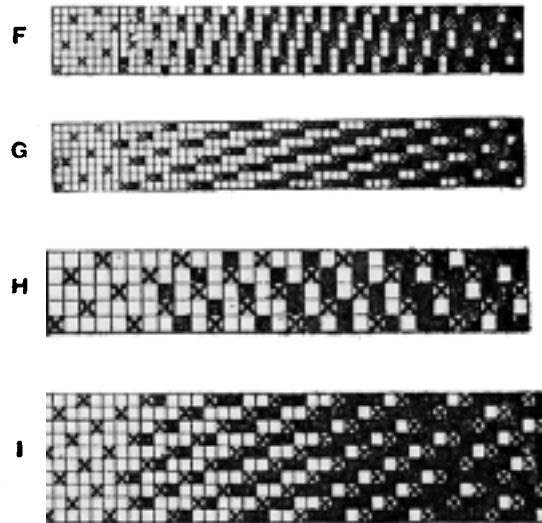

Fig. 286.

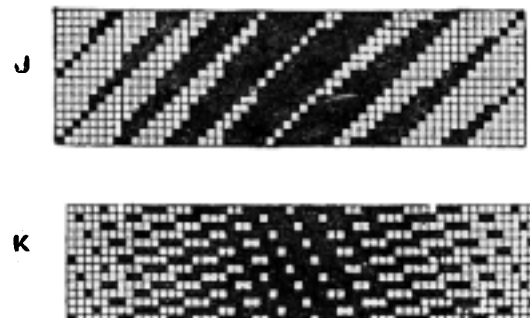

Fig. 287.

of the base marks. A comparison of the warp and weft floats in the centre five sections of F and G will show that the method of adding the marks influences the appearance of the weave. F gives more of a warp than a weft surface, as the horizontal weft floats are broken up; hence this method is suitable for fabrics in which the warp is better material than the weft, or when a preponderance of warp float is required on the surface in the figure. G is directly opposite to this, as the

addition of the marks at the side yields a gradually increasing weft surface and breaks up the warp floats; and this method should therefore be employed when the weft is the better material. As a general rule, a richer effect is obtained by adding the marks at the side because the weft is usually more lustrous than the warp.

H and I in Fig. 286 illustrates two methods of shading applied to the 5-sateen weave. In H the marks are added to the top of the base marks, and four degrees of

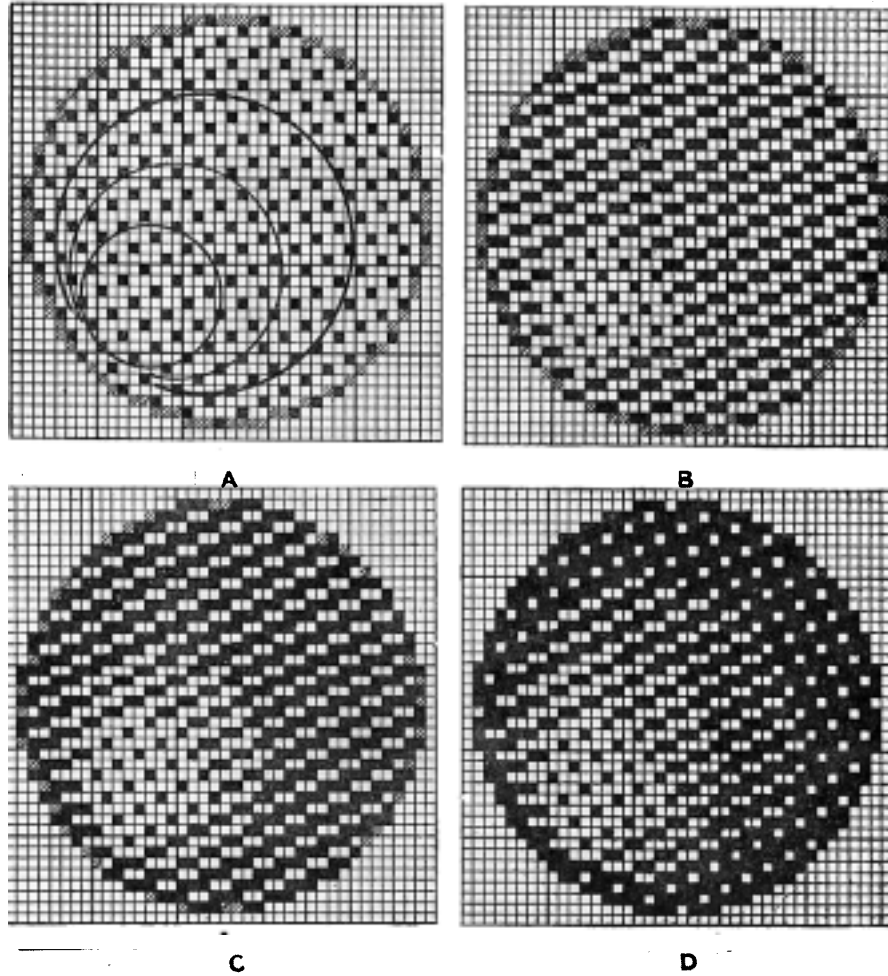

Fig. 286.

light and shade are formed. I is similar to H except that the marks are added at the side, while the 5-sateen is changed to the 10-sateen in the end section in order to give further variety.

Double Shading.—The examples given in Figs. 285 and 286 illustrate the principles upon which weaves are shaded, but in the form shown, the designs may be used in the production of shaded weave stripes. Only single-shading, however, is represented—that is, the weaves are shaded only in one direction, so that a com-

plete change from weft to warp surface is made where the first and last ends join. In double-shading, which is illustrated at J and K in Fig. 287, the severe contrast in light and shade, produced in single-shading, is avoided, as the weaves gradually merge into each other in both directions. J in Fig. 287 shows the combination of 8-thread twills, running from 1-and-7 to 7-and-1 by adding one mark more in each section, and then back again to 1-and-7 by adding one mark less in each section. K in Fig. 287 is based upon a 7-thread sateen weave, and is constructed in a similar manner to J, the additional marks being placed at the side of the base marks.

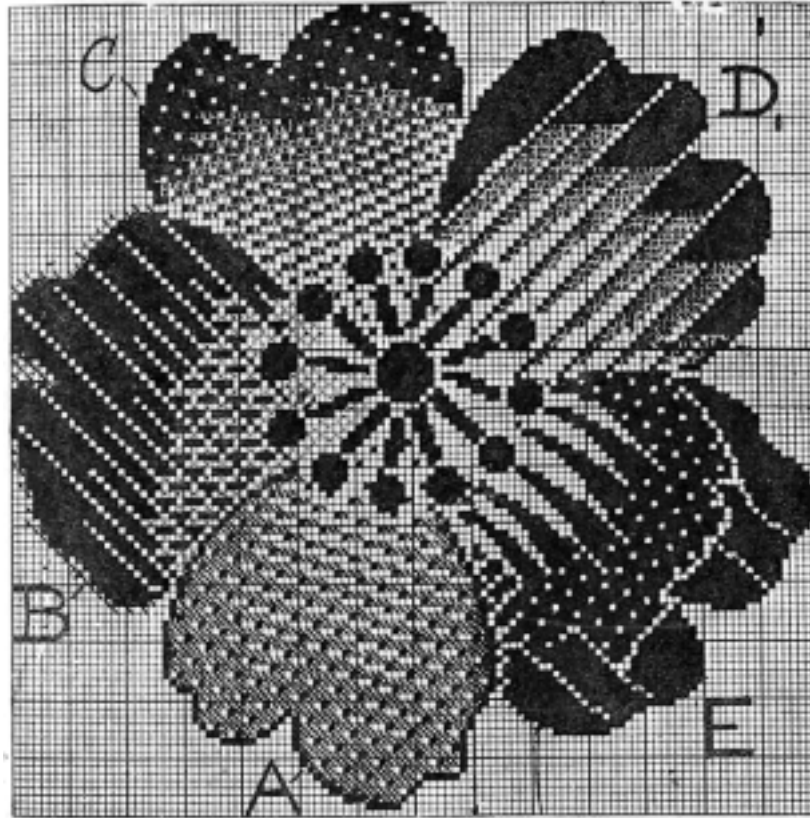
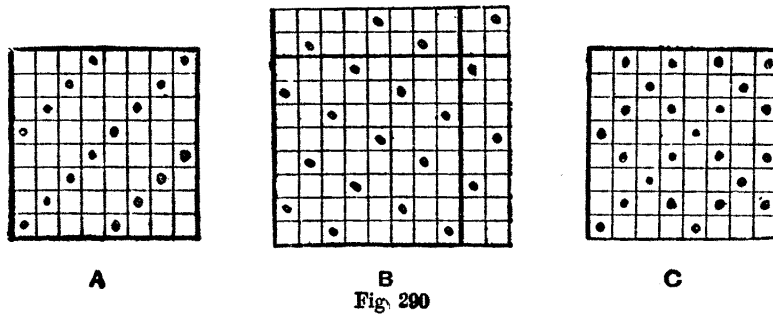

Fig. 289.

Shaded Development of Figures.—Fig. 288 illustrates, step by step, the method of developing a figure in 5-sateen weaves as a shaded effect after the outline of the figure has been indicated on the point-paper. (1) As shown at A, the space to be shaded is divided into as many sections as there are changes in the base weave, and the latter is inserted entirely over the space. The sections need not be equal in size as the given space may be divided up unequally so as to allow either warp or weft to preponderate on the surface. (2) As shown at B, the weave in the first section is left as it is, and a mark is added to each sateen mark in the 2nd, 3rd, and 4th sections. (3) As indicated at C, a second mark is added in the 3rd and 4th

sections; and (4) as shown at D, a third mark is added in the 4th section. It is better to add the marks always at the same side of the base marks, and it is usually more convenient to add them singly, as shown, than to paint over the whole of the figure in one colour, and put in the shaded weave in a second colour.

For the purpose of illustration, several different methods of shading a figure



are shown in Fig. 289. At A the 8-sateen weave is employed for the base, and the weft is brought mostly to the surface, the method therefore being suitable for a fabric in which the warp is inferior to, or possesses less lustre than the weft. The twill method of shading, indicated at B, is suitable for a somewhat coarse texture in which a plain ground, or a ground weave based upon plain, is employed. The binding of

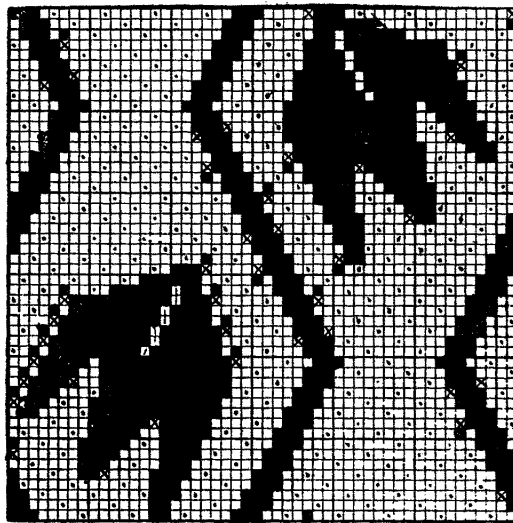

Fig. 291

the figure in twill order brings out the effect more boldly and with greater lustre than when a sateen weave is employed. The shading shown at C is based upon the 5-thread sateen, and as this weave is firmer in structure than the 8-thread sateen, it may be used in a lower texture than the latter. Boldness of outline and variety

of effect are obtained in C by changing the 5-sateen to the 10-sateen along the outer edge of the figure. At D the 6-thread twill is employed as the base; this weave being changed to the 11-and-1 twill along the outer edge of the figure. A, B, C, and D correspond with the methods illustrated in Figs. 285 and 286; but E shows another system of development, which is sometimes employed when boldness and variety of effect are required. The 8-sateen weave about the centre of E produces a somewhat flat effect compared with the outer edge and the shaded portion of the figure.

INSERTION OF GROUND WEAVES

The difference in appearance between the figure and ground of a design may be due to a difference in material, colour, or weave, or a combination of these; the distinction should always be sufficiently pronounced for the figure to show clearly. When the ground pattern is due to the method in which the threads are

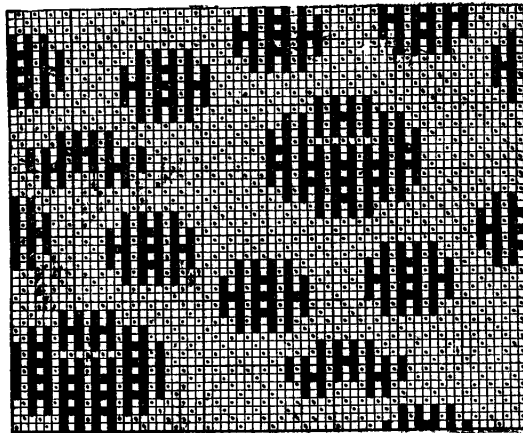

Fig. 292.

interlaced, it is usually necessary to avoid weaves that will produce a bold effect, in order that the prominence of the figure will not be reduced.

Printed Ground Weaves.—Design paper can be purchased upon which the most commonly used ground weaves are printed in small dots, as shown at A, B, and C in Fig. 290. The 1-and-3 twill dot shown at A is chiefly employed for plain and 1-and-3 twill grounds. In addition to enabling the cards to be cut without the ground weave being filled in, the dots enable the outline of the figure to be easily painted in so as to fit with the ground weave.

Joining of Figure and Ground.—In using design paper upon which the 5-sateen weave is printed, as shown at B in Fig. 290, certain of the ground dots that are in contact with the edge of the figure require to be taken out, in order that a proper junction will be made between the figure and the ground. Also, when this causes a float of more than five to be formed it is necessary for the float to be broken by the insertion of an additional mark. This is illustrated by the design shown in Fig. 291, which is arranged with the lines of the figure running at different angles on the point-paper. The crosses show the dots which require to be taken out, and the full squares the marks which are then inserted to stop the long warp floats which

would otherwise appear as stitching marks on the face of the cloth. In inserting any ground weave which does not fit with the moves at the edge of the figure, modifications require to be made at the junction of the figure and ground, as shown in Fig. 291, in order to stop floats that are too long, and to ensure that a clear edge to the figure is formed.

The style of printed design paper, shown at C in Fig. 290, is chiefly used for ordinary fabrics woven with plain ground, in place of the 1-and-3 twill dotted paper. It is, however, specially useful in designing for plain ground cloths in which alternate warp threads are composed of a special yarn which is employed in forming the figure. The dots serve as a guide in painting in the warp figure to fit with the plain ground, and also enable the figuring threads to be readily distinguished from the others. The design shown in Fig. 292 illustrates these points, and shows how the dots on the alternate even threads should be modified under the figure to prevent the formation of long floats of weft on the back of the cloth.

Crêpe Ground Weaves.—The insertion of ground weaves of a crêpe character, such as those shown at D and E in Fig. 293, is usually a tedious process unless a special method of working is employed. A careful examination will usually show that

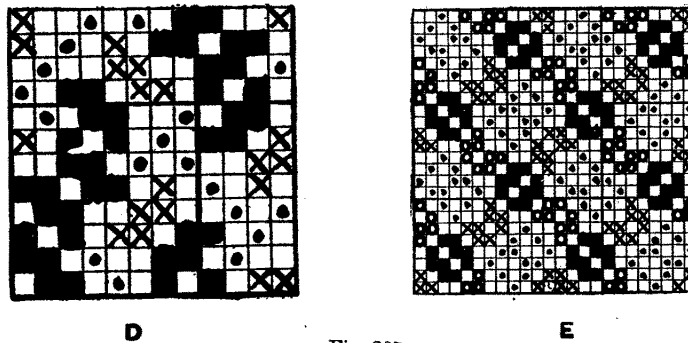

Fig. 293.

the weave marks have not been put together in a haphazard fashion in a crêpe, but that a definite system of construction has been employed which can be made use of in filling in the weave as a ground effect. In the examples different marks are used for the different parts of the weaves, in order that in each the basis of construction may be more readily seen. Thus both D and E in Fig. 293 are arranged on the turnover or reversed principle, and by inserting the weaves, step by step, in the order in which the different marks are indicated a complex effect may be made to appear simple, as the different parts can be put together from memory. For example, the weave shown at E in Fig. 293 may be inserted at four stages. First, that portion of the weave which is shown by the full squares is filled in over the required surface. This is followed by the portion indicated by the crosses, and the ground at this stage has a diagonal appearance, which is afterwards converted into a diamond shape by inserting the portion shown by the circles. The space which remains is then readily filled in by inserting the weave represented by the dots.

When the different parts of a figure are somewhat detached from each other, so that a fair amount of ground space is left between them, the method shown in Fig. 294 may be adopted with advantage in inserting a difficult weave. The

ground weave is first indicated upon a separate piece of point-paper cut the full width of the design, and upon a convenient number of picks. A line is then drawn as close to the figure as is convenient for the correct joining of the figure with the ground, and the ground is inserted around the figure within the lines. Commencing with the first portion of the design the ground sheet of point paper is doubled to fit the space in which there is no ground inserted, and it is pinned to the design until the cards have been cut from this section. It is then moved to the next position, re-

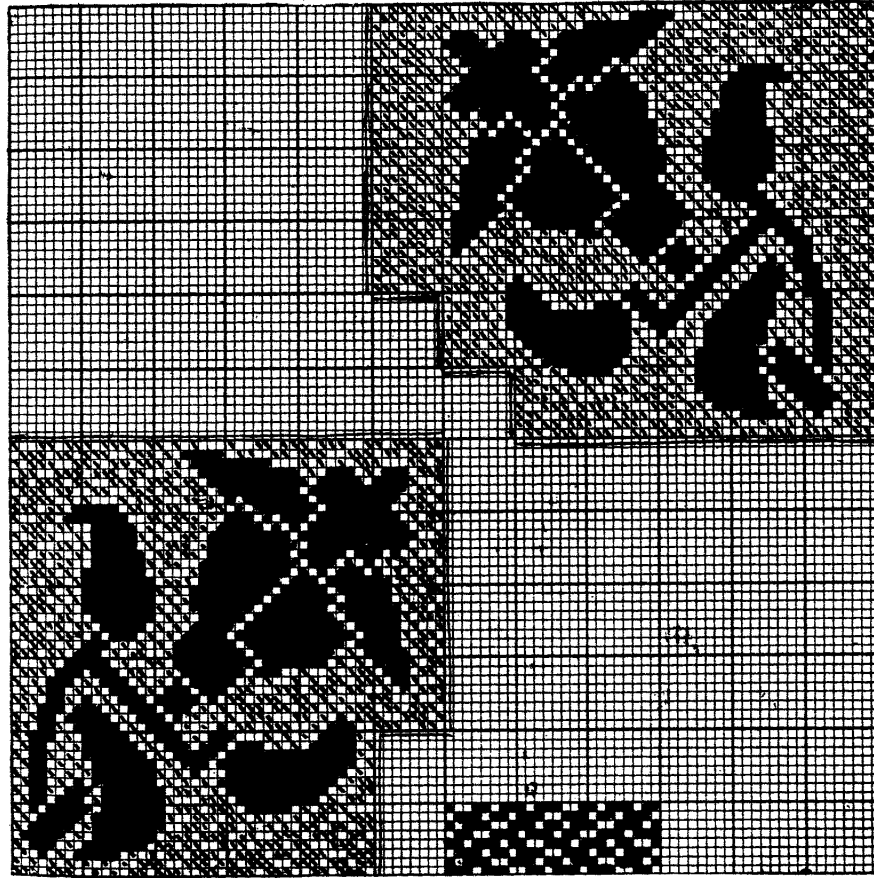

Fig. 294.

doubled (if necessary) to fit the space between the parts of the figure, and another section of the design is cut, the process being repeated until the cutting is completed.

Stencilling Ground Weaves.—In another method of inserting difficult ground weaves, the weave is indicated upon a separate piece of design paper, and small holes are punched in the squares where marks are shown. The separate piece is then placed on the design sheet and brushed over with a wash of colour, and the process is repeated until the whole of the ground has been stencilled in except at the edges of the figure. The joining of the ground and the figure is afterwards readily effected.

CORRECT AND INCORRECT DESIGN DRAFTING

The chief points to note in painting in a figure on the point-paper are (1) to

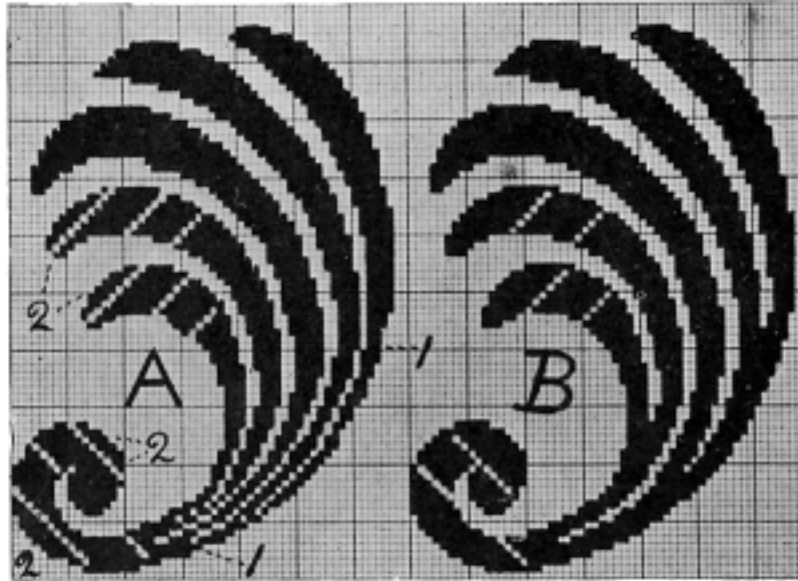

Fig. 295.



Fig. 296.

form a good outline, and (2) to have the figure sufficiently massive and without weak places caused by fine lines. To obtain these results it is not always advisable to strictly follow the outline drawing, but to modify the form of the figure in painting it in. Typical illustrations of defective and good point-paper work are given for comparison at A and B in Fig. 295. In A the outline is defective because, in following the curves—say, in moving from the horizontal or the perpendicular to the angle of 45° , as shown at 1—the moves are not properly graduated. For example, commencing with the bottom pick of the figure shown at A, a float of 8 is followed by moves of 3, 4, 2, 3, 1, 2, on succeeding picks. The proper outline, as shown at B, is obtained by moves of 4, 3, 3, 2, 2, 1;

that is, the distance moved at each succeeding pick is gradually reduced as the curve approaches the angle of 45° , after which the distance moved is gradually increased on succeeding ends until the perpendicular is reached.

In binding the long floats of the figure in twill order, a good outline and mass may be made weak if the binding weave is inserted too near the edge of the figure. This defect is shown at the places marked 2 in A, Fig. 295, whereas B shows the binding weave inserted in such positions on the figure that the outline and mass are preserved. Further, a comparison of the lower portion of A and B will show how weakness of outline and of mass, due to fine lines, may be avoided.

An unsuitable method of designing a figure on the point-paper is sometimes the cause of an otherwise well-balanced design showing a line or bar in the woven effect. This may occur under the following conditions:—(1) When both the warp

and weft yarns are floated in turn on the face of the fabric, or when two colours of warp or weft are used in producing the figure, without sufficient care being



Fig. 297.



Fig. 298

taken to ensure that each kind of float is regularly distributed. The defect is made more pronounced when there is a strong contrast between the figuring

colours. (2) When a horizontal section of the design is given a longer float, and consequently made to show more prominently than the succeeding section, although there may be an equal amount of ornament in each section. (3) When the ground of the fabric is very firmly woven, the ground picks which precede and follow a portion of figure, tend to crowd the loosely bound picks of the latter together, and barriness is thus promoted, because the space occupied by the figure is reduced. In the texture shown in Fig. 296, which has been produced from the sketch given in Fig. 297, a bar appears, which may be said to be due to the combined influences of the preceding. As shown in the corresponding sectional plan given in Fig. 298, the leaves are developed in weft and the flowers in warp float, which instead of being regularly distributed, occur at intervals in large masses. Also, the contrast between the colours of warp and weft is strong, while in addition, the firmly-woven ground of the fabric, by crowding the lightly-bound figure to some degree, has increased, in some parts, the relative amount of the space occupied by the ground. A suitable method of developing the design would be to form all the figure in weft float, not too loosely bound, with the veins in the leaves and the flowers in warp float.

The construction of a design upon point-paper can, in most cases, be greatly simplified by employing a method of working that is appropriate to the basis upon which the design is constructed. For this reason, in the following chapters, the designing of figures upon the recognised bases is considered along with convenient methods of point-paper construction.

CHAPTER XVI

COMPOSITION OF DESIGNS AND ARRANGEMENT OF FIGURES

Methods of Composing Jacquard Designs—Conditions to Observe in Designing Figured Fabrics—Factors which Influence Woven Design—Construction of Sketch Designs—Bases of Textile Design—Geometric Ornamentation—Unit and Repeat Compared. Construction of Symmetrical Figures. Reversing Inclined Figures. Unit Repeating Designs.

Methods of Composing Jacquard Designs.—There are three chief ways in which figure designs for textile fabrics are composed, viz. :—

- (1) By geometric arrangement.
- (2) By the conventional treatment of natural or artificial forms.
- (3) By the adaptation or reproduction of earlier designs.

(1) Designs which are purely geometric in form result from the embellishment of intersecting vertical, horizontal, diagonal, circular, and radiating lines; and from the creation of spaces by the lines. Such designs may include conventionalised forms, or they may be adaptations of earlier styles.

(2) In "conventionalising" a natural or artificial object the form is treated in a manner that renders it a suitable ornamental feature of the texture upon the surface of which it is displayed. It is generally necessary to simplify the form of an object, only the essential and characteristic features being abstracted; and, as a rule, the most important and beautiful parts are emphasised at the same time that they

are made subservient to the general arrangement of the design. Realistic treatment in the cloth, except in such textures as "woven pictures," should not be practised beyond what will assist in showing the form to advantage. As an example, the conventional treatment of a rose is illustrated in Fig. 299 (which represents a silk trimming fabric), in which the "weave development" imparts a certain degree of realism to the form. The different weaves in the figure, however, have the effect of showing the ornament more clearly by causing the light to be reflected in a varying manner from the different parts. If all the figure had been treated in the same way it would have appeared flat and uninteresting, and would have been less suitable for the purpose of the cloth, while the expensive material, of which the figuring yarn is composed, would not have been made the best use of. In contrast with Fig. 299, the flat treatment of a leaf is illustrated in Fig. 368, which suits the structure and purpose of the cloth, and the means by which it has been woven.

In some cases woven forms are used to convey a meaning, as in representations of the thistle, the shamrock, a lover's knot, etc., the term "symbolic" being then applied to the treatment. Most frequently, however, the sole object of employing conventional forms is to beautify the material, in which case, the treatment is termed "aesthetic." Sometimes, conventionalised natural forms are combined with forms that are "invented," as shown in Fig. 325, while again designs are sometimes composed entirely of invented forms.

(3) The adaptation of earlier designs has been practised from the earliest periods, and it may be said that almost all modern styles have resulted from previous



Fig 299.

ones by the process of evolution. "To adapt" is a more rational method of procedure than to endeavour to work entirely originally by putting aside all that has been previously accomplished. There are innumerable ways in which former designs may be modified and applied; by small variations new styles may be gradually evolved which finally possess few of the original features.

The term "traditional" is applied to ornament which has been handed down from age to age without losing its original characteristics, although it may have been modified from time to time to suit the requirements of different periods. More or less exact reproductions of historic designs are yet made from famous rugs, tapestries, altar cloths, etc., while copies of recent designs are made by competitors in the same market, and when similar effects are required in cloths that are cheaper than the originals. At the present time, however, designs are most frequently adapted from cloths with the idea of reproducing the ornament in a new form (see p. 242).

Conditions to Observe in Designing Figured Fabrics.—The following is a summary of the principal conditions that have to be observed in designing figured fabrics :—

(1) The ornament should be applicable to the build of the cloth, the nature of the materials employed, and the mechanical means of production, and be suitable for the purpose of the fabric. A style of ornament, that is appropriate to one class of cloth, may be quite unsuited to another class; the same form may, however, be suitable for different classes of cloths, but it may require to be treated in a different manner in each case.

(2) With some few exceptions, the ornament should be chiefly in solid form or mass, and not in outline. The structure of a woven texture makes it necessary for even the finest lines of a design to be massive (to a greater or less degree according to the cloth) in order that they will show in proper contrast with the ground.

(3) One complete repeat of a design (as in all mechanically repeated designs) must be capable of being enclosed within a rectangular space, the boundary lines of which correspond vertically and horizontally with the direction of the warp and weft threads. The rectangular shape makes it necessary for all textile designs to conform, to some extent, to a geometric basis of construction, but the ornament itself need not be geometrical.



Fig 300.

(4) The ornament must join perfectly at the top and bottom, and at the sides of the repeat, in order that when the design is repeated longitudinally and transversely, the pattern will be continuous and unbroken. "Woven squares," in which the ends and sides are not required to join, as in carpets and tablecloths, are an exception to this rule, but usually in these cloths a central figure is required to join to a border. In stripe designs it is only necessary

to ensure that the figure joins correctly at the top and bottom of the repeat. This is illustrated in Fig. 313, the dotted horizontal line in which indicates the position where repetition occurs. The width of a stripe must, however, be suitable for the repeat in width of the complete design, while the figures in each stripe must be in proper relation to those in the neighbouring stripes.

(5) The ornament should be properly balanced. A design is defective if the repetition of the figure causes vertical, horizontal, or diagonal lines to be formed in the cloth when such are not desired. Uniform distribution of the primary masses is first necessary, then any details that are added should be arranged to give even balance of the ground spaces. The analysis of good textile designs will show that the orderly arrangement of the parts is almost invariably due to certain bases or principles having been employed in their construction. Previous to sketching a design, base lines may be drawn within the rectangular repeat area in order to