

LUNAR SPACE ELEVATORS FOR CISLUNAR SPACE DEVELOPMENT

**Phase I Final Technical Report
by
Jerome Pearson, Eugene Levin, John Oldson and Harry Wykes**

Research Subaward No.: 07605-003-034

Star Technology and Research, Inc.
3213 Carmel Bay Drive, Suite 200
Mount Pleasant, SC, 29466-8513

Principal Investigator: Jerome Pearson

Submission date: 2 May 2005

Period Covered: October 2004-April 2005

This material is based on work supported by NASA under Grant #07605-003-034.

Any opinion, findings, and conclusions or recommendations expressed in this material represent the views of the authors, and do not necessarily reflect the views of the National Aeronautics and Space Administration.



Table of Contents

Section	Page
Executive Summary	1
Introduction	3
Vision	5
Lunar Space Elevator Design	8
Basic Considerations	8
Configurations	8
<i>Vertical Design with Counterweight</i>	9
<i>Balanced Design without Counterweight</i>	9
<i>Uniform Design “Conveyer Belt”</i>	11
<i>Curved Design for Polar Access</i>	12
<i>Tramway for Polar Access</i>	13
Materials	15
<i>Use of Existing Composites</i>	15
<i>Fail-Safe Design for Safety, Reliability, and Repair</i>	16
<i>Improved Materials and Carbon Nanotubes</i>	17
System Components	17
<i>Climber System Design</i>	17
<i>Orbit Transfer Vehicles</i>	23
<i>Tramway Construction and Vehicles</i>	23
Key Technology Challenges	24
Lunar and Advanced Materials	24
Robotic Construction Using Lunar Resources	24
Dynamics and Control	25
Autonomous Operations	25
Operations, Economics, and Payoffs	26
Operational Concept	26
Payload Flows	27

LSE Cost Analysis	27
<i>Launcher Cost Projections</i>	27
<i>Orbital Transport</i>	28
<i>Elevator Mass and Transport Cost</i>	28
<i>Development Cost</i>	29
Lunar Space Elevator Payoffs	29
Building the Lunar Space Elevator	30
Steps in Construction	30
Using Lunar Resources	30
Launching Lunar Materials	31
Material Forming and Fabrication	32
Construction Techniques	35
Conclusions	40
Feasibility	40
Impact	40
Development	40
Phase II Plans	40
Appendix	41
References	65

List of Figures and Tables

Figure	Title	Page
1.	Lunar Space Elevator System Concept	1
2.	Lunar Space Elevators about L1 and L2	5
3.	Required Tapers for Earth, Mars, and Moon Space Elevators	8
4.	LSE Ribbon and Counterweight Mass vs. Height	9
5.	Tension Profile of a Two-Segment Balanced LSE	10
6.	Mass of the Balanced LSE vs. Height	11
7.	L1 and L2 Space Elevators with Polar Support Tower	12
8.	Maximum Latitude vs. Material Strength	13
9.	Lunar Space Elevator and Tramway	14
10.	Maximum Tramway Spans vs. Support Tower Height	15
11.	Multiple-Ribbon Fail-Safe Design	16
12.	Robotic Climbing Vehicle	18
13.	Drive Motors, Attitude Control, and Ribbon Interface	20
14.	Solar Arrays and Climber Structure	19
15.	Structural Arrangement for Controlling Center of Gravity	20
16.	Details of Tires and Ribbon Interfaces	20
17.	Perigee Radius vs. Height of Payload Release on LSE	23
18.	Clementine Mosaic of Lunar Polar Hydrogen	28
19.	Structural Concept to Route Tension Forces	29
20.	Lunarcrete Block with Wire Tension Insert	30
21.	Wiring Multiple Blocks Together	31
22.	Lightweight Towers for Tramway Support	36
23.	Encapsulating Lunar Regolith with Fused Aluminum	37
24.	Truncated Octahedrons as Space-Filling Blocks	32
25.	Blocks with Threaded Aluminum Inserts	32
26.	Habitat Constructed with Either of These Systems	33
Table	Title	Page
1	Candidate Materials for LSE Compared with Carbon Nanotubes	15

Nomenclature

A	cross-sectional area of space-elevator ribbon
g	gravitational acceleration
L	tether length
r	selenocentric radius vector
R	geocentric radius vector
r_0	radius of the Moon
s	arclength along the unstretched tether
T	tether tension
t	time
v_0	circular orbital velocity at the lunar surface
v_t	transverse wave velocity in the tether
α	tether inclination to the local horizon
η	non-dimensional parameter, v_0^2/v_t^2
μ	gravitational parameter of the Earth
μ_L	gravitational parameter of the Moon
ρ	tether mass per unit length
ω	angular velocity of the orbital motion of the Moon

Abbreviations and Acronyms

CW	counterweight
GEO	geostationary Earth orbit
HEO	high Earth orbit
LEO	low Earth orbit
LLO	low lunar orbit
LSE	lunar space elevator
L1	collinear Lagrangian point between Earth and the Moon
L2	collinear Lagrangian point beyond the Moon
SE	space elevator
TR	taper ratio, cross-sectional area at L1/cross-sectional area at base

Executive Summary

System concept

This report proposes the lunar space elevator as a revolutionary method for facilitating development of cis-lunar space. The concept combines lunar space elevators with solar-powered robotic climbing vehicles, a system for lunar resource recovery, and orbit transfer space vehicles to carry the lunar material into high Earth orbit. The lunar space elevator provides a “highway” between Earth orbit and the Moon, to bring lunar products into Earth orbit, and to carry supplies from Earth orbit to lunar bases.

The system, seen below in an artist’s concept against the background of a lunar topographic map with elevations, consists of a lunar space elevator balanced about the L1 Lagrangian point on the near side of the moon, connected with surface tramways connecting the elevator ribbon with lunar mineral deposits and with ice deposits in craters near the pole. Robotic vehicles, as shown in the inset, use solar power to carry minerals and propellants along the tramway and up the ribbon to beyond the L1 balance point. At the top of the elevator, the payloads are released into Earth orbit for construction of space complexes and for propellant depots for spacecraft leaving Earth orbit. In addition, payloads from Earth orbit can be propelled by ion rockets to the reverse elliptical orbits, and then rendezvous with the lunar space elevator to be carried down to the lunar surface.

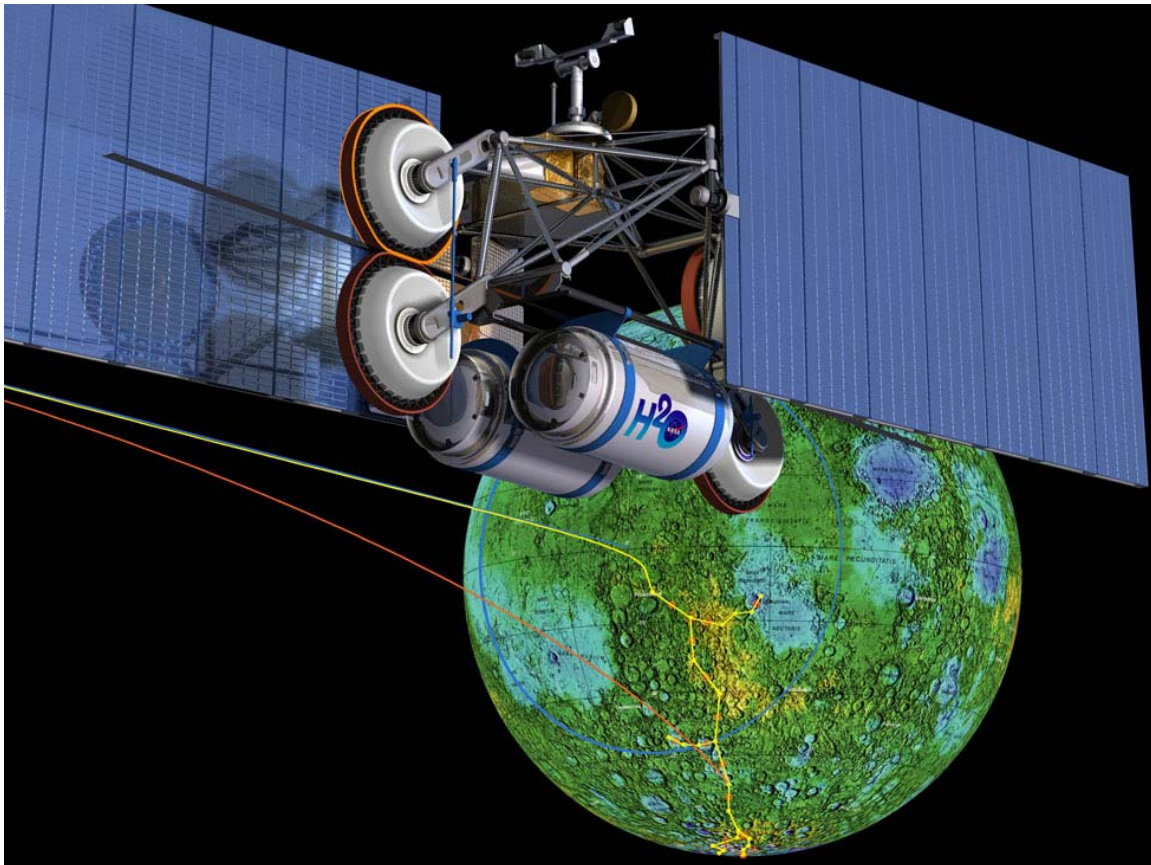

Figure 1. Lunar Space Elevator System Concept

Performance and Cost

A lunar space elevator using existing high-strength composites with a lifting capacity of 2000 N at the base equipped with solar-powered capsules moving at 100 km/hour could lift 584,000 kg/yr of lunar material into high Earth orbit. Since launch costs may be about \$1,000/kg then, this material would be worth more than half a billion dollars per year, resulting in greatly reduced costs and creating a new paradigm for space development.

Technology Challenges

To build the lunar space elevator and to operate it successfully will require that we identify and address some key enabling technologies. One key technology is the application of advanced composites with better strength/density values, and the potential use of lunar materials. A second technology is the use of robotic construction on the lunar surface, preferably using indigenous materials, to reduce the cost of construction. A third is mastering the dynamics and control of the lunar space elevator structure itself. Finally, to make the system cost effective, the operation of the LSE and its components must be autonomous, to minimize the requirements for human operation or intervention.

Building the Lunar Space Elevator

The construction system creates adaptable sets of identical geometric shapes of small blocks and wires made from locally available lunar materials, using automated block assembly and wire forming to construct complex shapes. This architecture is a new way to create a lunar base for robotic and human operations on the surface.

Vision and Significance

Lunar space elevators will revolutionize the way we operate in cislunar space, and can be a key piece in the development of the Moon and the use of its resources for advanced space development. It can contribute greatly to the new vision for a Moon-Mars initiative by:

- Providing lunar materials in Earth orbit at less cost than launching from the Earth
- Providing an unlimited supply of construction material in Earth orbit
- Providing for continuous supplies to lunar installations
- Providing the basis of a new paradigm for robotic lunar construction and development
- Supporting astronomical observatories on the lunar farside

Conclusions

The results of this phase I effort demonstrate that the lunar space elevator is feasible, and can be constructed of available materials to fit in the timeframe of the NASA Moon-Mars initiative. The lunar space elevator requires only technology advances commensurate with current plans for return to the Moon. It will provide unlimited amounts of lunar material for constructing large solar power satellites and shielded habitats space complexes in Earth orbit. With the use of lunar polar ices, the lunar space elevator can also provide large quantities of propellant in Earth orbit for use by vehicles bound for the Moon or Mars. The lunar space elevator also provides a low-cost means for transporting infrastructure components from Earth orbit to the lunar surface.

In Phase II, we will create a detailed development plan for this revolution in the future of cis-lunar space.

Introduction

The space elevator is a connection between the surface of a planet and a terminus beyond the stationary orbit radius, where a counterweight maintains the structure in tension and in balance between its synchronous orbit velocity and the planet's gravitational attraction. The space elevator was invented first by Leningrad engineer Yuri Artsutanov¹ in the 1960's, but was not noticed by the Western spaceflight community until the Principal Investigator Jerome Pearson² invented it independently and published in *Acta Astronautica*. For a planet or single body, the space elevator can be balanced about any point in the geostationary orbit. For a moon, however, the three-body dynamics dictates that a lunar space elevator must be balanced about one of the collinear Lagrangian points L1 or L2. The lunar space elevator was invented first by the PI³, followed independently by Artsutanov⁴. According to Levin, the lunar space elevator was mentioned much earlier by Tsander⁵ in a Russian language publication.

The space elevator must be constructed of extremely strong, lightweight materials, because it is tapered exponentially with of the planet's gravity field and the strength/density of the building material. Compared with the Earth space elevator, lunar space elevators are far less demanding of materials. Rather than waiting for carbon nanotubes to be developed into structural materials, we can use existing high-strength materials such as T1000G carbon fiber, or, with protective coatings, Spectra 2000, Zylon, or Magellan M5. These all have breaking lengths of several hundred kilometers under 1 g, and would require taper ratios of less than ten between the base and the Lagrangian balance points.

Brad Edwards⁶ received NIAC funding to examine an Earth space elevator using carbon nanotubes. There are annual space elevator symposia and sessions at the IAF Congress this year in this rapidly changing field. The Earth space elevator concept has now been advanced in the construction system, the cargo lifting system, and especially in materials⁷. However, there are two very difficult problems to be overcome in building the Earth space elevator—the necessity for a material such as carbon nanotubes, which may not be available for construction for decades, and the problem of interference with all other spacecraft and debris in Earth orbit. Because the space elevator is a fixed structure that extends from the equator to beyond the geostationary orbit, every satellite and every piece of debris will eventually collide with it, typically at greater than orbital velocity. This means that for safety the Earth space elevator must be constantly controlled to avoid these obstacles, or they must be removed, requiring an enormous space cleansing.

Shorter rotating tethers have been proposed by Moravec, Carroll⁸, and by Hoyt and Forward⁹ as propulsion systems for transporting masses to and from the Moon, but there are several difficulties in achieving their visions. They are based on momentum exchange tethers, catching and throwing masses from their tips, and touching down instantaneously at several points on the lunar surface. This requires precise control of the tether tip, precise rendezvous with the target masses, and precise catching of the incoming masses from another rotating tether. The low lunar orbit rotating tether's orbit must be carefully controlled and adjusted to precisely touch the surface. Also, the rotating tethers require that the mass flow be balanced between Earth and the Moon, or they must make up the momentum by other means, usually by solar power and electric propulsion. Finally, the incoming masses are on hyperbolic orbits, so if a catch is missed, the payload is lost; there is no second chance.

In contrast, our proposed lunar space elevators¹⁰ are passive, fail-safe, involve no high-speed rendezvous catches or throws, are stabilized by counterweights beyond the L1 or L2 points, and have no need for balancing the mass flow or for re-boosting. Masses would be carried up or down the lunar space elevators by electrically driven, wheeled vehicles, gripping the ribbon of the space elevator and using solar or beamed laser power⁷. These cargo carriers would move at a moderate speed, but provide constant mass flow, like a pipeline. A robot station at the top would launch payloads of radiation shielding, building materials, and finished constructions from the lunar mine to high Earth orbit. From there, they could be further moved to LEO or to the surface of the Earth for other uses.

Vision

Lunar space elevators will make possible the development of lunar resources and their availability for large-scale operations in cislunar space. The lunar space elevator architecture, shown schematically below, consists of three systems: a lunar construction system, a lunar space elevator system, and a cislunar transportation system.

The construction system is a unique and streamlined method for creating the basic building blocks for lunar and orbital construction. The space elevators use both Lagrangian points to provide access to nearside and farside equatorial regions and the polar regions as well. Solar-powered vehicles climb the space elevators to take payloads beyond the Lagrangian points with excess orbital energy. From there, small robotic space tugs complete the cislunar transportation system to take them to high Earth orbit for use in construction, shielding, habitats, and solar power satellites.

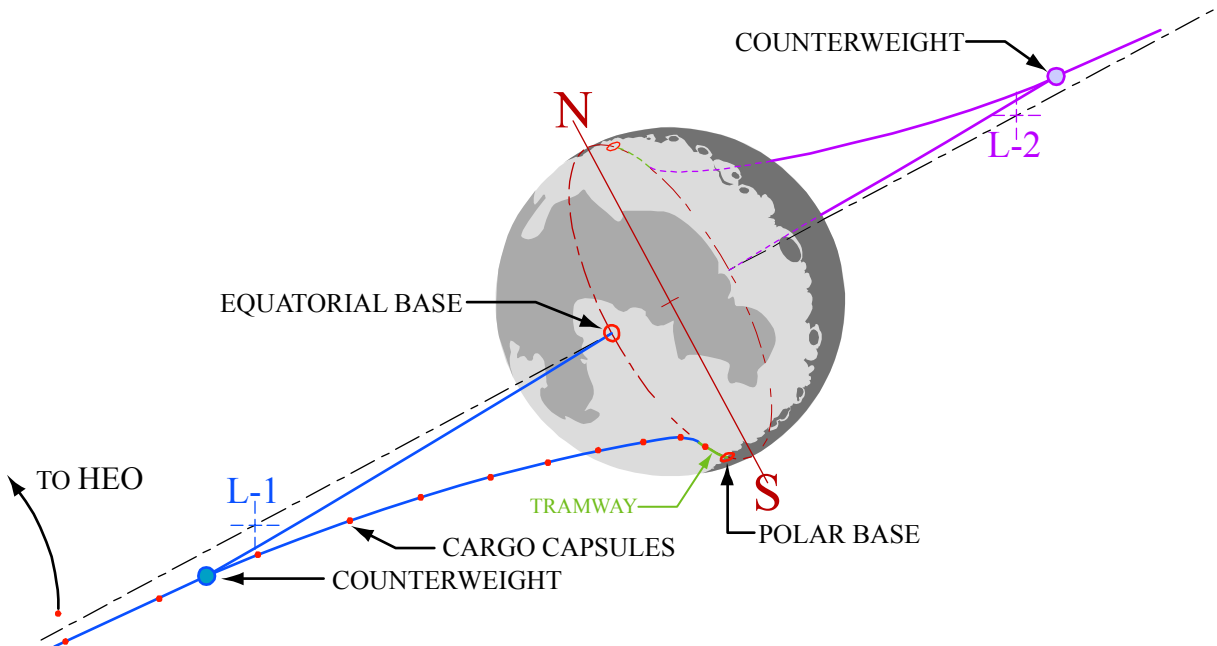

Figure 2. Lunar Space Elevators about L1 and L2

Two types of lunar space elevator are proposed, balanced about the L1 and L2 Lagrangian points. L1 is $58,021 \pm 3183$ km from the center of the Moon toward the Earth, and L2 is $64,517 \pm 3539$ km from the center of the Moon away from the Earth. The variations are due to the 0.055 eccentricity of the lunar orbit. The L1 LSE is slightly easier to build and is constantly visible from the Earth; the L2 LSE is slightly better for launching masses into Earth and lunar orbits.

These space elevators can also support development of the lunar maria resources on the near side, and support an astronomical observatory on the far side, away from the Earth's electromagnetic interference. The poles may be the key to lunar resource development. The Clementine and Lunar Prospector missions indicated that there may be valuable deposits of hydrogen ices in permanently dark craters near the poles. These could be invaluable as a source of rocket propellant for propulsion in cislunar

space. There may also be permanently sunlit mountain peaks near the lunar poles, allowing for the generation of continuous solar power, even through the 14-day lunar night. This could greatly assist a mining base near the pole.

To access the poles, the space elevators must have a different form—with non-vertical segments that curve away from the equator and toward the poles, connecting the resources near the lunar poles with the transportation system. The maximum latitude that can be reached is limited by the material strength/density, which was demonstrated theoretically by one of us (Levin¹¹). Depending on how close our tether building material allows the base to be moved toward the pole, it will be necessary to provide a certain length of a tramway-like connection to reach the polar mining base.

As the lunar space elevator is constructed, extending from the L1 or L2 balance point, the lower tip of the space elevator ribbon will naturally reach the surface at the equator. Additional strands can then be lowered and towed by a surface vehicle toward the poles, and anchored at convenient mountain peaks at the latitude where they are tangent to the surface. These additional ribbons not only make the lunar space elevator redundant and fail-safe, but they will be extended from lunar mountain peak to peak until they reach mining bases near the poles. This would create direct connections between the polar mining and refining bases and the launch stations beyond L1 and L2.

Significance

We expect lunar mining, refining, and construction plants on the surface, with useful objects constructed from lunar resources, carried up the lunar space elevators by solar-powered cargo capsules, and dropped from the tip of the space elevator into high Earth orbit for use in the next phase of space development. Lunar space elevators will revolutionize the way we operate in cislunar space, and will greatly reduce the cost of getting building material into Earth orbit.

The lunar space elevator can be a key piece in the development of the Moon and the use of its resources for advanced space development, and it can contribute greatly to the new vision for a Moon-Mars initiative announced by President Bush in January of 2004. We propose to take advantage of these positive attributes by demonstrating the paradigm shift that lunar space elevators could make in our next moves back to the Moon, to Mars, and on into deep space.

In addition, the lunar space elevator can be a stepping stone to the Earth space elevator. Lunar space elevators do not require super-strength materials, and do not endanger all Earth satellites. Lunar space elevators are twice the length of the Earth space elevator, but because of the Moon's much smaller mass they can be constructed of existing materials. In addition, there are few satellites in lunar orbit, no man-made debris, and fewer meteoroids are expected. The Earth space elevator and the lunar space elevator both need traveling vehicles to carry cargo along their ribbons of material, and they are both orders of magnitude longer than any structure yet constructed in space. For these reasons, the lunar space elevator is an excellent testbed for examining many of the technology challenges of the Earth space elevator, including the dynamics and stability of long structures in space, control of the lateral and longitudinal oscillations, and vehicles climbing rapidly along their great lengths.

The lunar space elevator allows us to re-discover the Moon for space habitats, after the romance in the 1970s with space colonies at L4 and L5. The Moon's polar regions may

provide mountain peaks of permanent sunlight for continuous solar power, and valleys of permanent darkness for mining condensed ices. The Moon also provides a constant gravity force to keep the muscles, bones, and vestibular systems of the inhabitants in better shape while requiring less exercise than the zero gravity of space stations.

We will examine the radical paradigm shift for the development of cislunar space that will occur when we have available abundant raw materials and manufactured products that can be continuously delivered into Earth orbit for development of extensive space facilities, space stations, space hotels and tourism centers, and space power stations and manufacturing facilities. The use of lunar material, without the heavy burden of lifting the material out of the Earth's deep gravity well, could allow the production of power and materials without encroaching on the Earth's biosphere, and could provide attractive and radiation shielded destinations in cislunar space. The use of lunar hydrogen could also provide propellant to greatly reduce the cost of expeditions to Mars.

The effectiveness of this vision will depend on the kinds and amounts of material flows that such a system could support, and the potential uses and payoffs of the final products for operations in Earth orbit. It will also depend on the amount of mass required for the lunar space elevators and the construction system compared with the expected annual throughput. In Phase I, we looked at the promise and the problems inherent in such a system vision.

Lunar Space Elevator Design

Basic Considerations

Unlike the Earth space elevator, balanced about any point in geostationary orbit, the lunar space elevator can be balanced only about the L1 or L2 Lagrangian points. In addition, because of the peculiarities of the three-body system, the balanced lunar space elevator is longer than the balanced Earth space elevator, and the lunar space elevator requires a larger counterweight for the same relative distance beyond the balance point.

Because of the Moon's small mass, lunar space elevators are far less demanding of materials than Earth space elevators; they can be constructed of existing composites. This is also true for Martian space elevators, as shown in Figure 3. The required area taper ratio between the balance point and the surface is plotted in terms of the characteristic height of the material, which is the maximum length of a hanging cable of the material under a 1-g gravity field. Current composites have characteristic heights of a few hundred kilometers, which would require taper ratios of about 6 for Mars, 4 for the Moon, and about 6000 for the Earth. The mass of the Moon is small enough that a uniform cross-section lunar space elevator could be constructed, without any taper at all.

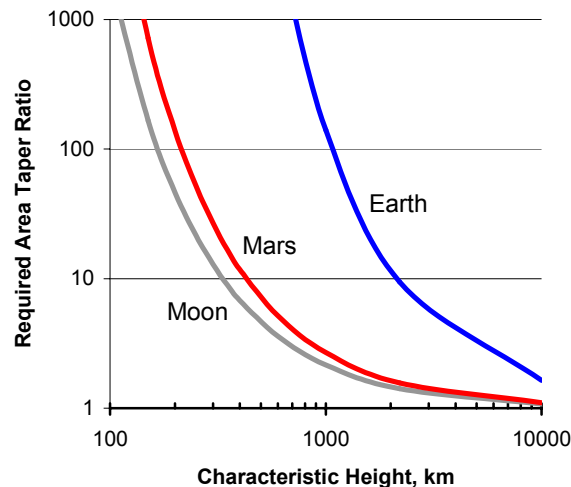

Figure 3. Required Tapers for Earth, Mars, and Moon Space Elevators

Configurations

These design requirements allow several possible configurations for the lunar space elevator. It can take the classic vertical, exponentially tapered form, extending above the L1 balance point to a counterweight that provides balance. It can be a balanced design without a counterweight, by extending far enough above the Lagrangian point. It can be curved, and touch down at latitudes away from the equator. And in the case of the Moon, it can be uniform in cross-section, built in the form of a conveyer belt with the

ribbon in motion, carrying payloads fixed to it, rather than having payloads move along the ribbon. We discuss all these alternative configurations in the following sections.

Vertical Design with Counterweight

Figure 4 gives an indication of the variation of the relative masses of the ribbon and the counterweight with height of the LSE. The figure assumes M5 fiber with a base area of 0.69 mm^2 , and the standard exponential taper for constant stress. Note that for long space elevators, the mass can be all ribbon, and for short space elevators, the mass is almost entirely counterweight, as suggested by Pearson¹² for attaching a tethered communication satellite on the lunar farside.

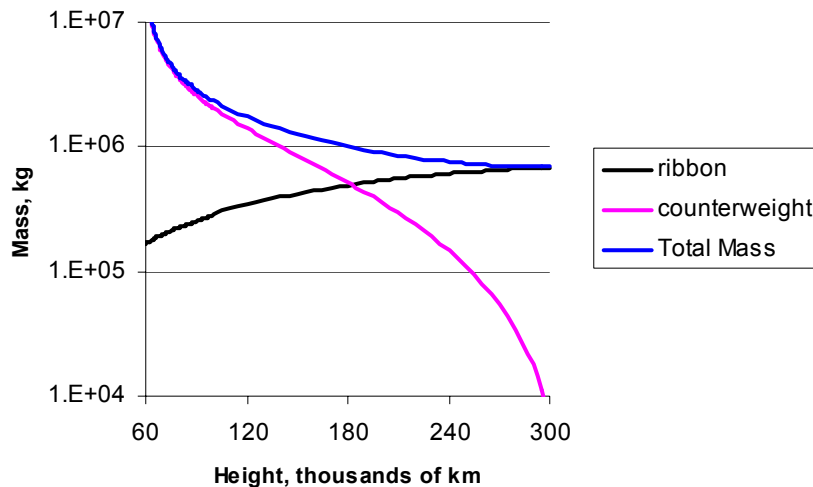

Figure 4. LSE Ribbon and Counterweight Mass vs. Height

One interesting aspect of the lunar space elevator design is that more of the total mass is in the counterweight than for the Earth space elevator for the same relative length. Because this counterweight can total 1-10 million tons, providing the material is a major problem. Kirk Sorensen of MSFC suggested that one possibility is to retrieve an asteroid nearly in the Earth's orbit, such as 2000SG344, which is about 20-50 m in diameter. It has a mass of 10-200 million kg, and would require only 200 m/s ΔV to retrieve. However, providing an asteroid counterweight would certainly be a difficult solution; using lunar regolith could be faster and easier.

Balanced Design without Counterweight

If the variation in cross-sectional area with height is modified from the standard exponential taper, the lunar space elevator could be built in a balanced configuration without a counterweight, and could be much shorter than with the classic taper. This would solve the problem of providing the enormous counterweight for the LSE.

The tension profile for a balanced lunar space elevator design is shown in Figure 5. This design has the normal base area and taper from the surface to L1, but provides four

times the area above L1. For $L < L1$ it has an M5 safety factor of 2 and up, and for $L > L1$ the M5 safety factor is 8 and up.

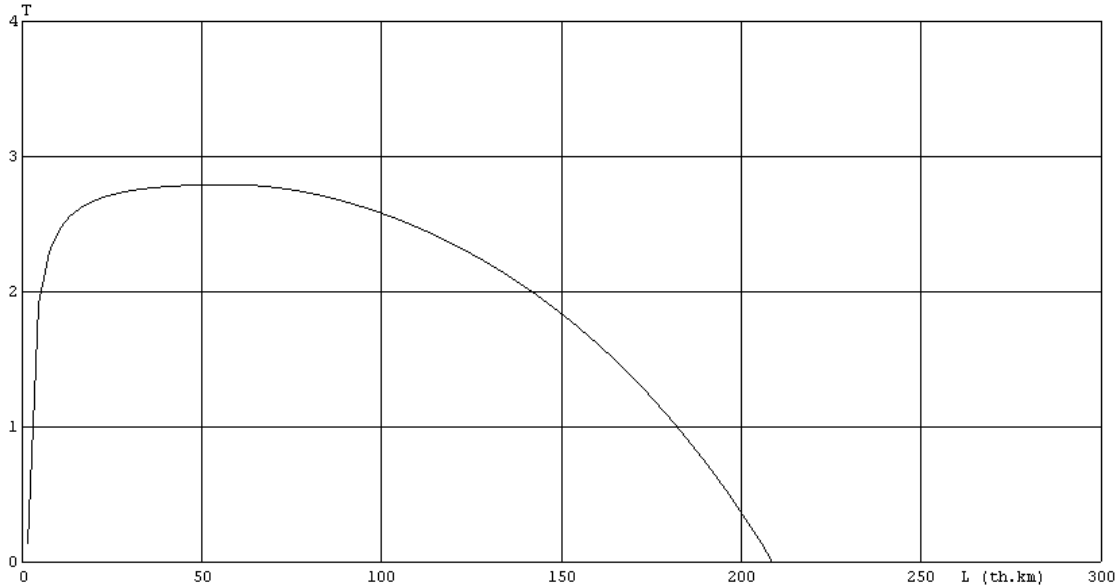

Figure 5. Tension Profile of a Two-Segment Balanced LSE

The mass of this balanced lunar space elevator is only 2.28 times as much as the baseline area LSE reaching 290,000 km, but it has 4 times less meteoroid damage risk, less creep, and more margin for aging. We could extend the larger constant area segment down to $L = 25-30,000$ km, and make only the lower part tapered.

Actually, rather than using a dead-mass counterweight, the ribbon can be balanced by not tapering the upper part as strongly as the constant-stress design would call for, with the extra ribbon mass taking the part of the counterweight, and also strengthening it against the danger of meteoroids.

To replace the counterweight, we could make 2 segments:

- 25,000 km tapered segment, with a safety factor of 2+, near the surface
- 180,000 km (or less) uniform segment, with a safety factor of 8+, for the rest

This length can drop payloads from the end into LEO and receive payloads from LEO. The mass is shown in Figure 6.

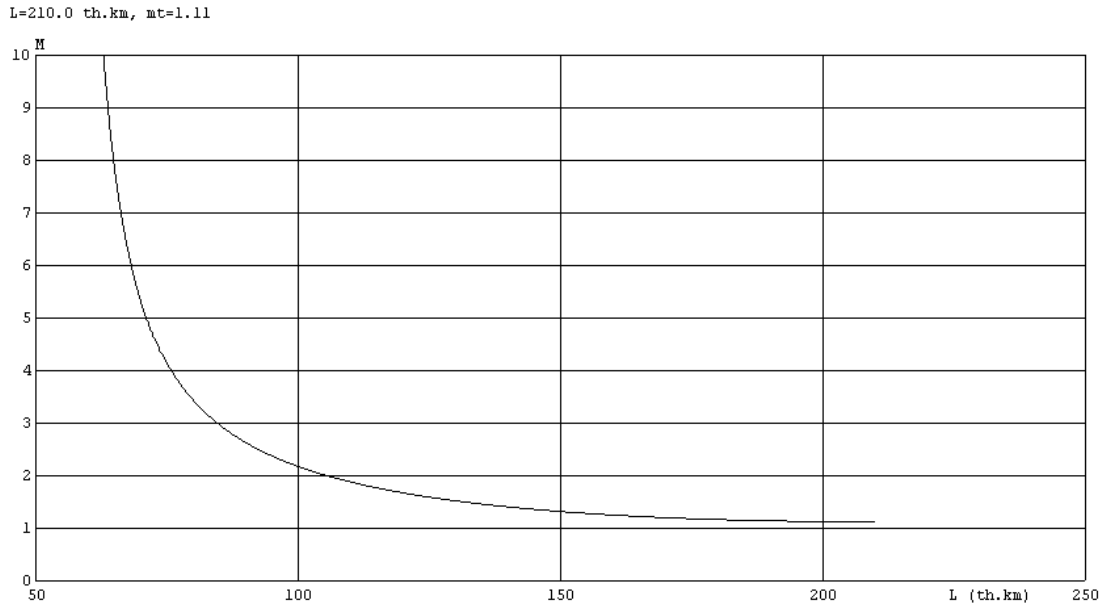

Figure 6. Mass of Balanced LSE vs. Height

The longer, balanced LSE has advantages for launching payloads to Earth orbits, because payloads released from higher on the elevator will reach orbits with lower perigee, and can even reach LEO. The trade-off is between reducing or eliminating the counterweight, but requiring more high-strength ribbon material.

Uniform Design “Conveyer Belt”

It is possible to build a lunar space elevator that has constant diameter, with a continuous ribbon over reels at the top and bottom like a conveyer belt, so that the payloads just have to be connected to the ribbon, and don’t need their own power. This would also eliminate the wear of the payload tires on the ribbon, and the speed limit, because large reels at the base and at L1 could move the ribbon rapidly undue weight or stress penalties.

For the Moon, we can build a non-tapered lunar ribbon if the characteristic height is 275 km or more. M5 fiber has 570 km, and with a safety factor of 2, the characteristic height h is 285 km, so it is just possible to make a non-tapered ribbon of M5. The carrying capacity is just the extra stress available over supporting its own weight, so materials with a higher value of h would be very helpful. It may also be possible to assume some de-rated carbon nanotube fibers by 2020 or so for this purpose.

This system, like the balanced system, solves the problem of providing the enormous counterweight, but it has one important disadvantage—without intermediate reels, it would be very difficult to provide multiple ribbons for redundancy, and a single meteoroid break would destroy the system.

Curved Design for Polar Access

We would like to connect the Lagrangian points directly to the lunar poles, but that is impossible, even for an infinitely strong material. Curving the space elevator to anchor it away from the equator takes additional strength from the material, and there is a latitude limit at which the ribbon becomes horizontal. In a paper at the 3rd Space Elevator Conference, Anders Jorgenson calculated the maximum latitude for an Earth-based space elevator to be 47 degrees. Blaise Gassend¹³ calculated the path of climbers on non-equatorial cables, and found that vibration may be dangerous.

Ivan Bekey suggested using a tall tower at the pole, and allowing the ribbon to hang from the tower without extending below the surface level. Figure 7 is a sketch of the concept, with the ribbon just grazing the lunar surface. However, even with carbon nanotubes, the polar tower would have to be hundreds of kilometers high. This seems impractical at present.

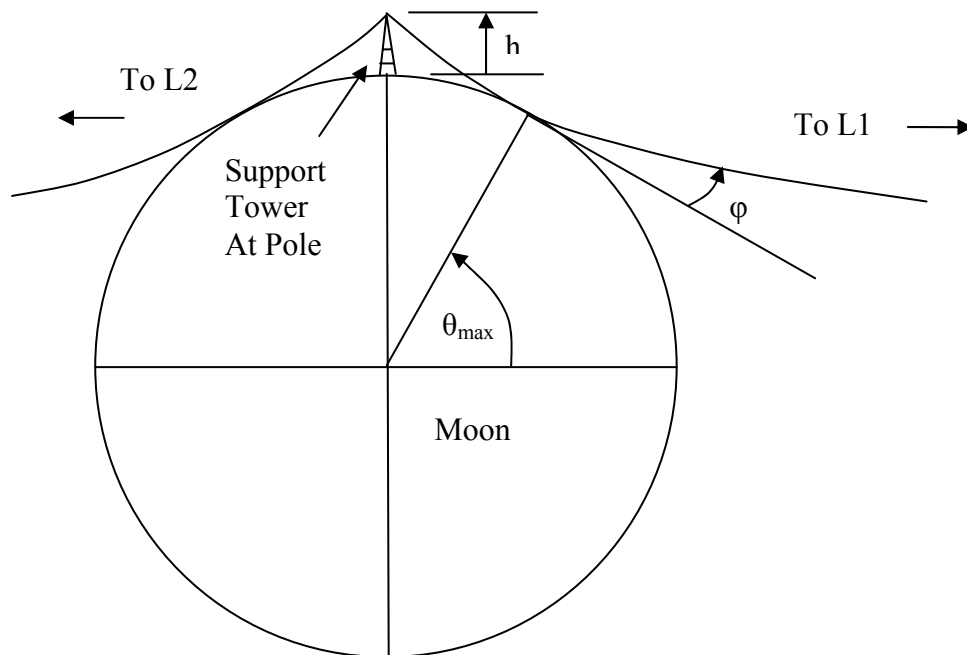

Figure 7. L1 And L2 Space Elevators With Polar Support Tower

To reach a non-equatorial base, the cable would have to be dropped from L1, touch the lunar surface at the equator, towed by a ground vehicle to the pole, and raised to the top of the tower, or at least to a tower located at θ_{max} , from which another section can be laid to the tower at the pole. θ_{max} is a function of the tension and the maximum stress in the cable, and increasing it will increase the taper ratio and the total mass required for a given material. This means there is a trade-off between the ribbon mass and the number and height of the towers required.

Geoff Landis¹⁴ proposed a space elevator based on a tower in compression combined with an upper cable in tension, and showed that the combination was lighter than the simply tensile or the simply compressive design. Similarly, using lunar towers allows reaching higher latitudes.

Eugene Levin (see Appendix) calculated the maximum lunar latitude achievable as a function of the characteristic height of the ribbon material, which allows us to calculate the tower heights necessary. This also gives some insight into the tradeoffs between stronger materials and higher towers. These calculations are more complicated than the Earth space elevator, because of the 3-body problem of the Earth-Moon system.

However, this takes a large fraction of the material strength, as shown in Figure 8. In this figure, the abscissa is η , the ratio of the square of the transverse wave velocity of the material, $v_t^2 = T/\rho$, to the square of the circular velocity at the lunar surface, $v_0^2 = \mu/r_0$. For M5 fiber with a safety factor of 2, $\eta \approx 1$.

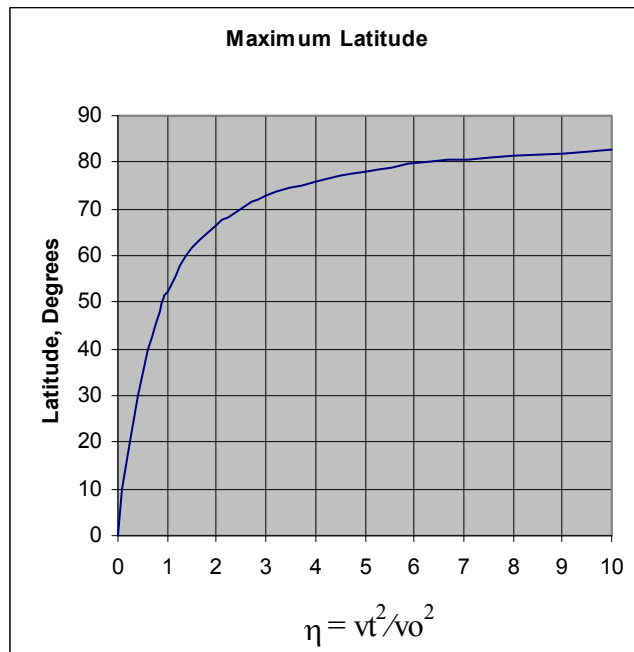

Figure 8. Maximum Latitude as a Function of Material Strength

Using a ribbon of M5 fiber, the LSE bottom end could be towed to a latitude of about 36 degrees and retain about half its strength for lifting payloads. The maximum latitude attainable by M5 is 52.5 degrees, but that takes all its strength, leaving no margin for lifting payloads. Even carbon nanotubes could reach a latitude of only 76 degrees, which still leaves a distance of 426 km overland to the pole. This means that a tramway will be required to reach the poles, no matter what the material.

However, taking half the stress limit to reach 36 degrees saves only about 1000 km of tramway, but it halves the throughput of the entire system. Much higher productivity can be obtained by just using a vertical configuration, and taking the tramway the entire 2700-km distance from the equator to the pole.

Tramway for Polar Access

These results show that curving the LSE is possible, but that it significantly increases the tension, reduces its carrying capacity, and cannot reach all the way to the poles. These

results lead us to our baseline design of the vertical lunar space elevator combined with overland tramways to reach the poles. The concept is shown below in Figure 9.

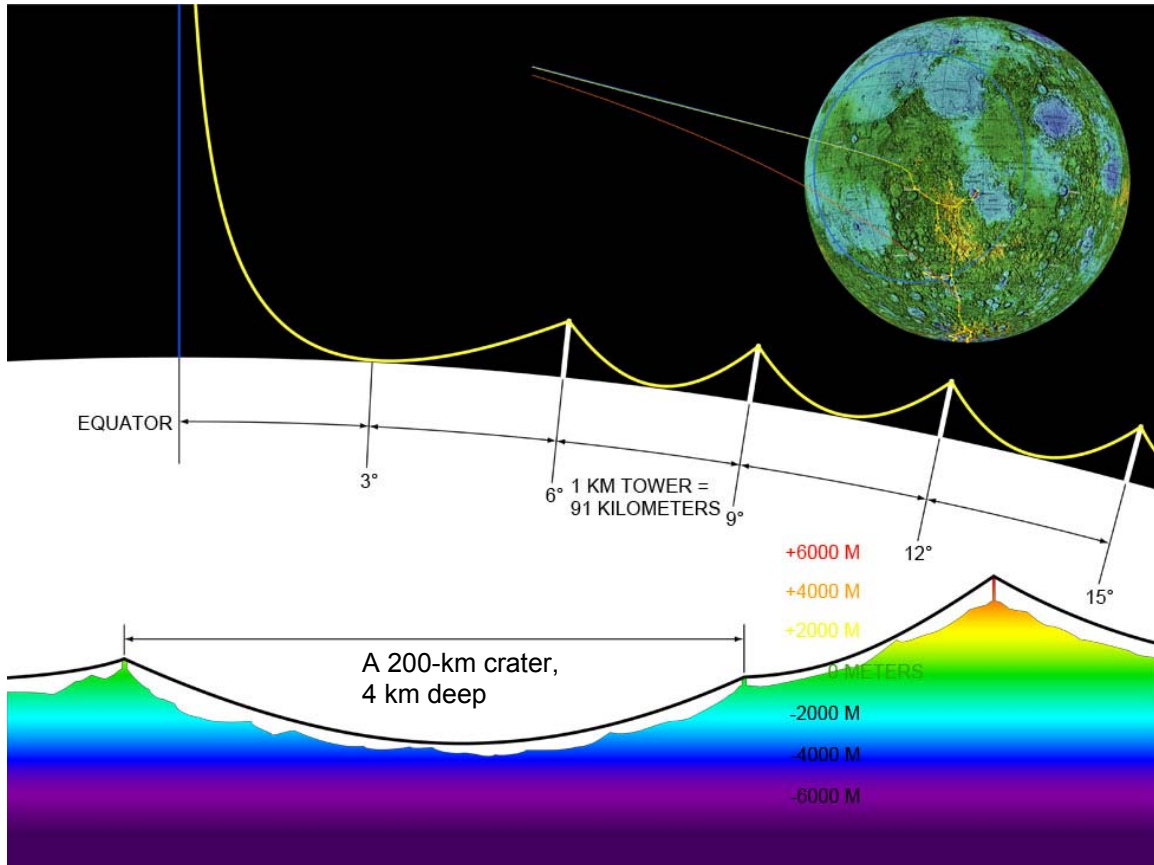

Figure 9. Lunar Space Elevator and Tramway

Because of the Moon's low gravity, large spans between support towers would be possible. Over level terrain, a 1-km tower could span 3 degrees of latitude without an M5 ribbon sagging to the ground. If the towers could be located on strategic mountain tops or crater rims, the span could be increased. This means that only a few tens of towers could span the distance from the equator to the pole. The spans in degrees of latitude are shown for different height towers in Figure 10.

The tramway support towers could be constructed with a very lightweight construction method, such as the tensegrity concept shown later in Figure 22. These have been constructed to considerable heights in a 1-g field on Earth, and are very lightweight and capable of supporting heavy loads. On the Moon, there should be little difficulty in making towers 1 km high, which is the gravitational equivalent to just 165 meters on Earth, or somewhat less than the height of the Washington Monument.

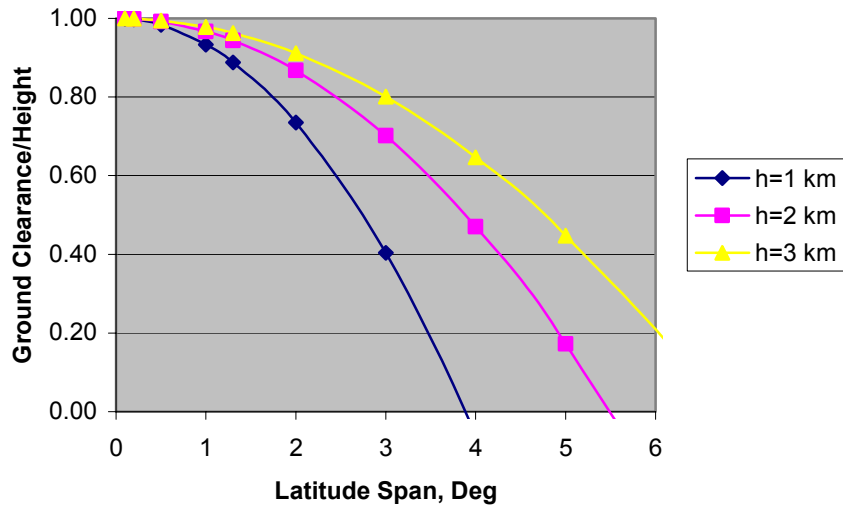

Figure 10. Maximum Tramway Span vs. Height of Support Tower

Materials

Use of Existing Composites

The space elevator must be constructed of extremely strong, lightweight materials, to support its weight over the tens of thousands of kilometers of length; even then, for minimum mass it must be tapered exponentially as a function of the planet's gravity field and the strength/density of the building material. The table below shows some candidate materials for lunar space elevators, with density, stress limit, and the breaking height (the longest cable that can be suspended in 1 g). Lunar space elevators require much lower material strengths than the Earth space elevator, which will require carbon nanotubes (shown in Table 1 for comparison). All these materials, save the carbon nanotubes, are available now.

Table 1. Candidate Materials for LSE Compared with Carbon Nanotubes

Material	Density ρ , kg/m ³	Stress Limit σ , GPa	Breaking height $h = \sigma/\rho g$, km
SWCN*	2266	50	2200
T1000G†	1810	6.4	361
Zylon PBO‡	1560	5.8	379
Spectra 2000¶	970	3.0	316
M5**	1700	5.7 (9.5)	342 (570)
Kevlar 49††	1440	3.6	255

*Single-wall carbon nanotubes (laboratory measurements)

†Toray Carbon fiber

‡Aramid, Ltd. Polybenzoxazole fiber

¶Honeywell extended chain polyethylene fiber

** Magellan honeycomb polymer (with planned values)

†† DuPont Aramid fiber

Our baseline material for the ribbon is M5 fiber, which is advertised now, and may be improved. We expect a 50% increase in the M5 fiber capabilities by the time the lunar space elevator is constructed, which seems reasonable in light of past progress. Note that the LSE does not depend on the availability of carbon nanotubes for the building material.

Fail-Safe Design for Safety, Reliability, and Repair

Micrometeoroid damage is a major consideration in lunar space elevator survivability. We have determined that a ribbon shape provides the greatest protection against severing by meteoroids, while still allowing the wheeled climbers to grip the material. However, a single ribbon would not be fail-safe. A break would result in a catastrophic loss of the entire system. Even though a break near the surface or near the top would allow time for an adjustment of the balance through moving masses at L1, the wave propagation velocity in the high-strength material would result in a destructive tensile impulse that seems too difficult to overcome.

For this reason, we have decided upon a multiple ribbon system. With interconnections every so often, if one section is severed, the parallel section can take the load until robotic repair vehicles can replace the missing ribbon. The multiple ribbons are more versatile than the multi-strand tether proposed by Forward and Hoyt¹⁵. The interconnections might be on the order of 100 km apart, small enough that a repair climber could carry the mass of 100 km of replacement ribbon. Multiple ribbons also naturally allow two-way traffic up and down the elevator. This makes it easier to carry payloads from Earth down the ribbon to the Moon, at the same time that lunar materials are being carried up the ribbon for launch to Earth orbit.

The lunar space elevator multiple ribbons would be connected at intervals by cross members, as shown in the sketch of Figure 11. The nominal safety factor varies with the number of parallel ribbons, as shown in the table. A 3-ribbon design may be the best choice, as pointed out by John Oldson.

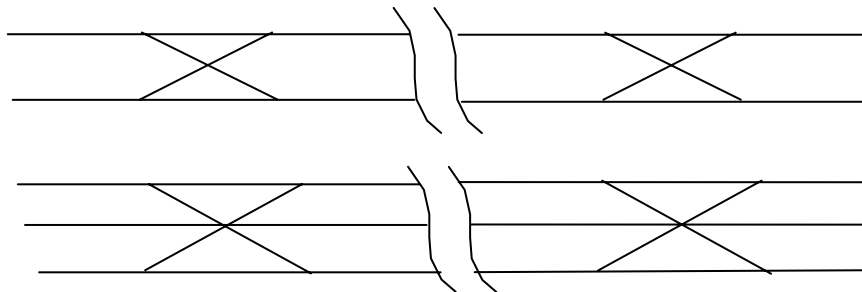

Number of Ribbons, n	2	3	4	5	6
Safety Factor, f_0	4	3	2.7	2.5	2.4

Figure 11. Multiple-Ribbon, Fail-Safe Design

The risk of meteoroids has been addressed by Levin¹¹ and by Carroll¹⁶ in the NASA Guidebook for Analysis of Tether Applications. From Levin, the mean time in years between meteoroid cuts for a ribbon h mm wide and L km long is:

$$T = 6 h^{2.6}/L$$

A 200,000 km, 30 mm ribbon will be cut in 2.5 months, 50 mm in 9 months, and 100 mm in 4.6 years. Multiple ribbons reduce this risk. The probability of having a 20 km 30 mm ribbon cut in a month (the duration of a typical repair mission) is 4×10^{-5} . The probability of having two parallel sections cut in a month is 2×10^{-9} . We have 10^4 sections. The probability of losing a dual-line LSE is thus equal to 2×10^{-5} . This is close to failsafe, but damaged sections must be replaced every few months. This can be done from way stations with repair climbers and spare ribbon sections.

Multiple ribbons and regular replacement of ribbon sections has another advantage: the speed of the climbers could be increased, raising throughput directly. We could accept the increased wear on the ribbon, and replace worn sections the same way we replace broken sections. Higher climber speeds would also reduce the time required for a payload to be carried up the entire 200,000-km length of the extended lunar space elevator; at 30 m/s, they could cover the distance in less than 3 months.

Improved Materials and Carbon Nanotubes

There is considerable research going on in the United States, Japan, and Europe in trying to develop carbon nanotubes into practical composite materials. In the next few years, we may see significant advances in this area, with either conventional composites that are augmented with fibers of carbon nanotubes, or perhaps even a complete carbon nanotube material that has much higher stress limits. Either of these advances would be very significant for the capability of the lunar space elevator. Since carbon nanotubes have about four times the stress/density ratio of M5 fibers, a lunar space elevator built with even de-rated carbon nanotubes would have much higher throughput. This would significantly reduce the cost per kilogram of lunar materials delivered into Earth orbit. During Phase II, we will assess this progress, and evaluate the chance of such materials being available in the 2025 time frame.

System Components

There are several distinct types of vehicles that will be used in the construction and operation of the lunar space elevator. During the construction phase, we will need high-lsp orbit transfer vehicles to carry the initial ribbon mass and the ground installation mass from LEO to L1 or the lunar surface. We will then need construction vehicles to erect the tramway and to build the surface mining and refining installations. During the operational phase, we will need ribbon climbing vehicles, which can also carry payloads along the tramway ribbon. We will also need smaller OTVs to carry the lunar payloads to LEO and Earth materials to the Moon. We examined the climbers in some detail during the Phase I study.

Climber System Design

The maximum speed of the climbers on the ribbon is a critical parameter, because it largely sets the maximum throughput of the system. The operational speed is also

limited by the size of the initial ribbon, because there is a minimum width of ribbon required for the climber rollers to grip the material without causing undue stress and wear. Brian Laubscher has used a maximum climber speed of 200 km/hr, or 55 m/s, in analyzing the Earth space elevator. We have taken a more conservative approach, and used a nominal velocity for the climbers of 15 m/s. We will address this in more detail in Phase II.

Our current concept for the robotic climbing vehicle is shown in Figure 12 moving horizontally on the tramway. This robotic climber has a baseline mass of 540 kg. This allows 100 climbers to be spaced over the length from the surface to L1 without exceeding the stress limit of 2000 newtons for the single ribbon. An equal number could be arrayed on the “down” ribbon.

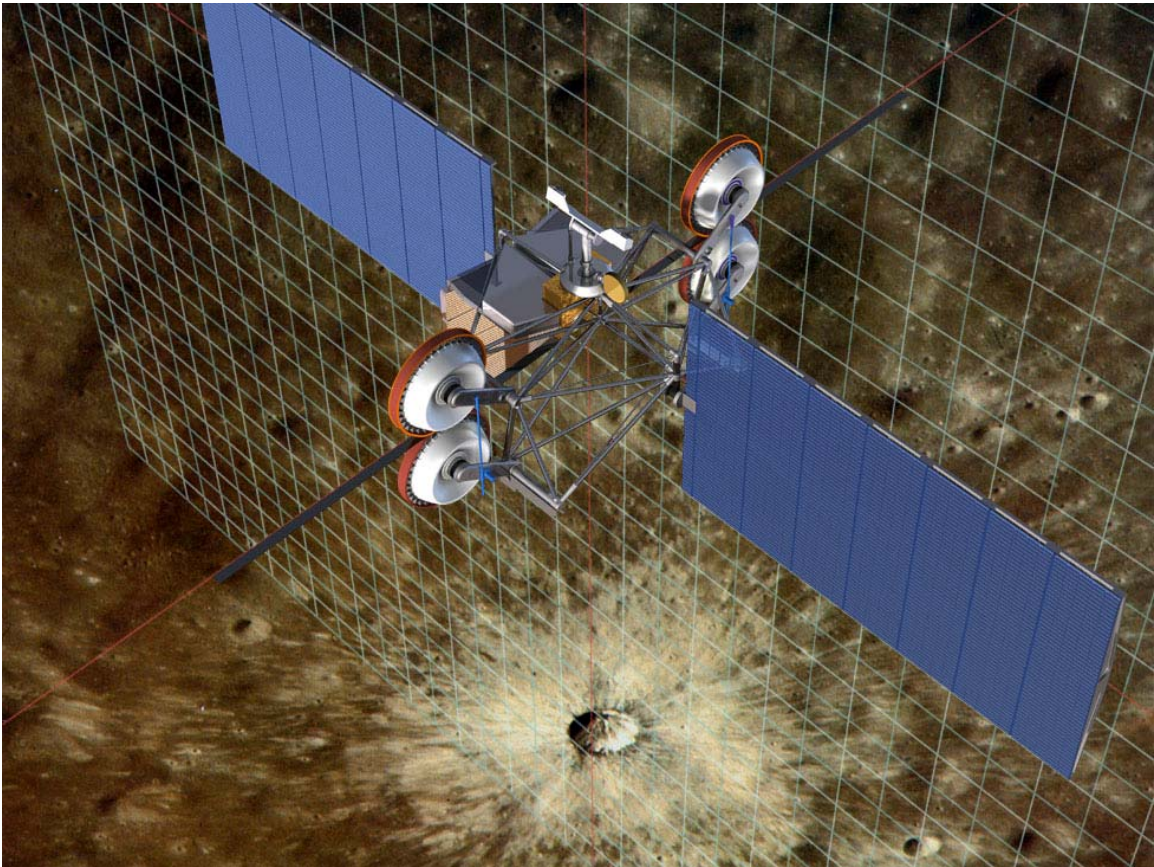

Figure 12. Robotic Climbing Vehicle

The climbers must power themselves up the ribbon, and this they do by gripping the ribbon between two large tires, to spread the load. The motive force is provided by electric motors, and the power for the motors is derived from solar arrays, as shown in the figure.

The power required to climb the ribbon is a strong function of the lunar gravity field, which drops off drastically over the first few percent of the distance to L1. The nominal

velocity of 15 m/s would require 10 kW at the surface, but drops to less than 100 watts at just 7% of the way to L1. Climbers equipped with just 2 kW of power, achievable from modest-sized arrays, could start slowly, then accelerate as their weight dropped, and exceed the average velocity at heights where the friction and load on the ribbon is much lower.

The climber solar arrays will be in the shade on the lower part of the ribbon for half of each month. However, because of the 5° inclination of the lunar orbit to the ecliptic, the maximum shade reaches just 29% of the distance to L1 at new moon, and there is no shade during the half of the orbit between first quarter and last quarter. By launching the climbers during the daylight, the long-term average of 100 climbers on the ribbon can be maintained. Since each climber takes about 50 days to reach L1, there would be two groups of climbers on the ribbon, with a gap between them. Alternatively, laser light could be beamed from the base of the ribbon, as proposed for the Earth space elevator.

To alleviate the problems of lack of sunlight and high required power near the base of the ribbon, the climbers might be launched from the base with a certain velocity, and at the apex of their trajectories, attach to the ribbon. We have not examined the dynamics of this situation, but it can be addressed in Phase II. Also, it may be possible to provide the climbers with magnetic levitation to reduce the wear on the ribbon, if conductive inserts could be incorporated into the ribbon material. Finally, each way station might be able to sling the climbers up to the next station, without touching the ribbon at all. Or the climbers might be equipped with mechanical devices to interact with thicker sections of the ribbon every 100 m or so, to provide the impetus of velocity to fly to the next section. Above L1, and on the downward ribbon, this same device would keep the speed of the climber reasonably small.

The climbers will bow the ribbon due to the Coriolis force from their velocity. With the ascending ribbon on the west and the descending ribbon on the east, this force will separate instead of entangling the ribbons. The climbers will also tend to twist the ribbons. To handle this problem, gyroscopic precession might be used; the mechanism illustrated in Figure 13 on the next page shows the concept. Precession produces a force at right angles to the force applied to it. If the climber in the illustration is going up and the flywheel is rotating in the same direction as the drive wheel, twisting the flywheel in the direction shown will result in a force around an axis parallel to the ribbon. With flywheels in both wheels the combined force would be about the centerline of the ribbon. In this example it would be counterclockwise when viewed from the rear.

The split field coil design shown may be more complex than is really needed. In reality, a standard motor and actuator would work and most likely need to move only in the plane shown. Torque applied to the flywheel is countered by torque on the drive wheel, probably an undesirable steering input. Two or more sets of drive wheels in a train may be necessary to resist this force. The flywheel need not be powered unless it is to be used. If a twist is detected, it is powered up, moved to a new position until the desired effect is achieved, then straightened out and turned off. Changing speed changes the force during the process. The drawing scales to a tire one meter in diameter and grids that appear in various views are one meter divided by lighter half meter lines. The ribbon shown is 10 cm wide.

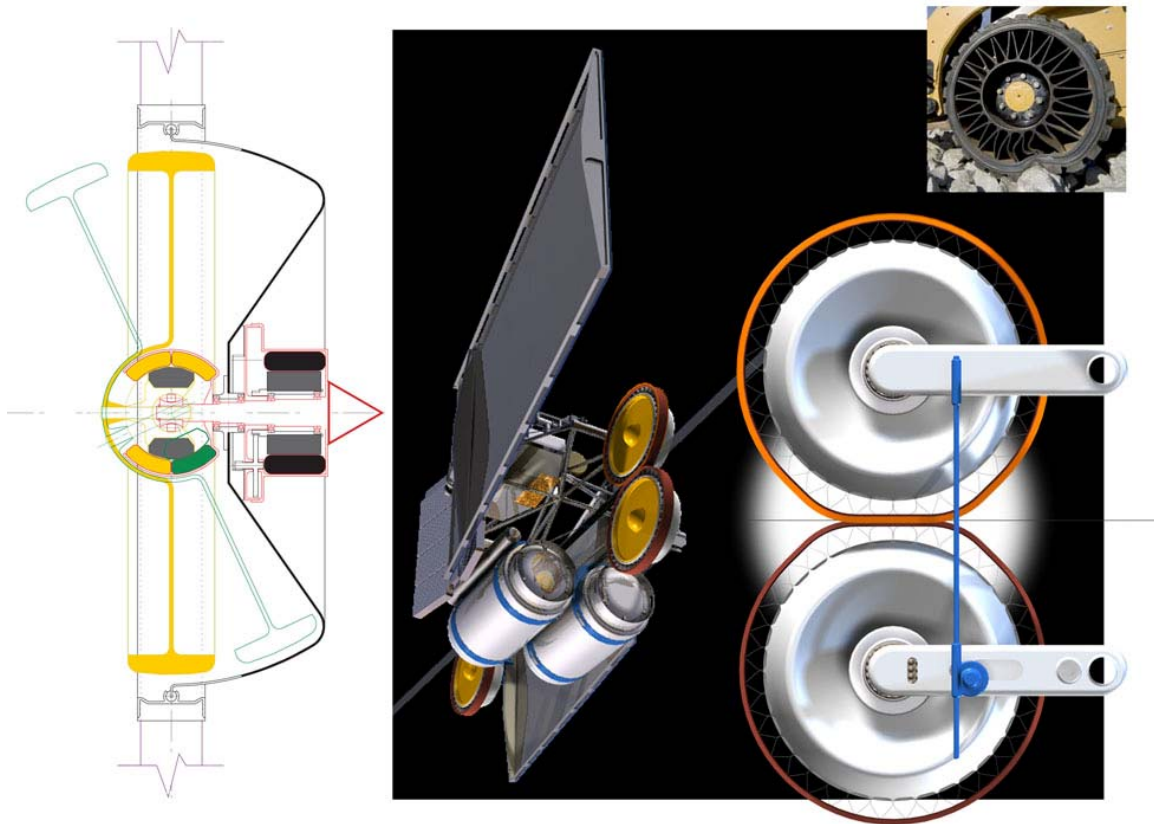

Figure 13. Drive Motors, Attitude Control, and Ribbon Interface

Figure 14 shows conceptually how the solar arrays and the climber structure are operated. The solar panels are articulated to allow them to stay roughly perpendicular to the sunlight. They have a 160° range of movement fore and aft and a motor which allows them to rotate around their long axis. We have considered other options such as parabolic concentrator/Sterling motor combination and would like to pursue them further in Phase II. We have a unique situation in that we could use the mechanical motion of the Sterling motor directly without conversion to electrical energy avoiding the losses that entails.

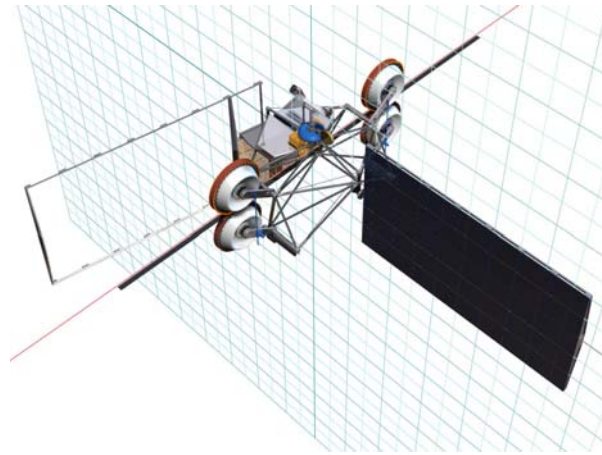

Figure 14. Solar Arrays and Climber Structure

The ideal climber would operate on the tramway as well as in space but the mild gravity field near the lunar surface comes into play. On the vertical portion of the ribbon, with no gravity, the vehicle center of gravity needs to be at the center of the ribbon. Near the surface, a c.g. below the ribbon will keep the vehicle upright. What's more when a load is suspended from the climber its c.g. changes. To deal with these variables the wheels are mounted on arms that allow them to be positioned vertically over a range of a meter. The ribbon moves with them. Figure 12 shows an empty climber on the tramway. The wheels are in the highest position and the c.g. is below the ribbon. Figure 15 shows two front views with a payload below the vehicle. The wheels are fully down to align the c.g. of the combined vehicle/payload with the ribbon. The components of the vehicle are distributed so as to create a clear zone in the center that can accommodate tramway ribbon supports (the "L" shape shown in red on the right side) and the vertical range of ribbon placement while clearing the payload and structure. Without a payload the wheels would be raised and the red support would be much higher.

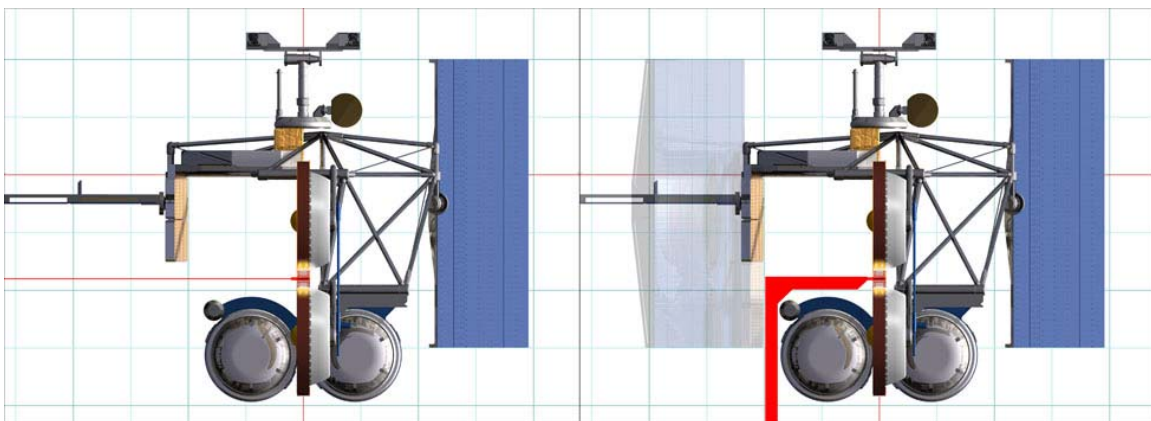

Figure 15. Structural Arrangement for Controlling Center of Gravity

The view on the left shows the situation that arises when multiple ribbons come together in space. The resulting “X” shaped connections require clearance to the side as well. The battery pack has been shortened and the solar array is turned sideways as the vehicle passes over one of the ribbon junctions. A much longer battery pack can be used with a single ribbon and the solar panel is never in conflict. That condition is shown with a ghosted underlay on the right and in most of the other illustrations.

Figure 16 shows a detail of how the large tires spread the load on the ribbon, reducing the added stress due to the climbing and improving traction. The deformable tires are supported by curved springs that distribute the force and accommodate variations in ribbon thickness when the vehicle passes over a patch or a support tower. The inset in the upper right corner of Figure 13 shows a “Tweel”, a non-pneumatic experimental tire/wheel from Michelin that demonstrates the principle. The deformable tire approach allows steering by tilting the wheel relative to the ribbon which reduces the rolling radius on one side of the tire. The actuator shown in blue would regulate the pinching force between the tires or spread them apart if a climber needs to be removed from the ribbon. An orange flange is shown on one of the wheels that could trap the ribbon like the flanges on a railroad truck. However, the ribbon would have to be stiff enough to accept pressure on its edges. Alternately, the rings could also serve as a sensor that corrects steering if it detects ribbon contact. A system that minimizes contact with the ribbon is preferred. We have incorporated a binocular camera system borrowed from the Mars rovers that could sight down the ribbon, tracking lateral alignment relative to the wheels and detecting approaching supports, damaged sections or a stalled climber. We anticipate a semi-autonomous system with the computer handing over to a human when it detects a problem.

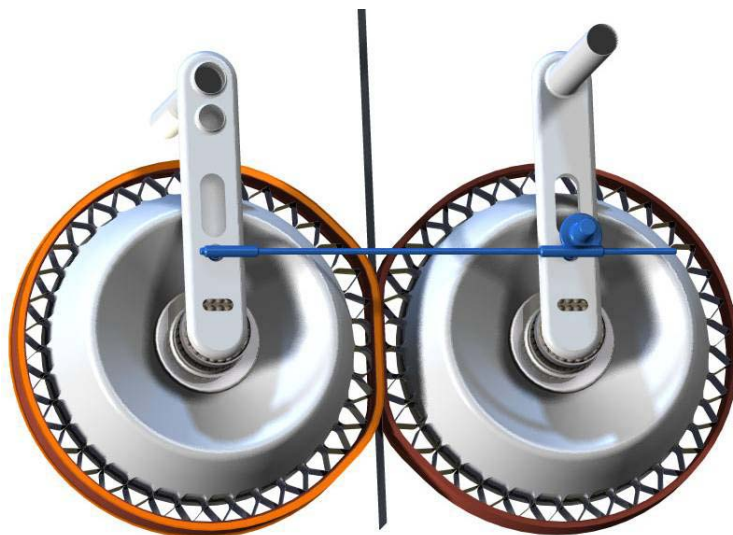

Figure 16. Detail of Tires and Ribbon Interface

A space-frame chassis design is illustrated. The various tubes could be carbon fiber and a system devised to disconnect them at the joints. The wheel assemblies are identical at both ends and the solar panels are interchangeable. This approach provides

maximum flexibility. The climbers can be delivered in pieces and assembled, plus parts can be salvaged as components fail. Presumably, the climber could run on only one of the four motors in an emergency.

This design attempts to demonstrate a credible solution with an emphasis on simplicity and non-exotic mechanical solutions. In Phase II we can consider a greater range of possibilities. Perhaps the most exotic might be a climber that uses only one side of the ribbon, clinging to the surface by exploiting van der Waals molecular forces. In theory a force of 100 kN/m^2 could be achieved this way. Another area that needs thought concerns lunar dust. We might need to devise an electrostatic device to repel it from the ribbon or it might be immaterial.

Orbit Transfer Vehicles

Orbit transfer vehicles will be required to carry the lunar payloads from the upper elevator to Earth orbit, and to carry Moon-bound payloads back from Earth orbit. The climber vehicles can provide the power from their solar arrays, and a high-Isp propulsion system can be mated with the climber to provide the delta-V to reach Earth orbit. This propulsion system may just shuttle between Earth orbit and L1, while the climbers move over the entire course, from polar mines or equatorial bases to LEO and back.

Tramway Construction Vehicles

Since the climbers can adjust for horizontal or vertical ribbons, they can move the entire length of the ribbon, from L1 to the pole. Being solar powered, they will face the same problem of being in the shade for about half of each month. However, the horizontal motion along the tramway will require far less power than the lifting portion of the trip up the vertical ribbon, so it may be possible to fit them with batteries to store energy. It may also be possible to provide a conductor on the tramway to provide power to the vehicles.

During the tramway construction phase, a robotic vehicle will be required for erecting the support towers and stringing the ribbon between them. In this phase, ribbon is carried overland by a lunar rover, which also doubles as a tower-building system. Using construction materials from the lunar surface factory, the vehicle would build the towers from the bottom up, and raise them vertically, without the need for erecting them by rotating them from horizontal to vertical. As each new structural part is inserted in the bottom of the tower, the top rises until it reaches the required height. As we mentioned, a total of about 30 towers would be sufficient to reach from the equator to the pole.

Key Technology Challenges

To build the lunar space elevator and to operate it successfully will require that we identify and address some key enabling technologies. One key technology is the application of advanced composites with better strength/density values, and the potential use of lunar materials. A second technology is the use of robotic construction on the lunar surface, preferably using indigenous materials, to reduce the cost of construction. A third is mastering the dynamics and control of the lunar space elevator structure itself. Finally, to make the system cost effective, the operation of the LSE and its components must be autonomous, to minimize the requirements for human operation or intervention.

Lunar and Advanced Materials

The strength to density ratio of the elevator ribbon is the primary parameter in the elevator design, with a high value critical for making the system cost effective. Currently, materials such as M5 and Spectra have the highest strength to density ratio, but a lunar elevator made from these materials, while technically possible, would not be cost effective. An advanced version of M5 was selected in Phase I as the baseline material. However, carbon nanotube based materials have the potential to dramatically improve the performance of the LSE. We expect to see great progress in developing higher strength composites in the next decade, because their use would revolutionize many aspects of military and space operations, enabling lighter air vehicles and perhaps even single-stage-to-orbit launch vehicles. The progress in this field will be monitored under this task, as well as any new high strength materials.

There has been some examination of the use of lunar materials to make composites, and we expect that in the next 5-10 years there will be additional advances made, as soon as the new robotic lunar explorers start their operations around 2008. The observations of these vehicles, coupled with ground experiments on artificial lunar soil and the Apollo samples, may lead to credible ways to mine and fabricate spun lunar basalt for the lunar space elevator ribbon. This would greatly reduce the cost of launching additional ribbon material from the Earth.

Robotic Construction Using Lunar Resources

There will be many operations on the lunar surface necessary to build and operate the lunar space elevator. There will be mining operations near the pole for lunar ices and at different locations along the tramway for exploiting mineral deposits. It will be necessary to provide power plants, perhaps with large solar arrays on mountain peaks near the pole. And the construction of the tramway, with its tens of support towers, will require an extensive operation on the lunar surface. All of these operations will be vastly improved, and reduced in cost, by the use of robotic vehicles, and the use of as much indigenous lunar materials as possible.

Cost efficient development of this large infrastructure will need a high degree of robotic or telerobotic (some remote human control) operation for low-cost construction. Advances in telerobotic capabilities (with a large time delay) have been demonstrated by the Spirit and Sojourner Mars rovers. Telerobotic operations on the lunar surface should

be much easier than Mars, with constant visibility from Earth and time delays of only seconds.

With successful robotic and telerobotic operation, the remaining key to the construction process is the use lunar resources. The overwhelming example of lunar resource use will be in the expected water ice near the lunar poles. Using this resource will not only provide life support to the manned bases on the moon, but will also become probably the most important lunar export to Earth orbit for propellant depots for space vehicles leaving Earth orbit. The use of lunar materials for construction of the equator-to-pole tramway support towers will also be of great importance in reducing the overall cost of lunar space elevator system development.

Dynamics and Control

The lunar space elevator will be the longest structure ever built in orbit. It will even exceed the length expected for the Earth space elevator. There are several dynamics issues that need to be addressed in building such an extremely long structure. Because of its great length, the LSE will have very low frequencies of lateral vibration; higher modes will have higher frequencies, but all the modes will probably have low natural damping, and therefore be prone to forced excitations. There will be forced oscillations induced by the libration and orbit eccentricity of the Moon; traveling waves induced by the motion and release of the climbers; and even oscillations induced by the gravitational effects of the sun. The natural frequencies and mode shapes of these vibration modes must be analyzed and understood, as well as the dynamics of the capture and release of payloads traveling between the LSE and Earth orbit.

The solutions to these dynamics problems will likely require the use of active control. The natural damping of the space elevator ribbon can be augmented by active damping introduced at the way stations, at L1, and on the lunar surface to absorb traveling waves. It may also be possible to modulate the speed or acceleration of the climbers to provide active damping suppression. Whatever solution or solutions are selected, they will be necessary for the successful and safe operation of the lunar space elevator.

Autonomous Operations

The ideal for the lunar space elevator is to have every aspect of operations, from mining, refining, power production, tramway vehicles, climbers, and catch and release of payloads, completely autonomous, with very little human intervention. Maximum autonomy is a requirement for cost effective operation many proposed systems to be deployed in space in the decades to come, in addition to the LSE. The elevator must be able to operate effectively with no onsite human presence, of course, but it may be cost effective to have supervisory control by humans on Earth, given that the maximum time delay for teleoperations will be about 2.5 seconds. To repair micrometeoroid damage, including actual cuts, autonomous or teleoperated repair capability will be needed. Lunar surface operations will probably require minimal onsite human intervention.

The key enabling technologies of advanced materials, robotic construction with lunar materials, control of the dynamics, and autonomous operations, will all be addressed in our Phase II program; these key technologies appear to be difficult, but certainly not intractable. Overcoming these potential obstacles can help ensure the success of the lunar space elevator program.

Operations, Economics, and Payoffs

Operational Concept

The lunar space elevator operational concept is to carry material from the lunar equator and the poles to Earth orbit and from Earth orbit to the Moon. This allows lunar-derived construction materials and propellants to be delivered into Earth orbit, and allows Earth-launched supplies and equipment to be delivered to lunar bases and installations.

The lunar space elevator will function like a “highway” between Earth orbit, L1, and points on the lunar surface. Materials from the lunar highlands and from the maria will be used as raw materials in producing building materials, shielding, and a variety of structural shapes that can be launched via lunar space elevator to HEO, GEO, and LEO. Payloads to different orbits can be launched by simply choosing the point on the LSE for their release. The resulting orbit is highly elliptical, with perigee at the desired altitude, and apogee near the end of the lunar space elevator. These orbits can then be circularized by low-thrust, high-efficiency propulsion systems. The chart of Figure 17 shows the Earth-orbit perigee attained by release from different heights on the LSE. Releasing from high up on the lunar space elevator allows the payloads to reach perigees in LEO. Payloads in LEO can be lifted by low-thrust propulsion to rendezvous and dock with the LSE, and then travel down the elevator ribbon to the surface.

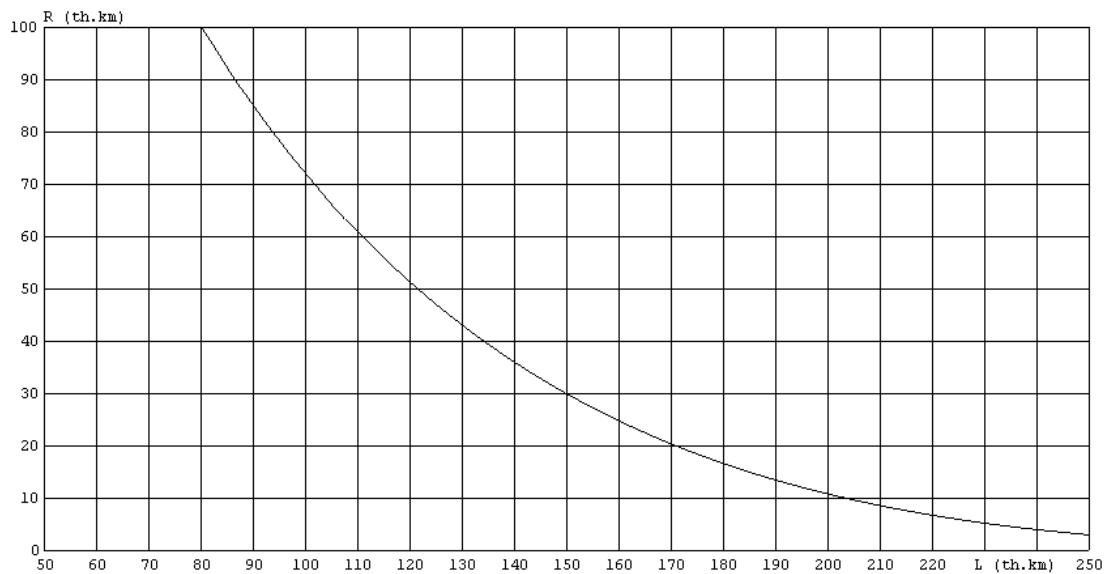

Figure 17. Perigee Radius vs. Height of Payload Release on LSE

$$R_p = R_a^4 / (2 R_o^3 - R_a^3)$$

$$R_a = R_o - L, \quad R_o = \text{Moon's orbit radius}$$

Payload Flows

Lunar materials shipped to Earth orbit will consist of a variety of lunar resources:

- Lunar regolith to HEO for shielding and general construction
- Lunar plagioclase, feldspar, anorthite, etc., for Earth-orbit construction
- Lunar water, oxygen, aluminum, and sulfur to LEO for propellant depots
- Lunar water from the poles to lunar bases for life support

Earth payloads shipped to the LSE and the lunar surface will include potential counterweight masses for LSE construction, return of lunar climber solar arrays to the surface for re-use, and Earth-launched materials bound for the Moon. Note that the LSE is like a pipeline, with large but slow throughput, so it will not carry human cargo. However, the LSE could carry a large quantity of materials and supplies to complement the human passengers who will move by faster chemical rockets to and from the Moon. The result will be a large reduction in the cost of moving payloads from LEO to the Moon, and the availability of lunar materials at a reasonable cost in Earth orbit.

To carry this large tonnage, we could use a fleet of 50 tugs, using ion rockets or electrodynamic thrusters, to take the Earth supplies from LEO to the LSE and bring the lunar products back to LEO. Each tug would consume about 10-20 kW of solar power, produce 0.5-1 N of thrust, and transfer 500-kg payloads in about 2 months. Each tug could move 1.5-2.5 tons per year, and 50 tugs could move 75-125 tons per year, or a million kg per decade.

To support the tugs, we would need to launch 10 tons each month to LEO, of which 10% is fuel for the tugs. The tugs will be departing daily; for the first few years, they will be carrying only LSE parts, but later some of them could deliver lunar fuel to other spacecraft. The tugs could be scaled to the most efficient size and power, which might be as high as 300 kW in some scenarios.

LSE Cost Analysis

The performance of the lunar space elevator depends on the carrying capacity of the ribbon material, which is a function of the available material strength and the total mass of the ribbon. The cost of the lunar space elevator depends on Earth-orbit launch costs, orbital transfer to lunar trajectories, and the cost of developing and operating the system.

Launcher cost projections

A simple spreadsheet cost model for the lunar space elevator was developed, using a strategy from Nock¹⁷ et al. in their work on Moon-Mars transport economics. Launch mass to LEO is used as the standard parameter for costing. Rather than attempting to project launch costs to LEO well into the future, we use three values, low (\$0.3M/t), medium (\$1M/t), and high (\$3M/t), to convert launch mass to cost. The high end of this range is based on the published cost and performance of the Falcon V launch vehicle, currently under development by SpaceX (www.spacex.com), and scheduled for launch during the second quarter of 2006. The current estimated cost is \$15.9M plus range fees, and the payload to a Cape Canaveral inclination, 200 km altitude circular orbit is

6020 kg, which gives a cost per tonne of \$2.64M. Allowing a modest amount for range fees, we round this up to \$3M/t. Taking this cost as the upper end of the range seems reasonable, but actual demonstration of flights at these rates is needed. Note this is a big reduction from the \$10M/t of current launchers, which was the value used by Nock. Given the published goal of SpaceX founder Elon Musk to develop even lower cost vehicles, assuming the midrange of \$1M/t to LEO is probably a conservative cost for the time frame of the LSE. The low end is consistent with the ambitious goals of various paper studies of advanced launchers, but is not out of line looking two or three decades in the future.

Orbital Transport

A magnetoplasmadynamic (MPD) thruster system currently being developed at JPL¹⁸ is assumed for the LEO-to-L1 leg. The assumed Isp was 4000 s, with an efficiency of about 82% and a thrust of 12.5 newtons. A total mass/power ratio of 10 kg/kW was assumed for sizing the inert mass of the system. The payload and inert mass were sized at 20 and 2 t, respectively, and performance computed with these numbers. Round trip transit time, returning empty to LEO, is about 6 months.

Two additional components must be added: The mass required on the lunar surface, and the transport needed to go from L1 to the lunar surface. It is somewhat less costly, in terms of total mass in LEO, to use high Isp electric propulsion to low lunar orbit, then switch to a chemical rocket needed for a soft landing. However, for simplicity, we chose to use oxygen/hydrogen chemical rockets for the entire trip. An Isp of 465 s was assumed for an RL-10 class engine. Also, return trip propellant was assumed to be available on the lunar surface, where it would be derived from polar ice. Larger or smaller use of lunar derived propellants could change the mass required for this leg by significant amounts, but lunar propellants would only have a major impact overall if they are available in LEO for the transport to L1.

The Delta-V's used are based on Earth to escape and Moon to escape, and are therefore a bit conservative. Actual systems would have losses not accounted for which would balance out these assumptions.

The orbit transfer delta-V's assumed were:

LEO to L1 high thrust: 3350 m/s

LEO to L1 low thrust: 7800 m/s

L1 to lunar surface: 2640 m/s (includes some margin for soft landing)

Elevator Mass and Transport Cost

The current mass estimate for the lunar elevator, with an added 10% margin, is just over 6100 t, plus an additional 100 t on the lunar surface. Adding in the xenon propellant for the cargo transport, plus oxygen-hydrogen chemical propellant for the lunar surface transport, gives a total LEO mass of 8000 t. Multiplying by the assumed range of transport costs gives a total cost for launch of 2.4 B\$ at the low end, to 24 B\$ at the high end.

Development Cost

With the original assumptions of a higher range of launch costs, we felt development costs could be ignored relative to launch cost. With the lower range used here, this is no longer the case, and it is likely that development costs will be dominant at the lower end of launch cost. On the other hand, a mature industry for carbon nanotube products, sustained by the much larger terrestrial and traditional aerospace markets, could pay for all development of the main component of the system, the elevator ribbon. As a rough estimate, we would put the development cost range at \$1-10 B, or roughly comparable to the launch cost range. This number is completely dependent on the system details and the technology available decades in the future, and must therefore be regarded as very rough.

No discounted economics were used, for a couple of reasons. The revenue stream being discounted is not well defined, and the LSE will probably be part of a larger government funded program not driven by standard cost accounting.

Lunar Space Elevator Payoffs

Potential Impact on Long Term NASA Plans

NASA is currently undergoing a major transformation, explicitly due to the radical change in the stated goals of the agency put forward by President Bush early in 2004. Follow-on documents, including the Aldridge Report¹⁹ in 2004 and the NASA FY 2006 Budget Request and the companion report "The New Age of Exploration" (both available on the NASA website) give a broad view of the goals of this "Moon-Mars Initiative," possible timelines, and major developments needed to bring about the goals. The goal is to send humans back to the Moon no later than 2020, followed by human exploration of Mars sometime afterwards. Along the way, key supporting technologies will be deployed. Specifically cited is the use of in situ space resources, such as the probable lunar polar ice deposits.

The LSE fits into this new vision from several standpoints. First, it can serve as a focal point for the development and deployment of advanced autonomous systems, but close enough to Earth to allow monitoring and some near real time control. Second, it can serve the infrastructure needs of the lunar base activity, currently planned as a precursor for the Mars missions, by moving cargo down to the surface and water for propellant up to L1. If the lunar activities grow to include more ambitious plans for radio or optical telescopes, the savings from the LSE is even higher. Third, the clearest quantitative benefit comes from serving the large demand for propellant inherent in recurring human missions to Mars, and related unmanned activities on Mars and beyond. Once the mass flow leaving LEO reaches this level, the benefits of having oxygen and hydrogen available in quantity in LEO and high Earth orbit are clear.

Finally, there is a new underlying sense in the new vision that one fundamental purpose of the space program is to inspire, as well as create the needed infrastructure for a bold exploration program. The LSE could do more than just lower the cost for achieving this vision—it could be a visible inspiration to all the people of Earth, whenever the Moon is in the sky, of the new realm of humanity.

Building the Lunar Space Elevator

Steps in Construction

These are the basic steps required for development of the LSE infrastructure.

1. Launch ribbon to LEO, and then to L1, with large launch vehicles and ion rockets
2. Maintaining balance about L1, extend ribbon upward and down to the lunar surface
3. Launch mining equipment to pole
4. Launch mining equipment, tower builders, factory, and climbers to lunar equator
5. Construct 2-way catenary from equator to pole with tower builder
6. Test complete operation

Using Lunar Resources

As part of the development of the concept of the lunar space elevator, we looked at the requirements for construction on the lunar surface, the possibility of using lunar resources for construction, and the methods that could be used to build the system. It appears that the major lunar product will be the building materials and raw materials that are widely available in the lunar regolith. The one key mineral resource that is localized is the water ice expected in craters near the poles. The other natural resource is the nearly continuous sunlight available at mountain peaks very near the poles. Thus our focus was on mining and refining the lunar regolith to produce blocks and wires, and potentially fibers for reinforcing the space elevator itself, and strengthening it for carrying larger loads.

One potential lunar resource is solar power. There are two ways to enjoy essentially continuous sunlight in cislunar space. The first is using stabilized spacecraft or elevator stations at L1 and L2. The L1 sunlight will be invaluable in the initial space elevator construction. The initial construction phase will begin with a vehicle launched from Earth to L1, and maintained in position near the balance point with thrusters. The vehicle could easily have 100 kW of power from thin-film solar arrays, and have power continuously, except during eclipses. Even those could be eliminated by using a controlled halo orbit about L1 that would take only a small thrust to maintain, using Hall thrusters powered by the solar arrays.

The second way to achieve nearly continuous sunlight is on mountain peaks at the poles. Substantial work has been done on the topography of the lunar polar regions, following the success of Clementine and Lunar Prospector. The sun as seen from the Moon librates 1.5 degrees in elevation, making "winter" the worst time of the year for illumination.

The paper by Bussey, Spudis and Robinson²⁰ summarizes their work on well-lit locations as well as permanently dark locations at the lunar south pole. They found that the pole itself, located on the rim of the crater Shackleton, was the best location in the south, receiving 80% sunlight in winter. A second location 10 km away receives about 73% illumination, and together the two sites receive 98% illumination (presumably in winter).

Since topographic databases²¹ now exist for the polar regions, it should be possible to review these findings, extend them to the north polar area, and do the calculation of how high a tower would need to be to receive a certain increase in sunlight, or conversely, how fast and far a mobile solar array would need to go to stay in sunlight most or all of

the time. Online radar pictures of the south polar area are available²², and a Clementine mosaic is also available²³. Clementine data for hydrogen (water) is shown in Figure 18.

From expected ices in deep craters near the lunar poles, water ice, frozen carbon dioxide, and perhaps ammonia ices will be available to provide the complete complement of organic elements to add to the inorganic aluminum, titanium, magnesium, and oxygen from the maria and the highlands. We have developed scenarios in which the LSE connects these various nodes for a most efficient transportation system.

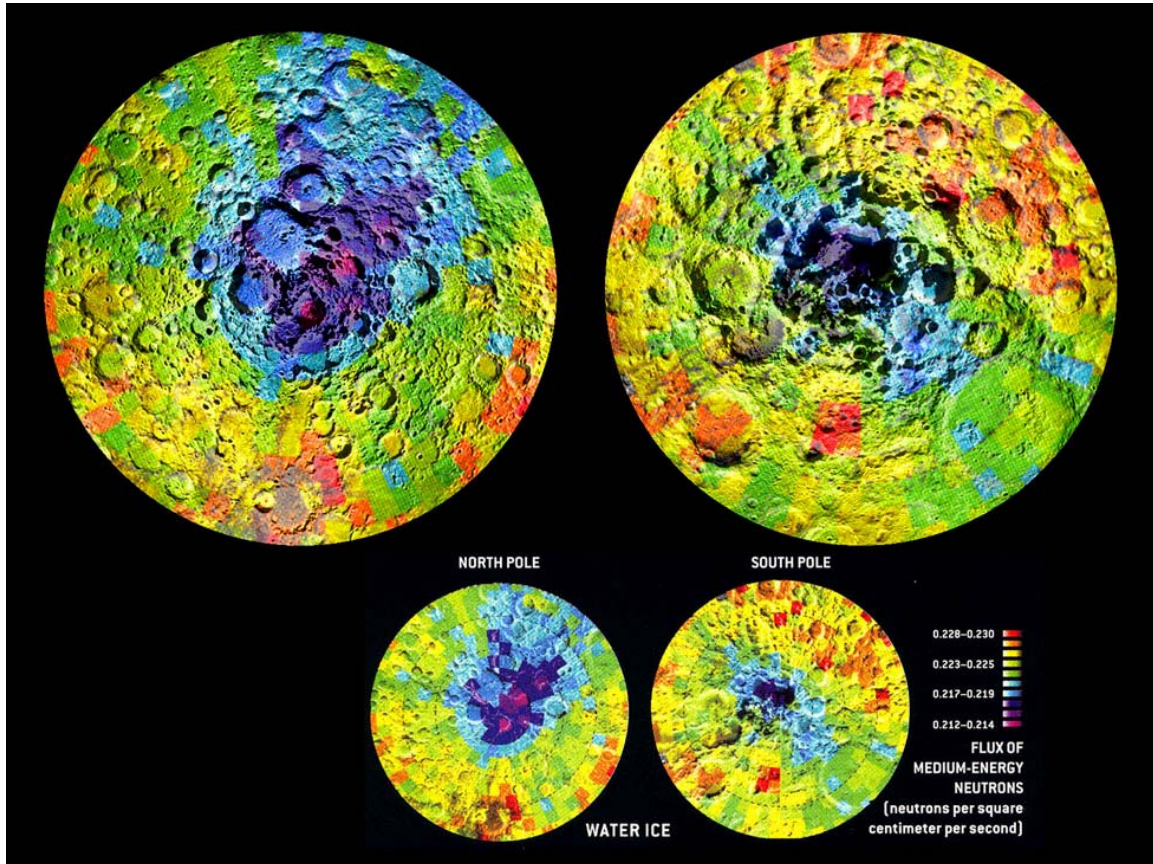

Figure 18. Clementine Mosaic of Lunar Polar Hydrogen

Launching Lunar Materials

Since the counterweight is so much of the mass, a first step is to get the counterweight into position at L1, and keep it there by ion rocket or other high-Isp thruster until the initial strand touches down to stabilize it. Since Earth launching is the major portion of the cost of getting material into L1, perhaps we can use the orbital debris already in orbit, shepherd it with ED thrusters, and carry it with ion rockets to L1 for the counterweight. Or we could use the external tanks of the proposed Shuttle-C for ballast, outfit them with ion rockets like the SMART-1, and ferry them to L1. One promising technique is to use a rotating tether to launch lunar materials to rendezvous with the lunar space elevator. Finally, we may retrieve an asteroid from a near-Earth's-orbit

location, and capture it into L1 for the counterweight. That may be the final CW, while the initial counterweight could be composed of space debris, external tanks, or lunar materials.

Kirk Sorensen of NASA MSFC also suggested that we could build the counterweight from lunar materials by having a mass driver on the Moon or a rotating tether on a tower to throw materials to L1. A 1990 paper by Bob Zubrin discusses the concept, in the context of launching LOX tanks into lunar orbit, for use by lunar landers from Earth for the delta-V for the lunar landing and takeoff. They could refuel both going to the Moon and returning, reducing their required mass and increasing their payload.

Eugene Levin analyzed the use of a lunar sling for launching materials into lunar orbit for use by the lunar space elevator.

Material Forming and Fabrication

Blocks and Wires

We developed structural concepts that would route tension forces from all three Cartesian axes through the same block, but systems of interlocking blocks could handle tensions in the X, Y, and Z directions independently. Both approaches have yielded systems that seem to solve the problem. They are all interlocked mechanically and have the potential of being made entirely from lunar materials. The concepts are based on research by Wykes²⁴.

XYZ Geometry

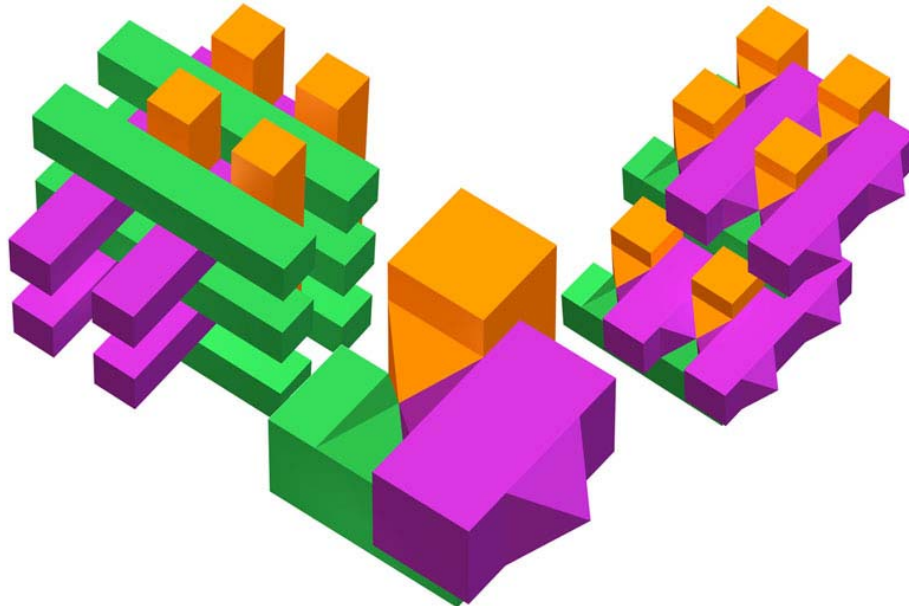

Figure 19. Structural Concept to Route Tension Forces

The image at the left in Figure 19 shows an array of colored columns in which green represents the X direction, violet represents Y and orange represents Z. This composition may be repeated indefinitely but it creates cube shaped voids in the structure. These cube shaped voids have six faces, each on the surface of a different column. By attaching a pyramid shape to these surfaces the void is filled. A cube with a

pyramid on either end is called a pencil cube. This system modifies that shape by adding two half cubes to two of the sides. The resulting blocks can be connected in chains at these faces and completely fill the space.

Lunarcrete is widely accepted as a lunar construction material and would work for us as well. T. D. Lin has proposed a Dry-Mix/Steam-Injection procedure for casting concrete in space. We envision an automated system of molds like ice cube trays. Dry cement and aggregate would be exposed to 180° steam for 18 hours and finished parts would emerge with no additional curing required. Concrete created this way develops a compressive strength of 700 MPa, more than twice the performance achieved with conventional casting without the 28 day cure cycle. The creation of traditional solid concrete structures on the moon with this process would be a daunting challenge. The universal blocks we are proposing are a few centimeters long and an automated production factory might be delivered to the moon by a single spacecraft. This central factory on the lunar surface could distribute the universal blocks anywhere on the moon that an extensive tramway system could reach.

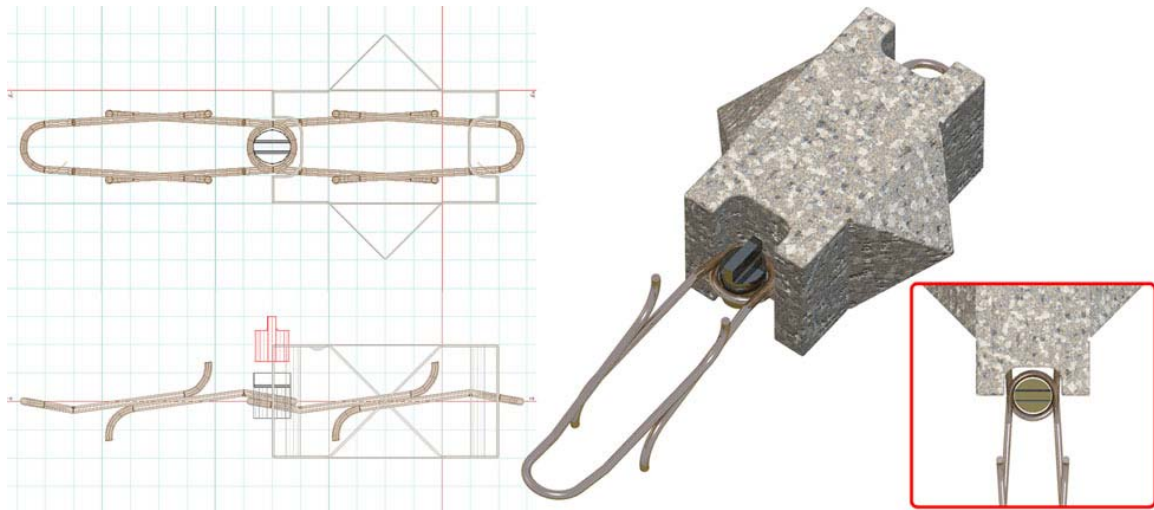

Figure 20. Lunarcrete Block with Wire Tension Insert

A Wire Tension Insert

Figure 20 shows two views of a Lunarcrete block with an insert molded-in. Concrete requires reinforcement if it is to be exposed to any substantial tensile loads. In this example two roughly U-shaped wires are welded where they intersect and configured so the projecting loops will overlap the loops of adjacent blocks. Molded into the concrete they create a system that allows the blocks to be joined into a continuous column.

This concept carries the tensile loads down the center of each block column. A quarter-turn key is proposed which can be placed between overlapping loops and rotated by a robotic arm. The space between the loops is wider than it is long so that an oblong key clears the wires when inserted but stretches and tensions the wires when rotated 90°.

The final design may have a slight concavity to keep the wires centered and it may need a wider head that contacts the block when twisted. A symmetrical version with a head on both sides would allow disassembly from either side. We can roll the shape into a wire then cut and cold-head the pieces. Alternately, they can be cast in an investment material or reusable ceramic mold. The wires and the key may be heat treated after forming if we need to get greater strength or toughness. Case hardening is also a possibility.

The wires in this example are .060" but could be considerably larger if required. This seems about right for mild steel. By welding two relatively imprecise pieces we can control the critical length to establish the desired pre-load on the assembled column. We will need to study potential structures to decide what this value should be, but if we assume a structure with an internal pressure of 15 psi and blocks with a 1" cross sectional area we would need to generate 60 pounds of force between blocks in each chain to keep them from separating under the load. Since this is 30 pounds/wire it seems like a reasonable number and there is no absolute requirement that the blocks stay in contact under all conditions. In fact, absolute precision of fit is not likely and we may need to keep the blocks slightly undersize. Compression loads will pass through the faces that do contact each other and the structure would shift slightly under load, which may be good. It would be a "self-designing structure." It may actually mimic the behavior of a metallic solid.

Figure 21 shows how multiple blocks would be wired together. Fasteners have been proposed that would facilitate attachment to the ends of each chain of blocks. The design in the center is created entirely from wire and might be produced at the site. Alternately, a thin titanium sheet can be formed into shapes which bridge two block columns and accept conventional fasteners. A design like this may be beyond the limits of lunar manufacturing but they are relatively light and can be stacked very compactly for shipment.



Figure 21. Wiring Multiple Blocks Together

Wire Element Forming and Welding

The wire used to reinforce the blocks could also be manufactured on the moon. The regolith found in many areas contains iron nodules that could be extracted with a magnet, melted, cast and drawn into wire. This wire is itself a universal building material that can be formed into countless other products. For instance, open lattice flooring or shelves could be produced on site. It can even be the principal material for a tensegrity tower to support the catenary tramway system. Examples can be seen below.

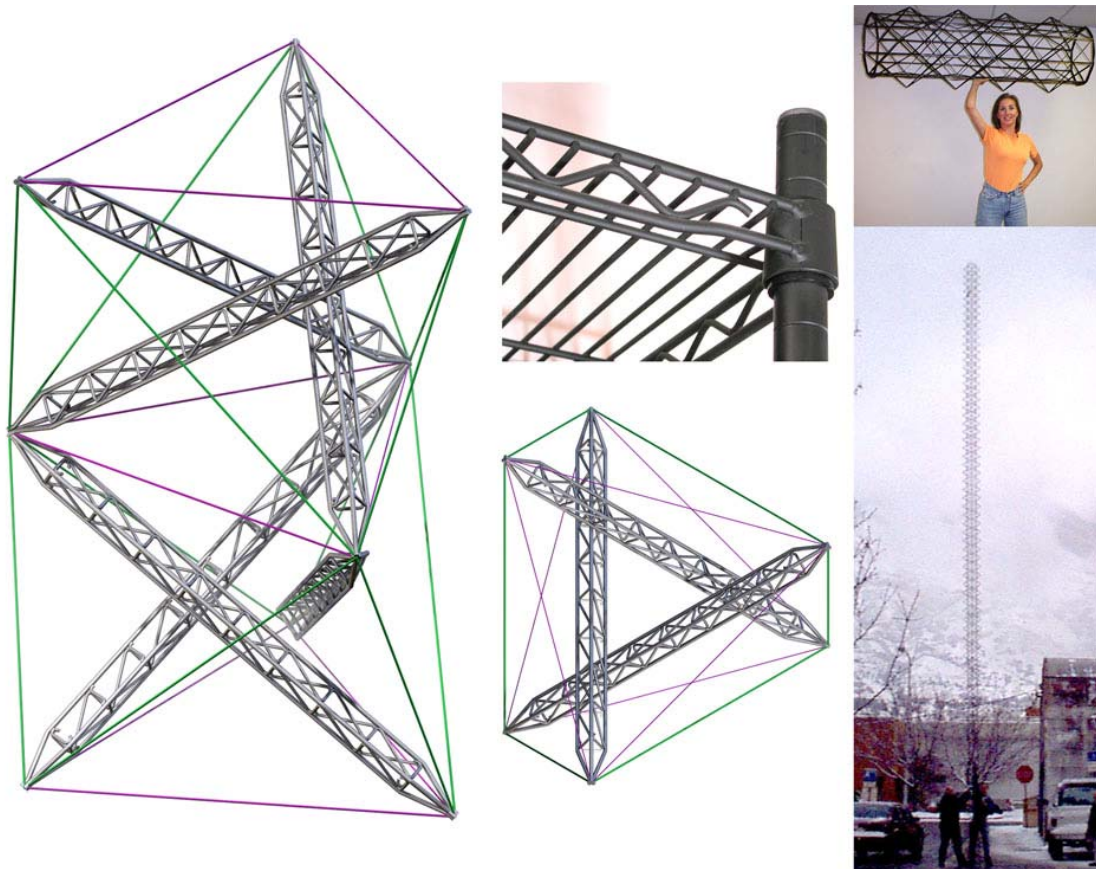

Figure 22. Lightweight Towers for Tramway Support

A basic tensegrity module is shown at the left and in plan view. When compressed, the rotations of the two sub-units are canceled. The compression members are formed from bent and welded wire in a manner similar to Metro shelving. A stack of these modules can become a compression member for an even larger tensegrity structure. This process resembles the replication that occurs in fractal geometry and can be repeated several times to create enormous structures from very little material. It is one way we could construct towers for the catenary tramway system that are a kilometer or more in height. The two photos at the right are of IsoTruss products that follow similar principles.

Construction Techniques

Since aluminum can be extracted from the lunar regolith in some areas, it might be the basis for a block system. One approach is a concept we call encapsulation. Aluminum

capsules are formed by impact extrusion like a soft drink can or by electro-deposition. They are filled with a mixture of regolith and aluminum particles, preheated to a temperature just below melting and compressed. The metal fuses and the result is a block with a metallic skin that should not require additional reinforcement. The process is illustrated in Figure 23.

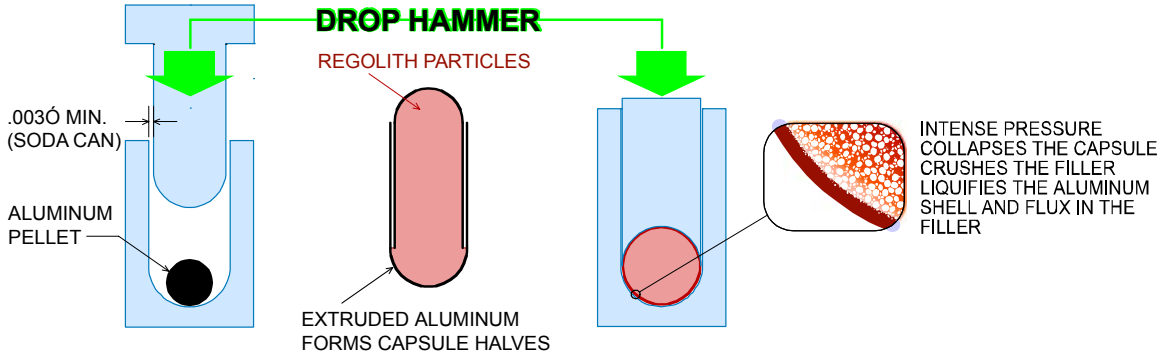

Figure 23. Encapsulating Lunar Regolith with Fused Aluminum

The Truncated Octahedron

A second block system is based on the truncated octahedron, one of several all-space filling solids. It is also symmetrical in the Cartesian planes. It lends itself to compression molding and might be formed by the encapsulation process. One interesting property is shown below. When the square faces of the blocks are joined a matrix is formed in which the spaces are identical to the blocks. A structure would have the option of being 50% open or solid. If it's solid it would actually consist of two independent systems of blocks that are interlocked but need not be attached.

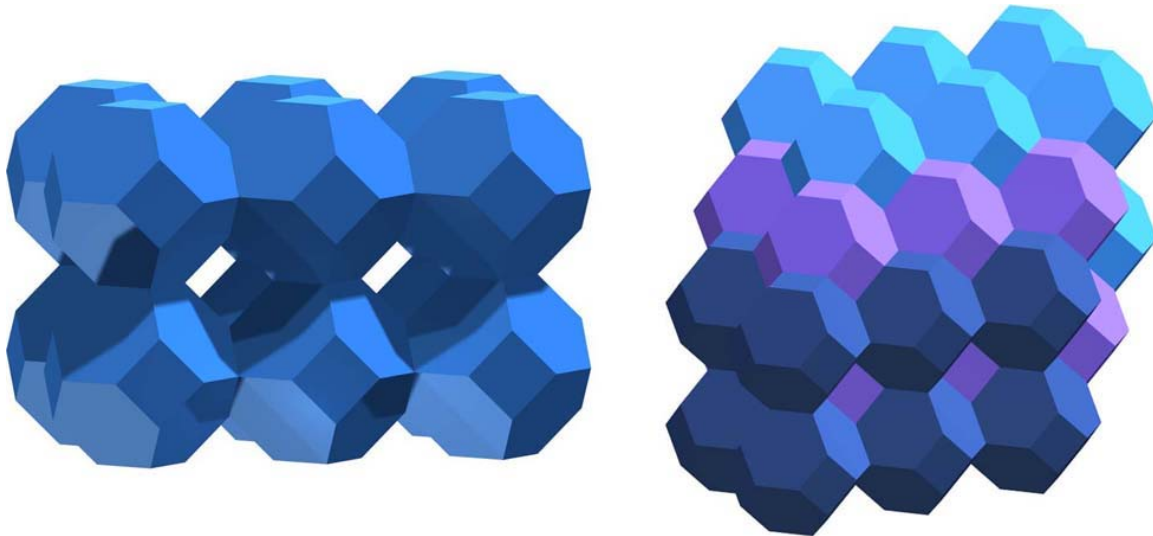

Figure 24. Truncated Octahedrons as Space-Filling Blocks

The blocks may be joined in a variety of ways. Small conical bumps in the center of each face could be fused by an electrical discharge (projection welding) or adhesives might be used. Acrylic adhesive systems that coat one surface with a resin and the other with a catalyst are found in industry and various other systems might be adapted

like the use of Ultraviolet light to trigger a catalyst. Mechanical fasteners could be employed. The formed blocks could be drilled and joined with various devices such as pop rivets. The system below uses an aluminum threaded insert which collapses and expands when the screw is tightened. A related design might allow the blocks to be disassembled and reused like the Lunarcrete approach discussed previously.

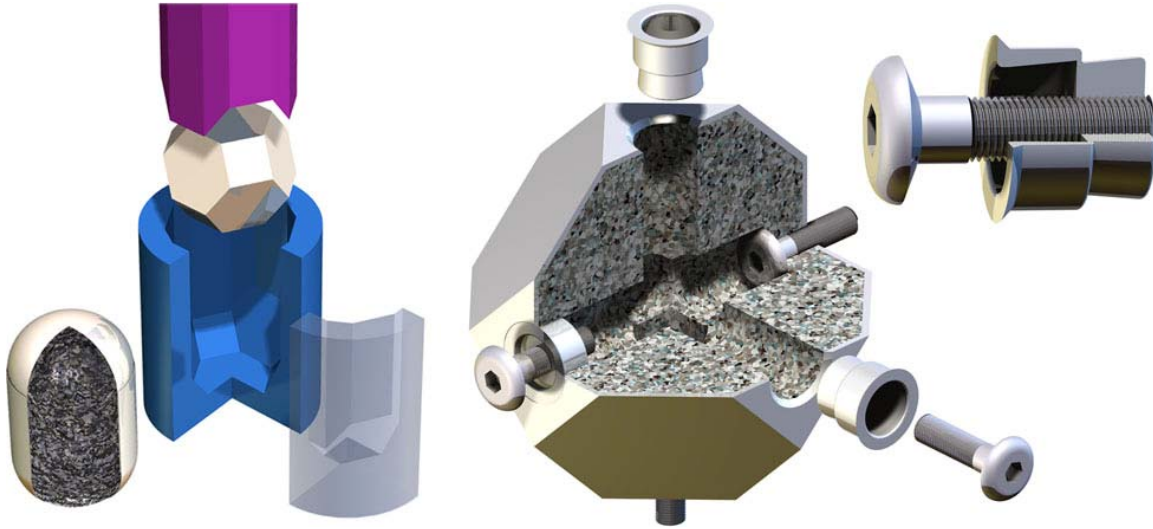

Figure 25. Blocks with Threaded Aluminum Inserts

Constructing Useful Structures

Figure 26 illustrates how either of the block systems could be employed to produce a basic habitat. To minimize the tension requirements imposed by internal air pressure we chose a series of spherical shapes. They could be constructed by a teleoperated or computer controlled arm on a central mast which is moved to the next location as each chamber is completed.

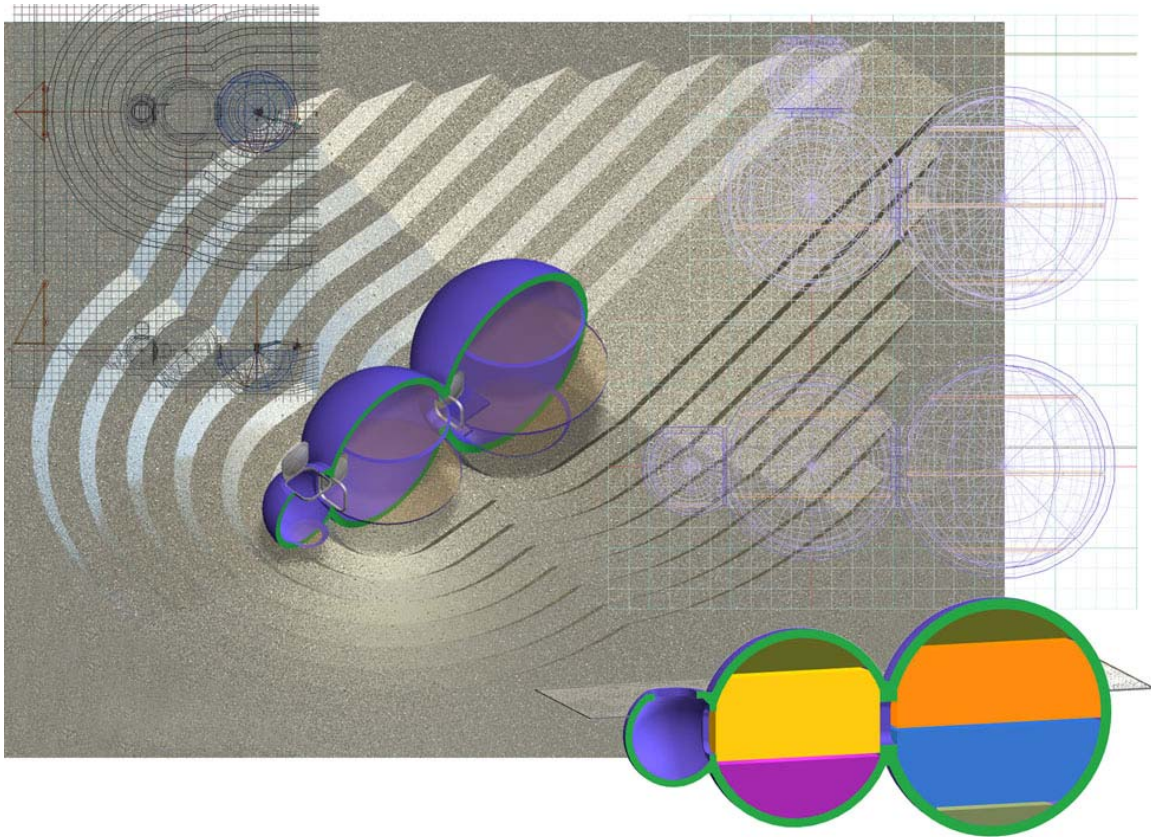

Figure 26. Habitat Constructed With Either of These Systems

Block construction would generally proceed in layers somewhat like stereolithography. New blocks can be added to existing structures and each new chamber in the example would be directly joined to the previous one. We will look at designs for additional elements that might create smooth surfaces and air-lock sealing flanges. Wire loops offer a way for an assembler robot to grip the surface and they give it a way to precisely locate itself, assuming it has a 3D map of the structure in its memory and has counted its moves from the last cardinal point. A dimple on the block could indicate to the robot on which end, and in which direction, to add a new block. If we can create autonomous assembler robots that crawl over the outside of a structure we can build without elaborate framing. We can take obsolete structures apart and recycle the parts. We can also modify existing structures, e.g., like adding a wing or a carport or a second story.

Although the blocks provide some degree of radiation protection long term habitation would require a meter or more of regolith as shielding and the easiest way to accomplish that is to bury the structure. Since we are producing the building materials from refined regolith we have shown an excavation that can be continued indefinitely and deepened to accommodate larger units. A robotic excavator would transport the raw material up the ramps to the processing plant and return finished blocks for assembly. Depleted regolith would be used to refill the trench. Since the LSE can transport large amounts of lunar materials into Space, blocks and wire are potential export items that could be utilized in Space construction at L1 or in LEO.

Towers, Vehicles, and Potential Lunar Material Ribbons

A review of the literature on lunar derived tether materials, mainly the late 1970's and early 1980's, shows that one group spun actual glass using an Apollo 12 basalt simulated composition, but did not report properties²⁵. It seems likely that some processing will be required to achieve an optimum lunar based fiber material, and there is literature discussing general chemical processing, including a sodium hydroxide basic and HF acid leach for separation of various components²⁶.

One interesting candidate is fused silica fibers. Produced in lab quantities, fused silica in vacuum has remarkable properties, but one major drawback. The mean tensile strength under vacuum and at room temperature reported in Kelly and MacMillan²⁷ is 9 GPa, with a density of 2.2, but a modulus of 73.5 GPa. This is an elongation of over 10% at failure, but corresponds to a characteristic height of 417 km with no de-rating. (Further strength increases occur at lower temperatures, but the modulus remains the same.) Making and using this material would be a challenge, but it has a high potential benefit.

It is not yet clear what the optimum amount of processing and desired product is, if any, in this context. However, the cost savings of being able to use lunar materials are obvious, and they are certainly candidates for the large counterweight mass.

Lin, a Portland cement expert, suggests hydrogen reduction of lunar ilmenite. He also suggests a steam process which produces a finished product in 18 hours. Most of the water associated with concrete production is needed because of the wet casting process and must be dried out of the finished product to achieve any strength. A relatively small percentage is the "water of hydration" and actually involved in the chemical reaction. Such schemes could be adapted to "sulfurcrete," sintered aluminum dust, etc., assuming that lunar water could be obtained from the ices near the poles.

Alternate Fibers Based On Lunar Materials

One method for reducing the overall cost of the lunar space elevator is to use *in situ* lunar materials to make fibers that are strong enough to reinforce the initial ribbon. This could greatly increase the carrying capacity of the LSE, and also greatly reduce the amount of material that must be lifted out of the Earth's gravity well.

Lunar aluminum, silicon, iron and titanium are abundant. Aluminum has a relatively low density, is relatively abundant and can be used to create high strength fibers. Its strongest form seems to be sapphire, which can be grown as long single crystals or whiskers. The processes involved might even benefit from the microgravity environment at L1. Perhaps we could grow continuous crystal strands that could go directly into the ribbon assembler. Sapphire whiskers are almost as strong as graphite whiskers, although they are more than twice as heavy.

Another material which compares favorably is quartz whisker. Silicon is plentiful and if we can generate whiskers in space they would be many times stronger than glass fibers made from the same element. Fibers in a metal matrix are also currently popular, and an application might be sapphire whiskers in glassy aluminum foil. Glass fibers with metal coatings might be used, since there is no water or oxygen problem.

Conclusions

Feasibility

The results of this phase I effort demonstrate that the lunar space elevator is feasible, and can be constructed of available materials to fit in the timeframe of the President's Moon-Mars initiative. The problems of materials transportation, environmental degradation, robotic construction, and system utilization have been addressed and found to be tractable.

Development

The development of the lunar space elevator system would require efforts and technology advances that are commensurate with current plans for return to the Moon, and for development of lunar installations.

Impact

The main output of the lunar space elevator system is a large supply of lunar material that can be used for construction of large space complexes in Earth orbit, such as large solar power satellites and shielded habitats. In addition, with the use of lunar polar ices, the lunar space elevator can provide large quantities of propellant in Earth orbit for use by manned vehicles bound for the Moon or Mars. The lunar space elevator also provides a low-cost means for transporting infrastructure components from Earth orbit to the lunar surface.

Phase II Plans

In Phase II, we will develop more detailed cost estimates of the lunar space elevator system, and will create a detailed development plan for this revolution in cis-lunar space development. We will look in more detail at the climber design, operations, and speed, with laboratory experiments, and will address the key enabling technologies.

E. M. LEVIN

LUNAR TETHER TRANSPORT

**Prepared for
STAR Technology and Research, Inc.**

March 8, 2005

CONTENTS

Nomenclature	2
1. Transfer Trajectories to the Lunar Elevator	3
2. Characteristics of Tether Configurations	6
3. Non-Equatorial Configurations	11
4. Fail-Safe Elevator	14
5. Transfer Trajectories to the Lunar Surface	15
6. Spinning Tethers for Launch and Capture	17
7. Conclusions	22
References	23

NOMENCLATURE

- E = longitudinal stiffness of the tether
 \mathbf{g} = gravitational acceleration
 L = tether length
 m_A = end-mass
 m_k = embedded masses
 p = focal parameter of the orbit
 \mathbf{r} = celenocentric radius-vector
 \mathbf{R} = geocentric radius-vector
 r_0 = radius of the Moon
 R_L = radius of the Moon's orbit
 s = arclength along the unstretched tether
 t = time
 T = tether tension
 v_1 = circular orbit velocity
 v_t = transverse wave velocity in the tether
 α = tether inclination to the local horizon
 γ = tether elongation
 μ = gravitational parameter of the Earth
 μ_L = gravitational parameter of the Moon
 ρ = tether mass per unit length
 $\boldsymbol{\tau}$ = unit vector along the tether line
 ω = angular velocity of the orbital motion of the Moon
 Ω = angular velocity of rotation about the attachment point
 $(\dot{})$ = differentiation with respect to time
 (\prime) = differentiation with respect to the arclength

1. TRANSFER TRAJECTORIES TO THE LUNAR ELEVATOR

The concept of the lunar space elevator was introduced by Pearson [1] and Tsander [2]. It takes advantage of the fact that the rotation of the Moon is gravitationally stabilized by the Earth and the Moon has a much weaker gravitational field compared to the Earth. This allows a long tether to be attached to the surface of the Moon and stretch beyond either of the Lagrangian libration points L_1 or L_2 .

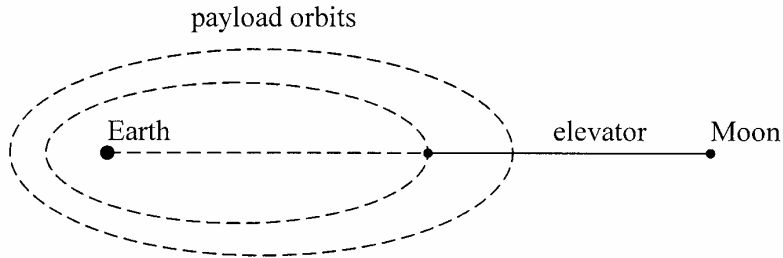

Fig. 1. The lunar space elevator.

A tether deployed in the direction of L_1 can greatly facilitate payload transfer between the Earth and the Moon. As suggested by Jerome Pearson, payloads from the Earth will arrive at one of the docking ports on the elevator, as shown in Fig. 1, and then move along the elevator to the surface of the Moon. Payloads from the Moon will move from the lunar surface to one of the docking ports along the elevator where they will be released into elliptic orbits.

To provide arrivals and departures with a very small relative velocity at the docking port, the payload must be at the apogee of its orbit moving with the orbital velocity equal to

$$V_a = \omega R_a, \quad \omega = \sqrt{\frac{\mu}{R_L^3}}, \quad (1)$$

where ω is the angular velocity of the orbital motion of the Moon, R_a is the radius of apogee, μ is the gravity constant of the Earth, and $R_L \approx 384,400$ km is the radius of the Moon's orbit. For simplicity, we assume here that the Moon is in a circular orbit and its mass is negligible compared to the mass of the Earth.

The focal parameter of the orbit is equal to

$$p = \frac{c^2}{\mu}, \quad c = R_a V_a = \omega R_a^2, \quad (2)$$

or

$$p = \frac{\omega^2 R_a^4}{\mu} = \frac{R_a^4}{R_L^3}. \quad (3)$$

On the other hand,

$$p = \frac{2R_p R_a}{R_p + R_a},$$

where R_p is the perigee radius, which gives us a simple formula

$$R_p = \frac{p R_a}{2R_a - p} = \frac{R_a^4}{2R_L^3 - R_a^3}. \quad (4)$$

Note that this formula does not account for the attraction of the Moon and can be applied only to distances that are significantly larger than the distance to the Lagrangian point L_1 .

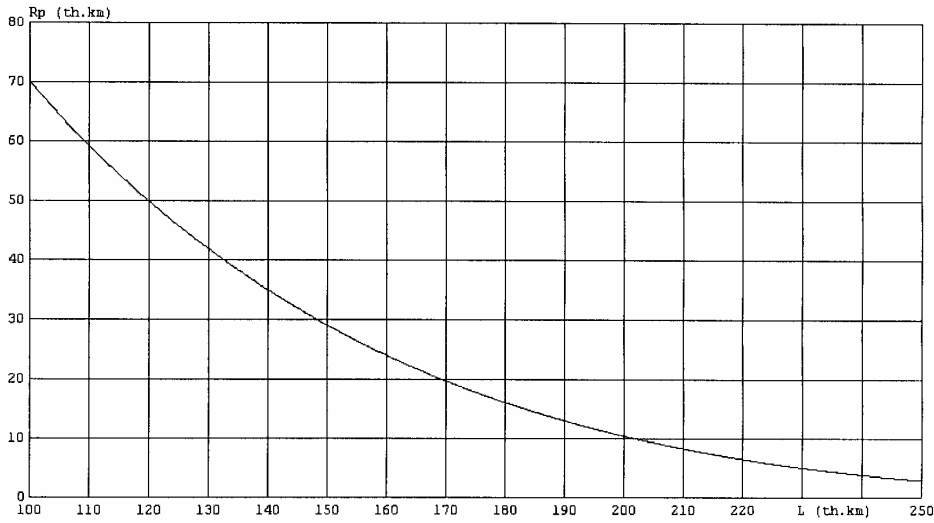

Fig. 2. The perigee radius of the rendezvous orbit as a function of the distance from the lunar surface.

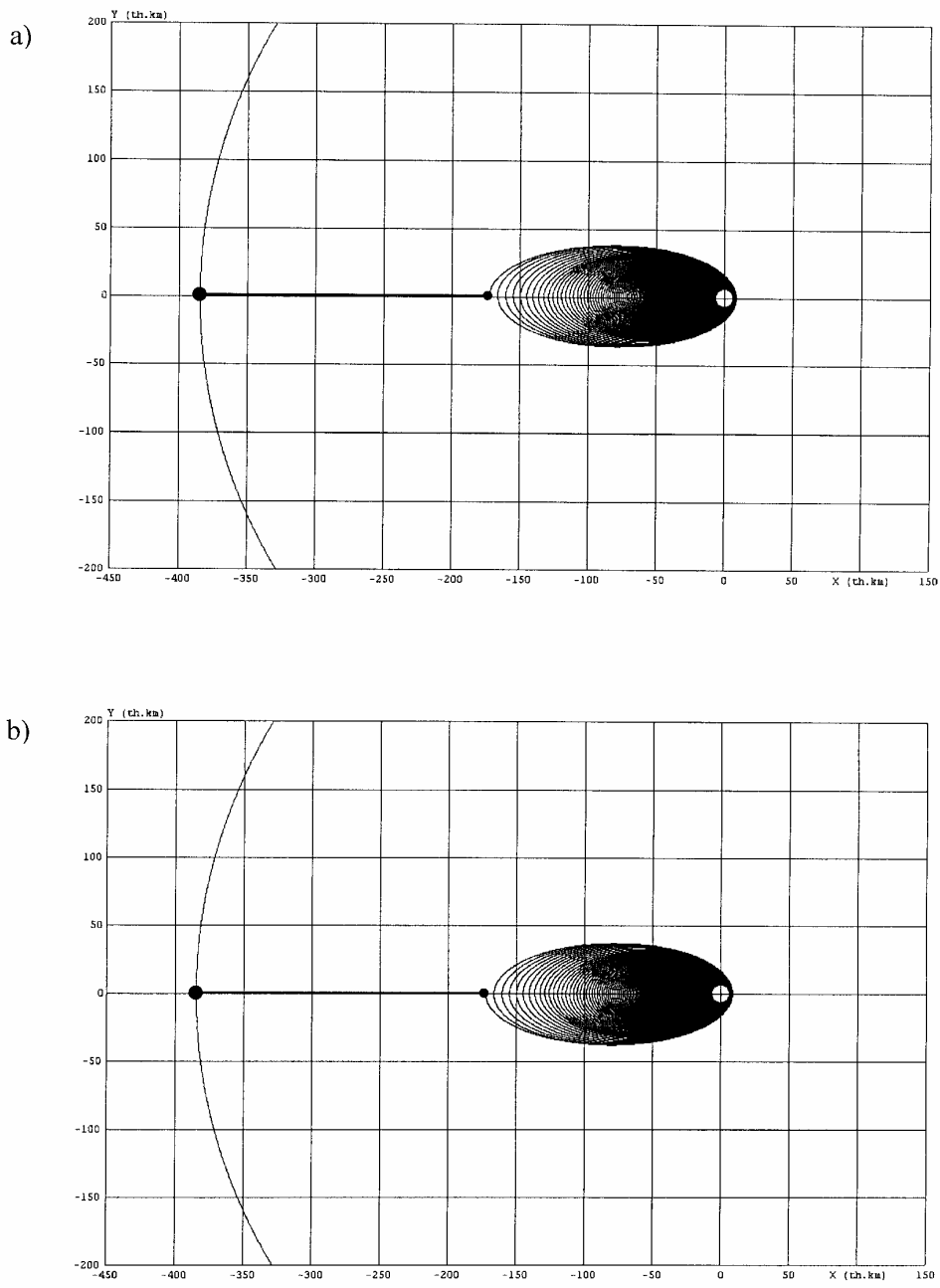

Fig. 3. Low thrust transfer trajectories between LEO and the lunar elevator.

Fig. 2 shows how the perigee radius of the rendezvous orbit depends on the distance from the lunar surface L , taking into account that $R_a = R_L - r_0 - L$, where $r_0 \approx 1737.4$ km is the radius of the Moon.

This chart helps us in selection of the optimal tether length. If the tether is longer than 215,000 km, then the perigee of the payloads released from its tip will be too low. On the other hand, if the tether is significantly shorter than 200,000 km, then the perigee will be too high and extra fuel will be required to deliver the payloads to LEO. We can therefore conclude that the optimal tether length is around 200,000 km.

Fig. 3 shows a typical low thrust transfer trajectory from LEO to the tip of a 210,000 km long tether (a) and a return trajectory (b). They require relatively small amounts of fuel. An ion engine with a specific impulse of 3000 sec will consume only 12-13% of the dry mass of the spacecraft for each transfer. The fuel consumption drops in a reverse proportion to the specific impulse. With a specific impulse of 5000 sec, it will be less than 8%. A typical transfer with a maximum acceleration of 2 mm/s^2 takes about 5-6 months.

2. CHARACTERISTICS OF TETHER CONFIGURATIONS

Generally, the lunar space elevator consists of a number of bodies, such as docking ports or service stations, connected with tethers. The bodies are modeled as point masses m_k and the end-mass m_A , as shown in Fig. 4. Point B is attached to the Moon surface.

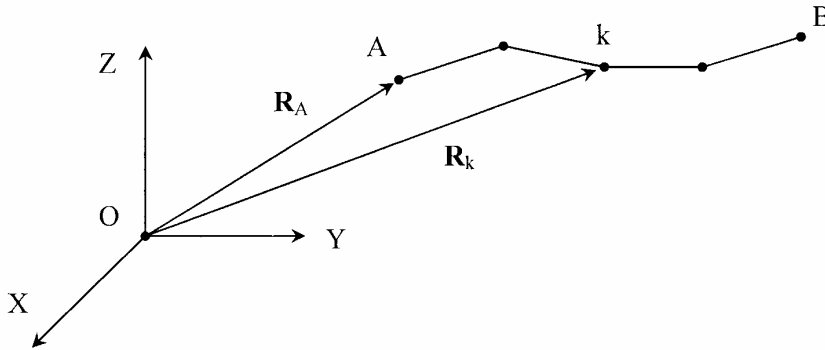

Fig. 4. Positions of the elements of the lunar elevator.

The motion of the tether with respect to an inertial frame of reference $OXYZ$ is described by the partial differential equation

$$\rho \ddot{\mathbf{R}} = \mathbf{T}' + \rho \mathbf{g} + \mathbf{F}, \quad (5)$$

where dots denote differentiation with respect to time t , primes denote differentiation with respect to the arclength s , ρ is the tether mass per unit length, \mathbf{g} is the gravity acceleration, \mathbf{F} are non-gravitational forces per unit tether length, and \mathbf{T} is the tether tension vector tangent to the tether line,

$$\mathbf{T} = \frac{T}{\gamma} \mathbf{R}', \quad \gamma = |\mathbf{R}'|. \quad (6)$$

The motion of the end mass and embedded masses is described by the ordinary differential equations

$$\begin{aligned} m_A \ddot{\mathbf{R}}_A &= \mathbf{T}_A + m_A \mathbf{g}_A + \mathbf{F}_A, \\ m_k \ddot{\mathbf{R}}_k &= \mathbf{T}_{k+} - \mathbf{T}_{k-} + m_k \mathbf{g}_k + \mathbf{F}_k, \end{aligned} \quad (7)$$

where \mathbf{T}_{k-} and \mathbf{T}_{k+} are the tether tension forces acting on body k from the two adjacent tether segments.

To evaluate mechanical characteristics of the lunar elevator, we will assume that the Moon is in a circular orbit, the gravitational fields of the Earth and the Moon are Newtonian, the displacement of the center of mass of the Earth–Moon system from the center of the Earth can be neglected, the non-gravitational forces are insignificant, and the elastic deformation of the tether can also be ignored. Under these assumptions, there exist stationary motions in which the whole system rotates as a rigid body at the angular velocity $\boldsymbol{\omega}$ of the Moon's orbital motion [3].

With respect to a frame of reference $Oxyz$ that rotates with the Moon, the stationary motions represent equilibria and are described by the following equations,

$$\begin{aligned} \mathbf{R}' &= \mathbf{T}/T, \\ \mathbf{T}' &= \rho \boldsymbol{\omega} \times (\boldsymbol{\omega} \times \mathbf{R}) - \rho \mathbf{g}, \\ \mathbf{T}_A &= m_A \boldsymbol{\omega} \times (\boldsymbol{\omega} \times \mathbf{R}_A) - m_A \mathbf{g}_A, \\ \mathbf{T}_{k+} &= \mathbf{T}_{k-} + m_k \boldsymbol{\omega} \times (\boldsymbol{\omega} \times \mathbf{R}_k) - m_k \mathbf{g}_k, \end{aligned} \quad (8)$$

where $T = |\mathbf{T}|$,

$$\mathbf{g} = -\frac{\mu \mathbf{R}}{R^3} - \frac{\mu_L \mathbf{r}}{r^3},$$

μ is the gravity constant of the Earth, μ_L is the gravity constant of the Moon, \mathbf{R} is the geocentric radius, and \mathbf{r} is the celenocentric radius.

The equilibrium equations are solved in the following way. First, some position of the end-body A is chosen. With a given R_A , the third equation of (8) defines the tension vector \mathbf{T}_A . Together they constitute initial conditions for the first two equations of (8). These are ordinary differential equations which are then integrated along the tether. At points k , the tension is incremented according to the last equation of (8). The point of intersection of the tether line with the lunar surface (if it exists) becomes point B . This point exists if the starting point R_A is located on the segment OL_1 or sufficiently close to it.

When point A is located on the segment OL_1 , the tether is stretched radially along the Earth–Moon line. The end-point tension T_A in the radial configuration is given by

$$T_A = m_A \left(\frac{\mu}{R_A^2} - \frac{\mu_L}{r_A^2} - \omega^2 R_A \right) = m_A u_A \omega^2 (r_A - r_1), \quad (9)$$

where

$$u = 1 + \frac{2 - \varkappa - \varkappa_1}{(1 - \varkappa)^2 (1 - \varkappa_1)^2} + \varepsilon \frac{\varkappa + \varkappa_1}{\varkappa^2 \varkappa_1^2}, \quad (10)$$

$\varkappa = r/R_L$, r is the celenocentric radius, $R_L \approx 384,400$ km is the radius of the Moon's orbit, $\varkappa_1 = r_1/R_L$, r_1 is the distance from the Moon to the libration point L_1 and $\varepsilon = \mu_L/\mu \approx 1/81.3$ is the Moon-to-Earth mass ratio. The coefficient u varies between approximately 8 and 11 in the range of interest, as shown in Fig. 5.

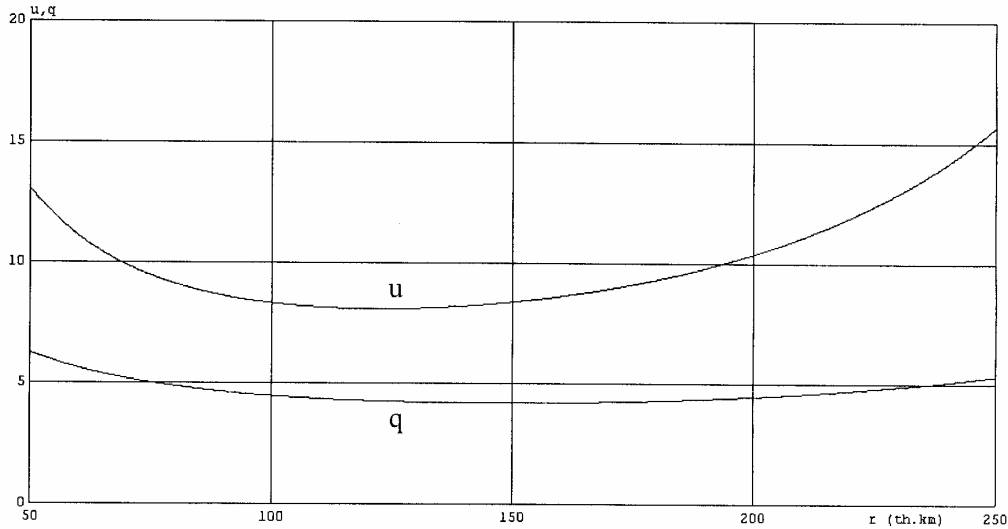

Fig. 5. Coefficients u and q as functions of the distance from the Moon.

The variation of the tether tension along the radial configuration can be described by the following equation derived from (8)

$$\frac{dT}{dr} = \rho \left(\frac{\mu_L}{r^2} + \omega^2 R - \frac{\mu}{R^2} \right) = \rho u \omega^2 (r_1 - r). \quad (11)$$

It shows that the tension reaches its maximum at the libration point L_1 ($r = r_1$) and drops monotonously when moving away from the libration point in both directions, $dT/dr < 0$ with $r > r_1$, and $-dT/dr < 0$ with $r < r_1$.

Let us assume that there are no embedded masses and the tether is uniform with $r > r_1$ and tapered and uniformly stressed ($T/\rho = \text{const}$) with $r < r_1$. Then, we have

$$\begin{aligned} T &= T_1 - \rho q \omega^2 (r - r_1)^2 && \text{with } r \geq r_1, \\ T &= T_1 \exp[-q \omega^2 (r - r_1)^2 / v_t^2] && \text{with } r < r_1, \end{aligned} \quad (12)$$

where T_1 is the tether tension at the libration point L_1 , $v_t = \sqrt{T/\rho} = \text{const}$ is the transverse wave velocity along the tapered section of the tether ($r < r_1$), and the coefficient

$$q = \frac{1}{2} + \frac{1}{(1 - \varkappa)(1 - \varkappa_1)^2} + \frac{\varepsilon}{\varkappa \varkappa_1^2}. \quad (13)$$

is shown in Fig. 5 as a function of the distance from the Moon.

According to (12), the profile of the tether linear density is given by

$$\begin{aligned} \rho &= \rho_1 && \text{with } r \geq r_1, \\ \rho &= \rho_1 \exp[-q \omega^2 (r - r_1)^2 / v_t^2] && \text{with } r < r_1, \end{aligned} \quad (14)$$

where ρ_1 is the linear density at the libration point.

Using relations (12) and the equilibrium condition (9), the end-mass can be expressed as

$$m_A = \frac{\rho_1 v_t^2}{u_A \omega^2 (r_A - r_1)} \left[1 - \frac{q_A \omega^2 (r_A - r_1)^2}{v_t^2} \right], \quad (15)$$

and the total tether mass can be expressed as

$$m_t = \rho_1 (r_A - r_1) + \rho_1 \int_{r_0}^{r_1} \exp \left[- \frac{q \omega^2 (r - r_1)^2}{v_t^2} \right] dr, \quad (16)$$

where $r_0 \approx 1737.4$ km is the radius of the Moon.

Close to the libration point, when $r_A - r_1 \ll v_t/\omega$, the end-mass is very big compared to the tether mass. It drops with the tether length until it vanishes at

$$r_A^* = r_1 + \frac{v_t}{\omega \sqrt{q_A}}. \quad (17)$$

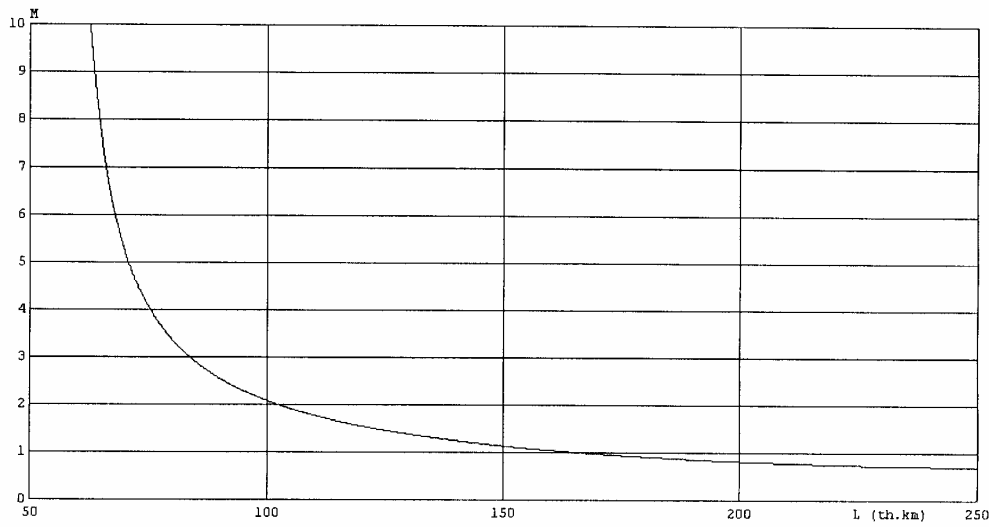

Fig. 6. The total mass of the system as a function of the tether length.

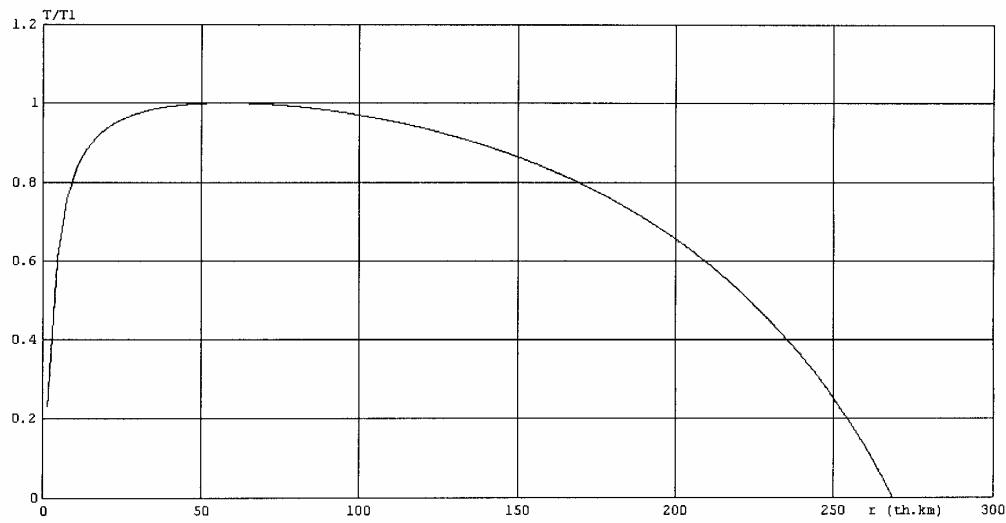

Fig. 7. The profile of the tether tension.

The total mass of the system drops with the tether length, as shown in Fig. 6. However counterintuitive, it reflects a drastic decrease of the end-mass with tether

length increase. This chart presents the ratio $(m_A + m_t)/(\rho_1 R_L)$ of the total mass of the elevator to the characteristic mass of a uniform tether with the length equal to the radius of the Moon's orbit. Here, the tether is made of M5 with a safety factor of 3, which allows a maximum transverse wave velocity of $v_t = 1.36$ km/s. The corresponding tension profile T/T_1 according to (12) is shown in Fig. 7.

We see that the lunar elevator without the end-mass has a minimum total mass. However, in the given example, the tether length is longer than optimal for payload transfer, as discussed in the previous section. For a lunar elevator without the end-mass to be balanced with a given length, the maximum transverse wave velocity must be equal to

$$v_t = \sqrt{q_A} \omega (r_A - r_1). \quad (18)$$

For a length of 210,000 km, it gives $v_t = 0.88$ km/s. A tether of M5 would have had this transverse wave velocity if it were 2.4 times heavier in the uniform segment $r > r_1$. Instead of making the tether heavier, this extra mass needed to balance the lunar elevator with a given length can be provided by embedded masses, such as docking ports and service stations.

3. NON-EQUATORIAL CONFIGURATIONS

There is some interest to anchor the tether not in the equatorial region, but closer to the poles because of the proximity of some geological resources. In this case, the tether will still stretch far beyond the libration point L_1 , but it will be curved near the surface of the Moon.

The difference between the Earth's gravitational pull and the centrifugal force in the vicinity of the Moon can be approximated as

$$-\frac{\mu \mathbf{R}}{R^3} - \boldsymbol{\omega} \times (\boldsymbol{\omega} \times \mathbf{R}) \approx \omega^2 [3\mathbf{e}_L(\mathbf{e}_L, \mathbf{r}) - \mathbf{e}_z(\mathbf{e}_z, \mathbf{r})], \quad (19)$$

where \mathbf{e}_L is a unit vector of the Earth-to-Moon direction, $\mathbf{e}_z = \boldsymbol{\omega}/\omega$, \mathbf{R} is the geocentric radius and \mathbf{r} is the selenocentric radius. Relative to the lunar attraction, it contributes at most

$$\frac{3\omega^2 r}{\mu_L/r^2} = \frac{3\mu}{\mu_L} \left(\frac{r}{R_L} \right)^3,$$

where R_L is the radius of the lunar orbit. This ratio is very small on the lunar surface, and is only 0.02 at 10 lunar radii, and about 0.1 half-way to the libration point L_1 .

If the radius of the tether line curvature is on the order of a few lunar radii, than the tether configuration can be approximated by a solution to the following

simplified problem,

$$\mathbf{r}' = \frac{\mathbf{T}}{T}, \quad \mathbf{T}' = \rho \frac{\mu_L \mathbf{r}}{r^3}. \quad (20)$$

This system of ordinary differential equations always possesses the integral of the moment of the tension force

$$\mathbf{r} \times \mathbf{T} = \mathbf{c}, \quad (21)$$

which means that all equilibrium tether configurations are planar.

In case of a uniform tether, system (20) also has the integral of tension

$$T = T_* - \rho \frac{\mu_L}{r}, \quad (22)$$

where T_* is the tension at the infinity.

In case of a tapered uniformly-stressed tether ($T/\rho = v_t^2 = \text{const}$), the integral of tension takes the form

$$T = T_* \exp\left(-\frac{\mu_L}{rv_t^2}\right). \quad (23)$$

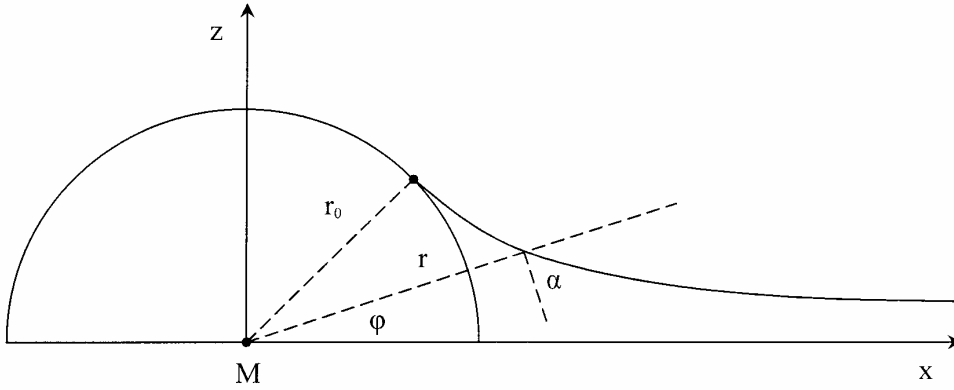

Fig. 8. Geometry of a non-equatorial configuration.

Combining integrals (21) and (22) or (23), the inclination α of the tether line to the local horizon can be found from the relation

$$\frac{1}{\cos \alpha} = \frac{Tr}{c}, \quad (24)$$

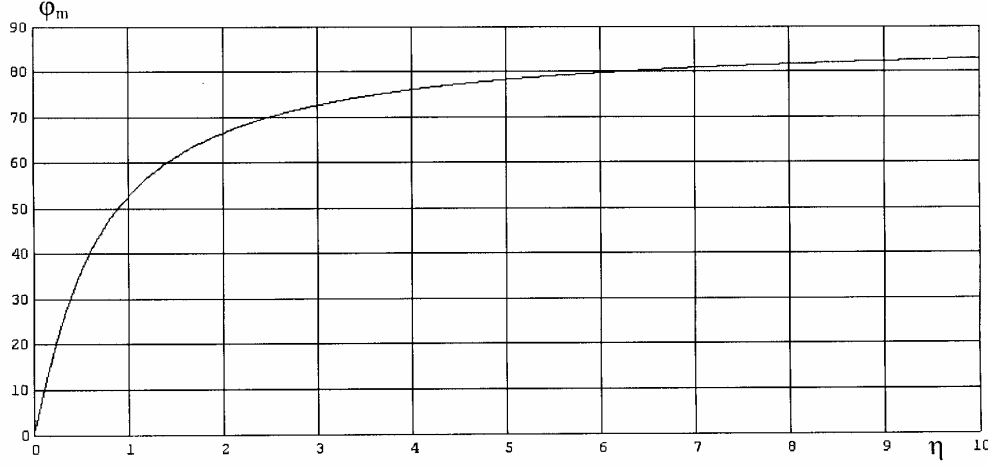

Fig. 9. The maximum latitude as a function of η .

and the tether configuration can be described in polar coordinates as

$$\frac{d\varphi}{dr} = -\frac{\cot \alpha}{r} = -\frac{1}{r} \left(\frac{1}{\cos^2 \alpha} - 1 \right)^{-1/2}, \quad (25)$$

where φ is a polar angle (Fig. 8). This equation has a closed form solution

$$\varphi = \varphi_0 - \int_{r_0}^r \left(\frac{1}{\cos^2 \alpha} - 1 \right)^{-1/2} \frac{dr}{r}. \quad (26)$$

The highest latitude reach is achieved when the tether is horizontal at the attachment point. For a tapered tether in this case, we have

$$\frac{1}{\cos \alpha} = \xi \exp \left(\frac{\xi - 1}{\eta \xi} \right), \quad \eta = \frac{v_t^2}{v_0^2}, \quad (27)$$

where $\xi = r/r_0$, and r_0 is the radius of the Moon, and $v_0 = \sqrt{\mu/r_0} \approx 1.68$ km/s is the circular orbit velocity on the surface of the Moon. Now, solution (26) can be rewritten as

$$\varphi = \varphi_0 - \int_1^\xi \left[\xi^2 \exp \left(2 \frac{\xi - 1}{\eta \xi} \right) - 1 \right]^{-1/2} \frac{d\xi}{\xi}, \quad (28)$$

and the maximum latitude φ_m can be expressed as

$$\varphi_m = \int_1^\infty \left[\xi^2 \exp \left(2 \frac{\xi - 1}{\eta \xi} \right) - 1 \right]^{-1/2} \frac{d\xi}{\xi}. \quad (29)$$

Fig. 9 shows how the maximum latitude depends on the parameter η . For a tether of M5 with a safety factor of 2, $\eta \approx 1$, and the maximum latitude is about 52° . With a safety factor of 3, $\eta \approx 0.67$, and the maximum latitude is about 43° .

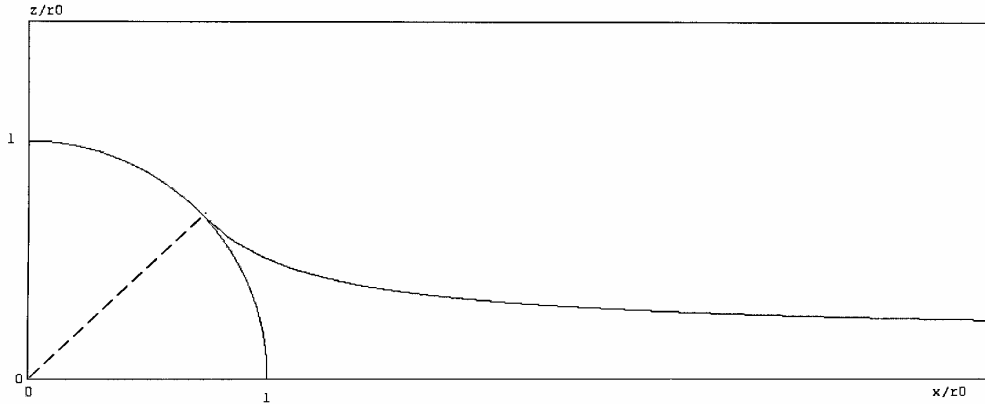

Fig. 10. A non-equatorial configuration of a tapered tether.

Fig. 10 shows the shape of a non-equatorial configuration of a tapered tether made of M5 with a safety factor of 3.

4. FAIL-SAFE ELEVATOR

To reduce meteor danger, the tether for the lunar space elevator must be a thin and fairly wide ribbon instead of a conventional compact strand. A simple formula derived in [3] can be used to evaluate an average time between subsequent meteor punctures that may result in tether failure,

$$\tau \approx 6h^{2.6}/L$$

where τ is the time measured in years, h is the ribbon width in millimeters, and L is the tether length in kilometers.

According to this formula, a ribbon 55 mm wide and 200,000 km long may suffer one potentially dangerous meteor puncture per year. While this is only an order-of-magnitude estimate, it still indicates that some measures should be taken to drastically reduce the probability of tether failure.

One of the options is to use multiple ribbons. The ribbons must be held apart at a distance much larger than their width and they must be connected to each other with diagonal ribbon segments at certain intervals. Two configurations of this kind are shown in Fig. 11. This concept is similar to the concept of a fail-safe tether formulated in [5].

If the elevator is made of n ribbons, and one ribbon segment is cut, then the

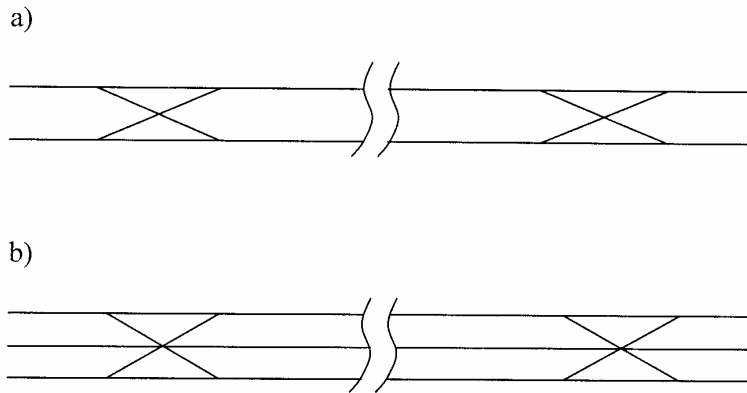

Fig. 11. Fail-safe designs for the lunar elevator.

tension in the remaining ribbons is increased by $k_n = n/(n-1)$ times and the safety factor is reduced by k_n times. It means that the nominal safety factor f_0 must be chosen k_n time higher than the minimum allowable safety factor f_m ,

$$f_0 = f_m \frac{n}{n-1}. \quad (30)$$

The table below shows the nominal safety factor f_0 as a function of the number of ribbons n when the minimum allowable safety factor f_m equals 2. A three-ribbon design may be the best choice here, as pointed out by John Oldson.

n	2	3	4	5	6
f_0	4	3	2.7	2.5	2.4

If a ribbon segment is cut, it needs to be replaced in a time during which the probability of a second cut in a parallel ribbon segment remains low.

5. TRANSFER TRAJECTORIES TO THE LUNAR SURFACE

With a little extra fuel, the low thrust transfer trajectories depicted in Fig. 3 can be extended to the lunar surface. Fig. 12 shows a typical low thrust transfer

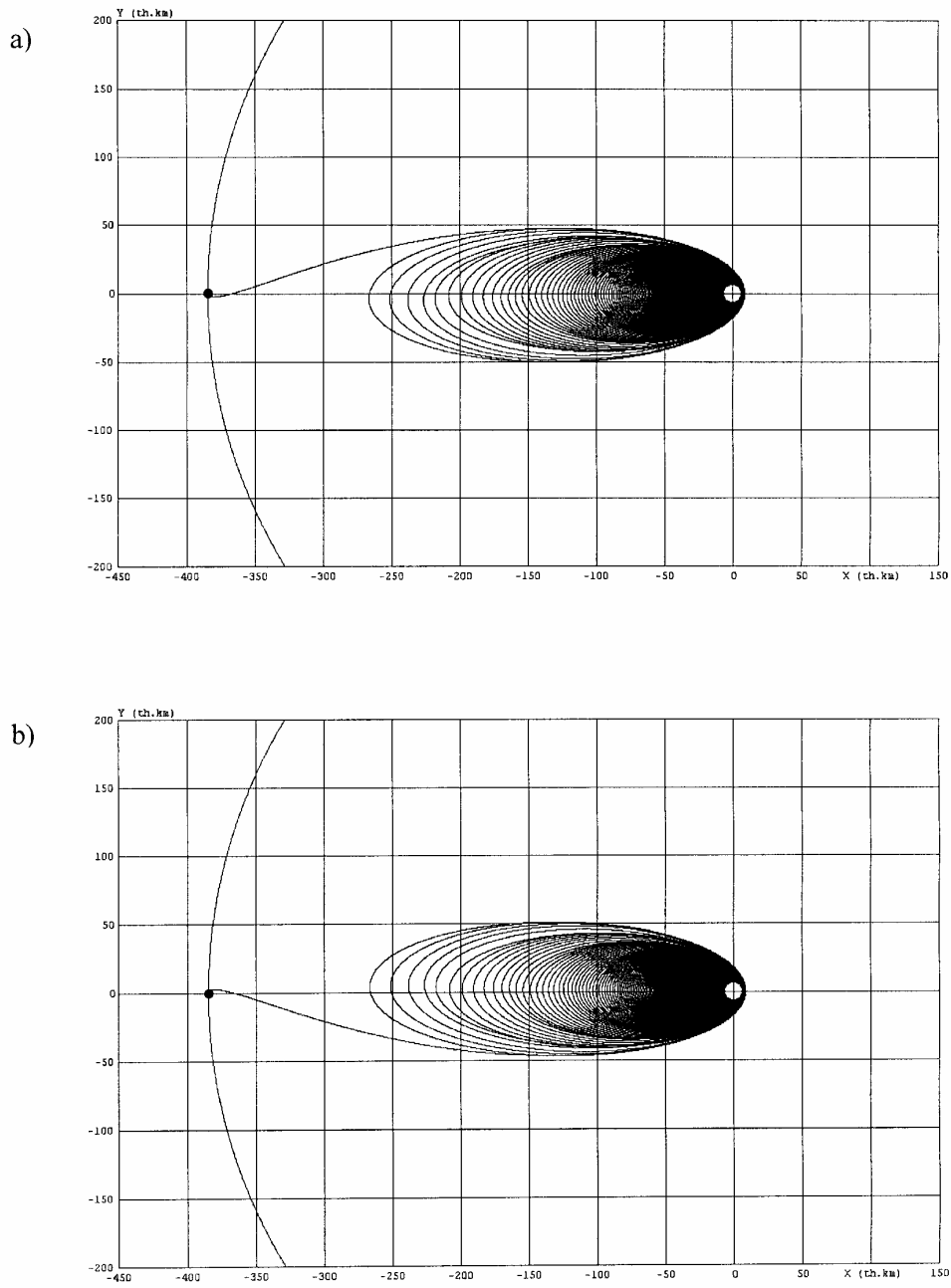

Fig. 12. Low thrust transfer trajectories between LEO and the lunar surface.

trajectory from LEO to the far side of the Moon (a) and a return trajectory (b). An ion engine with a specific impulse of 3000 sec will require only 14-15% of the dry mass of the spacecraft for each transfer. The fuel consumption drops in a reverse proportion to the specific impulse. With a specific impulse of 5000 sec, it will be less than 9%. A typical transfer with a maximum acceleration of 2 mm/s^2 takes about 6-7 months.

The trajectory shown in Fig. 12(a) arrives at the surface level on the far side of the Moon with a tangent velocity of 2.58 km/s, and the trajectory shown in Fig. 12(b) departs from the same point with the same velocity. A spinning tether facility to capture and launch payloads with these arrival and departure conditions is described in the next section.

6. SPINNING TETHERS FOR LAUNCH AND CAPTURE

The system consists of two end-bodies B_1 and B_2 attached to the central hub C with tethers. The central hub C is elevated above the lunar surface (Fig. 13) and the whole system is spinning about C at such a rate that the centrifugal forces keep the tethers above the lunar surface and the linear velocities of the end-bodies are sufficient for escape from the sphere of influence of the Moon.

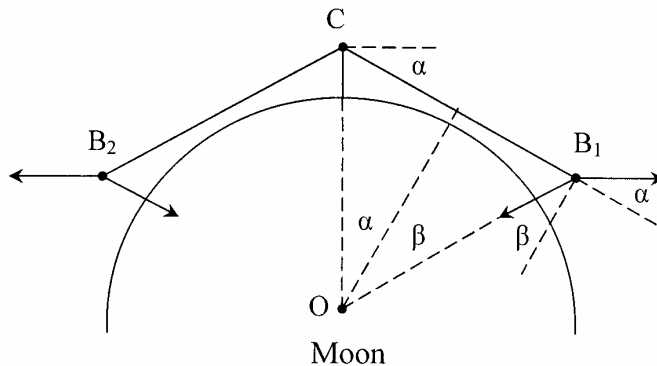

Fig. 13. Geometry of the spinning tether configuration.

This system may be used for launching payloads from the Moon and capturing payloads coming from the Earth. To be launched, a payload must be delivered to

the hub C and then moved along the tether toward one of the end-bodies, where it is released into an escape trajectory. The payload mass is assumed small compared to the end-body mass. After the payload release, the system must regain the energy and angular momentum under the effect of the control torques at the hub.

To be captured, an incoming payload must approach one of the end-bodies on a rendezvous trajectory with a matching velocity, where it is captured at the closest distance.

The arms of the tether system do not need to be symmetrical, but the distance between the hub and the counterweights must be variable within a certain range to be able to compensate for the dynamic loads associated with the payload release and capture procedures.

Assuming that the tether mass is relatively small compared to the counterweight masses, the equilibrium condition is described as

$$\Omega^2 D \sin \alpha = g \cos \beta, \quad (31)$$

where Ω is the angular rate of rotation about the axis OC , $D = L \cos \alpha$ is the distance of the end-body from the rotation axis OC , L is the tether length, the angles α and β are shown in Fig. 13, $g = \mu_L/R_1$ is the gravity acceleration at the end of the tether, μ_L is the gravity constant of the Moon, $R_1 = R/\cos \beta$ is the celenocentric radius of the end-body, R is the distance from the center of the Moon to the tether line CB_1 .

The tether is taut under the condition

$$\Omega^2 D \cos \alpha > g \sin \beta. \quad (32)$$

The total tether length and the linear velocity of the end-body are given by

$$L = R(\tan \alpha + \tan \beta), \quad v = \Omega L \cos \alpha. \quad (33)$$

Using these relations, we can reduce the equilibrium condition to

$$\frac{v^2}{v_1^2} \tan \alpha = (\tan \alpha + \tan \beta) \cos^2 \beta \quad (34)$$

where

$$v_1 = \sqrt{\mu_L/R_1} = \sqrt{\mu_L \cos \beta / R}$$

is the circular orbit velocity at the radius R_1 . The equilibrium condition can be rewritten as

$$\tan \alpha = \frac{\tan \beta \cos^2 \beta}{v^2/v_1^2 - \cos^2 \beta}. \quad (35)$$

The taut tether condition can be reduced to

$$\tan \alpha \tan \beta < 1. \quad (36)$$

It is satisfied in a wide range of angles, including the region $\alpha + \beta < \pi/2$, $\alpha \geq 0$, $\beta \geq 0$.

The tether should move entirely above the lunar surface, and therefore, the elevation H of the hub C above the surface should be greater than

$$H > \frac{R}{\cos \alpha} - R = R \left(\frac{1}{\cos \alpha} - 1 \right). \quad (37)$$

With small angles $0 < \alpha \ll 1$ and $0 < \beta \ll 1$, we find that

$$\alpha \approx \frac{L}{R} \frac{v_1^2}{v^2}, \quad \beta \approx \frac{L}{R} \left(1 - \frac{v_1^2}{v^2} \right). \quad (38)$$

The minimum elevation of the central hub is given by

$$H_m = R \left(\frac{1}{\cos \alpha} - 1 \right) \approx R \frac{\alpha^2}{2} = \frac{L^2}{2R} \frac{v_1^4}{v^4}. \quad (39)$$

The maximum tether length for a given elevation H is defined by

$$L_m = \frac{v^2}{v_1^2} \sqrt{2RH}. \quad (40)$$

When launching a payload in a circular orbit ($v = v_1$), we have

$$\alpha = \frac{L}{R}, \quad \beta = 0, \quad H_m = \frac{L^2}{2R}, \quad L_m = \sqrt{2RH}, \quad (41)$$

and the lowest point is at the end of the tether. If the hub is mounted on the top of a mountain 4 km high, then the maximum tether length is 118 km. With this length, we have $\alpha \approx 8^\circ$, and the centrifugal acceleration of the end-body is equal to 2.4 Earth's g 's.

When launching a payload in a parabolic orbit ($v = \sqrt{2} v_1$), we have

$$\alpha = \beta = \frac{L}{2R}, \quad H_m = \frac{L^2}{8R}, \quad L_m = 2\sqrt{2RH}, \quad (42)$$

and the elevation of the end-body is the same as the elevation of the central hub, while the lowest tether point is in the middle of the tether. If the hub is mounted on the top of a mountain 4 km high, then the maximum tether length is 236 km.

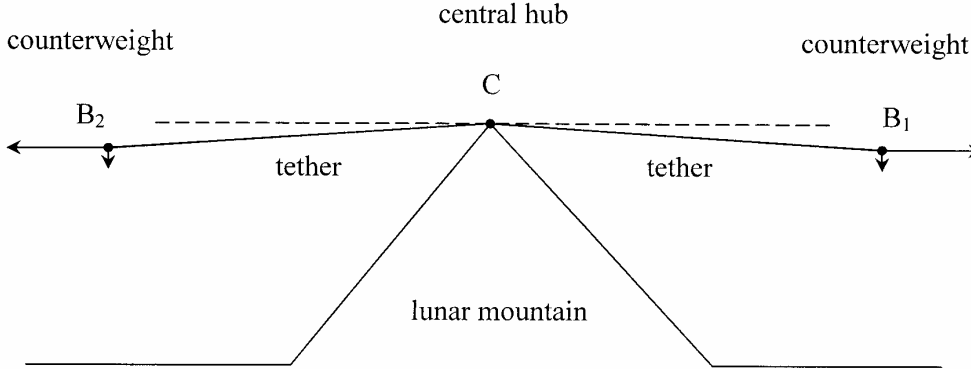

Fig. 14. A spinning configuration of a short tether.

With this length, we have $\alpha \approx 8^\circ$, and the centrifugal acceleration of the end-body is equal to 2.4 Earth's g's.

If the length of the tether is small compared to the maximum length, $L \ll L_m$, then it is almost horizontal, as shown in Fig. 14.

A variety of system configurations is shown in Fig. 15. Configuration (a) is the simplest, but it is hard to control because of differential rotation of the arms. The rest of the configurations are made triangular-based in order to be geometrically "rigid". The configurations do not have to be geometrically symmetrical, like (b), (c), and (d), but they can have one longer arm for launching and capturing and shorter arms for dynamic balancing, like (e), (f), and (g).

All tethers in these configurations should be of variable length in order to provide flexibility in dynamic load balancing.

There are also "ballooning" tether configurations, like those depicted in Fig. 16. Configurations of this type offer some benefits in capturing payloads because they do not require a perfect timing between the rotation phase and the moment of the closest approach. The tether tension in a "ballooning" configuration of radius r is equal to

$$T = \rho \Omega^2 r^2 = \rho v^2, \quad (43)$$

where ρ is the tether mass per unit length, and v is the linear velocity. This means that the transverse wave velocity in the tether is equal to the linear velocity,

$$v_t = \sqrt{T/\rho} = v. \quad (44)$$

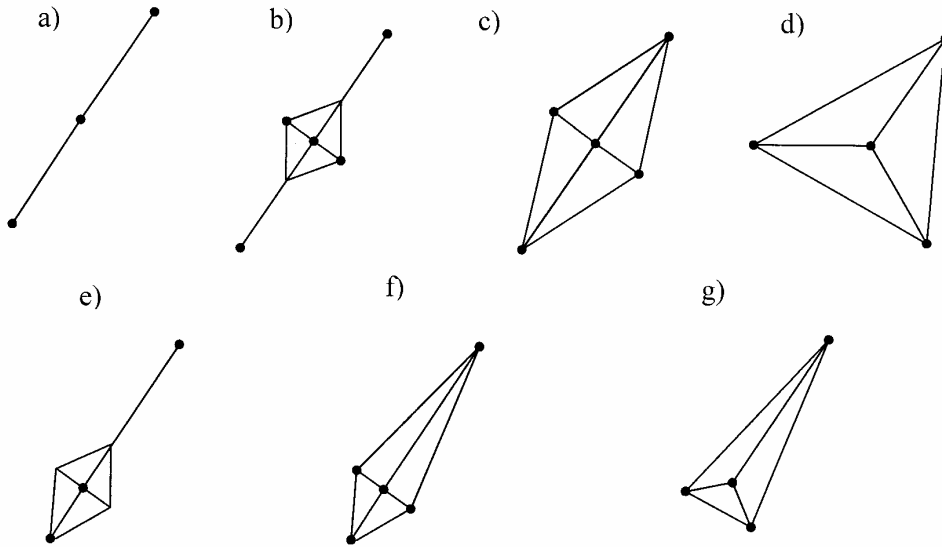

Fig. 15. Various configurations for launch and capture.

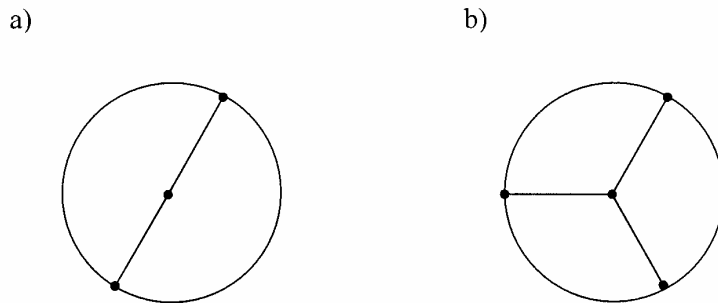

Fig. 16. "Ballooning" configurations.

The transverse wave velocity in a tether made of M5 fibers loaded to a half of its strength (safety factor of 2) is approximately equal to the circular orbit velocity v_1 , and it is approximately equal to the parabolic orbit velocity $\sqrt{2}v_1$ at the break tension.

The maximum tension in a spinning uniform radial tether of length L carrying a counterweight of mass m is reached at the hub and is equal to

$$T_m = \frac{1}{2} \rho \Omega^2 L^2 + m \Omega^2 L = \frac{1}{2} \rho v^2 + m \frac{v^2}{L}. \quad (45)$$

The maximum transverse wave velocity is then equal to

$$v_t = \sqrt{\frac{T_m}{\rho}} = v \sqrt{\frac{1}{2} + \frac{m}{m_t}}, \quad (46)$$

where $m_t = \rho L$ is the mass of the tether. A tether of M5 with a safety factor of 2 spinning with a linear velocity equal to the parabolic orbit velocity $\sqrt{2}v_1$ can support itself, but not a counterweight. To support a counterweight, it has to be tapered.

After a payload release, the tether facility must restore its energy. This is done by applying control torques at the center hub. The time Δt required to restore the energy is determined by a simple relation

$$\frac{\Delta m v^2}{2} = P \Delta t,$$

where Δm is the payload mass, v is the payload release velocity, and P is the power transformed into the kinetic energy of the tether system. Then, the payload launch rate can be estimated as

$$\frac{\Delta m}{\Delta t} = \frac{2P}{v^2}. \quad (47)$$

With $P = 100$ kW and $v = 2.58$ km/s, it gives an impressive value of 3 tons/day.

7. CONCLUSIONS

The two lunar-based tether systems considered in this report provide dynamically viable and effective ways of transporting payloads from LEO to the Moon surface and from the Moon surface to LEO or any other Earth orbit. The first system is utilizing a long tether stretching from the Moon surface half way to the Earth. The second system is utilizing a fast spinning tether on the surface of the Moon.

Both systems eliminate major fuel expenditure conventionally associated with landing payloads on the Moon and lifting payloads from the Moon. The payload transportation between LEO or other Earth orbits and the lunar tether facilities is

performed by space tugs with ion engines whose fuel consumption amounts to only a small fraction of the payload mass.

REFERENCES

1. PEARSON, J. Anchored Lunar Satellites for Cislunar Transportation and Communication. *J. of the Astronautical Sciences*, **17** (1979), 39–62.
2. TSANDER, F. *Selected Papers*. Zinatne, Riga, 1978, (in Russian).
3. BELETSKY, V.V. AND LEVIN, E.M. Dynamics of Space Tether Systems. *Advances in the Astronautical Sciences*, AAS, **83**, 1993, Univelt, Inc.
4. GASSEND, B. Non-Equatorial Uniform-Stress Space Elevators, The Space Elevator: 3rd Annual International Conference, Washington, DC, June 28-30, 2004.
5. FORWARD, R.L. AND HOYT, R.P. Failsafe Multiline Hoytether Lifetimes, AIAA paper 95-28903, 1st AIAA-SAE-ASME-ASEE Joint Propulsion Conference, San Diego, CA, July 1995.

References

-
- ¹ Artsutanov, Yuri, "V Kosmos na Electrovoze (in Russian, Into Space on a Train)," *Komsomolskaya Pravda*, July 31 1960.
 - ² Pearson, Jerome, "The Orbital Tower: A Spacecraft Launcher Using the Earth's Rotational Energy," *Acta Astronautica*, Vol. 2, pp. 785-799, Sep/Oct 1975.
 - ³ Pearson, Jerome, "Anchored Lunar Satellites for Cislunar Transportation and Communication," *Journal of the Astronautical Sciences*, Vol. XXVII, No. 1, pp. 39-62, Jan/Mar 1979.
 - ⁴ Artsutanov, Yuri, "The Earth-to-Moon Highway," (in Russian), *Technika-Molodyegi*, No. 4, 21, 35, 1979.
 - ⁵ Tsander, F., *Selected Papers*, Zinatne, Riga, 1978, (in Russian).
 - ⁶ Bradley C. Edwards, "Design and Deployment of a Space Elevator," *Acta Astronautica*, Vol. 47, 2000, p. 735.
 - ⁷ Edwards, Bradley C. and Westling, Eric A., *The Space Elevator*, published by Edwards & Westling, January, 2003.
 - ⁸ Carroll, J. A., "Preliminary Design of a 1 Km/Sec Tether Transport Facility," Final Report on NASA Contract NASW-4461, 78 pp March 1991.
 - ⁹ Hoyt, Robert, and Chauncey Uphoff, "Cislunar Tether Transport System," 35th Joint Propulsion Conference, AIAA 99-2690, Los Angeles, CA, 20-24 June 1999.
 - ¹⁰ Pearson, J., Levin, E., Oldson, J., and Wykes, H., *The Lunar Space Elevator*, IAC-04-IAA.3.8.3.07, 55th International Astronautical Congress, Vancouver, Canada, October 4-8 2004.
 - ¹¹ Beletsky, V. V., and Levin, E. M., "Dynamics of Space Tether Systems," *Advances in the Astronautical Sciences*, Vol. 83, American Astronautical Society, Springfield, VA, 1993.
 - ¹² Pearson, J., "Lunar Anchored Satellite Test," AIAA/AAS Astrodynamics Conference, AIAA 78-1427, August 1978.
 - ¹³ Gassend, B., *Non-Equatorial Uniform-Stress Space Elevators*, The Space Elevator: 3rd Annual International Conference, Washington, DC, June 28-30, 2004.
<http://www.mit.edu/people/gassend/publications/NonEquatorialUniformStressSpaceElevators.pdf>
 - ¹⁴ <http://www.islandone.org/LEOBiblio/SPBI119.HTM>
 - ¹⁵ Forward, R.L. AND Hoyt, R.P., *Failsafe Multiline Hoytether Lifetimes*, AIAA Paper 95-28903, 1st AIAA/SAE/ASME/ASEE Joint Propulsion Conference, San Diego, CA, July 1995.
 - ¹⁶ http://cfa-www.harvard.edu/spgroup/TetherHBK_file4.pdf
 - ¹⁷ Nock, K.T. et al., *Cyclical Visits to Mars via Astronaut Hotels*. NIAC Phase II Final Report, 2003.
 - ¹⁸ Lerner, E. J., *Plasma Propulsion in Space*, *Industrial Physicist*, Vol. XX, pp. 16-19, October 2000.
 - ¹⁹ Aldridge, E.C. et al., *Report of the President's Commission on Implementation of United States Space Policy*, 2004.
 - ²⁰ Bussey, D.B.J., P.D. Spudis, and M.S. Robinson (1999) *Illumination conditions at the lunar south pole*, *Geophys. Res. Lett.*, V. 26, pp. 1187-1190.
 - ²¹ Bussey, D.B.J. et al (2003) *Permanent shadows in simple craters near the lunar poles*, *Geophys. Res. Lett.*, V. 30, No. 6, pp. 11-1 – 11-4.
 - ²² http://www.nasm.si.edu/research/ceps/research/Moon/South_pole_map.jpg
 - ²³ <http://www.cmf.nrl.navy.mil/clementine/water/southpole.JPG>
 - ²⁴ Wykes, H., "A Widely Adaptable Habitat Construction System Utilizing Space Resources," *Vision 21 conference*, Cleveland, OH, NASA CP 10129, May 1994.
 - ²⁵ Mackenzie, J.D. and R.C. Claridge (1979) *Glass and Ceramics from Lunar Materials*. In: *Space Manufacturing Facilities 3*, eds. J. Grey and C. Kropp, AIAA. Pp. 135-140.
 - ²⁶ Waldron, R.D. and D.R. Criswell (1982) *Materials Processing in Space*. In: *Space Industrialization*, V. 1, ed. B. O'Leary, CRC Press, pp. 97-130.
 - ²⁷ Kelly, A and N.H. MacMillan (1986) *Strong Solids*, 3rd ed. Oxford, p 371.