



Bestätigung der Übereinstimmung mit dem Original.
Düsseldorf, den 13.02.84 Unterschrift:

V. Wicksbeck

DEPARTMENT OF THE ARMY TECHNICAL MANUAL
DEPARTMENT OF THE AIR FORCE TECHNICAL ORDER

TM 9-1985-2
TO 11A-1-26

**GERMAN EXPLOSIVE
ORDNANCE**
(BOMBS, FUZES, ROCKETS
LAND MINES, GRENADES
AND
IGNITERS)

DEPARTMENTS OF THE ARMY AND THE AIR FORCE
MARCH 1953

Britische und amerikanische Maße und Gewichte

Längenmaße

1. Einne (in)	$\frac{1}{12}$ inch	2,54 mm
1. inch (in)	12 lines	2,54 cm
1. foot (ft)	12 inches	30,48 cm
1. yard (yd)	3 feet	91,44 cm

Handelsgewichte

1. grain (gr)	0,0648 g	
1. dram (dr)	27,34 grains	1,77 g
1. ounce (oz)	16 drams	453,35 g
1. pound (lb)	16 ounces	453,35 g
1. quarter (qr)	28 pounds	12,7 kg
U.S.A	25 pounds	11,34 kg

TM 9-1985-2/TO 11A-1-26

GERMAN EXPLOSIVE ORDNANCE

(BOMBS, FUZES, ROCKETS
LAND MINES, GRENADES
AND
IGNITERS)



United States Government Printing Office

Washington : 1953

Chapters 5 and 8 are published in TM 9-1985-3/TO 11A-1-26.

DEPARTMENTS OF THE ARMY AND
THE AIR FORCE

WASHINGTON 25, D. C., 16 March 1953

TM 9-1985-2/TO 39B-1A-9 is published for the information and guidance of all concerned.

[AG 471.6 (20 Feb 53)]

BY ORDER OF THE SECRETARIES OF THE ARMY AND THE AIR FORCE:

OFFICIAL:

WM. E. BERGIN
Major General, USA
The Adjutant General

J. LAWTON COLLINS

Chief of Staff, United States Army

OFFICIAL:

K. E. THIEBAUD
Colonel, USAF
Air Adjutant General

HOYT S. VANDENBERG

Chief of Staff, United States Air Force

DISTRIBUTION:

Active Army:

Tech Svc (1) except 3, 5 (5), 9 (10); Tech Svc Bd (2); AFF (2); OS Maj Comd (5); Base Comd (2); MDW (1); A (2); CHQ (2); Div (2); Sch (1) except 5 (5), 9 (50); Dep 9 (3); POE (2); OSD (1); PRGR 9 (3); Ars 9 (1); Proc Dist 9 (1); T/O & E: 9-500 FA, FB, FC, FE, FF (1).

NG: None.

Army Reserve: None.

For explanation of distribution formula, see SR 310-90-1.

CONTENTS

<i>Chapter</i>	<i>Page</i>
1. BOATS -----	1
2. FUELS -----	125
3. ROCKETS -----	193
4. LAND MINES, GRENADES, AND IGNITERS -----	261

GERMAN EXPLOSIVE ORDNANCE

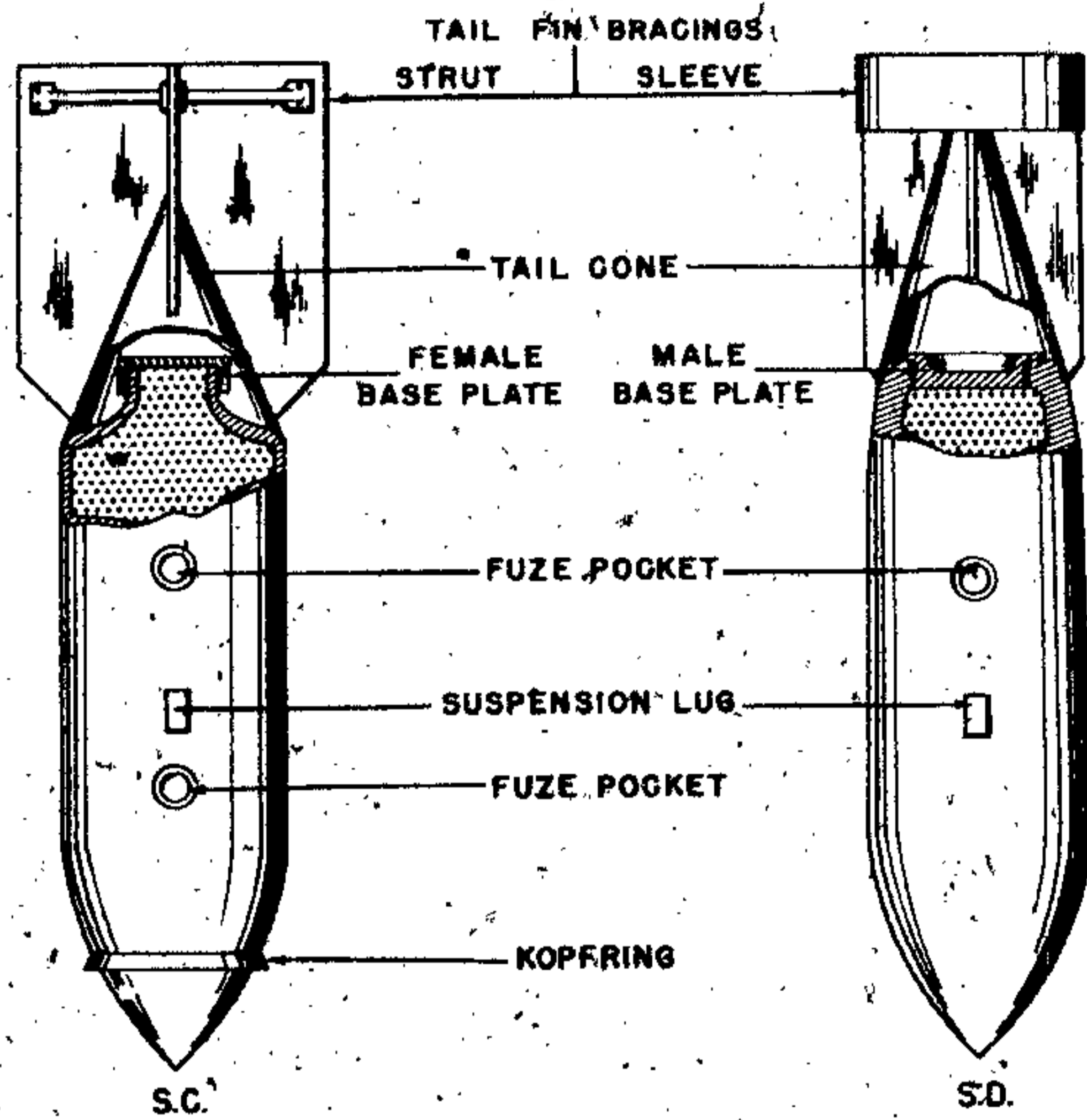

Figure 1—Bomb Component Positions

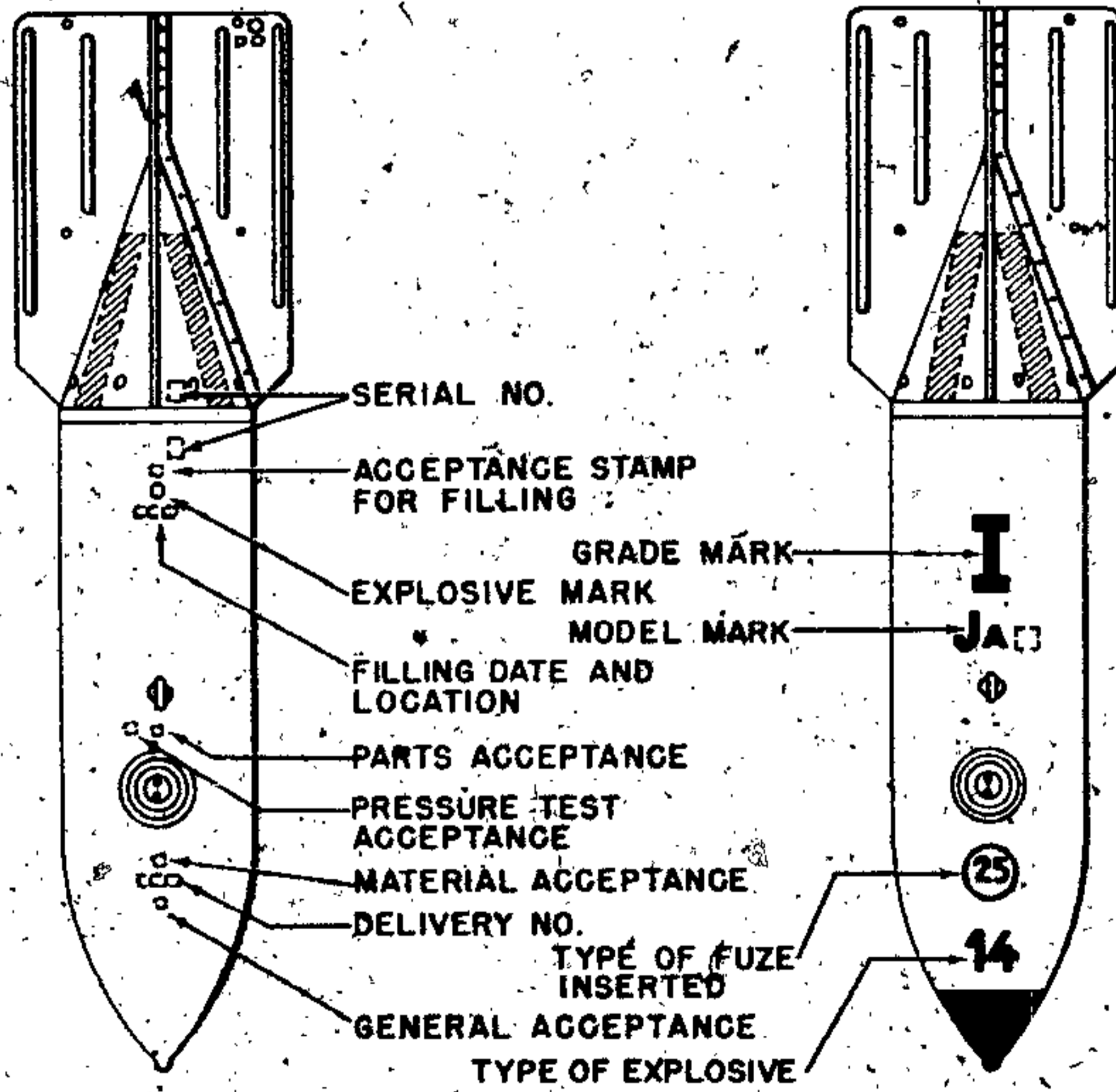

Figure 2—Paint Markings and Stampings

Chapter 1

GERMAN BOMBS

INTRODUCTION

The following list gives the abbreviated designations used for the identification of German bombs, the full German designation and the English equivalent.

DESIGNATION	GERMAN	ENGLISH
SC	Sprengcylindrische	H. E. cylindrical general purpose.
SB	Sprengbombe	High capacity bomb.
SA		High capacity bomb.
SD	Spreng Dickenwand	H. E. thick walled, semiarmor piercing, fragmentation.
SD (small)	Spreng Dickenwand	Anti-personnel.
SBe	Splitter Beton	Concrete fragmentation bomb.
PC	Panzerdurchschlag cylindrische	Cylindrical armor-piercing bomb.
PD	Panzer Dickenwand	Armor-piercing.
BT	Bomben Torpedo	Torpedo bomb.
SP	Splitter	Fragmentation, (anti-personnel).
ZC	Zementcylindrische	Cement cylindrical.
BLC	Blitzlichtcylindrische	Photoflash.
KC	Kampfstoffcylindrische	Chemical cylindrical.
NC	Nebelcylindrische	Smoke cylindrical.

General

The three principal types of German demolition bombs are: "Spreng Cylindrisch" (SC) or General Purpose bombs, "Spreng Dickenwand" (SD) or splinter bombs (SAP) and "Panzer Cylindrisch" (PC) or armor piercing bombs. In addition to these three general types there are: SB and SA types of bombs for maximum blast, SBe concrete bombs, PD armor piercing bomb and the BT (Bomben torpedo) bomb. (See figs. 1 and 2.)

The SC or general purpose bombs are used primarily for general demolition work. The SC 250 and SC 500 may be fitted with two athwartships fuze pockets instead of the usual one. These two bombs are usually associated with time and protective fuzing. The other SC bombs are fuzed either instantaneously or with a short delay. SC

bombs have thin parallel walls with a comparatively heavy nose. Usually they are of three piece welded construction. SC bombs have a loading factor of approximately 55 percent and are filled in most cases with cast TNT, powdered amatol or trialen. Bomb identification for the SC type is made easy by the presence of yellow paint on the tail cone.

The SB type of bomb is designed to give maximum blast effect. It has very thin walls and loading factors run as high as 80 percent. Fuzing is instantaneous.

The SD "splinter" or fragmentation bombs are used primarily against personnel, tanks, all types of armored and unarmored vehicles, and against other surface targets which are vulnerable to fragmentation damage. They are usually fuzed instantaneously and may have extension rods from the nose to actuate the fuze above the ground. The walls are thick, the thickness being uniform throughout the sides with a slightly heavier nose. They are usually forged in one piece. They have a loading factor of approximately 35 percent and are filled with TNT, amatol or trialen. Bombs may be identified by the presence of red paint on the tail cone. (This should not be confused with the base coat of red lead which is used on all German bombs.)

SD (small antipersonnel bombs). A special grouping of these is desired, for they are a very distinctive group and not just a miniature model of the larger type. Bombs have thick walls and a low loading factor. A mechanical instead of electric fuze is used in most of these bombs and bombs are usually carried in containers. SC bombs of this type are so designated, but it seems they might more correctly be called SD to keep classification uniform.

SBe or concrete bombs are used for the same purpose as SD's. They have thick concrete walls reinforced with steel. Loading factor is around 20 percent and a low power explosive is normally used.

GERMAN EXPLOSIVE ORDNANCE

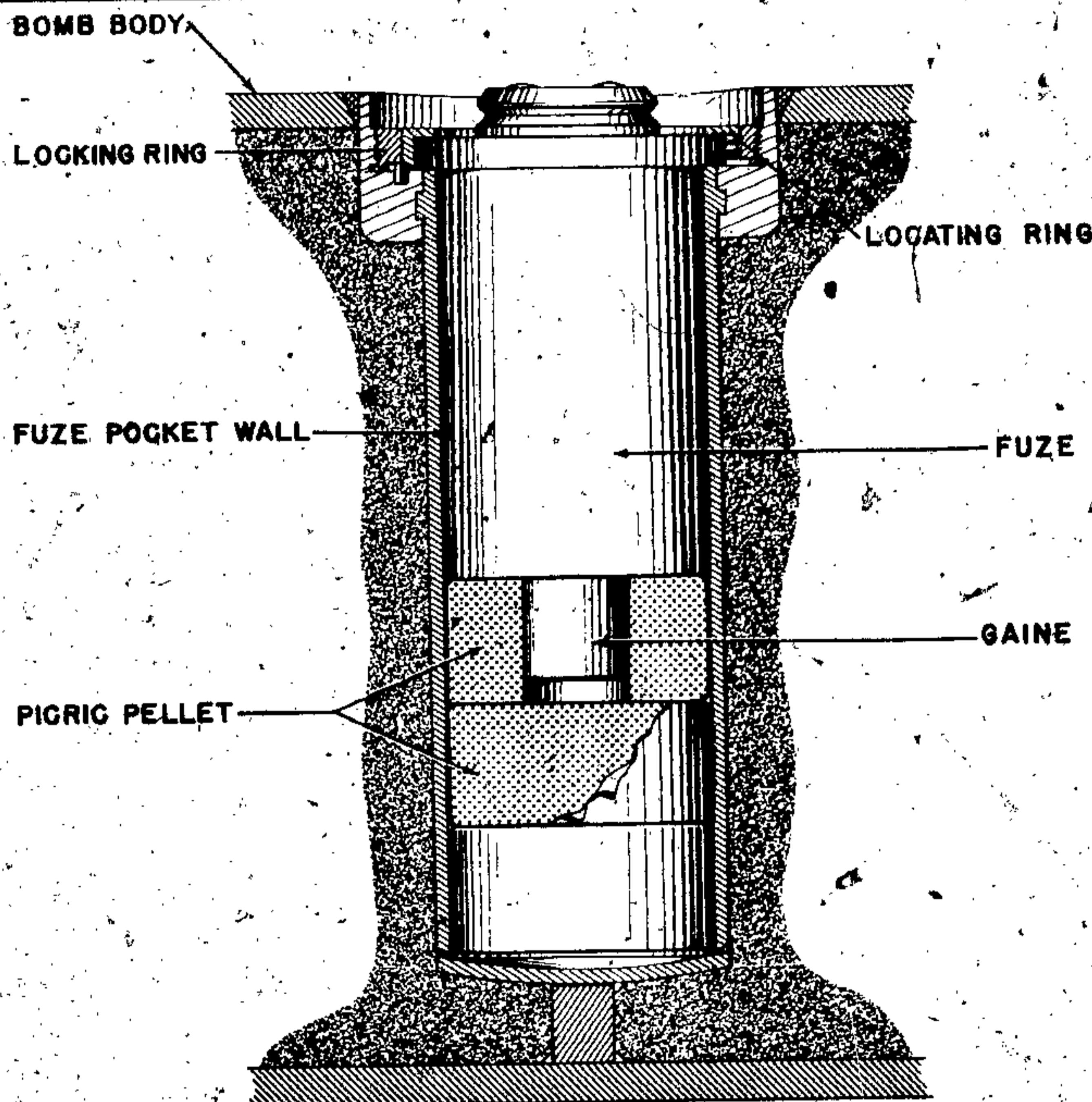

Figure 3—Fuze Pocket In Bomb

The PC or armor-piercing bombs are used primarily against ships and fortifications. They are fuzed with a short delay for penetration. PC bombs are slightly streamlined with a heavy nose and thick walls. The thickness of the walls decreases toward the base of the bomb. They are made of cast steel and the nose is specially hardened. PC bombs have a loading factor of approximately 20 percent and are filled with a TNT wax mixture. PC bombs may be identified by the presence of dark blue paint on the tail cone. PC bombs have been used as SD's for fragmentation and fuzed instantaneously; if so, the dark blue may be over-painted with red.

The PD is even more exclusively armor piercing. Bombs are thinner, longer, have thicker case and a lower loading factor.

BT. The BT (bomben torpedo) was put into production during the last 2 months of the war,

but was never used operationally. It is designed along the lines similar to a torpedo except for the after section where there are three large tail fins. The missile has no propulsion except that induced by gravity and the forward motion of the mother aircraft.

SA 4000 (EXPERIMENTAL) is a very large high capacity bomb. The loading factor is about 80 percent. It was never used operationally against the allies.

MISC. PLANE DESTROYING BOMBS. The aircraft towed paravane bomb is a small 2-kg bomb towed by a plane. The plane destroying bomb is a small charge with a pull type igniter and safety fuze.

Coloring

Bombs which are carried in internal bomb racks (up through 500 kg) are usually colored dark green. Bombs which are carried in external bomb



Figure 4—Suspension

racks (1,000 kg and over) are usually colored sky blue. Color may also be controlled by the conditions of the bomb stowage. Aluminum, tan, buff, etc., are colors that may be used.

Typical Bomb Explosive Train

The fuze is located in an athwartship fuze pocket extending the full internal diameter of the bomb. (See fig. 3.) The fuze is usually held in the top of the fuze pocket by a locking ring and a locating ring. Threading into the bottom of the fuze is a steel case called the gaine. The gaine is filled with a P. E. T. N.-wax mixture. A small pellet of lead azide and lead styphnate mixture is positioned in the top of this gaine. These pellets may be of granular TNT. In bombs with powdered fillings, a column of granular TNT pellets is placed longitudinally in the bomb adjacent to the fuze pocket.

Tail Construction

Two tail types are used. The first type, a sheet steel tail, is usually made in four pieces to form a cone with four fins. The fins may be unbraced, braced with tubular struts, or braced with a cylindrical strut (ring). The second type is of magnesium alloy. The cone and four fins are cast in one piece. The fins may be braced with a cylindrical strut of the same material.

Suspension

Bombs up to and including some of the 500 kg types can be suspended either horizontally or vertically. (See fig. 4.) The remaining 500's and all larger types are suspended horizontally. All vertical suspension is by an eyebolt threaded into the nose of the bomb. Horizontal suspension is by an eyebolt for the 50 kg series, either an eyebolt or a threaded T-type lug for the 250 kg and 500 kg series, and by means of an H-type lug for the larger series bombs. The H lug is secured either

to a carrying band or directly to the bomb body. The SC 1000 and SC 1200 type bombs have been using a U bolt secured to the carrying band on the latest models.

Kopfring

Kopfrings (nose rings) are sometimes fitted to the nose of SC bombs to prevent excessive penetration against land targets and to prevent ricochet against sea targets. (See figures 5A and 5B.) Kopfrings may also be found on the SD 70 and SD 1700 bombs when they are used against above-mentioned targets.

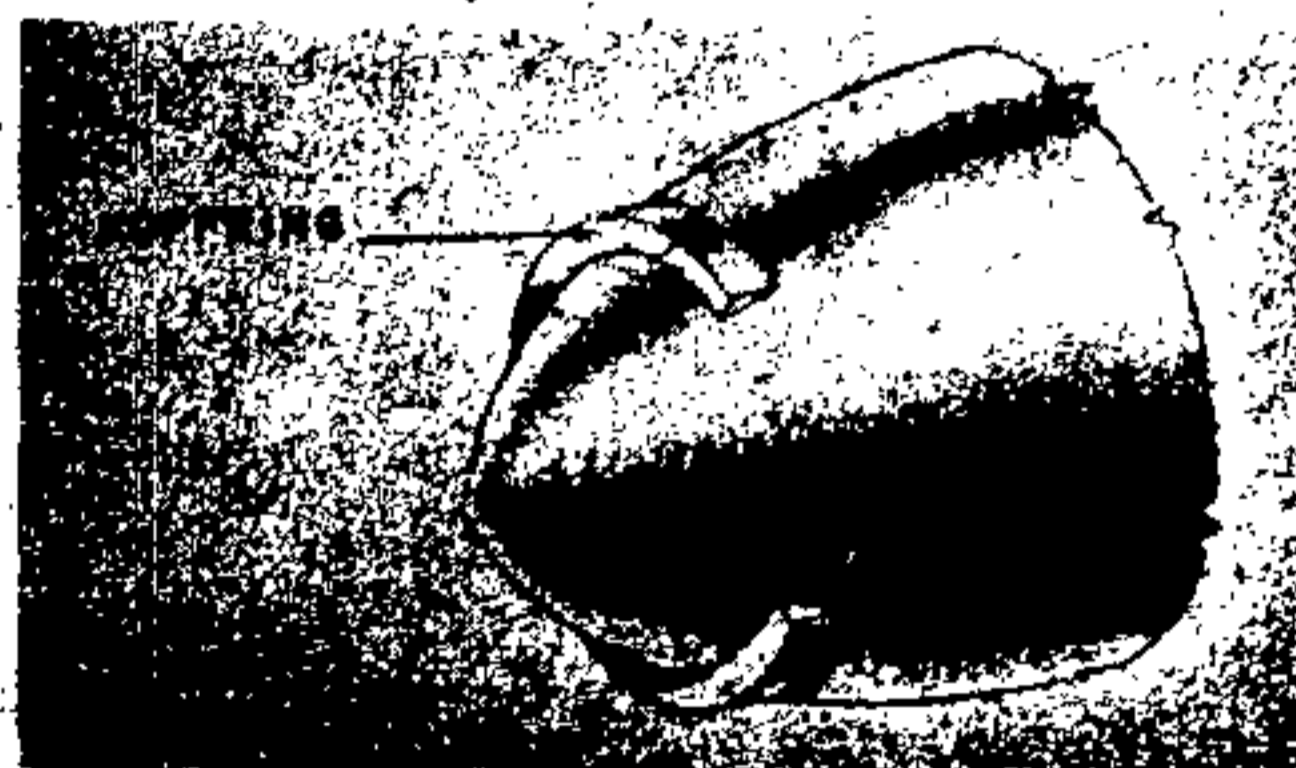

Figure 5A—Kopfring



Figure 5B—Kopfrings

GERMAN EXPLOSIVE ORDNANCE

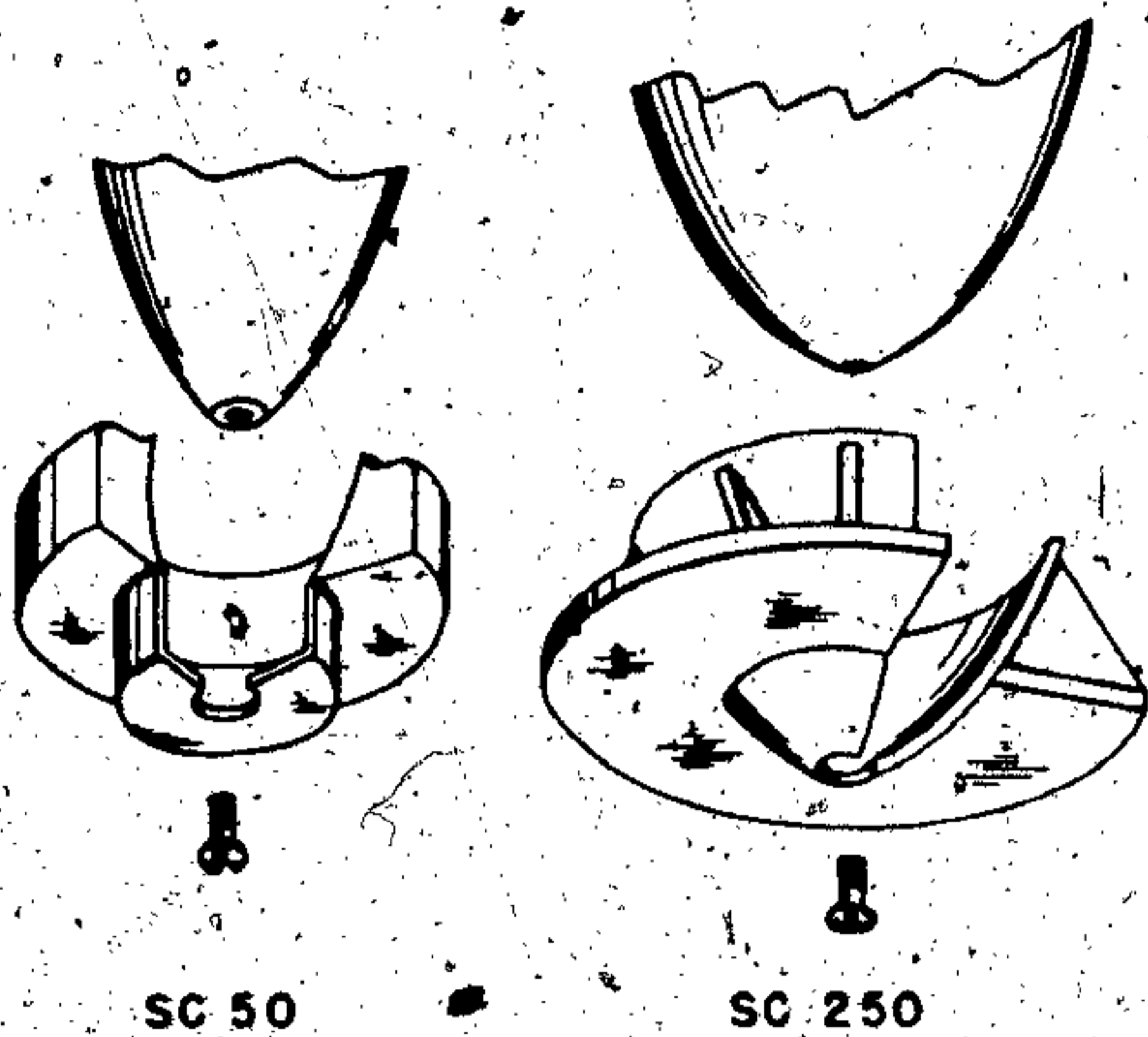

Figure 6—Antiricochet Plates

Antiricochet Plates

The antiricochet plates are used for the same general purpose as the kopfring but are entirely different in construction. Type I, which is used only on the SC 250 kg bombs, is constructed of a conical cup and a dished plate welded to it. (See fig. 6.) The conical cup is of $\frac{3}{16}$ inch steel and designed to fit as a sheath over the nose of the bomb. A dished plate, 10 inches in diameter, fits over the cup and is welded to it. Eight stiffening ribs, also of $\frac{3}{16}$ inch steel, are welded between the plate and the cup. The entire assembly is attached to the nose of the bomb by means of a threaded bolt which passes through a hole in the apex of the cone.

Type II is used on the SC 50 kg bombs. A circular plate, $5\frac{1}{4}$ inches in diameter and $\frac{15}{16}$ inch thick, is machined conically to fit over the nose of the bomb. Welded to this plate is a circular cup, $2\frac{1}{16}$ inches in diameter and drilled centrally to take a bolt for securing the entire assembly to the bomb.

Dinort Rods

Dinort rods are secured to the nose of the SD type bomb and used to obtain a "daisy cutter" effect on impact. There are two types: steel rods and wood rods. (See fig. 7.)

STEEL ROD. The rod consists of a drawn steel tube with a circular steel plate welded to the base and a steel cup welded to the top. A threaded lug

is welded to the upper end of the tube and passes through a hole in the cup. This lug screws into the suspension lug socket at the nose of the bomb.

STEEL RODS

	SD 50	SD 70	SD 250	SD 500
Length of Rod.....	23.0"	23.0"	14.8"	14.8"
Diameter of Rod.....	1.70"	1.75"	2.75"	2.70"
Diameter of Plate (base).....	4.7"	4.7"	9.45"	12.0"
Diameter of Cup (top).....		3.0"	5.5"	

WOODEN ROD. The rod consists of the square, center stick with two square pieces of wood nailed to the base. Two U-shaped steel plates welded together, are secured to the upper end of the main member by light woodscrews. A bolt, welded to the plates, is threaded to screw into the nose suspension lug socket at the nose of the bomb.

WOODEN ROD

Overall length.....	22.0"	
Width of center section.....	2.25" (square)	
Width of base.....	Smaller piece 4" (square)	Larger piece 4.25" (square)

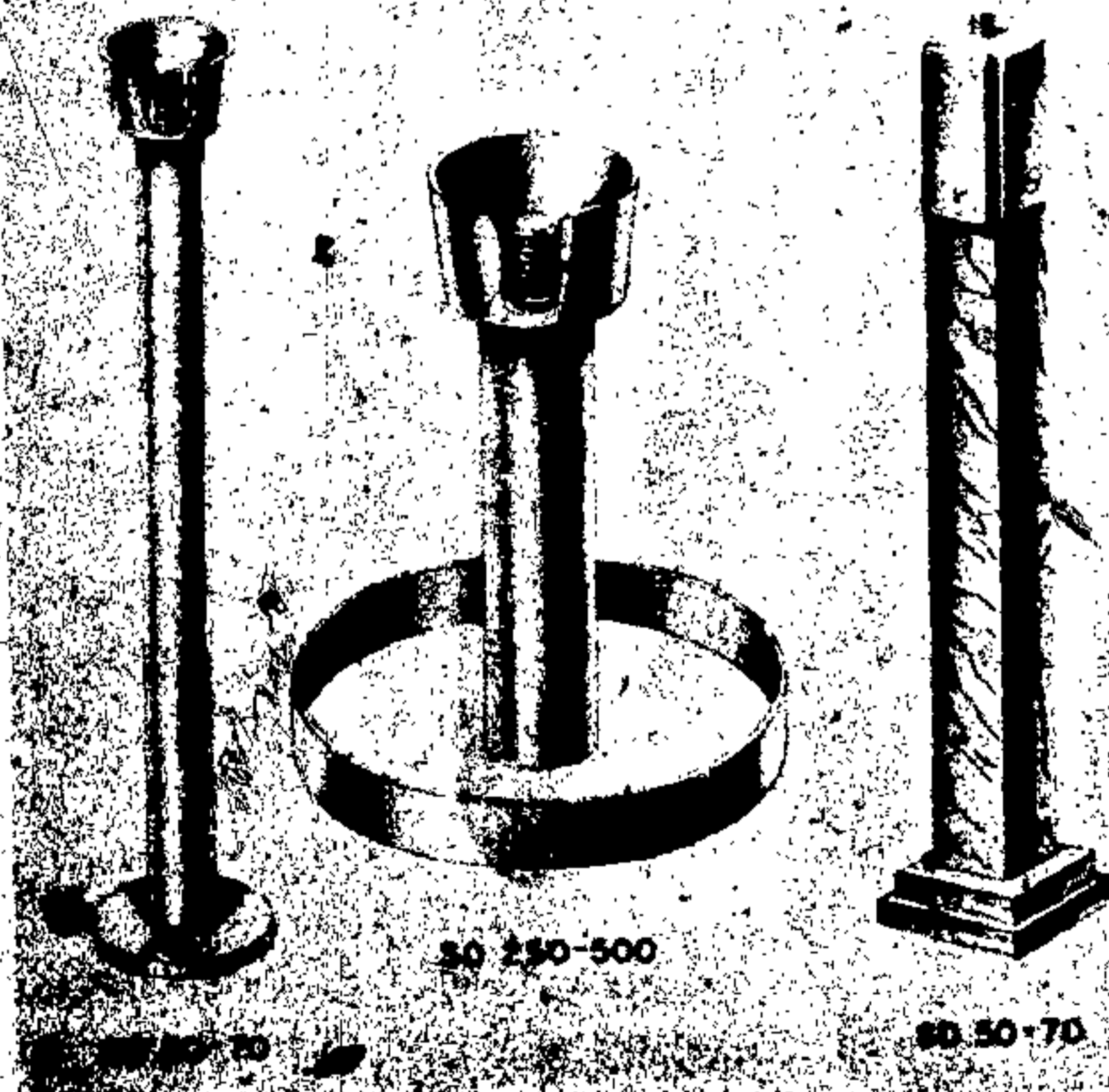

Figure 7—Dinort Rods

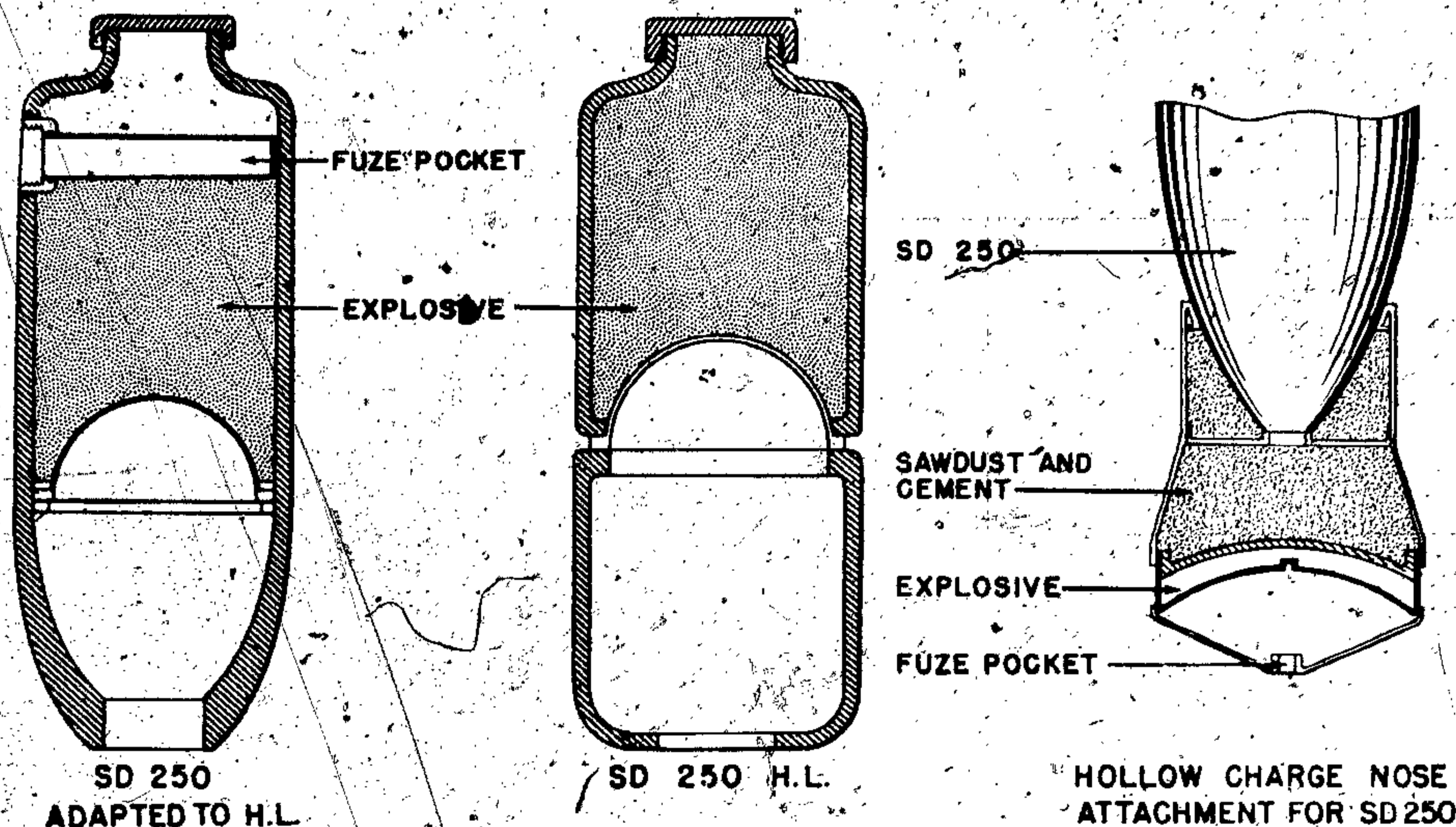

Figure 8—SD and H.L. Hollow Charge Bombs

SD AND HL HOLLOW CHARGE BOMBS HOLLOW CHARGE NOSE DEVICE

CONSTRUCTION. In SD 250 bombs having a hollow charge, the cavity is semicircular in section. The cavity in the SD 500 is a truncated cone, the larger diameter being 30 cms and the smaller diameter, 11 cms. (See fig. 8.)

The H. E. charge has a metal lining for the cavity which is supported on a flange and in order to permit the formation of the jet, the flange is located at a distance from the nose of the bomb of approximately 1.5 times the diameter of the cavity. The opening at the nose of the bomb is approximately $5\frac{1}{4}$ inches.

The 250 H. L. will penetrate 35 cms of armor plate. The 500 H. L. will penetrate 62.5 cms of armor plate or 350 cms of concrete. The performance figures for the 800 H. L. are not available but it appears that with an H. E. charge of 110 kg it was hoped to penetrate 100 cms of armor or 6 meters of reinforced concrete. They are generally filled with amatol 50/50 or 60/40.

The special nose device for use with SD 250 bombs consists of a hollow charge which is to be attached to a bomb of standard type. This charge which weighs about 4 kg is detonated by its own fuze located in the nose of the device. In order that detonation of hollow charge shall not damage the bomb, the space between the charge and the bomb is filled with a mixture of sawdust and cement.

REMARKS. Details of these types were obtained from documentary evidence only.

The SD hollow charge bomb proved disappointing in performance and modifications were made which resulted in the production of the H. L. type of bomb.

The special nose device for the SD 250 obtains greater penetrating power from low altitudes. It produces a hole in the armor through which bomb can pass. Bomb has a short delay fuze so that detonation of bomb will occur inside the target. Documents state that such a bomb will penetrate 7 cms of armor plate.

GERMAN EXPLOSIVE ORDNANCE

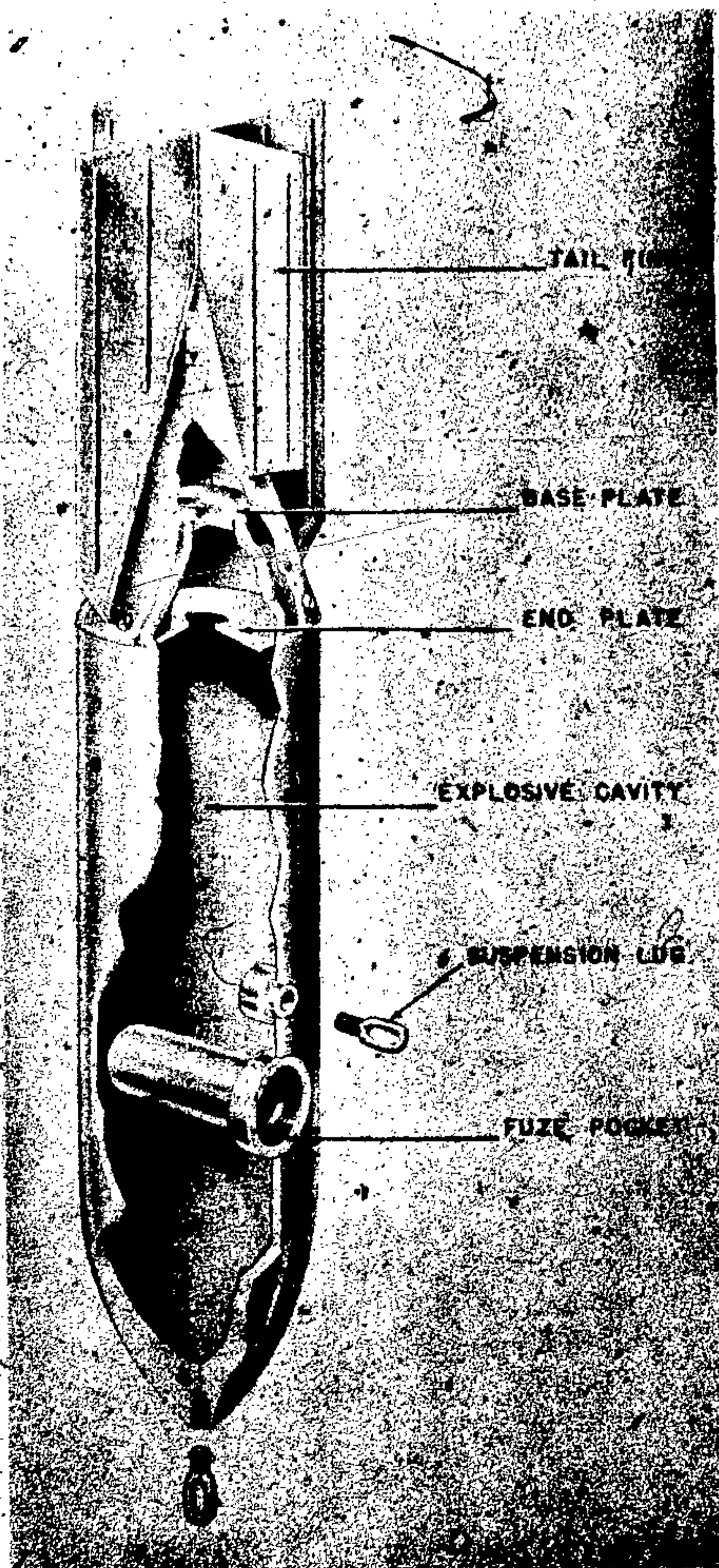

Figure 9—SC 50 Bi Bomb

SC 50-kg Bi

DATA:

Over-all Length: 46.1 in.
 Body Length: 30.0 in.
 Body Diameter: 7.9 in.

Wall Thickness: 2.0 to 2.6 in.
 Tail Width: 11.0 in.
 Tail Length: 16.1 in.
 Filling: Cast TNT, Amatol or Trialen.
 Weight of Filling: 24.4 kg.
 Total Weight: 55.5 kg.
 Charge/Weight Ratio: 43.75%.
 Fuzing: Series 5 or 8.
 Color: Dark gray or green over-all.

CONSTRUCTION. The Bi is a one-piece cast steel body machined down. All the fittings are welded in place. It is very similar to the Ja and L Series.

The bomb is threaded at the base to take a male base plate. A steel diaphragm with a central hole is located $3\frac{3}{4}$ inches forward from the base plate. When the bomb is loaded, the filling charge comes only to this diaphragm. (See fig. 9)

The tail cone is sheet steel constructed in four pieces, and welded together. The assembled cone is secured to the bomb by means of eight screws.

There is one transverse fuze pocket located just forward of the horizontal suspension lug. The bottom end of the pocket is secured to the opposite wall by a weld. It is long enough to accommodate the normal sized electric fuze and two picric pellets.

In the nose female threads take an eye-bolt for vertical suspension. The bomb may include a shock plate welded to the nose, to help prevent ricochet when used against water targets.

SC 50 GRADE I—Ja, L, and Stabo

DATA:

Over-all Length: Ja and L: 43.3 in. Stabo: 61.8 in.

Body Length: 30.0 in.

Body Diameter: 8.0 in.

Wall Thickness: 0.16 to 0.24 in.

Tail Length: 16.1 in.

Tail Width: 11.0 in.

Filling: Cast TNT; powdered amatol; or cast trialen.

Weight of Filling: 21 to 25 kg

Total Weight: 48 to 55 kg.

Charge/Weight Ratio: 46%.

Fuzing: 5; 8; or 25B; ELAZ (38) for water targets. Stabo may also take 17 or 57.

CONSTRUCTION. The Ja has a one-piece drawn steel body. The L is the same as Ja except the body is of seamless tubular steel. The Stabo

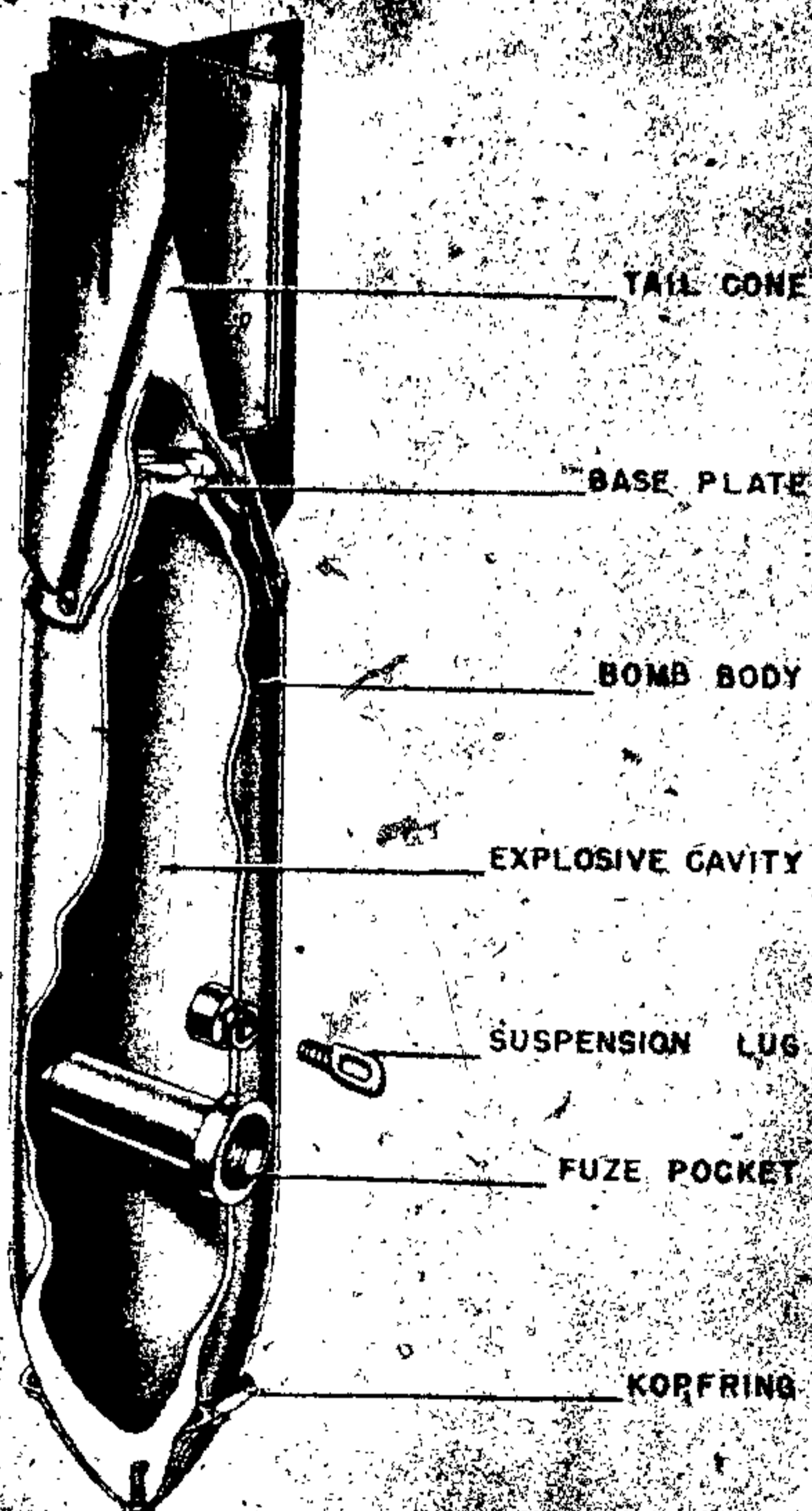

Figure 10—SC 50 Grade I Bomb

is like the Ja, with a threaded lug forged to the nose of the bomb. A steel spike 18.5 inches long, 1.8 inches in diameter can be secured to this lug. (See fig. 10.)

The sheet steel tail cone is secured to the bomb body by eight screws. More recent models have a collar welded around the neck of the bomb and the tail cone is secured to this collar by screws. The holes in the tail fins are used when screamers are attached.

Bombs can be modified for use on water targets by removing the tail fins. It is claimed ballistics are not changed up to an altitude of 200 meters. Fuze ELAZ (38) is used on this type of target.

Its maximum delay of five seconds allows 12 to 18 meters of water travel.

When water targets are the object of an attack an antiricochet plate is bolted to the nose. This permits a much smaller angle of impact without ricochet.

SUSPENSION. Horizontal or vertical by an eyebolt.

COLOR. Sandy grey or dark green over all. Yellow stripes on each segment of cone.

SC 50 GRADE II—JB, JC, J, J/2

DATA:

Over-all Length: 43.3 in.

Body Length: 26.4 in.

Body Diameter: 8.0 in.

Wall Thickness: 0.16 in. to 0.24 in.

Tail Length: 16.1 in.

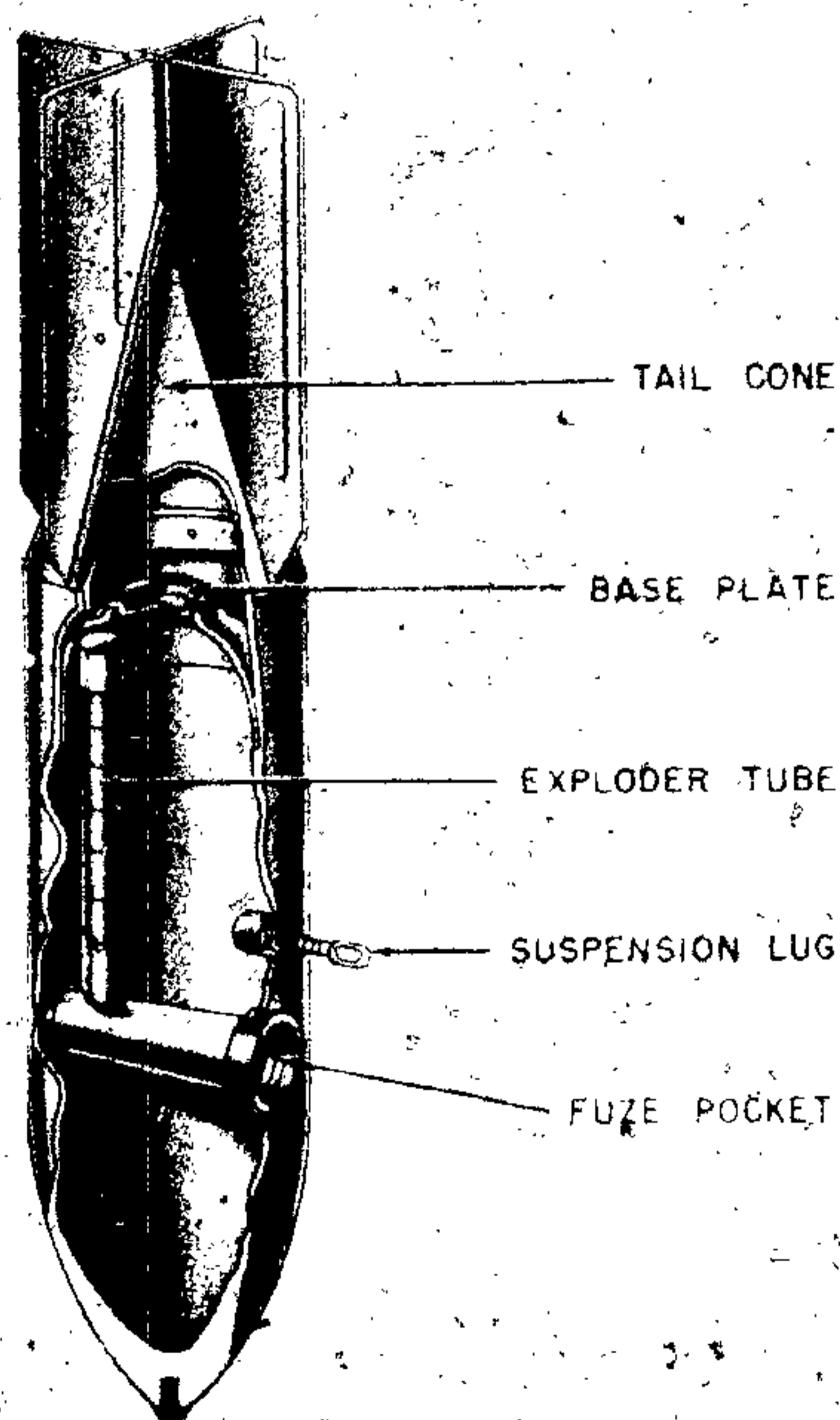

Figure 11—SC 50 Grade II Bomb

GERMAN EXPLOSIVE ORDNANCE

Tail Width: 11.0 in.

Filling: Cast TNT; powdered Amatol; or cast Trialen.

Weight of Filling: 21 to 25 kg.

Total Weight: 48 to 55 kg.

Charge Weight Ratio: 46%.

Fuzing: 5, 8, and 25. ELAZ (38) for water targets.

CONSTRUCTION. The JB has a one-piece nose and body. The base is welded to the body. The JC has a pressed steel nose and drawn steel body. Here the nose and base are welded to body. The J was the early model of the JB and they are identical in construction. The J/2 is very similar

to the JC, the quality of the steel being the real difference. It was produced only in limited quantities.

The sheet steel tail cone is riveted to a ring which is secured to the bomb body by eight screws. The small holes on the fins are used to attach screamers. (See fig. 11.)

Grade II can also be modified for use against water targets. Same modification and results as for Grade I are claimed.

SUSPENSION. Either horizontal or vertical.

COLOR. Sandy grey or dark green; yellow stripe on each section of tail cone.

SC 250—TYPES 1, 2, AND 3; J, L, L2, B AND K

DATA:

Over-all Length: 64.5 in. L2 (Stabo) 87 in.

Body Length: 47.0 in.

Body Diameter: 14.5 in.

Wall Thickness: 0.3 in. wall to 2.8 in. at nose.

Tail Length: 25.0 in.

Tail Width: 20.0 in.

Filling: 60/40 Amatol, TNT; TNT and wax or woodmeal and aluminum powder and naphthalene and ammonium nitrate.

Weight of Filling: 287 lbs.

Total Weight: 548 lbs.

Chg/Wt Ratio: 52%.

Fuzing: 5 series, 17 and 50 series. 57 in Stabo.

CONSTRUCTION:

TYPE 1: Includes Models J, L, and L2. J is of one piece construction forged steel; L is one piece construction tube steel; L2 is two piece construction, nose forged steel, body tube steel. (See fig. 12.)

TYPE 2: J is two piece construction forged steel.

TYPE 3: Includes Models J, B, and K. J is three piece construction; nose, forged steel; body, tube steel; and base, forged steel. B is three piece construction; nose, cast steel; body, tube steel; and base, arched case steel. K is three-piece construction; nose, case hardened steel; body, tube steel; and base, cast steel.

SUSPENSION. Suspension is either horizontal or vertical.

COLOR AND MARKINGS: Field grey, sky blue or aluminum over-all. Yellow stripes on the tail.

REMARKS. The L2 type is sometimes equipped with a spike making it detonate above the ground.

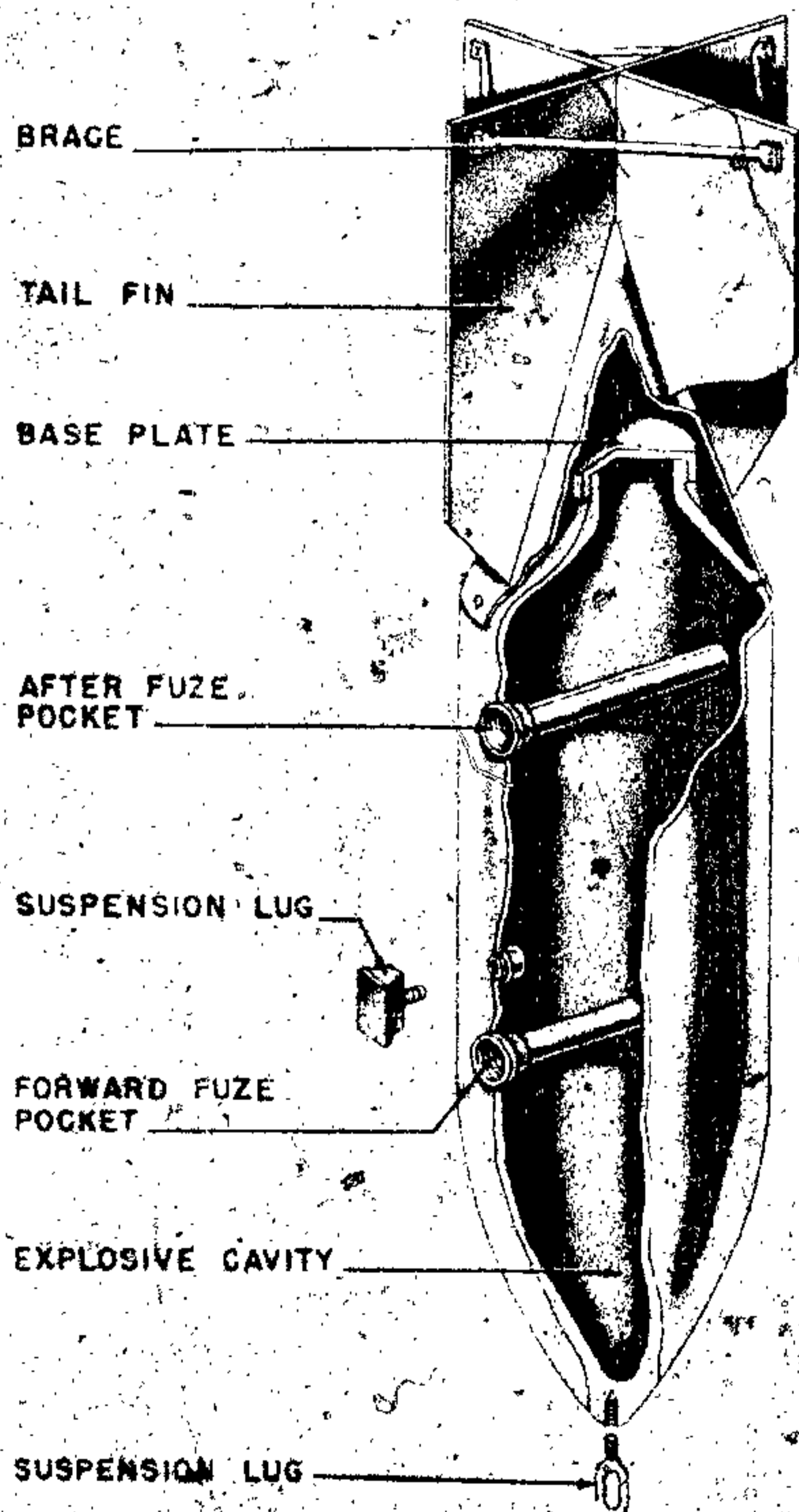

Figure 12—SC 250 Bomb; types 1, 2, and 3

Spike is 22½ inches long and 3 inches in diameter.

SC 500-kg GRADE III (K, L2 J)

DATA:

Over-all Length: 80 in.

Body Length: K—55.7 in. L2—58.5 in. J—57.0 in.

Body Diameter: 18 in.

Wall Thickness: 0.3 in. wall to 3.2 in. nose.

Tail Length: 29.5 in.

Tail Width: 25.0 in.

Filling: 40/60 or 50/50 Amatol TNT, Trialen.

Bombs recovered with Trialen filling have cylindrical paper wrapped pellets 1½ in. in length and diameter forming a column along the main axis of the bomb. These pellets are composed of RDX/Alum/Wax. Some bombs have approximately 500 pellets in addition distributed throughout the filling.

Weight of Filling: 220 kg.

Total Weight: 500 kg.

CHG/WT Ratio: 44%.

Fuzing: 5, 17, and 50. 38 for antisub.

CONSTRUCTION. The SC 500-kg Grade III bomb is constructed in three sections: nose piece, center section, and tail closing assembly. The steel nose is cast and machined to the proper dimensions, and then welded to a drawn steel tube known as the center section. The tail closing assembly consists of a sheet steel dome, and a steel connecting ring. The flat steel connecting ring is riveted to the outside of the dome, and then the whole assembly is secured to the after end of the center section with 16 countersunk bolts. (See fig. 13.) The tail assembly is placed in this position only after the bomb has been filled with explosive.

There are two transverse fuze pockets in this series. The forward pocket generally contains the impact fuze and the after pocket has either a type 17 time fuze or a type 50 antidisturbance fuze. In case the bomb is to be used in antisubmarine work, the forward fuze pocket will contain a type 38 fuze. A kopfring will also be added for this type of work.

SUSPENSION. Horizontal suspension only by means of an "eye" bolt.

COLOR. Field grey, sky blue or aluminum body with yellow stripes on the tail cone. When a merchant ship silhouette is stenciled in yellow

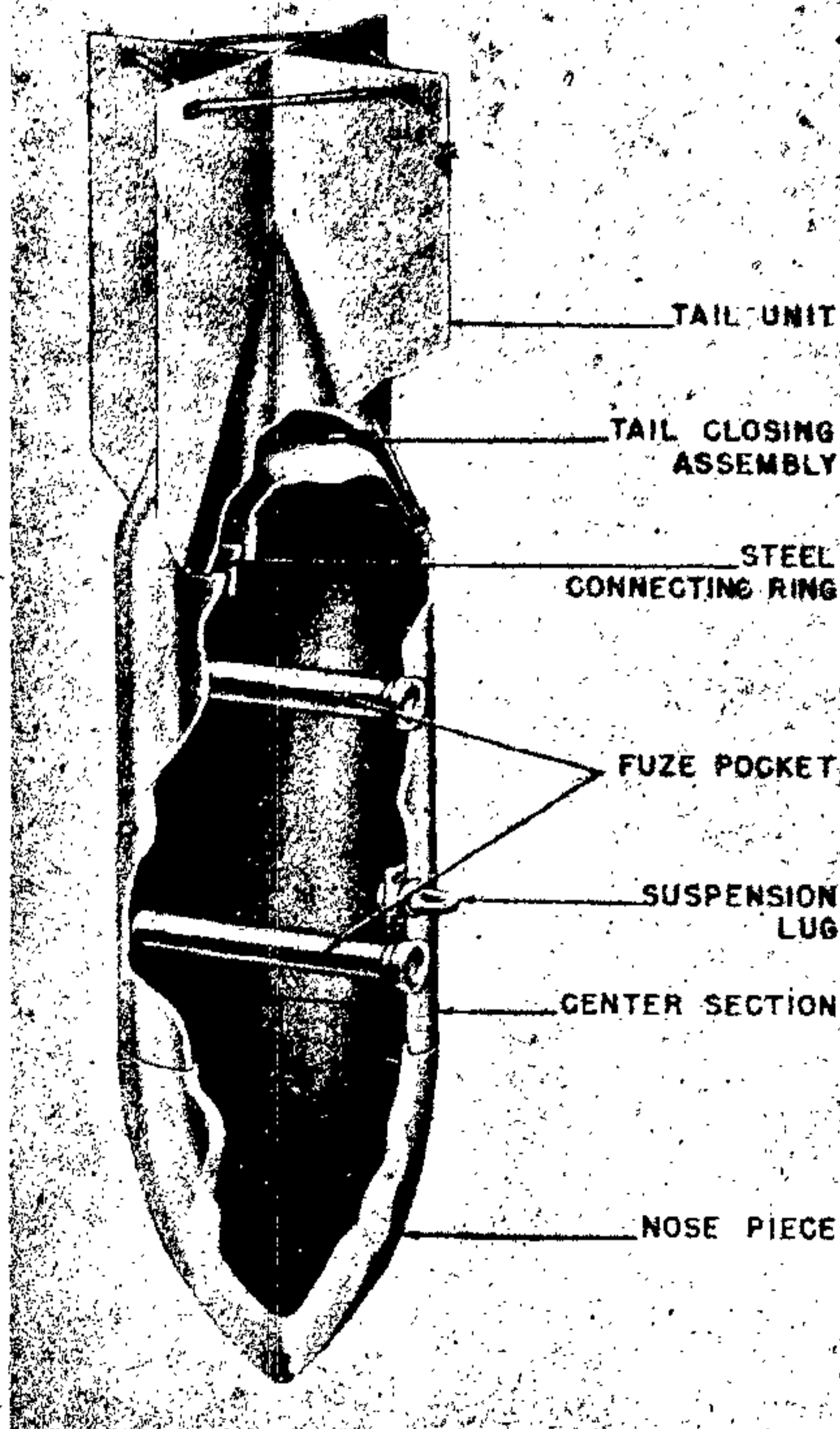

Figure 13—SC 500-Kg Bomb

on the tail cone, it indicates Trialen (105) filler.

SC 1000 HERMAN (C, L, AND L2)

DATA:

	C	L	L2
Over-all length	109.5 in.	99.9 in.	109.5 in.
Body length	75.0 in.	68.6 in.	75.0 in.
Body diameter	28.0 in.	25.5 in.	25.8 in.
Wall thickness	0.4 in.	0.4 in.	0.4 in.
Tail length	46.5 in.	46.5 in.	46.5 in.
Tail width	24.0 in.	25.3 in.	24.0 in.
Filling	40/60 Amatol TNT; TNT aluminum powder woodmeal; Trialen (105).		
Weight of filling	620 kg.	530 kg.	600 kg.
Total weight	1,090 kg.	1,002 kg.	1,002 kg.
Chg/wt ratio	57%	53%	60%
Fuzing	28B2 Extension Cap III, AZ25B and AZ (55).		

GERMAN EXPLOSIVE ORDNANCE

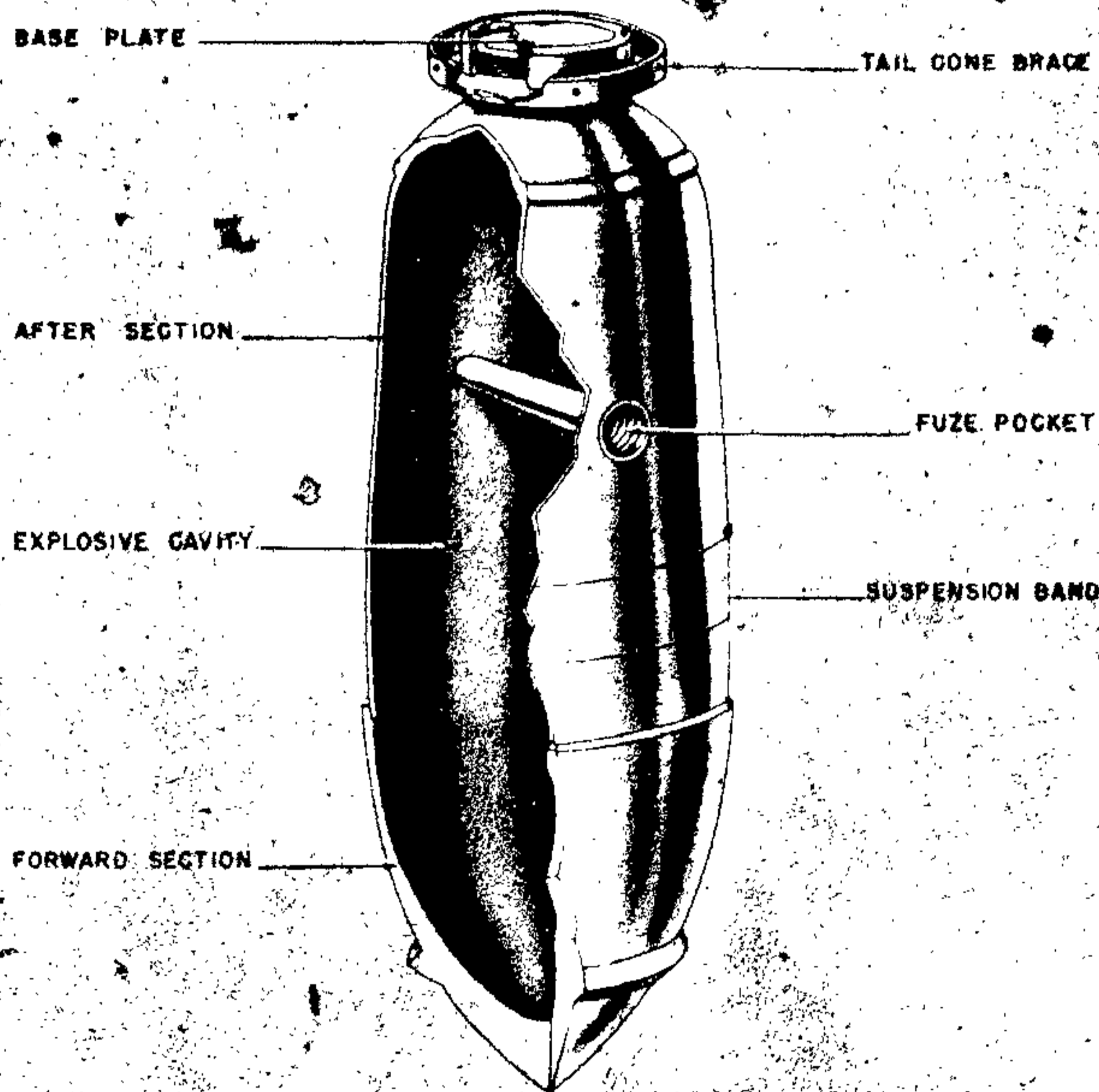

Figure 14—SC 1000-Kg Bomb

CONSTRUCTION. The SC 1000 and SC 1000 L2 general demolition bombs have a drawn steel tube body. A very heavy constructed pointed nose is welded to the forward end of the drawn steel body. The after end of the bomb body is threaded to take a female base plate. The tail attachment brace is tack welded to the body just forward of the base plate.

The magnesium alloy tail unit is of welded construction and is equipped with ring type strut. The unit is secured to the bomb body in two ways; it is welded directly to the bomb where the base of the cone contacts the body, and it is also bolted to the tail attachment brace with 16 round head bolts. (See fig. 14.)

This series of bombs are equipped with only one transverse fuze pocket. It is located approximately 8 inches off the suspension lug, and usually contains one of the El A Z (55) series fuzes.

In addition to the booster pellets in the transverse fuze pocket, a central exploder tube of high grade TNT is located in the center of the explosive cavity. This tube runs almost the entire length of the cavity and is used to insure high order detonation.

The nose of the bomb is always fitted with the large size kopfring.

SUSPENSION. Horizontal by means of an H-type lug.

COLOR. Sky blue with a yellow strip on the tail cone.

REMARKS. When filled with Trialen (105), in place of yellow stripes on the tail cone a silhouette of a ship is stencilled in yellow paint. On the bomb body is stencilled "nur gegen handelschiffen" (use only against merchant ships). It is stated that against nonarmor plated targets it gives off a good mining and blast effect, also good under-

water results. Low level attacks using this bomb cannot be made because of the lack of safety for the releasing plane.

SC 1200

DATA:

Over-all Length: 109.5 in.

Body Length: 75.0 in.

Body Diameter: 25.6 in.

Wall Thickness: 0.45 in.

Tail Thickness: 46.5 in.

Tail Width: 26.0 in.

Filling: Trialen

Weight of Filling: 631 kg.

Total Weight: 1,117 kg.

Chg/Wt Ratio: 57%.

Fuzing: (28)B, Extension Cap III.

CONSTRUCTION. The SC 1,200-kg bomb is very similar in construction to the SC 1000 series. The body is a drawn steel tube to which has been welded a heavy cast steel nose. The after-end of the body is constructed to take a female base plate. There is one transverse fuze pocket located off the suspension lug. (See fig. 15.) A Kopfring is welded to the nose.

The magnesium alloy tail unit is similar to that on the SC 1000 series and is secured to the bomb in the same manner.

SUSPENSION. A suspension band is placed around the body of the bomb at the center of gravity. Secured to this band is an H-type suspension lug.

COLOR. Sky blue over-all with a yellow stripe on the tail cone.

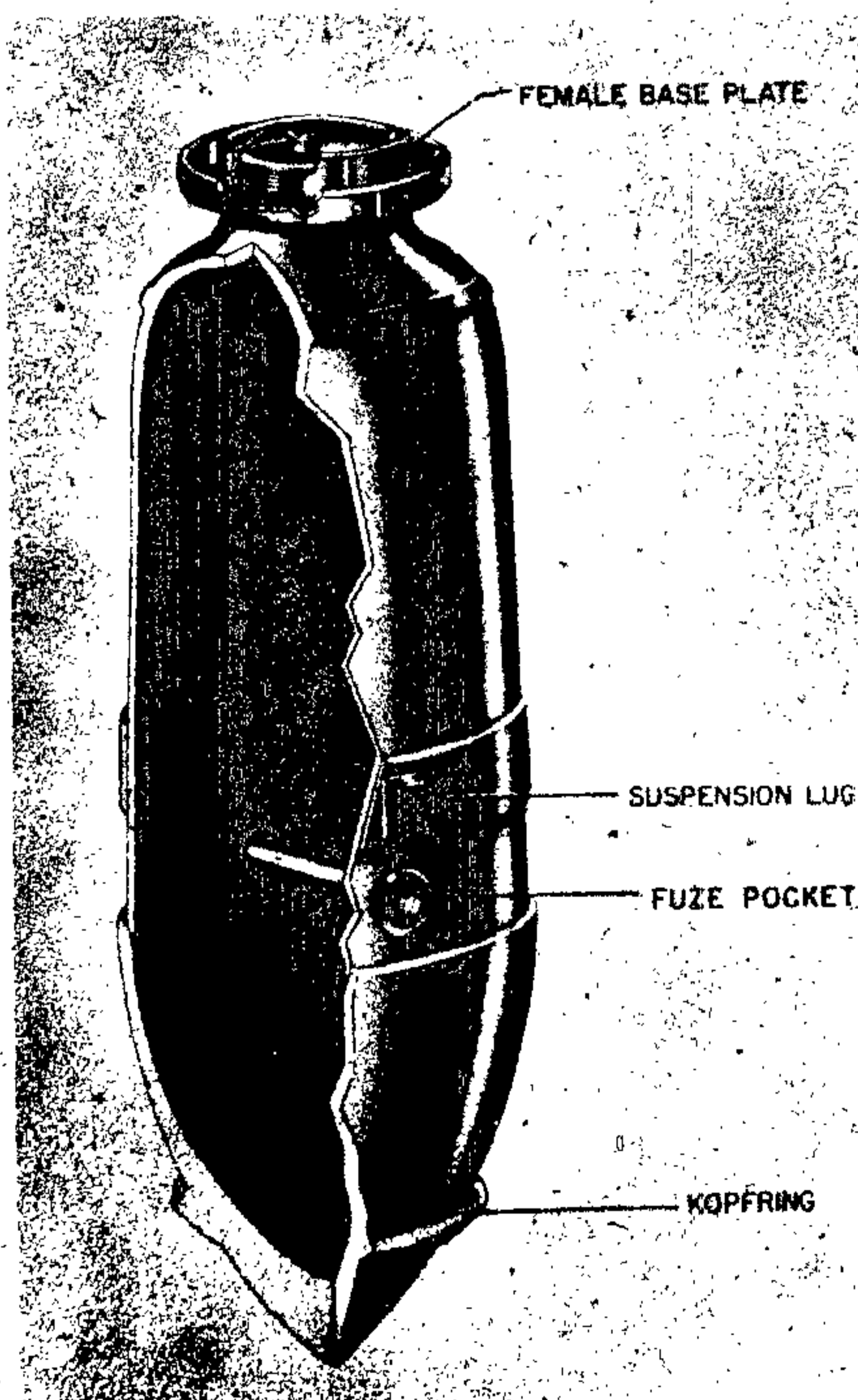

Figure 15—SC 1200-Kg Bomb

GERMAN EXPLOSIVE ORDNANCE

SC 1800 SATAN

DATA:	SC1800	SC1800B
Over-all Length	147.9 in.	137.7 in.
Body Length	107.0 in.	106.0 in.
Body Diameter	26.0 in.	26.0 in.
Wall Thickness	0.5 in.	0.5 in.
Tail Length	55.2 in.	44.7 in.
Tail Width	36.0 in.	26.0 in.
Filling	40/60 Amatol, TNT, and Trallen 105.	
Fuzing	(28) B*	(28) B* or 25B.

CONSTRUCTION. The SC 1800-kg bomb has the same general construction as the SC 1000 and

SC 1200 series. It is fitted with a single fuze pocket.

The tail unit is constructed of sheet steel. The four fins are braced with diagonal bars on the SC 1800 model and with the ring type brace on the SC 1800B model. (See fig. 16.) The SC 1800 series has the central TNT exploder tube like the SC 1000.

SUSPENSION. Horizontal, using the H-type suspension lug.

COLOR. Sky blue over-all with yellow stripe on tail cone.

REMARKS. If filled with Trallen 105, the following will be stencilled on the case. "105" "Bei Abwurf auf land nicht im Tiefangriff und nur o. V." (Not to be released from a low height on land targets; always nondelay.)

SC 2,000-KG

DATA:

Over-all Length:	136.5 in.
Body Length:	106 in.
Body Diameter:	26.0 in.
Wall Thickness:	17/32 in.
Tail Length:	44 3/4 in.
Tail Width:	24 1/2 in.
Filling:	40/60 Amatol.
Weight of Filling:	975 kg.
Total Weight:	1950 kg.
Chg/wt. Ratio:	50%.

CONSTRUCTION. The entire body is forged into one piece and is machine finished externally. A triangular ring (Kopfring) is welded on the nose to prevent excessive ground penetration. A 5/8-inch plate is welded inside the casing beneath the H-type suspension lug to act as a stiffener. The bomb contains one transverse fuze pocket located just aft of the suspension lug. A 2-inch diameter steel bar with threaded holes in each end also runs transversely but at right angles to the fuze pocket. These holes receive the detachable trunnion screws which are used only for dive bombing. A dished tail retaining ring containing 24 holes is welded to the bomb casing near the base. Twelve small screws affix the tail assembly to this. (See fig. 17.)

The tail is made of 3/32-inch sheet steel. Each fin and cone segment is formed from one pressing and the four components are welded together. A closed cylindrical container 6 1/2 inches long and

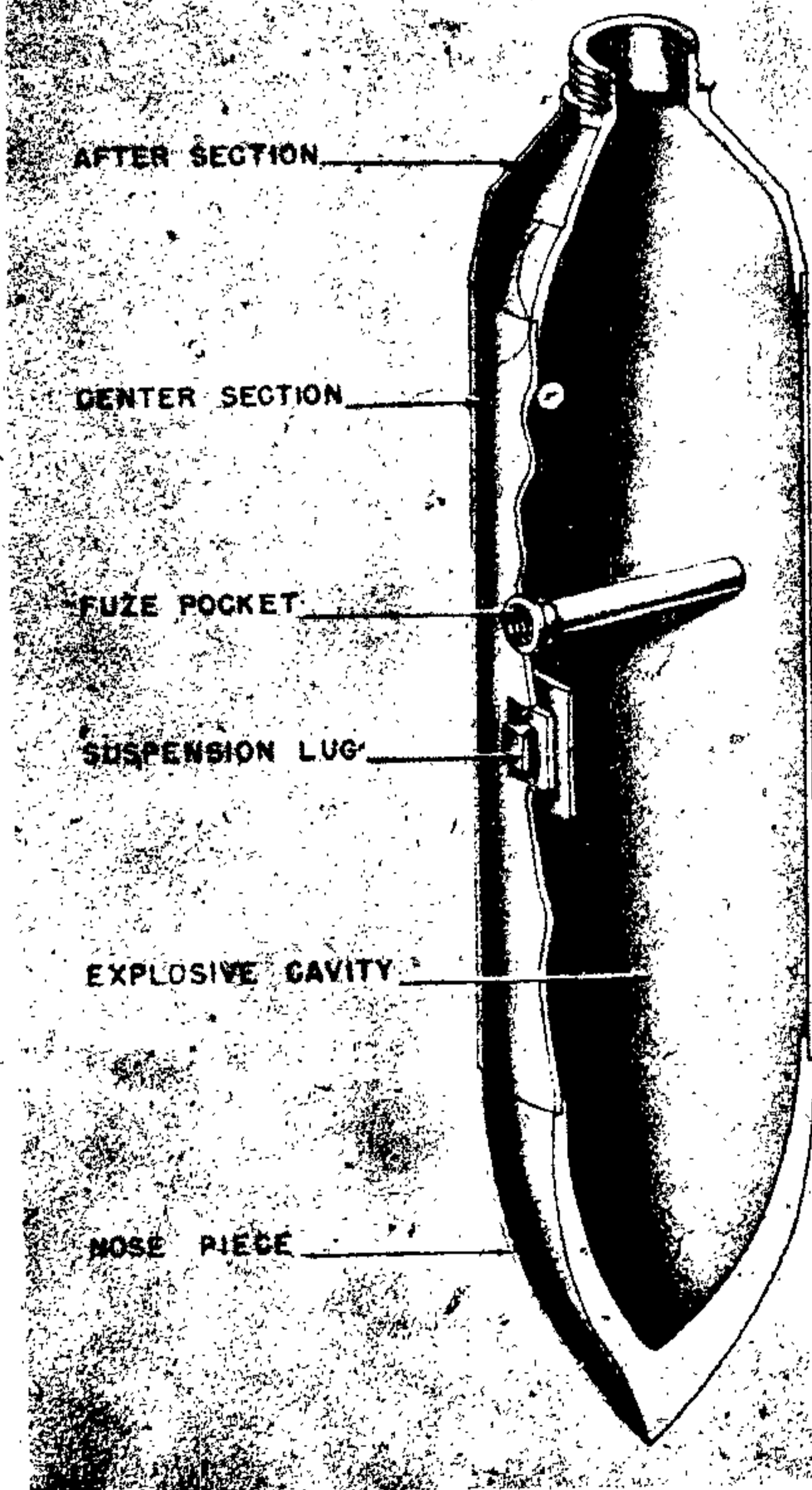

Figure 16—SC 1800-Kg Bomb

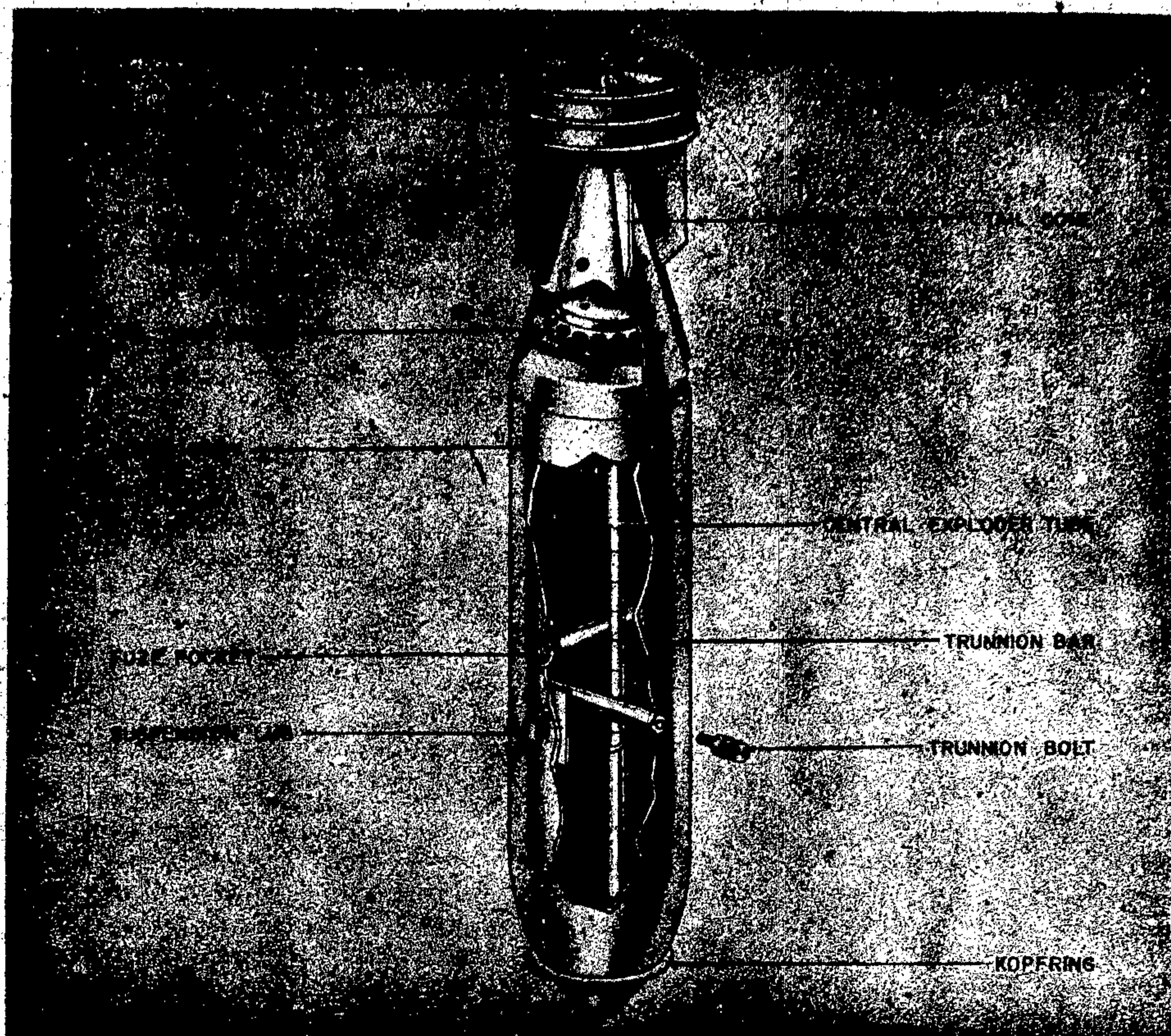

Figure 17—SC 2000-Kg Bomb

$3\frac{5}{16}$ inches in diameter is located in the center of the tail assembly aft of the tail cone. This is closed at the rear by a threaded male plug with a conical spring mounted on its inner side. The dive bombing trunnions are stored in this space until and if they are to be used.

SUSPENSION. Horizontal, H-type lug, or by trunnions. Trunnions screw into the sides of the bomb 90° from carrying lug.

COLOR. Dull black over-all in color. Markings stencilled in white. There is a $4\frac{1}{2}$ -inch yellow band painted about half way down the body.

SC 2500 MAX

DATA:

- Over-all Length: $154\frac{1}{4}$ in.
- Body Length: $94\frac{3}{4}$ in.
- Body Diameter: 32 in.
- Wall Thickness: $1\frac{7}{32}$ in.
- Tail Length: $66\frac{1}{2}$ in.
- Tail Width: 33 in.
- Filling: Trialen 105; 40% Amatol mixture of RDZ, TNT and aluminum.
- Total Weight: 2,400-kg approx.
- Fuzing: Forward fuze pocket; AZ (24) A.
After fuze pocket: ElAZ (28) A.

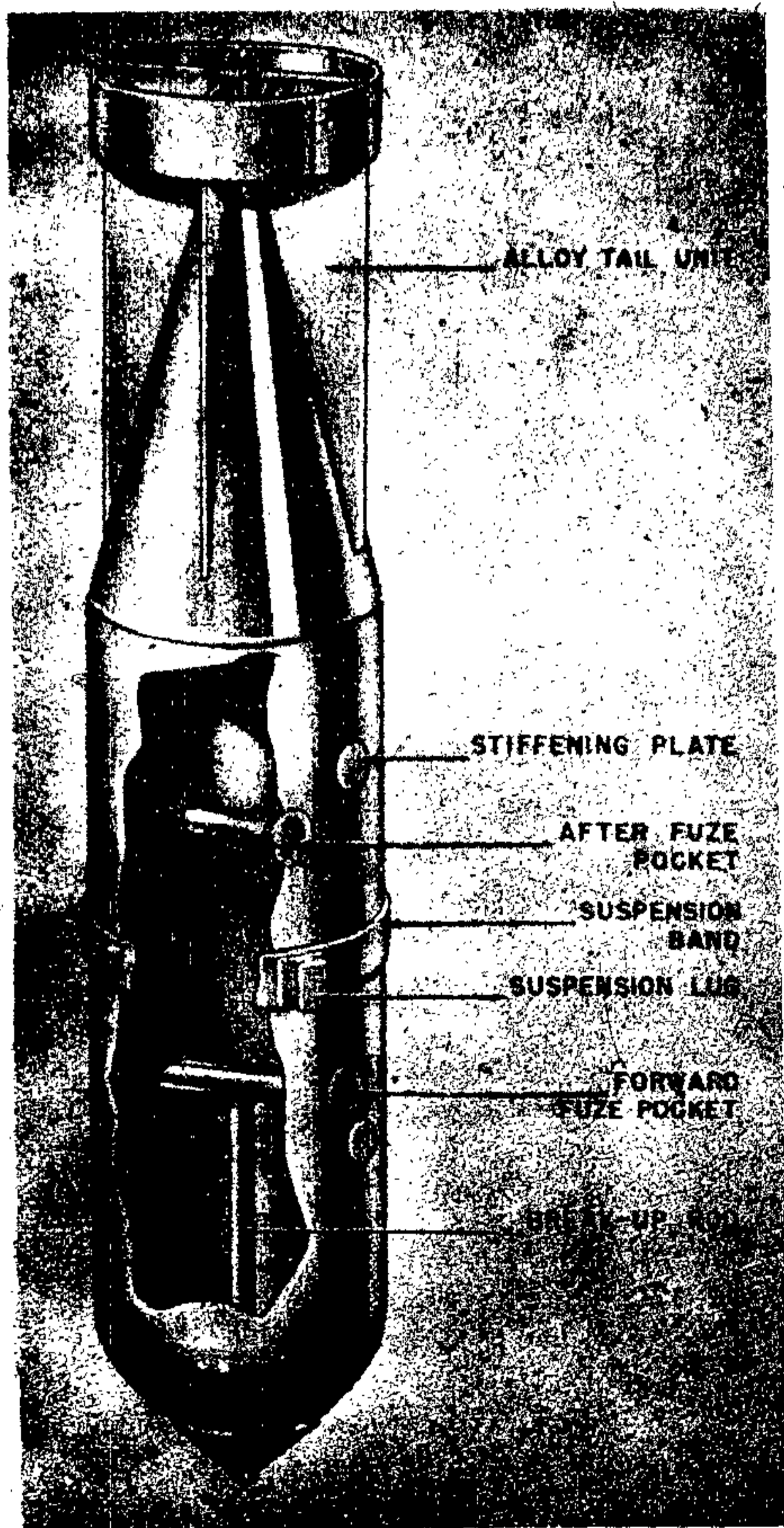

Figure 18—SC 2500-Kg Bomb

CONSTRUCTION. The SC 2,500 has an aluminum body with a welded head and tailpiece. There are two welded fuze pockets. The rear fuze pocket is in the plane of the suspension lug. The forward pocket is rotated about 30° to the right. This pocket is connected to the nose of the bomb by a tube which extends a break-up functioning rod. (See fig. 18.). This rod, which is central to the axis of the bomb, will on distortion of the nose

crush the lower section of the (24) fuze to explode the bomb. A kopfring is welded to the nose.

The tail of the SC 2500 is aluminum and of the drum type.

SUSPENSION. Horizontal by an H-type lug. A suspension band is placed around bombs to give a solid base for the suspension lug.

COLOR AND MARKINGS. Sky blue over-all. SC 2500 is stenciled on the body in letters 3 inches high. Two yellow stripes are painted on the body between the tail fins. A few anti-shipping bombs have been found with the following stenciled on the body: "Bei abwurf auf land nicht im tiefangriff und nur o.V." (not to be released over land in low level attack and always without delay). This type is thought to be filled with Trialen 105.

REMARKS. The bomb is very similar to the SB 2500. The main difference is that the SC is made of aluminum while the SB is made of steel. The bomb is filled through the nose. Because of the rupture-type fuze, bombs cannot be dropped safe.

THE GERMAN SB 400 KUGEL K—"KURT" APPARATUS

DESCRIPTION. The German "KURT" apparatus is a spherical, hydrostatically operated, aircraft-laid, skip bomb; a copy of a similar device used by the British. It was designed to operate like a skipping stone over a smooth water surface for use against ship targets, power plants, lock gates, tidal installations and similar harbor facilities.

The information contained in this report was obtained through the interrogation of German scientists and prisoners of war. Complete specimens of this device have been shipped to the United States Navy Ordnance Investigation Laboratory.

Development of the "KURT" apparatus was commenced in the late 1943 at the German airforce experimental center (E-Stelle), Travemunde, Germany. The original model was a sphere approximately 30 inches in diameter and weighing 400-450 kg. It contained two fuzes; one, a type 59 fuze with a 23-second powder delay train, and the other, a hydrostatic, type 44 fuze. The effective range of this spherical missile was calculated at 400 meters. To increase the range to 4,000 meters a rocket propulsion unit was fitted to the sphere. Some experiments were carried out with the propulsion unit but no actual tests were made.

Work was stopped on this device in August 1944 when efforts were directed to more advanced projects. Because of the scarcity of documents and test datum it is impossible to substantiate adequately the information obtained through interrogation.

The first experiments were carried out with a model having the same weight and dimensions as the final "KURT" warhead. The ideal altitude for the attacking plane was calculated at 20 meters and at a speed of 700 km/h. It was found that, under ideal conditions, the missile had an effective range of 400 meters. To increase the range and to offer more protection for the attacking aircraft, a rocket propulsion unit was added. The modified "KURT" with rocket assistance included an air tail with its elevators preset to an angle of 10° to prevent sharp trajectory as in the case of the sphere without rocket assistance. (Because of the essentially shorter running distance of the sphere without rocket assistance, sharp trajectories and slight deviations from the target course were disregarded.) This modification proved unstable in flight because the assembly tended to rotate about its longitudinal axis, deviating from the target course to such an extent that the target would be missed completely. To obviate this large deviation and to give the missile directional stability, a

gyroscope was installed. However, no further tests were made.

DETAILS

A. WARHEAD:

Diameter: 750 mm.

Thickness of case: 10-12 mm. (steel).

Weight of charge: 300 kg.

Total weight of sphere: 400-450 kg.

The warhead, a spherical shell, is filled with cast hexanite and contains two fuze pockets. A transverse pocket, housing two KRÜPP hydrostatic fuzes which replaced the type 59 fuze, runs through the sphere and is open at both ends. The other pocket is set at an angle of 45° to the transverse pocket and contains a type 44 hydrostatic fuze.

B. MID-SECTION. The cylindrical mid-section houses a gyro unit which is operated by a gas evolved from a burning element. It also houses the lifting lug and the explosive coupling which severs the warhead from the propulsion unit. (See fig. 19.)

C. ROCKET SECTION. The rocket section is a steel cylinder 18 inches in diameter and 36 inches long. It houses the rocket propellant and 18 venturis. The weight of the propellant is approximately 90 kg.

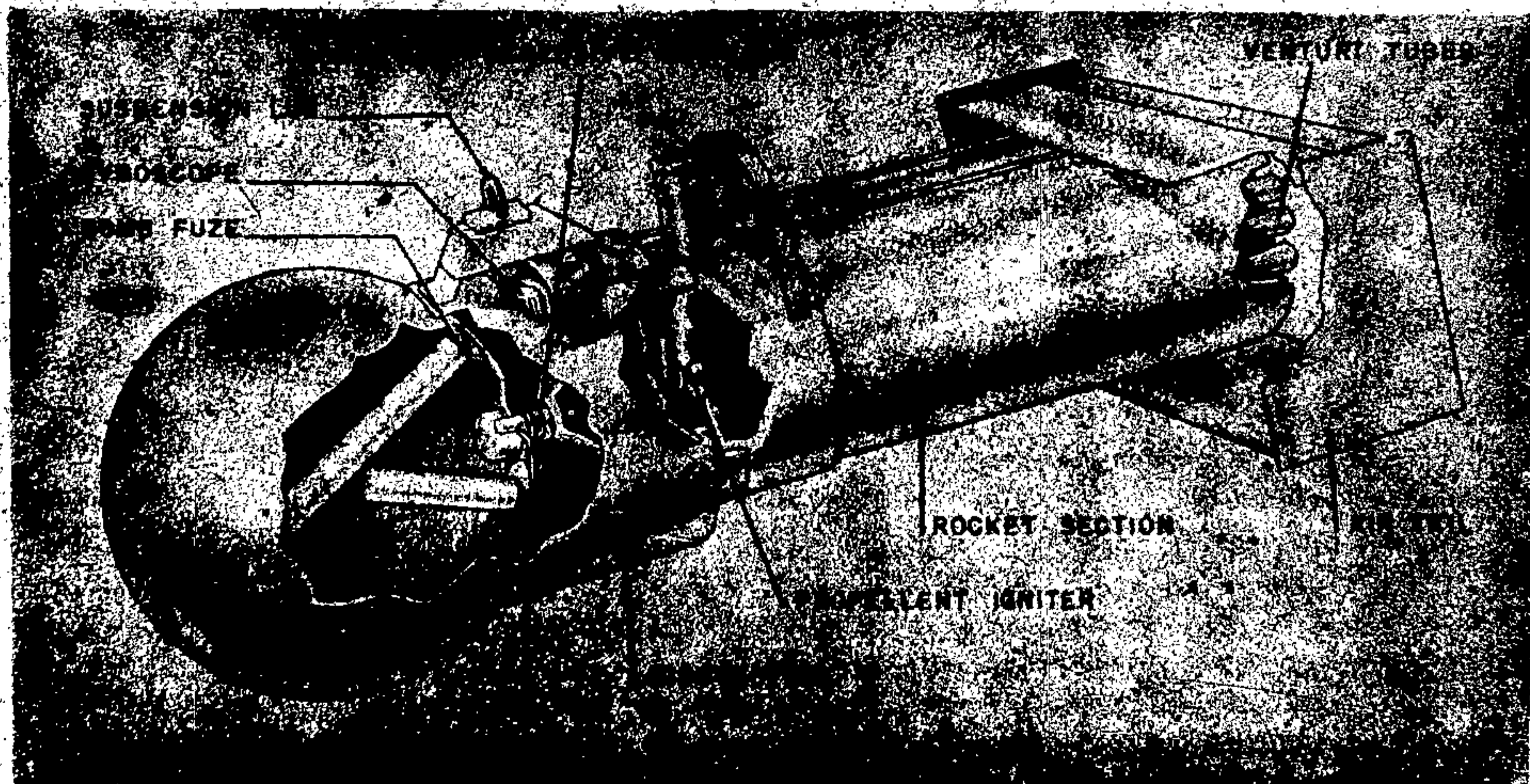

Figure 19—SB 400 Skip Bomb (Kugel K-Kurt Apparatus)

GERMAN EXPLOSIVE ORDNANCE

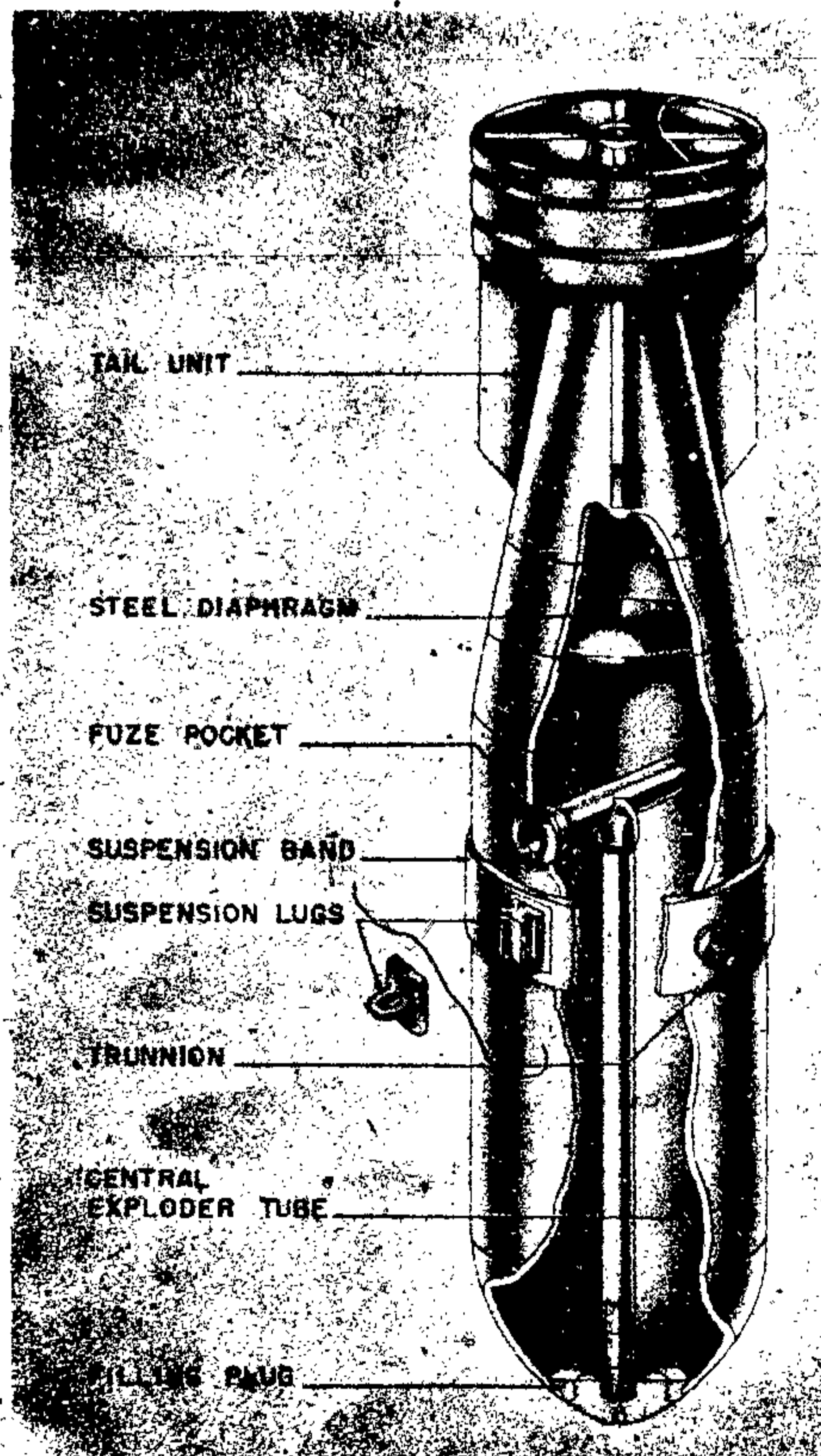

Figure 20—SB 1000-Kg Bomb

D. AIR TAIL. The air tail is the same as used with the bomb-torpedo. It is made of plywood and its elevators are controlled by the gyro. Dimensions of the air tail: 18 by 36 by 50 inches. Total length of the KURT apparatus is 80 inches.

OPERATION

A. WITHOUT ROCKET PROPULSION:

Plane speed: 700 km/h.
Plane altitude: 20 m minimum—50 m max.
Speed of Kugel on impact: 180 meters/sec.
Effective distance: 400 meters.

B. WITH ROCKET PROPULSION:

Plane speed: 700 km/h.
Plane altitude: 20 m minimum—50 m max.
Speed of Kugel with rocket assistance: 330 m/second.
Speed of Kugel on impact: 320 m/second.
Distance through air before impact: 1,000—1,500 meters.
Effective distance: 2,500—4,000 meters.

C. THE RANGE DEPENDS ON:

1. Height of plane.
2. Speed of plane.
3. Surface of water.

Under ideal conditions the Germans considered the Kugel without propulsion 100 percent accurate at a range of 400 meters when dropped from an altitude of 20 meters at 700 km/h. If the missile was dropped from heights greater than 50 meters or at speeds less than 700 km/h the effective range was decreased due to deviations from the target course. Rough waters also caused serious deflections which could not be controlled.

D. FUZES. In the original Kugel without propulsion, two hydrostatic fuzes were used; a type 59 fuze that was designed to operate after a delay of 23 seconds, and a type 44 fuze designed to operate at a depth of 8 meters. The sphere was later modified to accommodate two Krupp fuzes for normal hydrostatic operation at 8 meters, and an electrical time delay fuze in case the missile penetrated the ship's hull.

E. CONDENSER FUZE. A condenser fuze, ElAZ 49, functions in the following manner:

1. Ignites an explosive element which starts the gyro immediately upon release of the missile from the plane.
2. Ignites the rocket propellant by exploding a 1-kg black powder charge after a delay of 0.5 second.
3. Allows either one of two possible types of electric fuzes used, to be armed (electric hydrostatic or electric time delay).
4. Fires the explosive coupling after a delay of 4.5 seconds.

When the rocket propellant is ignited it burns from 3 to 4 seconds. One-half second after the rocket impulse ceases, the explosive coupling fires, severing the sphere from the after body. The rocket section drops off and the sphere continues toward the target. The missile then hits the target and sinks. When at a depth of 8 meters, one

of the hydrostatic fuze is actuated to fire the main charge.

SB 1000

DATA:

Over-all Length: 104 in.

Body Diameter: 26 in.

Tail Length: 26 in.

Tail Width: 26 in.

Filling: RDX/A1/Wax biscuits in Trialen 106 matrix.

Weight of Filling: 735 kg.

Total Weight: 1,000 kg approx.

Chg/Wt Ratio: 0.74% approx.

Fuzing: ELAZ (55) A with nose switch.

CONSTRUCTION. The bomb has a welded sheet metal body. A drawn steel threaded nose piece is of streamlined construction to reduce air resistance while bomb is attached to plane. (Earlier models had a welded nose piece.) There is no base plate. The bomb is filled through nose and an exploder tube runs along the central axis from

the fuze pocket to the nose. It is filled with TNT pellets. (See fig. 20.)

Electric leads run through center of bomb connecting fuze and nose switch.

Bomb has a drawn steel cone-type tail.

REMARKS. Due to thin case and brisant explosive, this bomb is sensitive to small arms fire.

SUSPENSION. Horizontal by H-type lugs or trunnions for use if carried by dive bombers.

SB 1000 PARACHUTE BOMB

DATA:

Over-all Length: 72 in.

Body Length: 65½ in.

Elliptical Body: 31 by 16½ in.

Wall Thickness: 0.06 to 0.125 in.

Filling: Main filling—Dinitro benzene, 48%; RDX, 15%; ammonium nitrate, 37%; biscuit filling—ammonium nitrate, 51%; calcium nitrate, 31%; RDX, 16%.

Chg/Wt Ratio: 80%.

Fuzing: ELAZ (55) A/M.

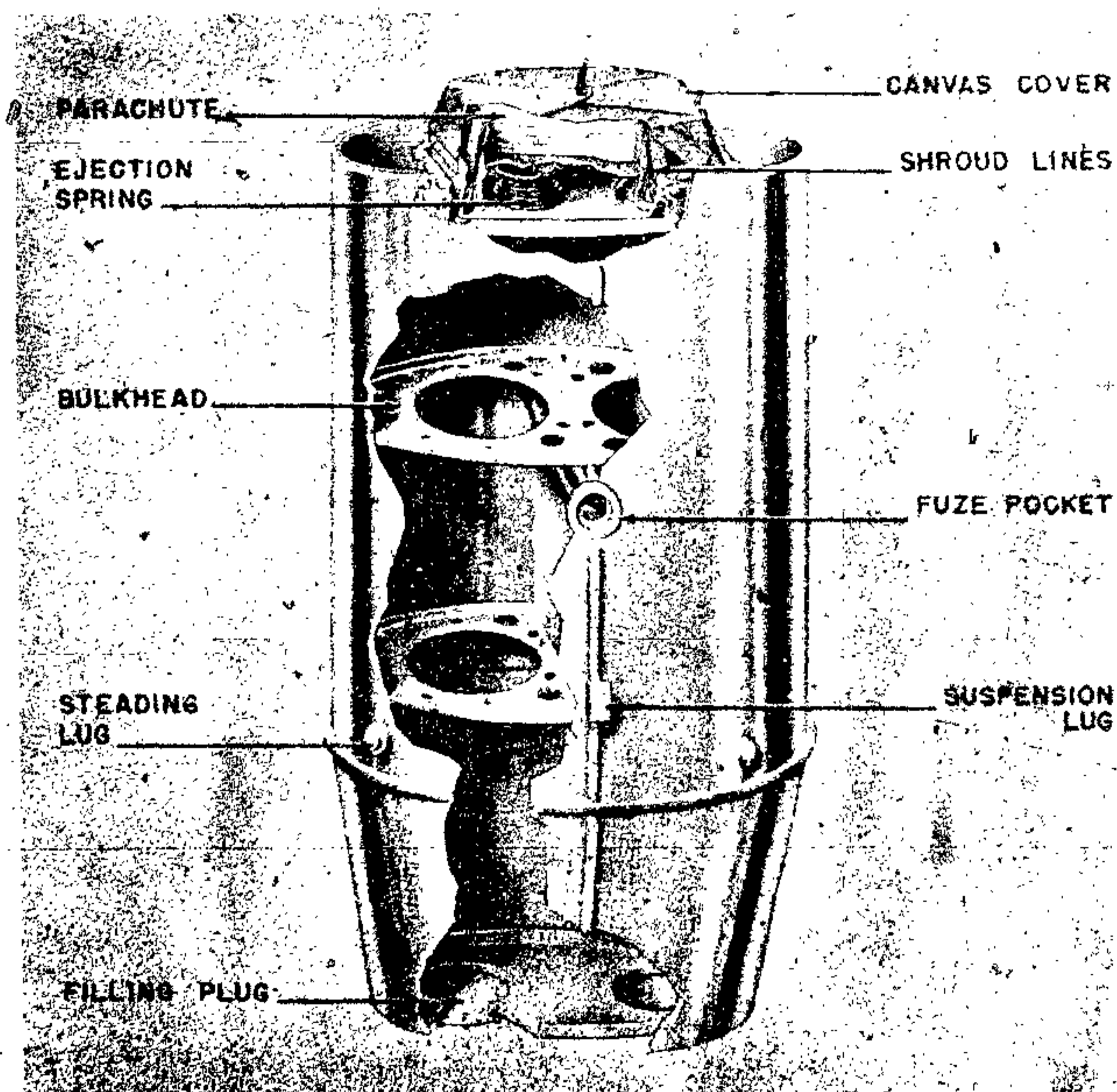

Figure 21—SB 1000-Kg Parachute Bomb

GERMAN EXPLOSIVE ORDNANCE

CONSTRUCTION. The parallel sided body of the SB 1000 is made of steel plate and is roughly elliptical in end section. It is formed by two halves which are welded together externally. The bomb body is strengthened by a longitudinal bulkhead and two perforated diaphragms all welded into position. The base plate is welded into the body 2½ inches from the end. The recess so formed is used to house the parachute container.

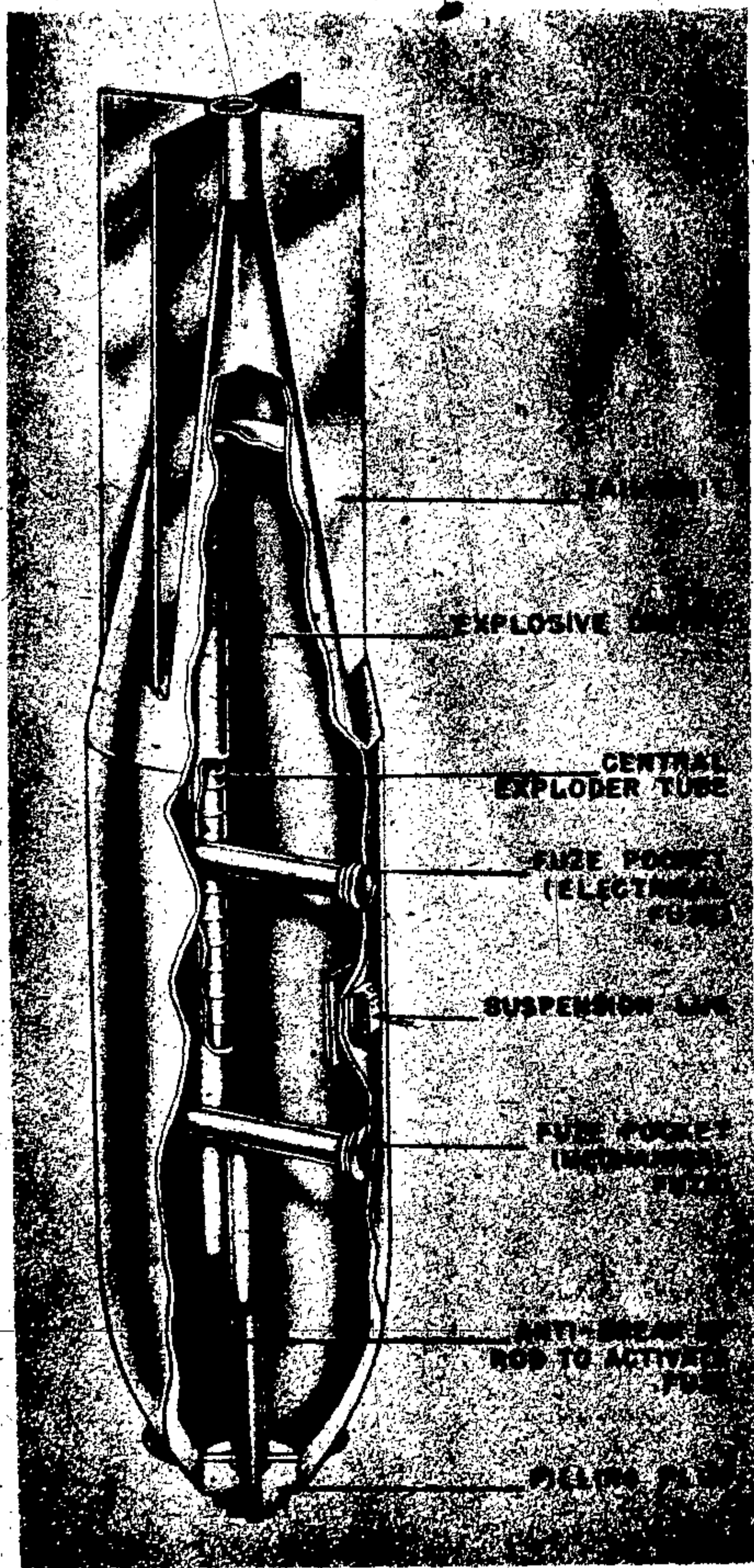

Figure 22—SB 2500-Kg Bomb

The fuze pocket is welded into a slot in the longitudinal bulkhead. Nose plate is welded into position and has in it filling holes. There is a nose extension in the center of the nose plate which houses the impact switch, 55 A/M fuze. The fuze pocket is connected to the impact switch by two wires which are housed in a metal tube. The parachute container, a thin metal box, is positioned between two ribs riveted to the base plate. It is secured to the base of the bomb by bolts. Inside the outer box an inner container is welded to the base of the outer box. Four extension springs are secured to the base of the inner container and are also attached to a plywood platform which is the base for the parachute. The parachute is folded on the plywood, the platform depressed, compressing the spring then held in place by canvas flaps secured over the top. The under flap carries a loop of cord which is threaded through eyelets of the other three flaps, a quick release pin is passed through the loop, thus retaining assembly against action of the spring. (See fig. 21.)

OPERATION. On release from aircraft the quick release pin is withdrawn from the loop by a time parachute release which can be set for delays of 2, 3, 4, 5, or 6 seconds. This device obtains its delay by means of a spring and cog wheel.

The parachute is of coarse weave vegetable matter. Red, green, and blue parachutes have been found. There are 16 double parachute shroud lines.

SUSPENSION. Horizontal.

COLOR AND MARKINGS. The bomb casing is painted field gray with the following markings stenciled in black along the body.

SB 1000/410—52A+, 52A.

It has been assumed that the figure "410" refers to the type of aircraft by which the bomb is carried. ME 410.

SB 2500-kg

DATA:

- Over-all Length: 145 in.
- Body Length: 87¾ in.
- Body Diameter: 31 in.
- Wall Thickness: 17/32 in.
- Tail Length: 66½ in.
- Tail Width: 33 in.
- Filling: 40/60 Amatol or Trialen 105.
- Total Weight: 2,400 kg.

Fuzing: AZ (24) A in forward fuze pocket;
EIAZ (28) A in rear fuze pocket.

CONSTRUCTION. The main difference between this and the SC 2,500-kg type max are: the construction is of steel instead of aluminum alloy and the filling extends into the tail cone with the object of keeping the charge/weight ratio as high as possible. The case is constructed in three parts, a cast steel nose, with a cast steel base welded to the cylindrical body. The nose of the bomb is fitted with a filling plug to which is fitted a tube extending to the forward fuze pocket, the tube houses a rod which on impact crushes the impact fuze and activates the bombs. There are two transverse fuze pockets; the forward pocket houses the anti-break-up fuze and the after pocket is for the normal impact type fuze.

The tail unit is a four fin drum type. The cone portion is sheet steel and the fins and tail drum are constructed of alloy. (See fig. 22.)

SUSPENSION. Horizontal by an H type. The suspension lug is keyed to a securing plate locked by bolts.

COLOR AND MARKINGS. Sky blue over-all. Two yellow stripes are painted on the body between the tail fins. SB 2500 is stenciled on body.

SD 50 (D50; D50D; D50L)

DATA:

Over-all Length: 43.0 in.

Body Length: 23.5 in.

Body Diameter: 8.0 in.

Wall Thickness: 0.4 wall to 1.8 in. nose.

Tail Length: 23.5 in.

Tail Width: Type I, 11 in.; Type II, 10.5 in.

Filling: TNT.

Weight of Filling: 16.4 kg.

Total Weight: 55.0 kg (approx.).

CHG/WT Ratio: 30%.

Fuzing: 55; 55A; EIAZ (38)* for water targets.

CONSTRUCTION. The body of the SD 50 is a one-piece steel casting. When machined down it has provisions for one transverse fuze pocket just forward of the horizontal carrying lug. It is threaded at the base to accept a male type filling lug. (See fig. 23.)

Either the type 1 or type 2 tail assemblies can be used. Type 1 has a cast alloy adapter with sheet steel vanes. The four vanes are not supported by

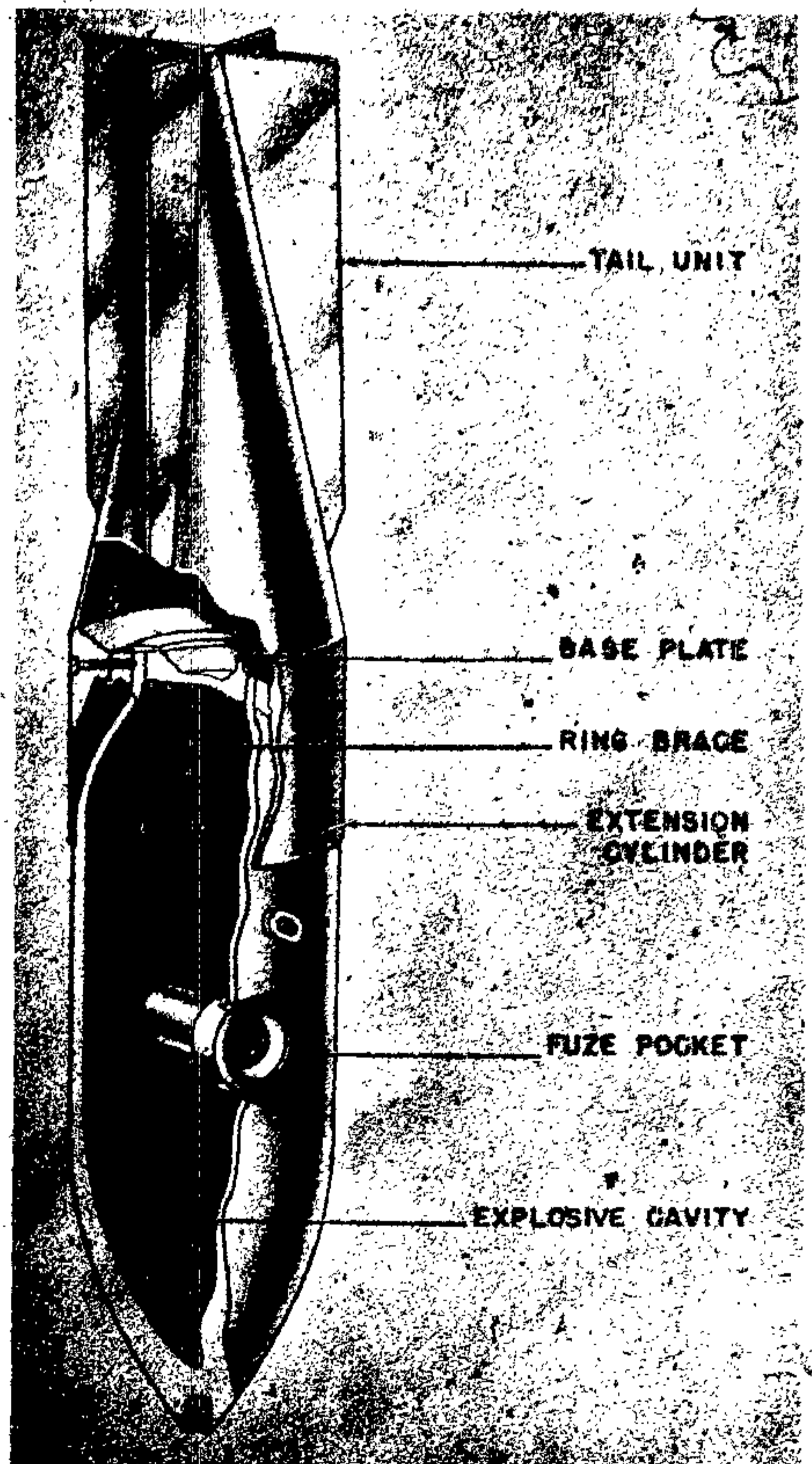

Figure 23—SD 50-Kg Bomb

struts. Type 2 is a one-piece construction assembly of cast magnesium alloy with no strut supports for the tail fins.

In addition to the horizontal carrying lug, there are threads machined in the nose to take an "eye" type lug for vertical suspension.

SUSPENSION. Horizontal or vertical.

COLOR. Bomb is dark green over-all and tail cone is striped with red.

REMARKS. A small angle iron kopfring is normally fitted to the bomb. In addition to the

GERMAN EXPLOSIVE ORDNANCE

kopfring a 24-inch diamort rod may be added to obtain prepenetration detonation of the bomb. An extension rod used with the (55) A can be used for the same purpose.

When the bomb is used against water targets, the tail fins are removed. It is claimed that the ballistics are not changed by removing the tail fins providing the dropping range is less than 200 meters. The ELAZ (38) fuze with a maximum delay of 5 seconds allows for water travel of 12 to 18 meters.

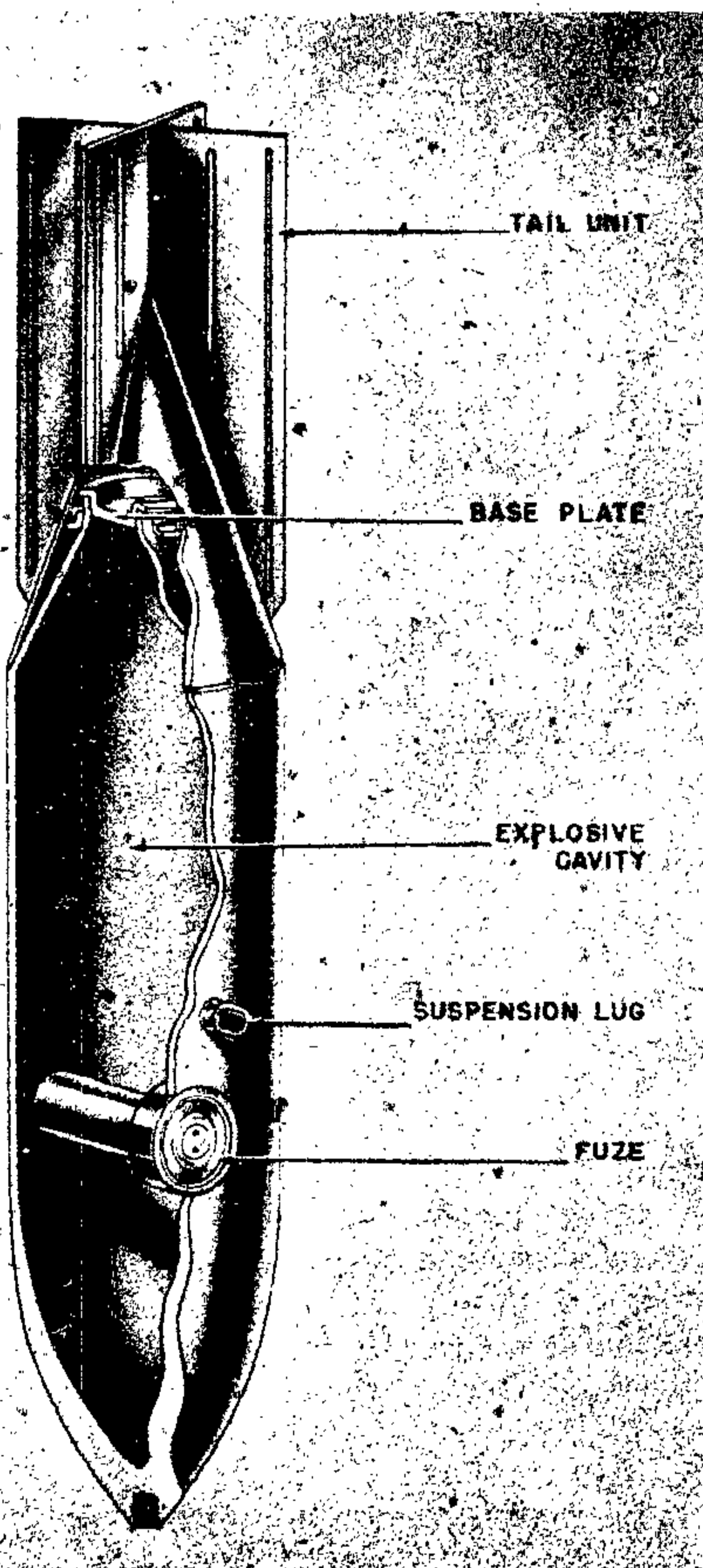

Figure 24—SD 70-Kg Bomb

SD 70-kg

DATA:

Over-all Length: 43.2 in.
Body Length: 28.0 in.
Body Diameter: 8.0 in.
Wall Thickness: 0.4 in.
Tail Length: 16.0 in.
Tail Width: 11.0 in.
Filling: TNT.
Weight of Filling: 21 kg.
Total Weight: 66 kg.
Chg/Wt Ratio: 39%.
Fuzing: (25) B; (55); (89) B with parachute.

CONSTRUCTION. The SD 70 body is of one-piece forged steel and is normally fitted with a kopfring. The tail is of sheet steel construction and the fins are ribbed to supplant the diagonal fin braces.

This bomb, on occasion, is fitted with a parachute. The tail unit is removed and a sheet metal cylinder 18 inches long and $7\frac{3}{4}$ inches in diameter is attached to base of bomb. Contained in the cylinder is a red lattice type parachute 5 feet square with four double shroud lines. The shroud lines are secured by means of four U-shaped brackets to a collar over which the base plate screws. The over-all length of the cylinder and bomb is approximately 45 inches. (See fig. 24.)

SUSPENSION. Horizontal or vertical suspension is used.

COLOR. Bomb is field grey over-all. Red stripes on tail fin.

REMARKS. Parachute bomb apparently designed to give air burst.

SD 250 kg D250, D250 JB, D250 L, D250 DL

DATA:

Over-all Length: 64.5 in.
Body Length: 34.4 in.
Body Diameter: 14.5 in.
Wall Thickness: 0.6 wallpoint 3.5 in.
Tail Length: 38.2 in.
Tail Width: 20.0 in.
Filling: TNT.
Weight of Filling: 79 kg.
Total Weight: 250 kg.
Chg/Wt. Ratio: 32%.
Fuzing: 8; 5 series.

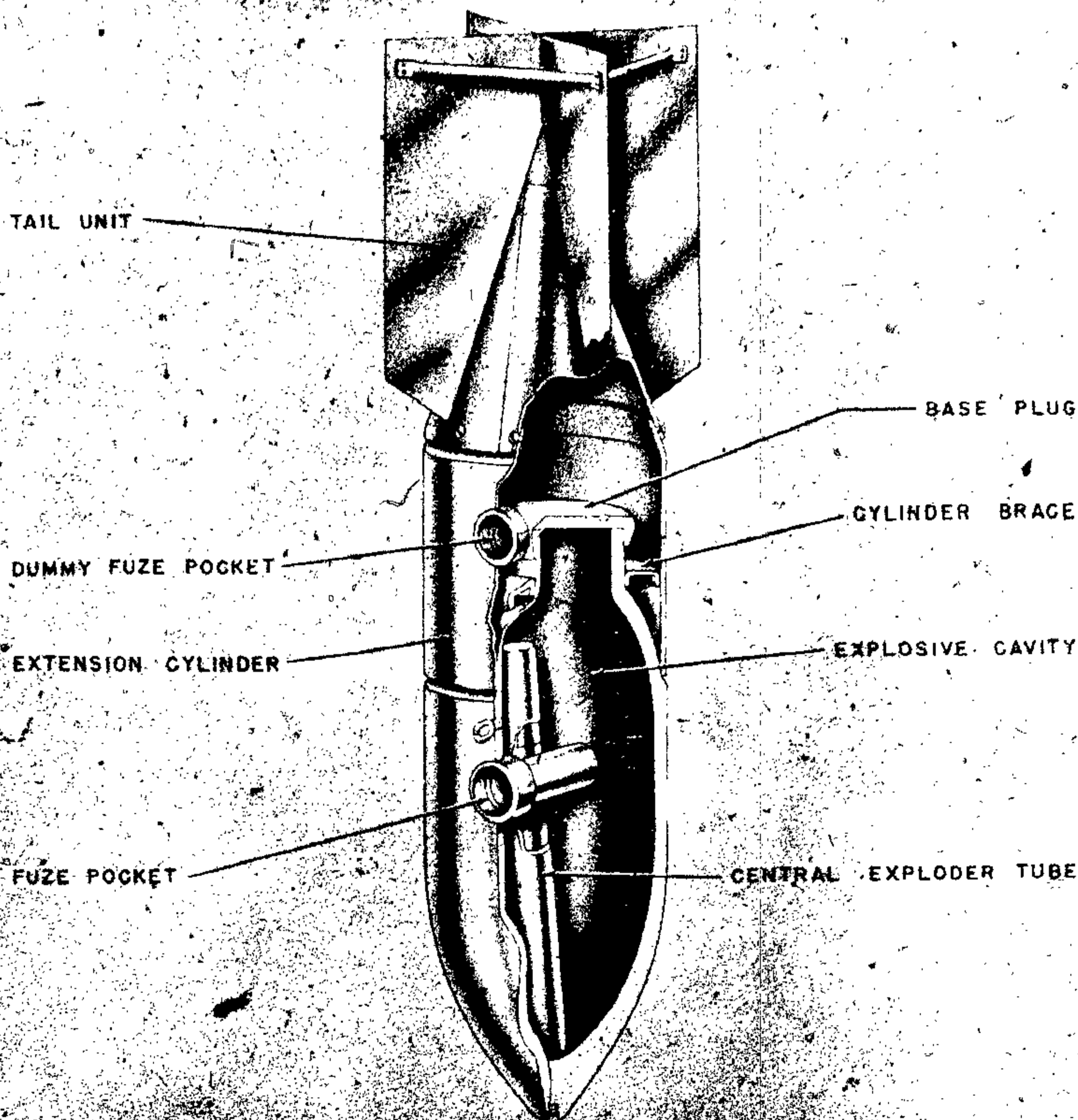

Figure 25—SD 250-Kg Bomb

CONSTRUCTION. Bomb is of three-piece construction. Nose and tail pieces are welded to main part of body. One fuze pocket. A female base plate is used. (See fig. 25.)

The tail is of sheet steel construction. Four vanes are welded to a cone. There are also box-type struts of bar steel. Extension cylinder has a dummy fuze head.

SUSPENSION. Horizontal or vertical.

COLOR. Bomb body and tail are painted dark

green, sky blue, or aluminum. Tail cone is striped with red or blue.

NOSE SPIKES FOR SC 50 Stabo, SD 70 Stabo, SC 250 Stabo, AND SC 500 Stabo

DATA :	TOTAL WEIGHT	LENGTH	
		OF SPIKE	DIAMETER
SC 50 Stabo	62 kg	47 cm	4.5 cm
SD 70 Stabo	77 kg	47 cm	4.5 cm
SC 250 Stabo	282 kg	57 cm	7.5 cm
SC 500	305 kg	60 cm	7.5 cm

GERMAN EXPLOSIVE ORDNANCE

SD 500, SD 500 A AND SD 500 E

DATA:

Over-all Length: 82.0 in.
 Body Length: 54.0 in.
 Body Diameter: 17.5 in.
 Wall Thickness: 1.0 in. wall; point 5.0 in.

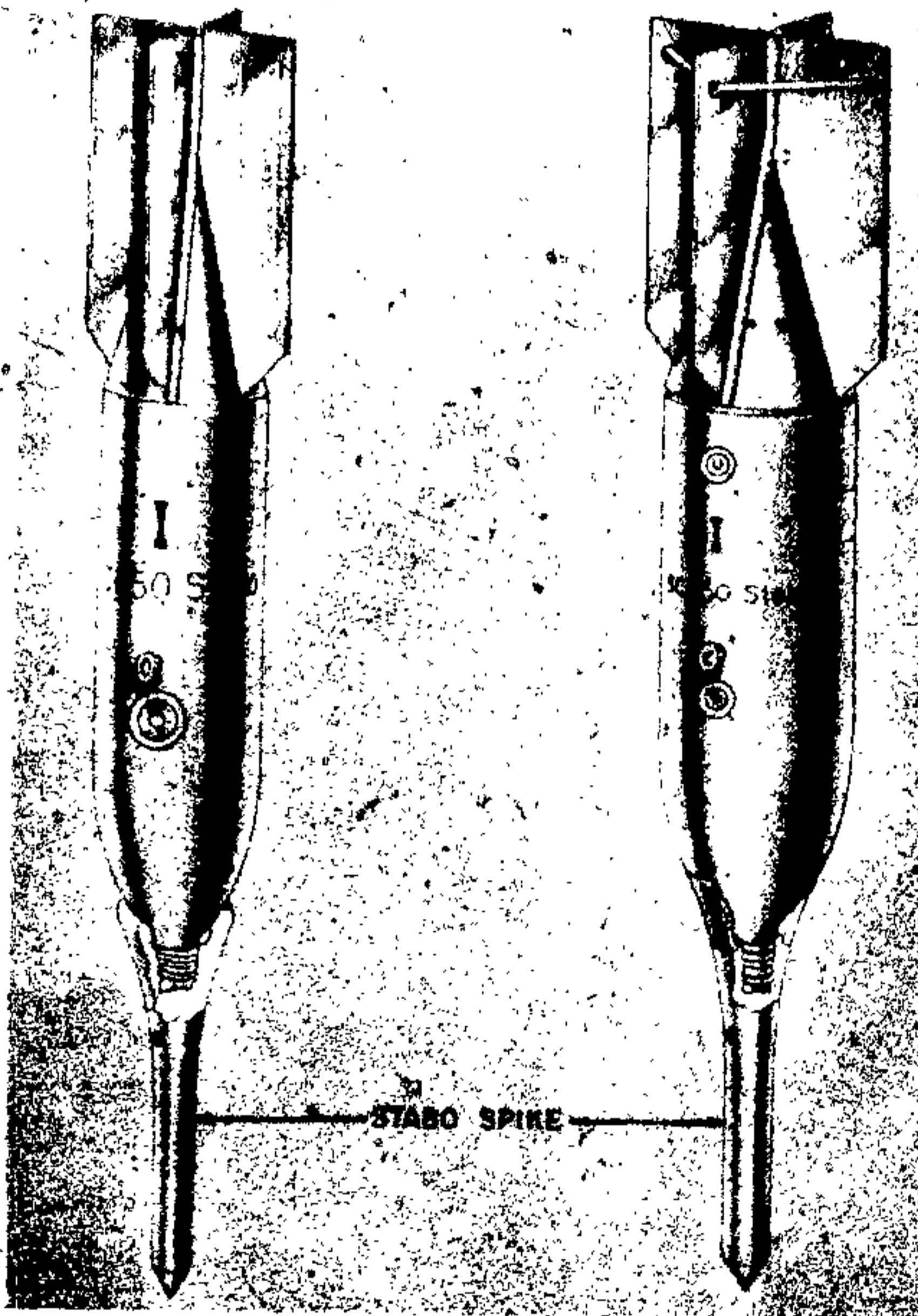

Figure 26—Nose Spikes for Stabo Bombs

CONSTRUCTION. Stabo bombs have a threaded lug forged to the nose of the case. Stabo spikes screw on to this threaded lug. The same spike fits both SC 50 and SD 70 and is of one-piece construction. The SC 250 and SC 500 Stabo spikes have an additional piece, a pressure plate, which fits between the bomb case and spike to increase the rigidity. The spikes are used in low altitude attacks to prevent ricochet. A 1-cm hole through the spike allows use of a bar to screw spike securely to bomb. (See fig. 26.)

REMARKS. Stachebomben, or "Stabo" for short, are used in low altitude attacks to ensure the bomb does not ricochet. The SC 250 and SC 500 are both two fuze pocket bombs and fuzing is usually a time fuze 17 or 57 and an antidisturbance fuze (50). The SC 50 Stabo and SD Stabo are normally fuzed with a (55).

Discs fitting on the end of these spikes have been found. It is thought nose switches have been used to give instantaneous action.

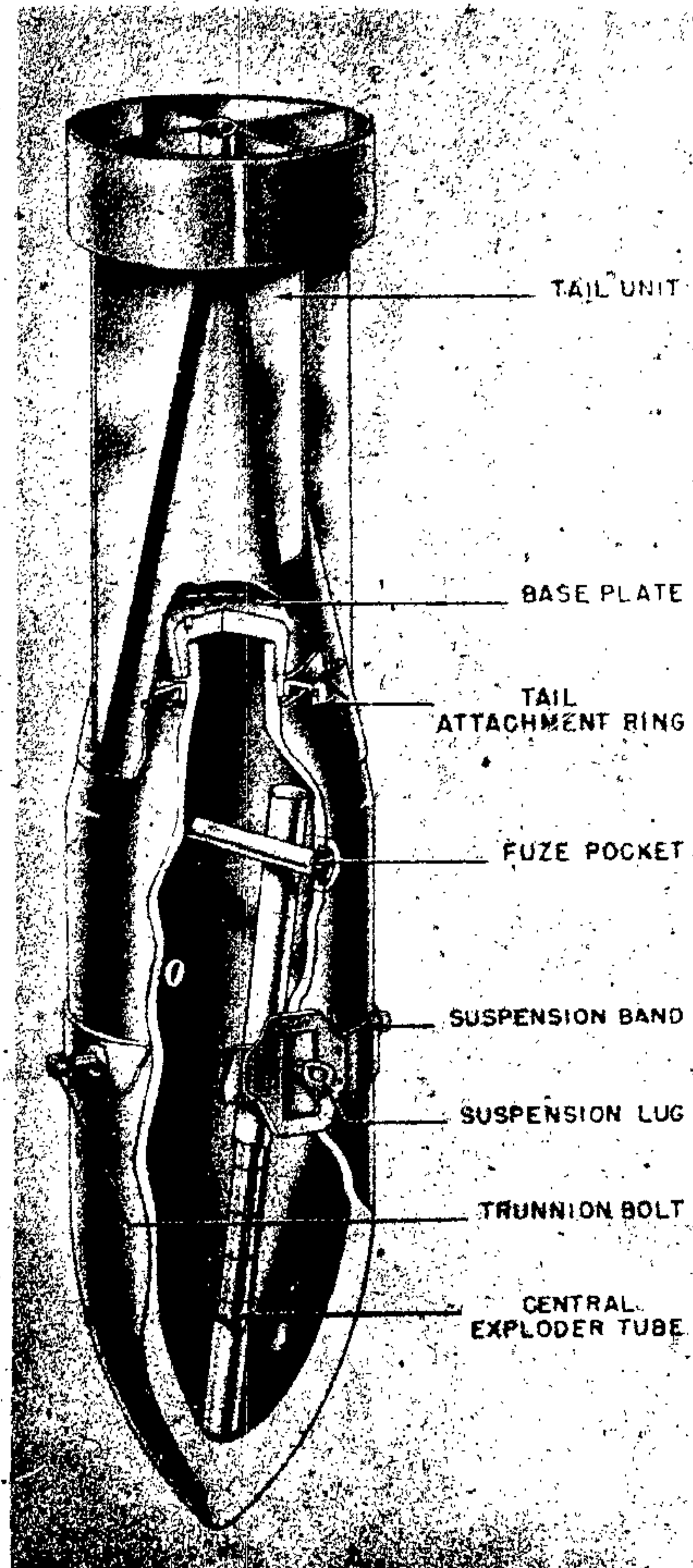

Figure 27—SD 500-Kg Bomb

Tail Length: 35.5 in.
 Tail Width: 18.0 in.
 Filling: Amatol—60/40; TNT and wax.
 Weight of Filling: 200 kg approx.
 Total Weight: 535 kg.
 CHG/WT Ratio: 37%.
 Fuzing: 5 series.

CONSTRUCTION. All bombs in the SD 500 series are of one-piece drawn steel construction. The main difference between the three modifications is the variation in wall thickness.

One transverse fuze pocket is located aft the suspension band. To insure high order detonation, a central exploder tube has been inserted longitudinally through the explosive cavity. (See fig. 27.)

The tail unit is constructed of sheet steel and has a ring type strut. The unit is secured to the bomb in the same manner as the tail on the SC 1000 bomb.

A parachute type tail unit for this bomb has been found. This unit is composed of a detachable sheet metal parachute container, open lattice type parachute, and a standard base plate with an additional web and ring of cast steel spot welded together to form an anchorage for the parachute shackles. (Only one such unit has been found.)

SUSPENSION. Horizontal, by means of an H-type lug secured to a suspension band.

COLOR. Field grey over-all with red stripes on cone. "D500 stg" stenciled on body in black.

SD 1700

DATA:

Over-all Length: 129.6 in.
 Body Length: 92.0 in.
 Body Diameter: 26.0 in.
 Wall Thickness: 0.9 in. wall to nose, 3.5 in.
 Tail Length: 46.5 in.
 Tail Width: 24.0 in.
 Filling: TNT; Amatol 60/40.
 Weight of Filling: 730 kg.
 Total Weight: 1,703 kg.
 CHG/WT Ratio: 43%.
 Fuzing: 28 B₆, Extension Cap II.

CONSTRUCTION. Body is of one-piece, forged steel construction. A single fuze pocket is used with an extension cap fuze in the nose. The base of the bomb is threaded to take a normal female type base plate. A cast steel kopfring is welded

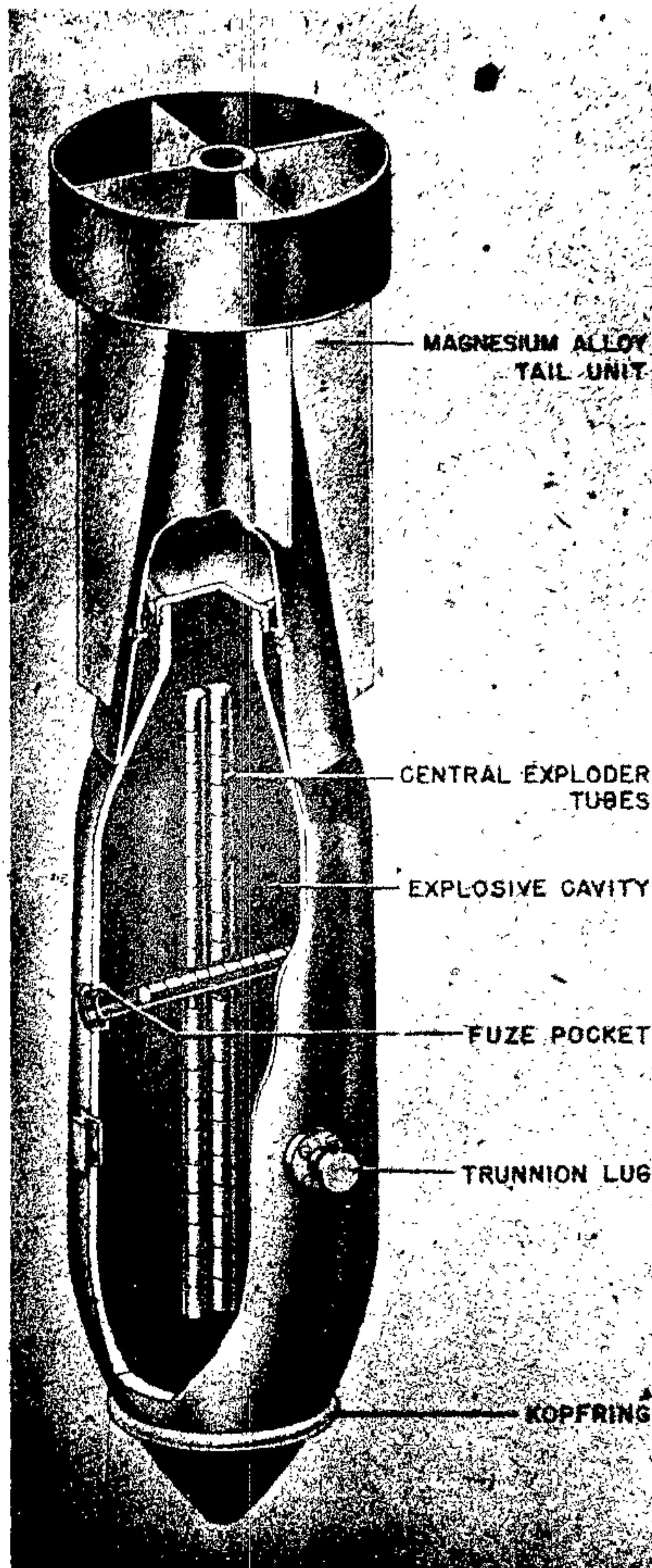

Figure 28—SD 1700-Kg Bomb

to the nose as a preventative against excessive penetration. (See fig. 28.)

The tail is made of light alloy and is of the cylinder type. The 8-inch wide band is attached to the fins by rivets. This band is known as a ring type strut.

GERMAN EXPLOSIVE ORDNANCE

SUSPENSION. Horizontal by means of an H-type suspension lug.

COLOR. Black or sky blue over-all. Red stripes on tail. "D1700" stenciled on opposite sides of body in letters 40-mm high.

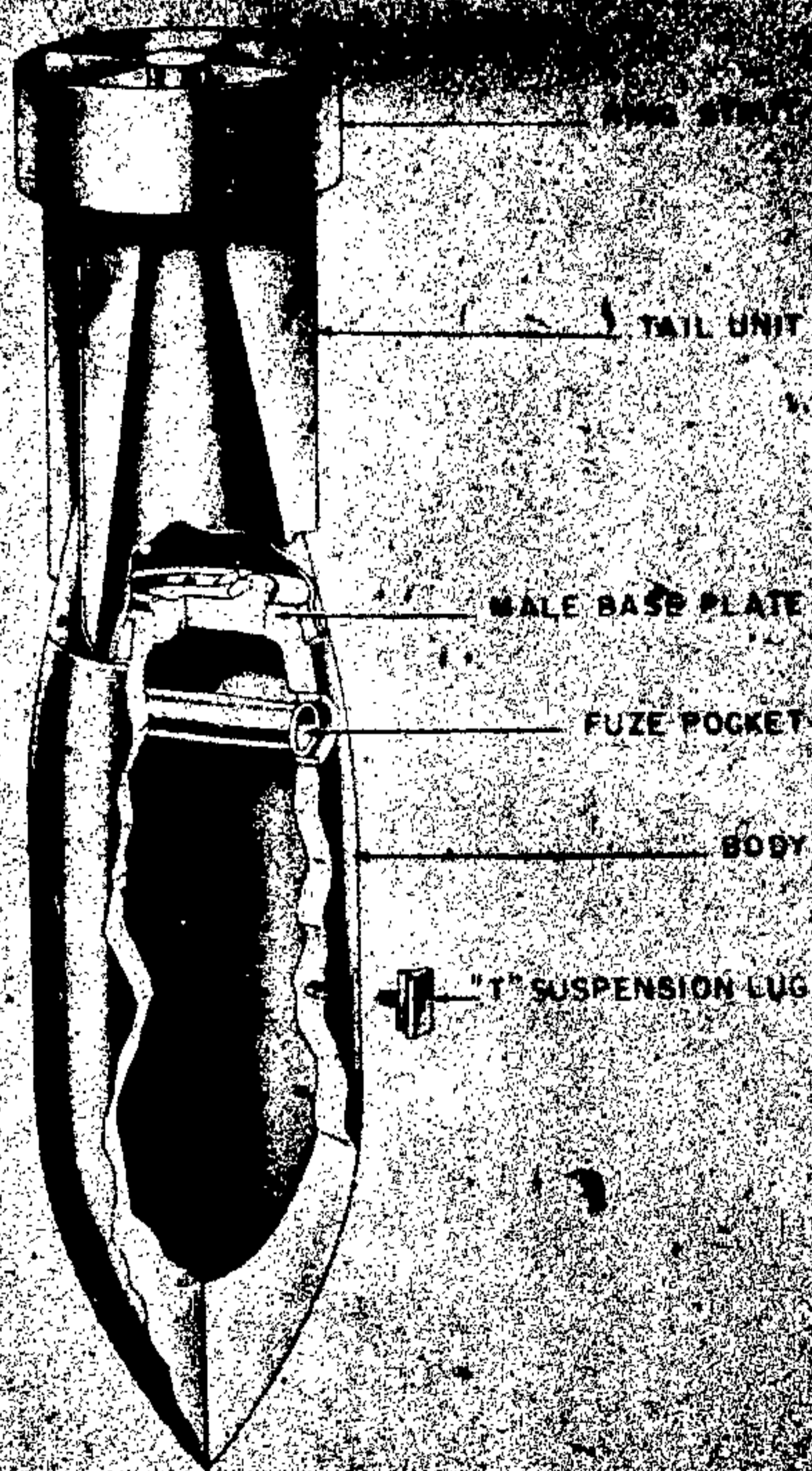

Figure 29—PC 500-Kg Bomb

PC 500-kg, D500 E, AND D500 L

DATA:	D500E	D500L
Over-All Length	68.2 in.	78.8 in.
Body Length	42.3 in.	53.8 in.
Body Diameter	15.6 in.	15.0 in.
Wall Thickness	1.4 in. wall	0.9 in. wall
	9.0 in. point	8.3 in. point
Tail Length	27.5 in.	30.5 in.
Tail Width	15.5 in.	16.0 in.
Filling	Cast TNT: 60/40 Amatol; TNT and Wax.	Cast TNT: TNT and Wax.

Weight of Filling	75 kg.	78 kg.
Total Weight	539 kg.	416 kg.
CHG/WT Ratio	14%	19%
Fuzing	(5) series	(35).

CONSTRUCTION. There are two types of the PC 500: Type E and Type L. Both types have a one-piece forged steel body and one transverse fuze pocket. The fuze pocket is located aft the horizontal suspension lug. (See Fig. 29.) The bomb is machined to accommodate a male type tail closing plug. The tail assembly can be either of sheet steel or magnesium alloy. The tail unit in either case is of the cylinder type. Both types have the sheet metal ring which is used for bracing the fins. The tail unit is secured to the bomb body by means of 12 screws.

SUSPENSION. Horizontal by means of an "eye" bolt or T-type lug.

COLOR. Field grey or aluminum over-all. Dark blue stripe on tail cone.

PC 1000-kg ESAU

DATA:

Over-All Length	85.5 in.
Body Length	58.5 in.
Body Diameter	19.8 in.
Wall Thickness	1.5 in. wall to 13.4 in. point.
Tail Length	32.0 in.
Tail Width	19.8 in.
Filling	TNT and Wax.
Weight of Filling	160 kg.
Total Weight	1,000 kg.
CHG/WT Ratio	16%.
Fuzing	(28) A or 35; Extension Cap II.

CONSTRUCTION. The body of the PC 1,000-kg armor-piercing bomb is of one-piece forged steel. The nose is very heavy and this construction decreases the size of the explosive cavity. There is one fuze pocket located aft the suspension lug. Through the center of the explosive cavity is an additional exploder tube. (See fig. 30.)

The tail unit is constructed of magnesium alloy and is attached in the same manner as used with the SC 1,000 series.

SUSPENSION. Horizontal. This bomb uses a suspension band with the H-type lugs secured to it. At 90° from the suspension lug in both directions are two trunnion bolts for dive-bombing.

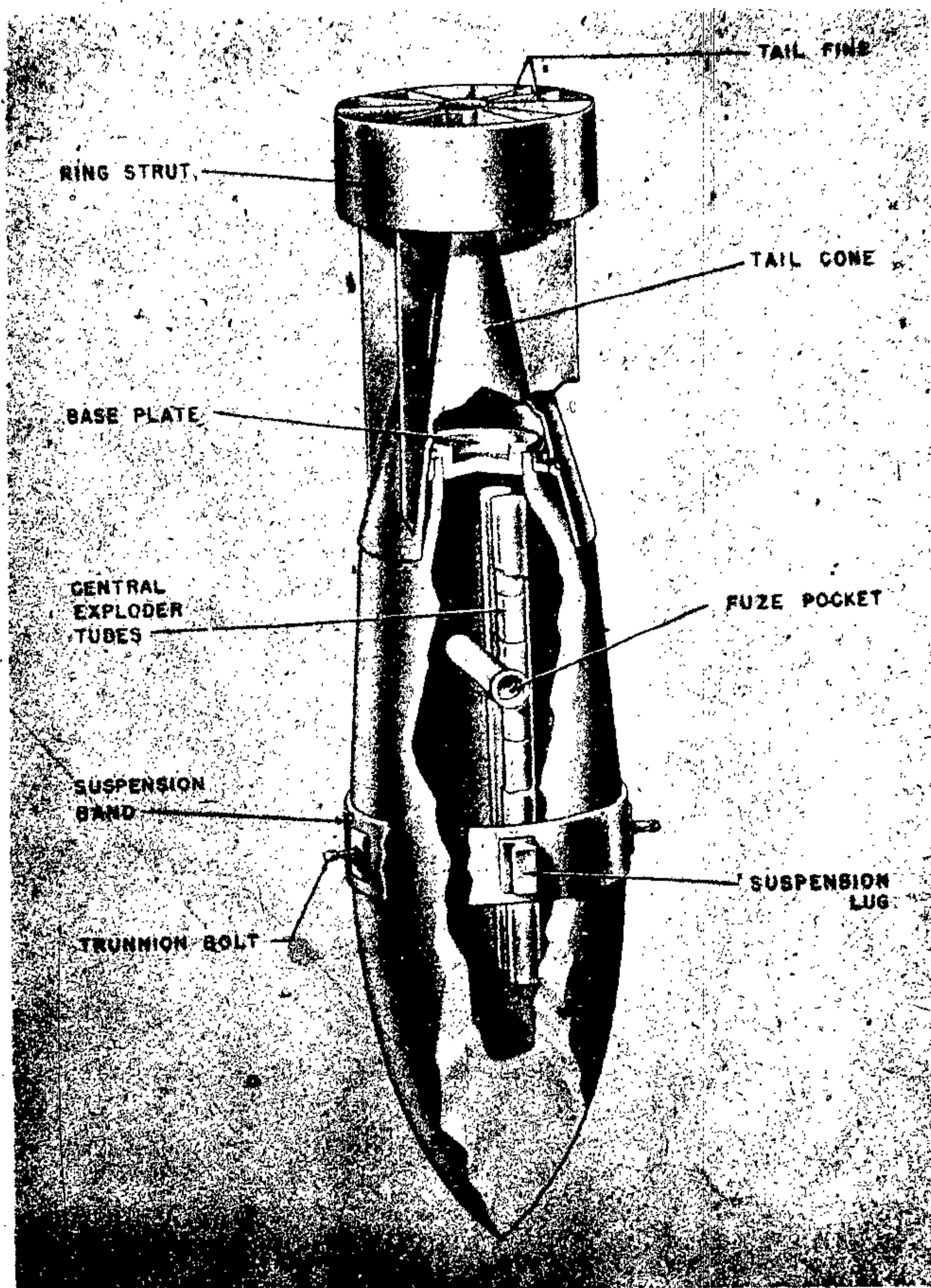

Figure 30—PC 1000-Kg Bomb

COLOR. Sky blue with aluminum tail. Blue stripe on tail cone.

PC 1,400-kg FRITZ

DATA:

Over-all Length: 110.8 in.

Body Length: 75.7 in.

Body Diameter: 22.0 in.

Wall Thickness: 1.25 in. wall to 12.5 in. point.

Tail Length: 43.3 in.

Tail Width: 22.0 in.

Filling: TNT and Wax; Trialen.

Weight of Filling: 300 kg.

Total Weight: 1,400 kg.

CHG/WT Ratio: 21.4%.

Fuzing: (28) A or 35; Extension Cap III.

CONSTRUCTION. The bomb body is of one-piece forged steel construction. There is one

GERMAN EXPLOSIVE ORDNANCE

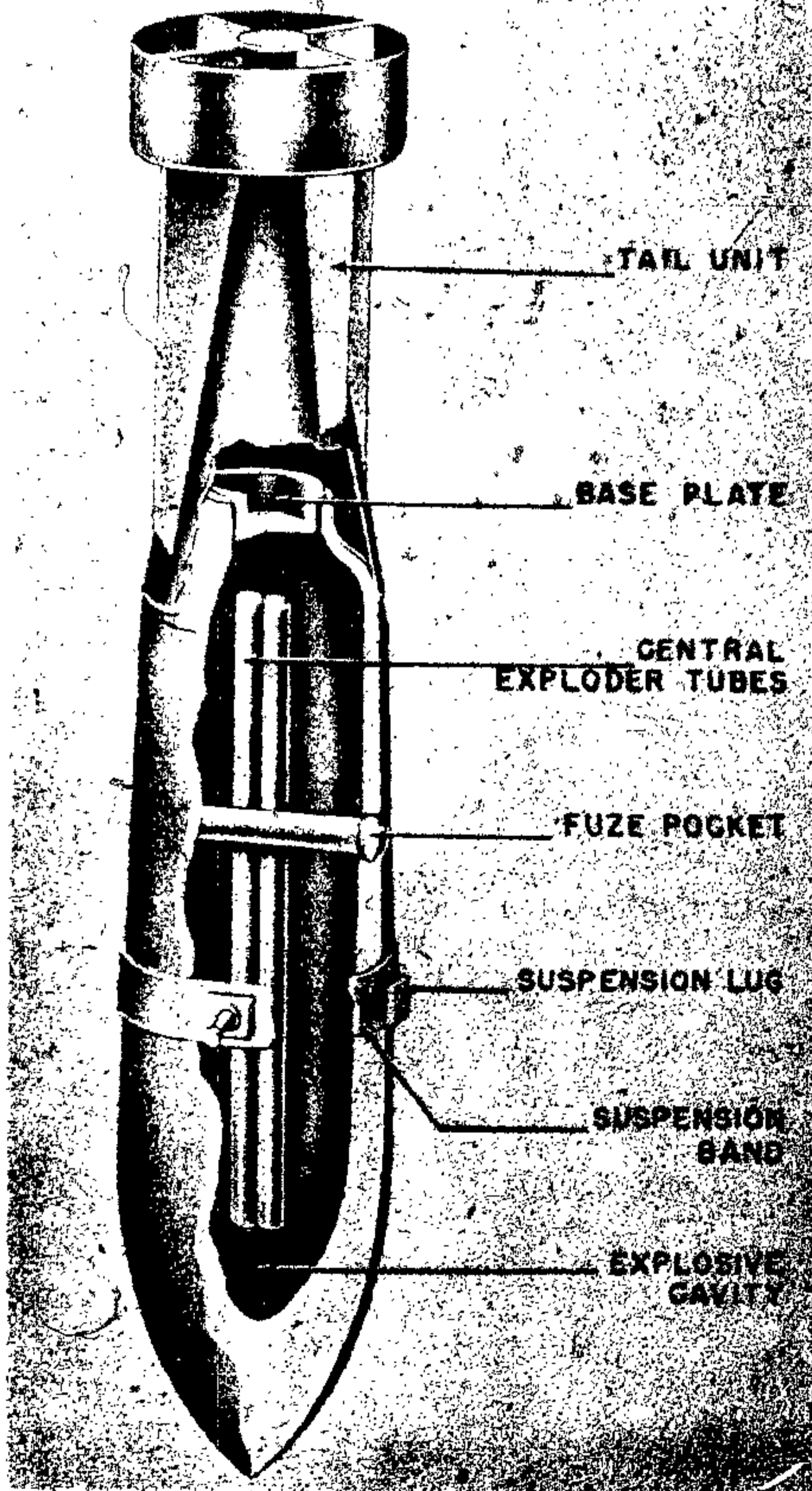

Figure 31—PC 1400-Kg Bomb

transverse fuze pocket located aft of the carrying lug. Two exploder tubes containing tetryl run lengthwise through the explosive cavity just left of the fuze pocket. The base of the bomb body is closed with a male base plate. (See fig. 31.)

The bomb tail is of the cylinder type, the cylinder being 6 inches deep. It is constructed of either cast aluminum or magnesium.

SUSPENSION. Suspension of the bomb in the

racks is horizontal by means of an H-type lug or by two trunnions on the carrying band.

COLOR. Sky blue over-all or sky blue with aluminum tail. Red or blue stripes on tail.

PC 1,600-kg

DATA:

Over-all Length: 110.8 in.

Body Length: 65.7 in.

Body Diameter: 21.0 in.

Filling: RDX, aluminum and wax.

Weight of Filling: 230 kg.

Total Weight: 1,600 kg.

Chg/Wt Ratio: 14.4%.

Fuzing: ELAZ (49) P16.

CONSTRUCTION. The body is of two-piece construction with a cylinder type tail. (See fig. 32.) It is designed to penetrate 180 mm of panzer steel or 2.5 meters of reinforced concrete at a striking angle of 60°.

REMARKS. Usually dropped at an altitude of 4,000 to 6,000 meters.

The production of this bomb was stopped in October 1942. Bombs then on hand were used and not replaced.

SUSPENSION. Horizontal.

COLOR: Blue stripes on tail.

PC-RS BOMB SERIES

DESCRIPTION. This series of rocket assisted armour piercing bombs consists of the following missiles; PC 500 Rs, PC 1000 Rs, and the PC 1800 Rs. In general the three types are of similar three piece construction; the warhead, the distance piece, and the tail section. The tail section contains the rocket motor.

Each series is fitted for horizontal suspension by means of a single "eye" or H-type suspension lug. In addition to the suspension lug, there is a set of trunnions fitted to the bomb. They are located 90° around from the lug and approximately 2 inches further aft. The trunnions are used for suspension only under dive-bombing conditions.

WARHEAD. The warhead is identical to the normal armour-piercing (PC) bombs of respective size except for the fuze pocket arrangement. In the PC-Rs series the transverse fuze pocket has

been omitted. The impact fuze is part of the 49 series and is found screwed into the base of the warhead. The warhead is filled through the base and the explosive cavity is then closed by means of a male type base plate.

DISTANCE PIECE. The distance piece is a steel cylinder internally threaded at both ends. Its main purpose is to connect the warhead to the tail section. The charging head for the fuzeing system is threaded into the after end of the distance piece just forward of the tail piece junction. The electrical leads from the charging head pass through this cylinder; one to the impact fuze and the other to the pyrotechnic rocket igniter.

TAIL SECTION. The tail section is another steel cylinder with twelve stabilizing fins at the after end. This total of 12 fins is made up of 4 large fins and 8 small fins. The end of the tail unit is closed by means of a fixing plate. The fixing plate has six circular openings positioned so as to take the end of the venturi tubes from the rocket motor. The large opening in the center of the fixing plate will allow any gas emitted from the pressure release valve in the rocket motor to escape.

ROCKET MOTOR. The rocket motor is housed within the tail section. It consists of the following parts: main pressure chamber, six propulsion venturi, six metal spacers at each end of the pressure chamber to hold and properly space the propellant sticks, an igniter pad of black powder, and a spring loaded pressure release valve used as a safety measure.

There are 19 sticks of rocket powder in each motor, dimensions of which can be found in the accompanying chart. The latest type of rocket powder used in these missiles was dinitrodiglycol.

FUZEING SYSTEM. The 49 fuze has been developed in three series: A, B, C, and they are used in the PC 500, 1000, 1800 Rs bombs respectively. Each series consists of three parts; the charging head, the pyrotechnic fuze for igniting the rocket motor, and the electrical impact fuze for detonating the warhead when the missile strikes a target. Wiring diagrams and complete operation of the system can be found in the Bomb Fuze section.

OPERATION. When the missile is released from the mother aircraft, electrical charge is imparted to the charging head. This charge is passed on to both the pyrotechnic fuze and the electrical impact fuze. The pyrotechnic delay is ignited immediately. After 3 or 4 seconds it burns through to the

black powder igniter. The black powder then ignites and starts the propellant powder in motor burning.

The electrical charge which is passed on to the impact fuze loads and the condensers and arms the fuze. On impact one or all of the trembler switches close. This action completes the firing circuit and sets off the electrical detonator which

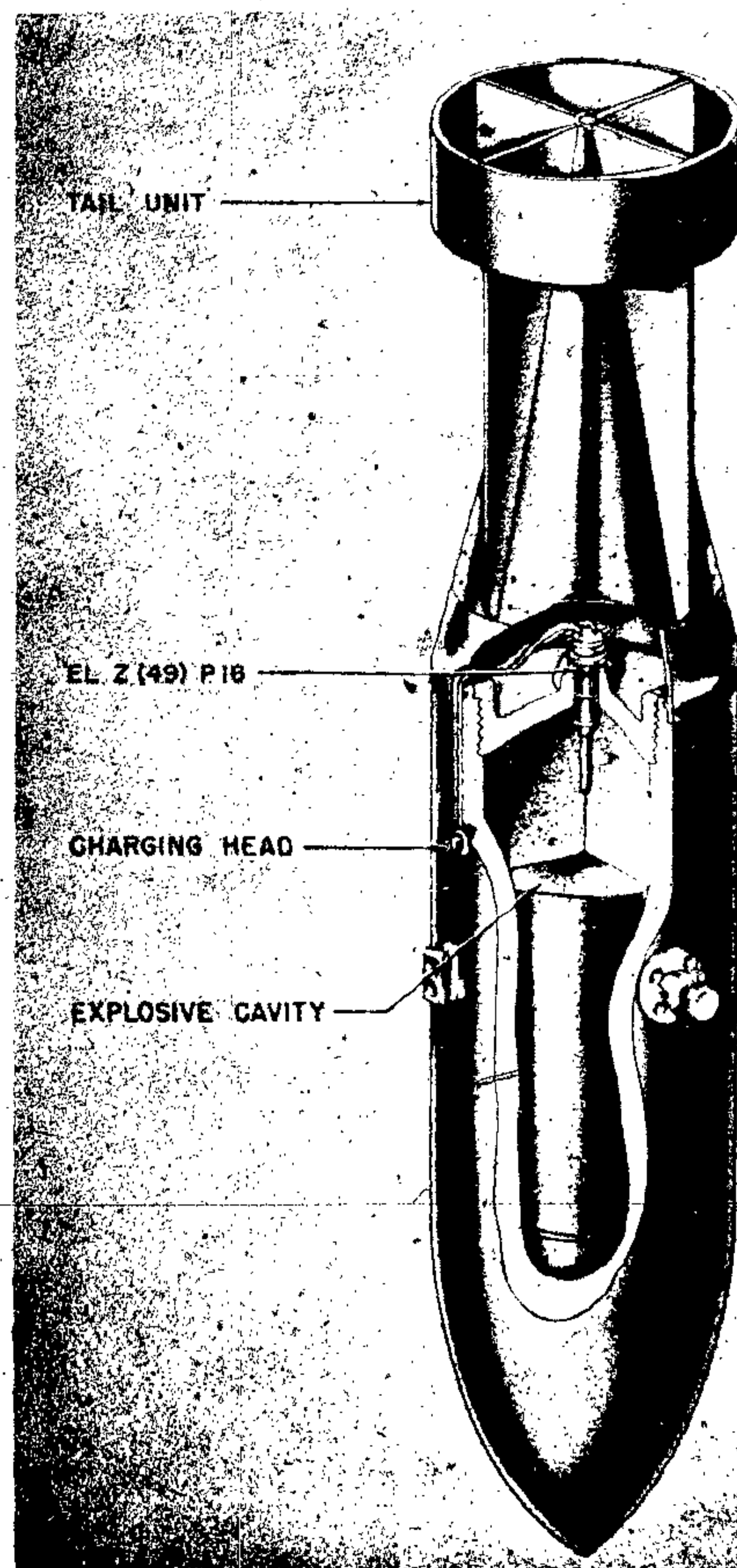

Figure 32—PC 1600-Kg Bomb

GERMAN EXPLOSIVE ORDNANCE

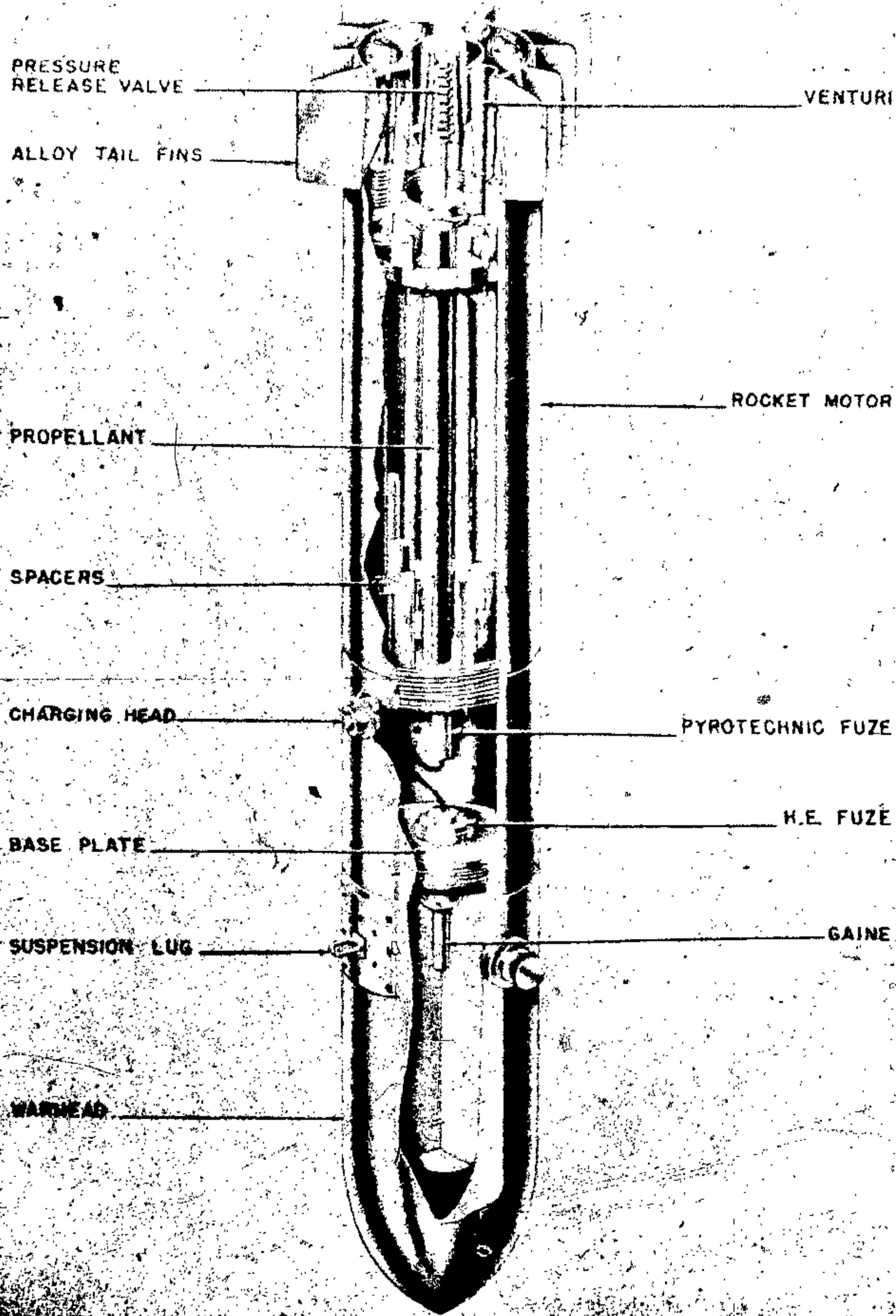

Figure 33—PG 500 RS Bomb

in turn sets off the gaine and finally the main charge.

PC 500 RS

DATA:

Over-all Length: 81 $\frac{3}{4}$ in.
Body Length: 33 in.

Body Diameter: 11 $\frac{1}{4}$ in.
Filling: Very pure cast TNT in an aluminum container in the nose. Rest of filling is alternate layers of good and poor quality TNT.
Weight of Filling: 14 kg.
Total Weight: 490 kg.
CHG/WT Ratio: 3%.

Fuzing: Charging head—(49) A1, (49) B1, (49) B1. Ex.; Pyrotechnic—(49) A11, (49) B11; Impact—(49) A, (49) A111, (49) B111.

CONSTRUCTION. The rocket container is attached to the base of the bomb by a cylindrical steel distance piece which is threaded internally on both ends—one end threading over the bomb base and the rocket container threading into the other end. (See fig. 33.)

In the side of the distance piece is filled an electric fuze head marked (49) B1 with charging plungers connecting to (49) B11 and (49) B111 fuzes. Fuze (49) B11, a pyrotechnic fuze with a delay of 3 seconds is used for igniting the rockets. Fuze (49) B111 is an electrical impact fuze fitted into the base plate of the bomb, giving a fractional delay action to the bomb after striking the target.

Nineteen rockets are placed in the rocket container. Twelve are $25\frac{5}{8}$ inches long by $2\frac{1}{16}$ inches diameter and seven are $27\frac{5}{8}$ inches long by $2\frac{1}{16}$ inches diameter. Weight of rocket section is 146 kg.

The tail is 2 feet 4 inches (large diameter): 1 foot 10 inches (small diameter).

SUSPENSION. Horizontal.

COLOR AND MARKINGS: NL 6 40.

PC 500 RS is stenciled in black on the side of the bomb.

PC 1000 RS

DATA:

Over-all Length: $86\frac{3}{4}$ in.

Body Length: 45 in.

Body Diameter: $14\frac{1}{2}$ in.

Filling: Very pure cast TNT in an aluminum container in the nose. Rest of filling is alternate layers of good and poor quality TNT.

Weight of Filling: 54 kg.

Total Weight: 987 kg.

Chg./Wt. Ratio: 5.5%.

Fuzing: Charging head—(49) B1; (49) BA1; Pyrotechnic—49 B11; Impact—49 B111, 49 BA111, 49 C111.

CONSTRUCTION. The rocket container is attached to the base of the bomb by a cylindrical steel distance piece which is threaded internally on both ends; one end threading over bomb base and rocket container threading into other end. The

tail is 2 feet 4 inches, large diameter; and 1 foot 10 inches, small diameter.

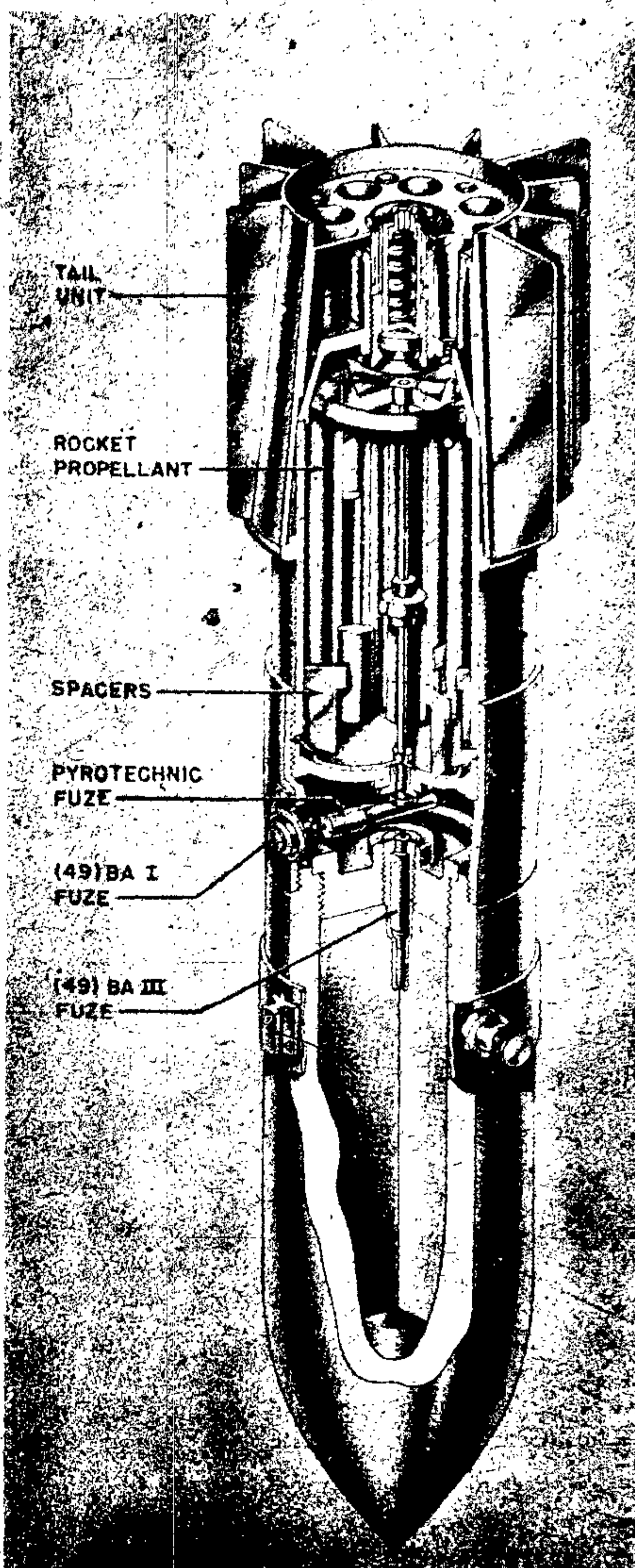

Figure 34—PC 1000 RS Bomb

GERMAN EXPLOSIVE ORDNANCE

The rockets consist of candles contained in a separate compartment at the base of the bomb and

are held in position by spacers. This compartment forms a pressure chamber from which the gases, generated by the candles, escape through six propulsion venturi tubes. The tubes are sealed with pitch until combustion is effected. The pressure chamber is provided with a spring-loaded pressure release valve at the base. (See fig. 34.)

It is stated that the rockets burn for approximately 3 seconds after ignition and leave a trail of flame 150 feet long behind the bomb.

The bomb is usually of A. P. design, but instead of the exploder pocket lying transversely with the fuze head at one side, it is fuzed through the base plate which lies ahead of the rocket compartment.

The pyrotechnic fuze ignites the rocket about 2½ seconds after the bomb is released. Actually, bomb can be dropped without the rocket being ignited.

SUSPENSION. Horizontal.

COLOR AND MARKINGS. Sky-blue. Blue stripes between tail fins. Stenciled:

Achtung vor Beladung

ZSK Ausschalten

Abwurf Z. S. K. O. V. Schalten

unt 28, 5, 41

PC 1000 RS

PC 1800 RS

DATA:

Over-all Length: 107 in.

Body Length: 66½ in.

Body Diameter: 21 in.

Wall Thickness: 1½ to 12 in. tapering.

Filling: Very pure cast TNT in an aluminum container in the nose. Two pre-cast Trialen charges in thick cardboard cylindrical cartons which are waxed into the bomb casing, completes the filling. One specimen had 3 blocks of nitroguanidine in nose and 10 blocks of RDX/Wax/Al in two cardboard cylinders in the body.

Weight of Filling: 360 kg.

Total Weight: 2,057 kg.

Chg/Wt Ratio: 17.5%.

Fuzing: Charging head (49) C1; Pyrotechnic (49) C2; Impact (49) C3.

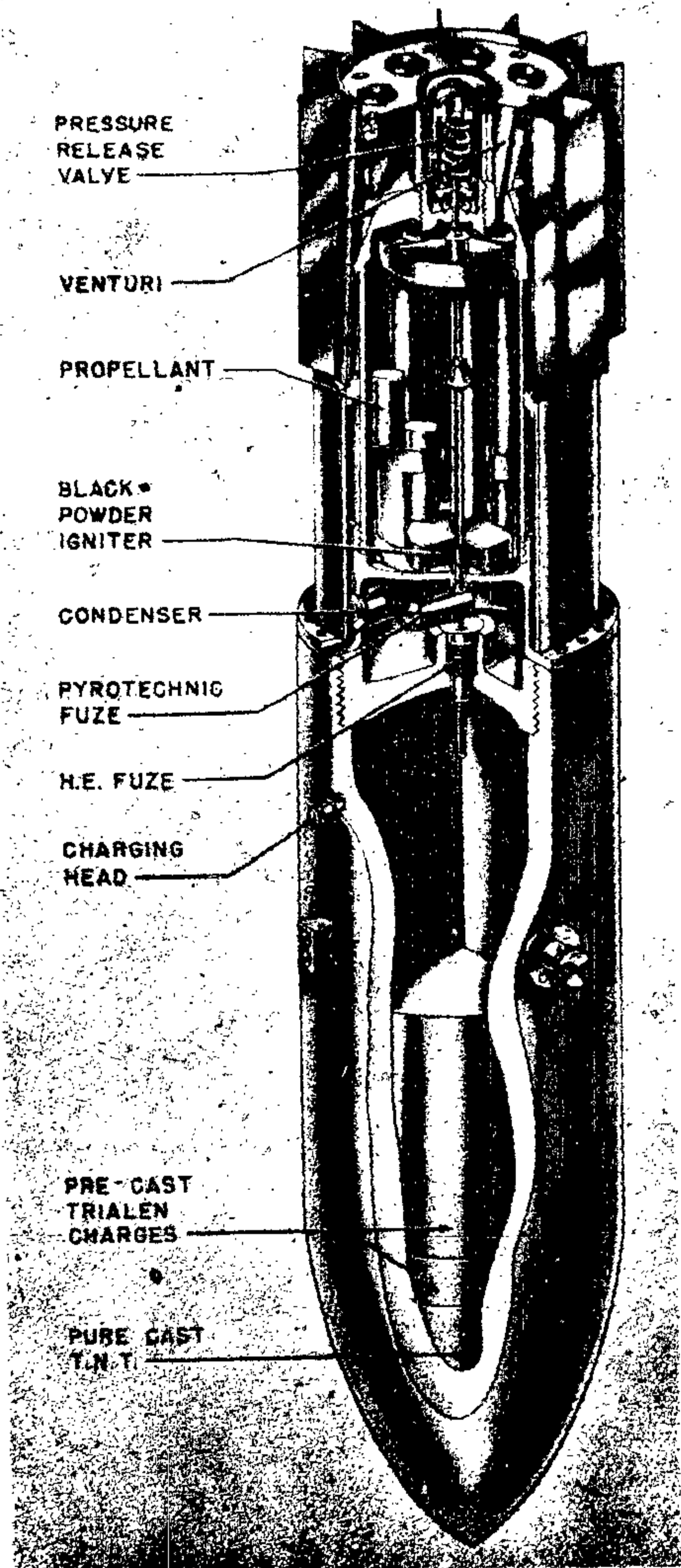

Figure 35—PC 1800 RS Bomb

CONSTRUCTION. Typical rocket bomb construction with single fuze pocket in distance piece.

Nineteen rockets are used—ten 22½ inches long, eight 20⅞ inches long and one 11¼ inches long. All have a diameter of 2⅝ inches. Rocket unit weighs 422 kg. (See fig. 35.)

SUSPENSION. Horizontal.

COLOR AND MARKINGS. Bomb body and tail are sky blue in color. Rocket unit and distance piece are olive drab. Stenciled on body:

Konus vor Velastungen

Schutzen

unt 13, 10, 42

Achtung vor beladung

Zsk Aussenalten

PC 1800 RS

PD 500-kg

DATA:

Over-all Length: 6 ft. 11 in.

Body Length: 4 ft. 6½ in.

Body Diameter: 11 in.

Tail Length: 2 ft. 6½ in.

Tail Width: 1 ft. 11 in.

Filling: (109) RDX/Wax/Al. The filling, designation 109, has previously been found in PC 1800 RS, associated with a nose filling block of nitroguanidine.

Weight of Filling: 32 kg.

Total Weight: 500 kg (approx.).

Charge Weight Ratio: 6.4%.

Fuzing: AZ (49) P5.

CONSTRUCTION. The body of the PD 500 is constructed of drawn steel. Compared to the weight of the bomb, it has a very small explosive cavity. In place of the normal transverse fuze pocket, there is a charging head. Electrical leads pass from the charging head to the fuze which is found in the base plate. (See fig. 36.)

The magnesium alloy tail unit is screwed to the base of the bomb with 24 screws.

SUSPENSION. Horizontally by means of an H-type lug.

COLOR. Sky blue over-all with a red stripe on tail cone.

REMARKS. The bomb is stated to be intended

for attacking armored targets, especially warships. It is dropped in horizontal flight from a height of at least 11,500 feet.

The penetration of armor is stated to be 5½ inches, increased in later models to 6¼ inches. It is of two-piece construction. The leads from the charging head traverse through a machined hole in the drawn steel bomb body. This bomb employs an H-type carrying lug.



Figure 36—PD 500-Kg Bomb

GERMAN EXPLOSIVE ORDNANCE

1/2-kg ANTIPERSONNEL PARACHUTE BOMB

DATA:

Over-all Length: 4 1/4 in.
 Body Length: 2 1/4 in.
 Body Diameter: 1 7/16 in.

Wall Thickness: 3/16 in.

Weight of Filling: 1 oz.

Total Weight: 16 oz.

CHG/WT Ratio: 6 2/3%.

Fuzing: Pull percussion igniter.

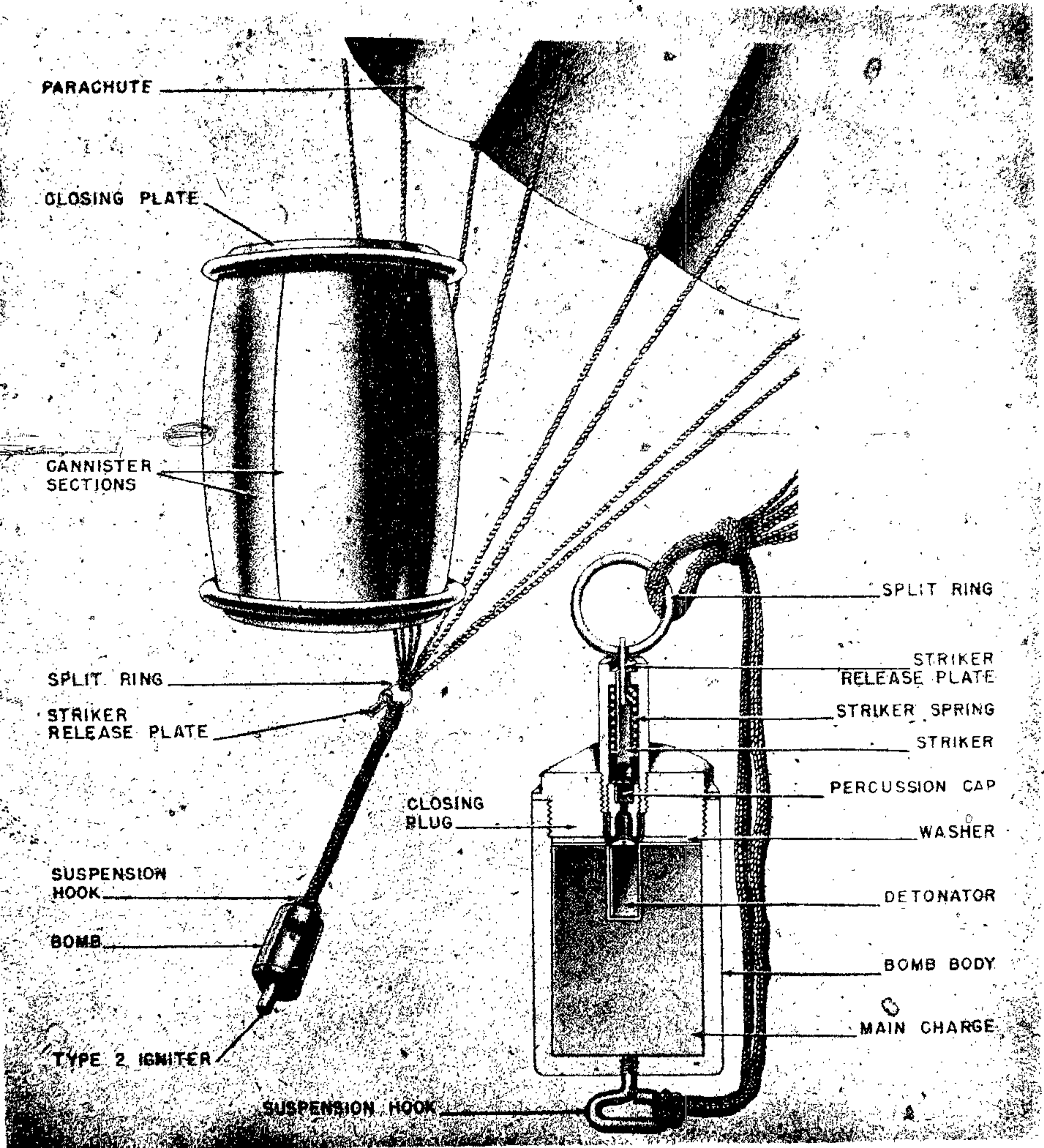

Figure 37—1/2 Kg Antipersonnel Parachute Bomb

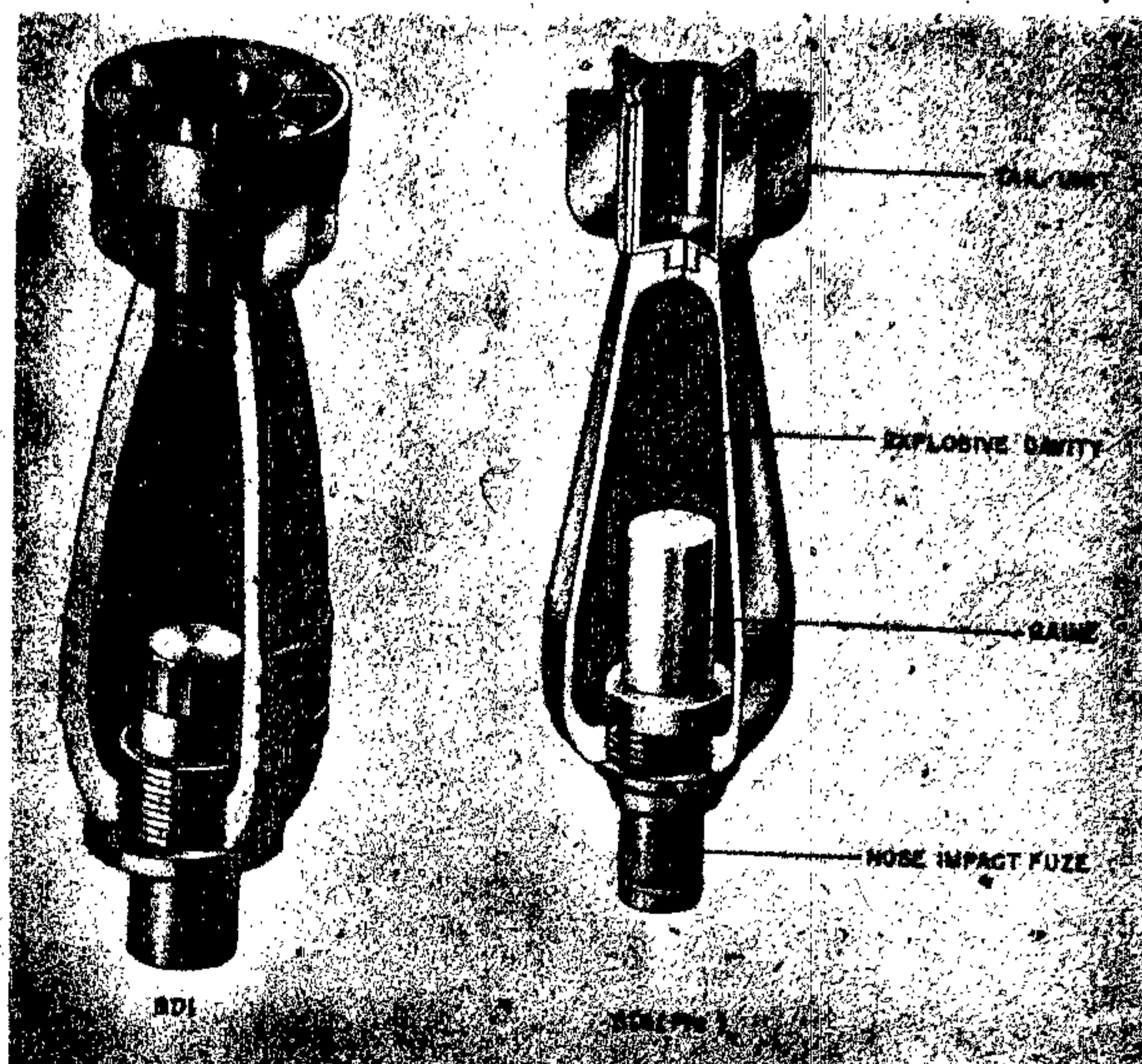

Figure 38—SD 1-Kg Mortar Bomb

CONSTRUCTION. The assembly is composed of two parts—the bomb and the canister. The body is cylindrical and made of cast steel. The base and head are internally threaded, the base to accept a suspension hook and the nose for a steel closing plug. Attached to the suspension hook is a cord which is also tied to a split ring. The parachute is attached to the split ring by eight cords. The split ring is also attached to the pull friction igniter which is threaded into the steel closing plug.

The bomb assembly is housed in a barrel-shaped aluminum canister, the body of which is formed in two separate sections and closed at the ends by twin closing plates. (See fig. 37.)

OPERATION. On release of bomb, canister comes apart and bomb falls clear. When the parachute opens, the shrouds pull the striker release plate out. The striker is then forced into the percussion cap. This action explodes the bomb.

SUSPENSION. Thought to be carried in large containers.

COLOR AND MARKINGS. Canister — unpainted aluminum. One red bar on closing plate indicates 2 seconds delay. Two red bars on closing

plate indicate 4 seconds delay for the pull percussion igniter.

1-kg SD MORTAR BOMB, SD 1, SD 1 FRZ

DATA:	SD 1	FRZ
Over-all Length	6.7 in.	6.06 in.
Body Length	4.25 in.	3.75 in.
Body Diameter	2.0 in.	2.0 in.
Wall Thickness	0.4 in. nose. 0.2 in. tail.	0.12 in.
Tail Length	1.25 in.	1.22 in.
Tail Width	2.0 in.	2.0 in.
Filling	Cast TNT.	Amatol 30/70; Granular TNT.
Total Weight	2 lbs.	1.1 lb.
Fuzing	(73), (73) A, (73) A2.	(73) B2.

Nose impact mechanical.

CONSTRUCTION: Both bombs have a steel body. The SD 1 tail assembly is of light metal. A tubular frame supports eight light metal fins and a drum. Tail assembly screws into bomb.

The FRZ tail assembly also screws into base of bomb. It is in the form of a cup with three sheet metal pieces spot welded on to it to form six fins. Both sheet steel and aluminum tails were used. (See fig. 38.)

GERMAN EXPLOSIVE ORDNANCE

SUSPENSION. SD 1: 392 bombs in AB 500-1 container; 224 bombs in AB 250-2 container; 50 bombs in AB 70-D1 container.

Packing is nose to tail with tail cup of each forming a safety device for fuze behind it.

FRZ bombs are carried in AB 70-D1 container and packed in the same manner as the SD1 bombs.

COLOR AND MARKINGS. SD1 yellow, FRZ—Body is mustard color. Tail (sheet steel) black, (cast aluminum) natural color. Ogive is painted red on Amatol-filled bombs. Markings on FRZ:

NX	}	Stenciled in black
AEM-5-38		
NX-E-6-37		
109		

AK 1927-12-38—Stamped

REMARKS. The FRZ is a French bomb used by the Germans.

2-kg "BUTTERFLY" SD 2A AND SD 2B

DATA:

Over-all Length: 3.5 in.

Body Length: 3.1 in.

Body Diameter: 3.0 in.

Wall Thickness: $\frac{3}{8}$ in.

Filling: Cast TNT surrounded by a layer of bitumen composition.

Weight of Filling: 7.5 oz.

Total Weight: 4.4 lbs.

CHG/WT Ratio: 11.4%.

Fuzing: SD 2A; (41) (airburst or impact).

SD 2B: (41) A (Airburst or impact) (67)

(Delay 5-30 min.) (70) B (Antidisturbance).

CONSTRUCTION. The body of the bomb is a cylindrical cast iron casing. A fuze pocket is situated transversely in the side of the body. The SD 2A and SD 2B differ only in the method in

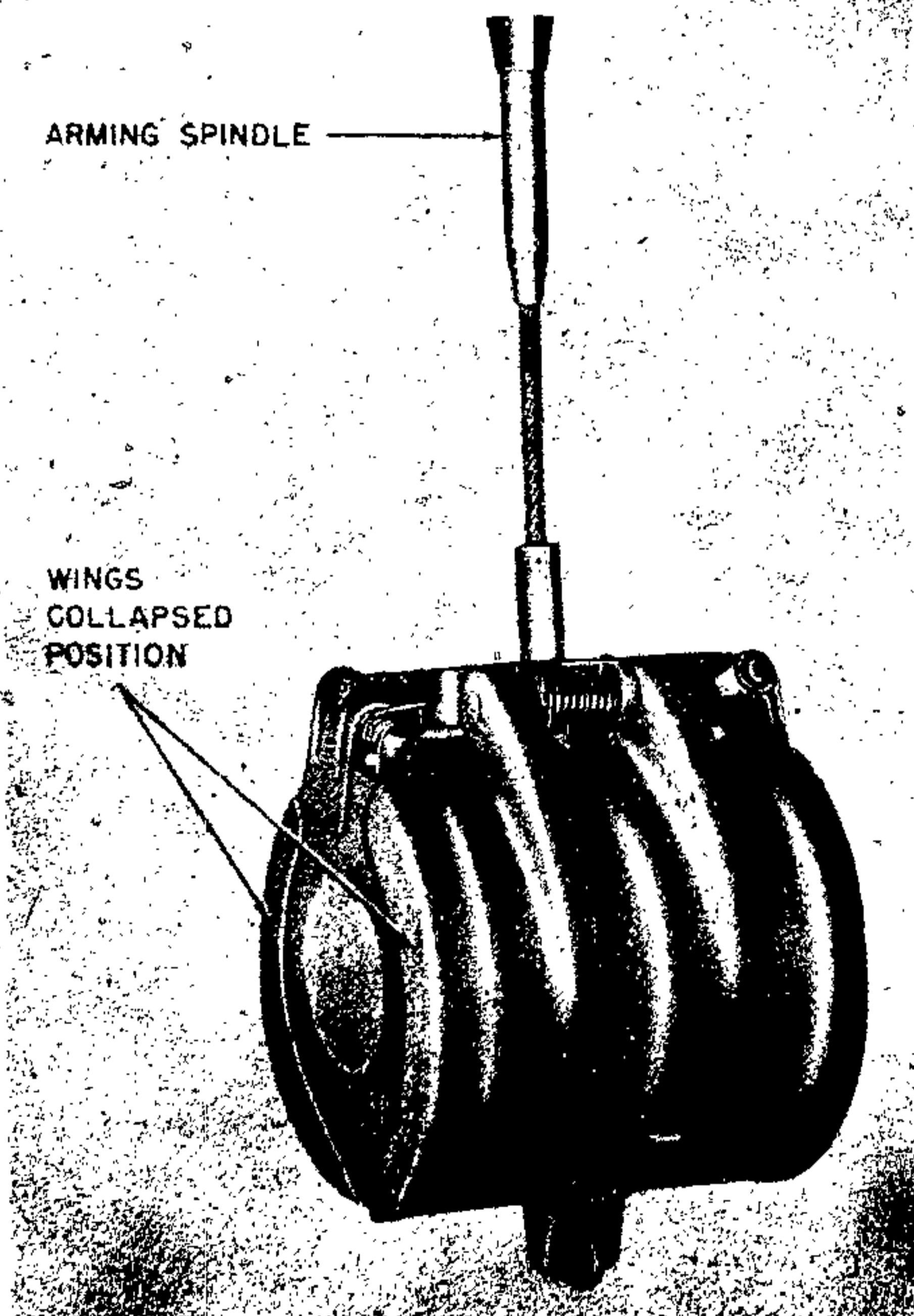

Figure 39A—SD 2-Kg "Butterfly" Bomb

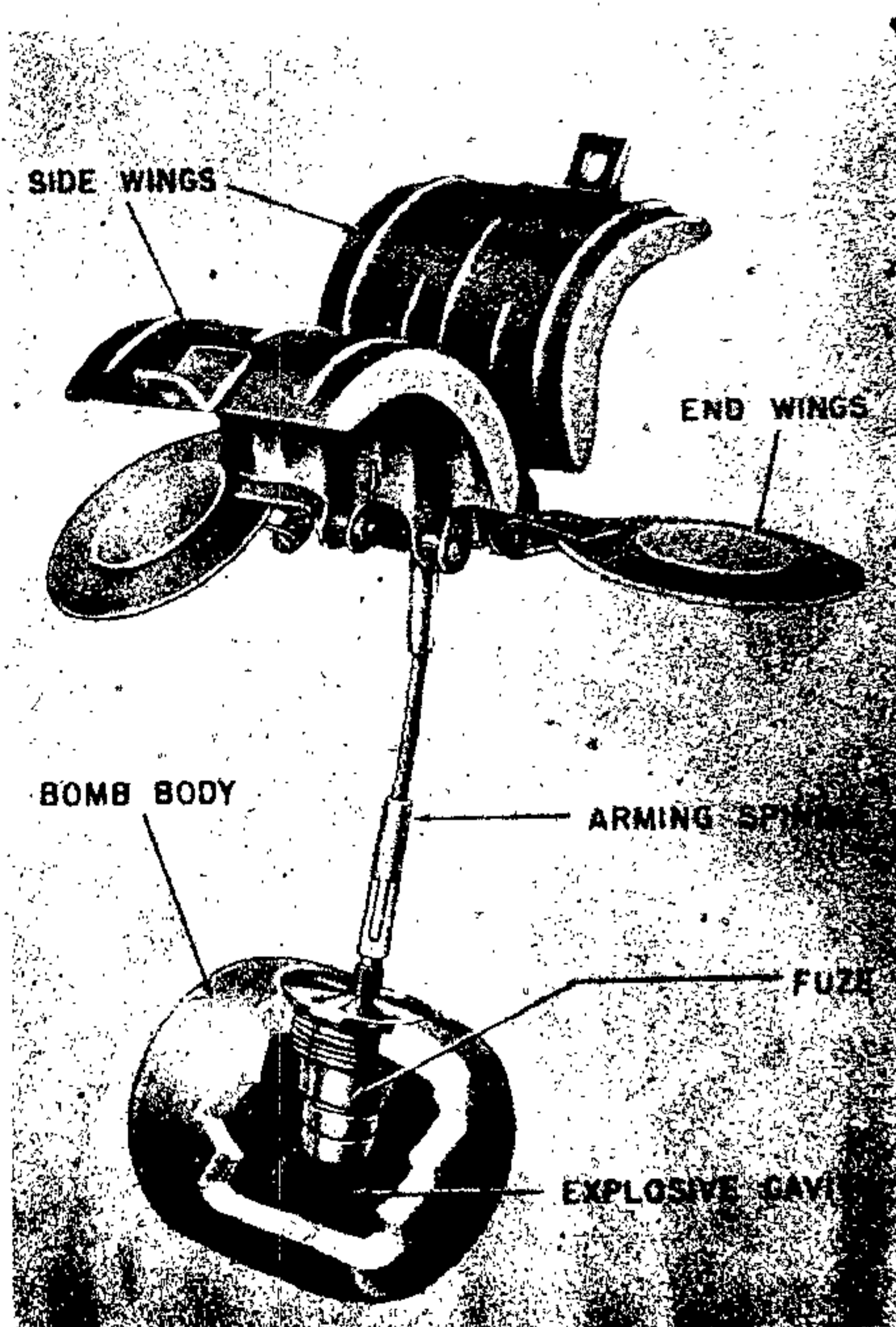

Figure 39B—SD 2-Kg "Butterfly" Bomb

which the fuze is secured in the bomb. The fuze is threaded into the SD 2A while it is secured in the SD 2B by a bayonet joint and two U-shaped safety clips.

The bomb body is encased in a thin sheet steel container made in four pieces—two end flaps and two pieces covering the sides of the bomb. (See figs. 39A and 39B.) These parts are hinged together, the hinges being mounted with torsion springs tending to force the parts of the wings away from the body, but are prevented from opening until a safety pin is pulled when container opens. After release, the wings because of their air drag, rise to the upper end of the 6-inch wire cable connected to the fuze. The rotation of the wings relative to the bomb body arms the fuze. When fuze (41) A is employed in the bomb, the wings consist of two triangular shaped flaps.

SUSPENSION. 23 bombs in the AB 23 SD 2 container; 108 bombs in the AB 250-3 container; 6 bombs in the Mark 500 Roden container; 24 bombs in the AB 24t container.

COLOR. Body of bomb may be painted either black, lead-grey, red, yellow, or field grey. If the bomb is painted field grey it may have a $\frac{3}{4}$ -inch yellow band on the body, the wing assembly will be painted field grey with a yellow stripe on the inside and outside of the wings and may have a $\frac{3}{4}$ -inch red stripe at right angles to the yellow stripe on the wings. If the bomb body is painted yellow, the wings will be painted yellow with a $\frac{3}{4}$ -inch strip of red on the wings. In addition to the specific color combination given, the wings may be field grey or unpainted.

SB 3-kg

DATA:

Over-all Length: $13\frac{5}{8}$ in.

Body Length: $13\frac{5}{8}$ in.

Body Diameter: $3\frac{3}{16}$ in.

Wall Thickness: $\frac{1}{16}$ in.

Tail Length.

Tail Width.

Filling.

Weight of Filling: 4 lb.

Total Weight: $6\frac{1}{2}$ lb.

Chg/Wt. Ratio: 61.5%.

Fuzing: (23) A.

CONSTRUCTION. The case consists of a

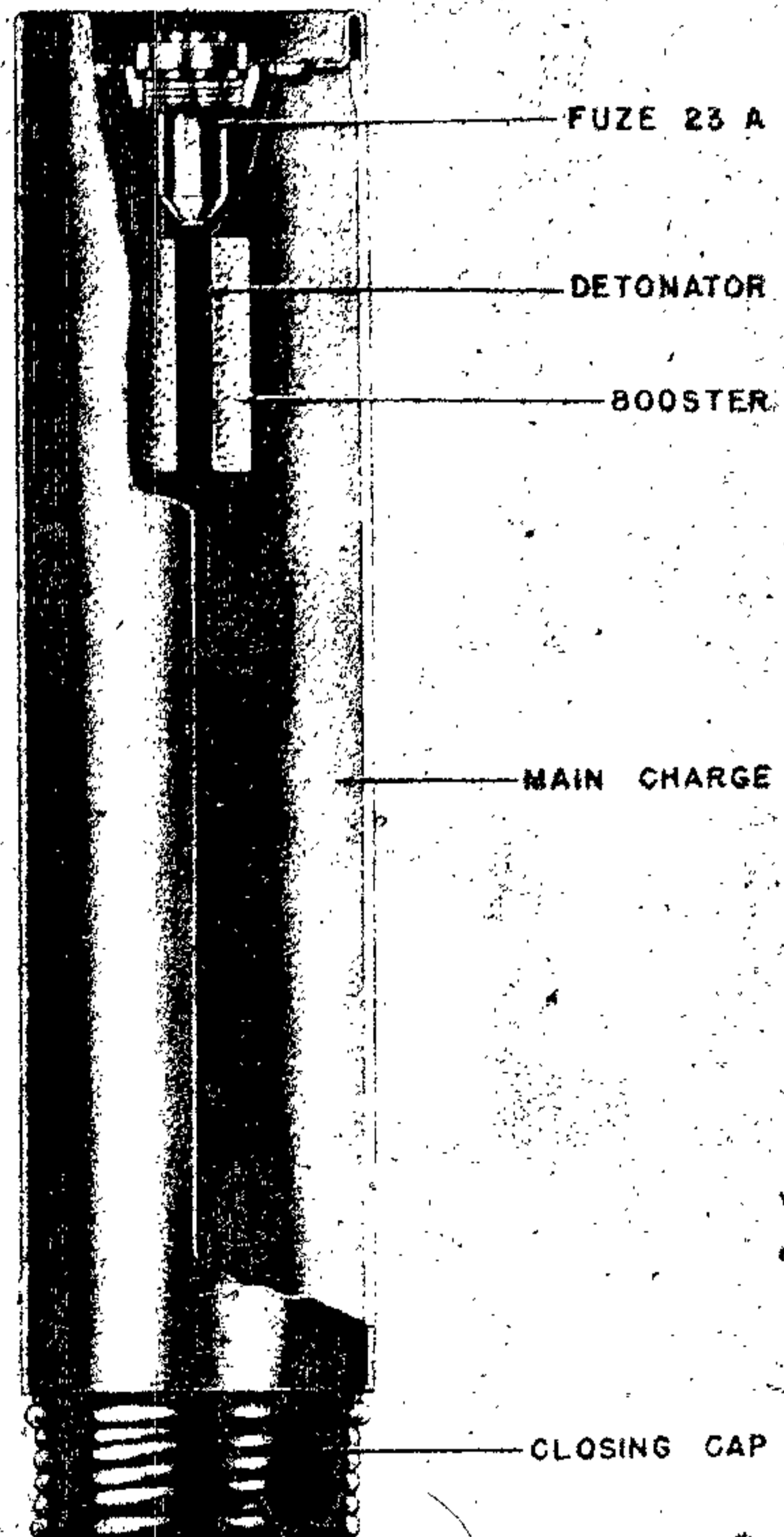

Figure 40—SB 3-Kg Bomb

welded steel tube $\frac{1}{16}$ inch thick, which has a pressed steel filler cap threaded on to the nose. Two cardboard discs cover the filling under the nose cap. (See fig. 40.)

A steel fuze adapter, of spot welded construction, is crimped on to the base of the bomb. No fuzes were found in the specimen recovered, but enemy documents indicate that these bombs are fitted with the mechanical impact all-ways acting (23) A fuze. Design of adapter in base confirms documentary evidence.

There is no form of tail or stabilizing ring.

SUSPENSION. Thought to be carried in containers.

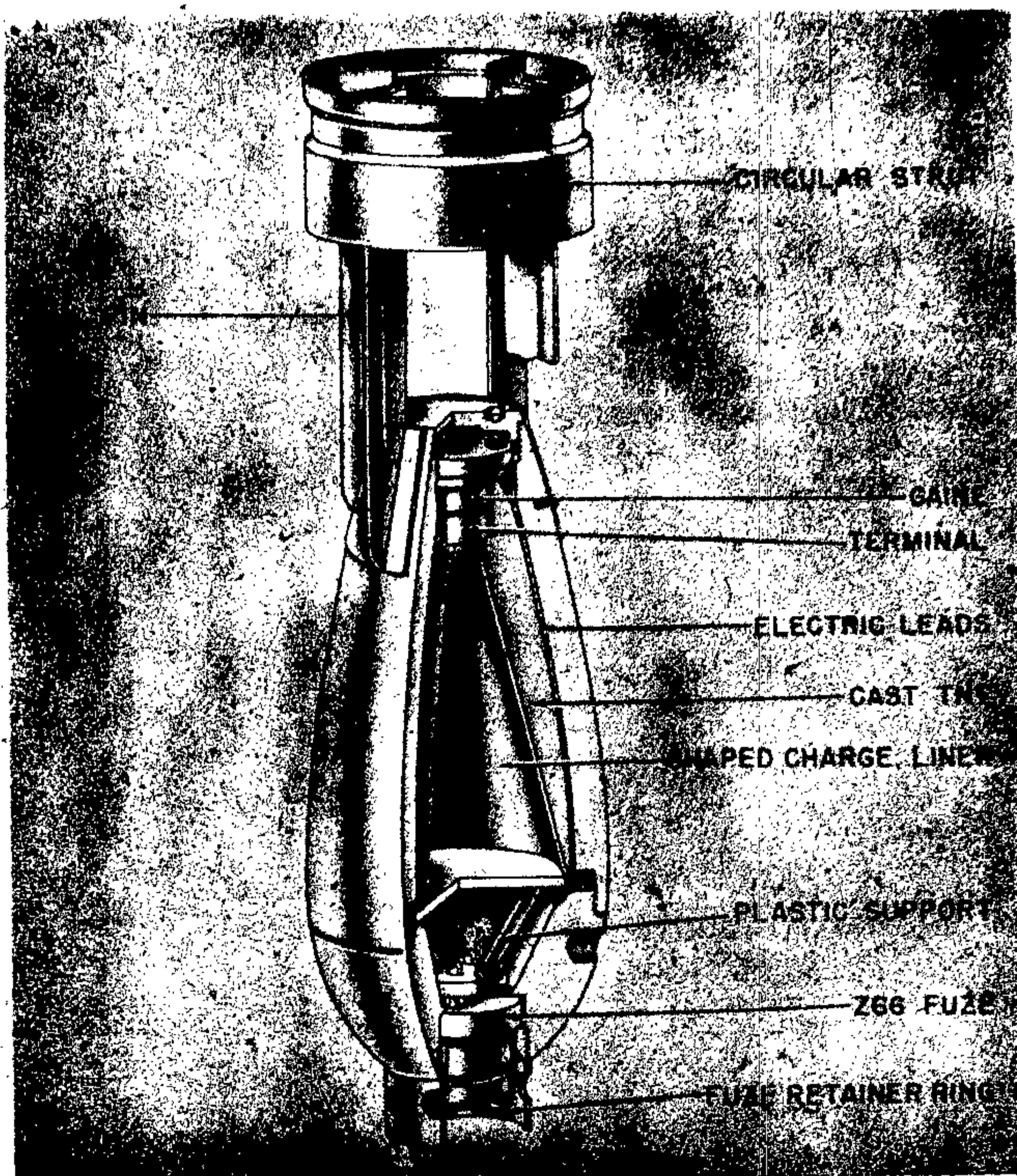

Figure 41—SD 4-Kg HL Hollow Charge Bomb

COLOR AND MARKINGS. Two yellow stripes, diametrically opposite, run length of case. Stenciling in black on case:

SB 3.

114.

Wurfur AB 36.

10 bb 242.

REMARKS. Captured documents have pointed to the existence of the 3-kg SB 3 but only one specimen has been found.

SD 4 HL HOLLOW CHARGE ANTIPERSONNEL AND VEHICLE BOMB

DATA:

Over-all Length: 12 $\frac{1}{8}$ in.

Body Length: 7 $\frac{3}{4}$ in.

Body Diameter: 3 $\frac{9}{16}$ in.

Wall Thickness: $\frac{3}{8}$ in.

Tail Length: 5 $\frac{1}{8}$ in.

Tail Width: 3 $\frac{9}{10}$ in.

Filling: TNT; TNT-RDX (46/54).

Weight of Filling: 12 oz.

Total Weight: 9 $\frac{1}{4}$ lb.

Chg/Wt. Ratio: 8.1%.

Fuzing: Z (66).

CONSTRUCTION. The bomb is cast iron and consists of a body into which is screwed the nose cap and the male base plate. A copper plated steel spring fits into a recess machined in the base plate and bears against a plastic igniter holder containing an electric detonator. The igniter holder fits

over a brown plastic insulating adapter which houses the gaine and has two terminals to which the wire leads of the detonator are connected. Two electric leads are connected to the terminals

and are led along the inside of the body to the nose fuze. A 32° truncated conical-shaped steel liner is flanged at its base, the flange being slotted at three points to accommodate the two electric leads

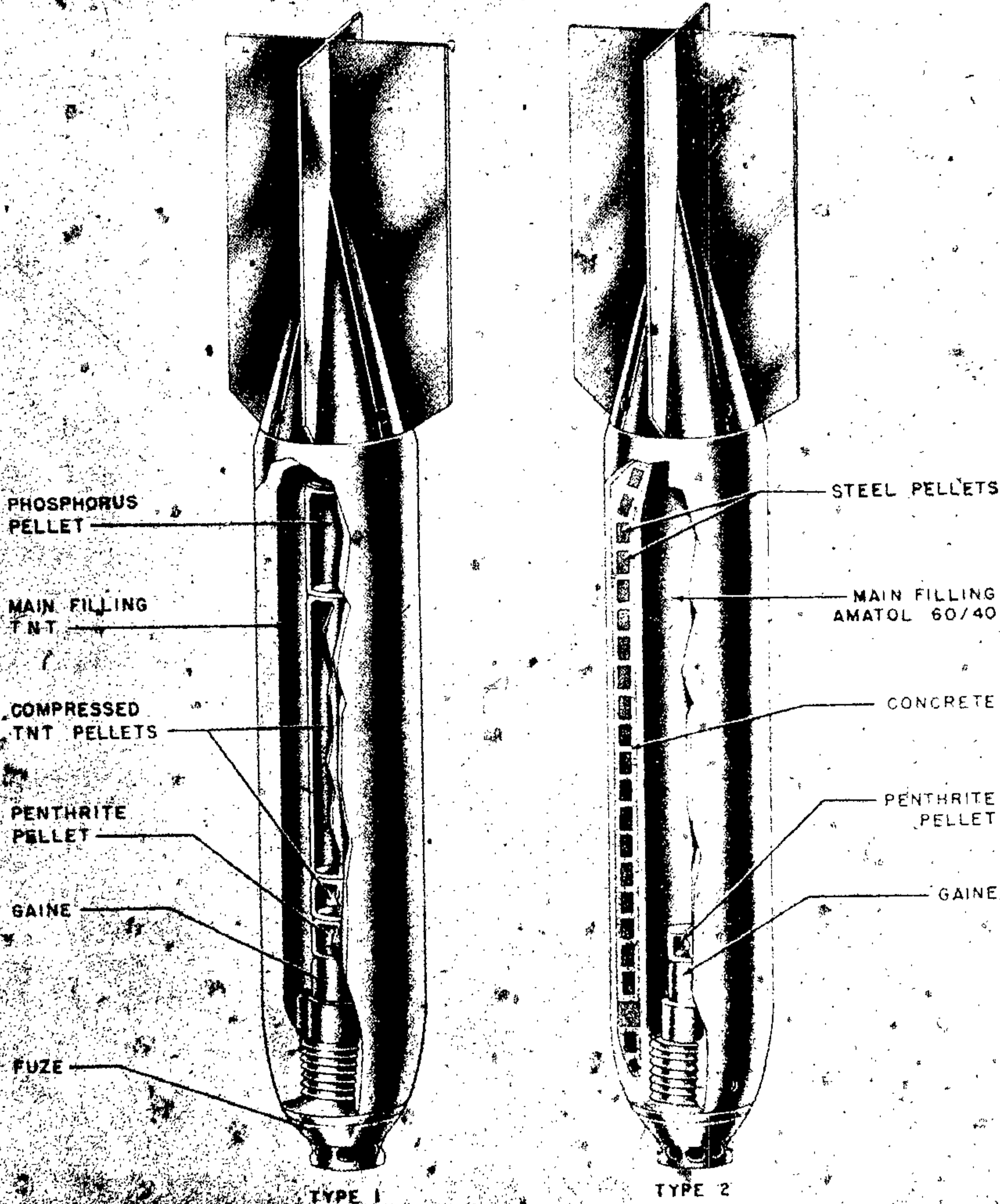
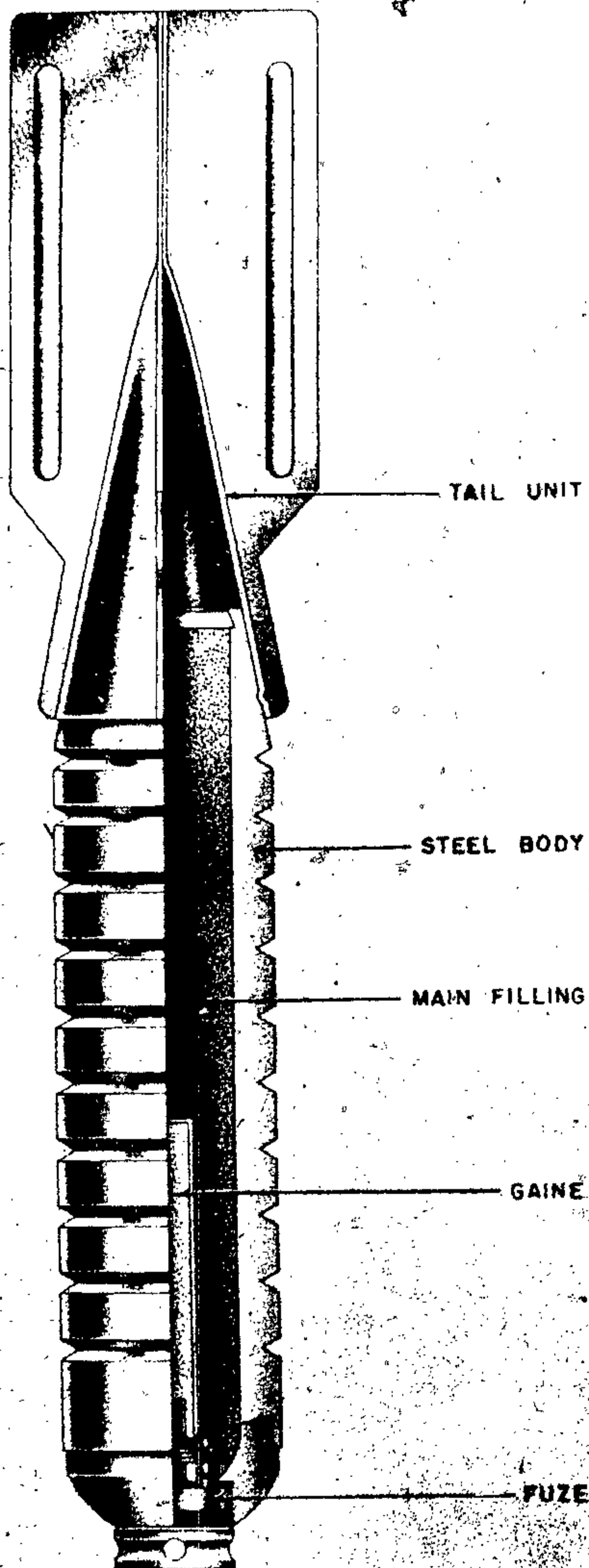

Figure 42—SD 10A Antipersonnel Bomb



and the locating pin.⁵ The explosive filling is poured through the base of the body around the cone. A plastic support is secured between the flange of the cone and the nose piece. Two holes are drilled through this support for the terminal pins of the fuze to which the electric leads are soldered. The fuze seats on a shoulder in the nose and is secured by a fuze retainer ring which has eight outlet vents. (See fig. 41.)

The tail is sheet steel. It is of the ring strut type with four longitudinal struts spot welded. Each strut forms one segment of the tail cone. The tail is secured to the body by means of four prongs punched into corresponding recesses in the bomb body.

On impact, the (66) fuze induces an electric current which passes via the electric leads to the detonator. The squib is thereby fired, setting off the gaine and the charge.

SUSPENSION:

74 bombs in AB 500-1 container.

40 bombs in AB 250 container.

Bombs are packed nose in tail, thus increasing fuze safety.

COLOR AND MARKINGS. Buff or fawn color over-all. The marking "SD4HL" is stencilled on the body. It is presumed the H means Hohl or hollow, and L stands for Ladung or charge.

SD 10A TYPES I, II, AND SD 10FRZ ADAPTED FRENCH BOMB

DATA:

Over-all Length: 21.6 in.

Body Length: 12.7 in.

Body Diameter: 3.4 in.

Wall Thickness: 0.6 in.

Tail Length: 8.5 in.

Tail Width: 4.7 in.

Filling: TNT; Amatol 60/40.

Fuzing: Z (66); AZC 10 (Hut) * (3).

CONSTRUCTION:

TYPE I: The case, parallel-sided, is constructed of cast steel terminating in a shallow dome at the base. The nose of the bomb, which is thicker, is tapped to accommodate the fuze and has two holes bored transversely for grub screws to secure the fuze. (See fig. 42.)

TYPE II: The bomb is constructed with a double casing of drawn steel. The space between the

Figure 43—SD 10C Antipersonnel Bomb

inner and the outer shells is closely packed with steel pellets set in concrete. The pellets are cubes, having sides of about 7 mm. The over-all thickness of the bomb case is about 0.6 inch. The outer shell is 2 mm. thick and has a nose piece integral with it. It is closed at the base by a steel disk over which the shell is folded. The inner shell is 3-mm. thick and terminates at the base in the form of a truncated cone. The two shells are scarf jointed together just behind the nose. Four steel supports are welded between the inner and outer walls of the nose and act as spacers.

The SD10FRZ French bomb is very similar to German Type I. The tail is constructed of four sheet steel pressings welded together, each pressing forming a segment of the tail cone and one fin. The tail is secured by four rivets and four indentations.

For Types I and II, a long exploder system is used when the filling is TNT. This consists of a normal gaine; one penthrite pellet, two compressed TNT pellets and one phosphorus pellet. The main filling terminated about 1.9 inches from the nose and so permits the use of the AZC 10 (Hut) * (3) fuze. The Z (66) fuze's gaine fits only partly in the exploder pocket.

When the main filling is 60/40 amatol, a short exploder system is used, with a normal gaine and one penthrite pellet. The bomb is filled to within 1.2 inches of the nose so the AZC 10 (Hut) * (3) fuze cannot be used.

SUSPENSION. Seventeen of these bombs are carried in the AB 250-2 container.

COLOR. Body and tail unit are olive green. Body has D10A13 or 14 stencilled in black on it. Tail has 4 red stripes down cone between fins. Type II has 1/2 inch red stripes on outer edge of tail fins.

SD 10C

DATA:

Over-all Length: 20.5 in.
 Body Length: 12.2 in.
 Body Diameter: 3.0 in.
 Wall Thickness: 0.55 in.
 Tail Length: 9.4 in.
 Tail Width: 3 in.
 Weight of Filling: 0.75 kg approx.
 Total Weight: 7 kg approx.
 Chg/Wt. Ratio: 11% approx.
 Fuzing: EAZ. (66) A

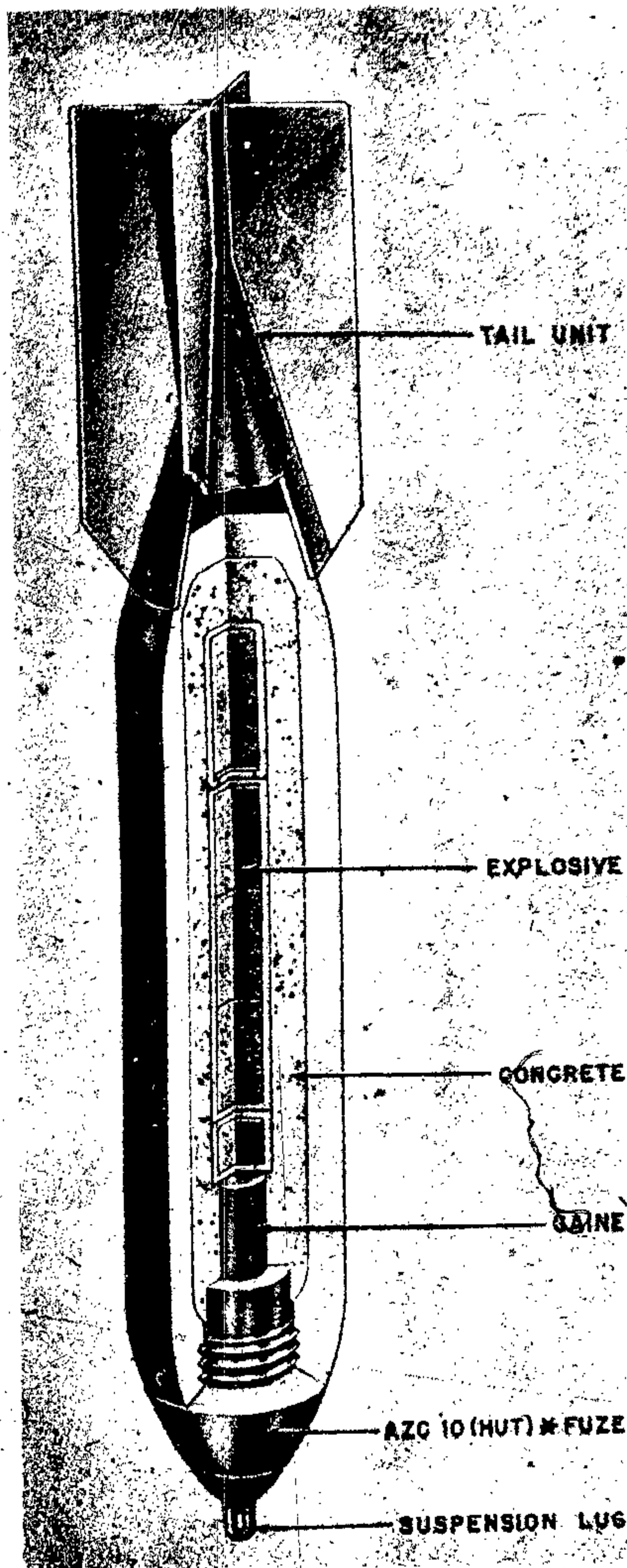

Figure 44—12-Kg SC 10 Concrete Bomb

GERMAN EXPLOSIVE ORDNANCE

CONSTRUCTION. The cast steel body of the bomb is closed at the tail by a sheet steel plate shrunk in position. Externally the tail end is machined to form a seating for the tail unit. Nine angular grooves, machined in the body ensure good

fragmentation. The fuze adapter, internally threaded to accept the airflow control ring of the fuze EAZ (66) A, is shrunk into a recess formed in the nose of the bomb body. The main filling is recessed at the nose end to accommodate a long gaine. (See fig. 43.)

The tail unit, secured to the bomb body by four indentations, is formed of four similar sheet metal pressings riveted together.

SUSPENSION. 28 bombs in a AB 250-2 container.

COLOR AND MARKINGS. Khaki over all. Stenciled on body, SD 10C.

12-kg. SC 10 CONCRETE BOMB

DATA:

Over-all Length: 23.0 in.

Body Length: 12.75 in.

Body Diameter: 3.25 in.

Wall Thickness: 0.5 in.

Tail Length: 9.0 in.

Tail Width: 5.0 in.

Filling: TNT.

Weight of Filling: 0.9 kg.

Total Weight: 0.12 kg.

CHG/WF Ratio: 7.5%.

Fuzing: AZC 10 (hut)* (3) nose fuze.

CONSTRUCTION. There are two types of this bomb: (1) A forged or cast body with base an integral part of body. The nose is threaded to receive the fuze; (2) A body consisting of two casings each 0.1 inch thick, welded together, the space between being filled with small steel pellets imbedded in concrete.

The tail is of sheet steel. It has four fins welded to cone. Cone secured to body by rivets or screws. (See fig. 44.)

SUSPENSION. Vertical in clusters of five.

COLOR. The body and tail assembly are painted dark grey.

REMARKS. Aside from the fuze, fuze adapter and markings, the SC 10 bomb is the same bomb as the SD 1A.

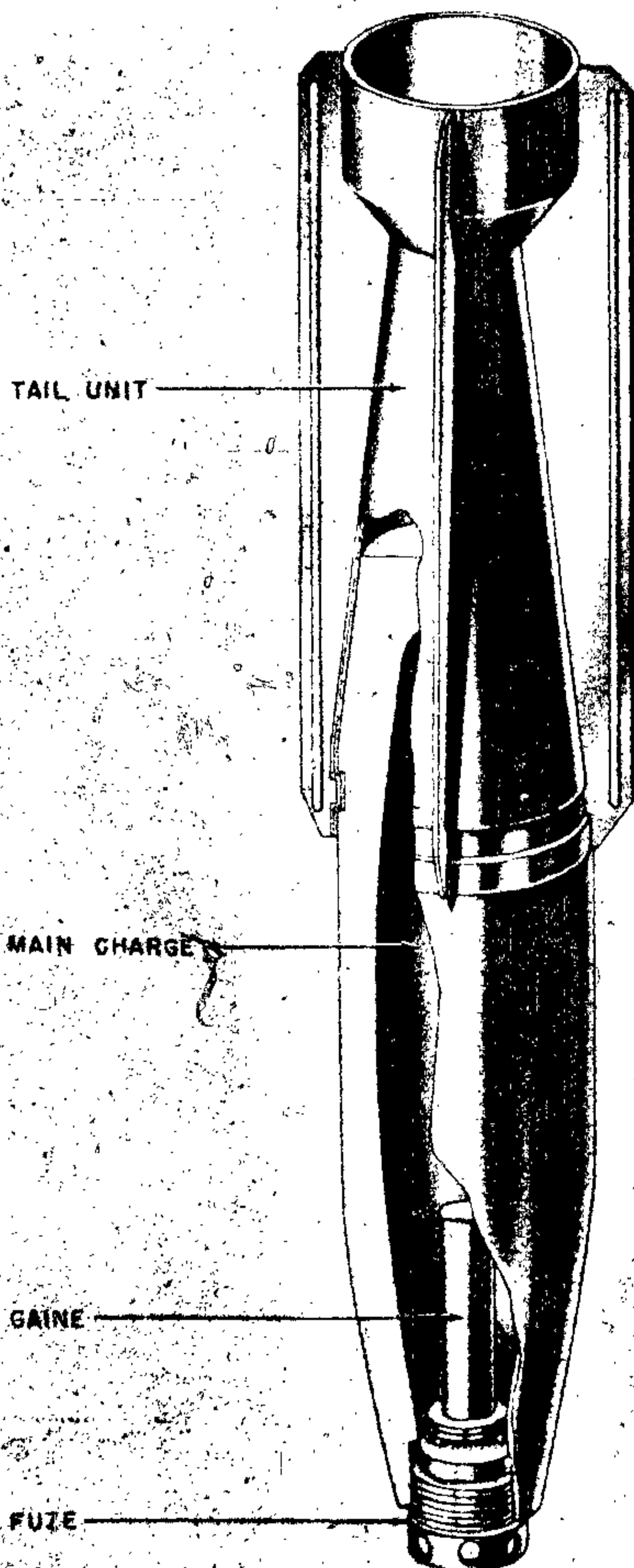

Figure 45—SD 15-Kg Converted German Shell Bomb

SD 15 CONVERTED GERMAN PROJECTILE BOMB

DATA:

Over-all Length: 24.2 in.

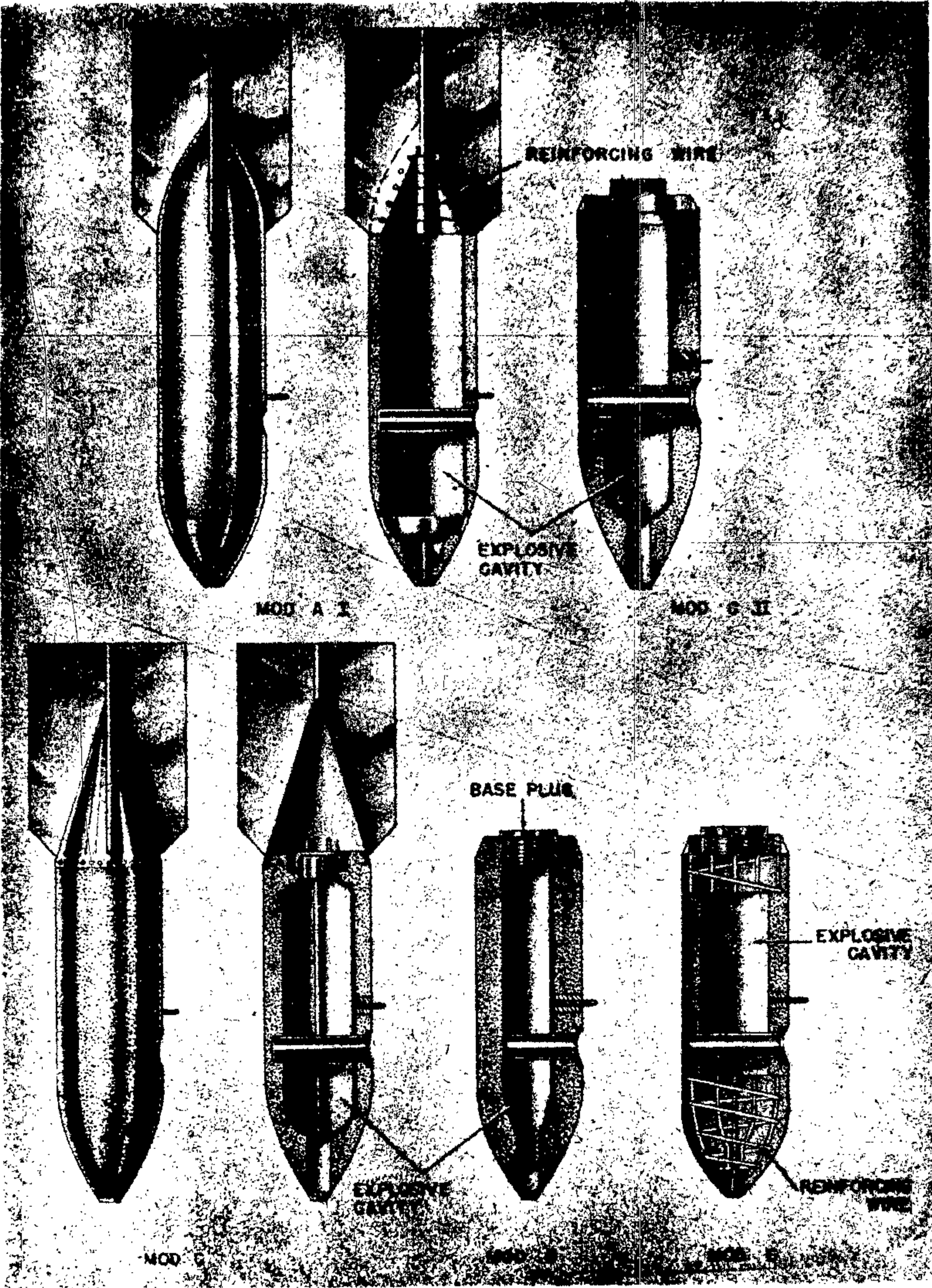

Figure 46—SBe 50-Kg Concrete Bomb

GERMAN EXPLOSIVE ORDNANCE

Body Length: 15.5 in.
 Body Diameter: 4.1 in.
 Wall Thickness: 9/22 in. nose to 1 in. in base.
 Tail Length: 12.4 in.
 Tail Width: 3.75 in.
 Fuzing: EAZ (66) A.

CONSTRUCTION. The bomb body is a converted 105-mm howitzer projectile. (See fig. 45.) It is formed of a hollow single piece steel casting, internally threaded at the nose end to accommodate the airflow control ring. The main filling is shaped at the nose to accommodate an NP 10 Ger-

man projectile gaine which is enclosed in a cardboard sheath.

The tail unit is of sheet steel and is formed of four similar sections spot welded together to form the tail cone and four fins. The four fins are braced at their rear ends by a circular stabilizing strut. The tail unit is secured to the bomb body by crimping within an annular groove machined in the bomb body.

SUSPENSION. It is reported that 24 bombs are carried in an AB 500-1D container.

COLOR. Body is dark green with khaki-colored tail.

SBe CONCRETE BOMB (50-kg AI, AII, C, CII, D, E)

DATA:	AI	AII	C	CII	D	E
Over-all Length	42"5	42"9	43"1	42"7	43"1	43"1
Body Length	35"6		28"0	28"6	28"7	28"7
Body Diameter	7"9	7"9	7"9	7"9	7"9	7"9
Wall Thickness	"9		1"6	1"5	2"0	1"5
Tail Length	16"0		16"1	16"1	16"1	16"1
Tail Width	11"0		11"0	11"0	11"0	11"0

Filling: In earliest specimens, TNT. In all later specimens a naphthalene explosive mixture. This latter is a lower performance explosive, used perhaps for better fragmentation.

Total Weight: 49-52 kg.

Fuzing: 55.

CONSTRUCTION. The concrete walls in all these models are loaded with small fragments of scrap metal. (See fig. 46.) The explosive filling of the model A1 is surrounded by a thin sheet metal container which acts as a former for the concrete. The fragmentation effect of this bomb was apparently unsatisfactory, owing to excessive weight of explosive causing pulverization of the concrete. An attempt was made to improve it in Model C by reducing the weight of the explosive and increasing the thickness of concrete while still retaining the metal explosive container. A further modification along these lines was made in Model D, but it seems that the quantity of explosive had been reduced to too low a limit, and in Model E the weight of explosive is increased in amount to be the same as Model C. The metal explosive container, however, has been dispensed with, and the concrete has been precast on a gridled steel rod framework. The steel framework is welded to a cast steel plug at the nose and a cast steel ring at the tail. The tails are of sheet steel. Early

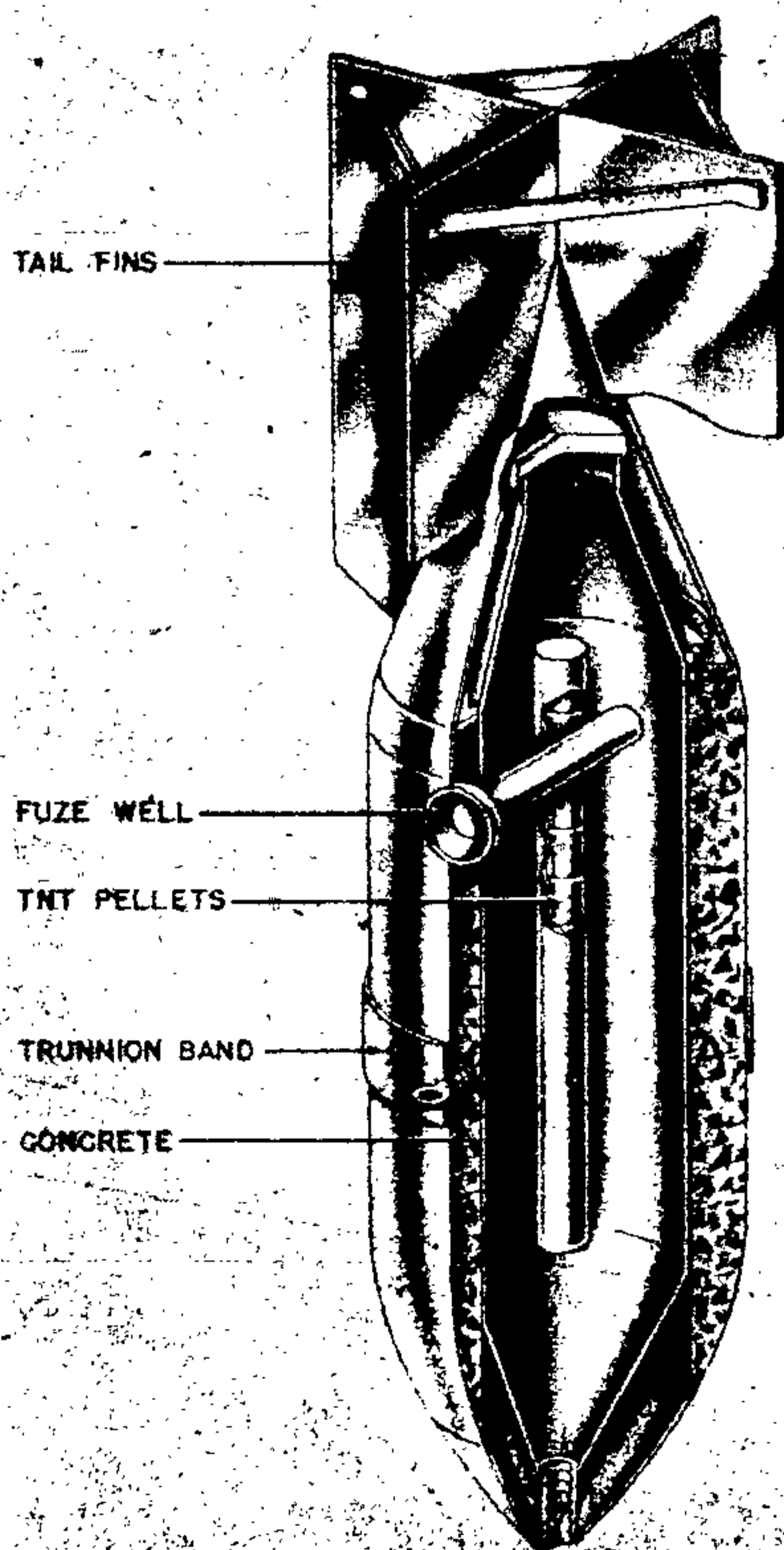

Figure 47—SBe 250-Kg Concrete Bomb

models had the tail set in concrete. Later models have a detachable tail.

SUSPENSION. Vertical or horizontal suspension is used.

COLOR. Bright green over all.

SBa 250-kg CONCRETE BOMB

DATA:

Over-all Length: $64\frac{1}{16}$ in.

Body Diameter: $14\frac{5}{8}$ in.

Wall Thickness: $2\frac{1}{8}$ in.

Tail Length: $24\frac{13}{16}$ in.

Tail Width: 20 in.

Filling: Ammonium nitrate with a small percentage of wood meal and aluminum. There is also a column of TNT pellets.

Weight of Filling: 46 kg.

Total Weight: 250 kg.

Chg/Wgt. Ratio: 18%.

Fuzing: (55) or (25) B.

CONSTRUCTION. The bomb body consists of a $\frac{1}{8}$ inch metal explosive container. Surrounding the container is a 2-inch concrete apron with scrap steel-embedded throughout. A single transverse fuze pocket is used. A metal piece $\frac{3}{16}$ inch thick, of saucer shape, is the nose piece for bomb. (See fig. 47.)

The tail is sheet steel with four single braces.

SUSPENSION. Horizontal. The lug is attached to the trunnion band which is removable.

COLOR. Blue green over-all. Stenciled in black between trunnion band and fuze pocket.

LF

SBcC

105/40

Forward of trunnion band, twice, 180° apart:

110

On nose: 25

B

SA 4,000-kg

DATA:

Over-all Length: $175\frac{3}{4}$ in.

Body Length: $138\frac{1}{2}$ in.

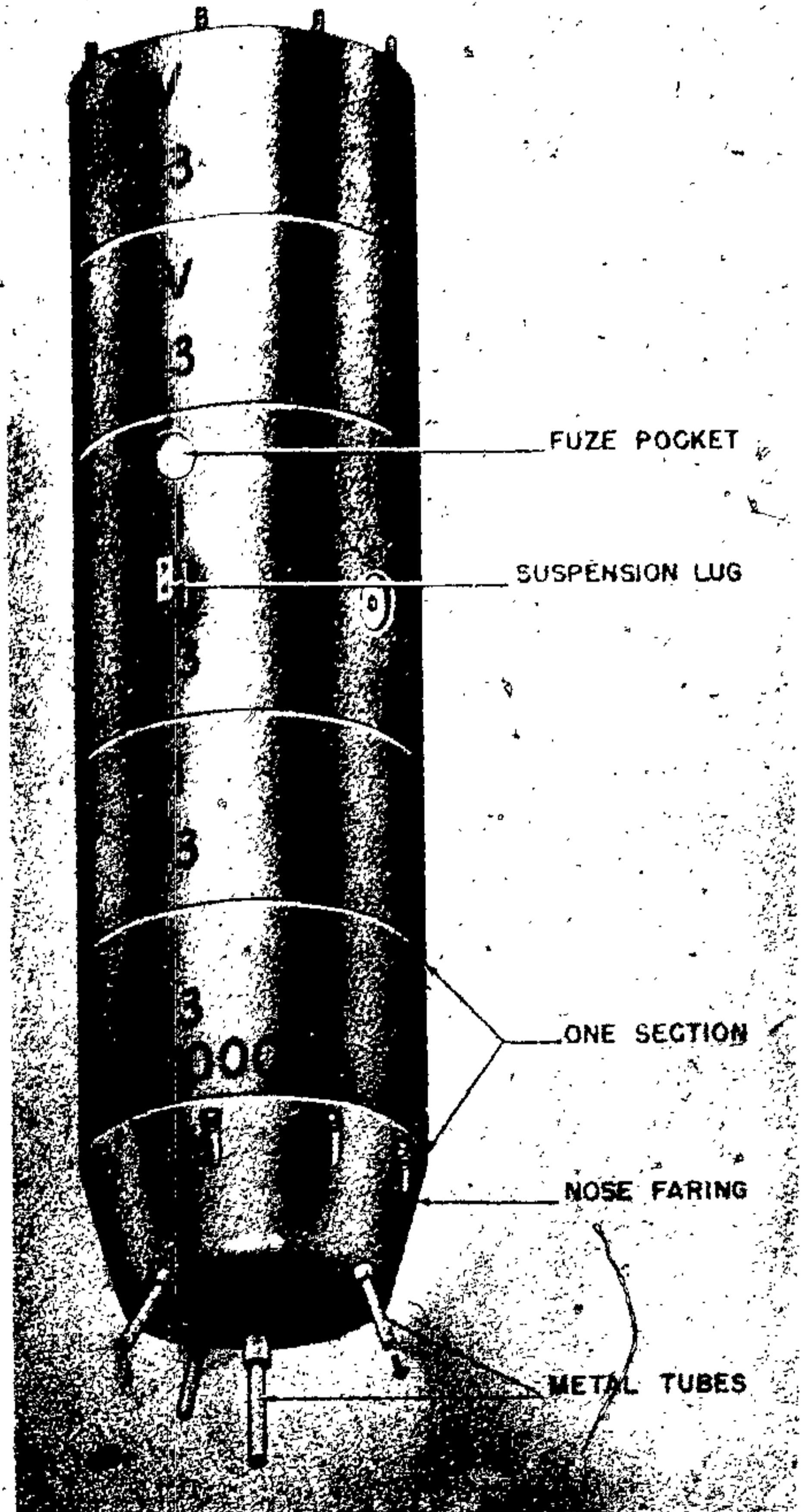

Figure 48—SA 4000-Kg Bomb

Body Diameter: $37\frac{1}{2}$ in.

Wall Thickness: $\frac{1}{8}$ in.

Filling: Matrix 50/50 amatol biscuits; aluminum/wax/RDX.

Total Weight: Approximately 9,000 lb.

CONSTRUCTION. Bomb is made in five sections. The central section is 2 feet $4\frac{3}{4}$ inches long and remaining sections are 1 foot $10\frac{1}{4}$ inches long. Sections are cylindrical in shape and of sheet steel construction. (See fig. 48.)

GERMAN EXPLOSIVE ORDNANCE

Each section has ends closed by a circular steel plate in which six holes are drilled and six steel tubes welded into position. When the five sections are assembled, six tie rods are passed through the steel tubes and secured at the extreme ends of the bomb by a washer and two nuts.

A central exploder tube is formed in each section in the same manner as the connecting tubes. Twenty-four picric acid pellets are stowed in the exploder tube of the central section and 18 pellets in each of the other exploder tubes. Exploder

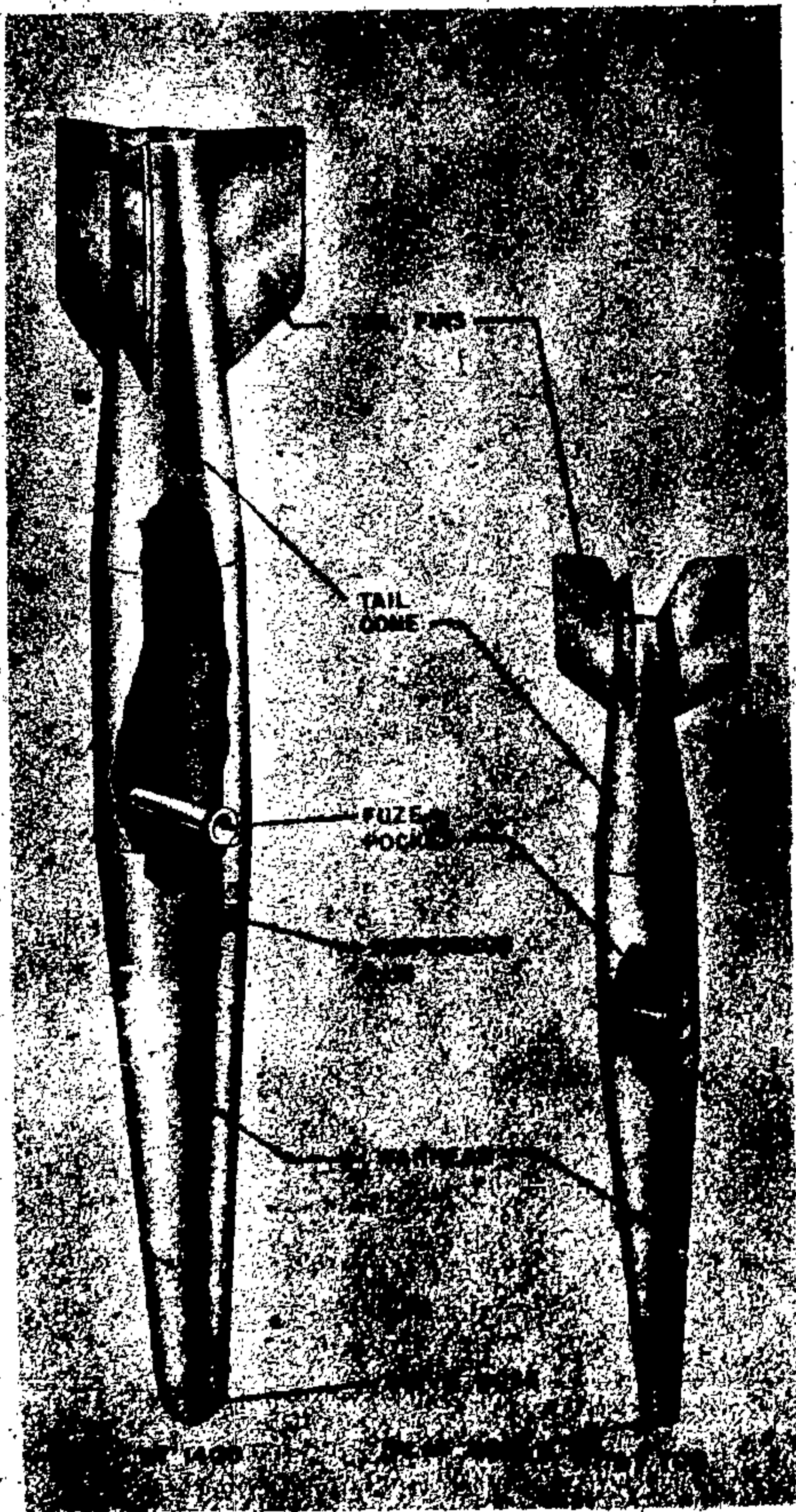

Figure 49—1400-Kg Bomber Torpedo

tubes are closed at each end by a cardboard disc held in position by a threaded washer.

A circular felt pad is placed between each section when bomb is assembled.

Three filling holes are provided in each section.

The nose fairing consists of a truncated conical section to which is welded a convex section; an internally threaded collar is welded to the convex section. A steel tube 3 feet 11/4 inches long is screwed into this collar. Three similar collars at an angle of 120° to each other are positioned off center on the convex section. Three steel tubes 9 1/8 inches long are screwed into these collars. The truncated conical section of the nose fairing is recessed at eight points to accommodate bolts which secure fairing to bomb.

The ends of the long and three small tubes are fitted with steel closing plugs.

A transverse fuze pocket is located in the central section. Fuze pocket appears to terminate at central exploder tube.

No fuze has been found with the bomb but the threaded holes in the steel closing plugs accept the nose switch of the (55) A fuze. Also, there are slots in the truncated conical section of the nose that may be for electric cable leads. Locating ring attached to each bomb is of normal type and not of slotted type used with (55) A fuze.

Eight bolts which screw into the external plate of the after section appear to be for attachment of a tail unit, but no tail unit was found.

SUSPENSION. The central section is fitted with a suspension lug. Lug being capable of limited lateral rotation. Section is also recessed and threaded at sides for fitting of trunnions.

COLOR AND MARKINGS. Fawn colored overall, sections are marked I, II, III, IV, and V. SA 4000 is painted in large black letters on the body. The letter V plus serial number of bomb is also present. The three specimens examined were 2, 3, and 7.

BI (BOMBEN TORPEDO)

GENERAL. The aircraft torpedo is an expensive complicated weapon. The proportion of explosive weight is low. Mass production is lengthy and expensive. In addition present day performances of torpedo engines limit the speed and range of the projectile. Both of these items are essentials for accuracy and safety from antiaircraft fire.

A relatively simple weapon would result were the torpedo engine and the control gear omitted. If this simplified weapon were launched so that the greater portion of the distance to the target was covered through the air, as with an ordinary bomb, the initial speed of launch would be retained over nearly all the range. The projectile would enter the water just short of the target and carry on in the direction of its flight in air by reason of its momentum in the same way as does a torpedo. To prevent it from going too deep before detonation, a relatively flat angle of entry into the water is necessary.

Such a weapon was developed in Germany during the closing months of the war, and it was called the Bomben Torpedo. It combines the characteristics of the bomb to travel a long distance in a short time interval with the characteristics of a torpedo in that underwater travel eliminates range errors.

DETAILS. The BT was developed in four sizes: 200 kg, 400 kg, 700 kg, and the 1,400 kg. They all incorporated the same general shape and construction, and were entirely of steel. They were constructed in three pieces; the warhead (two sections) and the tail section. (See fig. 49.) The forward section of the warhead was in the shape of a truncated cone, and the after section of the warhead was cylindrical. The transverse fuze pocket was located in the cylindrical section just aft the point where the two sections were welded together. The suspension lug T-type, was secured to the warhead just forward of this weld at the center of gravity.

TAIL SECTION. The tail section was also in the shape of a truncated cone. There were three very large fins spaced 120° apart at the after end of the section. This type of tail provided excellent stability for the bomb while it was in the air. The tail section was secured to the after section of the warhead in such a manner that when the missile struck the water, it was jettisoned.

Early in the experiments, a BT 1000 was worked on and this missile had a rocket motor inside the tail section. This idea was soon dropped as it proved impractical for the missile.

FUZING SYSTEM. A magnetic fuze which reacts to the variable magnetic field of a ship is necessary for the most successful position of detonation under the keel of the ship. Work on this

aspect of the bomb was found to be far from complete. The susceptibility to disturbances and the reaction capacity of such fuzes had not been investigated thoroughly either. A magnetic proximity fuze, however, is necessary for greater release ranges and for curved underwater trajectories.

Good detonation positions can be achieved with straight underwater travel if the fuze is set to go off after a specific distance through the water. The angle of entry must naturally not be altered as the underwater travel depends on the angle of entry. The time delay set on the fuze can be determined most simply by assuming a constant time for underwater travel.

In designing the fuze system, the following points must be borne in mind. An impact fuze with or without delay is required for direct hits on the ship. Further, the speed and range of release must be functioned very accurately for a preset time as the tolerance of plus or minus 0.1 second can only be achieved with a clockwork fuze. Finally, the tail section must be jettisoned by explosive bolts or by some other adequate method on impact with the water.

UNDERWATER BEHAVIOR. The bomb must in no event ricochet off the water not even in flat angles of entry, but must continue without deviation of its path of entry.

It is known that with ogival noses, as seen in the illustration of the BT 1400, a bomb will ricochet off the water when it strikes at a flat angle. By using a flat nose, as seen in the illustration of the BT 700, or better yet by using a spoiler plate, this ricochet at flat angles is definitely avoided. The frontal surface of the spoiler plate is made in the form of a section of a sphere of radius equivalent to the distance between the surface of the spoiler plate and the bomb center of gravity. As the flow of force is practically perpendicular to the upper surface of the body when it is awash, the resulting flow of force must go through the center of gravity and thus it causes no turning moment.

A spoiler plate with the same diameter as the bomb however, has a high water drag. The ideal situation is to have the size of the plate less than the greatest caliber of the bomb body and so shaped that only the spoiler plate and no other part strikes the surface of the water at flat angles of entry.

GERMAN EXPLOSIVE ORDNANCE

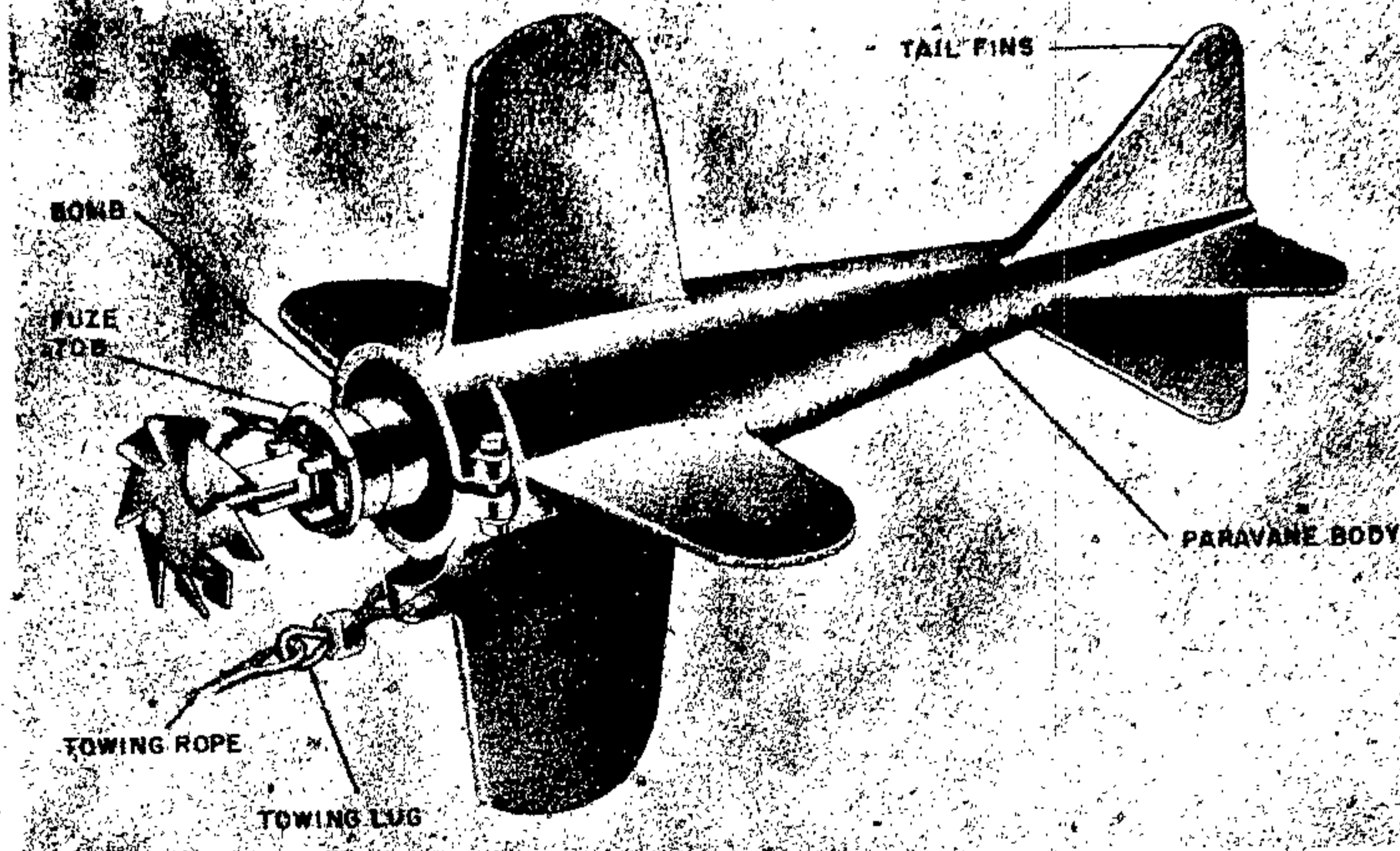

Figure 50—2-Kg Airplane Towed Paravane Bomb

AIRCRAFT TOWED PARAVANE BOMB (2 kg)

DATA:

Over-all Length: 15.7 in.
Length of Bomb: 3.4 in.
Body Diameter: 3.2 in.
Wall Thickness: $\frac{3}{8}$ in.
Total Weight: 6.5 lb.
Fuzing: (70) B.

CONSTRUCTION. The assembly is comprised of the paravane body, the bomb, and the modified (70) B fuze. (See fig. 50.)

The paravane body is a sheet-steel cone, formed of two sections welded together. At its rear end, four sheet steel tail fins are welded to the cone.

Equally spaced around the cone, forward of the tail fins, are drilled four longitudinal rows of six $\frac{1}{8}$ inch holes, two of these rows being drilled slightly forward of the other two. The purpose of these holes is not known.

Towards the end of the cone are welded four equally spaced metal planes of airfoil cross-section. They are offset to the longitudinal axis of the cone. To one plane is welded a metal eye which forms an anchor for the towing lug.

The front end of the cone has a T slot, forming two lugs, to each of which is welded a boss, one boss being screw-threaded to accept the tensioning screw, the whole forming a circlip by means of

which the bomb is secured to the paravane body.

The bomb consists of a cylindrical iron casting, open at one end and filled with H. E. The filling is shaped to accommodate the fuze body and game.

A seating is formed within the upper wall of the casting for the (70) B fuze. Above this seating the wall is built up to form a bayonet type socket to secure the fuze in a similar manner to that in S. D. 2-kg bombs.

SUSPENSION. The bomb is suspended horizontally by a boss welded to the forward end of the cone.

COLOR AND MARKINGS. The tail and paravane cone are painted dark green; the body is yellow with a red stripe.

INCENDIARY, SMOKE, AND PRACTICE BOMBS

INTRODUCTION. Incendiary, smoke and practice bombs are covered in this section. They are for the most part like the high-explosive bombs in appearance but have for their main filling elements other than high explosive.

Incendiary bombs range in size from the 1-kg magnesium bomb to the 500-kg oil filled flam. The smaller types are ordinarily carried in containers and the larger bombs are carried in bomb racks like a similar size high explosive bomb.

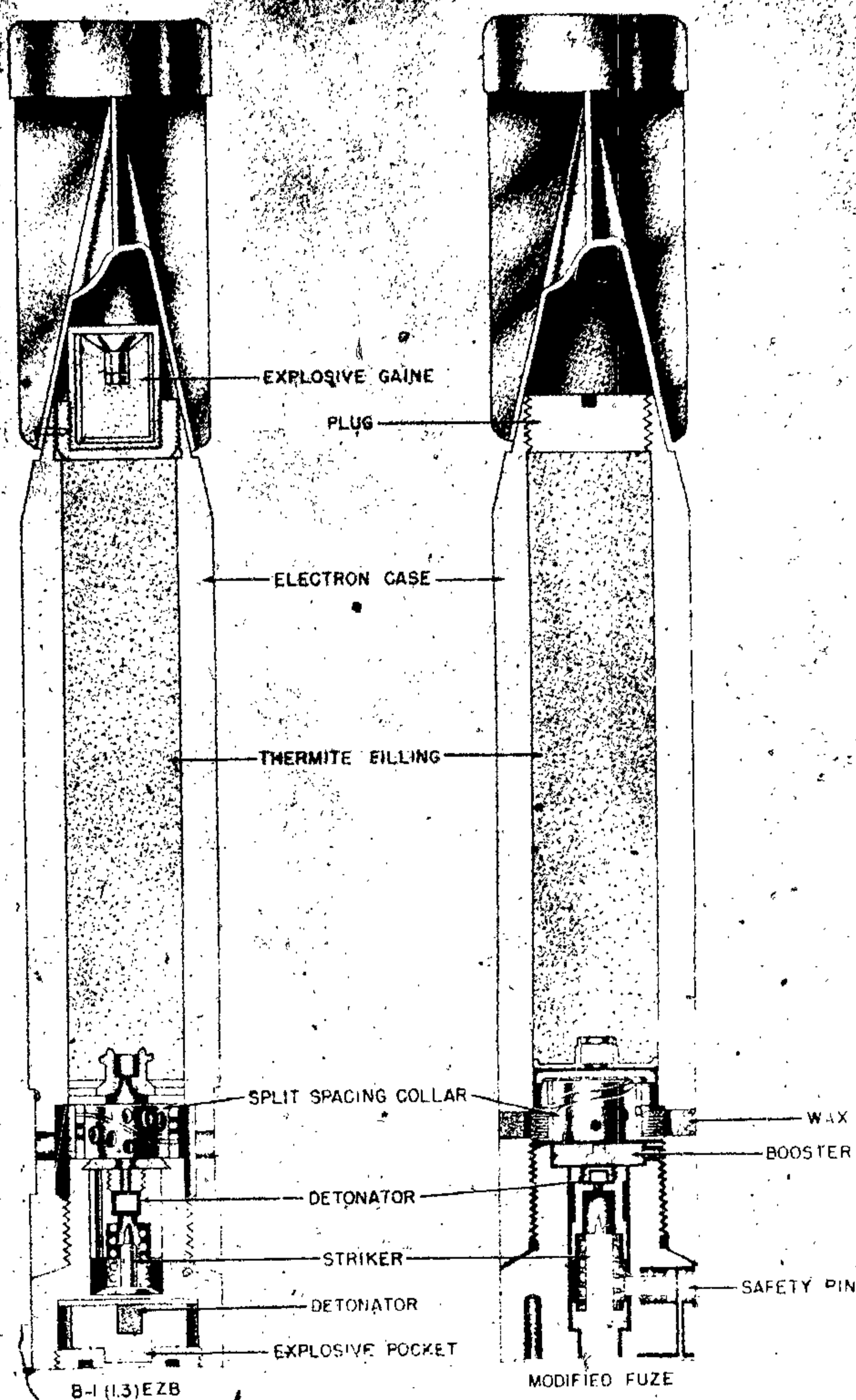

Figure 51—1-Kg B1E, B1EZE, B1EZB Incendiary Bomb

The 1- and 2-kg magnesium bombs often have a small antipersonnel charge incorporated in the bomb to discourage fire fighters. The larger types,

also, usually have a small explosive charge but this is for the purpose of scattering the incendiary mixture.

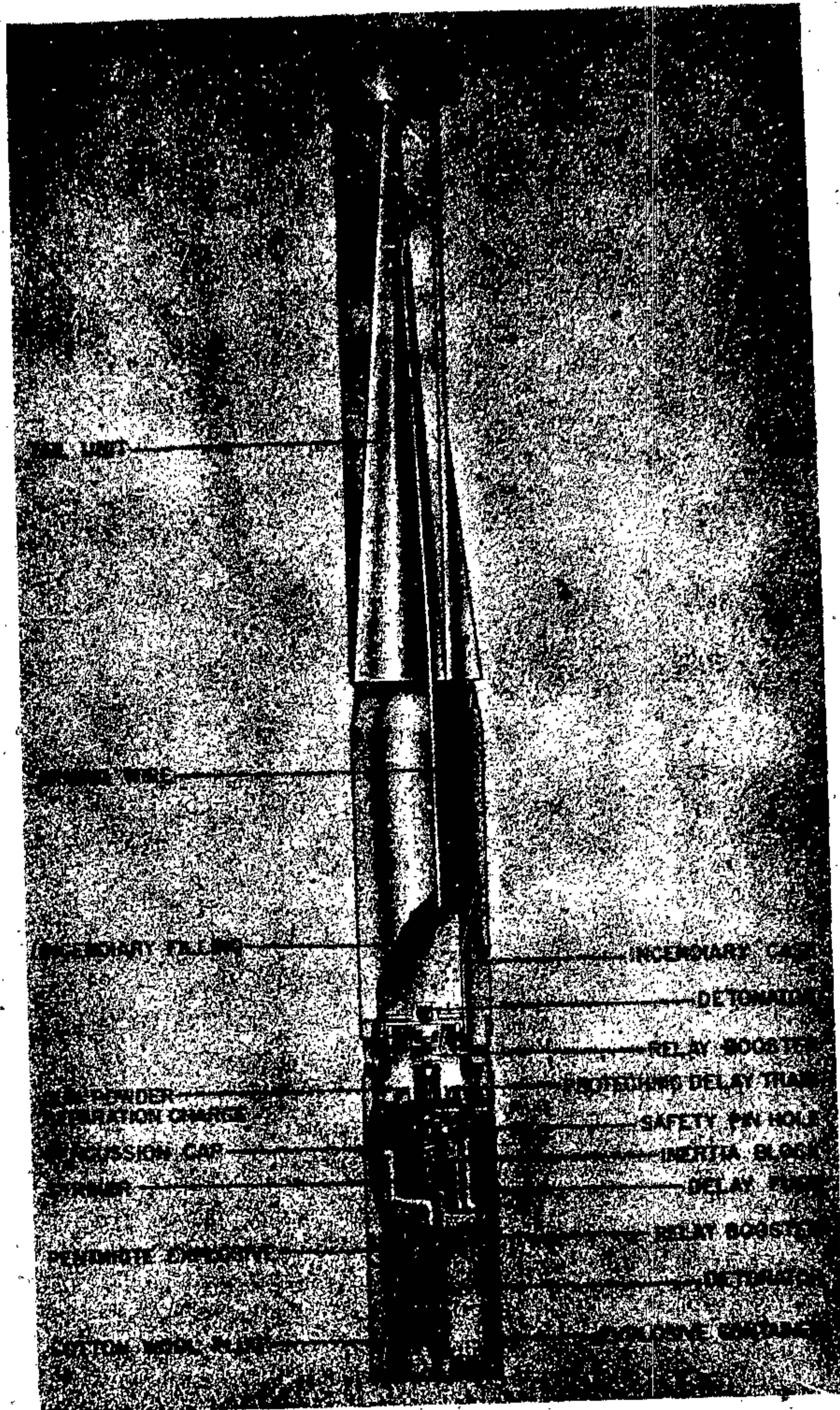

Figure 52—2-Kg B2EZ Incendiary Bomb

Smoke bombs also are usually of conventional size and appearance. They have a fuze, usually mechanical, designed to operate on impact, which ignites a smoke producing composition.

Practice bombs are cheaply constructed. The great majority are built of concrete, a notable exception being the rocket assisted practice bomb which is almost identical except for explosive

charge with the high explosive bomb. They are built to simulate the service bomb in handling and ballistics. Most practice bombs have either flare or a smoke producing attachment incorporated into the bomb in such a way as to mark the point of impact of the bomb.

1-kg. and 1.3-kg INCENDIARY BOMBS DATA:

Over-all Length: 13.54 in.
Body Length: 9.75 in.
Body Diameter: 2.0 in.
Wall Thickness: $\frac{3}{8}$ in.
Tail Length: 4.75 in.
Tail Width: 2.0 in.
Type of Filling: Thermitite.

CONSTRUCTION. The body is a cylindrical alloy casting, threaded internally at the nose to receive the fuze holder and fuze. The after body is tapered to receive the sheet metal, three-finned drum-shrouded tail assembly. The 1.3-kg and 1-kg bombs are identical except that the nose of the former is made of steel, while that of the latter is of light alloy. (See fig. 51.)

REMARKS. There are three bombs to each set, as follows:

1. B1E and B1.3E: Fuze ignites an incendiary mixture.
2. B1EZA and B1.3EZA: Bomb is identical to 1, but a penthrite filled gaine, threaded into the tail, detonates thermally in about 5 minutes.
3. B1EZB and B1.3EZB: These are similar to paragraph 1 but a penthrite filled pocket in the nose detonates thermally after about $\frac{1}{2}$ to 5 minutes.

SUSPENSION. These bombs are carried in a number of different sizes and types of containers.

COLOR AND MARKINGS. The bomb is unpainted magnesium; the tail is dark green. The B1EZA and the B1.3EZA may have a red A stenciled on the nose and probably will have a Z stamped on the body near the tail. The B1EZB and the B1.3EZB may have a red B stenciled on the nose and a Z stamped on the body near the tail.

2-kg B2EZ INCENDIARY BOMB

DATA:

Over-all Length: 20.75 in.
Body Length: 12.25 in.

Body Diameter: 2.0 in.

Wall Thickness: $\frac{7}{16}$ in.

Tail Length: 0.5 in.

Tail Width: 2.0 in.

Type of Filling: Incendiary—Thermitite H. E. Penthrite and Wax.

Fuzing: AZ (63).

CONSTRUCTION. This bomb consists of three main components: a tail unit, an incendiary body, and an H. E. attachment. The incendiary body is tapered at the after end to fit into the long tail cone and is reduced in diameter at the forward end to fit into the steel H. E. container. A steel plug is fitted into the after end of the incendiary body, while at the forward end are located an igniter pellet, a distance piece, a relay pellet and a black powder separating charge and housing. (See fig. 52.)

The H. E. container accommodates the penthrite charge and the fuze. The fuze is armed by a long arming rod which passes through the tail section and locks a spring-out safety pin. A metal wind cap, or drogue, is attached to the after end of the rod.

SUSPENSION. These bombs are carried in several different sizes and types of containers.

COLOR AND MARKINGS. The incendiary body is painted olive green, the tail dark green, and the H. E. container black, unpainted, or dark red. A Z is stamped on the body near the tail, and a red Z is stenciled on the nose.

2.2-kg B2.2EZ INCENDIARY BOMB

DATA:

Over-all Length: 20.75 in.

Body Length: 9.25 in.

Body Diameter: 2.0 in.

Wall Thickness: $\frac{3}{8}$ in.

Tail Length: 4.75 in.

Tail Width: 2.0 in.

Type of Filling: Incendiary Thermitite H. E. TNT.

Fuzing: AZ 8312 B.

CONSTRUCTION. This bomb is similar to the 1-kg incendiary bomb, with modifications to the fuze container. These alterations are: external threading on the nose to receive a sleeve; an additional hole to receive a spring-out safety pin; the addition of a train of burning composition leading

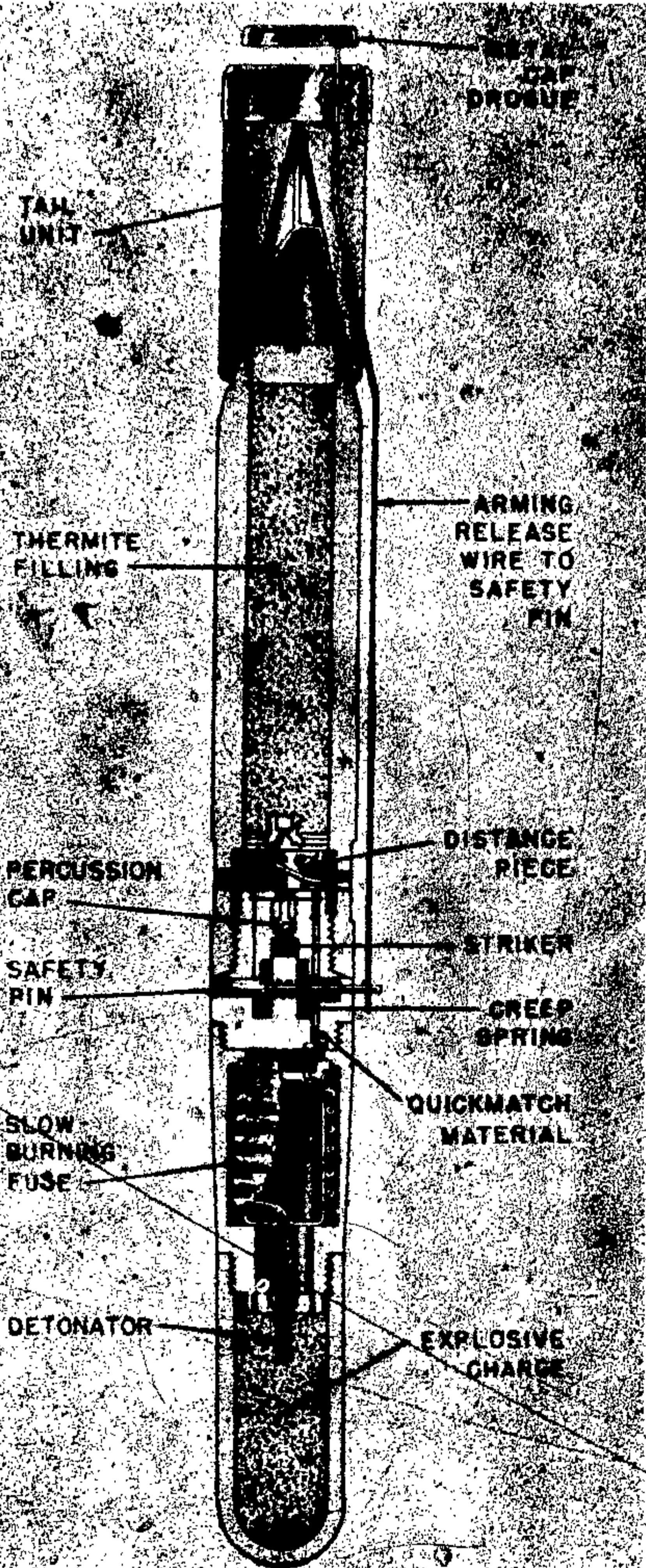

Figure 53—2.2-Kg B2.2EZ Incendiary Bomb

to the sleeve. The sleeve contains a length of safety fuse wound on a metal spool. The H. E. container is threaded to the base of the sleeve and contains a detonator to which the safety fuse leads. (See fig. 53.)

SUSPENSION. These bombs are carried in several different sizes and types of containers.
COLOR AND MARKINGS. The incendiary bomb proper is painted green over-all, the tail unit is painted dark green; the sleeve is unpainted and the H. E. container is painted bright red. The letter Z is stamped on the incendiary body near the tail.

SPRENGBRAND C 50 (50-kg INCENDIARY BOMB)

DATA:

- Over-all Length: 42.5 in.
- Body Length: 28.0 in.
- Body Diameter: 8.0 in.
- Wall Thickness: 0.15 in.
- Tail Length: 16.0 in.
- Tail Width: 11.3 in.
- Type of Filling: Burster Charge: TNT Fire Pots: Thermite in electron containers. Triangular: Thermite Containers.
- Weight of Filling: 20.0 lbs. TNT.
- Total Weight: 75 lbs. (approx.)
- Fuzing: (25) B or (28) A impact fuzes; (89) B aerial burst fuze.

CONSTRUCTION. This bomb is similar to the 50-kg SC Type III in its external features, differing only in that (1) it has a single-piece machined steel case; (2) the base plate is attached by aluminum shear screws instead of steel screws; (3) a filling plug is located in the nose of the bomb. (See fig. 54.) The bomb is filled with TNT as far back as the fuze pocket. A steel diaphragm just aft of the fuze pocket divides the bomb into two sections. In the fuze pocket is located a bakelite gaine containing a black powder biscuit, and a steel-encased gaine containing a delay pellet and detonator, the whole assembly being held in place in the base of the fuze pocket by a leaf spring. A hole leads through the after side of the fuze pocket and through the steel diaphragm to a silk bag of black powder, which serves both as the igniting and expelling charge for the remaining contents of the bomb body. The incendiary units are placed around a long triangular hollow steel column. Three double grids are placed in annular fashion around this column. Each pair of grids has four orange-colored biscuits of highly inflammable material pressed between them. These biscuits are ignited by the flash from the black powder expelling charge and, in turn, ignite the small in-

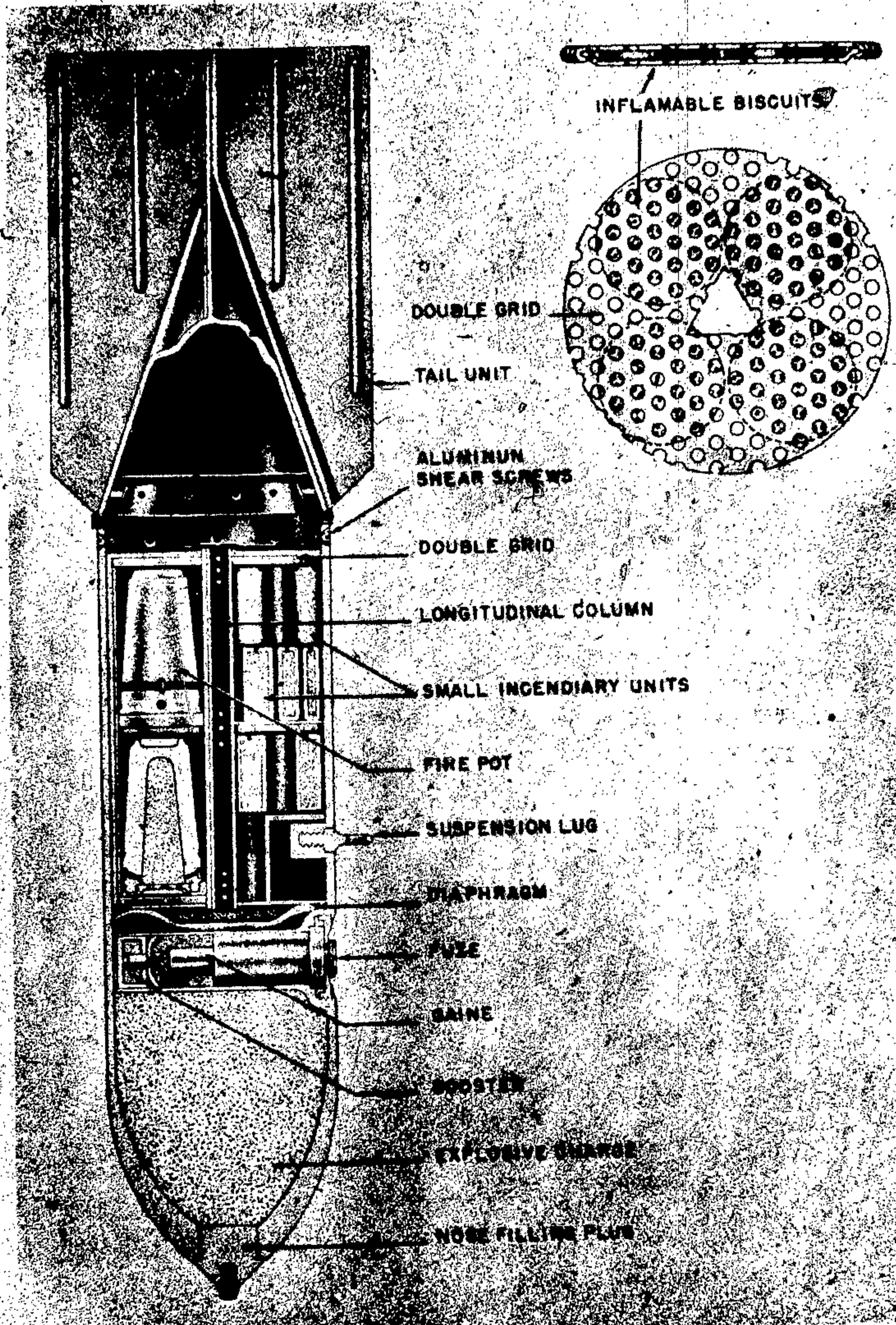

Figure 54—Sprengbrand C-50 Bomb

GERMAN EXPLOSIVE ORDNANCE

incendiary units directly and the quickmatches of the six large units. The explosion of the black powder charge also shears the aluminum screws securing the base plate and ejects the incendiary elements over an area of about 100 yards. About 1 second after expulsion, the delay element in the booster reaches the detonator and fires the TNT charge in the nose of the bomb.

SUSPENSION. The bomb may be suspended either horizontally or vertically by an eyebolt.

COLOR AND MARKINGS. The body and tail may be painted blue-grey or dark green, while the base plug is red. The small incendiary elements are painted brown, while the firepots may be bright red or green.

REMARKS. The bomb contains, besides the TNT charge, 6 fire pots and 67 small triangular metal incendiary elements.

250-kg FLAM C 250 A, FLAM C 250 B, and FLAM C 250 C INCENDIARY BOMB

DATA:

Over-all Length: 64. in.

Body Length: 46.75 in.

Body Diameter: 14.0 in.

Tail Length: 24.75 in.

Tail Width: 20.0 in.

Type of Filling: Oil incendiary mixture and TNT bursting charge.

Fuzing: (25) A or (28) B.

CONSTRUCTION. The bomb, containing an oil mixture, consists of a steel body made of two longitudinal halves welded and crimped together. (See fig. 55.) The three bombs are almost identical, differing only in minor constructional details. The tail assembly differs considerably from normal German construction. The four fins are riveted directly to the after coned portion of the bomb body and are secured to each other by $\frac{5}{8}$ -inch tubular struts.

COLOR AND MARKINGS. These bombs are painted dark green over-all, with two $\frac{5}{8}$ -inch red stripes, one around the nose and one around the middle of the body. "Flam C 250 A (B or C)", and all four fins are similarly stamped. The secondary markings depend upon type of filling used in the respective bombs.

250-kg KC 250 FLAM INCENDIARY BOMB;

DATA:

Over-all Length: 63.0 in.

Body Length: 40.0 in.

Body Diameter: 14.5 in.

Wall Thickness: $\frac{1}{16}$ in.

Tail Length: 25.0 in.

Tail Width: 21.0 in.

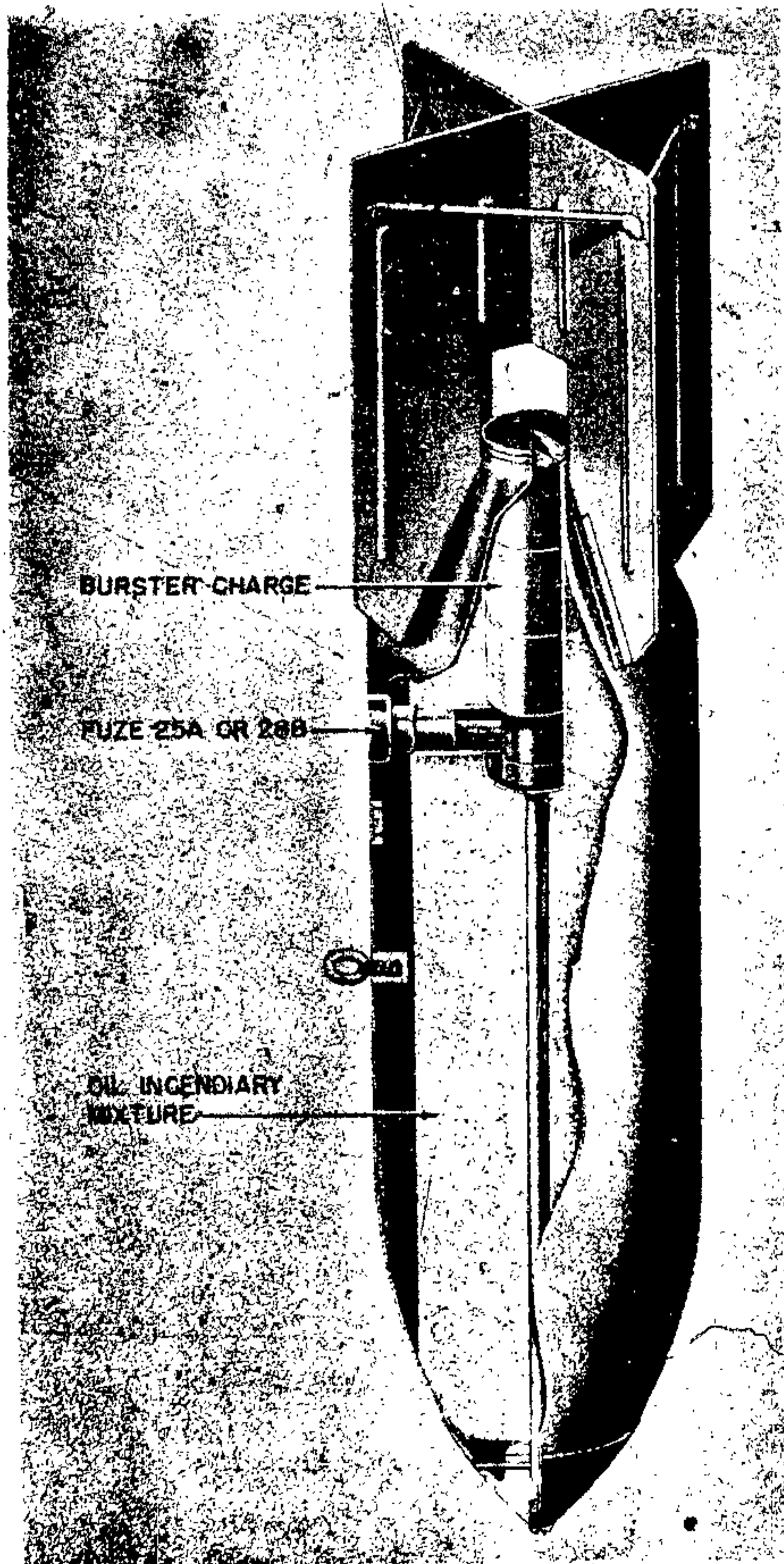

Figure 55—Flam C 250 A Bomb

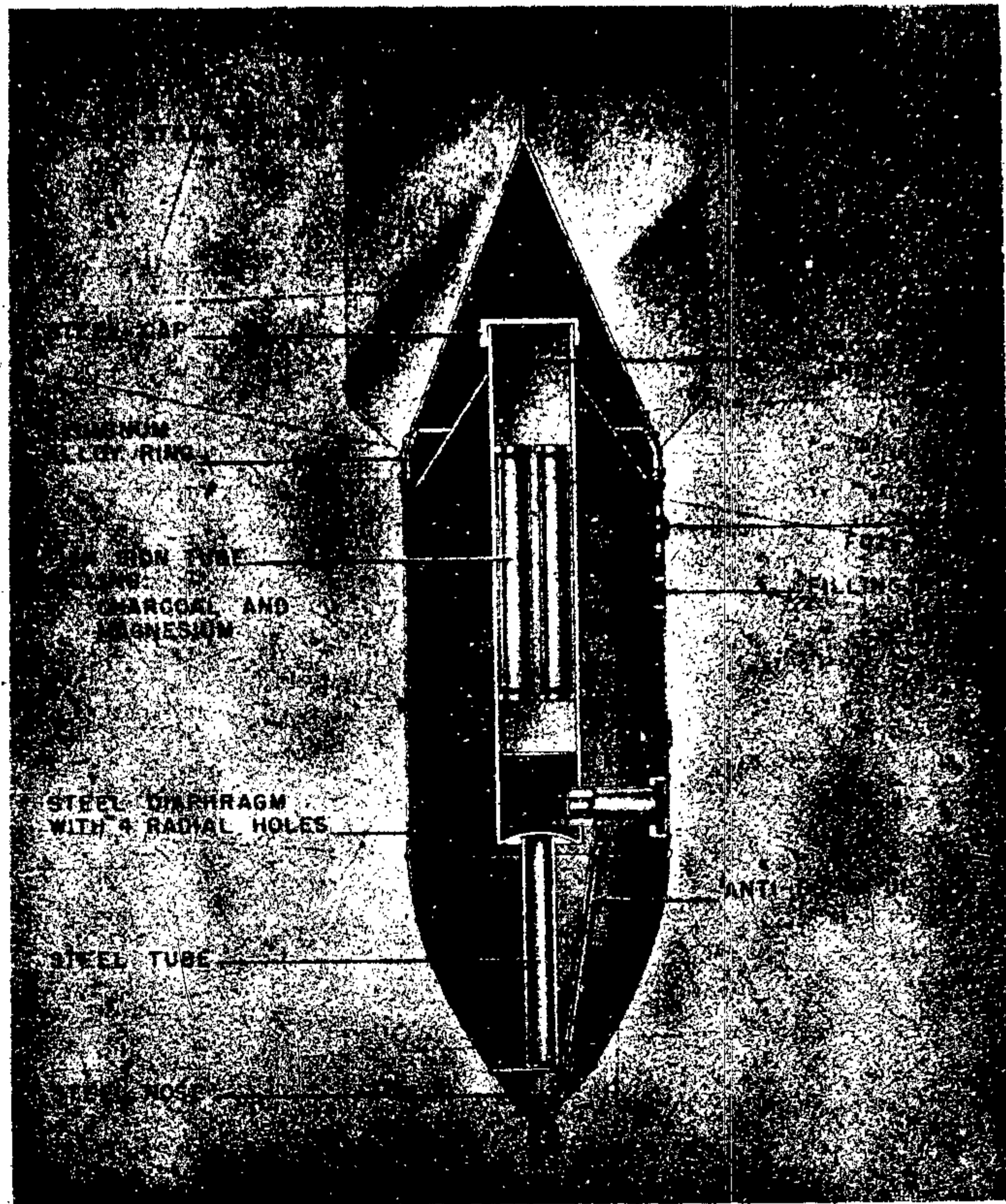

Figure 56—KC 250 Flam Bomb

Type of Filling: Oil incendiary mixture, with TNT bursting charge.

Weight of Filling: 50.0 kg.

Total Weight: 110.0 kg.

Chg/Wt. Ratio: 45.5%.

Fuzing: (26).

CONSTRUCTION. The bomb body consists of a steel cylinder to which is welded an ogival nose section of light sheet steel. A cast steel nose piece is welded to the sheet steel nose section. A truncated cone of sheet steel is welded to the base of the body cylinder and is fitted to the after portion of the central exploder tube. A steel tube runs

from the nose of the bomb to a point on the fuze pocket just above the bottom of the fuze. An anti-break-up rod is placed in this tube and serves to activate the fuze if the regular trembler switches fail to function. (See fig. 56.)

The tail assembly consists of a cone to which four fins are welded. The cone is riveted to the after end of the body cylinder. Bar-type struts reinforce the four tail fins.

OPERATION. On impact the fuze functions and fires the 1.25 kg TNT charge. This explosion not only breaks open the case but it ignites the petroleum filling and allows the charcoal and

GERMAN EXPLOSIVE ORDNANCE

magnesium filled tubes to mix with the petroleum. This mixture creates an extremely hot fire and a very difficult fire to control.

SUSPENSION. This bomb may be suspended either horizontally or vertically by a single suspension eyebolt.

COLOR AND MARKINGS. The body and tail assemblies are painted dark grey over all.

500-kg FLAM C 500 INCENDIARY BOMB

DATA:

Over-all Length: 65.5 in.

Body Length: 62.0 in.

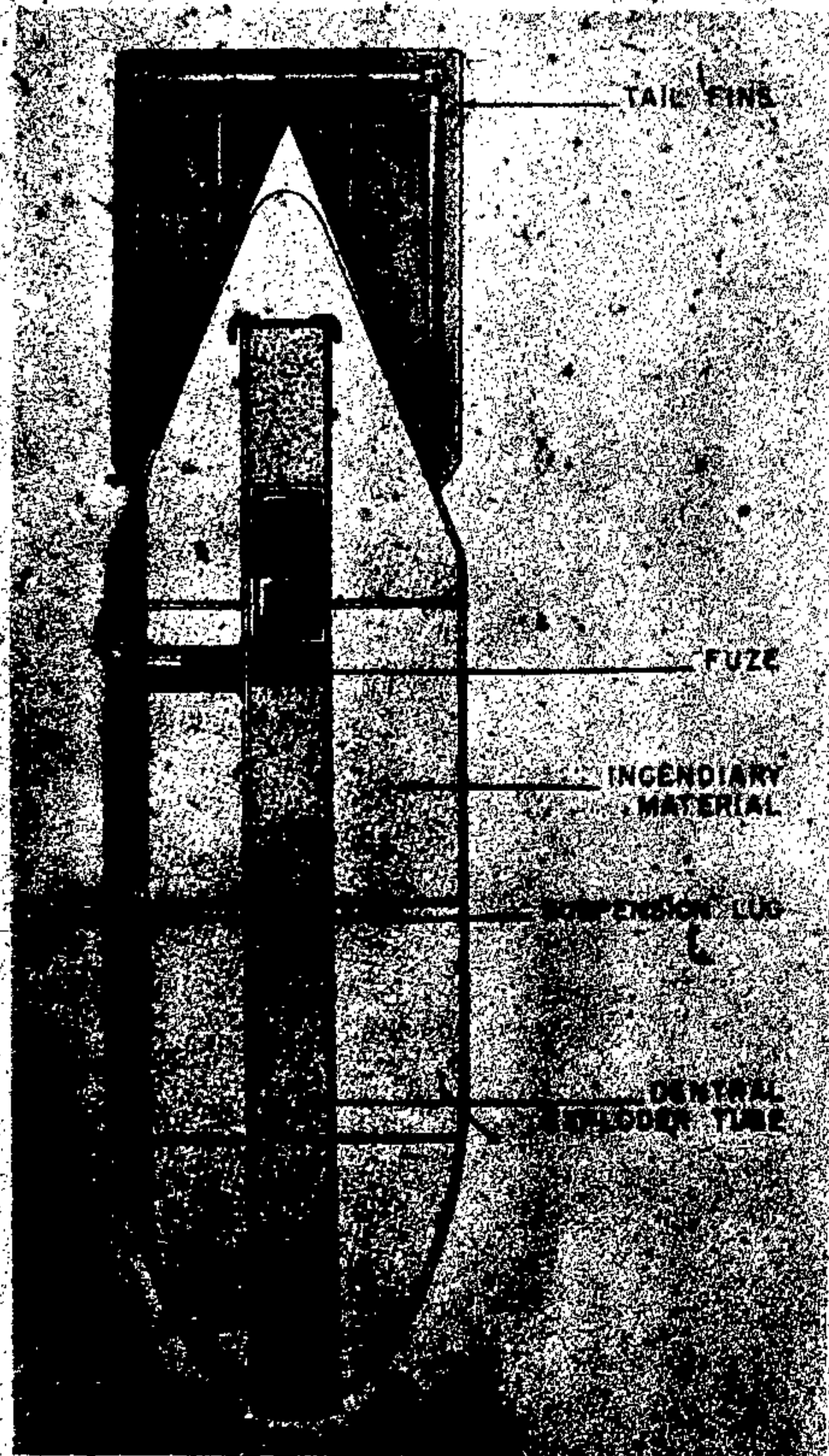

Figure 57—Flam C 500 Bomb

Body Diameter: 18.0 in.

Wall Thickness: $\frac{1}{16}$ in.

Tail Length: 21.5 in.

Tail Width: 24.0 in.

Type of Filling: Oil incendiary mixture 30% benzine, 70% petroleum, with TNT bursting charge.

Total Weight: 250 kg (approx.).

Fuzing: (25) B or (28) A.

CONSTRUCTION. This bomb consists of a cylindrical body to which are added a rounded nose section and a pointed tail section, all of sheet steel construction. A single fuze pocket is located forward in the side of the bomb body. A central exploder tube runs the length of the bomb case. Two baffle plates are welded to the bomb body where the sections are welded together. (See fig. 57.)

The four sheet steel tail fins are secured directly to the after cone of the body. The fins are braced with bar-type struts.

COLOR AND MARKINGS. The bomb and tail assembly are painted dark grey over all. Two $\frac{7}{8}$ -inch red bands are painted around the body 9.5 and 33 inches from the nose.

SUSPENSION. Horizontal by means of an "eye" type suspension lug.

REMARKS. This bomb, when stenciled "ABB 500" in black letters, is used as a container for 1-kg incendiary bombs.

50-kg BRAND C 50 A INCENDIARY BOMB

DATA:

Over-all Length: 43.2 in.

Body Length: 30.0 in.

Body Diameter: 8.0 in.

Wall thickness: $\frac{1}{8}$ in.

Tail Length: 16.0 in.

Tail Width: 7.8 in.

Type of Filling: Benzine, 86%; phosphorus, 4%; pure rubber, 10%.

Weight of Filling: 30 lb. (approx.).

Total Weight: 90 lb. (approx.).

Fuzing: (25) B or (28) A.

CONSTRUCTION. The bomb body consists of a single piece of steel forging, very similar to the SC 50-kg grade 1 bomb, with a single fuze pocket located forward in the side of the bomb casing. (See fig. 58.)

The tail assembly consists of four sheet metal fins and a tail cone, which is attached to the collar on the base of the bomb body by screws.

SUSPENSION. This bomb may be suspended either horizontally or vertically by means of a single eyebolt.

COLOR AND MARKINGS. The bomb body is painted dark grey or green over-all, with the rear of the bomb painted red and a red band around the center of the bomb body. The tail assembly may be painted dark grey or grey-green with longitudinal yellow stripes on the tail cone.

On those bombs in which the filling is enclosed in glass, a drawing of a glass container is stenciled in red on the bomb body between the fuze and the nose, on the side remote from the fuze.

REMARKS. Later models of this bomb have the phosphorus filling contained in a glass cylinder inside the bomb body.

50-kg BRAND C 50 B INCENDIARY BOMB

DATA:

Over-all Length: 43.5 in. (approx.)

Body Length: 30.5 in.

Body Diameter: 8.0 in.

Wall Thickness: $\frac{1}{16}$ – $\frac{1}{8}$ in.

Tail Length: 17.0 in.

Tail Width: 7.8 in.

Type of Filling: White phosphorus.

Total Weight: 77 lb. (approx.)

Fuzing: ELAZ (28).

CONSTRUCTION. This bomb consists of a rolled sheet steel cylinder, seam welded longitudinally. The base and nose portions are welded circumferentially to the bomb body. The nose portion of this bomb is much larger than that of the Brand C 50 A, and the base plate filling cap is of the female type with two studs projecting rearwards. (See fig. 59.)

The sheet steel tail assembly is secured over and to the base of the bomb body by means of two screws which enter the vertical arms of the L-shaped brackets, welded to the shoulder formed at the base of the bomb. Four positioning plates are also welded to this shoulder and aid in positioning the tail on the bomb.

The bomb houses a single fuze pocket, located forward on the side of the bomb body. An exten-

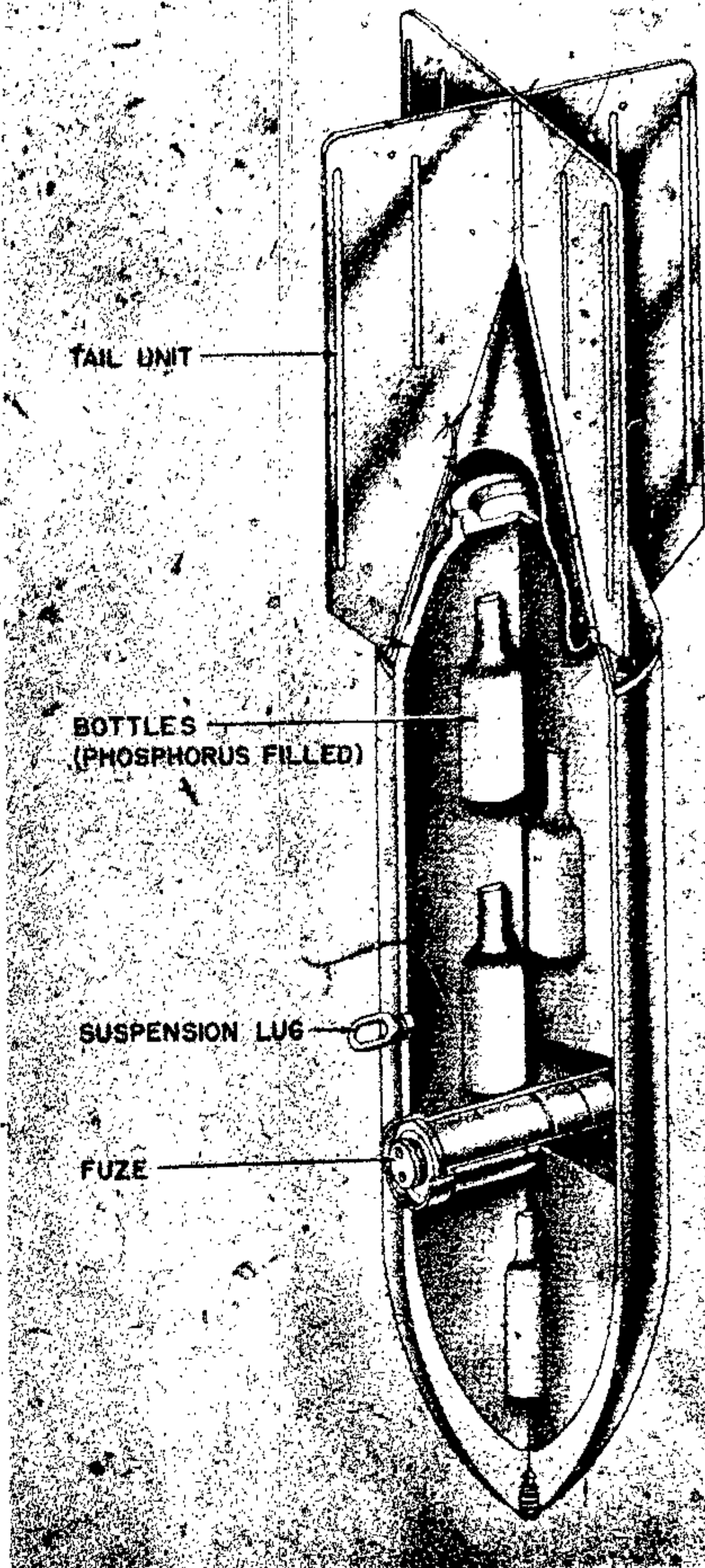

Figure 58—Brand C 50 A Bomb

sion tube extends from the nose of the bomb to the forward side of the fuze pocket. A wooden plug was found in the tube of the recovered specimen of this bomb.

OPERATION. When the impact fuze functions, the detonation of the picric ring in the fuze pocket splits open the bomb casing, ejects some or all of

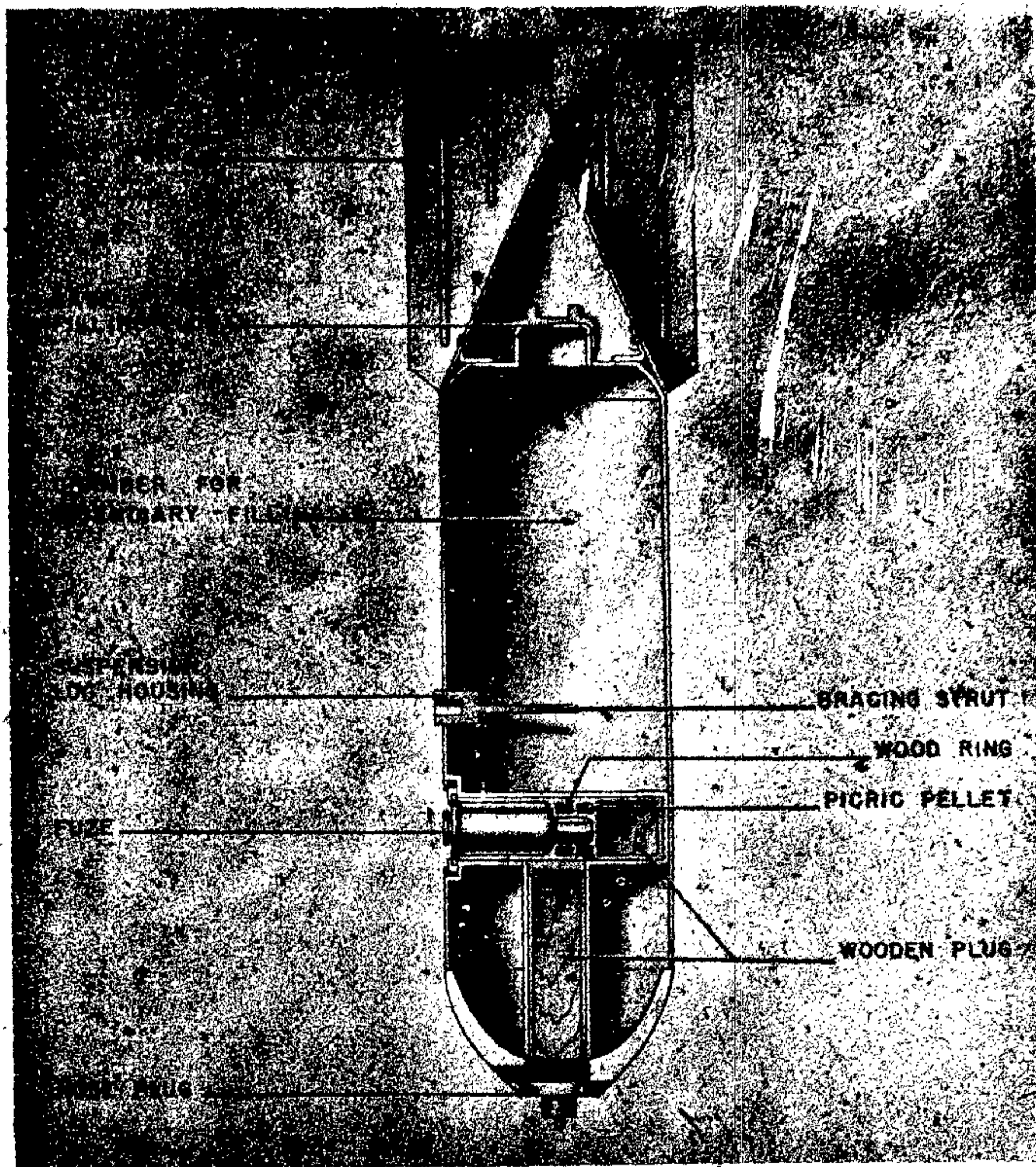

Figure 59—Brand C 50 B Bomb

the incendiary filling, and breaks the bottle containing the white phosphorus, which ignites the incendiary filling.

SUSPENSION. This bomb is fitted for horizontal suspension only.

COLOR AND MARKINGS. The bomb is painted light fawn over-all with a red priming coat. The following markings were found on the specimen recovered:

On the bomb body:

- "Brand C 50 B" (black).
- Red band $\frac{5}{8}$ inch wide.
- "10 PQ" (red).
- Bottle 3 inches long (red).

On the bomb nose:

- Red band $\frac{3}{4}$ inch wide.
- "Brand C 50 B" stamped on nose plug.

250-kg BRAND C 250 A TYPE I AND II INCENDIARY BOMB

DATA:	TYPE I	TYPE II
Over-all Length.....	64.0 in.	64.0 in.
Body Length.....	46.7 in.	46.3 in.
Body Diameter.....	14.5 in.	14.5 in.
Wall Thickness.....	0.3 in.	0.3 in.
Tail Length.....	25.0 in.	25.0 in.
Tail Width.....	20.0 in.	20.0 in.
Type of Filling: Petroleum, 87.7%; polystyrene, 11.7%; phosphorus, 0.5%.		
Fuzing: ElAZ (25) B in forward pocket. Dummy fuze head in after pocket.		

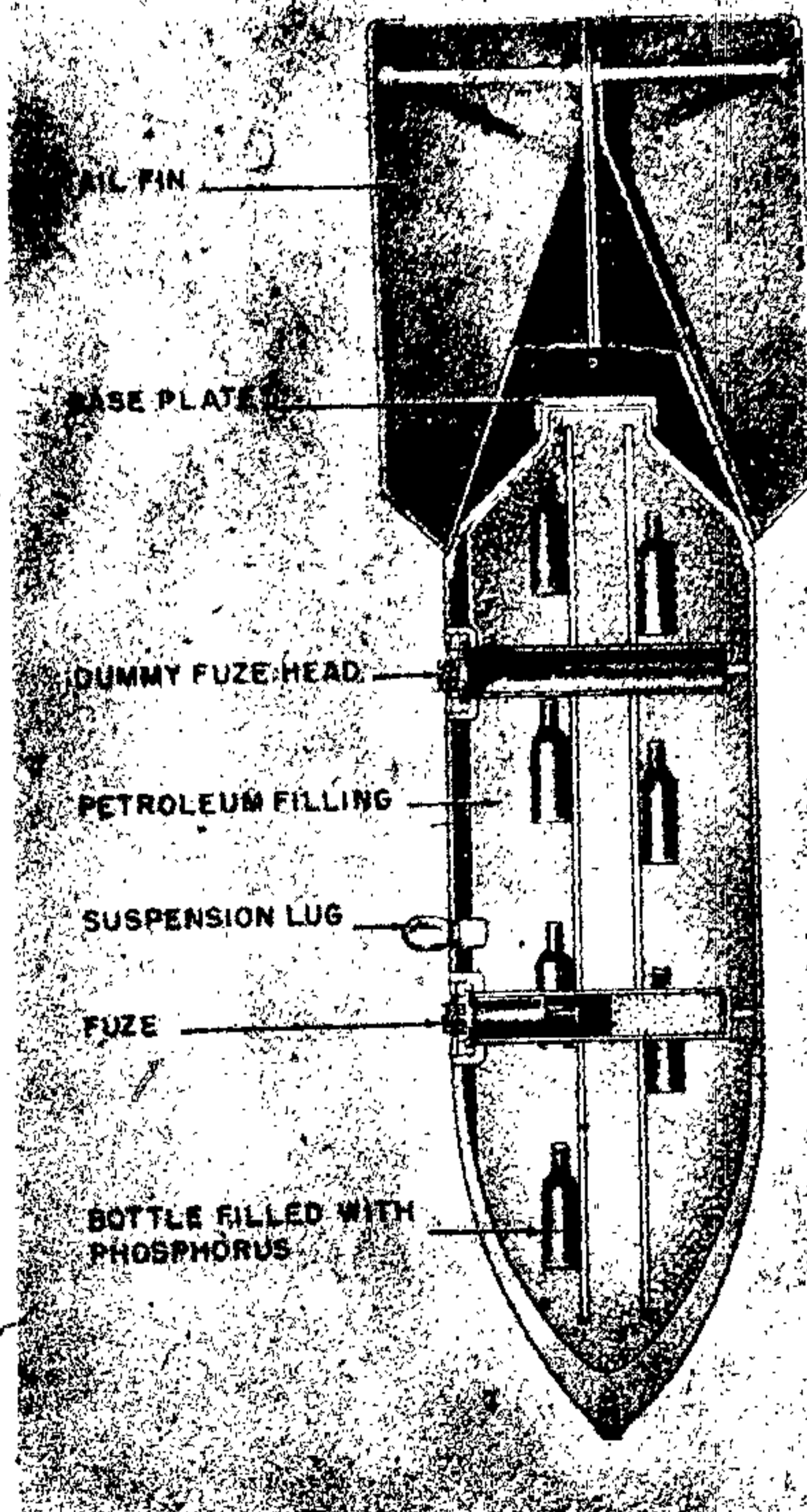

Figure 60—Brand C 250 A Bomb, Types I and II

CONSTRUCTION. TYPE I.—This bomb consists of a one-piece forging with a female-type base plate. A rubber washer is fitted under this plate, but is not visible externally. (See fig. 60.)

TYPE II.—This bomb is of welded construction with a female-type base plate. A thick black rubber washer projects about $\frac{1}{2}$ inch from the under edge of the plate.

The filling is contained in the bomb body in the form of a thickened liquid fuel. Supported in the filling by four metal bands fitted to a wooden framework are 16 brown glass bottles in four rows, containing a very brittle form of white phosphorus.

OPERATION. On impact, the fuze fires the gaine and the picric burster pellets, breaking the

case and scattering the filling over a radius of about 70 yards. The filling ignites spontaneously, burning with a great deal of smoke.

SUSPENSION. This bomb may be suspended either horizontally or vertically by an eyebolt.

COLOR AND MARKING. The body and tail are painted blue-grey overall with a 1 inch red band located just aft of the side suspension eyebolt. The after end, from shoulder to base plate, has only the usual red priming coat. Between the red band and the rear fuze pocket are the following words stenciled in red: "Achfung Vor Sonnen Strahlung Schutzen" (not to be stored in the sun). Immediately below this is "Brand C 250 A" in black letters. Further markings are found between the fuze pocket and the shoulder.

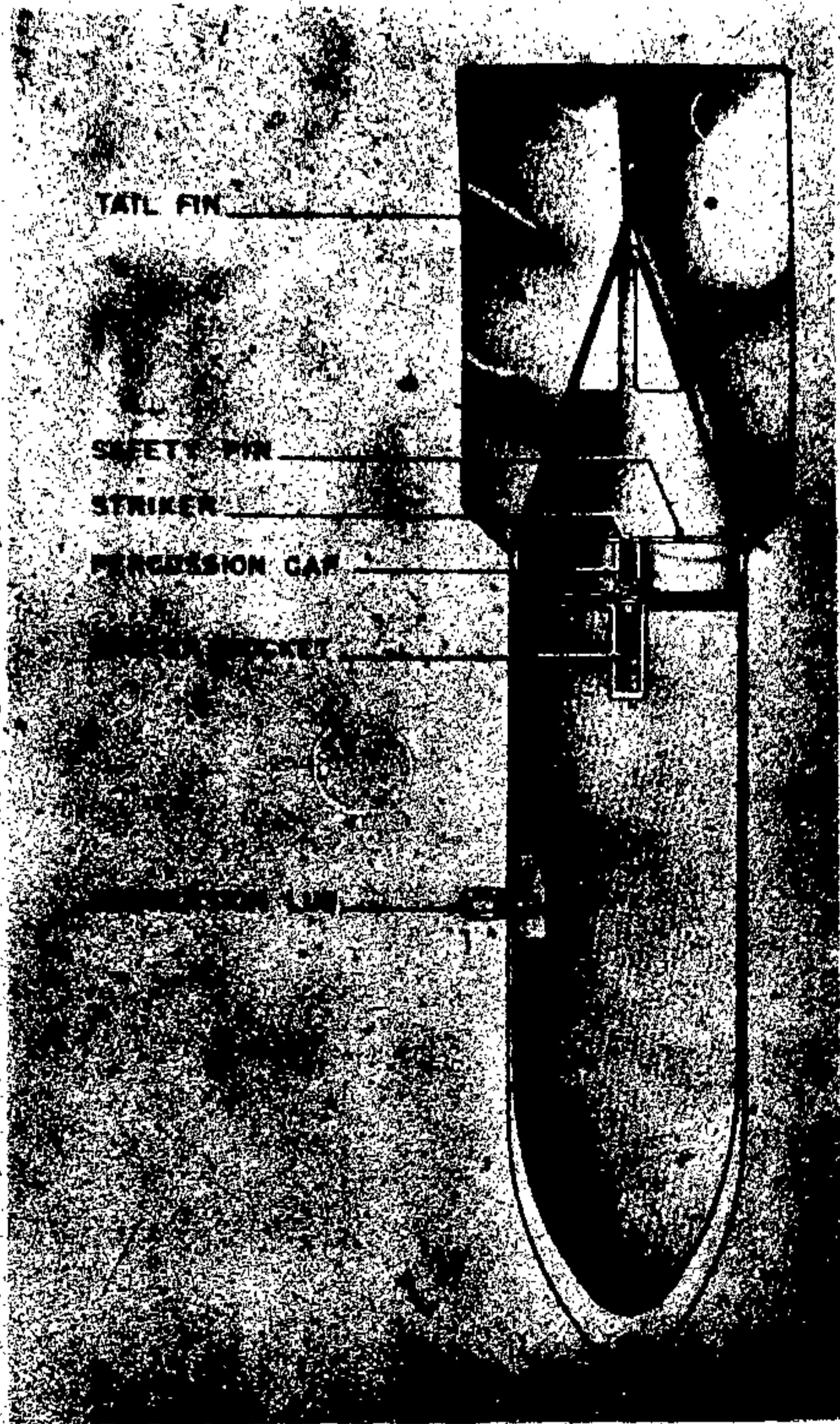

Figure 61—NC 50 Smoke Bomb

NC 50 SMOKE BOMB

DATA:

- Over-all Length: 26.75 in.
- Body Length: 10.75 in.
- Body Diameter: 7.75 in.
- Wall Thickness: 0.16 in.—0.24 in.
- Tail Length: 16.0 in.
- Tail Width: 11.0 in.
- Filling: Light grey smoke-producing powder smelling strongly of camphor.
- Total Weight: 109 lb.
- Fuzing: (46) mechanical impact.

CONSTRUCTION. The body is a normal 50-kg bomb seamless steel tube with a cast steel nose welded to it. The circular hole in the wall of the

bomb which normally gives access to the fuze pocket is covered over by a steel disk welded flush with the bomb wall. The base plug is secured to the bomb body by eight screws and is pierced by five holes. The fuze is located over the central hole by four brackets welded to the fuze and the base plug. Beneath the plug and covering the filling is a thin metal plate also pierced by five holes; 4.5 inches from the tip; from there, four one-inch white bands run back to the shoulder. "N. C. 50" is stenciled on the body and is believed to be an abbreviation for "Nebel Cylindrisch 50 kg" (Smoke Cylinder 50 kg). (See fig. 61.)

NC 50 WC NC D/SEE—SMOKE MARKER BOMB

DATA:

- Over-all Length: 3 ft. 7 in.
- Body Diameter: 7.75 in.
- Tail Width: 11 in.
- Filling: Smoke producing composition.
- Fuzing: Mechanical impact fuze built into bomb.

CONSTRUCTION. The bomb consists of four main parts: the outer casing, tail cone, nose and a central cylinder which protrudes from the nose and extends aft to the forward part of the tail cone where it is terminated by a fuze housing crimped to it. This fuze housing extends the full length of the tail cone. The outer casing is empty except for metal ribs and braces which locate and support the central tube. The four tail fins are tack welded to this cone. The central cylinder contains the smoke producing agent. It is held in the outer casing by six bolts at the nose; a rubber washer waterproofs this joint. The igniter is contained in a pocket at the rear end of the central tube immediately below the fuze. The fuze housing is located by four set screws to insure that the correct distance is maintained between the flash cap and the igniter. (See fig. 62.)

The fuze has a spring loaded strike held away from the flash cap by retaining ball. They are held in place by a release rod passing down through the center of the striker. At the tail end, this rod passes through a circular plate and is held by a split pin. The circular plate is fastened by three screws to a drogue plate which is lipped over the tail fins. It is fastened to the tail by four projections from the fins which pass through the slots and are then bent over. Waterproofing at

the tail is provided by a rubber seal. On impact with the water, the tail drogue is wrenched off and carries the fuze release rod with it. The fuze fires and the smoke producing agent is ignited. When the bomb floats to the surface, heat destroys the rubber seal and smoke is emitted.

SUSPENSION. Vertical or horizontal.

COLOR AND MARKINGS. Bomb casing is painted aluminum; the tail is olive green; the protruding portion of the central cylinder is yellow. "NC 50 WC" is stenciled transversely across

the body just forward of the shoulder. "Nicht für Senkrecht-Aufhängung" stenciled longitudinally from nose aft to the other marking.

SIMILAR BOMBS. NC D/See: This bomb, a floating, 50-kg smoke bomb, is constructed similarly to the NC 50 WC. It gives off a white fog or smoke. The over-all weight is approximately 22 kg. It is fitted with the AZ (46) fuze. As the fuze is installed when the bomb is shipped the safety precautions must be highly respected.

NC 250 S SMOKE BOMB

DATA:

- Over-all Length: 5 ft. 3 in.
- Body Diameter: 14½ in.
- Wall Thickness: ¼ in.
- Tail Length: 25 in.
- Tail Width: 20 in.
- Filling: Mixture of chlorosulphonic acid (40%) and sulphur trioxide (60%).
- Fuzing: ELAZ (26).

CONSTRUCTION. The NC 250-S is similar in size and construction to the German C 250 (Flanf) bomb. The central tube contains a wooden block 20½ inches long and 4¼ inches in diameter, cardboard disks, and a circular block of TNT 9 inches long and 4¼ inches in diameter. The bomb is fuzed with a ELAZ (26) which has a normal gain and one picric ring pellet. The fuze operates directly on impact detonating the burster charge of TNT in the central tube. The main filling is scattered to give a large concentration of smoke. (See fig. 63.)

SUSPENSION. Horizontal.

COLOR AND MARKINGS. The body is silver, the tail olive drab. The forward part of the nose, a ¾-inch stripe part-way back on the nose, and a 1-inch stripe just aft of the suspension lug are painted white. "NC 250 S" is stenciled aft of the second band.

REMARKS. The filling is a corrosive mixture which, when in contact with the air, emits white smoke.

SD 1 TYPE PRACTICE BOMB

CONSTRUCTION. Bomb resembles the SD 1 H. E. bomb and is of approximately the same weight and size.

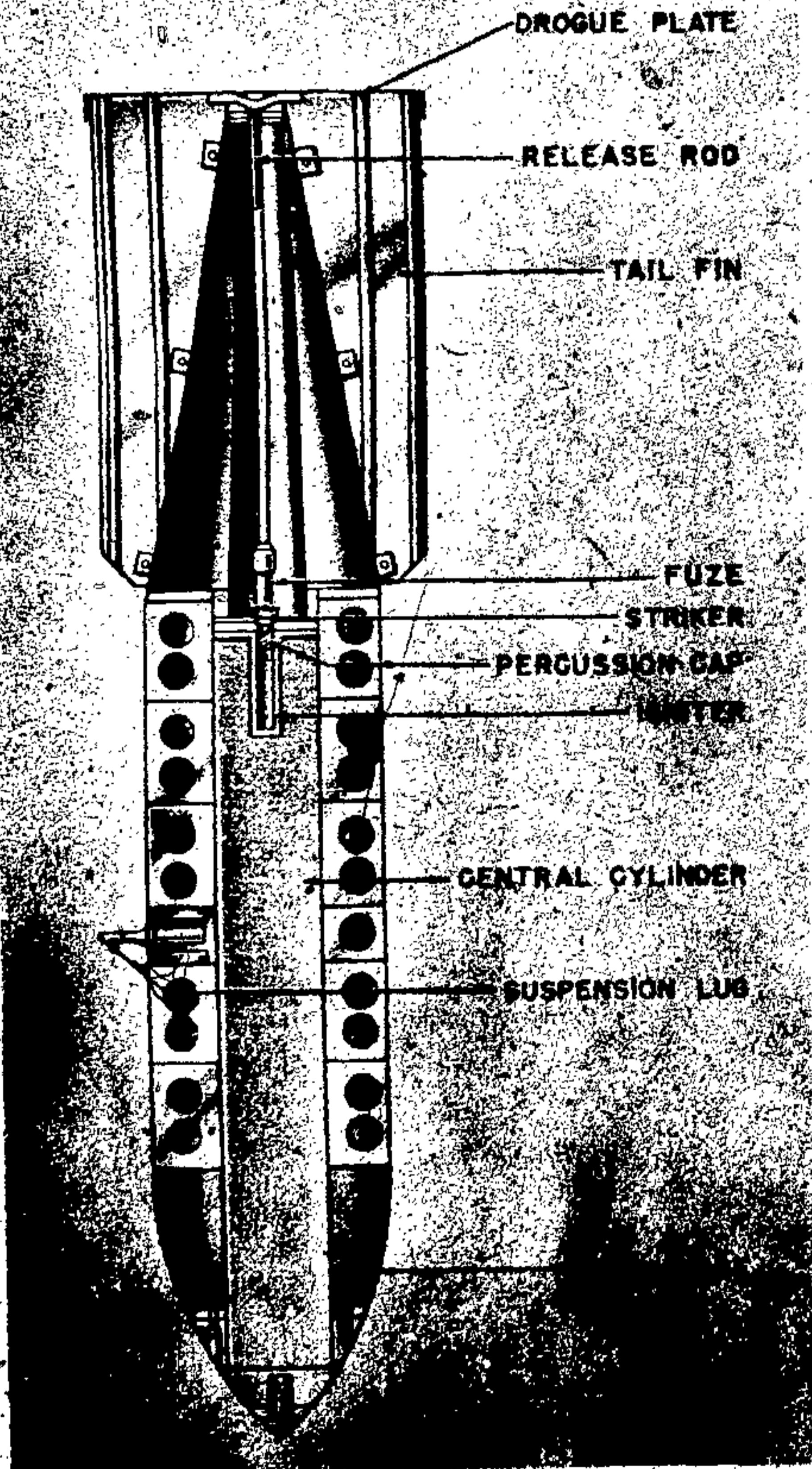

Figure 62—NC 50 W. C. Smoke Bomb

GERMAN EXPLOSIVE ORDNANCE

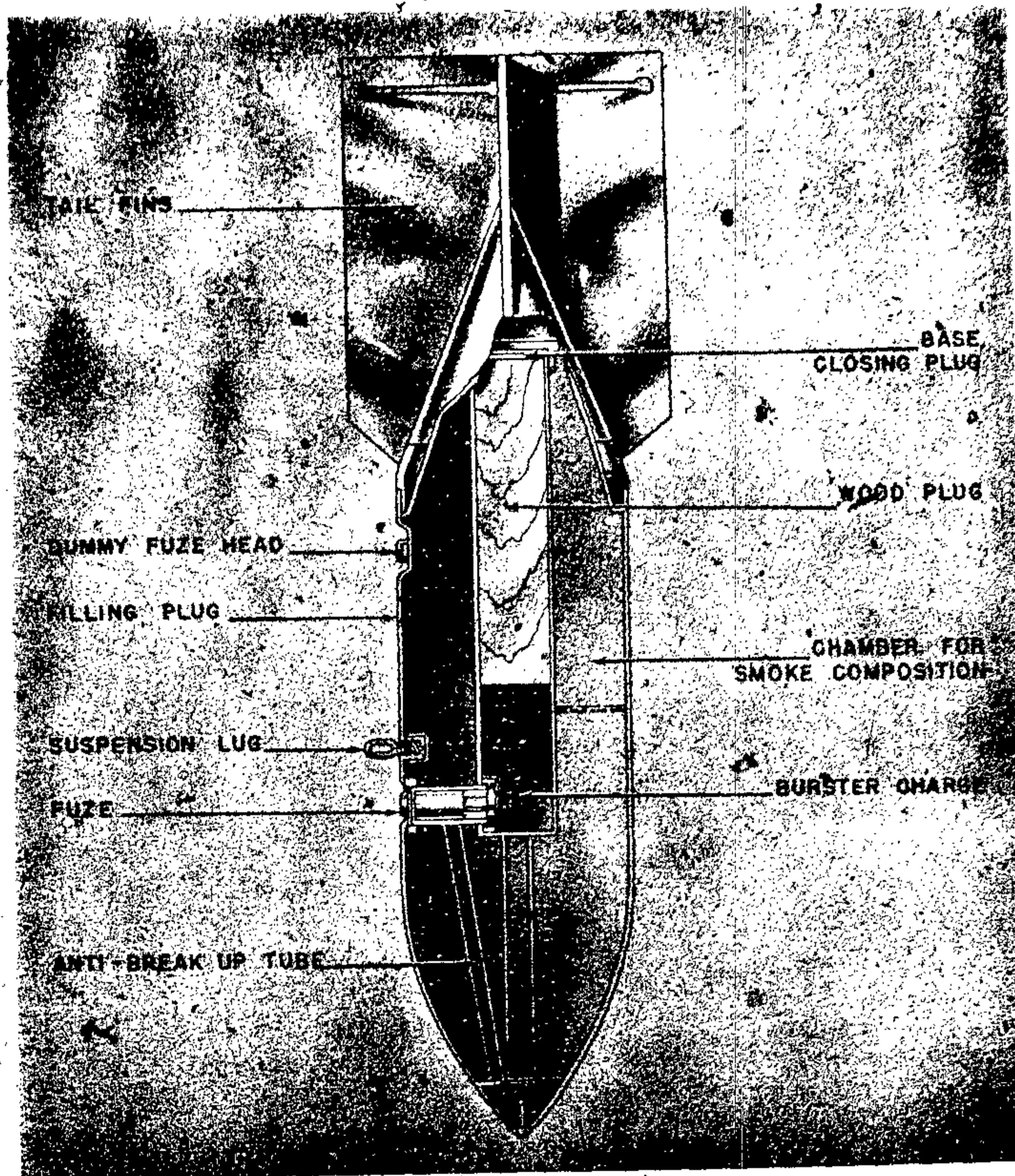

Figure 63—NC 250 S Smoke Bomb

Body is constructed of concrete reinforced with irregularly shaped metal chippings. (See fig. 64.)

A normal eight-vane type of tail unit is secured to the body by a bolt embedded in the concrete cast.

In the nose of the bomb a length of concrete-filled, metal tubing is inserted to resemble the AZ (73) A fuze.

Lengths of iron wire soldered to the tail securing bolt and to the metal tubing in the nose of the bomb serve to strengthen the cast concrete.

COLOR AND MARKINGS. The specimen examined was unpainted and devoid of markings.

SD 2 PRACTICE BOMB

CONSTRUCTION. Bomb consists of a normal unfilled SD 2-bomb case and is secured by a nut and bolt. Welded vertically to the upper surface of this band is a length of steel tubing. (See fig. 65.)

Secured to the steel tubing is a short length of steel cable which is attached to the normal drogue retainer. The drogue is formed of a curved sheet steel pressing.

COLOR AND MARKINGS. The body, metal band and drogue of the specimen examined are painted black, and are devoid of markings.

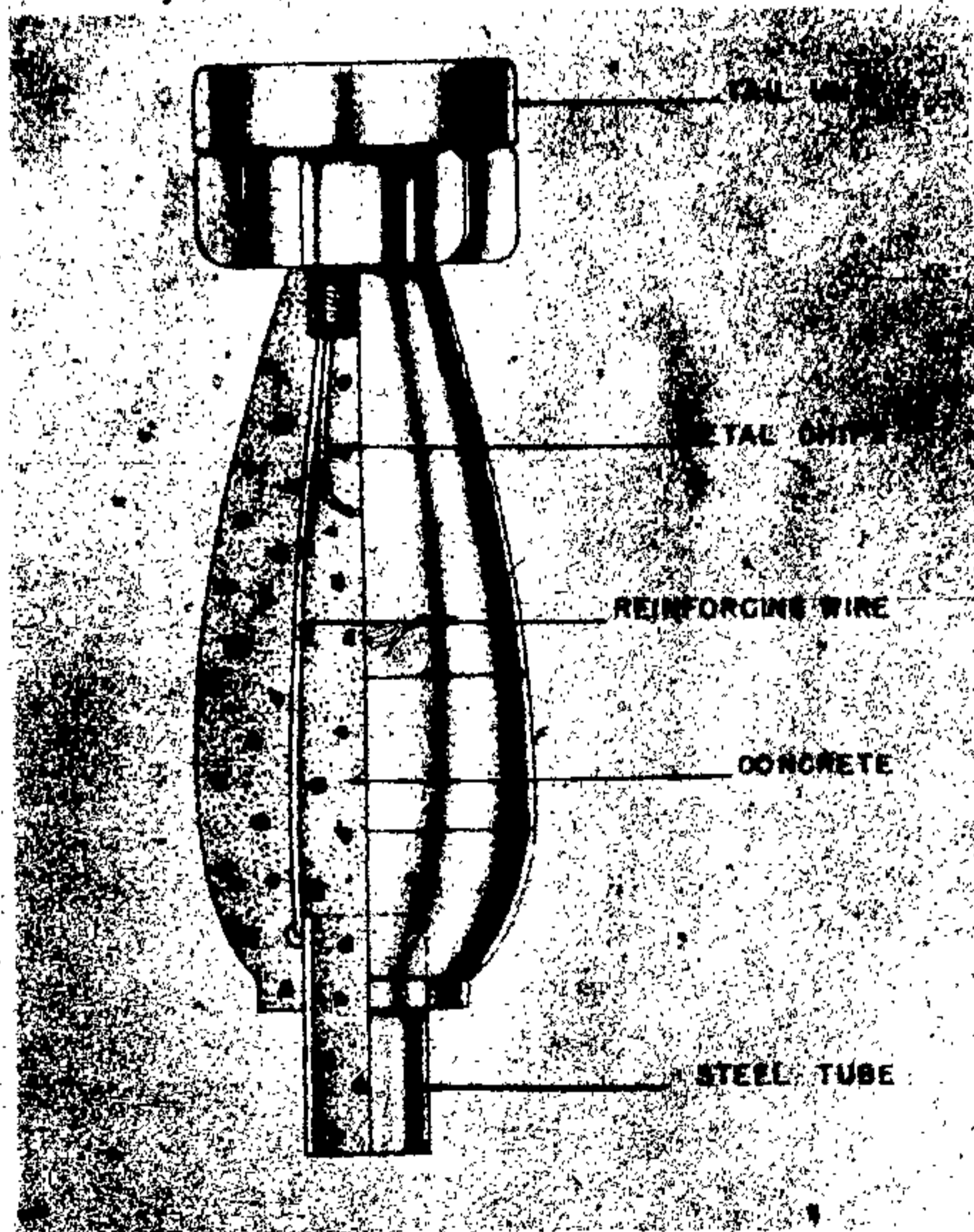

Figure 64—SD 1 Type Practice Bomb

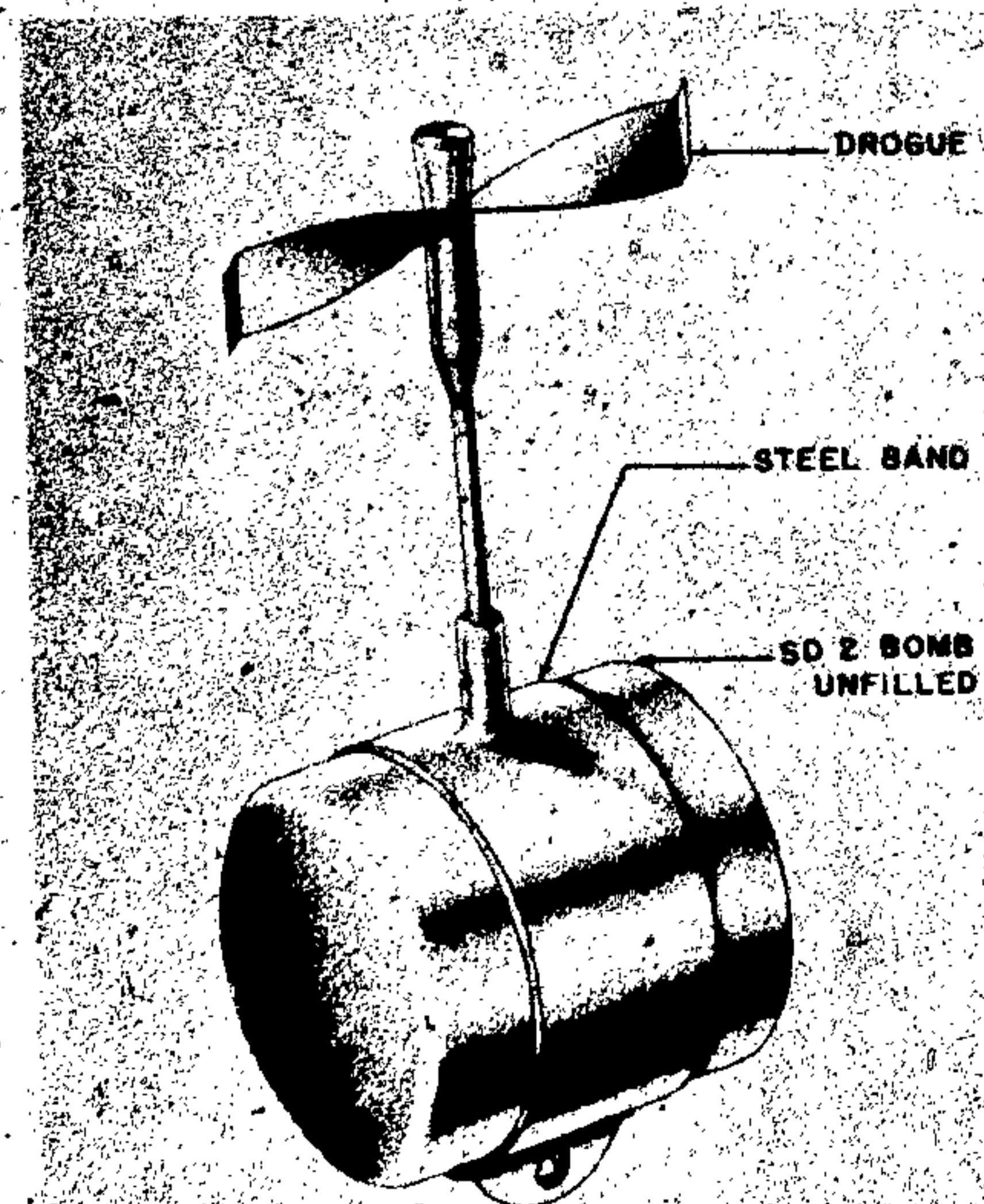

Figure 65—SD 2 Type Practice Bomb

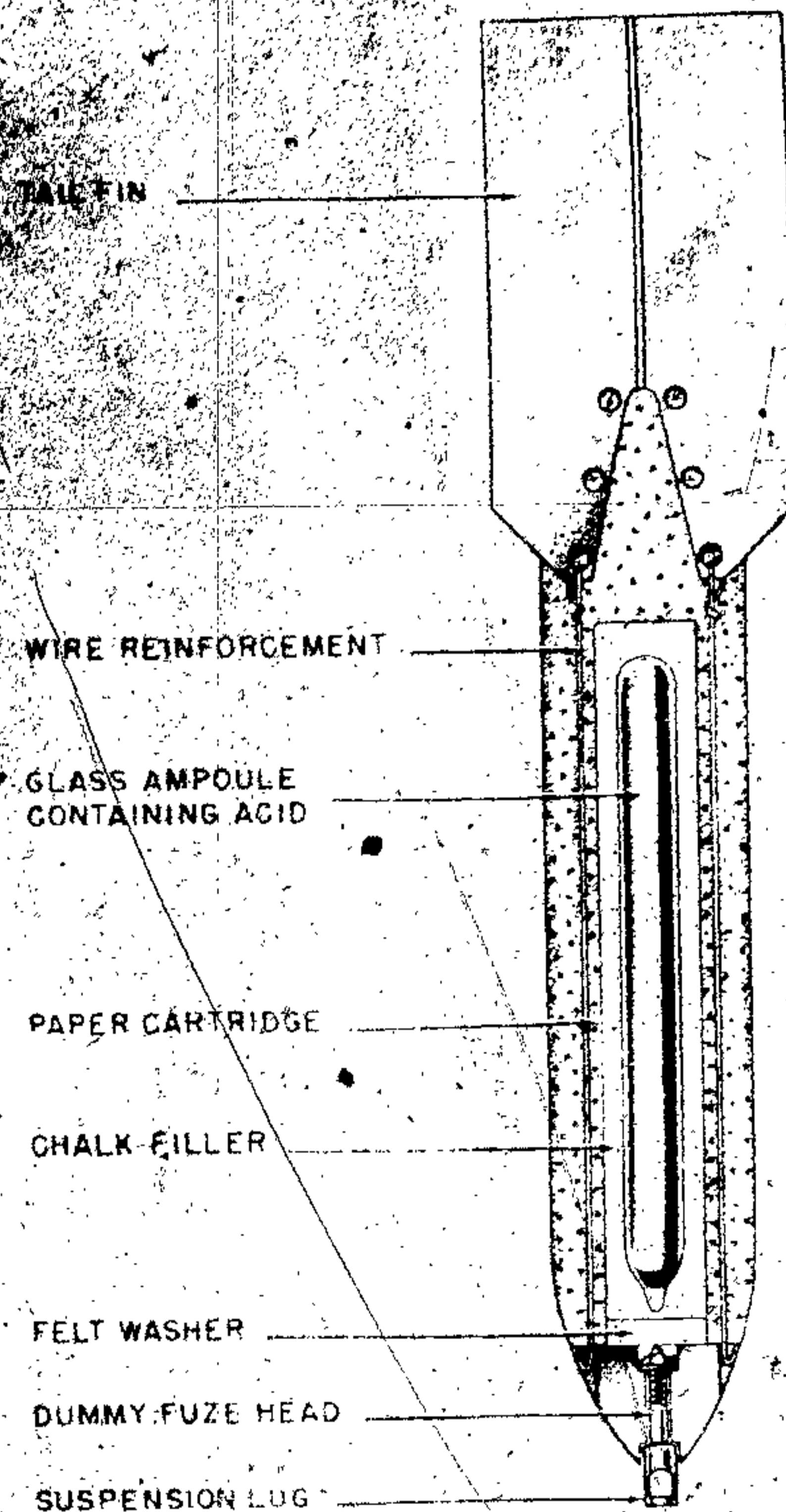

Figure 66—ZC 10-Kg Concrete Practice Bomb

ZC 10-kg CONCRETE PRACTICE BOMB

DATA:

- Over-all Length: 23 in.
- Body Length: 12³/₄ in.
- Body Diameter: 3¹/₄ in.
- Wall Thickness: 0.5 in. side to 0.86 in. tail.
- Tail Length: 8³/₈ in.
- Tail Width: 4⁵/₈ in.

CONSTRUCTION. The bomb has a concrete body of the same dimensions as the SC 10. A conical dummy fuze head of block bakelite is fitted to the nose end of the bomb. This fuze head is secured by four evenly spaced wires imbedded in

GERMAN EXPLOSIVE ORDNANCE

cement extending through the bomb. The wires pass through four housings in the bakelite fuze head, and are secured in position at the nose by turning over the protruding ends. The other ends of the four wires are secured by passing each wire through separate eye holes provided at the base of the sheet metal fins and turning over the ends. (See fig. 66.)

A central cavity 11 inches in length is formed within the body to accept a paper cartridge. The cartridge is separated at the nose end from the dummy fuze head by a $\frac{1}{8}$ -inch thick felt washer.

The paper cartridge contains a glass ampoule,

surrounded by a filling of chalk, the ampoule contains either chlorosulphonic acid or fuming hydrochloric acid. On impact, the glass ampoule breaks to release its contents from which smoke emits to mark the point of impact.

The four tail fins, comprising two sheets of metal which are slotted and interlocked together, are partly moulded into the concrete at the tail end and are secured by two additional lengths of wire which run laterally through the eye holes and are fastened by twisting the ends of the wire together.

COLOR AND MARKINGS. Body unpainted with 2-inch white band at nose. Tail vanes aluminum color; nose, black. LFB 110 stenciled on body.

ZC 50 CONCRETE PRACTICE BOMB TYPES I AND II

DATA:

- Over-all Length: 43 $\frac{1}{2}$ in.
- Body Length: 27 in.
- Body Diameter: 7 $\frac{3}{4}$ in.
- Tail Length: 16 in.
- Total Weight: 50 kg approx.
- Fuzing: AZ 46 charging head.

CONSTRUCTION. In Type I the nose, body and tail cone are formed of fine concrete all in one piece. The four tail fins of sheet metal are filled to the tail cone when concrete is poured.

On either side of bomb are two cavities, which are covered by wooden slats. Cavities contain paper cartridges holding chalk and an ampoule of chlorosulphonic acid or fuming hydrochloric acid.

Type II is very similar, the differences merely being to allow for the insertion of a tracer candle, in the tail and a charging head for its initiation. (See fig. 67.)

Two steel wires lead from the fuze into the central stiffening tube and thence to a pair of terminal sockets in the tail cone. The tracer is fired by the terminal sockets on release from the plane and burns for approximately 55 seconds.

SUSPENSION. Vertical or horizontal.

COLOR AND MARKINGS. Sand color over all. Stenciled on body—Type I, "ehk elo3"; Type II, "ehk all3."

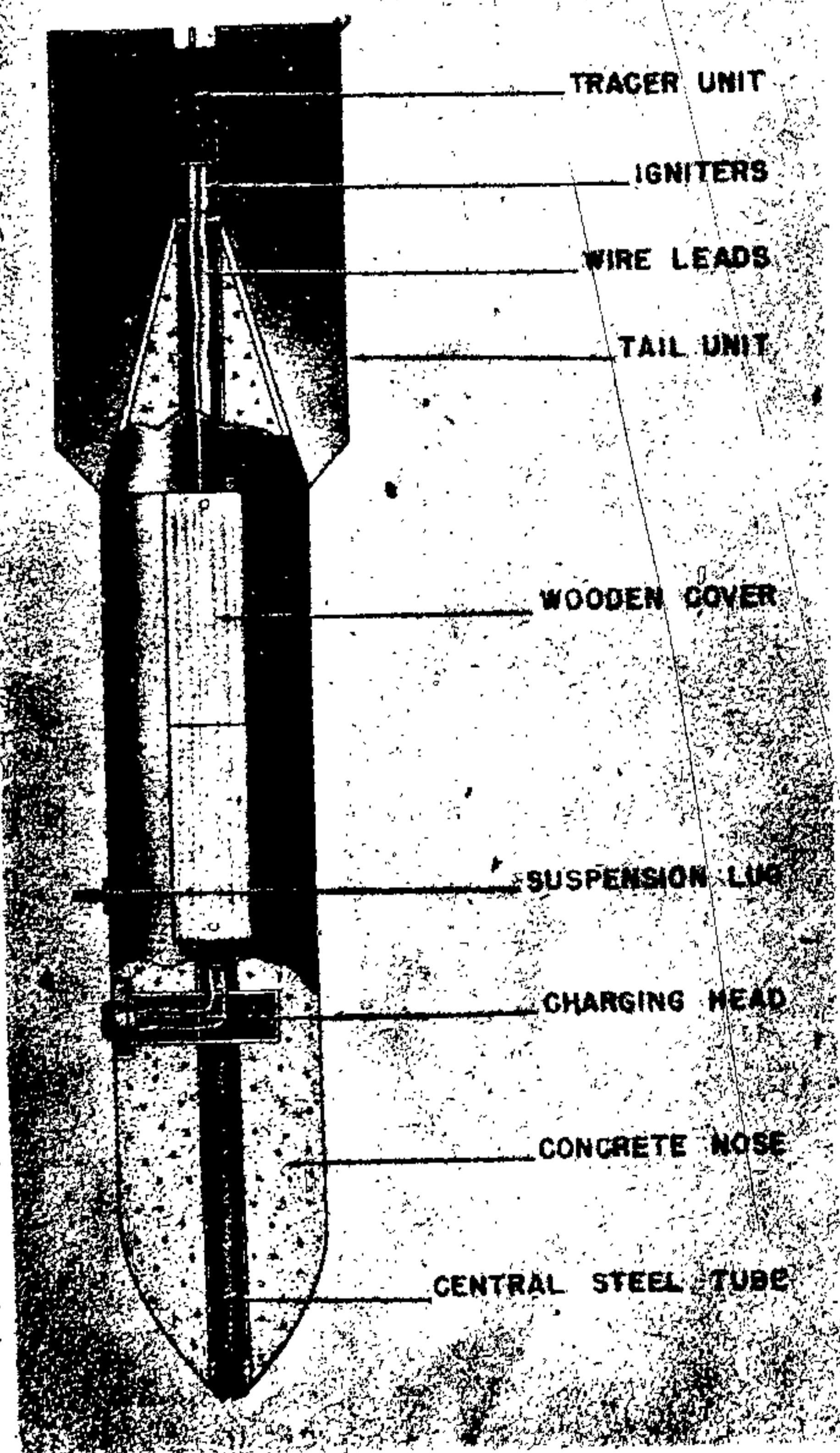

Figure 67—ZC 50-Kg Concrete Practice Bomb,
Types I and II

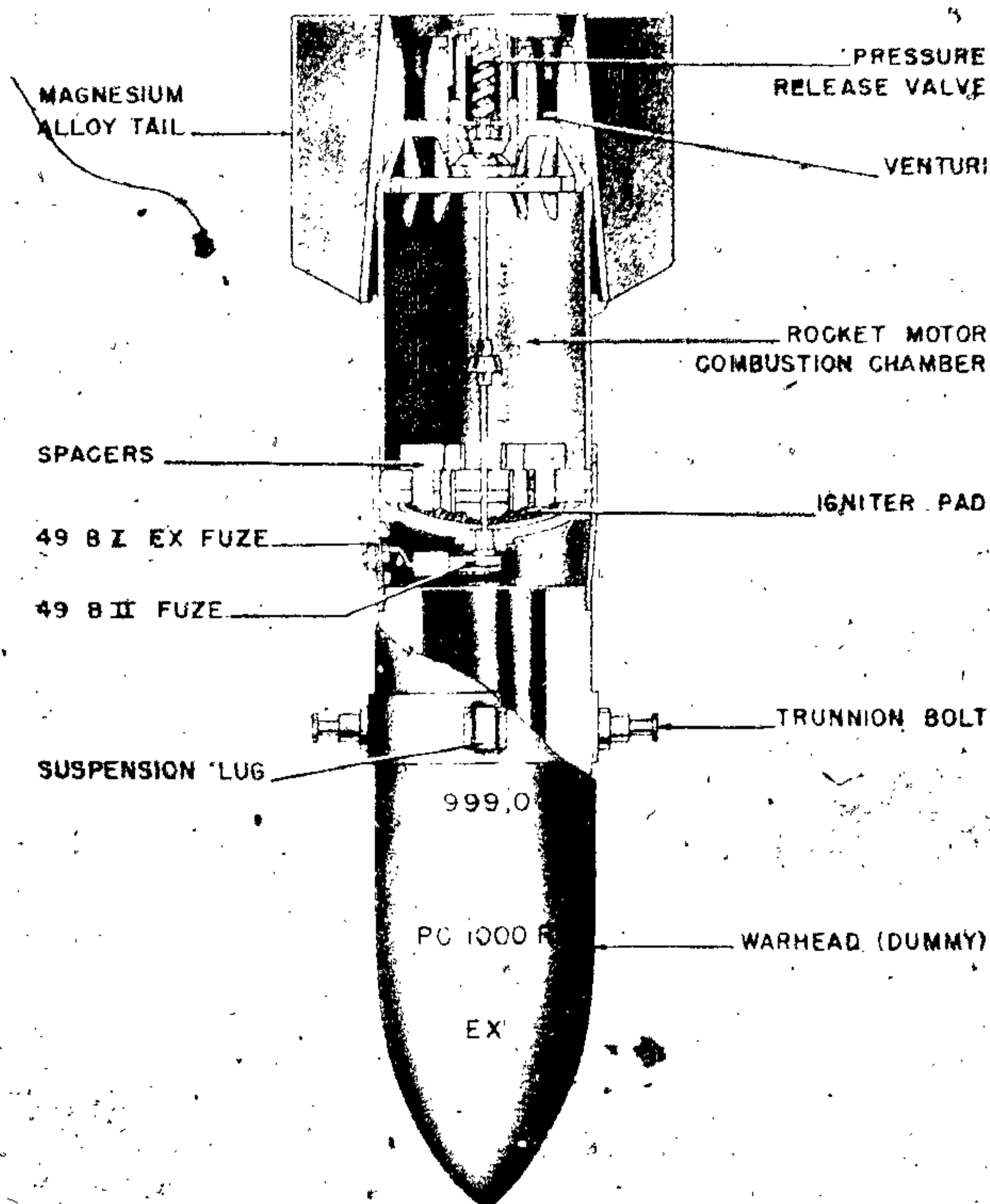

Figure 68—PC 1000 RS EX Practice Bomb

PC 1000 RS EX PRACTICE

DATA:

Over-all Length: 7 ft. 2 $\frac{3}{4}$ in.

Body Length: 3 ft. 9 in.

Body Diameter: 1 ft. 3 $\frac{1}{2}$ in.

Total Weight: 993 kg.

Fuzing: Charging head 49BI EX pyrotechnic
49BII EX.

CONSTRUCTION. The body of the PC 1000 RS EX is identical in construction to the PC 1000 RS. In place of the normal explosive charge, the cavity contains sand or some comparable material as a substitute. (See fig. 68.)

The fuzing system consists of the 49 BI EX

charging head and the 49 BII EX pyrotechnic fuze for igniting the rocket motor. Complete information can be found in the following section on fuzes.

There are 19 rockets in the rocket motor. Six are 22 $\frac{1}{2}$ inches long and have 2 $\frac{15}{16}$ inches diameter; 12 are 20 $\frac{7}{8}$ inches long with diameter of 2 $\frac{15}{16}$ inches; and 1 is 11 $\frac{1}{4}$ inches long with 2 $\frac{15}{16}$ inches in diameter. Total weight of rocket unit is 263 kg.

The tail is 2 feet 4 inches in large diameter and 1 foot 10 inches small diameter.

SUSPENSION. Horizontal by means of a H-type lug secured to a suspension band.

GERMAN EXPLOSIVE ORDNANCE

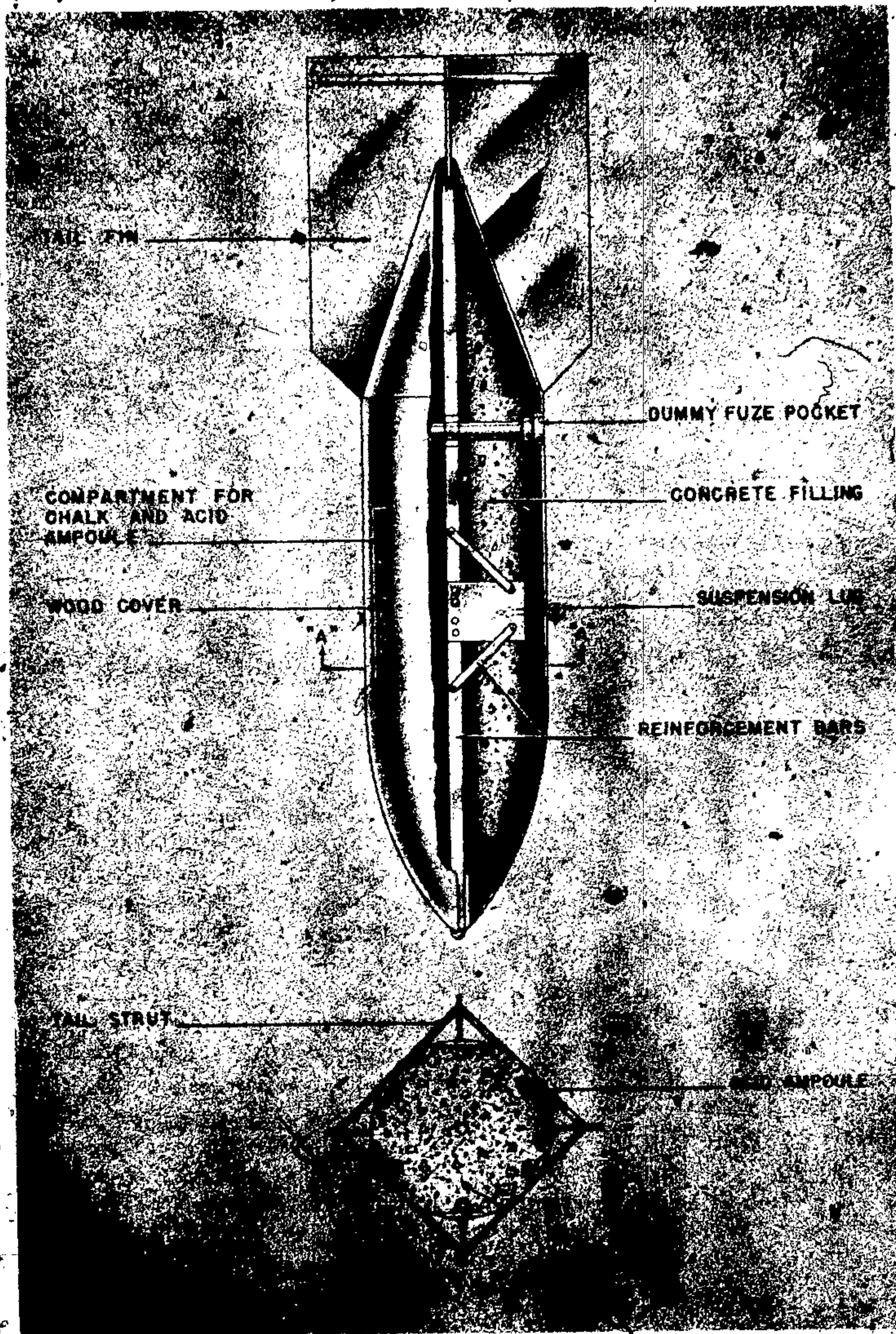

Figure 69—ZC 250-Kg Concrete Practice Bomb (Smoke)

COLOR AND MARKINGS. Bomb body: red-dish brown. Spacer, rocket container and tail, mustard color.

Markings die stamped:

403
unt 18, 7, 43
403
hh9
43CP03

Stenciled:

scharf
unt 18, 2, 43
499410
PC 1000 RS
EX

ZC 250-kg CONCRETE, PRACTICE, SMOKE

DATA:

Over-all Length: 65.0 in.

Body Length: 49.5 in.

Body Diameter: 14.5 in.

Tail Length: 25.0 in.

Tail Width: 20.0 in.

Total Weight: 250 kg.

CONSTRUCTION. The body of the bomb is concrete reinforced with steel. (See fig. 69.)

Evenly spaced about the body, though staggered, are six cavities, each 13 inches long and $2\frac{1}{2}$ inches wide, housing glass ampoules $10\frac{1}{2}$ inches long and 1 inch in diameter. They are enclosed in a protective wrapping of $\frac{1}{4}$ inch thick impure chalk retained in a gummed paper wrapping. The ampoules are retained within their cavities by $\frac{1}{8}$ inch thick wood covers, each secured flush with the surface of the bomb body by two screws; the wood protective cover in each case is weakened centrally by a $\frac{3}{16}$ inch deep saw-cut. Each glass ampoule is stated to contain 142 grams of chlorosulphonic acid, containing probably as impurities, small quantities of sulphur and ferrous sulphate; fuming hydrochloric acid is said to be an alternative. On impact the glass ampoules break to release their contents and smoke arises.

The sheet steel tail has four fins.

SUSPENSION. Horizontal by means of an "eye" bolt.

COLOR. Bright green over-all.

PYROTECHNICS

INTRODUCTION. This section describes German aircraft pyrotechnics. It includes flares, photographic flash bombs, markers, smoke generators, etc.

Basically, German flares consist of a cylindrical container housing an illuminating element, which upon being ignited by a pull friction igniter or time fuze, burns vigorously producing great illumination and intense heat. The flare may or may not have a parachute, depending upon the use for which it is intended. The illuminating element consists either of a single or a multiple candle unit which varies in intensity of illumination and color, according to its purpose. Methods of carrying flares vary with the individual sizes. Large flares may be suspended horizontally while small flares may be carried in containers.

German photographic flash bombs are similar in external appearance to conventional 50-kg bombs and parachute flare cases. Their fillings may be either flare composition or incendiary mixture, ignited by electrical or mechanical aerial burst fuzes.

Markers, used by the Germans consist principally of cylindrical cardboard containers, filled with a colored flare composition which is ignited by an impact type fuze. A few individual markers do not follow this pattern of construction. Some are merely containers of brightly colored powder, which are dumped into the sea from low altitudes to mark positions. Others are modified parachute flares of various colors.

Fundamentally, German smoke generators are smoke pots modified for dropping from aircraft. Each consists of a cylindrical aluminum case, containing a smoke producing composition which is ignited by a pull friction igniter. A parachute is used in some cases to retard the fall of the generator. Large smoke generators may be suspended from racks while small ones, known as smoke pots, are carried in containers.

LC 10 SINGLE CANDLE PARACHUTE FLARE

DATA:

Over-all Length: 15 in.

Body Diameter: $3\frac{5}{8}$ in.

Fuzing: Clockwork (89) Fuze.

flare body. The opening at the tail is closed by a steel cup. The suspension eye bolt is secured to the end of the cup.

OPERATION. The 89 fuze begins to function

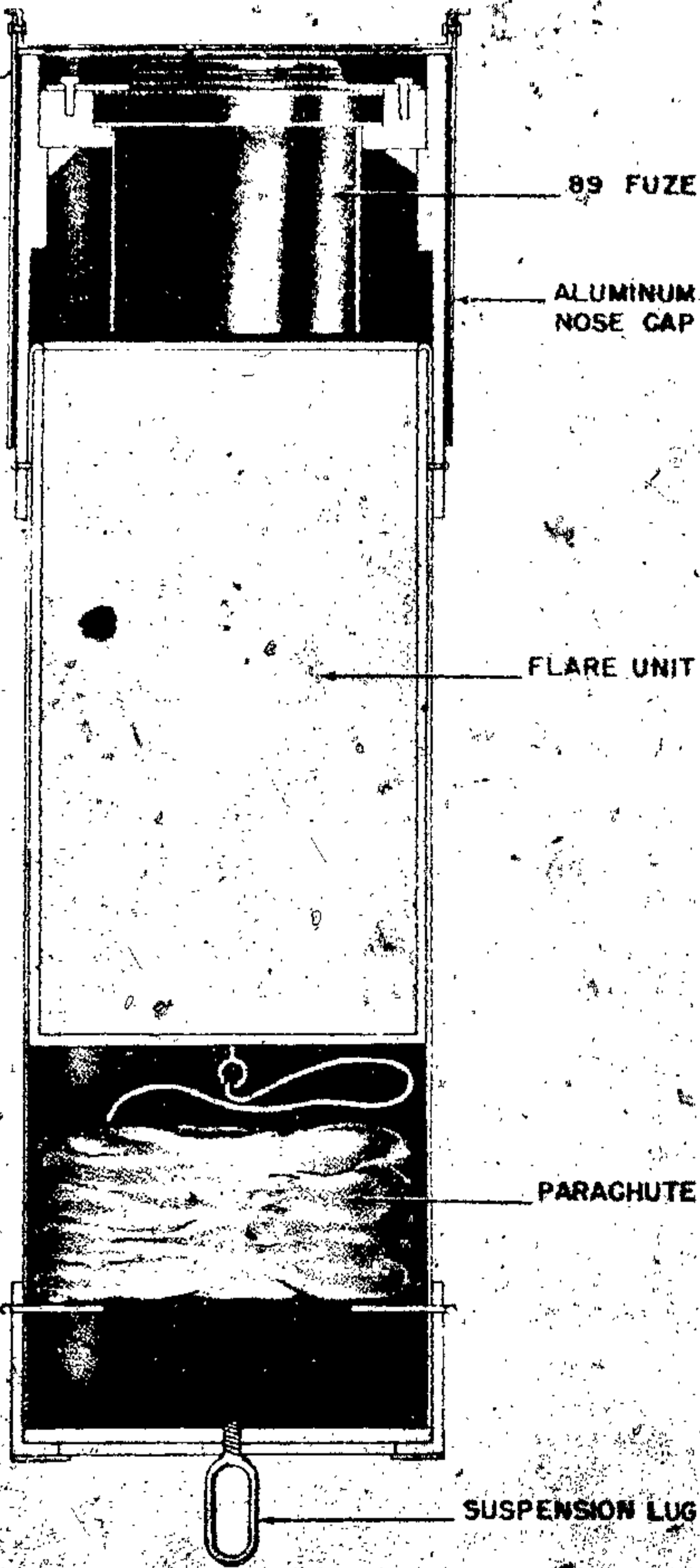

Figure 70—LC 10 Single Candle Parachute Flare

CONSTRUCTION. The LC 10 single candle parachute flare consists mainly of an aluminum cylinder, the flare candle contained in a cardboard liner, an 89 clockwork fuze and a parachute. The fuze is located in a steel sleeve at the nose end of the flare body. (See fig. 70.) This sleeve is attached to the body by three screws. An aluminum cap fits over the steel sleeve leaving the fuze exposed.

The parachute is located in the tail end of the

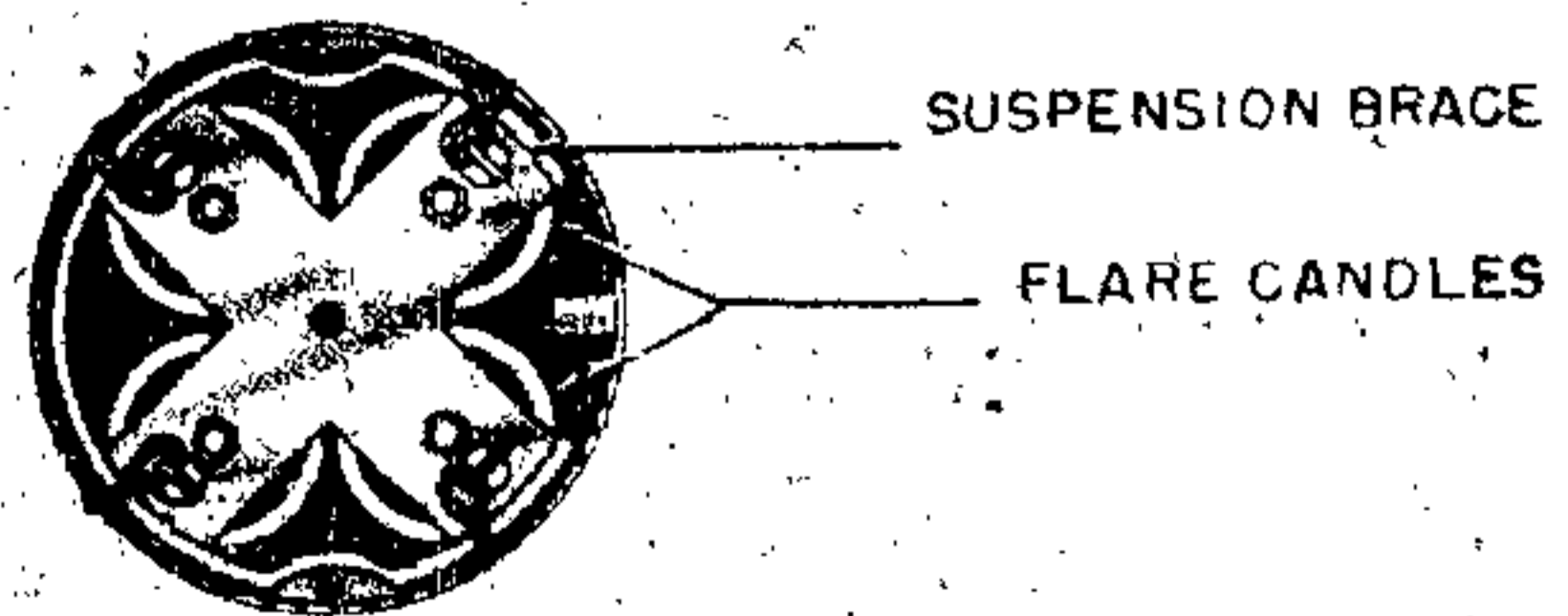
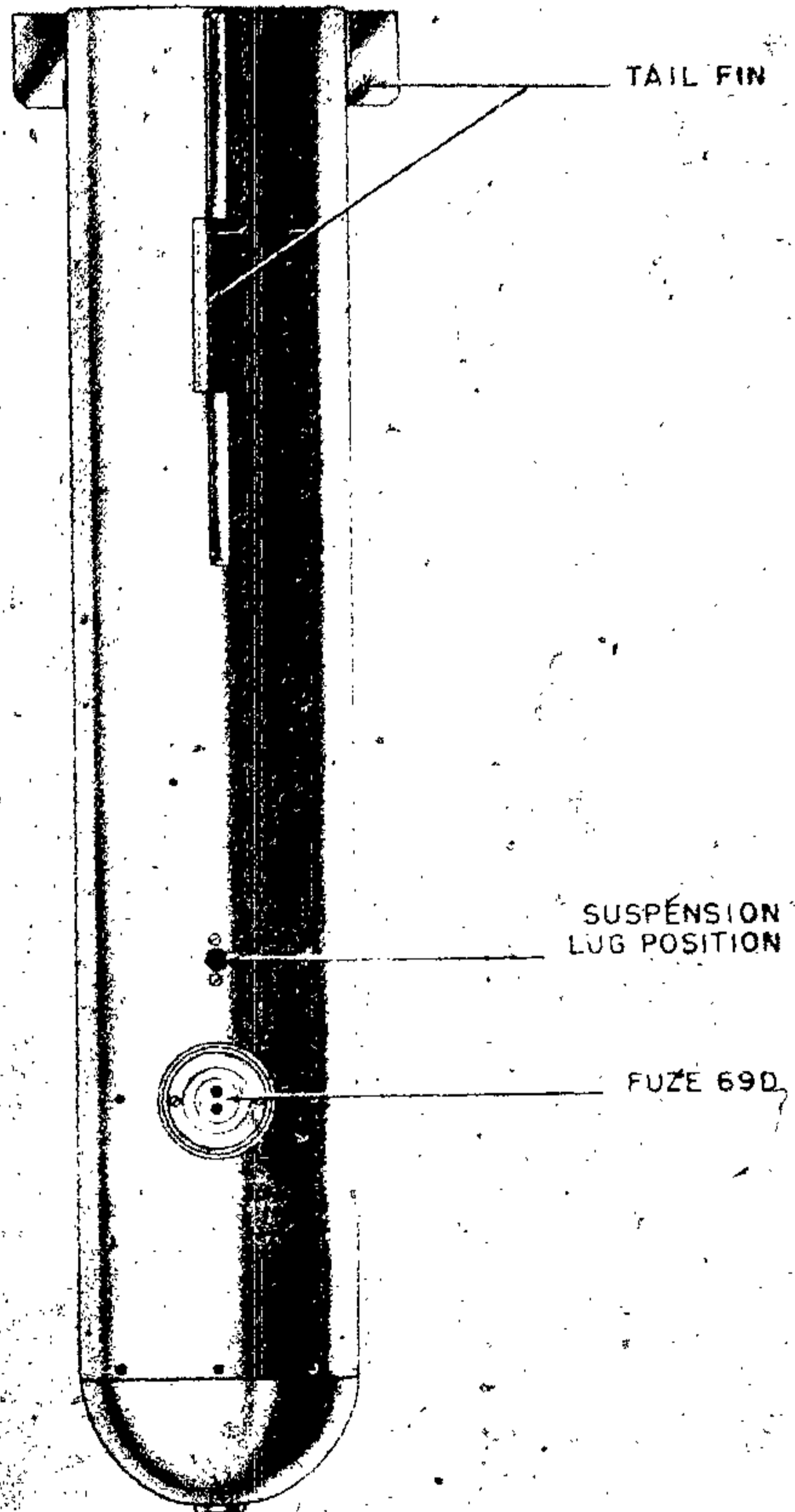

Figure 71—FB 50 Single Candle Parachute Flare

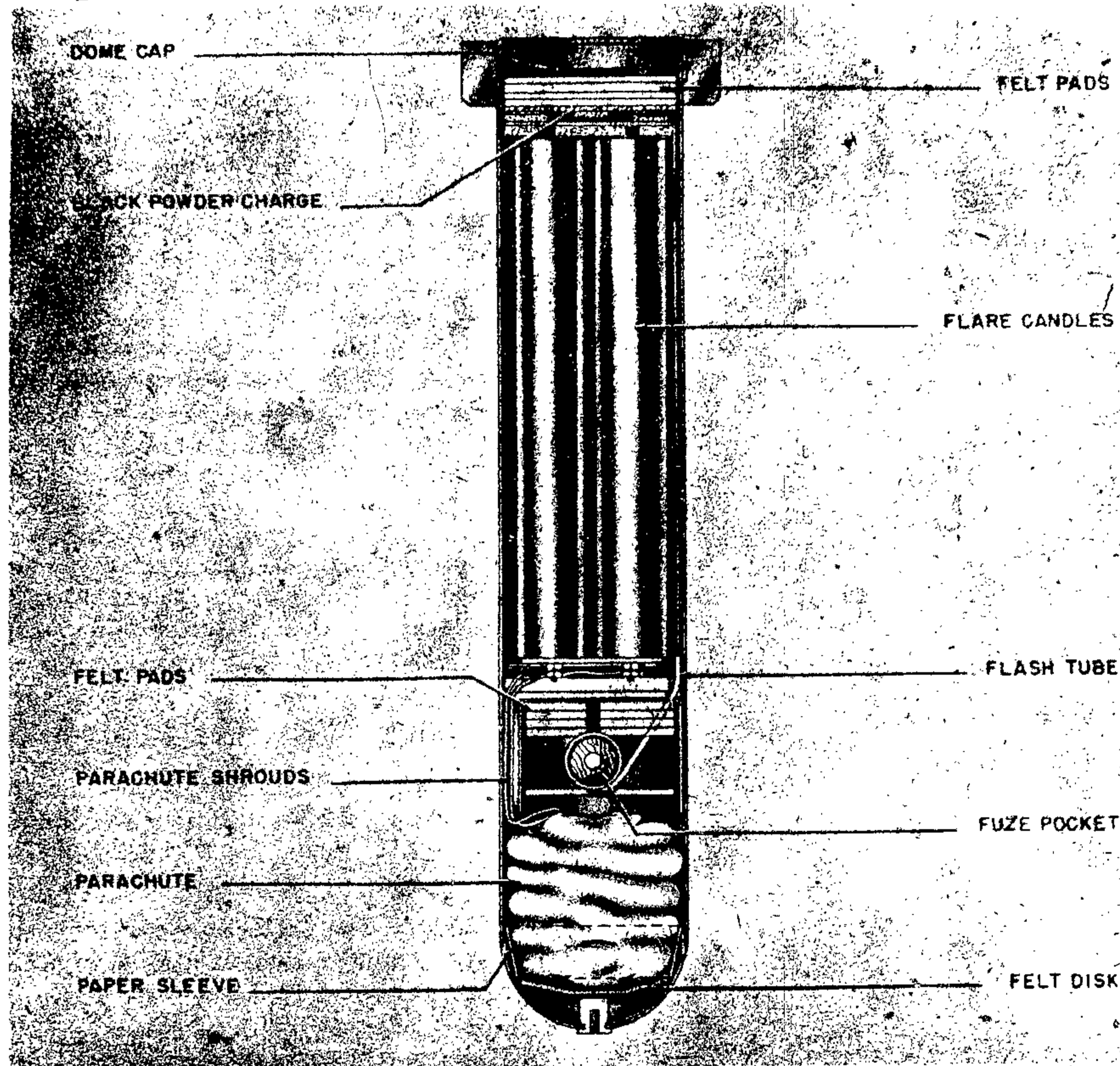

Figure 72—LC 50 F Ausf. C Parachute Flare

when the flare is dropped. At a predetermined time the fuze fires and ejects the candle and its parachute from the body. The candle is ignited by the same action.

SUSPENSION. ABB 500 incendiary containers.

**PARACHUTE FLARE FB 50 (SINGLE CANDLE)
AND LC 50 F Ausf. C (FOUR CANDLE)**

DATA:	FB 50	LC 50 Ausf C
Over-all Length.....	42.5 in.	42.5 in.
Body Length.....	42.5 in.	42.5 in.
Body Diameter.....	8.0 in.	8.0 in.
Wall Thickness.....	3/32 in.	3/32 in.

Filling: Flare composition.
Total Weight: 76 lbs.
Fuzing: (59) A (with pyrotechnic delay incorporated in fuze.

CONSTRUCTION. The body consists of a case made of seamless aluminum tubing; a pan-shaped plate over which the tube is crimped and secured by 24 aluminum rivets, and a dome-shaped cover secured to the tube by six brass shear screws. A concave steel plate stiffens the nose for vertical suspension. A felt disc supports the parachute which is stowed behind a paper sleeve. The fuze pocket is of steel and contains the fuze and wooden

GERMAN EXPLOSIVE ORDNANCE

quickmatch holder. Eight semicircular fibre pads and one disc are wedged around the fuze pocket. Four strands of quickmatch pass from the holder via a rubber tube and an aluminum tube to a black powder charge in the tail-end. Immediately behind the ejector cup are two fibre discs, shaped to allow passage of the rubber quickmatch tube,

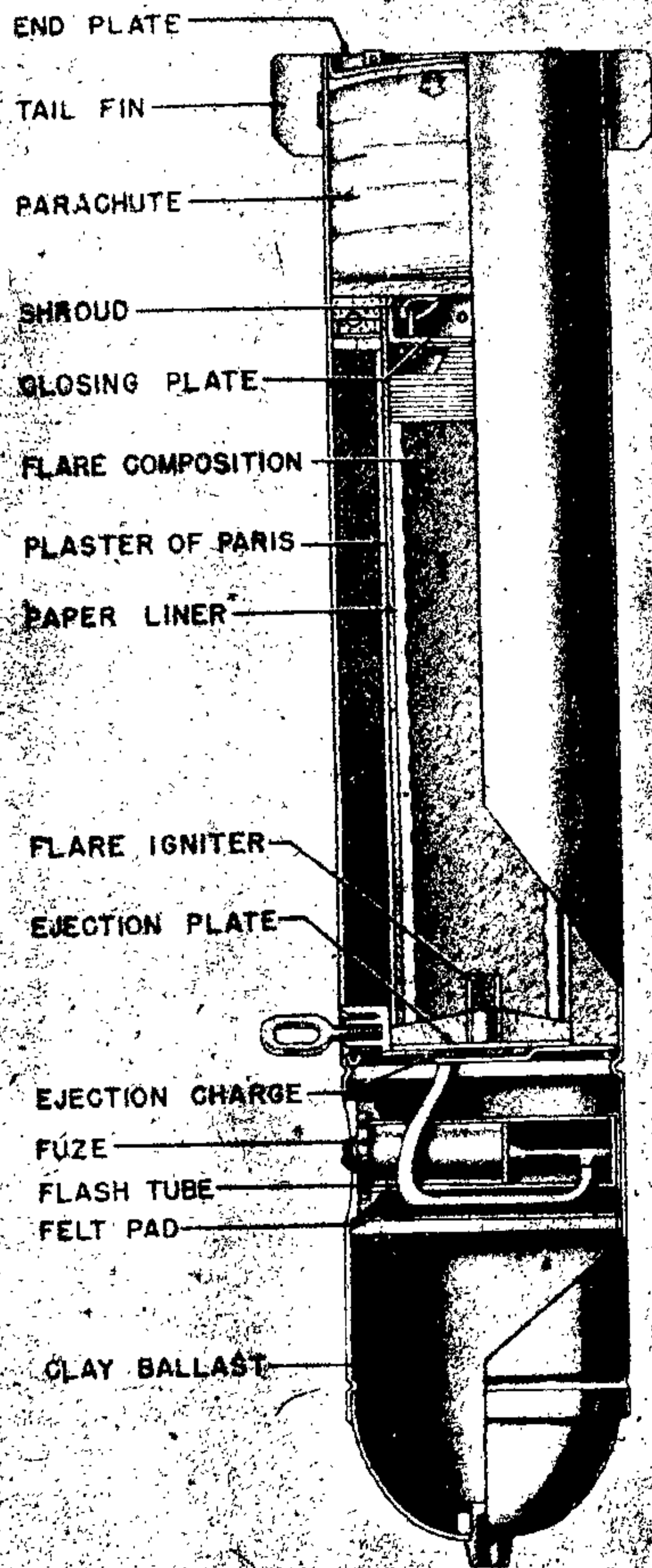

Figure 73—LC 50 F Ausf. E Parachute Flare

the parachute suspension wires and to accommodate the side suspension block. The four candles are held together by a steel plate in the form of a cross bolted on to them. There are four eyebolts screwed to each arm of the cross to take the parachute wires. A $\frac{3}{16}$ -inch steel wire welded around the cross ensures easy passage of the candles on ejection from the casing. Each candle is provided with a match igniter at its base. On release, the pyrotechnic delay in the fuze is ignited. This fires the quickmatch which in turn ignites the black powder charge in the tail. The charge ejects the candles by shearing the brass screws, the candles simultaneously being ignited through perforations in the ejector plate. (See figs. 71 and 72.)

There are no tail fins on the case of the single candle flare but the four candle flare has four fins riveted to the case, two of which are 16 inches long and two 3 inches long, all being 2 inches wide.

These are located at the far end of the case from the parachute. The parachute is of celanese, 13 feet in diameter. It is attached to the candles by 12 silk shroud lines 10 feet long and woven steel wire.

SUSPENSION. Vertical or horizontal.

COLOR AND MARKINGS. The body, tail fins, and domed cap may be unpainted aluminum or painted black all over. Manufacturer's markings may be stenciled on the case near the domed cap.

REMARKS. The flare composition is: aluminum, 16.5 percent; barium nitrate, 75.8 percent; sulphur, 7.7 percent; volatile matter, 0.2 percent. Both flares burn slightly longer than 5 minutes. Candlepower: single candle, 216,000; four candle, 600,000.

LC 50 F Ausf. E PARACHUTE FLARE

DATA:

Over-all Length: $42\frac{1}{8}$ in.

Body Length: $42\frac{1}{8}$ in.

Body Diameter: $7\frac{11}{16}$ in.

Type of Filling: Flare composition.

Flare Candle:

Over-all Length: $20\frac{3}{8}$ in.

Diameter: 4.8 in.

Weight: 23.14 lbs.

Fuzing: El Zt Z(9) or El Zt Z(59) A.

Stabilizing Fins: 2- $2\frac{3}{4}$ in; 2-16 in.

CONSTRUCTION. The container of the parachute flare is a drawn steel cylinder 1 mm thick compressed circumferentially to form two internal flanges. The forward end is enclosed by a dome cover and the after end by a plate. (See fig. 73.) A cardboard disc separates the fuze pocket from the 12 pounds of clay ballast in the nose. The cardboard disc is retained by a ring which has an L-section and is spot welded to the inside of the container. The domed cover which fits inside the container is located near the forward flange. It is secured by the rim at the forward end of the container. The fitting in the cover is threaded to take a suspension lug.

The wooden block beneath one fuze has a central hole and a side channel through which the flash from the fuze ignites the powder train in the rubber tube. This in turn ignites the black powder charge in the diaphragm. The diaphragm is positioned by the after internal flange and the plaster of paris cylinder. The single flare candle is within this cylinder and sealed by the washer. The parachute shrouds are wound around the top of the candle and a cardboard ejector disc is placed below the folded parachute. A tight fitting felt pad is inserted above the parachute and is held in place by the end plate. This latter is secured by six soft metal screws which are easily sheared. Of the four stabilizing fins on the tail of the container, one pair is $2\frac{3}{4}$ inches long while the other is 16 inches long.

The candle is an aluminum tube closed at one end, with a paper liner containing the compressed flare composition. A light aluminum container inserted in the concave end of the candle contains the black powder igniter. At the other end of the candle a heat insulating layer, consisting of cast plaster, is provided to protect the shrouds of the parachute. The latter are arranged in two groups connected by two 4-foot lengths of S. W. R. to the closing plate, which is riveted to the container.

The parachute, 4 feet in diameter, is made of 12 sections of artificial silk and vented at the center.

SUSPENSION. Horizontal.

COLOR AND MARKINGS. Exterior painted black with one marking "Ausf. E" stenciled in on a silver patch just forward of the fuze pocket. The markings on the parachute are: Gerat LC 50 F Ausf. C.

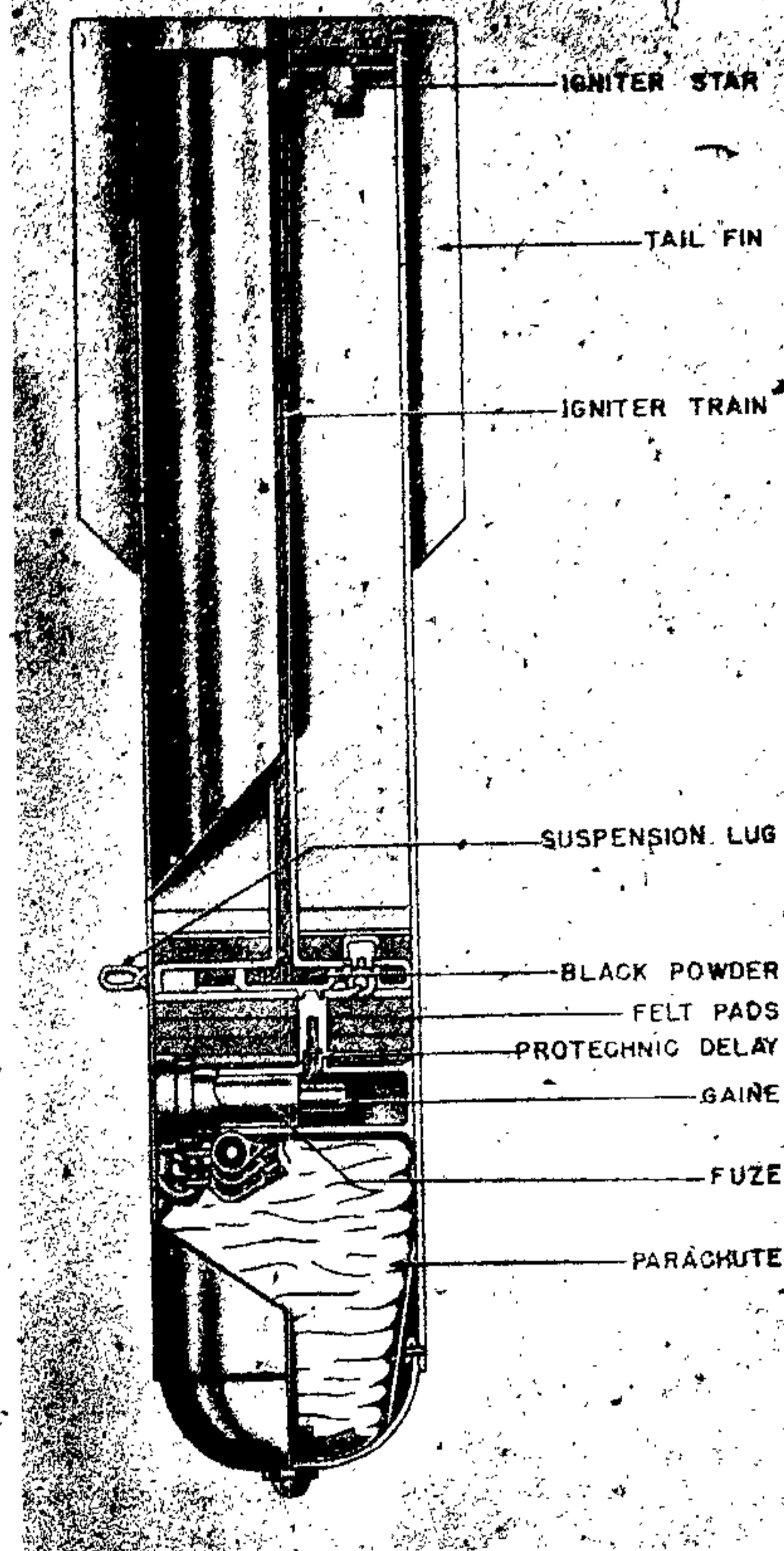

Figure 74—LC 50 F Ausf. G Parachute Flare

LC 50 F Ausf. G PARACHUTE FLARE

DATA:

- Over-all Length: 43 in.
- Body Diameter: 7.87 in.
- Tail Width: 11.0 in.
- Type of Filling: Flare composition.
- Total Weight: 32 kg (approx.).
- Fuzing: (9) or (59) B.

CONSTRUCTION. The body of the LC 50 F Ausf. G parachute flare is constructed of sheet aluminum. The base is closed off by a flat plate and secured to the cylinder by 12 rivets. A para-

GERMAN EXPLOSIVE ORDNANCE

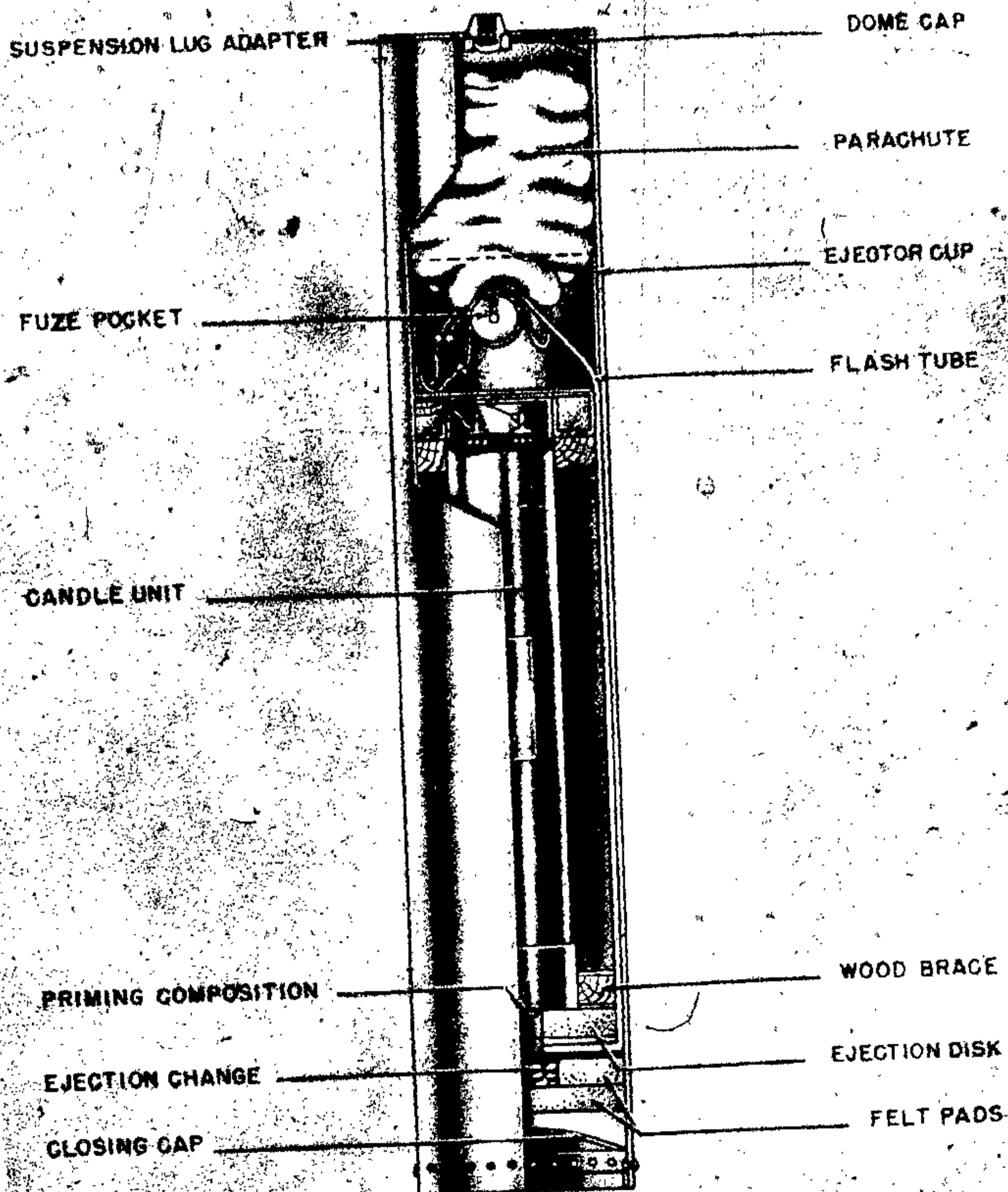

Figure 75—Mark C 50 FA Parachute Flare

chute closing cap forms the forward end of the container. (See fig. 74.)

The parachute is found in the forward part of the container between the parachute closing cap and the fuze pocket. The suspension lug is located a few inches aft of the fuze pocket. The suspension lug brace contains the black powder puff and also connects the flash channel from the fuze pocket to the central igniter train. The remaining part of the container aft of the suspension lug is filled with flare composition.

OPERATION. After release, the airburst fuze

functions to explode 3 grams of black powder in bakelite gains which in turn lights pyrotechnic delay to explode a powder puff. Pressure exerted by the resultant gases forces the parachute against the parachute closing cap to shear the retaining rivets, and so permit the ejection of the parachute into the air stream. Simultaneously the flash from the powder puff ignites the igniter train leading centrally through the flare candle to the five igniter stars which in turn ignite and ensure a substantially even ignition of the flare composition. It appears that the gases produced by the ignition of

the igniter stars exert sufficient pressure to shear the rivets retaining the flare composition closing disc.

REMARKS. Information on this flare is based upon translation of a German document.

SUSPENSION. Vertical or horizontal.

COLOR AND MARKINGS. Body and tail are dull black. "LC 50 F Ausf. G" is stenciled in 40-mm white letters on two sides of body 35 mm behind the suspension lug.

MARK C 50 FA PARACHUTE FLARE

DATA:

Over-all Length: 42.0 in.

Body Diameter: 7.85 in.

Fuzing: El Zt Z (59) A; El Zt Z (59) B; Z (89) C.

CONSTRUCTION. The flare body is an aluminum cylinder with no tail fins. (See fig: 75.) The nose is a flanged and slightly domed cap secured to body by four shear screws. A nose eyebolt is attached to nose cap. The interior of the nose cap is lined with a felt pad. Between this pad and the fuze pocket lies the cotton parachute. The parachute, vented at top, has a circumference of 21 feet, 4 inches and is made in 8 sections. The parachute shrouds are arranged in two groups of four, each group being connected to a suspension cable. The two suspension cables are attached to two brackets which are bolted to the candle unit lid.

An old flat type locking ring secures the 59A fuze in the fuze pocket. The ejector cup is a sliding fit in the flare body but is prevented from movement by the indentations (until the ejector charge functions).

Retained in position at the base of the fuze pocket by a small grub screw is the quickmatch holder mounted in plastic material. The bundle of quickmatch is placed centrally down this holder to connect at right angles with the quickmatch relay.

The quickmatch relay "lead-in" tube, which is for some distance of rubber and then of aluminum alloy, passes through slots in the intervening plates, and extends the length of the candle unit to the ejection charge.

The candle unit measures 22 by 4 inches diameter and bears marking similar to those found on

the flare body. It is primed at the base with an ignition composition.

Placed between the candle unit ejector disc and the termination of the quickmatch relay is a further layer of ignition composition.

The ejection charge consisting of "Pebble" gunpowder is contained within a felt holder. The remaining space in the base of the flare is occupied by two packing washers, one of felt, and one of clay.

Riveted to the flare body is the domed base closing cap which is further secured by an inward turning-over of the cylindrical body to overlap the closing cap.

OPERATION. During the fall of the parachute flare, the aerial burst fuze functions and the flash is passed to ignite the quickmatch within the quickmatch holder. It is relayed via the rubber tube and the aluminum alloy tube to ignite the priming composition. This in turn initiates the gunpowder ejection charge.

The gases formed by the burning of the gunpowder force the ejector disk and with it the candle unit ejector cup, and parachute toward the nose cap. The pressure of the parachute against the interior of the nose cap shears the four screws permitting the parachute and candle unit to be ejected from the flare body.

Simultaneously the flash from the burning gunpowder has ignited the priming composition at the bottom of the flare to ignite the flare composition.

No information has been received regarding the burning time of the candle unit.

COLOR AND MARKINGS. Body is black over all. Stenciled on body in green paint: "Mark C50FA" or "Mark 50 F/A." The parachute is marked:

LETTERUNGS—NT 6

EESFELD

ANGEFEITIGT SEP. 193

B. G. TEXT 12 WERKE

K. G. S. HENKING

BERLIN—TEMPLEHOF

MARK 50 KASK TARGET INDICATING FLARES

DATA:

Over-all Length: 41.0 in.

Body Diameter: 7.7 in.

Tail Length: 15.0 in.

GERMAN EXPLOSIVE ORDNANCE

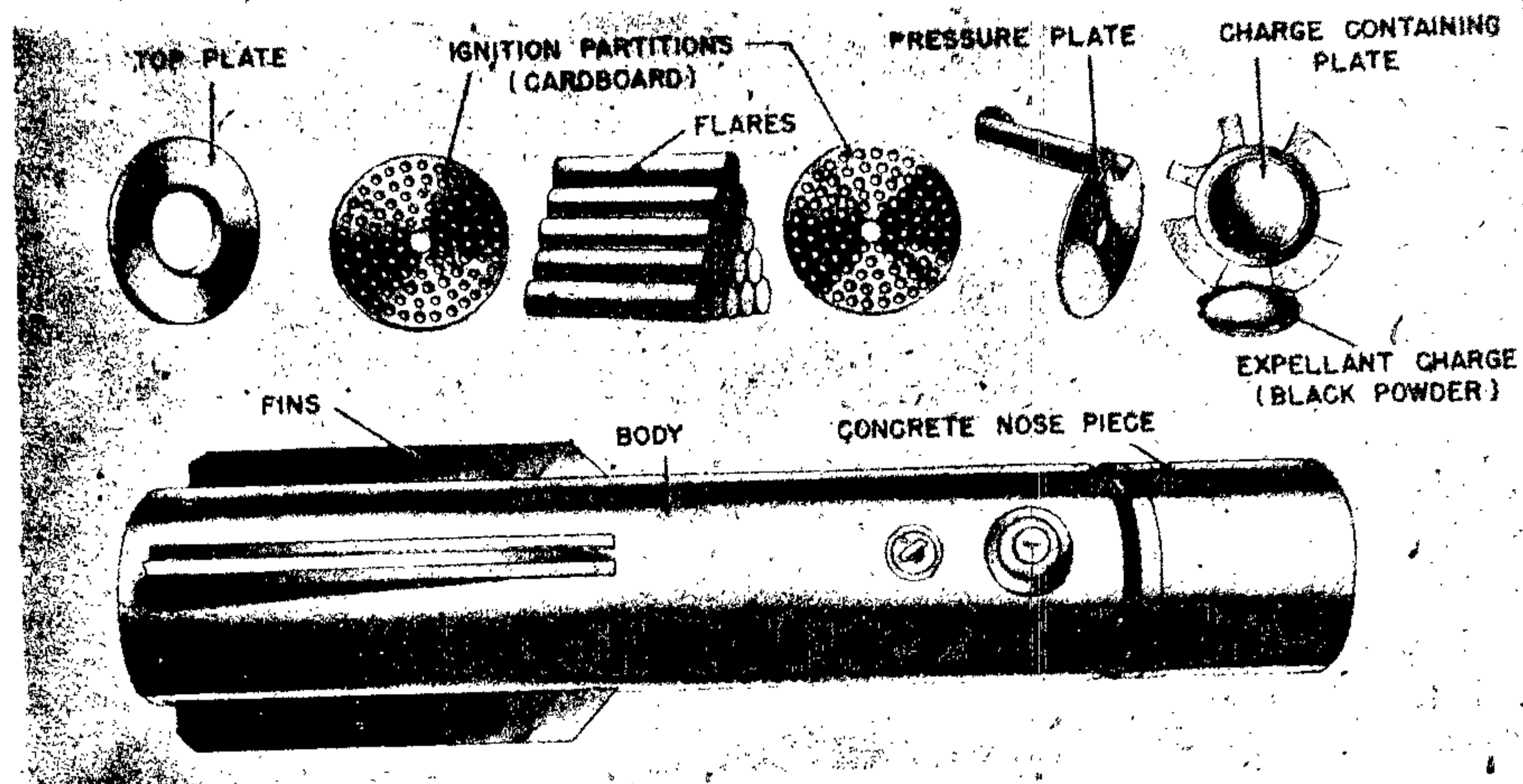

Figure 76—Mark 50 Kask Target Identification Flare

Tail Width: 10.3 in.

Filling: Illuminating composition, black powder expellant charge; smokeless powder ignition disks.

Fuzing: 89B fuze.

CONSTRUCTION. The body is a cylinder of sheet metal with a constant external diameter. A truncated cone of concrete is firmly fixed to the nose by a 0.75-inch bolt. (See fig. 76.)

The fuze pocket contains a drilled hole to allow passage of flame to the rear of the container. Immediately to the rear of the fuze pocket is the charge containing plate, so positioned that the hole in it is directly over the flame port in the fuze pocket. A bag of black powder lies in the charge containing plate.

To the rear of the charge and resting on the charge retaining plate is the pressure plate. This pressure plate has a central flash hole through it and also has an extension welded to a cutaway semicircle on its circumference to allow for movement of the plate without hindrance from the internal portion of the suspension eyebolt.

Resting on the pressure plate is the first of three ignition partitions. Each partition consists of two perforated cardboard plates, between which are pressed discs of smoking powder.

A bundle of 20 target indicating flares rests on the ignition partitions. Each flare is approxi-

mately 6 inches long and 1½ inches in diameter. The outer covering of each flare is waxed cardboard and there is a smear of quick-fire composition at one end. The flares are placed so that the end on which the quick-fire composition is located is toward the fuze pocket.

Above the layer of 20 flares there is another ignition partition, then a bundle of 21 flares, followed by still another ignition partition and 21 flares, making a total of 62 individual flares contained in the body.

To the rear of the last bundle of flares are two pads of felt and one cardboard pad. The top plate retains all the contents in the container and is fixed to the body by means of four light aluminum shear rivets. The tail consists of four stabilizing fins welded at 90° intervals around the body.

SUSPENSION. A single standard German eyebolt screwed to the side of the body supports the "Mk 50 Kask" in the plane.

REMARKS. As the missile falls to earth after release, it maintains a nose down position in flight due to the weight of the concrete nose piece. The fuze functions while falling. The expellant charge is ignited, blows the pressure plate to the rear, shearing the retaining rivets, and top plate falls free, ejecting the individual flares. At the same time that the ejection is occurring, the flash from the propellant charge is transmitted to the

ignition partitions which ignite the target flares. Once ignited, the flares burn with a white flame for 1 second and then with a red flame.

PARACHUTE FLARE, SINGLE CANDLE FLARE (PULL FRICTION IGNITERS)

DATA:

- Over-all Length: 42.0 in.
- Body Diameter: 7.8 in.
- Filling: Flare composition.
- Fuzing: El. Zt. Z (59) B and friction igniters.

CONSTRUCTION. This flare is similar in size and general construction to the Mark C 50 F/A flare. The principal difference is that the candle is reversed and ignited by pull friction igniters instead of black powder charge which ejects it from the main casing. (See fig. 77.)

The friction igniters are similar in design to the ZDSCHN and 29 pull igniter with the addition of a pyrotechnic delay of 3½ seconds screwed into the base. Around the end of the pyrotechnic tube of both igniters a length of quickmatch is

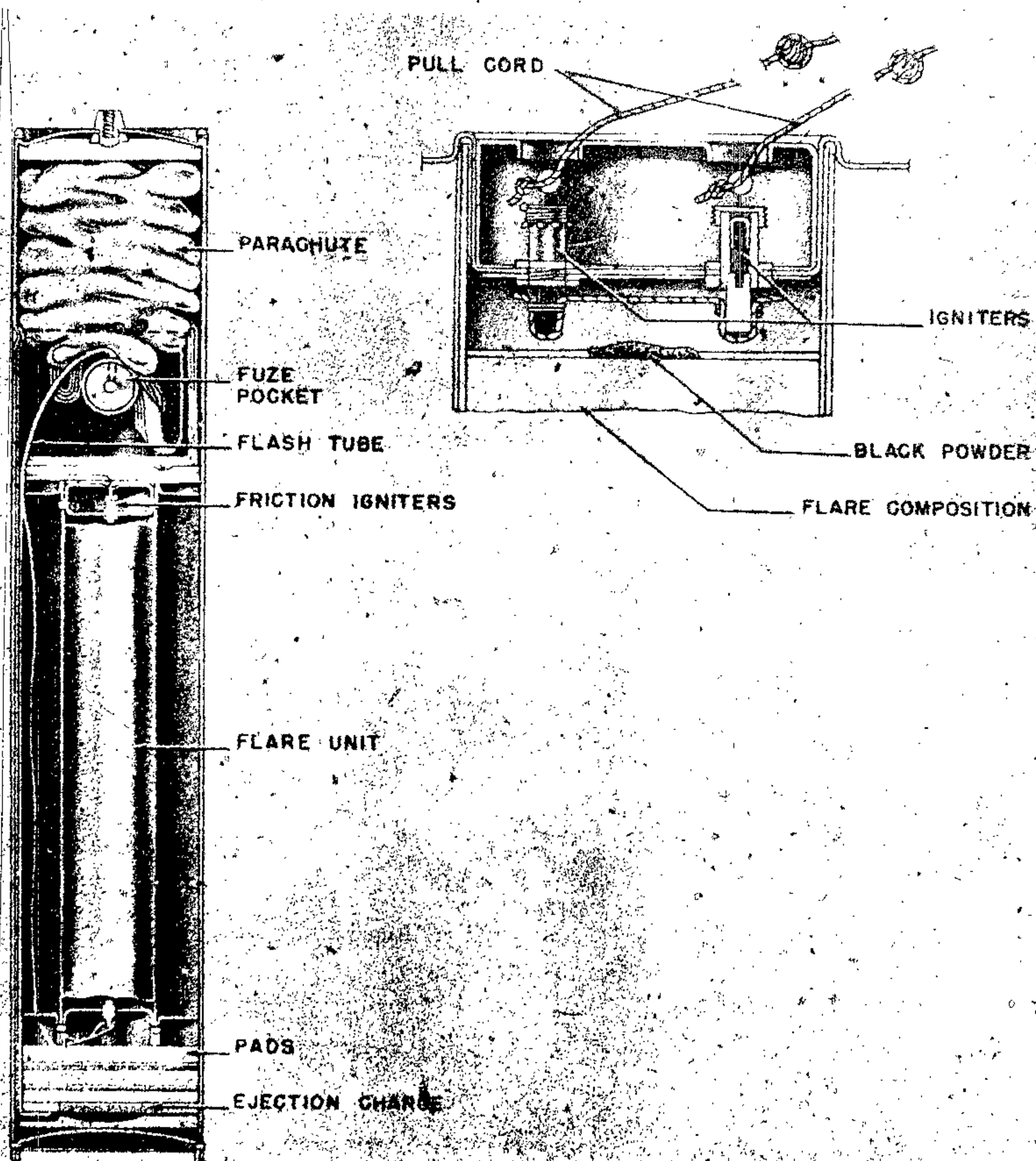

Figure 77—Parachute Flare with Pull Igniter

GERMAN EXPLOSIVE ORDNANCE

secured by this cord. Immediately below this quickmatch a thin cardboard disc holding a black powder primer closes the base of the flare candle. Thin cords connect the igniters to the eye for the parachute shackles; each of these cords is knotted around the weakened centers of the wooden detents before passing through slots in the metal disc. The detents act as a safety device by fouling

the metal disc should the cords be pulled while the candle is still in place.

OPERATION. A pre-set time after release from the aircraft, the (59) B fuze operates and via the quickmatch train fires the ejection charge. Rivets retaining the nose closing cap are sheared and the parachute and candle ejected. The pull of the parachute is first taken by the friction igniter

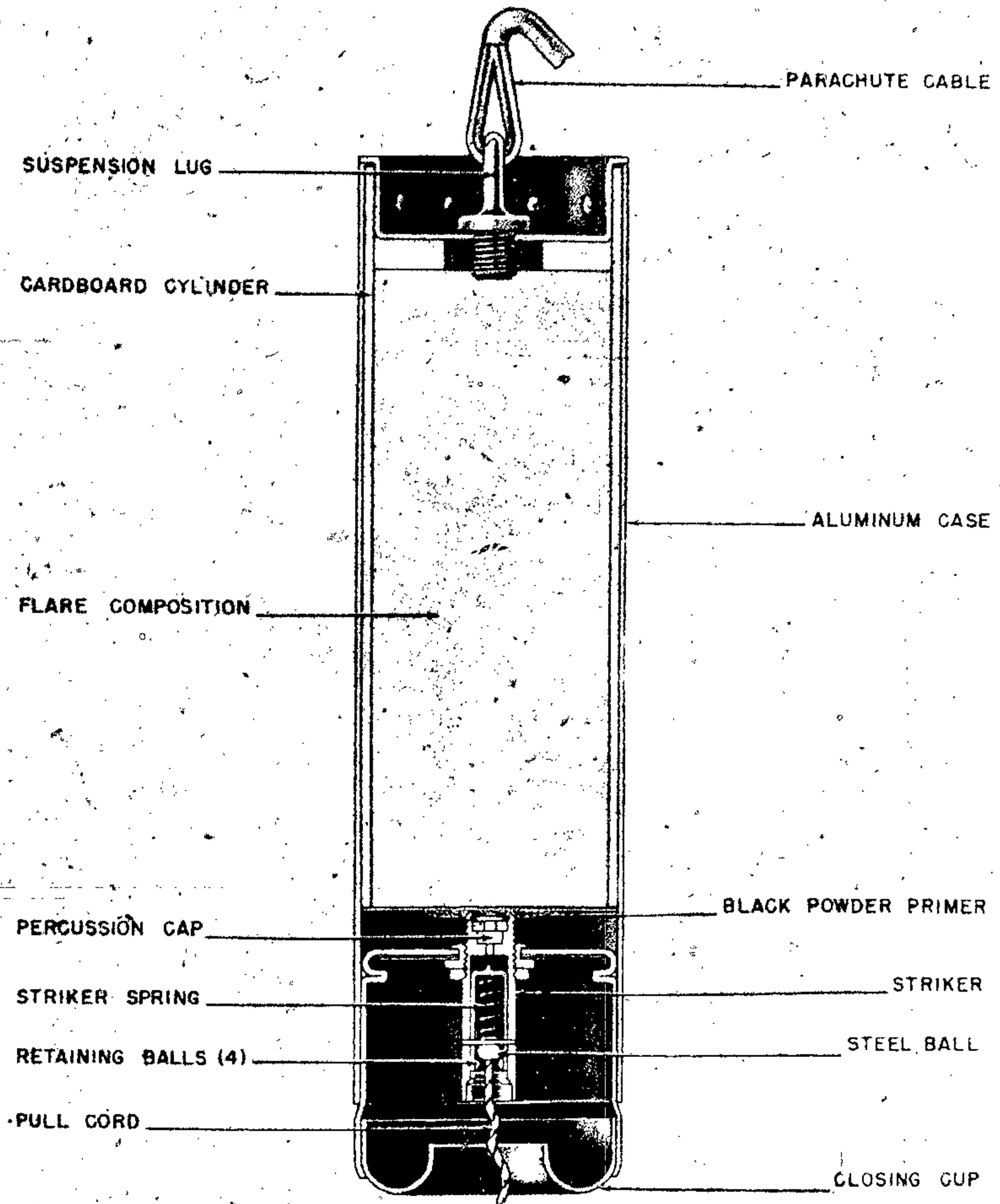

Figure 78—Parachute Flare (White)—Single Unit

ords and the candle is ignited after 3½ seconds, by which time it is suspended normally from the parachute. The candle burns for 5 minutes.

SUSPENSION. Vertical or horizontal.

COLOR AND MARKINGS. The casing is painted black over aluminum. Three panels on the outside surface are left unpainted and the following typical markings are stenciled in on black:

Nur fur etc 50 V III

DEPYFAG—M

39. Lief 6.

SINGLE CANDLE UNIT, PARACHUTE FLARE (WHITE)

DATA:

Over-all Length: 13.25 in.

Body Length: 13.25 in.

Body Diameter: 2.40 in.

Wall Thickness: 0.05 in.

Filling: Flare composition.

Fuzing: A number (31) pull-percussion igniter is used to ignite the flare candle; a Zt Z (89) B clockwork aerial burst fuze opens the container.

CONSTRUCTION. The body is an aluminum cylinder closed at both ends. The nose closing cup is approximately 2 inches long by 2.25 inches in diameter and is crimped in position by four indentations. It is open at the nose end and perforated at the base where it is sealed by a sheet of tinfoil. Centrally in the base of this cup is secured an internally threaded bush to accommodate the (31) igniter. The ¾-inch deep tail closing cup is secured by means of 8 rivets and carries a suspension eyebolt centrally. The parachute, attached to this eyebolt by means of a wire cable 36 inches long, is 4 feet in diameter with a 3.75-inch air vent in the center. Eight shroud lines from the parachute terminate in a loop which is in turn attached to the (31) igniter. (See fig. 78.)

The candle unit consists of a cylindrical pressed cardboard case approximately 10.75 inches long and 2.3 inches in external diameter. This case, 0.1 inches thick, contains the flare composition at the head of which is a cardboard washer with a priming of black powder.

OPERATION. On release of the container from the aircraft, the aerial burst fuze Zt Z (89) B operates to open the container and to scatter the 41 flares. The parachute on each individual flare opens thereby exerting a pull on the (31) igniter firing cable. The slotted striker cylinder is pulled back, compressing the striker spring, until the four steel balls are ejected into the recessed end of the fuze body and the hollow steel ball-shaped clip is pulled free. This releases the spring-loaded striker which is impelled onto the detonator. The flash from the primer cap ignites the black powder primer which in turn ignites the flare composition.

REMARKS. This flare is believed to be similar in size and construction to the red single candle flare carried in the Mark 250-BK container.

SUSPENSION. 41 of these single candle flares are contained in the Mark 250-LK containers.

COLOR AND MARKINGS. Unpainted aluminum. Longitudinally near suspension lug marked:

FERTIGUNFIRMA dbc
LIEFFERUNGSNUMMER 46/42

PARACHUTE FLARE, SINGLE CANDLE FLARE, I WHITE AND II RED

DATA:

	WHITE	RED
Over-all Length	19 in.	13.3 in.
Body Diameter	3¾ in.	3.4 in.
Filling	Flare composition.	
Fuzing	Pull friction igniters.	

CONSTRUCTION. The body of the white flare is of aluminum with a sheet steel cap at the top secured by adhesive tape. The flare is fitted with two pull igniters, one in the side of the case and one in the top of the flare candle. (See fig. 79.) There are two black powder charges in each flare, one to blow out the parachute, housed in the top of the case, and the other to ignite the candle. When the airburst fuze causes the container to open in mid-air, each flare falls away and in so doing operates the side pull igniter which fires a black powder charge blowing out the parachute. As the parachute opens, the pull igniter at the top of the candle operates. This fires a short length of safety fuze which burns for about 16 seconds, before initiating the second black powder charge which ignites the candle. This flare burns with a white light.

GERMAN EXPLOSIVE ORDNANCE

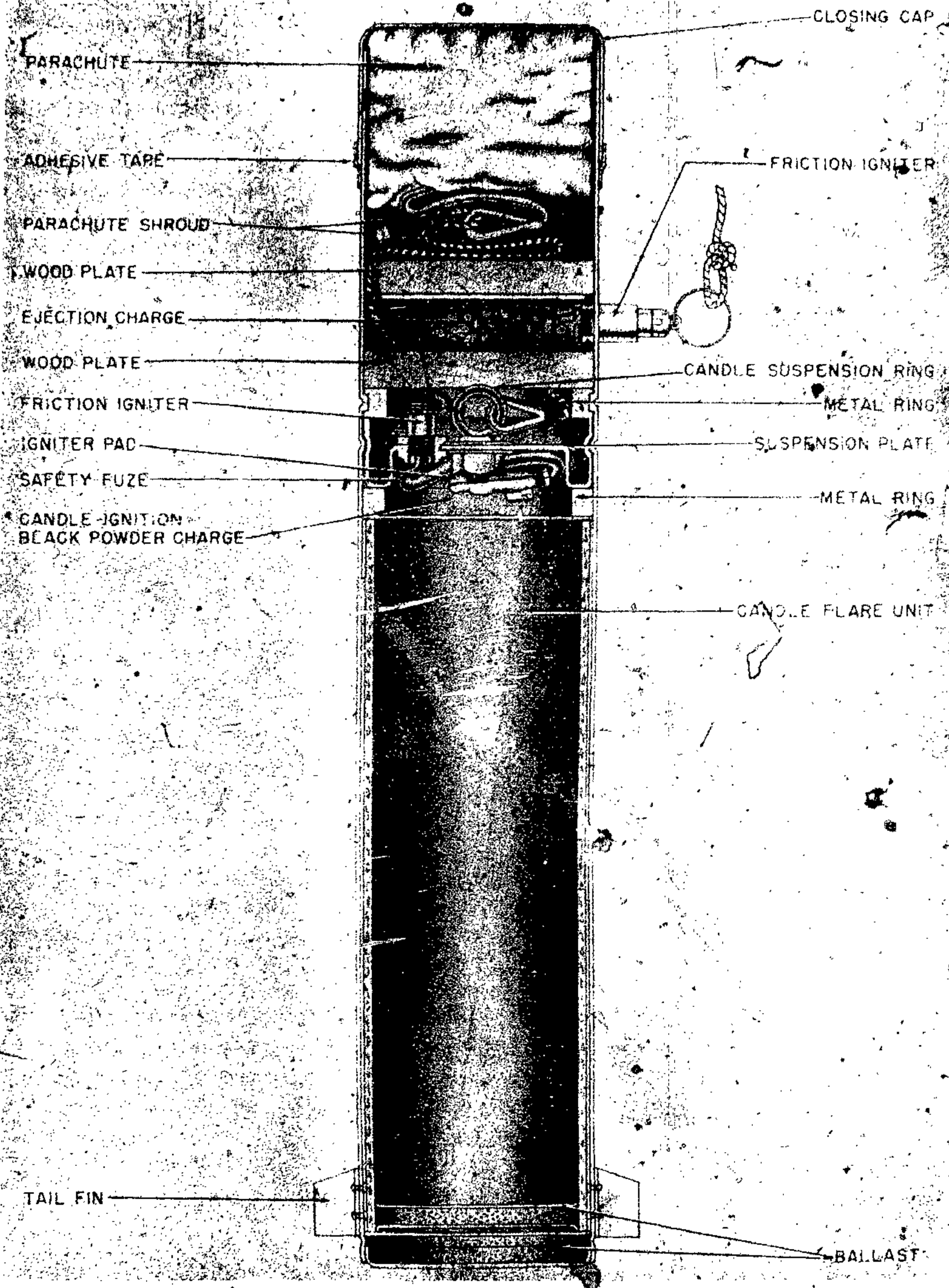

Figure 79—Parachute Flare (Red)—Single Unit

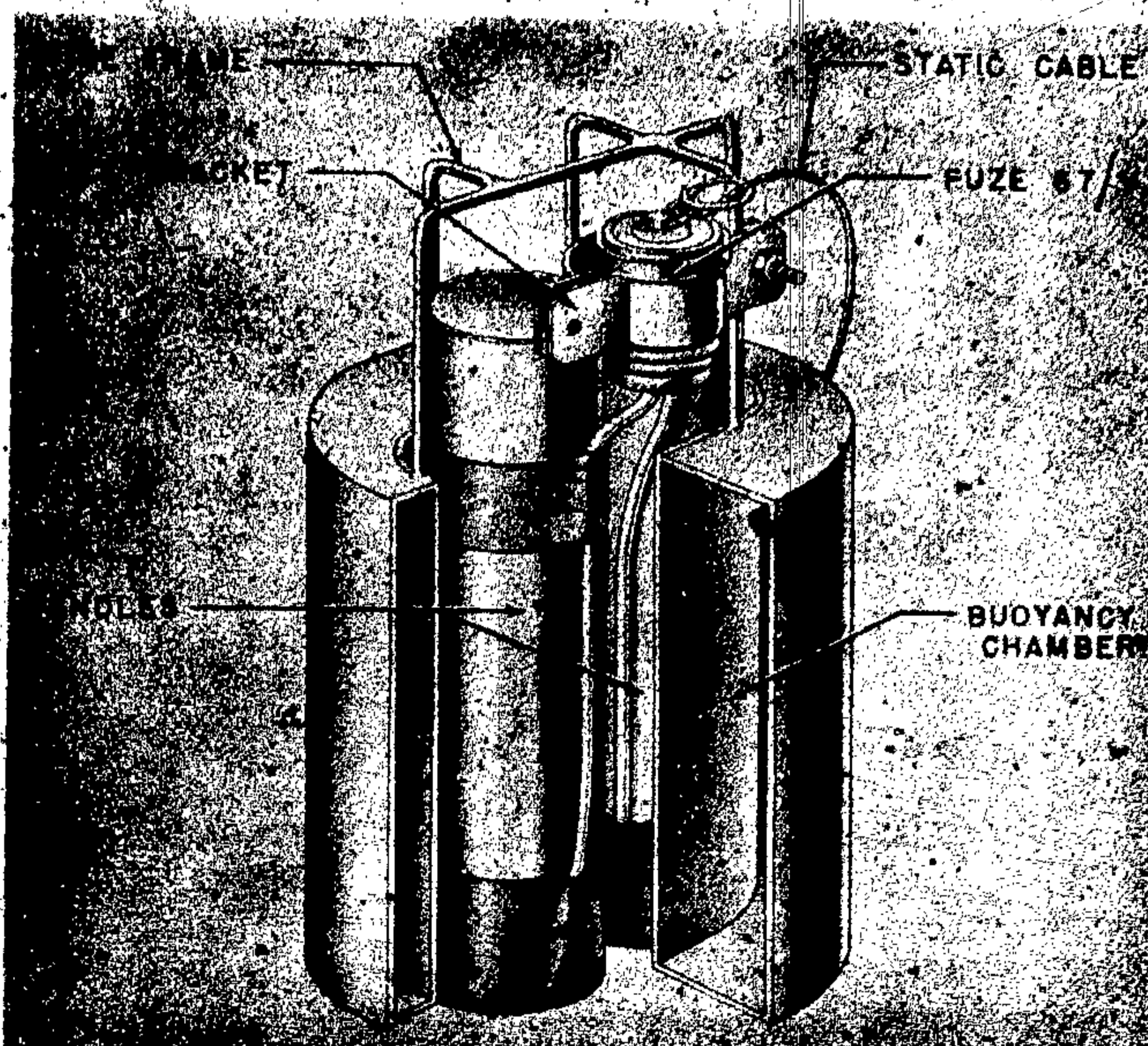

Figure 80—Mark S Flare, Types 1 and 2

A flare has been recovered which is similar in construction except that the case has been cut $\frac{1}{4}$ inch above the metal ring washer and turned over the washer to secure it in position. The over-all length is thereby reduced and only one igniter remains. On release from the container, the parachute opens and operates the friction igniter. The flash ignites the safety fuze and after a predetermined delay the igniter and ejection charges force off the nose cap and eject the candle which simultaneously is ignited by the priming layer composition. There is no ballast in the nose of this flare. It burns for approximately 6 minutes with a red light.

SUSPENSION. Ten of the white flares are fitted into the ABB 500 M10 container or nine flares plus six SD2 bombs are fitted into the Mark 500 Boden 6 SD2 container. The red flare was found in close proximity to a 250 BK container. Each flare is attached to the container by a short length of wire cable, secured at one end to a bracket in the container and at the other to the pull igniter in the side of the flare.

MARK S FLARE, TYPES 1 AND 2

Data:	TYPE 1	TYPE 2
Over-all Length	11.5 in.	7.5 in.
Body Diameter	7.5 in.	7.5 in.
Filling	Flare composition.	
Fuzing	67/V fuze or pull friction igniter.	

CONSTRUCTION. Each flare is composed of a buoyancy chamber, a candle unit, and a fuze. (See fig. 80.) The buoyancy chamber is constructed of sheet steel and is roughly cylindrical in shape with two flattened surfaces to facilitate packing within the container. It is sealed at both ends by a sheet metal plate. Through the center and welded to these plates is a sheet which provides protection and support for the portion of the candle unit extending below the buoyancy chamber. The candle units consist of two candles fitted within the center tube and secured in place by a wooden wedge. The main flare composition is contained in a waxed cardboard tube which in some cases fits within an aluminum outer casing. Both flare candles are sealed at the base with either

GERMAN EXPLOSIVE ORDNANCE

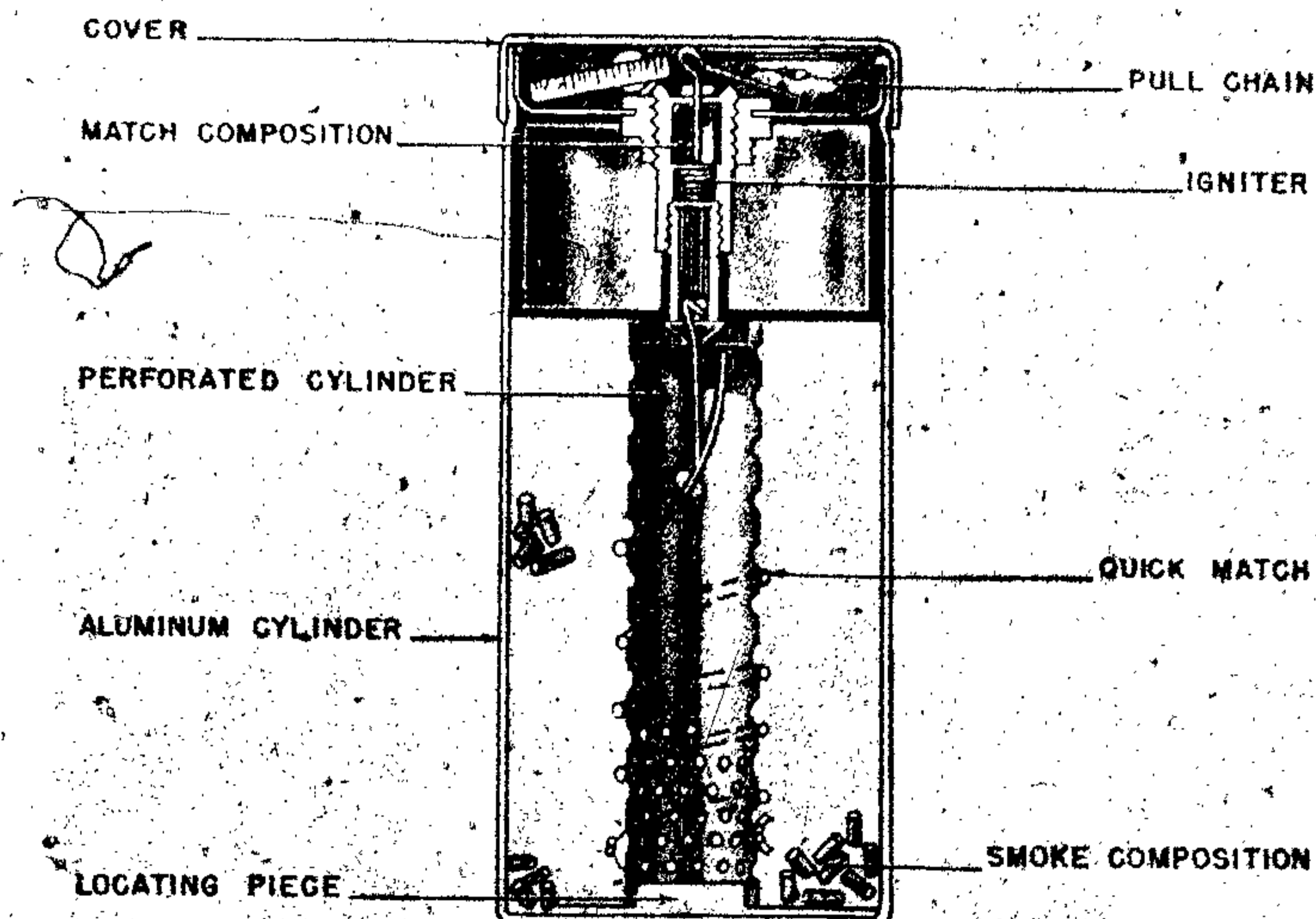

Figure 81—Smoke Flare, Orange, 160

a thin coating of red plastic paint or fabric coated with shellac or in some cases left open exposing the flare composition. At the head of each candle and set within the main flare composition is an aluminum cup filled with grey powder. Above this is positioned a cardboard washer primed with coarse grained black powder. If fuze with the 67/V the head of the candle unit is enclosed by a metal cap. Passing from the fuze between the metal cap and the body of the flare candle is a length of safety fuse which terminates within a shalloon bag containing black powder. This bag is positioned in the center of a wooden collar. The fuze itself is secured to the frame by a bracket. Attached to the base of the fuze is a bakelite adapter to which is fitted the safety fuse from the head of the first candle.

A static cord from the fuze arming pin is secured to a bracket in the lower section of the container. If fuze with a pull igniter, the candle head is fitted with brass wire gauze beneath which are fitted one and a half inflammable biscuits. The head of the candle is open exposing the cardboard washer primed with coarse grained gunpowder. The igniter is secured to the bracket at the head of the buoyancy chamber so that its nose

makes direct contact with the inflammable biscuits. The static cord runs from the igniter to a bracket in the flare container.

Type 2 flares may be found without either a fuze or igniter in which case the head of the first candle is closed by a metal cap in which are two holes. Beneath the cap is a wooden collar housing two shalloon bags, the first containing normal black powder and the second a light green compound. Exactly how these unfuzed flares are ignited is not known.

OPERATION. When the container opens, the flares fall free. The static cord functions either the arming device of the 67/V or the pull igniter, whichever is fitted to the flare. The flare enters the water and returns to the surface, floating with the head of the flare just clear of the water. When the first candle is three-quarters burnt, a piece of safety fuse running to the second candle is ignited and after a short delay the second candle is ignited. Each candle has a burning time of approximately $2\frac{3}{4}$ minutes which, allowing for overlap when both candles are burning, gives a total continuous burning time of 5 minutes for each flare.

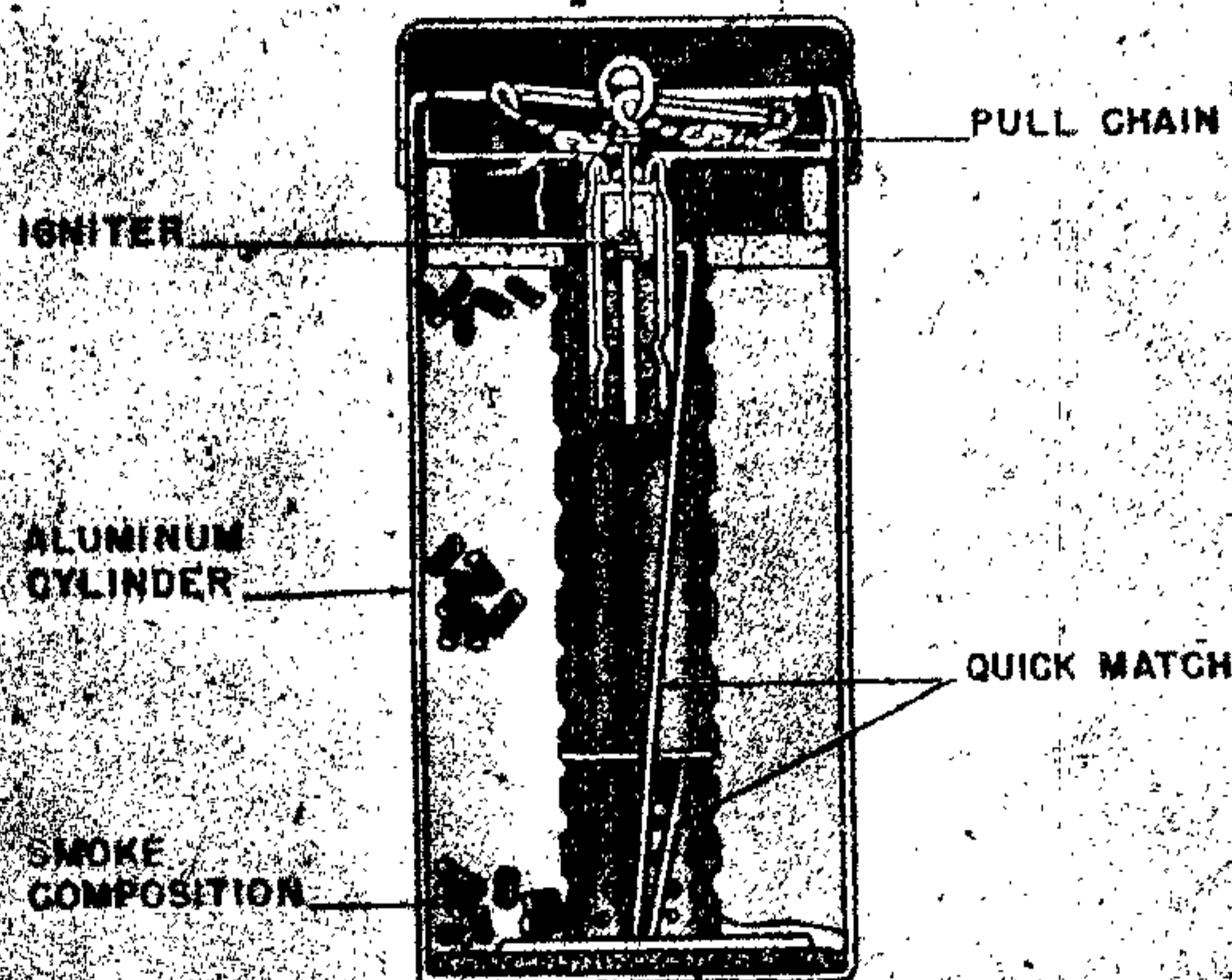

Figure 82—Smoke Flare, Orange, 80

SUSPENSION. The flares are carried in "Mark 70 S" and "Mark AB 70-1" containers; two type 1 and one type 2 flare in each container.

COLOR AND MARKINGS. The candle unit is unpainted aluminum or cardboard; the buoyancy chamber is unpainted steel. If the 67/V fuze is used, the delay is marked on the buoyancy chamber.

SMOKE FLARES—ORANGE 160, ORANGE 80

DATA:	160	80
Over-all Length.....	4.0"	3.4"
Body Diameter.....	1.8"	1.5"
Wall Thickness.....	1/16" (approx.)	1/16" (approx.)
Type of Filling.....	Smoke comp.	
Weight of Filling....	52.0 grams	37.0 grams.
Total Weight.....	132.0 grams	74.0 grams.
Chg/Wt Ratio.....	40.0%	50.0%..
Fuzing.....	Pull igniters	

CONSTRUCTION. The outer case of the flare is an aluminum cylinder with base. A push-on type lid is held in place over the top of the case by a strip of adhesive tape. Inside the flare, at the base is a locating piece with a raised section at the center over which slides a perforated aluminum cylinder. On the outside of this cylinder is wound a length of quickmatch, the upper free end of which projects into the top of the cylinder.

Between the perforated cylinder and the outer case is the smoke filling. The perforated cylinder is positioned at the upper end by a loose-fitting disc over which sits a metal ring. (See figs. 81 and 82.) The igniter is located in an inverted cap, held in place by a locknut. The cap has four smoke escapes covered by cellophane.

The orange 80 differs from the 160 in that the aluminum locating discs and ring of the 160 have been replaced by similarly shaped cardboard pieces. The inverted cap to which the igniter is secured contains six holes instead of four. The outer cap is held by a bayonet joint and adhesive tape.

OPERATION. Both igniters function on the same principle. The igniter containers hold a compressed powder pellet (in the orange 160) or a rubber tube containing a length of safety fuse. Above the powder pellet or safety fuse is a friction cap through which passes the friction wire. The friction wire is coiled at its lower end to resist the pull. A pull-chain is attached to the ring at the top of the friction wire. When this is pulled, the friction wire passes through and ignites the cap which in turn ignites the powder pellet or safety fuse.

REMARKS. These flares are used as wind drift indicators.

SUSPENSION. Placed and ignited by hand.

1. SMOKE SIGNAL FLARE; 2. SMOKE SIGNAL FLARE A. R. D. R.; 3. DISTRESS SIGNAL TORCH

DATA:

Over-all Length.....	4.9''	8.8''	12.5''
Length of Body.....	3.6''	8.0''	11.3''
Diameter of Body.....	1.8''	3.4''	1.4''
Thickness of Wall.....	0.04''	$\frac{5}{64}$ ''	

Filling: Smoke-producing flare compound; position.
Fuzing: Pull igniters.

CONSTRUCTION. 1. Case is a sheet aluminum cylinder with base formed as part of the cylinder and with upper disc crimped to the body. The filling is contained in a ribbed plastic cylinder. (See fig. 83.)

2. Case is a sheet aluminum cylinder with both base and top plates crimped into the body. A lower and an upper spacer disc with hollow cylinders attached locate four perforated aluminum tubes. A cardboard disc is painted with black powder and rests on the upper disc. A metal ring holds the cardboard and spacer disc in place. The filling is divided into layers by discs. (See fig. 84.)

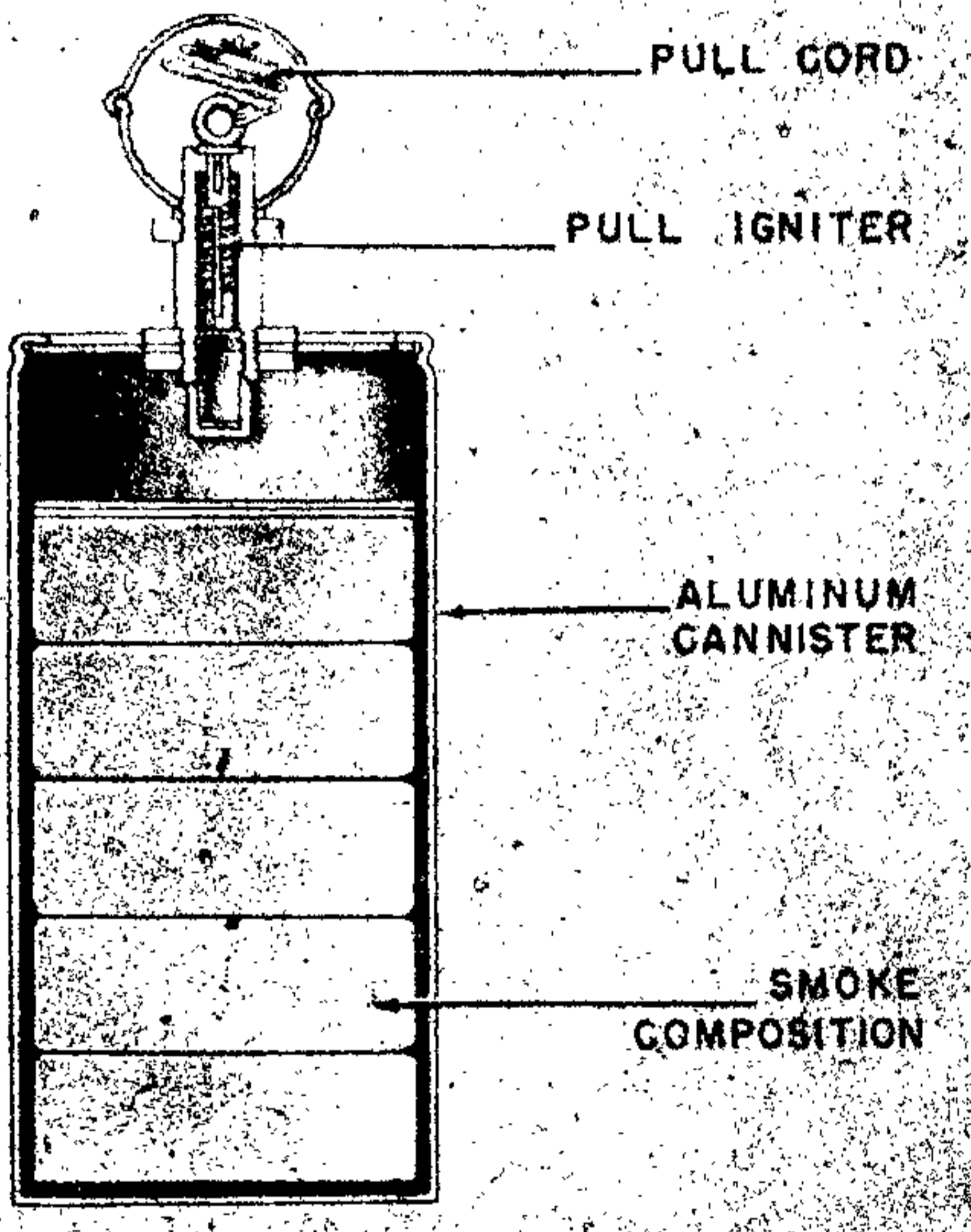

Figure 83—Smoke Signal Flare

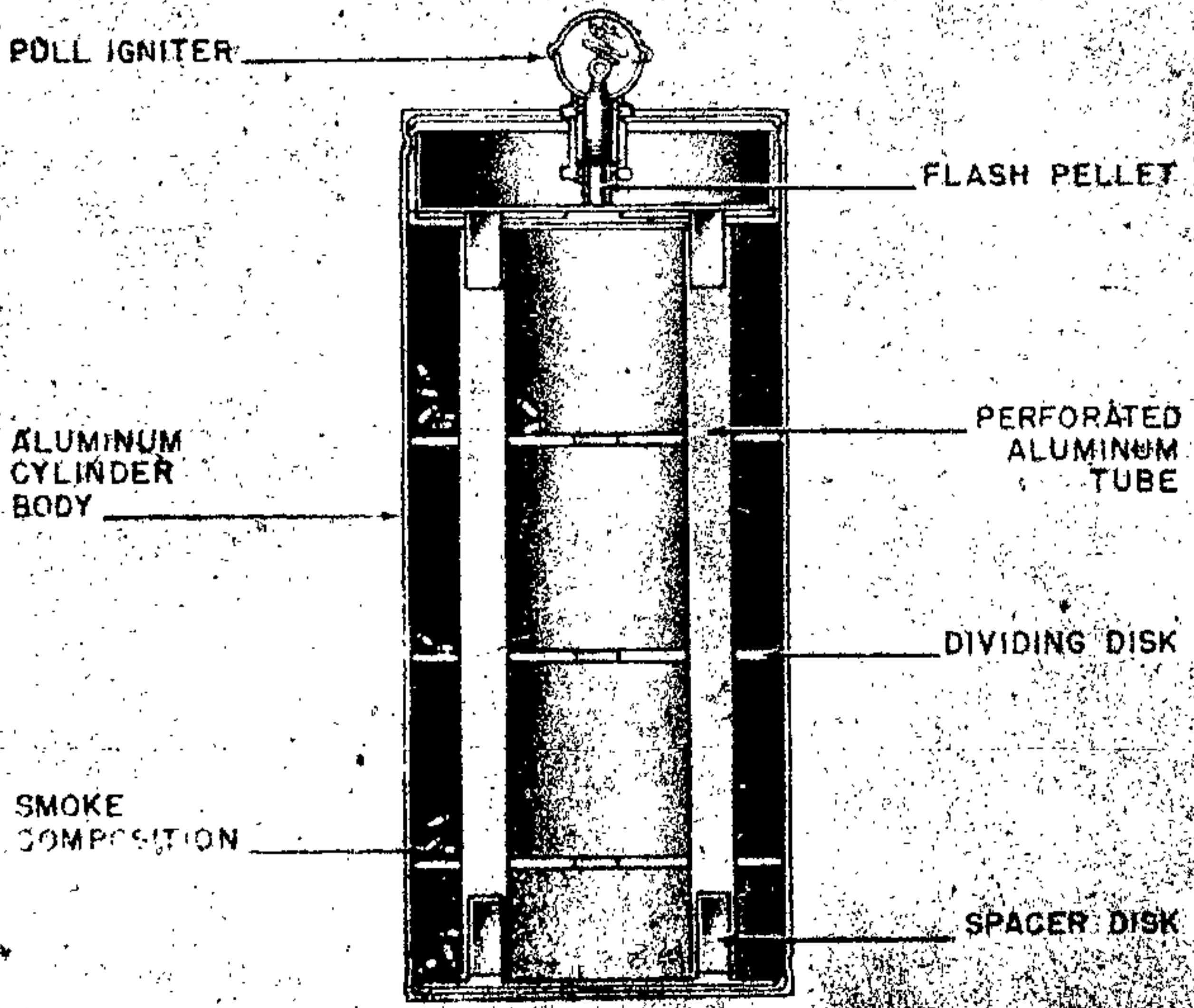

Figure 84—Smoke Signal Flare A. R. D. R.

3. Case is a sheet aluminum cylinder. The base is a cement disc secured by four screws and retains the folding handles. The top plate is crimped into the body and the igniter is covered by a cap held in place by adhesive tape. Above the cement base disc are three pressed cylinders of flare composition which burn respectively red, white, and red. On top of the upper flare cylinder is a disc of ignition mixture. A cardboard washer above this is held in place by a metal cylinder. (See fig. 85.)

In all three types the igniter is held in place by two lock nuts. The closing disc of the flares may have one or more holes to emit smoke.

REMARKS. 1 and 2 are used as navigation aids by pilots; 3 is used as a distress signal.

COLOR. 1. Painted yellow; cap of igniter is red; 2. Painted to indicate color of smoke, so far either red or violet; 3. Painted red with white paper strip around body at location of white flares.

PHOTOGRAPHIC FLASH BOMB BLC 50 (30-kg)

DATA:

Over-all Length: 43.0 in.

Body Length: 26.4 in.

Body Diameter: 7.8 in.

Wall thickness: $\frac{3}{32}$ in.

Tail Length: 16.0 in.

Tail Width: 11.0 in.

Filling: Flare composition.

Fuzing: (9) fuze.

CONSTRUCTION. In exterior appearance, this bomb is similar to the SC 50-kg type I except that the case is made of sheet steel with a heavy nose section. There is a circular steel plate just forward of the fuze pocket and the nose section is not filled. The base plate is attached by shear screens. The tail is similar to that of the SC 50-kg bomb consisting of four vanes welded to a cone which is riveted to a base plate. (See fig. 86.)

SUSPENSION. Vertical or horizontal.

COLOR AND MARKINGS. The bomb case may be painted yellow or aluminum with "BLC 50" and manufacturers' markings stenciled in black. The tail assembly is painted dark grey.

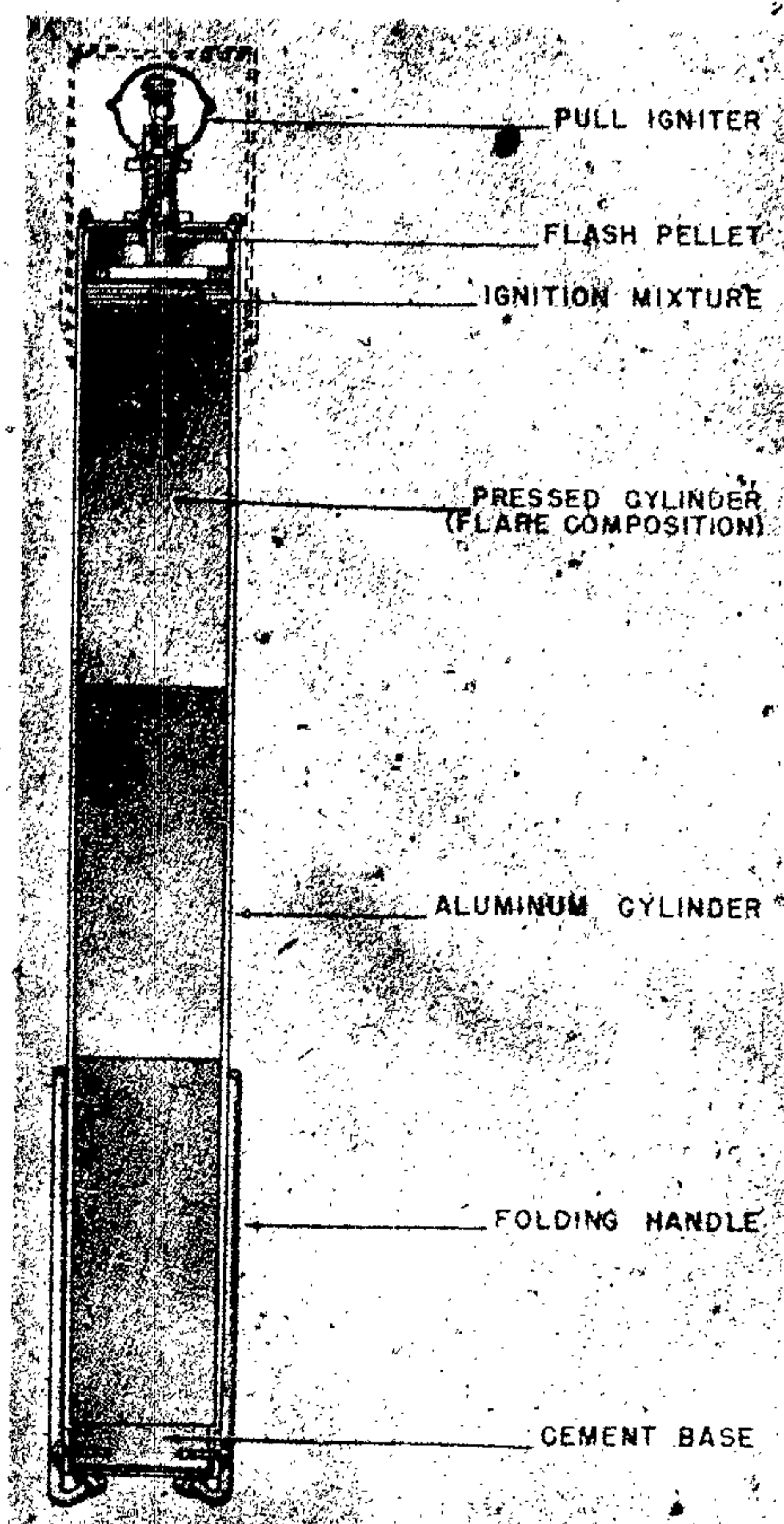

Figure 85—Distress Signal Torch

BLC 50 PHOTOFLASH BOMB

DATA:

Over-all Length: 42.9 in.

Max. Body Diameter: 8.0 in.

Diameter Across Tailfins: 11.0 in.

Length of Detonating Fuse: 31.5 in.

Weight of Standard Charge: 15.0 kg.

Peaklight Intensity: 450 million Hefner candles.

Time of Peak Intensity: 70 milliseconds.

Total Light Output: 63 million Int. candle seconds.

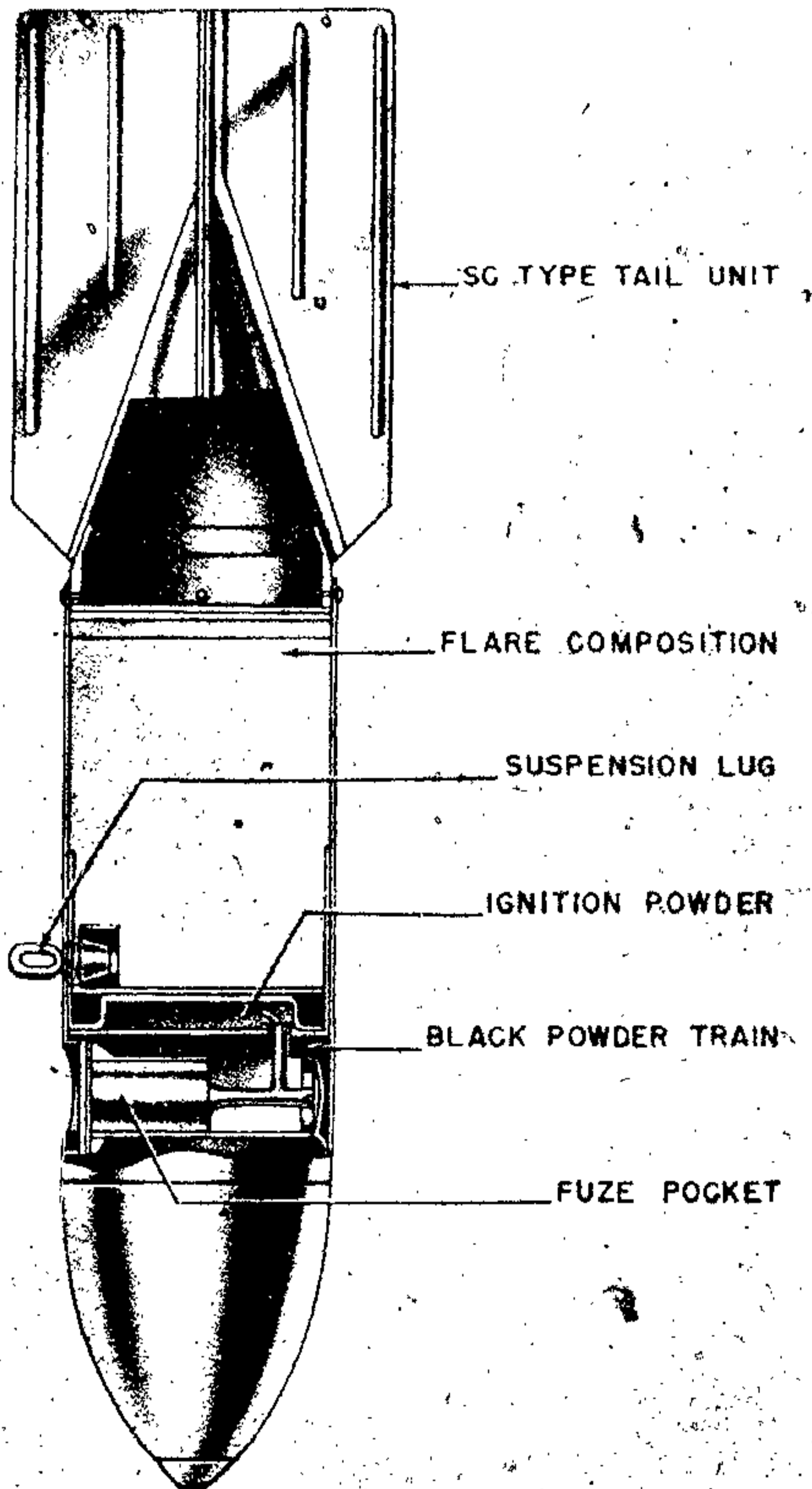

Figure 86—BLC 50 (30-Kg) Photoflash Bomb

GENERAL. It has been found that the Luftwaffe employed a photoflash bomb containing powdered aluminum, which was scattered into the surrounding air by the explosion of the inner core of black powder. Due to the heat of the explosion, the aluminum powder burned in the oxygen of the air and produced a rapid flash. The bomb weighed considerably more than the conventional type of photoflash bomb, which employs an intimate mixture of powdered oxidizing agent and magnesium or aluminum, and it produced a slightly lower peak candle power output. The time to reach peak intensity was also lower. However, the German

bomb possessed a very great advantage in fact that it was not sensitive to bullet impact, and was therefore much safer to employ.

DESCRIPTION. The BLC 50 photoflash bomb consists of a comparatively light steel casing approximately 42.9 inches long and 8 inches in diameter. (See fig. 87.) The total weight of the bomb is 42 kg. There is a heavy concrete nose piece which acts as a ballast to stabilize the flight of the bomb. The bomb itself consists of three approximately concentric tubes. The outer tube contains 15 kg of aluminum "pyroschliff," which is an extremely fine, flaked aluminum powder, having the following characteristics:

- Metal content: 87-92%.
- Fat content: Less than 0.1%.
- Moisture: Less than 0.5%.

Another tube placed within the outer tube contains 3.5 kg of black powder, serving as the explosive which scatters and ignites the outer charge of aluminum powder. The black powder, "Marine-Geschutz" pluver, possesses the following characteristics:

- Moisture content: Less than 1.3%.
- Granulation range: 0.68 to 1.3 mm.
- Chemical composition:
 - Potassium nitrate: 75%.
 - Sulphur: 9%.
 - Beech charcoal: 16%.

The black powder is exploded by means of an 80-cm length of detonating fuse which is placed inside a third tube passing through the black powder charge. The ends of the detonating fuse are dipped in a 4 percent solution of collodion, and allowed to dry.

The bomb is ignited by means of the standard type of electrically ignited delay fuze which is inserted in the fuze well in the side of the bomb.

REMARKS. In order to increase the usable light output of the BLC 50 photoflash bomb, the following researches were carried out recently:

A. The fine, flaked aluminum "pyroschliff" powder was replaced with an atomized aluminum powder called "griess." The new, atomized powder possessed spherical particles, and therefore had approximately twice the apparent density of the flaked form. Approximately 30 kg of the atomized powder could be placed in the volume formerly occupied by 15 kg of aluminum "pyro-

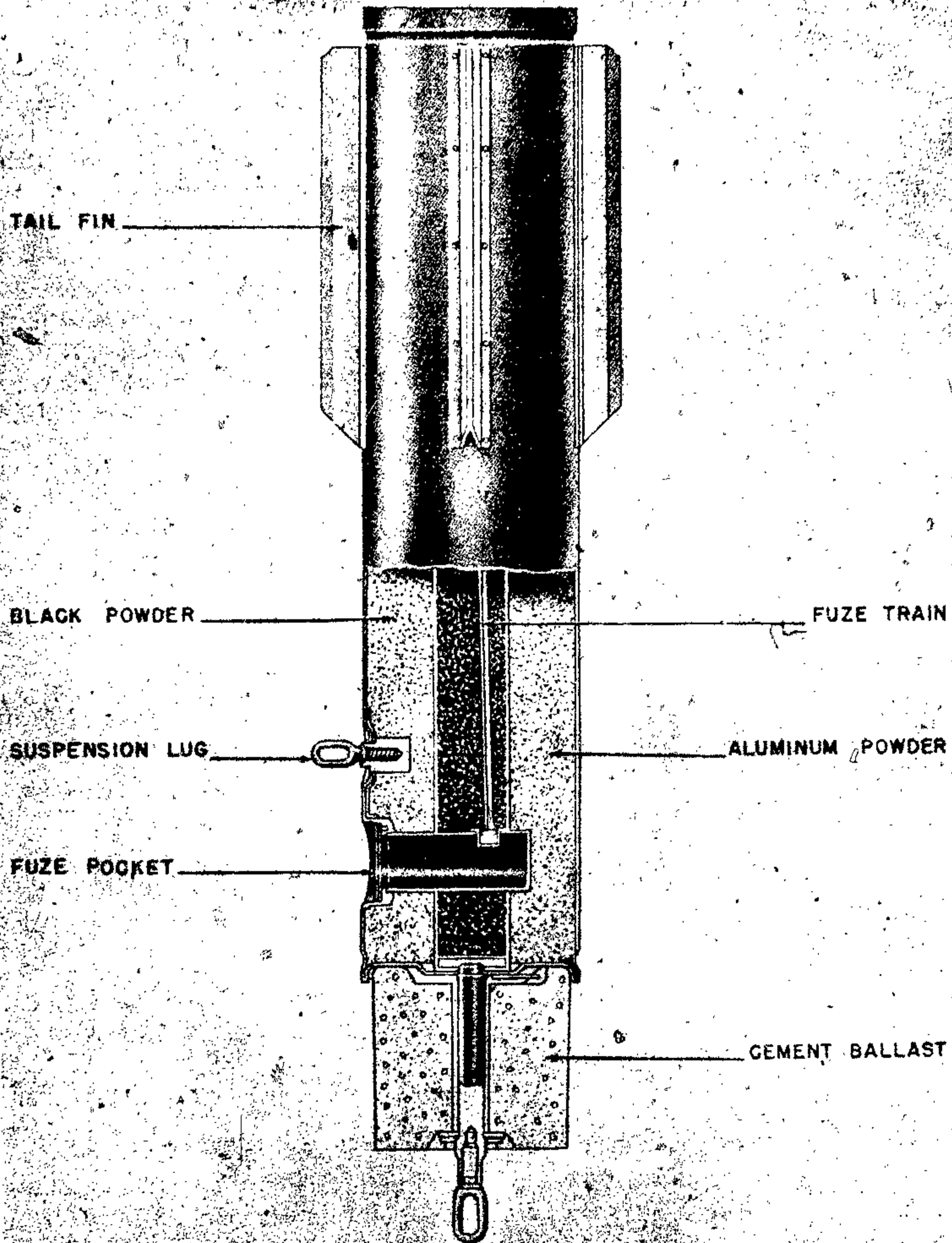

Figure 87—BLC 50/A Photoflash Bomb

schliff." This procedure increased the peak intensity from 450 to 800 million Hefner candles. However, the flash was very much slower, that is, the time to reach peak intensity was longer, and the total duration of the flash was longer. It was also

stated that the results could not be reproduced, because of variations in the characteristics of the atomized aluminum powder.

B. The 15 kg charge of flaked aluminum powder was replaced by 28 kg of pellets (13 mm diam-

GERMAN EXPLOSIVE ORDNANCE

eter and 7 mm height) composed of the following composition:

- Magnesium powder: 39%.
- Barium nitrate: 53%.
- Synthetic phenolic resin: 6%.
- Talcum: 2%.

These pellets were packed in the outer tube of the bomb together with 9 kg of black powder and then a length of detonating fuze added.

This bomb, when exploded, produced a peak intensity which was only 80 percent of that of the standard BLC 50 bomb. The time to reach peak intensity (100 milliseconds) was longer than that of the standard bomb, and the durations of the flash at one-half and one-tenth maximum intensity were much longer (230 and 550 milliseconds, respectively). In addition, this bomb was found to be sensitive to bullet impact.

C. The standard 15 kg aluminum powder charge was replaced by one huge pellet weighing 24 kg. The composition of the pellet was as follows:

- PTN: 50%.
- Magnesium powder: 50%.

The results of the firing tests conducted with this bomb were very disappointing. They indicated a peak intensity only one-fifth of that of the standard bomb. The flash was very slow, since the durations at one-half and one-tenth maximum intensity were 500 and 1,000 milliseconds, respectively.

D. The standard 15-kg charge of aluminum powder was replaced by one composed of 28 pellets of the following composition:

- Sodium nitrate: 45%.
- Magnesium: 50%.
- Wax: 5%.

Each pellet had hollow axial space, weighed 900 gm, and measured 60 mm diameter and 220 mm in height. The total weight of pellets placed in the bomb was 25.2 kg. A length of detonating fuze was passed through each pellet and all of the ends of the fuze bound together.

The results of the firing tests conducted with this bomb indicated that the total peak intensity was approximately the same as that of the standard bomb. However, the peak intensity measured through a yellow filter (which is considered important when photographing at night in the presence of a slight ground haze) was 20 percent

greater. Although the time intensity curve for the flash rose at the same rate as that of the standard bomb, the duration of flash was very much longer, being 400 and 800 milliseconds at one-half and one-tenth maximum intensity respectively. This indicated that the total light output was very much greater than that of the standard bomb. However, this light would not be usable if short exposures were employed. In addition the bomb was found to be sensitive to bullet impact.

E. In order to decrease the time of the flash, and thereby raise the peak intensity and concentrate it in a small time interval, a bomb was loaded using the same general procedure as C, but pressing each pyrotechnic pellet into a separate steel case in order to increase the confinement. Detonating fuze was inserted through each pellet as before. The results of tests with this bomb showed that the peak intensity could not be appreciably raised. The bomb was also found to be sensitive to bullet impact.

F. The results of all of the above tests indicated that the peak intensity, and therefore the total usable light output, in a short exposure time could not be increased appreciably. However, most of the experimental bombs produced longer flash durations, with intensities consistently as high as that of the standard bomb. Therefore, efforts were directed toward the utilization of longer exposure times. A camera, known as the "E-5," employing a moving film holder to compensate the movement of the airplane, was developed recently (Source B). The "E-5" camera makes possible the use of very long exposure times, and thus permits the use of photoflash bombs producing a long, slow flash. In this manner the total usable light output can be multiplied three to four times.

Safe photoflash bombs, employing outer layers of large amounts of atomized magnesium or aluminum powder can then be used, because all of the light of the relatively slow flash is useful.

TARGET INDICATOR (RED)

DATA:

- Over-all Length: 13.25 in.
- Body Diameter: 3.4 in.
- Filling: Flare composition.
- Fuzing: Pull igniter.

CONSTRUCTION. Flare composition is contained in a cardboard cylinder which fits into an aluminum casing and seats against a washer touching the suspension plate. (See fig. 88.) It is secured at the nose end by two plates, the end of the casing being slightly indented to hold these. The suspension plate holds an eye to take the parachute shackle, and a pull igniter which is connected by a $4\frac{3}{4}$ inch length of safety fuse to a small bag containing gunpowder. This serves both to set off the igniter pellet in the top of the candle and to eject the latter from the casing when it falls freely to earth and acts as a ground marker. The pull igniter is attached to the loop of the shroud lines by a cord; the opening of the parachute gives the necessary pull for operating the igniter. There are two small fins at the nose end of the container; their purpose is not clear.

REMARKS. Container from which indicators were recovered was marked with a red band corresponding to the color of the flare.

SUSPENSION: The indicator is carried in Mark 250 BK-3SD2 container.

MARKER BOMB (SEA)

DATA:

Over-all Length: 4 ft. $8\frac{1}{2}$ in.

Body Diameter: 8 in.

Wall Thickness: $\frac{1}{32}$ in.

Tail Length: 9 in.

Tail Width: 10 in.

Fuzing: Inertia weight switch.

CONSTRUCTION. The sheet steel, bomb-shaped body is supported internally by a series of eight annular strengthening bulkheads. Welded to the after end of the body is a tail cone which terminates in a short parallel sided tube over which is assembled an adapter designed to accept the aluminum body of the lamp unit. Four stabilizing fins are welded to the tail cone and strengthened by metal struts. The nose portion of the bomb body is welded to the parallel-sided portion of the body and terminates in an annular flange to which the solid steel nose plug is bolted through a castellated collar. The rear face of the nose plug has been recessed to form a housing approximately $1\frac{1}{2}$ inches deep for the battery unit which is assem-

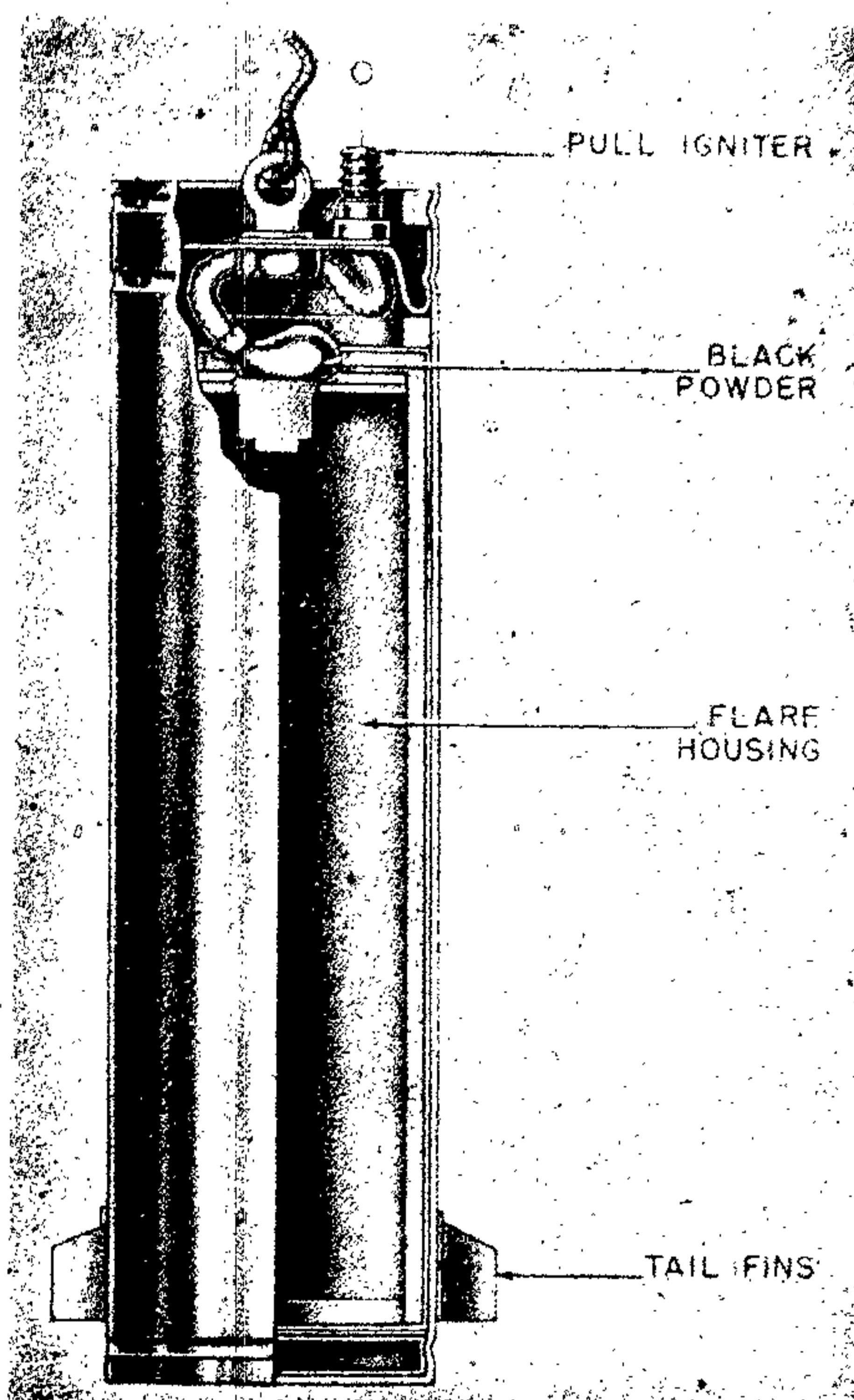

Figure 88—Target Indicator (Red)

bled inside a central tube of drawn steel $18\frac{1}{2}$ inches long and $4\frac{1}{8}$ inches internal diameter. The battery unit consists of a series of small dry cells contained within an insulate cylinder. (See fig. 89.)

Provision is made for six cells in each layer, the cells being arranged around a central tube through which a retaining bolt passes to secure it to the nose plug. The rear end of this tube is closed by means of a closing cap to which an annular brass contact disc is secured and which is held in place by means of a washer and nut. A contact is located in the tail adapter by a grub screw and slot arrangement. Passing through the contact bush and screwing into the tail adapter is a lamp unit which consists of a cast aluminum body with an

GERMAN EXPLOSIVE ORDNANCE

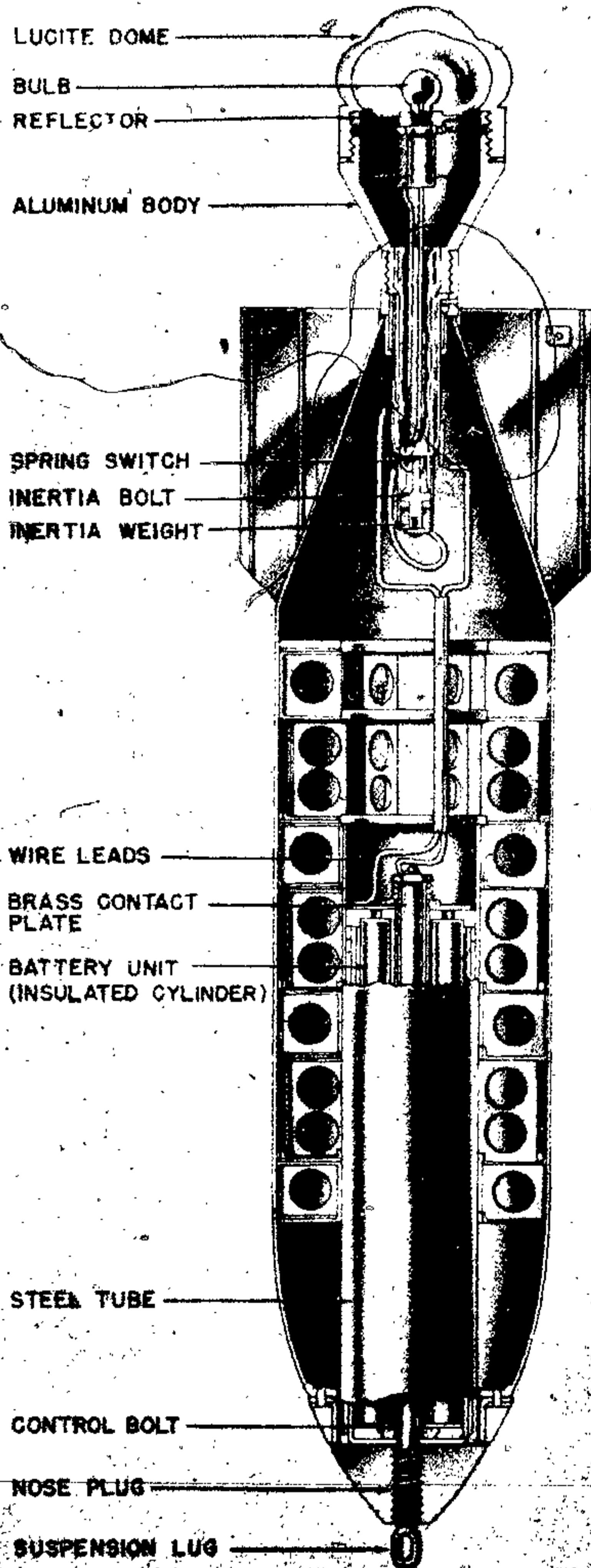

Figure 89—Sea Marker Bomb

insulated contact rod secured through the base of the casting by two grub screws. At the base of the rod, a spring switch is mounted with leads to the battery unit and the lamp unit.

Positioned between the two arms of the spring switch is an insulated inertia bolt which breaks the contact until closed on impact. The lamp unit is spring mounted to protect it from shock and covered by a lucite type dome. When the marker is released from the aircraft, the inertia bolt is positioned between the plates of the spring switch and one side of the circuit between the lamp and the batteries is broken. On impact, the inertia bolt is forced out of position and the circuit between the lamp and battery is completed. As the batteries fill, only a portion of the bomb body and all joints are made tight by rubber washers, the marker floats on the surface of the water, and it is assumed, provides a recognition or bearing point for aircraft.

SUSPENSION. Vertical.

COLOR AND MARKINGS. Painted yellow over-all.

No markings.

LUX EZ 50 SC (SEA MARKER)

CONSTRUCTION. The marker is constructed in two parts. The rear portion consists of a cylindrical steel container to the rear end of which are attached four metal fins; behind these is situated a flat metal base plate of the same diameter as the marker and having attached to it a spring loaded platform which in turn houses a green silk drogue. Projecting also from the base plate is a frosted globe.

At the other extremity of the rear portion of the marker is situated a fuze pocket sealed by a steel disc and locking ring. Forward of this and next to it is a carrying lug. The front portion of the marker consists of a heavy steel nose which is internally attached to the rear portion, the joint being visible as a thin groove. Screwed to the end of the nose is a circular steel plate which serves as a kopfring. (See fig. 90.)

The forward portion of the marker contains another fuze pocket. Forward of this is a small hole covered by a thin steel disc held by a spring clip; a similar hole is situated on the other side of the nose diametrically opposite to it. Passing down the side of the marker is a piece of thin S. W. R. which passes through a small hole where the two halves of the marker join together.

OPERATION. Immediately upon release from the aircraft the drogue is pulled out by means of a rip cord attached to the aircraft and the (17) A fuze in the forward end of the marker is charged. The speed of the marker's fall is slightly reduced by the drogue. Upon striking the water it sinks to the bottom, burying its nose.

After a preset delay up to 72 hours, the (17) A fuze fires a small charge of gunpowder contained in a bakelite gaine. The pressure created by this explosion releases the catch holding the two halves of the marker together. The front portion of the marker is forced off the rear portion by its spring-loaded plunger. As soon as the two halves separate, the electrical hydrostatic switch on the rear portion is free to close on release of water pressure. The rear portion of the marker having positive buoyancy now rises to the surface of the water, unwinding as it does so the S. W. R. contained on the drum of the forward portion of the marker which now acts as an anchor.

As soon as the cylindrical rear portion reaches the surface, the hydrostatic switch closes. The battery is now connected up in parallel with the motor and the lamp. The motor revolves and by means of a gear train operates a contact breaker, thus causing the 24-watt bulb to emit a series of light flashes. The frequency, alternation, and duration of the flashes emitted vary in each marker.

The closing of the hydrostatic switch also allows the battery to charge the (17) A fuze. After a delay the fuze fires. The electro-magnetic current inducer attached to it produces a flow of electricity which fires two ignition bridges in the end plates of the marker. The flooder plugs are blown out thus destroying the marker by permitting it to sink.

SUSPENSION. Horizontal by standard German eyebolt.

REMARKS. A soluble plug on the drogue housing allows the drogue to break free from the marker after it has entered the water.

COLOR AND MARKINGS. The complete marker is colored fawn and has the following stenciled in black on the side:

Kennung K. B., Seiklange 200 m, ZW

Verbrauchen B 15

On the nose is stenciled: LUX. E 250.

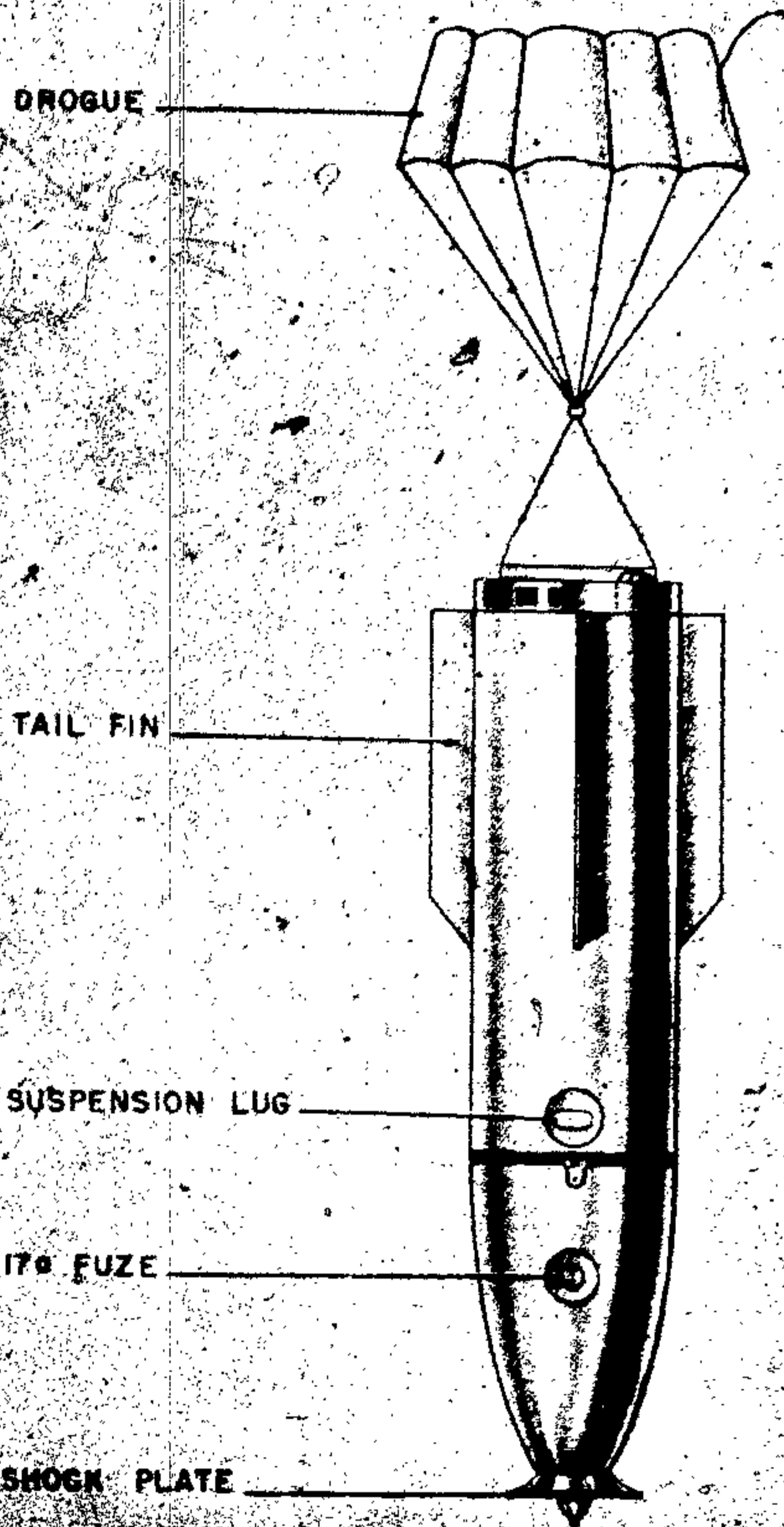

Figure 90—Lux EZ 50 SC Sea Marker

SINGLE UNIT GROUND MARKER, MARK 3 GRUN

DATA:

Over-all Length: 13 in.
Body Length: 11.75 in.
Body Diameter: 3.25 in.
Wall Thickness: 0.25 in.
Filling: Flare composition.
Fuzing: (67).

CONSTRUCTION. The outer casing consists of a thin sheet steel cylinder with a single seam running the entire length of the case. Two sheet

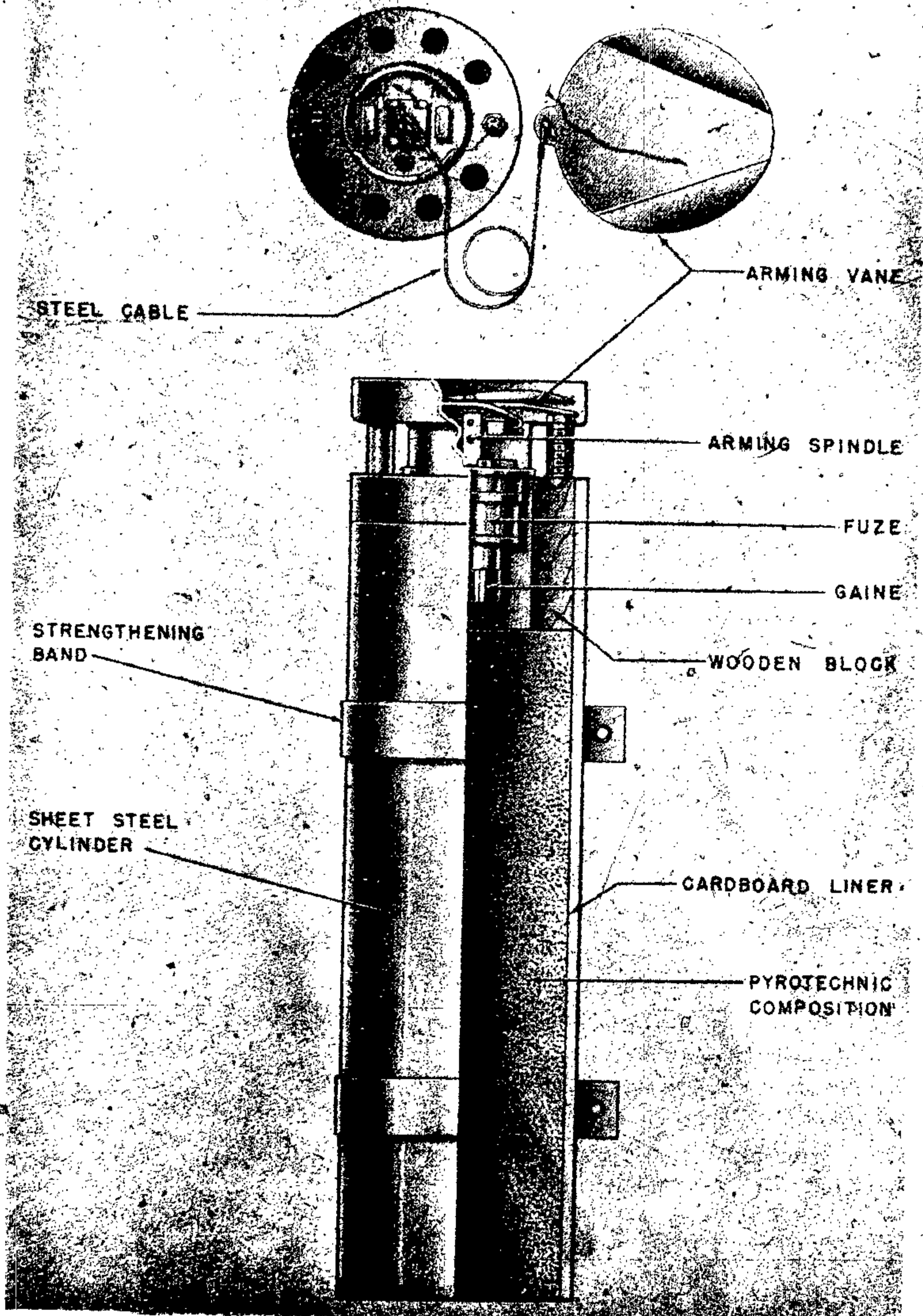

Figure 91—Mark 3 Single Unit Ground Marker (Green)

steel strengthening bands are fitted externally to the steel cylinder. Each strengthening band is secured in position by a nut and bolt. A cardboard cylinder within the steel cylinder forms a lining for the pyrotechnic composition. A cylindrical wooden block is housed in the upper portion of the cardboard cylinder. The wooden block, cardboard cylinder, and a steel cylinder are secured together by means of three small panel pins. A pressed steel cover cap fits over the upper portion of the cardboard cylinder and wooden block protruding beyond the steel cylinder. The cover cap is designed to permit entry of the fuze body but engages the flange on the upper portion of the fuze body. The cover cap is secured to the cardboard cylinder and wooden block by means of three panel pins. (See fig. 91.)

The steel housing for the arming vane is secured to the cover cap by means of two nuts and screws, the screws being fitted with distance pieces. The wooden block is countersunk at two points to accommodate the screw heads. The flanged portion of the arming vane housing has eight vent holes. The lower cylindrical portion of the housing has a slot for observing the position of the arming spindle of the fuze; it is also recessed at two points on the lower surface to permit the housing to fit over and engage the upper surface of the projecting lugs of the fuze. The upper cylindrical portion of the housing is drilled at four points for housing the safety wire; it also has a recess for accommodating the arming wire attachment lug on the arming vane. The arming vane consists of a circular sheet steel plate, two segments of which are bent over in opposite directions at an angle 45°. Ten inches of light steel cable is secured to the arming vane and the arming spindle of the fuze. The arming vane is a loose fit within the arming vane housing. The steel cable is stowed below the arming vane, the latter being retained in position by the safety wire.

The fuze is a normal (67) fuze fitted with a bakelite gaine case filled with gunpowder. It is believed that a bursting charge is incorporated in the lower portion of the pyrotechnic filling in order to discourage attempts to extinguish the target marker on the ground.

OPERATION. On release from the aircraft and subsequent opening of the container, the safety wire is withdrawn presumably by means of a static cord. Alternatively the safety wire may be with-

drawn prior to stowing the marker in the container. The current of air passing through the vent holes in the arming vane ejects the arming vane. By reason of its shape, the arming vane is rotated as the missile falls. This rotation unscrews the arming spindle of the fuze thus permitting the clockwork mechanism of the fuze to function.

The missile falls to the ground and once the present delay on the fuze has expired, the gunpowder in the gaine case is ignited. The resulting flash ignites the pyrotechnic composition and ejects the cover cap, fuze, and arming vane housing.

The pyrotechnic filling burns with a strong greenish flame for approximately 3½ minutes. A slight explosion occurs when the bursting charge is ignited.

COLOR AND MARKINGS. Fawn-colored.
"Mark 3 Grun."

PARACHUTE RECOGNITION SMOKE GENERATOR

DATA:

Over-all Length: 20 in.

Maximum Diameter: 8 in.

Fuzing: Pull friction igniter.

Filling: Smoke producing composition. (Heat stable blue dye 42% mixed with potassium chlorate 33% and lactose 25%.)

Total Weight: 27.5 lb.

CONSTRUCTION. The smoke generator has an aluminum cylindrical-shaped body divided into two sections. One section houses the smoke-producing parts and the other the parachute. (See fig. 92.)

The smoke-producing section is divided into sections by 3 metal plates. These metal plates are connected by 12 metal distance rods. Eight of these distance rods are equally spaced around the circumference of the plates while the remaining four are spaced equal distance from and closer to the center. The smoke canisters are held in two tiers, each of four canisters. The arrangement of rods ensures that the smoke canisters are firmly held. Four 1.4-in. holes are drilled in the plates for the igniting tubes.

The individual smoke canisters are aluminum cylinders lined with stiff waterproof paper. They contain four annular blocks, three of smoke composition and one of a clay-like substance. The

GERMAN EXPLOSIVE ORDNANCE

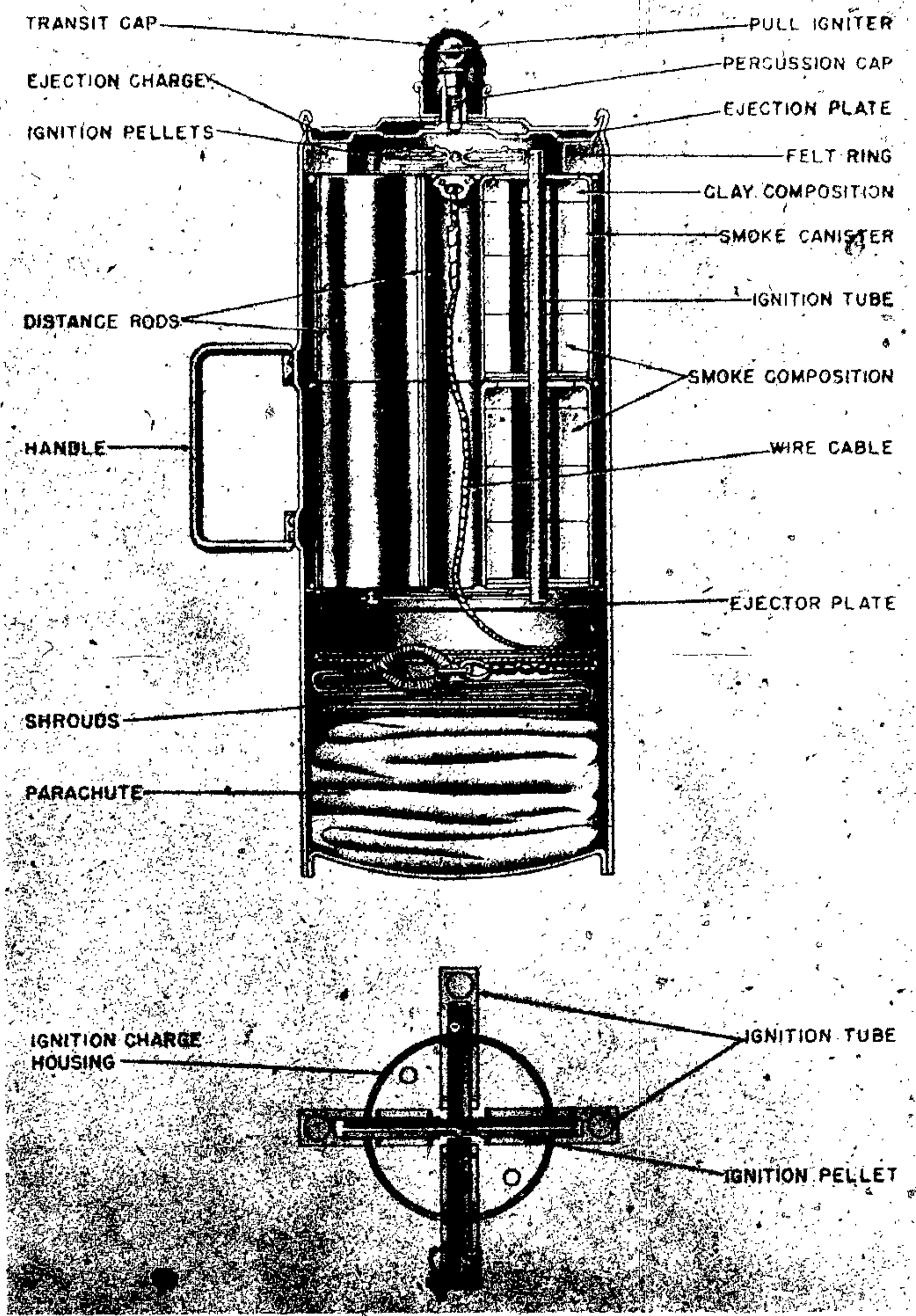

Figure 92—Parachute Recognition Smoke Generator

priming composition is gunpowder and each of the three smoke composition blocks has a small quantity placed in loose at the base before pressing to ensure ignition between one block and the next. Each canister emits smoke of good density for about 26 seconds.

The ignition pellets are arranged to accept flash of ejection charge and distribute it to the four ignition tubes, each of which pierce the center of two smoke canisters. A total of 14 gunpowder ignition pellets are packed in these tubes. The ejection charge consists of one-half ounce of fine

mesh gunpowder. It is positioned directly below the pull igniter. Below this is the first metal ejector plate. It has a hole in the center which allows the flash to ignite ignition pellets. In the lower part of container, directly above the parachute, the second ejector plate is positioned. This prevents the parachute from becoming damaged or entangled in the outer container.

The parachute canopy is made of continuous

filament viscose rayon. It is built up from 12 panels each 4 feet 11 inches wide by 6 feet 10 inches high. Attached to the canopy are 12 rigging lines each 13 feet long which in turn are attached to an eyeloop which is secured to the top plate of the container.

OPERATION. The transit cap is removed; then the friction igniter knob is unscrewed and pulled longitudinally. The generator is then allowed to

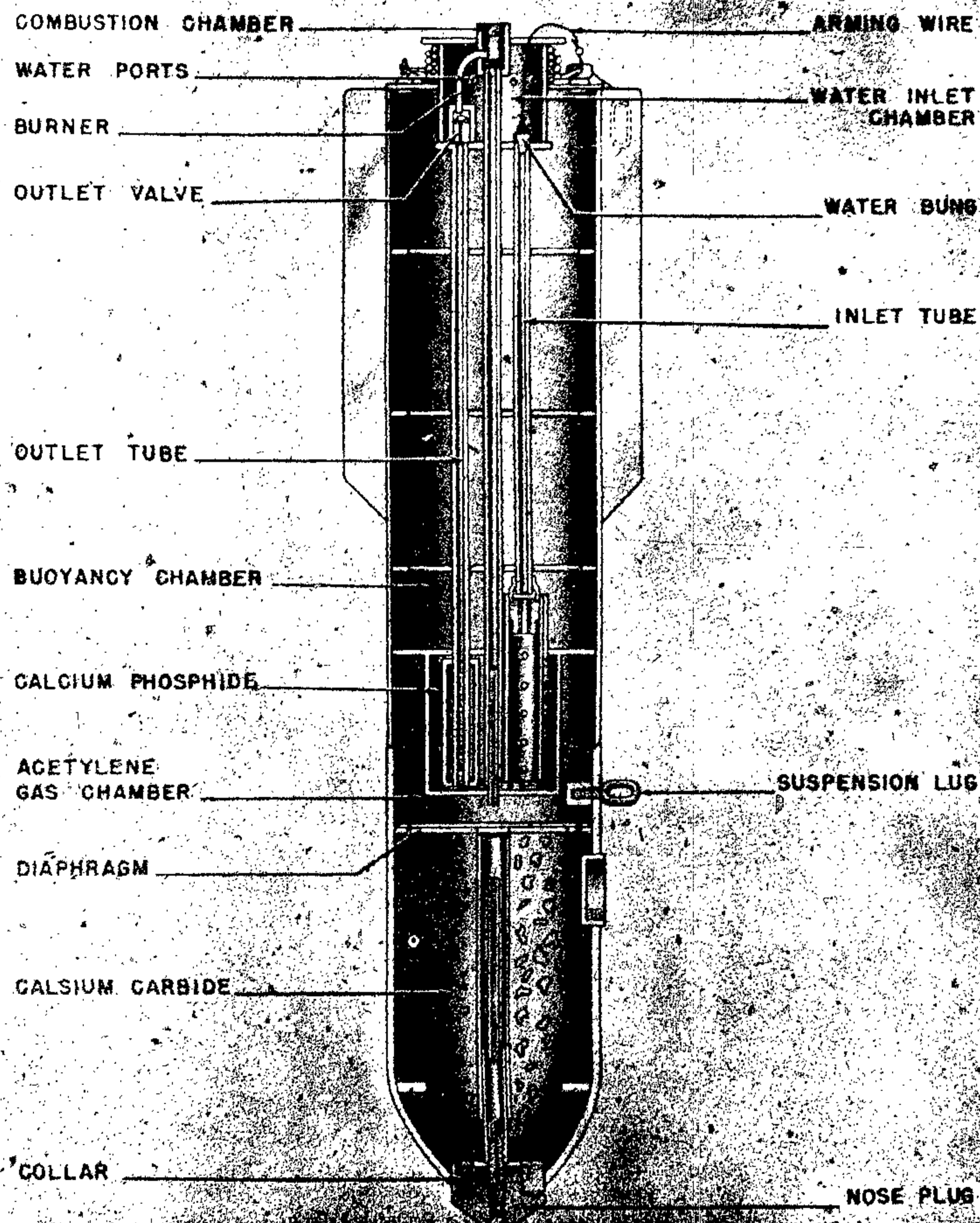

Figure 93—Lux N Flame Float

GERMAN EXPLOSIVE ORDNANCE

fall clear. After a delay of 4 to 5 seconds, the igniter functions and the flash from the detonator passes to the ejector charge, which on exploding forces out the contents of the container to be supported by parachute when this opens. Pellets on ignition pass the flash to the perforated ignition tubes.

"LUX N" (FLAME FLOAT)

DATA:

Over-all Length: 3 ft. 6 in.

Body Diameter: 8 in.

Tail Length: 15.75 in.

Fuzing: None. Float ignited by chemical reaction between calcium phosphide and water.

CONSTRUCTION. The body is made of two hollow cylinders welded together. (See fig. 93.) The nose is welded to the body and is provided with a welded collar which is threaded to receive either a nose plug or a suspension lug. Just forward of the normal suspension lug is an inset similar to a Rheinmetal fuze head. Four sheet steel fins form the tail. Projecting from the base is a small compartment around which the silk mooring cord may be coiled. Two wooden grips are attached to this cord. Two winged nut screw plugs are fitted on opposite sides of this compartment giving access to the buoyancy compartment. Internally the float is divided into six compartments—the calcium carbide container, the acetylene gas compression chamber, the calcium phosphide chamber, the buoyancy chamber, the water inlet chamber, and the combustion chamber. On leaving the aircraft, a rubber bung is withdrawn by pulling the arming wire. The float sinks below the surface on its initial dive and water enters the ports and passes down the inlet tube into the calcium phosphide chamber thus generating phosphine. The phosphine passes up the outlet tube through the nonreturn valve to the burner where it ignites spontaneously to form a pilot jet. At the same time water enters through the channels in the nose and passes through a perforated tube into the carbide compartment. The acetylene evolved passes through the perforated diaphragm into one compression chamber and thence to the burner where it is ignited by the pilot jet.

According to the instructions stenciled on the body the float, once it has served its purpose, should be sunk by removing the winged nut screws

which permits the buoyancy chamber to fill with water.

SUSPENSION. Vertical or horizontal.

COLOR AND MARKING. Yellow over-all with the following stenciled markings:

Around body:

LUX N

969

At tail along body:

VOR HANDABWURF SICHERUNGSSEIL
AUSZIEHEN

Diagonally at tail:

NACH RETTUNG GERAT VERSENKEN
DURCH ENFERNEN DER FLUGEL-
SCHRAUBEN

FLAME FLOAT, LUX S (TYPE 1, TYPE 2, TYPE 3)

DATA:

	TYPE 1	TYPE 2	TYPE 3
Over-all Length	20.9"	20.9"	20.9"
Body Diameter	5.5"	5.5"	5.0"
Filling: Calcium Carbide and Calcium Phosphide.			
Weight of Filling	3.9 lbs.	13.5 lbs.	13 lbs.
Total Weight	14.3 lbs.		

CONSTRUCTION. The body is sheet metal and in the form of a cylinder. (See fig. 94.) At the side there is a lever, the fixed end being embedded in lead. At the top there is a capstan formed by two flange-like pieces of metal. A silken mooring cord is wound around the capstan and attached at one end to a wooden float and by the other end to one of the flanges. A central jet projects from the top of the cylinder from which acetylene gas is emitted when the float is activated. It is enclosed in a short tube, welded to the top of the cylinder to form the combustion chamber. A second duct to emit phosgene gas is formed by a narrow tube curving toward the central jet through a slot in the side of the combustion chamber. The slot also allows any water collecting in the combustion chamber to drain away.

OPERATION. The lever arm located at the side of the flare is freed from its safety wire and pulled outward, breaking it away so as to leave a hole of entry for water. When in the sea, water enters

to react with calcium phosphide and carbide. Acetylene gas is produced from its jet and is ignited by phosphine gas emerging from the other jet. Phosphine ignites immediately on exposure to air, thus if the acetylene is extinguished by a wave, it will be re-ignited by the phosphine. It takes approximately 3 minutes from the time of immersion for the phosphine to be evolved in sufficient quantity to produce flame. The acetylene gas may take a little longer and may not ignite until a period of 10 minutes has elapsed.

REMARKS. All types are similar in operation with only slight variations in construction and appearance. The Lux S differs little in internal functioning from the Lux M.

The Lux S can be seen from a distance of approximately 6.5 km at normal eye level when the observer is standing 3 meters above sea level.

COLOR AND MARKINGS. Yellow over all with the word "Lux S" stenciled in black on side.

CONTAINERS

INTRODUCTION

German containers can be subdivided into (1) those designed to scatter their contents before impact and (2) those intended to carry their contents safely to earth. The latter are few in number and simple in principle. They are a means of getting limited quantities of supplies to specific location. In general, they consist of a compartment to house the supplies and a parachute to bring it safely to earth. No explosive opening devices are incorporated.

Containers designed to scatter their contents from a height can be subdivided upon either of two bases:

- a. Droppable containers and containers retained in the aircraft; or,
- b. By content, as bombs, flares or a combination load of both bombs and flares.

Nondroppable containers may be jettisoned but are primarily intended to be used repeatedly. They are constructed to carry and scatter a great number of small incendiary bombs, the release mechanism being such that desired spacing of the bombs is possible.

Droppable containers are fitted with fuzing and opening devices designed to release the contained missiles after a predetermined time of fall from

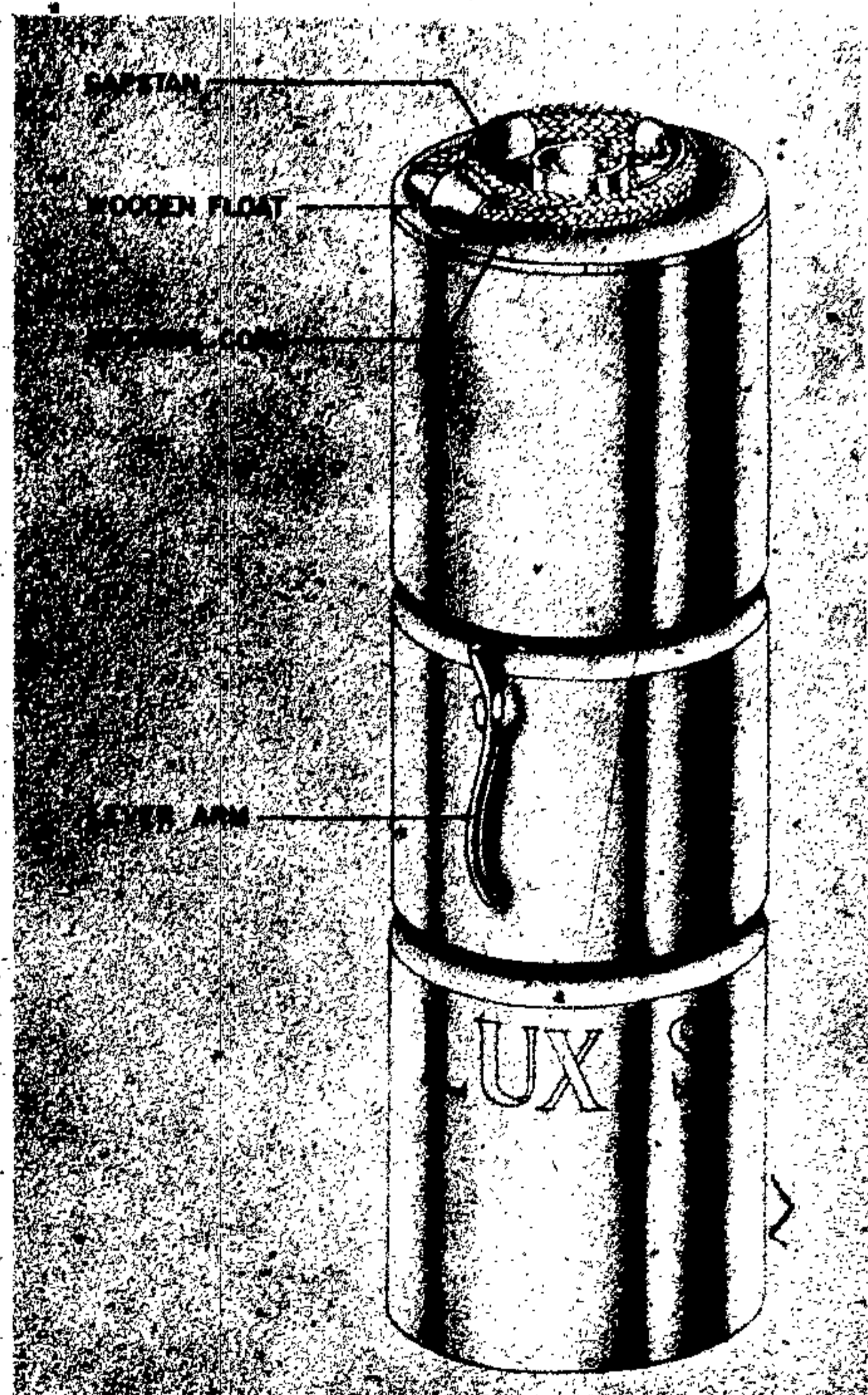

Figure 94—Lux S Flame Float, Types 1, 2, and 3

the aircraft. Some of these containers are merely clustering devices, some are bomb shaped and hinge at the after end, others release missiles through large ports.

The contents of bomb containers are chiefly small antipersonnel or incendiary bombs and flares, the 1-, 1.3-, and 2-kg electron incendiary bombs, SD1, SD2 and SD10 A/P bombs being the ones most frequently used. A common practice is to include a small number of SD2 bombs in a container of flares.

BDC 10, CLUSTER CONTAINER

DATA:

Body Diameter: 10 in.

Filling: 5-SC10; 5-SD10A bombs.

Fuzing: Z69 CII.

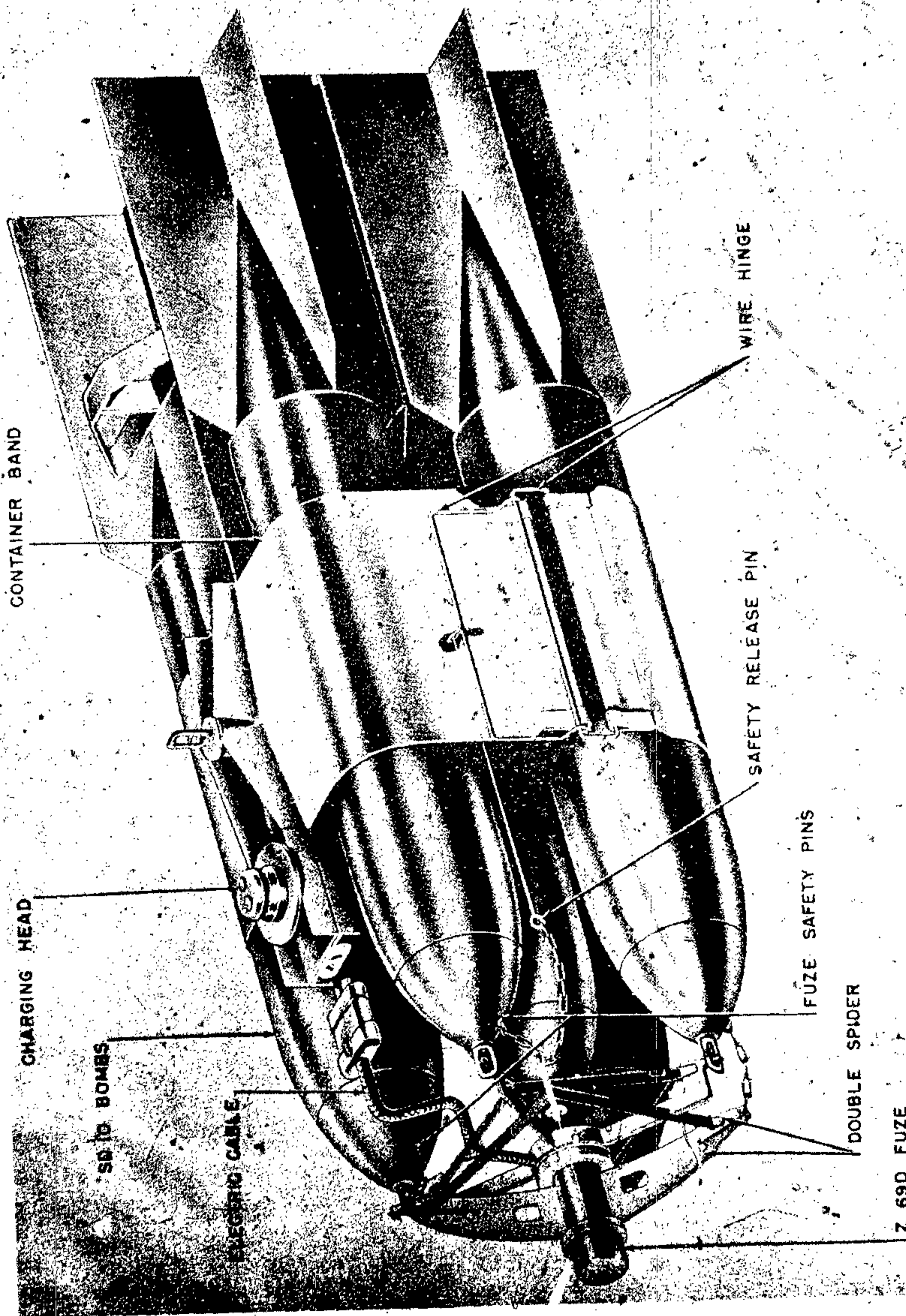

Figure 95—BDE 10 Container

CONSTRUCTION. Bombs are held together by a band of metal 5½ inches wide, and by a double "spider" which hooks through their suspension lugs, the outer spider being connected to the safety pins by small chains. The top half of the band is attached to a beam carrying the suspension lug and a charging head similar to a Rheinmetall fuze head. A lead from one plunger in this head goes to a socket, and into this socket fits a plug from the release device. The lower half of the band is attached to the upper by wire hinges held together by two safety pins, one on each side. These pins are attached to the outer arming spider by small chains. The lower half of the band is split and

held together by two "bottle screws" forming a means of tightening the band around the bombs during assembly. (See fig. 95.)

OPERATION. On release from the aircraft, an electric cap in the arming spider is fired; this, after a short delay, ignites a small charge which blows off the front spider, thus pulling out the safety pins of the individual bombs and also the safety pins which hold the band together. The bombs then separate and arm as they fall. This carrier gives a much closer "pattern" on the ground than could be obtained by dropping the bombs in a stick.

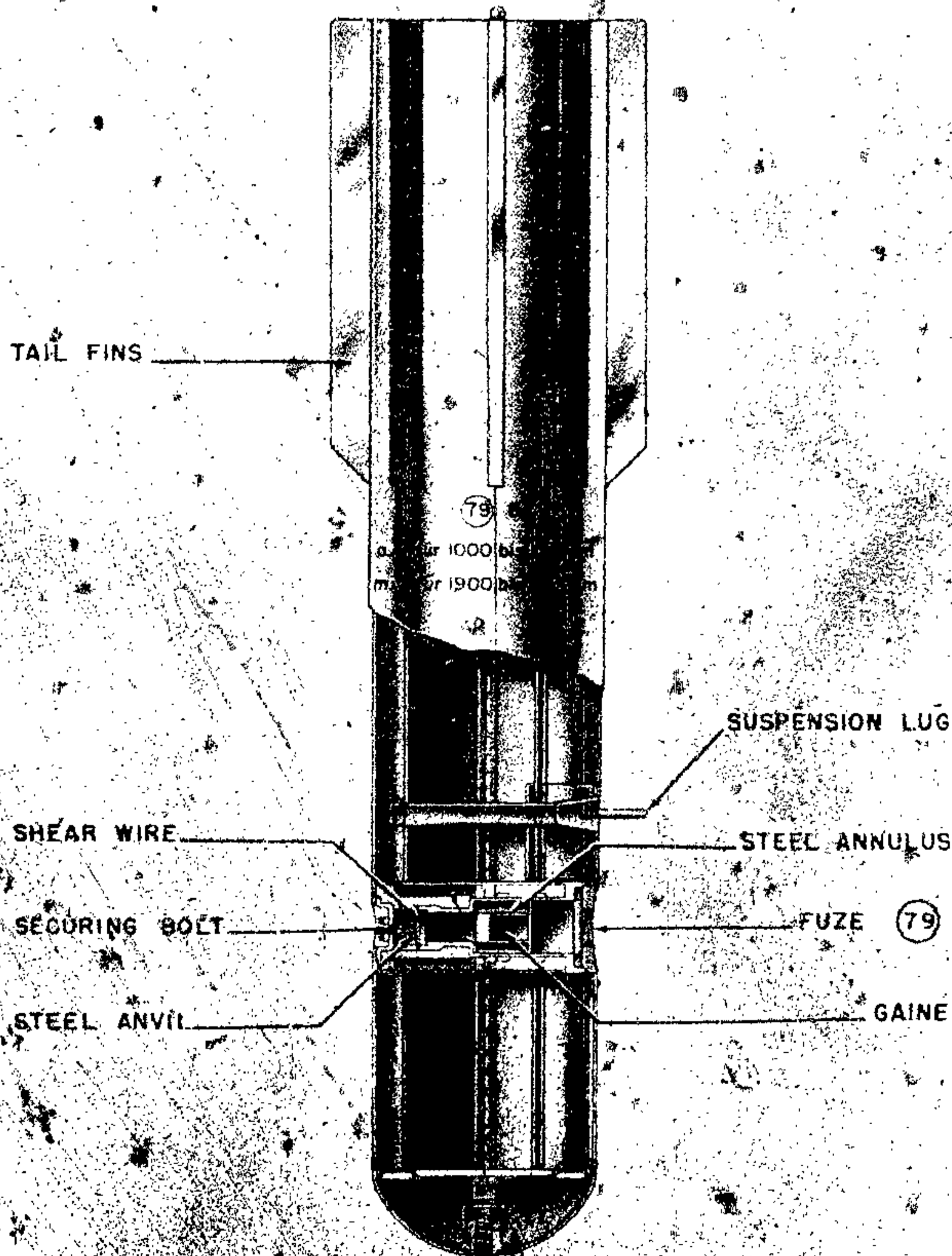
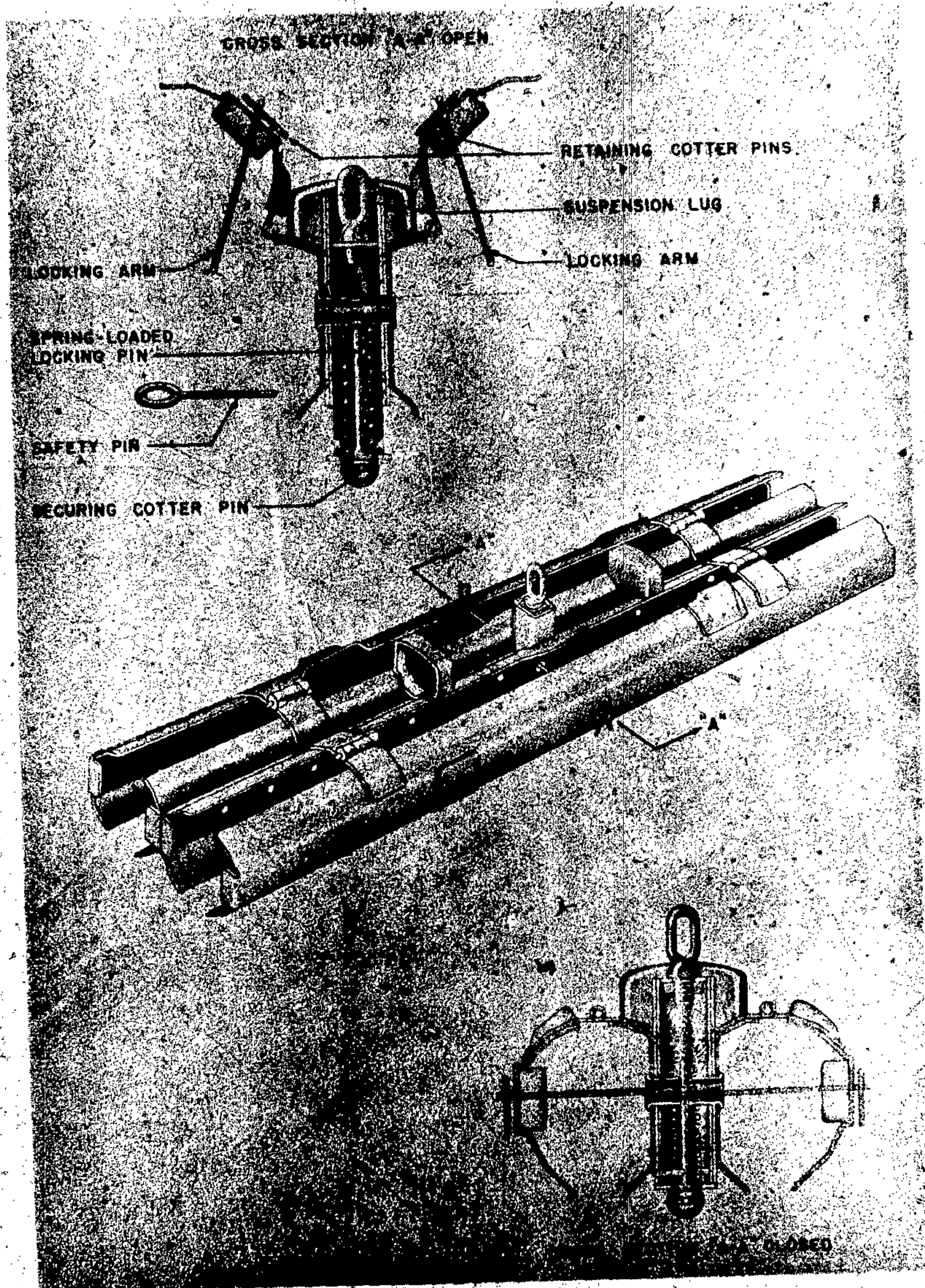

Figure 96—AB 23 SD 2 Container

GERMAN EXPLOSIVE ORDNANCE



AB 23 SD 2 CONTAINER**DATA:**

Over-all Length: 43.5 in.
 Body Diameter: 8.0 in.
 Tail Width: 11 in.
 Filling: 23 SD2 bombs; strips of metal coated paper.
 Total Weight: 101 lb. estimated.
 Fuzing: (79) A; (79) B.

CONSTRUCTION. The container holds 6 bombs in the forward compartment and 17 in the after compartment. Compartments are created by sheet metal discs held in place by steel rods. The case is divided into two halves longitudinally. When the bombs are placed in the container, these two halves are held together by a shear wire which passes through a steel anvil, in the lower part of the fuze pocket. When the aerial burst fuze operates, this wire is sheared by the explosion of the small exploder under the fuze. The case opens and allows the bombs to fall out. The fuze pocket is surrounded by a row of rivets which hold the steel washer in place to support the pocket. (See fig. 96.)

By removing the two bulkheads on either side of the fuze pocket, these containers can be employed to drop strips of metal coated paper for disrupting radar operations.

SUSPENSION. Horizontal by means of an eyebolt.

COLOR AND MARKING. The body is painted dark green and has two red bands running longitudinally the length of the tail fins. Between the

tail fins and suspension lugs are stenciled in white the following letters:

(79) B
 o.V. fur 1000 bis 1900 M
 m.V. fur 1900 bis 2500 M
 2 cma1 42

In large black letters: AB23SD2.

Between the fuze pocket and nose, in white:

79A Fur
 m.V. fur 1000 bis 1900 M

Settings for fuzes are also stenciled on bomb.

AB 24T SD 2 CONTAINER

CONSTRUCTION. The AB 24T container has seven main parts: the safety pin, the spring-loaded locking pin, the cotter pin securing the spring-loaded locking pin, the locking arms, the retaining cotter pins, the suspension lug (secured to the locking pin) and the double "barreled" container. Each "barrel" contains 12 SD 2 bombs. This container is very similar to the AB 70-3 container except for the release mechanism. (See fig. 97.)

After the container has been loaded on the plane, the safety pin is removed. On release, the spring-loaded locking pin, locking arms and suspension lug assembly move downward. This movement in conjunction with the force exerted by the 24 sets of SD 2 wings causes the two outboard sides of the double "barreled" container to fly open, thereby releasing the SD 2 bombs.

SUSPENSION. Horizontal.

COLOR AND MARKINGS. Light grey or "sky

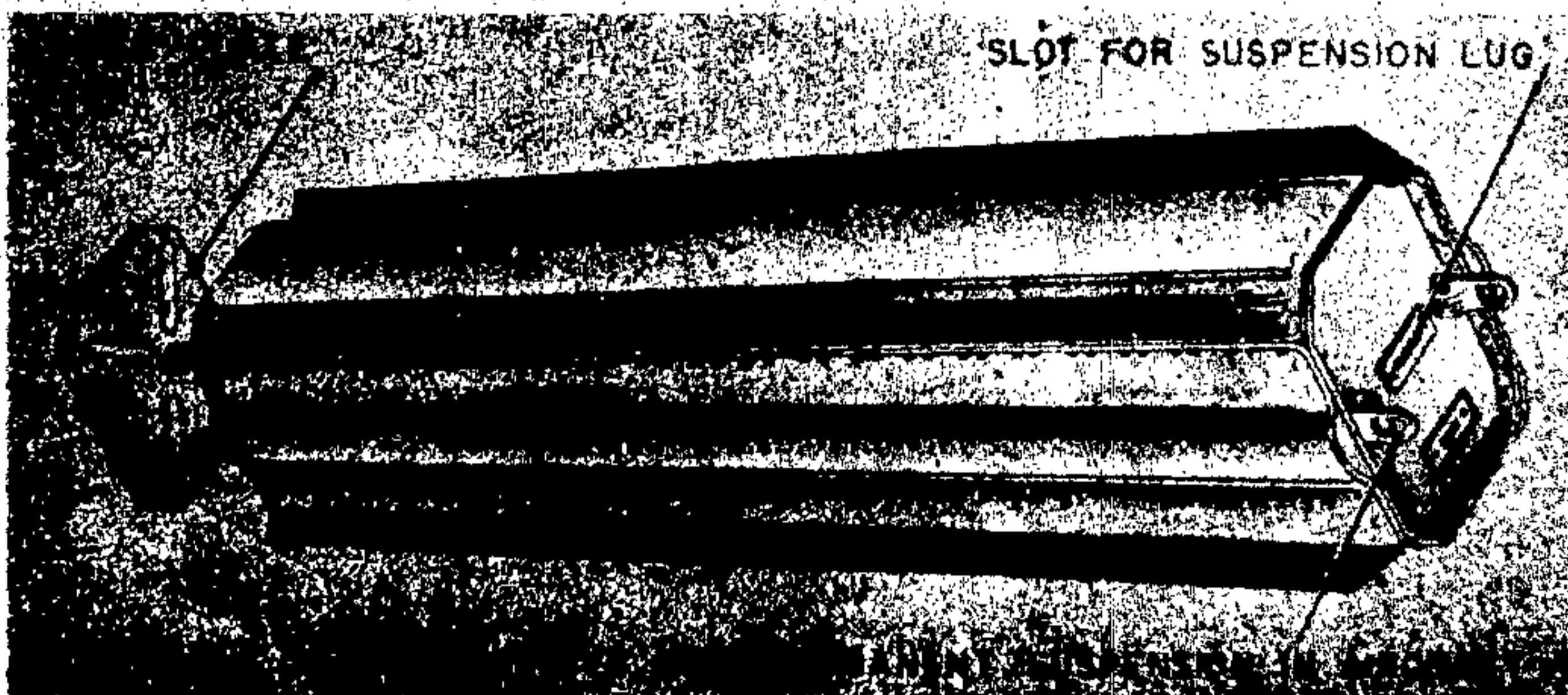

Figure 96—AB 36 Container

GERMAN EXPLOSIVE ORDNANCE

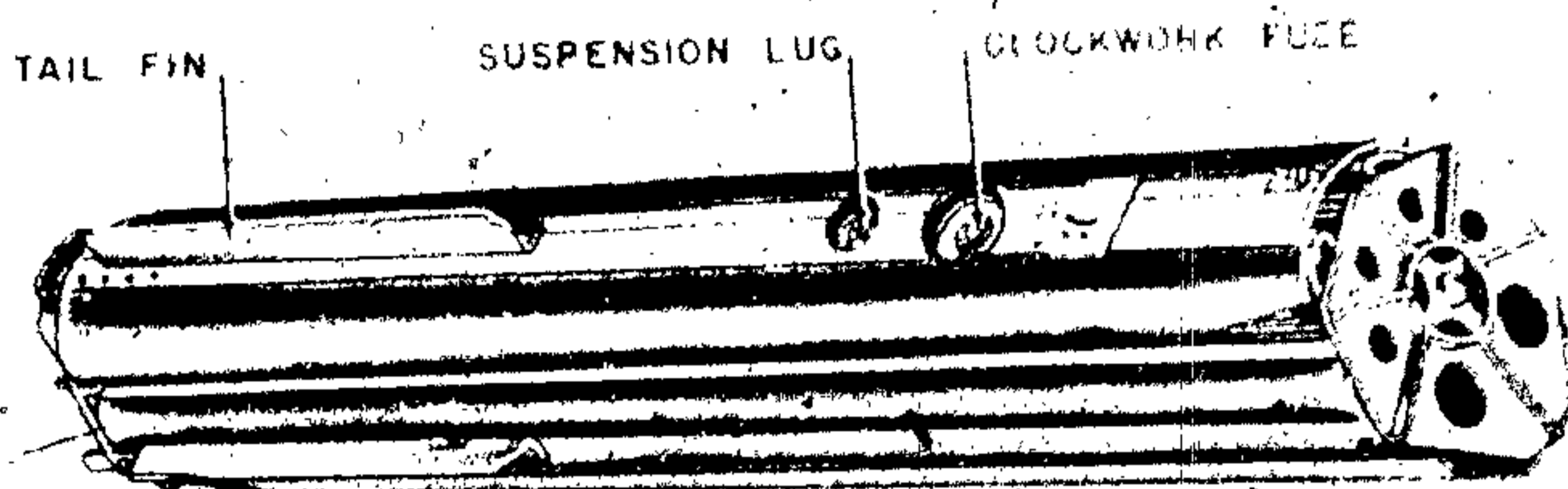

Figure 99—BSK 36 Container

blue. Stenciled on body in red: "Vorn"; "Nor-furatsissen Aufhingungen." In black: AB 24T SD 2.

REMARKS. Container is not suitable for release above 300 feet. At this height bombs cover an area of 60 to 100 feet wide, and 100 to 200 feet long with greatest concentration in center.

A German document states container cannot be jettisoned safe but aircraft are permitted to land with container.

AB 36 AND BSK 36 THREE-SIDED CONTAINER

DATA:	AB 36	BSK 36	3-SIDED
Over-all Length	42 in.	43 in.	42 in.
Body Diameter	8.0 in.	8.0 in.	8.5 in.

Filling:

- AB 36—36 1 kg 1B's or 24 2 kg 1B's.
- BSK 36—16 2 kg 1B's.
- 3-sided container—36 1 kg 1B's.

Fuzing:

- AB 36—Clockwork or electrically fired detonator.
- BSK 36—Central release rod.
- 3-sided—Clockwork release mechanism.

CONSTRUCTION. The AB 36 container is of

sheet steel construction. (See fig. 98.) It is divided along its longitudinal axis into two halves which are welded to a hinged bottom plate. The opening device is usually an electrically fired cartridge with a powder train delay; however, a clockwork release mechanism may be used.

The container is released. After a short delay the opening device functions. The two halves of the container hinge outward and the bombs fall free.

SUSPENSION. Horizontal.

COLOR. Dark green over-all in color.

CONSTRUCTION. The BSK 36 is a rectangular aluminum container with a 43-inch vertical rod running up through the center. (See fig. 99.) The rod carries three trays with felt pads on which the incendiary bombs are stacked vertically around the rod. When released the rod and the bombs fall away; the rectangular container stays with the plane.

SUSPENSION. Vertical. The rod carries a lug at its top end which is engaged with the bomb rack of the carrying aircraft.

COLOR. Grey or aluminum over-all.

CONSTRUCTION. The three-sided container is

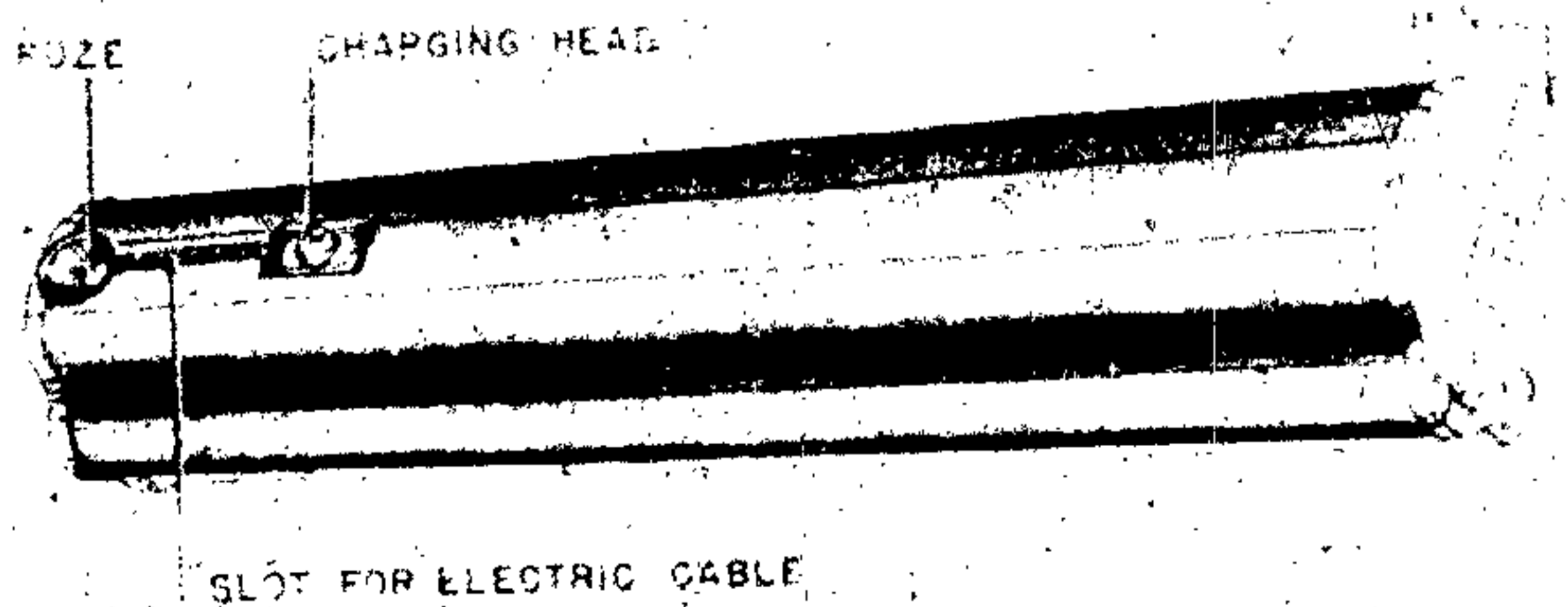

Figure 100—Three-Sided Container

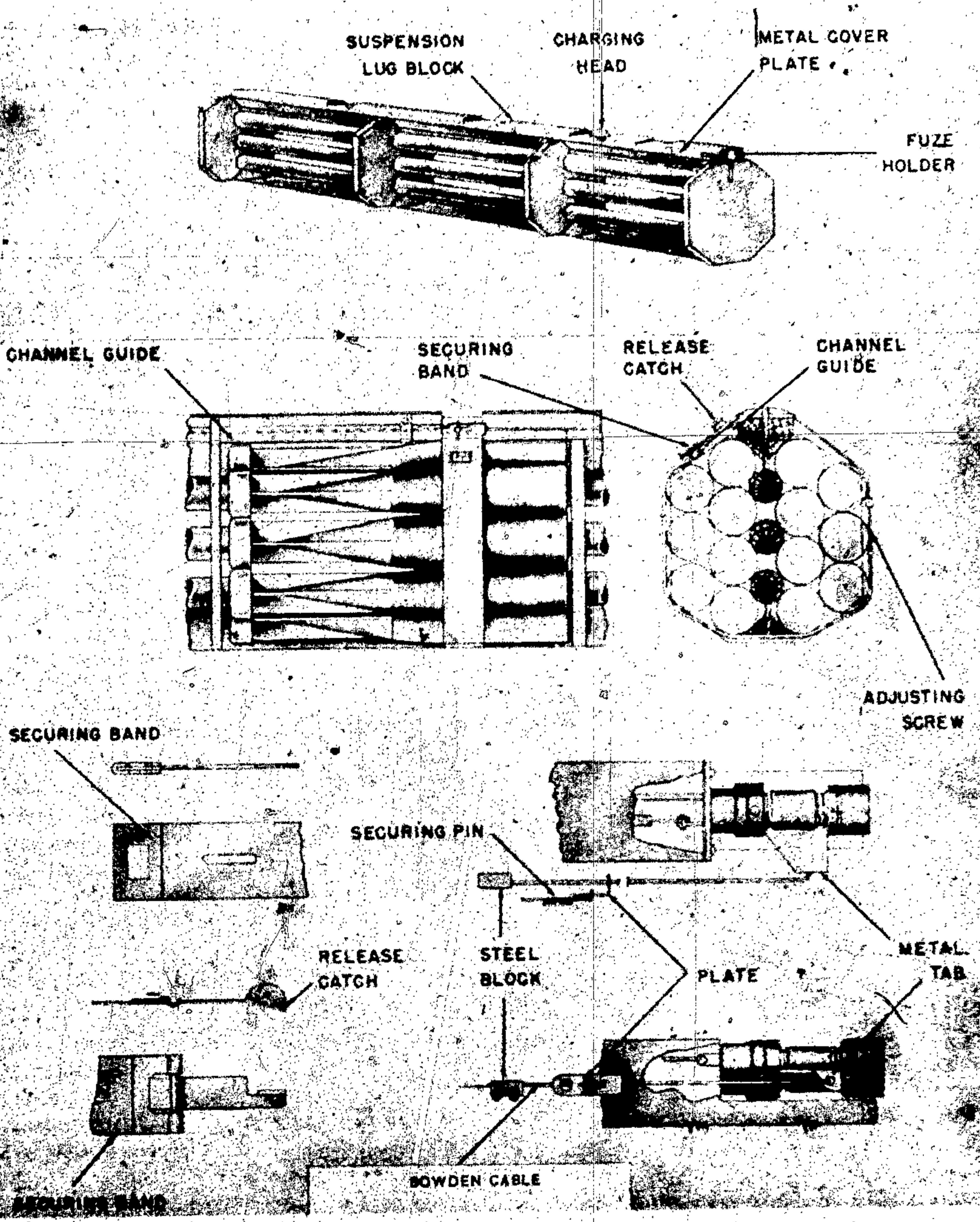

Figure 101—AB 42 Container

of sheet steel construction. (See fig. 100.) It consists of three side pieces and a separate piece which together form a cylinder. A clock work

release mechanism is used to dump the load by separating the cylinder parts.
SUSPENSION. Vertical or horizontal.

GERMAN EXPLOSIVE ORDNANCE

COLOR AND MARKINGS. Grey or black over-all.

The clock work release mechanism has inscribed on it: "Achtung!" (note).

"Versogerungswerk Auf Ziechen" (Wind up retarding mechanism).

AB 42 CONTAINER

DATA:

Over-all Length: 28½ in.

Width: 7¾ in.

Height: 9 in.

Filling: 42 1 kg incendiaries.

Fuzing: 69B and a charging head.

CONSTRUCTION. The container is constructed of wood with small metal fittings. Three double compartments 13¾ inches long are formed by four wooden partitions ¼ inch thick. Compartments are rectangular in shape with the corners cut off. The top and bottom spars are made up of five thin pieces of wood glued and nailed together. They are of flat cross sections and their inner sides are shaped to form a seating for two rows of 1-kg incendiary bombs. The three center spars are of circular cross section 1 inch in diameter. They pass through holes in the inner partitions and are glued into recesses cut in the end partitions. Each compartment contains 14 1-kg incendiary bombs held in a cluster against the round wooden spars by a steel securing band which passes through slots in the top and bottom spars. The top spar carries a suspension lug block, the charging head and the fuze holder. Two insulated wires passing through a channel cut in the top spar connect the fuze with the charging head. (See fig. 101.)

From the side of the fuze holder a short metal tab projects through a slot in the side of the metal cover plate. A bowden cable, passing through three aluminum channel guides, is connected to the tab at one end and a weak anchorage on the remote end of the container at the other. The cable has three small steel blocks, each located by two small bolts. Each bomb securing band is fastened by a release catch on one end of the band, which passes through a slot in the other end, and which has a small hole drilled in it. Securing pins passing through these holes lock the bands. These pins are carried by three small plates, which are threaded on the bowden cable. Adjusting screws are provided for the band assembly.

On release from aircraft, the fuze is charged. After a set delay, the fuze fires, forcing off the part of the fuze holder to which the metal tab is attached. The bowden wire is torn away from its anchorage at the remote end and the three blocks bearing against the flanges of the plates effect the withdrawal of the securing pins. The securing bands are then free to open and release the bomb.

SUSPENSION. Horizontal.

COLOR AND MARKINGS. Black or grey over-all. "AB 42" is stenciled in red on the end.

AB 70-1 OR MARK 70 S CONTAINER

DATA:

Over-all Length: 43½ in.

Body Diameter: 8 in.

Wall Thickness: ¼ in.

Tail Length: 16 in.

Tail Width: 11 in.

Filling: 3 Mark S flares.

Fuzing: Z (89) B.

CONSTRUCTION. Container is identical in external construction to the AB 23 SD 2 container. (See fig. 102.)

The bottom section of the container is divided by two walls, forming three compartments. The forward compartment houses a shortened version of Mark S flare. The center compartment provides clearance for the fuze pocket and the rear compartment houses two Type 1 Mark S flares.

When charge is passed to fuze, predetermined delay starts running out. Fuze then fires initiating burster charge within gaine. Explosion forces anvil from the fuze pocket, shearing the shear wire and causing container to hinge open. Static cords connect each flare fuze to the container. When flare falls away, flare fuze is thus initiated.

SUSPENSION. Horizontal or vertical. An internally threaded suspension bolt is welded to nose of bottom section and a twin bar of steel, surmounted by an internally threaded suspension eye-bolt housing is welded to bottom section 2 inches in rear of the rear wall.

COLOR AND MARKINGS. Light khaki over-all. Dull red stripes between tail fins.

Stenciled on container: Either Mark 70 S or

Mark AB 70-1
3 Marks.

"Rot" or "Weiss" (Red or White).

When container is stenciled "Brenndaner 0-5" flares are normally fitted with friction nondelay igniter.

If stenciled "Brenndaner 5-15" the flare in the front compartment functions as above but the two remaining flares are fitted with 67/V fuzes set to function after 5 and 10 minutes.

AB 70-3 CONTAINER

DATA:

Over-all Length: 39.75 in.

Body Diameter: 7.5 in.

Wall Thickness: 0.06 in.

Filling: 22 SD 2 bombs.

Total Weight: 52 kg.

Fuzing: Z 69D.

CONSTRUCTION. The container consists of a center beam and two casings, each of which are

attached to the center beam by two hinges. The center beam consists of two sheet steel plates, spot welded together along their longer flat axis, then forming divergent arcs that conform to the curvature of the SD 2 bombs. (See figs. 103A, 103B, and 103C.)

A U-shaped bracket is fixed between the two steel plates of the center beam by means of rivets. This bracket serves as an attachment for the suspension eyebolt, the fuze assembly and the bomb release unit. A steel tube, parallel with the lateral axis of the container, is secured to the two steel plates of the center beam, within the U-shaped bracket by means of flanged surfaces at the ends of the steel tube.

The two upper arc-shaped portions of the center beam each have 11 U-slots to permit, dependent upon the methods of stowage, the protrusion of either the arming cables or safety pin lugs of

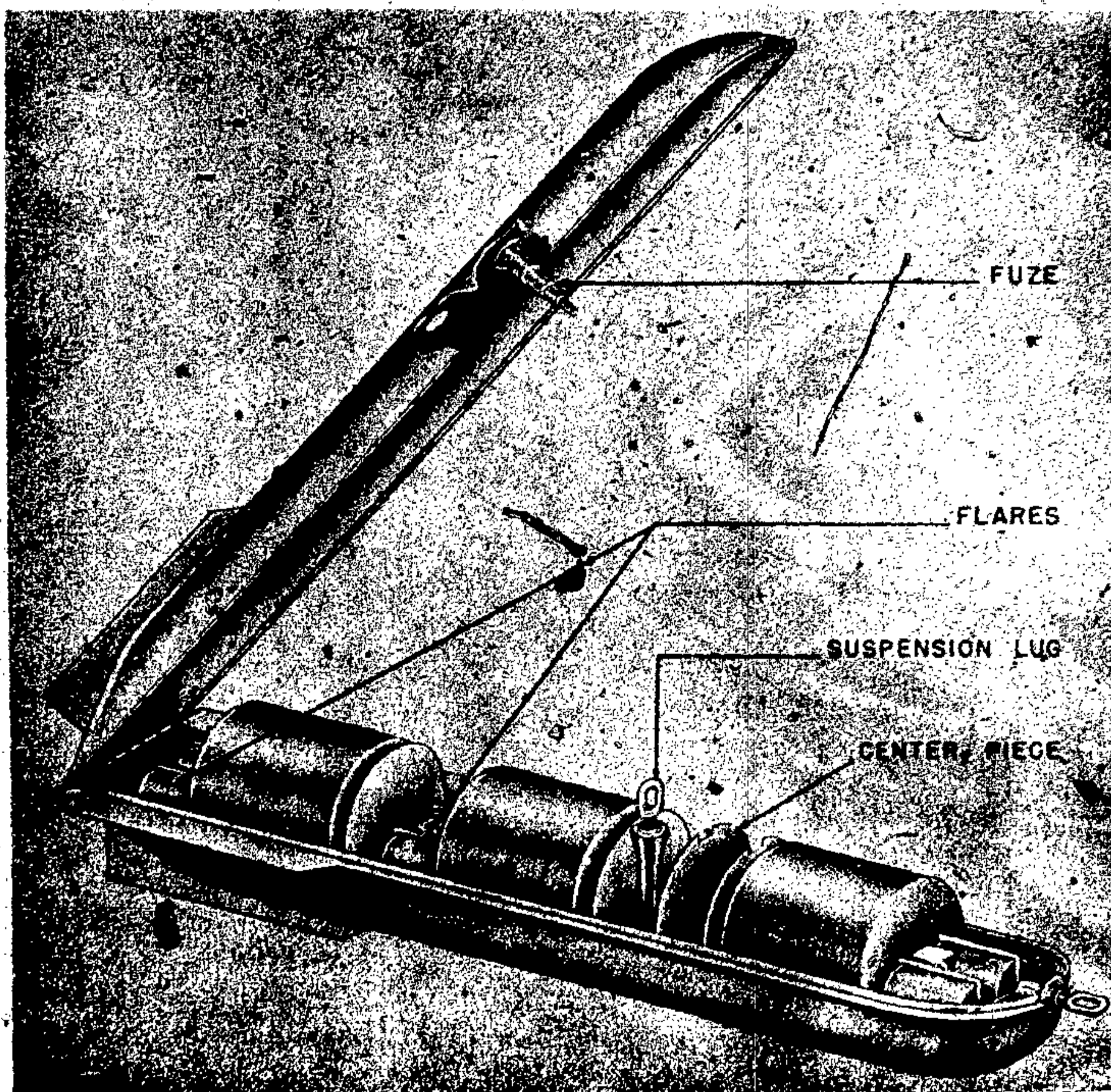

Figure 102—AB 70-3 Container

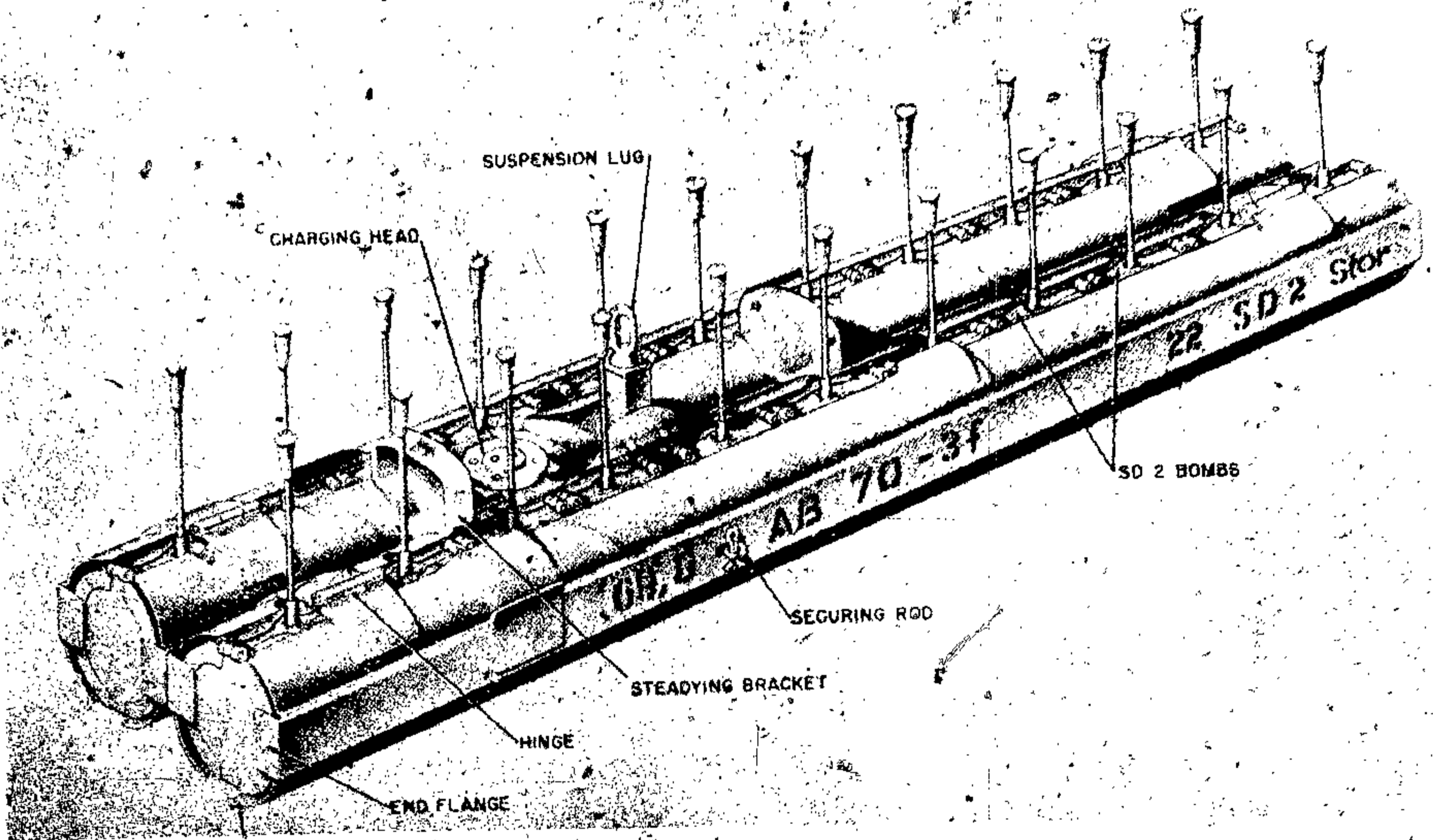

Figure 103A—AB 70-3 Container

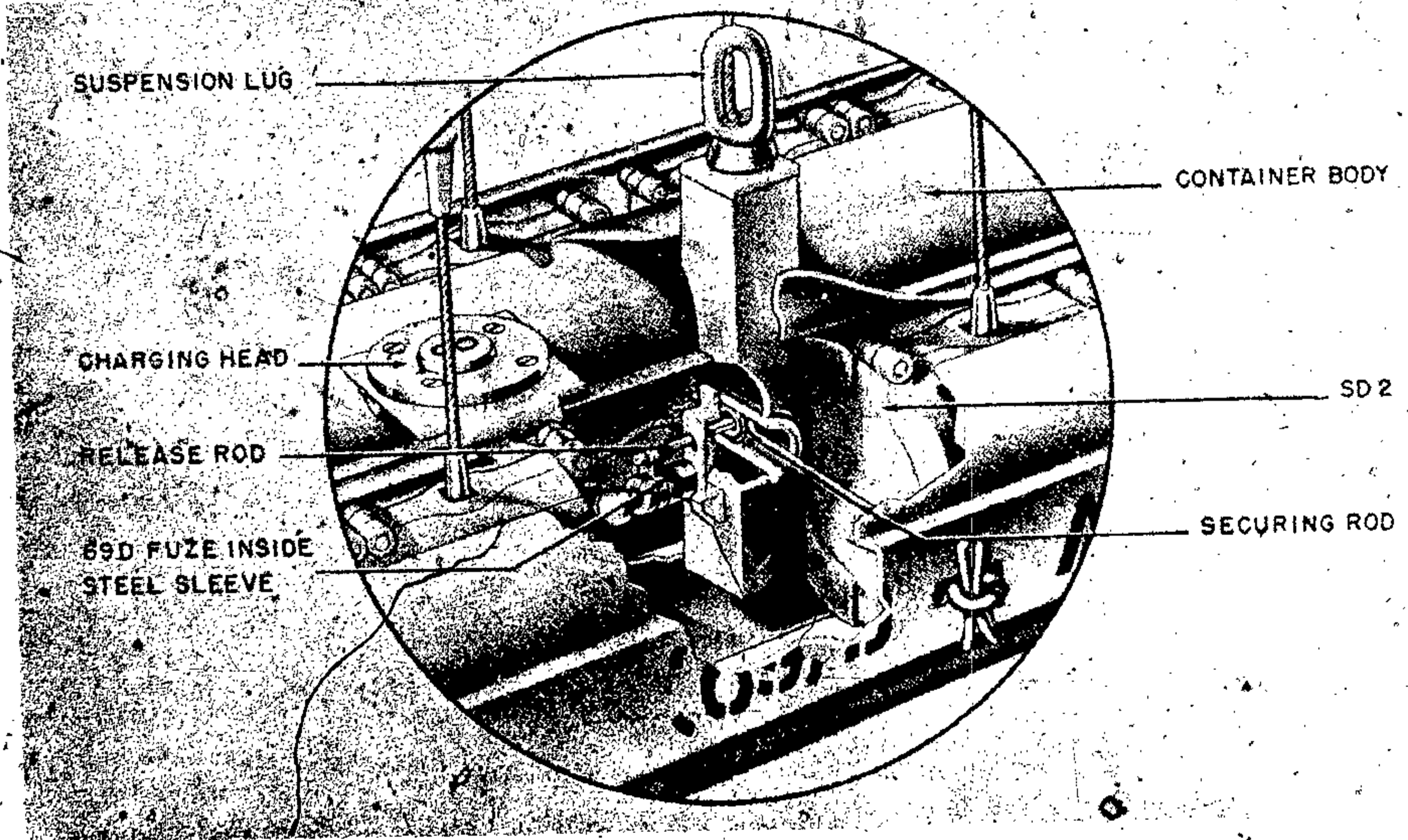

Figure 103B—AB 70-3 Container

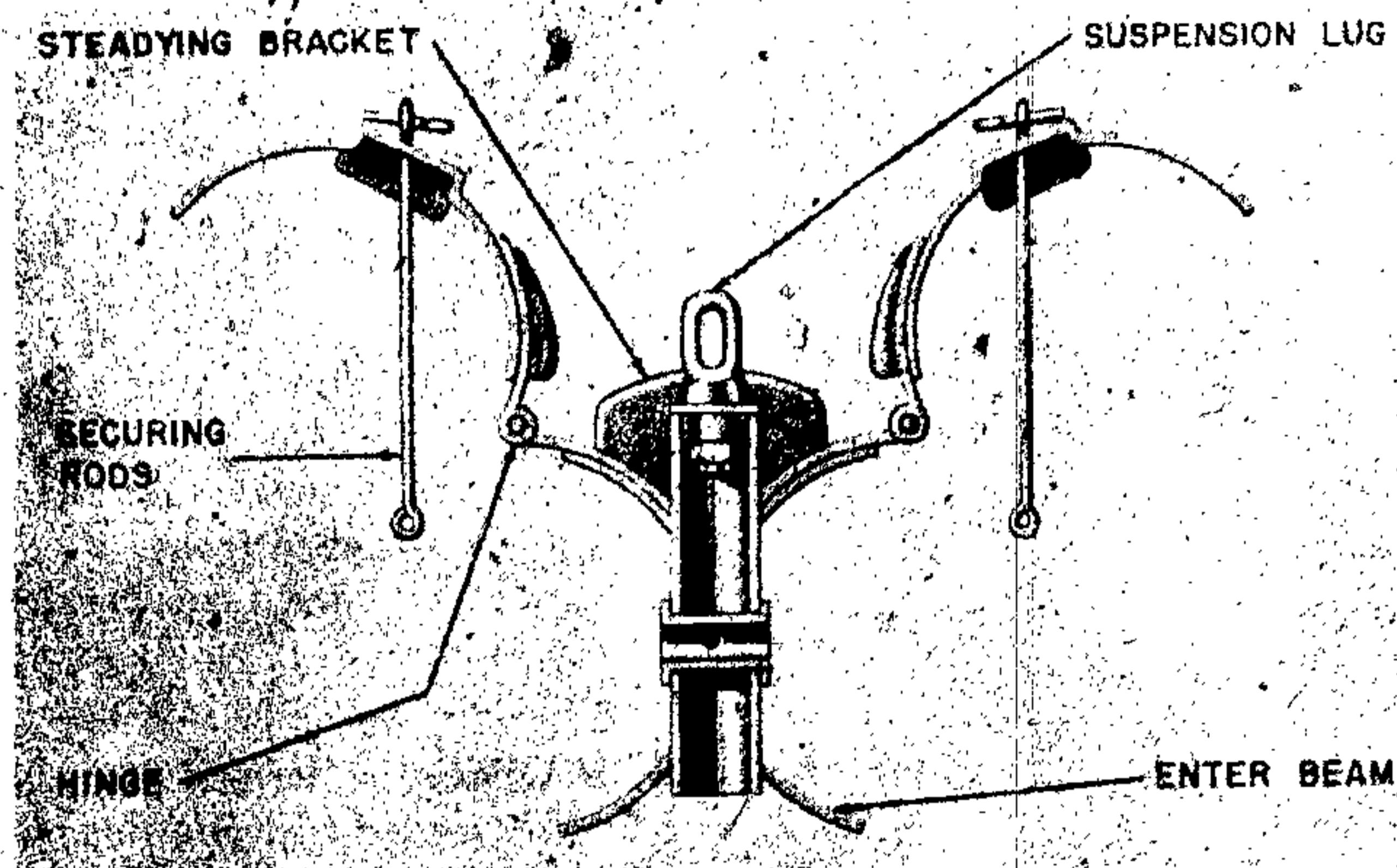

Figure 103C—AB 70-3 Container

the vanes of the SD 2 bombs. Two steadying brackets are welded to the center beam.

The charging head is screwed to a small steel platform welded to the center beam. A flanged strengthening plate is welded to the lower arc-shaped portions of the center beam. The rectangular flanges, at the extremities of the main beam and the casings, retain the SD 2 bombs within the carrier in the longitudinal axis. A steadying plate is spot welded to each of the casings. There is a small slot in each of the casings opposite the U-shaped bracket to accommodate the two securing rods.

The base plate of the fuze pocket is secured to the U-shaped bracket by means of two nuts and bolts. The fuze pocket and enclosed spring-loaded electric terminal are secured to the base by two screws. A steel circlip around the 69D fuze provides the negative contact for the fuze. Two red covered cables, enclosed in a yellow waterproof cover, complete the electric circuit from the charging adapter to the fuze assembly.

A strong steel sleeve, with a threaded steel cap, is a sliding fit over the fuze pocket. The threaded steel cap is fitted with a small circular polystyrene window for visually checking that the fuze is present. The steel release rod is attached to the steel sleeve by means of a steel clip. This release rod passes through an aperture in the fuze pocket base and thence through opening in the U-shaped

bracket and steel tube. When assembled, the steel sleeve is secured to the fuze pocket by wire. Two securing rods, with "eyes" formed at either end, secure the casing to the central beam after the loading of the SD 2 bombs. The inner eyes enter the steel tube in the central beam, in which position the end of the release rod passes through the eyes, thereby retaining the securing rods. The outer eyes pass through the slots in the respective casings, and are secured on the outside of each casing by the steel split pins. The container is loaded with 11 bombs between the center beam and casing on each side.

OPERATION. On release from aircraft, an electric charge is imparted to the 69D fuze via the charging adapter; after a delay of 1 second, the propellant charge within the fuze is ignited.

The gas pressure generated drives forward the steel sleeve, disengaging the release rod from the inner eyes of the securing rods. The casings are forced outwards by the weight of the bombs and the tendency for drogues to spring open. (See fig. 103B.)

SUSPENSION. Horizontal.

COLOR AND MARKINGS. Light brown overall. Stenciled in black:

(69)D AB 70-3F

22 SD 2 Stor.

Gew 52 kg

GERMAN EXPLOSIVE ORDNANCE

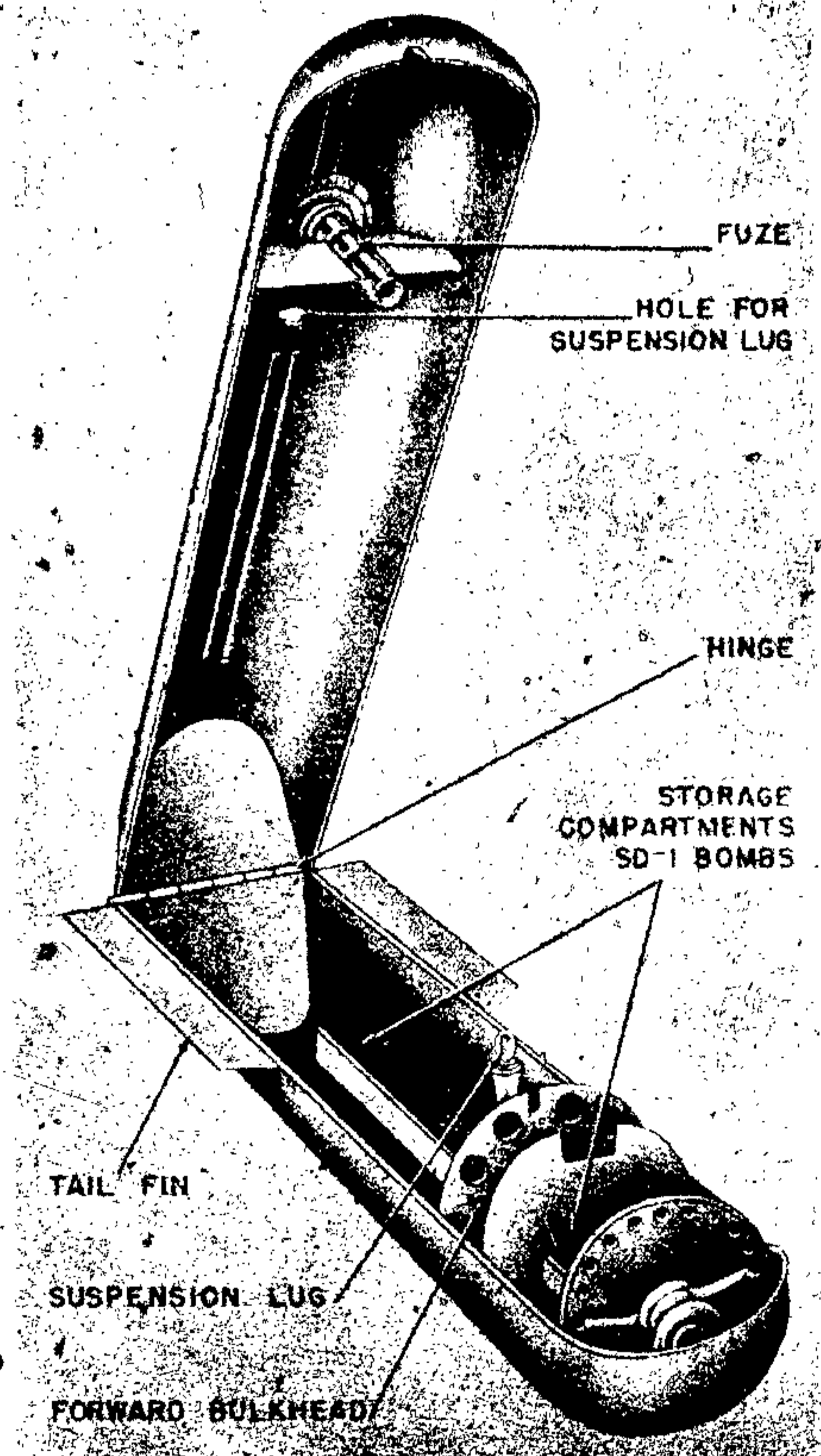

Figure 104—AB 70D1 Container

AB 70D1 CONTAINER

DATA:

Over-all Length: 43.5 in.
 Body Diameter: 8.0 in.
 Wall Thickness: 0.03 in.
 Tail Length: 16.0 in.
 Tail Width: 11.0 in.
 Filling: 50 SD 1 bombs.
 Total Weight: 56 kg.
 Fuzing: El Zt Z (79) A.

CONSTRUCTION. In the forward compartment between the forward and central bulkhead

are stored a cluster of ten bombs, loosely held together by a strip metal cluster band. (See fig. 104.) The forward bulkhead is perforated by 11 holes but bomb fuzes do not protrude through these holes.

In the after compartment four clusters of bombs are stowed. Each cluster loosely held by a strip metal cluster band. Of these four after clusters, the fuzes of the first protrude through the 10 perforations in the after bulkhead. While the fuzes of the remaining clusters are inserted in the hollow tails of the cluster in front.

When aerial burst fuze operates, wire is sheared by the explosion of small exploder under fuze. Case opens and bombs fall out.

REMARKS. A German document states that the AB 70D1 loaded with SD 1 bombs are not entirely safe in transport. Aircraft are not permitted to land with AB 70D1 containers. It is impossible to jettison AB 70D1 safe. Minimum height of release is 150 meters.

SUSPENSION. Horizontal or vertical.

COLOR AND MARKINGS. Field grey or olive green over-all.

Stenciled (near tail): AB 70D1.

Stenciled (forward of fuze pocket): Gewicht CA 56 kg.

AB 250-1 CONTAINER

DATA:

Over-all Length: 64 $\frac{1}{4}$ in.
 Body Diameter: 15 $\frac{1}{8}$ in.
 Wall Thickness: $\frac{3}{32}$ in.
 Filling: 96 SD 2 bombs.
 Fuzing: Z 69D.

CONSTRUCTION. The container consists of a center beam to which are attached three pairs of semicircular casings. The whole forming a cylinder bisected vertically by the center beam.

The center beam is composed of two mild steel pressings, welded together to form, in cross section, an octagonal tube extending to an upper and a lower double-sheet web which open at their extreme extremities to form V-channels. The upper and lower channels are reinforced by pressings welded within the V-channels.

Spaced within the octagonal tube are four pairs of octagonal plates, grooved at right angles on their inner faces. When fitted together, the

grooves correspond and make four interconnected radial tubes in the form of a cross.

Holes drilled in the center beam correspond with each horizontal tube. Extensions to the vertical tubes are formed within the upper and lower webs. Guide plates centrally drilled are spaced within each lower vertical tube.

The holes cut in the wall of the center beam accommodate the arming cables of the SD2 bombs.

Distance pieces are fitted to the external faces of the central beam.

A release plate hinged at its forward end is fitted to the outside of each casing.

A small slot cut in the release plate corresponds with a similar slot cut in each casing.

Bomb positioning ribs are welded to the inner face of each casing.

After loading the container, the holes cut in each casing permit the withdrawal of the bomb safety clips. The nose fairing and the tail dome are formed by welding metal pressings to the front and rear pairs of casings respectively. The charging adapter is screwed to a small stud plate fitted within the upper channel. The suspension lug platform, containing the suspension lug housing, is welded to metal arms riveted to the walls of the upper channel.

The lateral guides within the lower channel, form seatings for the bracket of the front, central and rear release rods. The steel link rods are formed with "eyes" at each end. The inner eye enters a horizontal tube, in which position the appropriate release rod passes through the eye, thereby securing the link rod. The outer eye

passes through the slots in the casing and release plate and is secured on the outside by a steel split pin. Double compression springs are fitted in the lower vertical tube between the guide plate and the release rod bracket. The base plate of the fuze pocket is secured within the lower channels by means of two nuts and bolts.

A fuze pocket and enclosed spring loaded electric terminal are secured to the base plate by two screws. A steel circlip around the fuze provides the negative contact for the circuit.

One red covered and one yellow covered cable enclosed within a red waterproof cover complete the electric circuit between the charging adapter and the fuze assembly.

A strong steel sleeve with a threaded steel cap, is a sliding fit over the fuze pocket. The threaded steel cap is fitted with a small circular polystyrene window for visually checking the presence of the fuze.

One extension rod passes through the front lateral guide and front release rod bracket, thus retaining the front release rod.

The longitudinal bracket forms a guide for the release piston. The release piston rod, passing through the central lateral guides, retains the central release rod. The release piston springs are compressed between a sealing machined on the release piston rod and the central lateral guide.

The bell crank lever pivoted in the longitudinal bracket has a small metal plate laterally attached to its long arm. The nose of the bell crank lever, passing through the longitudinal bracket, retains the release piston. The notched plate at the tail

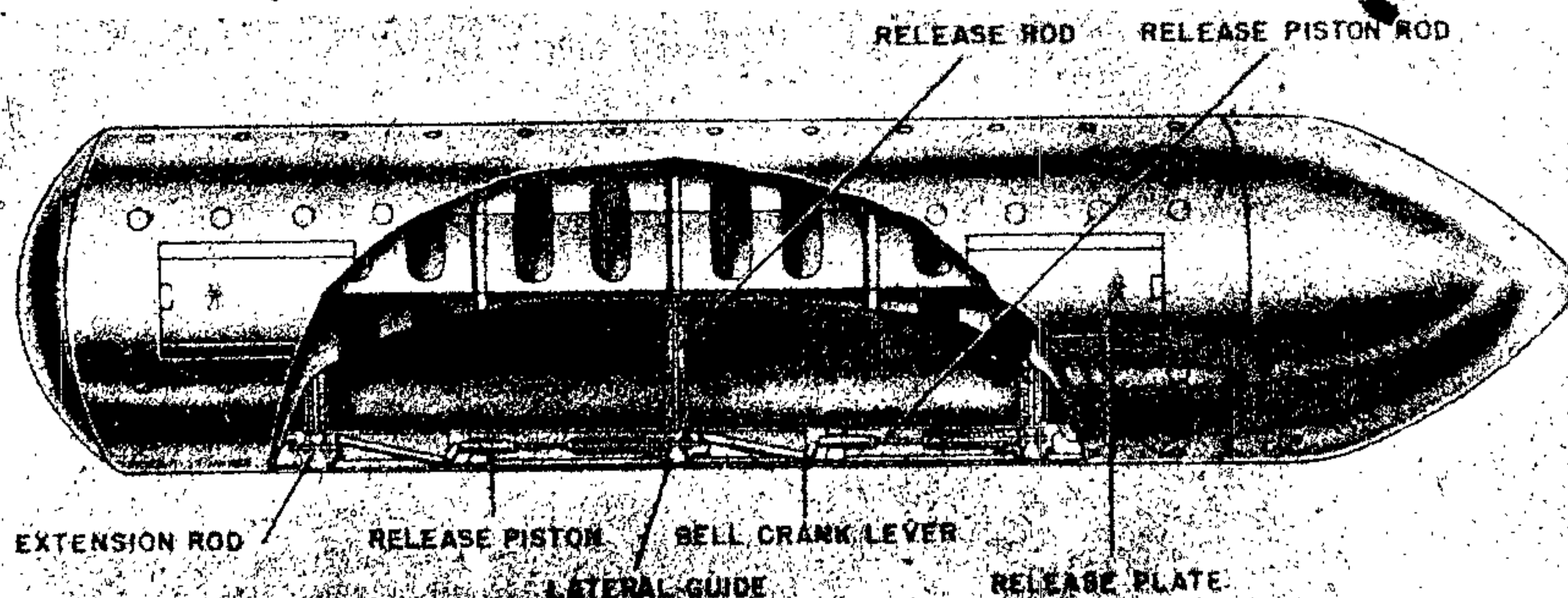

Figure 105—AB 250-1 Container

GERMAN EXPLOSIVE ORDNANCE

of the bell crank lever being retained by the extension rod prevents the rotation of the bell crank lever. A similar mechanism to the rear of the central release rod provides for the operation of the rear release rod, the exception being that the rotation of the second bell crank lever is prevented by the release piston rod. (See fig. 105.)

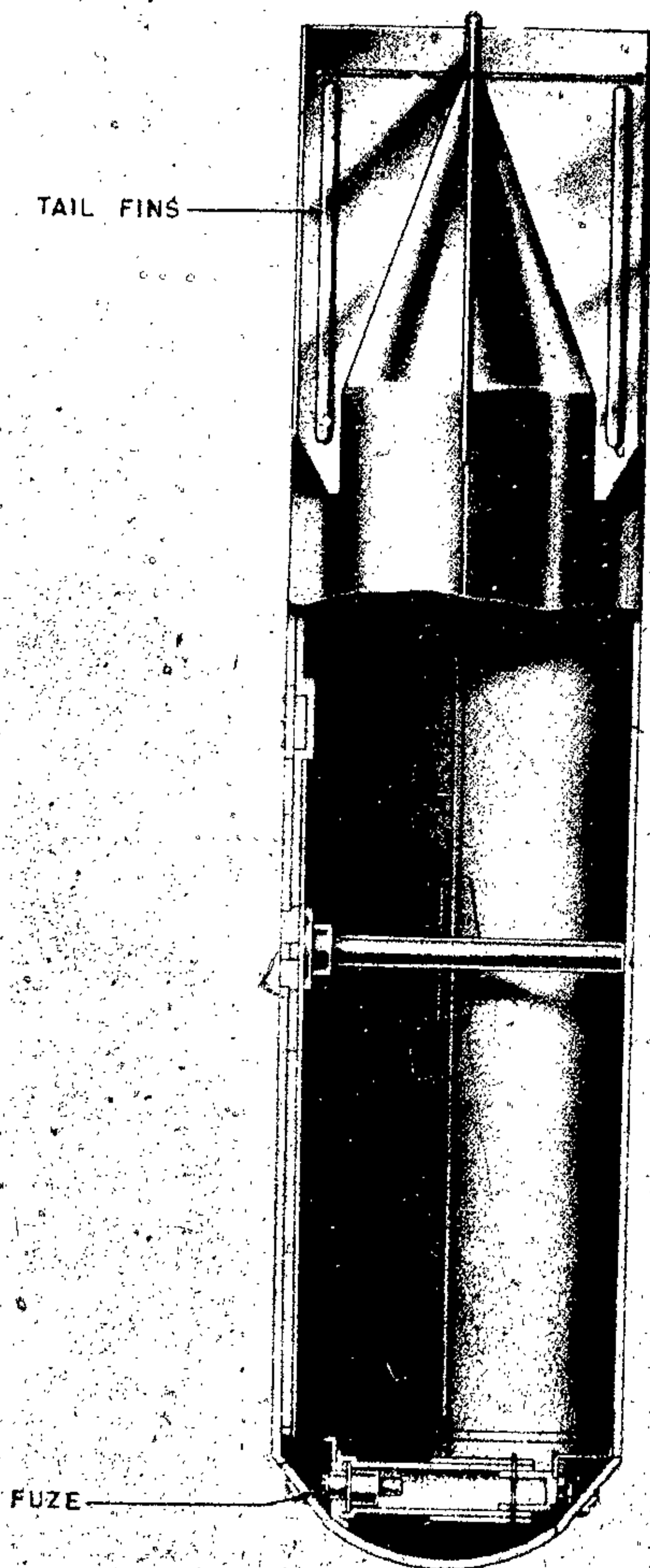

Figure 106—AB 250-2 Container

OPERATION. On release from aircraft, the fuze fires after the approximately 1-second delay propellant charge is ignited. Pressure drives the steel sleeve downward, the steel sleeve extension, and extension rod. The extension rod disengages from the front release rod bracket. The front release rod under the influence of its springs moves downward and fires the link rods. Airflow passing under the release plate causes the casings to move outward, thus firing the bombs. This movement is assisted by the weight of bombs and the tendency of the drogues to spring open. The first bombs then fall away. As the extension rod moves forward, it is also disengaged from the notched plate at the tail of the bell crank lever.

The bell crank lever is now free to rotate and the release piston moves forward under the influence of its springs and bears on the nose of the bell crank lever rotating it out of the piston guide. This releases the piston rod bracket, thereby releasing the central casing. The rear casings are now freed in a similar manner. The small plate on the bell crank lever appears to prevent the simultaneous release of the casings. On release of the first pair of casings, the bell crank lever rotates until the small metal plate bears against the casing. The bell crank lever is now unable to rotate further until the front casings are clear of the lower channel. This momentarily delays the release of the second pair of casings. This serves to increase the scatter of the bombs.

AB 250-2 CONTAINER

DATA:

Over-all Length: 63.7 in.

Body Diameter: 14.7 in.

Tail Length: 19.7 in.

Tail Width: 14.7 in.

Filling: 224 SD 1 bombs, 17 SD 10A bombs, 144 SD 2 bombs.

Total Weight: 221 kg.

Fuzing: (79) A; (69) D; 79 B, 69 E.

CONSTRUCTION. The body is of mild sheet steel in two longitudinal halves hinged at the tail. It is divided into three compartments; dome-shaped nose compartment, cylindrical central compartment and cone-shaped tail compartment. The nose compartment houses the fuze pocket welded to a bracket which, in turn, is welded to the upper half of the container. The two halves of the container are presumably held

together by a securing nut and a shear wire which passes through an anvil in the lower half of the fuze pocket. (See fig. 106.)

The sheet steel tail of four fins, braced by two bars riveted to opposite fins, is welded to both the central cylindrical and cone-shaped tail portions of the container.

The SD 1 bombs are housed in the central compartment. No packing pieces have been found.

When the SD 10A bombs are carried, a three-ply plywood or cardboard partition is inserted making two compartments. The front compartment holds eight bombs and the rear nine. The bombs are positioned by a wooden structure placed in the center of the compartments. The odd bomb at the rear is stowed within this structure. Each cluster is held by small wooden blocks bound by two steel tapes.

SUSPENSION. Horizontal. Welded to the lower half at the point of balance of the loaded container is a stout metal transverse suspension strip provided with a metal plate tapped to take a suspension lug.

COLOR AND MARKINGS. Khaki over all with two red stripes on tail cone.

Stenciled on container for SD 1 bombs:

AB 250-2
224 SD 1
Gew 215 kg
(79) A
(69) D

Stenciled on container for SD 10A bombs:

AB 250-2
17 SD 10A
(69) E
(89) B

AB 250-3 TYPES I AND II CONTAINER

DATA:

Over-all Length: 63.7 in.
Body Diameter: 14.7 in.
Tail Length: 19.7 in.
Tail Width: 14.7 in.
Filling: 108 SD 2 bombs.
Total Weight: 250 kg.
Fuzing: (89) B.

CONSTRUCTION. The container is similar in construction to the AB 250-2. It however, has been modified by adding an additional pair of stabilizing fins and is fitted with side trunnions for

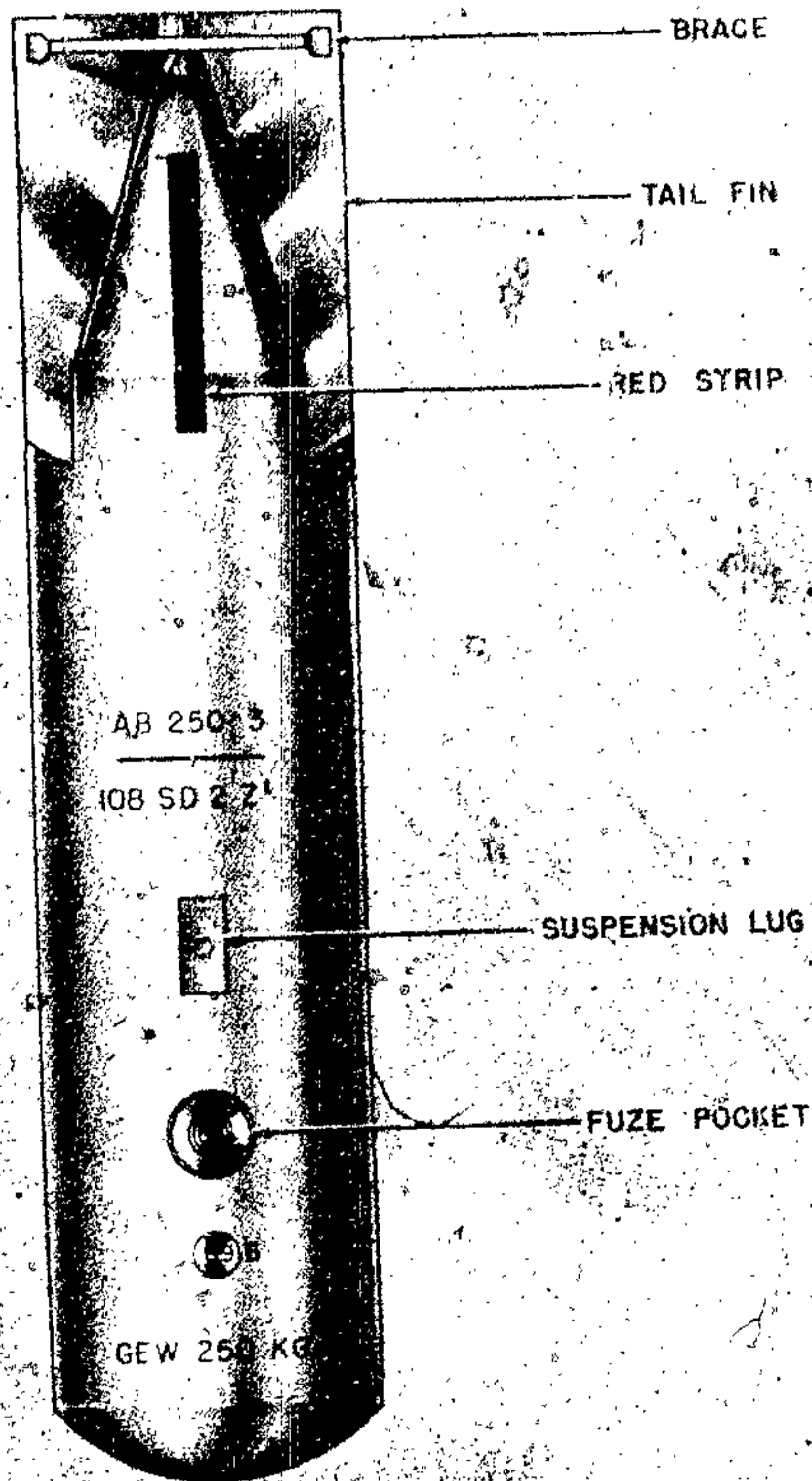

Figure 107—AB 250-3 Container, Types I and II

employment with dive bombers. (See fig. 107.) Type II has a dummy fuze pocket added.

REMARKS. The SD 2 bombs found in one container were of the modified design, without drogue and with the arming vanes cut to a triangular shape.

COLOR AND MARKINGS. Dark green over all with two longitudinal red stripes on tail cone.

Stenciled on Type I:

AB 250-3 (89) B
108 SD 2ZT; Gew 250 kg.

Stenciled on Type II:

AB 250-3 (89) B
105 SD 2ZT;

GERMAN EXPLOSIVE ORDNANCE

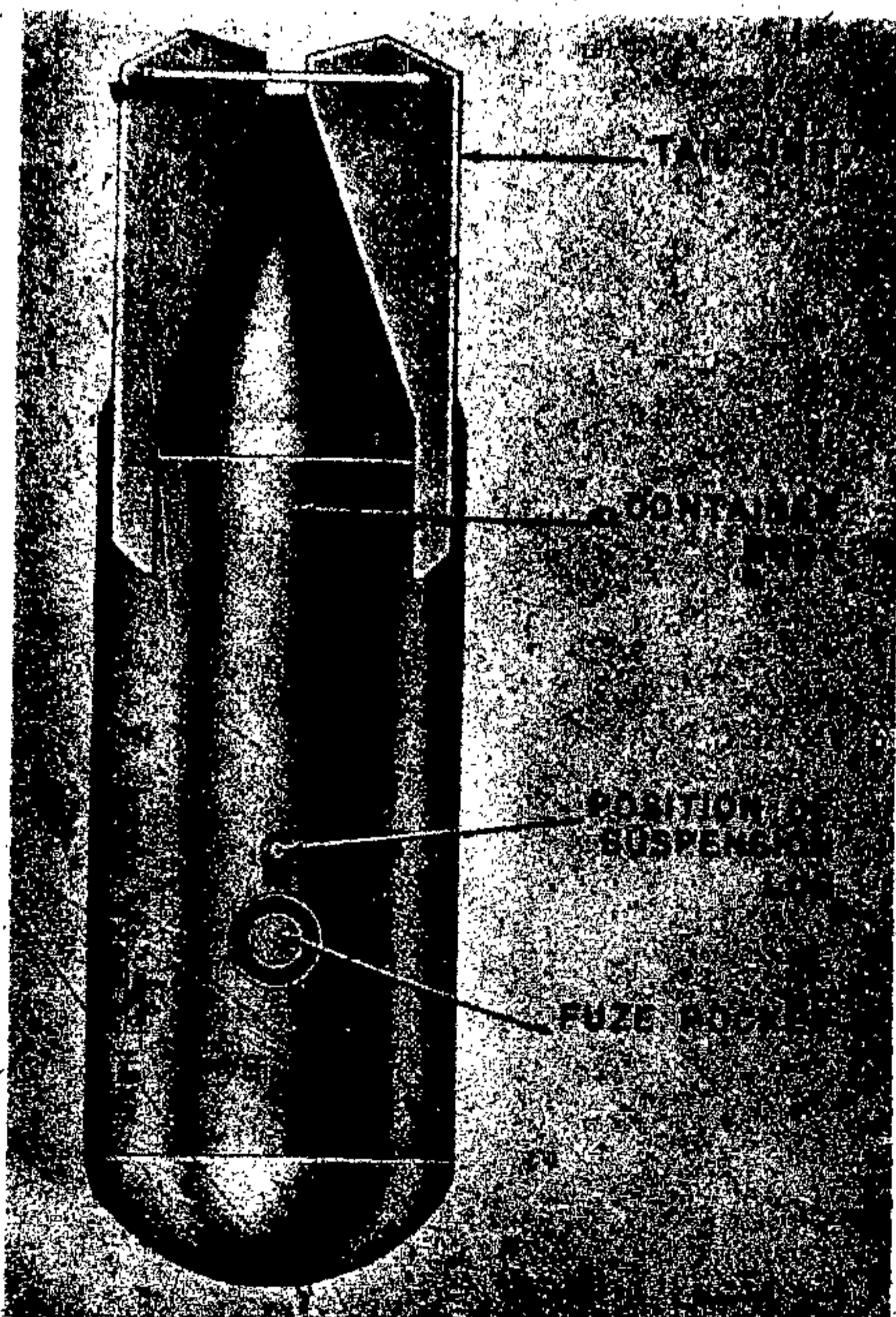

Figure 108—AB 250 KZ Boden Container

AB 250 KZ BODEN CONTAINER

DATA:

Over-all Length: 49.0 in.
 Body Diameter: 14.5 in.
 Wall Thickness: 0.075 in.
 Tail Length: 19.5 in.
 Tail Width: 13.5 in.
 Filling: 19 parachute flares 3 SD 2 bombs.
 Fuzing: ZT 89B.

CONSTRUCTION. The container body is made of sheet steel. It is built in two pieces, hinged at the tail. (See fig. 108.)

A subsidiary container for 3 SD 2-kg. bombs is secured to the bottom half of the container by means of a wire cable secured to the base of the suspension strut.

OPERATION. On release from the aircraft, the clockwork mechanism of the fuze is initiated and after the predetermined delay period the fuze

functions to initiate the bursting charge. This shears an unusually heavy shear pin and then the container opens on the tail hinge. The flares fall away and are ignited via friction pull igniters attached by eight cord loops to the main shroud lines.

The subsidiary SD 2 container falls away and on reaching the end of its cable receives a jerk causing the locking wire to break. The container opens and spills the three SD 2 bombs.

The flares are the metal cylindrical type, 13.5 inches long, 3.25 inches diameter.

SUSPENSION. Horizontal.

COLOR AND MARKINGS. Khaki. Stenciled on body:

AB 250 KZ Boden
 19 Mark SB2

MK 250 LK AND MK 250 BK FLARE CONTAINER

DATA:

Over-all Length: 49 in.
 Body Diameter: 14.5 in.
 Wall Thickness: 0.075 in.
 Tail Length: 19.5 in.
 Tail Width: 19.0 in.

Filling:

LK, 41 single candle parachute flares;
 BK, 25 modified red flares and three SD 2 bombs.

Fuzing: Zt Z (89)B

CONSTRUCTION. The Mk 250 LK is constructed in two halves, which open along the longitudinal axis and which is hinged at the tail.

The nose and tail cone is secured inside the body by spot welds.

On the lower half of the body, a strengthening rib is welded to the bottom longitudinally. Seven locating plates are welded inside the joining edges of the two halves to insure alignment.

The fuze pocket is welded to the upper half of the container. The lower end of the fuze pocket is increased in wall thickness. Inserted into the lower part of the fuze pocket, and secured by a $\frac{5}{32}$ -inch steel shear pin, is the steel anvil. Around the base of the anvil is a collar upon which the base of the fuze pocket is seated. A steel tube, welded to the underside of the anvil, is internally threaded to receive the container locking bolt. A steel collar is inserted in the fuze pocket and rests on the top of the anvil, and when assembled the

fuze gaine locates inside this collar. (See fig. 109.)

The container is held closed by the locking bolt. Locking bolt is held in the tube which is welded to the anvil. The anvil is held by the shear pin. When container is dropped, the fuze initiates the burster charge. The explosion forces the anvil down. The shear wire is broken. The locking bolt is then forced out and container opens.

Four tail fins are spot welded to the cone, the two on the upper half being slotted to facilitate loading on the bomb rack. An ordinary strengthening strut is riveted between the pairs of fins on each half of the tail cone.

The Mk 250 BK differs from the Mk 250 LK in that no cutaway portion exists in the upper tail fins and that it contains a subsidiary container for three SD 2-kg H. E. bombs similar but of approximately half the length of that described under the Mk 500 Boden 6SD. This container is secured to the bottom half of the larger container by means of a double wire cable secured around the base of the suspension strut. Large container operates the same as Mk 250 LK. The SD 2 container falls until it reaches the end of its cable. The resultant jerk causes locking wire to break and it then opens.

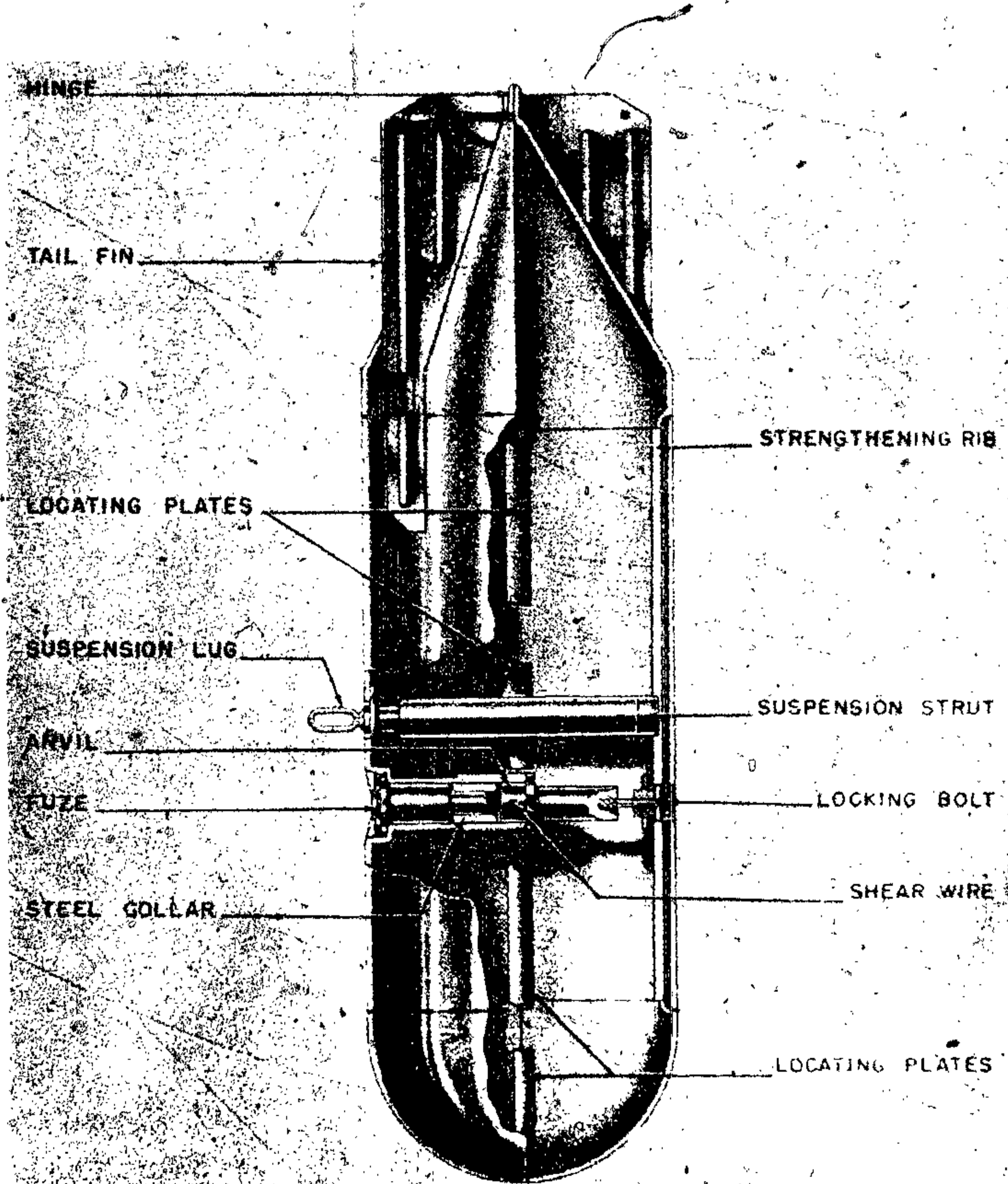

Figure 109—Mark 250 LK Container

GERMAN EXPLOSIVE ORDNANCE

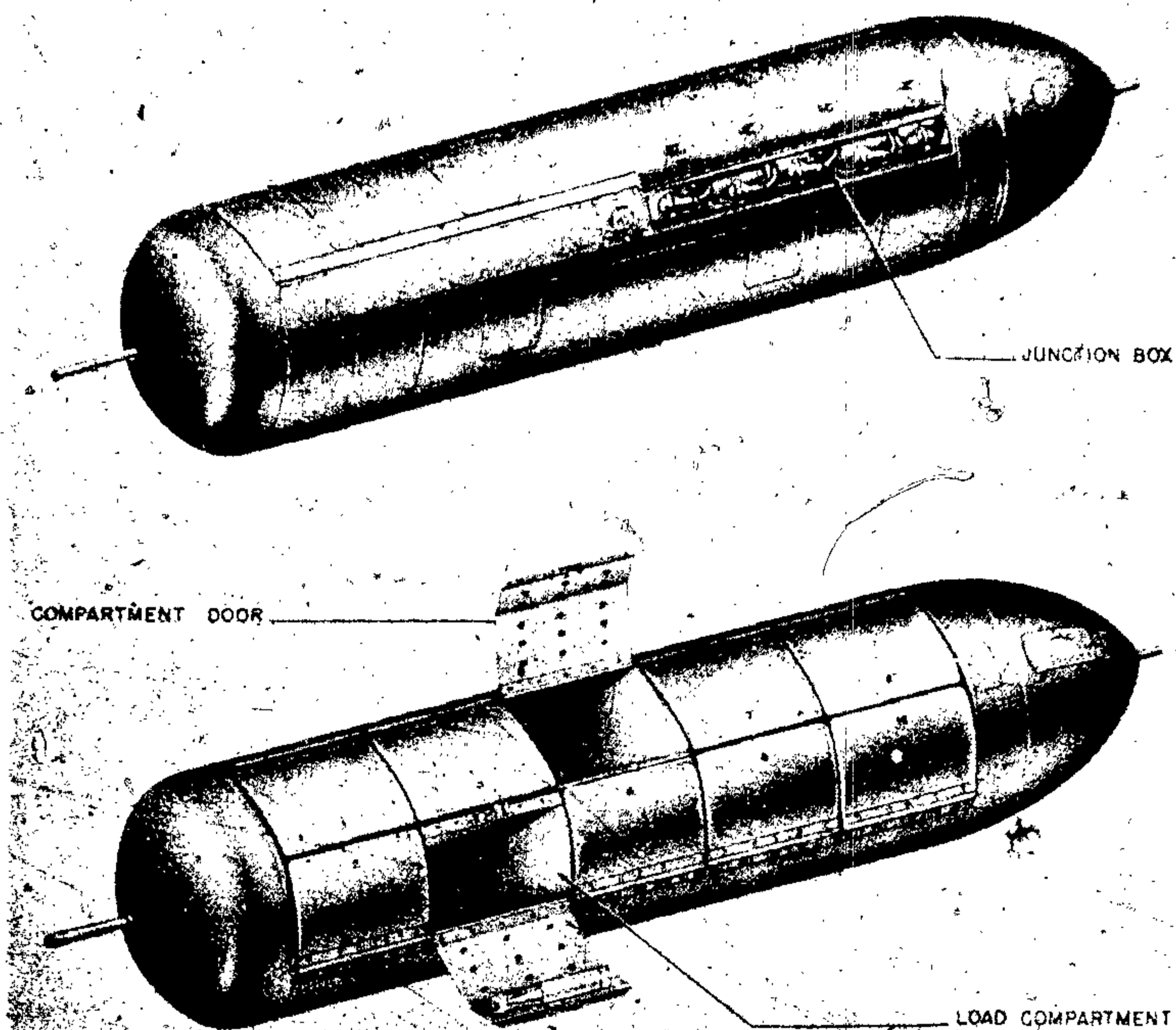

Figure 110—BSB 1000 Container

SUSPENSION. Horizontal. The suspension lug threads into a suspension block welded to a suspension strut which itself is welded to the bottom of the lower half of the container. A rectangular plate is welded over the top suspension block and bears on the underside of the upper half when the container is closed.

COLOR AND MARKINGS. Both containers are khaki colored over-all, but the body markings differ.

Mk 250 LK is marked:

Mk 250 LK
41 Weiss
(89) BOF

Mk 250 BK is marked:

Mk 250 BK
3 SD 2

A red bar 8 inches long and 1 inch wide is stenciled immediately above the nose weld.

BSB 360, BSB 700, AND BSB 1000 INCENDIARY BOMB CONTAINERS

DATA:	BSB 360	BSB 700	BSB 1000
Over-all Length	7'9"	10'3"	8'11"
Body Length	1'8"	2'2"	2'2"
Wall Thickness	0.06"	0.06"	0.09"
Filling:			
BSB 360,	320 1 kg 1B's.		
BSB 700,	702 1 kg 1B's.		
BSB 1000,	570 1 kg 1B's.		
Weights:			
BSB 360,	435 kg.		
BSB 700,	900 kg.		
Fuzing:			
BSB 360,	cable release.		
BSB 700,	electrical solenoid release.		
BSB 1000,	electrical release unit.		

CONSTRUCTION. The BSB 360 is a sheet steel cylinder with a blunt nose and tapered tail section.

The cylinder is divided into four compartments, each containing eight bombs. The two doors of the container are opened manually by a cable, each door opening two compartments and releasing bombs in groups of 180. This container generally remains in the aircraft after dropping the load.

SUSPENSION. Horizontal. Container retained in plane.

COLOR. Black over-all.

CONSTRUCTION. The BSB 700 is a sheet steel cylinder with a blunt nose and conical tail section. Cylinder has six compartments, each containing 117 bombs. The contents of each compartment are released by means of trap doors operated from an axial spindle, the release mechanism being controlled electrically through a solenoid. Bombs are released in batches of 69 and 48 from each compartment. Each compartment has an expendable outer door and inner rotating door (rotated by action of the solenoid). This container remains in the aircraft after dropping the load.

SUSPENSION. Horizontal. Container remains with plane.

COLOR AND MARKINGS. Black over-all. Stenciled on bomb body:

Betadezant 700-5

Leengewicht 205 kg

Gesamtgewicht 900 kg

CONSTRUCTION. The BSB 1000 has a sheet steel cylindrical body. The blunt nose and conical tail sections are attached by bolts and rivets. The nose and tail sections are recessed to take a transport loading bar. The main body is internally divided along its longitudinal axis by a hollow central bulkhead which houses the release rods. Each half of the main body is further divided into 5 compartments by bulkheads, thus making 10 compartments. Ten spring loaded compartment doors are hinged to the underside of the container. These doors are held by hook releases which are connected by the release rod to the electrical release units fitted with manually operated release switches for use in loading. No fuze is fitted and it is assumed that the electrical lead passes into the junction box and selection mechanism housed in the tail, the latter functions to space the 570 bombs as desired. In operation, the electrical

charge passes through the junction box and causes the selector mechanism to function. Current is passed to release units, and these open the release hooks through the medium of the release rod. The weight of the bomb forces doors open and bombs fall, the spring loaded doors then closing to preserve streamlined containers. (See fig. 110.) This container also remains in the aircraft after dropping the load.

SUSPENSION. ~~Horizontal.~~

COLOR AND MARKINGS. Light khaki or grey over-all. "Leerewicht 210 kg" is stenciled on body.

AB 500-1 CONTAINER

DATA:

Over-all Length: 80 in.

Body Diameter: 18 $\frac{7}{8}$ in.

Wall Thickness: $\frac{1}{8}$ in.

Tail Length: 28.75 in.

Tail Width: 24 $\frac{3}{8}$ in.

Filling: 37 SD 10A or 392 SD 1, or 184 1-kg incendiary or 28 SD 10 FRZ, or 116 2-kg incendiary.

FUZING: 89B; 69E; 69D; charging head Ledekopf MVOV 500-1. Two fuzes and a charging head are used.

CONSTRUCTION. Container is divided along longitudinal axis into two halves hinged at the tail. The nose compartment contains the fuze assembly, the central compartment accommodates the bombs, and the tail compartment being empty, forms part of the tail structure. A metal strip is welded to one-half the container and forms a spigot for the two halves to close on. A pressed metal plate having a central channel runs the length of the central compartment. (See fig. 111.)

The internal structure varies as to bombs carried. When SD 10 FRZ bombs are carried, they are loosely packed. Fifteen bombs are carried in rear of central compartment and thirteen forwards. They are not secured by bands. Containers for SD 10A bombs are divided internally into two compartments. The central compartment of the container is divided into two halves by a plywood sheet. Eighteen bombs are accommodated in the forward half and nineteen bombs in the rear half. Each cluster is secured by steel bands which slip into the channel on one side and are wedged in by the wood strip. On the other side the bands are secured together by split pins which pass through

GERMAN EXPLOSIVE ORDNANCE

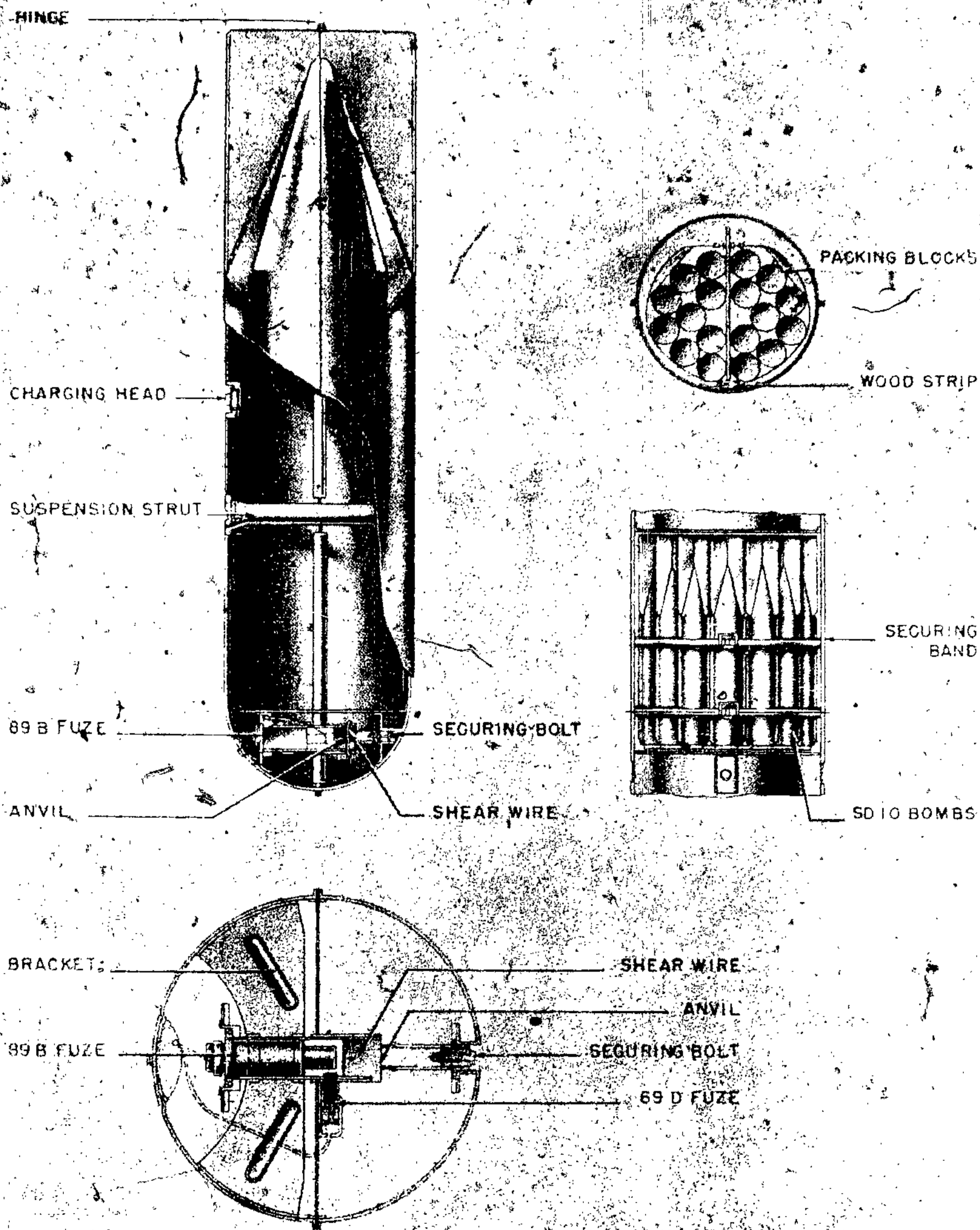

Figure 111—AB 500-1 Container

loops at the ends. Metal strips looped around the steel bands split the pins. Wooden packing blocks are recessed to receive the bands. In the forward compartment the cluster of bombs is divided by slats of wood and the suspension strut.

The sheet metal tail fins of each half are braced by a bar welded between them.

The charging head Ladekopf MVOV 500-1 is housed in a steel block welded to the container wall about midway down. A four-core electric cable from the charging head to the nose is carried in a metal tube welded to the inner wall. The cable enters the nose compartment through a hole drilled in the forward bulkhead. The fuze pocket is located in the nose by two brackets and welded to the forward bulkhead and sides of the container. The lower end of the pocket receives the anvil retained by the shear wire. A tubular extension to the anvil is arranged to receive the bolt, which secures the closed container after assembly. Welded to the side of the fuze pocket is a short length of tube which contains the Z 69E fuze; the bayonet fitting three pin plug closes this tube and connects the fuze with the charging head. A Zt (89) B fuze is held in the fuze pocket by usual locking and locating rings and is connected to the charging head by a charging attachment. Access to the fuze assembly is gained by a hole cut in the wall of the nose, and closed by a cap having a bayonet fitting.

OPERATION. On release from aircraft, an electrical charge is transmitted via the charging head to either or both fuzes. After a predetermined delay, depending on the fuze selected, fuze operates to detonate the bursting charge. This overcomes the shear wire and forces anvil from fuze pocket. The two halves of the container swing back on the hinge and contents spill out.

SUSPENSION. Horizontal.

COLOR AND MARKINGS. Light Khaki overall.

According to contents; following stenciling is found on body:

AB 500-1	AB 500-1	DB 500-1
Fuz 184 B1.3EZ	37 SD 10A	392 SD 1
Fuz 116B ZEZ	Gew 47 kg	Gew 415 kg
89B	69E	89B
69E	89B	69D

In containers filled with SD 1's the 69D has been painted out and a wooden plug replaces the 69D fuze.

AB 500-3A CLUSTER ADAPTER

DATA:

Over-all Length: 31 1/4 in.

Body Diameter: 16 1/2 in. x 17 3/4 in.

Filling: 4 SD 50 kg or 4 SK 70 kg, or 50 kg and 100 kg French bombs.

Fuzing: 69 series fuze, charging head Ladekopf 15.

CONSTRUCTION. The cluster is built around two longitudinal channel plates 1/8 inch thick. They are pressed into splayed U-shaped channels at the top and the bottom of the assembly respectively and joined together by two steel plates which form a central longitudinal bulkhead with a double wall. Triangular plates welded between the bulkheads and the outer ends of the upper channel act as stiffeners. (See fig. 112.)

At about the middle the two plates, forming the bulkhead, are then shaped to form a rectangular compartment. It is presumed that when German bombs are carried this compartment contains a junction box and charging attachment for the Rheinmetall fuzes mounted in the bombs. Holes are punched in each side of the compartment and are shaped to take fuze head attachments. A hole is drilled in the top main supporting plate to enable a connecting cable to be threaded through the bulkhead.

At each end of the top channel a pair of shaped steel crutch pads are pivoted on either side of the plate. They are to fold over the top bombs and act as pressure plates for steadying brackets in the aircraft bomb rack.

Wood packing, shaped like saddle pieces for the bombs, are clipped to the sides of the central bulkhead.

Two wide thin sheet steel carrying bands are hinged to the top channel and locked into the bottom channel by the release mechanism. Each band is in two halves coupled by an adjustable right and left handed screw which functions as a turnbuckle.

Suspended from the nose of the top channel is a rigid structure of steel strip in the form of two inverted Y's. This is presumed to carry a locking device for mechanically armed nose fuzes, mounted in French bombs.

GERMAN EXPLOSIVE ORDNANCE

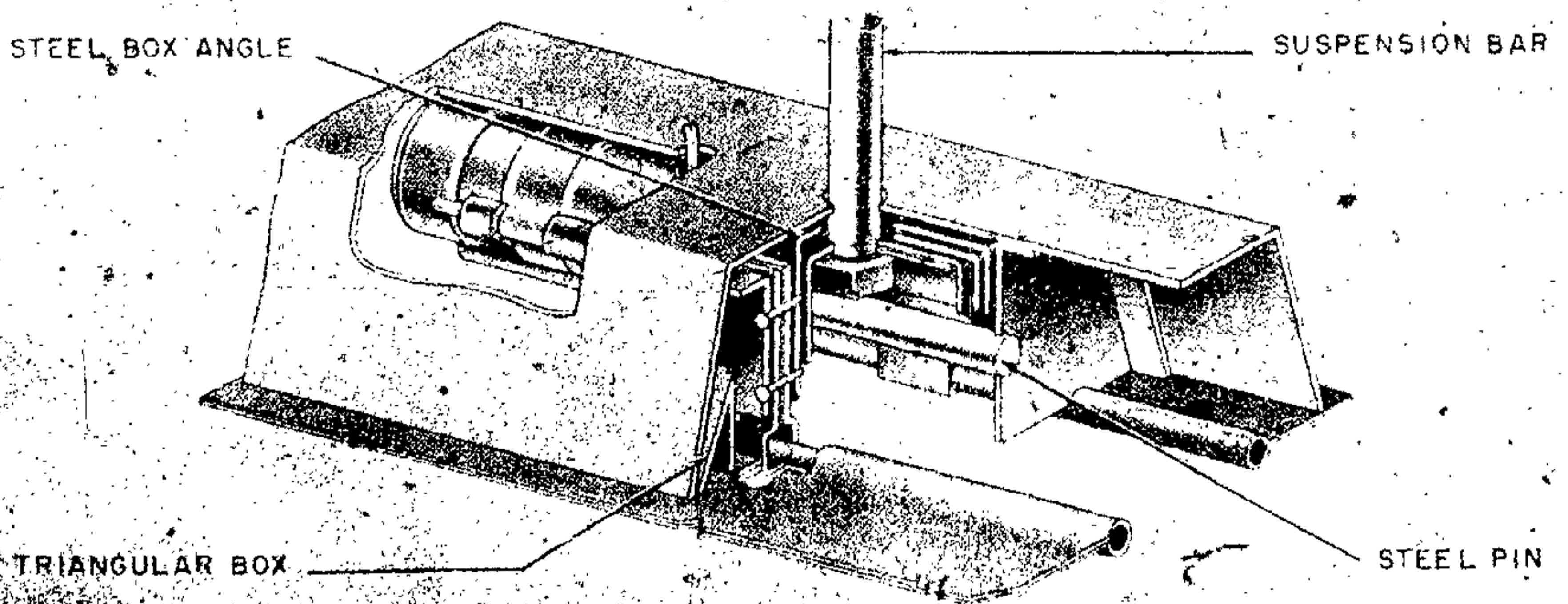
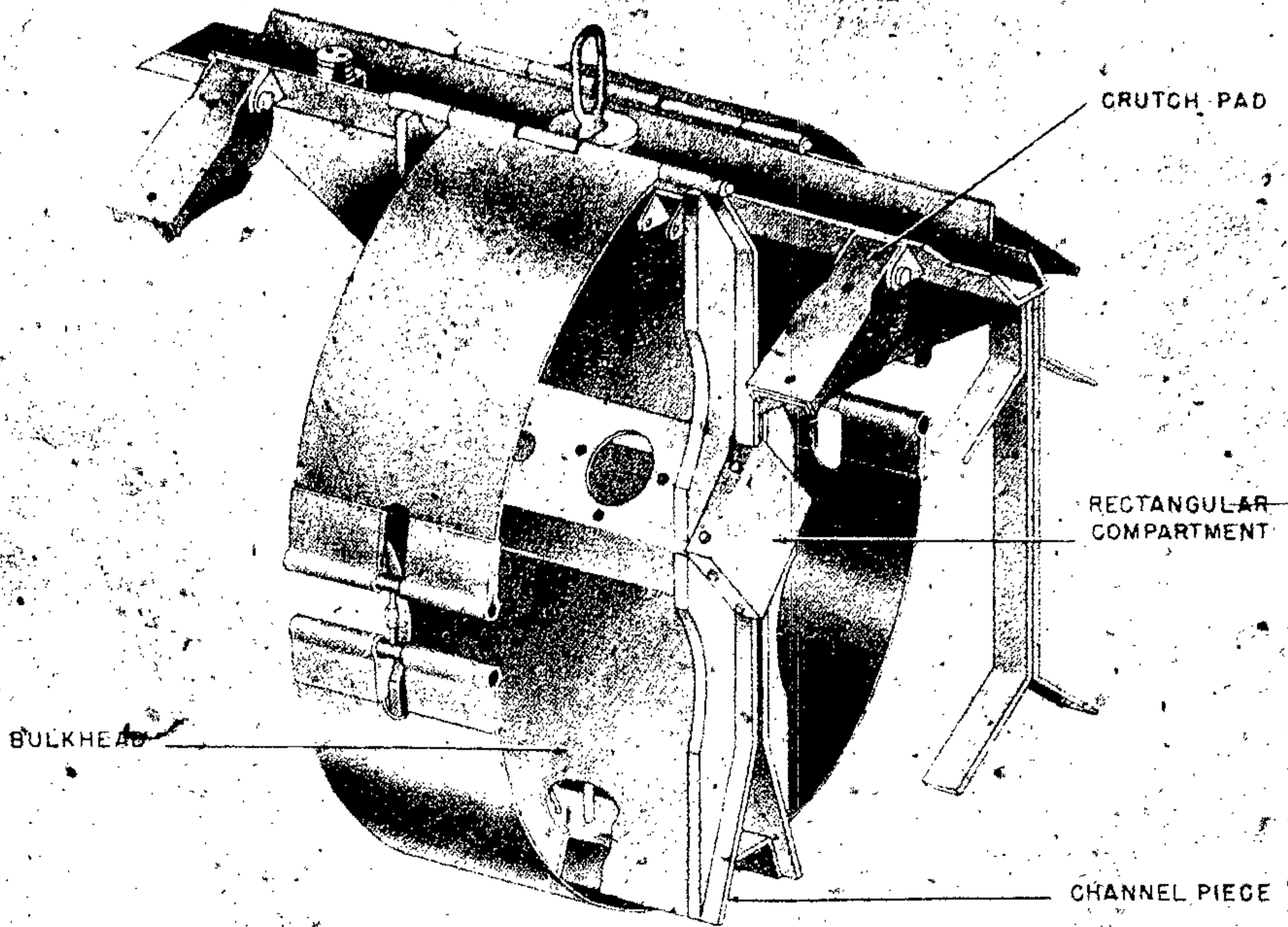

Figure 112—AB 500-3A Cluster Adapter

The container has an electropyrotechnic fuze of the 69 series. A Ladlekopf charging head is mounted on a steel pressing, welded within the top channel towards the rear end. An electric cable passes from this, through the central bulkhead to the 69 fuze which is mounted on the side of the release mechanism, within the bottom channel. A second cable may be connected to a junction box within the rectangular compartment, when the container is loaded with German bombs.

A rectangular pressed steel box is secured to the end of the suspension bar, within the bottom channel, by a nut. Steel box angles slotted to engage round the bar, and which are riveted to the loops, slide into one another and beneath the steel box.

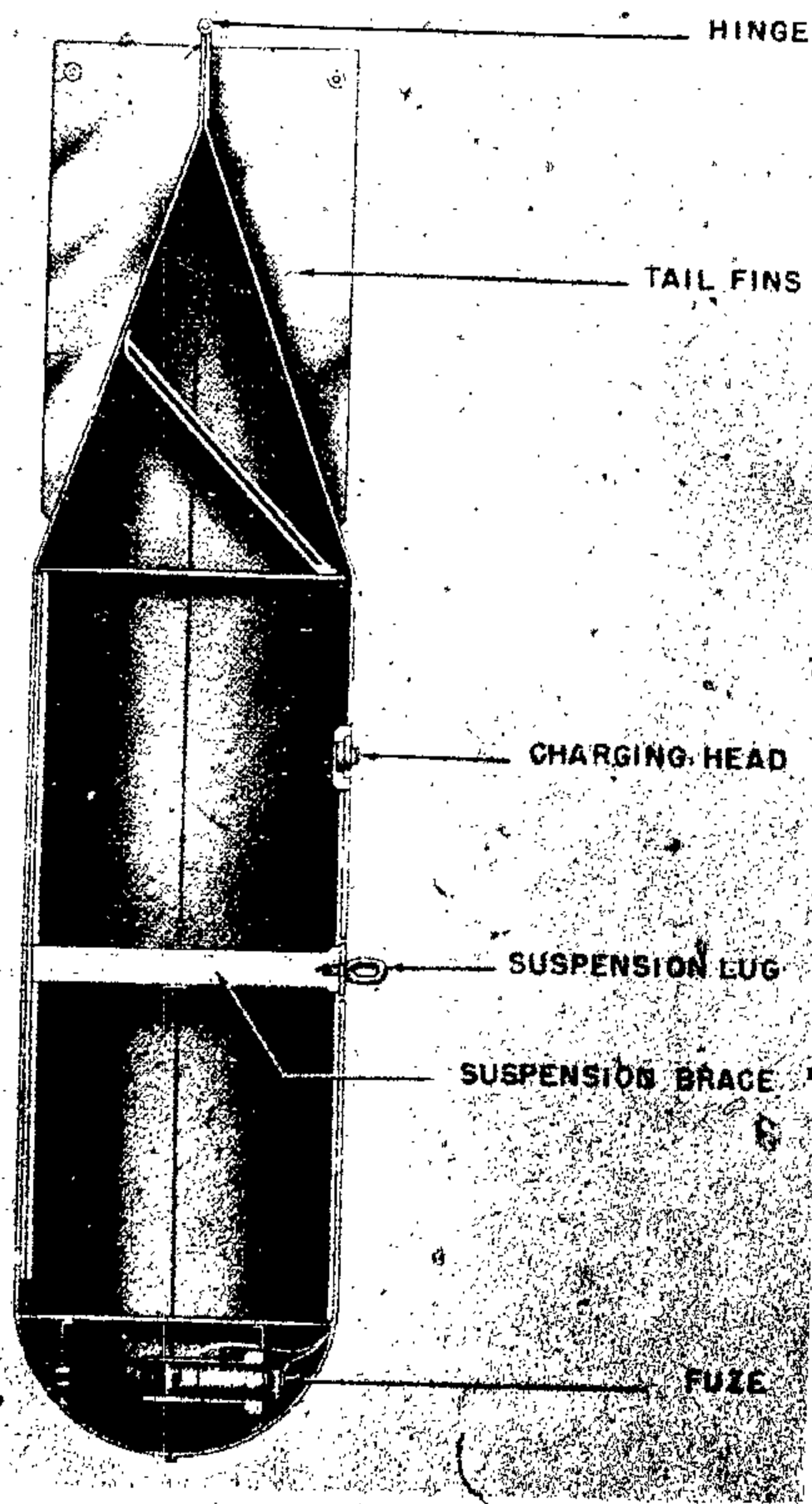

Figure 113—AB 500-1B Container

The loops are hinged to the bottom of the carrying bands. Steel wedges are riveted to the reverse sides of the loops to keep the assembly wedged within the channel.

Small steel triangular boxes are welded to the bottom of the carrying bands to facilitate release.

The assembly is locked while there is upward tension on the suspension bar.

On either side of the assembly, two brackets are welded within the channel. A third bracket supports the fuze pocket. A steel pin, attached to the remote end of the fuze pocket is threaded through holes drilled on the bracket and locks the suspension bar and assembly in the "up" position should tension on the bar be released. When the container is released from the aircraft, an electric current is pressed via the charging head to the 69 fuze. After a set delay the fuze fires, forcing off the remote end of the fuze pocket, which carries the locking pin with it. The tension on the carrying bands then forces the suspension bar down and the locking assembly is released.

When German bombs are carried, a second circuit from the charging head passes the electric current, via a junction box, in the central rectangular compartment, to the Rheinmetall fuzes in the bomb.

COLOR AND MARKINGS. Khaki over-all. Stenciled in black on body: AB 500-3A.

AB 500-1B CONTAINER

DATA:

Over-all Length: 80 in.
Tail Length: 29 in.
Tail width: 17 in.
Diameter of body: 18 in.
Filling: 28 SD 10 FRZ bombs.
Fuzing: 69E.

CONSTRUCTION. The AB 500-1B container is similar to the AB 500-1. (See fig. 113.)

The 28 SD FRZ bombs are accommodated in the central compartment of the container, 15 bombs being accommodated in the rear portion and 13 bombs in the forward portion.

Bombs are loosely packed nose to tail and are not secured by bands.

MARKINGS. Markings on container: 28 SD 10 FRZ.

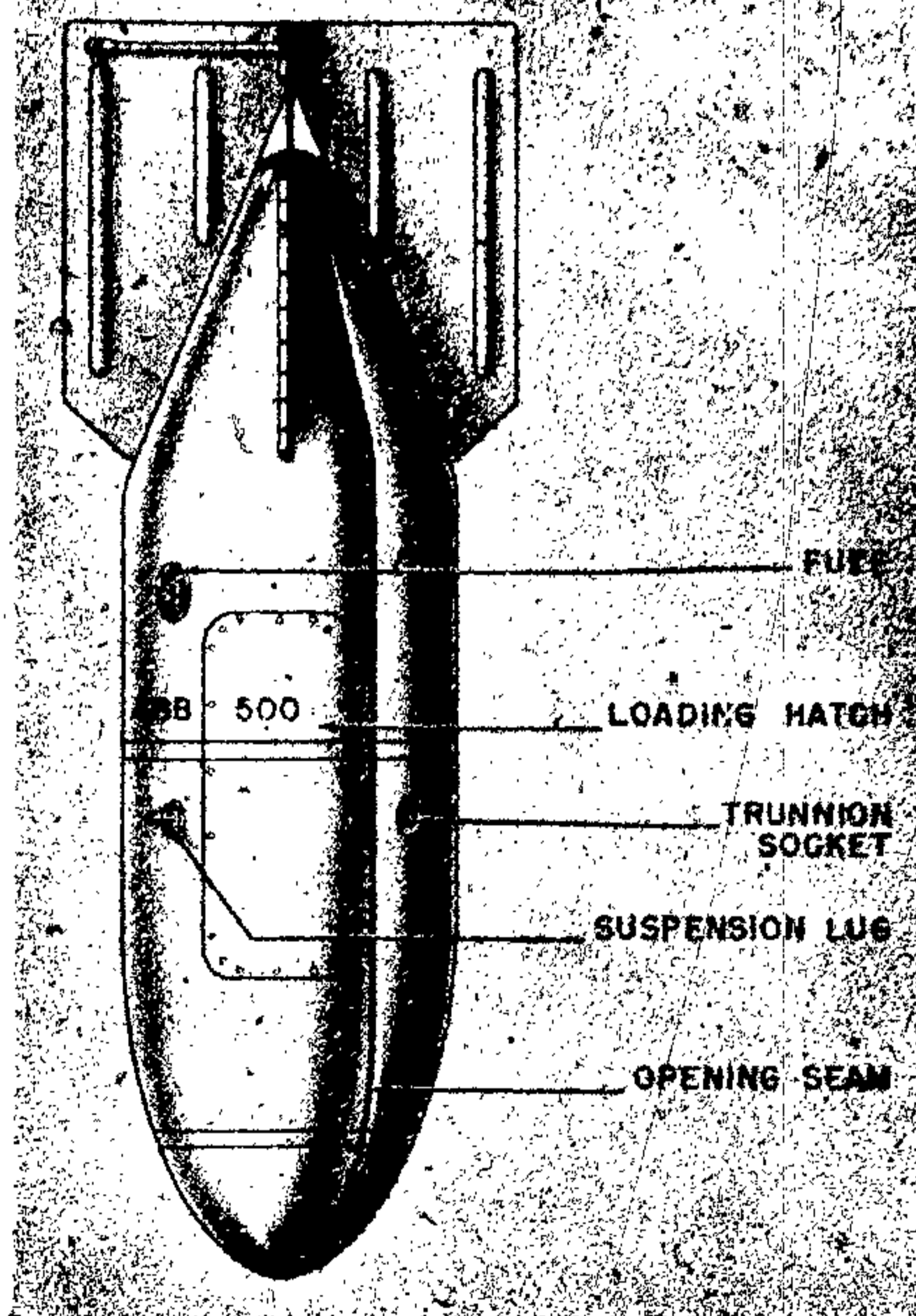

Figure 114—ABB 500 Container.

ABB 500 CONTAINER

DATA:

Over-all Length: 69.6 in.

Body Length: 25.2 in.

Body Diameter: 18.4 in.

Wall Thickness: 0.05 in.

Tail Width: 25 in.

Filling: 133 1-kg incendiaries, 2,200 "crow's feet."

Total Weight: 152.4 kg.

Fuzing: El Zt Z (9) A; El Zt Z 79 A; Z 89.

CONSTRUCTION. The body is cylindrical shaped similar in appearance to a SC bomb except for the nose, which is more blunt. (See fig. 114.) The bomb is divided into two halves longitudinally and united by a rolled joint. The vanes and other fittings are welded. A loading hatch is screwed to the body just forward of the fuze pocket. There is only one fuze pocket which is 7¾ inches in depth. Fuze pocket contains one

annular picric acid pellet fuze and a wooden cylindrical packing piece.

OPERATION. The aerial burst action of the fuze and picric acid pellet splits the case in half down a weak weld.

REMARKS. The bomb container is a C 500 flam casing adapted to carry approximately 133 1-kg incendiary bombs.

Among the 1B's found in one container were some chalk cement rods (with a wire core) 1.9 inches in diameter (possibly used as filling pieces).

SUSPENSION. Horizontal.

COLOR AND MARKINGS. Inside and outside of container is painted a dull slate grey. There are two red bands; one is around the midsection of the bomb body, and the other is around the nose of the bomb.

Letters "ABB 500" are stenciled in black at center of bomb between the fuze pocket and the suspension lug.

Letters "1941 bbZ 170 7" appear on tail fin.

"STREUBRAND C 500" CONTAINER**DATA:**

Over-all Length: 69.5 in.
 Body Length: 18.8 in.
 Tail Length: 24.5 in.
 Tail Width: 25.0 in.
 Filling: 1,200 green celluloid incendiary boxes immersed in water.

CONSTRUCTION. Container is similar in appearance and dimensions to ABB 500 container with the exception that loading hatch is absent as in the AB 500-1. (See fig. 111.)

A $\frac{7}{16}$ -inch internal diameter steel tube, welded to the upper half of the casing directly above the longitudinal joint of the two halves of the container, connects at right angles to the side of the fuze pocket to which it is also welded.

A single length of green detonating fuze leads from this tube to turn along the longitudinal joint and run round the nose of the container, returning via the junction of the tail to enter the $\frac{7}{16}$ -inch tube. At intervals along the longitudinal joint

steel clips are placed to secure the detonating fuze firmly in position.

The two halves are hermetically sealed together by welding at the longitudinal seam. Inside the container is a steel strut, which is used to give support to the two halves of the casing. The strut is weakened in one place.

Screwed to the fuze in the normal way is a standard gaine projecting into a wood packing piece. One end of the detonating fuze is housed in this packing piece to contact the side of the gaine.

On release of the container, fuze is charged. After a short delay, fuze fires, firing gaine which in turn detonates the detonating fuze. Detonating wave travels round the seam of the container to separate the two halves. The weak part of the internal supporting strut is broken and the two halves are parted.

REMARKS. The streubrand C 500 appears to have been an inefficient incendiary weapon, and the method of separating the two halves of the container may have been found to be unsatisfactory in practice since damage to exposed detonating fuze would result in failure.

MARK 500 BODEN CONTAINER**DATA:**

Over-all Length: 69.6 in.
 Body Diameter: 18.4 in.
 Wall Thickness: 0.05 in.
 Tail Length: 24 in.
 Tail Width: 2 in.
 Filling: 9 or 15 single candle flares and 6 SD 2 bombs.
 Fuzing: E1 Zt Z (9) A; 79; 89.

CONSTRUCTION. This container is similar to the AB 500. The tenth flare normally carried in the ABB 500 has been replaced by a subsidiary container for 6 SD 2 bombs. (See fig. 115.)

Instead of the usual opening device, the container is opened by means of a continuous strand of detonating cord (green with pink filling, thought to be penthrite) which circumscribes the container at the junction of the two halves.

The subsidiary container for the 6 SD 2 bombs is anchored by the double wire cable to the U-shaped bracket positioned in the lower half of the body to one side of the internal suspension strip. The 6 SD 2 container is formed along the longi-

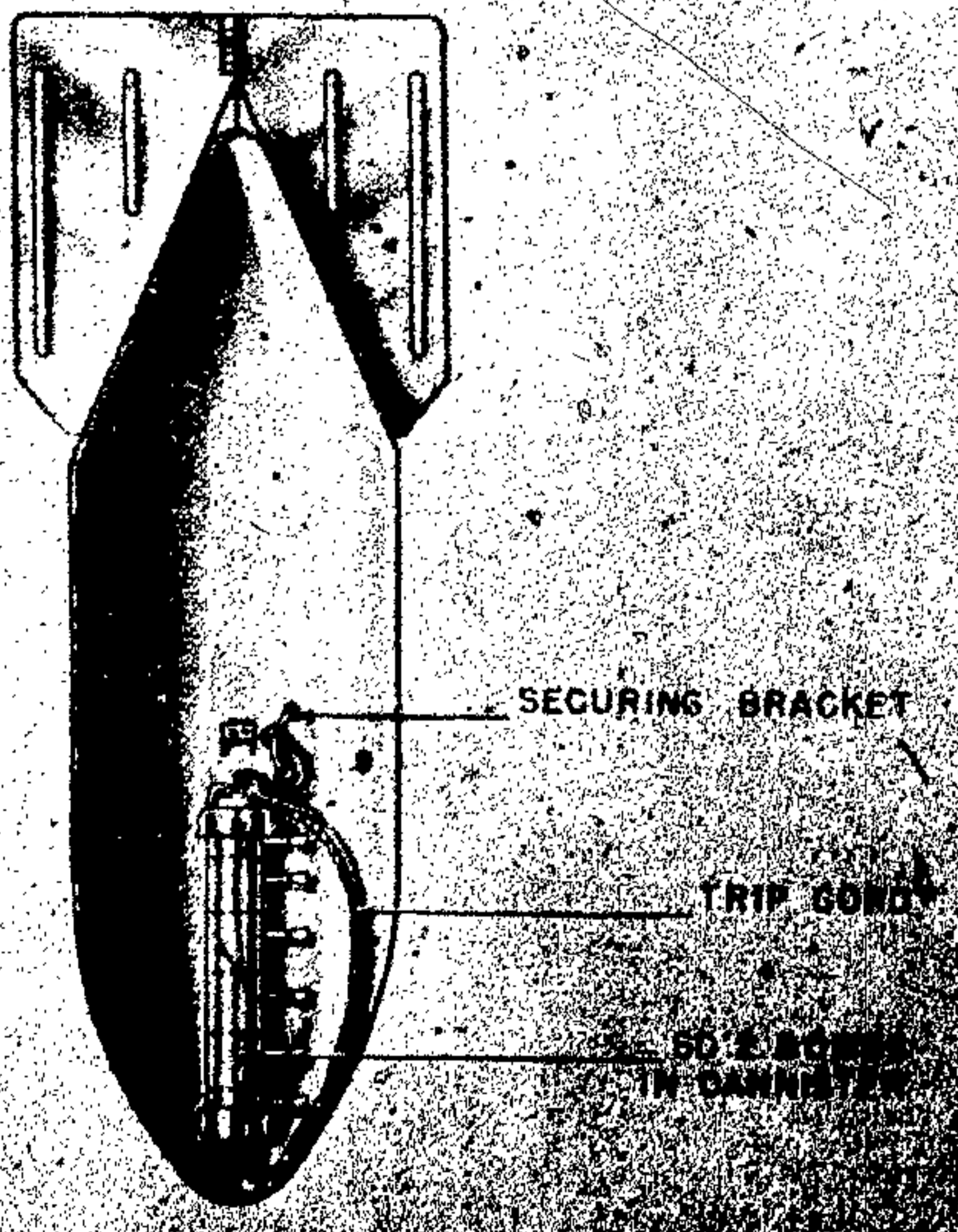

Figure 115—Mark 500 Boden Container

GERMAN EXPLOSIVE ORDNANCE

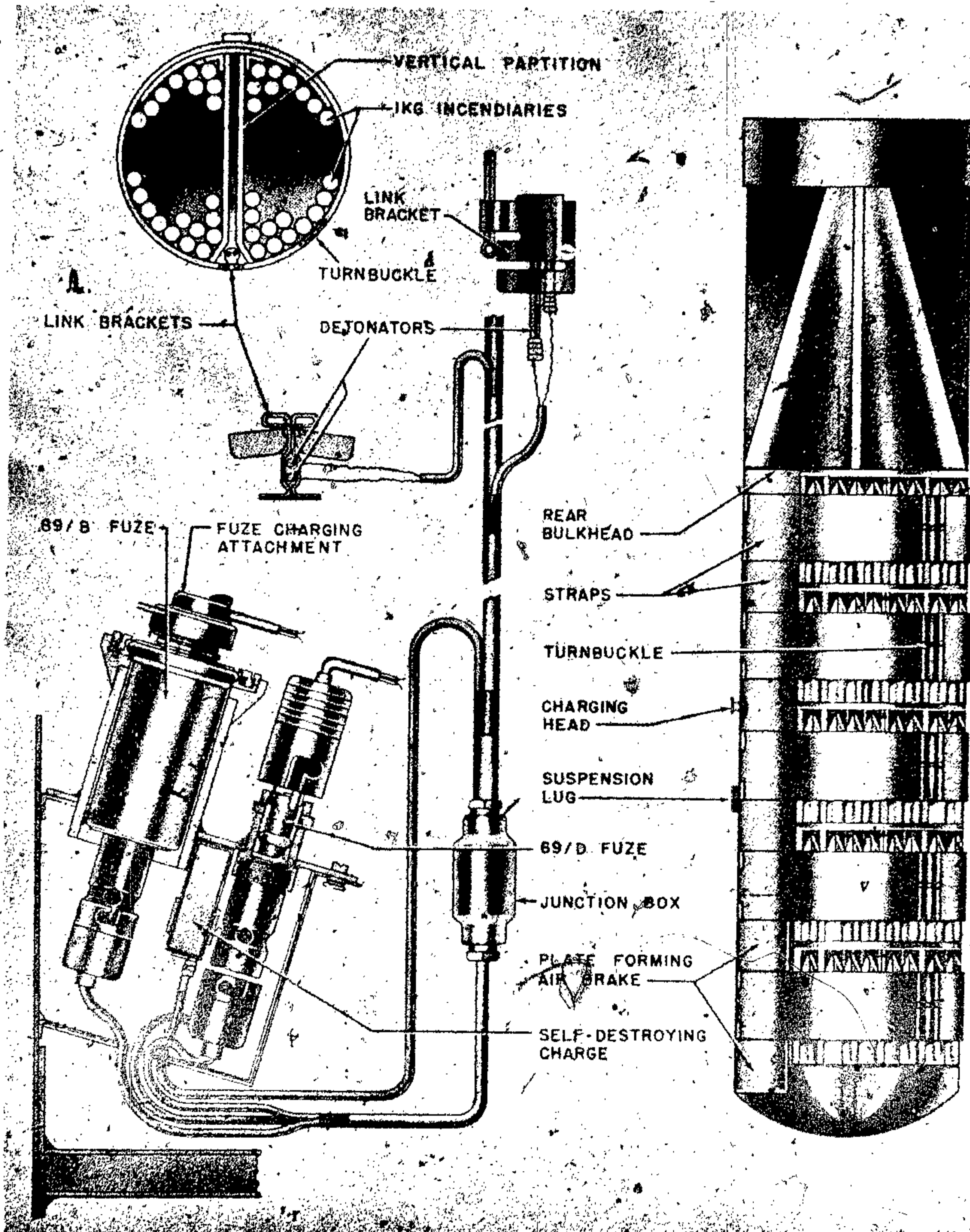

Figure 116—AB 1000-2 Container

itudinal axis, in two halves, retained by the two steel female end caps drilled at the side to admit the thin container securing wire. Secured to each end cap is a U-shaped bracket, a 0.25-inch round bar, to which is attached the double wire cable.

After the 6 SD 2 container falls free, it is arrested by the double wire cable. The jerk is so applied to the end cap that it suffices to break the securing wire and the end cap is pulled off. The bombs then are free to fall away.

SUSPENSION. Horizontal.

COLOR AND MARKINGS. Slate grey or black over-all. Stenciled between fuze pocket and suspension lug:

Mark 500 Boden
6 SD

AB 1000-2 CONTAINER

DATA:

Over-all Length: 123 in.

Body Diameter: 26 in.

Wall Thickness: 0.075 in.

Filling: 620 1kg 1B's, or 246 1 kg 1B's and 234 2 kg B.2 EZ, or 372 2 kg B.2 EZ.

Fuzing: Two Z(69)D, Zt Z89B and a charging head. Three fuzes in all are in containers in addition to charging head.

CONSTRUCTION. The body is T-shaped in cross section. The longitudinal axis of the container is formed by two sheet steel plates 26½ by 70 inches. Indented together with circular spot welded pressings and welded along their greater dimensions to two U-shaped girder pieces. Two circular sheet steel plates form the nose and tail bulkheads. A slightly domed sheet steel nose is welded to the nose bulkhead and is reinforced by a tubular steel sheet approximately 8 inches long welded to both the bulkhead and the domed nose. A sheet steel top plate is welded to the upper U-shaped girder to form an arc-line canopy extending 13½ inches on either side of the girder. The top plate is recessed to receive the H-type suspension lug and to accommodate the fuze pocket. (See fig. 116.)

The central support for the tail unit is a steel bar welded to a square plate which in turn, is riveted to the tail bulkhead. A flanged circular sheet steel plate is spot welded to the tube and

tail cone for added support. The tail fins consist of two layers of sheet steel pressed together, each layer being part of the adjoining quadrants of the tail cone. Fuzes are housed in a thin sheet steel box inside the tail cone and are welded to the tail bulkhead. An inspection hatch in the tail gives access to the fuzes.

On the under side of the fuze box are two steel clips which accommodate the 4-ounce penthrite charge provided to destroy the electromagnet generating units attached to the bottom end of fuze. Five sections containing incendiary bombs can be arranged in each side of the center bulkhead of the container. Each section is separated by semicircular sheet steel separator plates. The bombs are held in place by five sheet steel retaining bands which are drawn tightly around the bombs and container by turnbuckles. Each strap is held in position at the lower edge of the vertical position by a large split pin anchored to a bracket support which carries a small charge consisting of two detonators. Two rectangular steel plates near the nose hinge outward when the forward band is severed and form air brakes.

The fuze pocket accommodates the charging head from which six orange colored cables are led to the fuzes. Two of the cables are connected by a fuze charging attachment to the head of the (89) B fuze; the remaining four cables are connected in pairs to two bayonet joint charging attachments housing the (69) D fuzes. Six leads pass from the fuzes to a junction box in the tail unit. Leading from the junction box are three cables for each of the six points (five retaining bands and the destroying charge on the steel fuze box); plus six black colored cables, all of which are enclosed in a green cover. Four of these leads branch off to each of the five retaining bands (two wires to each det.) and four leads branch off to the self-destroying charge. All detonators on the (89) B fuze circuit are instantaneous while the detonators on the (69) D fuze circuits have delays varying from 1 to 6 seconds, the variance between detonators being 1 second. They are so placed that the 1-second delay is on the band nearest the tail unit, the 2-second delay is next, etc. The 6-second delay detonator is used on the self-destroying charge of the fuze box. On release, an electrical charge is imparted to one of the plungers of the charging head, depending on which of the fuzes

GERMAN EXPLOSIVE ORDNANCE

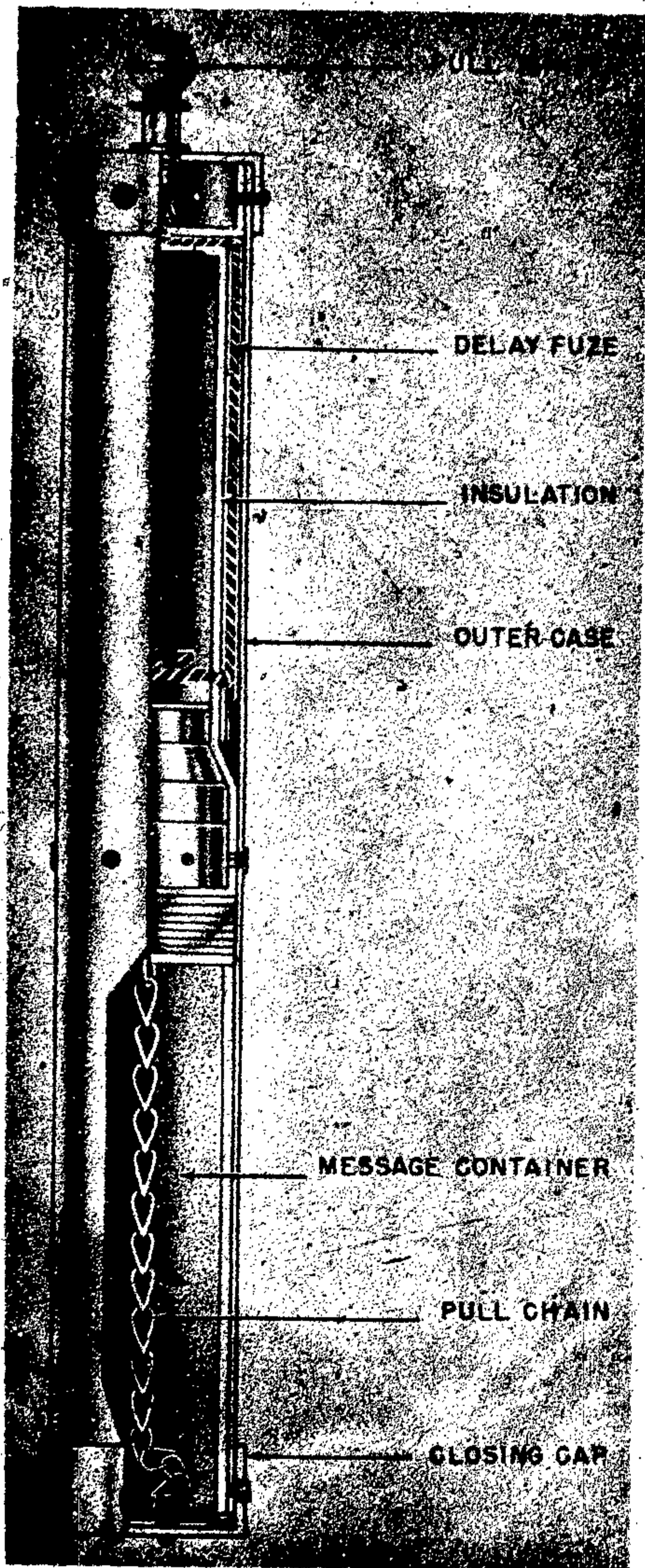

Figure 117—Message Tube (sea)

is to be used. The fuze functions and ignites a black powder pellet which drives a piston forward. A projection of the piston strikes a soft iron core in the center of a coil of copper wire enclosed within a magnetic sheath. The rapid displacement of this iron core induces an electric current in the coil which is passed to the junction box and then to the detonators which sever the bands.

Containers can be dropped from low altitudes with the (89) B fuze and instantaneous detonators used to secure a heavy concentration of bombs, or containers can be dropped from high altitudes with the (69) D fuze and varying delay detonators used. This would give a wide dispersion of the bombs.

SUSPENSION. Horizontal.

COLOR AND MARKINGS. Light khaki.
Markings on body are:

AB 1000-2

B.1.3 EZ

B 2 EZ

MESSAGE TUBES (SEA AND LAND)

DATA:	SEA	LAND
Over-all Length	14.75 in.	15.75 in.
Body Diameter	2.6 in.	2.0 in.
Total Weight	2.25 lb.	1.5 lb.

CONSTRUCTION. The sea message tube is made of aluminum and is painted yellow. The top is closed by a disc with a friction igniter through it. The igniter has a red top and a delay pellet giving a delay of 1 second. The aluminum smoke container is below the igniter. It contains a red-brown powder, the surface of which has a black powder charge to start the burning of the smoke mixture. The container is made watertight by tightening the wing nut. (See fig. 117.)

The smoke container is 5.4 inches in length, has a diameter of 1.75 inches and weighs 0.75 pound.

The land message tube is made of aluminum and is painted red. The top cover holding the red-topped friction igniter (1 second delay) is a push fit over the container. Through a hole in the cup-shaped aluminum piece near the cover protrude the ends of four strands of quickmatch. These strands run down the side of the smoke container and meet several pieces of fire quick-

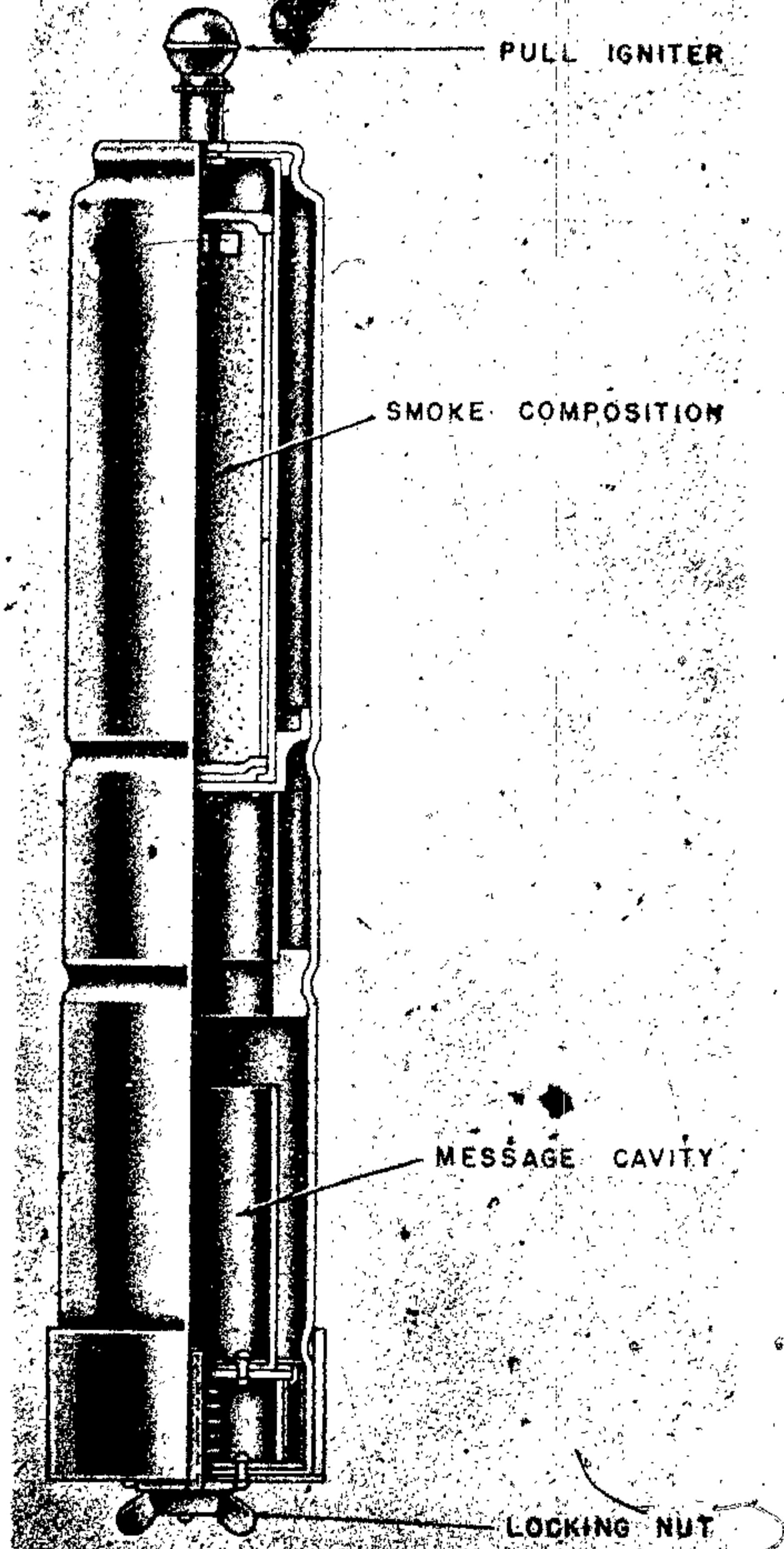

Figure 118—Message Tube (land)

match below the smoke container. (See fig. 118.) When ignited, the reddish brown powder gives off a very bright yellow smoke.

The smoke container is 5 inches in length, has a diameter of 1.75 inches and a weight of 10.3 ounces.

COLOR AND MARKINGS. Yellow over-all. Markings:

- Meldebusche (land)
- Unegefährlich (not dangerous)
- Wechtige Moldung (important message)
- Sofort Weitergeben (forward at once)

GERMAN EXPLOSIVE ORDNANCE

Table 1.—Loads of

AIRCRAFT	DUTY	RANGES IN MILES	BOMB LOADS IN POUNDS	BOMB STOWAGES: WEIGHTS IN KILOGRAMS
Do 17 Z	R; NF; B	880-1440	NIL, 2,200	2 x 50 or 2 x 250
Do 18	R	1845-2640	440	4 x 50
Do 24	R; B	1485-1800		12 x 50
Ju 86	Transport	800-980	NIL, 2,200	4 x 250 or 16 x 50 or
Ju 87 B and R	DB; GA	370-975	990, 2,200	1 x 250 (or 500) and 4 x 50 or 1 x 1000 or 4 x 50 and 4 clusters of antipersonnel 5 x 12 or 4 x 50 and "banded" 5 x 50.
Ju 87 D	DB	100-1220	2,200, 4,000	1 x 250 and 4 x 50 or 1 x 1400 or 1 x 1800 or 1 x 500 (or 1,000) and 4 x 50 (or 2 x 250).
Ju 87 C	DB	370-975	990, 2,200	1 x 250 (or 500) and 4 x 50 or 1 x 1000 or 1 torpedo 740-900.
Ju 88	B; DB; ML; GA	1140-2680	4,400, 6,400	10 x 50 and 4 x 250 or 10 x 50 and 4 x 500 or 2 x 500 and 2 x 1000 or 2 x 1400 or 1 x 1800.
Ju 88 B	B; R	990-1160	1,400, 8,800	4 x 1000.
Ju 88 Fighter	NF; GA	654-1538	1,100	10 x 50.
Ju 90	Transport	785-1630	7,700	8 x 250 and 30 x 50.
Me 109 E	GA; B	450-1050	550	4 x 50 or 1 x 250 or 92 x SD 2.
Me 109 F Bomber	B; GA	450-570	550	4 x 50 or 1 x 250 or 92 x SD 2.
Me 109 G Bomber	B; GA	420-550	550	1 x 250 or 4 x 50 or 92 x SD 2 or 1 x 500.
Me 109 T	F; B	400-950	550	4 x 50 or 1 x 250.
Me 110 Bomber	B; GA	630-735	2,640, 4,000	4 x 50 and 2 x 500 or 1 x 500 and 1 x 1,000 or 4 x 50 and 1 x 500 and 1 x 1,000. In addition 96 x SD 2.
Ju 86	R; B	1,400-1,750	550, 2,200	1 x 250 or 16 x 50 or 4 x 250.

BOMBS

German Aircraft

AIRCRAFT	DUTY	RANGES IN MILES	BOMB-LOADS IN POUNDS	BOMB STOWAGES: WEIGHTS IN KILOGRAMS
He 111	ML; R; B; T	540-1,930	4,400, 7,620	32 x 50 or 8 x 250 or 32 x 50 (or 8 x 250) and 1 (or 2) x 1,000 or 1 x 1,800 or 1 x 2,500.
He 115	R; B; ML; T	1,380-1,975	1,750, 2,200	4 x 250 or 2 x 500 or 1 x 1,000 or Torpedo 740-900.
He 129	GA; DB	350-690	220, 770	2 x 50 or 4 x 50 and 48 x SD 2 or 2 x 50 and 1 x 250 or 2 x 50 and 96 x SD 2 or 6 x 50.
Bv 138	R; B; ML	990-3,120	660	6 x 50 or 2 x 250.
Bv 141 B	R; GA	550-720	440	4 x 50.
Fi 167	R; T; B	940-1,120	2,200	4 x 250 or 2 x 500 or Torpedo 740-900.
He 177	B; T; R	3,000-3,150	15,800	2 x 2,500 or 4 x 1,800 or 10 x 250 and 2 x 1,800 or 96 x 50.
FW 189	AC; GA	620-970	440	4 x 50.
FW 190 Bomber	B; GA	410-960	550, 1,100	1 x 250 or 1 x 500 or 96 x SD 2.
Ar 196	F; R; B	350-980	220	2 x 50.
FW 200 C ("Konder", "Kurrier", "FW 200 K").	ML; T; B	2,270-2,430	3,300, 8,800	6 x 500 or 4 x 500 and 2 x 1,000 or 2 x 500 and 2 x 250 and 12 x 50 or 2 Torpedoes.
Me 210 Bomber (1)	B	1,495-2,605	2,200, 4,400	2 x 500 or 2 x 250 or 1 x 1,000 or 1 x 1,000 and 2 x 250 (or 500).
Do 215	R; NF; B	810-1,450	2,200	20 x 50 or (2 x 250).
Me 210 Bomber (2)	B; GA; F	1,310-1,460	1,100, 4,400	2 x 250 or 1 x 500 or 1 x 1,000 and 2 x 500.
Do 217 E and K	B; DB; ML; T	1,165-2,445	4,400, 6,600	4 x 50 and 4 x 500 or 2 x 1,000 or 8 x 50 and 2 x 500 or 2 x 1,000 and 2 x 500 or 1 x 1,400 or 1 x 1,800 or Torpedo 740-940.
Do 217	NF; GA	1,180-1,975	880	8 x 50.

NB: AC: Army Cooperation. B; Bomber. DB: Dive Bomber. F: Fighter. GA: Ground attack. ML: Mine Laying. NF: Night Fighter. R: Reconnaissance. T: Torpedo Dropping.
 Ranges and bomb loads are normal and maximum. The first bomb stowage is normal, the others alternative.

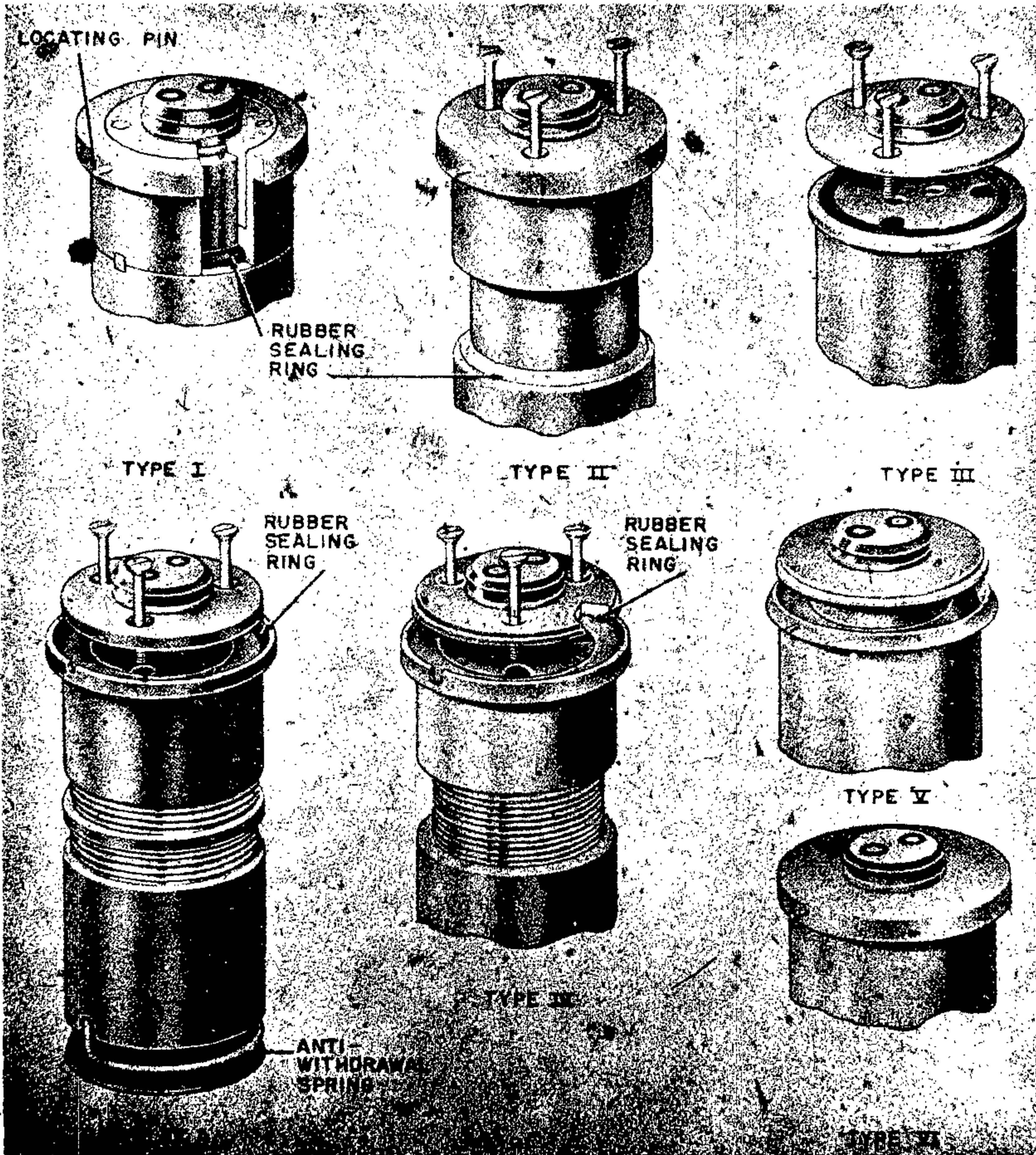

Figure 119—Types of Fuze Construction

GERMAN FUZES

INTRODUCTION

GENERAL. The development of electrical time and impact fuzes has been carried on in Germany since 1926. The greater part of the work has been done by the Rheinmetall Borsig organization. All the work in this line was under the direction of Herr H. Rhulemann.

The original object of the development was to produce an electrical time fuze for projectiles, which could be set at the instant of firing. This part of the development lagged in the early stages, and the development of electrical bomb fuzes was begun. This work was very successful and the electrical bomb fuze was adopted by the Luftwaffe in 1937. It is estimated that about 1 million time fuzes and 20 million impact fuzes were used since their adoption.

CONSTRUCTION. The construction of electrical bomb fuzes has remained generally the same since they were first adopted in 1937. For the purposes of this book, construction will be divided into case and internal circuit construction.

A. Case Construction. The fuze cases for all electrical bomb fuzes have maintained, generally, the same external appearance even though there are six different types of construction. An external view of a typical electrical fuze is shown in figure 120. Figure 119 shows the six types of construction. All types of construction use aluminum for the case except type 5 which has a thin sheet steel case.

The raised portion on top of the fuze is called the fuze head or boss. One or two plungers, depending on the type of fuze, are located in the fuze head and are insulated by black ebonite collars. The side of the fuze head is grooved to accommodate the charging head from the electrical charging unit in the aircraft. The flat portion surrounding the head is referred to as the fuze shoulder. On the side of the fuze shoulder and in line with the two plungers is a small locating pin which serves to keep the fuze in the proper position

in the fuze pocket. The female threads at the base of the fuze are there to receive the standard explosive gaine.

B. Internal Circuit Construction. The internal construction of the typical electrical bomb fuze can be divided into two sections: the upper section, and the lower section. (See fig. 121.) Figure 122 shows the various types of trembler switches found in German fuzes. The upper section is called the switch block. It is a polystyrene moulding which has been machined to take the various plunger contacts, the trembler switches, and in some cases the long delay igniter bridge.

The lower section contains the storage and firing condensers, the resistances, and the instantaneous and short-delay igniters. These parts are held in place by the black bitumen caulking substance.

The condensers are constructed of metal foil strips separated by wax paper and all wound on one cardboard cylinder. The carbon resistances normally fit into this cylinder. It may also contain the long delay cold cathode tube which is true for the El AZ (9).

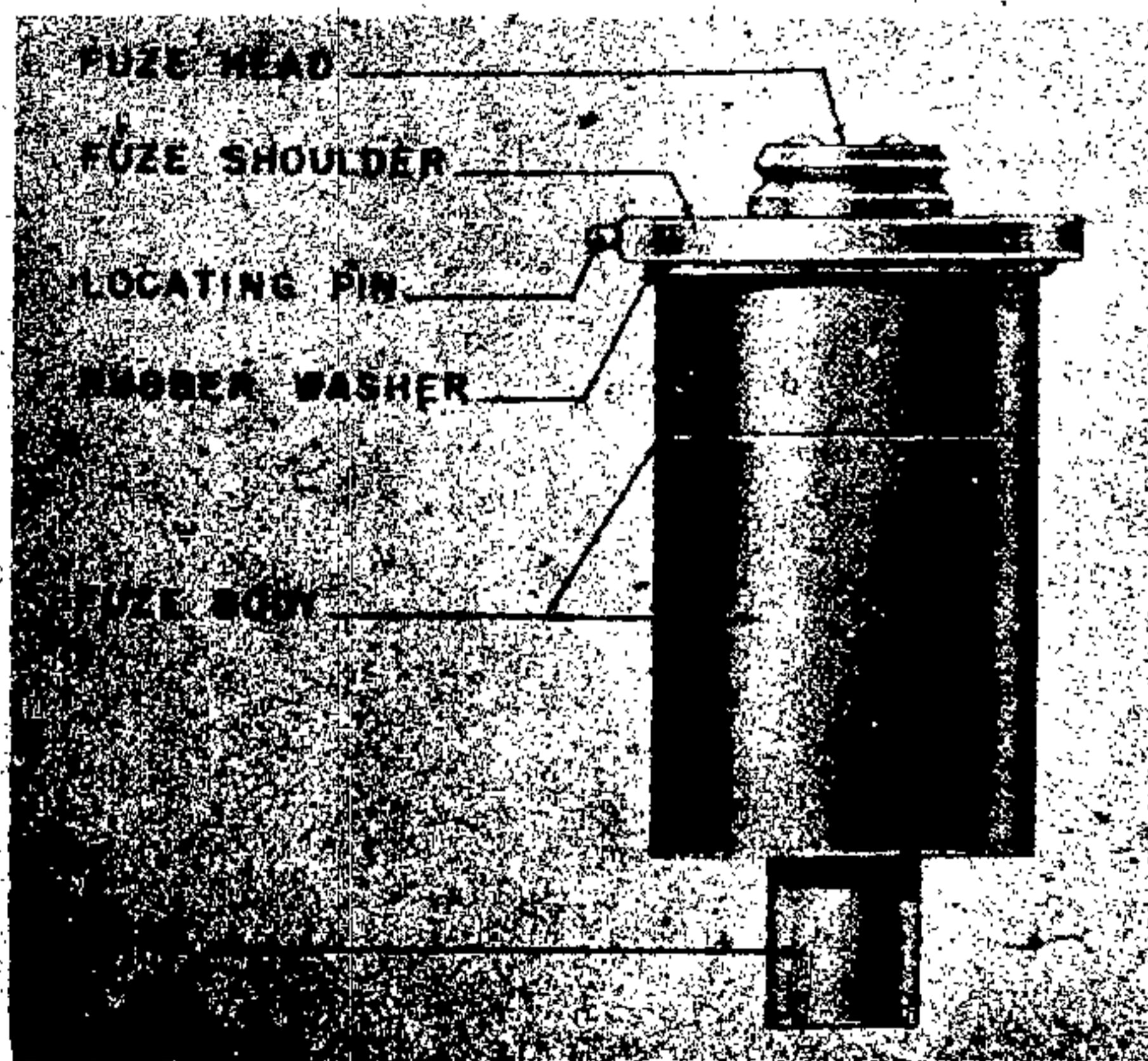

Figure 120—Typical Electrical Bomb Fuze

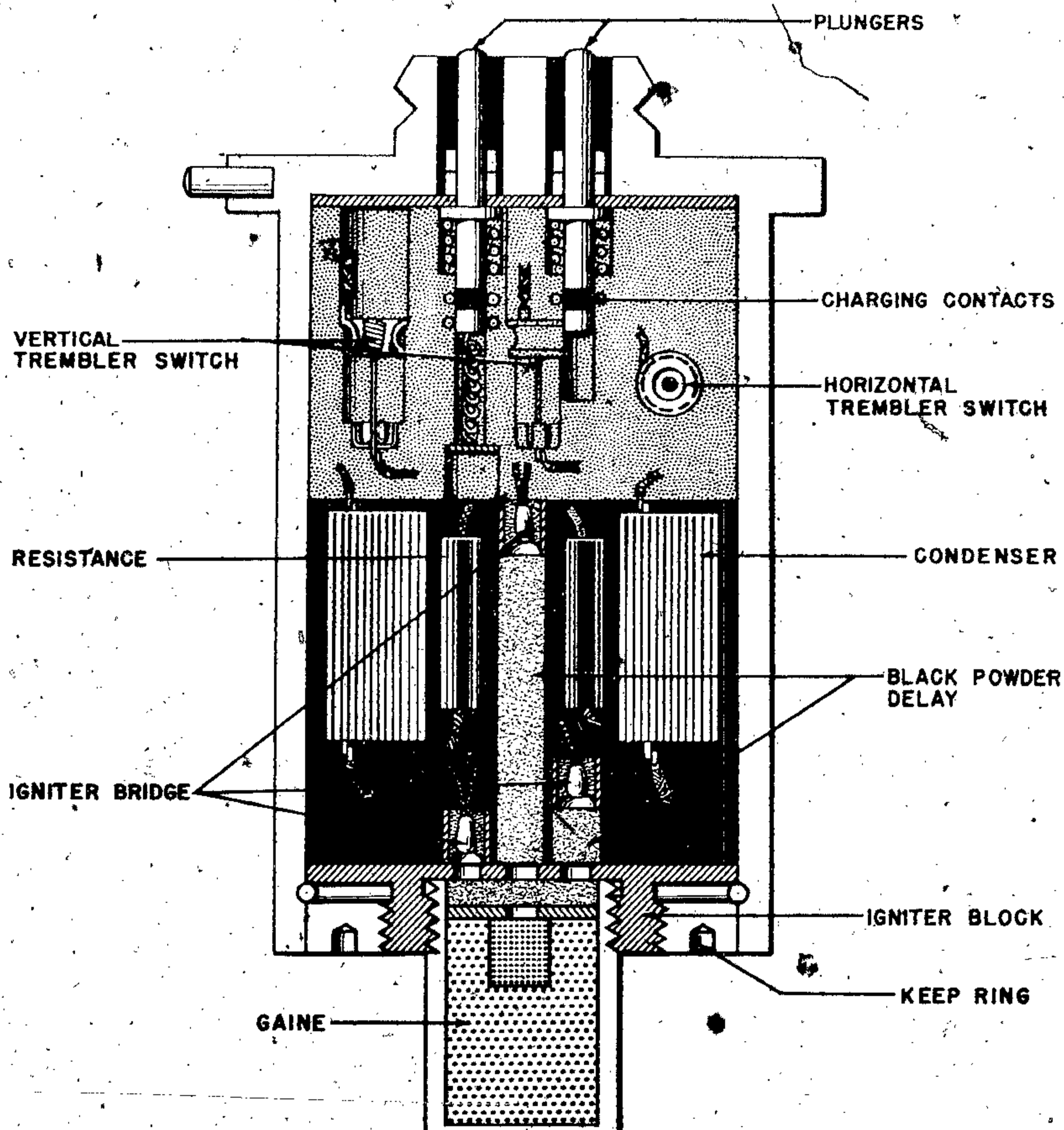

Figure 121—Internal Construction of Electrical Bomb Fuze

The igniter block fits into the bottom of the fuze and contains the black powder flash pellet, three holes leading from the pellet to the igniter bridges, and the short delay train.

ELECTRICAL PRINCIPLES. To illustrate the principle of the three circuit electrical fuze, a schematic diagram is shown in figures 123 and 130.

A. Charging Circuit Operation. The charging circuit in the plane is of special interest. As the

bomb is loaded in the aircraft, the charging head is clamped on the fuze head. The charging pins contact the plungers and depress them so that they make electrical contact with the storage condensers. The two charging pins are connected to the sliding contacts located in the charging arm. These contacts close when the bomb has fallen from one to three inches from the rack. This prevents charging of the fuze while the bomb is still in the aircraft. The two sliding contacts are connected to the positive terminal of the 240V. battery. The

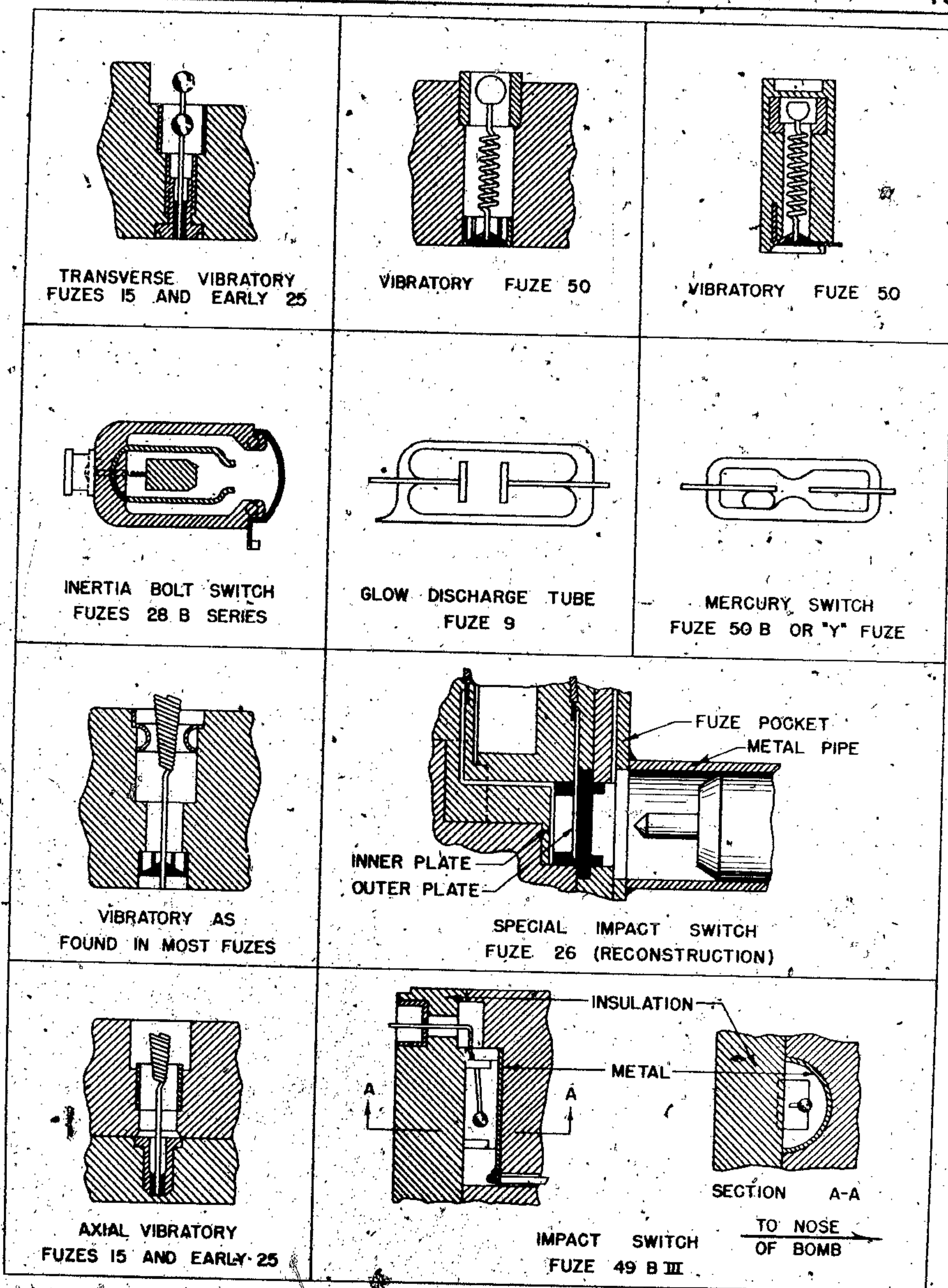

Figure 122—Types of Trembler Switches

GERMAN EXPLOSIVE ORDNANCE

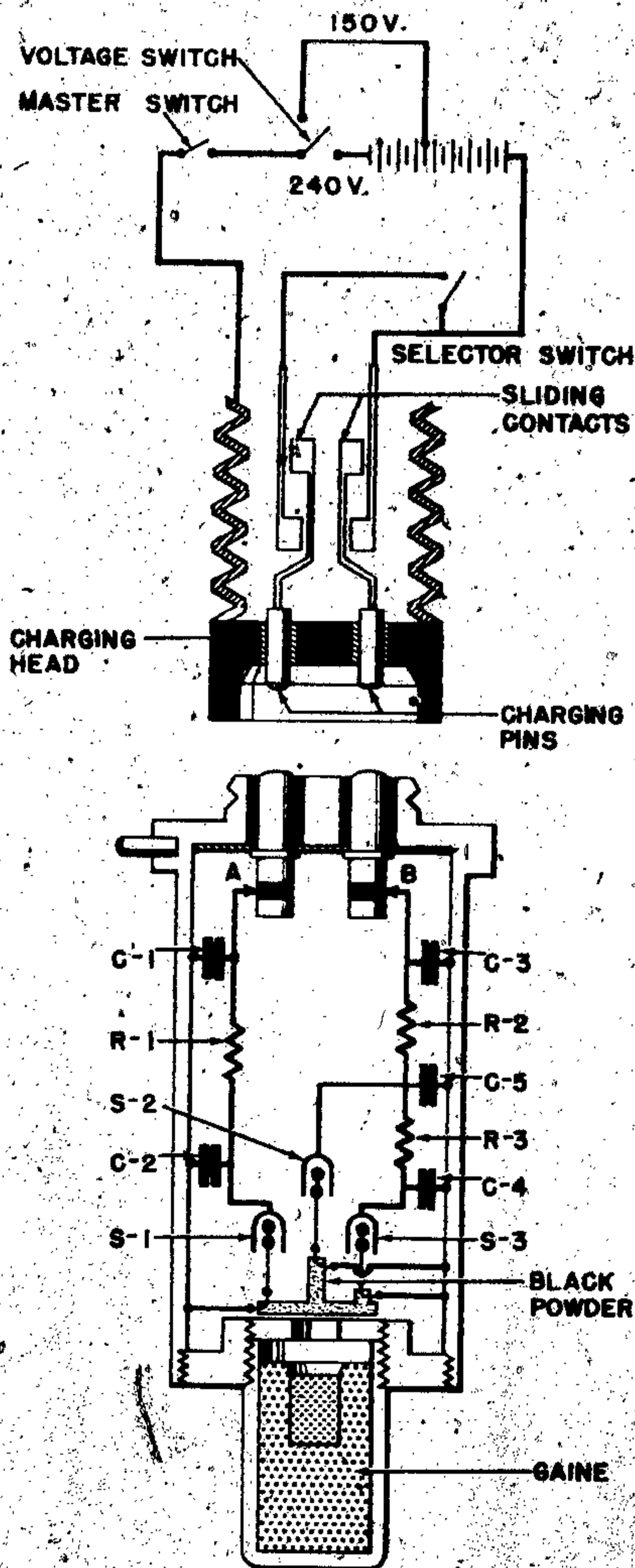

Figure 123—Wiring Diagram of Three Circuit Electrical Fuze

B plunger circuit is connected directly, while the A plunger circuit is connected through a "ZSK" or selector switch. This switch has two positions: open (MV), with delay; and closed (OV), with-

out delay. The battery is tapped at 240 volts and 150 volts. These two leads run to the voltage switch. The voltage switch can be set at 150 volts for level bombing or 240 volts for dive bombing. It cannot be used to open the circuit. The voltage switch is connected to the master switch which is used to jettison the bombs. Supposedly it is closed only when the aircraft is over enemy territory. The master switch is connected to the charging head which contacts the fuze head and completes the electrical circuit throughout the fuze body to the storage condensers.

B. Fuze Circuit Operation. For the purpose of illustration we shall assign arming times for the three circuits as follows: Instantaneous circuit, 8 seconds; short delay circuit, 8 seconds; long delay circuit, 2 seconds.

When the selector switch is closed, both storage condensers are charged in the manner described in the above paragraph. (See fig. 123.) The charge placed on the storage condenser C-1 leaks slowly through the resistance R-1 into the firing condenser C-2. The time required for the current to pass to the firing condenser C-2 and build up sufficiently to fire the igniter is called the arming time. At the same time the charge on the storage condenser C-3 is leaking through the resistance R-3 into the firing condenser C-4 and through the resistance R-2 into the firing condenser C-5. On impact the trembler switches, S-1, S-2, and S-3 momentarily make contact with the trembler cavities causing the current to flow through the igniter bridges. The bridges become heated and fire the match composition surrounding them. When all three igniter bridges fire at the same time the instantaneous bridge fires the flash pellet and detonates the bomb through the normal explosive train. The short and long delay trains just started to burn at the time of detonation.

If the selector switch is held open, then no charge will pass to the instantaneous circuit but the B plunger, remote from the locating pin, will carry the charge to the storage condenser C-3. The circuit through the resistance R-2 to the condenser C-4 becomes armed before the circuit through R-3 to C-5. If the bomb has been dropped with a falling time of less than 8 seconds, the latter circuit will not be armed before impact and the igniter bridge used with the trembler switch S-2 will fire the long delay pellet which, acting through the explosive train of the

fuze, will detonate the bomb. If the bomb is dropped with a falling time of greater than 8 seconds, both circuits will be armed before impact but because of the shorter delay train used in conjunction with the trembler switch S-4, the short delay will initiate the final explosive train.

Time fuzes contain essentially the same basic parts as the impact fuzes except that the trembler switches are replaced by a vacuum tube which becomes conducting at a critical known voltage. At the instant the bomb is started on its trajectory, an electric charge is placed on the storage condenser, and another smaller charge is placed on the firing condenser. The time setting of the fuze is adjusted by varying the amount of charge placed on the firing condenser. During flight, part of the charge on the storage condenser leaks through the resistor to the firing condenser. As the charge on the firing condenser increases, the voltage across the tube increases. When the firing voltage of the tube is reached, the firing condenser discharges through the tube and igniter, firing the fuze.

Both the storage and the firing condensers of German electrical time fuzes are charged in order that the voltages used can be kept reasonably low. An increased time setting requires an increased voltage.

Advantages of Electrical Fuzes

A. The fuzes can be set by remote control im-

mediately prior to the instant of firing. Dead time is eliminated in time fuzes, and impact fuzes can be set for instantaneous or delayed actions as each bomb is used.

B. Electrical impact fuzes are extremely rapid in action because the only mechanical part, the trembler switch, has but little inertia and friction. With an "instantaneous" fuze setting, a bomb can be made to explode without deep penetration of the target.

C. The electrical scheme has great flexibility. The same components were used in a variety of time and impact fuzes having nearly identical appearance but a wide range of characteristics.

D. The fuzes are safe to handle, ship and store. Whereas in most mechanical fuzes the source of energy to ignite is always present (as a stressed spring, for instance), energy is not introduced into the electrical fuze until the moment of use. Extensive trials were made with voltages as high as 2,000,000 volts, which showed that properly designed electrical fuzes are not affected by atmospheric electricity.

E. The electrical fuzes are less expensive to manufacture than mechanical fuzes having the same characteristics, when made in comparable quantities. The cost ratio is about two to three. Another feature which reduces the cost per unit is the fact that parts which are out of tolerance for time fuzes could be used in the impact fuzes.

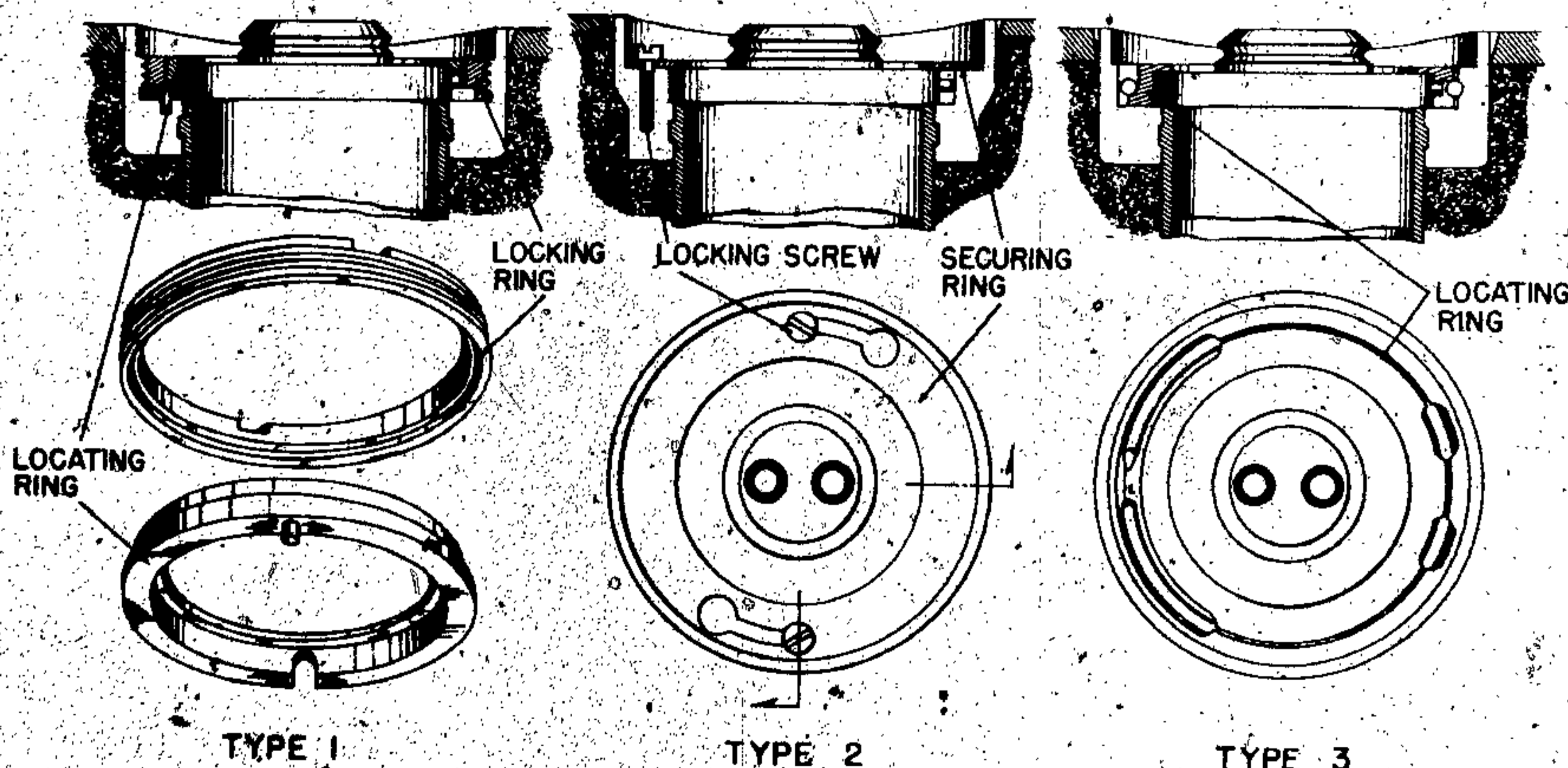

Figure 124—Methods of Securing the Fuze in the Bomb

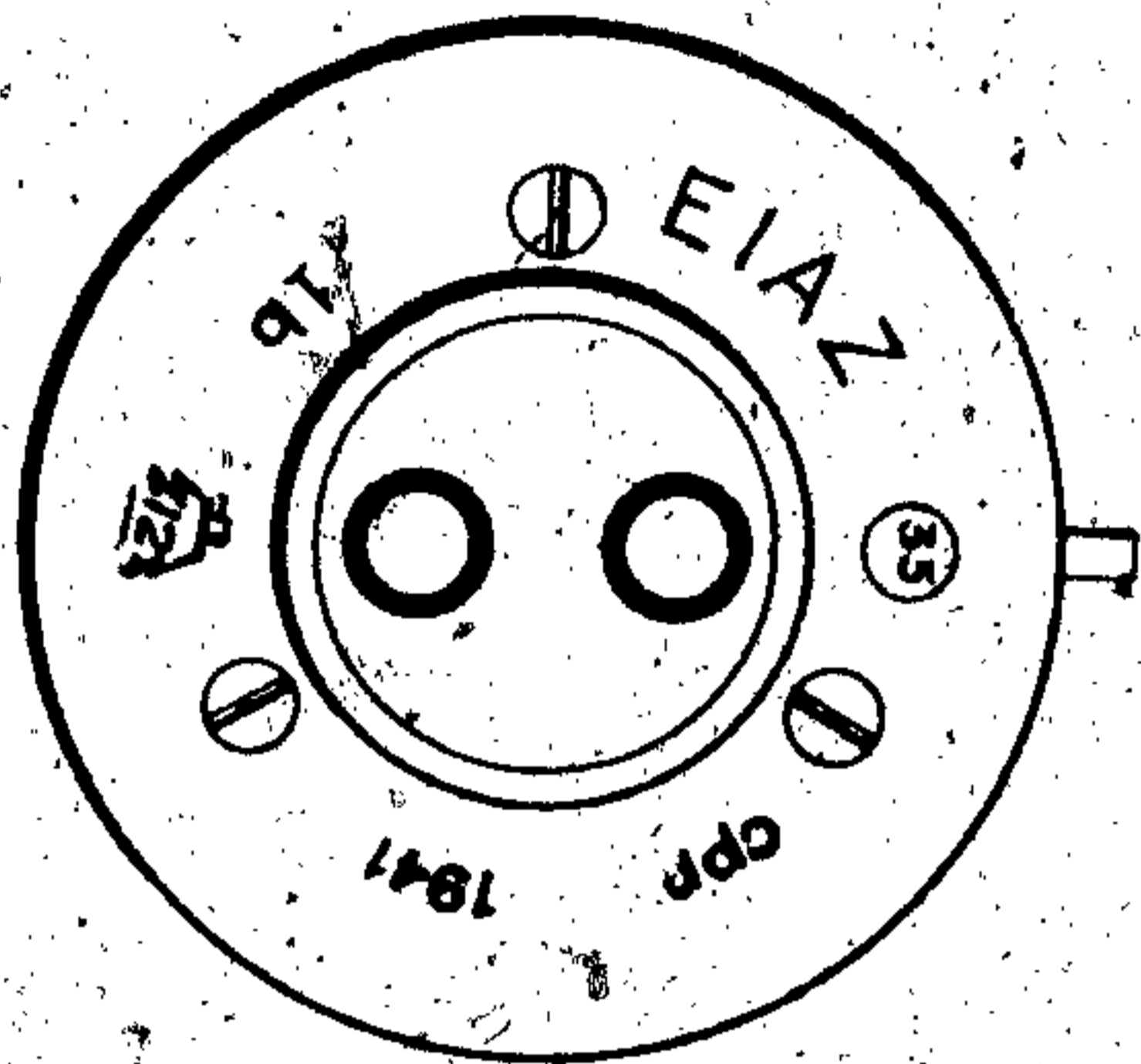

Figure 125—Fuze Markings

Methods of Securing the Fuze in the Bomb

Three methods were used for this purpose; the bayonet joint type, the securing pin type, and the locating and locking ring type. The latter was most commonly used during the war. In this type, the locating ring keeps the fuze in the proper position in the fuze pocket and the locking ring secures it there. (See fig. 124.)

Markings and Identification

Fuzes generally have the markings on the fuze shoulder, although certain older designs had the markings on the fuze head. The markings on

German fuzes must be noted very carefully for in most cases they are the only means of identification. (See fig. 125.)

The most important marking on the fuze is the number, which is usually circled. This number designates the type of fuze. The units digit is the type number; that is, type 5 fuzes are electrical impact fuzes; type 7 fuzes are time fuzes; type 0 fuzes are protective fuzes, etc. This number is preceded by a number of abbreviations; thus, El. A. Z. means Electrical Impact Fuze. The letter Z is usually found just at the locating pin with the number designation following.

The "cpp 1941" is the factory designation and the date of manufacture. The "1b" is the factory lot number and the German eagle stamping is the inspector's stamp. Any of the last three may be omitted.

Attachments

A. EXTENSION CAPS (fig. 126).—These are used on large SC bombs, and all PC bombs.

B. DUMMY FUZE HEADS (fig. 127).—These are used on the SD 250 and on the various C 250 incendiaries.

C. BRACKETS.—These are used on the PC 500, SD 500 and the SC 500.

D. TRANSIT CAP (fig. 128).—These are fitted on all German fuzes prior to loading the bombs in the aircraft.

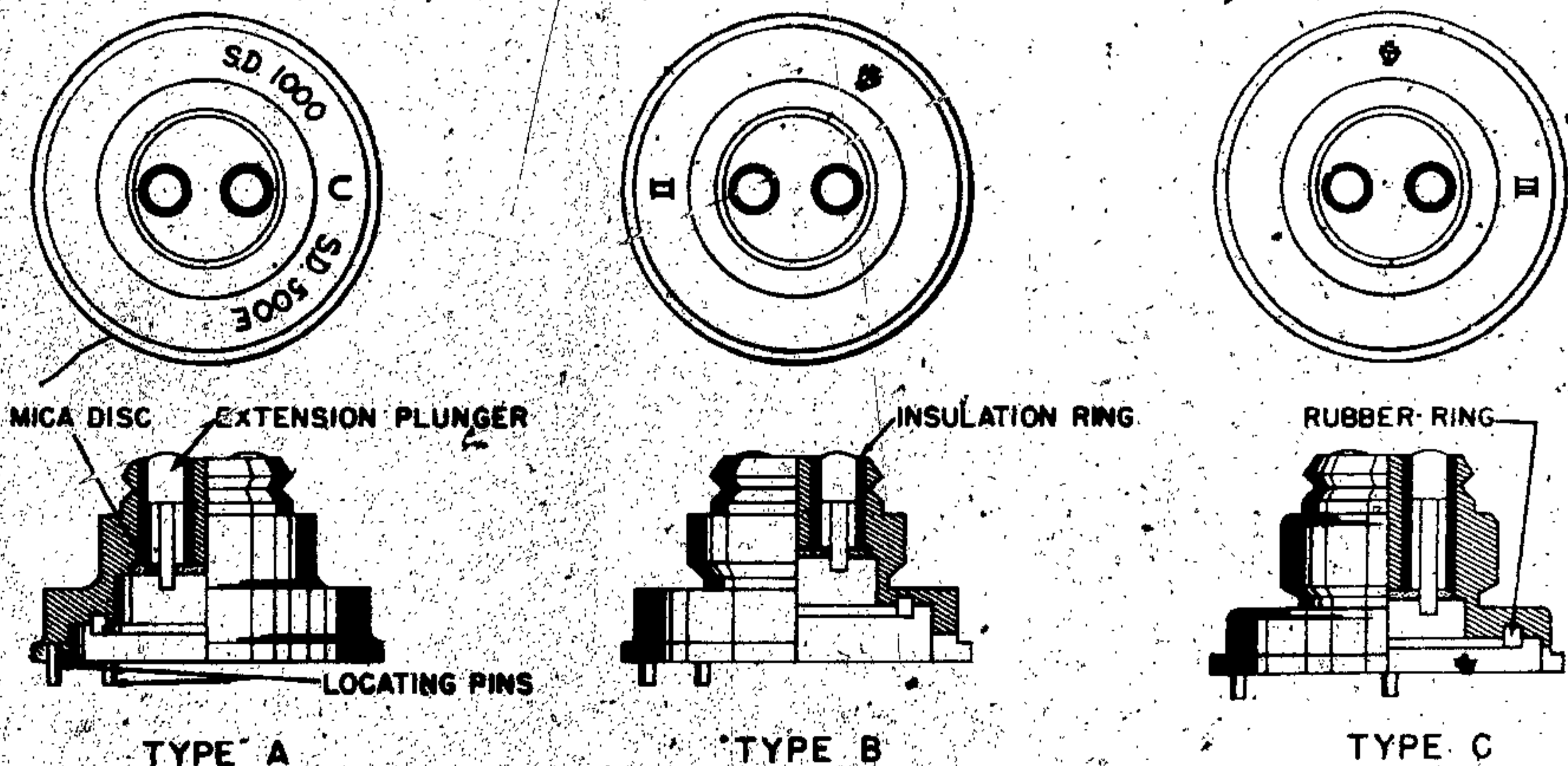

Figure 126—Extension Caps

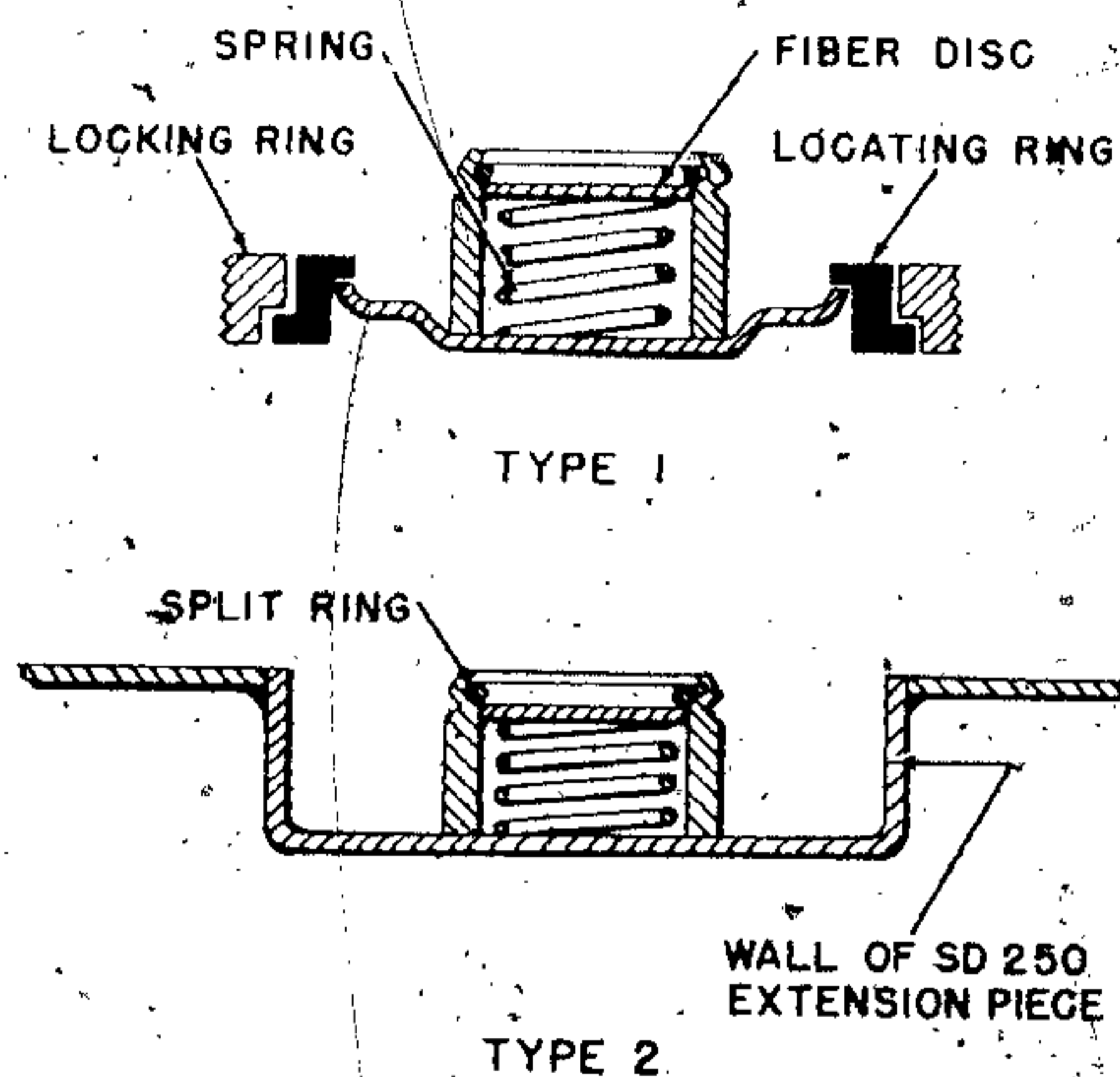

Figure 127—Dummy Fuze Heads

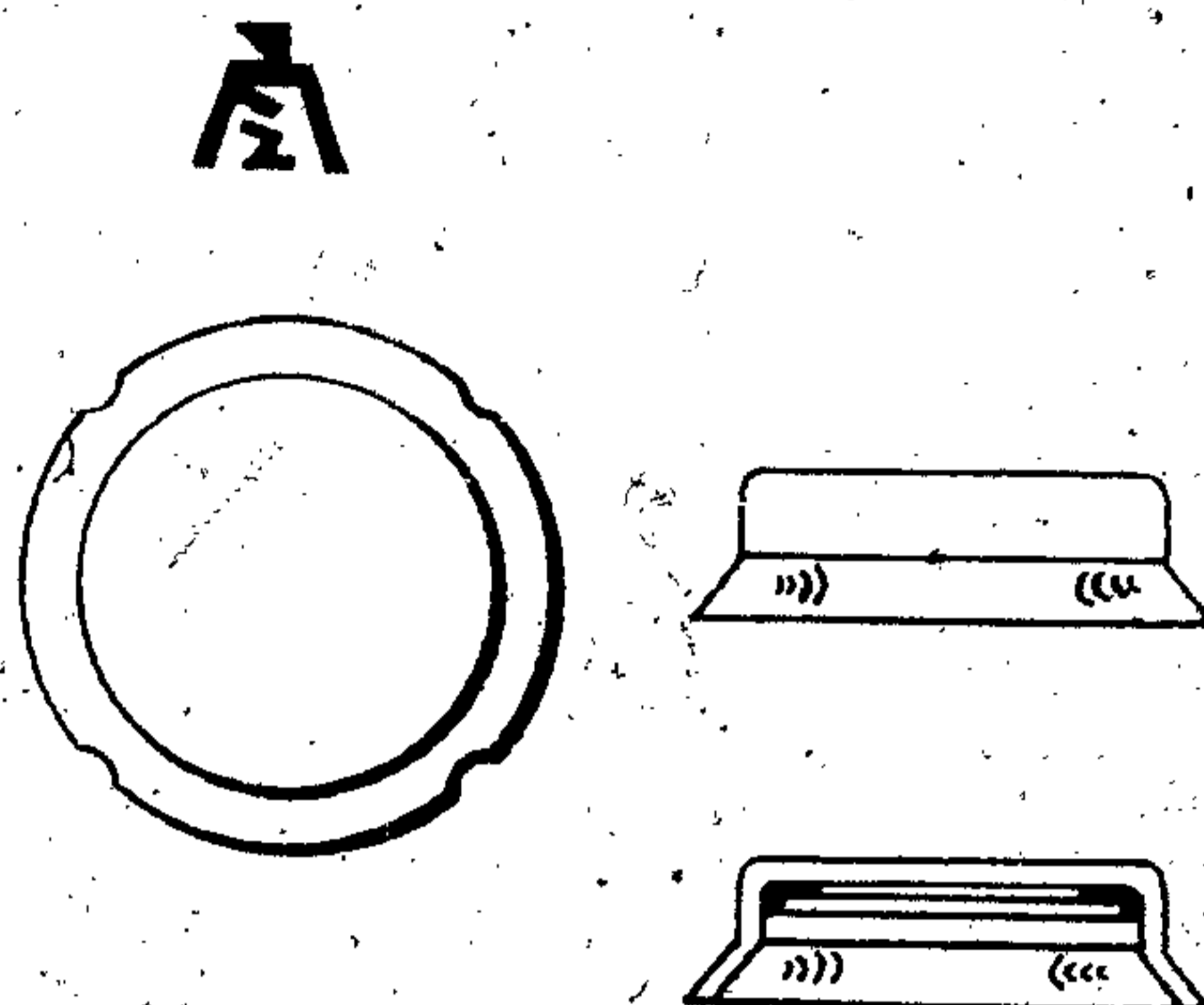

Figure 128—Transit Caps

ITEM	SYMBOL	REMARKS
PLUNGERS		<p>"A" PLUNGER IS ADJACENT TO AND "B" PLUNGER IS REMOTE FROM THE LOCATING PIN OF THE FUZE.</p> <p>PLUNGERS ARE SHOWN IN THE UNDEPRESSED POSITION.</p>
CONTACTS		<p>DOWNWARD MOVEMENT OF PLUNGERS CHANGES POSITION OF INSULATED AND CONTACT SURFACES IN RESPECT TO WIRE CONTACTS.</p> <p>INSULATED SURFACES SHOWN IN BLACK.</p>
RESISTANCE		<p>1 MΩ = 1 MEGOHM = 1,000,000 OHMS</p>
CONDENSER		<p>1 μF = 1 MICROFARAD</p>
IGNITER BRIDGE		
IMPACT SWITCH		VIBRATORY TYPE UNLESS OTHERWISE STATED.
PYROTECHNIC DELAYS		SHORT - LESS THAN ONE SECOND.
		LONG - ONE SECOND AND OVER.

Figure 129—Electrical Symbols

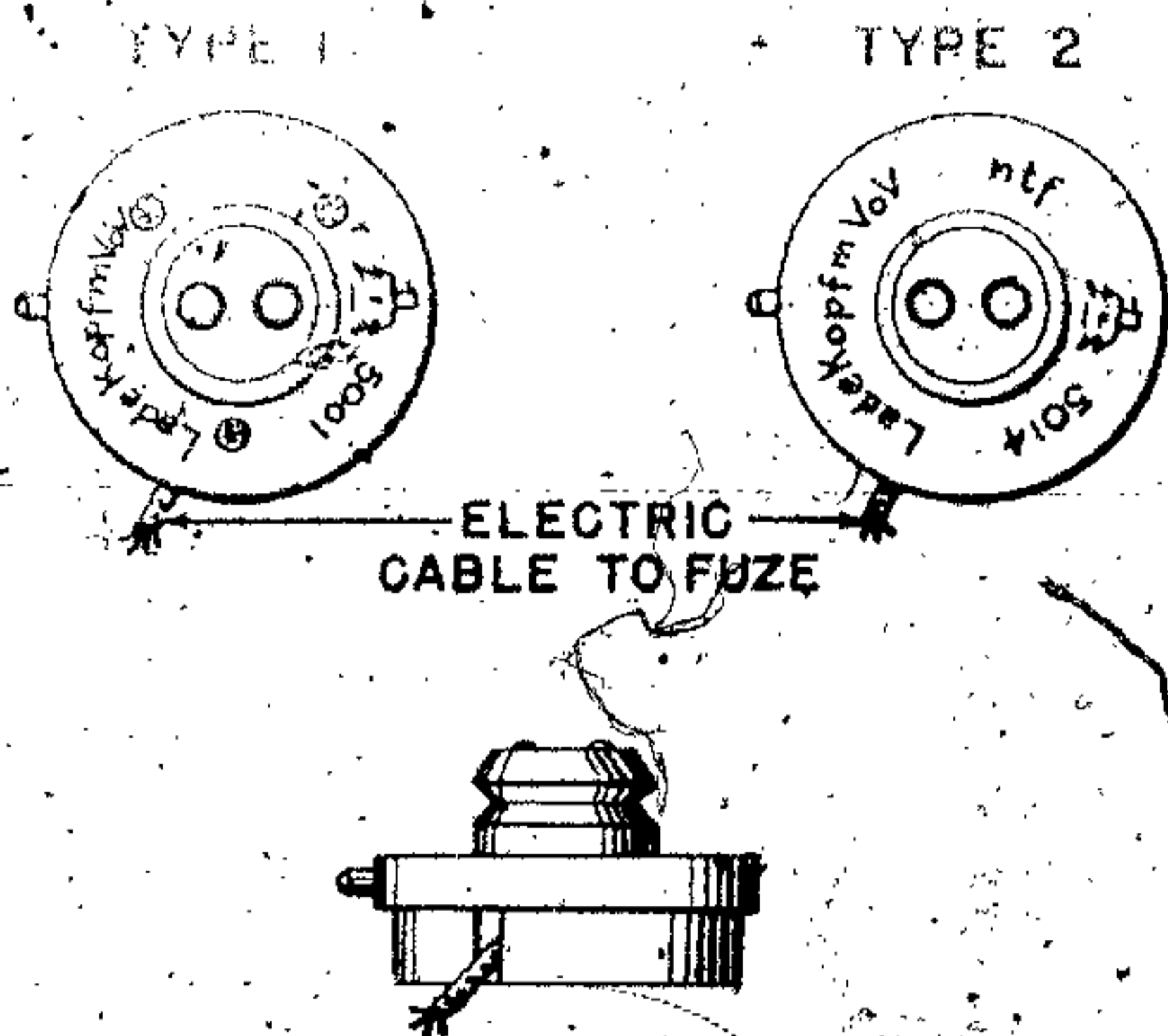

Figure 130—Charging Heads

E. CHARGING HEADS (fig. 130).—These are used on certain incendiary, antipersonnel, and PC-RS series bombs.

Typical Nomenclature

GERMAN ABBREVIATION	GERMAN	ENGLISH
1. El. A. Z.	Elektrischer Aufschlagzunder	Electric impact fuze.
2. El. Zt. Z.	Elektrischer Zeitzunder	Electric time fuze.
3. El. Z.	Elektrischer Zunder	Electric fuze.
4. L. Zt.	Langzeit	Long time (delay).
5. M. V.	mit Verzögerung	with delay.
6. o. V.	ohne Verzögerung	without delay.
7.	vor Beladen entfernen.	to be removed before loading.
8.	Verzugszeit	safety time.
9. V. Z.	Versugszündung	safety fuzing.
10. Z.	Zünder	fuze.
11. Zt.	Zeit	time.
12. Zus.	Zusatz	addition.
13.	Zunderzwischenstück.	fuze extension cap.

(41) MECHANICAL CLOCKWORK

DATA:

Bombs Used in: SD 2A butterfly bomb.
 Color: Unpainted.
 Material: Zinc alloy case around brass and steel mechanism.
 Possible Actions: Aerial burst or impact.
 Arming Times: 2.9 to 3.5 seconds.
 Principal Markings: (41).
 Secondary Markings: Zeit blx, AZ 34-41.

DESCRIPTION. The (41) fuze is a small clockwork type fuze which threads into the SD-2 butterfly bomb. (See fig. 131.) It has two possible operational actions: aerial burst or impact. The fuze is armed through action of the drogue vanes which turn as the bomb descends, threading the arming spindle out of the path of the release arm. When the bombs are released from the container, the drogue vanes rotate causing the arming spindle to thread out of the path of the release arm.

OPERATION. The fuze may be set for air burst ("zeit") or impact ("AZ"). If set on "zeit", the setting button (12) depresses the inertia pellet (4). This allows the stop arm (5), release arm (8), and release cam (6) to rotate clockwise until the slot in the release cam (6) is presented to the striker (9). The striker is then free to move into the detonator.

If the fuze is set to function on impact the setting screw is turned to "AZ" and the fuze functions as follows: Pressure of spring loaded striker (9) on release cam (6) turns release arm (8) clockwise through gear train (1) until stop arm (5) bears against spring held inertia pellet (4). On impact the inertia pellet (4) falls from the path of the stop arm (5) allowing it to continue in a clockwise direction until the groove in the release cam (6) is presented to the striker. The striker (9) is then free to move into the detonator.

REMARKS. The fuze is screwed into the bomb.

(41)A MECHANICAL CLOCKWORK

DATA:

Bombs Used in: SD 2B butterfly bomb.
 Color: Unpainted.
 Material: Alloy casing, steel and brass mechanism.
 Arming Times: 2.9 to 3.5 seconds.
 Principal Markings: (41) A cot; AZ (impact); Zeit (aerial burst).
 Secondary Markings: Z/42.

DESCRIPTION. The operation of the (41)A is the same as the operation of the (41). (See fig. 132.) The (41)A differs from the (41) in three ways: The (41)A is held in the SD 2B by means of a bayonet joint and U-shaped securing strips. The vanes are V-shaped and have a greater pitch than the vanes of the (41). The detent is in the shape of a truncated cone instead of a cylinder. This shape is associated with the

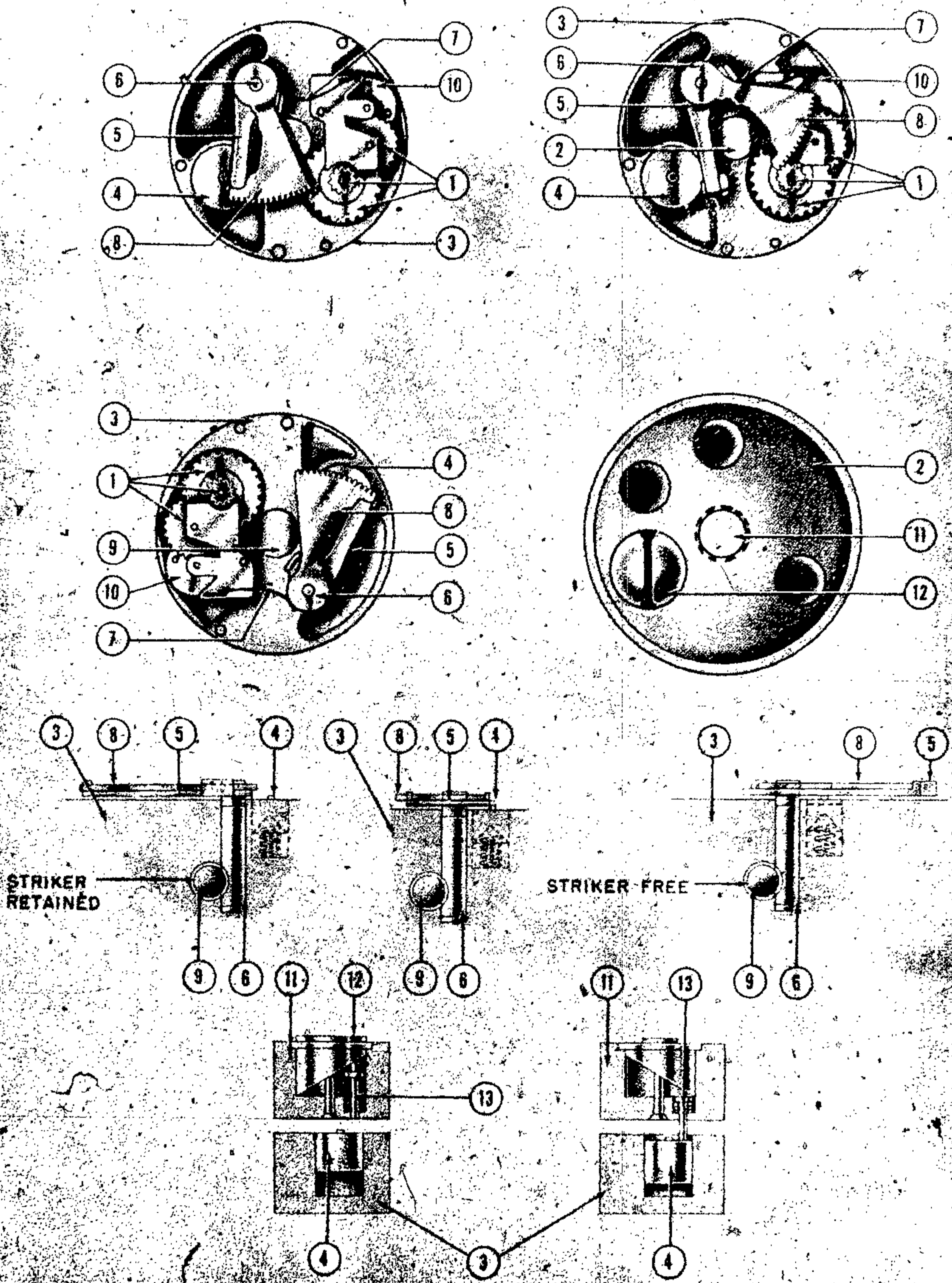

Figure 131—(41) Mechanical Clockwork Fuze

GERMAN EXPLOSIVE ORDNANCE

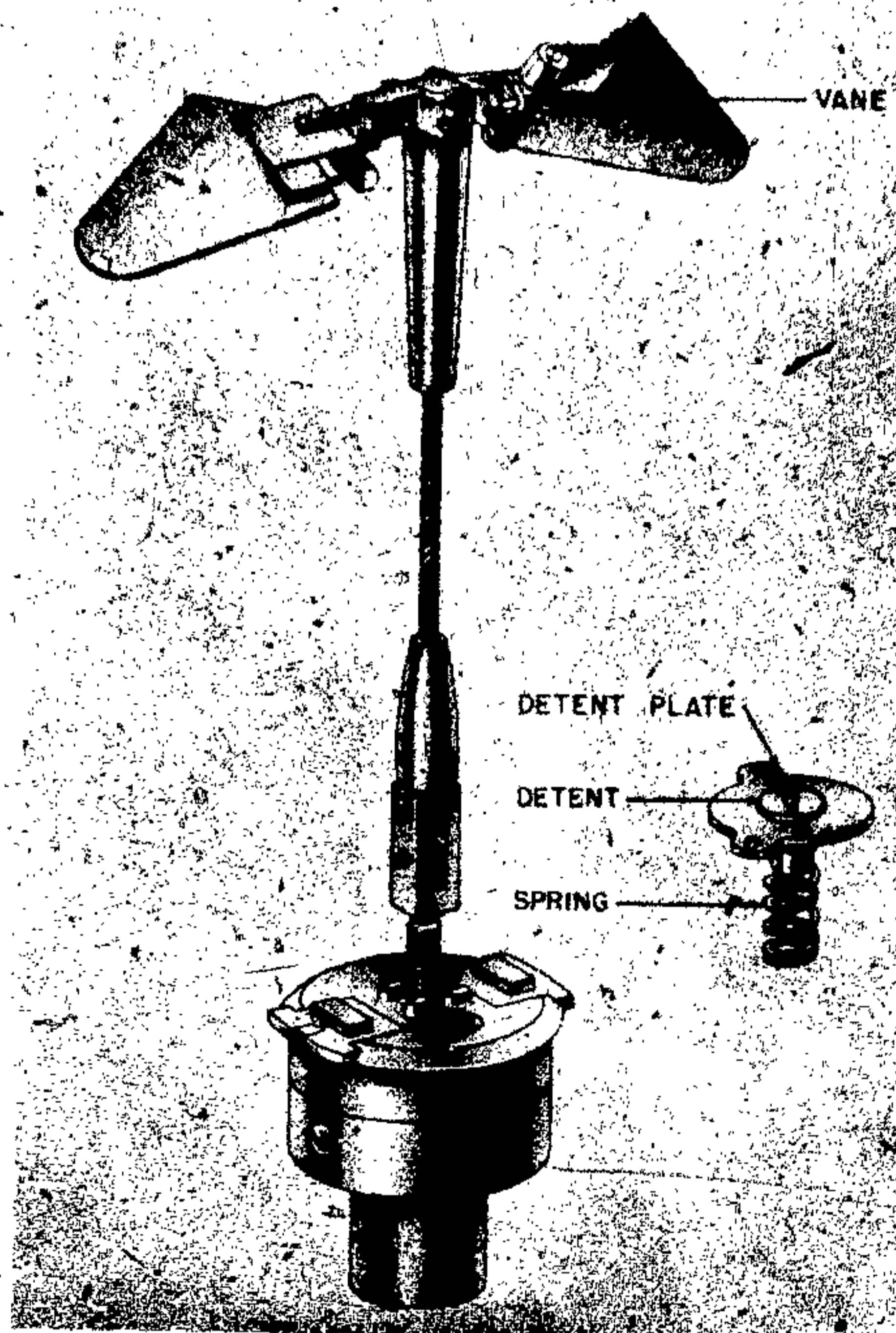

Figure 132—(41)A Mechanical Clockwork Fuze

“all-ways” action. The spring holding this detent is stronger than the spring in the (41) and therefore this fuze is less sensitive.

(3) MECHANICAL IMPACT NOSE FUZE

DATA:

Bombs Used in: 12 kg A/P SC 10.

Color: Unpainted aluminum.

Material: Aluminum alloy.

Possible Actions: Instantaneous or 6 second delay.

Arming Times: 2.5 seconds.

Principal Markings: AZC 10 (Hut)* (3).

Secondary Markings: Rh/S. 195 1938.

DESCRIPTION. The upper body of the fuze is cone-shaped. A suspension lug is the clock-work arming mechanism. Several recesses for screws, and spanner openings are cut into the lower part of the cone. A cylindrical piece, threaded to screw into the nose of the bomb, is formed with the lower

conical section. This cylindrical part is bored to receive the primer housing which surrounds the striker channel. Below this is placed a fitting holding a powder train with a cap beneath and the base is closed with a standard gaine. (See fig. 133.)

Desired setting is obtained by adjusting a grub screw which is screwed into the fuze body and interrupts the flash channel.

OPERATION. When the bomb is released from the container, the safety pin is withdrawn and releases a spring-loaded safety bolt which frees the hammer. The hammer is a part of the suspension lug. The removal of the safety pin releases the spring loaded safety bolt which engages the teeth on the pinion. As the safety bolt moves in a direction perpendicular to the plane of the paper, it rotates the pinion which in turn moves the gear train. When a recess on the safety bolt comes opposite the spring-loaded plunger, the plunger springs out disengaging the inertia striker thus arming the fuze. On impact, the striker is forced downwards against the creep spring and detonates the percussion cap. If the fuze is intended for instantaneous action, the flash from the cap passes through the channel to the explosive cap which in turn detonates the gaine.

(23)A MECHANICAL IMPACT TAIL FUZE

DATA:

Bombs Used in: Brand, 10 kg; NB, 2 kg; SG, 3 kg; single unit parachute flare.

Color: Treated metal.

Material: Steel.

Possible Action: Instantaneous.

Arming Times: 3 turns of arming spindle.

Principal Markings: None.

Secondary Markings: None.

DESCRIPTION. This fuze is constructed entirely of steel and the unpainted body is devoid of markings. (See fig. 134.) The fuze is formed of two main portions, the fuze body and the striker mechanism. The body consists of a steel collar, externally threaded to screw into the missile, and a steel housing seated within the collar. A retaining ring, screwed into the upper portion of the steel collar, retains a steel block. The steel block forms a cone shaped seating. A similar seating is formed at the base of the steel housing.

Fitted between the two conical seatings is the striking mechanism, consisting of the striker, striker guide, and detonator cap holder. The striker has a rounded head which sits in the upper conical seating. The striker is drilled to house the two diametrically opposed steel retaining balls.

The striker guide is a sliding fit over the striker and screwed to its base is the detonator cap holder. The holder is rounded and seats upon the conical seating of the steel housing. Between the striker head and the detonator cap holder is a creep spring.

An arming rod screws into the steel block, passing into the striker and forcing the steel balls outwards. A lug formed on the arming rod, forms an anchorage for a steel wire, $4\frac{1}{2}$ inches long, to the other end of which is attached an arming vane.

(24) MECHANICAL IMPACT AND BREAK-UP FUZE

DATA:

Bombs Used in: SC 2,500 kg.

Color: Dark grey.

Material: Light alloy, brass and steel.

Possible Actions: Instantaneous or short delay (length of delay not known).

Arming Times: Safety arming time of 10 seconds provided by gear train.

Principal Markings: (24) with cancellation (X) over stamped.

Secondary Markings: Serial number stamped on fuze.

DESCRIPTION: The (24) is basically identical to the (24) A. The operation of the two fuzes is

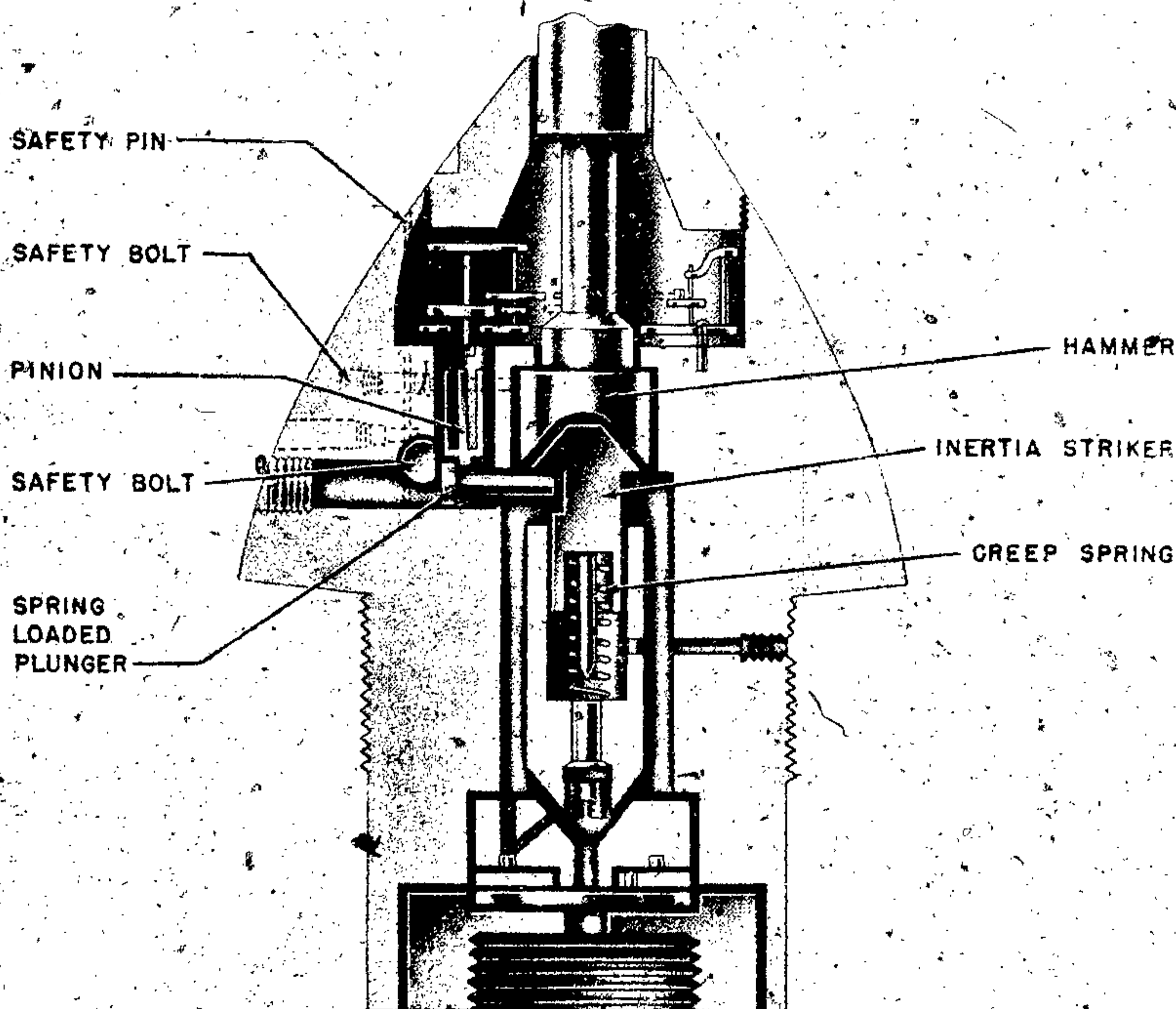

Figure 133—(3) Mechanical Nose Impact Fuze

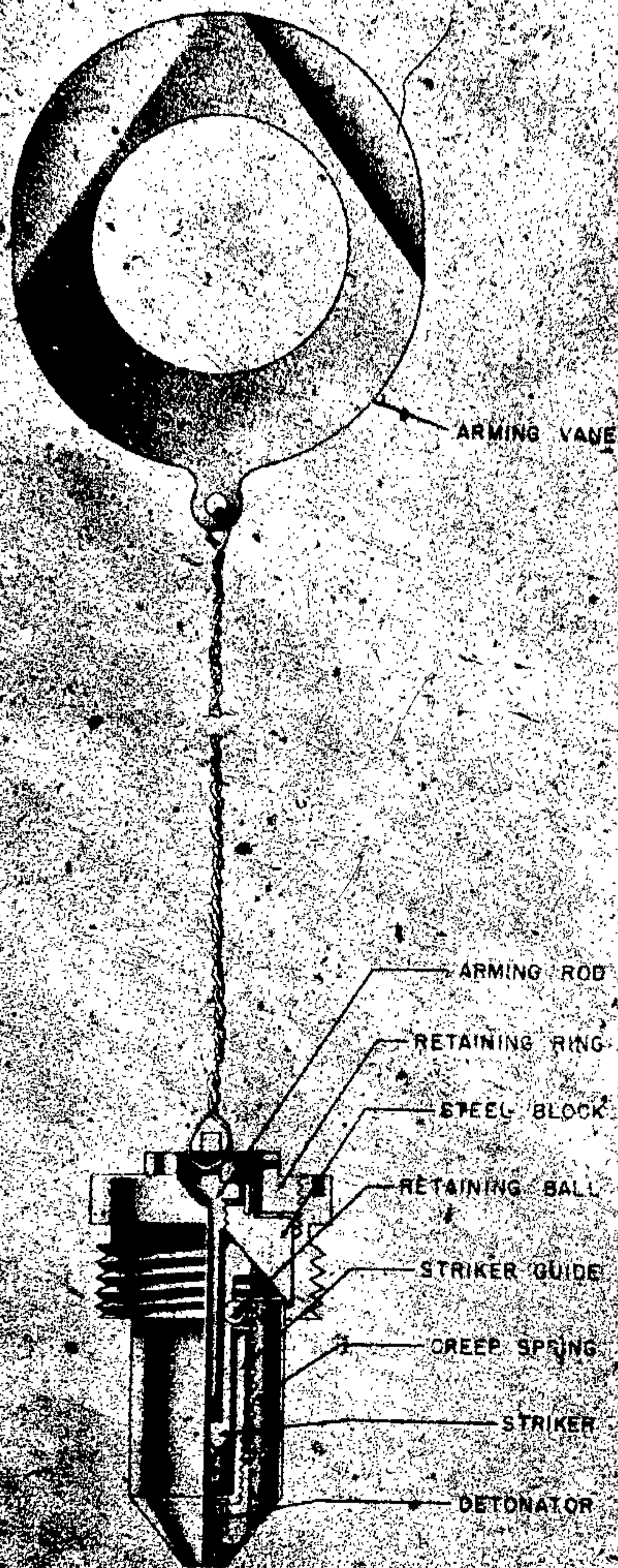

Figure 134—(23)A Mechanical Tail Impact Fuze

identical. The fuze is secured in the bomb in the same manner as the (24) A.

Two pieces of wood secured together by four wire staples form an annular packing between the upper and lower fuze bodies on the (24). The

(24) A has metal case surrounding this portion. (See fig. 135.)

REMARKS. This fuze has the same anti-break-up device as the (24) A, to prevent breaking up of the bomb on impact with hard targets.

(24)A MECHANICAL IMPACT AND BREAK-UP FUZE

DATA:

Bombs Used In: SC 2,500 kg.

Color: Dark grey.

Material: Light alloy brass and steel.

Possible Action: Short delay—break-up (instantaneous).

Principal Markings: AZ (24)A.

Secondary Markings: None.

DESCRIPTION. The AZ (24) is a mechanical impact fuze with a safety arming period of 10 seconds provided by the clockwork gear train. There are two striker systems incorporated: An inertia striker system to operate on impact and an anti-rupture striker to function in case there is any distortion of bomb or fuze pocket on impact. (See fig. 136.)

The two striker systems are located at opposite ends of the fuze separated by a flash channel approximately 260-mm. long.

There are two pieces of wood secured together by 4 staples to form the packing between the two sections of the fuze. The only difference between the (24) and (24) A is in the metal covering around the wood packing. The (24) A has the metal covering and the (24) does not.

OPERATION. On release from the aircraft, the cover and safety pin are pulled away from the fuze allowing the detent bar to move across. The speed of this movement is governed by a clockwork gear train.

After 10 seconds the detent bar has moved sufficiently for the spring loaded plungers A and B to move into the recesses in the detent bar. The movement of plunger A releases and arms the striker system and the movement of plunger B releases a shutter which in turn allows the spring-loaded detonator to move along the channel and position itself opposite the percussion cap of the bottom of the fuze. The percussion cap is part of the anti-rupture device.

On impact the inertia striker pellet pierces the detonator cap, the flash from which ignites the

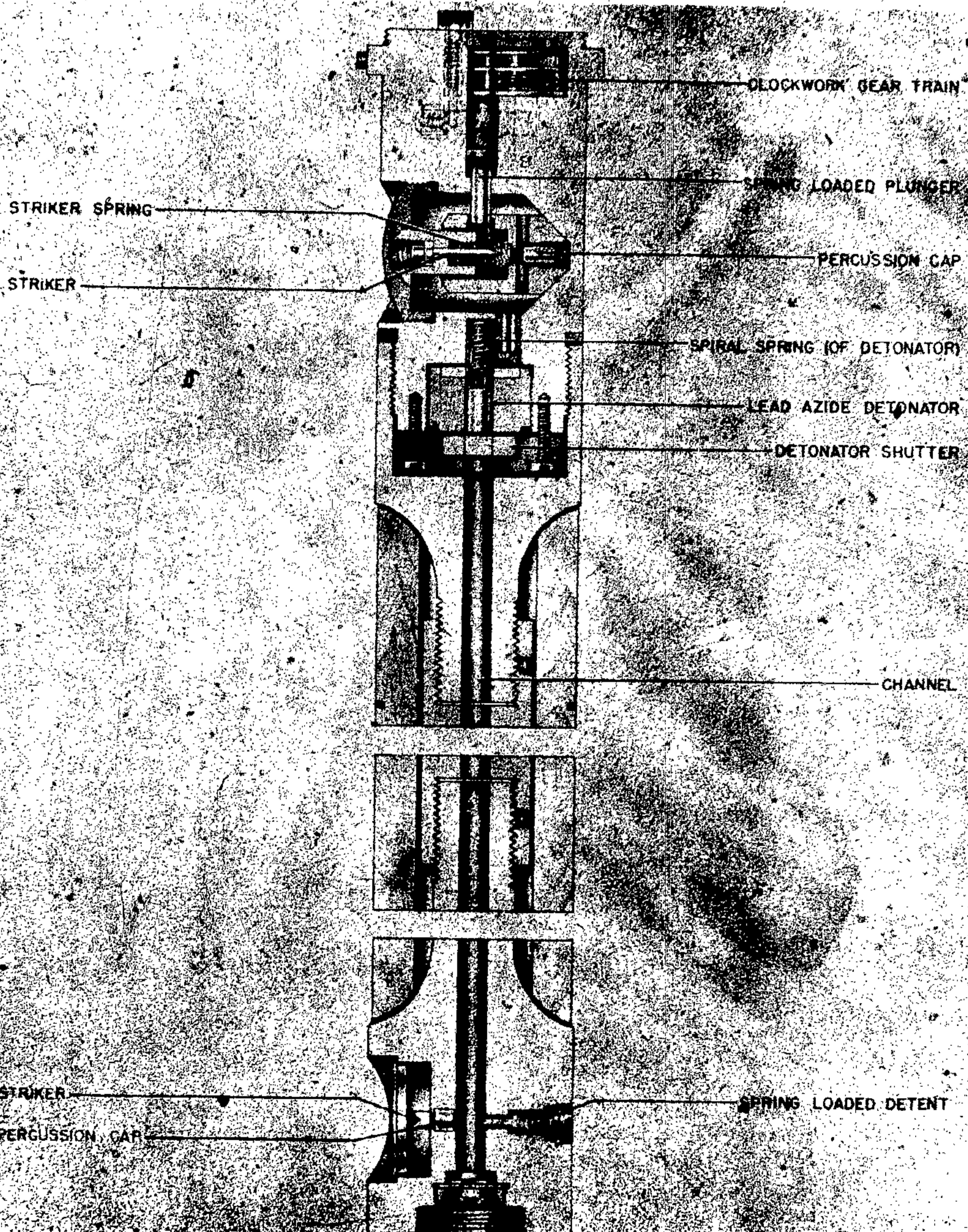

Figure 135—(24) Mechanical Antibreak-up Fuze

GERMAN EXPLOSIVE ORDNANCE

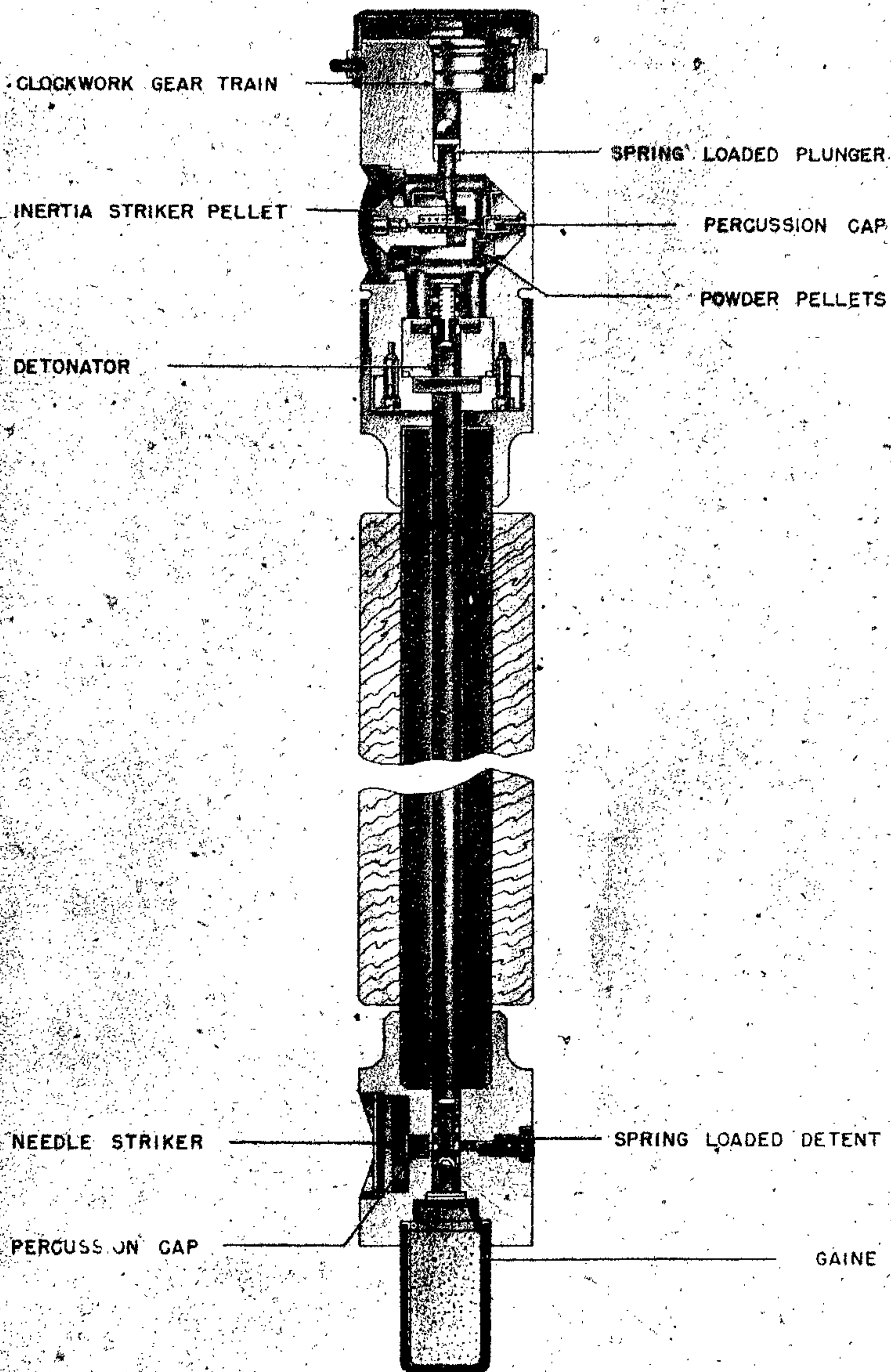

Figure 136—(24)A Mechanical Impact Fuze with Antibreak-up Switch

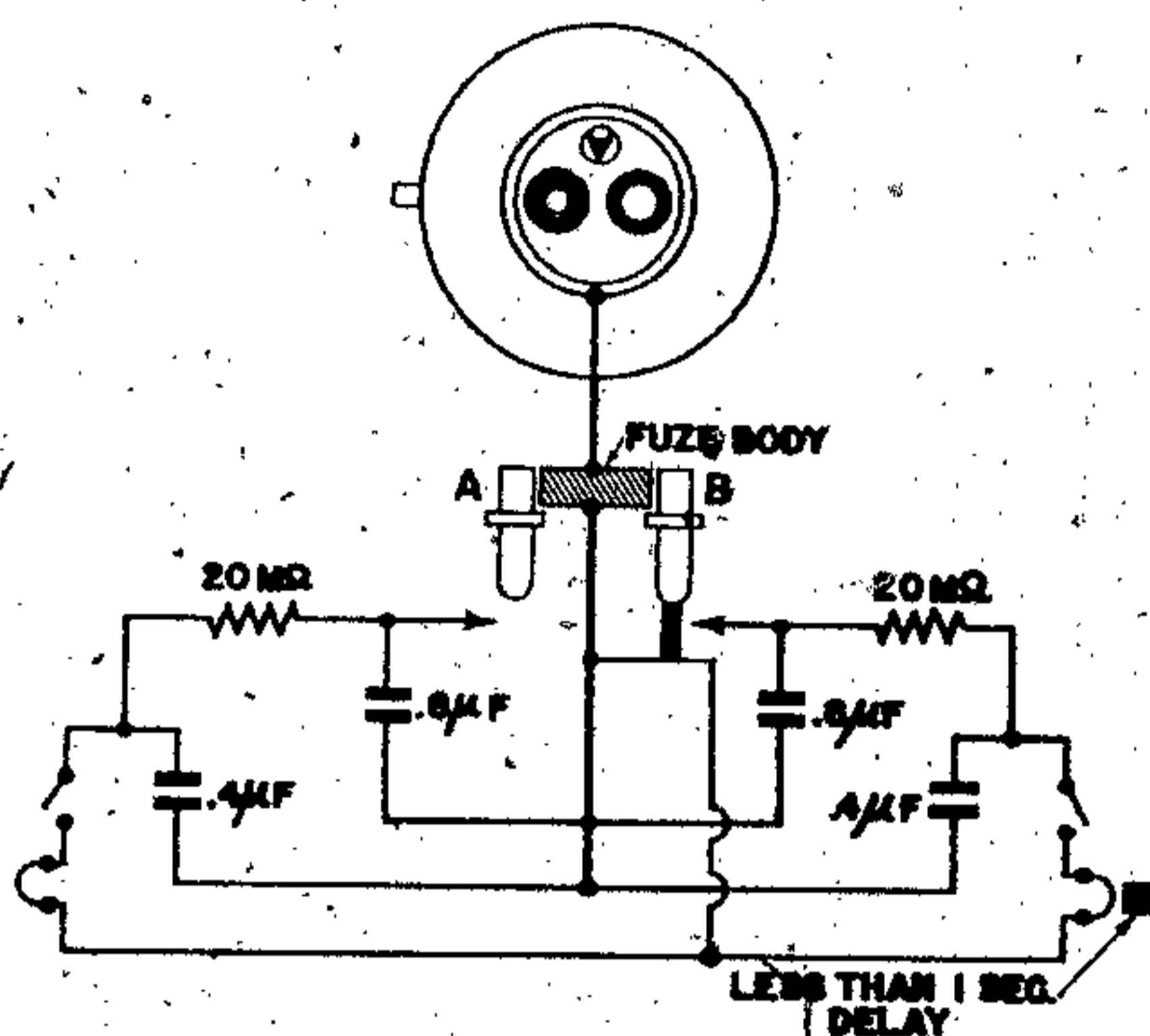

Figure 137—(A) Electrical Impact Fuze

powder pellets. This second flash travels through the channel to the spring-loaded detonator. This detonator sets off the gaine and main charge.

On impact should there be an excessive distortion of the bomb or fuze pocket, the striker in the antirupture device is forced by the ram into the percussion cap. The flash from this cap ignites the detonator, which in turn sets off the gaine and main charge.

(A) ELECTRICAL IMPACT FUZE (OBSOLETE)

DATA:

Bombs Used in: H. E. bombs—during Spanish Civil War; now obsolete.

Color: Unpainted.

Material: Aluminum.

Principal Markings: (A).

Secondary Markings: None.

Possible Actions: Instantaneous. Short delay—less than 1 second.

DESCRIPTION: The fuze contains two firing circuits, one charged from each plunger. Safety switching is accomplished by depression of the plain plunger B, switching off both firing circuits. (See fig. 137.)

(5) ELECTRIC IMPACT FUZE (OBSOLETE)

DATA:

Bombs Used in: H. E. bombs.

Color: Aluminum or brass with white ring around charging head.

Material: Aluminum or brass.

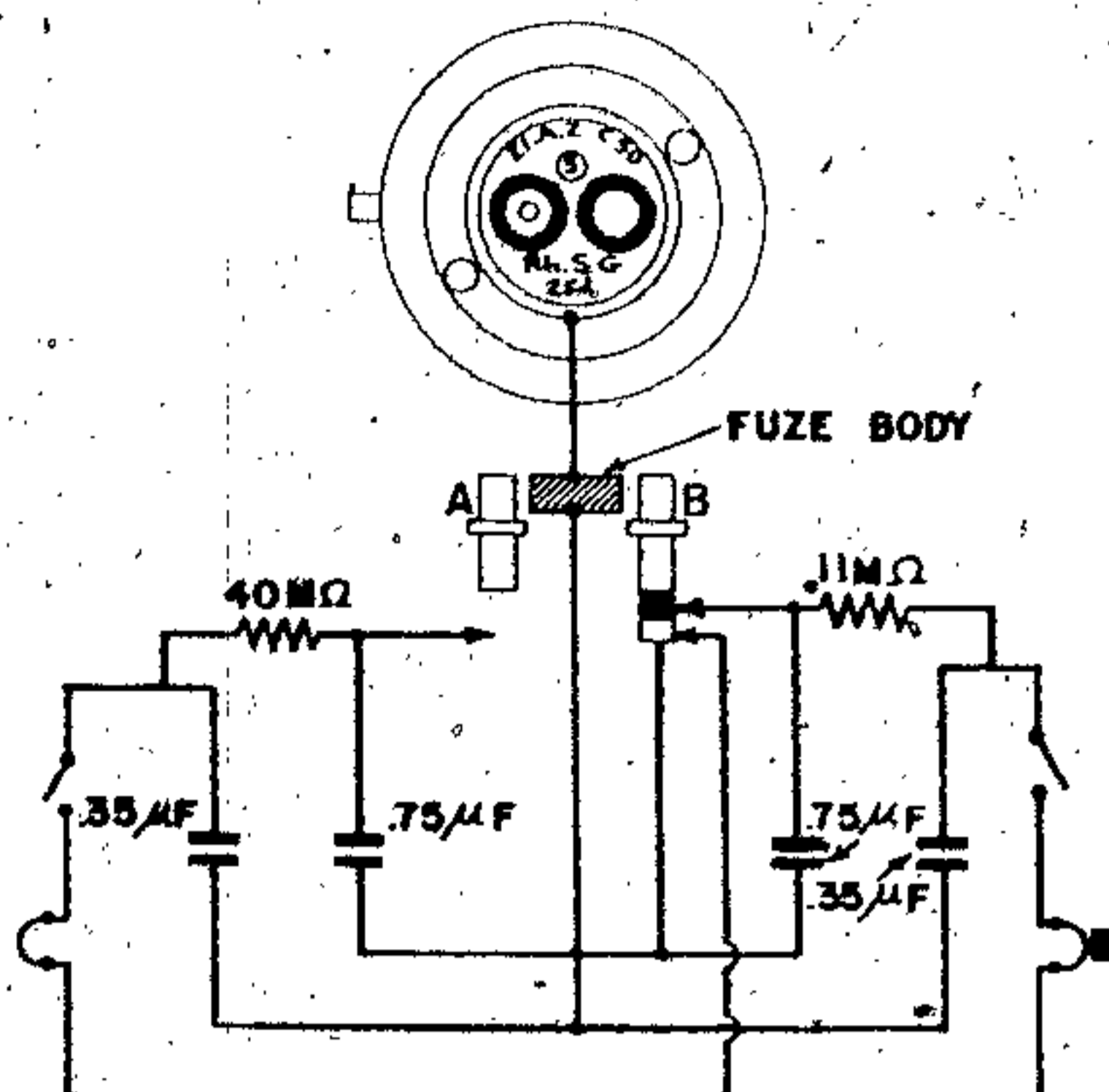

Figure 138—(5) Electrical Impact Fuze

Possible Actions: Instantaneous. Short delay (less than 1 second).

Arming Times.

Principal Markings: El. A. Z. C50 (5)

Secondary Markings: Rh. S. G. Rh. S. 1936
25 d 30 e

DESCRIPTION: The circuit diagram of this fuze is the same as that of the 28 (*). It employs two circuits, one of which charges from each plunger. The construction of this fuze is Type 1.

SAFETY SWITCHING: Depression of the plain plunger B switches off the igniter bridges. (See fig. 138.)

(15) ELECTRICAL IMPACT FUZE (OBSOLETE)

DATA:

Bombs Used in: H. E. bombs.

Color: Aluminum.

Material: Aluminum.

Principal Markings: El. A. Z. C 50 (15)

Secondary Markings:

Rh. S. 195-37

Rh. S. 195-38

Rh. S. 195-39

Rh. S. 195-40

Rh. S. 325-1935

Rh. S. 325-1938

Rh. S. 325-1939

Rh. S. 325-1940

A. D. 1940

B. C. 1940

GERMAN EXPLOSIVE ORDNANCE

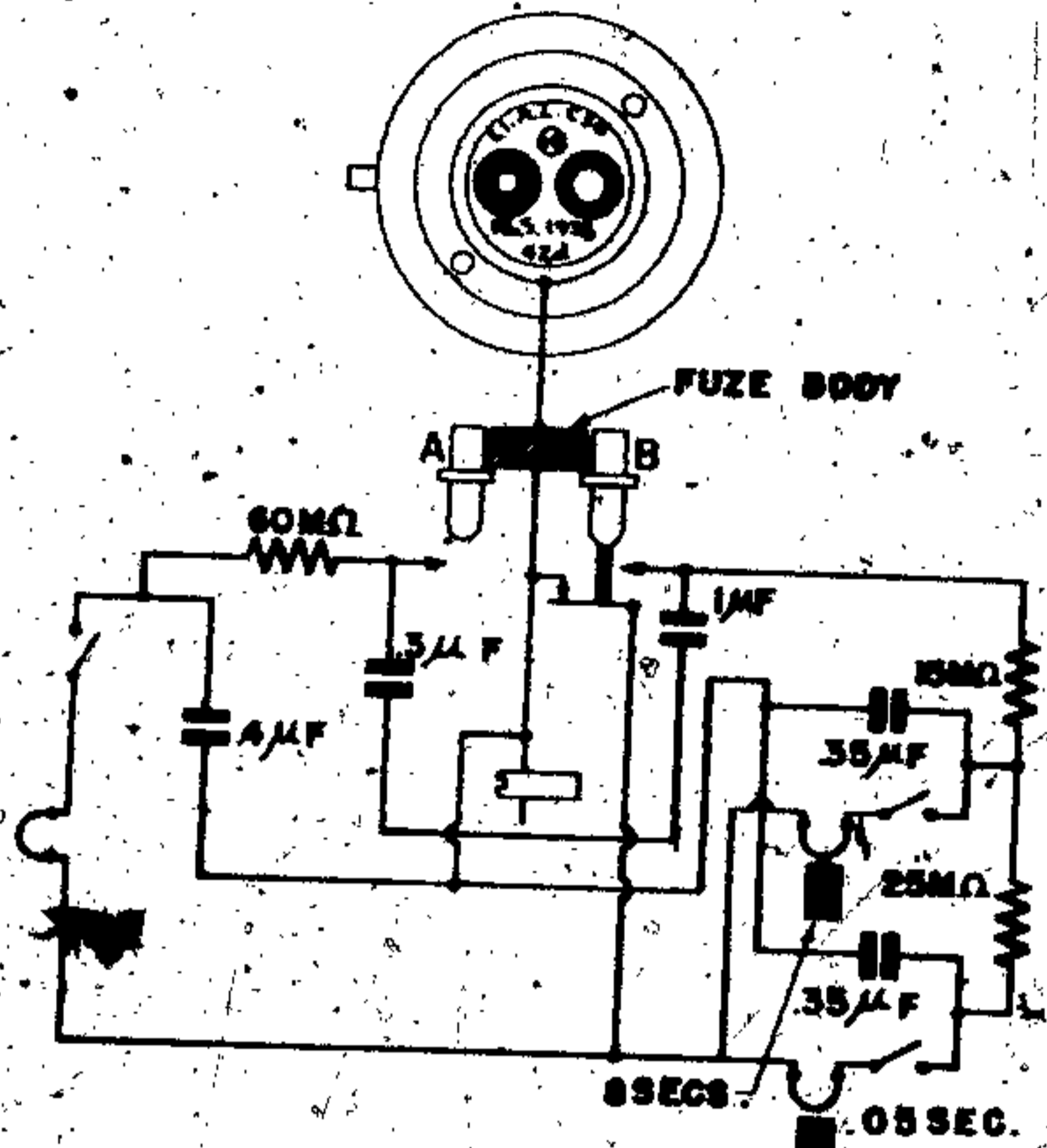

Figure 139—(15) Electrical Impact Fuze

DESCRIPTION. The fuze has three firing circuits and is of type 1 construction. It may be found reversed in the fuze pocket (rotated 180°) and a stop plug inserted in the base of the fuze to direct the flash from the instantaneous puffer to a 1-second delay pellet.

SAFETY SWITCHING. Depressing the plain plunger B switches off the igniter bridges via a separate switch. (See fig. 139.)

ARMING TIMES:

LEVEL FLIGHT (150 v.)	DIVING FLIGHT (240 v.)
1. Instantaneous. 7.5–11.8 sec.	3.7–5.6 secs.
2. 0.05-sec. delay. 8.5–13.0 sec.	5.7–8.7 secs.
3. 8-sec. delay. 1.5–3.0 sec.	0.9–1.6 secs.

POSSIBLE ACTIONS:

NORMAL SETTINGS	REVERSED SETTINGS
1. Instantaneous.	1. 1.0-sec. delay.
2. 0.05-sec. delay.	2. 0.05-sec. delay.
3. 8-sec. delay.	3. 8-sec. delay.

(25) (OBSOLETE; (25)A; (25)A*; (25)A—ELECTRICAL IMPACT FUZE**

DATA:

Bombs Used in: H. E. bombs.
Color: Dark grey.
Material: Aluminum.

Principal Markings: El. A. Z. (25); (25) A; (25) A* ; (25) A**.

Secondary Markings:

Rh. S. 1939	FC 1940
Rh. S. 1940	AC 1940
Rh. S. 195-1940	edr 1941
AD 1940	gyx 1941
FC 1940	dtf 1941
AD 1941	wtf 1941
1940	BC 1941
AB 1940	edr 1941
BC 1940	

DESCRIPTION. The fuze has three firing circuits and is of type 2 construction. A screw in the head operates a switch which cuts out the short delay circuit leaving only the long delay under plunger B. (See fig. 140.)

SAFETY SWITCHING. Each plunger cuts off the opposite arming circuit when depressed.

ARMING TIMES FOR (25):

LEVEL FLIGHT (150 v.)	DIVING FLIGHT (240 v.)
1. Instantaneous. 10.0–15.5 sec.	5.5–8.5 sec.
2. 0.08-sec. delay. 10.0–15.3 sec.	6.8–10.2 sec.
3. 14-sec. delay. 0.8–1.3 sec.	0.4–0.8 sec.

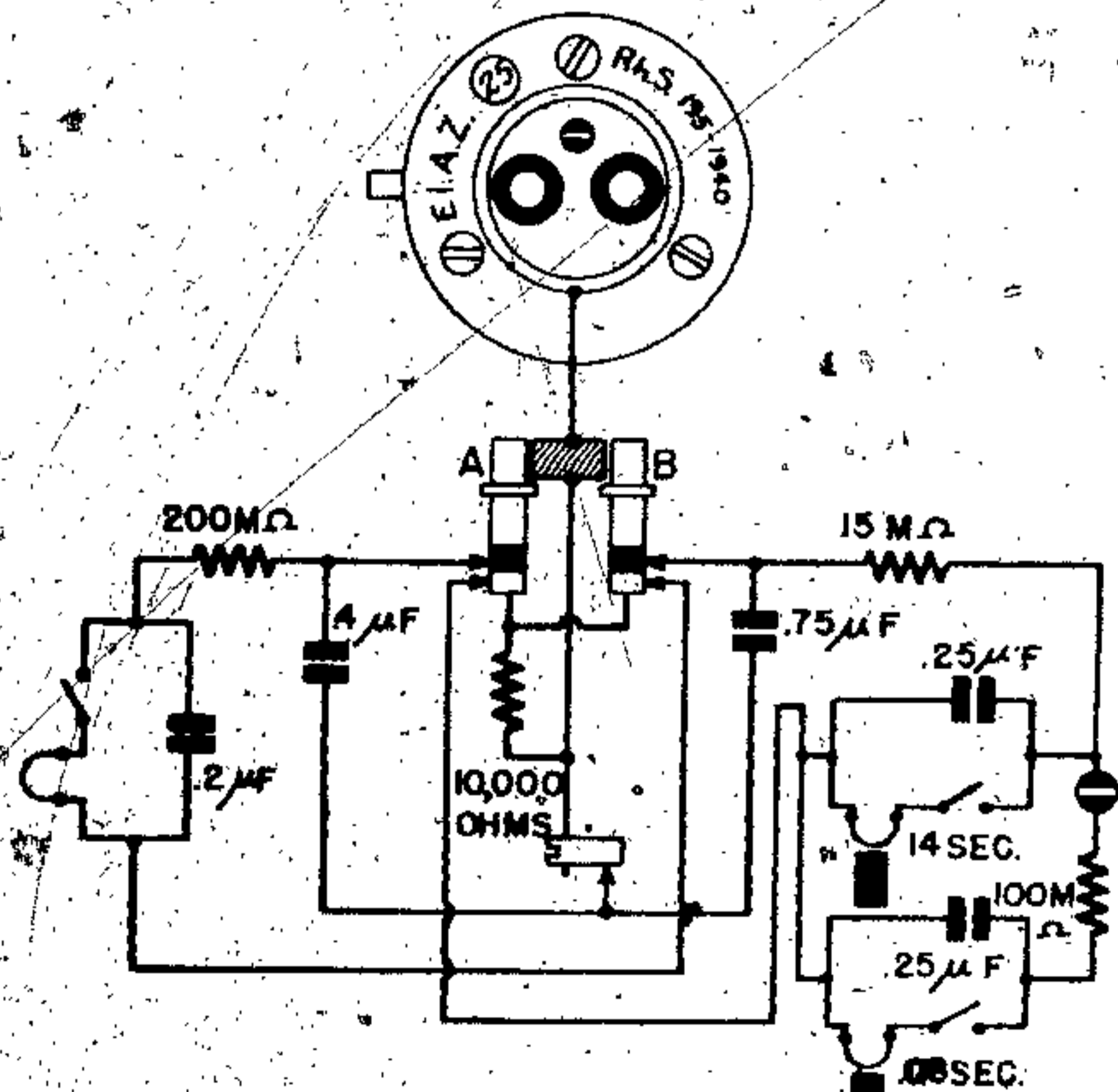

Figure 140—(25) Electrical Impact Fuze

POSSIBLE ACTIONS FOR (25), OTHERS SIMILAR:

SWITCH SETTING I	SWITCH SETTING II
1. Instantaneous.	1. Instantaneous.
2. 0.08-sec. delay.	2. 0.08-sec. delay cut off.
3. 14-sec. delay.	3. 14-sec. delay.

REMARKS. The (25)A differs from the (25) in that the 200 M resistor is reduced to 60 M. Arming time is about one-third. The 10,000-ohm resistance is omitted. The (25)A* differs from (25)A only in wiring connections.

(25)B; 25B—ELECTRICAL IMPACT FUZE

DATA:

Bombs Used in: SC 50-500; any incendiary requiring impact fuzing, and possibly PC bombs.

Color: Dark grey.

Material: Aluminum.

Principal Markings: El. A. Z. 25B and (25)B;
El. A. Z. 25B and (25)B; El. A. Z. (25)B.

Secondary Markings:

drz 42	dtf 1942
dtf 1941	cpp 1942
gyx 1941	BC 1941
cpp 1941	bm 1942
edr 41	bmv 1941
edr 42	bl 42
gyx 1942	cpp 1940

DESCRIPTION. The fuze is of type 2 construction with four firing circuits, three of which are under B plunger. A screw in the fuze head operates a switch which cuts out the two short delay circuits, leaving only the long delay circuit under plunger B.

SAFETY SWITCHING. The depression of either plunger switches off the opposite arming circuit. (See fig. 141.)

POSSIBLE ACTIONS:

SWITCH SETTING I	SWITCH SETTING II
1. Instantaneous.	1. Instantaneous.
2. Short delay (under 1 sec.).	2 and 3. Both short delays cut off.
3. Short delay (under 1 sec.).	
4. 17-sec. delay.	4. 17-sec. delay.

REMARKS. This is the most commonly used impact fuze.

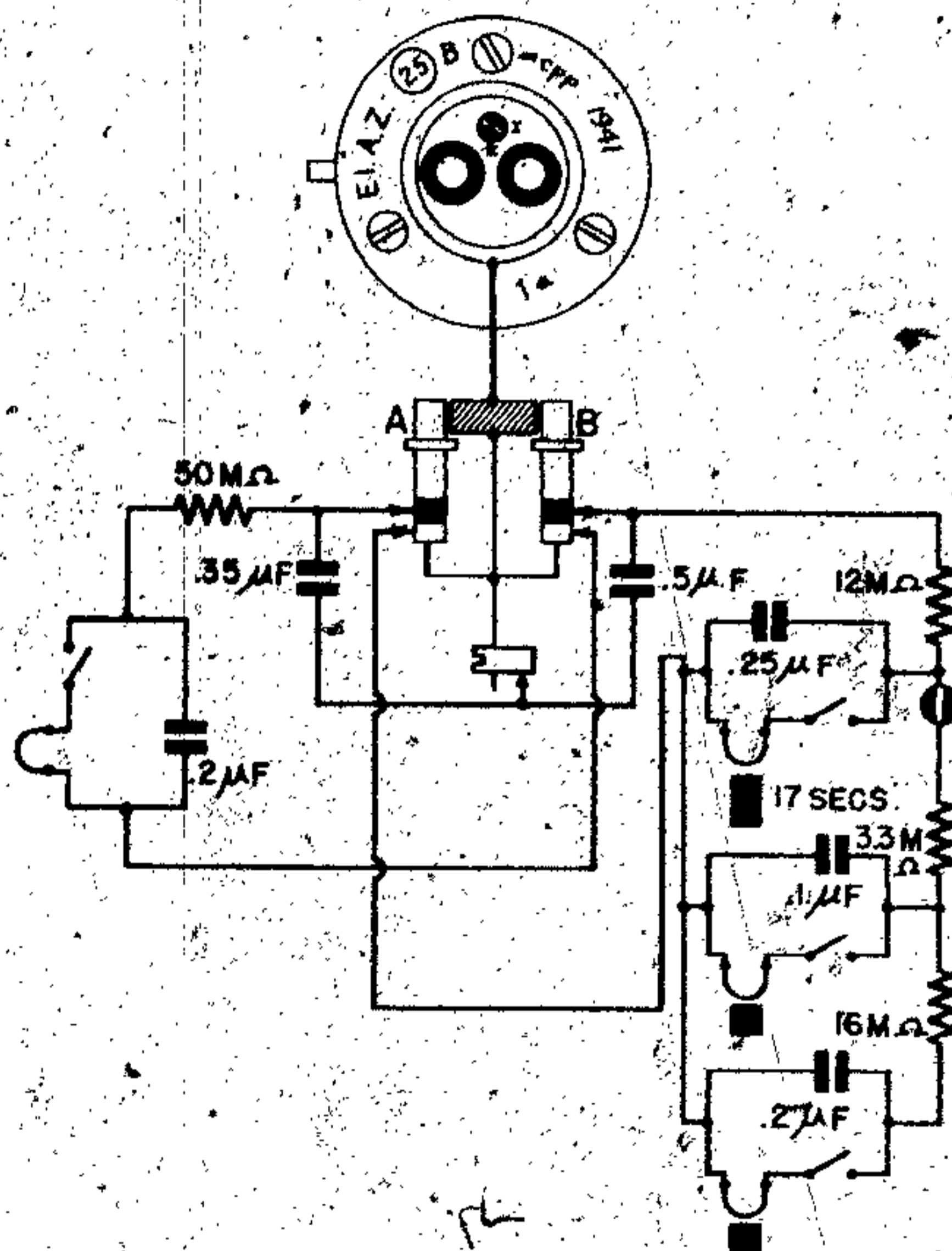

Figure 141—(25)B Electrical Impact Fuze

(25)C AND (25)D ELECTRICAL IMPACT FUZE

DATA:

Bombs Used in: H. E. bombs as for (25)B.

Color: Dark grey.

Material: Aluminum in (25)C. Aluminum, sheet steel and plastic in (25)D.

Principal Markings: El. A. Z. (25)C; El. A. Z. (25)D.

Secondary Markings:

BL 42 on (25)C.

dtf f 15e on (25)D.

DESCRIPTION. The fuze is of type 2 construction and has four firing circuits, three of which are under plunger B in a parallel-series arrangement. A screw in the fuze head operates a switch which cuts out one of the short delay circuits leaving one short delay and the long delay under plunger B. Switch in position I—ON; position II—OFF.

SAFETY SWITCHING. The depression of either plunger switches off the opposite firing circuit. (See fig. 142.)

GERMAN EXPLOSIVE ORDNANCE

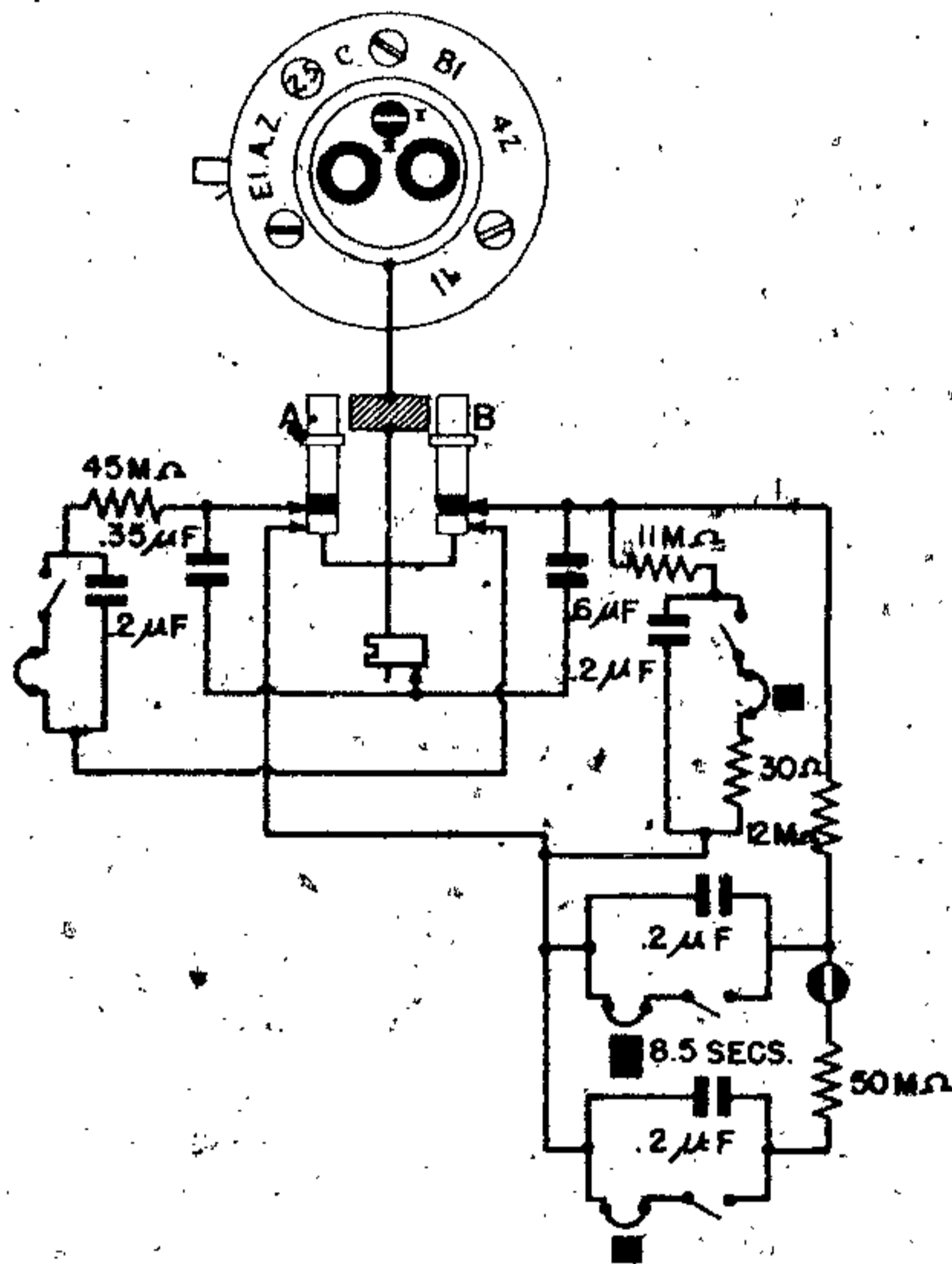

Figure 142—(25)C Electrical Impact Fuze

POSSIBLE ACTIONS:

SETTING I	SETTING II
1. Instantaneous.	1. Instantaneous.
2. Short delay (under 1 sec.).	2. Short delay (under 1 sec.).
3. Short delay (under 1 sec.).	3. Cut out.
4. 8.5-sec. delay.	4. 8.5-sec. delay.

REMARKS. The (25)D resembles the (25) tp in material and construction, but is operationally identical to the (25)C. In one recovered (25)D the setting screw had been replaced by a metal plug. The long delay of the (25)D is reportedly 12.3 seconds.

(35) ELECTRICAL IMPACT FUZE

DATA:

Bombs Used in: H. E. bombs and commonly in PC bombs for penetration.

Color: Dark grey with yellow paint on shoulder.

Material: Aluminum.

Possible Actions:

1. 0.06-0.08 (not variable) delay.
2. 0.06-0.08 (not variable) delay.

Principal Markings: El. A. Z. (35).

Secondary Markings:

AA 1940 cpp 1941

AB 1940 AB 1941

rhs 1940

DESCRIPTION. The fuze is of type 2 construction and has two firing circuits, both of which charge from plunger B.

SAFETY SWITCHING. Depression of plunger A cuts off both arming circuits. (See fig. 143.)

ARMING TIMES:

LEVEL FLIGHT (150 v.)	DIVING FLIGHT (240 v.)
1. 0.06-0.08 sec. delay 2.1-3.0 sec.	1.4-2.2 sec.
2. 0.06-0.08 sec. delay 1.6-2.0 sec.	1.0-1.5 sec.

(45) AND (45)A ELECTRICAL IMPACT FUZE

DATA:

Bombs Used in: (45) not yet recovered in any bomb. (45) A in SC 50.

Color: (45), dark grey. (45) A, unpainted fuze head with yellow shoulder.

Material: Aluminum and sheet steel.

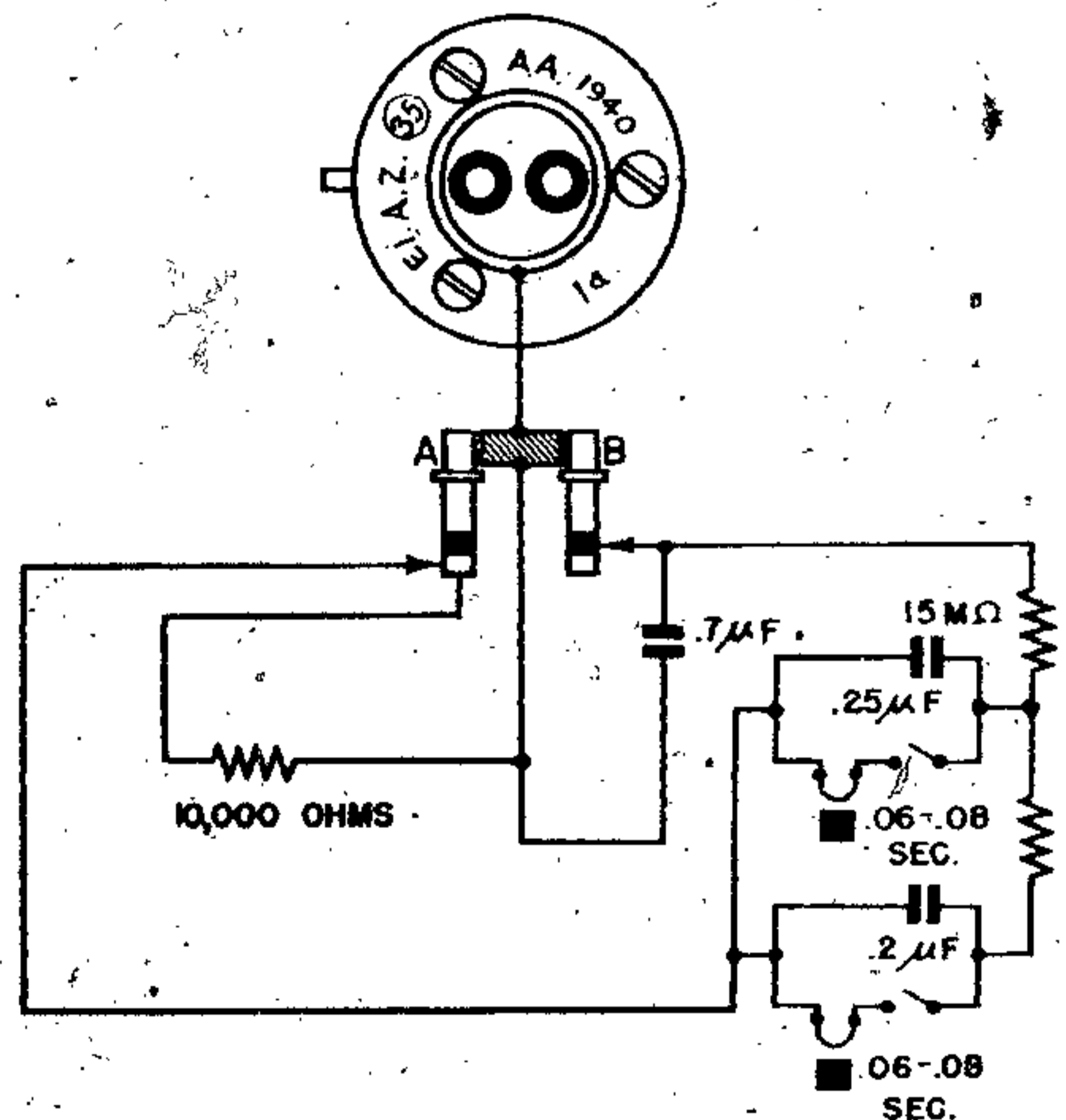

Figure 143—(35) Electrical Impact Fuze

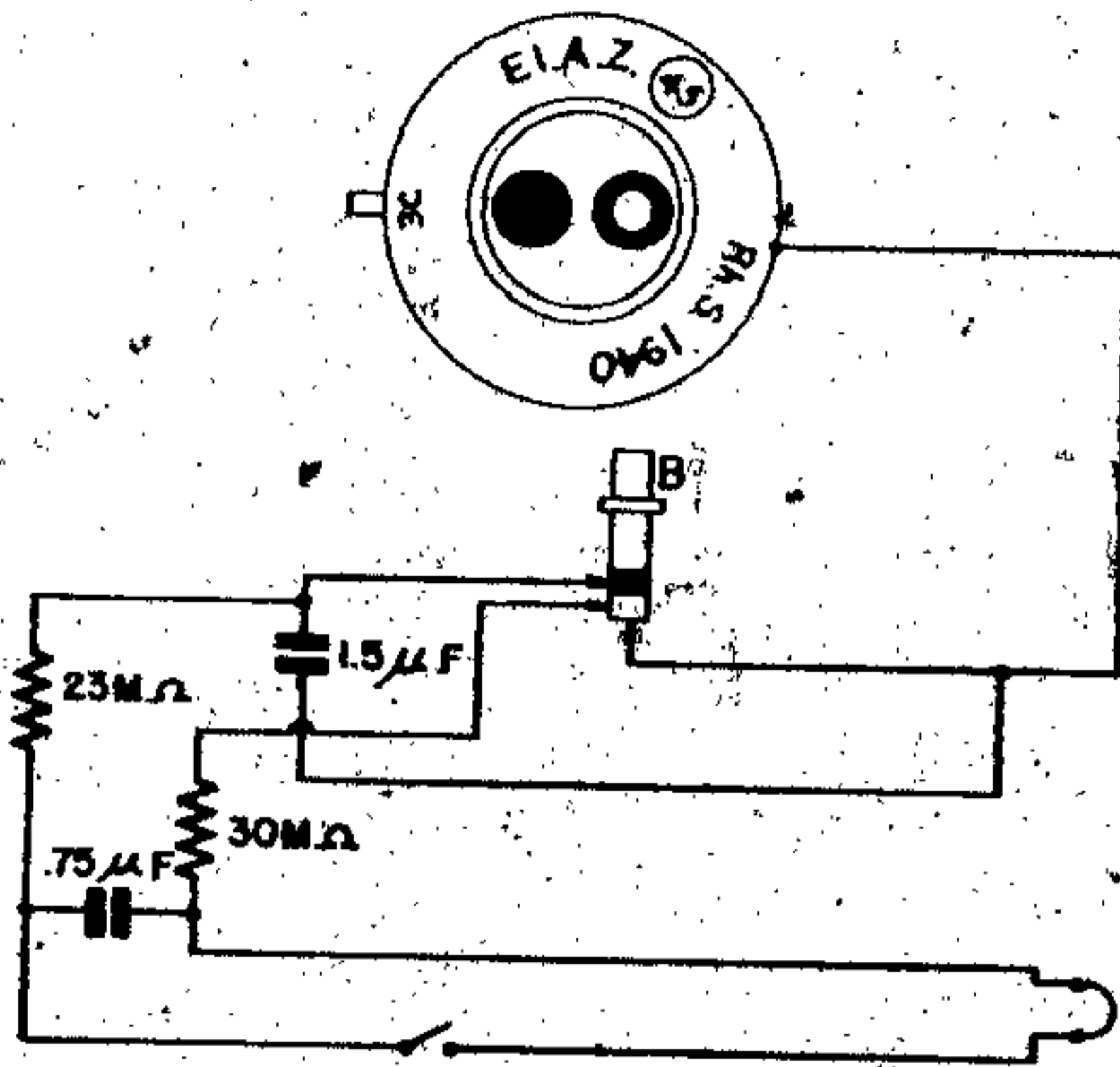

Figure 144—(45) Electrical Impact Fuze

Possible Action: Unknown for (45). As found, the fuze gives only instantaneous action. However, it is probable that various delay pellets can be threaded into the fuze above the gaine. The (45) A gives either instantaneous action of 0.08-second delay.

Principal Markings: El. A. Z. (45); El. A. Z. (45) A.

Secondary Markings:

Rh. S. 1940 on (45).

cpp a 16 e on (45) A.

DESCRIPTION. The (45) fuze is of type 5 construction and has one firing circuit which is charged from the B plunger. The (45) A is a two-circuit fuze.

SAFETY SWITCHING. Depression of the B plunger cuts off the arming circuit. (See fig. 144.)

(55) AND (55)tp ELECTRICAL IMPACT FUZE

DATA:

Bombs Used in: SD bombs, S Be bombs, and any bomb requiring instantaneous action.

Color: Dark grey (55) tp—aluminum.

Material: Aluminum, sheet steel, and plastic.

Possible Actions:

1. Instantaneous.
2. 14-second delay.

Principal Markings: El. A. Z. (55); El. A. Z. 55, El. A. Z. (55)tp; El. A. Z. (55): raised let-

ters in sunken panel, and El. A. Z. (55): raised letters in two sunken panels.

Secondary Markings:

bm 41	cpp 1941	amh 42
bg 41	edr 41	bo 41
Rh. S. 1940	bn 1941	dnv 41
gyy 41	bn 41	dmo 41
bv 41	gyz 41	FJ 40
bl 41	erm 1941	FF 40
dvw 41	emh 1942	bg 1941
AA 1940	FN 40	crm 42
drz 41	dms 41	FB 41
bt 1941	bpt 41	cpp 1942
crm 1941	FD 40	bm v 1941
FW 40	bc 1941	bm v 1942
FB 40	GB 40	

DESCRIPTION. The fuze is of type 5 construction with two firing circuits, one of which is charged from each plunger. (See fig. 145.)

SAFETY SWITCHING. Depression of either plunger switches off the opposite firing circuit.

ARMING TIMES:

LEVEL FLIGHT (150 v.)		DIVING FLIGHT (240 v.)
1. Instantaneous.	3.0–7.0 sec.	1.7–3.6 sec.
2. 14-sec. delay.	0.7–1.6 sec.)	0.4–0.9 sec.

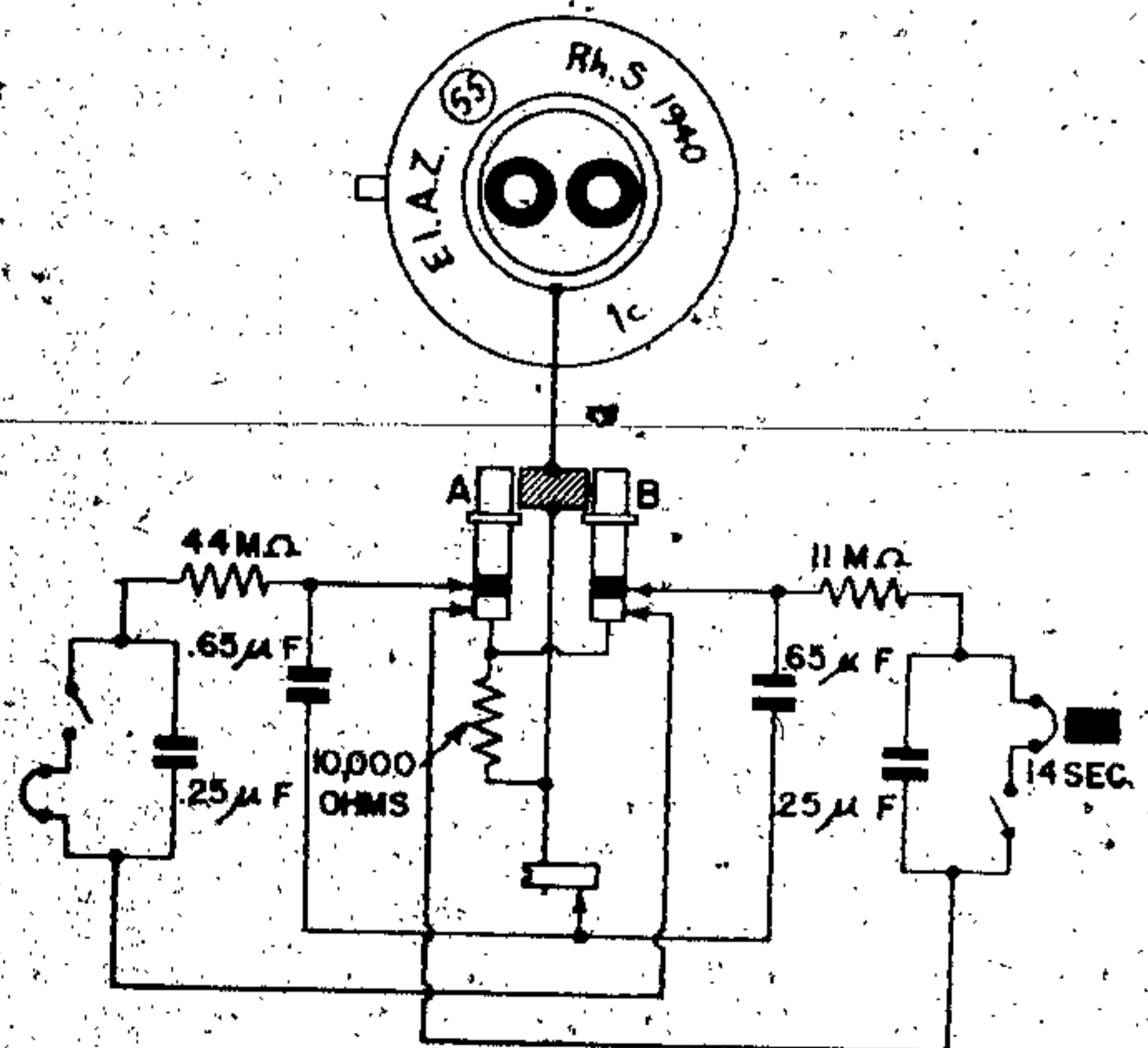

Figure 145—(55) Electrical Impact Fuze

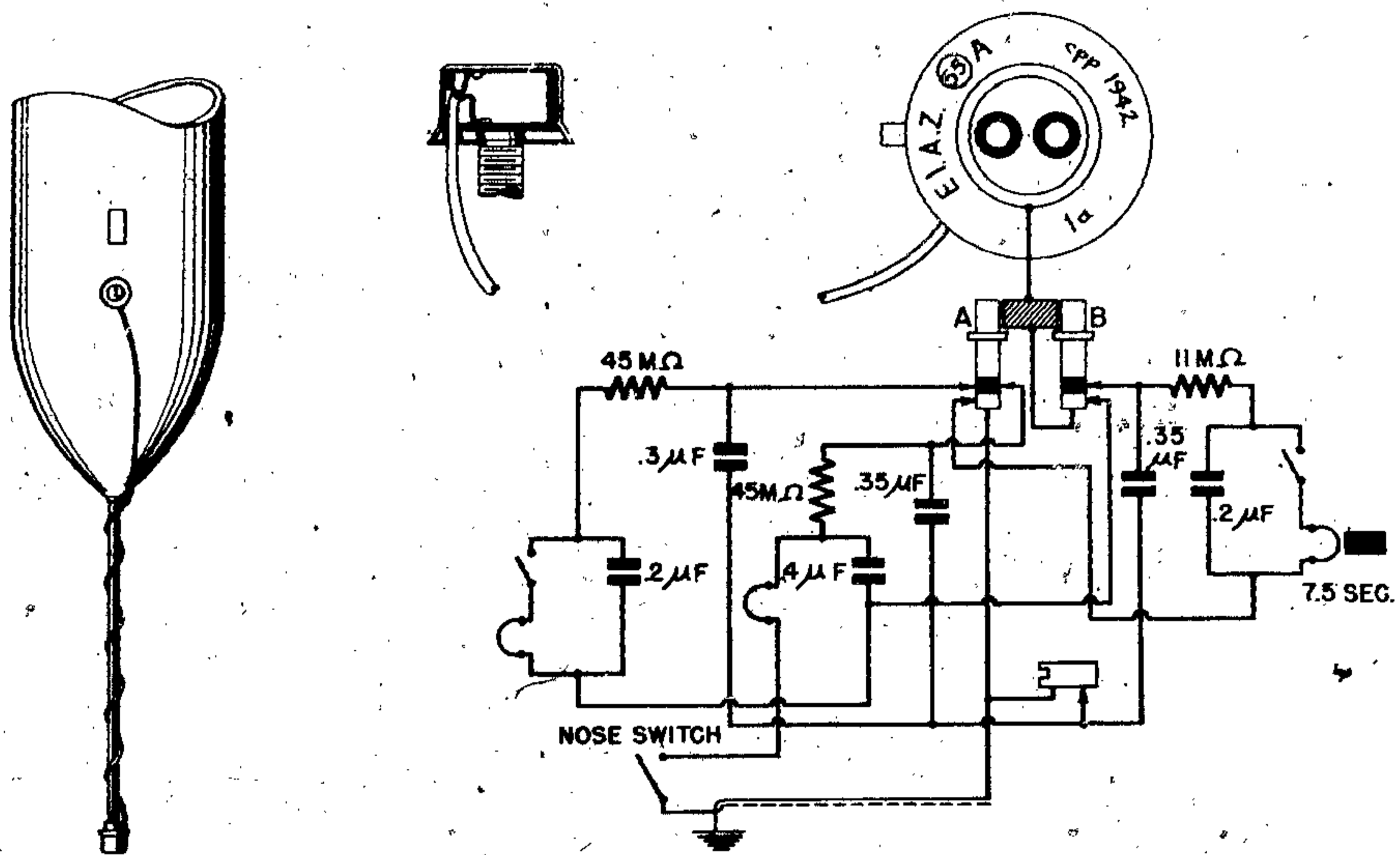

Figure 146—(55)A Electrical Impact Fuze

(55)A, (55)A/M, (55)A* ELECTRICAL IMPACT FUZE

DATA:

Bombs Used in: SD bombs, S be bombs, or any bomb requiring instantaneous fuzing. (55)

A/M used in SB 1000 H. E. parachute bomb.

Color: Dark grey or unpainted.

Material: Aluminum, sheet steel, and plastic.

Principal Markings:

El. A. Z. (55) A, Ele. A. Z. (55) A.

El. A. Z. (55) A*, El. A. Z. (55) A/M.

Secondary Markings:

c.p.p. 1942

c.p.p. 1940

c.p.p. x with Ele. A. Z. (55) A

gyx a with El. A. Z. (55) A/M

DESCRIPTION. The fuze is of type 5 construction and has three firing circuits; two instantaneous circuits from A plunger, and one long delay circuit from the B plunger. (See fig. 146.)

SAFETY SWITCHING. Depression of either plunger switches off the opposite arming circuits.

POSSIBLE ACTIONS:

1. Instantaneous—by a normal trembler switcher.

2. Instantaneous—by an external contact switch.
3. Long delay—7.5 sec. for El. A. Z. (55) A; 9.0 sec. for El. A. Z. (55) A*; and 12.7 sec. for Ele. A. Z. (55) A. Not known for El. A. Z. (55) A/M.

ARMING TIMES:

LEVEL FLIGHT (150 v.)	DIVING FLIGHT (240 v.)
1. Instantaneous (internal 4.2-sec. switch).	2.2 sec.
2. Instantaneous (external 4.9-sec. switch).	2.3 sec.
3. Long delay 1.0 sec.	0.55 sec.

26, (26) ELECTRICAL IMPACT FUZE (SPECIAL)

DATA:

Bombs Used: KC 250 KC 250 "Flam."

Color: Green.

Material: Aluminum.

Possible Action: Instantaneous.

Principal Markings: El. A. Z. 26 and El. A. Z. (26).

DESCRIPTION. The 26 electric impact fuze is

of a special type using only a single firing circuit under the B plunger. The A plunger may or may not be present. The reservoir condenser can be charged after depressing the plunger remote from the locating pin. This action in addition to charging the condenser also serves to break the connection between the firing condenser and the igniter. In addition to an impact trembler switch of the normal type, a pressure switch is included consisting of two small discs of thin metal. The outer disk is mounted 0.1 inch from the fixed inner switch. This metal is usually brass. An open tube leads from the nose of the bomb to this pressure switch, contact is made through the side of the fuze pocket. The air pressure switch as it is commonly called, is closed when the bomb is a few feet away from its target. This condition is resultant of an increased aerodynamic pressure in the air column filling the tube. Should this air pressure switch fail to function the normal vibrating trembler switch operates on impact, detonating the explosive charge of the bomb instantaneously. (See fig. 147, parts A and B.)

OPERATION. The fuze is located in the bomb with the B plunger remote from the nose of the bomb. The storage condenser is charged through

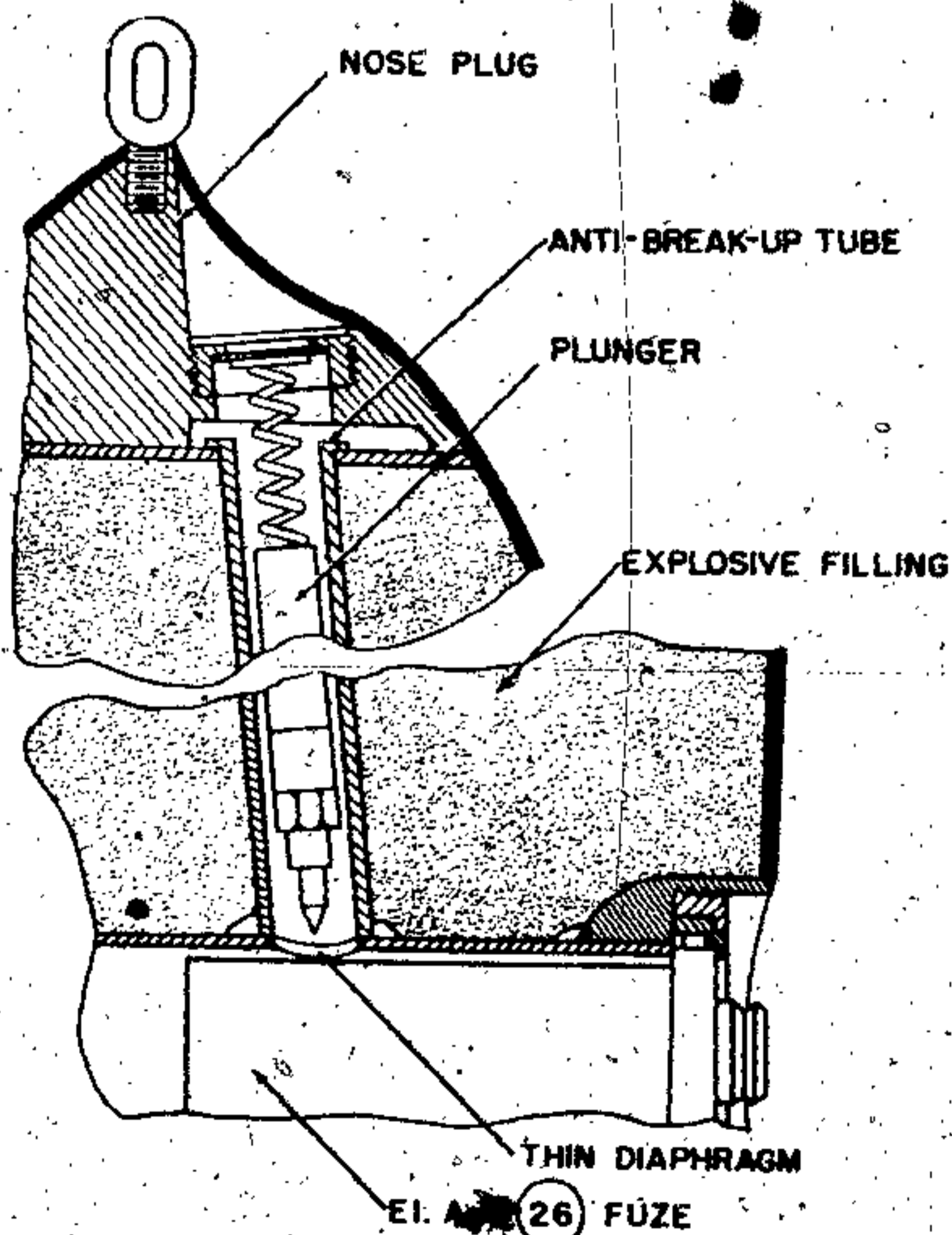

Figure 147A—(26) Electrical Impact (Special)

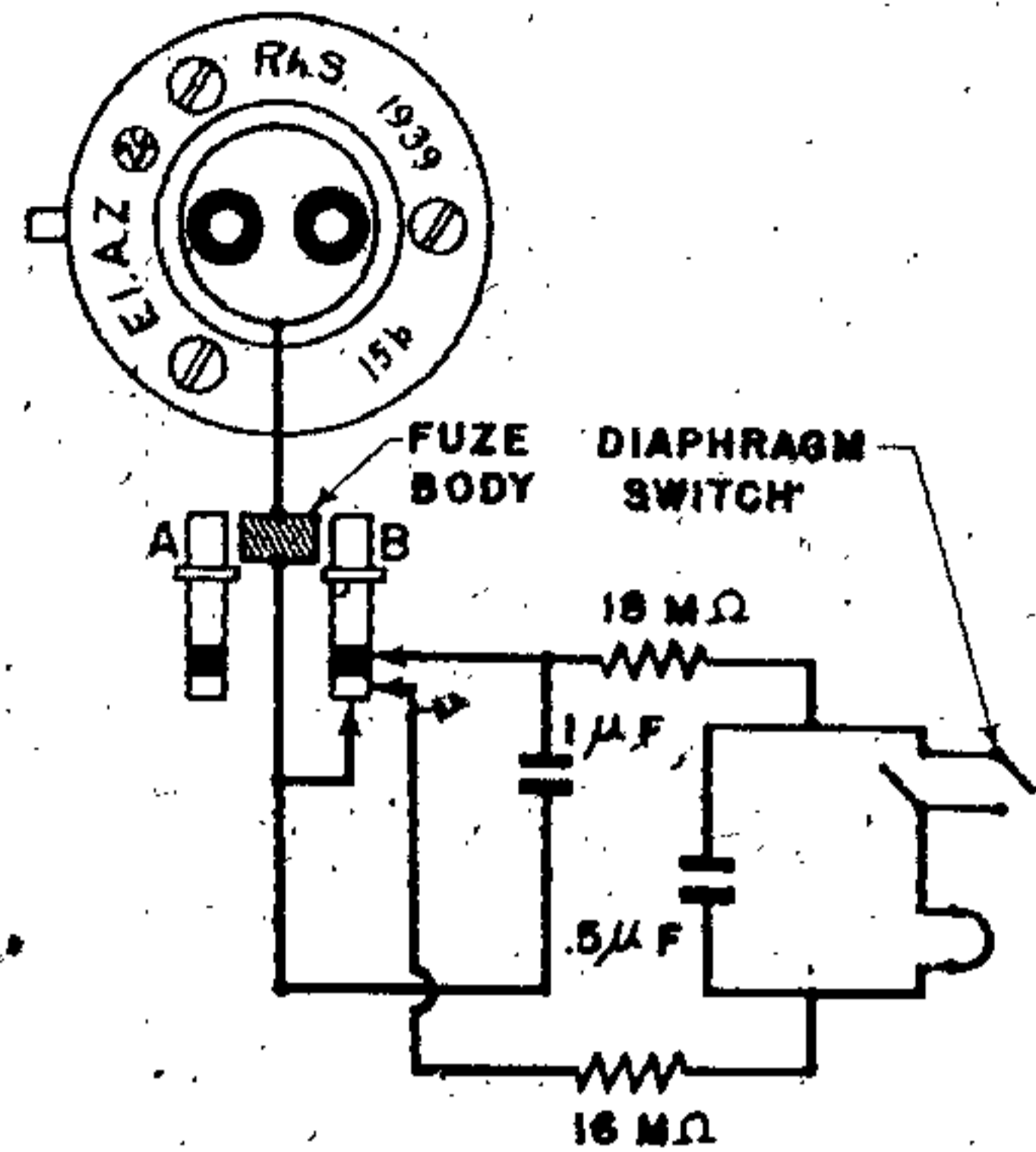

Figure 147B—(26) Electrical Impact (Special) Wiring Diagram

this plunger and, when the proper charge has leaked through the resistance, the firing condenser is then charged and the fuze is armed. Future functioning of the fuze is normal except in the case where the air pressure diaphragm switch operates. The most likely use for the fuze as mentioned above, is in bombs having a vesicant liquid filling to insure good scattering of the filling.

(46) MECHANICAL IMPACT TAIL FUZE

DATA:

Bombs Used in: KC 50 gas bombs.
 Color: Charging head, aluminum; fuze body, black.
 Material: Aluminum, steel, brass, etc.
 Possible Actions: Instantaneous.
 Arming Times.
 Principal Markings: A. Z. (46).
 Secondary Markings: cma r.

DESCRIPTION. This is an electrically armed, mechanical tail fuze. A charging head is secured in the transverse fuze pocket of the bomb by locking and locating rings. This fuze pocket is merely a well to hold the charging head, and is not a full scale transverse fuze pocket. The wires from the charging head run along the inner wall of the bomb case to the tail through a pipe welded to the wall and end in a female electrical plug.

GERMAN EXPLOSIVE ORDNANCE

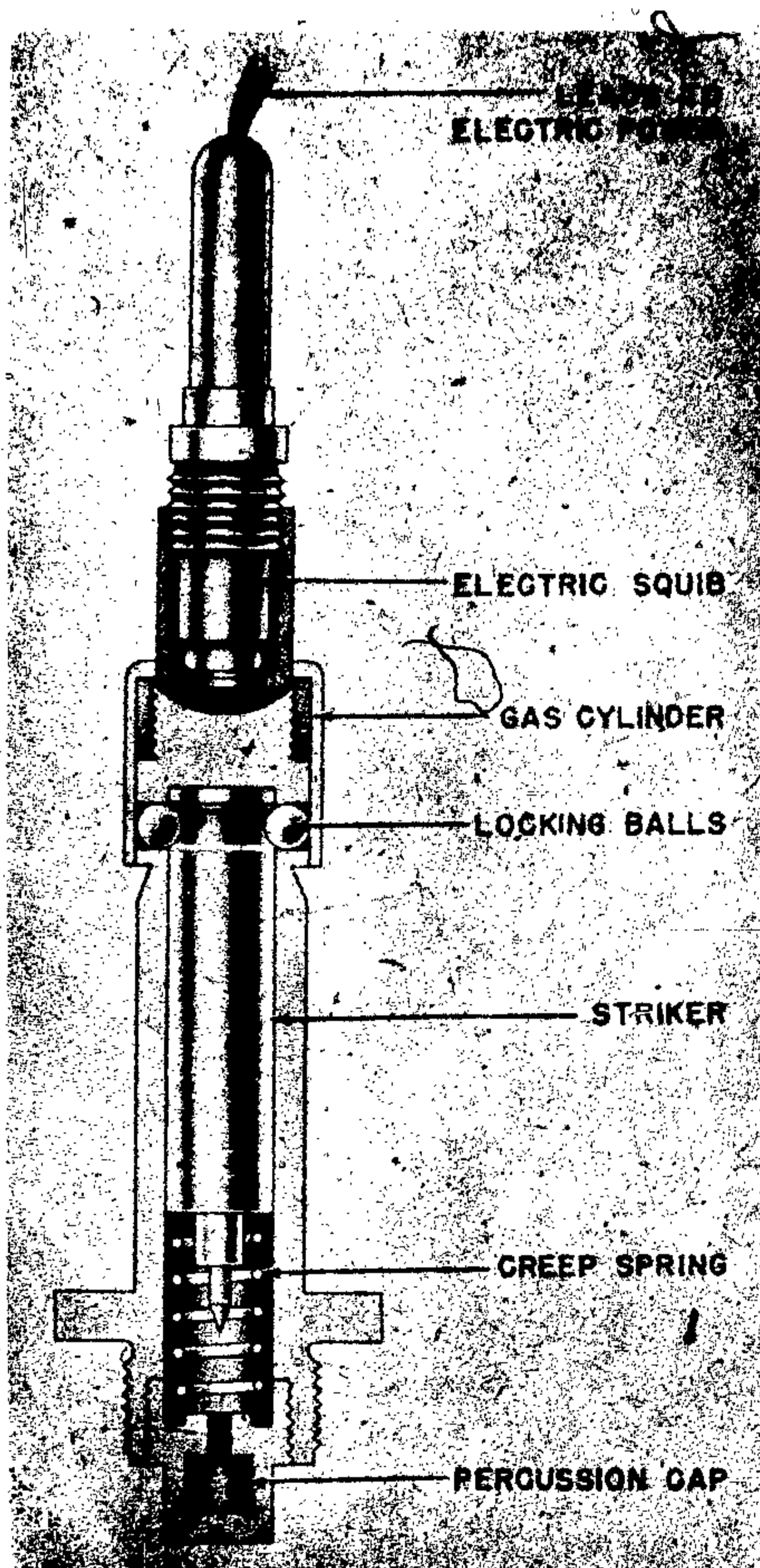

Figure 148—(46) Electrical Impact Tail Fuze

A male plug is inserted into this and is connected by a double wire to an electrical squib in the rear of the mechanical portion of the fuze. This mechanical portion of the fuze, which consists of a fuze body, squib housing, gas cylinder, striker, locking balls, creep spring, and detonator holder, is shipped as a separate component in the packing box containing the bomb, and is placed in the bomb prior to loading in aircraft. (See fig. 146.)

OPERATION. On release from the aircraft, a charge of electricity is sent through the charging head to fire the electrical squib. The expanding gases produced by the firing of the squib force the gas cylinder up and off the fuze body releasing the striker locking balls. The fuze is now armed.

On impact the striker overcomes the creep spring and fires the detonator.

(66) SPECIAL IMPACT FUZE

DATA:

Bombs Used in: SD 10A.

Color: Dark plastic fuze case. Vane assembly unpainted.

Material: Plastic, steel, zinc, aluminum, etc.

Possible Actions: Instantaneous.

Arming Times.

Principal Markings: Z (66) (not visible in assembled fuze).

Secondary Markings:edr Z 15.

DESCRIPTION. Wound on a plastic former (1) are 54 turns of shellac insulated copper wire of 30 SWG. The mean diameter of the coil so formed is 0.75 inch. Two thicknesses of thin plastic strip are wound around the circumference of the coil to insulate the winding from the two soft iron pieces (2) and (3), which enclose the three external surfaces of the coil and act as a magnetic shield against any stray external fields. (See fig. 149.)

The coil assembly is housed in the black opaque plastic molding (4), and is retained in position by the transparent plastic molding (5), which is a push fit. Mounted in the molding (5) are two metal pins (6) and (7) to which are attached respectively the contact projections (8) and (9). The ends of the winding of the coil are threaded through a nipple which projects from the former (1) through the soft iron piece (3). One of these ends is attached to the metal pin (6) while the other is connected to one end of the spring wire (10). A small quantity of bitumastic (11) completes the insulation.

When the fuze is assembled the aluminum alloy collar (12) is retained within the molding (4) by a magnetized steel cylinder (13). This latter is a push fit within the coil assembly and is itself retained by two small projections (14) on the molding (5). Screwed down into the collar (12), which is itself prevented from rotating by a keyway (15), is an aluminum spindle (16). When the

fuze is in the unarmed condition, a projection (17), from the base of this spindle retains the spring wire (10) in the position shown dotted so that it makes contact with the projection (8) thus producing a closed circuit in the coil. The base of the molding (5) is then closed by a plastic disc (18), which is pressed into position.

Mounted on the spindle (16) so that it can rotate freely is the zinc alloy casting (19) with six impeller blades on its outer surface. The casting is retained in place by the composition washer (20), which is held by turning over the edge of the casting.

The igniter unit is housed in a separate bakelite

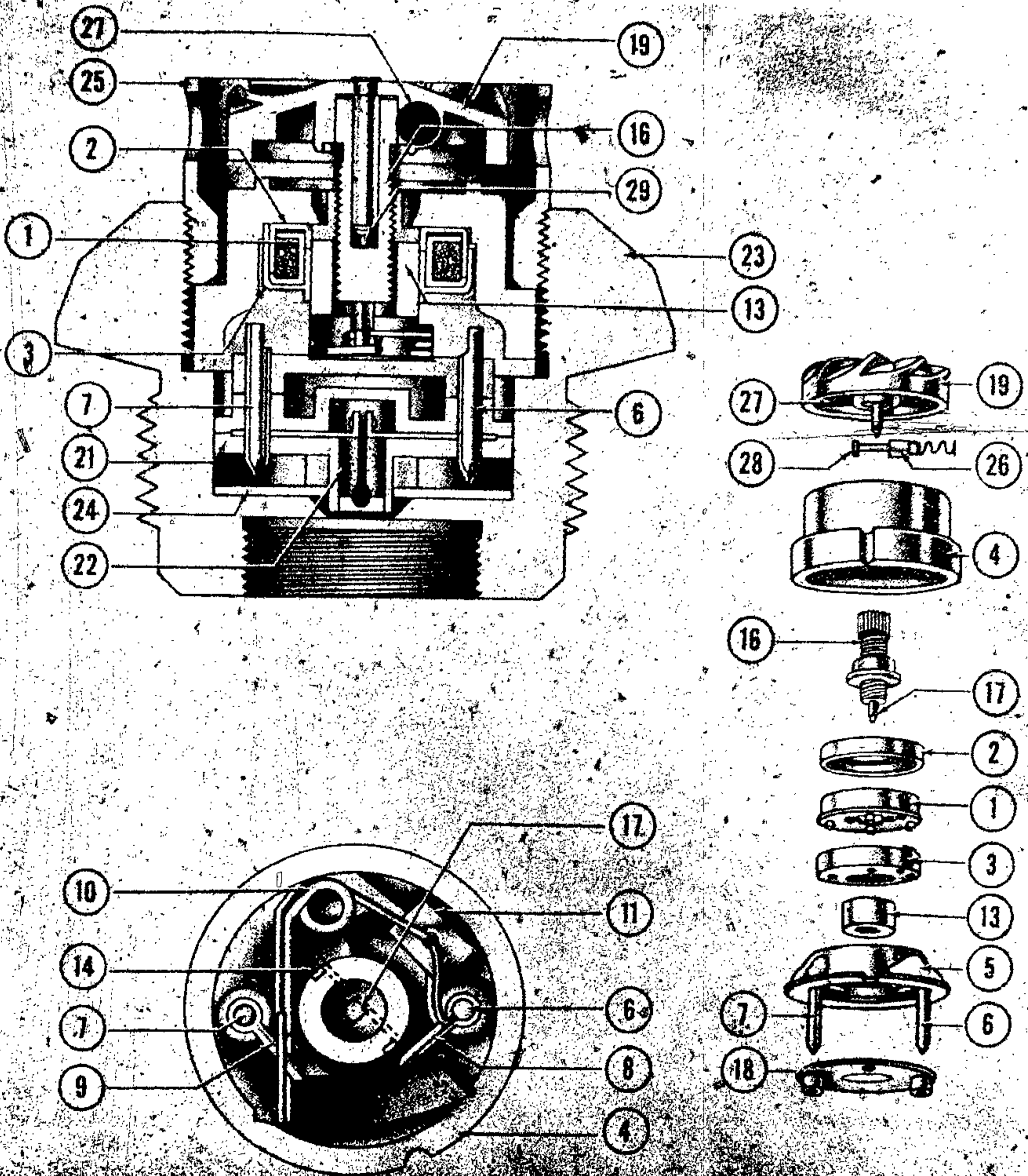

Figure 149—(66) Special Impact Fuze

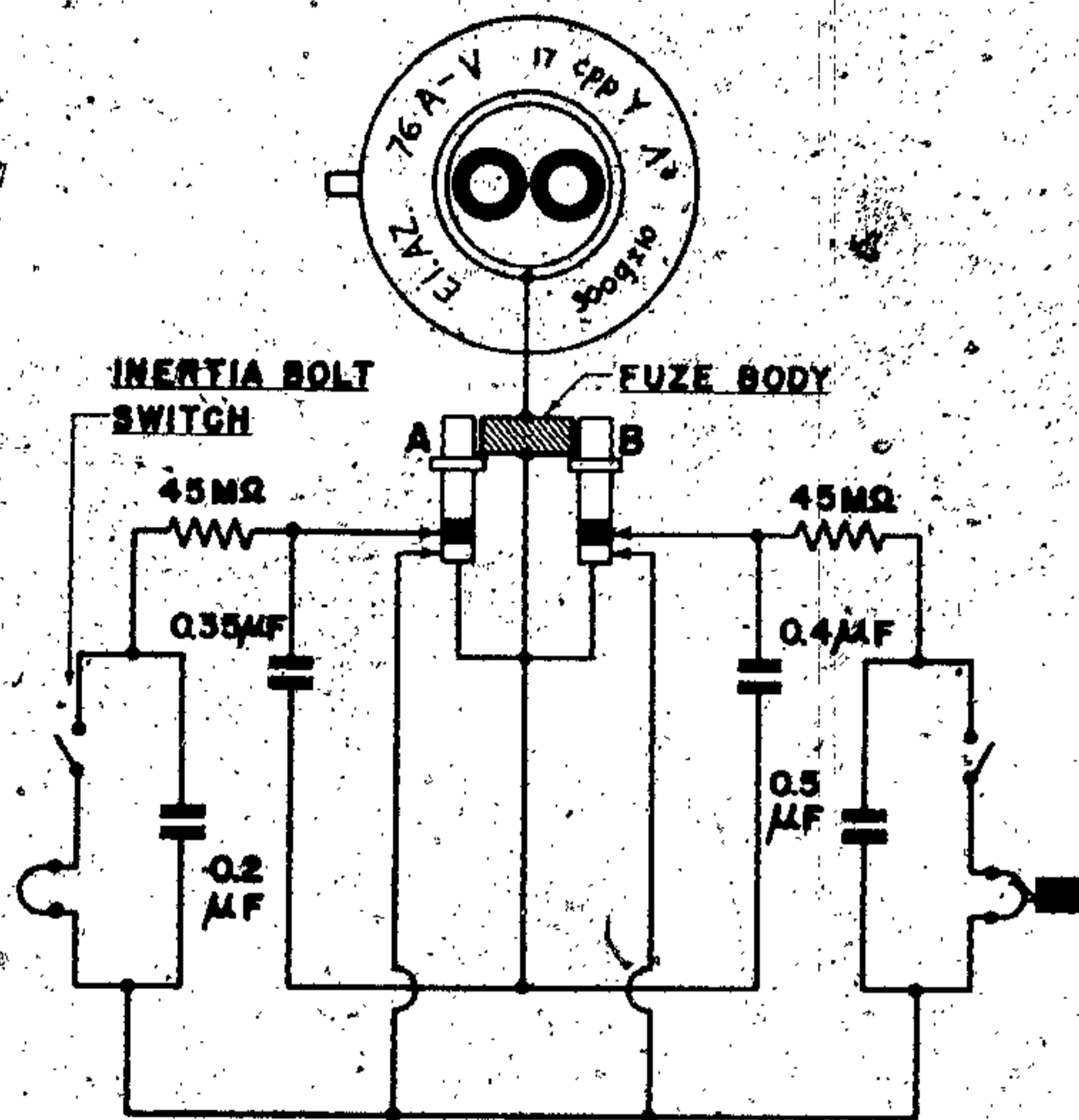

Figure 150—(76)A Electrical Impact Fuze

molding (21) into which plug the metal pins (6) and (7) to make contact with the wires leading to the firing bridge (22).

This complete assembly is housed in a steel adapter (23), the metal pins (6) and (7) being insulated from it by a cardboard washer (24). The assembly is retained in position by the screw-threaded steel collar (25) which surrounds the impeller blades and is perforated by four circular holes to allow the passage of air.

OPERATION. When the fuze bomb is released, the flow of air over the surface of the impeller blades and out through the holes in the collar (25) causes free rotation of the casting (19) until such time as the rotational speed is sufficient to bring the safety clutch into operation. This latter consists of a spring loaded inertia bolt (26), which is housed in the channel (27). Centrifugal force causes the inertia bolt to compress the spring and move along the channel so that the flange (28) engages with the knurled surface of the spindle (16) and causes this latter to rotate with the casting (19). This rotation causes the spindle to withdraw from the collar (12) thus releasing the spring wire (10) which flies across and makes contact with the pin (9) bringing the igniter bridge

into series with the coil. The spindle (16) cannot completely withdraw from the collar (12), since the base of the threaded portion of the spindle is turned over. On impact with the ground, the spring loaded plunger (29) attached to the casting (19) and projection down the center of the spindle (16) is depressed and the spindle rammed into the fuze against the steel cylinder (13). The two projections (14) are then sheared and the compression of the spring insures the sudden rapid movement of the magnetized steel cylinder (13) causing a magnetic field to pass rapidly across the coils of the winding, and thus produce a small flow of electricity which fires the bridge (22). The flash from this bridge then passes to the standard gaine screwed into the base of the steel adapter (23).

REMARKS. The arming time of this fuze depends upon the speed of rotation of the casting (19), which in turn depends upon the air flow over the impeller blades. This can be regulated by the size of the holes in the steel collar (25). In another specimen recovered these holes were elongated and had evidently proved unsuccessful since a second collar with circular holes had been welded in position over the first.

(76)-A ELECTRIC IMPACT FUZE**DATA:**

Bombs Used In: H. E. bombs against resistant targets.

Material: Aluminum head, sheet steel body, plastic base.

Color: Dark grey.

Possible Actions: Instantaneous, short delay.

Markings: El. A. Z. 76-A 17 cpy Y 300g ± 10 o. v.

DESCRIPTION. The body casing, painted dark grey, is of seamless sheet metal construction. It is similar to the 55 fuze construction. The normal type fuze head is unpainted.

The polystyrene molding has been cut away in one place to accommodate the new inertia bolt switch. This switch is a piston plunger type operating against a creep spring. On static loading, a force of 260g-300g is required to close the switch. Some fuzes have been found with a very short powder delay train.

There are two firing circuits charged one from each plunger. The circuit under the B plunger is fired by the usual impact switch and initiates a short delay. The circuit under the A plunger is fired through the inertia bolt switch. Safety switching is accomplished by depressing both plungers thereby disconnecting the reservoir condensers from the two firing circuits. (See fig. 150.)

The condenser roll is inserted from the regular practice. The leads from the condenser tags are embedded in the outer layers of paper.

OPERATION. The operation of this fuze is the same as for all normal electrical impact fuzes. If only the B plunger is charged, the regular impact switch fires a short delay. If both plungers are charged the inertia bolt switch fires for instantaneous action. Then if the inertia switch fails, the delay will still function and fire the main charge.

(106)* ELECTRICAL IMPACT FUZE**DATA:**

Bombs Used in: Flying bomb (Peenemunde 16).

Color: (106)*, dark grey; (106), head half red and half green.

Material: Aluminum, steel and plastic.

Possible Action: Instantaneous.

Arming Times: Depends on setting of switch in Veeder counter mechanism.

Principal Markings: El. A. Z. (106)*. Ent. (106) complementary component for El. A. Z. (106)*.

Secondary Markings: cpy a 5; cpy y 3.

DESCRIPTION. The El. A. Z. (106)* is essentially a switching device for three electric igniters within it, and is normally battery operated. Ent. (106) is a complementary component acting as an electric reservoir, which can supply sufficient current to fire the electric igniters (r) and (w) of the (106)* fuze if the leads from the 30 volt battery should be damaged. Neither the (106)* nor the (106) has plungers and only the (106)* contains explosive components.

The fuze case (5) is of mild steel, and is of the type well known in the (55) fuzes. There is no charging boss, however; the top (6) of the fuze is flat and fitted with two nipples (7) and (8), through each of which two red leads pass. These nipples take the place of the charging plungers of the ordinary "condenser" fuze.

Immediately under the top of the fuze is a molding (9) of brown plastic which has two housings containing sockets (10), (11), to take the pins of two plugs (12), (13). (See fig. 151A.) One plug may be distinguished from the other when viewed from the outside of the fuze by a narrow unpainted surround to the nipple remote from the locating pin of the fuze; the surround of the nipple adjacent to the locating pin being painted dark grey like the rest of the fuze. No distinction can be made by the leads—all four being red. In some fuzes the nipples remote from the locating pin of the fuze is also unpainted and the nipple itself has crossed grooves (knurled), while the nipple adjacent to the pin is painted dark grey and has longitudinal grooves (splined). The threaded ring which holds the plug adjacent to the locating pin in position is stabbed in. The other ring is not so connected.

The upper molding (9) contains an electric igniter (p) in a metal tube. Under this molding is another molding (18) of brown plastic which contains three switches (1), (2), (3) and a small metal pot (19) of thermite. This thermite is ignited by the igniter (p). It is possible that there is a small delay pellet between the igniter and the thermite. A spring (20) tends to open

GERMAN EXPLOSIVE ORDNANCE

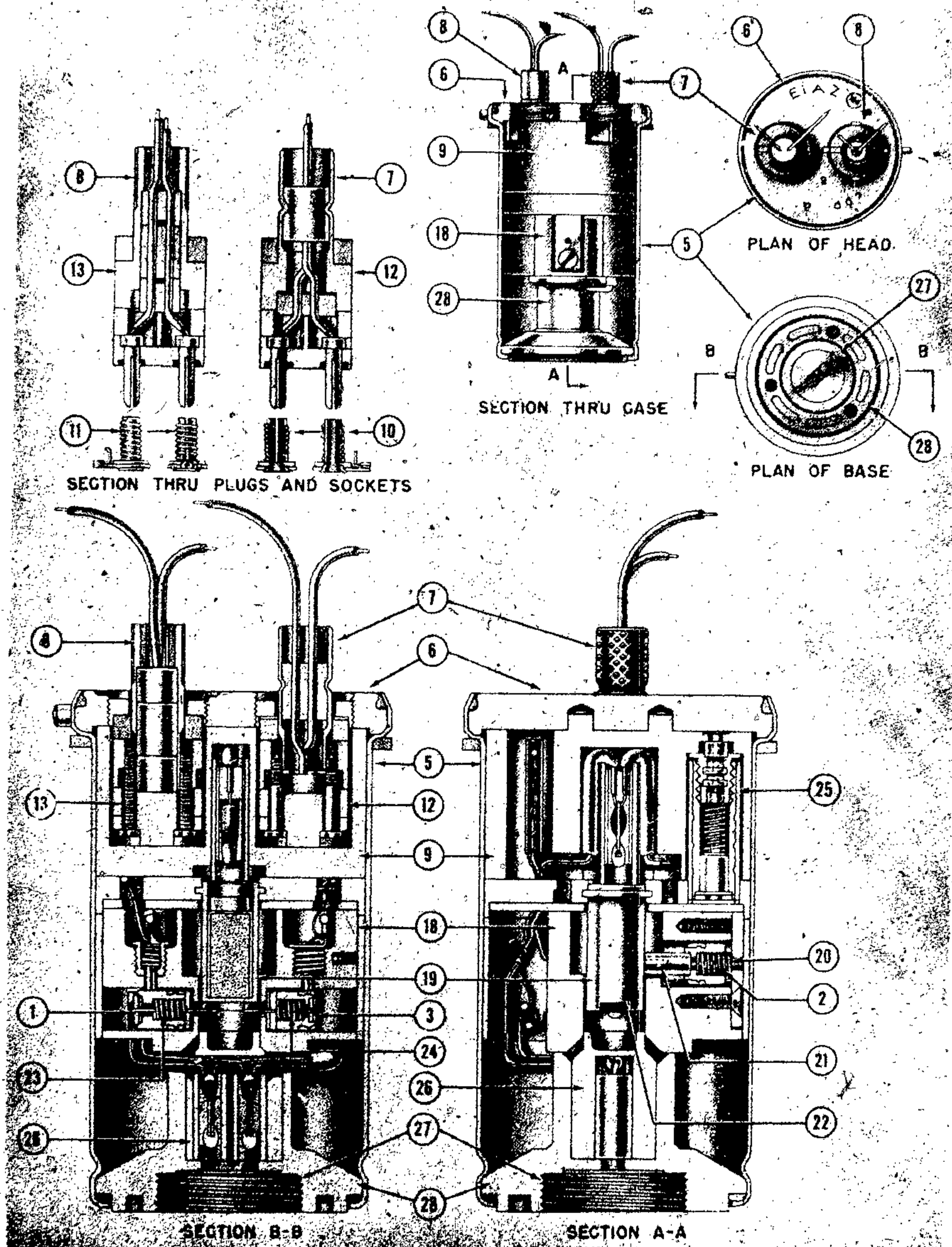

Figure 151A—(106)* Electrical Impact Fuze

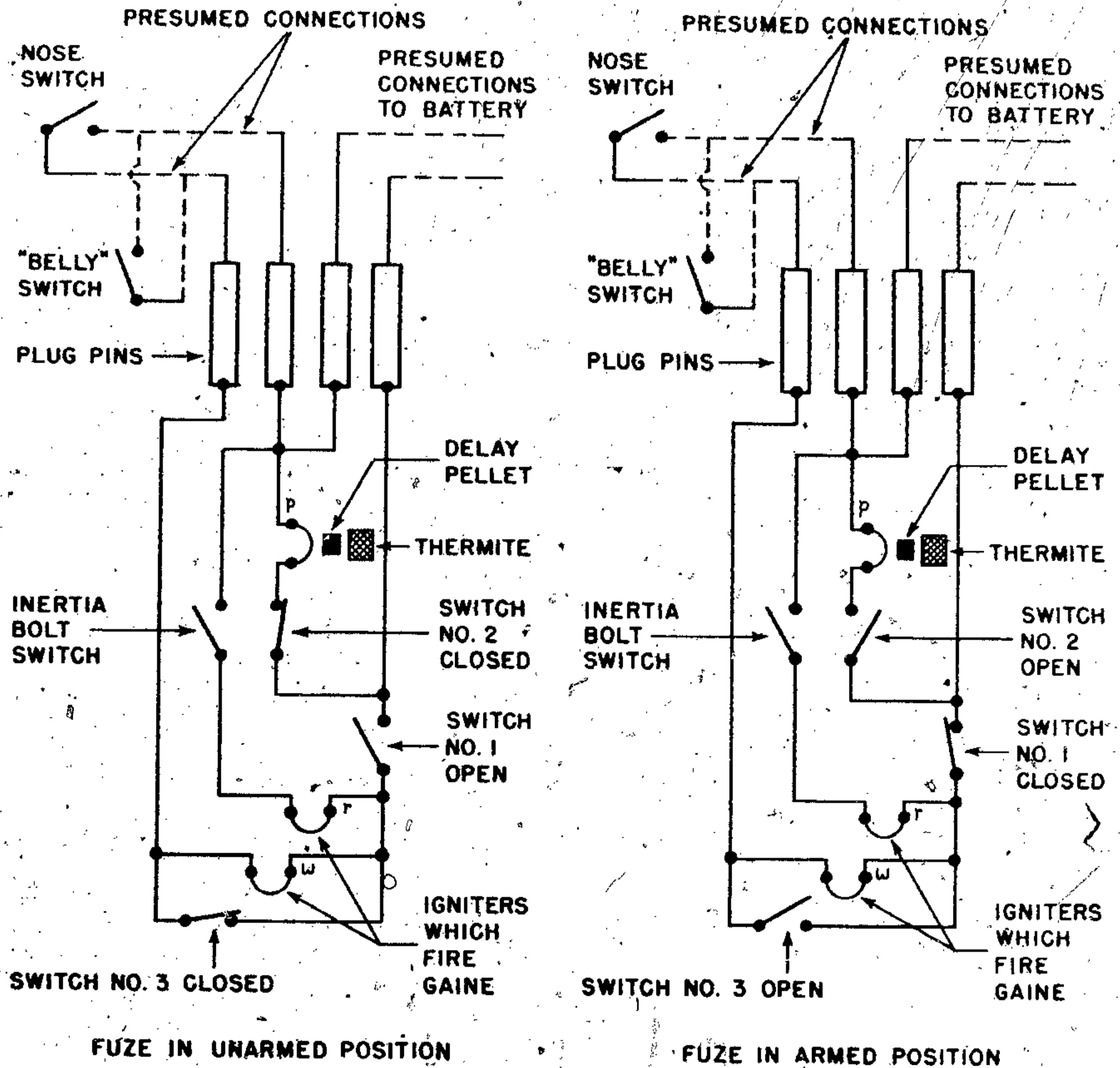

Figure 151B—(106)* Electrical Impact Fuze Wiring Diagram

switch No. 2, but in the unarmed fuze it is prevented from doing so by the presence of a small polystyrene pellet (21) (tubular for about half its length). Switch No. 1 is held open and switch No. 3 is held closed by the restraining pull of short wires attached to the thermite pot (19) by blobs of fusible Woods metal in the groove (22) against the springs (23) and (24) which tend to open and close them respectively. The three switches operate by the substitution, against a spring contact, of a metal segment for an insulating one, or vice versa; in the same way as the charging plungers of an ordinary electric impact fuze.

Above the top of the molding (18) and in a recess in the molding (9) is an inertia bolt switch (25) marked "150 g ± 10%", so oriented that it closes the circuit when the flying bomb falls on its nose. At the bottom of the molding (18) and towards the base of the fuze is a molded plastic fitting (26) in which there are two igniters (r) and (w) of the green tipped and hence, presumably, of the "sensitive" type. These igniters are in such a position that the flash from them can pass directly to a normal German gaine which screws into the threaded hole (27) in the plastic molding (28) which forms the bottom of the fuze.

GERMAN EXPLOSIVE ORDNANCE

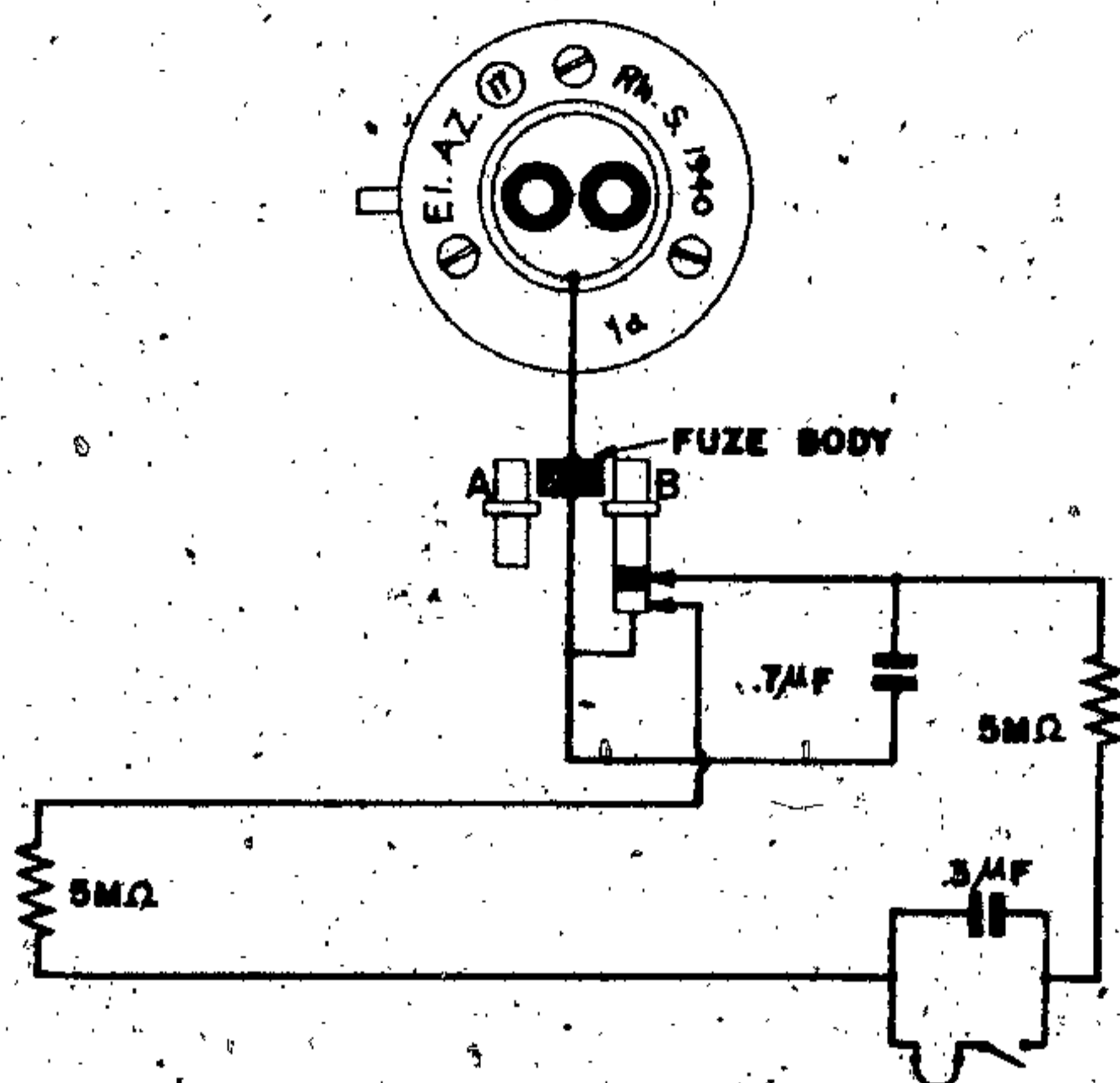

Figure 152—(17) Electrical Clockwork Time Fuze

The flying bomb is fitted with two firing switches external to the fuze; a nose switch and a belly switch. The first is of the diaphragm type as used with fuze (55)A. It closes the circuit when the nose of the bomb hits a target, the movable diaphragm of the switch being forced into contact with the fixed plate by the spindle of the air-log. The second is a simple push button switch covered by a streamlined plastic molding; the push button being depressed by the molding when the flying bomb "pancakes." These two switches are electrically in parallel and closing of either of them fires the igniter (w) (see circuit-diagram). A 30-volt dry battery in the aircraft supplies the energy for firing the igniters in the fuze (106)*, connections being made via the unit (106) and a contact in the Veeder counter of the flying bomb.

Before and for a few minutes after the flying bomb has been launched the fuze is unarmed. Switch 1 is open and hence accidental closing of the inertia-bolt switch cannot fire the igniter (r). Switch 3 is closed and thus short-circuits the igniter (w) and prevents it from being fired by accidental closing of the nose or belly switches. Switch 2 is closed. Several minutes after the bomb has been launched a contact in the Veeder counter is closed and applies the battery to the fuze (106)* via the unit (106) thus firing the igniter (p). The latter ignites the thermite, the

heat from which softens the pellet (21) allowing switch 2 to open and throw the igniter out of circuit. (The object of this appears to be to prevent a drain on the battery due to any residual conductivity in the igniter.) The heat from the thermite also melts the blobs of fusible Woods metal in the groove (22). This allows switch 1 to close and switch 3 to open, arming the fuze. When the fuze is armed, closing of the inertia bolt switch or the nose or belly switches allows current from the battery to fire either of the igniters, thus detonating the bomb. (For wiring diagram of this fuze see fig. 151B.)

(17) ELECTRICAL CLOCKWORK TIME FUZE

DATA:

Bombs Used in: SC 250 and SC 500 has been found in other bombs.

Color: Aluminum or dark grey.

Material: Aluminum.

Possible Actions: Long delay time—1½ to 80 hours delay after impact. Set to operate 2 to 72 hours after impact with ±10% accuracy.

Principal Markings: El. A. Z. (17).

Secondary Markings: Rh. S. 1940.

DESCRIPTION. The fuze is of type 3 construction and has a single electric firing circuit under plunger B. Depression of plunger B switches off the arming circuit. (See fig. 152.)

The clockwork time mechanism is contained in an aluminum case which threads into the bottom of the electric fuze. A spring loaded plunger projects into the balance wheel and prevents the clock from starting. The striker is held by a pawl, which is retained by the cam surface of the panel release arm. Rotation of this arm is prevented by an elbow piece which rests against the timing disc. The timing disc is rotated by the clockwork; one revolution equalling 72 hours. A tripping slot in the timing disc receives the elbow piece and allows rotation of the pawl release arm at the proper time.

The clock is set by turning the timing disc in a counterclockwise direction. To prevent firing during setting, a projection called the "safety sector" is located under the timing disc. This safety sector bears against the elbow piece until the clock starts to operate.

On impact the electric fuze operates and fires a pyrotechnic pellet. This pellet burns out and frees the spring loaded clock release plunger from the balance wheel of the clock allowing the clock to start. The clock turns the timing disc in a counterclockwise direction by means of a reduction gear system. When the tripping slot comes oppo-

site the elbow piece, the spring loaded elbow piece drops into it. This causes the pawl release arm to rotate and free the tripping pawl from its cam. The pawl is forced aside by the spring loaded striker which strikes the detonator. The flash from the detonator travels through a channel and fires the mine.

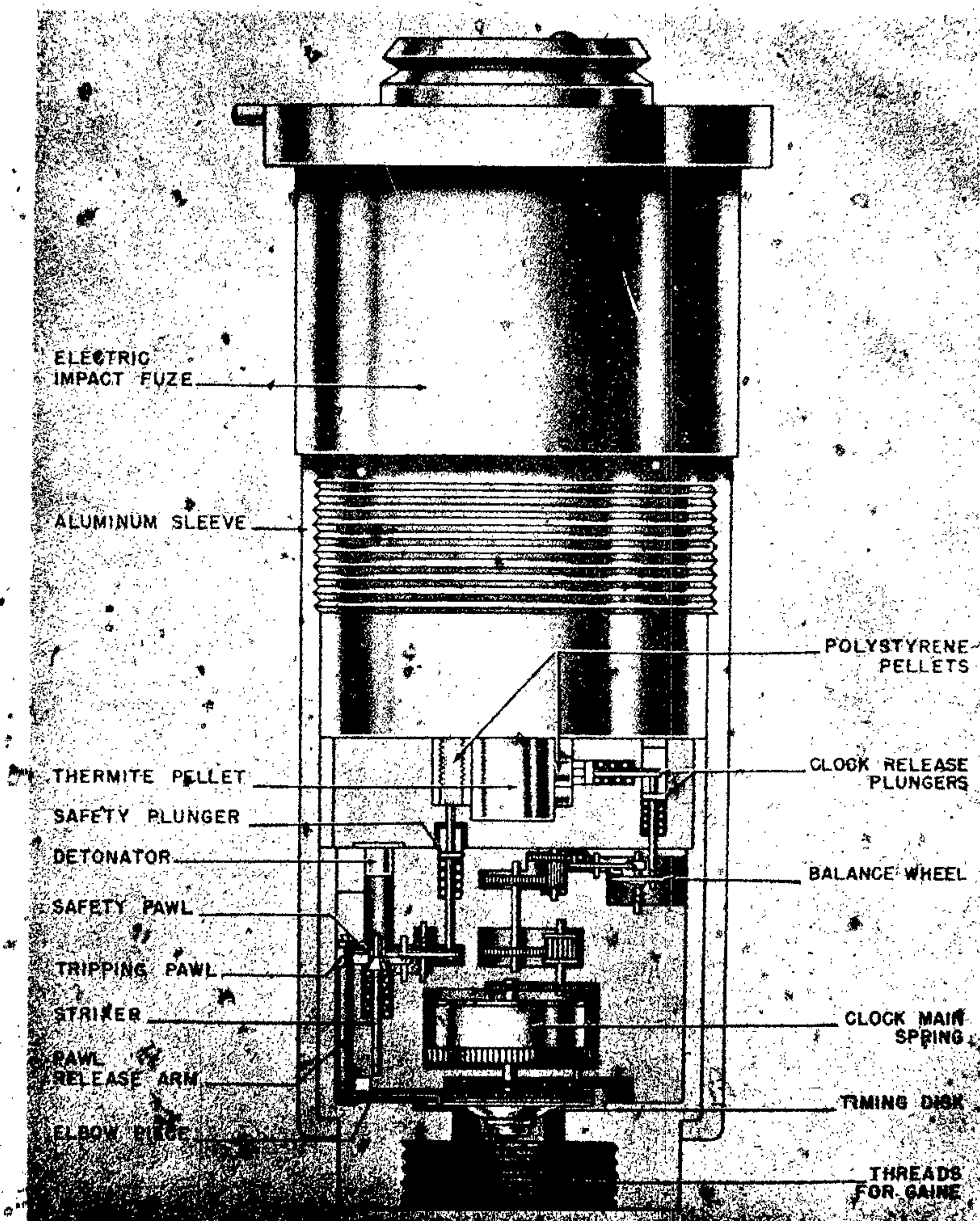

Figure 153A—(17)A Electrical Clockwork Time Fuze

GERMAN EXPLOSIVE ORDNANCE

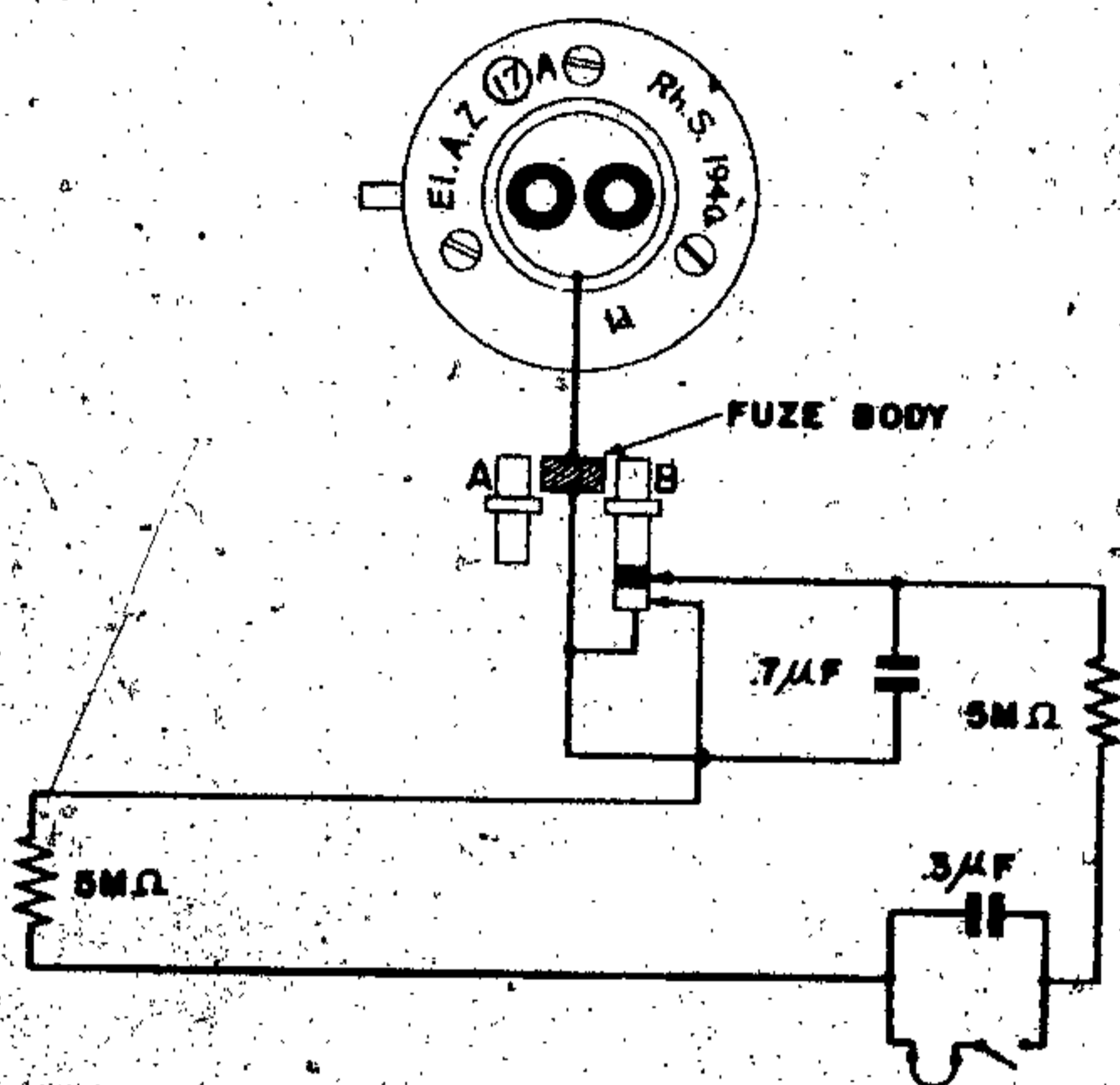

Figure 153B—(17)A Electrical Clockwork Time Fuze Wiring Diagram

REMARKS. This fuze may be used for demolition by charging the fuze from a battery. The storage cap may be replaced after the fuze is armed.

(17)A, (17)A*, ELECTRICAL-CLOCKWORK TIME FUZE

DATA:

Bombs Used In: SC 250 and SC 500; has been found in other bombs.

Color: Aluminum or dark grey.

Material: Aluminum.

Possible Actions: Long delay, time—1½ to 80 hours' delay after impact. Set to operate 2 to 72 hours after impact with ± 10% accuracy.

Principal Markings: El. A. Z. (17)A; may be unmarked; L. Zt. Z. (17)A*.

Secondary Markings: Rh. S 1940; may have none; bmv 1941; bmv 1942; bp 1941.

DESCRIPTION. The fuze is of type 4 construction and has a single electric firing circuit under plunger B. Depression of plunger B switches off the arming circuit. The A plunger is usually missing in this fuze. The wiring diagram for the (17) fuze also applies to the (17)A.

The clock mechanism and its case are held in position under the electric fuze by an aluminum or a mild steel sleeve which threads onto the electric fuze. (See fig. 153A.) The steel sleeve has

a rubber sleeve around its lower section. The clock case may be made of aluminum or plastic.

The clockwork is similar to that in the (17) with the addition of a safety pawl which withholds the striker from the detonator. This is a spring loaded sliding pawl, and not a pivot. The pawl is held by the safety plunger, which rests against a polystyrene pellet held in an aluminum collar. The collar is set into a plastic moulding in the top of the clock case (fig. 153A) and fits around the aluminum projection on the bottom of the electric fuze. This projection contains a charge of thermitite. The clockwork is inverted to place the timing disc directly above the gain hole and so simplify winding and setting the clock. A flash channel, leading from the detonator to the gain, is cut in the side of the clock case (fig. 153A).

OPERATION. On impact the electrical fuze operates and fires the thermitite charge which melts the two polystyrene pellets (m. p. = 90° C.). The pellet on the left (fig. 153A) allows the safety plunger to move up and release the safety pawl, which slides away from the striker shoulder. The pellet on the right allows the clock release plunger to operate freeing the balance wheel. The clock starts and rotates the timing disc in a counter-clockwise direction through a system of reduction gears. When the tripping slot comes to the elbow piece, the spring-loaded elbow piece falls into it allowing the pawl release arm to rotate and free its cam from the tripping pawl. This pawl is forced aside by the spring loaded striker. The striker hits the detonator which flashes through the channel and fires the gaine.

REMARKS. L. Zt. Z. (17) A* is similar to the (17) A but has a longer delay between the time the impact switch functions and the starting of the clock. The circuit is similar to the (17) (fig. 153B).

(17) B, (17) B*, (17) b*, ELECTRICAL CLOCKWORK TIME FUZE

DATA:

Bombs Used in: SC 250 and SC 500; may be found in other bombs.

Color: Dark grey; markings in white paint on (*) models.

Material: Aluminum.

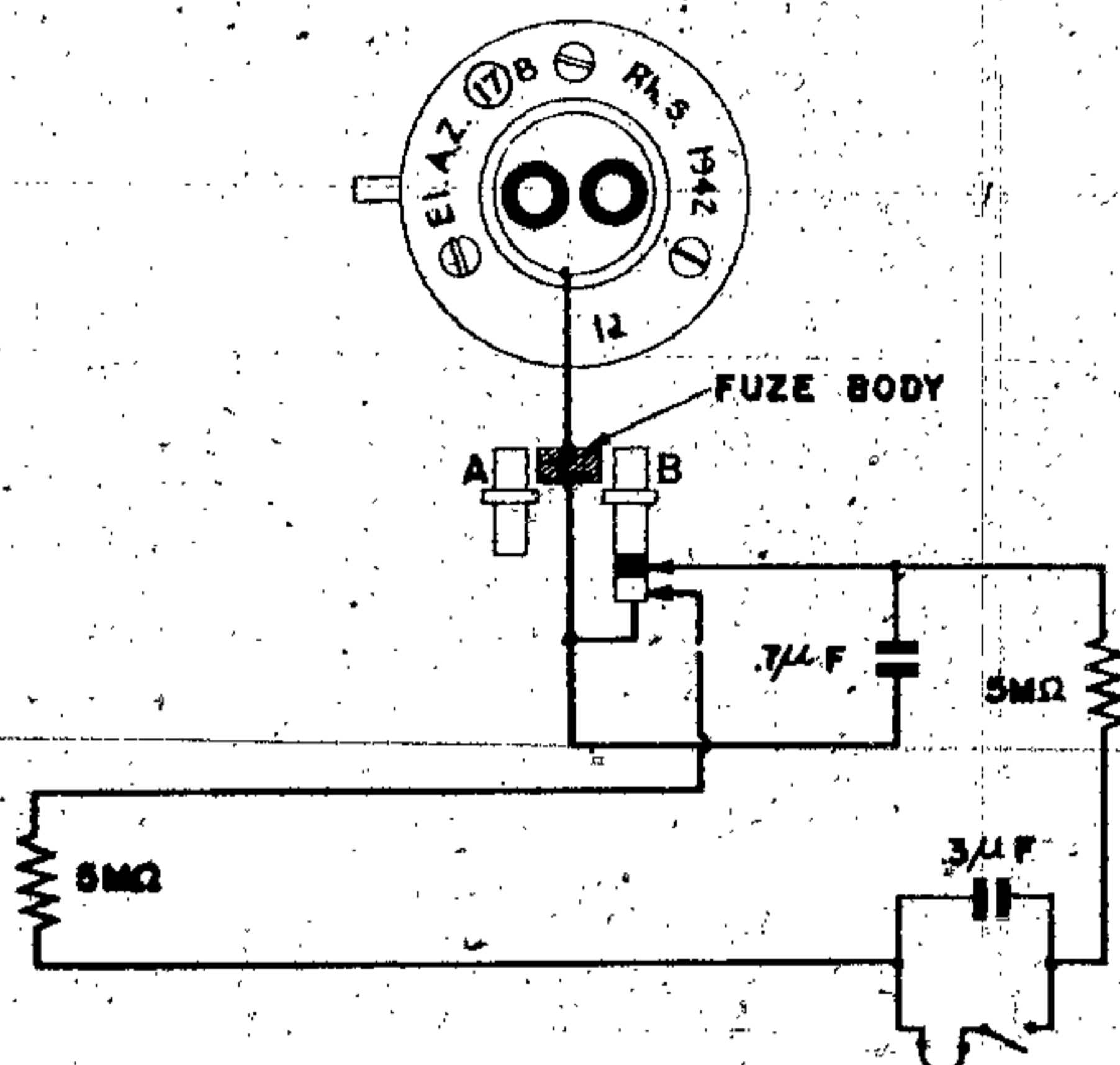

Figure 154—(17)B Electrical Clockwork Time Fuze

Possible Actions: Long delay time—3 to 135 minutes delay after impact. Set to operate 5 to 120 minutes after impact with $\pm 10\%$ accuracy.

Principal Markings: El. A.Z. (17) B, stamped; L. Zt. Z. (17) B*, painted; L. Zt. Z. (17) b*, painted.

DESCRIPTION. The (17) B series fuzes are the same as the (17) A in operation and construction except for a change in the number of gears and gear ratios in the clock of the (17) B which shortens the possible time settings. (See fig. 154.)

Z.17 Bm. MECHANICAL CLOCKWORK TIME FUZE

DATA:

Bombs Used in: Hs 293 flying bomb, SC 1000, PC 1000, SC 500, BSB 1000, etc.

Color: Top, aluminum; body, red.

Material: Aluminum, brass and steel.

Possible Actions: Long delay time—3 to 135 minutes delay after impact. Set for 5 to 120 minutes delay with $\pm 10\%$ accuracy.

Arming Times: Arms when arming pin is pulled.

Principal Markings: Z 17 Bm stenciled on fuze head.

Secondary Markings: cpp 6a.

DESCRIPTION. The Z 17 Bm fuze has a cylindrical body with an inner flange at the lower end to serve as a seat for the aluminum sleeve containing the normal (17) B type inverted clockwork, and internally threaded at its base to receive the gaine. The clockwork release mechanism, which takes the place of the electric section of the (17) B, is located just above the clockwork. This mechanism contains a Y-shaped release plate with the release plate spring between the arms of the Y. One of the arms of the Y retains the spring loaded balance wheel stop plunger. The other arm retains the spring loaded safety plunger, which holds the safety pawl under the firing pin shoulder. The release plate is centrally pierced to accept the end of the safety pin. The base of the Y rides in a guide slot and limits the lateral motion of the release plate. The compressed release plate spring tends to force the release plate away from the tops of the plungers which bear against the arms of the Y. This action is prevented as long as the safety pin is in place.

Closing piece, centrally pierced to take the safety pin, closes the top of the fuze body. The safety pin is held in place in the fuze by an aluminum plate, which is attached to the safety pin and locked to the closing piece by a retaining washer. A pull-ring is attached to the top portion of the safety pin.

GERMAN EXPLOSIVE ORDNANCE

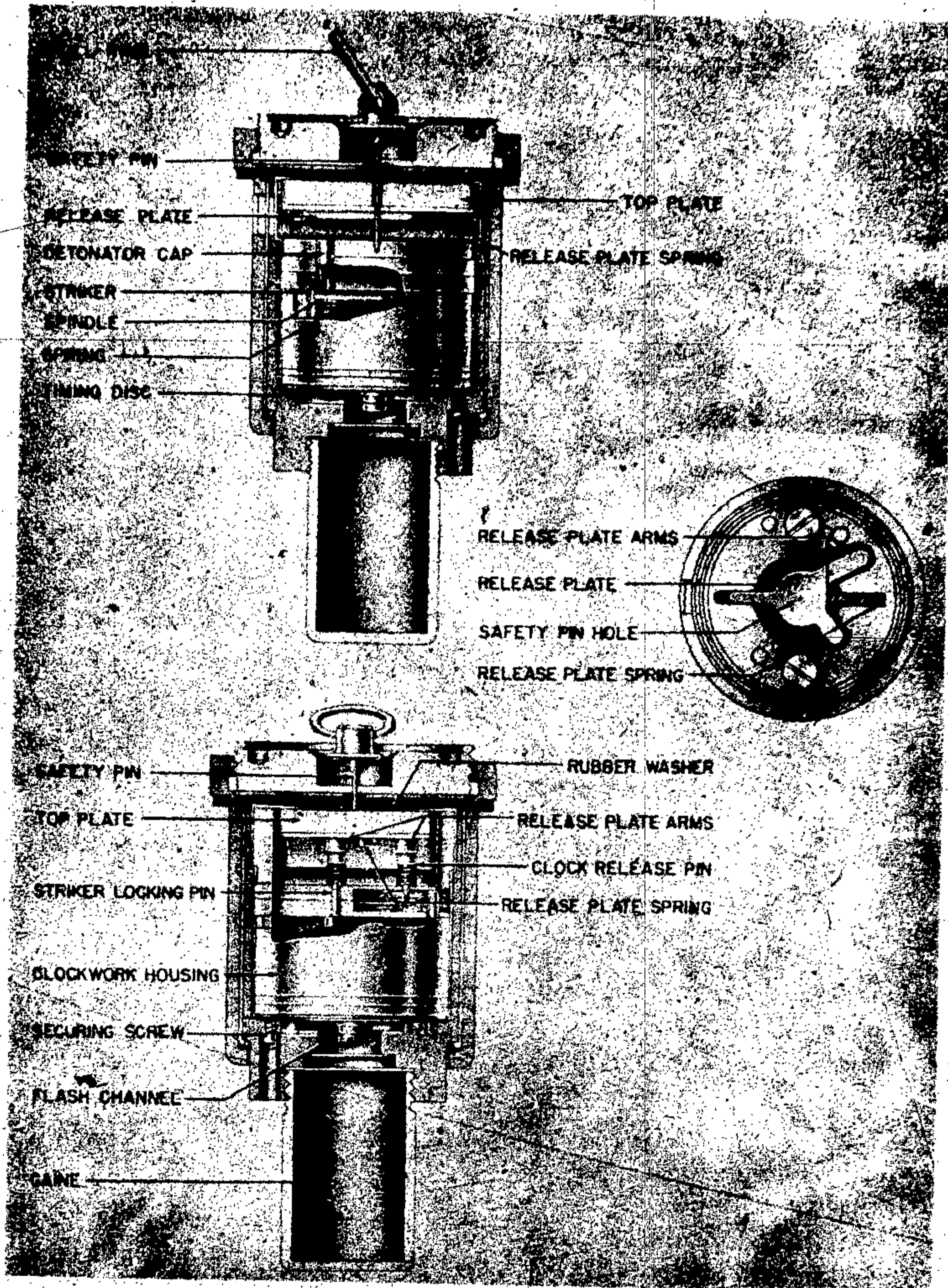

Figure 155—Z 17 Bm. Mechanical Clockwork Fuze

OPERATION: On withdrawal of the safety pin, the release plate spring forces the freed release plate arms clear of the balance wheel plunger and the safety plunger. Both plungers, under the influence of their respective springs, are forced

upward allowing the clock to start and at the same time allowing the safety pawl to move from under the striker shoulder. The remainder of the fuze operation is the same as in the (17) A. (See fig. 155.)

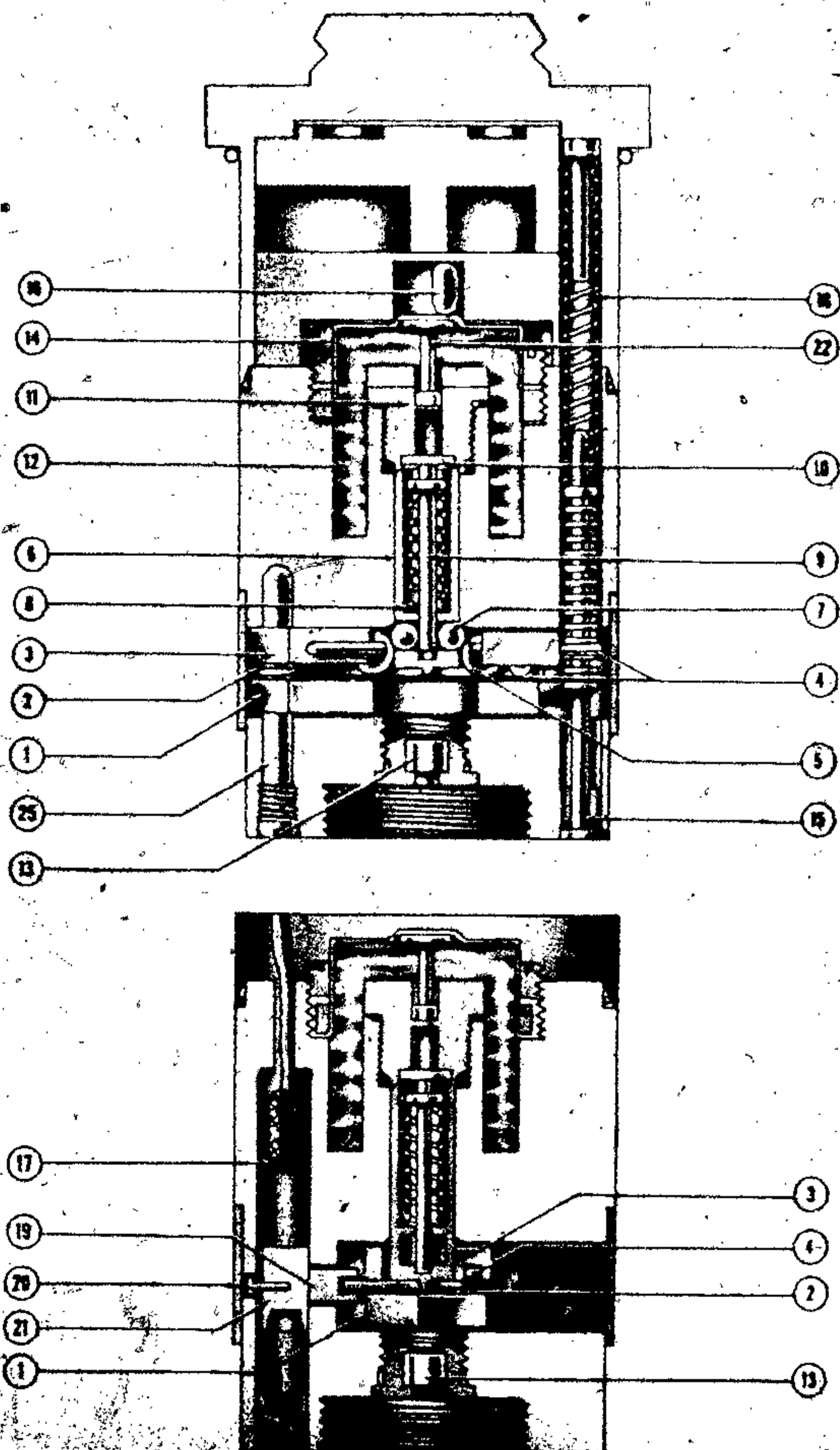

Figure 156A—(57) Electrical Chemical Time Fuze

(57) ELECTRICAL CHEMICAL TIME FUZE

DATA:

Bombs Used in: Not found in bombs. Enemy documents state "for use in H. E. bombs (Stabo type)." Could be used in any H. E. bomb with an antidisturbance fuze.
 Color: Dark grey; yellow paint around head.

Material: Aluminum.
 Possible Actions: Long delay time, antiwithdrawal, and antirupture.
 Principal Markings: El. A. Z. (57).

DESCRIPTION. The fuze is of type 2 construction and is fitted only with the B plunger. The B plunger is connected directly through a

OPERATION. Upon release from the plane, a charge passes through a small resistance and fires the two igniters (16) and (17) immediately.

1. MECHANICAL ARMING ACTION. The explosion of the vertical igniter (17) drives the piston (21) downward shearing the shear pin (20). The detent (19) is now free to move into the space formerly occupied by the piston, releasing pressure on the knife edge (2) which allows the anti-withdrawal plunger (15) to move downward against the picric ring pellet. The wire (4) is held up in position by the safety block (1). On impact, the safety block (1) pivots toward the nose of the bomb from beneath the striker, and is locked in position by a spring-loaded detent. The fuze is now fully armed. Note, that before this time the chemical delay feature could not operate the detonator because of the presence of the safety block; i. e., impact is necessary before the fuze can fire.

2. CHEMICAL TIME ACTION. The force of the explosion of the horizontal igniter (16) impinging on the solvent chamber cover (14) drives the perforator (22) down through the aluminum disk in (11). This permits the solvent to attack the plastic plug (10). After the required delay, the plastic plug is soft enough to permit the plunger (9), impelled by the striker spring (8), to rise and free the striker balls (7), which move inward. The striker, which had been held in position only by the pressure of the striker balls (7) on the retaining balls (5), is freed by the inward movement of the striker balls, and is driven home by the striker spring (8) against the "26" cap (13) to initiate the explosion train.

3. MECHANICAL ANTIWITHDRAWAL ACTION. If any attempt is made to withdraw the fuze after impact, the anti-withdrawal plunger (15) will move downward impelled by the spring (18). As the antiwithdrawal plunger (15) moves downward it carries with it the wire (4) until the wire is pulled from the retainer block (3).

The retainer block (3) (containing the retainer balls) is now free to pivot out from under the striker, impelled by a small spring and the striker. The striker continues downward, firing the cap (13). Tests indicate that a withdrawal of only $\frac{1}{16}$ inch or one turn of the locking ring is necessary to permit the antiwithdrawal device to work. No attempt should ever be made to withdraw this fuze.

4. ANTI-RUPTURE DEVICE. The anti-rupture device incorporated in the fuze depends on the weakening of the wire (4), which prevents the retainer block (3) from pivoting out from beneath the striker. If the bomb should strike a hard target, resulting in excessive deceleration, the retaining block (3) will set forward, due to inertia, bending or shearing the wire (4). The movement thus allowed to the retainer block (3) displaces the retaining balls (5) relative to the striker balls (7) sufficiently to permit the striker (6) to move downward and fire the detonator (13). Also, any excessive distortion of the fuze in the bomb will operate the antiwithdrawal device.

(67) MECHANICAL TIME FUZE

DATA:

Bombs Used in: SD 2B "Butterfly" bomb.

Color: Grey.

Material: Zinc alloy casing. Brass and steel mechanism.

Possible Actions: Long delay time. Set for delay firing from 0 to 30 minutes after impact.

Principal markings: (67).

Secondary Markings: eov 3/42; AZ Zeit.

DESCRIPTION. Fuze is located centrally in upper longitudinal surface of bomb and is secured in bomb by two projections which are held in the grooves in bomb body. Fuze is locked in position by two securing strips which fit into the grooves and into the undercut on the two lugs. The tabs seated in the slots, prevent rotational movement of the fuze when in position.

Over-all dimensions are the same as (41). The fuze consists of three castings, the clockwork mechanism, and the arming rod. The arming rod is similar in all respects to that of the (41) and is operated in exactly the same manner.

Figure 157 is diagrammatic and represents the relative positions of the moving parts of the fuze in the unarmed and fired positions. In the unarmed position the spring loaded striker is held cocked by a projection on the striker cam engaging in a slot in the striker arm. Keyed to this spindle is the striker arm, the other end of which abuts the setting plate cam and thus prevents rotation of the striker cam and release of the striker. Attached to a collar which can rotate independently about the striker cam is a spring loaded lever arm fitted with

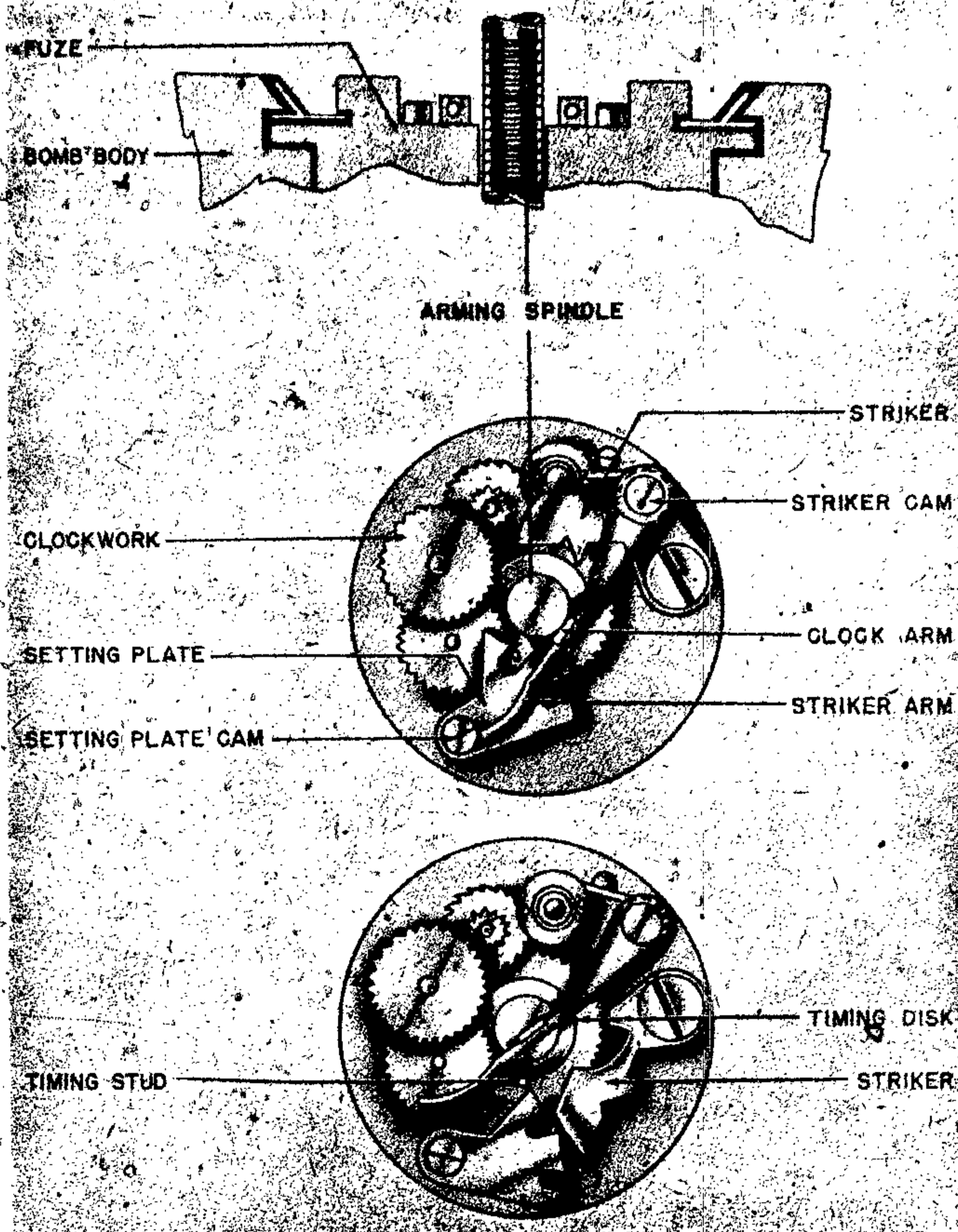

Figure 157—(67) Mechanical Clockwork Time Fuze

an upstand and a clock pin. When the arming spindle is screwed fully home, the clock pin engages with a balance wheel and thus locks the escapement of the clockwork mechanism.

The fuze is armed when the arming rod has been withdrawn $\frac{1}{4}$ inch. The lever arm is then free to move, and the clock pin releases the escapement of the clockwork mechanism. The movement of the lever arm is limited by means of a stop which also prevents reinsertion of the arming rod.

The main spring of the clockwork mechanism is

housed in a casing secured to the reverse side of the plate. One end of the main spring is attached to the casing, and the other to the boss of the timing disk. Rotation of the timing disk causes a timing stud protruding from it to engage in the slots of the setting plate and rotate the setting plate cam. When this setting plate moves clear of the timing stud as shown in figure 157, a slot in the setting plate cam permits the striker arm to move across thus releasing the striker, which fires a cap and initiates the bomb.

Three rotations of the driving pinion are required to move the setting plate through the full limit of its traverse. Each rotation of the pinion takes approximately 10 minutes, according to the state of tension of the main spring, thus maximum time delay possible is 30 minutes. If the setting plate is disengaged before fuze is armed the fuze will function as soon as the arming rod is withdrawn. By varying the initial positions of the timing stud and setting plate, the fuze can be set to function at any desired time delay from zero to 30 minutes after arming rod is withdrawn.

67/V MECHANICAL CLOCKWORK TIME FUZE

DATA:

Bombs Used in: Mk A. B. 70 container to ignite 2 of the 3 candle units housed in the container.

Can be used in any H. E. bomb with standard fuze pocket or the flying bomb as a delay fuze in normal operation, or for delayed demolition.

Color: Bronzed grey.

Material: Mazak, brass and steel.

Possible Actions: Time delay—0 to 3 minutes setting with $\pm 10\%$ accuracy. Recovered with 10- and 20-minute settings.

Arming Times: Immediately on withdrawal of safety pin.

Principal Markings: 67/V.

Secondary Markings: eov; 20 (delay setting in minutes).

DESCRIPTION. The 67/V is a 67 fuze which has been modified and encased in a fuze body that fits the standard German fuze pocket. The two main parts of the 67/V fuze are the modified 67 fuze and the external fuze body. The 67 fuze has

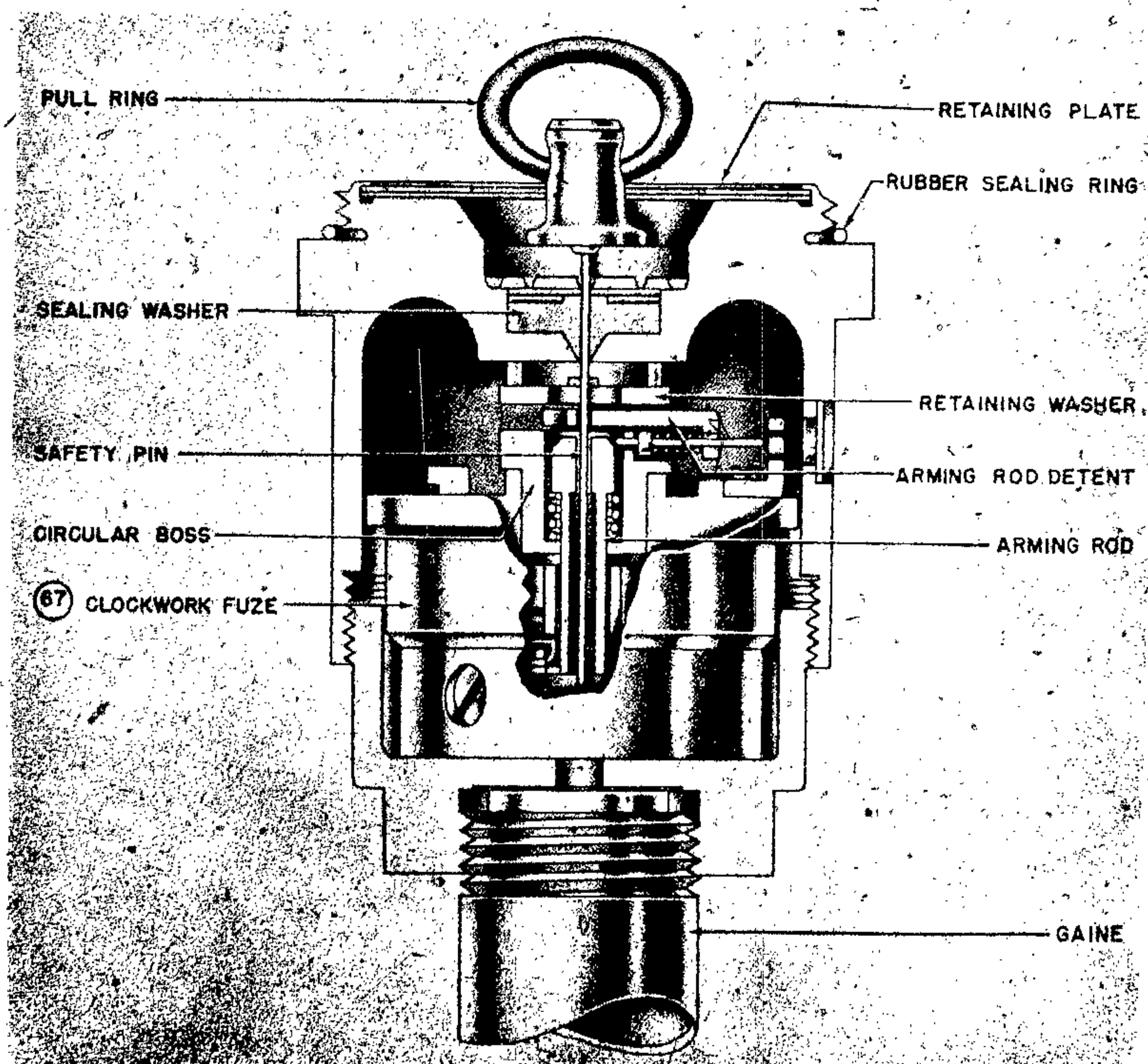

Figure 158—67/V Mechanical Clockwork Time Fuze

GERMAN EXPLOSIVE ORDNANCE

been modified externally so that it will fit into the upper part of the fuze body. A circular boss, which has been machined centrally to accommodate the hollow arming rod and its spring, is sweated to the square boss on the upper surface of the fuze head. The arming rod is interposed in the path of the balance wheel stop lever, thereby preventing the clockwork from functioning. The arming rod, which is spring loaded upward, is held in the down position (safe) by the longer arm of the L-shaped arming rod detent. This detent is in turn under pressure of a spring which tends to force it toward the outside of the fuze body. The arming rod detent is prevented from moving outward and releasing the arming rod by the safety pin, which passes through a hole in its longer arm and extends down through the hollow arming rod. (See fig. 158.)

The external fuze body is comprised of an upper and a lower section. The upper body is formed with the normal flange and locating pin. An externally threaded boss is positioned above the flange. The boss accepts the transit cap. The head of the body has been undercut to accommodate the safety pin plate while the upstand is spun over to secure the retaining plate in position. Four reinforcing buttresses are equally spaced around the internal wall of the body and form a seating for the head of the 67 fuze.

OPERATION. On withdrawal of the safety pin, the arming rod detent spring forces the detent out-

ward in its slot freeing the arming rod. The arming rod spring then forces the arming rod upward, disengaging it from the balance wheel stop lever. The stop lever is forced to rotate clear of the balance wheel. The remainder of the fuze operation is the same as that of the 67 fuze.

REMARKS. Eight indentations on the upper surface of the inner housing provide a positive means of identifying this fuze when the safety pin has been withdrawn, and distinguishes it from the VZ (80), (80) A, and Z 17 Bm, which are similar to it in shape.

The delay time in minutes for each fuze is stamped in the outer wall of the fuze body beneath the locating pin and is repeated on the body of the 67 fuze and the mainspring casing.

28(*) ELECTRIC IMPACT FUZE

DATA:

Bombs Used in: H. E. bombs.

Color: Dark grey.

Material: Aluminum or brass.

Possible Actions: (a) Instantaneous. (b) 0.15 sec. delay.

Principal Markings: El. A. Z. C 50 28 (*).

Secondary Markings:

Rh. S. G. (brass case).

Rh. S. 1936.

Rh. S. 195-36.

DESCRIPTION. This fuze, similar to the El. A. Z. C 50 (5), has two firing circuits, one charge from each plunger. Early models of the fuze were constructed of brass, but later ones are made of aluminum. The designation of the fuze is marked on the fuze boss.

Safety switching is accomplished by depressing the B plunger, which switches off both firing circuits. (See fig. 159.)

ARMING TIMES:

	LEVEL FLIGHT (150 v.)	DIVING FLIGHT (240 v.)
Instantaneous:	3.6-5.1 sec.	2.0-2.9 sec.
0.15-sec. delay:	1.5-3.3 sec.	0.9-1.6 sec.

REMARKS: 1. This fuze is obsolete. 2. Type 1 construction.

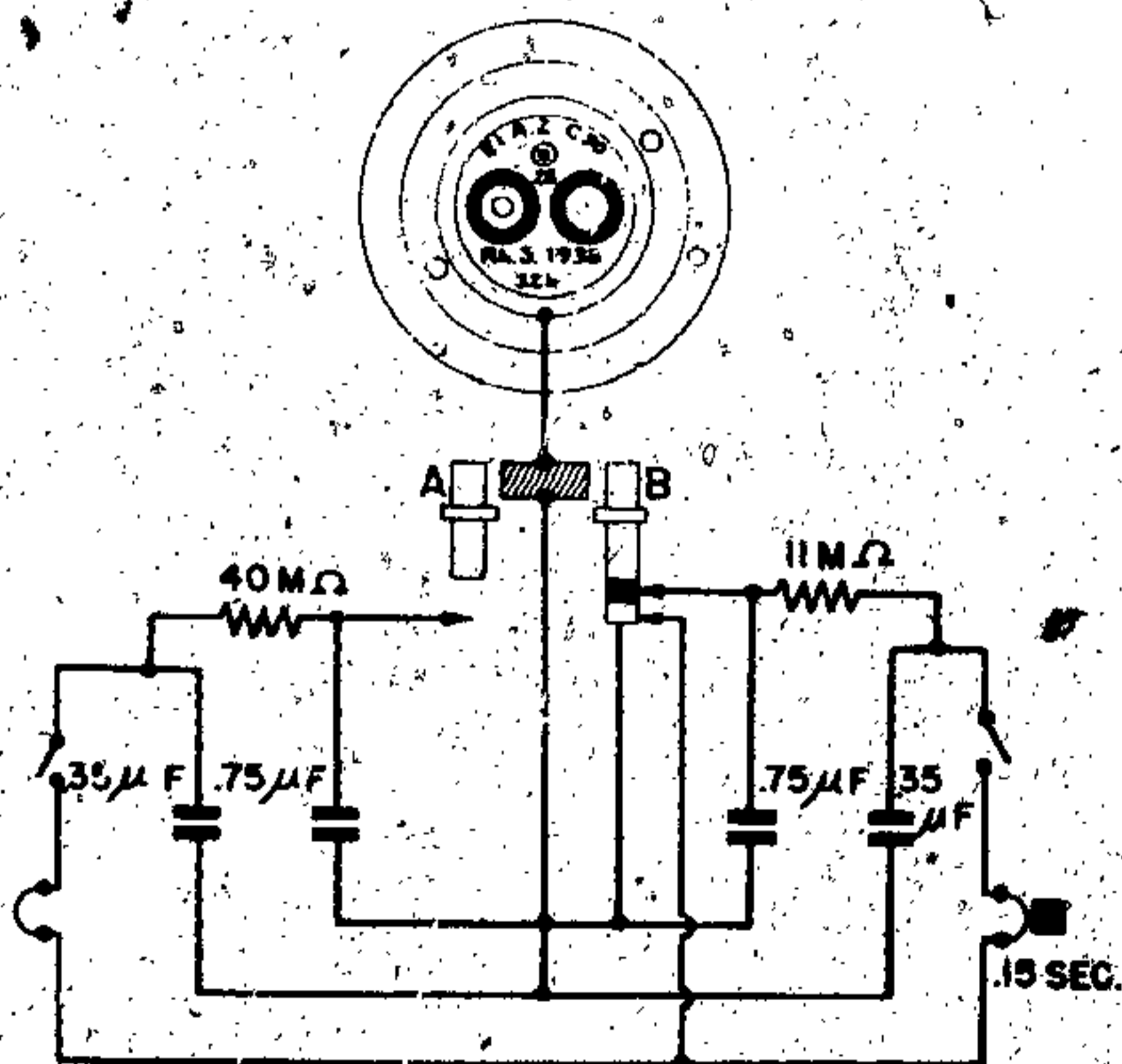

Figure 159—(28)* Electrical Impact Fuze

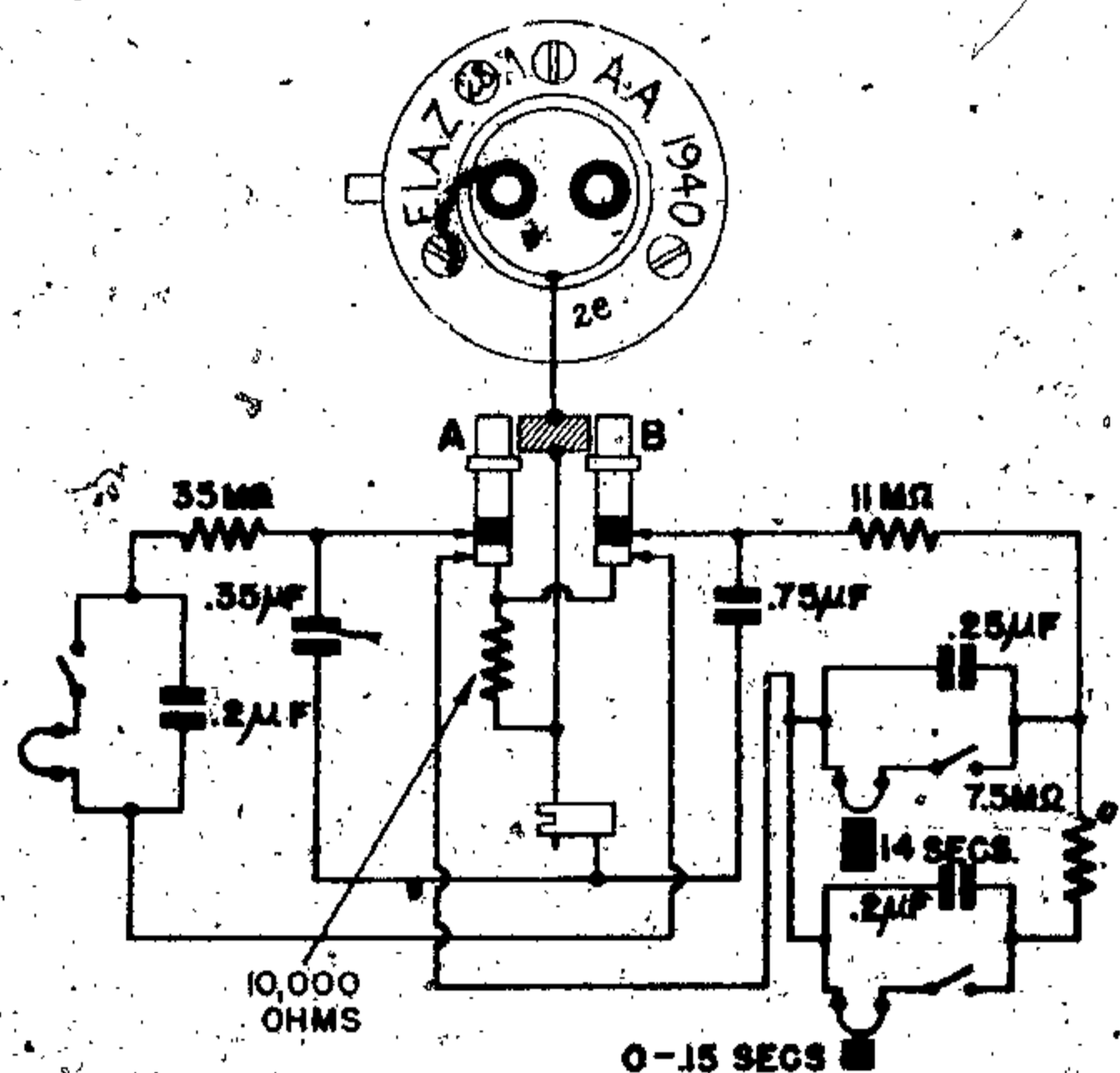

Figure 160—(28)A Electrical Impact Fuze

(28)A ELECTRIC IMPACT FUZE**DATA:**

Bombs Used in: H. E. bombs, as for (25) B.

Color: Dark grey; yellow paint on shoulder.

Material: Aluminum.

Possible Actions: (a) Instantaneous. (b) 0.15-sec. delay. (c) 14-sec. delay.

Principal Markings: El. A. Z. (28) A.

Secondary Markings:

AA 1940 cpp 1942.

AB 1940 Rh. S. 1939.

FC 1940.

cpp 1941 Rh. S. 1940.

DESCRIPTION: The circuit of this fuze is similar to that of the (38), although the values of the components differ. Three firing circuits are incorporated.

Safety switching is accomplished by depression of either plunger, which switches off the opposite arming circuits. (See fig. 160.)

ARMING TIMES:

LEVEL FLIGHT (150 v.)	DIVING FLIGHT (240 v.)
Instantaneous: 1.6-2.8 sec.	1.0-1.5 sec.
0.15-sec. delay: 2.1-3.3 sec.	1.4-2.2 sec.
15 sec. delay: 0.7-1.3 sec.	0.3-0.7 sec.

REMARKS: 1. Type 2 construction.

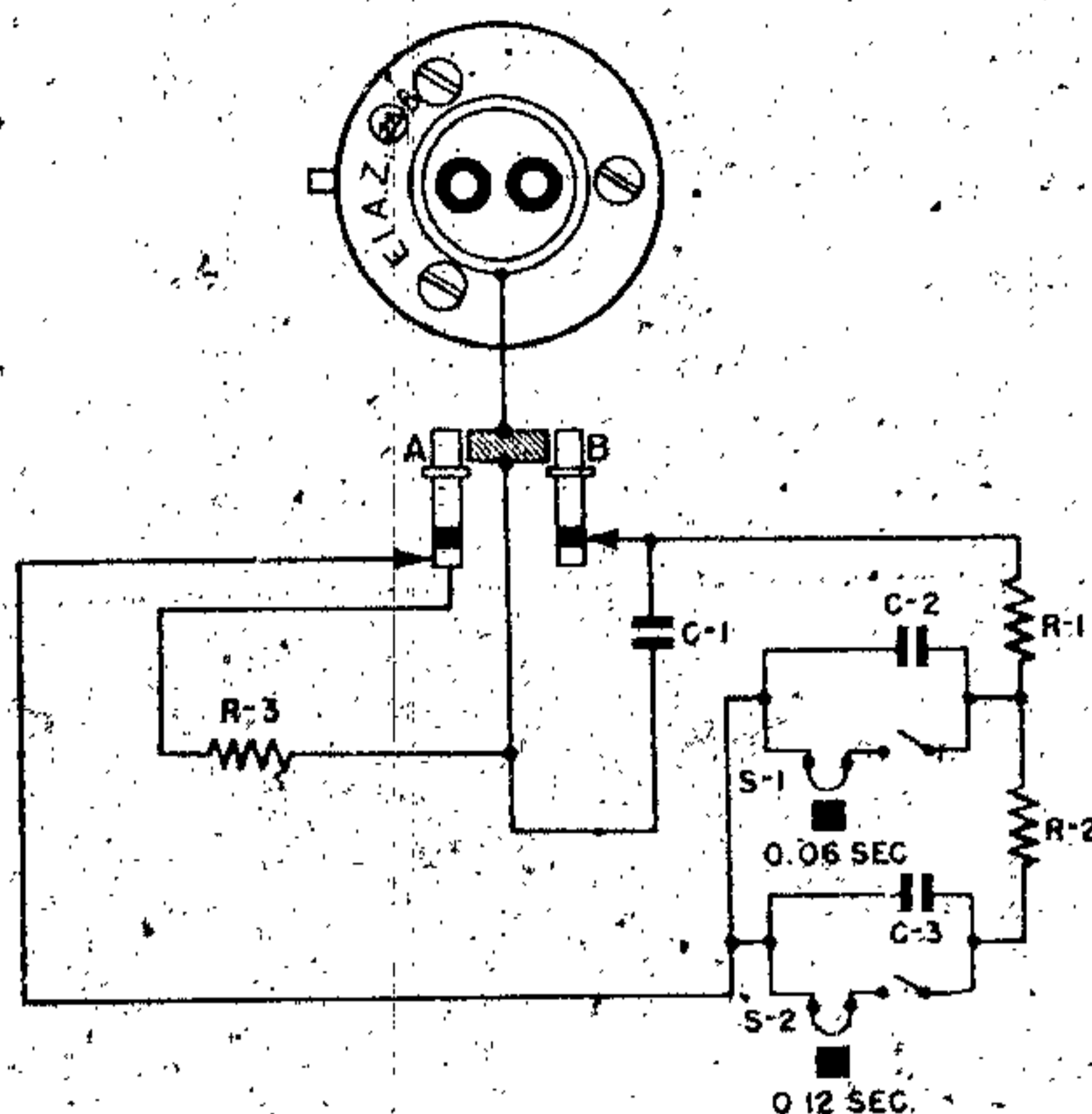

Figure 161—(28)B Electrical Impact Fuze

(28)B ELECTRIC IMPACT FUZE**DATA:**

Bombs Used in: SC bombs against sea targets.

Possible Actions: (a) 0.06-sec. delay. (b) 0.12-sec. delay.

Principal Markings: El. A. Z. (28) B.

Secondary Markings.

DESCRIPTION. The circuit of this fuze is similar to that of the (35) though the values of the components differ. Both firing condensers are charged from the same charging condenser, and the delays are both less than 1 second. The values of the delays are variously given in German documents, and range from 0.06 to 0.12 second.

This fuze is not commonly found, though it was designed to be employed in medium and heavy SC bombs against sea targets. In this employment, however, the fuze was replaced by the (28) B07, which in turn was replaced by the (25) B. (See fig. 161.)

(28)B² AND (28)B⁶ ELECTRIC IMPACT FUZE**DATA:**

Bombs Used in: H. E. bombs.

Color: Dark grey; yellow paint on shoulder.

Material: Aluminum.

Possible Actions: (a) Instantaneous. (b) 0.06-0.08 sec. delay.

(28)B⁰⁷ ELECTRIC IMPACT FUZE

DATA:

Bombs Used in: H. E. bombs.
 Color: Dark grey; yellow paint on shoulder.
 Material: Aluminum.
 Possible Actions: (a) Instantaneous. (b) Short delay. (c) Short delay.
 Principal Markings: El. A. Z. (28) B⁰⁷.
 Secondary Markings: bmv 1941. bmv 1942.

DESCRIPTION. This fuze differs from the other (28)B type fuzes in having three firing circuits, all charged from the same charging condenser. Instantaneous action and two short delays (each less than one second) may be obtained, but the instantaneous switch is of the inertia-bolt type and will operate only against highly resistant targets.

Safety switching is accomplished by depression of the A plunger, which switches off all arming circuits. (See fig. 163.)

REMARKS. 1. Construction type 2.
 2. This fuze is being replaced by the (25)B.

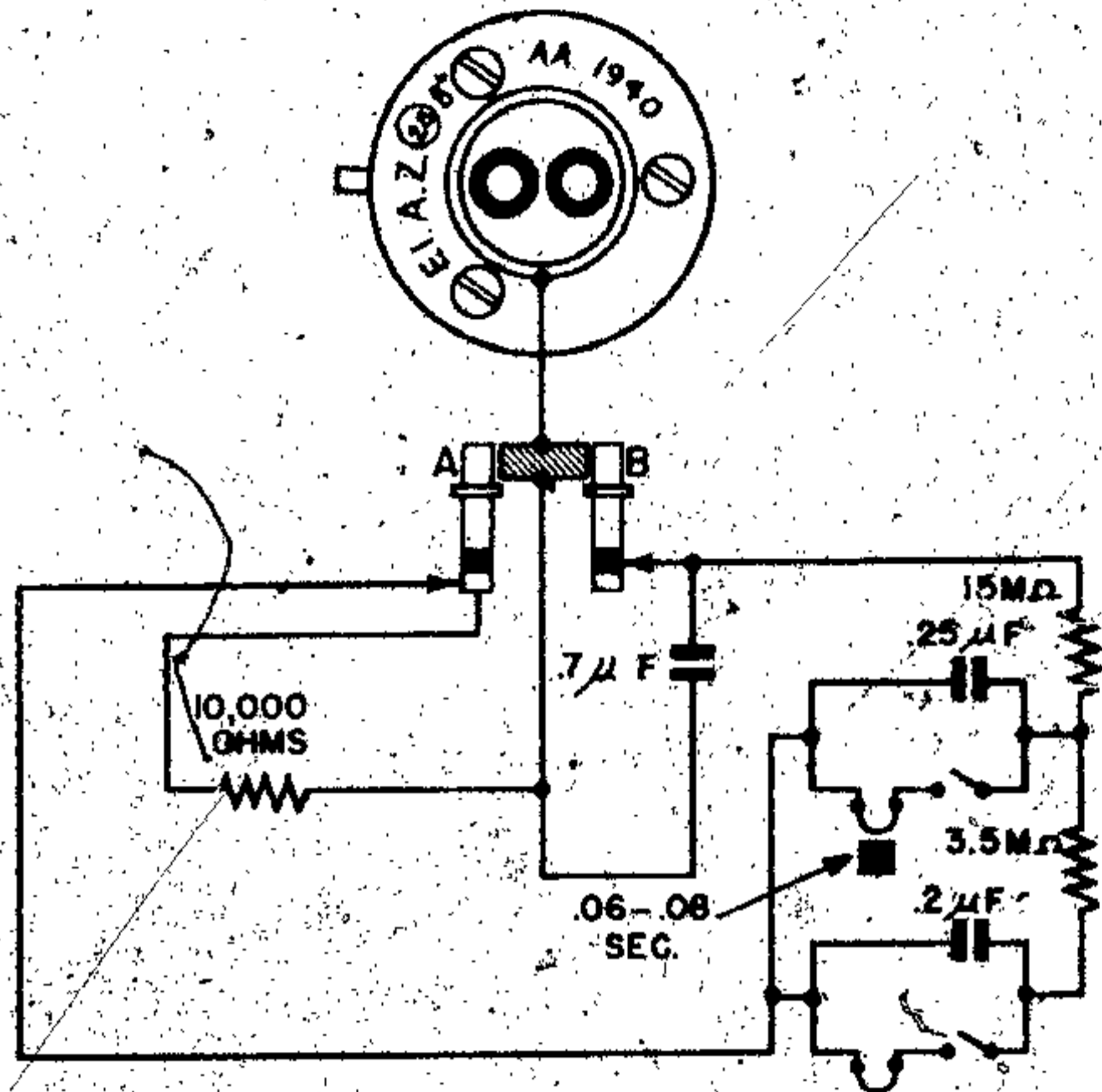

Figure 162—(28)B⁰⁷ Electrical Impact Fuze

Principal Markings:

- El. A. Z. (28) B².
- El. A. Z. (28) (B)².
- El. A. Z. (28) B³.

Secondary Markings:

- AA 1940 bmv 1940.
- AA 1941 bmv 1941.
- FC 1940 bmv 1942.
- c 1940 Rh. S. 1940.

DESCRIPTION. Two firing circuits are employed in these fuzes, both charged through the B plunger. The impact switch closing the instantaneous firing circuit is an inertia bolt switch and operates only against resistance targets; i. e., upon deceleration of about 5,000 g.

Safety switching is accomplished through depression of the A plunger, which switches off both arming circuits. (See fig. 162.)

ARMING TIMES:

	LEVEL FLIGHT (150 v.)	DIVING FLIGHT (240 v.)
Instantaneous:	1.8-3.2 sec.	1.4-2.2 sec.
Short delay:		

REMARKS. 1. Type 2 construction. 2. These fuzes have also been recovered with the charging condenser connected to the A plunger. 3. An inherent delay of about 0.01 second is present in the instantaneous circuit.

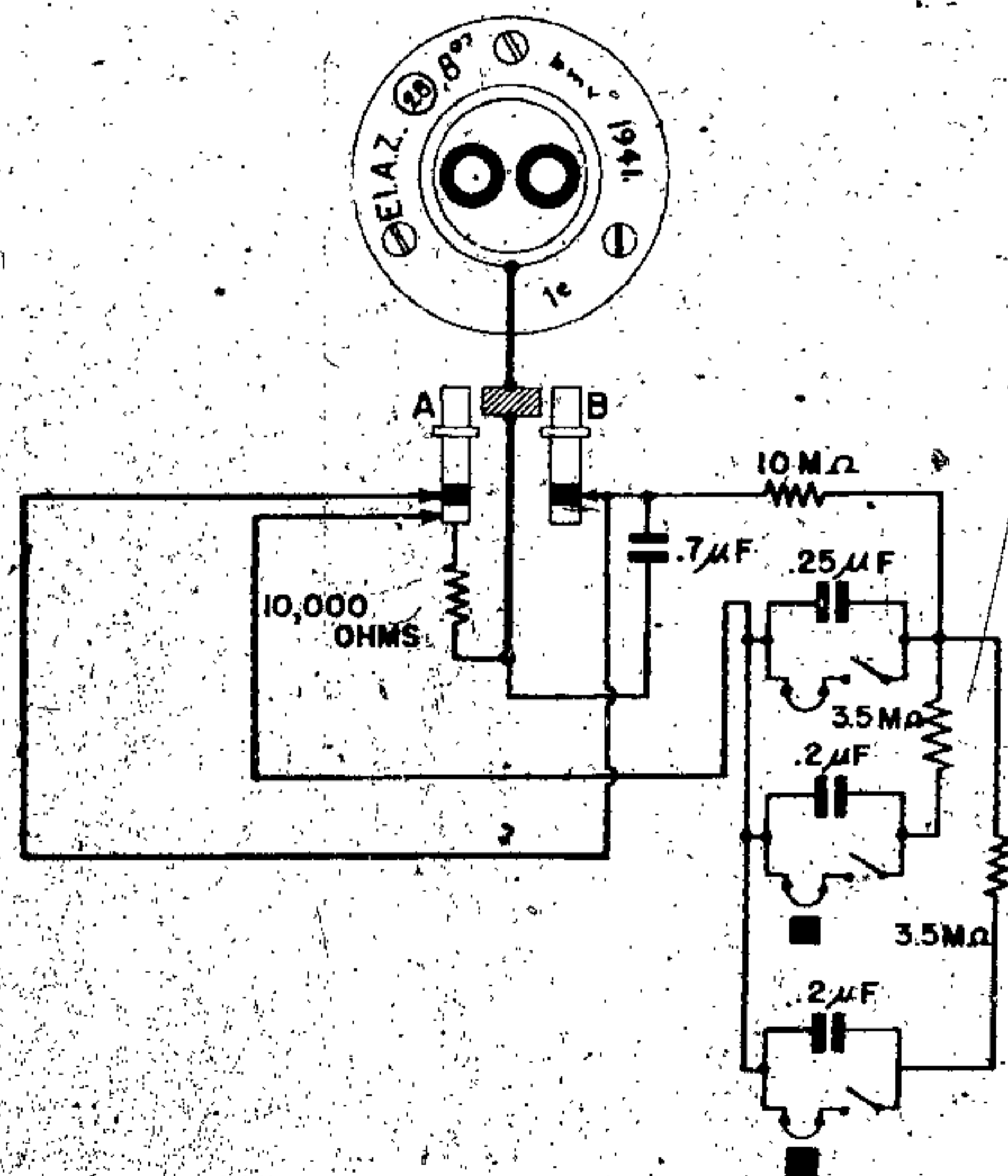

Figure 163—(28)B⁰⁷ Electrical Impact Fuze

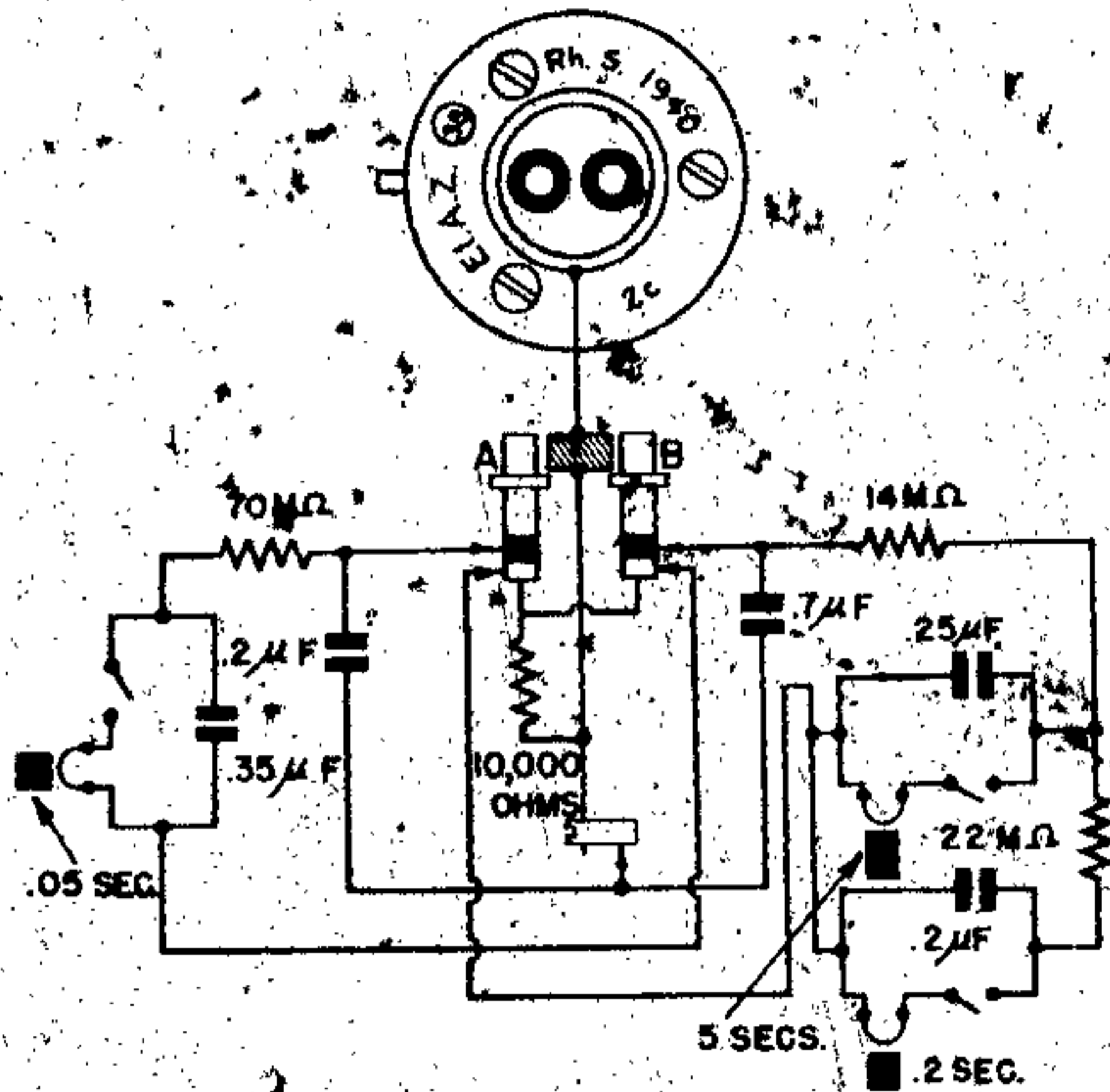

Figure 164—(38) Electrical Impact Fuze

(38) ELECTRIC IMPACT FUZE

DATA:

Bombs Used in: H. E. bombs.
 Color: Dark grey.
 Material: Aluminum.
 Possible Actions: (a) 0.05-sec. delay. (b) 0.2-sec. delay. (c) 5.0-sec. delay.
 Principal Markings: El. A. Z. (38).
 Secondary Markings: Rh. S. 1940 bmv 1941. Rh. S. 1941 bmv 1042. Rh. S. 1938 bmv 42. A. A. 1940 Rhs. 195-1940.

DESCRIPTION. This fuze was designed for use against sea targets in SC bombs from 250 to 1,800 kg. It has also been found in SD bombs 50 to 500 kg and in the Flam C 250, and is employed in the 1400 FX bomb. A 250-kg bomb, with or without a shortened tail, has been fitted with this fuze for use as an antisubmarine bomb.

There are three firing circuits incorporated in the fuze: two short delay and one long.

Safety switching is accomplished by depressing either plunger, which switches off the opposite firing circuit. (See fig. 164.)

ARMING TIMES:

	LEVEL FLIGHT (150 v.)	DIVING FLIGHT (240 v.)
0.05-sec. delay:	7.7-13.8 sec.	3.6-6.0 sec.
0.20-sec. delay:	6.2-9.8 sec.	4.1-6.1 sec.
5.00-sec. delay:	1.2-2.0 sec.	0.6-1.0 sec.

REMARKS. (1) Type 2 construction.

(38) MODIFIED ELECTRIC IMPACT FUZE

DATA:

Bombs Used in: H. E. bombs.
 Color: Dark grey.
 Material: Aluminum.
 Possible Actions: (a) 0.05-sec. delay. (b) 0.20-sec. delay. (c) 5.00-sec. delay.
 Principal Markings: El. A. Z. (38).
 Secondary Markings: bmv . . . a . . . 14e.

DESCRIPTION. This fuze is in all respects identical to the normal (38) fuze, except that an additional switch has been added to the long delay firing circuit, wired in parallel with the usual switch.

The additional switch is of the normal vibratory type with its axis parallel to that of the fuze. The axis of the usual switch is transverse to the axis of the fuze. This switch arrangement is presumably intended to give greater certainty of action in low level attack, for which the fuze would be set to operate at relatively long delay.

Safety switching is accomplished by depressing either plunger, which switches off the opposite firing circuit. (See fig. 165.)

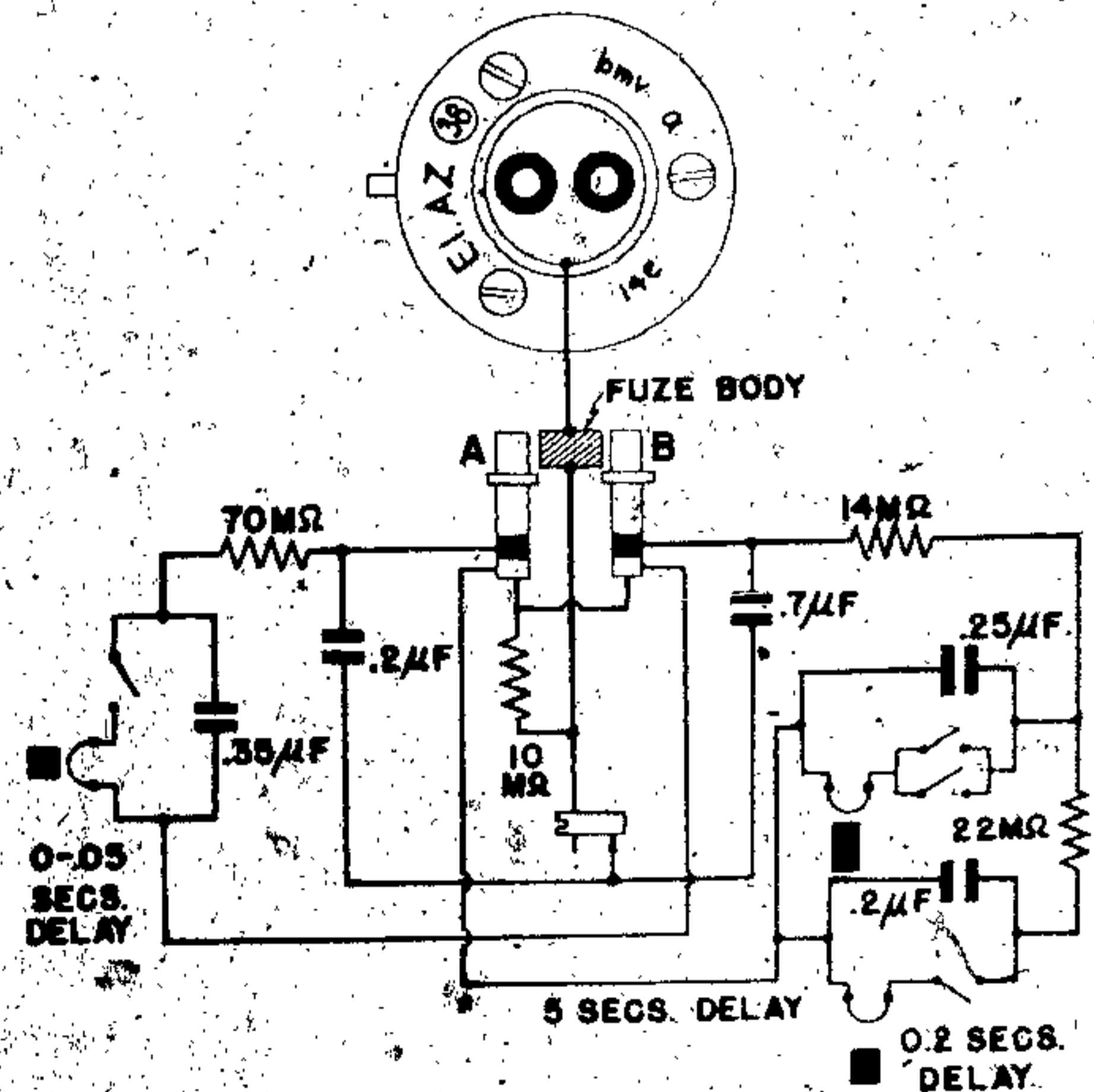

Figure 165—(38) Modified Electrical Impact Fuze

GERMAN EXPLOSIVE ORDNANCE

ARMING TIMES:

	LEVEL FLIGHT (150 VOLT)	DIVING FLIGHT (240 VOLT)
0.05-sec. delay	7.3-13.8 sec.	3.6-6.0 sec.
0.20-sec. delay	6.2- 9.8 sec.	4.1-6.1 sec.
5.00-sec. delay	1.2- 2.0 sec.	0.6-1.0 sec.

REMARKS: 1. Type 2 construction.

(38 sl) ELECTRIC IMPACT FUZE

Bombs Used In: SC 250 kg, used as depth bomb.

Color: Dark grey or green.

Material: Aluminum.

Possible Actions: (a) short delay; (b) delay (approx 1 sec.).

Principal Markings: El. A. Z. 38 sl.

Secondary Markings: cpp 1942; cpp 1942, 539.

DESCRIPTION. This fuze was developed to supersede the (38) when employed in the SC 250 kg used as an antisubmarine bomb. This fuze incorporates two firing circuits, a short delay of under 1 second and a longer delay of about 1 second. The longer delay in the green fuze is 0.75 second; that in the dark grey fuze is 1.3 seconds.

Safety switching is accomplished by depressing either plunger which switches off the opposite firing circuit. (See fig. 166.)

REMARKS. 1. Type 2 construction.

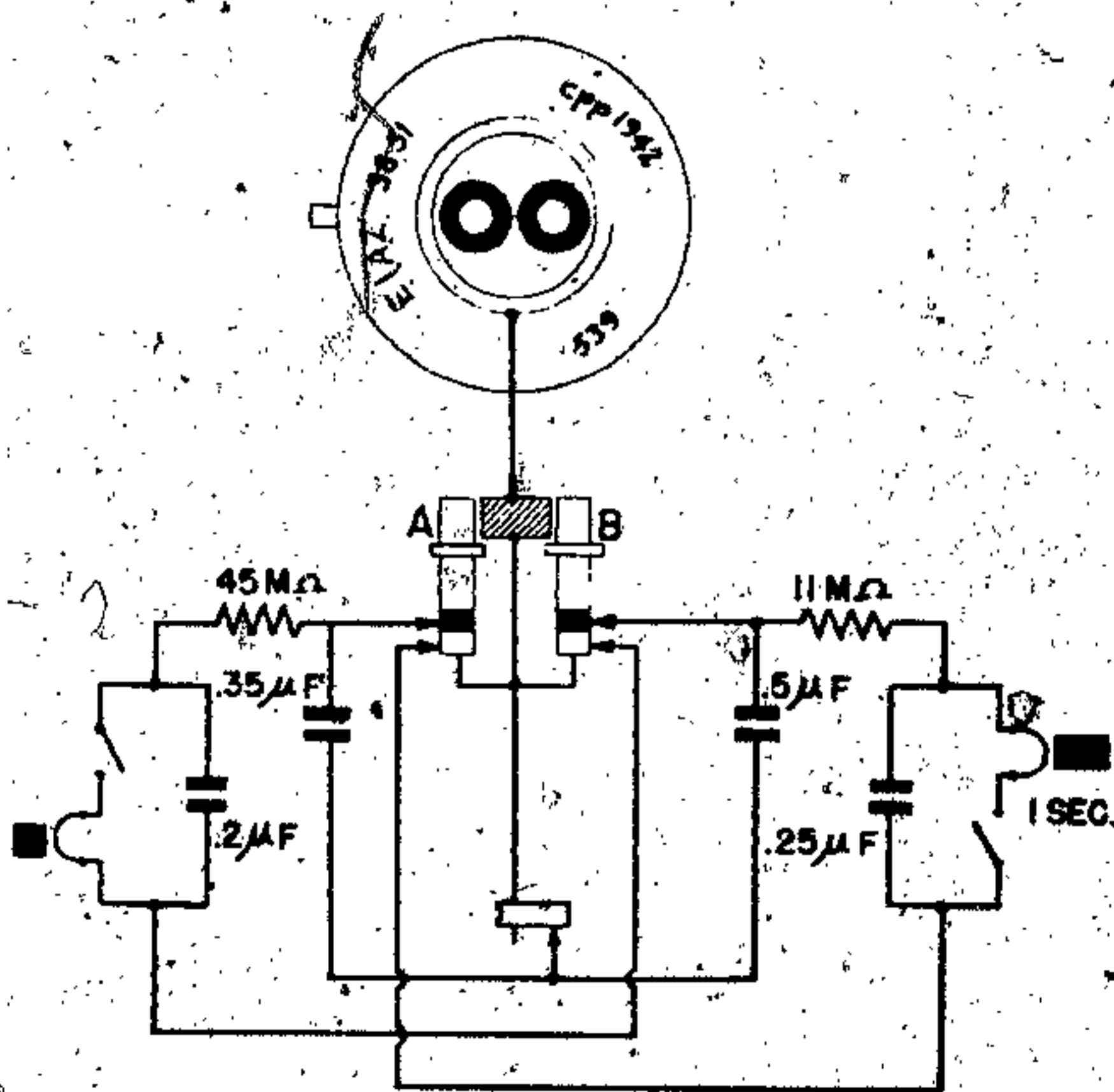

Figure 166—(38 sl) Electrical Impact Fuze

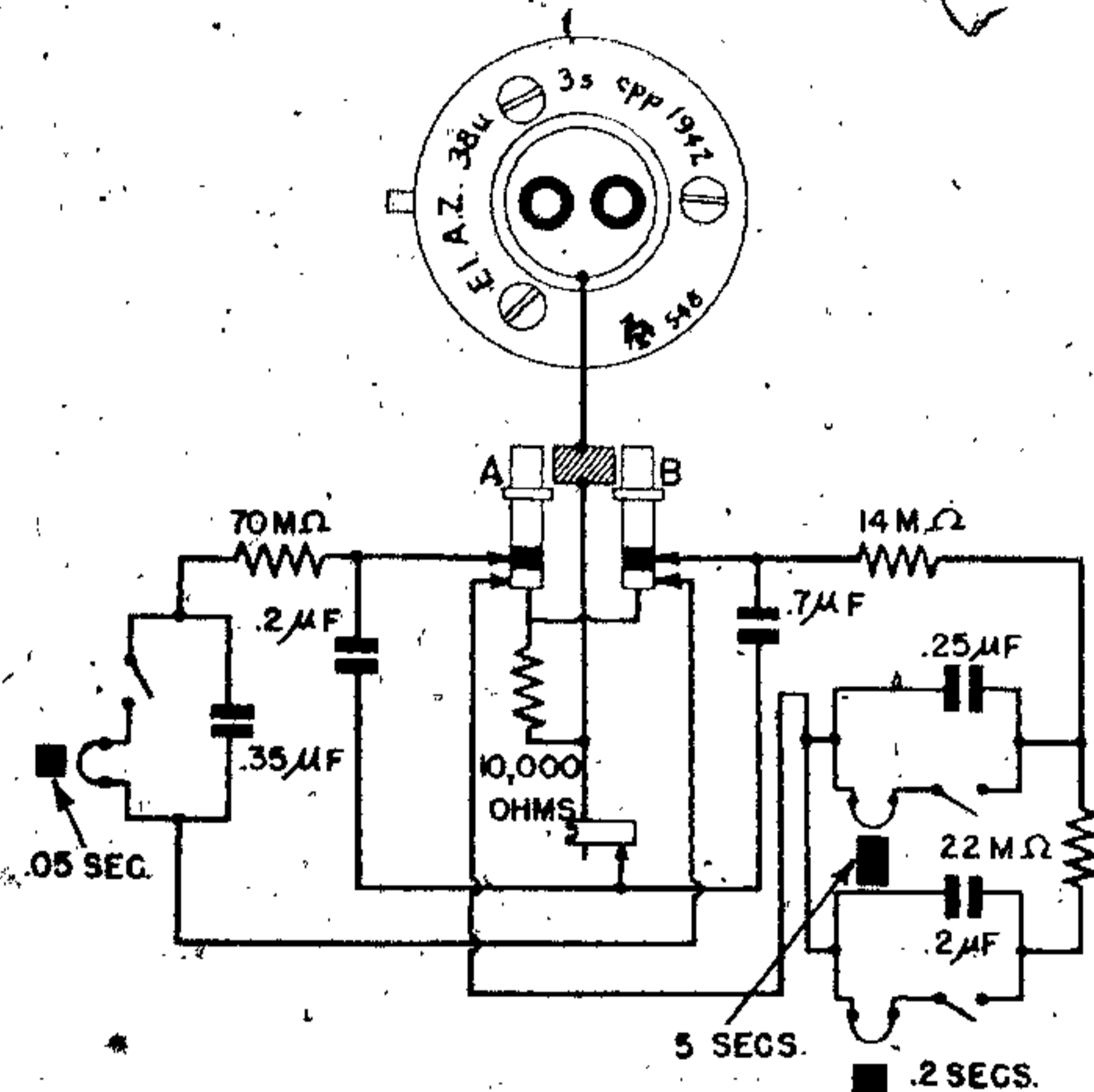

Figure 167—(38 u) Electrical Impact Fuze

(38 u) ELECTRIC IMPACT FUZE

DATA:

Bombs Used In: H. E. bombs.

Color: Head less boss light blue red band around body.

Material: Aluminum.

Possible Actions: Instantaneous.

DESCRIPTION. The (38 u) was found first in the SC 50 kg bombs and identical with the El. A. Z. 38 in all essentials. The only known difference is in coloring. The fuze is of type 5 construction. For wiring diagram, see El. A. Z. 38. (See fig. 167.)

(38)B ELECTRIC IMPACT FUZE

DATA:

Bombs Used in: F. X. 1400 and H. E. bombs.

Color: Dark grey.

Material: Aluminum.

Possible Actions: Two short (less than 1 sec.) pyrotechnic delays.

Principal Markings: El. A. Z. (38) B.

Secondary markings: edr 42 bmv a le; bmv 42; bmvq.

DESCRIPTION. This fuze incorporates two firing circuits and differs from other type 8 fuzes by having an additional condenser added to the

(9), (9) A, (9)* ELECTRICAL AERIAL BURST FUZE

DATA:

- Bombs Used in:
 - Mk 500 Boden 6 SD 2.
 - ABB 500 M10 (Boden).
 - Parachute flares.
 - Photoflash bombs.
- Color: Red.
- Material: Aluminum.
- Principal Markings:
 - El. Zt. Z. C50 (9).
 - El. Zt. Z. C50 (9)*.
 - El. Zt. Z. (9).
 - El. Zt. Z. (9) A.
 - El. Zt. Z. (9).

DESCRIPTION. This fuze is similar to the normal Rheinmetall electric fuze with the exception of a third plunger in the head of the fuze. It is smaller than the two normal contact pins and is used for test purposes only. The A and B plungers are connected, when depressed, to the firing and reservoir condensers respectively. Safety switching is accomplished by depressing both plungers. Each plunger disconnects one pole of the igniter bridge. (See fig. 169.)

The El. Zt. Z. (9) A is identical in essentials with fuze (9) except that the resistance is 22 megohms instead of 42 megohms. This reduces delay time 50 percent.

OPERATION. The A plunger (contact pin) conveys an initial charge to the firing condenser.

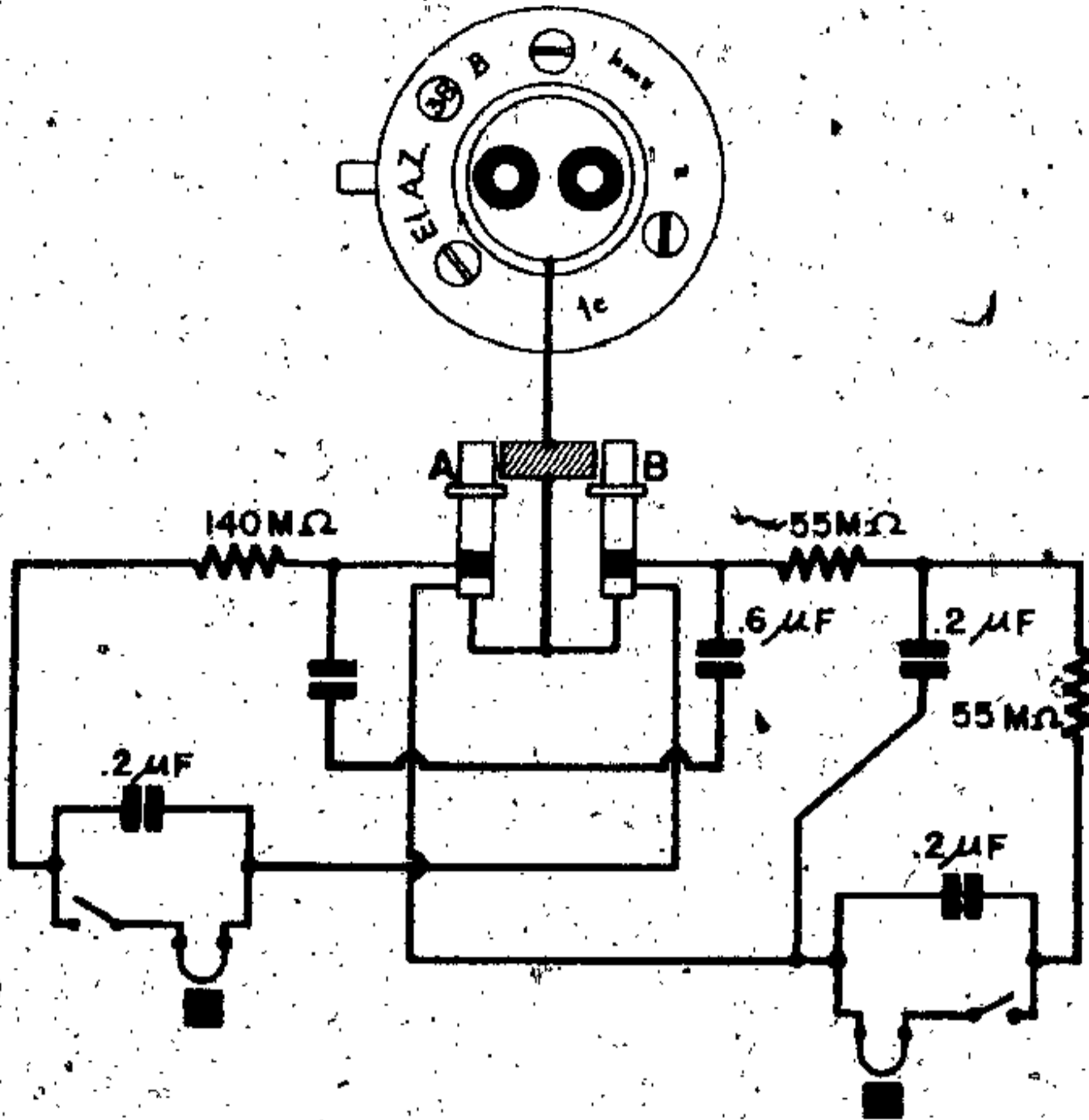

Figure 168—(38)B Electrical Impact Fuze

B side to increase the arming time. Both vibratory switches are coaxial with the fuze. All other fuzes have one switch transverse to the fuze's axis. Both circuits have short pyrotechnic delays, each of less than 1 second. (See fig. 168.)

Safety switching is accomplished by depressing either plunger, which switches off the opposite arming circuit.

ARMING TIMES:

	ORDINARY IGNITER		SENSITIVE IGNITER	
	A SIDE	B SIDE	A SIDE	B SIDE
150-volt	15.7 sec.	22.0 sec.	9.4 sec.	14.6 sec.
240-volt	8.1 sec.	13.1 sec.	5.3 sec.	9.9 sec.

(38) C ELECTRIC IMPACT FUZE

DATA:

- Bombs Used in: F. X. 1400 or H. E. bombs.
- Color: Dark grey.
- Material: Aluminum.
- Possible Actions: (a) instantaneous; (b) short delay (less than 1 sec.).
- Principal Markings: El. A. Z. (38) C.
- Secondary Markings: cpp. Y.

DESCRIPTION. This fuze is identical in all respects to the (38) B, except that the A side of the circuit is fitted with instantaneous action rather than short delay.

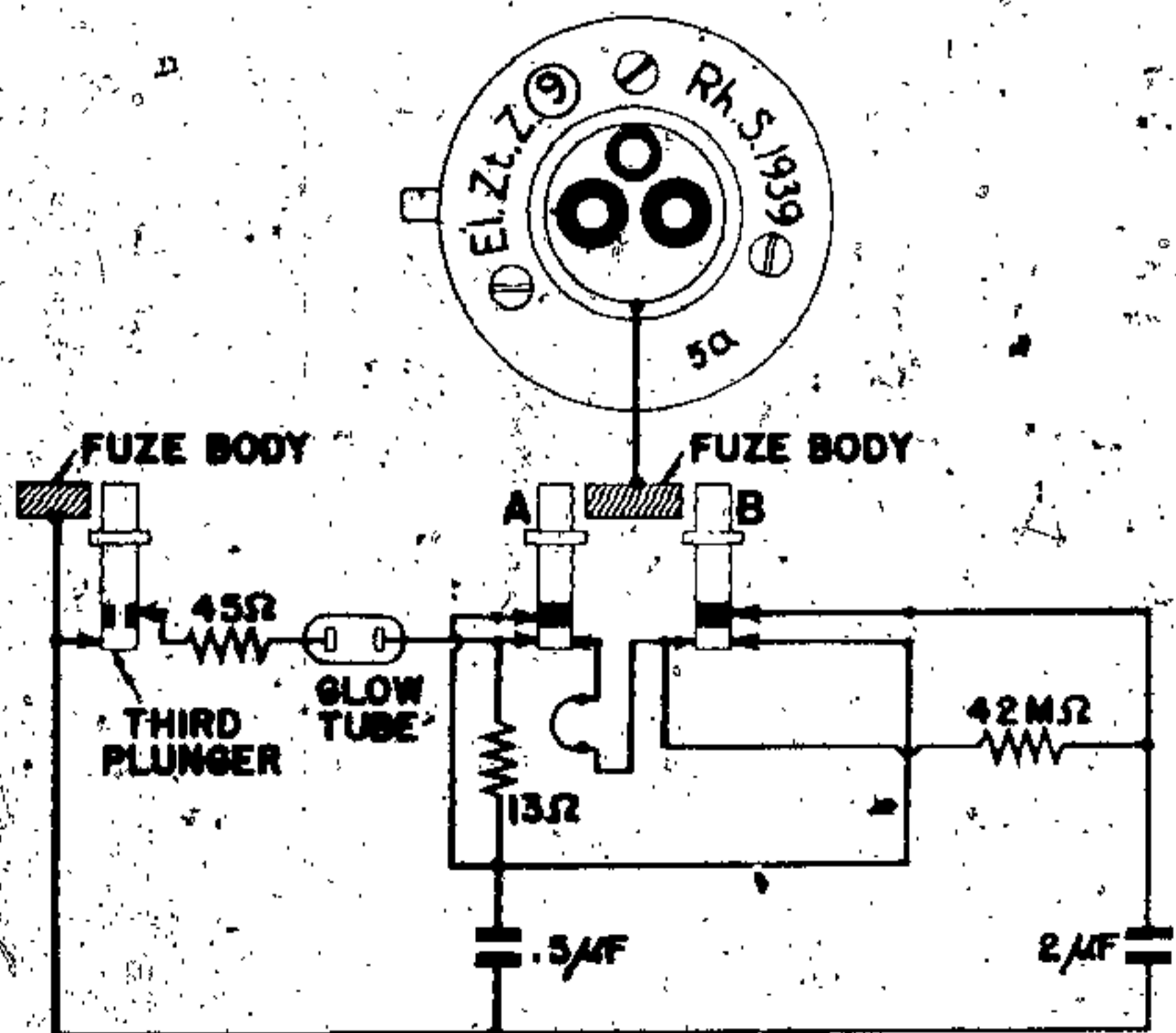

Figure 169—(9) Electrical Aerial Burst Fuze

GERMAN EXPLOSIVE ORDNANCE

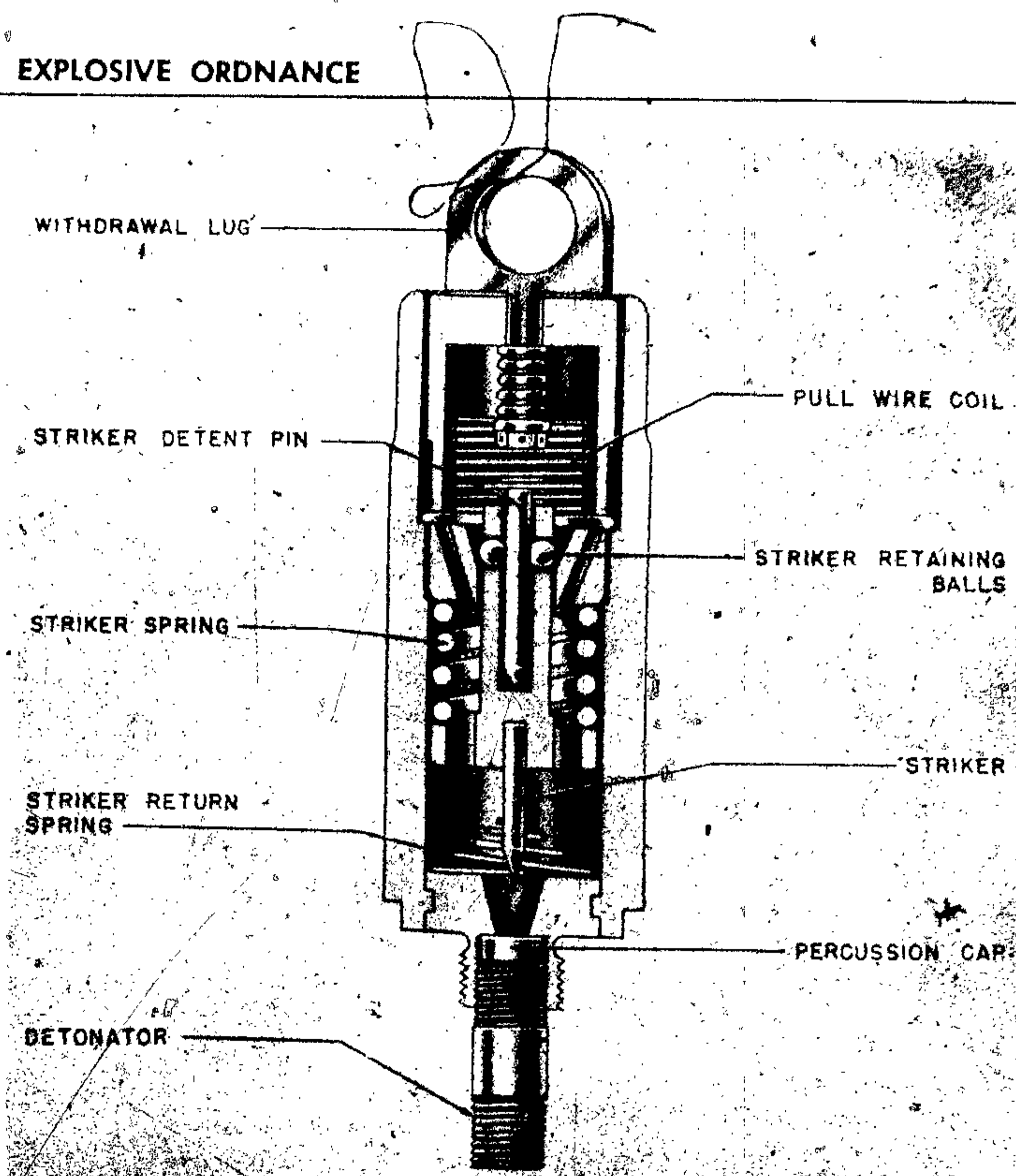

Figure 170—(29) Mechanical Aerial Burst Fuze

The amount of this charge determines the time lapse before firing and is controlled. The charging condenser is loaded as usual through the B plunger.

This fuze is designed to operate after a predetermined time. The glow discharge tube acts as a switch in this fuze. When the voltage on the firing condenser builds up to the required figure, the gas (Argon) within the glow discharge tube ionizes and allows the charge to pass through the tube. This fires the match composition and subsequently the powder delay train.

(29) MECHANICAL AIR BURST FUZE

Bombs Used In: LC 10f parachute flare.

Color: Dark brown.

Material: Body, bakelite; mechanism, steel and brass.

Possible Actions: Aerial burst after short delay.

Arming Times: Immediately on release from aircraft.

Principal Markings: None.

Secondary Markings: None.

DESCRIPTION. This fuze is used in the LC 10f single candle unit parachute flare. It is presumed that a small range of variable delays may be used with the fuze by fitting varying lengths of safety fuze in the safety fuze housing. The fuze consists of a bakelite housing containing a closing cap, withdrawal lug, a safety spring, a striker pellet guide, a striker pellet, a striker detent pin, a firing spring, two ball detents, and a striker return spring. (See fig. 170.) The withdrawal lug and

the closing cap are retained by a cord which is attached to the flare parachute.

OPERATION. As the flare falls away, the safety spring is extended until it is tensioned sufficiently to withdraw the striker detent pin. The ball detents are now free to move inward, and the striker pellet is forced by the firing spring to carry the striker into the percussion cap. At the end of its travel, the striker pellet compresses the striker return spring. The flash from the cap ignites the delay element, and after the appropriate delay, the flash from the safety fuze functions the missile. To allow the gases of combustion to escape, the striker return spring moves the striker pellet back a sufficient distance to remove the striker point from the cap.

(49)A AND (49)B ASSEMBLIES, ROCKET BOMB FUZES

DATA:

Bombs Used in: PC 500 RS; PC 1000 RS.

Color: Aluminum.

Material: Aluminum.

Possible Actions:

(49) AI and BI—Charging head.

(49) AII and BII—Pyrotechnic aerial burst.

(49) AIII and BIII—Electric impact fuze.

Principal Markings:

(49) AI, (49) AII, (49) AIII.

(49) BI, (49) BII, (49) BIII.

DESCRIPTION. (49) AI and BI: This fuze consists of a charging head, located in the side of the distance piece of the rocket. This charging head houses the polystyrene molding housing, the plungers, and the contact wires leading to the bakelite molding. Two U-shaped clips, attached to the bakelite molding, secure in position the two pin plugs, one of which is red, the other black. These plugs are grooved to receive the clips. An insulated three-core cable, only two cores of which are used, leads from the black plug to the rocket ignition fuze, while a two-core cable leads from the red plug to the bomb fuze.

(49) AII and BII. This fuze, sometimes found unmarked, is a pyrotechnic aerial burst fuze threading into the forward end of the rocket container. It ignites the rocket propellant after a delay of about 3 seconds after the bomb is dropped.

The fuze body is threaded internally at the upper end to receive the aluminum closing cap, which is bored centrally to admit the three-core cable. Two leads of this cable pass through a rubber washer and a bakelite distance piece and are soldered to the twin terminals in the bakelite plug. The lower fuze body is screwed to the upper fuze body and houses both the aluminum holder containing the igniter into which pass the two leads from the terminals, and the delay pellet holder, which contains a powder pellet in its lowest portion. The lower fuze body receives the powder train holder which is threaded externally to screw into the rocket propellant chamber.

(49) AIII and BIII: This is an electrical impact fuze located in the base of the bomb proper. The fuze head consists of a gland set in a block of brown insulation. The two-core cable passes through the gland. The fuze is fitted with only one firing circuit, incorporating a short delay for penetration purposes. The B plunger in the charging head, on depression, switches off the arming circuit. (See fig. 171.)

OPERATION. On release from the aircraft, the charging head is charged. Since the head contains

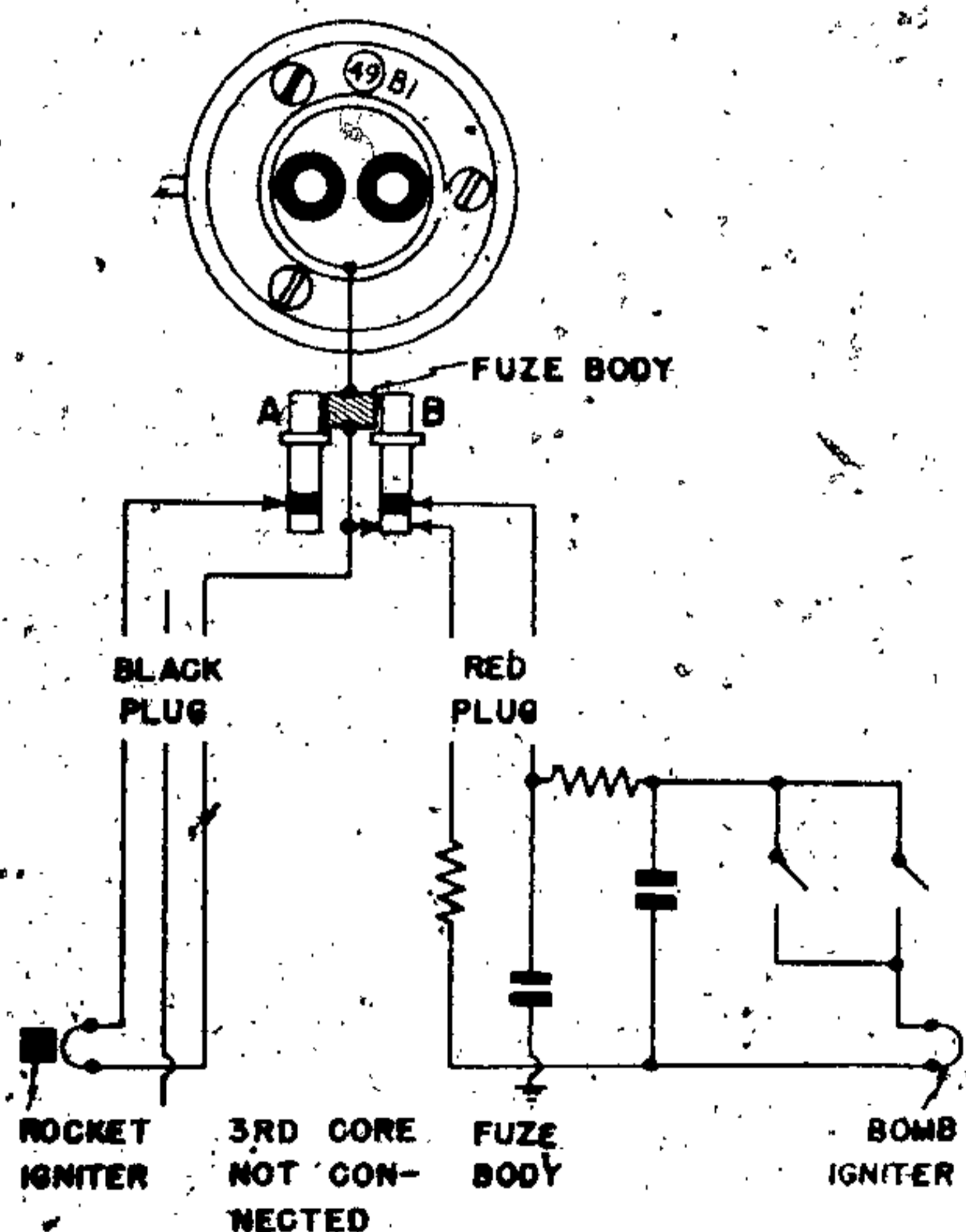

Figure 171—(49)B Rocket Bomb Fuze Assembly

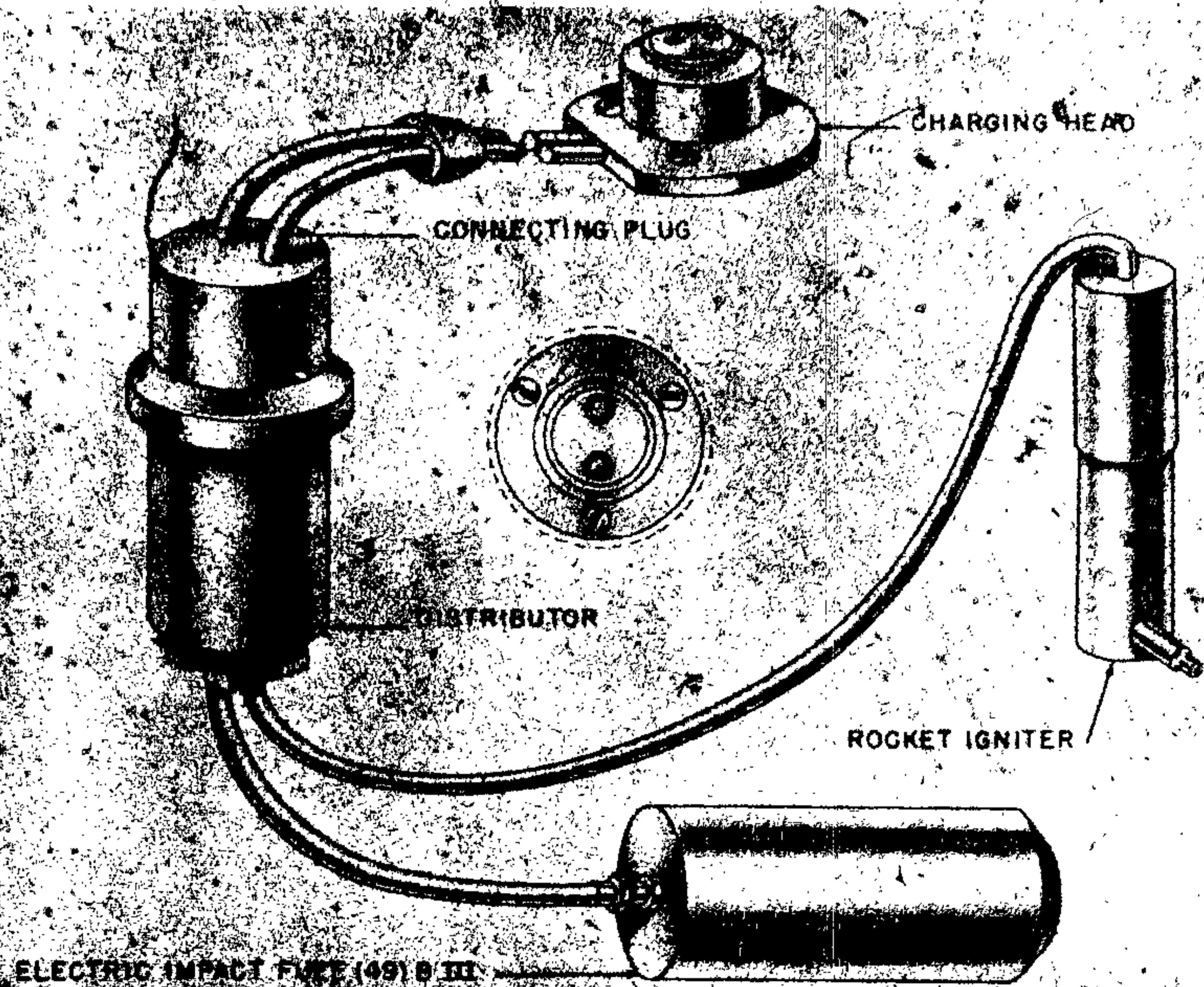

Figure 172—(49)C Rocket Bomb Fuze Assembly

no condensers, the charge passes directly to the rocket ignition fuze and the bomb fuze. In the rocket ignition fuze, the igniter bridge fires the delay pellet and thence the powder train which ignites the propellant in the rocket chamber.

The charge entering the bomb fuze passes through the resistances to the storage condenser and the circuit is completed by either of two vibratory impact switches. The firing of the igniter bridge detonates the mine and the bomb.

(49) C ASSEMBLY, ROCKET BOMB FUZES

DATA:

Bombs Used in: PC 1800 RS.

Color: Aluminum.

Material: Aluminum.

Possible Actions:

- (49) C: Charging head.
- (49) CI: Distributor.
- (49) CII: Rocket igniter.
- (49) CIII: Bomb fuze.

Principal Markings: (49) C, (49) CI, (49) CII, (49) CIII.

Secondary Markings: None.

DESCRIPTION. (49) C CHARGING HEAD: The charging head is located in a recess aft of the suspension lug on the bomb proper. It is connected by a connector plug and protected cable to the distributor.

(49) CI DISTRIBUTOR: The distributor is located in the side of the distance piece separating the bomb from the rocket propellant container. Its function is to pass the charge directly from the charging head to the bomb fuze, and to the rocket ignition fuze after a delay. The delay is accomplished by a condenser-glow tube circuit, as in the (9) fuze.

(49) CII ROCKET IGNITION FUZE: This fuze is similar to the (49) BII.

(49) CIII BOMB FUZE: This fuze is similar to the (49) BIII fuze.

OPERATIONS. On release from the aircraft, the charge passes from the charging head to the distributor, and from the distributor directly to the bomb fuze and after a delay to the rocket ignition fuze. During flight, the rocket ignition fuze operates and ignites the rockets. On impact the bomb fuze initiates the explosion of the bomb, after a short delay for penetration purposes. (See fig. 172.)

(59) MECHANICAL AIR BURST FUZE

DATA:

Bombs Used in: Parachute flares; photoflash bombs.

Color: Unpainted.

Material: Aluminum.

Possible Actions: Aerial burst after short delay.

Arming Times: Immediately upon release from plane.

Principal Markings: (59).

Secondary Markings: None.

DESCRIPTION. The fuze body consists of a cylindrical lower case, which is part of the shoulder or flange of the fuze. Projecting down from the flange is a metal ring which fits the sides of the fuze pocket. Another metal ring projects upward from the flange. Inside the opening formed by this ring fits a safety cap held in position by three spring-loaded balls. A retaining collar fits around the ring to hold these springs in place. Under the safety cap is coiled $2\frac{1}{2}$ feet of lanyard twine attached to an arming pin placed in the central hole in the striker pellet. Resting against a shoulder of a tapered fitting inside the fuze and located in a channel in the striker pellet are two steel balls, which prevent movement of the spring-loaded striker. Beneath the striker is a percussion cap, and screwed into the base of the fuze is a pyrotechnic delay of $7\frac{1}{2}$ seconds.

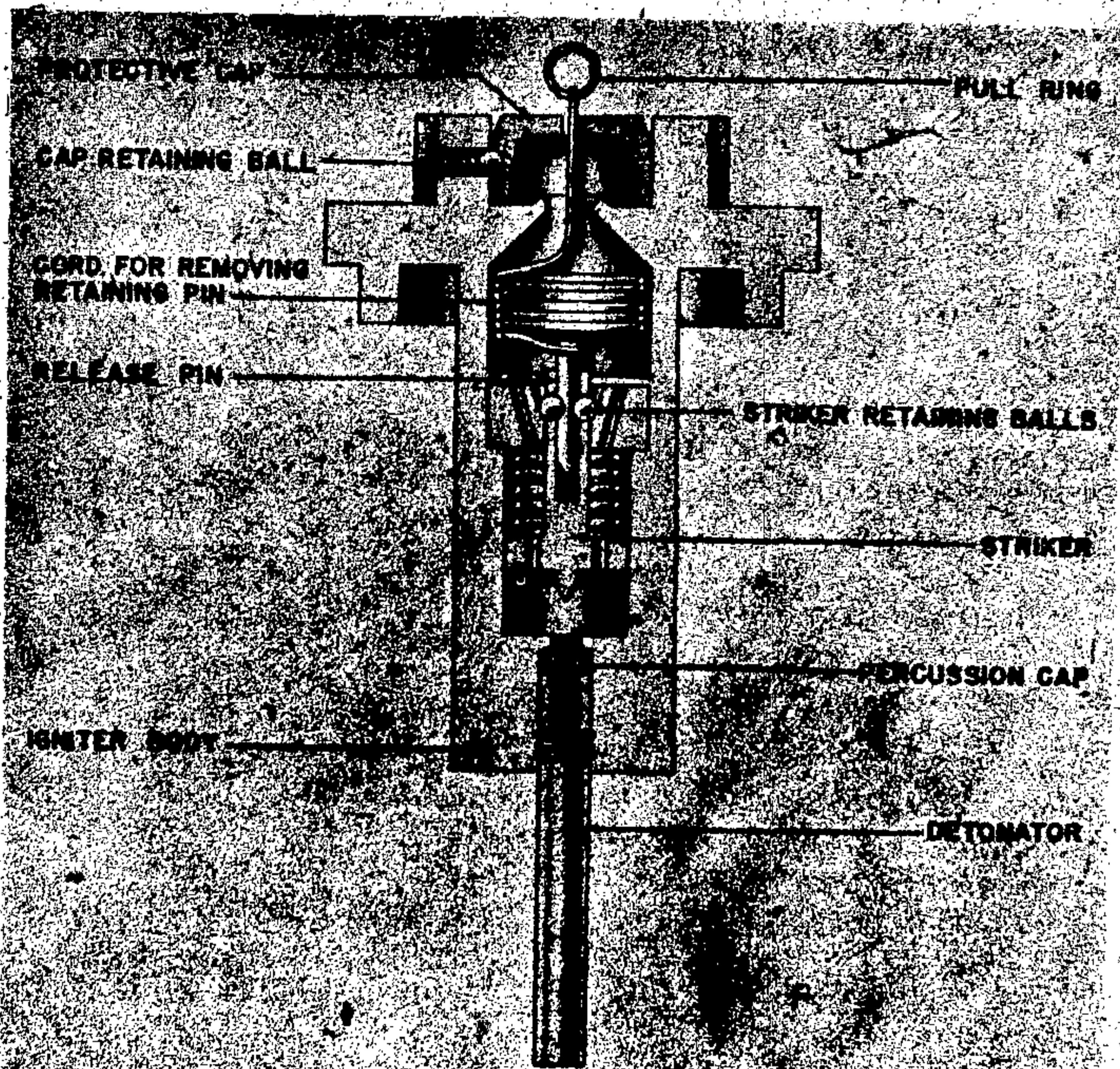

Figure 173—(59) Mechanical Aerial Burst Fuze

GERMAN EXPLOSIVE ORDNANCE

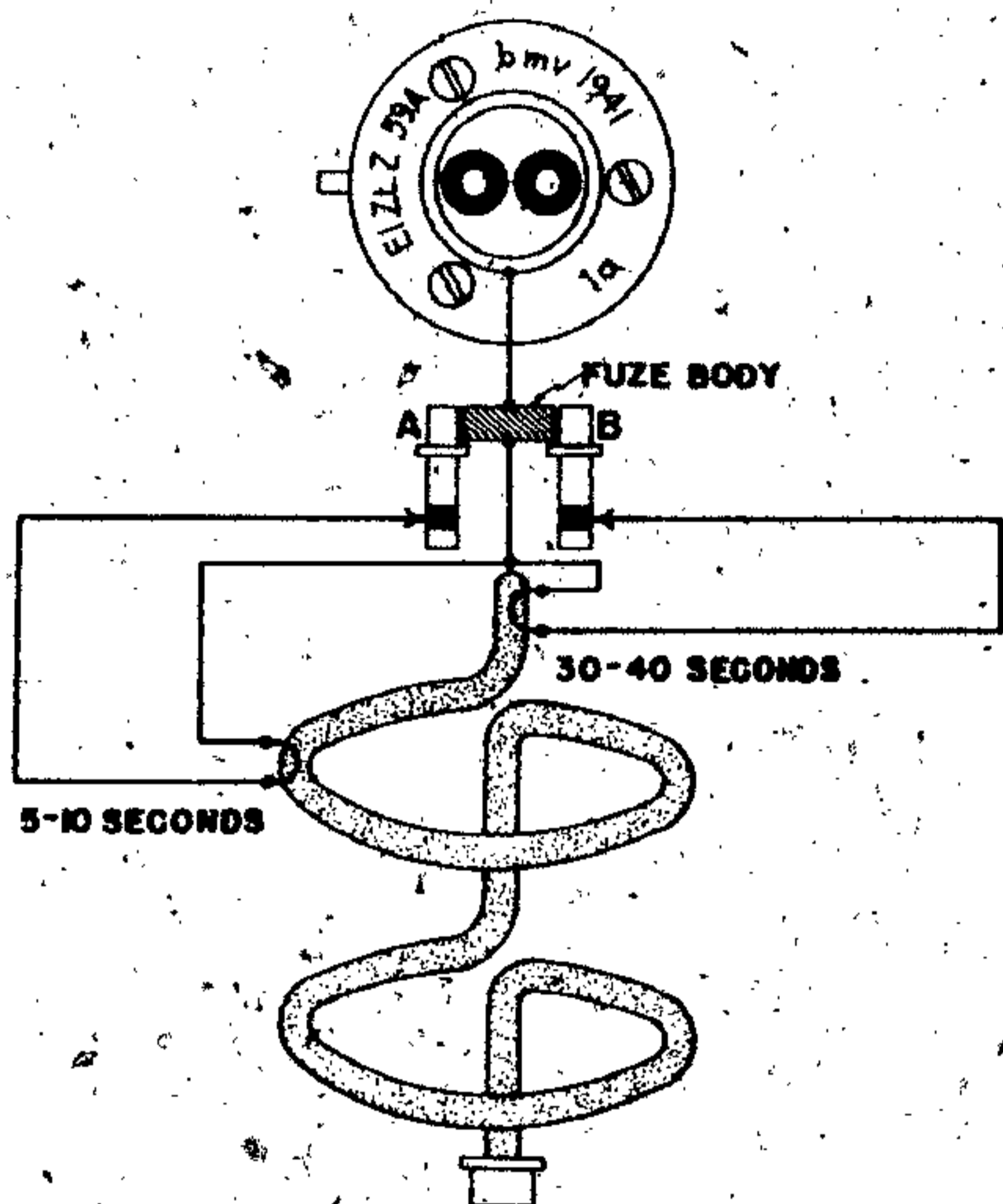

Figure 174—(59)A Electrical Aerial Burst Fuze

OPERATION. When the bomb is placed in the plane, the twine outside the cap is secured to the dropping gear. When the bomb is released, this twine unreels and becomes taut by reason of the knot under the safety cap. This knot pulls off the cap, uncoils the 2½ feet of twine, and withdraws the arming pin. The balls then fall inwards, and the striker is forced by its spring into the percussion cap. The flash from the cap ignites the 7½-second pyrotechnic delay train, which in turn initiates the bomb or flare.

REMARKS. 1. This fuze is believed to be obsolete. (See fig. 173.)

59A (59)A, ELECTRIC AERIAL BURST FUZE

DATA:

Bombs Used In: Antipersonnel and incendiary containers.

Color: Red or unpainted.

Material: Aluminum.

Possible Actions: Air burst: (a) 12 sec.; (b) 41 sec.; (c) 58 sec.

Markings: El. Zt. Z. 59A; El. Zt. Z. (59)A.

DESCRIPTION. This fuze consists of two igniter bridges connected directly to the two plung-

ers without any intervening condensers or resistances. The bridges are thus fired as soon as the bomb or flare leaves the aircraft, initiating pyrotechnic delay trains which provide the aerial burst functioning. The shorter delay is fired from the A plunger, the longer delay from the B plunger. If both plungers are charged, the short delay will function; if the B plunger only receives the charge, the longer delay will result. (See fig. 174.)

REMARKS. The only important difference between the 59A and the (59)A is in the length of the fuze body. This factor is significant mainly for purposes of identification. The (59)A is approximately twice as long as the original 59A. The inner construction is essentially the same except that it is spread over a greater area.

(59) B ELECTRIC AERIAL BURST FUZE

DATA:

Bombs Used in: SC 250; parachute flares, LC50, FA50.

Color: Red.

Material: Aluminum.

Possible Actions: Air burst: (a) 12 sec.; (b) 41 sec.; (c) 58 sec.

DESCRIPTION. The main purpose of this fuze

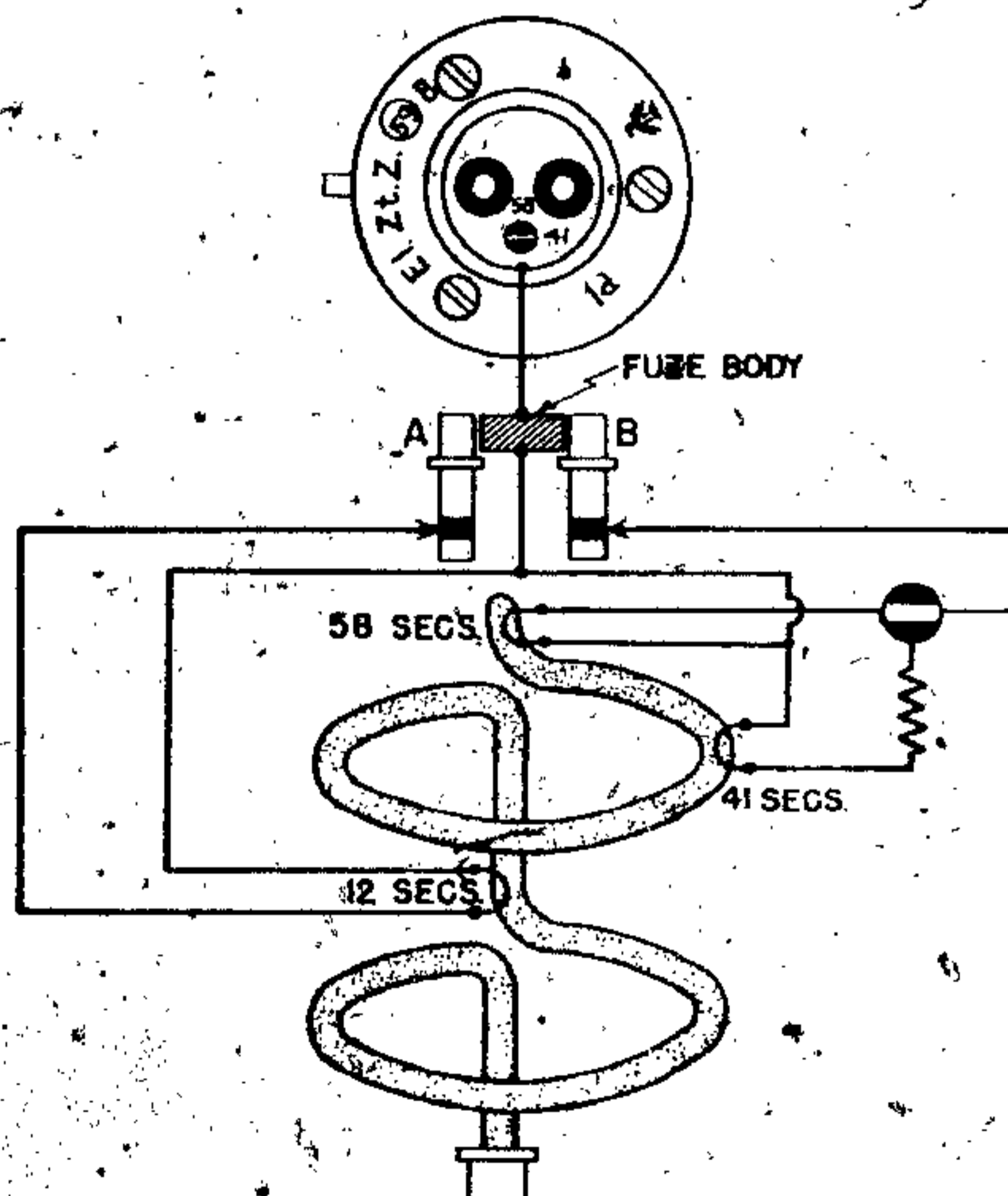

Figure 175—(59)B Electrical Aerial Burst Fuze

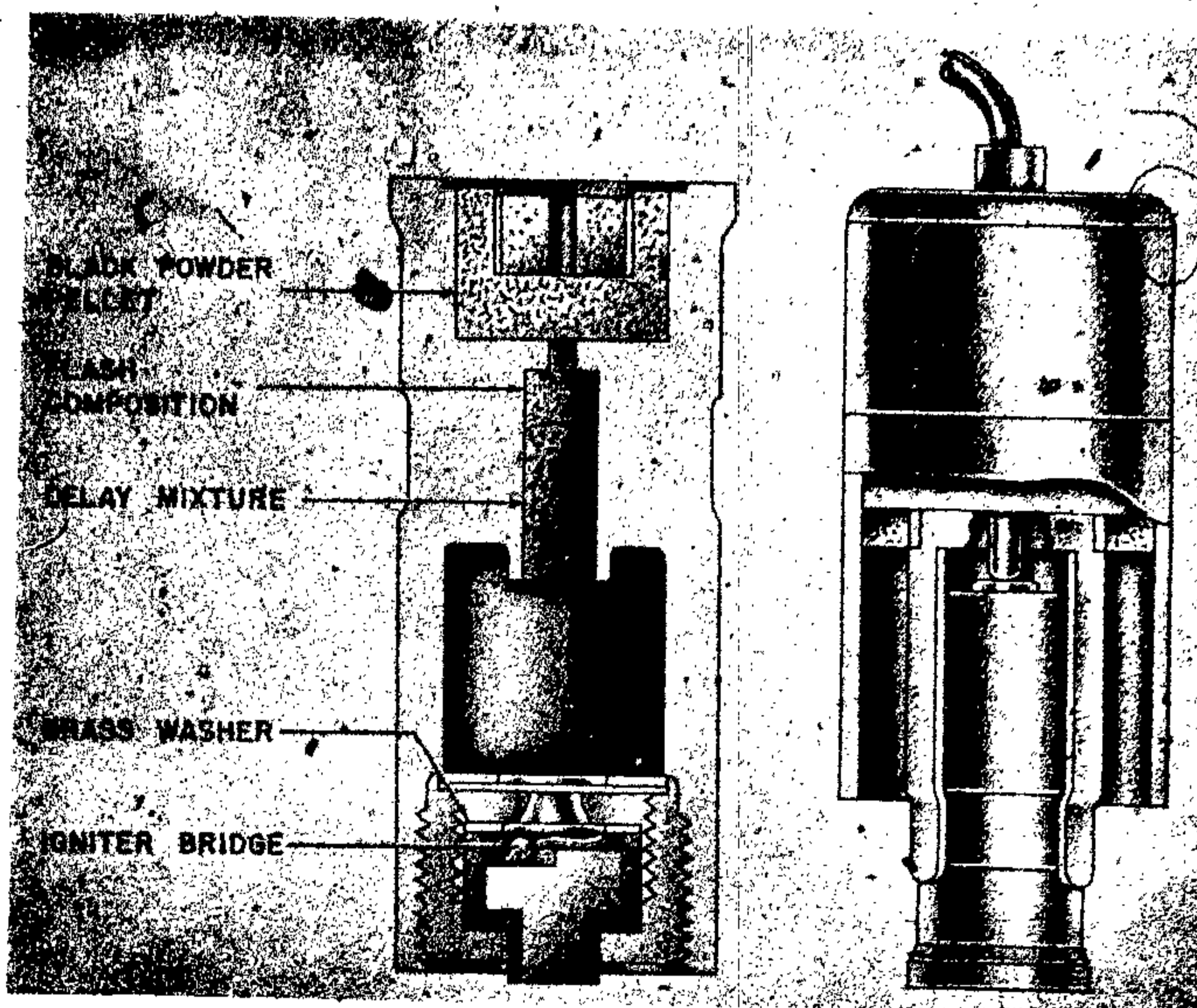

Figure 176—69CII Electrical Aerial Burst Fuze

is for use in parachute flares and other air-burst munitions. It has been used in H. E. bombs but not with too much success. It generally resembles fuzes of the 59 and 79 series, but is externally distinguished from these by the possession of a rotary switch in the head. This switch is located between but slightly off-set from the two charging plungers. The switch can be turned to two positions marked "58" and "41" respectively.

Internally the fuze differs from the ones mentioned above by having three igniters instead of the conventional two. The short delay circuit and igniter are under the A plunger while the other two circuits are under the R plunger. A choice between the two circuits under the R plunger can be made by means of the rotary switch.

There are two pyrotechnic time-rings joined in series and each of the three igniters can ignite this pyrotechnic train at an appropriate point giving three possible delays. (See fig. 175.)

OPERATION. The igniter under the A plunger is in such a position as to give a 12-second delay. The other two igniters are under the R plunger and give 41- and 58-second delays respectively.

If the short delay is required, both plungers are charged and when the missile is released from the aircraft, the igniter under the A plunger fires, giving the minimum 12-second delay. If a longer delay is necessary, only the R plunger is charged and then the actual delay received is dependent upon the rotary switch setting.

69 CII, 69D, 69E, ELECTRIC AERIAL BURST FUZE (PROTECHNIC DELAY)

DATA:

Bombs Used in: AB 250, 500 and 1000; AB 36; BDC 10.

Color: Unpainted.

Material: Aluminum.

Possible Action: Aerial burst.

Markings:

Z69B 1.3-3.5 sec. delay.

Z69C 0.3-1.0 sec. delay.

Z69D 0.7-1.2 sec. delay.

Z69E 4.0-5.5 sec. delay.

DESCRIPTION. The Z 69D is an electric aerial burst fuze with a pyrotechnic delay. (See fig. 176.)

GERMAN EXPLOSIVE ORDNANCE

The body is of aluminum and has a small flange at the top. It has stamped along a circumferential groove in its wall, the markings: Z 69D cpp 1a Y. Screwed into the base is an aluminum collar which houses the firing device. This latter consists of a brass contact which is insulated from the collar by a molding of plastic. Lying on top of this is the igniter bridge. The ground return from this bridge to the fuze case is made via the projection in the brass washer, the aluminum securing ring, and the collar itself. The cavity surrounding the firing bridge is filled with a quantity of loose black powder and is closed by a thin aluminum disc held by the washer which is retained in position by turning over the end of the collar. The joint is made waterproof by a thin coat of green paint covering this end of the collar. At the other end a thick coat of white sealing compound is applied after the collar has been screwed into the fuze body. (See fig. 176.)

OPERATION. On release from the plane, the igniter bridge fires, igniting the loose black powder, which in turn ignites the delay mixture. On expiration of the burning of the delay, the solid black powder pellet and the perforated blue pellet are ignited. These in turn fire the gaine, allowing the container to open.

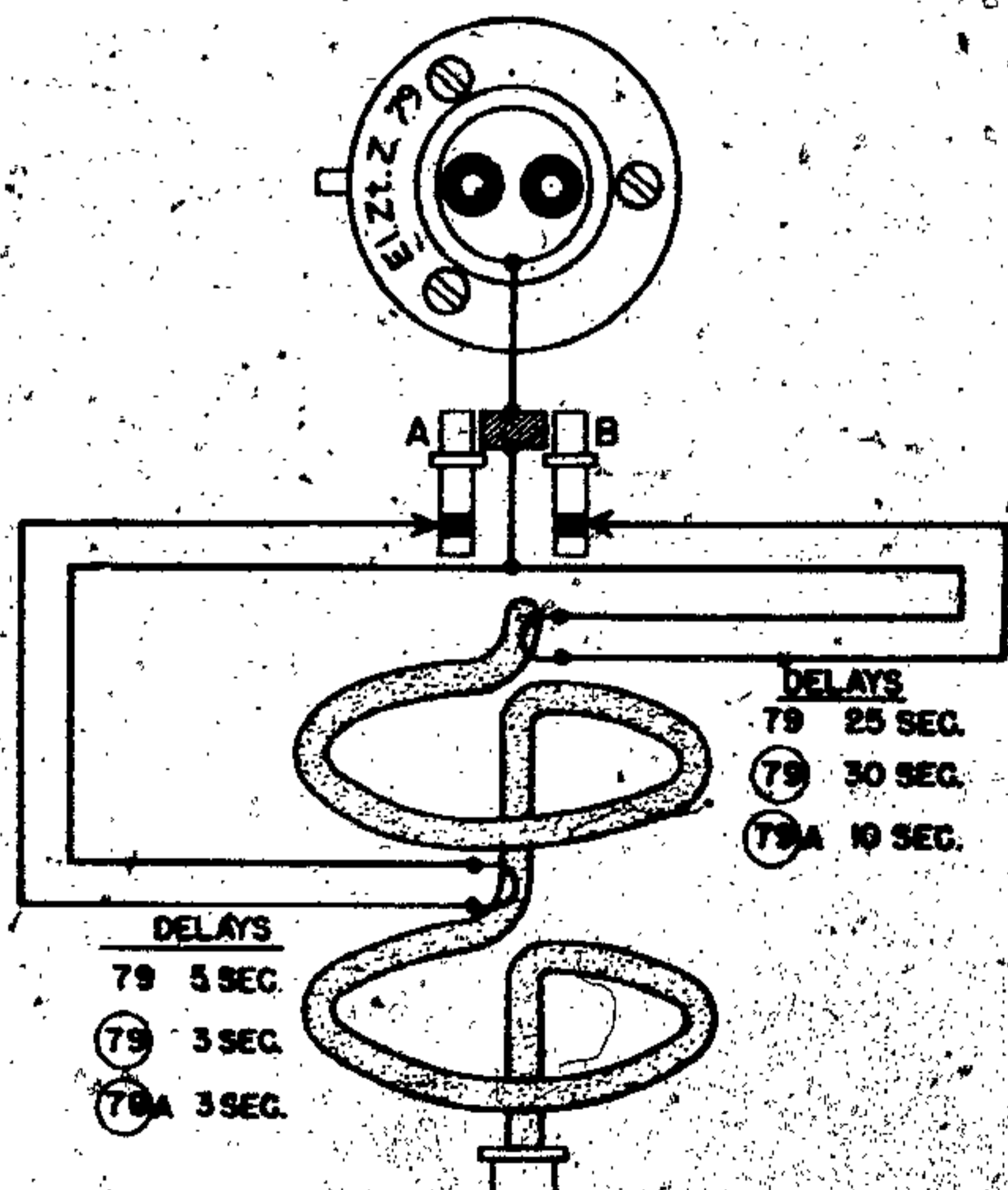

Figure 177—79 Electrical Aerial Burst Fuze

REMARKS. This fuze is employed in the fuze assembly for the AB 250-2 container and provides an alternative delay to the (79), a fuze which is a part of the assembly.

The Z 69CII is used in the BDC 10 container for the SC 10-kg bombs. It is similar to the Z 69D in all respects save in the composition of the powder in the delay channel, giving it a slightly shorter delay time.

The Z 69E fuze is similar in operation to the Z 69D but differs somewhat in internal and external construction. It is employed in the AB 500-1 container and is used in conjunction with the (89)B fuze. The fuze is reported to give a delay of approximately five seconds.

79 (79), (79)A ELECTRICAL AERIAL BURST (PYROTECHNIC)

DATA:

Bombs Used in:

- Parachute flares.
- Photoflash bombs.
- A/P and incendiary containers.
- SC 250 and SC 500.

Color:

- 79—unpainted.
- (79) and (79)A—red.

Material: Aluminum.

Possible Actions:

- 79—5 and 25 sec.
- (79)—3 and 30 sec.
- (79)A—3 and 10 sec.

Principal Markings:

- El. Zt. Z. 79.
- El. Zt. Z. (79).
- El. Zt. Z. (79)A.

DESCRIPTION. The Z 79 fuze resembles the 59A. There are two firing bridges, one located in the plastic molding and one within the aluminum block on whose outer faces are the powder delay trains.

The fuze is unpainted aluminum. The plungers are of type 14 and the time delays are approximately 5 and 25 seconds. (See fig. 177.)

The Z (79) resembles the short fuzes 59A. It is painted red and has two delay periods of 3 and 30 seconds.

The Z (79)A fuzes resemble the (59)B. The plastic molding is the same as in the latter fuze except that the switch is omitted, though the

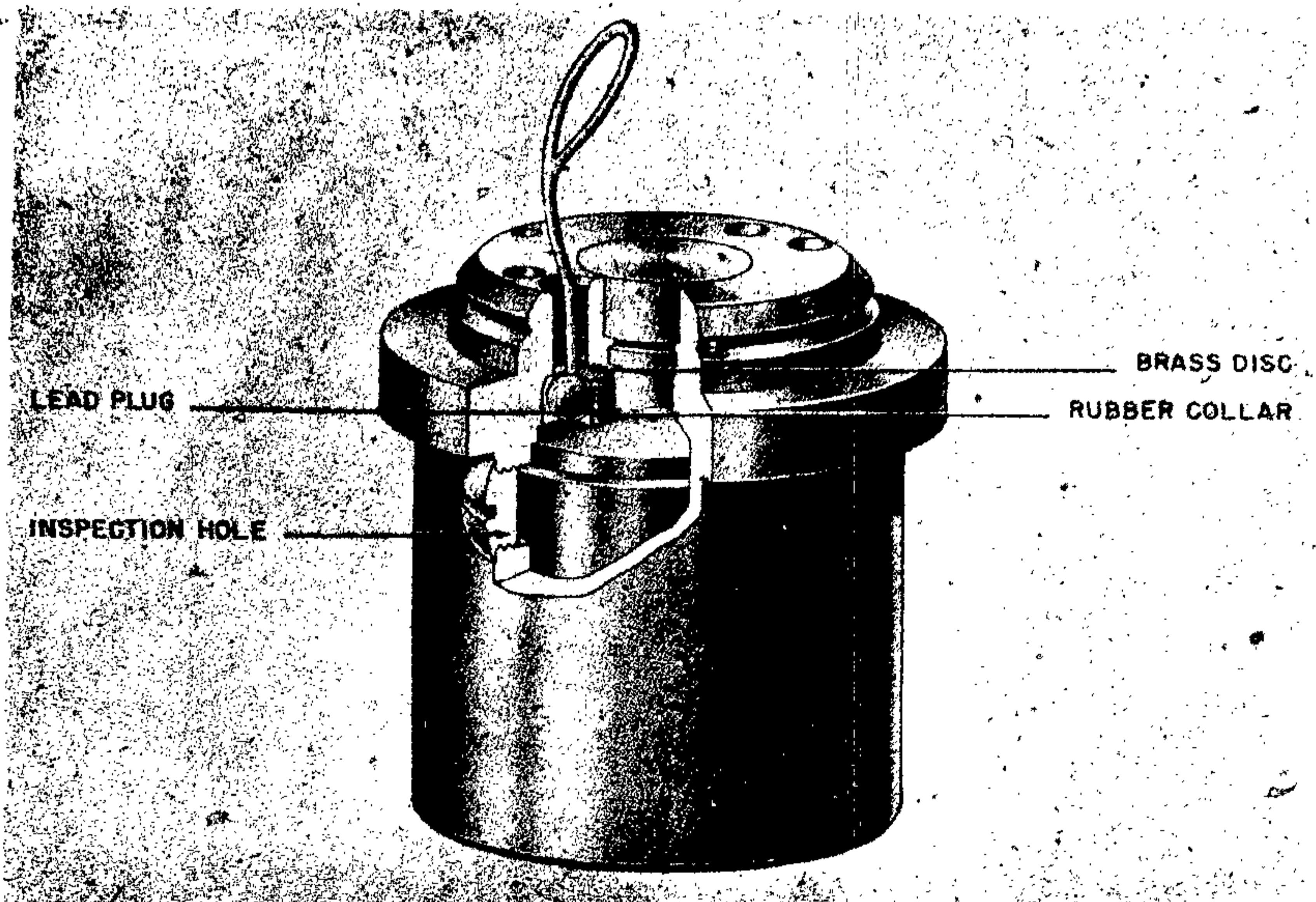

Figure 178—(89) Clockwork Aerial Burst Fuze

metallic contacts are in place, and thus there is no alternative delay in the circuit.

(89) CLOCKWORK AERIAL BURST

DATA:

Bombs Used in: Photographic flash bomb parachute flare—LC 20 containers—ABB 500 M.10 (Boden).

Color: Red.

Material: Aluminum (construction type VI).

Possible Actions: 80-sec. delay maximum.

Arming Times: Immediately on release from plane.

Principal Markings: Z (89); Zt. Z. (89).

Subsidiary Markings: 1941 bp 395; 42 bp e.

DESCRIPTION. The length of the fuze is 2.2 inches and the head is oversized (one-half inch larger than normal). Within the fuze case is a clock mechanism similar in operation and construction to the clock used in the (17) series. The gearing has been changed to give delay times up to 80 seconds. This delay may be varied by rotating the setting button. A projection on the under-

side of the setting button engages a nub on the timing disc and turns it to the desired setting.

The clock is prevented from starting by a spring loaded plunger passing through the balance wheel. The plunger is held down by a lead plug seated in a rubber collar. The collar is retained by a brass disc. The lead plug is connected to the dropping gear by a 3-inch brass cable. (See fig. 178.)

OPERATION. When the bomb or flare is released from the aircraft, the lead plug holding down the arming plunger is pulled free of the rubber collar by means of the brass cable attached to the bomb rack. This action allows the spring-loaded plunger to remove itself from the balance wheel. The clockwork is now allowed to start and after running the preset time, it releases the striker to fire the fuze.

REMARKS. The (89) has no charging plunger and is therefore easily distinguishable from all other (9) types. The fuze is not initiated electrically and the time delay is provided by the clock.

GERMAN EXPLOSIVE ORDNANCE

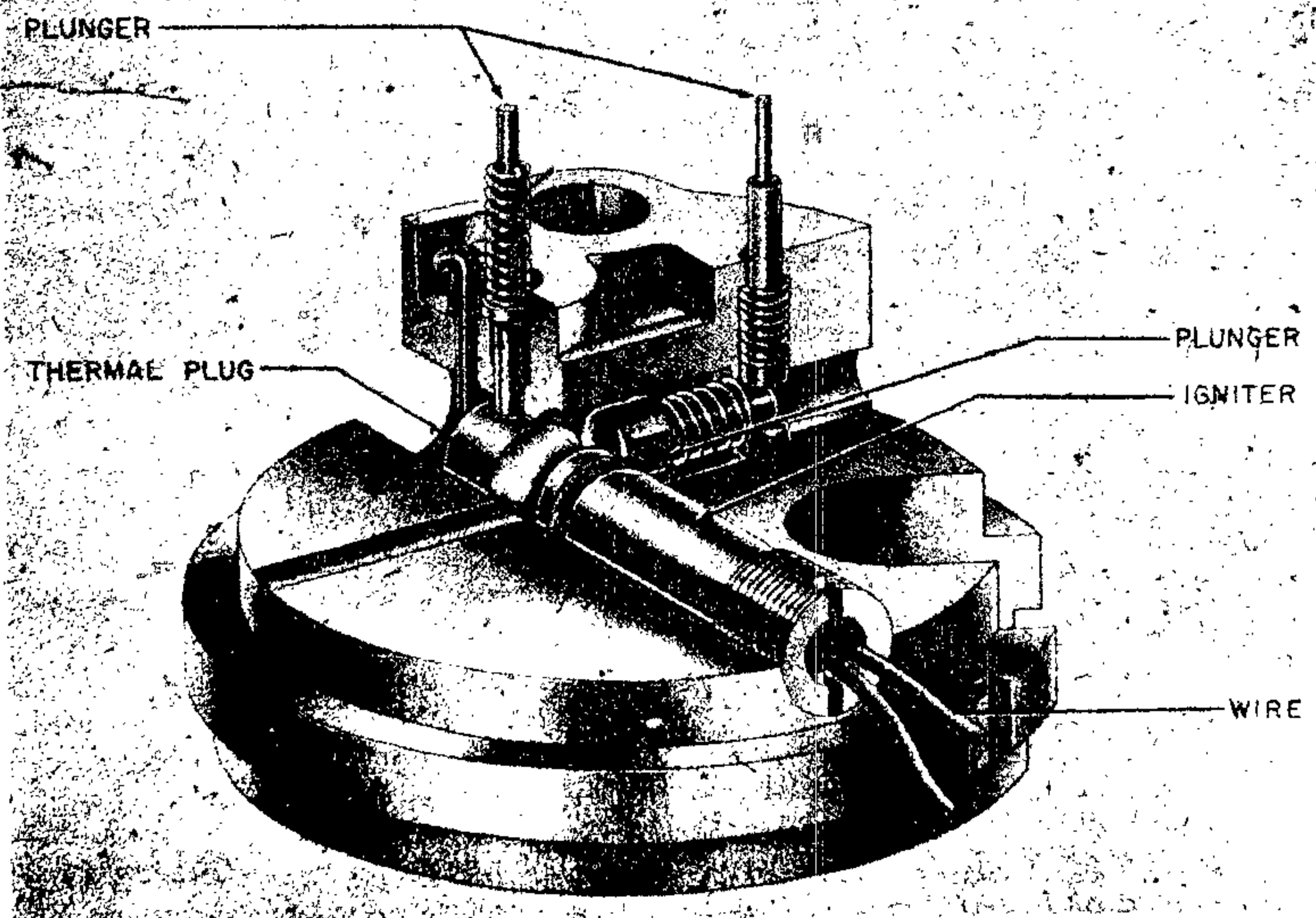
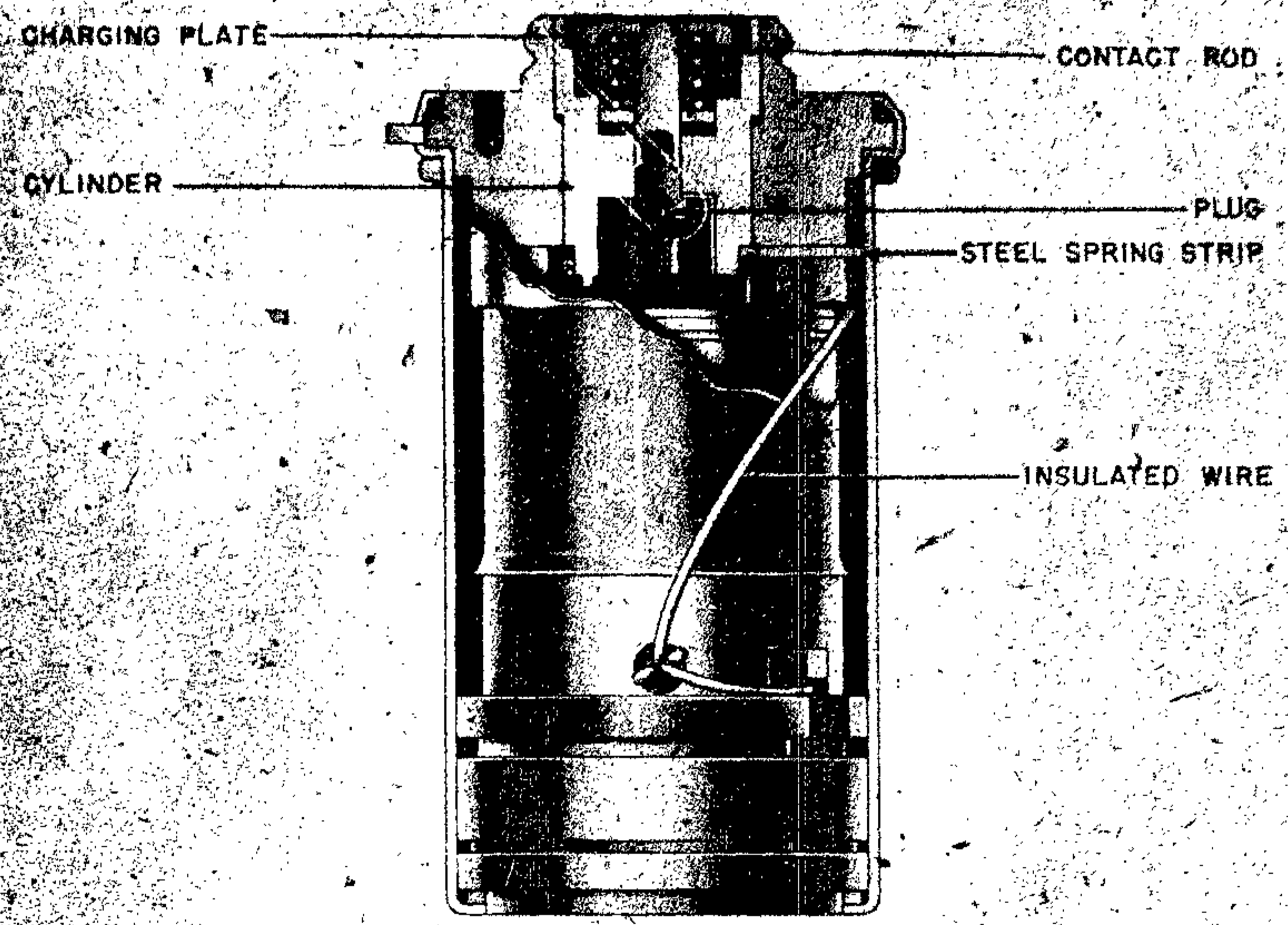

Figure 179—(89)B Clockwork Aerial Burst Fuze

(89)B (89)C CLOCKWORK AERIAL BURST**DATA:**

Bombs Used in: AB 250, AB 500, AB 1000,
FA 50 "Mark 50 F/A."

Color: Red.

Material: Sheet steel and aluminum.

Possible Actions:

Z 89B—1- to 80-sec. delay.

Z 89C—2 to 160 sec.

Markings: Z 89B, Z 89C on the spring loaded charging plate is "Nurfur Hand. Einstellung"—Not for hand setting.

Arming Times: Immediately on release from aircraft.

DESCRIPTION. The Z 89B is an electrically initiated clockwork fuze to give aerial burst. The mechanism is enclosed in a sheet metal casing similar to the 55 type fuze. The head of the fuze is machined to take a normal charging head but has one single charging plate instead of the two charging plungers. Attached to the charging plate is the contact rod, the lower end of which is machined externally to accept the insulated boss.

The time setting bush is rotatable and has a slot on the upper surface to take the time setting key. Projecting from the lower extremity of the time setting bush is a lug which contacts the nub on the timing disk.

The metallic strip A makes electrical contact with the contact rod when the disc is depressed. Strip A is continuous with metal ring B against which spring strip C presses. The latter metal strip is insulated from the body of the fuze and is connected to the firing bridge by means of an insulated wire. The return circuit is completed to the body of the fuze by a second insulated wire. The wires are external to the clock.

The clockwork mechanism is similar to the (17) series clock. It has one spring-loaded detent to hold the flywheel of the clock immovable and a second spring-loaded detent for safety device. This second detent holds the striker safety shutter in place.

The electrical igniter is so positioned that when it is fired, the thermal action created removes the detents, retaining the plug, allowing the spring loaded detents to remove themselves from the clock. Now the clock can run its set time. (See fig. 179.)

OPERATION. While the bomb is in the aircraft, the charging pins keep the charging plunger depressed. On release, a charge is passed through the igniter via the contact ring and second contact strip thereby firing it.

The explosion as mentioned above by either force or thermal action removes the retaining plug, the detents fly out and the clockwork begins to function. When the slot in the timing disc rotates to a point opposite the release nib, this spring loaded nib moves into the slot. This action frees the striker which is forced onto the detonator firing the fuze.

(89)D CLOCKWORK AERIAL BURST FUZE**DATA:**

Bombs Used In: Containers.

Color: Head—aluminum with red ring on circumference. Body—dark grey.

Material: Head—aluminum; Body—sheet steel.

Possible Actions: 2—83½ secs.

Arming Times: Immediately on release from aircraft.

Principal Markings: drh Z (89) D 58.

DESCRIPTION. The Zt. Z. (89) D fuze is similar to the Zt. Z. (89) B. On release from aircraft, the igniter is fired electrically, the clockwork mechanism started and the safety shutter released in an identical manner with that of the Zt. Z. (89) B. The timing disc, operated by the clockwork mechanism, rotates to bring the timing disc slot in line with the nib of the striker release arm. When this position is reached, the striker rotates, due to the action of the cam surfaces of the striker projection and steel pillar acting under the influence of the striker spring. When the striker projection is clear of the steel pillar, the striker spring forces the freed striker on to the detonator cap. (See fig. 180.)

REMARKS. This fuze has never been recovered in a container and therefore the types in which it is used are not known.

ZUS. 40 (TYPE II) MECHANICAL ANTIWITHDRAWAL FUZE**DATA:**

Bombs Used in: SC 250 & 500 Under a (17), (17) A, or (17) B.

Color: Unpainted.

GERMAN EXPLOSIVE ORDNANCE

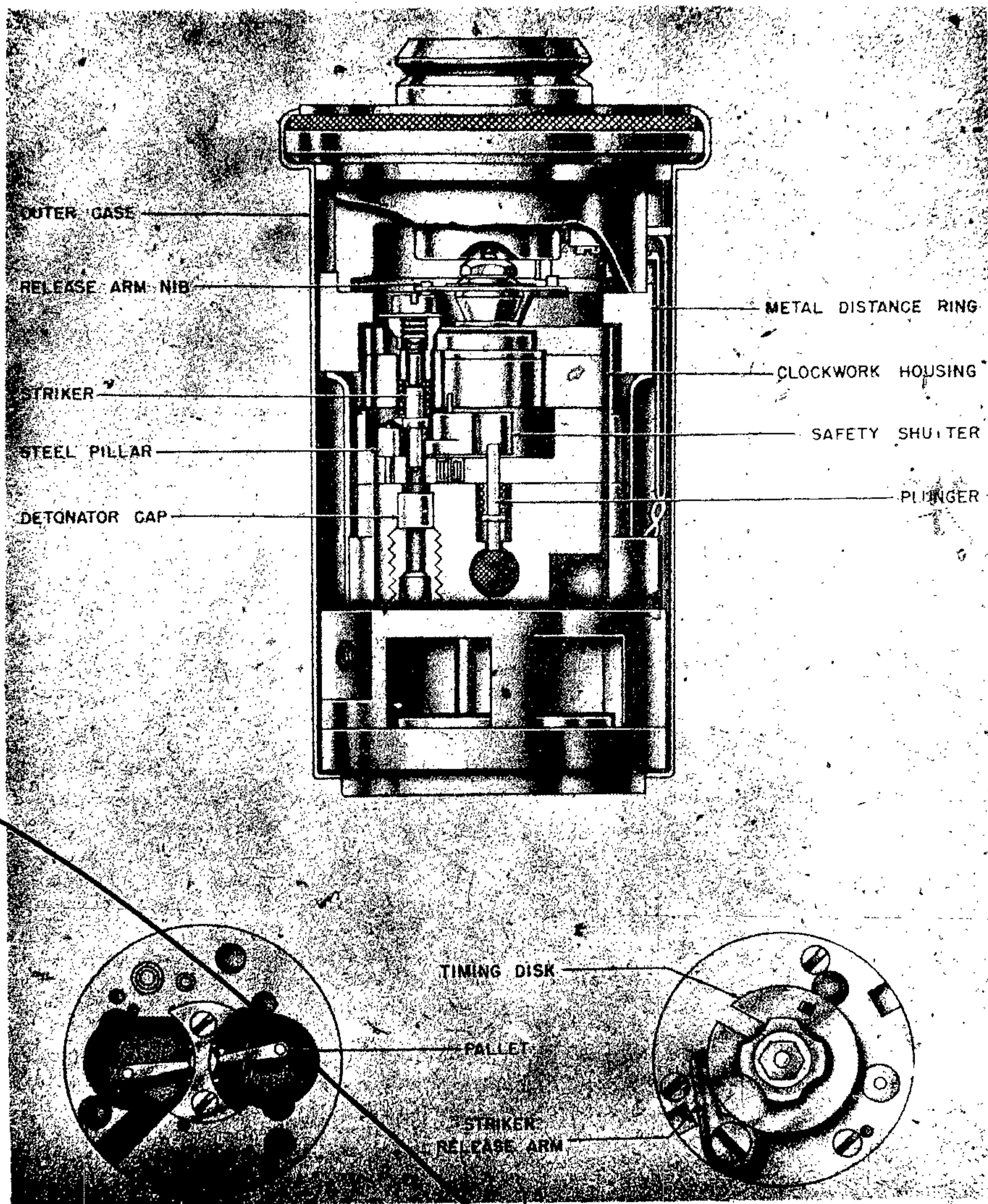

Figure 180—(89)D Clockwork Aerial Burst Fuze

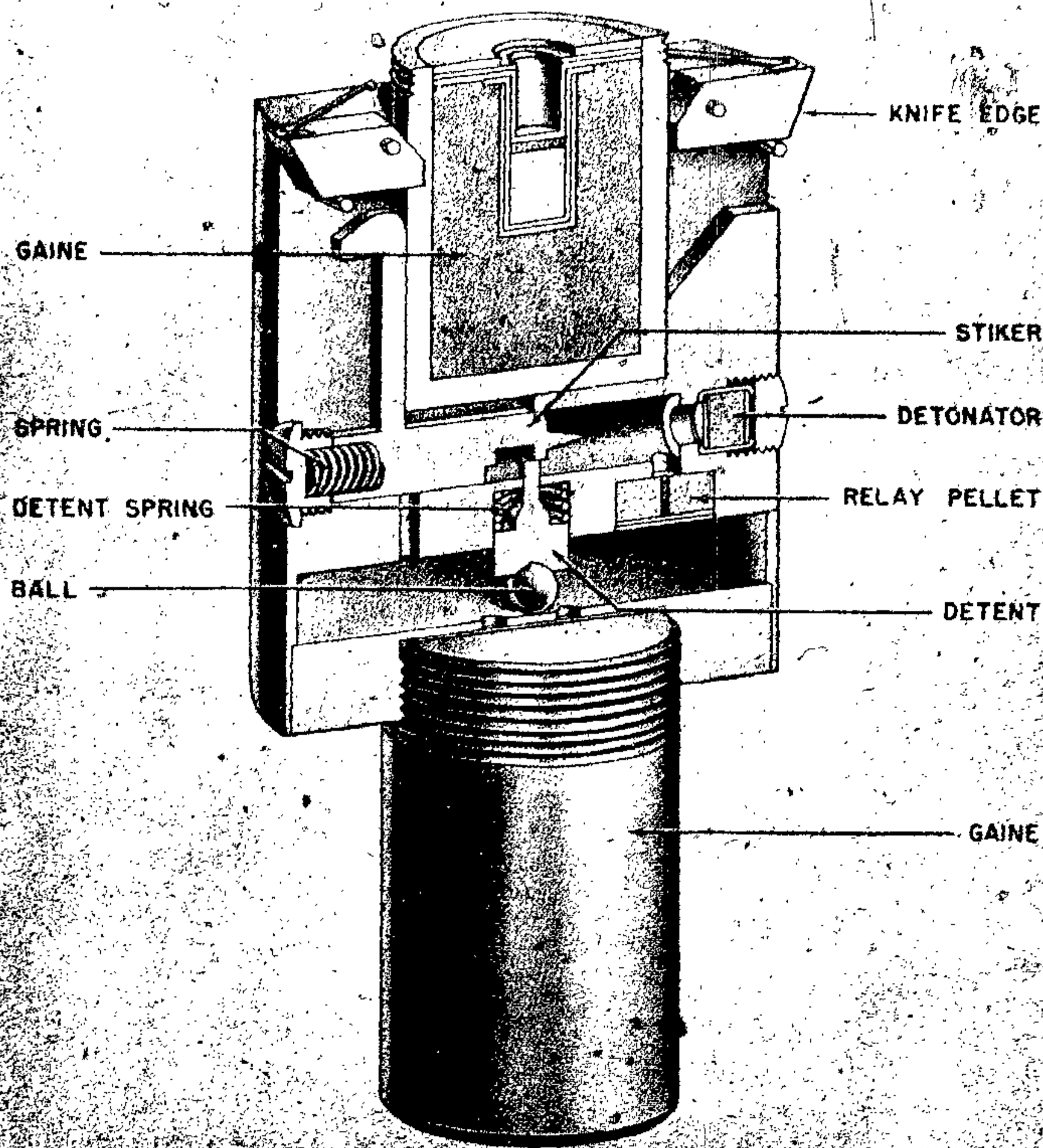

Figure 181—ZUS 40 (Type I) Mechanical Antiwithdrawal

Material: Aluminum.

Possible Actions: Instantaneous, on withdrawal of (17) type fuze.

Principal Markings: Zus. 40.

Secondary Markings: AA 1940, 392, bmv 41.

DESCRIPTION: This fuze is designated as a protective device to prevent withdrawal of a time fuze from a bomb. The fuze fits around the gainé of the time fuze which it is protecting, and another gainé is threaded into the base of the Zus. 40. (See fig. 181.)

The device is cylindrical with a central opening in the upper surface to receive the gainé of the fuze which it protects. In one side of the wall is an arm attached to a spring-loaded striker sliding in

a channel. This arm is restrained by the gainé of the Rheinmetall fuze. A detonator is located at the other end of this channel and is held in position by a threaded brass plug. A small flash channel below the detonator leads to the booster pellet. A small black powder charge intensifies the flash from the detonator. Located in a chamber below the striker is a spring-loaded detent held in position by a steel ball. The base of the Zus. 40 is closed by a plate threaded to receive a gainé. To prevent withdrawal of the Zus. 40 when the time fuze is removed, spring-loaded knife edges in this model are placed in the upper surface of the device. Two knives with piano wire springs bite into the sides of the fuze pocket and resist upward movement.

GERMAN EXPLOSIVE ORDNANCE

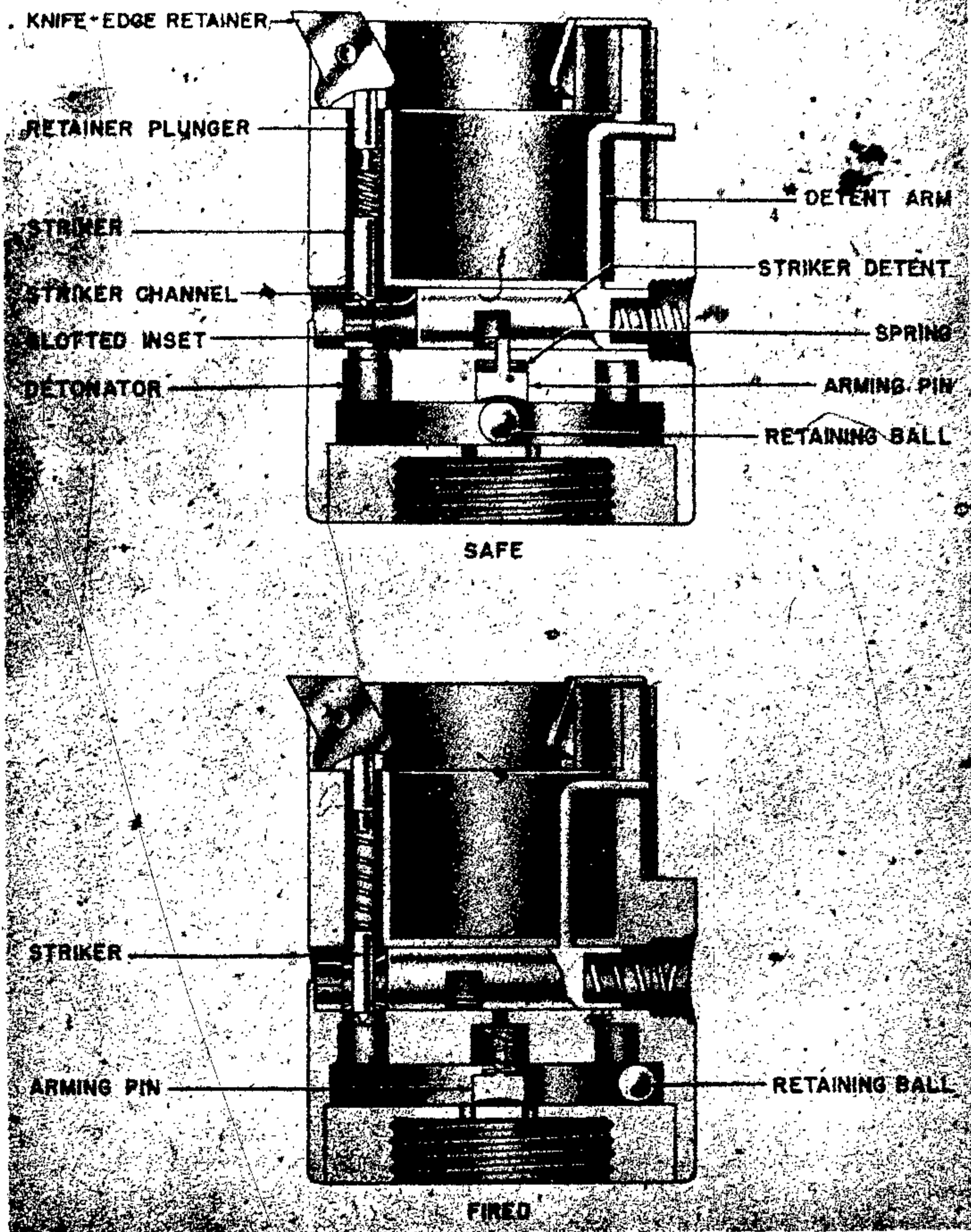

Figure 182—ZUS 40 (Type III) Mechanical Antiwithdrawal

OPERATION. Before the fuze is placed in the fuze pocket, the striker is retained by the spring-loaded detent and ball. When the time fuze gaine is inserted into the top of the Zus. 40, the striker arm is forced back into the body of the Zus. 40. This moves the striker back against its spring and removes the shoulder of the striker from the detent. On impact, the steel ball moves toward the nose of the bomb, forcing the detent upward

through camming action. As soon as the ball is free from under the detent, the detent moves down and out of the striker cavity. The Zus. 40 is now armed. When the time fuze is withdrawn 0.6 inch the striker arm is freed, and the striker moves across to hit the detonator. The detonator fires the relay, which flashes through the hole to the gaine, exploding the gaine and the bomb.

ZUS. Z. 40 (TYPE II), MECHANICAL ANTIWITHDRAWAL FUZE

DATA:

Bombs Used in: SC 250 and 500 under a (17), (17) A, or (17) B.

Color: Unpainted.

Material: Plastic.

Possible Actions: Instantaneous, on withdrawal of (17) type fuze.

Principal Markings: Zus. Z. 40.

DESCRIPTION. This fuze is similar to the Zus. 40, but is made of light plastic material and has three knife edges to prevent removal from the fuze pocket. These knife edges are actuated by spring-loaded plunger, rather than by light piano wire, as with the Zus. 40. In all other respects, this fuze is identical to the Zus. 40.

ZUS. Z. 40 (TYPE III), MECHANICAL ANTIWITHDRAWAL FUZE

DATA:

Bombs Used in: SC 250 and 500 under a (17), (17) A, or (17) B.

Color: Unpainted.

Material: Aluminum.

Possible Actions: Instantaneous, on withdrawal of (17) type fuze.

Principal Markings: Zus. Z. 40.

DESCRIPTION. Externally this fuze is similar to the Zus. Z. 40 plastic (type II) model, but the body is made of metal, and the component parts have in some cases been redesigned and the mode of operation altered. (See fig. 182.)

The body of the fuze has been drilled vertically beneath one of the three knife-edged retainers, to accommodate the striker, striker spring, and retainer plunger. The detonator is located in a housing formed vertically beneath the striker housing. Interposed between the striker and the detonator is the striker detent. This detent, designed on the lines of the striker of the earlier types of the Zus. Z. 40 is drilled to provide a striker channel, while a slotted inset, secured in the forward extremity of the detent, accommodates the striker point and allows for movement of the detent along its housing. The striker detent is machined on its under side to accept the stem of the arming pin, which, when the fuze is unarmed, is retained in position by the retaining ball.

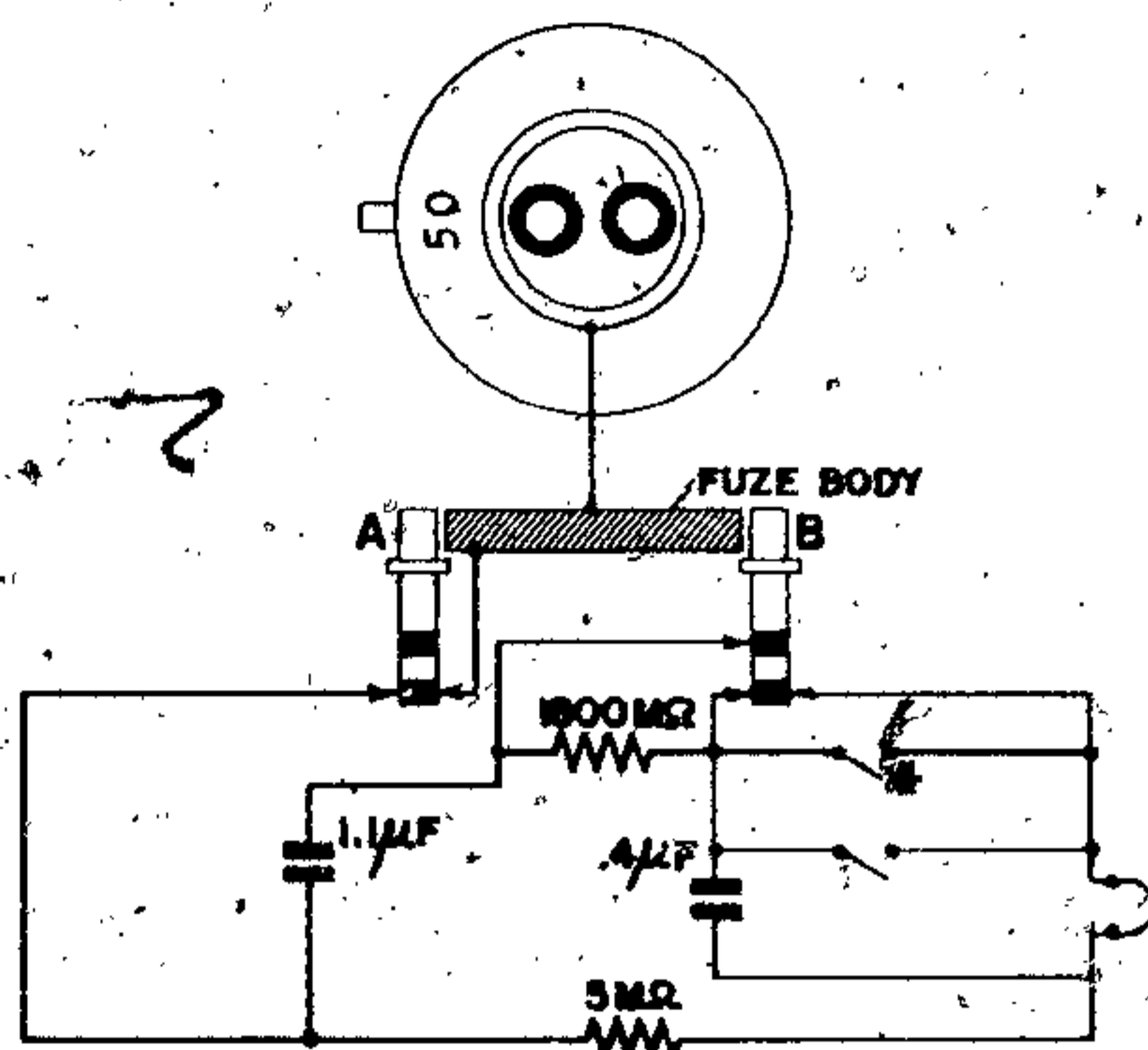

Figure 183—50 Electrical Antidisturbance Fuze

OPERATION. Before impact the retaining ball locks the arming pin in the housing on the under side of the striker detent. The striker detent masks the detonator and retains the striker point within the slot. On impact, the retaining ball is forced out of position from beneath the arming pin, and the arming pin spring forces the pin clear of the striker detent. The striker detent is now held in position only by the detent arm, which bears against the gain of the time fuze. When the time fuze is withdrawn, the detent is forced along its housing under the action of its spring. The striker channel is thus brought into alignment with both the striker and the detonator, and the striker is forced by its spring into the detonator. The resultant flash, passing through the flash holes in the base of the fuze, initiates the gain and subsequently the main charge of the bomb.

50 ELECTRIC ANTIDISTURBANCE FUZE

DATA:

Bombs Used In: SC 250 and 500 in conjunction with a type 7 fuze.

Color: Green.

Material: Aluminum.

Possible Actions: Instantaneous, on disturbance of bomb.

Arming Time: 3 min. (approx.).

Principal Markings: 50.

Secondary Markings: None.

GERMAN EXPLOSIVE ORDNANCE

DESCRIPTION. This fuze contains only one firing circuit and incorporates a very high resistance to give a long arming time, allowing the bomb to be completely at rest before the fuze arms. The two switches are typical inertia type, only more sensitive than those found in ordinary impact fuzes. They operate on a deceleration of only 1/3 g.

Safety switching is accomplished by depression of the A plunger, which acts as a switch in the ground circuit. Depression of the B plunger will fire the fuze. If the B plunger is found depressed, release of the plunger may also cause the fuze to fire. (See fig. 183.)

REMARKS. 1. Construction type 2.

(50) ELECTRIC ANTIDISTURBANCE FUZE

DATA:

Bombs Used in: SC 250 and 500 in conjunction with a type 7 fuze.

Color: Green.

Material: Aluminum.

Possible Actions: Instantaneous, on disturbance of bomb.

Arming Time: 5 min. (approx.).

Principal Markings: El. Z. (50).

Secondary Markings: AA 1940 cpp 1941.

DESCRIPTION. This fuze is similar to the 50, but incorporates two firing circuits. The B

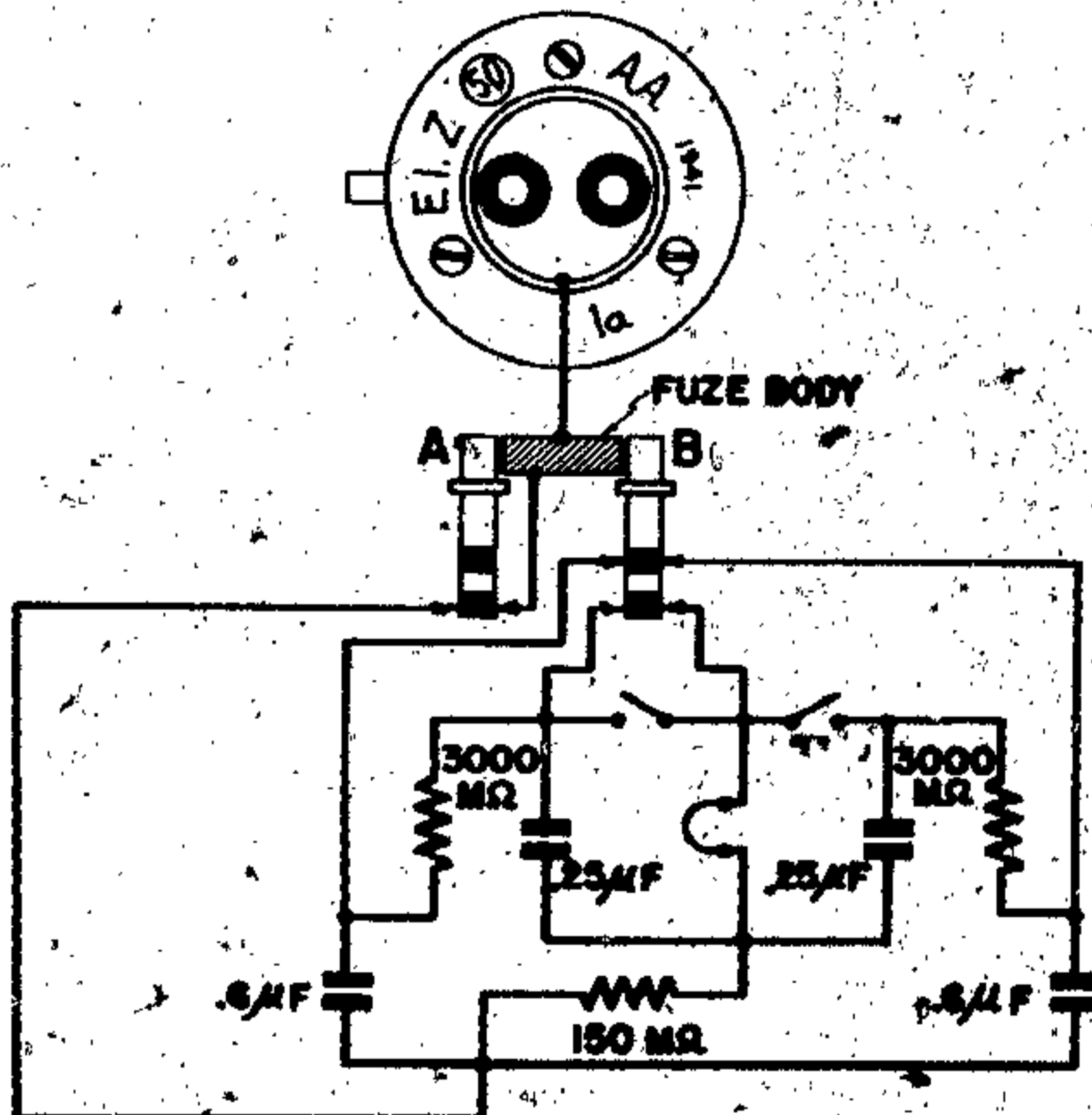

Figure 184—(50) Electrical Antidisturbance Fuze

plunger charges two reservoir condensers, each of which is capable of firing the single igniter bridge through its own sensitive switch. The switches are similar to the vibratory type found in the 50 fuze, operating on 1/3-g deceleration.

The A plunger acts as a switch in the ground circuit, while depression of the B plunger will fire the fuze. (See fig. 184.)

The resistance in this fuze has been increased, giving a longer arming time (about 5 minutes) than is found in the 50 fuze.

REMARKS. 1. Construction type 2.

(50) YELLOW TOP ELECTRIC ANTIDISTURBANCE FUZE

DATA:

Bombs Used in: SC 250 and 500 in conjunction with a type 7 fuze.

Color: Green; yellow around fuze head.

Material: Aluminum.

Possible Actions: Instantaneous, on disturbance of bomb.

Arming Times: 3.5-4.0 min. (approx.).

Principal Markings: El. A. Z. (50).

Secondary Markings: cpp 1941.

DESCRIPTION. This fuze incorporates two firing circuits and is similar in almost all respects to the ordinary (50) fuze. The A plunger, however, is of a new type. On depression it acts as a

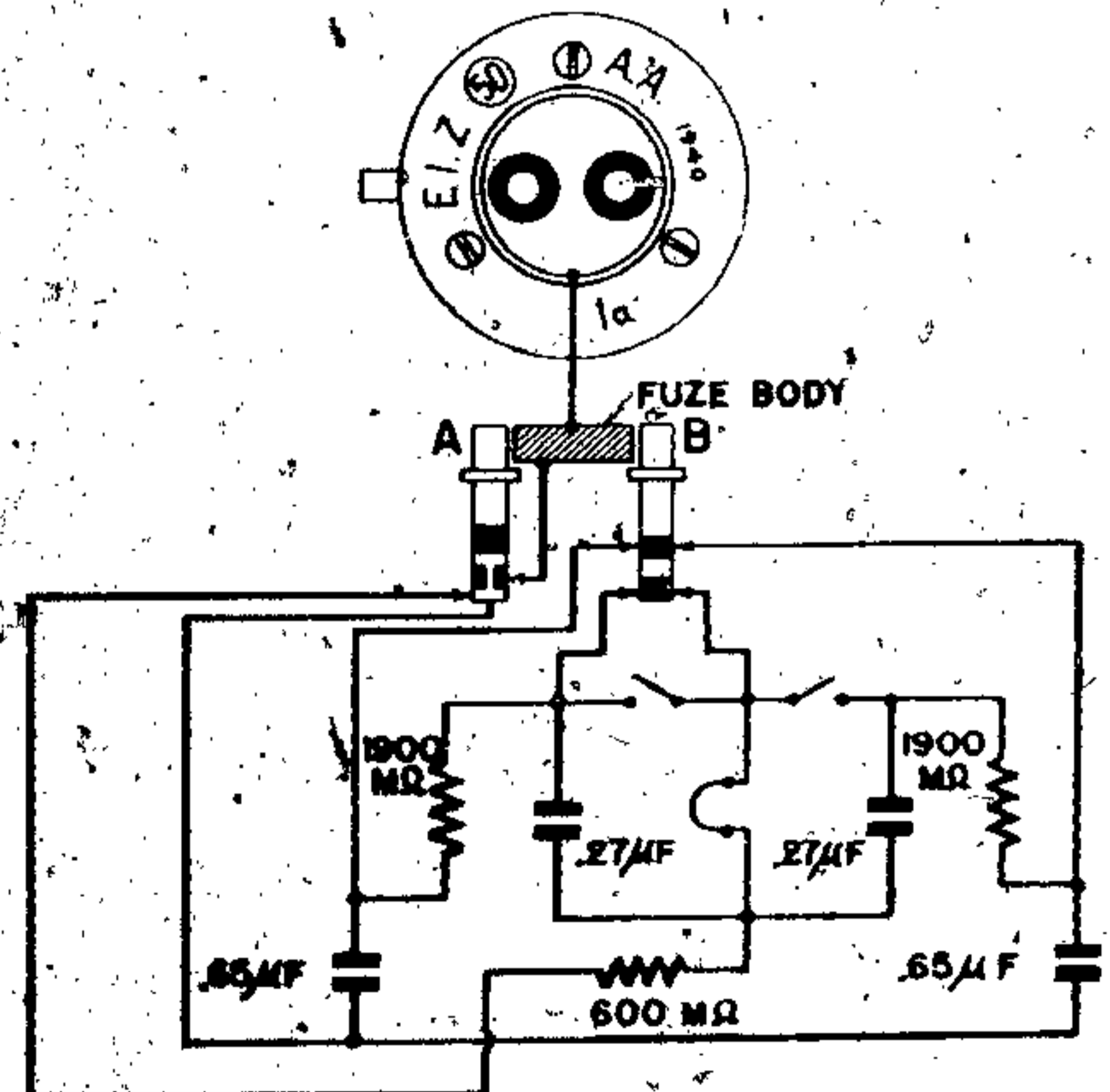

Figure 185—(50) Yellow Top Electrical Antidisturbance Fuze

switch in both the arming and firing circuits. (See fig. 185.)

The yellow paint around the head of the fuze

indicates that the fuze is unsuitable for low level attack.

REMARKS. 1. Type 2 construction.

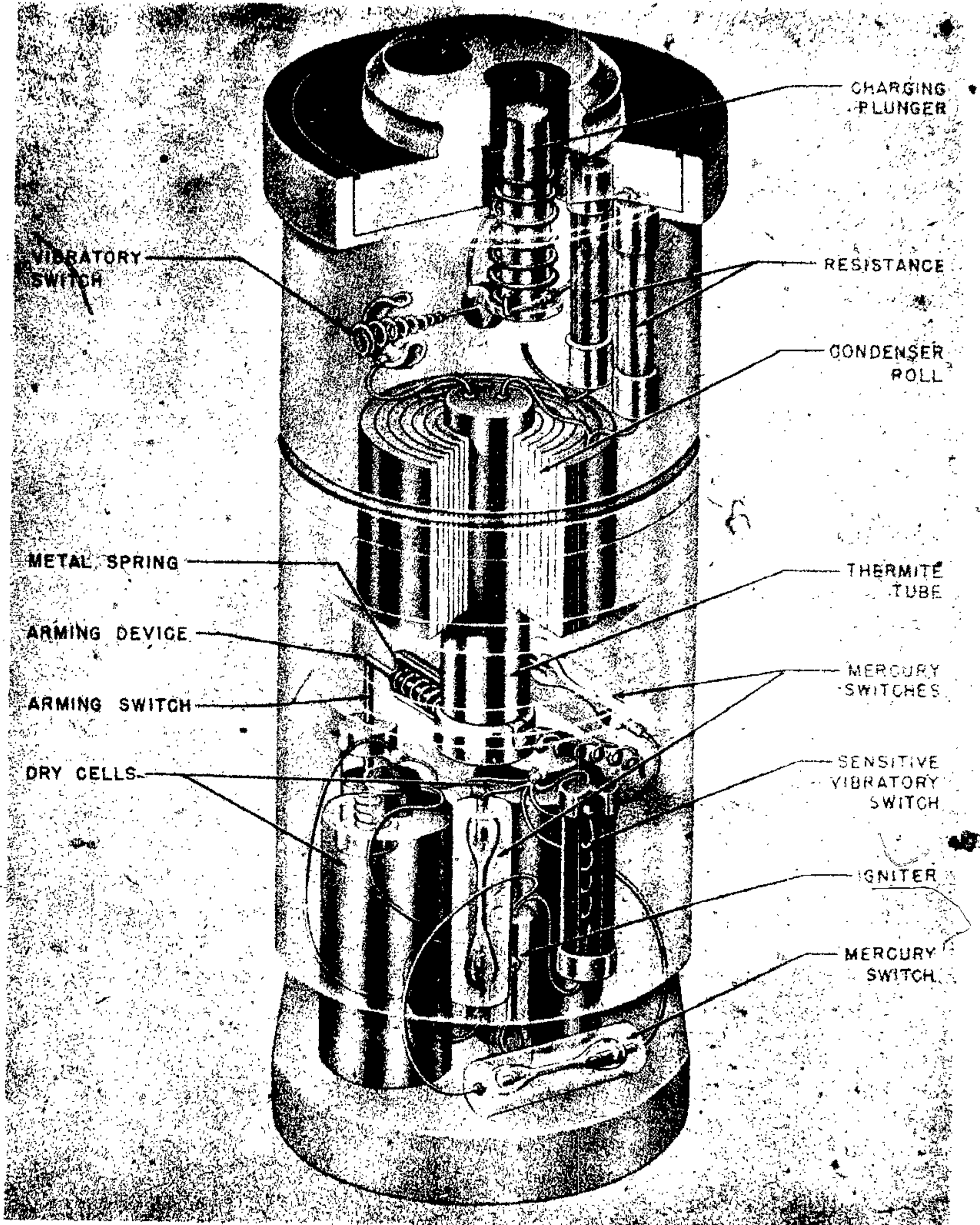
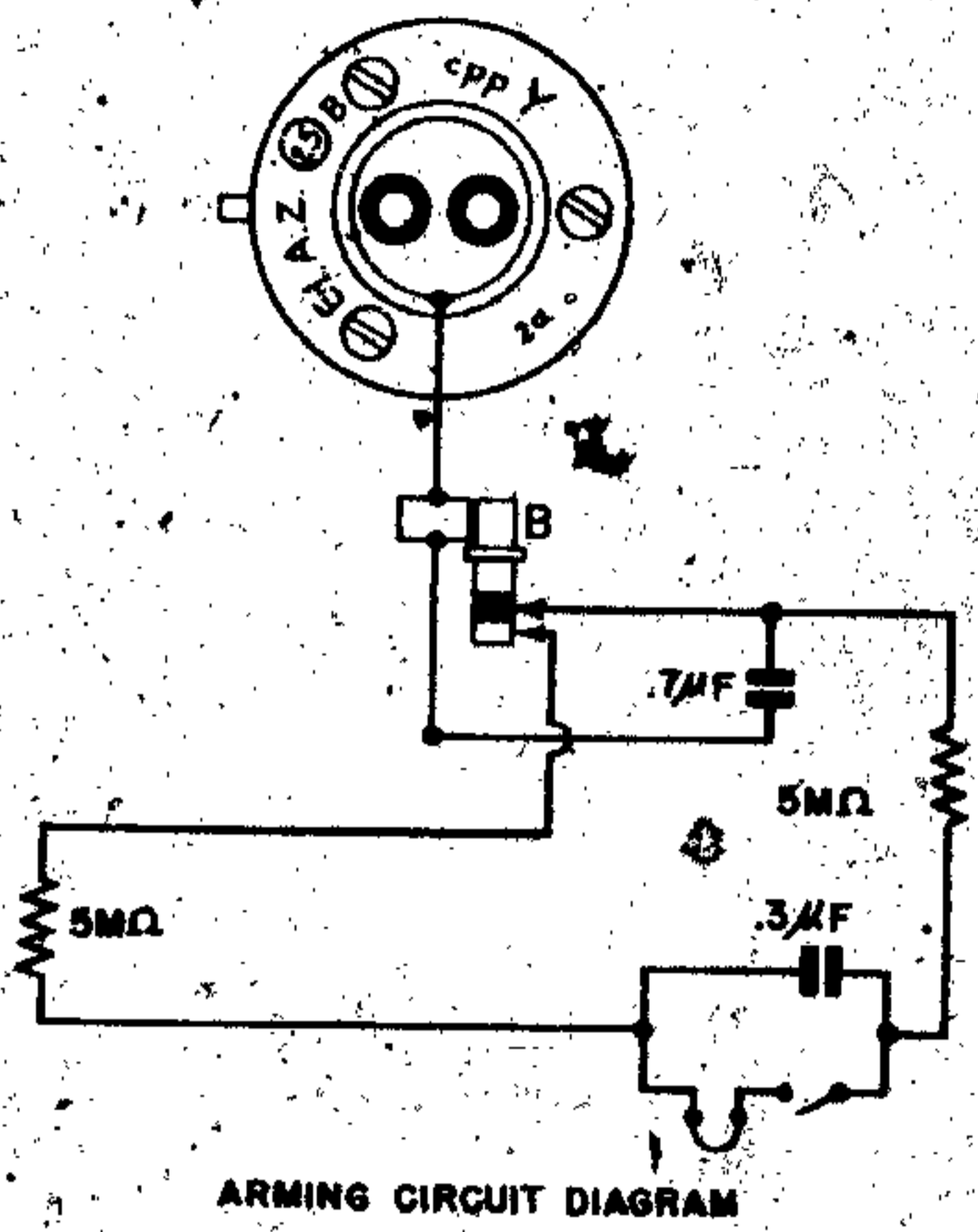
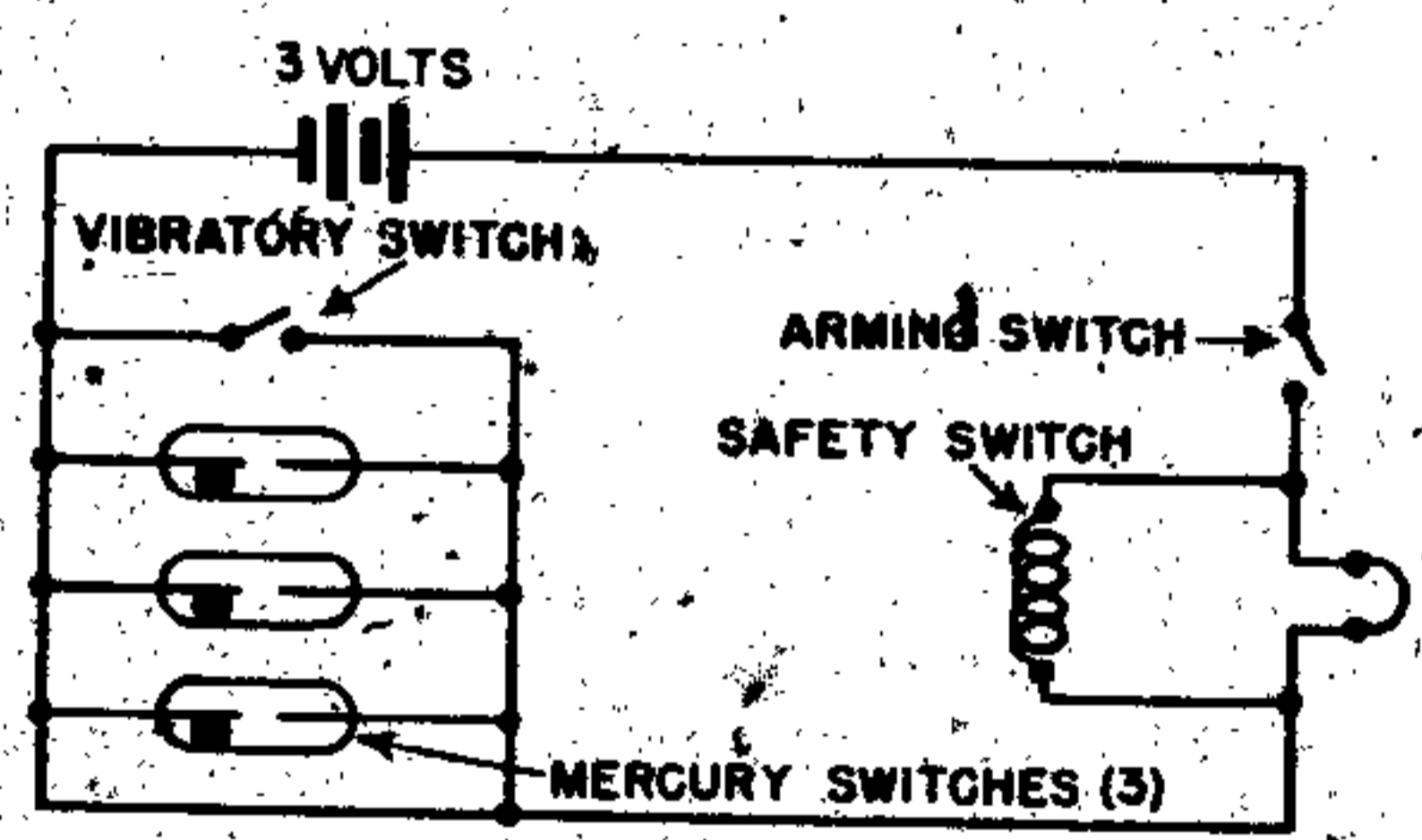

Figure 186A—50 b or "Y" Electrical Antidisturbance

GERMAN EXPLOSIVE ORDNANCE



ARMING CIRCUIT DIAGRAM



FIRING CIRCUIT DIAGRAM

Figure 186B—50 b or "Y" Electrical Antidisturbance Wiring Diagram

50b or "Y" ELECTRIC ANTIDISTURBANCE FUZE

DATA:

- Bombs Used in: H. E. bombs, alone or with other Rheinmetall fuzes.
- Color: Dark grey.
- Material: Aluminum.
- Possible Actions: Instantaneous, on disturbance of bomb.
- Principal Markings: El. A. Z. (25) B; El. A. Z. (25) B.
- Secondary Markings:

Fuze head.	Fuze body.
cpp Y 2a.	bmv 13e *42.
cpp Y 3a.	50b cpp *38.
	1942.

DESCRIPTION. The fuze consists of two main parts, the upper part which has a liquid-tight closed inner end is very similar to the upper portion of the (17) A fuze and serves a similar purpose (heat from a thermite charge, via an aluminum cylinder, arms the lower part of the fuze). The switch on the fuze head is a dummy, as also is one of the plungers. One specimen has been recovered with no switch on the fuze head.

The lower section of the fuze contains a polystyrene molding, which houses a simple wiring circuit, which connects two 1.5-volt dry cells with a low tension electric igniter. The circuit is connected in parallel with four sensitive switches. Three of these are of the mercury type, while the fourth is a normal vibratory switch. Two of the mercury switches are in the horizontal plane, at right angles to each other. The third mercury switch and the vibratory switch are in the vertical plane, parallel to the longitudinal axis of the fuze.

In the hinge of a collet which receives the aluminum incendiary boss from the upper section of the fuze is a fusible metal plug, which anchors one end of a spring under tension. This spring, while so anchored, acts as a safety device by short-circuiting the electric igniter. A secondary safety device is contained in the flange of the collet, where a polystyrene pellet is positioned to prevent a spring-loaded electric contact plunger from arming the firing circuit. (See fig. 186A and 186B.)

A gaine is screwed into the base of the fuze, and the flash channel of the gaine contains a pressed powder delay pellet.

The base of the fuze is conical in shape, and around the base runs a split steel ring. When the fuze is withdrawn, the ring rides up the slope of the cone and jams against the side of the fuze pocket, preventing withdrawal of the fuze.

OPERATION. On impact the thermite composition held in the container in the upper section of the fuze is ignited by the flash from the igniter bridge. This incendiary composition heats the walls of the aluminum boss of the fuze body which melts both the polystyrene pellet contained in the flange of the collet and the fusible metal plug contained in the hinge of the collet.

Under the influence of its spring, the contact plunger moves forward to arm the firing circuit. Under its own tension, the metal spring is drawn clear of the fused metal plug and ceases to short

circuit the igniter bridge. The fuze is now fully armed.

The fuze now operates as a normal (50) fuze so far as the vibratory switch is concerned, while a rotation of 2° is sufficient to close one or more of the mercury switches. These four switches are

wired in parallel, and the closing of any one will immediately complete the firing circuit and fire the igniter bridge. The flash from the low tension igniter bridge ignites the relay pellet in the gaine holder, and the flash from this pellet initiates the explosive gaine and detonates the bomb.

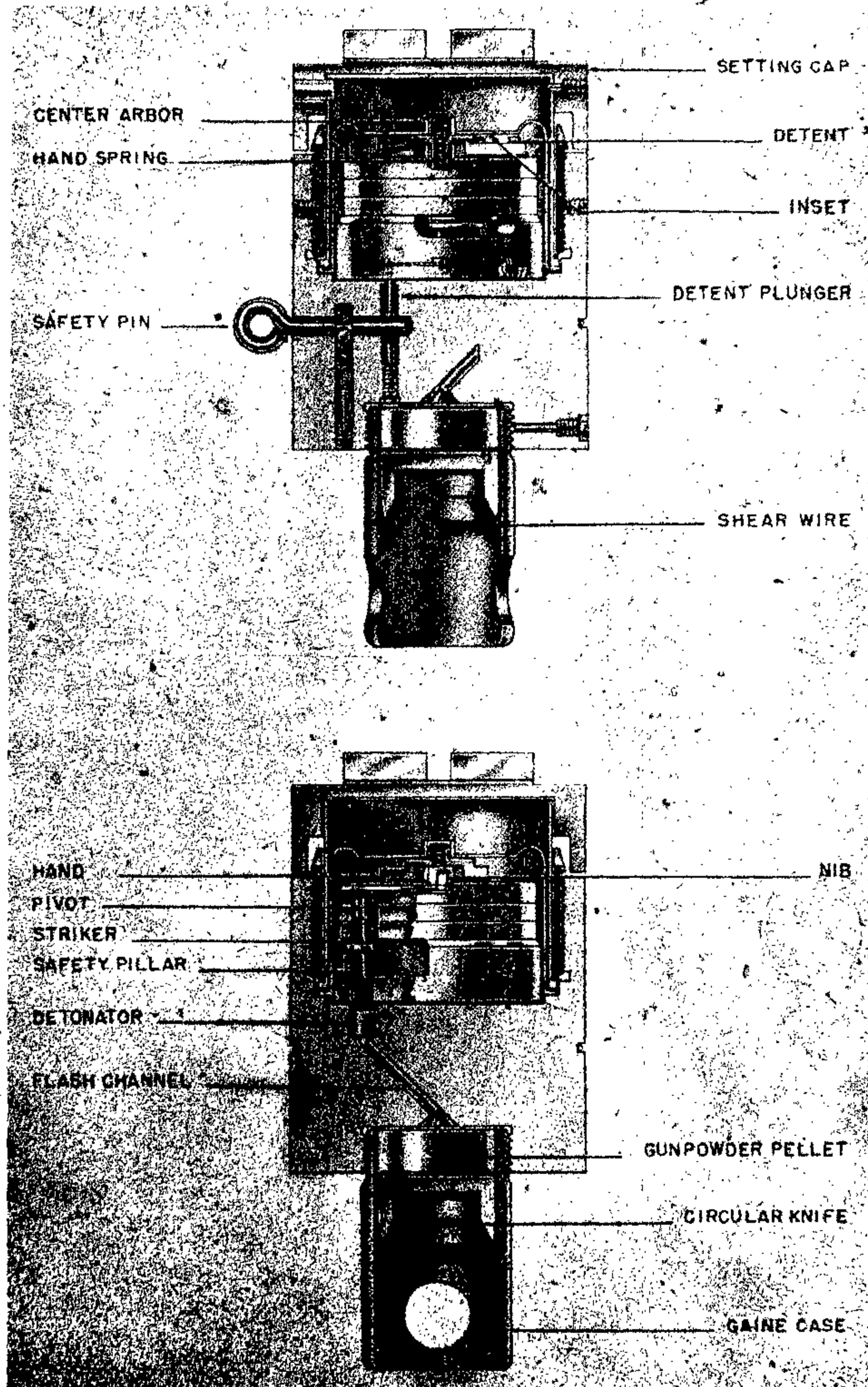

Figure 187—FZ 60 Clockwork Aerial Burst Fuze

GERMAN EXPLOSIVE ORDNANCE

REMARKS. 1. Construction type 4A. 2. It is reported that this fuze can remain active for several months.

FZ 60 CLOCKWORK AERIAL BURST FUZE

DATA:

Bombs Used in: Supply-dropping container.
Color: Unpainted.

Material: Aluminum.

Possible Actions: Up to 60 seconds after release.

Arming Times: Immediately on release.

Principal Markings: FZ 60.

Secondary Markings: drh 1943.

DESCRIPTION. The fuze is employed to shear a cable on a supply container to release the parachute. The fuze is housed within a recess cut in



Figure 188—(70) B Clockwork Antidisturbance Fuze

one of the four tail fins of the container and is secured in position by two metal straps. (See fig. 187.)

The fuze consists of a normal clockwork mechanism housed in a cylindrical aluminum container. The fuze is held in the unarmed position until release from the plane by a safety pin. This safety pin holds an arming detent upwards against the tension of its spring and in engagement with the escapement mechanism of the clock.

OPERATION. When the container is released from the plane, a static cord removes the safety pin, freeing the arming detent and allowing the clock to begin functioning. When the clock has run out its prescribed setting, a striker is freed and allowed to strike a detonator. The flash from the detonator passes through the flash channel in the base of the fuze body and ignites the powder pellet located in the gaine. A circular knife, retained by a shear wire, is located beneath the powder pellet in the gaine, and the parachute release cable is passed through two holes in the base of the gaine immediately below the knife. The explosion of the powder pellet forces the circular knife through the shear wire and causes it to sever the cable.

(70)A CHEMICAL-MECHANICAL LONG DELAY AND ANTIDISTURBANCE FUZE

DATA:

Bombs Used in: SD-2B.

Color: Unpainted.

Material: Alloy.

Possible Actions: Antidisturbance; long delay.

Arming Times: 5 min. (approx.)

DESCRIPTION. Although this fuze has not as yet been recovered, its existence has been ascertained from examination of many captured enemy documents.

The fuze is an antidisturbance fuze, depending on position, with a chemical long delay of from 4 to 30 hours as a self-destructive device. The fuze has the same appearance as the (41)A fuze, with small differences in the spindle and the fuze head. The fuze is partially armed by the rotation of the arming spindle, and is fully armed after about 5 minutes, when the celluloid plate on the short delay striker dissolves. If the bomb remains without disturbance, the long delay mech-

anism comes into operation as a self-destructive device.

The fuze can be used in the SD 2B ("Butterfly bomb"), which has a bayonet type fitting for the fuze.

Employment of this fuze against a retreating enemy is forbidden because of the danger to own troops. Like the (70) B fuze, it is to be used against targets behind the front line for harassing effect only.

(70) B, (70) B/1, CLOCKWORK ANTI-DISTURBANCE FUZE

DATA:

Bombs Used in: SD 2B.

Color: Unpainted.

Material: Alloy metal.

Possible Actions: Antidisturbance.

Arming Times: 5 seconds after impact.

Principal Markings: (70) B, (70) B/1.

Secondary Markings: "cja" and date, as: "8/42", etc.

DESCRIPTION. This fuze can be distinguished by the markings and by the raised boss on the fuze head. It is otherwise similar in appearance to the (67) fuze. (See fig. 188.)

The clockwork mechanism completes its run in three periods: during descent, for about $\frac{1}{2}$ second; on impact, for about 5 seconds; after disturbance, for about 1 second.

The mainspring of the fuze is wound around a stud and engages a release pin, tending to force the driving wheel in a clockwise direction. This driving wheel, mounted on a boss, carries two projecting pins and has a slot through which the arming rod passes into the lower fuze casing. One sector of the driving wheel is toothless.

The balance wheel controls the running speed by the action of the two pallet bosses on the escapement. Attached to one of these bosses is a small spring (not shown) which bears against the arming rod and so locks the mechanism until the arming rod is withdrawn during descent.

An inertia spring is anchored by a screw and carries on its free end a stop pin projecting from a weighted boss. A loosely mounted inertia block is supported by a length of spring steel held in place by a stud.

The striker assembly, containing a striker spring, striker, and cap, is identical to that of the (41) fuze. The striker is held cocked by the detent

GERMAN EXPLOSIVE ORDNANCE

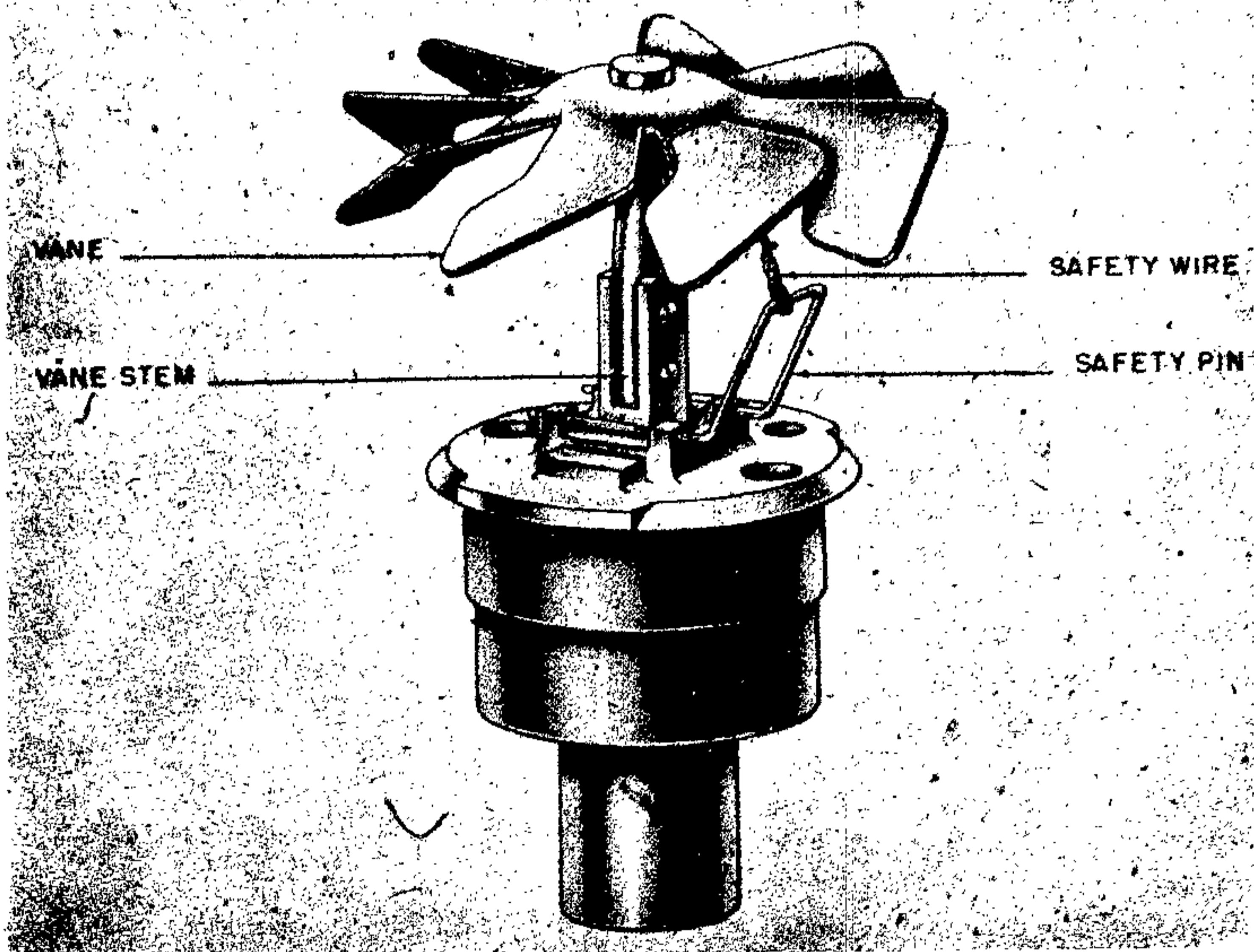

Figure 189—(70) B Modified Antidisturbance Fuze

spindle, on which is mounted the striker detent lever, which is prevented from rotating by the restraining arm.

OPERATION. The safety pins or wires are reeved through the holes in the studs on the top of the fuze head and also through the holes in the arming rod. These are removed before the bomb is loaded in the container.

On release from the container, the vanes rotate and withdraw the arming rod from the fuze body, freeing the balance wheel. This allows the clock mechanism to run until the release pin comes against the inertia spring stop pin.

On impact the inertia moves downwards, clearing the release pin. The clock mechanism then restarts until the stop pin comes up against the nib on the inertia block. This leaves the fuze in a fully armed condition.

Any subsequent shock will displace the lightly balance inertia block, disengaging the nib from the stop pin. The clock mechanism then begins its final run.

After running for about 1 second, the toothless sector of the driving wheel comes into line with

the pinion of the escapement which therefore ceases to control the running speed of the clock. The driving wheel continues to run with increased momentum until the release pin hits the restraining arm and disengages it from the striker detent lever. The compressed striker spring is then free to force the striker into the cap and explode the bomb.

REMARKS. 1. The (70) B/1 is identical to the normal (70) B, except for minor modifications in the clockwork mechanism.

(70) B, CLOCKWORK ANTIDISTURBANCE FUZE (MODIFIED)

DATA:

- Bombs Used in: Aircraft towed paravane bomb.
- Color: Unpainted.
- Material: Alloy metal.
- Possible Actions: Antidisturbance.
- Arming Times: About 5½ seconds after arming vanes released.
- Principal Markings: (70) B.
- Secondary Markings: 13.

DESCRIPTION. The modified (70) B fuze is

similar to the normal (70) B, with the following exceptions:

A. An arming vane stem, with an eight-bladed arming vane attached, is fixed to the arming spindle by two screws in the normal manner;

B. No inertia spring is fitted;

C. The stud which forms the driving wheel pivot is provided with right-hand, instead of left-hand threading;

D. In storage, a thin wire secures the arming vane to the safety pin. (See fig. 189.)

OPERATION. When the arming vanes are released, the vanes rotate and withdraw the arming spindle. When the spindle has been withdrawn about one-quarter inch, the escapement locking spring is freed and the clockwork mechanism commences to arm the fuze.

After about $5\frac{1}{2}$ seconds, the driving wheel stop pin is brought to bear against the nib of the release block, and the clockwork is stopped by this engagement. The fuze is then fully armed.

Any subsequent disturbance of the fuze or bomb will cause the fuze to function in a manner identical to that described for the normal (70) B.

VZ (80) MECHANICAL IMPACT "ALL-WAYS" ACTION FUZE

DATA:

Bombs Used in: HS 293 (to destroy equipment).

Color: Unpainted.

Material: Aluminum.

Possible Actions: Instantaneous.

Markings: VZ (80) cpp 3by.

DESCRIPTION. This fuze is housed in the radio compartment of the HS 293 immediately to the rear of the warhead. It is a sensitive "all-ways" action impact fuze and its only function is to destroy the radio equipment. (See fig. 190.)

The fuze is constructed so as to fit into the standard fuze pocket. The fuze body is threaded internally at the base to take a standard gauge and externally to take the charge case which is filled with penthrate wax (approximately 6 ounces).

A chamber machined through the lateral axis of the fuze accommodates the striker assembly. The inner wall of this chamber is a concave truncated cone against which the detonator holder bears.

The striker assembly consists of the striker body, striker needle, creep spring and detonator holder. The head of the striker body is conical in shape and bears against the circular closing cap which is positioned in the mouth of the machined chamber.

When the striker assembly is assembled in the fuze, the striker body partially enters the detonator holder and is retained clear of the detonator by means of the creep spring.

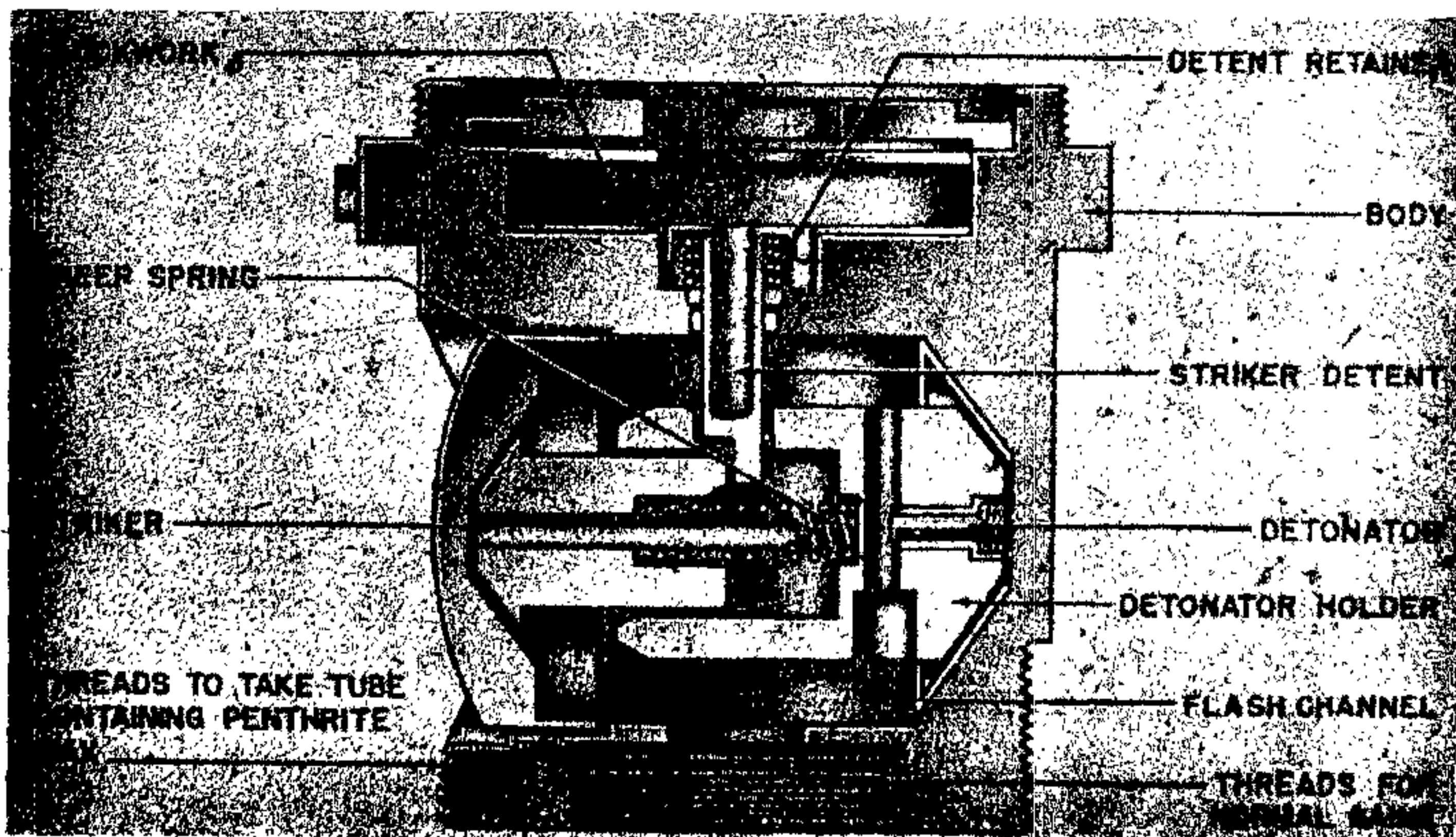

Figure 190—VZ (80) Mechanical All-Ways Action Fuze

GERMAN EXPLOSIVE ORDNANCE

A safety feature is incorporated by means of a striker detent. A detent retainer, one end of which is attached to a wheel in the clockwork mechanism, keeps the striker detent in position until approximately 5 seconds after the bomb leaves the aircraft. The clockwork regulates the length of arming time.

OPERATION. When the bomb is released from the aircraft, an arming link or static cord pulls out the safety pin which locks the striker detent retainer. On this action the extended spring attached to the striker detent retainer exerts its force upon the retainer moving it clear of the striker detent. The speed at which this takes place is governed by the clockwork gear train. When the retainer is clear of the striker detent, the detent spring forces it away from the striker assembly.

The fuze is now armed with only the creep spring maintaining the striker clear of the detonator cap. On impact, the striker body moves forward against the creep spring and the point of the striker impinges upon the detonator firing it. The flash passes through the channel as shown and

sets off the gaine and then the main charge; the main charge consisting of the penthrite wax in the container around the gaine.

(80) A, MECHANICAL IMPACT, "ALL-WAYS" ACTION FUZE

DATA:

Bombs Used in: "V-1", flying bomb.

Color: Unpainted.

Material: Aluminum.

Possible: Actions: Instantaneous.

Arming Times: 6-7 minutes.

Principal Markings: (80) A.

DESCRIPTION. This fuze is very similar in appearance and construction to the VZ (80) but differs from it in the following respects: (a) The lower part of the fuze body is not threaded to receive the special explosive-filled pocket which is fitted to the VZ (80); (b) the clock-work which controls the arming time runs for 6 or 7 minutes before the fuze arms, as against about 5 seconds for the VZ (80).

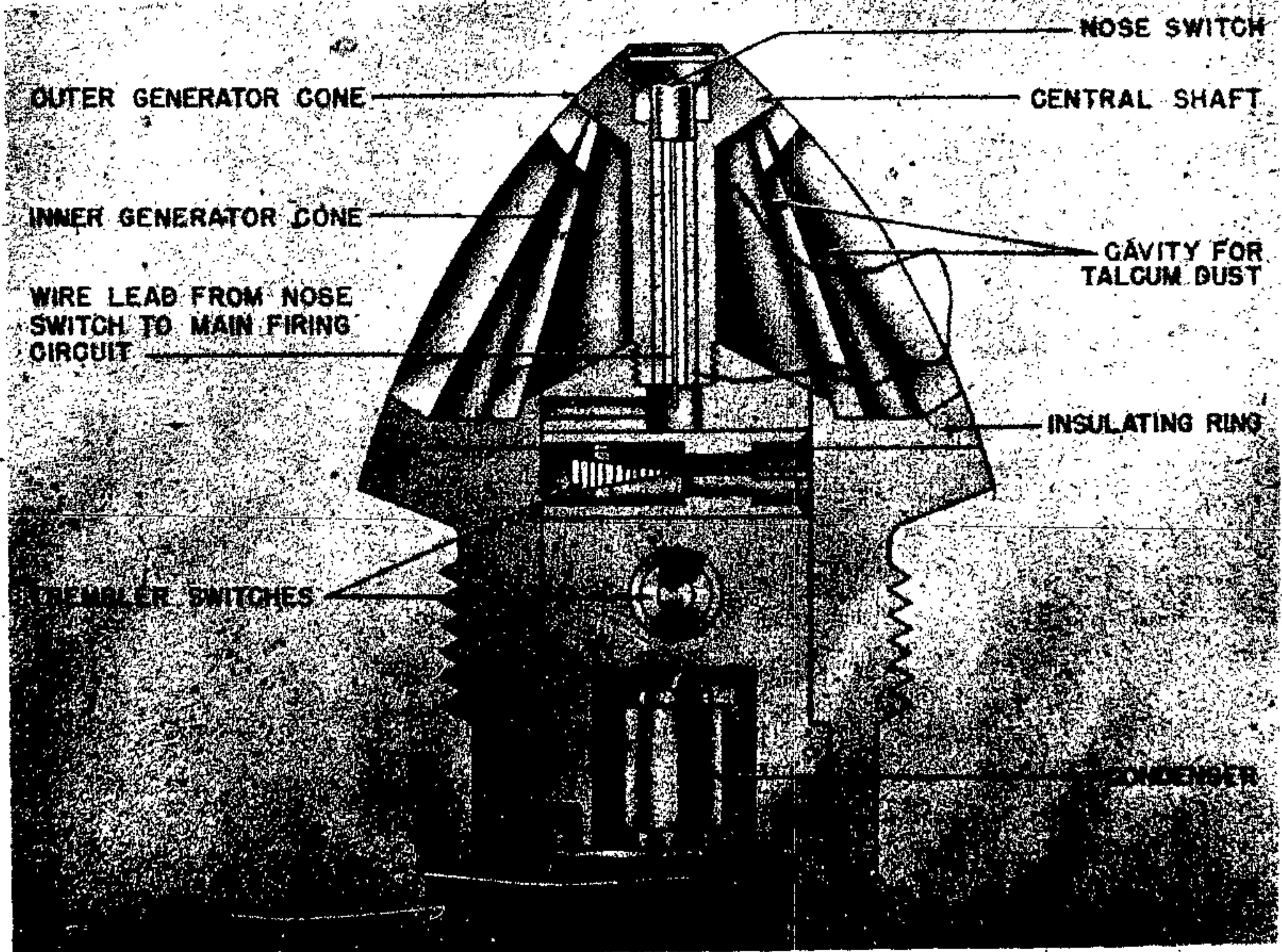

Figure 191A—Dust Fuze for SD-10 Bomb

There is no marking on the fuze head.

OPERATION. When the bomb is launched, the arming ring of the fuze is pulled, removing the central part of the aluminum diaphragm and the spiralled arming wire. The removal of the latter releases a lever which frees the balance wheel of the clock and allows the clock to begin operating. After 6 or 7 minutes, the arm holding down the arming bolt springs to one side, and the arming detent is forced out by its spring. The fuze is now fully armed and functions in a manner identical to that of the VZ (80).

DUST FUZE FOR GERMAN SD 10 BOMB

DESCRIPTION. The principle of charging a condenser electrostatically by means of a dust field was developed several years ago by the electrical fuze laboratory of Rheinmetall Borsig. It was decided early in 1943 to incorporate such a principle into fuzes for the projectiles and small bombs.

The original tests on the feasibility of dust type arming fuzes for small bombs were carried out using the EI 224.02 37-mm. projectile fuze especially adapted for the SD 4 antipersonnel bomb. The test data resulting from the use of this equipment proved to be very inadequate.

In order to further develop this principle for use in bombs, an impact nose fuze was developed for the SD 10 antipersonnel bomb which incorporated a larger static generator than which has previously been used.

This fuze was so designed that the static generator necessary for creating the required electrical charge could be installed in the base of the old A. Z. C. 10 mechanical impact fuze. For the sake of simplicity this fuze can be divided into two main parts: A—the upper half which consists of the static generator and one impact switch, and B—the lower half which consists of the body of the fuze. A plexiglas insulating ring separates the static generator from the main body of the fuze. (See figs. 191A and 191B.)

The constituent components for each part are as follows:

A. Upper part (static generator):

1. Central shaft.
- 1a. Nose impact switch.
2. Outer generator cone.
3. Inner generator cone.
4. Plexiglas insulating ring.

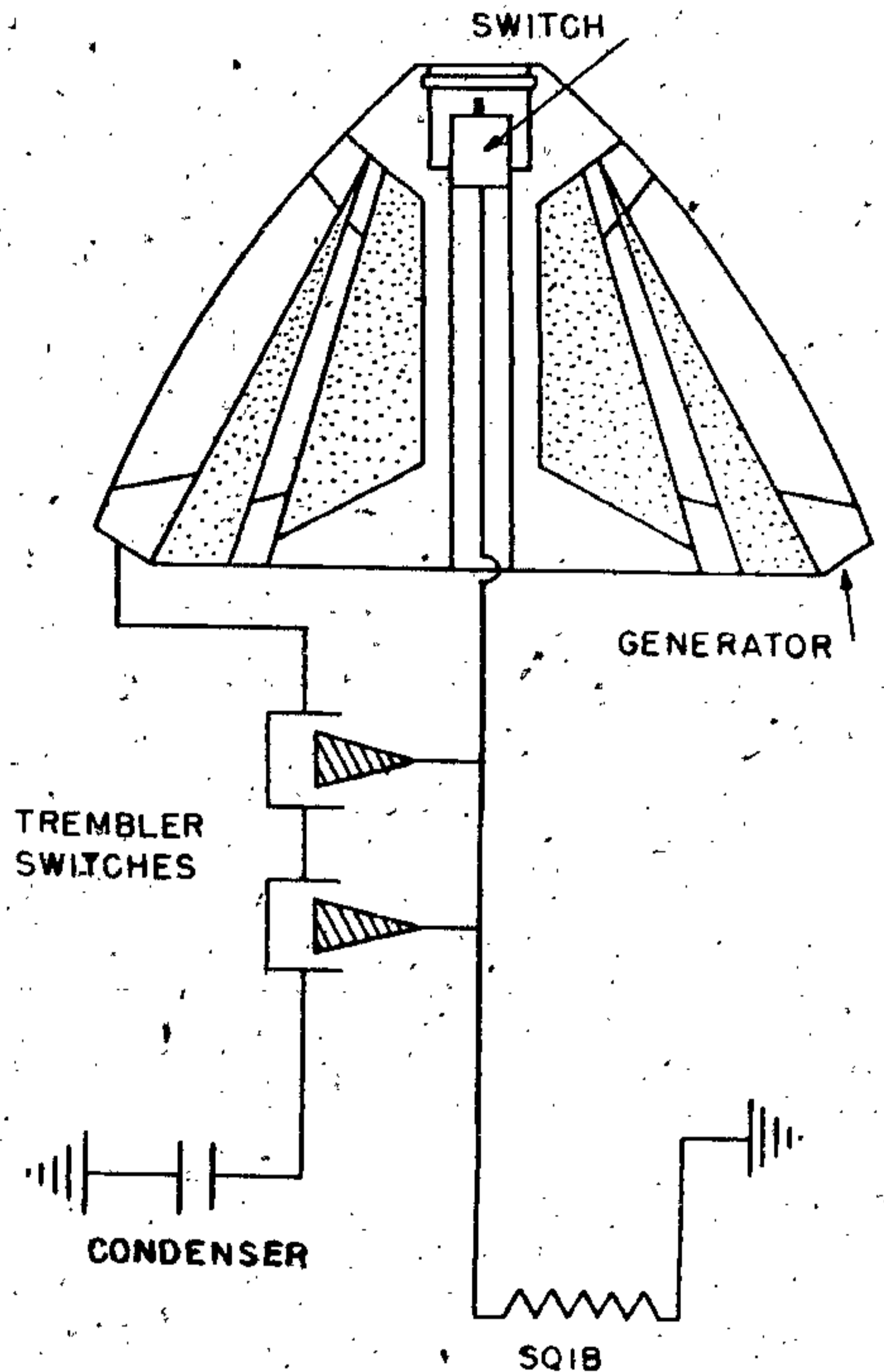

Figure 191B—Dust Fuze for SD 10 Bomb Wiring Diagram

B. Lower half (fuze body):

1. Fuze body.
2. Plastic circuit housing.
 - 2a. Tumbler switches.
 - 2b. Condenser.
3. Squib.
4. Tracer cup.
5. Tracer cup cover.

The central shaft performs two functions. Its primary function is to hold the static generator together. This is accomplished by threading the lower end of the shaft into the plastic housing within the fuze body itself. By this means the two generating cones are forced down on the insulating ring and held fast. The secondary function of the shaft is to house one impact switch of the firing circuit and the insulated tube for the electric lead to the switch.

GERMAN EXPLOSIVE ORDNANCE

The over-all dimensions of the fuze are as follows:

Height: 4 inches.

Diameter: 2.7 inches.

The over-all height does not include the gaine or booster which normally threads into the base of the fuze.

The outer generator cone dimensions are as follows:

Over-all height: $1\frac{1}{2}$ inches.

Outside diameter at base: $2\frac{9}{16}$ inches.

Outside diameter at top: $1\frac{5}{16}$ inches.

Over-all thickness of cone wall: $\frac{1}{32}$ inch.

Number of slits: 17 or 19.

Length of slits: $1\frac{1}{2}$ inches approximately.

Width of slits: $\frac{1}{32}$ inch.

The inner generator cone dimensions are as follows:

Over-all height: $1\frac{3}{8}$ inches.

Outside diameter at base: $1\frac{11}{16}$ inches.

Outside diameter at top: $\frac{3}{4}$ inch.

Over-all thickness of cone wall: $\frac{3}{32}$ inch.

Number of slits: 13 to 15.

Length of slits: $1\frac{1}{16}$ inch approximately.

Width of slits: $\frac{1}{32}$ inch.

The insulation dimensions are as follows:

Outside diameter: $2\frac{23}{32}$ inches.

Inside diameter: $1\frac{3}{16}$ inches.

General thickness: $\frac{3}{32}$ inch.

Built-up thickness at outside perimeter: $\frac{1}{32}$ inch.

The firing circuit is set up along the lines of all standard fuze firing circuits. The generator is connected to the condenser by a wire lead which runs up through the plastic housing, across the upper side of the plexiglas insulating ring and makes contact with the outer generating cone. The other lead from the condenser is grounded to the lower fuze body. A lead from the nose switch is connected in series with the two spring type trembler switches and also the squib and then grounded.

OPERATION. The plastic cap covering the slits on the head of the fuze is removed just before the bombs are dropped. As the bombs fall free, the air stream enters the fuze via the slits in the outer generating cone. This action disturbs the talcum dust and creates a dust screen in and around the forward part of the fuze.

The electrostatic charge is developed when the dust particles come into violent contact with each other and with the two generator cones. The condenser is connected to the two generator cones and draws off the charge as it is built up. A charge more than sufficient for igniting the detonator on impact is developed by controlling the quantity of dust within the fuze.

Anyone of three switches (two trembler switches set at right angles to each other, and a nose contact switch) will close the circuit and fire the fuze on impact. An extremely low energy electric igniter is used with this type of fuze so that even though a small part of the charge leaked off of the condenser, the charge left would be enough to fire the fuze.

GERMAN ROCKETS

INTRODUCTION

General.

The value of the rocket as a weapon of war has been proved during the conflict of the past 5 years. Even with the vast amount of work that has been done on the rocket during this war, there is a great deal of work still to be done in perfecting it.

During the past few years research work in this field has brought about the following improvements over the old types:

1. The accuracy has been increased by rotating the projectile. This is effected by using skew venturi. The rotations developed range between 1,000 and 1,500 r. p. m. and considerably reduce the deviations of the projectile due to the influence of the wind.

2. The range has been increased by using a greater weight of propellant in addition to the development of a new powder: Nitrodiglycol. This new powder is more efficient than black powder and results in greater range and less smoke formation on firing.

3. Multibarrel projectors carrying up to 42 rounds have been developed by the Germans to effect a greater rate of fire. Reloading these new projectors is carried out mechanically.

When these first new efforts proved successful, great new exertions were made on the part of the Germans to develop more effective rocket weapons: rocket-propelled depth charges, antitank weapons, antiaircraft rockets, flares and aircraft bombs with rocket propulsion were tried out; and at the peak of the research program came the radio-controlled long range rocket which was still under development at the end of the war in Europe.

Solid Fuel Rockets

For the purpose of this book it is not necessary to go into the original work done on the powder rocket. The following is a brief résumé on the construction of the rocket at the beginning of this

war. The rocket motor consists of the combustion chamber sealed at one end and the base plate which threads into the open end of the combustion chamber. The base plate has a series of holes in it some of which are parallel to the axis of the rocket and some of which are inclined 45° to the axis.

PROPELLANT. The propellant used at this time is the solid nitrodiglycol type. Its advantage lies in the high calorific value and smokelessness, also in the slow rate of burning. Its density is 1.5 kg/m^3 , which is less than black powder, but this is compensated by the higher calorific value. The range for an 8.6 cm rocket using this type of propellant is 1,200 meters. Maximum velocity is 200 m/sec with a burning time of 5 seconds. This is not considered very good performance and so the rocket is used only against low level attacks.

As long as long range is not required, powder may be used for rocket propulsion. It must, however, be remembered that powder rockets are heavy (heavy combustion chamber) and that the charge weight ratio is small. An attempt might therefore be made to develop powder rockets of light construction, by using some arrangements for reloading the combustion chamber so that a larger weight of propellant may be carried. This should increase the range. Experiments on these lines have been carried out in Germany, but it was found that in order to insure reliable operation, the constructional complications became very great. This reduces use of the main advantages of rockets—less weight and simple construction.

STABILIZATION. The foundation for the method of stabilization was the spinning shell. By placing the venturis askew to the main axis of the rocket produced a sufficient spin. This action gives rise to a gyroscope effect and tends to resist all external disturbing forces. This method has given very good results and is greatly superior to the fin stabilization, which is inherently subject to wind errors.

GERMAN EXPLOSIVE ORDNANCE.

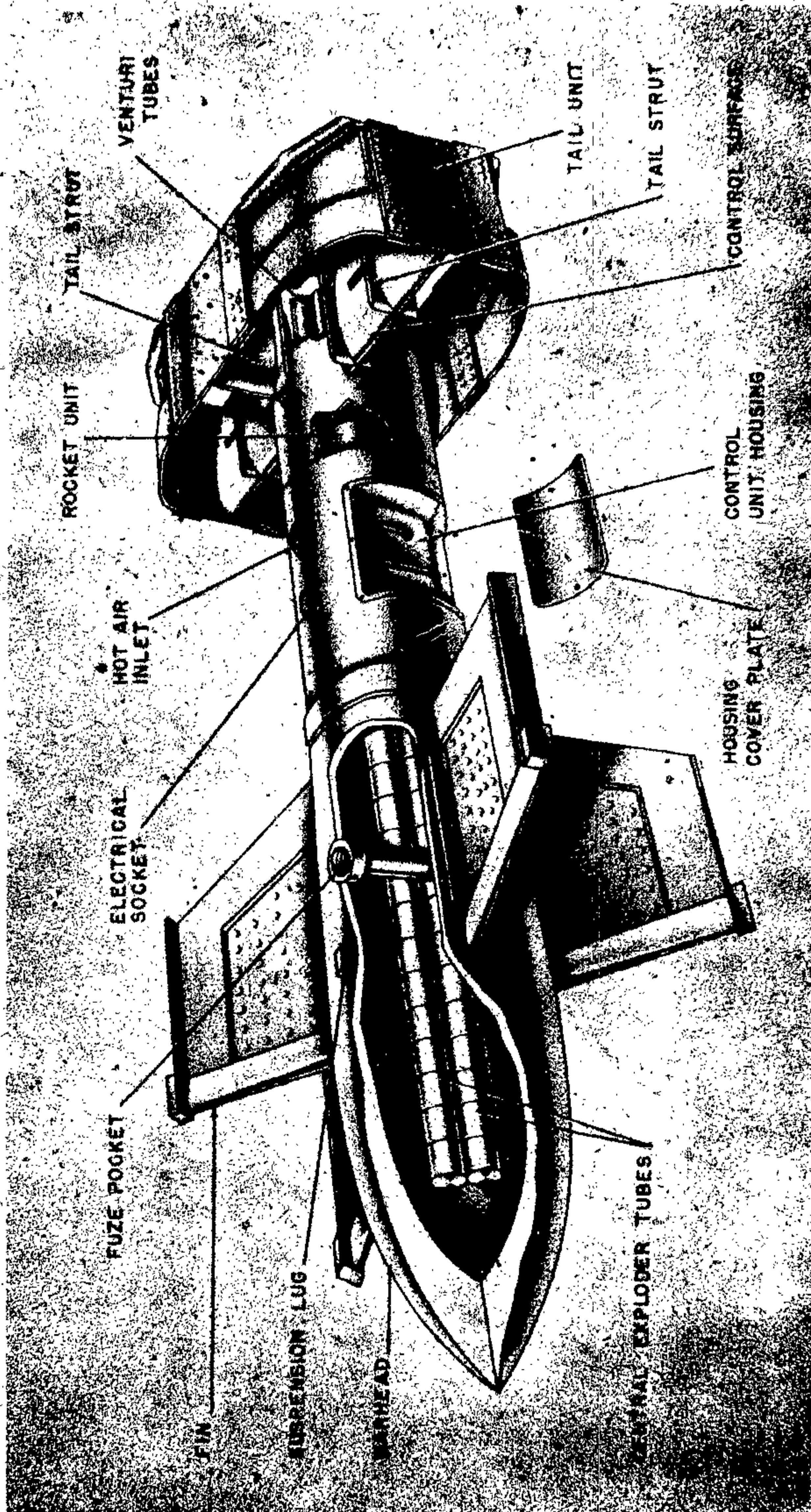

Figure 192-1400 FX

Liquid Fuel Rockets

The liquid fuel rockets are superior to powder rockets as regards to:

1. Weight ratio of the propellant carried.
2. Greater energy available in the liquid propellant.

LIQUID PROPELLANT. For example, when 5 gm of powder is required for an impulse of 1 kg-sec, only 0.3 to 0.4 gm of hydrogen-oxygen mixture is required for the same impulse. It will be seen that there is, in this case, a vast difference in the energy content of the propellant, moreover, the density of the liquid fuels is far greater than that of powder. The time of burning is increased, greater velocity is reached, and altogether the advantage lies in much lighter construction, i. e., deadweight of the rocket, since the fuel and oxygen containers can be made of thin steel sheet. The combustion chamber also becomes lighter.

However, the load on the combustion chamber becomes a problem, because of the greater energy and therefore higher temperatures; but this problem was solved. Combustion temperatures for powder rockets are approximately 980° to $1,000^{\circ}$; they are $3,000^{\circ}$ to $4,000^{\circ}$ for oxygen-hydrogen mixtures, and in addition there is the boiling point of the mixture, the boiling points of hydrogen and oxygen being -253° and -183° respectively. These temperatures make severe demands on the material, and it is necessary to look for new alloys which can withstand these demands.

It is, of course, possible to consider other fuels than a hydrogen-oxygen mixture, e. g., petrol, benzol, methyl alcohol, petroleum, spirit, etc., together with liquid oxygen. These fuels have the advantage of a high boiling point and do not require special materials for the tanks; these are only needed for the oxygen.

FUEL TANKS. For the hydrogen and oxygen containers, for example, it is possible to use an alloyed steel, covered with a thin lead coating; if the rocket is to be used only once. At low temperatures (-183° to -253°), all metals except copper become hard and brittle; however, copper remains ductile even down to such temperatures, and is therefore the best material to use for the fuel tanks.

The containers for liquid fuels at temperatures lower than -160° are best made spherical (e. g., V-1), since this form offers the greatest strength.

They must be insulated, but this offers no difficulties.

PC 1400 FX RADIO-CONTROLLED GLIDER BOMB

DATA:

- Over-all Length: 130 in.
- Length of the Control Unit Housing: 16 in.
- Length of Fins at the Root: $31\frac{5}{8}$ in.
- Length of Fins at Outer Edge: $18\frac{1}{4}$ in.
- Length of Fin Leading Edge: $18\frac{5}{8}$ in.
- Max. Width of Tail Unit: 48 in.
- Min. Width of Tail Unit: $33\frac{3}{4}$ in.
- Span of the Fins: $58\frac{3}{4}$ in.
- Weight of Filling: 270 kg.
- Total Weight (Approximate): 1,650 kg.

GENERAL DESCRIPTION. The PC 1400 FX is a radio controlled glider bomb designed for attack against capital ships or similar targets. The complete missile consists of three distinct units the H. E. armour piercing warhead, the control unit housing, and the tail assembly. There are four aluminum alloy fins secured to the missile at approximately the center of gravity. The purpose of these fins is to give the bomb sufficient lift so that the control surfaces in the tail unit can exercise adequate influence.

WARHEAD. The warhead is an ordinary PC 1400 kg bomb to which the four above mentioned fins have been attached. It has one transverse fuze pocket located aft the H-type suspension lug. Two horizontal exploder tubes are centered in the warhead to insure high order detonation on impact. (See fig. 192.) The usual filling for the warhead is 50/50 amatol.

FUZING. The type fuze generally used has the El. A. Z. 38B electrical impact fuze set to operate with a very short delay. The fuze is sometimes fitted with an extension cap. Alternative fuzes which have been found in the missile are the El. A. Z. 28A and the El. A. Z. 35. The wiring diagrams and the operation of each of these fuzes can be found in the bomb fuze section.

CONTROL UNIT HOUSING. The control unit housing, made of cast magnesium alloy, is attached between the base of the H. E. warhead and the tail unit. This space contains the gyroscopes, radio receiver, power source, and a small demolition charge for destruction of the control unit.

GERMAN EXPLOSIVE ORDNANCE

There are two gyroscopes mounted 90° to each other in the after section of the control unit. These two gyros control the stabilizing flaps on two of the tail surfaces.

The directional apparatus consists of the radio receiver and the servo motors which take the impulses from the radio. The power source is a 24-volt battery. This equipment operates four control surfaces measuring 8 cm by 1½ cm, which are located on the trailing edge of each of the four fins. These control surfaces are actuated in pairs; two of them control the lateral direction of the bomb, and the other two, its trajectory.

The demolition charge consists of approximately 1½ pounds of penthrite wax. It is fuzed usually with the VZ 80 "all-ways action" fuze. The main purpose of this charge is to destroy the directional equipment in case the fuze for the main charge in the warhead fails to function.

TAIL UNIT. The tail unit consists of an inner cast magnesium alloy tail cone fitted with two long and two short cast magnesium alloy struts.

OPERATION. Bombing with the PC 1400 FX is carried out in conjunction with the Lotfe 7D bomb sight. The only extra duty of the operator being to switch on the gyroscope of the bomb some 2 minutes before the moment of release. The aim of the bombardier is taken the same way as in ordinary bombing. As the bomb is released, the aircraft is throttled back and put into a climb with the flaps down. This action is to insure not overshooting the missile. Once the requisite reduction in speed has been effected, the pilot flattens out. At this time, corrections in the course of the missile can be taken if necessary. At the moment of release, the bombardier starts a stop-watch going. The bomb cannot be controlled during the first 15 seconds after release. On the 16th second, the operator takes control of the missile. It has been estimated that the missile can be guided with a margin of error of only 50 meters from an altitude of 7,000 meters.

The bomb takes 42 seconds to reach the ground from 7,000 meters, and 38 seconds from 6,000 meters. The lowest possible height for satisfactory release is 4,000 meters. At the moment of impact, the bomb, dropped from 7,000 meters, is said to have a velocity of 270 meters per second.

Hs 117

DESCRIPTION. This missile, probably better known as the "Schmetterling," is a rocket propelled, radio controlled, missile for use against bomber formations. Some versions are for ground-to-air and some for air-to-air operations. The fuselage is of the conventional type mounting a single vertical tail surface and a single horizontal surface. The horizontal surface is mounted well above the center line of the fuselage. The arrow-head wing is mounted on the center line of the fuselage. The forward section of the fuselage is nonsymmetrical in order to accommodate a proximity fuze and a propeller-driven generator.

This missile is launched from the ground from a simple two armed zero length rail launcher. The two arms support the missile at the wing roots at about the center of gravity. Two assisted take-off units are used for ground launching, one above and one below the fuselage. At the end of burning these ATO units are jettisoned by means of explosive bolts which throw them clear from the airframe. The air launched version does not use ATO units but is simply dropped from a standard bomb shackle.

Some of these models are automatically homed and some are remote controlled. A single gyro automatic pilot is used for stabilization.

DETAILS

AIRFRAME. TYPE AND DESCRIPTION. For general dimensions and outside appearances see fig. 193, Model C. The main units of the fuel system form the backbone of the fuselage. At the forward end is the steel air flask nested into the forward end of an aluminum Salbei tank. Next comes an aluminum casting through which passes the main wing spar, and which is also used to space the hydrocarbon tank further aft for the proper distribution of the C. G. of the fuel since it is desired to have the fuel C. G. coincide with the C. G. of the entire aircraft. On the after end of the hydrocarbon tank another aluminum casting is bolted which supports the main propulsion unit and the air stabilizer structure. All of these tanks and castings are securely bolted together, forming the entire backbone of the aircraft. This structure is covered with sheet aluminum. The nose section, also formed of aluminum, is screwed to the forward end.

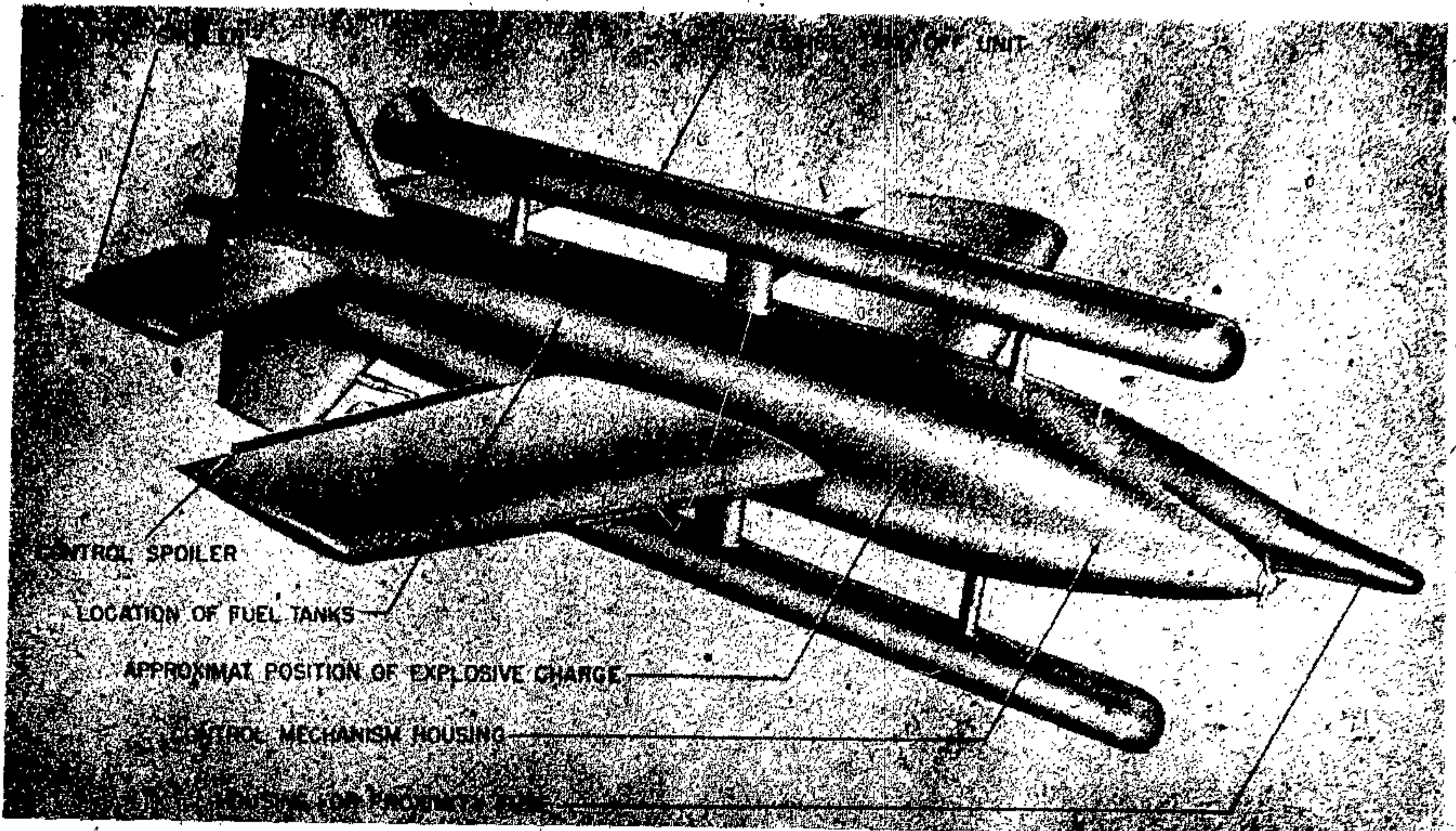

Figure 193—Hs 117 (Hs 297) "Schmetterling"

The wing and tail are built-up sections consisting of a cast magnesium frame with an aluminum covering. The cast magnesium wing frame is extremely light in weight and is rigid.

AERODYNAMIC CHARACTERISTICS OR PECULIARITIES. This missile is controlled in roll by spoilers on the trailing edges of the wings. These spoilers work out of phase with one another.

The missile is controlled in elevation by trailing edge spoilers on the horizontal stabilizer. These spoilers work in phase with one another.

Yaw is controlled by the trailing edge spoilers on the wings.

Spoiler control was used for this model because, as in other missiles, it gave adequate and easy control as compared to other systems and produced less drag. The spoilers also present a much more simple method of control than other systems.

This missile is rather unique in that assisted take-off rockets are placed both above and below the fuselage mounted in the vertical plane of the center line of the fuselage.

It is also interesting to note the extent of asymmetry of the forward portion of the fuselage. It was considered by the designer, Prof. Wagner, that horizontal asymmetry would be less harmful

than vertical asymmetry, the asymmetry being necessary to correctly place the generator propeller and the fuze.

For reasons of stability, the missile, upon ground launching, makes at least one complete roll about its longitudinal axis. If at the end of this roll the air speed is not great enough for adequate stability it will make a second complete roll. Seldom, however, is the second roll necessary. This roll event is built into the control equipment and is entirely automatic. During launching, the acceleration is about 8 g.

DESIGN AND PERFORMANCE DATA:

PRINCIPAL DIMENSIONS:

- Length over-all: 429 cm.
- Length of fuselage: 369 cm.
- Span of wings: 200 cm.
- Height of vertical rudder: 92 cm.
- Diameter of fuselage: 35 cm.

PRINCIPAL WEIGHTS:

- Weight empty: 150 kg.
- Launching weight: 430 kg.
- Weight at target: 175 kg.
- Weight of assisted take-off units: (each 90 kg) 180 kg.

GERMAN EXPLOSIVE ORDNANCE

Main power fuel: 12.7 kg.
Main power oxidizer: 59.2 kg.
Compressed air: 3 kg.
Explosive: 25 kg.

PERFORMANCE:

Maximum velocity: 250 m/sec.
Average velocity: 240 m/sec.
Maximum range: 20 km.
Service ceiling: 10.5 kg.
Absolute ceiling: 13 km.

MAIN PROPULSION SYSTEM. The main power unit is a liquid rocket with a pressurized fuel feed and a variable automatic thrust. The following are weights, performance and dimensions of the main unit:

WEIGHTS:

Main power fuel (Tonka): 12.7 kg.
Main power oxidizer (Salbei): 59.2 kg.
Compressed air: 3.0 kg.
Charged weight: 159.0 kg.
Weight empty: 80.0 kg.

PERFORMANCE:

Total launching impulse: 14,000 kg./sec.
Main thrust unit impulse: 12,500 kg./sec.
Total impulse: 26,500 kg./sec.
Launching thrust (see Operating Technique):
3,500 kg./sec.
Maximum thrust of main unit: 380 kg.
Minimum thrust of main unit: 60 kg.
Burning time of main unit: 40-90 sec.
Maximum combustion chamber pressure: 40 atm.
Average thrust: 220 kg.
Average time of burning: 57 sec.

DIMENSIONS (COMBUSTION CHAMBER):

Over-all length of main thrust unit: 17 in.
Over-all diameter: 4½ in.
Throat of nozzle diameter: 1¼ in.
Exit of nozzle diameter: 2⅞ in.

OPERATING AND OPERATIONAL TECHNIQUE OF THE HS 117 PROPULSION SYSTEM. Because aerodynamic characteristics at high speed change rapidly with small changes in speed, to make the control problems as simple as possible, it was decided that the speed of the missile should be held as nearly constant throughout the flight as was practicable. This was accomplished by automatically regulating the thrust output of the main jet in relation to the velocity of

the missile, 240 m/sec. being the arbitrary average velocity. This regulation was accomplished by balancing the two pressures taken from a pitot static tube across two opposed aneroid barometric elements which, in turn, by means of electrical contacts, actuate an electric motor which operates a fuel control valve limiting the flow of fuel to the combustion chamber. A constant proportion of the two reactants entering the combustion chamber must be maintained at all times at a ration of 2 parts nitric acid to 1 part hydrocarbon. If one or the other of the reactants is allowed to collect in the combustion chamber an explosion will occur. The nitric acid is also used to cool the nozzle. It flows into the cooling jacket at the after end of the nozzle and then flows forward and enters the combustion chamber where it meets the hydrocarbon. No ignition apparatus is necessary as these two fuels are self-igniting.

Professor Wagner was not satisfied with the motors which were developed by Dr. Sbyrowsky of BMW, feeling that they were too heavy. Dr. Conrad, of the Berlin Technical High School, had been obtained by BMW to improve the motor design. Dr. Conrad was experimenting with un-cooled liquid fuel motors for this project and at least two forms of combustion chamber material had been tried; one a form of graphite and the other a material built up of many layers of a very pure ceramic material such as silica or alumina. These showed considerable promise and might have been incorporated in later designs. Other liquid fuels were also being considered. By means of various refinements it was hoped that the missile speed could be raised from a Mach No. 0.75 to 0.8.

Both reactant tanks are built of aluminum and are carefully machined. The outside casting is bored so that a closely fitting piston (without rings) will slide in it. In operation the liquid side of the tank is initially full, forcing the piston against the head. As air enters the head, the piston travels to the right, forcing liquid out of the tank. The object of this design is to insure that when the tanks are less than half full no slugs of compressed air are fed down the reactant pipes as the aircraft performs tight maneuvers. Although the motor would re-ignite after stopping, a collection of one of the two reactants would cause an explosion. On the forward side of the air bottle is a connection to which is T'ed a filling plug

and pressure gage which reads up to 250 kg/sq. cm. The bottle is charged with air to 220 atms. On the aft connection to the bottle is a diaphragm which is punctured by an electrically fired squib. The outlet from this connection leads to a regulator which delivers air to the two reactant tanks at 40 atms. (590 lbs./sq. in.). On each side of each reactant tank there is a diaphragm valve which is blown when the 40 atms. pressure appears at that point. This is done to prevent any possible contact of the reactants during storage or handling, and also to insure that both fuels enter the combustion chamber at the same time in order to prevent an explosion. At full thrust, nitric acid enters the combustion chamber through 16 holes, and the hydrocarbon through 8 holes of equal size. The thrust regulation is obtained by the aforementioned regulator motor, operating (through a gear train) a rotary valve plate which blocks off the holes limiting the amount of fuel which can enter the combustion chamber (fuel pressure being constant) and also maintaining the fuel ratio of 2 to 1.

INTELLIGENCE AND CONTROL SYSTEM (ELECTRICAL); TYPE AND DESCRIPTION. This missile at first mounted a Friesicke & Hoptner receiver which operated at about 6 m. The equipment was considered as too complicated and heavy for the missile and consequently was superseded by a further development of the "Staru" radio receiver for the Hs 293. This new receiver was of the super-regenerative type having a much smaller form factor than the previous Hs 293 receiver, and was designated the E230-3.

For controlling the missile, the controlling ground station sends out a high-frequency signal which, by modulation with a lower frequency and appropriate keying, conveys to the missile directions for altitude, or elevation, and azimuth. By referring to its gyro the missile is able to interpret and follow these signals. On the ground, the signals are manually initiated by means of a "joystick" control which sets the pitch and yaw directions for the missile to follow, and which the missile will follow until the position of the stick is changed.

On the ground, the courses of the target and the missile are followed by means of an optical sighting device. From observations with this device, missile course corrections are set which will bring

it to the target. No homing devices had been applied to this missile, although they had been discussed and were under development in several firms. Professor Peterson of AEG had been working for some time on a universal radar ground computer for guiding flak missiles to their target. RIM wanted Wagner to incorporate this in the Hs 117 control, but he wished to keep it in its original simple state. In the future he intended to develop homing devices to supplement his visual control for use in thick weather. It is reported that Wagner would have liked to have this missile beam guided to a radar followed target, but he felt that German radar was too inaccurate for the job.

Various developments for the radio control of this missile were being carried out by several firms. Some work was being done in the range from 20 to 40 cm. These frequencies were desirable since they could be beamed and were interfered with less by the jet than the longer wave lengths. Shorter wave lengths were not considered, since suitable tubes were not developed. In some cases, jet interference could be reduced by changing reactants. In all cases solid powder gave the most trouble. It was considered that Telefunken was doing the best work in radio control. They were concentrating on 40 cm.

The electrical power for this missile was delivered by a propeller driven generator located in one of the two noses of the missile. On the ground, before launching, this same generator was driven by a motor in an outside power source. During this period the propeller did not turn as it was provided with a three ball free-wheeling cam device.

The missile is stabilized about its longitudinal axis only by one gyro.

LIMITATIONS OF THE CONTROL SYSTEM AND MISSILE. The only apparent limitation of this missile lies in the fact that it cannot be seen and consequently followed in overcast weather. If homing devices, other than optical, were incorporated, this limitation would no longer exist.

WARHEAD AND FUZE

WARHEAD. Considerable divergence of opinion existed in the RIM on the effectiveness of warheads with blast effect only as against fragmentation or incendiary pellet filling, but when the tests

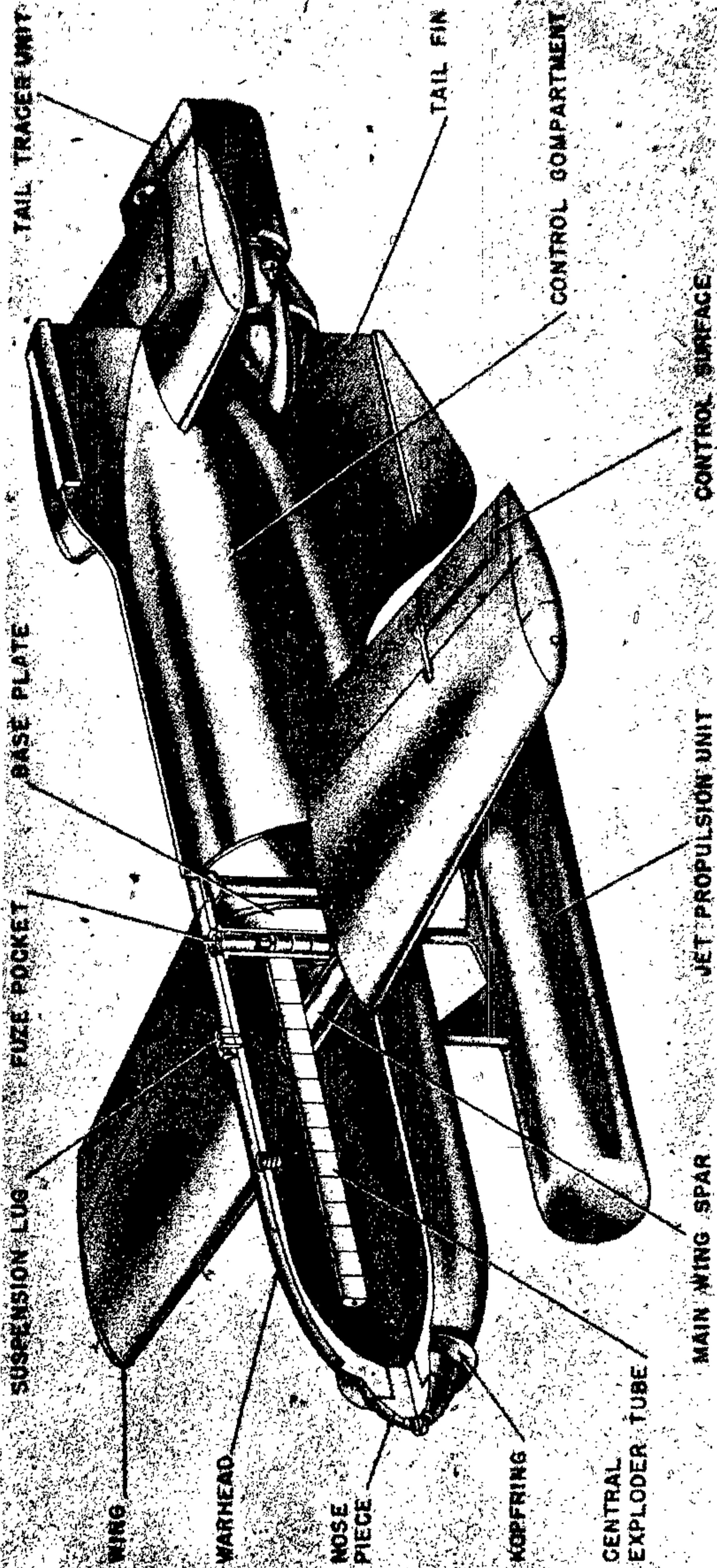

Figure 194—Hs 293 Glider Bomb; Hs 298

of the Hs 117 had been completed in the summer of 1944, the first series was ordered in August of that year with a blast effect warhead weighing 25 kg filled with "Trialen" which was manufactured by Wasag at Reinsdorf near Wittenberg.

FUZE. It was intended to use a proximity fuze whenever developed and available. The performance specifications for the fuze required operation between 6 to 10 meters. It was intended that a small clock work arming device would arm the missile about 10 seconds after take-off. Another device is incorporated, probably working off of the control gyro, which explodes the main charge if the missile rolls over on its back in flight, in which case all controls would be reversed, making the missile uncontrollable from the ground by an operator who would not be aware of this condition. Another timing device was incorporated which operated 120 seconds after launching to destroy the missile.

AUXILIARY EQUIPMENT FOR THE MISSILE. This missile is equipped with two assisted takeoff units, one above and one below the fuselage, each provided with nozzles offset at an angle such that the lines of thrust intersected at about the C. G. of the aircraft. In launching, the lower booster is fired first, thus forcing the missile upward and forward off the launcher which is a simple two armed cradle supporting the missile at the wing roots (zero length rails). There is a 2½-meter firing lanyard, which fired the top unit automatically. Both units then burn until their powder is burned out by which time the main jet has been ignited and takes over. Each assisted takeoff unit has a total weight of 90 kg and contains 40 kg of powder charge. Burning takes place from the inside out only since the outside is treated with "Polygon," a plastic preparation which prevents burning on the surfaces to which it is applied. The booster thrust totals 3,500 kg lasting for about 4 seconds. It burns at a rate of about 5.8 grams per sec. This thrust brings the missile up to a speed of about 240 m/sec. These booster units are known as SG (Schmidding Gerat) 33. They were developed by Schmidding in Bodenbach, and used powder made by Wasag, located near Wittenberg. At the end of the booster burning time, the boosters are jettisoned by means of a power charge and piston device. Also under discussion as a method of dropping

the boosters was a device which depended upon the reduction of the pressure within the booster unit itself.

LAUNCHING DEVICE. This missile is launched from a simple two-armed cradle which supports each wing at its root in such a way that an upward and forward motion of the projectile will carry it free from the launcher. There is no movable dolly on this launcher. The launcher is manually aimed in elevation and azimuth in response to signals received from a fire-control point. Sighting devices for the launcher were contemplated but were never incorporated.

Hs 293 A-1

DATA:

Over-all Length: 381.9 cm.
 Span of Wing: 310.0 cm.
 Span of Horizontal Stabilizer: 113.6 cm.
 Span of Vertical Stabilizer: 98.0 cm.
 Diameter of Fuselage: 47.0 cm.
 Diameter of Power Unit: 33.0 cm.
 Over-all Height (Approx.): 109.0 cm.
 Average Chord (Approx.): 79.3 cm.
 Wing Area (Total): 2.4 sq. meters.
 Wing Loading (Launch): 441.0 kg/sq. m.
 Wing Loading (Target): 390.0 kg/sq. m.
 Weight of Warhead: 500.0 kg.
 Weight of Launching: 1045.0 kg.
 Weight at Target: 967.0 kg.
 Weight of Fuel: 78.0 kg.
 Maximum Velocity: 260.0 m/sec.
 Average Velocity: 230.0 m/sec.
 Maximum Range at—
 2.2-km alt.: 4.0 km.
 4.0-km alt.: 5.5 km.
 5.0-km alt.: 8.5 km.
 Radius of Turn: 800.0 meters.
 Designed "G": 3.0 g.

DESCRIPTION. The Hs 293 A-1 has principally an aluminum, stressed skin, spot welded structure. The forward portion of the fuselage is structurally the bomb casing with an aluminum covering or fairing. (See fig. 194.) Fastened to the rear of the bomb is a vertical plastic beam (about ⅜ inch thick) which runs to, and is fastened to, the after portion of the fuselage. The radio and the associated gear for the controlling of the bomb are mounted on either side of this plastic beam. On the after corner of this beam

GERMAN EXPLOSIVE ORDNANCE

is mounted a roller. The after portion of the fuselage is a stressed-skin, semimonocoque structure with a rail (for the aforementioned roller on the plastic beam) mounted on the top inside of the structure. Quick disconnection fasteners are mounted at the connection between the rear of the bomb fairing and the forward end of the rear fuselage to be quickly detached and rolled off the bomb and plastic beam, giving quick and complete access to all of the control gear. The wing and tail are aluminum and of the usual built-up type.

AERODYNAMIC CHARACTERISTICS. The missile is controlled in roll by the normal type of ailerons on the trailing edge of the outer portion of the wing. The ailerons also control the yaw effect. It is controlled in pitch by the normal type of control surfaces on the trailing edge of the horizontal tail surface.

CONTROL SYSTEM. The control system consists of the following parts:

A. Receiving set E-230. This unit could use any one of the 18 channels, each of which were 100 kc apart in the band between 48 and 49.7 mc/s and could be changed easily in the field to satisfy the operation requirements for frequencies.

B. "Aufschaltgerate" for damping and smoothing the receiver signals.

C. Three-phase AC gyro for stabilization in roll and yaw. It has a precession rate of 2° per minute.

D. High resistance double potentiometer for proportioning the data.

E. 210-volt D. C. generator for the receiver.

F. A transformer with built-in relays to activate the aileron surface magnets.

G. Elevator mechanism with an "Oemiz" motor and potentiometer for returning the elevator to its normal position.

H. An iron nickel plate battery of 24 volts with approximately 14 amp/hours.

This missile, because of the type of intelligence used, is limited to use in good, clear weather and with air superiority. It is subject to jamming, and this, therefore, may limit the use to targets where jamming equipment is not installed.

A joystick type of control was used in the parent aircraft. This control box made use of a very clever cam arrangement which gave proportional control.

WARHEAD. The warhead was constructed in one section of drawn steel. The base plate was

welded in position. The nose filling plug was threaded and held in place by two set screws. A kopfing was welded to the nose just behind the nose plug. One transverse fuze pocket was located aft of the suspension lug. A central exploder tube was used in the explosive cavity to insure high order detonation of the warhead on impact with the target.

OPERATION. Upon locating the target, the carrier aircraft makes its approach to the trajectory distance, and in the last part of its dive, sets a course such that the target can be seen 30° to 60° to the right of the course. Shortly before release time and particularly at the moment of release, the carrier aircraft must be in a horizontal position. At the time of release the aircraft must have a minimum speed of 334 km/hr if the He 111 is used, and 400 km/hr if the He 177 or the Do 217 are used.

The missile is released and directed to the target by the bombardier. Immediately after release, the speed of the aircraft may be reduced, but the release altitude and direction should be maintained for a period of approximately 10 seconds. After this interval of time, it is not essential to maintain release altitude and course direction. It is important that any change in flight course be done slowly and carefully so that the target remains on the side of the bombardier during the entire flying time of the missile. The field of view of the operator and the freedom of the carrier plane in approach vary according to the type of aircraft. In all carrier planes, there should be a field of view of approximately 110° to the right. The flying time of the Hs 293 A-1 should not be greater than approximately 100 seconds.

REMARKS. The Hs 293 is the outgrowth of the "Gustav Schwartz Propellerwerke" glide bomb which was first designed in 1939. The further development of this glide bomb by Henschel represents their first attempt at a radio controlled missile.

The original Schwartz design was a pure glide bomb guided on a straight course by means of an automatic pilot. The method of attack entailed high altitudes for the carrier aircraft in order that sufficient range could be attained and still be out of antiaircraft fire.

Henschel took over the work of further developing this missile in early 1940, and it was decided

to use some form of propulsion for the missile so that attacks at low altitude and increased range could be made. The Hs 293 A-1 was the first model to be used operationally with the new motor.

In as much as all future models under development were very similar to the Hs 293 A-1, it will be the only missile of this series discussed in detail. The following is a list of projects which emerged from the original Hs 293 A-1:

Hs 293 B: This was a wire-controlled version of the original radio-controlled series, designed to be used in the event of a jamming of the radio control mechanism of the original series bombs. The G. A. F. considered that up to 70 percent disturbance was permissible before a change-over to the wire-controlled series would be necessary. Since these conditions were never attained, the Hs 293 B was never put into operational use.

Hs 293 C: This missile was a modified version of the Hs 294 and had a detachable warhead, etc., in the same manner as the Hs 294, but a conventionally shaped body. The fuzes included an impact fuze with a short delay to allow for penetration in cases where the missile struck a ship above its waterline, an impact fuze which detonated immediately on impact after it had entered the water, and a fuze operated by a spinner which detonated the missile after a passage of 45 meters through the water. This subtype was designated the Hs 293 C during its development stage, but when large scale production was to start, it was changed to the Hs 293 A-2, and was to replace the original radio-controlled series for general purpose use against shipping targets.

Hs 293 D: This was a projected type of missile to be fitted with a television camera in the nose. The camera was designed to repeat data back to the missile controller. The camera was designed to swing vertically and was aimed in the line of flight by a small wind vane on the outside of the projectile. As the projectile was rudderless, and in theory should not yaw in flight, there was no need to allow for any traverse in the camera mounting. About 20 of these missiles were built and test flown, but the television gear proved unreliable, and the project was abandoned.

Hs 293 E: This was purely an experimental model built to try out a system of spoiler controls to replace the conventional aileron mechanism. These controls were incorporated in the final model of the Hs 293 A-2 (above), but were never

employed operationally, since by the time the bomb was brought into large scale production, the G. A. F. had no aircraft left for antishipping purposes.

Hs 293 F: This was a tailless missile which was never developed beyond the design stage.

Hs 293 H: This missile was intended to be released and controlled in flight by one aircraft and detonated by a second observing aircraft, which would be flying in position where it would be easy to observe the impact of the missile against the target. The project was abandoned because it was felt that the detonating aircraft would be unable to remain directly over the target long enough to carry out its function.

Hs 293 V6: This subtype was developed for launching from jet-propelled aircraft at launching speeds up to 200 meters/second. This involved modification of the wing span of the missile so that it could be carried within the undercarriage of the aircraft. The Ar. 234 aircraft was to be used as the parent plane, and since it was not as yet available at the conclusion of the war in Europe, the missile never progressed beyond the design stage.

Hs 298

DESCRIPTION. This missile was designed primarily as an air-to-air weapon to be carried on fighter aircraft as well as the bomber types. The fuselage is of the conventional type mounting twin vertical tail surfaces at the ends of the single horizontal tail surface, the horizontal tail surface being mounted high on the fuselage. The arrowhead wing is placed about the center of the fuselage. The nose, like the Hs 117, is symmetrical, the asymmetry on this missile being in the vertical plane. For the propulsion system this missile uses a two stage powder rocket. Spoiler type of aerodynamic controls is used.

This missile used a short length of launching track mounted underneath the parent aircraft.

DETAILS. The following detailed report is written around the Hs 298 V-2, as this model is considered the basic model of this series.

AIRFRAME

TYPE AND DESCRIPTION. The fuselage is a stressed aluminum skin structure. The wing and tail are cast magnesium with an aluminum cover-

GERMAN EXPLOSIVE ORDNANCE

ing. The cast magnesium wing frame is extremely light in weight and rigid.

AERODYNAMIC CHARACTERISTICS OR PECULIARITIES. The missile is controlled in roll and yaw by trailing edge spoilers on the wings. It is controlled in elevation by spoilers on the horizontal stabilizer. Trailing edge spoilers were used because they gave an adequate and simple control as compared to other systems and produced less drag.

The forward part of the fuselage of this missile, like that of the Hs. 117, is nonsymmetrical; however, in this missile the assymetry is in the vertical plane. The reason for this change is not known. The after section of the fuselage also has a peculiar shape in that it ends in two tubular shapes, placed one above the other. The top one is the smaller of the two and accommodates either a flare or a light for the purpose of recognition and enabling the pilot to follow it. The lower circular cross section accommodates the powder rocket motor.

DESIGN DATA:

Principal Dimensions:	V-1	V-2
Length Over-all.....	328	249 cm.
Length of Fuselage.....	180	191 cm.
Span of Wings.....	129	127 cm.
Span of Horizontal Stabilizer	53	53 cm.
Height of Vertical Rudder...	29	31 cm.
Diameter of Fuselage.....	39 x 20	39 x 25 cm.

Principal Weights:

Launching weight: 120 kg.
 Weight of Target: 98 kg.
 Weight of Propulsion Unit: 33 kg.
 Explosive: 48 kg.

Performance:

Average Horizontal Speed: 240 m/sec.
 Mach. No.: 0.75.
 Max. Range (approx. 5,000 m alt.): 3.5 km.
 Min. Range: 0.6 km.
 Ceiling Above Launching Point: 1.3 km.
 Max. Elevation for Attacks from Below: 50°.

In April 1944, production of 2,500 Hs. 298's was ordered by RIM with a peak production rate of 300 airframes per month. In July 1944, the RIM ordered the production of an additional 2,000.

POWER PLANT. PROPULSION MOTOR DATA.

The power plant is a powder rocket with two combustion chambers exhausting through the same nozzle and having the following component weights:

Total Rocket Motor Weight: 27 kg.
 Booster Charge Weight: 5 kg.
 Main Powder Charge Weight: 6 kg.
 Weight Empty: 16 kg.
 Total Propellant Weight: 11 kg.

The following is the rocket motor performance:

Duration of Burning of Main Rocket: 25 sec.
 Duration of Burning of Booster: 5.5 sec.
 Thrust of Launch With Booster: 150 sec.
 Booster Impulse: 1,200 kg. sec.

FUEL. The fuels of this motor are dry powder. The booster is a single perforated charge with a high burning rate. The main fuel consists of a round hollow shaped charge having a very slow burning rate. In the hollow cavity of this charge are placed alternate slugs of material, first a slug of powder with a very high burning rate (apparently similar to black powder) followed by a slug of inert material. These slugs are packed one against another throughout the core of the main slow burning powder. This combination presented only few problems, the main one being the sensitivity of the fuel to temperature. For a time it was thought necessary to heat the projectile while still attached to the launching aircraft, but experiments in this direction had not been completed.

OPERATION. Apparently the powder available for the main charge burned too slowly to use the standard end burning technique, so a complicated procedure was worked out. In order to obtain sufficient area for burning, a conical burning surface is used. To prevent this surface from degenerating to a section of a sphere as the charge burns, the peculiar core construction was devised. This consists of alternate plugs of an inert material and a very rapid burning powder. With the proper geometry of these plugs, the speed of core burning can be maintained which will preserve the original core angle. The chamber pressure is lower during the burning of the main charge than during the boost. It was desired to decrease the throat diameter of the nozzle to compensate for this effect, but this was never achieved.

INTELLIGENCE AND CONTROL SYSTEM

(ELECTRICAL). TYPE AND DESCRIPTION. The radio receiver and other electrical equipment of this missile was made as similar as possible to that of the Hs 117, the main difference being the arrangements to accommodate the two-wire control

that is used for this missile. Since all radio directed missiles are subject to jamming, the Germans, including Wagner's group, have experimented extensively with this two-wire missile control. All Henschel missiles are adaptable to wire control.

It is interesting to note the crude form of air speed measuring device intended to control the throw of the spoilers in the same proportion to the missile speed. This device is mounted on the top of the tail portion. This restriction to the throw of the spoilers is probably done by inserting the spoiler solenoid circuits by means of a resistor on the pivoted, spring returned support of the pear-shaped speed measuring plug.

Power for the electrical system was obtained from a propeller-driven generator. This missile was limited to use against targets with a speed of 140 meters a second or less.

WARHEAD AND FUZE. **WARHEAD.** This missile contains a 48 kg thin case blast effect charge. It is reported to be placed around the outside of the propulsion unit, which appears necessary from space considerations and is desirable in that the C. G. of the propellant charge can be held nearer to the C. G. of the entire unit. A small amount of insulation protects the explosive from the heat of the propelling charge.

FUZE. The missile was designed for the C-98 "Abstandszunder" high frequency proximity fuze; however, nearly any of the other proximity fuzes would work. This missile also incorporated a self-destroying fuze which operated at a certain time interval after launching.

LAUNCHING DEVICE. This missile uses a rail type launcher 60 cm in length hung on the carrier aircraft on the under side of the fuselage or wing of either bomber or fighter aircraft.

V-1

GENERAL. The V-1 is a bomb constructed in the form of a midwing monoplane with a single fin and rudder. The after portion of the fuselage is surmounted by a jet-propulsion unit. Two general types were found; the automatically controlled missile, and the piloted missile. (See fig. 195.)

General performance figures are as follows:

Speed at End of Launching Ramp: 400 km/hr.

Airspeed of Recent Models: 900 km/hr.

Older Models Airspeed: 800 km/hr.

Maximum Range (approximate): 200 km.

The bomb is launched by a fin attached to a piston fired from a long catapult. The catapult tube has a slit running its entire length through which the fin projects. The launching fuels are hydrogen peroxide and potassium permanganate used in combination. Either type of missile can also be launched from H. E. 111 or H. S. 177 aircraft.

Control of the V-1 in flight is effected by an automatic pilot unit monitored by a magnetic compass. The only control surfaces are a pair of elevators and a vertical fin. The control equipment causes the V-1 to:

A. Climb to a predetermined altitude and level off.

B. Execute a right or left turn of predetermined duration, if desired.

C. Maintain the correct altitude.

D. Follow the desired compass course.

E. After the proper distance has been travelled, go into its final dive.

The models which were modified to have a human pilot aboard had the conventional stick and pivoted-crossbar flight controls. A gyro compass was mounted in a chock-mounted bracket with a small 24-volt wet battery and a 3-phase inverter. This assembly was mounted on the deck between the pilot's knees, so that the compass was just below the instrument panel.

These bombs were intended specifically to be launched from aircraft. The pilot was to fly his missile toward his target until he was relatively certain of accuracy, then lock the controls and attempt to save himself. Although the pilots were equipped with parachutes, according to one Luftwaffe executive in a V-1 assembly plant, it was expected that 99 percent would not survive.

AIRFRAME. The V-1a is constructed in the form of a mid-wing monoplane surmounted by a jet-propulsion unit. Except for the nose and the control surfaces which are of light metal, the structure is entirely of steel.

There are variations of the order of two feet maximum in the dimensions of various models, but the following characteristics are given as representative:

Length of fuselage: 6,655 mm.

Length of propulsion unit: 3,415 mm.

Over-all length: 8,325 mm.

Maximum diameter of fuselage: 840 mm.

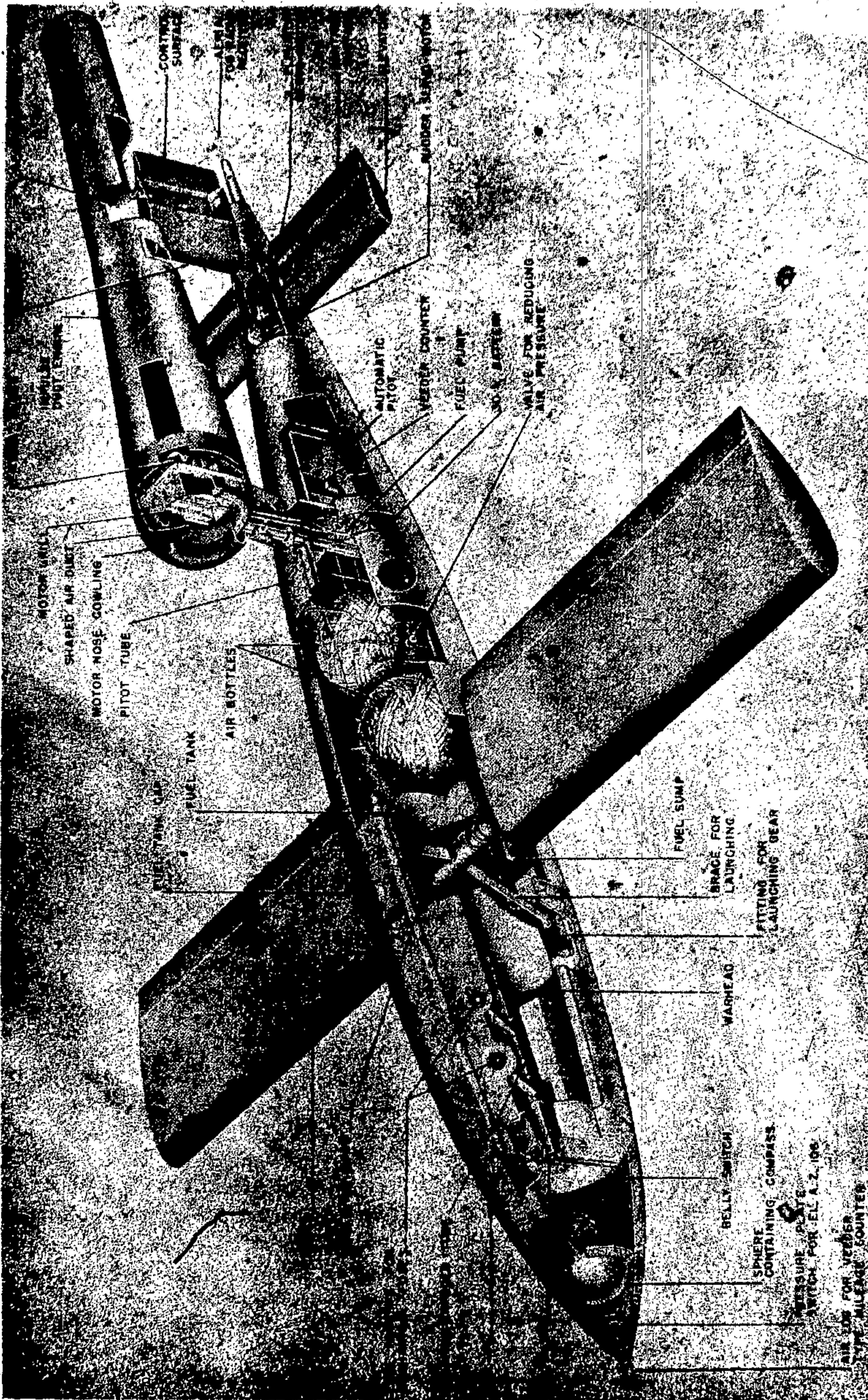

Figure 195—F. Z. G. 76 "V-1" Flying Bomb

Maximum diameter of propulsion unit: 577 mm.

Wing Span: 5,370 mm.

Root Chord: 1,220 mm.

Tip Chord: 813 mm.

Wing Area (Gross): 5,116,000 sq. mm.

Aspect Ratio: 4.7

The mainplane is built around a continuous tubular spar which passes through a sleeve mounted across the center of the pressurized fuel tank.

The two wing sections which are of steel construction throughout, are designed for rapid assembly on the spar. There was no ailerons and the plane has no dihedral.

The tail unit has a single fin and rudder and is mounted on a cone which forms the rear end of the fuselage. The plane is fitted with elevators which, together with the rudder, are operated by a pneumatic servo mechanism housed inside the fuselage. The fuselage houses the following units:

Magnetic compass.

Warhead.

Pressurized fuel tank.

Compressed air tanks.

Automatic pilot control unit.

Radio transmitter (if carried).

Pneumatic servo motors.

INTELLIGENCE AND CONTROL SYSTEM. The intelligence and control system is made up of the following principal units:

Main steering control gyro.

Rate gyro for turn control.

Rate gyro for pitch control.

Aneroids altitude control.

Clock for timing of turn.

Magnetic compass for monitoring gyro.

Air log for determining range.

Spring-operated diving mechanism.

Pneumatic servos.

After launching, the V-1a climbs until it reaches the altitude for which it has been set into the clock mechanism, and straightens out onto a course controlled by the compass through the gyro. After the air log registers the proper distance travelled, the spring mechanism removes the gyro control and sets the missile into its final dive.

MAIN STEERING CONTROL GYRO. The main gyro is located on the forward side of the automatic pilot assembly and consists of an air-driven gyro,

double gimbal mounted, with normal axis of spin in a vertical plane through the missile's axis and inclined about 30° from the horizontal. The inner gimbal axis is normally in a vertical plane at right angles to the axis of spin and the outer gimbal axis is horizontal and at right angles to the axis of the V-1. Cam followers with mechanical linkages utilize the motion of the gyro in each of its two components relative to the chassis to traverse a small compressed air nozzle across two holes, thus building up a higher pressure in one or the other of the pressure tubes when the position is off normal.

Two precessing magnets are mounted on the side of the gyro, one for producing right-hand precession for azimuth control, and the other left-hand. The circuits from the magnets are controlled by the clock during the turn and by the magnetic compass thereafter.

Precession in a vertical plane is produced by a reaction force from the escape through side vents of the compressed air after it has been used to drive the gyro motor. These vents are on the sides of the forward bearing housing and are partially covered by two pendulous strips of brass. If the spin axis, owing to friction or any other cause, tilts up or down from its desired position, the pendulums will cover more of the vents on one side and less on the other, resulting in a horizontal reaction force and causing a vertical precession back to the proper angle of tilt.

The main gyro is locked in its normal position during the launching and uncaged electrically when a switch on the fuselage is operated by a protrusion on the end of the launching ramp.

RATE GYRO FOR TURN CONTROL. The auxiliary gyros are for the purpose of introducing a rate-of-charge element into the control, so as to avoid the jerkiness and possible "hunting" inherent in a control which is directly proportional to error.

The horizontal rate gyro spins normally about a horizontal axis at right angles to the ship's axis. It is mounted in a frame which can have a restricted motion about a fore and aft horizontal axis. This frame is held in a normal position by a leaf spring, and it also has an air dashpot for damping. As on the main gyro, the frame carries an air jet which plays between two receiving holes, and produces a differential pressure in the connecting tubes whenever the rate gyro is displaced

GERMAN EXPLOSIVE ORDNANCE

from its normal position. The output tubes are cross-connected to the corresponding tubes from the horizontal take-off element of the main gyro.

In operation, a sudden change in horizontal angle of the ship will result in a corresponding change in rate gyro position relative to its frame, providing a pressure differential opposing this change. The spring force, modified by that of the dashpot, gradually brings the rate gyro back to its normal position. It acts during this transient period only, smoothing the response of the missile to the main gyro.

The pressures in the differential tubes are resultant or composite pressures from both the main gyro horizontal take-off element and the horizontal rate gyro. The differential pressure between the two tubes actuates the pneumatic servo described below.

RATE GYRO FOR PITCH CONTROL. The rate gyro for pitch control is a duplicate of the horizontal rate gyro but has its normal axis of spin vertical. Its differential pressure take-off tubes are cross-connected to those from the elevation element of the main gyro.

ANEROID ALTITUDE CONTROL. This is an altitude control with an adjusting knob graduated in millibars atmospheric pressure between 700 and 1,000. Turning the knob changes the tension of a spring which is balanced against atmospheric pressure on the principle of the aneroid barometer. A pneumatic servo controlled by this unit tilts the framework supporting the main gyro.

In operation, as the V-1 climbs to higher altitude, the lower barometric pressure results in a backward movement of the spring, diaphragm and piston, and a tilting upward of the frame. The gyro maintains its original angle between axis of spin and the horizontal, and there is produced a relative motion between the air jet holes of the vertical take-off which acts in the end through servos to lower the elevators and thus reduce the climb of the plane. This continues until an altitude is attained at which a proper balance is reached, and the missile then flies a level course in an atmosphere whose pressure in millibars is that at which the adjusting knob has been set.

CLOCK FOR TIMING OF TURN. The clock controls the delay before the turn begins, and the duration of the turn. The turning feature is for the purpose of enabling the V-1 to be launched against a target which is not in line with the launching

ramp, and making it more difficult for the enemy to determine the location of the launching ramp by observation of the line of flight. The delay before turning also reduces the probability of crashing since the V-1 is enabled to attain a more satisfactory altitude and velocity before attempting any evolutions. The delay mechanism runs for a maximum of about 10 minutes, although it has scale markings only up to 3 minutes (on the minute wheel, plus 60 seconds on the second wheel). The turning time may be set anywhere between zero and 60 seconds.

The turning is effected by the closing of one of the horizontal precessing magnet circuits by the clock mechanism. The direction of turn is controlled by a switch mounted on the clock, and the rate of turn may be set between the limits of approximately one-tenth degree per second and 1 degree per second by varying a register in the magnet circuit.

MAGNETIC COMPASS FOR MONITORING GYRO. After completion of the turn, the clock mechanism completes the circuits by which the mastery gyro is controlled in azimuth by the magnetic compass. The main shaft of the compass, which is housed in the nose of the missile, carries a cam so arranged that its edge will partially block the flow of air between either of two pairs of jets. This produces a differential pressure in its output tubes whenever the missile is not on the desired magnetic course. These output tubes are connected to an air relay which energizes the proper precessing magnet to bring the gyro to its desired setting.

AIR LOG FOR DETERMINING RANGE. Range is determined by an air log driven by a small propeller-like spinner located at the nose of the missile. Counter wheels clock off the air distance and at a pre-set distance an electric contact is made which detonates a small charge to operate the diving mechanism.

SPRING-OPERATED DIVING MECHANISM. The charge detonated by the air log mechanism releases a spring-loaded lever which depresses the elevators to the dive position and locks them. It also lowers two small hinged plates beneath the lower surface of the horizontal stabilizer, which are of different sizes and cause the V-1 to turn as it dives in.

PNEUMATIC SERVOS. In flight the control surfaces of the V-1 are operated by piston-type pneumatic servos driven by air from the main pressure

bottles, and pneumatically controlled by the differential pressure outputs from the automatic pilot control unit.

RADIO TRANSMITTER. Some V-1 bombs were equipped with a one-tube radio transmitter for the apparent purpose of enabling the launching crew to follow the flights with direction finding equipment in order to obtain plotting and wind data.

When the radio was used it was mounted in the tail of the fuselage abaft the automatic pilot unit. It included a wheel type coding unit and batteries to power both the transmitter and the coding unit. The antenna, which is approximately 450 feet long is wound on a long rod and arranged in such a manner that it will be drawn out by the airstream after the missile is launched.

PROPULSION UNIT. The propulsion unit, which is mounted above the after end of the fuselage, has an over-all length of 11 feet 3 inches. It tapers down from a maximum diameter of 1 foot 10 $\frac{3}{4}$ inches at the forward end to 1 foot 4 inches about half way along its length; the rear portion is cylindrical. The unit is carried above the fuselage on two supports with shock-absorbing mountings to insulate the control system from vibration.

At the front of the unit there is a rectangular grill opening which is built up from a series of finned diecast strips. Between each pair of diecastings there is a flat strip built up from two pieces of sheet steel. A series of small spring leaves is disposed along each side of the strip. Each pair of leaves is secured by two hollow rivets which also serve to hold the strips together.

Air pressure at the front of the grill, combined with a vacuum at the rear, causes the spring leaves to open and admit a charge of air. The fuel is forced by air pressure from the tank in the fuselage to nine jets which project from the back of the grill. The flow of fuel through the feed pipes is arranged to synchronize with the opening and closing of the spring leaves, so that a pulsating flow of fuel is obtained.

The jets, which are in three rows, project into three venturi openings. These openings are formed by two hollow members extending across an open box structure secured to the rear of the grill, and having two sides shaped to complete the upper and lower venturi.

In operation, a charge is admitted, the fuel is injected, and combustion takes place. The rise of pressure inside the combustion chamber closes the

spring leaves and the exhaust gases are expelled through the open rear end of the tube. As the pressure in the combustion chamber falls, the air pressure again causes the spring leaves to open and a fresh charge is admitted and the cycle of events repeated.

The following estimated figures were obtained for the equipment:

Diameter: 580-600 mm.

Range: 700 km.

Static thrust: 500 kg.

Speed: 640 km/hr.

Weight: 215 kg.

Pressure ratio in compressor: 2.8.

Specific fuel consumption: 1.4 lbs/hr.

PRESSURIZED FUEL COMPARTMENT. The fuel compartment is located in the central section of the fuselage and consists of a steel cylinder of 130 gallons capacity with no armor protection and no self-sealing feature.

The fuel used is a low grade aviation gasoline similar to that which the Germans used in their training aircraft. Air from the pressure bottles is supplied to the upper part of the fuel compartment and forces the fuel out to the jets in the combustion chamber, by way of a control unit incorporating diaphragm valves.

PRESSURE BOTTLES. The pressure bottle compartment contains two spherical compressed air bottles 1 foot 9 $\frac{1}{2}$ inches in diameter. The air from the bottles, which are filled to about 2,100 pounds per square inch is used to keep the fuel under pressure and to operate the automatic pilot and servo units.

WARHEAD. The warhead is bolted to the forward end of the pressurized fuel compartment and is approximately equivalent in size and effect to the German SB 1,000-kg thin case bomb, the charge-weight ratio being exceptionally high. The thickness of the bomb casing is about 2 mm. The explosive filling is TRIALEN 106, same as that used in the SB 1000. There are three fuze pockets in the warhead: Two transverse fuze pockets which house the mechanical delay fuzes, and one central exploder tube which takes the El. A. Z. 106 electrical impact fuze at the forward end.

FUZING SYSTEM. In designing the fuzing system of this bomb, the Germans wanted to insure detonation on impact, so they included a "belly switch".

GERMAN EXPLOSIVE ORDNANCE

in addition to the nose switch, and the inertia bolt switch. These three switches all operated through an adaptation of the Rheinmetall electric fuze El. A. Z. 106. In addition to the electrical system, two mechanical fuzes; one "all-ways" action impact fuze and one mechanical clockwork delay fuze, were used to further insure detonation of the missile.

ELECTRICAL SYSTEM. The electrical system consists of the impact fuze El. A. Z. 106, the Ent. 106 which is mainly a container for the second condenser and the choke coils, the "belly" switch, and the nose switch.

The El. A. Z. 106 is located in the axial fuze pocket and is essentially a switching device. The aluminum fuze head has two female electric inlets. The electrical connections are made by means of a three-contact plug, the larger prong serving as a locating pin. Under the fuze head is a plastic moulding which houses an electrical igniter. Below this a second housing contains a thermite pot around which are grouped three spring loaded switches. One is held in its closed position by a polystyrene plug, the other two are connected to the bottom of the thermite pot by means of lumps of Wood's material. An inertia bolt switch rated at 150 g plus 10° is mounted so that it will be activated on nose impact.

The Ent. 106 is bolted to a circular bracket on the warhead, close to the El. A. Z. 106. It contains a large tinfoil condenser, two iron core choke coils, a 0.95 M ohm resistance all separated by beeswax and held in plastic housings.

The nose switch is directly behind the rear end on the air log shaft. It consists of a diaphragm switch mounted on a collapsible rod. On impact this nose switch can be closed either by the shaft of the air log being driven back, or the outer tube may collapse and make contact with the inner tube completing the circuit. These two switches will function only if the nose of the bomb itself is subjected to impact and distortion.

The "belly" switch is on the underside of the nose housing in a projection called the blister. It is a simple push button type of switch which will close the firing circuit in the event of a belly landing.

As the bomb progresses through the air, the airscrew of the air log rotates and causes the Veeder counter to rotate backward to zero. The length of the safety period is determined by the

initial setting of this Veeder counter. At the zero mark, it closes the electrical contact and throws the 30-volt dry battery into the fuze circuit. This causes the condenser in the Ent. 106 component to become charged and fires the electric bridge through switch No. 1. This electric bridge ignites the thermite pot directly below it, which in turn melts the polystyrene plug on the spring-loaded switch No. 1, and the switch opens. The heat from this thermite pot also causes switch No. 2 to close and switch No. 3 to open. This operation removes the shunt across the igniter No. 2 and puts the return line to the battery into the circuit. The electrical system at this point is fully armed.

If the bomb strikes nose first, the diaphragm switch will close and fire the warhead through igniter No. 2, or the inertia switch in the El. A. Z. 106 will close and fire the warhead through igniter No. 1. If the bomb glides to the ground, the belly switch which is in parallel with the nose diaphragm switch will fire the warhead.

MECHANICAL FUZE SYSTEM. The mechanical fuze system consists of the 80 A all-ways action impact fuze and the Z. 17 Bm clockwork delay fuze. These two fuzes are usually found in the forward and aft transverse fuze pockets respectively.

The 80 A is used primarily as insurance against the possible malfunctioning of the electrical fuze system on impact. The diagrams and operation of this fuze can be found in the Bomb Fuze section.

The Z. 17 Bm is intended only as a demolition fuze. If there was ever a complete failure of both systems when the bomb landed on enemy territory, this fuze would detonate the warhead within a few minutes after the missile had landed and thereby keep the valuable intelligence out of the enemy's hands.

V-2

DESCRIPTION. The V-2, also known by the Germans as the A-4, is a streamlined missile 45 feet 10 inches long with a body diameter of 5 feet 5 inches. The nose is very sharply pointed and the afterbody carries four external fins mounted in quadrature. The weight at take-off is 14 tons, of which 1 ton is explosive, and 9 tons is used up in the first minute.

A large steel venturi is used for propulsion. The fuels, alcohol and liquid oxygen, are pumped into the motor at the rate of 9 tons per minute by a

permanganate-hydrogen peroxide turbine which develops 460 horsepower. The thrust produced is 28 tons.

In flight the missile is controlled by fins in the tail surfaces which are positioned by hydraulic servo-mechanisms controlled by an elaborate intelligence system:

The intelligence system consists of the following:

1. Two gyros to provide stability about the three axes of the missile.

2. A radio (optional) to provide azimuth control by flying on a beam.

3. A radio or integrating accelerometer to turn off the motor at a specified velocity, to provide range control.

4. A time switch control to bend the missile over toward the target after it is launched vertically.

After an elaborate preparation requiring much time, personnel and equipment, the V-2 is fired vertically from a metal mobile stand. A few seconds after it is in the air the time switch control causes it gradually to bend over in the direction of the target. After 1 minute of flight the motor is turned off, the missile being at an angle of about 45° and having a velocity of about 3,400 miles per hour. For the remainder of the flight, the V-2 follows the trajectory of a free body in space, reaching a maximum height of about 50 miles before returning to the surface of the earth. About 5 minutes after take-off it strikes the earth some 200 miles from the launching site with a velocity of approximately 1,800 miles an hour. At this instant, the warhead and any remaining fuel explode.

TECHNICAL DATA OF THE APPARATUS.

The following details included as pertinent information of the V-2 were taken from the translation of a German Manual on the subject. (See fig. 196.)

A. MEASUREMENTS:

Length of warhead: 2,010 mm.

Length of control: 1,410 mm.

Length of the middle part: 6,215 mm.

Width of the ventilating split between the middle part and the tail: 5 mm.

Length of the tail: 4,401 mm.

Total length of the A 4: 14,036 mm.

Caliber: 1,651 mm.

Length of fins: 5,935 mm.

Diameter of outer edge of fins: 3,564 mm.

B. WEIGHTS:

1. Warhead: 1,000 kg.

Payload: 750 kg.

Empty weight of nose: 250 kg.

2. Control: 450 kg.

+ Additional ventilation: + 30 kg.

"Mischgerat": 17 kg.

"Verdoppler": 14 kg.

Gyro (roll and yaw): 4.2 kg.

Gyro (pitch): 5.4 kg.

Two batteries: 52 kg.

Fuze firing circuit: 5 kg.

"Kommando" battery: 8.7 kg.

3 Invertors: 38 kg.

3 Regulators: 4.8 kg.

"Kommando" receiver: 19 kg.

Main junction box: 30 kg.

Pull away plug (side of body): 8 kg.

3. Middle section: 742 kg.

Shell (cell): 418 kg.

Conduit and Cables: 30 kg.

Frame Ring: 18 kg.

Fire Wall: 11 kg.

A-Tank: 121 kg.

B-Tank: 76 kg.

4. Engine Block: 931 kg.

Motor: 422 kg.

Frame: 56 kg.

Pump: 159 kg.

P-Battery: 75.5 kg.

T-System: 73 kg.

Heat Exchanger: 6.7 kg.

5. Tail: 750 kg.

Tail Rib Section: 475 kg.

Servo-Motors: 160 kg.

6. Remainder: 105 kg.

Pressure Pieces: 60 kg.

7. Total Empty Weight of A 4: 4,000 kg.

8. Filled Weight of A-Tank.

(to overflow): 4,900 kg.

9. Filled Weight of B-Tank.

(empty space of 0.29 cubic meters): 3,800 kg.

10. Filled Weight of T-Tank: 175 kg.

11. Filled Weight of Z-Tank: 13 kg.

12. Total Weight of a 4 Fully Tanked: 12,700-12,900 kg.

13. Weight of Fuels (in Pipes Cooling Jacket Heat Exchange and T-System): 210 kg.

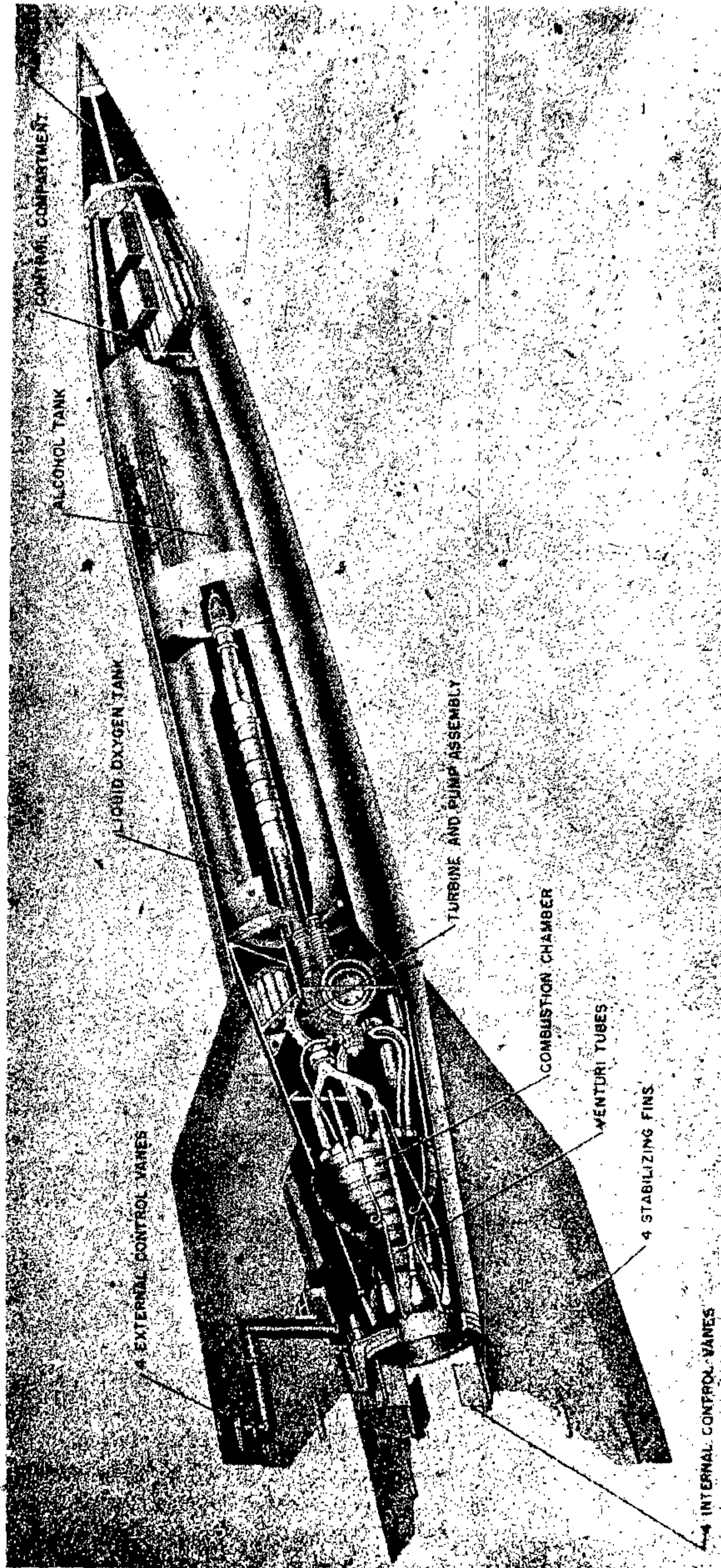

Figure 196--A-4 "V-2" Rocket

C. PERFORMANCES: Individual Parts:

1. Control Room:

Two Batteries: 27 volts, 20 ampere hours.
One "Kommando" Battery: 50 volts, 1.3 ampere hours.

Firing Circuit: 27 volts.

Three Invertors: DC/AC 3-phase.

Invertors: Motor: 27 volts, 12 volts, 10,000 r. p. m.

Generator: 40 volts, 500 cycles, 180 watts.

Three Regulators for Invertors: Regulation 1 percent.

"Verdoppler" Transmitter: Output 15 watts, wavelength 6.5 meters, frequency 46 Mc.

2. Engine Block:

Electrical Armatures: Constructed for 24 volts.

Turbines:

Capacity Ca.: 21 kg/sec.

Revolution: 3,800 r.p.m.

Output: 460 hp.

Additional thrust by Venting Ca.: 50 kg.

A-Pump: Revolutions Ca.: 3,800 r.p.m.

Output: 190 hp.

Output pressure: 18.7 atm.

Output Ca.: 72 kg/sec.

B-Pump: Revolutions Ca.: 3,800 r.p.m.

Output: 270 hp.

Output pressure: 22 atm.

Output Ca.: 58 kg/sec.

T-System: T and Z output pressure: 31 atm.

T-Stoff Flow Ca.: 2.1 kg/sec.

Z-Stoff Flow Ca.: 0.2 kg/sec.

Pressure in Steam Chamber: 25 atm.

Steam Produced: 2.3 kg/sec.

Fresh Steam Temperature: 385° C.

Pressure Reducing Setting: 31 atm.

P-Batteries: Number of Bottles: 7.

Contents: 7 liters per bottle.

P-Pressure: 200 atm.

Total Amount: 12.25 kg=9,600 liters.

Heat Exchanger Flow: 0.3 kg/sec. of A-Stoff; 2.3 kg/sec of steam.

Temperature of Outflow: 280° C.

Temperature of A-Stoff (After Going Through Heat Exchanger) Ca.: 0° C.

Motor: Fuel Consumption per Second in Preliminary Stage:

A-Stoff Ca.: 38 kg.

B-Stoff Ca.: 35 kg.

Total Ca.: 73 kg.

Fuel Consumption per Second in Main Stage:

A-Stoff Ca.: 72 kg.

B-Stoff Ca.: 58 kg.

Total Ca.: 130 kg.

Mixing Proportion: B:A: 0.81.

Fuel Injection Pressure into Motor: 18 atm.

Pressure in Combustion Chamber: 14.5 atm.

Temperature in Combustion Chamber: 2,000° C.

Exit Velocity of Gases Ca.: 2,000 m./sec.

Inner Efficiency (WA/WA TH=Actual to Theoretical Exit Velocity): 95 percent.

Thrust: 25,700 kg.

3. Total Apparatus:

Shooting range Ca.: 300 km.

Ceiling Ca.: 80 km.

"Brennschluss" height Ca.: 28 km.

"Brennschluss" range Ca.: 25 km.

"Brennschluss" Maximum Velocity Ca.: 1,500 m/sec.

Burning time Ca.: 60-63 sec.

Flight time Ca.: 320 sec.

Speed at target Ca.: 800 m/sec.

Angle with Perpendicular At "Brennschluss": 47°.

Greatest Impact Pressure: 8-10,000 kg sq/meter (Reached in 45 sec at 12 km height at 650 m/sec).

Highest heating of the Skin: 300°-500° C.

Lifting Acceleration Ca.: 1g. (9.81 m/sec²).

Maximum Acceleration (at Top of 25-ton thrust) Ca.: 6g.

D. OTHER DATA—TOTAL APPARATUS.

Evaporation Out of the Filled Device of the A-Stoff:

In the first hour Ca.: 320 kg.

In the second hour Ca.: 160 kg.

In the third hour Ca.: 130 kg (and following hours.)

Rigidity of the apparatus:

Untanked: up to 23 m/sec wind speed.

Tanked: up to 35 m/sec wind speed.

Transportation.

Height of the Device: 4.2 meters.

Transportation.

Width of the Device: 3.22 meters.

Transportation.

Length of the Device: 14.7 meters.

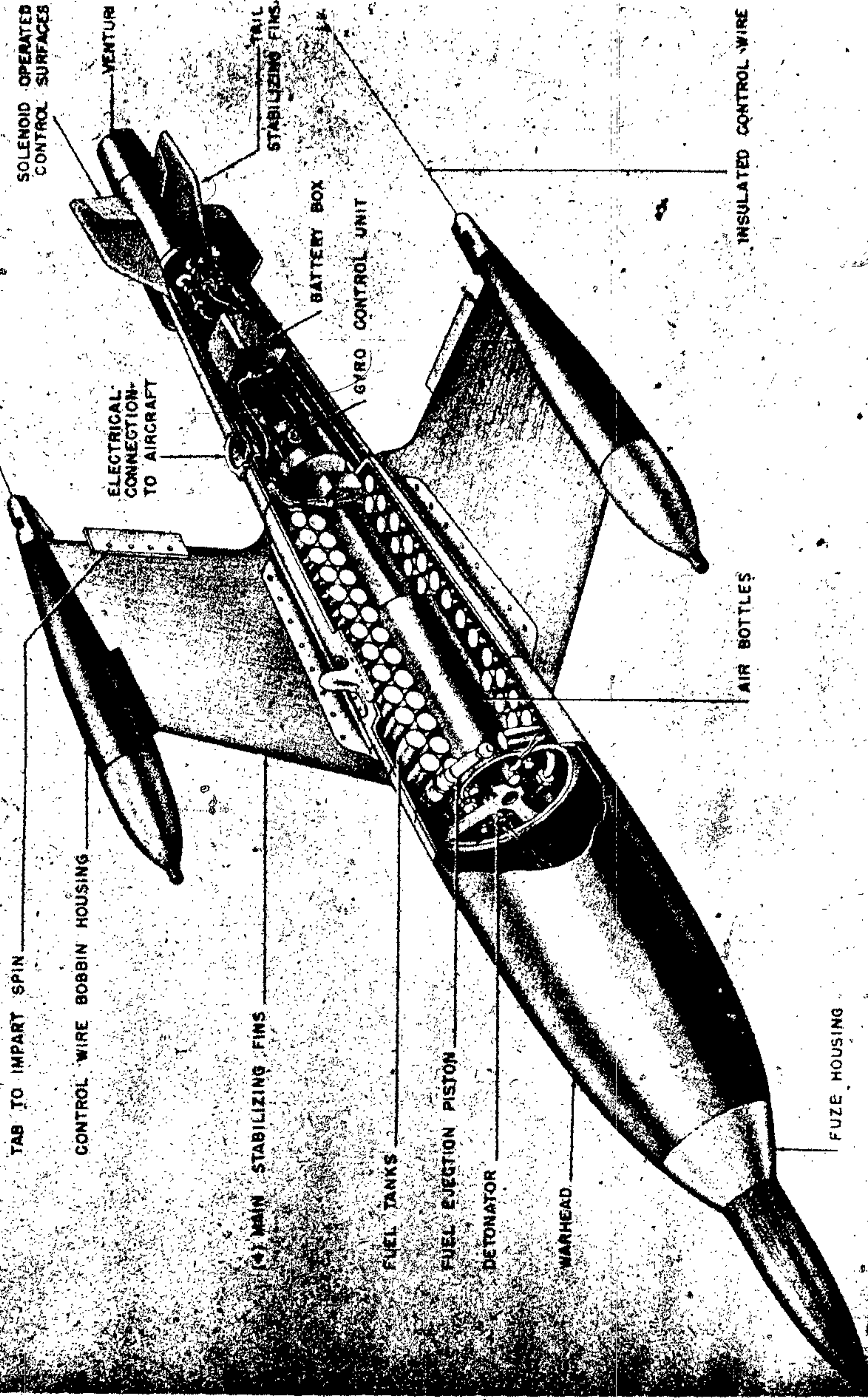

Figure 197A—X-4 Missile

The apparatus with full A-Stoff can stand up to 6 hours without impaired function.

The servo-motors must warm up 30 minutes before shooting. Taking into consideration the insulation condition of the wiring system a detanking of A-Stoff can not take place in the meantime, since in most cases an undesirably high deterioration of the condition of the wiring system is unavoidable as a result of the sweating. The insulation coefficient for the 27 volts wiring system measured at the break-away plug at terminals 1-4 against the body is 10,000 ohms.

X-4

GENERAL DESCRIPTION. The X-4 is a fin-stabilized guided missile with a proximity fuzed warhead developed specifically for use by fighter planes against enemy bomber formations. (See figs. 197A and 197B.)

Stabilization is obtained by four large fins fitted symmetrically to the body and steering is achieved by rake spoilers operating in four small tail fins which are interdigitated with respect to the large fins. In appearance, it is quite similar to "Fritz X" except that it is much smaller, the warhead

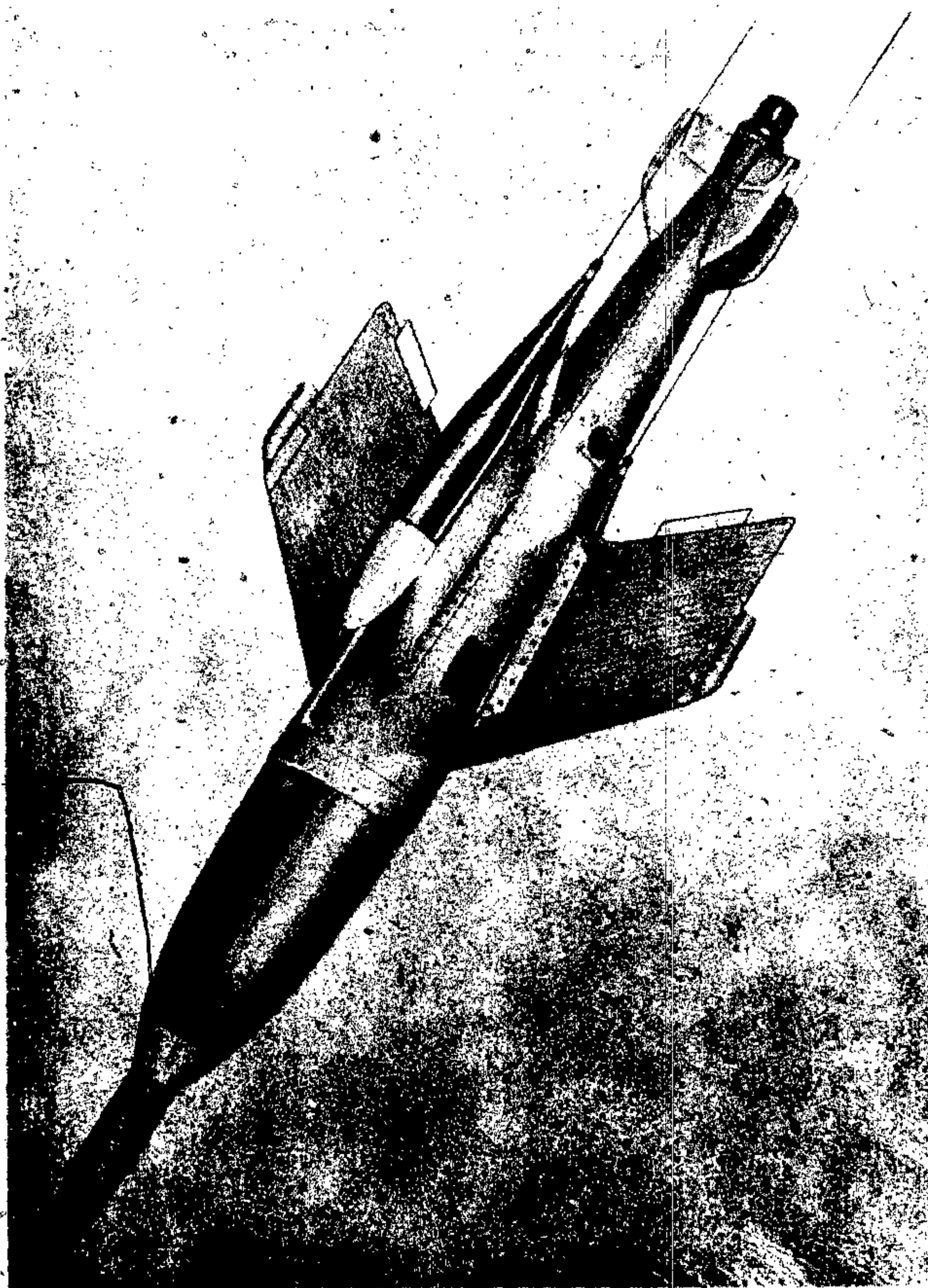

Figure 197B—X-4 Missile

GERMAN EXPLOSIVE ORDNANCE

weighing only 20 kg and the total weight being 60 kg. It is launched without assisted take-off from fighter planes. It can be either wire-controlled by an operator in the fighter plane or it can be used as a self-steering target seeker by the use of acoustic homing. If it is wire-controlled, some sort of rocket propulsion is to be used; while if acoustic homing is used, it is proposed to dispense with the rocket propulsion unit.

OPERATIONAL ASPECTS. The principal operational use of the X-4 would be for fighter use against large enemy bomber formations. Of course, the wire-control version would necessitate the launching plane remaining in the vicinity in order to control the flight of the missile and this would in turn seriously restrict its maneuverability. On the other hand, if acoustic homing were used, the X-4 could be launched and the parent plane could immediately execute an evasive maneuver.

With the 20-kg warhead, it is extremely doubtful that much damage could be done to a four-motored bomber at a distance of 15 meters, the operating range of "Kranich." The effectiveness would undoubtedly be increased if the power plant were dispensed with and the payload doubled, as would be the case if acoustic homing were utilized.

If the X-4 with acoustic homing were used in conjunction with a plane of the ME 262 type, it would be quite a formidable weapon to counter enemy bomber formations, and could probably be used for other tactical purposes as well.

DETAILS. AIRFRAME. The airframe of X-4 consists of a cylindrical body 190 cm in length and 22 cm maximum diameter on which are mounted four large plywood fins fitted to the midsection of the missile and four small tail fins in which the rake spoilers are mounted. The main wing span is 58 cm.

Rotation about the longitudinal axis achieved by small trim tabs attached to the four large stabilizing fins. These give a rotational speed of $1\frac{1}{2}$ r.p.s., which in turn is used to give greater stability in flight and also permits greater manufacturing tolerances in the entire assembly. The main fins are swept back at an angle of 45° , which gives a maximum air speed of 270 m/sec. However due to the comparatively short range over which this weapon is to be used, it is not expected to attain

a velocity of greater than 240 m/sec before it reaches the target.

Steering is effected by means of rake spoilers located in the tail fins. These spoilers vibrate at a rate of 5 cycles per second, control being effected by making the period during which the spoiler projects from one side longer than that during which it projects from the other. When the two periods are equal, no control is applied. This method of steering has the disadvantages of appreciable drag and a certain amount of delay, but has the advantage of simplicity and instantaneous mechanical response.

DESIGN DATA:

Launching weight: 60 kg.

Weight less fuel: 50 kg.

Wing surface: 0.56 sq. m.

Wing loading: 200 kg/m.²

Maximum speed in horizontal flight at 6,500 m altitude: 270 m/sec.

Lateral acceleration in horizontal flight at 6,500 altitude: 40 m/sec.²

Total energy available during 33 sec burning time: 1,600 kg/sec.

POWER PLANT. The Bi-fuel liquid propellant motor is the BMW 109-548 rocket motor using a mixture of Salbei (98 to 100 percent nitric acid) and Tonka 250 (57 percent crude m-xylidine with 43 percent triethylamine). This motor is capable of delivering an initial thrust of 150 kg which drops to about 25 kg after 30 seconds.

The solid propellant which it was proposed to use was "Mixture 167" by Wasag. Initial thrust is 120 to 140 kg which is also reduced to about 25 kg after 30 seconds.

Of course, there were also plans under way to eliminate the propulsion unit entirely, in which case the payload could have been appreciably increased.

INTELLIGENCE AND CONTROL SYSTEM.

In all the proposed versions of X-4, the missile rotates and therefore only one gyro is needed. When wire control is used, the principal purpose of the gyro and commutator system is to translate the right-left and up-down signals into the proper pulses to feed to the rake spoilers in the tail fins. The gyro is spun up while the missile is still attached to the launching aircraft. During the flight of the missile, the gyro is not power driven. The gyro was made by Th. Horn, Leipzig.

The wire control system consists essentially of a small joystick control unit mounted in the aircraft, a pair of control wires and a receiving unit in the missile consisting of a gyroscope and a pair of relays. The control unit contains two drums which revolve at a rate of r.p.s., one drum controlling azimuth and the other elevation. The control wires consist of 2 insulated single strand Swedish spring-steel wires of 6,000 m length and 0.22 mm diameter. The receiving unit in the missile is quite simple consisting primarily of a polarized relay for azimuth control and unpolarized marginal relay for elevation control. The polarized relay responds only to polarity changes in the direction of the current flow through the wires while the unpolarized marginal relay responds only to changes in the value of the current, regardless of its polarity. In this way, both azimuth and elevation control signals can be transmitted simultaneously over the same pair of wires.

The relays are connected to the spoiler solenoids in the tail fins, through the gyro commutator system. This arrangement converts the left-right and up-down signals into the proper pulses which are to be fed to the solenoids actuating the spoilers. The power supply is a small 9-volt dry battery located in the afterbody of the missile.

During the flight tests, there were no detrimental effects from static electrical charges accumulating on the wires and the mechanical difficulties had been solved by paying out the wire from the bobbins on the missile and similar bobbins on the parent plane simultaneously. Wire control was selected primarily because, compared to radio remote control, it is practically jamproof.

In March 1945, there was also under development a plan to dispense with the power plant and wire control and to use an acoustic homing system "Pudel" as the control device. This system is based on the same fundamental principles as the acoustic proximity fuze "Kranich." It consists essentially of a mica and 0.03 mm aluminum foil diaphragm connected to a carbon microphone, the output of which is fed to a single stage amplifier and relay output. This assembly is mounted at an angle of approximately 60° to the longitudinal axis of the body and the sound passes into the diaphragm through a series of wire mesh screens which serve to attenuate differences of air pressure due to rotation but not the sound of motors and

propellers of enemy aircraft. A small lyre arrangement is attached to the vibrating system in such a way as to broaden out the mechanical resonance curves of the individual components of the system. The composite curve of the acoustic system with the 15-wire lyre attached is practically flat from 200 to 400 cycles. The wire mesh screens attenuate the slow air pressure variations about 40 or 50 db, whereas the sound vibrations of 200 to 400 cycles are attenuated only 1 db.

As the X-4 rotates, if the missile is homing directly on the target, the output of the microphone will be constant and there will be no modulation output and consequently no steering corrections. If the missile is not aimed directly at the target, there will be generated a modulation frequency of 1½ cycles per second, the rotation speed of the X-4. This modulation frequency of 1½ cycles per second is used to transmit information to the spoilers through the gyrocommutator system. For this purpose, the normal gyrocommutator system has been modified to some extent. Only 8 models of "Pudel" have been built and so far no flight tests have been made.

The modification of X-4 with "Pudel" and also equipped with the "Kranich" acoustic proximity fuze when launched from a fighter plane of the ME 262 type appears to be a weapon of great promise, since after launching, the fighter pilot can immediately take evasive action. The range of the acoustic homing device is expected to be about 1,000 meters, so that if it were launched at a range of 2,000 meters, the first 1,000 meters of its flight would be uncontrolled.

WARHEAD AND FUZE. When X-4 was originally conceived, it was expected to use a 20-kg. cast-steel warhead enclosing the explosive material. However, due possibly to the shortage of steel in Germany at the beginning of 1945, some thought was being given to the use of an uncased molded plastic type of warhead which was to be attached to the afterbody by wood screws and had an adaptor for the nose fuze attached to the nose in the same way.

The fuzing system consisted of the acoustic proximity fuze "Kranich" which forms the nose of the missile, an impact and graze fuze, and a self-destroying fuze which operates 35 seconds after release. The acoustic and impact fuzes are armed 7 seconds after release. The acoustic fuze consists of a light diaphragm actuated mechanism which

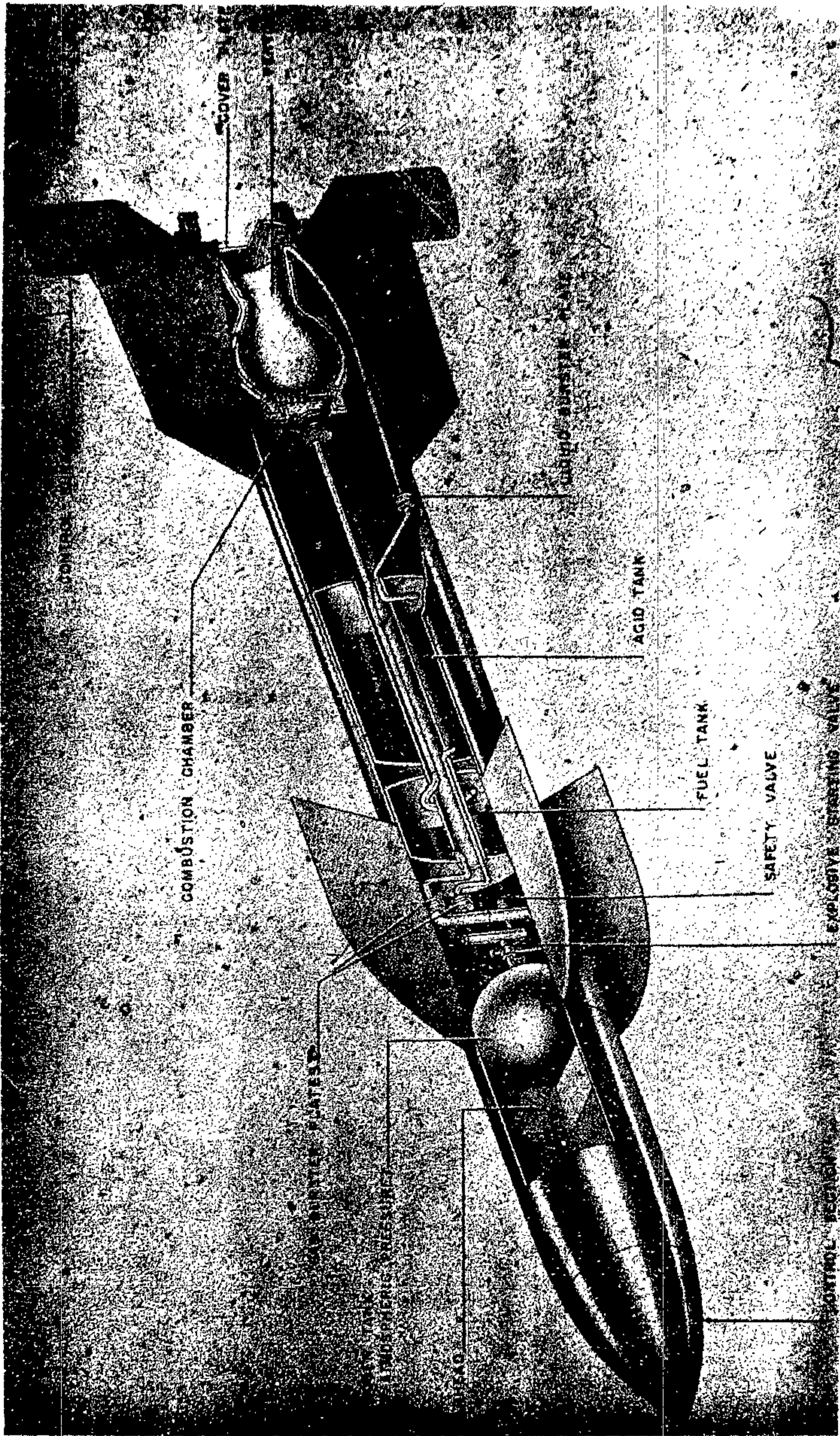

Figure 198—Wasserfall

responds to the sound of aircraft propellers at a range of 15 meters. This fuze has a time delay of $\frac{1}{60}$ second to make it more effective. A complete description of "Kranich" has been given in other Intelligence Reports. Specimens have been shipped to Naval Research Laboratory, Washington, D. C., on Consignment Tag No. 3980.

LAUNCHING DEVICES. Originally the X-4 was being carried only by the Focke-Wolf 190. However, it was later planned to use it also in connection with ME 262 and DO 335. The missile is suspended from the parent craft by means of ETC70A1, which is a modified 70-kg bomb-rack with a 7-prong umbilical cord and provision for two control wires. The X-4 is released electrically when the pilot presses the bomb release switch.

WASSERFALL C-2

GENERAL DESCRIPTION

A. This flak rocket was given the name Wasserfall and the designation C-2 8/45.

B. The C-2 was designed to be launched vertically from the ground, and traveling at a supersonic speed to be guided into bomber formations where it would be exploded.

C. The Wasserfall resembles a half-size V-2 with small wings. It has a similar motor and is launched in much the same manner. Its control gear is also similar. (See fig. 198.)

It could reach a maximum speed of about 770 meters per second in about 45 seconds after which time the speed would decrease as the fuel would be exhausted. It could still chase targets until its speed had dropped to about 350 meters per second. Its maximum fighting ranges were: 18 kilometers in height and 26 kilometers in horizontal range. It was designed to withstand maneuvers of up to 4.4 g. The missile was guided by radio signals from the ground until approaching the target at which time a self-contained homing system was to lead it in. It was planned to incorporate a proximity fuze to explode the weapon close to the bombers.

With these properties the Germans expected every other missile to bring down a bomber making 2 g evasive maneuvers at a speed of 250 meters per second.

OPERATIONAL ASPECTS

A. The Wasserfall was planned for use from the ground against air targets, specifically bomb-

ers. Suggested locations for launching sites were along the French coast and the approaches to major targets of bombers.

B. The launching site requires much equipment and, although mobile, would thus be subject to attack. Lack of maneuverability against relatively slow airplanes would have inhibited its effective use.

C. The Wasserfall was expected to be both cheaper and more effective than ordinary flak for the results obtained. Only operational use could prove this point.

CONCLUSIONS. The Wasserfall was not completed and thus offers no immediate possibilities as a weapon without much further work on the control system.

RECOMMENDATIONS. It is believed that an intensive study of the Wasserfall will yield much information on the principles and the use of a supersonic guided missile.

DETAILS

AIRFRAME. A. TYPE AND DESCRIPTION. In over-all appearance the Wasserfall resembles a half-size V-2 with small wings. The approximate dimensions are:

Length: 7,800 mm.

Caliber: 880 mm.

Wing span: 1,890 mm.

Tail span: 2,500 mm.

There are four small biconvex dorsal wings at the center of gravity to assist in making turns. In line with these wings are four stabilizing fins at the tail. Control surfaces are fitted on the stabilizing fins both in the air stream and in the gas stream of the jet motor.

B. AERODYNAMIC CHARACTERISTICS. The Wasserfall is designed to catch, while traveling at a supersonic speed, a target having a velocity of 250 meters per second doing 2 g maneuvers.

Essentially the missile travels at and is designed for supersonic speeds. However, the transition from zero speed at launching to the supersonic range is not instantaneous and some additional control is desirable during this interval. This is supplied by the gas stream fins which are present for the first 5-15 seconds of flight. Once the supersonic range is reached the air stream fins supply sufficient control while the jet stream fins add a drag. Consequently they are jettisoned at that time.

GERMAN EXPLOSIVE ORDNANCE

The missile is designed to stand maneuvers up to 4.4 g. The wings will support a lift of 8,000 kg per pair to which the body, tail, etc., add about another 4,000 kg making a total lift of 12,000 kg.

The missile weighs about 3,500 kg at take-off, but the weight drops continually to about 1,500 kg by the time the fuel is exhausted. Thus at take-off the lateral acceleration should not exceed 3 g, increasing to 4.4 g as the fuel is consumed. To allow for this the control applied to the servo is made weak at first and is gradually brought up to its full power.

Wind tunnel tests of models made may be found in report No. UM 6013 dated February 1945 in the Göttingen documents. Evidence obtained at the wind tunnels at Kochel shows that at least six different shapes have been tried out to get the best aerodynamic results.

C. DESIGN DATA. The missile is fabricated from mild steel to the shape shown in Figure 198. It may be broken down into the following parts:

1. Nose: Contains the homing device (zielsuchendes Geraet) fuzes (Zuender) and explosive (Sprengstoff).
2. Nitrogen tank: (Druckluftbehälter).
3. Visol tank: (Brennstoffbehälter).
4. Wings: (Flügel).
5. Salbei tank: (Salbeibehälter).
6. Control system: Mounted to rear of Salbei Tank.
7. Tail: Supports motor (Brennkammer), tails (Flosse), air rudders (Lufttruder), and jet rudders (Stahltruder).

D. PRODUCTION DATA. The following remarks apply to all parts of the missile. The only production was by the Electromechanische Werke at Peenemünde for the developmental testing. Estimates of this production range from 40 to 275 units.

Estimates were drawn up for the men, material and space needed for the mass production of 5,000 monthly.

PROPULSION SYSTEM. A. TYPE AND DESCRIPTION. A liquid jet motor drive is used which develops an 8,000 kg thrust for 45 seconds. The motor burns a self-igniting mixture of Salbei (nitric acid) and Visol (a hydro-carbon mixture) in a chamber with a venturi nozzle.

B. CHARACTERISTICS:

- Thrust: 8,000 kg.
- Total impulse: 360,000 kg.
- Launching acceleration: 1.2 to 2.6 g.
- Final acceleration: Ca. 4 g.
- Fuel consumption: 41 kg/sec.
- Specific impulse: 180 to 195 sec.

C. DESIGN DATA. The general arrangement is indicated in figure 198. The foremost flask contains nitrogen at a pressure of 200-300 atmos. This flask is 8 to 13 mm thick and is not wire wound. The compressed gas passes through a reducing valve to 30 atmos and is used to force the liquids out of their storage tanks. This flask and the two storage tanks are made of rolled and welded steel.

The forward storage tank contains about 400 kg or 430 liters of Visol. Visol is a rather variable fuel according to the ingredients available or the intended-use. A typical Visol mixture is: 40 percent isopropyl alcohol; 40 percent vinyl ether; 2 percent water; 18 percent of four other ingredients including 1 percent of a dope to control the ignition delay time.

Visol is a contracted code name for vinylisobutylether. A Diesel oil may also be used in place of Visol.

The rear tank contains about 1,500 kg or 1,100 liters of the oxidant Salbei. Salbei is a mixture of 90 percent nitric acid (including 3 percent water) and 10 percent sulfuric acid. No attempt is made to make the acid water free as it would be reabsorbed from the air before it was ever used. The sulfuric acid was added to prevent corrosion by the nitric acid of the steel available for the tanks.

As already mentioned, the fuel and oxidant were forced out by pressure. The fuel is removed through a swinging pipe hanging down in the tanks. As this pipe is subjected to the same acceleration as the fuel, its end is always covered by liquid. This design gives a lightweight removal system which removes practically the last drop of liquid although the liquids are being swished around in the tanks. It is said this system increased the maximum altitude obtainable by 4 kilometers over a pump arrangement that was tried.

Both fuel and oxidant are passed through a valving arrangement which introduces both liquids into the motor at the same time under full flow.

Valves in the various pipe lines are opened simultaneously by explosive charges. Just before each liquid enters the motor there is a diaphragm. These diaphragms stop the liquid until it has built up to practically full pressure at which time the diaphragm bursts and allows a full flow of liquid, from the start, to enter the motor.

The ratio of liquids by weight is Salbei to Visol from 5 to 1 up to 8 to 1 depending upon the actual Visol mixture being used.

The Visol is fed directly to the nozzle head. The Salbei first passes through the cooling jacket of the motor before going to the nozzle head. In some cases some of the Salbei is also injected through cooling holes into the combustion chamber. The two liquids ignite within 0.01 to 0.1 second after contact. An expansion ratio of 2.5 to 1 up to 3.9 to 1 is obtained in the motor. The gas exit velocity is approximately 1,850 meters per second.

Brennschluss (turning off of the motor) had not been settled. Provisions were made for several methods, which were:

1. Letting the motor use up all of the fuel
2. Turning off the motor by radio signal
3. Turning off the motor at a predetermined velocity by means of an integrating accelerometer.

INTELLIGENCE AND CONTROL SYSTEM

A. TYPE AND DESCRIPTION. Many systems were tried or proposed which, although radically different in details, are very similar in function. Three gyros are used to prevent oscillations about the three axes. Remote radio control is used to guide the missile toward the target. A homing device is to be used in the final part of the chase to guide the missile to within killing distance of the target. Finally a proximity fuze is to explode the missile. In addition there is a relay transmitter in the missile to enable the personnel on the ground to follow it.

B. CHARACTERISTICS. The control system must be capable of guiding the missile very close to a target which is making 2 g curves at a velocity of 250 meters per second.

C. DESIGN DATA: 1. RUDDERS AND RUDDER MACHINES. In each of the four tail fins there is a pair of rudders in the air stream and the jet stream. Each pair of rudders is driven by one all-electric servo motor. The armature of the servo motor oscillates at 50 cycles a second to reduce the back

lash to almost zero. Roll control is applied to all rudders.

2. GYROS. Three course gyros are used to prevent the missile from oscillating. The take-off cards on the gyros are positioned by the remote radio control to keep the gyros oriented with respect to the desired path.

3. REMOTE CONTROL RADIO RECEIVER. This unit receives command signals from the ground control station to direct the missile towards the target. The "Strassburg" E230V is employed, as the receiver.

4. RELAY TRANSMITTER. A transponder triggered from the ground radar to indicate the angle of roll of the missile by measurement of the polarization of the wave transmitted is known under the code name "Reuse."

5. "MISCHGERAET". An electrical computing device which receives signals from the control radio and the gyro, mixes these signals, and sorts them out for the various rudder motors.

6. HOMING DEVICE. A device to make the missile home in very close to the target. None had been sufficiently developed to test in the missile. It is a prerequisite as the ground control is not sufficiently accurate to guide the missile close enough to the target to do damage.

7. POWER SUPPLY. Batteries, invertors, regulators, etc., to power the control system.

8. WARHEAD, FUZE, FIRING CIRCUIT. About 305 kilograms of explosive were to be used. Of this about 100 to 150 kg would be concentrated in the nose. The remainder would be distributed throughout the body much in the form of primercord. This distributed charge was necessary to destroy the missile in mid-air as it would be used over friendly territory. The warhead was expected to have a destructive range of 40 meters.

9. AUXILIARY EQUIPMENT. The Wasserfall required considerable ground equipment for the remote control. Equipment is required not only for the transmittal of control signals to the missile, but also to track both the missile and the target. The missile is guided so that it is always on the line between the target and the ground observer.

Preferably the tracking is done optically. In this case, the operator has only to keep the missile and the target lined up in the optical field. However, radar tracking must be provided for the

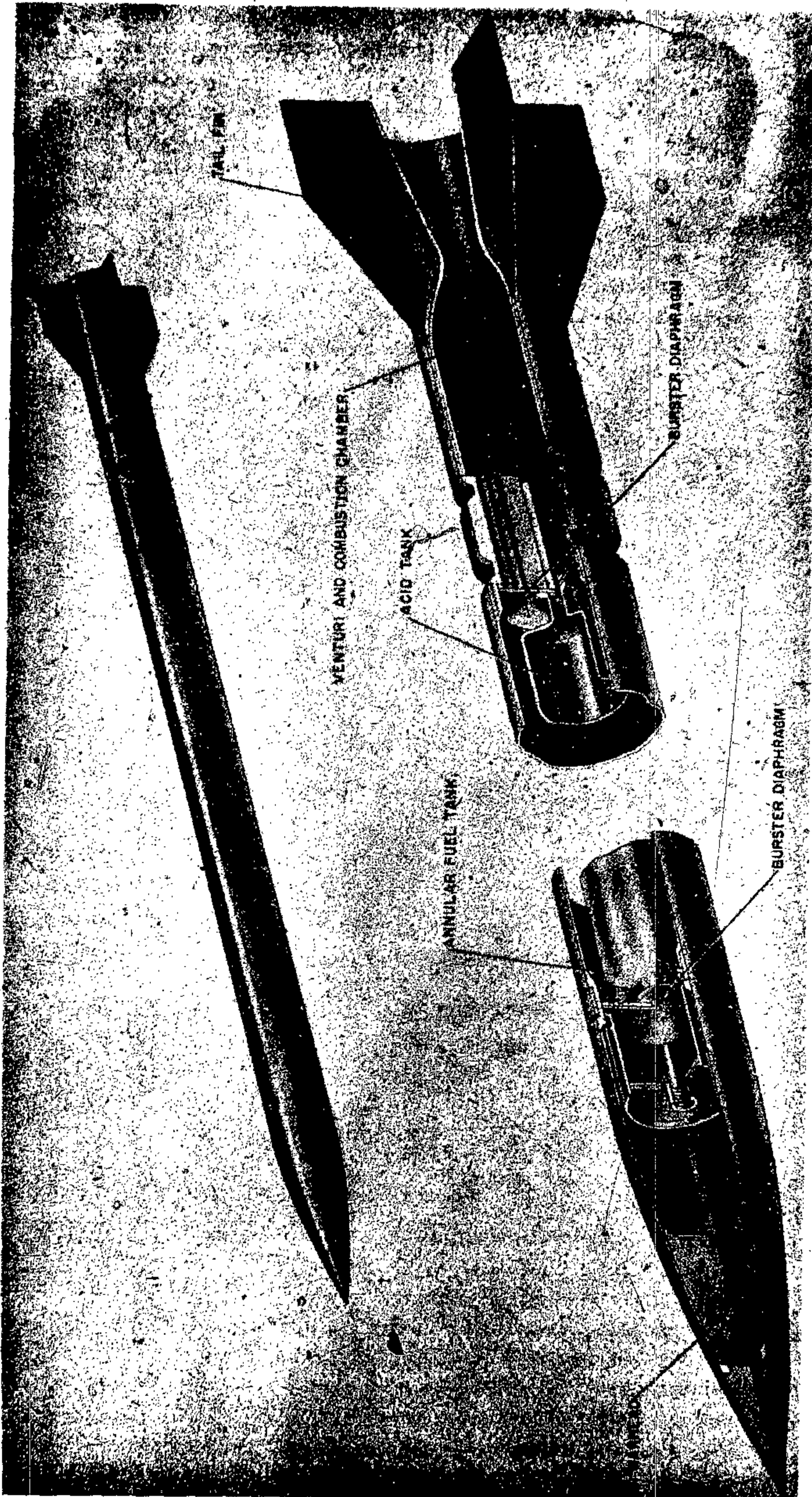

Figure 199—Taifun

many times that optical tracking will be inadequate. The radar tracking system and control system known as the "Elsass" consists of the following functional parts:

Mannheim radar.—Radar set to track the target. It also measured the distance between the target and the missile.

Rheingold.—The Rheingold follows the missile and measures the roll position of the missile by determination of the angle of polarization of the signals sent out by the "Ruese" relay transmitter in the missile.

Indicator.—The indicator displays information obtained from the Mannheim and the Rheingold:

Azimuth and elevation of target and missile.

Distance to target and missile.

Roll position of missile.

Kehl control transmitter.—An operator sits before the indicator and by means of a joy stick control keeps the missile in line with the target. This joy stick controls the command signals sent out by the "Kehl" control transmitter to the "Strassburg" receiver in the missile. By this transmitter the operator may also fire a fuze in the missile when his indicator shows the missile is at the target.

TAIFUN BILQUID ROCKET

GENERAL. The rocket Taifun is a biliquid rocket reputed to be fired in groups of 65 from a launching machine known as the Dobgerate. From all indications, it never passed beyond the experimental stage.

The projectile is approximately 2.1 meters long and 10 centimeters in diameter. The greater part is taken up with the fuel tanks which contain Visol and acid. The acid is housed in a central aluminum tank, while the Visol is contained in the annular tank between the inside tank and the outer skin of the missile. The walls of both tanks are 1 mm thick. (See fig. 199.)

The acid tank is supported in the rocket shell by two aluminum end plates bolted to its end flanges. These end plates are perforated so as to connect the fuel tanks at the upper end to the cartridge pot, and at the lower end to the liquid sprays. A thin aluminum rupturing diaphragm covers the holes in the two end plates.

Behind the solid steel nose piece there is a hollow chamber for housing the 500 grams of explosive,

the impact fuze, and the igniting device for setting off the cartridge pot.

The cartridge pot is just aft the chamber which houses the warhead and the fuzing system. When the contents of the cartridge pot begin to burn, a gas is generated which is used to expel the liquids from the tanks and force them into the combustion chamber.

The combustion chamber and venturi are made of mild steel mostly 1 mm thick, but the thickness increases at the venturi throat to 2½ to 3 mm. At the end of 2 seconds operation, the temperature of the venturi reached 300° to 400°. It was possible to use a venturi experimentally for five runs, after which it had to be renewed.

DATA:

Dimensions:

Total length: 2.10 meters.

Maximum diameter: 0.10 meter.

Length of tanks:

Acid tank: 1.15 meters.

Annular tank: 1.20 meters.

Diameter of tanks:

Acid tank: 0.08 meter.

Annular tank: 0.10 meter.

Weights:

Nose Piece: 1.30 kg.

Outer Shell: 3.25 kg.

Tanks: 1.75 kg.

Combustion Chamber: 1.50 kg.

Thrust Block: 0.73 kg.

Thrust Disk: 0.70 kg.

Rest: 1.77 kg.

Total (empty): 11.00 kg.

Charge in Warhead: 0.50 kg.

Expellant Cartridge: 0.50 kg.

Acid: 8.60 kg.

Fuel (Vizol): 2.30 kg.

Total (loaded): 22.90 kg.

FEUERLILIE MODEL F-25

DESCRIPTION. The F-25 is one of the "Feuerlilie" series of rocket-propelled guided missile which the LFA (Luftfahrtforschungsanstalt Hermann Goering E. V.) located at Volkenrode/Braunschweig, Germany, was developing in order to obtain aerodynamic data in the near sonic and supersonic regions. Although the primary purpose of the Feuerlilie series development was to obtain aerodynamic data, some

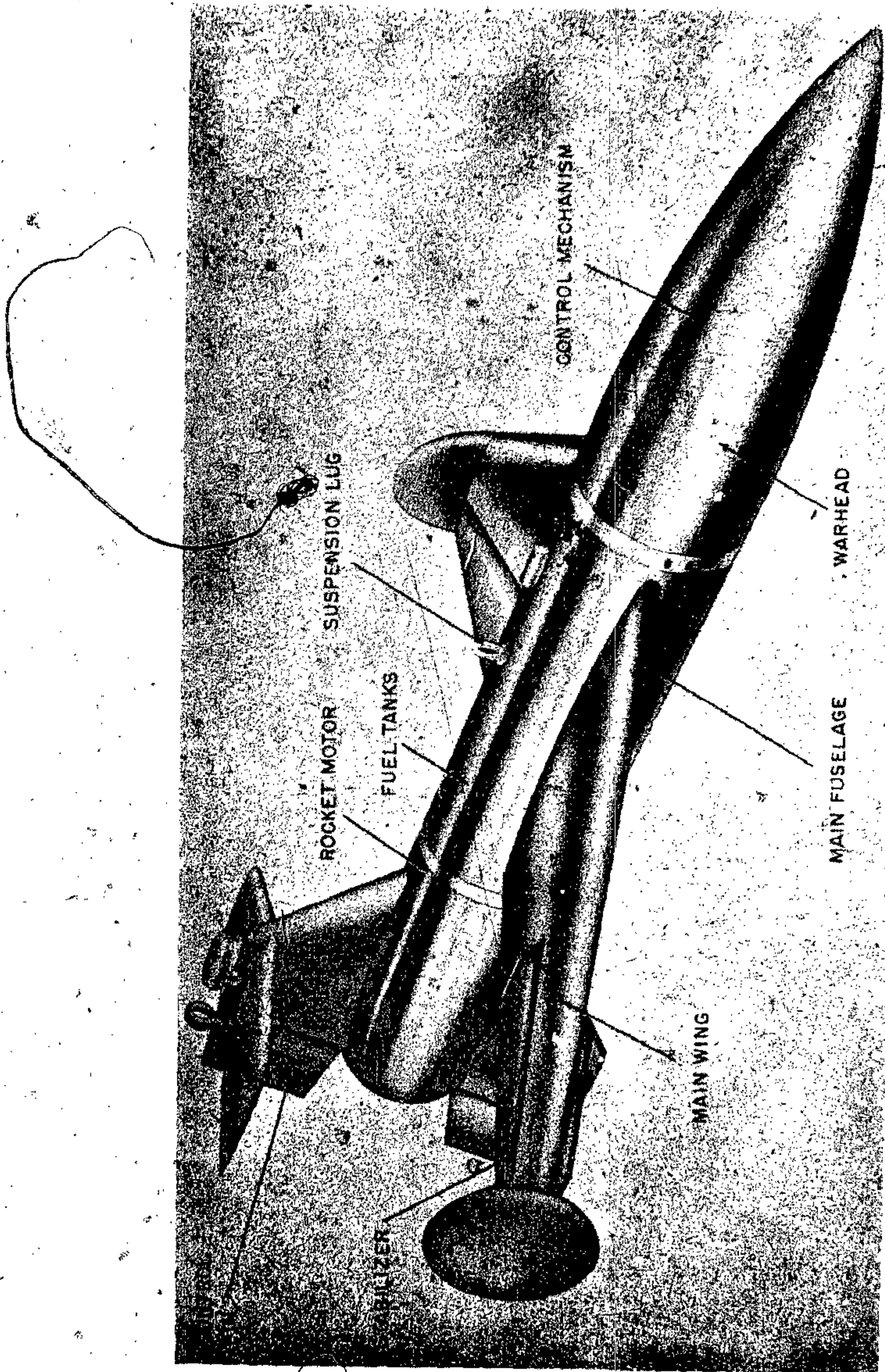

Figure 200—Feuerlille F-25; Feuerlille F-55

thought was also being given to the possibility of using certain models, such as the F-25, for actual production as a weapon of war. This model has a fuselage 2 meters in length and 25 cm maximum diameter with two wings attached to the midbody. The main wing span is 112 cm. The rocket drive is of the solid propellant type. The F-25 was a ground-launched rocket, which could reach an altitude of 3,000 meters with a horizontal range of 5,000 meters.

HISTORY OF DEVELOPMENT. Development work on F-25 was started in the spring of 1943 by Dr. Gerhard Braun of LFA. The fuselage was built by the Ardet Werke, located in Breslau. About 20 models were built, of which 10 or more were tested successfully at Leba, near the Ostsee in Pomerania. However, the low maximum speed of 220 meters per second makes the results of no great significance. Development work was stopped in the fall of 1944.

CONCLUSIONS. Since the Feuerlilie F-25 was primarily a research project, it is of interest from an historical standpoint only.

DETAILS. AIRFRAME. The airframe of the F-25 consists of a 2-meter fuselage to which two main wings are attached near the mid body. The wings are provided with ailerons to give roll stabilization in flight. (See fig. 200.)

POWER PLANT. The power plant used for F-25 is of the solid propellant type RI 502 and was built by Rheinmetall-Borsig.

DESIGN DATA:

Weight of propellant: 17.5 kg.

Burning time: 6 sec.

Thrust: 500 kg.

Total weight of missile: 115 kg.

To produce an even thrust for aerodynamic data purposes, a blowoff valve located between the two venturis is provided. This valve opens at a pressure of 100 atmos.

CONTROL SYSTEM. The roll stabilization system used for F-25 was the same as that used for Hecht; i. e., one gyro was installed with its axis perpendicular to the missile axis in such a way as to increase the effective moment of inertia of the missile in roll. If a disturbance sets up a roll moment, the gyro would tend to precess, which would

in turn cause the ailerons to reverse the roll of the missile. When no damping was provided with this system, excessive roll occurred. A mechanical dash-pot was added to remedy this condition.

The main reason for the choice of this type of gyro control was that the weight and space requirements were less than for the conventional available auto-pilot devices. The gyros were procured from Kreislergerat, Berlin.

No attempt was made to remotely control the flight of Feuerlilie F-25.

WARHEAD AND FUZING. Since the F-25 was only a test model, no warhead was provided.

A Rheinmetall-Borsig time fuze was used to ignite the flares mounted on the wing tips to insure satisfactory tracking of missile in flight.

LAUNCHING. The F-25 was launched from the ground at an angle of 10°-30° to the vertical.

FEUERLILIE MODEL F-55

DESCRIPTION. The F-55 is another of the Feuerlilie series of rocket propelled guided missiles which the LFA (Luftfahrtforschungsanstalt Hermann Goering E. V.) located at Volkenrode/Braunschweig, Germany was developing in order to obtain aerodynamic data in the transonic region. Although the primary purpose of the Feuerlilie series development work was to obtain aerodynamic test data, there is evidence that a certain amount of thought was being given to the possibility of using the F-55 as a weapon.

The Feuerlilie F-55 has a fuselage 4.8 meters in length and a diameter of 55 cm. The wing span of the two main fins which are attached to the afterbody of the fuselage is 2.6 meters. The first F-55 had a solid propellant rocket drive, but later models used a liquid rocket motor with a dry powder assisted take-off unit.

The F-55 was to be ground launched and it was expected to reach an altitude of 4,800 meters with a maximum horizontal range of 7,500 meters. Elaborate plans were also being made to install telemetering and to follow the flight path of the missile by cine-theodolites.

HISTORY OF DEVELOPMENT. Development work on F-55 was started about May 1944 by Dr. Gerhard Braun of LFA. The body for the F-55 was built by Ardet Werke, Eberswalde, Breslau.

GERMAN EXPLOSIVE ORDNANCE

The production scheduled for experimental models of F-55 for the year 1945 called for a total of 35 with deliveries of at least 3 per month for the first 10 months of the year. These were to be tested with various stabilizing systems and the later models were also to be equipped with telemetering and remote control equipment.

The first model of F-55 with solid propulsion was tested at Leba, Pomerania in May 1944, with satisfactory results, a Mach number of 1.25 being attained. The second model with a liquid fuel system and take-off unit was tested at Poenemunde on 11 December 1944; this model went into a spin about its pitch axis shortly after leaving the launching track. The third model had been sent out to Poenemunde for testing, but had not yet been tested.

CONCLUSIONS. Since the Feuerlilie F-55 was primarily a research project, it is of interest largely from the standpoint of the methods tried and the techniques of flight observations used.

As the F-55 like the F-25 was a manifestation of the Velkenrode research groups' ideas, it undoubtedly represents a high order of an aerodynamic development and requires treatment as such. The Braunschweig documents, duplicated by the United States Army Air Forces and evacuated to Wright Field, Dayton, Ohio, include comprehensive reports on the Feuerlilie series.

DETAILS. AIRFRAME. The airframe of the Feuerlilie F-55 consists of a fuselage 4.8 meters long, and having a maximum diameter of 55 cm. There are two sharply swept back wings having a span of 2.6 meters. Two vertical fins are mounted at the extremities of the wings, this position being chosen to keep them out of the wake of the body.

The outer halves of the trailing edges of the wings are movable so as to give aileron control. No rudder is provided, yaw control being obtained from aileron action.

POWER PLANT. The power plant used for the first model of F-55 was the RI 503 solid propellant type built by Rheinmetall-Borsig. For the second and third propulsion unit designed by Dr. Conrad of DVX (Deutsche Versuchsanstalt für Kraftfahrzeug und Fahrzeugmotoren) located in Berlin. In addition, an assisted take-off unit "Pirat," a solid propellant rocket was used.

DESIGN DATA:	SG 20	PIRAT ATO.
Thrust.....	6,400 kg	10,000 kg.
Time of burning..	7 sec	2.7 sec.
Weight of fuel...	210 kg	150 kg.
Impulse.....	45,000 kg sec	27,000 kg sec.

CONTROL SYSTEM. On the first model of F-55, no roll stabilization was used. On the second and third models, gyro equipment developed by Fischl of DFS (Deutsche Forschungsanstalt für Segelflug) was tried. This system used a single gyro with Askania pneumatic rubber servos. It was expected that the rubber would provide the necessary mechanical damping, but due to the fact that the only test flight on which this system was used failed, it was impossible to determine whether or not this was the case. On subsequent models, it was proposed to use a Horn gyro system consisting of two gyros, one of which was used for damping only. This system was also to be used with the Askania pneumatic servo systems of remote control.

In connection with the Feuerlilie program, a new telemetering system "Stuttgart" had been developed which had 12 channels and gave 20 values per second with an accuracy of ± 5 percent. This system was designed by the Forschungsanstalt Graf Zeppelin, located at Stuttgart/Ruit.

WARHEAD AND FUZING. Since the F-55 was primarily a research missile in the early stages of its development, there was no provision made for a warhead. Like the F-25, a Rheinmetall-Borsig time fuze was used to ignite the flares mounted on the wing tips to insure satisfactory tracking of the missile in flight by means of cine-theodolites.

LAUNCHING. The F-55 was launched from an inclined ramp built by Ardelt Werke, Breslau. The launching angle was 20° to the vertical.

RHEINTOCHTER

GENERAL DESCRIPTION. The Rheintochter is a radio-controlled anti-aircraft rocket designed for ground launching against bomber formations. The first model Rheintochter 1, is a two stage rocket having a total launching weight of 1,750 kg. The starting rocket has a burning time of only 0.6 second, after which it drops off, the main stage then being automatically ignited. Stabilization was achieved by six fins attached to the

rear of the main body of the rocket and four fins attached to the starting unit. The rocket was to be remote radio controlled with the possibility of using an infra-red homing device together with a proximity fuze to detonate the missile in the midst of the bomber formation. The control surfaces were located at the nose of the missile. It attained a final velocity of 360 meters per second, and could reach a height of 6 kilometers with a maximum horizontal range of 12 km.

The Rheintochter 1 was replaced by the development of the Rheintochter 3. The remainder of this discussion will be on the second model and will go into considerable detail.

In the Rheintochter 3, the rear take-off unit was dispensed with and replaced by two auxiliary take-off units mounted on the sides of the body of the rocket. The main rocket stage could be either a liquid or a solid propulsion unit, depending on the availability of fuels. The Rheintochter 3 is designated as R-3f when a liquid propulsion unit is used and R-3p when a solid propellant is employed in the main rocket stage. The control and steering mechanism are identical in both Rheintochter 1 and Rheintochter 3. The Rheintochter 3, however is allowed to rotate about its axis in flight and instead of six stabilizing fins, it is provided with only four. (See fig. 201.)

DETAILS. AIRFRAME. The Rheintochter 3 consists of a main fuselage 500 cm. long and 54 cm. in diameter, having four large swept-back main fins and two auxiliary take-off units mounted on the sides of the body between the two pairs of fins. As in the Rheintochter 1, the control surfaces are mounted in the nose section but are of a somewhat different aerodynamic design.

The main fin span is 220 cm. the four fins being attached to the body so that the angle between successive fins is 90°.

As in Rheintochter 1, the main fuselage is constructed partly of aluminum plate, partly of steel alloy plate and partly of a material called ELEKTRON. The fins were to be constructed of LIGNOFOL, a highly compressed laminated wood, but for mass production purposes, plywood could have been used.

DESIGN DATA:

Dimensions:

Length: 500 cm.

Span: 220 cm.

Diameter: 54 cm.

Weight:

Empty: 525 kg.

Take-off units: 440 kg.

Main stage fuel: 88 kg.

Main stage oxydizer: 336 kg.

Main stage compressed air: 18 kg.

Explosive: 160 kg.

Launching weight: 1,570 kg.

Weight at target: 685 kg.

POWER PLANT

A. R-3f LIQUID PROPULSION UNIT. The R-3f liquid propulsion unit requires fuel tanks carrying 336 kg of Salbei, 88 kg of Visol and 18 kg of compressed air at a pressure of 250 atmospheres to provide pressure feed to the combustion chamber.

B. R-3p SOLID PROPELLANT UNIT. The R-3p solid propellant unit utilizes 5 rods of diglucol dinitrate weighing 90 kg each, making a total weight of 450 kg.

DESIGN DATA (R-3f):

Launching altitude: Angle.

Total launching impulse: 105,000 kg/sec.

Velocity at end of combustion: 410 m/sec.

Velocity at target: 400-200 m/sec.

Take-off units: 2 dry powder rockets.

Take-off unit impulse: 25,000 kg/sec.

Take-off unit thrust: 28,000 kg.

Main stage rocket impulse: 80,000 kg/sec.

Main stage burning time: 45 sec.

Main stage thrust: 1,700-2,300 kg.

CONTROL SYSTEM. Since remote control radio roll stabilization was found to be unsatisfactory, it was decided that Rheintochter 3 would be allowed to rotate at the rate of one revolution per second about its longitudinal axis, just as X-4 rotates. Since the X-4 gyrocommutator system for converting control impulses to the proper control surfaces in turn was available, it was thought that this system could also be used for Rheintochter 3.

The combination radar tracking and remote control system "Elsass" or possible "Brabant," the decimeter version, was to be used for guiding the flight of the "Rheintochter 3," just as proposed for Rheintochter 1. However, the "Elsass" development was not far enough along to permit field tests to determine whether it was satisfactory.

WARHEAD AND FUZING. In the liquid propulsion version R-3f, the warhead is carried between the Salbei and Visol fuel tanks in that sec-

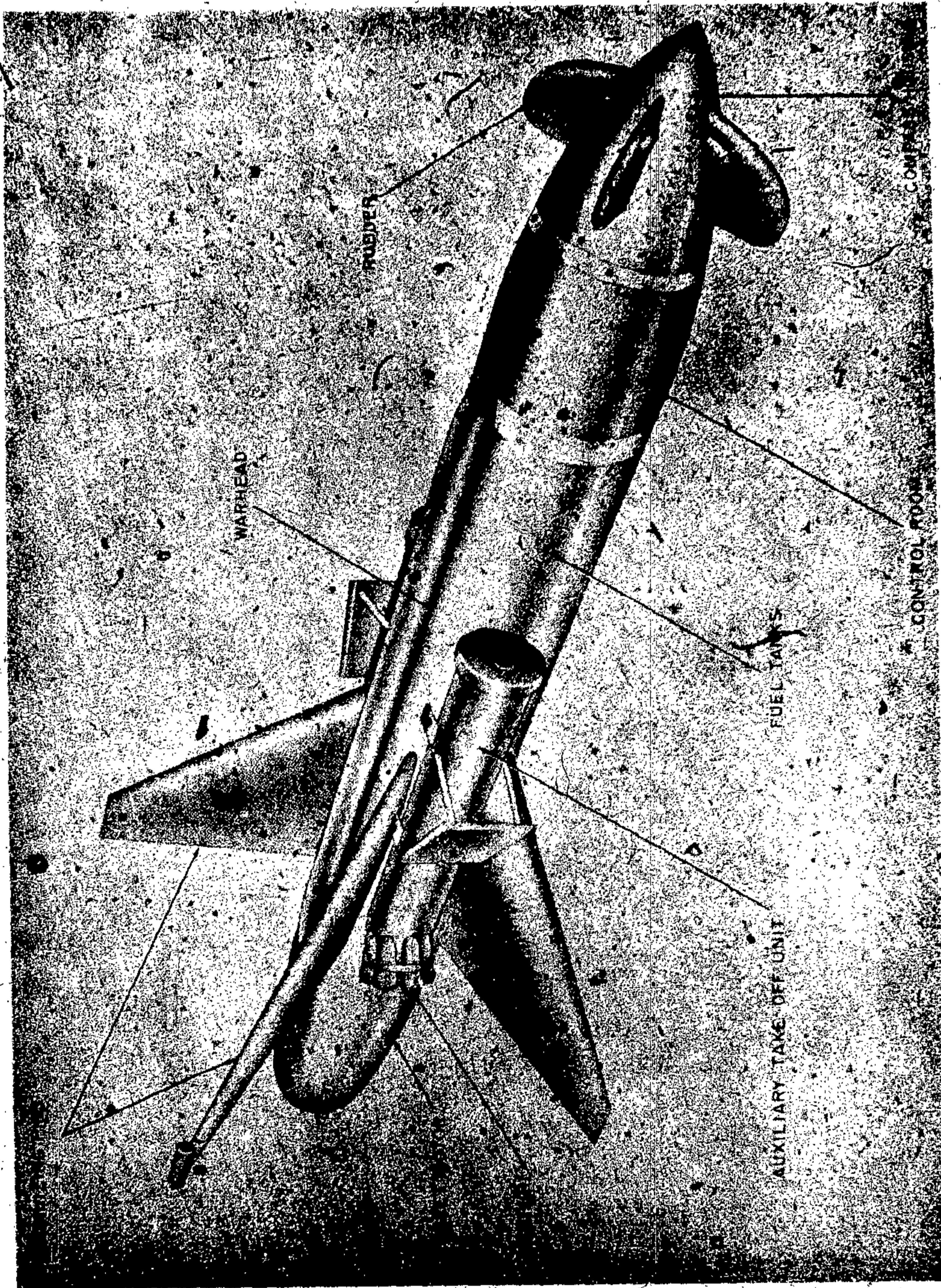

Figure 201—Rheinlochter R-3

tion of the main fuselage to which the main fins are attached.

In the solid propellant version R-3p, the warhead is located farther forward between the control compartment and the propelling charge. The warhead consists of 150 kg of high explosive.

The fuzing system for Rheintochter 3 had not been finally decided upon. Several plans were under consideration, all of which contemplated the use of a complicated fuzing system, which would not only serve to detonate the missile, but also take care of detaching the ATO units after one second and igniting the main jet. In addition of course, a time feature would be embodied to detonate the missile after 50 seconds in the air so that it would not fall and explode on friendly territory. The Rheintochter 3 was also to be fitted with an impact fuze and a proximity fuze of some sort, either acoustic, infra-red, or radio. Among the proximity fuzes considered were "Kranich," "Kakadu," "Marabu," "Fox," and several others.

As pointed out in the History of Development, plans were also under way to utilize some sort of homing device in "Rheintochter," but these plans were still in a very nebulous state.

AUXILIARY EQUIPMENT. Like Rheintochter 1, Wasserfall and the other guided AA rocket, Rheintochter 3, requires a great deal of auxiliary ground equipment, such as computers, optical gear, range finders, etc., for remote control purposes.

LAUNCHING EQUIPMENT. The launching equipment for Rheintochter 3 is identical with that used for Rheintochter 1 and has already been described in the report on the latter missile.

GREAT ENZIAN

DESCRIPTION. The Enzian was conceived as a ground to air flak weapon. Its secondary purpose was that of an air-to-air weapon. Models E-1, E-2, and E-3 were the test and experimental articles. All flight tests were carried out with the E-1. The E-4 was the production design using an improved rocket motor, designed by Dr. Conrad instead of the Walter biquid used in the earlier designs. As the foregoing is the only major difference in the four models, they will be discussed as one; however, there exists another type, E-5, which being a basically different type will be covered in a separate report to avoid confusion.

The E-4 is a flying wing design of striking similarity to the Me-163. Its total weight is 1,800 kg which includes the weight, 320 kg of the four assisted take-off units. The war head weight is 500 kg. The airplane is constructed of wood, having an over-all length and span of four meters. It attained its velocity of 300 m/sec with a main thrust unit delivering 2,000 kilograms initially decreasing to 1,000 kg during the flight. Duration of power was 72 seconds, resulting in a vertical range of 16,000 meters and a horizontal range of 25,000 meters.

The four assisted take off units deliver a combined thrust of 6,000 kilograms for 4 seconds, giving the missile which attains an end speed of 24 m/sec and an acceleration of 3.6 g from a launching ramp 6.8 meters in length. The assisted take-off units are jettisoned after 5 seconds.

Although it was anticipated that E-4 would be used as an air-to-air weapon with slight modification, principally reduced fuel load, all experimental flight testing had been done from ground to air. A standard 88 mm gun carriage was adapted for use as a launching platform by the simple addition of two iron rails 6.8 meters long. A traverse of 360° and a vertical firing arc from 0° to 85° were obtained. Air launching of the device was routine; i. e., dropping free from underneath the parent aircraft flying in the direction of the target.

The speed on leaving the launching rails is 24 m/sec; to avoid the possibility of stall no control is applied until the flying speed has reached approximately 55 m/sec. For practical purposes an elapsed time of 5 seconds is allowed between the triggering of the launching mechanism and the first control signal. The Enzian, as were practically all German guided missiles, was directed to the target vicinity by radio control. When the target approach was within the range of the homing device, the latter took charge of the missiles final run in. Coincidence or line of sight navigation was used under favorable conditions; however, several methods were accepted for night or reduced visibility use.

AIRFRAME. The Enzian E-4 airframe was a flying wing type having no horizontal stabilizer and a fixed vertical fin. Control was effected through trailing edge flaps which act together as

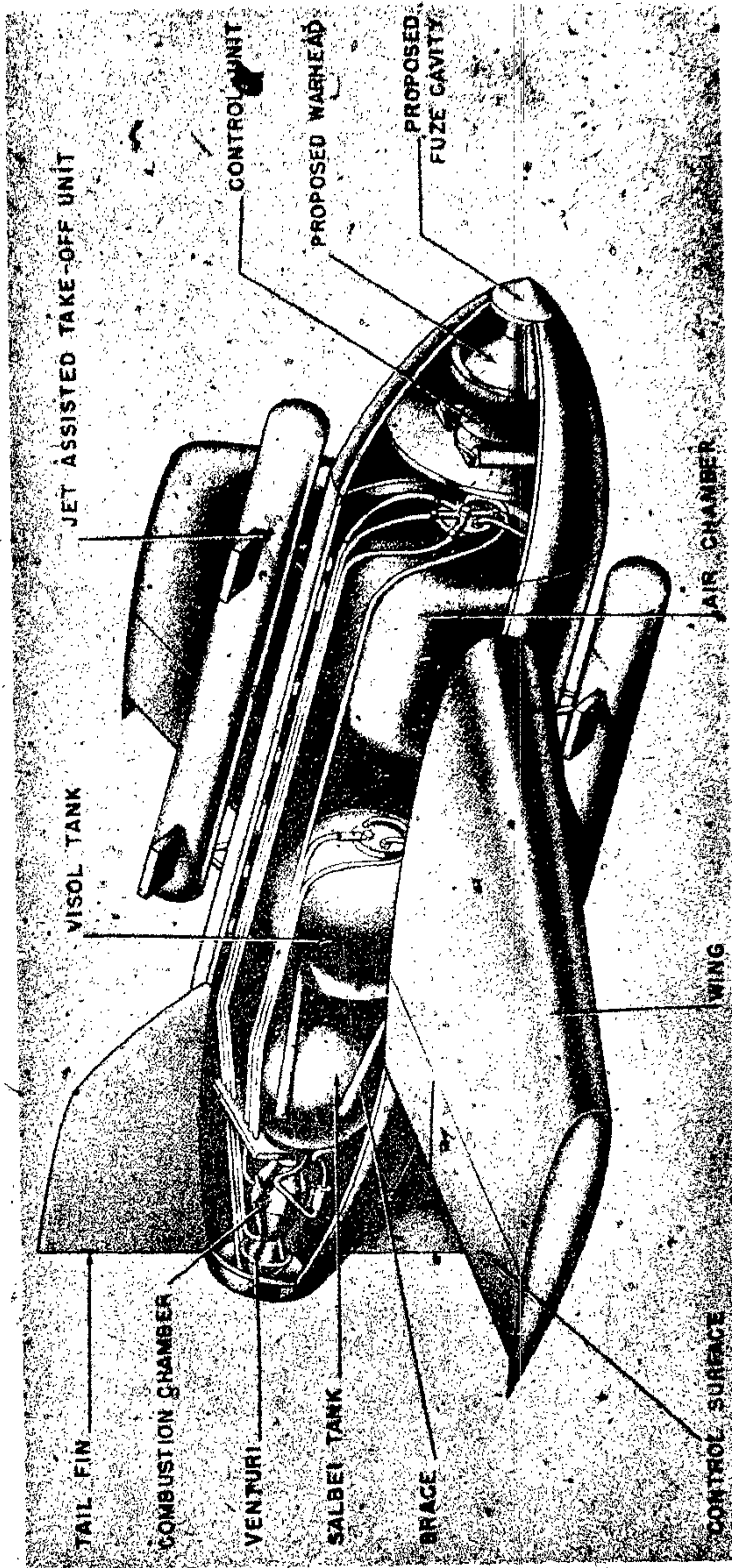

Figure 202—Enzian E-4

elevators and differentially as ailerons. The basic dimensions are as follows:

Length: 4 meters.
 Span: 4 meters.
 Maximum diameter, fuselage (Circular cross section): 0.88 meter.
 Root thickness: 20 percent root chord.
 Tip thickness: 10 percent root chord.
 Wing area: 5 square meters.
 Airfoil: NACA symmetrical; no twist.
 Dihedral: Zero.
 Chord root: 1.25 meters.
 Chord tip: 0.98 meter.
 Sweepback: 30°.
 Weight E-4 complete: 1,800 kg.
 Empty (including Warhead): 833 kg.
 Warhead: 500 kg.
 Motor: 97 kg.
 Fuel: 550 kg.
 Assisted take-off units: 320 kg.
 Airframe, Including Control Gear: 333 kg.

For the purposes of an air-to-air missile the fuel weight was reduced to 150 kg and the assisted take-off units discarded. (See fig. 202.)

The airframe was designed to be built of wood because of current metal shortage, but provisions were made for conversion to metal stampings. The production process was to use hot plate gluing methods for fabricating a pressed or plywood material.

AERODYNAMIC PECULIARITIES AND CHARACTERISTICS

Aerodynamically the E-4 appear normal. Its stability in flight tests was accepted as good. The E-48s design performance follows:

Maximum velocity (design): 300 m/sec.
 (Measured Walther motor): 240 m/sec.
 End speed launching: 24 m/sec.
 Minimum speed for safe control: 55 m/sec.
 Vertical range: 16,000 meters.
 (Measured Walther motor): 7,000 meters.
 Horizontal range: 25,000 meters.
 Turning radius: 500 meters.

PROPULSION UNIT. Although the Walther power plant was originally intended for the Enzian and was used in the test flights, it was entirely unsatisfactory and replaced by the Conrad motor. A brief discussion of which is considered sufficient for the purposes of this report.

The bifuel liquid rocket motor uses Salbei (92% HNO_3 + 8% H_2SO_4) and Visol, the ratio of weights being 1.4 to 1. The total quantity of fuel, 550 kg, is exhausted in 72 seconds during which time the thrust is reduced from its initial 2,000 to 1,000 kg at end of burning. As pressure reduction between the air bottle and liquid tanks is through a simple orifice plate, the progressive reduction in the combustion chamber operating pressure is the direct result of the air bottle's gradual exhaustion. Equal pressure is applied to both liquids and metering is effected by the resistance of the connecting pipes and not that of the nozzles. The total impulse (108,000-110,000 kg sec) corresponds to a mean S. I. of 199; however, Wurster states that the mean propellant consumption 5.5 gm/kg sec rises to 5.6 at start and end of burning operation and that the S. I. is of consequence approximately 182.

Although the mixture, Salbei and Visol, is spontaneously inflammable, the Enzian motor used an electrically ignited powder starter in the combustion chamber to effect ignition. This system had the advantages of smoother ignition and less risk of explosion than spontaneous combustion. A further precaution against explosion was taken by starting the salbei feed first by shortening its supply pipes and setting its bursting disks at slightly lower pressure than those of the Visol system.

The propulsion unit's arrangement, dictated by C. G. considerations, as follows: (1) air bottle; (2) visol tank; (3) salbei tank; (4) combustion chamber. The air flask was originally inflated to a pressure of 200 atmos. (See fig. 202.)

The liquids are retained in their tanks by means of bursting disks selected to rupture at 15 atmospheres at entry and 36 atmospheres at exit. All tanks are made of mil steel 2 mm thick and no corrosion treatment, enamel, or protective coating was employed as the only General Staff requirement was that the containers should withstand 6 months storage after being filled with salbei and fuel.

The weights of component parts of the motor are as follows:

Combustion chamber: 24 kg.
 Air bottle: 19 kg.
 Spherical tank: 30 kg.

GERMAN EXPLOSIVE ORDNANCE

Spherical tank: 24 kg; 97 kg.

Fuel weight: 550 kg.

Effective S. I. Fuel and Motor = $199 \times \frac{550}{647} = 170$

Relative to use of an air pressure fuel feed system versus a turbine-pump system, Wurster states that according to German figures the former is lighter up to impulses of 200,000 kg/sec and has the additional important advantage of requiring no time for running up to speed. He cited the ME 163 which requires 4-5 seconds to run the turbine up to its operational speed of 30,000 pointing out that such delay is prohibitive for a flak rocket.

INTELLIGENCE AND CONTROL SYSTEMS.

Operationally it was expected to use the Enzian in the following manner: Launch it toward and direct it to the target vicinity under radio control using the new German equipment Kogge and either line of sight or radar navigation. When the missile's approach to the target came within the operating range of the particular selfseeking head employed, the latter would assume control and direct the Enzian to the target's proximity on a modified homing course. The proximity fuze at predetermined distance activates the warhead which was designed to ensure maximum coverage and effective damage of the target from 45 meters. (See par. on warhead below.) It is considered pertinent to note here that the Germans were doing extensive research work on the theory of homing courses. Their principal investigations appeared to be based on compromises lying between a pure chaser or homing course and a straight interception route procured by interjecting self navigation into the intelligence system.

Initial planning provided for the Enzian's use of one of several type homing devices and proximity fuzes currently being developed or combinations of the above. Tests had not progressed beyond operation with the standard German radio control, the 6-meter "Strassburg-Kehl," developed by Telefunken and Strassfurt Rundfunk. The "Kogge" designed by Telefunken to operate on a 24-cm wave length was destined for use in the production Enzians.

The I. R. device, "Madrid," developed by Kepka of Vienna, an acoustic device developed by Telefunken and Messerschmidt, or an electronic device were projected for use as homing heads. These articles had been laboratory tested by their manufacturers only as separate entities.

Metamorphosis of the internal control system from two axis stabilization involving the use of four gyros to acceptance of one axis stabilization using a Horn gyro having two gymbal rings is outlined above under experimental testing. Standard Siemens electric servos are used to actuate the control surfaces.

WARHEAD AND FUZING. Three types of warhead of equal weight, 500 kilograms, were projected for the E-4. The type which seemed to have accrued the most favor among the Messerschmitt engineers and the local flak officers was built up of a metal shell or container 1½ mm thick. The shell was lined with cylindrical pellets cast of mild steel 20 by 30 mm containing an incendiary core! The explosive cast into the resulting cavity contained a booster charge and fuze in its forward end on the longitudinal axis.

Tests of the above type warhead showed that it could be expected to put 1.5 pellets in an area of 1 square meter at a range of 65 meters.

The second type of warhead incorporated 550 small rockets driven by gunpowder (see sketch below) which had been developed by one of the SS laboratories and were to be used as part of the armament of the ME 262. The rockets were mounted in the warhead to fire forward in a 30° cone from a maximum range of 300 meters; their effective range, however, was 550 meters and at that range each rocket was considered capable of destroying a bomber.

The third type warhead was straight explosive dependent only on concussion to destroy the target.

Both proximity and self-destruction fuzes were provided. The proximity fuzes were projected on the I. R., Electronic, and Acoustic principals; however, the latter had essentially been dropped by the designers as the maximum range at which the actuating impulse was of sufficient magnitude was too small to derive most effective results from the warhead.

AUXILIARY EQUIPMENT. Four powder jets assisted take-off units delivering a total of 6,000 kilograms thrust for 4 seconds are used to launch the Enzian. The JATO's produced by Rheinmetall-Borsig weigh 80 pounds each. They are attached by explosive bolts which release the cases by firing at the end of burning. Small wings fitted to the JATO's assist in the jettisoning.



Figure 203A—A9/A10 Long Range Missile

A-9, A-10 LONG RANGE MISSILE

GENERAL DESCRIPTION. The A-9 is similar in appearance and results to the A-4b but is of different internal construction. It was proposed to develop and manufacture the A-9 in place of the A-4; however, this would require much reconversion and the A-4b, which could be put into operation much quicker, was being pushed as a stop-gap. (See fig. 203A.) It was to have a Salbei-Visol rocket motor very similar to the missile Wasserfall. It is shot into the air like a V-2 and bent toward the target, but rather than falling, it glides over the target where it goes into a vertical dive. It would travel about 600 km in 17 seconds.

A proposal was made to launch it from a catapult at supersonic speed to increase the range. It was also proposed to install a pressurized cabin

and use a human pilot. The pilot would drop the warhead on the target and then return to his base. A retractable landing gear would be used in the landing which, it was felt, could be carried out at a speed as low as 160 km per hour.

Although the A-10 was never built, the calculations were completed for this unit which was to be used as an assist take-off motor for the A-9. It supplies a thrust of 200 tons and would be jettisoned after it had served its purpose. When the A-10 is jettisoned, the A-9 would have a velocity of 1,200 meters per second and the A-9 motor would begin to function. The ultimate velocity was expected to be 2,800 meters per second. The A-9/A-10 combination was expected to have a range of 5,000 km. It was also proposed to use a human pilot in this combination. (See fig. 203B.)

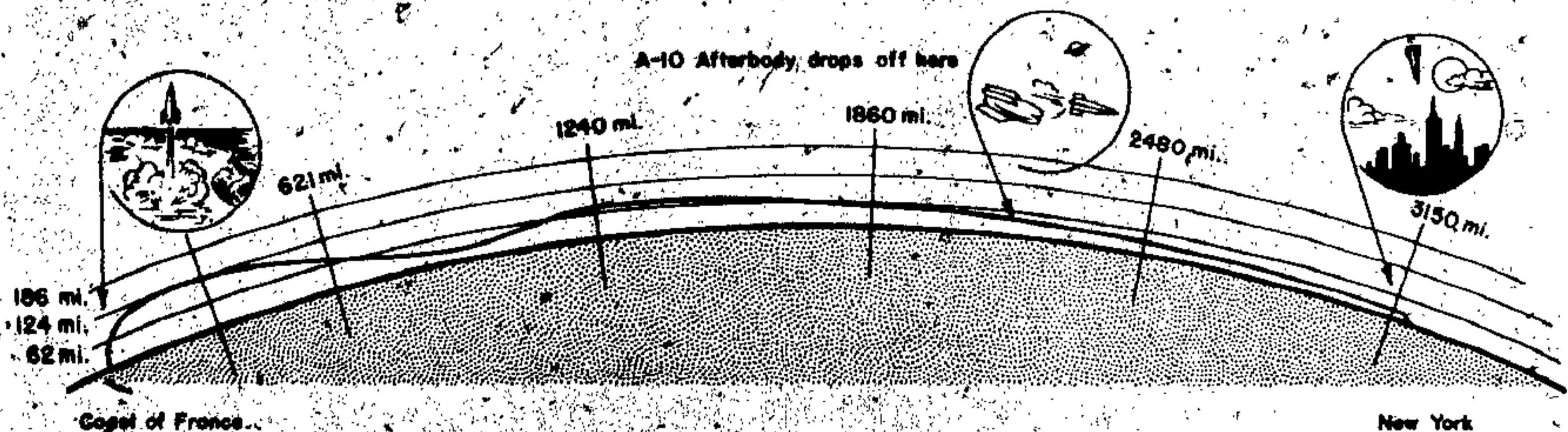

Figure 203B—A9/A10 Long Range Missile

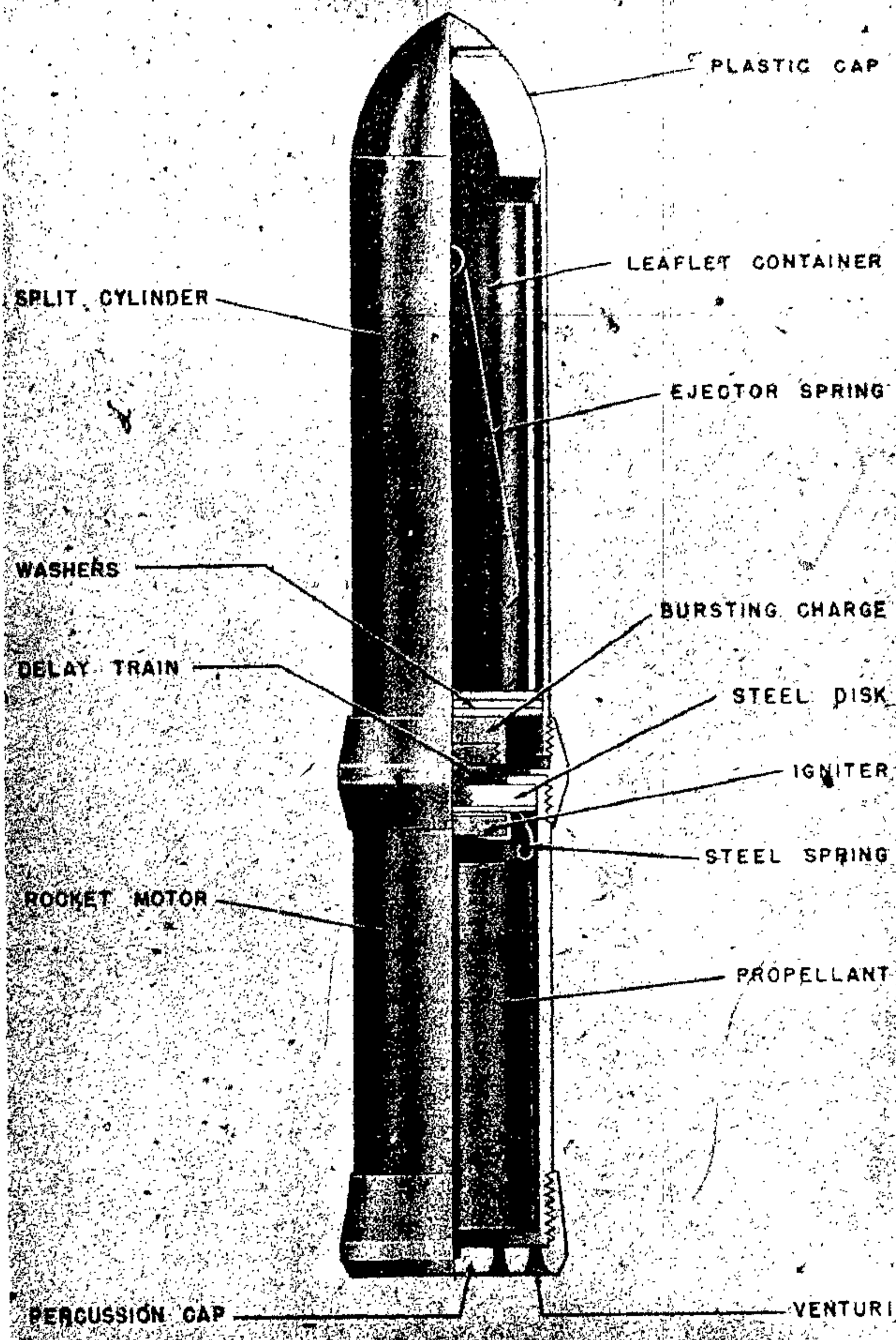

Figure 204—7.3-cm Propaganda Rocket

7.3-cm. PROPAGANDAGRANATE 41

DATA:

- Weight (without leaflets): 7 pounds 3 ounces.
- Length Over-all: 16.1 inches.
- Weight of the Propellant: 1 pound 1 ounce.
- Weight of Propellant Unit: 3 pounds.
- Maximum Diameter: 2.85 inches.

DESCRIPTION. The projectile consists of two steel tubes, screwed into a central joint. The lower tube contains the rocket motor and the upper tube serves as a container for the leaflets. The projectile is spin stabilized and is fired from the Propagandawerfer, which is a single launching tube. (See fig. 204)

The rocket motor is formed by the lower tube and a screwed-on base plug. The base plug has 12 venturi set in 2 rings; those in the inner ring are straight and those in the outer ring are offset. A copper percussion cap is located centrally in the base of the plug.

The propellant consists of a cylindrical stick with nine longitudinal drillings. One of these is central, and the other eight are in a ring around the central drilling. An ignition charge is located in a holder at the forward end of the propellant. This is fired by the flash from the percussion cap passing up the central hole of the propellant.

The upper tube is the leaflet container and it is closed by a bakelite cap. The leaflets are contained within a cylinder split longitudinally and are wrapped around a steel spring which is kept under compression. Below the leaflets, one bakelite washer and two cardboard washers, is the bursting charge, incorporating a delay train which is fired by the heat from the ignition charge for the propellant.

OPERATION. The operation of this projectile is very simple. When the heat from the ignition charge ignites the bursting charge, the contents of the upper tube are ejected; as the split cylinder emerges, it falls apart and allows the compressed spring to scatter the leaflets packed around it.

7.3-cm RAKETEN SPRENGGRANATE

DATA:

General:

- Caliber: 7.29 cm.
- Over-all length: 11.09 inches.
- Over-all weight: 6.00 lbs.
- Nature of the fuze: Nose percussion.

Warhead:

Material: Steel.

Dimensions:

- Over-all length: 4.22 inches.
- Maximum diameter: 2.85 inches.
- Diameter at nose: 0.81 inch.
- Wall thickness: Varies from 0.23 inch aft to 0.12 inch forward.

Weight:

Weight of filling: 0.62 lb.

Body tube:

- Over-all length: 6.34 inches.
- Over-all Diameter: 2.60 inches.
- Wall thickness: 0.10 inch.

Base:

- Over-all Diameter: 2.86 inches.
- Over-all height: 1.29 inches.
- Number of Venturi: 14; A. 7 offset (outer circle); B. 7 straight (inner circle).

DESCRIPTION. This is a spin-stabilized projectile of conventional design, consisting of a warhead and a rocket motor. The projectile is essentially the same as the 7.3-cm propaganda-granate 41, except that a warhead provided with a percussion fuze and self-destroying delay has replaced the leaflet container. (See fig. 205.)

The projectile is fired from the Fohn Gerat, a 35-frame launcher with fast elevating and transverse gears. The launcher is capable of firing 35 rockets simultaneously.

The self-destroying feature of the rocket plus the characteristics of the launcher suggest that the projectile is intended for use against low flying aircraft in the form of barrage fire.

WARHEAD. The warhead is ogival in shape and open at the rear where it is threaded internally to receive the rocket motor. The explosive filling is a preformed charge of 280 grams of RDX/TNT/wax pressed in a block and wrapped in wax paper.

The warhead is doubly fuzed, being fitted with a nose percussion fuze and a self-destroying base fuze. The RAZ 51 is screwed directly into the nose of the warhead. In the base of the charge is a cavity which accommodates the self-destroying delay, located in a tube screwed into a metal plug in the forward end of the motor. The delay consists of a quick-fire igniter, initiated by the motor ignition charge, and what appears to be a tracer composition. When the tracer composition burns out, it flashes through an orifice into a primer-detonator which detonates the main charge.

ROCKET MOTOR. The rocket motor consists of a plane cylindrical body and a cup-shaped base plate. The body is screwed into the warhead at the forward end and into the flange of the base plate at the rear. The forward end of the rocket motor has a flange below which is located a metal closing plate which separates the warhead from the propellant compartment and also holds the rear end of the self-destroying assembly for the

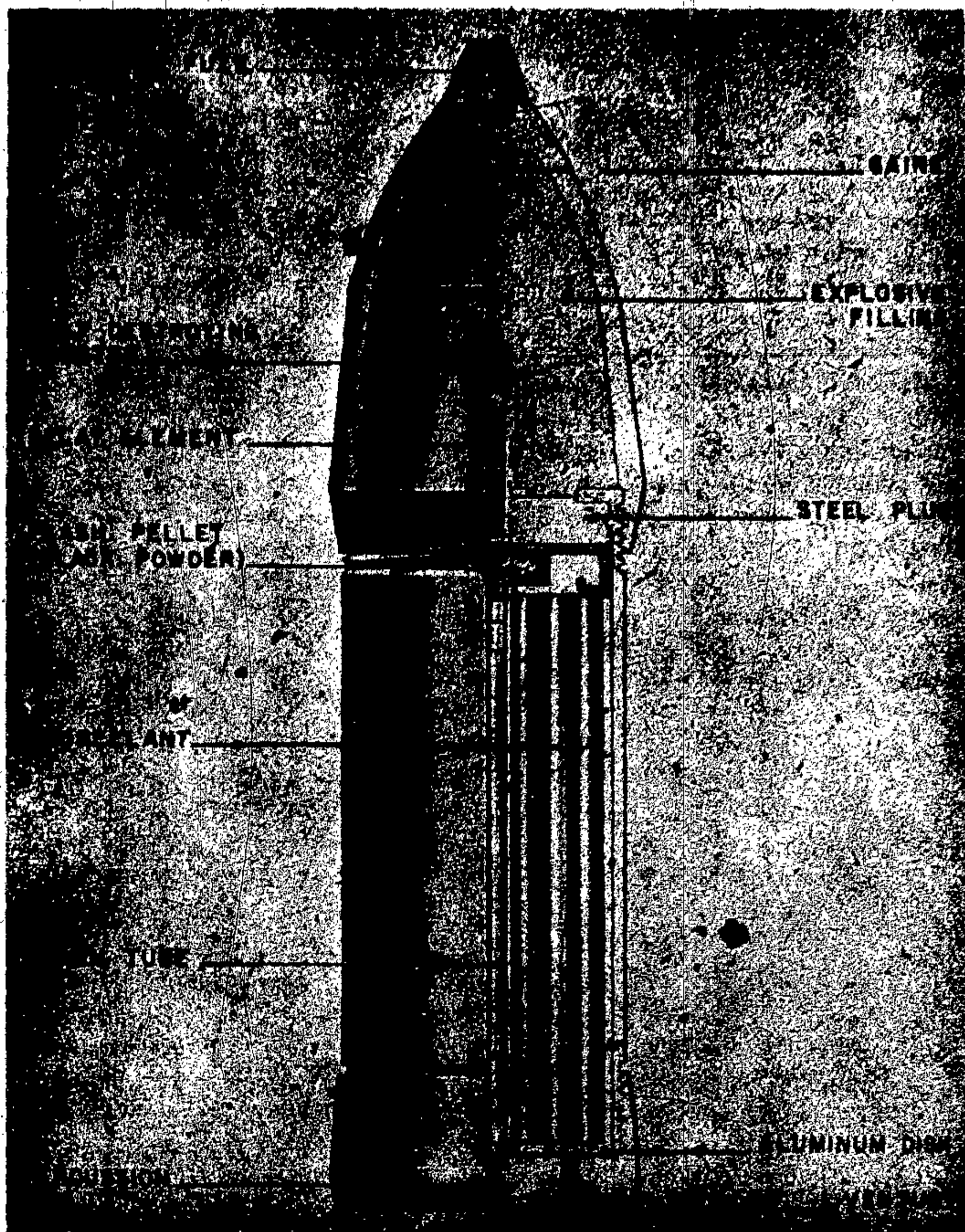

Figure 205—7.3-cm R. Sprgr Rocket

explosive charge. Below this plate is a stamped metal supporting ring containing the ignition charge for the propellant.

The base plate, which screws on the rear end of the body, has seven outer offset venturi, seven straight venturi, and a central drilling for a percussion primer.

The propellant charge consists of a single cylindrical stick with a central perforation and eight outer perforations. Raised ribs around the circumference of the propellant serve to keep it clear

of the motor body and permit external burning. Two $\frac{1}{8}$ -inch blocks of powder, cemented to the base of the charge, act as spacers and keep the venturi free from obstruction.

The charge is ignited by the flash from the percussion primer. The flash is transmitted along a celluloid tube in the central drilling to the ignition charge at the forward end of the propellant. The celluloid tube is of conventional design. It contains a quickmatch train and is closed at each end by a cylindrical block of gunpowder.

8-cm RAKETEN SPRENGGRANATE (H. E. AIRCRAFT ROCKET)

DATA:

General:

- Caliber: 78 mm.
- Over-all length: 28.5 inches.
- Weight (complete round): 15 pounds 3 ounces.
- Filling: Flaked TNT.
- Warhead: Material: Steel.
- Dimensions:
 - Length: 8 inches.
 - Diameter: 3 inches.
- Rocket motor: Material: Steel.
- Dimensions:
 - Length: 12.8 inches.
 - Diameter (outside): 3.07 inches.
 - Diameter (inside): 2.75 inches.
 - Weight: 4 pounds, 5.25 ounces.
- Venturi: Material: Steel.
- Dimensions:
 - Length: 7.48 inches.
 - Outside length of fins: 5.31 inches.
 - Rear diameter across fins: 7.87 inches.
 - External:
 - Internal: 3.34 inches.
 - Weight: 2 pounds, 0.25 ounces.
- Inlet:
 - Maximum diameter: 2.48 inches.
 - Minimum diameter: 0.782 inch.
 - Length: 0.92 inch.
- Throat: Diameter: 0.782 inch.
- Outlet:
 - Minimum diameter: 0.782 inch.
 - Maximum diameter: 1.653 inch.
- Grid:
 - Diameter: 2.72 inches.
 - Thickness: 0.51 inch.
 - Weight: 3 ounces.
- Propellant: Double base powder in mono perforated stick form.

DESCRIPTION. This is a fin-stabilized projectile with an appearance typical of small caliber aircraft rockets. The internal arrangement of the projectile suggests that it was possibly copied or adapted from a standard Russian aircraft rocket. Although this rocket almost certainly was designed primarily as an aircraft weapon, it was also fired from a multiple-frame ground launcher known as the 8-cm Raketen Bielfachwerfer. The projectile consists basically of an H. E. warhead,

a rocket motor, and a tail unit incorporating a single venturi and stabilizing fins.

WARHEAD. The warhead of the projectile is a steel cylinder with an ogival nose into which is built a fuze system. The rear of the head is closed by an adapter plug which also forms the junction with the rocket motor.

The main H. E. filling consists of a pressed flake TNT and is built up from three perforated pellets which fit around the exploder tube incorporated in the fuze system. At the nose end is a small cardboard washer; at the base are two waxed-paper washers, and around the exploder magazine is a waxed-cardboard tube. Between the shell wall and the explosive is a thin layer of bituminous material. The outer surfaces of the pellets are waxed.

ROCKET MOTOR. The body of the motor is formed by a cylinder which is machined down slightly between the ends. The forward end of the cylinder is threaded internally to screw over the adapter plug which forms the junction with the warhead. Four studs in the body, two at each end, guide the projectile in the launcher. The base of the motor body is closed by the motor closing plate, which is in the form of a single venturi to which four stabilizing fins are spot welded.

The propellant consists of six sticks, of which two are slightly shorter than the other four. The four longer sticks are located by a supporting grid which is a push fit in the venturi assembly. The other two sticks are supported on the two primary igniters attached internally to the walls of the rocket motor.

The ignition system consists of two ignition charges, one at each end of the propellant, and a primary igniter. The primary igniter is in the form of two copper tubes, each screwed internally over the end of the steel guiding studs which pass through the motor body at the rear end. A brass rod, insulated by a rubber sleeve, passes through the guiding stud and bears against a brass contact inside the copper tube. This contact passes through the tube into a small cardboard container holding a loose composition charge of gunpowder. Wires from the contact to the walls of the copper tube serve to ignite the charge. The circuit is presumably formed by two leads, one to the brass rod in each guiding stud, and is grounded to the rocket body.

GERMAN EXPLOSIVE ORDNANCE

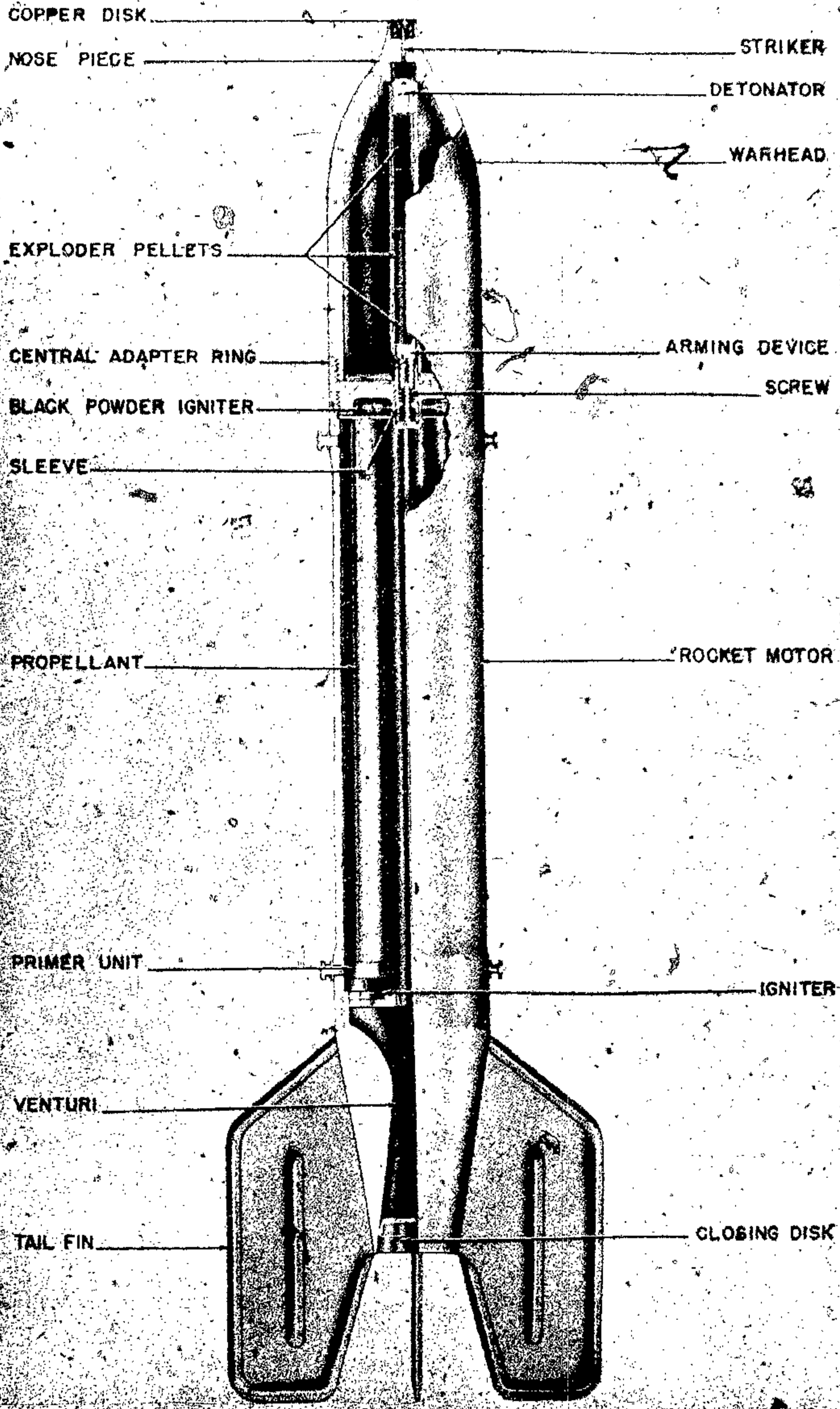

Figure 206—8-cm Aircraft Rocket

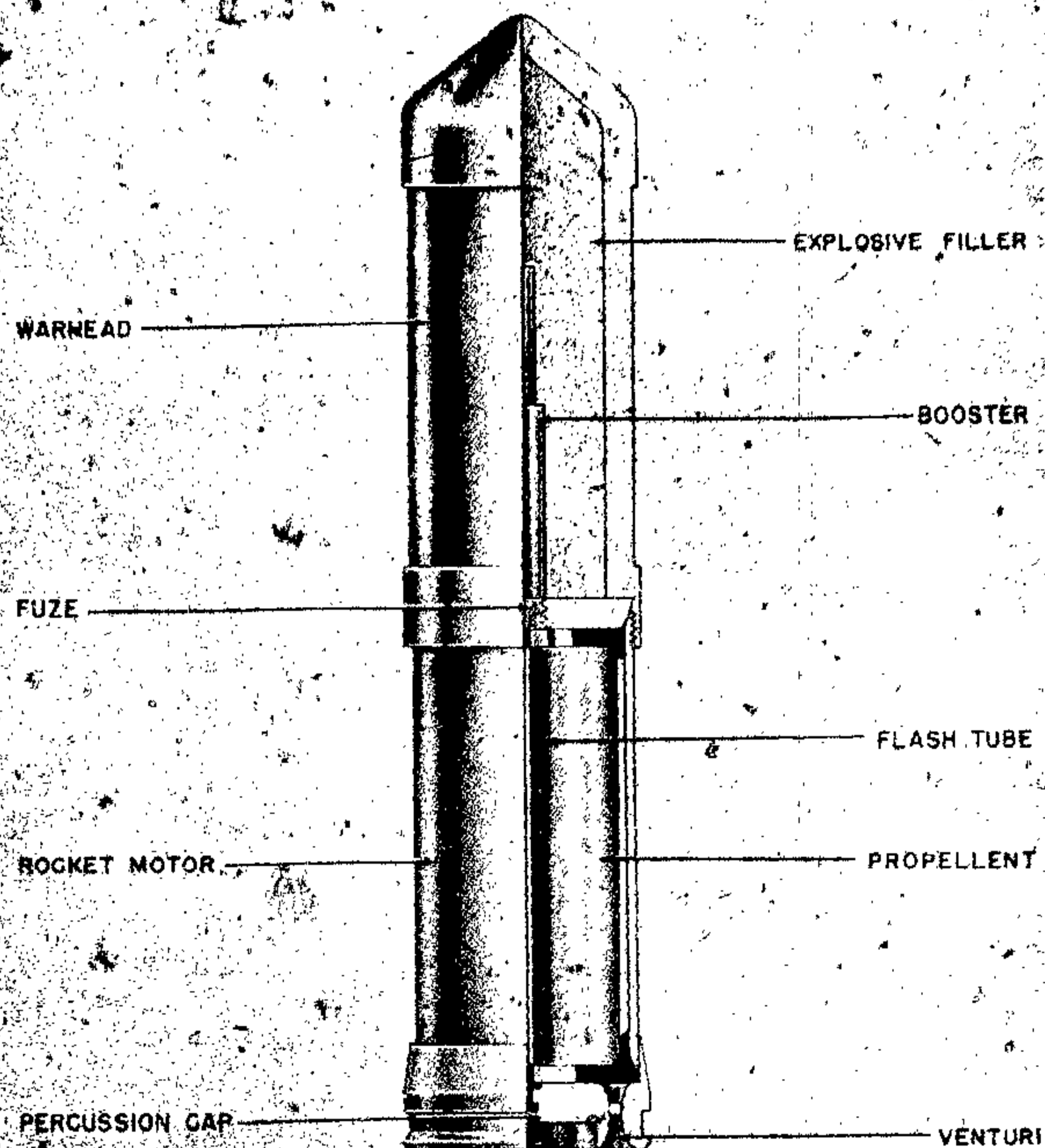

Figure 207—8.6-cm H. E. Rocket (Naval)

FUZING SYSTEM. This rocket has a fuze which has been designed specifically for it. The arrangement of the system is shown in figure 206. The fuze consists of a steel nose piece which contains a light alloy striker supported by a light creep spring. Below the nose piece is a steel magazine tube, into the forward end of which is screwed the detonator housing. Directly below the magazine tube is the arming mechanism which consists of a metal sleeve containing a spring loaded screw and the plunger. Holding the spring loaded screw and the plunger in position is a fusible metal ring. When assembled, the plunger fits into the lower end of the magazine and the booster pellets rest on it.

When in the position as shown in figure 206 the detonator is beyond the reach of the striker and the fuze is unarmed. When the rocket is fired, the heat of the burning propellant is con-

ducted through the wall of the spigot and melts the fusible metal ring. The plunger, magazine, and detonator are then free to move forward under the action of the spring. The extent of this forward movement depends upon the acceleration of the rocket. Approximate measurements indicate that if this is less than 40-50 g the detonator is sufficiently forward to be fired by the striker.

8.6-cm H. E. ROCKET (SPIN STABILIZED)

DATA:

- Nature of projectile: Multiple base-venting, spin-stabilized pusher rocket:
- Caliber: 8.6 cm.
- Over-all length: 16.25 inches.
- Over-all weight: 17 pounds 13 ounces.
- Nature of filling: H. E.
- Nature of fuze: Base.

GERMAN EXPLOSIVE ORDNANCE

Warhead:

Length: 9.55 inches.

Diameter: 3.35 inches.

Type of filling: Cast TNT.

Rocket Motor:

Length: 6.7 inches.

Length of propellant chamber: 6.08 inches.

External diameter: 3.18 inches.

Internal diameter: 2.94 inches.

Weight of filled motor: 6 pounds 12.25 ounces.

Propellant length: 5.90 inches.

Diameter of propellant: 2.78 inches.

Weight of propellant: 2 pounds 7.75 ounces.

Analysis:

Potassium nitrate: 75.5 percent.

Carbon: 15.35 percent.

Sulphur: 9.15 percent.

Volatile material: 0.86 percent.

DESCRIPTION. This rocket consists of a H. E. head, a motor, and a venturi assembly. An integral base fuze, centrifugally armed and pressure fired, is located in the base of the H. E. head. A standard booster assembly is employed. (See fig. 207.)

The H. E. head threads over the rocket motor housing, which contains a single, multiperforated, propellant grain. A venturi assembly, with eight jets drilled in it, is threaded to the base of the motor. A single threaded hole in the center of the venturi assembly contains a percussion primer.

On the forward end of the motor housing is a fitting which receives one of three interchangeable delay trains. The rockets bear markings to indicate which of the delay trains have been assembled. Those marked "/400/" and "/800/" contain, in addition to the delay train, a fuze with a striker retained by four arming balls and a spring collar. A light anticreep spring is placed between the striker and the detonator.

Centrifugal force causes the balls to move outward against the collar and arm the fuze. The delay train is initiated by the propellant grain, and when the delay expires, the pressure developed forces the striker against its spring and into the detonator. Impact with some resistant object before the expiration of the delay will force the striker into the cap. In the case of the round marked "/600/" no striker mechanism is included, and the delay initiates the detonator and booster directly, giving only self-destroying action.

REMARKS. This is a naval round, designated "8.6 cm R. Spr. 400 Wsm. (600 Wsm, 800 Wsm.)."

The H. E. head is painted canary yellow overall; the motor body, dark green.

It is estimated that this projectile would reach a maximum height of 8,000 feet, if fired at a quadrant elevation of 90°.

8.6-cm R Lg 1000 ROCKET

DESCRIPTION. The 8.6 cm R Lg 1000 (flare) and the 8.6 cm R Dg 1000 (wire) differ only in the contents of the body. The flare rocket contains a parachute-suspended flare having a burning time of 30 to 35 seconds. The wire rocket contains, in place of the flare element, a spool of wire which is suspended by the parachute. No explosive is attached to either the parachute or the wire. (See fig. 208.)

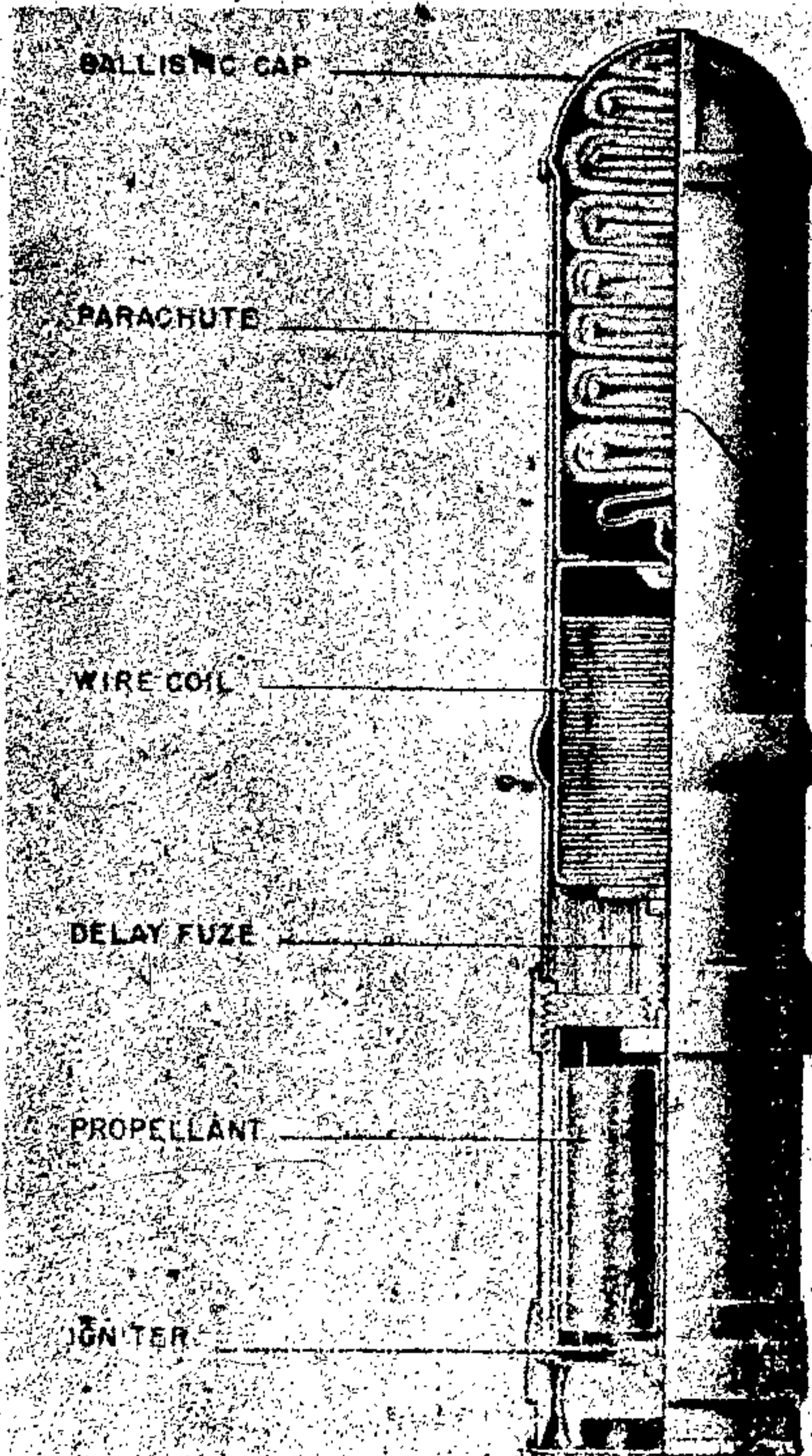

Figure 208—8.6-cm Illuminating Rocket (Naval)

The flare element is contained in a light metal can which is directly above the base delay pyrotechnic fuze. The parachute fits above the wooden plug midway up the tube. The forward end of the body is closed with a light ballistic cap which is pushed out by the ejecting parachute-flare unit. The base of the body is closed with a wooden block which rests on the lip of the adapter. The adapter is welded to the body and serves as a bourrelet as well as the attachment between the motor and the body. The pyrotechnic time base fuze of 8.5 seconds burning time is ignited by the burning of the propellant in the rocket motor.

The motor is similar to that of the 8.6 cm R Sgr L/4.8 except that the nozzles are changed to accommodate the reduced propelling charge.

The black powder propellant grains 100 mm long and 70 mm in diameter, weighing 750 grams, is mounted in a manner similar to the Spgr L/4.8. The diglycol propellant consists of two concentric cylinders 80 mm in length and having diameters of 70/40 and 35/5 mm, weighing 420 grams. A flash tube runs through the central 5-mm diameter hole of the inner grain from the rear igniter up to the forward igniter. The igniters and grains are held in position by a three-armed grid at each end of the grain. It is indicated that the grid is of plastic material instead of the usual metal construction.

DATA:

Motor:

Propellant: Black powder, diglycol.

Nozzles: 8, 4.

Throat diameter: 4.50, 5.45.

Cant angle: 9°.

Nozzle K: 234, 480.

Performance:

Thrust: 150.

Burning time: 1.20.

Impulse: 80.

Range: 1,000 m.

Nozzle design factors:

Diameter of Jet ring: 69 ± 0.1 mm.

Entrance cone angle (first): 60°.

Entrance cone angle (second): $15^\circ \pm 15$ min.

Length of cone (first): 1.5 mm.

Length of cone (second): 5.5 mm.

Throat length: 3.0 ± 0.5 mm.

Expansion cone angle: $1.0^\circ \pm 10$ min.

LAUNCHING. The launcher used in the various tests consists of a single barrel weighing 40 kg. It is denoted as the 8.6 cm R Ag M 42.

8.6-cm ANTI-AIRCRAFT ROCKET SPIN STABILIZED

DATA:

Over-all length: 16.5 inches.

Diameter: 3.39 inches.

Total weight: 11.0 pounds.

DESCRIPTION. This rocket is constructed of steel in four sections; Projectile body, parachute container, cable container, and rocket motor. (See fig. 209.)

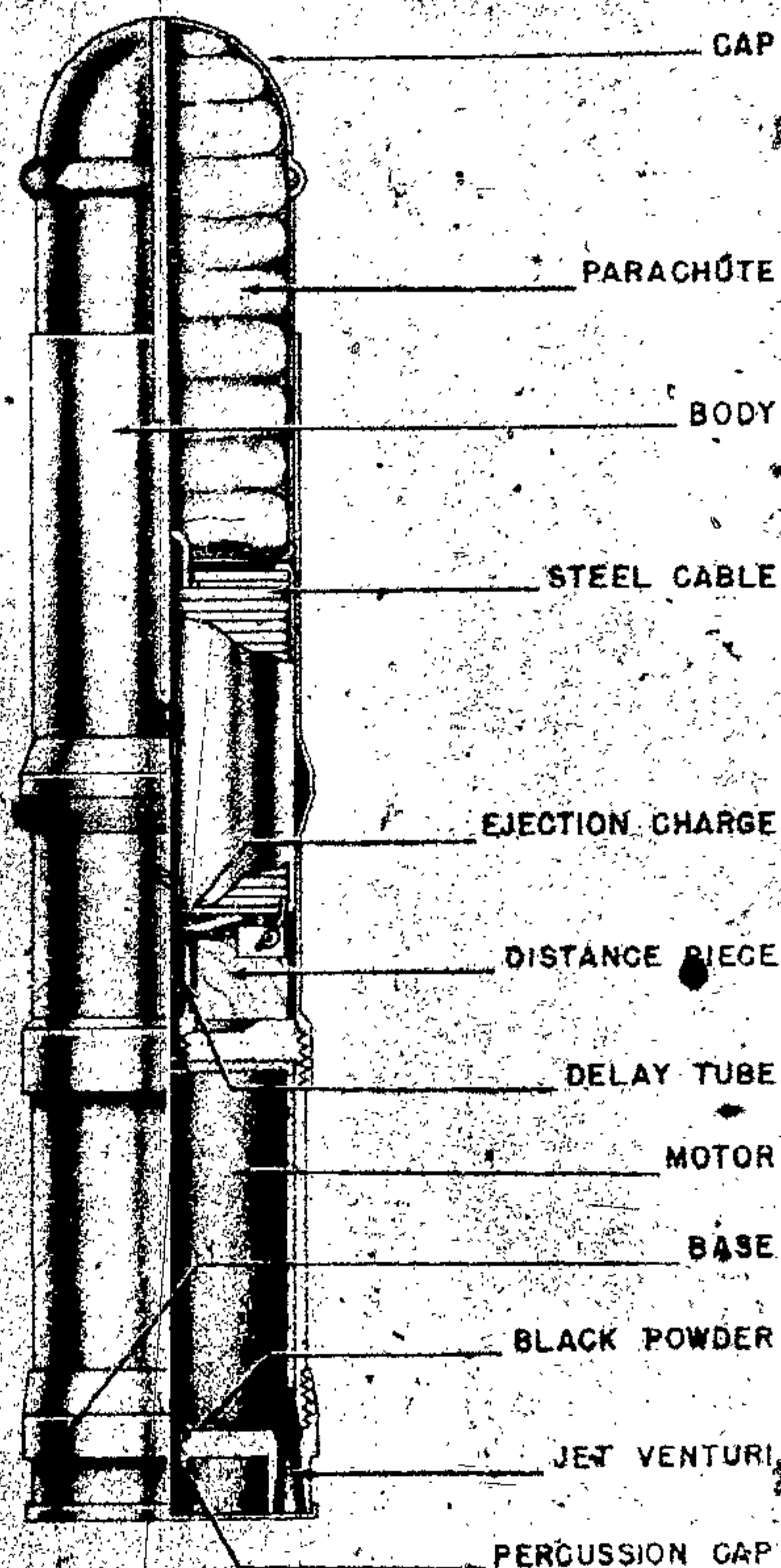

Figure 209—8.6-cm Antiaircraft Rocket (Naval)

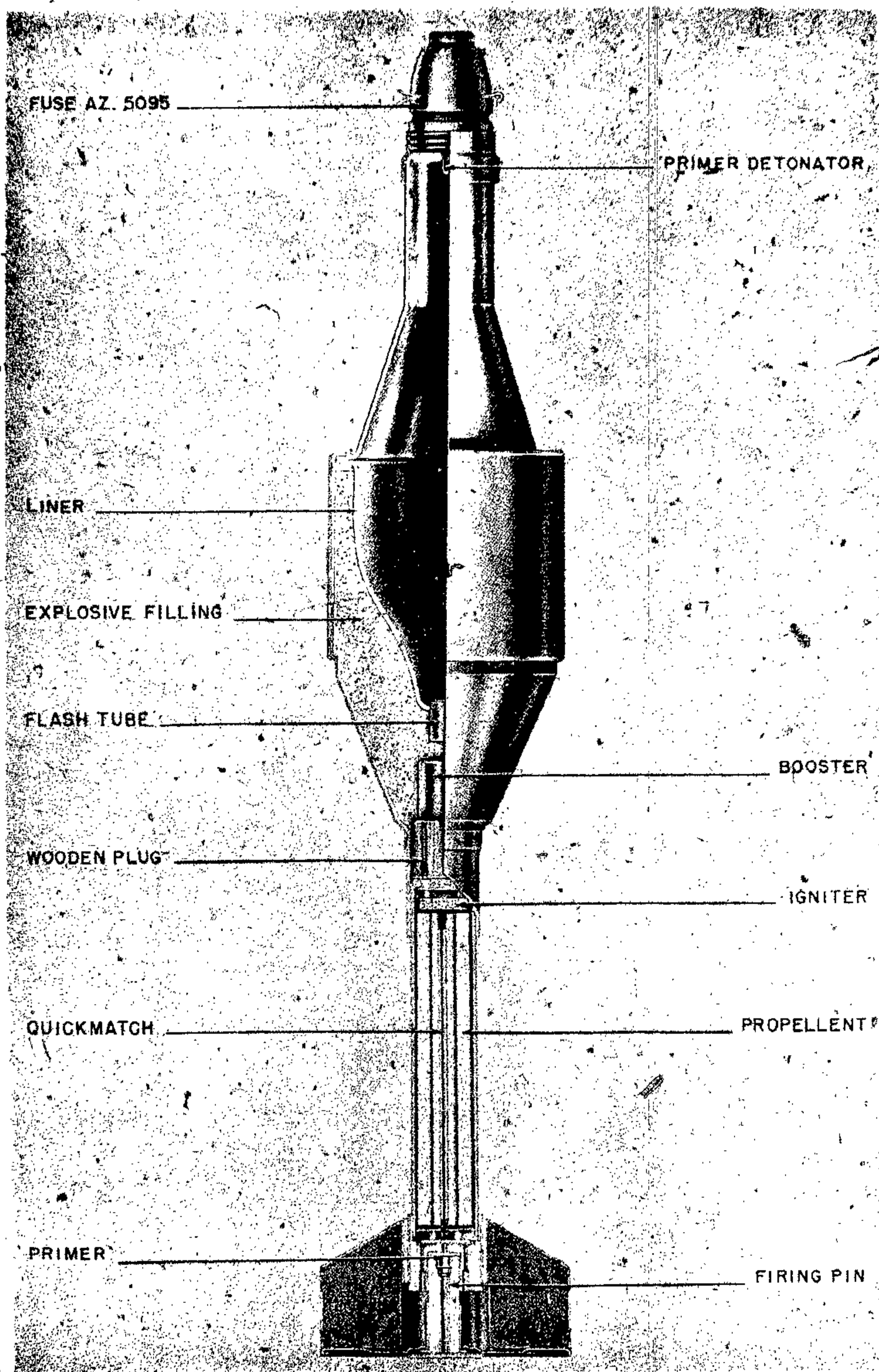

Figure 210—8.8-cm Hollow Charge Antitank Rocket

PROJECTILE BODY. The projectile body consists of a cylindrical container, internally threaded aft to receive the rocket motor and open at the forward end to receive the parachute container. The body of the projectile has a raised pressing near the center of its length to provide a forward bearing surface while in the projector.

PARACHUTE CONTAINER. The parachute container is divided longitudinally into two halves held together by adhesive tape and is a sliding fit in the forward end of the body. The parachute measures 20 inches deep by 36 inches in diameter when open, and is made of yellow silk with a red stripe running down the center of each gore.

CABLE CONTAINER. The cable container is located in the body just aft of the parachute container. The cable container is nothing more than a steel cylinder filled with 310 feet of steel wire. The forward end of the wire is attached to the parachute shrouds. Separating the cable container from the head of the motor is a perforated wooden distance piece, which is recessed to form a seating for an ejection charge and centrally bored to house a delay tube containing black powder.

ROCKET MOTOR. The motor consists of a steel tube $\frac{1}{8}$ -inch thick, closed at its forward end, which is drilled centrally and threaded to receive the delay tube. The propellant grain is a single solid cylinder, and is primed at the base end with gunpowder. The motor is closed at the after end by a threaded venturi assembly drilled around the outer periphery to form 8 jets. A percussion cap is fitted in a central hole in the base of the venturi assembly.

OPERATION. Near the end of the burning period of the rocket motor, the delay tube is initiated by the heat of the burning propellant and eventually ignites the ejection charge at the base of the cable container. The explosion of this charge ejects the cable and parachute containers from the forward end of the body and splits open the parachute container. The parachute opens and withdraws the coiled cable from its falling container.

REMARKS. (1). This round was originally designed to protect small naval vessels and merchant shipping from low-level attack, but it may have played a ground role as well. The ceiling of the rocket is estimated at about 8,000 feet.

8.8-cm H. E. HOLLOW CHARGE ROCKET, FIN STABILIZED

DATA:

Nature of projectile: Multiple-venting, non-rotating, fin stabilized pusher motor.

Caliber: 8.87 cm.

Over-all length (complete round): 19.4 inches.

Total weight (complete round): 5 pounds, 13.6 ounces.

Nature of fuze: Instantaneous nose percussion.

Nature of filling: Cyclotol.

H. E. Head:

General shape: Cylindrical main body; truncated, conical impact cap and rear section.

Dimensions:

Over-all length: 10.47 inches.

Diameter of Bearing Surface: 3.494 inches.

Depth of cavity liner: 3.67 inches.

Wall thickness:

Main body: 0.045 inch.

Impact cap: 0.090 in.

Cavity Liner: 0.06 inch.

Forward Diameter, Impact Cap: 1.356 in.

Weights:

Empty: 4 pounds 0.75 ounce.

Filling: 1 pound 7.14 ounces.

Filling: Cyclotol.

Markings:

Cylindrical Portion of Body:

Stenciled in purple: WAA 424.

Stenciled in black: Tpn 2.3. 44D LM 4312.

Rear Portion of Body: Stenciled in white: 43 fcc 47.

Fuze: Either A. Z. 5095 or A. Z. 5095/1 instantaneous nose percussion fuzes.

DESCRIPTION. This projectile is fired from the mobile antitank rocket launcher 8.8 cm Raketenwerfer and is similar in appearance to the 8.8 cm Raketen Panzerbüchse Granate 4322. The projectile, which is fin-stabilized, consists basically of an H. E. head, a motor tube, and a tail-fin assembly. (See fig. 210.)

H. E. HEAD. The head of the projectile consists of the body containing the cyclotol hollow-charge located by a cavity liner and an impact cap. The impact cap is flanged at the rear end to bear against the cavity liner and is fitted at the forward end with an adapter, threaded to receive

GERMAN EXPLOSIVE ORDNANCE

either of two nose percussion fuzes, the A. Z. 5095 or the A. Z. 5095/1.

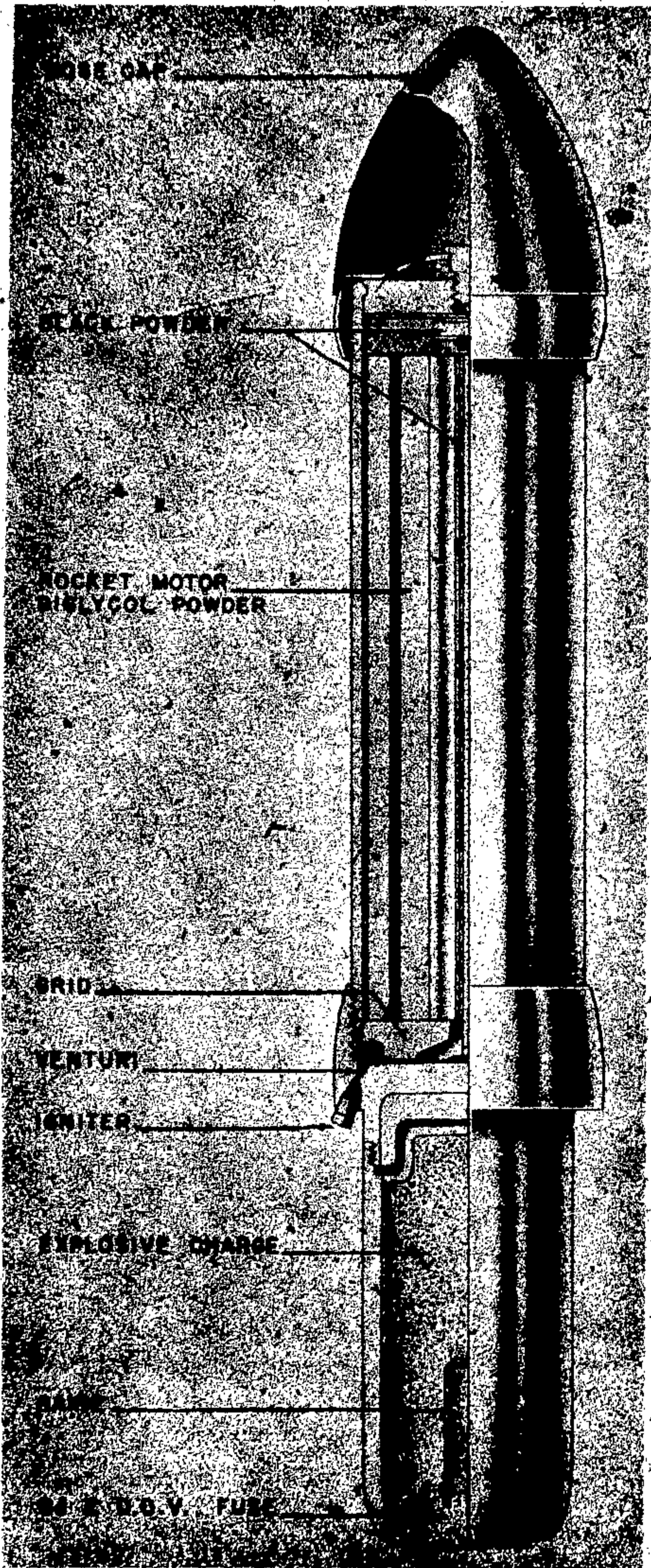

Figure 211—15-cm H. E. Rocket

Two pressed flanges at the forward end of the body secure the impact cap and the cavity liner. The rear end of the body is conical in shape and fits over a tail adapter which forms the junction with the motor tube. A reinforcing sleeve is pressed into position over the cylindrical portion of the body and provides the forward bearing surface of the projectile.

At the lower end of the cavity liner is a flash tube below which is located the gaine; this consists of an aluminum cup containing a charge of PETN and wax and a detonator. The gaine is separated from the motor tube by a wooden plug which acts as a buffer and which also provides the necessary thermal insulation between the motor and the gaine.

MOTOR TUBE. The forward end of the motor tube is sealed and threaded to screw into the tail adapter. The rear is screwed into the venturi block.

The propellant consists of a single stick with 14 small longitudinal perforations and a single axial drilling of larger diameter. Three lands around the outside of the stick keep the propellant from touching the inside of the tube and ensure an external burning surface. Two grids, one at each end, are used to support the propellant; each grid is a triangular metal platform on three legs. At the rear there is a wire mesh between the grid and the propellant to prevent any unburnt particles from blocking the venturi drillings.

Between the grid and the propellant at the forward end is an ignition charge mounted so that it is free to burn on both surfaces. A celluloid tube, containing a thin strip of what appears to be nitrocellulose powder, is located in the axial drilling of the propellant; both ends of the tube are capped with a block of black powder. This train serves to transmit the flash from the primer to the ignition charge at the forward end of the motor tube.

TAIL-FIN ASSEMBLY. The tail-fin assembly consists of a venturi block, stabilizing fins, obturator, and percussion igniter.

The venturi block, which is screwed over the end of the motor tube, has six venturi drillings parallel to the axis of the projectile. These are each formed by two drillings of different diameter; instead of taper there is a sudden step from the smaller to the larger diameter. The block is drilled and tapped in the center to receive the

firing-pin adapter. A collar on the rear of the firing-pin adapter holds the obturator in position around the rear of the fin assembly. A percussion cap is mounted in the forward end of the firing-pin adapter, immediately in rear of the quick-match train. The adapter is machined down to a separation point near the rear end; when the projectile is fired, the adapter severs, and the rear portion remains in the breech together with the obturator.

The six stabilizing fins are mounted in three pairs around the venturi block and are strengthened by a sleeve fitted around the fins and under the forward lip of the obturator.

REMARKS. 1. The German designation for this round is "8.8 cm R. Pz. B. Gr."

2. This same round, modified for percussion firing, is used in a single tube, two-wheel launcher, the "8.8-cm Raketenwerfer 43."

15-cm H. E. ROCKET, SPIN STABILIZED

DATA:

Over-all length: 38.55 inches.

Diameter: 6.22 inches.

Total weight: 70 pounds.

Propellant weight: 14 pounds.

Type of filling: TNT.

Weight of filling: 4.5 pounds.

Fuzing: Bd. Z. D. O. V.

DESCRIPTION. This rocket resembles an elongated gun projectile with a bulbous nose cap. The round consists of a forward motor body containing the seven single-perforated propellant grains and the after H. E. container. (See fig. 211.) An enlarged diameter ogival ballistic cap is threaded to the forward end of the motor, and a venturi assembly with 26 drilled jets threads over the base of the motor. The venturi assembly also is threaded externally at its after end to receive the machined steel bursting charge container. An H. E. charge in a fiber container is placed in the steel shell case, separated from the base of the motor by an iron spacer to provide an insulating air void between the H. E. and propellant charges. A booster adapter, containing the booster charge and threaded to receive the base fuze, screws into the base of the H. E. shell.

The propellant grains are supported fore and aft on a pair of metal grids. A black powder igniter charge is placed over the rear grid, and

a second black powder charge is contained in an aluminum holder between the head of the motor and the forward grid. The two charges are connected by a black powder filled cellulose tube, which passes through the perforation of the central grain. An electric igniter is fitted into 1 of the 26 jets.

REMARKS. 1. This round is designated "15-cm Wgr. 41 Spr."

15-cm SMOKE AND CHEMICAL ROCKET, SPIN STABILIZED

DATA:

Over-all length: 40.16 inches.

Diameter: 6.22 inches.

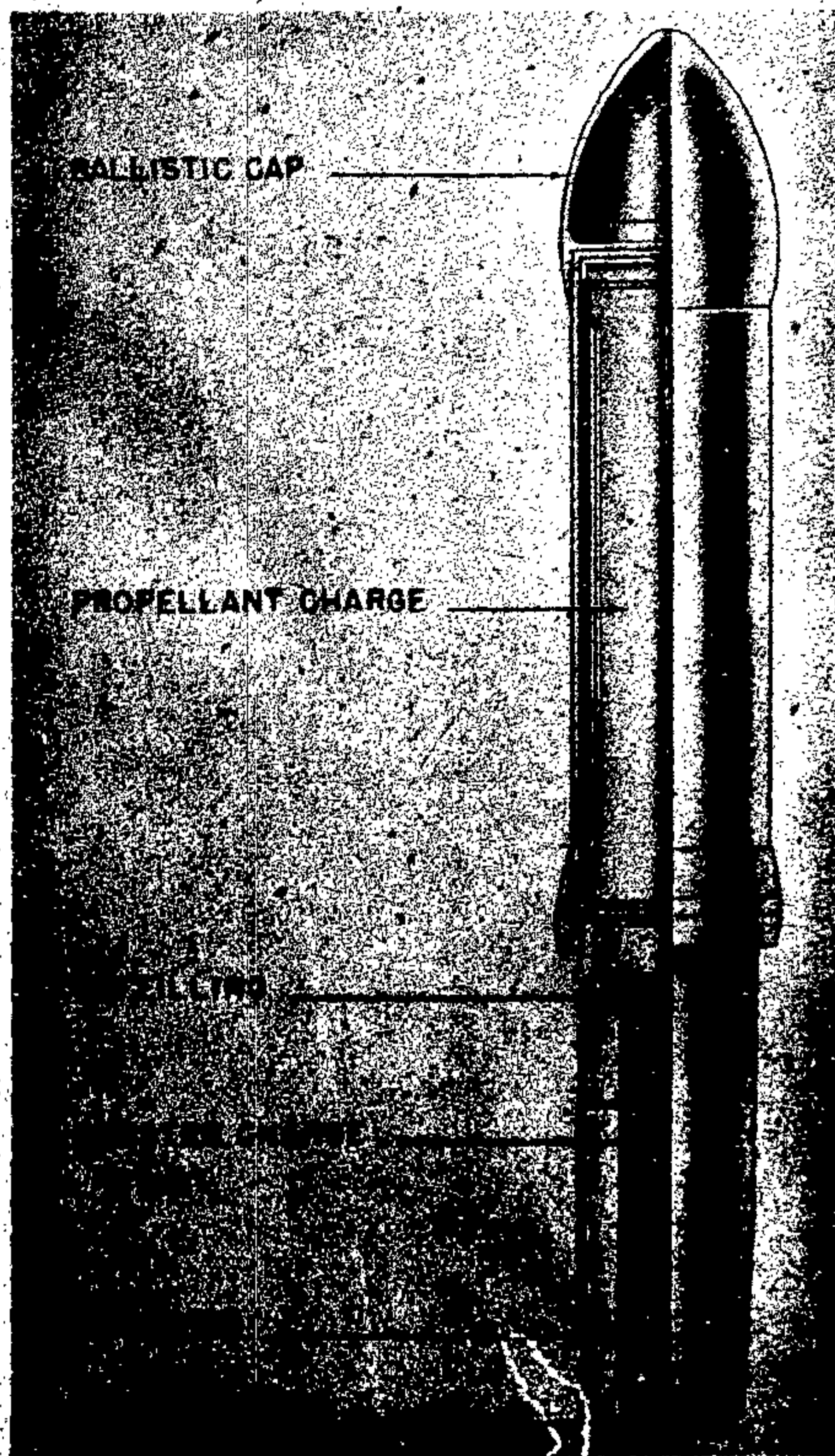

Figure 212—15-cm Smoke and Chemical Rocket

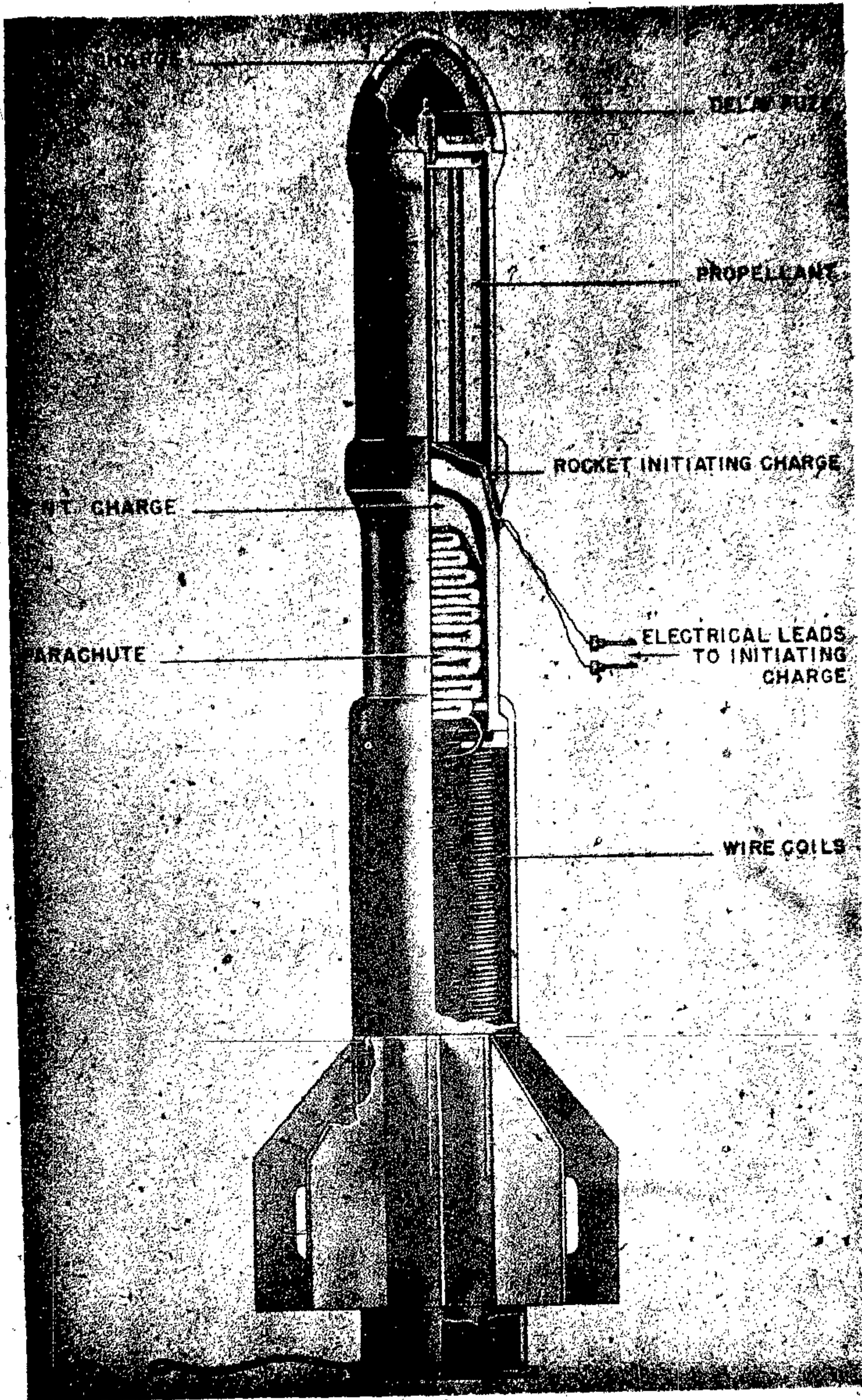

Figure 213—15.2-cm Antiaircraft Rocket

Total weight: 79 pounds.
 Propellant weight: 14 pounds.
 Type of filling: Smoke composition.
 Weight of filling: 8.5 pounds.
 Fuzing: Bd. Z. D. O. V. Zldg. C/98 Np.

DESCRIPTION. Except for the shell after body, this rocket is identical to the 15-cm H. E. rocket. The motor arrangement is identical to the latter, and the shell is similarly attached to the motor. The shell for the smoke rocket is 4.5 inches longer than that for the H. E. round and is somewhat differently constructed. The shell consists of a thin-walled steel cylinder with a long burster charge container threaded into the after end. This container holds 3.05 pounds of picric acid. The container is threaded to receive a base fuze and a short exploder. The smoke composition is located between the shell body and the outer wall of the burster container. (See fig. 212.)

REMARKS. 1. The German designation for this round is "15-cm Wgr. 41 Nb."

2. This round may also be employed as a chemical shell. When so used, the German designation is "15-cm Wgr. 41 Grunring."

15.2-cm ANTI-AIRCRAFT ROCKET, FIN STABILIZED

DATA:

Over-all length: 58.2 inches.
 Diameter: 7.09 inches.
 Total weight: 150 pounds.
 Propellant weight: 11 pounds 10 ounces.
 Length of grain: 11.7 inches.
 Cable length: 950 yards.
 Diameter:
 Main parachute: 11 feet.
 Pilot parachute: 6 feet.
 Type of filling:
 Upper H. E. charge: RDX/Wax, 95/5.
 Lower H. E. charge: RDX/Wax, 95/5.
 Weight of filling:
 Upper H. E. charge: 2 pounds 6 ounces.
 Lower H. E. charge: 1 pound 10 ounces.

DESCRIPTION. This projectile is of the "aerial-wire-barrage" type and is used to project a steel cable into the air by means of a rocket. (See fig. 213.) One end of the cable is fixed to the ground and the other to a large support parachute and a smaller drag parachute. When

the cable has paid out, the parachutes are pulled from their housing. The projectile is fin-stabilized and consists, from nose to tail, of the rocket motor, parachute housing, and upper and lower cable housing.

ROCKET MOTOR. The rocket motor consists of a motor body, which is screwed into the parachute housing, and an ogival nosepiece containing a TNT destruction charge. The motor body is a cylinder closed at the forward end and open at the rear. There is no base plate, but the propellant gases are allowed to escape through four venturi drillings in the forward end of the parachute housing. The propellant is a single, cylindrical, multiperforated stick and is ignited by means of an electrical base igniter, a train along the central drilling, and an ignition charge in a grid at the forward end. Leads to the electrical igniter pass through one of the venturi drillings. A delay fuze in the forward end of the motor body ignites the destruction charge in the nosepiece.

PARACHUTE HOUSING. The parachute housing, which is a cylinder closed at the forward end, serves not only to house the large main support parachute and the smaller drag parachute, but also as a base plug for the rocket motor. The forward end has four venturi drilled obliquely in the sides of the body.

At the forward end of the parachute housing is a TNT destruction charge enclosed in asbestos. Although this has a primer, there is no means of initiation; it is assumed, therefore, that this charge is set off by sympathetic detonation from the charge in the nose of the projectile. Below this destruction charge is the main parachute wrapped in asbestos and below it the small drag parachute.

CABLE HOUSING. The cable housing is constructed in two separate halves. The upper half is attached to the base of the parachute housing and accompanies the projectile on its flight. The lower portion of the housing has a flanged base, which fits into the mounting and remains on the ground. The finned tail unit is spot welded to the upper half and fits over the lower portion. This maintains the projectile in position until it is fired. A slot is provided in two of the fins through which a wire is passed, holding the lower section in position; this wire should be removed before firing.

GERMAN EXPLOSIVE ORDNANCE

A continuous length of approximately 950 yards of $\frac{1}{8}$ -inch steel cable is coiled in equal lengths inside each portion of the cable housing. The end of the cable in the upper portion is attached to the parachute, and the other end passes through a hole in the bottom of the lower portion and terminates in an eyebolt secured to the launching frame.

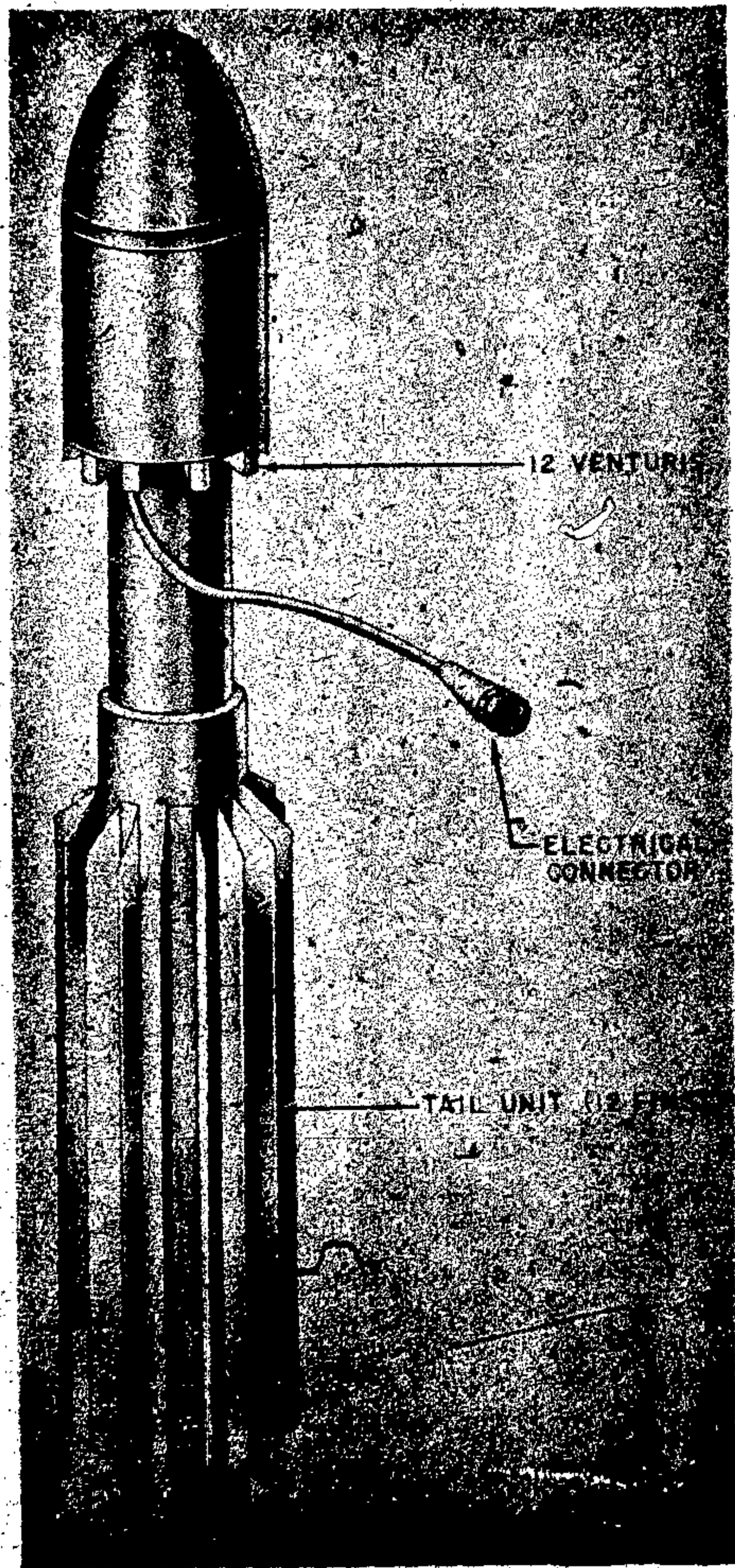

Figure 214—20-cm Antiaircraft Rocket

OPERATION. The actual barrage consists of the support parachute, drag parachute, and cable. The projectile is evidently launched from some kind of frame (no specimen of this had yet been recovered), to which the lower portion of the cable housing is fixed. When the propellant charge is ignited, the projectile climbs until, theoretically, the whole of the cable has paid out. The drag parachute and the main support parachute are then withdrawn from the parachute housing and the main unit continues on its course, leaving the cable suspended in the air.

When the propellant burns out, the destruction charge in the nose piece, actuated by the delay fuze, destroys the rocket motor and parachute housing. It is presumed that the charge in the forward end of the parachute housing is at this point set off by sympathetic detonation to assist in this destruction.

20-cm ANTI-AIRCRAFT ROCKET, FIN STABILIZED.

DATA:

Over-all length: 64.3 inches.

Diameter: 8.0 inches.

Total weight: 159 pounds 3 ounces.

Propellant weight: 11 pounds 9.5 ounces.

DESCRIPTION. This rocket is similar in design and operation to the 15.2-cm anti-aircraft rocket but is much cruder in construction. The round consists of a rocket motor at the forward end, a middle compartment containing the parachute and the cable housing surrounded by the fin sleeve. (See fig. 214.)

OPERATION. On firing, the cable housing remains on the ground, and the rest of the assembly is projected into the air, uncoiling the cable from its housing. When the cable is completely unspooled, the parachute is withdrawn through the fin sleeve. The separation of parachute and motor operates a pull igniter, which initiates a demolition charge contained in a central tube in the motor.

REMARKS. The round is painted dark green over-all.

21-cm H. E. AIRCRAFT ROCKET, SPIN STABILIZED

DATA:

Over-all length: 49.2 inches.

Diameter: 8.27 inches.

Total weight: 241.3 pounds.
 Propellant weight: 39.5 pounds.
 Length of grain: 21.67 inches.
 Diameter of grain: 2.46 inches.
 Type of filling: Amatol 40/60.
 Weight of filling: 22.4 pounds.
 Fuzing: Z 23 LA 0.15; P. D. F. with inst. or delay setting. Hbgr. Z. 35 K S/30 M. T. F.

DESCRIPTION. This is a streamlined, aircraft rocket projectile, consisting of an H. E. shell, externally threaded at the base to screw into the rocket motor and at the nose to receive a ballistic cap. (See fig. 215.) A booster container is threaded into the nose of the shell and receives the nose fuze. A wooden actuating rod separates the fuze from the tip of the ballistic cap.

The motor body is a cylindrical steel body machined externally to form fore and aft bourrelets. A venturi assembly, drilled to form 22 jets, threads into the base of the motor. The jets are inclined at an angle of 16° to impart a rotary motion to the rocket in flight. An electric squib is threaded into the center of the venturi assembly. The propellant charge consists of 7 single-perforated grains supported by a metal grid at the after end. A ring-shaped black powder igniter is placed at the base of the charge and a second igniter is located at the forward end of the charge. These two ignition charges are connected by a length of quickmatch in a celluloid tube, which passes through the perforation of the central propellant grain.

REMARKS: 1. The German designation for this round is "21 cm Wgr. 42 Spr."

2. The round is painted green over-all.

28-cm H. E. ROCKET, SPIN STABILIZED

DATA:

Nature of projectile: Multiple baseventing, spin-stabilized, pusher rocket.

Caliber: 280 mm.

Filled weight (complete round): 83 kilograms (183 lbs.).

Over-all length (complete round): 1,190 mm (46.41 inches).

Nature of fuze: Nose percussion delay action.

Nature of filling: H. E.

Maximum range: 2,339 yards.

WARHEAD:

General shape: Cylindrical canister with rounded ends, one of which receives the fuze and the other the tail unit.

Material: Sheet steel.

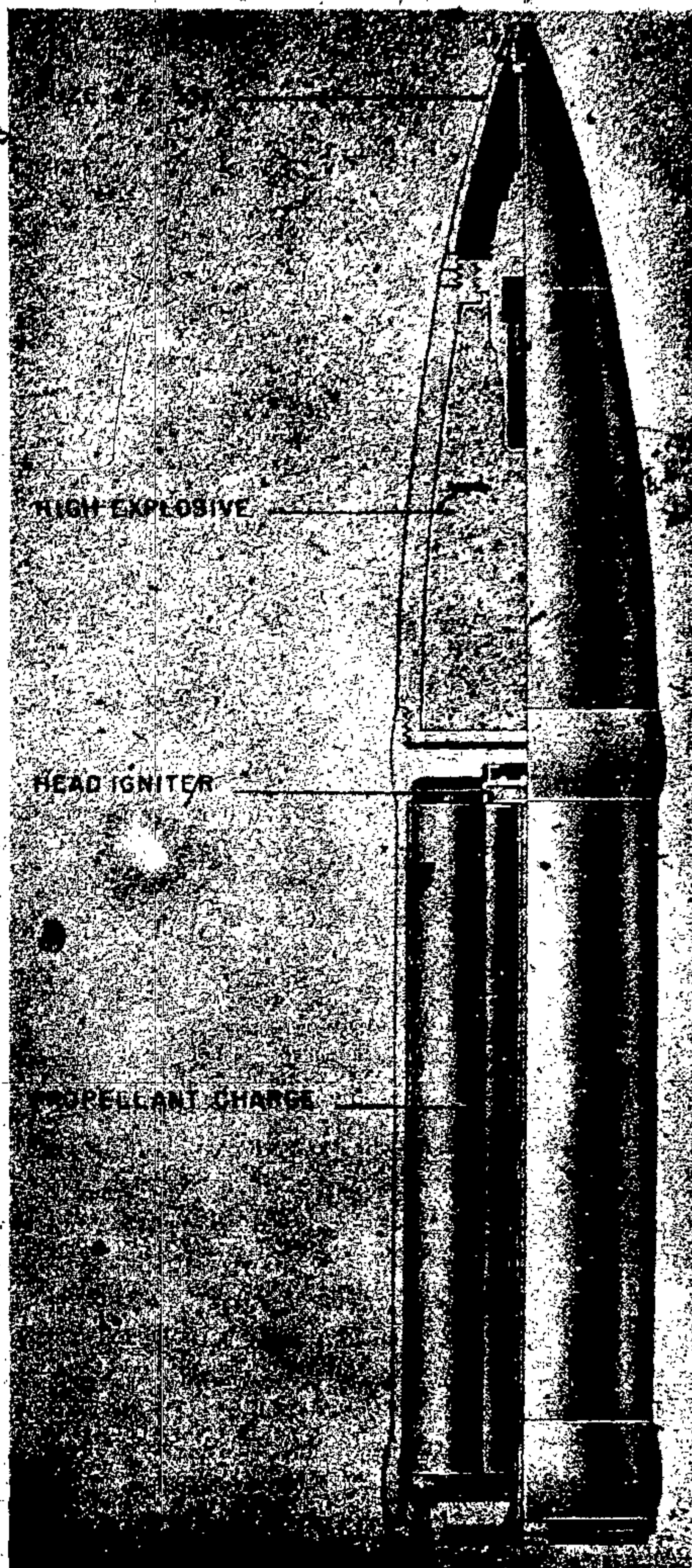

Figure 215—21-cm Aircraft Rocket

GERMAN EXPLOSIVE ORDNANCE

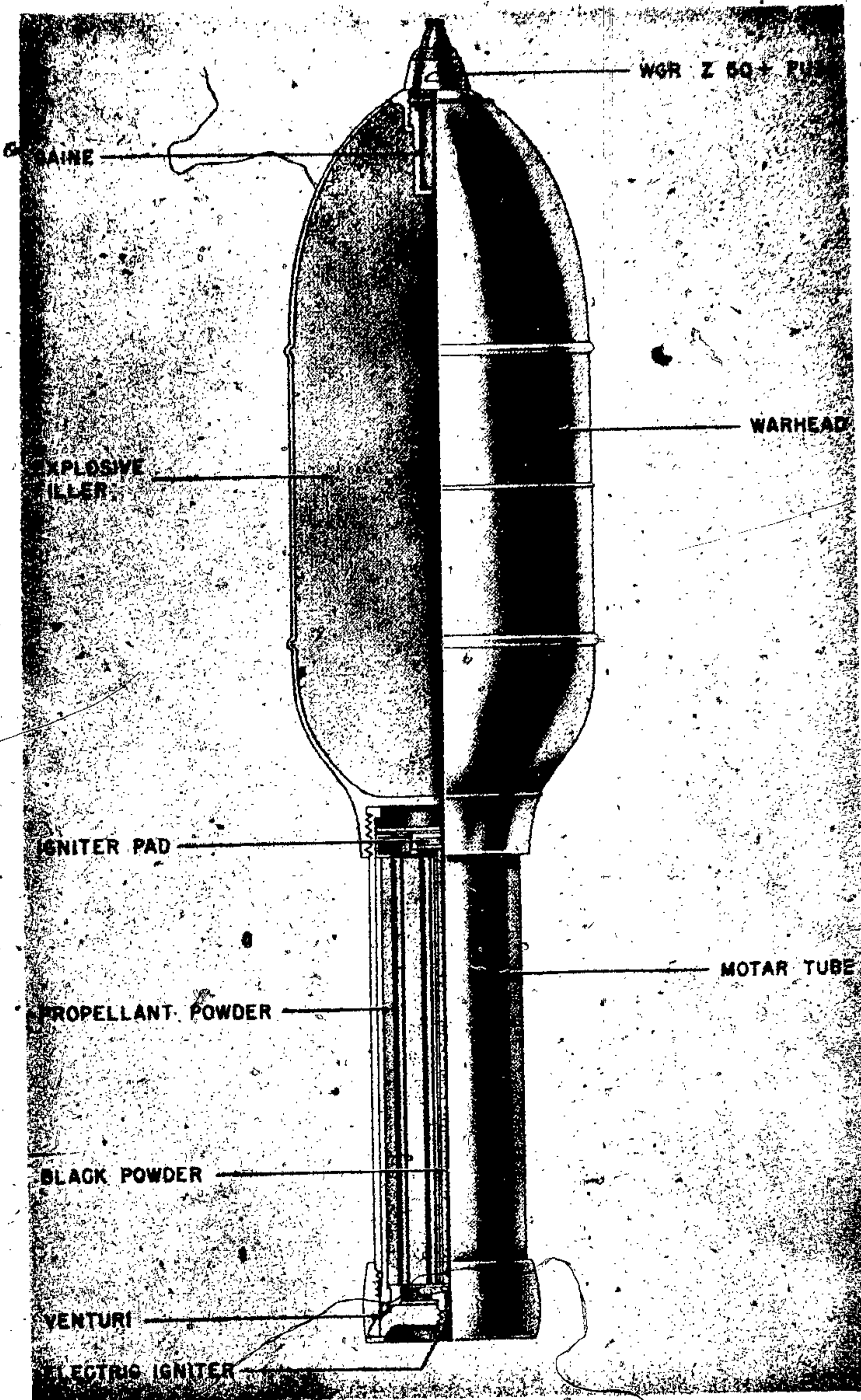

Figure 216—28-cm H. E. Rocket

Over-all length: 720 mm.
 Diameter: 280 mm.
 Wall thickness: 1 mm.
 Weight of filling: 36 kilograms.
 Filling: Amatol or TNT.

MARKING:

On nose: 28 cm Wk. Spr.
 On body: 13 Mr. 5.6.42.G.

METHOD OF IGNITION

INITIATOR. A separate electrical initiator enclosed in an aluminum tube and bakelite container, and which may be fired from a 4-volt battery, is screwed into the central drilling in the base. For firing single rounds, initiators are provided, connected by 15 inches of two-strand insulated wire to a plug, and action is instantaneous on application of voltage. For firing from the Wurfgerat (four-frame stand), four initiators, externally similar in appearance, are provided, wired in series. One only (tagged "0") is instantaneous and the remaining three (tagged "2," "4," and "6") include powder pellets so as to fire after intervals of 2, 4, and 6 seconds respectively.

IGNITION CHARGE:**Nature:**

Head: Compressed gunpowder.
 Base: Nitrocellulose in powder in the form of six-pointed, star-shaped flakes.

Weight:

Head:
 Base: 10 grams.

Container:

Head: Flat, circular aluminum with open end towards propellant.
 Base: porous, rough-cloth bag.

Positioning:

Head: In a pressed-steel housing supported by a flanged split ring.
 Base: In center of grid.

Markings:

Head: None.
 Base: Wx. Man. St. P (2.25/23) dt1938/5
 WO.7.842W.

DESCRIPTION—GENERAL. This is a spin-stabilized projectile consisting of a large warhead with a rocket motor of smaller diameter attached at the rear. The projectile is electrically fired from the wooden crate in which it is carried or from a multiple launcher consisting of a number

of frames of similar dimensions. The layout of the complete projectile is shown in figure 216.

WARHEAD. The warhead is a thin steel shell sealed at the rear, where it has a flange threaded to take the rocket motor. Two raised bearing surfaces on the body locate the projectile in the firing frame and also reduce lateral friction. An adaptor in the nose of the warhead is threaded to take a nose percussion fuze and a gaine holder.

ROCKET MOTOR. The rocket motor is in the form of a cylinder screwed into the rear of the warhead and closed at the rear by a plug in which are a number of offset venturi drillings.

The propellant, which consists of a single stick, is located at the forward end by a flanged metal spacing ring which also contains the ignition charge, and at the rear by a metal grid holding the rear ignition charge. The base plug screws over the motor body and has a central drilling tapped to receive an adaptor for the electrical igniter.

REMARKS. 1. This rocket is designated the "28 cm Wfk. Spr."

2. The round is painted grey over-all, with stencillings in black and white letters.

30-cm MEB H. E. ROCKET, SPIN STABILIZED

DATA:

Nature of projectile: Multiple base-venting, spin-stabilized, pusher rocket.

Caliber: 30 cm. Over-all length (Complete Projectile): 48.44 inches.

Over-all weight (Complete Projectile): 278 pounds.

Nature of Fuze: Nose percussion.

Nature of Filling: Amatol.

Maximum Range: 4,976 yards (range tables).

Warhead:

General shape: Elliptical with rounded forward end and truncated tail.

Material: Sheet steel.

Dimensions:

Over-all length: 29.5 inches.

Maximum diameter: 12.125 inches (across rib).

Wall thickness: 0.109 inch.

Diameter at Tail, External: 8.938 inches.

Diameter at Tail, Internal: 8.625 inches.

Diameter at nose: 4.563 inches.

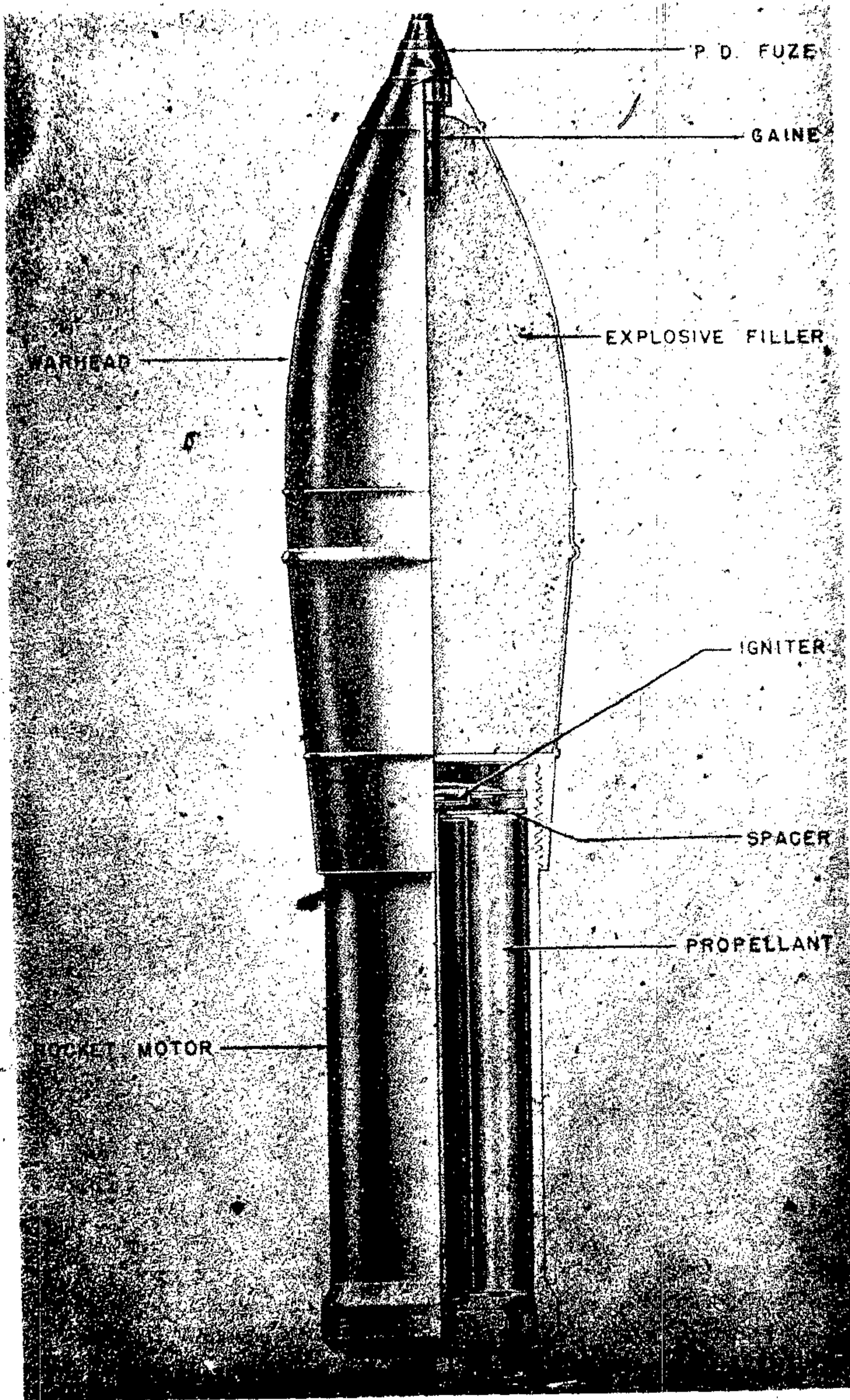

Figure 217—30-cm H. E. Rocket

Weights:

Empty: 49 pounds 12 ounces.

Weight of Filling: 98 pounds 6 ounces.

Filling: 60/40 amatol.

Markings:

Stamped on Nose of Head: 23.

Stenciled in White Approximately 4 Inches

Below Fuze: 30 cm WK 42 Sp.

Stenciled on Rear Center: 13 Jg 29 9 42.

Stamped on Lower End: 42, CKI.

Fuze:

Nature: Point detonating instantaneous nose fuze Wgr. Z.50+

Weight with Adapter: 1 pound.

Action: The fuze is armed in two steps: by withdrawing a safety pin before firing and by centrifugal action after firing.

DESCRIPTION. This projectile is similar in design to the 28- and 32-cm rockets, being spin-stabilized and consisting of a forward warhead to the rear of which is attached a rocket motor of smaller diameter. (See fig. 217.)

WARHEAD. The warhead is constructed of two sections of sheet steel, a nose piece and a tail, the four sections being joined together by circumferential welds. A single rib around the center of the projectile serves to reduce friction against the side of the launcher.

The nose piece is threaded to receive a nose fuze, Wgr. Z.50 and a gaine, and the tail internally threaded to screw onto the forward end of the rocket motor. The H. E. filling consists of 96 pounds of amatol.

ROCKET MOTOR. The rocket motor is of conventional design and consists basically of a cylindrical body and a vase plug incorporating the venturi and igniter assemblies.

The body is machined internally and externally and is closed at the forward end, where it is threaded to screw on the tail of the warhead. This end section is not flat but is slightly concave internally to permit a more even distribution of pressure. The rear end of the body is threaded internally to receive the base plug which has 18 offset venturi drillings and a central drilling to take an electrical igniter.

The propellant, which consists of seven mono-perforated sticks, is located by two grids, one at each end of the motor body. A celluloid tube containing a quickmatch train and plugged at

each end by a gunpowder pellet, is located in the drilling in the central stick and transmits the flash from the igniter to the ignition charge at the forward end of the motor.

REMARKS. 1. The German designation for this round is "30 cm Wkf. 42 Spr."

2. The round is painted dark green over-all, with black and white stencillings.

32-cm INCENDIARY ROCKET, SPIN STABILIZED

DATA:

Over-all length: 48.6 inches.

Diameter: 13.0 inches.

Total weight: 174 pounds.

Propellant weight: 14.24 pounds.

Length of grain: 16¼ inches.

Diameter of grain: 4⅞ inches.

Type of filling: Kerosene mixture.

Weight of filling: 87.69 pounds.

Fuzing: Wgr. Z. 50.

DESCRIPTION. This rocket consists of a large, bomb-shaped head, filled with an incendiary mixture and burster ignition tube, and a motor body to which the head is threaded. The head has raised ridges fore and aft to provide bearing surfaces, and near the nose is a filling plug. An adapter is threaded into the burster container, the base of the adapter containing a booster charge. The burster contains two sets of one solid and one ring penthrate pellet. Between the sets of pellets is located a magnesium filled ignition charge container, through the center of which passes a burster stick of penthrate.

The motor contains a single propellant grain with one central perforation and eight smaller perforations arranged at equal intervals around the central one. Eight longitudinal grooves are formed along the exterior of the grain. In each groove is fitted a tubular celluloid inhibitor. Through the large central perforation is passed a length of quickmatch in a celluloid tube. This serves to connect the head igniter with a primary ignition charge located in a cloth bag at the after end of the propellant grain. The primary ignition charge and the propellant grain are supported by a metal grid attached to the venturi assembly. The venturi assembly, drilled to form 26 jets at a 16° angle, is threaded to screw into the after end of the motor body. A threaded hole

GERMAN EXPLOSIVE ORDNANCE

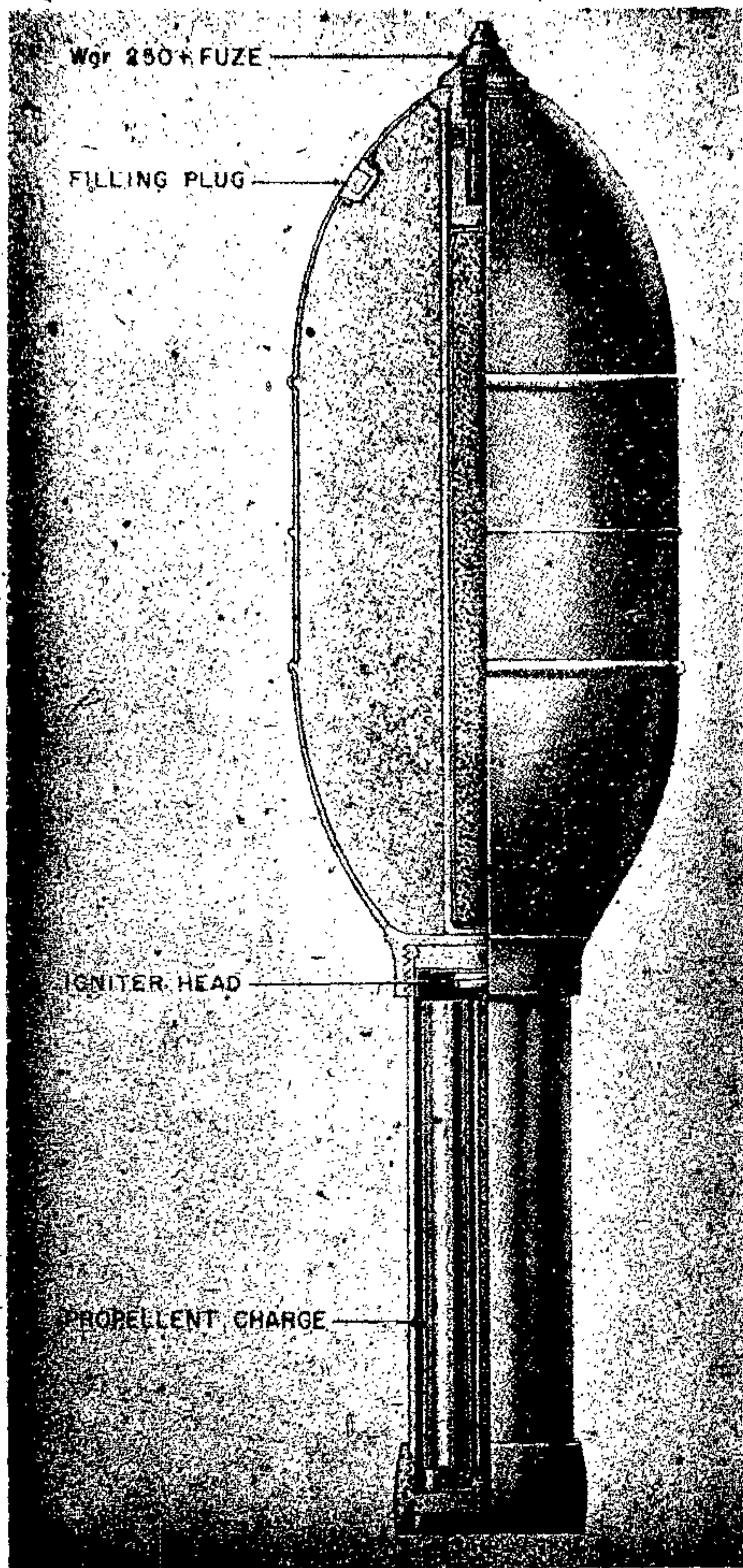

Figure 218—32-cm Incendiary Rocket

in the base of the venturi assembly accomodates the electric igniter. (See fig. 218.)

REMARKS. 1. The German designation for this round is "32-cm Wfk. M. Fl. 50."

2. The round is painted dark green over-all.

3. Although recovered only with an incendiary filling, it is reported that this round may also contain a chemical charge.

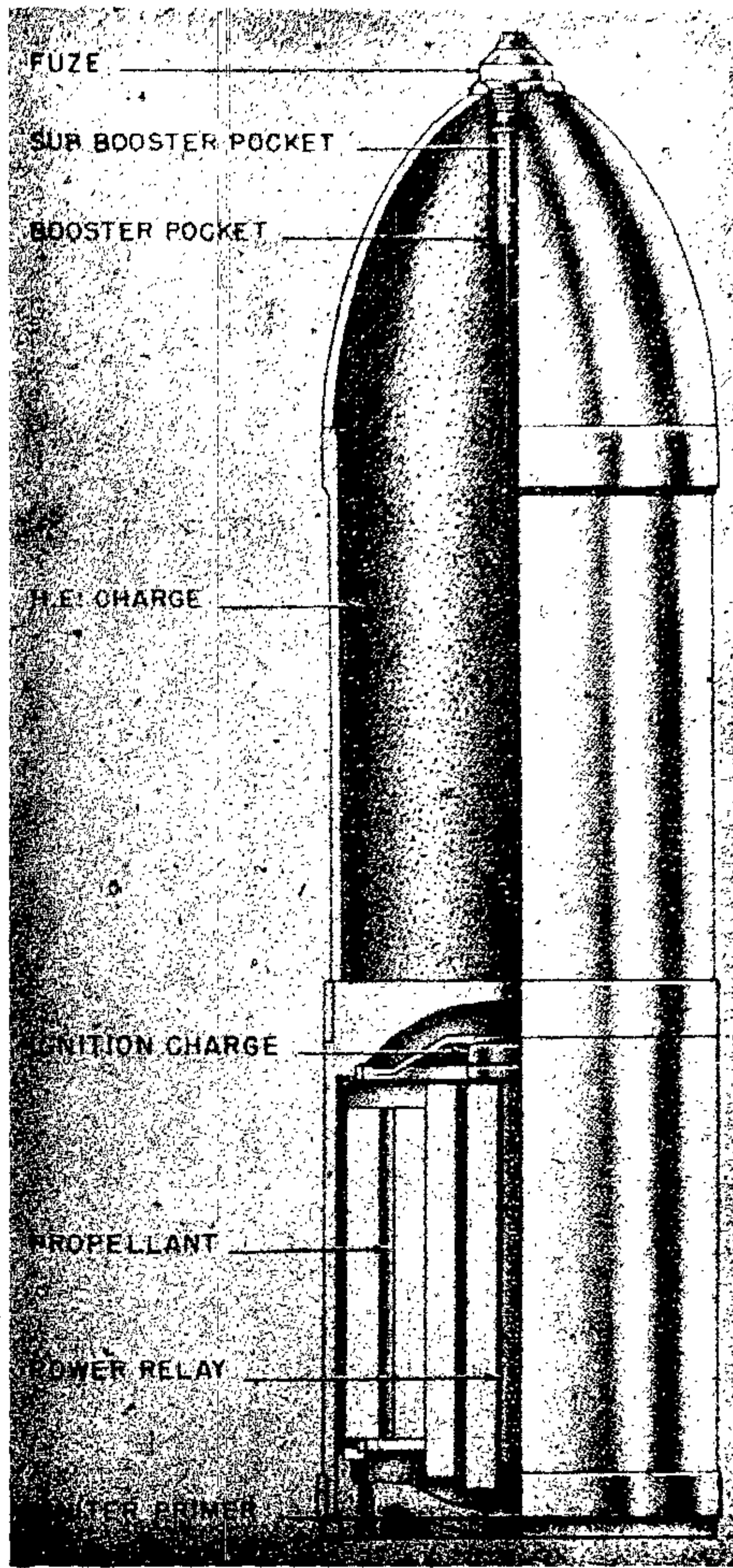

Figure 219—38-cm H. E. Rocket

38-cm H. E. ROCKET, SPIN STABILIZED

DATA:

Over-all length: 56.68 inches.

Diameter: 14.94 inches.

Total weight: 761 pounds.

Propellant weight: 88.5 pounds.

Type of Filling: 50/50 Amatol, poured.

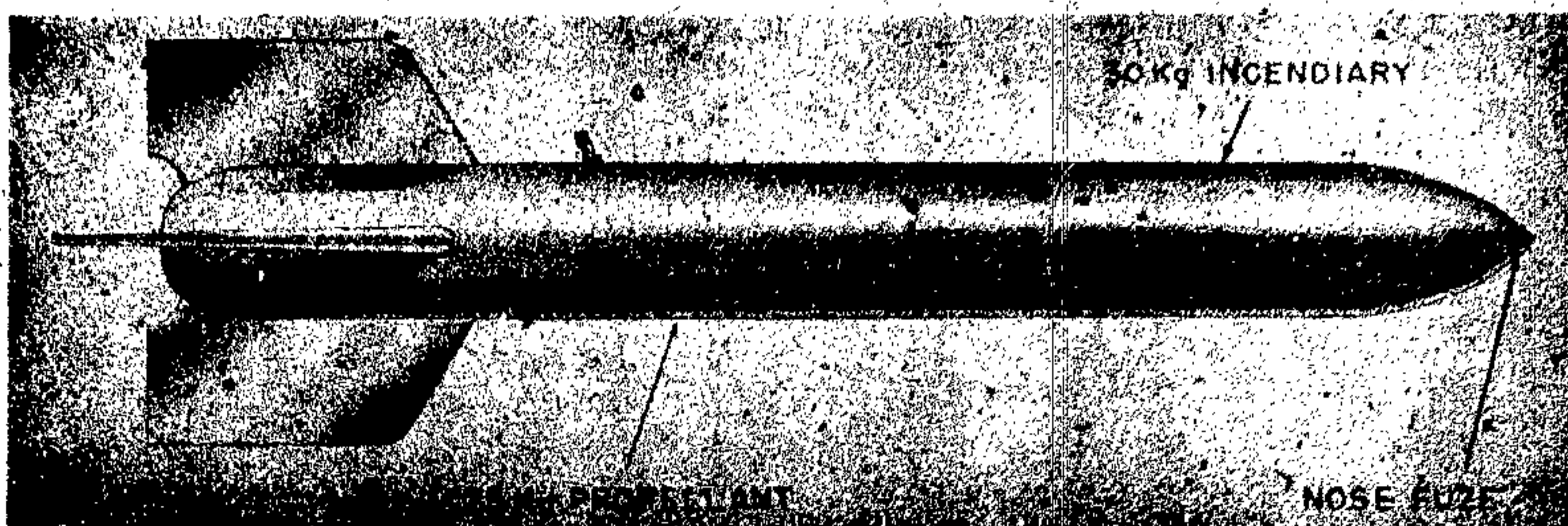

Figure 220—R 100 BS Rocket

Weight of Filling: 270 pounds.

Fuzing: P. D. F. (designation unknown).

DESCRIPTION. The H. E. body is of two-piece welded construction and is threaded internally at the after end to receive the motor body. The booster pocket and fuze adapter is welded in position at the *forward* end. (See fig. 219.)

The motor contains the propellant charge and igniters and is threaded internally to receive the venturi assembly. A relay igniter charge, consisting of three bags of gunpowder, is located in the perforation in the central propellant grain. The venturi assembly is drilled to form 32 jets at an angle of 14°. In the center of the assembly is located a threaded hole for the electric squib. A rear spacer ring welded to the *forward* end of the venturi assembly acts as a grid and positions the outer row of propellant grains.

REMARKS. 1. The German designation for this round is "38 cm R. Sprgr. 4581."

2. The round is painted dark green over-all, with an 0.8-inch white band painted around the center of gravity, and with black stencilling.

3. This round is notable among German rockets because of the steel splines inserted in the after end of the motor. These splines engage the rifling of the projector liner and aid in imparting an initial rotation to the projectile.

R 100 BS AIR-TO-AIR ROCKET

GENERAL DESCRIPTION. The R 100 BS air-to-air incendiary rocket was originally designed as an uncontrolled rocket for attacking bomber formations from fighter aircraft. This project was started in the latter part of July 1943. During the latter part of 1944, however,

it was decided to use the Oberon Gerät to control the bursting point of the rocket thereby improving the chance of a strike from a negligible value to a probability of about 0.4.

Details of the rocket are somewhat sketchy but the salient features seem to be that the total weight was 100 kg 180 cm in length with a maximum diameter of 210 mm. The propellant, consisting of 25 kg of normal rocket propellant, gave the projectile an impulse of 4,200 kg/sec with a burning time of 0.9 second. The maximum range was estimated at 2,000 meters and the maximum velocity 550-600 m/sec. (See fig. 220.)

The warhead weighed 30 kg and contained 460 incendiary cylinders filled with thermite, each weighing 55 grams. These cylinders were so arranged as to be stable during flight and fired forwards in a 60° cone. They were intended to ignite the aircraft petrol tanks and had a lethal range of about 18 meters. The incendiary cylinders had a velocity of 500 m/sec at ejection in addition to the velocity of the rocket.

LAUNCHING. Four of these projectiles were slung underneath the wings of a Me 262 and were launched electrically by rather complicated launching gear which comprised the following:

1. AZ 420 Kreisvisier (gyro sight).
2. A radar range meter which is referred to as FUG 217 or 218.
3. A relative velocity meter known as the Oberon clock.
4. An Elfe, which apparently accepted signals from other components and carried out some sort of computation.
5. An altitude/angle computer.
6. A remote fuze setter.

GERMAN EXPLOSIVE ORDNANCE

It has been stated that the rockets were launched electrically by means of the sight when the correct range (as measured automatically by the radar range-finder) was reached and not fired by the pilot. These four projectiles could be launched either singly or in salvo, for which purpose a ripple firing mechanism with a 0.1-second interval was incorporated. No control was applied after launching.

REMARKS. Although this weapon had under-

gone satisfactory tests and was actually being produced, it never was, however, used operationally because of delays in the firing gear.

8.6-cm R. Spgr L/5.5 ROCKET

DESCRIPTION. The 8.6-cm R. Spgr L5.5 rocket has a longer motor and a smaller payload than the Spgr L/4.5. (See fig. 221.) The details of construction of the motor are similar to the Spgr L/4.5 in that the motor closure is not fixed permanently to the motor tube. A KLAZ 40 impact-firing nose fuze is employed.

The propellant grain consists of two concentric cylinders of a diglycol propellant, extended to different diameters than for the other grains. The length is 220 mm and the diameters are 66/41 and 32/71, with a total weight of 1,000 grams. The forward igniter is a 40-mm disk of incendiary material.

DATA:

Motor:

Propellant: Diglycol.

Nozzles: 10.

Throat diameter: 5.25.

Cant angle: 17°.

Nozzle K: 495.

Performance:

Thrust: 57°.

Burning time: 0.52.

Impulse: 185.

Velocity (maximum): 300 m/sec.

Range: 4,500 m.

REMARKS. This rocket has the same design factors as shown for the 8.6 cm RLg 1000 rocket except for the throat diameter and uses the same type launcher.

8.6-cm R. Spgr L/4.5 ROCKET

GENERAL. In July 1944, a new series of 8.6-cm R. Spgr's was designed; the L/4.5 being the smallest rocket of the new series. The nozzle plate is threaded on to the motor tube and the loose motor closure design is employed. The body of the projectile has been lightened and the base fuze cavity eliminated. A KLAZ 40 impact-firing nose fuze is used in place of a self-destructive pyrotechnic time fuze that is used with the Spgr L/4.8. (See fig. 222.)

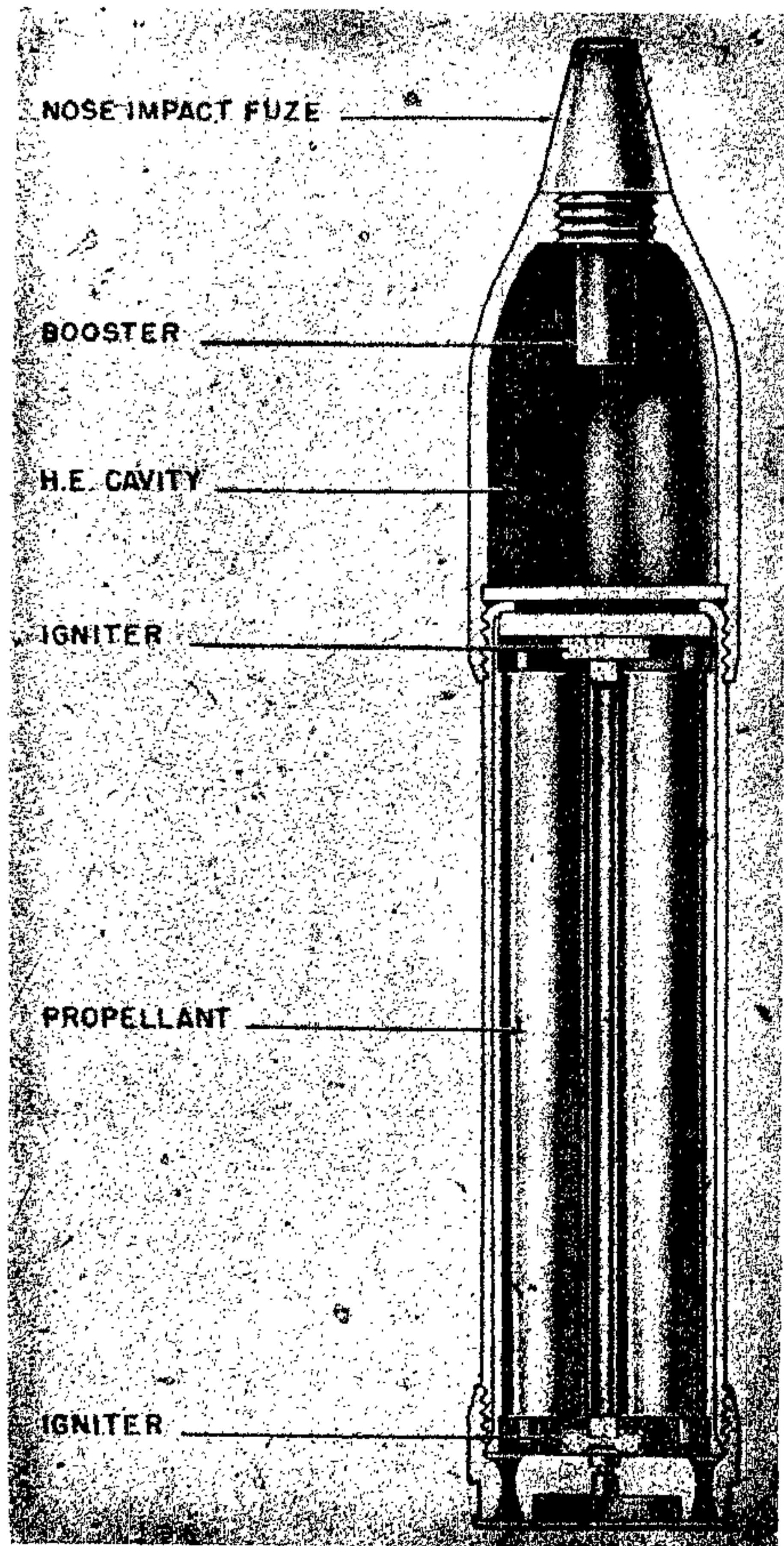

Figure 221—8.6-cm R. Spgr L/5.5 Rocket

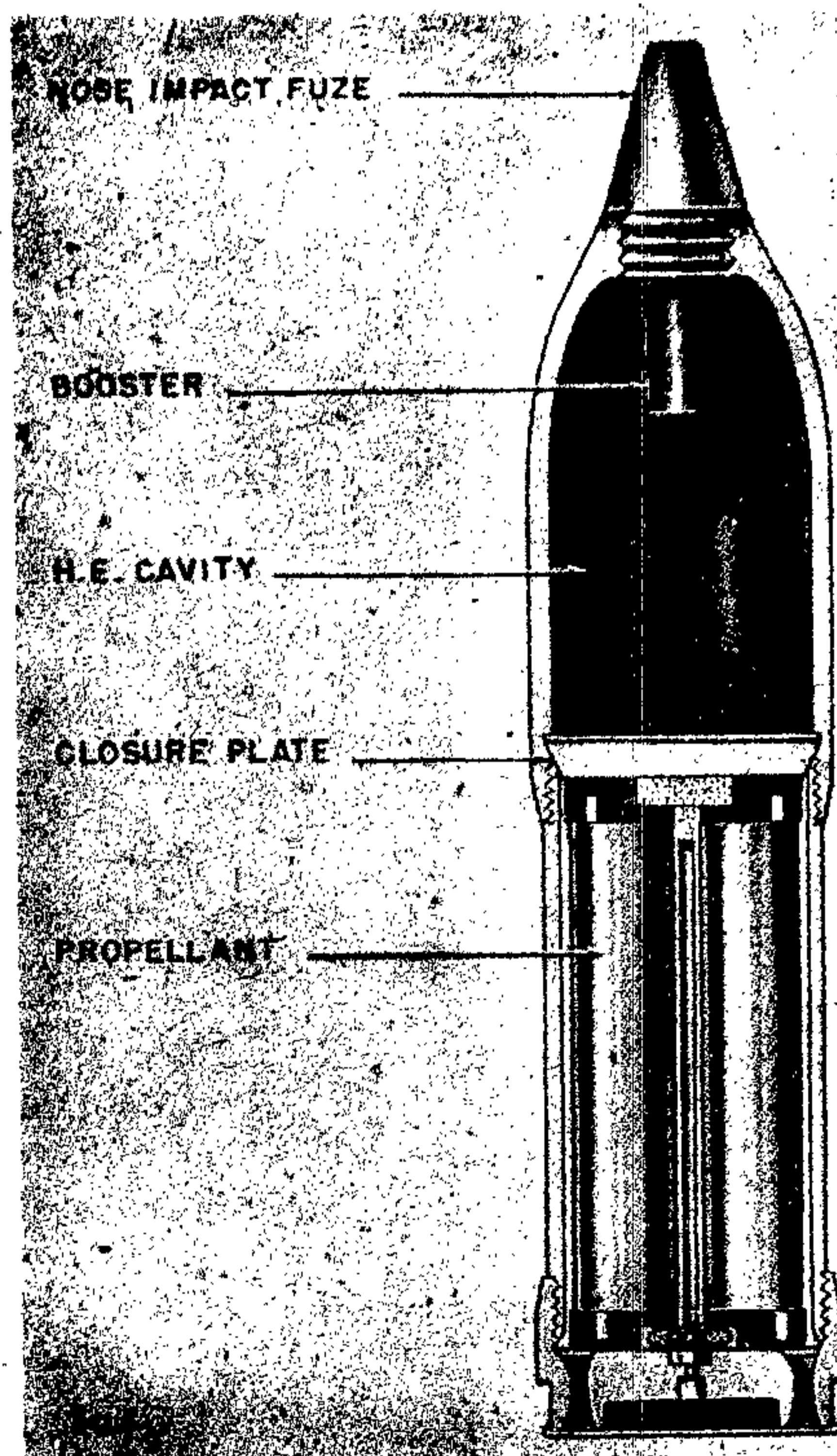

Figure 222—8.6-cm R. Spgr L/4.5 Rocket

DESCRIPTION. The ignition train for the motor consists of a percussion cap, rear igniter of granular black powder and a flash tube running up the central hole of the inner propellant grain to the forward igniter. The forward igniter consists of a 30-mm diameter disk of incendiary material, which is not black powder.

The propellant grains are two concentric cylinders, 130 mm in length, having diameters of 70/40 and 35/7 mm and weighing 680 grams. The grains and igniters are held in place by a light three-armed grid of plastic.

DATA:

Motor:

Propellant: Diglycol.

Nozzles: 4.6.

Throat diameter: 6.90, 5.25.

Cant angle: 12°.

Nozzle K: 460, 525.

Performance:

Thrust: 243.

Burning time: 1.22 minutes.

Impulse: 116.

Velocity (maximum): 250 m/sec.

Range: 3,500 m.

REMARKS. This rocket has the same design factors as shown for the 8.6-cm RLg 1000 rocket except for the throat diameter and uses the same type launcher.

GERMAN EXPLOSIVE ORDNANCE

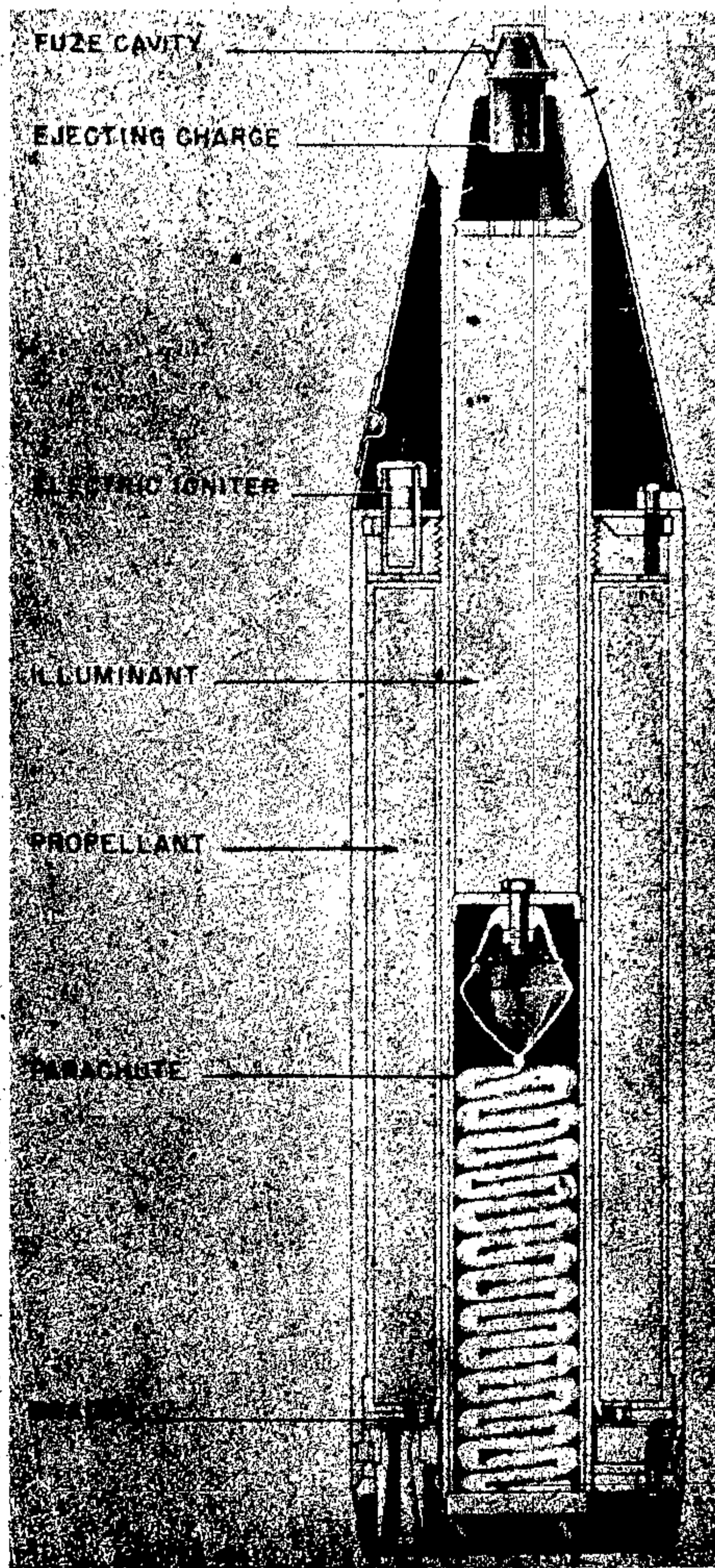

Figure 223—21-cm R-Lg Rocket

21-cm R-Lg. ROCKET

DATA:

Ballistics:

Caliber: 21 cm.

Bourrelet diameter: 21.4 cm.

Total weight: 60.0 kg.

Length: 5.1 cal.

Length (fuzed): 109.0 cm.

Maximum velocity: 560 m/sec.

Maximum ordinate: 5,400 m.

Spin Velocity: 11,900 rev/sec.
 Moment of Inertia:
 Longitudinal: 0.0334 mkg/sec².
 Transverse: 0.363 mkg/sec².
 Stability factor: 1.5.
 Launching Velocity: 19:1 m/sec.
 Launching Time: 0.118 sec.
 Motor performance:
 Nozzle K: 500 cm²/cm².
 Burning Time: 3.3 sec.
 Impulse: 3,040 kg sec.
 Velocity: 560 m/sec.
 Motor Volume: 12,600 cm³.
 Number of nozzles: 6.
 Throat Diameters: 1.48 cm.
 Nozzle Area: 10.3 cm².
 Nozzle Length: 7.5 cm.
 Cant angle: 9°.
 Expansion cone angle: 12°.

DESCRIPTION. The rocket projectile is a high-altitude, rearward-ejecting parachute-suspended flare. (See fig. 223.) The rocket consists of two concentric cylinders, the inner tube containing the flare and the outer containing the rocket propellant. Six nozzles, arranged symmetrically around the base of the motor, are canted to provide the spin necessary to stabilize the projectile. The launcher used for the tests at Unterlüss was a single-barreled launcher designated "21-cm R Ag M 42," which had a barrel 1.12 meters in length.

ROCKET MOTOR. The 21-cm R Lg rocket motor has a unique design, considering the usual German construction. The motor tube has a groove cut into the inner wall, one near each end of the tube. The purpose of the two grooves is to provide a seat for a ring-type retainer to secure the closure plates. The closure plates have thin obturator disks to prevent the escape of the hot propellant gases around the closures. The upper closure uses one obturator disk and the lower closure two. The second obturator disk is unnecessary at the top of the motor because of the threaded fit of the central tube containing the flare unit and the upper closure.

The assembly procedure is rather complicated due to the closure plate system. First, the nozzle plate is assembled with the grid and obturators. The assembled nozzle plate is fitted into the tube and the locking ring retainer seated

in the retainer groove. An annular locking plate, which has the skirt crimped onto it, is bolted to the nozzle plate. The locking plate seats on the base of the motor tube and stresses the nozzle plate against the ring retainer. Three bolt positions, 180° apart, are used to attach the nozzle plate and the locking plate.

The propellant grain consists of a single tube of R 6 m diglycol propellant 19.2 by 10.8 cm in diameter and 51.0 cm in length, weighing 15.2 kg. This grain is placed upon the grid in the motor tube. An igniter of 70 grams of black powder, contained in a ring-shaped plastic case, is placed on the top of the propellant grain. The front motor closure is then secured to the motor by means of a retainer ring and locking plate. A chamber for the electric igniter is permanently attached to the top closure and provided with a screw-on cap to enable insertion of the igniter after the motor has been loaded. After insertion of the electric igniter, the flare unit, with the wind-shield attached, is fitted into the motor and threaded into the upper motor closure. The manner in which the electric igniter makes an external contact cannot be determined from the information available.

Two construction designs are given for the nozzle assembly. Both types have insert nozzles, i. e., the nozzles are individually assembled to the nozzle plate. In both cases, the nozzle plate is drilled and reamed 6 places, 60° apart, at the desired cant angle of 9°. The hole is then drilled out to a larger diameter for a short distance on the exit side of the plate forming a seat for the flange on the nozzle. The inside of the nozzle plate hole is made slightly conical in the first design. After the nozzle has been inserted, the entrance cone of the nozzle is swaged outward into this cone, thus securing the nozzle to the nozzle plate. The newer design shows the nozzle pressed into a cylindrical hole in the nozzle plate omitting the swaging operation. This is sufficient, since the effect of the high-pressure gases flowing out of nozzle is to have a net forward thrust on the nozzle, thus forcing it more firmly against the shoulder of the nozzle plate.

FLARE UNIT. The flare unit is contained in a cylinder which is equal to the full length of the rocket. The front of the cylinder forms the nose of the rocket and carries the time-fuze and the ejecting charge. The ejecting charge consists of

GERMAN EXPLOSIVE ORDNANCE

35 grams of black powder. A thin conical windshield streamlines the forward end of the flare chamber into the body of the motor. The flare unit contains 7.5 kilograms of illuminant and has a burning time of 120 seconds. The flare unit fits in the forward part of the tube and the parachute in the rearward part of the tube. The parachute is contained in a split metal container which

transmits the thrust of the ejecting charge to the base closure plug. The base closure plug is attached to the central cylinder by 3-mm diameter wires which are sheared by the thrust from the ejecting charge. The entire flare unit fits into the rocket and threads onto the forward closure. The rearward end of the flare unit projects through the nozzle plate and is obturated by a thin collar.

GERMAN LAND MINES, GRENADES, AND IGNITERS

PAPPMINE (A/T)

DATA:

- Diameter or width: 12 inches.
- Depth: 5 inches.
- Explosive: Pressed TNT.
- Explosive weight: 11 pounds.
- Color: Black.
- Material: Cardboard.
- Pull or pressure required: 750-790 pounds.
- Fuzing: Special.

DESCRIPTION. The Pappmine is an antitank mine made entirely of nonmetallic materials to prevent detection by electric mine detectors. (See fig. 224.) It derives its name from the material of the mine body, "pappe," or paper cardboard. The mine, which is black in color, consists of a container and lid, the lid covering the full depth of the container. The top and bottom edges are rounded and lid and container are held together by a band of cardboard.

In the center of the lid is a 2 $\frac{3}{4}$ -inch pressure

plate of thick green glass which resembles a threaded and knurled glass stopper. Inside the mine is a glass igniter set into about 11 pounds of pressed TNT.

IGNITER ASSEMBLY. In the center of the top of the charge is a hole, approximately 1 inch across and 2 inches deep, which houses the igniter assembly. The igniter, which is entirely of glass, resembles the R. Mi. Z. 42 in shape, including the pin through the striker.

The body of the igniter is stated to taper toward the bottom and contains a central tube containing an ignition mixture of unknown reddish composition. The bottom of this tube is connected to a short chamber containing what appears to be a priming charge.

OPERATION. Pressure on the pressure plate forces its undersurface down on the head of the igniter. This crushes the internal glass tube and the initiating flash passes to the priming charge at the base of the tube, thus exploding the main

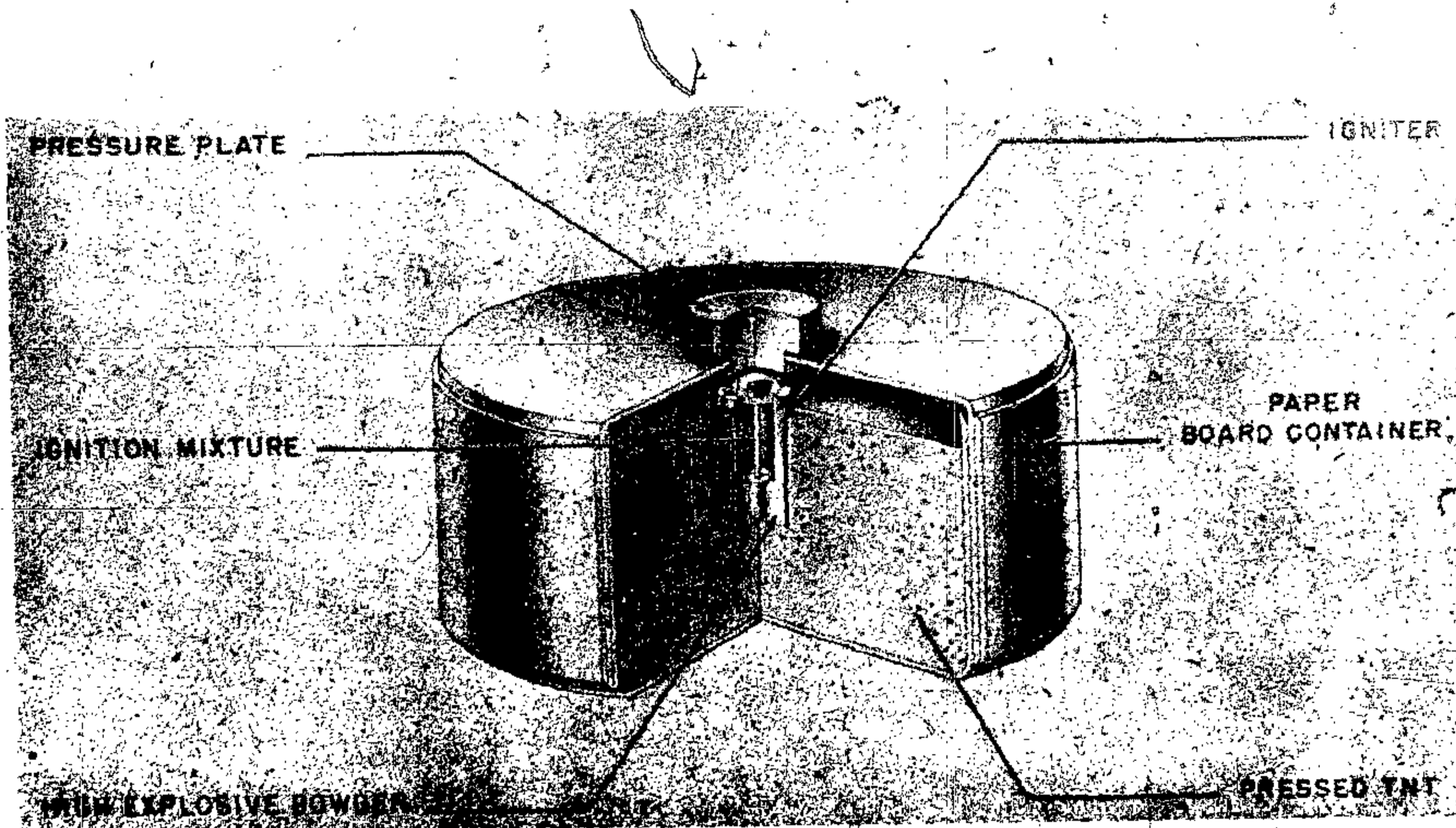

Figure 224—Pappmine Antitank Mine

GERMAN EXPLOSIVE ORDNANCE

charge. A 3-second delay may be incorporated in the igniter. Pressure on the cardboard side of the mine will not set it off.

REMARKS. This information is taken from a captured German document.

PANZERSCHNELL MINE (A/T)

DATA:

Length: $10\frac{3}{4}$ inches.

Depth: 4 inches.

Explosive: Picric acid.

Explosive weight: 13.2 pounds.

Color: Buff and green.

Material: Wood.

Pull or pressure required: 6-11 pounds.

Fuzing: A—ZZ. 42; B—Buck chemical.

DESCRIPTION. These two wooden box mines are similar to the Schumine although somewhat larger. (See fig. 225.) Both A and B types are very similar, consisting of a wooden box containing 6 kg of picric acid in damp proof paper. The initiating charge in each case is a standard 200-gm charge built up on wooden blocks to enable the igniter to fit into it. On the inside cover of the box is painted the letter A or B showing the type of mine, and a label, giving instructions for installation.

OPERATION. Type A is actuated by pressure on the box lid, causing the shearing of two $\frac{1}{2}$ -inch wooden dowels and pressing out the link pin of the Z. Z. 42 igniter.

Type B is actuated by pressure on the box lid shearing $\frac{3}{4}$ -inch wooden dowels and exerting pressure on the head of the two Buck chemical igniters.

MAGNETIC ANTITANK CHARGE (PANZERHANDMINE 3)

DATA:

Diameter: $5\frac{1}{2}$ inches.

Depth: $10\frac{3}{4}$ inches.

Total weight: 8 pounds.

Explosive: TNT or RDX/TNT.

Explosive weight: $2\frac{1}{3}$ pounds.

Material: Paper board.

Fuzing: Friction igniter.

DESCRIPTION. This charge is an assault weapon designed to be placed on enemy tanks or similar targets, to which it adheres by means of magnets. (See fig. 226.)

The body is of paper board and encases the charge and the magnets. A web-carrying handle is attached to a metal neck band. The hemispherical cavity of the hollow charge is closed with a sheet metal liner.

Three pairs of magnets are mounted on the inside of the paper board skirt. They are protected in transit by an iron keeper ring which has a web handle fastened to it to facilitate withdrawal. On one side of the keeper are three equidistant

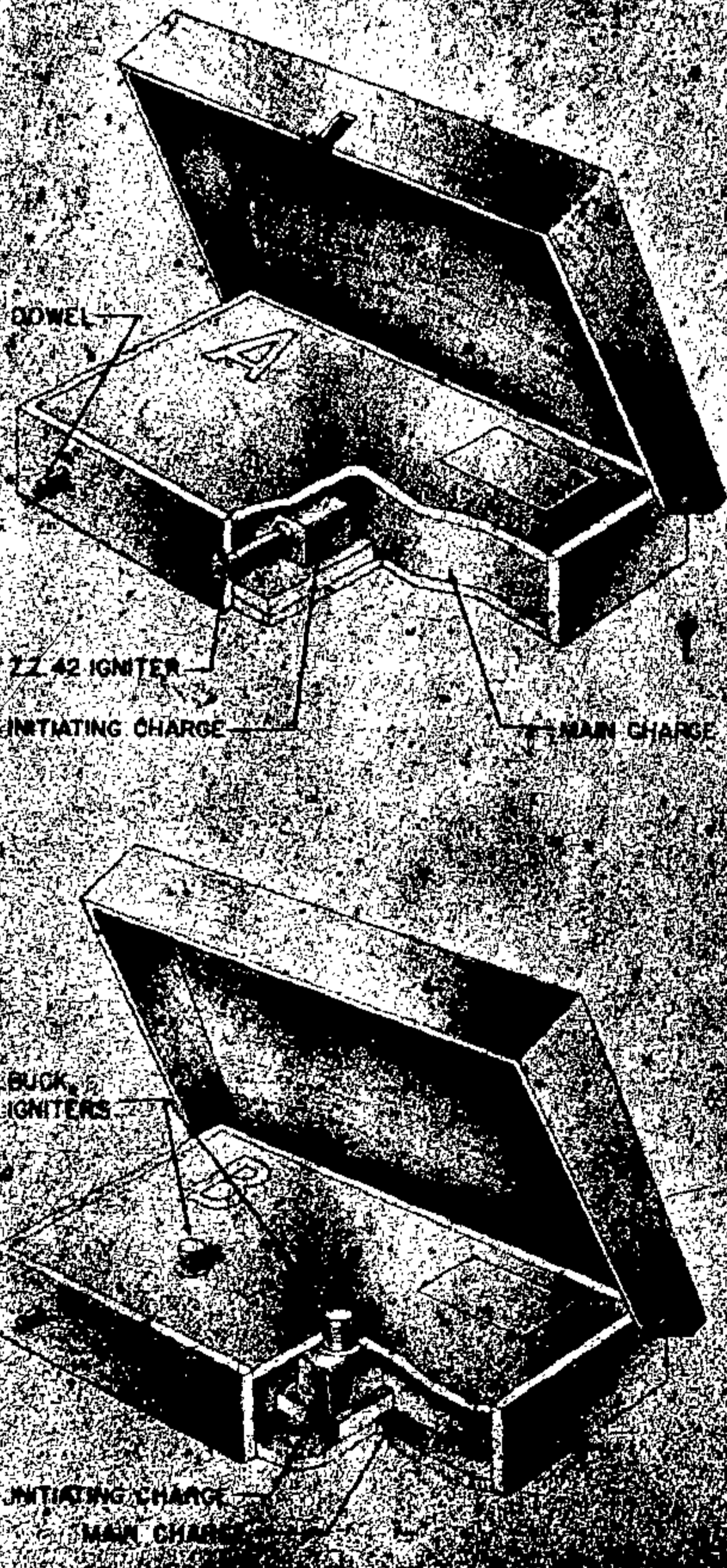

Figure 225—Panzerschnell Antitank Mine

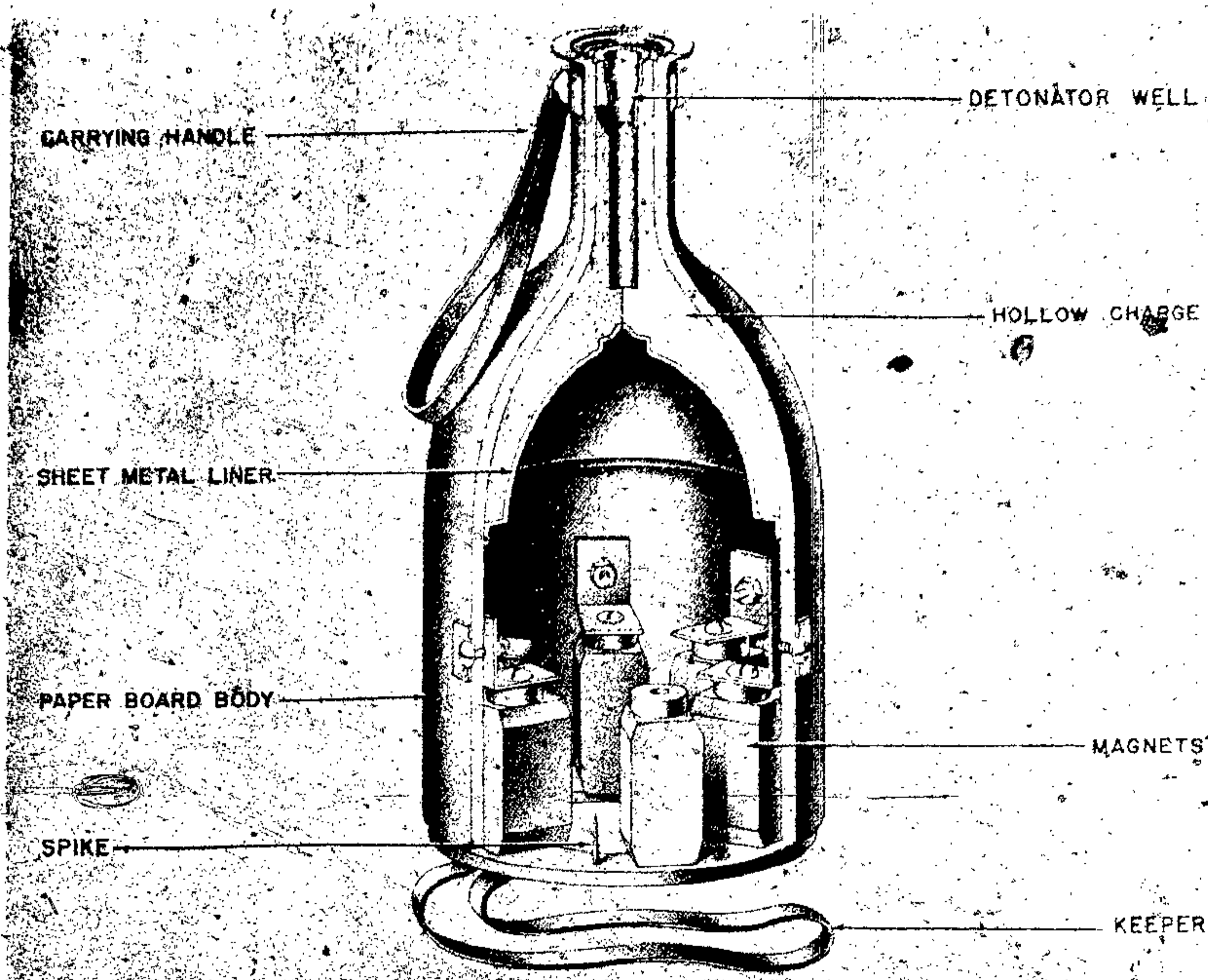

Figure 226—Panzerhandmine 3 Antitank Magnetic Charge Mine

spikes so that the charge can be attached to a wooden surface. In transit the keeper is reversed and the spikes are positioned between the magnets.

The charge is fired with a $7\frac{1}{2}$ -second friction igniter.

OPERATION. Information is lacking as to how the charge is placed and fired. It is apparently designed to be placed by hand on the tank and the igniter pulled after it has been positioned. German documents make no mention of the charge being thrown.

**WOODEN BOX MINE 42 (HOLZMINE),
(A/T)**

DATA:

- Length: 13 inches.
- Diameter or width: 12 inches.
- Depth: $4\frac{1}{2}$ inches.
- Total weight: 18 pounds.
- Explosive: Amatol 50/50.

Explosive Weight: $11\frac{1}{2}$ pounds.

Color: Gray with red band on one end.

Material: Wood.

Pull or Pressure Required: 200–400 pounds.

Fuzing: Z. Z. 42.

DESCRIPTION. The mine consists of a compartmented wooden box which contains the explosive charge. As shown in the cutaway drawing, a Z. Z. 42 igniter, which rests on a supporting block, projects into explosive charge. (See fig. 227.) A pressure block, immediately above the igniter, is supported by a shear flange which is secured to the outer wall of the box by wooden dowel pins.

OPERATION. A pressure of 200 pounds or more on the pressure block shears the dowels. Shear flange, forced down, pushes out the pin in the Z. Z. 42. The freed striker, driven by spring, sets off a percussion cap-detonator-boost-main charge.

GERMAN EXPLOSIVE ORDNANCE

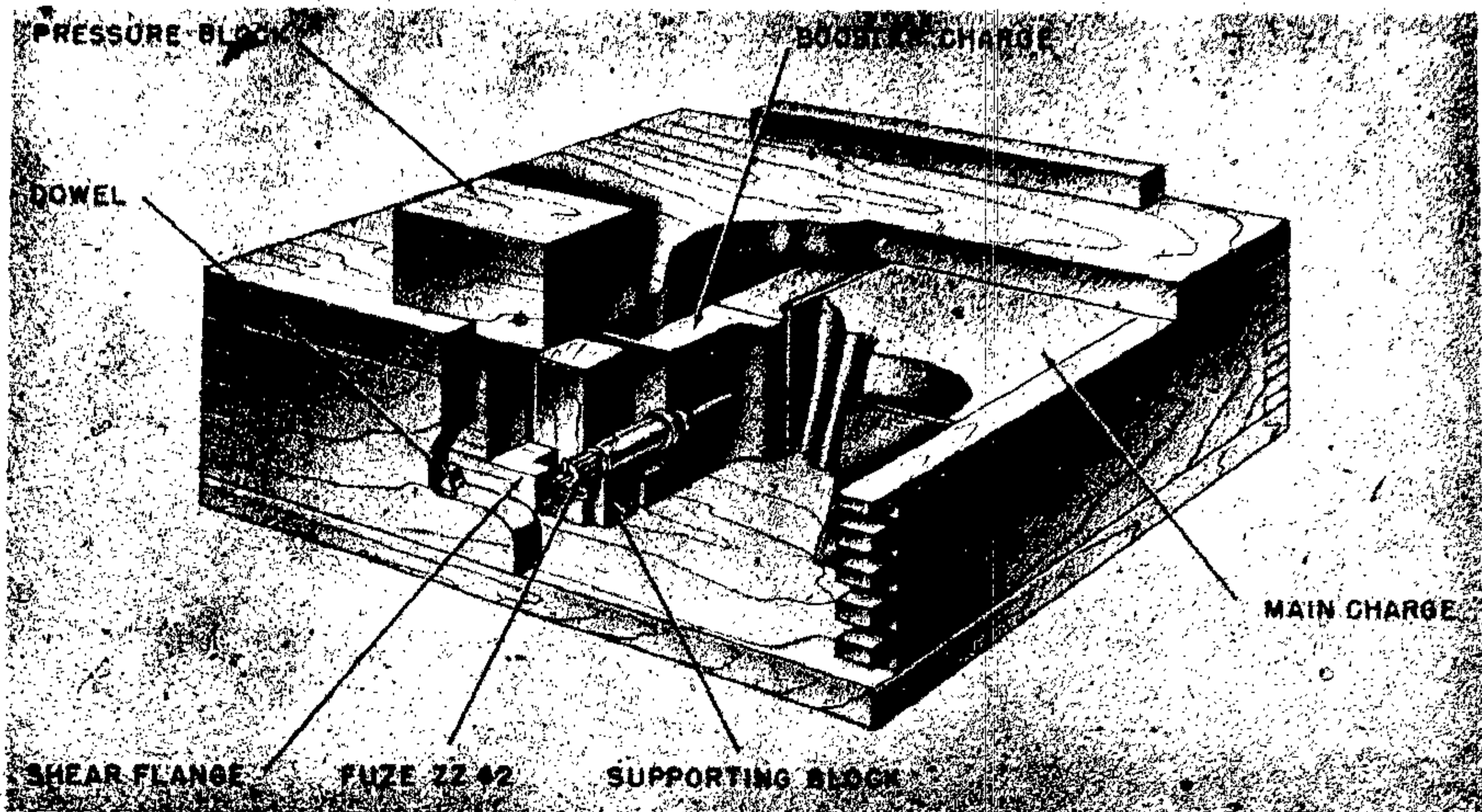

Figure 227—Holzmine 42 Antitank Mine

MARKINGS:

GERMAN	TRANSLATION
V. B. MI. 1	V. B. MI. 1
bestehend aus; 26	consisting of: 26
Sprengkörpern ohne	1928
Bohrung	pattern 200 gm charges
1 Sprengkörper mit	without igniter sockets
Bohrung	1 1928 200 gm charge
Verpackt, H. Ma. Bg	with igniter socket
28643 E1942'3	Packed
Zugehörige Zündungen	Igniter assembly
in besonderem	packed separately.
Packgefäß	

SPRENG RIEGEL, 8-kg (A/T)

DATA:

- Length: 33 inches.
- Depth: 3.25 inches.
- Explosive weight: 17.6 pounds.
- Color: Dull black.
- Material: Steel.
- Pull or pressure required: 880 pounds center;
440 pounds end.
- Fuzing: Z. Z. 42.

DESCRIPTION. The mine consists of two main components, the tray, see figure 228, and the charge.

TRAY. This is of sheet metal and carries a horizontal rib slightly above the shear wire holes. On its underside is the word UNTEN (bottom). Two shear wires pass through holes in the sides of the sheet 4 inches from each end. Holes 3/16 inch in diameter are located approximately 1-1/10 inches from each end and can be closed by small shutters on the outside of the tray. At the ends of the tray are flanges, of which one is solid while the other carries a central slot to permit insertion of the stirrup of the Z. Z. 42 actuating pin. On the outside of the tray at each end is a rotatable arrow which can be sent to SICHER (safe) or SCHARF in a counterclockwise direction (viewed from the outside). Rotation of the arrow will rotate the disc in a clockwise direction (viewed from the inside) and lift the arm into a horizontal position, where it is locked by the spring-loaded catch. In this position the Z. Z. 42 igniters bear against the flange of the arm and will function if the charge is depressed. The only method by which the catch can be withdrawn, allowing the arm to be lowered and disarming the mine, is by inserting a pin upwards through a small hole, 1.8 inches in diameter, in the base of the tray about 3/16 inch from its end. This forces upwards the arm of an angle-shaped piece; the other

LAND MINES, GRENADES, AND IGNITERS

arm of this piece engages in the end of the catch and withdraws it.

CHARGE. This is encased in a metal container which is provided with four igniter sockets—two end sockets for the main Z. Z. 42 igniters, as in the standard R-Mine 43, and two subsidiary sockets, also in the ends of the charge near the top left-hand corner when the charge is viewed end-on. These last two sockets are normally kept closed by screw plugs.

OPERATION. The mine will fire under a pressure of 440 pounds at the ends or a pressure of 880 pounds in the center. When these pressures are applied, one or both shear wires are sheared and the charge falls into the tray. As the charge falls, the detent pin is pushed out of one or both of the igniters by the shoulders of the actuating plate thus firing the mine.

REMARKS. Principal differences between Riegel Mine 8 kg. and Riegel Mine 43 are listed below:

1. There is no lid, the mine consisting of charge and tray only.
2. There is no spring-loaded shutter arrangement.

3. The arming device permits the mine to be transported in an unarmed state.

4. There are auxiliary igniter sockets at the ends of the charge, but none in the top or sides.

5. The shutters for closing the safety bar holes are on the outside of the tray and are not spring-loaded.

6. There is no reinforcing bar on the charge where it rests on the shear wire, nor is the tray lined inside to insure a neat shearing. Thus, in the specimen found, the shear wires had suffered noticeable saggings without being sheared.

HEAVY ANTITANK

DATA:

Length: 17 inches.

Diameter or width: 15 $\frac{3}{4}$ inches.

Depth: 10 $\frac{1}{2}$ inches.

Total weight: 300 pounds.

Explosive: TNT.

Explosive weight: 37 pounds.

Material: Cast iron.

Pull or pressure required: Varies.

Fuzing: D. Z. 35, Z. Z. 35.

DESCRIPTION. This mine is rectangular in shape, and its case and many of its component

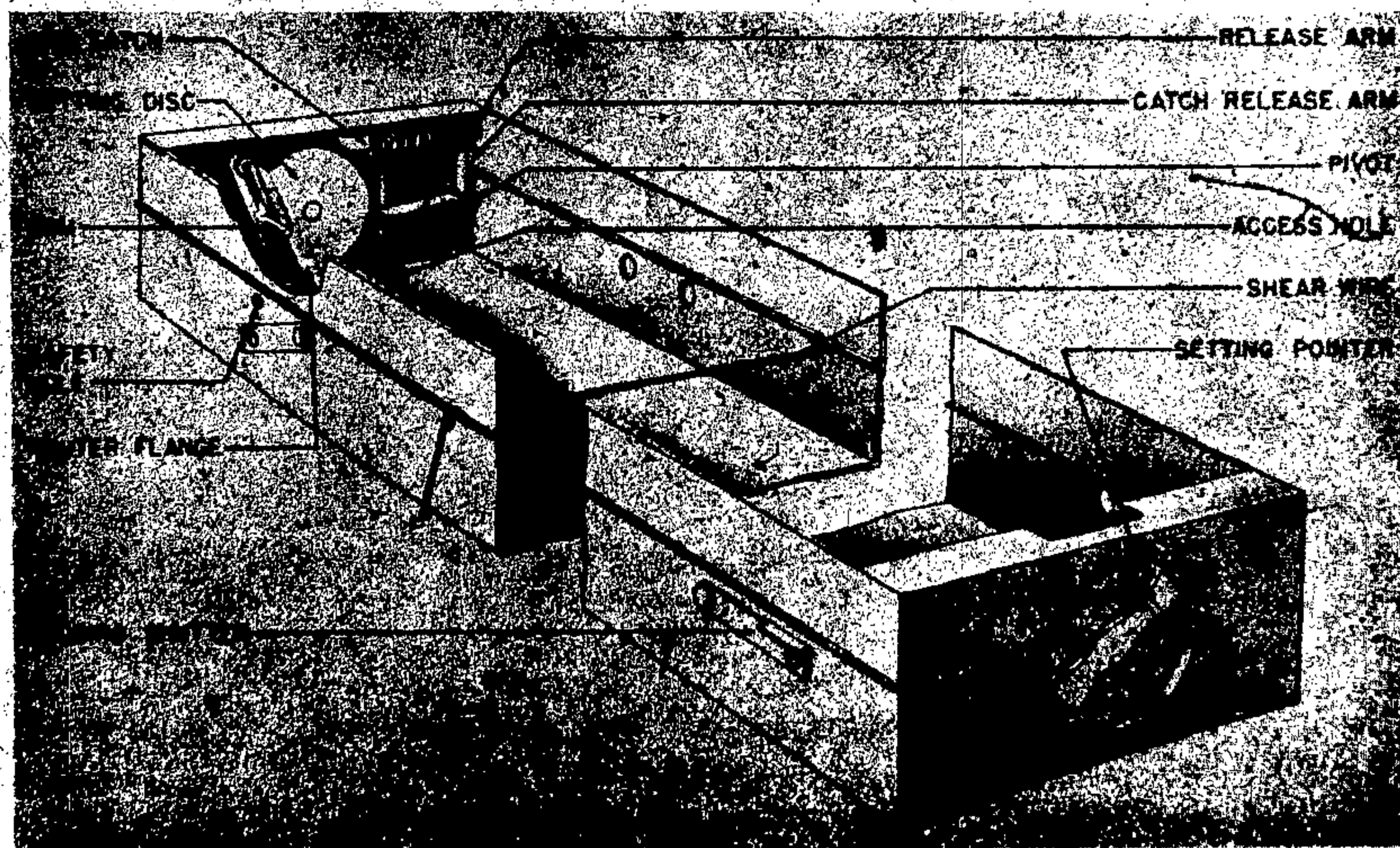

Figure 228—Spreng Riegel 8-Kg Antitank Mine

GERMAN EXPLOSIVE ORDNANCE

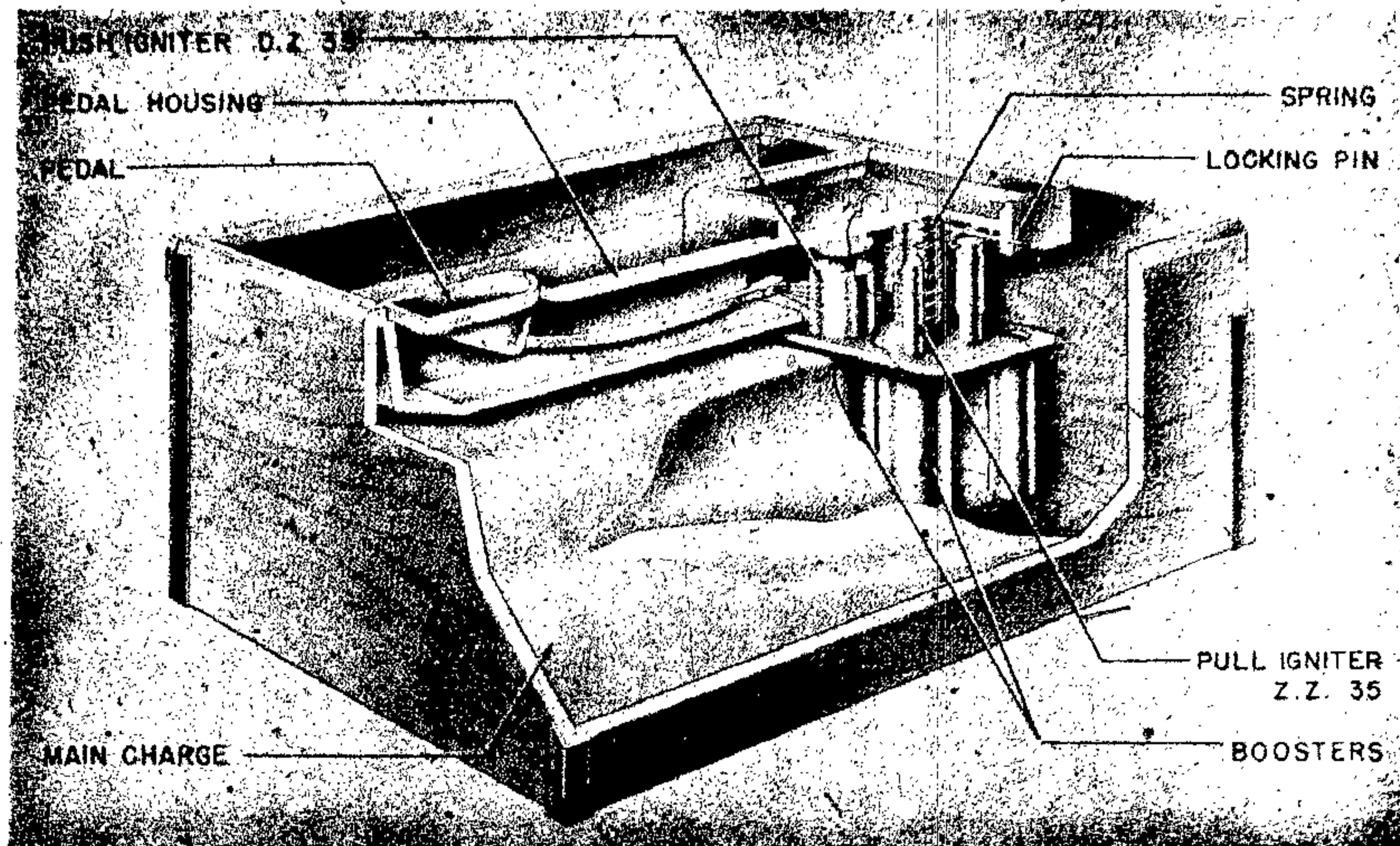

Figure 229—Heavy Antitank Mine

parts are made of cast iron. It consists of a box, a cover plate, a removable plug, and one or more firing mechanisms. (See fig. 229.)

1. **Box.** The box is made of cast iron and its dimensions are the same as those given in the description of the mine. Within the box is placed the main charge consisting of 84 blocks of TNT. The charge weighs 37 pounds and is contained in a zinc or galvanized iron box, the lid of which is held in place by either a wire or a webbed strap. Three posts, which are drilled and tapped at the top, project vertically from the floor of the box and support a base plate which in turn supports the main firing mechanism. The base plate is screwed to the supports by studs. Holes are provided in the floor of the box for anchoring it in place by either bolts or stirrups. A centrally located hole is also provided, to take the standard pull igniter Z. Z. 35 for the purpose of connecting an additional explosive charge in the form of a booby trap. Adjacent to the top corners of the box and away from the firing mechanism end, journals are provided in which trunnions formed in the cover plate have bearing. The journals and the trunnions form hinges for the cover plate. The supporting plate is fastened by studs to the posts. A stud is screwed into the plate and supports a heli-

cal spring in a vertical position. The spring is formed from square section spring steel approximately $\frac{1}{8}$ inch square.

2. **COVER PLATE.** The cover plate fits into and covers the top of the box. When the cover plate is in position, the trunnions are fitted into the journals and a lug formed under the free (swinging) end of the cover plate rests on the helical spring which holds the cover plate level with the top edges of the box. One corner of the cover plate has a rectangular recess into which is fitted the removable plug. The cover plate is provided with top recesses into which road material may be inserted to match the surrounding road surface. The undersurface of the cover plate is deeply grooved or scored to form a grid so that the cover will form shrapnel when the mine explodes. The cover plate is also provided with a pedal housing into which a pedal is inserted. The pedal is found with several short strings or wires attached to its end. The exact purpose of the pedal is not clear, but it is assumed that it is used to extract the safety pins of the firing mechanism by means of the strings or wires. It is stated in the latest information available that a pressure of 100 pounds on the pedal may fire the mine. However, the exact construction is not clear. The pedal may

LAND MINES, GRENADES, AND IGNITERS

also be fastened to a booby trap, and therefore great care must be taken in removing it from the cover plate. A U-bolt is provided on the top surface of the cover plate for lifting the plate.

3. **REMOVABLE PLUG.** The removable plug is rectangular in shape and fits into the corner recess of the cover. To its underside is attached an eyed rod which projects through the hole of the cover plate when the plug is in place. On the top side of the plug is attached a U-bolt which is used to lift the plug. The plug provides access to a locking pin.

4. **FIRING MECHANISM.** The firing mechanism consists of the following:

A. **MAIN PUSH IGNITER.** Standard push igniter, type Z. Z. 35 is mounted on the base plate by being screwed into the hole provided for it in this plate. A detonator and booster charge is mounted beneath the plate. The booster charge is 4 inches long and $1\frac{3}{4}$ inches in diameter. When pressure is applied to the cover plate, the head of the igniter is depressed downward, and the igniter fires the detonator and booster charge and the main charge.

B. **PULL IGNITER.** Standard pull igniter, type Z. Z. 35 is used as a booby trap device for the mine. The igniter is mounted on the base plate and is provided with a second detonator and booster charge mounted below the supporting plate. The projecting head of the pull pin is connected by a cord or wire to an auxiliary firing assembly. A dowel pin is mounted on the base plate. A small helical spring rests on the head of the dowel pin and is held in place by a sleeve which rides over the dowel pin. The closed head of the sleeve is provided with a loop to which the wire is fastened. When the cover plate is in place, the lug presses on the eye loop, thus compressing the spring. To keep the sleeve from rotating, it is provided with a lug which rides in a groove formed in the dowel pin. The locking pin passes through the loop and is locked to the cover plate by a bracket. If the cover plate is lifted, the sleeve is pulled upward, and at the same time the wire pulls and fires the igniter. The igniter fires the detonator and booster, which in turn explodes the main charge. Even if the locking pin is removed, care must be exercised not to lift the cover quickly, as the spring, which is in compression, will force the sleeve upward with sufficient strength

to fire the igniter. This firing mechanism constitutes a booby trap.

C. **ADDITIONAL BOOBY TRAP DEVICES.** Pull igniters may be installed to provide booby traps while the mine is disarmed. A wire may be attached to the eye of the rod and to a pull igniter below the cover plate, which will be fired if the removable plug is extracted. It is also stated that pull igniters may also be inserted within the blocks of the charge. It is the practice of the Germans to insert, in each standard block of explosive, a threaded metal sleeve to accommodate a standard pull igniter. Thus any two blocks may be interconnected by an igniter which will fire upon being separated. This also is of the nature of a booby trap. An additional firing device and charge may be connected to the hole in the base of the box, which will fire if the box is lifted. This also is considered a booby trap.

OPERATION. The mine is fired by a downward pressure exerted on the cover plate, which pivots on the trunnions. This pressure compresses the main pressure igniter, which fires the charge. The height of the pressure igniter head may be adjusted so that varying degrees of compression of the helical spring, holding up the cover plate, will fire the mine. Thus, the mine may be set to fire under the weight of a man or reconnaissance vehicles, or it may be set so that it will explode only under heavy tanks. Also, when the mine is provided with booby traps it may be actuated in a number of different ways. The main booby trap is the pull igniter. The mine may also be fired by lifting the removable plug when dismantling the charge, when removing the pedal, or when removing the box from its hole in the road.

EMPLOYMENT. This mine is used for road blocks where action has been static for a period of time. The length of time required to lay the mines prevents their effective use in fast moving warfare.

TELLERMINE 35 (A/T)

DATA:

Diameter or width: $12\frac{1}{2}$ inches.

Depth: 3 inches.

Total weight: 20 pounds.

Explosive: TNT.

Explosive weight: 12 pounds.

Color: Gray or dark green (European pattern); tan (desert pattern).

GERMAN EXPLOSIVE ORDNANCE

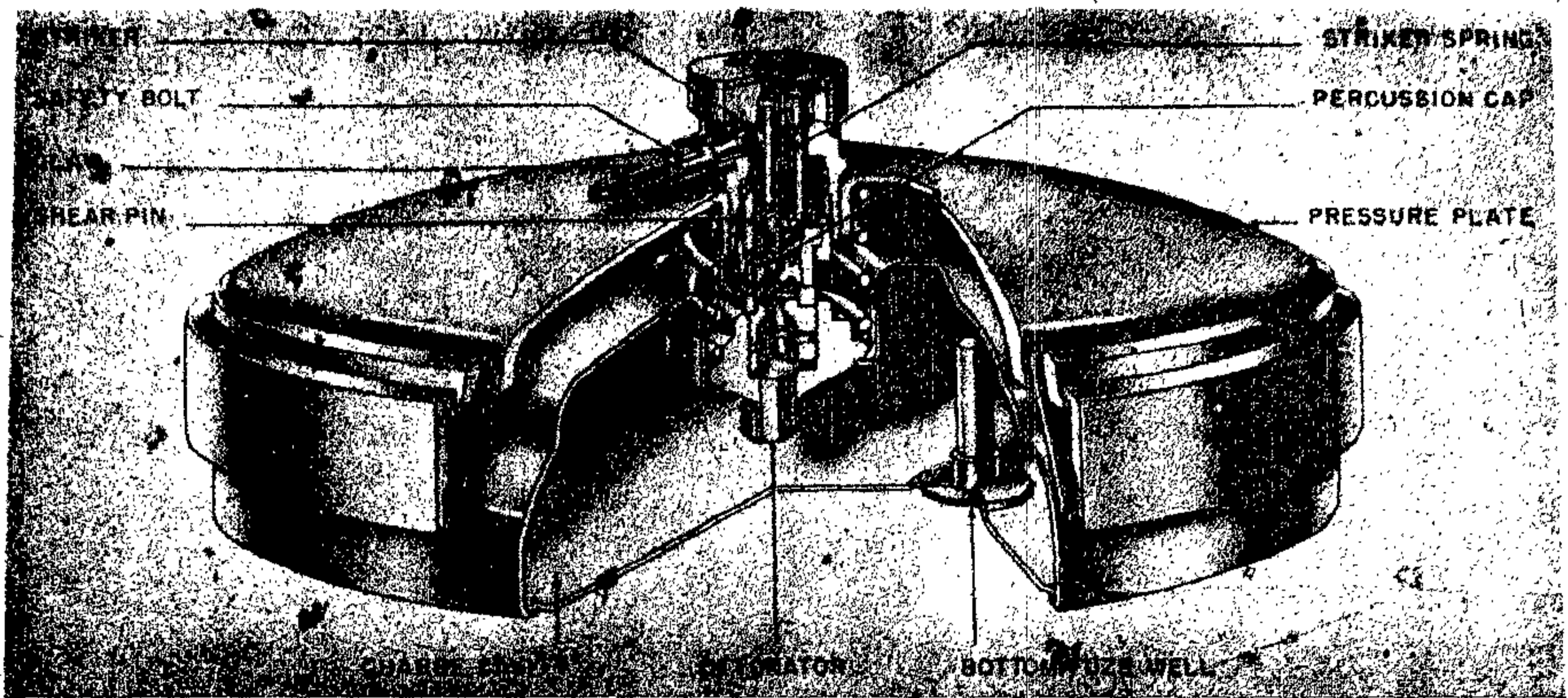

Figure 230—Tellermine 35—Antitank

Material: Steel.

Pull or pressure required: 200–400 pounds.

Fuzing: T. Mi. Z. 35 (may use secondary anti-withdrawal igniters).

DESCRIPTION. The body of the mine is a circular metal box with a dome-shaped top surface containing 11 pounds of high grade pressed TNT. A "floating" cover is held down by a heavy metal ring attached to the body and is supported in the center by a heavy spring. A compressible rubber ring serves as a cushioned seat for the bottom of the igniter. A threaded washer locks in the detonator and an adjusting collar serves to position the igniter. The igniter is screwed into the mine cover until it bears firmly on the rubber washer. (See fig. 230.)

There are two receptacles in the mine body, one in the side and one in the bottom, threaded to receive secondary firing devices. Either pull friction igniter Z. Z. 35 or ZDSCHN. ANZ.-29 with a detonator is used for the secondary firing.

A rubber strip seals the junction between the cover and the body of the mine against the entry of water and dirt.

OPERATION. Pressure of 200–400 pounds on the cover depresses the cover and the igniter housing. The igniter housing presses on top of the striker, shearing shear pin which holds striker in the cocked position. Driven by the striker spring, the striker spring sets off the percussion cap, detonator, booster, and main charge.

REMARKS. The operation of the mine is affected by the position of the adjusting collar in the body. If the collar is screwed beyond its correct position, a greater pressure on the mine cover is required to compress the spring sufficiently to cause the igniter to fire. Conversely, if the collar is screwed in short of its correct position, less pressure is required on the mine cover and the mine is relatively more sensitive.

TELLERMINE 35 (STEEL) (A/T)

DATA:

Diameter or width: 12½ inches.

Depth: 3½ inches.

Total weight: 21 pounds.

Explosive: TNT.

Explosive weight: 12 pounds.

Color: Gray.

Material: Steel.

Pull or pressure required: 250 to 400 pounds.

Fuzing: T. Mi. Z. 35; T. Mi. Z. 42; T. Mi. Z. 43.

DESCRIPTION. The Tellermine 35 (steel) is a modification of Tellermine 35. The pressure plate is corrugated for extra strength and a booster charge has been added under the detonator and around the secondary igniter wells. (See fig. 231.)

When either the T. Mi. Z. 42 or T. Mi. Z. 43 igniters is employed a screw plug in the top of the mine covers the igniter.

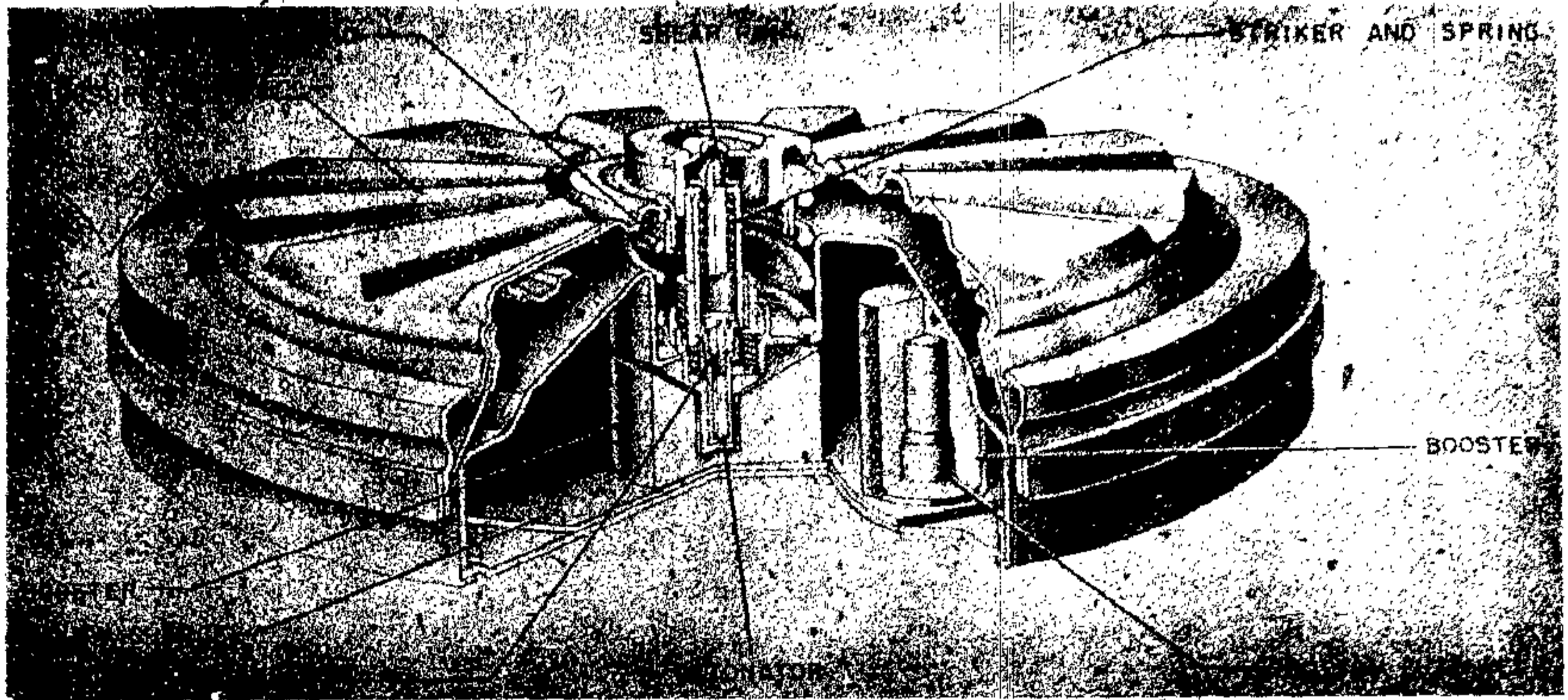

Figure 231—Tellermine 35 (Steel Antitank)

OPERATION. Operation of the mine, when fuzed with the T. Mi. Z. 35, is the same as that described for the Tellermine 35.

When either the T. Mi. Z. 42 or T. Mi. Z. 43 is used, sufficient pressure on the pressure plate causes the screw plug to bear on the top of the igniter, breaking the shear wire and causing it to fire.

TELLERMINE 42 (A/T)

DATA:

Diameter or width: 12 $\frac{3}{4}$ inches.

Depth: 4 inches.

Total weight: 20 pounds.

Explosive: TNT.

Explosive weight: 12 pounds.

Color: Gray.

Material: Steel.

Pull or pressure required: 250 to 400 pounds.

Fuzing: T. Mi. Z. 42; T. Mi. Z. 43.

DESCRIPTION. The Tellermine 42 is similar to the Tellermine 35 except that the pressure plate

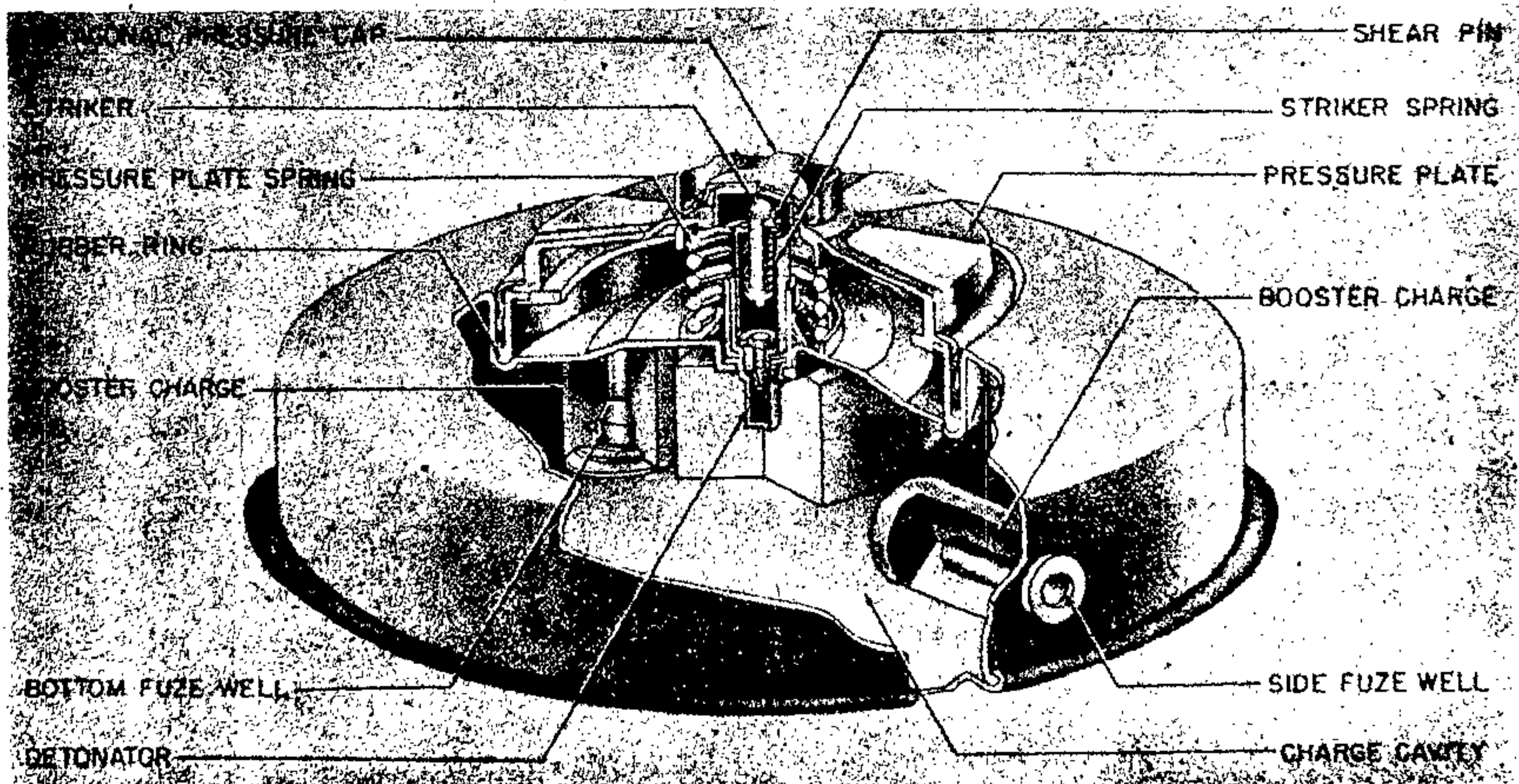
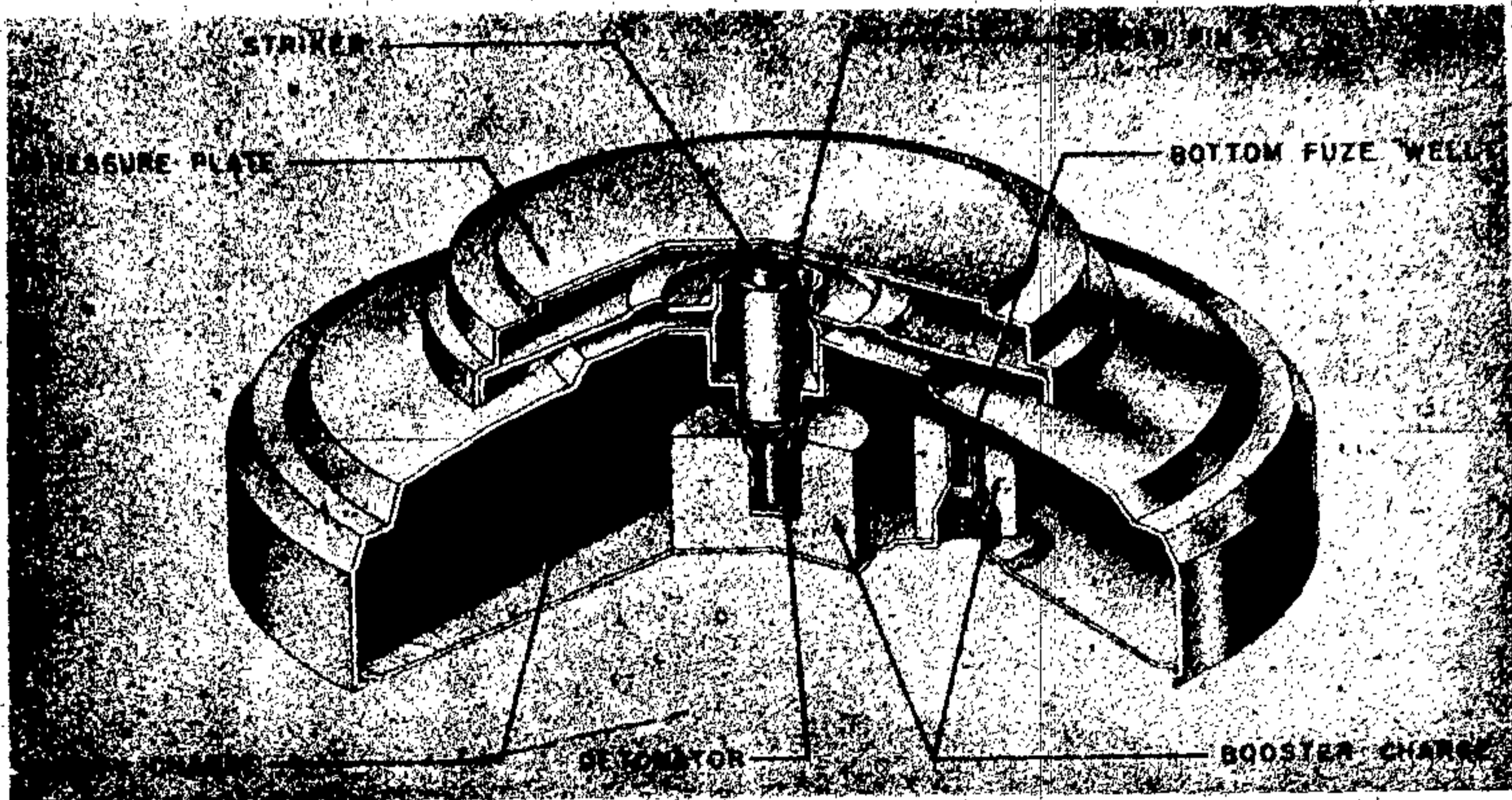

Figure 232—Tellermine 42—Antitank

GERMAN EXPLOSIVE ORDNANCE



Figur 233—Tellermine 43—Antitank

is much smaller and does not include the entire top surface. The main igniter, the T. Mi. Z. 42, is placed in the receptacle in the center of the mine. Then the pressure cap is screwed onto the pressure plate and comes to rest on the head of the striker. (See fig. 232.)

OPERATION: Pressure of 250 to 400 pounds on the pressure plate forces the pressure cap down, since it is fixed to the pressure plate, and compresses the heavy spring and detonates the mine.

TELLERMINE 43 (PILZ OR MUSHROOM) (A/T)

DATA:

- Diameter or width: 12.5 inches.
- Depth: 4 inches.
- Total weight: 18 pounds.
- Explosive: TNT.
- Explosive weight: 12 pounds.
- Color: Gray.
- Material: Steel.
- Pull or pressure required: 250 to 400 pounds.
- Fuzing: T. Mi. Z. 42; T. Mi. Z. 43.

DESCRIPTION: This mine is similar to the T. Mi. 42 except that the pressure plate is solid; i. e., there is no threaded hole for the insertion of the igniter and no screw cap. The entire pressure plate will unscrew from the mine and reveal the T. Mi. Z. 42 or T. Mi. Z. 43 igniter. The walls of the mushroom-shaped pressure plate are thin and there is no heavy spring under the pressure plate. (See fig. 233.)

OPERATION. Downward pressure on the mushroom will crush the walls and force the head of the striker down, igniting the mine.

T. Mi. 29 (T-5) (A/T)

DATA:

- Diameter of width: 10 inches.
- Depth: 2.75 inches.
- Total weight: 13.25 pounds.
- Explosive: Cast TNT.
- Explosive weight: 10 pounds.
- Color: Olive green.
- Material: Zinc.
- Pull or pressure required: 100 or 275 pounds.
- Fuzing: Z. D. Z. 29.

DESCRIPTION. This is a light antitank mine. The zinc casing is in two parts: the top, and the base. The top slides into the base and is secured by eight tabs which pass through slots in the base, and are bent over and soft soldered. The internal surfaces are painted with shellac. The base is dished for strengthening with six rectangular troughs. The top is slightly domed and has three adapters sweated into shallow recesses. The adapters have sockets to take Z. D. Z. 29 igniters. (See fig. 234.)

There are three additional sockets provided for fitting antilifting igniters. Two of these are in the side of the casing, diametrically opposite to one another and 4 inches to the right of center of each handle; the other is in the center of the

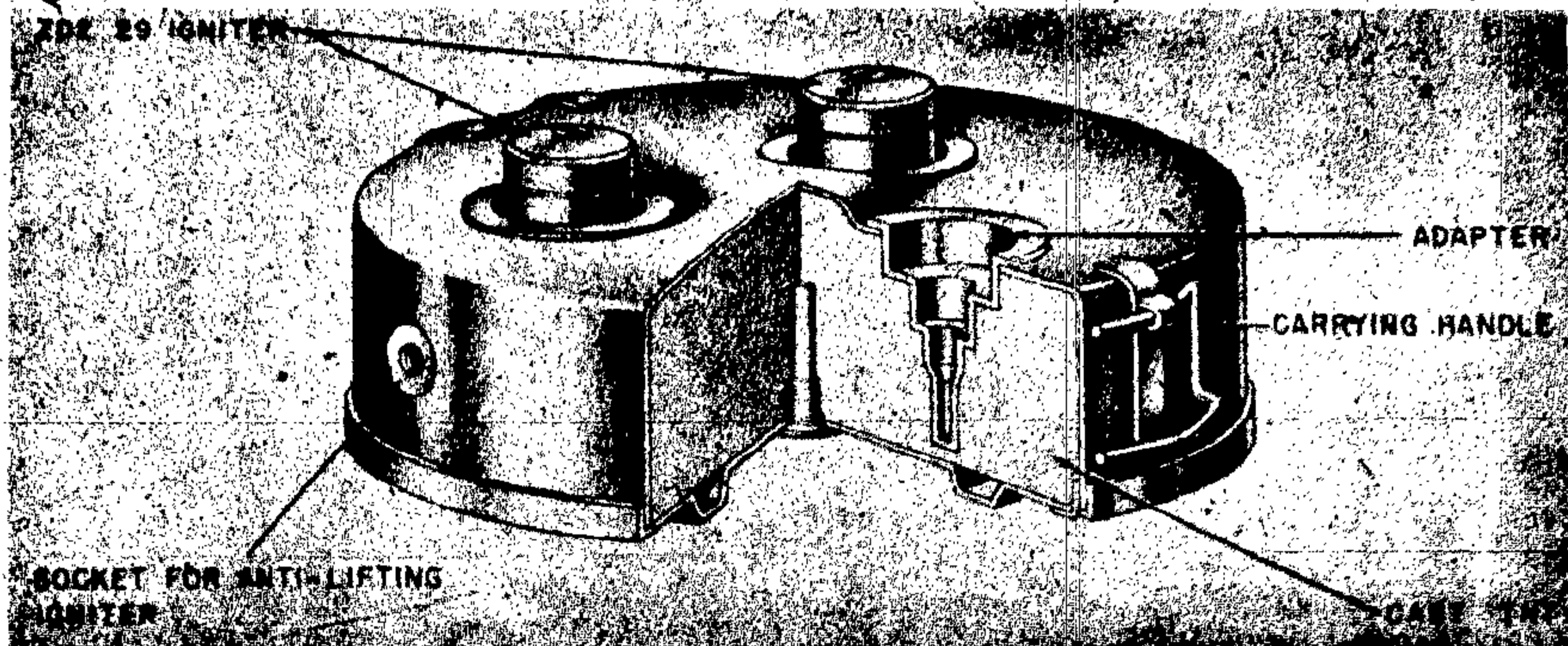

Figure 234—T. Mi. 29 (T-5) Mine—Antitank

base. All of these igniter sockets are sweated into the casing, and in addition, have a locating device in the form of two brass pins, which fit into slots on either side of the hole in the mine casing. Two steel carrying handles are held within loops of brass strip sweated to the casing. The handles are shaped to fit close to the casing when folded.

OPERATION. Sufficient pressure on one or all of the igniters, fires the igniter, booster, and main charge.

TOPF MINE A (A/T)

DATA:

- Diameter: 12.5 inches.
- Depth: 5.5 inches.
- Total weight: 20 pounds.
- Explosive weight: 12.5 pounds.
- Color: Black.
- Material: Plastic.
- Pull or pressure required: 330 pounds.
- Fuzing: Topf mine igniter.

DESCRIPTION. The main parts of the Topf

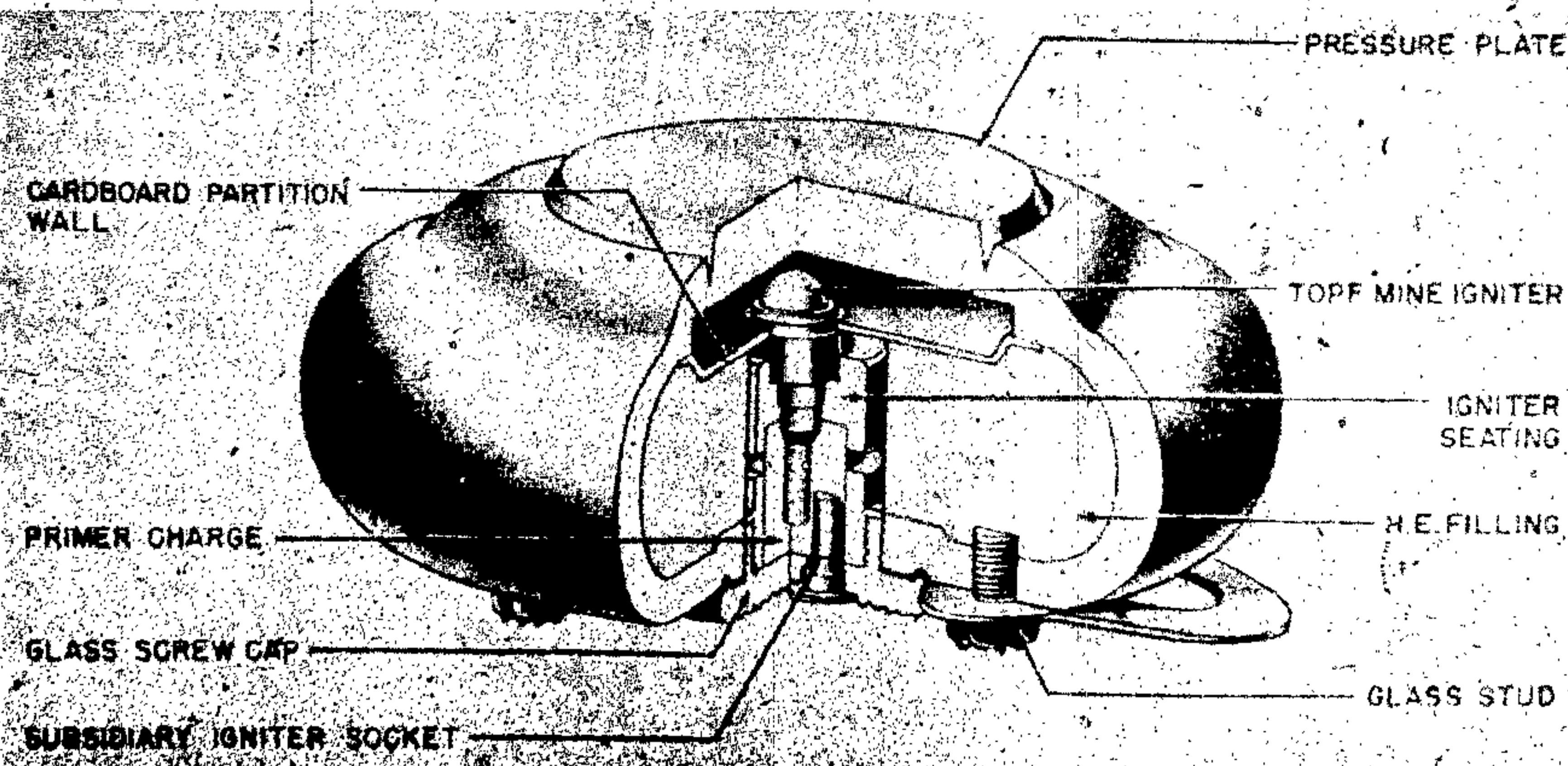

Figure 235—Topf Mine A—Antitank

GERMAN EXPLOSIVE ORDNANCE

mine are the mine body, the primer plug assembly and the igniter. (See fig. 235.)

MINE BODY. The mine body is a hollow cylindrical disk of plastic material filled with H. E. Its top face is formed as a circular pressure plate surrounded by a shear groove. The cylindrical recess in the center of the mine body accommodates the primer plug. The carrying handle is fixed to the mine bottom by two glass screws. Another glass screw in the mine bottom acts as a filler plug.

PRIMER PLUG ASSEMBLY. The primer plug assembly consists of a glass screw cap and the cylindrical igniter seating, made of compressed bituminous cardboard material. The top face of the igniter seating bears a deep pocket with an inside screw thread to accommodate the Topf mine igniter. The remaining space between the glass screw cap and the igniter seating is filled with the primer charge. In addition to the pocket for the Topf mine igniter, there is a subsidiary igniter socket leading into the primer charge from the bottom through a hole in the glass screw cap. This subsidiary igniter socket has a standard igniter screw thread, and a thin bakelite detonator pocket to protect it against moisture. A circular ridge, moulded on the side of the glass screw cap nearest to the mine body presses against a rubber washer when the primer plug assembly is fitted into the mine.

IGNITER. The igniter is an entirely nonmetallic pressure igniter without a safety device, and functions on chemical-mechanical action. It is used, together with a nonmetallic detonator, as the main igniter for the Topf mine.

The main parts of the igniter are a hollow cylindrical glass igniter body, and a hemispherical pressure head fitting into the igniter body.

Inside the igniter body there is a circular celluloid disk with two small spherical glass capsules, containing liquid chemicals, fixed on to it by means of an adhesive. The lower part of the igniter body has two male screw threads, the larger one fitting into the igniter seating, while a protective detonator pocket of plastic material is held by the smaller screw thread. A circular shear ridge halfway up on the pressure head rests on the top rim of the igniter body and so holds the head in position with its flat portion slightly projecting into the igniter body, just above the two glass capsules.

OPERATION. Under a load of at least 150 kg (330 pounds) the pressure plate of the Topf mine shears along its shear groove and thus comes to rest on the pressure head of the igniter. This in turn gives way by the severing of its shear ridge and thus smashes the two small chemical glass capsules inside the igniter body. The chemicals therein make contact with each other causing a flash which sets off the detonator, and so the mine.

R MINE 43 (A/T)

DATA:

Length: 31.5 inches.
Diameter or width: 3.75 inches.
Depth: 3.5 inches.
Total Weight: 20.5 pounds.
Explosive: TNT.
Explosive Weight: 8.8 pounds.
Color and Markings: Light khaki. "R. Mi. 43" stenciled on lid.
Material: Sheet steel.
Pull or Pressure Required: 880 pounds center; 440 pounds ends.
Fuzing: Z. Z. 42.

DESCRIPTION. The mine consists of three main parts: a sheet steel tray, an encased charge of TNT contained in the tray, and a lid which fits over the tray and acts as a pressure plate. (See fig. 236.)

TRAY. The tray is of spot-welded sheet steel construction. Shear wires are threaded through the tray $\frac{7}{8}$ inch from the bottom, to support the charge. Reinforcing strips are welded inside the tray at the shear points. Each end of the tray is folded over on top to form slotted pressure plates to actuate Z. Z. 42 igniters fitted to each end of the charge. Reinforcing plates, welded to the sides of the tray in the corners, are bent over as supports to these pressure plates. Swivel clips are provided to protect the igniters. $1\frac{1}{2}$ inches from each end are holes through which safety bars are threaded to keep the charge clear of the shear wires in the unarmed condition. These bars are secured by safety pins attached by cord which may be wound around the mine. Spring-loaded shutters are provided to block the holes on withdrawal of safety bars. The shutters are in the form of a spring-loaded angle strip which swings on pivot pins. These shutters can be manipulated from the bottom of the tray through holes $\frac{3}{8}$

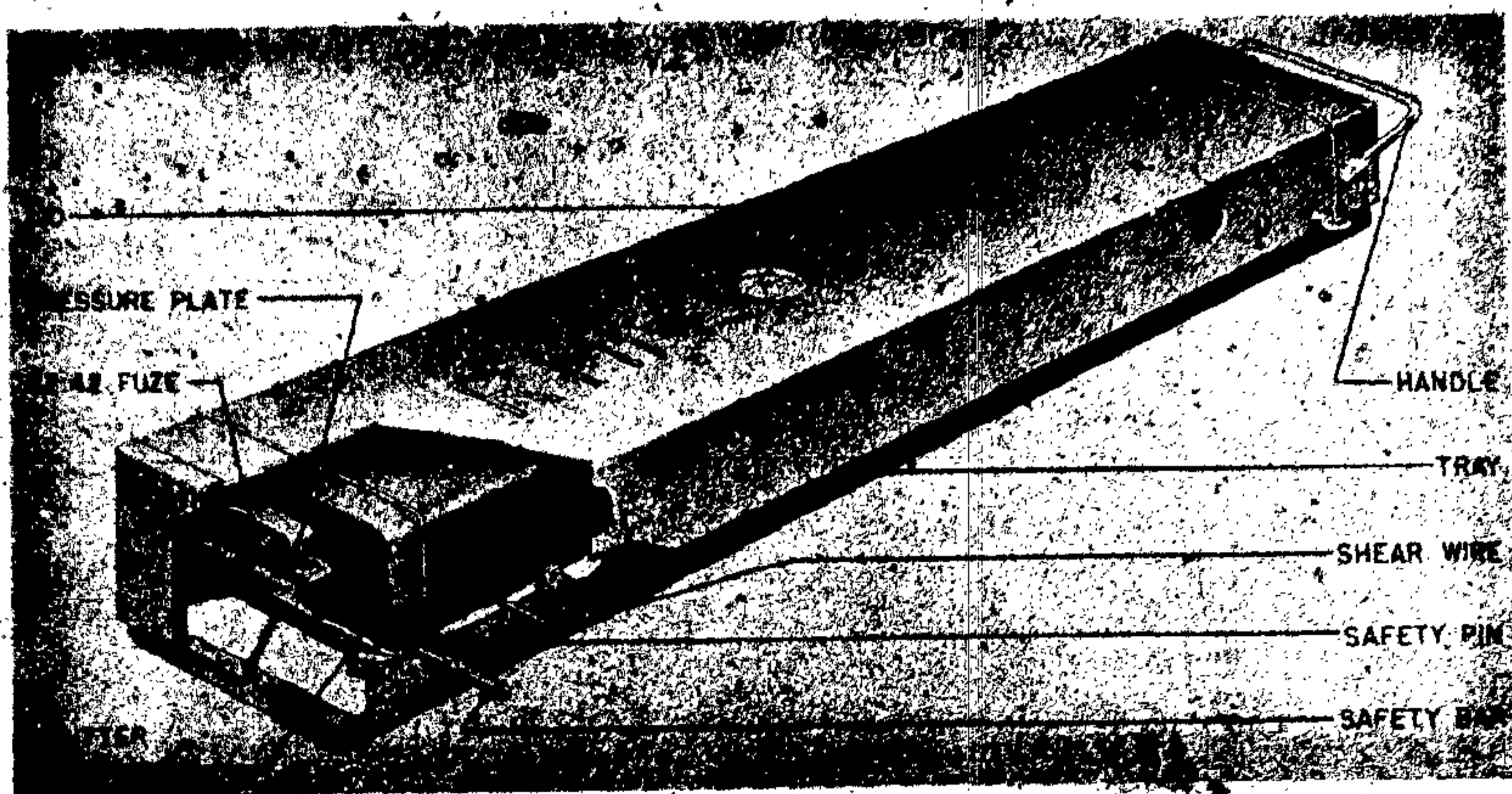

Figure 236—R Mine 43—Antitank

inch from the end by means of a bar or large nail. One side of the tray is slotted in two places to accommodate antilifting igniters which may be fitted to sockets provided in the one side of the charge. There is a thin red band painted along the sides of the tray $\frac{1}{2}$ inch from the bottom to indicate the correct position of the lid when the mine is armed.

CHARGE. The charge which has a metallic casing is provided with five igniter sockets. Two are for the main igniters, type Z. Z. 42, one at each end; these are not visible from the outside when the mine is laid. The other three are for antilifting igniters; one is in the center of the top of the charge; and the other two in one side 5 inches from the ends. Two shear battens fixed to the bottom of the charge insure double shear action. Two channels are also fixed to the bottom of the charge; these fit over the safety bars.

LID. The lid is of spot-welded sheet steel construction. It is fitted with a handle at one end. Holes are positioned to correspond with the sockets provided for antilifting igniters in the charge. Two slots are provided for the shear wires; these may be bent over after the lid is fitted. There are also two slots into which the safety bars slide, and white paint marks are found above these slots to correspond with similar marks on the tray. Mines are transported singly in a wooden packing case with main igniters and safety bars in position.

Protecting paper strips cover the igniter holes in the lid. The cords attached to the safety bars are wound round the mine.

OPERATION. After the mine is laid and the antilifting or trip wire igniters are fitted, the two safety bars are withdrawn.

The mine is fired by one of four ways:

1. Pressure on the lid sufficient to show one or both of the shear wires.
2. Functioning of the antilifting or trip wire igniters fitted into the sockets provided.
3. Reverse of one main igniter, type Z. Z. 42, with its wings below the end pressure plate so that it will function if an attempt is made to lift the charge from the tray. Only one igniter can be reversed to operate in this manner.
4. Electrically by remote control.

The mine also lends itself to the usual booby trap devices such as a trip wire attached to the handle of the lid.

ALUMINUM MINE (A/P or A/T)

DATA:

- Diameter or width: 12 inches.
- Depth: $3\frac{3}{4}$ inches.
- Total weight: 14 pounds.
- Explosive: Cheddite with tolite boosters.
- Explosive weight: 7 pounds.
- Color: Tan.
- Material: Aluminum alloy.

GERMAN EXPLOSIVE ORDNANCE

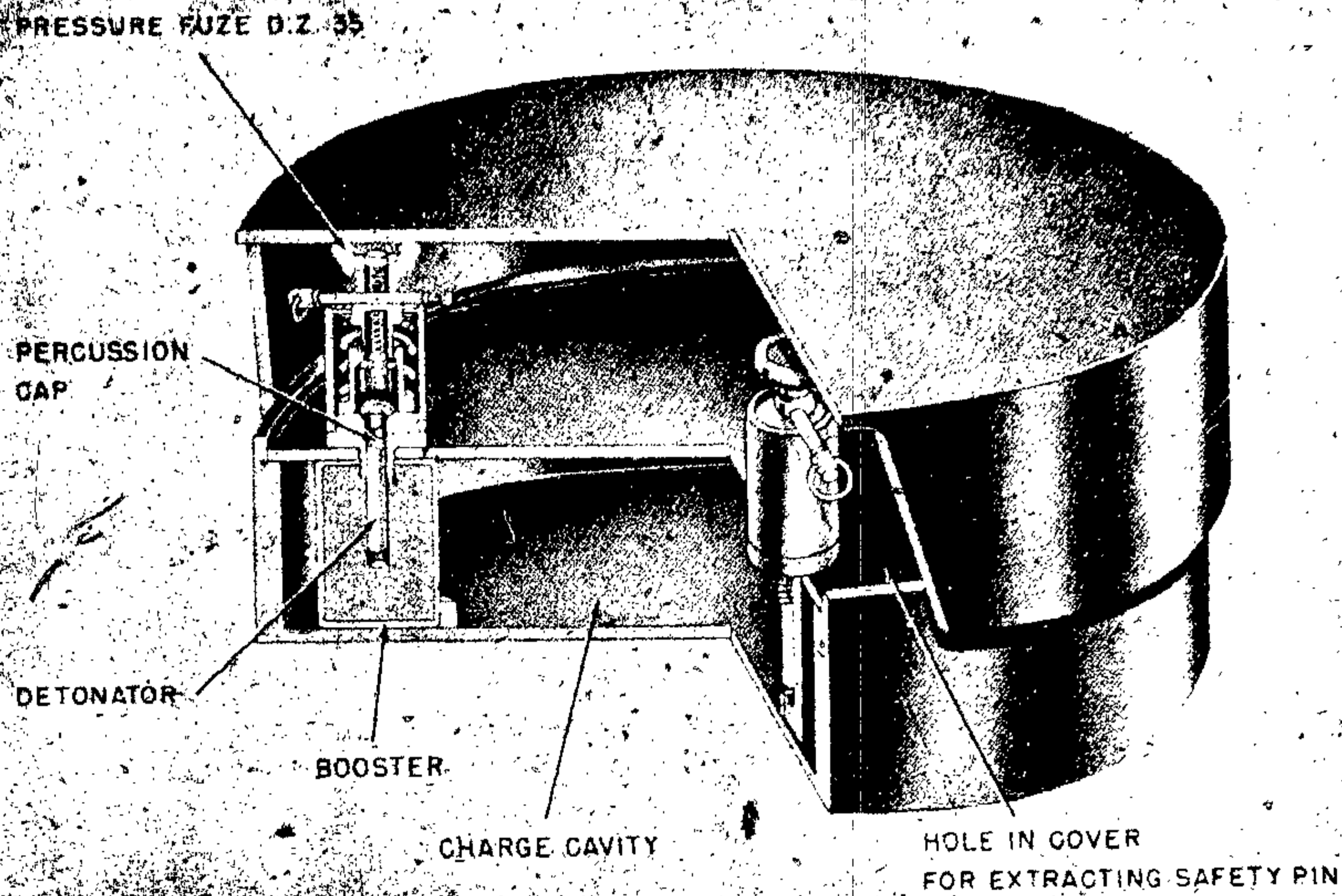

Figure 237—Aluminum Antitank or Antipersonnel Mine

Pull or pressure required: 130 pounds on sides.
390 pounds in center.
Fuzing: D. Z. 35; T. Mi. Z. 42.

DESCRIPTION. The lower portion of the mine is a flattened cylindrical case which contains the explosive. The explosive is covered by a flat aluminum disc. Three igniter wells, located 120° apart are positioned in the explosive. Three D. Z. 35 igniters with No. 8 detonators are screwed into these wells. An aluminum lid is placed over this assembly to act as a pressure plate. (See fig. 237.)

OPERATION. 1. Pressure of 130 pounds on sides to 390 pounds in center depresses cover and sets off one or more of three pressure fuzes, either German D. Z. 35 or T. Mi. Z. 42.

2. Fuzes explode detonators, boosters, main charge.

L. P. Z. (LIGHT A/T OR A/P)

DATA:

Diameter or width: 10½ inches.

Depth: 5 inches.

Total weight: 9 pounds.

Explosive: TNT.

Explosive weight: 5 pounds.

Color: Gray.

Material: Sheet metal.

Fuzing: Special.

DESCRIPTION. This is a light antitank mine, convertible to antipersonnel. The explosive charge is contained in two saucer-shaped covers and an outer cover serves as a pressure plate. Five igniters are built into the mine and spaced radially around it. The igniter strikers, which face upwards toward the top of the mine, are held under spring tension and are cocked in position by locking balls. A flame tube or flash channel leads from each of the igniter caps to a central chamber over the main detonator. The safety screw threads into this chamber and when it is screwed tightly clockwise, the white line marked "SICHER" on screw head is opposite white mark on mine. The beveled end on the screw closes the flash hole leading to the detonator. Three bolts, radially spaced, serve to secure the main charge to the pressure plate. (See fig. 238.)

OPERATION. Pressure crushes the mine cover,

LAND MINES, GRENADES, AND IGNITERS

and forces one or more igniter housings downward over their plungers. This action compresses the outer spring, allowing the steel locking balls to be forced outward into upper recesses, releasing the striker. The released striker, driven by the striker spring, explodes the percussion cap. Flame from the cap travels through the flame tube and chamber, and ignites the detonator—booster—main charge.

REMARKS. If the mine is used against personnel, bottom fuze nuts are removed and the mine, resting on threaded end of plungers, is placed on a flat hard surface. Light pressure on the mine cover depresses the entire mine and forces the plungers upward into the igniter housings.

GLASSMINE 43 (f) (A/P)

DATA:

- Diameter or width: 6 inches.
- Depth: $4\frac{1}{8}$ inches.
- Explosive: Sprengkorper 28.
- Explosive weight: Approximately 7 ounces.
- Color: Clear.
- Material: Glass.

Pull or pressure required: 20 to 25 pounds.

Fuzing: Hebelzunder Buck chemical.

DESCRIPTION. The mine consists of a glass "dish" which is covered by a thin glass shear plate. The explosive charge is a standard sprengkorper 28 German demolition block. Either the Buck chemical igniter or the "Schuko" igniter may be employed as shown in the accompanying drawing. A metal safety fork fits into grooves in the pressure plate, providing a bridge to the outer edges of the mine, and supports the safety fork until such time as the mine is laid. (See fig. 239.)

A grooved shoulder on the inside of the case, about 2 inches from the bottom, supports the igniter plate. When the Schuko igniter is used the igniter plate consists of a thin sheet metal plate which has a central hole for the igniter. When the Buck chemical igniter is used, however, an igniter plate having the same diameter and igniter hole but of stronger design is employed. Four circular corrugations on the plate not only serve to strengthen it, but also to raise the igniter hole by $\frac{3}{8}$ inch.

The mine is stated to be proof against sea, air and sea water, and with each mine is supplied sufficient cement putty to ensure this. The putty

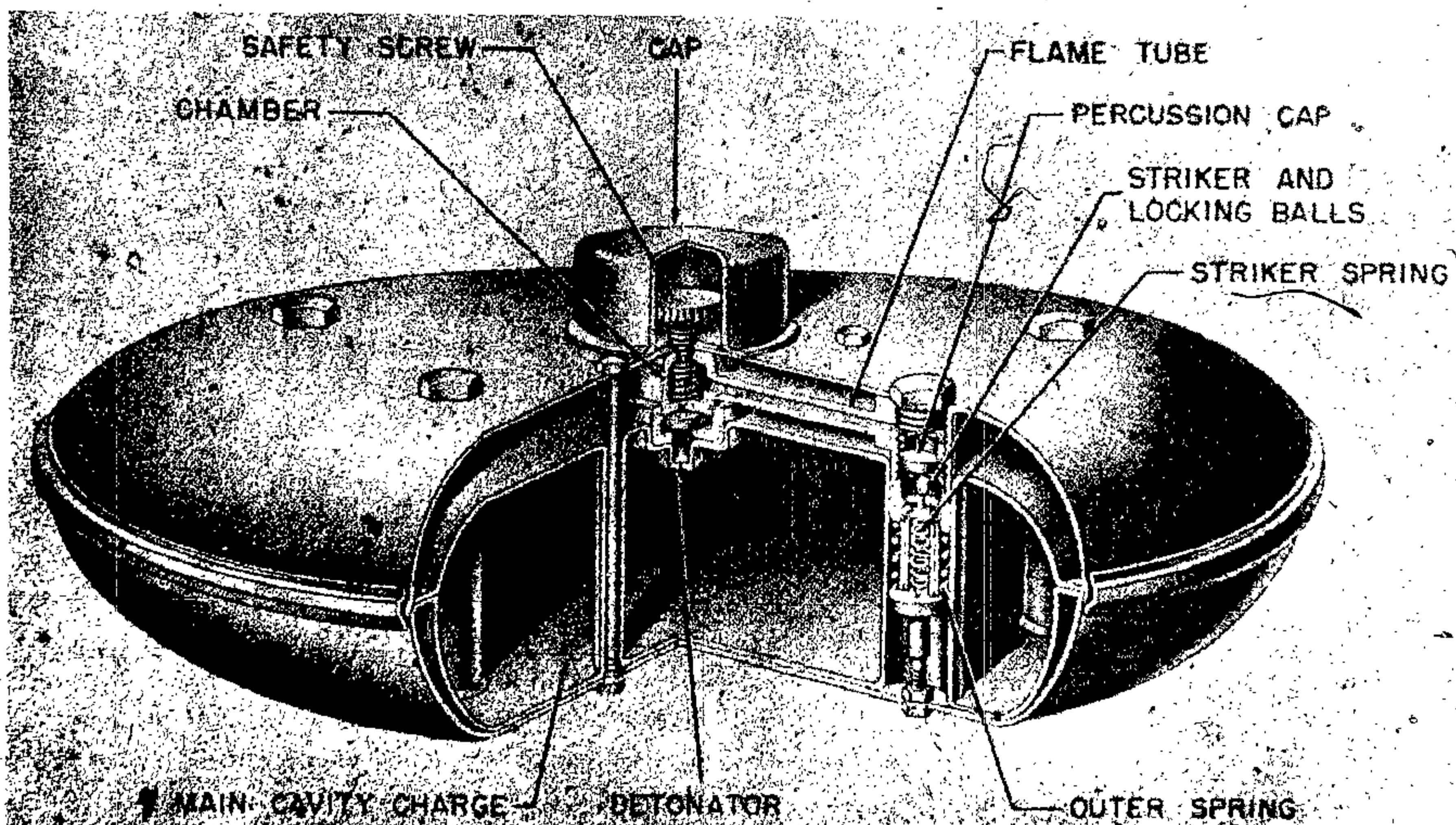

Figure 238—L. P. Z. Light Antitank or Antipersonnel Mine

GERMAN EXPLOSIVE ORDNANCE

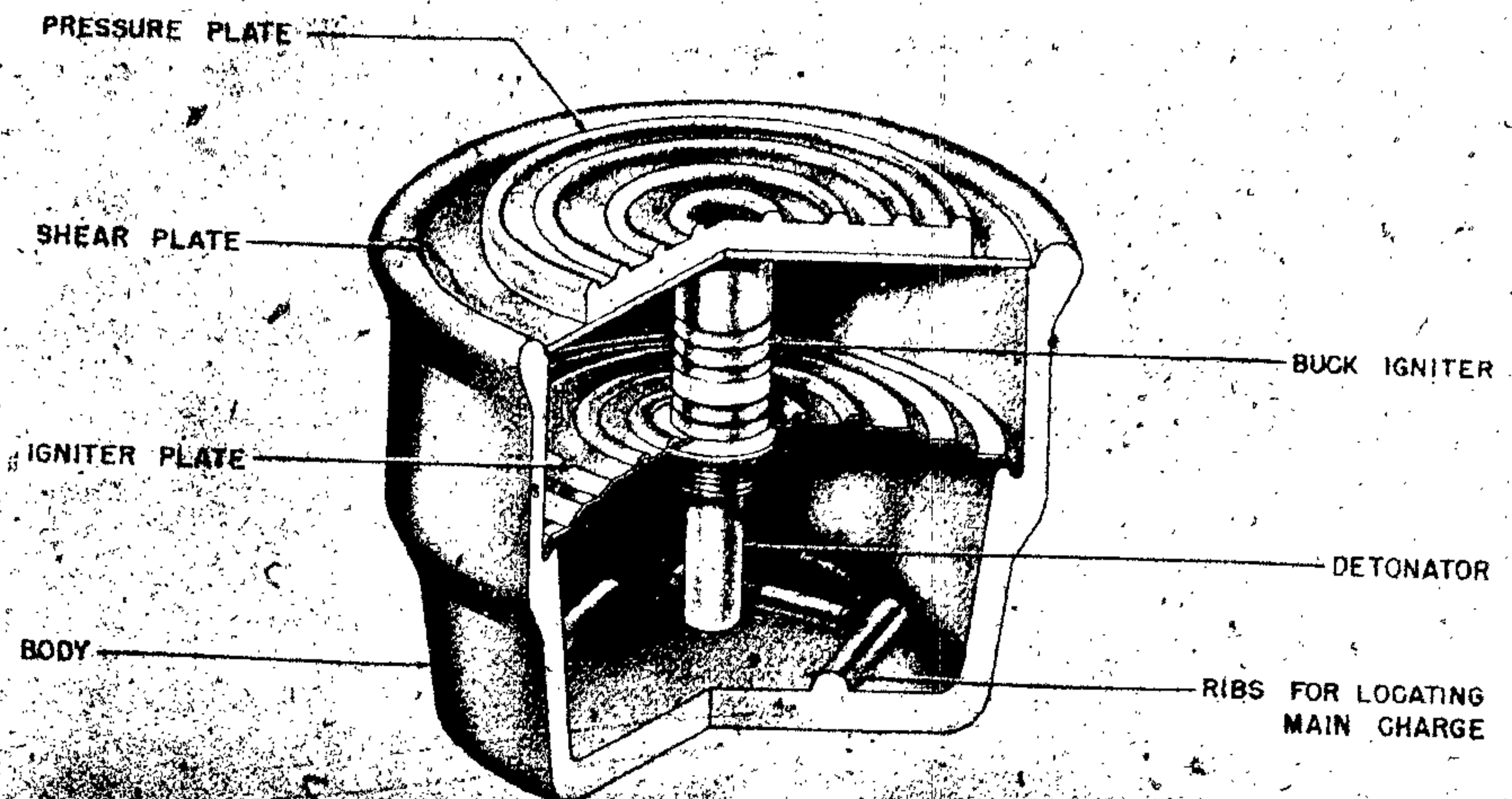

Figure 239—Glassmine 43 (f)—Antipersonnel

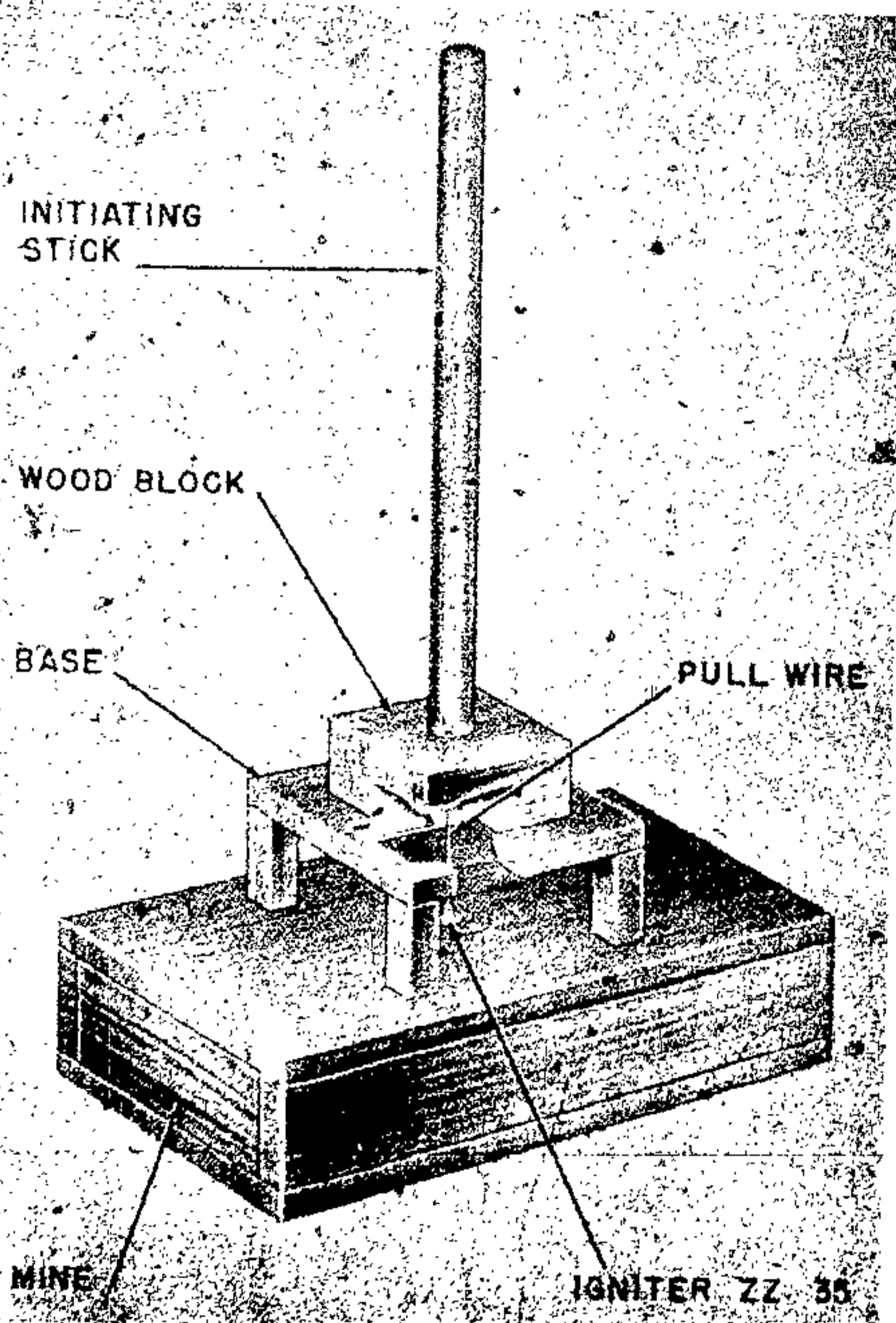

Figure 240—B-Stabmine—Antipersonnel

is used around the circumference of the igniter plate and around the edge of the glass shear plate.

OPERATION. When sufficient pressure is applied to the glass pressure plate, the shear plate is broken and crushes the top of the Buck igniter or trips the actuating lever of the Schuko igniter, depending on which igniter is used.

"B-STABMINE" (CONCEALED STICKMINE) (A/P)

DATA:

Length: 10 inches.

Diameter or width: 6 inches.

Depth: 3½ inches.

Color: Camouflage brown.

Material: Wood.

Pull or pressure required: 9 to 13 pounds.

Fuzing: Z. Z. 35.

DESCRIPTION. The body of the mine consists of a wooden box containing the explosive charge. (See fig. 240.) The initiating stick is fixed in a wooden block which is wedged into a base raised on supports above the cover of the box. In the base of the wooden block is a metal hook to which is attached a wire, the other end being secured to the eye of the pull igniter Z. Z. 35. The pull igniter is held in a metal clamp in the cover of the box.

LAND MINES, GRENADES, AND IGNITERS

OPERATION. Movement of the stick pulls the wire and thereby fires the igniter and the charge.

EMPLOYMENT. Used in tall grass and on beaches.

STOCKMINE (A/P)

DATA:

Length: Approximately 22 inches (including picket).

Diameter or width: 2.8 inches.

Total weight: 4.6 pounds (mine only).

Explosive: Bohrpatrone 28.

Explosive weight: 100 g.

Material: Concrete (shrapnel-filled)—wooden picket.

Pull or pressure required: 6 to 11 pounds.

Fuzing: Z. Z. 42 (normal); Z. Z. 35; Z. U. Z. Z. 35.

DESCRIPTION. The mine itself consists of a concrete cylinder which is made of weak cement and mortar. (See fig. 241.) This cement holds pieces of shrapnel. Inside the concrete cylinder is the explosive charge. In the mines found in North Africa, this charge was Bohrpatrone 28, an explosive which is designed for use in tropics. However, this cavity may be filled with ordinary commercial cartridges. An igniter, fitted with a detonator, fits into the recess in the top of the mine. The mine is mounted on a wooden picket about 1 foot 4 inches long, driven into the ground.

OPERATION. Actuation of the igniter fires the detonator which in turn fires the explosive charge. The firing of the mine causes a belt of shrapnel to be thrown out in all directions and the concrete is reduced to dust. The effective radius is approximately 30 yards.

EMPLOYMENT. Stock mines usually are laid in depth on narrow tracks and in ravines and defiles. They can also be laid in staggered rows to form mine belts.

CONCRETE BALL MINE (A/P)

DATA:

Diameter or width: 10 inches.

Total weight: Approximately 2.2 pounds.

Color: Gray.

Material: Concrete.

Fuzing: ZDSCHN-ANZ 29.

DESCRIPTION. The spherical shaped body of the mine consists of concrete with embedded

shrapnel used as an aggregate. A central cavity is provided for insertion of the explosive charge which may be either two 500-gram charges and a 200-gram charge or only one 500-gram charge may be used with the 200-gram charge so that the igniter assembly is countersunk into the mine. (See fig. 242.)

OPERATION. The igniter may be pulled by hand, initiating the safety fuse which in turn, fires the detonator and charge. In such a case, the mine may be rolled down a hill or cliff into enemy troops. It is possible to peg the igniter to a stake below the

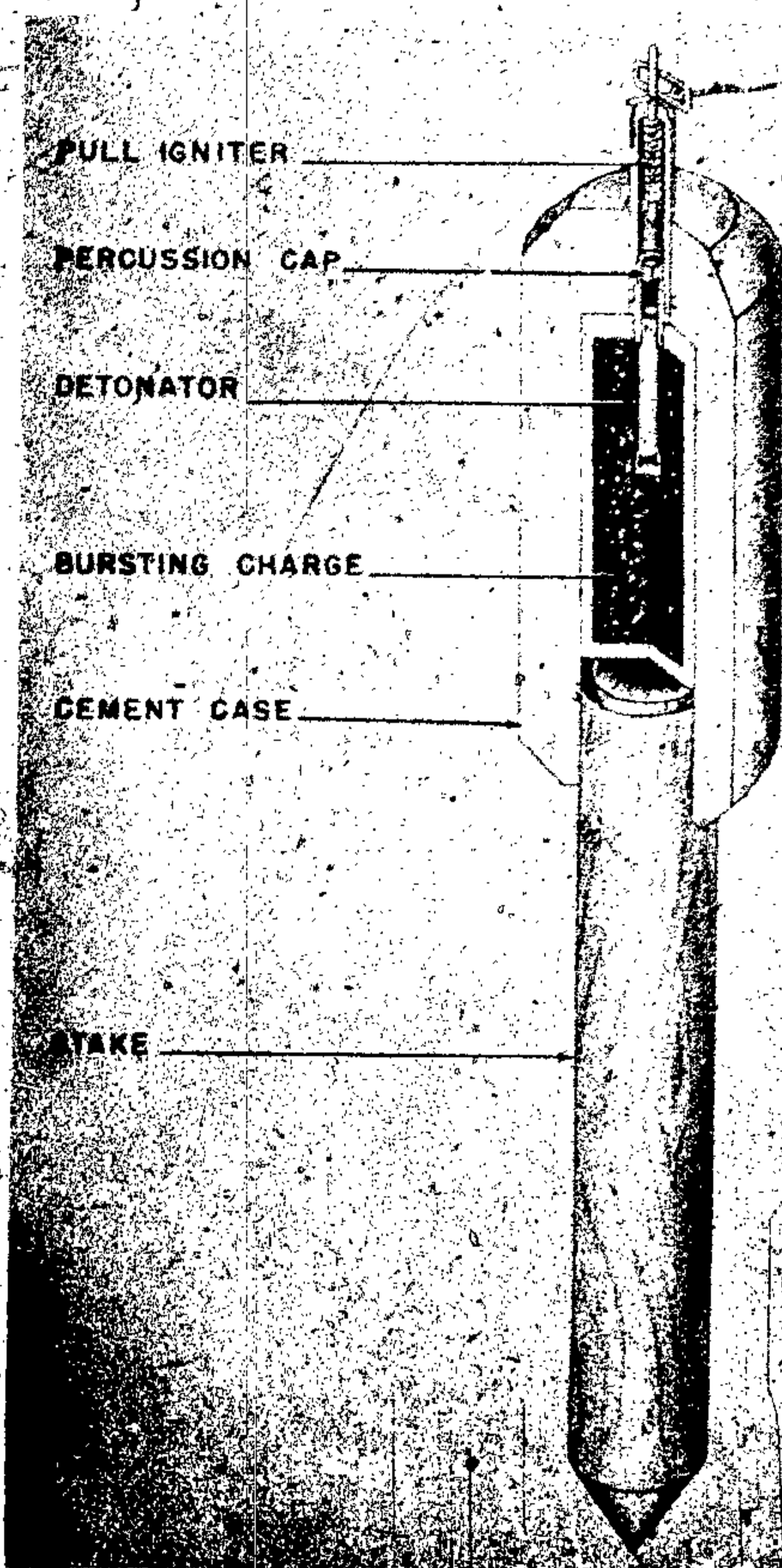

Figure 241—Stockmine—Antipersonnel

GERMAN EXPLOSIVE ORDNANCE

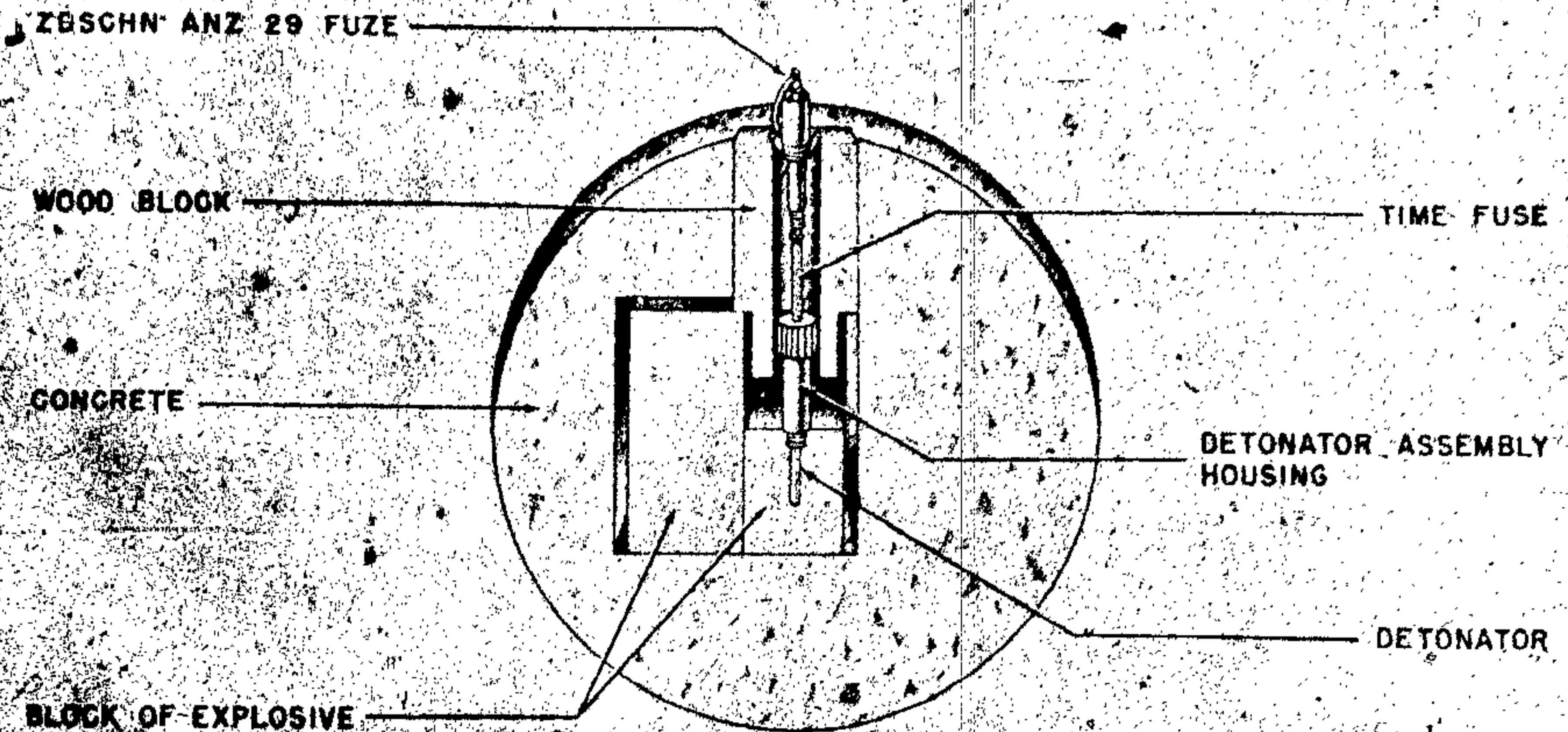

Figure 242—Concrete Ball Mine—Antipersonnel

bomb in such a way that if an attempt is made to remove the mine, the igniter will be actuated.

Material: Impregnated plywood.

Pull or pressure required: 6 to 11 pounds.

Fuzing: Z. Z. 42.

SCHUMINE 42 (A/P)

DATA:

Length: 5.04 inches.

Diameter or width: 3.86 inches.

Depth: 1.8 inches.

Total weight: 1.1 pounds.

Explosive weight: 1/2 pound.

Color: Unpainted.

DESCRIPTION. The mine consists of a wooden box which contains a 1/2 pound demolition block fitted with a Z. Z. 42 igniter and detonator. The box is covered with a hinged lid. (See fig. 243.)

OPERATION. Pressure on the box lid pushes the pin out of the igniter, freeing the striker and causing detonation of the igniter cap, detonator and explosive charge.

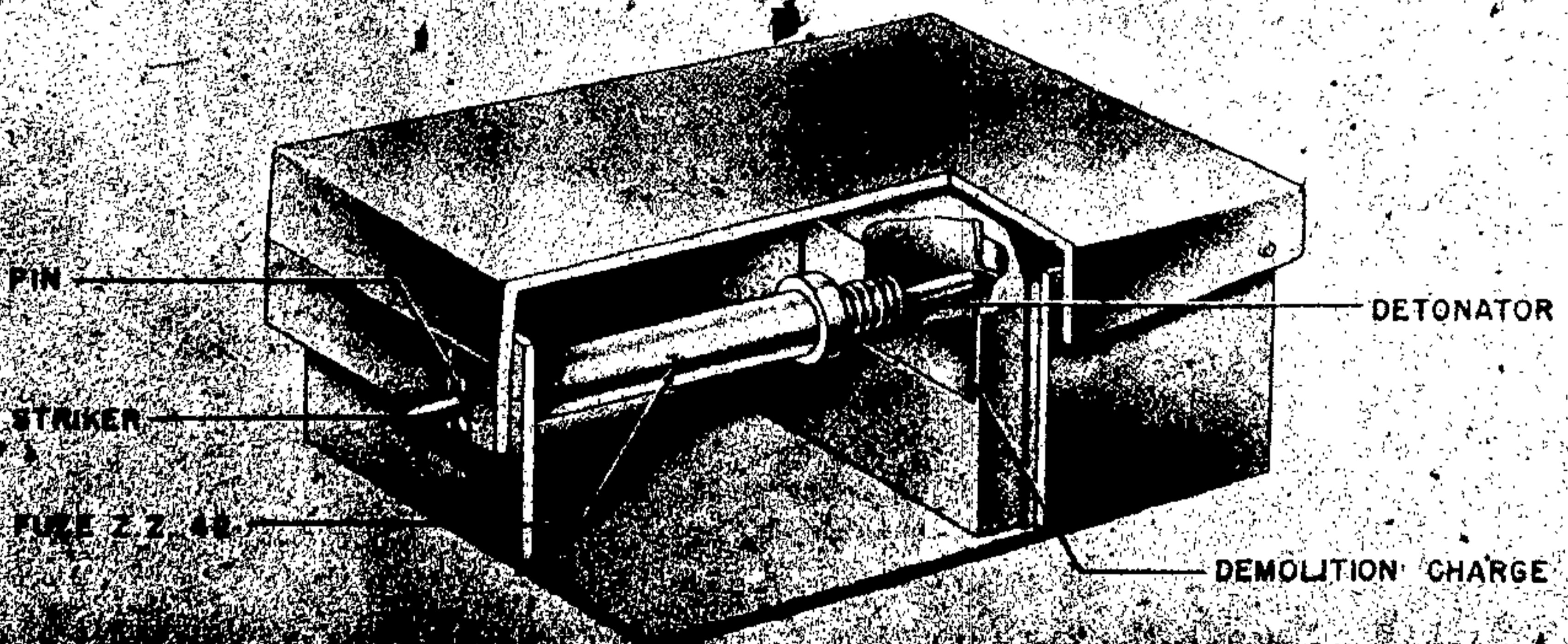

Figure 243—Schumine 42—Antipersonnel

REMARKS. A modified Schumine with a special large lid and sloping front, designed to employ the Z. Z. 35 igniter, was also encountered. The sloping front engages on an actuating pin pushed through the normal wire hole in the top of the igniter. The modified mine has a hole in the lid so that a cord can be tied to the safety pin and the igniter armed from a safe distance.

BEHELFSMINE W-1 (A/P)

DATA:

- Length: 4.6 inches (with igniter).
- Diameter or Width: 1.9 inches.
- Explosive: Picric acid and granulated TNT.
- Explosive Weight: 4 ounces.
- Material: Steel.
- Pull or Pressure Required: 35 pounds.
- Fuzing: Buck chemical igniter.

DESCRIPTION. The W-1 is an antipersonnel mine improvised from a French 50 mm mortar shell from which the nose fuze and tail fins have been removed. A Buck chemical igniter is fitted by means of a plastic adapter. (See fig. 244.)

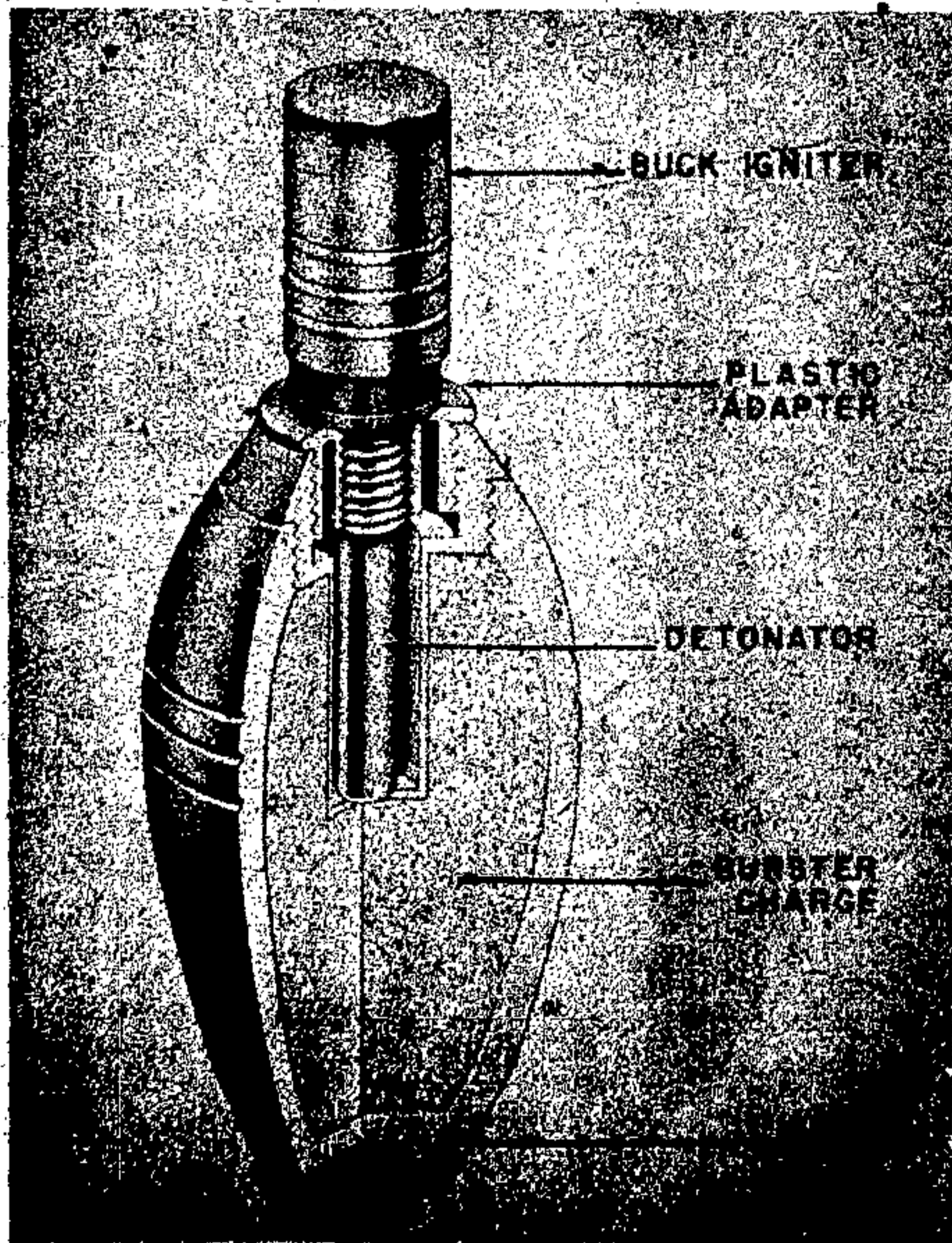

Figure 244—Behelfsmine W-1—Antipersonnel

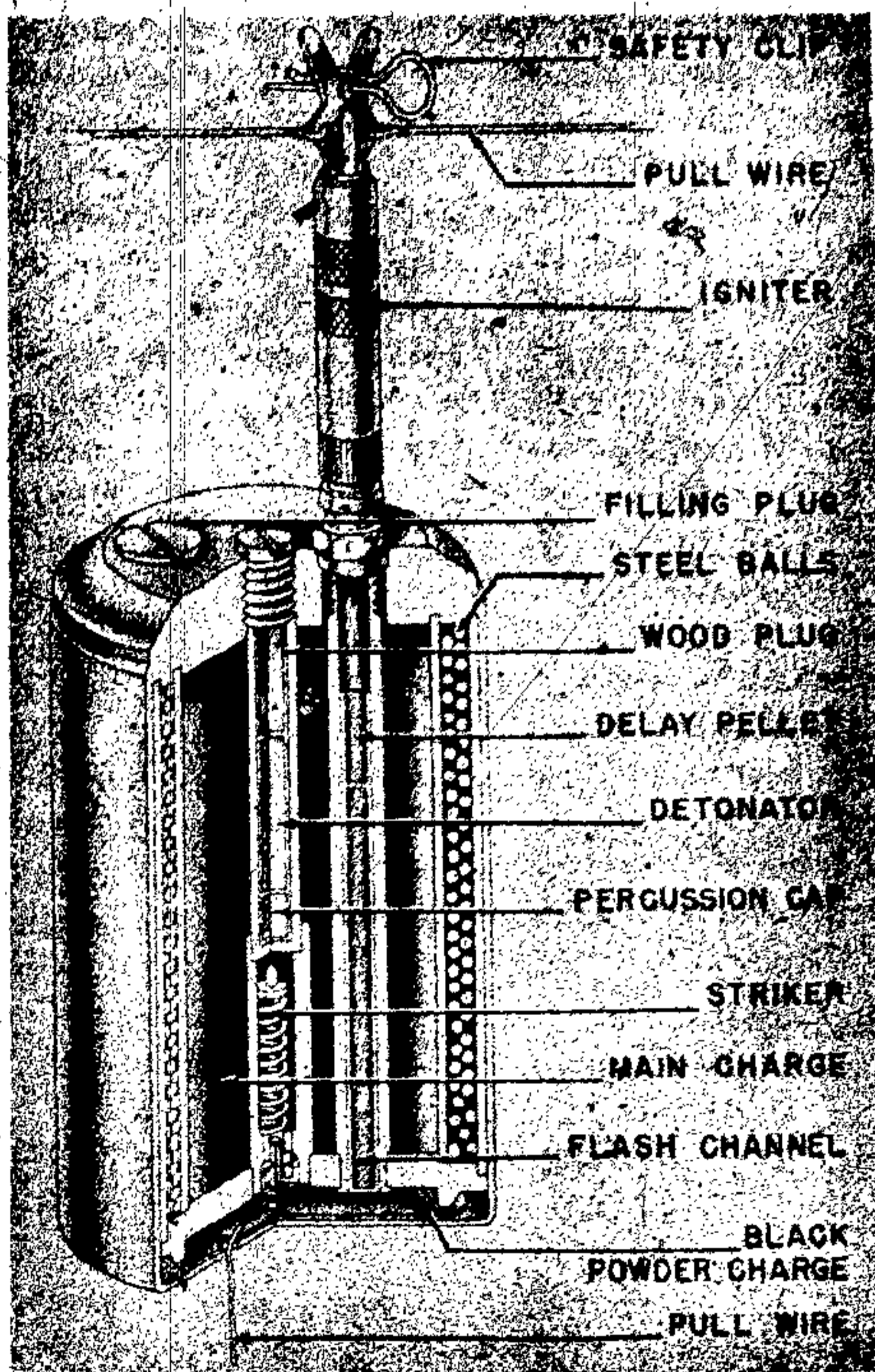

Figure 245—S-Mine 44—Antipersonnel

OPERATION. When the Buck igniter is crushed by pressure, a chemical reaction is set up which causes ignition of the detonator and then the mine.

S-MINE 44 (A/P)

DATA:

- Diameter or width: 4 inches.
- Depth: 5 1/8 inches.
- Total weight: 8.8 pounds.
- Color: Camouflage yellow.
- Material: Steel.
- Pull or Pressure Required: 21 pounds pressure or 14 pounds tension.
- Fuzing: S. Mi. Z. 44.

DESCRIPTION. The main differences between the S-Mine 44 and the S-Mine 35 are in the use of a push-pull type igniter (S. Mi. Z. 44) and the fact that the mine detonates at a predetermined

GERMAN EXPLOSIVE ORDNANCE

height, of approximately 36 inches. For recognition purposes it should be noted that the igniter tube is not located in the center of the mine as it is in the S-Mine 35.

The mine consists of an outer steel case containing an inner canister. (See fig. 245.) The canister holds the TNT explosive charge which is surrounded by small shot. In the cover plate there are three screw-covered openings; one for pouring the charge, one for the igniter socket beneath which is the propellant (3 gm of burning gunpowder), and a 4½-second delay pellet all in a celluloid case, and a third opening for a pull igniter and detonator. The pull igniter is at the base of the center tube and immediately above it is a flash cap for initiating the detonator. The pull igniter contains a spring-loaded striker, the sleeve of which is held beneath the internal shoulders of the igniter case by two balls which are prevented from moving inward by a pin in the

base of the igniter. The pin is attached to about 2 feet 10 inches of coiled wire to the base of the outer case.

OPERATION. After the detonator has been inserted and the igniter fitted and armed by withdrawal of a safety pin, the igniter can be operated either by pressure or pull on the trip wires. Operation of the igniter initiates the 4½-second delay pellet. After the delay the propellant is fired, throwing the mine upwards. When the coiled wire is fully extended it pulls the pin from the igniter, thus allowing the retaining balls to move inward and release the striker upwards to fire the cap, detonator, and bursting charge.

EMPLOYMENT. The mine is employed in the same manner as the S-Mine 35 for pressure or tension operation.

REMARKS. This information is taken from a captured German document.

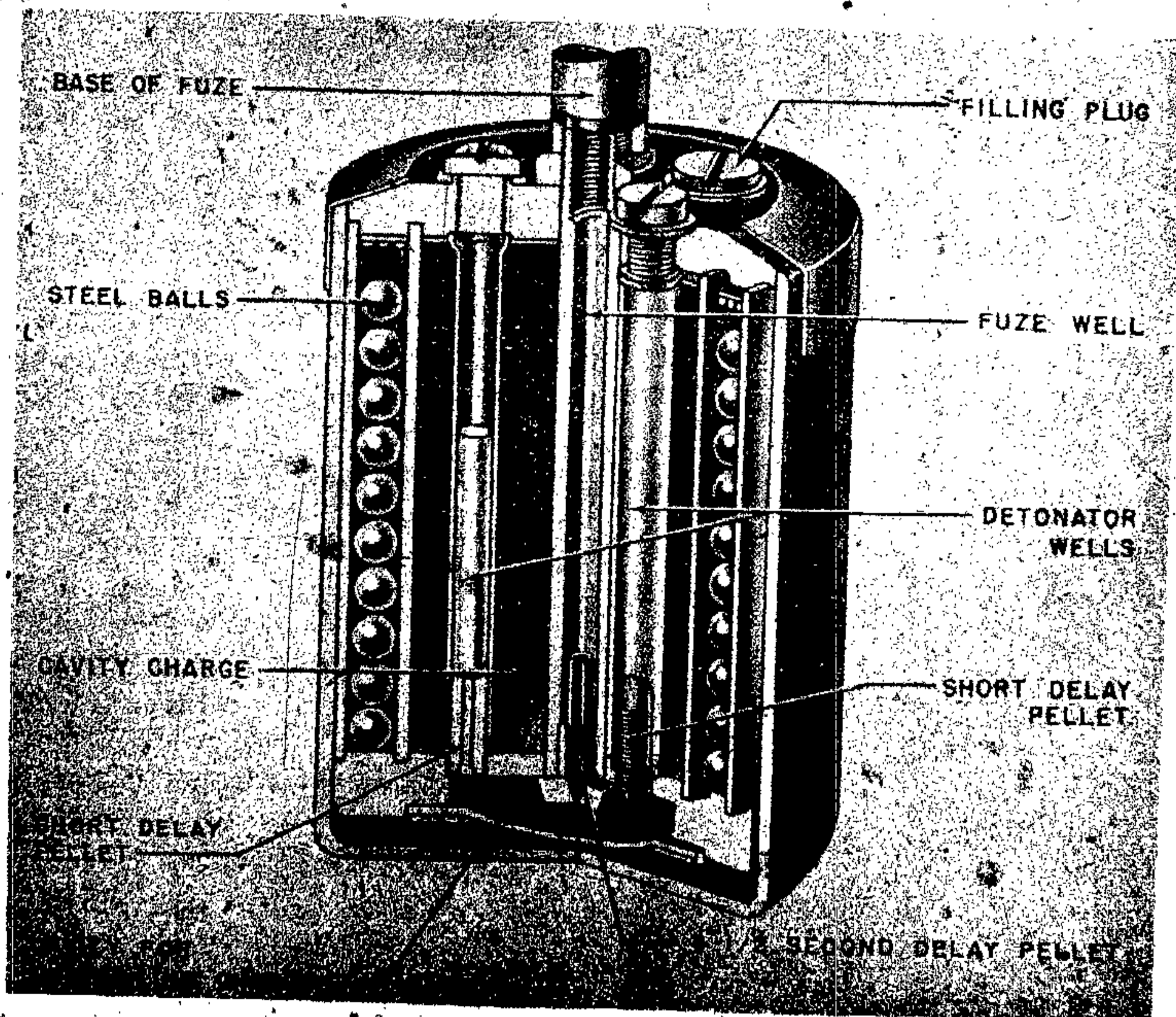

Figure 246—S-Mine 35—Antipersonnel

S-MINE 35, SCHUTZENMINE A/P

DATA:

Diameter or width: 4 inches in diameter.

Depth: 5 inches w/o fuze.

Total weight: 9 pounds.

Explosive: TNT (or Amatol).

Explosive weight: 6½ ounces.

Color: Normally brown with greenish tinge.

Material: Steel.

Pull or pressure required: 9 to 13 pounds.

Fuzing: S. Mi. Z. 35; E. S. Mi. Z. 40; Z. Z. 35; Z. U. Z. Z. 35.

DESCRIPTION. The S-Mine resembles a tin can in size and shape and was originally referred to as the "Fruit Tin" mine by the British. It consists of an outer steel case and an inner canister which contains approximately 350 steel balls. A central steel tube running axially through the mine receives the igniter at its upper end and acts as a flash channel. A 4½-second delay fitting is threaded into the bottom of this tube. A gun powder ejection charge is located beneath the inner canister. Three detonator tubes are spaced radially around the inner canister, 120° apart. A short delay element is fitted into the bottom of each of these detonator tubes. The space between the detonator tubes is filled with explosive, either TNT or amatol. (See fig. 246.)

There were various modifications in the early production models of the S-mine, including detonator tubes made of compressed paper, minor technical differences, and use of irregular pieces of metal for shrapnel instead of steel balls.

OPERATION. The mine may be operated by pressure or by pull. If it is to be operated by pressure, a standard pressure igniter, type S. Mi. Z. 35 is screwed into the top of the tube. If the mines are to be operated by pull, a Y-connection is screwed into the top of tube and two standard igniters of the Type Z. Z. 35 or Z. U. Z. Z. 35 are screwed into the branches of the Y. Z. Z. 42 and electrical igniter E. S. Mi. Z. 40 also can be used. In either case, when an igniter is fired, the flame produced ignites the 4½-second delay powder of the tube which in turn ignites the powder charge. The powder charge then explodes forcing the mine proper out of the canister and into the air. At the same time the explosion of the powder charge ignites the delay powder tubes. The delay in these tubes is long enough to permit the mine to rise

3 to 5 feet into the air before the detonators in the tubes are ignited. The detonators then explode the charge and the steel balls are dispersed in all directions. The effective range of these balls is between 150 and 200 yards.

EMPLOYMENT. When used as a pull-operated mine, it is laid in a cylindrical hole and held in place by four stakes. Trip wires are attached to the igniters and stretched out in opposite directions. The wires are run 4 inches above the ground and pass through eye screws fixed to the top of wooden stakes. The recommended length for the trip wires is 21 yards with the supporting stakes at 7 yard intervals.

REMARKS. Various antilifting devices are employed with the mine.

**"EISMINE" 42, FLASCHENEISMINE
(Fl. Eis. Mi.) A/P**

DATA:

Length: 10.5 inches.

Diameter or width: 4 inches (maximum).

Total weight: 5 pound 10 ounces.

Explosive: Gelatin-Donarit.

Explosive weight: 4 pounds.

Color: Clear color.

Material: Glass.

Pull or pressure required: Varies with igniter.

Fuzing: S. Mi. Z. 35; Z. Z. 42; Fl. Es. Mi. Z. (normal).

DESCRIPTION. The mine consists of a thick glass bottle resembling a quart milk bottle. In some models there is a booster charge of penthrite wax in the neck. There is a wooden plug with a conical recess and a central hole located at the top of the bottle neck. The Fl. Es. Mi. Z. igniter, with detonator crimped on, fits into this hole with the detonator extending down into a hole in the booster. An aluminum cap screws onto the top of the bottle over the igniter, with the igniter striker being just below the cap. When in place the cap is waterproofed with a sealing compound and over this fits a rubber cap to assure complete waterproofing. (See fig. 247.)

OPERATION. Sufficient pressure on the igniter causes detonation of the mine.

EMPLOYMENT. The original German theory for the use of these mines was that they should be suspended on 6-foot lengths of wire below the

GERMAN EXPLOSIVE ORDNANCE

surface of ice-covered rivers. The mines were placed 16 feet apart and at intervals mines were

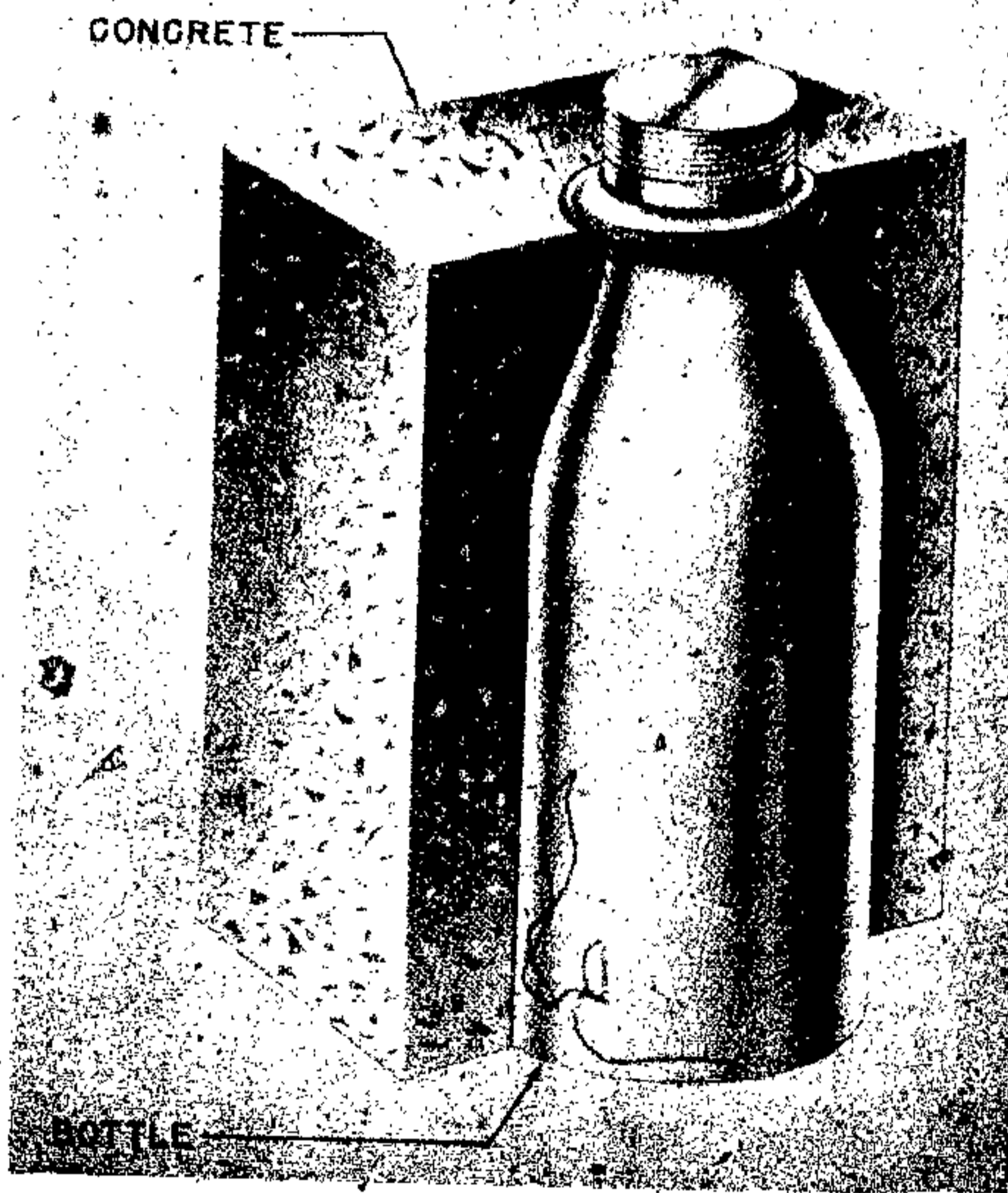

Figure 247—Eis mine 42—Antipersonnel

set to be ignited by electric detonation. The explosion of one mine would set up a sympathetic detonation which would explode those in the adjacent area.

The mines were later used for A/P ground mines, employing the Fl. Es. Mi. Z. igniter and adapted for use with other pressure type igniters.

REMARKS. The mine is set in concrete to serve as an A/P land mine.

"POT" MINE OR "MUSTARD POT" MINE BEHELES-SCHUTZEN MINE (A/P)

DATA:

- Diameter or width: 3 inches.
- Depth: 3.5 inches (including igniter).
- Total weight: 12.5 ounces.
- Explosive: Powdered picric acid.
- Explosive weight: 4 ounces.
- Color: Mustard brown.
- Material: Steel.
- Pull or pressure required: 35 pounds.
- Fuzing: Buch chemical igniter.

DESCRIPTION. The mine consists of a cylindrical body and a crush igniter, screwed into the top of the body by means of an adapter. (See fig. 248.) The body, which is of pressed steel, contains the explosive filling of approximately 4

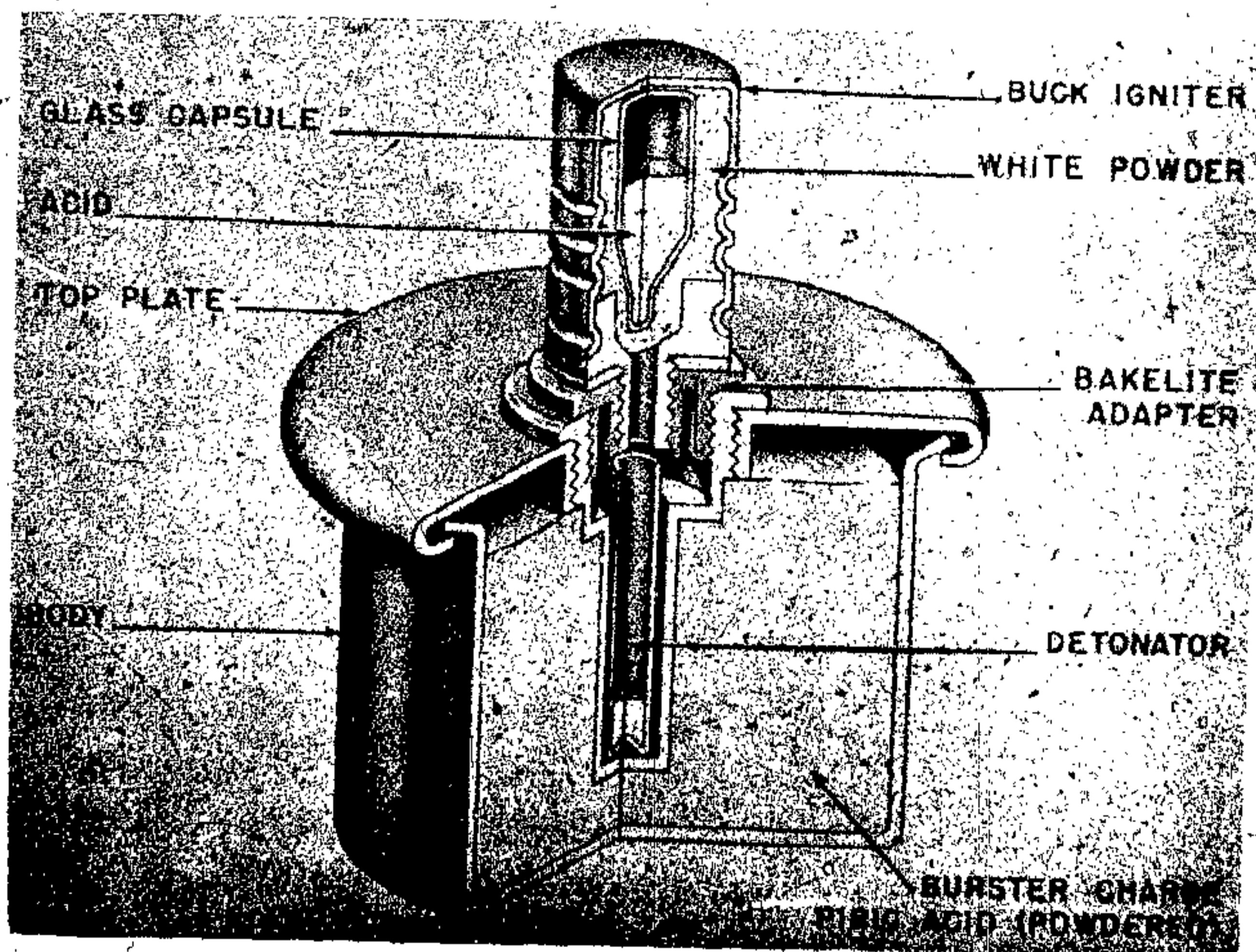

Figure 248—Mustard Pot Mine—Antipersonnel

ounces of powdered picric acid, and carries the top plate which is fixed by means of a rolled, overlapping flange 0.2 inch thick.

In the center, the top plate bears a screw thread into which is screwed an adapter which takes the igniter. The adapters found in different specimens are of different materials, such as brass and plastic in various colors, suggesting local manufacture of not very high standard.

OPERATION. A moderate pressure on the top of the igniter crushes the metal drum and the glass ampoule inside it. The acid pours into the white powder and a flash results from their chemical interaction, setting off the detonator, and in turn, the mine.

REMARKS. This mine was manufactured for the Germans by the French. There are other variations of this mine which embody minor manufacturing differences.

BZ-24, NbBZ-38 (FRICTION PULL TYPE)

DATA:

Length: $2\frac{6}{10}$ inches.

Diameter: $\frac{1}{4}$ inch O. D.

Material: Soft lead sheath, brass fitting, steel tube.

DESCRIPTION. The igniter consists of a lead tube or sheath connected to a threaded brass fitting by a steel tube. The steel tube is threaded on both ends and contains the powder delay pellet. The lead sheath contains a copper capsule which holds the friction composition. A friction wire is coiled to provide resistance to pulling and is joined to the pull loop. The pull loop extends through the lead tube, which is flattened or pressed together at the upper end, thus preventing the loop and friction wire from being freely and inadvertently withdrawn. A protective cap which protects the delay pellet must be removed before using the igniter. A colored band at the base of the lead sheath is presumed to identify the type of delay pellet contained. The NbBZ-38 has a white band for purposes of identification. (See fig. 249.)

OPERATION. When the loop is pulled, it frees itself from the soft lead tube, drawing the friction wire through the friction composition contained in the capsule. The resulting flame ignites the delay pellet. When the delay pellet burns through, it ignites a fuze or a detonator attached

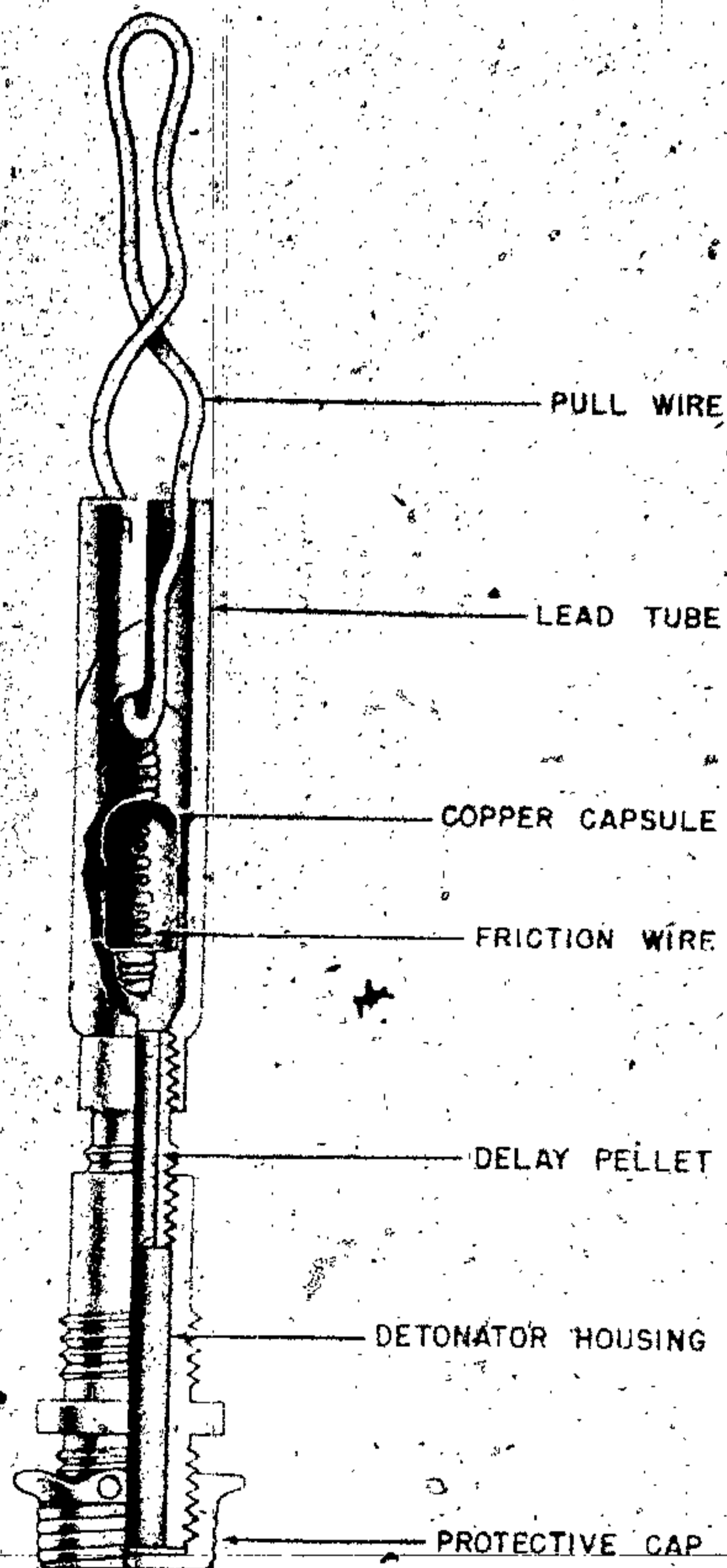

**Figure 249—BZ-24 Friction Igniter Pull Type;
NbB Z-38 Friction Igniter Pull Type**

to the fitting. The pellet used with the stick grenade has a delay of $4\frac{1}{2}$ seconds.

EMPLOYMENT. This igniter is used with the German "stick" grenade and also the smoke grenade. When used with the stick grenade, the entire igniter is screwed into the head end of the handle by means of the threads on the fitting. The loop is attached to the trip cord in the handle of the grenade.

The igniter used with the stick grenade is marked "BZ-24" and the igniter used with the smoke grenade is the NbBZ-38.

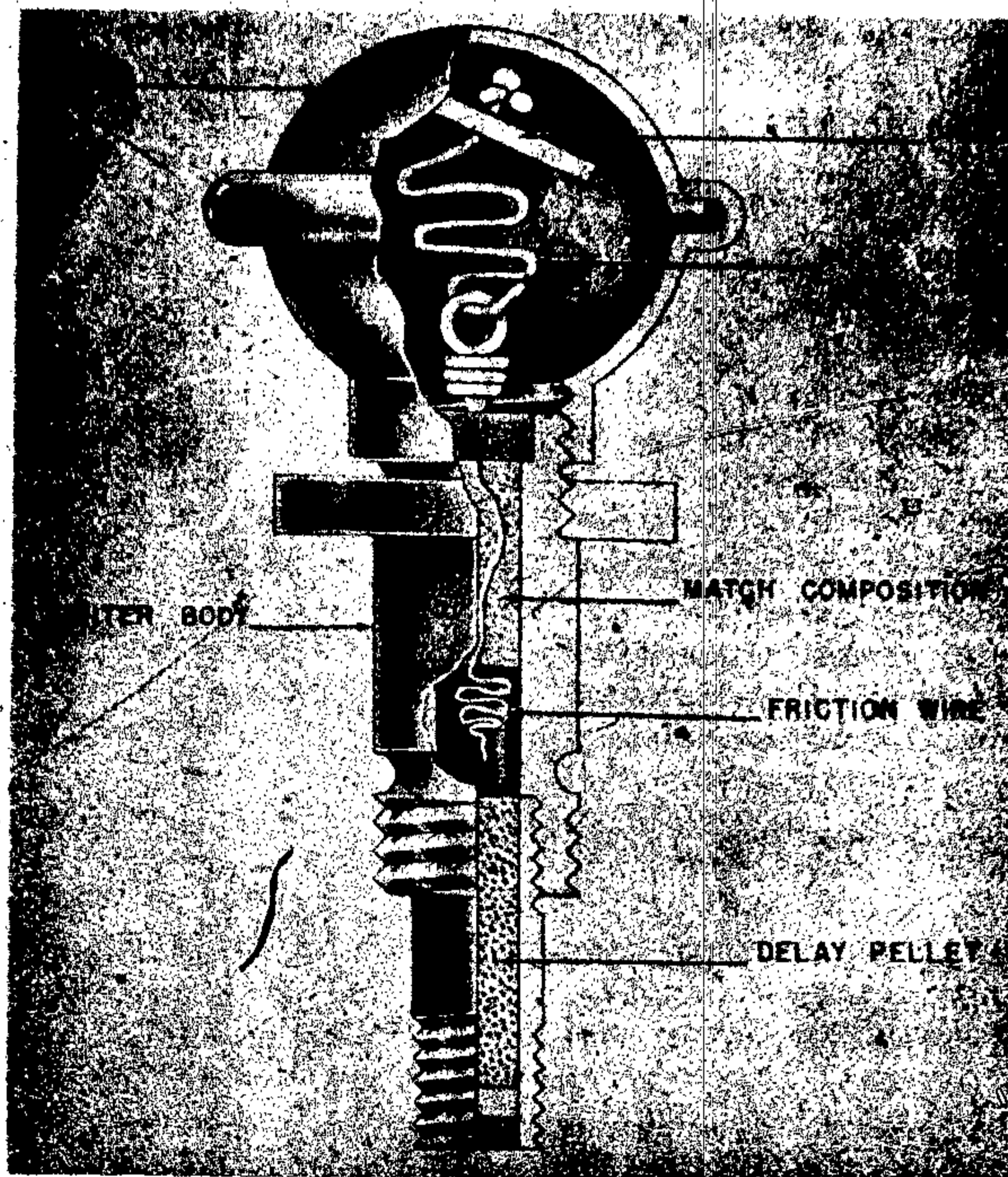

Figure 250—B. Z. E. Friction Igniter Pull Type

B. Z. E. FRICTION PULL TYPE

DATA:

Length: $2\frac{1}{10}$ inches.

Diameter: $\frac{7}{8}$ inch O. D.

Color: Blue with egg grenade; red with smoke flare.

Material: Brass body; steel tube.

DESCRIPTION. The short body of this igniter is usually made of brass and contains a friction composition in which a friction pull wire is cast. (See fig. 250.) The lower end of the friction wire is coiled to provide resistance which serves to ignite the friction composition when the wire is drawn through it. The upper end of the friction wire has a loop to which is fastened one end of a cord about $2\frac{1}{4}$ inches long. The free end of the cord is attached to a disk which is within the head. The steel tube attached to the body contains a "delay pellet" of compressed powder,

which in turn, serves to ignite a fuze or detonator.

OPERATION. When the head is unscrewed and the cord is pulled out, the friction wire ignites the friction composition and this in turn ignites the compressed powder delay pellet in the steel tube. When the delay pellet burns through, it ignites the attached fuze or detonator.

EMPLOYMENT. When used with the "egg" grenade, the igniter head under present practice is colored blue and the body is fitted with a $4\frac{1}{2}$ -second delay pellet in the tube. When used with "message tubes" smoke flare, the igniter head at present is colored red and the body is fitted with a 1-second delay pellet in the tube.

BZ-39 (FRICTION PULL TYPE)

DATA:

Length: 3 inches.

Diameter: $\frac{1}{4}$ inch O. D.

Material: Aluminum.

DESCRIPTION. The body is made of aluminum, and has a wall of two thicknesses which forms a shoulder. On this shoulder rests the distance tube to prevent longitudinal movement of the coiled part of the pull wire. (See fig. 251.) This pull wire passes through the friction composition contained in a cap which is held in position by the rubber retaining plug. Screwed to the other end of the igniter body is the adaptor which is also threaded externally to screw into the handle of the stick grenade. The delay composition consists of black powder which gives a delay of 7 seconds. This delay composition is covered with the small quantity of flash producing composition and the whole filling is protected by the green cellophane disk which is secured in position by the rubber washer.

OPERATION. The coiled part of the pull wire is attached to a cord located in the hollow handle of the stick grenade, is drawn through the friction composition which ignites. The resultant flash passes up the distance tube to ignite the delay composition which burns for 7 seconds before igniting the flash composition which in turn ignites the ignition mixture in the ignition tube N. 4 to bring about the ignition of the smoke composition in the head of the grenade.

EMPLOYMENT. Smoke hand grenade, Model 39.

ZDSCHN-ANZ-39 (FRICTION PULL TYPE)

DATA:

- Length: 2 1/8 inches.
- Diameter: 7/8 inch (head).
- Color: Field gray.
- Material: Aluminum.

DESCRIPTION. The ZDSCHN-ANZ 39 consists of a short cylindrical body, the top of which has an external left hand thread to take the spherical cap. This cap contains the pull disk to which is attached one end of the short length of the pull cord, the other end of which is attached to the coated friction wire. (See fig. 252.) Within the body is the friction composition contained in a copper capsule. The coated friction wire passes through this composition. The copper capsule is retained in the body of an internal shoulder and a retaining disk. Above the retaining disk is a retaining collar, held in place by the closing end

of the igniter body, forming an internal rim. At its base, the igniter body is reduced in diameter and threaded externally. When not in use, a brass transit cap is fitted to the base to protect the friction composition.

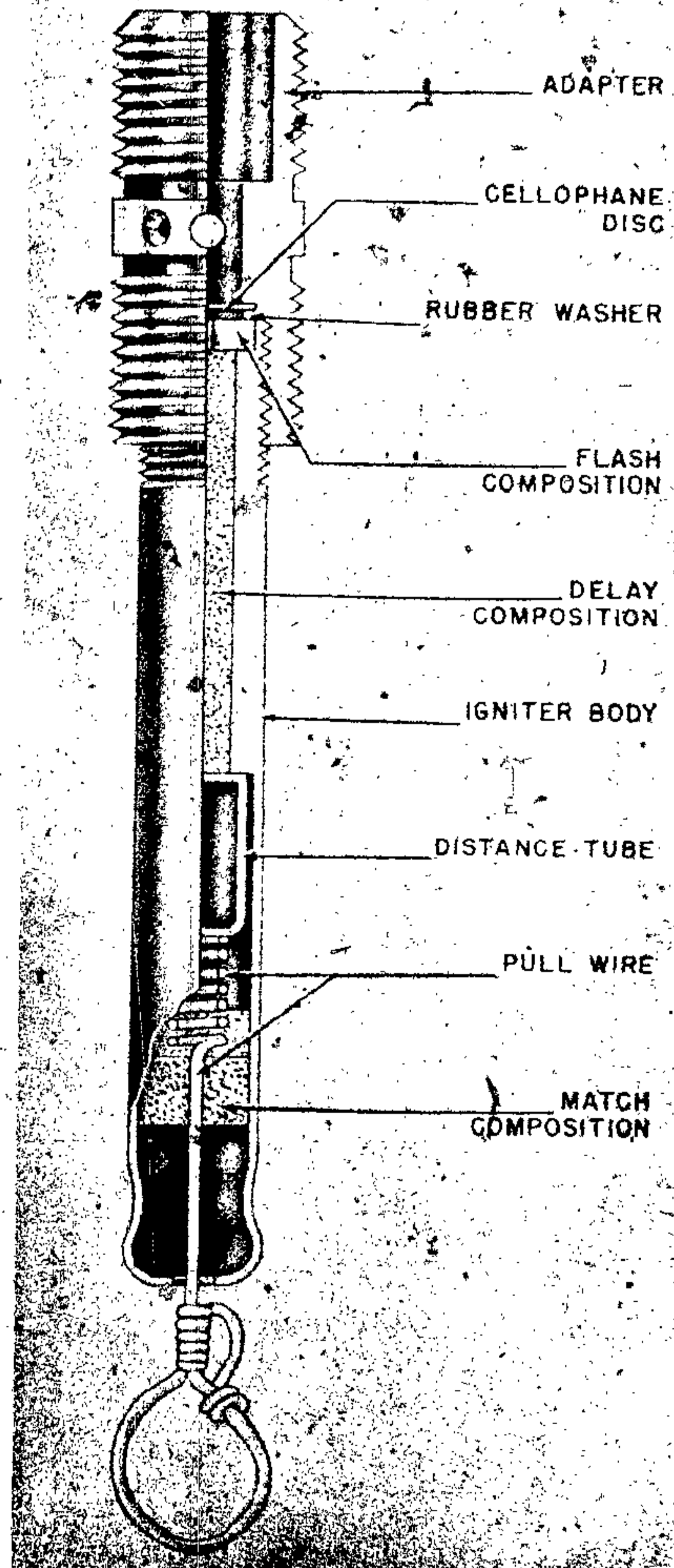

Figure 251—BZ-39 Friction Igniter Pull Type

GERMAN EXPLOSIVE ORDNANCE

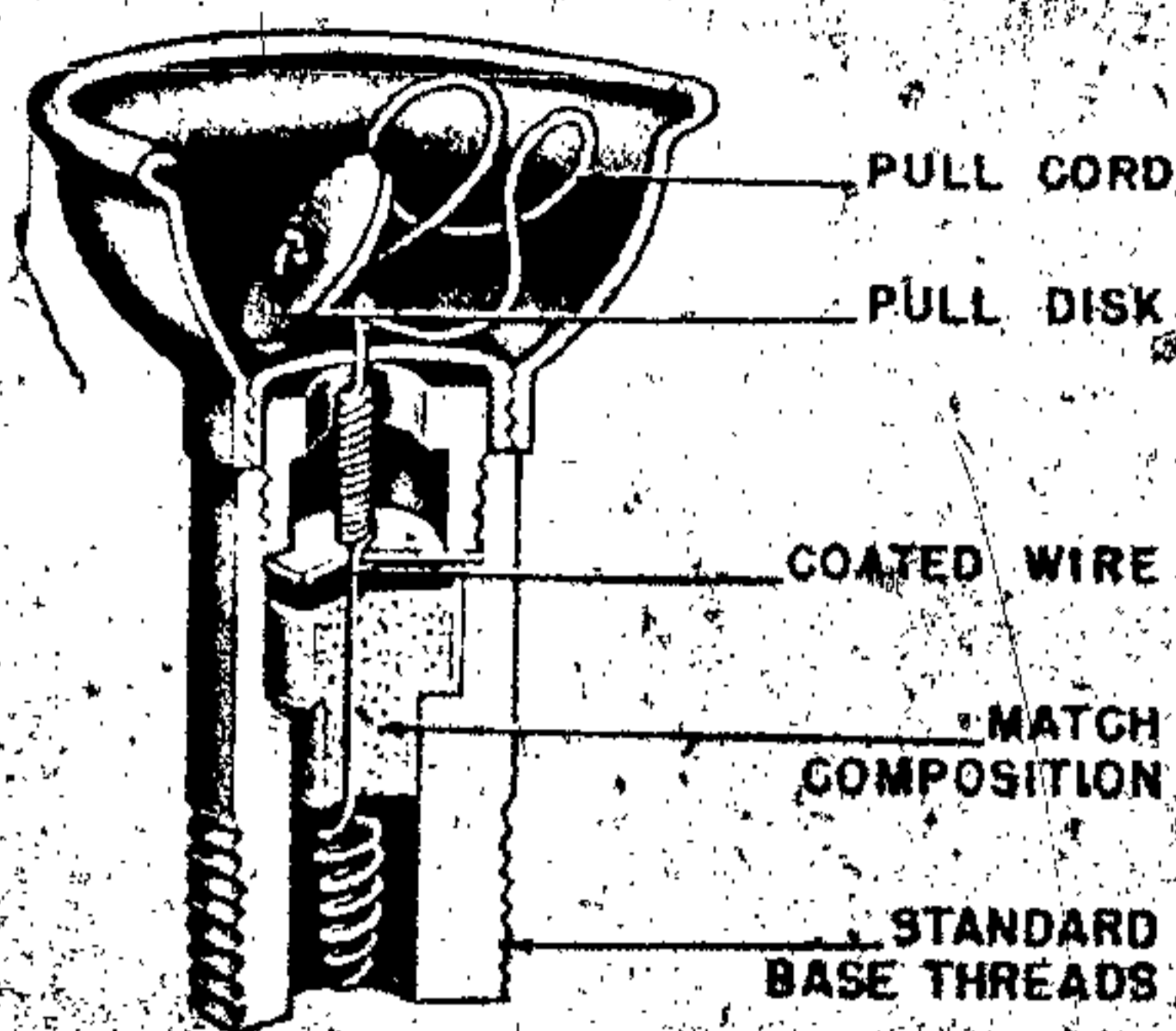

Figure 252—ZDSCHN-ANZ-39 Friction Igniter Pull Type

OPERATION. The spherical cap is unscrewed and the friction wire is pulled through the friction composition by means of the pull disk and cord to ignite the friction composition.

EMPLOYMENT. This igniter is primarily used for the ignition of safety fuze in demolition work. Also, it is used to ignite smoke candles, to booby trap Tellermines, and grenades, and to set off improvised mines and booby traps.

ANZ-29 (FRICTION PULL TYPE)

DATA:

Length: 11½ inches.
Diameter: 1.2 inches O. D.
Color: Unpainted.
Material: Brass.

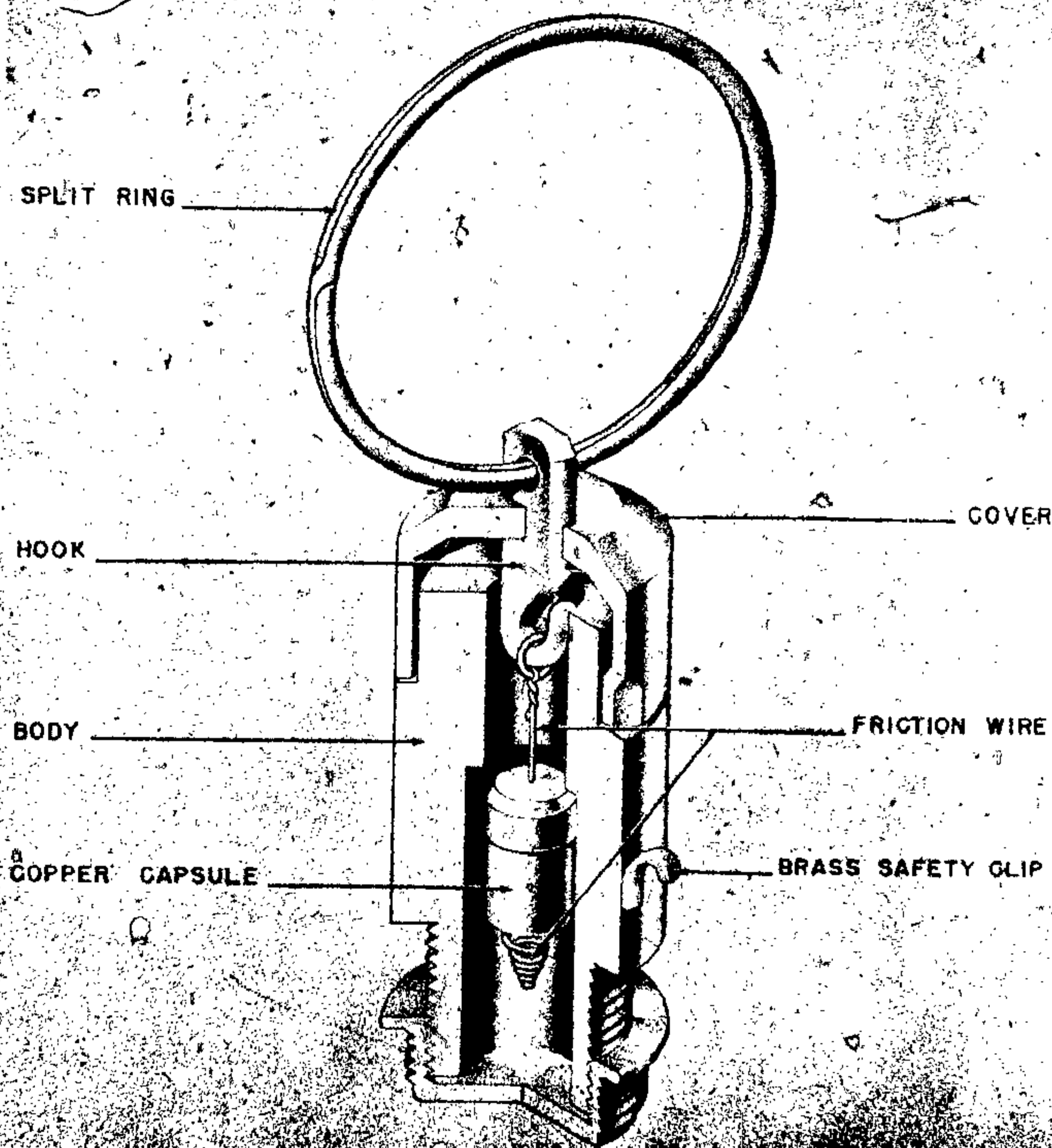

Figure 253—ANZ-29 Friction Igniter Pull Type

DESCRIPTION. This German igniter is normally used to ignite a fuze or detonator, which in turn is used to fire or ignite Tellermines, smoke candles, or prepared charges. When prepared for use, the igniter is screwed into one end of a short metal connecting tube, into the opposite end of which is pressed the safety fuze or detonator. The body of the igniter is usually made of brass and contains a copper capsule closed by a copper cap. A friction pull wire passes through the capsule, which contains a friction match-composition. The friction wire is tightly coiled at one end and is attached to a hook at the other end. The coiled end of the wire forms a resistance to pulling. The hook is soldered or otherwise firmly fixed into a slot in the cover. To align the split ring and the hook, and to resist rotational or other minor movements of the friction wire, the cover is deeply crimped into a recess provided in the body of the igniter. The safety split ring is secured to the body by a curved brass safety clip. A protecting cap screwed onto the threaded end of the body provides protection to the igniter when not in use. (See fig. 253.)

OPERATION. A pull on a trip wire attached to the safety ring separates the cap and hook from the body, thus drawing the friction wire through the friction composition, which action ignites the friction composition and in turn the attached fuze or detonator.

EMPLOYMENT

1. This igniter is used to set off Smoke Candle No. K. S. The igniter is attached by means of a cord or wire to the tank so that when the smoke candle is tossed out of the tank the igniter is fired automatically.

2. The igniter is often used as a secondary firing device for Tellermines. A prepared detonator which screws into the base of the mine is connected to the igniter by a fuze about 2½ inches long. To ignite the Tellermine, the safety ring of the igniter is pegged to the ground below the mine so that when the mine is lifted or displaced, the mine is actuated.

3. When used as the igniter for the 3-kilogram prepared charge (TNT), the igniter is fastened by means of a connecting tube to a fuze which is attached to the charge.

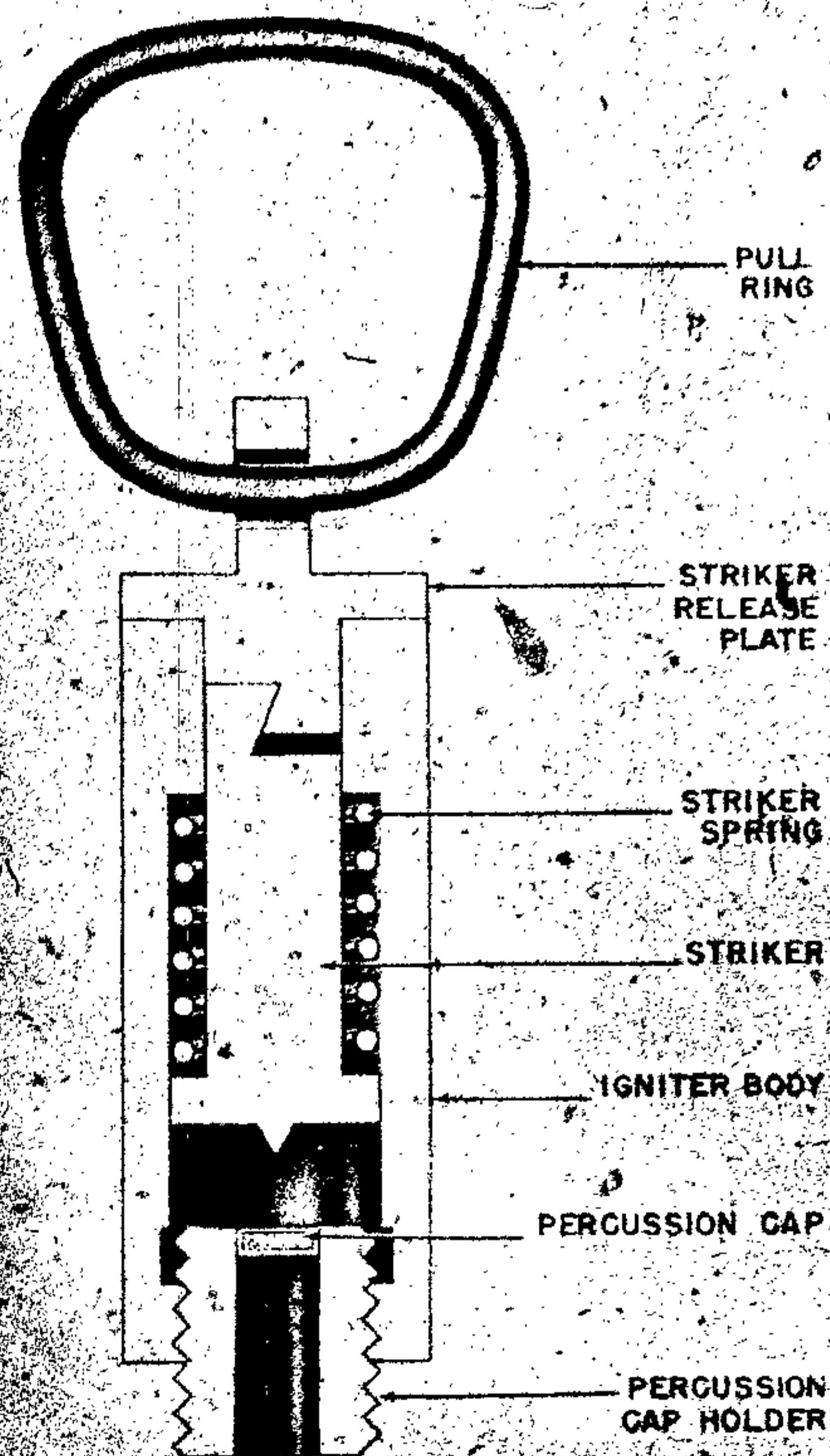

Figure 254—Safety Fuse Igniter, Percussion Type

SAFETY FUSE IGNITER (PERCUSSION TYPE)

DESCRIPTION. Igniter consists of a cylindrical brass body containing a spring loaded striker held in position by a friction fit of the Z type with a cap to which is attached a large steel ring. The percussion cap holder is threaded outside throughout the entire length, thus allowing it to be screwed into the igniter in either a safe (percussion cap away from the striker) or armed (percussion cap toward the striker) position. (See fig. 254.)

OPERATION. A strong pull on the steel ring detaches the striker release plate from the striker, permitting the striker spring to drive the striker into the percussion cap.

EMPLOYMENT. Used to ignite the safety fuse.

GERMAN EXPLOSIVE ORDNANCE

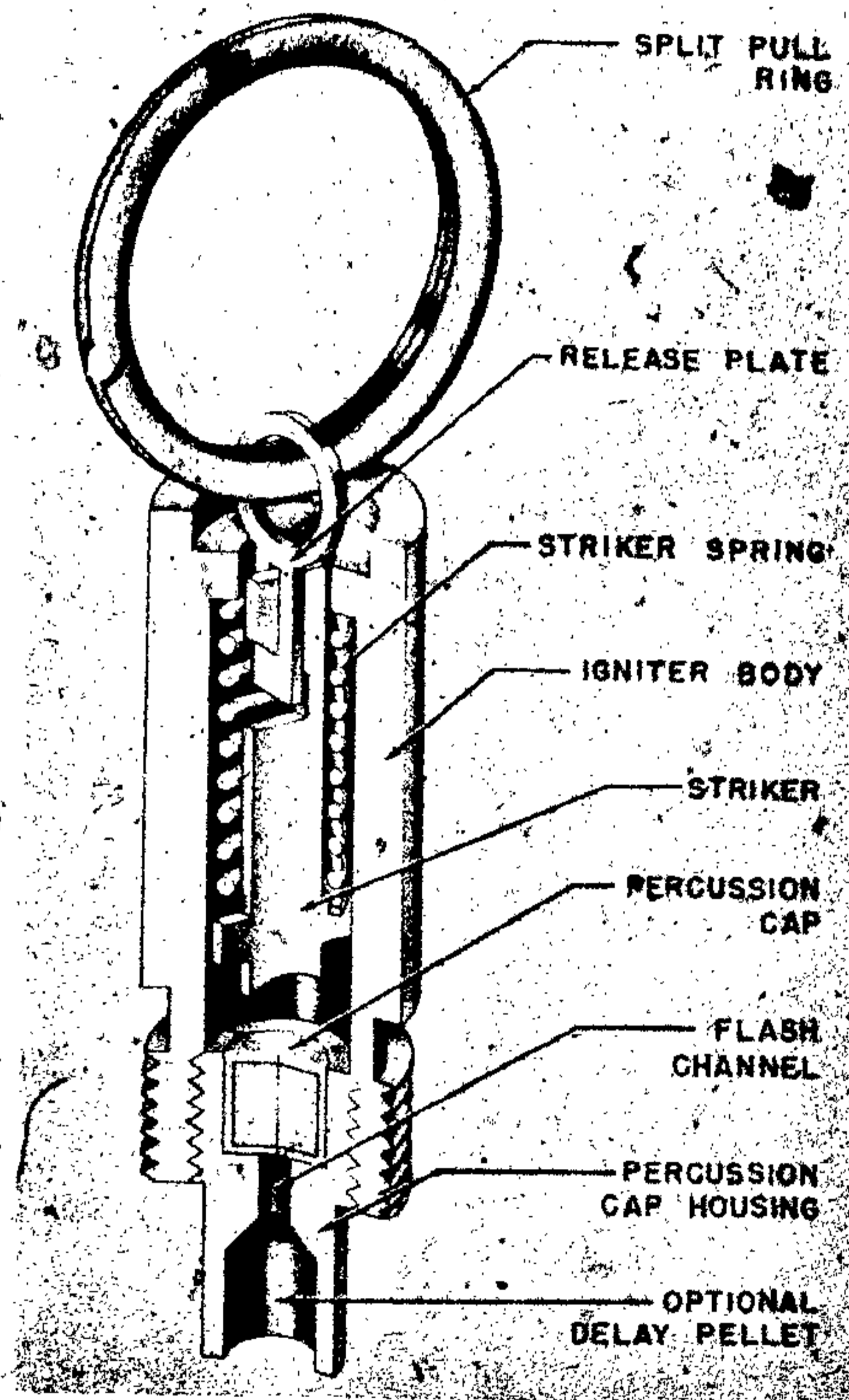

Figure 255—Type 2 Pull Percussion Igniter

PULL PERCUSSION IGNITER (TYPE 2)

DATA:

Length: 2 inches.

Diameter: $\frac{3}{8}$ inch.

Color: Gray or black.

Pull or Pressure Required: 20 pounds.

Material: Brass and steel.

DESCRIPTION. The body is constructed of brass and houses the striker assembly. It is internally threaded at the base to accept the percussion cap housing and externally threaded to engage the bomb into which the igniter is fitted. A $\frac{3}{16}$ -inch hole is drilled from the base to a point $\frac{1}{8}$ -inch from the head, forming a housing for the striker assembly. The igniter body is drilled centrally at the head to give clearance to the striker release plate (See fig. 255.)

The striker assembly consists of a striker, striker spring, and striker release plate. The striker is constructed of $\frac{1}{32}$ inch steel plate, with two shoulders at the head, to form a seating for the striker spring, and a recess in the stem into which the striker release plate engages. The striker has no point. The striker release plate is constructed of $\frac{1}{32}$ -inch steel plate and is key-shaped, with a $\frac{1}{8}$ -inch hole drilled at the head to accept the split ring. The stem is slotted to engage the striker.

The brass percussion cap housing is externally threaded to engage the igniter body. It is divided into two compartments, between which is a flash hole. A percussion cap is housed in the top compartment, and a short delay pellet is housed in the lower compartment, incorporating a delay of either two or four seconds.

OPERATION. A sharp pull on the split ring causes the striker release plate to be drawn from the igniter body, carrying with it the striker and compressing the striker spring. When the release plate is withdrawn fully from the igniter body, it disengages from the striker and the striker is released. The compressed striker spring then forces the striker to impinge upon the percussion cap.

EMPLOYMENT. This igniter was designed for use with the "New type Parachute Antipersonnel Bomb" but it is suitable for use with mines and booby traps.

Z. Z. 35 (PULL TYPE)

DATA:

Length: $2\frac{7}{8}$ inches.

Diameter: 1.2 inches O.D.

Color: Unpainted.

Pull or pressure required: 15-20 pounds.

Material: Brass.

DESCRIPTION. This igniter is suited for use with trip wires in operating various types of mines and booby traps. The body of the igniter is generally made of brass and consists of the following four parts: The main housing, the guide piece which is screwed to the main housing, the spacer piece which is screwed to the guide piece and the lower piece which is screwed to the spacer piece. The main housing contains the sliding cylinder and the compression spring. Housed within the sliding cylinder are the striker spring, the striker

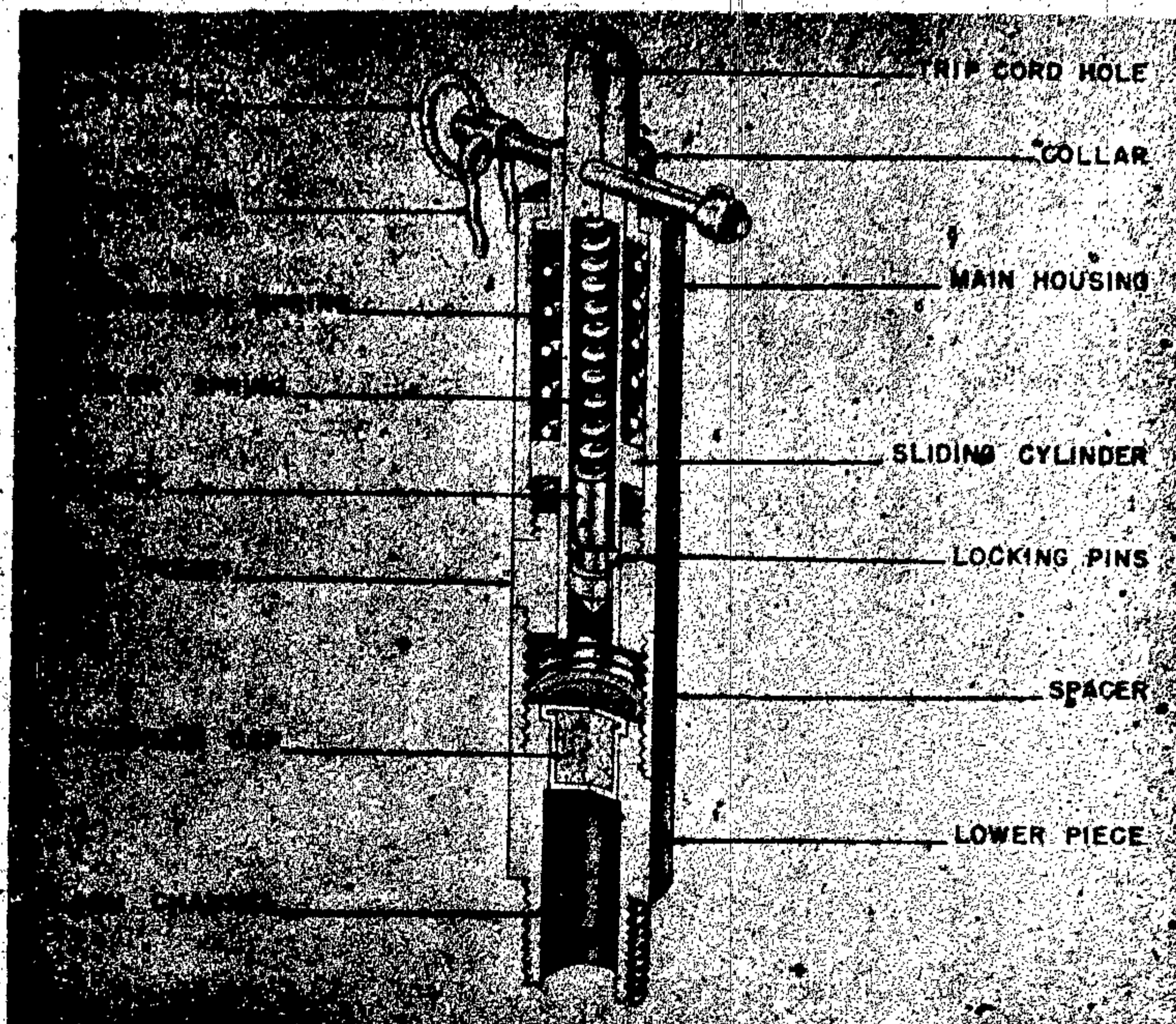

Figure 256—Z. Z. 35 Pull Igniter

and the two opposing locking pins which hold the striker in place. The lower piece contains the percussion cap. In the unarmed condition, the safety pin passes through the neck of the sliding cylinder and the holes in the collar. The pin is prevented from falling out by the nut, and by the clip which clamps around the collar. (See fig. 256.)

OPERATION. After arming, a pull on the trip wire moves the plunger upward against the resistance of the compression spring. The two locking pins are forced outward when they come opposite the open spaces, releasing the striker. The released striker, driven by the striker spring, sets off the percussion cap.

EMPLOYMENT. This igniter is standard for S mines and prepared charges, for booby trapping Tellermines, and for booby traps employing trip wires. Threaded base fits all standard charges, grenades and mines.

31 (PULL TYPE)

DATA:

- Length: $3\frac{5}{8}$ inches.
- Diameter: 1 inch O. D.
- Color: Field gray.
- Pull or pressure required: 5 pounds.
- Material: Brass.

DESCRIPTION. This igniter consists of the outer body, hollowed striker, firing spring, four steel balls, a guide piece and a hollowed ball to which the pull string is attached.

OPERATION. Tension on the pull cord pulls the striker up and compresses the firing spring which rests against the guide pin. The guide pin rides in the slot of the striker. As the striker is pulled up, the steel balls move out into a recess in the outer body and allow the hollow ball and cord to pull free. The tension of the firing spring and the beveled shoulder of the recess force the steel balls in and the striker is driven down on the percussion cap. (See fig. 257.)

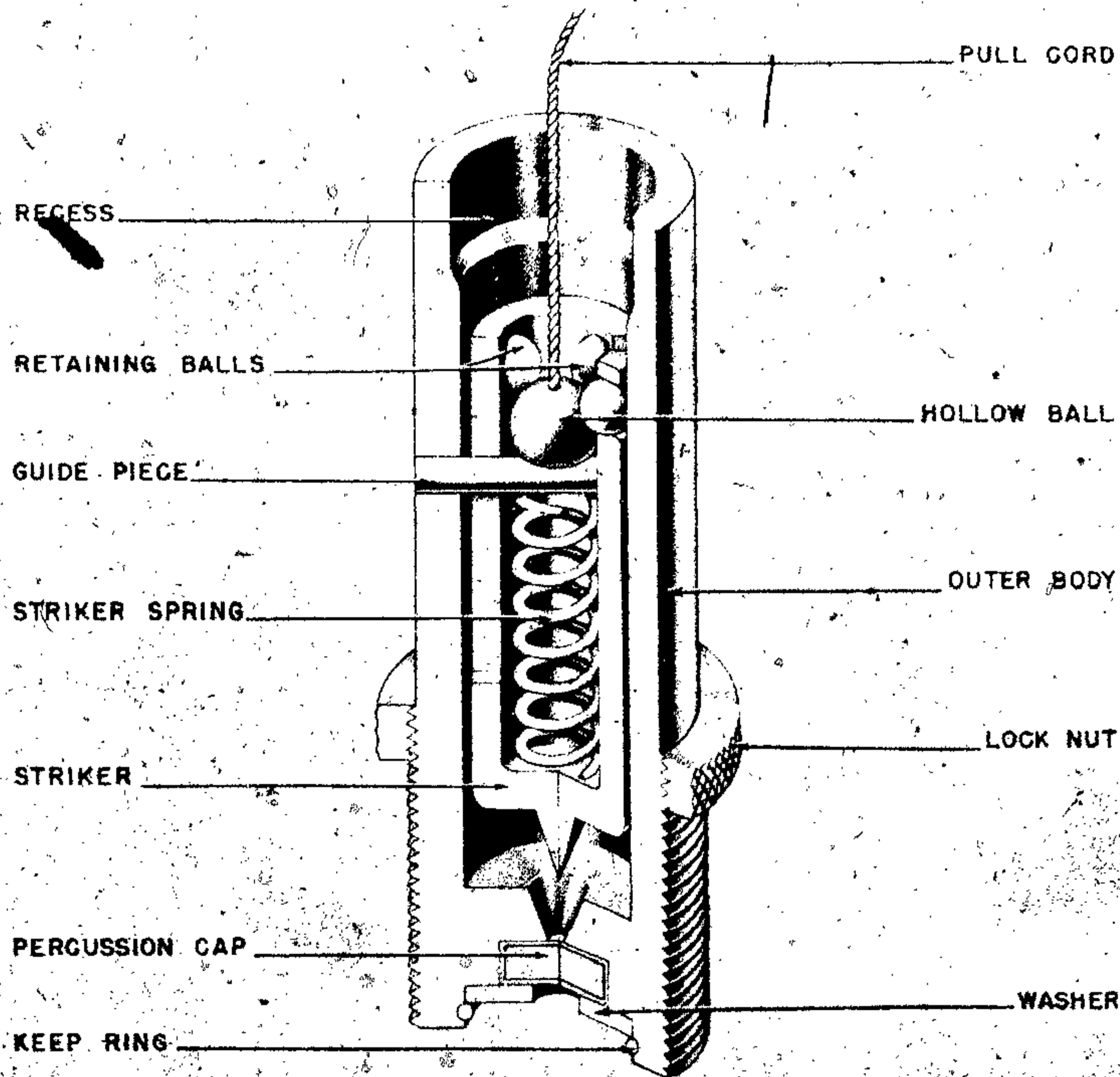

Figure 257—Type 31 Pull Igniter

EMPLOYMENT. Apparently designed for use with antipersonnel mines and with booby traps.

Z. U. Z. Z. 35 (PULL AND TENSION RELEASE TYPE)

DATA:

- Length: $4\frac{3}{8}$ inches.
- Diameter: $\frac{1}{2}$ inch O. D.
- Color: Field gray.
- Pull or pressure required: 9-13 pounds.
- Material: Brass.

DESCRIPTION. This type of igniter is generally used with mines and prepared charges which are actuated by wires in tension. The body of the igniter consists of four parts: The main housing, the guide piece, the spacer piece, and the lower piece. The main housing contains the sliding cylinder and the compression spring. The lower

piece contains the percussion cap. Housed within the sliding cylinder are the striker spring, the striker, and the two opposing pins which hold the striker in place. At the top of the sliding cylinder is a hole, through which a trip wire is securely tied. The collar has two diametrically opposite slotted openings, having a clearance of $\frac{1}{32}$ inch for the free movement of the safety pin. The safety pin has a nut at one end. When in a "safe" position the safety pin is inserted far enough through the hole to permit the shoulder on the safety pin to fit in the recess or groove provided on the upper end of the housing, and the clip is fitted around the collar. When the safety pin, the nut, and the clip are in the position described, the igniter cannot be fired, since any pull of a cord attached to the ring will cause the loose link ring to open and the cord to become detached.

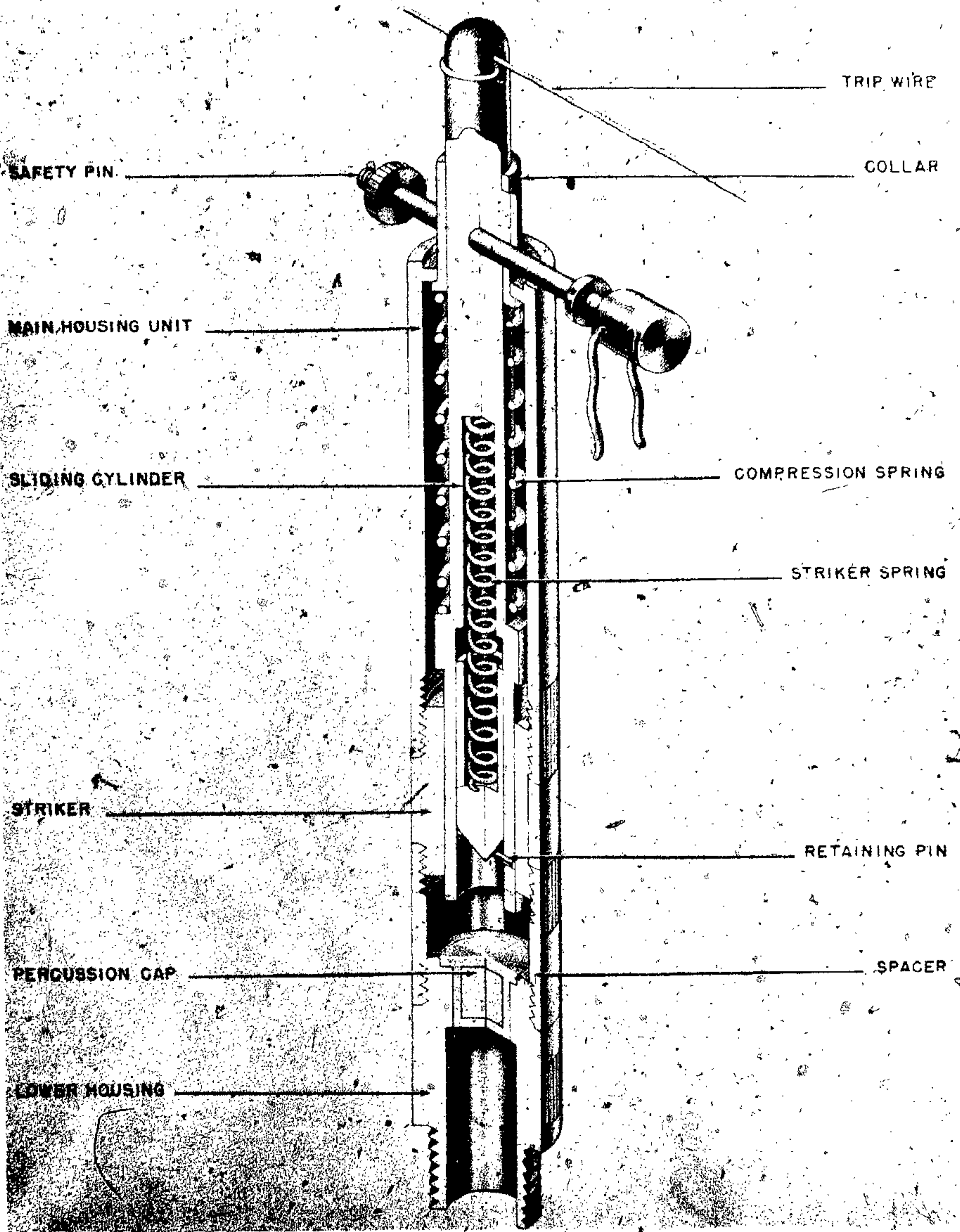

Figure 258—Z. U. Z. Z. 35 Pull and Tension Release Igniter

GERMAN EXPLOSIVE ORDNANCE

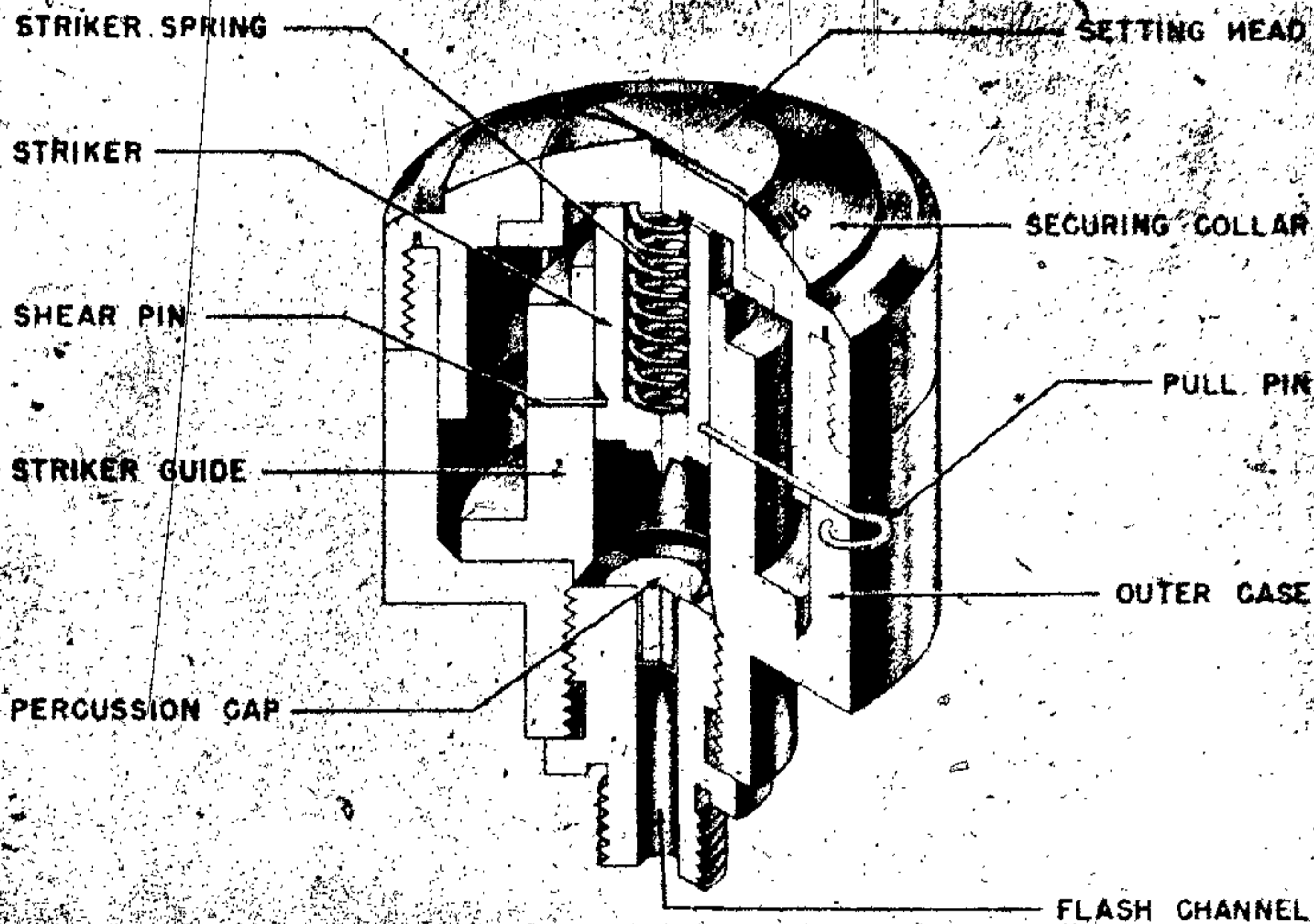

Figure 259—Z. D. Z. 29 Igniter—Pressure and Pull

OPERATION. The trip wire on this fuze must be under tension as the fuze is fired by pulling on the trip wire or by loosening, breaking or cutting it. Pulling on the trip wire causes the sliding cylinder to be pulled outward against the resistance of the compression spring. This permits the two locking pins to be forced outward into the upper open space and frees the striker. Cutting or breaking the trip wire permits the compression spring to force the sliding cylinder downwards, permitting the locking pins to be forced outwards into the lower open space and freeing the striker. In both cases, the freed striker is driven into the percussion cap by the compressed striker spring. (See fig. 258.)

EMPLOYMENT. This igniter is used extensively with S. mines, prepared charges and booby traps.

REMARKS. This igniter proved so dangerous to use that a number were returned to the factory for modification. The modified igniters are stamped Nur Zugzunder (only pull fuze). Interior works are the same but the trip wire slot was cut from the end of the sliding cylinder and the igniter was fired by withdrawal of the safety pin to which the trip wire was attached.

Z. D. Z. 29 (PRESSURE, PULL TYPE)

DATA:

Length: 2½ inches.

Diameter: 1⅞ inches O. D.

Pull or pressure required: 100–275 pounds.

Material: Metal.

DESCRIPTION. This German igniter is a firing device designed to function either as a pressure igniter or as a pull igniter. The igniter body has a base plug and a pressure head and houses a striker assembly. The base plug is threaded for attaching the igniter to a detonator and it holds a percussion cap. To prevent the base plug from being unscrewed from the body, a set screw is provided. The head has a free fit to permit its rotation in the bushing, which is fixed to the body by a threaded collar. A pin is fixed to the head. The striker assembly consists of a striker, two shear pins, a pull pin, a metal guide, and a helical spring. The striker has a circular groove which receives the ends of the shear pins and the pull pin to hold the striker in the cocked position. Just above the groove are the beveled cuts. The cut is beveled to permit any pin under either beveled cut to be pushed out of the path of the striker. The guide

LAND MINES, GRENADES, AND IGNITERS

is attached to the body by the screws and has two lugs. These lugs limit the rotation of the head by confining the movement of the pin, which is a part of the head, to a path between the lugs. The pull pin extends to the outside of the body through an opening under which is engraved the word "zug" (pull). The igniter is provided with a safety key, which fits into the igniter through an opening under which is engraved the word "sich" (safe). (See fig. 259.)

The top of the head has a cut-mark and a slot beside which is engraved the word "druck" (pressure). Three setting marks "zug" (pull), "125 kg" and "45 kg" appear on the top of the bushing. The head may be turned so that the mark comes opposite any one of the three setting marks by using a coin or similar object in the slot. When the mark is opposite each setting mark, the pin which protrudes slightly above the flange of the head fits into a small indentation on the underside of the bushing. There are three of these indentations to correspond to the three setting positions. The striker is engaged to the head by the pin so that it will rotate with the head. As the head, together with the striker, is turned to each setting position, the pins and the pull pin ride in the groove. In this manner one or both of the shear pins and the pull pin can be brought in position to hold the striker. If the pin is positioned in one of the beveled cuts, it is not effective to resist the downward movement of the striker. The safety key is a strip of flexible metal which fits between the striker and the percussion cap. If the striker is accidentally released, a slot in the safety key will intercept the striker. If this happens, the safety key cannot be withdrawn and the igniter will not function.

Igniters recovered in Italy did not have firing pressures stamped on the settings, but had the letters Z for Zug or pull; S for Schwer or heavy; and L for Leicht or light. Firing pressures on these igniters were not verified as the igniters were not complete.

OPERATION. This igniter may be adjusted to operate under any of the three different settings described below. The igniter is armed first by adjusting the setting and then by removing the safety key from the igniter. A long wire or cord is attached to the loop on the safety key, and the safety key is pulled out from a safe distance. To

set the igniter to fire at 275-pound pressure, turn the movable head so that the mark is opposite "125 kg." When the required load is applied, both shear pins are sheared and the pull pin is pushed outward as its ends ride the beveled cut, thus releasing the striker. The compressed firing spring drives the striker downward, setting off the percussion cap. To set the igniter to fire at 100-pound pressure, turn the movable head so that the mark is opposite "45 kg."

Note that the setting pin is now stopped by the lug. When the required load is applied, one of the shear pins is sheared; the other shear pin and the pull pin are pushed outward as their ends ride the beveled cut. This releases the striker and causes the device to fire as previously described. To set igniter to fire as a pull igniter, turn movable head so that the mark is opposite the word "zug." When the pull pin is withdrawn by a trip wire, thus releasing the striker, the two shear pins are pushed outward as their ends ride in the beveled cuts; the firing is as described for the pressure igniters.

EMPLOYMENT. This igniter is specified for use in the assembly of antitank, antivehicle, or antipersonnel mines.

Z. Z. 42 (PULL OR PRESSURE TYPE IGNITER)

DATA:

Length: $3\frac{7}{16}$ inches.

Diameter: $\frac{1}{2}$ inch O. D.

Color: Black.

Pull or pressure required: 6 to 11 pounds.

Material: Bakelite.

DESCRIPTION. The cylindrical plastic body which is threaded internally at its base to take the brass detonator holder, houses the steel striker spring, the steel striker and the felt and steel striker spring retaining washers which also serve to centralize the striker. (See fig. 260.)

The striker spindle is diametrically pierced toward its upper end to receive the steel detent pin, which forms the link and the loop.

The detonator holder accepts, at its upper end, the detonator cap and, at its lower end, the detonator. The detonator holder is closed by the safety transit cap which is removed prior to the insertion of the detonator when arming a mine.

GERMAN EXPLOSIVE ORDNANCE

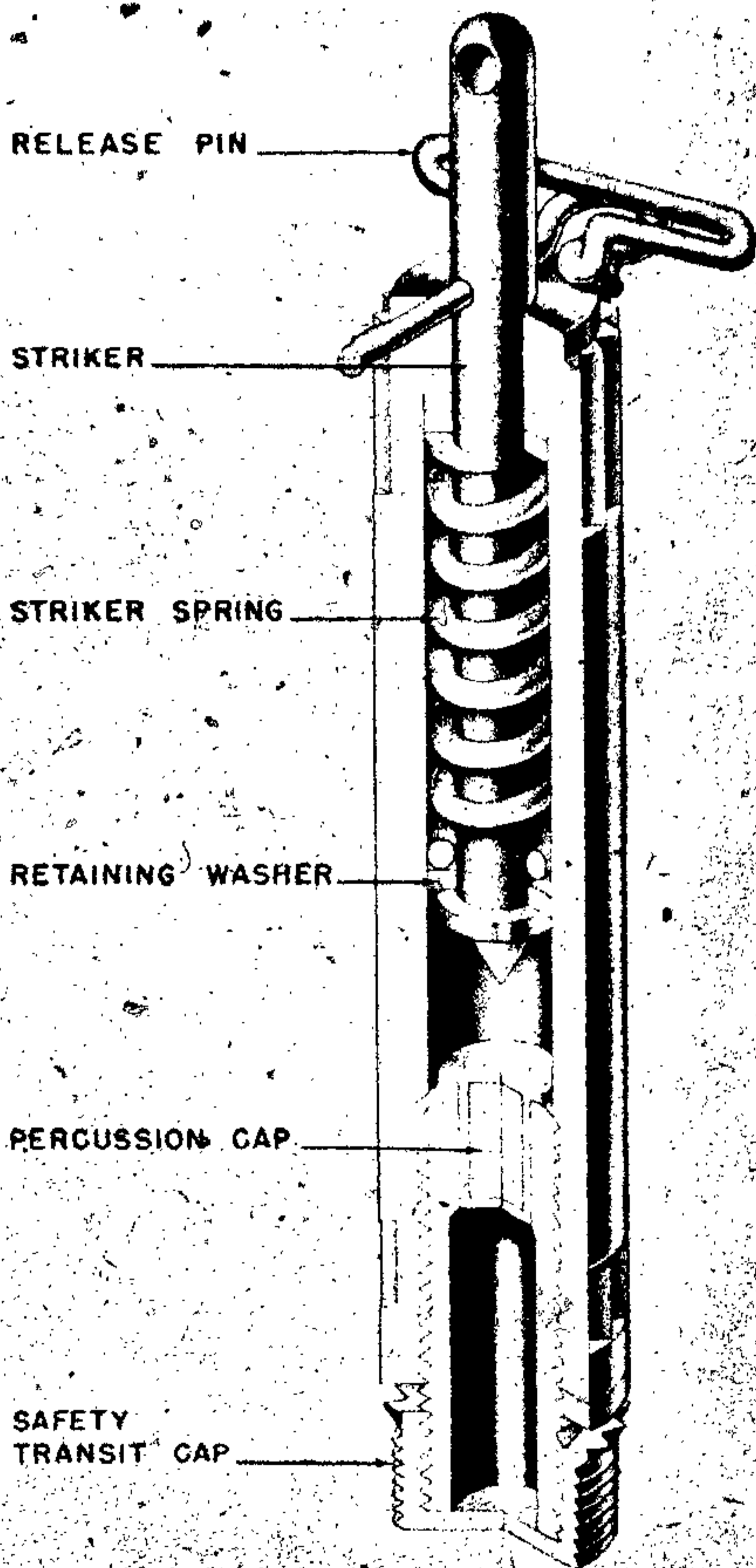

Figure 260—Z. Z. 42 Igniter—Pressure and Pull

OPERATION. Pulling on the trip wire attached to the striker end withdraws the detent pin and releases the striker. The striker, driven by the striker spring, is driven into the percussion cap, initiating the detonation of the mine.

EMPLOYMENT. Designed for use in booby traps and with the stock mine.

REMARKS. This igniter has been found made entirely of metal. It may also be used as a tension release device by removing the detent after

affixing a tension wire through the end hole in the striker.

S. MI. Z. 44 (PUSH-PULL TYPE)

DESCRIPTION. This igniter, resembling the Z. Z. 42, consists of a steel case screw-threaded to accept an adapter bush in which is secured an igniter cap. The adapter is screw-threaded to screw into the mine. A spring-loaded striker, accommodated in the case, is assembled so that the striker spindle protrudes through the upper end of the case. The striker is retained in the cocked position by two winged detents, the jaw of which engages in recesses machined in the striker spindle. The detents are maintained in this position by a retaining collar, mounted on the case, with which the detents engage. They are secured against displacement by a safety pin through a hole drilled in each detent. (See fig. 261.)

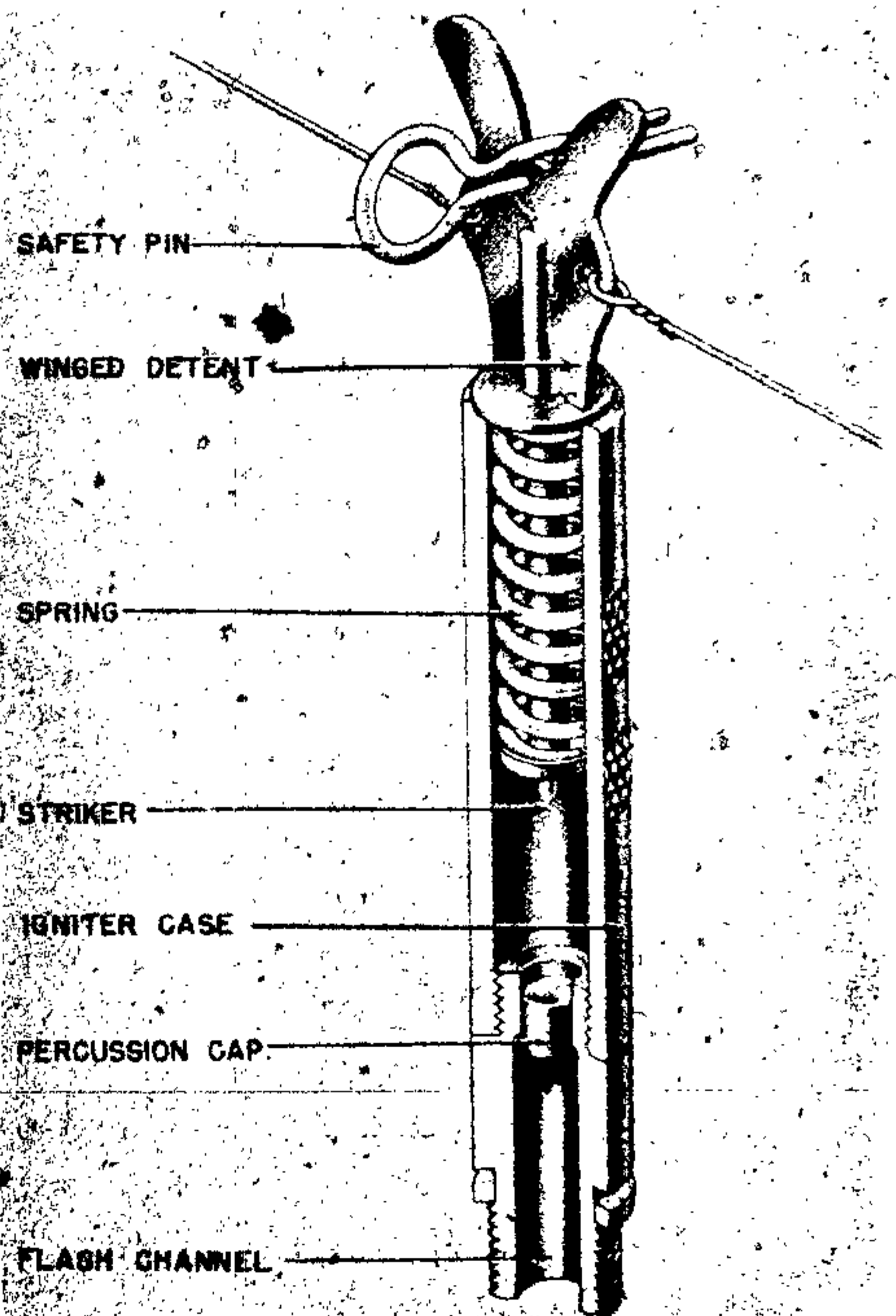

Figure 261—S. Mi. Z. 44 Igniter—Pressure and Pull

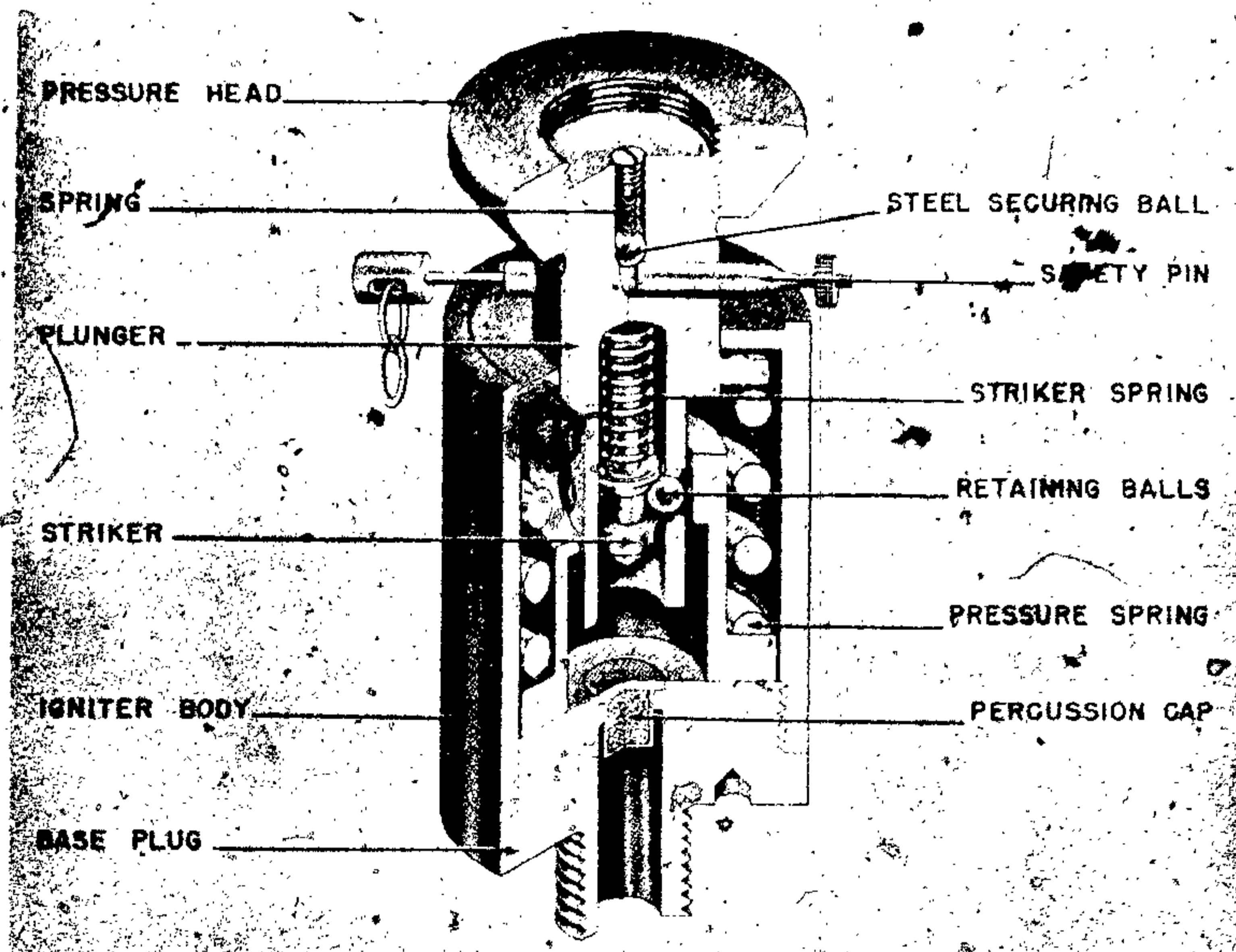

Figure 262—D. Z. 35 (A) Pressure Igniter

OPERATION. The igniter is armed after withdrawal of the safety pin. After arming, a pressure of 21 pounds or a pull of 14 pounds on the wings opens them sufficiently to release the striker. The striker, driven by the striker spring, impinges upon the percussion cap and fires the mine.

EMPLOYMENT. This igniter was developed for use with the S-Mine 44 and improvised mines. Mines fitted with the S. Mi. Z 44 are normally buried with only the wings of the igniter showing. In winter, however, the whole head of the igniter must be above ground.

D. Z. 35 (A) (PRESSURE TYPE)

DATA:

- Length: 2¾ inches.
- Diameter: 1¼ inches.
- Color: Brown.
- Pull or Pressure Required: 130 to 160 pounds.
- Material: Aluminum.

DESCRIPTION. The igniter body houses a plunger assembly and has a base plug containing

a percussion cap. The plunger assembly consists of a movable cylindrical plunger to which is screwed a pressure head, the top of which is adjustable in relation to the top of the plunger, and a striker. The plunger rides in the guide, and is held in position by the pressure spring. The lower part of plunger is bored to receive the striker assembly. The striker or firing pin is held in position within the plunger by the two steel balls which seat in holes in the plunger. The safety device is the pin, with a nut. The pin fits into hole and prevents the plunger from moving downward. To prevent the safety pin from accidentally falling out when the nut is off, a steel ball, under pressure from a spring, fits into a groove in the safety pin. Pressure on the steel ball can be varied by means of the adjusting screw directly over it. (See fig. 262.)

OPERATION. This igniter is armed by first removing the safety pin nut and then withdrawing the safety pin. Pressure on the pressure cap forces the cylindrical plunger downward against the resistance of the pressure spring. Two locking

GERMAN EXPLOSIVE ORDNANCE

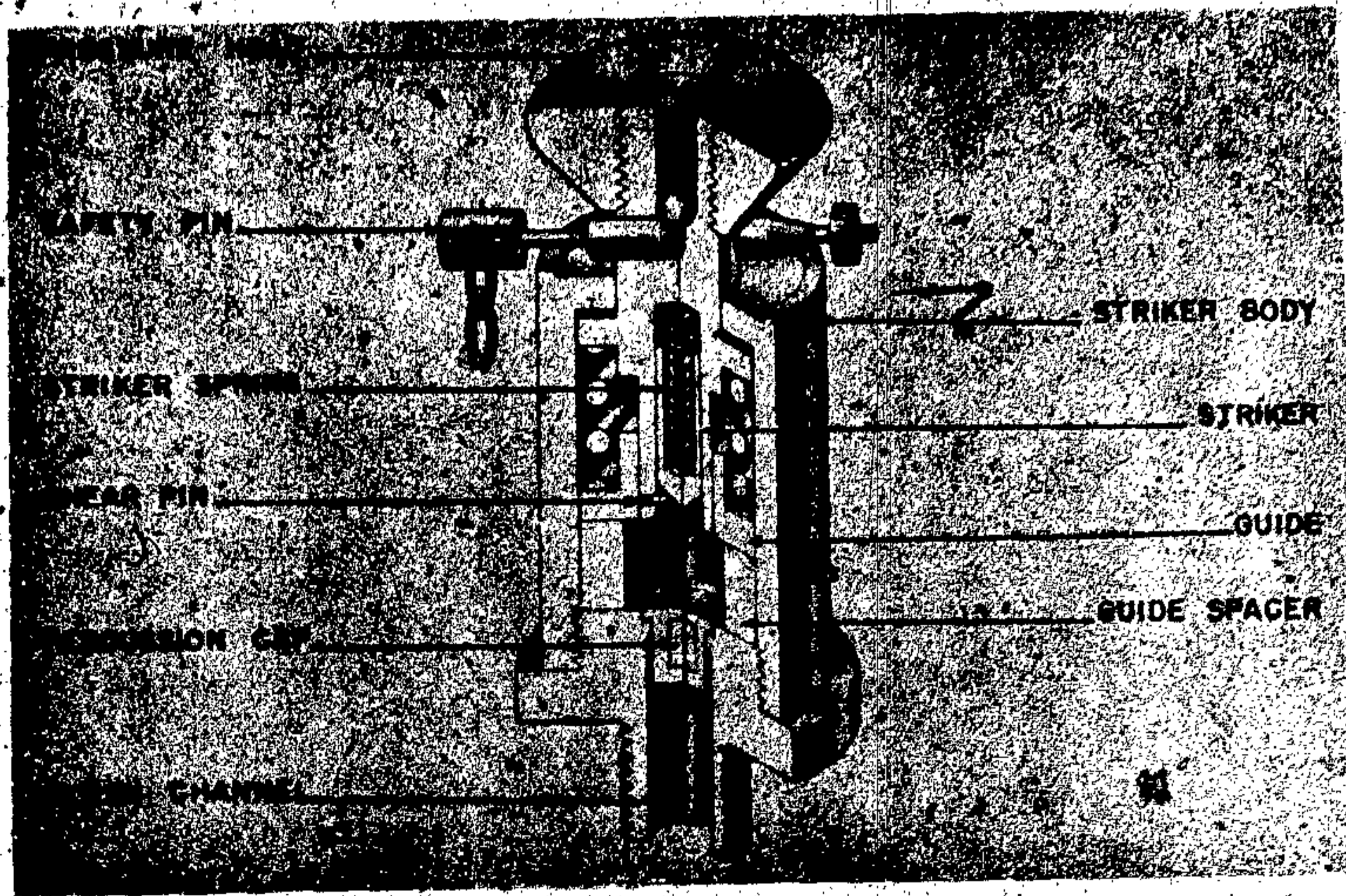

Figure 263—D. Z. 35 (B) Pressure Igniter

balls are then forced outward into the lower open space, releasing the striker. The striker driven by the striker spring, sets off the percussion cap.

EMPLOYMENT. Used to fire prepared charges of the type where pressure, as from heavy vehicles, can be readily applied. It is also used as the main igniter in the heavy antitank mine.

D. Z. 35 (B) (PRESSURE TYPE)

DATA:

Length: 2¾ inches.

Diameter: 1 inch.

Color: Unpainted.

Pull or Pressure Required: 15 to 20 pounds.

Material: Brass.

DESCRIPTION. This type is similar to the larger type (D. Z. 35 (A)) except for two short pins, guide, and guide spacer. (See fig. 263.) The pins have the same function as the steel balls in the preceding description. The guide and guide spacer combined replace the longer guide found in the larger type. The pressure required to operate this igniter is much less than is required to operate the large type igniter.

OPERATION. This igniter is armed by first removing the safety pin nut and then withdrawing

the safety pin. Pressure on the pressure cap forces the cylindrical plunger downward against the resistance of the pressure spring. The locking pins are then forced outward into the lower open space, releasing the striker. The striker, driven by the striker spring, sets off the percussion cap.

EMPLOYMENT. Used to fire prepared charges of the type where pressure, as from vehicles, can be readily applied. It is also used extensively in booby traps.

SCHUKO IGNITER (PRESSURE TYPE)

DATA:

Length: 6 cm.

Diameter: 4.8 cm.

Color: Black.

Pull or pressure required: Approximately 40 pounds.

Material: Metal.

DESCRIPTION. The igniter consists of an inverted L-shaped tube, the vertical arm of which is screw-threaded externally to screw into the mine. The horizontal arm, into which is fitted the percussion cap, is screw-threaded internally to accept the steel striker housing, and is shaped externally to provide, on the top, a lug to take the actuating lever pivot.

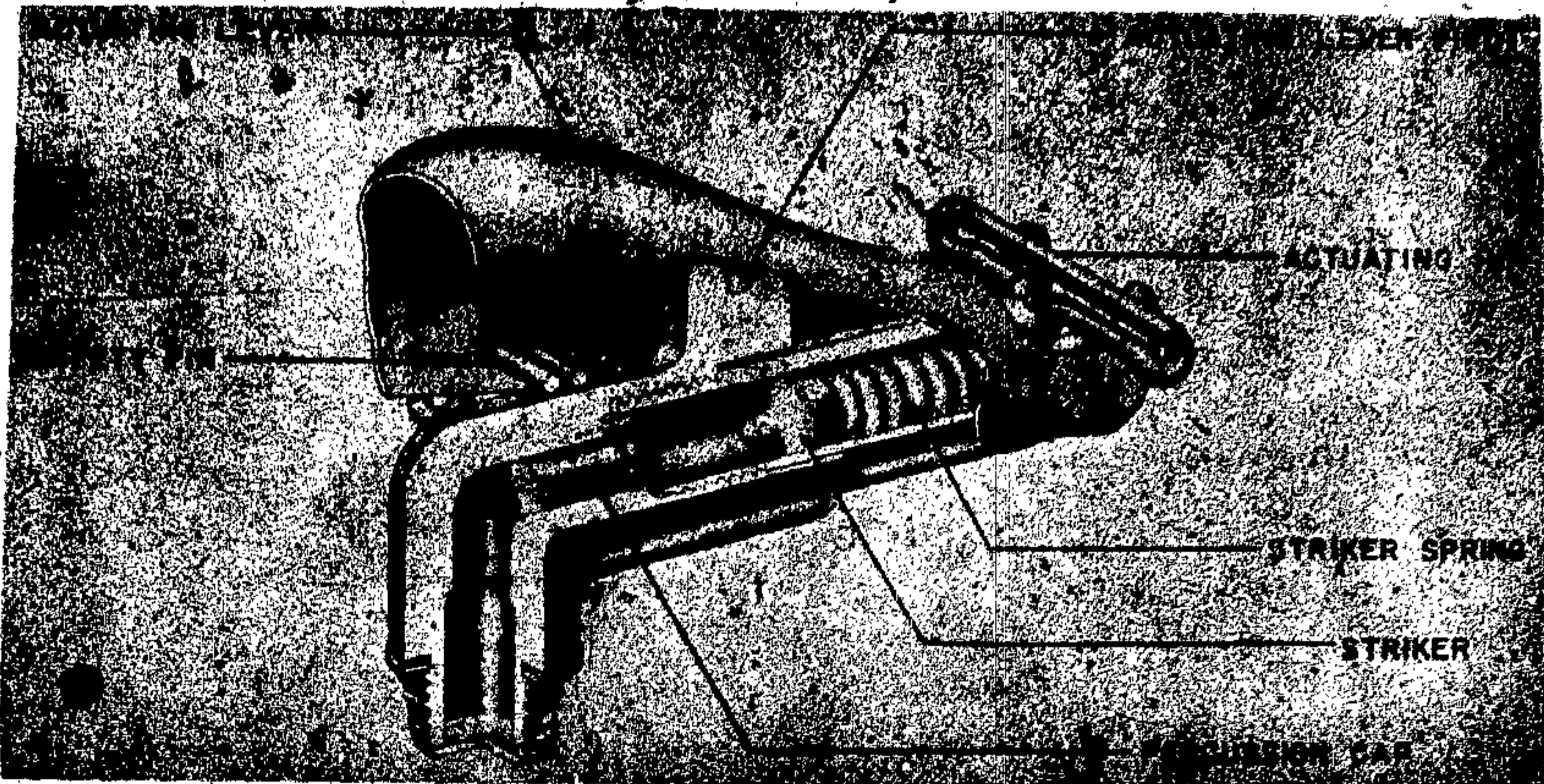

Figure 264—Schuko Pressure Igniter

The striker housing contains a striker and striker spring. The striker is retained in a cocked position by a striker retaining pin which has two shoulders over the end of an actuating lever.

The actuating lever consisting of a hollow metal tripping piece, is pivoted on a rivet, and is fitted with a safety pin resting on the "elbow" of the igniter body.

OPERATION. After removal of the safety pin, a downward pressure on the actuating lever will cause it to bear against the shoulders of the striker retaining pin. A pressure of approximately 40 pounds will force out the striker retaining pin and so release the striker to fire the percussion cap. (See fig. 264.)

EMPLOYMENT. Used in the Glasmine 43 as an alternative to the Buck igniter.

PX 32 (PRESSURE TYPE)

DATA:

Length: 3½ inches.

Diameter: 1 inch.

Material: Metal.

DESCRIPTION. The striker bolt is apparently constructed in two parts, the inner component supporting at its top end the hollow pressure cap on the top of which is a small metal vane. The bolt is contained in a stout casting and is normally

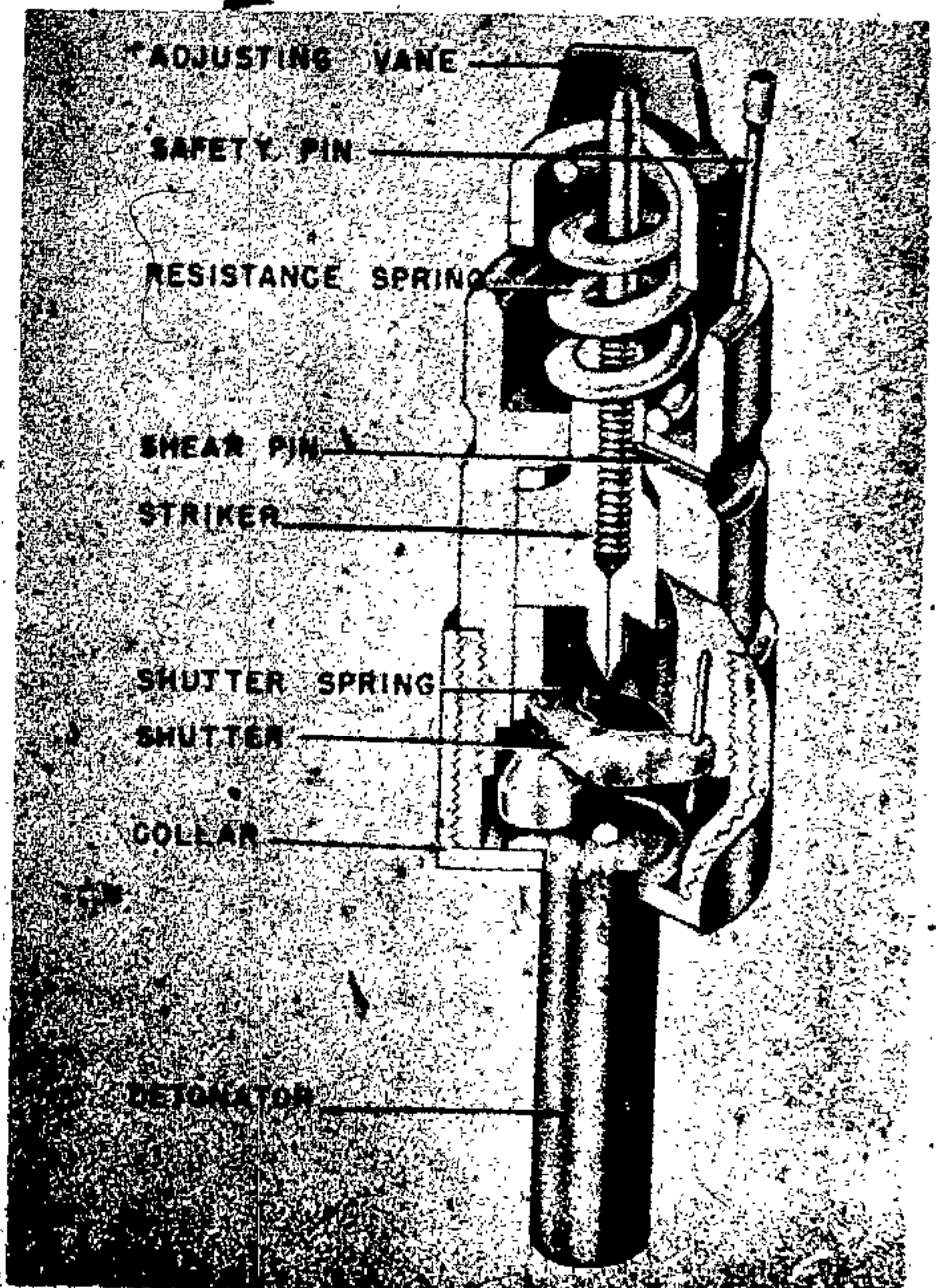

Figure 265—PX 32 Pressure Igniter

GERMAN EXPLOSIVE ORDNANCE

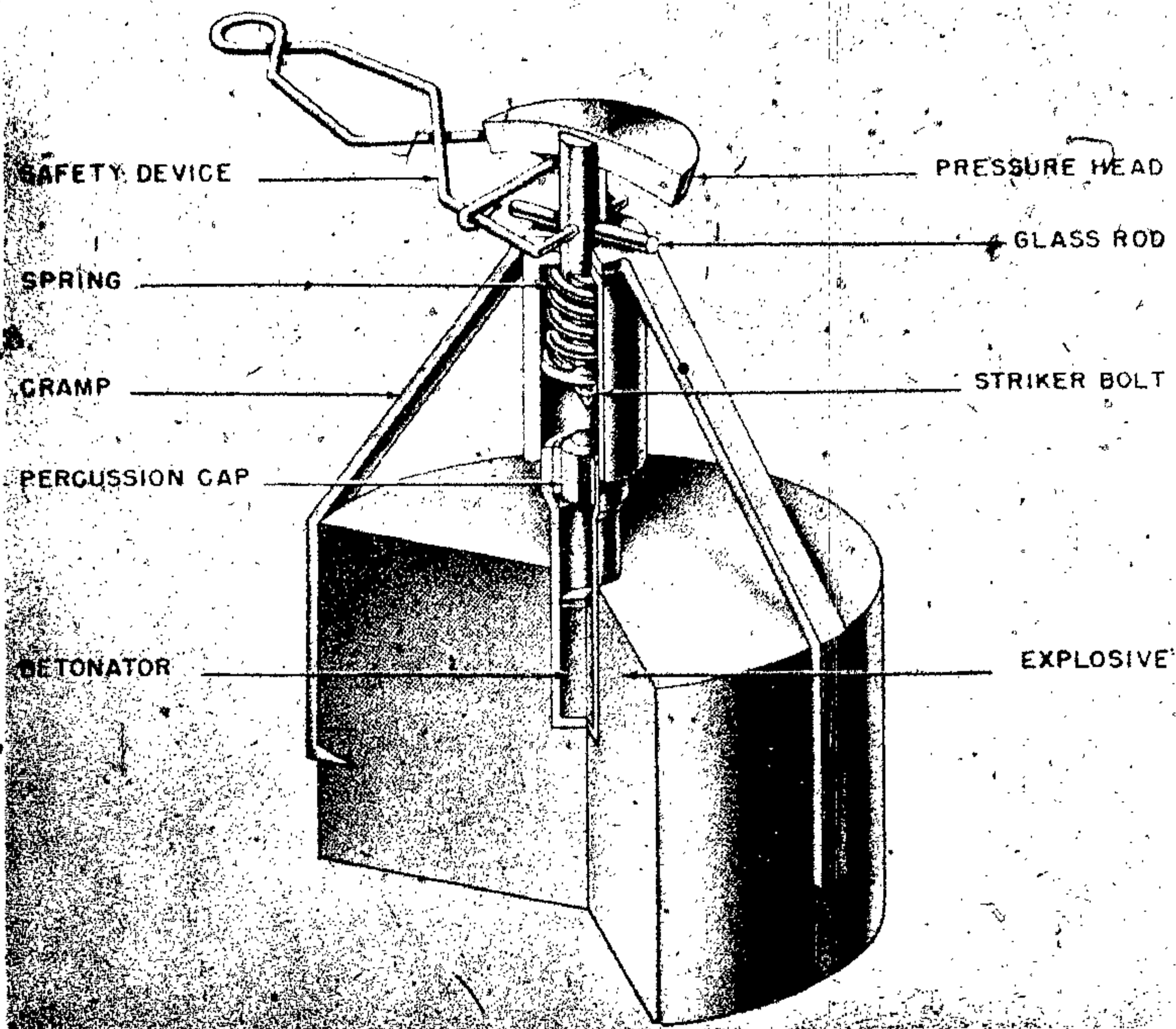

Figure 266—Weissman Pressure Igniter

retained in that position by a spring when the horizontal safety pin is removed. The base of this igniter is the percussion cap and a No. 8 detonator. Above the percussion cap is a safety device consisting of a small wing shaped shutter which is pivoted at one end. When the igniter is unarmed this shutter is held over the percussion cap, against the action of a small spring, by the vertical safety pin. (See fig. 265.)

OPERATION. Pressure on the pressure cap overcomes the resistance spring and shear pin and forces the striker into the percussion cap. Flame from the percussion cap ignites the detonator.

EMPLOYMENT. Designed for use as a push or impact igniter on improvised mines.

WEISSMAN IGNITER (PRESSURE TYPE)

DATA:

Length: $2\frac{3}{8}$ inches w/det.

Diameter: $\frac{5}{8}$ inch O. D.

Material: Metal (glass shear pin).

DESCRIPTION. It consists of a spring loaded striker bolt at the top of which is a grooved pressure head. The bolt is held against the spring by a small glass rod, 0.05 inch in diameter, which passes through a hole in the bolt and by a safety device. This safety device consists of a small pair of tongs, the turned-in ends of which fit into another housing in the bolt and are retained in position by the small spring cramp. In the base of this igniter is a percussion cap and the short No. 8 detonator. The igniter and detonator assembly are fitted to the H. E. by the thin metal cramp. (See fig. 266.)

OPERATION. In operation it is assumed that the safety tongs are removed by withdrawing the clamp. Pressure or a blow on the pressure head will then shatter the glass rod and allow the spring to drive the striker on to the percussion cap.

EMPLOYMENT. Designed to be used as a push igniter for improvised mines, etc., or as an impact igniter for H. E. charges when used in an assault.

S. Mi. Z. 35 (PRESSURE TYPE)

DATA:

- Length: $3\frac{3}{4}$ inches.
- Diameter: $\frac{3}{4}$ inch.
- Color: Olive drab.
- Pull or pressure required: 8 to 10 pounds.
- Material: Aluminum.

DESCRIPTION. The body of the igniter consists of three parts; the upper housing, center housing, and the lower housing. The upper housing contains the pressure spring and the plunger, which has three antennae attached to its upper end. The central housing acts as a guide for the plunger. The lower part contains the percussion cap and is threaded for attachment to the mine.

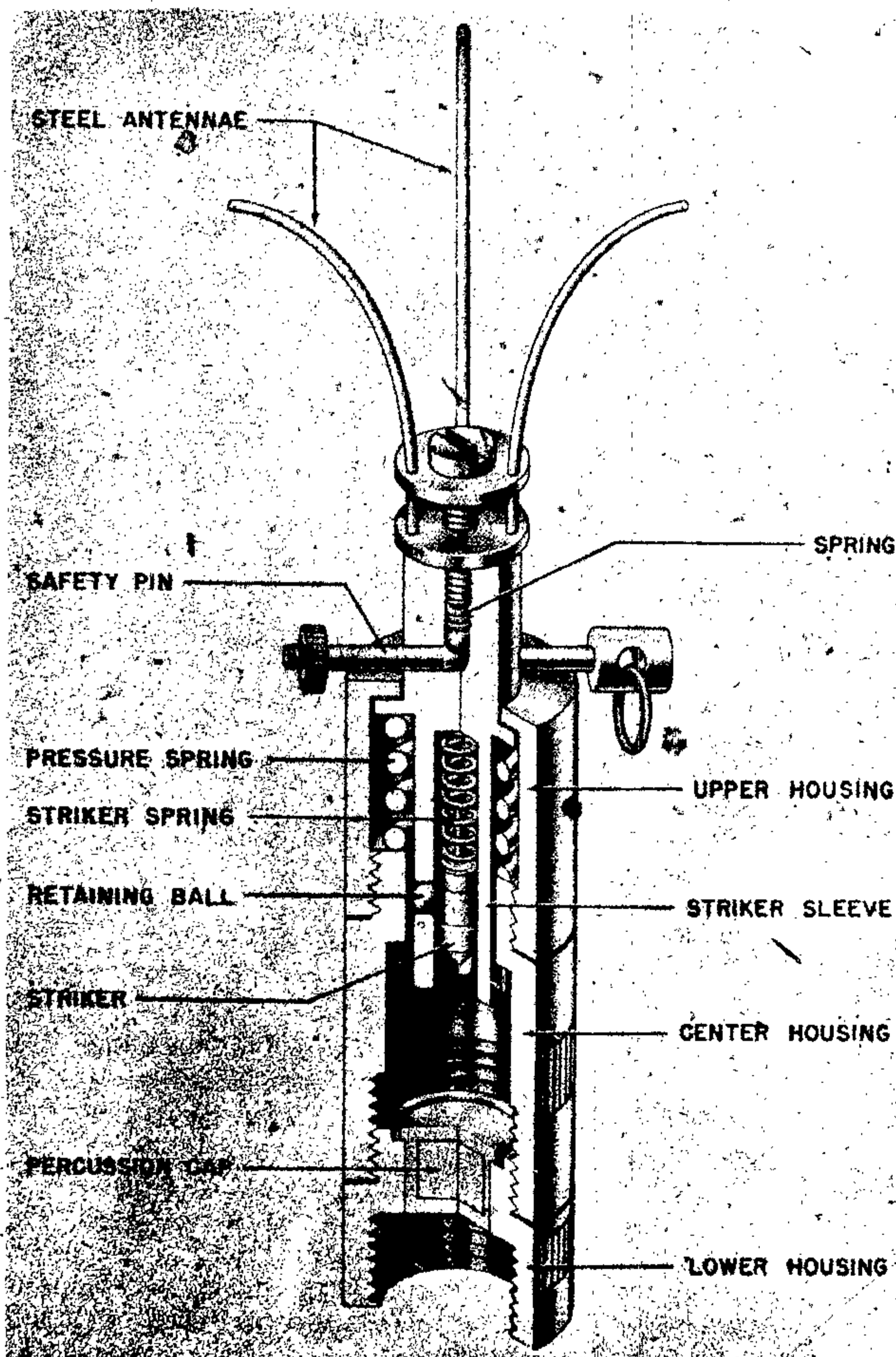

Figure 267—S. Mi. Z. 35 Pressure Igniter

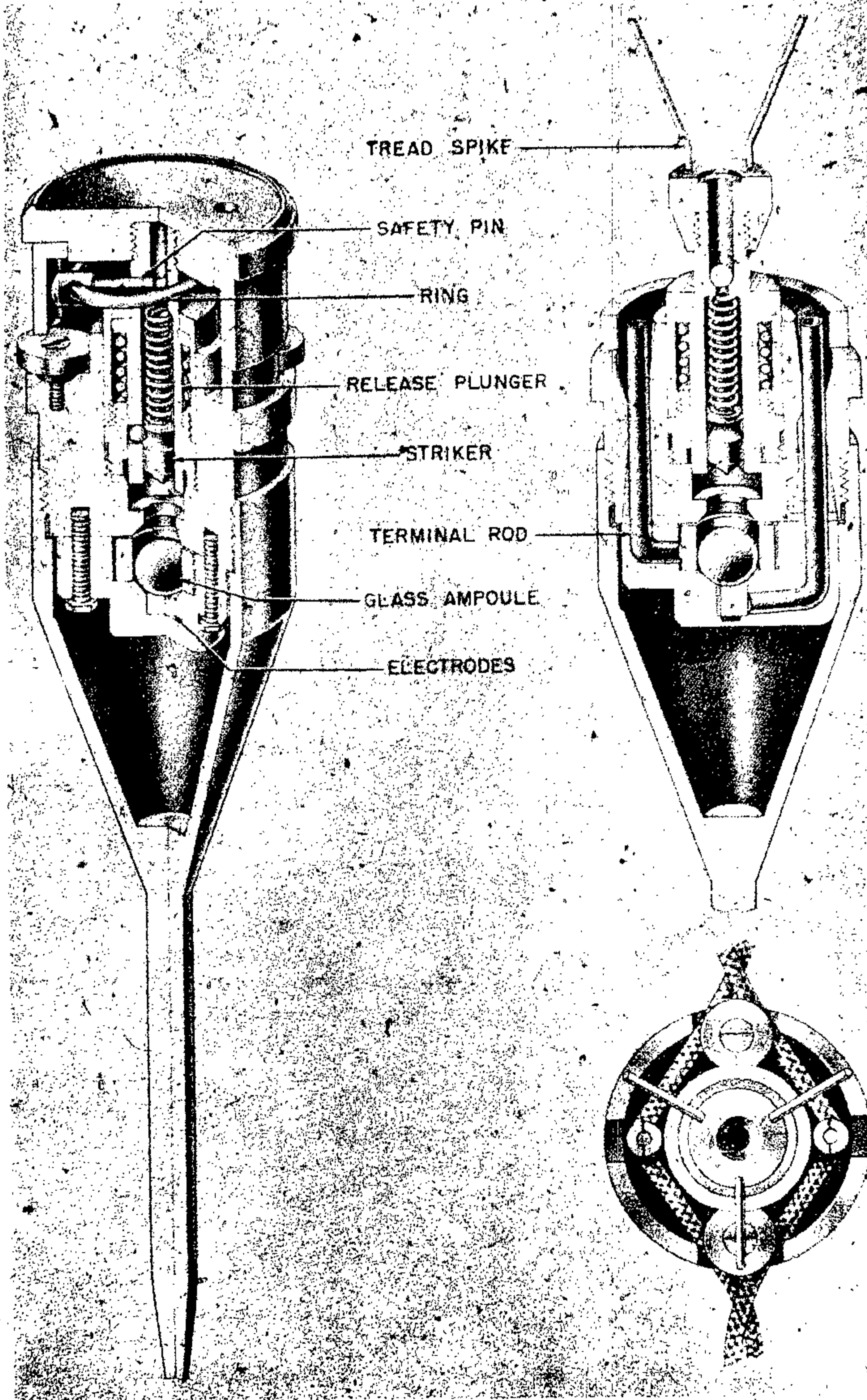

Figure 268—E. S. Mi. Z. 40 Pressure Igniter (Electric)

The striker assembly consists of the striker, the striker spring and two locking balls which hold the striker in a cocked position. The striker and striker spring are contained in a plunger, being retained there by the locking balls. The upper end of the plunger is pierced to take the safety pin. The safety pin is fitted with a locking nut and is retained in position by a spring-loaded locking ball.

OPERATION. After the safety pin is removed, the igniter is armed. Eight or ten pounds of pressure on the prongs overcomes the resistance of the pressure spring and depresses the plunger. When the plunger has been sufficiently depressed, the locking balls are freed and the striker released. The striker is then driven into the percussion cap by the striker spring. (See fig. 267.)

EMPLOYMENT. This igniter has been developed for use with the S or bounding mine. Usually only the tips of the prongs are above ground.

E. S. Mi. Z. 40 (ELECTRIC TYPE)

DATA:

Length: 8 inches.

Diameter: 2 inches O. D.

Color: Fuze—black. Bridge—aluminum.

Pull or Pressure required: 15 pounds.

Material: Fuze—ebonite. Bridge—aluminum.

DESCRIPTION. The igniter is housed in an ebonite moulding into which is screwed a pressure igniter mechanism similar in operation to the S. Mi. Z. 35 igniter. The igniter has a transit cap the wall of which is recessed to accommodate the safety pin. This safety pin is provided with a ring which is folded back over the igniter head. When the igniter is laid in position, the transit cap is removed and the three-pronged "tread-spike" which is a push fit on to the striker release plunger is mounted in its place. In place of the detonator cap, as fitted to the S. Mi. Z. 35, is housed the glass ampoule in a cup shaped recess in the porcelain fitting which is screwed into the base of the molding. This ampoule contains an orange liquid which, when released, forms the electrolyte for a small cell. The electrodes of this cell are formed by the lining of the recess and are attached to the two terminal rods. The assembly is completed by the aluminum cup which screws on to the base of the ebonite moulding over

the porcelain fitting and terminates in a spike for insertion into the ground. (See fig. 268.)

Nine of these igniters are wired up in parallel with 2 feet 7 inches of wire between each igniter and 5 feet 3 inches of wire leading away from one end of the chain of igniters and terminating in two plugs which are protected during transit by the caps. The plugs fit into sockets in the bridge which screws on to the mine. This bridge incorporates an electric flash housed in the aluminum tube which is protected during transit by the cap. Other components consist of the pressure bar which enables the igniters to be used in pairs, the bridge assembly holder and the pressure plate which is to be used in conjunction with the igniter in soft ground.

OPERATION. Pressure on the prongs of the electric detonator depresses the release plunger, releasing the two steel locking balls in the head of the striker and permitting the striker spring to drive the striker into the glass ampoule containing the electrolyte. The electrolyte sets up current between the electrodes and this current induces a flash in the flash tube of the firing bridge, exploding the mine.

EMPLOYMENT. These electric spikes are used to explode the S mine. The two chains of nine igniters used with each S mine greatly enlarge the igniter area for one mine making possible equally effective mine fields although fewer mines are used.

T. Mi. Z. 35 (PRESSURE TYPE)

DATA:

Length: 2¼ inches.

Diameter: 1⅝ inches O. D.

Pull or pressure required: 250 to 400 pounds.

Material: Brass.

DESCRIPTION. The body is generally made of brass and houses a cylindrical-shaped assembly which has a free fit in the igniter body. The collar screws to the bottom of the body to hold the cylindrical assembly in place in the body. Clearance is provided so that the body and the internal cylindrical assembly can move vertically with respect to each other, except as prevented by the safety devices, to be described later, and the shear pin. The internal cylindrical assembly consists of a body which acts as a guide for the striker or

GERMAN EXPLOSIVE ORDNANCE

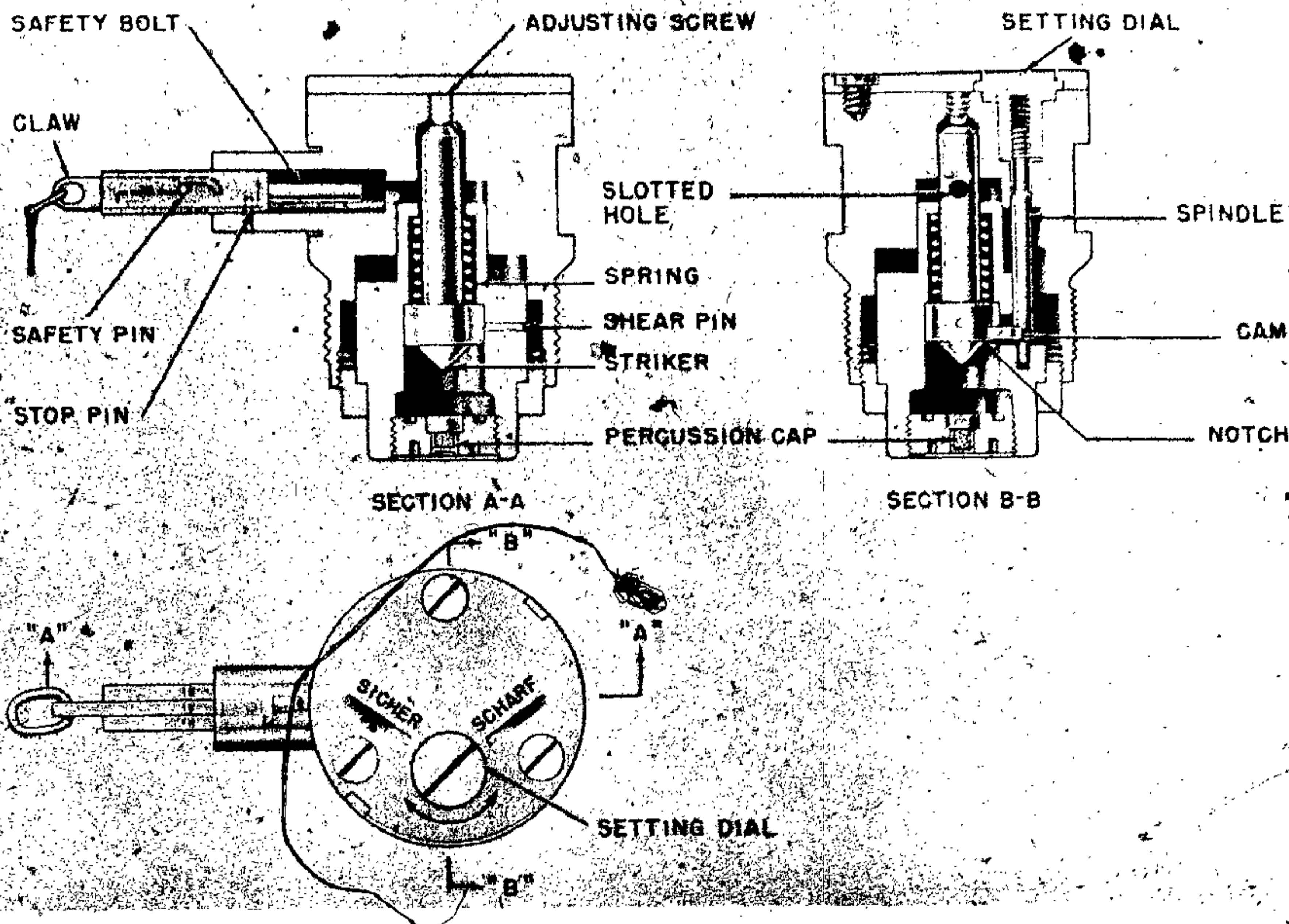

Figure 269—T. Mi. Z. 35 Pressure Igniter

firing pin and a base plug, containing the percussion cap. When igniter safety devices are disengaged, the striker is held in a cocked position within the guide body by the striker spring under compression and the shear pin. A cover plate is fastened by screws to the top of the igniter body and contains a setting dial. The plan of the igniter shows markings "SICHER" (safe), "SCHARF" (armed), and a red dot on the setting dial. A white line appears under "SICHER" (safe) and a red line appears under "SCHARF" (armed). A slot is provided on the setting dial to permit turning. (See fig. 269.)

The igniter has two safety devices. The main safety device consists of a safety bolt which passes through a slotted hole in the striker and prevents full movement of the striker pin if, for instance, the shear pin should be damaged or sheared, and locks movement between the body and the cylindrical body. The safety bolt is moved in or out of the "safe" position by means of a claw to which is attached a flexible wire. A stop pin in the body

prevents the complete removal of the safety bolt. The claw and wire are removable and will probably be missing in captured mines when found in the armed condition. The cylindrical bolt is designed with a shoulder to center it in the hole in the igniter body. The enlarged portion of the bolt is slotted to receive the claw, which is engaged by the pin. The secondary safety device is designed to hold the striker off the shear pin until the igniter is armed. The secondary safety device is a spindle with its upper end secured to the setting dial in the cover plate of the igniter. The spindle's lower end has attached to it a cam. The cam is equivalent to a 130° sector of a spiral ramp. The device is in a "safe" position when the red dot on the setting dial is opposite the white line under the word "SICHER" (safe). In this position the cam fits underneath a notch cut into the shoulder of the striker. The device is armed, except the bolt, by turning the setting dial counterclockwise until the red spot is opposite the red line under "SCHARF" (armed). This operation rotates the

LAND MINES, GRENADES, AND IGNITERS

cam to clear the notch of the striker, thus releasing the striker until it is supported only by the shear pin. In this position the full compression of the spring is resisted only by the shear pin.

OPERATION. This igniter is armed by turning the setting dial counterclockwise until the red spot is opposite the red line under "SCHARF" and then withdrawing the safety bolt until it is latched by the stop pin. After arming, sufficient pressure applied at any point on the lid of the mine will move the igniter body downward in relation to the internal firing assembly. When the body reaches a point where the top of the striker has made contact with the adjusting screw, further downward movement will force the striker downward, thus shearing the shear pin. The compressed striker spring will then force the striker into the percussion cap, firing it.

EMPLOYMENT. This igniter was especially designed for use as the main igniter in the Tellermine.

REMARKS. This igniter is subject to blast effect.

T. Mi. Z. 42 (PRESSURE TYPE)

DATA:

Length: 2.1 inches.

Diameter: .85 inch.

Color: Dark green.

Pull or pressure required: 250 to 400 pounds.

Material: Steel.

DESCRIPTION. The cylindrical shaped body is bored to receive the striker, striker spring, and detonator cap housing. The striker is dome-shaped at its upper end and is drilled transversely to accept the shear pin. At the lower end of the striker, a collar forms the seat for the striker spring. A longitudinal inclined slot is machined in the lower end of the striker to prevent air cushioning. A retaining cap, screwed to the detonator cap housing, holds the detonator in a central position. (See fig. 270.)

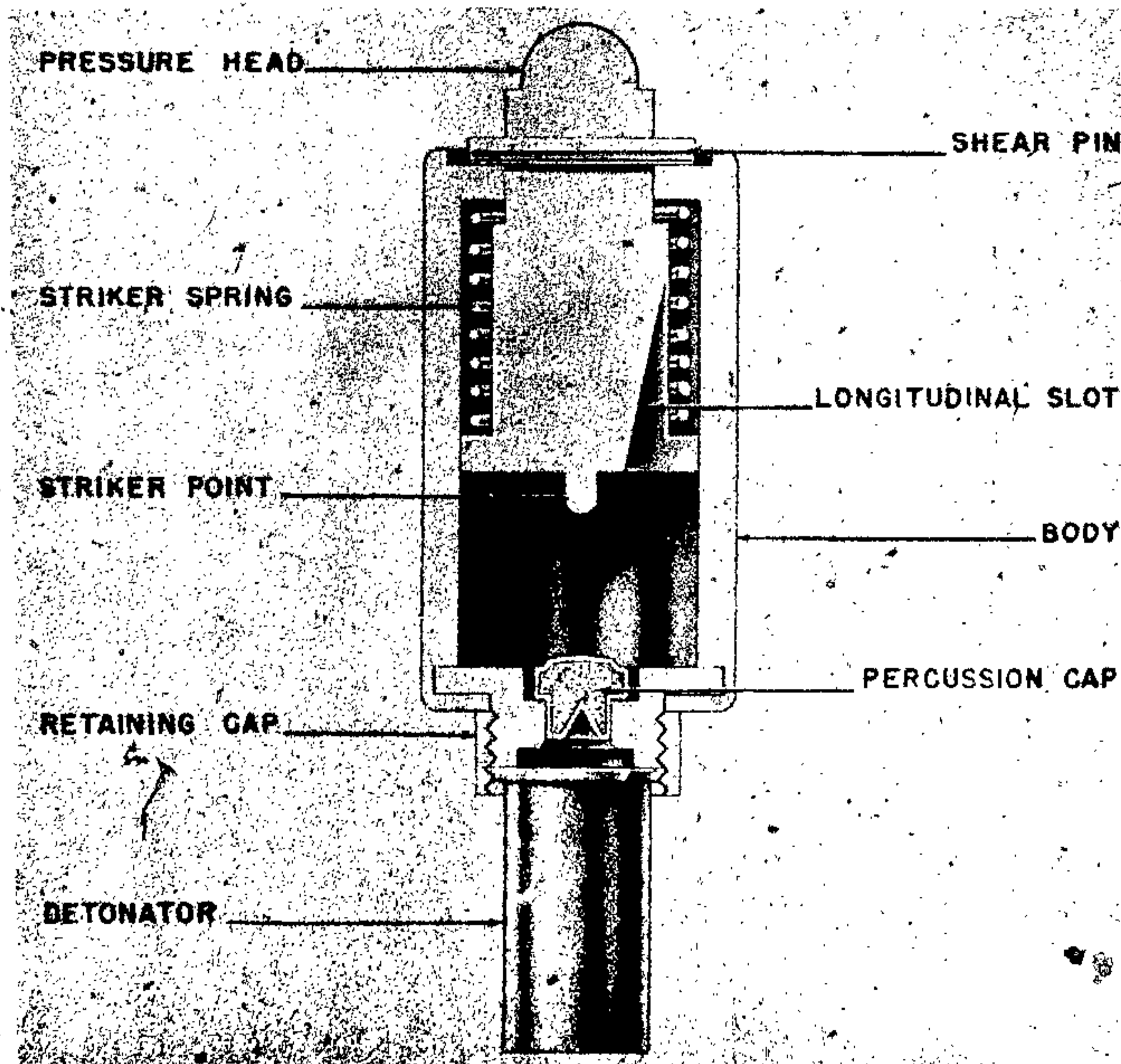

Figure 270—T. Mi. Z. 42 Pressure Igniter

GERMAN EXPLOSIVE ORDNANCE

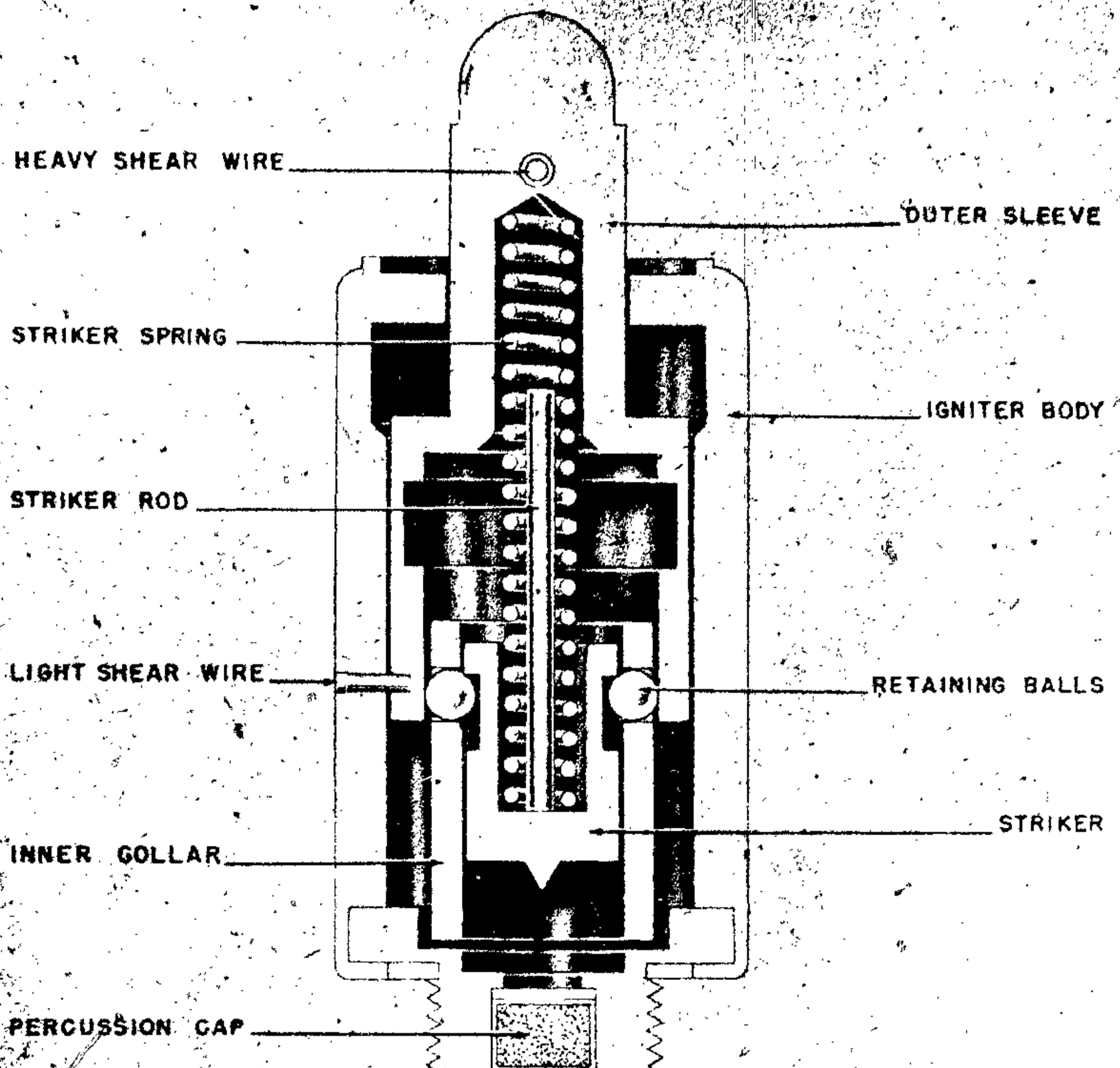

Figure 271—T. Mi. Z. 43 Pressure Igniter

OPERATION. Sufficient pressure on the striker head causes the shear pin to break, releasing the striker. The freed striker is driven into the detonator cap by the compressed striker spring.

EMPLOYMENT. This igniter is used with the T. Mi. 35 steel, T. Mi. 42 and 43 mushroom. It does not have standard German threading.

T. Mi. Z. 43 (PRESSURE TYPE)

DATA:

Length: $2\frac{1}{4}$ inches.

Diameter: $\frac{7}{8}$ inch.

DESCRIPTION. The igniter consists of an outer casing into which is pressed a cap holder. Inside the casing is an outer sleeve, the upper part of

which is solid and protrudes through the top of the casing. This portion of the sleeve is fitted with a strong shear wire, and the lower casing is connected to the outer casing by a weak brass shear wire. Inside the outer sleeve is a plain tubular inner collar, containing the striker head. The striker head is held in a cocked position by two retaining balls which fit in holes in the inner collar and bear against the outer collar and a groove in the striker head. The striker head carries a rod which serves to position the striker spring. (See fig. 271.)

OPERATION. A detonator is screwed onto the threaded end of the igniter and the entire assembly is inserted into the mine. Arming is carried out by screwing down the pressure cap; i. e., the

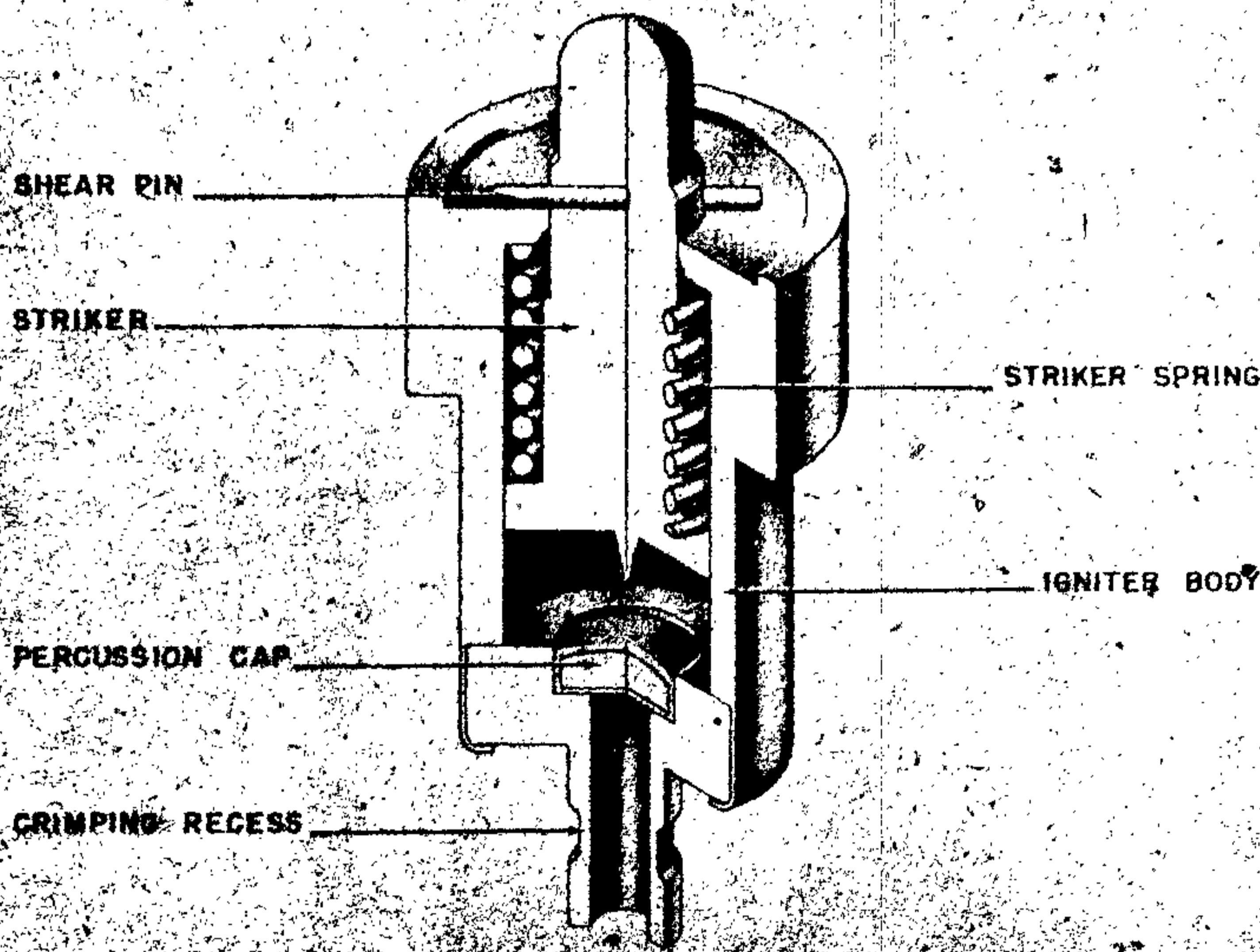

Figure 272—Mi. Z. 530 (e) Pressure Igniter

nilled cap on the T. Mi. 35 and T. Mi. 35 modified, the hexagonal cap on the T. Mi. 42, or the mushroomhead pressure plate of the T. Mi. 43 (mushroom). This forces down the outer sleeve, shearing the brass shear wire with an audible snap. The mine is now ready for use. The outer sleeve is free to move up or down relative to the rest of the igniter if the pressure cap is raised or lowered and the igniter will function in either of two ways:

1. If the pressure plate of the mine is depressed by a vehicle, the outer sleeve is pressed down until the shear wire is sheared, the balls escape above the shoulder of the sleeve and the striker is free to be driven into the percussion cap by the striker spring.

2. If the pressure cap is unscrewed, the outer sleeve is forced upwards by the striker spring until the balls escape below the shoulder and the striker is released to be driven into the percussion cap by the striker spring. The balls are not released until the pressure cap is nearly unscrewed.

EMPLOYMENT. The igniter can be fitted into the following mines:

- T. Mi. 35 adapter to take T. Mi. Z. 42.
- T. Mi. 35 (steel).

T. Mi. 42.

T. Mi. 43 (mushroom).

It is, however, unlikely to be used with either of the 35 types since there is no satisfactory way of adjusting the height of the socket which fits below the base of the igniter, or of locking it in position. Fitting the T. Mi. Z. 43 to these mines, therefore might be unsafe. Captured documents indicate that use of this igniter is confined to the T. Mi. 42.

MI. Z. 530 (e) (PRESSURE TYPE)

DATA:

Pull or Pressure Required: Approximately 640 pounds.

Material: Metal.

DESCRIPTION. The igniter consists of a steel body housing a striker and striker spring. (See fig. 272.) The striker is retained in a "cocked" position by a shear wire which runs through the striker stem and rests on the upper surface of the body. At the base of the igniter, is the percussion cap housing which extends to form a flash channel. This extension bears an annular groove into which

GERMAN EXPLOSIVE ORDNANCE

can be crimped a standard German detonator (Sprengkapsel No. 8 A1).

OPERATION. Pressure on the head of the striker stem shears the shear wire and allows the striker spring to drive the striker into the percussion cap. The resultant flash passes through the flash channel and initiates the firing of the detonator and main charge.

EMPLOYMENT. This igniter was manufactured by the Germans for use in the British anti-tank mines Mk. 3.

TOPF IGNITER (PRESSURE TYPE)

DATA:

Length: 2 inches.

Diameter: $\frac{7}{8}$ inch O. D.

Color: Frosted glass.

Pull or Pressure Required: 150 kgs (on mine).

Material: Glass.

DESCRIPTION. The igniter consists of a hollow, cylindrical, glass body into which fits a solid pressure head. The body is screw-threaded externally to take (a) the detonator pocket, and (b) to screw into the igniter seating contained in the body of the mine. The detonator pocket is made of plastic. Inside the igniter body are two glass ampoules containing liquid. These are fixed by adhesive to a circular celluloid disk. A collar formed round the pressure head seats on the upper rim of the igniter body, the lower face of the head being held just clear of the glass ampoules. A circumferential shear groove is formed round the pressure head.

OPERATION. A pressure of 150 kg on the pressure plate of the Topf mine will cause it to shear and bear against the pressure head of the Topf igniter. This pressure head will, in turn, be forced into the glass ampoules which will be crushed. The interaction of the liquids will ignite

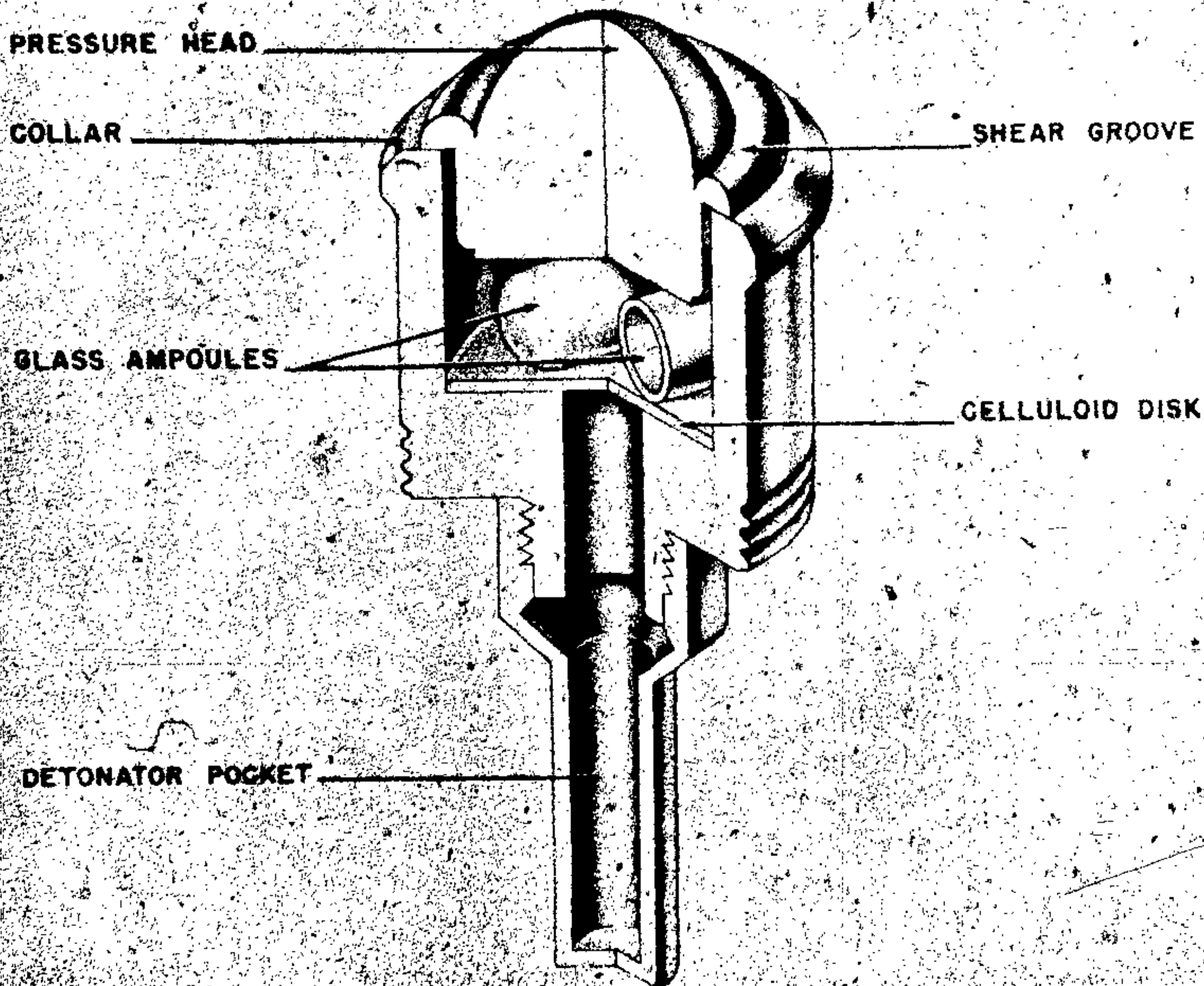

Figure 273—Topf Pressure Igniter

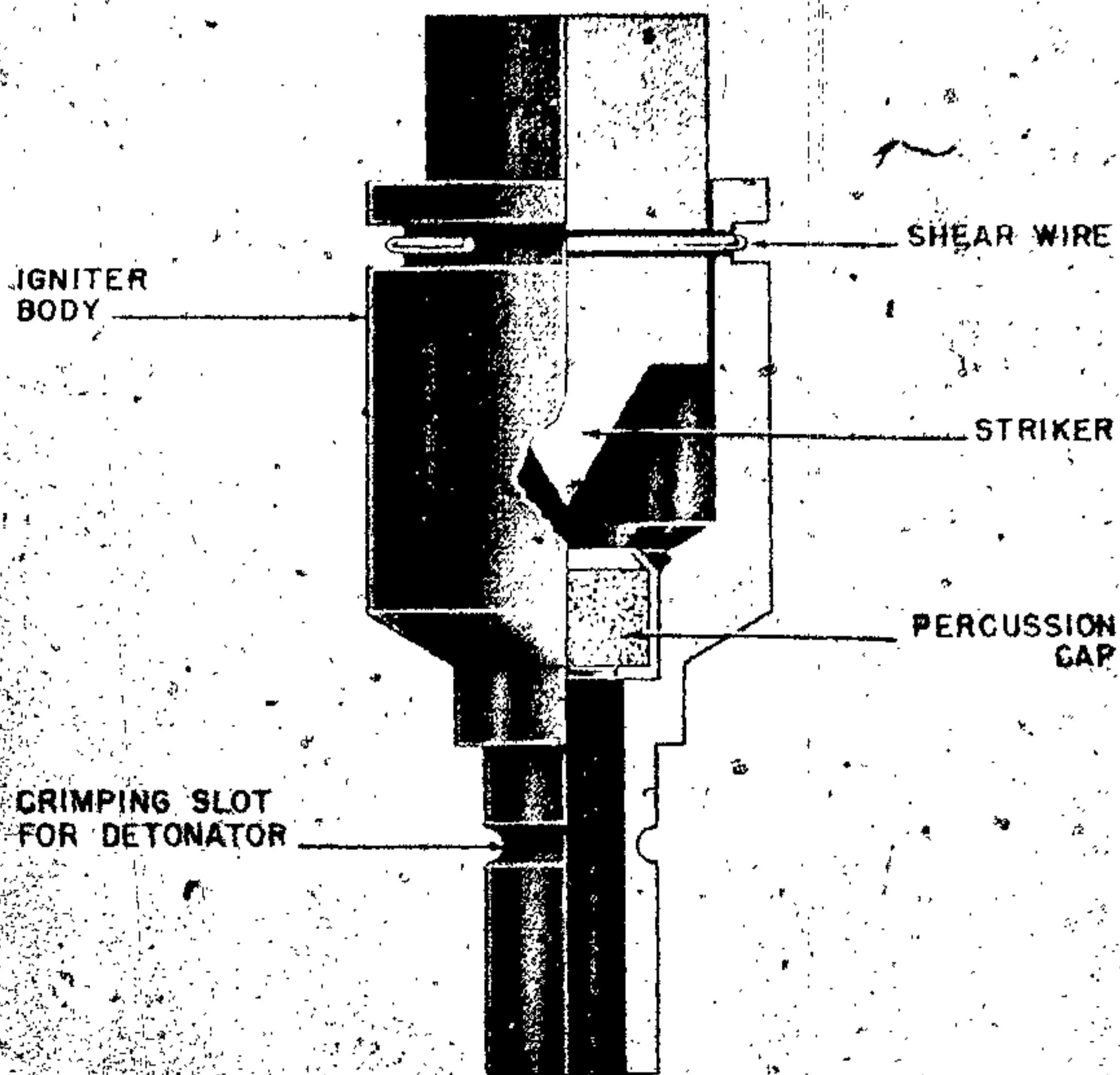

Figure 274—Fi. Es. Mi. Z. Pressure Igniter

the detonator, thus igniting the primer and finally the main charge of the mine. (See fig. 273.)

EMPLOYMENT. Designed for use with the Topf mine.

FI. ES. MI. Z. (PRESSURE TYPE)

DATA:

- Length: 1.5 inches.
- Diameter: $\frac{7}{16}$ inch.
- Color: Dark green.
- Pull or pressure required: 11 pounds.
- Material: Brass.

DESCRIPTION. The body of the igniter forms a housing for the striker and for the detonator cap. The lower end terminates in a sleeve to which the detonator can be crimped. Holes are drilled in the body to accept the copper shear wire which passes through the striker, the ends being bent into the cannellure. (See fig. 274.)

OPERATION. Pressure on the head of the striker shears the copper shear wire and forces the striker into the detonator cap. The subsequent flash passes to the detonator which in turn initiates the main charge of the mine.

EMPLOYMENT. This igniter was designed for use with the antipersonnel glass bottle mine (Eis-meine 42).

ALL-EXPLOSIVE DEVICE (PRESSURE RELEASE TYPE)

DATA:

- Total weight: $9\frac{1}{2}$ ounces.
- Height: $1\frac{1}{8}$ inches.
- Length: $3\frac{7}{8}$ inches.
- Width: 2 inches.
- Color: Greyish black.
- Pull or pressure required: 1 pound.
- Material: Cast explosive brass.

DESCRIPTION. The body of the device is made up of two oblong blocks of molded explosive, held together by two hollow brass bolts. The explosive, a greyish-black substance of smooth texture, is believed to be one of the many forms of Nipolit. The inner surfaces of both blocks bear molded recesses to retain the metal striker mechanism. A threaded detonator well is positioned at one end to receive the cap and detonator assembly. Four holes pass through the charge, two at either

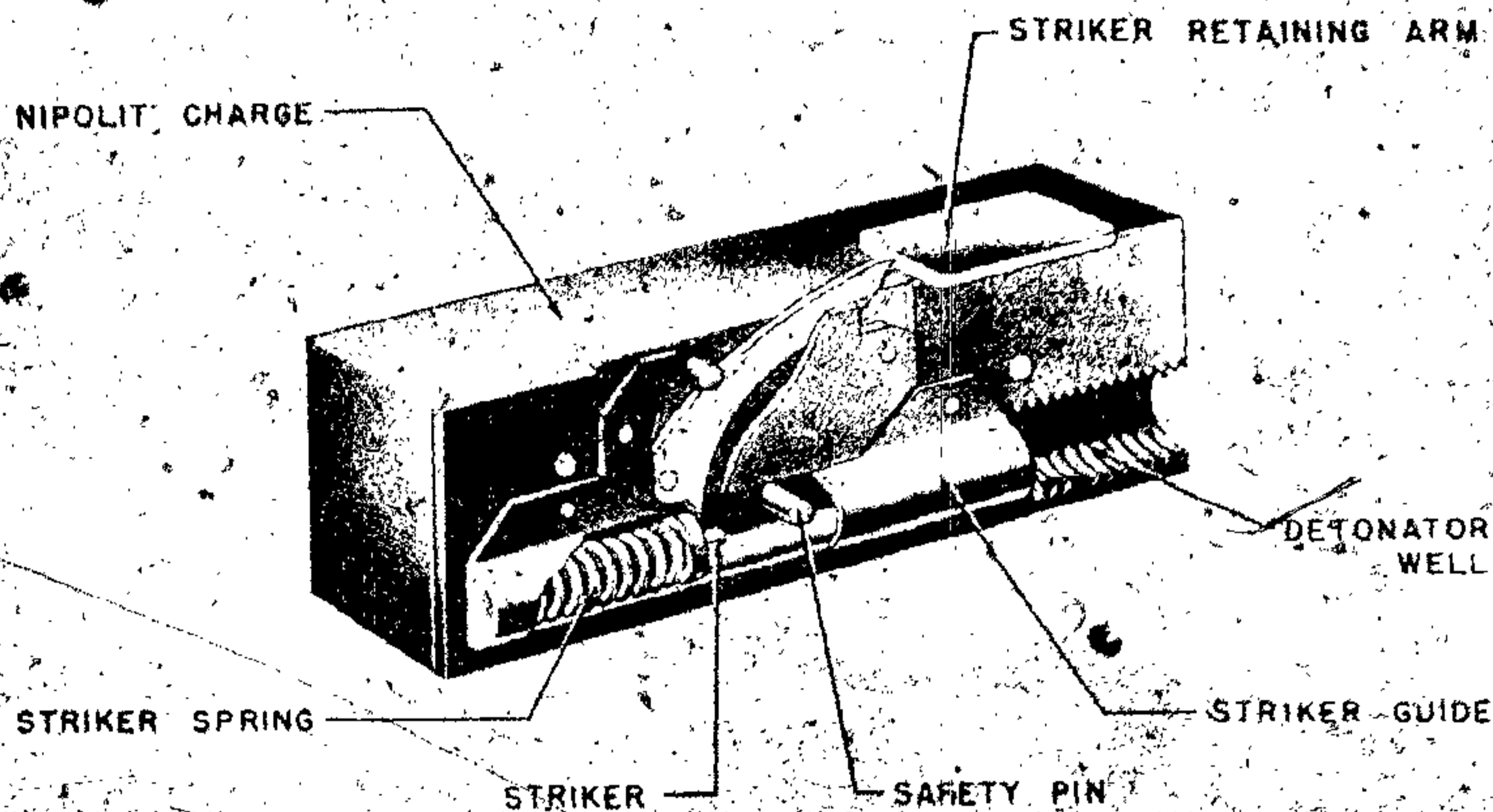

Figure 275—All-Explosive Pressure Release Device

end, for the bolts and two for the safety pins. The cap and detonator assembly is believed to consist of a hollow threaded plug of the same explosive material. The cap and detonator drop into the plug and are then screwed into the wall. (See fig. 275.) The striker mechanism consists of a stamped sheet metal housing, a striked retainer arm, striker spring and striker. In the armed position the striker spring and striker are positioned in the tubular striker guide at the base of the housing and are restrained from firing by a notch or detent in the retaining arm which bears against the shoulder of the spring-loaded striker. The retaining arm pivots at one end on a small bolt positioned above the detent. The two safety pin holes in the metal housing coincide with holes that pass through the explosive body. The upper safety pin passes directly over the retaining arm and prevents it from pivoting. Another hole passes through the tubular base of the housing and is an added safety precaution in that it prevents the striker from striking the cap.

OPERATION. After the device has been placed under the object to be booby trapped, the safety pins are removed. When the external weight is lifted, the striker retaining arm, under the pressure of the striker spring, pivots upward releasing the striker and firing the percussion cap. The cap in turn fires the detonator and the main charge. No booster is required.

EMPLOYMENT. This device is designed for use as a booby trap and can be readily used beneath ordinary household objects as well as mines and other suitable objects.

BUCK IGNITER, CHEMICAL CRUSH-ACTUATED TYPE

DATA:

Length: $1\frac{5}{8}$ inches.

Diameter: $\frac{13}{16}$ inch.

Color: Tan.

Pull or Pressure Required: Approximately 5 pounds.

Material: Brass tube; Aluminum alloy foil.

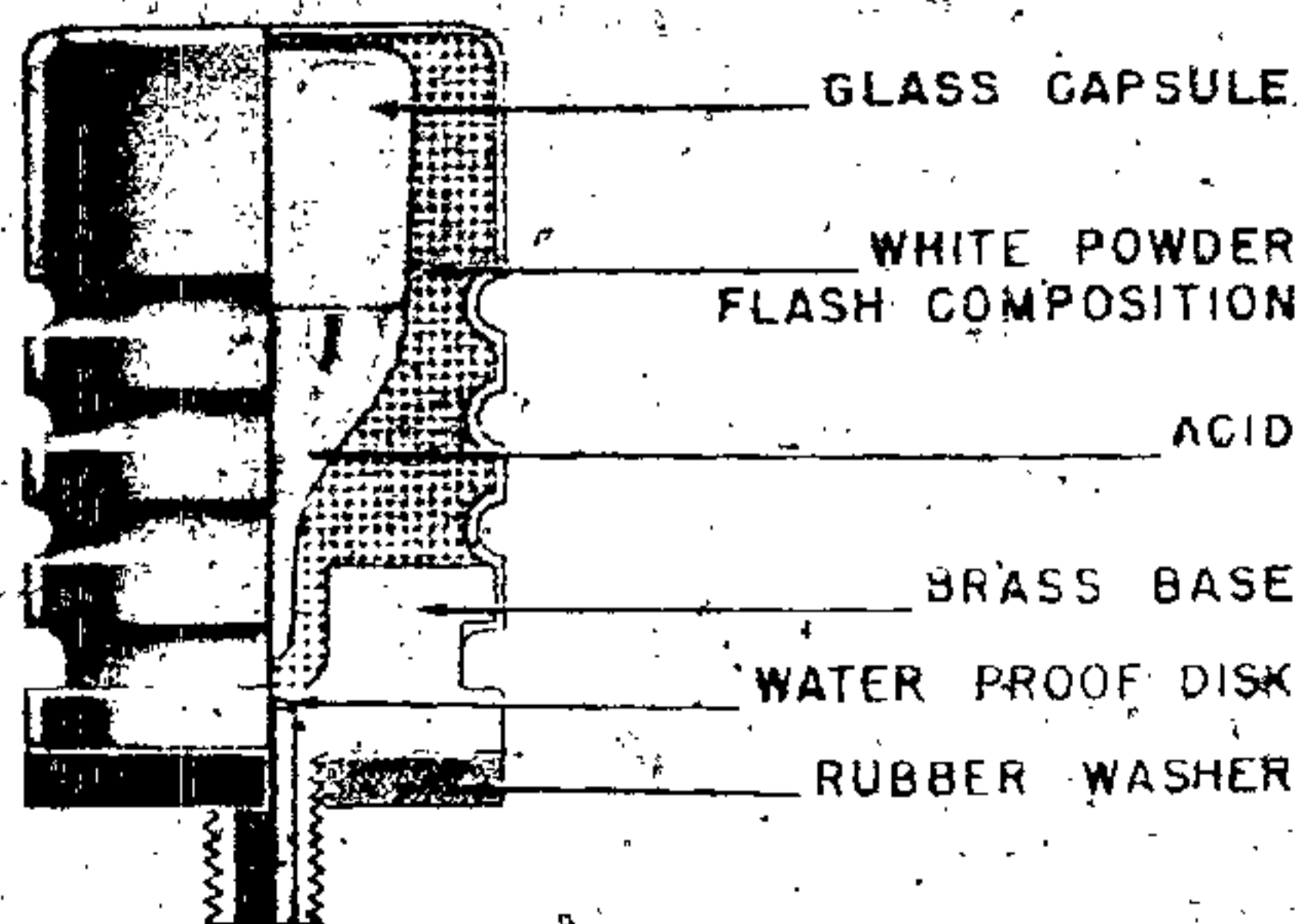

Figure 276—Buck Igniter—Chemical Pressure

LAND MINES, GRENADES, AND IGNITERS

DESCRIPTION. The igniter consists of a thin aluminum alloy foil drum containing a glass ampoule of sulphuric acid and a white powdered flash composition containing naphthalene. (See fig. 276.) The drum is crimped to facilitate crushing from vertical pressure. The glass ampoule is fixed to the top of the drum with pitch. A waterproof paper disk confines the flash composition powder in the igniter and prevents moisture from entering. The drum is secured to a brass base by crimping and a rubberized washer is placed around the threaded portion of this base. The thread is standard and will fit any German booby trap or demolition device.

OPERATION. When pressure is applied, the foil drum is dented and the ampoule is broken. The sulphuric acid contained in the ampoule mixes with the powdered flash composition and the flash resulting from the chemical reaction fires the detonator.

EMPLOYMENT. This igniter has been used principally with the antipersonnel "Pot" mine, but is adaptable for use with any type of German booby trap or demolition device.

LONG-DELAY IGNITER (CLOCKWORK TYPE)

DATA:

Length: $3\frac{5}{8}$ inches.

Diameter: $1\frac{1}{4}$ inch.

Color: Black.

Pull or Pressure Required: 21-day maximum.

Material: Bakelite.

DESCRIPTION: The body houses a rotating disk used for setting the delay, a clockwork mechanism, a battery, and an electrical circuit with a match composition bridge.

The rotating disk has 21 graduations corresponding to the number of days of delay required. The setting is accomplished by rotating the disk until the number corresponding to the number of days delay required corresponds with the pin which is held in tension against the side of the disk by the spring (A). (See fig. 277.)

The clockwork is geared to the rotating disk by gear wheels and is wound by to and fro movements of the winding ring.

A bakelite cover is threaded onto the body over

the time disk while a detonator is screwed into the bottom of the igniter.

OPERATION. When the slot in the time disk comes opposite the pin, the pin is forced into the slot by spring (A). This closes the electrical circuit between the casing and the battery and fires the match composition.

EMPLOYMENT. This igniter is used in conjunction with large scale demolitions where a long delay is required. Several of the igniters may be used on each charge. Although the charges are generally composed of blocks of cast explosives, these igniters will be imbedded in pieces of plastic explosive which is in contact with the main cast charge.

J-FEDER 504 (CLOCKWORK LONG-DELAY)

DATA:

Length: 7 inches.

Diameter: $3\frac{3}{8}$ inches O. D.

Color: Black.

Pull or Pressure Required: $\frac{1}{4}$ hour to 21 days.

Material: Aluminum or bakelite.

DESCRIPTION. The body is an aluminum casting which in its upper portion houses the clock, and in its lower portion the striker mechanism. The top is closed by a screwed cap with a rubber ring washer below it and into the base is screwed the cap holder having leather washers as shown. A key is provided for screwing home this holder. (See fig. 278.)

On removing the cover, the clock is exposed. The knurled cylinder is provided for winding the clock while the center knob stamped Zt, is for setting the clock for any desired delay up to 21 days. The minimum delay is $\frac{1}{4}$ hour.

The delay times are marked on the edges of the disks; the days figured in red, and the hours figured in black. The setting is visible through the window and is indicated by the pin. This latter is connected with the lever arm which allows the trip lever to release the striker at the end of the delay period.

At the 24-hour marking on the black inscribed disk and at the 21-day marking on the red-inscribed disk are slots which allow the pin to move into the channel. These slots are aligned at the zero reading at which position the striker is released. The slot in the disk is covered by a

GERMAN EXPLOSIVE ORDNANCE

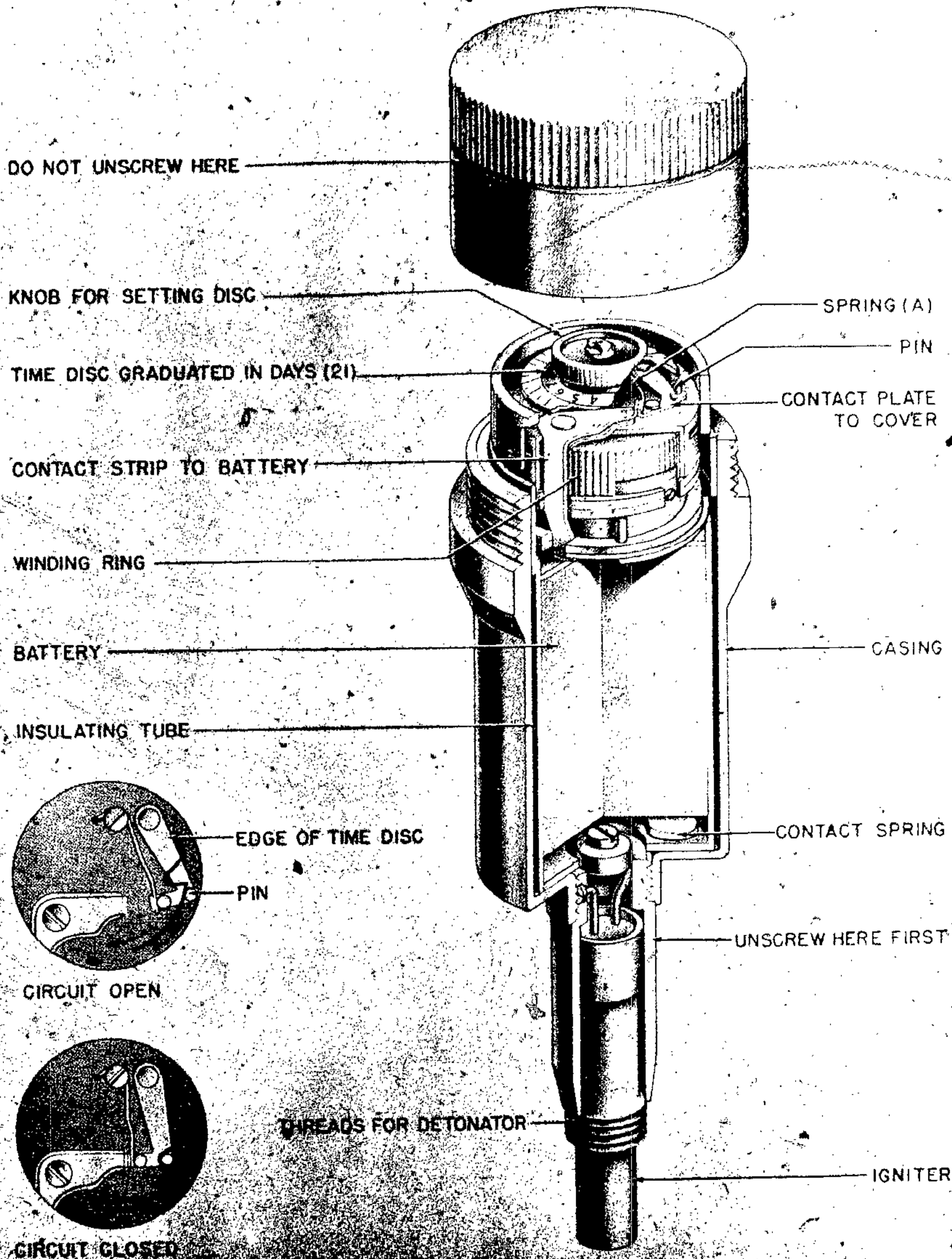

Figure 277—Long-Delay (21-day) Clockwork

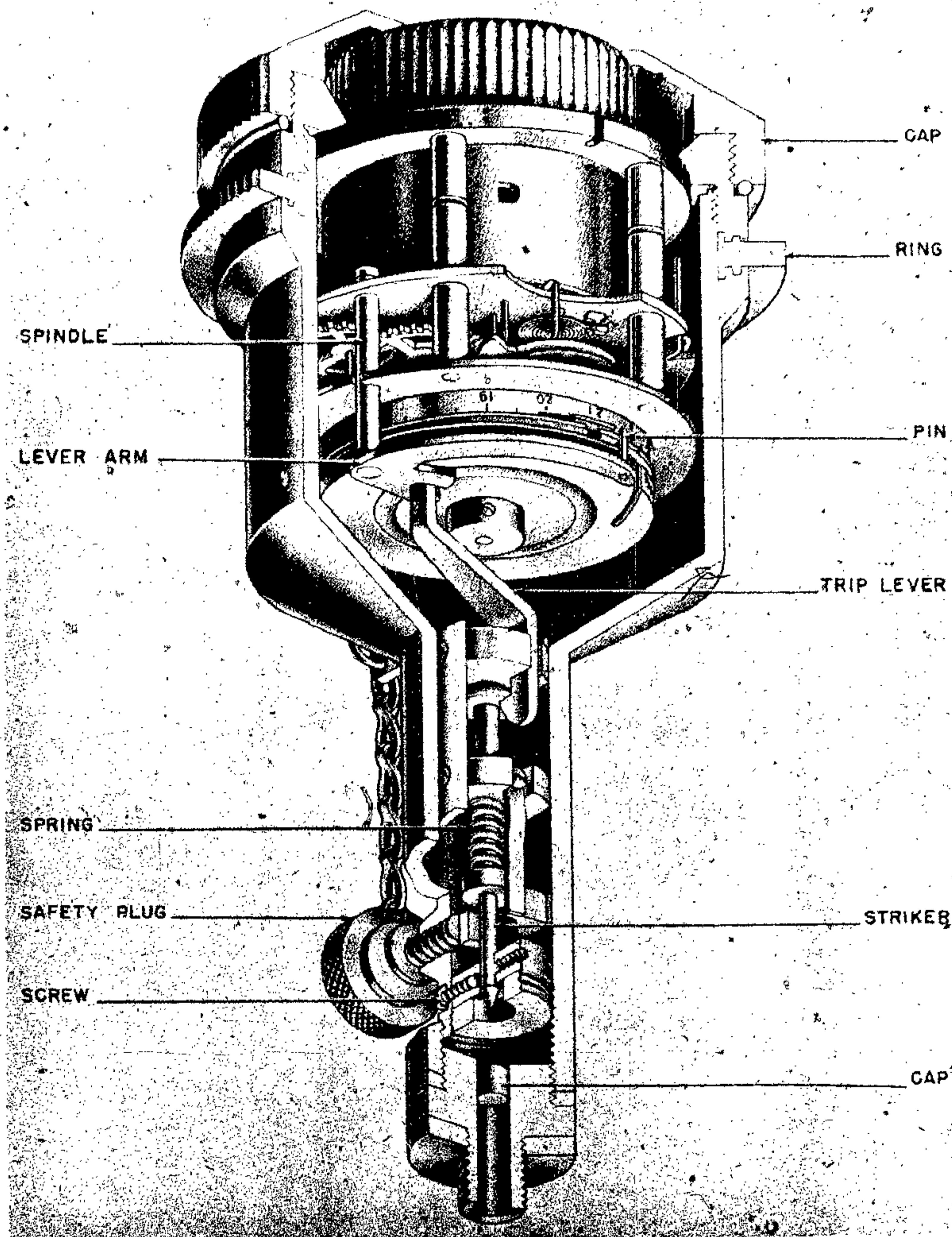

Figure 278—J-Feder 504 Clockwork

lightly-sprung steel strip which is pushed back by the pin as the clock approaches the zero setting. As this strip can only be pushed in one direction, it provides a safety device to prevent the striker being released while the clock is being set by the

knob. A further safety device for the preservation of the clock mechanism is provided by the bent steel wire. This passes through, and is secured to, the spindle, so that when the latter rotates with the lever at the end of the delay period

GERMAN EXPLOSIVE ORDNANCE

the short limb of this steel wire presses against the balance wheel and stops the clock. If this was not provided the clock could continue working and by further rotation of the disks, the pin would jam

or would be deformed. This is important since provision is made for testing the clock and it is thought that the clock mechanism may be intended for re-use.

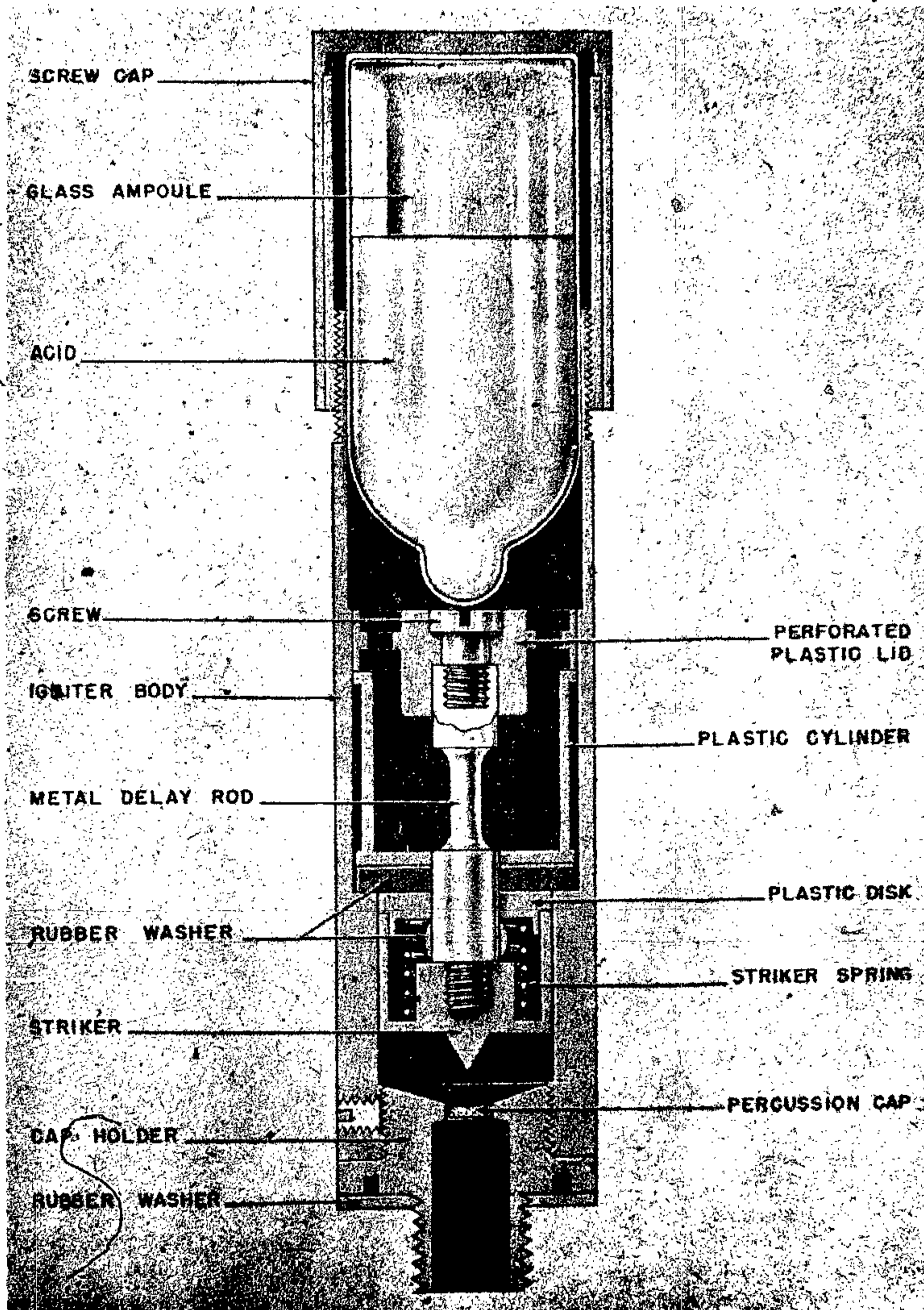

Figure 279—C. M. Z. 41W Chemical Delay Igniter

The clock is started by the movement of the ring through an angle of about 30°. Two screws, passing through the ring, project into the clock mechanism. Between them is the lever arm to which is attached a thin spring steel strip. In the stop (steht) position this latter is in contact with the balance wheel of the clock and holds it. When the red mark on the ring is moved to the go (geht) position the lever moves the steel strip so that it gives motion to the balance wheel and then moves clear of it. The ring is held in either the "stop" or "go" positions by the shaped steel spring, and the lever arm is held by the shaped spring.

The striker mechanism is retained in the body by the four screws. The striker is held in the cocked position by the trip lever. The movable piece is a transport safety device. In the "safe" position this is pushed over by the spring strip so that the striker is prevented from reaching the cap. The screw marked "SCHARF" replaces this when the apparatus is set for action. The stem of this screw projects far enough into the striker mechanism to push over the movable safety piece to allow the full movement of the striker when released. The accessory is provided with the equipment. It screws in, in place of the cap holder, and is to be used for recocking the striker after test or after use.

OPERATION. At the end of the delay period, the lever arm on the rotating control disk bears against the trip lever, causing it to release the striker. The striker, driven by the striker spring, is then forced into the percussion cap, firing it.

EMPLOYMENT. Used for large scale delayed demolitions. Delays are possible from 1/4 hour to 21 days.

C. M. Z. 41W. (CHEMICAL-MECHANICAL TYPE)

DATA:

Length: 5 1/2 inches.

Diameter: 1 1/4 inches.

Color: Brown.

Material: Bakelite.

DESCRIPTION. Externally, the igniter consists of a cylindrical brown bakelite housing with a male thread at one end to take a deep bakelite arming cap. The other end bears a female thread into which a metallic percussion cap and detonator assembly is screwed. (See fig. 279.)

Internally, a glass ampoule containing the liquid chemical agent rests on a bakelite striker retaining disk so that approximately half the ampoule protrudes from the housing into the threaded arming cap. The striker retaining disk rests on a narrow shoulder of the igniter housing and has four seep holes that pass through it to the reaction chamber below. A partition in the igniter housing is positioned below the striker retaining disk, and with it, forms the enclosed reaction chamber. The spring loaded striker shaft is made of a special white metal and is fastened to the striker retaining disk by means of a small screw.

The striker shaft passes through the reaction chamber and terminates in the striker head. Only a restricted portion of the striker shaft is exposed to corrosion within the reaction chamber. All other parts are carefully covered with rubber sealing washers to prevent the liquid agent from seeping out of the reaction chamber and coming into contact with other metal parts. The striker spring is compressed between the shoulders of the striker head and the housing partition. The percussion cap and detonation assembly is threaded to fit any standard German charge and is fitted with a rubber washer and transit cap.

The delay periods have been calculated for the following temperatures:

68° F., 3 to 5 1/4 days.

32° F., 21 to 31 days.

-31° F., 96 to 167 days.

The chemical reaction ceases below -40° F. but resumes as soon as the temperature rises above that point.

OPERATION. The threaded arming cap is removed and the glass ampoule is inserted into the igniter body, neck first, in order to insure complete drainage. The cap is then screwed on until a slight resistance is felt by its contact with the ampoule. A Sprengkapsel No. 8 is placed in the percussion cap and detonator assembly and the igniter is screwed into the mine or charge. By turning down the threaded cap still further, the glass ampoule is broken and the liquid chemical agent trickles through the four seep holes of the striker retaining disk into the reaction chamber below. The igniter is now "functioning" but may be handled for a period of 5 hours. The chemical corrodes through the exposed portion of the striker shaft, releasing the spring loaded striker

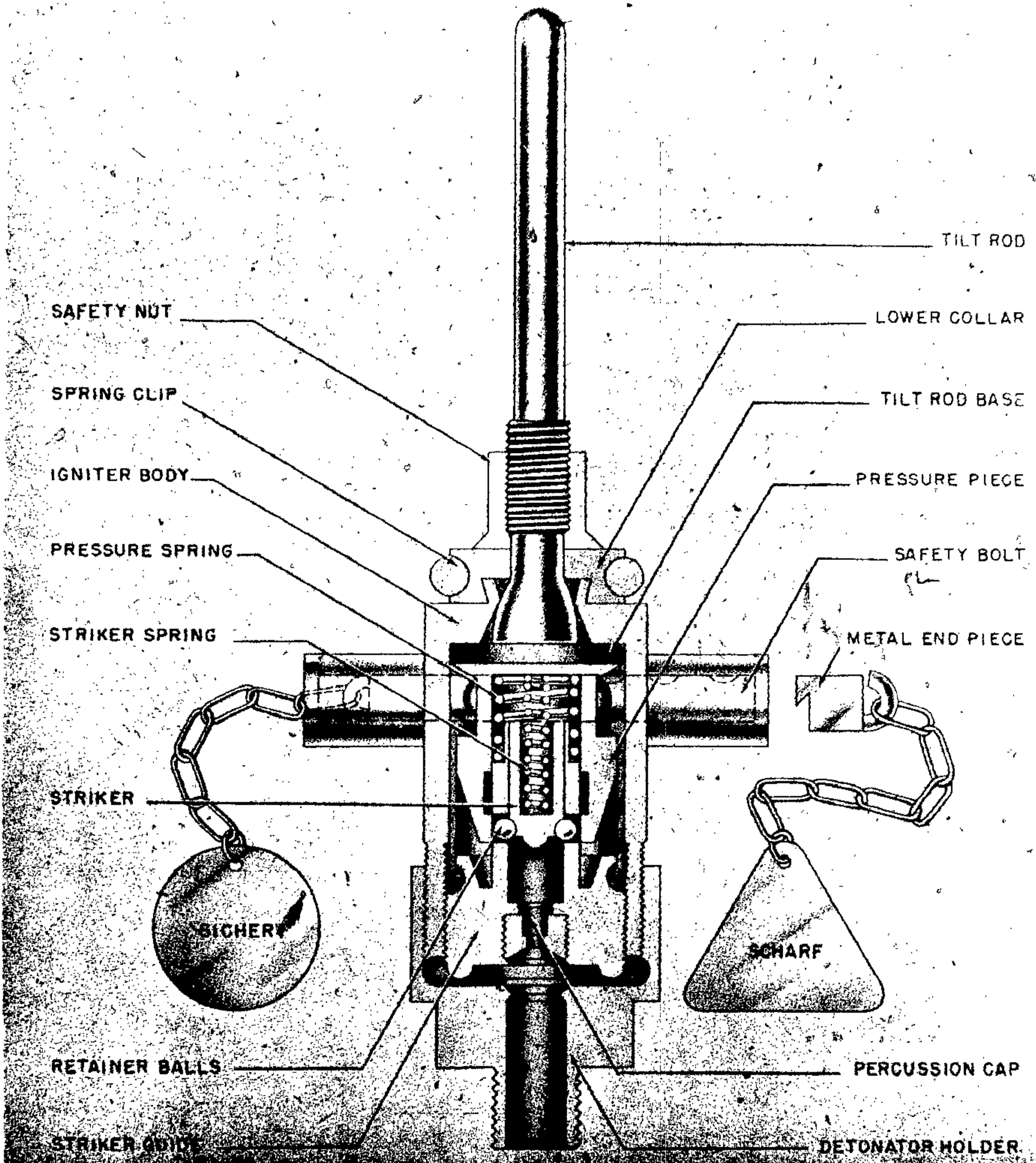

Figure 280—Kippzunder 43, Tilt Type

which fires the percussion cap, detonator, booster and main charge.

EMPLOYMENT. This igniter is used for delayed action demolition.

KIPPZUNDER 43 (TILT TYPE)

DATA:

Length: 3-inch body; 24 $\frac{3}{4}$ -inch extension rod.
Diameter: $\frac{7}{8}$ -inch O. D.

Color: Black.

Pull or Pressure required: 15 to 25 pounds (1½ pounds with extension rod).

Material: Brass.

DESCRIPTION. The igniter consists of a tilt rod, and a 24-inch extension rod, connected to a cylindrical body containing the striker mechanism into the base of which is screwed the cap and detonator assembly. The igniter is designed to function when the tilt rod is tilted in any direction. (See fig. 280.)

The igniter body contains the tilt rod and tilt rod base; these are locked firmly against the top flange of the body by the safety bolt. Waterproof packing seals the joint between the tilt rod base and the body.

Inside the igniter body is a concentric hollow cylinder known as the pressure piece. The pressure spring is held against the top of the pressure piece by a striker guide, containing two holes in which are positioned two locking balls which hold the striker in a cocked position against the striker spring.

A retainer nut screws over the underside of the body and holds the entire striker mechanism inside the igniter body. A striker guide nut is screwed into the inside thread of the striker guide in order to distance the percussion cap.

A separate cap and detonator assembly is used with this igniter and is designated the "Zundersprengkapsel 43." It consists of an externally threaded sleeve to hold the cap and detonator which can be screwed into the igniter and into standard igniter sockets of mines. Two washers are provided for waterproofing.

The end of the tilt rod is fitted to take an extension rod which increases the leverage considerably.

OPERATION. Lateral pressure of 15 to 25 pounds exerted in any direction on the tilt rod, or 1½ pounds if the extension rod is used, causes the sliding pressure piece to be depressed. When the pressure piece has been depressed sufficiently, the locking balls are freed and striker is released. The striker, driven by the striker spring, sets off the percussion cap.

EMPLOYMENT. This igniter is primarily intended for use on antitank mines. It is screwed into the booby trap wells on the undersides of standard antitank mines, the mines then being laid upside down. It is ideal for use on booby traps and antipersonnel mines.

NEW TYPE TILT IGNITER (PRESSURE (TILT) TYPE)

DATA:

Length: Approximately 5 inches.

Diameter: 15/16 inch.

Material: Metal.

DESCRIPTION. The basic principles of this igniter are similar to those of the Kippzunder 43. The striker, striker guide, pressure piece, striker spring, pressure spring, retaining balls, and tilt rod base are all the same as the Ki. Z. 43 igniter. This igniter, has, however, an entirely different safety device. A safety nut is screwed down tightly against a four-piece collar that is retained in place by a spring clip. This nut and collar, which are about the base of the tilt rod, restrain the movement of the tilt rod, making it less sensitive. (See fig. 281.)

A safety bolt is housed on the side of the igniter and fits under one side of the tilt rod base preventing its movement. The safety bolt runs through a safety bolt housing stamped at the ends "SICHER" (safe) and "SCHARF" (armed). There is a curved indentation in the safety bolt which allows free movement of the tilt rod base when this indentation is positioned directly under the rod. Movement of the safety bolt is controlled by a spring loaded ball fitting into one of three recesses. At either end of the safety bolt are metal pieces connected to lengths of chain.

The igniter is normally carried with the safety bolt held in position by the spring loaded ball being in the middle recess. Both metal end pieces will then be in the safety bolt housing.

After positioning the igniter in the mine, a pull on the wire "SCHARF" will move the safety bolt until the spring loaded ball drops into the recess at that end. The curved indentation will then be directly under the tilt rod base and the igniter armed. The metal piece will pull away from the "SCHARF" end of the safety bolt. The safety nut and collar may be removed or left in position as required.

OPERATION. Pressure on the tilt rod lowers the pressure piece, releases the retaining balls and frees the striker to impinge upon the percussion cap.

EMPLOYMENT. This igniter is designed for use with antitank mines. The igniter is screwed

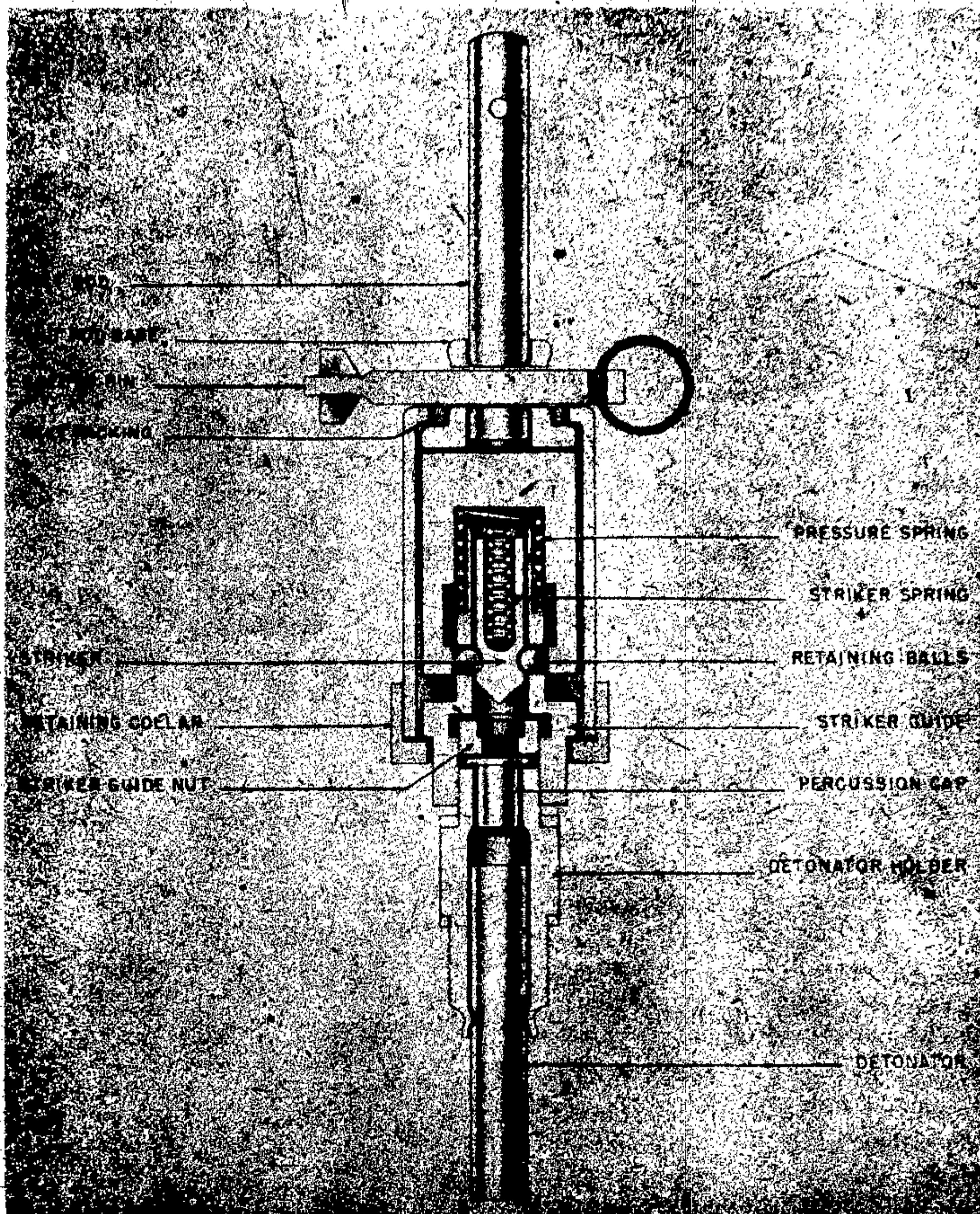

Figure 281—New Type Tilt Igniter (Pressure Tilt Type)

into the booby trap well on the under side of the mine, the mine being laid upside down.

KNICKZUNDER 43 (TYPE I AND TYPE II, SNAP TYPE)

DATA:

Length: 36 inches.

Material: Type I—Metal, Type II—Metal and plastic.

DESCRIPTION. Both types of this igniter have a cap holder and transit cover at the lower end. They are of standard thread and can be screwed into the igniter sockets of any mine or prepared demolition charges. (See fig. 282.) The type I igniter consists of two main parts, the main body and the extension. The extension is composed of five tubular sections, placed end to end, enclosed in a thin metal sheath, and it houses five interconnected tension hooks. The main body houses a

LAND MINES, GRENADES, AND IGNITERS

hollow striker to the head of which is riveted a striker needle. The striker body is transversely drilled to accommodate the cross pin to which is assembled the snapping piece. The upper end of

the snapping piece in turn engages the lower tension hook. The striker spring is housed within the striker and is compressed between the head of the striker and the base of the striker stop. The main

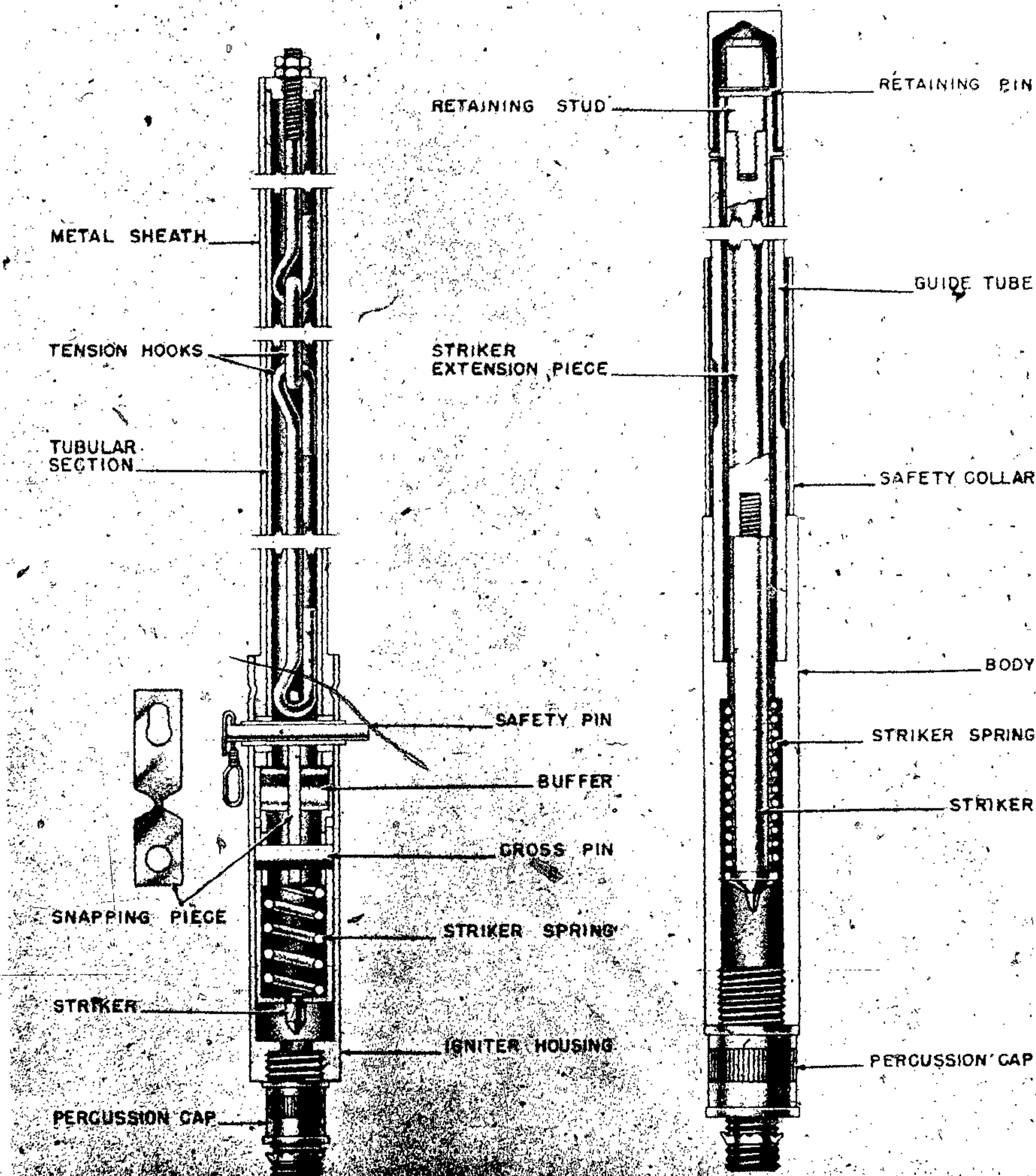

Figure 282—Knickzunder 43, Types I and II, Snap Type

GERMAN EXPLOSIVE ORDNANCE

body is drilled transversely and a thin bushing is passed through the body and the snapping piece to form a guide for the assembly of the safety pin. The ends of the safety pin are drilled to accept an arming cord and a retaining wire respectively.

The type II igniter consists of a main body and an extension, which houses a striker, a striker extension piece, and a striker spring. The extension is waisted just above the main body of the igniter. This weakened portion is protected during transit and installation by a safety collar in the form of an outer removable collar. The striker is screwed into the brittle, plastic striker extension piece. A female socket in the other end of the extension piece, strengthened by a ferrule, accommodates a retaining stud. The striker is retained in a cocked position by a retaining pin which passes through the retaining stud.

OPERATION. Both types of igniter are armed by removal of their respective safety devices. Lateral pressure on the extensions will cause the igniters to function.

The extension in the type I igniter will bend and tend to snap at the junctions of the tubular sections. The tension hooks will, in consequence, exert a pull on the snapping pieces and the striker. The striker spring will be compressed until the striker bears against the shoulder of the striker stop when further tension will cause the snapping piece to break at its weak link. The striker, thus

released, is forced forward under the influence of its spring to hit the cap and explode the mine.

Lateral pressure on the type II igniter will cause the extension to snap at its weakened point, and will also break the plastic striker extension piece, thus releasing the striker to impinge upon the cap and so explode the mine.

EMPLOYMENT. These snap igniters were designed to insure the functioning of antitank mines lying between two tracks of enemy mines. In addition, they are suitable for use under thick snow layers which prevent the functioning of the usual type of antitank igniter. When used with Reigel mines, or Tellermines, on the surface, the mines are secured with four supporting stakes and held down by tension wires or hooked pickets. An additional charge of 10 pounds of H. E. is laid with these mines. Tellermines are laid upside down with the snap igniter screwed into the bottom igniter pocket.

E. Z. 44 ANTILIFTING DEVICE (RELEASE OF PRESSURE TYPE)

DATA:

Height: 13/4 inches.

Diameter: 5 inches.

Pull or Pressure Required: Release of weight.

Material: Metal.

DESCRIPTION. The device consists of four

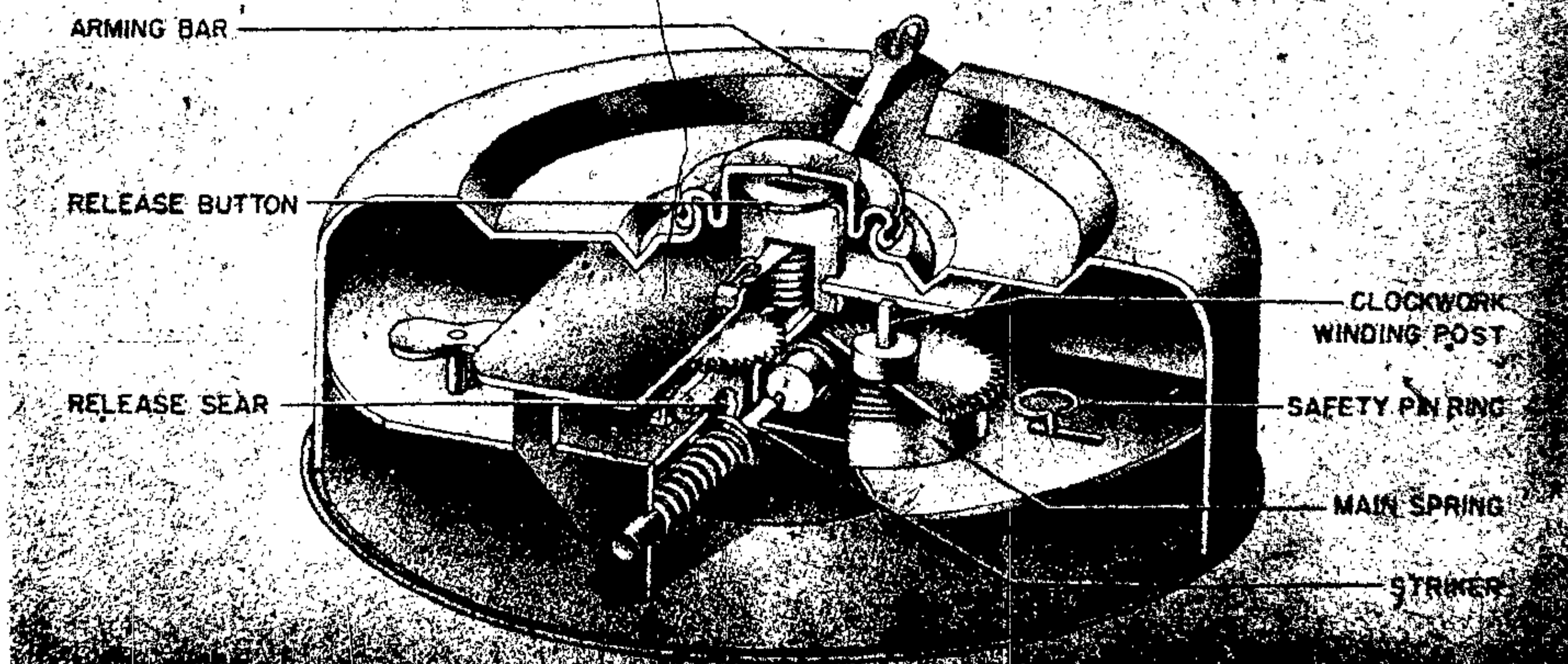

Figure 283—E. Z. 44 Antilifting Device

LAND MINES, GRENADES, AND IGNITERS

main parts: The upper casing, the base plate, the clockwork and striker mechanism, and the explosive filling. It is of sheet steel approximately 1 mm thick. (See fig. 283.)

UPPER CASING. The upper casing of sheet metal is of one piece and has strengthening corrugations on its upper surface. Situated centrally is an opening 1 inch in diameter, through which protrudes the release button keyed to a metal release fork. In the upturned lip of the opening is a small slot $\frac{3}{8}$ inch long to allow passage of the arming bar. This latter is a thin steel bar having a ring at its outer end. The clockwork mechanism winding post protrudes through the upper casing and the hole is made weatherproof.

BASE PLATE. The base plate is of sheet steel and has a circumferential lap joint to secure the upper casing. This base plate is not secured to the internal parts.

EXPLOSIVE FILLING. The explosive filling consists of two circular segments of cast TNT enclosed in waxed paper. The lower portion has a housing for the cap and standard detonator assembly.

STRIKER MECHANISM. The internal metal structure consists primarily of a semicircular metal plate to which all the parts are clamped. On the underside of the plate is fixed the striker assembly, consisting of a spring-loaded metal striker. The metal sear is pivoted and is held down at its inner end by means of the small spring fitted to the release button fork. The sear holds back the striker at the beveled stop so long as pressure is applied to the release button. The striker is further secured before arming by the safety pin which is of thin steel wire 2 inches long and passes through a small slot in the base plate and terminates in a small ring.

CLOCKWORK MECHANISM. The clockwork mechanism consists of a strong main spring which drives the governing spinner by a set of gear wheels enclosed in metal casing. The mechanism is wound at the post by means of a key. (No specimen of this latter has yet been recovered.) In the safe position the clockwork is jammed by the arming bar which also holds down the release fork and button.

No exact figure can be given for necessary pressure to hold down the release button, but this is

probably between 4 to 6 pounds. The device will function when the button is allowed to rise about $\frac{1}{2}$ inch.

OPERATION. To arm, the clockwork mechanism is wound and the device placed under any object, for instance a mine. The arming bar is then pulled out by means of a cord or wire attached to the ring.

When released, the clockwork runs for about 35 to 40 seconds and the expanding mainspring gradually forces the safety pin ring outwards, thus withdrawing the safety pin. This latter operation taking an average of 10 to 15 seconds. The striker is now only retarded by means of the sear, which in turn, is held in place by the compressed spring of the release button. Removal of the weight from the release button allows the striker spring to force up the sear by means of the beveled stop. The striker thus moves forward to fire the cap and so detonates the TNT. Such detonation, if under an antitank mine, would thereby also detonate the mine.

EMPLOYMENT. This mechanism is used beneath land mines as an antilifting and antiremoval device.

STICK HAND GRENADE MODELS 24 AND 39, STIELHANDGRANATES 24 AND 39

DATA:

Model 24:

- Over-all Length: 1 foot 2 inches.
- Diameter of body: $2\frac{3}{4}$ inches.
- Color of Body: Olive drab.
- Weight: $\frac{1}{2}$ pound.
- Weight of Explosive Filler, 6 ounces.
- Explosive Filler: TNT.
- Igniter: B. Z. 24.
- Delay: 4 to 5 seconds.

Model 39:

- Over-all Length: 1 foot 4 inches.
- Color: Olive drab.
- Weight: 1 pound 6 ounces.
- Weight of Explosive Filler: 7 ounces.
- Igniter: B. Z. 24.
- Effective Blast Radius: 16 yards.
- Delay: 4 to 5 seconds.

DESCRIPTION. These grenades are similar in all characteristics except size.

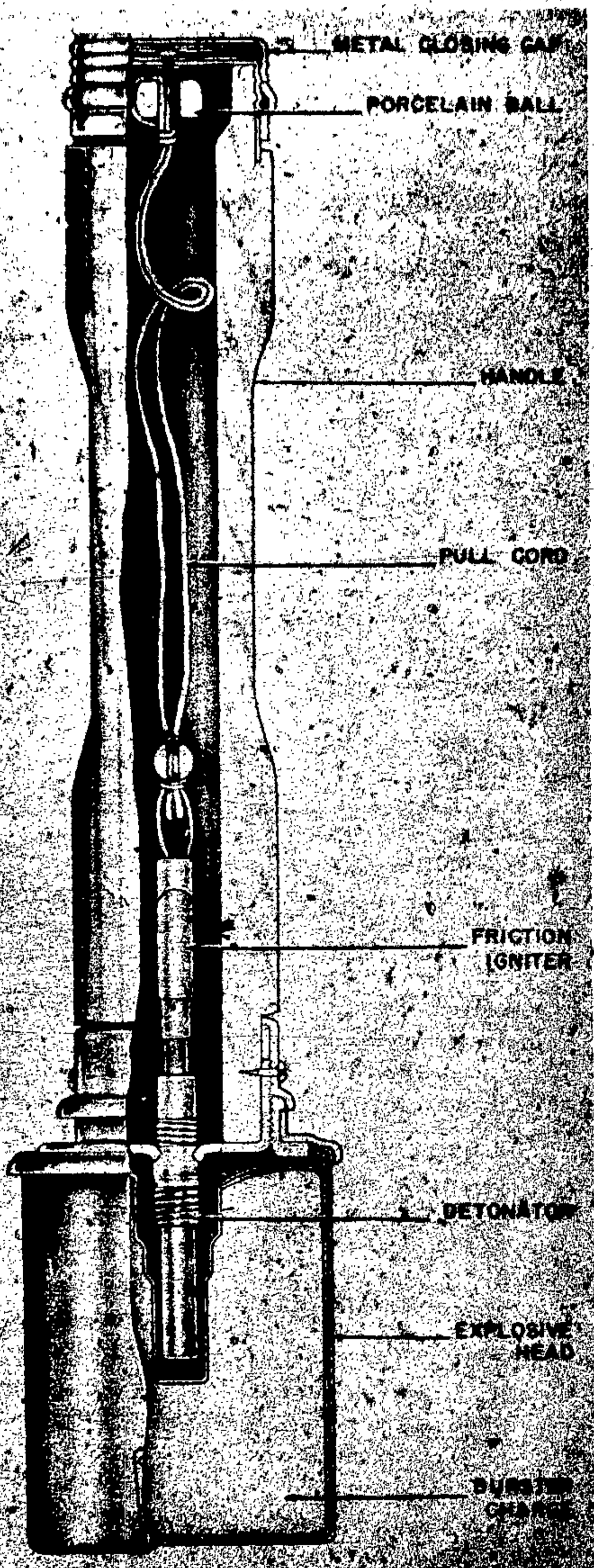

Figure 284—Model 24 Stick Hand Grenade; Model 29 Stick Hand Grenade

These grenades consist of a thin iron or steel casing, or head, containing the explosive filler, which is screwed onto a hollow wooden handle, through the center of which runs a double length of cord. This cord is attached at one end to a lead ball which is part of the igniter, and at the other end to a porcelain ball. The cavity in which the porcelain ball rests is closed by a metal cap that screws on. Inside the cap is a spring-actuated metal disc that prevents movement of the porcelain ball. (See fig. 284.)

These grenades use igniters B. Z. 24 consisting of a lead tube or sheath connected to a threaded brass fitting by a short steel tube. The steel tube is threaded on both ends and contains the powder delay pellet. The lead tube contains the copper capsule which holds the friction composition. The friction wire is cast in the friction composition and contained in the capsule which is coiled at the bottom to provide resistance to pulling and joined to the "pull" loop at its opposite end. When the loop is pulled, it frees itself from the lead tube drawing the wire through the friction composition and the resulting flame ignites the delay pellet.

OPERATION. The metal cap is unscrewed from the handle and the porcelain ball is pulled. This will pull a wire through the delay pellet. The grenade is then thrown and after a 4- to 5-second delay the delay pellet will initiate the detonator.

STICK HAND GRENADE, MODEL 43, STIELHANDGRANATE 43

DATA:

- Over-all Length: 1 foot 3 inches.
- Diameter of Body: 2 $\frac{3}{4}$ inches.
- Weight: $\frac{1}{2}$ pound.
- Weight of Explosive Filler: 6 ounces.
- Explosive Filler: TNT.
- Igniter: B. Z. E.
- Delay: 4 to 5 seconds.

DESCRIPTION. This grenade consists of a thin iron or steel casing, or head, containing the explosive filler. This is secured to the wooden stick handle by four deep stabs. (See fig. 285.) The igniter screws into the top of this head and is of the standard pull friction type, had a blue head and a 4- to 5-second delay.

This grenade differs from the standard Model 24 stick grenade only in the position of the igniter

LAND MINES, GRENADES, AND IGNITERS

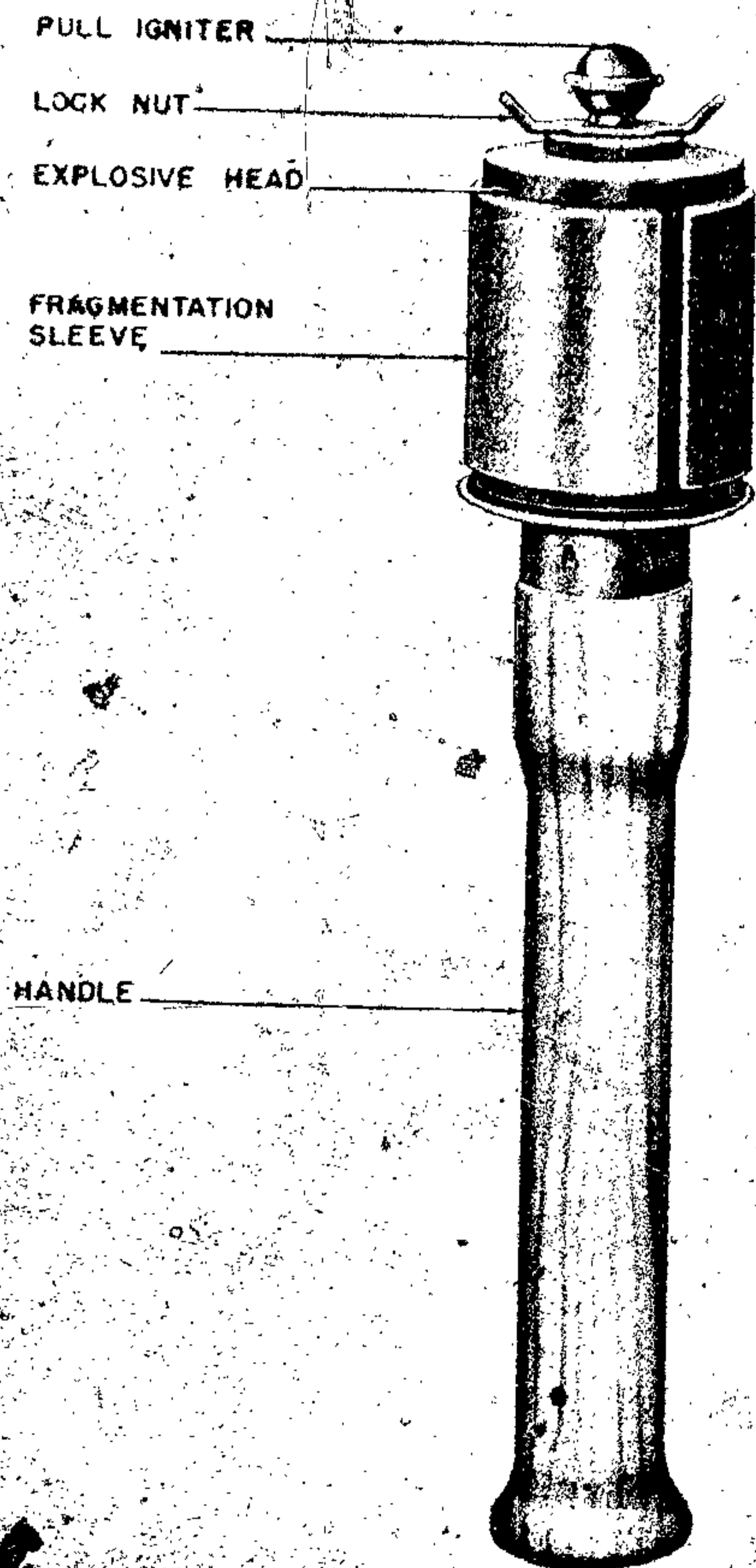

Figure 285—Model 43 Stick Hand Grenade

and method of affixing the explosive head to the stick handle. Usually this type is found with a fragmentation sleeve.

EGG-TYPE HAND GRENADE, EIERHANDGRATE 39

DATA:

Over-all Length: 3 inches.
Maximum Diameter: 2 inches.
Color: Black body with blue igniter head.
Weight: 12 ounces.

Igniter: B. Z. E.

Delay: 4 to 5 seconds.

DESCRIPTION. This is a small thin-cased offensive type grenade with a high proportion of a low-grade explosive. It is ignited by a friction type igniter and a 4- to 5-second delay pellet. (See fig. 286.) This grenade uses the B. Z. E. friction-type igniter. The short body of this igniter is usually made of brass and contains a friction composition in which a friction pull wire is cast. The lower end of the friction wire is coiled to provide resistance which serves to ignite the friction composition when the wire is drawn through it. The upper end of the friction wire has a loop to which is fastened one end of a cord. The free end of the cord is attached to a disk which is within the head. The head screws on to the top of the body and a steel tube containing the delay pellet screws into the bottom of the body.

OPERATION. The igniter head is unscrewed and pulled, thus drawing the wire through the friction composition and igniting the delay pellet. The grenade is then thrown and after a delay of 4 to 5 seconds the delay pellet will initiate the detonator thus setting off the explosive filler.

REMARKS. There has been found a practice

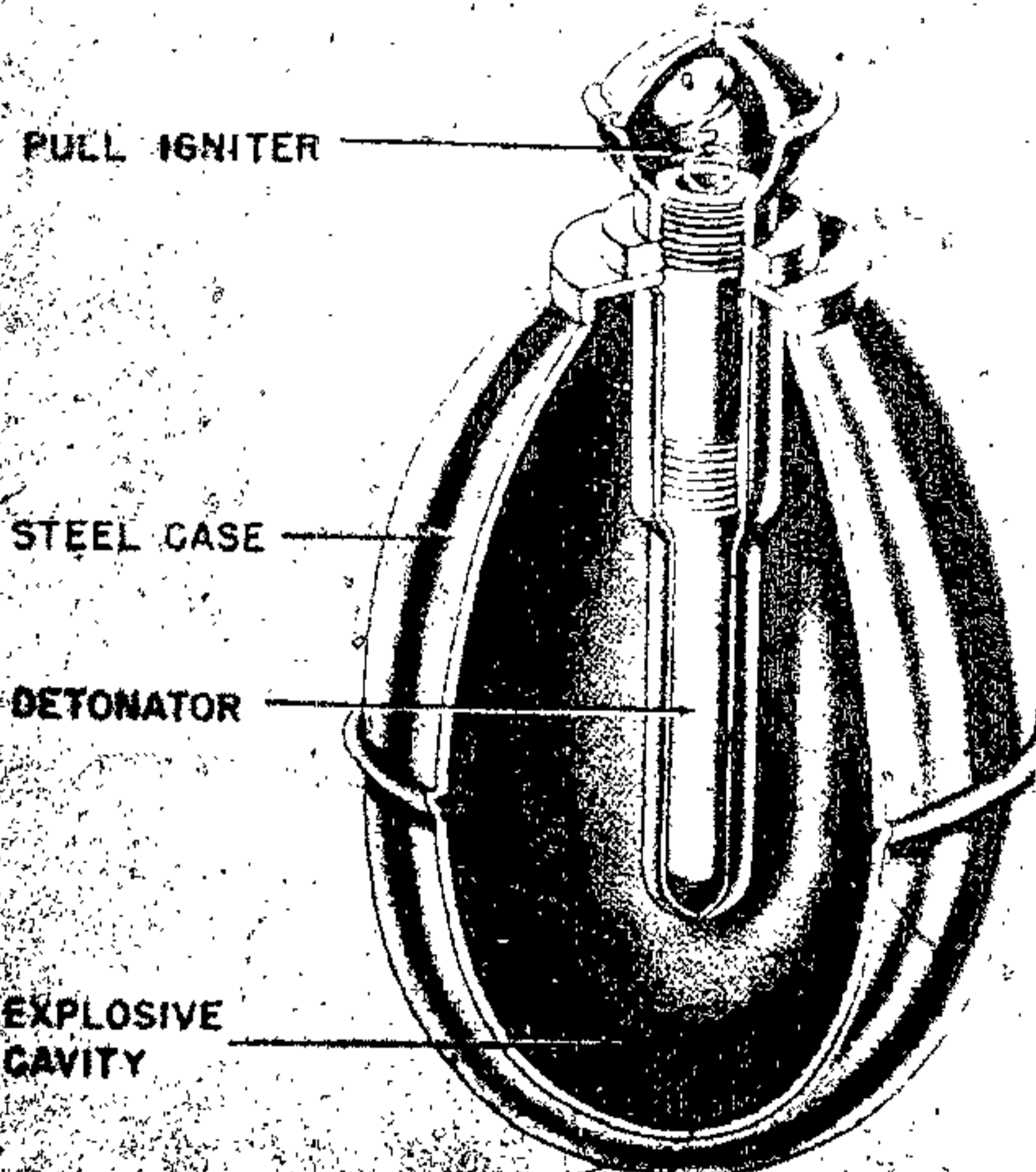

Figure 286—Egg Type 39 Hand Grenade

GERMAN EXPLOSIVE ORDNANCE

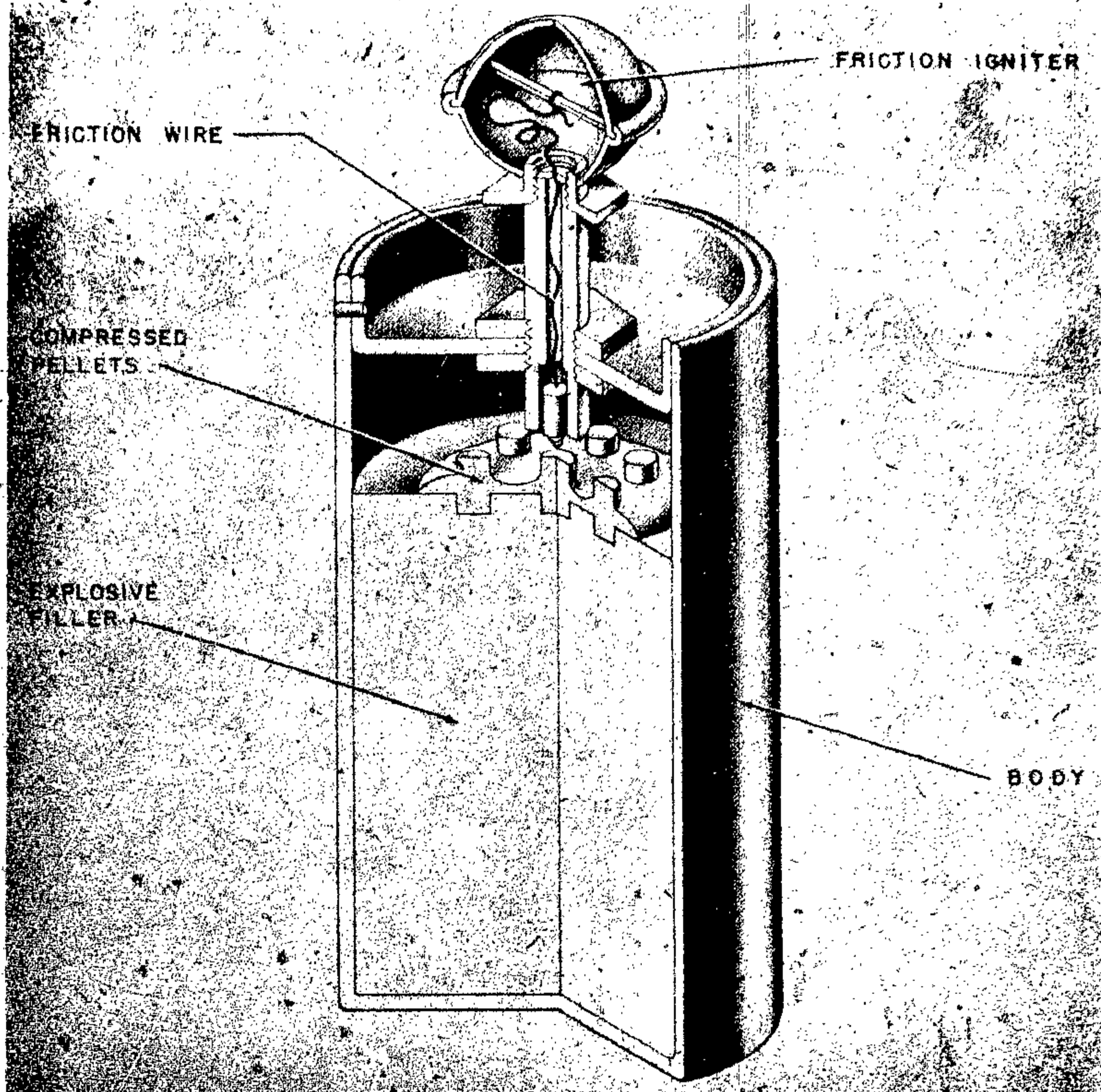

Figure 287—Shaving Stick Hand Grenade

hand grenade of this type containing a spotting charge with the B. Z. E. igniter. The German designation of this is the Eierhandgranate 39 (Ub). A modified egg grenade has also been found with a ring attachment on the base.

SHAVING STICK GRENADE

DATA:

Over-all Length: $3\frac{5}{8}$ or 4 inches.

Color: Body is painted yellow; the head of igniter blue.

Maximum Diameter: 2 inches.

Igniter: B. Z. E.

Delay: 4 to 5 seconds.

DESCRIPTION. This is a thin-cased "offen-

sive" grenade with the B. Z. E. friction igniter screwed into the top. The body of this grenade is an aluminum cylinder painted yellow. There are two models of this grenade, one being $3\frac{5}{8}$ inches in length and the other 4 inches in length. (See fig. 287.)

OPERATION. The head of the igniter is unscrewed and pulled, thus drawing the wire through the friction composition and igniting the delay pellet. The grenade is then thrown and after a 4- to 5-second delay, the delay element will initiate the detonator.

REMARKS. This grenade may be used as a booby trap by the insertion of a D. Z. 35 pressure igniter.

**MAGNETIC ANTITANK GRENADE, HOFT
HOHL LADUNG 3 kg**

DATA:

- Over-all Length: $4\frac{3}{8}$ inches.
- Maximum Diameter: $3\frac{1}{16}$ inches.
- Color: Field grey.
- Total Weight: 7 pounds 11 ounces.
- Filler: RDX/TNT.
- Weight of Filler: 3 pounds 5-ounces.
- Igniter: B. Z. 24.
- Delay: 4.5 or 7 seconds.

DESCRIPTION. This grenade is painted field grey and is fitted with magnets which are sufficiently powerful to cause it to adhere to a vertical surface. The main filling is contained in a pressed metal container which is conical in shape with an elongated apex serving the dual purpose of forming a hand-grip and accommodating the exploder pellet of PETN/Wax. This latter is housed in a metal tube protruding from the underside of the screw-threaded closing cap. The metal tube is screw-threaded internally to receive the igniter. (See fig. 288.)

Attached to the base of the conical portion by means of six bolts protruding through the container is a plywood framework carrying three horseshoe type magnets. During transit these magnets are fitted with a keeper which must, of course, be removed before using the charge. A brass chain terminating in a hook is attached to the frame.

This charge is reported to penetrate as much as 110 mm. of armor. The penetration is acquired through the use of the shaped charge formed around the 60° angle cone.

There are two igniters used in this grenade: one having a delay of $4\frac{1}{2}$ seconds and the other having a delay of 7 seconds. The first igniter has a blue cap and the second has a yellow cap.

OPERATION. The friction igniter is pulled and this will ignite the delay element. When the grenade strikes a tank the magnets cause it to cling to the side and at the end of the delay time the igniter will detonate the exploder pellet and main filling.

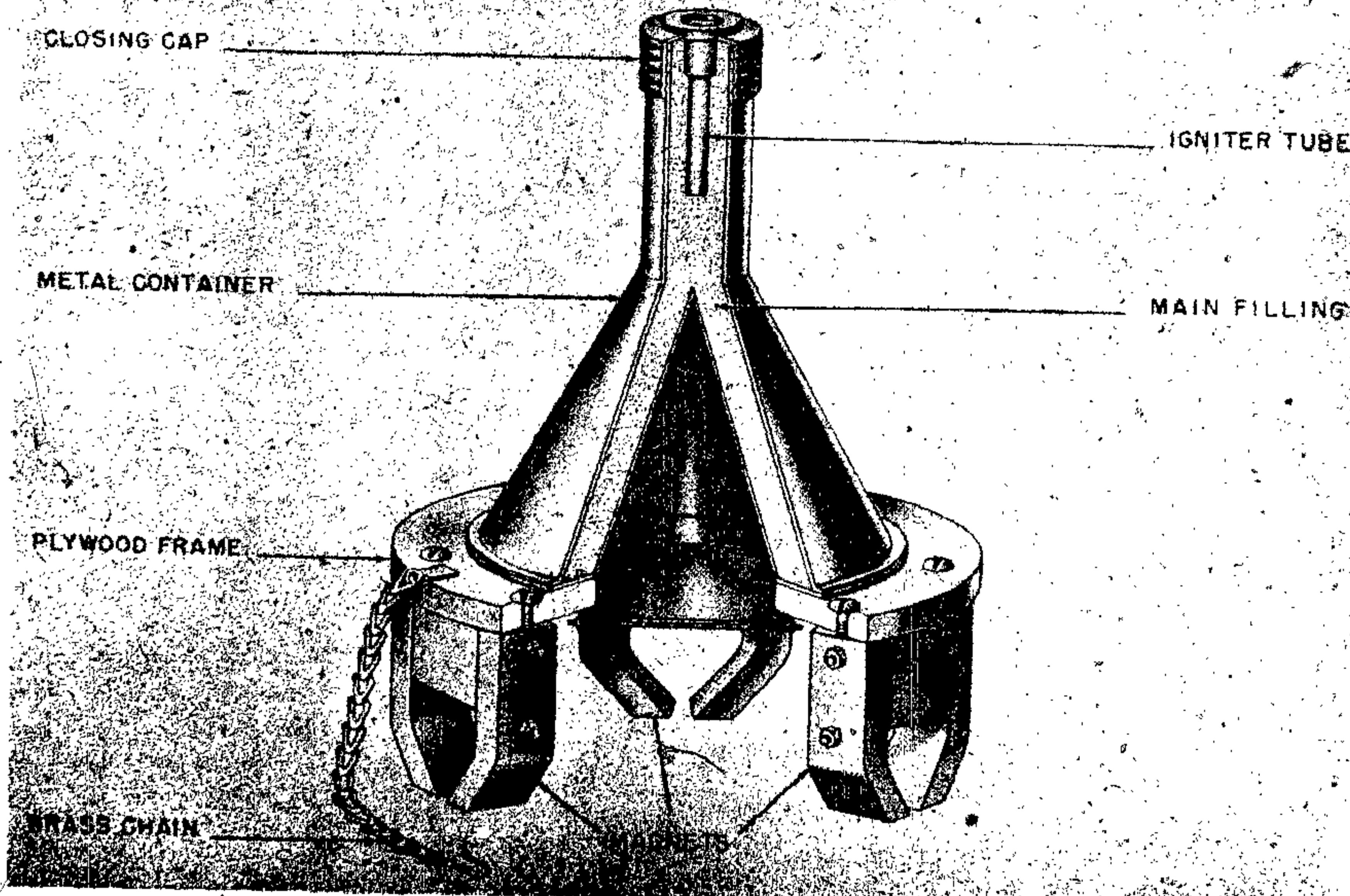

Figure 288—Magnetic Antitank Hand Grenade

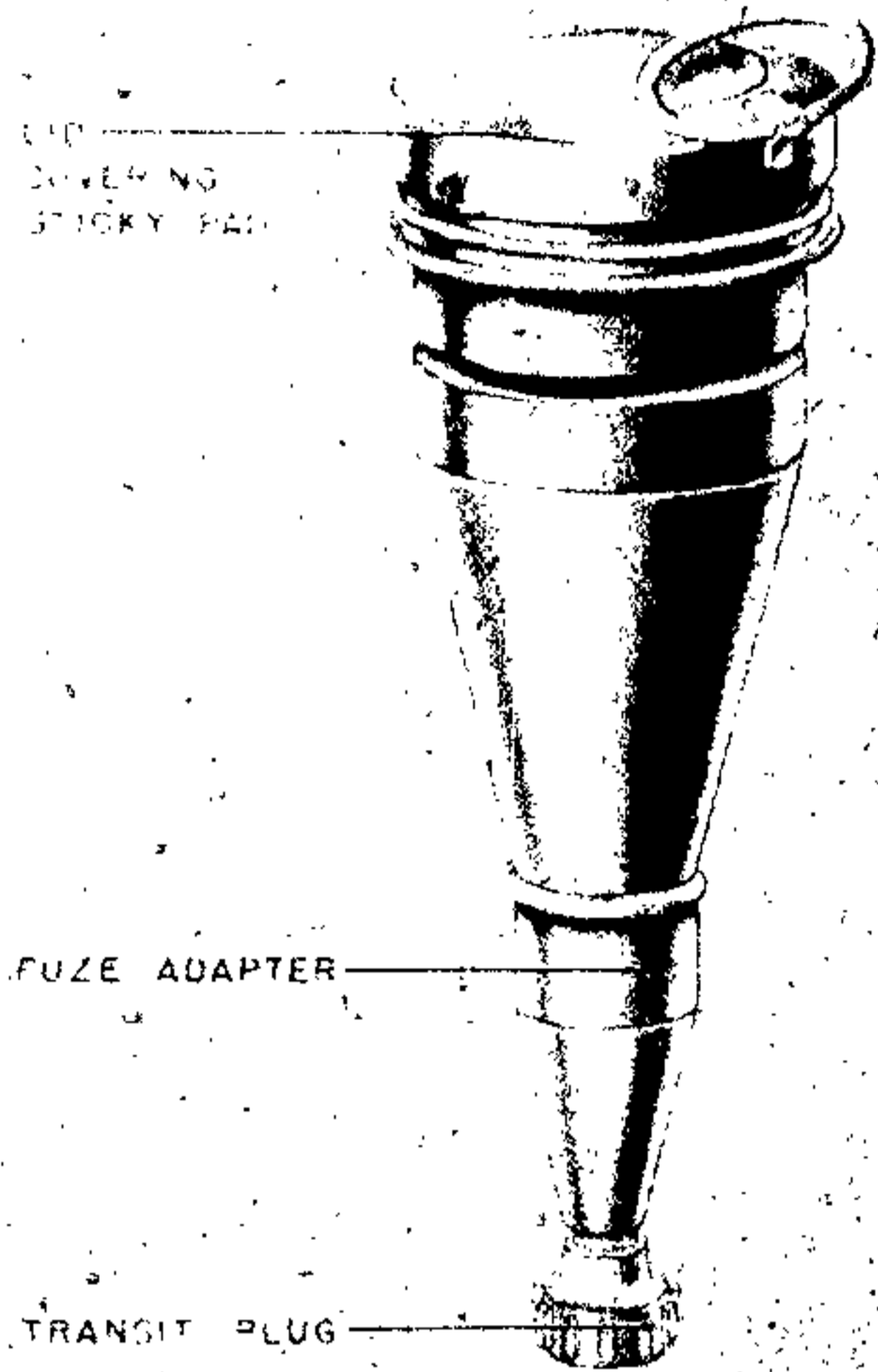

Figure 289—Hollow Charge Sticky Hand Grenade

**HOLLOW CHARGE GRENADE
(STICKY TYPE)**

DESCRIPTION. The grenade consists of a tapering steel body containing the hollow charge with a flat sticky pad at the nose covered by a press-on lid with a small handle. The base of the grenade is fitted with a tapering fuze adapter terminating in an internally threaded hole for an igniter. This hole is covered by a black plastic plug in transit. It is presumed that the standard egg grenade igniter is used with this grenade employing a 4½-second delay and used with a No. 8 detonator. (See fig. 289.)

REMARKS. No information is available as to whether this grenade is thrown or placed against the target. It is possible that it may be lobbed for short distances.

ANTITANK GRENADE (PANZERWURFMINE)

DATA:

- Over-all Length: 21 inches.
- Length of Body: 9 inches.
- Length of Fins: 11 inches.
- Diameter of Body: 4½ inches.
- Color of Body: Grey.
- Markings: P. W. M. 1 (L).

Weight: 1 kg.
Filling: Cast TNT.

DESCRIPTION. The grenade consists of a metal body and a wooden handle to which are attached four canvas fins. The fins are held against

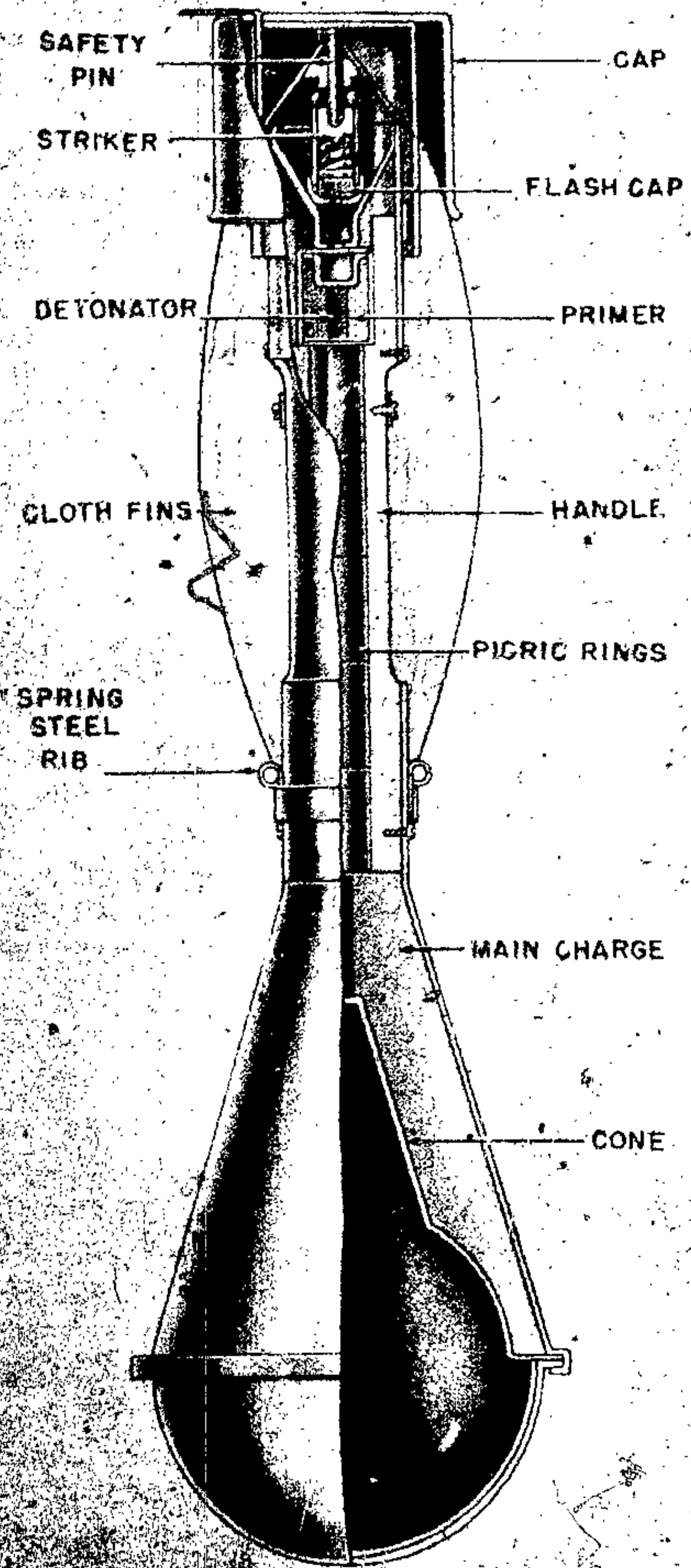

Figure 290—Panzerwurfmine Hollow Charge Hand Grenade

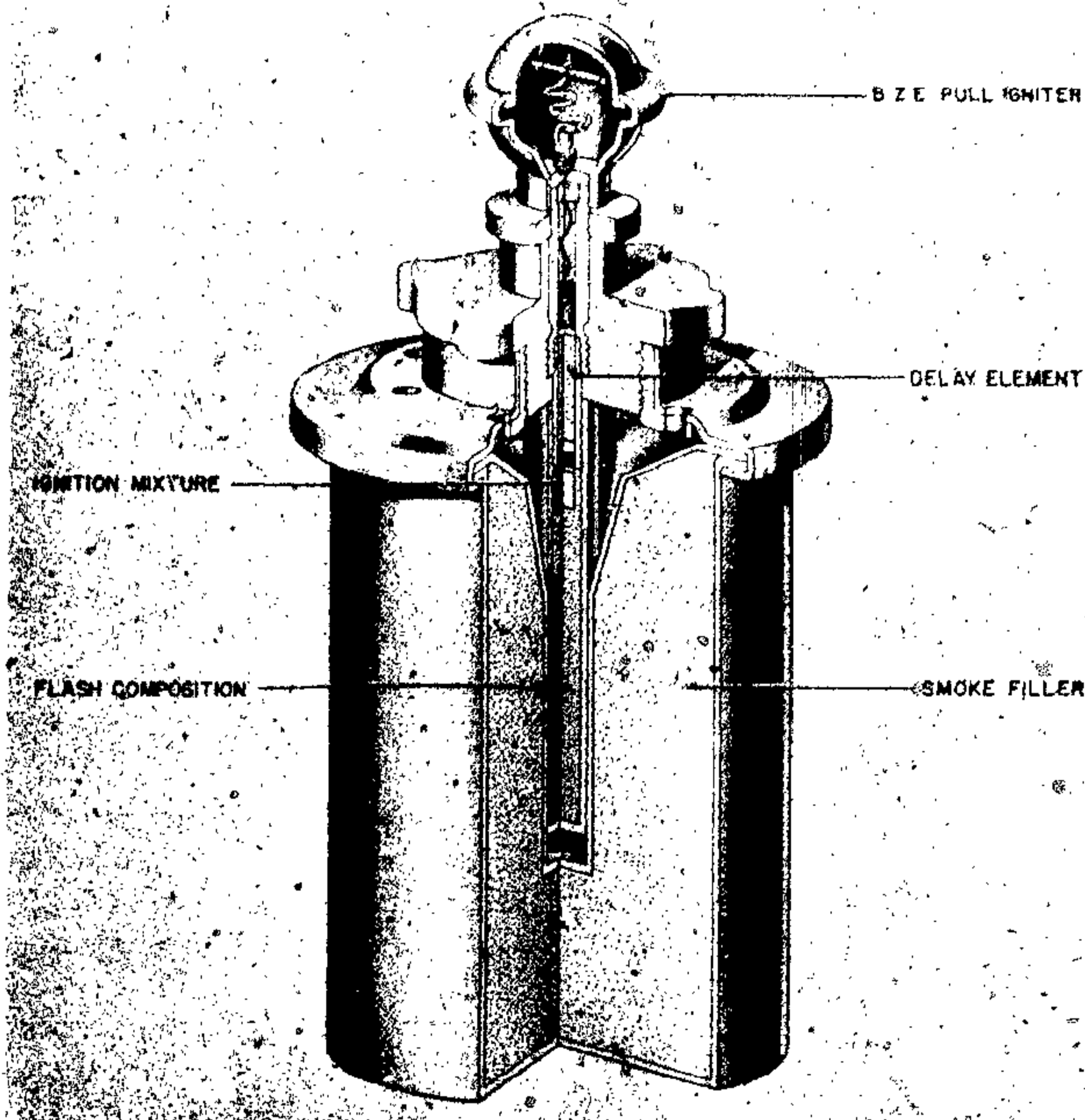

Figure 291—Type 41 Smoke Hand Grenade

the handle, before throwing, by a metal cap at the base of the handle. The body is made in two pieces crimped together and attached to the handle by a metal band. (See fig. 290.)

The fuze is located at the top of the handle and consists of a striker which is held away from the primer by a creep spring and two steel balls. The two balls fit into a recess in the striker and are held outward by a safety pin fitting between them, thus causing them to bear against the top of the striker housing and prevent the striker from moving down. Attached to the safety pin is a small length of tape which is held in by the metal cap and a semicircular clip attached to one fin and fitting around the handle.

Beneath the primer and in the base of the handle is a detonator and a picric acid gainé. The main filler is cast around a cone in the body to give a hollow-charge effect.

OPERATION. Before throwing, the cap over the end of the handle is pulled off and the fins held

against the handle.

When the grenade is thrown, the four fins fly out because of their spring ribs. When the clip attached to one fin is pulled away from the housing, this releases the tape which unwinds and pulls the safety pin out of the striker. During flight the safety balls move in freeing the striker which compresses the creep spring on impact setting off the primer, detonator, gainé and main filling.

**SMOKE HAND GRENADE 41 AND
PROTOTYPE NÉBELHANDGRANATE 41**

DATA:

Over-all Length: 4.7 inches.

Maximum Diameter: 2.3 inches.

Color: Olive drab.

Total Weight: 21 ounces.

Filling: (HC) Berger type mixture. Zinc and Hexachlorethane.

Ignition: B. Z. E.

Delay: N4 Ignition Tube: 4½ seconds.

GERMAN EXPLOSIVE ORDNANCE

DESCRIPTION:

PROTOTYPE. This grenade consists of a body which is the head of the smoke hand grenade 39 into which the B. Z. E. igniter is fitted by means of an adapter made of some synthetic resin. The adapter is threaded externally to screw into the neck of the grenade body and internally to receive the igniter. The closed end of the ignition tube is painted green. Nb. Hgr. 39 is stencilled in white over a broken white band around the body.

It has the eight smoke emission holes of the Model 39.

MODEL 41. This grenade is of the same construction as the Nebelhandgranate 39 and the Nebelhandgranate 41 prototype. However, the body has been modified so that in order to take the B. Z. E. igniter an adapter is not necessary. A dished plate with a small central neck in the top replaces the old wide screw neck plate which required the adapter. There are only two smoke

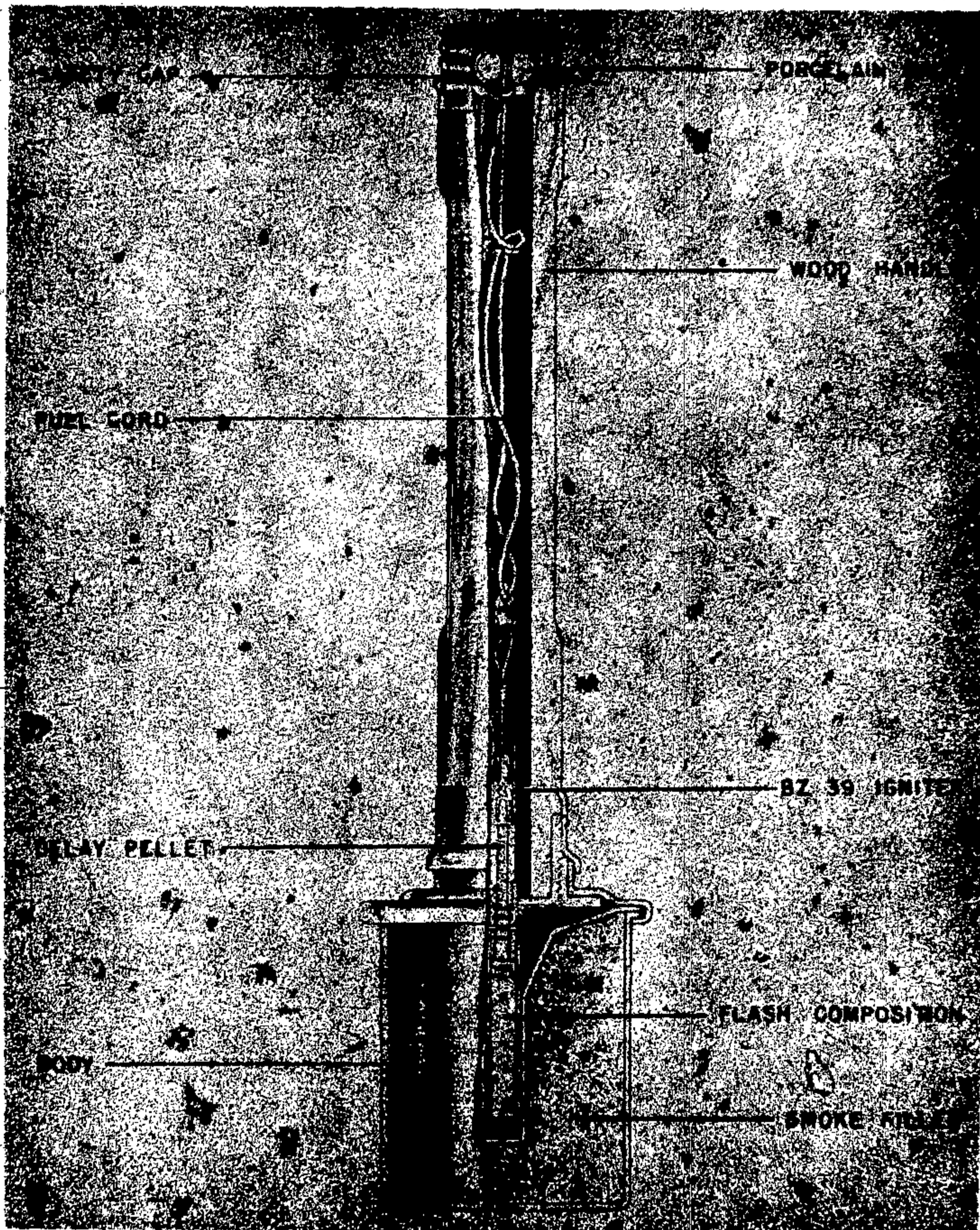

Figure 292—Type 39 Smoke Hand Grenade

emission holes. The letters Nb. Hgr. 41 and a broken line are stencilled in white on the grenade body. (See fig. 291.)

OPERATION. The igniter and adapter are removed from the grenade body. The N4 ignition tube is inserted, painted end first, into the central channel of the grenade head. The adapter and igniter are then replaced. The blue painted cap in the igniter is unscrewed and pulled. This functions the igniter. The grenade is then thrown and after the 4½ second delay has elapsed, smoke is emitted through the emission holes for 2 minutes. Because of the short duration of the smoke, this grenade is used when accuracy in placing a small screen is most important, such as screening machine gun nests and pill-boxes.

**SMOKE HAND GRENADE 39
(NEBELHANDGRANATE 39)**

DATA:

- Total Weight: 1 pound 14 ounces.
- Over-all Length: 14 inches.
- Ignition: B. Z. 39.
- Delay: 7 sec.-N4 Ignition Tube.
- Filling: (HC) Berger mixture, zinc and hexachlorethane.
- Color: Olive drab.
- Markings: White band 8 inches wide around center of handle and lettering Nb. Hgr. 39 stencilled in white around the body above a broken white band.

DESCRIPTION. This grenade closely resembles the H. E. stick grenade 24 in external form and size. However, instead of the H. E. filling this grenade is filled with a Berger smoke mixture. There are eight holes in the base of the head through which the smoke escapes. The handle has three horizontal corrugations at the screw cap end to assist in differentiation by touch. (See fig. 292.)

OPERATION. Insert the friction igniter into the handle and then place the open end of the flash cap into the recess in the top of the friction igniter, finally screwing the head onto the handle. Then, by removing the screw cap and pulling the igniter, the delay is ignited and the grenade may be thrown. Smoke is emitted for two minutes. Because of the short duration of the smoke, this grenade is used where accuracy in placing a small

screen is most important, such as screening machine gun nests and pillboxes.

SMOKE GRENADE (BLENDKORPER 14)

DATA:

- Over-all Length: 6 inches.
- Maximum Diameter: 2½ inches.
- Total Weight: 13.2 ounces.
- Filling: (FM) (Titanium Tetrachloride).
- Weight of Filling: 10.6 ounces.

DESCRIPTION. This grenade is a tear drop shaped glass flask sealed at the upper end by drawing out the flask. The sealed tip is protected by a cardboard sleeve, sealed with a plaster of paris type material. (See fig. 293.)

OPERATION. The munition is used by throwing against a hard surface which breaks the flask. The titanium tetrachloride then vaporizes, forming an effective smoke cloud if relative humidity is high. The smoke cloud is then at low relative humidity.

EMPLOYMENT. The grenade is used to produce a small smoke screen to blind the enemy. It is also used to patch gaps in larger screens.

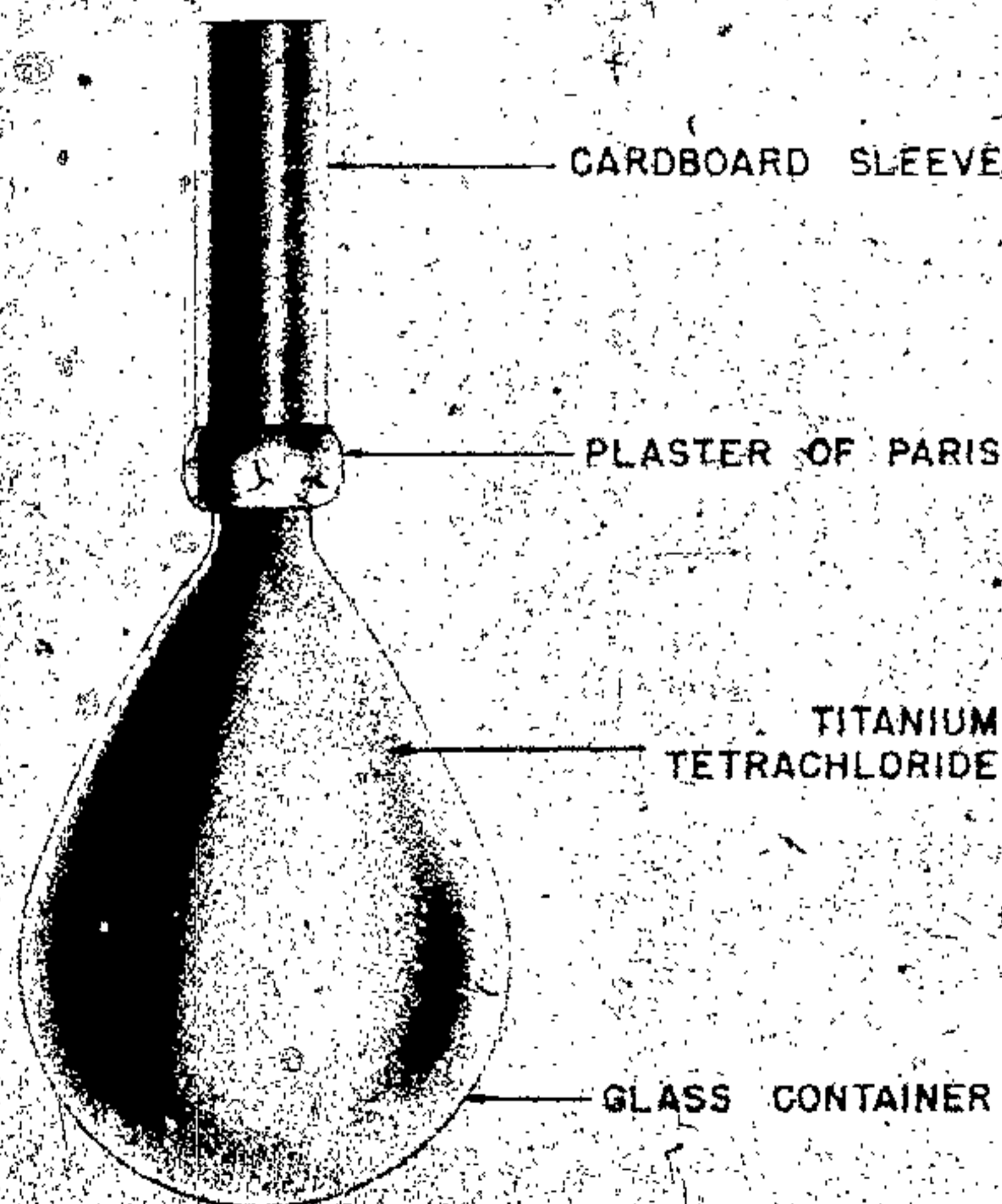

Figure 293—Blendkorpor 14 Smoke Hand Grenade

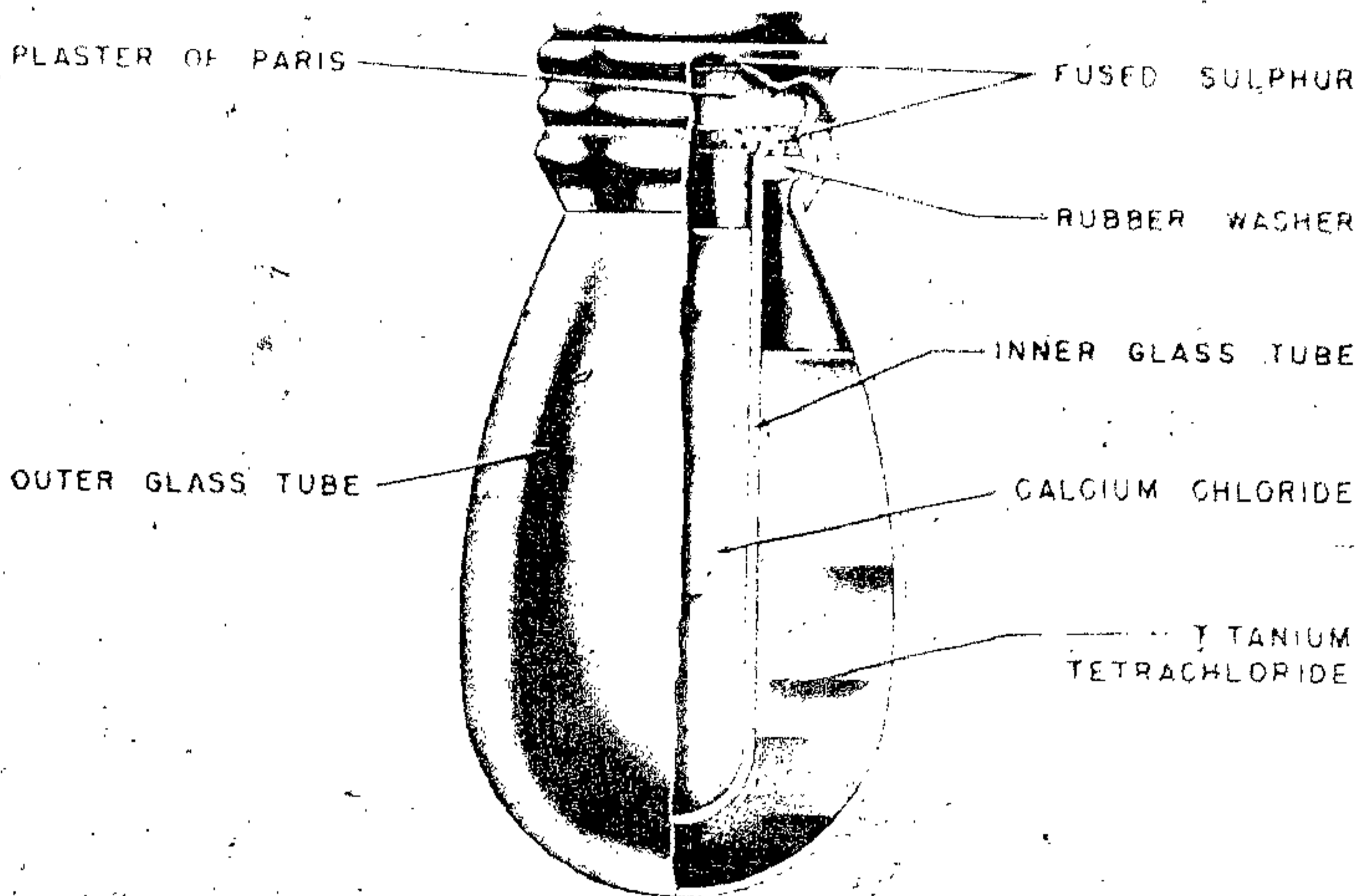

Figure 294—Blendkorper 24 Smoke Hand Grenade

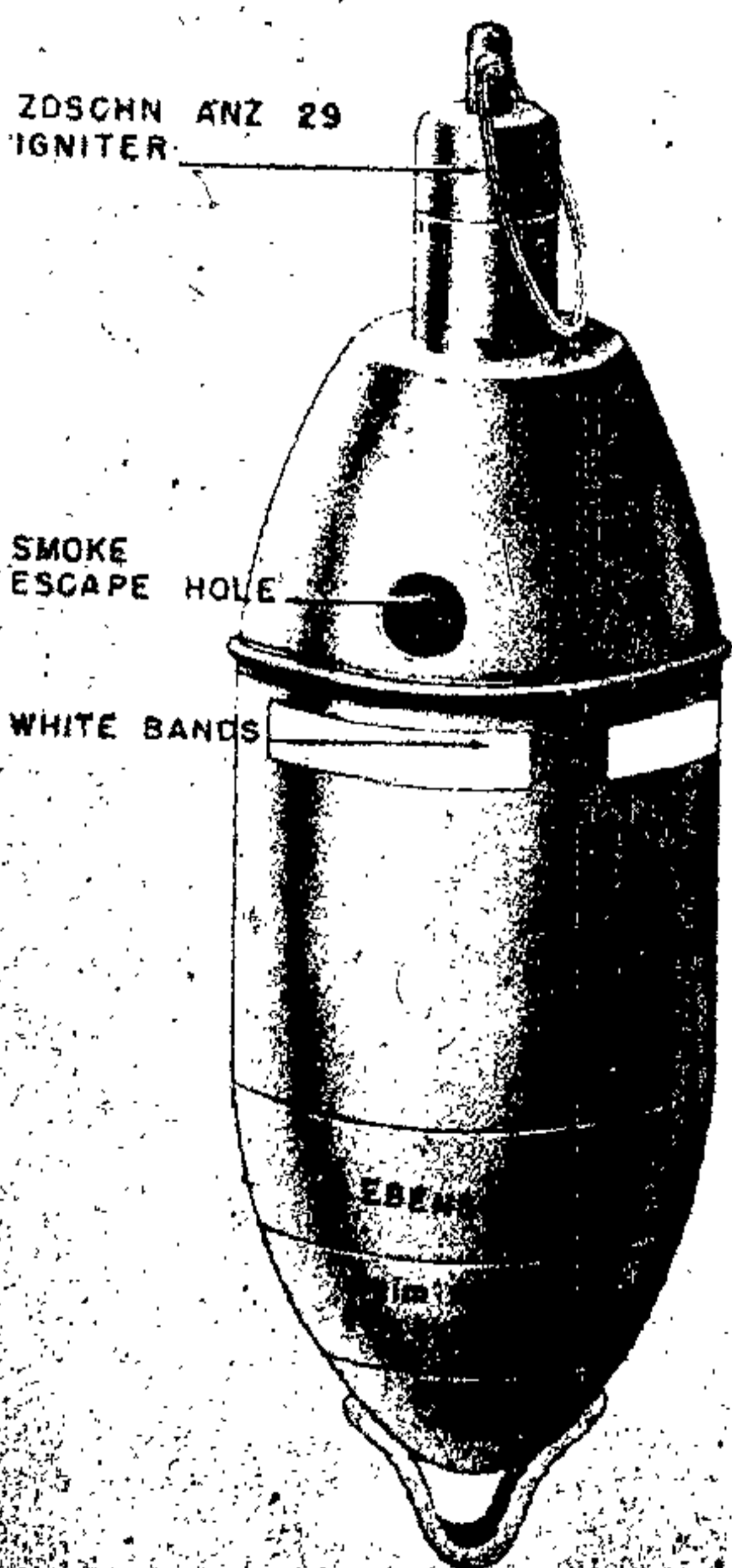

Figure 295—Egg Type Smoke Hand Grenade

SMOKE GRENADE (BLENDKORPER 24)

DATA:

Over-all Length: 4.8 inches.

Maximum Diameter: 2 1/2 inches.

Total Weight: 17 ounces.

Filling and Filling Weight: 270 g. titanium tetrachloride (outer flask). 36 g. aqueous solution of calcium chloride (inner flask).

DESCRIPTION. The grenade consists of an outer glass bulb of molded construction, and an inner glass tube which seats and is sealed on the neck of the outer flask. (See fig. 294.) There is a white plastic washer at the junction. The grenade is sealed by a sulphur and cement plug. The solution of calcium chloride is supplied in the inner tube to provide water necessary for the reaction so that the grenade will cause an effective smoke at conditions of low relative humidity. The calcium chloride has probably been added to lower the freezing point of the water, thus the grenade is practical in a cold dry climate.

OPERATION. The grenade is thrown and upon impact with a hard object it breaks causing a smoke.

EMPLOYMENT. It is for use to blind the enemy and also to repair gaps in larger screens.

SMOKE HAND GRENADE (EGG TYPE)

DATA:

- Over-all Length: 5.3 inches.
- Over-all Diameter: 1.96 inches.
- Body Length: 4.1 inches.
- Body Diameter: 1.7 inches.

DESCRIPTION. The grenade body is of thin metal and is of an elongated egg shape. At the bottom a small metal loop is welded or riveted on, and at the top there is a threaded hole to take the igniter. Near the top are three holes in the body for smoke emission. (See fig. 295.)

The igniter used with this grenade is the standard pull type ZDSCHN^{ANZ} 29. This igniter has a brass body and a steel ring at the top. The igniter screws into the top of the grenade and functions when the ring is pulled.

The grenade is identified by three white bands stencilled around the body and the letters "NB

Eihgr. 42." A label near the bottom of the grenade warns that the fumes can be fatal in an enclosed space.

**HAND SMOKE SIGNAL (RED)
(HANDRAUCHZEICHEN-ROT)**

DATA:

- Over-all Length: 4.9 inches.
- Maximum Diameter: 1.8 inches.
- Total Weight: 4.4 ounces.
- Filling: Red Dye-ortho methoxy phenylazo B-naphthol, 55 percent; potassium chlorate, 20 percent; lactose, 10 percent.
- Unidentified light oily material, 15 percent.
- Total Weight of Filling: 54.0 grams.
- Ignition: Match-head striker.

DESCRIPTION. This signal is included as an example of many German colored smoke signals. (See fig. 296.) It is a cardboard cylinder with a

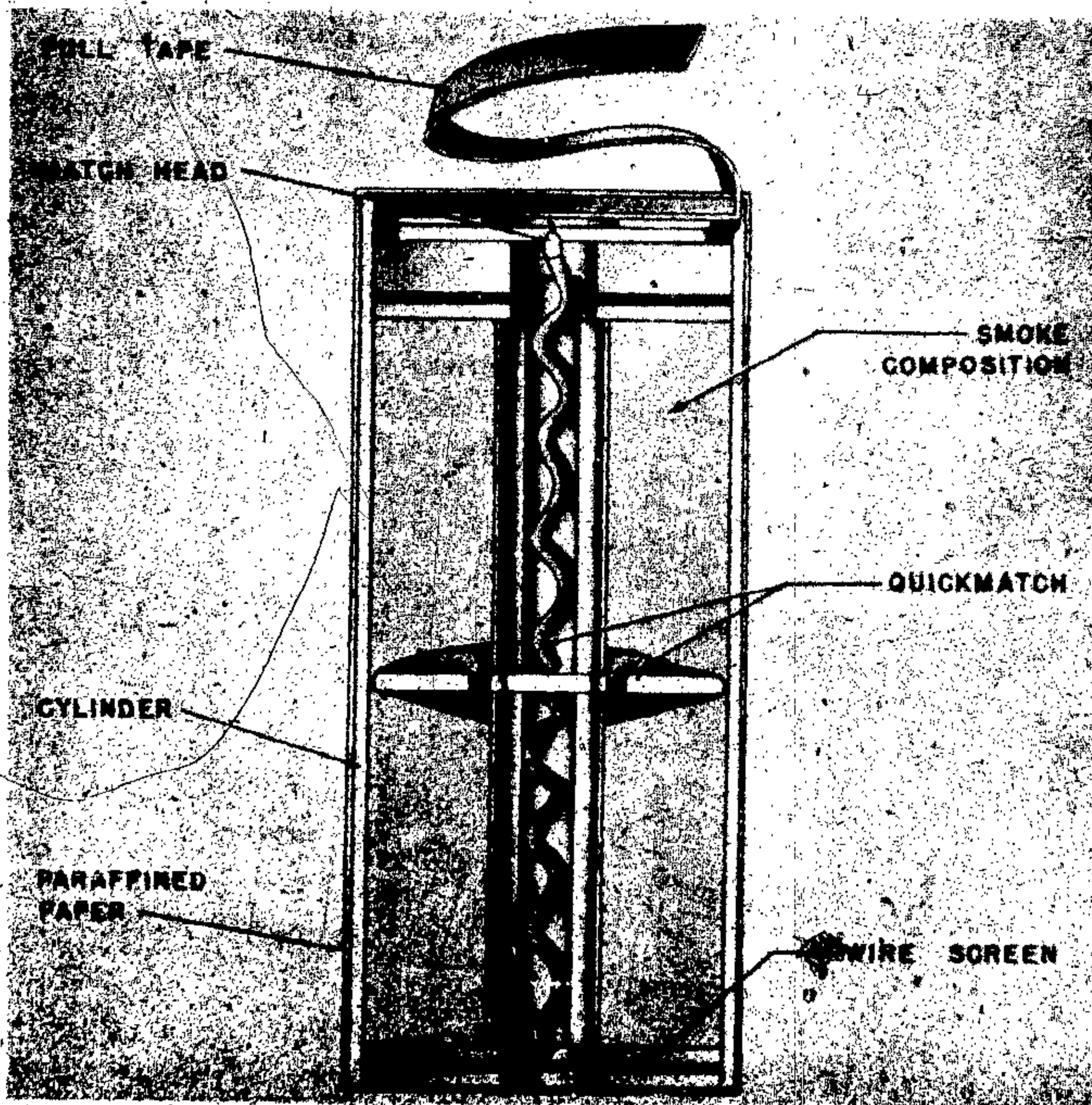

Figure 296—Red Smoke Signal Hand Grenade

GERMAN EXPLOSIVE ORDNANCE

cardboard pull tape lid at the fuze end and a glued-in cardboard disk with an emission hole at the other end. The whole signal is wrapped in red paraffined paper upon which the name and instructions are printed. Beneath the pull tape lid is a cardboard striker ring, one half the top side of which is coated with a red phosphorus abrasive mix. A paper wad separates this and the match head. Beneath the match head is a cardboard inner cover and a wire screen. A perforated metal cylinder containing the quick-match sheath is partitioned in the middle by a cardboard disk which is impregnated with gunpowder and has two diametrically opposite holes in it. At the emission end is another wire screen and the cardboard disk with a tissue paper covered emission hole.

OPERATION. By striking the striker ring on the match head the quickmatch is ignited. This burns its entire length and ignites the gun powder disk which is in direct contact with the inflammable smoke mixture. Smoke is then emitted at both ends of the cylinder. The signal may be placed or thrown.

REMARKS. German smoke signals numbers 350, 160, and 80 which are orange, are analogous to this signal but differ in some respects. There are also similar signals in yellow and violet.

EMPLOYMENT. It is used as a signal from the ground to an air observer.

LACHRYMATORY GRENADE

DATA:

Over-all Length: 5 inches.

Maximum Diameter: 1½ inches.

Color: Aluminum.

Filling: C. A. P.

DESCRIPTION. The case is made of thin sheet aluminum. Within the case, below the lid, is a cylindrical holder retained in position by four indentations in the case which correspond to four indentations in the holder. This holder has a screwed projection to take the friction igniter. The latter has a short piece of cord, 10 cm in length, attached to a wire loop. Below the holder is a dish-shaped aluminum piece which contains a small compressed charge of black powder. On the upper side of this charge is a thin disk of white powder. The main filling consists of ten cylindrical pellets of a yellow compound and one pellet of a white substance wrapped in cellophane. The charge is held between the two dish-shaped pieces. The grenade generates a lachrymatory vapor when ignited and the vapor escapes through the holes in the holder. The containers are unpainted aluminum, and the lid is secured by a piece of adhesive tape colored blue. They are safe to handle when the lids are in place. To disarm the grenade, the igniter may be unscrewed from the holder, taking care not to twist the wire in so doing. (See fig. 297.)

OPERATION. The lid is removed and the friction igniter is pulled. The vapor will be emitted through the holes in the holder.

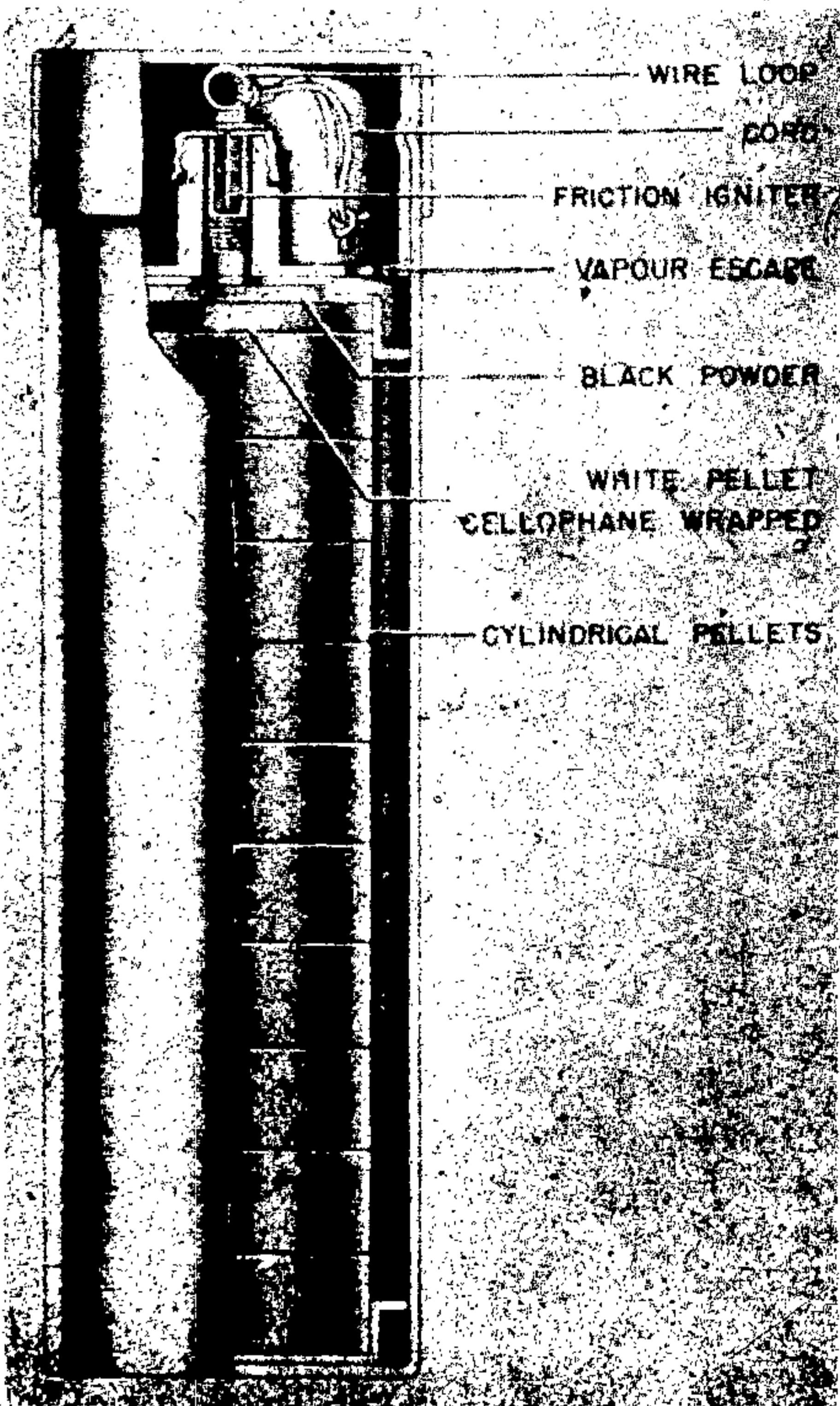

Figure 297—Lachrymatory Hand Grenade

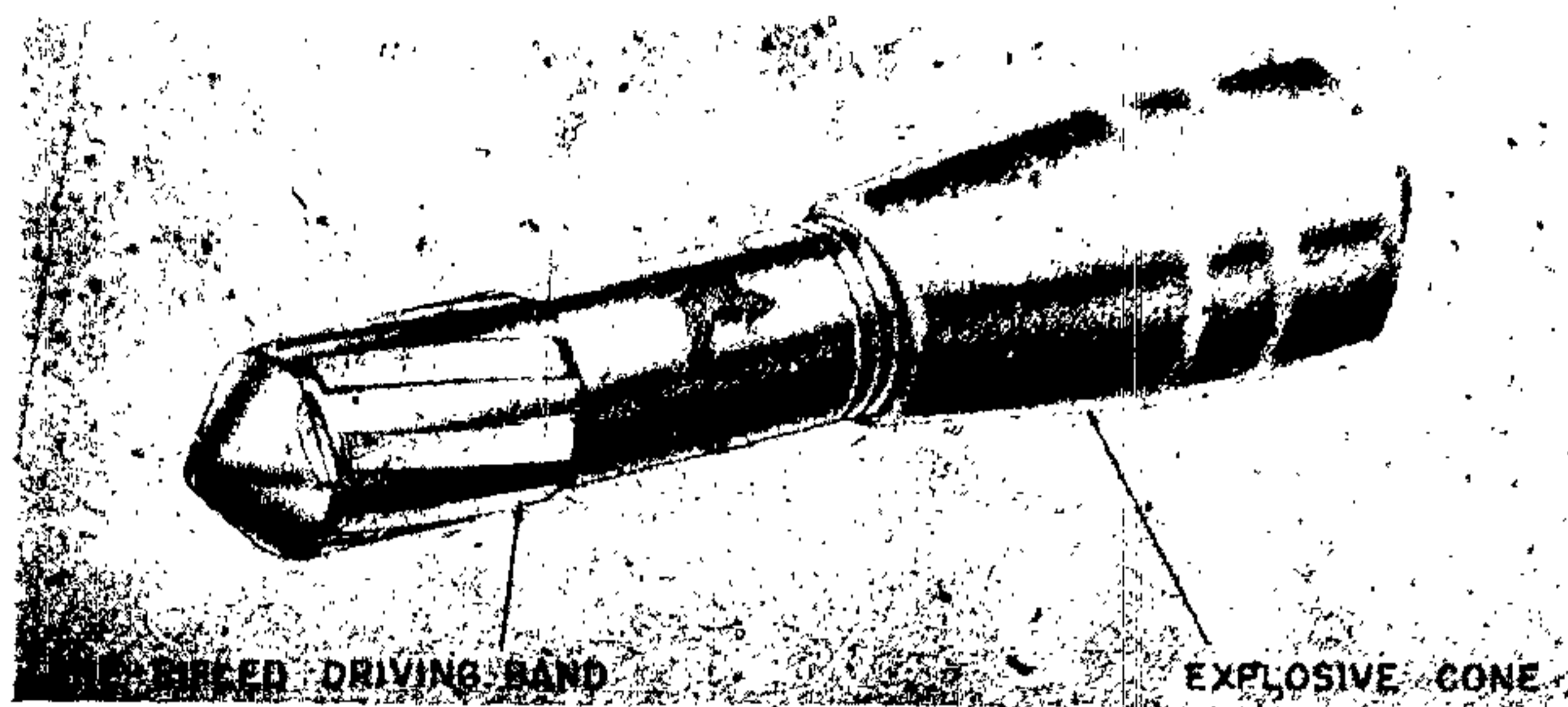

Figure 298—46-mm Hollow Charge Rifle Grenade

**RIFLE GRENADE (S. S. GEWEHR
PANZERGRANATE 46 mm)**

DATA:

- Weight: 15½ ounces (approximately).
- Over-all Length: 7.7 inches (195 mm).
- Length of Stem: 4 inches (102 mm).
- Maximum Diameter of Head: 1.8 inches (46 mm).
- Diameter of Stem: 1.2 inches (30 mm).

DESCRIPTION. This grenade has an unpainted, phosphate, streamline body and is closed by a conical, unpainted steel impact cap. (See fig. 298.) The stem has the normal prerifling to fit the rifled discharge cup. The base plug is conical and provided with two screw flats.

The propelling cartridge consists of a lacquered steel cartridge case with a diameter of 7.92 mm, crimped at the neck and sealed with wax. The cap is colored yellow.

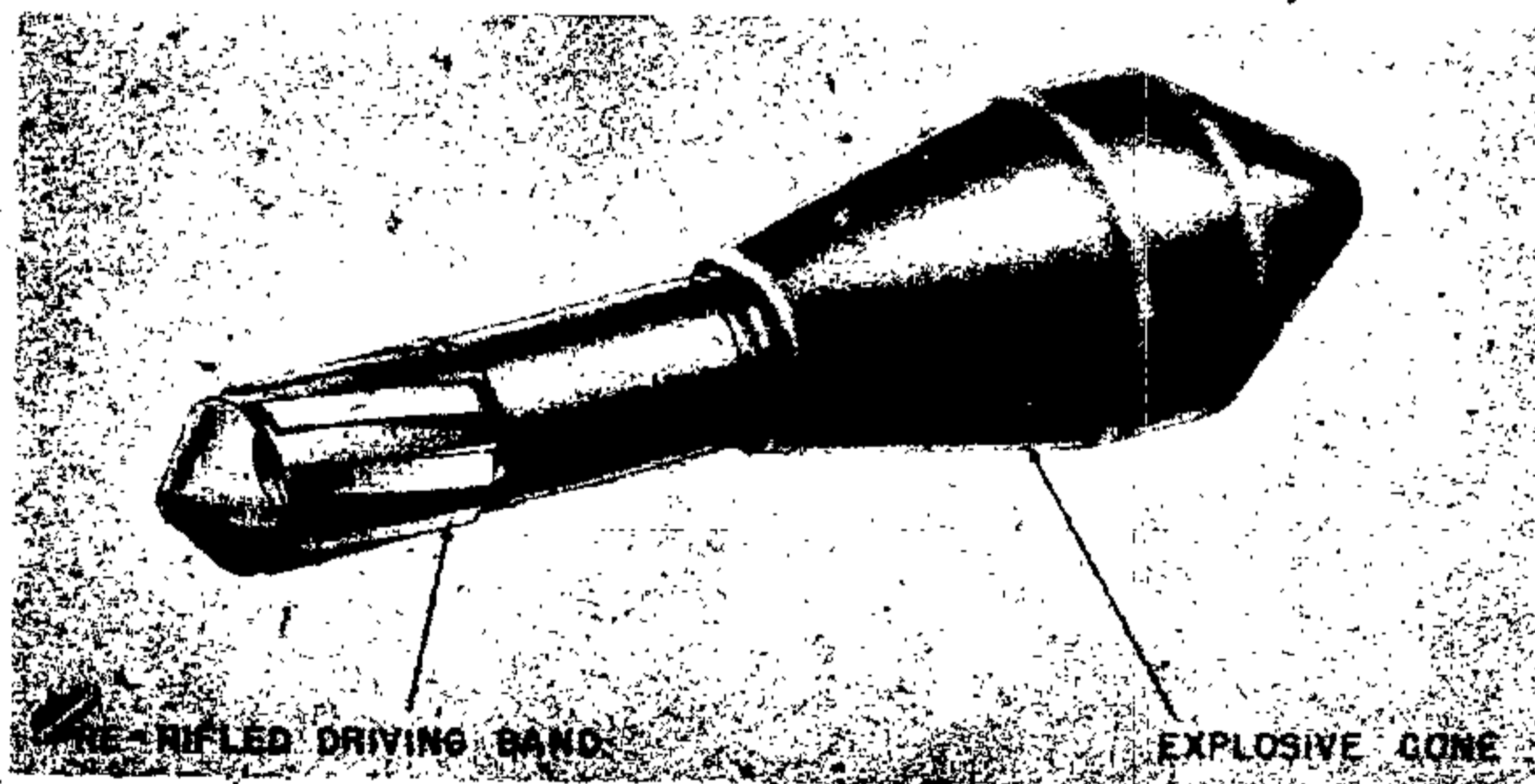

Figure 299—61-mm Hollow Charge Rifle Grenade

**RIFLE GRENADE (S. S. GEWEHR
PANZERGRANATE 61 mm)**

DATA:

- Weight: 9 ounces (approximately).
- Over-all Length: 9.4 inches (238 mm).
- Length of Stem: 4 inches (102 mm).
- Maximum Diameter of Head: 2.4 inches (61 mm).
- Diameter of stem: 1.2 inches (30 mm).

DESCRIPTION. This grenade consists of a streamlined, unpainted phosphated steel body closed at the head by a conical, black, pressed steel impact cup. (See fig. 299). The stem is of steel and has the normal prerifled section to correspond with the rifling in the discharge cup. The base plug is conical and is provided with two screw flats.

The propelling cartridge consists of a lacquered steel cartridge case, the extended neck of which encloses a small wooden pellet. The cap is uncolored.

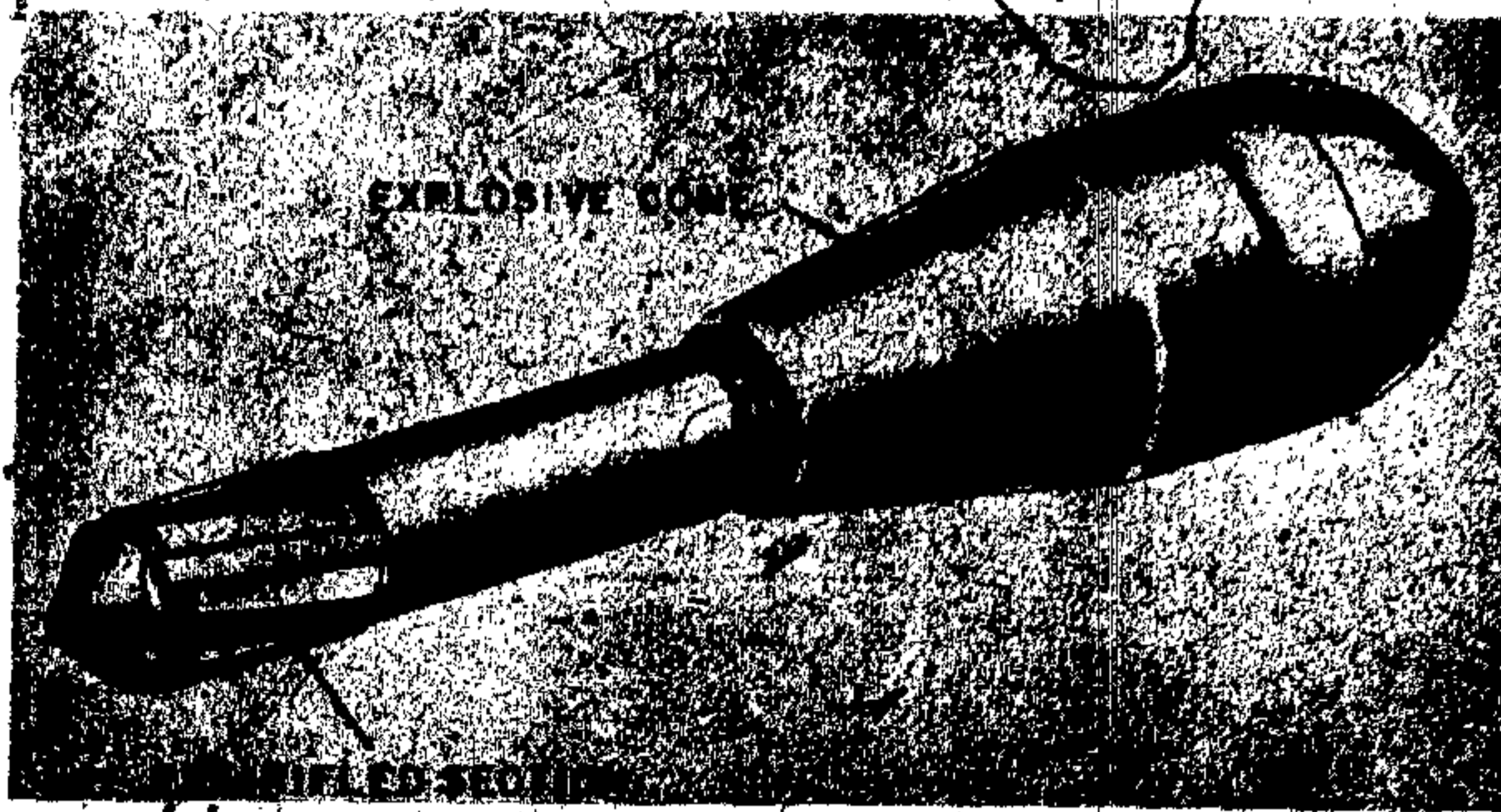

Figure 300—Hollow Charge Rifle Grenade

RIFLE GRENADE (HOLLOW CHARGE TYPE)

DATA:

- Over-all Length: 244 mm.
- Widest Diameter: 61 mm.
- Diameter of Stem: 30 mm.
- Weight: 9 ounces (approximately).

DESCRIPTION. This grenade is similar to the S. S. Gewehr Panzergranate 61 except that it is unpainted and that the impact cap is approximately hemispherical. (See fig. 300.) The stem is of steel and has the normal prerifled section to correspond with the rifling of the discharger cup. The base plug is conical and is provided with two screw flats.

The propellant charge consists of a lacquered steel cartridge case, the end of which contains a light wooden pellet. The cap is uncolored.

ANTIPERSONNEL RIFLE OR HAND GRENADE (GEWEHR SPRENGGRANATE)

DATA:

- Over-all Length: 5.5 inches.
- Maximum Diameter: 1.2 inches.
- Color: Black body. Aluminum fuze and base.
- Total Weight: 9 ounces.
- Explosive Filler: PETN/Wax.
- Weight of Filler: 1.1 ounces.
- Maximum Range: 550 yards.
- Delay: Self-destroying, 11 seconds; friction igniter, 4½ seconds.

DESCRIPTION. This grenade consists of a body with explosive filling and detonator, a fuze body carrying the direct action fuze, a friction

igniter, and a base fitment carrying the delay of the self-destroying system. (See fig. 301.) The body is in the form of a steel tube having a diaphragm near the bottom. It is screw threaded at the nose to receive the fuze body and the base to receive the base fitment. The diaphragm is screw threaded centrally to receive the delay igniter.

The filling is penthrite wax contained in a cardboard container. The explosive has a central cavity which holds the detonator encased in an aluminum container at one end, and receives the igniter delay pellet from the diaphragm at the other end.

The fuze is made of aluminum and is of the direct action type. The base of the fuze body is threaded externally to enter the grenade body and internally to receive a detonator holder. It consists of a striker held away from the primer by a creep spring and a coiled spring. Around the coiled spring is an inertia pellet resting on four fingers of a stirrup spring fixed in the base of a stirrup spring retainer. The inertia pellet has a groove cut on the inside of it. The friction igniter which is similar to the B. Z. 24 used with stick hand grenades screws into the central channel of the diaphragm. The igniter pellet has a delay of 4½ seconds.

The rifled base fitment is screw threaded externally to screw into the base of the grenade and internally at the base to receive a closing plug. A 6½-second delay pellet contained in a brass holder is situated in the base.

The propelling cartridge is a 7.92 mm cartridge closed at the shoulder by crimping. The propellant consists of 0.9 grams of nitrocellulose flakes.

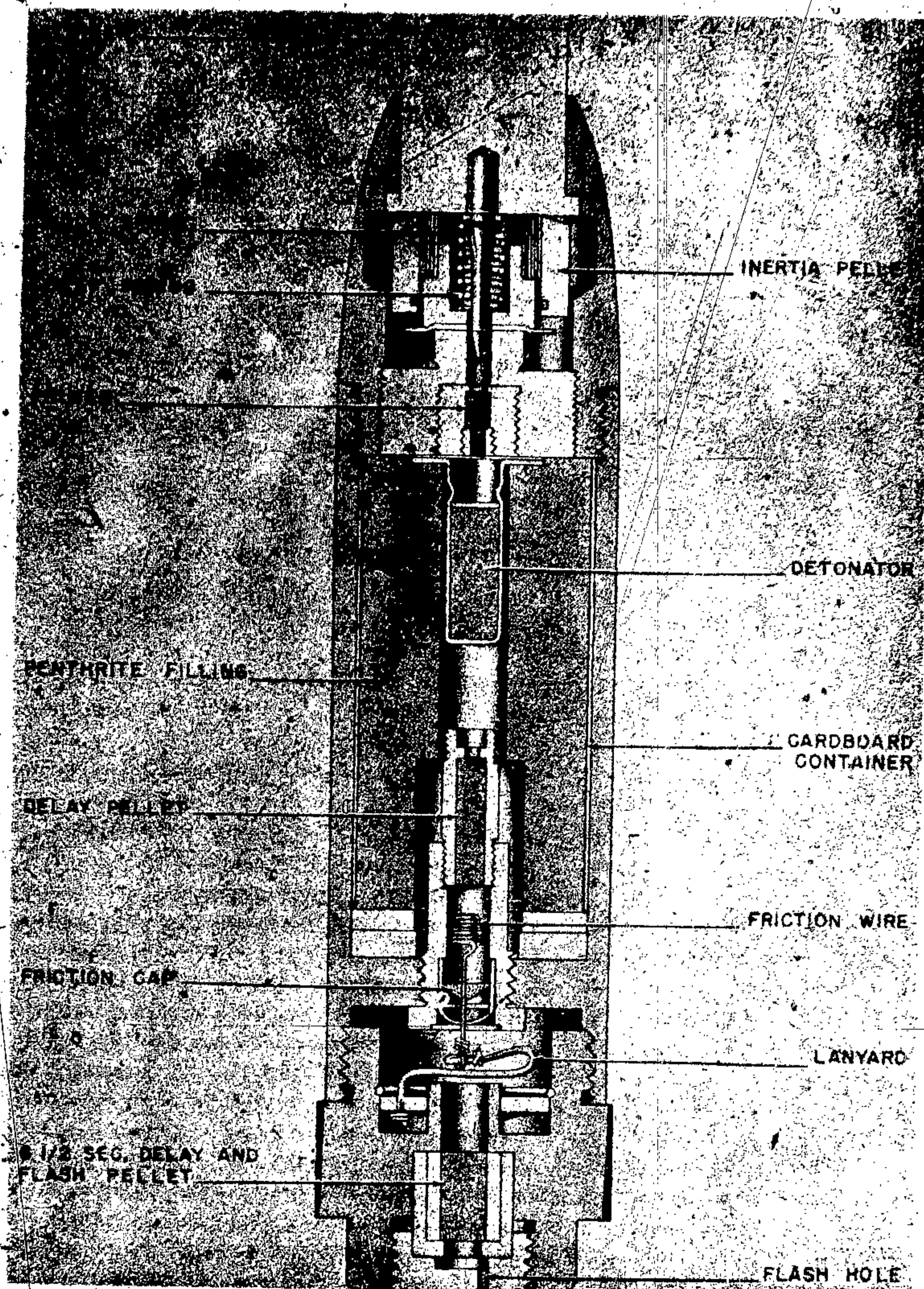

Figure 301—Hand or Rifle Grenade

OPERATION. 1. AS A RIFLE GRENADE. *a.* On discharge the inertia pellet of the fuze is driven downwards and the ends of the stirrup spring are forced into the grooves of the inertia pellet thus

holding it down. The clock spring is now held in position by the collar of the striker pin and the stirrup spring retainer. On deceleration the clock spring flies outward, assisted by centrifugal

GERMAN EXPLOSIVE ORDNANCE

force, into the recess in the fuze body. On impact the striker compresses the creep spring and penetrates the primer whose flash explodes the detonator.

b. Should the fuze not function, the grenade

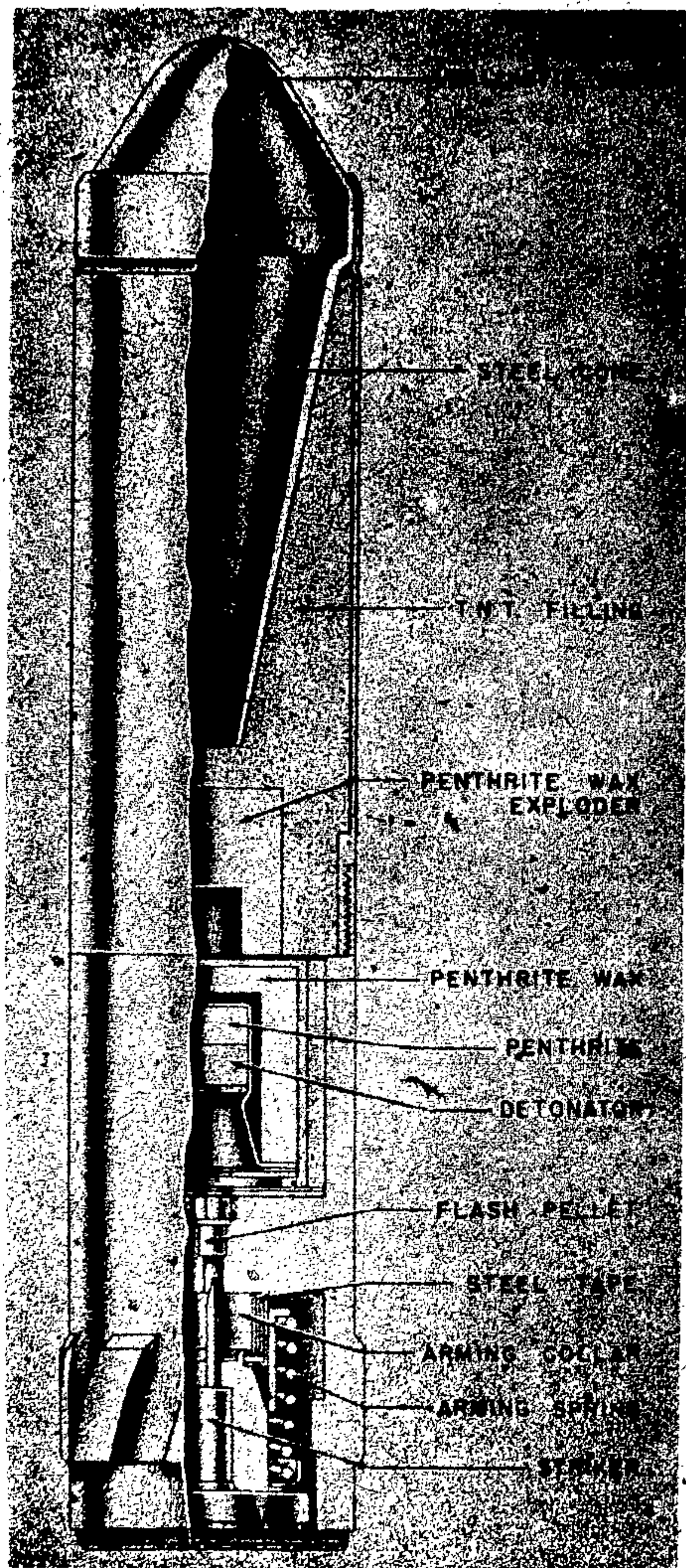

Figure 302—Antitank Hollow Charge Rifle Grenade

will be self-destructive. On firing, the flash enters the hole in the closing plug and ignites the delay pellet which burns for $6\frac{1}{2}$ seconds. This then fires the friction igniter which will give an additional delay of $4\frac{1}{2}$ seconds and then fires the detonator.

2. AS A HAND GRENADE. a. The base fitment is unscrewed and the cord of the friction igniter pulled. This gives a delay of $4\frac{1}{2}$ seconds and then fires the detonator.

ANTITANK RIFLE GRENADE (GEWEHR PANZERGRANATE)

DATA:

Over-all Length: 6.4 inches.

Maximum Diameter: $1\frac{3}{16}$ inches.

Color: Front half is black and back half is aluminum.

Total Weight: 8.8 ounces.

Filler: TNT.

Weight of Filler: 1.75 ounces.

Range: 50 yards.

DESCRIPTION. This grenade is fired from the rifle 3 cm discharger cup (Schliessbecher) which can be fitted to most types of German rifles. It is constructed in two parts, the head and the stem. The head is a seamless steel tube with the forward portion containing a hollow charge cone and the explosive filling, being closed at the forward end by a light ballistic cap. The main filling of TNT is poured around the cone and there is a cavity formed in the after part of the main filling in which the exploder of penthrite wax is inserted. (See fig. 302.)

The stem is made of light alloy or aluminum and is screwed onto the head of the grenade. The stem is divided into two compartments, the lower containing the fuze, the upper the gaine. In the septum is a small flash pellet held in place by a perforated screw plug. The gaine consists of a light alloy case into which is inserted a light alloy top hat containing the detonator, the space between being filled with penthrite wax. A preengraved driving band is formed around the stem 6 mm from the rear.

The fuze is in the after portion of the stem and consists of a striker over the top of which fits a retaining spring with four prongs bent downward into grooves in the striker body. Around the striker body is an arming collar which has two

grooves cut on the inside. An arming spring is compressed between a lip on the arming collar and a second collar at the bottom of the striker body. Around the inside of the arming collar and resting on the striker body is a steel tape which acts as an additional safety device and prevents any possibility of the fuze being accidentally armed when screwing on the base plug.

The entire assembly is closed by a base plug which positions the fuze by a stem which fits into a recess in the rear of the striker body.

OPERATION. On firing, the shock of discharge causes the arming sleeve to set back against its spring. The four prongs of the retaining spring are forced out of the lower groove in the arming sleeve and engage in the upper groove, retaining the arming sleeve in its lower position. This allows the steel tape to unwind and the striker is then free to move forward on impact firing the mine.

37-mm H. E. ANTITANK STICK GRENADE

DATA:

Over-all Length: $29\frac{1}{8}$ inches.

Length of Stick: $16\frac{7}{16}$ inches.

Length of Body: $12\frac{1}{4}$ inches.

Total Weight: 18 pounds 12 ounces.

Weight of Filler: 5 pounds 5 ounces.

Explosive Filler: Dinitroanoline with TNT.

Base Fuze: Bd. Z. 5130.

Point Fuze: A. Z. 5075.

DESCRIPTION. The complete round, which is made up of the hollow charge stick grenade and the propellant, is fired from the 3.7-cm P. A. K. gun. (See fig. 303.)

The stick grenade has a steel rod which fits into the bore, and a concentric perforated sleeve which fits around the barrel of the gun. A pressed steel cap forms the nose of the grenade giving it the required stand-off distance. The hollow charge is at the rear of the steel cone and consists of two blocks of dinitroanoline with TNT. Two detonators are set in the base of the grenade, one facing in each direction. A nose fuze of the instantaneous percussion type and a tail fuze also instantaneous are present.

The steel rod which fits into the bore of the gun is a hollow tube closed at the base end. The base fuze is a percussion type fuze very sensitive to shock. It is armed by setback which releases a

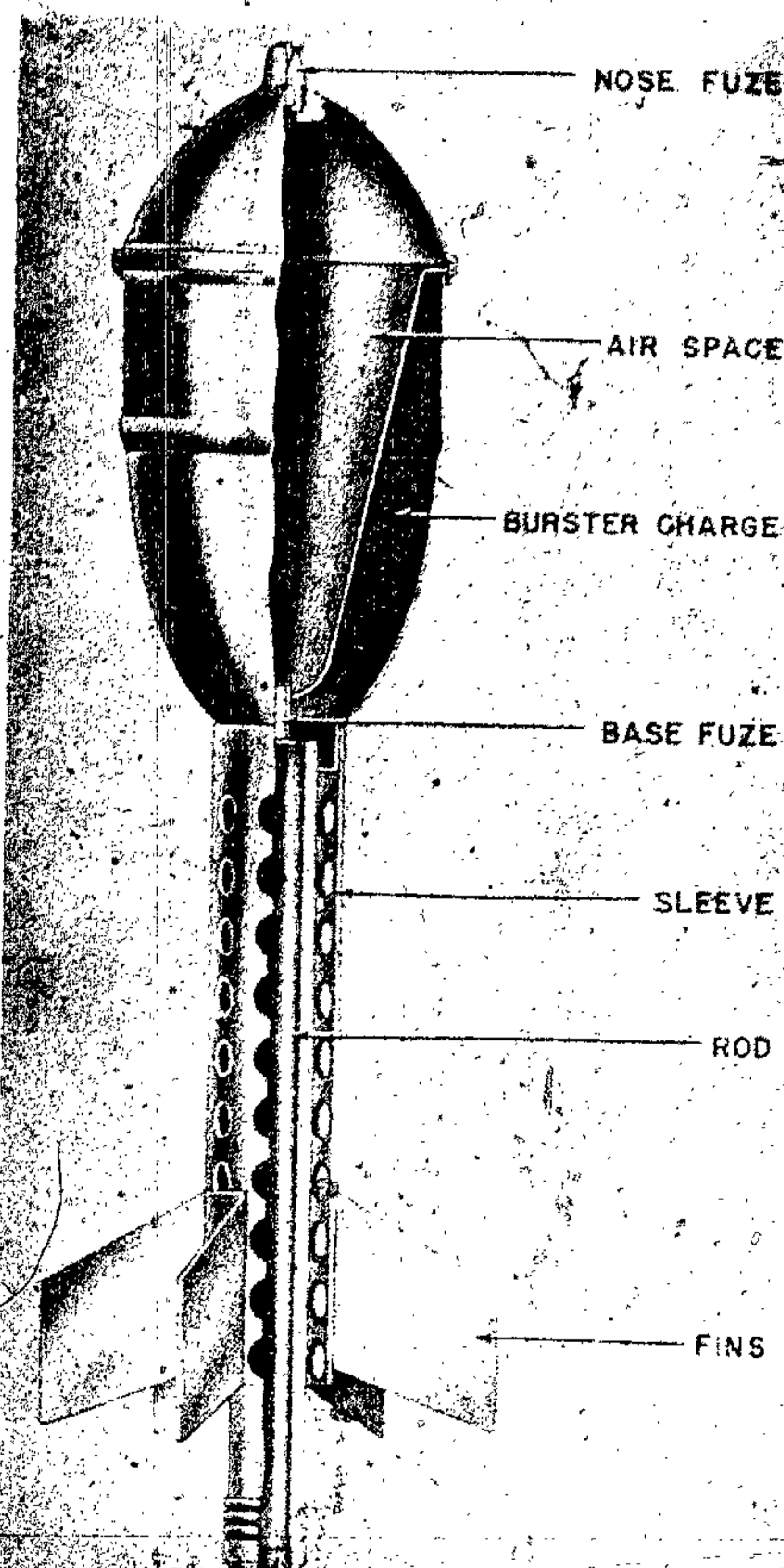

Figure 303—37-mm Hollow Charge Rifle Grenade

spring loaded detent allowing a steel ball to move away from the striker. Upon impact the striker moves forward against the action of a very weak creep spring.

The nose fuze consists of a striker held away from the primer by a creep spring and a coiled spring. Around the coiled spring is an inertia pellet resting on four fingers of a stirrup spring fixed in the base of a stirrup spring retainer. The inertia pellet has a groove cut around its internal circumference.

GERMAN EXPLOSIVE ORDNANCE

Two detonators are located at the base of the main charge. One detonator faces toward the nose fuze to receive the flash from there, and the other detonator faces the tail fuze to receive its flash.

The propelling charge is contained in a steel

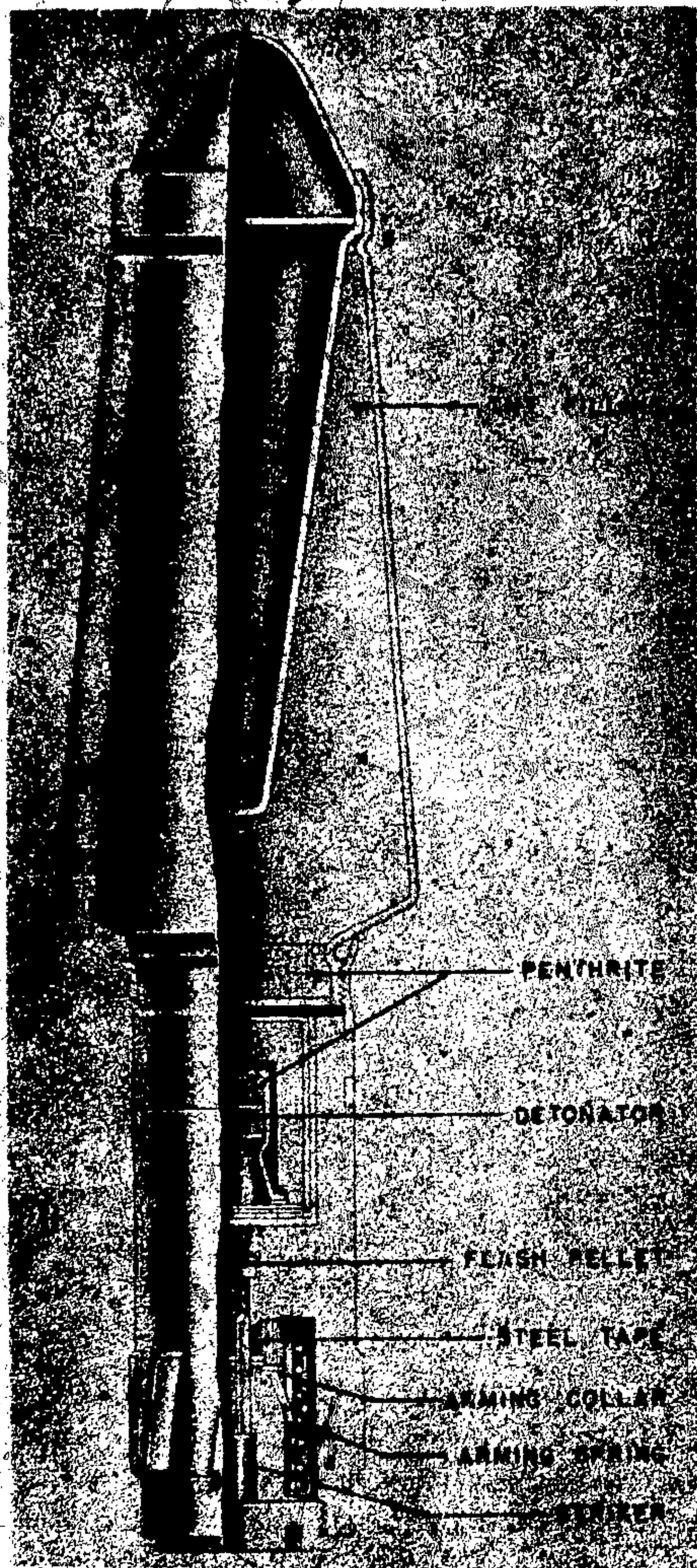

Figure 304—Large Hollow Charge Rifle Grenade

cartridge case. The charge consists of diethylene glycol dinitrate tubular stick powder with an igniting charge of nitrocellulose granular powder, and a percussion type primer consisting of mercury fulminate and black powder.

OPERATION. On discharge the inertia pellet of the nose fuze is driven downwards and the ends of the stirrup spring are forced into the grooves of the inertia pellet thus holding it down. The clock spring is now held in position by the collar of the striker pin and the stirrup spring retainer. On deceleration the clock spring flies outward, assisted by centrifugal force, into the recess in the fuze body. At the same time the base fuze is being armed. In the event of direct impact the nose fuze will function the grenade, but in the event of graze action, the base fuze will function the grenade.

LARGE ANTITANK RIFLE GRENADE, GROSS GEWEHR PANZERGRANATE

DATA:

Over-all Length: 7 inches.

Maximum Diameter: $1\frac{3}{4}$ inches.

Color: Black over-all.

Total Weight: $13\frac{1}{2}$ ounces.

Weight of Filler: $4\frac{1}{2}$ ounces.

Filler: TNT.

Range: 100 yards.

DESCRIPTION. This grenade is fired from the rifled 3-cm discharger cup (Schliessbecher) which can be fitted to most types of German rifles. It is of the hollow charge type and consists of a steel head containing the explosive and light alloy or steel and plastic stem containing the fuze and gaine. (See fig. 304.) The propelling cartridge contains a wooden bullet.

The body which is of pressed steel contains a steel cone around which the main filler of TNT is cast. A steel washer with a small central hole rests on the open end of the cone and above the latter is a steel ballistic cap. At the bottom of the TNT is an exploder pellet of penthrate wax.

Two varieties of the stem have been found, one entirely of light alloy, the other of plastic with a steel shank by which it is screwed on to the head of the grenade. At the base of the stem is a rifled band which corresponds with the rifling in the discharger cup. The stem is divided into compartments by a perforated septum, the lower containing the fuze, the upper the gaine. In the

septum is a small flash pellet held in place by a perforated screw plug. The gaine consists of a light alloy container into which is inserted a light alloy top hat containing the detonator, the space below being filled with penthrite wax

The fuze is in the after portion of the stem and consists of a striker over the top of which fits a retaining spring with four prongs bent downward into grooves in the striker body. Around the striker body is an arming collar which has two grooves cut on the inside. An arming spring is compressed between a lip on the arming collar and a second collar at the bottom of the striker body. Around the inside of the arming collar and resting on the striker body is a steel tape which acts as an additional safety device and prevents any possibility of the fuze being accidentally armed when screwing on the base plug.

The entire assembly is closed by a base plug which positions the fuze by a stem which fits into a recess in the rear of the striker body.

OPERATION. On firing, the shock of discharge causes the arming sleeve to set back against its spring. The four prongs of the retaining spring are forced out of the lower groove in the arming sleeve and engage in the upper groove, retaining the arming sleeve in its lower position. This allows the steel tape to unwind and the striker is then free to move forward on impact firing the gaine.

HOLLOW CHARGE GRENADE (SCHUSS Gg. P-40)

DATA:

Over-all Length: 9.3 inches.

Maximum Diameter: 2.4 inches.

Color: Olive green.

Markings: Blue band around projection at the base of body.

Length of Body: 3.1 inches.

Filler: Cyclonite/Wax.

DESCRIPTION. The grenade consists of a stream-lined bell-shaped body, with a slightly convex closing disk of aluminum, a graze fuze which screws into a projection on the base of the body, and a vaned tail unit which screws on the base of the fuze and is closed by a rubber plug. (See fig. 305.)

The body is made of thin steel and is stream-lined with a cylindrical projection welded at the

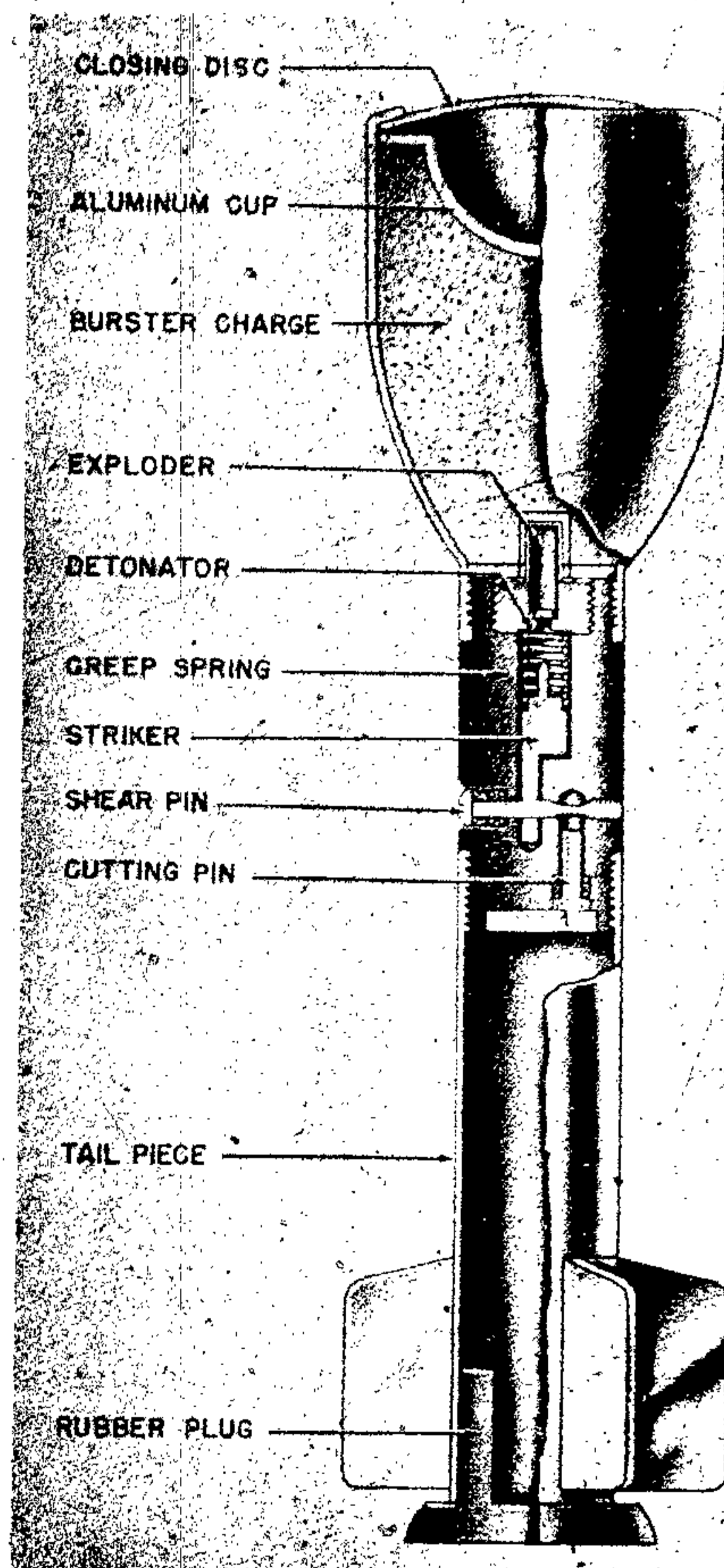

Figure 305—Schuss Gg. P-40 Hollow Charge Rifle Grenade

base. The projection is screw-threaded internally for the insertion of the fuze. A hole in the base of the body is fitted with an aluminum cup to accommodate the protruding magazine of the fuze. The head of the body is closed by a concave disk of aluminum which is secured by the overturned rim of the body.

The bursting charge consists of cast cyclonite-wax with a hemispherical cavity in the head. The

GERMAN EXPLOSIVE ORDNANCE

cavity is fitted with an aluminum liner of corresponding shape with a flange which fits inside the body at the head.

The fuze is cylindrical with an external screw-thread at each end for assembly as the connecting piece between the tail unit and the body. A central recess contains the striker and creep spring and is closed at its enlarged front end by an alu-

minum magazine which is screwed in and contains a detonator and an intermediary explosive. A transverse channel near the base contains a spring-loaded screwed shearing pin which engages in a recess in the stem of the striker. Another channel containing a cutting pin with spring, is bored from the base of the body and communicates with the shearing pin at a point where the shearing pin is reduced in diameter. A circular plate, secured in a recess in the base of the body by two screws, retains the cutting pin in its channel. The base end of the cutting pin passes through a hole in the circular plate and is thus exposed to the pressure of the propellant gases.

The tail unit screws on to the base of the fuze and consists of a drawn-steel tube with six vanes formed in pairs. The cartridge is placed inside the tube for transport and the tube is closed at the base by a rubber plug. The cartridge is of the 7.92-mm small arm type with an undyed hollow wooden bullet.

OPERATION. The grenade is fired from the spigot type discharger. On firing the hollow wooden bullet is shattered by the propellant gases, which project the grenade. The propelling gases overcome the spring of the cutting pin and drive the pin forward, causing it to cut the shearing pin away from its screwed end. The shearing pin is then ejected by the spring held in compression under its head, and thus leaves the striker held off the detonator only by the creep spring. On graze the momentum of the striker overcomes the creep spring and the detonator is pierced.

PROPAGANDA RIFLE GRENADE—GEWEHR PROPAGANDA GRANATE

DATA:

- Over-all Length: 5.7 inches.
- Total Weight: 8 ounces.
- Weight Without Leaflets: 7 ounces.
- Delay: 9 seconds.
- Range: 500 yards.

DESCRIPTION. This grenade is fired from the rifled 3-cm discharger cup (Schliessbecher) which can be fitted to most types of German rifles. The body of this grenade is a steel case with a pre-rifled base. (See fig. 306.) Inside the base there is a 9-second delay fuze and an ejecting charge for the pamphlets. Two steel leaflets packing covers are held loosely inside the case and fitting over the top

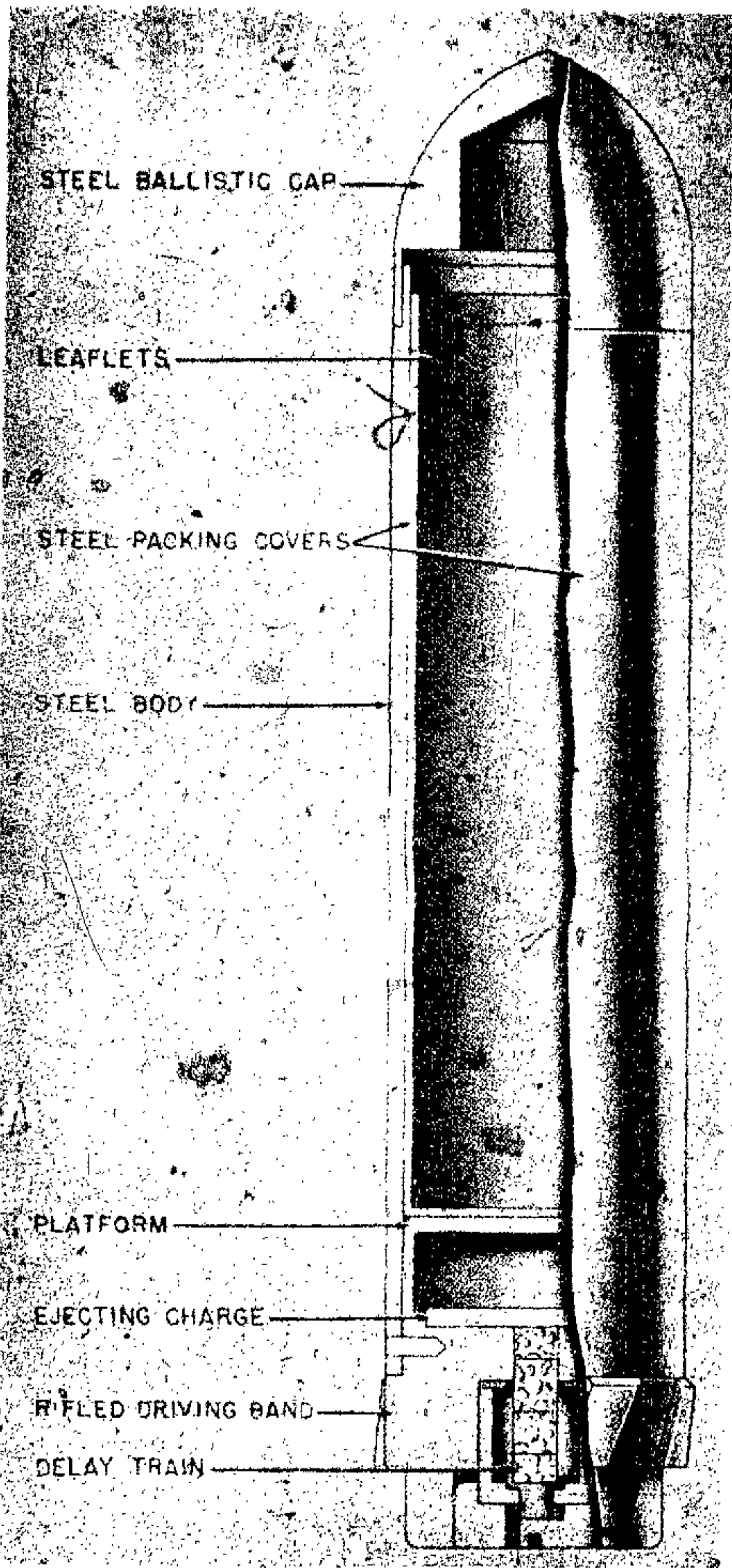

Figure 306—Propaganda Rifle Grenade

of these is a removable steel cap. The leaflets are inserted by removing the steel cap and rolling the leaflets tightly making sure that they do not show above the rim of the case. The cap is then replaced.

The case and cap are varnished to protect them from rust and the ejecting charge is protected by a cardboard disk to prevent moisture from causing deterioration.

The propelling cartridge is distinguished from other rifle grenade cartridges by a red ring around the base.

OPERATION. When the grenade is fired, the propelling cartridge will ignite the delay fuze.

Approximately 9 seconds after discharge, the delay fuze will set off the ejecting charge, blowing off the cap and forcing the leaflets out the nose.

ILLUMINATING STAR ON PARACHUTE RIFLE GRENADE — GEWEHR FALLSCHIRM-LEUCHTGRANATE (Gw. F. S. St. Gr.)

DATA:

Length: 6.88 inches.

Diameter: 1.18 inches.

Weight: .280 g.

Color and Markings: White cap. "Gewehr Fallschirmleuchtgranate" stencilled on body.

Propellant: 1.5 g propellant enclosed in a cartridge case which is closed with a wooden bullet.

DESCRIPTION. This grenade consists of a thin-walled body which contains another internal container. (See fig. 307.) The internal container holds the parachute and illuminating star. The grenade has a thin conical cap and is fitted with two delay pellets and two ejection charges.

OPERATION. On firing, delay 1 is ignited by the flash from the propellant gases. After 6.5 seconds of flight, ejection charge 1 is initiated. This ejects the container holding the star and parachute. At the same time, delay 2 is initiated. During this part of the flight, the cap hangs from the container by means of a cord. After delay 2 has burned through (2 seconds), ejection charge 2 is initiated and the parachute and star ejected. It is stated that distances up to 650 meters may be illuminated.

REMARKS. Each grenade is packed together with a propellant charge in a cardboard container.

HOLLOW CHARGE GRENADE FAUSTPATRONE

DATA:

Over-all Length: 41 inches.

Length of Tube: 31.5 inches.

Length of Body: 19.5 inches.

Caliber of Tube: 1.75 inches.

Weight of Grenade: 6.62 pounds.

Weight of Tube and Grenade: 11 pounds.

Weight of Filler: 3.4 pounds.

Effective Range: 33 yards.

DESCRIPTION. The Faustpatrone consists of

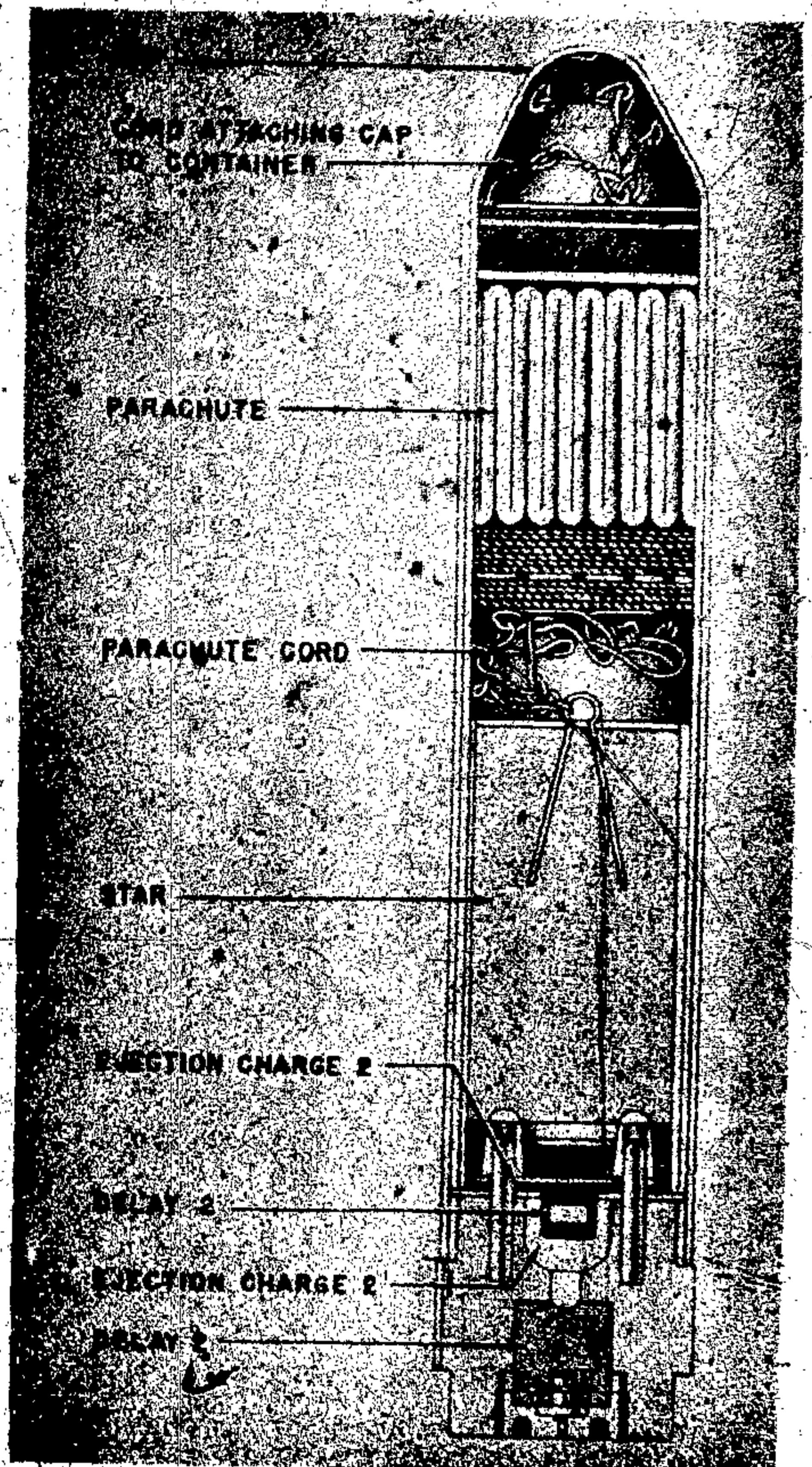

Figure 307—Illuminating Rifle Grenade

GERMAN EXPLOSIVE ORDNANCE

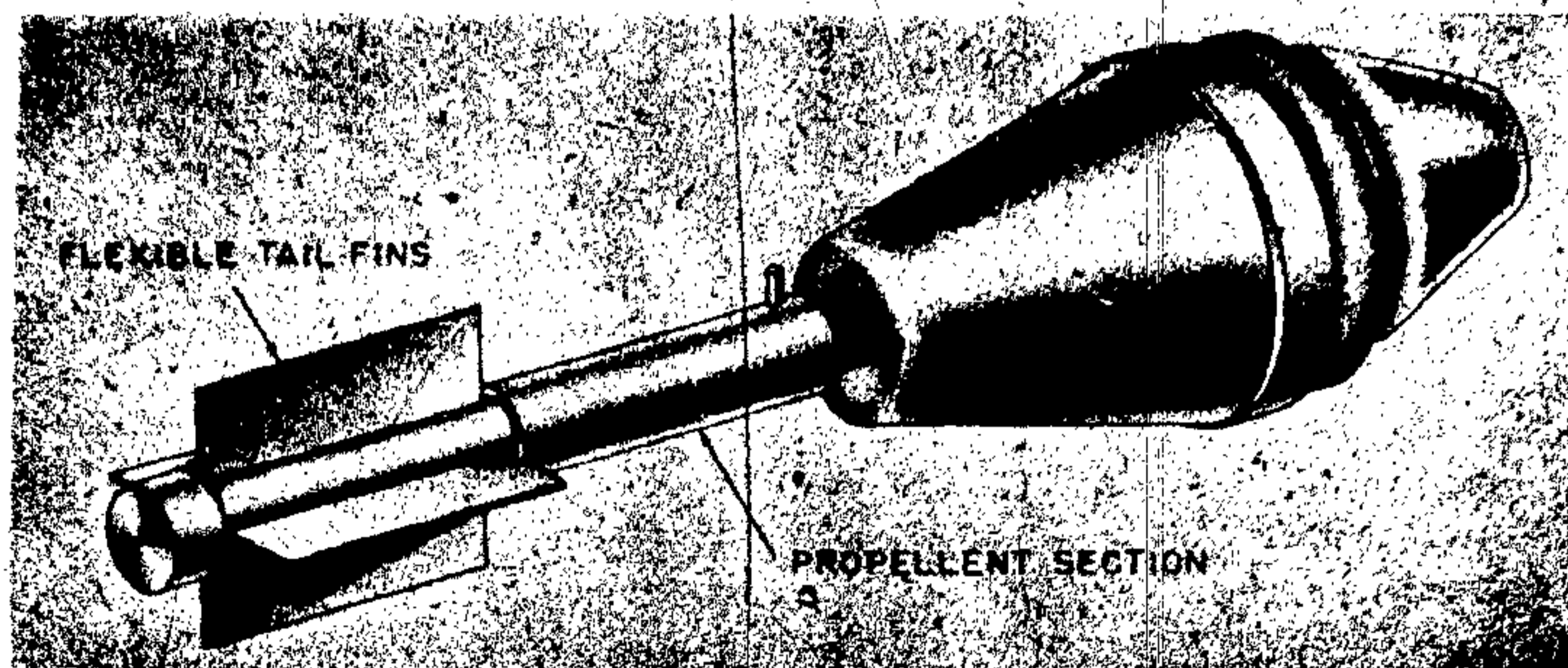

Figure 308—Faustpatrone Hollow Charge Grenade

a large hollow charge H. E. grenade and a projecting tube. The grenade consists of a large head and a cylindrical body terminating in a tail to which are attached four spring steel stabilizing fins. (See fig. 308.) The body contains a base fuze and a booster.

The projector is a simple metal tube in which is located a propellant charge contained in a waxed cardboard container held in position by a set screw. On the opposite side of the set screw is an igniter situated below a flash hole. On top of the tube is a simple firing mechanism with release button, firing pin and spring and a safety catch. There is also a folding sight.

OPERATION. The grenade is armed by unscrewing the tail and inserting the booster and fuze, open ends facing each other. The tail is then replaced. The fins are wrapped around the tail and the grenade inserted into the tube. The pressure of the fins against the inside of the tube serves to retain the grenade in position.

The firing mechanism is cocked by pushing the lock forward until the release button emerges. The lock then slides back to its original position. The weapon is now cocked and "safe."

To make ready for firing the lock is rotated 90° to the left. The tube is held under the right arm, the left hand supporting the forward part. Aiming is accomplished by aligning the sight, placed vertical to the tube. The sight is adjustable for a range of 33 yards. To fire, depress the release button, thus allowing the striker to go forward. The tube cannot be used a second time.

SAFETY PRECAUTIONS. 1. Set Faustpatrone to "fire" only when using. The Faustpatrone

can be set to safe again if it has not been fired.

2. To set from "fire" to "safe", turn bolt to vertical, then push fully forward and hold. Press release button and allow it to slide back slowly so that firing pin spring is allowed to expand. Snap sight back onto tube and replace the split pin.

3. On discharge, a sheet of flame up to 6 feet long comes from the rear end of the tube. Great care must be taken that the flame and bits of wadding do not hit either the firer or anyone standing behind him. The danger zone extends up to 30 feet. There must be a clear space (i. e., no earth, stones or wall) for the flame at least 6 feet behind the tube.

4. If propellant charge fails, do not attempt to fiddle around with the weapon. It must be laid aside carefully and exploded. Delayed explosions may still occur. Should the hollow charge detonator fail to explode, the grenade must on no account be touched but must be exploded by placing an explosive charge against it.

5. During practice firing with live ammunition, an area of 800 yards around firer and target must be closed off. Firer must wear steel helmet.

PISTOL GRENADE (WURFKORPER LEUCHTPISTOLE)

DATA:

- Over-all Length: 6.89 inches.
- Maximum Diameter: 3 inches.
- Color: Olive green.
- Delay: 4.5 seconds.
- Range: 80 yards.

DESCRIPTION: This grenade is fired from the 27-mm Walther signal pistol. It consists of the

normal egg-hand grenade attached to a plastic stem or body by a retaining tube. (See fig. 309.) The plastic stem contains the firing pin, delay igniter, detonator, and a base adapter for the propelling charge. The end of the stem is closed before firing by a cardboard cap.

The retaining tube fits through the hollow stem and is threaded to it. The retaining tube is also threaded to the grenade body and contains in its forward part the 4.5-second igniter. In the base of the tube is a fuze consisting of a firing pin held away from the primer by a creep spring and safety pin. An alloy flash tube connects the primer to the delay igniter.

Screwed into the base of the plastic stem is a base adapter containing a primer and propelling charge.

OPERATION. Before firing the safety pin is pulled out and the grenade is then armed. The stem is placed in a barrel reinforcing tube which is inserted previously in the barrel of the pistol. On impact the firing pin overcomes the creep spring and impinges the primer thus igniting the delay igniter which will detonate the explosive after a delay of approximately 4.5 seconds.

PISTOL GRENADE H. E. EGG TYPE

DESCRIPTION. This grenade is fired from the latest type Walther 27-mm signal pistol. It is used without the addition of a rifled liner of reinforcing tube in the barrel, or the special sights used with the hollow charge grenade. The folding butt on the pistol may be used but is not necessary; the pistol can be held in the hand for firing if the arm is slightly bent. (See fig. 310.)

The difference from the old grenade 361 L. P. lies in the projector stem. The stem on this grenade has a sliding fit in the smooth bore of the pistol. It consists of a wooden cylinder with thin metal reinforcing sleeves at each end. A grenade adapter is screwed to the forward end of the projector stem and contains a 4½-second delay pellet.

At the after end the stem is firmly held in a short metal cartridge case which contains the percussion cap. Inside this end of the stem are the propellant, the striker and the initiating percussion cap.

For loading the plastic cap is removed from the forward end of the stem and an egg grenade, complete with detonator, is screwed to the stem. The

complete grenade is loaded into the pistol from the muzzle end until a spring locking ring on the stem engages in a groove at the breach of the barrel. The grenade is firmly held and cannot fall out.

OPERATION. There is no safety pin and the

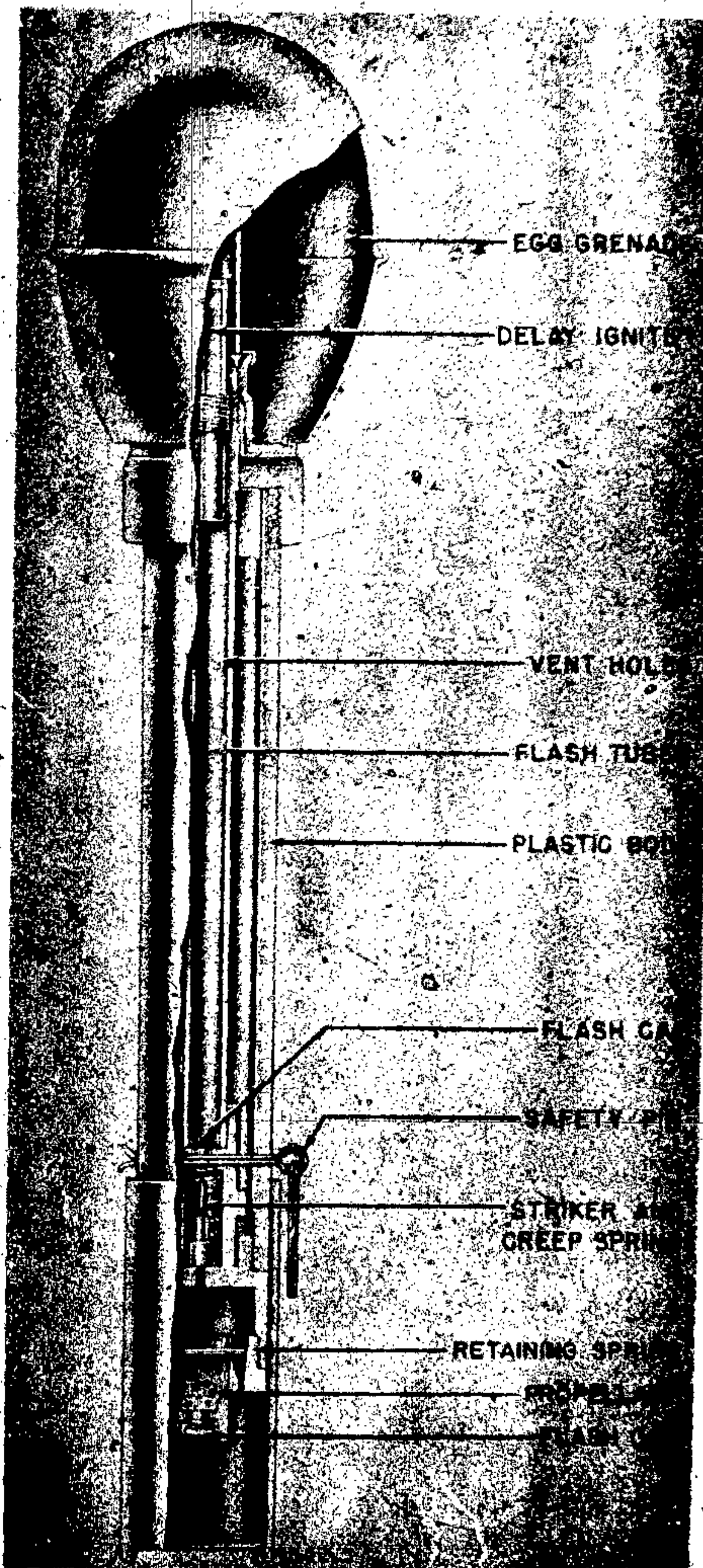

Figure 309—27-mm Pistol Grenade.

GERMAN EXPLOSIVE ORDNANCE

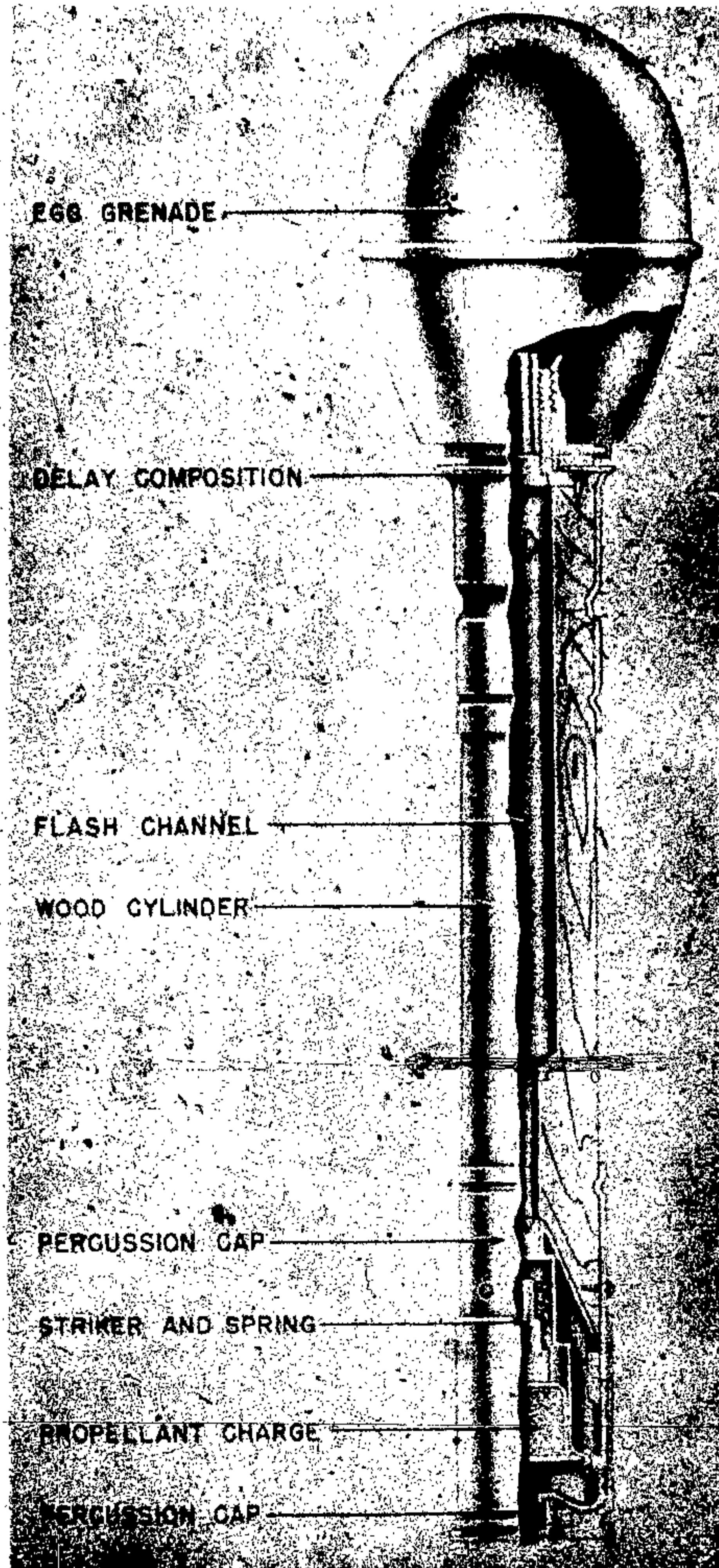

Figure 310—27-mm Egg Type Pistol Grenade

grenade is safe until fired. When fired the grenade and stem are propelled from the short cartridge case and at the same time the striker in the stem is driven forward to the percussion cap. A flash travels through the hollow stem and ignites the delay pellet. After 4½ seconds the grenade detonates.

**PISTOL GRENADE (26-mm WURFGRANA-
TEPATRONE), 326 LEUCHTPISTOLE**

DATA:

- Over-all Length: 4.5 inches.
- Maximum Diameter: 1 inch.
- Color: Yellow.
- Weight of Complete Round: 4.2 ounces.
- Weight of Projectile: 3.2 ounces.
- Filler: TNT.
- Weight of Filler: 7 grams.

DESCRIPTION: This grenade consists of a projectile having the appearance of a miniature mortar shell and a brass cartridge case. The two parts are crimped together. (See fig. 311.)

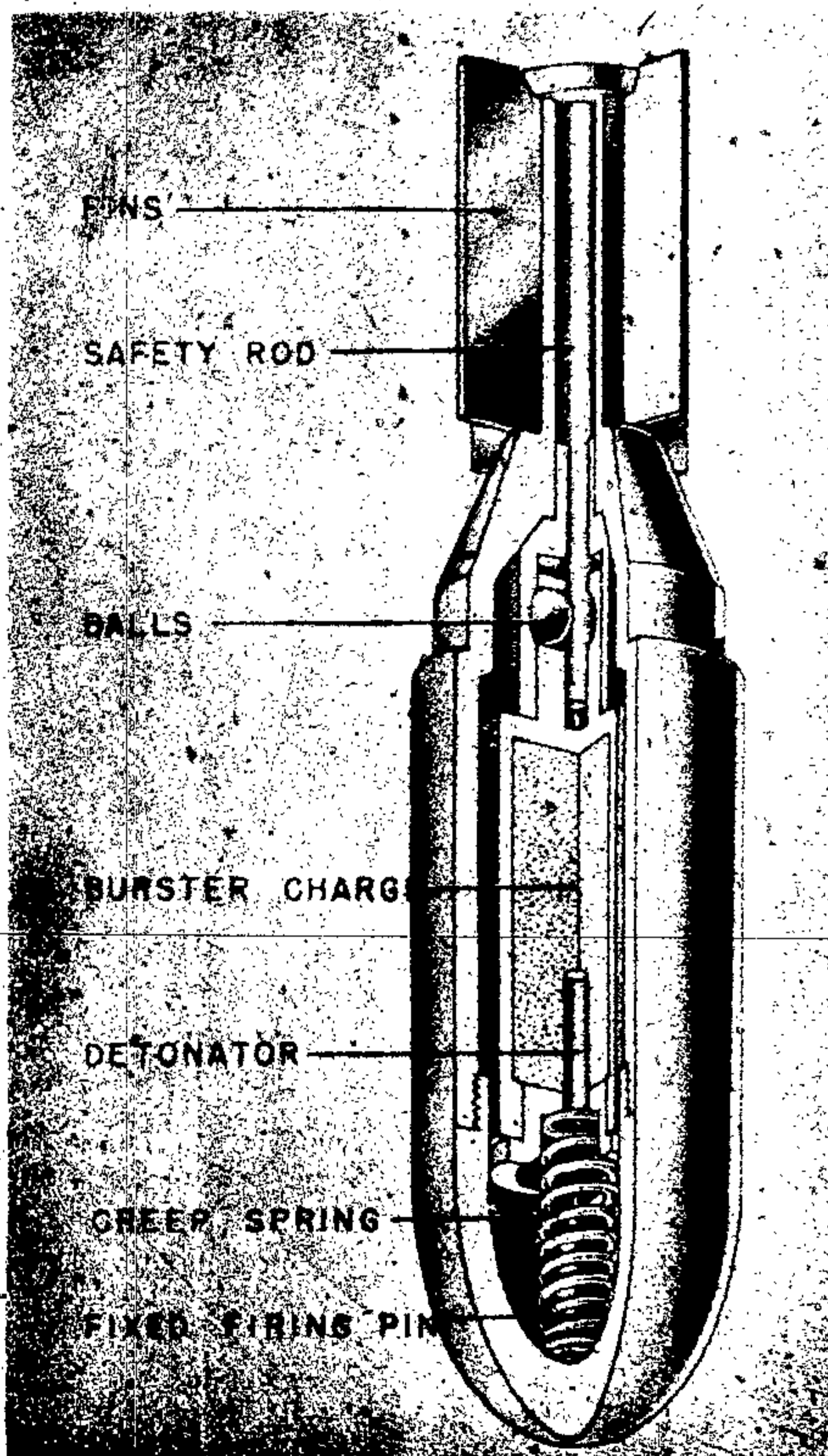

Figure 311—26-mm Pistol Grenade

The grenade itself is constructed in two parts: The nose cap and the body. The nose cap is rounded and screws into the body of the grenade. Within the body is a case containing the detonator and main filling. Between the case and the fixed firing pin in the nose cap is a creep spring. The case is prevented from moving forward before firing by two metal balls fitting into a hole in the base of the carrier and resting in grooves in a platform in the body. An arming rod fits between the balls holding them out.

On the base are four fins which have the same diameter as the body. Contained in the cartridge case which fits over the after part of the grenade is about 0.1 ounce of rifle powder.

OPERATION: On firing, the arming rod will be forced out of the base by setback. This will happen after 10 to 12 yards of flight and the grenade is then armed. When the rod falls out, the balls will move in and the case is free to move forward except for the creep spring. On impact, the case moves forward and the detonator moves onto the fixed firing pin thus exploding the grenade.

H. E. CARTRIDGE FOR 27-mm (1-INCH) GRENADE PISTOL (SPRENGPATRONE FÜR KAMPFPISTOLE)

DATA:

- Over-all Length: 3 inches.
- Color: Unpainted aluminum.
- Weight of Complete Round: 5 ounces.
- Weight of Projectile: 3½ ounces.
- Filler: PETN/Wax.
- Weight of Filler: 339 g.
- Propellant: Graphited black powder.

DESCRIPTION.—This grenade consists of a die cast aluminum container which encases a steel tube containing the explosive. The fuse screws to the steel tube and the tube and aluminum container are secured by knurling and indents. The propellant charge is contained in a cup which has a push fit to the grenade with 10 holes in the cup to lead the gases to the base of the grenade. (See fig. 312.)

The grenade has five grooves making one-quarter turn in the length of the projectile, grooved on the aluminum body. The steel liner is threaded internally to take a nose percussion

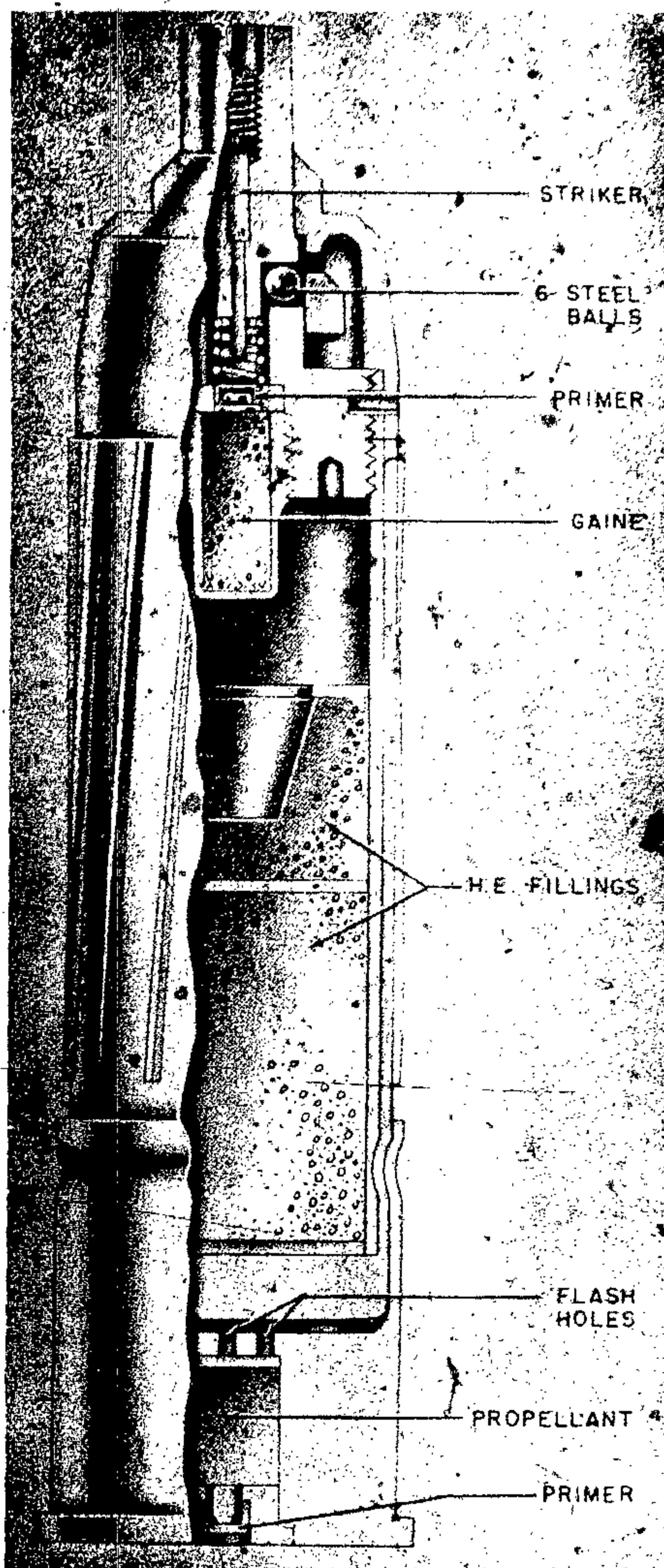

Figure 312—H. E. Cartridge for 27-mm Grenade Pistol

fuze. The explosive filler consists of two penthrite wax pellets separated by cardboard discs.

The fuze is a direct action type and is fitted with

GERMAN EXPLOSIVE ORDNANCE

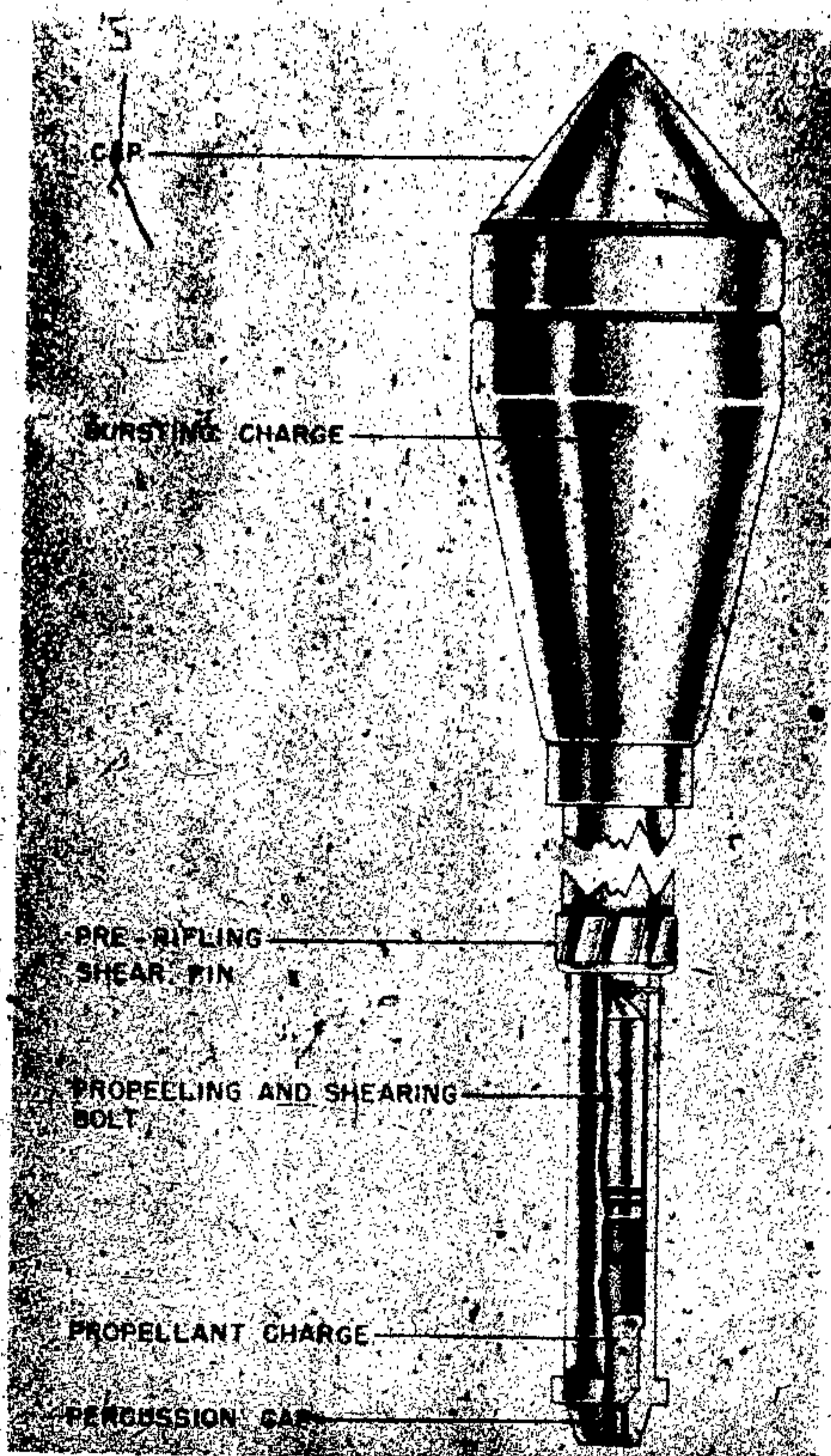

Figure 313—Pz. W. K. 42 L. P. Hollow Charge Pistol Grenade

a protruding striker head. The striker is held away from the primer by six steel balls which rest in a groove in the striker and on a platform of the fuze. These balls are kept in position by a steel collar which is supported on three aluminum pins. There is also a creep spring between the striker and the primer. Beneath the primer there is a gaine contained in an aluminum case and consisting of lead azide and lead styphnate in the upper part and PETN in the lower part. Between the gaine and the main filling there is an empty air space.

The discharge cup is a push fit with the base of the grenade which is turned down to fit into the cup. The cup has in its base a lead styphnate primer contained in a brass holder. Forward of the cap is the propelling charge of black powder and 10 holes to lead the gases to the base of the grenade.

OPERATION. On firing, the propelling charge propels the grenade and it rotates because of the rifling on the body. On setback the collar in the fuze moves back crushing the aluminum pins and because of centrifugal force the balls then fly outward, freeing the striker which is kept off the primer by the creep spring. On impact, the striker impinges the primer setting off the gaine and main filler.

HOLLOW CHARGE SIGNAL PISTOL GRENADE (Pz. W. K. 42 L. P.)

DATA:

- Weight: 0.6 kg (1 pound 5 ounces).
- Diameter of Head: 61 mm (2.4 inches).
- Diameter of Tail Tube: 22 mm (0.875 inch).

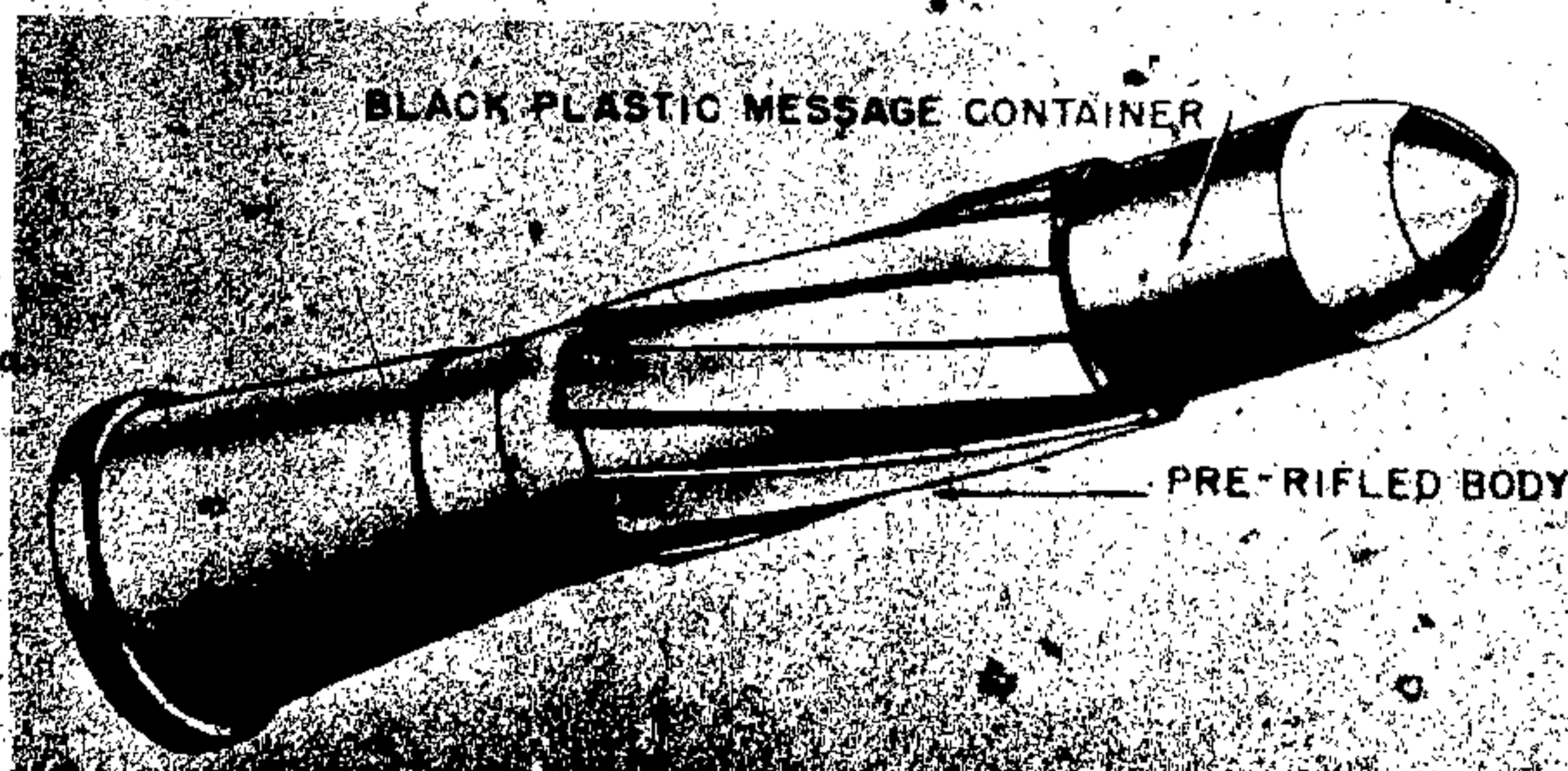

Figure 314—27-mm Message Pistol Grenade

DESCRIPTION. The head of this grenade is pear shaped, contains the hollow charge and is fitted with an impact cap at the forward end. (See fig. 313.) At the rear is the tail tube containing the graze fuze, detonator and gaine. A short length of this tube is prerifled. Attached to this tail tube by a shear pin is a thinner tube containing the propellant, percussion cap and shearing bolt.

The grenade is fired from the latest German Walther 27-mm signal pistol. In order to fire this grenade, the signal pistol is fitted with a 23-mm rifled linear, a special sight, and a folding butt.

OPERATION. The complete round is loaded into the signal pistol from the muzzle end. The propellant tube fits freely in the fore until the prerifled band hits the muzzle. At that point the grenade has to be screwed into the rifling of the pistol. The grenade is safe until fired.

On firing, the propellant gases drive forward the shearing bolt which breaks the shear pin and the grenade is discharged. The graze fuze in the tail unit is armed by setback as the grenade leaves the pistol.

PISTOL GRENADE MESSAGE

DESCRIPTION. The round consists of a prerifled aluminum grenade with a plastic head and an aluminum cartridge case. The black plastic head contains a message form and a pencil and screws on to the body. (See fig. 314.) The prerifled body contains a smoke generator, a colored silk streamer and an ejection charge. The aluminum case is marked "Nachr Z." The round is designed for use in the 27-mm. rifled signal pistol.

OPERATION. On firing, the flash from the propellant ignites the delay pellet in the grenade base plate. This, in turn, ignites the ejecting charge which expels the message container, smoke generator and silk streamer from the grenade body in flight.

27-mm MULTISTAR SIGNAL CARTRIDGE

DATA:

Over-all Length: 6 inches.

Maximum Diameter: 1.06 inches.

Filling: Propellant and Pyrotechnic.

DESCRIPTION. The cartridge consists of a

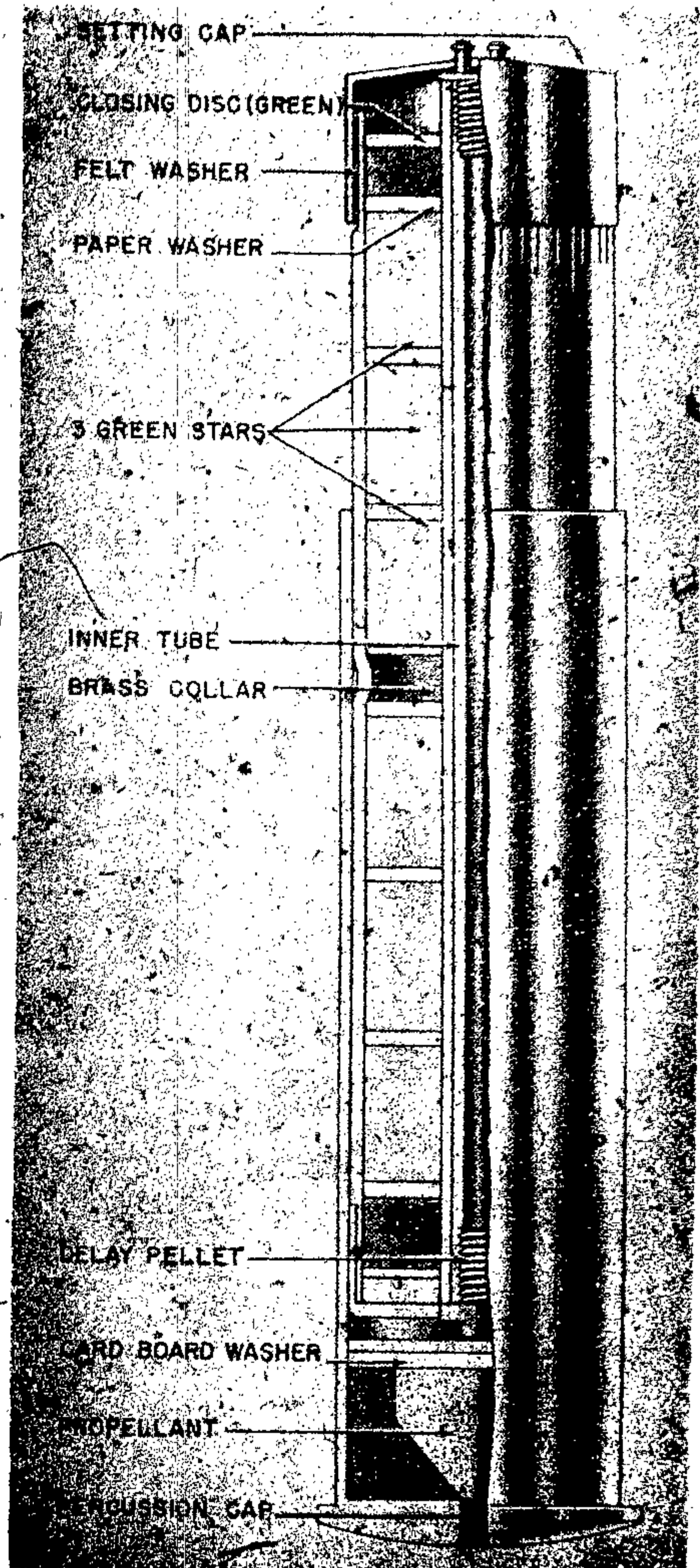

Figure 315—27-mm Multistar Pistol Cartridge

light alloy outer container complete with the propelling charge and an inner container in which there are six star units. (See fig. 315.) Running through the center of the star units is an assembly

GERMAN EXPLOSIVE ORDNANCE

of two brass tubes which are held in position by a central cannellure into which the inner container is indented and fixed by means of a steel pin. The outer tube has one set of six flash holes which coincide with the inner surfaces of the six stars. The inner tube has six sets of holes in the outer tube by means of the setting cap, which is fixed to the inner tube by a spring retaining clip on the closing screw. The inner tube contains gunpowder and is closed at the inner end by a screwed plug which contains a delay pellet. It is used for signaling.

OPERATION. The desired combination of colored stars is obtained by moving the index mark on the setting cap to the appropriate position on the scale, which is graduated from 0 to 40. The six combinations of stars are:

(1) 3 red 3 green	(2) 1 red 2 green	(3) 3 red 1 green
(4) 1 red 3 green	(5) 2 red 2 green	(6) 2 red 1 green

Commencing with 3 red and 3 green at "0", its other combinations would be obtained at settings 7, 14, 21, 27, and 34 respectively.

In firing, the inner container is ejected, and after the delay pellet has burned through, the flash passes immediately along the whole length of the inner tube, igniting and ejecting the stars in accordance with the setting. The stars which are not ignited remain in the container and fall to earth intact.

Table 2.—German rifle grenade propelling cartridges

CARTRIDGE FOR—	GERMAN NAME	POWDER FILLING IN T. P. (1.4; 2.0; 50; 25) GRAMS	MARKING	USED ONLY BY	REMARKS
1. Large A. P. grenade.	G. Treib. Patr. fur Gr. G. Pzgr.	1.9	Black wooden bullet.	Large A. P. grenade.	
2. Propaganda grenade	G. Kart. fur G. Propgr.	1.7	Red ring	Propaganda grenade.	In the future to be used only for rifle propaganda grenade.
3. Propaganda grenade (old type).	G. Kart. (Alter Art) fur G. Propgr.	1.7	2-mm wide red ring on neck of cartridge case.	Propaganda grenade.	Obsolete.
4. Small A. P. grenade.	G. Kart. fur G. Pzgr.	1.1	Black ring	A. P. grenade	Packed attached to grenade.
5. Small A. P. grenade.	G. Kart. (Alter Art) fur G. Pzgr.	1.1	Black ring (partly)	Small A. P. grenade.	Obsolete.
6. H. E. grenade	G. Kart. fur G. Sprgr.	1.0	Yellow ring	H. E. grenade (288 g).	In the future to be used only for H. E. grenade.
7. H. E. grenade (old type).	G. Kart. (Alter Art) fur G. Sprgr.	1.0	Yellow ring (partly)	H. E. grenade (288 g).	Obsolete.
8. H. E. grenade (old type).	G. Kart. (Alter Art) fur G. Sprgr.	.85		H. E. grenade (288 g).	Packed attached to grenade.