



Calhoun: The NPS Institutional Archive
DSpace Repository

Theses and Dissertations

1. Thesis and Dissertation Collection, all items

1994-12

The misuse of special operations forces

Winters, Edward G.; Paro, Kent A.

Monterey, California. Naval Postgraduate School

<http://hdl.handle.net/10945/30550>

Downloaded from NPS Archive: Calhoun



Calhoun is a project of the Dudley Knox Library at NPS, furthering the precepts and goals of open government and government transparency. All information contained herein has been approved for release by the NPS Public Affairs Officer.

Dudley Knox Library / Naval Postgraduate School
411 Dyer Road / 1 University Circle
Monterey, California USA 93943

<http://www.nps.edu/library>

NAVAL POSTGRADUATE SCHOOL MONTEREY, CALIFORNIA



THESIS

THE MISUSE OF SPECIAL OPERATIONS FORCES

by

Edward G. Winters and Kent A. Paro

December, 1994

Thesis Advisor:

Gordon H. McCormick

Approved for public release; distribution is unlimited.

Thesis
W651265

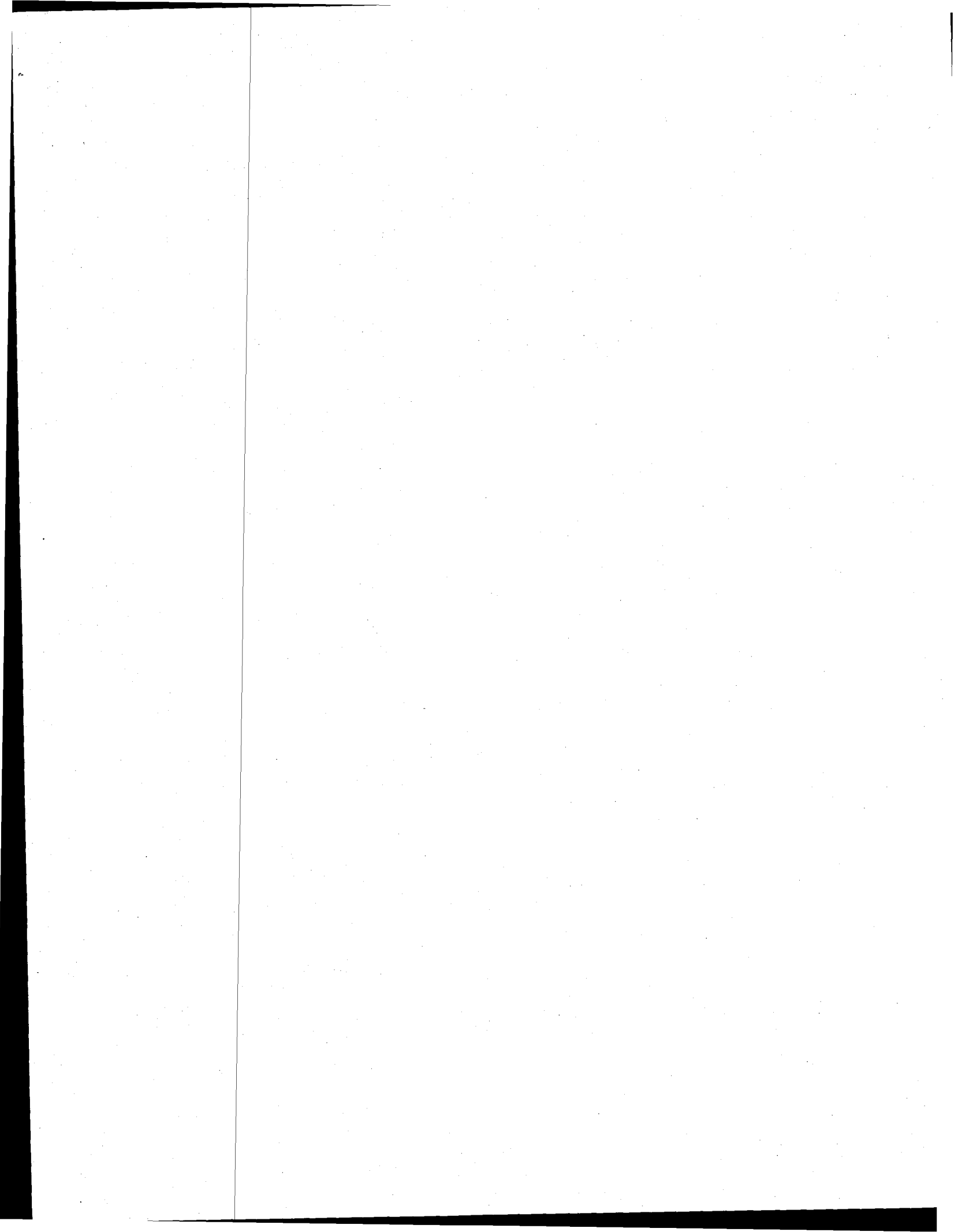

REPORT DOCUMENTATION PAGE

Form Approved OMB No. 0704-0188

Public reporting burden for this collection of information is estimated to average 1 hour per response, including the time for reviewing instruction, searching existing data sources, gathering and maintaining the data needed, and completing and reviewing the collection of information. Send comments regarding this burden estimate or any other aspect of this collection of information, including suggestions for reducing this burden, to Washington Headquarters Services, Directorate for Information Operations and Reports, 1215 Jefferson Davis Highway, Suite 1204, Arlington, VA 22202-4302, and to the Office of Management and Budget, Paperwork Reduction Project (0704-0188) Washington DC 20503.

1. AGENCY USE ONLY (Leave blank)	2. REPORT DATE December 1994	3. REPORT TYPE AND DATES COVERED Master's Thesis	
4. TITLE AND SUBTITLE: THE MISUSE OF SPECIAL OPERATIONS FORCES		5. FUNDING NUMBERS	
6. AUTHOR(S) Edward G. Winters and Kent A. Paro			
7. PERFORMING ORGANIZATION NAME(S) AND ADDRESS(ES) Naval Postgraduate School Monterey CA 93943-5000		8. PERFORMING ORGANIZATION REPORT NUMBER	
9. SPONSORING/MONITORING AGENCY NAME(S) AND ADDRESS(ES)		10. SPONSORING/MONITORING AGENCY REPORT NUMBER	
11. SUPPLEMENTARY NOTES The views expressed in this thesis are those of the author and do not reflect the official policy or position of the Department of Defense or the U.S. Government.			
12a. DISTRIBUTION/AVAILABILITY STATEMENT Approved for public release; distribution is unlimited.		12b. DISTRIBUTION CODE	
13. ABSTRACT (maximum 200 words) By their nature, special operations forces (SOF) are central to policy in a world-order dominated by low-intensity conflicts. Therefore, the proper use of SOF is essential. Based on published doctrine and decision making theory, this thesis develops a theory that defines misuse and provides a systematic framework for analyzing the use of SOF. Misuse occurs at the decision point. We have quantified the decision process and determined that misuse occurs when SOF are used while GPF have an <i>absolute</i> and <i>comparative advantage</i> , or, misuse occurs when SOF are not used while they have both an <i>absolute</i> and <i>comparative advantage</i> over GPF. The concepts of <i>absolute</i> and <i>comparative advantage</i> are crucial to our theory of the misuse of SOF. <i>Absolute advantage</i> is achieved if the expected value of conducting a specific mission outweighs the expected cost. Assuming that both forces have an <i>absolute advantage</i> , the force with the greatest expected value-to-expected cost ratio is said to have the <i>comparative advantage</i> . <i>Absolute</i> and <i>comparative advantage</i> are the necessary and sufficient conditions for proper use and allow us to delineate specific types of errors. Through the use of four case studies, illustrative of four types of error, this thesis demonstrates a systematic method of considering the proper employment of SOF.			
14. SUBJECT TERMS: Special Operations Forces; Misuse; Paitilla; Operation JUST CAUSE; Merrill's Marauders; Mayaguez; Operation URGENT FURY; Decision Making Theory; Decision Tree; Expected Value; Expected Cost.		15. NUMBER OF PAGES 205	16. PRICE CODE
17. SECURITY CLASSIFICATION OF REPORT Unclassified	18. SECURITY CLASSIFICATION OF THIS PAGE Unclassified	19. SECURITY CLASSIFICATION OF ABSTRACT Unclassified	20. LIMITATION OF ABSTRACT UL

NSN 7540-01-280-5500

Standard Form 298 (Rev. 2-89)
Prescribed by ANSI Std. Z39-18 298-102

Approved for public release; distribution is unlimited.

**THE MISUSE OF SPECIAL OPERATIONS
FORCES**

by

Edward G. Winters

Lieutenant Commander, United States Navy

B.S., University of West Florida, 1979

Kent A. Paro

Lieutenant, United States Navy

B.S., United States Naval Academy, 1986

Submitted in partial fulfillment

of the requirements for the degree of

MASTER OF ARTS IN NATIONAL SECURITY AFFAIRS

from the

NAVAL POSTGRADUATE SCHOOL

December 1994

Author:

Edward G. Winters

Kent A. Paro

Approved by:

Gordon H. McCormick, Thesis Advisor

Kneale T. Marshall, Second Reader

Thomas C. Bruneau, Chairman
Department of National Security Affairs

TK0513
W051265
C.K

ABSTRACT

By their nature, special operations forces (SOF) are central to policy in a world-order dominated by low-intensity conflicts. Therefore, the proper use of SOF is essential. Based on published doctrine and decision making theory, this thesis develops a theory that defines misuse and provides a systematic framework for analyzing the use of SOF. Misuse occurs at the decision point. We have quantified the decision process and determined that misuse occurs when SOF are used while GPF have an *absolute* and *comparative advantage*, or, misuse occurs when SOF are not used while they have both an *absolute* and *comparative advantage* over GPF. The concepts of *absolute* and *comparative advantage* are crucial to our theory of the misuse of SOF. *Absolute advantage* is achieved if the expected value of conducting a specific mission outweighs the expected cost. Assuming that both forces have an *absolute advantage*, the force with the greatest expected value-to-expected cost ratio is said to have the *comparative advantage*. *Absolute* and *comparative advantage* are the necessary and sufficient conditions for proper use and allow us to delineate specific types of errors. Through the use of four case studies, illustrative of four types of error, this thesis demonstrates a systematic method of considering the proper employment of SOF.

TABLE OF CONTENTS

I. THE MISUSE OF SPECIAL OPERATIONS FORCES 1

 A. INTRODUCTION 1

 B. SCOPE OF THE THESIS 4

 C. WHAT IS THE MISUSE OF SOF? 6

 1. Doctrinal Foundation 6

 2. Misuse 7

 D. THE DECISION TREE 11

 E. PRINCIPLES AFFECTING PROBABILITIES 17

 1. Positive Affects on Probability 21

 2. Negative Affects on Probability 27

 F. FACTORS AFFECTING VALUE AND COST 30

 1. Political Value 31

 2. Military Value 32

 3. Political Cost 34

 4. Military Cost 35

 G. CASE STUDY METHODOLOGY 37

II. PAITILLA AIRPORT OPERATION 41

 A. INTRODUCTION 41

 B. BACKGROUND 42

 1. Political and Military 42

 2. Task Force White 47

 C. OBJECTIVE 48

 D. ALTERNATIVES 50

 1. U.S. Army Ranger Option 50

 2. U.S. Marine Amphibious Assault Option 52

3. Probability of SEALs, Rangers, and Marines	53
4. Political Value	57
5. Military Value	58
6. Political Cost	58
7. Military Cost	60
E. EXECUTION	61
F. ANALYSIS	66
III. MERRILL'S MARAUDERS AT MYITKYINA	69
A. INTRODUCTION	69
B. BACKGROUND	70
1. Political and Military	70
2. Merrill's Marauders	74
C. OBJECTIVE	79
D. ALTERNATIVES	81
1. Probability of Merrill's Marauders and Chinese GPF	82
2. Political Value	84
3. Military Value	85
4. Political Cost	86
5. Military Cost	86
E. EXECUTION	87
F. ANALYSIS	89
IV. THE MAYAGUEZ CRISIS	93
A. INTRODUCTION	93
B. BACKGROUND	98
1. Mayaguez - the Crisis	98
2. Political	100
3. Military	104

C. OBJECTIVES	108
1. Mission Objectives	108
2. Reconnaissance Objectives	109
D. ALTERNATIVES	111
1. Probability of SOF and GPF	112
2. Political Value	115
3. Military Value	117
4. Political Cost	117
5. Military Cost	118
E. ANALYSIS	119
V. OPERATION URGENT FURY	121
A. INTRODUCTION	121
B. BACKGROUND	122
1. Grenada	122
2. Political	124
3. Military	127
C. OBJECTIVE	129
D. ALTERNATIVES	130
1. Probability of SOF and GPF	130
2. Political Value	131
3. Military Value	133
4. Political Cost	133
5. Military Cost	135
E. ANALYSIS	136
VI. CONCLUSIONS	139
APPENDIX A. PROBABILITY WORKSHEET	143

APPENDIX B. OPERATION RICE BOWL	145
APPENDIX C. POLITICAL AND MILITARY VALUE AND COST CODING	149
APPENDIX D. PAITILLIA AIRPORT: OPERATION JUST CAUSE	153
APPENDIX E. MERRILL'S MARAUDERS AT MYITKYINA	155
APPENDIX F. MAYAGUEZ INCIDENT	157
APPENDIX G. GRENADA - OPERATION URGENT FURY	159
APPENDIX H. MAPS	161
SELECTED BIBLIOGRAPHY	185
INITIAL DISTRIBUTION LIST	189

EXECUTIVE SUMMARY

An analytical definition of the misuse of SOF does not exist. Misuse is both a difficult problem to define and a problem that must be avoided. The post-cold war world has produced hundreds of relatively minor conflicts, or "operations other than war." These conflicts present decision makers with numerous options that are less cut and dried than the options in previous conflicts. In those conflicts, the lines between democracy-and-communism, good-and-evil, and black-and-white were clearly defined. In today's conflictual environment, there seems to be a threshold of media exposure and numbers of casualties that drives American foreign policy and the subsequent use of military force. Sixty-six civilians killed by mortar fire in the Markale market in Sarajevo appeared to breach the "entrance threshold" for U.S. decision makers. Eighteen dead U.S. servicemen on the streets of Mogadishu, meanwhile, appeared to violate the "exit threshold" for U.S. decision makers. In an environment full of uncertainty, both international and domestic political ramifications, and intense media scrutiny, the proper use of SOF is essential. Misuse results in either a failed mission or an inordinate price for success. This thesis develops a theory of misuse and provides a systematic method of addressing, analyzing, and avoiding this problem.

Our theory is based on published doctrine and decision making theory and is directed to SOF. The elements of probability, political and military value, and political and military cost leap from the doctrine. Our theory demonstrates a method of considering these elements and assigning probabilities and resulting pay-offs to the decision tree. The decision tree allows us to quantify, in an abstract way, the decision to use or not to use SOF instead of GPF. Assuming that something must be done by either SOF or GPF, it is our belief that misuse occurs at the decision point because decision makers lack understanding of SOF limitations and capabilities. We have quantified this decision process and determined that misuse occurs when SOF are *used* while GPF have an *absolute* and *comparative advantage*, or, misuse occurs when SOF are *not used* while they have both an *absolute* and *comparative*

advantage over GPF. The concepts of *absolute* and *comparative advantage* are crucial to our theory of the misuse of SOF.

If the *expected value* of SOF conducting a specific mission is greater than the expected cost of SOF conducting the mission, then SOF have an *absolute advantage*. This same ratio of *expected value-to-expected cost* is calculated for GPF, and assuming that both forces have an *absolute advantage*, used to compare the two forces. The force with the greatest *expected value-to-expected cost* ratio is said to have the *comparative advantage*. *Absolute* and *comparative advantage* are the necessary and sufficient conditions for proper use and allow us to delineate specific types of errors. Errors of commission and errors of omission are derived from our definition of misuse. Simple errors involve mistakes of *comparative advantage* while complex errors involve both *absolute* and *comparative advantage* mistakes. These four types of errors were the focus of our case studies.

The case studies were chosen to represent four commonly believed cases of misuse that illustrate the four different types of errors. The tragic SEAL mission at Paitilla airport during Operation JUST CAUSE is commonly referred to as a misuse of SOF because "it wasn't a SEAL op," implying a simple error of commission. This was the only case study of misuse that we found to be a proper use of SOF. Merrill's Marauders, one of the forefathers of today's Rangers, are commonly believed to have been misused as line infantry against Japanese Divisions, implying a complex error of commission. We found this to be true. Errors of omission are more difficult to apply to a case study, as the argument is necessarily counterfactual. Both the Mayaguez incident and Operation URGENT FURY received intense criticism for the lack of accurate intelligence provided to the ground forces, and have spurred some SOF advocates to question the non-application of SOF. These cases, based on their environment of context, were believed to represent simple and complex errors of omission respectively. Both case studies, however, resulted as simple errors of omission.

Every mission is launched with a decision maker calculating the *expected value* and the *expected cost*. It may be an intuitive, ad hoc determination made in the back of his mind

or part of a staff briefing that includes the probability of success and the expected casualties. Regardless of what it is called, it is a process that weighs *expected value* and *expected cost*. This thesis provides a systematic theoretical framework that defines the variables that should be taken into consideration in such a process and highlights their inter-relationships. If we agree that *expected value* and *expected cost* exist, and we accept the framework established in this thesis as a starting point, then we can begin to have a meaningful disagreement about the misuse of SOF. To date, there is no agreed upon systematic way of approaching the problem.

What is the cost of misuse? Two costs are paid, and neither is acceptable. First, misuse may result in a failed mission. Either SOF were used and failed, or they were not used and the mission failed. Failed missions carry with them limited to zero political and military value, as well as the subsequent political and military costs. These values and costs have increased in the post-cold war world and the United States cannot afford to conduct operations that do not meet the necessary and sufficient conditions for proper use. Proper use may not equal mission success, but it certainly creates a conducive environment. Second, misuse may result in paying an inordinate price for success. This causes an overall political and military inefficiency that may teach decision makers the wrong lessons and may result in more inefficiency down the road, fostering a continual cycle of paying a high price for success. An interesting and counter-intuitive point illuminated by this thesis is that mission failure does not necessarily signal misuse. Conversely, mission success does not imply the proper use of SOF. Just because "it worked the last time" does not mean it will work again.

To avoid misuse, decision makers must think in terms of *absolute* and *comparative advantage*. The factors affecting the probability of success for each phase must be considered, as well as the value and cost associated with each branch of the decision tree. The *expected value* and *expected cost* must be calculated and the *absolute* and *comparative*

advantage established. These are the necessary and sufficient conditions to avoid the misuse of SOF.

I. THE MISUSE OF SPECIAL OPERATIONS FORCES

A. INTRODUCTION

This thesis is about the misuse of special operations forces (SOF). Much is written about military failures and even more about special operations failures. Whether the authors of this literature are targeting high-ranking political and military leaders; advocating sweeping, military-wide changes; or attempting to expiate military failure; the raid on Sontay¹ and the mishap at Desert One² invariably sneak into the analysis. Critics have tended to focus on the political and military ramifications of failure and have neglected to scrutinize the decision to employ or not to employ SOF in the first place.³ This thesis is not about success or failure of special operations, per se, but the misuse of SOF.

Two problems have historically led to the misuse of SOF: a lack of institutional control and a lack of understanding. The formal institutionalization of SOF in 1986 has

¹ The raid on Sontay (Operation Kingpin) was launched on 20 November 1970 to rescue prisoners of war suspected of being held at Sontay, North Vietnam. The rescue force reached the objective, however, the prisoners had been moved sometime earlier. The mission was a tactical success, but a strategic failure.

² The mishap at Desert One occurred on 25 April 1980 during Operation RICE BOWL. A rescue force was being sent to rescue American hostages being held by a contingent of Iranian Revolutionary Guards at the American Embassy in Tehran. The mission was aborted and eight American servicemen died in an accident at Desert One as the force was trying to begin exfiltration.

³ For axioms and theories on military failure see the following: Eliot A. Cohen and John Gooch, Military Misfortunes: The Anatomy of Failure in War, (New York: Vintage Books, 1990); James F. Dunigan and Raymond M. Macedonia, Getting It Right: American Military Reforms after Vietnam to the Gulf War and Beyond, (New York: William Morrow and Company, Inc., 1993); Richard A. Gabriel, Military Incompetence: Why the American Military Doesn't Win, (New York: Hill and Wang, 1985); The Holloway Commission, Rescue Mission Report, August 1980; Lucien S. Vandenbroucke, Perilous Options: Special Operations as an Instrument of US Foreign Policy, (New York: Oxford University Press, 1993).

greatly alleviated the first problem.⁴ However, despite doctrinal and procedural changes, the second problem continues. Misuse results in both the inefficient application of available forces and, in some cases, the learning of the wrong lessons. John M. Collins summarized the primacy of the efficient use of SOF best when he wrote in his report to Congress:

Plans presently call for the smallest US military establishment since the Korean War ended 40 years ago. Deep force reductions are in progress. It may be difficult to maintain the remainder at present high standards, because planned results from austere defense budgets could prove overly optimistic unless a major crisis reverses current trends...*The Department of Defense (DoD) more than ever needs to extract maximum value from every dollar.*⁵

Perhaps most important are the wrong lessons decision makers may learn from tactical successes achieved while misusing SOF.

The success of a mission tends to prompt praise from the media and "high-fives" among decision makers, while preventing close scrutiny of the decision making process. Regardless of tactical success, misuse may occur. James Dunnigan and Raymond Macedonia have termed this counter-intuitive concept the "insidious Victory Disease." They elucidate the problem of learning the wrong lessons from military success when they write:

It worked so well the last time, let's do it again next time. When a nation is defeated, it generally looks for a different way to fight the next war. The old ways obviously didn't work and new techniques are not only sought out but practiced vigorously. The winners have a different attitude, best summed up as 'Don't mess with something that works.' Actually, this attitude was once sound advice. But in the last two centuries, new technologies have arrived at an ever-increasing rate and winners and losers have had to adapt to change

⁴ In 1986 the Cohen-Nunn Amendment created an Assistant Secretary of Defense for Special Operations and Low-Intensity Conflict (ASD-SO/LIC) and the United States Special Operations Command (USSOCOM).

⁵ John M. Collins, Special Operations Forces: An Assessment 1986-1993, (Washington, D.C.: Congressional Research Service, July 30, 1993), p. 1, emphasis added.

quickly, or else. The Victory Disease tends to make winners blind to these needed changes.⁶

Misuse of SOF, regardless of tactical success, is a costly endeavor for a defense establishment facing austere conditions in the near future. A better understanding of SOF is still needed.

This thesis develops a theory of the misuse of SOF. The theory describes the variables associated with determining the *expected value* and *expected cost* of employing both SOF and general purpose forces (GPF) for a specific mission. We demonstrate that through the use of our decision framework, leaders can effectively determine whether or not SOF or GPF hold an *absolute* and/or a *comparative advantage*. *Absolute advantage* is defined as a condition that exists when the *expected value* of conducting a specific mission is greater than the *expected cost*. Once *absolute advantage* is established, the *absolute advantages* of SOF and GPF are compared to determine *comparative advantage*. Although holding an *absolute* and *comparative advantage* does not guarantee mission success, they establish the necessary and sufficient mission advantage conditions for proper use of SOF and GPF. This thesis provides both an analytical definition of misuse and a systematic framework for considering the variables associated with *expected value* and *expected cost*. If we can determine the variables associated with *expected value* and *expected cost*, we can begin to consider how and why SOF are misused. Through the use of four case studies, representing four different types of errors and four commonly perceived misuses, we show how the theory can be applied to combat operations and assist in understanding the proper use of SOF.

⁶ Dunigan, p. 30.

B. SCOPE OF THE THESIS

We begin by identifying the scope of our problem. This requires developing mission boundaries that are not well defined on the military operations continuum.⁷ As Joint Pub 3-05 states:

The five principal missions of SO [special operations] are UW [unconventional warfare], DA [direct action], SR [special reconnaissance], FID [foreign internal defense], and CT [counterterrorism]. While SOF provide unique, versatile, and flexible forces designed primarily to meet these missions, conventional forces may be required for support, depending upon mission circumstances. However, the inherent capabilities of SOF also make them suitable for employment in a range of collateral SO mission activities, such as HA [humanitarian assistance], counterdrug, and personnel recovery operations, among others. All of these missions can be conducted and are especially applicable in a coalition warfare environment, where SOF capabilities make them especially useful in this short term and/or limited scope operational arrangement of forces.⁸

Unconventional warfare, foreign internal defense, and counterterror operations have limited competitive applicability to GPF.⁹ The collateral special operations missions such as: security assistance, humanitarian assistance, antiterrorism and other security activities, counterdrug, personnel recovery, and special activities, either also have limited applicability

⁷ FM 100-5, Operations, provides the range of military operations, classified as war (combatant) and operations other than war (either combatant or noncombatant), conducted in the states of environment of war, conflict, and peacetime. SOF conduct missions at each end of the spectrum with obviously limited applications in large scale combat operations (high end of the continuum), and almost exclusive application in counterterrorism operations (mid-range on the continuum). For this reason, no clear boundaries of responsibility can be derived from this continuum.

⁸ Joint Pub 3-05, Doctrine for Joint Special Operations, 1993, p. II-2.

⁹ While USMC units, in particular, do conduct missions of this type, and some "conventional" operations such as the bombing of Libya in 1986 may be termed counterterror operations, we do not believe that there is significant competition and conflict between SOF and GPF in these mission areas.

to GPF, or are beyond the scope of this thesis. This thesis focuses on direct action and special reconnaissance missions.

Direct action and special reconnaissance missions require doctrine and skills that are similar between SOF and GPF.¹⁰ Direct action missions for SOF may include raids, ambushes, or direct assault; the emplacement of munitions and other devices; the conduct of standoff attacks by fire from air, ground, or maritime platforms; to provide terminal guidance for precision-guided munitions; and the conduct of independent sabotage.¹¹ The principles applied by SOF in the conduct of these missions are a subset of the Army's nine principles of war.¹² Special reconnaissance missions complement national and theater intelligence collection assets and systems, providing an overlap in the broad sense. Joint Pub 3-05 qualifies special reconnaissance as:

obtaining specific, well-defined, and time sensitive information of strategic or operational significance. It may complement other collection methods where there are constraints of weather, terrain-masking, hostile countermeasures and/or other systems availability.¹³

¹⁰ While this thesis focuses on comparative cases between SOF and GPF, our theory applies to ALL missions involving SOF, including missions on the "softer side" of SOF and other missions that are not comparative between SOF and GPF. The factors and variables affecting *expected value* and *expected cost* in missions other than DA and SR are different than those presented in this thesis.

¹¹ Joint Pub 3-05, p. II-5.

¹² FM 100-5 lists the nine principles of war as: objective; offensive; mass; economy of force; maneuver; unity of command; security; surprise; and simplicity. Some of these are directly applicable to SOF and will be discussed in greater detail later. For a complete description of the principles of special operations, see CDR William H. McRaven, The Theory of Special Operations, M.A. Thesis, Naval Postgraduate School, Monterey, California (June 1993), pp. 4-9.

¹³ Joint Pub 3-05, p. II-7.

By limiting the scope of this thesis, we are limiting the variables affecting the theory. Although we believe our Theory of the Misuse of SOF is applicable across the spectrum of special operations missions, and even within the SOF community, it was developed solely from the examination of direct action and special reconnaissance missions. All usage of the concept of misuse, henceforth, applies to these types of missions. Additionally, the misuse of GPF, while implicit to this theory, is beyond the explicit scope of this thesis.

C. WHAT IS THE MISUSE OF SOF?

1. Doctrinal Foundation

The doctrinal foundation clearly exists to avoid the misuse of SOF. Joint Pub 3-05.3, Joint Special Operations Operational Procedures, advises how to avoid "misapplication of SOF" by applying the criteria of "appropriateness, feasibility, and supportability." The doctrine states that:

Commanders should recognize the high value and the limited resources of SOF and ensure that the benefits of successful mission execution are measurable and in balance with the risks inherent in the mission. Measurement of risk should take into account not only the potential for loss of SOF units, but the risk of adverse effects on U.S. diplomatic and political interests should the mission fail.¹⁴

No clear definition of the misuse of SOF exists, yet, any special operator can give a "catch phrase" example of what they believe misuse is. An analytical definition of misuse is lacking within the SOF community, or anywhere else. The concepts mentioned above, and prevalent throughout published doctrine, are captured by our Theory of the Misuse of SOF and applied in a manner consistent with decision making theory.

¹⁴ Ibid., p. IV-8.

2. Misuse

Utilizing existing doctrine, it is clear that misuse occurs at the point at which the decision to use, or not to use, SOF is made. We have developed a definition of the misuse of SOF through the application of doctrine and decision theory. Our definition is based on the assumption that some military action must be executed by either SOF or GPF. The definition is as follows:

- Misuse occurs when SOF are *used* while GPF have an *absolute* and *comparative advantage*, or,
- Misuse occurs when SOF are *not used* while they have an *absolute* and *comparative advantage* over GPF.

The concepts of *absolute* and *comparative advantage* are crucial to the Theory of the Misuse of SOF and are grounded in the literature of decision making and decision analysis. *Absolute advantage* for both SOF and GPF is represented by the proposition:

(1) *If for a given force type $\frac{EV}{EC} > 1$, then that force type has an Absolute Advantage.*

EV refers to the *expected value* and EC the *expected cost* of carrying out a specific mission by any given force type. We assume that EV and EC are measured in the same units. If the *expected cost* outweighs the *expected value* of a specific mission then that force does not have an *absolute advantage*. This constitutes a misuse of that force.

As we demonstrate later, *expected value* and *expected cost* are based, in part, on subjective probabilities and resulting payoffs assessed by experts in the field. Subjectivity is something that we cannot escape when discussing decision making in an uncertain environment and military operations are conducted in a most uncertain environment. *Absolute advantage* is calculated first for both SOF and GPF. Assuming both forces have *absolute advantages*, these are used to determine *comparative advantage*. Obviously, if only one force has an *absolute advantage*, it also ipso facto, has a *comparative advantage*.

Comparative advantage is simply a comparison of SOF and GPF *absolute advantages*, and is represented by the equation:

$$(2) \quad \frac{\frac{EV}{EC_{SOF}}}{\frac{EV}{EC_{GPF}}} = \text{Comparative Advantage}$$

If the result of Equation (2) is greater than one, SOF have the *comparative advantage*. If the result is less than one, GPF have the *comparative advantage*. Although it is unlikely, if the result of Equation (2) equals one, neither force has the *comparative advantage*. This relationship demonstrates which force has the higher benefits-to-cost ratio, and, therefore, which unit is the most cost effective package to task with a specific mission.

We have already determined that the misuse of SOF occurs when they are used and do not hold an *absolute* and *comparative advantage*, or, SOF are not used in spite of holding an *absolute* and *comparative advantage*. *Comparative advantage* allows us to begin to identify possible types of errors. Two types emerge from our definition of misuse: errors of commission and errors of omission. Errors can be further defined by the degree to which the errors do or do not meet the necessary and sufficient conditions for the proper use of SOF, and the various possible combinations of *absolute* and *comparative advantage* (AA and CA respectively). The types of errors are presented in Table 1 below.

The Table is directed to SOF and the conditions as they relate to SOF. Simple errors of commission occur when both SOF and GPF have an *absolute advantage*, SOF does not have a *comparative advantage*, but SOF is used. Complex errors of commission occur when GPF have both an *absolute* and *comparative advantage*, SOF do not have either, but SOF are still used. Simple errors of omission occur when both SOF and GPF have an *absolute advantage*, however, SOF have the *comparative advantage* but are not used. Complex errors

of omission occur when SOF have both an *absolute* and *comparative advantage* while GPF have neither but SOF are not used.

Type of Error	Simple				Complex			
	SOF		GPF		SOF		GPF	
	AA	CA	AA	CA	AA	CA	AA	CA
Commission	yes	no	yes	yes	no	no	yes	yes
Omission	yes	yes	yes	no	yes	yes	no	no

Table 1. Table of Misuse of SOF

The *absolute / comparative advantage* graph, Figure 1, represents the theory in terms of *expected value* and *expected cost*. The x-axis represents the *expected value-to-expected cost* ratio of GPF. The y-axis represents the *expected value-to-expected cost* ratio of SOF. The *absolute advantage* threshold for both SOF and GPF is located where the *expected value-to-expected cost* ratio equals one for each force. *Expected value-to-expected cost* ratios that fall above the horizontal white line represent an *absolute advantage* for SOF while ratios that fall to the right of the vertical line represent an *absolute advantage* for GPF. The *comparative advantage* line is presented as a forty-five degree line where the *expected value-to-expected cost* ratios of both SOF and GPF are equal. Ratios above and to the left of the line represent a *comparative advantage* for SOF while ratios below and to the right of the line represent a *comparative advantage* for GPF. These three lines are not the guarantors of mission success, but represent the necessary and sufficient conditions for proper use of SOF and GPF.

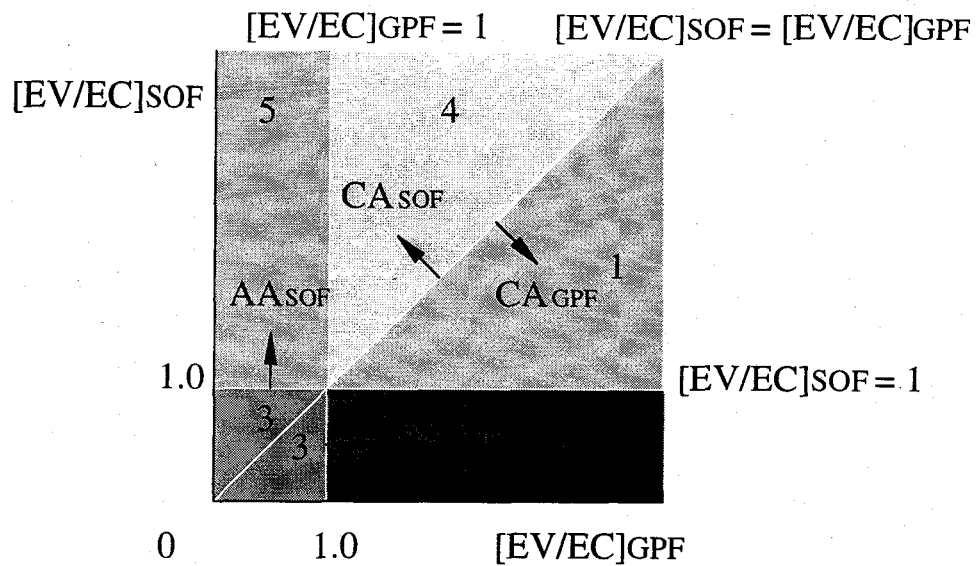

Figure 1. Absolute/Comparative Advantage Graph

The areas identified by numbers in Figure 1 represent the ratios of SOF and GPF *absolute advantages* where the following types of errors, identified in Table 1, occur:

- 1) Simple error of commission.
- 2) Complex error of commission.
- 3) Error beyond the scope of this thesis.¹⁵
- 4) Simple error of omission.
- 5) Complex error of omission.

¹⁵ If neither force has an *absolute advantage*, but one force is used, this could be considered a gross error of commission. This is represented by the area marked (3) in the Absolute/Comparative Advantage Graph, but is beyond the scope of this thesis.

In order to quantify *expected value* and *expected cost* to establish *absolute* and *comparative advantage* and the different types of errors that define the misuse of SOF, we have chosen a method of decision analysis known as the decision tree. The decision tree enables us to account for the diverse factors affecting the probability of success and the payoffs associated with various outcomes of a specific mission. The decision tree provides a method to evaluate past decisions, prompt discussion based on an analytical framework, and increase understanding of the proper use of SOF in order to alleviate the future misuse of SOF.

D. THE DECISION TREE

A decision tree provides a graphical representation of the decision making process and a method of quantifying and evaluating the expected results from various possible outcomes. Decision making, as David Anderson, Dennis Sweeney, and Thomas Williams depict the process, includes: defining the problem, identifying the alternatives, determining the criteria, evaluating the alternatives, and choosing an alternative.¹⁶ We assume that the first three decision making steps listed above are a given, and provide a method, with our theory, for completing the last two steps. Decision trees have been a standard instrument of decision analysis since the 1960's,¹⁷ and provide a tool to establish the *expected value* and *expected cost* of using SOF or GPF for a specific mission.

Influence diagrams provide a useful starting point for the development of a decision tree. Figure 2 shows the structure of the decision problem in the form of an influence diagram.¹⁸

¹⁶ David R. Anderson, Dennis J. Sweeney, and Thomas A. Williams, An Introduction to Management Science: Quantitative Approaches to Decision Making, (St. Paul, MN: West Publishing Company, 1991), p. 3.

¹⁷ Kneale T. Marshall and Robert M. Oliver, Decision Making and Forecasting: With Emphasis on Model Building and Policy Analysis, Draft Copy, 1994, p. 11.

¹⁸ For a complete discussion of decision trees see Anderson (et al), pp. 597-649. For a complete discussion of decision trees and influence diagrams see Marshall and Oliver.

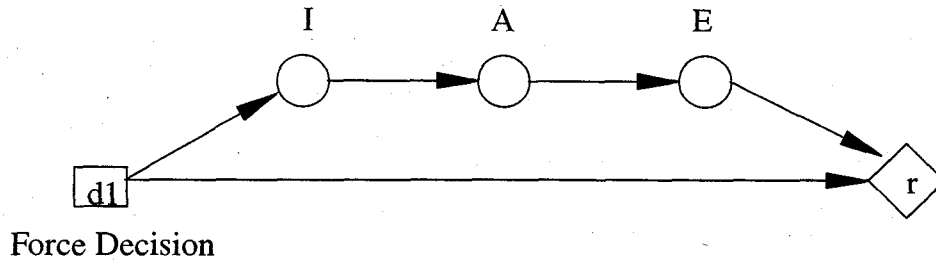

Figure 2. Influence Diagram for the use of SOF

Decisions, in Figure 2, are represented by square nodes. In our model, (d1) represents the decision to use either SOF or GPF to conduct a specific mission. Circular nodes represent uncertain events that cannot be controlled by the decision maker. Our model breaks a specific mission into three phases representing the three uncertain events that we believe influence the resulting payoff but cannot be controlled by the decision maker or the operator. These three uncertain events include: deployment, insertion and infiltration (I); actions at the objective (A); and exfiltration, extraction, and redeployment (E). The results, or payoffs, of the decision process and each subsequent state of nature are represented by diamond nodes (r). The connectors, or arrows, are used to diagram a possible dependence between one element of the model and another. In this case, the result of a mission is said to depend on both the force decision directly and the force decision and its affect on the success of the insertion phase, success during actions at the objective, and the success of the extraction phase. These relationships are depicted in the influence diagram.

Decision trees can be as simple or as complex as desired. In the interest of simplicity, we have included only one decision node and two possible results for each uncertain event in our model. The decision tree, like the influence diagram, shows the sequence of events in time from left to right. The decision tree in Figure 3 was developed from the influence diagram in Figure 2 and shows the same sequential ordering of events. The respective uncertain events and their two possible outcomes are shown dividing off of each node.

We assume that each node results in an all or nothing event, success or failure, with the subsequent payoffs for each condition. Although this is unrealistic, for comparative purposes, this assumption serves to simplify an otherwise unwieldy problem. Decision theory usually considers one resulting payoff for a decision. Our theory, by contrast, considers four types of both value and cost to determine the overall *expected value* and *expected cost*. Therefore, our theory requires eight iterations. These calculations are each computed using the same basic equations discussed below.

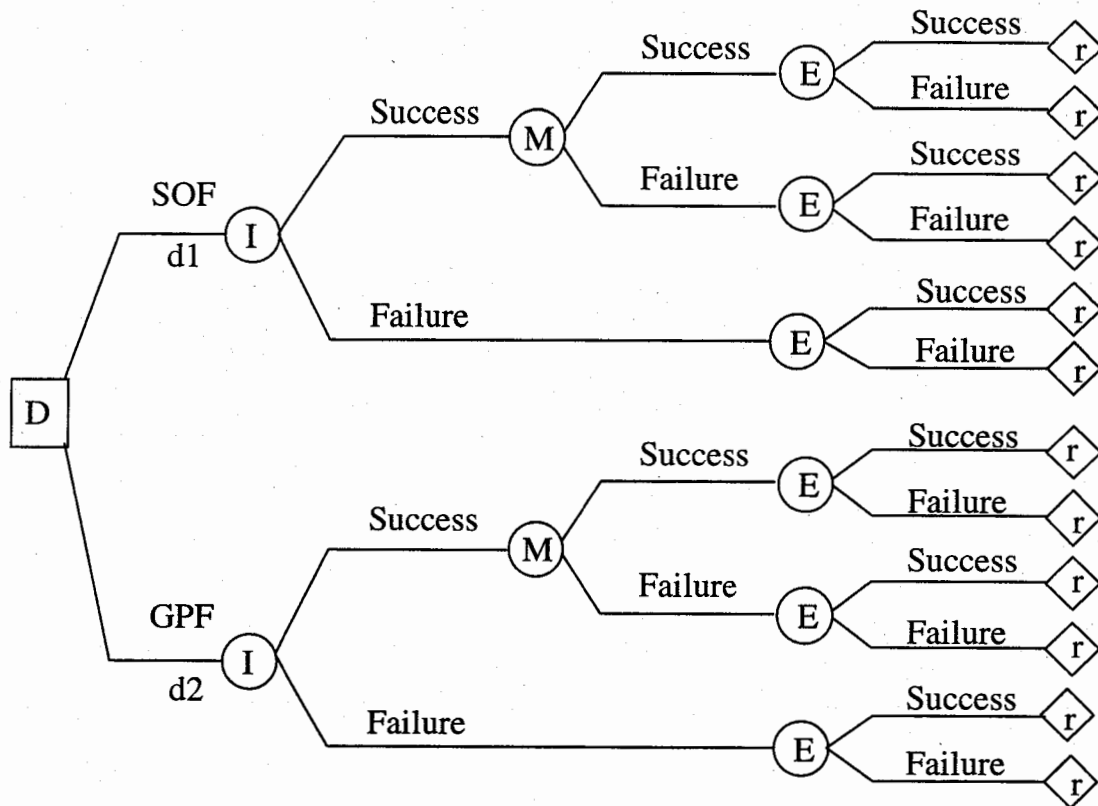

Figure 3. Decision Tree for SOF Employment

Expected value is a function of political and military value while *expected cost* is a function of political and military cost. The *expected value*, or cost, is calculated using the basic decision tree equations taken from Anderson, Sweeney, and Williams.¹⁹ Let:

(3) $N =$ the number of possible outcomes of an uncertain event

(4) $P (s_j) =$ the probability that outcome s_j occurs

Since one and only one of the N uncertain events can occur in each phase, the associated probabilities must satisfy the following two conditions:

(5) $P (s_j) \geq 0$ for every outcome s_j

(6) $\sum_{j=1}^N P (s_j) = P (s_1) + P (s_2) + \dots + P (s_N) = 1$

The values for $P (s_j)$ are, in part, subjective, yet relative between SOF and GPF, and are based on several factors discussed in detail below. The *expected value* and *expected cost*, either political or military, of decision alternative d_i are defined as:

(7) $EV (d_i) = \sum_{j=1}^N P (s_j | d_i) V (d_i , s_j)$

(8) $EC (d_i) = \sum_{j=1}^N P (s_j | d_i) C (d_i , s_j)$

¹⁹ Anderson (et al), p. 603.

(9) Where $P (s_j | d_i) = \text{Probability } s_j \text{ occurs, given decision } d_i.$

In the example in Figure 3, there are ten conditional probability distributions, each of which has two outcomes, so $N = 2$. For each of these ten, $s_1 = \text{Success}$ and $s_2 = \text{Failure}$. For each path leading away from the decision node, D, to a resulting payoff, r, there are several types of value and cost to be considered. The types of value and cost that we have identified include: *international political value; domestic political value; military effectiveness value; military target value; international political cost; domestic political cost; military opportunity cost; and military cost of casualties* to both personnel and equipment. Each type of value and cost is calculated using the equations presented above. These different types of values and costs will be discussed in greater detail below, however, using Equations (7) and (8) for each type of value and cost provides the variables associated with the total *expected value* and the total *expected cost*. The overall *expected value* and *expected cost* are found by taking a weighted sum of the four *expected values* and *costs* as shown in the following equations:

$$(10) \quad EV_{SOF \text{ or } GPF} = w_1 EV_{Int'l Pol} + w_2 EV_{Dom Pol} + w_3 EV_{Msn Eff} + w_4 EV_{Tgt Val}$$

$$(11) \quad EC_{SOF \text{ or } GPF} = w_5 EC_{Int'l Pol} + w_6 EC_{Dom Pol} + w_7 EC_{Opp} + w_8 EC_{Cas/Skill/Exp/\$ \$ \$}$$

In these equations, w_i 's are included to allow unequal weighting of the factors that comprise the overall *expected value* and *cost*.

The assumption that underlies these equations is that all values and costs are measured in the same units. As Marshall and Oliver note, the danger of this assumption is that:

If the problem under consideration has performance attributes for which there are no obvious measurement units, one must not assume that the weights assigned to these attributes are dimensionless and hence can be normalized in any desired manner. For a model to be consistent it should have the same rules for combining attributes that cannot be measured directly as it does for those that can.²⁰

Multi-attribute problems of this type force the decision maker "to think carefully about the validity of linear trade-offs among the attributes."²¹ For simplicity in the remainder of this thesis, we assume that the attributes are weighted equally and set $w_i = 1$ for $i = 1, 2, \dots, 8$.²²

The values for the different types of $V(d_i, s_j)$ and $C(d_i, s_j)$ are also, in part, subjective, but coded with a clear scale of political and military value and cost. Because of the model's subjective nature, it serves as a framework to approach decision making. It will be useful in defining the misuse of SOF, highlighting the variables that influence *expected value* and cost, and examining the proper and improper use of SOF. Given a mission, the decision maker determines the probabilities of each state of nature in each phase. Then the various values and costs are determined for each path leading away from the decision node to the resulting diamond nodes. For example, the decision maker must determine what the values and costs are if the insertion succeeds, the actions at the objective succeed, and the extraction fails. Similarly, each path is examined and coded for value and cost. Equations (7) and (8) allow the decision maker to calculate each type of *expected value* and *expected cost*, and Equations (10) and (11) are used to calculate the *expected value* and *expected cost* of using a particular force for a specific mission. Equations (1) and (2) then provide the

²⁰ Marshall and Oliver, p. 328.

²¹ Ibid., p. 390.

²² For a complete discussion of the following: decision sapling with two attributes; the added cost of conflict resolution; assessment of trade-offs through preferences; a hierarchical multi-attribute model; and multi-attribute utility, see Marshall and Oliver, pp. 327-391.

necessary and sufficient conditions for proper employment of either force. The variables affecting *expected value* and *expected cost* for a specific mission are discussed below.

E. PRINCIPLES AFFECTING PROBABILITIES

Joint Pub 3-05.5, the Joint Special Operations Targeting and Mission Planning Procedures manual, provides additional doctrinal foundation for the proper use of SOF. The manual "describes the special operations joint tactics, techniques, and procedures for the targeting and mission planning process."²³ The doctrine, no doubt, arose from the perception of misuse of SOF prior to the formal institutionalization of the community and is primarily focused on long range planning of theater strategies. Time sensitive missions and crisis response are mentioned and require a compression or truncation of the targeting and planning cycle, but involve the same phases and variables. The question of probability is constant throughout the doctrine. As the doctrine proceeds through the targeting and planning cycles, and the subsequent analyses and reporting requirements placed on SOF commanders, the following references to probability are made. In the SOF Feasibility Assessment (FA) the doctrine directs the commander to describe the "feasibility as a target," "feasibility of getting to/from the target area," and "probability of mission success."²⁴ In the Initial Assessment, the commander is directed to determine the "probability of team insertion," the "probability of team resupply," the "probability of team extraction," and the "overall probability of mission success."²⁵ In the SOF Plan of Execution, the commander is directed to provide the "probability of success assessment" for each course of action being considered,²⁶ and in the Mission Support Plans the commander is directed to determine the "probability of mission

²³ Joint Pub 3-05.5, Joint Special Operations Targeting and Mission Planning Procedures, Joint Chiefs of Staff, 10 August 1993, p. iv.

²⁴ Ibid., p. C-1.

²⁵ Ibid., p. D-2.

²⁶ Ibid., p. G-2.

success."²⁷ Clearly, doctrine mandates that probabilities need to be determined, however, no analytical method for arriving at these probabilities is provided. Commanders determine probabilities based on their experience and judgement, providing probabilities that can be nothing more than subjective.

Estimating the probabilities that allow us to calculate *expected value* and *expected cost*, as well as establish the typology of misuse, are a function of knowledge and judgement. This process can, by no means, be considered to be an exact science. As Marshall and Oliver explain:

If one interprets such a probability as a measure on a scale where 1.0 means you are certain an event will occur and 0 means you are certain it will not, *expected value* [and *expected cost* are] simply a weighted average of possible results that reflect one's knowledge and judgement.²⁸

Some have determined that probabilities are nothing more than "a matter of conjecture," citing the dynamic complexities involved in determining the probability of success and failure in military missions.²⁹ In order to frame the problem in the most exacting manner possible and to establish a basis for "conjecture," we have identified probability as a function of several variables discussed in detail below.

The variables affecting the probabilities of the three phases of a specific mission fall into two broad categories: the variables that positively affect the probability of success, and the variables that negatively affect the probability of success. Positive variables affecting probability are a function of friendly capabilities and limitations and the principles of special

²⁷ Ibid., p. H-1.

²⁸ Marshall and Oliver, p. 28.

²⁹ The Holloway Commission, p. 57. The Commission wrote that in attempting "to precisely appraise the remaining part of the operation [Operation Rice Bowl, to rescue American hostages held in Iran] and to measure probability of success," required analysis of an extremely complex set of variables. They deferred the analysis because of the conjecture involved.

operations. Negative variables affecting probability are a function of enemy capabilities and the inherent difficulties of the mission. Friendly capability variables include: the *mission skill* required and possessed by each unit, the *mission proficiency* of each unit, each unit's *firepower* and available supporting fire relative and applicable to the enemy, physical and material *readiness*, *deployment availability* and the ease of deployment of each unit, the degree to which each phase *corresponds with unit doctrine*, and the *supportability* of friendly forces in either a sustained engagement or sustained operations. The *principles of special operations* include: *simplicity*, *security*, *rehearsals*, *surprise*, *speed*, and *purpose*. They are grouped in this category because they positively affect the ability of chance to intervene negatively in the mission.

Enemy capability and mission difficulty variables are said to negatively influence the success of each phase. Enemy capability variables include the enemy's various orders of battle (OOB), specifically: his *force OOB*, *communications and electronic OOB*, and *weapons OOB*. *Mission difficulty* is the final negatively influencing variable. If a positively influencing variable is said to be high, then the probability of success is high as well. Conversely, if a negatively influencing variable is said to be high, then the probability of success is correspondingly low. All of these variables are coded on a scale of 0-100 for each phase of a mission and are a function of the factors discussed in detail below.

Appendix A provides a probability worksheet for tabulating the value that decision makers assign to each of these variables in each phase of the mission. The worksheet is meant to be applied to the total force package with obvious implications. For example, SOF being inserted by helicopter do not require much proficiency to be transported in the back of the aircraft. The associated aircrew, by contrast, may require high proficiency to complete the mission. The applicable parts of the force package need to be examined to determine the coding on the probability worksheet. Additionally, one variable may far outweigh all other variables in determining the probability of success for each phase. For example, a unit with the highest capabilities may have a low probability of success during the insertion phase if there are no platforms available to insert them in a manner that corresponds with the unit

doctrine. SOF can be marked with X's while the GPF are marked with O's. The probability worksheet provides a basis for determining a general probability of success for a specific SOF or GPF unit. It also highlights the relative differences between both SOF and GPF, and the individual unit and each phase of the mission. The decision maker will be able to assign probabilities based on his knowledge and judgement and the relative differences between the units and the phases. While still a form of conjecture, the framework established by our theory allows decision makers to think about and discuss the merits of using one force over another. Although no GPF could have reasonably been tasked to conduct Operation RICE BOWL, the rescue of the hostages held at the American Embassy in Iran in 1980, we will use the SOF used in that mission to demonstrate the method of determining the probabilities for each phase.

The product of the first two probabilities provides the decision maker with the probability of "mission success." The product of all three probabilities determines the probability of executing the mission and recovering friendly forces. Because of the factors mentioned above and discussed in detail below, none of the probabilities will ever reach one, and consequently, the more phases of the mission there are, the lower the overall probability of success. If only the first two phases are considered as criteria for mission success, then the probability of success will be higher than if all three phases are considered. We are not advocating one way missions. We note this to highlight one possible advantage of unmanned and highly technical means available to conduct direct action and special reconnaissance missions in only two phases. In terms of probability alone, these means have a distinct advantage over SOF. Other factors such as the need for plausible denial, the availability of high tech means, a requirement for a precision assault in populated areas with no collateral damage, or a requirement for detailed and specific intelligence, to name a few, may require the use of SOF in spite of a comparative probability deficit. The discussion of variables affecting probability continues below with the variables that affect probability of success positively and negatively.

1. Positive Affects on Probability

Mission skill refers to all of the skills that will be required for a specific mission. Various skill types and levels are required for different missions and each unit has a different level of mission skill for each different type of mission. Furthermore, each mission has varying skills required to execute each phase of the mission, including the coordination between two different units assigned different aspects of a mission. For instance, the Special Forces Operational Detachment-Delta (SFOD-D) members involved in Operation RICE BOWL were required to have limited skills until they reached their objective and for a portion of their exfiltration. The aircrews were required to have the highest mission skills during the infiltration and exfiltration portions of the mission. The mission skills required for a specific mission are determined by the decision maker and coded for each phase of the mission, on a scale of 0-100, for each unit of the force package and their capabilities. An aggregate value for the total force is then entered on the probability worksheet. The *mission skills* required for SOF and GPF ground forces may be dissimilar due to doctrine and tactics, but are relative to the forces themselves and their level of skill. The mission statement will highlight the importance of different methods of infiltration and execution and the differences in probability due to mission skills will become evident. Various reporting requirements, such as Status of Readiness and Training (SORTS), and unit commanders, provide a source of information to the decision maker regarding the skills possessed by each force.

Mission proficiency speaks to the timing of training in certain mission skills and the level of proficiency maintained by the unit. The soldier that has successfully maintained qualification in specific mission essential skills is more likely to perform successfully on a mission requiring those skills than one who received one time training and has not maintained his skills. Shooting skills, fire and maneuver, demolitions, and command and control, to name a few, are important to SOF and GPF alike, and are all highly perishable skills that require regular proficiency training to maintain. The SORTS and unit commanders, once again, provide a source for decision makers to determine the level of mission proficiency of different units. The *mission proficiency* of a unit is determined,

relative to the best case scenario of that unit, and coded between 0-100. The SFOD-D members had trained specifically in the skills required to rescue the hostages in Iran for more than four months and were completely proficient in the skills required to carry out the mission. The aircrews, on the other hand, had never completed a *full* dress rehearsal and were not completely proficient in all of the skills required of them.

Firepower refers to the amount of firepower, both integral to the unit and from supporting arms, that the unit can bring to bear on the enemy, relative to the enemy. In other words, what is the disposition of firepower, bullet for bullet, pound for pound, caliber for caliber, relative to both the enemy and the target. The Fortress at Eben Emael provides an example of GPF having the *firepower*, relative to the enemy, to reach the target and strike with bombers. However, in spite of effectively defeating the defenses and reaching the objective, air power alone did not possess sufficient *firepower*, relative to the target, because the gun mounts were hardened against air attack.³⁰ The *firepower* of the friendly forces is compared against likely enemy forces and the *firepower* they might encounter, additionally, friendly firepower required to accomplish the mission is examined. These values are coded between 0-100 for both SOF and GPF. The SOF that conducted Operation RICE BOWL had more *firepower* than any force they might have encountered prior to and during the rescue operation. Following the execution of the actual rescue and the possible reaction from Iranian forces, the rescue force had additional firepower on call to support their exfiltration and extraction. Published doctrine, the Joint Munitions Effectiveness Manual for both SOF and GPF, intelligence estimates, unit standard operating procedures, and the unit commanders provide a source for decision makers to determine how *firepower* may affect probability in each phase of a mission.

Readiness, both physically and materially, does not refer to *mission skill* and *proficiency* as discussed above, and can provide an interesting trade-off between *readiness* and *mission skill* and *proficiency*, at the extremes. *Readiness* requires proper maintenance

³⁰ McRaven, p. 108.

of both personnel and equipment. Much like a racing car that needs regular maintenance during the rigors of racing. In extremes the following may occur: kept in the pits too long *readiness* is maximized and skills and proficiency are wasted; kept on the track too long and skills and proficiency are maximized to the detriment of *readiness*. Additionally, as SOF are generally smaller in numbers than GPF, the loss of key personnel or leaders due to injury or sickness, may have a more drastic affect on SOF *readiness*. Single, planned operations, such as Operation RICE BOWL, are generally at the high end of the *readiness* continuum while missions conducted during war, or quick reaction contingencies, require closer scrutiny of *readiness* of forces. Post operations reports, situation reports, training schedules, SORTS, maintenance reports and schedules, and unit commanders can provide the decision maker with the information to determine *readiness* of a unit.

Deployment availability refers to how quickly a unit can be ready to deploy for a mission and how easily the force can be deployed on the mission. Timing and logistics are the key elements of this variable and is obviously more important when applied to short term crisis response missions than to mission during war. Although this variable does not directly impact success of each phase of a mission, it plays an important role when considered in context with the mission statement. The political and military goals outlined by the mission statement may limit decision makers to the forces that can meet requirements for a timely response, low signature, and limited enemy reaction to movement of friendly forces. Conversely, political and military requirements may demand a timely response with a large signature and an anticipated enemy reaction. The small size of SOF generally gives them an advantage in this variable if the mission requires a timely, low signature military response to a crisis, but becomes more logistically dependent during times of war. Joint Pub 3-05.5 indicates that "time-sensitivity can play an important part in categorizing a target and determining its appropriateness as a SO target."³¹ The doctrine continues by defining time-sensitive targets as requiring an immediate response, and providing an operationally small

³¹ Joint Pub 3-05.5, p. IV-1.

time window, and cautioning against declaring a mission feasible or infeasible based on time-sensitivity alone.³² Clearly, the SOF used for Operation RICE BOWL were able to quickly and easily deploy once they were ordered to execute. Prior planning and preparations coupled with the deliberate nature of the mission allowed this to happen. Decision makers can look to unit standard operating procedures, Time Phased Force Deployment Logistics List (TPFDLL), and the unit commanders for information to assign relative values for *deployment availability* and code between 0-100.

Corresponding doctrine refers to the degree to which each phase corresponds with the unit's doctrine. Logically, if a mission completely corresponds with the doctrine of a unit, that unit has a higher probability of success than a unit which is operating outside published or normative doctrine. This variable is coded between 0-100 and may be the same value for SOF and GPF although they might accomplish the mission differently. This variable received some close examination from the Holloway Commission when they examined the question of using different helicopter pilots than the ones involved in the accident at Desert One. To paraphrase the question they posed, they asked if *doctrine correspondence* was more difficult to adjust to than the transition to an aircraft variant. They concluded "that learning new and vastly different complex mission skills [skills required by doctrine] is far more difficult than transitioning to an aircraft of similar design and performance characteristics."³³ While carefully avoiding blame to any pilots involved, the Commission highlighted the importance of *doctrine correspondence* and recommended the formation of "an operational helicopter unit responsible for maintaining mission capability in this area."³⁴ Unit doctrine and unit commanders can provide the decision maker with the information required to determine to what degree the three phases of the mission, as planned and/or required, correspond with the doctrine of the unit.

³² Ibid., p. IV-2.

³³ The Holloway Commission, p. 35.

³⁴ Ibid., p. 36.

Supportability speaks to the logistics tail and outside support a unit necessarily introduces to the mission. This variable includes the assets needed for deployment to support the unit before, during, and after the mission. This support includes: transportation of personnel and equipment; transportation and logistic support at a forward staging base (FSB); insertion platforms not inherent to the unit; close air support; naval gunfire support; command and control support; and intelligence support. These variables produce more of a limiting affect on the unit than an actual affect on the probability of success of each phase of a mission. They provide a dose of reality of what is required for the effort and are routinely considered prior to deploying a force. Operation RICE BOWL included a significant, yet well-managed, supportability variable that in the final analysis did not hinder the probability of mission success. The TPFDLL, mission concept, unit doctrine, and unit commanders can provide the decision maker with the information to determine the affect of supportability on probability of success.

The *principles of special operations*, as described in McRaven's Theory of Special Operations, provide the lowest common denominator between SOF and GPF and their respective operational principles. The *principles of special operations* are a subset of the principles of war and therefore afford the decision maker the ability to examine the mission, and SOF and GPF, with the same lens. The principles include: *simplicity; security; repetition; surprise; speed; and purpose*. McRaven summarizes the primacy of these concepts in obtaining what he calls relative superiority, and limiting the affects of chance, when he writes:

Special Operations Forces succeed, in spite of their numerical inferiority, when they are able to gain *relative superiority* through the use of a simple plan, carefully concealed, repeated and realistically rehearsed, and executed with surprise, speed and purpose.³⁵

³⁵ McRaven, p. 17.

These principles can be almost inversely related between SOF and GPF, particularly in the case of *surprise* and *repetition*. Some GPF require *surprise* while others can use their ability to maneuver and bring massive, offensive firepower to bear with little to no *surprise* involved. Additionally, the fluid nature of operations normally conducted by GPF precludes the necessity for numerous repetitions of the full mission profile. In describing the principles of special operations, McRaven describes the principle of *simplicity* as containing three elements that are critical to success: "limiting the number of objectives; good intelligence; and innovation."³⁶ The purpose of *security* "is to prevent the enemy from gaining an unfair advantage through foreknowledge of the impending attack," and with particular care for the timing and means of insertion.³⁷ *Repetition* "is indispensable in eliminating the barriers to success," and should include one or two full dress rehearsals prior to the mission.³⁸ Failing the ability to "(s)trike the enemy at a time and place, or in a manner, for which he is unprepared,"³⁹ "surprise is gained through deception, timing, and taking advantage of the enemy's vulnerabilities."⁴⁰ *Speed* is simply a function of time on target, unlike the relative relationship that exists for conventional or large scale warfare, where action, reaction, and counter action are the norm of doing business. The final principle is *purpose*. Every operator must understand the purpose as it is defined by the mission statement, and make a personal commitment to achieving that end.⁴¹ In order to determine the probability of accomplishing each phase of the mission, the decision maker can review training records, SORTS, and mission concepts to determine the affect, and the dependence of the mission on

³⁶ Ibid., p. 17.

³⁷ Ibid., p. 21.

³⁸ Ibid., pp. 23-24.

³⁹ Joint Pub 3-05, Doctrine for Joint Special Operations, p. E-5.

⁴⁰ McRaven, p. 27.

⁴¹ Ibid., pp. 34-36.

the *principles of special operations*. These principles are coded positively between 0-100, coding will be high if they assist friendly forces in achieving the objective and low if they do not add to the probability of success. For the most part, Operation RICE BOWL coded on the high end of the *principles of special operations* variables. The discussion of variables affecting probability continues below with the variables that affect probability of success negatively.

2. Negative Affects on Probability

Enemy OOB refers to the location, manning level, morale, level of training, combat effectiveness, current effectiveness, missions and functions, capabilities, operational limitations, and equipment status of ground, naval, and/or air forces at or near the objective with a response capability. The applicable enemy forces are analyzed against the particular type of force being considered for the mission, and coded between 0-100 in a negative coding scheme. All of the variables mentioned above had to be considered for Iran, as well as the forces from other countries besides Iran, for Operation RICE BOWL. The *ground OOB* was virtually negligible except for at the embassy, where they were significant. The *naval OOB* was significant electronically, especially as far as the Soviet forces were concerned, in detecting the raiding force as they entered Iranian airspace, and is discussed below. The *air OOB* was negligible as far as actual air patrols, but significant electronically in penetrating coastal air defense zones and is discussed below. Since the *OOB* in Iran did not pose a serious and continual threat to the friendly forces, the *enemy OOB* is considered fairly low, and the probability worksheet is coded with the negative, or inverse, of the *enemy OOB*. Since the tactics and doctrine that SOF and GPF operate under differ considerably, the implications of *enemy OOB* are different between SOF and GPF. While SOF have been known to defeat forces numerically superior to them, this phenomenon generally occurs when SOF have properly planned and prepared for a specific mission and fully utilize the principles of special operations. Contact with large, unexpected enemy forces generally leads to mission failure or abort for SOF, while larger GPF can more easily adapt to the situation and continue with the mission based on their operating tactics and doctrine. Decision makers

will need accurate intelligence to accurately establish the value of this variable and the following two variables.

Enemy communications and electronic OOB refers to enemy fixed communications sites in the area, types of communications, who is communicating with whom, role of each site in overall defense posture, enemy portable communications abilities, both coastal and air early warning capabilities, local electronic countermeasures (ECM) capability, local electronic counter-countermeasures (ECCM) capability, local electronic support measures (ESM) capability, enemy direction finding (DF) capability, local civilian electronic OOB, undersea electronic OOB and its ability to detect small craft, ground sensors in the area, and non-electronic means of detection such as sentries, animals, and other personnel detection measures. Essentially, this variable accounts for the enemy's ability to detect the friendly force, and is coded negatively as above. In Operation RICE BOWL the greatest enemy threat of detection and subsequent reporting to higher authority occurred as the raiding force entered Iranian airspace. Once inside Iran, the force was relatively safe from electronic detection. Again, this variable may differ between SOF and GPF as operating tactics and doctrine are dissimilar between the two forces.

Weapons OOB refers to the missile and AAA defense sites and their locations, functions of sites, operational characteristics, types of personal weapons in and around the target, types of land and sea mines in and around the target, and types of booby traps in and around the target. The essence of this variable is the enemy's ability to react once they have detected the friendly forces. The raiding force in Operation RICE BOWL experienced some vulnerability to the Iranian weapons OOB when they breached the airspace of Iran. The threat then subsided and increased exponentially the second night as the force moved via vehicle to the embassy. The greatest threat would have been reached as the force began their assault and attempted to exfiltrate with the hostages. The Iranian *weapons OOB* would have continued to increase to the level of the worst case scenario, and this is the value to be used in the probability worksheet for the actions at the objective phase. At this same time, the rescue force would have obtained a marked increase in firepower support, in the form of AC-

130 gunships, providing close air support during this phase. This factor should not be considered for determining the enemy weapons OOB. An important point that these events raise is that the variables are coded independently from each other and events such as this. The highest *weapons OOB* for the enemy would be considered high and therefore coded low for the friendly force, while the high *firepower* support provided by the AC-130 would be considered high, and therefore coded high for the friendly force. Considering the two variables independently allows a realistic estimate of probability and may cancel each other out in the final analysis. Obviously, different variables are more important than others at certain times. The decision maker must use his knowledge and judgement to determine which variables are most important for each phase of the mission. Probabilities are also affected by variables outside the control of either the friendly force or the enemy. Other elements, such as the inherent difficulty of a mission, contribute negatively to the probability of success.

Mission difficulty varies across the three phases of a mission. Deployment, infiltration and insertion, as well as exfiltration, extraction, and redeployment, are a function of mechanical dependence, terrain and obstacles, weather conditions, distance, and time. *Mission difficulty* at the objective is based on the above variables, in addition to the difficulty increasing as time on target increases, and the objectives become more complicated, spread out, and numerous. This variable was the most limiting in Operation RICE BOWL as the insertion involved 14 aircraft, 242 personnel, infiltrating across the barren mountain ranges of Eastern Iran and through the unforeseen haboobs, 624 nautical miles to the refueling point at Desert One, with a second movement of helicopters during night one and their subsequent cache at the lager site, and limited by the cover of darkness. The objectives had been limited by intelligence gathered just prior to launch, however, there was a possibility of increasing the number of objectives once inside the embassy compound, the complex nature of the mission at the embassy could not be avoided, and time on target was critical to mission success. This variable is coded negatively, the more difficult a mission becomes, the lower the probability of success. The decision maker need only examine the mission concept to

determine the complexity and subsequent mission difficulty of a proposed mission, and its subsequent affect on probability of success.

A summary of the probability worksheet, as it applies to Operation RICE BOWL, is provided as Appendix B. The worksheet shows a probability of success that is greater than most of the probabilities calculated in our case studies. As we will demonstrate in the next section, however, the SOF involved in Operation RICE BOWL were also playing for higher stakes than most special operations, and all of our case studies. The value of accomplishing the mission was extremely high, as were the costs of failure. Now we turn our attention to the questions of value and costs of conducting a mission, and how it relates to our theory of the misuse of SOF.

F. FACTORS AFFECTING VALUE AND COST

Before a mission is launched, decision makers have already calculated an *expected value* and an *expected cost* of the specific mission, although it may not be considered in such terms. These values and costs can further be broken down into political and military values and costs. Although doctrine does not implicitly address these values and costs, the implications are clear: decision makers must determine the *expected value* and *expected cost* of conducting a mission before the mission is launched. As in the case of probability, the need for value and cost judgements is mandated but no method is provided. Doctrine suggests that "an imprecise understanding of SOF capabilities or the improper employment or support of SOF at any level of command can result in mission failure, attendant *political costs*, and possible loss of the entire force."⁴² Furthermore, the doctrine speaks to value and cost as it states that "commanders should clearly assess the risk by comparing the *value of the target* to the possible loss of the force and the attendant embarrassment to the nation or negative impact on the theater campaign."⁴³ As the probability of success or failure of each

⁴² Joint Pub 3-05, p. I-4, emphasis added.

⁴³ Ibid., p. D-2, emphasis added.

phase of a mission are subjective, so are the resulting payoffs, or value and cost, of each branch of the decision tree.

Many times, when perfect information is unavailable, decision theory resorts to assigning low, medium, or high as the resulting payoffs. We have modified this procedure, and provide a coding scheme in Appendix C. The coding of these subjective values and costs places a relative weighting on an otherwise largely subjective variable, and allows us to provide an effective comparison of SOF and GPF. For simplicity, we have selected two important types of political and military values and costs. Political value and cost is differentiated as international and domestic, while military value is coded as the percent of the mission completed, or mission effectiveness, and the value of the target. Military cost is coded as the opportunity cost and the cost of casualties to both personnel and equipment. These eight resulting payoffs, in the form of either value or cost, will be discussed in detail below, and again, Operation RICE BOWL will serve as an illustrative case to better understand our coding scheme.

1. Political Value

Political value can be gained both internationally and domestically from conducting a specific mission. *International political value* is obtained if the mission is perceived to satisfy the national interest of one or more of our allies, and/or the mission demonstrates or communicates a clear signal of direction, resolve, or capability meant to influence or deter other international actors. In times of war, the *international political value* that can be gained from a mission is largely based on the ability of the mission to satisfy the national interests of one or more allies. The number of these common interests or objectives, with a single or multiple allies, determines the level of *international political value* obtained. During operations other than war, international political value is primarily derived from the ability of the mission to send a clear message or signal to other international actors. The message or signal may have the effect of firming allied support, demonstrating U.S. resolve and convincing an adversary to reverse a course of action, or deterring further posturing or aggression from an international actor. These effects may be seen individually or

simultaneously when a mission is launched during periods of peace or war. The *international political value* of a successful outcome to Operation RICE BOWL would have been the highest possible value. Terrorism was one of the major objectives against which the United States and her allies were combatting, and a successful mission would have demonstrated an unprecedented resolve and capability in the international arena. A failed outcome also garnered some *international political value*, in that, a clear message of resolve emerged from the audacity of the mission.

Domestic political value is obtained if the American public perceives the mission as important to our national interest and/or the mission demonstrates an amount of effective leadership or capability. National interest concerns generally become the foremost concern in missions conducted in operations other than war. Similarly, effective leadership is most evident during, although not limited to, these same types of operations. Unless a war is as quick, as decisive, and as well covered by the media as Desert Storm, the amount of *domestic political value* is limited. A successful outcome to Operation RICE BOWL would have maximized the *domestic political value* as Ted Koppel began his "days of the hostage crisis" count and Americans perceived the hostages as one of the single, most important, national interests. Additionally, a successful mission would have demonstrated unprecedented capability, courage and leadership to the American public. A failed outcome to Operation RICE BOWL carried with it, limited *domestic political value*.

2. Military Value

Military value is quantified by the percent of the mission completed and the value of the target in a specific mission. The percent of the mission completed, or *mission effectiveness*, could obviously be coded as an all or nothing event, the mission was completed or it was not. However, because of the nature of direct action and special reconnaissance missions, there lies an area between all or nothing where some military value is gained by completing a portion of the mission. Suppose the mission calls for the coordinated destruction of a control van and the eight air defense artillery (ADA) batteries that the van services, to be conducted almost simultaneously with an air strike. The force on the ground

places charges on the control van that do not detonate high order, and the control van is left unaffected but seven of the eight ADA batteries are destroyed. The mission was not completed, yet the mission had a severe military effect on the enemy and some military value was obtained. This is an attritional concept that identifies the probable military affect of completing the mission, partially completing the mission, and failing to complete any portion of the mission. Hostage rescue operations, like Operation RICE BOWL, fall more closely into the all or nothing category and would be coded closer to either end of the coding spectrum for each outcome, success or failure.

Target value is derived from the classification of the target as strategic, operational, and tactical. As Joint Pub 3-05.5 states, the above terms "are not standardized within the Department of Defense,"⁴⁴ however, we will be using the terminology presented in Joint Pub 3-05.5 as applicable to our coding scheme. The doctrine states that:

Strategic targets are vital to the enemy's overall political, military, and economic operations or psychological stability. The objective of a mission against such a target is to severely impede the enemy's capability to carry on with the theater or overall war effort.⁴⁵

The doctrine continues:

Operational targets are deemed critical to the enemy's capability to conduct successful campaigns. Such targets include logistic and C3I actions required to support and direct tactical operations.⁴⁶

Finally, the doctrine notes:

Tactical targets affect the enemy's capability to conduct battles on a relatively localized basis. Tactical military ground targets usually extend no higher

⁴⁴ Joint Pub 3-05.5, p. II-9.

⁴⁵ Ibid., p. II-9.

⁴⁶ Ibid., p. II-9.

than divisional level. Typical SO tactical targets would include command posts, individual ships, police stations, local telephone exchanges, and individual aircraft.⁴⁷

The doctrine further stresses to decision makers that they must consider how the "mission will affect the enemy's ability to function effectively at the strategic, operational, and tactical levels of war." The doctrine assigns strategic targets the highest value and tactical targets the lowest value, and cautions the decision maker that "strategic targets are rare and tactical ones plentiful."⁴⁸ This variable is an all or nothing variable, dependent on success or failure of the mission, and the *target value* as discussed above. Targets can be broken down at the strategic level as the single, most important, national strategic target, a national strategic target, and a theater strategic target. The hostages in Operation RICE BOWL would have to be considered the single, most important, national strategic target, making the coding of *target value* as high as possible.

3. Political Cost

Like political value, political cost can be incurred internationally and domestically from conducting a specific mission. *International political cost* is based on the perceptions of international actors, allies and enemies alike. The perception of being militarily weak, acting inappropriately, appearing indecisive, or being militarily and politically incompetent can lead to allies distancing themselves, speaking out against the U.S., or a loss of credibility with allies and enemies. Unlike *international political value*, *international political cost* is more likely to be incurred, across the board, regardless of the state of environment (war, conflict, or peace) the mission is conducted under. The *international political cost* of successfully completing Operation RICE BOWL included probable condemnation from the Arab community for violating the sovereignty of Iran, and possible adverse reaction to heavy Iranian casualties. A failed attempt came with the perception of incompetence price tag, and

⁴⁷ Ibid., p. II-10.

⁴⁸ Ibid., p. II-10.

a loss of credibility as far as both our allies and our enemies were concerned, as well as some of those costs incurred with success.

Domestic political cost is incurred if the American public loses confidence, Congress subsequently takes action, and the media begins to question the leadership of decision makers. Both the *domestic political value* and the *military cost of casualties*, figure into the calculus of determining *domestic political cost*. The American public is intolerant of casualties suffered during a mission conducted to achieve a goal that is not perceived to satisfy a vital national interest. Because of this phenomenon, *domestic political cost* is more dependent upon getting all, or a high percentage, of U.S. forces back alive than on mission success, although mission success does have a vital role in determining *domestic political cost*. As most authors agree in one form or another, the failed rescue mission "eventually contributed to the defeat of Jimmy Carter for a second term."⁴⁹ The public lost confidence in his ability to lead, Congress conducted numerous hearings immediately following the failed attempt, and the media blitz was second only to the Watergate attacks on President Nixon. Had the mission succeeded, however, *domestic political cost* would have been zero.

4. Military Cost

Military cost is expressed in terms of the *opportunity cost* incurred, and the cost of the skill and experience of casualties and the dollar cost of casualties to equipment. *Opportunity cost* is an economic term which speaks to the opportunity lost by employing the force on one mission vice another possible mission. The number of units, either SOF or GPF, and the number of other possible employment opportunities make up *opportunity cost* in our theory. With no other missions to be conducted, the *opportunity cost* is zero, regardless of how many units the decision maker has at their disposal. Conversely, with many missions that could be conducted by a unit, and limited units to conduct them, the *opportunity cost* of using that unit is high. *Opportunity cost* is generally higher during times

⁴⁹ Gabriel, p. 103.

of war than during operations other than war because of the number of missions available. The *opportunity cost* for conducting Operation RICE BOWL was essentially zero because there were no other missions for that unit to conduct at that time. Had another, equally pressing and dyer, hostage rescue mission outside of the United States been needed, the *opportunity cost* of conducting either would have been extremely high.

The *cost of casualties* is based on the percentage of casualties, their replaceability, and the dollar cost of equipment casualties. In purely military terms, the cost of training, the incalculable cost of skill and experience, and the investment of training time, coupled with the lag time of replacement, generally make the *cost of casualties* to SOF greater than the *cost of casualties* to GPF on a soldier for soldier scale. The percentage scale that we have provided in the coding scheme, levels the playing field and replaceability establishes a relative difference between SOF and some GPF. Highly technical GPF such as pilots and aircrew are generally coded on a similar or higher scale than SOF. The dollar cost of casualties to equipment, invariably favors the use of SOF, however, the decision maker must calculate the trade off between: a failed mission, sixty highly trained SOF personnel killed, and low dollar cost; and a failed mission, one B-2 Bomber and crew lost, and a very high dollar cost. While dollar costs are worth considering, more emotional and less well-defined costs are usually more important to decision makers. The *cost of casualties* in Operation RICE BOWL was extremely high as the ground element was of a one of a kind nature at the time and virtually irreplaceable in the short term.

The tenets of our theory have been described above. Our definition of the misuse of SOF was provided with the concepts of *absolute* and *comparative advantage* established as the necessary and sufficient conditions for proper use of SOF. The machinations of the decision tree were explained with the framework used to consider and determine both the probability of success of each phase of a specific mission, and the payoffs of each subsequent branch of the decision tree. The next section describes our case study methodology and the manner in which we intend to validate our theory of the misuse of SOF.

G. CASE STUDY METHODOLOGY

To further explain the Theory of the Misuse of SOF, we will present four historical cases and provide an analysis of each. The cases were selected because they are commonly believed cases of misuse and they are representative of the four types of errors identified in Table 1 and Figure 1. The SEALs at Paitilla airport during Operation JUST CAUSE are commonly believed to have had an *absolute advantage* but not a *comparative advantage* and to represent a simple error of commission. Merrill's Marauders operating in Burma during World War II are commonly believed to have possessed neither an *absolute* or *comparative advantage* but were used to defeat the Japanese at Myitkyina and are believed to represent a complex error of commission. The Mayaguez incident and Operation URGENT FURY have both been criticized for their intelligence failures and the failure to use SOF for gathering intelligence. SOF were believed to hold an *absolute* and *comparative advantage* for both operations but were not used. Because of the threat and environment, GPF were believed to hold an *absolute advantage* during the Mayaguez incident and therefore represents a simple error of omission. The threat and environment were more complex in Grenada and GPF were believed to hold neither advantage prior to Operation URGENT FURY and therefore represents a complex error of omission.

We limited the period under analysis from the beginning of World War II to the present. As Eliot Cohen noted in his work Commandos and Politicians, World War II "inaugurated a new class"⁵⁰ of SOF as technology enabled small groups of men to usher in a different type of warfare. The institutionalization of SOF began in the 1960s with the creation of Special Forces and SEAL Teams, however, Rangers began operating during World War II. The framework decision makers operated under during World War II was much different than today's environment, however, the same principles are applicable to the early uses of SOF. Additionally, the cases selected are well known and reasonably well documented in the general literature in order to avoid obscure missions and to facilitate quick

⁵⁰ Eliot A. Cohen, Commandos and Politicians: Elite Military Units in Modern Democracies, (Center for International Affairs, Harvard University, 1978), p. 19.

discussion. The four cases sufficiently demonstrate the validity of the theory and show the relationship between *expected value*, *expected cost*, and the concepts of *absolute* and *comparative advantage*.

The basis of our research was proceeded by official reports and records. When possible, we relied completely on the official literature to determine values of the probabilities and payoffs. When this was not possible we ensured that at least three secondary sources supported our evaluation. The historical dust has completely settled on Merrill's Marauders and we were able to rely almost completely on official reports for their study. Because of slow declassification procedures the dust has not settled on the other three cases and required extensive reliance on secondary sources. Because of the subjective nature of decision making in an uncertain environment, and the subsequent subjective nature of our theory, the threat of skeptics accusing the authors of "cooking the books" is real. No doubt countless special operators, general purpose force members, and academics will have differing views from our analysis of each case. That said and acknowledged, once we agree that there exists such concepts as *expected value* and *expected cost* of conducting a specific mission, that one or both force may have what we have termed an *absolute advantage*, and that one force has or does not have a *comparative advantage*, then we can begin to agree to disagree about probabilities and payoffs, and unravel the misuse of SOF.

After a brief synopsis of the events surrounding each mission, the cases are divided into six sections which include the following: the background, which provides the political and military setting surrounding a specific mission; the objective of the mission; the alternatives available to the decision maker, including a discussion of the factors affecting the probabilities of each uncertain event and the political and military values and costs associated with the objective; the execution of the mission, omitted for counterfactual errors of omission; and an analysis of the operation, including the *expected value* and *expected cost* of the mission and the subsequent necessary and sufficient conditions for the proper use of SOF.

We will provide a decision tree for each mission, calculate the *expected value* and *expected cost*, and explain why misuse did or did not occur. Because we believe misuse occurs when decision makers lack understanding of SOF, through the use of our theory, the decision tree for each specific mission, and an *absolute* and *comparative advantage* graph for each specific mission, we hope to continue to break down the wall between SOF and decision makers.

The next four chapters will discuss each case study in detail and demonstrate the four types of errors associated with the misuse of SOF. The analysis will show how SOF are misused and demonstrate the usefulness of our theory. The necessary and sufficient conditions for the proper use of SOF is both an *absolute advantage* and a *comparative advantage*. Although the theory is abstract and heuristic in nature, these necessary and sufficient conditions are useful and can be used as a powerful tool to alleviate misunderstanding and subsequent misuse of SOF.

II. PAITILLA AIRPORT OPERATION

A. INTRODUCTION

On the early morning of 20 December, 1989, three platoons of U.S. Navy SEALs⁵¹ and their command, control and communications (C³) element approached the beach at the southern end of Paitilla Airport, Panama City, Panama. As they proceeded, they could see the explosions and tracers from gunfire illuminating to the northwest.⁵² Operation JUST CAUSE, formerly BLUE SPOON, was in progress. A half hour earlier, Commander Joint Task Force South (CJTF South)⁵³ advanced H-hour "from 0100 to 0045 in the area of Panama City, trying to resurrect a semblance of tactical surprise following 'premature contact' between PDF (Panamanian Defense Force) and American forces."⁵⁴ The SEALs could not make the new time line. They were consequently forced to execute a mission that was compromised before they had reached the target.

⁵¹ SEALs are an elite U.S. Navy commando unit. The acronym, SEAL, is taken from the environments in which these commandos operate - SEa, Air, and Land)

⁵² Malcolm McConnell, JUST CAUSE. The Real Story of America's High-Tech Invasion of Panama, (New York, NY: St. Martin's Press, 1991), pp.130-137. The fires observed by the SEALs were likely coming from the Comandancia, PDF headquarters, under attack by Task Force (TF) Gator, a TF Bayonet element which included M-113 armored personnel carriers (APC) from the 4th Battalion, 6th Infantry Regiment of the 5th Infantry Division (Mechanized); Charlie Company 1st Battalion, 508th Infantry (Airborne); and supporting fires from an AC-130 Spectre Gunship.

⁵³ Ibid., pp. 30-31. Lieutenant General Carl Stiner, Commander of the XVIII Airborne Corps was tasked as Commander Joint Task Force South (CJTF South) as a result of General Maxwell Thurman's lobbying. General Thurman was Commander in Chief of U.S. Southern Command (CINCSO) during JUST CAUSE.

⁵⁴ Ibid., pp. 33-39. At 0026 on 20 December 1989, an element of TF Bayonet (Bravo Company, 5th Battalion, 87th Infantry of the 193d Infantry Brigade), enroute in Humvees to their assigned target, exchanged gunfire with an unknown PDF unit outside the Albrook Air Station guard post. Operation JUST CAUSE was compromised.

When the operation was over, the mission had been accomplished. Repeated fire fights with enemy forces, however, had resulted in the death of four SEALs and the wounding of another eight. The SEAL casualty rate was perceived to be inordinate. This resulted in the Paitilla mission becoming the most controversial of JUST CAUSE. The decision to utilize SEALs for this mission has been condemned by military scholars and critics. It has also led to a great deal of dispute within the special operations community. This is particularly true among Naval Special Warfare (NSW) personnel. Proponents of the decision to use the SEALs assert it was Clausewitz' *friction of war*, "the force that makes the apparently easy so difficult"⁵⁵ that led to the casualties. Opponents of the decision, claim that the airport was not a SEAL mission and suggest that it should have been assigned to U.S. Army Rangers⁵⁶ or U.S. Marines. Initially, we assumed this case study was an example of misuse, but the results of our investigation supported a contrary conclusion.

In this chapter, we provide a historical overview of the 20 December, 1989 Paitilla Airport mission of Operation JUST CAUSE. We investigate the SEAL option that was employed and two additional options, one SOF and the other GPF. We evaluate whether or not there was an *absolute advantage* associated with the SEAL option and each of the alternate options, weigh these factors to determine the *comparative advantage*, and determine if there was a misuse of SOF.

B. BACKGROUND

1. Political and Military

In May 1989, the Panamanian people voted General Manuel Antonio Noriega out of his position of power by defeating his puppet presidential candidate, Manuel Solis Palma.

⁵⁵ Carl Von Clausewitz, *On War*, (Princeton, New Jersey: Princeton University Press, 1984), p. 121.

⁵⁶ McConnell, p. 54. Author notes the mission was more suited for Rangers.

Guillermo Endara was elected in the first free Panamanian presidential election in 21 years.⁵⁷ Remarkably enough, the democratic process was successful even after Noriega attempted to fix the election by using his Dignity Battalion (Digbats)⁵⁸ to physically attack the Endara candidacy, by allowing his military personnel multiple ballots, and by stealing and altering election results. Even so, Noriega's man lost the election. The Panamanian people were outraged when Noriega declared the election invalid. The Endara candidacy looked to the north for assistance as the Panamanian people waited for the U.S. to resolve the parody.⁵⁹

The United States did not respond, so in the early morning of 3 October 1989, soldiers of the PDF 4th Infantry Company (Urraca) and troops of the Security Company (the Dobermans)⁶⁰ took Noriega prisoner as he entered the Comandancia. Noriega was given the opportunity to stand down and install the elected Endara presidency.⁶¹ Noriega refused this option and stalled for time. The dictator was held prisoner for several hours while PDF units failed to attempt a rescue. Instead, many units waited passively to see what the outcome would be. The renegade unit that had captured Noriega requested U.S. assistance. Assistance was not forthcoming.⁶² In the face of U.S. indecision, the 7th Company of the

⁵⁷ Thomas Donnelly, Margaret Roth, and Caleb Baker, Operation JUST CAUSE: The Storming of Panama, (New York, NY: Lexington Books, 1991), pp. 2-6.

⁵⁸ McConnell, p. 5. The Dignity Battalion or Digbats were "citizens he (Noriega) had recently had armed and trained as a PDF auxiliary militia." They were extremely loyal to Noriega. During the presidential campaign, they assaulted Endara's Vice Presidential Candidate, Guillermo "Billy" Ford, and fatally shot his body guard. They beat supporters to intimidate the public into casting their ballots for Noriega's candidate.

⁵⁹ Donnelly, p. 46.

⁶⁰ The Dobermans were Noriega's fiercest riot squads.

⁶¹ McConnell, p. 9.

⁶² *Ibid.*, pp. 9-11. General Thurman, the new commander of U.S. Southern Command (SOUTHCOM), and his staff had been advised of the impending coup several days in advance but did not take the information seriously assuming it was a Noriega attempt to deceive and embarrass the United States. SOUTHCOM was unaware of the 0630 attempt

Macho de Monte and a mechanized column of Battalion 2000 responded in an attempt to release of Noriega. When it was clear the U.S. would not back them, the renegades surrendered. Noriega personally executed the leader of the coup after hours of brutal torture. This had been the second failed coup attempt in 17 months.⁶³ Democracy in Panama had collapsed and the public as well as elements of the military objected.⁶⁴

Noriega was also at odds with his one time supporter, the U.S.. Noriega reportedly was involved in extensive narcotrafficking and money laundering operations with Colombian Cartel barons.⁶⁵ In addition, he was warming up to communist regimes in Central America and the Caribbean as well as world wide.⁶⁶ The Panama Canal Treaty, governing control

until several hours after it occurred. Even then, they were slow to respond. The United States finally provided a Marine blocking force on the Bridge of the Americas. This action denied some of Noriega's most loyal troops, the 6th and 7th Mechanized Infantry companies - the Macho de Monte, access to the Comandancia. U.S. soldiers also blocked the gates of Fort Amador. (Maps 1 and 2) Loyal Noriega forces based on Fort Amador, the 5th Cholo Infantry Company, did not challenge the blockade. The coup leader, Major Moises Giroldi Vega, wanted to turn Noriega over to the U.S. but this was boggled at the highest levels. SOUTHCOM had no idea how to proceed under these conditions.

Southcom had only blocked only two of four routes into the Comandancia, and eventually the 7th Company of the Macho de Monte from Rio Hato and a mechanized column of Battalion 2000 from Fort Cimarron surrounded the Comandancia. Before long it was over as the once feared Doberman and Urraca soldiers surrendered without resistance and were marched off to prison and torture, if they were lucky.

⁶³ Ibid., p. 6. The first coup attempt against Noriega occurred in May 1988. It was actually crushed by Giroldi, the man who led the second coup.

⁶⁴ Donnelly, p. 46. Author identifies numerous outbreaks of civil violence and protest as a result of Noriega's actions.

⁶⁵ Ibid., p. 19. "On 4 February 1988, two Florida grand juries... indicted Noriega on separate charges rising out of his connection with the drug cartels." See also, Greg Walker, At The Hurricane's Eye: U.S. Special Operations Forces from Vietnam to Desert Storm, (New York, NY: Ivy Books, 1994), p. 141.

⁶⁶ McConnell, p. 10. Noriega had established normal relations with Cuba, Nicaragua, and the Soviet Union. See also, Walker, p. 141.

over the waterway, was coming to a conclusion and the United States did not want the canal to fall under the control of a hostile regime. Name calling, accusations and threats between President Reagan, and later President Bush, and Noriega escalated. Bush repeatedly called for the Panamanian people to oust Noriega.⁶⁷

The United States first considered removing Noriega from power as early as November 1987.⁶⁸ Early contingency plans (CONPLANs) did not regard the PDF as an enemy force. The new planning order from the Joint Chiefs of Staff (JCS) which directed the defense of the Panama Canal and American citizens, however, regarded the PDF as a hostile force.⁶⁹ The new plans, originally developed under the code name ELABORATE MAZE, and later PRAYER BOOK, covered a wide range of combat and post-combat operations. BLUE SPOON was the combat portion of the plan and included "varying options and troop lists, ranging from forces already stationed within Panama to very large forces coming in to augment them. Elaborate plans were made to cover a range of contingencies from conducting a surgical operation oriented on Noriega all the way to full-scale combat operations."⁷⁰ Between early 1988 and December 1989, the Joint Task Force (JTF) conducted numerous partial and full mission profile rehearsals in both the U.S. and in Panama in preparation for the various options.

By December 1989, the situation in Panama had deteriorated to an all time low. Though Noriega's popularity had plummeted, he had declared himself Panama's "Maximum Leader"⁷¹ and directed the PDF and his Digbats to harass all U.S. citizens. In response, the

⁶⁷ Ibid., p. 2.

⁶⁸ Donnelly, p. 17.

⁶⁹ McConnell, p. 29.

⁷⁰ Donnelly, p. 18.

⁷¹ McConnell, p. 38.

United States exercised its rights to move troops and conduct operations in the Canal Zone.⁷² Noriega and the PDF saw these actions as provocation operations. Many of the operations were rehearsals for the BLUE SPOON CONPLAN.⁷³

The final straw came on the night of 16 December, 1989 when PDF soldiers first shot and killed a U.S. Marine officer at a road block and later took a U.S. Naval officer and his wife into custody. The officer, a SEAL, was badly beaten while his wife was fondled and threatened with rape. The next morning General Thurman telephoned General Colin Powell, Chairman of the Joint Chiefs of Staff (CJCS), and recommended the execution of Operation BLUE SPOON. Later that afternoon, General Powell returned General Thurman's call with President Bush's order to execute the long awaited, well rehearsed plan to invade Panama and remove Noriega from power.⁷⁴

What followed would be the largest military operation since the Vietnam War.⁷⁵ The overall objective was to remove Noriega from his position of power and replace him with the elected president, Guillermo Endara. This meant neutralizing PDF loyal to Noriega and removing Noriega from Panama to face charges in the U.S. The U.S. assault began within three days of receiving the president's order to invade Panama.

⁷² Ibid., p. 2. The Carter - Torrijos Accord (Panama Canal Treaties of 1978) gave U.S. forces the right to operate and maneuver within the Panama Canal Zone.

⁷³ Ibid., pp. 32-33 and Donnelly, p. 31. Southcom executed SAND FLEA, PURPLE STORM, TOTAL WARRIOR and other exercises in the Canal Zone as rehearsals for the BLUE SPOON contingency.

⁷⁴ Ibid., p. 19.

⁷⁵ Ibid., p. 29. See also, Vandenbroucke, p. 174. JUST CAUSE was also one of the largest special operations endeavors in history. 4100 special operations personnel and 71 special operations aircraft were employed.

2. Task Force White

Task Force White (TF White) was the Naval Special Warfare (NSW) or SEAL contingent of both operation BLUE SPOON and JUST CAUSE. TF White, commanded by Commander Naval Special Warfare Group Two (NSWG-2),⁷⁶ was assigned several missions of which the Paitilla Airport mission was the largest.⁷⁷

Elements from SEAL Team Four (ST-4) were tasked to execute the assault on Paitilla Airport. The ground assault element was made up of three sixteen-man platoons commanded by a seven-man C³ element. Special Boat Unit Twenty Six (SBU-26) and Naval Special Warfare Unit Eight (NSWU-8) personnel also had support roles in the Paitilla Airport operation. The MK III Patrol Boat (PB) and crew that escorted/towed the combat rubber raiding craft (CRRC) to their insertion point and maintained the afloat C³ element were SBU-26 assets.⁷⁸ In addition, NSWU-8 personnel in cayugas (Panamanian canoes) provided reconnaissance teams to the east of the airport.⁷⁹ The ground C³ element was augmented by
→ two Air Force Special Operations Combat Control Teams (CCT) communicators. Finally,
→ an Air Force Special Operations AC-130 Spectre Gunship assigned exclusively to the Paitilla

⁷⁶ NSWG-2, as well as SEAL Team Two and SEAL Team Four, were home based at the Naval Amphibious Base, Little Creek, Virginia.

⁷⁷ McConnell, pp. 144-145. Elements from SEAL Team Two (ST-2) would destroy a PDF patrol boat that was pier side in Balboa Harbor. Naval Special Warfare Unit Eight (NSWU-8) SEALs and members of Special Boat Unit Twenty-six (SBU-26), both stationed in Panama, would provide security for ships in the Panama Canal. They would also block one escape route of the PDF units and Noriega at the Caribbean entrance to the canal. See also, Joel Nadel and J. R. Wright, Special Men and Special Missions: Inside American Special Operations Forces 1945 to the Present, (London: Greenhill Books and Pennsylvania, Stackpole Books, 1994), p. 205.

⁷⁸ Interview with Lieutenant Commander (LCDR) Cliff Olsen, 4 November 1994. LCDR Olsen was Delta Platoon commander during the Paitilla Airport mission. He provided most of the details concerning what actually happened during the mission.

⁷⁹ Nadel, p. 206.

mission was to loiter 8000 feet⁸⁰ above the target throughout the mission to provide fire support and intelligence for the ground force.

The mission plan called for the PB to tow/escort the SEALs in their CRRCs from Rodman Naval Station to the CRRC insertion point. (Maps 1 and 3) From there the CRRCs would transport the force to the beach opposite the southern end of the airport runway. The SEALs would move up each side of the runway securing the airport and blocking the runway as they moved. Finally, when they reached the PDF hangar, they were to disable Noriega's aircraft.

C. OBJECTIVE

As already discussed, the overall objective of Operation JUST CAUSE was to remove Noriega from power and replace him with elected President Endara. The importance that was placed on capturing Noriega to face narco-trafficking charges cannot be over emphasized. JTF planners were greatly concerned about eliminating the possibility of Noriega's escape once the invasion began.⁸¹ The reason for this is obvious: Noriega had many extremely loyal supporters within Panama. Failure to capture him could have resulted in the U.S. facing the same problem years later upon the return of an exiled Noriega. Many of the planned operations were designed to eliminate the possibility of such a calamity.⁸²

→ The SEAL mission was to deny Noriega one of several escape routes from Panama.⁸³ Noriega's private Learjet was protected by PDF security forces in a hangar at the northwest

⁸⁰ Department of the Air Force, Head Quarters Air Force Special Operations Command, AFSOC Regulation 55-130, Volume X, 1 October 1991, p. 4. See also, Walker, p. 157. Walker wrote that the AC-130's orbit was 3000 feet over the runway.

⁸¹ McConnell, p. 37. During the initial phases of the operation, F-15 aircraft stood by in holding patterns to be prepared to intercept the aircraft of a fleeing Noriega.

⁸² Interview with Commander (CDR) Patrick Toohey on 11 November, 1994. CDR Toohey was the ground force commander for the Paitilla airport mission.

⁸³ Toohey interview and McConnell, p. 53.

end of the Paitilla Airport runway. BLUE SPOON planners were concerned that once the fighting had started Noriega might have made his way to the airport and fled the country.⁸⁴

A secondary concern was the possibility of Paitilla Airport being used to land troops to rescue Noriega or reinforce the PDF within the city as was done during the October 89 coup attempt.⁸⁵ Considering Operation JUST CAUSE attacked every element of the PDF that was capable of providing support to Noriega or reenforcement to other PDF units, this was unlikely. Still, JTF planners wanted to eliminate every available opportunity for escape or reinforcement.

Paitilla Airport is a civilian airport that is located on southern coast of Panama City north of the Bay of Panama. (Map 2) It's 3500 foot runway has a north south alignment. Its southern end approaches the bay to within several hundred yards. It lies in the midst of heavily populated Panama City with high- and low-rise apartments and embassy buildings to its west, a secondary school compound and slums to its east, and a major highway bordering its northern end.⁸⁶ (Map 3) In addition to Noriega's aircraft, the airport serviced only private airplanes. Many of the private aircraft were suspected of being owned and operated by the Colombian drug cartels.⁸⁷ The runway is flanked with a number of aircraft hangars on the west and by the control tower, administration buildings and several hangars on the east. A number of private aircraft were parked on the ramp outside the hangars on the west side of the runway. Suspected cartel aircraft were located in the hangars on the west

⁸⁴ McConnell, p. 53. JTF planners suspected Noriega would try to escape to one of three countries, Nicaragua or Cuba because of cultivated communist ties and Colombia because of his may allies in the drug trade.

⁸⁵ Ibid., p. 53. During the October 1989 coup attempt, the 7th Company of the Macho de Monte flew into Tocumen Air Base from Rio Hato to rescue Noriega.

⁸⁶ Ibid., p. 51, Walker, p. 147, and Nadel, p. 206.

⁸⁷ Walker, p. 154.

side of the runway.⁸⁸ The civilian population's proximity to the airfield resulted in a concern for collateral damage and civilian casualties.⁸⁹

The SEALs were directed to disable Noriega's aircraft and deny use of the runway by any other aircraft. They intended to accomplish this by puncturing the Learjet's tires and moving aircraft and other obstacles onto the runway to block any other aircraft that might attempt to land to evacuate Noriega or reinforce PDF elements. The SEALs accomplished their mission but it was at great cost to human life.

D. ALTERNATIVES

In addition to the above TF White option, one U.S. Army Ranger option and one a U.S. Marine Corps amphibious assault force option will be described for the Paitilla mission.

1. U.S. Army Ranger Option

As with the TF White option, a Ranger option would have required the short notice deployment of a Ranger Company plus (approximately 150-200 soldiers) from a continental U.S. (Conus) home base.⁹⁰ The Rangers could have been forward deployed to Panama on two C-130s or one C-141. This would have allowed for a locally launched helicopter borne assault on Paitilla. With the air assault, the Rangers could have simultaneously attacked all target threat areas and maintained tactical surprise over the PDF. This option would have required the deployment of a minimum of six additional UH-60 Blackhawk helicopters to Panama prior to D-day.⁹¹ These helicopters would have been transported on two to five C-

⁸⁸ McConnell, pp. 52-64. Also Toohy and Olsen interviews.

⁸⁹ Ibid., p. 53.

⁹⁰ 1st Battalion is located at Hunter Army Airfield, Georgia, 2nd Battalion is located at Ft Lewis, Washington, 3rd Battalion is located at Ft Benning, Georgia along with the Regiment.

⁹¹ To infiltrate a Ranger Company plus a headquarters element would require twelve UH-60 helicopters or 2-3 MH-47 helicopters. If the Rangers were permitted to move in two waves instead of one, six UH-60s would have been adequate. If the Ranger's indigenous vehicles (Range Rovers - armed with dual 50 calibre machine guns) were also

5A aircraft depending on which helicopter option was to be used.⁹² This would have raised the movement signature of the overall operation but it probably would not have affected the compromise of JUST CAUSE.⁹³ Though signature would not have posed a problem, the Air Force was already stretching its airlift capability limits. Additional requirements may not have been supportable.

The Rangers could have exercised the same method of insertion that was used by the SEALs, the waterborne approach from a forward staging base (FSB). The same type of logistics support would have been required for the Rangers that was required for the SEALs. The Rangers, however, would have required more assets for infiltration.⁹⁴

A third option available to the Rangers was the air land or air drop assault via two C-130 aircraft. This option would have eliminated the need for an FSB since the Rangers could have dropped or landed directly on their target from their deployment aircraft. As a result, the Ranger deployment would not have increased the signature of JUST CAUSE with troop and/or helicopter movement into Panama prior to H-hour.

Operation JUST CAUSE was an air traffic controllers nightmare with hundreds of transport and attack helicopter and fixed wing aircraft involved in the initial assault alone.⁹⁵ Assets, especially helicopters, were tasked to their limit. This precluded a SEAL helicopter

inserted, two MH-47s would have been required in addition to the UH-60s.

⁹² A minimum option of either six UH-60s or two MH-47s would both require two C5As while the maximum package would require five C5As, two for the MH-47s and three for the UH-60s.

⁹³ McConnell, p. 25. On the eve of JUST CAUSE, the PDF reported that U.S. transport aircraft were landing at Howard Air Force Base (HAFB) every 5 minutes. The additional aircraft required to support the Rangers probably would not have affected operational compromise.

⁹⁴ With three times the number of personnel, the Rangers would have required three times the number of CRRCs and additional PBs to tow the CRRCs and Rangers to the insertion point.

⁹⁵ McConnell, p. 37.

assault on Paitilla. During the initial planning phases, the waterborne SEAL option had been approved largely because it had not required helicopters.⁹⁶ Presumably, a Ranger helicopter borne or air assault would have also been disapproved.⁹⁷ In addition, Paitilla was small⁹⁸ and did not offer a good target for either the air land or air drop assault. There were also problems with the use of Rangers in a waterborne operation.⁹⁹ Because there were problems with all the Ranger options we applied the air assault option the decision tree framework since it would have been the Ranger's most preferred option.

2. U.S. Marine Amphibious Assault Option

A U.S. Marine option would have required the deployment of an Amphibious Ready Group (ARG) within several days steaming time of Panama. ARG amphibious ships could have launched a rifle company reinforced (150-175 soldiers) in their 11-12 indigenous Amtrack vehicles to role ashore opposite Paitilla airfield at H-hour.¹⁰⁰ Amtracks not only would have protected the soldiers from small arms fire but could have been used to block the runway. This would have eliminated the need to move aircraft.

There was some concern among Marines over the Amtrack's ability to negotiate the extensive mud flats seaward of Paitilla Airport.¹⁰¹ Even if the Amtracks could not be used,

⁹⁶ Toohey interview.

⁹⁷ Donnelly, p 85. Other Ranger targets included Rio Hato and Torrijos/Tocumen airfields.

⁹⁸ Nadel, p. 206. The entire airport was only 5000 feet long and its location in the city made parachute operations precarious.

⁹⁹ Rangers are much less proficient at waterborne operations than SEALs; a CRRC insertion of this magnitude would have been extremely difficult both mechanically and in command and control aspects.

¹⁰⁰ At the time of JUST CAUSE, ARGs carried 11-12 amtracks which hold 16-28 Marines each.

¹⁰¹ Olsen interview. The mud flats opposite Paitilla reach out as much as half a mile from the shore at low tide.

light cushioned assault craft (L-CACs) could have infiltrated the Marines and either Amtracks or light armored vehicles (LAV).¹⁰²

The Marine option would have required the positioning of the amphibious contingent within 1000 miles of Panama for an extended period of time. This raised two problems: first, the irregular deployment of amphibious ships would have increased the U.S. military signature in the region and possibly compromise the impending BLUE SPOON operation.¹⁰³ Secondly, Marines embarked on ships are highly restricted in the type of training they can accomplish which would have resulted in mission skills deterioration if they had been embarked for a lengthy period of time.

Early in the planning phase of BLUE SPOON, the use of Marines was considered, but the Marines did not have the assets to commit an ARG to within two to three days distance of Panama. In addition, had the Marines been able to keep an ARG and its battalion size expeditionary force staged within striking distance of Panama, they would have likely been tasked with a mission of higher priority than Paitilla Airport. At least, they would have been tasked with several other missions in addition to Paitilla. Consequently, all the assets mentioned above would not have been available for the airport. Subsequently, we assumed that a rifle company with one L-CAC and three LAVs could have been assigned the Paitilla mission with the other ARG assets assigned to other missions.

3. Probability of SEALs, Rangers, and Marines

Appendix D contains the completed probability worksheet for the SEAL, Ranger and Marine options for the Paitilla airfield mission. For this case study, we consider only the infiltration and the actions at the objective phases of the operation. The mission called for

¹⁰² At the time of JUST CAUSE, ARGs carried six LAVs. Each LAV could carry six soldiers. Also each ARG carried two L-CACs which could carry either four LAVs or two amtracks each.

¹⁰³ Panama had no means to detect the ARG but it is possible that it could have received intelligence on the ARG's position indirectly from the Soviets or by watching Cable Network News (CNN).

the force to secure the airport and hold it until relieved by elements of the 82d Airborne Division, about five hours after H-hour. When exfiltration was executed, it was administrative and had no effect on the probability of success for the overall mission or the *expected values and costs*.

We remind the reader that the values for the different variables are the values that the planners would have assigned based on the information and intelligence they had prior to the execution of the mission. Obviously, we now know more about the disposition of the enemy, the problems with communications, the compromise of H-hour, etc. Subsequently, we can assign more accurate values to the variables. Unfortunately, the planners did not have this luxury so we tried to assign values we believe the planners would have used.

During the infiltration phase, all three options had high values in almost every category with only a few significant exceptions. The high values reflect the high priority of the overall mission and the amount of time that was allowed to prepare for it. In addition, the infiltration techniques used were all methods that the particular forces were extremely proficient in. In addition, the enemy forces had no means to counter the infiltration techniques. The only exceptions were with the *availability* and *supportability* of the Rangers and the *availability* of the Marines. In the Ranger case, both the Rangers and support helicopters were not available because they were tasked with other missions. Both of these variables were determining factors in selecting the force for this mission. In the case of the Marine option, they were not available even within the theater to execute the mission. *Supportability* was not considered a limiting factor for the Marine option since if the Marines had been available, they could have relied on mission support assets within the ARG.

The probability of success for the actions at the objective for Paitilla was very high. Even with the smallest of the three forces considered, the mission planners provided such an unbalanced application of force that there was little chance that the airport would not be secured. Each force had high values for *mission skill* and *mission proficiency* since the airport mission required no skills that were not repeated during their routine training or that were not repeatedly practiced during the mission rehearsals. The *firepower* of each force,

though there was a substantial difference between the options, was vastly superior to the expected firepower of the enemy and directly applicable to it. *Readiness* of the forces was high since this was a standing CONPLAN that had much preparation time.

Availability was the first area that showed a significant breakout among the three options. SEALs were available for the mission with significant assets to successfully execute it. Rangers were available within the theater but were tasked with higher priority JUST CAUSE missions. The Marine ARG was not available even for consideration since it was deployed on a western Pacific cruise.

Corresponding doctrine shows a significant breakout of the SEAL option from the other two. The actions at the objective directly correspond to Ranger and Marine doctrine. SEAL doctrine, however, does not include working in larger than platoon size elements, securing large objectives or defensively holding a target.

The PDF at the airport were estimated to be well trained soldiers. However, the *Enemy OOB*, *Communications/electronics OOB* and the *Weapons OOB* were not significant threats to any of the three options. All three options had high values in these categories, although the values were slightly different depending on the size of the friendly force. The Marines, protected in their LAVs, were particularly invulnerable to the enemy forces.

Mission difficulty was low for both the Rangers and the Marines because both options included an adequate amount of soldiers to execute a mission. In addition, they were completely familiar with the mission and experienced at executing it. As a result, the values were high. For the SEALs, *mission difficulty* was high since the target was much larger than a normal SEAL target, they did not have a large enough force to execute all mission objectives simultaneously, and the mission was outside their doctrine. Consequently, the value for *mission difficulty* was low for the SEAL.

Supportability on the Paitilla mission meant close air support by either the AC-130 or in the case of the Marine option, Cobra gunships. In all three cases the assets would have been available and the coding would have been high.

The remaining variables, the *principles of special operations*, all had high values with no significant break out except in the case of *simplicity*. Considering *simplicity*, the mission would have been uncomplicated for the Rangers and Marines because of the size of their force and vast experience they had with similar and more complex targets. The same mission was complex for the SEALs based on the number of target objectives, the dispersion of the objectives on the target, the size of the target, the smaller number of SEALs and their lack of experience in this type of mission.

The value for *Security* was affected negatively because security concerns for the entire operation had restricted the friendly force from a target reconnaissance until the day before D-day (D-1). *Repetition* value was high because the SEALs, like all JUST CAUSE forces, had executed numerous rehearsals prior to the actual mission.¹⁰⁴ We assumed that if a different option had been chosen, the selected force would have been involved in the rehearsals.

The value for *Surprise* was down slightly since the influx of military aircraft into Howard Air Force Base (HAFB) would have eliminated at least strategic surprise if not operational surprise. (Map 1) *Speed* was not a key variable in this operation because there was little consequence of remaining on the target for extended periods of time since the PDF was being attacked everywhere and could not have likely provided reinforcement to the airport. *Purpose* was high in all options because of the situation in Panama; U.S. military and civilian personnel were being attacked by Noriega's PDF.

The probability worksheet shows that the Marines and Rangers were equally capable of executing the mission with the Rangers having a slight advantage over the Marines on the objective and the Marines having a slight advantage during infiltration. The SEALs had the highest value for infiltration but their value for actions at the objective were lower than the Rangers' and Marines'. These variables, along with the values and costs, which will be discussed next, will be applied to the decision tree model as illustrated in Appendix D.

¹⁰⁴ McConnell, p. 60.

4. Political Value

Prior to Operation JUST CAUSE, American citizens in Panama were being mistreated by PDF and Digbat militia, the canal was in jeopardy of falling into the hands of a nation unfriendly to the U.S., democracy disappeared, and the self proclaimed "Maximum Leader" of Panama was a narcotrafficker. Noriega was at the root of these problems. When President Bush decided to use force, it was not only because the political value of removing Noriega had become very high, but also because the political cost of letting him remain in Panama had escalated.

Operation JUST CAUSE met the criteria for high *international political value* (IPV). It showed that Bush would not be pushed around by a third world thug; it demonstrated the U.S. resolve to support democracy; it showed U.S. allies a hard stance against narcotrafficking; and it ensured the Panama Canal would remain in friendly hands.

The *international political value* of the Paitilla mission would have been unchanged regardless of which option was used. Since the objectives of the Paitilla mission contributed to the large objective of JUST CAUSE, the international political value was high for all Paitilla options provided all the objectives were accomplished. For example, if the airport was secured, but only after Noriega's escape by that route, the *international political value* of seizing the airport would have been much less.

Domestic political value is based on American's perception of a mission's importance and demonstrated U.S. leadership. Bush's actions would distinguish him as a president that would not stand for criminal violators of democracy. More importantly, it demonstrated that he would protect the American public. Finally, the security of the canal was clearly a U.S. national interest. Again, mission failure was highly unlikely and since both objectives of the Paitilla mission contributed to the JUST CAUSE objectives, the *domestic political value* was high for all three options. Again, the value was somewhat less with partial mission failure, such as Noriega's escape.

5. Military Value

The *military value* of the entire operation was based on the Panama Canal's strategic importance. Without Noriega's removal, the future could have produced a Panama unfriendly to the U.S. and possibly friendly to U.S. enemies. As U.S. basing rights expired at the end of the century, our adversaries might have replaced us, on what were once U.S. facilities.

In the short term, it was the military and their families that were being assaulted by the PDF and Digbats. The climate in Panama was becoming more and more adversarial to the U.S. military. SOUTHCOM needed to change this for the safety of its own people.

Like political value, the military value would have been the same for all three options because success had the same "big picture" results regardless of which force executed the mission.

Estimated military effectiveness of the Paitilla mission as well as the entire operation was high because of the overwhelming force that was applied by the U.S. The target value of the overall operation was high but as we discussed, it was difficult to know the value of the particular Paitilla mission. We assigned a low-medium value since the likelihood of Noriega using this avenue of escape was low, as was the likelihood of PDF reinforcement through the airport.

6. Political Cost

Failure to defeat the PDF and install the Endara presidency was nearly impossible with the ratio of forces drastically on the side of the U.S. The capture of Noriega, however, was not as certain. Anything less than total victory, which included Noriega's capture, could have resulted in embarrassment to the administration, loss of credibility, distancing of allies and harsh criticism from enemies.

Some *international political costs* were likely to be incurred even with overwhelming victory. For example, the United States could have been criticized for using too much force,

creating too much collateral damage, causing civilian casualties, and violating the sovereignty of another nation.¹⁰⁵

With victory all but assured in both the overall operation and the Paitilla mission, the *international political costs* would have been low although extensive collateral damage¹⁰⁶ and the invasion of another country's sovereignty would have some negative effect. For the Paitilla mission, there could be minor differences between the cost incurred by the different options. The amount of force that could have been applied for each option was different; the Marines would have had the greatest ability to apply force, followed by the Rangers and then the SEALs. The strict rules of engagement (ROE) attempted to minimize collateral damage to civilians and property, however, requirements to complete the mission could have outweighed the ROE. This was the case in the actual SEAL execution of the mission.

Domestic political costs were mounting in the months before JUST CAUSE. President Bush had to act or lose the confidence of the nation. There were several plans to remove Noriega, each applying different levels of military force. Applying minimal force might not have accomplished the objectives leaving Bush with a *Bay of Pigs* type catastrophe and American citizens in Panama at the mercy of the PDF and Digbats. Applying a medium amount of force might allow the PDF to resist much longer and escalate American casualties, something the American public would not support. This left Bush with one option, application of overwhelming force even though it would likely result in some *international political costs*. The likelihood of only limited casualties was high and the *domestic political costs* were low for the overall operation. In the case of the Paitilla mission, the resistance at the Airport was estimated as minimal and casualties were not expected so the *domestic political cost* was also estimated to be low. There would have been minor differences

¹⁰⁵ It is likely that many Latin American countries saw this action as a resurgence of forced U.S. influence in Latin America even if they disapproved of what was happening in Panama.

¹⁰⁶ This applied to the Paitilla mission since it was situated in the middle of a densely populated area.

between the estimated *domestic political costs* for the different options. With American casualties being the key variable since mission success was all but guaranteed, the Marines in LAVs had the lowest chance of sustaining casualties followed by the Rangers and then the SEALs.¹⁰⁷

7. Military Cost

For the overall mission, *opportunity costs* were minimal. The United States was not involved in any other military confrontation and the forces to accomplish the objectives were readily available. For the Paitilla mission there were no *opportunity costs* for the SEALs because there were no other missions for the Paitilla SEALs to be tasked with.¹⁰⁸ For the Ranger option, the *opportunity costs* were high since they were assigned several other higher priority missions. Finally, for the Marine option, the *opportunity costs* were also high because they had other commitments that kept them from even becoming part of the BLUE SPOON CONPLAN.

While the dollar costs to the military for deployment was high, in terms of casualties, skills and experience the overall military costs were moderate. During the operation, the cost varied between the units. Overall, only 23 American soldiers lost their lives during the operation. As far as the military was concerned, these were probably acceptable losses for the entire operation.

¹⁰⁷ The Rangers would have had a slight advantage over the SEALs. With their larger numbers the Rangers could have secured the airport faster and would have been exposed to danger for less time.

¹⁰⁸ NSWG-2 commands all three east coast SEAL Teams and though the teams are regionally oriented, (ST-2 is responsible for providing SEALs to Europe, ST-4 is responsible for providing SEALs to SOUTHCOM, and ST-8 is responsible for providing SEALs to Africa and on the MARGs) NSWG-2 can augment one team with platoons or assets from another when he considers it necessary. For example, SEAL Team Four SEALs were tasked with the Flamenco Island mission when it was still valid. Because ST-4 also had other platoon commitments, they were virtually out of trained SEALs to execute the Balboa Harbor ship attack. Consequently, NSWG-2 tasked ST-2 with the mission. When the Flamenco Island mission disappeared, so did the requirement for a number of ST-4 SEALs.

At Paitilla, the likelihood of material losses was low for any of the forces because of the nature of the mission. Personnel *casualty costs* were possible but considered minimal. For the SEAL option at Paitilla, again since the resistance was considered minimal, *casualty costs* would have been estimated as low. The Ranger option which would have provided an even more unbalanced force against the PDF would have been less likely to suffer casualties. Finally, the Marines led by armored vehicles would face the lowest chance of incurring casualties of any type.

The resulting values and costs discussed above along with the probability variables, are applied to our decision tree. Before providing the complete analysis of this case, we will describe the execution of the mission next.

E. EXECUTION

The mission for TF White, as well as all other JUST CAUSE participants, began with the 17 December 1989 short notice alert and deployment orders for elements of NSWG-2, ST-2, and ST-4.¹⁰⁹ TF White recalled and loaded out all personnel that were to participate in the mission. By the evening of 18 December the force was enroute from Little Creek, Virginia to HAFB, Panama aboard two C-141 Starlifter aircraft. Once TF White arrived at HAFB, they were moved overland via bus and truck to Rodman Naval Station. (Map 1) An operations center was established at the NSWU-8 compound, TF White's FSB.

Planning, preparation, equipment checks, and briefings continued until about 2100, 19 December, when the Paitilla assault force loaded their fourteen CRRCs and rendezvoused with waterborne C³ element aboard the 65-foot PB support/escort vessel. The PB towed the CRRCs from near Rodman to the CRRC insertion point 2000 yards seaward¹¹⁰ of the southern end of Paitilla Airport. (Map 3) Though there were other options for the SEAL insertion, the waterborne assault was chosen primarily because there was a lack of air assets

¹⁰⁹ McConnell, p. 51.

¹¹⁰ Ibid., p. 47.

and because the JTF planners did not want to compromise JUST CAUSE with additional ground movements.¹¹¹

At approximately 0050¹¹² the CRRC broke away from the PB.¹¹³ The SEALs reached the beach and established a perimeter at about 0100, the original H-hour, and then began moving up the runway.

Two 16-man platoons¹¹⁴ (Bravo and Golf) leap frogged up the west side of the runway while the third 16-man platoon (Delta) and the seven-man ground C³ element¹¹⁵ moved up the east side of the runway. The tasks of Bravo and Golf were to disable the Learjet, secure the buildings on the west side of the runway, block the runway with civilian aircraft and other obstacles, and establish a blocking force to the north to prevent access from the highway. The mission of Delta on the east side of the runway was to secure the control tower and buildings on the east side of the runway. The mission of the ground C³ element was to maintain command of the mission and to provide a link to the afloat C³ element and the AC-130 Spectre Gunship circling 8000 feet above the airfield and to direct supporting fires if necessary.

¹¹¹ Toohey interview. Overland infiltration was proposed but denied because the number of vehicles required to move the SEALs to the target could have compromised JUST CAUSE. Air drop and air assault were both ruled out because of the lack of air assets.

¹¹² McConnell, p. 47.

¹¹³ The PB provided a platform for the afloat C3 element during the entire Paitilla mission and a weapons platform to protect the CRRC in case of compromise during the infiltration phase. CRRC are extremely vulnerable in the water if they are detected on their own. The PB could have provided protection with its MK 19 - 40 mm grenade launcher, twin 50 caliber machine guns, two M-60 machine guns, and 80 mm mortar.

¹¹⁴ A SEAL platoon is composed of 16 men: two officers, one chief petty officer, one E-6 leading petty officer and 12 other enlisted men between the rank of E-3 to E-5.

¹¹⁵ Olsen interview. The seven man C3 element included the ground force commander, two CCT personnel, a SEAL Lieutenant responsible for overseeing communications, two corpsman and one other enlisted shooter to provide security.

As Bravo and Golf platoons moved up the west side of the runway they encountered civilian maintenance and security personnel¹¹⁶ in the hangars suspected to be operated by cartel personnel. Objections from the hangars arose when the SEALs began moving aircraft onto the runway. The platoons identified themselves as American soldiers and directed the personnel to evacuate the airport. What started generally as a verbal confrontation turned into a brawl as SEALs subdued and bound those refusing to leave the hangars.

While moving up the east side of the runway, the C³ element received a transmission indicating that a helicopter was inbound and Noriega could be on board. The ground force commander (GFC) ordered Delta to terminate their movement forward and establish an ambush in preparation for the aircraft.

In the following moments, the C³ element received another transmission that three armored personnel carriers (APC) were traveling in the direction of the airport along the highway to the north. This reinforced suspicions that Noriega was inbound; possibly the APCs were going to the airport to ensure it was secure for his arrival and subsequent departure.¹¹⁷

The GFC warned the platoons on the opposite side of the runway and directed them to move up the runway to counter the APCs as quickly as possible. The platoon carried several AT-4 shoulder fired antitank rockets¹¹⁸ which would have provided substantial defense against the APCs. The platoons accelerated their movement toward the north and the PDF hangars.

¹¹⁶ McConnell, pp. 63-64. Some of those encountered were uniformed and clearly official airport security, however, others of the more seedy and less intimidated variety were most likely the cartel's security personnel.

¹¹⁷ Toohey and Olsen interviews. No aircraft ever arrived at the airport and thought the APCs were traveling along the highway they were enroute to some other destination as they simply passed by the end of the runway.

¹¹⁸ Olsen interview.

As Bravo and Golf reached the PDF hangars, Golf platoon second squad set up on line in firing positions opposite the first open bay of the PDF hangars. Noriega's Learjet could be seen inside along with several PDF security personnel. Also visible in the hangar were several 55 gallon drums and a forklift that could have provided cover and concealment for the enemy. At this point, another verbal confrontation and standoff ensued as the PDF refused to evacuate the hangars.

Golf platoon first squad was by this time the lead element and was moving north adjacent to the northern most PDF hangar bay and toward the northern end of the airfield to intercept the APCs. They moved in an L-shaped formation with the base of the L to the north toward the possible APC approach and the vertical part of the L parallel to the hangars to their west. This trained their firepower in the direction of the two areas that posed the greatest threat.

There are a number of accounts of what happened next. Some say a PDF security guard opened fire on the lead element.¹¹⁹ Other accounts say one of the SEALs in the lead element saw a PDF soldier move into a covered position and level his AK-47 on the lead element. The SEAL instinctively opened fire on the PDF.¹²⁰ As the lead element dropped to the ground to take firing positions, many were struck with the opening volley of enemy fire. In addition, their position on the runway with no cover and little concealment¹²¹ provided shooting gallery like conditions for the PDF. Even shots that were fired low found their mark as they hit the concrete and then traveled along the runway to the prone SEALs only thirty yards away.¹²²

¹¹⁹ McConnell, p. 65.

¹²⁰ Toohey interview.

¹²¹ McConnell, p. 65. McConnell says thin skinned Cessna and Piper aircraft "parked on the grassy ramp" provided little concealment for the SEALs.

¹²² Toohey Interview said the SEALs were on the pavement, however, McConnell, p. 65, said they were in the grass strip next to the pavement.

The SEALs returned a tremendous amount of fire. Unfortunately, the squad with the best vantage point to strike the enemy was the squad that had just taken the casualties. Seven of the eight squad members were hit with only the platoon commander escaping the enemy's initial volley from the hangar.¹²³ Second squad of Golf platoon maneuvered to suppress the fire from the hangar. Second squad personnel, who attempted to rescue downed personnel from first squad, also became casualties. The platoon commander radioed for help, reporting mass casualties to the GFC. The GFC ordered both Bravo and Delta platoons to provide assistance to Golf. Delta moved across the runway to the northern flank and Bravo moved directly opposite the hangar. It was at this point that more casualties were suffered by Bravo platoon.

The GFC, whose element was farthest from the firefight, left one SEAL officer and the CCT behind to raise communications with the AC-130 as he raced across the runway to the PDF hangar. He arrived to find the full force of the SEAL weaponry pouring into the hangar. There was no longer any return fire. The GFC called a cease fire and directed the movement of the casualties into a perimeter and then called for a medical evacuation (medevac) for the wounded troops. The medevac came approximately an hour later.

Throughout the rest of the early morning hours, the SEALs blocked and secured the runway in preparation for their turnover to the 82d Airborne Division at 0600 that day. Their relief did not come until 37 hours after H-hour at 1400 on December 21. It was not the 82d Airborne that relieved the SEALs. Instead, it was 250 Army Rangers who arrived in six MH-47 Chinook helicopters to relieve them.¹²⁴

¹²³ McConnell, p. 67.

¹²⁴ Ibid., p. 95, and Toohey interview. The SEALs were not relieved as scheduled because the scheduled relief was an 82d Airborne follow on mission for after they had secured their original targets. Because of icing problems at Pope AFB, North Carolina, most of the twenty C-141s scheduled to transport the 82d Airborne to Panama were delayed. Much of the 82d did not reach their primary targets until daylight and encountered unexpected resistance since all prospects of surprise were lost and the enemy had the chance to prepare. As a result, they were not able to relieve the SEALs.

Other incidents occurred such as: sporadic sniper fire, threats of mustering PDF assaulters, securing of the outlying runway areas by the SEALs, and reinforcement by other elements of TF White and TF Blue.¹²⁵ These incidents were not specific to the success or outcome of the assigned mission so they will not be discussed in further detail.

We remind the reader that it is not the purpose of this thesis to determine the cause of casualties or to place blame. These aspects are covered in detail only because they are the root of controversy concerning this mission. It is, however, the purpose of this thesis to determine whether or not the *expected value* of the mission outweighed the *expected cost*. With this in mind, we move on to the analysis of the mission.

F. ANALYSIS

We initially believed that the SEAL execution of the Paitilla Airport mission represented a simple error of commission. We thought the *expected value* for the mission would be greater than the *expected cost* giving the SEALs an *absolute advantage* for the mission. We also assumed that the SEALs would not possess the *comparative advantage* because we expected that one of the other options had a greater *absolute advantage* than the SEALs. The results are quite the contrary. As Appendix D illustrates, both the Marines and the Rangers had higher *expected values* than the SEALs by a relatively narrow margin. However, their *expected costs* were much higher than that of the SEALs resulting in lower *absolute advantages*. Consequently, the SEALs had both an *absolute advantage* and the *comparative advantage* and the mission was not a case of misuse.

We have already discussed the variable that most strongly affected the outcome; opportunity costs. In both the Marine and the Ranger options, the forces either had higher priority JUST CAUSE missions or commitments elsewhere in the world that kept them from being employed on the Paitilla mission. In this case, since the other values and costs were relatively constant between the different options, the large difference in opportunity costs determined which force should have been used. Had opportunity costs not been a factor, the

¹²⁵ Walker, p. 143. TF Blue was another SEAL contingent.

Marines, followed by the Rangers, would have been the best choice to execute the mission. Use of SEALs would have been a simple error of commission as originally thought.

Another variable that should have had more effect in determining the proper use or misuse of SOF was availability. However, when availability was averaged with the other sixteen variables of the probability worksheet, the low score the Marines and Rangers received were countered by the higher scores. Clearly, there are some variables that carry more weight than others especially when they are at the extremes: if a force is not available to execute a mission, they are not available and the highest scores in all the other areas can not get the mission accomplished. Additionally, it is likely that the significance or importance of one variable will change from mission to mission.

In summary, Appendix D provides a completed decision tree for the use of SOF versus the use of GPF for the Paitilla Airport mission. Using Equations (7), (8), (10), and (11); the values and costs discussed above; and the probabilities discussed above, the resulting *expected values* and *expected costs* from the decision tree are as follows:

$$\begin{array}{lll} EV_{SEALS} = 259.3 & EC_{SEALS} = 49.5 & EC_{SEALS} - OC_{SEALS} = 49.5 \\ EV_{RANGERS} = 262.8 & EC_{RANGERS} = 118.9 & EC_{RANGERS} - OC_{RANGERS} = 38.9 \\ EV_{MARINES} = 264.2 & EC_{MARINES} = 133.4 & EC_{MARINES} - OC_{MARINES} = 33.4 \end{array}$$

To demonstrate the effect of the opportunity cost on the Marine and Ranger options, their *expected costs* minus their opportunity costs were also included.

In the Paitilla Airport case study, SEALs had an *absolute advantage* and a *comparative advantage*. This demonstrates proper employment of SOF.

III. MERRILL'S MARAUDERS AT MYITKYINA

A. INTRODUCTION

"GALAHAD is okay. Hard fight at Nphum. Cleaned up Japs and hooked up. No worry there."¹²⁶ With these thoughts, General Joseph W. Stilwell sent Merrill's Marauders on their final mission, to strike and seize Myitkyina. Merrill's Marauders were the only U.S. combat troops in the China-Burma-India (CBI) theater, and had been modeled after Orde C. Wingate's Chindits in response to Allied pressure for greater U.S. involvement in the CBI theater. The Marauders numbered roughly 3000 men, and had received three months of unconventional, or special operations, training. As Charleton Ogburn Jr. explains:

It was often noon before you had a chance even to wash your face or brush your teeth. Our meals we ate without sitting down, standing before tables constructed of red-sandstone slabs on posts, while pariah kites perched about waiting to pounce on any unguarded morsel. After dark we had critiques on the exercises we had held during the day - until these were extended to last overnight. We shot off quantities of ammunition, mostly at informal or pop-up targets; 3rd Battalion had brought back from the Pacific a conviction of the uselessness of conventional firing ranges. There was scouting and patrolling, squad and platoon attacks upon entrenchments, pillboxes, roadblocks, bivouacs, practice booby-trapping, taking airdrops, evacuating wounded, trailing and trail concealment, demolition, and approaching, withdrawing from and crossing rivers. There were attacks under varying conditions by half the battalion against the other half. (Said the training schedule nervously: "This attack to be without ammunition.") And there were marches.¹²⁷

¹²⁶ Quote from General Stilwell's diary, 11 April 1944, cited in E. D. Smith, Battle for Burma (New York: Holmes and Meier Publishers, Inc., 1979), p. 72.

¹²⁷ Charleton Ogburn, Jr., The Marauders (Greenwich, CT: Fawcett Publications, Inc., 1956), pp. 58-59. General Samuel V. Wilson, a member of Merrill's Marauders and a respected General Officer with vast experience in special operations, has said that Ogburn's book "is exquisitely accurate." See "Interview with General Samuel V. Wilson" by Dr. J.W. Partin; Rice, VA; 11 July 1988; held at U.S. Special Operations Command.

Throughout the seven months the Marauders operated in the CBI theater, they conducted three prolonged missions that culminated at Myitkyina. The first mission was to provide a blocking force near Walawbum, the second was another blocking mission at Shaduzup and Inkangahtawng, and the final mission was to take Myitkyina. The siege at Myitkyina began on 17 May 1944 and lasted until 3 August 1944. The Allies won a hard-fought victory but only 100 out of 3000 Marauders participated in the final battle. Merrill's Marauders had fought valiantly to the point of decimation and today's Rangers wear the Marauder colors and insignia. How can a successful operation that is heralded as one of the birthplaces of the modern Rangers be considered a misuse of SOF? We examine this question in detail below.

B. BACKGROUND

1. Political and Military

The political situation in the CBI theater was dictated by the critical military situation the Allies found themselves in by mid-1942. At the end of May 1942, the Japanese held most of Burma and there were no longer any Allied troops on Burmese soil, except a relatively small corner in the north that was held by the Chinese.¹²⁸ The Japanese, as Charles F. Romanus and Riley Sunderland state in the subseries *THE CHINA-BURMA-INDIA THEATER*, of the series *UNITED STATES ARMY IN WORLD WAR II*:

had completely isolated China by land and could reasonably hope to isolate it by air. From Burma they could launch their attacks into China or India as they chose. From Burma they could bomb Calcutta and its neighboring cities, the very center of the Indian war effort, or they could reach far into Western China.¹²⁹

¹²⁸ Smith, p. 31.

¹²⁹ Charles F. Romanus and Riley Sunderland, *Stilwell's Mission to China* (Washington, D.C.: Office of the Chief of Military History, 1953), p. 148.

The Japanese had defeated forces from China, India, Burma, Great Britain, and the United States with a force of "10 infantry and 2 armored regiments with ample air support."¹³⁰ Stilwell had arrived in theater on 24 February 1942 and had participated in the walk-out from Burma.¹³¹ He was immediately faced with numerous military and political problems that continued through the walk-out and into the planning process of an offensive campaign to retake Burma.

The Lend-Lease Act of 1941 provided extensive material support to Chinese forces.¹³² Chiang Kai Shek, however, preferred that "offensive action in China Theater be the task of American aircraft and American airmen."¹³³ The command relationships were dynamic and complex,¹³⁴ and continual requests by Stilwell for U.S. combat troops were

¹³⁰ Ibid., p. 148.

¹³¹ Ibid., p. 93.

¹³² Ibid., pp. 13, 14, 15, 30, 386.

¹³³ Ibid., p. 261. Numerous references are made by Stilwell about Chiang Kai-shek personally and Chinese military aims to preserve the nationalist military strength in order to fight Mao and his communist forces after World War II. Personal comments are generally directed at "Peanut" as Stilwell was wont to call Chiang Kai-shek. He writes of Peanut "same as ever - a grasping, bigoted, ungrateful little rattlesnake" and the Chinese government, "a gang of thugs... intriguing, double-crossing, lying reports. Hands out for anything they can get; their only idea to let someone else do the fighting; indifference of 'leaders' to their men...And we are maneuvered into the position of having to support this rotten regime and glorify its figurehead, the all-wise great patriot and soldier - Peanut. My God!" in Ogburn, p. 29, and Joseph W. Stilwell arranged and edited by Theodore H. White, The Stilwell Papers (New York: William Sloane Associates, Inc., 1948), p. 207.

¹³⁴ Romanus and Sunderland, Stilwell's Command Problems, (Washington, D.C.: Office of the Chief of Military History, 1956), pp. 6-7. Stilwell eventually became, all at once: Commanding General, United States Armed Forces CBI; Commanding General, Northern Combat Area Command; Deputy Commander, South-East Asia Command; and Chief of Staff China Theater. See also William R. Peers and Dean Brelis, Behind the Burma Road, (Boston, MA: Little, Brown and Company, 1963), p. 151.

denied.¹³⁵ The Sino-American political situation and the lack of significant U.S. military presence made Stilwell's position problematic at best. Plans for an offensive against the Japanese were initiated as Burma was being lost. Initial correspondence and meetings between the Allies created more difficulties, however, than actual plans. In June 1942, Chiang Kai-shek issued what came to be known as the Three Demands, calling for: three American divisions, 500 combat planes fighting on the front, and an increase in aerial support to 5,000 tons per month.¹³⁶ Stilwell realized that if Washington flatly refused Chiang Kai-shek's demands, Stilwell's leverage and usefulness would be gone. Stilwell analyzed the situation and determined that the British and Chinese had to be persuaded to join in the retaking of Burma. He also decided that the reopening of the lines of communication between Burma and China was the essential solution to the strategic problems of China.¹³⁷ Subsequent meetings and plans continued to foster debate and compromise as the Allies searched for the solution in the CBI theater of operations.

In the months May 1942 - April 1943, the Allies planned their offensive. ANAKIM was the first plan to emerge. The plan was to break the blockade of China and reform the Chinese Army by defeating the Japanese in Burma. The "Chennault plan"¹³⁸ was appealing to the Chinese and the President, in spite of allied strategic bombing efforts producing little effect. Stilwell and Chennault were called to Washington for the TRIDENT conference in May 1943.¹³⁹ The Joint Chiefs of Staff fully supported ANAKIM. The President, however,

¹³⁵ Romanus and Sunderland, Stilwell's Mission to China, pp. 75, 121, 151, 179, 222, 242, 246, 247.

¹³⁶ Ibid., p. 172.

¹³⁷ Ibid., p. 178.

¹³⁸ Ibid., pp. 250-254. Chennault claimed that with 105 fighters, 30 medium bombers, and 12 heavy bombers he could defeat Japan by: attacking Japanese-held objectives in China; destroying the Japanese Air Force when it tried to defend them; and then bombing the Japanese home islands after the Japanese Air Force had been destroyed.

¹³⁹ Ibid., pp. 317-320.

wanted immediate action in Burma and favored the air option. The TRIDENT conference ended with an agreement that encompassed the Chennault plan and made ANAKIM a smaller operation to take north Burma without significant Chinese participation.¹⁴⁰ Italy's surrender breathed fresh life into the combined planning, and the QUADRANT conference held in Quebec from 19-24 August 1943 was called to weigh the new Allied situation.

Prime Minister Churchill had invited Brigadier General Orde C. Wingate to the conference where his views on Long-Range Penetration Groups (LRPG) and their effectiveness were well received. General Marshall agreed to form an American LRPG with the codename GALAHAD. Furthermore, Marshall directed the formation of a special air unit to support Wingate's Chindits and GALAHAD.¹⁴¹ The South-East Asia Command (SEAC) was established with Vice-Admiral Lord Louis Mountbatten as the Supreme Allied Commander, and Stilwell as his Deputy. As Romanus and Sunderland state about the QUADRANT conference, "(t)he strategic decisions...were a reaffirmation of TRIDENT, calling for the occupation of north Burma (D Day, mid-February 1944) to establish overland communications with China, and by taking Myitkyina to broaden the air route to China, for its saturation with transport aircraft could now be foreseen." Preparations for Allied amphibious operations would continue, however, there were no specific plans. Additionally, "the Hump route was to be built up to intensify operations against the Japanese, keep China in the war, maintain a larger Fourteenth Air Force in China, and equip and train Chinese forces."¹⁴²

¹⁴⁰ Ibid., pp. 327-333.

¹⁴¹ Ibid., p. 366. GALAHAD was the codename of the 5307th Composite Unit (Provisional), they were coined "Merrill's Marauders" by James Shepléy of *Time* and *Life* after their commanding officer, Brigadier General Frank D. Merrill. Number 1 Air Commando was the elite air unit's title. It was a custom-made aggregation of liaison aircraft, helicopters, light bombers, fighters, gliders, and transports.

¹⁴² Ibid., p. 363. Message from Marshall to Stilwell.

The political dilemmas produced out of military fact and necessity were complex. Each participant had his own agenda and disposition to one another's agenda. Stilwell faced a highly politicized military environment. He was pressured by civilian and military leaders to produce grand results with meager resources while the spirit of cooperation was severely lacking among the allies. He seized command, from the British, of the only U.S. combat force available, and effectively commanded the Chinese forces. The brief background discussed above is meant to provide an appreciation for the convoluted political and military situation that unfolded in the CBI theater during World War II. It is by no means a complete description of the elements at work in CBI during that period, and should be recognized as such.

2. Merrill's Marauders

Following Marshall's directive of 1 September 1943 ordering the formation of a special commando unit of "jungle-tested veterans who would operate with the Chindits in the coming campaign,"¹⁴³ the 5307th Composite Unit Provisional began to be formed on 5 September and was fully manned by 20 September.¹⁴⁴ "Jungle-tested veterans" were asked to volunteer for a short duration, unspecified "hazardous" mission.¹⁴⁵ The War Department's concept was "that the unit was provided for one major mission of three months' duration, whose close might find the unit so exhausted and depleted that its survivors would require three months' hospitalization and rest."¹⁴⁶ By the end of October 1943, GALAHAD had reached India. They came under SEAC's operational control and began training under Wingate's doctrines. General Sam Wilson stated that this initial training consisted of the following:

¹⁴³ David W. Hogan, Jr., U.S. Army Special Operations in World War II, (Washington, D.C., Center of Military History, Department of the Army, 1992), p. 98.

¹⁴⁴ Romanus and Sunderland, Stilwell's Command Problems, p. 34.

¹⁴⁵ Hogan, pp. 112-113.

¹⁴⁶ Romanus and Sunderland, Stilwell's Command Problems, p. 34.

Mostly training in light infantry tactics. Again, patrolling, ambushing, quick strikes on pre-selected targets, checking out all of our weapons. It was shakedown training. We were a fairly seasoned outfit--at least the people in the outfit were fairly seasoned when we began that three months of training. It was fine-tuning training. Nothing surprising in it all, I don't think. We did a lot of swimming and a lot of stream-crossing. We had not done a lot of that. That was important.¹⁴⁷

The organization was broken into three battalions. Each battalion was broken down into two combat teams with 16 officers and 456 enlisted men.¹⁴⁸ As Romanus and Sunderland describe:

The combat team had a rifle company of three rifle platoons and a heavy weapons section, a heavy weapons platoon to support the rifle company, a pioneer and demolition platoon, a reconnaissance platoon (I & R platoon), and a medical detachment. The combat team had 306 M1 rifles, 52 submachine guns, 86 carbines, 4 81-mm. mortars, 4 60-mm. mortars, 2 heavy machine guns, 2 light machine guns, and 3 2.56-inch rocket launchers.¹⁴⁹

There had been much discussion about the proper employment of the LRPG at the Quebec Conference. One school of thought held that the LRPG were wasted if they were used too far in the interior of Burma, "that their proper use, given the circumstances of jungle terrain and air supply, was for short envelopments."¹⁵⁰ Stilwell was of this school. As Ogburn notes, Stilwell was the quintessential practitioner of the progressive series of short hooks to the enemy's rear area, and that was the way in which Merrill's Marauders were to be used.¹⁵¹

¹⁴⁷ Partin, "Interview with General Samuel V. Wilson," p. 5.

¹⁴⁸ Romanus and Sunderland, Stilwell's Command Problems, pp. 34-36.

¹⁴⁹ Ibid., p. 35.

¹⁵⁰ Ibid., p. 36.

¹⁵¹ Ogburn, p. 25.

Stilwell began the campaign to reenter Burma southward through the Hukawng Valley with the Chinese 38th Division and elements of the 22d Division in December 1943. (Map 4) The Japanese opposing the offensive were the 55th and 56th Regiments of the 18th Division. (Map 5 and 6) On the China side of Burma, eleven divisions of the Chinese Expeditionary Force attacked to the west against the Japanese 56th Division. One Japanese division, the 54th, was left in reserve.¹⁵² Stilwell's strategy, which had twice been attempted prior to the arrival of Merrill's Marauders, "was to get a force around behind the 18th Division, in what is called an envelopment, and destroy it, which would leave the Kamaing Road [major north-south road] to his Chinese divisions."¹⁵³ Merrill's Marauders conducted three distinct operations in Burma and their objectives included: to envelop the 18th Division's east flank and block the Kamaing Road at Shaduzup, but later changed to, near Walawbum and attack the Japanese 18th Division command post;¹⁵⁴ to place a blocking force behind the 18th Division at Shaduzup and Inkangahtawng;¹⁵⁵ and the taking of Myitkyina.¹⁵⁶ (Map 7) The final operation is the focus of this chapter, however, the first two operations are worth some mention.

Early on 24 February 1944, Merrill's Marauders, led by the three intelligence and reconnaissance (I & R) platoons, began their south-eastward looping patrol around the Japanese right flank. (Map 8) Within two days, two of the I & R platoons had made contact with the Japanese, which continued throughout this first mission.¹⁵⁷ General Tanaka, the commander of the Japanese 18th Division, was prematurely informed on 1 March 1944 of

¹⁵² Romanus and Sunderland, Stilwell's Command Problems, pp. 119-121.

¹⁵³ Ogburn, p. 91.

¹⁵⁴ Romanus and Sunderland, Stilwell's Command Problems, pp. 146-150.

¹⁵⁵ *Ibid.*, pp. 175-176.

¹⁵⁶ *Ibid.*, pp. 204-205.

¹⁵⁷ Ogburn, p. 97-130.

the American's presence in Walawbum. This was the chance Tanaka had been waiting for. As Romanus and Sunderland describe:

Quickly analyzing his situation, he decided that the Chinese 22d and 38th Divisions were moving so slowly that he could contain them with a small rear guard while the main strength of the 18th Division hurled itself on the Americans. On 2 March he made his decision, and the movement back began on 3 March.¹⁵⁸

Organized attacks against Merrill's Marauders began on 4 March and continued through 8 March while the Chinese divisions fought south and south-east toward Walawbum. On 8 March, the 18th Division escaped from Stilwell's trap, "but in so doing it had yielded control of the greater part of the Hukawng Valley to the Allies, and the Chinese Army in India could celebrate a well-earned victory."¹⁵⁹ (Map 9) As for Merrill's Marauders, Ogburn states that:

In five days, the American Forces in Action Series notes in its history of the unit, 'the Americans had killed 800 of the enemy, had cooperated with the Chinese to force a major Japanese withdrawal, and had paved the way for further Allied progress. This was accomplished at a cost to the Marauders of eight men killed and 37 wounded. Up to this point, 19 patients had been evacuated with malaria, eight with other fevers (mostly dengue), 10 with psychoneurosis, and 33 with injuries. Miscellaneous sickness totalled 109.' Of the 2,600 men, more or less, who set forth from Margherita, about 2,300 remained to carry on.¹⁶⁰

Four months after the offensive campaign in Burma had begun, the Allies had achieved their first victory, and Stilwell was anxious for more.

¹⁵⁸ Romanus and Sunderland, Stilwell's Command Problems, p. 150.

¹⁵⁹ Ibid., p. 158.

¹⁶⁰ Ogburn, p. 130.

Following the victory at Walawbum, neither SEAC or the Chinese government enthusiastically supported Stilwell. Mountbatten sent a mission to London and Washington to plead for cancellation of the campaign and Chiang Kai-shek was ordering his generals to proceed slowly.¹⁶¹ Stilwell, in an effort to achieve success before he could be ordered to cease operations, ordered Merrill's Marauders to split up and conduct missions similar to the first. (Map 10) The 1st Battalion, followed at a day's interval by a regiment of Chinese, was to make a shallow envelopment toward Shaduzup. (Map 11) The 2d and 3d Battalions, followed by another Chinese regiment, was to make a wide swing to the east, south, and then west toward Inkangahtawng.¹⁶² (Map 12) The 1st Battalion moved toward their objective on 13 March 1944, participated in numerous skirmishes, and cut fresh trails around alerted Japanese forces. On 28 March 1944, 1st Battalion achieved complete and overwhelming surprise over the Japanese forces and established their roadblocks.¹⁶³ The Japanese feared a situation like Walawbum and withdrew west of the 1st Battalion on 29 March 1944.

The 2d and 3d Battalions began their march on 12 March 1944. Their orders were modified and the force was ordered to split into 2d Battalion (plus) and 3d Battalion (minus) in order to block both the Kamaing Road and the approaches from the south of Tanai valley. The Japanese forces at Inkangahtawng were too strong and the Marauders were forced to withdraw from their blocking positions on 23 March 1944, against vigorous Japanese pursuit. (Map 13) At about this time, intelligence indicated that Japanese forces were moving north in the Tanai valley to attack the Chinese forces descending on Shaduzup, and 2d Battalion (plus) was ordered to intercept and block any movements north of Nphum Ga.¹⁶⁴ Merrill ordered 2d Battalion to defend the high ground of Nphum Ga which controlled the airfield that 3d Battalion would defend at Hsamshingyang. Both battalions were in place by 28

¹⁶¹ Romanus and Sunderland, Stilwell's Command Problems, p. 160.

¹⁶² *Ibid.*, p. 176.

¹⁶³ *Ibid.*, pp. 183-185.

¹⁶⁴ *Ibid.*, pp. 180-183.

March 1944, having been engaged with the Japanese for more than thirty-six hours almost without interruption.¹⁶⁵ (Map 14) For eleven days the 2d Battalion, isolated and surrounded, withstood heavy attacks and shelling while the 1st, which had been moved hastily once communications were established with Merrill, and 3d battalions attempted to break through to them. Up to this point, Stilwell had used the Marauders in the strategic role envisioned by himself and Merrill. The change to a static defensive role represented a radical change in the concept of the Marauders' employment.¹⁶⁶ (Map 15) Finally, on 9 April 1944, the 1st and 3d battalions reached the 2d, and the Japanese withdrew south. Only 1,400 Marauders remained, and they were "utterly exhausted, half starved, with many suffering from dysentery and malaria."¹⁶⁷ The Marauders anticipated a lengthy rest, but Stilwell, as mentioned in the beginning of this chapter, had other ideas. He wanted to capture Myitkyina.

C. OBJECTIVE

Following ANAKIM, TRIDENT, and numerous other planning meetings, the Allied objectives remained fluid. Strangely, just prior to the raid on Myitkyina, "(a)llied authorities were engaged in discussing whether Myitkyina's capture was worth while and should be attempted."¹⁶⁸ Mountbatten and Stilwell had prepared the plan of operations in October 1943, based on the directives of the TRIDENT and QUADRANT Conferences. The objectives prescribed by the Combined Chiefs of Staff included:

1. to carry out operations for the capture of Upper Burma in order to improve the air route and establish overland communications with China. Target date: mid-February, 1944.
2. to continue to build up and increase the air routes and air supplies of China, and the development of air facilities with a view to:

¹⁶⁵ Peers and Brelis, p. 158.

¹⁶⁶ Hogan, pp. 115-117.

¹⁶⁷ Smith, p. 72.

¹⁶⁸ Romanus and Sunderland, Stilwell's Command Problems, p. 200.

- a. Keeping China in the war.
- b. Intensifying operations against the Japanese.
- c. Maintaining increased U.S. and Chinese Air Forces in China.
- d. Equipping Chinese ground forces.¹⁶⁹

The 300 divisions in the Chinese order of battle were of dubious quality, and the bolstering of the fighting capabilities of such a large resource was of utmost importance to Stilwell. Myitkyina, however, remained *The Objective*. Romanus and Sunderland provide two reasons for the importance of Myitkyina as an Allied objective:

In the first place, its geographic position at the southern tip of the hump of mountains over which the transports flew from India to China meant that its capture would greatly improve the air route to China. As long as the Japanese held the Myitkyina airstrips, the threat of their fighters forced the U.S. aircraft to fly far to the north, then swing south to the Kunming air terminals. This increased fuel consumption and cut the pay load.¹⁷⁰

They continue:

Secondly, since fall 1942 the U.S. engineers had been building a road south from Ledo, Assam, which was intended to cross north Burma and ultimately link with the old Burma Road. The Hukawng and Mogaung valleys, down which the Ledo Road was being constructed, enter(ed) the Irrawaddy valley, which is the most habitable part of north and central Burma, within a few miles of the Myitkyina-Mogaung area. Both towns are on the rail and road net of prewar Burma, so when the Ledo Road reached them the engineering problem would become one of improving existing facilities rather than constructing new ones in the virgin wilderness. Therefore, taking the Myitkyina-Mogaung area was the prerequisite to completing the Ledo Road and opening a ground line of communications, with an all-weather road and gasoline pipeline, to China.¹⁷¹

¹⁶⁹ Ibid., p. 9.

¹⁷⁰ Ibid., pp. 9-10.

¹⁷¹ Ibid., p. 10.

Stilwell had several alternatives to achieve this objective. He could have solely used the Chinese GPF to fight the set-piece battles, or, he could have used both the Chinese GPF and Merrill's Marauders to fight these same conventional battles. These alternatives had various factors affecting their *expected value* and *expected cost*. These alternatives, the factors affecting their probability of success in each phase, and their political and military value and cost are discussed below.

D. ALTERNATIVES

Faced with the coming monsoon season, Stilwell realized that "if he was to take Myitkyina he must take it with a quick bold stroke before the rains began."¹⁷² He hoped to persuade Tanaka that the principal effort was coming down the Mogaung valley while a task force of Marauder survivors plus two Chinese regiments and a Kachin¹⁷³ screen would move east over the Kumon Range and strike directly on the Myitkyina airstrip.¹⁷⁴ Stilwell hoped that Myitkyina's garrison would "be depleted to help defend Mogaung from the Chindits."¹⁷⁵ The specialness of this initial mission was clear, the Marauders and their attached forces were to take a route to Myitkyina that was 65 miles long, over a 6,000 foot pass, through

¹⁷² Ibid., p. 204.

¹⁷³ Ibid., p. 36. Romanus and Sunderland describe the Kachins as the "(m)ost powerful of the Burman peoples in the path of the projected North Burma Campaign...They are a great fighting stock who have cut their way into Burma from the mountains to the north. Expert woodsmen, and uncannily adept at invoking the nats, or minor deities, of the surrounding hills, the Kachins reminded some of those Americans who worked with them of the American Indian in his greatest days. They had a trait that sometimes amused and sometimes touched the Americans who sought to enlist them against the Japanese: their culture did not recognize deceit in personal relations... The Kachins' potentialities as scouts, guides, and irregulars were obvious...The force thus formed was known as the Kachin Rangers."

¹⁷⁴ Ibid., p. 226. The airstrip was about two miles west of the town of Myitkyina.

¹⁷⁵ Ibid., p. 205.

dense jungle,¹⁷⁶ and achieve, if not strategic then tactical surprise on the Japanese garrison left at Myitkyina. Following the seizure of the airfield, the mission took on a different flavor as Merrill's Marauders were used to fight linear, set-piece battles for terrain. In terms of alternatives, this is our point of departure, and where we believe misuse occurred.

In lieu of a counterfactual scenario and the development of ways in which Merrill's Marauders could have been used instead, the alternatives we are limiting ourselves to, are: the conventionalization of Merrill's Marauders to fight set-piece battles for terrain during the siege; and strictly using GPF for the set-piece battles during the siege at Myitkyina. Each alternative had different factors affecting the probability of their success, as well as, certain values and costs associated with each alternative. Appendix E provides the complete graphical representation, in the form of a probability worksheet and a completed decision tree, of the factors and variables discussed below.

1. Probability of Merrill's Marauders and Chinese GPF

Appendix E contains the completed probability worksheet for Merrill's Marauders and the Chinese GPF. Each variable is coded for the insertion and actions at the objective phase. The extraction phase is omitted in this case because the mission called for seizing and holding the airstrip outside Myitkyina, followed by the town of Myitkyina. Merrill's Marauders generally have the advantage during the insertion phase except for the variable of *mission difficulty* and *readiness*. The terrain the Marauders faced was extremely difficult. Additionally, the Marauders suffered from severe illness brought on by physical exertion and lack of substantial food in a wet, dense jungle environment. The Chinese GPF fought their way down the Kaiming Road and continued to fight through the Mogaung valley in order to reach Myitkyina. The biggest obstacle to the Chinese GPF reaching Myitkyina was the Japanese themselves. Our framework was developed around special operations and it is hard to consider the siege at Myitkyina as a special operation in any sense. For this reason, variables become difficult to discern and place in all three phases of our decision tree. As

¹⁷⁶ Louis Allen, Burma: The Longest War, (New York: St. Martin's Press, 1984), p. 365.

shown in Appendix E, Merrill's Marauders had a slight advantage during the insertion phase, considering all variables equally. For the purpose of our decision tree, we have determined that Merrill's Marauders had an 80% chance of completing the insertion. The Chinese GPF, by contrast, had a slightly lower probability than Merrill's Marauders, around 70%.

The relationships between the coded probability of the two forces for each phase provides a relative difference between one alternative and another, while the most significant variables allow the decision maker to determine what that difference is. In our case, the advantage Merrill's Marauders had by taking an unexpected and difficult route with limited Japanese forces was offset by the difficulty of actually taking that route. The greater resistance met by the Chinese GPF and the subsequent loss of *surprise* were offset by the relative ease of their mission and their *mission skill* and *proficiency*. Interesting relationships exist between the phases and the coding of each force. The relative relationships between forces may change between phases, as well as, the relative coding of each independent force between phases. Once the mission was launched, the *availability* variable becomes not applicable as we move into the actions at the objective phase.

The Chinese GPF generally have an advantage during the actions at the objective phase. The important variables during this phase include: *mission skill*, *mission proficiency*, *firepower*, *corresponding doctrine*, and *mission difficulty*. The Chinese GPF had a larger advantage than Merrill's Marauders during the insertion phase and were coded as having an 80% probability of completing actions at the objective. Because they were a specially trained, light-infantry organization developed for special operations, Merrill's Marauders were given a 60% probability of completing the actions at the objective. The probabilities themselves are obviously subjective. The relative difference of each factor and subsequent probability, both between forces and between phases, however, is highlighted by the probability worksheet.

2. Political Value

The case of Merrill's Marauders is unique to our framework in that SOF and GPF are not of the same country. Subsequently, as our theory applies to the United States and the decision process of U.S. decision makers, the various values and costs of this case, and their weight to U.S. decision makers, are generally skewed. Merrill's Marauders have higher resulting values, but at the same time, higher resulting costs, than the Chinese GPF. This is unique in our case studies, and may speak to coalition warfare and how values and costs are considered among Allies. *International political value* is dependent upon a successful mission. Because of the unique nature of this case, this value is greater for U.S. SOF than Chinese GPF in terms of the United States. The successful completion of the mission by Merrill's Marauders would result in the accomplishment of one of several objectives. It would also have the additional benefit of demonstrating extreme resolve and capability in a theater with limited resources.¹⁷⁷ The resulting political, military, and psychological affect on Japanese forces would be significant. Sole use of Chinese GPF would have also led to the accomplishment of one of several objectives. The Chinese, however, were expected to fight their long-time enemy and would have had less significant political, military, and psychological affects on the Japanese.

Domestic political value is dependent upon the American public perceiving the mission as important to our national interest and/or demonstrating an amount of effective leadership. Again, because of the alternatives in this unique case, *domestic political value* is greater for SOF than GPF. The Marauders enjoyed ongoing media attention. Attention that was also given to Chinese GPF, although to a lesser extent. Obviously, a successful operation, across our decision tree, by Merrill's Marauders would have been reported to the American public and would have resulted in some *domestic political value*. The reporters and political leaders would have made the American public aware of the importance of

¹⁷⁷ Romanus and Sunderland, *Stilwell's Command Problems*, p. 4. The authors point out that "with the exception of transport aircraft, [Stilwell] received little in the way of supplies and manpower from the United States; to a great degree Stilwell was left to carry out his mission with what resources he could conjure up in China and India."

Myitkyina, the objective would have been viewed as an important national interest, and Stilwell would have been perceived as providing good leadership. Limited *domestic political value* could have been gained from a failed mission because the "boys" would have been "fighting their hearts out" in a far off land. Failure to complete insertion or extract the force, had no *domestic political value*. The Chinese GPF might have obtained limited *domestic political value*, but only in the case of a successful mission. The American public had so much war material on their collective plates, that limited *domestic political value* would have been gained by Chinese operations. Stilwell would have been perceived as an effective leader of the Chinese GPF. As shown in Appendix E, the political values of completing the mission were greater for Merrill's Marauders than the Chinese GPF, this is not the case with military value, as we demonstrate below.

3. Military Value

The military value we have referred to as *mission effectiveness* is a function of the portion of the mission completed and the ability of the friendly force to inflict damage to the enemy. If the mission is completed, in either the SOF or GPF case, then *mission effectiveness* is given the highest value. To the contrary, if insertion is not completed, in either the SOF or GPF case, then the *mission effectiveness* is given the lowest value. When the mission is attempted, but not completed, the GPF's *firepower* generally prevails. Merrill's Marauders, with limited *firepower* but excellent accuracy, would have been expected to achieve minor military effect on the enemy if the mission failed. The GPF Chinese, with combined arms, would have been expected to achieve significant military effect on the enemy. The *target value* is the military value of the target and does not change between SOF and GPF. In the case of the town of Myitkyina, the airstrip was the actual theater-strategic target while the adjacent town was a necessary addendum, and thus, a theater-strategic target as well.

4. Political Cost

Like political value, the unique aspects of this case affect the political cost. Because the framework applies to U.S. decision makers, the political costs are skewed against SOF. *International political cost* is generally incurred when the mission fails, and moreso when the force fails to insert. The *international political cost* to U.S. decision makers of a failed Chinese GPF mission, however, would be reduced by reflecting on the Chinese military rather than the U.S. military. An argument could be made that by not acting and allowing the Chinese to fail, the U.S. could expect to incur some political cost. It is important to remember, however, that we are assuming that Merrill's Marauders would have been gainfully employed in a different manner. Successful missions, across our decision tree, do not incur political costs. A failed mission for SOF would have given the perception of a militarily weak force and caused a loss of credibility. A failed mission for GPF would have caused the United States to lose credibility. Failure to insert SOF would have made the U.S. look militarily weak, incompetent, and our Allies would have spoken out against us. Failure to insert GPF would have given the perception of military weakness and caused a loss of credibility with both our Allies and enemies.

Domestic political cost, again, favors the non-American GPF. In the case of Merrill's Marauders, the media and public would have questioned the leadership if the mission failed and the force was not extracted. A failed mission and failure to insert would have resulted in a public loss of confidence and a media attack. In the case of Chinese GPF, this cost would have been limited to the media and the public questioning the leadership if the mission failed or the force failed to insert. The *domestic political cost* is implicitly related to the *domestic political value*, the military cost in terms of casualties, and how the media presents the "facts" to the public.

5. Military Cost

The *opportunity cost* is generally greater for SOF than GPF. Merrill's Marauders were the single U.S. combat unit in theater and they were the single SOF directly available to Stilwell. With one SOF unit, there were many other missions the SOF could have been conducting, but were not. The Chinese GPF on the other hand, were one of several units of

their kind with several types of similar missions they could be conducting. *Opportunity cost* is the same throughout our decision tree for each respective force. The cost of casualties is generally higher for SOF than GPF. Merrill's Marauders were well-trained. They had three months of intensive training prior to operations and received the benefit of training from actual combat operations, additionally, they held a high level of skill and experience that was irreplaceable in the short term. The Chinese GPF were also well-trained and held a high level of skill and experience, however, the training was at a different level of complexity and necessary cohesion, and they were generally more easily replaceable in the short-term. The resulting *cost of casualties*, based on months of experience, would result in the spectrum of light-to-heavy casualties as the mission progressed down the resulting cost of success-to-failure, with the replaceability of forces and the cost of skill and experience separating SOF from GPF. Before the complete analysis of this case, we briefly describe the execution of the mission below.

E. EXECUTION

Merrill's Marauders were down to 1,400 troops following the seige at Nphum Ga and had to be combined with Chinese troops to fill their ranks.¹⁷⁸ The three combat teams that were created began their advance to Myitkyina on 28 April 1944, an advance that would take the Marauders over treacherous terrain and add 65 miles to the 500 they had already marched. (Map 16) Half of the animals died of exhaustion or fell into gorges during the march and the men were further harassed by fevers and dysentery.¹⁷⁹ After two engagements with Japanese forces, one of the three teams of Merrill's Marauders attacked the airstrip west of Myitkyina and the ferry terminal at Pamati, just southwest of the airstrip, on 17 May 1944. (Map 17) "The attack went like a service school demonstration, for though the Japanese

¹⁷⁸ Ibid., p. 223.

¹⁷⁹ Ibid., pp. 225-226.

knew Myitkyina was in danger, the actual assault was a complete surprise."¹⁸⁰ The Marauders sent the prearranged code signal that the airstrip had been captured in good condition and food, ammunition, and infantry were to begin reinforcing the force. They also sent word for the other two teams of Marauders to quickly assist the forces at Myitkyina. Reinforcements were disappointing as anti-aircraft weapons and construction engineers were some of the first forces to be flown in. The remaining portion of Merrill's Marauders did not arrive until two days later.

The Japanese did not reinforce the airstrip on 17 May and the Marauders concluded that the Japanese did not hold Myitkyina in strength.¹⁸¹ Several attempts to capture the town were failures. The three combat teams were reshuffled back to Merrill's Marauders and the Chinese regiments, and the Japanese began to reinforce the town. By 23 May 1944, the Allies were on the defensive and faced a formidable Japanese force as "an estimated 3,000 to 4,000 enemy had come in"¹⁸² to reinforce and take the offensive. During this period, Merrill's Marauders' evacuation rate was between 75 and 100 casualties a day and 2d Battalion was down to twelve men.¹⁸³ The Marauders continued to fight pitched battles against the attacking Japanese while suffering physically from the previous three months of arduous duty. (Map 18) Ogburn states that to be evacuated:

a man had to run a fever of 102 degrees or better for three consecutive days and be certified as unfit by a board of medical authorities before being tagged for evacuation. All the same, at the end of May only 200 of the 3,000 men with which the 5307th had started - a remnant of 1st Battalion - were

¹⁸⁰ Ibid., p. 226.

¹⁸¹ Military Intelligence Division, Merrill's Marauders, (Washington, D.C.: U.S. War Department, 1945), p. 108.

¹⁸² Ibid., p. 110.

¹⁸³ Romanus and Sunderland, Stilwell's Command Problems, p. 237.

considered fit to remain at Myitkyina. The point was now clear. 'Galahad,' wrote Stilwell in his diary, 'is just shot.'¹⁸⁴

With the deterioration of the situation in Myitkyina, Stilwell ordered that any Marauders able to walk were to be sent to Myitkyina immediately, to continue the fight.

Marauders were moved between the rear and Myitkyina as "New GALAHAD" were sent into battle, "receiving instruction in their weapons in the planes taking them to Myitkyina."¹⁸⁵ Myitkyina fell on 3 August 1944 and New GALAHAD participated with roughly 200 original Merrill's Marauders in the capture of the town. Merrill's Marauders for our purpose, however, were essentially decimated by the beginning of June 1944. Officially, the 5307th was disbanded on 10 August 1944.

F. ANALYSIS

Employing Merrill's Marauders during the seige at Myitkyina represents a complex error of commission. Arguably the most heinous misuse of SOF. The case represents the danger "of placing SOF under the operational control of GPF commanders without a corresponding special headquarters to assist in planning, training and administrative requirements."¹⁸⁶ Missions were planned by GPF planners¹⁸⁷ and no mechanism for the training and assignment of replacements existed. We recognize that no doctrine for the use of SOF existed during World War II, however, as David Hogan notes:

¹⁸⁴ Ogburn, p. 240.

¹⁸⁵ Ibid., p. 243.

¹⁸⁶ Michael M. Kershaw, "Integration of SOF and GPF," M.A. Thesis, Naval Postgraduate School, Monterey, CA, December 1994, p. 123.

¹⁸⁷ Merrill and Hunter, the two commanders of the Marauders, each thought and planned in "conventional" terms. As Ogburn notes: "Hunter had a belief in the Army, a belief in discipline, and a deep aversion to prima donnas...when he came to write up the lessons learned from GALAHAD, (Hunter) emphasized that they chiefly confirmed the hard lessons learned in the past and embodied in Army doctrine," p. 239.

No doctrine, or even a generally accepted concept, of the proper employment of Ranger units existed in World War II, and, thus, one technically cannot accuse the Army of misuse of the Rangers. Nevertheless, the repeated use of specially selected and trained troops to carry out tasks for which their light organizations were ill suited, tasks which any line outfit could have performed, was a wasteful practice for an Army which faced chronic shortages of combat manpower. . . . GALAHAD, otherwise known as 'Merrill's Marauders,' served as line infantry and suffered heavy losses. . . .¹⁸⁸

Apparently, Stilwell did not recognize the unconventional potential he had under his command and did not understand the greater, strategic, role that the Marauders could have played in his overall campaign.

The *expected value* of using Merrill's Marauders, a theater-strategic force, to conduct tactical operations to achieve an overall strategic goal was not greater than the *expected cost* of using the Marauders in this manner. They did not hold either an *absolute advantage* or a *comparative advantage* for the mission of defeating the Japanese at Myitkyina. The Chinese GPF had both advantages in conducting tactical set-piece battles against the Japanese.

The most significant costs associated with using Merrill's Marauders to fight pitched-battles were the military costs. Assuming that Stilwell would not have been willing to allow Merrill's Marauders to simply recover from the physical trauma they had suffered while conducting continual operations in a harsh environment for three months, the *opportunity cost* of using them in a line infantry role was significant. Japanese reinforcements and supplies continued to flow into Myitkyina once the seige began and Merrill's Marauders could have been used to conduct intelligence, raiding, or sabotage operations. Additionally, each casualty to Merrill's Marauders was irreplaceable and represented a loss of valuable

¹⁸⁸ Hogan, "Rangers Lead the Way?: The Problem of Misuse of U.S. Army Ranger Units in World War II," unpublished paper, based on material in David W. Hogan, Jr., Raiders or Elite Infantry?: The Changing Role of the U.S. Army Rangers from Dieppe to Grenada, (Westport, CT: Greenwood Press, 1992).

training in special operations skills and unit standard operating procedures, as well as an intangible loss of unit integrity and cohesion.

General Wilson was asked whether the Marauders represented a case of a misuse of light infantry, per se? Or if the Marauders were left in the field too long? His explanation was as follows:

No. The concepts were sound. The concepts worked. There was just the appropriate level of gamble and risk in the things that we were asked to do. We were well-trained enough, cocky enough, and mean enough to pull them off. At Myitkyina, regardless of what happened, we were sort of like a guy at the gaming tables who was going to make one last big splurge when he should have known that he had spent all his luck. He should have pulled every single member of the Marauders, devoted a little time to putting us in a camp back somewhere in the tea plantations of Assam, and given us a chance to put on a little weight, to loll around in the sun, to drink some Bullfight brandy and Rosa rum, and to chase little Indian girls. . . If he had done that, we could have gone back as soon as the rainy season was over, and we could have done it for them all over again. Instead, on the 10th of August 1944, there were 100 combat effectives left in the field, and 99 of those weren't very effective. They had simply been used up until there was nothing left. There, I think, was his mistake.¹⁸⁹

The *expected value* of using the Marauders as infantry until they were all "used up," did not outweigh the *expected cost*.

Appendix E provides a completed decision tree for the use of Merrill's Marauders versus the use of Chinese GPF to conduct the seige-type infantry battles at Myitkyina which resulted in the decimation of the only special operations force in the theater. Using Equations (7), (8), (10), and (11); the values and costs discussed above; and the probabilities discussed above, the resulting *expected values* and *expected costs* from the decision tree are as follows:

$$EV_{\text{SOF}} = 142.4$$

$$EC_{\text{SOF}} = 170.0$$

$$EV_{\text{GPF}} = 148.4$$

$$EC_{\text{GPF}} = 99.6$$

¹⁸⁹

Partin, p. 16.

Merrill's Marauders did not hold an *absolute* or *comparative advantage* but were used, demonstrating a complex error of commission. The next case examines the Mayaguez incident and the application of our theory to a simple error of omission.

IV. THE MAYAGUEZ CRISIS

A. INTRODUCTION

By 0630 , Lieutenant Colonel (LtCol) Austin, the acting ground force commander (GFC),¹⁹⁰ realized that the situation on the beach was well beyond precarious. "Expecting a 'walk-ashore' operation, the Marines instead flew into the teeth of a defense prepared by numerically superior, well-entrenched, and well-disciplined Khmer Rouge soldiers evidently expecting an attack on the island."¹⁹¹ Commencing at approximately 0615,¹⁹² the United States attempted to insert a 179-man Marine reinforced rifle company¹⁹³ on Koh Tang¹⁹⁴ to rescue the American crew of the *S.S. Mayaguez*.¹⁹⁵ The Marines were met with ferocious resistance.

¹⁹⁰ Marine Corps Gazette, October, 1977. p. 29. LtCol Austin was the Marine ground force commander.

¹⁹¹ Christopher Jon Lamb, Belief Systems and Decision Making in the *Mayaguez* Crisis, (Gainesville, FL: University of Florida Press, 1988), p. 21. With the nearly constant fly over of surveillance aircraft and continued attacks on Cambodian gunboats, Khmer soldiers undoubtedly knew that a U.S. attack was imminent.

¹⁹² Gazette, p. 21. All times are local for the Gulf of Thailand. See also Vandembroucke, p. 102.

¹⁹³ Roy Rowan, The Four Days of Mayaguez, (New York, NY: W. W. Norton & Company, Inc., 1975), p. 201.

¹⁹⁴ Ibid., p. 89. Koh Tang is a small jungle island approximately three miles long and two miles wide. It is located about thirty-four miles southwest of Kompong Som, Cambodia. At least some of the *Mayaguez* crew were believed to be held on Koh Tang when the rescue operation was launched. (Maps 19, 20 and 21)

¹⁹⁵ Ibid., pp. 15, 37, 49-50. The *S.S. Mayaguez* was a 31 year old, 504-foot, 10,485-ton container ship owned and operated by U.S. Sea-Land Services, Incorporated. It had a crew of forty and carried 274 thirty-five-foot containers when it was captured.

The first two helicopters to approach the eastern helicopter landing zone (HLZ) were shot down.¹⁹⁶ One was hit by a hail of intense automatic weapons fire and at least two rocket propelled grenades (RPG) causing it to crash in the water about fifty yards from the beach. Seven Marines, two Navy corpsman and the Air Force co-pilot were either killed in the crash or by enemy fire. Three more Marines were cut down in the surf as they exited the downed aircraft and tried to reach the tree line. Ten Marine and three Air Force survivors swam seaward as they watched their equipment and weapons being consumed in the inferno of the crash. The second helicopter made a controlled crash at the surf line. Its crew and passengers were able to move to the tree line and establish a perimeter. Several of the Marines were wounded.¹⁹⁷

At the western HLZ, things were just as perilous. Of the first two helicopters to approach the beach, only one was able to disembark troops. After leaving the beach, it crashed into the water killing one of its crew members. The other helicopter was critically damaged and limped back to Thailand with one engine shot out and the Marines still aboard.¹⁹⁸ LtCol Austin's helicopter, carrying the battalion command group, was forced to land at the shoreline about 1,200 meters southwest of the western HLZ because of intensive enemy resistance at the HLZ.¹⁹⁹ (Map 21)

¹⁹⁶ Gazette, p. 28. Two HLZs, one on the northwest beach and one on the northeast beach of Koh Tang, had been selected for the infiltration of the Marines. (Map 21)

¹⁹⁷ Ibid., pp. 29-30.

¹⁹⁸ Ibid., p. 30. The helicopter that returned to Thailand had to land 50 miles short of its destination, Utapao, because of damage the aircraft sustained.

¹⁹⁹ Ibid., p. 30.

Of the 179 marines that should have been ashore within the first moments of the operation, 109 were spread out at three separate locations, fighting for their lives.²⁰⁰ Of these 109, several were already badly wounded.

To add to the problem, the Marines' key communications equipment was lost or destroyed in the downed helicopters. This severed their vital link to close air support which was on station overhead. Additionally, it would be another four and a half hours before the Marines could expect reinforcement.²⁰¹ What had begun as a mission to rescue forty merchant sailors who had been captured by Cambodian military personnel, had turned into a fight for the Marines' own lives. The Marines attempted to link their three elements together and establish defensive positions against the numerically superior, well armed, and well dug in combat seasoned enemy forces.

To make matters worse, of the eight helicopters in the first wave, all but one had been destroyed or were critically damaged. With the addition of four other helicopters, only five were available to lift the second and subsequent waves of Marines.²⁰² The original plan called for twelve helicopters.²⁰³ Not only had the unexpected enemy resistance drastically reduced the fighting strength of the first wave of Marines, it severely jeopardized the movement of reinforcements to Koh Tang by crippling the means to deliver them.

²⁰⁰ Ibid., p. 30. Twenty-nine Marines were with the command group; sixty were at the western HLZ; and twenty were at the eastern HLZ. See also, Vandenbroucke, p. 102 and Lamb, p. 22. Other interpretations of the first hour of the invasion claim that at the end of the first hour, only 58 Marines were ashore and 14 of them were dead. The insertion was unexpectedly and effectively resisted, regardless of which account is more accurate.

²⁰¹ Ibid., p. 28.

²⁰² Ibid., p. 31. Additional helicopters included those used to move Marines to the *USS Holt* for the boarding of the *Mayaguez*, another that had been declared down until the situation on Koh Tang had necessitated it being declared flyable, and one other aircraft that arrived in Utapao after the 0415 launch of the first wave of Marines.

²⁰³ Ibid., p. 28.

At approximately the same time the first wave of Marines were coming ashore, the *Mayaguez*' crew was released from Kompong Som by their Cambodian captors.²⁰⁴ By 1015 the crew of the S.S. *Mayaguez* had been recovered by the U.S.S. *Wilson*.²⁰⁵ Since all crew members were recovered, President Ford issued the order to cease all offensive military operations and to withdraw forces from Koh Tang.²⁰⁶ This added to the delay between the first and second waves of Marines. The second wave was turned back toward Utapao to off load its Marines so empty aircraft could be used to evacuate the Marines ashore. LtCol Austin requested the reinforcements continue on their original course to Koh Tang because the additional troops would be required so Austin could withdraw his force without being overrun.²⁰⁷ When reinforcements finally arrived, they were also met with fierce resistance. Only four of the five helicopters were able to insert their passengers. The fifth was forced to limp back to the Thai coast for an emergency landing.²⁰⁸

Once the additional Marines were ashore and the wounded were extracted, the mission objective changed from what was originally a rescue operation of the *Mayaguez* crew to a rescue operation of the Marines. Extraction attempts continued into darkness and resulted in the evacuation of all but three Marines.²⁰⁹

In the end, fifteen U.S. military personnel lost their lives, three more were missing in action and fifty were wounded.²¹⁰ Had it not been for the courageous performance of the

²⁰⁴ Lamb, p. 21.

²⁰⁵ Rowan, p. 216. See also Vandenbroucke, p. 106.

²⁰⁶ Ibid., p. 217.

²⁰⁷ Ibid., p. 217. See also Lamb, p. 25.

²⁰⁸ Gazette, p. 33.

²⁰⁹ Lamb, p. 29. Three Marines were accidentally left behind and presumably overrun by Khmer Rouge soldiers after the evacuation helicopters departed. See also, Vandenbroucke, p. 112.

²¹⁰ Ibid., pp. 29, 31, 223. See also Head, p. 141.

Marines, airmen and sailors, the entire force could have been lost. Luck was certainly on the U.S. side. The loss of one helicopter filled with Marines during infiltration or extraction could have easily doubled or tripled the number of U.S. casualties.²¹¹ Also, U.S. Pacific Command's (PACOM) helicopter heavy lift capability was devastated; only one of the eleven helicopters used in the operation was not badly damaged or destroyed.²¹² Additionally, fifty-five Cambodian soldiers lost their lives while seventy were wounded on Koh Tang.²¹³

Christopher Lamb asked the question "why did a numerically inferior American assault force attack (Koh) Tang when Marine Corps' doctrine calls for a three-to-one numerical superiority over enemy forces during this type of operation?"²¹⁴ Why did the Marines meet with such fierce resistance when they expected it to be minimal? Was there some intelligence shortfall that led the Marines to believe that the forces on Koh Tang were far less significant? Why were the intelligence estimates provided to the Marines so inaccurate? Finally, was there some other option that was not used that could have provide the Marines with a more accurate intelligence picture than that which was available?

We contend that SEALs, who were deployed in the Pacific Theater, were available to conduct reconnaissance of Koh Tang and could have provided the assault force with valuable intelligence concerning the disposition of enemy forces on the island. As Commander Bosiljevac wrote about the assault on Koh Tang:

²¹¹ Ibid., pp. 28-32, Casualties could have been much higher particularly if one of the extraction helicopters had been hit while leaving Koh Tang or if a midair collision had occurred. One of the helicopters was overloaded with 44 Marines aboard in addition to their crew.

²¹² Richard G. Head, Frisco W. Short, and Robert C. McFarlane, Crisis Resolution: Presidential Decision Making in the Mayaguez and Korean Confrontations, (Boulder, CO: Westview Press, 1978), p. 141.

²¹³ Vandenbroucke, p. 112.

²¹⁴ Lamb, pp. 32, 136. See also, Vandenbroucke, pp. 88-89, and Head, p. 120.

No SEAL or UDT (Underwater Demolition Team) element was used for a clandestine reconnaissance of the island prior to the assault, as is characteristic of most amphibious operations. Such a mission is completely within the design and character of UDT/SEAL teams. A small reconnaissance party of combat swimmers might well have been able to discover that the captured crew was not on the island. At the very least, they would most likely have been able to notify planners of the heavily fortified bunkers and weaponry the Khmer Rouge had on line.²¹⁵

Because SOF were not employed, we assert this case study is an example of an error of omission.

This case study compares a SOF (SEAL platoon) which was not employed, with GPF (reconnaissance aircraft) which were employed. It should be noted that the use of SOF in this case would not have excluded the use of GPF. The best intelligence results are usually obtained when a variety of means are used. In this case, both GPF and SOF should have been used.

B. BACKGROUND

1. Mayaguez - the Crisis

At 1612 on 12 May 1975, U.S. National Military Command Center (NMCC) received a message from the American Embassy Jakarta, Indonesia that the merchant ship S.S. *Mayaguez* had been seized on the high seas.²¹⁶ Earlier that day, the *Mayaguez* was transiting at about 12.5 knots following a standard sea lane and trade route in the Gulf of Thailand from Hong Kong to Sattahip, Thailand. At about 1418, she was fired upon by a Cambodian gunboat and subsequently boarded and captured by Cambodian military forces.²¹⁷ At the

²¹⁵ T. L. Bosiljevac, SEALs: UDT/SEAL Operations in Vietnam, (New York, Ivy Books, 1990) pp. 178-179.

²¹⁶ Gazette, p. 25.

²¹⁷ Head, p. 101. See also, Lamb, p. 18. The *Mayaguez* sailed a regularly scheduled shuttle service between Hong Kong, Sattahip, and Singapore.

time of the incident, the *Mayaguez* was sailing in international waterways approximately 60 miles from the mainland Cambodian coast in the vicinity of Poulo Wai Island.²¹⁸ (Maps 19 and 20)

The ship's captain was directed to follow the gunboat to an anchorage about seven miles north of Poulo Wai, where the ship remained throughout the night.²¹⁹ On 13 May, the ship, with its crew and their captors aboard got underway by 0845 and moved to an anchorage one mile north of Koh Tang.²²⁰ That evening, the *Mayaguez* crew was loaded onto two fishing boats and transported into an inlet one hundred yards from the beach.²²¹ Unknown to the U.S., the crew was kept on the two boats throughout the night.²²² They were told they would be returned to the *Mayaguez* the following morning.

The next morning, the crew was moved to the larger of the two fishing boats and set sail in the direction of the *Mayaguez*. Before reaching the container ship, the fishing boat changed course to starboard and headed in the direction of the mainland.²²³ The fishing vessel made a quick anchorage in Kompong Som Harbor and then sailed to Koh Rong Sam

²¹⁸ Ibid., pp. 101-106. Ownership of this island, as well as others in the Gulf of Thailand, had been contested for a number of years by several countries, to include South Vietnam. See also: Rowan, p. 47.

²¹⁹ Lamb, p. 19.

²²⁰ Rowan, pp. 83-84.

²²¹ Ibid., p. 95.

²²² Ibid., p. 168. The fishing boat and crew were Thai. They had been captured by the Cambodians five days earlier for entering waters that the Cambodians claimed as territorial.

²²³ Ibid., pp. 129-131.

Lem, one of two islands that protected Kompong Som Harbor.²²⁴ There the crew was moved ashore and held in a barracks type facility throughout the night.²²⁵

At 0620 the following day, the fishing boat was underway for the *Mayaguez* with all crew members aboard.²²⁶ While enroute to the *Mayaguez*, they were intercepted and recovered by the U.S.S. *Wilson* at approximately 1007.²²⁷

2. Political

The *Mayaguez* seizure occurred at a time when the prestige of the United States in Asia was at an all time low. After more than ten years of a controversial war in Southeast Asia, a war that resulted in the loss of 58,000 American lives,²²⁸ "the United States had suffered a demoralizing military and political setback with overtones concerning its continued reliability as an ally which went far beyond the Asian context."²²⁹ U.S. policymakers were seriously concerned about the nation's image. Having witnessed the recent collapse of two U.S. allies in Cambodia and South Vietnam, they feared that both enemies and allies would conclude that the U.S. either would or could no longer defend its vital interests.

South East Asia had recently undergone tremendous political change with the fall of regimes friendly to the U.S. in both South Vietnam and Cambodia. Communists forces had captured Phnom Penh on 17 April and Saigon on 30 April, only weeks before the *Mayaguez* incident. In addition, North Korea had become increasingly hostile toward South Korea

²²⁴ Ibid., p. 158.

²²⁵ Ibid., pp. 160-161

²²⁶ Ibid., p. 207.

²²⁷ Ibid., p. 214.

²²⁸ Vandembroucke, p. 74.

²²⁹ Head, p. 102.

since the fall of South Vietnam.²³⁰ The Ford Administration saw the aggression as a test of U.S. resolve and capability.

The United States' international leadership ability was also impaired by events that had occurred elsewhere on the globe. In the Middle East, U.S. efforts to secure an agreement for a disengagement of forces between Israel and Egypt had been unacceptable to the Israelis. U.S. inability to influence even its closest allies was in question. In addition, just nine months before the *Mayaguez* was seized, the strength of the U.S. Presidency had been dealt a crippling blow when under public and congressional pressure, President Nixon had resigned. As a result, Vice President Ford assumed the Presidency without the benefit of a political mandate from the electorate. To make matters worse, Ford lost credibility on the domestic front when he immediately pardoned Nixon. Finally, the oil crisis was having drastic effects on the U.S. economy as well as the economies of the world.²³¹ The apparent decline of the U.S. caused much doubt about the nation's ability to function as a world leader.

The situation in Cambodia was also tenuous. After thirty years of fighting in Southeast Asia, the last ten resulting in victory over the U.S., the Communists had toppled the last non-Communist governments in Cambodia and the Republic of Vietnam. The new communist government in Phnom Penh attempted to establish their nationalist credentials and legitimacy by pursuing several initiatives. This included mass executions of the members of the defeated regime.²³² Partly due to this, the country remained in chaos with little visible sign of centralized control.

In addition, the new leadership in Phnom Penh moved to extend their territorial waters to ninety miles from shore. The expanded limits included Paulo Wai, Koh Tang and other islands that Cambodia had historically claimed. More importantly, it included a major

²³⁰ Vandembroucke, p. 74. See also Rowan, p. 141.

²³¹ Head, p. 102.

²³² *Ibid.*, p. 103. "It has been estimated that as many as six hundred thousand Cambodians were killed or died during the first months after the Lon Nol government fell;" this was almost one tenth of the countries population.

trade route to Asian ports. The new Cambodian government planned to seize any foreign vessels that violated the new limits. Consequently, the *Mayaguez* attack was not an isolated incident. Several Thai fishing boats had been seized and released on 2 May,²³³ a South Korean ship was fired upon in an attempt to capture her on 4 May, several South Vietnamese small craft were seized and released on 6 May, and a Panamanian ship was seized on 7 May and held for 36 hours before she was released. On the same day the *Mayaguez* was captured, a Swedish ship had been fired on but out ran the Cambodian gunboats and a Thai freighter had been seized and held for two hours off Poulo Wai.²³⁴

After the seizure, the United States made an attempt to settle the crisis through diplomatic channels. The administration, however, placed little hope in a non-military solution.²³⁵ There were problems determining who to negotiate with because the new Cambodian government was not well established, it had few foreign missions, and the U.S. had no diplomatic relations with the new regime.²³⁶ In addition, the U.S. had no way of knowing whether the incident was the individual act of a local commander or a considered act by the new Cambodian government. Consequently, the United States passed demands through both the Foreign Ministry of the People's Republic of China and the Cambodian Embassy on 13 May. The Chinese and Cambodian embassy officially refused to forward the demands to the Phnom Penh government, though there was little doubt that the message was

²³³ Rowan, p. 50. A border dispute between Thailand and the Khmer Rouge, led to Thai fishing boat seizures.

²³⁴ Head, p. 103. See also Rowan, pp. 67, 140 and Vandenbroucke, p. 85.

²³⁵ Vandenbroucke, p. 77.

²³⁶ Ibid., pp. 75-76, 86.

received.²³⁷ The United States also attempted to use United Nations channels to effect a release of the ship.²³⁸

On 15 May, Phnom Penh finally responded with a radio broadcast that attacked the U.S. for intentionally violating their territorial waters in an attempt to provoke an incident and conduct espionage. They also assailed the U.S. for attacking Cambodian gunboats with U.S. attack aircraft within Cambodian territorial waters. The same message included Cambodia's intent to release the *Mayaguez*, though it stated the release was not a result of U.S. threats. The broadcast actually began just minutes before the Marines began landing on Koh Tang.²³⁹

At the same time that the U.S. was seeking a diplomatic solution to the *Mayaguez* crisis, President Ford ordered the U.S. Military to prepare for a forceful rescue mission of the container ship and her crew. The ultimatum the U.S. presented to the Cambodian leaders conveyed to the world that the U.S. still took seriously any challenge to its interest. It also gave the American people a sense that the Administration was firmly in charge of the situation. Ironically, had the Cambodians desired to release the ship and crew, the ultimatum made it more difficult for them to do so without losing face.²⁴⁰ A military confrontation was almost inevitable.

²³⁷ Head, p. 116. "President Ford directed that a strong diplomatic protest note be delivered to Cambodian authorities via the PRC." See also Rowan, p. 175. The Chinese had the note for a day before they returned it in an attempt to "preserve a degree of formal disassociation." It is also likely that the Chinese did not want to leave themselves open to Soviet criticism by serving as an "American lackey." See also Vandenbroucke, pp. 78-81.

²³⁸ Vandenbroucke, p. 81.

²³⁹ Rowan, pp. 203-204. See also, Vandenbroucke, p. 105.

²⁴⁰ Vandenbroucke, p. 77.

3. Military

When the *Mayaguez* was captured there were few PACOM forces in the Gulf of Thailand. The *Mayaguez* was seized just two weeks after the completion of Operation FREQUENT WIND, the evacuation of Saigon, and four weeks after Operation EAGLE PULL, the evacuation of Phnom Penh. The U.S. armada which had stood off the coast of Vietnam and Cambodia had been dispersed. U.S. warships were delivering evacuees to other locations and returning to their normal operating stations. There were only two U.S. Navy ships, the *U.S.S. Harold E. Holt* and the *U.S.S. Henry B. Wilson*, within twenty-four hours steaming time of the *Mayaguez* when it was seized.²⁴¹

Commander in Chief, Pacific (CINCPAC), Admiral Noel Gayler, commanded operations within the Pacific theater. Gayler assigned Commander, U.S. Support Activity Group/7th Air Force (COMUSSAG/7AF), Lieutenant General John J. Burns, as Commander Task Force 79 (TF-79) and the on scene commander/central coordinating authority for the recovery operations.²⁴²

Early on 13 May, CINCPAC directed the destroyer *U.S.S. Holt*, the guided missile destroyer, *U.S.S. Wilson* and the *U.S.S. Coral Sea*²⁴³ carrier task group to proceed to the

²⁴¹ Gazette, p. 25, 29. See also Rowan, p. 73-74.

²⁴² USCINCPAC, Command History, 1975, Appendix VI, "The *SS Mayaguez* Incident," (San Francisco, 1976), p. 5. "Air Force and Marine assets were placed under the operational control of, and Naval assets (minus the Marines) supported COMUSSAG/7AF." See also Gazette, pp. 25-26, Vandenbroucke, pp. 94-98, and Rowan, pp. 176-177.

²⁴³ Rowan, p. 143. After President Ford gave the execution order, PACOM and CJCS requested a twenty-four hour delay of the operation. The delay to 16 May would have given the *Coral Sea* carrier battle group the opportunity to reach the area of operations (AO) and act as the forward staging base for the Marines. With the Marines and assault helicopters staged on the *Coral Sea* instead of at Utapao, the time between the first and second waves of Marines would have been reduced from over four hours to only minutes. Reportedly, this was denied because the Administration wanted to act before the *Mayaguez* crew could be moved to the mainland. The administration feared that if the crew was moved ashore, the U.S. would be subjected to months of negotiation, thus, vulnerable to another *Pueblo* type crisis. See also, Vandenbroucke, pp. 82, 90-91, Lamb, pp. 122-123, and Head, p. 122.

waters off Kompong Som, Cambodia.²⁴⁴ In addition, 1,100 Marines of the Third Marine Division stationed on Okinawa and in the Philippines were flown to Utapao Air Base in Thailand.²⁴⁵ (Map 19) Finally, the 56th Special Operations Wing and heavy helicopters of 7th AF were deployed to Utapao.²⁴⁶ Utapao was the closest U.S. base to the crisis location.²⁴⁷

Supporting roles were played by both carrier launched Naval and land based Air Force strike aircraft. In addition, Air Force slow moving propeller driven OV-10 Broncos and AC-130 Spectre gunships were used to provide close air support and reconnaissance of the *Mayaguez* and Koh Tang. Navy P-3 Orion aircraft were tasked early in the operation to locate and collect intelligence on the *Mayaguez* and later to collect intelligence on Koh Tang.

We found this justification suspect since the administration had already known that at least some of the prisoners had been moved to the mainland on 14 May. We surmise that the Administration actually wanted to punish Cambodia before the prisoners were released. Considering several other ships had been taken and released by the Cambodians in the past two weeks, it was likely that the *Mayaguez* and her crew would also be released. It is also possible that the ship was held longer than the other ships as a result of the U.S. threats to retaliate if the ship was not released within twenty-four hours. See Lamb, pp. 124-127. Had the Cambodians succumbed to the U.S. demands, they would have likely lost prestige in the Asian world. If the U.S. had attacked Cambodia after the crew had been released rather than while the prisoners were still being held, international criticism would have been more likely.

²⁴⁴ Gazette, p. 25.

²⁴⁵ Vandembroucke, p. 94. Elements of the 3d Marine Amphibious Force (III MAF), Battalion Landing Team (BLT) 2/9 from Okinawa and a company from 1st Battalion in the Philippines, deployed to Utapao. See also, Rowan, p. 69.

²⁴⁶ Gazette, p. 26. Helicopters were drawn from two squadrons: the 21st Special Operations Squadron (CH-53s) and the 40th Aerospace Rescue and Recovery Squadron (HH-53s). There were a total of fourteen CH/HH-53 helicopters deployed to Utapao, however, one crashed on the night of 13 May leaving only thirteen for the operation. Two were assigned Search and Rescue (SAR) responsibilities leaving only eleven for the Marine infiltrations. Three of the eleven were assigned to the *Mayaguez* recovery mission leaving eight available for the operation on Koh Tang.

²⁴⁷ Lamb, p. 29.

The SOF element that was not employed during the *Mayaguez* operation, was SEAL Team One's Delta Platoon. At the time of the incident, the platoon was deployed to Subic Bay in the Philippines.²⁴⁸

The disposition of enemy forces was critically under estimated by U.S. intelligences sources. Contrary to the estimates disseminated to the Marines, Koh Tang was a well fortified island.²⁴⁹ Post operation estimates of the enemy troop strength range from 140-300 well-armed and well entrenched Khmer communist troops. In addition, there were at least seven U.S. made gunboats operating in the vicinity of Koh Tang during the crisis.

On the mainland, there were 2400 Khmer troops that, theoretically, could have responded to the incident with aircraft and gun boats from Kompong Som and Ream.²⁵⁰ Because of the Khmer's ability to respond and increase the danger for the Marines, President Ford ordered the bombing of Kompong Som Harbor and Ream Airfield simultaneous with the retaking of the *Mayaguez* and the landing at Koh Tang. (Map 22)

Prior to the operation, there had been three intelligence estimates of the enemy disposition on Koh Tang.²⁵¹ The first, which was the only estimate the Marines have acknowledged receipt of, greatly underestimated the enemy strength at about 20-30 Khmer Rouge irregulars. This estimate initially came from a former Cambodian Naval Officer who had allegedly been on the island recently. It was supported by interviews with Cambodian refugees who had also allegedly been on the island.²⁵² A second estimate, provided by Intelligence Pacific (IPAC) on 13 May, concluded there were ninety to a hundred soldiers,

²⁴⁸ Orr Kelly, Brave Men Dark Water: The Untold Story of the Navy SEALs, (Novato, CA: Presidio Press, 1992), p. 175. See also, Bosiljevac, pp. 78-79.

²⁴⁹ Head, p. 104. Fortification was probably a result of expected confrontations with Vietnam or Thailand over ownership of Koh Tang and other islands.

²⁵⁰ Vandenbroucke, p. 84.

²⁵¹ Lamb, p. 129.

²⁵² Gazette, p. 27. See also, Vandenbroucke, p. 99.

on Koh Tong. These soldiers were reportedly augmented with a heavy weapons squad of ten to fifteen soldiers armed with a 82-mm mortar, a 75-mm recoilless rifle, three machine guns and two rocket launchers. The most accurate estimate, which was furnished by Defense Intelligence Agency (DIA) on 12 May, identified an enemy of 150 to 200 regular Khmer soldiers that were thought to possess several 82-mm mortars, several 75-mm recoilless rifles, numerous machine guns and numerous rocket launchers. Supposedly, the third estimate never reached the USSAG and neither the second or third estimates ever reached the Marine assault force.²⁵³

GPF intelligence assets undoubtedly included spy satellites and high flying sophisticated reconnaissance aircraft. These assets had photographic equipment that should have identified at least some of the Cambodian fortifications on Koh Tang.²⁵⁴ It appears that either because of the time critical nature of the operation, kinks in the intelligence dissemination process, or poor interservice cooperation, the Marines were not provided with the essential intelligence that these assets should have provided. Instead, the Marines relied on photographs taken by the GFC with a hand held camera during a leaders reconnaissance over Koh Tang. In addition, the Air Force and Navy reconnaissance and attack aircraft as well as the AC-130 gunships continuously flew over the island taking photographs, drawing

²⁵³ Lamb, pp. 129-130. There were other failures inherent to this operation in addition to the error of omission that is the subject of this chapter. Had there been no dissemination problems, there would probably not have been as great a need for SOF to execute a reconnaissance of the target. In this chapter, we do not attempt to determine the source of the intelligence problem. Instead, our results are based on the fact that only aircraft and satellite reconnaissance were accomplished and the Marines did not get the intelligence they needed. Had a ground reconnaissance been accomplished, the Marines would have known the intelligence estimate that they received was inaccurate. See also Vandenbroucke, pp. 88-89, 99-100, and Head, p. 120.

²⁵⁴ Vandenbroucke, p. 99-100.

enemy fire and identifying the sources of that enemy fire.²⁵⁵ Again, this information never reached the Marine planners.

As already mentioned, LtCol Austin did conduct a leaders reconnaissance from an Army U-21 aircraft flying 6000 feet over Koh Tang. Unfortunately, the dense vegetation concealed the enemy strength below.²⁵⁶

C. OBJECTIVES

1. Mission Objectives

Secretary of Defense James Schlesinger, has written, 'The purpose of the engagement of U.S. military forces was simply to extract our people from Cambodia--and to provide a lesson for the Cambodians and others.' Scowcroft was even blunter: 'Frankly, we argued the strikes on the mainland as militarily justified and theoretically, of course, we struck targets that could have aided them [the Cambodians] in the operation. In fact it was a demonstration--a punitive strike.'²⁵⁷

Vandenbroucke wrote, "the air strikes against Cambodia had little to do with recovery of the crew."²⁵⁸ It can be argued that these missions were designed to eliminate Cambodia's ability or will to respond while the operation on Koh Tang was in progress. However, it was more likely that the purpose of the bombing missions was to "convince the Cambodian Government of U.S. resolve and to serve as a potent warning to other would be aggressors."²⁵⁹

²⁵⁵ Ibid., pp. 79, 99. An AC-130, employing sophisticated scanning devices, located at least three gun emplacements on a key beach where Marines planned to land.

²⁵⁶ Lamb, p. 134. See also, Vandenbroucke, p. 99.

²⁵⁷ Vandenbroucke, p. 85.

²⁵⁸ Ibid., p. 84.

²⁵⁹ Ibid., p. 85.

The Marine mission to "... seize, occupy, and defend the island of Koh Tang, hold the island indefinitely (for a minimum of forty-eight hours) and to rescue any of the crew members of the *Mayaguez* found on the island, simultaneously seize *Mayaguez* and remove the ship from its current location,"²⁶⁰ was undeniably concerned with the recovery of the *Mayaguez* and her crew. In addition, the rescue operation would send a clear message to U.S. allies and enemies alike, that the U.S. still had the ability and resolve to defend its vital interests.

In summary, the objectives of the operations were to recover the *Mayaguez* and her crew, punish the Cambodians for attacking the U.S., demonstrate U.S. resolve and military strength, and deter future aggression by our enemies.²⁶¹

2. Reconnaissance Objectives

The reconnaissance objectives were to locate and track the crew of the *Mayaguez* and collect information on the disposition of enemy forces. As already mentioned, it was simple good luck that the failure of the reconnaissance assets to provide intelligence in these two areas did not result in a disaster for the Marines. The GPF intelligence assets were not able to locate and keep track of the *Mayaguez*' crew.²⁶² This was critical because of the possibility of killing the *Mayaguez* crew with friendly fire during the assault on Koh Tang. Preparatory fires were not used because the commanders feared such action would jeopardize the crew.²⁶³ Undeniably, knowing the location of the crew would have been valuable to the assaulters. However, in this case, knowing where the crew was not located might have been enough to help the mission succeed. For example, if the U.S. knew the *Mayaguez* crew was not located in the immediate vicinity of the HLZs, preparatory fires could have been used to soften the HLZs, thus making the insertion less opposed and less hazardous.

²⁶⁰ Gazette, p. 27.

²⁶¹ Vandenbroucke, pp. 84-85, 112-113, Head, p. 110 and Lamb, pp. 89-101.

²⁶² Lamb, pp. 137-144.

²⁶³ Vandenbroucke, p. 88.

The second and more immediately impacting shortfall was the inability of the GPF intelligence assets to provide the Marines with an accurate estimate of the enemy's strength on Koh Tang.²⁶⁴ The Marines sustained numerous casualties and actually made no significant advance. For the most part, Marines held in defensive positions until they were evacuated. Had the *Mayaguez* crew actually been on the island, the Marines' effort to advance and find them would have resulted in many more casualties if, in fact, the Marines could have rescued the crew. Undoubtedly, the U.S. could have eventually moved enough Marines ashore to secure the island but it could have been at the cost of the crew's lives. As Lucien Vandembroucke explained, in a rescue mission, the force must attack and neutralize the enemy very quickly so they do not have the opportunity to take reprisals against the prisoners.²⁶⁵

Had a SEAL platoon been inserted to conduct a reconnaissance mission on Koh Tang prior to the Marine assault, their primary objective would have been to determine the disposition of the enemy force ashore. This would have included enemy strength and positions, particularly in the areas of the HLZs. Secondly, if the SEALs could not determine the location of the crew, they could have at least determine where the crew was not located. This could have allowed for preparatory fires against the enemy. In addition, the SEAL platoon could have identified a large area for employment of the 15,000 pound BLU-82 bomb for the purpose of making an alternative HLZ.²⁶⁶ This option was not used for the infiltration because it posed a threat to the crew whose location was unknown.

²⁶⁴ Lamb, pp. 129-137.

²⁶⁵ Vandembroucke, pp. 86-87.

²⁶⁶ Lamb, pp. 27-28, 97. The BLU-82 is the largest conventional bomb in the U.S. inventory. Delivered from a C-130, it can be used to clear vegetation to create HLZs in jungle environments. Its use during the assault on Koh Tang was rejected because the location of the *Mayaguez* crew was unknown and the planners did not want to jeopardize their safety. One BLU-82 was dropped on Koh Tang to deter the enemy attack against the Marines during the evacuation but it was not used until after the *Mayaguez* crew had been recovered. See also, Gazette, p. 28.

D. ALTERNATIVES

There were numerous GPF assets available to conduct intelligence gathering operations against the enemy forces on Koh Tang. Both the Air Force and Navy had sophisticated fast and slow moving aircraft with high technology photographic equipment that were capable of taking detailed overhead photograph of the target.²⁶⁷ In addition, both the Navy's P-3 Orion and the Air Force's AC-130 gunship had night vision capability and extended loiter time. Finally, tactical fighter and attack aircraft continually flew over the island at high speeds attracting anti-aircraft artillery (AAA) from the enemy ground forces. The knowledge and location of AAA in itself was valuable intelligence since the Marines were infiltrating by helicopter. It appears as though even this information did not reach the Marines. All of these assets were used, however, as already mentioned, they did not provide the Marines with an accurate assessment of enemy disposition on Koh Tang.

The single asset that could have provided an accurate assessment was the SOF element, Delta Platoon of SEAL Team One, that was staged and ready at Subic Bay. Execution of such a mission was consistent with SEAL standard operation procedures and doctrine.²⁶⁸ Up to forty-eight hours in advance of the Marine assault force, part or all of the fourteen-man SEAL platoon and their CRRCs could have been inserted into the area of Koh Tang island by boat, ship, submarine, helicopter or fixed wing aircraft. After approaching within 2000 yards of the island, the remainder of the distance could have been negotiated by swimmers. The SEALs would have first conducted reconnaissance of the designated HLZs and their surrounding area to determine if they were suitable for the Marine insertion. If they were not suitable, they would have designated other HLZs possibly for the use of the BLU-82.

²⁶⁷ Ibid., p. 143. Strategic assets that should have been available for the mission, though none of the literature specifically identifies them, were the SR-71 and U-2 spy planes and spy satellites. In addition, tactical reconnaissance assets such as the RF-4 were available.

²⁶⁸ Nadel, p. 129.

It was unlikely that the SEALs could have located the prisoners without compromising the mission but it was highly likely that they could have determine the prisoners were not being held in the area of the designated HLZs. As a result preparatory Naval Gunfire Support or close air support could have been utilized.

After the intelligence had been collected, the SEALs could have exfiltrated using one of the many possible techniques already discussed for insertion and provided the Marines with the valuable target intelligence. If time had been too critical to allow for extraction, the SEALs would have sent the intelligence out using encrypted radios and waited for the Marines to come ashore before they exfiltrated. This last option would have provided the Marines with up-to-date, real time intelligence. In addition, it would have provided guidance for the inbound helicopters and additional fire power on the HLZs.²⁶⁹

1. Probability of SOF and GPF

Appendix F contains the completed probability worksheet for SOF and GPF. Each variable was given values for each of the three mission phases for the GPF but only for the first two phases of the mission for SOF. Though the SEALs could have, theoretically, been extracted, we selected the option in which the SEALs radioed the intelligence back to the planners and remained ashore until the Marines assaulted the island. We assumed that based on mission constraints the SEALs would not have had enough time to infiltrate, execute the actions at the objective and then exfiltrate to Utapao with the intelligence. Remaining ashore would have provided the Marines more planning time with the initial intelligence and continuous intelligence updates.

The GPF (reconnaissance aircraft of various types) values were high for all variables in both the infiltration and exfiltration phase of the operations. This was primarily based on the routine nature of the mission and the aircraft's invulnerability to enemy capabilities. In the actions at the objective phase, GPF dropped slightly in several categories but remained

²⁶⁹ The SEALs could have preset demolitions to detonate just prior to the arrival of the helicopter to disrupt or eliminate close enemy resistance or to provide a diversion. In addition, they could have marked the HLZs with smoke or flares.

high overall. The *readiness* value was down slightly because the sophisticated equipment required to execute the mission demanded a great deal of maintenance to keep it functioning properly. The *enemy weapons OOB* value was down slightly because there was a minute possibility that reconnaissance aircraft could have been hit by small arms fire or AAA. *Mission difficulty*, the category where GPF received their lowest value, was down based on the GPF's inability to identify enemy positions through the thick vegetation on Koh Tang. Finally, the *speed* value was lower than most of the others because some of the aircraft had limited loiter time on target. In addition, high speeds of many of the aircraft made it difficult to observe the target for any extended period of time unless the aircraft was at a high altitude. *Speed*, as described in Chapter I, was generally assumed to be beneficial because it referred to how fast the mission could be accomplished when minimum time on target was advantageous. In the case of reconnaissance, remaining on target for extended periods of time may be a mission requirement. Consequently, *speed*, restricted by loiter time, would have been detrimental. For this mission, the ability to loiter outweighed the need to get off the target, at least for the aircraft since they were relatively safe from any enemy action.

The values for SOF were not nearly as high as the values for GPF. For the most part, this can be attributed to the higher risks that the SEALs would have been exposed to. Any confrontation with the enemy, whether at sea confronted by gunboats or ashore confronted by security patrols, could have been disastrous for the SEALs. This was dependent on the force ratios which was in favor of the enemy on the ground. Consequently, the SEALs' *fire power; enemy OOB; communications, electronic OOB; enemy weapons OOB; and surprise* were all relatively low compared to other categories and to the values the GPF received. *Surprise* in a reconnaissance operations refers to not being compromised while on the mission. *Surprise*, or better stated, remaining undetected was essential to the SEAL platoon so its value was down slightly.

Speed was a variable that worked against the SEALs in this scenario since they would have been required to remain on target to collect intelligence for a long period of time.

Unlike the aircraft that were subject to only a minimal amount of danger, the SEALs would have been in considerable danger for the entire time they were ashore.

Mission *security* could have played an important role in the decision not to use SOF. Reconnaissance missions have been disapproved because the operational commander thought the need for intelligence was not as great as the need for *security* or protecting the primary mission from compromise. In the Mayaguez case, we do not believe that *security* was a limiting variable because Koh Tang was continuously surrounded and overflown by U.S. aircraft and Cambodian gunboats were regularly being attacked. The Khmer Rouge on the island must have already expected an attack. Their suspicions may have been the initiative to send the *Mayaguez* crew to the mainland in view of U.S. aircraft and the subsequent release of the crew a day later.

On the other hand, reconnaissance was a routine mission for the SEALs. Consequently, the SEALs secured high values in *mission skill*, *mission proficiency*, and *corresponding doctrine*.

Reconnaissance missions are not generally considered difficult when the mission parameters allow the reconnaissance element to remain stationary to observe a target. However, in the Mayaguez case, the SEAL element would have been tasked to locate the forty crew members so, the value for *mission difficulty* would have been high. The more the reconnaissance element had to move around, the more likely it was that they would have been compromised, thus the more difficult the mission became.

Appendix F shows our decision tree with probabilities assigned to each phase of the mission based on the above values. Next we will discuss the political and military values and cost that will be applied to the decision tree to determine the *expected values* and *expected costs* for both SOF and GPF.

2. Political Value

Prior to U.S. military actions to recover the *Mayaguez* and her crew, the *political value* of the entire operation was assumed to be extremely high by U.S. leaders. Considering the recent fall of friendly governments in Saigon and Phnom Penh to communist insurgencies, and North Korea's belligerence toward the U.S. and South Korea, the Ford Administration had to act decisively in order to maintain some semblance of power in the international community as well as at home. The Administration feared inaction would lead to another *Pueblo* incident that would require extended negotiations and leave the U.S. resembling a "helpless giant."²⁷⁰

It is relatively easy to measure the *political value* of the overall *Mayaguez* operation, however, it is difficult to measure the *political value* of a ground reconnaissance operation that was never executed. Considering the reconnaissance was not executed, little value was given to the option by U.S. leaders at the time. It is unlikely that the planners did not consider sending a reconnaissance team ashore since the tactic was standard operating procedure for amphibious assaults. Probably, the SEAL mission was decided against because of time constraints or undeserved confidence in the intelligence already available to the planners. In retrospect, if the *Mayaguez* crew had been on the island, the mission that the Marines executed may not have resulted in their rescue. Instead, it is likely that it would have resulted in the recovery of their bodies and additional casualties for the rescue force. The *political value* of a failed rescue mission relative to a successful mission would be very low. On the other hand, if the rescue mission had been successful because the ground reconnaissance was successful, the reconnaissance would share the same high *political value* that the rescue mission achieved.

We applied the *political value* of the rescue mission to the ground reconnaissance. Had a ground reconnaissance been executed, the Marines would have known the intelligence estimates that they had used to plan their mission were wrong. They could have made

²⁷⁰ Vandembroucke, pp. 74-84, 112, Lamb, pp. 30-31, 157-166, and Head pp. 144-148.

adjustments in their plan to ensure a quick victory on the island.²⁷¹ A quick victory, demonstrating leadership, resolve, and potency would bring about the highest possible *political value*.

International political value for the overall mission was high. The mission demonstrated U.S. resolve and capability to secure its vital interest. This was particularly important in Asia, an area of the world where U.S. prestige and influence had plummeted. Decisive action and success would have established the President as a strong leader, and send a clear message to U.S. allies and enemies alike. Even failure to rescue the *Mayaguez* crew would have had some *international political value* since it would have demonstrated to our enemies that they would be punished for taking action against U.S. assets.

The same can be said of *domestic political value*. Success would have assured the President's leadership ability for the American people. In addition, it would have demonstrated his resolve to protect U.S. interest and U.S. citizens. This was particularly important for President Ford since the position of U.S. president had been tainted by his predecessor, Richard Nixon. The American people had lost faith in the Presidency and decisive action and success in the face of a crisis was one way to get it back. Failure, on the other hand would result in little *domestic political value* and might confirm the public's lack of faith in the Presidency.

The *political value* of the over all operation can also be applied to the GPF reconnaissance missions because they provided intelligence that had some impact on the success of the overall operation. They were unable to provide accurate intelligence on the disposition of enemy forces on Koh Tang or the location of the crew of the *Mayaguez*, but they did provide essential information on the location of the *Mayaguez* and the mainland

²⁷¹ To strengthen their plan, the Marines could have delayed the mission a day so the operation could have been launched from the *Coral Sea* affording only minutes between the waves of assaulters vice hours; they could have used preparatory fires to soften the beach; they could have secured alternate landing zones; and they could have begun the assault with a larger force using all available helicopters for the insertion instead of wasting three to transport Marines to the *Holt* for the recovery of the *Mayaguez*.

targets that were bombed. The *political values* were lower than those achieved by SOF because the GPF contribution to the success of the rescue mission was less than what could have been expected from a SOF option.

3. Military Value

The *military value* of a ground reconnaissance was either considered to be minimal or the mission was considered to be infeasible because of time constraints or the fear of mission compromise. It is hard to imagine that the Marine planners would even consider not using SEALs to perform reconnaissance ashore since it was standard amphibious assault doctrine. In retrospect, the military value of the ground reconnaissance was extremely high, even critical to mission success. As already mentioned, had the *Mayaguez* crew been ashore on Koh Tang, the plan that was executed could have jeopardized their lives as well as the lives of many more Marines. The SOF values for both *mission effectiveness* and *target value* would have been high. A ground reconnaissance would drastically increase the Marines' *mission effectiveness*. In addition, since the *Mayaguez* crisis was at the center of world attention and the rescue of the crew members was the stated top priority mission, the *target value* was also high.

The GPF's *target value* would not have been as high as the values assigned for SOF. Although they provided essential elements of information for the mainland targets, their support of the primary target was less than adequate. *Mission effectiveness* value for collection of intelligence on the disposition of enemy forces on Koh Tang and the location of the *Mayaguez* crew would have been much lower than the value assigned to SOF.

4. Political Cost

The *political cost* of success would have been low both internationally and domestically. There was the possibility that the U.S. would have been criticized for attacking military facilities at Kompong Som since it was unlikely that Cambodia could have responded effectively with reinforcements from the mainland even if the U.S. had not attacked the bases. If the U.S. had not bombed the targets, the U.S. Military had the assets

to intercept any reinforcements the Cambodians might have launched toward Koh Tang.²⁷² In addition, some *international political cost* occurred as a result of the U.S. using the base in Utapao to launch the rescue mission. Publicly the Thai government denounced the use of their soil to launch the mission. This was actually a move to save face in the Asian community because privately Thailand approved of the operation.²⁷³

The *political cost* of failure could have been high both domestically and internationally. Although the U.S. would have demonstrated resolve it would have also demonstrated impotency and would have lost prestige.

The *political cost* of using GPF would be similar to the political cost for SOF because both missions would have contributed to success of the overall operation. The *international political cost* of using GPF could have been slightly higher than using SOF because their mission could have carried them into airspace claimed by third party nations (ie. Thailand or Vietnam) and lead to official protest.

5. Military Cost

Military *opportunity costs* for SOF would have been negligible. The platoon that was deployed to Subic Bay was there to support contingency operations in the Pacific theater. There were no other contingencies elsewhere in the theater so the SEALs were readily available. The *casualties costs* for SOF would likely have been low considering a successful mission. In addition, since their mission would have likely reduced the casualties suffered by the Marines and Air Force crews and helicopters, the *casualty costs* would have been considered extremely low.²⁷⁴

²⁷² Vandenbroucke, pp. 84-65.

²⁷³ Head, p. 146.

²⁷⁴ Lamb, pp. 30-32. Although the cost of casualties was significant on Koh Tang, they were only as low as they were because of luck and a courageous performance by the assault force. Casualties could have been much higher. The use of SOF could have corrected the inaccurate estimation of enemy forces and eliminated or reduced the casualties.

As with SOF, *opportunity costs* were low for GPF since this was the only crisis at the time. It is, however, likely that some strategic intelligence assets were used and, consequently, they were not available to execute their regular missions of spying on the Soviets and Chinese. As a result, minimal *opportunity costs* existed. *Casualties cost* were fairly low for GPF because there was little chance that the reconnaissance aircraft could have been shot down by the Cambodians.²⁷⁵ Since the GPF were unable to provide the essential intelligence that the Marines needed on Koh Tang, GPF *casualty costs* cannot be related to reduced assault force casualties as was the case with the SEALs.

The political and military costs and values are shown in Appendix F. Next we discuss the application of the cost and values to our decision tree to determine the *expected values* and *expected costs* of both SOF and GPF.

E. ANALYSIS

Expected Costs for both SOF and GPF were low compared to the *expected values* so both SOF and GPF had absolute advantage for the target. The Probability Worksheet values were significantly higher for GPF than they were for SOF and the *expected costs* of SOF were significantly higher than the *expected costs* of GPF. However, the great difference in *mission effectiveness* of SOF over GPF resulted in SOF having a significantly higher *expected value* than GPF. As a result, SOF had the *comparative advantage* between SOF and GPF. Since GPF were used and SOF were not used, this demonstrates a simple error of omission.

In this case, GPF and SOF were not in competition for the same mission. Whether SOF were employed or not employed, the GPF would have executed their reconnaissance missions. Since it was not a matter of using SOF instead of GPF, rather using SOF in addition to GPF, the comparison should actually have been the value of the GPF plus the

²⁷⁵ If, by chance, an SR-71 Blackbird or other expensive high technology intelligence gathering aircraft was lost during the operation, the *casualty costs* for the aircraft would have been high in dollar value. More importantly, the *casualty costs* would have been high because of the loss of a limited strategic asset.

value of SOF versus the value of GPF alone. With this in mind, even if SOF did not have the *comparative advantage* over GPF, as long as it did have *absolute advantage*, the SOF option could have been executed without violating our theory.

The use of both SOF and GPF assets in reconnaissance missions may not always be advantageous. If the GPF had been a squad of Marines sent in to reconnoiter the island, their mission would have provided the same intelligence that the SOF mission would provide. In a case such as this, SOF would compare directly to GPF since either one or the other would have been used.

In summary, Appendix F provides a completed decision tree for the use of SOF versus the use of GPF to conduct reconnaissance missions. Using Equations (7), (8), (10), and (11); the values and costs discussed above; and the probabilities discussed above, the resulting *expected values* and *expected costs* from the decision tree are as follows:

$$EV_{\text{SOF}} = 251.3$$

$$EC_{\text{SOF}} = 46.3$$

$$EV_{\text{GPF}} = 127.7$$

$$EC_{\text{GPF}} = 29.9$$

In the *Mayaguez* case study, SOF had an *absolute advantage* and a *comparative advantage* even without adding the *absolute advantage* of GPF to that of SOF but were not used. This demonstrates a simple error of omission.

V. OPERATION URGENT FURY

A. INTRODUCTION

In October 1983 President Ronald Reagan ordered the commencement of Operation URGENT FURY, the U.S. invasion of the eastern Caribbean island nation of Grenada. (Map 23) The Operation began on 25 October 1983 and hostilities ended on 2 November 1983. President Reagan and military leaders characterized the operation similarly. The recently declassified "Operation URGENT FURY Lessons Learned Executive Summary" summed this characterization by both the administration and military leadership when it stated:

URGENT FURY, a joint combat operation conducted in the eastern Caribbean island of Grenada, was accomplished in a most successful manner...Peacekeeping operations are continuing. The outcome of this military mission reaffirmed the outstanding professionalism, dedication and flexibility of all the forces involved in this effort.²⁷⁶

The island had been divided into two sectors, the northern sector was the responsibility of the U. S. Marines and the southern sector was the responsibility of SOF. (Map 24) Both sectors were under control in relatively short order, and on the surface the operation seemed a resounding success for the United States. As some of the harshest critics even admit, "(w)hatever else the invasion of Grenada was, it was a political success."²⁷⁷ Militarily, however, the operation was criticized for several reasons, the most important, for our

²⁷⁶ USCINCLANT, Post Operation Report, "Operation URGENT FURY Lessons Learned Executive Summary," (Norfolk, VA: 1983), p. 1.

²⁷⁷ Gabriel, "Scenes From an Invasion: How the U.S. Military Stumbled into Victory in Grenada" in The Washington Monthly, February 1986, p. 41. Numerous critics offered various critiques of the military operations in Grenada, most notably the above mentioned author, and: Benjamin F. Schemmer, "JCS Reply to Congressional Reform Caucus' Critique of the Grenada Rescue Operation" in Armed Forces Journal International, July 1984, pp. 13-18 and 99; and, Edward N. Luttwak, The Pentagon and the Art of War, (New York: Simon and Schuster, 1984). All found fault with the military operations but recognized the political value of the operation.

purposes being, intelligence. Every decision maker, participant, and critic agreed that the intelligence was virtually non-existent and the lack of good intelligence severely hindered the operation. We believe that this represents a complex error of omission. SOF had both an *absolute* and a *comparative advantage* if used to conduct an SR mission and could have significantly changed the intelligence picture, but were not used.

Since this argument is essentially counterfactual, we will develop a counterfactual scenario based on our theory to demonstrate how the *expected value* of using SOF to conduct SR missions prior to URGENT FURY might have outweighed the *expected cost*. We examine this phenomenon in detail below.

B. BACKGROUND

1. Grenada

Since being "discovered" by Columbus in 1498 Grenada was subsequently colonized by the French and then became subject to British sovereignty pursuant to the Treaty of Paris in 1763.²⁷⁸ During the 1950s and 1960s, the people of Grenada began a movement toward independence, led for the most part by Eric Gairy. In 1967, by virtue of a conference held in Oxford in the summer of 1965, Grenada was given "statehood in association with the mother country."²⁷⁹ The quest for independence continued, complete with political unrest and civil disturbances, until 7 February 1974, when Grenada became an independent state within the Commonwealth. Gairy became Prime Minister, and "[s]ome measure of internal stability was subsequently imposed by [his] increasingly repressive, though pro-western, government."²⁸⁰ Opposition to Gairy involved different groups and underwent various permutations throughout this period. The most prominent group was the New Jewel

²⁷⁸ William C. Gilmore, The Grenada Intervention: Analysis and Documentation, (New York: Facts on File, Inc., 1984), p. 11.

²⁷⁹ Ibid., p. 17.

²⁸⁰ Ibid., p. 19.

Movement (NJM). Founded in 1973, the group reacted to changing circumstances pragmatically, rather than out of some Marxist-Leninist determinism as some have stated, and participated in the bloodless coup d'etat of 13 March 1979.²⁸¹ Maurice Bishop became the Prime Minister of the People's Revolutionary Government (PRG) and Hudson Austin assumed command of the small People's Revolutionary Army (PRA).²⁸²

Bishop was a popular and charismatic leader, who between 1979 and 1983 had accomplished two major achievements. He had tried to "break away" from the western world economically and politically,²⁸³ and he showed that a Caribbean revolutionary government could mobilize its people for national reconstruction.²⁸⁴ By all outward appearances, Bishop's position was secure in October 1983 when he took a week long tour of Eastern Europe, followed by two days of talks with Cuban officials on the way home.²⁸⁵ Dissatisfaction with his repressive leadership, however, resulted in his house arrest on 13 October 1983 by members of the Central Committee of the NJM. Several other Cabinet Ministers were also arrested, enraging the Grenadians who supported Bishop's government. After almost a week of mild protests, Bishop was rescued by a crowd of Grenadians on 19 October 1983. The crowd, after rescuing Bishop, turned toward the capital, seemingly with the intent of freeing other detained Cabinet Ministers. PRA troops intervened and fired into the crowd, causing a significant number of civilian casualties. The armed forces immediately re-arrested Bishop and the other Ministers, and executed them. The Revolutionary Military Council (RMC) was formed, headed by General Hudson Austin, and a "round-the-clock,

²⁸¹ Gordon K. Lewis, Grenada: The Jewel Despoiled, (Baltimore, MD: John Hopkins University Press, 1987), p. 15.

²⁸² Gilmore, p. 20.

²⁸³ Lewis, p. 32. He points out that this was not a Grenadian initiative, but a Cuban idea proposed after decades of relations that continued to grow closer.

²⁸⁴ Ibid., p. 33.

²⁸⁵ Gilmore, p. 30.

shoot-on-sight 96 hour curfew [was] imposed."²⁸⁶ Political outrage and international condemnation followed swiftly.

2. Political

Following the NJM seizure of power in 1979, U.S. Ambassador Frank Ortiz wrote to Bishop that the United States "would view with displeasure any tendency on the part of Grenada to develop closer ties with Cuba." Bishop responded that: "No country has the right to tell us what to do or how to run our country, or who to be friendly with. We are not in anybody's backyard, and we are definitely not for sale." From this point on, relations between the United States and Grenada deteriorated rapidly.²⁸⁷ The Carter administration decided to treat Bishop with "hands-off hostility," and President Reagan intensified the antagonism upon taking office, rather than change the basic U.S. policy.²⁸⁸

Poor relations stagnated or worsened for the four years between 1979 and 1983. Grenada had sought assistance from Eastern Bloc countries and received it. The U.S. government either turned a blind eye to Grenada or took steps to hinder her progress. The crisis of 1983 came about in an environment of ill-will, inauspicious political ties, and economic punishment of the Bishop regime. In President Reagan's "National Security Address to the Nation" on 23 March 1983, he revealed an aerial reconnaissance photograph of a runway being constructed at Point Salines. As he explained:

On the small island of Grenada, at the southern end of the Caribbean chain, the Cubans with Soviet financing and backing, are in the process of building an airfield with a 10,000-foot runway. Grenada doesn't even have an air force. Who is it intended for?

The Caribbean is a very important passageway for our international commerce and military lines of communication. More than half of all

²⁸⁶ Ibid., p. 32.

²⁸⁷ Robert J. Beck, The Grenada Invasion: Politics, Law, and Foreign Policy Decisionmaking, (Boulder, CO: Westview Press, 1993), pp. 25-26.

²⁸⁸ Ibid., p. 26.

American oil imports now pass through the Caribbean. The rapid buildup of Grenada's military potential is unrelated to any conceivable threat to this country of under 110,000 people and totally at odds with the pattern of other eastern Caribbean states, most of which are unarmed.

The Soviet-Cuban militarization of Grenada, in short, can only be seen as power projection into the region.²⁸⁹

The events of October served to intensify the anxiety of the Reagan administration and drive the President toward an invasion.

On Thursday, 13 October 1983, high-level discussions about Grenada began to be held. The various groups that began debate on Grenada included the Restricted Interagency Group (RIG) chaired by the State Department, and the National Security Council (NSC) Staff. Prior to Bishop's house arrest, the division in Grenadian politics was already being discussed.²⁹⁰ By Monday, 17 October 1983, American planning took "place in an interagency forum with representatives of all relevant agencies participating on a daily basis."²⁹¹ The murder of Bishop on Wednesday, 19 October 1983, brought about the beginning of "serious planning" for a "nonpermissive evacuation" of American citizens.²⁹² Accurate intelligence on the situation was unavailable at this time for at least three reasons: the curfew imposed by the RMC; the absence of a U.S. diplomatic presence; and Britain's loss of contact with its diplomats.²⁹³ The first day that the possibility of an American invasion of Grenada was considered at a cabinet-level meeting of the "Special Situations Group" (SSG) was Thursday, 20 October 1983. Secretary Weinberger and the Chairman of the Joint Chiefs of Staff, General Vessey, observed that a surgical strike to remove the Americans would be extremely

²⁸⁹ Ibid., p. 30.

²⁹⁰ Ibid., pp. 91-95. Beck provides an excellent blow-by-blow account of the high-level deliberations regarding Grenada prior to the invasion.

²⁹¹ Ibid., p. 97.

²⁹² Ibid., p. 100.

²⁹³ Ibid., p. 103.

difficult without securing the entire island and they began to seek improved intelligence and more time to plan the invasion.²⁹⁴ Vice President Bush chaired the meeting and immediately determined that steps must be taken to improve intelligence.²⁹⁵ The Crisis Preplanning Group (CPPG) also convened during this time, as both State and Defense agreed that planning a military operation was necessary.²⁹⁶ On Friday, 21 October 1983, President Reagan departed Washington for a golf week-end at Augusta, Georgia. It was felt that any changes to the President's itinerary would invite intense and undesirable speculation. Early on Saturday, 22 October 1983, the Organization of Eastern Caribbean States (OECS) formally invited the United States to invade Grenada. By early Saturday morning, the stage was set for Operation URGENT FURY.²⁹⁷

The SSG met Saturday morning and again Weinberger and Vessey stated that the invading forces needed to know "more about the weapons the Grenadian military possessed, their willingness to fight, and the willingness of Cubans."²⁹⁸ Additionally, Weinberger recommended "the use of Navy SEALs for pre-landing reconnaissance of the island."²⁹⁹ By 1130 the meeting was adjourned with a consensus among the key decision makers. The United States would attack Grenada. The tenets of the mission statement were ironed out, and the military planners were instructed to proceed on the basis of a "go order."³⁰⁰ Beginning on Saturday afternoon, "SR-71 and U-2 spy planes made repeated passes over

²⁹⁴ Ibid., p. 106.

²⁹⁵ Ibid., p. 107.

²⁹⁶ Ibid., pp. 104-105.

²⁹⁷ Ibid., pp. 113-115.

²⁹⁸ Reynold A. Burrowes, Revolution and Rescue in Grenada: An Account of the U.S.-Caribbean Invasion, (Westport, CT: Greenwood Press, 1988), p. 78.

²⁹⁹ Beck, p. 133.

³⁰⁰ Ibid., p. 135.

Grenada while Grenadian radio transmissions were monitored."³⁰¹ Additionally, the National Security Agency began to reposition reconnaissance satellites to provide imagery of the island. Other planning groups also continued to intensify their preparations for the coming invasion.

Any doubts that the invasion of Grenada would receive a "go order," were quickly erased by a tragic event in the Middle East. Early on Sunday, 23 October 1983, the U.S. Marine headquarters in Beirut, Lebanon was bombed, causing extensive U.S. Marine casualties. President Reagan returned to Washington and began considering the events in Beirut and then Grenada.³⁰² By late in the evening, several hours prior to receiving the written request from the OECS for military assistance, President Reagan signed the order authorizing "the Grenada operation to take place no later than dawn, October 25."³⁰³ Monday, 24 October 1983 was a day dominated by invasion preparation, not policy deliberation.

3. Military

On Monday, 24 October 1983, military plans began to be finalized. Admiral Wesley McDonald, USCINCLANT, convened a meeting at his headquarters in Norfolk, Virginia. The Grenada operation was described as a "coup de main" or "one-punch knockout" and the commanders were assured that there was no cause for worry. "(O)nce the PRA recognized that American troops were involved in the operation, they would promptly surrender; the Grenadian anti-aircraft gunners were poorly trained and did not represent a threat; and the Cuban workers would not fight."³⁰⁴ A Navy SEAL unit had failed to successfully insert on Sunday night to recon the airfield at Point Salines and Major General Richard A. Scholtes, the SOF commander, "advocated a twenty-four hour postponement of the invasion to

³⁰¹ Ibid., p. 138.

³⁰² Ibid., pp. 146-147.

³⁰³ Ibid., p. 150.

³⁰⁴ Ibid., p. 159.

improve intelligence."³⁰⁵ After some heated discussions, McDonald was convinced that the operation should proceed on 25 October, although he did shift "H-hour" from 0200 to 0400 to permit further reconnaissance efforts.³⁰⁶

The short planning cycle and the expansion of the mission from one of naval presence/ show of force and possible non-combatant evacuation operation, to a full-scale invasion, increased the need for intelligence. The mission statement from the JCS, directed USCINCLANT to:

conduct military operations to protect and evacuate U.S. and designated foreign nationals from Grenada, neutralize Grenadian forces, stabilize the internal situation, and maintain the peace. In conjunction with OECS/friendly government participants, assist in restoration of a democratic government on Grenada.³⁰⁷

The concept of operations called for an amphibious assault at Pearls Airfield in the northern sector by the U.S. Marines while the U.S. Army Rangers and other SOF were assigned Point Salines Airfield and other specific targets in the St. Georges area of the southern sector. The 82nd Airborne Division was the designated reserve force tasked to relieve the southern sector on order. The Rangers and SOF encountered much stronger resistance from Cuban and Grenadian forces in the southern sector than anticipated. Elements of the Marine forces were withdrawn from the north and re-inserted near St. Georges to provide assistance to elements in that area.³⁰⁸ Every operation conducted during URGENT FURY would have benefited greatly from intelligence, yet only one unit from SOF was tasked with conducting a pre-

³⁰⁵ Ibid., p. 159.

³⁰⁶ Other sources also cite the belief that the USMC helicopter pilots could not fly at night as another reason for shifting H-hour. The effort to insert the same SEAL platoon on Monday night was another failure and the *only* attempt to get SOF eyes on the ground with enough time to make useful intelligence reports before the invasion.

³⁰⁷ USCINCLANT, p. 1.

³⁰⁸ Ibid., p. 2.

invasion SR mission.³⁰⁹ Actual operations are less of a concern to us than the SR missions that were not conducted and will be the focus of the remainder of this chapter.

C. OBJECTIVE

Under the sub-heading of "Reconnaissance," the USCINCLANT Lessons Learned stated, in part, "URGENT FURY operations highlighted the need to increase our capabilities and assets in this area."³¹⁰ Although it is unlikely that several SR missions conducted by SOF would have yielded all of the answers to planners' questions, a vast majority of the questions could have been addressed in some fashion. As Mark Adkins points out:

To ensure surprise, the planners had one need above all others: information. They needed intelligence on the Cuban presence on the island, the Cubans' and Soviets' likely reactions to attack, the PRA strengths, armaments, deployment, intentions, and morale. They needed to know what defenses had been set up at the airfields and where the PRA headquarters, communication centers, supply depots, and antiaircraft positions were. Because a main objective of the operation was the safety of foreign citizens, they needed to know where such persons were living, whether they were guarded, whether they were at one location or several, and how many were at each. They needed information on the geography of Grenada: the suitability of beaches for landing, the type of terrain, the road system, the hills, the layout of St. George's, and the details of approaches to selected targets. These were all critical for tactical planning.³¹¹

³⁰⁹ Another SEAL platoon attached to the ARG did conduct a hasty pre-invasion reconnaissance of the beach and airfield area around Pearls Airfield in the northern sector and provided the information that led to the cancellation of amphibious operations and the subsequent Marine helo assault on Pearls Airfield. This practice is a standard operating principle of amphibious operations and does not usually lead to the type of reconnaissance needed by the forces assaulting the entire island via different means.

³¹⁰ USCINCLANT, p. 4.

³¹¹ Major Mark Adkins, URGENT FURY: The Battle for Grenada, (Lexington, MA: Lexington Books, 1989), p. 128.

SR-71's, U-2's, and satellites could not provide this type of information, especially in the mountainous jungle terrain of Grenada. The objective of SOF should have been to gather as much of this information as possible and pass it on to follow-on forces prior to their arrival in Grenada.³¹² To achieve this objective, McDonald and Vice Admiral Joseph Metcalf III, the Joint Task Force Commander, had the alternative of tasking and inserting more SOF to conduct SR missions on the specific target areas and points of interest, in addition to using aircraft and satellite intelligence gathering methods. The various factors affecting the probability of success of each phase of the mission and different political and military value and cost associated with each branch of our decision tree are discussed below.

D. ALTERNATIVES

The environment and the timing of the invasion limited decision makers to forces that would be able to insert from the air or sea onto the island of Grenada. Insertion from the air, however, was severely limited by the geography and topography of Grenada, the enemy OOB, and intelligence on prospective drop zones. For simplicity we will build our counterfactual scenario around a successful insertion of SEALs conducted in roughly the same manner as the failed attempt. Appendix G provides the completed graphical representation, in the form of a probability worksheet and a completed decision tree, of the factors and variables discussed below.

1. Probability of SOF and GPF

Appendix G contains the completed probability worksheet for SOF and GPF. Each variable is coded for each phase. We are assuming that the SR mission would continue until friendly forces attacked the Grenadian and Cuban forces and extraction would be affected after friendly forces had been established on the island. This assumption is not applicable to GPF forces conducting reconnaissance as they are only able to provide reconnaissance

³¹² The two failures of the SEAL platoon to insert could be used to argue against this point, however, the loss of one Boston Whaler and four SEALs in one water-parachute operation is extremely unlikely and does not provide a basis for predicting the probability of success of future operations of this type. In spite of this, we do recognize the argument.

capabilities for limited amounts of time. GPF had a distinct advantage during all three phases in conducting what is generally considered a routine mission for them. Although the worksheet indicates a probability of almost 1.0 for GPF across the phases, we have assumed that nothing can have a probability of 1.0 in military conflicts and therefore give the GPF a probability of 95% for both the insertion and extraction phases. The actions at the objective phase required the GPF to rely heavily on technological devices while operating in their most vulnerable state and therefore give the GPF a probability of 90% for completing the actions at the objective phase.

Availability, mission difficulty, and the orders of battle are the limiting factors for the probability of a successful insertion phase for SOF. We have determined that SOF had an 85% probability of completing the insertion phase, assuming that *availability* did not provide a show-stopper. *Firepower* and *orders of battle* decreased the probability of success during the actions at the objective phase as SOF had to locate their target and evade the enemy to complete this phase. We have given SOF an 80% probability of completing this phase of the mission. The extraction phase has the highest probability of success, primarily because of the introduction of friendly forces. Limited by the *enemy orders of battle*, we have determined that SOF had a 90% probability of completing the extraction phase if they completed the mission, and 80% probability if they did not.

2. Political Value

Generally, political value is limited in SR missions. Unless the SR mission directly impacts the decision makers' actions, statements, or policies, little can be gained internationally or domestically from gathering intelligence that usually applies strictly to the military prosecution of an enemy. Once the mission and the operation are completed, some *international political value* can be gained if the SR mission is publicized and an ability to infiltrate whenever and wherever we want to is demonstrated. In the case of URGENT FURY, little *international political value* could be gained by a successful SR mission. Especially since our closest Allies, most notably Margaret Thatcher, the British Prime Minister, "raised strong objections to the entire operation and suggested that economic

sanctions might be more appropriate."³¹³ The only *international political value* to be obtained would be from demonstrating above average resolve and capability in conducting SR missions. Additionally, the aircraft and satellite intelligence gathering techniques are a proven capability that other international actors would take for granted, and therefore the use of SOF would result in a larger *international political value*. Obviously, failure to insert, complete the mission, or extract in the case of GPF assets, would yield no political value, internationally or domestically.

Domestic political value is similar to international political value in that SOF would receive a higher value coding than the GPF. The use of SOF, arguably, would have led to the gathering of much more tactically significant intelligence. The more significant intelligence would have increased the overall effectiveness of the operation, and the public would have perceived the operation as demonstrating both outstanding leadership and capabilities. Overall, the *domestic political value* of each mission would be greater than the *international political value* coded for each force. As Lewis painfully states:

There is no doubt, of course, that the Grenada invasion was seen by both the public and mass media as a proper and popular exercise of national power, accepting uncritically the president's version of a strike against a dangerous Communist outpost in the Caribbean, although most Americans had never even heard of Grenada before, or even knew where it was. Even more, it unleashed a mood of euphoric nationalistic jingoism just as the British attack on the Falklands a year before had let loose a similar jingoistic response in the British public...Not even the traditional 'liberal' press was immune to that temper.³¹⁴

Domestic political value, as we have demonstrated before, is more dependent on mission success AND extracting the forces.

³¹³ Burrowes, pp. 79, 118 and 120.

³¹⁴ Lewis, p. 122. He continues by speaking of the "well-orchestrated propaganda campaign" and the "misinformation" concerning the "requests" from Governor-General Scoon, etc.

3. Military Value

Military value, both *mission effectiveness* and *target value*, are dependent upon mission success for SR missions. Limited gray area exists where some affect is gained on the enemy. Like a hostage rescue mission, either the mission is accomplished or it is not. However, in this case, SOF does enjoy an advantage in terms of *mission effectiveness*. The smallest amount of intelligence that SOF could have provided, even if not complete, was more significant for most operators than the intelligence provided by airborne assets. SOF had a clear advantage in providing the type of information that we are building this counterfactual scenario around. In other words, for the type of reconnaissance we are advocating, SOF would have been able to provide more useful information to ground combat elements than the airborne assets. For this reason, a successful SOF mission was given a higher value coding than GPF. GPF success is coded fairly low due to the limited affect the intelligence they gathered had on military planning. Additionally, the information gathered by SOF could have been passed over secure radio nets instead of having to develop the imagery and either disseminate the information or attempt to describe the imagery gathered by GPF to appropriate users.

4. Political Cost

As eluded to earlier, *international political cost* was incurred in operation URGENT FURY regardless of the force or the success or failure of each phase of the mission. The international community was generally outraged at the U.S. military action, calling for a draft resolution in the United Nations (U.N.) condemning the armed intervention.³¹⁵ As Adkins notes:

Reagan had ordered an invasion of a foreign country, a country that was not the object of external attack. He intended, with token assistance, to occupy that country with U.S. forces temporarily and to crush any opposition. He was well aware of the international furor that would result, with the

³¹⁵ Anthony Payne, Paul Sutton, and Tony Thorndike, Grenada: Revolution and Invasion, (London: Croom Helm, 1984), pp. 175-176.

probability of almost worldwide condemnation, both inside and outside the United Nations. He did it in the knowledge that Britain, which had constitutional and Commonwealth links with Grenada, was strongly opposed... He did it without the support of Congress or, more important, the American people; they would learn about it after the event...He did it realizing that he was flying in the face of international law...He launched the largest U.S. military operation since Vietnam in circumstances that could end his presidency and jeopardize U.S. international relations for years to come. It was a decision of enormous import and of enormous risk, not from a military point of view - the United States could never actually lose the shooting war - but from the political consequences.³¹⁶

SOF would have exacted a slightly higher *international political cost* for any failures than GPF because of the nature of the perceived threat in Grenada, which was minimal. Additionally, compromise of SOF on Grenada might have resulted in the seizing of the American students as hostages, further repression of the Grenadians, and international action prior to the invasion.

Domestic political cost would have been minimal across the decision tree because of the perceived communist threat on Grenada. Any SOF failures, however, would have resulted in greater *domestic political cost* than the same GPF failure. A failure of SOF represented the failure of U.S. personnel on the ground in Grenada which would have most likely included some casualties, and would seem more personal to most Americans. Highly technical failures that included casualties could have been blamed away on sophisticated Soviet and Cuban air defenses and would have involved fewer casualties with a less personal public appeal. The lives of the American students would seem to have been a major *domestic political cost* to be considered. The literature, however, reflects an almost complacent attempt to locate, rescue, and protect the medical students on the island, and therefore we have determined that the compromise of SOF or GPF would not have resulted in the students being held hostage. This point is obviously refuted by the rhetoric of the time. We believe that this consideration, however, was not a factor in the decision to attempt to

³¹⁶ Adkins, pp. 106-107.

insert SEALs on Sunday night to conduct the reconnaissance mission. Because of the highly technical nature of reconnaissance aircraft and satellites, failure of any phase does not necessarily indicate a loss of forces whereas failure of any phase for SOF could indicate a major difficulty or loss of forces.

5. Military Cost

The *opportunity cost* of using SOF or GPF was relatively low, but slightly higher for SOF. Several missions were slated for SOF and subsequently conducted by SOF while more SOF remained available for tasking.³¹⁷ The GPF involved in conducting reconnaissance incurred little *opportunity cost* as there were no other missions for them to perform. The SOF used for this mission, however, were in theater already and did incur some slight *opportunity cost* because of the nature of the overall Operation and the heavy requirement for SOF. The *cost of casualties* was generally higher for GPF than SOF. The skill and experience of both SOF and GPF would have been essentially equal, however, replaceability of SOF in the short term would be more difficult than the replacement of aircrews and airframes. Additionally, any failures for SOF could be assumed to have a greater probability of casualties than a failure of GPF. As mentioned earlier, failure of any phase for GPF does not necessarily indicate the loss of an airframe, particularly in the Grenadian environment. Failed extraction, however, would result in a loss of aircraft and aircrew, and therefore incurs the highest possible cost. Had the environment been different and the failure of any phase represented a loss of an airframe and aircrew, the *cost of casualties* would have been greater for GPF than SOF. Because this is a counterfactual case and therefore there was no subsequent execution of the mission to describe, we continue with the analysis of this case.

³¹⁷ While CONUS based, these SOF could have been tasked with conducting the same type of insertion as the SEALs that failed, and could have easily been introduced in the theater. Command relationships would have been slightly ad hoc, however, the capability still existed to introduce these forces had they been deemed necessary.

E. ANALYSIS

The failure to use more than one SOF unit to conduct a special reconnaissance mission prior to Operation URGENT FURY represents an error of omission. We initially considered this case a complex error of omission. We assumed that the political and military environment prevented GPF from gathering the type of intelligence needed by mission planners and that they did not, therefore, hold an *absolute advantage*. Upon further review of the events surrounding the operation, it became clear that GPF did have an *absolute advantage*. However, their limited tactical utility prevented them from gaining the *comparative advantage*. This case, like the Mayaguez case, represents a simple error of omission. SOF had both an *absolute* and *comparative advantage* but were not used to their full extent. We recognize the limitations and concerns involved with using SOF to conduct an SR mission. The planning cycle was short, the perceived Grenadian and Cuban capabilities discounted the need for detailed intelligence, and there was a danger that compromise might end with the seizing of the students. SOF, however, provided the capability to gather much needed information, increasing the *expected value* of the operation significantly, at a low *expected cost*.

Some of the perceptions voiced by decision makers substantiate the need for a systematic framework. The day before the assault, during some heated discussions regarding the improvement of intelligence on Grenada, Admiral McDonald interjected:

I can't believe what I'm hearing around this table. All you're going to face is a bunch of Grenadians. They're going to fall apart the minute they see our combat power. Why are we making such a big deal of this?³¹⁸

³¹⁸ Beck, p. 159. Sholtes advocated a twenty-four hour postponement of the invasion to improve intelligence. The vigorous "exchange of views" that followed and sparked Admiral McDonald's remark, was put to rest after the State Department representative refused to delay the invasion because he was concerned about the stability of the OECS coalition.

While we are confident that the operators did not treat Operation URGENT FURY with the disregard exhibited by Admiral McDonald, the mindset shows the exact attitude that would precede an error of omission. Decision makers did not understand the capabilities and limitations of SOF and devalued the importance of intelligence. Adkins points this out as he writes about the decision to bump H-hour from 0200 to 0400 and finally 0500:³¹⁹

The conventional planners seemed to have no inkling what this would mean for those Special Operations Forces who needed darkness on D-day to carry out their missions. Navigational aids were deemed more important than the achievement of surprise... Given the planners' lack of information about the enemy, this flagrant disregard for the foremost of military principles was a professional blunder that came within an ace of wrecking the entire operation.³²⁰

Decision makers appear to have been locked in to launching the operation on the date originally given by the National Command Authority. They disregarded the importance of intelligence. The half-hearted attempt to gather last minute intelligence only resulted in jeopardizing the majority of SOF operations that immediately followed.

The most significant costs associated with the use of SOF were political. Costs that appear to have been acceptable to the administration at the time. The value of using SOF to gather intelligence, however, was significantly greater than the cost. The *military value* of the information needed to plan the tactical operations that ensued would have been well-worth any risks associated with the compromise of friendly forces. The *expected value* outweighed the *expected cost* of using SOF to conduct reconnaissance missions.

An interesting aspect of missions of this type is that even when SOF are used to conduct special reconnaissance missions, other GPF assets continue to gather the same

³¹⁹ This compromise occurred as a result to the heated discussions mentioned above. Sholtes wanted to delay twenty-four hours and McDonald agreed to move H-hour to 0400 in order to allow another attempt to gather intelligence. The other SOF forces that had D-day missions also required darkness and surprise to accomplish their missions.

³²⁰ Beck, p. 170.

intelligence they would gather if SOF were not used. In cases when both forces have an *absolute advantage*, the use of both forces increases the *expected value* of the intelligence effort. Obviously the overall *expected cost* increases also, however, the result is generally a greater increase in *expected value* than *expected cost*, and a net gain.

Appendix G provides a completed decision tree for the use of SOF versus the use of GPF to conduct reconnaissance missions. Using Equations (7), (8), (10), and (11); the values and costs discussed above; and the probabilities discussed above, the resulting *expected values* and *expected costs* from the decision tree are as follows:

$$EV_{\text{SOF}} = 180.9$$

$$EC_{\text{SOF}} = 129.1$$

$$EV_{\text{GPF}} = 117.1$$

$$EC_{\text{GPF}} = 98.8$$

SOF did hold an *absolute advantage* and a *comparative advantage* but were not used while GPF did hold an *absolute advantage*, demonstrating a simple error of omission.

VI. CONCLUSIONS

An analytical definition of the misuse of SOF does not exist. Misuse is both a difficult problem to define and a problem that must be avoided. The post-cold war world has produced hundreds of relatively minor conflicts, or "operations other than war." These conflicts present decision makers with numerous options that are less cut and dried than the options in previous conflicts. In those conflicts, the lines between democracy-and-communism, good-and-evil, and black-and-white were clearly defined. In today's conflictual environment, there seems to be a threshold of media exposure and numbers of casualties that drives American foreign policy and the subsequent use of military force. Sixty-six civilians killed by mortar fire in the Markale market in Sarajevo appeared to breach the "entrance threshold" for U.S. decision makers. Eighteen dead U.S. servicemen on the streets of Mogadishu, meanwhile, appeared to violate the "exit threshold" for U.S. decision makers. In an environment full of uncertainty, both international and domestic political ramifications, and intense media scrutiny, the proper use of SOF is essential. Misuse results in either a failed mission or an inordinate price for success. This thesis develops a theory of misuse and provides a systematic method of addressing, analyzing, and avoiding this problem.

Our theory is based on published doctrine and decision making theory and is directed to SOF. The elements of probability, political and military value, and political and military cost leap from the doctrine. Our theory demonstrates a method of considering these elements and assigning probabilities and resulting pay-offs to the decision tree. The decision tree allows us to quantify, in an abstract way, the decision to use or not to use SOF instead of GPF. Assuming that something must be done by either SOF or GPF, it is our belief that misuse occurs at the decision point because decision makers lack understanding of SOF limitations and capabilities. We have quantified this decision process and determined that misuse occurs when SOF are *used* while GPF have an *absolute* and *comparative advantage*, or, misuse occurs when SOF are *not used* while they have both an *absolute* and *comparative*

advantage over GPF. The concepts of *absolute* and *comparative advantage* are crucial to our theory of the misuse of SOF.

If the *expected value* of SOF conducting a specific mission is greater than the *expected cost* of SOF conducting the mission, then SOF have an *absolute advantage*. This same ratio of *expected value-to-expected cost* is calculated for GPF, and assuming that both forces have an *absolute advantage*, used to compare the two forces. The force with the greatest *expected value-to-expected cost* ratio is said to have the *comparative advantage*. *Absolute* and *comparative advantage* are the necessary and sufficient conditions for proper use and allow us to delineate specific types of errors. Errors of commission and errors of omission are derived from our definition of misuse. Simple errors involve mistakes of *comparative advantage* while complex errors involve both *absolute* and *comparative advantage* mistakes. These four types of errors were the focus of our case studies.

The case studies were chosen to represent four commonly believed cases of misuse that illustrate the four different types of errors. The tragic SEAL mission at Paitilla airport during Operation JUST CAUSE is commonly referred to as a misuse of SOF because "it wasn't a SEAL op," implying a simple error of commission. This was the only case study of misuse that we found to be a proper use of SOF. Merrill's Marauders, one of the forefathers of today's Rangers, are commonly believed to have been misused as line infantry against Japanese Divisions, implying a complex error of commission. We found this to be true. Errors of omission are more difficult to apply to a case study, as the argument is necessarily counterfactual. Both the Mayaguez incident and Operation URGENT FURY received intense criticism for the lack of accurate intelligence provided to the ground forces, and have spurred some SOF advocates to question the non-application of SOF. These cases, based on their environment of context, were believed to represent simple and complex errors of omission respectively. Both case studies, however, resulted as simple errors of omission.

Every mission is launched with a decision maker calculating the *expected value* and the *expected cost*. It may be an intuitive, ad hoc determination made in the back of his mind or part of a staff briefing that includes the probability of success and the expected casualties. Regardless of what it is called, it is a process that weighs *expected value* and *expected cost*. This thesis provides a systematic theoretical framework that defines the variables that should be taken into consideration in such a process and highlights their inter-relationships. If we agree that *expected value* and *expected cost* exist, and we accept the framework established in this thesis as a starting point, then we can begin to have a meaningful disagreement about the misuse of SOF. To date, there is no agreed upon systematic way of approaching the problem.

What is the cost of misuse? Two costs are paid, and neither is acceptable. First, misuse may result in a failed mission. Either SOF were used and failed, or they were not used and the mission failed. Failed missions carry with them limited to zero political and military value, as well as the subsequent political and military costs. These values and costs have increased in the post-cold war world and the United States cannot afford to conduct operations that do not meet the necessary and sufficient conditions for proper use. Proper use may not equal mission success, but it certainly creates a conducive environment. Second, misuse may result in paying an inordinate price for success. This causes an overall political and military inefficiency that may teach decision makers the wrong lessons and may result in more inefficiency down the road, fostering a continual cycle of paying a high price for success. An interesting and counter-intuitive point illuminated by this thesis is that mission failure does not necessarily signal misuse. Conversely, mission success does not imply the proper use of SOF. Just because "it worked the last time" does not mean it will work again.

To avoid misuse, decision makers must think in terms of *absolute* and *comparative advantage*. The factors affecting the probability of success for each phase must be

considered, as well as the value and cost associated with each branch of the decision tree. The *expected value* and *expected cost* must be calculated and the *absolute* and *comparative advantage* established. These are the necessary and sufficient conditions to avoid the misuse of SOF.

APPENDIX A. PROBABILITY WORKSHEET

Variable	Infiltration	Actions @ Obj	Exfiltration
Mission Skill			
Mission Proficiency			
Fire Power			
Readiness			
Availability			
Doct. Correspond			
Enemy OOB			
Comm/Elect OOB			
Weapons OOB			
Mission Difficulty			
Supportability			
Simplicity			
Security			
Repetition			
Surprise			
Speed			
Purpose			
Result			

APPENDIX B. OPERATION RICE BOWL

1. Probability worksheet for SOF used to conduct Operation RICE BOWL.

Variable	Infiltration					Actions @ Obj					Exfiltration				
Mission Skill					x					x					x
Mission Proficiency					x					x				x	
Fire Power					x					x					x
Readiness					x					x					x
Availability					x					x					x
Doct. Correspond				x						x					x
Enemy OOB					x				x					x	
Comm/Elect OOB					x				x					x	
Weapons OOB					x				x					x	
Mission Difficulty	x								x					x	
Supportability					x				x					x	
Simplicity					x					x					x
Security					x					x				x	
Repetition			x							x					x
Surprise			x			x									x
Speed				x				x					x		
Purpose				x						x					x
Result					x					x					x

2. Explanation: The insertion phase, inspite of extreme difficulty; lack of repetition; and necessity of surprise, all things being equal, obtains a relatively high probability of success. The actions at the objective phase obtains an even higher probability of success, once again, all things being equal. Finally, the extraction phase obtains the same high

probability of success as the insertion phase, based on the independent analysis of the variables, all considered equal. Obviously, all variables are not equal, and the decision maker will make value judgements on which variables are most important, or which variables affect the mission package the most. In a comparative situation, although an exact probability of success cannot be determined, a relative difference can be determined.

3. The completed decision tree with the subsequent probabilities, values and costs associated with each branch of the decision tree is presented below.

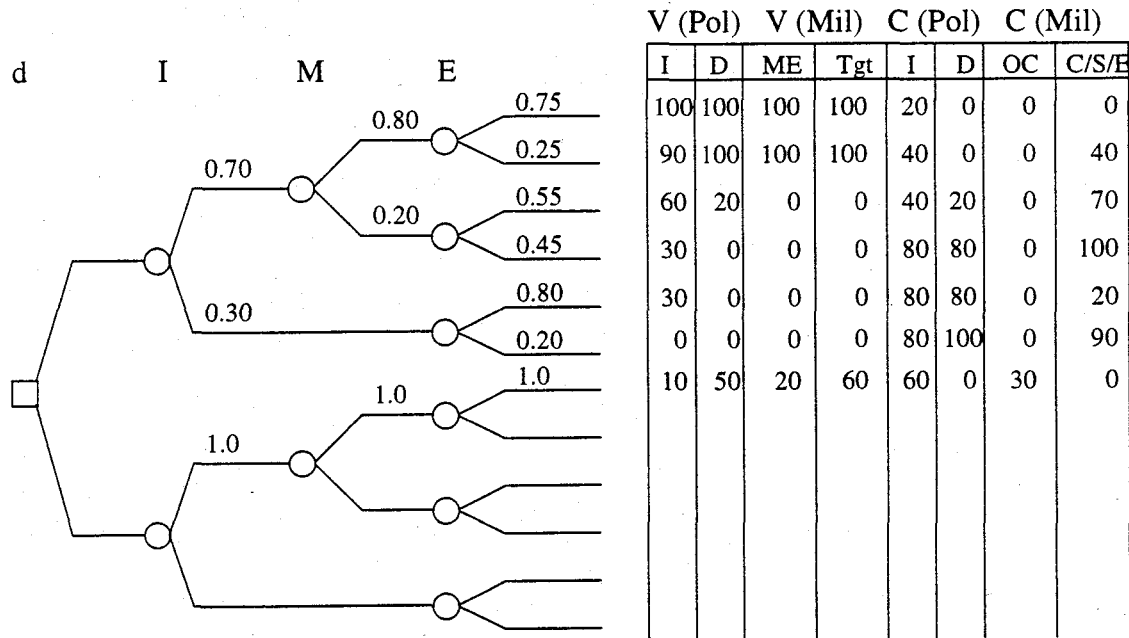

SOF: EV = 237.8 EC = 93.0 EV/EC = 2.56

The analysis was conducted versus the cost of doing nothing. To demonstrate the machinations of calculating *expected value* and cost, we have calculated the expected international political value below as an example:

$$\begin{aligned}
 & (0.70) [(0.80) [(100) (0.75) + (90) (0.25)] + \\
 & (0.20) [(60) (0.55) + (30) (0.45)]] + \\
 & (0.30) [(30) (0.80) + (0) (0.20)] = 68.3
 \end{aligned}$$

4. The *absolute/comparative advantage* graph is presented below with the ratio of SOF versus the cost of doing nothing indicated by an X.

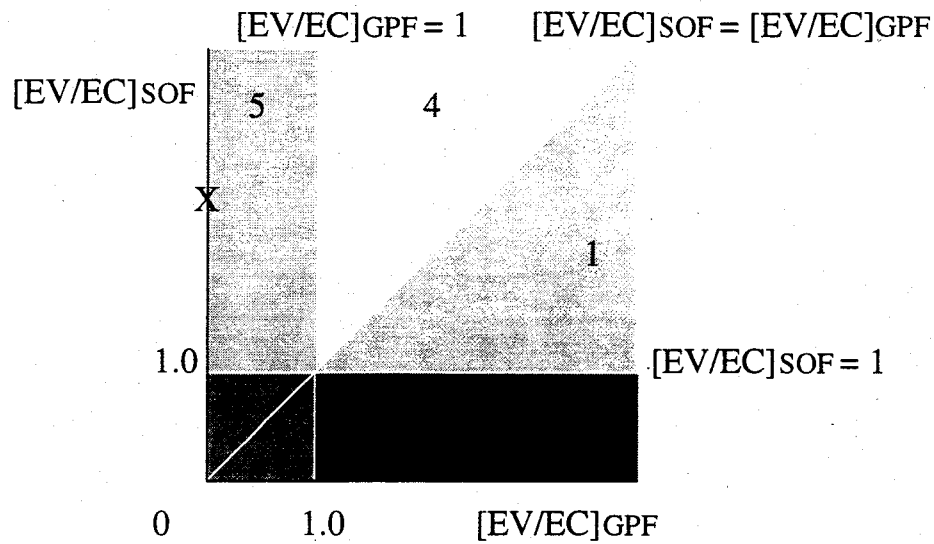

Clearly, the mission to rescue the American hostages in Iran was not a misuse of SOF.

APPENDIX C. POLITICAL AND MILITARY VALUE AND COST CODING

1. Political Value:

International Political Value

- 100 Single objective of United States and Allies and Demonstrate/communicate unprecedented resolve and capability
- 90 Demonstrate/communicate unprecedented resolve and capability
- 80 Single objective of United States and Allies
- 70 One of several (1-3) objectives of United States and Allies and Demonstrate/communicate extreme resolve and capability
- 60 Demonstrate/communicate extreme resolve and capability
- 50 One of several (1-3) objectives of United States and Allies
- 40 One of many (3-10) objectives of United States and Allies and/or Demonstrate/communicate above average resolve and capability
- 30 Demonstrate/communicate above average resolve and capability
- 20 One of many (3-10) objectives of United States and Allies
- 10 One of numerous (>10) objectives of United States and Allies and/or Demonstrate/communicate resolve and capability
- 0 Solely the objective of the United States and minimal deterrent value

Domestic Political Value

- 100 Perceived as single national interest, public willing to pay a high price and/or Demonstrates unprecedented leadership/capability
- 80 Perceived as vital national interest and/or Demonstrate outstanding leadership/capability
- 50 Perceived as an important national interest and/or Demonstrate good leadership/capability
- 20 Perceived as a national interest and/or Demonstrate effective leadership/capability
- 0 Perceived as non-national interest, not worth one American life, demonstrate poor leadership

2. Military Value:

Mission Effectiveness

- 100 Mission 100% complete, complete military effect on enemy
- 80 Partial mission complete, severe military effect on enemy
- 60 Partial mission complete, significant military effect on enemy
- 40 Partial mission complete, some military effect on enemy military
- 20 Partial mission complete, minor military effect on enemy
- 10 Partial mission complete, no significant military effect on enemy
- 0 Mission 0% complete, no military effect

Target Value

100	Single national strategic target
80	National strategic target
60	Theater strategic target
40	Operational target
20	Tactical target

3. Political Costs

International Political Cost

100	Complete condemnation of International Community (including Allies)
80	Perceived as militarily weak, indecisive, or incompetent, Allies distance themselves
60	Perceived as militarily weak, indecisive, or incompetent, Allies speak out against US
40	Perceived as militarily weak, indecisive, or incompetent, loss of credibility
20	Loss of credibility
0	None

Domestic Political Cost

100	Complete loss of public confidence, Congressional upheaval
80	Loss of confidence, Congressional hearings
50	Loss of confidence, media attack
20	Media/public question leadership
0	None

4. Military Cost

Opportunity Cost

100	One unit, multiple missions
80	One unit, many missions
70	One unit, several missions
60	Several units, multiple missions
50	Several units, many missions
40	Several units, several missions
30	Many units, multiple missions
20	Many units, many missions
0	Many units, several missions

Casualties, Skill, and Experience

100	100% casualties, irreplaceable in short term, high dollar cost of equipment casualty
90	Heavy casualties (50-100%), irreplaceable in short term
80	Heavy casualties (50-100%), replaceable in short term
70	Medium casualties (25-50%), irreplaceable in short term
60	Medium casualties (25-50%), replaceable in short term
50	Medium dollar cost of equipment casualty
40	Light casualties (0-25%), irreplaceable in short term
30	Light casualties (0-25%), replaceable in short term
20	Minimum casualties, low dollar cost of equipment casualty
0	0% casualties

APPENDIX D. PAITILLA AIRPORT: OPERATION JUST CAUSE

1. Probability worksheet for SEALs (indicated by S's) versus Rangers (indicated by R's) and Marines (indicated by M's) for the operation at Paitilla airport during Operation JUST CAUSE. If two or three forces are coded the same, they are represented by X's.

Variable	Infiltration						Actions @ Objective							
Mission Skill						X						S	X	
Mission Proficiency					S	X						X	R	
Fire Power						X					S	R	M	
Readiness						X							X	
Availability	M		R			S	M		R				S	
Doctrine Correspond						X			S				X	
Enemy OOB						X					S	R	M	
Comm/Elect OOB					X	R						S	X	
Weapons OOB					R	X						X	M	
Mission Difficulty					S	X			S				X	
Supportability		R			S	M							X	
Simplicity					S	X			S				X	
Security						X						X		
Repetition						X							X	
Surprise						X					X			
Speed					S	M	R					S	M	R
Purpose						X							X	
Result					R	M	S					M	R	S

2. The completed decision tree is presented below.

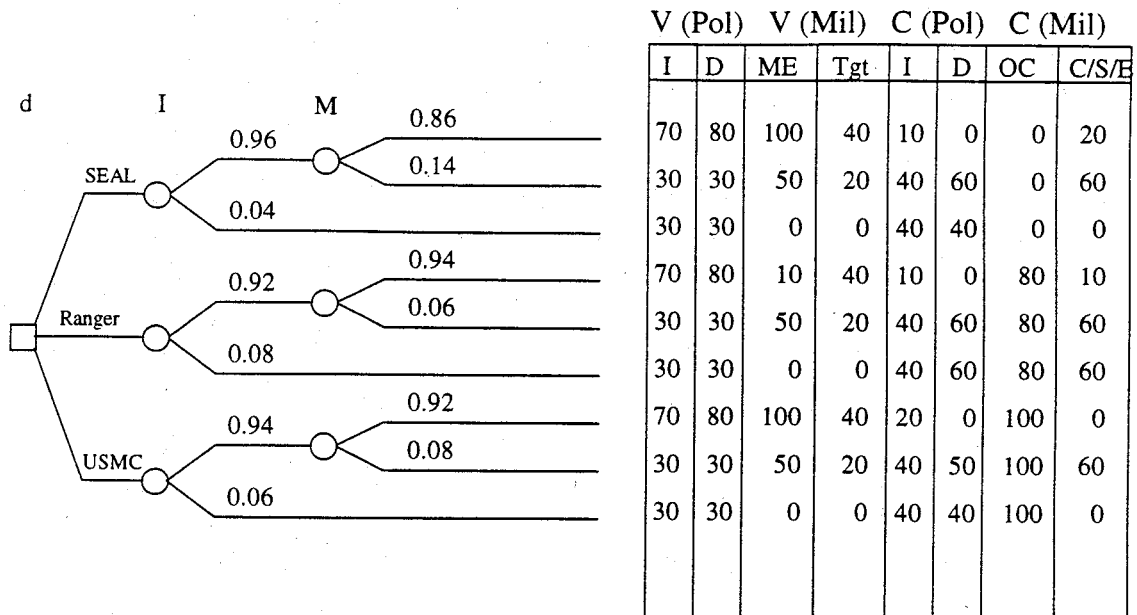

SEAL: EV = 259.3 EC = 49.5 EV/EC = 5.24
 Ranger: EV = 262.8 EC = 118.9 EV/EC = 2.21 EC-OC = 38.9 EV/(EC-OC) = 6.76
 Marine: EV = 264.2 EC = 118.9 EV/EC = 1.98 EC-OC = 33.4 EV/(EC-OC) = 7.91

3. The absolute/comparative advantage graph is presented below with the absolute advantage ratios of SEAL vs. Rangers and versus Marines indicated by R and M respectively.

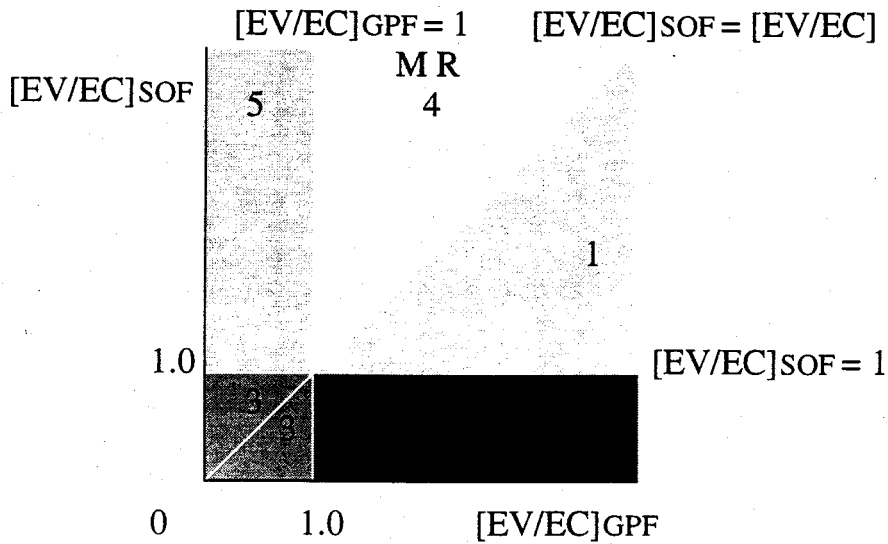

APPENDIX E. MERRILL'S MARAUDERS AT MYITKYINA

1. Probability worksheet for Merrill's Marauders (indicated by x's) versus Chinese GPF (indicated by o's) for the seige at Myitkyina. Both forces are represented by *'s.

Variable	Infiltration					Actions @ Objective						
Mission Skill				*				x		o		
Mission Proficiency					*				x	o		
Fire Power				x	o			x		o		
Readiness				x	o			x		o		
Availability					*			N	A			
Doctrine Correspond					*		x			o		
Enemy OOB				x	o			x		o		
Comm/Elect OOB					o	x			o		x	
Weapons OOB					o	x				x	o	
Mission Difficulty			x		o			x		o		
Supportability				x	o					x	o	
Simplicity					x	o				*		
Security					o	x			o		x	
Repetition					x	o			x		o	
Surprise					o		x		o		x	
Speed					o		x			o		
Purpose					o		x			o		x
Result					*			x		o		

2. The completed decision tree is presented below.

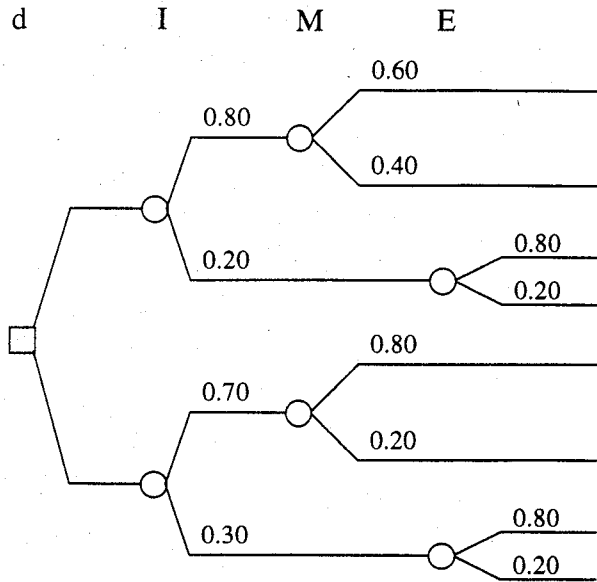

V (Pol)		V (Mil)		C (Pol)		C (Mil)	
I	D	ME	Tgt	I	D	OC	C/S/E
60	50	100	60	0	0	80	40
0	20	20	0	40	20	80	70
0	0	0	0	60	50	80	20
0	0	0	0	60	60	80	90
70	20	100	60	0	0	40	30
0	0	60	0	20	20	40	60
0	0	0	0	40	20	40	20
0	0	0	0	60	20	40	80

SOF: EV = 142.4 EC = 170.0 EV/EC = 0.84

GPF: EV = 148.4 EC = 99.6 EV/EC = 1.49

3. The *absolute/comparative advantage* graph is presented below with the absolute advantage ratio indicated by an X.

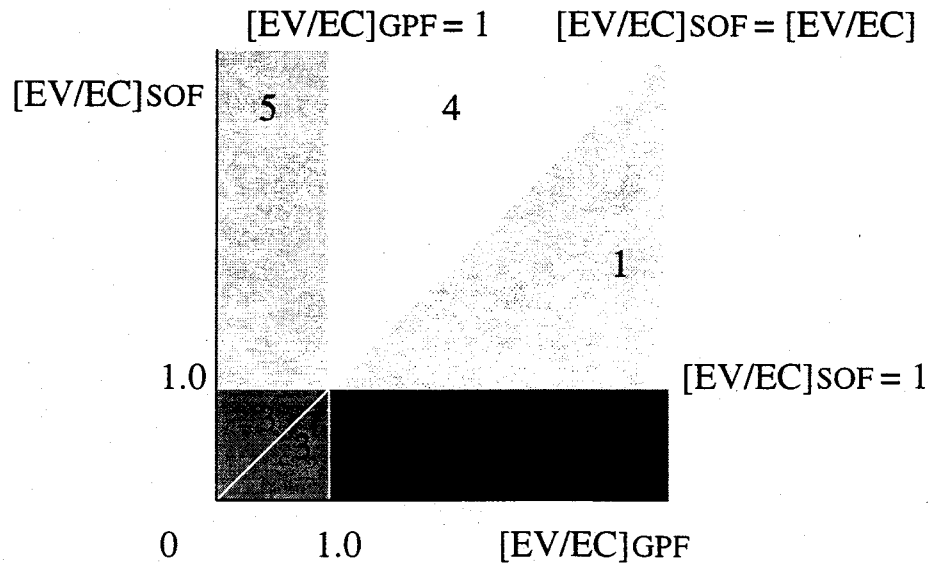

APPENDIX F. MAYAGUEZ INCIDENT

1. Probability worksheet for SOF (indicated by x's) versus GPF (indicated by o's) in conducting reconnaissance mission prior to operations on Koh Tang Island. When the coding of each is equal, it is represented by *'s.

Variable	Infiltration				Actions @ Obj				Exfiltration			
Mission Skill				*				*				
Msn Proficiency				*				*				
Fire Power		x		o	x			o				
Readiness				*				o x				
Availability				*				*				
Doctrine Corrspd				*				*				
Enemy OOB			x	o	x			o				
Comm/Elect OOB			x	o				x o				
Weapons OOB			x	o	x			o				
Mission Difficulty				*			x o					
Supportability			x	o				x o				
Simplicity				*				x o				
Security				x o				x o				
Repetition				x o				x o				
Surprise			x	o				x o				
Speed			x	o	x			o				
Purpose				*				*				
Result			x	o			x	o				

2. The completed decision tree is presented below.

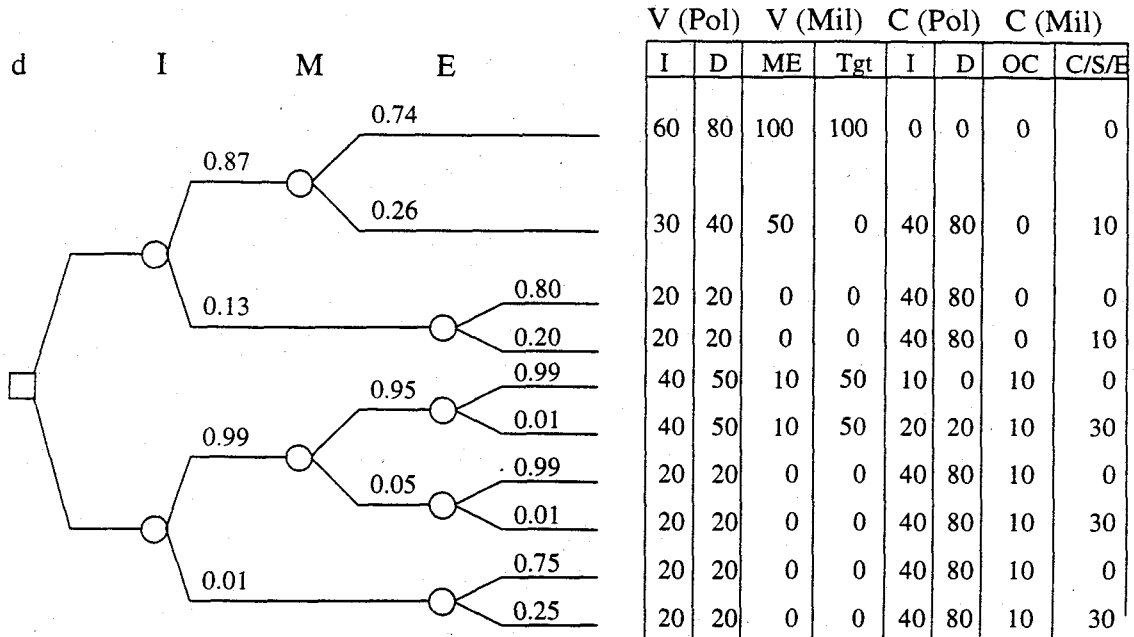

SOF: EV = 251.3 EC = 45.3 EV/EC = 5.55

GPF: EV = 127.7 EC = 29.9 EV/EC = 4.25

3. The *absolute/comparative advantage* graph is presented below with the advantage ratio indicated by an X.

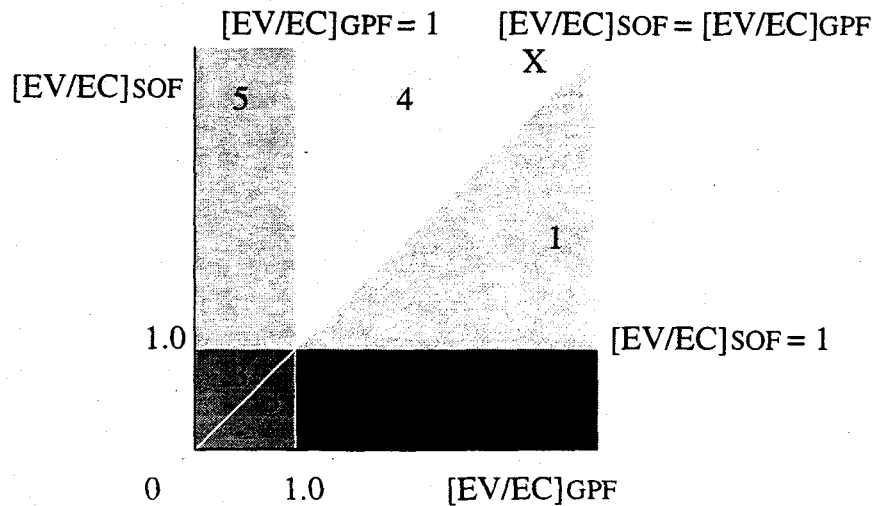

APPENDIX G. GRENADA - OPERATION URGENT FURY

1. Probability worksheet for SOF (indicated by x's) versus GPF (indicated by o's) in conducting reconnaissance mission prior to Operation URGENT FURY. When the coding of each is equal, it is represented by *'s.

Variable	Infiltration				Actions @ Obj				Exfiltration			
Mission Skill				x o				x o				x o
Msn Proficiency				x o				x o				x o
Fire Power			x	o			x	o			x	o
Readiness				*				x o				x o
Availability			x	o			NA				NA	
Doctrine Corrspd				*				*				*
Enemy OOB			x	o			x	o			x	o
Comm/Elect OOB			x	o			x	o			x	o
Weapons OOB			x	o			x	o			x	o
Mission Difficulty			x	o			x	o			x	o
Supportability			x	o			x	o				*
Simplicity			x	o			x	o			x	o
Security				*				x o				*
Repetition			x	o				x o				x o
Surprise			x	o			x	o				x o
Speed			x	o			x	o			x	o
Purpose				*				*				*
Result				x o				x o				x o

2. The completed decision tree is presented below.

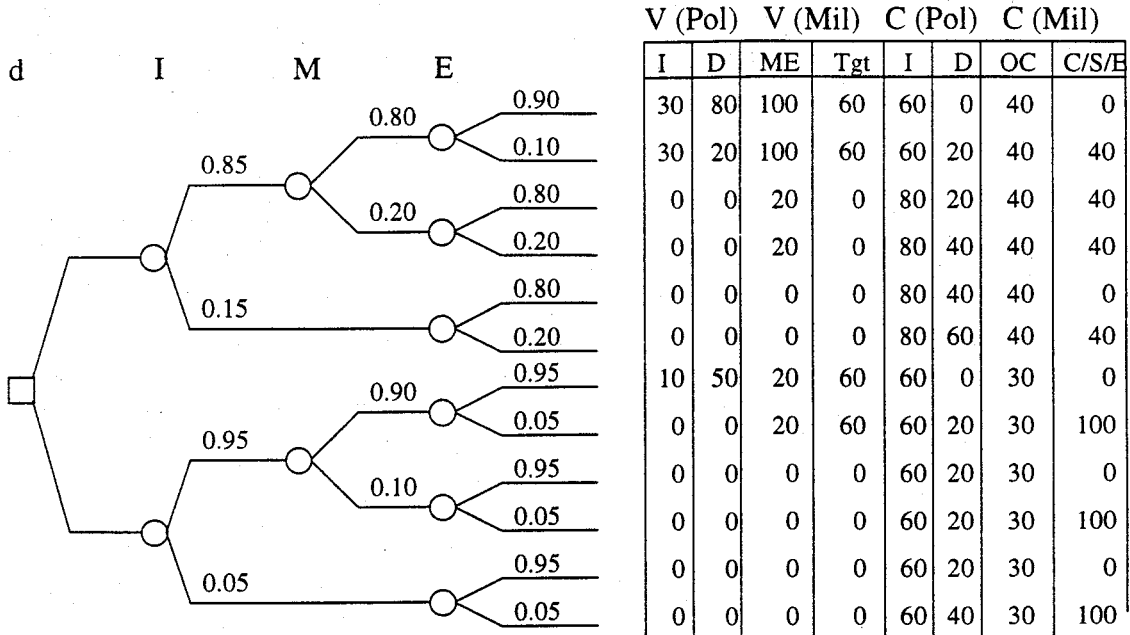

SOF: EV = 180.9 EC = 129.1 EV/EC = 1.40

GPF: EV = 117.1 EC = 98.8 EV/EC = 1.18

3. The *absolute/comparative advantage* graph is presented below with the advantage ratio indicated by an X.

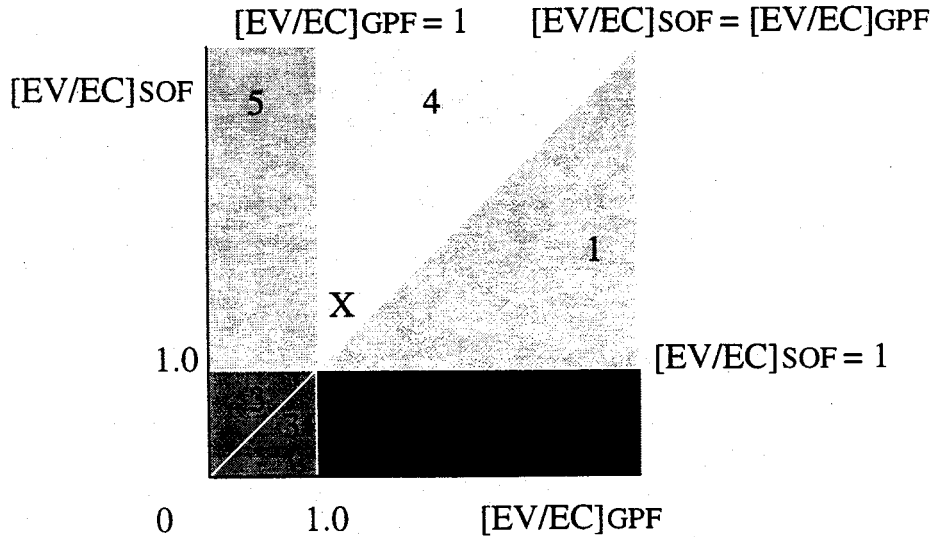

APPENDIX H. MAPS

1. Paitillia Airport Operation.

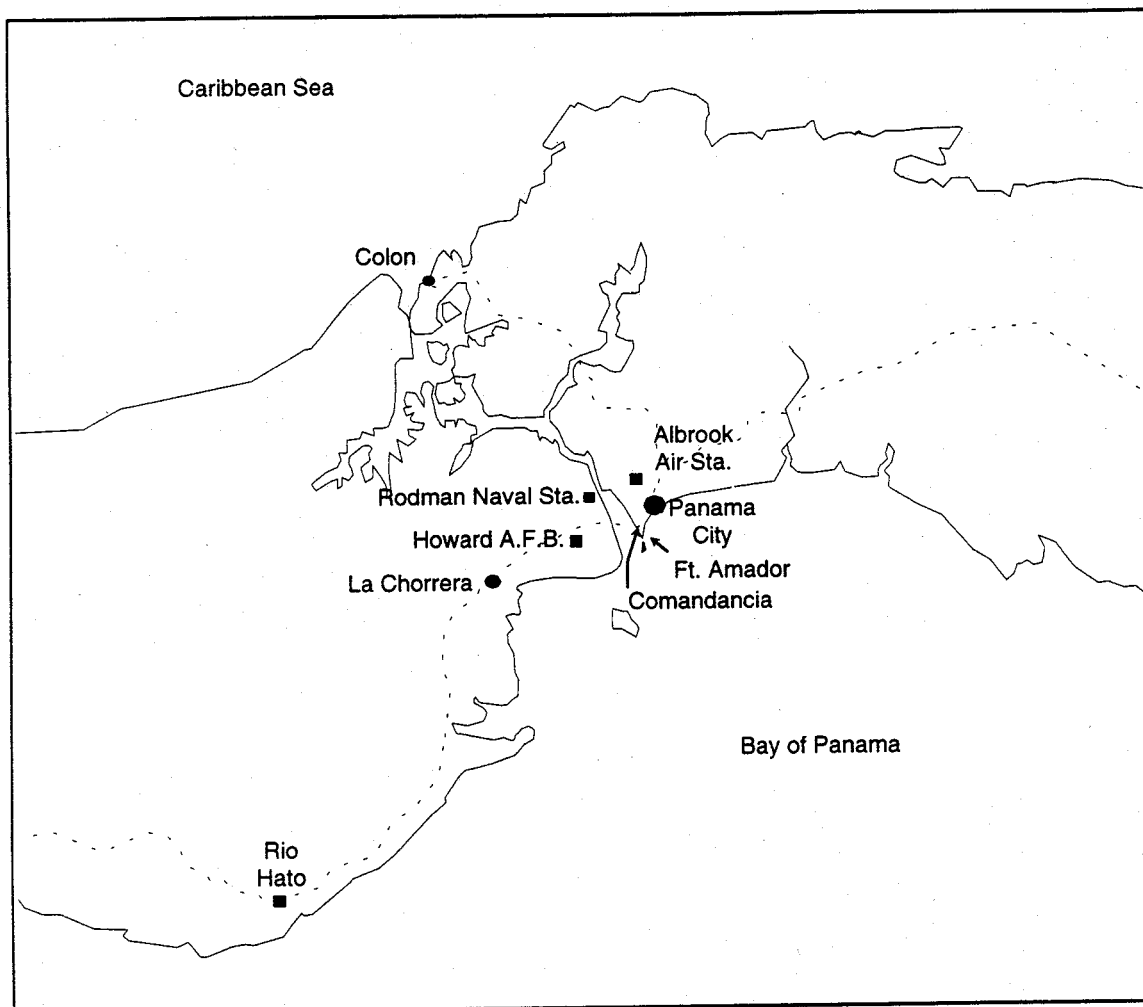

Map 1. Panama Canal and surrounding area. (Donnelly).

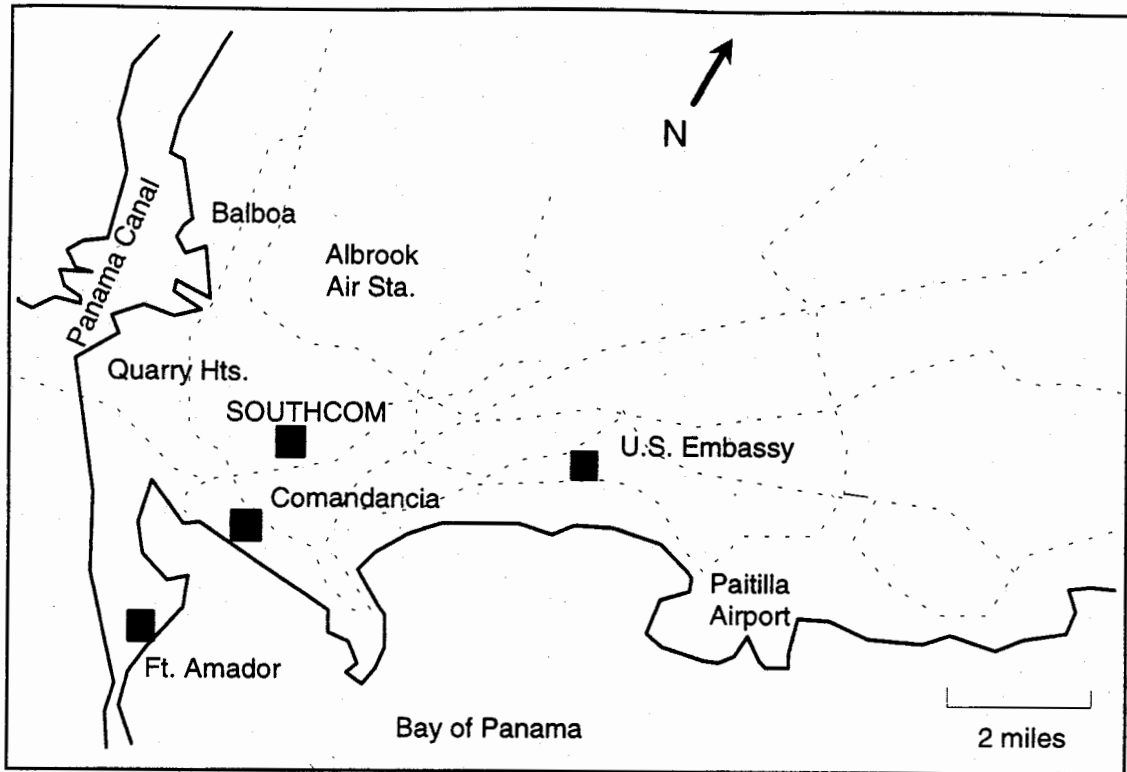

Map 2. Panama City. (Ibid.).

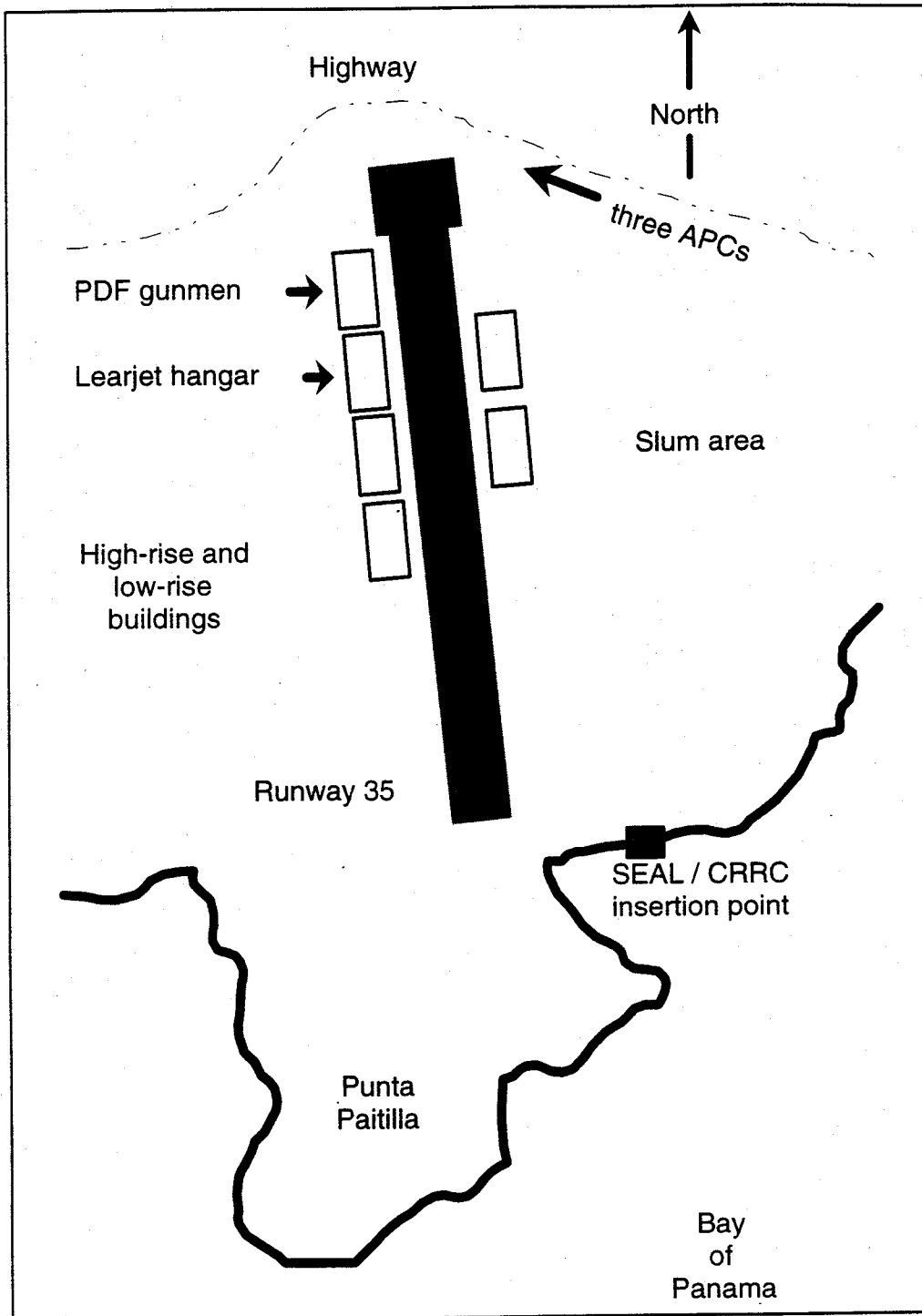

Map 3. Paitilla Airport. (Donnelly).

2. Merrill's Marauders.

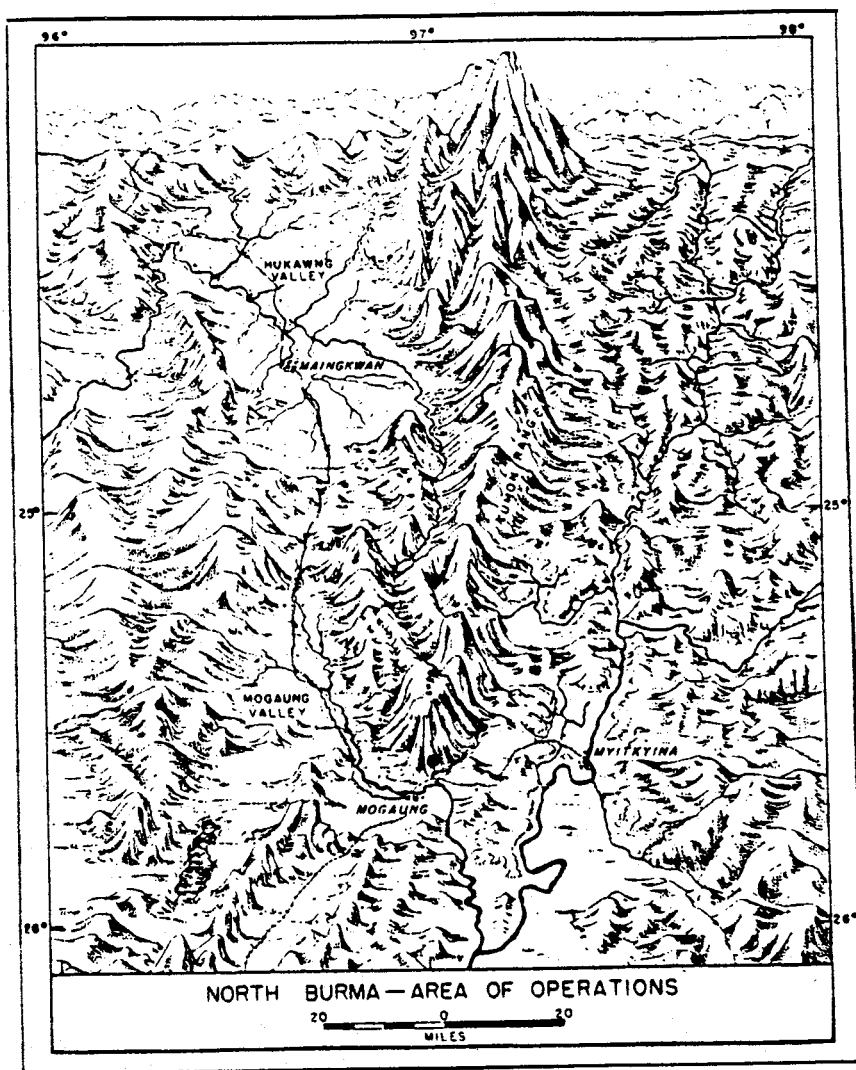

Map 4. North Burma area of operations. (Military Intelligence Division, Merrill's Marauders).

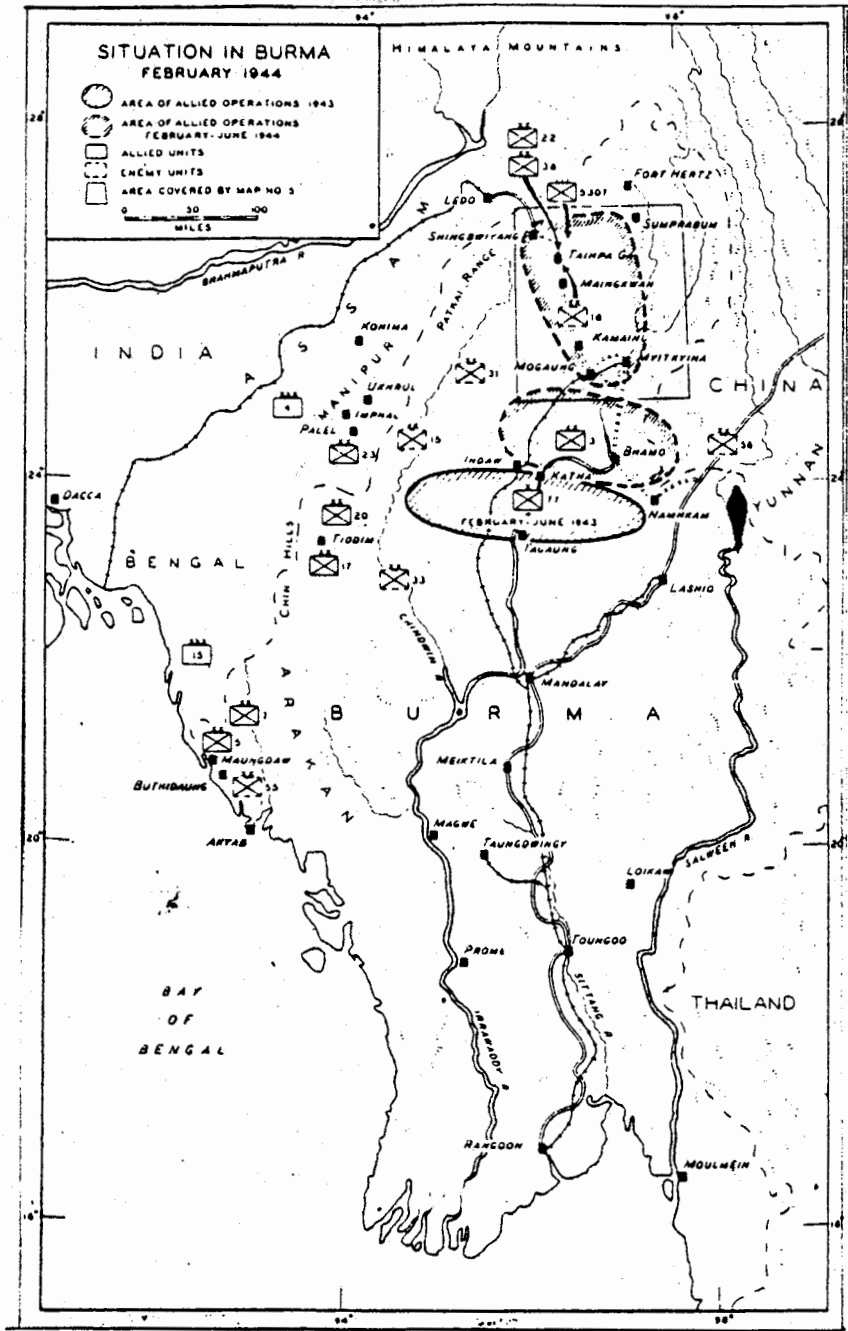

Map 5. Situation in Burma, February 1944. (Ibid).

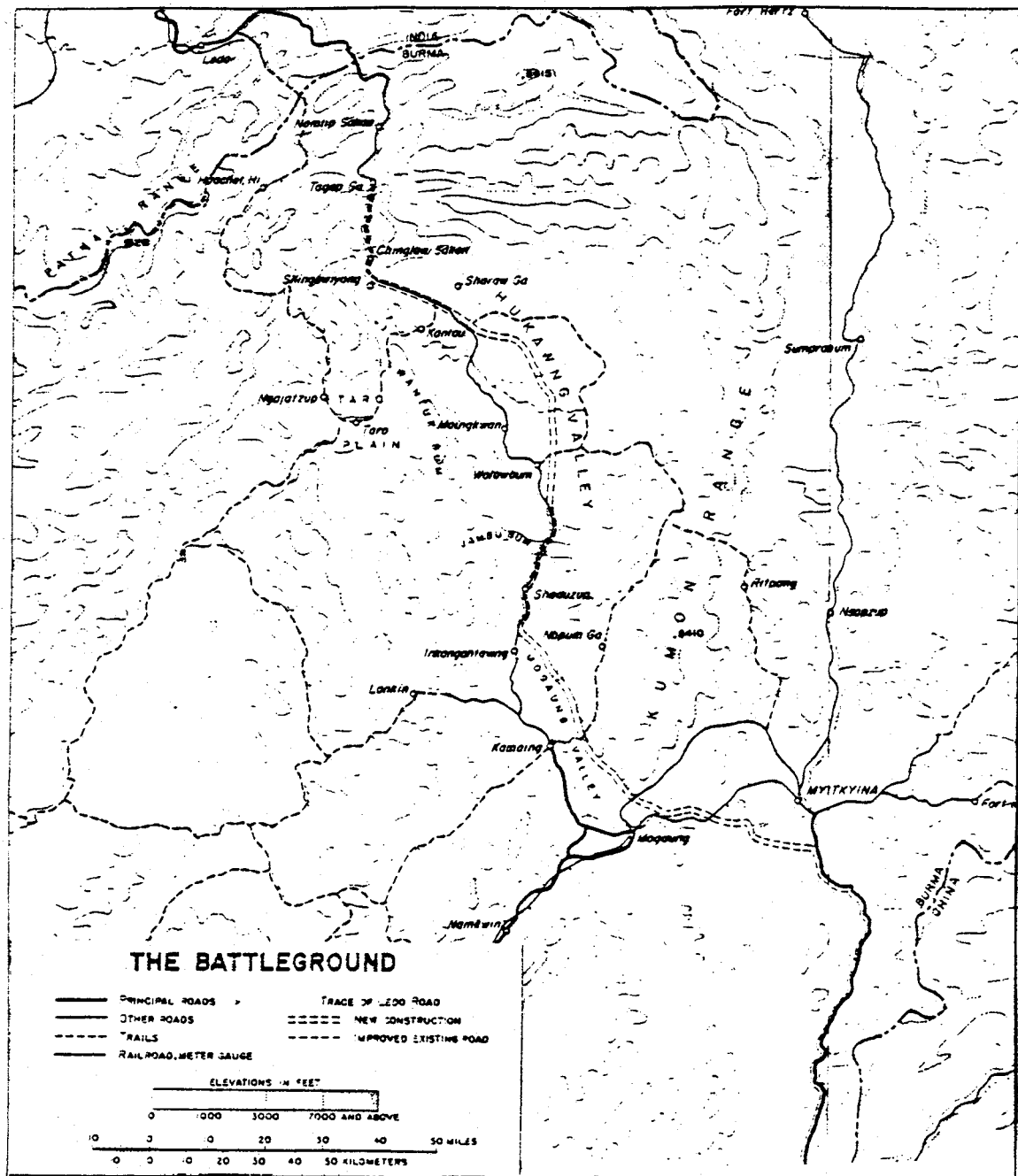

Map 6. The battleground of Merrill's Marauders. (Romanus and Sunderland, Stillwell's Command Problems).

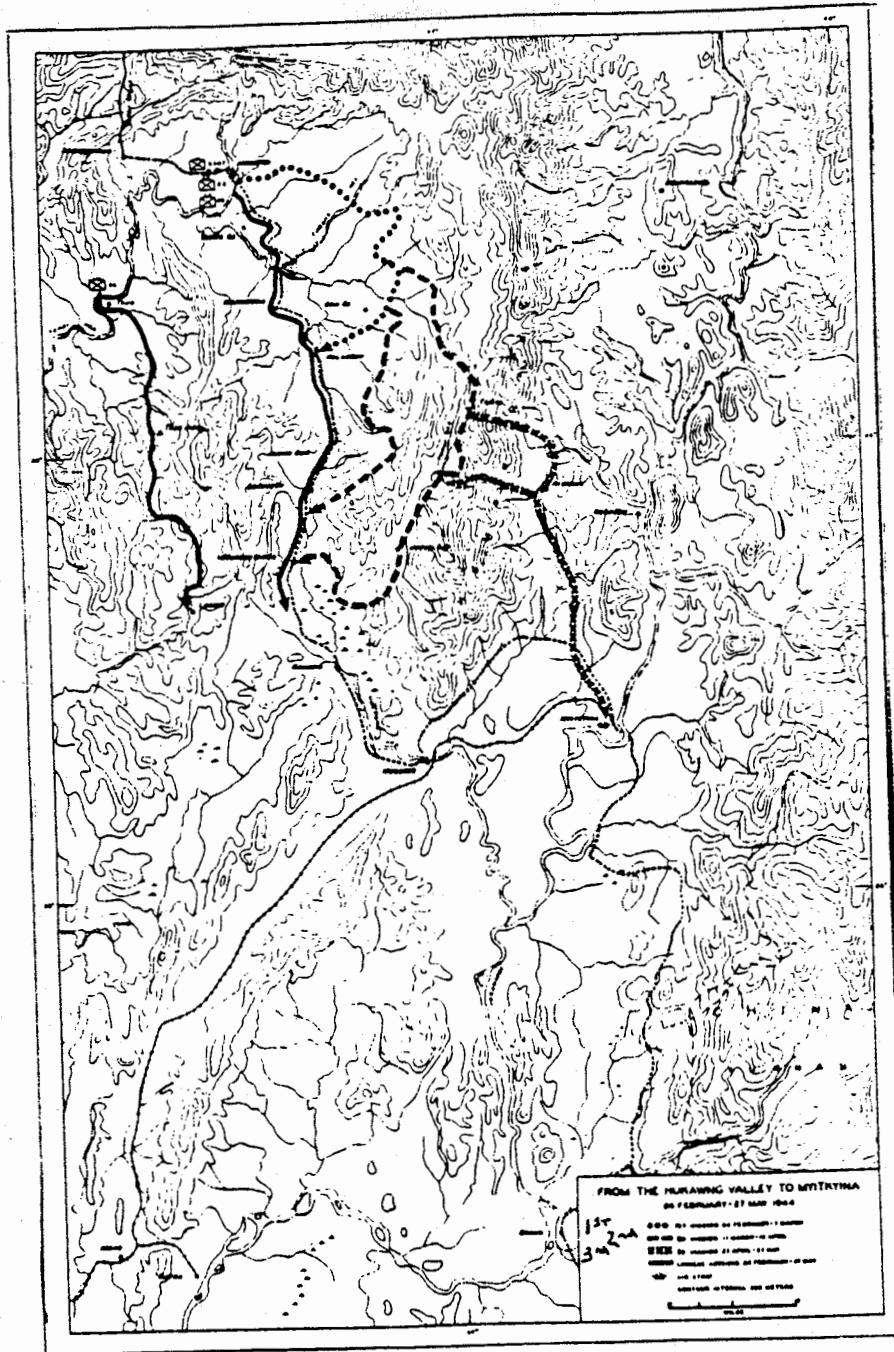

Map 7. From the Hukawng Valley to Myitkyina, the three missions conducted by Merrill's Marauders. (Military Intelligence).

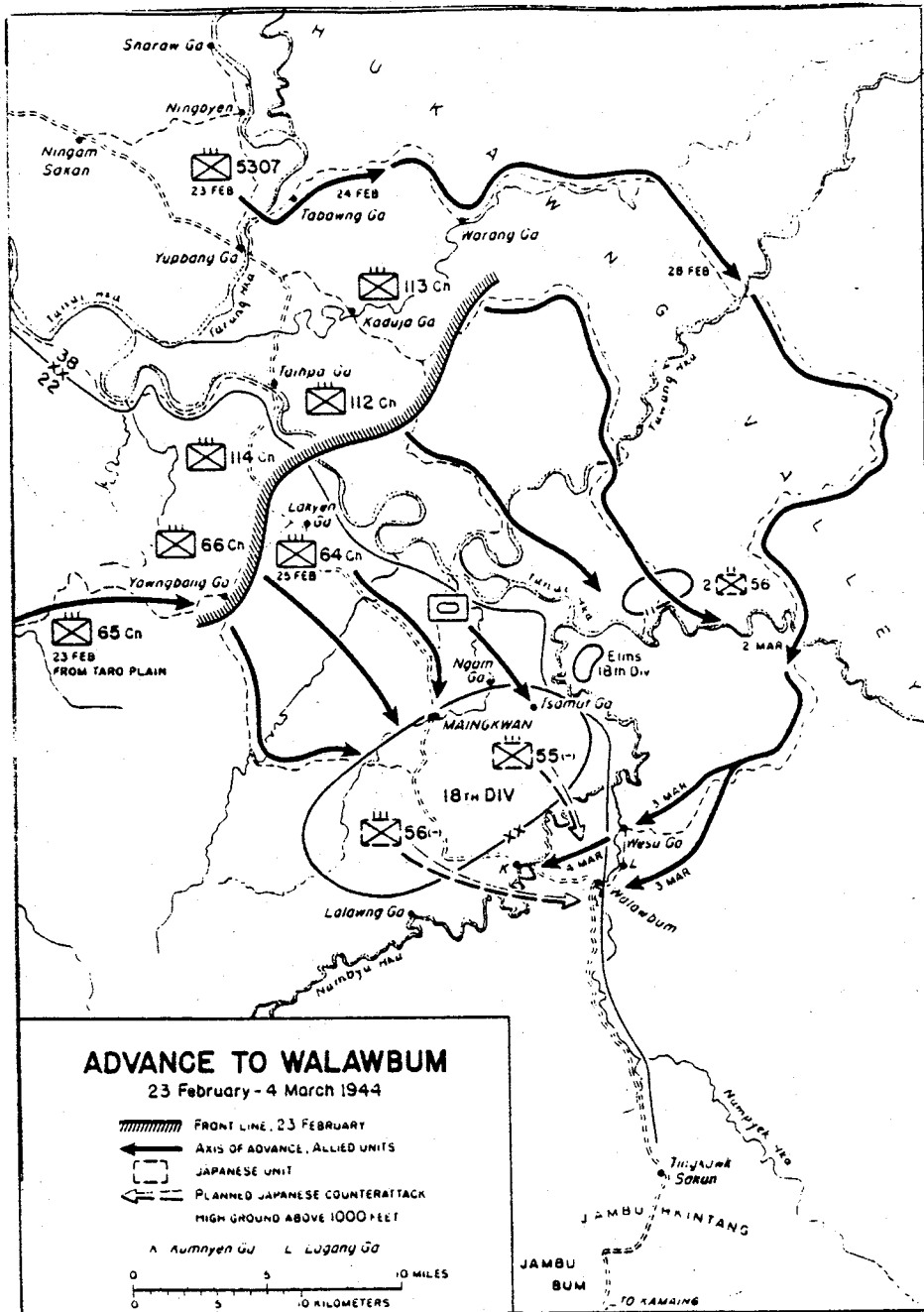

Map 8. Advance to Walawbum, 23 February - 4 March 1944.
(Romanus and Sunderland).

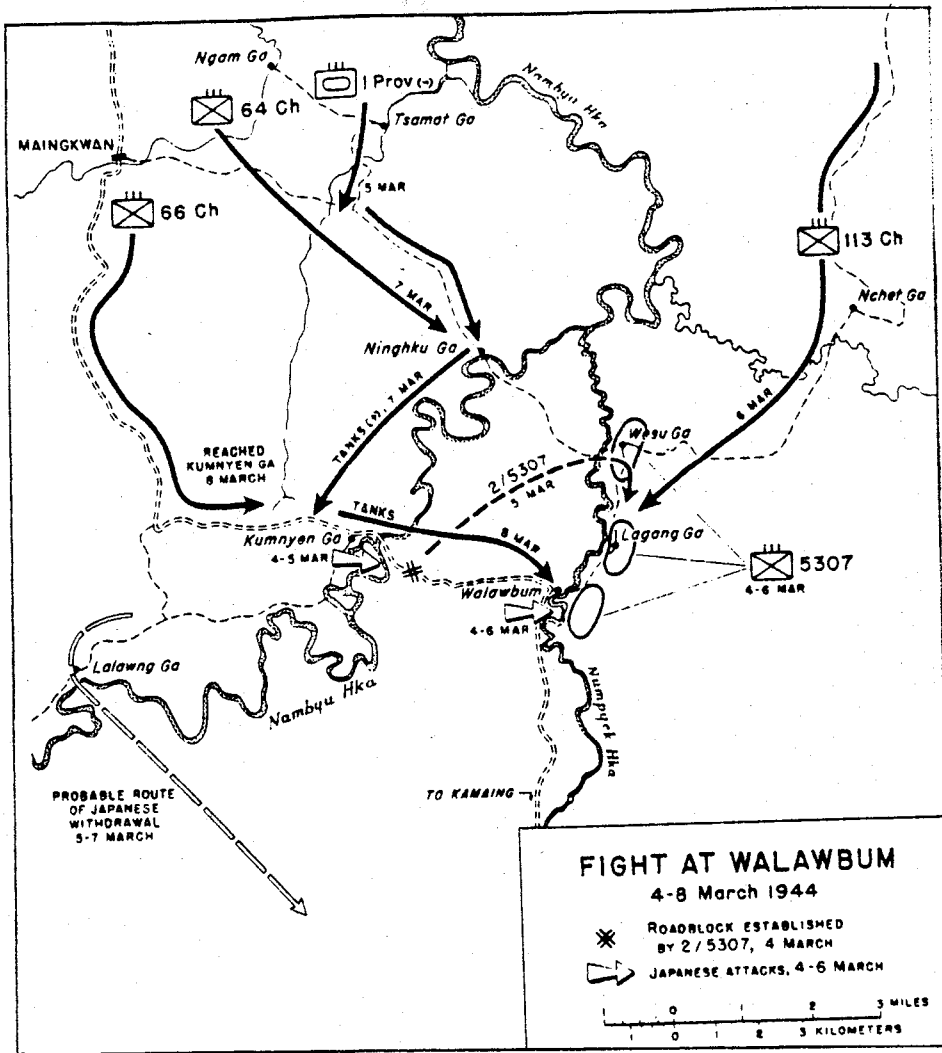

Map 9. Fight at Walawbum, 4-8 March 1944. (Ibid.).

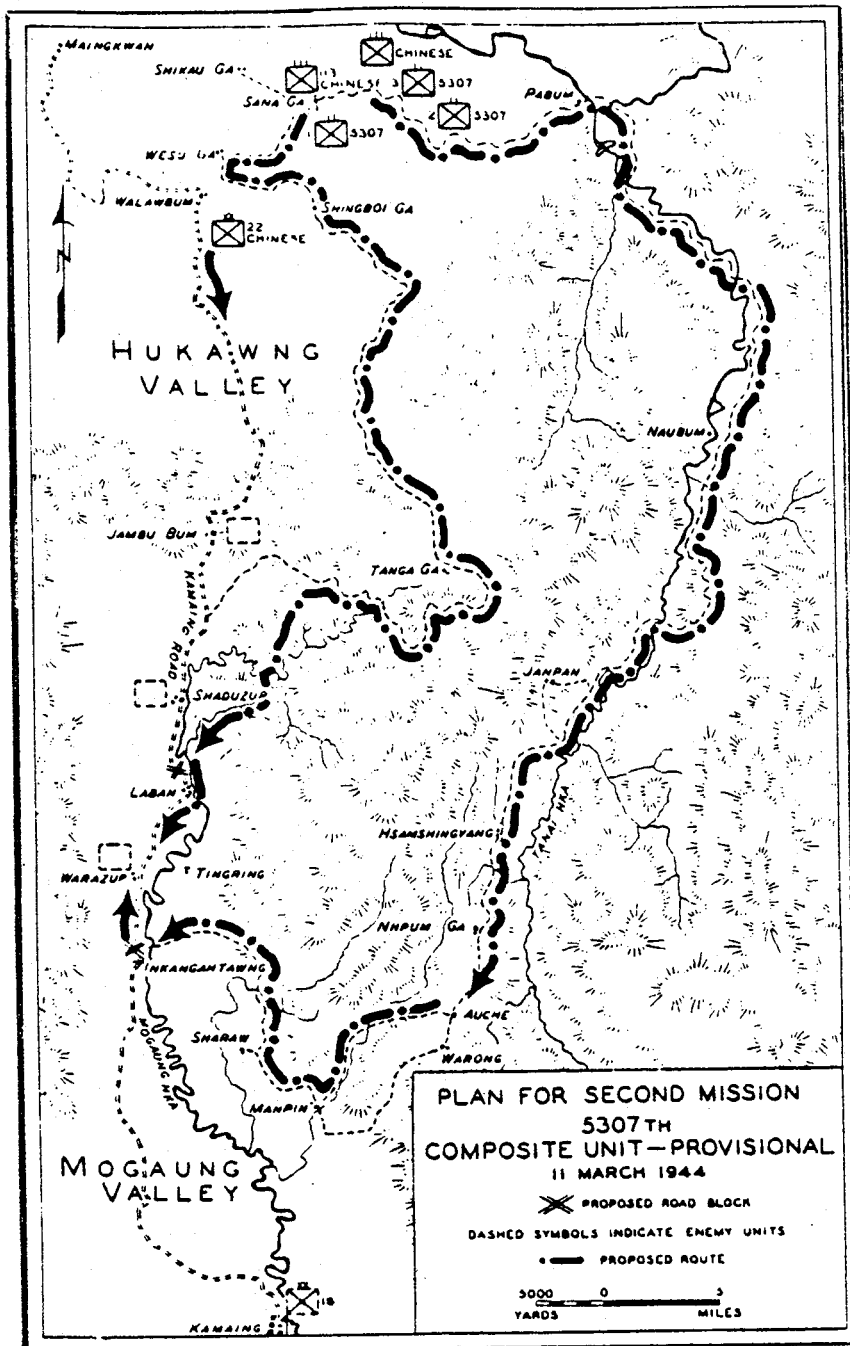

Map 10. Plan for second mission, 11 March 1944. (Military Intelligence).

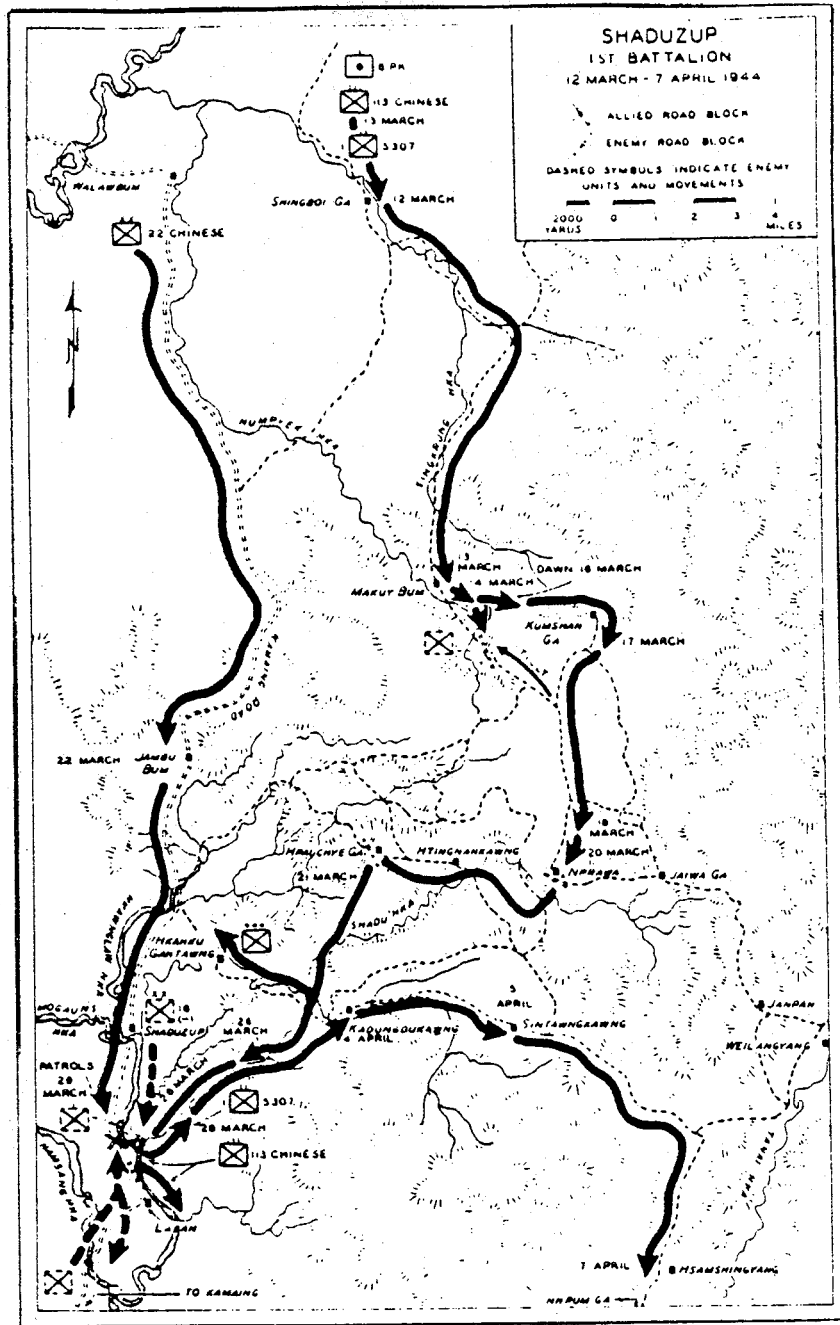

Map 11. Shaduzup, 1st Battalion, 12 March - 7 April 1944. (Ibid.).

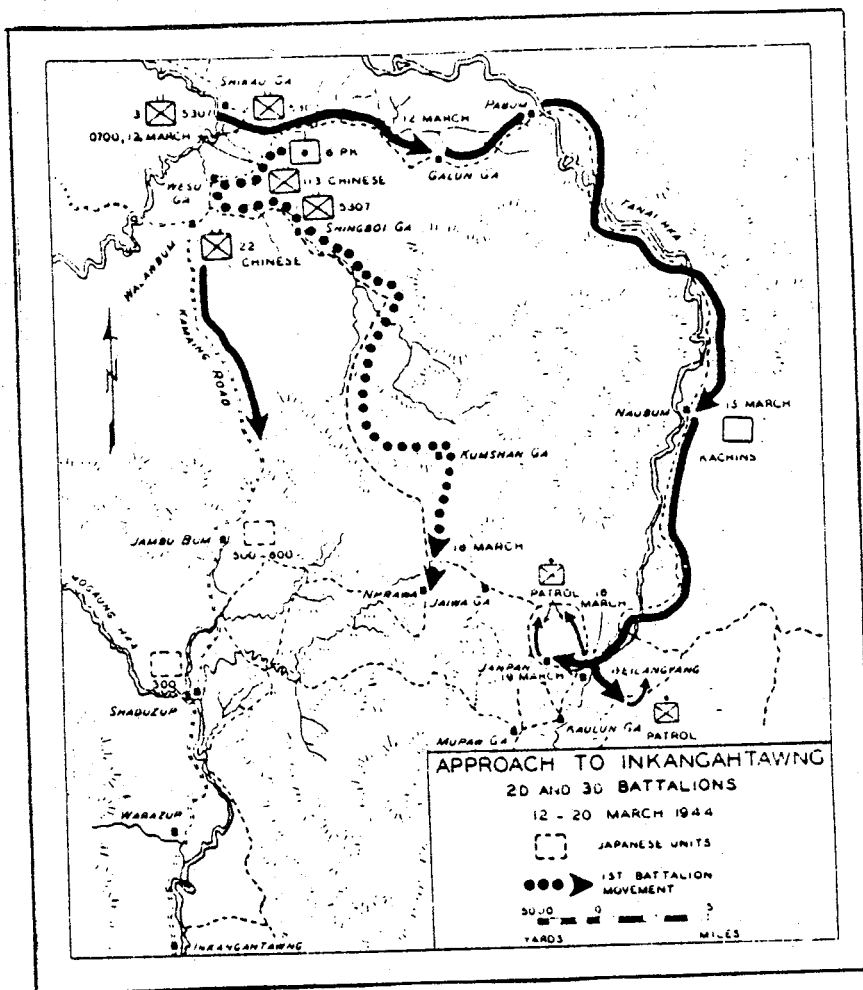

Map 12. Approach to Inkangahtawng, 2d and 3d Battalions, 12-20 March 1944. (Ibid.).

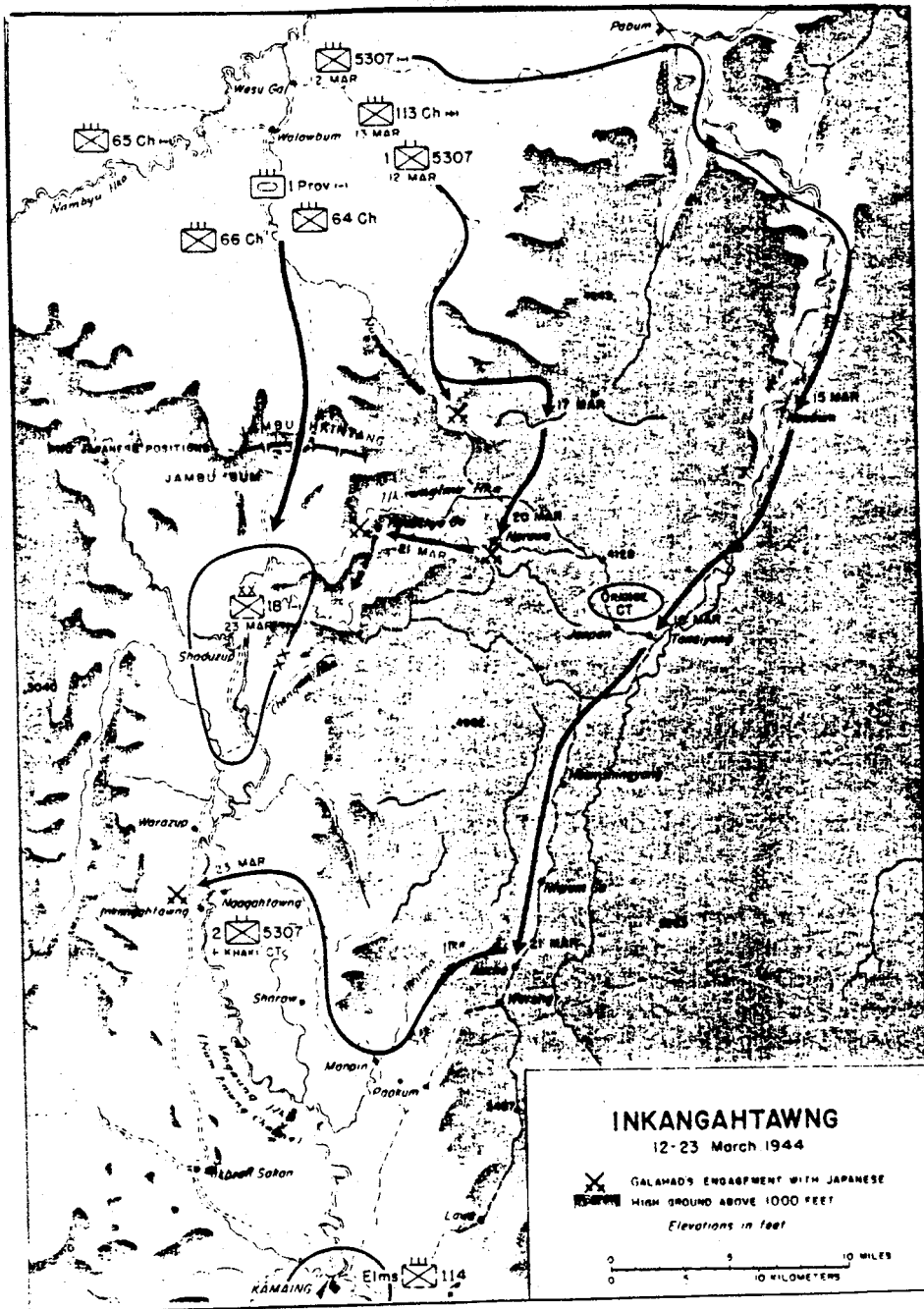

Map 13. Inkanghtawng, 12-23 March 1944. (Ibid.).

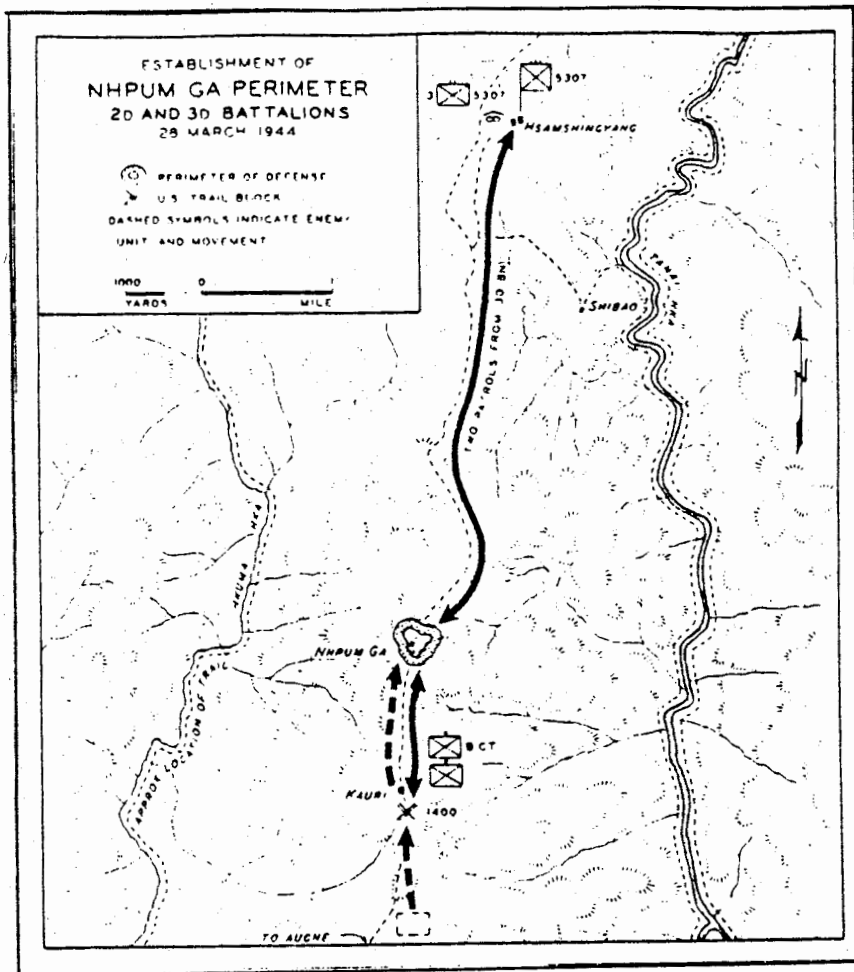

Map 14. Nhpum Ga perimeter, 2d and 3d Battalions, 28 March 1944. (Ibid.).

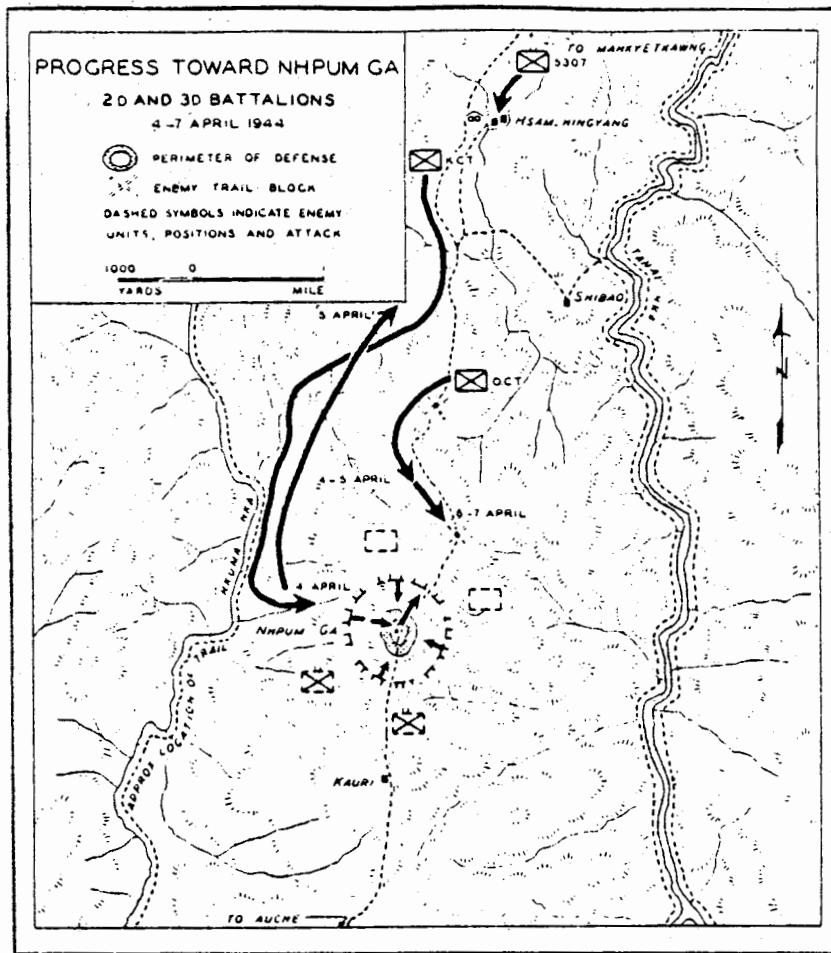

Map 15. Progress toward Nhpum Ga, 2d and 3d Battalions, 4-7 April 1944. (Ibid.).

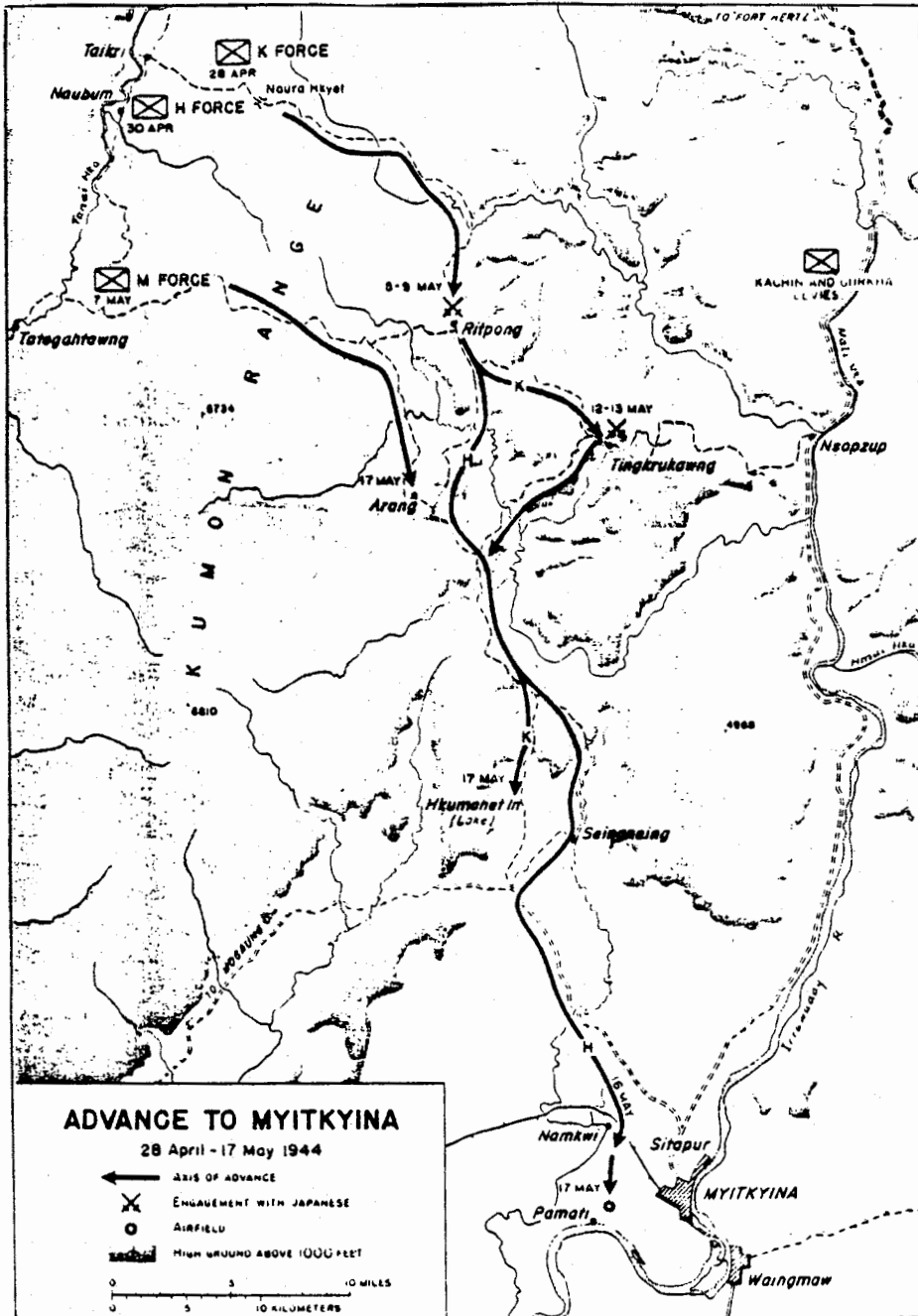

Map 16. Advance to Myitkyina, 28 April - 17 May 1944. (Romanus and Sunderland).

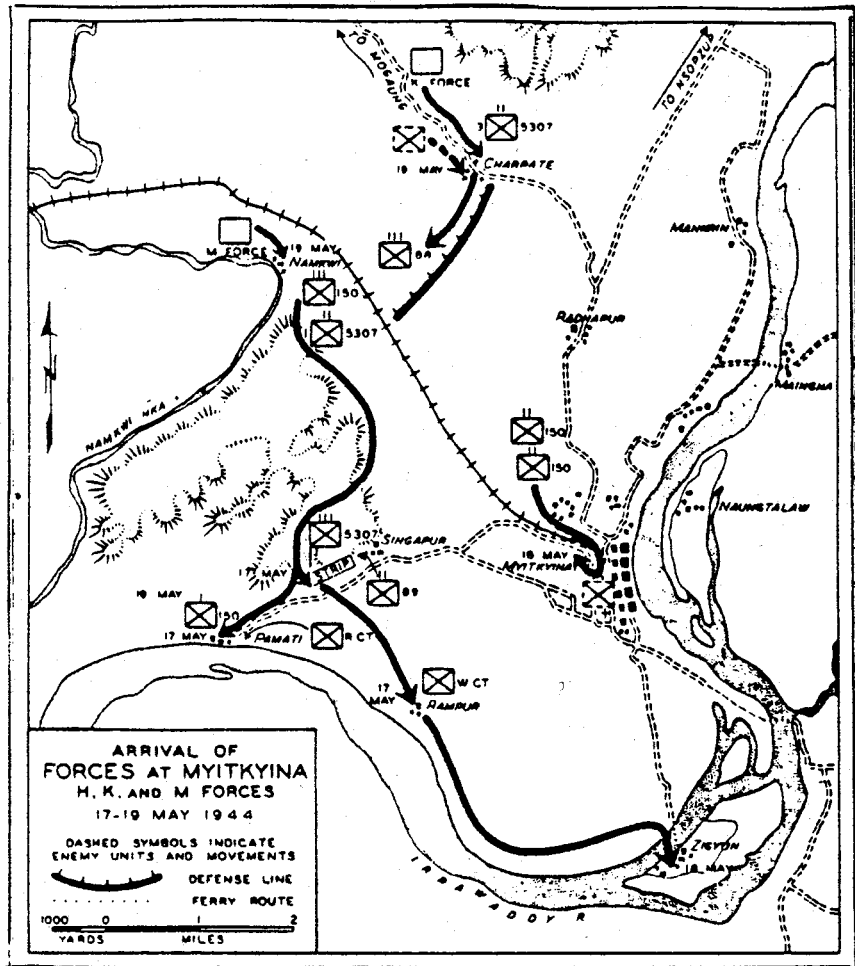

Map 17. Arrival of forces at Myitkyina, 17-19 May 1944. (Military Intelligence).

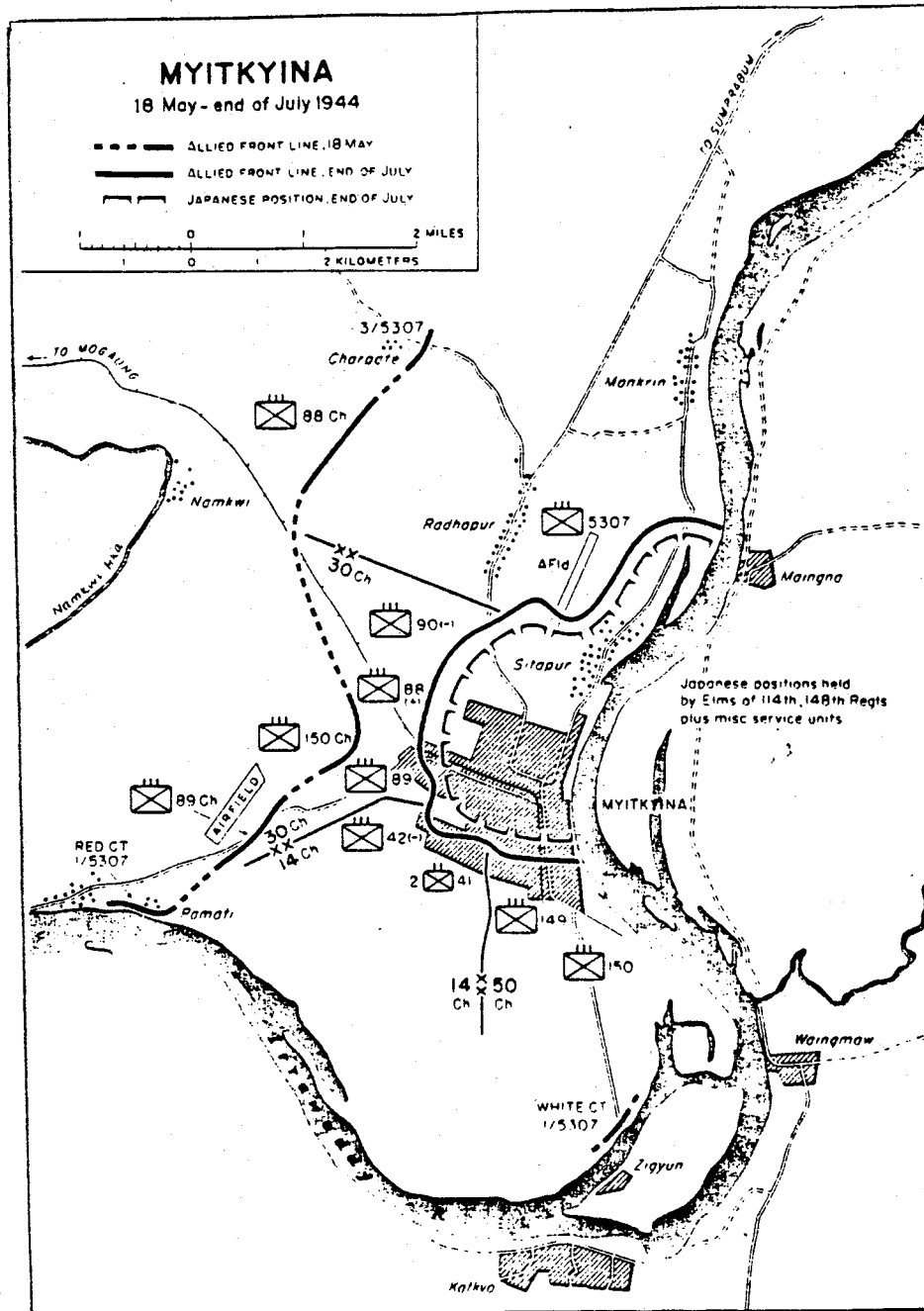

Map 18. Myitkyina, 18 May - end of July 1944. (Romanus and Sunderland).

3. Mayaguez Incident.

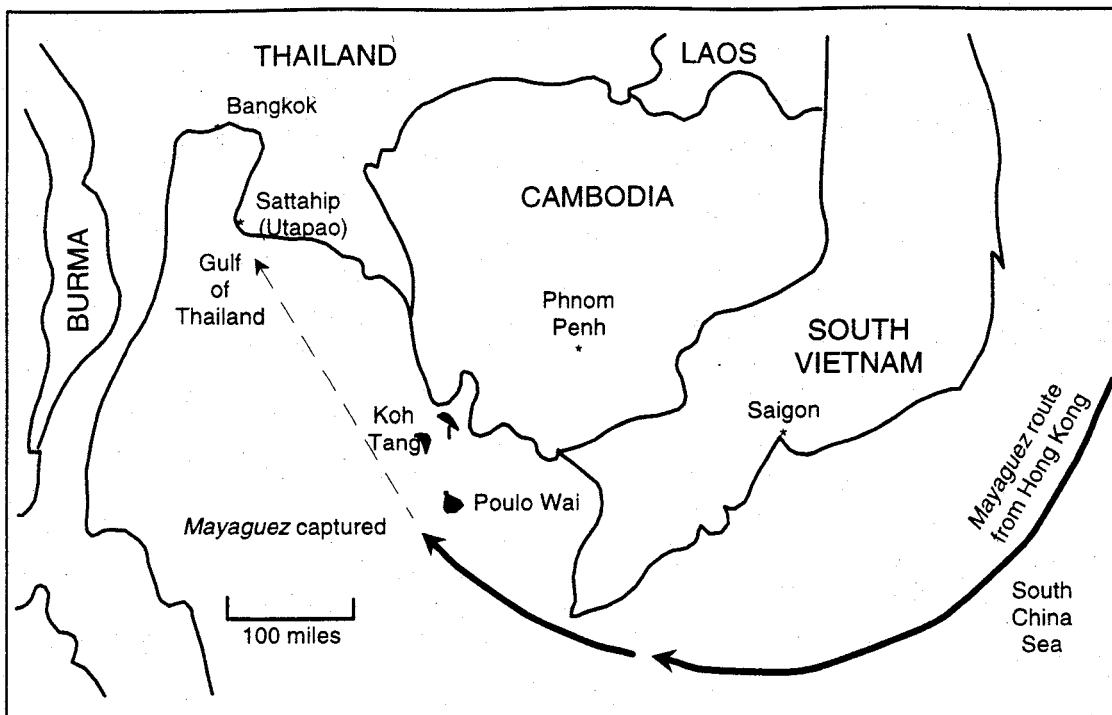

Map 19. *Mayaguez'* Hong Kong to Sattahip route. (Lamb).

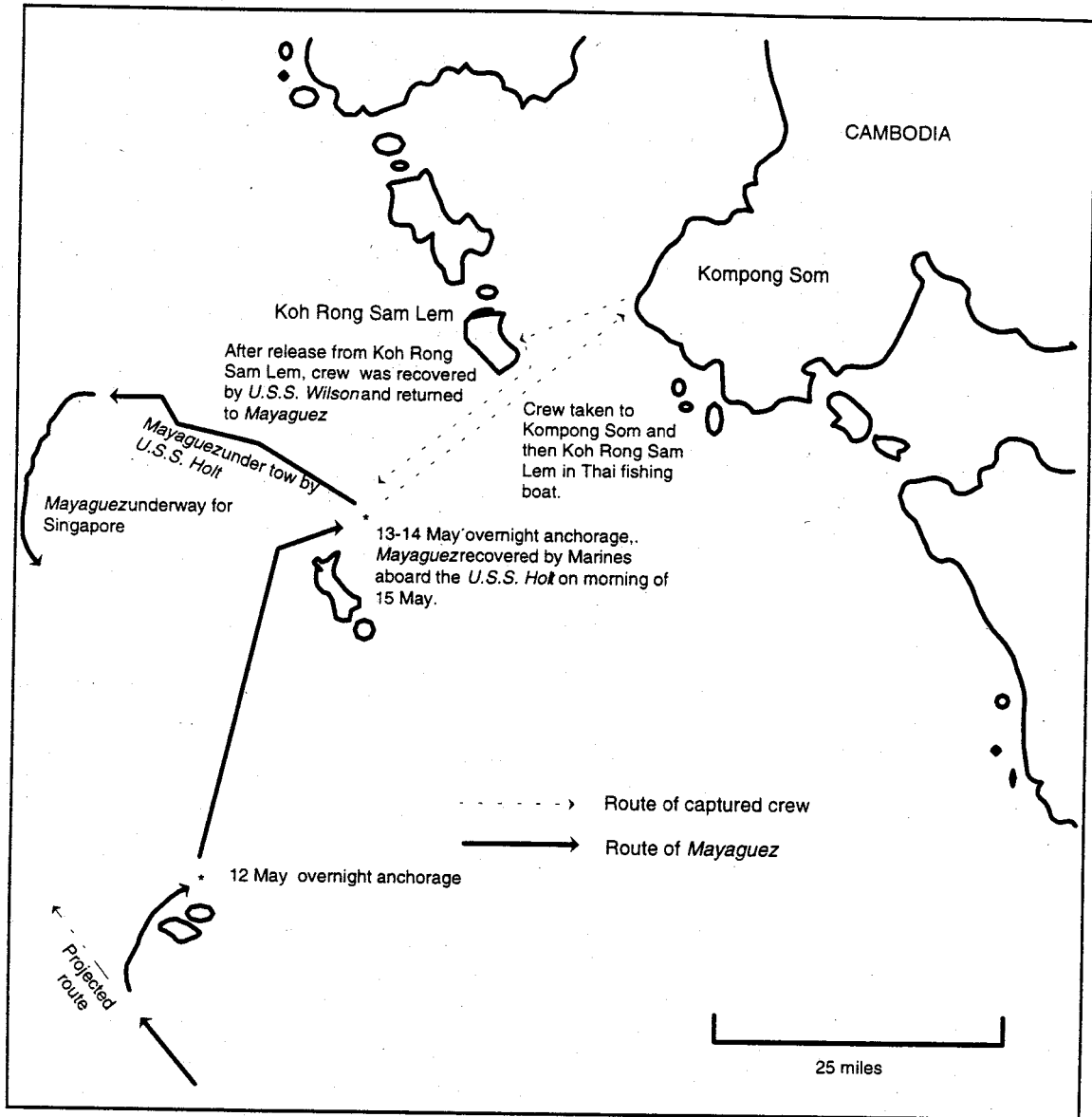

Map 20. Location of the *Mayaguez* and crew (12 - 15 May 1975). (Ibid.).

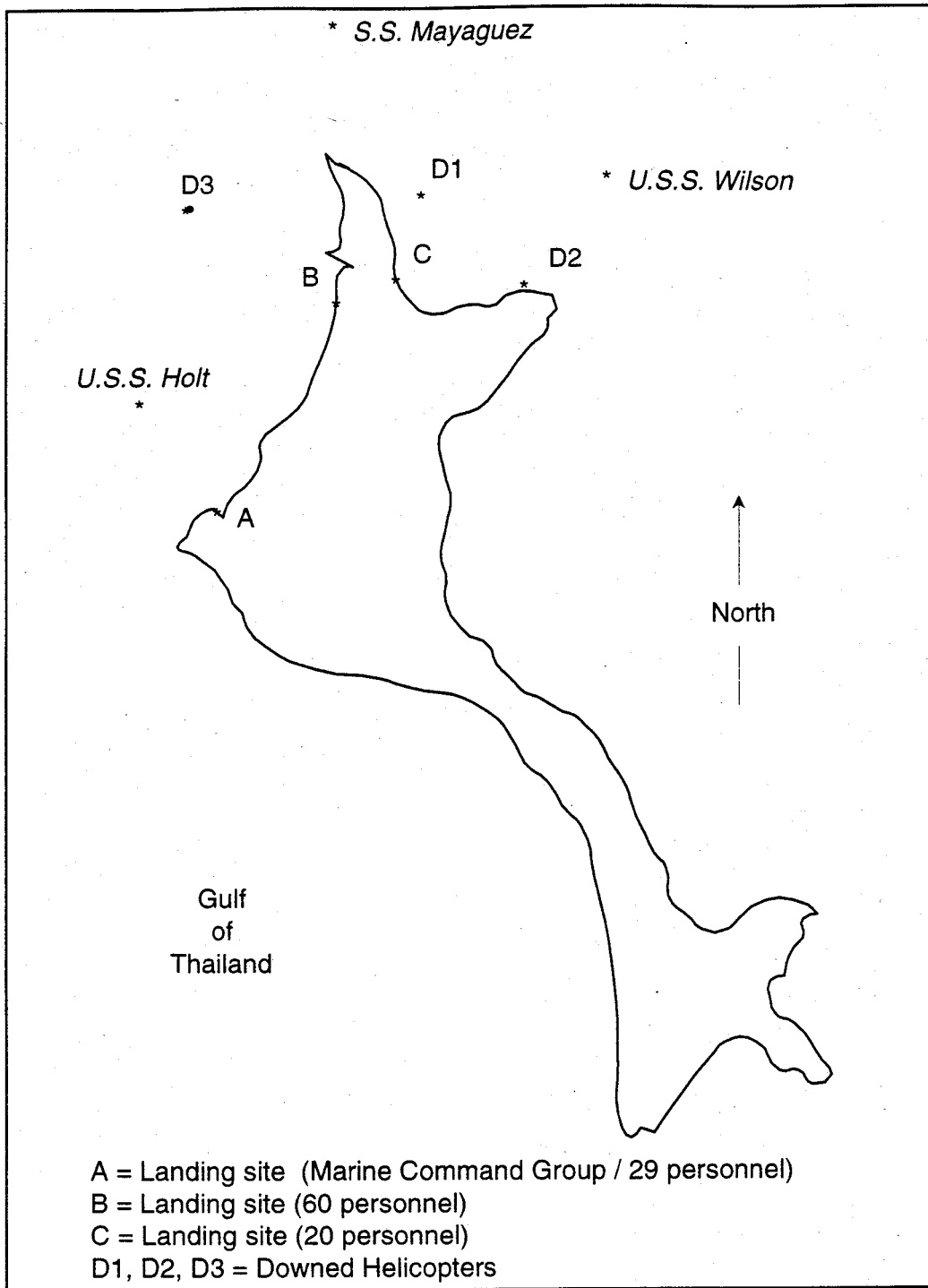

Map 21. Koh Tang rescue operation. (Head).

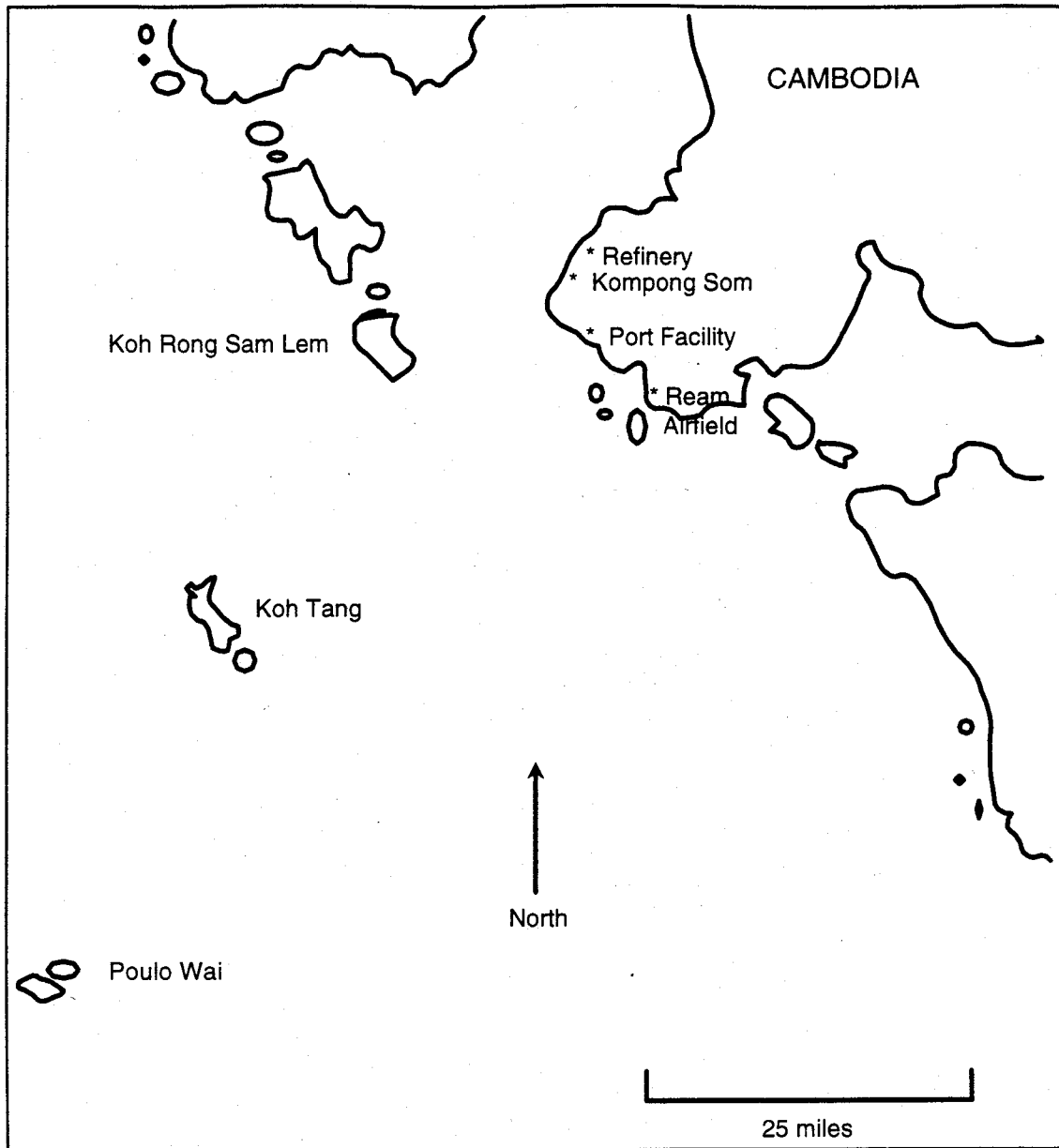

Map 22. Mainland Targets. Targets attacked by tactical aircraft from carrier *U.S.S. Coral Sea* are designated with asterisk. (Lamb).

4. Operation URGENT FURY.

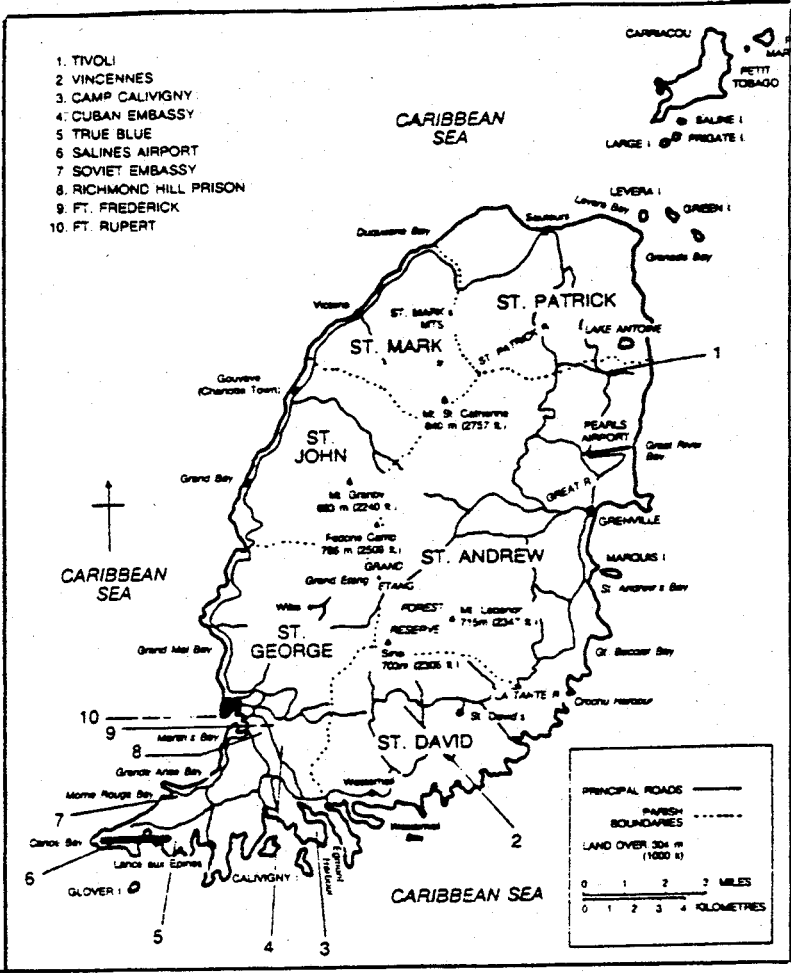

Map 23. Grenada and Points of Interest. (Adkins).

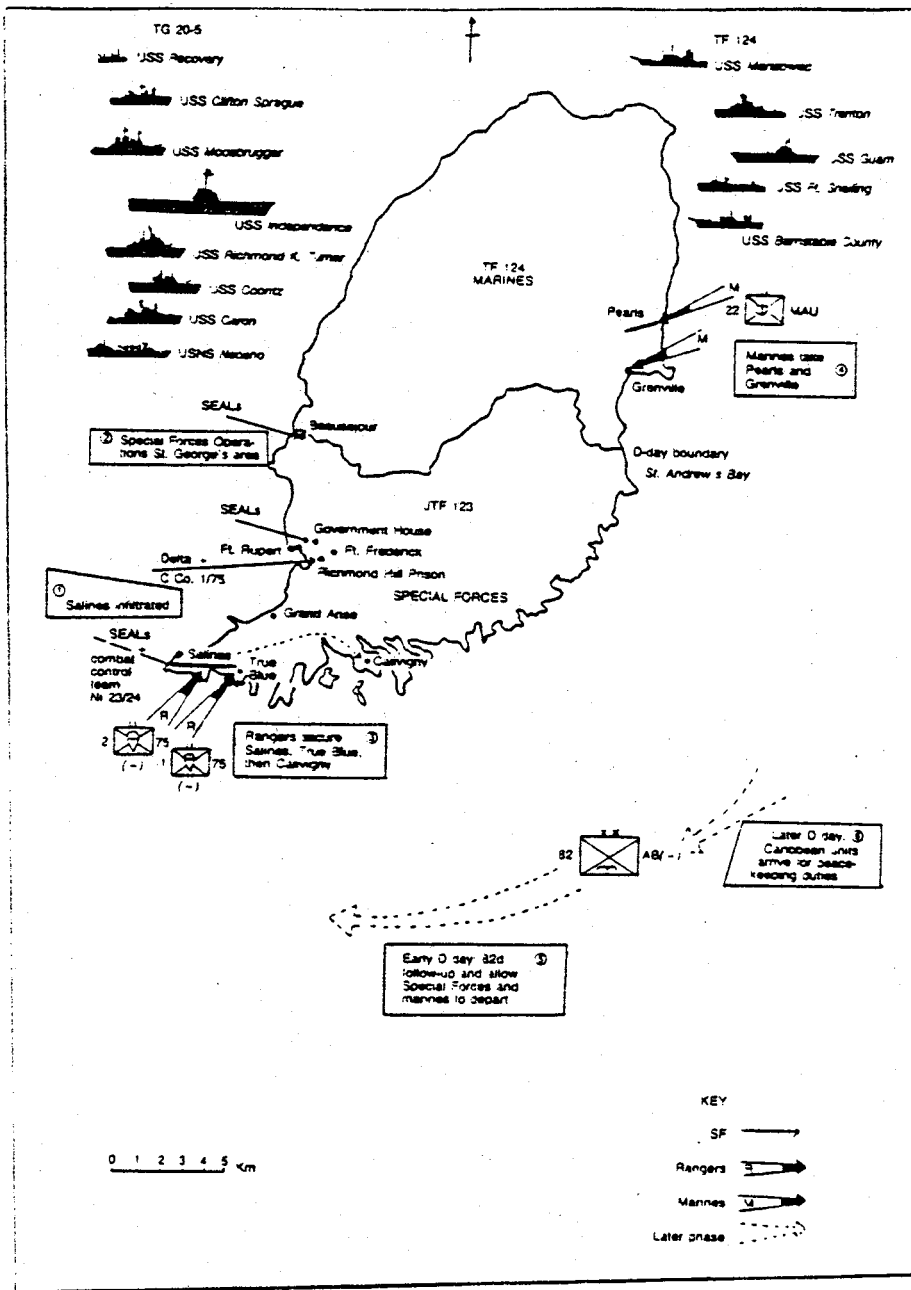

Map 24. D-day Assault Plan. (Adkins).

- Lewis, Gordon K., Grenada: The Jewel Despoiled, (Baltimore, MD: John Hopkins University Press, 1987).
- Marine Corps Gazette, October, 1977.
- Marshall, Kneale T., and Robert M. Oliver, Decision Making and Forecasting: With Emphasis on Model Building and Policy Analysis, (Draft Copy, 1994).
- McConnell, Malcom, JUST CAUSE. The Real Story of America's High-Tech Invasion of Panama, (New York, NY: St. Martin's Press, 1991).
- Military Intelligence Division, Merrill's Marauders, (Washington, D.C.: U.S. War Department, 1945).
- Nadel, Joel, and J.R. Wright, Special Men and Special Missions: Inside American Special Operations Forces 1945 to the Present, (London: Greenhill Books and Mechanicsburg, PA: Stackpole Books, 1994).
- Partin, Dr. J.W., "Interview with General Samuel V. Wilson," (Rice, VA, 11 July 1988).
- Payne, Anthony, Paul Sutton, and Tony Thorndike, Grenada: Revolution and Invasion, (London: Croom Helm, 1984).
- Peers, William R., and Dean Brellis, Behind the Burma Road, (Boston, MA: Little, Brown and Company, 1963).
- Ogburn, Charleton, Jr., The Marauders, (Greenwich, CT: Fawcett Publications, Inc., 1956).
- Romanus, Charles F., and Riley Sunderland, Stilwell's Command Problems, (Washington, D.C.: Office of the Chief of Military History, 1956).
- , Stilwell's Mission to China, (Washington, D.C.: Office of the Chief of Military History, 1953).
- Rowan, Roy, The Four Days of Mayaguez, (New York, NY: W.W. Norton & Company, Inc., 1975).
- Smith, E.D., Battle for Burma, (New York, NY: Holmes and Mier Publishers, Inc., 1979).
- USCINCPAC, Command History, 1975, Appendix VI, "The SS Mayaguez Incident," (San Francisco, CA, 1976).
- Walker, Greg, At the Hurricane's Eye: U.S. Special Operations Forces from Vietnam to Desert Storm, (New York, NY: Ivy Books, 1994).
- White, Theodor H., The Stilwell Papers, (New York, NY: William Sloane Associates, Inc., 1948).

SELECTED BIBLIOGRAPHY

- Adkins, Mark, URGENT FURY: The Battle for Grenada, (Lexington, MA: Lexington Books, 1989).
- Allen, Louis, Burma: The Longest War, (New York, NY: St. Martin's Press, 1984).
- Anderson, David R., Dennis J. Sweeney, and Thomas A. Williams, An Introduction to Management Science: Quantitative Approaches to Decision Making, (St. Paul, MN: West Publishing Company, 1991).
- Beck, Robert J., The Grenada Invasion: Politics, Law, and Foreign Policy Decisionmaking, (Boulder, CO: Westview Press, 1993).
- Bosiljevac, T.L., SEALs: UDT/SEAL Operations in Vietnam, (New York, NY: Ivy Books, 1990).
- Burrowes, Reynold A., Revolution and Rescue in Grenada: An Account of the U.S.-Caribbean Invasion, (Westport, CT: Greenwood Press, 1988).
- Clausewitz, Carl Von, On War, (Princeton, NJ: Princeton University Press, 1984).
- Collins, John M., Special Operations Forces: An Assessment 1986-1993, (Washington, D.C.: Congressional Research Service, 30 July 1993).
- Donnelly, Thomas, Margaret Roth, and Caleb Baker, Operation JUST CAUSE: The Storming of Panama, (New York, NY: Lexington Books, 1991).
- Gilmore, William C., The Grenada Intervention: Analysis and Documentation, (New York, NY: Facts on File, Inc., 1984).
- Head, Richard G., Frisco W. Short, and Robert C. McFarlane, Crisis Resolution: Presidential Decision Making in the Mayaguez and Korean Confrontations, (Boulder, CO: Westview Press, 1978).
- Hogan, David W., Jr., Raiders or Elite Infantry?: The Changing Role of the U.S. Army Rangers from Dieppe to Grenada, (Westport, CT: Greenwood Press, 1992).
- , U.S. Army Special Operations in World War II, (Washington, D.C., Center of Military History, Department of the Army, 1992).
- Kelly, Orr, Brave Men Dark Water: The Untold Story of the Navy SEALs, Novato, CA: Presidio Press, 1992).
- Lamb, Christopher Jon, Belief Systems and Decision Making in the Mayaguez Crisis, (Gainesville, FL: University of Florida Press, 1988).

INITIAL DISTRIBUTION LIST

		<u>No. Copies</u>
1.	Defense Technical Information Center Cameron Station Alexandria, VA 22304-6145	2
2.	Library Code 52 Naval Postgraduate School Monterey, CA 93943-5101	2
3.	Dr. Thomas C. Bruneau Chairman, National Security Affairs (NS/Bn) Naval Postgraduate School Monterey, CA 93943-5000	1
4.	Gordon H. McCormick (Code NS/Mc) Naval Postgraduate School Monterey, CA 93943-5000	1
5.	Kneale T. Marshall (Code OR/Mt) Naval Postgraduate School Monterey, CA 93943-5000	1
6.	John Arquilla (Code NS/Ja) Naval Postgraduate School Monterey, CA 93943-5000	1
7.	Jennifer Duncan (Code NS/Jd) Naval Postgraduate School Monterey, CA 93943-5000	5

- | | | |
|-----|---|---|
| 8. | LTC Hy Rothstein
(Code NS/Jd)
Naval Postgraduate School
Monterey, CA 93943-5000 | 1 |
| 9. | The Honorable H. Allen Holmes
Assistant Secretary of Defense of SO/LIC
The Pentagon RM 2E258
Washington, DC 20301-2500 | 1 |
| 10. | GEN Wayne A. Downing, USA
Commander in Chief
US Special Operations Command
7701 Tampa Point Boulevard
MacDill AFB, FL 33621-5323 | 1 |
| 11. | Commander in Chief
US Special Operations Command
ATTN: LTC Bob Smith, SOJ-5
7701 Tampa Point Boulevard
MacDill AFB, FL 33621-5323 | 1 |
| 12. | The JCS Staff
J-3 Special Operations Branch
Washington, DC 20318-3000 | 1 |
| 13. | Library
Naval War College
Newport, RI 02840 | 1 |
| 14. | Strategic Studies Group (SSG)
Naval War College
Newport, RI 02840 | 1 |
| 15. | Department of Military Strategy
National War College (NWMS)
Ft. Leslie J. McNair
Washington, DC 20319-6111 | 1 |

- | | | |
|-----|---|---|
| 16. | CDR Robert Schulz
Naval War College
686 Cushing Road
Newport, RI 02841-5010 | 1 |
| 17. | US Army Command & General Staff College
Concepts and Doctrine Directorate
ATTN: Mr. John B. Hunt
Ft. Leavenworth, KS 66027-6900 | 1 |
| 18. | Marquat Memorial Library
US Army John F. Kennedy Special Warfare Center & School
Rm. C287, Bldg. D3915
ATTN: Mr. Fred Fuller
Ft. Bragg, NC 28307-5000 | 1 |
| 19. | N-511, The Pentagon, Room 4D563
Officer of the Chief of Naval Operations
Washington, D.C. 20350 | 1 |
| 20. | Commander, Naval Special Warfare Command
NAB Coronado
San Diego, CA 92155 | 3 |
| 21. | Mr. Jim Roberts
ASD SOLIC
The Pentagon, Room 2E258
Washington, DC 20301-2500 | 1 |
| 22. | Dr. Russell H. S. Stolfi
819 Fifth Avenue
Hammond, OR 97121 | 1 |
| 23. | Hurlburt Base Library
16SVS/SVRL
ATTN: Susan Whitson
410 Cody Ave.
Hurlburt Fld, FL 32544-5417 | 1 |
| 24. | Ed Winters
901 Old Dominion Lane
Virginia Beach, VA 23451 | 2 |

25. LT Kent Paro 2
NSWU-1
PSC 455, Box 182
FPO AP 96540-1182
26. CPT Michael M. Kershaw 1
143 5th Artillery Road
Ft. Leavenworth, KS 66027
27. Mr. Matthew J. Hickey 1
2504 "D" Airy Hill Circle
Crofton, MD 21114