

Goliat

(c) M. Sirgo 2002

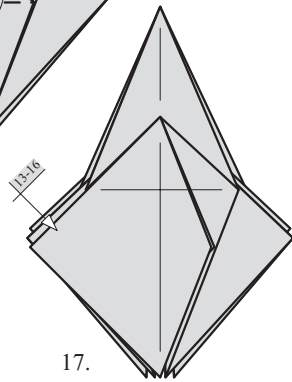

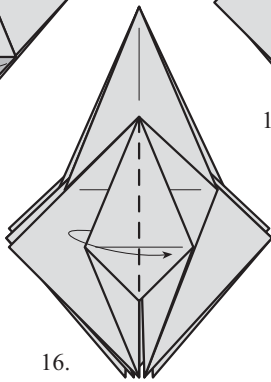

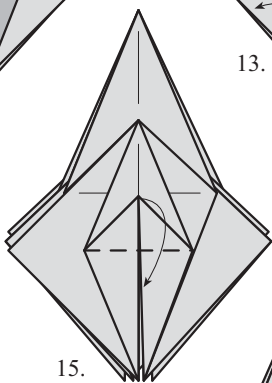
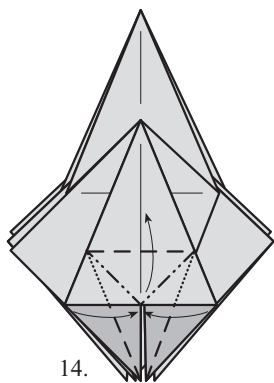
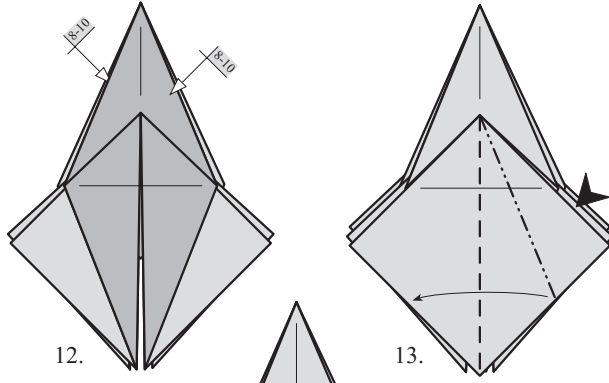
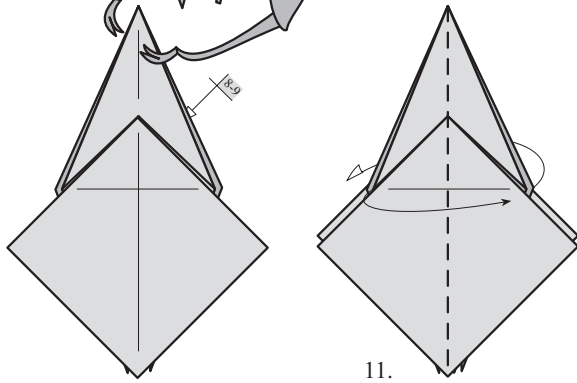
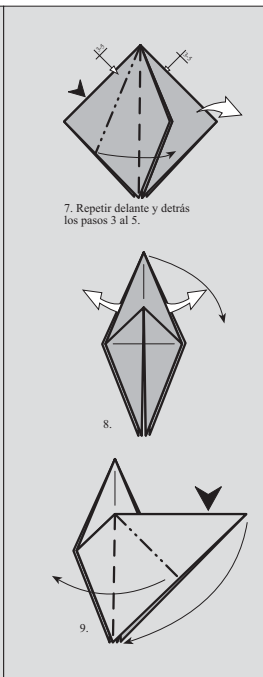
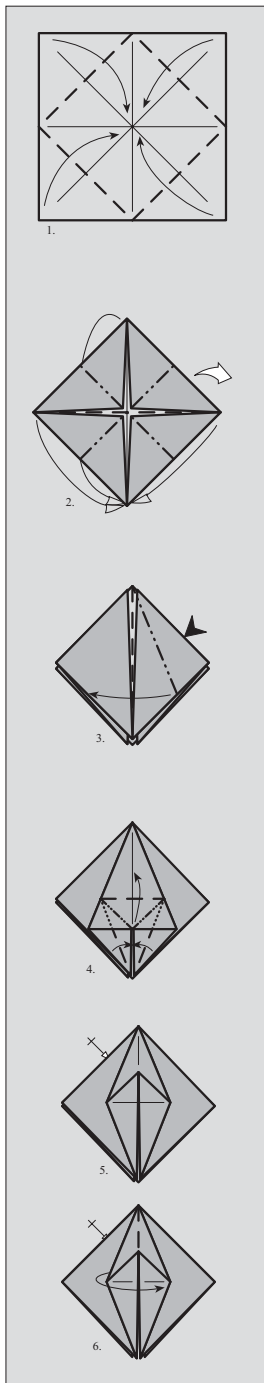
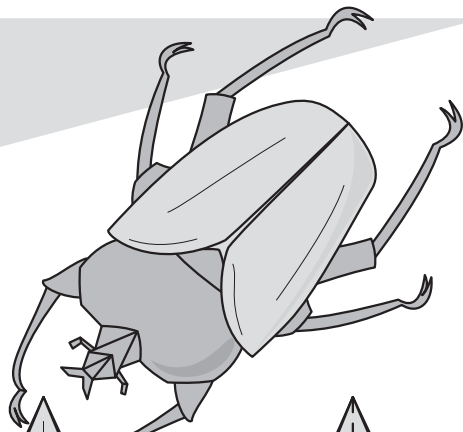
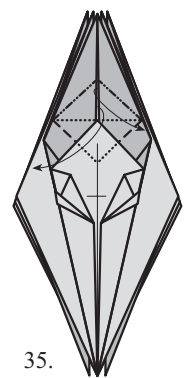
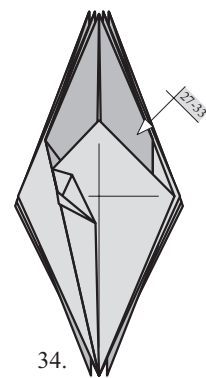
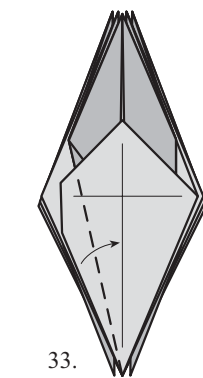
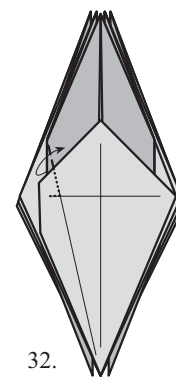
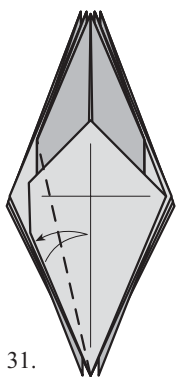
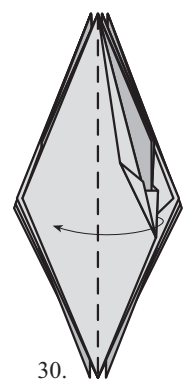
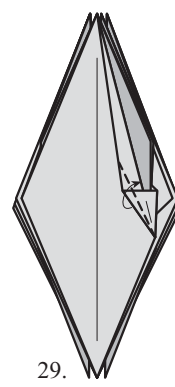
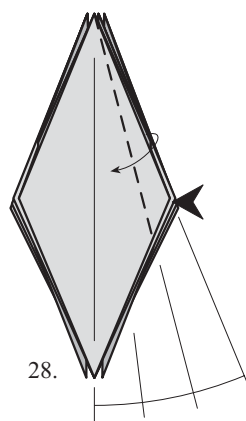
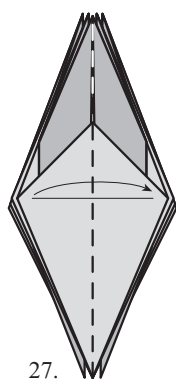
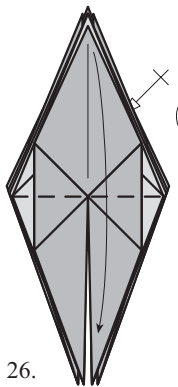
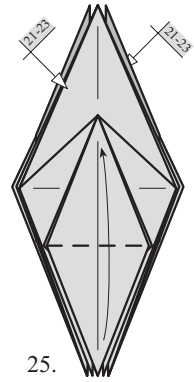
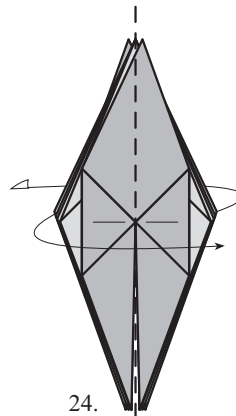
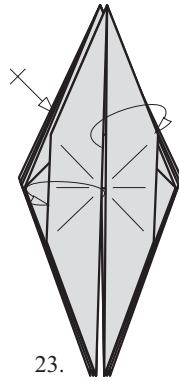
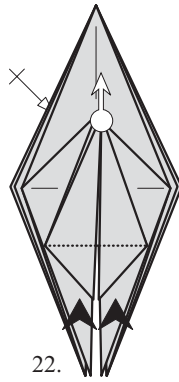
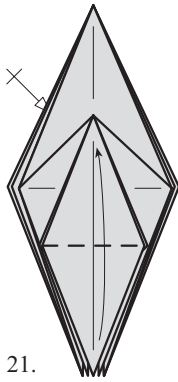
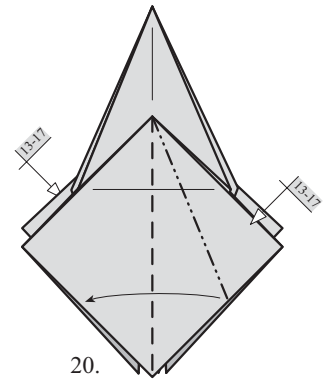
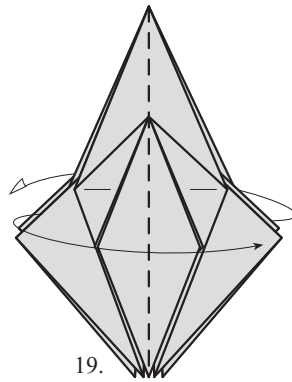
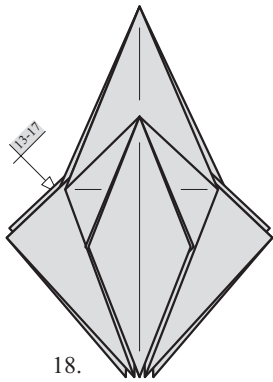
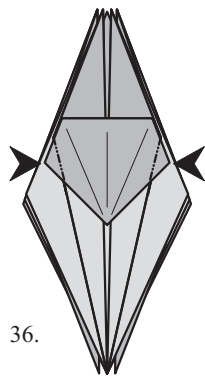

36.

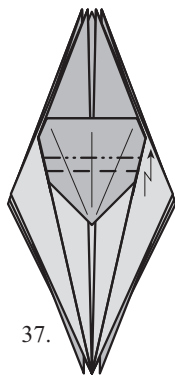

37.

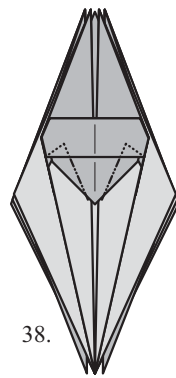

38.

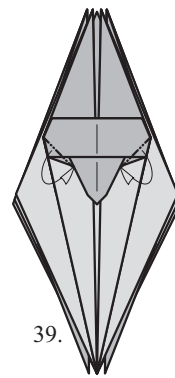

39.

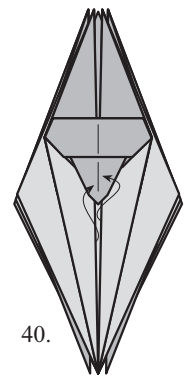

40.

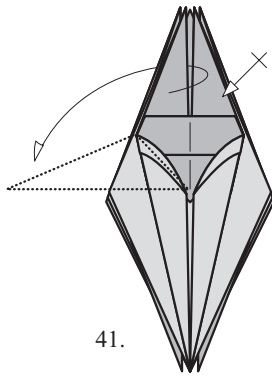

41.

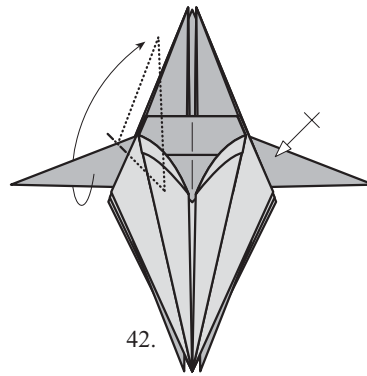

42.

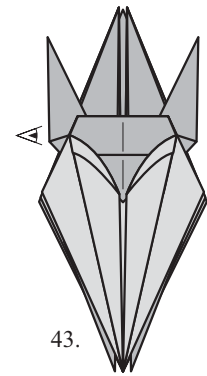

43.



44. Cuatro capas trabadas.



45. Destrabar.

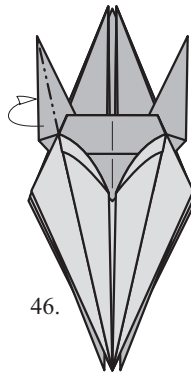

46.

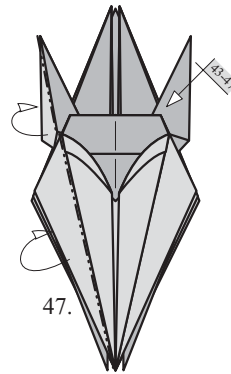

47.

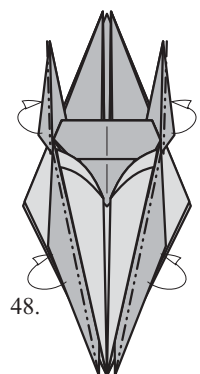

48.

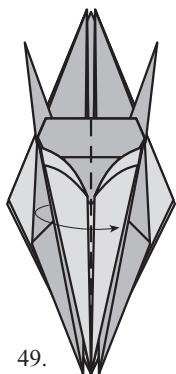

49.

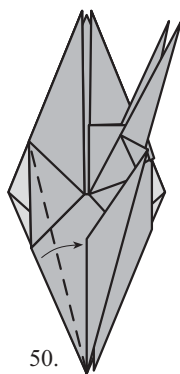

50.

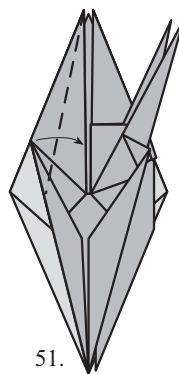

51.

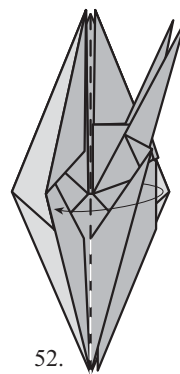

52.

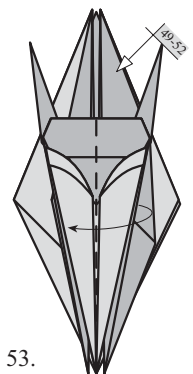

53.

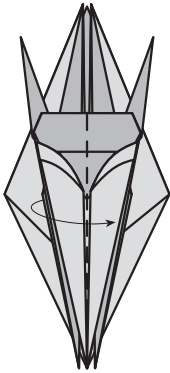

54. Pasar 2 capas.

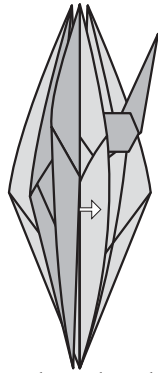

55. Desplegar destrabando, cuidado con las roturas. Este paso no es un cambio de color.

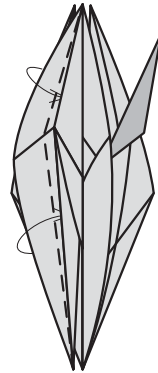

56. Introducir la capa extraida bajo la blanca.

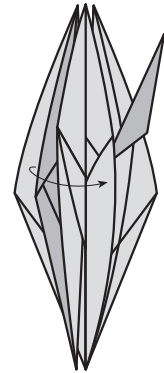

57. Cerrar.

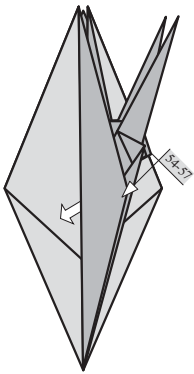

58.

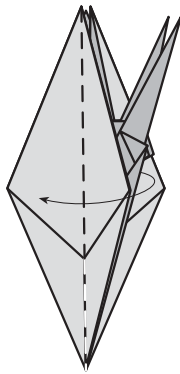

58-B.

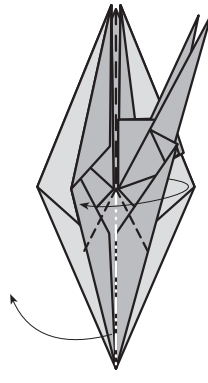

59.

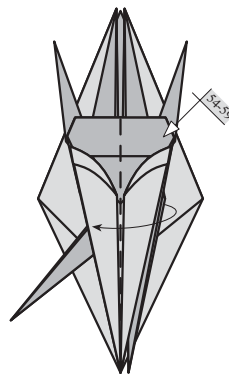

60.

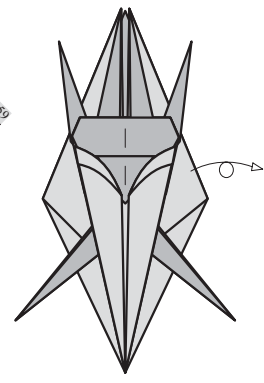

61.

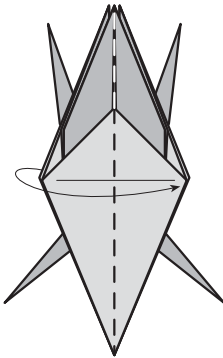

62. Pasar dos capas.

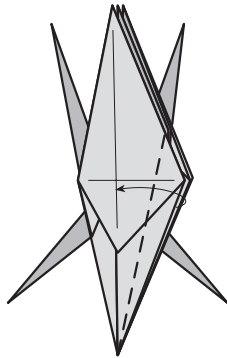

63. Doblar dos Capas.

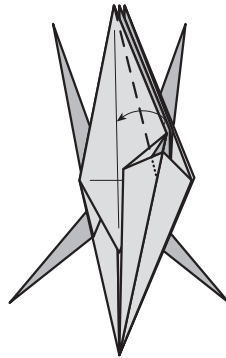

64. Doblar tres Capas.

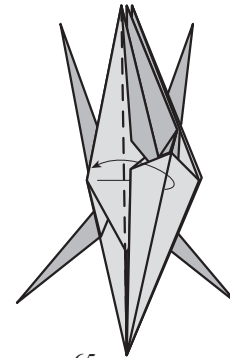

65.

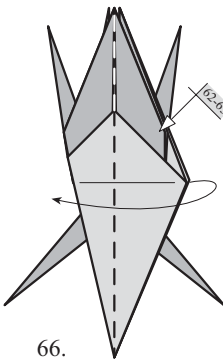

66.

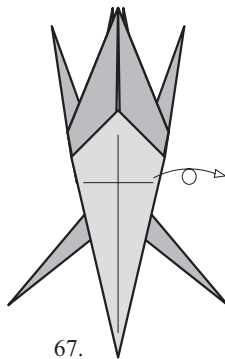

67.

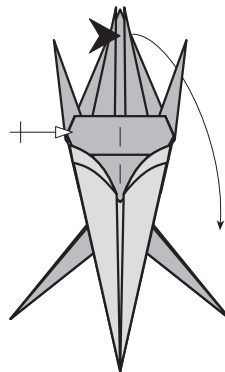

68. Pliege hendido, 2 capas al fondo y una al frente.

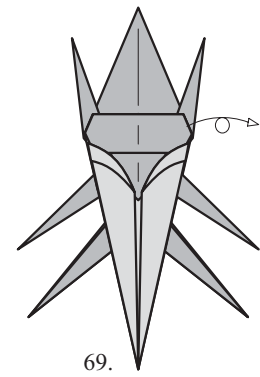

69.

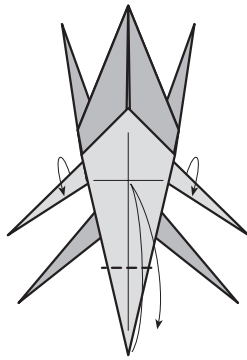

70. Saltar hacia delante las capas traseras.

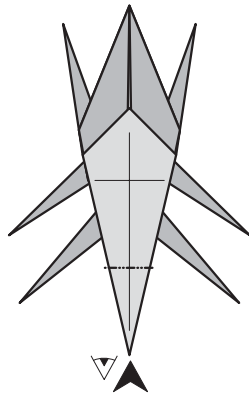

71. Hundido semicerrado difícil de hacer, no abrir el modelo.

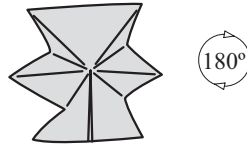

71-A.

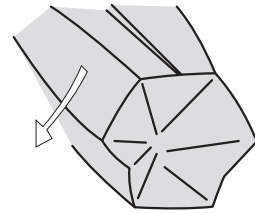

71-B. Sacar con cuidado. Es difícil, pero fundamental para dar volumen al abdomen.



71-C.

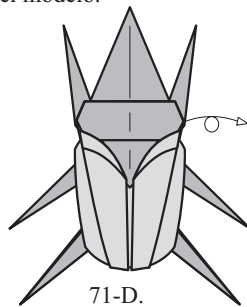

71-D.

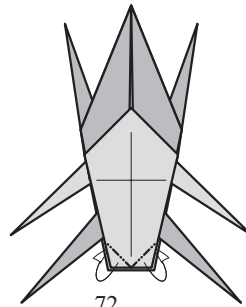

72.

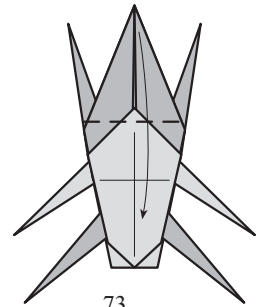

73.

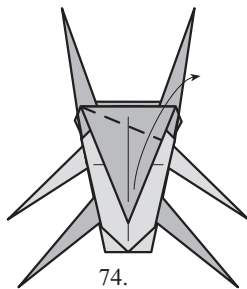

74.

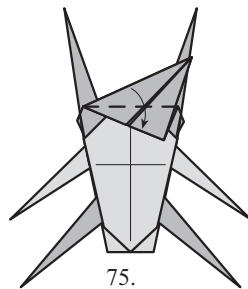

75.

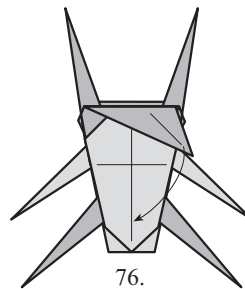

76.

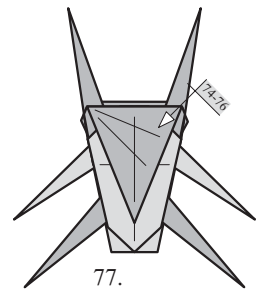

77.

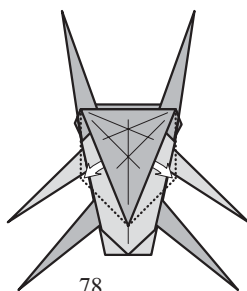

78.

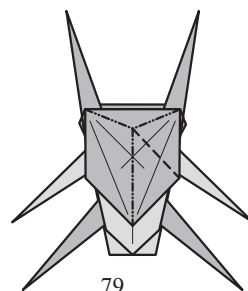

79.

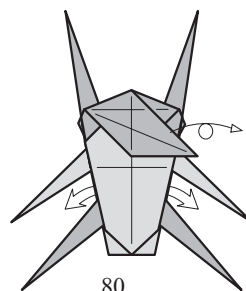

80.

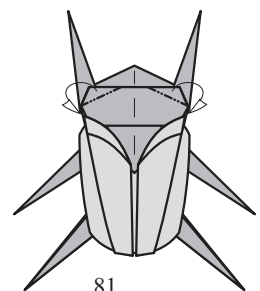

81.

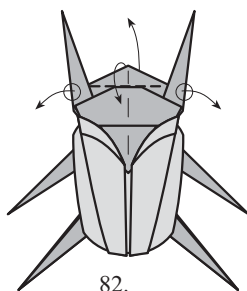

82.

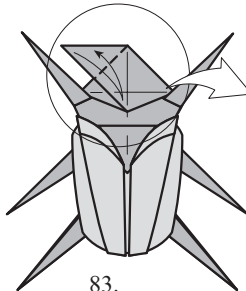

83.

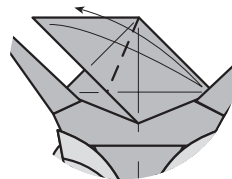

84.

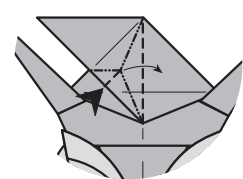

85.

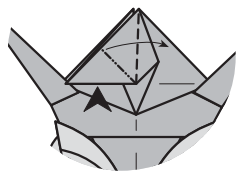

86.

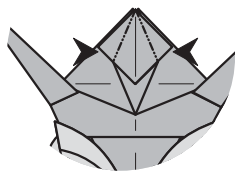

87.

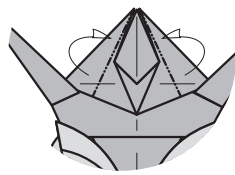

88.

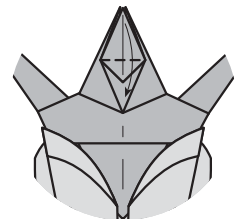

89.

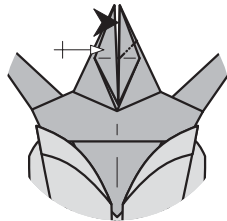

90.

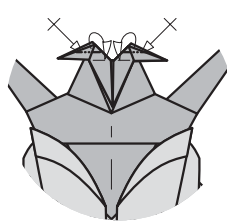

91.

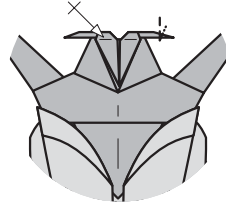

92.

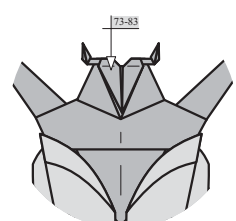

93.

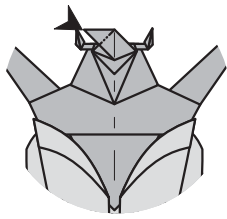

94.

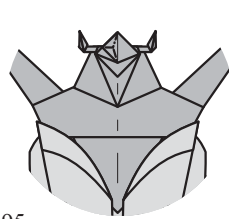

95.

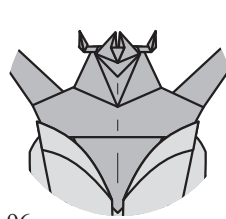

96.

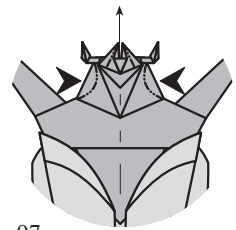

97.

Plegado de las patas

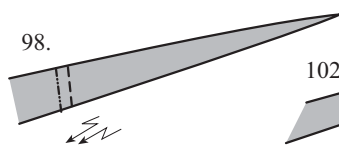

98.

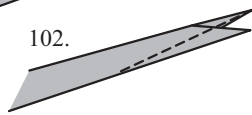

102.

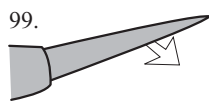

99.

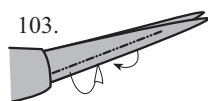

103.



100.

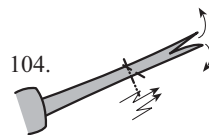

104.

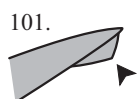

101.

