



TESLA

## MODEL S OWNER'S MANUAL



2018.48.12  
December 17, 2018



Overview.....	2	Maintenance.....	152
Interior Overview.....	2	Maintenance Schedule.....	152
Exterior Overview.....	3	Tire Care and Maintenance.....	153
Touchscreen Overview.....	4	Cleaning.....	159
Opening and Closing.....	8	Wiper Blades and Washer Jets.....	162
Doors.....	8	Fluid Reservoirs.....	164
Windows.....	13	Jacking and Lifting.....	167
Rear Trunk.....	14	Parts and Accessories.....	168
Front Trunk.....	17	Specifications.....	169
Interior Storage and Electronics.....	19	Identification Labels.....	169
Sunroof.....	21	Vehicle Loading.....	170
Seating and Safety Restraints.....	22	Dimensions and Weights.....	173
Front and Rear Seats.....	22	Subsystems.....	175
Seat Belts.....	25	Wheels and Tires.....	177
Child Safety Seats.....	28	Roadside Assistance.....	184
Tesla Built-In Rear Facing Child Seats.....	35	Contacting Roadside Assistance.....	184
Airbags.....	39	Instructions for Transporters.....	185
Driving.....	43	Consumer Information.....	187
Driver Profiles.....	43	Easter Eggs.....	187
Steering Wheel.....	45	About this Owner Information.....	189
Mirrors.....	48	Disclaimers.....	190
Starting and Powering Off.....	49	Reporting Safety Defects.....	192
Gears.....	51	Declarations of Conformity.....	193
Lights.....	53		
Instrument Panel.....	57		
Wipers and Washers.....	63		
Brakes.....	65		
Traction Control.....	68		
Park Assist.....	69		
Vehicle Hold.....	71		
Acceleration Modes.....	72		
Trip Information.....	74		
Getting Maximum Range.....	75		
Rear View Camera.....	77		
Dashcam.....	78		
Autopilot.....	79		
About Autopilot.....	79		
Traffic-Aware Cruise Control.....	82		
Autosteer.....	89		
Autopark.....	95		
Lane Assist.....	100		
Collision Avoidance Assist.....	102		
Speed Assist.....	105		
Using the Touchscreen.....	107		
Controls.....	107		
Climate Controls.....	116		
Maps and Navigation.....	122		
Media and Audio.....	127		
Phone.....	131		
Smart Air Suspension.....	133		
Calendar.....	135		
Security Settings.....	136		
HomeLink Universal Transceiver.....	137		
Connecting to Wi-Fi.....	139		
Software Updates.....	140		
Mobile App.....	141		
Charging.....	142		
Electric Vehicle Components.....	142		
Battery Information.....	144		
Charging Instructions.....	146		

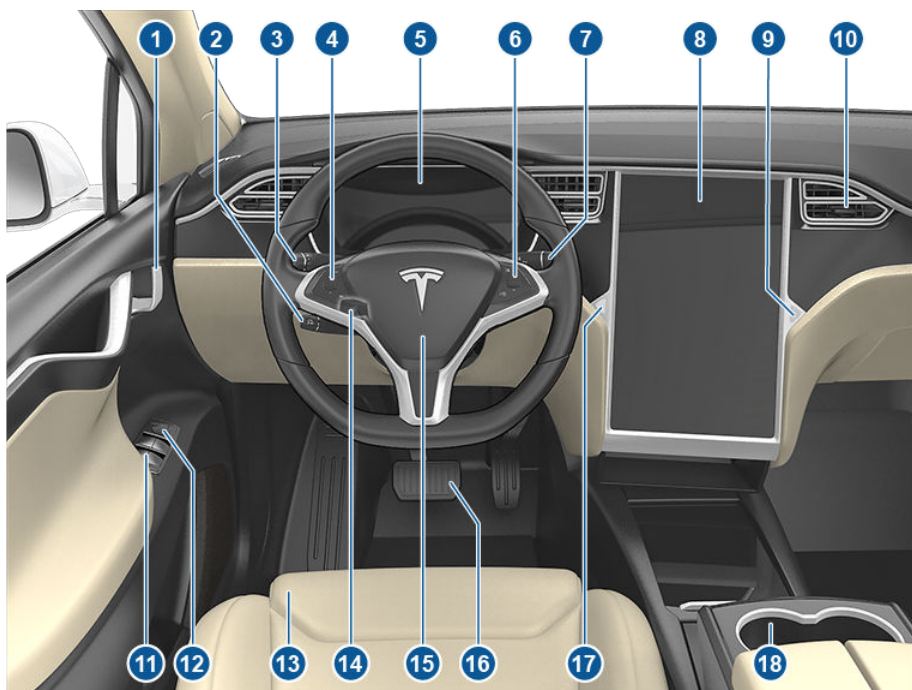

1. Interior door handles ([Opening Doors from the Interior](#) on page 10)
2. Traffic-Aware Cruise Control ([Traffic-Aware Cruise Control](#) on page 82) and Autosteer ([Autosteer](#) on page 89)
3. High beams ([High Beam Headlights](#) on page 55), Turn signals ([Turn Signals](#) on page 56), Wipers and washers ([Wipers and Washers](#) on page 63)
4. Steering wheel buttons - left ([Using Left Steering Wheel Buttons](#) on page 45)
5. Instrument panel ([Instrument Panel](#) on page 57)
6. Steering wheel buttons - right ([Using Right Steering Wheel Buttons](#) on page 46)
7. Gear selector ([Shifting Gears](#) on page 51)
8. Touchscreen ([Touchscreen Overview](#) on page 4)
9. Glovebox button ([Glove Box](#) on page 19)
10. Cabin climate control ([Climate Controls](#) on page 116)
11. Power window switches ([Opening and Closing](#) on page 13)
12. Exterior mirror adjustment switches ([Mirrors](#) on page 48)
13. Seats ([Front and Rear Seats](#) on page 22)
14. Steering column adjuster (hidden from view in the above image) ([Steering Wheel](#) on page 45)
15. Horn ([Horn](#) on page 47)
16. Brakes ([Brakes](#) on page 65)
17. Hazard warning lights ([Hazard Warning Flashers](#) on page 56)
18. Cup holders ([Cup Holders](#) on page 20)

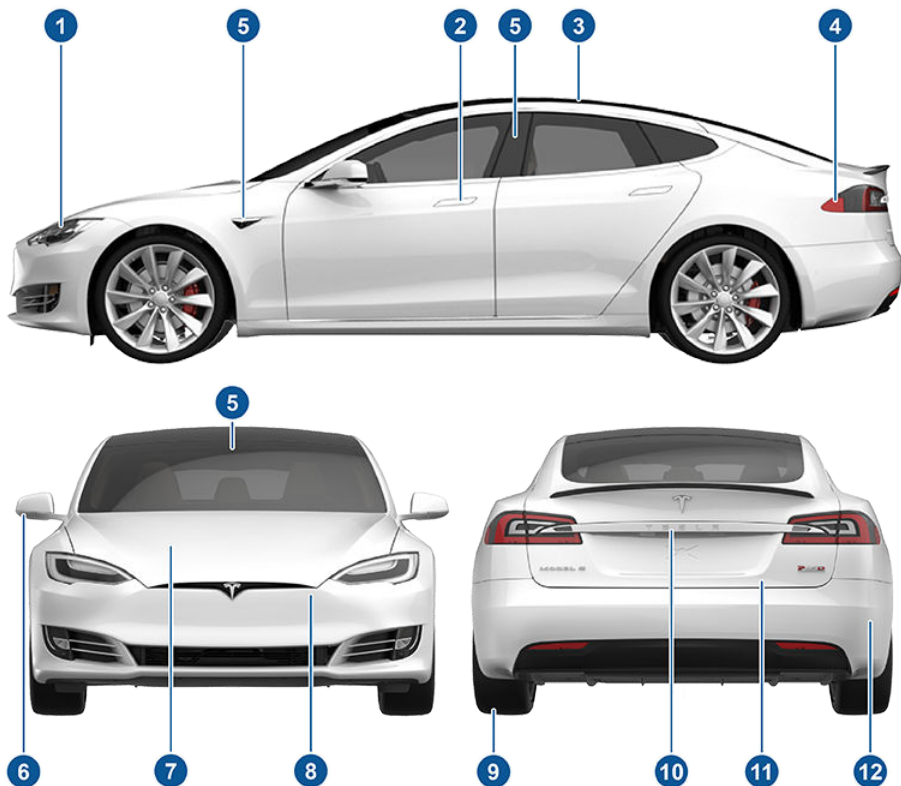

1. Exterior lights ([Lights](#) on page 53)
2. Door handles ([Using Exterior Door Handles](#) on page 10)
3. Sunroof (optional) ([Sunroof](#) on page 21)
4. Charge port ([Charging Instructions](#) on page 146)
5. Autopilot cameras ([About Autopilot](#) on page 79)
6. Exterior mirrors ([Mirrors](#) on page 48)
7. Hood/Front trunk ([Front Trunk](#) on page 17)
8. Radar sensor (hidden from view in the above image) ([About Autopilot](#) on page 79)
9. Wheels and tires ([Wheels and Tires](#) on page 177)
10. Rear view camera ([Rear View Camera](#) on page 77 and [About Autopilot](#) on page 79)
11. Rear trunk/liftgate ([Rear Trunk](#) on page 14)
12. Ultrasonic sensors ([Park Assist](#) on page 69 and [About Autopilot](#) on page 79)



The main components of the touchscreen are shown here. The touchscreen is used to control many features that, in traditional cars, are controlled using physical buttons (for example, adjusting the heating and air conditioning, headlights, etc.). You can also use the touchscreen to customize Model S to suit your preferences.

**Warning:** Always pay attention to road and traffic conditions when driving. To minimize driver distraction and ensure the safety of vehicle occupants as well as other road users, avoid using the touchscreen to adjust settings while the vehicle is in motion.

**Note:** The image below is provided for demonstration purposes only. Depending on vehicle options, software version and market region, your touchscreen may appear slightly different.

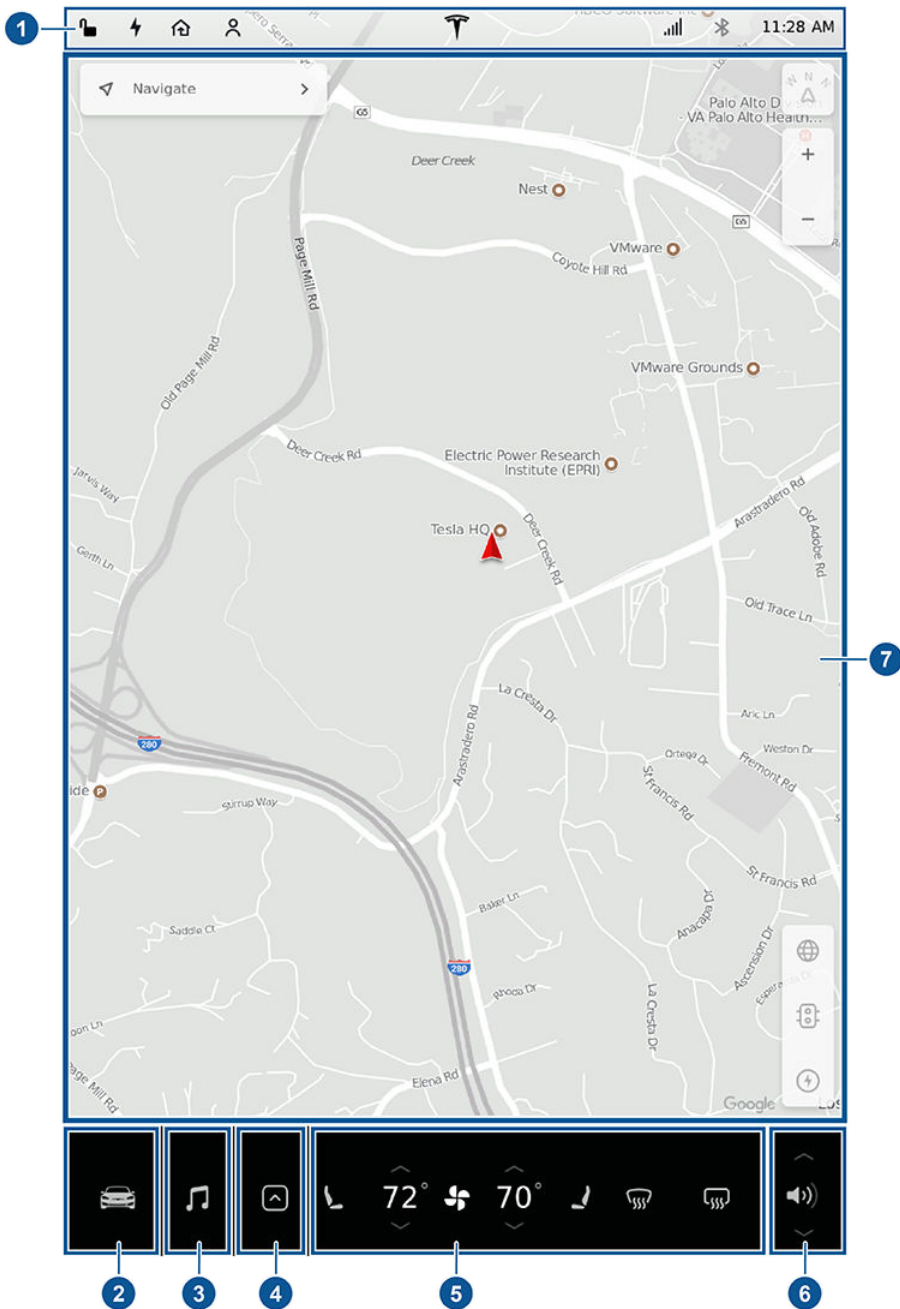



1. This area on the top of the touchscreen displays the time and provides shortcut to lock/unlock the vehicle, access vehicle information (the Tesla "T"), choose or set up a driver profile (see [Driver Profiles](#) on page 43), control HomeLink devices (if equipped) (see [HomeLink Universal Transceiver](#) on page 137), view network strength, and connect to Wi-Fi (see [Connecting to Wi-Fi](#) on page 139) and Bluetooth devices (see [Pairing a Bluetooth Phone](#) on page 131). If you see an exclamation mark, touch it to see warning messages that are in effect. If you see a yellow clock icon, a software update is available (see [Software Updates](#) on page 140).

**Note:** An airbag status symbol displays in the top right corner of the touchscreen only when Model S is powered on, ready to drive, and the airbag is turned off (see [Airbags](#) on page 39).

2. Controls. Touch to control features and customize Model S to suit your preferences (see [Controls](#) on page 107).
3. Media Player (see [Media and Audio](#) on page 127).
4. Touch the app launcher then choose from the following apps:

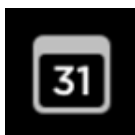

**Calendar.** See [Calendar](#) on page 135.



**Energy.** See [Getting Maximum Range](#) on page 75.



**Web.** Access the Internet using the web browser (if available).



**Camera.** Display the area behind Model S. This area also displays automatically whenever you shift into Reverse. See [Rear View Camera](#) on page 77.



**Call.** See [Phone](#) on page 131.

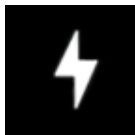

**Charging.** See [Charging Instructions](#) on page 146.

**Note:** Swiping up on the app launcher displays the most recently used app (provided an app is not currently being displayed).



5. Climate Controls (see [Climate Controls](#) on page 116).
6. Volume Control (see [Volume Control](#) on page 127).
7. The map displays on the touchscreen at all times (see [Maps and Navigation](#) on page 122).

**Note:** When you touch **Controls**, choose an app, or expand Media Player, the window displays on top of the map. To close the Controls window, touch **Controls** again or touch the **X** in the top corner of the window. To close an app, touch the **X** in the top corner of the window. To close Media Player, drag it all the way down to the bottom of the touchscreen or touch the icon again.

## The Tesla "T"

Touch the Tesla "T" at the top center of the touchscreen to display:

- Vehicle name (see [Naming Your Vehicle](#) on page 115).
- Battery size.
- Odometer.
- Vehicle Identification Number (VIN).
- Version of software currently installed on your Model S.
- Release notes associated with the currently-installed software version.
- This owner's manual.
- One-touch access to call Tesla Customer Support and Roadside Assistance.
- One-touch access to all discovered Easter Eggs (see [Easter Eggs](#) on page 187).





## Keyless Locking and Unlocking

Locking and unlocking Model S is convenient. Although you must be carrying a valid key, there is no need to use it. Model S has sensors around the driver's door that can recognize the presence of a key within a range of approximately three feet (one meter). So, you can keep your key in your pocket or purse and Model S detects it as you approach.

When you walk up to Model S carrying your key, the doors automatically unlock if Passive Entry is on (**Controls > Safety & Security > Passive Entry**). If a door handle is retracted, press it and it extends. If the **Auto-Present Handles** setting is turned on (see [Using Exterior Door Handles](#) on page 10), you do not need to touch the door handle. Instead, door handles extend automatically as you approach Model S. To open the rear trunk, press the switch located under the trunk's exterior handle.

**Note:** Model S must detect your key near the driver's door before the doors or rear trunk unlock.

**Note:** If Passive Entry is off, you must use the key to unlock Model S. See [Using the Key](#) on page 8.

**Note:** You can choose whether you want all doors, or just the driver's door, to unlock when you approach Model S carrying your key (see [Door Unlock Mode](#) on page 10).

When carrying your key with you, you can also open the rear trunk without having to use the key. Simply press the switch located under the trunk's exterior handle. Driver Door Unlock Mode (see [Door Unlock Mode](#) on page 10) must be off and the vehicle must detect the key near the driver's door before opening the rear trunk.

Model S also locks automatically. If you enable **Walk Away Door Lock**, Model S locks when you walk away carrying your key with you (see [Walk-Away Locking](#) on page 11).

While sitting inside Model S, you can also lock and unlock the vehicle by touching the icon on the touchscreen's status bar or by touching **Controls > Quick Controls**.

**Note:** Depending on date of manufacture and options selected at time of purchase, some Model S vehicles are not equipped with the automatic locking and unlocking feature.

## Using the Key

To quickly familiarize yourself with the key, think of the key as a miniature version of Model S, with the Tesla badge representing the front. The key has three buttons that feel like softer areas on the surface.

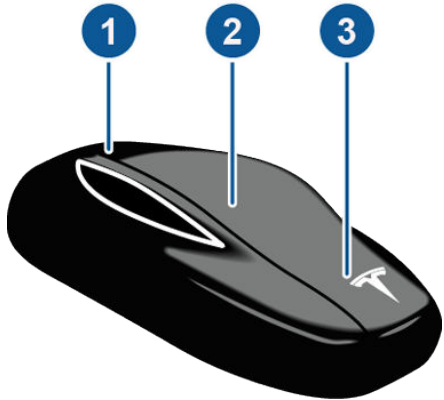

1. Trunk
  - Double-click to open the rear trunk.
  - If equipped with a powered liftgate, double-click to close the rear trunk. You can also single-click to stop the liftgate when it is moving.
  - Hold the button down for one to two seconds to open the charge port door.
2. Lock/Unlock All
  - Single-click to lock doors and trunks (all doors and trunks must be closed). Hazard warning lights flash once and door handles retract. If a door or the rear trunk is open, hazard warning lights flash three times and doors do not lock.
  - Double-click to unlock. Hazard warning lights flash twice and door handles extend. If a door or the rear trunk is open, hazard warning lights flash three times and doors do not lock.
3. Front trunk
  - Double-click to open the front trunk.

You do not need to point the key at Model S, but you must be within operating range (which varies depending on the strength of the key's battery).



If Model S is unable to detect the key, the touchscreen displays a message indicating that a key is not inside. Place the key where Model S can best detect it, which is below the 12V power socket (see [Key Not Inside](#) on page 49).

Radio equipment on a similar frequency can affect the key. If this happens, move the key at least one foot (30 cm) away from other electronic devices (phone, laptop, etc). If the key does not work, you may need to change its battery. If the key's battery is discharged, you can open Model S by following the unlocking procedure (see [Unlocking When the Key Doesn't Work](#) on page 11).

- ⚠ Caution:** Remember to bring the key with you when you drive. Although you can drive Model S away from its key, you will be unable to power it back on after it powers off.
- ⚠ Caution:** Protect the key from impact, high temperatures, and damage from liquids. Avoid contact with solvents, waxes and abrasive cleaners.

### Replacing the Key Battery

The key's battery lasts for approximately a year. When the battery is low, a message displays on the instrument panel. Follow these steps to replace it:

1. With the key placed button side down on a soft surface, use a small flat-bladed tool to release the bottom cover.

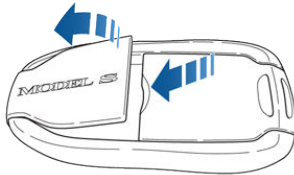

2. Remove the battery by lifting it away from the front retaining clips.

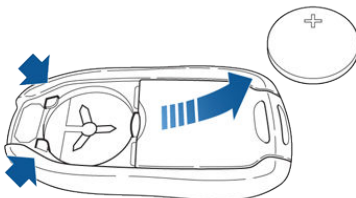

3. Insert the new battery (type CR2032) with the '+' side facing up.

**Note:** Wipe the battery clean before fitting and avoid touching the battery's flat surfaces. Finger marks on the flat surfaces of the battery can reduce battery life.

4. Holding the cover at an angle, align the tabs on the widest side of the cover with the corresponding slots on the key, then press the cover firmly onto the key until it snaps into place.

### Getting More Keys

If you lose a key or require an additional one, contact Tesla. Model S can recognize up to three keys.

When ordering a new key for Model S, take all available keys with you for reprogramming.



## Using Exterior Door Handles

A light press on a door handle extends it, provided Model S detects a valid key nearby and Passive Entry is on (**Controls > Safety & Security > Passive Entry**).

You can set the door handles to extend automatically whenever you approach the driver's side carrying the key. On the touchscreen, touch **Controls > Vehicle > Auto-Present Handles**.

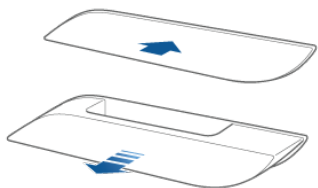

Insert your hand into the handle and pull to open the door.

Door handles retract if you do not use them within one minute after they extend. Just press a handle to extend it again. Door handles also retract a minute after the last door closes, when Model S begins moving, and when you lock Model S.

**Note:** To preserve battery life, Model S is designed to temporarily disable the **Auto-Present Handles** feature when:

- The key has been out of range for more than 48 hours.
- The key remains within range for five minutes after all doors have been closed.

In these cases, extend door handles by touching one of them, or by pressing the unlock button on the key. There is no need to reset the setting. The next time you approach Model S, provided the above conditions do not apply, handles automatically extend.



Whenever a door is open, the Door Open indicator displays on the instrument panel. Also, the image of the Model S on the touchscreen's **Controls > Quick Controls** window also provides a visual representation of an open door or trunk.

## Opening Doors from the Interior

To open a door, pull the interior door handle toward you.

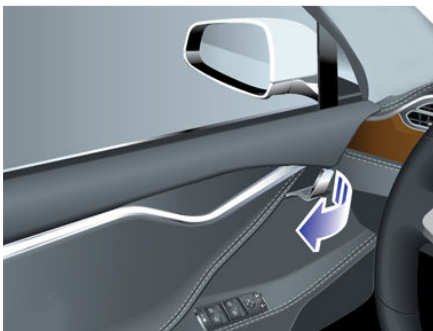

**Note:** To prevent children from opening rear doors using the interior handles, use the touchscreen, **Controls > Vehicle > Child-Protection Lock**, to turn on the child-protection locks (see [Child-Protection Lock](#) on page 11).

## Interior Locking and Unlocking

From inside Model S, you can use the touchscreen to lock or unlock doors and trunks, provided a valid key is inside the vehicle. Touch the lock icon on the touchscreen's status bar.

When you stop Model S and engage the Park gear, you can choose whether you want doors to unlock or remain locked. To do so, touch **Controls > Vehicle > Unlock on Park**. When enabled, doors automatically unlock when you engage the Park gear.

You can also unlock doors and present handles by pressing the Park button on the end of the gear selector a second time (for example, after pressing it one time to engage the Park gear).

**Note:** If a door or trunk is still open when you lock Model S, it locks when you close it.

## Door Unlock Mode

You can choose to unlock only the driver's door when you approach your vehicle carrying your key or when you shift into Park. To do so, touch **Controls > Vehicle > Driver Door Unlock Mode**.



## Child-Protection Lock

Model S has child-protection locks on the rear doors and liftgate to prevent them from being opened using interior handles. Use the touchscreen to turn child-protection locks on or off. Touch **Controls** > **Vehicle** > **Child-Protection Lock**.

**Note:** It is recommended that you turn child-protection locks on whenever children are seated in the rear seats.

## Drive Away Locking

Model S automatically locks all doors (including the trunks) whenever your driving speed exceeds 5 mph (8 km/h).

## Walk-Away Locking

Doors and trunks automatically lock whenever you walk away carrying the key or if the key is otherwise not detected by your vehicle (not present, dead battery, etc.).

To turn this feature on or off, touch **Controls** > **Vehicle** > **Walk-Away Door Lock**.

**Note:** Depending on date of manufacture and options selected at time of purchase, some Model S vehicles are not equipped with the Walk-Away Locking.

**Note:** If all doors are closed and you use the key to unlock Model S, walk away locking is temporarily suspended for one minute. If you open a door within this minute, it does not re-lock until after all the doors are closed and you have walked away with the key.

**Note:** If your vehicle was unlocked using the mobile app, it automatically locks after a short period of time with all doors closed. If parking in an area without cellular service, such as an indoor parking garage, ensure that you have a functional key fob readily available.

## Unlocking When the Key Doesn't Work

If Model S does not unlock when you walk up to it, or when you press the unlock button on your key, the key's battery may be dead. If this is the case, you can still unlock and drive Model S.

To unlock Model S (and disable the security alarm), first position the key near the base of the passenger side windshield wiper, as shown. Then press the front passenger door handle. If Model S doesn't unlock, try adjusting the position of the key. The key must be in the correct position.

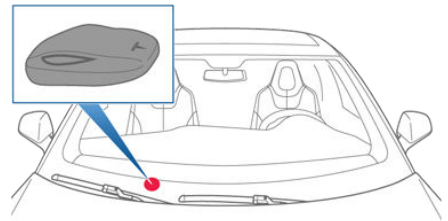

To drive Model S, place the key against the center console, immediately below the 12V power outlet, then press and hold the brake pedal to turn Model S on.

**Note:** Unlocking Model S using this method disables walk away locking. You must manually re-enable walk away locking after replacing the key's battery.

For instructions on how to replace the key's battery, see [Replacing the Key Battery](#) on page 9.



## Opening Interior Doors with No Power

If Model S has no electrical power, the front doors open as usual using the interior door handles. To open the rear doors, fold back the edge of the carpet below the rear seats to expose the mechanical release cable. Pull the mechanical release cable toward the center of the vehicle.

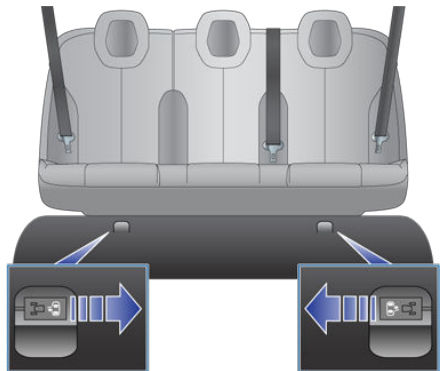



## Opening and Closing

Press down on a switch to lower the associated window. Window switches operate at two levels:

- To lower a window fully, press the switch all the way down and immediately release.
- To lower a window partially, press the switch gently and release when the window is where you want it.

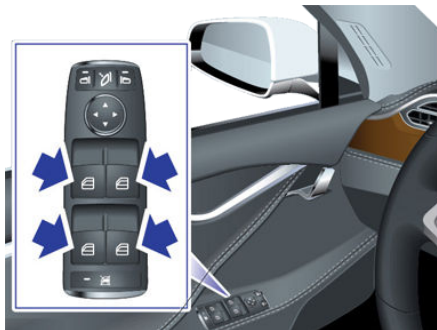

Similarly, pull a switch to raise the associated window:

- To raise a window fully, pull the switch all the way up and immediately release.
- To raise a window partially, pull the switch gently and release when the window is where you want it.

**⚠ Warning:** Before closing a window, it is the driver's responsibility to ensure that all occupants, especially children, do not have any body parts extended through the window's opening. Failure to do so can cause serious injury.

## Locking Rear Windows

To prevent passengers from using the rear window switches, press the rear window lock switch. The switch light turns on. To unlock rear windows, press the switch again.



**⚠ Warning:** To ensure safety, it is recommended that you lock the rear window switches whenever children are seated in the rear seats.

**⚠ Warning:** Never leave children unattended in Model S.



## Opening

To open the rear trunk, do one of the following:

- Touch the associated **OPEN** button on the touchscreen (**Controls > Quick Controls**).
- Double-click the rear trunk button on the key.
- Touch the trunk button on the mobile app.
- With Model S unlocked, press the switch located under the rear trunk's exterior handle.

**Note:** If **Passive Entry** is off, you must use the key to unlock Model S before you can use the switch to manually open the rear trunk. See [Using the Key](#) on page 8.



When a door or trunk/liftgate is open, the instrument panel displays the Door Open indicator light. The image of your Model S on the touchscreen also displays the open trunk.

To stop a powered liftgate while it is moving, single-click the rear trunk button on the key. Then, when you double-click the rear trunk button, it moves again, but in the opposite direction (provided it was not almost entirely open or closed when you stopped it). For example, if you single-click to stop the liftgate while it is opening, when you double-click, it closes.

To open the trunk from inside Model S in the unlikely situation that Model S has no power, see [Interior Emergency Trunk Release](#) on page 15.

**Warning:** Before opening or closing the rear liftgate, it is important to check that the area around the liftgate is free of obstacles (people and objects). Although the powered liftgate can detect obstacles, it can not detect all objects at all times.

Do not rely on the liftgate to sense an obstruction when opening or closing. You must proactively monitor the liftgate to ensure that it does not come into contact with a person or object. Failure to do so may result in damage or serious injury.

## Load Limits

Secure all cargo before moving Model S, and place heavy cargo in the lower trunk compartment.

**Caution:** To avoid damage, never load more than 175 lbs (80 kg) on the rear load floor (above the lower trunk compartment) or more than 285 lbs (130 kg) in the lower trunk compartment. Doing so can cause damage.

## Closing

If Model S is not equipped with a powered liftgate, close the rear trunk by pulling down on the liftgate and pushing firmly until it is fully closed.

To close the powered liftgate, do one of the following:

- Double-click the trunk button on the key.
- Touch the associated **CLOSE** button on the touchscreen (**Controls > Quick Controls**).
- Press the switch located on the underside of the liftgate (see [Adjusting the Opening Height](#) on page 14).

If a powered liftgate senses an obstruction when closing, it automatically opens and sounds two chimes. Remove the obstruction and try closing it again. If it cannot close the second time, powered operation is temporarily disabled. Close it manually to restore powered operation.

**Note:** The power closing feature is also temporarily disabled if you leave the powered liftgate open for more than an hour.

## Adjusting the Opening Height

If Model S is equipped with a powered liftgate, you can adjust its opening height to make it easier to reach:

1. Open the liftgate, then manually lower or raise it to the desired opening height.



- Press and hold the button on the underside of the liftgate for two seconds until you hear a confirmation chime.



- Confirm that you have set it to the desired height by closing the liftgate, then reopening it.

## Interior Release

To open the rear trunk from inside a Model S equipped with the Tesla Built-In Rear Facing Child Seats, press the interior release switch located inside the rear trunk and push the liftgate up. If Model S is locked and is equipped with a power liftgate, the first press unlocks the rear trunk and the second press opens it.

**Note:** If Model S is not equipped with the Tesla Rear Facing Child Seats, the switch may appear to exist, but it will be inactive and pressing it does not release the liftgate.



If Model S is equipped with the power liftgate, you do not need to push it up. When you press the release switch, it opens, and when you pull the switch, it closes.

**Note:** The interior release switch is disabled if child-protection locks are turned on (see [Child-Protection Lock](#) on page 11), or if Model S is moving.

## Accessing the Cargo Area

To access the cargo area inside the rear trunk, pull up the strap at the rear of the cargo cover. You can then fold the cargo cover forward or remove it from Model S.

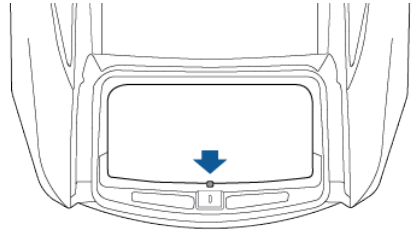

- ⚠ Caution:** Never load more than 175 lbs (80 kg) on the rear load floor (above the lower trunk compartment) or more than 285 lbs (130 kg) in the lower trunk compartment. Doing so can cause damage.

## Interior Emergency Trunk Release

An illuminated mechanical release located inside the rear trunk allows you to open the rear trunk from the inside if Model S has no electrical power. This mechanical release also allows a person locked inside to get out.

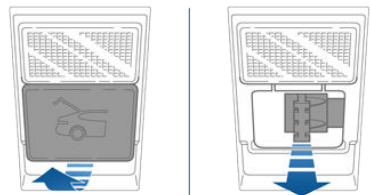

- Remove the cover by pulling its lower edge very firmly toward you.
- Pull the cable to release the latch.
- Push the rear trunk open.

**Note:** The button glows for several hours after a brief exposure to ambient light.

- ⚠ Warning:** Do not allow children to play inside the trunk or become locked inside. An unrestrained child could suffer serious injury or death in a crash. A child could suffer heat exhaustion if trapped in the vehicle, especially without climate control on. If your Model S is equipped with Tesla built-in rear facing child seats, see [Tesla Built-In Rear Facing Child Seats](#) on page





## Rear Trunk

35 and ensure all restrictions, instructions, and warnings are followed.



## Opening

To open the front trunk:

1. Ensure that the area around the hood is free of obstacles.
2. Touch the associated **OPEN** button on the touchscreen (**Controls** > **Quick Controls**), double-click the front trunk button on the key, or touch the front trunk button on the mobile app.
3. Pull the hood up.

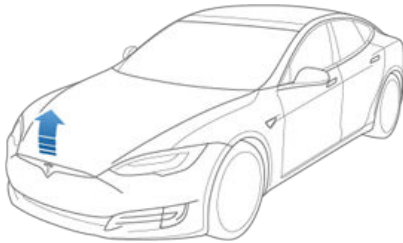

When a door or trunk/liftgate is open, the instrument panel displays the Door Open indicator light. The image of your Model S on the touchscreen also displays the open front trunk.

- Warning:** Before opening or closing the hood, it is important to check that the area around the hood is free of obstacles (people and objects). Failure to do so may result in damage or serious injury.

**Note:** The front trunk locks whenever closed and you lock Model S using either the touchscreen or externally using the key or mobile app, you leave Model S carrying your key (if [Walk-Away Locking](#) on page 11 is turned on), or when Valet mode is active (see [Valet Mode](#) on page 44).

## Closing

The Model S hood is not heavy enough to latch under its own weight and applying pressure on the front edge or center of the hood can cause damage.

To properly close the hood:

1. Lower the hood until the striker touches the latches.
2. Place both hands on the front of the hood in the areas shown (in green), then press down firmly to engage the latches.

3. Carefully try to lift the front edge of the hood to ensure that it is fully closed.

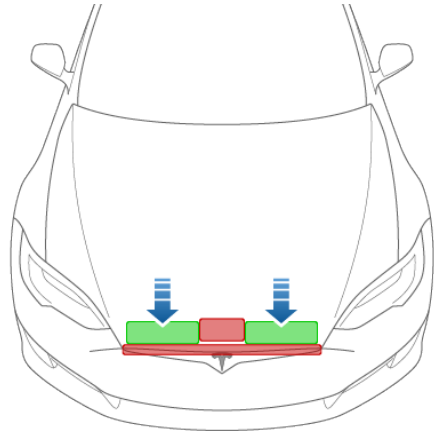

- Caution:** To prevent damage:

- Apply pressure only to the green areas shown. Applying pressure to the red areas can cause damage.
- Do not close the hood with one hand. Doing so applies concentrated force in one area and can result in a dent or crease.
- Do not apply pressure to the front edge of the hood. Doing so can crease the edge.
- Do not slam or drop the hood.

- Warning:** Before driving, you must ensure that the hood is securely latched in the fully closed position by carefully trying to lift the front edge of the hood upward and confirming there is no movement.

## Interior Emergency Release

An illuminated interior release button inside the front trunk allows a person locked inside to get out.

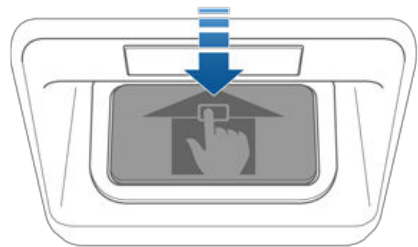



Press the interior release button to open the front trunk, then push up on the hood.

**Note:** The interior release button glows following a brief exposure to ambient light.

- ⚠ Warning:** People should never climb inside the front trunk. Never shut the front trunk when a person is inside.
- ⚠ Warning:** Care should be taken to ensure that objects inside the front trunk do not bump against the release button, causing the trunk to accidentally open.



## Glove Box

To open the glove box, press the switch located on the side of the touchscreen. If you leave the glove box open for five minutes, its light automatically turns off.

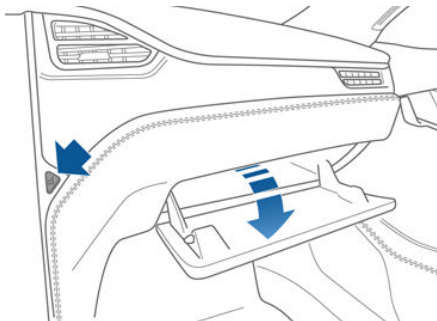

**Note:** The glove box locks whenever Model S is locked externally, using the key or walk-away locking. It also locks when Model S is in Valet mode (see [Valet Mode](#) on page 44). It does not lock when Model S is locked using the touchscreen.

**Warning:** When driving, keep the glove box closed to prevent injury to a passenger if a collision or sudden stop occurs.

## USB Connections

Your Model S has two USB connections located on the front of the center console that you can use to connect USB devices. To play audio files stored on a USB drive connected to these ports, see [Playing Media from Devices](#) on page 129. You can also use these connections to charge USB devices.

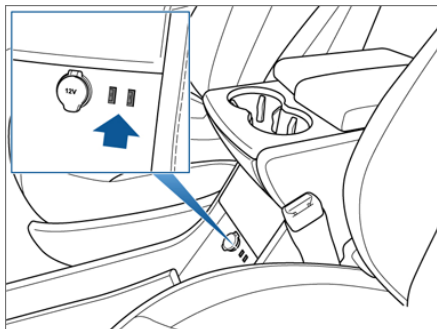

**Note:** Do not connect multiple devices using a USB hub. This can prevent connected devices from charging or from being recognized by the Media Player.

## 12V Power Socket

Your Model S has a power socket located on the front of the center console. Power is available whenever the instrument panel and touchscreen are on.

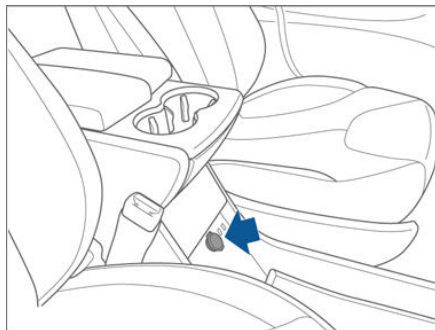

The 12V power socket is suitable for accessories requiring up to 11A continuous draw (15A peak) or a maximum of 150 continuous watts (180 watts peak).

**Note:** In situations where Model S is unable to detect the key (low battery, interference, etc.), place it immediately below the 12V power socket where Model S can best detect it.

**Warning:** The power socket and an accessory's connector can become hot.



## Cup Holders

To expose a front cup holder, slide back the armrest.

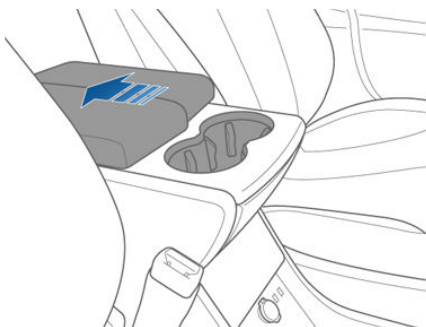

To expose rear cup holders (if available on your vehicle), press and release the cup holder face plate located at the back of the center console.

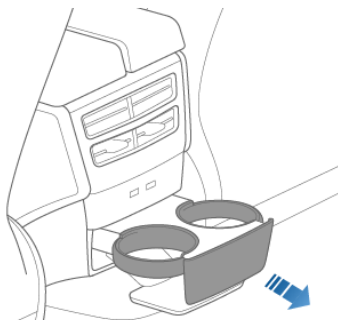



## Opening and Closing

If your Model S is equipped with a sunroof, you can vent and close the sunroof remotely using the mobile app or you can adjust the position of the sunroof by controlling it from the menu on your right scroll wheel.

For full control of the sunroof, touch **Controls** > **Quick Controls** on the touchscreen. Drag, or tap on, the image of the sunroof or touch the buttons next to the image of your vehicle. The sunroof moves to the selected position. To stop the sunroof from moving at any time, touch the image of the sunroof.

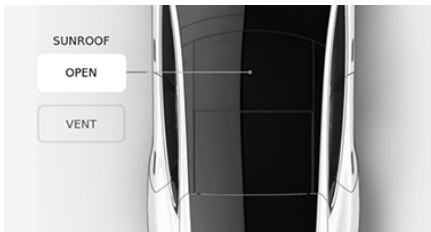

- **OPEN:** touch once to open the sunroof to its comfort position (75% open). Touch twice to open the sunroof fully.
- **VENT:** touch to open the sunroof slightly.
- **CLOSE:** touch to fully close the sunroof.

**Note:** If the sunroof detects any obstruction, it does not close. If, after removing the obstruction, it still does not close, touch and hold **CLOSE** to override the sunroof's anti-trap mechanism.

**Note:** If you find wind noise (which varies depending on driving speed) excessive, even with the sunroof in the comfort position, open a window slightly.

- ⚠ **Caution:** Remove snow and ice before opening the sunroof. Opening a sunroof covered in snow and ice can cause damage.
- ⚠ **Warning:** Do not allow occupants to extend any part of their body through the sunroof. Doing so can cause serious injury from flying debris, tree branches, or other obstructions.
- ⚠ **Warning:** Before closing the sunroof, ensure that occupants, especially children, do not have any body part extended through the sunroof opening. Failure to do so can cause serious injury.
- ⚠ **Warning:** Do not carry an object that protrudes through the sunroof. Doing so

can damage the sunroof's seals and anti-trap mechanism, and can cause injury to occupants.



## Correct Driving Position

The seat, head support, seat belt and airbags work together to maximize your safety. Using these correctly ensures greater protection.



Position the seat so you can wear the seat belt correctly, while being as far away from the front airbag as possible:

1. Sit upright with both feet on the floor and the seat back reclined no more than 30 degrees.
2. Make sure you can easily reach the pedals and that your arms are slightly bent when holding the steering wheel. Your chest should be at least 10 inches (25 cm) from the center of the airbag cover.
3. Place the shoulder section of the seat belt mid-way between your neck and your shoulder. Fit the lap section of the belt tightly across your hips, not across your stomach.

## Adjusting the Driver's Seat

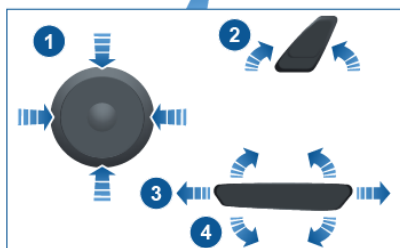
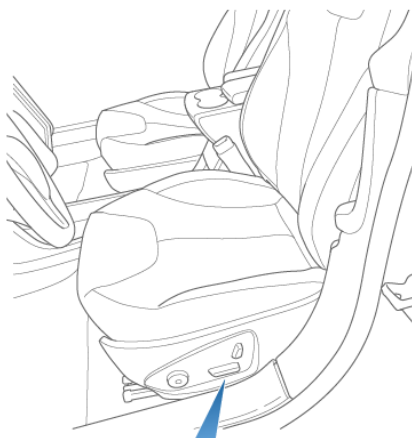

1. Adjust lumbar support.

**Note:** If your Model S is equipped with adjustable head supports, this button is also used to move the head support up or down (see [Head Supports/Restraints](#) on page 23). When you touch this button, the touchscreen displays a popup with an image of the seat. If the lumbar area on the image is not highlighted in blue, touch the lumbar area on the image to specify that you want to adjust lumbar support. The selection you choose is retained until you manually change it.

2. Adjust backrest.
3. Move seat forward/backward.
4. Adjust the seat's height and tilt angle.

**Warning:** Before adjusting a front seat, check that the area around the seat is free of obstacles (people and objects).

**Warning:** Do not adjust seats while driving. Doing so increases the risk of a collision.



- ⚠ Warning:** Riding in a moving vehicle with the seat back reclined can result in serious injuries in a collision, as you could slide under the lap belt or be propelled into the seat belt. Ensure your seat back is reclined no more than 30 degrees when the vehicle is moving.

## Folding Rear Seats

Model S has a split rear seat that can fold forward.

**Note:** If Model S is equipped with the optional executive rear seats, these seats do not fold forward.

Before folding, remove items from the seats and the rear footwell. To allow the rear seat backs to fold completely flat, you may need to move the front seats forward.

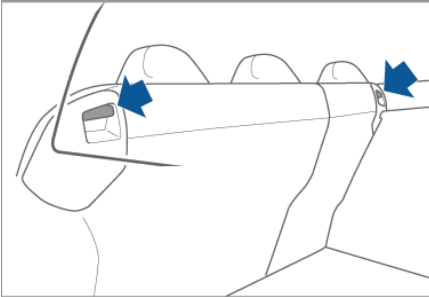

To fold a rear seat, pull the corresponding lever and fold the seat forward.

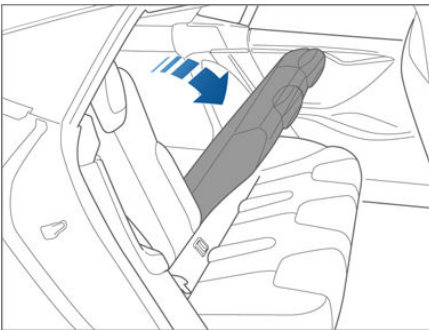

## Raising Rear Seats

Before raising a rear seat, make sure that the seat belts are not trapped behind the backrest.

Pull the seat back upward until it locks into place.

To confirm that the seat back is locked in the upright position, try pulling it forward.

- ⚠ Warning:** Always ensure the seat backs are locked in their upright position. Failure to do so increases the risk of injury.

## Head Supports/Restraints

If your Model S is equipped with adjustable head supports, use the round button on the seat to move the headrest up/down. The same button is used to adjust the seat's lumbar support (see [Adjusting the Driver's Seat](#) on page 22). Therefore, when you touch this button, the touchscreen displays a popup with an image of the seat. If the head support shown on the image is not highlighted in blue, touch this area on the image to specify that you want to adjust the head support. The selection you choose is saved until you manually change it. You can save the head support setting to your driver profile (see [Driver Profiles](#) on page 43).

**Note:** Head supports are not adjustable on early versions of Model S.

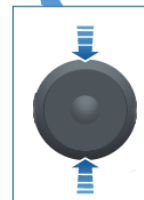
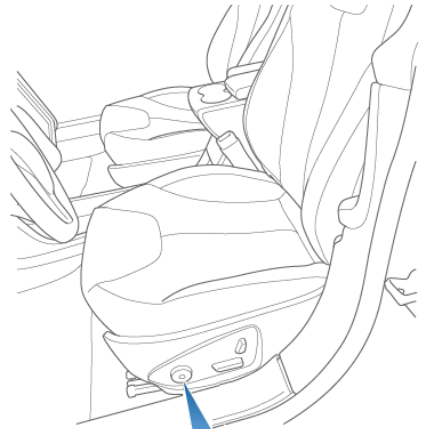





The second row seats have integrated non-removable head supports that cannot be adjusted.

## Seat Heaters

The front seats are equipped with heating pads that operate at three levels from 3 (highest) to 1 (lowest). To operate the seat heaters, see [Climate Controls](#) on page 116.

If Model S is equipped with the optional cold weather package, you can also control seat heaters in all rear seating positions, as well as heated wipers and washer nozzles by touching the climate controls on the touchscreen (see [Climate Controls](#) on page 116).

**Warning:** To avoid burns resulting from prolonged use, individuals who have peripheral neuropathy, or whose capacity to feel pain is limited because of diabetes, age, neurological injury, or some other condition, should exercise caution when using the climate control system and seat heaters.

## Seat Covers

**Warning:** Do not use seat covers in Model S. Doing so could restrict deployment of the seat-mounted side air bags if a collision occurs. It can also reduce the accuracy of the occupant detection system.



## Wearing Seat Belts

Using seat belts and child safety seats is the most effective way to protect occupants if a collision occurs. Therefore, wearing a seat belt is required by law in most jurisdictions.

Both the driver and passenger seats are equipped with three-point inertia reel seat belts. Inertia reel belts are automatically tensioned to allow occupants to move comfortably during normal driving conditions. To securely hold child safety seats, all passenger seating positions are equipped with an automatic locking retractor (ALR) that, by pulling the seat belt beyond the length needed for a typical adult occupant, locks the belt into place until the seat belt is unbuckled (see [Installing Seat Belt Retained Child Seats](#) on page 31).

The seat belt reel automatically locks to prevent movement of occupants if Model S experiences a force associated with hard acceleration, braking, cornering, or an impact in a collision.

### Seat Belt Reminders



The seat belt reminder on the instrument panel alerts you if a seat belt for an occupied seat is not fastened. If the belt remains unfastened, the reminder flashes and an intermittent chime sounds. If all occupants are buckled up and the reminder stays on, re-fasten seat belts to ensure they are correctly latched. Also remove any heavy objects (such as a briefcase) from an unoccupied seat. If the reminder light continues to stay on, contact Tesla.

**Warning:** Seat belts must be worn by passengers in all seating positions. Do not disable a seat belt reminder when the seating position is occupied by a passenger.

### To Fasten a Belt

1. Ensure correct positioning of the seat (see [Correct Driving Position](#) on page 22).
2. Draw the belt out smoothly, ensuring the belt lays flat across the pelvis, chest and mid-point of your collar bone, between the neck and shoulder.

3. Insert the latch plate into the buckle and press together until you hear a click indicating it is locked in place.

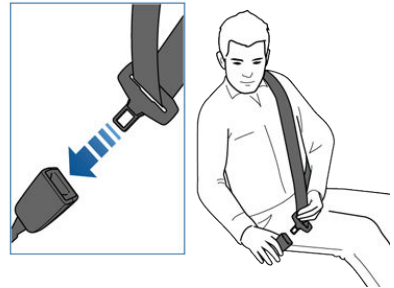

4. Pull the belt to check that it is securely fastened.
5. Pull the diagonal part of the belt toward the reel to remove excess slack.

### To Release a Belt

Hold the belt near the buckle to prevent the belt from retracting too quickly, then press the button on the buckle. The belt retracts automatically. Ensure there is no obstruction that prevents the belt from fully retracting. The belt should not hang loose. If a seat belt does not fully retract, contact Tesla.

## Wearing Seat Belts When Pregnant

Do not put the lap or shoulder sections of the seat belt over the abdominal area. Wear the lap section of the belt as low as possible across the hips, not the waist. Position the shoulder portion of the belt between the breasts and to the side of the abdomen. Consult your doctor for specific guidance.



**Warning:** Never place anything between you and the seat belt to cushion the impact in the event of a collision.

## Seat Belt Pre-tensioners

The front seat belts are equipped with pre-tensioners that work in conjunction with the airbags in a severe frontal collision. The pre-tensioners automatically retract both the seat belt anchor and the seat belt webbing, reducing slack in both the lap and diagonal portions of the belts, resulting in reduced forward movement of the occupant.

The rear outboard seats are equipped with shoulder pre-tensioners to retract the seat belt webbing to reduce forward movement of the occupant.

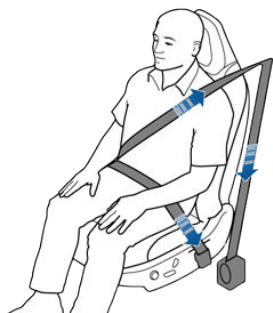

If the pre-tensioners and airbags did not activate in an impact, this does not mean they malfunctioned. It usually means that the strength or type of force needed to activate them was not present.

**Warning:** Once the seat belt pre-tensioners have been activated, they must be replaced. After any collision, have the airbags, seat belt pre-tensioners and any associated components checked and, if necessary, replaced.

## Testing Seat Belts

To confirm that seat belts are operating correctly, perform these three simple checks on each seat belt.

1. With the seat belt fastened, give the webbing nearest the buckle a quick pull. The buckle should remain securely locked.
2. With the belt unfastened, unreel the webbing to its limit. Check that unreeling is free from snags, and visually check the webbing for wear. Allow the webbing to retract, checking that retraction is smooth and complete.
3. With the webbing half unreeled, hold the tongue plate and pull forward quickly. The mechanism should lock automatically and prevent further unreeling.

If a seat belt fails any of these tests, contact Tesla immediately.

For information about cleaning seat belts, see [Seat Belts](#) on page 160.

## Seat Belt Warnings

**Warning:** Seat belts should be worn by all occupants at all times, even if driving for a very short distance. Failure to do so increases the risk of injury or death if a collision occurs.

**Warning:** Secure small children in a suitable child safety seat (see [Child Safety Seats](#) on page 28). Always follow the child safety seat manufacturer's instructions when installing.

**Warning:** Ensure that all seat belts are worn correctly. An improperly worn seat belt increases the risk of injury or death if a collision occurs.







**Warning:** Do not wear seat belts over hard, fragile or sharp items in clothing, such as pens, keys, eyeglasses, etc. The pressure from the seat belt on such items can cause injury.

**Warning:** Seat belts should not be worn with any part of the strap twisted.

**Warning:** Each seat belt assembly must be used by one occupant only. It is



dangerous to put a seat belt around a child being carried on an occupant's lap.

-  **Warning:** Seat belts that have been worn in a collision must be inspected or replaced by Tesla, even if damage to the assembly is not obvious.
-  **Warning:** Seat belts that show signs of wear (such as fraying), or have been cut or damaged in any way, must be replaced by Tesla.
-  **Warning:** Avoid contaminating a seat belt's components with any chemicals, liquids, grit, dirt or cleaning products. If a seat belt fails to retract or latch into the buckle, it must be replaced immediately. Contact Tesla.
-  **Warning:** Do not make modifications or additions that can prevent a seat belt mechanism from taking up slack, or that can prevent a seat belt from being adjusted to remove slack. A slack belt greatly reduces occupant protection.
-  **Warning:** Do not make modifications that can interfere with the operation of a seat belt, or that can cause a seat belt to become inoperable.
-  **Warning:** When seat belts are not in use, they should be fully retracted and not hanging loose. If a seat belt does not fully retract, contact Tesla.



## Guidelines for Seating Children

Your Model S seat belts in the front and second row seats are designed for adults and larger children. You must restrain infants and small children in the second row seats only, and you must use a suitable child safety seat appropriate for the child's age, weight, and size.

Never use child safety seats in the front row passenger seat.

**Warning:** Never seat a child on a seat with an ACTIVE AIRBAG in front of it. DEATH or SERIOUS INJURY to the child can occur.

Refer to the following label fitted to the sun visors.

**Note:** The images shown below are representative only and may not be identical to the labels in your vehicle.

United States:



Canada:

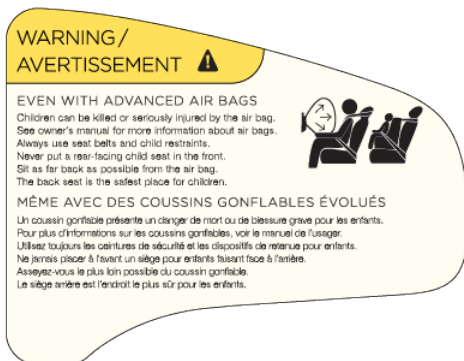

Mexico:

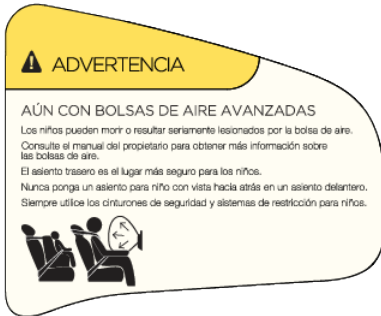

If your Model S is equipped with the optional Tesla built-in rear facing child seats, these seats are child safety seats and are designed only for children within a specific height and weight range (see [Tesla Built-In Rear Facing Child Seats](#) on page 35).



## Choosing a Child Safety Seat

All children age 12 and under should ride in the rear (second row) seats. Always use a child safety seat suitable for a young child's age and weight. The following table is based on child safety seat recommendations determined by National Highway Traffic Safety Administration (NHTSA). For more information, go to [www.nhtsa.gov/ChildSafety/Guidance](http://www.nhtsa.gov/ChildSafety/Guidance).

	Infants	Toddlers	Young children
Age	Birth to 1 year*	Over 1 year*	4 years and older, and less than 57 in. (145 cm) tall
Weight	Up to at least 20 lbs (9 kg)*	Over 20 lbs (9 kg) (minimum) and up to 40 lbs (18 kg)*	Over 40 lbs (18 kg)
Type of child safety seat	Rear facing (or convertible)	Forward facing (or convertible)*	Seat belt retained booster seat
Seat position	Rear facing only*	Forward facing*	Forward facing
Recommended attachment method	If combined weight of child and safety seat is up to 65 lbs (29 kg), attach using either LATCH** (lower anchor only) or the seat belt only.*** If combined weight of child and safety seat is over 65 lbs (29 kg), attach using the seat belt only.***	If combined weight of child and safety seat is up to 65 lbs (29 kg), attach using either LATCH** (both lower anchors and top tether anchor), or the seat belt and upper tether strap.*** If combined weight of child and safety seat is over 65 lbs (29 kg), attach using the seat belt and upper tether strap.***	Attach booster seats using the seat belt only.

\* Many child safety seats currently available allow children to ride rear-facing using the child safety seat's integrated 5-point harness for a longer period of time BASED UPON SPECIFIC HEIGHT AND WEIGHT LIMITS. Keep your child in a rear facing seat for as long as possible. CHECK THE CHILD SAFETY SEAT MANUFACTURER'S INSTRUCTIONS AND CAREFULLY FOLLOW ALL INSTRUCTIONS

\*\* LATCH - Lower Anchors and Tethers for Children. In Canada, this is also called Lower Universal Anchorage System (LUAS), or CANFIX.

\*\*\* Subject to instructions provided by the child safety seat manufacturer.

**Warning:** Laws that govern how and where children should be carried when traveling in a vehicle are subject to change. It is the driver's responsibility to keep up to date on, and comply with, all current regulations in the region(s) where Model S is driven. To check the child passenger safety laws for states in the U.S., go to: [http://www.ghsa.org/html/stateinfo/laws/childsafety\\_laws.html](http://www.ghsa.org/html/stateinfo/laws/childsafety_laws.html).



## Seating Larger Children

If a child is too large to fit into a child safety seat, but too small to safely fit into the standard seat belts, use a booster seat appropriate for the child's age and size. Carefully follow the manufacturer's instructions to secure the booster seat.

## Installing Child Safety Seats

There are two general methods used to install child safety seats:

- Seat belt retained - these seats are secured using the vehicle's seat belts (see [Installing Seat Belt Retained Child Seats](#) on page 31).
- LATCH retained - these seats can attach to anchor bars built into the vehicle's rear seats (see [Installing LATCH Child Seats](#) on page 31).

Check the child safety seat manufacturer's instructions and the table at [Child Safety Seats](#) on page 28 to determine which installation method to use. Some child safety seats can be installed using either method. Always follow the child safety seat manufacturer's instructions.

## Installing Seat Belt Retained Child Seats

First, make sure that the child safety seat is appropriate for the weight, height, and age of the child.

Avoid dressing the child in bulky clothing and do not place any objects between the child and the restraint system.

Adjust harnesses for every child, every trip.

To securely hold child safety seats, all passenger seating positions are equipped with an automatic locking retractor (ALR) that, by pulling the seat belt beyond the length needed for a typical adult occupant, locks the belt into place until the seat belt is unbuckled and the webbing is fully retracted. The ALR mechanism operates as a ratchet, winding in slack and preventing the seat belt from extending any further until it has been completely rewound. When installing a child safety seat, engage the belt's automatic locking retractor by pulling the seat belt webbing until it is fully extended. The ALR system engages only when the seat belt is at its maximum extension point.

**Note:** An automatic locking retractor disengages only when the seat belt is unbuckled and fully retracted. The belt can then be worn as a normal belt, sliding freely in and out and locking tight only in an emergency. Once disengaged, the belt must be fully extended to re-engage the locking mechanism whenever you install a child safety seat.

Always follow the detailed instructions provided by the child safety seat manufacturer. General guidelines are provided below.

1. Place the child safety seat in Model S, and fully extend the seat belt. Route and buckle the seat belt in accordance with the child safety seat manufacturer's instructions.



2. Allow the seat belt to retract, and remove all slack in the seat belt while firmly pushing the child safety seat into the Model S seat.
3. If the seat belt retained child safety seat has an upper tether, attach it to the back of the seat (see [Attaching Upper Tether Straps](#) on page 32).

## Installing LATCH Child Seats

Lower LATCH anchors are provided in the second row outboard seats. The anchors are located between the seat's back rest and rear cushion. The exact location of each anchor is identified by a child safety seat identification button, illustrated below. The button is located on the seat back, directly above its associated anchor.



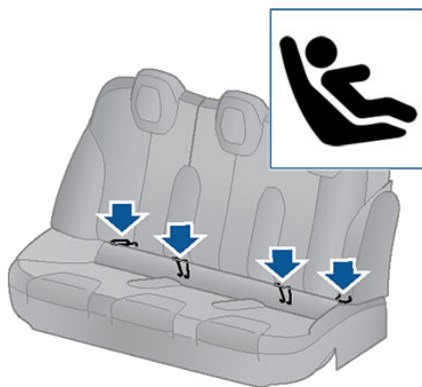

Install LATCH child safety seats in the outboard seating positions only. Use only a seat belt retained seat in the center position.



To install a LATCH child safety seat, slide the safety seat latches onto the anchor bars until they click into place. Carefully read and follow the instructions provided by the child safety seat manufacturer.

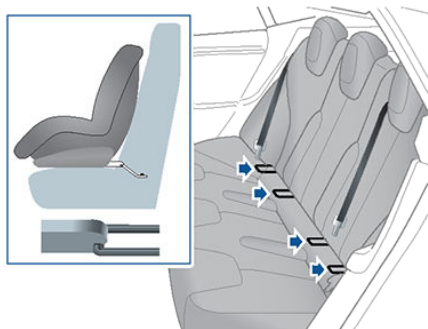

Once installed, test the security of the installation before seating a child. Attempt to twist the child safety seat from side to side and try to pull it away from the seat, then check to ensure the anchors remain securely in place.

**Note:** Lower LATCH anchors should not be used with child seats or booster seats that have an integrated safety belt in situations where the combined weight of the child plus the child restraint is more than 65 lbs (29 kg). In these situations, use the safety belt instead.

## Attaching Upper Tether Straps

If an upper tether strap is provided, attach its hook to the anchor point located on the back of the rear seats.

**Note:** The location of anchor points may not be readily visible but can be found by identifying a slice in the seat's material.

**Warning:** Tighten upper tether straps according to the instructions provided by the manufacturer of the child safety seat.

**Warning:** USE ONLY SEAT BELT RETAINED CHILD SAFETY SEATS IN THE CENTER SEATING POSITION.

For dual-strap tethers, position a strap on each side of the head support.

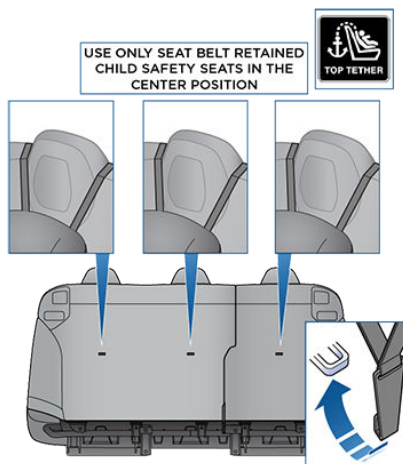



Always position single-strap tethers to run over the top of the head support.

**Note:** To prevent the single-strap tether from moving side to side, the top of the head support deforms.

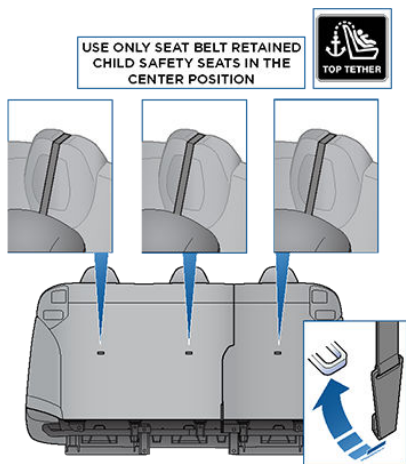

## Testing a Child Safety Seat

Before seating a child, always make sure the child safety seat is not loose:

1. Hold the child safety seat by the belt path and try to slide the safety seat from side to side and front to back.
2. If the seat moves more than one inch (2.5 cm), it is too loose. Tighten the belt or reconnect the LATCH retained child safety seat.
3. If you are unable to reduce slack, try a different seat location or try another child safety seat.

## Child Safety Seat Warnings

- Warning:** Extreme hazard! Do not seat a child on the front passenger seat even if you are using a child safety seat. This seat has an airbag in front of it. Although this airbag is disabled when Model S detects a lightweight passenger, do not rely on technology to protect your child.
- Warning:** Child restraint systems are designed to be secured in vehicle seats by lap belts or the lap belt portion of a lap-shoulder belt. Children could be

endangered in a crash if their child restraints are not properly secured in the vehicle.

- Warning:** According to collision statistics, children are safer when properly restrained in the rear seating positions than in the front seating positions.
- Warning:** Do not use a forward facing child safety seat until your child weighs over 20 lbs (9 kg) and can sit independently. Up to the age of two, a child's spine and neck are not sufficiently developed to avoid injury in a frontal impact.
- Warning:** Do not allow a baby or infant to be held on a lap. All children should be restrained in an appropriate child safety seat at all times.
- Warning:** To ensure children are safely seated, follow all instructions provided in this document and by the manufacturer of the child safety seat.
- Warning:** Children should ride in a rear facing child safety seat using the seat's integrated 5-point harness for as long as possible.
- Warning:** Do not use seat belt extenders on a seat belt that is being used to install a child safety seat or booster seat.
- Warning:** When seating larger children, make sure the child's head is supported and the child's seat belt is properly adjusted and fastened. The shoulder portion of the belt must be away from the face and neck, and the lap portion must not be over the stomach.
- Warning:** Never attach two child safety seats to one anchor point. In a collision, one anchor point may be incapable of securing both seats.
- Warning:** Child restraint anchors are designed to withstand only those loads imposed by correctly fitted child restraints. Under no circumstances are they to be used for adult seat belts, harnesses, or for attaching other items or equipment to the vehicle.
- Warning:** Always check harnesses and tether straps for damage and wear.
- Warning:** Never leave a child unattended, even if the child is secured in a child safety seat.
- Warning:** Never use a child safety seat that has been involved in a collision. Have



## Child Safety Seats

the seat inspected or replaced as described in the child safety seat manufacturer's instructions.



## Usage Restrictions

The optional Tesla built-in rear facing child seats are child restraint systems and must only be used for children over 37" (94 cm) tall and weighing between 35 and 77 lbs (16.2 to 35.2 kg).

Always ensure the top of the child's head cannot contact the vehicle and that the child is seated comfortably with the seat belts positioned and latched correctly. The child's pelvis must be held securely in place by the lap belt. Follow all instructions provided and do not use supplemental child safety seats in these seats.

**Note:** Whenever a child is seated in the Tesla built-in rear facing child seats, it is recommended that you set the climate control system to draw outside air into Model S instead of recirculating the air. This draws more air into the rear seating areas. See [Adjusting Climate Control Settings](#) on page 118.

## Opening

1. Remove the cover from the trunk floor and pull the strap to lift the seat assembly upward.

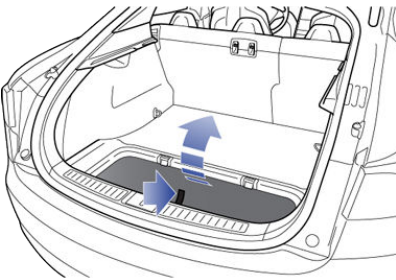

2. Push the seat assembly into position.

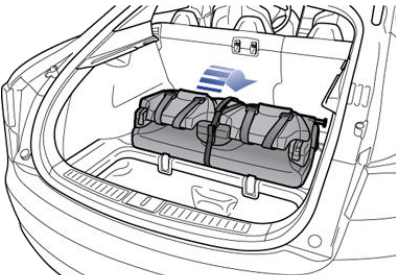

3. Undo the Velcro strap.

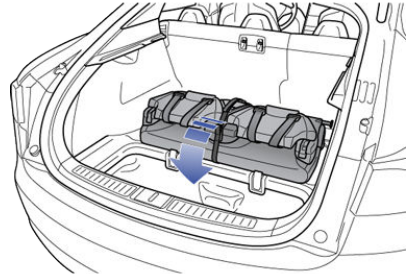

4. Pull the handle to release the head supports from the seat back, then pull the head supports toward you to unfold them.

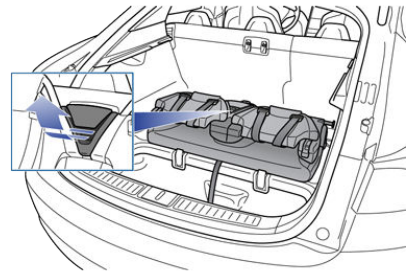

5. Raise the seat back to the upright position and push until it locks into position. Visually check to ensure that the retaining catches are engaged.

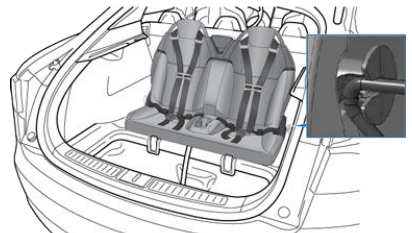

6. Check that the seat back and seat base are securely retained in the upright position by trying to pull the seat back toward you.

## Folding

- ⚠ Caution:** Before folding the seats, fasten the seat belts to prevent them from getting trapped in the seat mechanism and being damaged.



# Tesla Built-In Rear Facing Child Seats

1. Pull the handle to release the seat back and pull the seat back fully forward.

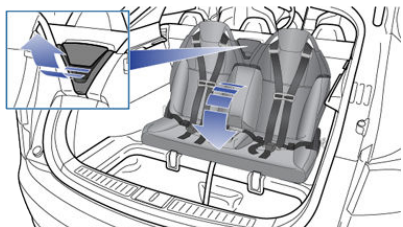

2. Push the lever to release the head supports from the seat back, then fold back onto the seat.

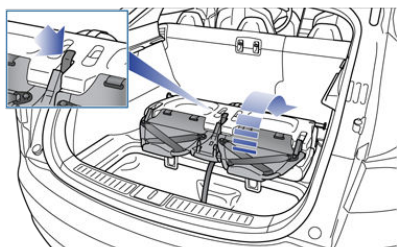

3. Secure the Velcro strap.

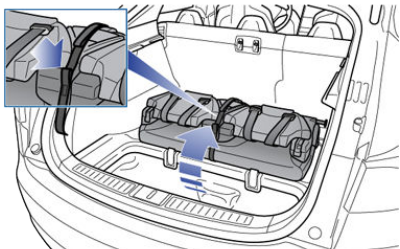

4. Pull the strap at the rear of the seat to fold the seat assembly into the trunk floor.

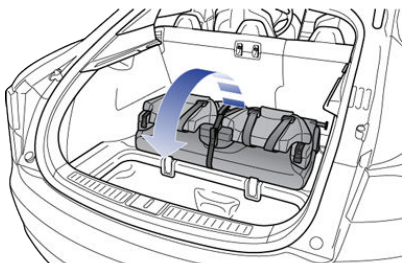

5. Replace the cover on the trunk floor.

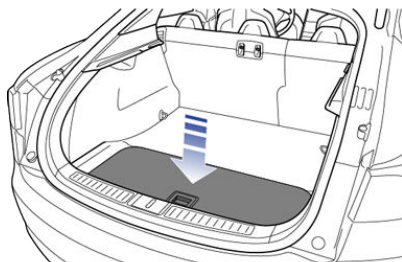



## Seating a Child

The Tesla built-in rear facing child seats are child restraint systems and must only be used for children over 37" (94 cm) tall and weighing between 35 and 77 lbs (16.2 to 35.2 kg).

Always ensure the top of the child's head cannot contact the vehicle and that the child is seated comfortably with the seat belts positioned and latched correctly. The child's pelvis must be held securely in place by the lap belt. Follow all instructions provided and do not use supplemental child safety seats in these seats.

**Note:** Whenever a child is seated in the Tesla built-in rear facing child seats, it is recommended that you set the climate control system to draw outside air into Model S instead of recirculating the air. This draws more air into the rear seating areas. See [Adjusting Climate Control Settings](#) on page 118.

1. Position the child in the seat with arms through the loops of the seat belts.
2. Connect the two halves of the seat belt tongue.
3. Insert the seat belt tongue into the buckle and ensure it is securely fastened.

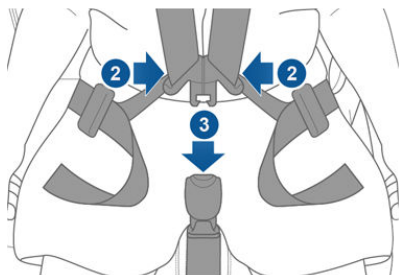

4. Adjust the shoulder belts so they run over the top of the child's shoulders and away from the face.
5. Connect the chest clip and adjust it to be as high as possible without causing the shoulder belts to touch the child's neck.

6. Pull the lower straps until the child is securely held in the seat.

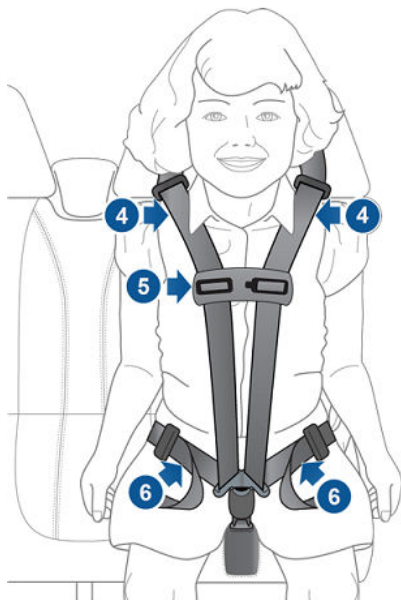



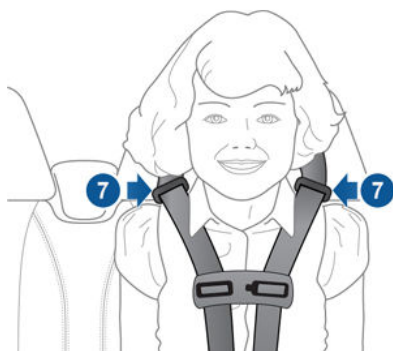









7. Slide the shoulder clips into place to ensure the upper portion of the belts remain positioned over the child's shoulders.



To release, press the button on the buckle, release the chest clip, and separate the two halves of the seat restraint.



## Warnings - Tesla Child Seats

-  **Warning:** The Tesla built-in rear facing seats are child restraint systems and must only be used for children over 37" (94 cm) tall and weighing between 35 and 77 lbs (16.2 to 35.2 kg).
-  **Warning:** Do not use supplemental child restraint systems, including booster seats, in the Tesla built-in rear facing child seats.
-  **Warning:** Always ensure that the top of the child's head cannot touch the vehicle and that the child is seated comfortably with the seat belts correctly fastened.
-  **Warning:** Follow all instructions and heed all warnings related to the Tesla built-in rear facing child seats. Failure to do so can compromise occupant safety.
-  **Warning:** Read all safety warnings and labels attached to the seats.
-  **Warning:** Do not leave children unattended in Model S, even if the child is secured in a child safety seat or a Tesla built-in rear facing child seat. In hot weather, the interior temperature can reach dangerous levels that can result in dehydration, serious injury or death.
-  **Warning:** Do not remove or replace the fabric on a Tesla built-in rear facing child seat. The covers are an integral part of the restraint's performance and should not be removed or replaced with any other type than those supplied by Tesla.
-  **Warning:** If the Tesla built-in rear facing child seats have been worn in an accident, they must be inspected or replaced by Tesla, even if damage is not obvious.
-  **Warning:** Before allowing a child to ride in the Tesla built-in rear facing child seats, check that the seat is securely held in the upright position by trying to pull the seat back toward you.
-  **Warning:** Do not remove the built-in rear facing child seats for any reason, including cleaning. To ensure safety of occupants, removal and installation must be performed by qualified Tesla service technicians.
-  **Warning:** Do not make modifications or additions that can interfere with the operation of the Tesla built-in rear facing child seats.
-  **Warning:** To prevent injury, ensure all loose items (bags, luggage, etc.) are

secured. In an accident, or during hard braking and sharp turns, loose items could cause injury.



## Location of Airbags

Airbags are located in the approximate areas shown here. Airbag warning information is printed on the sun visors.

Model S is equipped with an airbag and lap/shoulder belt at both front outboard seating positions. The airbag is a supplemental restraint at those seating positions. All occupants, including the driver, should always wear their seat belts whether or not an airbag is also provided at their seating position to minimize the risk of severe injury or death in the event of a crash.

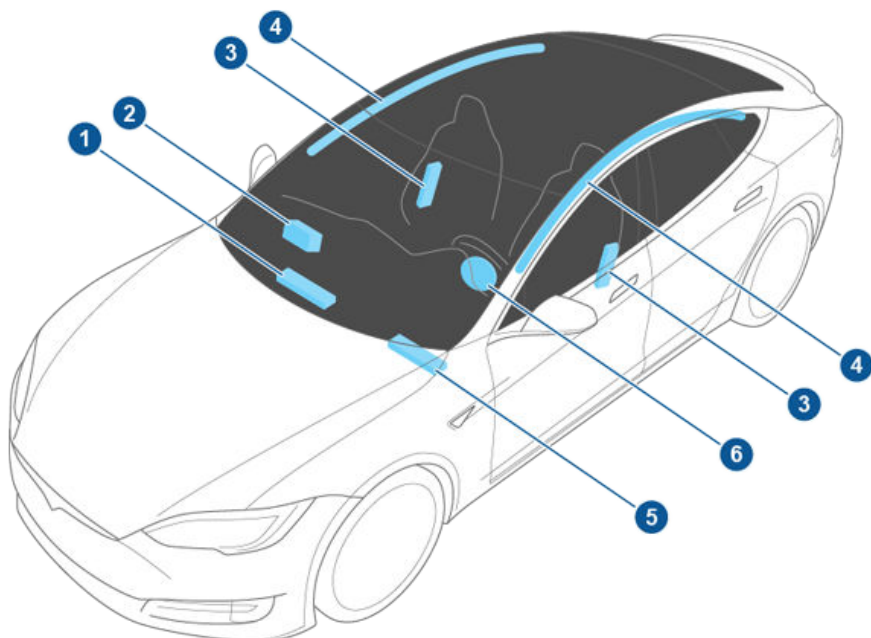

1. Passenger knee airbag
2. Passenger front airbag
3. Side airbags
4. Curtain airbags
5. Driver's knee airbag
6. Driver's front airbag





## How the Airbags Work

Airbags inflate when sensors detect an impact that exceeds deployment thresholds. These thresholds are designed to predict the severity of a crash in time for the airbags to help protect the vehicle's occupants.

Airbags inflate instantly with considerable force accompanied by a loud noise. The inflated bag, together with the seat belts, limits movement of occupants to reduce the risk of injury.

Front airbags are not ordinarily designed to inflate in rear collisions, rollovers, side collisions and when braking heavily or driving over bumps and potholes. Likewise, front airbags may not inflate in all frontal collisions, such as minor front collisions, underride collisions, or impacts with narrow objects (such as poles or trees). Significant superficial damage can occur to the vehicle without the airbags inflating and, conversely, a relatively small amount of structural damage can cause airbags to inflate. Therefore, the external appearance of the vehicle after a collision does not represent whether or not the front airbags should have inflated.

**⚠ Warning:** Before modifying your vehicle to accommodate a person with disabilities in a way that may affect the airbag system, contact Tesla.

## Types of Airbags

Model S has the following types of airbags:

- **Advanced front airbags:** The front airbags are designed to reduce airbag related injuries if children or small adults are riding in the front seats. On the driver's side, the front airbag works with a seat position sensor that adjusts the inflation level based on the seating position of the occupant. On the passenger's side, the airbag responds to a sensing system in the seat that determines whether or not the passenger side front airbag inflates, and optimizes the inflation level based on the weight of the occupant. Follow all warnings related to seating a child on the front passenger seat.
- **Knee airbags:** Knee airbags and the front airbags work together. The knee airbags limit the forward motion of the front seat occupants by restricting leg movement, thereby positioning the occupants so that the front airbags work more effectively.
- **Side airbags:** Side airbags protect the thorax region of the torso and the pelvis. They inflate only if a severe side impact occurs. Side airbags on the non-impacted side of the vehicle do not inflate.
- **Curtain airbags:** Curtain airbags help protect the head. Curtain airbags on both the impacted and non-impacted side of the vehicle will inflate only if a severe side impact occurs, or if the vehicle rolls over.



## Passenger Front Airbag

Model S has an occupancy sensor in the front passenger seat that controls the status of the airbags based on the weight of the occupant. If the passenger airbag is OFF, it will not inflate when a collision occurs, and the passenger airbag off indicator displays in the top right corner of the touchscreen. If the passenger airbag is ON, it will inflate when a collision occurs, and its status does not display in the top right corner of the touchscreen.



The Passenger Airbag Off indicator displays in the top right corner of the touchscreen only when the front passenger airbag is turned off.

**Note:** The occupancy sensor system meets the regulatory requirement of FMVSS 208 and automatically detects when inflating the passenger front airbags would be unnecessary or potentially harmful.

Weight in front passenger seat	Passenger airbag status
Empty	OFF
Up to 20 lbs/9 kg	OFF
20-100 lbs/9-45 kg*	OFF* or ON**
Over 100 lbs/45 kg	ON**

\*Values are approximate. A weight detected near the threshold can cause the airbag status to occasionally turn on and off depending on seating position and physique.

\*\*The absence of the passenger airbag off indicator in the top right corner of the touchscreen indicates that the passenger airbag is ON and will inflate in the event of a collision.

**Note:** It takes approximately six seconds after you power on Model S for the occupancy sensor to report accurate status of the front passenger airbag. As a result, when you first power on Model S, even in situations when it should be OFF because the passenger seat is either empty or carrying a weight of 20 lbs (9 kg) or less, the touchscreen can take up to six seconds to display the passenger airbag off indicator. If it fails to do so, contact Tesla

service immediately and seat passengers in the rear seating positions only.

If the passenger airbag is permanently on, even when the seat is empty, contact Tesla immediately.

To make sure the sensing system can correctly detect occupancy status, eliminate the following:

- Objects lodged under the seat.
- Heavy objects sitting on the seat (briefcase, large purse).
- Objects wedged between the seat back and seat cushion.
- Cargo interfering with the seat.
- After market items attached to, or sitting on, the seat (covers, mats, blankets, etc.).

These conditions can interfere with the occupancy sensor. If you have eliminated the above possibilities, and the airbag status is still incorrect, ask passengers to ride in the rear seats and contact Tesla to have the airbag system checked.

**Note:** The front passenger seat's sensing system affects the operation of the passenger front and side airbags only. The other passenger airbags are not affected.

**Warning:** Never seat a child on the front passenger seat, even if the passenger airbag is off. All occupants age 12 and under must ride in the rear seats (see [Child Safety Seats](#) on page 28).

**Warning:** To ensure accuracy of the occupant detection system, do not make any modifications to the front passenger seat.

**Warning:** Do not use seat covers on Model S. Doing so could restrict deployment of the seat-mounted side airbags if a collision occurs. It can also reduce the accuracy of the occupant detection system, if equipped.

## Inflation Effects

**Warning:** When airbags inflate, a fine powder is released. This powder can irritate the skin and should be thoroughly flushed from the eyes and from any cuts or abrasions.

After inflation, the airbags deflate to provide a gradual cushioning effect for the occupants and to ensure the driver's forward vision is not obscured.



If airbags have inflated, or if your vehicle has been in a collision, always have the airbags, seat belt pre-tensioners and any associated components checked and, if necessary, replaced by Tesla.

In a collision, in addition to the airbags inflating:

- Doors unlock, and the door handles extend.
- Hazard warning lights turn on.
- Interior lights turn on.
- High voltage is disabled.

To restore Battery power, use the touchscreen to manually power off Model S (see [Powering Off](#) on page 49), then press the brake to power it back on again.

## Airbag Warning Indicator



The airbag indicator on the instrument panel remains lit if the airbag system is malfunctioning. The only time this indicator should light up is briefly when Model S first powers up, in which case it turns off within a few seconds. If it remains lit, contact Tesla immediately and do not drive.

## Airbag Warnings

- Warning:** Do not place objects over or near airbags because any such objects could cause harm if the vehicle is in a crash severe enough to cause the airbag to inflate.
- Warning:** All occupants, including the driver, should always wear their seat belts, whether or not an airbag is also provided at their seating position, to minimize the risk of severe injury or death in the event of a collision.
- Warning:** Front seat occupants should not place their arms over the airbag module, as an inflating airbag can cause fractures or other injuries.
- Warning:** Airbags inflate with considerable speed and force, which can cause injury. To limit injuries, ensure that occupants are wearing seat belts and are correctly seated, with the seat positioned as far back as possible. The National Highway Traffic Safety Administration (NHTSA) recommends a minimum

distance of 10" (25 cm) between an occupant's chest and an airbag.

- Warning:** Do not use a child safety seat or seat young children on a seat with an operational airbag in front of it. Doing so can cause injury or death if the airbag inflates.
- Warning:** To ensure correct inflation of the side airbags, maintain an unobstructed gap between an occupant's torso and the side of Model S.
- Warning:** Passengers shouldn't lean their heads against doors. Doing so can cause injury if a curtain airbag inflates.
- Warning:** Do not allow passengers to obstruct the operation of an airbag by placing feet, knees or any other part of the body on or near an airbag.
- Warning:** Do not attach or place objects on or near the front airbags, the side of the front seats, the headliner at the side of the vehicle, or any other airbag cover that could interfere with inflation of an airbag. Objects can cause serious injury if the vehicle is in a collision severe enough to cause the airbag to inflate.
- Warning:** Following inflation, some airbag components are hot. Do not touch until they have cooled.



## Creating a Driver Profile

When you first adjust the driver's seat, steering wheel, or driver's side mirror, the touchscreen prompts you to create a driver profile to save these adjustments. Your profile also saves some of the preferences you make using the touchscreen's **Controls** window.



To add a new driver profile, touch the driver profile icon at the top of the touchscreen. Then touch **Add New Driver**, type the driver's name and touch **Create Profile**. Follow the onscreen instructions to save the seating position to the driver profile. You can also check the **Use Easy Entry** checkbox if you want to save (or use existing) Easy Entry settings (described below) in which the driver's seat and the steering wheel are automatically adjusted to make it easy to enter and exit Model S.

If you change the position of the steering wheel, driver's seat, or driver's side mirror after you have saved or chosen a driver profile, the touchscreen prompts you to save the new position or restore the previously saved position (other settings are automatically saved). To change a setting without saving or restoring, just ignore the prompt.

To adjust Model S based on a driver's profile, touch the driver profile icon and choose the driver name. The saved adjustments are automatically made.

**Note:** Valet mode is a built-in driver profile used to limit speed and restrict access to some Model S features (see [Valet Mode](#) on page 44).

**Note:** Depending on date of manufacture and options selected at time of purchase, some Model S vehicles are not equipped with the driver profile feature. Also, in cases where the vehicle is equipped with driver profiles, some features may not be automatically saved and adjusted based on the driver profile (for example, mirror position).

**Note:** To stop automatic adjustments that are in process based on a driver's profile, touch Stop on the Driver Profile dropdown menu. Automatic adjustments also stop if you manually adjust a seat, mirror or the steering wheel.

## Easy Entry

You can define an Easy Entry setting that moves the steering wheel and driver's seat to make it easy to enter and exit Model S. Any driver can use the Easy Entry setting by associating it with their driver's profile. When the Easy Entry setting is associated with a driver's profile, the steering wheel and driver's seat automatically adjust when the park gear is engaged and the driver's seat belt is unbuckled, allowing an easy exit from the vehicle. When returning to the vehicle and stepping on the brake pedal, settings automatically adjust back to the settings used by the most recent driver profile (or based on the key if it's linked to a driver profile).

To set up Easy Entry, touch the driver icon on the top of the touchscreen. Choose a driver profile, check the **Easy Entry** checkbox and follow the onscreen instructions to save how you want the steering wheel and seat positioned when entering and exiting Model S. Once created, the Easy Entry profile appears on the driver profile list and any driver can use these settings to enter and exit.

## Restoring a Driver's Profile



To adjust Model S based on a driver's profile, touch the driver profile icon on the touchscreen's status bar. Then choose the driver and Model S is adjusted based on the settings that have been saved to the chosen driver profile.

## See What's Saved

To see what settings are associated with a driver profile, touch the driver profile icon on the top of the touchscreen. Then touch **See what's saved**. A popup window lists all the settings that are saved to driver profiles.

**Note:** The settings that are associated with driver profiles may vary depending on the version of software currently installed on your Model S.



## Linking a Driver Profile to a Key

You can link a driver profile to a specific key to allow Model S to automatically select the correct driver profile when the linked key is detected as you approach the vehicle and open the driver's door. To link a driver profile to a key, enter Model S with the key and touch the driver profile icon on the top of the touchscreen. Select the driver profile you would like to link to the key, then touch **Link to Key Fob**.

**Note:** Model S only detects one key at a time. The driver profile is linked to the key that is detected by the vehicle at that time. Therefore, if you want to link driver profiles to multiple keys, ensure that only the key that you would like to link the driver profile to is within detection range while performing the linking procedure. Move all other keys outside of the detection range (at least three feet (one meter) away from Model S).

**Note:** Model S can support up to three linked keys. However, a driver profile can only be linked to one key.

To remove the link between a driver profile and key, touch the driver profile icon on the top of the touchscreen. Select the driver profile, then touch the **X** next to **Linked to Key Fob**.

## Valet Mode

When Model S is in Valet mode, the following restrictions apply:

- Speed is limited to 70 mph (113 km/h).
- Maximum acceleration and power are limited.
- Front trunk and glovebox are locked.
- Home and Work locations are not available in the navigation system.
- Voice commands are disabled.
- Autopilot convenience features are disabled.
- Most status bar functions are disabled.
- The Mobile Access setting is disabled.
- HomeLink (if applicable in your market region) is not accessible.
- Driver Profiles are not accessible.

- Wi-Fi and Bluetooth are disabled. When Model S is in Valet mode, you cannot pair new Bluetooth devices or view or delete existing paired devices.

**Note:** If a Bluetooth paired device or a known Wi-Fi network is within operating range (approximately 30 feet or 9 meters) of Model S in Valet mode, Model S will connect to it.

## Starting Valet Mode

With Model S in Park, touch the driver profile icon on the top of the touchscreen, then touch **Valet Mode**.

The first time you enter Valet mode, you will be prompted to create a 4-digit PIN that you will use to cancel Valet mode.

When Valet mode is active, the instrument panel displays the word **Valet** above the driving speed and the Valet mode driver profile displays on the touchscreen.

You can also use the mobile app to start and cancel Valet mode (provided Model S is in Park). When using the mobile app, you do not need to enter a PIN because you are already required to log into the app using your Tesla Account credentials.

**Note:** If the **PIN to Drive** setting is enabled (see [PIN to Drive](#) on page 136), you must enter the driving PIN before you can define or enter a Valet PIN. Once in Valet mode, Model S can be driven without the valet needing to enter the driving PIN.

**Note:** The **PIN to Drive** setting is not available when Valet mode is active.

If you forget your valet PIN, reset it from inside Model S by entering your Tesla Account credentials (which also cancels Valet mode). You can also reset your PIN using the mobile app.

## Canceling Valet Mode

With Model S in Park, touch the **Valet Mode** driver icon on the touchscreen's status bar, then enter your 4-digit PIN.

When you cancel Valet mode, all settings associated with the most recently used driver profile and climate control settings are restored, and all features are available.

**Note:** You do not need to enter a PIN to cancel Valet mode from the mobile app.



## Adjusting Steering Effort

You can adjust the feel and sensitivity of the steering system to suit your personal preference:

1. On the touchscreen, touch **Controls** > **Driving** > **Steering Mode**.
2. Choose a steering option:
  - **Comfort** - Reduces the effort required to turn the wheel. In town, Model S feels easier to drive and park.
  - **Standard** - Tesla believes that this setting offers the best handling and response in all conditions.
  - **Sport** - Increases the effort required to turn the wheel. When driving at higher speeds, Model S feels more responsive.

The only way to really know which option you like best is to try them.

## Adjusting Position

Adjust the steering wheel to the desired driving position by moving the control on the left side of the steering column. Using this control, you can move the steering wheel forward and backward and up and down.

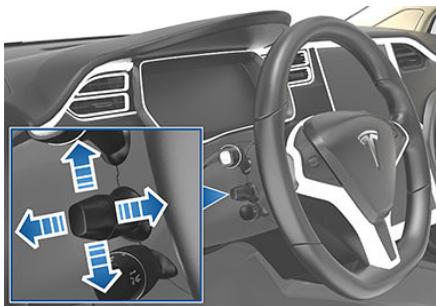

**Warning:** Do not make adjustments while driving.

## Using Left Steering Wheel Buttons

Use the buttons on the left side of the steering wheel to change radio stations, control the media player's volume, and to choose what displays on the left side of the instrument panel (whenever the Navigation app is not displaying instructions).

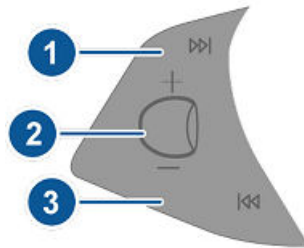

### 1. Next

If you are listening to local or satellite radio and you have defined more than one radio preset, press to play the next preset in the radio band that is currently playing. If you have not defined more than one preset, press to go to the next available frequency.

If you are listening to Internet radio, or to an audio file on a connected Bluetooth or USB device, press to skip to the next song or station.

If you have more than one favorite defined, press and hold to cycle through favorites.

### 2. Scroll Button

- To adjust the media volume, roll up or down.

**Note:** The scroll button adjusts the volume for media, navigation instructions and phone calls based on what is currently in use. As you adjust volume, the instrument panel displays the volume level and whether you are adjusting volume for media, navigation or phone.

- To mute the media volume, or to pause/play an audio file, tap the scroll button.



- To choose what displays on the left side of the instrument panel, hold the scroll button briefly until the available options are displayed. Roll the scroll button to choose **Empty, Car Status, Clock, Media, Energy, Trips**, etc. When the option you want is highlighted, tap the scroll button.

**Note:** The option you choose to display using the left scroll button is retained until you manually change it. It is also saved in your driver profile.

**Note:** Car status displays information such as status of doors and trunks, and on newer model vehicles, the tire pressure measurements.

- To restart the touchscreen, hold down both scroll buttons for approximately five seconds. See [Restarting the Touchscreen](#) on page 49.

### 3. Previous

Same as described above for Next, except it skips to the previous song or station. If you have more than one favorite defined, press and hold to cycle through favorites.

**Note:** Regardless of how you customize the left side of the instrument panel, it automatically changes to display navigation instructions (if applicable), or to let you know if a door or trunk is open when Model S is in driving gear.

## Using Right Steering Wheel Buttons

Use the buttons on the right side of the steering wheel to access call options while on a phone call, to choose what displays on the right side of the instrument panel, to adjust Model S features, and to use voice commands.

**Note:** Whenever you receive or make a phone call, the right side of the instrument panel automatically displays call options to help you easily handle phone calls on your Bluetooth-connected phone.

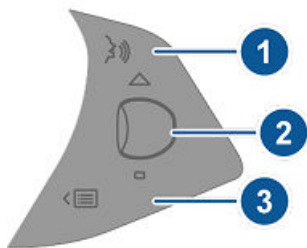

- Press to use a voice command to call a contact, navigate, or listen to Internet music. When you hear the tone, speak your command. Press again to end the voice command, or simply stop speaking. For details, see [Using Voice Commands](#) on page 47.

### 2. Scroll Button

- During a phone call, touch the scroll button to display call options that allow you to perform an action on the call.
- Roll the scroll button to adjust the most recently used feature from the feature list (see Menu button).
- To choose what displays on the right side of the instrument panel, hold the scroll button briefly until the available options are displayed. Roll the scroll button to choose **Empty, Car Status, Clock, Media, Energy, Trips**, etc. When the option you want is highlighted, tap the scroll button.

**Note:** Car status displays information such as status of doors and trunks, and on newer model vehicles, the tire pressure measurements.

**Note:** The option you choose to display using the right scroll button is retained until you manually change it. It is also saved in your driver profile.

- To restart the touchscreen, hold down both scroll buttons for approximately five seconds. See [Restarting the Touchscreen](#) on page 49.

### 3. Menu button

Press to display a menu that allows you to control the following Model S:

- Temperature.** Roll the scroll button to change the driver side temperature, or press the wheel to turn the climate control system on and off.
- Fan Speed.** Roll the scroll button to adjust the speed of the fan used to cool or heat the cabin.
- Display Brightness.** Roll the scroll button to change the brightness level of the displays, or press the wheel to restore default settings.
- Sunroof** (if equipped). Roll the scroll button to adjust the position of the sunroof.



- **Recent Calls.** If your phone is paired to Model S, roll the scroll button to view your recent calls. Press the scroll button to call the contact that's displayed. To pair your phone, see [Pairing a Bluetooth Phone](#) on page 131.
- **Contacts.** If your phone is paired to Model S, roll the scroll button to navigate to contacts in your phone. Your contacts are listed alphabetically by their last name. To pair your phone, see [Pairing a Bluetooth Phone](#) on page 131.

Press the menu button again to close the feature list.

## Using Voice Commands

You can use voice commands to call a contact, navigate to a location, or listen to Internet music. Tap the voice button on the upper right side of the steering wheel to initiate a voice command. When you hear the tone, speak your command. As you speak, the instrument panel displays an interpretation of your command. (It also displays tips to remind you of the type of commands you can speak.) When you finish speaking the command, tap the voice button again or simply wait.

- To call a contact on your Bluetooth-connected phone, say "Call" or "Dial", followed by the contact's first and/or last name(s). For example, "Call Joe" or "Call Joe Smith".
- To search for, or navigate to, a location, say "Where is", "Drive to", or "Navigate to", followed by an address, business name, business category, or landmark. For example, "Where is Stanford University?", "Drive to Tesla in Palo Alto", or "Navigate to Starbucks on Homestead in Cupertino". If you have defined a navigation address for your home or work locations, you can use a voice command to navigate there by saying "Navigate home" or "Navigate to work".
- To listen to an Internet music service, say "Listen to" or "Play", followed by the name of the song, album, artist, or combination. To improve voice recognition accuracy, provide multiple cues in your command, such as artist plus song (for example, "Listen to Yellow Brick Road" or "Play Yellow Brick Road by Elton John").

## Heated Steering Wheel

If Model S is equipped with the optional cold weather package, you can warm up the steering wheel by touching climate controls on the touchscreen (see [Climate Controls](#) on page 116). When turned on, radiant heat keeps the steering wheel at a comfortable temperature.

**Note:** Depending on date of manufacture, your Model S may not include a heated steering wheel, even when equipped with the optional cold weather package.

## Horn

To sound the horn, press the center pad on the steering wheel.

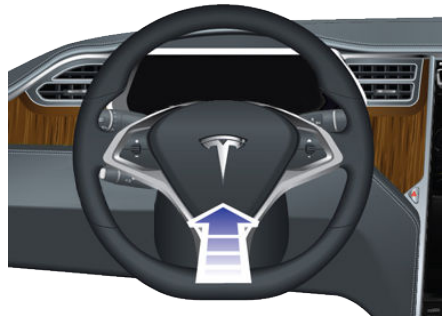





## Adjusting Exterior Side Mirrors

Press the button associated with the mirror you want to adjust (left or right). The button's light turns on and you can then press the dial to move the mirror to the desired position. Repeat for the other side mirror. If prompted, touch **Save** on the touchscreen to save the mirror adjustment in your driver profile.



To fold and unfold exterior mirrors, press the center button. You can set the mirrors to fold automatically whenever Model S is locked by touching **Controls > Vehicle > Mirror Auto-Fold**. The mirrors unfold automatically whenever you unlock Model S.

When you use the center button to fold the mirrors in for parking in a tight space, the mirrors remain folded in until your driving speed reaches 31 mph (50 km/h), or until you use the center button to unfold the mirrors.

**Note:** You cannot fold a mirror if driving above 31 mph (50 km/h).



The driver's side mirror automatically dims at night, in proportion to the level of glare from the headlights of a vehicle behind you (except when in Reverse gear). Also, both exterior side mirrors have heaters that turn on and off with the rear window defroster.

**Note:** Depending on date of manufacture and options selected at time of purchase, some Model S vehicles are not equipped with a side mirror that automatically dims at night and may not include heated side mirrors. In addition, mirror adjustments may not be saved to your driver profile.

## Mirror Auto-tilt When Reversing

Both exterior mirrors can automatically tilt downward when backing up. To adjust the auto-tilt position, shift into Reverse, then adjust the mirrors (press the button associated with the mirror you want to adjust, then press the dial to move the mirror to the desired position). Touch **Save** on the touchscreen to save the mirror adjustment in your driver profile.

When you shift back into Drive, the mirrors tilt back to their normal (upward) position. But now that you have adjusted them for backing up, they automatically tilt to the selected downward position whenever you shift into Reverse.

You can turn the auto-tilt feature on or off using the touchscreen, Touch **Controls > Vehicle > Mirror Auto-Tilt**.

**Note:** Depending on date of manufacture and options selected at time of purchase, some Model S vehicles are not equipped with Mirror Auto-Tilt.

## Rear View Mirror

The rear view mirror is adjusted manually. Except when in Reverse, the rear view mirror automatically dims in proportion to the level of glare from the headlights of a vehicle behind you.



## Starting

When you open a door, Model S powers on the instrument panel and touchscreen and you can operate all controls.

To drive Model S:

1. **PRESS THE BRAKE PEDAL** - Model S powers on and is ready to drive.
2. **SELECT A GEAR** - Move the gear lever all the way down for Drive and all the way up for Reverse. See [Shifting Gears](#) on page 51.

**Note:** If the PIN to Drive feature is enabled (see [PIN to Drive](#) on page 136), you must also enter a valid PIN on the touchscreen before you can drive Model S.

**Note:** If Passive Entry is off and you do not press the brake pedal to start Model S within approximately five minutes, a message displays on the instrument panel and you must use the key to lock then unlock Model S again before starting the vehicle.

Everything you need to know when driving Model S displays on the instrument panel.

### Key Not Inside

If Model S does not detect a key when you press the brake, the instrument panel displays a message telling you that a key is not inside.

If you receive this message, place the key in the center console cup holder where Model S can best detect it.

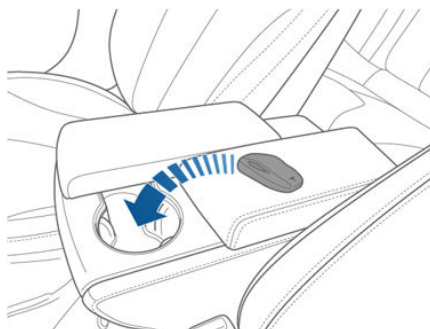

If Model S still does not detect the key, try holding it against the center console, immediately below the 12V power socket (see [12V Power Socket](#) on page 19). Or try using another key. If another key does not work, contact Tesla.

A number of factors can affect whether Model S can detect the key. These include a low battery in the key, interference from other devices using radio signals, and objects between the key and receiver.

Always keep the key with you. After driving, the key is needed to restart Model S after it powers off. And when you leave Model S, you must bring the key with you to lock Model S, either manually or automatically.

## Powering Off

When you finish driving, shift into Park by pressing the button on the end of the gear selector. The parking brake automatically engages and all systems keep operating. When you leave Model S with the key, it powers off automatically, turning off the instrument panel and touchscreen.

Model S also powers off automatically after being in Park for 15 minutes, even if you are sitting in the driver's seat.

Although usually not needed, you can power off Model S while sitting in the driver's seat, provided the vehicle is not moving. Touch **Controls > Safety & Security > Power Off**. Model S automatically powers back on again if you press the brake pedal or touch the touchscreen.

**Note:** Model S automatically shifts into Park whenever it is determined that you are exiting the vehicle, even when you shift into Neutral before exiting. To keep Model S in Neutral, see [Keeping Your Vehicle in Neutral \(Tow Mode\)](#) on page 51.

## Restarting the Touchscreen

If your touchscreen is unresponsive or demonstrates unusual behavior, you can restart it. To do so, shift into Park and hold down both scroll buttons on the steering wheel until the touchscreen turns black and the Tesla logo appears. Within approximately 30 seconds, the touchscreen restarts. If the touchscreen is still unresponsive or demonstrating unusual behavior, contact Tesla.

**Note:** Restarting the touchscreen does not power Model S off and on.

**⚠ Warning:** Paying attention to road and traffic conditions must always be the driver's highest priority. To ensure the safety of vehicle occupants as well as other road users, restarting the



touchscreen should be done only when the vehicle is in Park.



## Shifting Gears

When Model S is in Park, you must press the brake to shift to another gear.

Move the lever up or down to change gears.

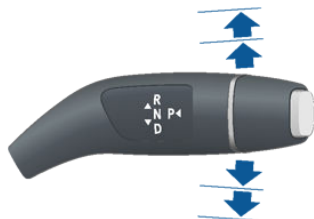

If you try to shift into a gear that the current driving speed prohibits, a chime sounds and the gear does not change.

### Reverse

Push the lever all the way up and release. You can only shift into Reverse when Model S is stopped or moving less than 5 mph (8 km/h). If moving less than 1 mph (1.6 km/h), you must press the brake.

### Neutral

Push the lever up or down to the first position and release to shift into Neutral. Neutral allows Model S to roll freely when you are not pressing the brake pedal.

If Model S is in Park and you use the touchscreen to release the parking brake (**Controls > Safety & Security**), Model S shifts into Neutral (see [Parking Brake](#) on page 66).

Model S automatically shifts into Park when you exit. To leave Model S in Neutral, use the touchscreen to engage Tow mode (see [Keeping Your Vehicle in Neutral \(Tow Mode\)](#) on page 51).

### Drive

Push the lever all the way down and release. You can shift into Drive when Model S is stopped or moving less than 5 mph (8 km/h) in Reverse. If Model S is moving less than 1 mph (1.6 km/h), you must press the brake to shift into Drive.

## Park

Press the end of the gear selector while Model S is stopped. Whenever Model S is in Park, the parking brake is applied.



Model S automatically shifts into Park whenever you connect a charge cable or if two or more of the following conditions are met simultaneously:

- The driver's seat belt is unbuckled.
- The occupancy sensor in the driver's seat does not detect an occupant.
- The driver's door is opened.

**Note:** The above conditions do not reflect a comprehensive list of reasons why Model S may automatically shift into Park and, in certain scenarios, it is possible for your vehicle to shift into Park when only one of the above conditions is true.

To make it convenient to pick up passengers, you can also unlock all doors and/or extend the door handles at any time by shifting into Park then pressing the Park button a second time.

## Keeping Your Vehicle in Neutral (Tow Mode)

Model S automatically shifts into Park whenever you finish driving and leave Model S. To keep Model S in Neutral when you exit, allowing it to roll freely (for example, pulling onto a transporter, etc.), activate Tow mode:

1. Shift into Park.
2. Press the brake pedal.
3. Touch **Controls > Service > Tow Mode**.

Model S beeps, and shifts into Neutral (which releases the parking brake).



When Tow mode is active, Model S displays this indicator light on the instrument panel, along with a message telling you that Model S will roll freely.

**Note:** In Tow mode, Model S does not shift into a driving gear. To cancel Tow mode, shift into Park or touch Tow mode again. Tow mode also cancels if you use the touchscreen to apply



the parking brake (**Controls > Safety & Security > Parking Brake**).



## Controlling Lights

Touch **Controls** > **Lights** on the touchscreen to control the lights.

In addition to the lights that you can control from the touchscreen, Model S has convenience lights that turn on and off automatically based on what you are doing. For example, you will notice interior lights, marker lights, tail lights, door handle lights, and puddle lights that turn on when you unlock Model S, when you open a door, and when you shift into Park. They turn off automatically after a minute or two or when you shift into a driving gear or lock Model S.

**Note:** The image below is provided for demonstration purposes only. Depending on vehicle options, software version and market region, your touchscreen may appear slightly different.

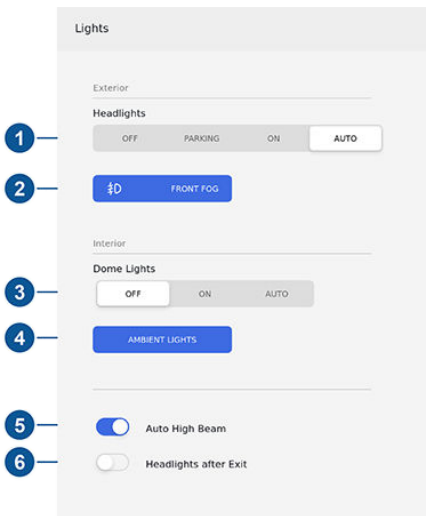

1. Exterior lights (headlights, tail lights, side marker lights, parking lights, and license plate lights) are set to AUTO each time you start Model S. When set to AUTO, exterior lights automatically turn on when driving in low lighting conditions. If you change to a different setting, lights always revert to AUTO on your next drive.

Touch one of these options to temporarily change the exterior light setting:

- **OFF:** Exterior lights turn off until you manually turn them back on or until the next time you drive. If daytime running lights are required in your region, the exterior lights used for this purpose are always on when Drive gear is engaged.
- **PARKING:** Only the side marker lights, parking lights, tail lights and license plate lights turn on.

**Note:** If daytime running lights are required in your region, the exterior lights used for this purpose are always on whenever a driving gear (Drive or Reverse) is engaged.

- **ON:** Exterior lights turn on.

**Warning:** Always ensure that your headlights are on during low visibility conditions. Failure to do so may result in a collision.

2. If equipped, touch to turn the fog lights on or off. Fog lights operate only when low beam headlights are on. When headlights are turned off, fog lights also turn off.



The front fog indicator displays on the instrument panel whenever the optional front fog lights are on.

**Note:** Depending on the market region and vehicle options, your vehicle may not be equipped with front and/or rear fog lights.

**Note:** In some regions, there is no control for the front fog lights. They operate in conjunction with the headlights and turn on only in situations where low beam headlights are on.

3. Turn the interior dome (map) lights on or off. If set to AUTO, all interior dome lights turn on when you unlock Model S, open a door upon exiting, or shift into Park.

**Note:** You can also manually turn an individual dome light on or off by pressing its lens. If you manually turn a dome light on, it turns off when Model S powers off. If Model S was already powered off when you manually turned the light on, it turns off after 60 minutes.

4. If you turn on AMBIENT LIGHTS, interior ambient lights turn on whenever the headlights are on.



5. If you turn on Auto High Beam (only available on Model S equipped with Autopilot components), your vehicle automatically switches from high beam headlights to low beam headlights when there is light detected in front of Model S. See [High Beam Headlights](#) on page 55.
6. If you turn on Headlights after Exit, the exterior lights remain on for a short period of time after you stop driving and park Model S in low lighting conditions. See [Headlights After Exit](#) on page 55.

**Note:** Model S has lights along the rim of the headlights, also referred to as “signature” lights. These lights automatically turn on whenever Model S is powered on and a driving gear is engaged. In the U.S. only, these lights turn off to conserve energy when you turn the Range mode setting on (see [Controls](#) on page 107 or [Driving Tips to Maximize Range](#) on page 75).



## High Beam Headlights

Push the left-hand steering column lever away from you to turn the high beam headlights on continuously. To cancel, pull the lever towards you.

To briefly flash the high beam headlights, pull the lever towards you.





The high beam headlights can automatically switch to low beam when there is light detected in front of Model S (for example, from an oncoming vehicle). To turn this feature on or off, touch **Controls > Lights > Auto High Beam**.

**Note:** Your chosen setting is retained until you manually change it.

In situations where high beams are turned off because AUTO HIGH BEAM is turned on and light is detected in front of Model S, you can temporarily turn on high beams by pulling the lever all the way toward you.

The following indicator lights are visible on the instrument panel to show the status of the headlights:

 Low beam headlights are on.

 High beam headlights are on. Illuminates when high beams are on but the Auto High Beam setting is turned off or if the Auto High Beam setting is turned on but is temporarily unavailable.

 High beams are currently turned on, and Auto High Beam is ready to turn off the high beams if light is detected in front of Model S.

 High beams are temporarily turned off because Auto High Beam is on and is detecting light in front of Model S. When light is no longer detected, the high beams will automatically turn back on.

**Warning:** Auto High Beam is an aid only and is subject to limitations. It is the driver's responsibility to make sure that the headlights are always adjusted as appropriate for the weather conditions and driving circumstances.

## Headlights After Exit

When you stop driving and park Model S in low lighting conditions, the exterior lights remain on. They automatically turn off after one minute or when you lock Model S.

You can turn this feature on and off by touching **Controls > Lights > Headlights After Exit**. When **Headlights After Exit** is off, the headlights turn off when you engage the Park gear and open a door.

## Adaptive Front Lighting System (AFS)

If equipped, the Adaptive Front Lighting System (AFS) automatically adjusts the beam of the headlights to improve your driving view. Electric sensors measure driving speed, steering angle and yaw (the rotation of the car around the vertical axis) to determine the optimum position of the headlights based on current driving conditions. For example, to improve visibility while driving on winding roads at night, the AFS casts the beam in the direction of the curve. When low beam headlights are turned on and when driving at lower speeds, AFS improves lateral illumination to increase the visibility of pedestrians and curbs, and to improve visibility when turning at a dark intersection, into a driveway, or when making a u-turn.

The Adaptive Front Lighting System (AFS) operates whenever headlights are on. If Model S isn't moving, or is moving in reverse, the adaptive headlights do not activate. This prevents the lights from inadvertently blinding other drivers.



If the AFS fails, the instrument panel displays an alert. Contact Tesla Service.





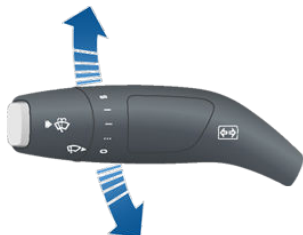

## Turn Signals

Move the left-hand steering column lever up (before turning right) or down (before turning left). The turn signals flash three times or continuously, depending on how far up or down you move the lever. Lightly push the turn signal lever up or down for a three-flash sequence. For a continuous signal, push the lever fully up or down.



The turn signals stop operating when canceled by the steering wheel, or when you return the lever to the central position.

-  The corresponding turn signal indicator lights up on the instrument panel when a turn signal is operating. You also hear a clicking sound.
- 

 **Warning:** If you have purchased the optional Enhanced Autopilot or Full Self-Driving Capability packages and Traffic-Aware Cruise Control is active, engaging a turn signal can cause Model S to accelerate when using Traffic-Aware Cruise Control in specific situations (see [Overtake Acceleration](#) on page 86).

 **Warning:** If you have purchased the optional Enhanced Autopilot or Full Self-Driving Capability packages and Autosteer is active, engaging a turn signal may cause Model S to change lanes.

## Hazard Warning Flashers

To turn on the hazard warning flashers, press the button located on the side of the touchscreen closest to the steering wheel. All turn signals flash. Press again to turn off.

**Note:** Hazard warning flashers operate even without a key nearby.



## Instrument Panel Overview

The instrument panel changes depending on whether Model S is:

- Off (shown below).
- Driving (see [Instrument Panel - Driving](#) on page 61).
- Charging (see [Charging Status](#) on page 150).

When Model S is off, the instrument panel shows remaining estimated range, status of doors, and outside temperature. When you press the brake, indicator lights flash on briefly along the top. Unless an indicator light applies to a current situation, it should turn off. If an indicator light fails to turn on or off, contact Tesla.









**Note:** The following illustration is provided for demonstration purposes only. Depending on vehicle options, software version, and market region, the information displayed may be slightly different.



The following indicators illuminate on the instrument panel to advise you or alert you of a specific condition.

Indicator	Description
	Low beam headlights are on.
	High beam headlights are on. Illuminates when high beams are on but the Auto High Beam setting is turned off or if the Auto High Beam setting is turned on but is temporarily unavailable. See <a href="#">High Beam Headlights</a> on page 55.
	High beam headlights are currently turned on, and Auto High Beam is ready to turn off the high beams if light is detected in front of Model S. See <a href="#">High Beam Headlights</a> on page 55.



Indicator	Description
	High beam headlights are temporarily turned off because Auto High Beam is on and is detecting light in front of Model S. When light is no longer detected, the high beams will automatically turn back on. See <a href="#">High Beam Headlights</a> on page 55.
	Parking lights (side marker lights, tail lights, and license plate lights) are on. See <a href="#">Lights</a> on page 53.
	Front fog lights (optional). See <a href="#">Lights</a> on page 53.
	Adaptive Front Lighting (if equipped). See <a href="#">Adaptive Front Lighting System (AFS)</a> on page 55.
	Electronic stability control systems are actively minimizing wheel spin by controlling brake pressure and motor power (indicator flashes). See <a href="#">Traction Control</a> on page 68. If this indicator stays illuminated, a fault is detected (contact Tesla immediately).
	A Smart Air Suspension fault is detected. Contact Tesla. See <a href="#">Smart Air Suspension</a> on page 133.
	A brake system fault is detected or the brake fluid level is low. See <a href="#">Brakes</a> on page 65. Contact Tesla immediately.
	Airbag safety. If this indicator does not flash on briefly when Model S prepares to drive, or if it remains on, contact Tesla immediately. See <a href="#">Airbag Warning Indicator</a> on page 42.
	An ABS (Anti-lock Braking System) fault is detected. See <a href="#">Brakes</a> on page 65. Contact Tesla immediately.



Indicator	Description
	<p>The parking brake is manually applied. See <a href="#">Parking Brake</a> on page 66.</p>
	<p>A parking brake fault is detected. Contact Tesla. See <a href="#">Parking Brake</a> on page 66.</p>
	<p>Vehicle Hold is actively applying the brakes. See <a href="#">Vehicle Hold</a> on page 71.</p>
	<p>Tire pressure warning. The pressure of a tire is out of range. If a fault with the Tire Pressure Monitoring System (TPMS) is detected, the indicator flashes. For a TPMS fault, contact Tesla. See <a href="#">Tire Care and Maintenance</a> on page 153.</p>
	<p>A door or trunk is open. See <a href="#">Doors</a> on page 8, <a href="#">Rear Trunk</a> on page 14, or <a href="#">Front Trunk</a> on page 17.</p>
	<p>A seat belt for an occupied seat is not fastened. See <a href="#">Seat Belts</a> on page 25.  <b>Note:</b> Depending on the date of manufacture, rear seating positions may not be equipped with a seat belt reminder.</p>
	<p>Electronic stability control systems are no longer minimizing wheel spin (i.e. on a Rear Wheel Drive vehicle, the traction control system has been turned off, or on an All-Wheel Drive vehicle, Slip Start has been enabled). See <a href="#">Traction Control</a> on page 68.</p>
	<p>Model S is in Tow mode and can roll freely. It does not automatically shift into Park when you exit. See <a href="#">Instructions for Transporters</a> on page 185.</p>
	<p>Flashes green when the left turn signal is operating. Both turn signal indicators flash green when the hazard warning flashers are operating.</p>



Indicator	Description
	Flashes green when the right turn signal is operating. Both turn signal indicators flash green when the hazard warning flashers are operating.





## Instrument Panel - Driving

When Model S is driving (or ready to drive), the instrument panel shows your current driving status and a real-time visualization of the road as detected by Model S's Autopilot components (see [About Autopilot](#) on page 79).

**Note:** The following illustration is provided for demonstration purposes only. Depending on vehicle options, software version, and market region, the information displayed may be slightly different.

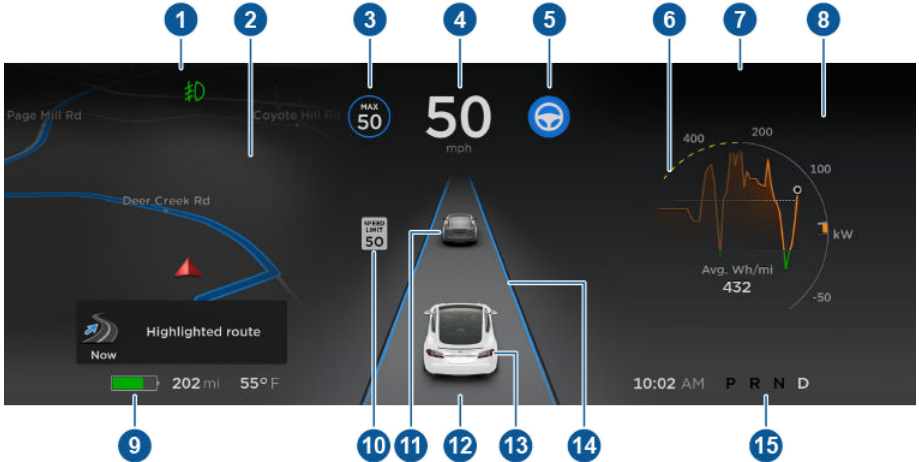

- Indicator lights display along the top to provide status (see [Instrument Panel Overview](#) on page 57).
- When you are actively navigating to a destination, navigation instructions display here. Use the left steering wheel buttons to change what displays on the left side of the instrument panel whenever navigation instructions are not displayed (see [Using Left Steering Wheel Buttons](#) on page 45).
- Traffic-Aware Cruise Control is cruising at a set speed. When Traffic-Aware Cruise Control is available but you haven't set a cruising speed, the icon is gray and the speed is not shown (see [Traffic-Aware Cruise Control](#) on page 82).
- Driving speed.
- Autosteer is actively steering Model S. When Autosteer is available but you haven't activated it, the icon is gray (see [Autosteer](#) on page 89).
- On the Energy graph, dashed lines appear on the power meter if Model S is limiting power. The dashed lines appear on the top portion (energy being used) when power available for acceleration is being limited, and on the bottom portion (energy being gained) when power that can be gained by regenerative braking is limited. Model S limits power for many reasons. Here are just a few examples:
  - Acceleration may be limited when the Battery is reaching a low state of charge or if the powertrain is hot.
  - Both acceleration and regenerative braking may be limited when the ambient temperature is either very high or very low.
  - Regenerative braking may be limited when the Battery is fully charged.

**Note:** Use the right steering wheel buttons to control what displays on the right side of the instrument panel (see [Using Right Steering Wheel Buttons](#) on page 46).



7. Pay attention to important alert messages that display here. If any alerts are in effect, you can view information about them by touching the alert icon (exclamation mark) on the touchscreen's status bar (the topmost area of the touchscreen).
8. Use the right steering wheel buttons to change what displays on the right side of the instrument panel whenever a phone call is not active (see [Using Right Steering Wheel Buttons](#) on page 46).
9. Total estimated driving distance (or energy) available. Instead of driving distance, you can display the percentage of battery energy remaining. To do so, touch **Controls** > **Display** > **Energy Display**.

**Note:** When anticipating when you need to charge, use range estimates as a general guideline only.

**Note:** In cold weather, some of the stored energy in the Battery may not be available on your drive because the Battery is too cold. When this happens, a portion of the Battery meter is blue and the driving distance value has a snowflake image next to it. If Model S is plugged in, you can heat your Battery using wall power by turning on climate control using the mobile app. When the Battery warms up, the blue portion on the meter and the snowflake image are no longer displayed.

10. The speed limit (if available) that is currently being detected by Speed Assist (see [Speed Assist](#) on page 105).
11. The car in front of you (if applicable).
12. Pay attention to important driving-related messages that appear at the bottom center of the instrument panel.
13. Your Model S.
14. When Autosteer is active and detects the driving lane, it is highlighted in blue (see [Autosteer](#) on page 89).

**Note:** If Navigate on Autopilot is active, the instrument panel displays the driving lane as a single blue line in front of Model S (see [Navigate on Autopilot](#) on page 92).

15. Currently selected gear: Park, Reverse, Neutral, or Drive.

**Warning:** Although the instrument panel shows surrounding traffic, some vehicles may not be displayed. Never rely on the instrument panel to determine if a vehicle is present (for example, in your blind spot). Always use your mirrors and perform shoulder checks.



## Wipers

To wipe the windshield, rotate the end of the left-hand steering column lever away from you. The steering column lever has five positions:

- 1st: Off.
- 2nd: Auto with low rain sensitivity.\*
- 3rd: Auto with high rain sensitivity.\*
- 4th: Continuous, slow.
- 5th: Continuous, fast.



For a single wipe, press and release the end of the lever.

If the wipers are set to Auto and Model S detects no liquid on the windshield, the wipers do not wipe.

When you operate the wipers, headlights automatically turn on (if they are not on already).

\*To enable the Auto settings, touch **Controls** > **Vehicle** > **Autowipers (Beta)**. When wipers are set to an Auto setting, Model S detects whether or not it is raining. The frequency at which they wipe depends on how much rain is detected on the windshield. When wipers are set to high rain sensitivity, the wipers turn on when Model S detects a light mist.

**Note:** The Auto setting is currently in BETA. If uncertain about using the Auto setting while in the BETA phase, Tesla recommends operating the wipers manually, as necessary.

**⚠ Caution:** Ensure the wipers are in the Off position before washing Model S to avoid the risk of damaging the wipers.

To extend the life of wiper blades, remove ice from the windshield before turning wipers on. Ice has sharp edges that can damage the rubber on the blades.

Periodically check and clean the edge of the wiper blade. If damaged, replace the blade immediately. For details on checking and replacing wiper blades, see [Wiper Blades and Washer Jets](#) on page 162.

**⚠ Caution:** In harsh climates, ensure that the wiper blades are not frozen or adhered to the windshield.

## De-icing Wipers

To make wiper blades easy to access so you can remove any ice and snow, shift Model S into Park, turn the wipers off, then use the touchscreen to move them to the service position. Touch **Controls** > **Service** > **Wiper Service Mode**. When parking in cold outdoor climates, it is helpful to leave Model S with the wipers in the service position. In this position, they are closer to the defrost vent, allowing you to thaw them by directing air from the climate control system towards the windshield.

**Note:** Wipers automatically return to their normal position when you shift Model S out of Park.

If Model S is equipped with the optional cold weather package, you can de-ice wipers by touching the climate control on the touchscreen (see [Climate Controls](#) on page 116). Wiper heaters automatically turn off after 15 minutes.

## Washers

Press the button on the end of the left steering column lever to spray washer fluid onto the windshield. You can press this button at two levels. Press partially for a single wipe, without any washer fluid. Press fully for both wipe and wash. When washing the windshield, the wipers will perform two wipes after you release the button, then a third wipe a few seconds later.



Periodically top up washer fluid (see [Topping Up Washer Fluid](#) on page 166).





### De-icing Washer Nozzles

If Model S is equipped with the optional cold weather package, washer nozzles have de-icers that turn on whenever the ambient temperature nears freezing, or when you turn on the heated wipers (see [Climate Controls](#) on page 116). The washer de-icers turn off when the heated wipers turn off (after 15 minutes), provided the temperature is warm enough to prevent freezing.



## Braking Systems

**Warning:** Properly functioning braking systems are critical to ensure safety. If you experience a problem with the brake pedal, brake caliper, or any component of a Model S braking system, contact Tesla immediately.

Model S has an anti-lock braking system (ABS) that prevents the wheels from locking when you apply maximum brake pressure. This improves steering control during heavy braking in most road conditions.

During emergency braking conditions, the ABS constantly monitors the speed of each wheel and varies the brake pressure according to the grip available.

The alteration of brake pressure can be felt as a pulsing sensation through the brake pedal. This demonstrates that the ABS is operating and is not a cause for concern. Keep firm and steady pressure on the brake pedal while experiencing the pulsing.



The ABS indicator flashes briefly on the instrument panel when you first start Model S. If this indicator lights up at any other time, an ABS fault has occurred and the ABS is not operating. Contact Tesla. The braking system remains fully operational and is not affected by an ABS failure. However, braking distances may increase.



If the instrument panel displays this indicator at any time other than displaying briefly when you first start Model S, a brake system fault is detected or the brake fluid level is low. Contact Tesla immediately.

### Emergency Braking

In an emergency, fully press the brake pedal and maintain firm pressure, even on low traction surfaces. The ABS varies the braking pressure to each wheel according to the amount of traction available. This prevents wheels from locking and ensures that you stop as safely as possible.

**Warning:** Do not pump the brake pedal. Doing so interrupts operation of the ABS and can increase braking distance.

**Warning:** Always maintain a safe distance from the vehicle in front of you and be

aware of hazardous driving conditions. While the ABS can improve stopping distance, it cannot overcome the laws of physics. It also does not prevent the danger of hydroplaning (where a layer of water prevents direct contact between the tires and the road).

Automatic Emergency Braking is designed to automatically brake in situations where a collision is considered imminent (see [Automatic Emergency Braking](#) on page 103).

**Warning:** Automatic Emergency Braking is not designed to prevent a collision. At best, it can minimize the impact of a frontal collision by attempting to reduce your driving speed. Depending on Automatic Emergency Braking to avoid a collision can result in serious injury or death.

### Brake Wear

Model S brake pads are equipped with wear indicators. A wear indicator is a thin metal strip attached to the brake pad that squeals as it rubs against the rotor when the pad wears down. This squealing sound indicates that the brake pads have reached the end of their service life and require replacement. To replace the brake pads, contact Tesla Service.

Brakes must be periodically inspected visually by removing the tire and wheel. For detailed specifications and service limits for rotors and brake pads, see [Subsystems](#) on page 175.

**Warning:** Neglecting to replace worn brake pads damages the braking system and can result in a braking hazard.

### Regenerative Braking

Whenever Model S is moving and your foot is off the accelerator, regenerative braking slows down Model S and feeds any surplus energy back to the Battery.

By anticipating your stops and reducing or removing pressure from the accelerator pedal to slow down, you can take advantage of regenerative braking to increase driving range. Of course, this is no substitute for regular braking when needed for safety.

**Note:** If regenerative braking is aggressively slowing Model S (such as when your foot is completely off the accelerator pedal at highway speeds), the brake lights turn on to alert others that you are slowing down.



**Warning:** In snowy or icy conditions Model S may experience traction loss during regenerative braking, particularly when in the **Standard** setting and/or not using winter tires. Tesla recommends using the **Low** setting (see [To Set the Regenerative Braking Level](#) on page 66) in snowy or icy conditions to help maintain vehicle stability.

The Energy app displays real-time feedback on the amount of energy being gained by regenerative braking. You can also display the power meter on either side of the instrument panel by choosing **Energy** using the scroll button on the steering wheel (see [Steering Wheel](#) on page 45).

The amount of energy fed back to the Battery using regenerative braking can depend on the current state of the Battery and the charge level setting that you are using. For example, regenerative braking may be limited if the Battery is already fully charged or if the ambient temperature is too cold.

**Note:** If regenerative braking is limited, a dashed yellow line displays on the power meter.

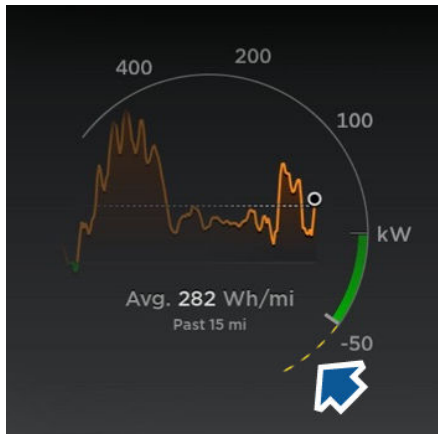

### To Set the Regenerative Braking Level

You can use the touchscreen to change the level of regenerative braking:

1. Touch **Controls > Driving > Regenerative Braking**.
2. Choose from two levels:

- **Standard:** Provides the maximum amount of regenerative braking. When you release the accelerator, Model S slows down, reducing the need to use the brakes.
- **Low:** Limits regenerative braking. When you release the accelerator, Model S takes longer to slow down and coasts further than if set to Standard.

### Parking Brake

The parking brake automatically engages when you shift Model S into Park, and releases when you shift into any other gear.



**Note:** The parking brake operates on the rear wheels only, and is independent of the pedal-operated brake system.

- Warning:** In snowy or icy conditions the rear wheels may not have sufficient traction to prevent Model S from sliding down a slope, particularly if not using winter tires. Avoid parking on hills in snowy or icy conditions. You are always responsible for parking safely.
- Warning:** Your Model S may display an alert if the road is too steep to safely park on or if the parking brakes have not properly engaged. These alerts are for guidance purposes only and are not a substitute for the driver's judgment of safe parking conditions, including specific road or weather conditions. Do not depend on these alerts to determine whether or not it is safe to park at any location. You are always responsible for parking safely.

Use the touchscreen to manually release the parking brake (which also shifts Model S into Neutral):

1. Touch **Controls > Safety & Security**.
2. Press the brake pedal, then touch **Parking Brake**. If Model S was previously in Park, it shifts into Neutral.



The parking brake indicator lights up on the instrument panel whenever you use the touchscreen to manually apply the parking brake.



If an electrical issue occurs with the parking brake, an amber parking brake fault message displays at the top of the instrument panel.



**Caution:** In the unlikely event that Model S loses electrical power, you cannot access the touchscreen and are therefore unable to release the parking brake. Contact Tesla.



## How It Works

The traction control system constantly monitors the speed of the front and rear wheels. If Model S experiences a loss of traction, the system minimizes wheel spin by controlling brake pressure and motor power. By default, the traction control system is on. Under normal conditions, it should remain on to ensure maximum safety.



This indicator flashes on the instrument panel whenever the traction control system is actively controlling brake pressure and motor power to minimize wheel spin. If the indicator stays on, a fault is detected with the traction control system. Contact Tesla Service.

**Warning:** If the above indicator remains illuminated in situations in which you have not enabled Slip Start (described next), the traction control system may not be operating correctly. Contact Tesla Service immediately.

**Warning:** Traction control cannot prevent collisions caused by driving dangerously or turning too sharply at high speeds.

## Allowing Wheel Slip

To allow the wheels to spin at a limited speed, you can enable Slip Start. Slip Start can be enabled only when Model S is moving 30 mph (48 km/h) or slower. Slip Start automatically disables when the speed exceeds 50 mph (80 km/h).

Under normal conditions, Slip Start should not be enabled. Enable it only in circumstances where you deliberately want the wheels to spin, such as:

- Starting on a loose surface, such as gravel or snow.
- Driving in deep snow, sand or mud.
- Rocking out of a hole or deep rut.

To allow the wheels to spin, touch **Controls** > **Driving** > **Traction Control** > **Slip Start**.



The instrument panel displays an alert message when Slip Start is enabled.

Although Slip Start is automatically disabled the next time you start Model S, it is strongly recommended that you disable it immediately after the circumstances that required you to enable it have passed.

**Note:** Slip Start cannot be enabled when you are actively using Traffic-Aware Cruise Control.



## How Park Assist Works

Model S has several sensors designed to detect the presence of objects. When driving slowly in Drive or Reverse (for example, when parking), the sensors alert you if an object is detected in close proximity of your Model S. Objects are only detected in the direction of the gear you selected; front objects in Drive, rear objects in Reverse.

**⚠ Warning:** You may not be alerted if Model S rolls freely in the opposite direction of the gear you selected (for example, you will not receive an alert if Model S rolls backwards down a hill while in Drive).

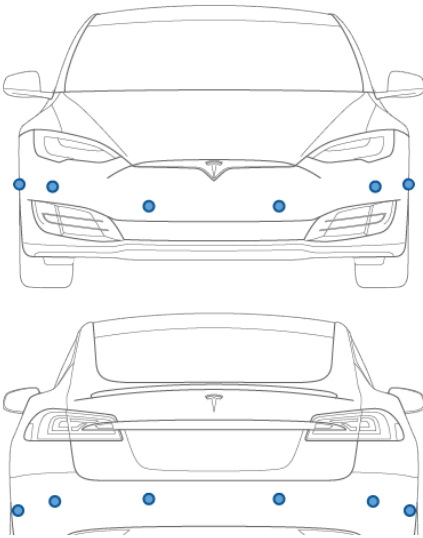

The sensors are activated when driving slower than 5 mph (8 km/h).

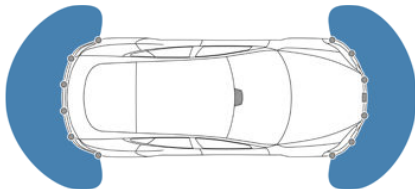

**⚠ Warning:** Never depend on Park Assist to inform you if an area you are approaching is free of objects and/or people. Several external factors can reduce the performance of Park Assist, causing

either no readings or false readings (see [Limitations and False Warnings](#) on page 70). Therefore, depending on Park Assist to determine if Model S is approaching an obstruction can result in damage to the vehicle and/or objects, and can potentially cause serious injury. Always inspect the area with your own eyes. When reversing, perform shoulder checks and use all mirrors. Park assist does not detect children, pedestrians, bicyclists, animals, or objects that are moving, protruding, located too far above or below the sensors, or too close or too far from the sensors. Park Assist is for guidance purposes only and is not intended to replace your own direct visual checks. It is not a substitute for careful driving.

## Visual and Audio Feedback

When you shift to Reverse, the Park Assist view displays on the left side of the instrument panel, showing objects that are in close proximity to the front and rear of Model S. This view closes when you shift into Drive unless an object is detected close to the front of Model S, in which case the Park Assist view closes automatically when your driving speed exceeds 5 mph (8 km/h). When reversing, visual feedback also displays on the touchscreen, immediately below the camera view (see [Rear View Camera](#) on page 77). You can manually close the park assist view on the touchscreen by touching the **X** in the upper left corner.

When driving with the Camera app displayed on the touchscreen, you can switch to the Park Assist view when driving at speeds below 5 mph (8 km/h). Touch the button located in the upper left corner of the Camera app window. This is useful if you need assistance with parallel parking.

If chimes are turned on (see [Controlling Audible Feedback](#) on page 70), an audible beep sounds as you approach an object. You can temporarily mute the chime by pressing the scroll button on the left side of the steering wheel or by touching the mute button on the bottom left corner of the Park Assist view.

**Note:** If a sensor is unable to provide feedback, the instrument panel displays an alert message.

**⚠ Caution:** Keep sensors clean from dirt, debris, snow, and ice. Avoid using a high



pressure power washer on the sensors and do not clean a sensor with a sharp or abrasive object that can scratch or damage its surface.

- ⚠ **Caution:** Do not install accessories or stickers on or near the parking sensors.

## Controlling Audible Feedback

You can use Park Assist with or without audible feedback. To turn chimes on or off, touch **Controls** > **Safety & Security** > **Park Assist Chimes**.

To mute the chimes temporarily, press the scroll button on the left side of the steering wheel or touch the mute button in the corner of the Park Assist view. The chimes are muted until you shift into a different gear or drive over 5 mph (8 km/h).

## Limitations and False Warnings

The parking sensors may not function correctly in these situations:

- One or more of the parking sensors is damaged, dirty, or covered (such as mud, ice, or snow).
- The object is located below approximately 8 inches (20 cm) (such as a curb or low barrier).

- ⚠ **Caution:** Shorter objects that are detected (such as curbs or low barriers) can move into the blind spot of the sensors. Model S cannot alert you about an object while it is in the blind spot of the sensors.

- Weather conditions (heavy rain, snow, or fog) are interfering with sensor operation.
- The object is thin (such as a sign post).
- A sensor's operating range has been exceeded.
- The object is sound-absorbing or soft (such as powder snow).
- The object is sloped (such as a sloped embankment).
- Model S has been parked in, or being driven in, extremely hot or cold temperatures.
- The sensors are affected by other electrical equipment or devices that generate ultrasonic waves.
- You are driving in a location where the sensors' ultrasonic waves are deflected away from the vehicle (such as driving next to a wall or pillar).

- The object is located too close to the bumper.
- A bumper is misaligned or damaged.
- An object that is mounted to Model S is interfering with and/or obstructing the sensor (such as a bike rack or bumper sticker).
- Model S rolls freely in the opposite direction of the gear you selected (for example, you will not receive an alert if Model S rolls backwards down a hill while in Drive).

## Other Parking Aids

In addition to Park Assist, when shifted into Reverse, the backup camera displays a view of the area behind Model S (see [Rear View Camera](#) on page 77).



When Model S is stopped, Vehicle Hold can continue to apply the brakes even after you remove your foot from the brake pedal. When driving on a hill or on a flat surface, brake as you normally would. After coming to a complete stop, simply press the brake pedal again (until the instrument panel displays the Vehicle Hold indicator light) to enable Vehicle Hold. You can then release the brake pedal and remain stopped, even on a hill.



This indicator displays on the instrument panel whenever Vehicle Hold is actively braking Model S.

To disengage Vehicle Hold, press the accelerator pedal or press and release the brake pedal.

**Note:** Shifting into Neutral also disengages Vehicle Hold.

**Note:** After actively braking Model S for approximately ten minutes, Model S shifts into Park and Vehicle Hold cancels. Model S also shifts into Park if it detects that the driver has left the vehicle.





The acceleration settings available on your Model S vary depending on date of manufacture and options chosen at time of purchase:

- **Chill:** limits acceleration for a smooth and gentle ride (available on all vehicles equipped with Autopilot hardware).
- **Standard:** provides the normal level of acceleration (available on non-Performance All-Wheel Drive vehicles and Rear Wheel Drive Model S vehicles equipped with Autopilot hardware).
- **Sport:** provides the normal level of acceleration (available on Performance All-Wheel Drive vehicles).
- **Insane:** increases peak torque by approximately 30 percent (available on Performance All-Wheel Drive vehicles not equipped with the Ludicrous upgrade).
- **Ludicrous:** increases peak torque by approximately 60 percent (available on Performance All-Wheel Drive vehicles equipped with the Ludicrous upgrade).

**Note:** Although Chill does not directly improve driving range, using the increased torque and power available in Insane or Ludicrous mode can reduce range and efficiency.

**Note:** When Chill is selected, Chill displays on the instrument panel above the driving speed.

In addition, a Performance All-Wheel Drive Model S also features Launch Mode to provide optimum acceleration on surfaces with good traction. For the specific driving instructions required to use Launch Mode, see [Launch Mode](#) on page 72.

To choose an acceleration mode, touch **Controls > Driving > Acceleration**.

## Max Battery Power

If you choose Insane or Ludicrous, additional power is available immediately. However, to achieve the absolute maximum power (designed for short term use), you can enable Max Battery Power, which heats the Battery to its ideal operating temperature to ensure access to 100% of available power. Heating the Battery can take over an hour, depending on environmental conditions and whether or not Model S is being driven.

To enable, touch **Max Battery Power**, which displays as blue text immediately below the acceleration setting. While the battery is being heated, the touchscreen displays a message providing you with an approximate wait time, and when the additional power is available, the message indicates that Max Battery Power is READY!

**Note:** Max Battery Power is designed to achieve maximum performance for short term acceleration and is not intended for daily driving. The tradeoff for the additional power boost is extra energy consumption and earlier power fade on long drives. The Insane or Ludicrous acceleration settings provide a significant increase in performance even without Max Battery Power. In fact, in normal driving situations, the additional power that can be achieved using Max Battery Power may not be noticeable.

**Note:** To support Max Battery Power, the charge level must be 20% or higher. You cannot initiate Max Battery Power if the charge level is less than 20%. In addition, Max Battery Power immediately cancels if at any time during its use, the charge level drops below 20%.

When using Max Battery Power, Model S consumes more energy as it keeps the Battery within an optimal temperature range.

To cancel Max Battery Power at any time, change the acceleration level to Chill or Sport (or touch the button in the Max Battery Mode popup). To prevent excess and potentially unnecessary energy consumption (for example, you leave the vehicle and forget to cancel Max Battery Power), Max Battery Power cancels automatically in three hours, regardless of whether you are still driving or have left the vehicle.

**Note:** Max Battery Power strives to keep the pack within an optimal temperature range. In addition to heating the Battery, Max Battery Power also cools the battery when necessary (for example, while driving at high speeds, during rapid acceleration, driving for long periods, etc.).

## Launch Mode

Launch Mode, available on Performance All-Wheel Drive vehicles only, provides optimum acceleration on surfaces with good traction.

**Note:** Hard acceleration including, but not limited to, using launch mode, increases stress on the vehicle's powertrain, and can cause



premature wear and aging of various components. Model S constantly monitors powertrain fatigue and damage, and notifies you if vehicle components need to be serviced.

**Warning:** Use Launch Mode only in appropriate locations where there is no cross traffic or pedestrians present. Launch Mode is designed for use on closed circuit driving courses. It is the driver's responsibility to ensure that driving style and acceleration do not endanger or inconvenience other road users.

### To Activate Launch Mode

1. Ensure the brakes are slightly warm by driving for a few minutes and using the brakes a few times.
2. If equipped, set the air suspension to **Low** (see [Smart Air Suspension](#) on page 133).
3. Set the acceleration level to **Insane** or **Ludicrous** and enable **Max Battery Power** (described above).

**Note:** You can use Launch Mode immediately after enabling **Max Battery Power**. There is no need to wait until Max Battery Power is in its READY state.

4. With Model S shifted into Drive and at a complete stop with the steering wheel straight, fully press the brake pedal with your left foot.
5. While still pressing the brake with your left foot, fully press the accelerator pedal with your right foot, then release the accelerator pedal. The instrument panel displays a message indicating that Launch Mode is enabled.
6. Within eight seconds, fully press the accelerator pedal a second time to pre-load motor torque, then within four seconds, release the brake.

When you release the brake, Model S launches forward.

**Note:** Launch Mode is not available if Slip Start has been enabled (i.e. wheels can spin). See [Traction Control](#) on page 68.

**Note:** Launch Mode is available only if the ambient temperature is 37° F (3° C) or warmer.



## Displaying Trip Information

Trip information displays on the touchscreen when you touch **Controls > Trips**. For the current trip, you can display distance, duration and average energy usage. You can also show distance and total and average energy used since your last charge and for additional trips.

To name or rename a trip, touch the trip's name, enter a new name for the trip, then press **Save**. To reset a particular trip meter, touch its associated **Reset** button.

You can display information for up to three trips on the instrument panel. Use the checkboxes to specify the trip(s) you want to display. Then use the scroll bar on the steering wheel to display the chosen trip(s) (see [Using Left Steering Wheel Buttons](#) on page 45 or [Using Right Steering Wheel Buttons](#) on page 46).

## Odometer

To display the odometer, touch the Tesla "T" at the top center of the touchscreen.



## Driving Tips to Maximize Range

You can maximize your driving range using the same driving habits that you use to conserve fuel in a gasoline-powered vehicle. In addition to driving habits, energy consumption depends on environmental conditions (such as exceptionally cold or hot weather and driving on roads with steep hills). To get the maximum range from a charge:

- Slow down your driving and avoid frequent and rapid acceleration.
- If safe to do so, modulate the accelerator pedal instead of using the brake pedal when gradually slowing down. Whenever Model S is moving and you are not pressing the accelerator pedal, regenerative braking slows down Model S and feeds surplus energy back to the Battery (see [Regenerative Braking](#) on page 65).
- Keep tires at the recommended inflation pressures (see [Tire Care and Maintenance](#) on page 153).
- Lighten your load by removing any unnecessary cargo.
- Fully raise all windows.
- Limit the use of resources such as heating, daytime running lights, and air conditioning. Using seat heaters to keep warm is more efficient than heating the cabin. To automatically limit the amount of power that the climate control system uses to maintain the temperature of the Battery and the cabin area, touch **Controls > Driving > Range Mode**.

The power meter on the instrument panel and the Energy app provides feedback on energy usage. With this feedback, you can become familiar with how driving habits and environmental conditions impact how much energy Model S is using.

## Energy App

Use the Energy app to view real-time and projected energy usage. Choose from two types of charts:

- **Consumption:** display how much energy Model S has consumed over the past 5, 15 or 30 miles (10, 25 or 50 km).

Touch **Instant Range** or **Average Range** to adjust the projected range estimation. Instant Range uses only the latest few data points to estimate the projected range, whereas Average Range uses the past 5, 15 or 30 miles (10, 25 or 50 km) of energy consumption to provide a more accurate projected range.

- **Trip:** If your Model S is equipped with navigation, you can monitor the amount of energy being used while navigating to a destination. You can track actual usage against the initial prediction. The green line represents the actual usage whereas the gray line represents predicted usage. To change the zoom level, touch the zoom icon located in the top right corner of the chart.

**Note:** The Trip chart displays energy usage only if you are currently navigating to a destination.

## Saving Energy

Model S has an energy-saving feature that reduces the amount of energy being consumed when Model S is not in use. On newer vehicles, this feature is automated to provide an optimal level of energy saving. However, on older vehicles, you can touch **Controls > Displays > Energy Saving** and choose from the following options:

- **OFF** - Model S shifts to the energy-saving mode at night (10 pm to 5 am).
- **ON** - significantly less energy is consumed whenever Model S is not in use. The start-up time of the instrument panel and Bluetooth could be slower.
- **Always Connected** - preserves cell connectivity when energy saving is active. This allows the mobile app to connect to Model S quicker, and provides immediate internet access when entering the car. Slightly more energy is consumed.

## Range Assurance

Model S helps protect you against running out of energy. Model S continuously monitors its energy level and proximity to known charging locations.



Touch the map's charging icon to toggle between displaying superchargers only, and displaying all chargers, including destination chargers, and visited chargers.

When you are at risk of driving beyond the range of known charging locations, the touchscreen displays a message giving you the opportunity to display a list of charging locations that are within range. When you select a charging location from the list, Model S provides navigation instructions and the turn-by-turn direction list displays the predicted amount of energy that will remain when you arrive at the charging destination.



## Camera Location

Model S is equipped with a rear view camera located above the rear license plate.

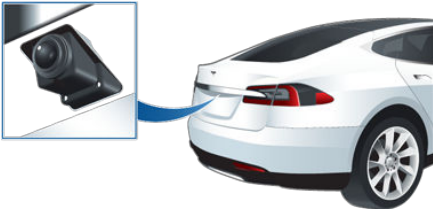

Whenever you shift into Reverse, the touchscreen displays the view from the camera. Lines show your driving path based on the position of the steering wheel. These lines adjust appropriately as you move the steering wheel.

**Note:** Visual feedback from the parking sensors displays on the instrument panel (see [Park Assist](#) on page 69).

**Note:** Depending on date of manufacture and options selected at time of purchase, some Model S vehicles are not equipped with parking sensors.

To display the view from the camera at any time:



Open the app launcher then touch the camera icon.

**Warning:** Never depend on the rear view camera to inform you if the area behind you is free of objects and/or people when reversing. The camera may not detect objects or barriers that can potentially cause damage or injury. In addition, several external factors can reduce the performance of the camera, including a dirty or obstructed lens. Therefore, depending on the rear view camera to determine if Model S is approaching an obstruction can result in damage to the vehicle and/or objects, and can potentially cause serious injury. Always inspect the area with your own eyes. When reversing, perform shoulder checks and use all mirrors. Use the camera for guidance purposes only. It is not intended to replace your own direct visual checks and is not a substitute for careful driving.

## Cleaning the Camera

To ensure a clear picture, keep the camera lens clean, and free of obstructions. Remove any buildup of dirt by occasionally wiping the camera lens with a soft damp cloth.

**Caution:** Do not use chemical-based or abrasive cleaners. Doing so can damage the surface of the camera lens.



## About Dashcam

**Note:** Dashcam is a BETA feature.

In addition to supporting Autopilot features, the narrow forward-facing camera can record and store video footage on a USB flash drive. This can be convenient in situations where you want a video recording of a particular incident, such as a collision. You can pause, resume, or save video recording directly from your vehicle's touchscreen.

**Note:** You are responsible for complying with all local laws, regulations, and property restrictions regarding video recordings when using dashcam. Dashcam is external only and does not record audio.

**Note:** Dashcam may not be available in certain market regions or in vehicles built before approximately August 1, 2017.

**Note:** Dashcam only works when Model S is powered on (see [Starting and Powering Off](#) on page 49). Dashcam does not record video when your vehicle is powered off.

## Using Dashcam

Dashcam requires a dedicated flash drive with FAT32 formatting (NTFS and exFAT are not currently supported). Before you can use the flash drive for dashcam, you must manually add a base-level folder in the flash drive called "TeslaCam" (without quotation marks). This folder is required for Model S to know where to store the video files; dashcam does not work without it.

After adding the required folder to your supported flash drive, insert it into one of your vehicle's front USB ports (see [Interior Storage and Electronics](#) on page 19). The rear USB ports are meant for charging mobile devices and do not support dashcam. When Model S recognizes the flash drive, which may take approximately 15 seconds, a dashcam icon appears in the status bar at the top of your touchscreen and dashcam automatically begins recording.

Touch the dashcam icon to control dashcam:



**RECORDING.** Tap the dashcam icon, when dashcam is paused, to start recording video on the flash drive. The dashcam temporarily stores approximately one hour of the most recent video footage on the flash drive before new video begins overwriting old video.



**PAUSED.** Press and hold the dashcam icon, when recording, to pause recording. Ensure that the dashcam is paused before removing the flash drive to avoid losing camera footage.



**SAVED.** Tap the dashcam icon, when recording, to archive the most recent ten minutes of video. The video files are saved on the flash drive with a unique timestamp. These saved video recordings are not overwritten by new recordings.

To access the video footage from dashcam, pause the dashcam, then remove the flash drive and use a personal computer to access the video files located in the "TeslaCam" folder.



**Caution:** You may lose up to the last 60 seconds of camera footage if you remove the flash drive before pausing dashcam or if your vehicle loses 12V power.



**Caution:** Use a flash drive that is dedicated to dashcam only. The flash drive cannot also be used to play media files, and Tesla is not responsible for any personal files becoming lost or corrupted.

**Note:** Tesla recommends using a flash drive with as much available storage as possible; saving the most recent ten-minutes of video requires approximately 300 MB, and the hour-long video footage loop requires approximately 1.8 GB of free space. If your flash drive does not have sufficient storage, an "X" displays on the dashcam icon and dashcam may be unable to save video files.

**Note:** Refer to [About Autopilot](#) on page 79 for information on limitations of the forward facing camera and how to clean it. For best results, ensure that both the camera and the windshield have good visibility.



## How It Works

Your Model S includes the following Autopilot components that actively monitor the surrounding roadway:

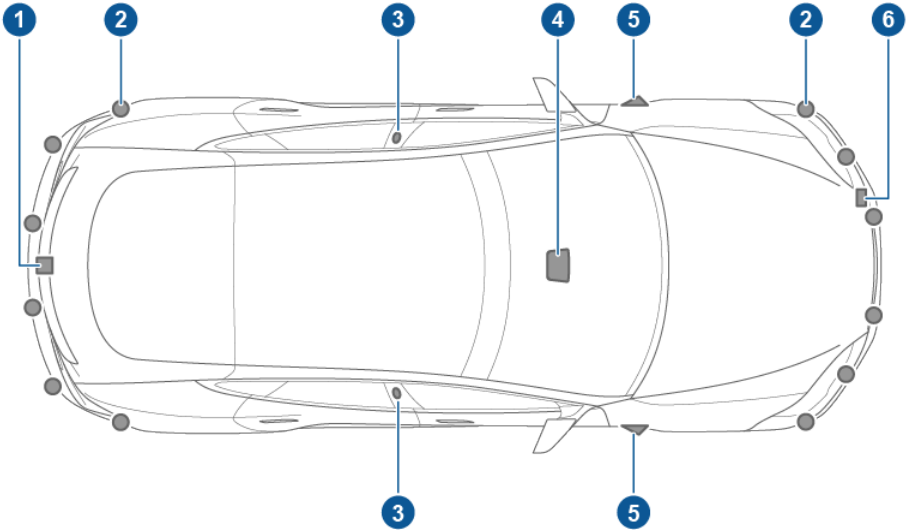

1. A camera is mounted above the rear license plate.
2. Ultrasonic sensors are located in the front and rear bumpers.
3. A camera is mounted in each door pillar.
4. Three cameras are mounted to the windshield above the rear view mirror.
5. A camera is mounted to each front fender.
6. Radar is mounted behind the front bumper on the left side of the vehicle.

Model S is also equipped with high precision electronically-assisted braking and steering systems.





## Features

These safety features are available on all Model S equipped with Autopilot components:

- Lane Assist (see [Lane Assist](#) on page 100).
- Collision Avoidance Assist (see [Collision Avoidance Assist](#) on page 102).
- Speed Assist (see [Speed Assist](#) on page 105).
- Auto High Beam (see [High Beam Headlights](#) on page 55).

These convenience features, designed to reduce driver workload, are available only if your Tesla vehicle is equipped with the optional Enhanced Autopilot or Full Self-Driving Capability packages:

- Traffic-Aware Cruise Control (see [Traffic-Aware Cruise Control](#) on page 82).
- Autosteer (see [Autosteer](#) on page 89).
- Autopark (see [Autopark](#) on page 95).

You can enable/disable Autopilot features and in some cases, control how they work. To access settings for Autopilot features, touch **Controls > Autopilot**.

## Calibration

Model S must maneuver with a great deal of precision when Autopilot features are being used. Therefore, before some features (for example, Traffic-Aware Cruise Control or Autosteer) can be used for the first time, some cameras must complete a self-calibration process.

Calibration typically completes after driving 20-25 miles (32-40 km), but the distance varies depending on road and environmental conditions. Driving on a straight road with highly-visible lane lines allows Model S to calibrate quicker. When calibration is complete, the features are available for use. Contact Tesla if your Model S has not completed the calibration process after driving 100 miles (160 km).

**Note:** If you attempt to use a feature that is not available until the calibration process is complete, the feature will not be enabled and the instrument panel displays a message.

**Note:** Model S repeats the calibration process if the cameras are serviced by Tesla and in some cases, after a software update.

## Limitations

Many factors can impact the performance of Autopilot components, causing them to be unable to function as intended. These include (but are not limited to):

- Poor visibility (due to heavy rain, snow, fog, etc.).
- Bright light (due to oncoming headlights, direct sunlight, etc.).
- Damage or obstructions caused by mud, ice, snow, etc.
- Interference or obstruction by object(s) mounted onto the vehicle (such as a bike rack).
- Obstruction caused by applying excessive paint or adhesive products (such as wraps, stickers, rubber coating, etc.) onto the vehicle.
- Narrow or winding roads.
- A damaged or misaligned bumper.
- Interference from other equipment that generates ultrasonic waves.
- Extremely hot or cold temperatures.

**Warning:** The list above does not represent an exhaustive list of situations that may interfere with proper operation of Autopilot components. Never depend on these components to keep you safe. It is the driver's responsibility to stay alert, drive safely, and be in control of the vehicle at all times.

**Caution:** If a windshield replacement is needed, take your vehicle to Tesla Service. This will ensure appropriate handling and mounting of the camera(s). Failure to do so can cause one or more Autopilot features to malfunction.

## Cleaning Cameras and Sensors

To ensure the various Autopilot components can provide information that is as accurate as possible, keep them clean and free of obstructions or damage. Occasionally remove any buildup of dirt by wiping the components with a soft cloth dampened with warm water.

**Caution:** Do not use chemical-based or abrasive cleaners. Doing so can damage surfaces.

**Caution:** Avoid using a high-pressure power washer.

**Caution:** Do not clean an ultrasonic sensor or camera lens with a sharp or abrasive



object that can scratch or damage its surface.



**Note:** Traffic-Aware Cruise Control is a BETA feature.

**Note:** If your vehicle is not equipped with the optional Enhanced Autopilot or Full Self-Driving Capability package, refer to the owner's manual on your vehicle's touchscreen for instructions on how to use Cruise Control.

If your Model S is equipped with Autopilot components (see [About Autopilot](#) on page 79), and you have purchased the optional Enhanced Autopilot or Full Self-Driving Capability package, the forward looking cameras and the radar sensor are designed to determine when there is a vehicle in front of you in the same lane. If the area in front of Model S is clear, Traffic-Aware Cruise Control maintains a set driving speed. When a vehicle is detected, Traffic-Aware Cruise Control is designed to slow down Model S as needed to maintain a selected time-based distance from the vehicle in front, up to the set speed. Traffic-Aware Cruise Control does not eliminate the need to watch the road in front of you and to manually apply the brakes when needed.

Traffic-Aware Cruise Control is primarily intended for driving on dry, straight roads, such as highways and freeways. It should not be used on city streets.

**Warning:** Traffic-Aware Cruise Control is designed for your driving comfort and convenience and is not a collision warning or avoidance system. It is your responsibility to stay alert, drive safely, and be in control of the vehicle at all times. Never depend on Traffic-Aware Cruise Control to adequately slow down Model S. Always watch the road in front of you and be prepared to take corrective action at all times. Failure to do so can result in serious injury or death.

**Warning:** Although Traffic-Aware Cruise Control is capable of detecting pedestrians and cyclists, never depend on Traffic-Aware Cruise Control to adequately slow Model S down for them. Always watch the road in front of you and be prepared to take corrective action at all times. Failure to do so can result in serious injury or death.

**Warning:** Do not use Traffic-Aware Cruise Control on city streets or on roads where traffic conditions are constantly changing.

**Warning:** Do not use Traffic-Aware Cruise Control on winding roads with sharp curves, on icy or slippery road surfaces,

or when weather conditions (such as heavy rain, snow, fog, etc.) make it inappropriate to drive at a consistent speed. Traffic-Aware Cruise Control does not adapt driving speed based on road and driving conditions.

## To Use Traffic-Aware Cruise Control

To use Traffic-Aware Cruise Control, you must be driving at least 18 mph (30 km/h), unless a vehicle is detected ahead of you. If a vehicle is detected ahead of you, you can use Traffic-Aware Cruise Control at any speed, even when stationary, provided Model S is at least 5 feet (150 cm) behind the detected vehicle.



When Traffic-Aware Cruise Control is available but is not actively cruising at a specified set speed, the instrument panel displays a gray speedometer icon on the left side of your current driving speed. The number shown in gray is the speed limit that is being determined by Speed Assist (see [Controlling Speed Assist](#) on page 105).

## Set the cruising speed

You can set the cruising speed to either:

- Your current driving speed. The minimum speed you can set is 18 mph (30 km/h) and the maximum is 90 mph (150 km/h). It is the driver's responsibility to cruise at a safe speed based on road conditions and speed limits.
- The speed limit, plus any offset you have specified (see [Speed Assist](#) on page 105).

To set the cruising speed to your current driving speed, move the cruise control lever up or down.

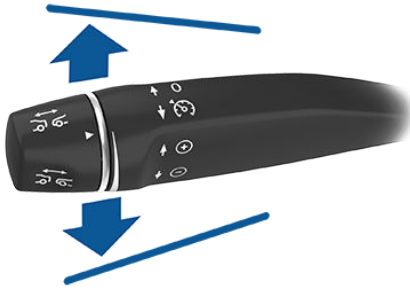

To set the cruising speed to the speed limit plus any offset you've specified using Speed Assist, pull the cruise control lever toward you. If you are already driving faster than the speed limit, the set speed does not adjust to the speed limit—it adjusts to your current driving speed. If you move the cruise control level up or down after setting Traffic-Aware Cruise Control to cruise at the speed limit, your set speed becomes your current driving speed.

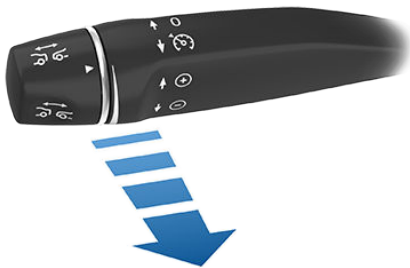

After setting the cruising speed, release the accelerator pedal to allow Traffic-Aware Cruise Control to maintain your set speed.



When the cruising speed is set, the speedometer icon on the instrument panel turns blue and displays the set speed.

**Note:** Double-pulling the cruise control lever toward you engages Autosteer (assuming it has been enabled as described in [Autosteer](#) on page 89). In this case, if you are not already cruising at a set speed, the cruising speed is set to either your current driving speed or the speed limit (plus any specified offset), whichever is greater.

**Warning:** When you adjust the cruising speed based on the speed limit, the set speed does not change when the speed limit changes. You must pull the cruise

control lever again to cruise at the new speed limit. You can also manually adjust your cruising speed at any time (see [Changing the Set Speed](#) on page 84).

**Warning:** Do not rely on Traffic-Aware Cruise Control or Speed Assist to determine an accurate or appropriate cruising speed. Always cruise at a safe speed based on road conditions and applicable speed limits.

## Cruising at the set speed

Traffic-Aware Cruise Control maintains your set cruising speed whenever a vehicle is not detected in front of Model S. When cruising behind a detected vehicle, Traffic-Aware Cruise Control accelerates and decelerates Model S as needed to maintain a chosen following distance (see [Adjust your following distance](#) on page 85), up to the set speed.

Traffic-Aware Cruise Control also adjusts the cruising speed when entering and exiting curves.

You can manually accelerate at any time when cruising at a set speed, but when you release the accelerator, Traffic-Aware Cruise Control resumes cruising at the set speed.

**Note:** When Traffic-Aware Cruise Control is actively slowing down Model S to maintain the selected distance from the vehicle ahead, brake lights turn on to alert other road users that you are slowing down. You may notice slight movement of the brake pedal. However, when Traffic-Aware Cruise Control is accelerating Model S, the accelerator pedal does not move.

**Warning:** Traffic-Aware Cruise Control may occasionally cause Model S to brake when not required or when you are not expecting it. This can be caused by closely following a vehicle ahead, detecting vehicles or objects in adjacent lanes (especially on curves), etc.

**Warning:** Due to limitations inherent in the onboard GPS (Global Positioning System), you may experience situations in which Traffic-Aware Cruise Control slows down the vehicle, especially near highway exits where a curve is detected and/or you are actively navigating to a destination and not following the route.

**Warning:** Traffic-Aware Cruise Control cannot detect all objects and, especially in situations when you are driving over 50 mph (80 km/h), may not brake/



decelerate when a vehicle or object is only partially in the driving lane or when a vehicle you are following moves out of your driving path and a stationary or slow-moving vehicle or object is in front of you. Always pay attention to the road ahead and stay prepared to take immediate corrective action. Depending on Traffic-Aware Cruise Control to avoid a collision can result in serious injury or death. In addition, Traffic-Aware Cruise Control may react to vehicles or objects that either do not exist or are not in the lane of travel, causing Model S to slow down unnecessarily or inappropriately.

**Warning:** Traffic-Aware Cruise Control may be unable to provide adequate speed control because of limited braking capability and hills. It can also misjudge the distance from a vehicle ahead. Driving downhill can increase driving speed, causing Model S to exceed your set speed (and potentially the road's speed limit). Never depend on Traffic-Aware Cruise Control to slow down the vehicle enough to prevent a collision. Always keep your eyes on the road when driving and be prepared to take corrective action as needed. Depending on Traffic-Aware Cruise Control to slow the vehicle down enough to prevent a collision can result in serious injury or death.

## Changing the Set Speed

To change the set speed while using Traffic-Aware Cruise Control, move the cruise control lever up (increase) or down (decrease) until your desired set speed is displayed.

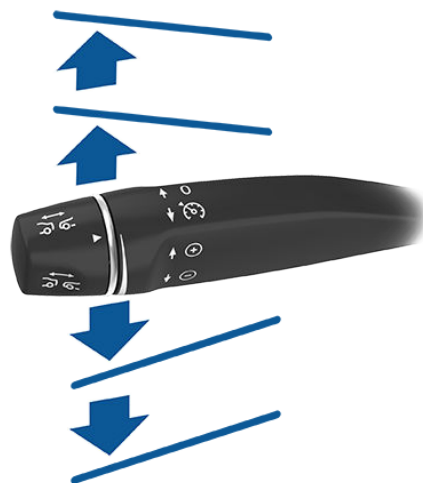

To increase/decrease speed by 1 mph (1 km/h), move the lever up or down to the first position and release. To increase/decrease speed to the closest 5 mph (5 km/h) increment, move the lever up/down to the second position and release. For example, if you are traveling at 57 mph and you move the lever up to the second position and release, the speed increases to 60 mph. You can also increase/decrease speed by holding the lever in the full up/down position and releasing when the desired speed displays below the cruise control icon.

**Note:** It may take a few seconds for Model S to reach the new cruising speed, assuming Model S does not detect a vehicle ahead driving slower than your set speed.



## HOLD State

When following a vehicle, Traffic-Aware Cruise Control remains active at low speeds, even when Model S comes to a full stop. When the vehicle is moving again, Traffic-Aware Cruise Control resumes operating at the set speed. However, under the following circumstances, Traffic-Aware Cruise Control goes into a **HOLD** state, in which case, you need to briefly press the accelerator pedal or pull the cruise control lever toward you (see [Canceling and Resuming](#) on page 86) to resume cruising. When the **HOLD** status is active, the instrument panel displays the **HOLD** icon and a message that indicates that you need to resume cruise control. The following circumstances can cause Traffic-Aware Cruise Control to go into the **HOLD** state:

- Model S has been at a standstill for 5 minutes.
- Model S detects a pedestrian (the **HOLD** state may clear when the pedestrian is no longer detected).
- Model S suddenly loses visibility of the vehicle in front of you.
- The ultrasonic sensors detect an obstacle in front of Model S.

## Cruising Near or On Freeway Exits

When cruising near an exit on a controlled access road (such as a highway or freeway) and engaging the turn signal toward the exit, Traffic-Aware Cruise Control assumes you are exiting and begins to slow down the vehicle. If you do not drive onto the exit, Traffic-Aware Cruise Control resumes cruising at the set speed. In a region with right hand traffic, this occurs only when you engage the right turn signal when driving in the right-most lane within 164 feet (50 meters) of an exit. Likewise in regions with left hand traffic; when engaging the left turn signal when driving in the left-most lane within 164 feet (50 meters) of an exit.

**Note:** The onboard Global Positioning System (GPS) determines if you are driving in a region with right or left hand traffic. In situations where GPS data is unavailable (for example, if there is inadequate signal), engaging the turn signal near an exit does not cause Traffic-Aware Cruise Control to slow down Model S.

When enabled while on a highway interchange or off-ramp, Traffic-Aware Cruise Control may reduce your set speed in 5 mph (5 km/h) increments – to as slow as 25 mph (40 km/h) – to better match the reported speeds of other Tesla vehicles that have driven at that specific location. To override this and continue cruising at your set speed, tap the accelerator pedal or move the cruise stalk. The new set speed is maintained for the duration of the interchange or off-ramp (unless you override it or cancel Traffic-Aware Cruise Control). After the interchange or off-ramp, the set speed may revert or change as necessary based on the new location. For example, if you merged onto a different highway, the set speed reverts back to the set speed that was in use before driving on the interchange.

**⚠ Warning:** In some cases (such as having insufficient data), Traffic-Aware Cruise Control may not automatically reduce the set speed on the highway interchange or off-ramp. Do not rely on Traffic-Aware Cruise Control to determine an appropriate driving speed. Tesla recommends driving at a speed that is safe for road conditions and within posted speed limits.

## Adjust your following distance

To adjust the following distance you want to maintain between Model S and a vehicle traveling ahead of you, rotate the cruise control lever to choose a setting from 1 (the closest following distance) to 7 (the longest following distance). Each setting corresponds to a time-based distance that represents how long it takes for Model S, from its current location, to reach the location of the rear bumper of the vehicle ahead of you.



As you rotate the cruise control lever, the instrument panel displays the current setting. Release the lever when the desired setting is displayed.



**Note:** Your setting is retained until you manually change it.

- Warning:** It is the driver's responsibility to determine and maintain a safe following distance at all times. Do not rely on Traffic-Aware Cruise Control to maintain an accurate or appropriate following distance.
- Warning:** Never depend on Traffic-Aware Cruise Control to adequately slow down Model S to avoid a collision. Always watch the road in front of you and stay prepared to take immediate corrective action.

## Overtake Acceleration

When following a vehicle with Traffic-Aware Cruise Control active, briefly engaging the turn signal (to indicate a move into the passing lane) accelerates Model S towards the vehicle ahead. By momentarily holding the turn signal lever up or down, you can quickly accelerate up to your set speed without having to press the accelerator pedal. The turn signal causes acceleration only when all of the following conditions are met:

- Traffic-Aware Cruise Control is operating and detects a vehicle in front of you.
- No obstacles or vehicles are detected in the target lane.
- Model S is traveling below the set speed, but over 45 mph (72 km/h).

Overtake Acceleration is intended as an aid when passing a vehicle ahead of you. When the turn signal is engaged, Traffic-Aware Cruise Control continues to maintain distance from the vehicle ahead, but allows you to drive slightly closer than your selected distance.

Acceleration cancels when one of the conditions happen:

- You reach your set cruising speed.
- Changing lanes takes too long.
- Model S gets too close to the vehicle ahead.

OR

- You disengage the turn signal.

**Note:** Overtake Acceleration occurs when you either fully engage the turn signal, or you hold the turn signal in the momentary position (partially engaged). When you release or disengage the turn signal, Model S stops accelerating (in the same way as when you release the accelerator pedal) and resumes the set speed.

- Warning:** Overtake Acceleration can cancel for many unforeseen reasons in addition to those listed above (for example, lack of GPS data). Stay alert and never depend on Overtake Acceleration to increase your driving speed.
- Warning:** Overtake Acceleration increases your driving speed whenever the appropriate turn signal is engaged, and accelerates Model S closer to the vehicle ahead. Although Traffic-Aware Cruise Control continues to maintain distance from the vehicle ahead, it is important to be aware that your selected following distance is reduced when Overtake Acceleration is active, particularly in cases where it may not be your intention to overtake the vehicle you are following.

## Canceling and Resuming

To manually cancel Traffic-Aware Cruise Control, briefly push the cruise control lever away from you or press the brake pedal. The speedometer icon on the instrument panel turns gray to indicate that Traffic-Aware Cruise Control is no longer active.



To resume cruising at the previously set speed, briefly pull the cruise control lever toward you.

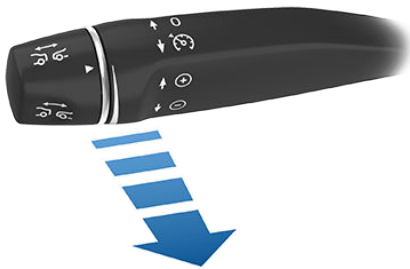

To resume cruising at the current driving speed, move the cruise control lever up or down, then release

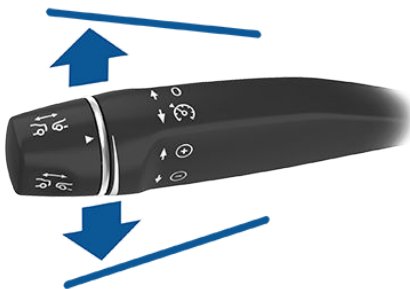

**Note:** When Traffic-Aware Cruise Control cancels, Model S does not coast. Instead, regenerative braking slows down Model S in the same way as when you move your foot off the accelerator when driving without Traffic-Aware Cruise Control (see [Regenerative Braking](#) on page 65).

**Warning:** Traffic-Aware Cruise Control cancels, or may not be available, in the following situations:

- You press the brake pedal.
- Your driving speed exceeds the maximum cruising speed of 90 mph (150 km/h).
- You shift Model S into a different gear.
- A door is opened.
- The view from the radar sensor or camera(s) is obstructed. This could be caused by dirt, mud, ice, snow, fog, etc.
- The traction control setting is manually disabled or is repeatedly engaging to prevent wheels from slipping.
- The wheels are spinning while at a standstill.

- The Traffic-Aware Cruise Control system is failing or requires service.

When Traffic-Aware Cruise Control is unavailable or cancels, Model S no longer drives consistently at a set speed and no longer maintains a specified distance from the vehicle ahead.

**Warning:** Traffic-Aware Cruise Control can cancel unexpectedly at any time for unforeseen reasons. Always watch the road in front of you and stay prepared to take appropriate action. It is the driver's responsibility to be in control of Model S at all times.

## Summary of Cruise Indicators



Traffic-Aware Cruise Control is available but is not actively controlling your speed until you activate it. The number shown in gray is determined by Speed Assist (see [Controlling Speed Assist](#) on page 105).



Traffic-Aware Cruise Control is operating and is either maintaining the set speed (no vehicle in front) or is maintaining a chosen following distance from a vehicle ahead (up to the set speed).



Model S has fully stopped but is in a **HOLD** state. If safe, press the accelerator pedal to resume cruising at the set speed.

## Limitations

Traffic-Aware Cruise Control is particularly unlikely to operate as intended in the following types of situations:

- The road has sharp curves.
- Visibility is poor (due to heavy rain, snow, fog, etc.).
- Bright light (such as from oncoming headlights or direct sunlight) is interfering with the view of the camera(s).
- The radar sensor is obstructed (dirty, covered, etc.).
- The windshield is obstructing the view of the camera(s) (fogged over, dirty, covered by a sticker, etc.).

**Warning:** The list above does not represent an exhaustive list of situations





## Traffic-Aware Cruise Control

that may interfere with proper operation of Traffic-Aware Cruise Control.



**Note:** Autosteer is a BETA feature.

If your Model S is equipped with Autopilot components (see [About Autopilot](#) on page 79), and you have purchased the optional Enhanced Autopilot or Full Self-Driving Capability packages, you can use Autosteer to manage steering and speed under certain circumstances. Autosteer builds upon Traffic-Aware Cruise Control (see [Traffic-Aware Cruise Control](#) on page 82), intelligently keeping Model S in its driving lane when cruising at a set speed. Autosteer also allows you to use the turn signals to move Model S into an adjacent lane (see [Auto Lane Change](#) on page 91). Using the vehicle's camera(s), the radar sensor, and the ultrasonic sensors, Autosteer detects lane markings and the presence of vehicles and objects for steering Model S.

- Warning:** Autosteer is a hands-on feature. You must keep your hands on the steering wheel at all times.
- Warning:** Autosteer is intended for use only on highways and limited-access roads with a fully attentive driver. When using Autosteer, hold the steering wheel and be mindful of road conditions and surrounding traffic. Do not use Autosteer on city streets, in construction zones, or in areas where bicyclists or pedestrians may be present. Never depend on Autosteer to determine an appropriate driving path. Always be prepared to take immediate action. Failure to follow these instructions could cause damage, serious injury or death.

## Operating Autosteer

Before you can operate Autosteer, you must enable it by touching **Controls > Autopilot > Autosteer (Beta)**.

52



To indicate that Autosteer is available (but not actively steering Model S), the instrument panel displays a gray Autosteer icon on the right side of the driving speed.

To initiate Autosteer, pull the cruise control lever toward you twice in quick succession.

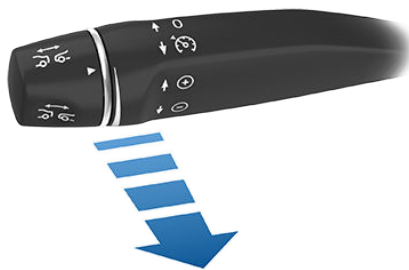

Autosteer briefly displays a message on the instrument panel reminding you to pay attention to the road and be ready to take over at any time. To indicate that Autosteer is now actively steering Model S, the instrument panel displays the Autosteer icon in blue. When Autosteer is able to detect lane markings, it also displays the driving lane in blue.

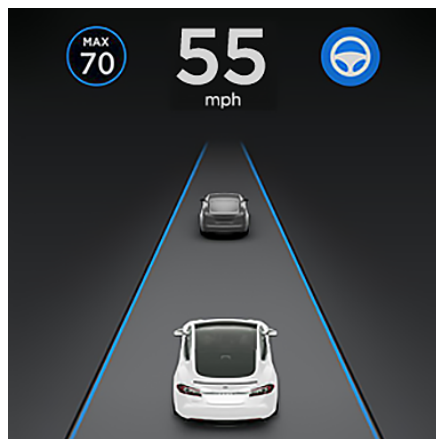

**Note:** To initiate Autosteer when there is no vehicle in front of you, you must be driving at least 18 mph (30 km/h) on a roadway with visible lane markings. If a vehicle is detected ahead of you, you can initiate Autosteer at any speed under 90 mph (150 km/h), even when stationary (if you are at least 5 feet (150 cm) away from the vehicle).

The instrument panel displays a message indicating that Autosteer is temporarily unavailable if you attempted to engage Autosteer when driving at a speed that is not within the speed required for Autosteer to operate. Autosteer may also be unavailable if it is not receiving adequate data from the camera(s) or sensors.



If Autosteer is unable to detect lane markings, the driving lane is determined based on the vehicle you are following.

In most cases, Autosteer attempts to center Model S in the driving lane. However, if the sensors detect the presence of an obstacle (such as a vehicle or guard rail), Autosteer may steer Model S in a driving path that is offset from the center of the lane.

**Warning:** Autosteer is not designed to, and will not, steer Model S around objects partially or completely in the driving lane. Always watch the road in front of you and stay prepared to take appropriate action. It is the driver's responsibility to be in control of Model S at all times.

### Restricted Speed

Autosteer is intended for use only by a fully attentive driver on freeways and highways where access is limited by entry and exit ramps. If you choose to use Autosteer on residential roads, a road without a center divider, or a road where access is not limited, Autosteer may limit the maximum allowed cruising speed. The maximum allowed cruising speed on such roads is calculated based on the detected speed limit including a Speed Assist offset of up to +5 mph (10 km/h). Any Speed Assist offset above +5 mph (10 km/h) is rounded down to +5 mph (10 km/h). However, you can select a more restrictive cruising speed by reducing the speed limit offset (see [Controlling Speed Assist](#) on page 105) or by adjusting the cruise control lever.

In situations where the speed limit cannot be detected when Autosteer is engaged, Autosteer reduces your driving speed and limits the set speed to 45 mph (70 km/h). Although you can manually accelerate to exceed the limited speed, Model S may not brake for detected obstacles. Autosteer will slow down to the limited speed when you release the accelerator pedal. When you leave the road, or disengage Autosteer by using the steering wheel, you can increase your set speed again, if desired.

### Hold Steering Wheel

Autosteer uses data from the camera(s), sensors, and GPS to determine how best to steer Model S. When active, Autosteer requires you to hold the steering wheel. If it does not detect your hands on the steering wheel for a period of time, a flashing white light appears along the top of the instrument panel and the following message displays:



Apply light force to steering wheel

Autosteer detects your hands by recognizing light resistance as the steering wheel turns, or from you manually turning the steering wheel very lightly (without enough force to retake control). Engaging a turn signal, using the cruise control lever to adjust the cruise speed or follow distance, or using any steering wheel button or scroll wheel also qualifies for your hands being detected by Autosteer.

**Note:** When your hands are detected, the message disappears and Autosteer resumes normal operation.

**Note:** Autosteer may also sound a chime at the same time that the message is initially displayed.

Autosteer requires that you pay attention to your surroundings and remain prepared to take control at any time. If Autosteer still does not detect your hands on the steering wheel, the request escalates by sounding chimes that increase in frequency.

If you repeatedly ignore hands-on prompts, Autosteer displays the following message and is disabled for the rest of the drive. If you don't resume manual steering, Autosteer sounds a continuous chime, turns on the warning flashers, and slows the vehicle to a complete stop.



Autosteer Unavailable for the Rest of This Drive

Hold Steering Wheel to Drive Manually

For the rest of the drive, you must steer manually. Autosteer is available again after you stop and shift the vehicle into Park.

### Take Over Immediately

In situations where Autosteer is unable to steer Model S, Autosteer sounds a warning chime and displays the following message on the instrument panel:



Take Over Immediately

When you see this message, **TAKE OVER STEERING IMMEDIATELY.**

### Canceling Autosteer

Autosteer cancels when:



- You start steering manually.
- You press the brake pedal.
- You push the cruise control lever away from you.
- The maximum speed that Autosteer supports–90 mph (150 km/h)–is exceeded.
- You shift into a different gear.
- A door is opened.
- An Automatic Emergency Braking event occurs (see [Collision Avoidance Assist](#) on page 102).

When Autosteer cancels, it sounds chimes and the Autosteer icon either turns gray to indicate that Autosteer is no longer active, or disappears to indicate that it is not currently available.

**Note:** If Autosteer cancels because you started steering manually, Traffic-Aware Cruise Control remains active and the set speed, if higher than your driving speed, is automatically changed to your driving speed. Disengage Traffic-Aware Cruise Control as you normally would, by briefly pushing the cruise control lever away from you or pressing the brake pedal.

To disable Autosteer so it is no longer available, touch **Controls > Autopilot > Autosteer (Beta)**.

## Auto Lane Change

When Autosteer is active, you can use the turn signals to move Model S into an adjacent lane without moving the steering wheel (which would cancel Autosteer).

**Warning:** It is the driver's responsibility to determine whether a lane change is safe and appropriate. Therefore, before initiating a lane change, always check blind spots, lane markings, and the surrounding roadway to confirm it is safe and appropriate to move into the target lane.

**Warning:** Never depend on Auto Lane Change to determine an appropriate driving path. Drive attentively by watching the road and traffic ahead of you, checking the surrounding area, and monitoring the instrument panel for warnings. Always be prepared to take immediate action.

**Warning:** Do not use Auto Lane Change on city streets or on roads where traffic conditions are constantly changing and

where bicycles and pedestrians are present.

**Warning:** The performance of Auto Lane Change depends on the ability of the camera(s) to recognize lane markings.

**Warning:** Do not use Auto Lane Change on winding roads with sharp curves, on icy or slippery roads, or when weather conditions (such as heavy rain, snow, fog, etc.) may be obstructing the view from the camera(s) or sensors.

**Warning:** Failure to follow all warnings and instructions can result in property damage, serious injury or death.

### Operating Auto Lane Change

Auto Lane Change is available whenever Autosteer is active. To change lanes using Auto Lane Change:

1. Perform visual checks to make sure it is safe and appropriate to move into the target lane.
2. Engage the appropriate turn signal.
3. Disengage the turn signal after you are in the target lane.

Auto Lane Change moves Model S into the adjacent lane in the direction indicated by the turn signal, provided the following conditions are met:

- The turn signal is engaged.
- The ultrasonic sensors and Autopilot cameras do not detect a vehicle or obstacle up to the center of the target lane.
- The lane markings indicate that a lane change is permitted.
- The view of the camera(s) is not obstructed.
- Your vehicle does not detect another vehicle in its blind spot.
- Midway through the lane change, Auto Lane Change can detect the outside lane marking of the target lane.
- Driving speed is at least 30 mph (45 km/h).



As the lane change is in progress, Overtake Acceleration is activated, allowing Model S to accelerate closer to a vehicle in front (see [Overtake Acceleration](#) on page 86). Midway through the lane change, Auto Lane Change must be able to detect the target lane's outside lane marking. If this lane marking cannot be detected, the lane change is aborted and Model S returns to its original driving lane.

**Note:** Auto Lane Change moves Model S one lane at a time. Moving into an additional lane requires you to engage the turn signal a second time after the first lane change is complete.

When using Auto Lane Change, it is important to monitor its performance by watching the driving path in front of you and the surrounding area. Stay prepared to take over steering at any time. As you are crossing over into the adjacent lane, the instrument panel displays the lane marking as a dashed blue line. Once in your new lane, lane markings are displayed as solid blue lines again.

In situations where Auto Lane Change is unable to operate at optimal performance, or cannot operate due to inadequate data, the instrument panel displays a series of warnings. Therefore, when using Auto Lane Change, always pay attention to the instrument panel and be prepared to manually steer Model S.

## Navigate on Autopilot

**Note:** Navigate on Autopilot is a BETA feature, available only in the United States while driving on roads located in the United States.

When using Autosteer on a controlled-access road (such as a highway or freeway), Navigate on Autopilot automatically exits at off-ramps and interchanges based on your navigation route. Along the highway portion of a navigation route, Navigate on Autopilot also changes lanes to prepare for exits and to minimize the driving time to your destination.

**Warning:** Navigate on Autopilot does not make driving autonomous. You must pay attention to the road, keep your hands on the steering wheel at all times, and remain aware of your navigation route.

**Warning:** As is the case with normal driving, be extra careful around blind corners, highway interchanges, and exits because obstacles can appear quickly and at any time.

**Warning:** Navigate on Autopilot may not recognize or detect oncoming vehicles, stationary objects, and special-use lanes such as those used exclusively for bikes, carpools, emergency vehicles, etc. Remain alert at all times and be prepared to take immediate action. Failure to do so can cause damage, injury or death.

## Enabling and Customizing Navigate on Autopilot

To enable Navigate on Autopilot, touch **Controls > Autopilot > Navigate on Autopilot (Beta)**. Then, to customize how you want Navigate on Autopilot to operate, touch **CUSTOMIZE NAVIGATE ON AUTOPILOT**:

**Speed Based Lane Changes:** Navigate on Autopilot is designed to perform both route-based and speed-based lane changes. Route-based lane changes are designed to keep you on your navigation route (for example, moving you into an adjacent lane to prepare for an upcoming off-ramp) whereas speed-based lane changes are designed to maintain a driving speed (not to exceed your cruising speed) that allows you to minimize the time it takes to reach your destination (for example, moving into an adjacent lane to pass a vehicle in front of you). Speed-based lane changes are optional. You can use this setting to disable speed-based lane changes or to specify how aggressively you want Navigate on Autopilot to change lanes to achieve the set cruising speed. The **MILD** setting is more conservative about lane changes and may result in a slightly longer driving time whereas **MAD MAX** is designed to allow you to reach your destination in the shortest driving time possible, but will only change lanes when safe to do so.

**Note:** The touchscreen displays route-based lane changes at the top of the map's turn-by-turn direction list to notify you that an upcoming lane changes is needed to stay on the navigation route.

## Operating Navigate on Autopilot

Once enabled, the Navigate on Autopilot button appears on the map's turn-by-turn direction list whenever a navigation route is active and the route includes at least one controlled-access road. Touch this button to allow Navigate on Autopilot to assist you on your journey. The turn-by-turn direction will then display the Autosteer icon next to maneuvers (such as freeway exits) that Navigate on Autopilot will handle.



Navigate on Autopilot activates and deactivates as appropriate, based on the type of road you are driving on. For example, if Navigate on Autopilot is turned on and Autosteer is active when you reach a supported controlled-access road, Navigate on Autopilot automatically becomes active.

Whenever Navigate on Autopilot is active, the instrument panel displays the driving lane as a single blue line in front of Model S:

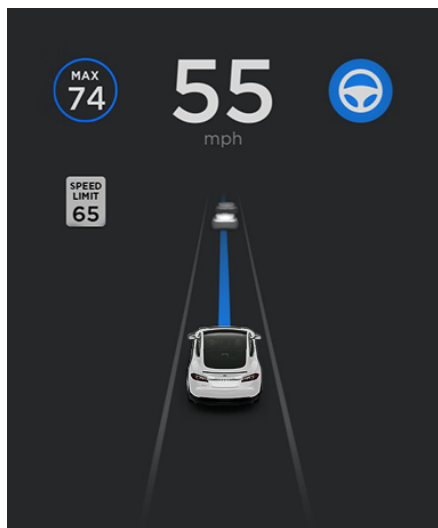

When Navigate on Autopilot is active and you approach an off-ramp or freeway interchange along your navigation route, the appropriate turn signal engages and Autosteer maneuvers Model S onto the off-ramp or interchange.

**Warning:** Never depend on Navigate on Autopilot to determine an appropriate lane at an off-ramp. Stay alert and perform visual checks to ensure that the driving lane is safe and appropriate.

When you leave a controlled-access road (for example, you exit a freeway or you enter a section of a highway that is no longer supported), Navigate on Autopilot reverts back to Autosteer— a unique triple-tone chime sounds and the instrument panel displays the driving lane lines in blue (instead of the single blue in front of Model S). When you exit onto an off-ramp, the instrument panel briefly displays a countdown message warning you of the distance remaining before Navigate on Autopilot reverts back to Autosteer.

**Note:** How Navigate on Autopilot determines navigation routes and maneuvers at freeway interchanges can be impacted by whether or not the navigation system is set up to use High Occupancy Vehicle (HOV) lanes. Therefore, ensure the **Use HOV Lanes** setting is appropriate for your circumstances (see [Maps and Navigation](#) on page 122). If the setting is off, Navigate on Autopilot never uses an HOV lane, regardless of time of day. If the setting is on, Navigate on Autopilot will exclusively use HOV lanes, whenever the option exists.

**Warning:** Even when Navigate on Autopilot deactivates at off-ramps, Autosteer remains active. Always be prepared to take appropriate actions such as stopping at red lights and stop signs, and yielding to other road users.

**Warning:** Navigate on Autopilot may not always attempt to exit at an off-ramp, even when the exit is determined by the navigation route. Always remain alert and be prepared to manually steer onto the off-ramp, or make a required lane change.

You can cancel Navigate on Autopilot at any time by touching the **Navigate on Autopilot** button on the map's turn-by-turn direction list (your vehicle will revert back to Autosteer), or by canceling Autosteer entirely (see [Canceling Autosteer](#) on page 90).

### Lane Changes

Navigate on Autopilot also changes lanes to either prepare Model S for an upcoming off-ramp, or to increase your driving speed (not to exceed your set cruising speed). A message displays at the top of the map's turn-by-turn direction list to notify you of upcoming lane changes that are required to stay on the navigation route. Before changing lanes, the line on the instrument panel shows the upcoming driving path:

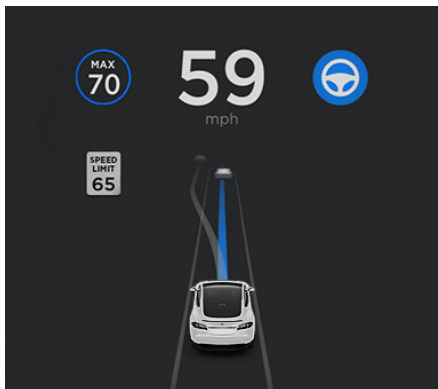

When the instrument panel displays a message asking you to confirm the lane change, pull the Autopilot stalk toward you or engage the appropriate turn signal. If you do not confirm the lane change within three seconds, a chime sounds to remind you that Navigate on Autopilot requires your confirmation to change lanes.

**Note:** If you ignore a route-based lane change suggestion (for example, you are driving in the left lane while approaching an off-ramp on the right side of the highway), Navigate on Autopilot will be unable to maneuver onto the off-ramp. In this case, the navigation system re-routes you to your destination.

**Warning:** Navigate on Autopilot may not always attempt to exit at an off-ramp or change lanes, even when an exit or lane change is determined by the navigation route. Always remain alert and be prepared to manually steer onto an off-ramp, or make a lane change to prepare for, or to exit at, an off-ramp or interchange.

### Be Ready to Assist

When attempting to change lanes or maneuver Model S, or when approaching construction zones, Navigate on Autopilot may be unable to determine the appropriate driving lane (for example, complex clover leaves and multi-lane off-ramps) and the instrument panel displays a alert indicating that Navigate on Autopilot is trying to maneuver and may require assistance. When you see the message, be prepared to take immediate action to ensure that it is safe and appropriate to complete the lane change or maneuver.

### Limitations

Autosteer and its associated functions are particularly unlikely to operate as intended when:

- Autosteer is unable to accurately determine lane markings. For example, lane markings are excessively worn, have been adjusted due to road construction, are changing quickly (lanes branching off, crossing over, or merging), objects or landscape features are casting strong shadows on the lane markings, or the road surface contains pavement seams or other high-contrast lines.
- Visibility is poor (heavy rain, snow, fog, etc.) or weather conditions are interfering with sensor operation.
- A camera(s) or sensor(s) is obstructed, covered, or damaged.
- Driving on hills.
- Approaching a toll booth.
- Driving on a road that has sharp curves or is excessively rough.
- Bright light (such as direct sunlight) is interfering with the view of the camera(s).
- The sensors are affected by other electrical equipment or devices that generate ultrasonic waves.
- Model S is being driven very close to a vehicle in front of it, which is blocking the view of the camera(s).

**Warning:** Many unforeseen circumstances can impair the operation of Autosteer. Always keep this in mind and remember that as a result, Autosteer may not steer Model S appropriately. Always drive attentively and be prepared to take immediate action.



If your Model S is equipped with Autopilot components (see [About Autopilot](#) on page 79), and you have purchased the optional Enhanced Autopilot or Full Self-Driving Capability package, Autopark uses data from the ultrasonic sensors and GPS to:

- Simplify parking on public roads by maneuvering Model S into parallel and perpendicular parking spaces. See [Parking on Public Roads](#) on page 95.
- Automatically park and retrieve Model S from outside the vehicle on private property. See [Using Summon](#) on page 97.

**Warning:** Summon is a BETA feature. Please use this feature with caution, staying prepared to take immediate action at any time.

**Warning:** Autopark's performance depends on the ability of the ultrasonic sensors to determine the vehicle's proximity to curbs, objects, and other vehicles.

## Parking on Public Roads

When driving, follow these steps to allow Autopark to maneuver Model S into a parking space:

1. When driving slowly on a public road, monitor the instrument panel to determine when Autopark has detected a parking space. When Autopark detects a potential parking space, the instrument panel displays a parking icon. Autopark detects parallel parking locations when driving below 15 mph (24 km/h) and perpendicular parking locations when driving below 10 mph (16 km/h).



**Note:** The parking icon appears only if the vehicle's position and/or the circumstances of the surrounding area are such that Autopark can determine an appropriate driving path. If Autopark cannot determine an appropriate path (for example, when driving on a narrow street where moving into the parking space causes the front of the vehicle to extend into the adjacent lane), you can either reposition the vehicle, find a different parking space, or park manually.

2. Check to determine if the detected parking space is appropriate and safe. If so, pull forward and stop approximately a car length ahead of the parking space (as you normally would when parallel parking or when backing into a perpendicular parking space).
3. Release the steering wheel, shift Model S into Reverse, then touch **Start Autopark** on the touchscreen.
4. When parking is complete, Autopark displays the "Complete" message.

In situations where Autopark cannot operate due to inadequate sensor data, the instrument panel displays a message indicating that you must manually park Model S.

**Note:** If you press the brake when Autopark is actively parking Model S, the parking process pauses until you touch **Resume** on the touchscreen.

**Note:** Autopark detects potential perpendicular parking spaces that are at least 9.5 feet (2.9 meters) wide with a vehicle parked on each side. Autopark detects parallel parking spaces that are at least 20 feet (6 meters), but less than 30 feet (9 meters) long. Autopark does not operate on angled parking spaces.





**Warning:** Never depend on Autopark to find a parking space that is legal, suitable, and safe. Autopark may not always detect objects in the parking space. Always perform visual checks to confirm that a parking space is appropriate and safe.

**Warning:** When Autopark is actively steering Model S, the steering wheel moves in accordance with Autopark's adjustments. Do not interfere with the movement of the steering wheel. Doing so cancels Autopark.

**Warning:** During the parking sequence, continually check your surroundings. Be prepared to apply the brakes to avoid vehicles, pedestrians, or objects.

**Warning:** When Autopark is active, monitor the touchscreen and instrument panel to ensure that you are aware of the instructions that Autopark is providing.

- The target parking space is directly adjacent to a wall or pillar (for example, the last parking space of a row in an underground parking structure).
- One or more of the ultrasonic sensors is damaged, dirty, or obstructed (such as by mud, ice, or snow).
- Weather conditions (heavy rain, snow, fog, or extremely hot or cold temperatures) are interfering with sensor operation.
- The sensors are affected by other electrical equipment or devices that generate ultrasonic waves.

**Warning:** Many unforeseen circumstances can impair Autopark's ability to park Model S. Keep this in mind and remember that as a result, Autopark may not steer Model S appropriately. Pay attention when parking Model S and stay prepared to immediately take control.

## To Pause Parking

To pause Autopark, press the brake pedal once. Model S stops and remains stopped until you touch **Resume** on the touchscreen.

## To Cancel Parking

Autopark cancels the parking sequence when you manually move the steering wheel, change gears, or touch **Cancel** on the touchscreen. Autopark also cancels parking when:

- The parking sequence exceeds seven moves.
- Model S detects that the driver is exiting the vehicle.
- A door is opened.
- You press the accelerator pedal.
- You press the brake pedal while Autopark is paused.
- An Automatic Emergency Braking event occurs (see [Collision Avoidance Assist](#) on page 102).

## Limitations

Autopark is particularly unlikely to operate as intended in these situations:

- The road is sloped. Autopark is designed to operate on flat roads only.
- Visibility is poor (due to heavy rain, snow, fog, etc.).
- The curb is constructed of material other than stone, or the curb cannot be detected.



## Using Summon

**Note:** Summon is a BETA feature. Summon is designed and intended for use only on private property where the surrounding area is familiar and predictable. When using Summon, you must continually monitor the vehicle. It is the driver's responsibility to use this feature safely, responsibly, and as intended.

With Summon, you can move Model S in and out of a parking space from outside the vehicle using the mobile app or the key. You can also customize Summon to park or retrieve Model S with a single touch of a button and to initiate parking automatically after you double-press the Park gear and exit the vehicle. Using data from the ultrasonic sensors, Summon maneuvers Model S forward or reverse into a parking space. When parking is complete, Summon shifts Model S into Park. Parking is complete when:

- Model S detects an obstacle in its driving path (within a chosen distance).
- Summon has moved Model S the maximum distance of 39 feet (12 meters).

OR

- In the case of reversing, Summon has reached the maximum **Summon Distance**.

To use Summon:

- **FIRST TIME ONLY:** Enable Summon and customize how it works (see [Customizing Summon](#) on page 97).
- Position Model S for parking (see [Position the Vehicle for Parking](#) on page 98).
- Initiate the parking maneuver using the mobile app, the key, or by double-pressing the Park gear. Detailed instructions are provided later.

You can summon Model S back to its original position if you previously Summoned it and the vehicle has remained in the Park gear. Using the mobile app or key, simply specify the opposite direction. Summon moves the vehicle along the original path provided the environment has not changed (i.e. no obstructions have been introduced). If obstacles are detected, Summon attempts to avoid the obstacles while staying as close as possible to its original path.

To cancel Summon and stop Model S at any time during a parking maneuver, use the mobile app, press any button on the key, press any of the door handles, or (if sitting in the vehicle) interact with the steering wheel, brake pedal, accelerator pedal, or gear stalk.

**Note:** If you want Summon to move multiple times in the same direction, up to the maximum of 39 feet (12 meters), cancel Summon and then re-initiate the parking process, choosing the same direction.

**Note:** Summon can move Model S a short distance laterally to avoid an obstacle but in doing so, does not return the vehicle to its driving path (i.e. Summon does not attempt to move Model S around an obstacle).

**Warning:** Summon is unable to operate as intended if the ultrasonic sensors are obstructed by a vehicle bra, excessive paint, or adhesive products (such as wraps, stickers, rubber coating, etc.).

**Warning:** Model S cannot detect obstacles that are located lower than the bumper, are very narrow (i.e. bicycles), or are hanging from a ceiling. In addition, many unforeseen circumstances can impair Summon's ability to move in or out of a parking space and, as a result, Summon may not appropriately steer Model S. Therefore, you must continually monitor the vehicle's movement and its surroundings and remain prepared to stop Model S at any time.

## Customizing Summon

Before operating Summon, use the touchscreen to enable it. Touch **Controls > Autopilot > Summon**.

Then touch **Customize** to specify how Summon operates whenever it parks or retrieves your vehicle:

- **Bumper Clearance:** Set the distance that you want Summon to stop from a detected object. For example, you may want Summon to stop within just a few inches of the garage wall. This distance applies only to objects detected directly in front of (when moving forward) or behind (when reversing) Model S.
- **Summon Distance:** Specify the distance Model S travels when backing out of a parking space.
- **Side Clearance:** Allow Model S to enter and exit very narrow parking spaces.

**Warning:** Parking in a narrow space limits the ability of the sensors to accurately detect the location of obstacles, increasing the risk of damage to Model S and/or surrounding objects.



- **Require Continuous Press** (U.S. Only): By default, Summon requires that you press and hold a button on the mobile app to move the vehicle during the parking process. When you set Require Continuous Press to **NO**, you can:
  - Park Model S by simply double pressing the Park gear, specifying the direction on the touchscreen (if reversing), then exiting the vehicle.
  - Park or retrieve Model S with a single touch of a button on the mobile app.
  - Park or retrieve Model S using the key.
- **Use Auto HomeLink** (if equipped): Set to **ON** if you want to activate HomeLink to open/close a programmed garage door that meets safety standards during the parking process. If enabled, the garage door automatically opens and closes when Model S enters or exits.

**Note:** This setting automatically opens and closes the garage door only when using Summon. To automate HomeLink in other situations (such as when driving), you must access the HomeLink device's main settings by touching the HomeLink icon on the top of the touchscreen (see [HomeLink Universal Transceiver](#) on page 137).

**Warning:** Do not use this setting with gates or with a garage door that does not meet safety standards. A garage door opener that does not have safety stop and reverse features (cannot detect an object in its path and then automatically stop and reverse) does not meet these standards. Using a garage door opener without these features increases the risk of injury or death.

**Note:** All settings associated with Summon are retained until you manually change them.

## Position the Vehicle for Parking

Before operating Summon, align Model S laterally with the parking space so Model S can move straight into the space in either Drive or Reverse. You must also position Model S within 39 feet (12 meters) of the parking space (the maximum distance that Summon can move Model S).

If applicable, open your garage door. As described earlier, this can be automated using Auto HomeLink (if equipped).

**Note:** Use Summon on flat driveways only where a raised concrete edge does not exceed approximately 1 in (2.5 cm).

## Operating Summon with the Mobile App

On the mobile app, start Summon and hold down the forward or reverse button to move Model S into the parking space. (U.S. Only): If **Require Continuous Press** is set to **NO** (see [Customizing Summon](#) on page 97), you do not need to hold down the button, just touch and release.

Summon shifts Model S into Drive or Reverse (based on the direction you specified) and drives into or out from the parking space.

**Note:** Summon cancels if your phone enters sleep mode or is turned off.

## Operating Summon with the Key (U.S. Only)

**Note:** To operate Summon with the key, **Require Continuous Press** must be set to **NO** (see [Customizing Summon](#) on page 97).

Follow these steps to park Model S from outside the vehicle using the key:

1. With Model S in Park, stand within 10 feet (3 meters) and press and hold the top center button on the key (Lock/Unlock All button) until the hazard lights blink continuously.

**Note:** The hazard lights flash once as Model S locks, then within five seconds, Model S powers on and the hazard lights flash continuously. Do not proceed to the next step until the hazard lights are flashing. If, after five seconds, the hazard lights are not flashing, release the button on the key, move closer to Model S, and try again. If Summon receives no further input within ten seconds, Summon cancels.

2. Press the Front Trunk button on the key to move Model S forward into the parking space, or press the Rear Trunk button to reverse Model S into the parking space.

## Initiate Automatic Parking Before Exiting the Vehicle (U.S. Only)

If Require Continuous Press is set to **NO**, you can initiate the parking maneuver from inside Model S before exiting:



1. While sitting in Model S with the vehicle powered on, double press the Park gear.

The instrument panel displays a message indicating that Summon is engaged, and the touchscreen displays a popup window.

2. On the touchscreen, choose the direction of travel.
3. Exit Model S and close the door.

**Note:** All doors and trunks must be closed.

**Note:** To cancel the parking maneuver before exiting the vehicle, touch **Cancel** on the popup window.

**Note:** If no direction of travel was selected on the touchscreen, Model S will not attempt the parking maneuver after you exit the vehicle.

Summon now drives Model S into the parking space according to the direction you specified on the touchscreen.

### Stopping or Canceling Summon

You can stop Model S at any time while Summon is active by pressing any button on the key or by using the mobile app. Summon also cancels when:

- A door handle is engaged or a door is opened.
- You interact with the steering wheel, brake pedal, accelerator pedal, or gear stalk.
- Model S detects an obstacle and cannot move forward for more than approximately two seconds.
- Summon has moved Model S the maximum distance of approximately 39 feet (12 meters).

### Limitations

Summon is unlikely to operate as intended in the following types of situations:

- The road is sloped. Summon is designed to operate on flat roads only.
- Summon has detected a raised concrete edge when moving forward into the parking location. Summon does not drive over an edge that is higher than approximately 1 in (2.5 cm).
- One or more of the ultrasonic sensors is damaged, dirty, or obstructed (such as by mud, ice, or snow).
- Weather conditions (heavy rain, snow, fog, or extremely hot or cold temperatures) are interfering with sensor operation.

- The sensors are affected by other electrical equipment or devices that generate ultrasonic waves.

**Note:** Summon is disabled if Model S is in Valet mode (see [Valet Mode](#) on page 44).

**Warning:** The list above does not represent an exhaustive list of situations that may interfere with proper operation of Autopark's Summon feature. It is the driver's responsibility to remain in control of Model S at all times. Pay close attention whenever Summon is actively moving Model S and stay prepared to take immediate action. Failure to do so can result in serious property damage, injury or death.



If your Model S is equipped with Autopilot components (see [About Autopilot](#) on page 79), the cameras monitor the markers on the lane you are driving in and the ultrasonic sensors and Autopilot cameras monitor the surrounding areas and the blind spot for the presence of a vehicle or other objects.

When an object is detected in your blind spot or close to the side of Model S (such as a vehicle, guard rail, etc.), colored lines radiate from the image of Model S on the instrument panel. The location of the lines correspond to the location of the detected object. The color of the lines (white, yellow, orange, or red) represents the object's proximity to Model S, with white being the farthest and red being very close and requiring your immediate attention. These colored lines only display when driving between approximately 7 and 85 mph (12 and 140 km/h). When Autosteer is active, these colored lines also display if driving slower than 7 mph (12 km/h). However, the colored lines do not display if Model S is at a standstill (for example, in heavy traffic).



Lane Assist warns you of undesired lane departures by vibrating the steering wheel slightly if a front wheel passes over a lane marking and the associated turn signal is off. This warning is active only when driving between approximately 36 and 90 mph (59 and 150 km/h). To turn this warning on or off, touch **Controls > Autopilot > Lane Departure Warning**. Your chosen setting is retained until you manually change it. It is also saved in your driver profile.

Lane Assist also warns you when a desired lane departure is not appropriate. When you engage the turn signal and a vehicle or object is detected in the adjacent lane you are planning to move into, the instrument panel displays a red lane line to indicate that you should not change lanes. When the vehicle or object is no longer detected, the lane line returns to normal.

Lane Assist also provides steering interventions if Model S drifts into (or close to) an adjacent lane in which an object, such as a vehicle, is detected. In these situations, Model S automatically steers to a safer position in its driving lane. This steering is applied only when Model S is traveling between 30 and 85 mph (48 and 140 km/h) on major roadways with clearly visible lane markings. When Lane Assist applies a steering intervention, the instrument panel briefly displays a warning message.

- ⚠ Warning:** Steering interventions are minimal and are not designed to move Model S out of its driving lane. Do not rely on steering interventions to avoid side collisions.
- ⚠ Warning:** Lane Assist features are for guidance purposes only and are not intended to replace your own direct visual checks. Never depend on Lane Assist to inform you of unintentionally driving outside of the boundaries of the driving lane or informing you that an object or vehicle is in your blind spot or close to the side of your vehicle. Several external factors can reduce the performance of Lane Assist. It is the driver's responsibility to stay alert, pay attention to the driving lane and always be aware of other road users. Failure to do so can result in serious injury or death.
- ⚠ Warning:** Lane Assist is designed to detect lane markings and may not detect the edge of a road, especially if the road has no curb. It is the driver's responsibility to drive attentively and stay within the boundaries of the driving lane.
- ⚠ Warning:** Before changing lanes, always visually check the lane you are moving into by using side mirrors and performing the appropriate shoulder checks. Several factors can affect the performance of the Lane Assist warnings, resulting in lack of, or false warnings (see [Limitations and Inaccuracies](#) on page 101).



## Limitations and Inaccuracies

Lane Assist cannot always clearly detect lane markings and you may experience unnecessary or invalid warnings in these situations:

- Visibility is poor and lane markings are not clearly visible (due to heavy rain, snow, fog, etc.). The exact detection zone of the ultrasonic sensors varies depending on environmental conditions.
- Bright light (such as from oncoming headlights or direct sunlight) is interfering with the view of the camera(s).
- A vehicle in front of Model S is blocking the view of the camera(s).
- The windshield is obstructing the view of the camera(s) (fogged over, dirty, covered by a sticker, etc.).
- Lane markings are excessively worn, have visible previous markings, have been adjusted due to road construction, or are changing quickly (for example, lanes branching off, crossing over, or merging).
- The road is narrow or winding.
- Objects or landscape features are casting strong shadows on lane markers.

Lane Assist may not provide warnings, or may apply inappropriate warnings, in these situations:

- One or more of the ultrasonic sensors is damaged, dirty, or obstructed (such as by mud, ice, or snow).
- Weather conditions (heavy rain, snow, fog, or extremely hot or cold temperatures) are interfering with sensor operation.
- The sensors are affected by other electrical equipment or devices that generate ultrasonic waves.
- An object that is mounted to Model S is interfering with and/or obstructing a sensor (such as a bike rack or a bumper sticker).

In addition, Lane Assist may not steer Model S away from an adjacent vehicle, or may apply unnecessary or inappropriate steering, in these situations:

- You are driving Model S on sharp corners or on a curve at a relatively high speed.
- Bright light (such as from oncoming headlights or direct sunlight) is interfering with the view of the camera(s).
- You are drifting into another lane but an object (such as a vehicle) is not present.

- A vehicle in another lane cuts in front of you or drifts into your driving lane.
- Model S is traveling slower than 30 mph (48 km/h) or faster than 90 mph (145 km/h).
- One or more of the ultrasonic sensors is damaged, dirty, or obstructed (such as by mud, ice, or snow).
- Weather conditions (heavy rain, snow, fog, or extremely hot or cold temperatures) are interfering with sensor operation.
- The sensors are affected by other electrical equipment or devices that generate ultrasonic waves.
- An object mounted to Model S (such as a bike rack or a bumper sticker) is interfering with or obstructing a sensor.
- Visibility is poor and lane markings are not clearly visible (due to heavy rain, snow, fog, etc.).
- Lane markings are excessively worn, have visible previous markings, have been adjusted due to road construction or are changing quickly (for example, lanes branching off, crossing over, or merging).

 **Warning:** The lists above do not represent every possible situation that may interfere with Lane Assist warnings. Lane Assist may not operate as intended for many other reasons. To avoid a collision, stay alert and always pay attention to the roadway when driving Model S so you can anticipate the need to take corrective action as early as possible.



If your Model S is equipped with Autopilot components (see [About Autopilot](#) on page 79), the following collision avoidance features are designed to increase the safety of you and your passengers:

- **Forward Collision Warning** - provides visual and audible warnings in situations when Model S detects that there is a high risk of a frontal collision (see [Forward Collision Warning](#) on page 102).
- **Automatic Emergency Braking** - automatically applies braking to reduce the impact of a frontal collision (see [Automatic Emergency Braking](#) on page 103).
- **Obstacle-Aware Acceleration** - reduces acceleration if Model S detects an object in its immediate driving path (see [Obstacle-Aware Acceleration](#) on page 104).

**Warning:** Forward Collision Warning is for guidance purposes only and is not a substitute for attentive driving and sound judgment. Keep your eyes on the road when driving and never depend on Forward Collision Warning to warn you of a potential collision. Several factors can reduce or impair performance, causing either unnecessary, invalid, inaccurate, or missed warnings. Depending on Forward Collision Warning to warn you of a potential collision can result in serious injury or death.

**Warning:** Automatic Emergency Braking is not designed to prevent all collisions. In certain situations, it can minimize the impact of a frontal collision by attempting to reduce your driving speed. Depending on Automatic Emergency Braking to avoid a collision can result in serious injury or death.

**Warning:** Obstacle-Aware Acceleration is not designed to prevent a collision. In certain situations, it can minimize the impact of a collision. Depending on Obstacle-Aware Acceleration to avoid a collision can result in serious injury or death.

## Forward Collision Warning

The forward looking camera(s) and the radar sensor monitor the area in front of Model S for the presence of an object such as a vehicle, motorcycle, bicycle, or pedestrian. If a collision is considered likely unless you take immediate corrective action, Forward Collision Warning is designed to sound a chime and highlight the vehicle in front of you in red on the instrument panel. If this happens, **TAKE IMMEDIATE CORRECTIVE ACTION!**

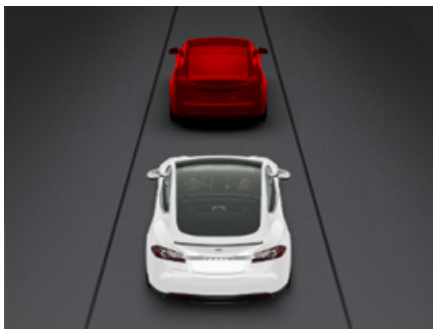

Warnings cancel automatically when the risk of a collision has been reduced (for example, you have decelerated or stopped Model S, or the object in front of your vehicle has moved out of your driving path).

If immediate action is not taken when Model S issues a Forward Collision Warning, Automatic Emergency Braking (if enabled) may automatically apply the brakes if a collision is considered imminent (see [Automatic Emergency Braking](#) on page 103).

By default, Forward Collision Warning is turned on. To turn it off or adjust its sensitivity, touch **Controls > Autopilot > Forward Collision Warning**. Instead of the default warning level of **Medium**, you can turn the warning **Off**, or you can choose to be warned **Late** or **Early**.

**Note:** Your chosen setting for Forward Collision Warning is retained until you manually change it. It is also saved in your driver profile.

**Warning:** The camera(s) and sensors associated with Forward Collision Warning are designed to monitor an approximate area of up to 525 feet (160 meters) in your driving path. The area being monitored by Forward Collision Warning can be adversely affected by road and weather conditions. Use appropriate caution when driving.



- ⚠ Warning:** Forward Collision Warning is designed only to provide visual and audible alerts. It does not attempt to apply the brakes or decelerate Model S. When seeing and/or hearing a warning, it is the driver's responsibility to take corrective action immediately.
- ⚠ Warning:** Forward Collision Warning may provide a warning in situations where the likelihood of collision may not exist. Stay alert and always pay attention to the area in front of Model S so you can anticipate whether any action is required.
- ⚠ Warning:** Forward Collision Warning operates only when driving between approximately 7 mph (10 km/h) and 90 mph (150 km/h).
- ⚠ Warning:** Forward Collision Warning does not provide a warning when the driver is already applying the brake.

## Automatic Emergency Braking

The forward looking camera(s) and the radar sensor are designed to determine the distance from a detected object traveling in front of Model S. When a frontal collision is considered unavoidable, Automatic Emergency Braking is designed to apply the brakes to reduce the severity of the impact.

When Automatic Emergency Braking applies the brakes, the instrument panel displays a visual warning and sounds a chime. You may also notice abrupt downward movement of the brake pedal. The brake lights turn on to alert other road users that you are slowing down.

### Emergency Braking in Progress

If driving 35 mph (56 km/h) or faster, the brakes are released after Automatic Emergency Braking has reduced your driving speed by 30 mph (50 km/h). For example, if Automatic Emergency Braking applies braking when driving 56 mph (90 km/h), it releases the brakes when your speed has been reduced to 26 mph (40 km/h).

Automatic Emergency Braking operates only when driving between approximately 7 mph (10 km/h) and 90 mph (150 km/h).

Automatic Emergency Braking does not apply the brakes, or stops applying the brakes, when:

- You turn the steering wheel sharply.
- You press and release the brake pedal while Automatic Emergency Braking is applying the brakes.
- You accelerate hard while Automatic Emergency Braking is applying the brakes.
- The vehicle, motorcycle, bicycle, or pedestrian is no longer detected ahead.

Automatic Emergency Braking is always enabled when you start Model S. To disable it for your current drive, touch **Controls** > **Autopilot** > **Automatic Emergency Braking**.

- ⚠ Warning:** It is strongly recommended that you do not disable Automatic Emergency Braking. If you disable it, Model S does not automatically apply the brakes in situations where a collision is considered likely.

- ⚠ Warning:** Automatic Emergency Braking is designed to reduce the severity of an impact. It is not designed to avoid a collision.

- ⚠ Warning:** Several factors can affect the performance of Automatic Emergency Braking, causing either no braking or inappropriate or untimely braking, such as when a vehicle is partially in the path of travel or there is road debris. It is the driver's responsibility to drive safely and remain in control of the vehicle at all times. Never depend on Automatic Emergency Braking to avoid or reduce the impact of a collision.

- ⚠ Warning:** Automatic Emergency Braking is designed to reduce the impact of frontal collisions only and does not function when Model S is in Reverse.

- ⚠ Warning:** Automatic Emergency Braking is not a substitute for maintaining a safe traveling distance between you and the vehicle in front of you.

- ⚠ Warning:** The brake pedal moves downward abruptly during automatic braking events. Always ensure that the brake pedal can move freely. Do not place material under or on top of the Tesla-supplied driver's floor mat (including an additional mat) and always ensure that the driver's floor mat is properly secured. Failure to do so can impede the ability of the brake pedal to move freely.





## Obstacle-Aware Acceleration

Obstacle-Aware Acceleration is designed to reduce the impact of a collision by reducing motor torque and in some cases applying the brakes, if Model S detects an object in its driving path. For example, Model S, while parked in front of a closed garage door with the Drive gear engaged, detects that you have pressed hard on the accelerator pedal. Although Model S still accelerates and hits the garage door, the reduced torque may result in less damage.

Obstacle-Aware Acceleration is designed to operate only when all of these conditions are simultaneously met:

- A driving gear is engaged (Drive or Reverse).
- Model S is stopped or traveling less than 10 mph (16 km/h).
- Model S detects an object in its immediate driving path.

To disable Obstacle-Aware Acceleration, touch **Controls > Autopilot > Obstacle-Aware Acceleration**.

 **Warning:** Obstacle-Aware Acceleration is designed to reduce the severity of an impact. It is not designed to avoid a collision.

 **Warning:** Obstacle-Aware Acceleration may not limit torque in all situations. Several factors, including environmental conditions, distance from an obstacle, and a driver's actions, can limit, delay, or inhibit Obstacle-Aware Acceleration.

 **Warning:** Obstacle-Aware Acceleration may not limit torque when performing a sharp turn, such as into a parking space.

 **Warning:** Do not rely on Obstacle-Aware Acceleration to control acceleration or to avoid, or limit, the severity of a collision, and do not attempt to test Obstacle-Aware Acceleration. Doing so can result in serious property damage, injury, or death.

 **Warning:** Several factors can affect the performance of Obstacle-Aware Acceleration, causing an inappropriate or untimely reduction in motor torque and/or undesired braking. It is the driver's responsibility to drive safely and remain in control of Model S at all times.

## Limitations and Inaccuracies

Collision Avoidance features cannot always detect all objects, vehicles, bikes, or pedestrians, and you may experience unnecessary, inaccurate, invalid, or missed warnings for many reasons, particularly if:

- The road has sharp curves.
- Visibility is poor (due to heavy rain, snow, fog, etc.).
- Bright light (such as from oncoming headlights or direct sunlight) is interfering with the view of the camera(s).
- The radar sensor is obstructed (dirty, covered, etc.).
- The windshield is obstructing the view of the camera(s) (fogged over, dirty, covered by a sticker, etc.).

 **Warning:** The limitations previously described do not represent an exhaustive list of situations that may interfere with proper operation of Collision Avoidance Assist features. These features may fail to provide their intended function for many other reasons. It is the driver's responsibility to avoid collisions by staying alert, paying attention, and taking corrective action as early as possible.

 **Caution:** If a fault occurs with a Collision Avoidance Assist feature, Model S displays an alert. Contact Tesla Service.



## How Speed Assist Works

When the Speed Limit Warning is turned on, the instrument panel displays a speed limit as determined by GPS data. Warnings (described later) take effect when you exceed this limit.



In situations where Speed Assist is unable to determine a speed limit (for example, speed limit signs and GPS data are not available at the current location), or if Speed Assist is uncertain that an acquired speed limit is accurate (for example, although a speed limit sign was initially detected, some time has passed before a subsequent sign has been detected), the instrument panel may not display a speed limit sign and warnings do not take effect.

If you set the speed limit warning to **Display** (see [Controlling Speed Assist](#) on page 105) and exceed the determined speed limit, the speed limit sign on the instrument panel increases in size.

If you set the speed limit warning to **Chime** (see [Controlling Speed Assist](#) on page 105) and exceed the determined speed limit, the speed limit sign on the instrument panel increases in size and Model S also sounds a warning chime.

**Note:** Speed limit warnings go away after ten seconds, or when Model S slows down below the specified limit.

**Warning:** Do not rely on Speed Assist to determine the appropriate speed limit or driving speed. Always drive at a safe speed based on traffic and road conditions.

## Controlling Speed Assist

To adjust the Speed Limit Warning setting, touch **Controls** > **Autopilot** > **Speed Limit Warning**, then choose one of these options:

- **Off** - Speed limit warnings do not display and chimes are not sounded.
- **Display** - Speed limit signs display on the instrument panel and the sign increases in size when you exceed the determined limit.
- **Chime** - In addition to the visual display, a chime is sounded whenever you exceed the determined speed limit.

You can also specify how the speed limit is determined:

- **Relative** - The speed limit is determined automatically based on detected traffic signs and GPS data. If desired, you can set a speed limit offset (+ or -) if you want to be alerted only when you exceed the offset speed limit by a specified amount. For example, you can increase the offset to +10 mph (10 km/h) if you only want to be warned when you exceed the speed limit by 10 mph (10 km/h).

**Note:** The offset from speed limit also affects the number shown in the gray speedometer icon on the left side of the driving speed on the instrument panel.

- **Absolute** - Manually specify any speed limit between 20 and 140 mph (30 and 240 km/h).

**Note:** GPS data is not always accurate. The GPS can miscalculate a road's location and provide the speed limit for a directly adjacent road that may have a different speed limit. For example, the GPS can assume Model S is on a freeway or highway when it is actually on a nearby surface street, and vice versa.

**Note:** Your chosen setting is retained until you manually change it. It is also saved in your driver profile.

## Limitations and Inaccuracies

Speed Assist may not be fully functional or may provide inaccurate information in these situations:



- The speed limits stored in the GPS database are incorrect or outdated.
- Model S is being driven in an area where GPS data is not available.
- A road or a speed limit has recently changed.

 **Warning:** The list above does not represent an exhaustive list of situations that may interfere with proper operation of Speed Assist. Speed Assist may fail to provide warnings for many other reasons.



## Overview

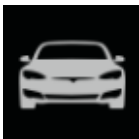

Touch **Controls** on the bottom corner of the touchscreen to control features and customize Model S to suit your preferences. The Controls window appears over the map. Touch an option on the left side of the window to display the associated controls and settings. By default, **Quick Controls** displays for quicker access to commonly used settings.



To close the Controls window, touch the **X** in the top left corner, touch **Controls** again, or swipe down on the window.



When an information icon displays beside a specific setting, touch it to display a popup that provides helpful details about the associated setting.

**Note:** The following illustrations are for demonstration purposes only. Depending on vehicle options, software version and market region, the options available may be different.



## Summary of Controls

The screenshot displays the Tesla Controls interface. On the left, a vertical list of controls is shown, with a blue circle '1' next to it. The list includes: Quick Controls, Suspension, Lights, Driving, Autopilot, Vehicle, Display, Trips, Navigation, Safety & Security, and Service. At the bottom of this list is a 'MANUAL' button. On the right, the main viewing area is shown, with a blue circle '2' next to it. This area displays the 'Exterior Lights' controls, which include: OFF, PARKING, ON (selected), and AUTO buttons; a blue 'FRONT FOG' button with a fog icon; LOCK and OPEN buttons; a top-down view of the car with a sunroof and vent area; SUNROOF OPEN and VENT buttons; a battery icon; and a bottom OPEN button. At the bottom of the main area is the 'Display Brightness' control, showing a sun icon, a slider set to 100%, and an AUTO button.

1. List of available controls. When you select an item from this list, its associated controls display in the main viewing area.
2. Main viewing area. The options available for your chosen controls category display here.



## Quick Controls

Quick Controls displays by default to provide quick access to commonly-used features. For many of these features, more options are available on the feature-specific tabs below Quick Controls.

- Exterior lights (see [Lights](#) on page 53).
- Doors and locks (see [Doors](#) on page 8).
- Sunroof, if equipped (see [Sunroof](#) on page 21).
- Charge Port (see [Charging Instructions](#) on page 146).
- Brightness: Adjust the brightness of the displays. Drag the slider to manually control the brightness of the instrument panel and touchscreen. Touch **Auto** to allow the displays to adjust automatically.

## Suspension

If Model S is equipped with Smart Air Suspension, touch to manually adjust the ride height (see [Smart Air Suspension](#) on page 133). Model S must be powered on and you must press the brake pedal before you can change suspension settings.

- ▲ **Warning:** Smart Air Suspension causes Model S to self-level, even when powered off. Therefore, when towing or lifting, you must engage **Jack Mode** to disable self-leveling (see [Instructions for Transporters](#) on page 185 and [Jacking and Lifting](#) on page 167).

## Lights

Control exterior and interior lights (see [Lights](#)) and turn the following settings on or off:

- **Auto High Beam:** If on, the high beam headlights can automatically switch to low beam when there is light (for example, from an oncoming vehicle) detected in front of Model S. See [High Beam Headlights](#).
- **Headlights after Exit:** If on, the headlights remain on when you stop driving and park Model S in low lighting conditions. They automatically turn off after one minute or when you lock Model S.



## Driving

- **Acceleration:** Choose an acceleration setting that determines whether acceleration is limited or increased (see [Acceleration Modes](#) on page 72).
- **Steering Mode:** Adjust the amount of effort required to turn the steering wheel. Sport feels more responsive whereas Comfort feels easier to drive and park (see [Adjusting Steering Effort](#) on page 45).
- **Regenerative Braking:** When you release the accelerator when driving, regenerative braking slows Model S and feeds any surplus energy back to the Battery. If set to **LOW**, Model S does not slow down as quickly, but also feeds less energy back to the Battery (see [Regenerative Braking](#) on page 65).

**Note:** Regardless of the setting selected, the energy gained by regenerative braking is reduced if the Battery is full, or is extremely cold or hot (in these cases, surplus energy is used to heat or cool it).

- **Traction Control:** In circumstances where you deliberately want the wheels to spin (for example, Model S is stuck in snow, sand, or mud), you can enable **Slip Start** (see [Traction Control](#) on page 68).
- **Creep:** When on, Model S applies forward torque in Drive and backwards torque in Reverse whenever you release the brake pedal (similar to a conventional vehicle with an automatic transmission). When off, Model S is free-rolling when you let your foot off the brake pedal and the motor does not apply torque until you press the accelerator pedal.

**Note:** The torque associated with Creep moves the vehicle slowly only on flat roads. When Model S is on a sloped surface (such as a steep hill or driveway), you must press the accelerator pedal to achieve forward or reverse movement.

**⚠ Warning:** Never rely on Creep to apply enough torque to prevent your vehicle from rolling down a hill. Always apply brakes to remain stopped or use the accelerator pedal to proceed up a hill. Failure to do so can result in property damage and/or a collision.

- **Range Mode:** If on, Model S conserves energy by limiting the power of the climate control system. Cabin heating and cooling may be less effective, but seat heaters can be used to provide warmth in colder climates. When turned on in an All-Wheel Drive vehicle, torque distribution between the motors is optimized to maximize range.



## Autopilot

Control the features that provide a safer and more convenient driving experience (see [About Autopilot](#) on page 79).

- **Autosteer (Beta):** Enable the auto steering feature (available only if your Model S is equipped with Enhanced Autopilot) (see [Autosteer](#) on page 89).
- **Navigate on Autopilot (Beta):** Available and only for use in the United States. Navigate on Autopilot automatically exits at off-ramps and interchanges based on your navigation route and can also make lane changes designed to prepare for exits and minimize the driving time to your destination (see [Navigate on Autopilot](#) on page 92).
- **CUSTOMIZE NAVIGATE ON AUTOPILOT:** Specify how Navigate on Autopilot performs lane changes (see [Navigate on Autopilot](#) on page 92).
- **Summon (Beta):** Automatically park and retrieve Model S from outside the vehicle on private property. See [Using Summon](#) on page 97.
- **CUSTOMIZE SUMMON:** Specify how Summon operates whenever it parks or retrieves your vehicle.
- **Speed Limit Warning:** Specify the type of warnings, if any, you receive when you exceed the detected speed limit (see [Speed Assist](#) on page 105).
- **Speed Limit:** Specify if you want Speed Assist to use a relative (with offset) or an absolute speed limit (see [Speed Assist](#) on page 105).
- **Offset:** If relative speed limit is selected, set a speed limit offset if you want to be alerted only when you exceed the offset speed limit by a specified amount (see [Speed Assist](#) on page 105).
- **Forward Collision Warning:** Specify if and when you want to receive visual and audible warnings in situations where there is a high risk of a frontal collision (see [Collision Avoidance Assist](#) on page 102).
- **Lane Departure Warning:** Specify if you want the steering wheel to vibrate slightly if a front wheel passes over a lane marking and the associated turn signal is off (see [Lane Assist](#) on page 100).
- **Automatic Emergency Braking:** Specify if you want Model S to automatically apply braking when a frontal collision is imminent (see [Collision Avoidance Assist](#) on page 102).
- **Obstacle-Aware Acceleration:** Specify if you want to automatically reduce acceleration when an obstacle is detected in front of your vehicle while driving at low speeds (see [Collision Avoidance Assist](#) on page 102).





## Vehicle

- **Driver Door Unlock Mode:** If on, only the driver's door unlocks when you shift Model S into Park. If off, all doors unlock.
- **Auto-Present Handles:** If on, door handles extend automatically as you approach Model S carrying a key. If off, you need to press the door handle to extend it.
- **Walk-Away Door Lock:** If on, doors automatically lock when you walk away from the vehicle, carrying your key with you (see [Walk-Away Door Lock](#)).
- **Unlock on Park:** If on, doors automatically unlock when you engage the Park gear (see [Interior Locking and Unlocking](#)). If **Driver Door Unlock Mode** is on, only the driver's door unlocks.
- **Child-Protection Lock:** If on, safety locks prevent the rear doors from being opened from inside the vehicle (see [Child-Protection Lock](#)).
- **Mirror Auto-Tilt:** If on, exterior mirrors tilt downward when reversing (see [Mirrors](#) on page 48).
- **Mirror Auto-Fold:** If on, exterior mirrors fold when you lock Model S with the key, mobile app, or walk-away locking. They extend automatically when you return. You can also fold the mirrors manually by touching the center mirror control button (see [Mirrors](#) on page 48).
- **Smart Preconditioning:** If on, Model S learns your driving schedule and automatically prepares your vehicle to drive. This minimizes the pause that you may experience as Model S powers up.

**Note:** Smart Preconditioning operates only when the energy remaining in the Battery is above 20% .

## Sunroof

Open, close, and vent the sunroof, if equipped (see [Sunroof](#) on page 21).



## Display

Manually control the brightness and the **DAY** (light background) or **NIGHT** (dark background) setting of the touchscreen and instrument panel. When set to **AUTO**, the brightness changes automatically between day and night brightness based on ambient lighting conditions.

**Brightness:** Drag the slider to manually control the brightness level of the displays. When **Auto** brightness is on, the displays are further adjusted based on both the surroundings and by learning your preferences (it remembers the type of manual adjustments you make).

**SCREEN CLEAN MODE:** Disable the touchscreen momentarily for cleaning purposes.

You can also customize how units are displayed:

- **Time Format:** Choose if time is displayed in 12 or 24 hour format.
- **Energy Display:** Display remaining energy and charging units as either a percentage of battery energy remaining, or as an estimate of the distance that you can drive. When you choose distance you can specify:
  - **Rated** - based on EPA testing.
  - **Ideal** - assumes ideal driving conditions based on driving at a steady speed of 55 mph (89 km/h) on a flat road, and using no additional energy (seat heaters, air conditioning, etc.).
- **Distance:** Choose if **MILES** or **KILOMETERS** are used when displaying range, speed, energy, trip meters, map searches and navigation routes.
- **Temperature:** Choose if temperature is displayed in °C or °F.
- **Tire Pressure:** Choose if tire pressures are displayed in **BAR** or **PSI**.

**Note:** Some market regions have additional settings that you can use to select the language displayed on the touchscreen, the language used for navigation, and the region-specific format used to display information such as dates, numbering, etc.

**Note:** Model S must be in Park to change the language. When you change the language, you experience a brief delay as the vehicle shuts down and restarts the touchscreen.

## Trips

View and reset the trip meters that summarize how far you have driven (see [Trip Information](#) on page 74).



## Navigation

Increase or decrease the volume of spoken navigation instructions by touching **-** or **+**, respectively. Decreasing all the way to the left mutes the instructions. You can also mute navigation instructions when a navigation route is active by touching the volume icon on the turn-by-turn direction list.

**Note:** This volume setting applies only to the navigation system's spoken instructions. Volume for Media Player and Phone remains unchanged.

Customize how the navigation system works by adjusting these settings:

- Touch **Trip Planner** to minimize the time you spend driving and charging (see [Trip Planner](#) on page 125).
- Touch **Online Routing** to be automatically rerouted to avoid heavy traffic (see [Online Routing](#) on page 125).
- Touch **Avoid Ferries** to be automatically rerouted to avoid ferries.
- Touch **Avoid Tolls** to be automatically rerouted to avoid tolls.
- Touch **Use HOV Lanes** to include High Occupancy Vehicle (HOV) lanes on your navigation routes. This is particularly useful when using Navigate on Autopilot (see [Navigate on Autopilot](#) on page 92).

**Note:** You can also display navigation settings by touching the settings icon on the map (see [Maps and Navigation](#) on page 122).

## Safety & Security

You can manually apply and release the **PARKING BRAKE** (see [Parking Brake](#) on page 66), **POWER OFF** the vehicle (see [Powering Off](#) on page 49), limit the acceleration and max speed (see [Speed Limit Mode](#) on page 115), and turn the following features on or off:

- **Park Assist Chimes:** If on, you will hear an audible beep when approaching an object while parking (see [Park Assist](#) on page 69).
- **Security Alarm:** Enable the security alarm (see [Security Settings](#) on page 136).
- **Passive Entry:** If on, doors automatically unlock and door handles extend (if Auto-Present Handles is on) whenever you approach Model S carrying a key. If off, you must use the key to unlock Model S. See [Using the Key](#) on page 8.

**Note:** You must press the brake pedal to power Model S on before you can change the Passive Entry setting. See [Starting](#) on page 49.

**Note:** If Passive Entry is off and you do not press the brake pedal to start Model S within approximately five minutes, a message displays on the instrument panel and you must use the key to lock then unlock Model S again before starting the vehicle.

**Note:** When you enable passive entry, it is recommended that you also enable **PIN to Drive** to increase security (see [PIN to Drive](#) on page 136).

- **PIN to Drive:** To increase security, you can prevent Model S from being driven until a 4-digit PIN (Personal Identification Number) is entered (see [PIN to Drive](#) on page 136).
- **Cabin Overheat Protection:** Reduce the temperature of the cabin in extremely hot ambient conditions for a period of up to twelve hours after you exit Model S (see [Cabin Overheat Protection](#) on page 121).
- **Allow Mobile Access:** Allow Tesla's mobile applications to access your Model S (see [Mobile App](#)).

**Note:** To disable Allow Mobile Access, enter your Tesla account credentials on the touchscreen.

- **DATA SHARING:** Allow sharing of road measurement data (see [Data Sharing](#) on page 191).



- Service**
- Tow Mode:** Prepare Model S for towing by keeping it in Neutral, which disengages the parking brake. See [Instructions for Transporters](#) on page 185.
- Wiper Service Mode:** Make wiper blades easy to access (see [Wiper Blades and Washer Jets](#) on page 162).
- FACTORY RESET:** Erase all personal data (saved addresses, music favorites, imported contacts, etc.) and restore all customized settings to their factory defaults (see [Erasing Personal Data](#) on page 115).
- MANUAL**
- Touch to display this manual, the Mobile Connector manual, and the Declarations of Conformity.
- Note:** You can also display this manual by touching the Tesla "T" at the top of the touchscreen.

## Naming Your Vehicle

To further personalize Model S, you can name it. The name you give your Model S will appear in the mobile app. To name your vehicle, touch the Tesla "T" at the top center of the touchscreen, then touch **Name Your Vehicle** (or touch the vehicle's existing name). Enter the new name in the popup then touch **Save**.

## Speed Limit Mode



Speed Limit Mode allows you to limit the acceleration and maximum speed – between 50 and 90 mph (80 and 145 km/h) – of your Model S. This feature is protected by a 4-digit PIN that you create when enabling it for the first time, and which must be re-entered in order to disable and re-enable it.

If your Model S comes within approximately 3 mph (5 km/h) of the selected maximum speed, a chime sounds and text appears on the instrument panel above the driving speed. Additionally, your mobile app will send you a notification.

To enable Speed Limit Mode:

1. Ensure the vehicle is in Park.
2. Touch **Controls** > **Safety & Security** > **Speed Limit Mode** on the touchscreen or **CONTROLS** in your mobile app.
3. Select the maximum driving speed that you would like to limit the vehicle to.
4. Drag the slider to the on position.
5. Enter the 4-digit PIN that will be required to disable Speed Limit Mode.

**Note:** If you forget the PIN, you can enter your Tesla Account login credentials to disable Speed Limit Mode.

-  **Warning:** Driving downhill can increase driving speed, causing the vehicle to exceed the selected maximum speed.
-  **Warning:** Speed Limit Mode is not a replacement for good judgment, driver training, and monitoring roadway speed limits and driving conditions. Accidents can occur at any speed.

## Erasing Personal Data

You can erase all personal data (saved addresses, music favorites, HomeLink programming, etc.) and restore all customized settings to their factory defaults. This is useful when transferring ownership of Model S. Touch **Controls** > **Service** > **FACTORY RESET**. Before erasing, Model S verifies your credentials by prompting you to enter the user name and password associated with your Tesla Account.



## Overview of Climate Controls

Climate controls are always available at the bottom of the touchscreen. To turn the climate control system on, touch the fan icon or adjust the cabin temperature. To turn it off, touch the fan icon and then touch the off button near the center of the popup window.

By default, climate control is set to the Auto setting, which maintains optimum comfort in all but the most severe weather conditions. When you adjust the cabin temperature in the Auto setting, the system automatically adjusts the heating, air conditioning, air distribution, and fan speed to maintain the cabin at your selected temperature. To override the Auto setting, touch the fan icon, turn off the Auto setting, then manually adjust your settings (see [Adjusting Climate Control Settings](#) on page 118). If you've manually adjusted individual settings, you can also revert back to Auto at any time by touching **AUTO** on the climate control popup window.

**Note:** The following illustration is provided for demonstration purposes only. Depending on vehicle options, software version, market region, and settings, the information displayed may be slightly different.

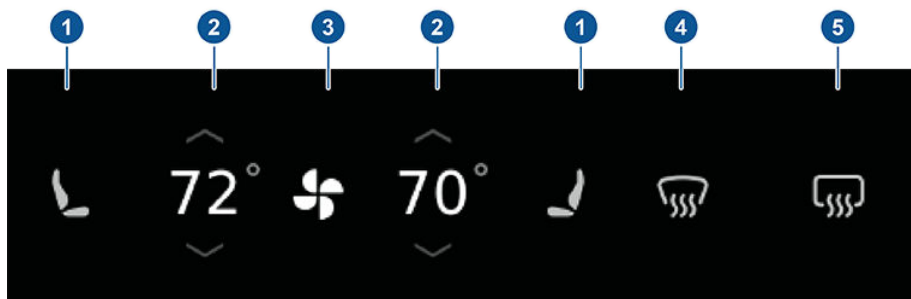

1. Seat heaters operate at three setting levels from 3 (highest) to 1 (lowest). When operating, the associated seat icon displays twisting lines that turn red to indicate the setting level. If equipped with ventilated seats, a popup appears that allows you to switch between heating and cooling. When cooling, the twisting lines turn blue.

**Note:** If Model S is equipped with rear seat heaters and/or the optional subzero weather package, you can also control seat heaters in the rear seats, heated wipers, and heated steering wheel by touching the fan icon then touching the seat tab.

2. Touch an up or down arrow to change the cabin temperature. To apply a temperature setting to both the driver and passenger side, touch **SYNC** on the popup that appears when you touch an arrow. When you apply the same temperature to both sides, only one temperature setting displays. Touch **SYNC** again to display separate temperature settings for the driver and passenger.
3. Touch the fan icon to turn on climate control and to manually customize settings to suit your preferences (see [Adjusting Climate Control Settings](#) on page 118). Touch and hold the fan icon to quickly turn off climate control. If your vehicle is equipped with the optional cold weather package, touch this icon to access controls for the rear seat heaters.
4. The windshield defroster distributes air flow to the windshield. Touch once to defog the windshield (the icon turns blue). Touch a second time to defrost the windshield (the icon turns red and the heating and fan operate at maximum levels). Touch a third time to turn off and restore the air distribution, heating, and fan to their previous settings.
5. Touch to warm up the rear window. When operating, the icon turns red. After 15 minutes, the rear window defroster automatically turns off. The exterior side mirrors are also heated whenever the rear window defroster is operating.

**Note:** Depending on date of manufacture and options selected at time of purchase, some vehicles are not equipped with a heater in the exterior side mirrors.



**⚠ Warning:** To avoid burns resulting from prolonged use, individuals who have peripheral neuropathy, or whose capacity to feel pain is limited because of diabetes, age, neurological injury, or some other condition, should exercise caution when using the climate control system and seat heaters.

**Note:** The climate control system is powered by the high voltage battery. Therefore, prolonged use decreases driving range.



## Adjusting Climate Control Settings

To adjust individual settings to suit your preferences, touch the fan icon at the bottom of the touchscreen to access individual climate control settings.

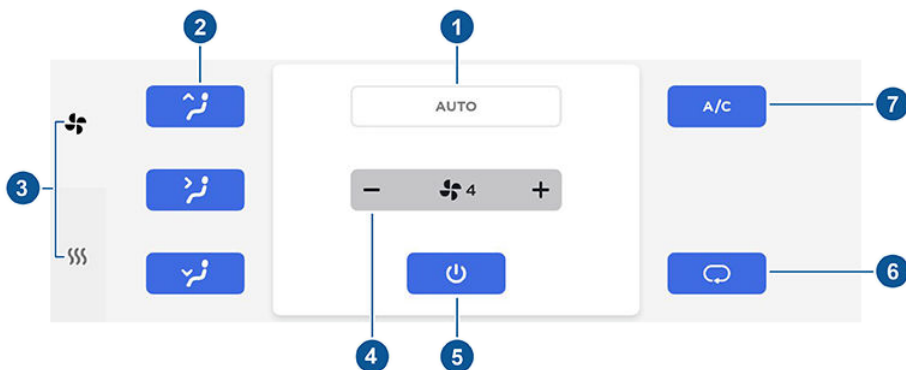

In addition to the settings shown, if Model S is in Park, the Keep Climate On setting displays when you touch the fan icon (see [Keep Climate On](#) on page 120).

1. Touch **AUTO** to change all settings back to their default values. The icon is blue whenever the climate control system is set to **AUTO**.
2. Choose where air flows into the cabin (windshield, face-level, or foot-level vents). You can choose more than one location.

**Note:** When air is directed to the foot-level vents, approximately one third of the air continues to flow to the windshield vents to assist in defogging. However, when air is directed to the face-level vents, air does not flow to the windshield because the air flowing through the face-level vents can assist in defogging the windshield.

3. If equipped with rear seat heaters and/or the sub-zero weather package, the climate control settings windows has two tabs. The general settings tab displays by default and is represented by the fan icon. Touch the heating icon to control the seat heaters in the rear seating positions, and to warm the steering wheel and wipers.

**Note:** You can also use this tab to control front seat heaters. The front seat heater controls are redundant with those on the main climate control panel.

4. Adjust the speed of the fan.

**Note:** Adjusting the fan speed may change your setting for how air is drawn into Model S in order to decrease or increase airflow. For example, if you set the fan speed at the highest setting when the air circulation is set to draw in outside air, the setting may switch to recirculating the air to achieve the high air flow.

5. Touch to turn off the climate control system and close the climate controls popup window.

**Note:** The popup window also closes if you touch the map, choose Media Player or an app, or display a controls window, even if the climate control system is turned on.



6. Choose how air is drawn into Model S:

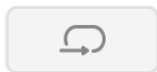

Outside air is drawn into Model S (see [Ventilation](#) on page 121). Although less efficient than recirculating the air in very hot or cold climate conditions, this setting draws more air into the rear seating areas, and is recommended when occupants are seated in the Tesla built-in rear facing child seats.



Air inside Model S is recirculated. This prevents outside air (traffic fumes) from entering, but reduces dehumidifying performance. Recirculating the air is the most efficient way to cool the front cabin area. To prevent the windshield from fogging in some conditions, briefly change the setting every hour to draw in outside air.

7. If your Model S is equipped with the Bioweapon Defense Mode feature, the HEPA (High Efficiency Particulate Air) filter ensures the best possible quality of air inside the cabin. When selected, outside air is filtered through the medical-grade HEPA filter in addition to the secondary filtration systems. The HEPA filter is extremely effective at removing particles, including pollution, allergens, bacteria, pollen, mold spores, and viruses. Both the HEPA filter and the secondary filtration system also contain activated carbon to remove a broad spectrum of odors and gases. When you engage Bioweapon Defense Mode, the fan operates at the highest speed. In addition, the positive pressure inside the cabin minimizes the amount of outside air that can leak into the vehicle.

**Note:** Some gases, such as carbon monoxide, are not effectively removed by activated carbon.

8. Turn the air conditioning on and off, respectively. Turning it off reduces cooling, but saves energy.

**Note:** Because Model S runs much quieter than a gasoline-powered vehicle, you may notice the sound of the A/C compressor as it is operating. To minimize noise, reduce the fan speed.





## Keep Climate On

The **Keep Climate On** setting allows you to keep the climate control system running when in Park, even after you've left Model S. This is useful when it is important to maintain the cabin temperature in hot or cold weather conditions (for example, when leaving groceries in Model S on hot days, you may want to use Keep Climate On to prevent spoilage). To use Keep Climate On, the Battery's charge level must be at least 20%.

To operate Keep Climate On:



1. Engage the Park gear. **Keep Climate On** is available only when Model S is in Park.
2. If necessary, adjust the climate settings.
3. Touch the fan icon then touch **Keep Climate On**.

The climate control system maintains your climate settings until you shift out of Park or manually turn it off. If the Battery's charge level drops to 20%, the climate control system automatically turns off and the Tesla mobile app sends you a notification reminding you to check on anything that you have left in Model S.

The next time you drive Model S, the climate control system continues operating using the previous settings from your most recent trip.

**Note:** The intrusion sensor (if equipped) automatically disables when Keep Climate On is active. However, you can override this behavior and keep the intrusion sensor enabled. To do so, touch **Controls > Safety & Security > Tilt/Intrusion** after enabling Keep Climate On. However, note that keeping the intrusion sensor enabled when Keep Climate On is active can trigger an alarm event as a result of air movement inside the cabin.

**Note:** Software updates are not performed when Keep Climate On is active.

-  **Warning:** You can adjust the climate control system remotely using the mobile app. However, if you use the mobile app to turn off the climate control system, Keep Climate On stops operating.
-  **Warning:** Keep Climate On turns off when the battery charge drops to 20%. Avoid using when the battery charge is low.
-  **Warning:** Never leave a child unattended in your vehicle.



## Ventilation

Outside air is drawn into Model S through the grill in front of the windshield. Keep the grill clear of obstructions such as leaves and snow.

To direct the flow of air inside Model S, move the interior vents up, down, or from side to side.

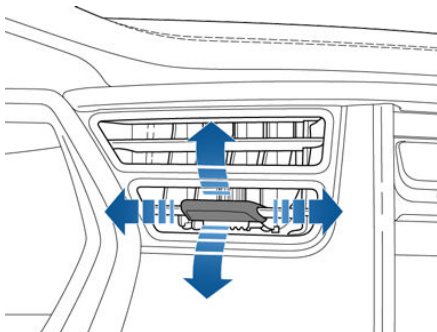

**Note:** You can direct the outer face level vents toward the side windows to help defrost or defog them.

## Cabin Air Filter

Model S has an air filter that prevents pollen, industrial fallout, road dust and other particles from entering through the vents. Tesla replaces the air filter at the regularly scheduled maintenance intervals of every 12 months, or every 12,500 miles (20,000 km).

## Cabin Overheat Protection

The climate control system can reduce the temperature of the cabin in extremely hot ambient conditions for a period of up to twelve hours after you exit Model S. Touch **Controls > Safety & Security > Cabin Overheat Protection** and choose:

- **OFF:** Disable Cabin Overheat Protection.
- **NO A/C:** Only the fan operates when the cabin temperature exceeds 105° F (40° C). This option consumes less energy but the cabin temperature may exceed 105° F (40° C).
- **ON:** The air conditioning operates when the cabin temperature exceeds 105° F (40° C).

**Note:** Cabin Overheat Protection operates only when the energy remaining in the Battery is above 20%.

**Warning:** Never leave children or pets in the vehicle unattended. Due to automatic shut-off or extreme outside conditions, the inside of the vehicle can become dangerously hot, even when Cabin Overheat Protection is enabled.

## Climate Control Operating Tips

- When you use the mobile app to turn on the climate control system, it automatically turns off after four hours or if the charge level drops to 20%. To cool or heat the cabin for a longer period, you must turn it on again.
- To conserve energy, you can limit the power of the climate control system by turning on Range Mode. Cabin heating and cooling may be less effective, but seat heaters can be used to provide warmth in colder climates. Touch **Controls > Driving > Range Mode**.
- If the climate control system is louder than you prefer, manually reduce the fan speed.
- In addition to cooling the interior, the air conditioning compressor also cools the Battery. Therefore, in hot weather, the air conditioning compressor can turn on even if you turned it off. This is normal because the system's priority is to cool the Battery to ensure it stays within an optimum temperature range to support longevity and optimum performance.
- To ensure the climate control system operates efficiently, close all windows and ensure that the exterior grill in front of the windshield is free of ice, snow, leaves, and other debris.
- In very humid conditions, it is normal for the windshield to fog slightly when you first turn on the air conditioning.
- It is normal for a small pool of water to form under Model S when parked. Extra water produced by the dehumidifying process is drained underneath.
- To reduce the temperature in the cabin in hot weather conditions, the fan may turn on to vent the cabin when the vehicle is parked. This occurs only if the battery's charge level is above 20%.



## Overview

The touchscreen displays a map at all times. Hold and drag a finger to move the map in any direction. Rotate the map in any direction by holding and turning two fingers.

Touch the icon in the top right corner of the map to set the map's orientation:



North Up - North is always at the top of the screen.



Heading Up - The direction you are driving is always at the top of the screen. The map rotates as you change direction. This icon has an integrated compass that indicates the direction you are driving.

**Note:** When navigating, this icon also allow you to toggle to the route overview which allows you to view an overview of your navigation route (see [Navigating](#) on page 123).

When you rotate or move the map, your current location is no longer tracked. The message "Tracking Disabled" displays briefly next to the map orientation icon and the icon turns gray. To re-enable tracking, touch the map's orientation icon to choose North Up or Heading Up.

Touch the **+** and **-** icons to zoom the map in and out on your current or chosen location. When you zoom in or out using these icons, tracking remains enabled.

Touch the following icons to customize what the map displays and to access navigation settings:

**Note:** These icons disappear after a few seconds when not in use. Touch anywhere on the map to re-display them.



Display/hide satellite imagery.



Display/hide traffic conditions. Green lines indicate no traffic; orange lines indicate light traffic; red lines indicate moderate traffic; and pink lines indicate heavy traffic. To ensure traffic is easy to identify along a navigation route, green traffic lines display under the blue route line, whereas orange, red, and pink traffic lines display on top of the blue route line.



Display/hide all charging locations and a popup list that includes the city and proximity of the corresponding stations on the map. Charging locations include Tesla Superchargers, destination chargers, and public chargers that you have used previously. See [Charging Locations](#) on page 124.

**Note:** Superchargers are always displayed on the map, even when charging locations are not displayed.



Increase or decrease the volume of spoken navigation instructions by touching **-** or **+**, respectively. Decreasing all the way to the left mutes the instructions. You can also mute navigation instructions when a navigation route is active by touching the volume icon on the turn-by-turn direction list.

Customize how the navigation system works by adjusting these settings:

- Touch **Trip Planner** to minimize the time you spend driving and charging (see [Trip Planner](#) on page 125).
- Touch **Online Routing** to be automatically rerouted to avoid heavy traffic (see [Online Routing](#) on page 125).
- Touch **Avoid Ferries** to be automatically rerouted to avoid ferries.
- Touch **Avoid Tolls** to be automatically rerouted to avoid tolls.
- Touch **Use HOV Lanes** to include High Occupancy Vehicle (HOV) lanes on your navigation routes. This is particularly useful when using Navigate on Autopilot (see [Navigate on Autopilot](#) on page 92).

**Note:** You can also access the above navigation settings by touching **Controls > Navigation**.

**Note:** The volume setting applies only to the navigation system's spoken instructions. Volume for Media Player and Phone remains unchanged.

Drop a pin by pressing and holding your finger anywhere on the map. When you drop a pin, or touch an existing pin, the chosen location is centered on the map, and a popup window provides information about the location. From this popup, you can navigate to the location, call the location (if a phone number is available) and add or remove the location from your list of favorite destinations (see [Recent, Favorite, Home and Work Destinations](#) on page 126).

## Navigating

To navigate to a location, touch **Navigate**, send the destination from your phone, or speak a voice command (see [Using Voice Commands](#) on page 47). You can enter or speak an address, landmark, business, etc. You can also choose a saved **Home** or **Work** location and select from a list of recently used locations (the most recent displays at the top of the list), including charging stations you have visited.

When you specify a location, the touchscreen zooms out to provide an overview of the route you need to travel, and, after calculating the route, zooms back in to your starting point and begins to provide instructions, and a turn-by-turn direction list that displays the first navigation instruction and an estimate of total mileage, driving time, and arrival time.

**Note:** You can remotely start navigation in your vehicle by using your iOS® or Android™ device's "share" functionality after giving access to the Tesla mobile app.

You can touch the instruction to expand the list to show each turn on your journey. Note the following about the turn-by-turn direction list:

- A battery displays below the destination to provide an estimate of how much battery energy will remain when you reach your destination. Touch to expand battery information to show a round trip estimate back to your starting point. See [Predicting Energy Usage](#) on page 125.
- If charging is needed to reach your destination and Trip Planner is enabled, the navigation route automatically includes Supercharger stops (see [Trip Planner](#) on page 125) and you may need to touch **BEGIN TRIP** to initiate navigation.
- If you won't have enough energy to reach your destination and there is no Supercharger on the route, an alert tells you that charging is needed to reach your destination.
- Each turn is preceded by the distance to the maneuver.
- To see the bottom of the list, you may need to drag the list upward.
- Touch the top of the list again to minimize it.

While navigating, the map tracks your location and displays the current leg of your trip. You can display the entire route at any time.



**United States Only:** If Navigate on Autopilot is enabled, you can turn it on for the navigation route by touching **Navigate on Autopilot** in the turn-by-turn direction list. Navigate on Autopilot is an extension of Autosteer that automatically changes lanes and steers Model S onto the appropriate exit(s) when navigating on controlled access roads (such as freeways). For details, see [Navigate on Autopilot](#) on page 92.



The route overview icon displays when a navigation route is active. Touch this icon at any time to view an overview of your navigation route, or to change the orientation of the map (see [Overview](#) on page 122), which also zooms the map to show the current leg of your trip. The black pin at the end of the route line represents your destination.



Mute/unmute navigation volume.

**Note:** You can also mute the volume of the navigation system by pressing the scroll button on the left side of the steering wheel while navigation instructions are being spoken. A volume control specific to navigation instructions is also available by touching the settings icon on the map (see [Overview](#) on page 122).

To stop navigating, touch **CANCEL**, located below the turn-by-turn direction list.

**Note:** If a data connection is not available, onboard maps allow you to navigate to any location, but you must enter the location's exact and complete address.

## Charging Locations

Superchargers always display on the map, represented by red pins that you can touch to display more information about the Supercharger location, navigate to it, or mark it as a favorite. When you touch the pin for a Supercharger location on the map, information about the Supercharger location is displayed, including the total number of Superchargers, the number of Superchargers available, the address of the Supercharger, and its approximate distance from you. The popup also displays amenities that are available at the Supercharger location, including restrooms, restaurants, lodging, shopping, and Wi-Fi.

The Supercharger location is operational. At locations that have multiple Superchargers, a row of bars displays above the icon, with each bar representing a Supercharger. This provides a quick visual to indicate how many superchargers are in use. If a Supercharger is in use, the bar is filled in.



**Note:** A supercharger pin is colored black if the supercharger is on your current navigation route.

The Supercharger location may be out of operation or is operating at a reduced capacity. Touch the pin to display details.



Touch the map's charging icon to display all nearby charging stations of the map. In addition to the Superchargers that are always displayed, the map shows destination chargers and any public charging stations that you have previously used. Display details about a charging location by touching its pin.



The location is equipped with a Tesla Wall Connector. Touch to display more information such as usage restrictions and available charge current. The charging list also displays your proximity to these charging stations.



**Note:** When the map is zoomed out and more than one Tesla Wall Connector is available in an area, the pin is round and displays the number of stations. Touch the pin to zoom in. Then you can touch an individual pins for detail about the charging location.

## Predicting Energy Usage

When navigating to a destination, Model S helps you anticipate your charging needs by calculating the amount of energy that remains when you reach your destination. The calculation is an estimate based on driving style (predicted speed, etc.) and environmental factors (elevation changes, weather, etc.). When navigating, the map displays this calculation at the bottom of the expanded turn-by-turn direction list (see [Navigating](#) on page 123). When the turn-by-turn direction list is compressed, touch the top of the list to expand it.

Throughout your route, Model S monitors energy usage and updates the calculation. A popup warning displays at the bottom of the turn-by-turn direction list in these situations:

- A yellow warning displays when you have very little energy remaining to reach your destination and should drive slowly to conserve energy. For tips on conserving energy, see [Getting Maximum Range](#) on page 75.
- A red warning displays when you must charge to reach your destination.

If you also want to know if you have enough energy for a round trip, touch the energy calculation to display an estimate of your round trip energy usage.

## Online Routing

Model S detects real-time traffic conditions and automatically adjusts the estimated driving and arrival times based on traffic. In situations where traffic conditions will delay your estimated time of arrival and an alternate route is available, the navigation system can reroute you to your destination. To turn this feature on or off, touch the map's settings icon (see [Overview](#) on page 122), then touch **Online Routing**. You can also specify the minimum amount of minutes that must be saved before you are rerouted by touching the arrows associated with the **Re-Route if it saves more than** setting.

## Trip Planner

Trip Planner helps you take longer road trips with confidence. If reaching your destination requires charging, Trip Planner routes you through the appropriate Supercharger locations. Trip Planner selects a route and provides charging times to minimize the amount of time you spend driving and charging. To enable Trip Planner, touch the map's settings icon (see [Overview](#) on page 122), then touch **Trip Planner**.

When Trip Planner is enabled and charging is required to reach your destination, the turn-by-turn direction list includes Supercharger stops and a recommended charging time at each Supercharger, and an estimate of how much energy will be available when you arrive at the Supercharger.

To remove Supercharger stops and display only directions, touch **Remove charging stops** at the bottom of the list of directions (if you remove charging stops, the turn-by-turn direction list may display an alert indicating that charging is needed to reach your destination). To add Supercharger stops to the directions, touch **Add charging stops**.

While charging at a Supercharger, the charging screen displays the remaining charging time needed to drive to your next Supercharger stop, or destination (if no further charging is needed). If you charge for a shorter or longer length of time, the charging time for subsequent Supercharger stops is adjusted.

**Note:** You can also monitor remaining charging time needed in the Tesla Mobile App.

**Note:** If a Supercharger located on your route experiences an outage, Trip Planner displays a



notification and reroutes you to a different Supercharger location.

If Trip Planner estimates that you won't have enough energy for your round trip, and there are no Superchargers available on your route, Trip Planner displays an alert at the top of the turn-by-turn direction list notifying you that charging is needed to reach your destination.

## Recent, Favorite, Home and Work Destinations

When you touch **Navigate** on the map, a list of **Recent** destinations appear and you can easily navigate to any recent destination by selecting it from the list.

If you frequently drive to a destination, you may want to add it as a favorite to avoid having to enter the location's name or address each time. When you add a destination as a Favorite, you can easily navigate to it by touching **Navigate > Favorites** and then selecting it from the list of favorites.



To add a destination to your Favorites list touch its pin on the map, then touch the heart icon on the popup window that appears. You will be prompted to name the Favorite. Enter a name (or leave as-is to accept the default name), then touch **Add to Favorites**. The heart becomes solid gray and the destination is included on the Favorites list.

To delete a Recent or Favorite destination, touch and hold it down briefly, then touch the **X** that appears.

The top of the navigation list also provides shortcuts for **Home** and **Work** locations. Touch to set an address to either of these locations. After entering the address, touch **SAVE AS HOME** or **SAVE AS WORK**. Then simply touch these shortcuts whenever you want to navigate home or to work.

To change the location associated with Home or Work, press and hold the shortcut icon and enter a new address in the popup window. To delete, press and hold the shortcut button, then touch **CLEAR HOME** or **CLEAR WORK**.

**Note:** Based on your usage patterns, you may be prompted to save a location as Home or Work.

**Note:** Once a Home or Work location is saved, Model S may prompt you to navigate to your

Work location in the mornings and to your Home location in the evenings and tell you how long it will take to arrive based on current traffic conditions.

For security reasons, if you sell Model S, it is recommended that you delete your Home and Work Locations. You can delete these individually or you can perform a factory reset to erase all personal data (see [Erasing Personal Data](#) on page 115).

## Map Updates

As updated maps become available, they are automatically sent to Model S over Wi-Fi. To ensure you receive them, periodically connect Model S to a Wi-Fi network (see [Connecting to Wi-Fi](#) on page 139). The touchscreen displays a message informing you when new maps are installed.



## Overview



Touch the Media Player icon at the bottom of the touchscreen to listen to AM (if equipped), FM or stream music (Tuneln, Slacker (if equipped)) or podcasts (if available). You can also listen to SiriusXM satellite radio (if equipped) and play audio files from a Bluetooth or USB-connected device.

Media Player provides three different levels of viewing that you can access by dragging the Media Player window upward or downward. Initially, just the Miniplayer displays. The Miniplayer, which occupies the least amount of space on the touchscreen, displays what's currently playing and provides only the basic functions, mostly associated with what's playing. Drag upward to display Recents and Favorites and access the icons you can use to change your media source (described next). Drag upward again to browse through all available options for the chosen type of source content.

Use the icons across the bottom of Media Player to change your media source (for example, FM, Streaming, or a Bluetooth-connected device). Use the tabs on the left to narrow down the type of content you want to browse through—the associated content displays on the right. For Radio, you can browse through Favorite Stations or you can touch **Direct Tune** to enter the frequency of a specific channel. For Streaming, you can browse through Favorites, Top Stations, DJ Series, and Genres. For Tuneln, you can browse through top podcasts, top stations or you can touch browse to filter by multiple options such as music, talk, sports, etc.

## Volume Control

Roll the scroll button on the left side of the steering wheel up or down to increase or decrease volume respectively. The scroll button adjusts the volume for media, navigation instructions, or phone calls, based on what is currently being heard through the speakers. You can also adjust the volume by touching the arrows associated with the speaker icon on the bottom of the touchscreen.

To mute the volume, press the left scroll button. Press again to unmute.

**Note:** Pressing the left scroll button during a phone call mutes both the sound and your microphone.

**Note:** If you're playing media and you receive a phone call, or the navigation system is speaking directions, the volume of what you are listening to is temporarily muted.

## Searching Media Content



Touch Media Player's magnifying glass icon to search for a particular song, album, artist, podcast, or station. Select a filter to narrow the scope of your search, or leave it at its default setting to include top results from all available source content. If available, touch **HD** to play high definition versions of the selected frequency.

**Note:** Use voice commands to search hands-free (see [Using Voice Commands](#) on page 47).

## AM (if equipped) and FM Radio



If available in your market region and location, Media Player provides AM and FM radio stations that you can select from the Radio source. Touch the next or previous arrows to move from one frequency to the next (or previous). Or touch **Direct Tune** to enter a specific frequency. If available, touch **HD** to play high definition versions of the selected frequency.

For easy access to radio stations you listen to frequently, mark it as a favorite so it's readily available in the Favorites list (see [Favorites and Recents](#) on page 129).

## SiriusXM Satellite Radio



If Model S is equipped with the optional sound package, you can listen to SiriusXM, a subscription-based satellite radio service. To receive satellite radio channels, you must provide the radio service provider with the radio ID for your touchscreen.

To display the radio ID:





1. Touch the radio source icon, then select SiriusXM from the list.
2. Move the channel selector to channel 0.
3. The Radio ID displays in the station information area.

To select a SiriusXM channel, you can either manually scroll through channel numbers, or you can browse channels by category.

**Note:** On early versions of Model S, SiriusXM radio is available only if the vehicle is equipped with a sunroof. To optimize aerodynamics, Model S does not have an external antenna.

## Internet Radio

Internet radio services are available over a data connection. To listen to Internet radio services, touch the Tune Internet radio, touch Media Player's streaming icon and choose the streaming service you want to listen (such as **TuneIn** or **Slacker**).



By default, TuneIn uses a Tesla account that has been set up for you. To sign in to your own TuneIn account, scroll to the bottom of any **TuneIn** window, touch **Sign In**, and enter your sign in information.

**Note:** When playing a TuneIn podcast, you can rewind or fast forward to any location in the podcast. On the Miniplayer, drag the slider to the desired location or touch the rewind or fast forward icons to move back or forward 15 seconds at a time, respectively.



Tesla also provides you with a complimentary Streaming Personal Radio account for four years. To use your own Slacker Plus or Premium account instead, scroll to the bottom of any **Streaming** window, touch **Sign In**, and enter your sign in information. Touch **Use High Bitrate** to stream higher quality sound (if your Model S is equipped with the optional Ultra High Fidelity Sound package), and then touch **LOGIN**. To switch back to your Tesla account, simply touch **USE TESLA ACCOUNT**; you don't need to enter a user name or password for your Tesla account. You can purchase your own Slacker Plus or Premium account at [www.slacker.com](http://www.slacker.com). Model S does not support basic (free) Slacker services.

Browse through the available categories and/or stations, and then touch what you want to play. When browsing through a large category such as genres, you may need to drag the window upward. When you choose an option that displays multiple results on a new window, touch the **BACK** button at the top of the window to return to the main browse page.

You can also use voice commands (available when speaking the English language) to play a specific song, artist, or album from an Internet radio service (see [Using Voice Commands](#) on page 47).

When listening to internet radio, the options available on Miniplayer vary depending on what you are listening to:

- Touch the next (or previous) arrows to play the next (and in some cases previous) available station, episode, or track being provided by the Internet radio service.
- Touch the **thumbs up** or **thumbs down** icon to like or dislike a song or podcast. When you like a song, the radio station plays similar songs. When you dislike a song, the song won't be played again.
- Touch the **DJ** icon (if available) to include commentary for the content you are streaming. DJ commentary includes music history and behind-the-scenes stories.



## Favorites and Recents

For most source content, your favorites display at the top of Media Player's expanded view for easy access (Streaming, TuneIn, Phone, or USB).



To add a currently playing radio station, podcast, or audio file to your Favorites list, touch the **Favorites** icon on Miniplayer.



To remove an item as a favorite, touch the highlighted **Favorites** icon on Miniplayer. You can also remove multiple favorites by expanding Miniplayer one level to show all favorites for the applicable type of source content. Then press and hold any favorite. An **X** appears on all favorites and you can then touch the **X** associated with any favorite you want to remove from your Favorites list.

To see selections that you have recently played, scroll up one level from Miniplayer and touch **Recent**. Your recently played selections are updated continuously so you don't need to remove them.

**Note:** Selections you play on FM radio stations do not display in your Recent selections.

## Playing Media from Devices



You can play audio files from a Bluetooth-connected device (like a phone) or a USB-connected flash drive. When you connect a Bluetooth-capable device, the name of the device displays when you choose the Phone source. When you connect a USB flash drive, Media Player displays the USB source content.

To play the next song in a selected playlist or album, touch the previous or next arrows on the left side of the steering wheel (see [Using Left Steering Wheel Buttons](#) on page 45). You can also shuffle tracks in a playlist or repeat a playlist or track using the shuffle/repeat icons (if available).

## USB Connected Flash Drives

Connect a flash drive to a USB connection (see [USB Connections](#) on page 19). Touch **Media Player** > **USB**, and then touch the name of the folder that contains the song you want to play. After you display the contents of a folder on the USB connected flash drive, you can touch any song in the list to play it. Or use the previous and next arrows in Miniplayer to scroll through your songs.

**Note:** To play media from a USB connection, Model S recognizes flash drives only. You can play media from other types of devices (such as an iPod) by connecting to the device using Bluetooth.

**Note:** Media Player supports USB flash drives with FAT32 formatting (NTFS and exFAT are not currently supported).

## Bluetooth<sup>®</sup> Connected Devices

If you have a Bluetooth-capable device such as a phone that is paired and connected to Model S (see [Pairing a Bluetooth Phone](#) on page 131), you can play audio files stored on it. You can also stream a music service from it (for example, Pandora or Spotify). Choose Media Player's **Phone** source, then touch the name of your Bluetooth-connected device, and then touch **CONNECT**.

Your Bluetooth device begins playing the audio file that is currently active on your device, and Media Player displays the Miniplayer view. If no audio file is playing on your device, use your device to choose the audio file you want to listen to. When the file begins to play, you can then use Miniplayer's next and previous icons to play other tracks.

**Note:** To play media from a Bluetooth-connected device, ensure that access to the device's media is turned on (see [Pairing a Bluetooth Phone](#) on page 131).

## Audio Settings



Press the equalizer icon at the bottom corner of Media Player to access audio settings for tone and balance. Other settings may be available based on your vehicle features and market region. For example, if equipped, you can turn options such as Dolby Surround and DJ Commentary on or off.



To adjust any of the five frequency bands (Bass, Bass/Mid, Mid, Mid/Treble, and Treble) drag the corresponding slider up or down the decibel (dB) bar.

To adjust balance, touch **Balance** and drag the center circle of the cross bars to the location in Model S where you want to focus the sound.



## Bluetooth® Compatibility

You can use your Bluetooth-capable phone hands-free in Model S provided your phone is within operating range. Although Bluetooth typically supports wireless communication over distances of up to approximately 30 feet (9 meters), performance can vary based on the phone you are using.

Before using your phone with Model S, you must pair it. Pairing sets up Model S to work with your Bluetooth-capable phone (see [Pairing a Bluetooth Phone](#) on page 131).

You can pair up to ten Bluetooth phones. Model S always automatically connects to the last phone that was used (provided it is within range). If you want to connect to a different phone, see [Connecting to a Paired Phone](#) on page 131.

**Note:** On many phones, Bluetooth turns off if the phone's battery is low.

**Note:** In addition to phones, you can also pair Bluetooth-enabled devices with Model S. For example, you can pair an iPod Touch or an iPad or Android tablet to stream music.

## Pairing a Bluetooth Phone

Pairing allows you to use your Bluetooth-capable phone hands-free to make and receive phone calls, access your contact list, recent calls, etc. It also allows you to play media files from your phone. Once a phone is paired, Model S can connect to it whenever the phone is within range.

To pair a phone, follow these steps while sitting inside Model S:

1. Ensure both the touchscreen and the phone are powered on.
2. Touch the Bluetooth icon on the top of the touchscreen.
3. On your phone, enable Bluetooth and ensure it is discoverable.
4. On the touchscreen, touch **Add New Device > Start Search**. The touchscreen displays a list of all available Bluetooth devices within operating distance.
5. On the touchscreen, touch the phone with which you want to pair. Within a few seconds, the touchscreen displays a randomly generated number, and your phone should display the same number.
6. Check that the number displayed on your phone matches the number displayed on the touchscreen. Then, on your phone, confirm that you want to pair.

7. If prompted on your phone, specify whether you want to allow Model S to access your contacts and media files. You can enable and disable access to contacts at any time, as described next.

When paired, Model S automatically connects to the phone, and the touchscreen displays the Bluetooth symbol next to the phone's name to indicate that the connection is active.

## Importing Contacts and Recent Calls

Once paired, you can use the Bluetooth settings screen (touch the Bluetooth icon on the touchscreen's top status bar) to specify whether you want to allow access to your phone's contacts and recent calls. If access is turned on, you can use the phone app to display, and make calls to, people in your list of contacts and on your recent calls lists (see [Using the Phone App](#) on page 132).

**Note:** Before contacts can be imported, you may need to either set your phone to allow syncing, or respond to a popup on your phone to confirm that you want to sync contacts. This varies depending on the type of phone you are using. For details, refer to the documentation provided with your phone.

**Note:** You can turn access to your contacts and recent calls on or off at any time by displaying the Bluetooth settings screen, choosing the phone, and then changing the setting associated with contacts and recent calls.

## Unpairing a Bluetooth Phone

If you want to disconnect your phone and use it again later, simply touch **Disconnect** on the Bluetooth settings screen. If you do not want to use your phone with Model S again, touch **Forget This Device**. Once you forget a device, you need to pair it again if you want to use it with Model S (see [Pairing a Bluetooth Phone](#) on page 131).

**Note:** Your phone automatically disconnects whenever you leave Model S.

## Connecting to a Paired Phone

Model S automatically connects with the last phone to which it was connected, provided it is within operating range and has Bluetooth turned on. If the last phone is not within range, it attempts to connect with the next phone that it has been paired with.



To connect to a different phone, touch the Bluetooth icon on the top of the touchscreen. The Bluetooth window displays a list of paired phones. Choose the phone you want to connect to, then touch **Connect**. If the phone you want to connect to is not listed, you must pair the phone. See [Pairing a Bluetooth Phone](#) on page 131.

When connected, the Model S touchscreen displays the Bluetooth symbol next to the phone name to show that the connection is active.

## Using the Phone App

When your phone is connected to Model S using Bluetooth, and you have allowed access to your phone's contacts (see [Importing Contacts and Recent Calls](#) on page 131), you can use the phone app to display and make a hands-free call to anyone listed on your phone:

- **Recent Calls** list. The list displays calls in chronological order with the most recent call listed first. You can display all calls or just those that are missed, incoming, or outgoing.
- **Contacts**: Contacts are listed in alphabetical order and can be sorted by first name or last name. You can also choose a letter on the right side of the list to quickly scroll to the names that begin with the selected character. When you touch a name on your contacts list, the contact's available number(s) displays on the right pane, along with other available information (such as address). Touch the contact's number to make a call.

## Making a Phone Call

You can make a phone call by:

- Speaking a voice command (English) (see [Using Voice Commands](#) on page 47).
- Selecting a contact or recent call from the menu on your right scroll button (see [Using Right Steering Wheel Buttons](#) on page 46).
- Choosing a number from your contact or recent calls list in the phone app.
- Using the Model S on-screen dialer in the phone app.

**Note:** If it is safe and legal to do so, you can also initiate a call by dialing the number or selecting the contact directly from your phone.

**Note:** You can also make a phone call by touching a pin on the map and choosing the phone number (if available) on the popup window.

## Receiving a Phone Call

When your phone receives an incoming call, the instrument panel and touchscreen display the caller's number or name (if the caller is in your phone's contact list and Model S has access to your contacts).

Touch one of the options on the touchscreen, or roll the scroll button on the right side of the steering wheel to **Answer** or **Ignore** the call (see [Using Right Steering Wheel Buttons](#) on page 46).

**Note:** Depending on the phone you are using and what speakers you used for your most recent call, your phone may prompt you to choose which speakers you want to use for the incoming call.

**Warning:** Stay focused on the road at all times while driving. Using or programming a phone while driving, even with Bluetooth enabled, can result in serious injury or death.

**Warning:** Follow all applicable laws regarding the use of phones while driving, including, but not limited to, laws that prohibit texting and require hands-free operation at all times.

## In Call Options

When a call is in progress, you can display the call menu on the instrument panel by pressing the top button on the right side of the steering wheel. Then roll the right scroll button and choose an option (see [Using Right Steering Wheel Buttons](#) on page 46). To adjust the call volume, roll the steering wheel's left scroll button during a call.



**Note:** If Model S is equipped with Smart Air Suspension, you may hear the sound of the compressor when Model S starts, as the system's reservoir fills with air.

Smart Air Suspension has both manual and automatic modes of operation.

## Height Adjustments

**⚠ Caution:** Before adjusting the suspension height, ensure Model S is clear of all obstacles, above and below.

Manually raising the height of Model S is useful when you need extra ground clearance, such as steep driveways or ramps, deep snow, speed bumps, parking curbs, etc. When the extra ground clearance is no longer needed, you should lower the vehicle.

With Model S powered on, or the brake pedal pressed, use the touchscreen to manually change the ride height. Touch **Controls > Suspension**, then choose from:

- **Very High.** When set to Very High, the suspension automatically lowers to High when driving speed reaches 35 mph (56 km/h).
- **High.** When set to High, the suspension automatically lowers to Standard when driving speed reaches 45 mph (73 km/h).
- **Standard.** The Standard setting ensures optimum comfort and handling under all loading conditions.
- **Low.** Lowering the height can make it easier to load or unload cargo and passengers.

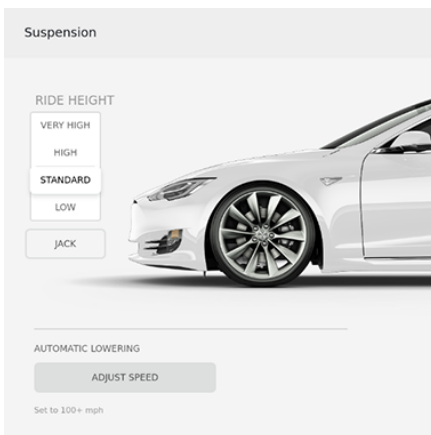

**Note:** Available settings depend on your driving speed and other conditions. For example, the suspension does not lower if a door is open.

## Location-Based Suspension

Location-Based suspension saves you from manually having to raise the suspension every time you arrive at a frequently-used location where a higher suspension is needed (steep driveways or ramps, deep snow, speed bumps, etc.).

Whenever you raise the suspension to **High** or **Very High**, Model S saves the location.

When you return to the saved location, Model S raises the suspension and the instrument panel displays this message:



### Note:

- When you are returning to a saved location and driving faster than the High and Very High suspension settings allow (see [Height Adjustments](#) on page 133), the suspension does not raise until Model S slows down.
- After leaving a saved location, the suspension may not lower based on an automatic lowering speed that you have set (**Controls > Suspension > Automatic Lowering**) until you are driving faster than the speed thresholds.
- If Model S reaches a saved location and the existing suspension setting is higher than the level that has been saved for that location, the suspension is not adjusted.

### To remove an auto-raising location

If you do not want the suspension to auto-raise at a saved location, touch the **X** in the auto-raising location status message that displays at a saved location. Doing so removes the auto-raise location and the suspension no longer raises automatically when you arrive at the location.

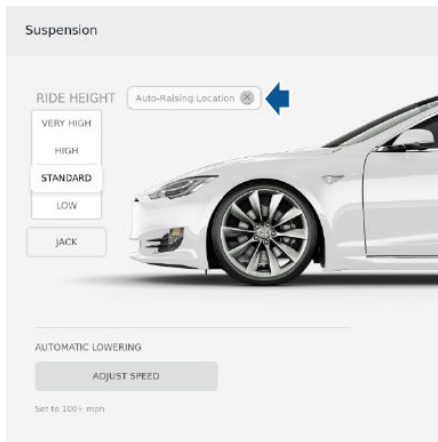

**Note:** Manually lowering the suspension to **Standard** or **Low** while at a saved location also removes the auto-raising location.

## Automatic Lowering

When Model S is moving above typical driveway or parking lot speeds, Smart Air Suspension automatically lowers ride height to improve aerodynamics and handling. For most average speed driving, the suspension is automatically set to Standard. As described above, when you make manual height adjustments, the suspension automatically lowers at increased driving speeds.

When carrying loads, Smart Air Suspension also maintains a level height between the front and rear.

You can adjust the speed at which the Air Suspension automatically transitions to the **LOW** ride height by touching **Controls > Suspension > Automatic Lowering** on the touchscreen. This setting is saved to your **Driver Profile**.

**Note:** You can temporarily override the ride height by pressing the brake pedal, touching an air suspension control in **Controls > Suspension**, and then manually choosing a ride height. Your suspension's automatic lowering setting is restored the next time you drive.



If a fault is detected that reduces the performance of the air suspension system, a yellow indicator lights up on the instrument panel. If the problem persists, contact Tesla.

## Jack Mode

Before jacking or lifting, set the suspension to **Jack** mode to prevent the self-leveling that occurs even when Model S is powered off.

Press the brake pedal, then touch **Controls > Suspension > Jack**.

To deactivate, touch **Jack** again.

**Note:** **Jack** mode automatically cancels when you drive over 4 mph (7 km/h).

**Note:** Model S also sets Jack mode automatically if it detects that the vehicle cannot lower to its target height, or if it detects that an object is supporting the vehicle's weight (for example the bumper of the vehicle is resting on a curb).



## Overview

The Calendar app allows you to view scheduled events from your phone's (iPhone® or Android™) calendar for the current and next day. The Calendar is conveniently integrated with navigation and the Phone app so you can navigate to, or dial into, your next meeting. The Calendar app requires that:

- The Tesla mobile app is running, you are logged in, and the Calendar Sync setting is enabled. The mobile app can then periodically (and automatically) send calendar data from your phone to Model S.  
**Note:** To ensure you have access to all features of the Calendar app, it is recommended that you use the most recent version of the mobile app.
- Your phone is connected to Model S via Bluetooth (for privacy reasons, calendar data displays only from a connected phone).
- Mobile access to Model S is turned on (touch **Controls > Safety & Security > Allow Mobile Access**).
- Both your phone and Model S have good connectivity.

When you enter Model S, the touchscreen can display a reminder of the day's events. You can customize if and when your calendar events are displayed by touching the settings icon located in the top left corner of the Calendar app, then choosing from one of the options available for the **Show Calendar Upon Entry** setting.

If a calendar event includes an address, a navigation arrow displays to indicate that you can touch the address to navigate to the event's location (if equipped with Navigation). When an event on your Calendar takes place within the next hour and has a uniquely specified address, the touchscreen notifies you if there is a better route due to traffic, even when you're not currently using navigation.

Touch an event's information icon to display all notes associated with the event. If the notes include one or more phone numbers, the information icon shows a phone icon and the calendar displays the first phone number found. Touch to initiate a phone call. You can also initiate a phone call by touching any number in an event's notes popup window (this is especially useful for conference calls). If the notes contain a web link, you can touch the link to open it in the web browser (if equipped).

If events are displayed from multiple calendars, touch the list icon in the top right corner to filter the list of events to show only those from one or more specified calendars.





## About the Security System

If Model S does not detect a key nearby and a locked door or trunk is opened, an alarm sounds and the headlights and turn signals flash. To deactivate the alarm, press any button on the key.

To manually enable or disable the alarm system, touch **Controls > Safety & Security > Security Alarm**. When enabled, Model S activates its alarm one minute after you exit, the doors lock, and a recognized key is no longer detected.

If your Model S is equipped with the Enhanced Anti-Theft upgrade, the horn sounds in situations where a locked door or trunk is opened and Model S does not detect a key nearby. If the **Tilt/Intrusion** setting is on, the horn also sounds if Model S detects motion inside the cabin, or if the vehicle is moved or tilted (for example, with a tow truck or jack). To turn the Tilt/Intrusion detection system on or off, touch **Controls > Safety & Security > Tilt/Intrusion**.

**Note:** If you plan to leave something that moves inside your locked Model S, remember to turn off **Tilt/Intrusion**. Motion detected inside Model S activates the intrusion alarm.

**Note:** The **Security Alarm** must be on to enable **Tilt/Intrusion**.

**Note:** The Intrusion Sensor automatically disables in situations where the climate control system is operating when you have left your vehicle (see [Keep Climate On](#) on page 120). To override, turn it on again after choosing Keep Climate On.

## PIN to Drive

To increase security, you can prevent Model S from being driven until a 4-digit PIN (Personal Identification Number) is entered. To enable this setting, touch **Controls > Safety & Security > PIN to Drive** and follow the on-screen prompts to create a driving PIN.

**Note:** When enabled, in addition to having to enter the 4-digit driving PIN to drive, you must also use it to enter Valet mode for the first time and create the 4-digit valet PIN that you can use to enter and exit Valet mode. When in Valet mode, Model S can be driven without the need for the valet to enter a driving PIN. In addition, the **PIN to Drive** setting is disabled whenever Valet mode is active.

If you forget your driving PIN, or to disable **PIN to Drive**, return to this setting, touch the link to enter your Tesla login credentials, then follow the on-screen prompts.



## About HomeLink

If your vehicle is equipped with the HomeLink® Universal Transceiver, you can operate up to three Radio Frequency (RF) devices, including garage doors, gates, lights, and security systems.

**Note:** Depending on date of manufacture, market region, and options selected at time of purchase, some vehicles are not equipped with a HomeLink Universal Transceiver.

## Programming HomeLink

1. Park Model S in front of the device you want to program, and have the device's remote control ready.

**Note:** Make sure you haven't reached the limit of learned remotes/vehicles. Most device receivers can learn up to five remotes/vehicles. If necessary, clear the receiver memory and restart the programming process. For information about clearing the receiver memory, refer to the owner documentation for your device.

2. Touch the HomeLink icon on the top of the touchscreen.
3. Touch **Add New HomeLink**, then use the onscreen keyboard to enter a name for your HomeLink device.
4. Touch **Program**.
5. Follow the onscreen instructions.

Once programmed, you can operate the device by touching its corresponding HomeLink icon on the touchscreen's status bar. HomeLink remembers the location of your programmed devices. When you approach a known location, the HomeLink control on the touchscreen automatically drops down. When you drive away, it disappears.

**Note:** For security reasons, delete your HomeLink devices if you sell your Model S (see [Deleting a Device](#) on page 137).

**⚠ Warning:** Your device might open or close during programming. Before programming, make sure that the device is clear of any people or objects.

**⚠ Warning:** Do not use the HomeLink Universal Transceiver with a device that does not have safety stop and reverse features. Using a device without these safety features increases the risk of injury or death.

## Auto Opening and Closing

To operate a HomeLink device without touching the touchscreen, you can automate the device to open as you approach and close as you drive away:

- Touch the HomeLink icon on the top of the touchscreen and choose the device you want to automate.
- Select the **Auto-open when arriving** checkbox.
- Touch the arrows to specify the distance you want your vehicle to be from the device before it opens.
- Select the **Auto-close when leaving** checkbox if you want the device to close as you drive away.

As you approach (or drive away from) a device that is set to operate automatically, the HomeLink status icon displays a count-down message to let you know when the device will automatically open. In situations where you don't want the device to automatically open or close, touch **Skip Auto-Open** or **Skip Auto-Close** at any time during the count-down message.

## Resetting the Location of the HomeLink Device

If you experience situations in which you sometimes drive up to your HomeLink device and it doesn't open, or the HomeLink icon on the touchscreen's status bar does not display the dropdown when you approach the device, you may need to reset the device's location. To do so, park as close as possible to the HomeLink device (garage door, gate, etc.) and display the HomeLink settings page by touching the HomeLink icon on the top of the touchscreen. Touch the name of the device you want to reset, then **Reset Location**.

## Deleting a Device

To delete a HomeLink device, touch the HomeLink icon on the top of the touchscreen. Touch the name of the device you want to delete, then touch **Delete**.

**Note:** You can also perform a factory reset to erase your HomeLink settings, along with all other personal data (saved addresses, music favorites, imported contacts, etc.). See [Erasing Personal Data](#) on page 115.



## Troubleshooting HomeLink

When programming a HomeLink device, the touchscreen walks you through a two-part programming process:

1. Model S records the signal from the remote. The touchscreen instructs you to stand in front of the vehicle, point the remote at the front bumper and press and hold the button until the headlights flash. When the headlights flash, Model S has learned the remote and you can touch **Continue** on the touchscreen. If the headlights do not flash, refer to the following guidelines.
2. The device's receiver learns Model S. The touchscreen instructs you to press the **LEARN** button on the device's receiver. If training the receiver does not work, refer to the following guidelines.

**Note:** Only devices that are equipped with a "rolling code" remote need to learn Model S. If you have an old device that is not equipped with a "rolling code" remote, the device does not need to learn Model S and you can skip this part of the process. You can also skip this part if your receiver is "Quick-Train" compatible.

### Headlights do not flash

- Check the batteries in the remote. It is a good idea to replace the batteries before you start programming.
- Hold the remote against the front bumper, with the button pressed, approximately 6 in (15 cm) to the left of the Tesla emblem. In some cases you must hold the button on the remote for up to three minutes.
- Check compatibility of the remote by contacting the HomeLink manufacturer ([www.homelink.com](http://www.homelink.com)).

### After programming, the device does not work

- Park Model S with its front bumper as close as possible to the HomeLink device (garage door, gate, etc.).
- Make sure you haven't reached the device receiver's limit of learned remotes/cars. Most receivers can learn up to five remotes/cars. If the receiver's memory is full, you must clear the memory and restart the programming process. For instructions on how to clear the receiver's memory, refer to the owner documentation provided with the HomeLink device.

- Make sure you are pressing the receiver's **LEARN** button. Most receivers have two buttons and a LED. One button is a **RESET** button and the other is a **LEARN** button. Pressing the **LEARN** button usually causes the LED to flash. For instructions on how to put the receiver into learning mode, refer to the owner documentation provided with the HomeLink device.
- Most devices stay in learning mode for only three to five minutes. Immediately after pressing the device's **LEARN** button, follow the instructions displayed on the touchscreen.



Wi-Fi is available as a data connection method and is often faster than cellular data networks. Connecting to Wi-Fi is especially useful in areas with limited or no cellular connectivity. To ensure fast, reliable delivery of Model S updates (see [Software Updates](#) on page 140), Tesla recommends leaving Wi-Fi turned on and connected to a Wi-Fi network. To connect to a Wi-Fi network:

1. Touch the **LTE** (or **3G**) icon in the touchscreen status bar. Model S will start scanning and display the Wi-Fi networks that are within range.
2. Select the Wi-Fi network you want to use, enter the password (if necessary), then touch **Connect**.

You can also connect to a hidden network that isn't shown on the list of scanned networks. Just touch **Wi-Fi Settings** and enter the name of the network in the resulting dialog box.

Once you have connected to a network, Model S automatically connects whenever the network is within range. If more than one previously connected network is within range, Model S connects to the one most recently used.

**Note:** You can also use a mobile hotspot or your phone's Internet connection via Wi-Fi tethering.

**Note:** At Tesla Service Centers, Model S automatically connects to the Tesla Service Wi-Fi network.



## Loading New Software

Model S updates its software wirelessly, providing new features throughout your term of ownership. Tesla recommends that you install software updates as soon as they are available. The first time you enter Model S after an update is made available, a scheduling window displays on the touchscreen. The scheduling window displays again at the end of your first driving session.

**Note:** Some software updates can take up to three hours to complete. Model S must be in Park while the new software is being installed. To ensure the fastest and most reliable delivery of software updates, leave the Wi-Fi turned on and connected whenever possible (see [Connecting to Wi-Fi](#) on page 139).

When a software update is available, a yellow clock icon appears on the touchscreen's status bar. Touch this clock icon to display the update window. You can then either:

- Schedule the update by setting the time you want the update to begin. Then touch **Set For This Time**. Once scheduled, the yellow clock icon changes to a white clock icon. You can reschedule the update any time before it begins.

OR

- Touch **Install Now** to immediately start the update process.

If Model S is charging when the software update begins, charging stops. Charging resumes automatically when the software update is complete. If you are driving Model S at the scheduled update time, the update is canceled and you need to reschedule it.

**Note:** Software updates are not performed when Keep Climate On or Smart Preconditioning is active.

**Note:** You can also start software updates using your Tesla mobile app.

**Note:** Over time, the touchscreen may display a software update window informing you to **SET FOR THIS TIME** or **INSTALL NOW**. This software update window will persist until you complete the installation of the software update. You must install all software updates as soon as they are available and any harm relating to the failure to install a software update will not be covered by the vehicle's warranty. Failure or refusal to install such updates may result in the inaccessibility of certain vehicle features (including incompatibility with digital media devices) or

in Tesla being unable to diagnose and service your vehicle.

**Note:** If software updates are not installed, some vehicle features may become inaccessible and digital media devices may become incompatible. Reverting to a previous software version is not possible.

If the touchscreen displays a message indicating that a software update was not successfully completed, contact Tesla.

## Viewing Release Notes

When a software update is complete, learn about the new features by reading the release notes. To display release notes about your current software version at any time touch the Tesla "T" at the top center of the touchscreen, then touch **Release Notes**.

Tesla strongly recommends reading all release notes. They may contain important safety information or operating instructions regarding your Model S.



## Overview

The Tesla mobile app allows you to communicate with Model S remotely using your iPhone<sup>1</sup> or Android<sup>™</sup> phone. With this app, you can:

- View the vehicle's estimated range.
- Check charging progress, stop charging, and receive notifications when charging is started, interrupted, almost complete, or complete.

**Note:** When Supercharging, additional notifications alert you when you will be charged idle fees for parking at a supercharger after charging is complete. The idle fees are waived if your vehicle is moved within five minutes of when the vehicle finishes charging. See [Supercharger Usage Fees and Idle Fees](#) on page 151.

- Check the interior temperature and heat or cool the cabin before driving (even if it's in a garage).
- Locate Model S with directions, or track its movement across a map.
- Flash lights or honk the horn to find Model S when parked.
- Vent or close the sunroof.
- Lock or unlock Model S from afar.
- Open the front or rear trunk.
- Enable valet mode.
- Start Model S remotely.
- Park or unpark Model S using Summon (see [Using Summon](#) on page 97).
- Support the Model S Calendar app by allowing the mobile app to send your phone's calendar data to Model S.
- Receive notifications when the security alarm has been triggered.
- Receive notifications of software updates.
- Start software updates from afar.
- Access your Tesla inbox and Loot Box.
- Enable/disable Speed Limit Mode and receive notifications when the vehicle's driving speed is within approximately 3 mph (5 km/h) of your selected maximum speed (see [Speed Limit Mode](#) on page 115).
- View the odometer, VIN, and current software version.

**Note:** The above list may not represent an exhaustive list of the functions available on the Tesla mobile app. To ensure access to new and improved features, download updated

versions of the mobile app as they become available.

## To use the mobile app

Follow these steps to allow the Tesla mobile app to communicate with your Model S:

1. Download the Tesla mobile app to your phone.
2. Log in to the Tesla mobile app by entering your Tesla account credentials.
3. Enable mobile access to your Model S by touching **Controls > Safety & Security > Mobile Access** (see [Controls](#) on page 107).

**Note:** Your phone must be connected to cellular service to allow the mobile app to communicate with your vehicle. If parking in an area without cellular service, such as an indoor parking garage, ensure that you have a functional key readily available.

**Note:** Tesla does not support the use of third party applications to contact Model S.



## High Voltage Components

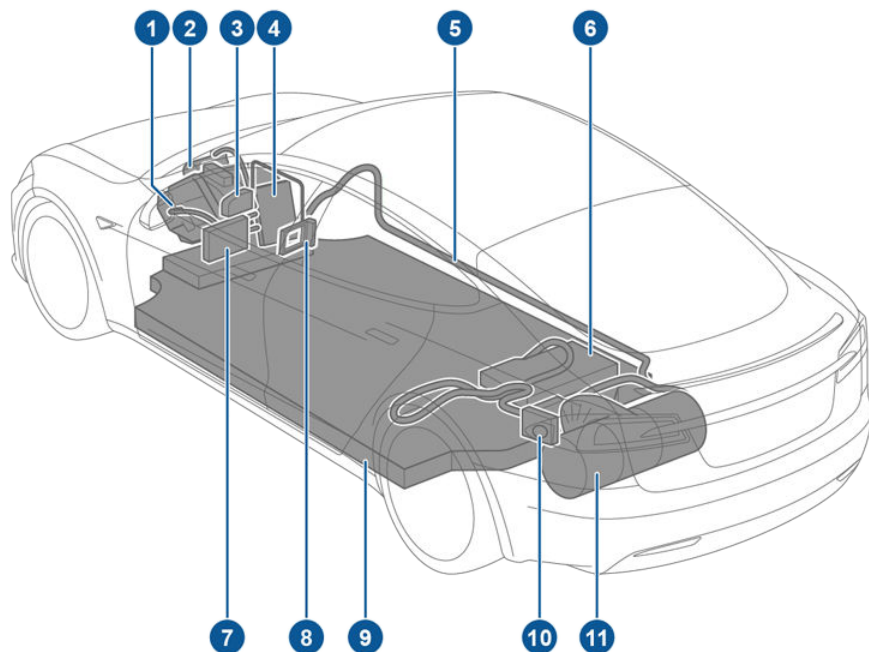

1. Front Motor (All-Wheel Drive vehicles only)
2. Air Conditioning Compressor
3. Battery Coolant Heater
4. Forward Junction Box
5. High Voltage Cabling
6. On-board Charger
7. DC-DC Converter
8. Cabin Heater
9. High Voltage Battery
10. Charge Port
11. Rear Motor

- Warning:** The high voltage system has no user serviceable parts. Do not disassemble, remove or replace high voltage components, cables or connectors. High voltage cables are typically colored orange for easy identification.
- Warning:** Read and follow all instructions provided on the labels that are attached to Model S. These labels are there for your safety.
- Warning:** In the unlikely event that a fire occurs, immediately contact your local fire emergency responders.



## Charging Equipment

Charging equipment designed specifically to charge your Model S is available from Tesla. A Tesla Wall Connector, which installs in your garage, is the fastest way to charge Model S at home.

In several market regions, Model S is equipped with a Mobile Connector and the adapter(s) you need to plug into commonly used power outlets. When using the Mobile Connector, first plug the Mobile Connector into the power outlet, and then plug in Model S. For more information about your Mobile Connector, see the Mobile Connector Owner's Manual (available on the touchscreen). Additional adapters can be purchased from Tesla.

Tesla also offers various adapters that allow you to plug Model S into the most commonly used public charging stations in your region. Connect the adapter to the charging station's charge cable, open the charge port door using the touchscreen (see [Charging Instructions](#) on page 146), and then plug in Model S.

For more information on the charging equipment available for your region, go to [www.tesla.com](http://www.tesla.com), choose your region, and then view the available charging options.





## About the Battery

Model S has one of the most sophisticated battery systems in the world. The most important way to preserve the Battery is to **LEAVE YOUR VEHICLE PLUGGED IN** when you are not using it. This is particularly important if you are not planning to drive Model S for several weeks. When plugged in, Model S wakes up when needed to automatically maintain a charge level that maximizes the lifetime of the Battery.

**Note:** When left idle and unplugged, your vehicle periodically uses energy from the Battery for system tests and recharging the 12V battery when necessary.

There is no advantage to waiting until the Battery's level is low before charging. In fact, the Battery performs best when charged regularly.

**Note:** If the Model S Battery becomes completely discharged in a situation in which towing is required, the owner is responsible for towing expenses. Discharge-related towing expenses are not covered under the Roadside Assistance policy.

The peak charging rate of the Battery may decrease slightly after a large number of DC Fast Charging sessions, such as those at Superchargers. To ensure maximum driving range and Battery safety, the Battery charge rate is decreased when the Battery is too cold, when the Battery's charge is nearly full, and when the Battery conditions change with usage and age. These changes in the condition of the Battery are driven by battery physics and may increase the total Supercharging duration by a few minutes over time.

## Battery Care

Never allow the Battery to fully discharge. Even when Model S is not being driven, its Battery discharges very slowly to power the onboard electronics. The Battery may discharge at a rate of approximately 1% per day. Situations can arise in which you must leave Model S unplugged for an extended period of time (for example, at an airport when traveling). In these situations, keep the 1% in mind to ensure that you leave the Battery with a sufficient charge level. For example, over a two week period (14 days), the Battery may discharge by approximately 14%.

Discharging the Battery to 0% may result in damage to vehicle components. To protect against a complete discharge, Model S enters a low-power consumption mode when the displayed charge level drops to approximately 0%. In this mode, the Battery stops supporting the onboard electronics and auxiliary 12V battery. Once this low-power consumption mode is active, immediately plug in Model S to prevent a jump-start and 12V battery replacement.

**Note:** If the vehicle is unresponsive and will not unlock, open, or charge, then the 12V battery may have become discharged. In this situation, contact Tesla.



## Temperature Limits

For better long-term performance, avoid exposing Model S to ambient temperatures above 140° F (60° C) or below -22° F (-30° C) for more than 24 hours at a time.

## Energy Saving Feature

Model S has an energy-saving feature that reduces the amount of energy being consumed by the displays when Model S is not in use. On newer vehicles, this feature is automated to provide an optimal level of energy saving. However, on older vehicles, you can control the amount of energy being consumed by the displays by touching **Controls > Displays > Energy Saving**. For more information on maximizing range and saving energy, see [Getting Maximum Range](#) on page 75.

## Battery Warnings and Cautions

-  **Warning:** The Battery has no parts that an owner or a non-Tesla authorized service technician can service. Under no circumstances should you open or tamper with the Battery. Always contact Tesla to arrange for Battery servicing.
-  **Caution:** If the Battery's charge level falls to 0%, you must plug it in. If you leave it unplugged for an extended period, it may not be possible to charge or use Model S without jump starting or replacing the 12V battery. Leaving Model S unplugged for an extended period can also result in permanent Battery damage. If you are unable to charge Model S, contact Tesla immediately.
-  **Caution:** The Battery requires no owner maintenance. Do not remove the coolant filler cap and do not add fluid. If the



instrument panel warns you that the fluid level is low, contact Tesla immediately.

 **Caution:** Do not use the Battery as a stationary power source. Doing so voids the warranty.



## Opening the Charge Port

The charge port is located on the left side of Model S, behind a door that is part of the rear tail light assembly. Before charging, park Model S to ensure that the charge cable easily reaches the charge port.

With Model S unlocked (or a recognized key is within range) and in Park, press and release the button on the Tesla charge cable to open the charge port door.

**Note:** If the charge cable is in range of the charge port door, you can press the button on the charge cable to open the charge port door even when Model S is locked or a recognized key is not in range.



You can also open the charge port door using any of these methods:

- On the touchscreen, use the app launcher to open the Charging app, then touch **Open Charge Port**.
- On the Model S touchscreen, touch **Controls > Quick Controls** then touch the charging icon.
- Press the charge port door when Model S is unlocked or a recognized key is nearby.
- On the key, hold down the rear trunk button for 1-2 seconds.

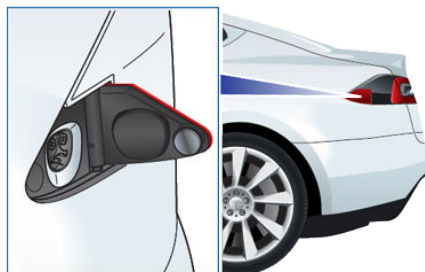

**Note:** The charge port lights up white when you open the charge port door. If you do not

insert a charge cable into the charge port within a few minutes after opening the charge port door, the charge port door closes. If this happens, use the touchscreen to open the charge port door again.

**⚠ Caution:** Do not try to force the charge port door open.

## Plugging In

If desired, use the touchscreen to change the charge limit and the charging current (see [Changing Charge Settings](#) on page 148).

To charge at a public charging station, attach an adapter to the station's charging connector. The most commonly used adapter(s) for each market region are provided. Depending on the charging equipment you are using, you may need to start and stop charging using a control on the charging equipment.

If you are using the Mobile Connector, plug it into the power outlet before plugging it into Model S.

Align the connector to the charge port and insert fully. When the connector is properly inserted, charging begins automatically after Model S:

- Engages a latch that holds the connector in place;
- Shifts into Park (if it was in any other gear);
- Heats or cools the Battery, if needed. If the Battery requires heating or cooling, you may notice a delay before charging begins.

**Note:** Whenever Model S is plugged in but not actively charging, it draws energy from the wall outlet instead of using energy stored in the Battery. For example, if you are sitting in Model S and using the touchscreen while parked and plugged in, Model S draws energy from the wall outlet instead of the Battery.

**⚠ Caution:** The connector end of the charge cable can damage the paint if dropped onto the vehicle.

## During Charging

During charging, the charge port light pulses green, and the instrument panel displays the charging status. The frequency at which the charge port light pulses slows down as the charge level approaches full. When charging is complete, the light stops pulsing and is solid green.



**Note:** If Model S is locked, the charge port light does not light up.

If the charge port light turns red while charging, a fault is detected. Check the instrument panel or touchscreen for a message describing the fault. A fault can occur due to something as common as a power outage. If a power outage occurs, charging resumes automatically when power is restored.

**Note:** When charging, particularly at high currents, the refrigerant compressor and fan operate as needed to keep the Battery cool. Therefore, it is normal to hear sounds during charging.

**Note:** Air conditioning performance is generally not affected by charging. However, under certain circumstances (for example, you are charging at high currents during a particularly warm day), the air coming from the vents may not be as cool as expected and a message displays on the instrument panel. This is normal behavior and ensures that the Battery stays within an optimum temperature range while charging to support longevity and optimum performance.

**Warning:** Never spray liquid at a high velocity (for example, if using a pressure washer) towards the charge port while charging. Failure to follow these instructions can result in serious injury or damage to the vehicle, charging equipment, or property.

## Stopping Charging

Stop charging at any time by disconnecting the charge cable or touching **Stop Charging** on the touchscreen.

**Note:** To prevent unauthorized unplugging of the charge cable, the charge cable latch remains locked and Model S must be unlocked or able to recognize your key before you can disconnect the charge cable.

To disconnect the charge cable:

1. Press and hold the button on a Tesla connector to release the latch. You can also touch **Stop Charging** on the touchscreen (see [Changing Charge Settings](#) on page 148).
2. Pull the connector from the charge port.
3. Push the charge port door closed.

**Note:** If Model S is equipped with a motorized charge port door, it automatically closes shortly after you remove the charge cable.

**Caution:** Tesla strongly recommends leaving Model S plugged in when not in use. This maintains the Battery at the optimum level of charge.

## Manually Releasing Charge Cable

If the usual methods for releasing a charge cable from the charge port (using the charge handle release button, touchscreen, or mobile app) do not work, carefully follow these steps:

1. Ensure that Model S is not actively charging by displaying the charging screen on the touchscreen. If necessary, touch **Stop Charging**.
2. Open the trunk (see [Rear Trunk](#) on page 14).
3. Open the flap on the left side of the trunk side trim.





- Press and hold the charge port's manual release lever towards the front of the vehicle to unlatch the charge cable.

**Warning:** Do not touch or attempt to remove the orange High Voltage cover. Failure to follow these instructions can result in electric shock and serious injury.

**Note:** If your vehicle does not have a charge port release lever (shown in the following image), discontinue this procedure and contact Tesla.



- Pull the charge cable from the charge port.
- Close the flap on the left side of the trunk side trim.

**Caution:** The release lever is designed for use only in situations where the charge cable cannot be released from the charge port using the usual methods. Continuous use may result in damage to the release lever or charging equipment.

**Warning:** Do not perform this procedure while your vehicle is charging or if any orange high voltage conductors are exposed. Failure to follow these instructions can result in electric shock and serious injury or damage to the vehicle. If you have any uncertainty as to how to safely perform this procedure, contact Tesla.

**Warning:** Do not attempt to remove the charge cable at the same exact time as you begin to press the release lever towards the front of the vehicle. Always press the release lever towards the front of the vehicle and hold it before you begin to remove the charge cable from

the charge port. Failure to follow these instructions can result in electric shock and serious injury.

## Charge Port Light

- WHITE:** The charge port door is open. Model S is ready to charge and the connector is not inserted, or the charge port latch is unlocked and the connector is ready to be removed.
- BLUE:** Model S detects that a connector has been plugged in.
- BLINKING BLUE:** Model S is communicating with the connector. Either Model S is preparing to charge, or a charging session is scheduled to begin at a specified future time.
- BLINKING GREEN:** Charging is in progress. As Model S approaches a full charge, the frequency of the blinking slows.
- SOLID GREEN:** Charging is complete.
- SOLID AMBER:** The connector is not fully plugged in. Realign the connector to the charge port and insert fully.
- BLINKING AMBER:** Model S is charging at a reduced current (AC charging only).
- RED:** A fault is detected and charging has stopped. Check the instrument panel or touchscreen for a fault message.

## Changing Charge Settings

The charging screen displays on the touchscreen whenever the charge port door is open. To display the charging screen at any time:



Touch the Apps icon, then touch the charging icon.

**Note:** The following illustration is provided for demonstration purposes only and may vary slightly depending on software version and market region.

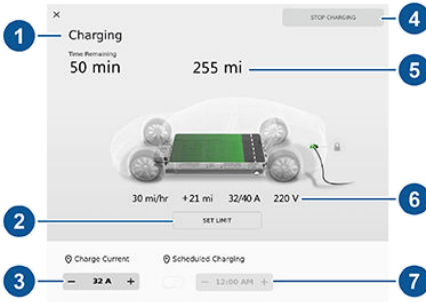

6. Charging rate per hour, estimated increase in driving distance (or energy) achieved so far in this charging session, current supplied/available from the connected power supply, and voltage supplied by the charge cable.
7. Location-specific schedule. With Model S in Park, set a specific time to begin charging at the current location. If, at the scheduled time, Model S is not plugged in at the location, charging starts as soon as you plug it in provided you plug it in within six hours of the scheduled time. If plugged in after six hours, charging does not start until the scheduled time on the next day. To override this setting, touch **Start Charging** or **Stop Charging** (see item 4). When you set a scheduled charging time, Model S displays the set time on the instrument panel and touchscreen.

**Note:** If charging at a Tesla Supercharger, and paid supercharging is potentially in effect, the charging screen also displays information about your previous or current Supercharger session (see [Supercharger Usage Fees and Idle Fees](#) on page 151).

1. Charge status messages (such as Charging Scheduled, Charging) display here.
2. To adjust the charge limit, touch **Set Limit**, and drag the arrow to change the charge limit setting. The setting you choose applies to immediate and scheduled charging sessions.
3. The current automatically sets to the maximum current available from the attached charge cable, unless it was previously reduced to a lower level. If needed, touch - or + to change the current (for example, you may want to reduce the current if you are concerned about overloading a domestic wiring circuit shared by other equipment). It is not possible to set the charging current to a level that exceeds the maximum available from the attached charge cable. When you change the current, Model S remembers the location. If you charge at the same location, you do not need to change it again.

**Note:** If Model S automatically reduced the current at a charging location because of fluctuations in input power (see the note in [Charging Status](#) on page 150), Tesla recommends charging at the lower current until the underlying problem is resolved and the charging location can provide consistent power.

4. Touch to open the charge port door or to start (or stop) charging.
5. Energy level.



## Charging Status

The following illustration is provided for demonstration purposes only and may vary slightly depending on the software version and market region.

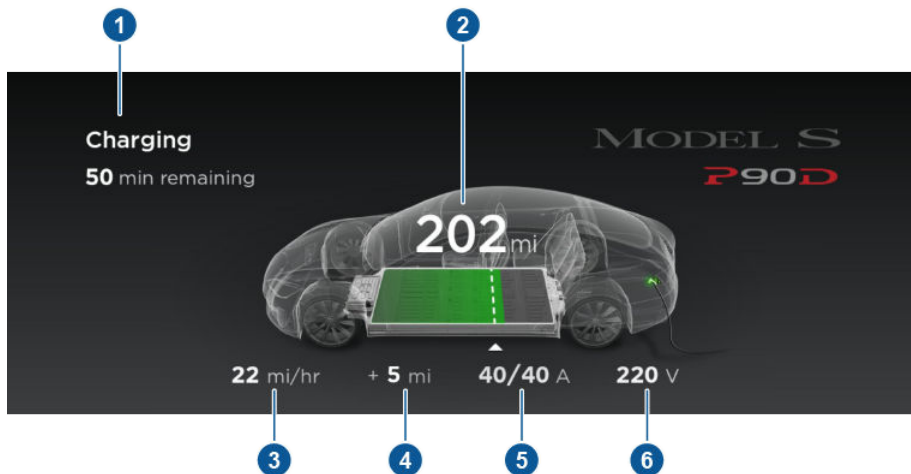

1. Charging status information. For example, when Model S is charging, it displays the time remaining until fully charged at the currently selected charge level. When a charging session is scheduled, it displays when charging starts.

2. Total estimated driving distance (or energy) available. To choose between displaying distance or energy percentage, touch **Controls > Display > Energy Display**.

**Note:** A portion of the battery image may appear blue. This indicates that a small portion of the energy stored in the battery is not available because the battery is cold. This is normal and no reason for concern. When the battery warms up, the blue portion no longer displays.

3. Charging rate per hour.

4. Estimated increase in driving distance (or energy) achieved so far in this charging session.

5. Current supplied/available from the connected power supply (see [Changing Charge Settings](#) on page 148).

6. Voltage supplied by the charge cable.

**Note:** If Model S is charging and detects unexpected fluctuations in input power, the charging current is automatically reduced by 25%. For example, a 40 amp current is reduced to 30 amps. This automatic current reduction increases robustness and safety in situations when an external problem exists (for example, a home wiring system, receptacle, adapter or cord is unable to meet its rated current capacity). As a precaution, when Model S automatically reduces current, it saves the reduced current at the charging location. Although you can manually increase it, Tesla recommends charging at the lower current until the underlying problem is resolved and the charging location can provide consistent power.



## Supercharger Usage Fees and Idle Fees

When charging using a Tesla supercharger, **SUPERCHARGING** information displays at the bottom of the charging screen. This information includes the location, the time that charging started, and an estimate of how much the session will cost. When you stop supercharging, the estimated cost of that session displays until a new supercharging session begins. If free charging is applicable, the estimated cost displays as zero.

**Note:** Estimated pricing is displayed for your convenience only and may not reflect the actual final price you will be charged for that supercharging session. Final pricing for supercharging sessions can be found in your Tesla Account.

When charging at a Tesla supercharger, you are subject to idle fees. Idle fees are designed to encourage drivers to move their vehicle from the Supercharger when charging is complete. Idle fees are in effect only when half of the Superchargers at a site are occupied. The Tesla mobile app notifies you when charging nears completion, and again when charging is complete. Additional notifications are sent if idle fees are incurred. Idle fees are waived if you move your vehicle within five minutes of charging completion.

Log into your Tesla Account to view fees and details about Supercharger sessions, track the remaining balance of free credits, set up a payment method, and make payments. Once a payment method is saved, fees are automatically paid from your account.





## Service Intervals

Regular maintenance is the key to ensuring the continued reliability and efficiency of your Model S.

Rotate the tires every 6,250 miles (10,000 km). Maintain the correct tire pressures, and take Model S to Tesla at the regularly scheduled maintenance intervals of every 12 months, or every 12,500 miles (20,000 km), whichever comes first. It is also important to perform the daily and monthly checks described below.

Model S should be serviced by Tesla-certified technicians. Damages or failures caused by maintenance or repairs performed by non-Tesla certified technicians are not covered by the warranty.

## Daily Checks

- Check the Battery's charge level, displayed on the instrument panel or mobile app.
- Check the condition and pressure of each tire (see [Tire Care and Maintenance](#) on page 153).
- Check that all exterior lights, horn, turn signals, and wipers and washers are working.
- Check the operation of the brakes, including the parking brake.
- Check the operation of the seat belts (see [Seat Belts](#) on page 25).
- Look for abnormal fluid deposits underneath Model S that might indicate a leak. It is normal for a small pool of water to form (caused by the air conditioning system's dehumidifying process).

## Monthly Checks

- Check the mileage to determine if the tires need to be rotated (every 6,250 miles (10,000 km)), and check the condition and pressure of each tire (see [Tire Care and Maintenance](#) on page 153).
- Check windshield washer fluid level and top up if necessary (see [Topping Up Washer Fluid](#) on page 166).
- Check that the air conditioning system is operating correctly (see [Climate Controls](#) on page 116).

 **Warning:** Contact Tesla immediately if you notice any significant or sudden drop in fluid levels or uneven tire wear.

## Fluid Replacement Intervals

Do not change or top up the Battery coolant or brake fluid. Tesla service technicians replace fluids at the regularly scheduled service intervals:

- Brake fluid. Every 2 years or 25,000 miles (40,000 km), whichever comes first.
- Battery coolant. Every 8 years or 100,000 miles (160,000 km), whichever comes first.

**Note:** Any damage caused by opening the Battery coolant reservoir is excluded from the warranty.

## High Voltage Safety

Your Model S has been designed and built with safety as a priority. However, be aware of these precautions to protect yourself from the risk of injury inherent in all high-voltage systems:

- Read and follow all instructions provided on the labels that are attached to Model S. These labels are there for your safety.
- The high voltage system has no user-serviceable parts. Do not disassemble, remove or replace high voltage components, cables or connectors. High voltage cables are colored orange for easy identification.
- If a collision occurs, do not touch any high voltage wiring, connectors, or components connected to the wiring.
- In the unlikely event that a fire occurs, immediately contact your local fire emergency responders.

 **Warning:** Always disconnect the charge cable before working underneath Model S, even if charging is not in progress.

 **Warning:** Keep your hands and clothing away from cooling fans. Some fans operate even when Model S is powered off.

 **Warning:** Some fluids (battery acid, Battery coolant, brake fluid, windshield washer additives, etc.) used in vehicles are poisonous and should not be inhaled, swallowed, or brought into contact with open wounds. For your safety, always read and follow instructions printed on fluid containers.



## Maintaining Tire Pressures

Keep tires inflated to the pressures shown on the Tire and Loading Information label, even if it differs from the pressure printed on the tire itself. The Tire and Loading Information label is located on the center door pillar and is visible when the driver's door is open.



The Tire Pressure indicator light on the instrument panel alerts you if one or more tires is under- or over-inflated.

The Tire Pressure indicator light does not immediately turn off when you adjust tire pressure. After inflating the tire to the recommended pressure, you must drive over 15 mph (25 km/h) for more than 10 minutes to activate the Tire Pressure Monitoring System (TPMS), which turns off the Tire Pressure indicator light.

If the indicator light flashes for one minute whenever you power on Model S, a fault with the TPMS is detected (see [TPMS Malfunction](#) on page 157).

On newer vehicles, you can display tire pressures on the instrument panel by choosing to display **Car Status** using the right or left steering wheel buttons (see [Using Left Steering Wheel Buttons](#) on page 45 or [Using Right Steering Wheel Buttons](#) on page 46). You can also choose whether you want to display tire pressures using BAR or PSI by touching **Controls > Display > Tire Pressure**.

## Checking and Adjusting Tire Pressures

Follow these steps when tires are cold and Model S has been stationary for over three hours:

1. Remove the valve cap.
2. Firmly press an accurate tire pressure gauge onto the valve to measure pressure.
3. If required, add or remove air to reach the recommended pressure.

**Note:** You can release air by pressing the metal stem in the center of the valve.

4. Re-check pressure using the tire gauge.
5. Repeat steps 3 and 4 as necessary until the tire pressure is correct.
6. Replace the valve cap to prevent dirt from entering. Periodically check the valve for damage and leaks.

**Warning:** Under-inflation is the most common cause of tire failures and can cause a tire to overheat, resulting in severe tire cracking, tread separation, or blowout, which causes unexpected loss of vehicle control and increased risk of injury. Under-inflation also reduces the vehicle's range and tire tread life.

**Warning:** Check tire pressures using an accurate pressure gauge when tires are cold. It takes only about one mile (1.6 km) of driving to warm up the tires sufficiently to affect tire pressures. Parking the vehicle in direct sunlight or in hot weather can also affect tire pressures. If you must check warm tires, expect increased pressures. Do not let air out of warm tires in an attempt to match recommended cold tire pressures. A hot tire at or below the recommended cold tire inflation pressure is dangerously under-inflated.

**Warning:** Do not use any tire sealant other than the type provided in a Tesla tire repair kit. Other types can cause tire pressure sensors to malfunction. If your Model S did not include a tire repair kit, you can purchase one from Tesla.



## Inspecting and Maintaining Tires

Regularly inspect the tread and side walls for any sign of distortion (bulges), foreign objects, cuts or wear.

**Warning:** Do not drive Model S if a tire is damaged, excessively worn, or inflated to an incorrect pressure. Check tires regularly for wear, and ensure there are no cuts, bulges or exposure of the ply/cord structure.

### Tire Wear

Adequate tread depth is important for proper tire performance. Tires with a tread depth less than 4/32" (3 mm) are more likely to hydroplane in wet conditions and should not be used. Tires with a tread depth less than 5/32" (4 mm) do not perform well in snow and slush and should not be used when driving in winter conditions.

Model S is originally fitted with tires that have wear indicators molded into the tread pattern. When the tread has been worn down to 4/32" (3 mm), the indicators start to appear at the surface of the tread pattern, producing the effect of a continuous band of rubber across the width of the tire. For optimal performance and safety, Tesla recommends replacing tires before the wear indicators are visible.

### Tire Rotation, Balance, and Wheel Alignment

Tesla recommends rotating the tires every 6,250 miles (10,000 km).

Unbalanced wheels (sometimes noticeable as vibration through the steering wheel) affect vehicle handling and tire life. Even with regular use, wheels can get out of balance. Therefore, they should be balanced as required.

If tire wear is uneven (on one side of the tire only) or becomes abnormally excessive, check the alignment of wheels.

**Note:** When replacing only two tires, always install the new tires on the rear.

## Punctured Tires

A puncture eventually causes the tire to lose pressure, which is why it is important to check tire pressures frequently. Permanently repair or replace punctured or damaged tires as soon as possible.

Your tubeless tires may not leak when penetrated, provided the object remains in the tire. If, however, you feel a sudden vibration or ride disturbance while driving, or you suspect a tire is damaged, immediately reduce your speed. Drive slowly, while avoiding heavy braking or sharp steering and, when safe to do so, stop the vehicle. Arrange to have Model S transported to a Tesla Service Center, or to a nearby tire repair center.

**Note:** In some cases, you can temporarily repair small tire punctures (under 1/4" (6 mm)) using an optional tire repair kit available from Tesla. This allows you to slowly drive Model S to Tesla or to a nearby tire repair facility.

**Warning:** Do not drive with a punctured tire, even if the puncture has not caused the tire to deflate. A punctured tire can deflate suddenly at any time.

## Flat Spots

If Model S is stationary for a long period in high temperatures, tires can form flat spots. When Model S is driven, these flat spots cause a vibration which gradually disappears as the tires warm up and regain their original shape.

To minimize flat spots during storage, inflate tires to the maximum pressure indicated on the tire wall. Then, before driving, release air to adjust tire pressure to the recommended levels.

## Improving Tire Mileage

To improve the mileage you get from your tires, maintain tires at the recommended tire pressures, observe speed limits and advisory speeds, and avoid:

- Pulling away quickly, or hard acceleration.
- Fast turns and heavy braking.
- Potholes and objects in the road.
- Hitting curbs when parking.
- Contaminating tires with fluids that can cause damage.



## Replacing Tires and Wheels

Tires degrade over time due to the effects of ultraviolet light, extreme temperatures, high loads, and environmental conditions. It is recommended that tires are replaced every six years, or sooner if required.

Wheel and tires are matched to suit the handling characteristics of the vehicle. Replacement tires must comply with the original specification. If tires other than those specified are used, ensure that the load and speed ratings marked on the tire (see [Understanding Tire Markings](#) on page 178) equal or exceed those of the original specification.

Ideally, you should replace all four tires at the same time. If this is not possible, replace the tires in pairs, placing the new tires on the rear. Always balance the wheel after replacing a tire.

If you replace a wheel, the TPMS (Tire Pressure Monitoring System) sensors need to be reset to ensure they provide accurate warnings when tires are under- or over-inflated (see [Resetting the TPMS Sensors](#) on page 157).

For the specification of the original wheels and tires installed on Model S, see [Wheels and Tires](#) on page 177.

**Warning:** For your safety, use only tires and wheels that match the original specification. Tires that do not match the original specification can affect the operation of the TPMS.

**Warning:** Never exceed the speed rating of your vehicle's tires. The speed rating is shown on the sidewall of your tires (see [Understanding Tire Markings](#) on page 178).

### Asymmetric Tires

Model S tires are asymmetric and must be mounted on the wheel with the correct sidewall facing outward. The sidewall of the tire is marked with the word OUTSIDE. When new tires are installed, make sure that the tires are correctly mounted on the wheels.



**Warning:** Road holding is seriously impaired if the tires are incorrectly installed on the wheels.



## Seasonal Tire Types

### Summer Tires

Your vehicle may be originally equipped with high performance summer tires or all season tires. Tesla recommends using winter tires if driving in cold temperatures or on roads where snow or ice may be present. Contact Tesla for winter tire recommendations.

**Warning:** In cold temperatures or on snow or ice, summer tires do not provide adequate traction. Selecting and installing the appropriate tires for winter conditions is important to ensure the safety and optimum performance of your Model S.

### All-Season Tires

Your Model S may be originally equipped with all-season tires. These tires are designed to provide adequate traction in most conditions year-round, but may not provide the same level of traction as winter tires in snowy or icy conditions. All-season tires can be identified by “ALL SEASON” and/or “M+S” (mud and snow) on the tire sidewall.

### Winter Tires

Use winter tires to increase traction in snowy or icy conditions. When installing winter tires, always install a complete set of four tires at the same time. Winter tires must be the same size, brand, construction and tread pattern on all four wheels. Contact Tesla for winter tire recommendations.



Winter tires can be identified by a mountain/snowflake symbol on the tire's sidewall.

When driving with winter tires, you may experience more road noise, shorter tread life, and less traction on dry roads.

## Driving in Low Temperatures

Tire performance is reduced in low ambient temperatures, resulting in reduced grip and an increased susceptibility to damage from impacts. Performance tires can temporarily harden when cold, causing you to hear rotational noise for the first few miles (kilometers) until the tires warm up.

## Using Tire Chains

Tesla has tested and approved Maggie Group Trak Sport P217 tire chains to increase traction in snowy conditions. These chains should only be installed on rear 19" tires. Do not use chains on 21" tires or on front tires. The approved tire chains can be purchased from Tesla.

When installing tire chains, follow the instructions provided by the tire chain manufacturer. Mount them as tightly as possible.

When using tire chains:

- Drive slowly. Do not exceed 30 mph (48 km/h).
- Avoid heavily loading Model S (heavy loads can reduce the clearance between the tires and the body).
- Remove the tire chains as soon as conditions allow.

**Note:** Tire chains are prohibited in some jurisdictions. Check local laws before installing tire chains.

**Caution:** Using non-recommended tire chains, or using tire chains on other sized tires can damage the suspension, body, wheels, and/or brake lines. Damage caused by using non-recommended tire chains is not covered by the warranty.

**Caution:** Do not use chains on a Model S equipped with 21" tires and do not use tire chains on front tires.

**Caution:** Ensure that the tire chains cannot touch suspension components or brake lines. If you hear the chains making unusual noises that would indicate contact with Model S, stop and investigate immediately.

## Tire Pressure Monitoring

Each tire should be checked monthly when cold and inflated to the recommended pressures that are printed on the Tire and Loading Information label located on the driver's door pillar (see [Maintaining Tire Pressures](#) on page 153). If your vehicle has tires of a different size than the size indicated on the vehicle placard or tire inflation pressure label, determine the proper tire inflation pressure for those tires.



As an added safety feature, your vehicle has been equipped with a TPMS that displays a tire pressure telltale (Tire Pressure Warning) on the instrument panel when one or more of your tires is significantly under- or over-inflated. Accordingly, when the Tire Pressure indicator light displays on the instrument panel to alert you about tire pressure, stop and check your tires as soon as possible, and inflate them to the proper pressure (see [Maintaining Tire Pressures](#) on page 153). Driving on a significantly under-inflated tire causes the tire to overheat and can lead to tire failure. Under-inflation also reduces range efficiency and tire tread life, and may affect the vehicle's handling and stopping ability.



If Model S detects a fault with the TPMS, this indicator flashes for one minute whenever you power on Model S.

**Note:** Installing accessories that are not approved by Tesla can interfere with the TPMS.



**Warning:** The TPMS is not a substitute for proper tire maintenance, including manually checking tire pressures and regularly inspecting the condition of tires. It is the driver's responsibility to maintain correct tire pressure, even if under- or over-inflation has not reached the level for the TPMS to trigger the Tire Pressure Warning on the instrument panel.

### Resetting the TPMS Sensors

After replacing one or more wheels (but not after replacing a tire or rotating wheels), the TPMS sensors need to be reset to ensure tire pressure warnings are accurate.

On newer versions of Model S, the TPMS sensors are reset automatically after driving over 15 mph (25 km/h) for longer than 10 minutes. But for older versions, follow these steps:

1. Inflate all tires to their recommended pressures, as indicated on the Tire and Loading Information label located on the door pillar.
2. Get ready to drive for ten minutes, then touch **Controls > Service > Reset TPMS**.

3. Follow the onscreen instructions.



**Caution:** Selecting the incorrect wheel size may result in false tire pressure warnings. If a tire pressure warning displays, exit the vehicle, close the rear trunk and all doors, wait for the touchscreen to go black, then re-enter the vehicle and ensure that the correct wheel size is selected before touching **Reset TPMS**.

**Note:** On some older versions of Model S, when changing to 21" wheels, the TPMS may generate false tire pressure warnings. Bring Model S to a Tesla Service Center for further adjustment.



**Warning:** Do not reset the TPMS sensors in an attempt to clear tire pressure warnings.

### Replacing a Tire Sensor

If the Tire Pressure warning indicator displays frequently, contact Tesla to determine if a tire sensor needs to be replaced. If a non-Tesla Service Center repairs or replaces a tire, the tire sensor may not work until Tesla performs the setup procedure.

### TPMS Malfunction

Model S has also been equipped with a TPMS malfunction indicator to indicate when the system is not operating properly.



The TPMS malfunction indicator is combined with the tire pressure indicator light. When the system detects a malfunction, the indicator flashes for approximately one minute after Model S powers on, and then remains continuously lit. This sequence continues upon subsequent vehicle start-ups as long as the malfunction exists. When the TPMS malfunction indicator is on, the system might not be able to detect or signal under- and over-inflated tires as intended.

TPMS malfunctions can occur for a variety of reasons, including installing replacement or alternate tires or wheels that prevent the TPMS from functioning properly. Always check the TPMS malfunction indicator light after replacing one or more tires or wheels on your vehicle to ensure that the replacement tires or wheels allow the TPMS to continue to function properly.



**Note:** If a tire has been replaced or repaired using a different tire sealant than the one available from Tesla, and a low tire pressure is detected, it is possible that the tire sensor has been damaged. Contact Tesla to have the fault repaired as soon as possible.



## Cleaning the Exterior

To prevent damage to the paint, immediately remove corrosive substances (bird droppings, tree resin, dead insects, tar spots, road salt, industrial fallout, etc.). Do not wait until Model S is due for a complete wash. If necessary, use denatured alcohol to remove tar spots and stubborn grease stains, then immediately wash the area with water and a mild, non-detergent soap to remove the alcohol.

Follow these steps when washing the exterior of Model S:

### 1. Rinse Thoroughly

Before washing, flush grime and grit from the bodywork using a hose. Flush away accumulations of mud in areas where debris easily collects (such as wheel arches and panel seams). If salt has been used on the highways (such as during winter months), thoroughly rinse all traces of road salt from the underside of the vehicle.

### 2. Hand Wash

Hand wash Model S using a clean soft cloth and cold or lukewarm water containing a mild, high-quality car shampoo.

### 3. Rinse with Clean Water











After washing, rinse with clean water to prevent soap from drying on the surfaces.

### 4. Dry Thoroughly and Clean Exterior Glass

After washing and rinsing, dry thoroughly with a chamois.

Clean windows and mirrors using an automotive glass cleaner. Do not scrape, or use any abrasive cleaning fluid on glass or mirrored surfaces.

## Cautions for Exterior Cleaning

-  **Caution:** Do not use windshield treatment fluids. Doing so can interfere with wiper friction and cause a chattering sound.
-  **Caution:** Do not use hot water or detergents.
-  **Caution:** Do not wash in direct sunlight.
-  **Caution:** If using a pressure washer, maintain a distance of at least 12" (30 cm) between the nozzle and the surface of Model S. Keep the nozzle moving and do not concentrate the water jet on any one area.
-  **Caution:** Do not aim water hoses directly at window, door or hood seals, or through wheel apertures onto brake components.
-  **Caution:** Avoid using tight-napped or rough cloths, such as washing mitts.
-  **Caution:** If washing in an automatic car wash, use Touchless car washes only. These car washes have no parts (brushes, etc.) that touch the surfaces of Model S. Using any other type of car wash could cause damage that is not covered by the warranty.
-  **Caution:** Ensure the wipers are off before washing Model S to avoid the risk of damaging the wipers.
-  **Caution:** Do not use chemical based wheel cleaners. These can damage the finish on the wheels.
-  **Caution:** Avoid using a high pressure power washer on the camera(s) or parking sensors (if equipped) and do not clean a sensor or camera lens with a sharp or abrasive object that can scratch or damage its surface.
-  **Warning:** Never spray liquid at a high velocity (for example, if using a pressure washer) towards the charge port while Model S is charging. Failure to follow these instructions can result in serious injury or damage to the vehicle, charging equipment, or property.





## Cleaning the Interior

Frequently inspect and clean the interior to maintain its appearance and to prevent premature wear. If possible, immediately wipe up spills and remove marks. For general cleaning, wipe interior surfaces using a soft cloth (such as microfiber) dampened with a mixture of warm water and mild non-detergent cleaner (test all cleaners on a concealed area before use). To avoid streaks, dry immediately with a soft lint-free cloth.

### Interior Glass

Do not scrape, or use any abrasive cleaning fluid on glass or mirrored surfaces. This can damage the reflective surface of the mirror and the heating elements in the rear window.

### Airbags

Do not allow any substance to enter an airbag cover. This could affect correct operation.

### Dashboard and Plastic Surfaces

Do not polish the upper surfaces of the dashboard. Polished surfaces are reflective and could interfere with your driving view.

### Leather Seats

Leather is prone to dye-transfer which can cause discoloration, particularly on light colored leather. White and tan leather is coated with an anti-soiling treatment. Wipe seats as soon as possible using a soft cloth moistened with warm water and non-detergent soap. Wipe gently in a circular motion. Then wipe dry using a soft, lint-free cloth. Using detergents or commercially available leather cleaners and conditioners is not recommended because they can discolor or dry out the leather.

### Polyurethane Seats

Wipe spills as soon as possible using a soft cloth moistened with warm water and non-detergent soap. Wipe gently in a circular motion. After cleaning, allow the seats to air dry.

### Cloth Seats

Wipe spills as soon as possible using a soft cloth moistened with warm water and non-detergent soap. Wipe gently in a circular motion. Then wipe dry using a soft, lint-free cloth. Vacuum the seats as needed to remove any loose dirt.

### Carpets

Avoid over-wetting carpets. For heavily soiled areas, use a diluted upholstery cleaner.

### Seat Belts

Extend the belts to wipe. Do not use any type of detergent or chemical cleaning agent. Allow the belts to dry naturally while extended, preferably away from direct sunlight.

### Tesla Built-In Rear Facing Child Seats

Vacuum the seats to remove any loose dirt. Wipe the seats with a soft cloth dampened with warm water. You can also use an upholstery cleaner designed for automotive use. Extend the belts to wipe. Allow the belts to dry naturally, preferably away from direct sunlight.





### Touchscreen and Instrument Panel

Clean the touchscreen and instrument panel using a soft lint-free cloth specifically designed to clean monitors and displays. Do not use cleaners (such as a glass cleaner) and do not use a wet wipe or a dry statically-charged cloth (such as a recently washed microfiber). To wipe the touchscreen without activating buttons and changing settings, you can enable clean mode. Touch **Controls** > **Display** > **Screen Clean Mode**. The display darkens to make it easy to see dust and smudges.

### Chrome and Metal Surfaces

Polish, abrasive cleaners or hard cloths can damage the finish on chrome and metal surfaces.

### Cautions for Interior Cleaning

-  **Caution:** Using solvents (including alcohol), bleach, citrus, naphtha, or silicone-based products or additives on interior components can cause damage.
-  **Caution:** Statically-charged materials can cause damage to the touchscreen or instrument panel.
-  **Warning:** If you notice any damage on an airbag or seat belt, contact Tesla immediately.
-  **Warning:** Do not allow any water, cleaners, or fabric to enter a seat belt mechanism.



- Warning:** Exposure to chemical cleaners can be hazardous and can irritate eyes and skin. Read and observe the instructions provided by the manufacturer of the chemical cleaner.

## Polishing, Touch Up, and Body Repair

To preserve the cosmetic appearance of the body, you can occasionally treat the paint surfaces with an approved polish containing:

- Very mild abrasive to remove surface contamination without removing or damaging the paint.
- Filling compounds that fill scratches and reduce their visibility.
- Wax to provide a protective coating between the paint and environmental elements.

Regularly inspect the exterior paint for damage. Treat minor chips and scratches using a paint touch-up pen (available for purchase from Tesla). Use the touch-up pen after washing but before polishing or waxing.

Repair rock chips, fractures or scratches. Body repairs should be performed only by a Tesla approved body shop. Contact Tesla for a list of approved body shops.

- Caution:** Do not use cutting pastes, color restoration compounds, or polishes containing harsh abrasives. These can scour the surface and permanently damage the paint.
- Caution:** Do not use chrome polish or other abrasive cleaners.

## Using a Car Cover

To preserve the cosmetic appearance of the body when Model S is not being used, use a genuine Tesla car cover. Car covers can be purchased from Tesla. See [Parts and Accessories](#) on page 168.

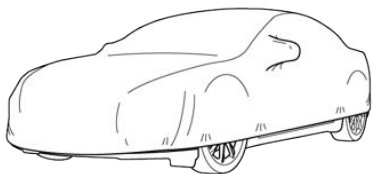

- Caution:** Use only a Tesla-approved car cover when Model S is plugged in. Using a non-Tesla car cover can prevent the

Battery from being adequately cooled during charging.

## Floor Mats

To extend the life of your carpet and make them easier to clean, use genuine Tesla floor mats (see [Parts and Accessories](#) on page 168). Maintain floor mats by regularly cleaning them and checking that they are properly attached. Replace floor mats if they become excessively worn.

- Warning:** To avoid potential interference with a foot pedal, ensure that the driver's floor mat is securely fastened, and never place an additional floor mat on top of it. Floor mats should always rest on top of the vehicle carpeting surface and not on another floor mat or other covering.



## Checking and Replacing Wiper Blades

**⚠ Caution:** Wiper blades do not lock into a lifted position. When cleaning or replacing a wiper blade, lift the wiper arm only a short distance from the windshield, just far enough to access the blade. Do not lift a wiper arm beyond its intended position. Doing so can cause damage that is not covered by the warranty.

To make wiper blades easy to access, turn off the wipers, shift Model S into Park, then use the touchscreen to move them to the service position. Touch **Controls > Service > Wiper Service Mode**.

**Note:** Wipers automatically return to their normal position when you shift Model S out of Park.

Periodically check and clean the edge of the wiper blade and check the rubber for cracks, splits and roughness. If damaged, replace the blade immediately to prevent damage to the glass.

Contaminants on the windshield, or on the wiper blades, can reduce the effectiveness of the wiper blades. Contaminants include ice, wax spray from car washes, washer fluid with bug and/or water repellent, bird droppings, tree sap, and other organic substances.

Follow these guidelines for cleaning:

- Clean the windshield using non-abrasive glass cleaner.
- Lift the wiper arm a short distance away from the windshield, just far enough to access the wiper blade, then wipe the blade clean using isopropyl (rubbing) alcohol or washer fluid.

If the wipers remain ineffective after cleaning, replace the wiper blades.

**Note:** For optimum performance, replace the wiper blades at least once a year.

To replace the wiper blades:

1. Turn off the wipers, shift Model S into Park, then use the touchscreen to move the wipers to the service position. Touch **Controls > Service > Wiper Service Mode > ON**.

**Note:** The wipers must be off to turn Service Mode on.

2. Lift the wiper arm a short distance away from the windshield, just far enough to access the wiper blade.

3. Hold the wiper arm (the wiper arm does not lock into a lifted position) and press the locking tab while sliding the blade down the arm.

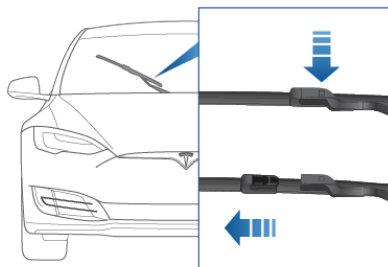

4. If necessary, temporarily place a towel between the wiper arm and windshield to avoid scratching the windshield.
5. Align the new blade on the wiper arm and slide it toward the hooked end of the arm until it locks into place.
6. Place the wiper arm against the windshield.
7. Turn Service Mode off.

If the problem persists with new blades, clean the windshield and wiper blades by wiping them with a soft cloth or sponge moistened with warm water and non-detergent soap. Then, rinse the windshield and wiper blades with clean water. The windshield is clean when water beads do not form.

**⚠ Caution:** Only use cleaning products approved for use on automotive glass and rubber. Inappropriate products can cause damage or smears, and create glare on the windshield.

**⚠ Caution:** Only install replacement blades that are identical to the original blades. Using inappropriate blades can affect the operation of the rain sensor and damage the wiper system and windshield.

## Cleaning Washer Jets

The position of the windshield washers is set at the factory and should never need adjusting.

If a windshield washer becomes blocked, use a thin strand of wire to clear any blockages from the nozzle.

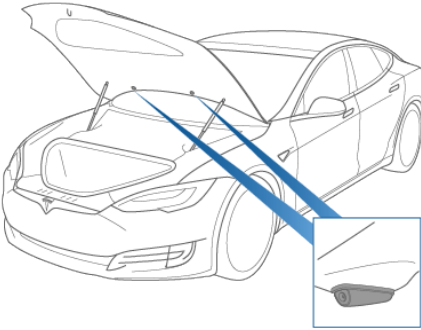

- ⚠ Warning:** Do not operate the washers while cleaning Model S. Windshield washer fluid can irritate eyes and skin. Read and observe the washer fluid manufacturer's instructions.



## Removing the Maintenance Panel

To check fluid levels, remove the maintenance panel:

1. Open the hood.
2. Pull the maintenance panel upward to release the clips that hold it in place.



**⚠ Caution:** The maintenance panel protects the front trunk from water. When re-attaching, make sure it is fully seated.

## Checking Battery Coolant

If the quantity of fluid in the cooling system drops below the recommended level, the instrument panel displays a warning message. Stop driving Model S as soon as safety permits and contact Tesla.

### Fluid Level Check

Tesla checks the Battery coolant level at the regularly scheduled maintenance intervals.

On a Rear Wheel Drive Model S, you can check the fluid level visually. **BUT DO NOT REMOVE THE FILLER CAP AND DO NOT ADD FLUID.** Doing so can result in damage not covered by the warranty. To check the fluid level, park Model S on level ground. When Model S is cool, remove the maintenance panel (see [Removing the Maintenance Panel](#) on page 164). The fluid level can be seen by looking at the outside marks on the side of the reservoir.

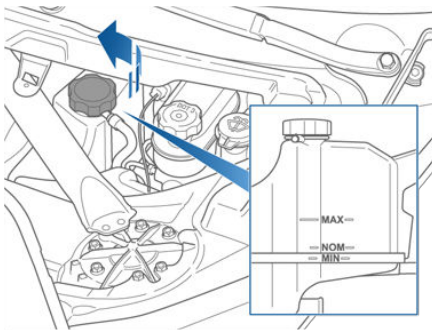

The fluid level should be between the MIN and the MAX marks. If you notice that the fluid level has dropped significantly, contact Tesla before using Model S.

### Do Not Top Up Battery Coolant

**⚠ Warning:** Battery coolant can be hazardous and can irritate eyes and skin. Under no circumstances should you remove the filler cap and/or add coolant. If the instrument panel warns you that the fluid level is low, contact Tesla immediately.

To maximize the performance and life of the Battery, the cooling system uses a specific mixture of G-48 ethylene-glycol coolant (HOAT). Contact Tesla for more specific information about the coolant.



## Checking Brake Fluid

**Warning:** Contact Tesla immediately if you notice increased movement of the brake pedal or a significant loss of brake fluid. Driving under these conditions can result in extended stopping distances or complete brake failure.



The Brake indicator on the instrument panel alerts you if the quantity of fluid in the brake reservoir drops below the recommended level. If it displays while driving, stop as soon as safety permits by gently applying the brakes. Do not continue driving. Contact Tesla immediately.

### Fluid Level Check

Tesla checks the brake fluid level at the regularly scheduled maintenance intervals. To check it yourself, park Model S on level ground. When Model S is cool, remove the maintenance panel (see [Removing the Maintenance Panel](#) on page 164).

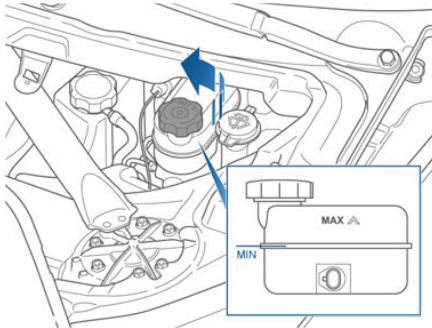

Check the fluid level visually by looking at the outside marks on the side of the reservoir without removing the filler cap.

The brake fluid level should always be between the MIN and the MAX marks.

**Note:** Although brake fluid level drops slightly during normal use as a result of brake pad wear, it should not drop below the MIN mark.

### Topping Up the Brake Fluid

Do not top up your brake fluid. Tesla service does this when you bring Model S in for regular servicing. The following instructions are provided for information purposes and future reference only:

1. Clean the filler cap before removing it to prevent dirt from entering the reservoir.
2. Unscrew the cap and remove it.
3. Top up the reservoir to the MAX mark using the appropriate brake fluid.
4. Replace the filler cap, ensuring it is fully secured.

**Warning:** Only use new fluid from a sealed air-tight container. Never use previously used fluid or fluid from a previously opened container—fluid absorbs moisture which decreases braking performance.

**Warning:** Brake fluid is highly toxic. Keep containers sealed and out of the reach of children. In the event of accidental consumption, seek medical attention immediately.

**Caution:** Brake fluid damages painted surfaces. Immediately soak up any spills with an absorbent cloth and wash the area with a mixture of car shampoo and water.



## Topping Up Washer Fluid

The only reservoir into which you can add fluid is the washer fluid reservoir, which is located behind the front trunk. When the level is low, a message displays on the instrument panel.

- Caution:** Do not add formulated washer fluids that contain water repellent or bug wash. These fluids can cause streaking, smearing, and squeaking or other noises.

Operate the washers periodically to check that the nozzles are clear and properly directed.

See [Wipers and Washers](#) on page 63.

To top up the washer fluid:

1. Open the hood.
2. Clean around the filler cap before opening it to prevent dirt from entering the reservoir.
3. Open the filler cap.

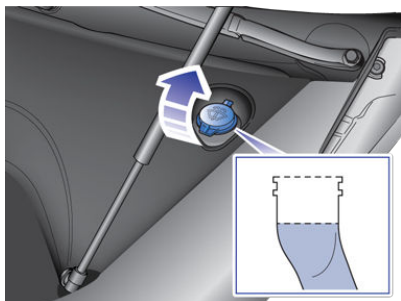

4. Fill the reservoir until the fluid level is visible just below the filler neck.
5. Replace the filler cap.

**Note:** Some national or local regulations restrict the use of Volatile Organic Compounds (VOCs). VOCs are commonly used as antifreeze in washer fluid. Use a washer fluid with limited VOC content only if it provides adequate freeze resistance for all climates in which you drive Model S.

- Caution:** Under no circumstances do you need to inspect or top up other fluid reservoirs. Two additional fluid reservoirs are located next to the washer fluid, but underneath the maintenance panel. In the unlikely event that you see a message on the instrument panel that one of these fluid levels is low, stop driving Model S as soon as safe to do so, and contact Tesla.

- Caution:** Do not spill washer fluid on body panels. Doing so can cause damage. Wipe

up spills immediately and wash the affected area with water.

- Warning:** In temperatures below 40° F (4° C), use a washer fluid with antifreeze. In cold weather, using a washer fluid without antifreeze can impair visibility through the windshield.
- Warning:** Windshield washer fluid can irritate eyes and skin. Read and observe the instructions provided by the washer fluid manufacturer.



## Jacking Procedure

Follow the steps below to lift Model S. Ensure that any non-Tesla repair facility is aware of these lifting points.

1. Position Model S centrally between the lift posts.
2. If your Model S is equipped with Smart Air Suspension, it automatically self-levels, even when power is off. Use the touchscreen to set the suspension as follows:
  - Touch **Controls** > **Suspension**.
  - Press the brake pedal, then touch **Very High** to maximize the height of the suspension.
  - Touch **Jack** to disable self-leveling.
3. Position the lift arm pads under the designated body lift points at the locations shown.

**Warning:** DO NOT position the lift arm pads under the Battery.

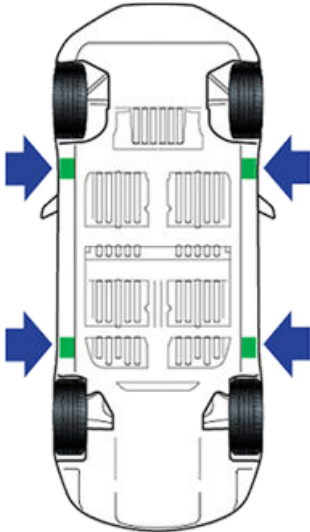

4. Adjust the height and position of the lift arm pads to ensure that they are correctly located.
5. With assistance, raise the lift, ensuring the lift arm pads remain in their correct positions.

**Note:** Jack mode cancels when Model S is driven over 4 mph (7 km/h).

**Note:** Jack mode may be unexpectedly enabled in situations where an object is supporting the vehicle's weight (for example the bumper of the vehicle is resting on a curb).

**Warning:** If your Model S is equipped with Smart Air Suspension, it automatically self-levels, even when power is off. You MUST disable this system by engaging Jack mode before lifting or jacking. If you do not disable Smart Air Suspension, Model S can attempt to self-level, causing serious damage, bodily injury, or death.

**Warning:** Never raise Model S when the charge cable is connected, even if charging is not in progress.

**Warning:** Do not work on an incorrectly supported vehicle. Doing so can cause serious damage, bodily injury, or death.

**Caution:** DO NOT lift from under the Battery. Place the lift arm pads under the designated body lift points only. The locations shown are the only approved lifting points for Model S. Lifting at any other points can cause damage. Damage caused by incorrectly lifting Model S is not covered by the warranty.





## Parts, Accessories, and Modifications

Use only genuine Tesla parts and accessories. Tesla performs rigorous testing on parts to ensure their suitability, safety, and reliability. Purchase these parts from Tesla, where they are professionally installed and where you can receive expert advice about modifications to Model S. Accessories are available for purchase from Tesla stores or online at [www.tesla.com/shop](http://www.tesla.com/shop).

Tesla is unable to assess parts manufactured by other distributors and therefore accepts no responsibility if you use non-Tesla parts on Model S.

**Warning:** Installing non-approved parts and accessories, or performing non-approved modifications, can affect the performance of Model S and the safety of its occupants. Any damage caused by using or installing non-approved parts, or by performing non-approved modifications, is not covered by the warranty.

**Warning:** Tesla does not accept liability for death, personal injury or damage that occurs if you use or install non-approved accessories or make non-approved modifications.

## Body Repairs

If Model S is in a collision, contact Tesla to ensure that it is repaired with genuine Tesla parts. Tesla has selected and approved body shops that meet strict requirements for training, equipment, quality, and customer satisfaction.

Some repair shops and insurance companies might suggest using non-original equipment or salvaged parts to save money. However, these parts do not meet Tesla's high standards for quality, fit and corrosion resistance. In addition, non-original equipment and salvaged parts (and any damage or failures they might cause) are not covered by the warranty.

## Using RFID Transponders

Model S has a metallic coating on the windshield that can interfere with signals sent from RFID transponders used by many toll systems. Most Model S vehicles, depending on date of manufacture, include an area in the windshield in which the metallic coating is cut out to accommodate transponders. This area, located on the right side of the rear view mirror, is the best location to mount a transponder. If your vehicle does not include this cut out area, mount the transponder to the rear window.

**Note:** You can also attach a weather-proof transponder to the front license plate.

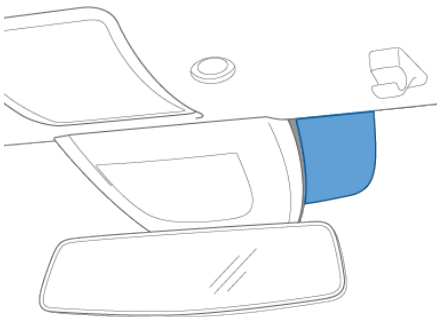



## Vehicle Identification Number

You can find the VIN at the following locations:

- Touch the Tesla "T" at the top center of the touchscreen. The popup window displays the VIN.
- Stamped on a plate located at the top of the dashboard. Can be seen by looking through the windshield.
- Printed on the Vehicle Certification label, located on the door pillar. Can be seen when the driver's door is open.

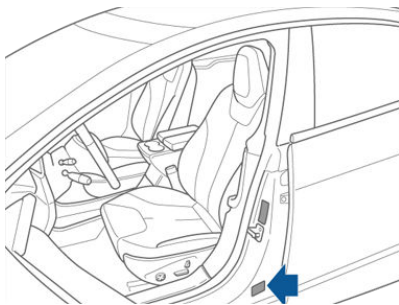

- On vehicles manufactured as of August 2015, the VIN is stamped on the chassis and can be seen by removing the sill panel on the front passenger door by gently prying it upward using a flat-bladed tool.

**Note:** The VIN was not stamped on the chassis on vehicles manufactured between approximately June 2, 2016 and Feb 28, 2017.

**⚠ Caution:** Removing the sill panel to view the VIN is not recommended because damage is likely to occur. The panel is held in place with fragile clips that break easily. Damage caused by removing the sill panel is not covered by the warranty.

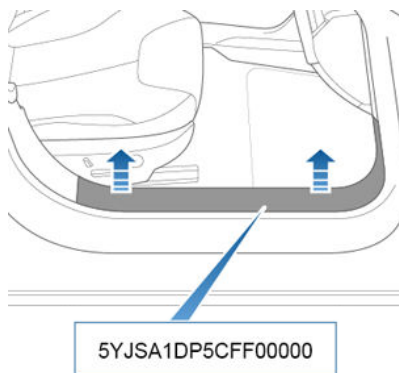

## Emission Control Label

The emission control label is located on the opening face of the liftgate.





## Load Capacity Labeling

It is important to understand how much weight your Model S can safely carry. This weight is called the vehicle capacity weight and includes the weight of all occupants, cargo and any additional equipment added to your Model S since it was manufactured.

Two labels attached to the center door pillar indicate how much weight Model S can safely carry. Labels are visible when the front door is open.

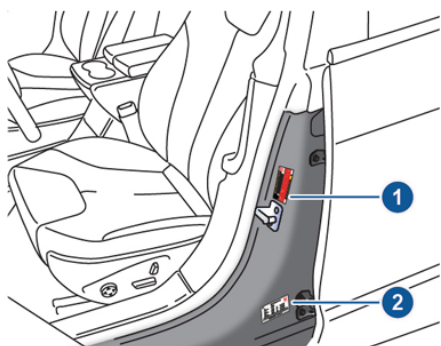

1. Tire and Loading Information Label
2. Vehicle Certification Label

**Warning:** Overloading Model S has an adverse effect on braking and handling, which can compromise your safety or cause damage.

**Caution:** Never load more than 300 lbs (136 kg) in the front trunk. Doing so can cause damage.

**Caution:** Never load more than 175 lbs (80 kg) on the rear load floor (above the lower trunk compartment) or more than 285 lbs (130 kg) in the lower trunk compartment. Doing so can cause damage.

**Caution:** Never store large amounts of liquid in Model S. A significant spill can cause electrical components to malfunction.

## Tire and Loading Information Label

The Tire and Loading Information label provides:

- The maximum number of occupant seating positions.
- The maximum vehicle capacity weight.

- The size of the original tires.
- The cold inflation pressures for the original front and rear tires. These pressures are recommended to optimize ride and handling characteristics.

U.S. and Canada:

**TIRE AND LOADING INFORMATION**  
RENSEIGNEMENTS SUR LES PNEUS ET LE CHARGEMENT

SEATING CAPACITY/NOMBRE DE PLACES - TOTAL X FRONT/AVANT X REAR/ARRIÈRE X  
LE POIDS TOTAL DES OCCUPANTS ET DU CHARGEMENT NE DOIT JAMAIS DÉPASSER

TIRE/PNEU	FRONT/AVANT	REAR/ARRIÈRE	SPARE/DE SECOURS
ORIGINAL TIRE SIZE / TAILLE DES PNEUS D'ORIGINE	depends on vehicle model	depends on vehicle model	NONE/AUCUN
COLD TIRE PRESSURE / PRESSION DES PNEUS À FROID	depends on vehicle model	depends on vehicle model	NONE/AUCUN

SEE OWNER'S MANUAL FOR ADDITIONAL INFORMATION. VOIR LE MANUEL DE L'USAGER POUR PLUS DE RENSEIGNEMENTS.

Mexico:

**INFORMACIÓN DE NEUMÁTICOS Y DE CARGA**

NÚMERO TOTAL DE PLAZAS - ADELANTE 2 ATRÁS

EL COMBINADO DE LOS OCUPANTES Y LA CARGA NUNCA DEBE EXCEDER

NEUMÁTICO	DELANTERO	TRASERO	REFACCIÓN
TAMAÑO DE NEUMÁTICO ORIGINAL			N/A
PRESIÓN DE INFLADO PARA LLANTAS EN FRÍO			N/A

CONSULTE EL MANUAL DEL PROPIETARIO PARA MÁS INFORMACIÓN

Never change this label, even if you use different tires in the future.

**Note:** If Model S is loaded to its full capacity, double check all tires to ensure they are inflated to their recommended pressure levels.

## Vehicle Certification Label

The Vehicle Certification label provides:

- GVWR - Gross Vehicle Weight Rating. The maximum allowable total mass of Model S. This is calculated as the weight of Model S, all passengers, fluids, and cargo.
- GAWR FRT and GAWR RR - Gross Axle Weight Rating for the front and rear axles. The GAWR is the maximum distributed weight that each axle can support.

United States:

GVWR	MFD BY TESLA, INC. WITH TIRES		
GAWR FRT	WITH TIRES	RIM	COLD TIRE PRESSURE
GAWR RR	WITH TIRES	RIM	COLD TIRE PRESSURE

THIS VEHICLE CONFORMS TO ALL APPLICABLE U.S. FEDERAL MOTOR VEHICLE SAFETY, BUMPER, AND THEFT PREVENTION STANDARDS IN EFFECT ON THE DATE OF MANUFACTURE SHOWN ABOVE.

Canada:



Mexico:



**⚠ Caution:** To prevent damage, never load Model S so that it is heavier than GVWR or exceeds the individual GAWR weights.

## Calculating Load Limits

1. Locate the statement “The combined weight of occupants and cargo should never exceed XXX kg or XXX lbs” on the “Tire and Loading Information” label.
2. Determine the combined weight of all occupants that will ride in the vehicle.
3. Subtract the combined weight of the occupants from XXX kg or XXX lbs (see Step 1).
4. The resulting figure equals the available cargo load capacity. For example, if the “XXX” amount equals 1400 lbs (635 kg) and there will be five 150 lb (68 kg) passengers in the vehicle, the amount of available cargo capacity is 650 lbs (1400 - 750 (5 x 150) = 650 lbs) or 295 kg (635 - 340 (5 x 68) = 295 kg).
5. Determine the combined cargo weight being loaded on the vehicle. That weight must not exceed the available cargo load capacity calculated in Step 4.

**⚠ Warning:** Trunks are the preferred places to carry objects. In a collision, or during hard braking and sharp turns, loose items in the cabin could injure occupants.

## Example Load Limit Calculations

How much cargo Model S can carry depends on the number and weight of passengers. The following calculated load limit examples assume passengers weigh 150 lbs (68 kg). If passengers weigh more or less, available cargo weight decreases or increases respectively.

### Driver and one passenger

Description	Total
Vehicle capacity weight	954 lbs (433 kg)
Subtract occupant weight (2 x 150 lbs/68 kg)	300 lbs (136 kg)
Available cargo weight	654 lbs (297 kg)

### Driver and four passengers

Description	Total
Vehicle capacity weight	954 lbs (433 kg)
Subtract occupant weight (5 x 150 lbs/68 kg)	750 lbs (340 kg)
Available cargo weight	204 lbs (93 kg)

The cargo weight should be distributed between the front and rear trunks.

**⚠ Caution:** Do not exceed the maximum front trunk load weight of 300 lbs (136 kg).

**⚠ Caution:** Never load more than 175 lbs (80 kg) on the rear load floor (above the lower trunk compartment) or more than 285 lbs (130 kg) in the lower trunk compartment. Doing so can cause damage.

## Towing a Trailer

**⚠ Warning:** Do not use Model S for towing purposes. Model S does not support a trailer hitch. Installing one could cause damage and increase the risk of a collision.

**⚠ Caution:** Using Model S for towing may void the warranty.



## Roof Racks

If Model S is equipped with a sunroof, you can carry up to 165 lbs (75 kg) using a Tesla-approved roof rack (see [Parts and Accessories](#) on page 168). A Model S equipped with a body color roof or a glass roof is incompatible with roof racks.



**Caution:** Do not use roof racks, or place any load, on the roof of a Model S that is equipped with a solid or all glass roof. Doing so can cause significant damage.



## Exterior Dimensions

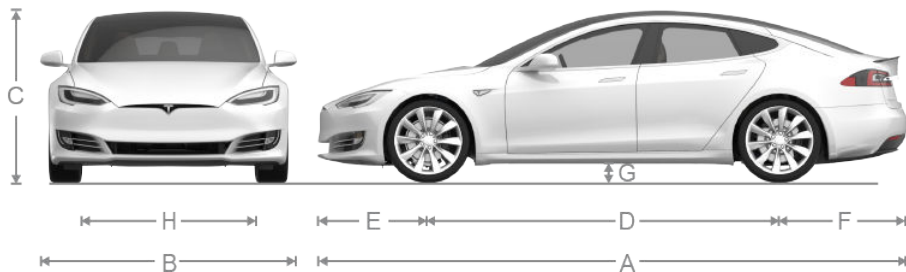

A	Overall Length	196 in	4,970 mm
B	Overall Width (including mirrors)	86.2 in	2,189 mm
	Overall Width (excluding mirrors)	77.3 in	1,964 mm
C	Overall Height	56.9 in*	1,445 mm*
D	Wheel Base	116.5 in	2,960 mm
E	Overhang - Front	36.9 in	929 mm
F	Overhang - Rear	42.55 in	1,081 mm
G	Ground Clearance - Coil Suspension (Rear Wheel Drive vehicle)	5.5 in*	139.7 mm*
G	Ground Clearance - Coil Suspension (All-Wheel Drive vehicle)	5.3 in*	134.6 mm*
G	Ground Clearance - Air Suspension	4.6 - 6.3 in	116.8 - 160 mm
H	Track - Front	65.4 in	1,662 mm
	Track - Rear	66.9 in	1,700 mm

\*Values are approximate. Dimensions can vary depending on a vehicle's options and various other factors.

## Interior Dimensions

Head Room	Front	38.8 in	986 mm
	Rear	35.3 in	897 mm
Leg Room	Front	42.7 in	1,085 mm
	Rear	35.4 in	899 mm
Shoulder Room	Front	57.7 in	1,466 mm
	Rear	55 in	1,397 mm
Hip Room	Front	55 in	1,397 mm
	Rear	54.7 in	1,389 mm



## Cargo Volume

Total cargo volume (rear seats not folded)	28.4 cu ft	804.2 L
Rear cargo volume	26.3 cu ft	744.7 L
Rear cargo volume (with seats folded down)	58.1 cu ft	1,645.2 L
Front cargo volume	2.1 cu ft	59.5 L

## Weights

Curb Weight* - 60/70/75	4,469 lbs	2,027 kg
Curb Weight* - 60D/70D/75D	4,647 lbs	2,108 kg
Curb Weight* - 90D	4,736 lbs	2,148 kg
Curb Weight* - P90D	4,841 lbs	2,196 kg
Curb Weight* - 100D	4,883 lbs	2,215 kg
Curb Weight* - P100D	4,941 lbs	2,241 kg
GVWR** - 60/70/75	5,710 lbs	2,590 kg
GVWR** - 60D/70D/75D	5,732 lbs	2,600 kg
GVWR** - 90D	5,820 lbs	2,640 kg
GVWR** - P90D	5,886 lbs	2,670 kg
GVWR** - 100D	5,939 lbs	2,694 kg
GVWR** - P100D	5,997 lbs	2,720 kg
Gross Axle Weight Rating - Front	2,866 lbs	1,300 kg
Gross Axle Weight Rating- Rear	3,196 lbs	1,450 kg
Trailer Towing	Not permissible	

\*Curb Weight = weight of the vehicle with correct fluid levels, no occupants and no cargo

\*\*GVWR = Gross Vehicle Weight Rating

**Note:** Values are approximate. Weights can vary depending on a vehicle's options.



## Motors

Type	AC induction motor, liquid-cooled, with variable frequency drive
Nominal Voltage	320 Volts
Maximum speed of large motors: - rear motor on all Rear Wheel Drive vehicles - rear motor on Performance All-Wheel Drive vehicles	16,000 rpm
Maximum speed of small motors: - front motor on all All-Wheel Drive vehicles - rear motor on non-Performance All-Wheel Drive vehicles	18,000 rpm
Maximum net power* and motor speed of large motors	Base: 285 kW @ 6,850 rpm Performance: 375 kW @ 5,900 rpm
Maximum net power* and motor speed of small motors	193 kW @ 6100 rpm
Maximum torque of large motors	Base: 440 Nm Performance: 650 Nm
Maximum torque of small motors	330 Nm
*Tested in accordance with ECE R85	

## Transmission

Type	Single speed fixed gear
Overall Final Drive Ratio	Small motor: 9.325:1 Large motor: 9.734:1
Reverse Gear	Reverse direction of motor, limited to 15 mph (24 km/h)

## Steering

Type	Rack and pinion with electronic power steering, speed sensitive
Number of turns lock to lock	2.05
Turning Circle (curb to curb)	38.8 ft (11.8 m)



**Brakes**

Type	4-wheel anti-lock braking system (ABS) with Electronic Brake Force Distribution, Integrated Advanced Stability Control and Electronic Accelerator pedal actuated regenerative braking system
Calipers	Four piston fixed
Rotor Diameters (ventilated)	Front: 13.98"/355 mm Rear: 14.37"/365 mm
Front Rotor thickness	New: 1.26"/32 mm Service limit: 1.18"/30 mm
Rear Rotor thickness	New: 1.10"/28 mm Service limit: 1.02"/26 mm
Front Brake Pad Thickness (excluding back plate)	0.393"/10 mm
Rear Brake Pad Thickness (excluding back plate)	0.354"/9 mm
Parking brake	Electrically actuated parking brake calipers

**Suspension**

Front	Independent, double wishbone, air spring or coil spring/telescopic damper, sway bar
Rear	Independent, multi-link, air spring or coil spring/telescopic damper, sway bar (air suspension vehicles only)

**Battery - 12V**

Rating	33 amp hour or higher
Voltage and Polarity	12V negative (-) ground

**Battery - High Voltage**

Type	Liquid-cooled lithium ion (Li-ion)
Rating	60, 70, 75, 85, 90, or 100 kWh (at beginning of life)
Nominal Voltage - 85, 90, and 100 kWh Nominal Voltage - 60, 70, and 75 kWh	350 V DC 300 V DC
Temperature Range	Do not expose Model S to ambient temperatures above 140° F (60° C) or below -22° F (-30° C) for more than 24 hours at a time.



## Wheel Specifications (Factory)

Wheel Type	Location	Size	Offset
19"	Front	8.0J x 19	1.575" 40 mm
	Rear	8.0J x 19	1.575" 40 mm
21" - Silver (standard)	Front	8.5J x 21	1.575" 40 mm
21" - Grey (standard)	Rear	8.5J x 21	1.575" 40 mm
21" - Silver and Grey (optional) Performance Plus vehicles	Rear	9.0J x 21	1.575" 40 mm

Lug Nut Torque	129 lb. ft (175 Nm)
Lug Nut Socket Size	21 mm
<b>Note:</b> For instructions on how to jack/lift Model S, see <a href="#">Jacking and Lifting</a> on page 167.	

## Tire Specifications (Factory)

Tire Type	Location	Size
19" wheels	All	P245/45R19
21" wheels	Front	P245/35R21
	Rear	P265/35R21*
*On a Performance All-Wheel Drive vehicle, the width of the rear tires may vary depending on date of manufacture. Some vehicles may be equipped with P245/35R21 tires on both front and rear.		
Tire pressures vary depending on the type of tires fitted. Refer to the tire pressures printed on the Tire and Loading Information label. This label is located on the center door pillar and is visible when the driver's door is open (see <a href="#">Maintaining Tire Pressures</a> on page 153).		
Winter tires can be purchased from a Tesla store.		



## Understanding Tire Markings

Laws require tire manufacturers to place standardized information on the sidewall of all tires. This information identifies and describes the fundamental characteristics of the tire. It also provides the tire identification number (TIN) for certification of safety standards, and in case of a recall.



1	Tire category. P indicates that the tire is for passenger vehicles.
2	Tire width. This 3-digit number is the width (in millimeters) of the tire from sidewall edge to sidewall edge.
3	Aspect ratio. This 2-digit number is the sidewall height as a percentage of the tread width. So, if the tread width is 205 mm, and the aspect ratio is 50, the sidewall height is 102 mm.
4	Tire construction. R indicates that the tire is of Radial ply construction.
5	Wheel diameter. This 2-digit number is the diameter of the wheel rim in inches.
6	Load index. This 2 or 3-digit number is the weight each tire can support. This number is not always shown.
7	Speed rating. When stated, indicates the maximum speed (in mph) at which the tire can be used for extended periods. Q=99 mph (160 km/h), R=106 mph (170 km/h), S=112 mph (180 km/h), T=118 mph (190 km/h), U=124 mph (200 km/h), H=130 mph (210 km/h), V=149 mph (240 km/h), W=168 mph (270 km/h), Y=186 mph (300 km/h).
8	Tire composition and materials. The number of plies in both the tread area and the sidewall area indicates how many layers of rubber coated material make up the structure of the tire. Information is also provided on the type of materials used.
9	Maximum tire load. The maximum load which can be carried by the tire.



10	Maximum permissible inflation pressure. This pressure should not be used for normal driving.
11	U.S. DOT Tire Identification Number (TIN). Begins with the letters DOT and indicates that the tire meets all federal standards. The next 2 digits/letters represent the plant code where it was manufactured, and the last 4 digits represent the week and year of manufacture. For example, the number 1712 is used to represent the 17th week of 2012. The other numbers are marketing codes used at the manufacturer's discretion. This information can be used to contact consumers if a tire defect requires a recall.
12	Treadwear grade. This number indicates the tire's wear rate. The higher the treadwear number is, the longer it should take for the tread to wear down. A tire rated at 400, for example, lasts twice as long as a tire rated at 200.
13	Traction grade. Indicates a tire's ability to stop on wet roads. A higher graded tire should allow you to stop your vehicle in a shorter distance than a tire with a lower grade. Traction is graded from highest to lowest as AA, A, B, and C.
14	Temperature grade. The tire's resistance to heat is grade A, B, or C, with A indicating the greatest resistance. This grading is provided for a correctly inflated tire, which is being used within its speed and loading limits.



## Uniform Tire Quality Grading

The following information relates to the tire grading system developed by the National Highway Traffic Safety Administration (NHTSA), which grades tires by tread wear, traction and temperature performance. Tires that have deep tread, and winter tires, are exempt from these marking requirements.

Where applicable, quality grades are found on the tire's sidewall between the tread shoulder and maximum section width. For example:

- TREADWEAR 180
- TRACTION AA
- TEMPERATURE A

The quality grades are described next.

**Note:** In addition to the marking requirements, passenger car tires must conform to Federal Safety Requirements.

### Treadwear

The treadwear grade is a comparative rating based on the wear rate of the tire when tested under controlled conditions on a specified government test course.

For example, a tire graded 150 wears one and a half times better on a government test course than a tire graded 100. The relative performance of tires depends on the actual conditions of their use, however, and can depart significantly from the norm due to variations in driving habits, service practices, road characteristics, and climate.

### Traction

The traction grades, from highest to lowest, are: AA, A, B, and C. These grades represent a tire's ability to stop on wet pavement as measured under controlled conditions on test surfaces of asphalt and concrete. A tire marked C might have poor traction performance.

**Warning:** Defective tires are dangerous. Do not drive if a tire is damaged, excessively worn, or is inflated to an incorrect pressure. The safety of the vehicle and occupants can be adversely affected. Check tires regularly for wear and to ensure there are no cuts, bulges or exposure of the ply/cord structure.

**Warning:** The traction grade assigned to the tire is based on straight-ahead braking tests, and does not include:

acceleration, cornering, hydroplaning or peak traction characteristics.

### Temperature

The temperature grades are A (the highest), B, and C, representing the tire's resistance to the generation of heat and its ability to dissipate heat when tested under controlled conditions on a specified indoor laboratory test wheel. Sustained high temperature can cause the tire to degenerate and reduce tire life, and excessive temperature can lead to sudden tire failure.

The grade C corresponds to the minimum level of performance that all passenger car tires must meet under the Federal Motor Safety Standard No. 109. Grades B and A represent levels of performance on the laboratory test wheel that exceed the minimum requirements.

**Warning:** A tire's temperature grade is established for a tire that is properly inflated and not overloaded. Excessive speed, under-inflation, or excessive loading, either separately or in combination, can cause heat buildup and possible tire failure.



## Tire and Loading Glossaries

### General Wheel and Tire Terms

Accessory Weight	The combined weight (in excess of those items replaced) of items available as factory installed equipment.
Bead	The inner edge of a tire that is shaped to fit to the rim and form an air tight seal. The bead is constructed of steel wires which are wrapped, or reinforced, by the ply cords.
Cold Tire Pressure	The air pressure in a tire that has been standing in excess of three hours, or driven for less than one mile.
Curb Weight	The weight of a standard vehicle, including any optional equipment fitted, and with the correct fluid levels.
Gross Vehicle Weight	The maximum permissible weight of a vehicle with driver, passengers, load, luggage, and equipment.
kPa (kilo pascal)	A metric unit used to measure pressure. One kilo pascal equals approximately 0.145 psi.
Maximum Inflation Pressure	The maximum pressure to which the tire should be inflated. This pressure is given on the tire side wall in psi (lbf/in <sup>2</sup> ). <b>⚠ Caution:</b> This pressure marked on the tire is the maximum allowed by the tire manufacturer. It is not the pressure Tesla recommends using for Model S.
Maximum Loaded Vehicle Weight	The sum of curb weight, accessory weight, vehicle capacity weight, and production options weight.
Production Options Weight	The combined weight of options installed which weigh in excess of 3 lb more than the standard items that they replaced, and are not already considered in curb or accessory weights.
PSI (lbf/in <sup>2</sup> )	Pounds per square inch (the unit used to measure tire pressure).
Recommended Tire Inflation Pressure	Tire inflation pressure, established by Tesla, which is based on the type of tires that are mounted on the vehicle at the factory. This information can be found on the Tire and Loading Information label located on the door pillar.
Rim	The metal support for a tire, or tire and tube, upon which the tire beads are seated.
Vehicle Capacity Weight	The number of seats multiplied by 150 lbs plus the rated amount of load/luggage.

### Load Carrying Definitions

Normal occupant weight	68 kilograms (150 lbs) times the number of occupants specified in the second column of the tables for calculating load limits (see <a href="#">Vehicle Loading</a> on page 170).
Occupant distribution	Distribution of occupants in a vehicle.
Passenger car tire	A tire intended for use on passenger cars, multipurpose passenger vehicles, and trucks, that have a gross vehicle weight rating (GVWR) of 10,000 pounds or less.



Rim diameter	Nominal diameter of the bead seat.
Rim size designation	Rim diameter and width.
Rim type designation	The manufacturing industry's designation for a rim by style or code.
Rim width	Nominal distance between the rim's flanges.
Vehicle maximum load on the tire	Load on an individual tire that is determined by distributing to each axle its share of the maximum loaded vehicle weight and dividing by two.
Vehicle normal load on the tire	Load on an individual tire that is determined by distributing to each axle its share of the curb weight, accessory weight, and normal occupant weight and dividing by two.

## Pneumatic Radial Tire Definitions

Bead separation	A breakdown of the bond between components in the bead.
Bias ply tire	A pneumatic tire in which the ply cords that extend to the beads are laid at alternate angles substantially less than 90 degrees to the center line of the tread.
Carcass	The tire structure, except tread and sidewall rubber which, that when inflated, bears the load.
Chunking	The breaking away of pieces of the tread or sidewall.
Cord	The strands forming the plies in the tire.
Cord separation	The parting of cords from adjacent rubber compounds.
Cracking	Any parting within the tread, sidewall, or inner liner of the tire extending to cord material.
Extra load tire	A tire designed to operate at higher loads and higher inflation pressure than the corresponding standard tire.
Groove	The space between two adjacent tread ribs.
Inner liner	The layer(s) forming the inside surface of a tubeless tire that contains the inflating medium within the tire.
Inner liner separation	The parting of the inner liner from cord material in the carcass.
Load rating	The maximum load that a tire is rated to carry for a given inflation pressure.
Maximum load rating	The load rating for a tire at the maximum permissible inflation pressure for that tire.
Measuring rim	The rim on which a tire is fitted for physical dimension requirements.
Open splice	Any parting at any junction of tread, sidewall, or inner liner that extends to the cord material.
Outer diameter	The overall diameter of an inflated new tire.



Overall width	The linear distance between the exteriors of the sidewalls of an inflated tire, including elevations due to labeling, decorations, or protective bands or ribs.
Ply	A layer of rubber-coated parallel cords.
Ply separation	A parting of rubber compound between adjacent plies.
Pneumatic tire	A mechanical device made of rubber, chemicals, fabric and steel or other materials, that, when mounted on an automotive wheel, provides the traction and contains the gas or fluid that sustains the load.
Radial ply tire	A pneumatic tire in which the ply cords that extend to the beads are laid at substantially 90 degrees to the center line of the tread.
Reinforced tire	A tire designed to operate at higher loads and at higher inflation pressures than the corresponding standard tire.
Section width	The linear distance between the exteriors of the sidewalls of an inflated tire, excluding elevations due to labeling, decoration, or protective bands.
Sidewall	The portion of a tire between the tread and bead.
Sidewall separation	The parting of the rubber compound from the cord material in the sidewall.
Snow tire	A tire that attains a traction index equal to or greater than 110, compared to the ASTM E1136-93 (re-approved 2003, incorporated by reference, see §571.5) Standard Reference Test Tire when using the snow traction test as described in ASTM F1805-00 (incorporated by reference, see §571.5), and that is marked with an Alpine Symbol specified in S5.5(i) on at least one sidewall.
Test rim	The rim on which a tire is fitted for testing, and may be any rim listed as appropriate for use with that tire.
Tread	The portion of a tire that comes into contact with the road.
Tread rib	A tread section running around the circumference of a tire.
Tread separation	The pulling away of the tread from the tire carcass.
Tread wear indicators (TWI)	The projections within the principal grooves designed to give a visual indication of the degrees of wear of the tread.
Wheel-holding fixture	The fixture used to hold the wheel and tire assembly securely during testing.





## Contacting Roadside Assistance

Tesla Roadside Assistance is available to you, 24 hours a day, 365 days a year, for the duration of your warranty period.

When contacting Tesla Roadside Assistance, please provide:

- The Vehicle Identification Number (VIN). The VIN is displayed when you touch the Tesla "T" at the top of the touchscreen. The VIN can also be seen on the upper dashboard by looking through the driver's side of the windshield.
- Your exact location.
- The nature of the problem.

Tesla Roadside Assistance is available to speak with roadside service professionals 24/7/365 to answer any questions and explain the proper procedure for transporting your Model S.

### Regional Phone Number(s)

Mexico: [1-800-228-8145](tel:1-800-228-8145)

United States and Canada: [1-877-79TESLA](tel:1-877-79TESLA) ([1-877-798-3752](tel:1-877-798-3752))

**Note:** The phone number is also available by touching the Tesla "T" at the top center of the touchscreen.



## When Transporting Model S

Always transport Model S with all four tires off the ground. A flatbed truck or comparable transport vehicle is recommended. A wheel lift and dolly can be used only when transporting Model S for a very short distance to reposition the vehicle for loading onto a flatbed truck or comparable transport vehicle (for example, the vehicle is located in a low-clearance garage) or if otherwise specified by Tesla. When transporting, whether on a flatbed truck or using a wheel lift and dolly, Model S can face either direction.

Do not transport Model S using any other method unless specified by Tesla. Follow the steps provided and observe all warnings and cautions. Damage caused by transporting your vehicle is not covered by the warranty.

**Note:** The following illustrations are for demonstration purposes only.

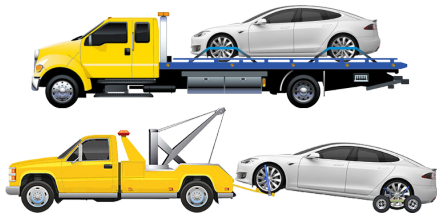

**Warning:** Model S is equipped with high voltage components (see [High Voltage Components](#) on page 142). Before transporting Model S as a result of an event (such as a collision) that may have compromised a high voltage component, it is important to assume that these components are energized. Always follow high voltage safety precautions (wearing personal protective equipment, etc.) until emergency response professionals have evaluated the vehicle and can accurately confirm that all high voltage systems are no longer energized. Failure to do so may result in serious injury or death.

## Disable Self-Leveling (air suspension vehicles only)

If Model S is equipped with Smart Air Suspension, it automatically self-levels, even when power is off. To prevent damage, you must activate Jack mode to disable self-leveling:

1. Touch **Controls** > **Suspension** on the touchscreen.

2. Press the brake pedal, then touch **Very High** to maximize height.
3. Touch **Jack**.

**Note:** Jack mode cancels when Model S is driven over 4 mph (7 km/h).

**Warning:** Failure to activate Jack mode on a Model S equipped with Smart Air Suspension can result in the vehicle becoming loose during transport, which may cause significant damage.

## Activate Tow Mode

Model S may automatically shift into Park when it detects the driver leaving the vehicle, even if it has previously been shifted into Neutral. To keep Model S in Neutral (which disengages the parking brake), you must use the touchscreen to activate Tow mode:

1. Shift into Park.
2. Chock the tires or otherwise ensure Model S is stable.
3. Press and hold the brake pedal, then on the touchscreen touch **Controls** > **Service** > **Tow Mode**.



When Tow mode is active, Model S displays this indicator light on the instrument panel, along with a message telling you that Model S is free-rolling.

To cancel Tow Mode, shift Model S into Park.

**Caution:** If the electrical system is not working, and you therefore cannot release the electric parking brake, attempt to jump start the 12V battery. For instructions, call Tesla Roadside Assistance. If a situation occurs where you cannot disengage the parking brake, use a self-loading dolly or tire skates. Before doing so, always check the manufacturer's specifications and recommended load capacity.

## Pull onto the Flatbed Truck

The method used to pull Model S onto the truck depends on whether a tow eye is available (provided with your vehicle at time of purchase).

If equipped with a tow eye:

1. Locate the tow eye.



- Remove the tow eye cover by inserting a small flat screwdriver into the slot located along the top of the cover, then prying gently to release the cover from the top snap

**⚠ Caution:** Keep the tow eye cover in a safe place so you can replace it when towing is complete.

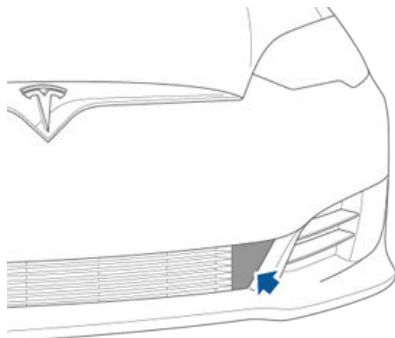

- Fully insert the tow eye into the opening, then turn it **counter-clockwise** until securely fastened.

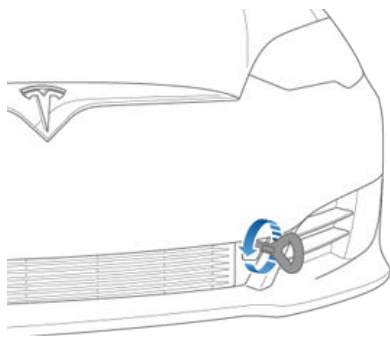

- Attach the winch cable to the tow eye.
- ⚠ Caution:** Before pulling, make sure the tow eye is securely tightened.
- Pull Model S slowly onto the flatbed truck.
- Shift Model S into Park by pressing the button on the end of the gear selector.

If not equipped with a tow eye:

- Attach the tow straps to the large hole on each of the rearmost lower suspension arms underneath the front of the vehicle.

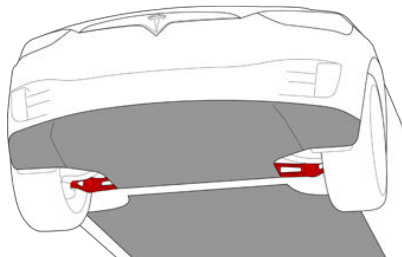

- To protect the underbody from any damage, place a protective barrier (such as a piece of wood) between the tow strap and the underbody.
- Pull Model S slowly onto the flatbed truck.
- Shift Model S into Park by pressing the button on the end of the gear selector.

## Secure the Tires

The vehicle's tires must be secured onto the truck using the eight-point tie-down method.

- Ensure any metal parts on the tie-down straps do not contact painted surfaces or the face of the wheels.
- Do not place tie-down straps over body panels or through the wheels.

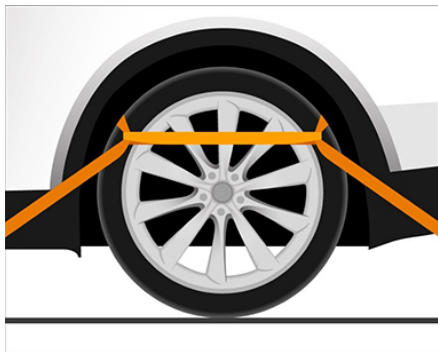

- ⚠ Caution:** Attaching tie-down straps to the chassis, suspension or other parts of the vehicle's body may cause damage.



But wait, there's more! Below is a list of the Easter Eggs that have been discovered so far and how to access them. Alternatively, touch the Tesla "T" (top center of the touchscreen) then drag the **About Your Tesla** box downwards for one-touch access to all discovered Easter Eggs.

For This...	Do This...
Atari Games	Feeling nostalgic? While in Park, access Atari games from your Easter Egg tray then select a game from the menu at the top, enter some quarters, and touch <b>Start</b> to play. Touch <b>Full</b> to enter full-screen and triple-tap your touchscreen to exit full-screen. Note that, depending on the game, you may need to use your steering wheel buttons to play.
Santa Mode	"What have you been longing for?" Enjoy the holidays year-round with this one! Simply initiate a voice command and say "Ho Ho Ho". Or, if you are feeling extra sour, you can say "Ho Ho Ho Not Funny" instead.
Rainbow Road	Need more cowbell? Visit Rainbow Road by pulling the cruise stalk toward you four times in quick succession while Autosteer is enabled.
Sketchpad	Triple-tap the Tesla "T" (top center of the touchscreen) and channel your inner Picasso. Show us what you got! Touch <b>Publish</b> to submit your artistic compositions to Tesla for critiquing.
Mars	Press and hold the Tesla "T" (top center of the touchscreen) then enter <b>mars</b> in the access code popup. The map shows your Model S as a rover on the Martian landscape, and the <b>About Your Tesla</b> box displays SpaceX's interplanetary spaceship.
007 (air suspension vehicles only)	Press and hold the Tesla "T" (top center of the touchscreen) and enter <b>007</b> in the access code popup. You are no longer a "Driver", you're a "Diver"! Touch <b>Controls</b> > <b>Suspension</b> to change your depth.
Ludicrous Speed (P100D vehicles only)	Press and hold the <b>Ludicrous</b> setting ( <b>Controls</b> > <b>Driving</b> > <b>Acceleration</b> > <b>Ludicrous</b> ) for approximately five seconds. Touch <b>Yes, bring it on!</b> if you want to go fast. To display power and acceleration readings on the instrument panel, press either scroll button briefly until the available options are displayed. Then, roll the scroll button to highlight <b>Readout</b> then press the scroll button again.
The Answer to the Ultimate Question of Life, The Universe, and Everything	Rename your car to <b>42</b> (see <a href="#">Naming Your Vehicle</a> on page 115) and notice the new name of your Model S.
Rainbow Charge Port	When Model S is locked and charging, press the button on the mobile connector ten times in quick succession. Neat, huh?
Romance Mode	You can't roast chestnuts by an open fire in your car, but you can still cozy up with your loved ones by this virtual fireplace. While in Park, access Romance Mode from your Easter Egg tray. Queue the music and get your romance on!



### Emissions Testing Mode

Holiday fun can come in surprising ways. Access Emissions Testing Mode from your Easter Egg tray, then select your preferred fart style and a target seat. Activate by pressing the left scroll wheel button when you're ready to "release" your prank.



## Document Applicability

Owner information is updated regularly to reflect updates to your vehicle. However, in some cases, recently released features may not be described. To display information about recently released features, view the Release Notes on the touchscreen. Release Notes are displayed on the touchscreen after a software update, and can be displayed at any time by touching the Tesla "T" at the top of the touchscreen, then touching the Release Notes link. If information related to how to use the touchscreen conflicts with information in the Release Notes, the Release Notes take precedence.

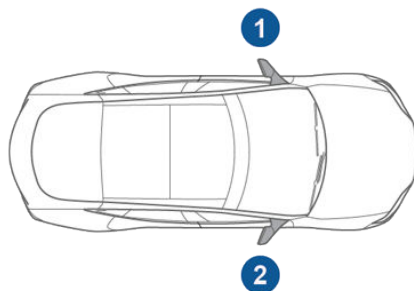

## Illustrations

Illustrations are provided for demonstration purposes only. Depending on vehicle options, software version, region of purchase, and specific settings, your vehicle may appear slightly different. Although the owner information is applicable to both right-hand drive and left-hand drive vehicles, many illustrations show only left-hand drive vehicles. However, the essential information that the illustrations are providing is correct.

## Errors or Inaccuracies

All specifications and descriptions are known to be accurate at time of publishing. However, because continuous improvement is a goal at Tesla, we reserve the right to make product modifications at any time. To communicate any inaccuracies or omissions, or to provide general feedback or suggestions regarding the quality of this owner information, send an email to [OwnersManualFeedback@Tesla.com](mailto:OwnersManualFeedback@Tesla.com).

## Location of Components

Owner information may specify the location of a component as being on the left or right side of the vehicle. As shown, left (1) and right (2) represent the side of the vehicle when sitting inside.

## Copyrights and Trademarks

All information in this document and all vehicle software is subject to copyright and other intellectual property rights of Tesla, Inc. and its licensors. This material may not be modified, reproduced or copied, in whole or in part, without the prior written permission of Tesla, Inc. and its licensors. Additional information is available upon request. Tesla uses software created by the Open Source community. Please visit Tesla's Open Source software website at <http://www.tesla.com/opensource>. HD Radio is a registered trademark of iBiquity Digital Corporation. The following are trademarks or registered trademarks of Tesla, Inc. in the United States and other countries:

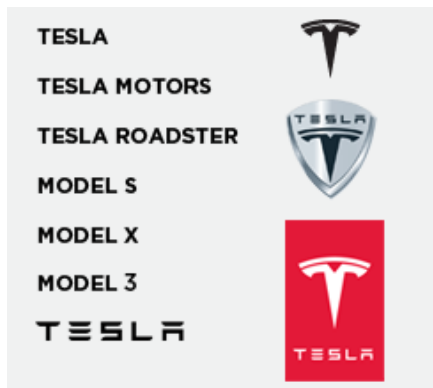

All other trademarks contained in this document are the property of their respective owners and their use herein does not imply sponsorship or endorsement of their products or services. The unauthorized use of any trademark displayed in this document or on the vehicle is strictly prohibited.



## Event Data Recorder (EDR)

Model S is equipped with an event data recorder (EDR). The main purpose of an EDR is to record, in certain crash or near crash-like situations, such as an air bag deployment or hitting a road obstacle, data that will assist in understanding how a vehicle's systems performed. The EDR is designed to record data related to vehicle dynamics and safety systems for a short period of time, typically 30 seconds or less. The EDR in Model S is designed to record data such as:

- How various systems in your vehicle were operating;
- Whether or not the driver and passenger safety belts were buckled/fastened;
- How far (if at all) the driver was depressing the accelerator and/or brake pedal; and,
- How fast the vehicle was traveling.

The data can help provide a better understanding of the circumstances in which crashes and injuries occur.

**Note:** EDR data is recorded by your vehicle only if a non-trivial crash situation occurs; no data is recorded by the EDR under normal driving conditions and no personal data (e.g., name, gender, age, and crash location) is recorded. However, other parties, such as law enforcement, could combine the EDR data with the type of personally identifying data routinely acquired during a crash investigation.

To read data recorded by an EDR, special equipment is required, and access to the vehicle or the EDR is needed. In addition to the vehicle manufacturer, other parties, such as law enforcement, that have the special equipment, can read the information if they have access to the vehicle or the EDR.

## Vehicle Telematics

Model S is equipped with electronic modules that monitor and record data from various vehicle systems, including the motor, Autopilot components, Battery, braking and electrical systems. The electronic modules record information about various driving and vehicle conditions, including braking, acceleration, trip and other related information regarding your vehicle. These modules also record information about the vehicle's features such as charging events and status, the enabling/disabling of various systems, diagnostic trouble codes, VIN, speed, direction and location.

The data is stored by the vehicle and may be accessed, used and stored by Tesla service technicians during vehicle servicing or periodically transmitted to Tesla wirelessly through the vehicle's telematics system. This data may be used by Tesla for various purposes, including, but not limited to: providing you with Tesla telematics services; troubleshooting; evaluation of your vehicle's quality, functionality and performance; analysis and research by Tesla and its partners for the improvement and design of our vehicles and systems; and as otherwise may be required by law. In servicing your vehicle, Tesla can potentially resolve issues remotely simply by reviewing your vehicle's data log.

Tesla's telematics system wirelessly transmits vehicle information to Tesla on a periodic basis. The data is used as previously described and helps ensure the proper maintenance of your vehicle. Additional Model S features may use your vehicle's telematics system and the information provided, including features such as charging reminders, software updates, and remote access to, and control of, various systems of your vehicle.

Tesla does not disclose the data recorded in your vehicle to any third party except when:

- An agreement or consent from the vehicle's owner (or the leasing company for a leased vehicle) is obtained.
- Officially requested by the police or other authorities.
- Used as a defense for Tesla in a lawsuit.
- Ordered by a court of law.
- Used for research purposes without disclosing details of the vehicle owner or identification information.



- Disclosed to a Tesla affiliated company, including their successors or assigns, or our information systems and data management providers.

In addition, and subject to local law, Tesla does not disclose the data recorded to an owner unless it pertains to a non-warranty repair service and in this case, will disclose only the data that is related to the repair. For additional information regarding how Tesla processes data collected from your vehicle, please review Tesla's privacy policy at [www.tesla.com/about/legal](http://www.tesla.com/about/legal).

## Data Sharing

For quality assurance and to support the continuous improvement of advanced features such as Autopilot, Tesla measures road segment data of all participating vehicles. All Tesla vehicles can learn from the experience of the billions of miles that Tesla vehicles have driven. Although Tesla shares this data with partners that contribute similar data, the data does not include any personally identifiable information about you or your vehicle. To allow data sharing, touch **Controls > Safety & Security > Data Sharing**, touch the **Yes** buttons to confirm that you agree to allow Tesla to collect the associated type of data, then submit your response.

**Note:** Although Model S uses GPS in connection with driving and operation, as discussed in this owner's manual, Tesla does not record or store vehicle-specific GPS information. Consequently, Tesla is unable to provide historical information about a vehicle's location (for example, Tesla is unable to tell you where Model S was parked/traveling at a particular date/time).

## Quality Control

You might notice a few miles/km on the odometer when you take delivery of your Model S. This is a result of a comprehensive testing process that ensures the quality of your Model S.

The testing process includes extensive inspections during and after production. The final inspection takes place at Tesla and includes a road test conducted by a technician.

## California Proposition 65

- Warning:** Operating, servicing and maintaining a passenger vehicle or off-highway motor vehicle can expose you to chemicals including phthalates and lead, which are known to the State of California to cause cancer and birth defects or other reproductive harm. To minimize exposure, wear gloves or wash your hands frequently when servicing your vehicle. For more information go to: [www.P65Warnings.ca.gov/passenger-vehicle](http://www.P65Warnings.ca.gov/passenger-vehicle).
- Warning:** Certain components of this vehicle such as airbag modules and seat belt pre-tensioners may contain Perchlorate Material. Special handling may be required for service or vehicle end of life disposal. See [www.dtsc.ca.gov/hazardouswaste/perchlorate](http://www.dtsc.ca.gov/hazardouswaste/perchlorate).
- Warning:** Battery posts, terminals, and related accessories contain lead and lead compounds. Wash hands after handling.





## Contacting Tesla

For detailed information about your Model S, go to [www.tesla.com](http://www.tesla.com), and log on to your Tesla Account, or sign up to get an account.

If you have any questions or concerns about your Model S, call 1-877-79TESLA (1-877-798-3752).

**Note:** You can also use voice commands to provide feedback to Tesla. Say "Note", "Report", "Bug note", or "Bug report" followed by your brief comments. Model S takes a snapshot of its systems, including your current location, vehicle diagnostic data, and screen captures of the touchscreen and instrument panel. Tesla periodically reviews these notes and uses them to continue improving Model S.

## Reporting Safety Defects - US

If you believe that Model S has a defect which could cause a crash or could cause injury or death, you should immediately inform the National Highway Traffic Safety Administration (NHTSA) in addition to notifying Tesla.

If NHTSA receives similar complaints, it may open an investigation. If it finds that a safety defect exists in a group of vehicles, it may order a recall and remedy campaign. However, NHTSA cannot become involved in individual problems between you, your dealer, or Tesla.

To contact NHTSA, you may call the Vehicle Safety Hotline toll-free at 1-888-327-4236 (TTY: 1-800-424-9153); go to [www.safercar.gov](http://www.safercar.gov); or write to: Administrator, National Highway Traffic Safety, 1200 New Jersey Avenue SE., Washington, DC 20590. You can also obtain other information about motor vehicle safety from [www.safercar.gov](http://www.safercar.gov).

## Reporting Safety Defects - Canada

If you believe that your Model S has a defect which could cause a crash or could cause injury or death, you should immediately inform Transport Canada, in addition to notifying Tesla. To contact Transport Canada, call their toll-free number: 1-800-333-0510.



## Key and Passive Unlocking System

### FCC Certification

Model Number	Mfr	MHz	Tested For
A-0749G02	Pektron	315	USA Canada Mexico Taiwan
A-0749G12	Pektron	315	USA Canada Mexico Taiwan

Per FCC ID AQO-002, the device(s) listed above complies with Part 15 of the FCC rules. Operation is subject to the following two conditions:

1. This device may not cause harmful interference, and
2. This device must accept any interference received, including interference that may cause undesired operation.

Changes or modifications not expressly approved by Tesla could void your authority to operate the equipment.

### IC Certification

The following device is used in vehicles in Canada:

- Key fob Model Number: 002 and A-0749G12 (315 MHz)
- Key fob Manufacturer: Pektron

Per IC 10176A-002, this device complies with Industry Canada license-exempt RSS standard(s). Operation is subject to the following two conditions:

1. This device may not cause harmful interference, and
2. This device must accept any interference received, including interference that may cause undesired operation.

### MIC Certification

Model Number	Mfr	MHz	Tested For
A-0749G04/A-0749G14	Pektron	315	Japan

### CE Certification

Model #	Mfr	MHz	Tested For
A-0749G01 and A-0749G11	Pektron	433	Europe Australia New Zealand Singapore South Korea



Model #	Mfr	MHz	Tested For
A-0749G05 and A-0749G15	Pektron	433	China Hong Kong Korea

The devices listed above comply with CE standards. Operation is subject to the following two conditions:

1. This device may not cause harmful interference, and
2. This device must accept any interference received, including interference that may cause undesired operation.

Changes or modifications not expressly approved by Tesla could void your authority to operate the equipment.

## NCC Certification

- Key fob Model Numbers: A-0749G01 (433 MHz), A-0749G02 (315 MHz), and A-0749G12 (315 MHz)
- Key fob Manufacturer: Pektron

According to NCC low-power radio wave radiation rate of motor management measures:

Article XII of the type certified by the low power radio, non-licensed, company, firm or user is not allowed to change the frequency, increase the power or change the characteristics of the original design and function.

Article XIV: The use of low-power radio-frequency devices shall not influence aircraft security and interfere with legal communications; interference phenomenon discovered over time, should be immediately suspended, and improved to no interference before use can continue. Legal communications, referring to the provisions of the Telecommunications Act of radio communications operations. Low-power radio communications shall tolerate radio wave interference from radiated devices, legal or industrial, scientific and medical.

## Tire Pressure Monitoring System

FCC IDs: TZSTPMS201, Z9F-201FS43X

IC ID: 11852A-201FS4X

The tire pressure monitoring system (TPMS) complies with Part 15 of the FCC rules and RSS-210 of Innovation, Science and Economic Development Canada. Operation is subject to the following two conditions:

1. This device may not cause harmful interference, and
2. This device must accept any interference received, including interference that may cause undesired operation.

Changes or modifications not expressly approved by Tesla could void your authority to operate the equipment.

## HomeLink

This device complies with Part 15 of the FCC rules, RSS-210 Industry Canada, and with EU Directive 2014/53/EU.

Operation is subject to the following conditions:

- This device may not cause harmful interference.



- This device must accept any interference received, including interference that may cause undesired operation.

Any changes or modifications to the device not expressly approved by the manufacturer or Tesla could void your authority to operate the equipment.

## Radio Frequency Information

This equipment has been tested and found to comply with the limits for a Class B digital device, pursuant to Part 15 of the FCC Rules. These limits are designed to provide reasonable protection against harmful interference in a residential installation. This equipment generates, uses and can radiate radio frequency energy and, if not installed and used in accordance with the instructions, may cause harmful interference to radio communications. However, there is no guarantee that interference will not occur in a particular installation. If this equipment does cause harmful interference to radio or television reception, which can be determined by turning the equipment off and on, try to correct the interference by one or more of the following measures:

- Reorient or relocate the receiving antenna.
- Increase the separation between the equipment and receiver.
- Connect the equipment into an outlet on a circuit different from that to which the receiver is connected.
- Consult the dealer or an experienced radio/TV technician for help.



## A

ABS (Anti-lock Braking System) [65](#)  
 absolute speed limit [105](#)  
 Acceleration settings [72](#)  
 access panel, removing [164](#)  
 accessories  
     plugging into power socket [19](#)  
 adaptive headlights [55](#)  
 air circulation [118](#)  
 air conditioning [116](#)  
 air distribution [118](#)  
 air filter [121](#)  
 air suspension [134](#)  
 air vents [121](#)  
 airbags [39](#)  
 alarm [136](#)  
 all-season tires [156](#)  
 always connected, setting [75](#)  
 Always Show Estimated Round Trip Energy [125](#)  
 anti-lock braking (ABS) [65](#)  
 audio  
     playing files [127](#)  
     steering wheel buttons [45](#)  
     volume control [127](#)  
 Auto High Beam [55](#)  
 Auto Lane Change [91](#)  
 auto-raising suspension [133](#)  
 automatic emergency braking [103](#)  
 Autopark [95](#)  
 Autopilot  
     Auto Lane Change [91](#)  
     automatic emergency braking [102](#)  
     Autopark [95](#)  
     Autosteer [89](#)  
     blind spot warning [100](#)  
     collision avoidance assist [102](#)  
     forward collision warning [102](#)  
     Navigate on Autopilot [92](#)  
     overtake acceleration [82](#)  
     overview [79](#)  
     side collision warning [100](#)  
     speed assist [105](#)  
     speed limit warning [105](#)  
     staying inside lane markings [100](#)  
     staying within speed limits [105](#)  
     Traffic-Aware Cruise Control [82](#)  
 Autopilot components [79](#)  
 Autosteer [89](#)  
 average range [75](#)

## B

backup camera [77](#)  
 battery (12V)  
     complete discharge [144](#)  
     specifications [176](#)

Battery (high voltage)  
     care of [144](#)  
     coolant [164](#)  
     specifications [176](#)  
     temperature limits [144](#)  
 battery (key), replacing [9](#)  
 bioweapon defense mode [121](#)  
 blind spot warning [100](#)  
 Bluetooth  
     devices, playing audio files from [129](#)  
     general information [131](#)  
     phone, pairing and using [131](#)  
 body repairs [168](#)  
 body touch up [161](#)  
 brake fluid replacement [152](#)  
 brakes  
     automatic in emergencies [103](#)  
     fluid level [165](#)  
     overview of [65](#)  
     specifications [176](#)

## C

cabin temperature control [116](#)  
 Calendar app [135](#)  
 California Proposition [65](#) [191](#)  
 camera (rear view) [77](#)  
 cameras (autopilot) [79](#)  
 car cover [161](#)  
 car status, displaying [45](#), [46](#)  
 car washes [159](#)  
 cargo area [15](#)  
 cargo volume [174](#)  
 carpets, cleaning [160](#)  
 CE certifications [193](#)  
 CHAdeMO [143](#)  
 chains [156](#)  
 change of ownership [115](#)  
 charge port [146](#)  
 charge port light [148](#)  
 charge port manual release [147](#)  
 charge port release lever [147](#)  
 charging  
     charge settings [148](#)  
     components and equipment [142](#)  
     instructions [146](#)  
     public charging stations [143](#)  
     scheduling [148](#)  
     status of [150](#)  
 charging locations, finding [124](#)  
 child protection  
     disabling rear window switches [13](#)  
 child seats  
     cleaning [160](#)  
     installing and using [28](#)  
     Tesla built-in rear facing [35](#)  
 child-protection  
     disabling liftgate and rear door handles [11](#)



- Chill acceleration [72](#)
- cleaning [159](#)
- climate controls [116](#)
- collision avoidance assist [102](#)
- console
  - 12V power socket [19](#)
  - cup holders [20](#)
  - USB ports [19](#)
- consumption chart [75](#)
- contact information
  - roadside assistance [184](#)
  - Tesla [192](#)
- coolant
  - Battery, checking level of [164](#)
  - Battery, replacement interval [152](#)
- copyrights [189](#)
- cruise control [82](#)
- cup holders [20](#)

## D

- dashboard overview [2](#)
- Dashcam [78](#)
- data recording [190](#)
- data sharing [190](#)
- declarations of conformity [193](#)
- delivery mileage [191](#)
- devices
  - Bluetooth, playing audio files [129](#)
  - connecting [19](#)
  - playing audio files from [129](#)
- dimensions [173](#)
- dome (map) lights [53](#)
- door handles [10](#)
- door labels [170](#)
- Door Unlock Mode [10](#)
- doors [8](#)
- doors, opening [8](#)
- drive away locking [11](#)
- Drive gear [51](#)
- driver
  - profiles [43](#)
  - seat adjustment [22](#)
- driving
  - seating position [22](#)
  - starting [49](#)
  - tips to maximize range [75](#)

## E

- Easter Eggs [187](#)
- easy entry, driver profile [43](#)
- EDR (event data recorder) [190](#)
- electric parking brake [66](#)
- emergency braking [102](#)
- emergency flashers [56](#)
- emergency rear door opening [12](#)

- emission label [169](#)
- energy
  - gained from regenerative braking [65](#)
  - range information [57](#)
- Energy app [75](#)
- energy saving mode [75](#)
- energy use predictions (navigating) [125](#)
- Erase & Reset [115](#)
- event data recording [190](#)
- exterior
  - car cover [161](#)
  - cleaning [159](#)
  - dimensions [173](#)
  - lights [53](#)
  - overview [3](#)
  - polishing, touch up, & repair [161](#)

## F

- factory defaults, restoring [115](#)
- factory reset [115](#)
- fan speed, interior [118](#)
- Favorites (Media Player) [129](#)
- Favorites (navigation) [123](#)
- FCC certifications [193](#)
- features, downloading new [140](#)
- firmware (software) updates [140](#)
- flash drives, playing audio files from [129](#)
- flashers, warning [56](#)
- floor mats [161](#)
- fluids
  - replacement intervals [152](#)
  - reservoirs, checking [164](#)
- fog lights [53](#)
- forward collision warning [102](#)
- front passenger detection [41](#)
- front trunk [17](#)

## G

- garage doors, opening [137](#)
- gates, opening [137](#)
- GAWR [170](#)
- gears [51](#)
- glove box [19](#)
- Gross Axle Weight Rating [170](#)
- Gross Vehicle Weight Rating [170](#)
- ground clearance [173](#)
- GVWR [170](#)

## H

- hazard warning flashers [56](#)
- head restraints [23](#)
- head supports [23](#)
- headlights



- headlights (*continued*)
  - adaptive [55](#)
  - after exit [55](#)
  - high beams [55](#)
- heated wipers [63](#)
- heating [116](#)
- height adjustments (suspension)
  - auto-raising [133](#)
  - automatic and manual settings [134](#)
  - disabling (Jack mode) [134](#)
- high beam headlights [55](#)
- high voltage
  - Battery specifications [176](#)
  - components [142](#)
  - safety [152](#)
- hills, stopping on [71](#)
- hitches [171](#)
- Home location [126](#)
- HomeLink
  - FCC certification [194](#)
  - programming and using [137](#)
- hood [17](#)
- horn [47](#)

- I
- IC certifications [193](#)
- identification labels [169](#)
- Insane acceleration [72](#)
- instant range [75](#)
- instrument panel
  - charging status [150](#)
  - cleaning [160](#)
  - overview of [57](#)
- interior
  - cleaning [160](#)
  - dimensions [173](#)
  - lights [53](#)
  - overview [2](#)
  - temperature control [116](#)
- Internet radio [128](#)
- intrusion detection [136](#)

- J
- J1772 [143](#)
- Jack mode [134](#)
- jacking [167](#)

- K
- Keep Climate On [120](#)
- key
  - FCC and IC certifications [193](#)
  - how to use [8](#)
  - key not inside [49](#)

- key (*continued*)
  - ordering extras [9](#)
  - replacing battery [9](#)
- keyless entry [8](#)

## L

- label
  - Tire and Loading Information [170](#)
  - vehicle certification [170](#)
- lane assist [100](#)
- lane change, automatic [91](#)
- lane departure warning [100](#)
- LATCH child seats, installing [31](#)
- Launch Mode [72](#)
- liftgate
  - adjust opening height [14](#)
  - opening [14](#)
- lifting [167](#)
- lights
  - adaptive headlights [55](#)
  - hazard warning [56](#)
  - headlights after exit [55](#)
  - turn signals [56](#)
- load limits [170](#)
- location tracking [122](#)
- location-based suspension [133](#)
- locking and unlocking doors [8](#)
- Ludicrous acceleration [72](#)
- lumbar support [22](#)

## M

- maintenance
  - brake fluid, checking [165](#)
  - cleaning [159](#)
  - daily and monthly checks [152](#)
  - fluid replacement intervals [152](#)
  - panel, removing [164](#)
  - replacing wiper blades [162](#)
  - service intervals [152](#)
  - tires [153](#)
  - washer fluid, topping up [166](#)
  - washer jets, cleaning [162](#)
- map orientation [122](#)
- map updates [126](#)
- mats [161](#)
- Max Battery Power [72](#)
- media [127](#)
- mileage upon delivery [191](#)
- mirrors [48](#)
- mobile app [141](#)
- Mobile Connector
  - description [143](#)
  - using [146](#)
- modifications [168](#)
- my car does what? [187](#)



## N

naming 115  
 Navigate on Autopilot 92  
 navigating 122, 123  
 NCC certifications 193  
 Neutral gear 51  
 NHTSA, contacting 192

## O

Obstacle-Aware Acceleration 102  
 occupancy sensor 41  
 odometer 7, 74  
 offset from speed limit 105  
 Online Routing 125  
 overhang dimensions 173  
 overtake acceleration 82  
 Owner Information, about 189

## P

Park Assist 69  
 Park gear 51  
 parking brake 66  
 parking, automatic 95  
 parts replacement 168  
 passenger detection 41  
 passenger front airbag 41  
 personal data, erasing 115  
 phone  
   steering wheel buttons 46  
   using 131  
 phone app 132  
 PIN 44  
 PIN to Drive 136  
 power management 75  
 power socket 19  
 power windows 13  
 powering on and off 49  
 Proposition 65 191  
 public charging stations 143

## R

radar 79  
 radio 127  
 Radio Frequency information 193  
 range  
   displayed on instrument panel 57  
   driving tips to maximize 75  
   regenerative braking 65  
 range assurance 75  
 Range mode 75  
 Re-route 125

rear seats, folding and raising 23  
 rear view camera 77  
 rear window switches, disabling 13  
 Recent (Media Player) 129  
 Recents (navigation) 123  
 regenerative braking 65  
 relative speed limit 105  
 release notes 140  
 restarting the touchscreen 49  
 Reverse gear 51  
 RFID transponders 168  
 roadside assistance 184  
 roof racks 172  
 rotating tires 154  
 Round Trip Energy (navigating) 125

## S

safety defects, reporting 192  
 safety information  
   airbags 42  
   child seats 33  
   rear facing child seats 38  
   seat belts 26  
 satellite radio 127  
 seat belts  
   cleaning 160  
   in a collision 26  
   overview of 25  
   pre-tensioners 26  
   wearing when pregnant 25  
 seat covers 24  
 seat heaters 116  
 seating capacity 170  
 seats  
   adjusting 22  
   heaters 116  
   Tesla built-in rear facing 35  
 security settings 136  
 sensors 79  
 service data recording 190  
 service intervals 152  
 Settings, erasing 115  
 shifting gears 51  
 Show Calendar Upon Entry 135  
 side collision warning 100  
 SiriusXM 127  
 slip start 68  
 software reset 115  
 software updates 140  
 software version 7  
 specifications  
   cargo volume 174  
   dimensions 173  
   exterior 173  
   interior 173  
   motor 175  
   subsystems 175





specifications (*continued*)

tires 177

weights 174

wheels 177

speed assist 105

Speed Limit Mode 115

speed limit warning 105

Sport acceleration 72

stability control 68

Standard acceleration 72

starting 49

steering specifications 175

steering wheel

adjusting position 45

adjusting sensitivity 45

buttons 45

heated 45

scroll buttons 45

steering, automatic 89

Streaming radio 128

summer tires 156

Summon 95

sunroof 21

supercharging

described 151

idle fees 151

pay-per-use fees 151

suspension 134

suspension specifications 176

## T

telematics 190

temperature

Battery (high voltage), limits 144

cabin, controls for 116

heated steering wheel 47

outside 57

tires 180

Teslacam 78

tie-down straps 186

Tilt/Intrusion detection 136

Tire and Loading Information label 170

tire noise 156

Tire Pressure Monitoring System

FCC certification 194

overview of 156

tire pressures, checking 153

tires

all-season 156

balancing 154

chains 156

inspecting and maintaining 154

pressures, how to check 153

quality grading 180

replacing 155

replacing a tire sensor 157

rotation 154

tires (*continued*)

specification 177

summer 156

temperature grades 180

tire markings 178

traction grade 180

treadwear grade 180

winter 156

toll system transponders, attaching 168

torque specifications 175

touch up body 161

touchscreen

clean mode 160

cleaning 160

overview 4

software updates 140

tow eye, locating 185

Tow mode 185

towing 185

towing a trailer 171

towing instructions 185

TPMS

FCC certification 194

overview of 156

Tracking Disabled 122

traction control 68

trademarks 189

Traffic-Aware Cruise Control 82

trailer hitches 171

transmission specifications 175

transponders, attaching 168

Transport Canada, contacting 192

transporting 185

trip chart 75

trip meter 74

Trip Planner 125

trunk, front 17

trunk, rear

child-protection lock 11

disabling interior handle 11

TunenIn radio 128

turn signals 56

## U

ultrasonic sensors 79

uniform tire quality grading 180

Unlock on Park 8

unlocking when key doesn't work 11

USB devices

connecting 19

playing audio files from 129

USB ports 19

## V

Valet mode 44



- vehicle certification label [170](#)
- Vehicle Hold [71](#)
- Vehicle Identification Number (VIN) [169](#)
- vehicle loading [170](#)
- vent, sunroof [21](#)
- ventilation [121](#)
- VIN (Vehicle Identification Number) [169](#)
- voice commands [45](#)
- volume control [4](#)
- volume control (media) [127](#)

## W

- walk away locking [11](#)
- Wall Connector [143](#)
- warning flashers [56](#)
- washer fluid, topping up [166](#)
- washer jets, cleaning [162](#)
- washers, using [63](#)
- weight specifications [174](#)
- wheel chocks [186](#)
- wheels
  - alignment [154](#)
  - replacing [155](#)
  - specifications [177](#)
  - torque [177](#)
- Wi-Fi, connecting to [139](#)
- windshield washer fluid, topping up [166](#)
- winter tires [156](#)
- wiper blades, replacing [162](#)
- wipers, de-icing [63](#)
- wipers, using [63](#)
- Work location [126](#)

TESLA