

Design and Development of NEA Scout Solar Sail Deployer Mechanism

Alexander R. Sobey* and Tiffany Russell Lockett*

Abstract

The 6U (~10 cm x 20 cm x 30 cm) cubesat Near Earth Asteroid (NEA) Scout¹, projected for launch in September 2018 aboard the maiden voyage of the Space Launch System, will utilize a solar sail as its main method of propulsion throughout its ~3-year mission to a Near Earth Asteroid. Due to the extreme volume constraints levied onto the mission, an acutely compact solar sail deployment mechanism has been designed to meet the volume and mass constraints, as well as provide enough propulsive solar sail area and quality in order to achieve mission success. The design of such a compact system required the development of approximately half a dozen prototypes in order to identify unforeseen problems, advance solutions, and build confidence in the final design product. This paper focuses on the obstacles of developing a solar sail deployment mechanism for such an application and the lessons learned from a thorough development process. The lessons presented will have significant applications beyond the NEA Scout mission, such as the development of other deployable boom mechanisms and uses for gossamer-thin films in space.

Introduction

The NEA Scout solar sail design comes as a successor to two 3U (~10 cm x 10 cm x 30 cm) cubesats: the NASA Marshall Space Flight Center developed solar sail NanoSail-D² and the Planetary Society solar sail LightSail-A³ (LightSail-B to be launched in 2016). Both spacecraft flew as technology demonstration missions in Low Earth Orbit: NanoSail-D in 2010 (Figure 1, left) and LightSail-A in 2015 (Figure 1, right). These two cubesats represent pathfinders on the way to utilizing solar sail propulsion in order to achieve science missions, such as the primary science objective for NEA Scout: image and characterize a Near Earth Asteroid. This mission would not ordinarily be possible with a 6U cubesat, however, NASA has taken an interest in applying cubesat form factors, methodologies, and risk to perform cost effective interplanetary science missions. Solar sail technology is a key to enabling that capability⁴. While it is conceivable for a 6U cubesat mission to reach a NEA with conventional chemical propulsion, both the number of targets and the launch window would be tightly constrained. By utilizing solar sail propulsion, intercepting a large number of targets in virtually any launch window is made possible. Cubesats are typically deployed as a secondary payload, and therefore have little to no control over changes in launch schedule and must remain flexible.



Figure 1. NanoSail-D 10-m² Sail (left) and LightSail-A 32-m² Sail (right)

* NASA Marshall Space Flight Center, Huntsville AL

NEA Scout Configuration

As a 6U, interplanetary cubesat, NEA Scout will address strategic knowledge gaps of near earth asteroids. The spacecraft accommodates an imager, star tracker, reaction wheels, avionics, power system, communications, and a reaction control system in addition to the solar sail subsystem (Figure 2). Volume is a premium within the fixed constraints of the 6U cubesat form factor (~10 cm x 20 cm x 30 cm). Mass, 14 kg total, is a demanding constraint as well. Solar sail acceleration is a function of sail area and spacecraft mass. To reach a target asteroid within 2.5 years and meet the 14-kg mass restrictions of the Space Launch System cubesat deployer, the total sail area needed to produce enough propulsion was calculated to be 86 m², deployed with four booms at 6.8 m of length each.

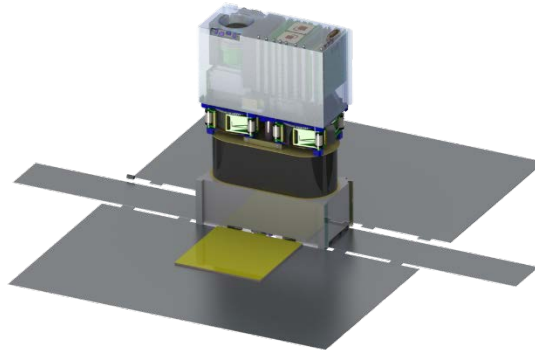

Figure 2. NEA Scout Flight Configuration as of September 2015

The solar sail subsystem (Figure 3) consists of a single 86-m² colorless polymer (CP1), 2.5-micron thick aluminized sail, sail spool assembly, four Elgiloy (stainless steel alloy variant) Triangular Rollable and Collapsible (TRAC)⁵ booms at 6.8 m each, a gear-driven boom deployer assembly, a stepper motor, a motor controller board, and a sensor suite. The deployer design is based on the successful Nanosail-D deployer system with exception to the addition of a stepper motor which provides a slower, controlled deployment, two boom deployers instead of one, sensor feedback, and a single sail design on an oblong spool. The sail spool assembly mounts atop of the boom deployer assembly. The sail spool is allowed to freely rotate about a center post as the sail deploys. The center post doubles as a channel for the wire harness and cabling from the reaction control thrusters at the forward (sun facing) portion of the spacecraft to the avionics box in the aft as well as providing structural support between the two halves.

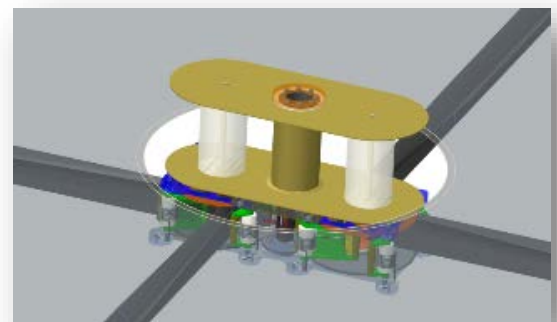
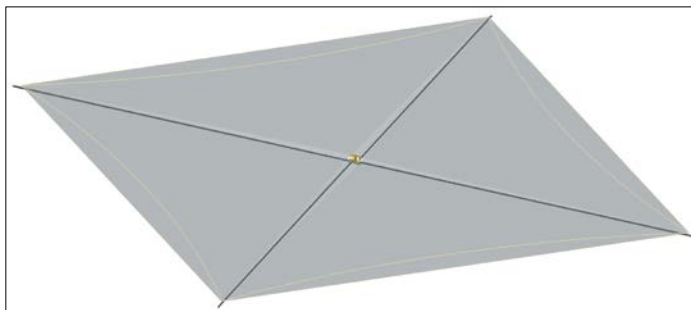

Figure 3. NEA Scout 86-m² deployed solar sail (left) and sail spool and boom deployer assembly (right)

The boom deployers displayed in Figure 4 consist of two boom spools, each with two booms per spool. Separating the booms into two spools is necessary due to the boom length requirement and the stowed volume constraint. The four booms each exit the deployer every 90 degrees. Each boom spool consists of a center hub, which the booms mount to, a thin top flange (shown in orange), and a geared bottom flange (shown in gray). The top flange primarily provides contact friction from the spool to the boom during deployment; therefore, only needs to be thick enough to avoid deflections into the top plate (shown in blue).

Due to packaging requirements, part thickness are kept minimal, specifically in long axis (3U direction) of the cubesat. The bottom geared flange remains thick to provide adequate gear contact with the center pinion gear, which is directly connected to the motor/gearbox.

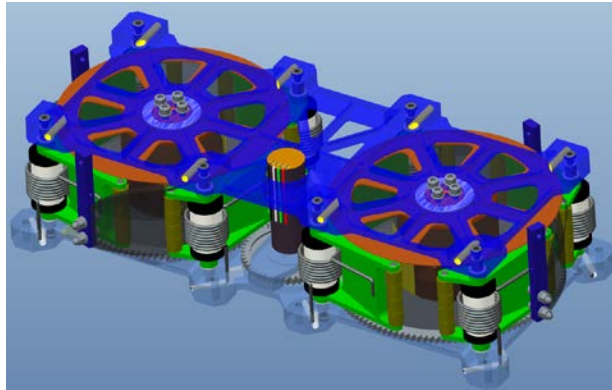

Figure 4. NEA Scout Boom Deployer Model Stowed

An earlier concept of the boom deployer consisted of two modular deployers which mounted onto the bus and connected through a center module containing the motor. One of the early concept deployer modules can be seen in Figure 5 both in Computer Animated Design and as a physical prototype. The benefits included ease of manufacturing and assembly. The concept was abandoned for the single base plate design primarily due to alignment concerns. With a single plate, it became significantly simpler to mount the three gears with minimal backlash while at the same time guaranteeing teeth would not bind during the large temperature fluctuations experienced during the early phases of the mission. Furthermore, a single base plate allowed for easier installation of the booms and greater alignment precision.

The 6.8-m-long TRAC booms typically have a slight bend upwards toward the weld side. This misalignment along the spine of the boom must be accounted for during installation of the boom. Each boom is to be installed in an orientation that minimized gravity effects (hanging downward). During installation, the tip of the boom is to be located at the desired plane perpendicular to the long axis (3U direction) before the boom is bolted/clamped at the root. By doing this for all 4 booms, the final plane of the sail can be controlled within acceptable angular limits. Finally, a single base plate allowed for load to be carried primarily through the plate itself instead of through the bus interface. This allows a mass reduction of the interface. Due to this design, the primary load path of the spacecraft is through the baseplate, which considers a single structure appealing.

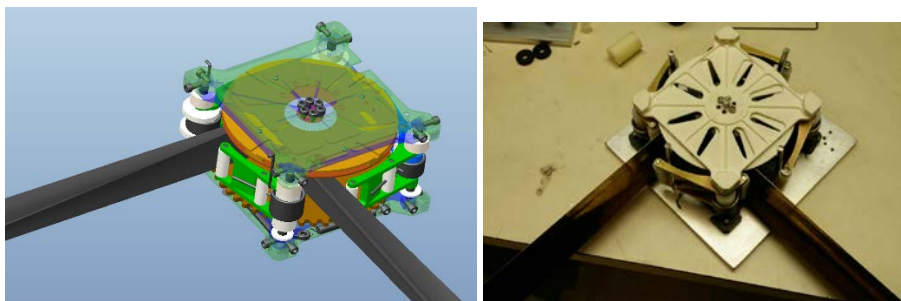

Figure 5. Early Concept: Modular Design of Deployers

From the cross-section view in Figure 6, the inside of the deployer can be viewed. In this view, the booms spools are shown as translucent in order for the boom clamps (shown in yellow) can be seen. The clamps attach each boom to the center hub (shown in brown) with two 100-degree countersunk screws. Also in Figure 6 on the right, both the clamp and the hub themselves are rounded near the top to allow for the

boom to flare out at the base and add stiffness to the boom section nearest the deployer. Both analysis and testing have shown this flare necessary to achieve the highest boom buckling performance.

The spring-loaded boom arms, shown in green in Figure 6, are used to contain the boom spool during pre-deployment as well as deployment. Torsion springs are located at each arm and place pressure onto the boom spool at the Rulon J PTFE rollers. The necessity of these arms and their function is discussed in greater detail under the 'Design Challenges' section. Rollers on the backside of the arms serve to help guide the booms out during deployment and reduce friction. The backside rollers do not place pressure onto the boom spool directly.

The boom tip standoff allows for the sail to be attached to the boom slightly above the boom. This standoff is able to tuck in closely to the deployer in order to maintain the tight volume requirement. The boom tip standoff also serves as a hard stop, not allowing the boom tip to retract further into the deployer. It was noted during the vibration testing of LightSail-A, that the boom tips would retract into the deployer slightly. The retraction was not a great amount, but enough to possibly cause a failure. It was suggested by the LightSail-A team to add a hard stop at the boom tips. The boom tip standoff serves this function.

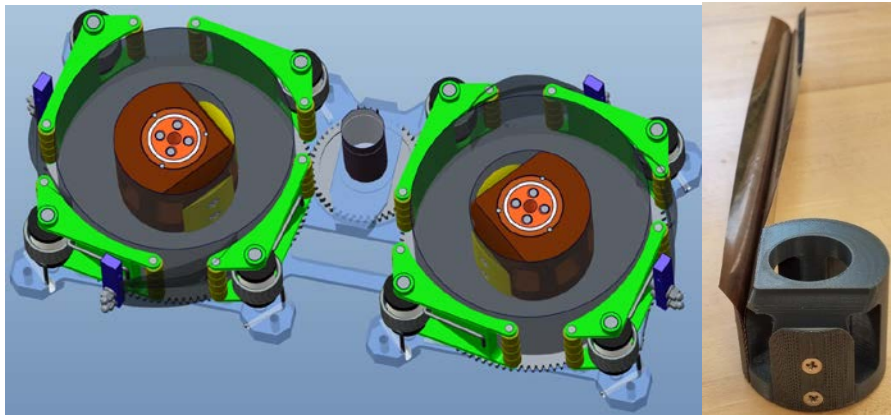

Figure 6. Cross-Section NEA Scout Boom Deployer Model Stowed (left) and Boom Attachment to Hub (right)

In order to minimize volume, Rulon J PTFE flanged sleeve bushings are used in place of bearings for the boom-spool interface. Two bushings contact both the top and bottom of the boom spool at center race. An example of this bushing can be viewed in Figure 7 shown in black (note the specific bushing in Figure 7 is standard PTFE and not the Rulon J variant). Both bushings sit on the top and bottom of the post. Only the bottom bushing is present in Figure 7. These bushings both significantly reduce friction and allow for tight alignment of the spools. As with several aspects of this design, volume constraints and form factor are the design drivers. Similar, but larger bushings are used for the sail spool.

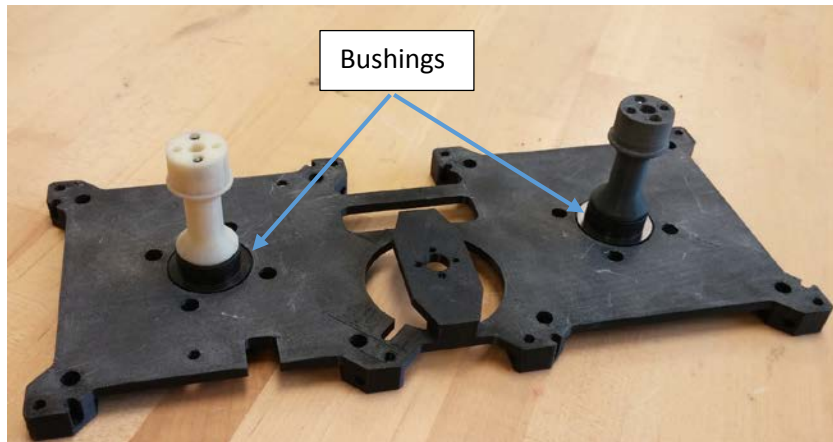

Figure 7. Baseplate with Posts and Bottom Bushing Mounted

The burn wire mechanism, shown in Figure 8, allows for the boom deployers to be locked down during launch and up until deployment of the sail. The mechanism itself is only a slight modification on the NanoSail-D burn wire mechanism that served the same purpose. The mechanism locks down one of the two spool geared flanges. By locking down one of the flanges, the entire geared system is unable to rotate.

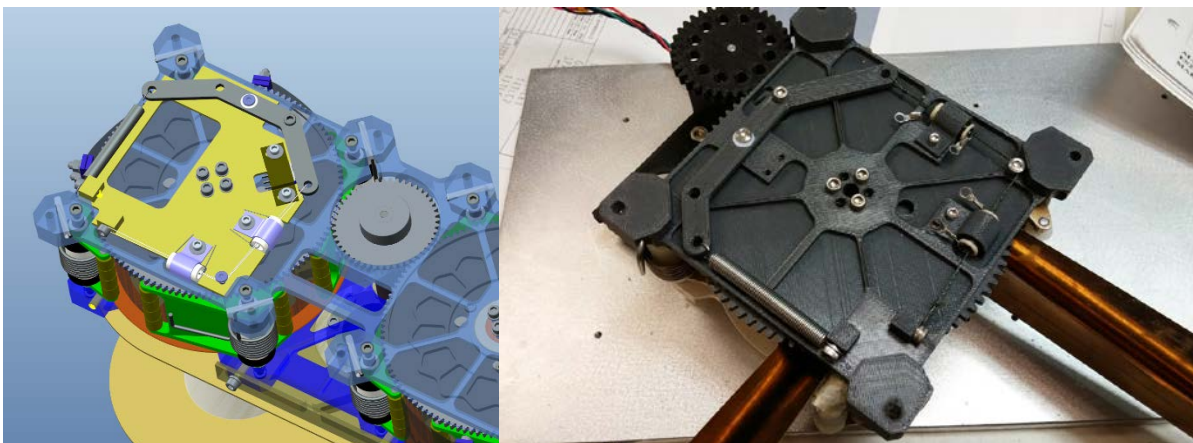

Figure 8. Burn Wire Mechanism (left) and Early Prototype Burn Wire Mechanism (right)

The geared flange (shown in Figure 9) is machined with a spoke pattern with sixteen recesses. These recesses allow the gear to be locked down at 22.5-degree intervals. The spring loaded lever (shown as gray in Figure 8) has a cylinder mounted to it (not shown). This cylinder fits into any one of the sixteen recesses of the spoke pattern when the gear is to be locked down. When locked down, a monofilament wire of 50-lb-test (220-N) Honeywell Spectraline is tied off to the spring-loaded lever in order to keep the cylinder tightly pressed into the recess. Once the Spectraline is cut, the spring-loaded lever swings open pulling the cylinder out of the recess into the gear's channel, allowing the spool to spin freely. In order to cut the Spectraline, two Nickel-Chromium wire heaters are added in series to the Spectraline (one being the primary heater and the other functioning as a redundant heater). The heater is a coiled Nickel-Chromium wire mounted into a ceramic sleeve. When enough current is run through the heater, in a matter of seconds, the Spectraline is effectively cut allowing the spring-loaded lever to fall into the open position. Ignoring minor dimensional adjustments, the burn wire mechanism remains similar to the NanoSail-D mechanism with the addition of a microswitch on the lever to provide feedback when the lever has opened.

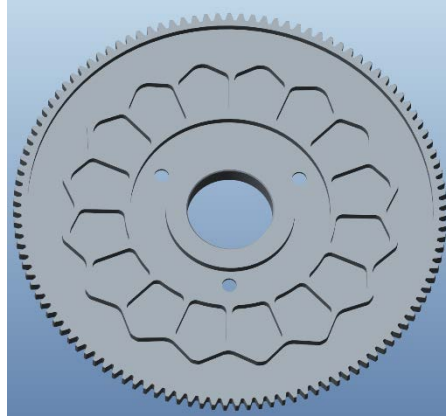

Figure 9. Spool Gear Machined with Spoke Pattern for Launch Lock

Design Challenges

Blooming

NanoSail-D, LightSail, and NEA Scout utilize Triangular Rollable and Collapsible (TRAC) booms originally developed and patented by the Air Force Research Laboratory (AFRL). NeXolve (Huntsville, AL) currently has the design license for manufacturing and is on contract to produce the engineering development unit booms for NEA Scout (Figure 10). As the sail for each mission grew 10 m², 32 m², and 86 m² respectively, the boom length also grew: 2.2 m, 4 m, and 6.8 m respectively. At larger lengths, new complications arose during deployment. For example, due to the strain energy developed while spooling, TRAC booms slip past one another during deployment, causing the boom wraps to expand radially and create a gap between the central hub and the first boom wrap. This reaction is referred to as 'blooming' and leads to complications during deployment. If not controlled properly during deployment, 'blooming' can lead to suboptimal deployment and possible failure (Figure 11).



Figure 10. Boom Deployer Prototype with flight-like TRAC booms

Both NanoSail-D and LightSail-A addressed issues with 'blooming,' therefore the problem was identified early in the design. Early attempts at creating a MSC Adams multibody dynamic simulation solution proved futile as the forces inside of the deployer were difficult to quantify. These forces include: strain energy in the boom, torsion on the boom arms, contact friction of the arm rollers on the boom, friction between the boom spool flanges and boom wraps, and friction between subsequent boom wraps. It was evident early in the design phase that prototypes would need to be developed in order to understand and control 'blooming.' With the aid of fused deposition 3D printing and machined parts, several prototypes were built, tested, and iterated upon.

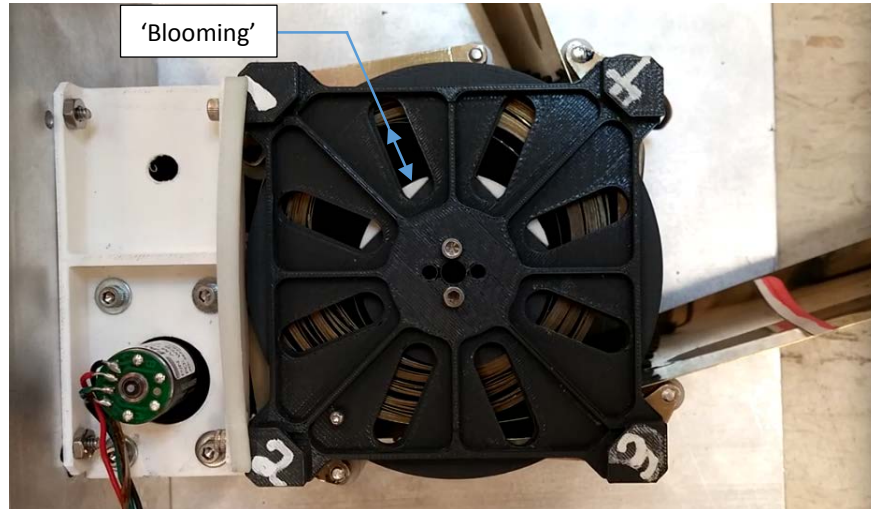

Figure 11. Point of deployment where 'blooming' causes failure

As seen in an early prototype in Figure 11, 'blooming' can cause a failure in primarily two modes: 1) the boom wraps expand radially into an oblong shape; eventually this shape can become large enough to bind up between boom arms 2) near to the end of deployment the gap at the center can become large enough that the boom root can possibly yield and bend backwards at the clamp. This second method of failure did not occur during lab tests as the deployment was halted before the root could yield, but if allowed to continue would have certainly occurred.

Several approaches have been developed in order to either eliminate or mitigate 'blooming' during deployment:

- 1) Adjustment of boom arm force on the boom wrap. By changing torsion springs, the contact force of the boom arms on the wrap can be adjusted to fit the necessary force. It was noted that as the boom length in the deployer increased, the required force also increased. A spring arm contact simulator was developed with compression springs and can be viewed in Figure 12. The compression springs allowed nearly instantaneous adjustment of the boom arm contact force. Once a force was found which eliminated blooming using the simulator, the compression spring force was then exchanged for a properly sized torsion spring creating the same force at the point of contact. It is to be noted that the greater the amount of force placed upon the boom wraps the more friction is introduced into the system and the greater the chance of locally yielding the boom. The contact force on the boom wraps should not be needlessly oversized.



Figure 12. Compression Spring Arm Contact Simulator

- 2) At the point of contact between the boom arms and the boom wraps, friction needs to be minimized to allow the booms to glide past each roller. Excess friction will exacerbate 'blooming.' Early on in the design cycle, the rollers were exchanged from nylon, as was heritage with NanoSail-D, to Rulon J PTFE.
- 3) Adding friction between boom wraps decreased the ability for the booms to expand radially. This method was first noted by the LightSail-A design team. In order for the boom wraps to expand radially and cause 'blooming' they must slide past one another. By increasing the friction between the boom wraps this sliding is made more difficult, helping to alleviate blooming. This was shown to work with TRAC booms by scratching the surface with medium-grit sand paper.
- 4) Increasing contact and friction between the spool flanges and boom wrap aids deployment. By having one or both flanges directly contacting the boom wraps 'blooming' can be impeded to a small degree. It is desirable to minimize any extra height between the flanges.
- 5) Increasing the packaging efficiency of the rolled boom pair will also aid in a successful deployment. Tighter packing can be achieved by pulling the booms outward as they are being spooled inward.
- 6) Reversing deployment at intervals can assist in deployment when 'blooming' does occur (e.g., for every 1 m deployed, reverse 10 cm and repeat). If the boom begins to expand radially, reversing direction will tighten up the spool eliminating momentary blooming. It was shown during prototype testing that the boom wraps will constrict inward before retracting the boom back into the deployer.
- 7) Adding points of contact at the boom arm significantly alleviate 'blooming.' As pictured in Figure 13, by adding a rocker-bogie to the boom arms, we can double the points of contact from four to eight and decrease the contact at each point by half. This method has been shown through testing to be one of the most effective techniques in reducing 'blooming.' Furthermore, if 'blooming' does occur, the rocker-bogie motion has proven to handle the oblong rotation of the boom spool without binding. The rocker-bogie simply rotates back-and-forth around the bulged section of the boom wrap, where the single roller would come into contact with the bulged section creating a large tangential force. This tangential force would cause a spike in the required motor torque, which causes failure. Unfortunately this rocker-bogie design is unable to fit in the NEA Scout design volume.

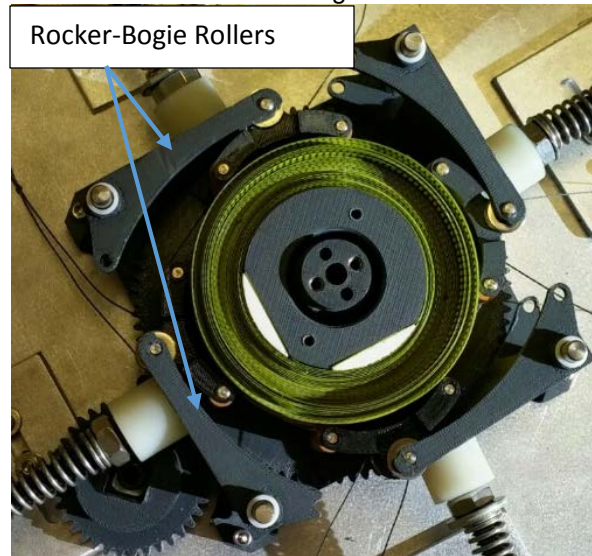

Figure 13. Deployer Prototype with Added Rocker-Bogie Rollers

These approaches are also applicable to other boom systems. In fact, during the development of the NEA Scout boom deployer, very slight modifications were made to allow for a split tape composite boom (Figure 14). The split tape composite boom spooled tighter and deployed with greater ease than the metallic TRAC boom. The improved deployment of the split tape composite boom when compared to the metallic TRAC boom can be attributed to 1) significant decrease in strain energy (comparable to force required to flatten the boom), 2) friction between boom wraps, and 3) ability to package into a tighter roll.

Despite the advantages of a split tape composite boom, including a large weight savings, its significantly greater height made it unable to package within the allotted volume. The composite boom required a height of 6.5 cm compared to 3.5 cm for the TRAC boom.



Figure 14. Split Tape Composite Boom Deployer

Stepper Motor

A stepper motor with a planetary gearhead is used to rotate the boom spools. It is important to note that given a well-balanced system the strain energy in the four booms will act to self-deploy the booms; therefore, ideally the stepper motor is used solely to hold back and step out the booms slowly. In practice, the motor is needed both to hold the booms back as well as push them out. NanoSail-D chose not to utilize a motor, and simply allowed the booms to self-deploy after activating the burn wire mechanism. This boom deployment took only a few seconds and could be considered too violent for a larger sail. Furthermore as the boom length increases, the necessity for a motor becomes more evident. LightSail-A chose to implement a DC motor with an encoder and a worm gear transmission into their single spool.

The limitation of the NEA Scout volume led to the use of a stepper motor with a planetary gearhead. The detent torque of a non-energized stepper motor is also seen as a benefit of a stepper motor and has proven to be enough force when combined with the gearhead to hold the boom in place. In place of an encoder, two infrared sensors are used to monitor deployment and provide feedback (shown in Figure 15; the brackets for each sensor are goldenrod). The first is an infrared gate sensor measuring a hole pattern machined into one boom spool's top flange (Figure 15, shown in orange, circled). This sensor provides 1.8-degree resolution at the boom spool. The second infrared sensor is attached to one of the boom arms and watches the boom as it exits the deployer. The sensor is positioned to read marks along the boom's welded edge. By measuring both the rotation of the spool and the deployment of the boom directly, it can be determined in real-time if and when 'blooming' occurs. The ability to measure possible 'blooming' allows for it to be mitigated by reversing the deployment as discussed earlier.

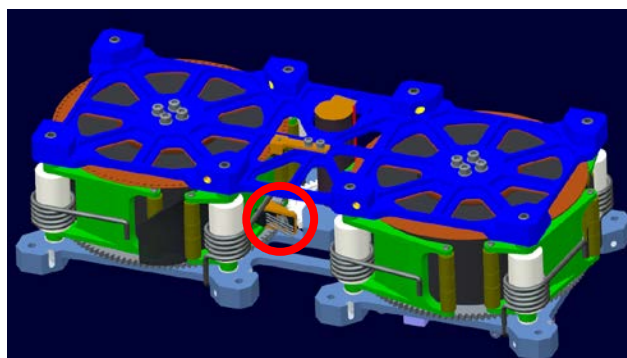

Figure 15. Boom Deployer with Two Infrared Sensors Visible

TRAC Boom Thermal Deflection

The solar sail design for NEA Scout produced many design challenges. The original baseline for NEA Scout was a four quadrant sail in order to benefit from the heritage designs of NanoSail-D and LightSail-A. However, after examining the thermal environment experienced by the TRAC booms, it became evident that thermal deformation would prove too great for an effective, quadrant designed solar sail. Initial results for an unloaded 7.3-m TRAC boom at a 30° angle of incidence to the sun indicated 1.48 m of tip displacement (Figure 16). This result is one to one orders of magnitude greater than what would be considered acceptable from Guidance, Navigation, & Control. This is caused by the low thermal conductivity along the thin profile of the boom, the self-shading one half of the boom's profile by the sunward half, and the suboptimal optical properties of the uncoated TRAC boom (solar absorptivity and infrared emissivity).

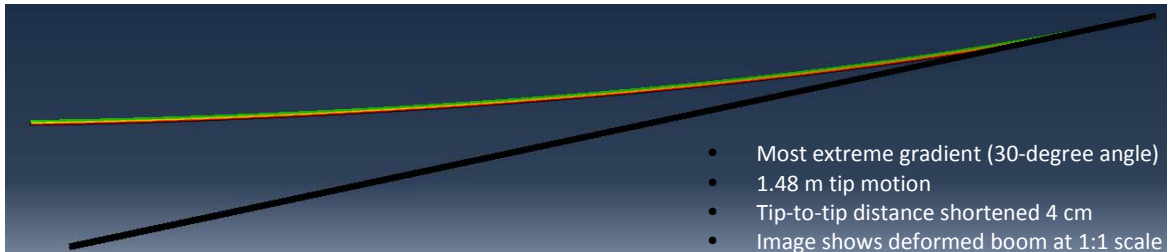

Figure 16. 7.3-m Uncoated, unshaded, unloaded TRAC Boom during thermal analysis simulations

Extensive analysis and testing were performed to determine the best method for mitigating boom thermal deflection, including an aluminum coating for the TRAC boom and the use of a 'sock' to keep the boom from direct sunlight. The final determination was to change the configuration to a single sail design, which would inherently shade that majority of the boom from the root to ~16 cm from the tip. An integrated model analysis shows that max out-of-plane boom tip displacement reduced from ~100 cm in the four quadrant case to ~4 cm in the shaded boom case (Figure 17). Figure 17 also shows a large amount of in-plane displacement that further convinced designers to move to a single sail. Additionally, the single sail increases the flatness of the sail, reducing the sail connection points from 12 to 4 interfaces.

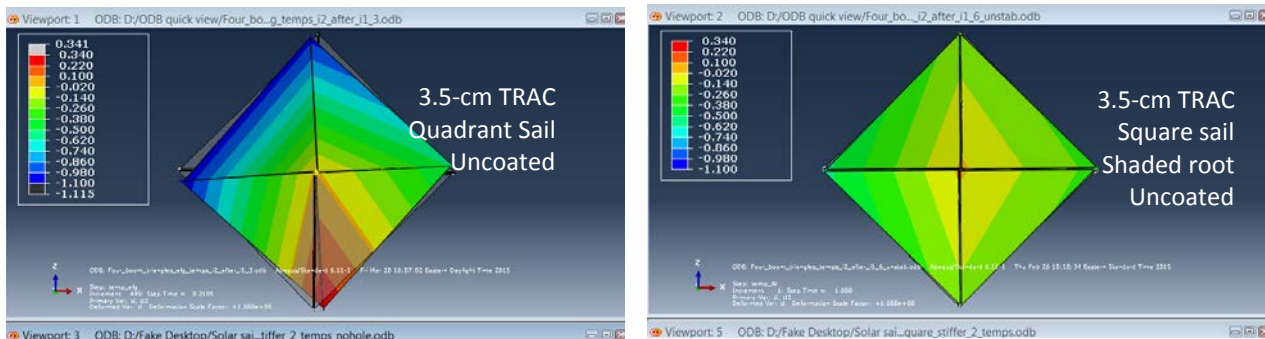

Figure 17. Thermal deformation results for the four quadrant and single quadrant sail

Sail Spool Design

Designing a deployment scheme for a single sail entailed further complexities for the solar sail deployment mechanism. Due to the placement of the solar sail deployment mechanism in the center of the spacecraft bus, the single square sail is packaged onto a single oblong spool (Figure 18) in order to maximize the available volume. When spooled, the sail fits onto the spool in the shape of a racetrack. To protect the sail from pinch points during deployment, foam will pad the structure supports within the sail spool.



Figure 18. Sail Spool Generation 1

The sail spool assembly mounts directly to the boom deployer at four points. A center post is utilized to connect the two halves of the spacecraft structurally and pass-through a relatively large cable bundle. Due to the single sail design and the location of the solar sail module within the spacecraft, both cable harnessing and the primary load path must go through the center of the spool. The center post acts both as a systems tunnel and as the primary load path from the avionics portion of the spacecraft to the cold gas portion. The spool rotates independently from the rest of the system around the center post with the aid of two flanged sleeve PTFE bushings located on the top and bottom of the spool-to-post interface. These two bushings can be viewed in Figure 19. Only a small force from the booms are required to unspool the sail from the spool. This has been demonstrated in half-scale testing.

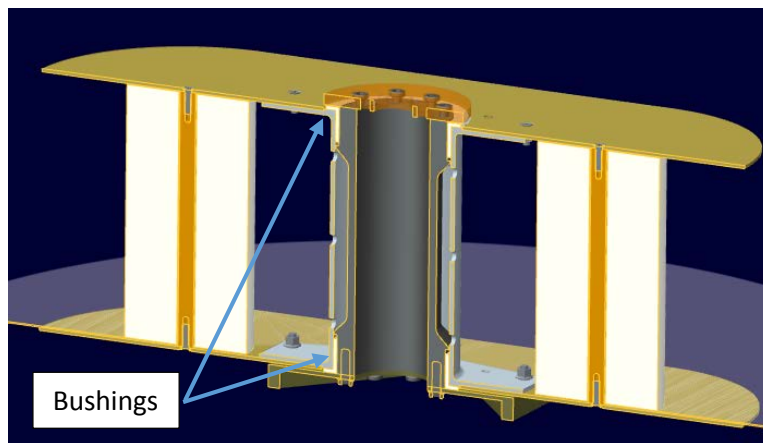

Figure 19. Sail Spool Cross-Section Engineering Development Unit

The center post (grey) remains hollow to allow for the bus cable harness to pass through.

Sail Connection to Booms

In order to optimize the load going into the sail, the connection of the boom tip to the sail corner will advance from a linear tension spring, as used by NanoSail-D and LightSail-A, to a constant force spring. The sail membrane is expected to thermally expand by ~2.9 cm more than the booms at each corner. In order to account for this, a long linear spring was designed with a low spring coefficient. Otherwise, a large force range would have to be accepted in the sail membrane and boom. By using a constant force spring, the force range should be constrained within a range of $\pm 5\%$ and the size of the spring can be reduced, thus reducing the total boom length. For half-scale testing, 3 tension springs in series were used, similar to what is shown in Figure 20.

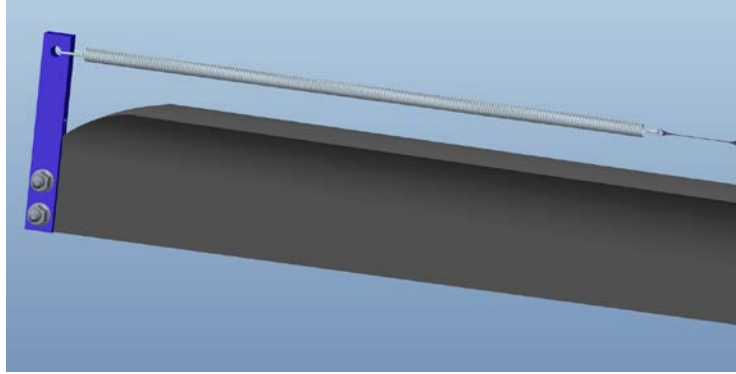

Figure 20. Boom Tip to Sail Connection: Linear Tension Spring

Sail Deployment Tests

In preparation for the full-scale deployment tests to be conducted during the spring of 2016, scaled deployment tests were planned to gain better understanding of the fully integrated system and test functionality. Evaluating ground support equipment, optional test locations, and observations of rips and potential dynamic behaviors caused by the deployment were primary goals of the half-scale deployment tests. Previous analysis and component tests that focused on blooming, thermal deformation, and boom buckling fed into the test results.

The scaled deployment test utilized a 36-m², 2.5-micron-thick Mylar material as a representative sail and four 4-m Elgiloy TRAC booms. For the first deployment (Figure 21), the team used two booms from AFRL and two produced by NeXolve. The second deployment utilized four 4-m TRAC booms manufactured by NeXolve. The sail spool and most of the deployer mechanism were fabricated from ABS material via a fuse deposition 3D printer. Metal fasteners, steel springs, ceramic rollers, and a stepper motor completed the deployer assembly.

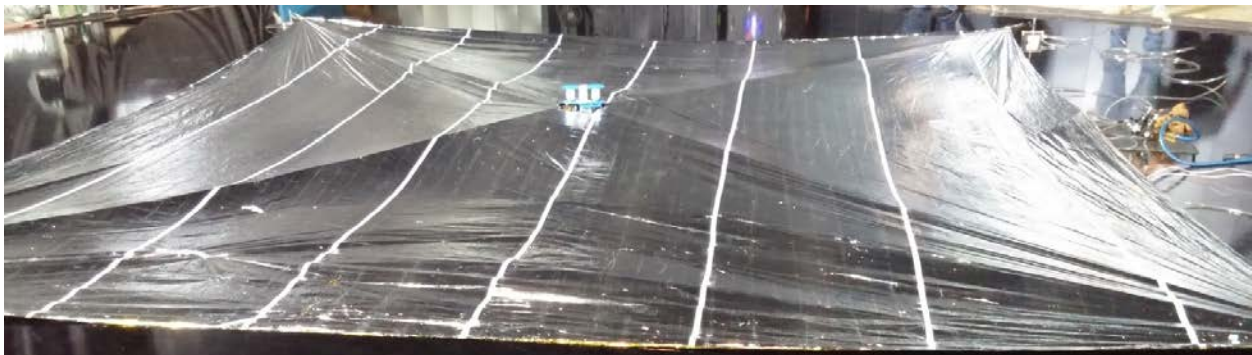

Figure 21. First Deployed Half Scale Sail

Anomalies

To fold the sail, the team performed a z-fold pattern from one end of the sail to the center and z-fold pattern from the other end of the sail to the center. With both sides of the sail meeting in the center, the sail is then manually spooled onto the sail spool assembly. The sail folding is performed with minimal damage to the sail. All holes and rips caused by handling were patched with Kapton tape. After both deployments, approximately 30 holes and rips were accounted for throughout the acreage of the sail with the largest rip being the diameter of a nickel (21 mm).

The first deployment utilized four TRAC booms available at the time: two manufactured by AFRL and two manufactured by NeXolve. The AFRL booms had been through numerous component testing in development of the boom deployer assembly. Therefore, the AFRL booms incurred various cracks, weld delaminations, and deformations along the length of the booms. These defects prevented the booms from tightly spooling within the boom assembly (Fig. 22). Upon visual inspection prior to the first deployment, the NeXolve booms spooled noticeably tighter than the AFRL booms, improving the assumed packing efficiency calculated from previous components tests with the AFRL booms.

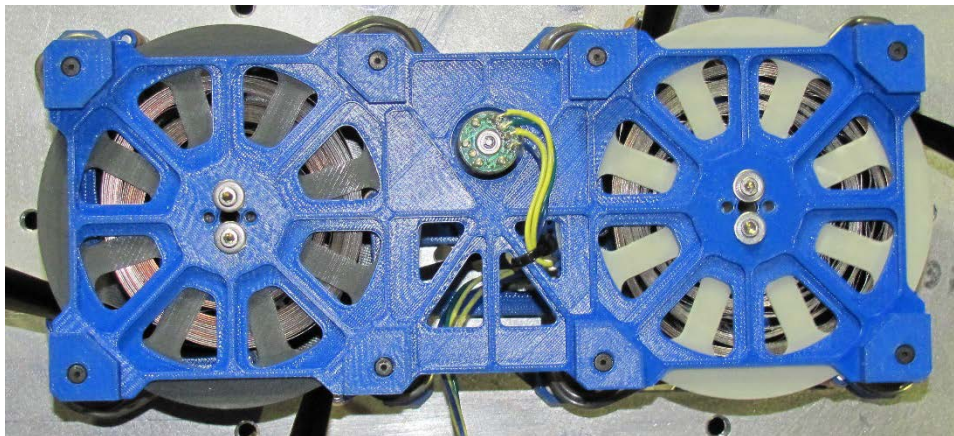

Figure 22. NeXolve (left) and AFRL (right) 4m TRAC booms spooled prior to first deployment

To overcome blooming, the team decided to deploy the sail in increments. The first 5 minutes of deployment extended the booms outward. Next, the deployer would be commanded to stop and reverse for 20 seconds. The reverse motion pulled the booms back into the deployer constricting the boom wraps around the center hub. This motion reduced the impact of ‘blooming’ while the booms continued to deploy. However, after the booms deployed approximately 3.5 m, the stepper motor stalled. The first deployment ended with the team manually deploying the final meter of boom and sail area.

The second deployment implemented lessons learned from the first deployment. The AFRL booms were replaced with newly manufactured booms provided by NeXolve. The sail material was refolded and spooled with Kapton patches for small knicks and rips. The stepper motor was replaced with a higher continuous torque output. Even though the 3D printed plastic gears were beginning to show wear, it was decided not to replace them at the time. This decision did not impact the second deployment. The full deployment went successfully with minimum blooming observed and without the need to mitigate ‘blooming’ by reversing the motor. The total deployment lasted 16 minutes for 36 m² of sail. The anticipated deployment time for the full sail is estimated to be approximately 30 minutes.



Figure 23. Deployed Solar Sail After Second Deployment

Conclusion

The challenges inherent in development of such technology with the unusually rigorous constraints of a 6U cubesat require a thorough development program. The resulting lessons are enlightening to the complexities of a successful solar sail mission. As the project continues towards the manufacturing and test of the 86-m² sail with 6.8-m Elgiloy TRAC booms, these lessons will prove instrumental in advancing solar sail capability and expanding the use of the technology. Solar sails will continue to advance and enable future missions similar to NEA Scout to perform science objectives, which would not have been possible give similar design and launch constraints.

References

1. McNutt, L.; Johnson, L.; Clardy, D.; Castillo-Rogez, J.; Frick, A.; and L. Jones. "Near-Earth Asteroid Scout." AIAA Space 2014 Conference; 4-7 Aug 2014; San Diego, CA; United States.
2. Whorton, M.; Heaton, A.; Pinson, R.; Laue, G.; and C. Adams. "NanoSail-D: The First Flight Demonstration of Solar Sails for Nanosatellites." Proceedings of the 22nd Annual AIAA/USU Conference on Small Satellites, Logan, Utah, USA, August 11-14, 2007.
3. Bidy, C.; and T. Svitek. "LightSail-1 Solar Sail Design and Qualification." Proceedings of the 41st Aerospace Mechanism Symposium, Jet Propulsion Laboratory, May 16-18, 2012.
4. Johnson, L.; Sobey, A.; Sykes, K.; "Solar Sail Propulsion for Interplanetary Cubesats." AIAA Propulsion and Energy 2015; 27-29 Jul 2015; Orlando, FL; United States.
5. Murphey, T. W.; and J. Banik. "Triangular Rollable and Collapsible Boom." The United States of America as Represented by The Secretary of The Air Force, assignee. Patent US 7895795 B1. 22 Oct 2007.