

Professional Driver's Manual

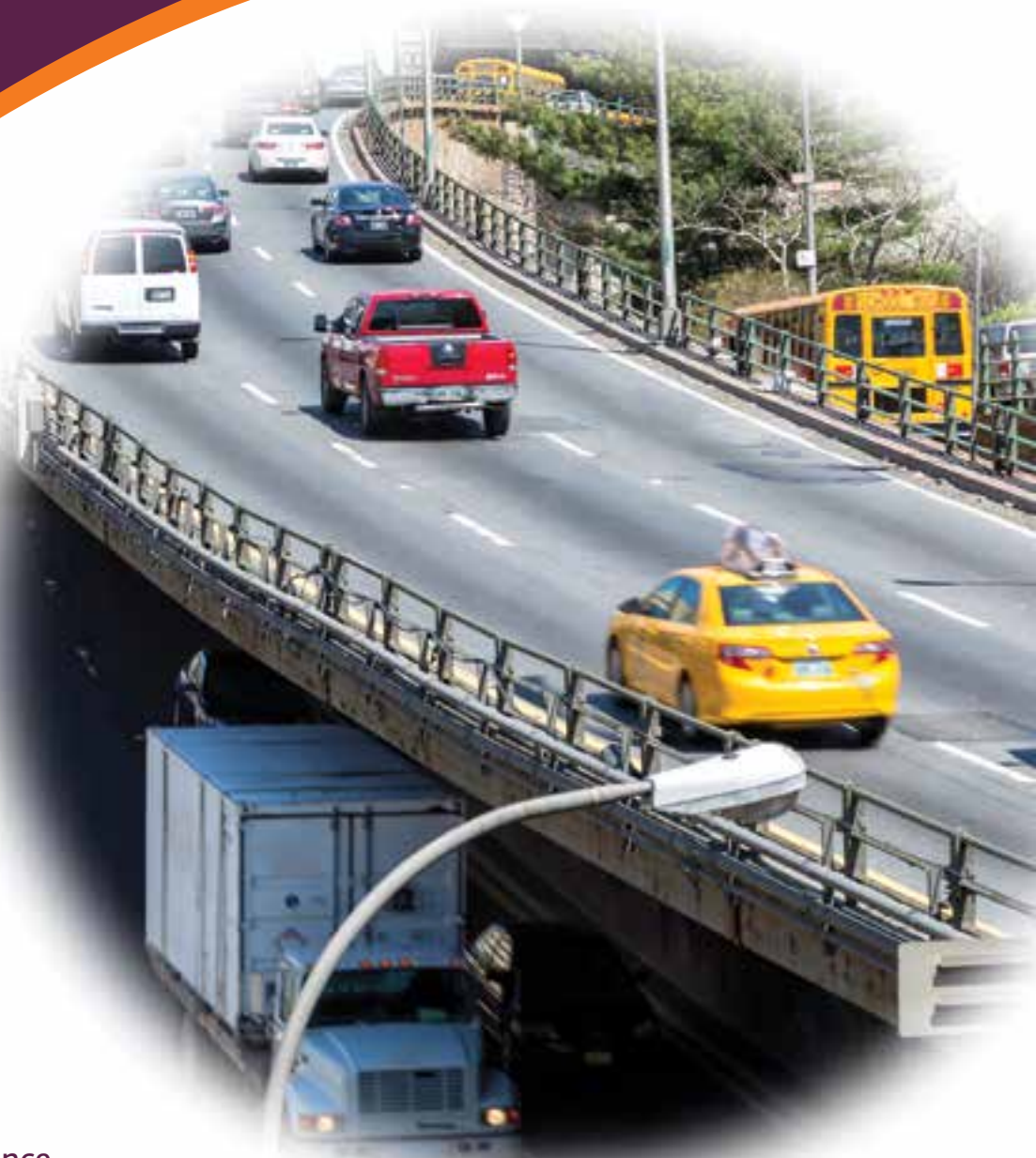

- Requirements for a Class 1–4 driver's licence
- How to drive safely and efficiently
- Pre-trip inspections



**Manitoba
Public Insurance**

Introduction

As an applicant for a professional (Class 1, 2, 3 or 4) driver's licence, you will need to know the information given in this manual and the *Driver's Handbook*. These manuals contain the basics of safe, professional driving.

As a professional driver you will have to ensure that your vehicle is properly maintained by performing commercial truck inspections in compliance with the Commercial Vehicle Trip Inspection Regulation (MR 95/2008) and, when necessary, in-service and pre-hill inspections.

Drivers must know and obey all laws and regulations for the areas in which they are operating and can be held responsible if they do not obey.

Before learning to drive a Class 1, 2, 3 or 4 vehicle, you must get authorized instruction in the class of vehicle you want to be licensed in. This manual will explain the types of driver's licences available and how to go about getting one. When you are ready, Manitoba Public Insurance will test your ability to operate the class of vehicle you wish to drive.

This manual is for general information only. For specific information see The Highway Traffic Act and/or The Drivers and Vehicles Act and regulations. All charges, additional premiums and fines are subject to change.







Sales of this manual are final and not refundable.

Table of Contents

Introduction	Inside front cover	Lighting, reflectors and markers	20
The class licence system	Foldout	Headlights	20
Basic licensing requirements	Foldout	Night driving	21
Test appointments	5	Vehicle operation	22
Scheduling your knowledge or road test	5	Steering—hand position	22
Knowledge test locations	5	Accelerator	22
Class 1, 2, 3 and 4 (bus or school bus only)		Clutch	22
road test locations	5	Double-clutching	22
Air brake and/or slack adjustment practical		When to change gears	23
test locations	5	Engine RPM	23
Mobile Test Units	5	Automatic transmission	23
Key points about your tests	6	Manual transmission	24
Section 1—Class 1 to Class 4 driver's licence requirements	7	Shift before starting down a hill	24
Medical standards	8	Shift before entering a curve	24
Medical examination report	8	Shift before or after railway crossings	24
Hearing	8	Visibility and safety	24
Vision	8	Speed-Weight-Distance	26
Medical re-examinations	8	Danger zone	27
Knowledge test	8	Shrinking the danger zone	27
Authorized Instruction	8	Timed-interval following distance	28
Road test	9	If you drive an ambulance or van	28
Commercial driver's licence (United States)	9	If you drive a bus, truck or truck and trailer	28
Commercial driver abstract	9	Driving the correct speed	29
Vehicles with air brakes	10	Traffic tempo	29
Section 2—Efficient and safe vehicle operation for all classes of vehicles	11	Tailgaters	30
A growing priority: fuel efficiency	12	Slow-moving vehicles	30
Making smart choices	12	Braking	31
Caring for your vehicle	12	Engine retarders	31
Starting your vehicle	13	Anti-lock braking system (ABS)	32
Smart driving practices	13	Combination braking	32
Keeping up with road conditions	13	Runaway lanes	33
Driving defensively	14	Checking tires, wheels and fasteners	34
Driving while impaired	14	Common driving conditions	36
Alcohol	14	Passing	36
Prescription drugs	14	Being passed	36
Illegal drugs	14	Lane changing	37
What are the consequences?	14	Curves	37
Criminal Code offences	15	Intersections	38
Licence suspension for other Criminal Code convictions	15	Backing	39
Driving while suspended—consequences	15	Parking lots, alleys and side roads	42
Safety considerations	16	Unattended or parked vehicles	42
Carbon monoxide poisoning	16	Railway crossings	43
Emotions	16	Adverse weather conditions	45
Drowsiness and fatigue	16	Reduced visibility	45
Hours of service regulation	17	Winter driving	46
Airbags	17	Winter road driving	46
Seatbelts	17	Gusting or strong winds	48
Distractions	17	Hydroplaning	48
Safety equipment	18	Wet brakes	48
Vehicle fires	19	Skids and their causes	49
Fire extinguishers	19	Overbraking	49
Fire prevention	19	Overaccelerating	49
		Oversteering	49
		Skid control and recovery	50
		Avoiding skids	50
		Jackknifing	51
		Test yourself on Section 2	52

Section 3—Additional information for Class 1 and Class 3 drivers	53		
Types of vehicles	54	Highway train	82
Turning	55	Dangers of skidding and jackknifing with a highway train	82
Turning radius	55	Highway train loading	82
Off-track	55	Tow truck	82
Turning at intersections	56	Test yourself on Section 3	83
Turning safely	56	Section 4—Additional information for Class 2 and Class 4 drivers	86
Right turns	57	Buses	86
Button hook	57	School buses	86
Extended approach	58	Railway crossings	86
Lane straddling	58	Emergency vehicles	86
Left turns	59	Driving a bus	87
Button hook	60	Right turns	87
Extended approach	60	Left turns	87
Lane straddling	60	Leaving the curb	87
Backing a tractor and trailer	62	Parked car hazards	88
Straight line backing skill test	62	Passenger safety	88
Connecting vehicles	63	Inside lights	88
Coupling a tractor and trailer	63	Cleanliness of vehicles	88
Uncoupling a tractor and trailer	64	Vehicle inspection	88
Vehicle and load dimensions	65	Defects and breakdowns	88
Height	66	Fuelling	88
Overheight	67	Baggage	88
Width	67	Loading and unloading passengers	89
Overwidth	67	Safety provisions	89
Length	67	Driver's vision	89
Overlength	68	Standing passengers	89
Pilot vehicles	68	Refusal to transport passengers	89
Weight	68	Passengers with disabilities	89
Overweight	68	Test yourself on Section 4	90
Period of spring road restrictions	69	Section 5—Vehicle trip inspection	91
Liability for damage by overweight vehicles	69	Trip inspection illustration	92
Bridges	69	Vehicle condition	94
Weigh stations	69	Trip inspection testing	94
About loads and loading	70	All Class 1, 2, 3 vehicles and Class 4 buses	95
Weight distribution	70	Vehicle trip inspection tear out sheet	101
Approximate distribution of total weight—vehicle plus payload	72	In-service inspections	103
Securing loads	73	Post-trip inspections	103
Load projections	74	Pre-hill inspection	103
Night travel by oversize vehicle	74	Section 6—For your information	105
Farm equipment on roads	74	Border crossings	106
Fastening tailgate	74	Driver training schools	106
Transporting dangerous goods	75	Organ and tissue donation	106
Classifying dangerous goods	75	Metric conversion table	107
Safety marks	75		
The marks of safety	76		
Special labels and placards	78		
Dangerous goods routes	79		
Documentation	79		
Transporting explosives	80		
Transporting livestock	80		
Transporting hanging meat	80		
Transporting bulk material	81		
Transporting liquids	81		
Special driving considerations for tank trucks	81		
Transporting dry bulk	81		

The Class Licence System

Manitoba Licence Class	Allows the Licence Holder to Operate	Minimum Age	Medical Requirements	Requirements	Test Charges
1 	<ul style="list-style-type: none"> Semi-trailer trucks¹. Includes all vehicles in Classes 2, 3, 4 and 5. 	18	<ul style="list-style-type: none"> Must meet medical and vision standards. Medical report required on initial application and periodically thereafter based on the age of the driver. Medical report valid for six months from the date completed by physician. Must obtain Authorized Instruction within this six-month time frame. 	<ul style="list-style-type: none"> Must hold a minimum Class 5I (Intermediate Stage) licence or Class 5A (Authorized Instruction Stage) licence to obtain authorized instruction in Classes 1-4. Must pass knowledge test. Requires supervising driver for Authorized Instruction. Must pass road test. For Classes 1, 2, 3 or 4 (buses and trucks only), the test includes a pre-trip inspection of vehicle (and air brake system if applicable) by the applicant. 	Class 1 Road Test \$50
2 	<ul style="list-style-type: none"> Buses² having a seating capacity of over 24 passengers (while carrying passengers). School buses³ having a seating capacity over 36 passengers (while carrying passengers). Includes all vehicles in Classes 3, 4 and 5. 				Class 2 Road Test \$45
3 	<ul style="list-style-type: none"> A truck with more than two axles. A combination of vehicles that includes a truck with more than two axles (not including a semi-trailer truck¹). A combination of vehicles consisting of a truck with two axles or Class 5 passenger vehicle, and a towed vehicle with a registered gross vehicle weight of more than 4,540 kg. Includes all vehicles in Classes 4 and 5. 				Class 3 Road Test \$45
4 	<ul style="list-style-type: none"> Ambulances and other emergency vehicles. Buses² with a seating capacity between 10 and 24 passengers (while carrying passengers). School buses³ with a seating capacity between 10 and 36 passengers (while carrying passengers). Includes all vehicles in Class 5. <p><i>Note: Individual municipalities may require a Class 4 licence to operate a Vehicle for Hire – contact your municipality for information.</i></p>				Class 4 Road Test \$35
5 	<ul style="list-style-type: none"> A passenger car (other than Class 4 vehicles). A bus² while not carrying passengers. A truck with two axles. A combination of vehicles consisting of a passenger car or a truck with two axles, and a towed vehicle with a registered gross vehicle weight of up to 4,540 kg. May operate Class 3 vehicles registered as a farm truck and the driver holds a Class 5I (Intermediate stage) licence or 5F (Full stage) licence. May operate a moped⁴, if 16 years of age or older. May operate infrastructure equipment or agricultural equipment on a provincial highway, or a highway within the municipal boundaries of a city, town or urban municipality, subject to supervising driver requirements. 	16 or 15½ if enrolled in a high school driver education course currently in progress	<ul style="list-style-type: none"> Medical report required when requested. Must meet vision standards. 	<ul style="list-style-type: none"> Must pass knowledge test for Class 5L (Learner Stage) licence (must wait seven days for re-test.) Requires supervising driver for Class 5L (Learner Stage) or Class 5A (Authorized Instruction) licence. Requires supervising driver for a Class 5I (Intermediate Stage) licence if carrying more than one passenger between the hours of midnight and 5 a.m. Must pass road test to advance to the Intermediate Stage (Minimum 15 months). (Must wait 14 days for re-test. Professional instruction required if five or more tests are needed.) 	Class 5 Road Test \$30
6 	<ul style="list-style-type: none"> Motorcycles. 	16	<ul style="list-style-type: none"> Medical report required when requested. Must meet vision standards. 	<ul style="list-style-type: none"> Driver must hold a valid licence of any class and stage. Must pass knowledge test (must wait seven days for re-test). Must obtain Class 6M (Motorcycle Training Course Stage) licence in order to complete motorcycle training course. The course is required before Class 6L (Learner Stage) licence is issued. (Contact Safety Services Manitoba for motorcycle course scheduling and fees.) Minimum nine-month Learner Stage. Must pass road test to advance to the Intermediate Stage (Minimum 15 months). (Must wait 14 days for re-test.) 	Class 6 Road Test \$30
Air Brake Endorsement 	<ul style="list-style-type: none"> Air brake endorsement permits the holder to drive vehicles equipped with air brakes in the class of vehicle for which the person is licensed. <p><i>Note: Drivers of a Class 3 truck registered as a farm truck equipped with air brakes are exempt from this requirement.</i></p>			<ul style="list-style-type: none"> Must pass knowledge test. Must pass Air Brake practical test for A (Authorized) endorsement. Must pass adjustment of the manual slack adjusters for S (Slack Adjuster) endorsement. No additional charge for the Air Brake practical test if it is completed at the same time you are road-tested for a higher class of licence. 	Practical Test \$30
					Knowledge Test \$10

1. A semi-trailer truck is a truck tractor and a semi-trailer combined.

2. A bus is any vehicle with a seating capacity of at least 11 persons (including the driver) used primarily to carry passengers. It excludes vehicles used for personal transportation by the owner or with the owner's permission.

3. School bus certificate is required. For further information, contact the Pupil Transportation Unit, Manitoba Education and Training at 204-945-6900.

4. Mopeds are not allowed to be driven on highways with a speed limit exceeding 80 km/h but may cross these highways.

All charges are subject to change.

Basic licensing requirements

The class licence system

Manitoba's class licence system recognizes the professional from the non-professional driver. To promote safety for all road users, drivers must meet vision, medical, knowledge and skill standards in order to operate a particular class of vehicle.

Who must take a driver test

You must take a driver test for the class of vehicle you wish to drive if you:

- have never been licensed for that class of vehicle
- have not held a Manitoba licence within the past four years
- hold a licence from outside Canada, the United States or from other jurisdictions whose licences are not exchangeable

You may be required to be re-tested if you:

- have been involved in traffic collisions or have convictions
- have had your licence suspended
- have a disease or disability that may affect your ability to drive safely

Authorized Instruction

To learn to drive Class 1 to 4 vehicles, drivers must apply for Authorized Instruction in the class of vehicle they want to drive. To obtain Authorized Instruction in classes 1 to 4, a driver must be minimum 18 years of age, hold a minimum Class 5I or Class 5A driver's licence, meet medical standards, pass the knowledge test and pay any charges required. To take a road test, the driver must hold a Class 5F licence (Full Stage).

Holders of Authorized Instruction for Class 1, 2, 3 and 4 driver's licences must be accompanied by a person who holds a valid driver's licence and has held a minimum Class 5F driver's licence for at least three years, of which two years are the same class of licence being sought. This person is known as the supervising driver and must sit in the seat nearest the driver.

To operate infrastructure equipment or agricultural equipment, a person must hold a valid minimum Class 5I driver's licence. This requirement applies on all provincial trunk highways, provincial roads and highways within the boundaries of a city, town or village. For further information please call 204-985-7000 or toll-free 1-800-665-2410.

Application and test requirements

A) Age limits and licence requirements

Any person 18 years of age or over who holds a minimum Class 5I or Class 5A driver's licence and meets the required knowledge, visual and medical standards for that class may apply for Authorized Instruction in Class 1, 2, 3 or 4.

B) Visual and medical requirements

All applicants for a Class 1 to 4 driver's licence must file a medical report approved by Manitoba Public Insurance before a learner's licence can be issued. Applicants who fail to meet the minimum medical standards will be denied a Class 1 to 4 licence. In addition, commercial class drivers are required to file periodic medical reports to ensure they have no medical conditions that may affect their driving ability. Drivers with certain medical conditions may have to file more often.

The applicant must also meet the minimum Class 1 to 4 vision standards. Applicants who fail to meet the minimum vision standards, with or without corrective lenses, cannot obtain a Class 1 to 4 licence. If corrective lenses are required for driving, this will be indicated on your licence. A vision report may be needed.

Manitoba Health will NOT pay for third party requests for medical reports including related examinations, tests or telephone calls to the physician. Applicants are responsible for these costs.

C) Knowledge test

For Class 1, 2, 3, 4, Air Brake and School Bus knowledge tests, applicants must pass the knowledge test for the class of licence they are applying for. This is not an open book test and cellphones or electronic devices cannot be used during the test. Knowledge tests are \$10 per test. Only one knowledge test per class of licence (Class 1 to 4) is allowed per day. You may repeat a Class 1, 2, 3, 4, Air Brake and School Bus knowledge test on the next working day.

D) Road test

Applicants for a Class 1, 2, 3 or 4 driver's licence must wait at least two weeks after they are issued Authorized Instruction in that class before taking a road test. Drivers must also hold a minimum Class 5F driver's licence.

The road test not only measures your ability to operate a specific class of vehicle, it also identifies errors that need to be corrected. You will be required to operate your vehicle in typical traffic situations in a safe and legal manner. You will be evaluated on your driving skills. Only authorized Manitoba Public Insurance employees may ride with you during the test.

A pre-trip inspection of the vehicle will also be needed for Class 1, 2, 3 and school bus tests.

Please make sure you check in 15 minutes before your appointment time. You must bring a vehicle in good working order and produce a Vehicle Registration Certificate confirming the vehicle is properly registered and insured. Failure to do so may result in the cancellation of the road test.

Only one road test per class of licence (Class 1 to 4) is allowed per day. You may repeat a road test (Class 1 to 4) on the next working day.

New residents

New residents to Manitoba may operate a motor vehicle in Manitoba with their valid out-of-province licence for up to three months before getting a Manitoba driver's licence. Testing requirements may be waived if you surrender a valid and equivalent class driver's licence from another jurisdiction. For further information on new resident drivers, please call 204-985-7000 or toll-free 1-800-665-2410.

Change of name or address

You are required to notify your Autopac agent or Manitoba Public Insurance within 15 days of any change in your name or address.

For more information visit mpi.mb.ca or call us at 204-985-7000 (in Winnipeg) or 1-800-665-2410 (outside Winnipeg).

Test appointments

Scheduling your knowledge or road test

- All knowledge and road tests are by appointment only. Visit any Autopac agent* to pay for your test and schedule your test appointment.
- Both knowledge and road tests are conducted during weekdays only (with the exception of holidays). Saturday appointments are available in Winnipeg. For hours of operation please see mpi.mb.ca or contact an Autopac agent.
- Your Autopac agent can provide you with details of available appointments at any testing location.
- You can schedule your test appointment up to eight weeks in advance.
- Knowledge and road tests are available in English and French. Specify your language preference when booking your appointment.

*For a list of Autopac agents, see mpi.mb.ca.

Key points about your tests

Cost*

- A knowledge test costs \$10.
- Costs for road/practical tests:
 - Class 1 licence: \$50
 - Class 2 or 3 licence: \$45
 - Class 4 licence: \$35
 - Class 5 licence: \$30
 - Class 6 licence: \$30
 - Air brake: \$30**

*Cost may change.

**There is no additional charge for the practical air brake test if you are taking a road test for a class 1, 2, 3, 4 or 5 licence and the vehicle you are using for the test is equipped with air brakes.

General testing information

- Please check in 15 minutes prior to your scheduled appointment time.
- There is a 30-minute time limit to complete a knowledge test.
- The knowledge test is not an open book test.
- Cellular phones and electronic devices are not allowed in the test area.
- Only one knowledge or road/practical test of the same class may be completed per day
- There is a 14-day waiting period between the issuance date of your learner's licence and the road test date for Class 1, 2, 3 and 4 licences.

For additional information or assistance, call your Autopac agent or the following numbers:

- In Winnipeg call 204-985-7000
- Outside Winnipeg call toll-free 1-800-665-2410

Section 1

Class 1 to Class 4 driver's licence requirements

1

Class 1 to Class 4 driver's licence requirements

Medical standards

Applicants for professional driver's licences must hold a valid minimum Class 5A or Class 5I driver's licence, be at least 18 years of age, and be medically fit and able to operate vehicles safely by meeting the following standards:

Medical Examination Report

A driver applying for a Class 1, 2, 3 or 4 licence must file a mandatory Medical Examination Report. Applicants are permitted to take the Class 1, 2, 3 or 4 knowledge test before the Medical Examination Report is approved. The medical report is valid for six months from the date your physician completes it. Your Authorized Instruction must be obtained within this six-month time frame. The knowledge test must be successfully completed and the Medical Examination Report approved prior to being issued Authorized Instruction.

People with certain medical conditions may be prohibited from holding a Class 1, 2, 3 or 4 driver's licence. However, most people with medical conditions or physical disabilities may be considered for a higher licence class provided specific medical standards are met. Drivers who are prohibited by the Registrar of Motor Vehicles to apply for a higher licence class are informed of their right to appeal the decision to the Medical Review Committee once complete medical information is filed.

Hearing

Drivers must meet specific hearing standards depending upon the class of licence desired and the type of goods transported. If a hearing impairment exists, an audiogram report may be required. Hearing aids may be used to achieve the hearing standards.

Contact Driver Fitness (see right) for further information.

Vision

Class 1, 2, 3 and 4 (emergency vehicles) drivers must have a vision acuity no less than $\frac{6}{9}$ with both eyes open and examined together with the worse eye no less than $\frac{6}{30}$. Visual fields must not be less than 150° with both eyes open and examined together.

Drivers who are applying for a Class 1, 2, 3 or 4 driver's licence and who require corrective lenses to meet the required visual standards may pass their vision screening while wearing glasses or contact lenses. Drivers wearing contact lenses are advised to carry glasses with them at all times while driving since there may be times when contact lenses have to be removed because of eye irritation.

Medical re-examinations

Under The Drivers and Vehicles Act the Registrar of Motor Vehicles requires certain drivers to be medically re-examined to determine their fitness and ability to drive. All Class 1, 2, 3 and 4 drivers must submit a Medical Examination Report form:

- every five years to age 45
- every three years to age 64
- annually at age 65 and over

Drivers may also need to be retested for their class of licence related to a medical condition. This may include a vision screening, a knowledge test and a road test in the type of vehicle for the class of licence held.

A pre-trip inspection and air brake inspection may also be required. Drivers may change to a lower driver's licence classification if they do not wish to hold the higher classification. In such cases, the medical requirements of the lower licence classification must be met.

For information regarding Medical Examination Report forms or questions about a medical condition please contact:

Manitoba Public Insurance

Driver Fitness
Box 6300
Winnipeg, Manitoba R3C 4A4
Telephone: 204-985-1900
Toll-free: 1-866-617-6676

Knowledge test

The knowledge tests for Class 1, 2, 3 and 4 are based on this manual. The knowledge test is not "open book."

Authorized Instruction

Upon meeting the medical requirements and passing the Knowledge test, the driver will be issued Authorized Instruction in the class of licence wanted.

Holders of Authorized Instruction for Class 1, 2, 3 and 4 must be accompanied by a person who holds a valid licence and has held a minimum Full Class 5 driver's licence for at least three years, of which two years are the same class of licence being taught or operated. The supervising driver must be in the seat nearest the driver, have less than .05 blood alcohol concentration, and cannot fail a drug screening test.

Road test

- A road test must be completed in a vehicle of the same class as the licence being sought. If you are uncertain please telephone your closest driver testing centre before the road test to be sure of the type of vehicle to bring for the test.
- A pre-trip inspection of the vehicle is part of this test and is explained later in this manual. Road test charges are not refundable if the test is cancelled because the vehicle fails to meet vehicle standards under The Highway Traffic Act and its regulations. Vehicles must have an adequate, clean, dry seat and seating area for the driver examiner.
- An inspection of the air brake system is required if the vehicle has air brakes. Applicants must ensure they have the necessary tools and equipment to do a brake adjustment on air brake-equipped vehicles. The *Air Brake Manual* gives information on air brake system inspection and adjustment.
- Inadequately completing the pre-trip and/or air brake inspections will result in stopping and failure of the road test.
- You must produce your valid vehicle registration and valid trailer registration (if applicable) before your road test. Failure to do so will result in a non-refundable road test cancellation.

For information regarding driver testing call:

Manitoba Public Insurance

In Winnipeg: 204-985-7000

Toll-Free: 1-800-665-2410

or visit a service centre or mobile testing unit in your area.

Commercial driver's licence (United States)

A Manitoba Class 1, 2, 3 or 4 driver's licence is acceptable as a Commercial Driver's Licence (CDL) in the United States. Certain medical conditions may prohibit a driver from operating a commercial vehicle there; these drivers will have a "Code W" restriction placed on their commercial licence.

The Federal Motor Carrier Safety Administration (FMCSA) requires that you must be 21 years of age and carry a completed medical card. The FMCSA also requires operators of commercial motor vehicles, including two-axle heavy truck with a gross vehicle or gross combination weight of 4,536 kg or more, to have medical certification when operating in the United States.

Drivers operating in the United States will have to participate in a drug and alcohol testing program administered by their employer.

FMCSA regulations apply to businesses that operate commercial motor vehicles in the United States and their drivers are required to have a CDL.

For more information contact:

Manitoba Trucking Association

25 Bunting Street

Winnipeg, Manitoba R2X 2P5

Telephone: 204-632-6600

Commercial driver abstract

Under the National Safety Code a motor carrier's safety fitness rating is affected by the driving offences of its employees. The Commercial Driver Abstract includes more information about an individual's driving record than a non-commercial driver abstract. This information will help a motor carrier decide how an employee's, or a potential employee's, driving record will affect its safety fitness rating.

The Commercial Driver Abstract includes information about convictions under various legislation including:

- The Transportation of Dangerous Goods Act (Canada)
- The Dangerous Goods Handling and Transportation Act and Regulations
- The Anhydrous Ammonia Handling and Transport Regulation
- Generator Registration and Carrier Licencing Regulation
- The Manifest Regulation
- Drivers Hours of Service Regulation
- Periodic Mandatory Vehicle Inspection Regulation
- Cargo Securement Regulation
- Vehicle Weights and Dimensions on Classes of Highways Regulation
- Commercial Vehicle Trip Inspection Regulation
- The Highway Traffic Act
- The Criminal Code of Canada
- The Drivers and Vehicles Act

Individuals can get a copy of their own driver abstract, either commercial or non-commercial, by applying and paying the required fee. An employer must have written permission from an individual before a copy of an employee's, or potential employee's, driving record will be released to him or her. The fee for the Commercial Driver Abstract is the same as the fee for the non-commercial Driver Abstract.

For more information contact:

Manitoba Public Insurance

Driver Records

Box 6300

Winnipeg, Manitoba R3C 4A4

Telephone: 204-985-0980

Toll-free: 1-866-323-0544

Fax: 204-954-5357

Vehicles with air brakes

If a vehicle has an air brake system, the operator must have an air brake endorsement on their driver's licence. The endorsement is shown in the "Air Brake" section on the driver's licence certificate.

To obtain an air brake endorsement, you must pass a knowledge test and a practical test based on the *Air Brake Manual*. This manual is available at your Autopac agent or Manitoba Public Insurance Service Centres throughout the province at a nominal charge.

The air brake test is carried out on a vehicle supplied by the applicant and includes:

- a practical demonstration of a pre-trip brake inspection along with a verbal explanation of the air brake components and their functions
- a demonstration that shows you can adjust a manual slack

Note: If a driver's licence is air brake endorsed and the holder wishes to upgrade to a Class 1, the air brake practical demonstration for a combination vehicle must be successfully completed.

Drivers should never take their brakes for granted. The braking system must be tested and the adjustment checked before placing the vehicle into service. Drivers must understand the braking system, realize its capabilities and limitations and learn to use them to the best advantage.

Heavy vehicles require powerful braking systems that are obtained by use of mechanical leverage and air pressure. Brakes must be used keeping in mind the heat generated by friction. If the heat becomes too great, braking effectiveness will be lost. The heavier the load and the faster the speed, the greater the force needed to stop.

It is important to remember that an air-brake-equipped vehicle, even with properly adjusted brakes, will not stop as quickly as a passenger car.



2

Section 2

Efficient and safe vehicle operation for all classes of vehicles

Efficient and safe vehicle operation for all classes of vehicles

A growing priority: fuel efficiency

As fuel costs are a significant portion of operating expenses, independent drivers and major transport companies are trying to accurately budget for fuel costs—and are actively searching for ways to keep those costs under control.

Of course, money isn't the only consideration. The environment is a key factor, too. Nearly 30 per cent of all greenhouse gas emissions in Canada are produced by the road transportation sector, a significant portion of them from heavy-duty vehicles.* Fortunately, there are many practical decisions you can make as a driver to be more fuel-efficient, from vehicle spec'ing to at-the-wheel techniques and behaviours.

Making smart choices

You may not be able to control gas prices, but your driving habits can reduce the amount of fuel you burn. Here are some steps you can take:

Preparation and planning

- Plan your route carefully: flat routes are more fuel efficient than mountainous routes; highway driving is more fuel efficient than city driving.
- Carefully consider your spec'ing options and always maximize your payload: instead of 60 per cent capacity, try to achieve 80 or 90 per cent capacity.
- Read the owner's manual for your vehicle and follow the manufacturer's driving recommendations.

Fuel and your engine

- When the temperature is above zero degrees Celsius, using summer fuel can improve fuel economy by as much as three per cent.**

Vehicle choice and accessories

- Optimize tractor/trailer aerodynamics: reducing aerodynamic drag by 10 per cent can reduce fuel consumption by about five per cent.**
- Consider using doubles or triples instead of single trailers where applicable.
- Use rib design tires when appropriate: they're more fuel efficient than using lug tires on the drive and steering axle.**
- Consider using low rolling resistance tires. Remember that super single tires provide lower rolling resistance as well as less weight.
- Choose lighter truck specifications where appropriate. Less vehicle weight means better fuel economy and can also offer more freight capacity increasing income per kilometre travelled.

- Use accessories such as oil pan heaters and block heaters (to help with cold starting and hasten lubrication), fuel heaters (to prevent fuel gelling), thermostatically controlled electric engine cooling fans, winter fronts, battery blankets and in-cab auxiliary heaters to improve productivity and fuel efficiency.

Dealing with the weather

Weather conditions affect fuel efficiency. Driving on snow-covered roads can increase fuel consumption by 15 to 20 per cent and fuel economy can be significantly affected by heavy winds.** Here are a few ways to minimize the effects of weather:

- Avoid bad weather where possible by changing trip times or routes.
- Adjust speed to suit the conditions; for example, reduce speed when there's a strong head wind.
- Slow down and maintain a safe following distance in order to better anticipate other vehicles in front of you.
- Don't park your tractor-trailer on an icy grade—getting stuck wastes fuel and time.

The road best travelled

Choosing to drive on a flat, multi-lane highway improves your fuel efficiency by:***

- four to 11 per cent compared to a flat two-lane highway
- as much as 18 per cent compared to a mountainous highway
- 25 to 35 per cent over taking a suburban route

Caring for your vehicle

Preventative maintenance plays a huge role in maintaining the health and efficiency of your vehicle. When your truck is serviced properly, you can run more efficiently and avoid unexpected downtime. Small problems should be fixed before they become bigger—and more expensive. In addition to regularly scheduled maintenance, you should also:

- Ensure your tires are inflated according to the manufacturer's recommendations—fuel consumption increases by about one per cent for each 10 pounds per square inch of underinflation.**
- Before you hit the road, make sure you've done a trip inspection—not only is it the law but it can also help you avoid unwelcome breakdowns during your travels.

*Source: Environment Canada: National GHG Inventory Report

**Source: Cummins MPG Guide: Secrets to Better Fuel Economy

***Source: Technology and Maintenance Council of the American Trucking Association

- It is a good idea to perform a post-trip inspection to spot problems that could delay you next time.
- Ensure all fluid levels are correct—underfilling or overfilling can damage your vehicle.
- Monitor your restriction indicator for signs of the air filter becoming plugged or contaminated.
- Continually monitor your vehicle's condition during your trip: check gauges, tires and cargo every three hours.

Starting your vehicle

Fuel efficiency starts when you turn your engine on. Proper warm-up helps lubricate components and seals reducing wear and leakage. Starting your truck properly can save money on fuel. Keep the following in mind:

- When starting your vehicle make sure you use zero throttle.
- Don't pump the throttle: the amount of fuel required for starting is pre-measured. Similarly, don't pump the throttle when cranking with older diesel engines with mechanical injection: it wastes fuel and can damage cylinder walls.
- Use ether sparingly when having difficulty starting your engine: excessive use can harm the engine.
- Let your vehicle warm up for three to five minutes; if the temperature is below zero degrees Celsius allow it to warm up for seven to 10 minutes. Don't rev it; let it warm up gradually.
- Ensure oil and air pressure are in their normal operating ranges.
- Warm your vehicle up after the initial idle time by driving easily; don't try to get too much speed out of the engine by pushing the throttle down hard.

Smart driving practices

Driving smart can save fuel and reduce wear and tear on your vehicle. Keep the following in mind:

- Back off the accelerator when going over the top of a hill and let gravity and momentum do the work.
- Use cruise control where appropriate.
- Reduce your speed—driving fast eats up fuel no matter what you drive. Generally, for every 10 km/h over 90 km/h you use 10 per cent more fuel.*
- Always use the clutch—failure to do so can result in a missed shift or damage the transmission.
- Practice progressive gear shifting. Shift between 1,400 and 1,600 rpm before you reach the maximum governed rpm. This can help reduce equipment wear, decrease noise levels and save fuel.***

- Use the highest gear possible to keep the engine in its most efficient rpm range.
- Use your retarder properly and turn it off when you don't need it—let the terrain work for you.

Idling: A special note

Idling a class eight truck engine** burns up to four litres of fuel per hour at 900 rpm. Turn off your engine when you stop for any length of time—you will save fuel, reduce maintenance requirements, prolong engine life and prevent unnecessary emissions. If a 10-truck fleet were to cut idling by an hour a day for 260 days, it would save approximately 10,400 litres of fuel (\$11,440 at \$1.10 per litre). A 100-truck fleet would save \$114,400 and a 500-truck fleet \$572,000.

Taking advantage of technology

New engine designs offer great benefits, delivering more horsepower and torque in lower rpm ranges. You can downshift at about 1,200 rpm and upshift at about 1,600 rpm—rather than 2,000 rpm. You shift less, save money and generate fewer emissions.***

Keeping up with road conditions

Smart, fuel-efficient driving is also safe driving. Different road and traffic conditions present different challenges. As a driver, it's important for you to keep the following in mind:

- Light: Adjust your driving per visibility. Wear sunglasses in bright conditions and reduce speed in poor light conditions.
- Posture: Keep your seat adjusted to the correct position for comfort, alertness, visibility and access to controls.
- Traffic: Try to travel at a constant speed, staying within the speed limit. Be considerate and give way to other drivers.

Street smart

Managing your vehicle's momentum using smart driving techniques allows you to keep your speed more constant and increase fuel efficiency.

*Source: Technology and Maintenance Council of the American Trucking Association

**Class eight truck: a truck over 14,969 kg (33,000 lb.) Gross Vehicle Weight Rating (GVWR)

***Source: CAT (Canadian American Transportation) Driving Tips

Driving defensively

Smart driving is both an attitude and a skill. A sharp mind and shrewd decision making can go a long way toward protecting your safety and the safety of others—not to mention increasing fuel efficiency. Defensive driving allows you to anticipate hazards and maintain a constant speed. When you drive defensively, you conserve your momentum—which means you don't have to continually build up lost speed. Power not used is fuel not burned. Here are some helpful tactics:

- Don't let frustration push you into making unsafe passes or other manoeuvres.
- Look ahead and anticipate stops. It's more efficient to coast to a stop than to brake.
- Maintain a safe driving distance of at least four seconds.
- Be aware of your blind spots and check them regularly.
- Be aware of your own physical and mental condition including the effects of alcohol and drugs, age, attitude, illness, fatigue, emotion and diet.

Safe stopping

Keep a safe following distance so you can always brake safely and efficiently. Driving at 70 km/h requires a stopping distance of about 90 m (300 ft.).

Driving while impaired

Alcohol

Impaired drivers are some of the most dangerous, unpredictable people on our roads and cause about one third of all traffic deaths in this province.* This is why, in Manitoba, the laws for drinking and driving are severe.

If your ability to drive is impaired, you may be charged with impaired driving regardless of the level of alcohol found in your blood. The safest rule to follow is: if you drink, don't drive. Alcohol or drug impairment delays reaction times, distorts vision and impairs judgment. Never mix drugs and alcohol—even in small quantities.

Remember, alcohol is a depressant, not a stimulant. It reduces alertness and slows normal reflexes. If you've had too much to drink, black coffee, food or a cold shower won't sober you up—only time will eliminate alcohol from your body.

Possession of alcohol in a commercial vehicle is strictly prohibited in the United States unless it is part of the load and is manifested. In Manitoba, alcohol must be out of the reach of the driver and the seal cannot be broken.

*Source: *Traffic Accident Report Database, 2013*

Prescription drugs

Tranquillizers, antidepressants, sleeping pills and similar prescription drugs can affect driving ability even if taken in the prescribed dosage. If you drive while impaired by medication, you can be charged with driving while impaired and face the same consequences as if you were impaired by alcohol. Discuss the possible effects of any medication with your doctor or pharmacist. Always carry prescription drugs in their original containers.

Illegal drugs

Illegal drugs may cause hallucinations, hostility and aggressiveness in addition to dulling normal thought processes and slowing down eye-hand coordination.

What are the consequences?

Manitoba's tough laws on driving while impaired apply to all motor vehicles including agricultural equipment, infrastructure equipment and off-road vehicles as well as vessels, aircraft and railway equipment. A vessel includes all craft usually larger than a row boat designed to navigate on water, including hovercrafts.

Drug impairment

Drivers suspected by police of being under the influence of any drug can receive an immediate 24-hour roadside license suspension.

Tiered Administrative Licence Suspensions

If you operate a motor vehicle with a blood alcohol concentration between .05 and .079 or fail a drug screening test, physical coordination test or drug recognition evaluation, you are subject to an immediate Tiered Administrative Licence Suspension. Tiered Administrative Licence Suspensions are progressively longer suspensions ranging from 72 hours to 60 days depending on how many previous suspensions have been issued to the driver within a 10-year period:

- 72-hour driver's licence suspension for a first occurrence
- 7-day driver's licence suspension for a first occurrence with a person under the age of 16 in the vehicle
- 15-day driver's licence suspension for a second occurrence
- 30-day driver's licence suspension for a third occurrence
- 60-day driver's licence suspension for fourth and subsequent occurrences

Receiving a Tiered Administrative Licence Suspension lowers your Driver Safety Rating by five levels. You may also be subject to a Driver Improvement and Control intervention. This could range from a warning letter to a further driver's licence suspension. You would also be required to pay a driver's licence reinstatement charge.

If you receive two or more suspensions within a 10-year period, you are also required to complete an Impaired Driver Assessment at the Addictions Foundation of Manitoba (AFM) at your own expense.

Three-month Administrative Licence Suspension

You will receive a three-month Administrative Licence Suspension if:

- your blood alcohol concentration is equal to or over .08
- your blood drug concentration is over 5 nanograms of THC
- your combined blood alcohol concentration is over .05 and your blood drug concentration is more than 2.5 ng of THC
- you refuse to provide a breath, saliva or blood sample to police

- you refuse to perform a physical coordination test or drug recognition evaluation, or refuse to follow a police officer's instructions regarding either test
- you have any concentration of illegal drugs in your system

Receiving this suspension lowers your Driver Safety Rating by five levels. You will also be required to pay a driver's licence reinstatement charge. Additional consequences may include:

- being charged under the Criminal Code of Canada
- vehicle impoundment (except infrastructure equipment)
- a mandatory Impaired Driver Assessment at your expense

For more information please visit mpi.mb.ca.

Impaired Driver Assessment

An assessment of your alcohol or drug use from the AFM Impaired Drivers' Program is required after an alcohol- or drug-related suspension. You will be required to sign a release authorizing the AFM to access your driving record.

You may be referred to an educational workshop, a risk reduction program or an AFM treatment program. You may also lose your licence and be disqualified from driving until your alcohol or drug use is under control.

Criminal Code offences

Criminal Code offences include the following:

- driving, or having care and control of a vehicle, while impaired by drugs or alcohol
- impaired driving causing bodily harm or death
- driving with a blood alcohol concentration equal to or over .08
- driving with a blood drug concentration over 5 ng of THC
- driving with a combined blood alcohol concentration over .05 and blood drug concentration over 2.5 ng of THC
- driving with any concentration of illegal drugs in your system
- refusing to provide a breath, saliva or blood sample to police upon request
- refusing to perform a physical coordination test or drug recognition evaluation, or refusing to follow a police officer's instructions regarding either test

If you are convicted* of an impaired driving offence under the Criminal Code, your driver's licence will be suspended and you will be disqualified from driving any type of vehicle. A conviction may result in a number of sanctions including:

- moving an additional five, 10 or 15 levels down the Driver Safety Rating scale
- a significant court-imposed fine
- possible imprisonment
- a court-imposed driving prohibition
- mandatory driver's licence suspension under The Highway Traffic Act

- possible participation in Manitoba's Ignition Interlock Program
- possible vehicle forfeiture

Some licence suspensions, disqualifications and court imposed driving prohibitions can be appealed to the Licence Suspension Appeal Board. If successful in the appeal, drivers may be required to participate in Manitoba's Ignition Interlock Program for impaired driving related driving suspensions and/or prohibitions.

For more information see our *Ignition Interlock Program* and *Impaired Driving* brochures at mpi.mb.ca.

**A discharge under the Criminal Code of Canada for certain driving-related offenses may be treated as a conviction under The Highway Traffic Act*

Licence suspension for other Criminal Code convictions

Driving a vehicle in Manitoba is a privilege. People convicted* of certain offences under the Criminal Code of Canada will lose that privilege. Some examples of these offences are: dangerous driving, criminal negligence, flight from police, auto arson, auto vandalism, take vehicle without owner's consent, auto theft, possession of property obtained by crime and possess, sell or purchase master keys.

A conviction* of any of these offences results in an automatic driver's licence suspension or eligibility to obtain a licence. It also disqualifies you from operating an off-road vehicle. Anyone convicted of any such offence faces a driver's licence suspension ranging from one year to life. Offenders under 16 years of age will have their suspension start on their 16th birthday.

Driving while suspended — consequences

Vehicles and off-road vehicles (ORVs) will be immediately impounded for a minimum of 30 days for driving while the person is suspended or prohibited from driving, or if the person is disqualified from operating an ORV.

The vehicle will be impounded even if it is owned or registered by someone other than the operator at the time of the offence. It is the owner's responsibility to ensure that the user is not suspended, prohibited or disqualified. Vehicle owners will be responsible for the costs of towing and storage, plus an impoundment fee, which must be paid before a vehicle is released.

Additional consequences of driving while suspended can include:

- imprisonment for up to five years and/or fines of up to \$2,000
- a non-appealable licence prohibition under the Criminal Code, which means that a work licence cannot be obtained
- a lifetime driver's licence suspension under The Highway Traffic Act
- additional driver's licence premiums once the driver's licence is reinstated

Safety considerations

Carbon monoxide poisoning

Carbon monoxide (CO) poisoning is an ever-present danger when you operate a motor vehicle. CO is odourless, colourless, tasteless and hard to detect. It is in the exhaust fumes of most motor vehicles. This makes it essential for you to keep a constant check on your exhaust system for leaks.

Never run your engine in a closed garage. Don't follow any vehicle too closely and maintain a safe distance between your vehicle and the one in front of you when you are stopped at traffic lights or stops signs.

If you get dizzy or drowsy while driving, stop, get out and get plenty of fresh air.

Emotions

Some collision investigations have traced the cause of the collision to an emotional disturbance that distracted the driver's attention from the driving task.

Safe driving demands the full attention of the driver at all times.

Arguments at home or at work, anger directed at other drivers, illness or financial problems are some of the things that can preoccupy a driver's mind and distract attention from the important job of driving.

Safety demands a driver's complete and constant attention to driving situations.

Drowsiness and fatigue

Most transport workers experience fatigue-related problems. These problems are not unique to truck driving.

It is estimated that driver fatigue or extreme tiredness is a factor in 30 to 40 per cent of all heavy truck fatalities. Drivers who are fatigued suffer from impaired memory, reduced alertness, concentration and ability to respond.

Studies indicate that drivers are usually unaware they are becoming fatigued and may exceed their own personal limits, which significantly increases the risk of having a collision. It is important that a driver maintain a regular sleep pattern as much as possible.

A proper diet and exercise will also help. Exercise can be accumulated during the day. This can be accomplished by exercising three times for 10 minutes over the course of the day. This is the same as one 30 minute exercise period. Before starting any exercise program consult with your physician.

Circadian rhythms—this is the internal clock that tells the body when to wake or sleep. The majority of people are most alert during the day and require rest at night. Depending on an individual's makeup, most people require between six and eight hours of sleep per night.

If enough sleep is not obtained over an extended period, the body will start to accumulate sleep debt that must be repaid. The sleeping time that has been missed must be made up with extended periods of sleep. Most people will notice they need a rest and will sleep many more hours than usual when they have gone for an extended period of time (usually after eight to 10 days) with reduced sleep. If a person continually robs their body of sleep for long periods, it will begin to affect their health.

If you're tired, get some sleep!



A driver may experience a condition called "micro sleep." This is a short period of time, usually just seconds, when the brain tunes out what is going on around it. A driver will have no knowledge of the last few seconds or sometimes minutes, cannot recall what has passed and may miss a highway exit or drive by a weigh station.

Fatigued drivers may also experience "highway hypnosis," where they become inattentive because of uninteresting terrain. When this happens, drivers may not be aware of their surroundings and will not be alert to changing traffic conditions. They could tailgate a vehicle and not be aware of the potential danger until it is too late.

Drivers who are extremely fatigued may fall asleep when driving down the highway. Before this happens, pull off the road and get some sleep.

Sleep hygiene is the length and quality of sleep a person receives daily. It is important for drivers to obtain a sufficient amount of quality sleep.

The effects and onset of fatigue are different for each person. It cannot be regulated or controlled other than by you. It is important to watch for the warning signs, and do what your body tells you.

Hours of service regulation

This regulation has been developed to help drivers and companies manage the driver fatigue factor, which is a major cause of truck collisions. It is important that professional drivers be very knowledgeable about the hours of service regulations.

For information on hours of service regulations contact:

Motor Carrier Division

Telephone: 204-945-3890

Airbags

Many vehicles are now equipped with airbags. They have been shown to reduce injury in high-speed collisions. Airbags work because they reduce the shock of the collisions by distributing the impact over a larger surface area of the body.

Airbags can be mounted in front of and beside the driver and front seat passenger. Some vehicles may also have side curtain airbags which cover the side windows front and back. The area in front of airbags must be kept clear; do not place items on the dash where the airbag is located.

If your vehicle is equipped with airbags, you should position your seat to a position that is also at least 25 cm from the steering wheel. This allows room for the airbag to inflate and protects you from further injury.

Consult your owner's manual for safety precautions.

At some point, you may need to deactivate an airbag. You must have approval from Transport Canada to do this.

For more information contact:

Transport Canada

1-800-333-0371

Seatbelts

All drivers and passengers must wear the complete seatbelt assembly in the cab or sleeper berth, unless exempted by law. It is the driver's responsibility to ensure that every minor is properly secured.

Note: Provincial law requires placing children in a size-appropriate car seat until they are at least 145 cm, 36 kg or nine years old.

No person shall operate a motor vehicle if the seatbelt assembly has been removed or modified to reduce its effectiveness.

Vehicle collisions are the leading cause of head injuries suffered by thousands of Manitobans every year. Seatbelts play a significant role in reducing head injuries.



Distractions

Distractions can be dangerous because they reduce your ability to respond as quickly as you should to emergencies. For example, studies show that there is a direct connection between hand-held electronic devices and dangerous driving. Drivers who use a hand-held electronic device while they're operating a vehicle significantly increase their crash risk. That's why in Manitoba it is illegal for drivers to use hand-held electronic devices when they are behind the wheel of a vehicle.

Distracted driving occurs whenever a driver's attention is occupied by an activity unrelated to operating the vehicle. Some other forms of driver distraction known to increase the likelihood of collisions include: adjusting the radio or MP3 player or changing CDs; communicating with people in other vehicles; eating; grooming; smoking or interacting with passengers.

Safety equipment

All regulated vehicles used for carrying passengers, vehicles used for carrying flammable goods (loaded or not) and pilot vehicles must carry fire extinguishers as outlined in the Vehicle Equipment, Safety and Inspection Regulation. The fire extinguishers must be kept in good working order. Other vehicles may have to carry a fire extinguisher as specified in a permit. However, it is recommended that all vehicles carry a fire extinguisher.

All regulated vehicles or trucks with a registered gross vehicle weight exceeding 3,700 kg must always carry two flares (lights or lanterns) or two reflectorized devices of a type and design approved as outlined in the Vehicle Equipment, Safety and Inspection Regulation. Should a vehicle become disabled, it should be moved as far off the travelled portion of the highway as possible.

Warning devices must be placed about 60 m ahead and 60 m behind the disabled vehicle. Place reflectors so that they will be illuminated by lights of any approaching vehicles.

It is recommended that every vehicle also carry a first-aid kit, fire axe, tools for minor repairs and survival gear when operating in cold weather and sparsely settled areas.

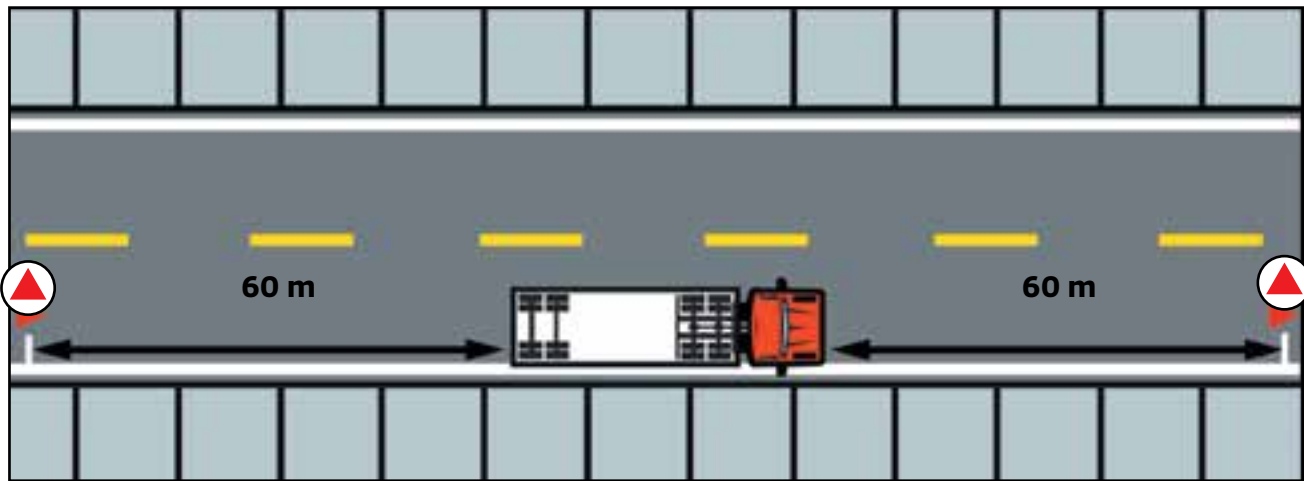

Vehicle Fires

Fighting a fire efficiently requires quick thinking and fast action based on training. All drivers should inspect the firefighting equipment on their vehicle daily. Know the types of fires that could occur on a particular vehicle, as well as with the load being carried.

The following is a general guide that could prevent loss of life or personal injury and reduce property damage:

- Don't risk your own life. Fuel fires can spread quickly or explode.
- Have the first passerby call the fire department. Warn others of the danger of explosion by fuel or flammable loads or exposure to toxic substances and tell them to keep back a safe distance.
- If a fire occurs on a combination unit, disconnect the tractor from the trailer and separate the units to a safe distance apart but only if you are sure you can do so safely.
- Whenever possible, fight fires with the wind at your back to lessen the chance of suffocation.
- For an electrical fire, disconnect battery cables first whenever possible. (Shutting off switches and disconnecting battery cables of vehicles involved in a collision can prevent fires from leaking fuel.)
- If a fire starts under the hood, don't throw the hood open—raise it very slightly to fight the fire. If the hood cannot be raised, spray the fire extinguisher from underneath the vehicle or through the radiator.
- Use the fire extinguisher only enough to knock down the flames; keep some in reserve for flare-ups.
- Water spreads fuel, oil and grease fires. Use fire extinguishers, sand or dirt to smother the fire.

Fire extinguishers

Multi-purpose dry chemical fire extinguishers marked B.C. extinguish grease, oil, fuel and electrical fires. If the cylinder is marked A.B.C., it will also extinguish Class A fires such as paper and cloth. The operator can safely use this extinguisher without fear of health hazard or bodily injury. Don't use a CO₂ (carbon dioxide) extinguisher in an enclosed space as there is danger of suffocation and it may cause blistering of the skin.



Fire prevention

Fire prevention in and around a vehicle is easier and cheaper than a vehicle fire. Practice the following rules:

- Never start a vehicle with a fuel leak. Repair the leak, wipe up any fuel spilled on the vehicle and the ground.
- Shut off engines when refuelling vehicles.
- Always ground the fuel hose nozzle against the filler pipe of the truck tank when fuelling.
- Don't smoke in garages or near fuelling areas.
- Never throw cigarette butts out of vehicle windows.
- Check tire pressure often. Soft tires build up heat. Tires which have been run when soft or flat should be left to cool before the vehicle is moved. If you must move the vehicle, the tire should be replaced first.
- Ensure parking brakes are fully released and service brakes are adjusted properly. Dragging brakes generate heat and can ignite grease in the wheel hubs when the vehicle stops. Make frequent checks of hubs and brake drums for overheating.
- Never start propane heaters with the trailer van doors closed.
- Keep fire extinguishers in good working condition.

Lighting, reflectors and markers

Note: Every lamp, reflex reflector and conspicuity treatment must be permanently attached in the location specified on pages 92 and 93 and must comply with all applicable requirements prescribed for it by FMVSS/CMVSS 108. The face of any device on the front/rear and sides should be, respectively, perpendicular and parallel to the vehicle's centerline, unless it is photometrically certified at installation angle. No part of the vehicle shall prevent any device from meeting its prescribed requirements unless an auxiliary device meeting all prescribed requirements is installed.

In Canada, manufacturers and importers of vehicles must have the proper certification test records demonstrating compliance of lighting components with all prescribed requirements.*

Headlights

Daytime running lights (DRL) are required on all motor vehicles built on or after December 1, 1989. DRL must be functioning and on at all times. Using headlights during the day can significantly reduce the chances of a collision as your vehicle is much easier to see.

*Source: Transport Canada



Night driving

Never drive so fast that you can't stop within the distance you can see ahead with your headlights. That means driving slower than usual, since under ideal night driving conditions you can see only 30 m ahead with low beams and 110 m ahead with high beams.

To reduce glare do not look directly at the headlights of oncoming traffic; instead, look to the right edge of the roadway. To cut glare from the rear, adjust your mirror or use a day-night mirror. Reduce your speed until your eyes have recovered from the glare.

Some additional points to minimize the hazards of night driving:

- Check your headlights regularly so the low beams reveal objects at least 30 m ahead without blinding oncoming drivers.
- Dim your lights at least 450 m from oncoming vehicles, and 60 m when following vehicles.
- Keep headlights clean.
- Keep the interior lights off so that your eyes will remain adapted to the dark.
- Slow down when meeting another vehicle or when nearing a curve.
- Watch for pedestrians and vehicles stopped at the edge of the road.
- If you must stop, pull off onto the shoulder and use your emergency flashing lights or other approved warning devices such as flares.
- Watch for highway signs—they're more difficult to see and read at night.
- Keep both the inside and outside of the windshield clean.



Always use low beams when approaching other cars. High beams will blind the other driver.



Use high beams only when driving in open country without other cars nearby.



Use low beams when driving by street lights, in fog and when following another vehicle closely.

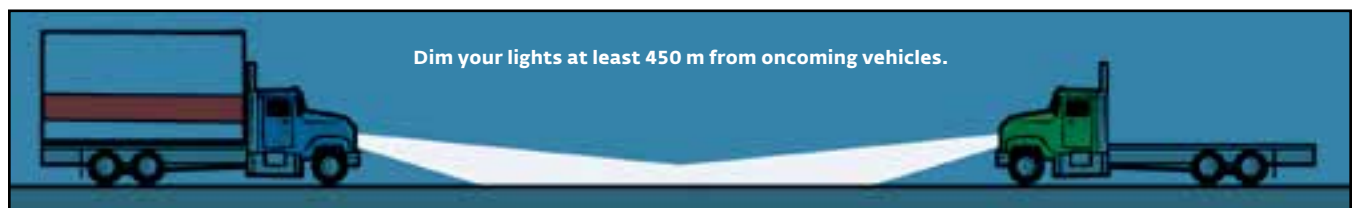

Vehicle operation

Steering—hand position

Advanced driving skills are needed to drive a heavy vehicle, whether it be a bus, a straight-body truck or a tractor and trailer. Since these vehicles are very large, a driver must gain experience handling them.

When turning a large vehicle you may have to turn the steering wheel several times (sometimes as many as eight times) to complete a left or right turn. Most vehicles are equipped with power steering and adjustable steering wheels that make operating the vehicle easier and more comfortable for the driver. It is recommended that the steering wheel be held with your hands at the nine o'clock and three o'clock position. This will allow for good control and, in the event of a collision and the vehicle is equipped with an airbag, it will inflate without injuring or being obstructed by your arms.

The driver of a vehicle should never turn the steering wheel with one hand (palming the wheel) or with one finger as they may not have full control of the vehicle.



Accelerator

To set a vehicle in motion, you have to accelerate (start) smoothly and gradually to avoid jerking the vehicle. The driver's foot should lie flat on the accelerator with the heel on the floor. For optimal engine performance, the driver should avoid abruptly applying and releasing the accelerator.

Drivers should accelerate slowly and steadily when starting from a stopped position. Drivers have more control over the vehicle. If the vehicle is over accelerated, particularly on poor or slippery road surfaces, the drive wheels can lose traction and could cause loss of control.

Clutch

The clutch makes it possible to disengage the transmission and the engine. By pressing the clutch pedal, the connection is broken between these two components, allowing the driver to change gears. The clutch pedal must be pressed with the left foot and held to move the gear lever. Avoid releasing the clutch too quickly. This can damage components leaving the vehicle unoperable. Also, do not let the clutch out too slowly or release it only enough to hold the vehicle from rolling on a hill when stopped. This will cause the clutch to heat excessively and wear out prematurely.

Some vehicles are equipped with a clutch brake to stop the rotation of the main shaft gears in the transmission when the clutch pedal is pressed all the way to the floor. You must not press the clutch all the way to the floor when changing gears when the vehicle is in motion. The clutch brake should be engaged only when the vehicle has come to a complete stop.

Double-clutching

Most heavy vehicles with manual transmissions require double-clutching to make changing gears easier. Double-clutching is simply depressing the clutch for each movement of the gear shift lever. The movements need to occur at the same time (synchronized) so you will need to practise before this skill can be mastered. This technique must be used for shifting both up and down. Even with synchromesh gears, shifting can be faster and smoother with the double-clutching method. It should be noted that there are manual transmissions that do not require double-clutching. Consult the operator's manual for the equipment being driven.

To double-clutch:

- Release the accelerator and at the same time press down the clutch pedal.
- Shift into neutral.
- Release the clutch.
- Increase or decrease the engine revolutions per minute (rpm) required for the next gear. The engine speed must be matched to the gear being selected—press lightly on the accelerator (to increase engine speed for downshifting) or release it slightly (to decrease engine rpm for shifting into a higher gear). This skill will come with practice.
- Press down on the clutch again.
- Shift into the desired gear.

- Release the clutch pedal and press down on the accelerator at the same time. If the transmission remains disengaged for too long when double-clutching, it may be hard to engage the gears. If this happens:
 - Shift back into neutral.
 - Release the clutch pedal.
 - Increase engine rpm.
 - Press down on the clutch.
 - Try shifting into a lower gear as the vehicle speed has most likely slowed.

When to change gears

There are two ways of knowing when to change gears:

1. According to the engine speed calculated in revolutions per minute (rpm):

Engine speed is determined by the gear selected and by the amount of pressure on the accelerator. To make efficient use of the engine's power, the engine speed and vehicle speed must be coordinated. Generally the higher the engine speed, the more power there will be in a given gear.

To know when the gears should be changed, glance at the tachometer and when the desired rpm is reached, change gears. Refer to the operator's manual for the proper rpm ranges for each gear on the vehicle being operated.

2. According to the vehicle speed measured in kilometres per hour (km/h):

If driving a vehicle that is not equipped with a tachometer, the gears will have to be changed in reference to the vehicle's speed. The operator's manual for the vehicle being driven will indicate the speed (km/h) range for each gear.

Engine RPM

An engine that does not turn over fast enough tends to jerk or lurch and can damage the vehicle. An engine that turns over too fast, on the other hand, consumes more fuel than is necessary and does not provide any more power than it would at a lower rpm.

Motor vehicle engines have a speed range within which they operate efficiently. It is often between 1,200 and 1,800 rpm, although there are some engines that operate at lower speeds.

Consult the operator's manual for the equipment being driven for the recommended rpm ranges for each gear.

The tachometer should be used to know when to change gears as it is more precise than using the sound of the engine or vehicle speed.

Automatic transmission

Many vehicles have transmissions that change gears automatically in response to speed and acceleration, by means of mechanical, electrical or hydraulic controls.

Drivers of such vehicles can also shift down to a lower gear for increased braking power when descending a hill. Downshifting prevents the transmission from automatically changing into a higher gear, keeping the vehicle speed slower. This can be very helpful in keeping the vehicle's brakes cooler as they will not have to be used as often when descending a steep hill.

This is an example of how the gears on an automatic transmission could be used:

- N (neutral): for starting the engine, stopping for an extended length of time and parking
- R (reverse): for backing up (bring the vehicle to a complete stop before changing from a forward gear to reverse and vice versa)
- D (drive) or 2-5: for normal forward driving conditions
- 2-3/2-4: lower gears for driving with heavy loads
- 2: for driving on slippery surfaces or up or down steep inclines
- 1: for driving very slowly when off the highway

Consult the operator's manual for information on the correct operation of the transmission.



Gear positions vary from one vehicle to the next.

Manual transmission

The gear shift lever is used to change gears. The gear you choose affects engine performance. The right gear depends on the transmission, the engine it is attached to, the load the vehicle is carrying and the highway being driven on.

Operating a manual transmission and engaging the right gear at the right time requires a lot of practice and skill. Since there are many different types of transmissions, consult the operator's manual for the vehicle being driven.

Shift before starting down a hill

Before starting down a hill, select a gear and slow down to a speed that can be controlled without hard braking or the brakes may overheat and lose their braking power.

Shift before entering a curve

Slow down to a safe speed and downshift to the correct gear before entering a curve. The correct gear will allow the engine power to be used to keep the vehicle stable while driving through the curve and provide good acceleration out of the curve. Driving through curves is explained in depth later in this manual.

Shift before or after railway crossings

You should not shift gears when crossing railway tracks. When approaching a railway crossing, the vehicle should be placed in an adequate gear that will allow the vehicle to completely cross the track. By not shifting gears when crossing railway tracks you avoid the chance of missing a shift, stalling the vehicle and/or blocking the railway tracks.

Visibility and safety

Larger vehicles usually offer a better view of the road ahead and to the sides than passenger cars. Larger windshields and a higher seating position provide a good view of the front, while large side view mirrors give a clear view of the road behind the vehicle. However, there may be blind spots to the side and right behind the vehicle.

Sometimes convex or spot mirrors may reduce the blind spots to the side of the vehicle. Also, some mirrors make things look smaller and farther away than they actually are.

In a city, a professional driver must try to drive in the curb or right lane on a multi-lane road, as larger vehicles do not usually speed up as fast or travel as quickly as passenger cars. The median or left lane is usually for fast-moving vehicles.

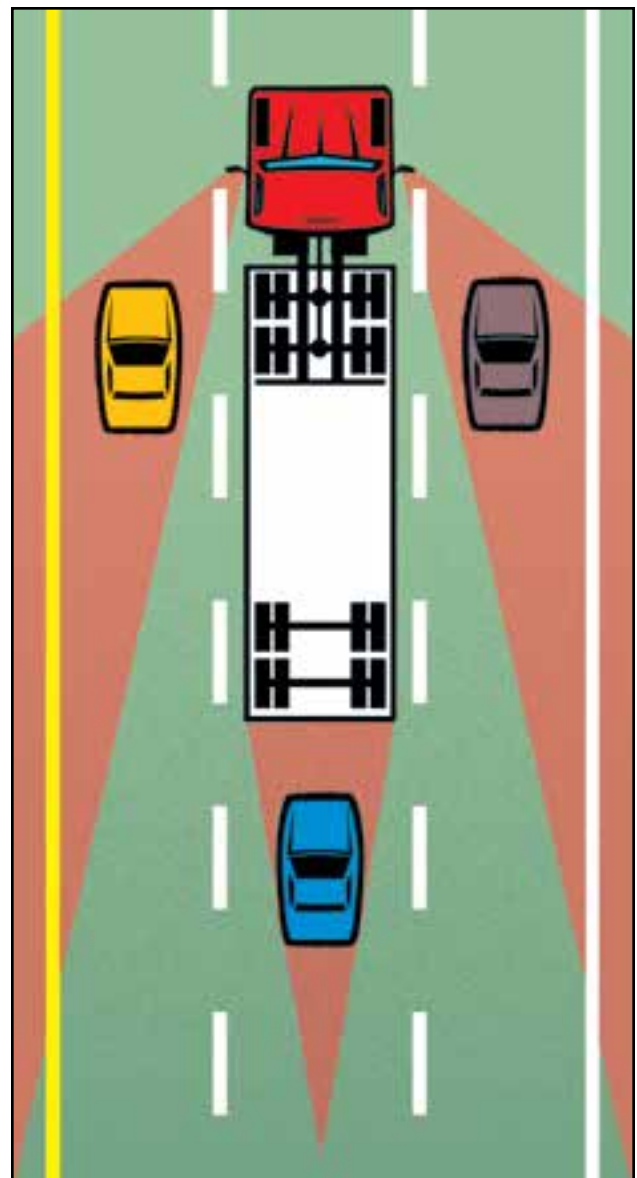



On a multi-lane highway the left lane is normally used as a passing lane for faster moving traffic. The law requires slower moving vehicles to travel in the right lane. This will have faster vehicles overtaking and passing on the left side of the vehicle, which is safer than being overtaken and passed on the right side.

A good driver constantly scans the traffic ahead, behind and to the sides. By looking well ahead the driver can pick up clues that will indicate speed changes and stops that may develop in the traffic pattern. By frequent glances in the rear and side view mirrors, the driver is alerted to vehicles that may be getting ready to pass, or following vehicles that will need plenty of warning of a stop, a change of direction or a lane change.



Drivers should always maintain a safe following distance from the vehicles ahead so that a smooth, gradual stop will be possible even if the vehicle ahead makes a "panic" stop. A gradual stop will also decrease the chances of being rear-ended by a tailgater, as the driver who is following too closely will have lots of notice that a stop or speed reduction is taking place.

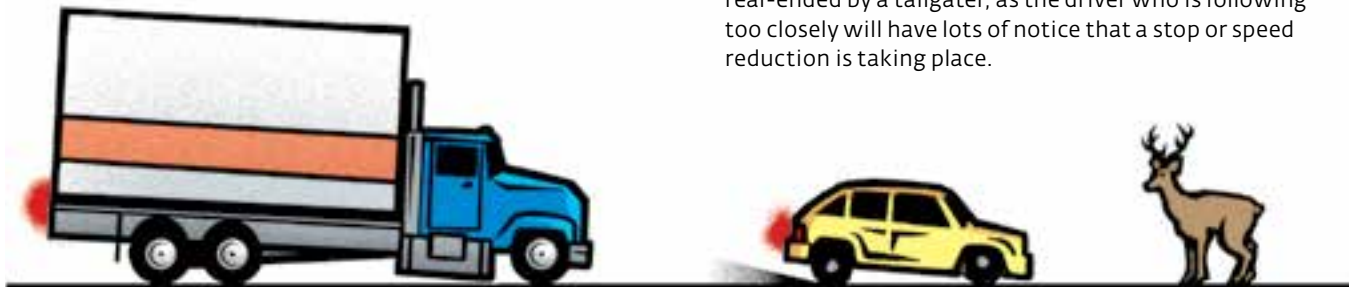

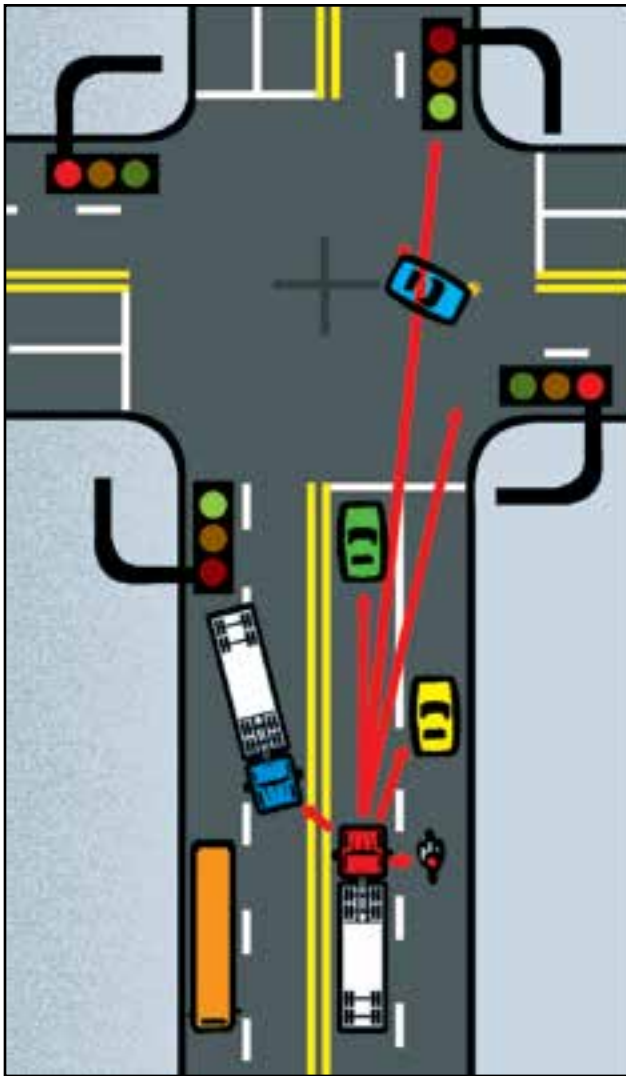

Drivers should look well ahead for traffic control signal lights, lane use and turn signals. Try to anticipate traffic control signal light changes before reaching an intersection. When a traffic control signal light has been green for some time it is known as a “stale” light and will probably change before the intersection is reached. Many streets have synchronized traffic control signal lights and drivers can adjust the speed of their vehicle to take advantage of this.

Speed-Weight-Distance

The distance required to stop a vehicle depends on its speed and weight, in addition to energy, heat and friction. The braking force required to stop a vehicle varies directly with its weight and speed. For example, if the weight is doubled, the braking force must be doubled to be able to stop in the same distance. If the speed is doubled, the braking force must be increased four times to be able to stop in the same distance. When weight and speed are both doubled, the braking force must be increased eight times to be able to stop in the same distance.

For example, a vehicle carrying a load of 14,000 kg at 16 km/h is brought to a stop in 30 m with a normal application of the brakes. If the same vehicle carried 28,000 kg at 32 km/h, it would require eight times the braking force to stop the vehicle in 30 m. This would be more braking force than the brakes could provide.

Danger zone

The danger zone of any vehicle can be described as the area directly in front of the vehicle in which the vehicle cannot be stopped. In the diagram below, the danger zone is shown as the red shaded area.

As speed increases, the danger zone increases. If road conditions are less than ideal because of rain, snow, ice or gravel, the danger zone is further increased. If the driver fails to reduce the vehicle's speed to suit these road conditions, the danger zone increases.

When conditions become less than ideal, vehicles can reduce their stopping distances by reducing their speed.

If another vehicle or a pedestrian enters the danger zone, it is not physically possible for a driver to stop in time to avoid a collision.

Braking distance in the danger zone will vary according to the weight of the vehicle, condition of the brakes and the condition of the road surface.

In the example below, the trucks are approximately two and one-half vehicle lengths from the crosswalk when their drivers see the pedestrian. Under ideal conditions, the driver travelling at 30 km/h may be able to stop just in time. However, even under ideal conditions, the driver of the truck travelling at 50 km/h cannot stop in time.

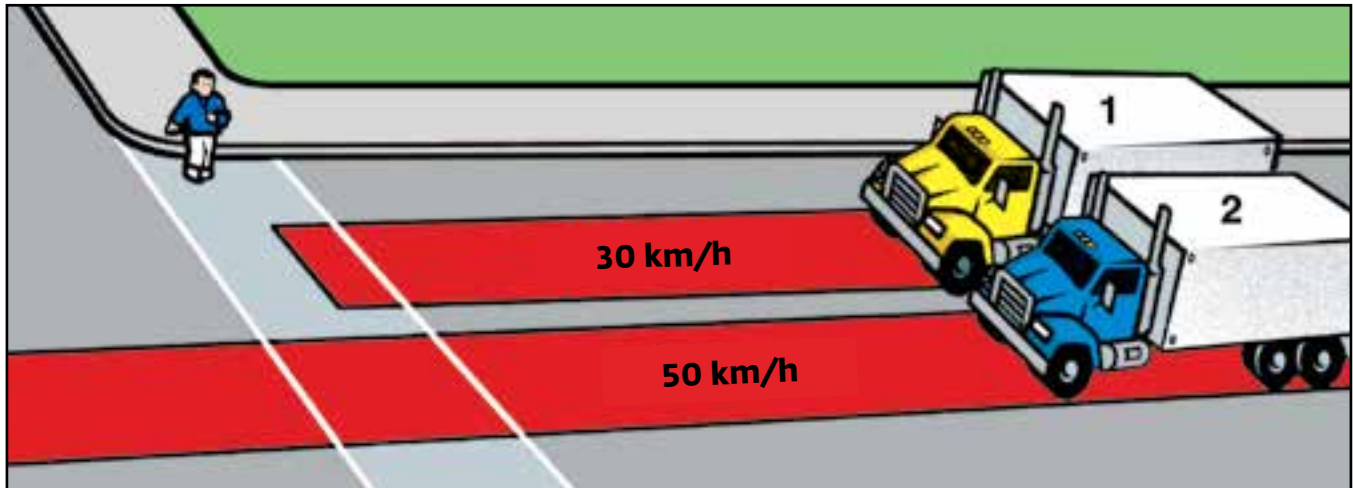

Shrinking the danger zone

The danger zone can be reduced if the vehicle's speed is reduced. The danger zone can also be reduced by the driver who forms the habit of "covering the brake" whenever a potential danger is developing.

In the example given, by removing the foot from the accelerator and putting it lightly on the brake pedal at the

time that the pedestrian is first seen, the driver's reaction time is reduced. Speed has been gradually reduced, with the foot off the accelerator, so the vehicle has a better chance of stopping ahead of the crosswalk rather than across the intersection.

Remember, it is easier to keep out of trouble than it is to get out of trouble.

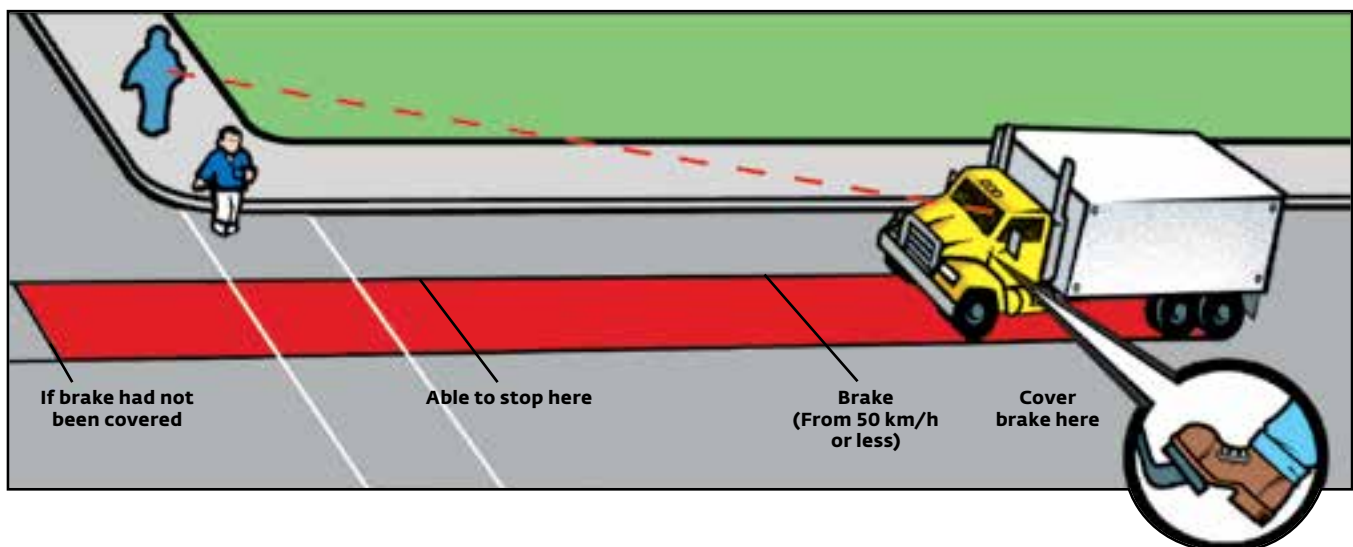

Timed-interval following distance

If you drive an ambulance or van

Use the minimum four-second rule to make sure the correct following distance is maintained. Staying four seconds behind the vehicle in front of you will give the correct following distance at any speed.

How to use the “four-second rule”:



1. To set a four-second distance watch Vehicle B ahead of you. When it passes an object on the roadway such as an overpass, sign post or tar strip, start to count.



2. When the rear of Vehicle B passes the object, count out the seconds like this: “One-thousand-and-one, one-thousand-and-two, one-thousand-and-three, one-thousand-and-four.” That’s four seconds.



3. If you reach the object after the correct number of seconds, you are following at the right distance for ideal driving conditions.



4. If, on the other hand, you reach the object before you have finished counting the correct number of seconds, you are too close. Drop back, pick a new checkpoint and count again.

If you drive a bus, truck or truck and trailer

Round out the length of your vehicle to the nearest metre and divide by three to determine your count. The count must never be less than four seconds, even if the number arrived at using this formula is less than four.

Example: If your truck and trailer are 14.4 m, round to 15 m ($15 \div 3 =$ five-second count).

When road conditions change because of rain, snow or ice, lengthen the count to suit the changing conditions.

A quick look at how the vehicle ahead of you is being driven may tell you what to expect. If the driver ahead is a tailgater, frequent panic stops can be expected. Never assume the other driver knows what they are doing.

A good driver maintains a safe following distance and has a longer, lighter brake application when stopping. This gives the driver behind plenty of notice that speed is decreasing.

Truck and trailer combination units need a longer stopping distance than most other vehicles because of the weight of the vehicle.

Brake adjustments, tire condition and inflation, along with load balance and weight, are critical for safe stopping.

Driving the correct speed

Traffic tempo

The speed at which a vehicle travels should depend upon road and traffic conditions, but the driver must also try to match this travelling speed with the surrounding traffic (traffic tempo) while staying within the speed limit.

The driver who travels faster than the traffic flow increases the chance of a collision. This could be from not maintaining a safe following distance with traffic ahead and not leaving any space in front for a fast stop. It also increases lane changes that are necessary to thread past slower vehicles, along with more decisions that have to be made as more problems are created. This increases

the chance of making a wrong decision. Also, pushing through traffic along with faster driving may result in mental fatigue.

A steady safe speed can save money and help the environment by not burning as much fuel.

The driver who travels slower than the traffic tempo may increase the chance of a collision from behind or the sides. Other drivers may become impatient and follow too closely or try to overtake when it is not safe to do so. They may cut in after passing, leaving the slow-moving driver with little or no room for a quick stop.



Tailgaters

Drivers of large vehicles such as buses, trucks and tractor-trailers must rely on outside mirrors for their rear vision. Tailgaters often sit in the blind spot directly behind large vehicles and may not be visible to the driver.

Tailgaters usually are persons who lack patience as well as foresight. This loss of patience could be caused by another vehicle's speed and handling. By observing traffic in the rear view mirrors, drivers of large vehicles can protect themselves against tailgaters by making it easier for them to pass. The tailgater is easier to deal with if they are ahead rather than behind.

It may not always be possible for the driver to prevent a rear end collision by these irresponsible drivers but if stops are gradual, the speed of impact will be considerably less.

It is illegal for regulated vehicles, trucks, highway buses or motor vehicles that are pulling another piece of equipment on a roadway outside of a restricted speed area to follow within 90 m of each other.

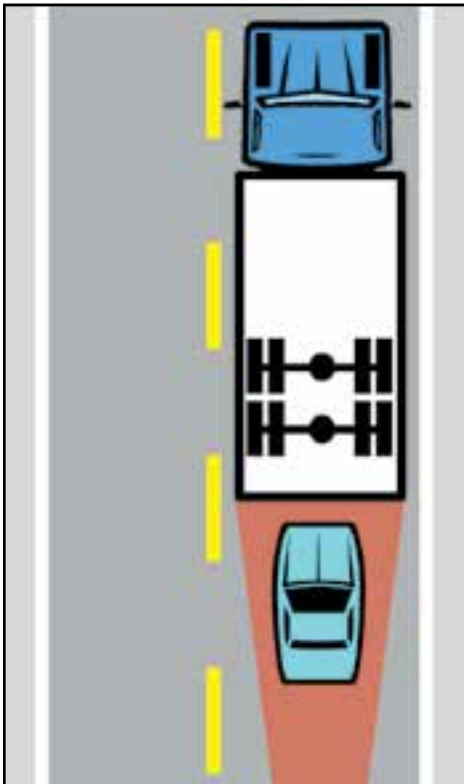

When nearing an upgrade with a passing lane provided, the driver of a vehicle that is travelling slower than normal traffic speed must use the right lane. When such lanes are not provided, the driver of a slower vehicle should allow the traffic that has built up behind to overtake at the soonest safe opportunity.

The experienced driver sets a pace in accordance with existing conditions and traffic tempo, maintains a safe stopping distance ahead and behind and maintains a driving space all around the vehicle. They have time to read the traffic pattern and continuously plan an escape route should the danger zones become occupied.

Slow-moving vehicles

The "slow-moving vehicle" sign may be displayed only on a vehicle, combination of vehicles or other machinery travelling at a speed of 40 km/h or less.



Braking

Bringing a vehicle to a stop on a level roadway usually requires only a single application of the braking system. The degree of application will be determined by the speed, weight and degree of emergency.

When the speed of the vehicle has been decreased sufficiently, the driver eases off the amount of brake application and the actual stop will be gradual. The professional driver can perfect stops by practising the amount of brake application release required to prevent a jerk back at the actual stop. This braking skill coupled with the factors of:

- looking ahead to anticipate stops
 - maintaining safe following distances
 - setting travelling speed in relation to seeing distance
- ensures a smooth stop every time. This is one of the ways passengers judge the driver's skill.

Stopping a vehicle without anti-lock brakes on an icy road surface will require the driver to lightly release or pump the brakes to prevent the wheels from locking up. A slowly-revolving wheel on an icy surface will be more effective than a locked wheel skidding on an icy surface.

Drivers going down steep grades such as a hill with a loaded vehicle should select a lower gear before starting downhill. This will allow the vehicle to operate at the control speed. Control speed is the speed at which the vehicle will travel downhill with the rpm just before governed speed or maximum rpm. This is achieved by selecting the proper gear for the grade of the road and the engine in the vehicle. Vehicles should be kept in gear throughout the descent as the vehicle should be slowing to down shift. This would not be the case if a shift is attempted on a steep downgrade.



To proceed down a grade, the driver controls the speed of the vehicle by “snubbing” the brakes. Snubbing is when a brake application is made at intervals to reduce the vehicle's speed and then the brakes are released. This brake application should slow the vehicle by eight km/h in three seconds. This can be remembered as the “8 in 3” rule. The driver should not allow the vehicle speed to increase eight km/h over the control speed before snubbing the brakes. Snubbing will help to prevent overheating of the brakes. If the brakes were allowed to overheat, it would cause the brake drums to expand, which could lead to brake fade or complete brake loss. Stopping on a slight downgrade is done in the same way as a level stop.

You must stop and check the brakes when signs are posted. In some provinces and states there is a fine for not doing so. This stop must also be recorded in the log book.

Engine retarders

Some vehicles have engine retarders to help slow the vehicle and assist in braking. There are many types of retarders; for example, exhaust, hydraulic and electric retarders.

Engine retarders should be used in addition to snubbing the brakes to ensure the vehicle is kept at the control speed and the engine stays below the governed rpm. Engine damage could occur if the speed of the vehicle is allowed to push an engine over the governed engine speed. The professional driver controls the speed of a vehicle so a stop can be made any time. Vehicles may have to be stopped on the way down a hill to prevent a collision or for an emergency.

All retarders can be turned on or off by the driver, and some retarders are adjustable. Engine retarders produce extra noise; therefore drivers of vehicles equipped with engine retarders should avoid unnecessary use of these systems in cities and residential areas. Gear selection is important because engine retarders are most efficient at higher engine rpm. Gear selection must be made before going down the grade, rather than attempting a gear shift on the downgrade. If a shift is missed and a gear cannot be found, the vehicle will have no control over its speed except for the brake system, which could fail.

The driver of a vehicle equipped with an engine retarder system must be familiar with the manufacturer's recommended use of the retarder under all road and weather conditions.

Note: Engine retarders are not allowed to be used on road tests.

Anti-lock braking system

An anti-lock brake system (ABS) is an electronic system that monitors and controls wheel speed during braking. The system monitors the wheel speed at all times. If it detects a wheel locking up during a brake application, the system releases brake pressure to that wheel only. This prevents the wheel from skidding and increases vehicle stability and control even in the most adverse situations, such as braking on wet or ice-slicked roads, through curves or during lane changes.

When driving a vehicle with an ABS, apply the brakes as normal to stop in time. When the ABS starts working, do not release the pressure you have applied to the brake pedal. Avoid pumping the brakes as the system automatically applies and releases the brakes up to five times per second, much faster than you can pump the brake pedal. When using an engine brake and you encounter a slippery road surface, the ABS will detect the wheel lock-up and automatically turn off the engine brake until traction is regained, then resume engine braking.

For information specific to your vehicle, refer to the operator's manual.

Combination braking

On combination vehicles (such as a truck and trailer or tractor-trailer) equipped with an air brake system, the trailer brakes are applied along with the tractor brakes by use of the foot valve. This is often referred to as "balanced braking." The application pressure of the trailer brakes is equal to the application pressure of the tractor brakes. The trailer brakes may be applied independently of the tractor brakes by use of the hand control valve. If the driver wishes, the amount of application on the trailer brakes may be increased during a foot valve application by using a higher application with the hand valve. Trailers equipped with electric or vacuum brakes are operated in a similar manner.

Caution must be exercised in making brake applications when the vehicle is negotiating a curve or travelling on wet or icy surfaces. Over-braking on vehicles without anti-lock brakes could result in jackknifing (see page 51 for definition) or skidding.

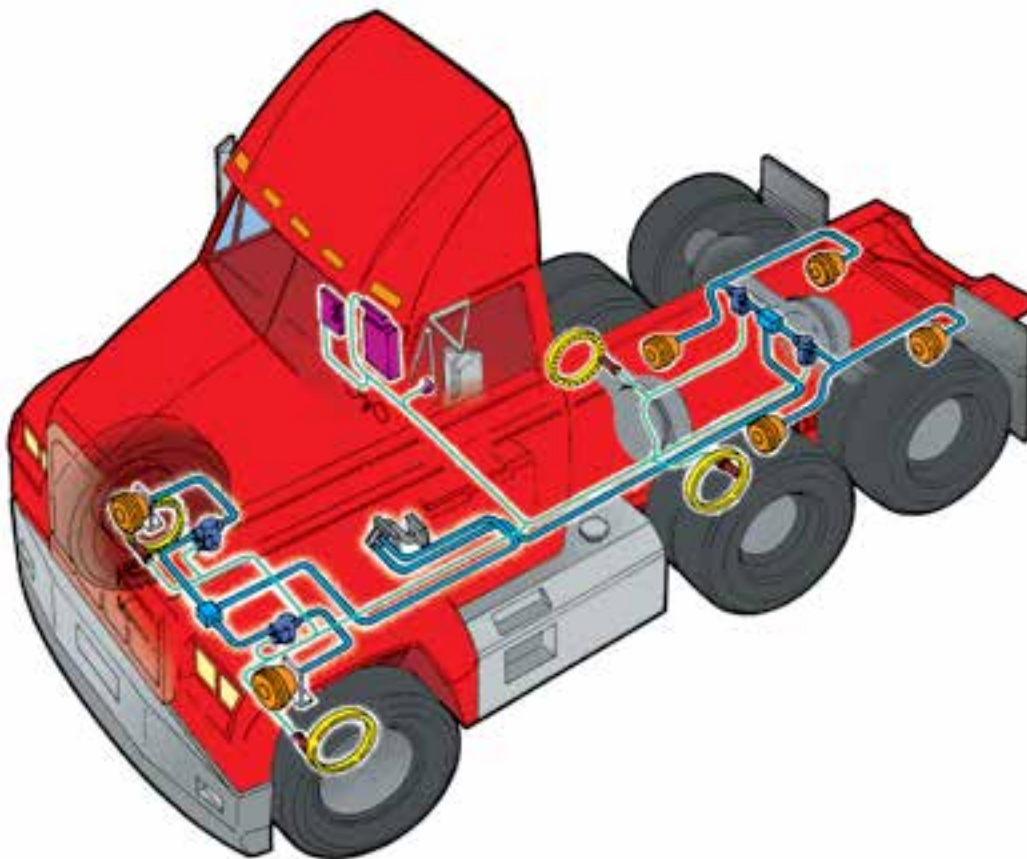

Runaway lanes

Runaway lanes are found in mountainous areas. These lanes are designed as emergency areas for the purpose of stopping trucks that experience brake failure when travelling down a very steep highway. These lanes are constructed of soft materials such as gravel, ashes and wood chips, for the sole purpose of stopping a runaway truck. As an out-of-control vehicle enters this lane, the soft materials will act as drag on the vehicle, slowing forward motion. The lanes are strategically placed so drivers can use the lane and stop safely without harming themselves or other drivers.

Proper procedure for a driver entering a runaway lane is to remove the foot from the accelerator, hang on tight to the steering wheel and steer straight up the lane. Following these simple steps will help keep the truck upright and not jackknife or roll over.

Knowing when to use a runaway lane is very important. If a driver is on a steep grade, brake fade may start to be noticed, followed by brake failure. This would be noticed by the amount of application air pressure that is being used during the snubbing of the brake. When descending a long grade snubbing the brakes, they will be applied and released many times.

If the vehicle's usual application air pressure is nine psi on a full brake application, if when descending a steep grade the application air pressure increases with each application of the brake, **there is a problem**. For example, the application air pressure could increase with each use of the brake from nine psi to 15 psi to 20 psi to 30 psi to 55 psi, before the brakes would fail. Many drivers hesitate when they first notice brake fade, thinking they can make it to the bottom of the grade safely. **This is not always the case**. The instant a problem is recognized a driver should take immediate action. If action is not taken, the speed of the vehicle will continue to increase. By the bottom of the grade it will be at maximum speed and the vehicle will not have any brakes.

These instances require rapid decision-making and reaction from the driver. If unsure, pull over where it is safe and inspect the brake system.



Checking tires, wheels and fasteners

The amount of control the driver can maintain over a vehicle depends upon the amount of friction between the tires and the road surface. Drivers are not allowed to operate a vehicle with bald or damaged tires as they could adversely affect the handling of the vehicle.

Before starting a trip, the driver must inspect tires for cuts, abrasions, bulges, tread and air pressure (using a gauge is the only sure method to know pressures are correct).

When inspecting the tires of a bus, truck or tractor with a GVWR of 4,500 kg or higher, check that the tread depth on the front steering tires is not less than 3.2 mm and on the rear tires, not less than 1.6 mm. When inspecting the tires of a vehicle with a GVWR of 4,499 kg or less, the tire tread depth must not be less than 1.6 mm on all tires. The tread wear should be even around the circumference of the tire and tread wear should be checked in three spots on each tire.

Retreaded tires are not to be used on steering axles. Check the sidewalls of each tire for cuts, tears and bulges. You should also ensure that tires on the same axle are not mismatched, such as a radial and non-radial tire or tires of different sizes.

Correct tire pressure is an important factor of tire wear and steering control. An over-inflated tire will result in centre tread wear. Over-inflation of a tire also results in less tread surface touching the road, which reduces the amount of traction.

An under-inflated tire results in wear on the outer edges of the tread surface. An under-inflated tire will not squeeze the water out from under the tire surfaces as well as a correctly inflated tire will. If the tire is under-inflated, it has more chance of riding up on a film of water (hydroplaning, explained later in this section). Traction between the tire and the road would be a lot less, as would steering control.

The rotation of the tires under load causes a flexing of the sidewalls. This flexing causes internal friction which generates heat. The tires release the heat to the atmosphere. If the correct tire size is used in accordance to the load carried, and tires have the proper inflation pressure at the start of the trip, the heat build-up will reach a heat balance temperature for which the tire is designed. The cooling rate will balance the heating rate.

If a tire is under-inflated, overloaded, or is subject to high speed, the flexing action will be increased. This will result in the heat build-up rate exceeding the cooling rate and the tire will overheat. As the heat builds up, it causes air pressure in the tire to increase to levels higher than the tire was designed for.

If the tire has the correct pressure when it is cool, the normal heat build-up will cause the pressure in the tire to increase and reduce the amount of wall flexing, controlling the heat build-up. If the driver lowers the tire pressure on a warm tire, the cooling balance is upset and the tire will generate more heat. Never let air out of (bleed down) a warm tire. Pressure should be checked and adjusted when the tires are cool.



1. Normal wear exposes the wear indicators between two or more adjacent grooves. Replace the tire when the wear indicators become visible.



2. Under-Inflation causes a tire to wear out at the edges first. This tire's smooth edges may cause skids on wet curves and must be replaced.

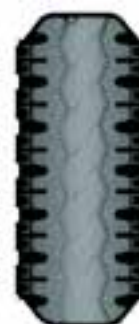

3. Over-Inflation causes a tire to wear out in the centre first. This tire is dangerously worn and must be replaced.



This information is meant as a guide. Consult your employer and manufacturer for specific tire requirements for the vehicle you operate.

Check the wheel lugs to ensure that there are no broken lugs or loose or missing wheel nuts. A wheel separating from the axle of a moving vehicle is very dangerous as it can cause injury or even death.

There are two types of wheel failures:

1. A wheel will come off the hub.
2. The entire wheel assembly will become dislodged from the vehicle.

One of the main reasons why wheels come off trailers and trucks is improper maintenance after installation of a tire. When a tire is installed the lug nuts are tightened on to the rim. As the vehicle travels, the rim will heat and expand. When the vehicle stops the rim will cool and contract. After this process is repeated it causes the lug nuts to loosen.

After a rim is reinstalled it is important to retighten and torque the lug nuts to 210–260 ft./lb. on five and six spoke cast wheels with $\frac{3}{4}$ inch studs and 450–500 ft./lb. on disk wheels (bud rims). Also, lug nuts should be retorqued at each major servicing of the vehicle or trailer.

During the driver's daily pre-trip inspection it is impossible for the driver to check specific torque. If the driver, using a wrench, detects a loose lug nut, that unit must be taken to a proper service centre and inspected by a qualified technician.

When a lug nut is being torqued and the nut is tight, if more than $\frac{1}{2}$ of a turn with a torque wrench is needed, this could indicate a more serious problem exists with the assembly. It should be disassembled by a qualified person to determine the cause.

Drivers can look for cracks in the rim, obvious looseness in nuts and slippage. If unsure, contact a qualified person.

When the entire assembly fails, it is usually the result of a bearing failure. It is difficult for a driver to detect this on a pre-trip inspection. However, there will be warning signs such as oil leaks from the bearing assembly and extremely hot wheel hubs. The driver should check to ensure that the vehicle is maintained in flawless condition at all times. During a trip the driver should stop every few hours to check the condition of the wheels; for example, loose lug nuts, oil leaks, slippage on the rim.

When a wheel or wheel assembly becomes separated it will actually travel faster than the speed of the vehicle. The reason for this is the tire is no longer under load. The average weight of a truck tire is about 181 kg. An 181-kg object moving at 100 km/h could do a lot of damage to other vehicles and persons if it were to come into contact with them. When the tire stops it may remain in the roadway, becoming a hazard if struck by other vehicles.



Common driving conditions

Passing

It can take considerable time for a truck to pass another vehicle or for another vehicle to pass a truck. This is especially true if the difference in speed (speed differential) between the two vehicles is slight.

When passing another vehicle, make sure you are not in the fast traffic lane longer than necessary. This action can make the traffic behind you reduce speed, resulting in “bunching” of vehicles, which creates a hazard particularly on freeways or high-speed highways.

Large vehicles have a louder exhaust resonance than passenger vehicles. Their size and highway noise often give the impression they are travelling at higher speeds than they actually are. When passing passenger vehicles, the driver of a large vehicle should be cautious in the event of startling the inexperienced or nervous driver.

Larger vehicles travelling at high speed create varying degrees of air turbulence (wind) that can be hazardous to smaller passenger vehicles. Vehicles traveling alongside the saddle tanks or near the rear of the trailer are likely to experience turbulence. Drivers of large vehicles must be alert for unsuspecting drivers who ride in these areas as they may be forced off a narrow roadway or drawn into the side of the vehicle.

Being passed

Drivers should not direct other drivers to pass, as this may encourage them to overdrive their ability. However, when other drivers pull out to pass, help them to pass safely by reducing speed. Avoid travelling alongside another vehicle for a long period of time.

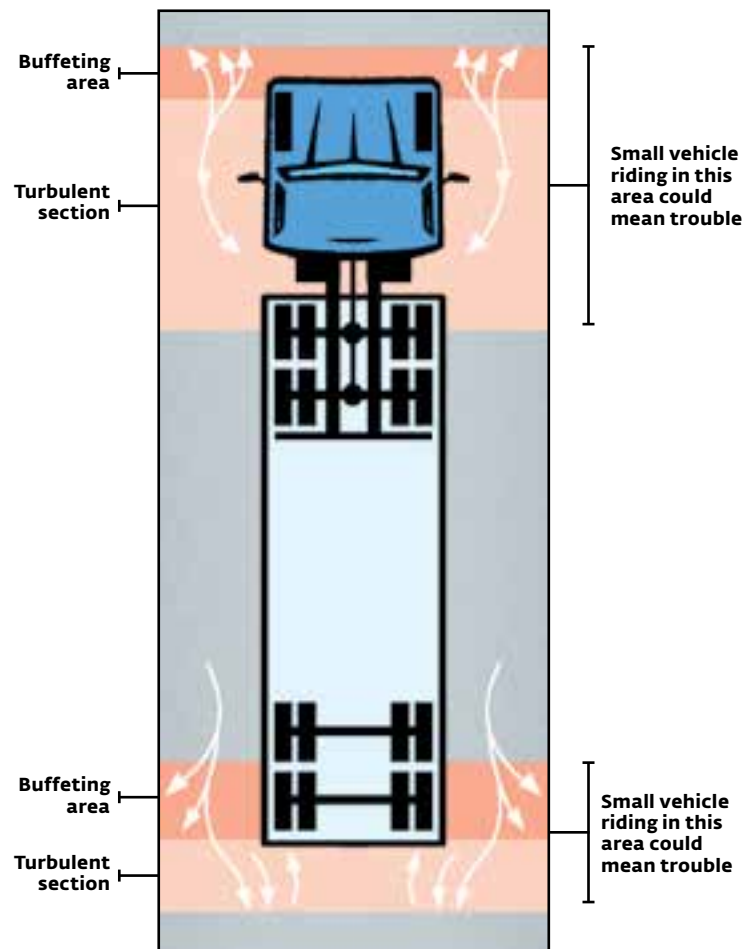

Lane changing

With all vehicles, it is important to make sure the lane is clear before changing lanes. Drivers of large vehicles must exercise extreme caution because they have large blind spots that must be checked before changing lanes.

The proper method for changing lanes is to first check the mirrors for traffic to the side of the vehicle and any traffic that may be approaching quickly that could interfere with the lane change, and then activate the turn signal in the direction of the lane change. Check the mirrors again including the convex mirror (if so equipped) and the blind spot looking down beside the cab of the vehicle or shoulder checking depending on the vehicle. If the way is still clear make the lane change leaving the turn signal on until the vehicle is completely in the new lane.

Large vehicles that must rely on mirrors only for their view to the rear should change only one lane at a time when on multi-lane roadways. Drivers who can check the roadway to the rear with a shoulder check can change more than one lane at a time on a multi-laned roadway as long as the proper signal and checks are performed and it can be done safely. Lane changes should never be conducted at intersections or over solid pavement markings.

Curves

A vehicle travelling in a straight line has a force called momentum. The higher the speed, the greater the momentum. A vehicle travelling around a curve develops a force called centrifugal force. The higher the speed, the greater the centrifugal force. The two forces (momentum and centrifugal) conflict with each other because centrifugal force tends to push a vehicle outwards from the centre of the curve in order to maintain straight-line momentum. Braking in a curve introduces a third force that reduces steering control and increases the effect of centrifugal force. This can cause a rollover, skid or jackknife. This risk increases as a vehicle's size, speed and weight increase.

In order to reduce the hazards, lower your speed before you enter the curve and, if needed, gradually apply slight power while in the curve. This will enable you to maintain better steering control of the vehicle while in the curve.

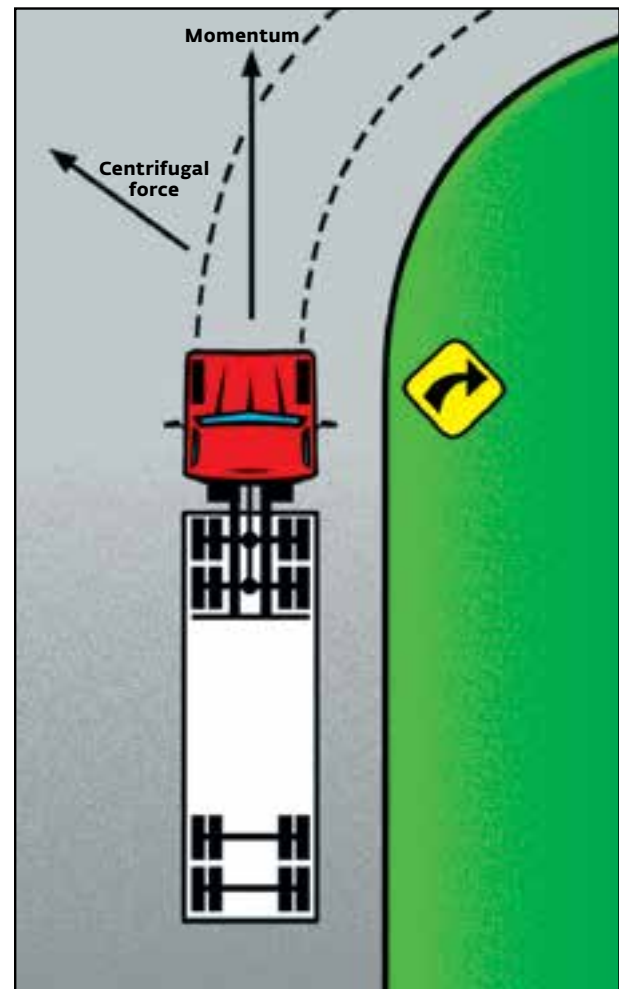

Intersections

Intersections are the crossing or meeting of two or more streets. More collisions are likely to take place at intersections than in any other area of driving. Knowledge of the right-of-way rules is essential for all drivers. The defensive driver does not depend on other drivers to obey these rules.

To avoid intersection collisions, follow these common sense practices:

- Never enter a limited-view intersection at a speed at which you cannot stop your vehicle safely should you need to do so.
- Do not assume you have the right-of-way, even when it is enforced by traffic signs or traffic lights. Look left and right before entering any intersection. Check for a violator who may run the traffic sign or traffic light.
- Look well ahead for "stale" green lights to avoid travelling through the intersection late. This can be accomplished by looking at the pedestrian crossing lights. If the signal telling the pedestrian not to cross the street is on or flashing, be prepared for the traffic signal to change. When getting the green "go" light, check left, right and ahead for the "late runners" before proceeding.
- Position your vehicle into the proper lane well before the turn at the intersection, giving proper signals well in advance to show other drivers you plan to turn. Slow gradually before entry and turn only when it can be done safely.
- Do not depend on other drivers to signal or execute their turns correctly.

Uncontrolled intersections are those not controlled by traffic lights or signs. When two vehicles approach this type of intersection, both must slow down. The vehicle on the left must always yield the right-of-way to the vehicle on the right. Nevertheless, the driver with the right-of-way must still exercise proper care and attention to avoid a collision.

The driver of a large vehicle should not use its size to bully other drivers for the right-of-way. Drivers of large vehicles should give the right-of-way rather than take it.

Drivers must give their full attention to each and every intersection, laneway or driveway, and keep the vehicle under full control at all times.

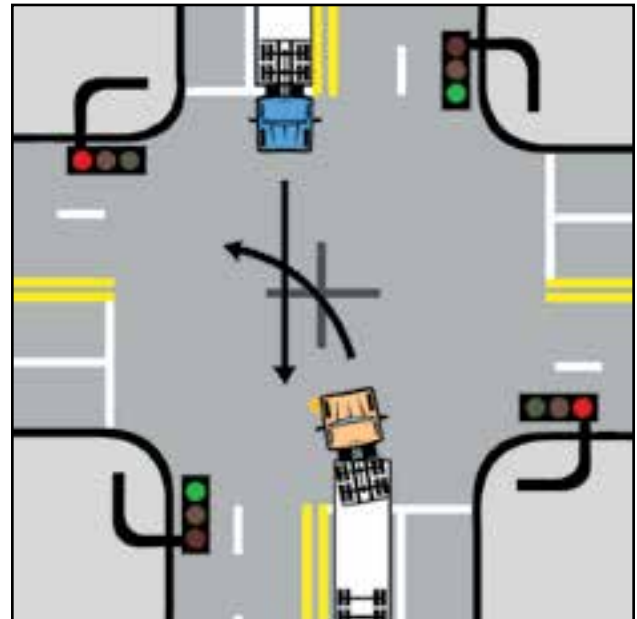

Backing

Backing up a large vehicle is one of the toughest and most important skills a driver must learn. The driver is always responsible for any incident that occurs when backing. Backing becomes dangerous any time the driver neglects to ensure the way is clear. The driver must be certain the way remains clear during the entire manoeuvre.

Investigation of "backing accidents" often indicates they are not "accidents," but are evidence of the driver's failure to observe.

All drivers can reduce backing accidents if they follow these backing rules:

- Avoid unnecessary backing—plan ahead to minimize backing distances.
- Use a guide whenever possible. The guide should stand to the rear of the vehicle where there is a clear, continuous view of the backing path the vehicle will follow. The guide must be visible to the driver in his mirror throughout the manoeuvre.

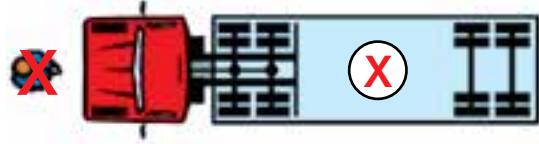
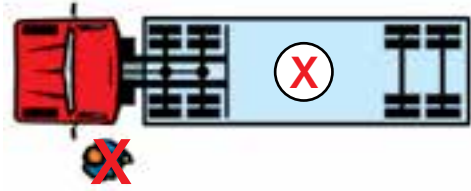

Guide has no view of vehicle's path.



Guide has view of vehicle's path and eye contact with driver.

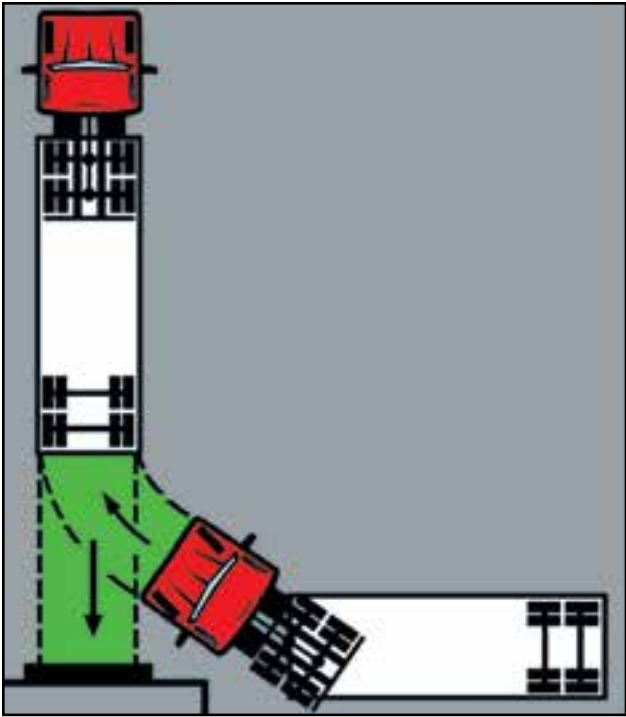

- Whenever possible, the approach should be planned so the area to be backed into is seen on the approach.

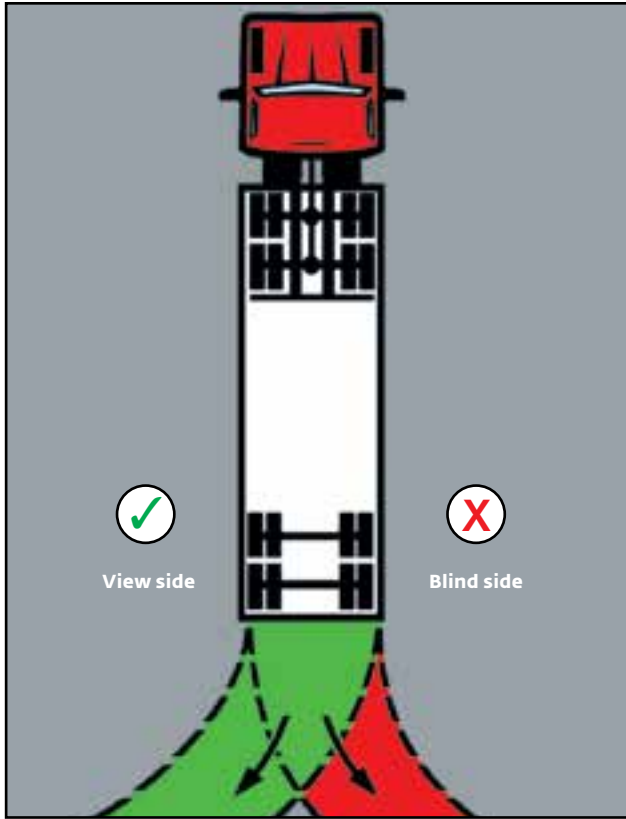

- The vehicle should not be backed into the blind side when it is possible to back to the view side.

- Vehicles should be backed out of traffic rather than into traffic. Driver A has backed out of traffic. When leaving the laneway, traffic will be readily observed.
 - Driver B has taken the easy way out of traffic but now faces the problem of backing into traffic to leave the laneway.
 - Before backing a vehicle when it is impossible to have a guide, the driver must:
 - Step out of the vehicle and look at the backing area for hazards.
 - Check for clearances and obstacles above, below, to the sides, to the rear and to the front of the vehicle.
 - Enter the cab, sound the horn and observe both mirrors while backing very slowly.
- A good practice is to sound the horn for each vehicle length travelled. If the backing distance is long, stops should be made to recheck behind, above, below, to the sides and ahead. Rather than making one long backing manoeuvre, it is safer to make a series of short backing manoeuvres.

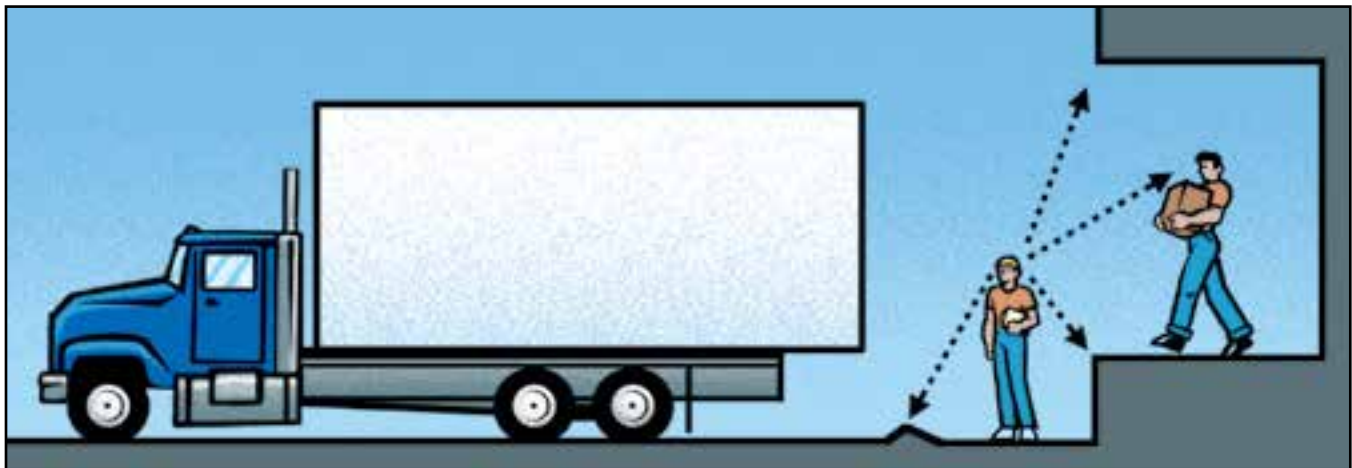
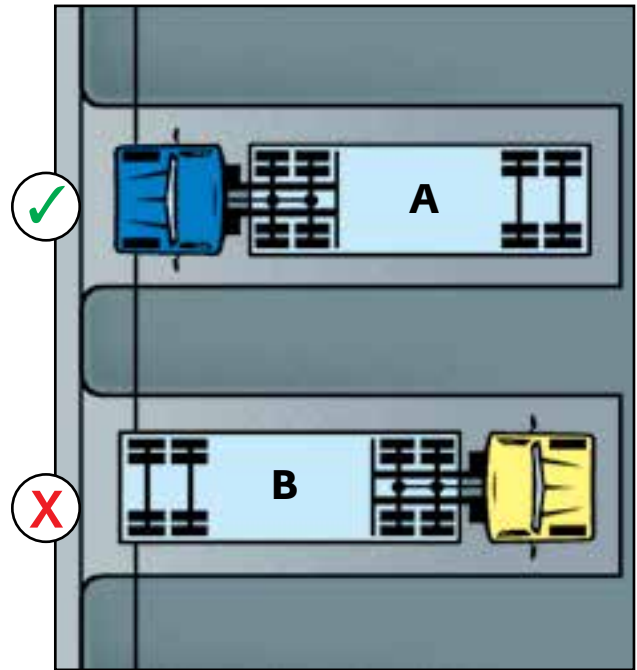

Parking lots, alleys and side roads

You are required to stop your vehicle immediately before the sidewalk area extending across the road whether you drive from a parking lot, alley, private road or side road onto a street, provincial road or provincial trunk highway.

After yielding the right-of-way to pedestrians in that area, or if there is no sidewalk area, proceed to a spot just before the road and check for oncoming vehicles. After yielding to vehicles, proceed when safe.



Unattended or parked vehicles

Prior to leaving a parked vehicle, the driver must ensure that the vehicle will stay in position when parked.

The following precautions must be observed to prevent a vehicle runaway:

1. Set the parking brake.
2. Stop the engine and place the transmission in the gear position recommended in the operator's manual.
3. If the vehicle is equipped with a two-speed axle, the axle must be in low range.
4. Remove the ignition key to lock the ignition.
5. If the vehicle is parked on a hill or an incline, the front wheels must be turned so that, if the vehicle moves, it will roll off the road. Special care must be taken when parking combination vehicles—make sure the steering wheels are turned so the trailer will roll off the road and not into traffic.
6. If the vehicle is a tractor-trailer, under no circumstances should the driver use the trailer hand valve alone to hold a parked unit if it is left unattended.

Railway crossings

The sign below (left) indicates a railway crossing ahead. Slow down, check to the right and left along the angle of the track shown on the sign and proceed only when safe.

The actual crossing is marked by a crossbuck sign (right).

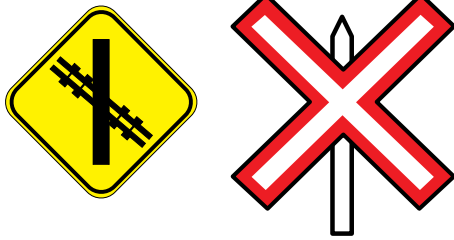

When approaching railway crossings, check both ways for trains and remember that they always have the right-of-way.

When stopping at a railway crossing, keep at least five metres away from the nearest rail in a restricted speed area and at least 15 m away in a non-restricted speed area. (A restricted speed area is any area within Winnipeg, an urban municipality, a local urban district under the Municipal Act or any other area, highway or portion of a highway designated by regulation.)

If you see a train coming, get ready to stop. Most motorists seriously misjudge the speed of trains, thinking they travel much slower than they actually do. It is also wrong to assume that trains must slow down at railway crossings.

Since many railway crossings do not have electronic signals warning you when to stop, the most important rule to remember is that trains always have the right-of-way at all railway crossings. In other words, at railway crossings, the safety of you and your passengers depends entirely on you, the driver.

Other safety points include:

- When there is more than one set of tracks, don't start across right after the train passes. Make sure there isn't another train coming on the other track.
- Half of all nighttime rail/highway crossing collisions are vehicles hitting trains. To avoid these collisions, slow down when you see the advance warning sign so that you can stop in time if you have to.
- Never move onto the tracks unless you're sure there is plenty of room on the other side of the tracks. Be sure the rear of your vehicle will clear the crossing. If traffic is backed up so that you can't get across the tracks, stop and wait at least five metres from the crossing until the traffic jam clears and it is safe to cross.
- Some vehicles must stop at all crossings. These include regular buses, school buses and vehicles carrying flammable materials. If you're following such a vehicle, be prepared to stop.

It is illegal to:

- Cross a railway crossing when warning signals are on (except as explained below).
- Shift gears when crossing railway tracks outside of a restricted speed area.
- Drive a vehicle through, around or under a crossing gate or barrier that is either closed or being opened or closed.
- Drive a vehicle onto a railway crossing unless there is sufficient space at the other side of the crossing to accommodate your vehicle without blocking a passing train.
- Park a vehicle within 30 m of the nearest rail of a railway crossing unless otherwise posted.

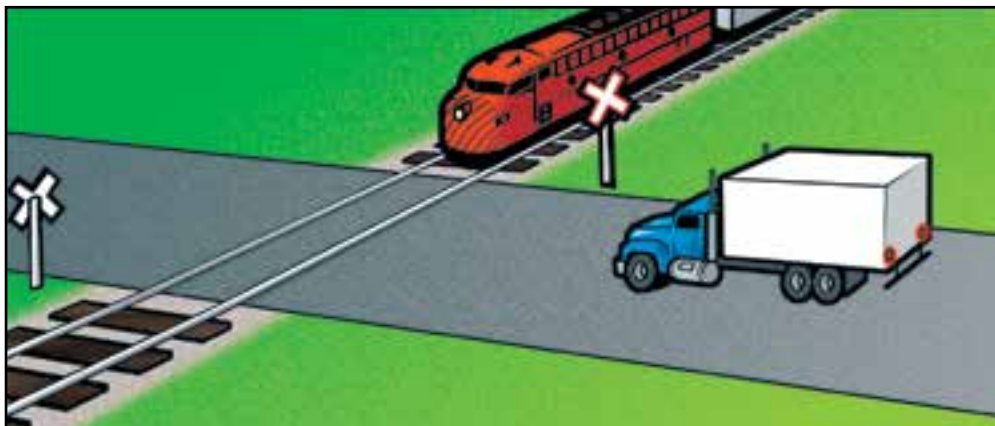



Drivers may cross a railway crossing when the warning lights are flashing if:

- The vehicle is brought to a complete stop first.
- The crossing is not protected by gates or barriers.
- The crossing is within a restricted speed area.
- The train is stopped or is a safe distance away.
- The crossing may be done safely.

You may not proceed under any circumstances if a railway crossing gate is in the “down” position unless directed by a flag person or a person of authority.

If a vehicle damages the railway warning equipment or the track, it is imperative that the driver notify the appropriate railway authority right away. For example, if a low bed trailer were to “snag” a track at a crossing and move it from its normal position, or if a vehicle were to knock over a warning light, the railway must be informed to prevent the chance of a collision.

In the event of a collision involving railway property or for information contact:

Canadian Pacific Railroad Police Service
1-800-551-2553

Canadian National Railroad Police Service
1-800-665-0581 or 1-800-465-9239

Adverse weather conditions

Drivers must take note of hazardous road conditions such as rain, ice, snow, fog, etc. and adjust their driving to the road conditions. If conditions are too extreme to continue a trip, stop and wait out the weather. You should make sure the vehicle you are driving has survival gear.



Adjusting to road conditions of ice, wet, sleet or snow requires:

- starting out at a slow speed and testing the steering and brakes for control
- lowering speed to suit ice or snow conditions and using tire chains if necessary
- using light brake applications to avoid wheel lock-up (gentle pumping action on vehicles that are not equipped with anti-lock brakes)
- avoiding sudden or jerky movements of the steering wheel
- keeping windows and windshields clear, inside and out, as well as keeping wiper blades, defrosters and lights in top condition so you can see and be seen
- keeping enough ventilation in the cab and making sure exhaust systems are free from leaks
- keeping alert for pedestrians, ice patches, bridge surfaces, blind intersections, snow plows and graders well ahead of the vehicle's path

If the vehicle is equipped with a manual front brake limiting valve, the driver can reduce the braking effort to the front wheels to improve the steering on slippery roads.

Reduced visibility

When driving with reduced visibility:

- Reduce your normal driving speed if you can't see the road ahead.
- Turn your headlights on low beam to cut down on glare in dense fog, heavy rain and snow. The use of fog lamps may increase visibility.
- Slow down when you see headlights or taillights. These lights may be on a vehicle that could pose a hazard to you until you know the vehicle is parked or moving on the roadway.
- Be prepared for an emergency stop. If visibility becomes too poor to continue driving safely, turn on your hazard flashers and cautiously pull off the travelled portion of the highway to stop in a safe location. Wait until visibility improves before continuing the trip.
- If speed is greatly reduced, turn on your hazard lights to help make your vehicle visible to other drivers.





Winter driving

When driving in winter, keep in mind that bridges and overpasses can be especially dangerous when the temperature is near the freezing point or when it is extremely cold. An invisible sheet of ice, referred to as “black ice,” may form on them because of condensation.

Road surfaces in the winter can have icy patches, black ice or drifts of snow across the highway. You will have to adjust your driving accordingly. When operating a large vehicle during a storm, keep in mind that drivers of smaller vehicles may use a large vehicle to guide them through the storm. Take this into account when braking.

Winter road driving

The winter road systems in Manitoba are basic access routes to remote northern communities and have no alignment standards. There are no posted speed limit signs and the recommended speed limit for vehicles with a maximum GVWR of seven tonnes or greater is 15 km/h on all ice roads. Winter roads are constructed on the natural terrain of the land and ice. They cross muskeg, rock ridges, streams, rivers and lakes. The road surface can get worse quickly due to changes in the weather. The chance of a collision increases if you do not drive according to the road conditions.

Following are some safety tips and information to help reduce the hazards when operating a vehicle on winter roads:

- Travel is not approved until a section officially opens. No regular inspection or maintenance is provided along the route prior to opening or after closing, increasing the potential risk to drivers. (A 24-hour voice report for winter road information to access remote isolated northern Manitoba communities is available by calling Highway Information Services at 204-945-3704 or toll-free 1-877-627-6237.)
- Travel on winter roads when they are not open could deteriorate and damage the road surface. Ruts created in the muskeg or land are both environmental and safety issues. Temporary road closures may be required to extend the use of the system.
- The road surface is packed snow or ice and the stopping distance of all vehicles is longer than on land roads. As a driver, you should be travelling at a speed that will allow you to safely slow down or stop if you encounter a hazard or approaching vehicle.
- Chains offer additional traction and should be used at the driver's discretion as they can deteriorate the snow-packed road surface.
- Winter roads are primarily used by heavy truck traffic delivering fuel, freight, groceries, machinery and building products. The contractor's maintenance equipment is slow moving and could be encountered on blind corners.

- The season may be shortened due to weather conditions and the traffic volumes will increase accordingly. Night travel is recommended for better visibility of traffic.
- Vehicles with a maximum GVWR of seven tonnes or greater that exceed the recommended ice road speed limit of 15 km/h could create an ice popout or wave movement in the ice causing a complete ice failure. When approaching land or meeting other trucks on an ice road reduce speed to prevent an ice way rebound.
- Drive close to the centre of all ice roads and not by the snow storage banks on the sides, as the banks have the added weight of the snow and slush.
- Do not stop or park trucks on any ice road as it encourages others to do the same and the constant weight of one or more trucks could create an ice failure. The loading and unloading of all trucks and storage of material is not approved on ice and should only occur on the land.
- Trucks should be staggered one kilometre apart when travelling in the same direction on an ice road.
- Ice road failures, sudden storms, ground drifting and whiteout conditions preventing travel and road maintenance can occur in sub-zero temperatures. Wilderness survival training and ice road driving courses are recommended.
- Driving across a ramp bridge placed on a pressure ridge must be done with caution, as there could be possible movement of the planks. If the planks have lifted or twisted, do not cross.
- Passing or meeting other vehicles should be done with great care due to swirling snow reducing visibility.
- The results of an unexpected delay, breakdown or collision when travelling in this isolated area can be life threatening if you are not prepared. It is the driver's responsibility to arrange for his or her own assistance. It may take a long time for assistance to arrive if there is trouble. Adequate clothing, personal medication, fuel to reach your destination, vehicle and survival equipment, cellular or satellite phone and/or CB communication are recommended for every vehicle travelling on the winter road system.
- First-time drivers on a winter road should be accompanied by an experienced driver who can identify sharp curves, slopes, signing and hazardous areas.
- All environmental accidents such as fuel spills, leaks or fires involving chemicals and hazardous materials must be reported to the appropriate provincial government department(s) and the RCMP. Immediate cleanup is required and is the responsibility of the driver transporting the dangerous goods.
- Commercial vehicle operators are required to maintain a 24-hour daily logbook when travelling on the winter road system. However, due to the rapid changes in road conditions that can occur and lack of safe places to rest, the driving and on-duty limitations of the Drivers Hours of Service Regulation 72/2007, section 7 are exempted under permit providing the conditions of the permit are met. The driver should be aware that the fatigue factor can occur and rest when required. While travelling on the winter road system the driver is required to remain in a constant state of awareness and no driver shall drive a commercial vehicle in a fatigue state.
- Notifying the destination point receiving the fuel or freight of the anticipated time of arrival will help reduce time on the system and provide an extra measure of safety in case you encounter difficulties.
- To avoid a load movement it is recommended that all loads be secured in accordance with Provincial requirements with equipment specifically designed for the intended use. Additional fastening devices to reduce load movement are recommended as the road surface is uneven, slippery and could be very rough.
- All overweight and overwidth loads require winter road permits that must be approved by the Region. Allow adequate time for ice testing when applying for overweight permits.
- Drivers should be aware of overhead utility lines in communities and call the appropriate utility if there is a concern about the height of the line.
- When approaching or travelling through a community drive with caution as the community residents have not seen increased truck traffic since the previous year.
- Due to environmental guidelines road users are responsible for their own abandoned vehicle and garbage removal.

Gusting or strong winds

Care must be taken when driving in gusting or strong winds as they can push your vehicle, making it difficult to remain in your lane. These winds can also cause the trailer being towed to sway or whip.

To maintain control, you should:

- Reduce your speed.
- Grip the steering wheel firmly.
- Compensate gently for the wind gusts as soon as the vehicle moves off course even slightly.
- Avoid passing other vehicles.
- Increase your following distance.
- Keep away from other vehicles on either side (on multi-lane roads).

Hydroplaning

This can occur when a combination of speed, tire wear, tire inflation or depth of the water on the roadway causes the tires to lose traction. In wet weather, tires will cut through water, wet snow and slush to maintain contact with the roadway at speeds of less than 50 km/h.

Hydroplaning could still occur at under 50 km/h if the tires are excessively worn or bald, under inflated, or if the water on the roadway is very deep. At higher speeds (70 km/h and higher), the wedge of water in front of the tires may pass under the tires and the tires will ride on the cushion of water. Traction will be greatly reduced.

To prevent hydroplaning:

- Check your tires for wear and inflation regularly.
- Reduce your speed even more when facing standing water and puddles.
- Drive in the tracks of preceding vehicles.

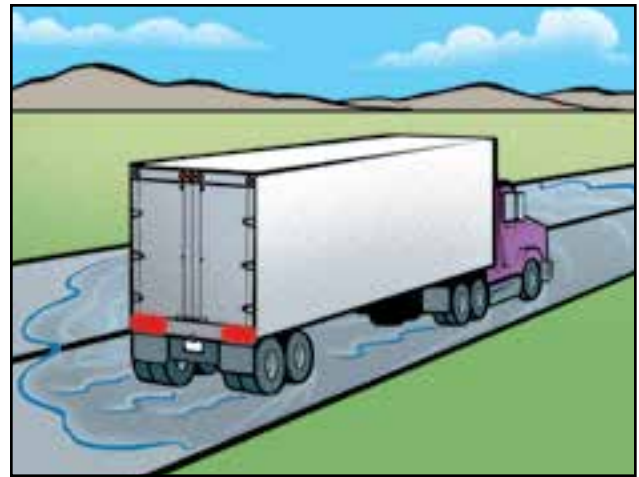

Wet brakes

Water entering the brake drums will reduce braking efficiency. Avoid driving through large puddles whenever possible. If it is necessary to drive through water on the roadway, lightly apply the brakes when approaching and place a slight drag on the brakes while driving through the water. The slight drag placed on the brakes will reduce the amount of water entering the brake drums and shoes.

During excessively wet conditions or after driving through water, test the brakes for safe operation by putting on the brakes slightly for a short distance to dry them out and restore normal braking. Speed should be reduced before driving through large pools of water on the roadway.

Skids and their causes

Most skids are caused by travelling too fast for the road conditions. Skids occur when tires lose their grip on the road surface. This could occur from overbraking, overaccelerating or oversteering, especially when negotiating a curve.

Overbraking

Overbraking will cause the wheels to lock, which could result in a skid. When a tire is skidding it has almost no traction so the tire will slide over the road surface. Since the lack of traction usually affects the drive wheels first (rear wheel drive vehicles), the rear end of the bus or straight-body truck will begin to skid. This will result in a longer stopping distance required and may also result in the rear end of the vehicle skidding sideways.

If driving a tractor-trailer using the trailer brakes alone can cause the vehicle to jackknife.



Overaccelerating

A skid will occur when the force of acceleration is greater than the traction between the tires and the road surface. This is more likely to occur when the road surface is slippery. If the wheels start to spin the rear end of the vehicle may skid sideways.

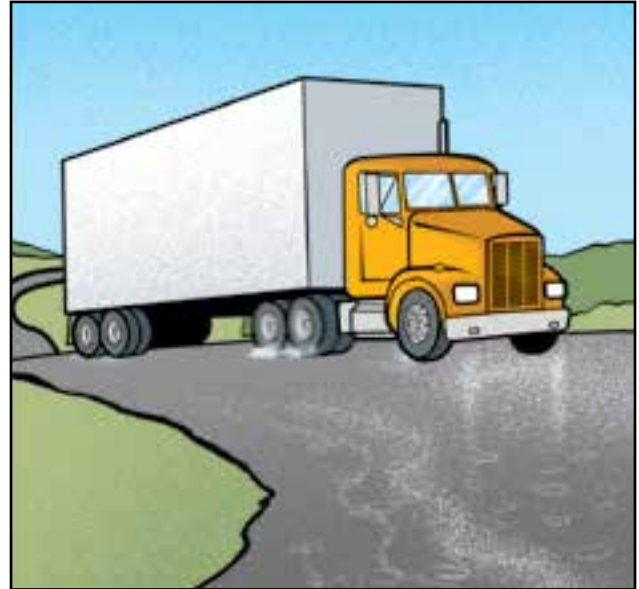

Oversteering

When driving around a curve, a vehicle tends to want to travel in a straight line; this is because of centrifugal force. The faster you are moving and the sharper the curve, the greater the centrifugal force will be. If a vehicle is driven too fast into a curve there may not be enough traction to counterbalance the centrifugal force and it will result in a skid. If you brake at this point, the wheels will lock and you will skid even faster.



Skid control and recovery

Before you can get control of the vehicle again, the cause of the skid must be corrected. For example, if the skid was caused by overbraking, the skid cannot be corrected as long as the wheels are locked. Likewise, if the skid was caused by a spinning wheel it is impossible to correct the skid if the wheel is spinning.

If the skid is caused by overbraking, release the brake pedal so the wheels start to turn and the tires regain traction with the road surface.

If the skid was caused by downshifting into too low a gear, press the clutch down and allow the vehicle to slow down.

If the skid is caused by overacceleration, release the accelerator and let the wheels stop spinning.

Whether a skid is caused by overbraking, overacceleration or oversteering, the rear end of the vehicle may skid (swing) out to the left or right. If the back end of the vehicle starts to skid, steer the vehicle in the direction of the skid.

Avoiding skids

The following rules will help you avoid a skid from taking place:

- Reduce the vehicle speed according to road conditions.
- Keep enough space between your vehicle and others on the roadway. This is especially important on slippery road surfaces.
- When braking a vehicle that is pulling a trailer, check the trailer in the rearview mirror. If the trailer starts to skid slightly, release pressure on the brake pedal.
- Avoid using the trailer brake hand valve by itself.

If the rear end of the vehicle skids to the left, steer to the left to straighten out the vehicle, then when it is almost straight steer to the right so the vehicle does not start to skid in the opposite direction. When the vehicle straightens out steer straight ahead.

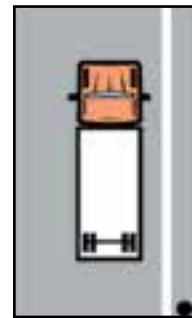
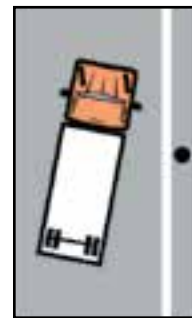
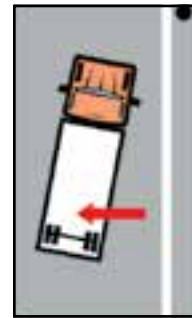

If the rear end of the vehicle skids to the right, steer to the right to straighten out the vehicle, then when it is almost straight steer to the left so the vehicle does not start to skid in the opposite direction. When the vehicle straightens out steer straight ahead.

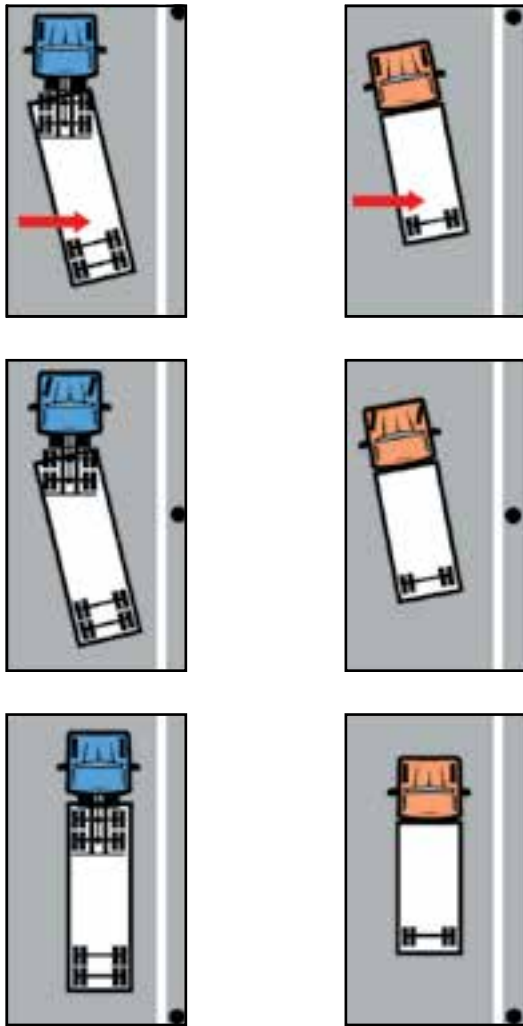

Jackknifing

A jackknife is when the tractor moves to an angle of 90° or less to the trailer. Jackknifing can be the result of an uncontrolled skid. The tractor's drive wheels lose traction and are pushed over to the left or right by the forward momentum of the trailer.

Skids can happen very quickly when the drive wheels lock or the tires lose traction. If traction is lost, it is important to quickly release the accelerator or brake pedal, depending on which is causing the tire to lose traction, to get control back.

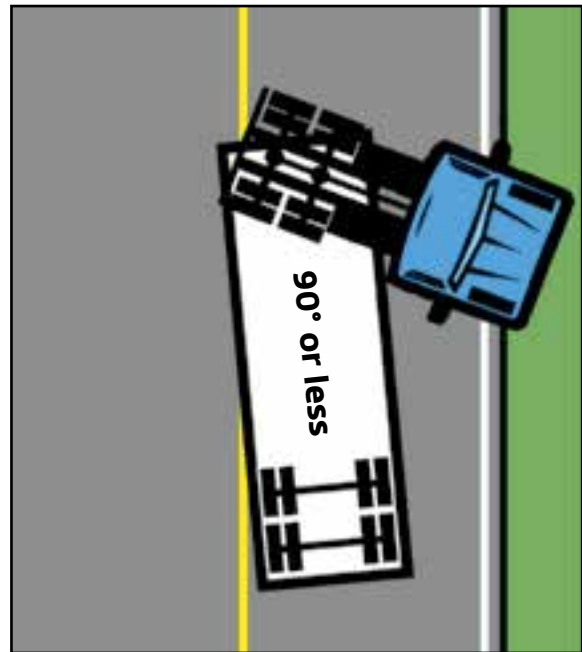

Test yourself on Section 2

Before reading further, you should be able to answer these questions if you are trying to get a Class 1, 2, 3 or 4 driver's licence. Answers to these questions are found in the preceding pages of this manual.

1. How can a driver anticipate a change in traffic signals when approaching an intersection?
2. If your vehicle is 11.5 m long, what time interval count would you use under ideal road and traffic conditions?
3. What should a driver consider when picking a safe driving speed?
4. In what way does a slow driver create a traffic hazard?
5. In what way does a fast driver create a traffic hazard?
6. What is the minimum following distance the driver of a commercial vehicle maintains when following another commercial vehicle outside of a restricted speed area?
7. What is the most effective way to deal with a tailgater?
8. What is the best way of reducing stopping distance?
9. What is meant by the danger zone of a vehicle?
10. What defensive measures can a driver take as they approach an intersection?
11. If the weight of the vehicle is doubled, by how many times must the braking force be increased to stop the vehicle?
12. If the speed of the vehicle is doubled, by how many times must the braking force be increased to stop the vehicle?
13. If the weight and the speed of the vehicle is doubled, by how many times must the braking force be increased to stop the vehicle?
14. What is the best way of applying the brakes:
 - a) on an icy road surface without ABS?
 - b) to control the speed on a steep grade?
15. How does a driver pick the "control speed" before going down any hill?
16. What is the advantage of using engine brake retarders?
17. Are engine brake retarders better at low engine rpm or high rpm?
18. Before going down a steep grade, at what point should the driver gear down?
19. Why should the driver not signal another vehicle to overtake and pass?
20. What action should the driver take when being passed by a smaller vehicle?
21. What should the driver do when it is necessary to drive a vehicle through water on the highway?
22. Why should you avoid passing another vehicle when your difference in speed is only slight?
23. What is the effect of air turbulence on smaller vehicles?
24. How can backing accidents be prevented?
25. When a guide is used in backing a large vehicle, what is the best position for the placement of the guide?
26. What are the three steps the driver should take before backing a large vehicle?
27. What precautions must be taken by the driver before leaving a vehicle parked on a grade?
28. What decides the amount of control the driver has over a vehicle on a curve?
29. What would be the effect on a vehicle that is travelling too fast in a curve?
30. Should the driver slow the vehicle in a curve or before entering the curve?
31. What is the effect of applying slight "power" in a curve?
32. What is meant by the term "stale green light"?
33. How can the driver safely test for an icy road surface?
34. Why should the driver reduce the speed of a vehicle at night?
35. What can the driver do to reduce night driving collisions?
36. When required to stop at a railway crossing, within how many metres of the nearest track should the driver stop the vehicle?
37. When is the best time to check tire pressure?
38. Why should the driver avoid bleeding the pressure down on a hot tire?
39. Should a driver shift gears while the vehicle is crossing a railway track?
40. When parking near a railway crossing, what is the minimum distance from the nearest track that the driver may park?
41. If you become drowsy when driving, what is the best thing to do?
42. Why should water not be thrown on a gasoline, oil or grease fire?
43. What could the driver do if a fire started in the trailer being pulled by their vehicle?
44. What precautions should be taken when using a CO₂ type fire extinguisher?
45. What emergency equipment must be carried on:
 - a) a truck with a registered gross vehicle weight exceeding 3,700 kg?
 - b) a regulated vehicle for passenger transportation?
46. If your large vehicle becomes disabled on a two-way highway, how far ahead and how far behind should the flares or reflectorized devices be placed?
47. What vehicles may be required to stop at railway crossings?

It is recommended that applicants who are preparing for a Class 1, 2, 3 or 4 examination also study the *Driver's Handbook*.

Section 3

Additional information for Class 1 and Class 3 drivers

3

Additional information for Class 1 and Class 3 drivers

Types of vehicles

Class 1 and Class 3 drivers must also have an understanding of the information contained in Section 4 of this manual.

Note: When reference is made to tractor-trailer the principles are basically the same as when operating a truck pulling a trailer with a GVWR of 4,540 kg or more.



Tractor (Class 3)



Straight body truck (Class 3)



Truck pulling a trailer with a GVW of more than 4,540 kg (Class 3)



Tractor trailer (Class 1)



Tractor tridem (Class 1)



Highway train (Class 1)

Turning

The degree of sharpness a vehicle will turn depends on two factors: the turning radius of the front wheels and the amount of off-track of the rear wheels.

Turning radius

The wheel on the inside of the turn must pivot sharper to travel on the shorter radius than the wheel on the outside of the turn.

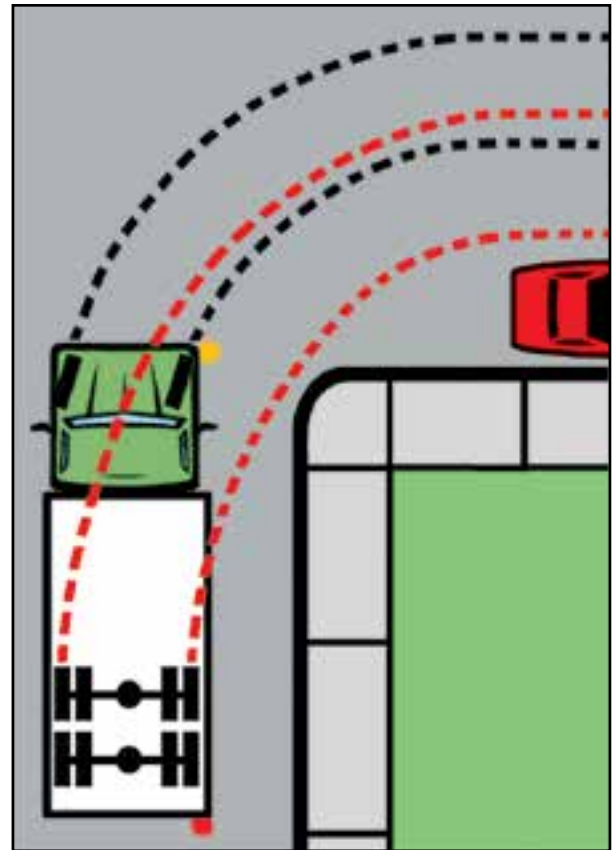

Off-track

The rear wheels of the vehicle do not pivot and therefore will not follow the same path as the front wheels. The greater the distance (wheel base) between the front wheels and the rear wheels of the vehicle, the greater the amount of off-track. The off-track path is a shorter radius than the path of the front wheels.

On a combination vehicle such as a tractor-trailer, the rear wheels of the tractor will off-track. The rear wheels of the trailer will off-track even more.

A combination of a tractor pulling a "pup" trailer with a draw bar has different turning characteristics than that of the tractor-trailer. The off-track of these vehicles is dependent upon the length of the draw bar and the wheel base of the vehicles.

The driver of a large vehicle must lead the turning arc of the front wheels in accordance with the sharpness of the curve and the amount of off-track of the vehicle.

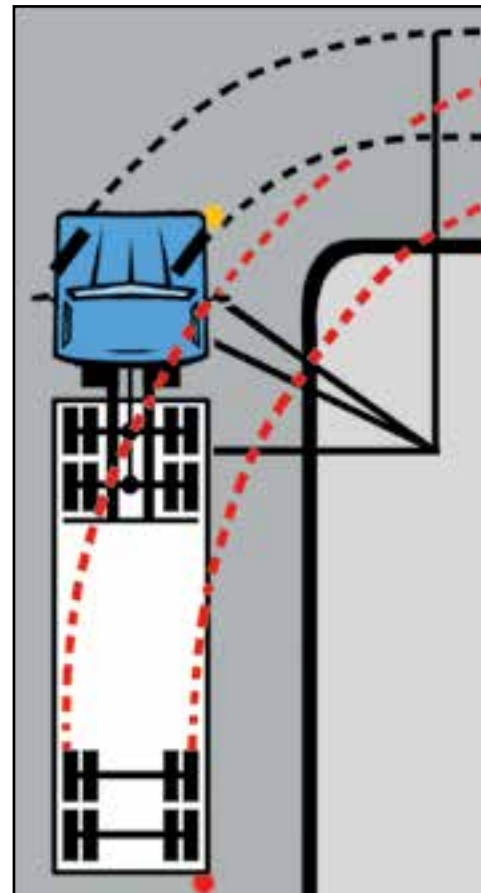

A curve to the right requires keeping the front wheels close to the centre line to prevent dropping the rear wheels off the pavement onto the shoulder of the road.

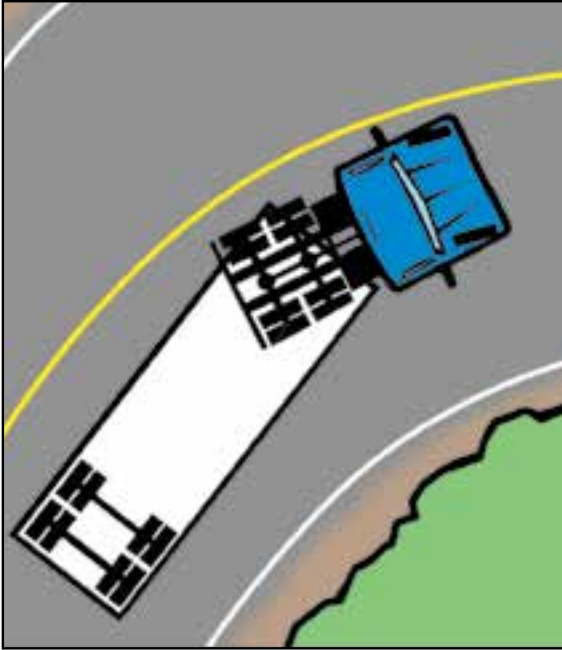

A curve to the left requires keeping the front wheels close to the right edge of the pavement to prevent the rear wheel from crossing into the other traffic lane.

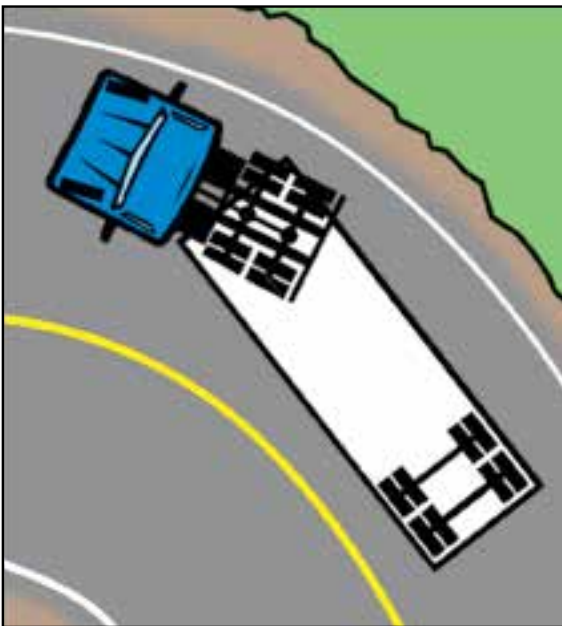

When crossing a narrow bridge with a curved approach, drivers of larger vehicles must exercise extra caution and skill. These drivers must be familiar with the amount of off-track of the vehicle and approach accordingly.

Turning at intersections

When making turns, a great deal of skill is needed along with an awareness of other vehicles, obstacles or the lack of space that can add to the difficulty of the turn.

When turning, drivers must think about the length of the vehicle and the influence it will have on the path the vehicle will take. The off-track of the rear wheels will be greater at intersections as the vehicle is turning sharper and drivers may have to use different methods (mentioned later in this section) for making turns to ensure they are completed safely.

Turning safely

To make a turn safely, the approach to the turn is very important. Generally, the following method should be followed when approaching the intersection:

- Adjust your speed to avoid having to brake while turning.
- Check your mirrors and blind spot, then turn on your signal light.
- Select the appropriate gear that will let you complete the turn without taking your hands off the steering wheel to change gears.
- Approach the intersection in the appropriate lane and determine what path you will use to complete the turn safely.

Right turns

For right turns at intersections the driver must take into account the fact that the rear wheels will follow a shorter path than the front. To make up for this, the front of the vehicle can use all of the space available on the roadway to ensure that the rear wheels of the vehicle remain on the pavement and within 1.5 m from the curb or side of the roadway. It is important for the rear of the vehicle to be in the correct approaching lane and to remain in the correct lane as the turn is completed to make sure another vehicle does not squeeze between the curb and the side of the vehicle.

The vehicle should complete the turn in the lane closest to the curb on the street that has just been entered. If a vehicle is parked within 30 m of the intersection in the curb lane it is okay to turn into the next lane nearest the curb lane if it does not interfere with traffic. Make sure that when you use all of the roadway to complete your turn you watch for pedestrians and other traffic. Also, do not drive over curbs, sidewalks or the median.

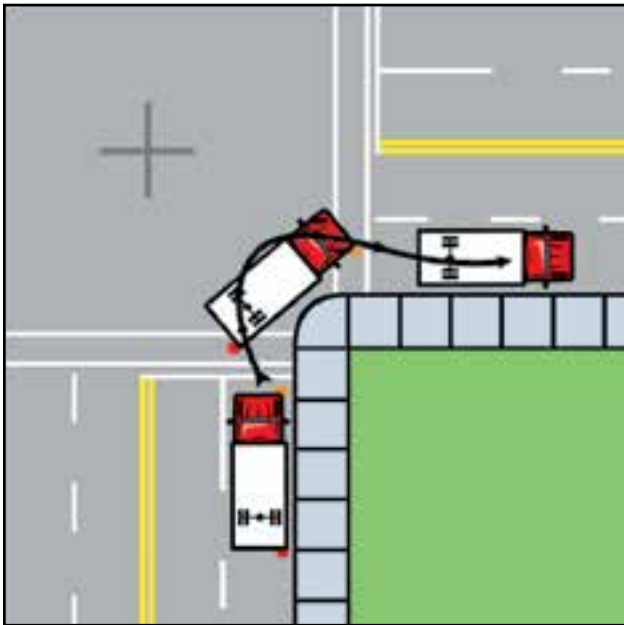

As there are different ways of making a right turn, the driver must decide which method to use taking into account the traffic on the roadway, the size of the streets and obstacles nearby such as hydro poles, signs and light standards. Remember the tractor can use any portion of the roadway that is available providing it does not bother other traffic, while the rear wheels of the vehicle or trailer must remain approximately 1.5 m from the curb or side of the roadway.

Practise turning in the vehicle you drive as the size and shape of the vehicle will affect the way you choose to make the turn.

A few options for right turns are:

- button hook
- extended approach
- lane straddling

See the following examples of these turns.

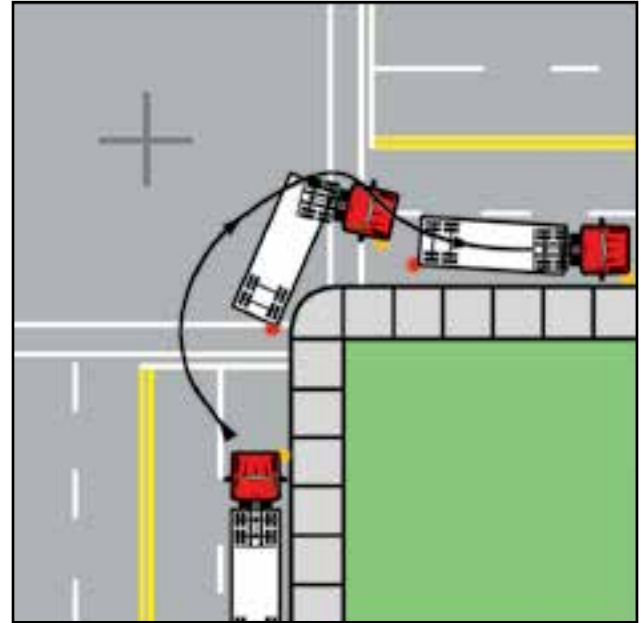

Button hook

Used when the only room available to manoeuvre is within the intersection, the button hook is performed as follows:

- Approach in the curb lane or the lane closest to the right side of the road.
- Turn your right turn signal on about 30 m from the intersection (150 m outside cities, towns or villages).
- Check your mirrors and make sure you know about the traffic around you.
- If you must stop at the intersection for a traffic light, do so far enough back that you will be able to make your turn.
- Be sure there is no traffic beside you and, when the tractor is close to the intersection, steer to the left. The tractor will swing out to the left. Watch the trailer and when it starts to pull away from the curb, steer quickly to the right. Continue scanning the intersection for potential dangers and watch the trailer to make sure it does not go over the curb but remains within 1.5 m of the curb.
- The critical point is reached when the tractor is at the sharpest point of the turn in relation to the trailer, as the right rear view mirror vision is limited.
- Steer the tractor into the curb lane and the trailer will follow; the turn should be finished in the curb lane.
- Turn off the turn signal.

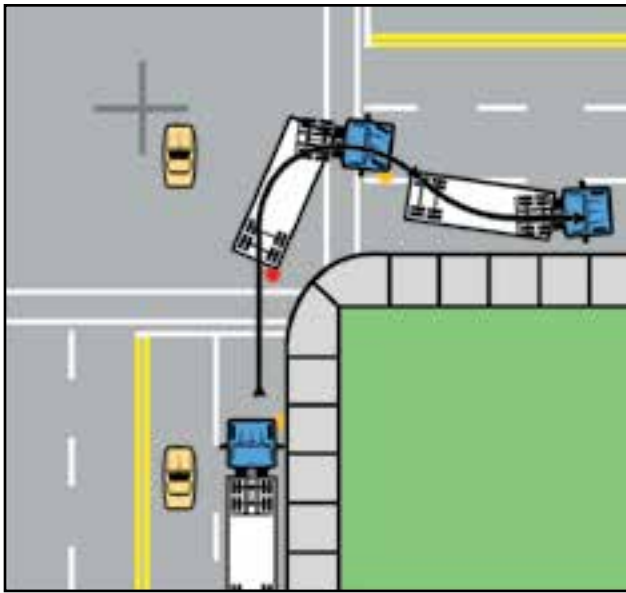

Extended approach

This turn would be used when the street you are turning from has traffic moving around you and the street you are turning onto is wide with ample room to manoeuvre.

A right turn with an extended approach is completed as follows:

- Approach in the curb lane or the lane closest to the right side of the road.
- Turn your right turn signal on about 30 m from the intersection (150 m outside cities, towns or villages).
- Check your mirrors and make sure you know about the traffic around you.
- Scan the intersection for possible dangers and take the necessary steps.
- Drive straight into the intersection and start turning when your vehicle is well into the intersection. Check the right rear view mirror and make sure the rear wheels do not drive over the curb but stay within 1.5 m of the curb. Continue the turn until the vehicle is around the corner and end the turn in the lane closest to the curb.
- Turn off the turn signal.

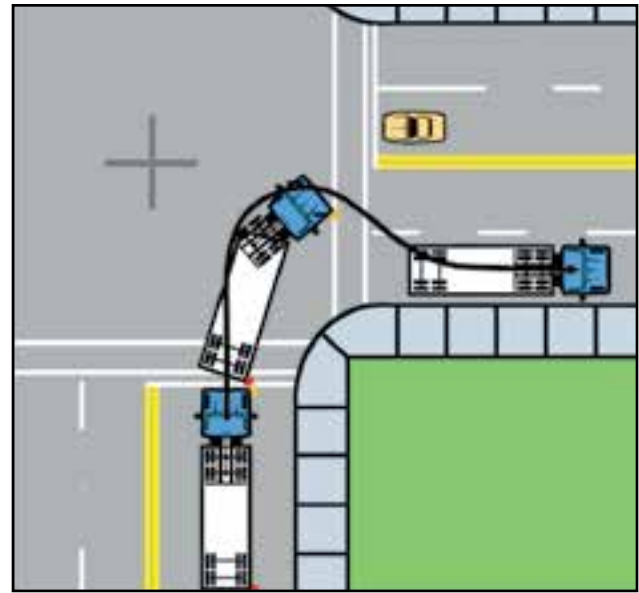

Lane straddling

This type of turn should only be used as a last resort. It can be very dangerous as traffic may try to pass on the right side of your vehicle and it can also be confusing to other traffic on the roadway. Use this type of turn when the street being turned onto is very narrow or space is limited.

A right turn when straddling the lane is performed as follows:

- Approach in the curb lane or the lane closest to the right side of the roadway.
- Turn your right turn signal on approximately 30 m from the intersection (150 m outside cities, towns or villages).
- Check your mirrors and make sure you are aware of the traffic's location around you. If safe, move your vehicle into the lane to your left only enough to complete the turn safely.
- As you enter the intersection, turn your steering wheel to the right. Continue scanning the intersection for dangers and watch the trailer to ensure it does not go over the curb but stays within 1.5 m of the curb.
- The critical point is reached when the tractor is at the sharpest point of the turn in relation to the trailer, as the right rear view mirror vision is limited.
- Steer the tractor into the curb lane and the trailer will follow. The turn should be finished into the curb lane.
- Turn off the turn signal.

Whenever possible, turns must be made from the proper lanes. When it becomes necessary for the driver to direct the vehicle over lane lines or centre lines to negotiate sharp turns, it is the driver's responsibility to make sure the turn can be made safely, without interfering with other traffic.

If there are two lanes side by side with signs indicating you are allowed to turn right from either lane, the turn should be made from the left-most lane. This will give you a larger turning arc and you should not have to worry about traffic to your left side.

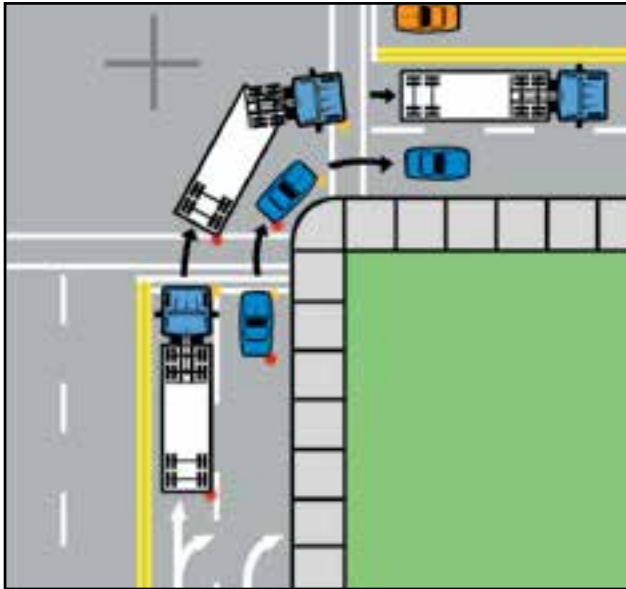

Left turns

When making left turns the driver must be aware of the off-track of the rear of the vehicle or trailer being pulled. The driver must make sure the trailer does not run into a vehicle stopped on the road or the median of the street that it is being turned onto.

There are different ways of making a left turn. The driver must decide which turn to use taking into account the position of traffic on the road, size of the streets and obstacles such as median, hydro poles, signs and light standards. Remember the tractor can use any portion of the roadway that is available without interfering with other traffic while the trailer must remain in the lane or path that a car would take. When making a left turn the rear wheels or the trailer wheels should be left of the centre of the intersection.

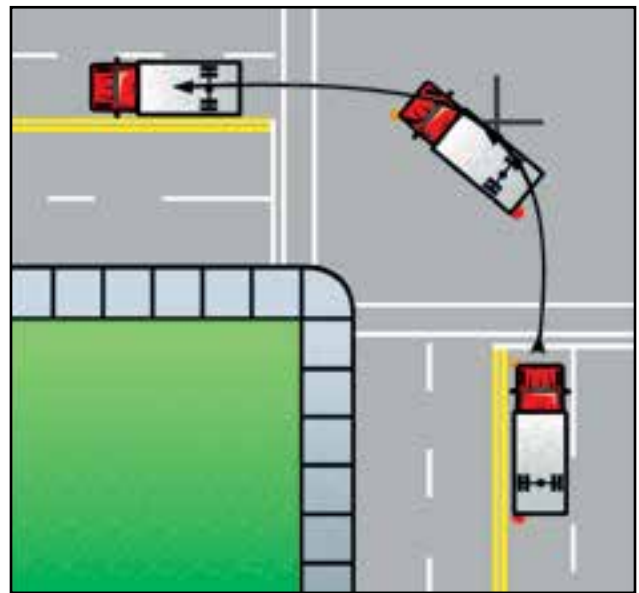

Practise turns in the vehicle you drive as the size and shape of the vehicle will affect the way you choose to make the turn.

A few options for left turns are:

- button hook
- extended approach
- lane straddling

See the following examples of these turns.

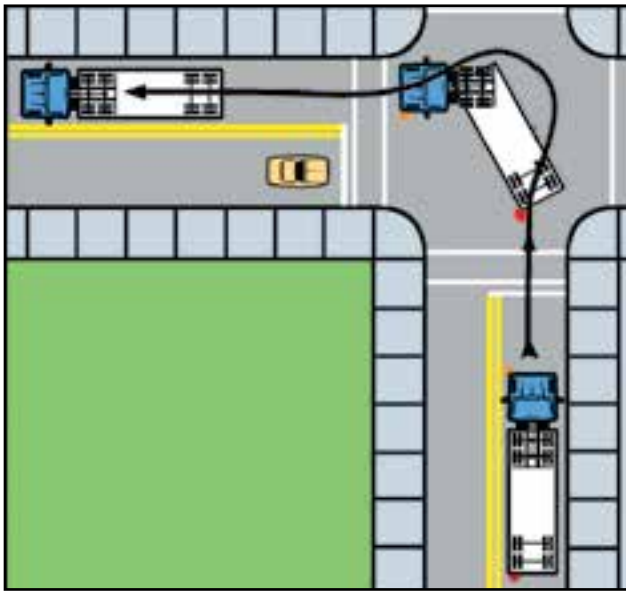

Button hook

Used when the only room available to manoeuvre is within the intersection, the button hook to the left is performed as follows:

- Approach in the lane closest to the centre line or median.
- Turn your left turn signal on about 30 m from the intersection (150 m outside cities, towns or villages).
- Check your mirrors and make sure you know about the traffic around you.
- If you must stop at the intersection for a traffic light, do so far enough back that you will be able to make your turn.
- As you approach the intersection, make sure there is no traffic beside you and, when the tractor is in the intersection, steer to the right. The tractor will swing out to the right. Watch the trailer; as it starts to move out to the right lane and when you know you can make the turn, steer quickly to the left. Continue scanning the intersection for dangers and watch the trailer to make sure it does not go over the median or collide with traffic stopped on the road.
- The critical point is reached when the tractor is at the sharpest point of the turn in relation to the trailer, as the left rear view mirror vision is limited.
- Steer the tractor into the lane closest to the centre line or median and the trailer will follow, the turn should be finished in this lane.
- Turn off the turn signal.

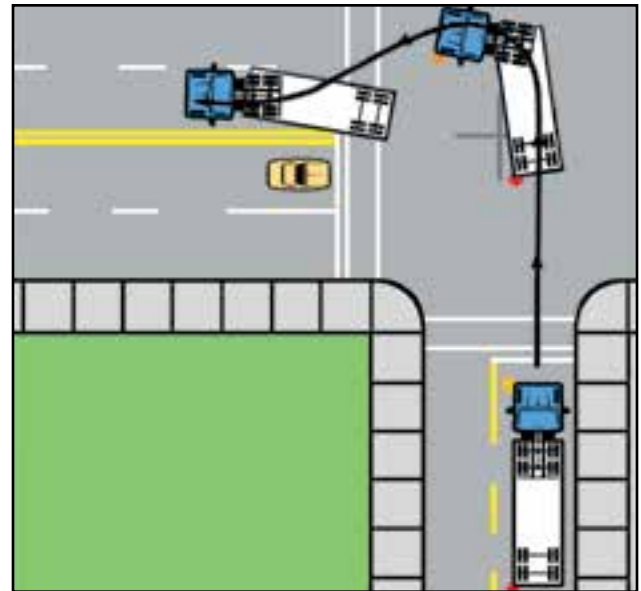

Extended approach

This turn would be used when the street you are turning from has traffic moving about you and the street you are turning onto is wide with lots of room to move.

A left turn with an extended approach is done as follows:

- Approach in the median lane or the lane closest to the centre of the roadway.
- Turn your left turn signal on about 30 m from the intersection (150 m outside cities, towns or villages).
- Check your mirrors and make sure you are aware of the traffic's location around you.
- Scan the intersection for any potential dangers and take the necessary precautions.
- Drive straight into the intersection, start turning when your vehicle is well into the intersection. Check the left mirror and make sure the wheels do not run into traffic or drive over the median. Continue the turn until the vehicle is around the corner and end the turn in the lane closest to the centre line or median.
- Turn off the turn signal.

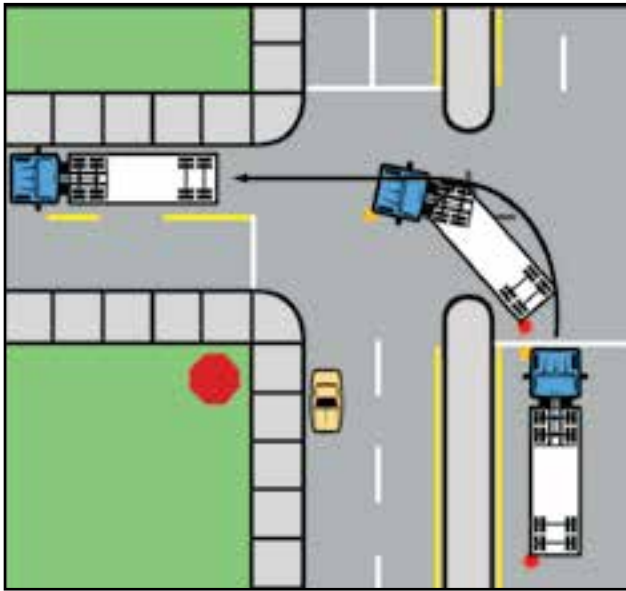

Lane straddling

This type of turn should only be used as a last resort as it can be very dangerous as traffic may try to pass on the left side of your vehicle. It can also be confusing to other traffic on the road. This type of turn would be used when the street being turned onto is very narrow or space is limited.

A left turn when straddling the lane is performed as follows:

- Approach in the median lane or the lane closest to the centre line of the road.
- Turn your left turn signal on about 30 m from the intersection (150 m outside cities, towns or villages).
- Check your mirrors and make sure you are aware of the traffic's location around you. If safe, move the vehicle into the lane to your right only enough to make the turn safely. Watch the trailer to make sure it remains within 1.5 m of the centre line or median.
- As you enter the intersection, turn your steering wheel to the left. Continue watching the intersection for potential dangers and watch the trailer to ensure it does not collide with any traffic on the roadway and that the trailer wheels do not go over the median. Also ensure the tractor wheels do not go over the curb of the street you are entering.
- The critical point is reached when the tractor is at the sharpest point of the turn in relation to the trailer, as the left rear view mirror vision is limited.
- Steer the tractor into the lane closest to the centre line and the trailer will follow; the turn should be completed in this lane.

Whenever possible, turns must be made from the proper lanes. When it becomes necessary for the driver to direct the vehicle over lane lines or centre lines to negotiate sharp turns, it is the driver's responsibility ensure such a movement can be made safely, without interfering with other traffic.

If there are two turn lanes side-by-side with signs indicating you are allowed to turn left from either lane, the turn should be made from the right-most lane. This will give you a larger turning arc and you should not have to worry about traffic to your right side.

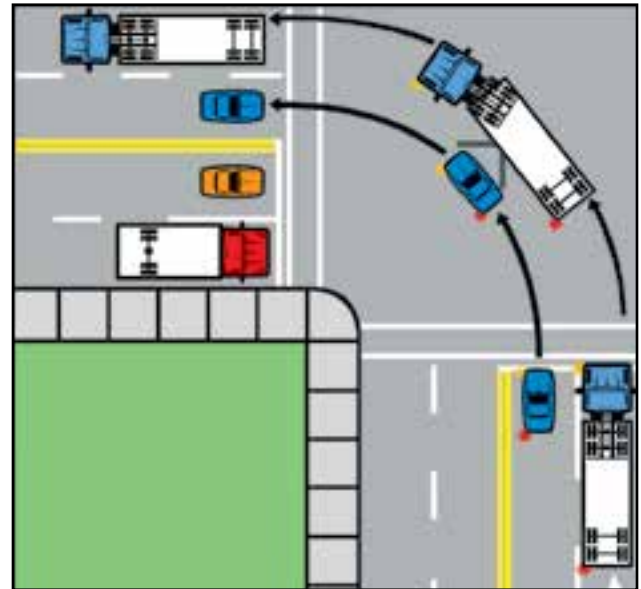

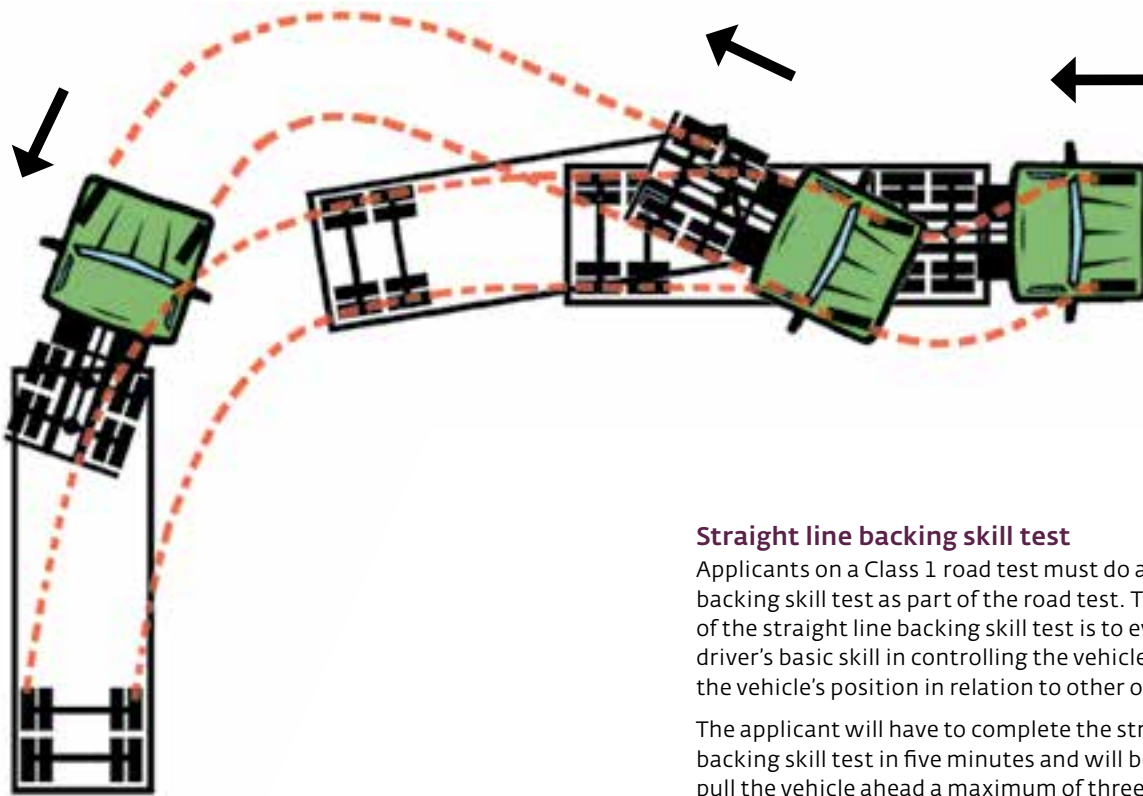

Backing a tractor and trailer

The control of a straight body vehicle when backing is done in the same way as that of a passenger vehicle.

When backing a tractor-trailer, the front wheels of the tractor must be turned in the opposite direction you want to move the rear of the trailer. To do this, place your hand on the bottom of the steering wheel and move your hand and the steering wheel in the direction you want the trailer to go.

Once the trailer is started in the direction you want it to go, you must steer the tractor to follow the trailer or a jackknife position will be reached.

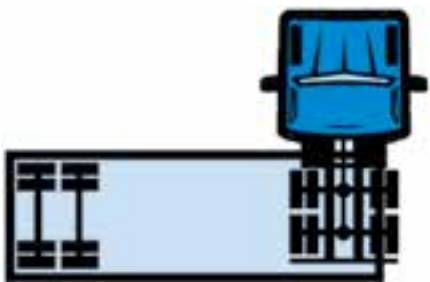

When the trailer has curved far enough, the tractor steering wheel must be straightened so the tractor will follow in line with the trailer. The tracking pattern of the tractor and trailer when backing is an S-shaped curve.

Straight line backing skill test

Applicants on a Class 1 road test must do a straight line backing skill test as part of the road test. The purpose of the straight line backing skill test is to evaluate the driver's basic skill in controlling the vehicle and judging the vehicle's position in relation to other objects.

The applicant will have to complete the straight line backing skill test in five minutes and will be allowed to pull the vehicle ahead a maximum of three times. The applicant will be backing the vehicle in a designated area with two parallel lines of cones 3.7 m apart and 18.5 m in length. The cones represent two trailers parked at a loading dock, between which the applicant must back the trailer without touching a cone or driving outside the parallel line of cones as this would be the same as hitting another trailer. The applicant must stop the vehicle with the rear of the trailer within one metre before or after the last cone.

Once the backing skill test is completed, the applicant will be required to remove the vehicle from the designated area, again without touching the cones or driving outside the parallel line of cones.

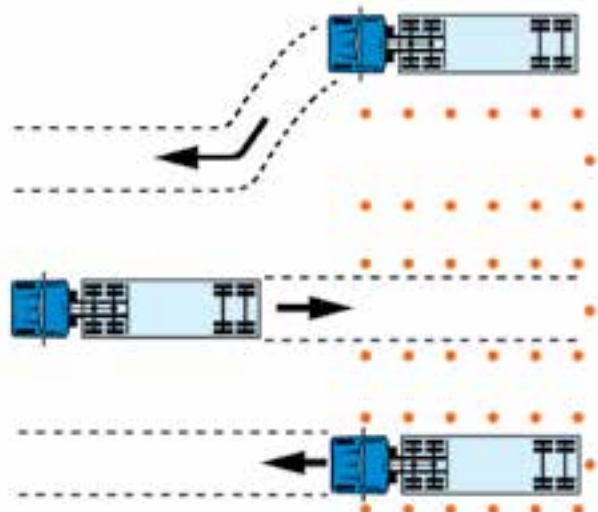

Connecting vehicles

When connecting a tractor to a trailer the draw bars or coupling devices must be in accordance with The Highway Traffic Act and its regulations.

These regulations require that the device be of sufficient strength to hold the vehicles together and be tied to main parts of the frames of the vehicles. If the trailer is less than 900 kg GVWR, a coupling device may be attached to a strong part of the frame on the towing vehicle.

Except for a motor vehicle pulling a pole trailer, the draw bar or coupling device between the motor vehicle and the trailer shall not exceed five metres in length.

When a coupling device is used (other than the fifth wheel coupler) an auxiliary safety chain or metal cable of equal strength to the coupling device must also be used to prevent separation in the event of the coupling device failing.

The trailer must not swerve or whip unreasonably when being towed by a motor vehicle. If the trailer whips or swerves, drivers must slow down and stop to determine the cause and stop it from happening again.

Coupling a tractor and trailer

When coupling to a trailer equipped with air brakes, it is important that the trailer is secured. If the trailer is equipped with spring brakes, the trailer brakes will remain in the applied position even if the trailer air tank is drained. Trailers left parked without spring brakes should have their wheels blocked to prevent rollaway. Air pressure in the trailer air tank will bleed down in accordance to the amount of leakage in the trailer system. If the trailer tank is drained, the trailer brakes will let go.

The following are approved steps to follow when coupling a tractor and trailer:

1. Before coupling the trailer, inspect the condition of the kingpin as well as the trailer apron.
2. Back the tractor in a straight line to the trailer with the fifth wheel opening in line with the trailer apron.
3. Stop before the fifth wheel makes contact with the trailer apron.



4. Check the fifth wheel coupler jaws to make sure they are open. Check the height of the fifth wheel with the trailer apron. Raise or lower the trailer landing supports as required.

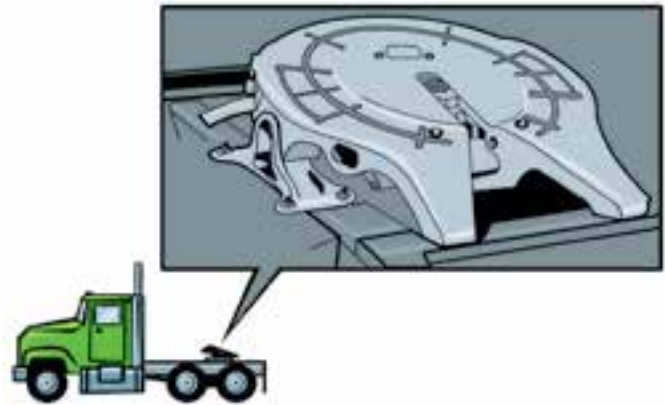

5. Connect the air lines of the braking system and the light cord to the trailer.

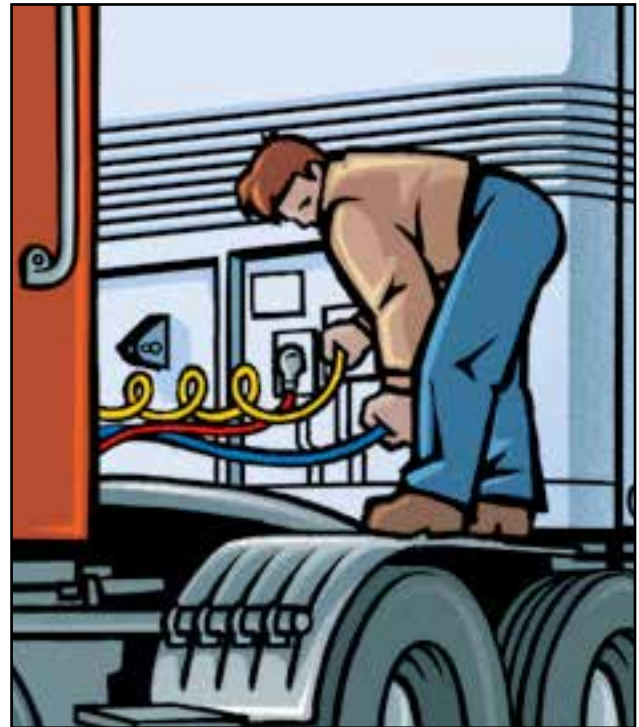

6. Check that cargo in the trailer is secure and that no one is inside the trailer or behind it.

7. Check that the trailer's sliding bogie lock bars pins are in position.

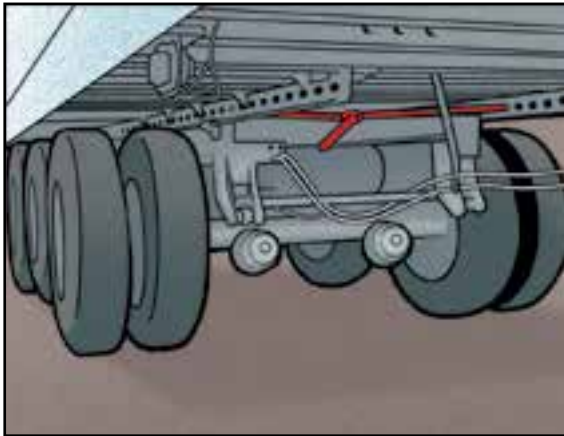

8. Open the trailer supply valve to charge the trailer. Apply the trailer brakes (test for application) and release (if trailer brakes do not release, air lines may be crossed).
9. Re-apply the trailer brakes and back under the trailer until the fifth wheel coupler jaws lock on the trailer kingpin.
10. Pull the trailer with a gentle tug forward with the trailer brakes applied to test if the coupler is locked.
11. Apply the parking brake.
12. Look under the trailer and visually check that the fifth wheel coupler jaws are properly locked around the kingpin and the trailer is resting flat on the fifth wheel.



13. Raise the landing supports and securely stow the crank. On air ride trailers, supply airbag suspension with air.

Uncoupling a tractor and trailer

The following are approved steps to follow when uncoupling a tractor and trailer:

1. Set the spring parking brakes. (Block the trailer wheels on grades or always on trailers without spring parking brakes.)
2. Check where the landing support pads will contact the ground to ensure that the surface is firm enough to support the trailer; use blocks if necessary. On trailers with manually operated air ride suspension, exhaust the air from the suspension airbags. On some trailers the suspension airbags will deflate automatically when the trailer supply valve is closed. If the suspension airbags are not deflated prior to uncoupling the tractor and trailer, the air may bleed out slowly and the trailer will roll forward and may damage the landing supports.
3. Lower the landing supports using high gear until the pads contact the ground, then slide the handle shaft to the low gear and crank until the trailer weight is partially lifted off the tractor.
4. Unlock the fifth wheel coupler.
5. Release the spring parking brakes. Apply the trailer brakes with the hand valve, pull ahead slowly until the trailer kingpin is released from the fifth wheel. Stop the tractor in this position in case the landing supports fail, then the trailer would still be supported by the tractor.
6. Disconnect the air lines and electrical cable, connect the glad hands to the dead end connectors if so equipped.
7. Pull the tractor clear of the trailer.

Vehicle and load dimensions

Vehicles and their loads are limited to height, width, length and weight in accordance with The Highway Traffic Act and its regulations. Provisions are made for issuing permits for vehicles carrying oversize or overweight loads.

Before transporting oversize loads (overwidth, overweight, overheight or overlength) the driver should make sure to have the proper permits. Permits for highway movement are issued in accordance with The Highway Traffic Act, and for city or municipal roads by the city or municipal authority.

For questions relevant to motor carriers or operators of regulated vehicles, such as legal weights and dimensions, permits, load securement, and safety fitness certificates, please visit www.manitoba.ca or contact Motor Carrier Branch at motorcarrier@gov.mb.ca: 204-945-3890 (toll-free 1-877-340-9068).

The conditions of the permit may state additional safety measures such as the use of a pilot vehicle, flags, signs or lights. The driver must comply with these requirements.

Regardless of the licence or permit issued, a driver must obey all signs posted by the appropriate provincial government department that limit the dimensions or weight of loads on any portion of the highway. To help the driver avoid damage to the vehicle and its load, and possible injury to other users of the highway, the driver must be alert to the warning signs at right.

It is important to observe these signs and take the appropriate action because in Manitoba, the driver or company are charged if a highway or structure is damaged by their vehicle or its load.



Pavement narrows ahead



Narrow bridge ahead



**Low structure clearance
4.1 metres**



Truck route



No trucks allowed



**Heavy trucks must not
travel in this lane**



**Weight restriction
for a roadway or bridge
of 10 tonnes**

Height

The driver must know the total height of the vehicle and load at all times. The maximum height of a vehicle on a highway is 4.15 m unless otherwise stated in a permit. Overhead clearances are posted before you arrive at an underpass or tunnel.



In some areas, overhead check bars and warning devices are installed so the driver can test the clearance of their vehicle.

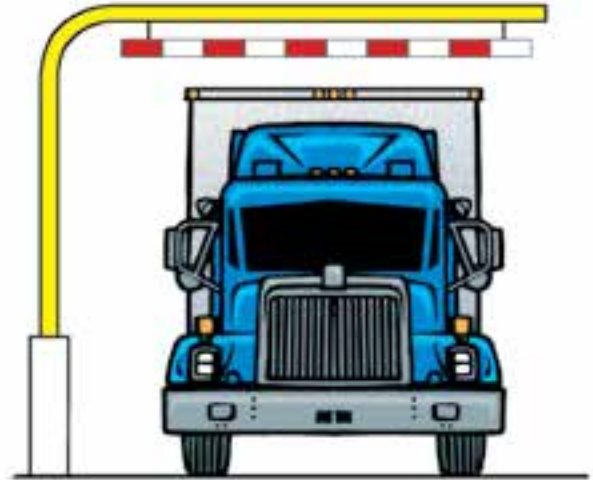

During winter months, snow buildup on the highway can reduce overhead clearance.

Special attention should be given for low overhead non-posted clearances such as:

- fire escapes in alleyways
- vehicle entrance doors
- building canopies overhanging the roadway
- low wires across driveways
- boulevard tree limbs overhanging the roadway

Overheight

A permit is required when the height exceeds 4.15 m. Permits will be only issued for loads that cannot be reduced (irreducible loads), so you cannot have two pieces of equipment stacked one on top of the other exceeding 4.15 m in height.

The overhead clearance on bridges and signs will determine the maximum height allowed on a permit. If the overall height exceeds 4.6 m the permit you obtain from the Motor Carrier Branch must be approved by Bell MTS, and if the height exceeds 5.2 m, Manitoba Hydro must also approve the permit.

The Highway Traffic Act states that both the owner and operator of a commercial vehicle will be held jointly responsible for any damage caused to an underpass due to the driver disregarding height warning signs.

Width

The maximum legal width of a vehicle and its load is 2.6 m. Vehicles transporting loose hay, straw or fodder can be loaded to a maximum of 3.7 m overall width.

Side-view mirrors and clearance lights that extend beyond the side of the vehicle are not considered in the overall width of the vehicle and are allowed an additional 20 cm on each side of the vehicle. Load securement devices are allowed to extend an additional 10 cm beyond the overall width on each side of the vehicle.

Drivers must be careful when operating large vehicles, particularly on narrow bridges or roadways and in road construction areas.

Winter driving conditions can add to the width hazards, particularly in the areas with a large buildup of snow. During such conditions the first rule of safety is to reduce speed.

Overwidth

A permit is required for widths exceeding 2.6 m.

Generally, to obtain a permit the load must be irreducible so you are not allowed to load two pieces of equipment side by side and exceed the normal 2.6 m in width.

When the width exceeds 4.6 m, escort vehicles, equipped in accordance with The Highway Traffic Act and its regulations, are required both in the front and rear of the escorted vehicle. The permit may be subject to approval by local authorities.

Wide load sign

Wide load signs must only be displayed when transporting a wide load.



Length

The final size factor facing the driver of large vehicles is length. The driver of a truck, for example, which has an "overhang" over the rear axle must be extra careful in narrow roadways and alleyways when negotiating tight turns. Allow for the "overhang" to avoid striking objects such as poles, parked cars and buildings. The driver must exercise caution in limited clearance areas.

The legal lengths of vehicles vary according to the type of vehicle:

- single vehicle: 12.5 m
- combination including truck or car pulling a trailer: 21.5 m
- tractor-trailer including load: 23 m

For a list of maximum lengths permitted for other vehicles, please contact Manitoba Infrastructure.

Overlength

Generally, permits are granted only when the length is irreducible. Permits are not issued for overlength loads carried on a type of truck other than a tractor-trailer or a combination type of vehicle.

A pilot vehicle, equipped according to The Highway Traffic Act and its regulations, must follow vehicles whose overall length exceeds 30 m. Flagging must be enforced at exits and entrances to highways while the vehicle is turning.

Pilot vehicles

Pilot vehicles are used to warn drivers they are approaching an oversize vehicle or load.

When an oversize or overload permit requires a pilot vehicle for escort purposes, the pilot vehicle shall be equipped with a yellow flashing light and shall display an illuminated "WIDE LOAD" or "D" sign.

When escorting an oversize vehicle or load:

- On a two-lane or four-lane highway, a pilot vehicle shall precede and follow the oversize vehicle or load at a distance of not less than 100 m and not more than 500 m.
- On a four-lane divided highway, the pilot vehicle shall follow the oversize vehicle or load at a distance of not less than 100 m and not more than 500 m. Drivers should be aware that the oversize vehicle or load may pose a threat to normal traffic patterns, particularly when passing the oversize vehicle or load on a two-way highway.



Weight

Vehicles are registered according to their GVWR. In Manitoba, this is the combined weight of the vehicle and its load. The maximum allowable GVWR is determined by such things as the number of axles, the spacing of the axles, size of tires, etc. It is illegal for vehicles to operate on a highway if the gross weight on a tire exceeds the rated capacity of the tire or if the gross weight on an axle exceeds the axle, suspension or brake manufacturer's rating of that component. As well, it is illegal for a trailer to be operated on a highway if the weight on the trailer exceeds the manufacturer's rating.

For maximum allowable GVWR, please contact Manitoba Infrastructure.

Overweight

A permit is required when maximum weights are exceeded as specified in the Vehicle Weight and Dimensions on Classes of Highway Regulations. For further information concerning oversize/overweight permit policy, please contact the Motor Carrier Branch.

Period of spring road restrictions

In spring, as the ground thaws, the base a highway is built on will soften. If trucks of normal weights were allowed to travel on this soft highway it would cause damage. For this reason certain highways are restricted to the amount of weight that can be hauled on them. Roadways are posted with the proper signs alerting the driver to the restricted weight.

Drivers convicted of using a weight-restricted road with a vehicle whose weight is over the allowable weight limit must pay fines based on the difference between the actual weight and the allowable weight.



Liability for damage by overweight vehicles

The Highway Traffic Act states that both the owner and operator of an overweight vehicle will be held jointly responsible for any damage it causes to any part of a highway.

Bridges

When approaching a bridge, the driver must observe the weight limit sign posted to ensure that the total vehicle and load weight is not in excess of the maximum safe weight.

More detailed information about size and weight regulations for groups of axles can be obtained by contacting Manitoba Infrastructure.

Weigh stations

All trucks or combination of trucks with a registered GVWR of 4,500 kg or higher must report as directed by signs to weigh stations.

Weigh stations are located throughout the province.

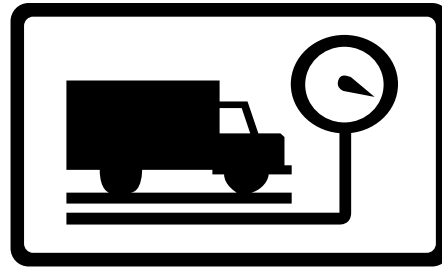

Signs are posted before the weigh station telling the driver to report to the weigh station to weigh axles, measure dimensions of vehicle and load, inspect driver's licence, log books, permits, vehicle registration and mechanical fitness, and to make sure the load is secure.

Whether the weigh station is stationary or portable, the driver must report as directed by the posted signs or on the request of a peace officer.

About loads and loading

Weight distribution

The weight distribution of cargo has a definite bearing on the handling characteristics of the vehicle as well as the life of the tires, frame, springs, axles, and bearings.

Even though the total load may not be over the total carrying capacity of the vehicle, poor distribution of weight could be overloading an axle or set of tires. Undue stress could be placed on the frame resulting in permanent damage and steering misalignment.

Distribution of weight will depend on the nature of the load. The loading of one piece of cargo that comprises the full load will present different problems from a load made up of a number of pieces of cargo.

The examples shown in the diagrams below may be referred to as a general rule for loading, but do not cover all situations that the driver may encounter.

A heavy concentrated load should be placed near the rear axles and on its long side if possible. Most of the load should be over the rear axles to get proper tire loading and reduce bending of the frame.

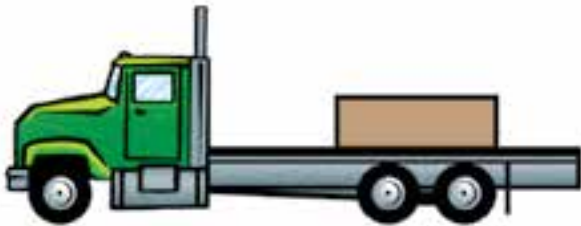

A tractor-trailer is the proper vehicle to use for a large load like the one shown below. By using the proper vehicle, damage to the truck and tires, and even serious collisions, may be avoided.

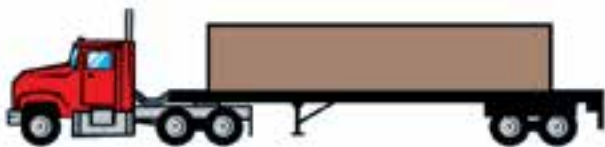

The proper place for the concentrated load illustrated below is just ahead of the rear axles with the longest side on the floor.



This loading distributes weight equally on all rear tires and reduces twisting and stress on the frame. Uniform crosswise loading also prevents axle housing and wheel bearing overload.

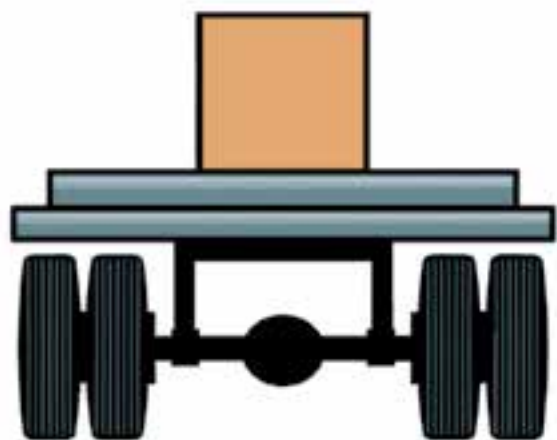

A very heavy concentrated load should not be positioned against the cab as the distribution of load may cause the frame to bend, perhaps permanently. It will also overload the front tires and may even cause a blowout on a worn tire. Difficult steering will also result.



The type of loading shown below should never be permitted. The frame could bend, the rear tires are extremely overloaded and enough weight is taken from the front tires to make steering almost impossible.



A very heavy load should not be positioned on one side. This overloads one spring and the tires on that side. This loading could cause the brakes to lock the wheels on the lighter side and cause flat spots on the tires or a skid on a wet surface.



The type of loading shown below results from using the wrong vehicle for the job. On rough roads, loading your vehicle like this can make your truck pivot on its rear wheels, taking the front wheels entirely off the road.



Approximate distribution of total weight—vehicle plus payload

Trailers are also designed for uniform load distribution as shown on the previous examples. The basic difference between loading trailers and trucks is, in the case of trucks, the average design provides for about 90 per cent of the payload on the rear tires and 10 per cent on the front tires. In the case of trailers, the payload should be spread equally between the rear tires and the fifth wheel, which transfers its load to the tractor.

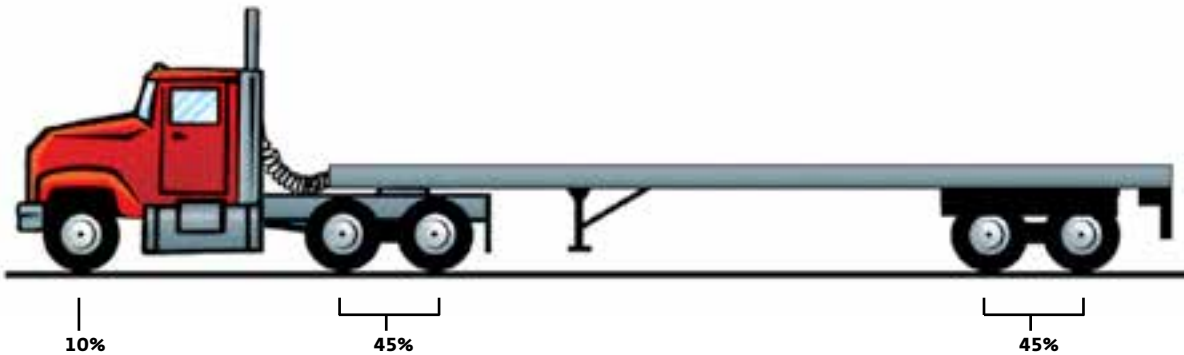

The examples below are obviously wrong. In the case of the first trailer, the heavy load at the rear is overloading the rear trailer tires. There is practically no load on the fifth wheel and the tractor rear tires could slip. Braking distribution would also be very uneven. Tailgate loading, of course, should never be practised, even in the interest of speed, as it puts a severe strain on the equipment and could result in a serious collision.

The load should be centred to give the proper wheel load distribution. The average truck has a central weight distribution point midway between the rear of the cab and the tailgate. The average tractor-trailer has a central weight distribution point at approximately the middle of the trailer.

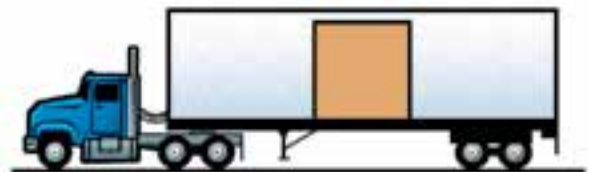

Securing loads

Secure the entire load to prevent shifting or loss of any portion of the load. Check often to make sure tie-downs or binder cables have not loosened, become slack or chaffed. When brakes are applied, an insecure load may shift forward.

Loads consisting of loose materials hauled in open boxes, such as wood chips, paper, refuse, gravel and stones should be covered with a tarpaulin to prevent littering the highway. Tarpaulins must be checked for security, as littering is an offence chargeable to the driver and the owner of the vehicle.

Side ledges of a box or trailer should be cleaned of debris before starting to avoid possible damage to other vehicles from debris falling off and hitting the vehicle.

The Cargo Securement Regulation adopts the National Safety Code for Motor Carriers Standard 10—Cargo Securement of the Canadian Council of Motor Transport Administrators, which contains the specific load securement requirements for loads of logs, dressed lumber, metal coils, paper rolls, concrete pipe, intermodal containers, vehicles as cargo, roll-on/roll-off and hook lift containers and boulders. General securement or containment provisions for all loads in general are also contained within the same code. Any driver engaged in transporting freight is required to know the specific standards on the safe and proper securement of loads.

For information regarding the securement of loads contact the Motor Carrier Branch.

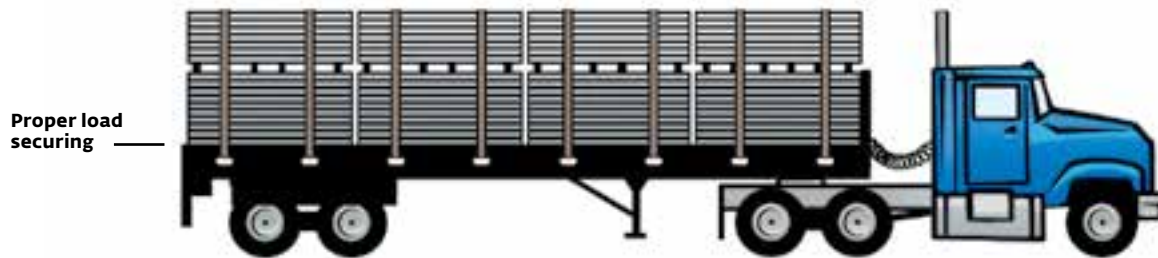

Securing components

Load projections

Check your load and equipment before driving. Extra wide or long loads require special permits and must also carry the stipulated warning signs.

Generally, these loads cannot be moved during hours of darkness. Some loads must not exceed the legal length but may overhang the vehicle body. If the rear overhang exceeds one metre, it must carry a red flag not less than 30 cm square at the end of the load. You must be able to see at least 60 m from the rear of the vehicle.

At night, there must be a red light or red reflector at the extreme rear of the overhang that is visible to approaching drivers.

A projection exceeding one metre beyond the front bumper is not allowed unless authorized in a permit.

Night travel by oversize vehicle

Where night travel of an oversize vehicle or load is authorized by a permit under The Highway Traffic Act, the vehicle or load must be equipped with and shall at all times that it is driven or operated on a highway have in operation the following clearance lamps in a conspicuous position as near the top of the vehicle or load as practicable:

- Two lamps, each of which casts a green or amber light visible from an oncoming vehicle, one of which is located on the left and one on the right side of the front of the vehicle or load
- Two lamps, each of which casts a red light visible from a vehicle approaching from the rear, one of which is located on the left and one on the right side of the back of the vehicle or load
- Two lamps, each of which casts a green or amber light visible from an oncoming vehicle and a red light visible from a vehicle approaching from the rear which are so positioned that one is on that portion of the vehicle or load that projects furthest to the right and one is on that portion of the vehicle or load that projects furthest to the left

Farm equipment on roads

When outside of cities, drivers need to watch for farm equipment that might be moving between fields. Many farm implements are very large and oddly shaped, and farm tractors, combines and other equipment move very slowly, with a maximum speed of 40 km/h. Drivers need to be aware that at highway speeds, you will approach a piece of farm equipment unexpectedly quickly. As well, farm implements can sometimes take up more than half of the road width, or if they are crossing a bridge, can take up the full width of the bridge.

The most important thing to remember when approaching farm equipment on the road is to slow down well ahead of time and to look closely at the implement when passing or meeting it to make sure you know how wide and how long it is.



Remember a valid Class 5 Intermediate Stage licence or higher is required to operate heavy and agricultural equipment on provincial highways and roads in urban areas. These types of vehicles include tractors, self-propelled farm equipment such as combines and heavy equipment such as front-end loaders, cranes, forklifts and graders. Provincial highways and urban roads do not include rural municipal roads, service roads or winter roads controlled or maintained by a local government such as a rural municipality.

Fastening tailgate

Your truck's tailgate must be closed and fastened, except when the truck is carrying an article of such length that it cannot be easily carried unless the tailgate is open.

Transporting dangerous goods

Federal and provincial legislation is in force to promote public safety when transporting dangerous goods. Canada's federal, provincial and territorial governments work together with the transportation industry to make sure that requirements for transporting dangerous goods are the same across the country and that they apply to all means of transportation whether it be by air, marine, rail or road.

Everyone in charge of a dangerous good anywhere along its journey is responsible for its safe transportation and must keep in mind:

- Whoever is in charge of dangerous goods must report to a designated authority in the event of:
 - any discharge, emission or escape of dangerous goods from any container, packaging or means of transport
 - a reportable dangerous occurrence or a collision involving dangerous goods
 - the loss, theft or misplacement of a consignment of products of certain classes of dangerous goods
 - a delay in delivery of certain explosives
- Anyone who handles, offers for transport, or transports dangerous goods must be a trained person or performing those duties under the direct supervision of a trained person. It is the employer's responsibility to ensure that employees are trained with respect to the dangerous goods that will be assigned to them. When training is complete, that person is issued a training certificate. Training certificates must be renewed every 36 months.

The consignor is responsible for:

- supplying the initial carrier with the appropriate safety marks, like placards (with the correct UN or NA / Product Identification Number as applicable)
- providing the initial carrier with the shipping document or waste manifest, as required

The carrier is responsible for:

- displaying the appropriate safety marks in the proper manner and location
- replacing any safety marks that are damaged or lost while the consignment is in the carrier's charge
- ensuring that all required documentation is complete and accompanies the consignment, that any change in the consignment while in their charge is documented and that when a consignment leaves the carrier's charge, copies of all necessary documents are passed on to the receiver
- loading and segregating the consignment if appropriate
- refusing consignments of dangerous goods that do not meet the requirements of the regulations
- retaining all documents for two years

The consignee is responsible for:

- completing, signing and forwarding all required documents for wastes to the proper authorities
- meeting the requirements of a consignor when returning empty packages, containers or vehicles that are not cleaned or purged so that no hazard exists

Classifying dangerous goods

The Dangerous Goods Transportation Act divides dangerous goods into nine classes according to the type of hazard involved. Some of the classes are further divided into divisions that identify the hazards more specifically. Refer to the dangerous goods illustration on the following pages. The regulation lists dangerous goods and describe their shipping name, classification and UN or NA / Product Identification Number. Classification is the responsibility of the manufacturer of the product, or in the case of hazardous waste, the generator of that waste. Classification must be completed before offering the product for shipment.

Safety marks

Safety marks are used to indicate the presence of dangerous goods and to identify their hazard class. The visible safety marks are generally the labels, placards and UN or NA / Product Identification Number.

Labels are used on packages, cylinders, drums and other small containers.

Placards are used on large containers (cap. over 454 l) and transport units.

UN or NA / Product Identification Numbers are four-digit numbers that are assigned to a specific product; e.g. Gasoline is UN 1203. A UN or NA / Product Identification Number is required to be displayed on a placard if the dangerous goods (other than dangerous goods included in Class 1 or Class 7), are transported in bulk or are described in the Federal Regulations.

The marks of safety

Class 1 — Explosives

- 1.1 A substance or article with a mass explosion hazard.
- 1.2 A substance or article with a fragment projection hazard, but not a mass explosion hazard.
- 1.3 A substance or article that has a fire hazard along with either a minor blast hazard or a minor projection or both, but not a mass explosion hazard.
- 1.4 A substance or article that presents no significant hazard; explosion effects are largely confined to the package and no projection or fragments of appreciable size or range are to be expected.
- 1.5 A very insensitive substance that nevertheless has a mass explosion hazard like those substances in 1.1.
- 1.6 An extremely insensitive substance that does not have a mass explosion hazard.

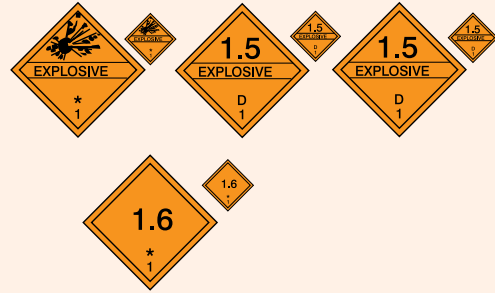

Class 2 — Gases

- 2.1 A flammable gas (red)
- 2.2 A non-flammable gas (green)
- 2.2 An oxidizing gas (yellow)
- 2.3 A poisonous gas (white)
- 2.4 A corrosive gas (white with compressed gas cylinder)

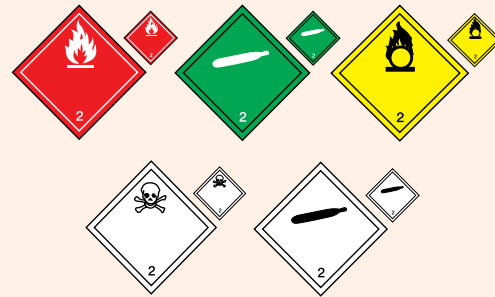

Class 3 — Flammable liquids

- 3.1 A liquid with a closed-cup flash point of not greater than 61°C.



Class 4 — Flammable solids; Substances liable to spontaneous combustion; Substances that on contact with water emit flammable gases (water-reactive substances)

- 4.1 A solid that under normal conditions of transport is readily combustible or would cause or contribute to fire through friction or from heat retained from manufacturing or processing or is a self-reactive substance that is liable to undergo a strongly exothermic reaction, or is a desensitized explosive that is liable to explode if they are not diluted sufficiently to suppress their explosive properties.
- 4.2 A substance liable to spontaneous combustion under normal condition of transport or when in contact with air, liable to spontaneous heating to the point where it ignites.
- 4.3 A substance that, on contact with water, emits dangerous quantities of flammable gases or becomes spontaneously combustible on contact with water or water vapour.



Class 5—Oxidizing substances and organic peroxides

- 5.1 A substance that causes or contributes to the combustion of other material by yielding oxygen or other substances whether or not the substance itself is combustible.
- 5.2 An organic compound that contains the bivalent “-O-O-” structure, which is a strong oxidizing agent and may be liable to explosive decomposition, be sensitive to heat, shock or friction, react dangerously with other dangerous goods or may cause damage to the eyes.



Class 6—Poisonous substances and infectious substances

- 6.1 A solid or liquid that is poisonous through inhalation of its vapours, by skin contact or ingestion.

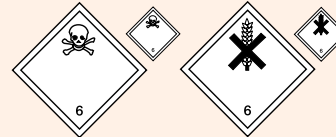

Class 7—Radioactive materials

- 7.1 Radioactive materials within the meaning of The Atomic Energy Control Act with activity greater than 74 kBq/kg.



Class 8—Corrosive substances—a flammable gas

- 8.1 A substance that causes visible necrosis of skin or corrodes steel or non-clad aluminum.



Class 9—Miscellaneous products or substances

- 9.1 Miscellaneous Dangerous Goods—a substance or product presenting dangers sufficient to warrant regulation in transport but which cannot be ascribed to any other classes.
- 9.2 An environmentally hazardous substance.
- 9.3 A dangerous waste.

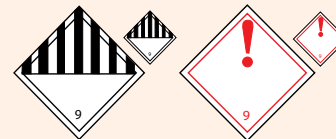

Special labels and placards

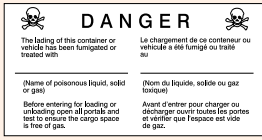

Fumigation sign



Ventilation requirements

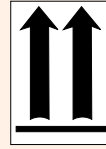

Package orientation



Special PCB requirements



Mixed load requirement



Tank car only Residues after unloading

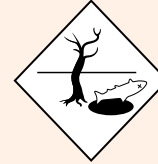

Marine pollutants International Convention for the Prevention of Pollution from Ships 1973 (MARPOL 73/78)

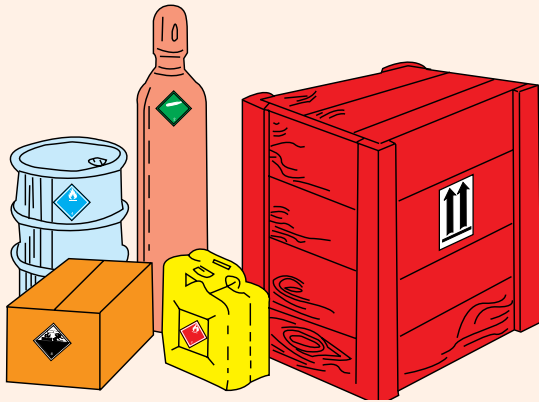

For bulk shipment the Product Identification Number is required.



Dangerous goods routes

Routes may be established within certain cities, towns and villages over which dangerous goods must be transported. These routes are identified with signs.

Dangerous goods routes are authorized by civic bylaw and the respective civic administration may be contacted for particulars of their dangerous goods route bylaw.

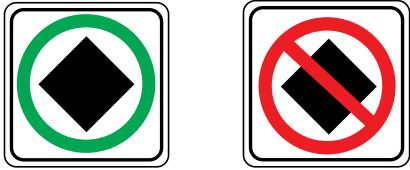

Documentation

Proper information on a shipping document helps make sure dangerous goods are handled and transported safely. It also provides valuable information to those who may have to deal with dangerous occurrences or collisions involving these goods.

The consignor must ensure that the shipping document contains all the required information in the order specified, that the document is signed and is accompanied by any other required documents or certificates, and that it is given to the initial carrier.

The regulations provide that the shipping document shall be located during transport as follows:

- When the driver is in the cab, one copy must be in the cab within the driver's reach or in a pocket mounted on the driver's door.
- When the driver is not in the cab, one copy must be on the driver's seat or in the pocket mounted on the driver's door.
- If the transport unit is a tractor-trailer and the trailer containing dangerous goods is detached and left in a parking area, leave a copy of the shipping document with the person in charge of the parking area.
- In cases that are not covered by the above, leave the shipping document in an accessible, identifiable waterproof receptacle securely attached to the transport unit.

The carrier must also ensure the document is passed along with the dangerous goods to any subsequent carrier or to the consignee.

Except when dangerous goods that are to be transported as "waste" or by air, any kind of shipping document may be used providing it contains all of the prescribed criteria for shipping documents required by the regulations.

After dangerous goods have been unloaded, a danger still exists because of residues that remain in the transport unit (e.g. bulk fuel haulers). The regulations provide that the carrier's copy of the shipping document is to be marked "residue last contained" and stay with the transport unit until it has been emptied, cleaned or purged so that no hazard exists.

When transporting "waste" dangerous goods, a "manifest" that is prescribed in the regulations must be used. A pamphlet explaining how to obtain and use the manifest is available from the federal or provincial environment department.

Vehicles displaying a dangerous goods placard must stop at uncontrolled railway crossings.

Drivers are required to notify the nearest police agency or fire department and, if in Manitoba, the provincial conservation department, in the event of spills or other hazards relating to dangerous goods. Rapid action in reporting spills may help stop serious incidents.

In the event of an emergency call CANUTEC (Canadian Transport Emergency Centre) collect at 613-996-6666 or *666 (cellular). If the spill or emergency is in Manitoba, also contact the Manitoba Environmental Accident Reporting Line at 204-945-4888 or 204-944-4888 (24 hours).

The above numbers are for reporting emergencies only.

For information on obtaining a Certificate of Training, contact the Manitoba Trucking Association.

For information concerning the handling and transportation of dangerous goods in Manitoba contact:

Manitoba Conservation Environment Operations Winnipeg Region

200 Saulteaux Crescent
Winnipeg, Manitoba R3J 3W3
Telephone: 204-945-7025

This office is for information only and not for emergency response purposes.

For information on federal regulations of the transportation of dangerous goods contact the Government of Canada, Dangerous Goods Surface Transportation at 204-983-5969.

Transporting explosives

Depending on the type of explosive a permit may be required. For information on the transportation of explosives contact:

Government of Canada

Dangerous Goods Surface Transportation

204-344 Edmonton Street
Winnipeg, Manitoba R3B 2L4
Telephone: 204-983-5969



Transporting livestock

The operator of a vehicle that is engaged in the transportation of livestock is responsible for making sure that such transporting is in compliance with the conditions outlined in The Highway Traffic Act.

When transporting livestock the operator must keep the vehicle clean and not overcrowded.

Cruelty to livestock is against the law. No person, while transporting livestock or other animals in a motor vehicle, shall permit any damage or injury to any of the animals or transport animals in such a way as to cause unnecessary suffering to any of them. Also, when transporting livestock the vehicle shall be equipped with partitions adequate to separate different species, kinds, classes, types or sizes of livestock.

Animals tend to shift back and forth and side-to-side to balance themselves while they are standing in a moving vehicle. This is important for the driver to know when negotiating curves on the highway as it may change the centre of gravity of the vehicle.

Transporting hanging meat

Hanging meat, which is usually transported in a refrigerated vehicle, can be very unstable because of the load having a high centre of gravity. When going around sharp corners, changing speed, accelerating or braking the driver must be extra cautious in order to keep the vehicle under control.

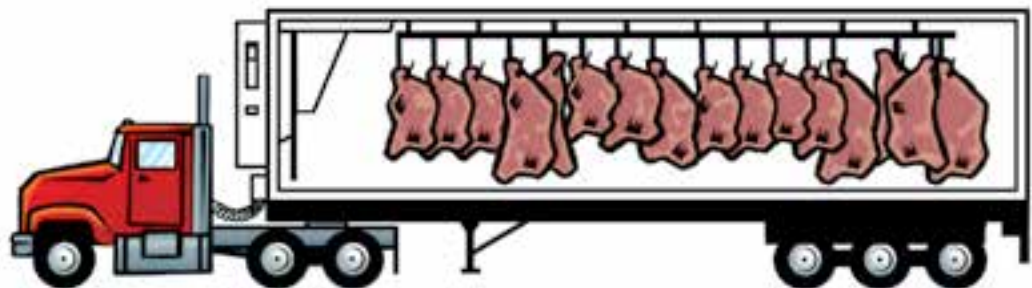

Transporting bulk material

When materials are unpackaged they are called “bulk.” For example, sand, soil, sod and wood chips are usually transported in bulk by a dump body-type truck. In most cases a bulk load must be covered with a tarpaulin and the driver must ensure the load does not fall from the vehicle. Loads of snow, earth or mud do not require a tarpaulin when they are being transported as long as the load does not fall off the vehicle.

Transporting liquids

Tank trucks are used to transport liquids or liquefied gaseous material. Operating tank trucks takes special skill because of the movement of the liquid in the tank and the high centre of gravity. Also, when a tank is partially filled, the movement of the liquid can have a direct impact on the handling or control of the vehicle.

Special driving considerations for tank trucks

When slowing or braking with a tank truck the liquid in the tank moves or “sloshes” to the front of the tank and then to the rear, then back to the front again. This creates a wave, and when it hits the end of the tank it tends to push the vehicle in that direction. If the vehicle is being operated on a highway which is slippery, the surge of the wave could place the vehicle in a dangerous situation. When operating a tank truck you must take into account and be aware of the risks at all times.

There are different types of tank trucks and trailers, including those seen below.

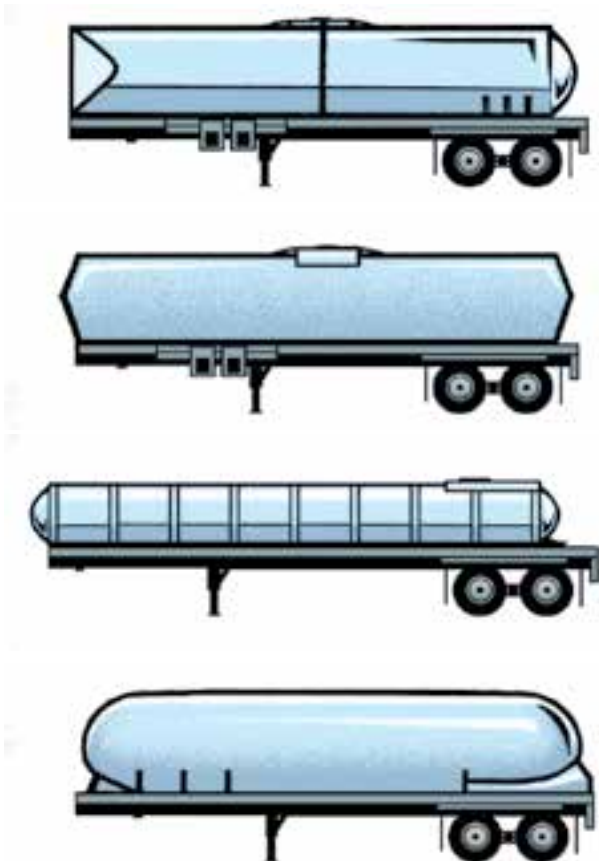

Some of the tank bodies have compartments. When filling or emptying different compartments on the same tank the driver should be aware of the weight distribution, ensuring that there is not too much weight at the front or rear of the vehicle. Some other tanks have compartments with baffles in them. These baffles are walls with holes in them which help control the forward and backward movement of the liquid. The liquid is not restricted from side-to-side movement, which can cause a driver to lose control and in extreme cases cause a vehicle to roll over. Drivers must take the necessary precautions when going around sharp curves or turning at intersections. This is especially crucial if the tank is partially filled.

Certain liquids will expand when they are heated. It is important the tank not be filled completely with these liquids because if heated they will expand and overflow or damage the tank. Most tanks are considered to be full when they have reached 70 per cent of the tank capacity.

Drivers should be familiar with product weights and other characteristics before proceeding to load. Some liquids, such as certain acids, are heavier and a tank may be overweight if filled. Therefore, a tank may only be filled partially to remain within the legal weight limits.

Transporting dry bulk

A vehicle with dry bulk tanks or hoppers has a high centre of gravity and caution must be taken when negotiating sharp turns and turns at intersections. The dry materials in the tank can shift and cause the vehicle to be unstable and hard to control.



Highway train

In this manual a highway train is defined as a combination vehicle made up of a tractor, more than one trailer, and may include a converter dollie.

This type of vehicle configuration is usually more difficult to drive. Its weight, size and number of articulations have a great deal of impact on vehicle control and stability. To reduce the risk of a collision, the driver of a highway train must:

- avoid making abrupt movements with the steering wheel
- remain constantly alert in order to avoid having to make a sudden change of direction

If you do not follow this advice, you may end up in a skid and lose control.

The emergency manoeuvres and techniques suggested for tractor-trailers do not always work well with highway trains. Drivers of these vehicles should be trained in the emergency procedures recommended for highway trains.

Combination vehicles with more than one trailer are subject to "rear amplification." Rear amplification is when the lateral acceleration by the tractor increases to the rear trailers. The highway tractor amplification factor is two, which means that the tractor's lateral acceleration is doubled at the rear trailer. This could increase in tight curves to a point where the rear trailer can no longer remain upright and rolls over. Drivers without training in the operation of highway trains may make a manoeuvre that they think is safe; however, it could result in the rollover of the last trailer.

Dangers of skidding and jackknifing with a highway train

Jackknifing can be caused by one of the following:

- The rear wheels of the tractor skid as a result of irregular braking or poor traction.
- The rear of the tractor swings forward as a result of irregular braking, an extremely uneven road surface, high winds or an abrupt turn of the steering wheel.
- The tail trailer pushes the lead trailer because of uneven load distribution and abrupt braking.

When the jackknife angle is over 15°, stabilizing the vehicle is almost impossible. Once the skid starts, if no corrective action is taken, the critical point can be reached in about one and a half seconds, after which it is virtually impossible to recover stability.

The best way to avoid this problem is to be aware of the situations that can quickly lead to skidding and jackknifing. Some of the more common reasons are:

- driving into curves too quickly causing the last trailer to skid
- overbraking causing a wheel to lock
- poor brake adjustment
- abrupt movements of the steering wheel when changing lanes causing the rear trailer to fishtail
- not paying attention to the traffic ahead and having to take evasive actions

Highway train drivers are far away from the rear trailer and because of the added articulation (hinged) points it is difficult for the driver to feel a skid coming or even sense the trailer bouncing. Drivers of these types of vehicles must check their rearview mirrors frequently.

Highway train loading

When connecting the trailers, the heaviest trailer should be hitched to the tractor. If this precaution is not taken, there is a risk of losing control.

Each trailer should be loaded so that the weight of the cargo is evenly spread over the axles. The correct axle load is essential for braking, traction and control of the vehicle. Also, the weight should be spread out in such a way that the centre of gravity is as low as possible in order to reduce the risk of the trailer being unstable and rolling over.

Tow truck

These are vehicles used to repair other vehicles or tow other vehicles. A Class 3 licence is required if the tow truck has more than two axles or if the towed vehicle's weight is over 4,540 kg. Otherwise, a Class 5 licence is required. All tow trucks must be equipped with a flashing or oscillating amber light clearly visible from a distance of 150 m. The flashing amber light may be operated only when a vehicle is being towed or as a hazard warning at the scene of a collision.

When towing a disabled vehicle, the distance between the two vehicles must not exceed five metres. You must also remove derelict or damaged vehicles from the highway so that they do not obstruct the free passage of other vehicles and clean up any debris lying on the highway as the result of a collision.

Test yourself on Section 3

How well have you understood the information covered in Section 3 of this manual? The answers to these questions are found in the preceding pages of this manual.

1. What determines the amount of off-track a vehicle will have?
2. What is the danger of allowing the rear wheels of the vehicle to cross over the centre line of the roadway when negotiating a left turn or curve?
3. What are the hazards of running rear wheels over curbs when making sharp turns to the right?
4. What precautions must the driver take before crossing the centre line of the roadway to negotiate a sharp turn to the right from a narrow roadway?
5. When it becomes necessary to block off more than one lane of traffic to negotiate a sharp turn, what special precautions must the driver take?
6. What preventative measures should the driver take before entering a narrow bridge from a curved approach?
7. Why is it important that the driver know the height of the vehicle and load?
8. What are some of the low overhead clearance hazards that may not always be indicated by a warning sign?
9. What is the maximum legal height of a vehicle and its load?
10. What factors determine the maximum allowable GVWR for which the vehicle may be licenced?
11. Do load limit signs posted before bridges and structures apply to all vehicles?
12. Are all commercial vehicles required to report to weigh scales?
13. What is required before oversize or overweight loads may be transported?
14. Which office should be contacted if your load is oversize?
15. Can "wide load" signs be displayed when a wide load is not actually being transported?
16. During travel at night, what must be used to mark the outside points of an overwidth load?
17. What effect does braking have on a load that is not tied down or secured?
18. What could result from placing too much weight over any one set of wheels, or over any one axle?
19. Should most of the weight of a load on a truck be placed directly behind the cab, slightly ahead of the rear axle or slightly behind the rear axle?
20. Should most of the weight of a load on a tractor-trailer be placed directly over the fifth wheel, at a midway point of the trailer or directly over the trailer axle?
21. If a load is allowed to escape from the vehicle, who can be held responsible?
22. Do loose loads of wood chips or similar materials need to be covered to prevent losing the load?
23. When is a pilot vehicle required to follow the vehicle it is escorting?
24. What is the maximum legal width of a vehicle to be operated on any highway?
25. What is the maximum length a load may project beyond the front bumper of a vehicle?
26. When a coupling device is used to join vehicles in combination (other than a fifth wheel) is an additional coupling device such as a chain or cable required?
27. Except for a pole trailer, what is the maximum length permitted for a draw bar or coupling device between vehicles?
28. When coupling a tractor to a trailer, must the air lines be connected before or after engaging the fifth wheel to the trailer pin?
29. How would you test to see that the fifth wheel jaws have locked to the trailer pin?
30. To uncouple a tractor from a trailer, are the air lines unhooked before or after separating the fifth wheel from the trailer pin?
31. Is it necessary to block the wheel of a trailer that is to be left for any length of time?

Section 4

Additional information for Class 2 and Class 4 drivers

4

Additional information for Class 2 and Class 4 drivers

Additional study of Section 2 of this manual and the *Driver's Handbook* is recommended.

Buses

Bus drivers require a Class 2 or higher class of driver's licence if the bus being operated has a seating capacity of over 24 occupants (including the driver) while carrying passengers. Passenger carrying vehicles with a seating capacity between 11 and 24 occupants (including the driver) require a Class 4 or higher class of driver's licence.

Passenger vehicles used for personal transportation by the owner or with the owner's permission require a Class 5 or higher class of driver's licence to operate.

School buses

School bus drivers require a Class 2 or higher class of driver's licence if the school bus being operated has a seating capacity of over 36 occupants (including the driver) while carrying passengers. School bus drivers require a Class 4 or higher driver's licence if the school bus being operated has a seating capacity between 11 and 36 occupants (including the driver) while carrying passengers.



Railway crossings

When approaching railway tracks, operators of school buses shall bring the school bus to a full stop not closer than five metres or more than 15 metres measured from the front of the bus to the closest railway track. The bus must come to a full stop whether it is carrying passengers or not. Once the school bus has stopped, the operator must fully open the service door, listen and look in both directions along the tracks for approaching trains, and not move the school bus unless it is safe to do so, closing the service door before moving the school bus.

A school bus certificate may be required to operate a school bus while carrying passengers.

For information regarding the operation of a school bus or information on school bus certificates, please refer to the *School Bus Driver's Handbook* or contact:

Pupil Transportation Unit, Manitoba Education and Training

507-1181 Portage Avenue
Winnipeg, Manitoba R3G 0T3
Telephone: 204-945-6900
Toll-free: 1-800-282-8069 Ext. 6900

Emergency vehicles

When responding to an emergency call emergency vehicle drivers can exceed the posted speed limits or proceed past a red traffic control signal light or stop sign. They must, however, sound an audible signal bell or siren and show a flashing red or a combination of flashing red and blue lights.

Emergency vehicle drivers must drive with regard for safety, and must consider the:

- condition and use of the highway
- amount of traffic that is on or may be expected on the highway
- nature and use being made of the emergency vehicle at the time



Driving a bus

Right turns

In making a right turn, drivers must avoid running over or scuffing the curb with the rear wheels.

To execute a sharp right turn (particularly with a forward control bus) the driver should position the bus one to two metres from the curb on the approach to the intersection, and then proceed straight until the curb line of the side street can be sighted through the front entrance door (as shown in the diagram).

Right turns into very narrow streets may require that the driver proceed well into the intersection before commencing the turn. It may be necessary to travel over the centre line as the turn is made. When this is necessary, the driver must use extreme caution to make sure a safe turn is made.

Left turns

Turning a large vehicle requires more attention and care than turning a passenger car. All left turns with buses, as with other vehicles, must be started in the left lane as close to the centre line or median as possible. With the bus positioned approximately one metre from the centre line or median, proceed straight until the intersecting curb line can be seen through the front left window. Complete the turn as near as possible into the left lane of the street you are entering. Narrow intersecting streets may require that you proceed straight ahead over the centre of the intersection before the turn can be started. When this is necessary, use caution.

Left turns from a one-way street into a one-way street will require the driver to adjust the turning arc in a similar manner as in the right hand turn to avoid running over or scuffing the curb with the left rear wheels. (For more information on turning, see Section 3.)

Leaving the curb

The driver should not rely only on the side mirror to check that traffic is clear before pulling out but should also glance over the left shoulder to verify the way is safe.

A turn signal light is required when a bus leaves the curb. The driver should not use the turn signal light until prepared to proceed from the curb.

Leaving the curb with a bus that has an overhang over the rear wheels requires the driver to use caution to avoid striking pedestrians, poles or sign posts located close to the curb.

Cars parked close to the front of the bus and vehicles approaching in the opposite direction are factors which the driver must assess before moving the vehicle from the curb.

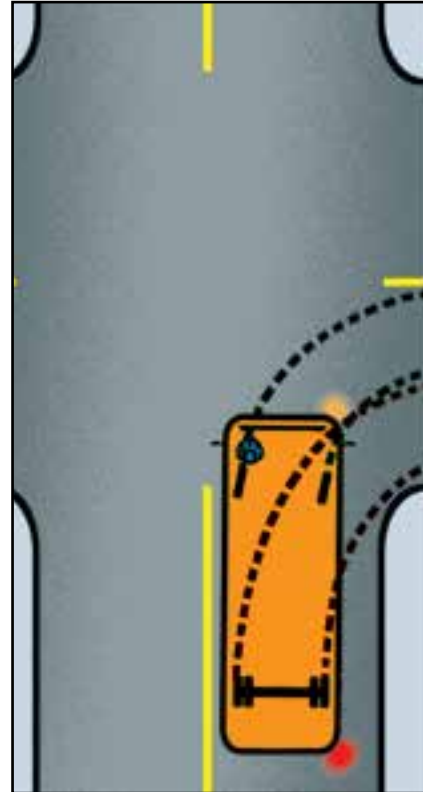

Right turn



Leaving the curb

Parked vehicle hazards

Passing parked vehicles requires the driver be constantly alert for hazards such as vehicles pulling out without warning, sudden opening of doors on the traffic side or pedestrians stepping out from between vehicles.

Watch for warning clues when passing a line of parked vehicles, such as:

- front wheels turned out
- driver sitting behind the wheel
- exhaust from tailpipes
- brake lights
- signal lights

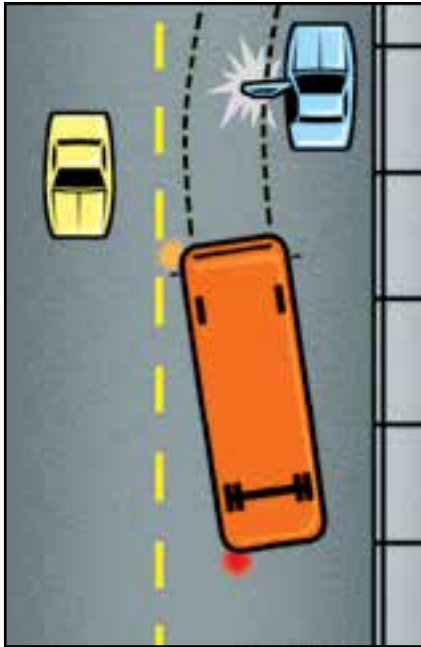

Parked vehicle hazards

Passenger safety

The prime consideration of the driver is the safe operation of the vehicle. This must take preference over maintaining schedules or any other factor that could contribute unsafe operation of the vehicle.

The driver operating a Class 2 or Class 4 vehicle must also consider of the comfort of passengers.

The operation of buses requires that the driver develop handling skills in accordance with the characteristics of the vehicle. A knowledge of the turning radius, amount of off-track of the rear wheels, overhang past the rear wheels and width of the vehicle are important factors the driver must know for the skillful handling of the vehicle.

Many passenger collisions have been attributed to improper operation by the driver, including:

- stopping improperly at the loading zone
- loading or unloading passengers when unsafe to do so
- unnecessary sudden stops or starts with standing passengers
- sharp turns at excessive speed
- improper operation of bus doors

Collisions of this type are preventable.

Inside lights

A public passenger vehicle should have a light or lights inside the vehicle that will light up the whole of the interior of the vehicle. As well, public passenger vehicles should have a lamp at each entrance door to light the entrance or exit steps of the bus.

Cleanliness of vehicles

A public passenger vehicle should be kept clean and sanitary at all times.

Vehicle inspection

The Registrar may require the owner or operator of a commercial vehicle to have their vehicle inspected to make sure that it is in a safe condition and complies with The Highway Traffic Act and its regulations.

Defects and breakdowns

During a trip parts of a public passenger vehicle may become defective. If continuing the trip would endanger the safety or comfort of any passenger, the vehicle should be brought to a stop. It should not proceed with passengers until the defect is remedied or the danger is removed. If the vehicle is unable to proceed because of a collision or breakdown, the driver should make immediate arrangements to transport the passengers to their destination without delay.

Fuelling

A vehicle should not be refuelled while the engine is running or in the presence of any open flame. When the vehicle is being fuelled the nozzle of the fuel hose must be kept in contact with the intake and be grounded to the fuel tank throughout the fuelling process. The opening through which the tank of the passenger vehicle is filled must be outside the body of the vehicle and be ventilated.

Baggage

All baggage or property transported in, or on, any public passenger vehicle must be loaded so as not to interfere with the entrance or exit of passengers and must be stowed to prevent it from falling on, or against, any passenger.

Loading and unloading passengers

When loading or unloading passengers, the driver should make sure that it can be done safely. If possible when loading or unloading passengers outside of a city, the vehicle should be stopped clear of the travelled portion of the highway to allow the other vehicles to pass and be visible to approaching traffic.



Safety provisions

A driver should not collect fares, make change or load or unload passengers while the vehicle is in motion. Unnecessary conversation with passengers should not take place while the vehicle is being driven.

Driver's vision

The driver's view ahead and to the right and left must not be obscured in any way. The driver must, at all times, have full movement of their arms and legs and ready access to emergency equipment. No passenger may sit to the left of the driver. In the case of a sedan-type vehicle, a maximum of two passengers, in addition to the driver, may be seated on the front seat and then only if there remains adequate room for the driver to operate the vehicle safely.

Standing passengers

No passenger may stand in a position that could obstruct the driver's vision or movements.

Refusal to transport passengers

No person may be refused passage on a public passenger vehicle when they present themselves at any regular scheduled stopping place and tender the regular fare, unless, at the time, the vehicle's seats are fully occupied. Persons may be refused passage if they are intoxicated, boisterous, disorderly or using profane or obscene language.

Passengers with disabilities

Persons with disabilities may require the assistance of a licensed animal. For example, a guide dog may accompany a visually impaired person onto a bus.

Test yourself on Section 4

How well do you understand the information contained in Section 4? The answers to these questions are found in the preceding pages of this manual.

1. What is the first consideration of the driver who operates a vehicle used for the transportation of the public?
2. Is it important that the driver of a bus know the length, width and wheel base of the vehicle?
3. What is the advantage of entering a sharp turn at a low speed?
4. If it is necessary to cross over a centre line or lane line to negotiate a sharp turn with a long wheel-base vehicle, what precautions should the driver take?
5. On a two-way street, in addition to checking the left side mirror, where should the driver of a vehicle look before leaving the curb?
6. What precautions must the driver of a bus take when leaving a parked position at which poles or sign posts are located near the vehicle?
7. Should the driver turn on the vehicle's turn signal lights before s/he is ready to leave the parking position?
8. What hazards should the driver expect when passing a line of parked vehicles?
9. What warning clues should the driver watch for when driving past a line of parked vehicles?
10. Under what conditions may the driver of an emergency vehicle exceed a posted speed limit?

Section 5

Vehicle trip inspection

5

Vehicle trip inspection

Trip inspection illustration

In order to understand how to conduct a proper commercial vehicle trip inspection, the following are suggested guidelines to use when inspecting your vehicle.

- 1 Approach the vehicle**
- Check vehicle body for damage
 - Check under vehicle for fluid leaks
 - Check that wheels are blocked

- 2 Parking brake**
- Check brake is set

- 3 Under the hood**
- Fluid levels
 - power steering fluid
 - oil
 - coolant
 - windshield washer fluid
 - Drive belts
 - Radiator
 - Hoses
 - Frame rails and cross members

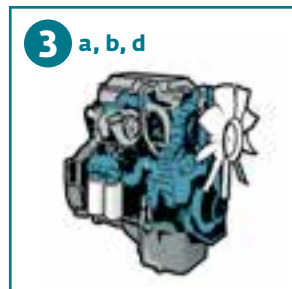

- 4 Driving compartment**
- Seat and seat belts
 - Mirrors
 - Windshield wipers and washer fluid
 - Horn
 - Lights
 - Steering wheel free play
 - Gauges and warning lights
 - Accelerator pedal
 - Heater and defroster
 - Windshield and windows

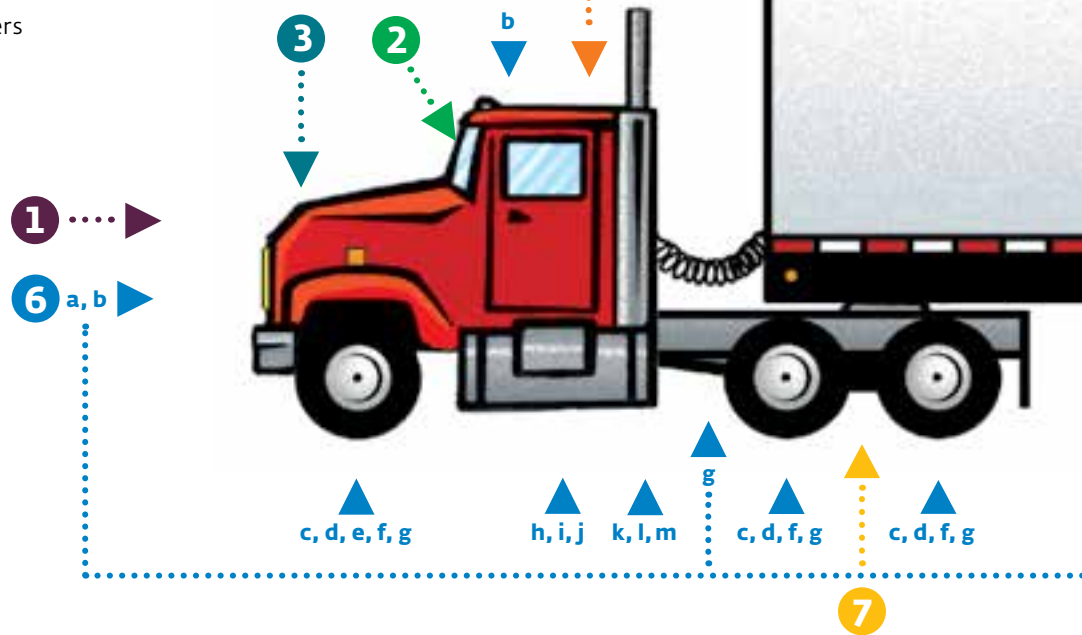
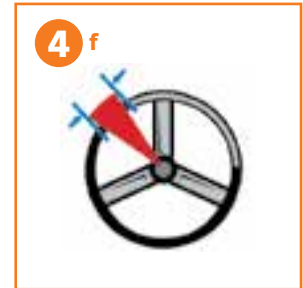

- 6 Walk-around**
- Grill and front bumper, licence plate
 - Headlights (high and low beam), clearance lights, identification lights, taillights, stop lights, side marker lights, licence plate light, reflectors, reflective markings, hazard lights and turn signals
 - Tires
 - Rims, spacers and fasteners

- Hub oil
- Suspension
 - springs
 - mounting hardware
 - suspension components
 - air suspension system (air leaks)
- Frame rails and cross members
- Doors, windows, grab handles and mirrors
- Safety inspection sticker

- Fuel tanks, brackets, steps and caps
- Batteries
- Exhaust system
- Cab securement
- Load securement
- Side of vehicle for damage
- Rear tailgate/doors
- Under-ride protection
- Landing supports
- Sliding bogie locking bars



- 5** **Emergency equipment**
- a. Flags, flares or reflectors
 - b. Fire extinguisher
 - c. First aid kit

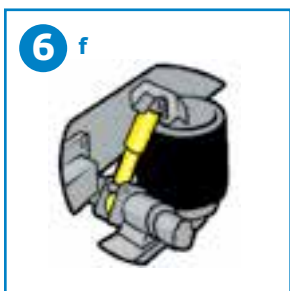
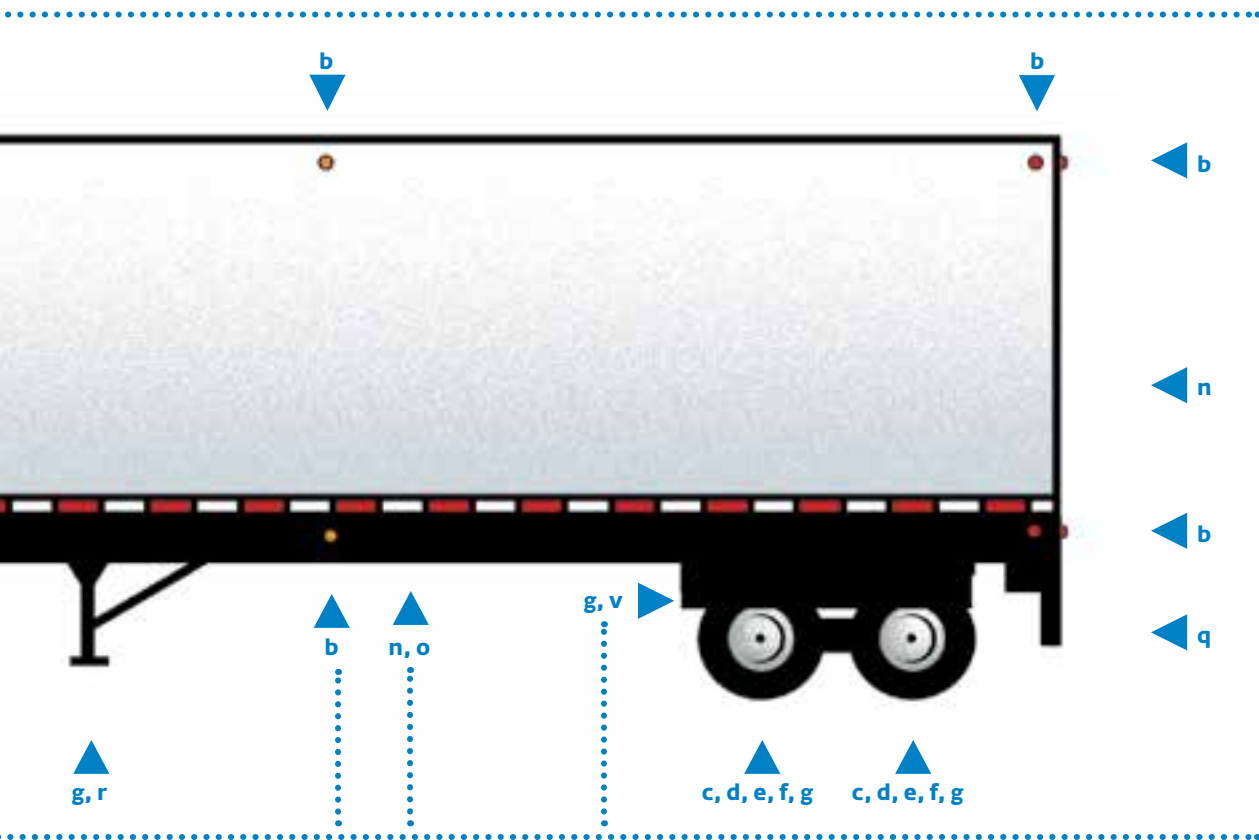
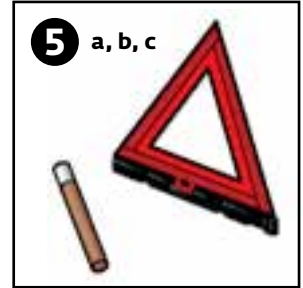

- 7** **Trailer hitch**
- a. Fifth wheel
 - b. Plate and kingpin

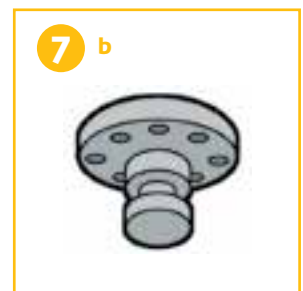
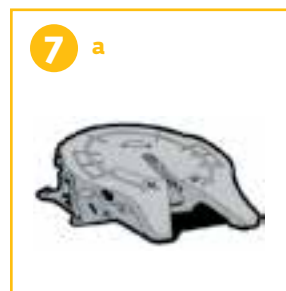

Vehicle condition

Every driver of a commercial motor vehicle and some private use vehicles must carry out and log a commercial vehicle trip inspection as outlined in The Highway Traffic Act and the Commercial Vehicle Trip Inspection Regulation (MR 95/2008). A commercial motor vehicle is:

- a. a motor vehicle with a GVWR of 4,500 kg or more that is a regulated vehicle
- b. a bus with a seating capacity of 11 or more, including the driver, that is used for transportation of persons or property on a highway for gain or compensation
- c. a school bus

The inspection will take place once every 24 hours that the vehicle is in service. (There is also an alternative inspection schedule for buses and motor coaches. Please see the Commercial Vehicle Trip Inspection Regulation for details).

Regardless of the maintenance policies of companies or vehicle owners, all drivers must be capable of determining if their vehicle is in safe operating condition as outlined in The Highway Traffic Act and the Commercial Vehicle Trip Inspection Regulation.

A person who carries out a commercial vehicle trip inspection in accordance with the regulation must make a trip inspection report in legible writing that contains the following:

- a.
 - (i) the licence plate or unit number of the vehicle
 - (ii) the vehicle's odometer reading if it is equipped with an odometer
 - (iii) the carrier's name
 - (iv) the date and time of inspection
 - (v) the name of the urban municipality or a description of the highway location where the inspection was performed
 - (vi) the legible printed name of the person who performed the inspection
- b. a record of the height and width of the vehicle and load, and if subsection 7(7) applies in respect of the vehicle, of the height and width of all loads carried by the vehicle since it was last inspected for the purposes of this regulation

If a driver believes or suspects that there is a safety defect, they must report that belief or suspicion to the carrier. If the defect is a major defect as defined by the Commercial Vehicle Trip Inspection Regulation, it must be reported immediately and the vehicle is not allowed to be in operation. Any other case must be reported in a timely manner.

Every commercial vehicle driver must have a current trip inspection report in their possession for the vehicle and any trailer attached. Checking a vehicle before starting out, as required by law, will often prevent costly delays as well as reduce the chances of a collision resulting from a mechanical failure.

Carrying out an efficient trip inspection in a minimum of time can be done by drivers who follow a systematic inspection.

For information on commercial motor vehicle and trailer trip inspections contact the Motor Carrier Division at 204-945-3890.

Trip inspection testing

For Classes 1, 2, 3 (including pickup trucks with a trailer over 4,540 kg) and Class 4 (buses), the applicant will be required to complete a trip inspection on the vehicle they supply as part of the road test. During the trip inspection, the applicant must be able to locate, identify and check the items or components as set out in this manual. Inadequately completing the trip and/or air/hydraulic brake inspection will result in the discontinuance and failure of the road test.

An applicant is expected to complete the trip inspection in a systematic manner to conserve time.

The trip inspection should take no more than 20 minutes to complete.

Details of a trip inspection will vary depending on the vehicle being inspected; however, the principle of making a trip inspection should always be followed.

If a vehicle is equipped with hydraulic brakes, a hydraulic brake system inspection as outlined in Part H on page 100 at the end of this section must be completed in conjunction with the trip inspection.

If a vehicle is equipped with air brakes, an air brake inspection will be conducted in conjunction with the trip inspection. All applicants operating air brake equipped vehicles will be required to complete the air brake system trip inspection as outlined in the *Air Brake Manual*.

Note: When upgrading your driver's licence from single to combination vehicles with air brakes, you will be required to demonstrate the complete air brake steps for combination vehicles.

Inadequately completing the trip and/or air/hydraulic brake inspection will result in the discontinuance and failure of the road test.

All Class 1, 2, 3 vehicles and Class 4 buses

Note: For Buses see also section 8. For vehicles with hydraulic brakes see also section H.

	Inspect	Inspection method	Report if																						
1	Approach vehicle and check:																								
1.1	Vehicle body for damage.	Visual	Damage that may affect safe operation.																						
1.2	Under vehicle and fuel tank for fluid leaks.	Visual	Excessive fluid leaks.																						
2	Enter driving compartment and check:																								
2.1	Park brake is applied.	Visual	Inoperative.																						
3	Engine compartment, check:																								
3.1	Fluid levels to ensure adequate: power steering fluid, oil, coolant (do not remove radiator cap if hot), transmission fluid, windshield washer fluid, brake fluid if hydraulic brake system.	Visual and manual	Levels are low. Fill adequately.																						
3.2	Drive belts for tension, cracking and wear.	Visual and manual	Belt deteriorated or loose.																						
3.3	Radiator for leaks and security.	Visual and manual	Leaks or loose.																						
3.4	Hoses for wear and leaks.	Visual and manual	Leaks or deteriorated.																						
3.5	Frame rails and cross members for cracks and bending.	Visual	Insecure, cracked or broken. Visibly shifted, cracked, collapsing or sagging frame members.																						
4	Driving compartment, check:																								
4.1	Seat and seatbelt is adjusted and in good shape.	Visually check that the seat is anchored. Manually operate the seat and ensure adjustment is correct. Visually and manually check seatbelt webbing and retractor assembly.	Seat is damaged or distorted. Seat fails to maintain selected adjustment. Any damage that may reduce effectiveness of the seatbelt.																						
4.2	Turn key on: system check, start engine, observe gauges and warning lights are functioning properly.	Visual	Warning lights, ABS lights or gauges not operating.																						
4.3	Accelerator pedal for binding or sticking.	Perform test with engine idling—depress accelerator pedal and release.	Pedal binding or engine will not return to idle.																						
4.4	Steering free play is not excessive.	Visually and manually inspect with the engine running on vehicles equipped with power steering. With the front wheels in a straight ahead position, turn the steering wheel until turning motion can be observed at the front wheels, turn the steering wheel in the opposite direction until motion can be observed at the front wheels; estimate the amount of steering lash (total movement observed at steering wheel rim before movement at front wheel).	Total movement greater than shown in the following table: <table border="1" data-bbox="1068 1392 1481 1820"> <thead> <tr> <th colspan="2">Truck</th> </tr> <tr> <th>Steering wheel diameter</th> <th>Steering lash: power/manual</th> </tr> </thead> <tbody> <tr> <td>less than 406 mm</td> <td>50 mm/75 mm</td> </tr> <tr> <td>406 mm to 500 mm</td> <td>75 mm/87 mm</td> </tr> <tr> <td>larger than 500 mm</td> <td>87 mm/100 mm</td> </tr> <tr> <th colspan="2">Bus</th> </tr> <tr> <td>less than 300 mm</td> <td>45 mm</td> </tr> <tr> <td>350 mm to 400 mm</td> <td>50 mm</td> </tr> <tr> <td>400 mm to 450 mm</td> <td>55 mm</td> </tr> <tr> <td>450 mm to 500 mm</td> <td>60 mm</td> </tr> <tr> <td>larger than 500 mm</td> <td>87 mm</td> </tr> </tbody> </table>	Truck		Steering wheel diameter	Steering lash: power/manual	less than 406 mm	50 mm/75 mm	406 mm to 500 mm	75 mm/87 mm	larger than 500 mm	87 mm/100 mm	Bus		less than 300 mm	45 mm	350 mm to 400 mm	50 mm	400 mm to 450 mm	55 mm	450 mm to 500 mm	60 mm	larger than 500 mm	87 mm
Truck																									
Steering wheel diameter	Steering lash: power/manual																								
less than 406 mm	50 mm/75 mm																								
406 mm to 500 mm	75 mm/87 mm																								
larger than 500 mm	87 mm/100 mm																								
Bus																									
less than 300 mm	45 mm																								
350 mm to 400 mm	50 mm																								
400 mm to 450 mm	55 mm																								
450 mm to 500 mm	60 mm																								
larger than 500 mm	87 mm																								

	Inspect	Inspection method	Report if
4.5	Horn is working and audible.	Activate system	Horn fails to sound or is below a reasonable audible level.
4.6	Windshield wipers and washer operation.	Visual and manual	Windshield wipers fail to wipe approximately 75 per cent of the windshield or contact the windshield properly or return to the "park" position. Windshield washer fails to apply solution to intended area of the windshield.
4.7	Heater/defroster operation.	Activate system	Defroster motor fails to operate in all selected positions. Airflow does not provide for unobstructed view through windshield.
4.8	Instrument lights are operational. Turn signal indicators operational. High beam indicator operational.	Visual and manual	Not operating.
4.9	Condition and cleanliness of windows and windshield.	Visual	Star or chip 12.7 mm or greater in diameter; or any intersecting cracks in glass area, swept by windshield wiper; or driver vision is obscured or limited.
4.10	Adjustment and cleanliness of exterior and interior mirrors.	Visual	Insecure or obstructed or fails to provide a clear view of highway to the side and rear. Any mirror that fails to maintain set adjustment. Clouded as to obscure vision.
5	Emergency equipment check:		
5.1	Flags, flares or reflectors are present (if applicable).	Visual	Advanced warning device(s) missing or broken.
5.2	Fire extinguisher is charged and stowed correctly (if applicable).	Visual	Fire extinguisher missing or discharged (applicable vehicles).
5.3	First aid kit is present (if applicable).	Visual	First aid kit is missing or seal broken (applicable vehicles).
6	Vehicle outside checks:		
6.1	Grill, hood and front bumper are secure, licence plate(s) valid and clean.	Visual and manual	Loose or broken, plates not valid.
6.2	Headlights (high and low beam), clearance lights, identification lights, taillights, stop lights, side marker lights, licence plate light, reflectors, reflective marking, hazard lights and turn signals are operational and clean.	Visually and manually inspect the operation of all the lights, except the hazard lights, with the vehicle engine running and the headlights, brake lights and all auxiliary lights illuminated. Inspect hazard lights with the ignition, headlights, brake lights and auxiliary lights in the off position, reflective marking present on side and rear of vehicle/trailer.	Any light is missing or broken or fails to illuminate when its control device is actuated or any lens or reflector is broken, cracked or missing, reflective markings missing.
6.3	Front tires for cuts, bulges, air pressure, and tread depth (not less than 3.2 mm on front steering tires). Rear tires for cuts, bulges, air pressure, tread depth (not less than 1.6 mm on rear tires), and no debris between dual tires.	Visual and manual	Any cords exposed due to wear or damage or evidence of tread separation or low air pressure. Insufficient tire tread depth. Any abnormal bump or bulge. Any tire in contact with another tire or any vehicle component other than a mud flap.

	Inspect	Inspection method	Report if
6.4	Mud flaps for security and condition.	Visual	Torn, insecurely mounted, missing or not full width of the tire track. Lower end of the mud flap is more than than 350 mm from the ground.
6.5	Rims for cracks and slippage, spacers for cracks or not seated properly, fasteners for tightness, and hub oil level is adequate (if applicable).	Visual and manual	Rim bent, loose or cracked, or mounting holes elongated. Spacers cracked or not seated properly, fasteners loose, missing, cross threaded or not flush with the stud. Wheel or lock rim assembly show signs of cracking or severe damage. Hub oil low.
6.6	Suspension for cracked or broken parts, deflated or leaking airbags.	Visually inspect for noticeable sag or lean.	Broken or missing springs or mounting hardware, visibly shifted leaf springs, loose U bolts or deflated or leaking airbags.
6.7	Frame rails and cross members for cracks or bending.	Visual	Insecure cracked or broken. Visibly shifted, cracked, collapsing or sagging frame members.
6.8	Door(s), window(s), grab handles and mirror(s) for security and provide a clear view.	Visual	Insecure or obstructed or fail to provide a clear view.
6.9	Safety inspection decal is valid, clean and visible (if applicable).	Visual	No decal present or expired decal.
6.10	Fuel tank for damage, brackets or straps for condition and security, fuel lines secured and not damaged or leaking.	Visual	Cap missing, tank or lines leaking or insecure.
6.11	Batteries for security and loose electrical connections.	Visual and manual	Loose.
6.12	Exhaust system and muffler for leaks and security.	Visually inspect with engine running.	Any leaks.
6.13	Cab securement and suspension— cab securely mounted, cab mounted airbags and lines for leaks, shocks secure and not leaking.	Visually and manually inspect (air pressure at normal operating pressure).	Cab not secure, any door that does not close securely air leak, airbag not inflated or bruised, cab tilts to one side, shock missing, broken leaking or mounts loose.
6.14	Load securement, side and bottom doors, attachment points and securement equipment (chains, wire rope, webbing hooks, binders, etc.)	Visual and manual	Attachment points are cracked, elongated or broken. Securement equipment is stretched, cracked, broken or inadequate strength or insufficient tie-down assemblies. Any load not secured in adherence to the Cargo Securement Regulation.
6.15	Sides of vehicle for damage or load for shifting (if applicable).	Visual	Any exterior body panel that is damaged or deteriorated so that it constitutes a hazard. Any compartment door that is loose or has missing or detached holding fixtures. Load must be properly secured before moving.
6.16	Rear tailgate/door(s) securely closed.	Visual	Cannot securely close.
6.17	Under-ride protection or rear bumper is secure (if applicable).	Visual	Insecure, broken or protruding and is hazardous.

Inspect	Inspection method	Report if
7 Additional checks for combination vehicles:		
7.1	Fifth wheel: Trailer is sitting properly on the fifth wheel, locking handle is locked and fifth wheel jaws are locked around the kingpin of the trailer. Fifth wheel slide locks are fully locked and not damaged. Connections other than fifth wheel: coupling devices are locked and securely mounted, all safety chains are attached securely.	Visual Cracked or insecurely mounted, any weld that is broken or latch lock that is inoperative, or eye or lunette worn more than 9.5 mm.
7.2	Electrical cord is properly connected, in good condition and stowed properly.	Visual Insecure, broken or protruding and is hazardous.
7.3	Trailer safety inspection decal is valid, clean and visible (if applicable).	Visual No decal present or expired decal.
7.4	Landing supports are in the up position and the crank handle is stowed properly. Check for any damage to the loading supports and structure.	Visual Landing supports are not in up position and/or crank handle improperly stowed. Any damage.
7.5	Sliding bogie locking bars or pins are secure and not damaged.	Visual Locking bars or pins are not secure or damaged.
7.6	Spare tire for security and condition (if applicable).	Visual Not secure or condition (see 6.3).
7.7	Trailer licence plate for validity.	Visual Licence not valid.
8 Additional checks for buses:		
8.1	All interior lights are operational.	Visual Not working.
8.2	Aisle and stairwell lights are operational.	Visual Not working.
8.3	Passenger seats and handrails for security.	Walk the full length of the interior of the bus, observe seat assemblies and attaching fixtures as well as stanchion bars. Any seat or attaching fixture that has a defect that may constitute a hazard to any person. Any stanchion bar that is not attached in its intended receptacle and presents a hazard to any person.
8.4	Emergency exits and warning buzzer are operational from inside and outside (if applicable).	Visual and manual Visibly damaged or not working. Blocked or obstructed.
8.5	Service door control is functional.	Activate entrance and exit door control mechanism. Any door that fails to function as intended. Brake or brake/accelerator interlock system fails to function as intended. Interlock system fails to release when doors are closed and locked.
8.6	Additional auxiliary heaters or air conditioners are operational.	Manual Does not blow air in desired location.

	Inspect	Inspection method	Report if
8.7	Interior condition of bus, floor, dash, steps, windows and operator's compartment.	Visual	Interior body panels are damaged and present a hazard to any person. Floor is damaged or worn and presents a hazard to any person. Dash area has defects that present a hazard to any person. Steps are not clean and in good condition to prevent tripping or slipping. Windows are not free from cracks or damage that may present a hazard to any person. Window latches and emergency release hardware are not present or in good condition. Operator's compartment has defects that may cause a hazard to the operator.
8.8	Wheelchair lift and kneeling feature or wheel chair ramp are operational (if applicable).	With engine running, cycle wheelchair lift, lower and raise kneeling bus or deploy ramp.	Audible alarm fails to function. Lift safety devices fail to function as intended. Lift does not complete cycle. Interlock system fails to activate and release as intended. Bus does not return to level position after kneeling.
8.9	Wheelchair restraints are operational and secure (if applicable).	Visual and manual	Restraint missing or inoperative.
8.10	Loading/unloading devices (lights, arm, stop sign).	Visual	Lamps do not operate alternately, crossing or stop arm do not extend fully when activated.

Note: There are several ways that buses can be inspected (contingent on design and function). Please see sections 3(2)(3) and (4) and the applicable Schedules of the Commercial Vehicle Trip Inspection Regulation for details.

Inspect	Inspection method	Report if
Hydraulic brake system inspection <i>Complete the brake check for vehicles with hydraulic brake system, as follows:</i>		
H.1	Electric motor (brake assist) (buses/trucks—only if equipped).	With the vehicle engine stopped, apply moderate pressure to the service brake pedal, electric motor operating should be audible.
H.2	Vacuum or hydraulic booster operation.	With engine stopped, depress the brake pedal several times, then with light foot force on the brake pedal, start the engine and the brake pedal should depress (N/A for vehicles equipped with electric motor brake assist).
H.3	Brake warning indicator (with parking brake released).	Visually inspect and apply service brake pedal.
H.4	Brake pedal reserve.	Brake warning indicator lamp operates continuously or when brake is applied.
H.5	Park brake.	Test with engine running if vehicle is equipped with power brakes, apply and maintain a moderate foot force to the service brake pedal for one minute.
H.6	Brake performance.	Apply parking brake and, with engine running at an idle and the transmission engaged, attempt to move the vehicle.
		Park brake fails to hold vehicle.
		Brake pull exists or brake performance appears to be less than adequate.



Trip inspection tear out sheet

You may use this checklist for your test. Do not add to or write on this form. If altered it cannot be used on the test. *The Professional Driver's Manual* has specific inspection information that must be studied prior to the test.

Note: The Commercial Vehicle Trip Inspection Regulation contains Schedules that outline what components need to be inspected and what constitutes a minor or major defect. These are the schedules that must be carried when operating commercial vehicles on Manitoba public roads and highways.

Key points:

- You need to locate the items to be checked and tell the examiner how and what you check on that part. Never assume the examiner has enough information and delete items. When the examiner is satisfied in your knowledge of the area you may be asked to move along.
- The pre-trip inspection should be done in a systematic manner to conserve time. It should take no more than 20 minutes to complete.
- If using a trailer with electric brakes, the system must be inspected to ensure it is operating properly.
- If a vehicle is equipped with air brakes, an air brake inspection will be conducted in conjunction with the pre-trip inspection. All applicants operating air brake equipped vehicles will be required to complete the air brake system pre-trip inspection as outlined in the *Air Brake Manual*.
- When upgrading your driver's licence from single to combination vehicles with air brakes, you will be required to demonstrate the complete air brake steps for combination vehicles.
- Inadequately completing the pre-trip and/or air brake inspection will result in the discontinuance and failure of the road test.

All Vehicles

1	Approach vehicle
2	Vehicle secure
3	Engine compartment
3.1	Fluids
3.2	Drive belts, hoses
3.3	Batteries
3.4	Frame rails and cross members
4	Driving compartment (in-cab)
4.1	Controls
5	Emergency equipment (if applicable)
6	Outside checks
6.1	Bumpers
6.2	Lighting equipment
6.3	Safety sticker
6.4	Tailgate, doors, mirrors, load
6.5	Licence plates
6.6	Fuel tank
6.7	Exhaust system
6.8	Tires
6.9	Rims
6.10	Suspension
6.11	Splash guards
6.12	Hub oil (if applicable)
7	Hydraulic brake inspection (non air brake vehicles only at this point)

Additional checks for combination vehicles

8	Fifth wheel/coupling device
9	Air lines, glad hands and electrical cord
10	Landing supports and crank handle
11	Sliding bogie locking bars/pin (if applicable)

Additional checks for buses

12	Interior lights
13	Seats and handrails, wheelchair restraints (if applicable)
14	Emergency exits (if applicable)
15	Service door(s)
16	Auxiliary heaters (if applicable)
17	Wheelchair lift or kneeling feature (if applicable)



In-service inspections

In addition to the trip inspection, trucks and trailers should be inspected at regular intervals throughout the trip. The driver should stop the vehicle clear of the travelled portion of the highway and check:

- wheel lugs and nuts
- tires for condition, pressure and overheating
- hubs and drums for heat
- brakes for operation (see *Air Brake Manual*)
- coupling devices
- load security
- drive lines and oil leaks
- lights and windshield visibility

Record all in-service inspections in the log book.

Post-trip inspections

At the end of the final trip of the day you should conduct an inspection on your vehicle. This is similar to a trip inspection. During this inspection you should check for any damage or defects that may have developed on your vehicle during the trip. Note any defects found during this inspection and add them to the report you completed during the trip inspection at the start of that day.

If the vehicle is equipped with air brakes, see the *Air Brake Manual* for additional items to be inspected.

Pre-hill inspection

Anytime a sign is posted that requires truck drivers to stop in the pull-out area and inspect their brakes before proceeding down the steep hill ahead, drivers must comply.

Before proceeding down the grade, truck drivers equipped with air operated braking systems must check:

- compressor is maintaining full reservoir pressure
- slack adjusters for push rod travel and take up slack if required, and you are authorized in slack adjustment
- for air leaks
- security of glad hands and lines
- drums for overheating
- emergency valve operation

Truck drivers equipped with hydraulic brake systems will check:

- pedal reserve
- vacuum booster operating
- drums for over-heating
- visual inspection for hydraulic fluid leaks



Section 6

For your information

6

For your information

Border crossings

Whenever a vehicle is crossing the border between Canada and the United States, the driver must stop and report to a customs officer. All drivers must report even if their load is in transit or bonded. There are no exceptions.

For information on border crossing please contact:

Government of Canada Border Information Services

Toll-free: 1-800-461-9999



Driver training schools

Becoming a safe professional driver requires both education and experience. Attending a driver training school will help you to obtain the necessary knowledge and skills.

Driver training schools and instructors are licensed by Manitoba Public Insurance. Driver training instructors are required to meet certain licensing and testing requirements before being licensed to provide instruction.

For further information about Driver Training Schools and instructors please contact:

Driver Training Permit Unit

Telephone: 204-985-8063

Toll-free: 1-800-665-2410 Ext. 8063

Email: permitunit@mpi.mb.ca



Organ and tissue donation

Every year in Canada, thousands of people wait for organ and tissue transplants. You can make the difference in some of those lives. Everyone has the potential to be an organ and tissue donor—generally, donors are healthy people of any age who have suffered an irreversible brain injury, as in a motor vehicle collision or a brain hemorrhage. Organs and tissues that can be donated include kidneys, heart, lungs, liver, pancreas, small bowel, corneas, bones and joints, skin and heart valves.

Transplant Manitoba and Tissue Bank Manitoba offer an online organ donation registry at signupforlife.ca. When you register your intent to be an organ and tissue donor, your decision is recorded in a Manitoba eHealth database. At the appropriate time your donation decision will be shared with your family so they can honour your decision.

It is important that you discuss your wishes regarding organ and tissue donation with your family. Other people you may want to inform are your clergy and family doctor. A Living Will is another place where you can record your wishes.

Professional drivers are encouraged to increase their knowledge by participating in training courses involving:

- First aid
- Care and handling of dangerous goods
- Defensive driving

Metric Conversion Table

A conversion to the metric system took place in Canada on September 1, 1977, and some commonly used conversions are listed below. Numbers have been rounded and therefore are not precise equivalents.

kPa to psi		psi to kPa	
5	0.72	1	6.89
10	1.45	2	13.78
15	2.17	3	20.68
20	2.90	4	27.57
25	3.62	5	34.47
30	4.35	6	41.36
35	5.07	7	48.26
40	5.80	8	55.15
45	6.52	9	62.05
50	7.25	10	68.94
60	8.70	15	103.42
70	10.15	20	137.89
80	11.60	25	172.36
90	13.05	30	206.84
100	14.50	35	241.31
150	21.75	40	275.78
200	29.00	45	310.26
250	36.29	50	344.73
300	43.51	55	379.20
310	44.96	60	413.68
350	50.76	65	448.15
400	58.01	70	482.62
415	60.19	75	517.10
450	65.26	80	551.57
500	72.51	85	586.04
550	79.77	90	620.52
585	84.84	95	654.99
600	87.02	100	689.47
650	94.27	105	723.94
700	101.52	110	758.41
725	105.15	115	792.89
750	108.77	120	827.36
800	116.03	125	861.83
850	123.28	130	896.31
900	130.53	135	930.78
950	137.78	140	965.25
1000	145.03	145	999.73
1050	152.29	150	1034.20

Length
1 inch = 2.54 cm
1 foot = 30.48 cm
1 mile = 1.61 km

Volume
1 pint = 0.57 l
1 quart = 1.13 l
1 gallon = 4.55 l

Speed
1 mph = 1.61 km/h
10 mph = 15 km/h
15 mph = 25 km/h
20 mph = 30 km/h
30 mph = 50 km/h
40 mph = 60 km/h
50 mph = 80 km/h
60 mph = 100 km/h

Converted Linear Measurements
8' 6" = 2.60 m
10' = 3.00 m
12' 6" = 3.80 m
13' 6" = 4.15 m
14' = 4.20 m
35' = 11.00 m
38' = 11.50 m
40' = 12.50 m
45' = 14.00 m
60' = 18.50 m
65' = 20.00 m
100' = 30.00 m
500' = 150.00 m

Converted Weight
10,000 lbs. = 4,500 kg
12,000 lbs. = 5,500 kg
20,000 lbs. = 9,100 kg
24,000 lbs. = 11,000 kg

Abbreviations
mm = millimetre
cm = centimetre
l = litre
km/h = kilometre per hour
m = metre
kg = kilogram
kPa = kilopascal



**Manitoba
Public Insurance**



This document was printed on Forest Stewardship Council® (FSC®) certified paper, an international certification and labelling system dedicated to promoting responsible management of the world's forests. For more information about our environmentally responsible practices, visit mpi.mb.ca.

\$10.00

1/19
DVL0021

Ce document existe aussi en français.

This document is also available on our website and the online version may be more current than this printed one.

mpi.mb.ca