

OLD!

THE ESSENTIAL GUIDE TO CLASSIC GAMES

# retro\* GAMER™

AMSTRAD | COMMODORE | SEGA | NINTENDO | ATARI | SINCLAIR | NEO GEO | SONY | COIN-OP | MOBILE

DEVELOPERS GO  
**BACK TO SKOOL**  
CELEBRATING DAVE REIDY'S  
CLASSIC SCHOOL SIMULATORS



**CONTACT  
SAM CRUISE**

ON THE CASE OF MICROSPHERE'S  
8-BIT DETECTIVE ADVENTURE

**ALSO INSIDE**

PITFALL: THE MAYAN ADVENTURE  
TEKKEN 1 & 2 | I, BALL | FLYING SHARK

# 40 YEARS OF PONG

DEVELOPERS CELEBRATE THE CREATION AND  
INFLUENCE OF ATARI'S ICONIC ARCADE GAME

THE DEFINITIVE GUIDE TO ANCO'S KICK OFF  
REVISITING LORDS OF CHAOS  
THE RISE AND FALL OF  
ELECTRIC DREAMS  
10 GAMECUBE  
CLASSICS



**VECTREX**

**COMPLETE GUIDE**  
GCE'S VECTOR-BASED  
MINIATURE ARCADE

**DUNGEON KEEPER**  
HOW BULLFROG  
REDEFINED A GENRE

ISSUE 104 £4.99 **NowGamer**



04



# THE WITCHER<sup>®</sup> 2

## ASSASSINS OF KINGS

### ENHANCED EDITION

“ONE OF THE BEST ADVENTURES  
WE’VE EVER UNDERTAKEN”

GAMESMASTER

THE AWARD-WINNING RPG COMES TO XBOX 360<sup>®</sup>

# OUT NOW!

[WWW.THEWITCHER.COM](http://WWW.THEWITCHER.COM) | [BUY.THEWITCHER.COM](http://BUY.THEWITCHER.COM) | [WWW.NAMCOBANDAIGAMES.EU](http://WWW.NAMCOBANDAIGAMES.EU)

The Witcher<sup>®</sup> is a trademark of CD Projekt RED sp. z o.o. The Witcher game © CD Projekt RED sp. z o.o. All rights reserved. The Witcher game is based on the prose of Andrzej Sapkowski. All other copyrights and trademarks are the property of their respective owners. © 2011 Namco Bandai Partners S.A.S. Marketed, published, manufactured and distributed by Namco Bandai Partners S.A.S. Xbox, Xbox 360, Xbox LIVE, and the Xbox logos are trademarks of the Microsoft group of companies and are used under license from Microsoft.

XBOX  
LIVE

CDPROJEKT

BANDAI  
NAMCO  
Games

18<sup>TM</sup>  
www.pegi.info

XBOX 360.

Jump in.

# THE RETROBATES

FAVOURITE BRITISH DEVELOPER

**DARRAN JONES**

Although I adore the Oliver twins for bringing *Dizzy* into my life, the Stampers are my favourite devs. Nearly everything they touched turned to gaming gold.

**Expertise:**

Juggling a beautiful wife, two gorgeous girls and an award-winning magazine

**Currently playing:**

*Super Hang-On*

**Favourite game of all time:**

*Strider*

**STUART HUNT**

Blimey that's a toughie. Mmm... let me think about it. Steve Crow, I'd have to say – a really nice guy who made some great games.

**Expertise:**

Games with flying bits in them

**Currently playing:**

*Ghost Recon: Future Soldier*

**Favourite game of all time:**

*Ghost Recon: Future Soldier*

**PAUL DRURY**

For his unique vision, his wonderfully weird games, for keeping the faith and for making my beloved *Sheep In Space*, it has to be Jeff Minter. My hero.

**Expertise:**

George Lucas

**Currently playing:**

*Max Payne 3*

**Favourite game of all time:**

*Sheep In Space*

**DAVID CROOKES**

Charles Cecil, because he's a cool guy and combines narrative with gameplay to an absorbing level. The Oliver twins were great for all of those childhood memories.

**Expertise:**

All things Amstrad CPC, *Dizzy*, Atari Lynx and PlayStation

**Currently playing:**

*Hambo* on iOS

**Favourite game of all time:**

*Broken Sword*

**JASON KELK**

Jeff Minter's a legend in my book since he's consistently produced shoot-'em-ups that are playable and bonkers in about equal measure.

**Expertise:**

Being a homebrew hero

**Currently playing:**

*Jetpac* (VIC-20)

**Favourite game of all time:**

*Io*

**IAIN LEE**

Simply because I am obsessed with *Max Payne 3* at the moment, it has to be Rockstar. You have to hand it to those guys: they keep pushing the boundaries.

**Expertise:**

Pretending to be an American on Xbox Live

**Currently playing:**

*Max Payne 3*

**Favourite game of all time:**

*Elite* (BBC Model B)



If there's one thing I've learned since editing *Retro Gamer*, it's this: the history of gaming isn't as clear as you'd think, and is often shrouded in mystery. In fact, when you consider the popularity of the industry, it's one of the worst-documented aspects of social history.

I read an article about *Super Mario Bros* by Frank Cifaldi on Gamasutra a few weeks back, which staggeringly revealed that no one knows for sure the date that *Super Mario Bros* was released in the US. It's astonishing to think that such a landmark game could have no reliable history attached to it. The article is not only a great piece of investigative journalism, but a truly fascinating read. It's also a rather depressing one, as it proves just how we're struggling to preserve and document gaming's rich history.

And it's such a big history to document. Even *Retro Gamer* has made mistakes in the past – and I'll dare say we'll make them in the future – but we've got a number of freelancers now who are as close to videogame historians as you can get, and we're determined to do our bit.

Oh, and before anyone says anything clever, our GameCube piece refers to its European anniversary.

Enjoy the magazine,



# CONTENTS



>> **Load 104** Breathing new life into classic games

## FEATURED

- 30 Cheap As Chips Dungeon Keeper**  
Why everyone should return to Bullfrog's strategy classic
- 32 The Making Of Tekken**  
Developer Yutaka Kounoe looks back at his popular arcade beat-'em-up
- 38 Kick Off: A Football Legacy 1989-1998**  
Stuart Campbell reveals the highs and lows of Anco's soccer franchise



- 58 Classic Game Contact Sam Cruise**  
Discover one of the Spectrum's best interactive adventure games
- 70 10 GameCube Gems**  
We highlight ten GameCube gems to celebrate its UK anniversary
- 78 The Making Of iBall**  
Behind the scenes of Timothy Closs's iconic 8-bit shooter
- 80 From The Archives Electric Dreams**  
Graeme Mason reveals the rise and fall of the 8-bit publisher

# 22 The Story of Pong

Developers and *Pong's* original creator celebrate the influence of Atari Inc's iconic arcade hit

## RETRO REVIVALS

- 46 Pitfall: The Mayan Adventure**  
How Activision recaptured the exploits of Pitfall Harry for a new generation
- 94 Flying Shark**  
Stuart Hunt takes to the skies and plays through Graftgold's superb Speccy conversion

## In the hot seat this month...



**12 ROD LAWTON**  
The editor responsible for turning Amstrad Action's fortunes around discusses cover tapes, its readers, and his love for Julian Gollop's excellent *Laser Squad*



**88 NICK JONES**  
He's dabbled in both music and game design, and freelanced for everyone from Hewson to Probe, before settling down with Shiny Entertainment. Nick Jones tells his story

imagineshop.co.uk

You can now order Retro Gamer and any of your other favourite Imagine titles from our online eShop. Don't delay, make sure you get your order today.

Head over to [www.imagineshop.co.uk](http://www.imagineshop.co.uk)



**subscribe here!**

**AND SAVE 30%**

Get a sub or get a paddlin'

Subscribe at [www.imaginesubs.co.uk](http://www.imaginesubs.co.uk)



“Sophisticated gameplay built on layers of simplicity”

Rory Milne



## 86 Classic Game

Rory Milne throws on his cape and battles wizards in Julian Gollop's classic strategy game *Lords Of Midnight*

## 60 Vectrex

Discover the best games and gear for the vector-based console



## 72 Working-Class Heroes

8-bit developers reveal the origins of classic videogame characters



## 48 Skool Daze

Artist Keith Warrington and 8-bit devs revisit Dave Reidy's Speccy hit



## 20 CAESAR THE CAT

We'd never heard of this Spectrum game before, but reader Stephen Westwood has convinced us that we now need to play it



## ESSENTIALS

- |    |                      |     |                      |
|----|----------------------|-----|----------------------|
| 6  | RetroRadar           | 18  | Back To The Nineties |
| 8  | Iain Lee             | 102 | Homebrew             |
| 10 | Paul Davies          | 106 | Letters              |
| 13 | Retro Diary          | 111 | Next Month           |
| 14 | Subscriptions        | 114 | End/Game             |
| 16 | Back To The Eighties |     |                      |

## RETRO RATED



- |     |                              |
|-----|------------------------------|
| 99  | Back To The Future: The Game |
| 99  | Mario Tennis Open            |
| 99  | VVVVVV                       |
| 100 | Monster World IV             |
| 100 | Retro Round-Up               |

- |    |                                  |
|----|----------------------------------|
| 96 | Diablo III                       |
| 98 | Sonic The Hedgehog 4: Episode II |
| 98 | Akai Katana                      |
| 99 | Trials Evolution                 |
| 99 | Max Payne 3                      |
| 99 | Mortal Kombat                    |



**Get online now!**

Visit the Retro Gamer website and upload your very own classic profiles

[www.retrogamer.net](http://www.retrogamer.net)





>> This month sees more crowd fund-raising, this time an interesting new documentary

from the creators of The Newsfield Years. We also report on the latest Retrovision retro event, and get excited about the long overdue sequel to Sonic And Sega All-Stars Racing

## \* CONTENTS



### 6 THE BIRTH OF UK VIDEOGAMES

We interview the creators of an exciting new crowd-funded documentary

### 8 IAIN LEE

More retro-related shenanigans from our lovable correspondent

### 9 RETRO VISION 2012

Paul Drury recounts the hijinks of this year's long-running retro show

### 10 PAUL DAVIES

The ex-editor of C+VG discusses the difficulty of classic computer games

### 11 SEGA RE-RALLIES

Sega finally reveals its plans for Sumo Digital's brand new racing sequel

### 12 A MOMENT WITH ROD LAWSON

The editor of Britain's best Amstrad magazine recounts his time in the industry

# THE BIRTH OF UK VIDEOGAMES

ALL-STAR CAST LINED UP FOR EXCITING NEW DOCUMENTARY

**B**ritain has a long and lengthy love affair with videogames, with many of its early bedroom coders and publishers still working in the industry today.

The early Eighties were easily one of the most important periods of Britain's contribution to gaming, thanks to the likes of Ultimate and Codemasters, and many talented developers ranging from Matthew Smith to Jon Hare, Jon Ritman, the Oliver twins and many others.

*From Bedrooms To Billions* is a new 90-minute documentary that is currently being funded on Kickstarter alternative Indiegogo, and it is already generating buzz within the industry thanks to the exciting all-star cast being promised by the film's creators, Anthony and Nicola Caulfield.

"The idea originally started out as a three-part TV series in 2008," begins Anthony when he tells us about the long-gestating project. "We had just finished two really large music projects, a Pink Floyd film called *Pulse* and an eight-part music TV series called *SoundCheck At Momo's*. Nicola and I had been saying for years that it was about time there was a properly put together documentary account of the story of the UK videogames industry. In the last ten years the only shows of note were *Thumb Candy*, presented by your very own Iain Lee, and more recently Charlie Brooker's *Gameswipe*."

The original idea was pitched to various broadcasters but began hitting several frustrating walls, delaying the project. "We were surprised at how little interest we got; the common answer [being] that gaming was a 'niche

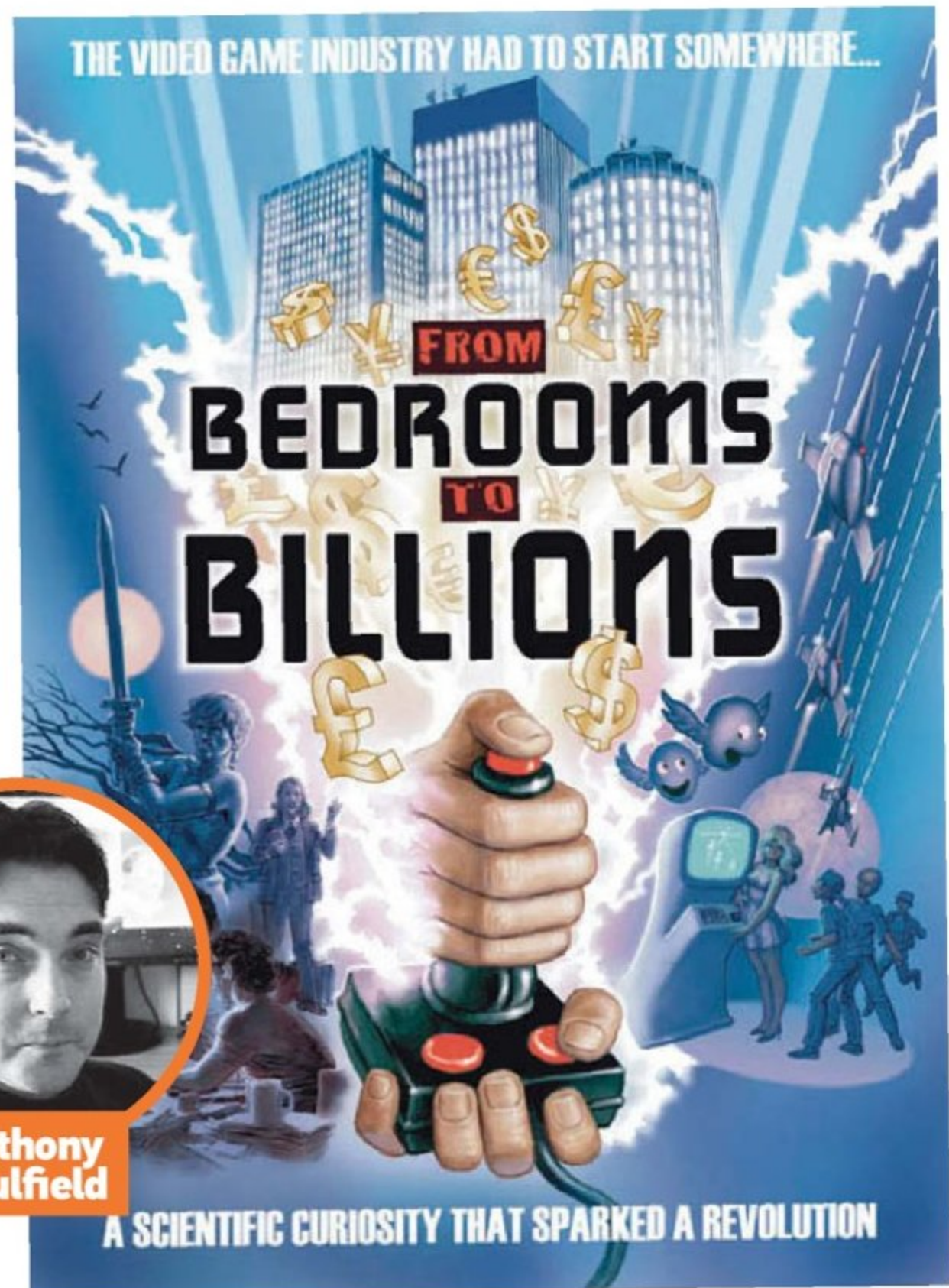

Anthony Caulfield

hobby', or that they wouldn't know where to 'place' such a show, or that no one would want to watch it," continues Caulfield. "What surprised us, though, was their complete lack of interest for such an important story in the history of British invention and industry."

"We're not talking about some fad that suddenly appeared then fizzled out; this was something that was borne out of enthusiastic interest and not necessarily commercial enterprise, that went on – along with contributions from

other countries – to be the biggest entertainment industry on the planet!"

Undaunted, Anthony tried another approach with the aim of creating a retro gaming DVD that would feature commentaries from popular developers like Matthew Smith. Despite the interesting concept and support from a big distributor, it was again scuppered. "Unfortunately, early into filming the company who were financing it were taken over and almost every active project was cancelled!"

**Nicola Caulfield**

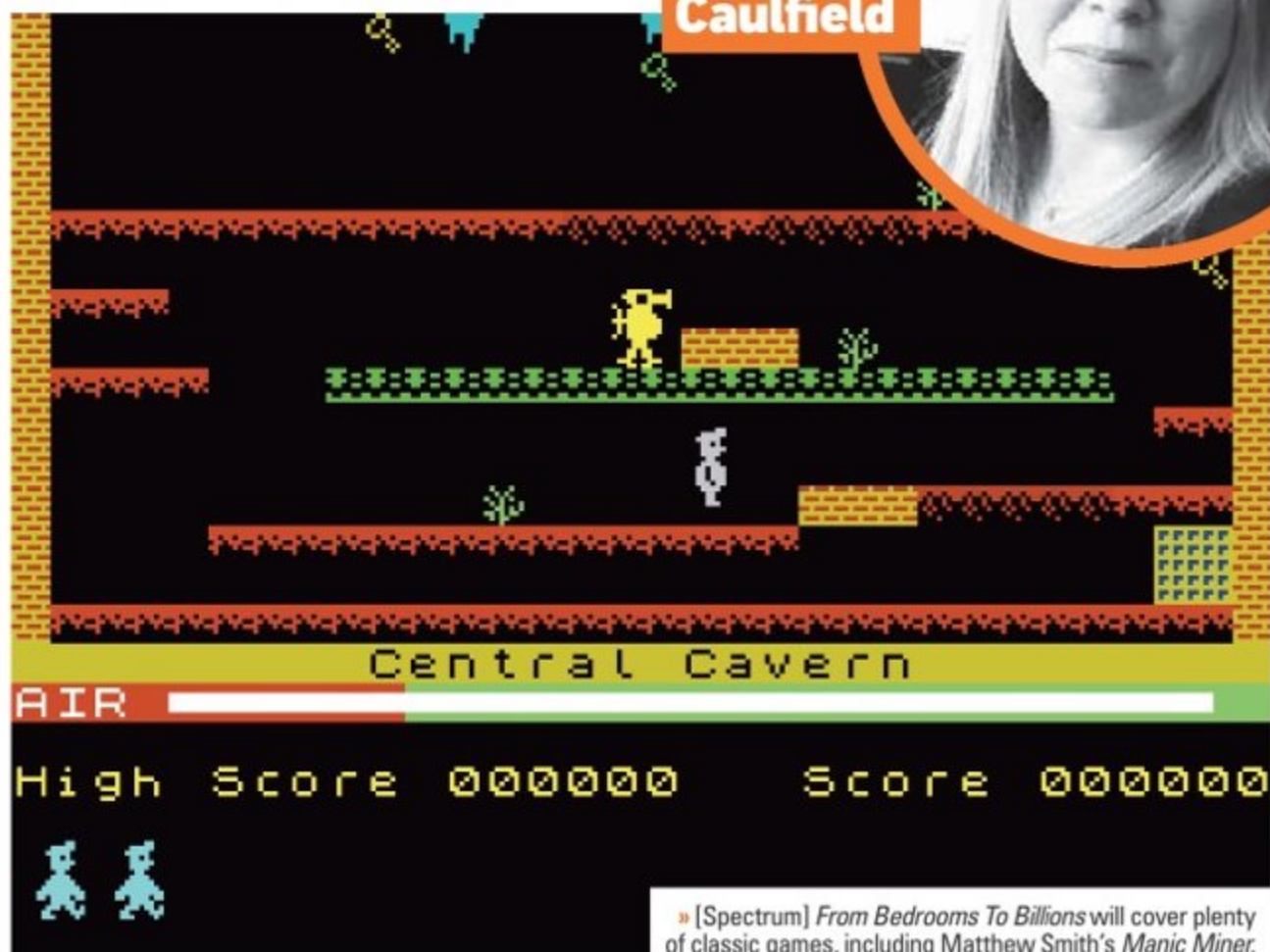

[Spectrum] *From Bedrooms To Billions* will cover plenty of classic games, including Matthew Smith's *Manic Miner*.



One of the perks will be to have your image drawn by *Crash's* Oliver Frey.

reveals Anthony. "We weren't happy because we had spent a lot of our own money up to that point, so we were left with several days of shot material and no real idea of what to do with it."

Fortunes looked to change with the BBC wanting to commission the three-part series to be shown after the excellent drama *Micro Men*, but once again the deal fell through. "At the very last minute they declined," recalls Anthony, "saying that a story on the UK videogames industry was way too niche, which considering some of the obscure subject matter on BBC Four raised our eyebrows!"

The success of Seth Gordon's *The King Of Kong: A Fistful Of Quarters* saw the Caulfields consider a film route, but this also proved problematic. "We thought we had achieved funding in 2010, but the UK Film Council were then shut down," says Anthony. "Then in 2011 we were approached about restructuring the film to tell the whole global story of the games industry and not just the

## “ We’re not talking about some fad that fizzled out ”

UK. We agreed and even released press releases, but that sponsor suddenly vanished, wasting more time and money, so we decided we would return to the original, core idea and not stop until we could finally tell that story."

That story could now be coming to fruition thanks to the aforementioned funding drive currently happening on Indiegogo. "We truly believe the only way this film will get made is if the retro gaming scene gets behind it and helps us get it funded," he continues. "Indiegogo provides a platform for projects like this; people can learn all about what we're trying to do and donate to the cause."

Like Kickstarter projects, numerous perks are being offered to help fund the \$35,000 needed to finish the documentary that range from digital and physical versions of the final product, to a reviewer's portrait drawn by Oliver Frey, who has also created the poster being used to promote the new documentary.

"He was our first choice to produce the poster for *From Bedrooms To Billions*," confirms Anthony. "When we were devising perks for the Indiegogo campaign, we knew that Oliver producing exclusive personalised artwork

for fans could be a real coup." The developers that the Caulfields have lined up are also going to be a massive draw for anyone who grew up in the Eighties.

Matthew Smith, Jon Hare, Archer Maclean, the Oliver twins, David Braben, Sandy White, Ian Livingstone, David Darling and Jeff Minter are just a few of the 40-odd developers that are due to be interviewed, with many more being promised. Even *Retro Gamer* regulars Iain Lee and Paul Drury will be turning up to wax lyrical about the days of old.

The UK industry was born during an extremely turbulent period, and for many it's an era that still resonates. It's this lightning that the Caulfields are so keen to bottle in *From Bedroom To Billions*.

"When we play retro games, especially the ones we used to play back in the day, they remind us, at least just for a moment, of a happy time or period in our lives we can never have back, when we perhaps had so much less to truly worry about," concludes Anthony. "If we can evoke an emotion like that in *From Bedrooms To Billions* then we will be very happy."

Interested in *From Bedrooms To Billions*? Head to [www.indiegogo.com/p/78873](http://www.indiegogo.com/p/78873) for more information. ✨

## A Cast Of Thousands

>> Here are just a few of the people due to appear in *From Bedrooms To Billions*

### Archer Maclean

Maclean has been behind some excellent 8-bit games including the excellent *Dropzone* and *IK+*.



### The Oliver twins

The co-founders of Blitz Entertainment are still working in the industry today. They are best known for the *Dizzy* series.



### Iain Lee

Regular columnist Iain Lee will also be making an appearance, although he won't be presenting the documentary.



### Matthew Smith

The talented creator of *Manic Miner* is notoriously publicity-shy, so his inclusion is great news for the documentary.



### David Braben

Braben, like the Oliver twins, continues to work in the industry and the industry continues to wait for *Elite IV*.



### Roger Kean

Several popular editors from classic magazines will feature in *From Bedrooms To Billions*, including *Crash's* co-founder.



### Sandy White

*3D Ant Attack* made a massive impact on the industry, so fresh insight from Sandy White is guaranteed.



### David Darling

Currently at Kwalee, David's contribution to the industry was *Codemasters*.



### Jon Hare

Sensible Software made a big impact on the UK gaming scene, notably with *Sensible Soccer*.



### Oliver Frey

The co-founder of *Zzap!64* and *Crash* will be contributing to *From Bedrooms To Billions'* perks.



[C64] Archer Maclean has already featured in the trailer, so expect his games to appear in the finished documentary.

## Here's the bio...

Iain Lee is a freelance broadcaster who loves gaming, particularly retro gaming. He used to present the 11 O'Clock Show, but please don't hold that against him. You can find more information about Iain at [www.iainlee.com](http://www.iainlee.com)



Hi there. My name's **Iain Lee**. You might remember me from Thumb Bandits and The 11 O'Clock Show, but now I'm here to confess my love for retro gaming



## Last Train To Geeksville

I was recently in Manchester station, waiting for my train home, and was starting to sweat quite a bit. I am a bit of a sweater at the best of times, or rather my right underarm is; my left is as dry as a dry bone, and just as delicious. But this was a different kind of sweat. The moisture permeating through my hair meant I was at the early stages of a migraine. I needed to dash off, get some really strong painkillers from the chemist then drink a whole bottle of water. If I do this early enough, I can halt the otherwise inevitable blindness and slurring of my words.

As I was mustering the strength to drag my weakening body to Boots, I was approached by a young couple who I had seen eyeing me up. Was I going to be asked what it was like being in *Two Pints Of Lager* – the number of times I am mistaken for Ralf Little is incredible – or maybe a reference to Daisy Donovan? For the record, I have not kept in touch and have no idea what she is doing now.

I was pleasantly surprised when the chap said: "I really like your column in **Retro Gamer**."

Ooh. This was a surprise. In the years I've been writing for **Retro Gamer**, this sentence has only ever been uttered to me three times, and one of them was by my wife. And I know for a fact she has never read it.

I was so pleased at hearing this, I immediately forwent my chance of pain relief and decided to indulge in some geeky banter, and I'm glad I did. Stuart\* turned out to be a thoroughly decent bloke

and even geekier about games than me. He claims to run a business – I doubt that, as he couldn't produce a card – and had a lovely girlfriend who, if I'm honest, was totally out of his league.

We talked and I spent far too long bullying him into buying a Dreamcast. With the migraine getting worse and sweat now pouring off me, I must have looked like a bug-eyed madman: "You MUST buy a Dreamcast. Seriously DO IT!"

My mental state was worsening and I don't remember much of what was said, but it did strike me that we are lucky to be part of a community who have this secret passion. Being a retro-head (© Iain Lee) is like being a mason, a secret community where with a sly wink and a nod, we can become friends immediately, in the shared knowledge that we are better than everyone else because we liked games before they got famous.

I propose we initiate a secret sign, like a handshake but without the ghastly physical contact. How about left hand slightly open, palm up, and right hand above it, miming waggling a joystick? If you think you're near a retro-head (© Iain Lee), make this symbol and see what happens. It should open a world of conversation. However, if it's a civilian you have approached, you have just made a sort of wonky wanking sign. So, you know, be careful.



I propose a  
secret handshake

\* I don't know if his name was Stuart





# RETROVISION 2012

THEY CAME TO PLAY. AND DRINK. AND DRESS UP

Look forward to this all year," beams Amy 'PinkFaerie' Ponting from beneath a rather fetching Batgirl costume. "And when I get here, I sort of explode."

Yes, this year's Retrovision, held in Oxford over the May Bank Holiday weekend, certainly went with a bang.

Now entering its second decade, RV is firmly established on the retro calendar, as the little show with the big heart, underlined by the fact that over £1,000 was raised for Cancer Research during the event.

"The charity aspect has become a big thing," says founder and green-headed honcho of RV, Markie Rayson. "It's about bringing people together to play, drink and get silly."

The silly side of the show was clearly on display, with various attendees indulging in some cosplay antics. Wandering through the main machine-packed room, we spotted Mario, Luigi, Marty McFly, Ico and Yorda, the latter eliciting a very different emotional response to the classic PS2 game.

Thankfully there were plenty of distractions. From a Binatone playing *Pong* on a tiny black-and-white telly to the ever-funky *Taiko Drum Master* and the marvellously convoluted *Star Trek* simulator *Artemis* on a giant projector screen, there was no shortage of games to lose yourself in. We were especially taken with the Jaguar setup, which included every commercial and homebrew release for the console, including super-rare titles like *Gorf Limited Edition CD*, a copy of which sold recently on eBay for \$900. "Every show I've taken my collection to, people have said, 'Isn't

» Ico's plaintive cry summoned the RV faithful each morning...



the Jaguar a bit shit?" explains Kieren Hawken, chief Jag evangelist. "By the end of the day, they've wanted one!"

RV's ethos of blending retro and modern with lashings of beer and curry was nicely demonstrated by the impressive roster of homebrew games launched at the show. They also provided the theme for the weekend's high-score competition, which saw the current top scores on an array of new games for old machines cleverly projected onto the ceiling, encouraging some heated rivalry amid the camaraderie.

The overall crown was won by Jonathan 'Mootown' Town, though we held the **Retro Gamer** end up by bagging the trophy for Protector on the Jaguar. We urge you to ignore rumours that we were the only entrant in this competition.



» Rock Band was another hit of the show.

The charity auction, masterfully compered by VintageMatt and Amy, and the rousing *Rock Band* sessions were also highlights of another great Retrovision. It may be small, but it's beautifully formed, so why not head to the Folly Bridge Inn in March 2013 and sample its delights for yourself? See [www.retrovision.org.uk](http://www.retrovision.org.uk) for further details. Many thanks to Jools for the photography.



» Mark 'The Emperor' Rayson rewards Jason 'Jasybee' Butwell for his *Galaga* Legions DX skills.



» Auctioneers Matt and Amy do thy bidding.

## What's brewing?

The homebrew previews of Retrovision 2012

### Soulless (C64)

This polished flick-screen arcade adventure is the latest release from Psytronik and comes packaged with a game map, poster and comic, making it a fine way to celebrate the C64's 30th birthday.



### Droidy Shooty Thing (Android/PC)

A pacey shoot-'em-up with an eye-melting 'trace' mode that adds some wonderfully psychedelic visuals to the blasting. Downloadable from [www.beercave.co.uk](http://www.beercave.co.uk).



### Trance Sector (C64)

Coded by Richard Bayliss, who produced *Sheepoid* for last year's show, this combines strategic pod-eating with rocket-dodging to form an addictive whole. Available from [tnd64.unikat.sk/t.html](http://tnd64.unikat.sk/t.html).



### Mixed Grill March (BBC)

A marvellous pastiche of the Wii's camp classic *Muscle March*, this isn't just a nod to some RV folklore; it's a meaty, twitchy challenge, worth tasting at [www.retrosoftware.co.uk](http://www.retrosoftware.co.uk).



# retrocolumns

>> PAUL DAVIES GIVES HIS VIEWS ON THE RETRO WORLD



Hello, retro gamers. My name is **Paul Davies**. I used to be the editor of C&VG and have also worked on a number of classic gaming magazines over the years

## Here's my bio...

In 1992 I started out on *Mean Machines Sega* and *Nintendo Magazine System*. In 1995 I became editor of *C&VG*. I led the *C&VG* website from 1998 until Christmas 2000, then I left journalism to be concept design manager at Criterion Games. I returned to journalism in 2002 and from 2005 I've been running my own company, Unlikely Hero.

## Believe You Can Fly

**A** *ngry Birds* aside, ever noticed how some of the most popular games in history have also been among the most complicated to control? One-button gaming is not the answer, mister.

There were plenty of straightforward coin-ops to tease paperclip credits from at the seaside in the Eighties. Granted, they were, most of 'em, alien blasters requiring not much strategy. Yet it was *Pac-Man* that gobbled the mass market back then, despite being rather more complicated than the norm.

This didn't matter, though, because *Pac-Man* was awesome. It was bright and colourful, and when you got your head around it, incredibly good fun. It kind of wasn't even a videogame; it was just *Pac-Man*. You had to try it, and then do your best to impersonate the sound effects. Like Wotsits and Monster Munch were not regular snacks. They transcended the notion of mere crisps.

Fast forward 15 years and the same sort of thing happened with *Tomb Raider*. When journalists first took charge of Lara Croft we thought the various trials were amazing in 3D, but possibly a bit too difficult. I remember discussing the peevis checkpoints and enjoying hearing about everyone's favourite T-rex tactics. Being tricky didn't stop *Tomb Raider* from becoming the everyman console game, the one game that everyone had played on a PlayStation, loved by every bloke and his missus.

Cab drivers that ferried us between appointments around town, having established our credentials, would confide that they didn't like games too much but they did like that one with Lara Croft.

Same thing is happening today with *Call Of Duty*, especially since *Black Ops*. At the time of writing, the latest figures point to 40 million active online users per month. That's double the worldwide sales achieved by *Super Mario World*, to give some idea of its popularity. As with all modern

shooters, the *COD* controls might be seen as intimidating. Nobody gives this a second thought.

So, trying to convince more people to play games purely by playing dumb is a fool's errand. That's not to say that one-button or even no-button gaming should be outlawed and all those responsible hanged. This is just my observation that, over the past 30 years, many of the most popular games have been fairly complex affairs. You know, *World Of Warcraft* – WTF? People are prepared to get over multiple menu boxes and buffering commands if the experience is too good to miss.

It's a clever conversation to have around the conference table when dreaming up ideas for the Next Big Thing – how do you get somebody who's happier just watching TV to start playing your TV game? Let's start with one button, because that's the least off-putting. Look at *Angry Birds*, look at *Tetris*. Simple is obviously best if approached from that angle.

But bearing in mind everything from *Street Fighter II* to *Skyrim*, I don't think you can ever say that an in-depth user interface stopped people devouring anything less than the good stuff.

You have to draw the line somewhere, though, and the Atari Jaguar controller asked too much of even the most hardened gamers in the mid-Nineties.

I have no idea what all those little buttons were for. They might have transformed *Atari Karts* into something incredible. Did anyone reading this try?

I don't think an in-depth interface stopped people devouring the good stuff



# SEGA RE-RALLIES

CLASSIC CHARACTERS REVEALED FOR SEGA'S NEW ALL-STARS RACING SEQUEL

**S**ega has one of the most iconic leagues of videogame heroes in the business, one to easily rival the mighty Nintendo. In fact, with popular mascots that include a man-piloted dragon and a big-fisted prince, insane taxi drivers and a forklift-driving martial arts master, Sega's heroes are the more diverse bunch. Therefore, the potential was certainly there for 2010's *Sonic & Sega All-Stars Racing* to give Nintendo a real run for its money in the mascot racer genre. However, the game wasn't as well received as Sega would have hoped.

Nevertheless, Sega has recently announced a sequel. *Sonic & All-Stars Racing Transformed* will add new faces to the racing franchise. Currently confirmed are Golden Axe's Gilius Thunderhead and Vyse from *Skies Of Arcadia*, as well as new karts that transform into boats and flying machines. Players will also now have the opportunity to level up the racers over the course of the game and gradually unlock them in a new adventure mode. And that the sequel has dropped Sega from its title suggests to us that we could see some guest characters from other studios appearing. Taking all of this into consideration, we're expecting this instalment to have a more *Diddy Kong*



[PS3] The sequel will introduce transforming cars. Matt Trakker will be green with envy.



Racing vibe than *Mario Kart*, which is certainly no bad thing.

With Sumo Digital back in the driving seat and *Transformed* benefiting from both sequel hindsight and input from ex-Bizarre Creations and Black Rock Studio personnel who have joined the developer, the odds certainly look good for this sequel delivering.

There were a number of aspects that we enjoyed in the original, and if the few niggles we found – the harsh difficulty spikes, clunky drift mechanics and unimaginative power-ups – are addressed sincerely then we see no reason why this sequel won't transform *All-Stars* into a solid racing franchise for Sega.

[PS3] Sega will no doubt begin drip-feeding fans the full character roster right up until the game's final release.



## Amazing titles on greatdigitalmags.com

### games™



After years of speculation, issue 123 of **games™** goes deep undercover to unearth the secrets surrounding the Steam console reportedly in development at Valve Software. The coverage continues with an interview with *Portal* co-creator Kim Swift, and an investigation of *Half-Life 2: Episode Three*.

### How It Works



This month **How It Works** reveals seven of Earth's most awe-inspiring wonders, from amazing structures like the Golden Gate Bridge and Burj Al Arab hotel, right through to hypersonic aircraft capable of travelling at over 13,000mph. We also detail 50 amazing facts about our planet's fascinating weather.

### Apps Magazine



Issue 21 of **Apps Magazine** offers up 50 Amazing Apps To Make You Go WOW! Some of the most innovative and exciting new apps you can download for iPhone, iPad or Android. Also in this issue you'll find the best mobile RPGs and reviews of *Marvel vs Capcom 2* and *Max Payne Mobile*.

### Learn more about greatdigitalmags.com



Imagine Publishing's **greatdigitalmags.com** makes it even easier to buy popular magazines like **Retro Gamer**, **SciFiNow** and **How It Works**. **greatdigitalmags.com** is an innovative new digital portal that offers access to every magazine in the Imagine Publishing portfolio. Regardless of your interests, you'll discover plenty of titles to suit your needs. Giving you instant access to Zinio and iTunes versions of your favourite magazines, this means that getting the latest issue has never been easier. Head to **greatdigitalmags.com** now.

## Wish upon a car

Characters that we'd like to see burning rubber in the sequel...

### Rez avatar

We heard a rumour that the nameless avatar in *Rez* was at one stage a character considered for the original game. If true, then it bodes well for appearing in the sequel, maybe in a *Tron*-style light cycle?



### Wonder Boy

A classic Sega hero, Wonder Boy, or rather Tom-Tom, made his debut in arcades before being ported to a number of consoles. Armed with his trusty axe and skateboard, he'd be perfect for a combat racer.



### Axel Stone

Ryo and his forklift proved martial arts heroes could work in the kart-racing genre, so why not *Streets Of Rage*'s Axel? He could drive the police car that turns up when you do a special attack in the first game.



### Joe Musashi

Joe has fought his fair share of vehicles, but driving them? Using *Shinobi III* for inspiration, we reckon a Pegasus-style flying horse that turns into a surfboard (obviously) would fit the bill quite nicely.



### Ristar

The boy star shares clear similarities with Sonic, thus we reckon he'd slot comfortably into the franchise. He could even use his extendable arms to grab his rivals and ride in their slipstream. Make it so, Sumo.



## \*A MOMENT WITH...

# Rod Lawton

This month, we met the longest-serving editor of the massively popular Amstrad Action, which was once the number one magazine for the CPC range of computers

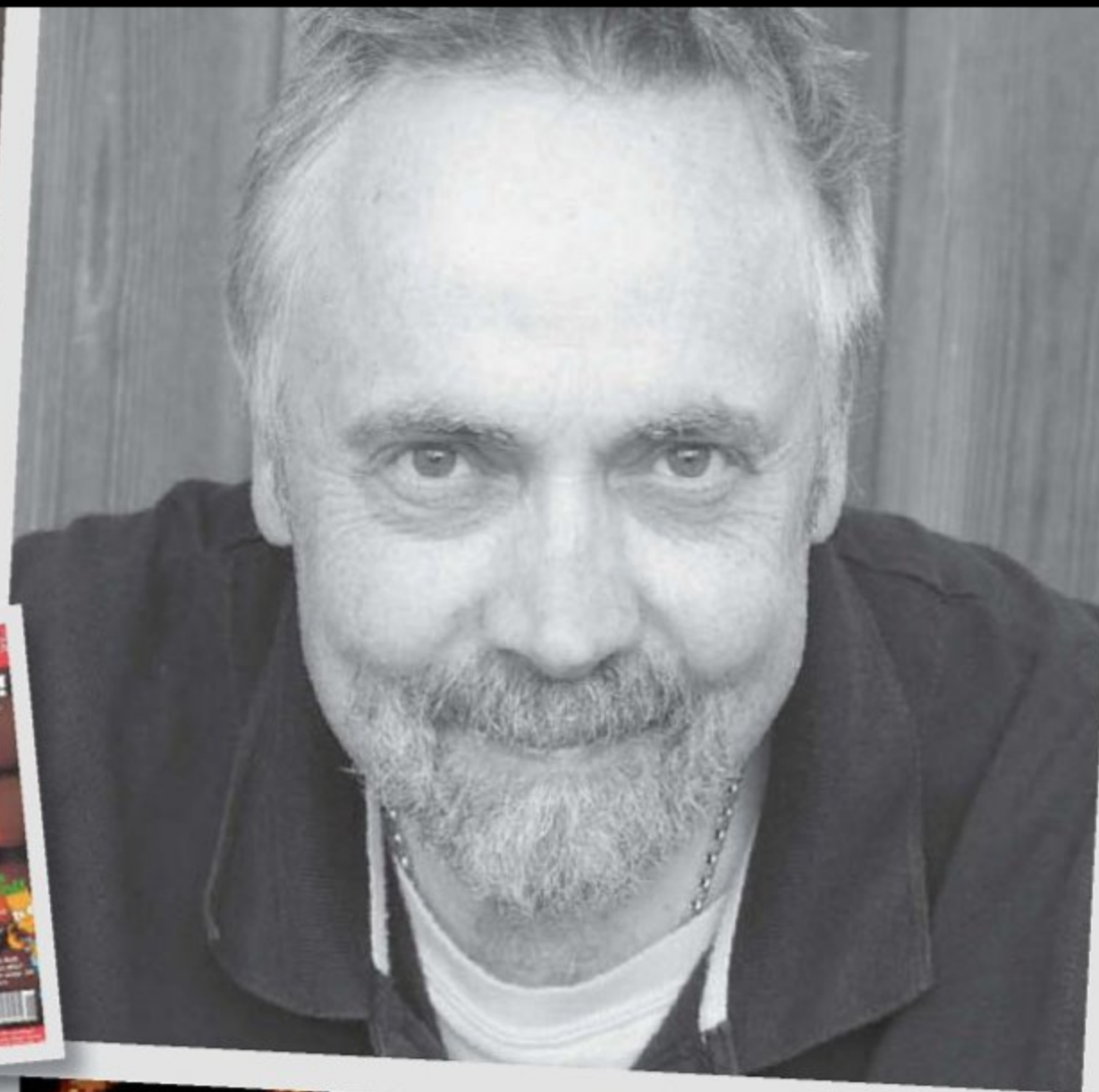

### Who is Rod Lawton?

Although he only arrived at Amstrad Action when it had reached issue 51, he made a major impact on the magazine, staying for three years. During this time he edited 39 issues of AA and was there for the launch of the Plus range of CPC machines. His magazines had a great sense of fun and sales rocketed to 37,000. He was also responsible for introducing the magazine's monthly covertapes

### What's your earliest gaming memory?

That would be Tetris, running on a four-colour PC.

### Which game means the most to you and why?

Laser Squad on the CPC! I loved the turn-based approach, the uncertainty and the strategy, especially when you played against another human.

### How did you get into journalism?

I wanted to make a career out of photography, but then found it was easier to sell articles to photo magazines than just photos on their own.

### How did you become editor of Amstrad Action and what was your perception of the magazine at that time?

The job came up while I was production editor on another Future Publishing title. I put myself forward for the job and got it. I

thought it was a somewhat old-fashioned platform and that the magazine was perhaps a tiny bit serious.

### What did you seek to do with the mag?

I'm not sure I had a plan, except maybe to make sure there was a balance between the serious stuff and having a bit of fun, both for the readers and for us working on the magazine.

### Were you pleased that the circulation actually went up to 37,000 at a time when the CPC was in decline? Why did this happen, do you think?

I was very pleased, and I never miss a chance to remind people about it even now. I think 8-bit computers still had plenty of life left in them even then, and the main thing was not to treat it as a declining market and not to lapse into what I'd call 'formula' publishing.

### What made AA stand out as the best CPC magazine and which writers did you particularly admire?

I think we had a bit of a laugh but took the readers and their wants seriously. We didn't always get it right, but I think it was obvious we were making the effort. I'm not going to name any particular writers because it wouldn't be fair to leave anyone out.

### Did the pleas for a covertape annoy you and were you pleased to finally announce them?



[Amstrad] Defenders Of The Earth was an excellent licence that earned the coveted Rave award.

## “ I think 8-bit computers had plenty of life in them ”

They were often a pain to sort out, but looking back it was the only way for most of our readers to get new and interesting software and just mess about with their computers – commercial software was pricey.

### What frustrated you about being the editor and what excited you?

I was frustrated when readers thought we were just a big business and didn't really know what we were doing, or didn't care. I was excited when an issue, a cover or a feature really came together, when we managed to explain something more clearly or came up with a really inspirational idea.

### Are there any moments that stand out in particular?

A swanky Amstrad press launch in Paris, followed by dinner on the Eiffel Tower. If only I could remember what it was about... [It was the launch of the Plus range and GX4000 console.]

### What do you think of gaming magazines today?

I don't read them, sorry. I use a PS3, but only for a handful of favourite games. GT5 is compulsory, and I was a Medal Of Honor fan back on the PS2, but once it left WWII I lost interest. Sad, eh? \*



[Amstrad] The Amstrad Action team were huge fans of Raff Cecco's games, giving Raves to many of them.

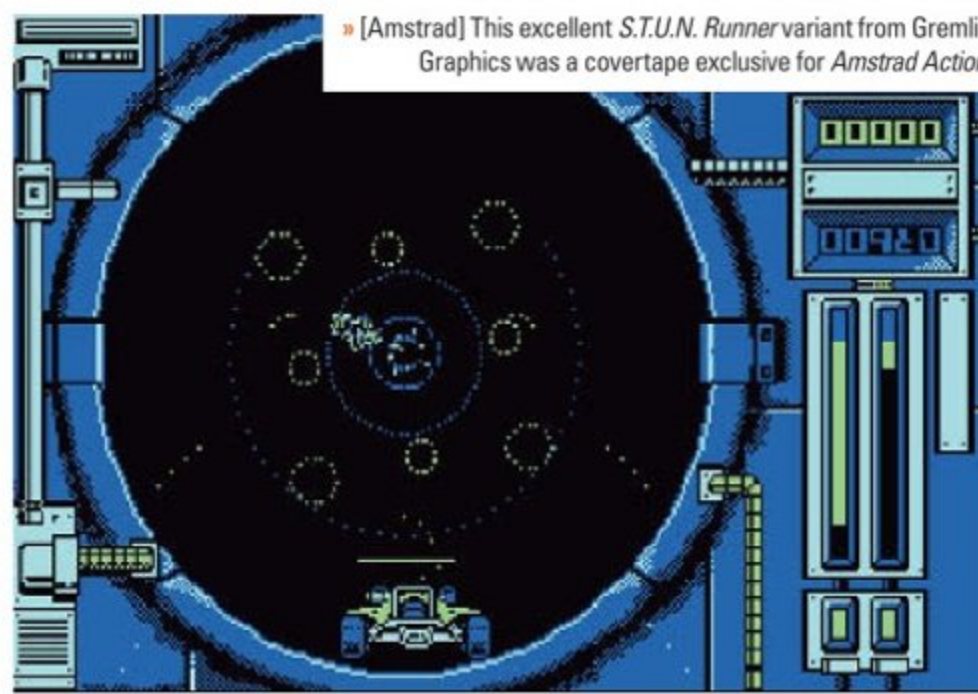

[Amstrad] This excellent S.T.U.N. Runnervariant from Gremlin Graphics was a covertape exclusive for Amstrad Action.

22 June – 19 July

# retrodiary

>> A month of retro events both past and present



22 June 1984

■ Micromania releases the space-based bouncy marsupial game, *Kosmic Kanga*. Great on the Spectrum; a stinker on the C64.



22 June 1996

■ id Software releases the first incarnation of first-person shooter *Quake*. Fragtastic.



22 June 2012

■ Capcom's *Steel Battalion: Heavy Armor* is due out in Europe exclusively on the Xbox 360.



23 June 2006

■ The uniquely playable *LocoRoco* makes its world-tilting debut on the PSP across Europe.



6 July 2007

■ Tecmo's *Ninja Gaiden* returns, this time to the PS3, with the European release of *Ninja Gaiden Sigma*.



6 July 2007

■ *Metal Slug Anthology* is released by SNK Playmore on the PS2. It's well received despite a lacklustre control system.



1 July 1986

■ Sharp Electronics releases a Nintendo-licensed amalgam of the Famicom and Famicom Disk System consoles, the Japan-exclusive Twin Famicom.



27 June 2003

■ *Sonic Adventure DX: Director's Cut*, an enhanced version of the Dreamcast game, is released in the UK on the GameCube.



6 July 2012

■ A bizarre mix of rhythm gaming and *Final Fantasy* will bring Square Enix's *Theatrhythm Final Fantasy* to the Nintendo 3DS in the UK.

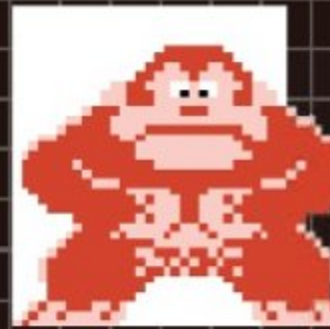

9 July 1981

■ *Donkey Kong* is released into arcades across the land and also marks the videogaming debut for Mario, aka Jumpman.



12 July 2002

■ Bandai releases an improved WonderSwan, the SwanCrystal, with a TFT LCD screen for enhanced clarity and colour.



13 July 1985

■ Sega releases its motorcycle racer *Hang-On* into arcades. It was designed by the aptly named Yu Suzuki.



16 July 1981

■ Nintendo releases its latest Game & Watch handheld, *Octopus*. Get the sunken treasure without the monster getting you...



15 July 1987

■ *Devil World* arrives in Europe on the NES. It's similar to *Pac-Man* and is the only Miyamoto-designed game not released in the US.



15 July 1983

■ Nintendo releases its Famicom in Japan. A mere three years later, the official European version (NES) was released...



13 July 2010

■ *DeathSpank*, an action RPG designed by Ron Gilbert, is released on PSN. The Xbox Live version followed the next day.



16 July 1984

■ Meet a new hero. Wally Week makes his first computer game appearance as the manic mechanic in *Automania* on the Spectrum.



19 July 2002

■ The *Gauntlet* franchise continues with *Dark Legacy* on its European GameCube release.



19 July 2002

■ Nintendo releases the terrific *Super Mario Sunshine*, exclusively on its GameCube console. Japan got first dibs...



19 July 2012

■ The new issue of *Retro Gamer* hits the streets!

**YES!** I would like to subscribe to Retro Gamer

### YOUR DETAILS

Title \_\_\_\_\_ First name \_\_\_\_\_

Surname \_\_\_\_\_

Address \_\_\_\_\_

Postcode \_\_\_\_\_ Country \_\_\_\_\_

Telephone number \_\_\_\_\_

Mobile number \_\_\_\_\_

Email address \_\_\_\_\_

(Please complete your email address to receive news and special offers from us)

### DIRECT DEBIT PAYMENT

**UK Direct Debit Payment - only £22.50 every 6 issues (Save 25%)**

 <b>Instruction to your Bank or Building Society to pay by Direct Debit</b> 	
<small>Please fill in the form and send it to: Imagine Publishing Limited, 800 Guillat Avenue, Kent Science Park, Sittingbourne, ME9 8GU</small>	
<small>Name and full postal address of your Bank or Building Society</small> To: The Manager Bank/Building Society Address Postcode	<small>Originator's Identification Number</small> 5 0 1 8 8 4
<small>Name(s) of account holder(s)</small> _____ <small>Branch sort code</small> _____ <small>Bank/Building Society account number</small> _____	<small>Reference Number</small> _____ <small>Instructions to your Bank or Building Society</small> Please pay Imagine Publishing Limited Direct Debits from the account detailed in this instruction subject to the safeguards assured by the Direct Debit guarantee. I understand that this instruction may remain with Imagine Publishing Limited and, if so, details will be passed on electronically to my Bank/Building Society. <small>Signature(s)</small> _____ <small>Date</small> _____
<small>Banks and Building Societies may not accept Direct Debit instructions for some types of account</small>	

### PAYMENT DETAILS

**YOUR EXCLUSIVE READER PRICE 1 YEAR (13 ISSUES)**

**UK £51.90 (Save 20%)**  **Europe – £70.00**  **World – £80.00**

#### Cheque

I enclose a cheque for £ \_\_\_\_\_  
(made payable to Imagine Publishing Ltd)

#### Credit/Debit Card

Visa  Mastercard  Amex  Maestro

Card number \_\_\_\_\_ Expiry date \_\_\_\_\_

Security number \_\_\_\_\_ (last three digits on the strip at the back of the card)

Issue number \_\_\_\_\_ (if Maestro)

Signed \_\_\_\_\_

Date \_\_\_\_\_

**Code: PAF104**

Tick this box if you do not wish to receive any promotional material from Imagine Publishing Ltd.  
 Tick this box if you do not wish to receive promotional material from other companies. Terms & Conditions apply. We publish 13 issues a year, your subscription will start from the next available issue unless otherwise indicated. Direct Debit guarantee details available on request. This offer expires without notice.

I would like my subscription to start from issue: \_\_\_\_\_

Saving of 25% is based on standard cover price of £4.99

**Return this order form to:** Retro Gamer Subscriptions Department, 800 Guillat Avenue, Kent Science Park, Sittingbourne ME9 8GU or email it to [retrogamer@servicehelpline.co.uk](mailto:retrogamer@servicehelpline.co.uk)

You can manage your subscription account online at [www.imaginesubs.co.uk](http://www.imaginesubs.co.uk)



# EXCLUSIVE SUBSCRIBER BENEFITS

**Start a Direct Debit today and for just £22.50 get the next six issues – saving over £16 a year**

- Save 25% on the cover price
- Free UK delivery and money-back guarantee on any unmailed issues
- Be the first to receive the latest Retro Gamer articles



# Subscribe & SAVE 250%

Retro Gamer is the **ONLY** magazine in the UK that's 100 per cent dedicated to the fascinating world of classic gaming. **Don't miss out!**

The UK's **ONLY** monthly magazine committed to classic gaming. Retro Gamer's pool of prestigious games industry retro experts work tirelessly to bring you a magazine devoted to the games of yesteryear.

Call Now  
**0844 848 8412**  
or subscribe  
**Online**

## THREE EASY WAYS TO SUBSCRIBE

### 1. Online

Order via credit or debit card, just visit  
[www.imaginesubs.co.uk/ret](http://www.imaginesubs.co.uk/ret)  
and enter code **PAF104**

### 2. Telephone

Order via credit or debit card on the phone, just call  
**0844 848 8412**  
Overseas: +44 (0) 1795 592 872 and quote code **PAF104**

### 3. Post or email

Please complete and post the form to  
**Retro Gamer Subscriptions Department**  
800 Guillat Avenue  
Kent Science Park  
Sittingbourne  
ME9 8GU

Or alternatively, you can scan and email the form to  
[retrogamer@servicehelpline.co.uk](mailto:retrogamer@servicehelpline.co.uk)

# BACK TO THE EIGHTIES

## CHARTS

DEC 1981



- ACORN ATOM**
- 1 Space Invaders (Bug-Byte)
  - 2 747 (Bug-Byte)
  - 3 3D Asteroids (Program Power)
  - 4 Minefield (A&F Software)
  - 5 Polecat (A&F Software)

» [Apple II] Be it a Granny Smiths or Cox's Orange Pippin, they all want to bite your face off. Dig a hole and spade them to death...

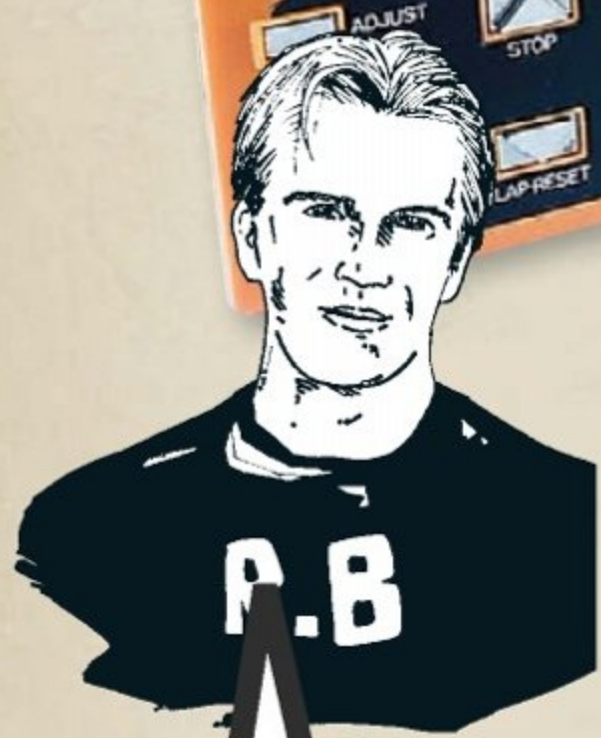

## THE LATEST NEWS FROM DECEMBER 1981

**DECEMBER 1981 – Video Genie materialises, BBC Micro arrives, Apple Panic on the Apple, tabletop and handheld mayhem, Tron on, Hitchhiker's takes no prisoners while Vasectomy is available on a ZX81. Richard Burton protects his plums...**

**C**hristmas 1981 brought us a new computer, the Video Genie I. Although not a new machine, it was essentially an upgrade to the earlier Video Genie release of 1980, incorporating the modulator, power supply unit and tape deck all in one bulky unit. It had 16K of ROM and 12K RAM containing Microsoft BASIC, and a quality keyboard, with a cost of around £299.

However, one of the Video Genie's selling points was its compatibility with the Tandy TRS-80 Model I computers, which opened up a not insubstantial pre-existing software library. Of course, had the TRS-80 enjoyed any sort of popularity in the UK then the Video Genie may have gleaned a modicum of success off the back of it.

More successful and certainly more fun was the official release of the BBC

Microcomputer System; the Model A had 16K RAM and the Model B 32K, and they were priced at £235 and £335 respectively for launch. The price went up immediately after Christmas due to rising production costs to £299 and £399.

Acorn Computers built the Model A and B after entering a bid for the BBC-run Computer Literacy Project, which saw various computer manufacturers, including Sinclair Research, enter their existing and prototype machines, with the winning model being accepted as the BBC's computer of choice and adopted into thousands of British schools.

Acorn's prototype Proton computer, the successor to its earlier Atom, was built within a week, won the competition and was later renamed the BBC Micro.

However, Clive Sinclair was still pushing the educational angle of his ZX81. A special deal with an educational distributor led to

heavily discounted ZX81s appearing in over 2,000 secondary schools across the UK.



» The Video Genie 1 was a machine that looked the business, mainly because it was more suited to business, despite being TRS-80-compatible.



» The BBC Micro swamped schools across the land. Clive Sinclair is not happy...

Given that the government-run computing scheme gave a choice of two computers – the new BBC Micro or the impressively named yet eye-wateringly expensive Research Machines 380Z – getting the cheap ZX81s into educational establishments was seen as a good business move for Sinclair.

Unfortunately, though, the BBC Micro began ousting the ZX81 thanks to its colour graphics, quality keyboard and disk drive access. Oh, and *Granny's Garden*.

Fancy a spot of *Apple Panic*? No, it's not some health lunacy regarding the scoffing of a bruised Russet but a *Space Panic* clone for the Apple II. As in *Space Panic*, you dispatch the baddies – in this case apples – by digging a hole, getting said apple to fall into the hole, and then smacking it over the stalk with your spade.

Being one of the first clones of the coin-op game, it piqued home computer gamers' interests, with nothing similar available at that time. It sold well, leading to its developer, Broderbund, making versions for the VIC-20 and Atari 8-bit systems.

With Christmas looming, new handheld and tabletop electronic games were in abundance. Two games from Grandstand Electronics' pocket range that were selling extremely well were *Mini Munchman* and *Crazy Kong*. These small handheld





### ZX81

- 1 QS Defender (Quicksilva)
- 2 QS Asteroids (Quicksilva)
- 3 Star Trek (Silersoft)
- 4 The Damsel And The Beast (Bug-Byte)
- 5 Volcanic Dungeon (Carnell Software)



### APPLE II

- 1 Castle Wolfenstein (Muse)
- 2 Space Eggs (Sirius Software)
- 3 Raster Blaster (BudgeCo)
- 4 Gorgon (Sirius)
- 5 Alien Typhoon (Star Craft)

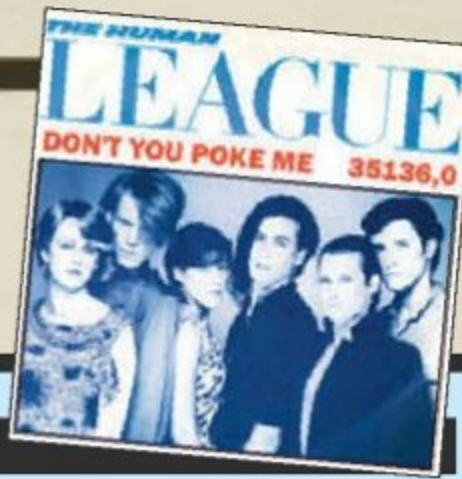

### MUSIC

- 1 Don't You Want Me (Human League)
- 2 Daddy's Home (Cliff Richard)
- 3 One Of Us (Abba)
- 4 Ant Rap (Adam & The Ants)
- 5 It Must Be Love (Madness)

## DECEMBER 1981 NEWS

A Cornish RNLI Penlee lifeboat, the Solomon Browne, was lost on 20 December when it was answering a distress call from the stricken Union Star, which had suffered engine failure eight miles off the coast of Cornwall.

Based in the port of Mousehole, the lifeboat was launched into treacherous conditions with hurricane force 12 winds and waves of over 60 feet.

Despite rescue attempts, the lifeboat was lost with all eight volunteer members. The following morning a search found the remains of the lifeboat, which had been smashed into small pieces. Seven bodies were also recovered from the water.

24 December saw the UK premiere of the movie musical *Shock Treatment*. Written by and starring Richard O'Brien,

it was a sequel of sorts to *The Rocky Horror Picture Show* in that it featured the characters Brad and Janet from that film, and also many of the original cast feature, portraying new characters.

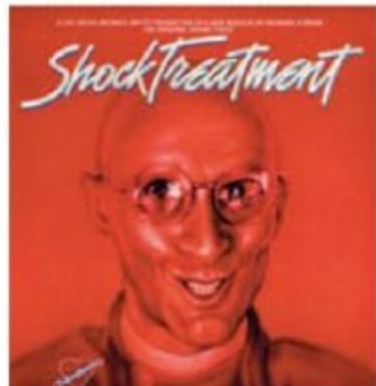

» O'Brien and co were back for one more Rocky-related blast.

*Shock Treatment* flopped badly and was critically panned but, despite this, it has developed a cult following thanks to its *Rocky Horror* connections.

Christmas Eve also brought the world premiere of *Mad Max 2*, which saw Mel Gibson reprise his role of Max Rockatansky, the drifter travelling through a post-apocalyptic Australian wasteland. In this second film, he helps wasteland settlers protect their precious oil refinery from a gang of marauders. Much violence and death ensues, along with critical acclaim and large box office takings.

LCD games were Grandstand's answer to Nintendo's Game & Watch, although the screens were viewed in portrait rather than landscape in this case.

Grandstand's big game for Christmas was the tabletop game based on the Bally/Midway arcade game, which was itself based on *Tron*, the upcoming Disney movie.

The game was notable for starting the familiar case design used for other Tomy/Grandstand games such as *Caveman*, *Lupin* and *Scramble*. Those were nice, but *Tron*'s case design was particularly lovely, with its smoked clear plastic body allowing the circuitry to be seen. Tomy also added extra fake circuitry decals to the rear of the case to add to the whole *Tron* vibe. £25.95 and it's yours...

CGL was also vying for your Christmas cash with *Galaxy Twinvader*. Similar in style to its chunky handheld *Galaxy Invader* game, this more robust tabletop offering looked great but didn't really give gamers anything new... even for late 1981.

It was a basic *Space Invaders* game for one player. The 'Twinvader' name referred

to the aliens trying to take you out by dropping other invaders on you rather than the conventional shooting method. Those hoping for a two-player game were suitably peeved...

Supersoft released a terrific text adventure for Commodore PET owners, *The Hitchhiker's Guide To The Galaxy*. The adventure was based on Douglas Adams' book, radio drama and TV series of the same name and referenced the source material thoroughly throughout. Unfortunately, therein lay the problem: *The Hitchhiker's Guide* was only based on rather than officially licensed from the book.

Nevertheless, the adventure launched, sold well and was received positively by gamers and reviewers alike. The inevitable legal action followed shortly afterwards...

Supersoft was forced to remove the game from sale. Determined not to waste a perfectly playable and profitable adventure game, programmer Bob Chappell set about completely rewriting it to remove every reference to *The Hitchhiker's Guide*, renamed it *Cosmic Capers* and put it back



» *Galaxy Twinvader* probably seemed like a good idea in the CGL planning meeting. Sadly, it was all very samey, even for 1981.

on sale. It didn't sell quite so well second time around...

Dodgy release of the month must surely go to Automata's compilation of a suite of 1K games, all with a hefty dollop of smutty, dubious or politically incorrect content. For £3 you would receive the suitably named *Can Of Worms*, which would let you play such gaming gems as *Acne* (squeeze pimples before they infest your face), *Vasectomy* (you're at the mercy of a short-sighted, drunken surgeon), *Hitler* (infuriate the Führer by putting a whoopee cushion under his seat) or *Royal Flush* (unblock the Royal sewer skilfully or it's brown alert)...

They weren't particularly playable or fun, but for creating such a diversity of software on a 1K ZX81, Mel Croucher and his Automata team, we salute you.



» [ZX81] Automata's *Can Of Worms* was a compilation of 1K games that were as raw as they come.

## THIS MONTH IN... ELECTRONIC GAMES



It was Christmas gift guide time in EG. Recommended products to pop from Santa's sack included *Champion Sensory Chess*

*Challenger*, *Pocket Simon* and Casio's CA-90 digital wrist watch – the first to feature a game, albeit a rubbish number memory tester.



## COMPUTER AND VIDEO GAMES



In a similar vein but for UK gamers was C&VG's Christmas electronic toys feature. The most impressive was the

Big Trak, a programmable vehicle that roved around, knocking lumps out of your furniture when it wasn't getting stuck on the rug.



## YOUR COMPUTER



YC took a look at a various games consoles vying for Christmas sales, including the Atari 2600 and Intellivision, as well as a host of lesser-known systems. "Video computer games are likely to prove more than a five-minute wonder in most households," it proclaimed.



# BACK TO THE NINETIES

» [SNES] *Star Fox 2* was virtually complete but never released. What a waste.

ITEM  
S 3



If you want to transform, hit **SELECT!**



**MARCH 1995** – Bullfrog sold, Battlemorph arrives, Mortal Kombat II doesn't, 11th Hour for 7th Guest, Nintendo goes Bond with Rare, The Chaos Engine is revved up once more and Tir Na Nog returns. Richard Burton avoids the Sidhe...

## THE LATEST NEWS FROM MARCH 1995

**E**lectronic Arts, which, for many years, had published several of Bullfrog Productions' games, including *Powermonger*, *Populous* and *Theme Park*, announced that it had bought the British software developer for a reported \$45 million.

The Atari Jaguar had endured a difficult time since launch, with criticisms regarding third-party software. This month the Jaguar appeared to be hitting back with a rich vein of software releases and several high-profile games announced for the system.

Atari revealed that it was working on a sequel to the original pack-in game for the American console release, the world-exploring 3D shooter *Cybermorph*. While the original was underwhelming, the new game, *Battlemorph*, improved on the original in every way.

It had faster frame rates; huge, texture-mapped worlds with finely honed graphics; terrific music; and a sense that time and care was taken developing the game. With its immersive, atmospheric worlds, adventurous elements, and the expansion of the free-roaming element, *Battlemorph* became a must-have title for the Jaguar when it was released for the Jaguar CD add-on later in the year.

While Atari and *Battlemorph* promised much and delivered, Acclaim was planning a trio of gaming loveliness. The three big

titles under development were *Judge Dredd*, a game based on the upcoming movie; *NBA Jam Tournament Edition*, a new version of its hit basketball game; and the eagerly awaited *Mortal Kombat II*.

Although release dates were still being pondered, it looked like the Jaguar was finally getting the third-party support it needed and deserved. Sadly, only *NBA Jam Tournament Edition* appeared, and despite being a fine basketball game, the no-show of *Mortal Kombat II* hinted that the system might have a testing future...

Nintendo was also pushing two new games for the SNES, with both utilising the Super FX 2 chip. *FX Fighter* and *Star Fox 2* were both being developed by Argonaut Software. Despite looking very promising, both were pulled prior to the release of the Nintendo 64. *FX Fighter* wasn't completed but was later released on the PC, while *Star Fox 2* was all but complete bar some debugging but still pulled as the impending release of the N64 and development of *Star Fox 64* took precedence.

*FX Fighter* was nowhere near as complete, and the early previews hinted that it looked like a poor version of *Virtua Fighter*. No great loss, then...

PC, CD-i and Mac owners were rejoicing with news that Virgin Games and Trilobyte would once again be combining to create *The 11th Hour*, a sequel to the hugely

successful *The 7th Guest*. The interactive horror movie puzzle game was a big hit, with its 3D rendered graphics and use of video cutaways. *The 11th Hour* promised more of the same. It delivered, although by the time it was belatedly released, the look and feel of the game was already dated and, in keeping with this month's running theme, the promised 3DO conversion was cancelled due to the poor reception and sales of the CD-i version.

Nintendo announced that it had signed a deal to create a game based on James Bond and his latest escapade, *GoldenEye*.



» [PC] It's back to the spooky house for the sequel to *The 7th Guest*.



» [Jaguar CD] *Cybermorph* came first. *Battlemorph* followed and was infinitely better.

# CHARTS

## MARCH 1995

### SNES

- 1 Super Star Wars: Return Of The Jedi (JVC)
- 2 Donkey Kong Country (Nintendo)
- 3 Earthworm Jim (Virgin Games)
- 4 Power Drive (US Gold)
- 5 Secret Of Mana (Nintendo)

### MEGA DRIVE

- 1 Cannon Fodder (Virgin Games)
- 2 FIFA Soccer 95 (Electronic Arts)
- 3 Jimmy White's Whirlwind Snooker (Virgin Games)
- 4 Micro Machines 2 (Codemasters)
- 5 PGA Golf Tour 3 (Electronic Arts)

### AMIGA

- 1 Sensible World Of Soccer (Virgin Games)
- 2 Theme Park (Electronic Arts)
- 3 Mortal Kombat II (Acclaim)
- 4 Cannon Fodder 2 (Virgin Games)
- 5 Premier Manager 3 (Gremlin)

### MUSIC

- 1 Think Twice (Celine Dion)
- 2 Love Can Build A Bridge (Cher, Chrissie Hynde & Neneh Cherry with Eric Clapton)
- 3 Don't Give Me Your Life (Alex Party)
- 4 Don't Stop (Wiggle Wiggle) (The Outthere Brothers)
- 5 Push The Feeling On (Nightcrawlers)

## THIS MONTH IN... SUPER PLAY



It was X-Men month in *Super Play*, with a feature on Marvel's band of mutants and reviews of two new X-Men SNES games, *Wolverine: Adamantium Rage* and *X-Men: Apocalypse*. Any good? Nope. Both were tediously formulaic side-scrolling yawn-'em-ups. Great source material yet again surrenders to crap gaming.

Both were tediously formulaic side-scrolling yawn-'em-ups. Great source material yet again surrenders to crap gaming.



## AMIGA CU AMIGA

A birthday celebration feature on the history of the Amiga headlined *CU Amiga* this month, which traced

the machine's humble beginnings from Amiga Corporation in the early Eighties and the proposed Lorraine computer to the less-than-impressive Amiga CD32, complete with eight-month lifespan and 100,000 sales.

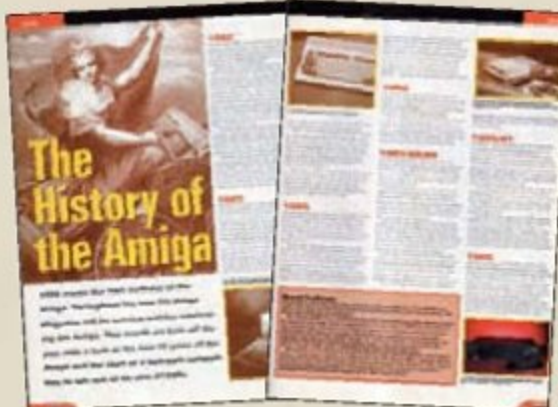

## THE ONE AMIGA



*The One* spoke to Acid Software. The *Skidmarks* developer was suffering with the collapse of Commodore. It bemoaned that "the bottom has fallen out of the Amiga market [...] and just when we were getting our shit together too". Not many more games followed...



» [Amiga] *The Chaos Engine 2*. Looks and sounds like the original but plays like a dog.

Magazines reported that Rare had been put in charge of creating the game and that it was due to appear on the SNES, with a release date pencilled in for Christmas '95.

*GoldenEye*? SNES? Really? Yes... and no. Despite the intention of creating a SNES *GoldenEye* game, it was quickly realised that the focus should be shifted, à la *Star Fox 2*, to the forthcoming N64. SNES *GoldenEye* was due to be a typical rail shooter, but nothing was ever developed. Thankfully, Nintendo decided to change it to a first-person shooter for the N64.

There was once a game called *The Chaos Engine* for a computer called the Amiga. It was a fantastic scrolling shoot-'em-up developed by The Bitmap Brothers. Everyone loved it. This was 1993...

This month brought terrific news: *The Chaos Engine 2* was on the way. A nation celebrated wildly with flags and cake and homebrew beer that smelled a bit funny. One of the best-loved Amiga games, one of the most revered shoot-'em-ups, was about to be made bigger, shinier and better.

The publisher, Renegade, revealed that *The Chaos Engine 2* would have a player-against-player split-screen mode rather than the original's co-operative team-up affair.

From the initial announcement to actual release, it took almost two years. Surely something this well-developed must be astoundingly awesome?

Magazine reviews thought it an excellent addition to Amiga gaming. Conversely, fans of *The Chaos Engine* were violently sick all over themselves at what the Bitmaps had done to their beloved game. As a sequel, it was awful. The gameplay had changed and was repetitive, and it was slow, awkward and just not what *Chaos Engine* fans wanted. As Amiga sequels rank, it was one of the most disappointing.

If you owned a Spectrum in 1984 and were fond of adventures, chances are your pants exploded with the release of Gargoyle Games' magnificent Celtic-tinged *Tir Na Nog*. 11 years later, Psygnosis revealed that it was to update and re-energise the old classic for a new audience of PC gamers.

While the graphics were to be produced from hand-painted drawings, the gameplay would remain the same, meaning lots of exploration and puzzles, and Sidhe to avoid.

Screenshots were seen, interactive CD previews were watched, and everyone waited... and waited. The curse of the abandoned software had struck again. *Tir Na Nog* was never released and the cancellation was never explained.



» [PC] *Tir Na Nog* was being remade. In keeping with Gargoyle Games' other titles, *Gath* and *Fomax*, it never came out.

## MARCH 1995 NEWS

One of Britain's most notorious and feared gangsters, Ronnie Kray, died on 17 March. The 61-year-old suffered a heart attack at Broadmoor Prison, where he was serving life for murder, and he died two days later.

Along with his brother Reggie, the pair ran a gang called The Firm in London's East End during the Fifties and Sixties. The severity of their punishments and beatings gave the brothers a notoriety that followed them into prison. They made a lot of money from crime but also despised certain criminal elements. Despite their brutality, they were well thought of in the East End, with many stating that the streets were a safer place when the Kray brothers were in charge.

20 March saw a terrorist attack on the Tokyo subway system when sarin gas was released on multiple lines of the Tokyo Metro. The Aum Shinrikyo cult claimed responsibility for the act, which left 13 dead and over 5,000 people requiring hospital treatment.

On 22 March, Russian cosmonaut Valeri Polyakov returned to Earth after spending a record 437 consecutive days in space aboard the Soyuz 18 and 20 missions. He had already racked up 240 days on the earlier Soyuz 6 and 7 missions, making a record for cumulative days in space of 678.

28 March gave us the tragic news that country singer Lyle Lovett and actress Julia Roberts were separating after less than two years of marriage. What was she thinking?



» Ronnie Kray with brother Reggie. They kept law and order... without the law...





# Caesar The Cat

A COLOURFUL CLASH OF CAT AND MOUSE

#51



» ZX SPECTRUM  
» MIRRORSOFT  
» 1984

**This single-screen Spectrum game has often been classed as 'educational software', and to be honest I can't see why. To me it's a simple game of fast reaction and is therefore about as educational as *Pac-Man*.**

You play a black-and-white cat, which, being quite fond of cats and not always needing to play the role of a muscle-bound gun-wielder, was its appeal to me. You basically have to catch mice in a larder and then escort them out the cat flap before they eat all the food. How is that educational? If it were teaching you about the behaviour patterns of cats then you would be catching mice outside, playing with them until they were half dead, and then bringing them inside the house for your owner to shriek at. Okay, so it's cuter this way.

All you have to do is think and react quickly, as your actions are timed by an ever-decreasing score, which ends the game when it reaches zero. You

acquire points by getting rid of the vermin but can easily miss the little critters, and, even worse, knock a jar from the shelf that will smash on the ground and lose you points and/or the game.

The cat is extremely cute and nicely animated, and the larder's shelves are full of colourful food. Despite, or probably because of, its simplicity, *Caesar The Cat* is a very addictive game. And what new games allow you to do something as simple as be a cat and catch mice? I guess you would feel more than a little short-changed nowadays, and something like this would probably be a short mini-game in a huge story-based adventure. Back in '84, though, this was enough to keep you glued.

So, through this game I got some idea of what it's like to be a cat.

All *Pac-Man* really taught me was that taking too many pills will make you feel like you're in a looping nightmare, but take a special pill and you will be able to face your demons and stamp them out. Actually, come to think of it, did I learn that from *Pac-Man* or was it my psychiatrist? \*

**RETROBATE  
PROFILE**

- » NAME: STEPHEN WESTWOOD
- » JOINED: JULY 2012
- » LOCATION: NOT GIVEN
- » OCCUPATION: NOT GIVEN
- » FAVE GAME SYSTEM: ARCADE

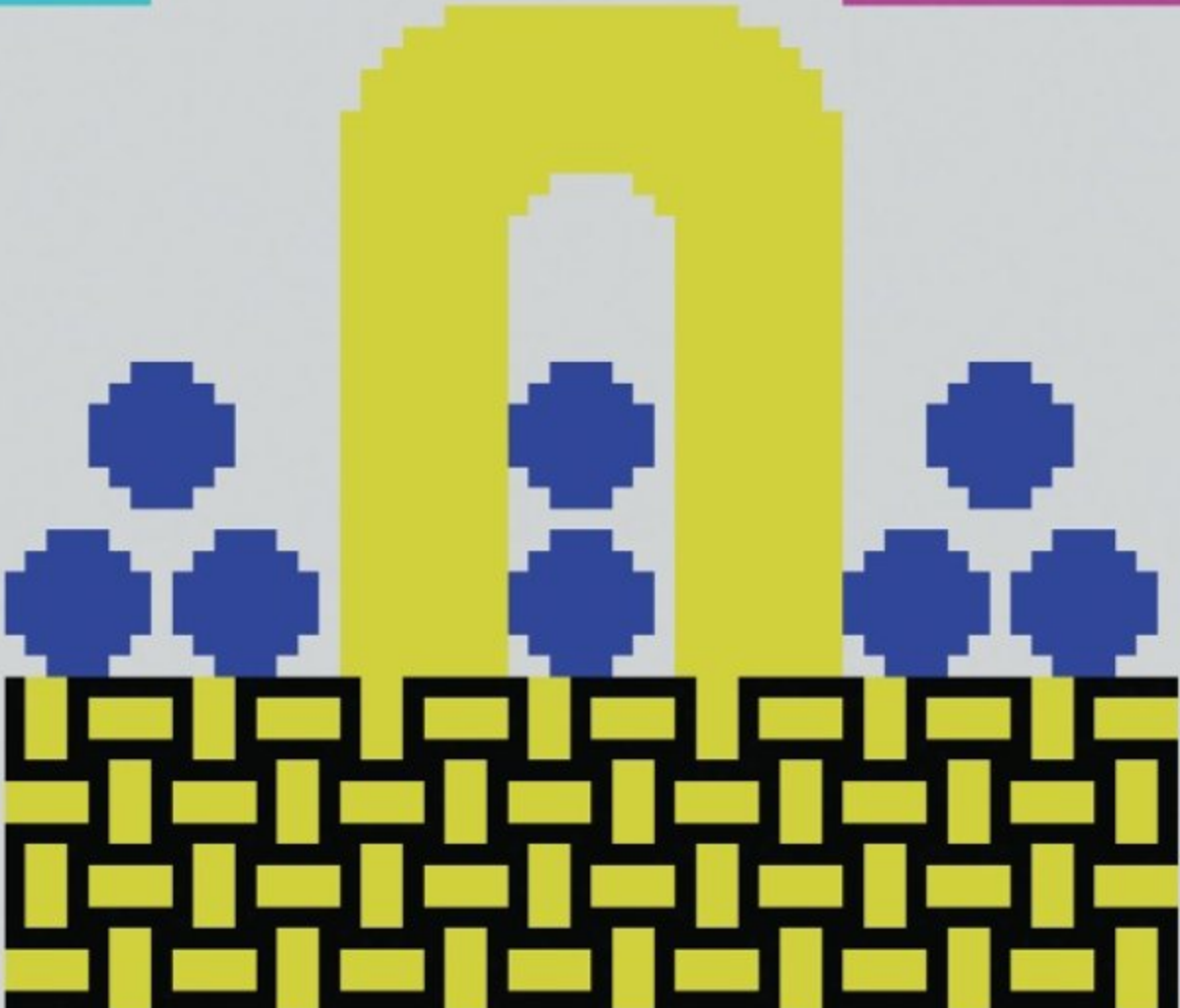
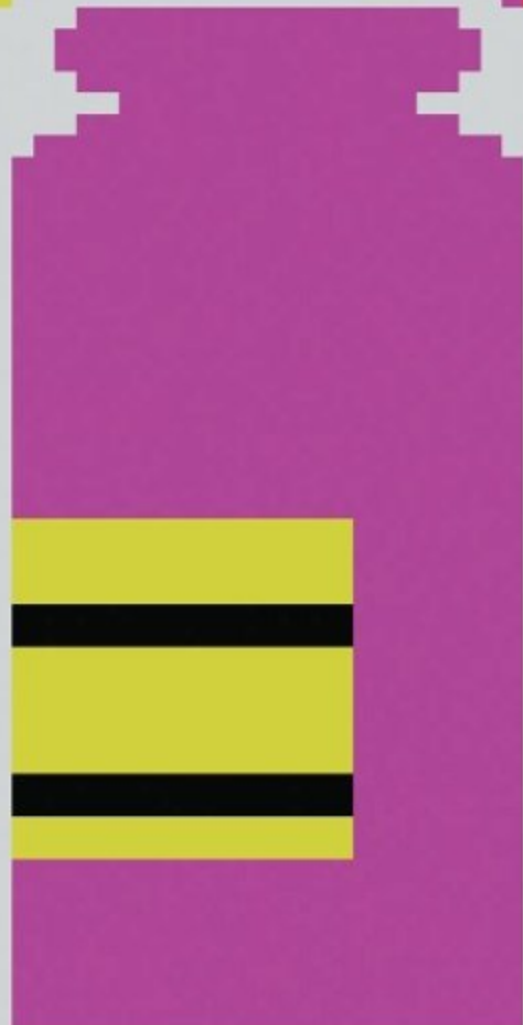
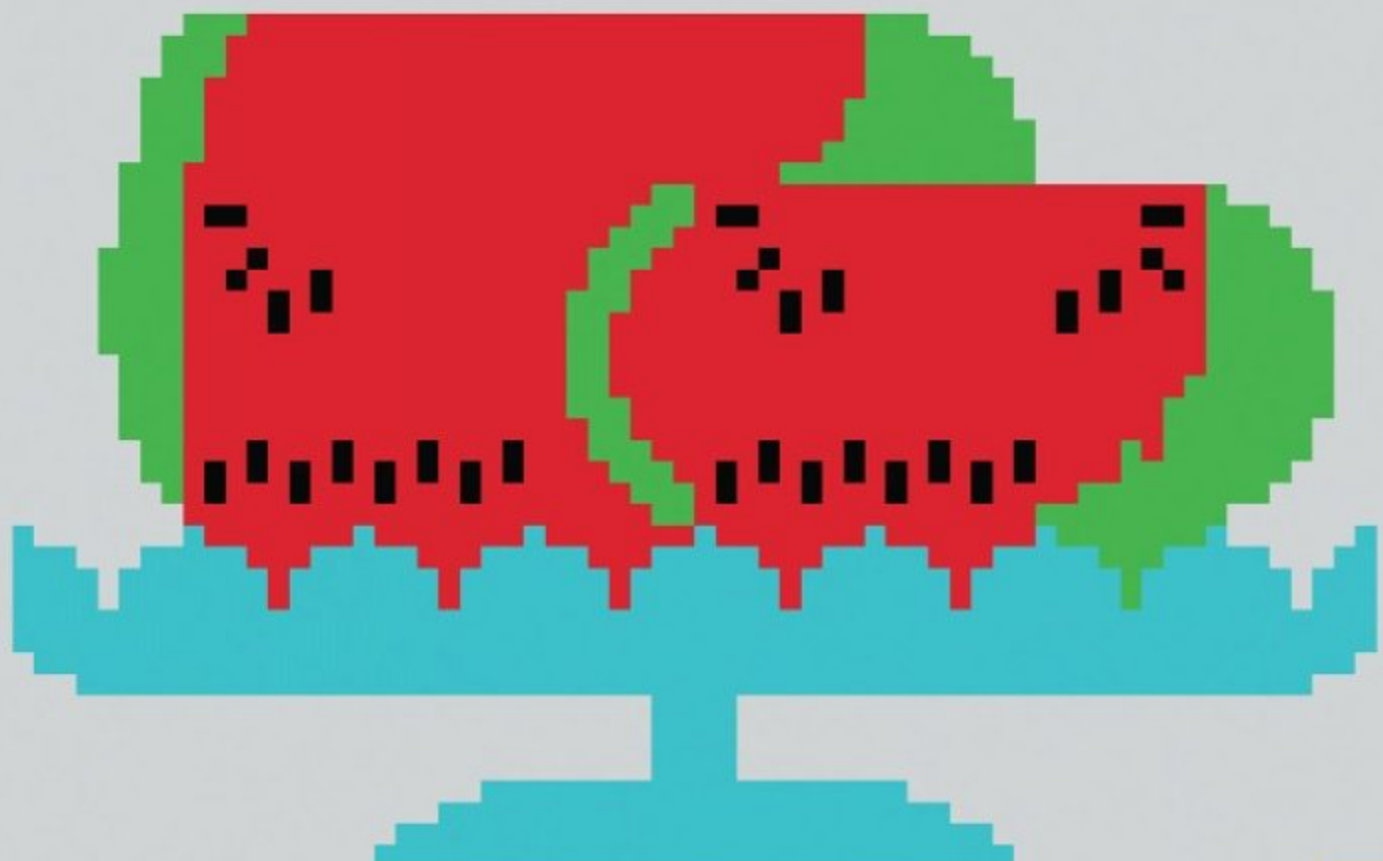
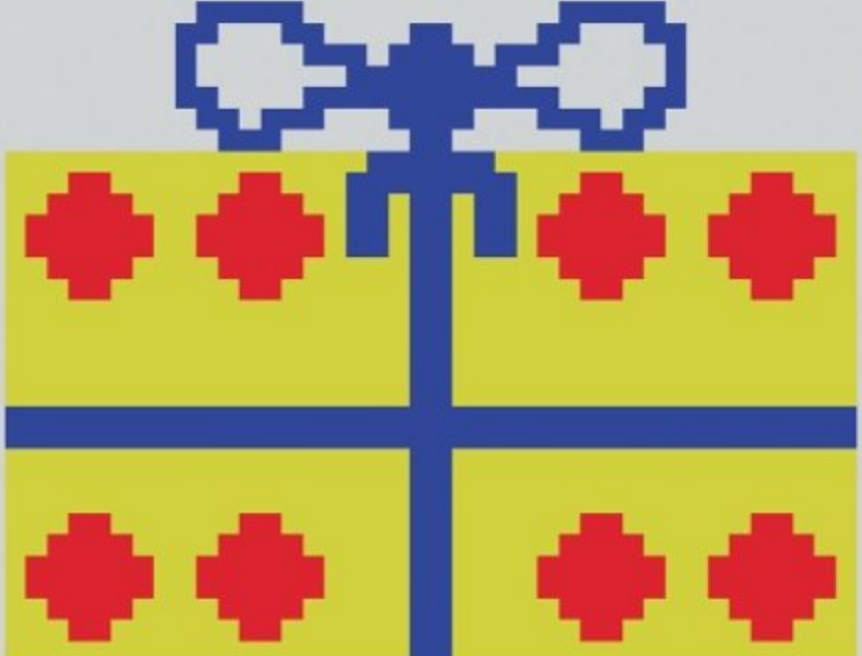

# The Story of PONG

**It was 40 years ago that a simple warm-up engineering project helped thrust a new industry and company into the public eye, forever changing how we view entertainment and becoming the digital fire for the modern caveman. Marty Goldberg takes us through the history and influence of Pong**

**They were at a turning point in their lives. Nolan Bushnell and Ted Dabney couldn't stay with Nutting Associates any more – that much was clear. But what were they supposed to do now to get their two-person game-engineering firm, Syzygy Engineering, out on the market?**

Nolan found the answer by cold-calling several of the 'old guard' arcade game firms in Chicago. Bally, which had purchased fellow manufacturer Midway three years before, was interested in their videogame technology, but not if the duo was still attached to Nutting.

Making a calculated decision, they gave notice at Nutting and rented a 2,000 square foot front-end office with back-end garage on Scott Boulevard to start up operations. Incorporating the company as Atari, they signed a contract with Bally to design a pinball machine, an electromechanical arcade game, and a video arcade game. Money from the contract would come in monthly, and combined with a coin-op route of pinball machines they had purchased from a fellow former Nutting employee, they had enough to get their small firm up and running and hire some employees.

Their first employee was Cynthia Villanueva, a babysitter for Nolan's



## 23

► This Pong cabinet, signed by Nolan Bushnell, now resides at the Computer History Museum in Mountain View, California.

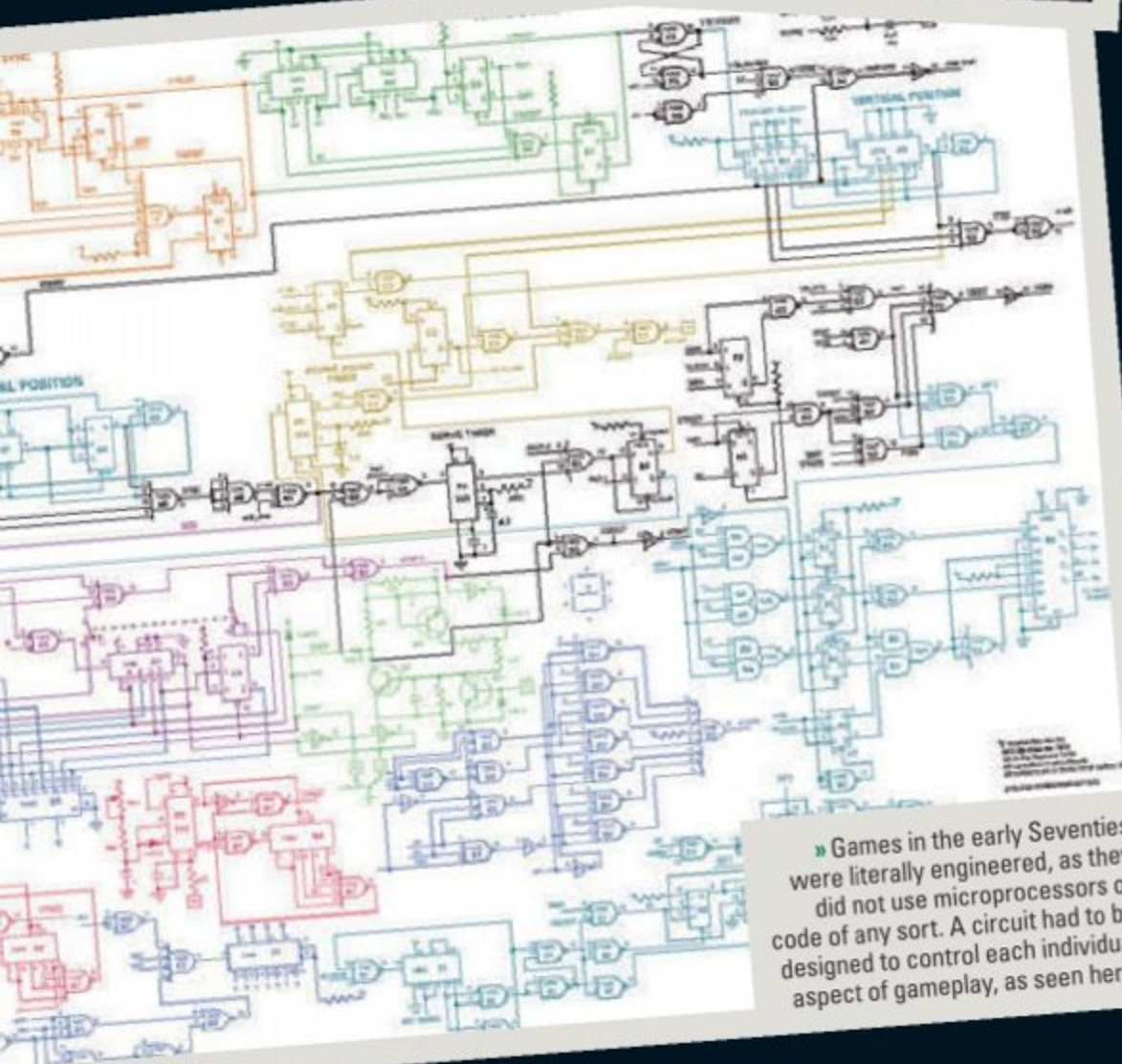

► Games in the early Seventies were literally engineered, as they did not use microprocessors or code of any sort. A circuit had to be designed to control each individual aspect of gameplay, as seen here.

kids who was hired as a combination secretary and work mother for the two, making sure they'd eat during the long hours at work.

It was the second employee, though, that has the real bearing on this story. Al Alcorn had been part of a stable of interns at Ampex's Videofile division when Nolan and Ted worked there. A burly American football player in high school who decided in college that his future lay in electrical engineering rather than the gridiron, he was on his six-month rotation when he first met Nolan and Ted. By the time they were starting up Syzygy Engineering at the end of May, Nolan paid the associate engineer a call.

"He offered me a salary – about \$1,000 a month – and ten per cent of the stock in the company," says Al. "I was already making \$1,200 a month as an associate engineer and the stock seemed worthless to me because I could care less. It was a nice token, but not that important to me. I accepted the offer because I thought that it would be fun."

Al had never seen a videogame before, and Nolan got him up to speed by plopping the diagrams for his and Ted's game, *Computer Space*, into his lap. In between looking over the technology, Al also had to pull his weight in the small startup where everyone had a role. Ted's was to build the pinball machine, keep the company's books, manage the facilities, and run the coin-op route. Nolan's job was to be Nolan – look over progress and, as Al puts it, "keep bullshitting" Bally that they were making progress so it would keep sending cheques. Al's role, besides engineering, was to help collect the coins on the route that was helping to keep Nolan and Ted afloat, since they weren't making a salary themselves.

"[Collecting the money] taught me about designing things that work in a public environment," Al says. "When a machine steals your money you feel you have a right to destroy it. So it has to be really well built, but still be cheap to manufacture. I learned a lot about that from collecting on the route."

Al's conditions were spartan, consisting of a work area with a single old oscilloscope that they all

shared. But the fun he was seeking was just about to begin.

## Pong begins...

It started with a challenge to make a game. Nolan wanted a driving game but had decided that Al needed to warm up with something simple. So Nolan lied to Al, claiming they had a contract with GE for a consumer videogame that had to use very few chips. Thinking back to the Magnavox Odyssey demo he had been to that past May where he saw a tennis game, he decided to tell Al the game was to be an electronic version of tennis. He then proceeded to describe what he saw of Magnavox's game, aiming to have Al tweak it further.

One thing was clear in Al's mind: he couldn't make heads nor tails of Nolan's unorthodox schematics that he'd been trying to study. Nolan had to walk through the basics of the spot-motion circuitry that Ted had designed, explaining how the sync generators work to draw things on the screen.

Al started out by getting a ball moving around on the screen, designing the circuits needed to change direction. This process shouldn't be lost on the reader, who may be more used to today's gaming world where *Pong* is commonly used as an intro to game programming. Arcade videogames didn't use microprocessors at this time, so there was no game code. In those days, videogames were engineered – no different to any other consumer product like a toaster, telephone or stereo. Game designers in the early Seventies were electrical engineers like Al, creating a circuit for every mechanic that would later be done in software.

When Al went to work on the iconic paddle controls for the game, several

## PONG MEMORIES



My first memories of *Pong* are from when my mum got me a Binatone TV Master MK IV in the late Seventies. It was fantastic – you could actually play games on your TV!

It may not look much by today's standards, but it was bloody good fun! So many great memories for a classic game!

**Jim Bagley, Ocean Software**

# HOME-GROWN PONG

A selection of the many Pong variants that were available on the home market

## 01. Magnavox Odyssey

Ralph Baer's influential console was created in 1972 and featured two hand controllers. It is the first home example of a console featuring a tennis game, and inspired Atari to create *Pong*.



01

## 02. Super Pong

Wanting to emulate the success of *Pong* in the home, Atari created Super Pong in 1976. Unlike similar home systems of the time, *Pong* was the only game available on it.



02



03

## 03. Wonder Wizard

General Home Products' Wonder Wizard is an interesting system, as it features a Magnavox Odyssey 300 circuit board in the original Magnavox casing. It features a number of games, including a *Pong*-like version of tennis.



04



05



06

## 04. Telstar Ranger

The Coleco Telstar Ranger was released in 1977 and is a six-game variant of the original Telstar that was released. It came with an authentic-looking pistol and two controllers, with the gun games being *Target* and *Skeet*.



07



08



09

## 05. Video System

This system from First Dimension looked interesting, with the first model being released in 1975. The better 1976 variant, which is the one shown here, played relatively complex variants of *Pong*, including an innovative four-player mode.



10



11



12

## 06. Television Tennis

Does exactly what it says on the tin. This home system was created by a small company called Executive Games and was first released in 1975. It's notable for its chunky design and unusual controllers.

## 07. Heathkit GD-1380

As with other systems featured here, the Heathkit is powered by a universal chip, in this case the AY-3-8500. It's a bit of an oddity, and not just due to its radio-like appearance. It only works on Heathkit TVs and the audio comes through the TV.

## 08. Interfab Pong IV Kit

Another interesting model, as it existed in three distinct forms: fully assembled, partly assembled or in kit form, requiring full assembly. Released by Interfab in 1976, it played just two games, *Tennis* and *Handball*.

## 09. VideoSport MK2

This stylish-looking system is one of the earliest European variants of *Pong*, appearing in 1974/1975. Created by British retailer Henry's, it included three games: *Tennis*, *Football* and *Hole In The Wall*.

## 10. Philips Tele-Spiel

We love the look of this, and not just because of its bright primary colours. It came packed with a *Pong* variant, and four additional games could be purchased. There's no scoring system, meaning players physically score games on the actual controller.

## 11. Videomaster Home TV Game

Another early European system, believed to have been first available in 1974. It played *Tennis*, *Football* and *Squash* and is notable for having a large number of variants.

## 12. Binatone

Distinctive thanks to its orange casing, it's another six-game system, possibly based on the same chip as the Telstar Ranger. It also includes two gun games, with the gun peripheral having a cool scope.

Images courtesy of David Winter. Visit [www.pong-story.com](http://www.pong-story.com) for more great information about *Pong*.



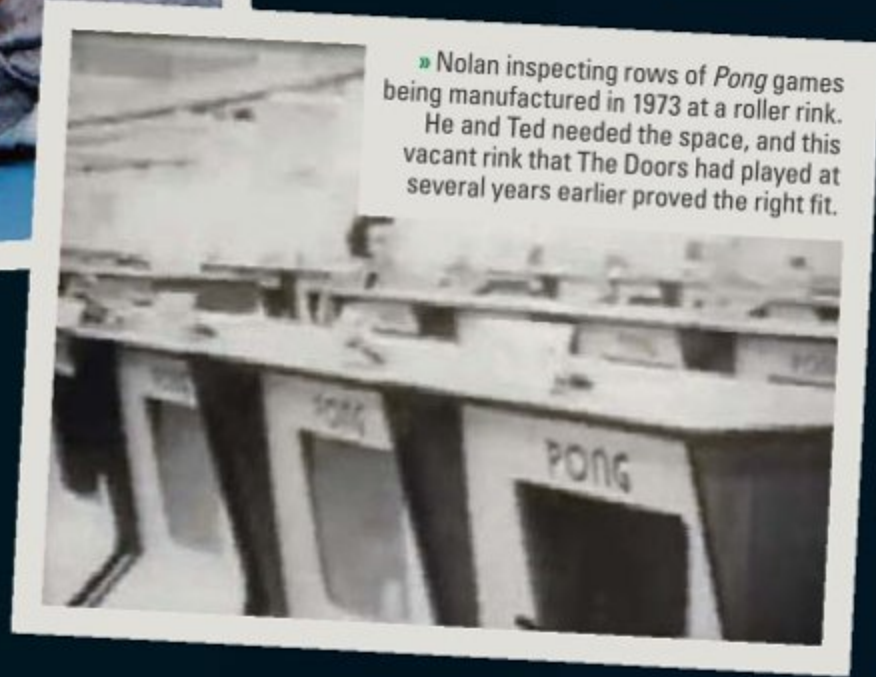

» Nolan inspecting rows of *Pong* games being manufactured in 1973 at a roller rink. He and Ted needed the space, and this vacant rink that The Doors had played at several years earlier proved the right fit.

## “We cut the numbers to Bally to one third. Bally still thought we had exaggerated the numbers”

ideas came rolling out from the creative part of his brain. Ideas that would become an important part of making it the fun game it is to play to this day.

First there was how to do a simpler version of the ‘English’ Nolan had described seeing on the *Odyssey*. Simply a way to make the ball volley off the paddle in unpredictable lines, it makes gameplay between opponents a bit more chaotic, like real tennis. The *Odyssey* uses a separate ‘English’ dial control, but AI was able to come up with a simpler method that proved just as fun.

The paddles in *Pong* are 16 pixels high, and by segmenting it into eight sections each, two pixels high, he was able to dictate how the ball angled off the paddle. The catch was the angles were an illusion created by horizontal and vertical speeds. The horizontal speed was set by how many times a volley occurred between the paddles, a feature that AI had added to make it more interesting.

“Nolan had told me that it had to be a consumer product,” he explains, “so I thought two guys could sit there and play it forever if the ball had just one speed. So I added the speed-up where after a certain number of volleys it would go faster and faster.”

Which segment of the paddle was hit would then decide the vertical speed of the ball. Hitting the top or bottom ones would imbue the ball with the highest speed, with each segment closer towards the centre decreasing. Finally, the middle two segments produce no vertical speed

change. Combined with the variable horizontal speed, players were now able to create a much more unpredictable, entertaining volley.

Another ‘feature’ that AI added to the game actually spawned from a defect in the design. The motion of the paddles on the screen is controlled by a special timer chip, the 555, which uses the motion of the spinner controllers as part of its control. A limitation in the chip caused the paddles not to be able to be drawn all the way to the top of the screen, leaving a small gap that a ball can fit through. Instead of coming up with a fix, AI decided to leave it in as a stalemate breaker.

Nolan’s demand for a low chip count made AI self-conscious through the coming months of the design process. At every turn and request from Nolan to add additional features, AI kept second-guessing how it could be done.

On-screen scoring, an on-screen net instead of one affixed to the TV screen, and then probably the most far-reaching request. When Ted and Nolan came to AI asking for the sounds of a crowd, something had to give. There just wasn’t a budget.

Nolan wanted cheering for scores; Ted wanted boos and hisses for missing a ball. They had to compromise with a blipping sound that’s now synonymous with early videogames and instantly identifies *Pong*.

By mid-August of 1972, about three months since he started, AI had completed his ‘test game’. Nolan was ready for AI to move on to his ‘real project’, the driving game they’d actually be providing to Bally. The tennis game would just fade off into the darkness. There was one problem, though: it was too much fun to play. Ted thought the game was a great finished product and should be the one they submitted to Bally, and Nolan wanted no part of that. The two had what Ted described as a “knockdown, drag-out” screaming match in each other’s faces. The end result was that Nolan agreed to at least test it out.

Going to AI and presenting it as his idea, Ted offered a plan to test out the game at one of their locations, still not letting on that there was no GE contract. AI agreed, still thinking the product had been a failure based on the cost specs he had been given. Ted got a television monitor ready for it, using the same gutting process he had developed when he first created the spot-motion circuitry

### PONG MEMORIES



we are only now working our way back to mass-market casual and social games.

**Trip Hawkins, founder of Electronic Arts**

*Pong* was truly the first casual game and the first social game. Everyone played it. I mean, everyone. It is ironic that videogames after *Pong* quickly became too complicated for the mainstream public and that

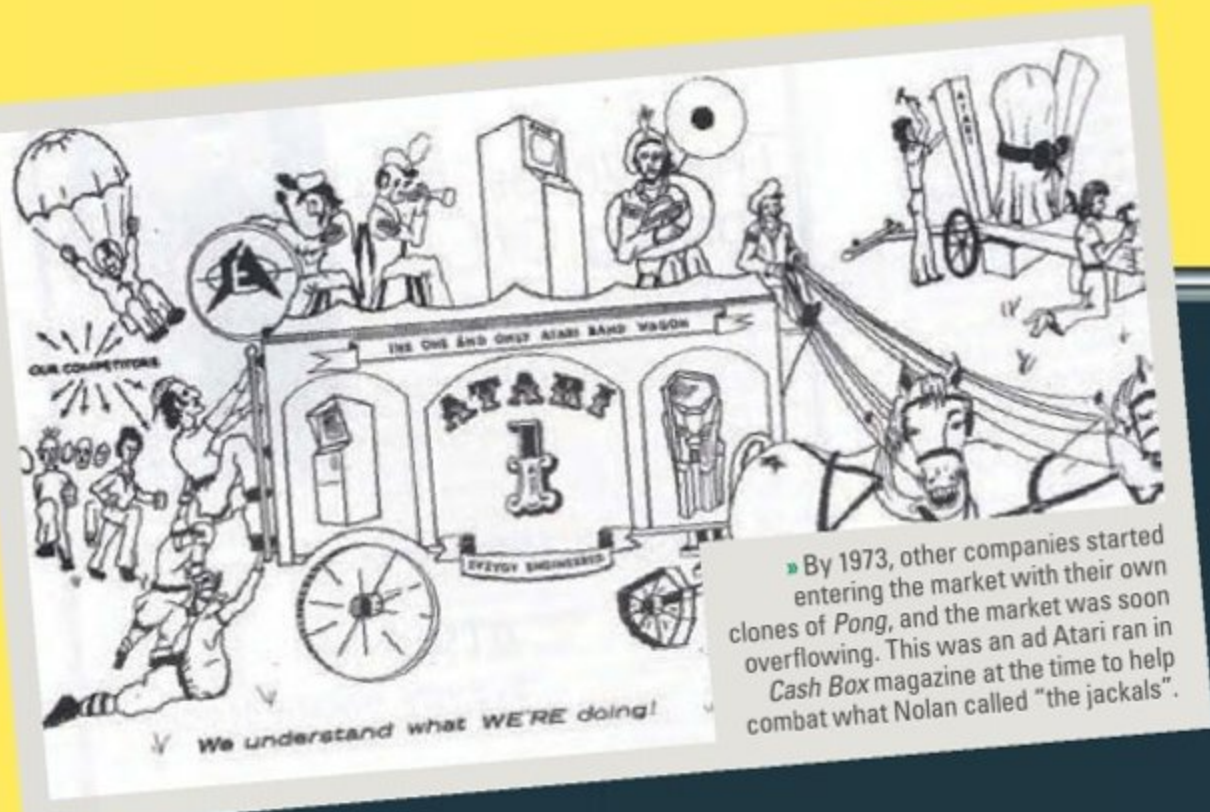

## “That’s when I said, ‘Either we build it ourselves or we go home. I don’t want to go home!’”

for *Computer Space*. He then built a cabinet over the following weekend – a half-sized, boxy design for the television and *Pong* prototype to sit inside. Painted in a garish red/orange colour to attract attention, its size ensured that it would have to be propped up on something to bring it to face level. There were no directions on the control panel, no description of what it was about, nothing. A box with a TV screen, two knobs, and a coin box. There was one thing printed on the metal control panel, though. A single word named after the sound of the game: *Pong*.

They decided to place it at their favourite location out of all of them on their coin-op route: a tavern called Andy Capps. With seven machines there already, they elected to set the *Pong* prototype on top of a barrel next to *Computer Space*.

The legend today goes that the machine stopped working because of overflowing coins, but that’s not the case of the first breakdown. The first time was because of cheap potentiometers, the electronic component that the spinners are actually made from. They’re usually rated for a certain number of turns, and AI calculated by the quantity of coins in the box that it was getting far more than

what it was rated for. Probably about 100,000 turns by the end of the month.

Then, shortly after that, AI got the call for the more famous problem. The owner of Andy Capps called him to say the machine stopped working and that they should come down and fix it because there were lines of people still waiting to play. After heading down and opening the coin box, AI suddenly found an avalanche of quarters flowing out. The only reason the game had stopped working was that the coin mechanism, appropriated for *Pong* from a laundry machine, had overflowed onto the circuit board. A simple fix, but also a promising start.

Nolan and Ted decided to go ahead and build another 12 *Pong* machines in more standard-sized cabinets. Ten would go out to the other locations on the coin-op route, and they’d keep one at the office. The final one would be sent to Bally to evaluate for the fulfilment of the videogame portion of their contract. Yes, Nolan had acquiesced after the success at Andy Capps.

### Success and manufacturing

The numbers kept coming in through September and they couldn’t believe it. The new *Pong*-filled coin-op route had almost tripled their earnings. Ted was making enough money to look at replacing his old car. This game was going to be a big moneymaker for Bally – if it ever responded.

Nolan kept in contact with Bally, but it was apparent that it was stalling. Ted explains: “We were getting plenty worried because our future was in Bally’s hands. We decided to put together an income report to give Bally some incentive. As we put this report on paper, the numbers looked impossible. We knew that they would think that we cooked the books.

### PONG MEMORIES



What’s funny is that I thought *Pong* was old-fashioned in 1982 when games like *Pac-Man* were on the scene, but today I find it a total joy to play. *Pong* is the eternal classic that excels because of its simplicity and fun gameplay!

Mark Bussler, Classic Game Room

“Since the numbers were so damned high, I suggested that we cut the numbers to Bally by one half. The numbers still looked unlikely, so I said that we needed to go to one third. A couple of the machines were much lower than the others, so Nolan suggested that we not cut those ones so drastically. I said that if we’re going to lie, we have to be consistent so we would remember what the lie was. He agreed.

“Believe it or not, Bally still thought we had exaggerated the numbers. They were still stalling, but they owned it so we were up a creek. That’s when I came up with the idea to get Bally to reject the game.”

Nolan, Ted and AI were in Nolan’s office, contemplating their frustration and trying to think about what they could do. Bally owned all the rights to *Pong*, since the game had been submitted as the videogame portion of the contract between the two companies. Even if they decided that they wanted to try to manufacture it themselves, they were legally and ethically proscribed from doing so.

Ted further explains: “That’s when I said, ‘Either we build it ourselves or we go home. I don’t want to go home!’ We went over what the costs would be and Nolan and AI agreed that we couldn’t afford to do it. I echoed my statement and said that we needed to make a decision. I said, ‘If we decide to build it ourselves then we can work on how to get it done. If not, we go home.’”

In the end, none of them opted for going home. Ted said he would handle the TVs and

### PONG MEMORIES



All of [Andrew’s and my] early programming attempts were to rewrite *Pong* on our brother’s ZX81. I wouldn’t be surprised if every games programmer that started in the late Seventies confessed that one of their first games was a *Pong* clone!

Philip Oliver, CEO of Blitz Games Studios



**Tennis For Two**

» YEAR: 1958  
 » SYSTEM: ANALOGUE COMPUTER/OSCILLOSCOPE  
 William Higinbotham fiddled around with one of Brookhaven National Laboratory's early computers for calculating missile trajectories to simulate a crude game of tennis. We're betting productivity at Brookhaven dropped dramatically.



**Top Players Tennis**

» YEAR: 1989  
 » SYSTEM: NES  
 This is the earliest example we could find of a celebrity-endorsed tennis game. The players in question are Chris Evert and Ivan Lendl. It also allows four people to play at the same time, as long as you have the relevant NES adaptor.

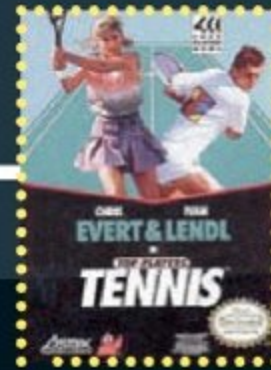

**Super Tennis**

» YEAR: 1991  
 » SYSTEM: SNES  
 Although it's not the most innovative game in our selection, *Super Tennis* definitely deserves to be here. It's quite simply the best 16-bit tennis game ever made, with a masterful selection of shots and incredibly nippy gameplay. Nice Mode 7 court effects as well.

**Jennifer Capriati Tennis**

» YEAR: 1992  
 » SYSTEM: MEGA DRIVE  
 There are lots of tennis titles that focus around classic male players, but this is the only one to be based on a popular female tennis star. While it plays a decent game of tennis, there are more notable titles to feature celebrity endorsements.



**Pete Sampras Tennis**

» YEAR: 1994  
 » SYSTEM: MEGA DRIVE, GAME GEAR  
 This fun offering from Codemasters featured Pete Sampras and was the first game to utilise the company's J-Card technology, allowing two pads to be plugged into the cartridge, and featured some fun mini-games, including a cameo from Dizzy.

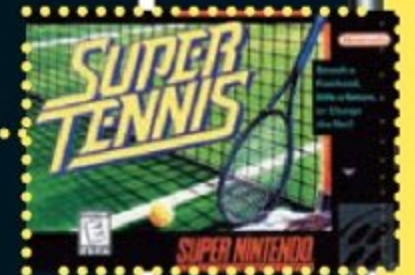

# ANYONE FOR TENNIS?

A look at the rich and varied world of videogame tennis

**Pocket Tennis Color**

» YEAR: 1999  
 » SYSTEM: NEO GEO POCKET  
 While it lacks the structure of *Mario Tennis*, this superb little offering remains our favourite handheld tennis game because it's so much fun to play. Sublime controls and an excellent two-player mode make it a timeless portable classic.



**Virtua Tennis 2**

» YEAR: 2001  
 » SYSTEM: ARCADE, DREAMCAST, PS2  
 Sega's original *Virtua Tennis* was so good that it became an extremely hard formula for Sega to improve on. It managed it, though, thanks to even more players and an improved single-player campaign, along with a pile of excellent mini-games.



**Mario Tennis**

» YEAR: 2000  
 » SYSTEM: NINTENDO 64, GAME BOY COLOR  
 Camelot's excellent tennis game proved that, with the right care, *Mario* could work in anything. Mini-games galore, excellent gameplay and a motley crew of Nintendo favourites turned *Mario Tennis* into one of the N64's best sports games.

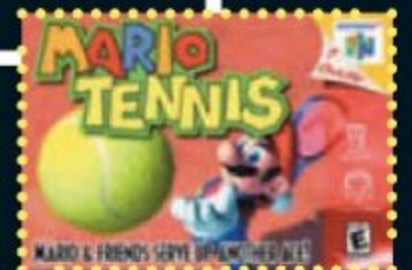

**Outlaw Tennis**

» YEAR: 2005  
 » SYSTEM: XBOX, PS2  
 An unusual tennis game, because the only endorsement isn't a player but political satirist Stephen Colbert, who commentates. While it tries to shock with its cast – a PhD stripper, a convict and a Jewish ninja, among others – it plays a rather rudimentary game of tennis.

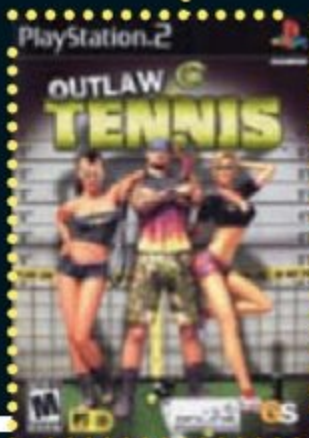

**Wii Sports**

» YEAR: 2006  
 » SYSTEM: WII  
 The pack-in game for Nintendo's Wii featured a truly wonderful game of tennis that really came into its own thanks to the innovative motion controls. The sequel in *Wii Sports Resort* was better thanks to MotionPlus control, but the original remains so much fun to play.

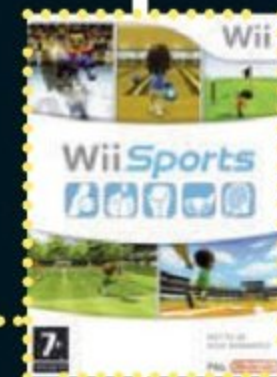

cabinets, and Al and Nolan could work on the boards and components. Nolan and Ted then crafted a letter to Bally as well as their strategy for when Nolan went in to meet with its management.

In a move that would make Obi-Wan Kenobi proud, they convinced Bally that this wasn't the droid it was looking for. An incredible feat, considering that Bally's subsidiary, Midway, was actually interested in releasing the game. Nolan managed to talk them out of it by playing both groups against each other, claiming to each that the other didn't want *Pong* so that in the end they really didn't. Per Ted's suggestion, they offered to replace it with another game, but only if Bally formally rejected *Pong*, returning the rights to Atari. When the formal letter came, the ruse had worked, but better than they had expected. Bally had cancelled the entire contract, including the pinball machine.

Ted set about designing the now-famous bright yellow and woodgrain

## “Without Pong, you'd have no Coleco or Nintendo entering videogames”

cabinet and getting the television sets they'd need to modify to put in the cabinets. The plan was to make 50 *Pong* cabinets to sell, a modest amount but one that would still strain the small amount of storage space they had in which to manufacture them.

After the design for the cabinet was done, Ted started looking for someone

to manufacture them in bulk. After one false start that was too cheaply put together, he found the answer in the form of PS Hurlbut, a local cabinet maker. Ted said they might not be able to pay for them all at once, but the owner said it was not a problem because of their line of credit through a local bank. Then, suddenly, two weeks later, he received a call that the cabinets were ready, to come pick them up. There

was no way Ted or Nolan had the transportation, but Hurlbut delivered them – all 50 at once. Atari didn't have the room for all of them inside the small leased area, let alone room to do the work to install the components.

By chance, though, the candle maker next door happened to move out in the middle of the night, leaving a vacancy. Without asking permission, Ted used a sabre saw to cut a large hole through the wall separating the two properties. Now they had plenty of room!

Ted also used his own money to pick up 50 13-inch black-and-white Hitachi TV sets that were going to be taken apart and used for the monitors inside each *Pong* unit. Costing \$3,000 in total, the investment out of his own pocket was well worth it in his mind. They had a chance to make more money in the long run.

In the meantime, Nolan had a slightly easier job getting the PCB manufacturing going. He literally just walked across the lot from their rental unit to another one where a small PCB manufacturer was located. Though he and Al also tracked down sources for the rest of the parts they needed, Nolan's overall job was... well, nobody really knew.

## Happy faces in your waiting room.



► In an effort to expand its locations and potential buyers, Atari promoted *Pong* to department stores and doctor's offices. Seen here is a flyer for *Dr Pong* and *Puppy Pong*, which are simply *Pong* housed in a waiting-room-friendly cabinet.

### PONG MEMORIES



*Pong* was such a seminal, powerfully influential game that Bill Budge's first Apple II high-res 6502 program was a *Pong* ball bouncing on the screen, and it blew him away. Creating the original *Pong* experience himself seven years after the original appeared was still an event of magnitude.

John Romero, Loot Drop

It was 27 November, and Ted and Al set about assembling the units, as did a few of the other people they had taken on. But Nolan largely stood around, watching while everyone assembled. Ted walked up to him and said: “What are you doing? We're assembling these things; now it's your job to go sell them.”

With what Ted describes as a “hang dog” look, Nolan went back to his office to start making calls. The price had already been decided: \$937 per *Pong* unit. Picked by Ted after he saw the number on the licence plate of a car in the parking lot, it put them in the sub-\$1,000 price point they wanted. Nolan returned only an hour later, looking white as a ghost. After making just three calls, he informed them that he had sold 300 units – 50 to one, 100 to another, and 150 to the last. They were in business!

### Legacy

While the Magnavox Odyssey and *Computer Space* had been first in the consumer and coin-op industries respectively, it was *Pong* that would really drive the move towards videogames in the public consciousness and jump-start both industries. By June of 1973, Atari had already sold 3,500 units, which was stellar in a time when



# PONG SEQUELS

## Pong Doubles (September 1973)

The first follow-up to *Pong*. *Pong Doubles* moves the game into a four-player variant by re-creating the doubles tennis format. Four staggered paddles controlled by four separate spinners create a unique co-operative version of *Pong*.



## Super Pong (February 1974)

This adds three paddles to the player's spinner and random starting points for the ball's serve. The three-paddle horizontal format was later leveraged vertically in games like Atari's *Avalanche* and Activision's *Kaboom!*



## Quadrapong (March 1974)

This is another move by *Pong* into the four-player realm. In this version, each player guards their own goal with their individual paddle. The player can only miss four times before their goal closes up and they're out.



## Pin Pong (October 1974)

The first pinball videogame, done *Pong*-style. It was still just a ball and paddle, but in this case the flippers were the paddles. There are no real flippers on screen; an image of a paddle angled to the real horizontal one is quickly substituted to create the illusion.



## Tournament Table (March 1978)

This is a collection of all of Atari's paddle-and-ball games in a single cocktail-style arcade cabinet. *Breakout*, *Quadrapong*, *Foospong*, *Handball*, and multiple variants of *Soccer*, *Hockey* and *Basketball*.



## PONG MEMORIES



*Pong* was probably my most desired toy that I never actually got. I loved the game – used to play in arcades – but it was always that little bit too expensive for us to buy. You can imagine my awe when I actually got to meet and subsequently become friends with Nolan Bushnell! Life is funny sometimes.

Gary Bracey, Ocean Software



» The inside of the first *Pong*. A simple wooden shelf with a standard 13-inch black-and-white Hitachi that Ted picked up. The prototype *Pong* sits in the bottom of the cabinet.

most runs of traditional coin-op games like pinball were 1,500 units. At the end of its manufacturing life, around 8,000 units were sold. This was all in the midst of an explosion of clones by other manufacturers, including Bally/Midway.

The press jumped on the new medium, whose name still hadn't been defined yet. It could be regularly seen labelled as TV tennis, TV games, Space Age games, video action games, electronic games, television skill games, video skill games, Space Age pinball and just plain videogames. But Atari's *Pong* and *Pong*-flavoured follow-ups were most assuredly in the front.

*Pong* reached such iconic status that it has influenced pop culture as well, becoming a recognisable symbol of the Seventies, with appearances in movies and television shows from that decade onward.

The impact of *Pong* on the industry simply cannot be diminished. It launched the company that was synonymous with videogames and high technology, solidified and trumpeted the home videogame industry, launched entire genres that branch from it, like the *Breakout/Arkanoid* style of games.

*Pong*, in all its simplicity, revolutionised the way we look at interactive entertainment. It created an

acceptance of the amusement industry at a time when it was associated with organised crime and back-room bars, and showed the promise of the future of high technology as it was entering the public consciousness.

Without the impact of *Pong*, you'd have no companies like Coleco or Nintendo entering videogames, both of which started with clones of the game. It was Atari's Japanese coin-op division, which started out making *Pong* machines in Japan, that was sold to Namco to become its own videogame division. Likewise, jukebox company Konami was inspired to enter the videogame industry over the success of *Pong*.

There are also the legions of game programmers, on just about every platform imaginable, who cut their teeth programming versions of *Pong* as their 'Hello world' beginner's app. *Pong* or versions of it have been ported to any system you care to mention precisely because of this.

With its recognition in museums and archives around the globe, *Pong*'s importance to industry and culture has come to its highest level. And now, here we are, 40 years later, paying homage to the game that started as a warm-up and truly warmed up the industry.

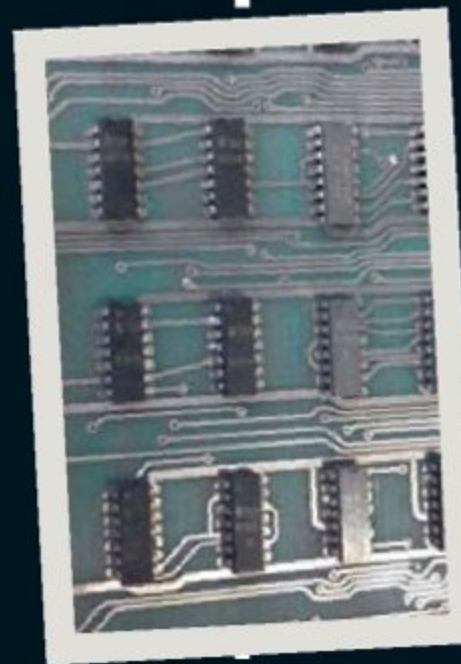

# CLASSIC GAMING ON A BUDGET CHEAP AS CHIPS



If there's one thing we've learnt about retro gaming, it's that your money can stretch an amazingly long way if you want it to. Granted, a mint copy of *Radiant Silvergun* is going to cost you a small fortune, but there are plenty of other worthy titles that can be picked up for less than a fiver...



» [PC] You can pick up monsters in order to quickly transport them to desired locations.



» [PC] The bigger you make your lair, the more monsters you'll attract to it.

## DUNGEON KEEPER



### INFO

- » SYSTEM: PC
- » ALSO AVAILABLE ON: N/A
- » RELEASED: 1997
- » PUBLISHER: ELECTRONIC ARTS
- » DEVELOPER: BULLFROG PRODUCTIONS

From *Theme Park* to *Magic Carpet* and *Syndicate*, Bullfrog delivered an outpouring of innovation that few developers could match, and it was never more apparent than with the excellent *Dungeon Keeper*.

To the uninitiated, *Dungeon Keeper* appears to be nothing more than a typical RTS game – a genre popularised by the success of *Command & Conquer*, and one that was rapidly saturating the PC market. *Dungeon Keeper* proved to be so much more, though, and while it utilised many of the core mechanics that had been a staple of the genre, it added its own typically unique Bullfrog spin.

*Dungeon Keeper's* masterstroke was that you weren't the good guy, but instead an evil overlord who was attempting to

overthrow the sickeningly sweet world by breeding a large number of outlandish minions. Imps provided most of your monster force and could mine out new areas for you, gather gold, transport traps and offer you unwavering loyalty. Far stronger monsters could be introduced into your dungeon, and could be powered up with new spells as they grew in stature, but they would often need numerous requirements to be met before they became loyal to you. Creating a lair and a hatchery of a certain size, for example, would attract the slow but strong Bile Demon, while an orc would require a more moderate training room and barracks before he joined your dark cause.

There were further issues when assembling your army, though, as some monsters didn't get on with others, so careful management was needed to ensure that your followers wouldn't turn on each other before you could eliminate your common foe. Add in an escalating wage bill, as more monsters flocked to your cause, and *Dungeon Keeper* became an incredibly rich resource-management game in which you became fully immersed.

As your dungeon grew in power it attracted the attention of the heroes that protected the lands you were ransacking. Said adventurers would begin to break into your hideout, and ranged from wily thieves who would make a beeline straight for your precious to deadly spell-flinging wizards.

In addition to being a unique take on a well-established genre, another key element to *Dungeon Keeper's* success was its brilliantly dark sense of humour. Misbehaving underlings could be smacked about by your disembodied hand; the torture-loving Dark Mistresses would happily torture themselves instead of training; and each new level featured a hilariously narrated spiel about the land you were invading.

*Dungeon Keeper* may be 15 years old now, but it remains just as addictive as the day it was released. Typically British and filled with delightfully clever touches, it proves that even the most well-trodden of genres can be revitalised with a bit of care, attention and genuine innovation.

Special thanks to [www.gog.com](http://www.gog.com) for supplying us with code.

### BUILD A BETTER DUNGEON



**1. Dungeon Heart**  
This is the beating heart of your dungeon. Literally. If it's destroyed, your days of evil will be at an end.



**2. Hatchery**  
Monsters need food to survive. This steady supply of delicious chickens will keep critters well fed and morale high.

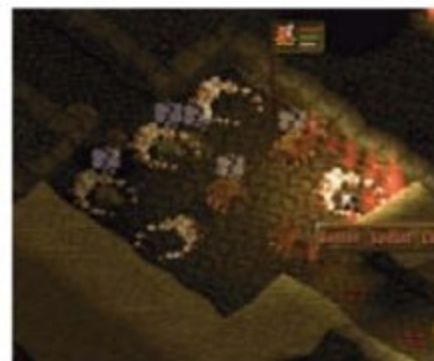

**3. Lair**  
All work and no rest make for dull monsters. These handy areas ensure your monsters will be in tip-top condition.



**4. Library**  
These areas are extremely important, as they enable you to research spells. Better spells mean better success.



**5. Training Room**  
Level-up your monsters by letting them train in these handy rooms. They'll have bigger muscles in no time.



**6. Treasure Room**  
There are rich gold veins to be mined in *Dungeon Keeper*. This is where you can dump your precious reserves.

# UK'S NO.1 INDEPENDENT PLAYSTATION MAGAZINE

NEW  
ISSUE  
OUT  
NOW

- ▶ BEST EXCLUSIVES
- ▶ BIGGEST REVEALS
- ▶ BREAKING NEWS
- ▶ TRUSTWORTHY REVIEWS
- ▶ INDUSTRY INSIGHT
- ▶ LONGEST-RUNNING PLAYSTATION MAGAZINE

Available  
now on the  
Apple iOS 5  
Newsstand  
app



## IT ONLY HAS EVERYTHING...

 facebook.com/PlayMagUK  youtube.com/PlayMagUK  twitter.com/PlayMag\_UK

Join the PlayNation @ [www.play-mag.co.uk](http://www.play-mag.co.uk)

## Get your copy today

✓ Print ✓ iPad  
✓ iPhone ✓ Android



Quality print edition on sale at [imagineshop.co.uk](http://imagineshop.co.uk)

Interactive digital edition on all platforms on sale at  
[www.greatdigitalmags.com](http://www.greatdigitalmags.com)

Also available at all  
good newsagents

THE  
MAKING  
OF

鉄





# 拳 TEKKEN

Within a few short years, Tekken had gone from lowly underdog to juggernaut franchise, but behind the scenes times were changing at Namco. Sorrel Tilley sat down with developer Yutaka Kounoe to hear all about the trouble with Tekken

The early Nineties saw an explosion in the popularity of 2D fighting. Inspired by the success of *Street Fighter II*, countless contenders entered the ring to duke it out for the top spot. While *Mortal Kombat* was locking horns with Capcom's golden child, and the likes of *Eternal Champions* were pootling about in the background, Sega had been working on a new breed. *Virtua Fighter* showed that 3D fighting games were the next big thing for arcades, and Namco wanted some of the action.

Yutaka Kounoe was in for a surprise, though. Fresh from working on *Point Blank*, he wasn't expecting his world to get turned upside down. "My role was mainly to ensure that the original arcade version was actually fun to play," he explains to us. "This meant I had to unify the different techniques, while preserving each character's individuality. For this purpose, I spearheaded a tuning team to manage the adjustments. I basically set up and led a Namco

version of Nintendo's Mario Club. I also created some of the character motions and things like that. Back then it was the dawning of polygonal animation, so a specialised group working on motion didn't exist yet. The designers had to do it themselves."

The creation of motion data was hard work because automated motion-capture technology was still in its infancy, meaning that animation had to be done by hand: "Essentially, we hardly used motion capture at all for *Tekken 1* and *2*," Kounoe reveals. "At that point, motion capture was just a developing industry, so we used a magnetic system to capture a portion of the movements we required. This was a method where everything had to be recorded with cables attached, and it wasn't suited to intense action, so we could only use it for reference. However, the promotional department leveraged the appeal of motion-capture technology for marketing, and made out that we had used it extensively. The motion in *Tekken* was minutely adjusted to perfection, frame by frame, so even if we had used motion capture, we would have had to redo most of it anyway."

Motion capture was the least of

Kounoe's worries, however; new policies were being put in place that would make *Tekken's* production unlike any game he had worked on before. "The creation of the *Tekken* series was completely different to the common development process," he says. "Normally, in Namco's corporate culture, game designers would put all of their carefully thought out ideas into a document, and before beginning work on it, everyone would be asked to consider the contents and submit ideas for improving the quality of the product. However, with *Tekken*, many staff members were recruited mid-career from other companies. The result was that this fundamental style of game design was cast aside and we started work on the game in the midst of an inter-developer battle. What's an inter-developer battle? It's a method whereby anyone can freely implement an idea they think is good, and if it's unpopular, other staff members can just overwrite the data with something else! This led to a lot of clashing of egos – it was a project where you'd gradually start to hear staff members spouting lines like, 'There's no way I'm losing to him!' There were members who liked to mouth off too, which pushed people to create



## IN THE KNOW

- » PUBLISHER: NAMCO
- » DEVELOPER: IN-HOUSE
- » RELEASED: 1994
- » PLATFORM: ARCADE, PLAYSTATION
- » GENRE: FIGHTING



» Tekken 2's promotional material boasted of the new time-release system.

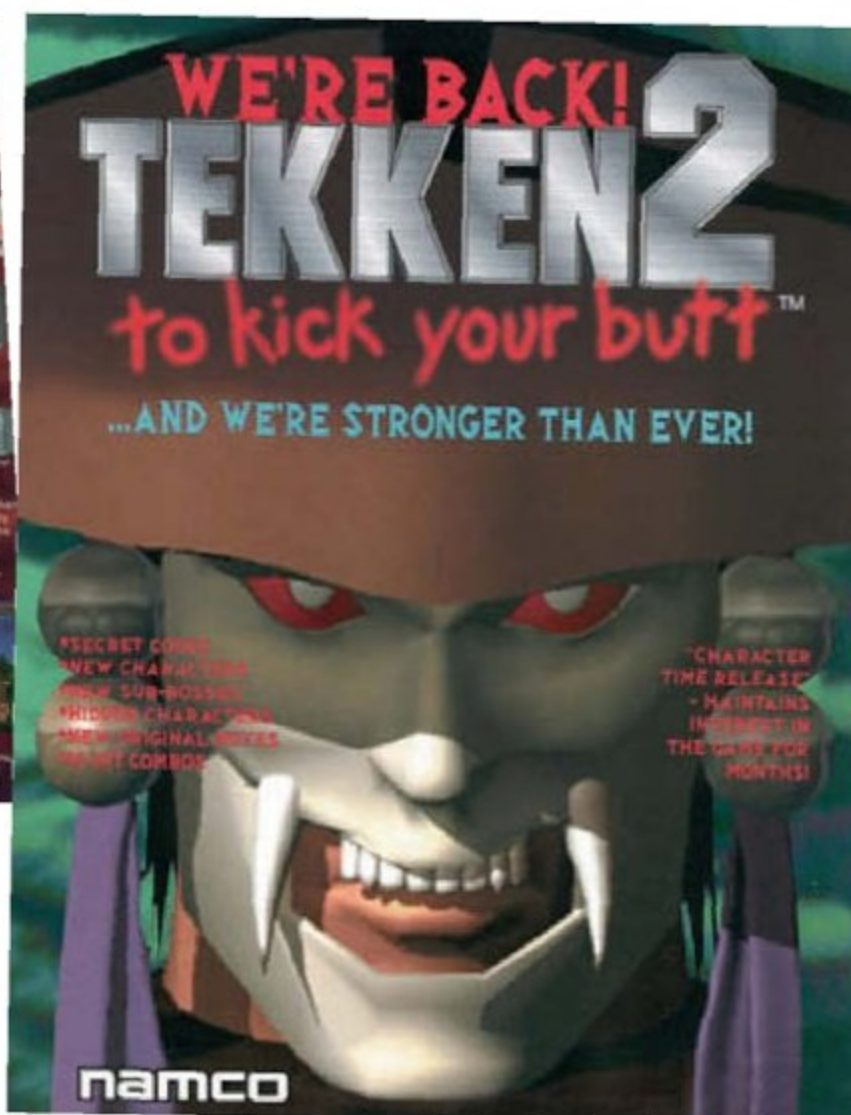

# THE MAKING OF

## A HISTORY OF VIOLENCE

How Namco established itself as one of fighting games' foremost developers



**Knuckle Heads [1993]**  
Namco entered the booming market for 2D fighting games with this four-player scrapper.



**The Outfoxies [1994]**  
Interactive environments and a range of inventive characters and weapons bring *Smash Bros* to mind.



**Soul Edge [1996]**  
Namco's experiment in gorgeous weapon-based combat spawned an entire series.



**SoulCalibur [1998]**  
Introduced eight-way movement and a new name, confirming the series as a major player.



**Tekken Tag Tournament [1999]**  
After three main entries, *Tekken* received this team-based spin-off in arcades and for the PS2's launch.



» [Arcade] If you thought *Tekken* was more grounded than *Street Fighter*, think again.



» [Arcade] Fan favourite Yoshimitsu has been practising his swordplay for *Tekken 2*.



» [Arcade] Paul's changed quite a bit since he made his debut in the original *Tekken*.

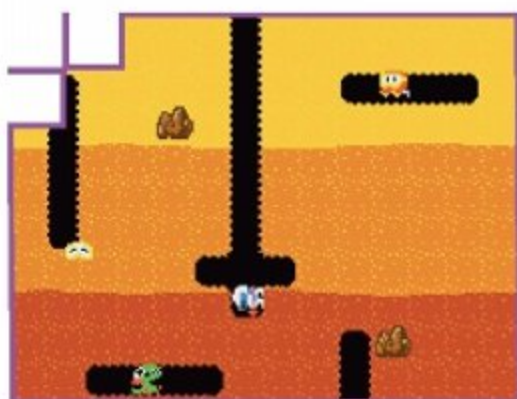

### DEVELOPER HIGHLIGHTS

**DIG DUG (PICTURED)**

SYSTEMS: ARCADE

YEAR: 1982

**POINT BLANK**

SYSTEM: ARCADE

YEAR: 1994

**TEKKEN**

SYSTEM: ARCADE

YEAR: 1994

things of such high quality that nobody would be able to say a word against them. That's the kind of unprecedented project it was."

The wiki-style development process led to motion data being overwritten without warning, combo techniques being joined up and disconnected, and daily modifications to characters' costumes. This constant stream of additions and alterations formed a bottleneck, and Kounoe's tuning team was working in it. "I set up the tuning team for the original *Tekken*, and steadily expanded it by adding new staff members," he remembers. "It went from just one part-timer and myself to 30 employees at its height. In my student days, I would spend each month aiming for the highest arcade scores in Japan; in my tuning team we had all taken up the job of high scorer. Those who 'graduated' from the team were later chosen for top producing and directing positions, and now they hold up the Namco brand. The members were all workaholics; we lived at the office. We used to line up chairs to sleep on because the floor was cold. We were constantly suffering from sleep deprivation because we had to test that every technique for every character functioned normally, so one by one we tried the moves in every

direction to confirm they worked. If the tuning team didn't exist, there would have been no *Tekken*. It was built by the earnest hard work of the staff.

"There was a mountain of problems with the project, most of which were resolved by the wrath of the major staff members. There was a very fierce and passionate collision of game design philosophies. There was also a very low level of efficiency, and the amount of work that each person produced was huge. Consequently, there was an unprecedented variety of ideas, rather than it being the creation of one designer. We ended up with a very bizarre game. The result of this was that unregulated raw materials were being implemented one after another, so the work of the tuning team became extremely difficult – having to retain the characteristics of each of these elements while balancing performance. With a normal development schedule, you make a plan that separates the raw elements so the differing styles and abilities are easily distinguished, and the man-hours required of the tuning team are small. With *Tekken*, designers were becoming obsessed with their own ideas, and continued implementing them at random. Trying to differentiate these ideas after they'd been added was

a process you could hardly call normal. I felt like I was solving a giant puzzle at the same time as making a game."

Kounoe and his colleagues were no strangers to all-nighters, but this was the first time inefficiency and competitiveness had been the cause. What caused this change? "There are many reasons for the change at Namco. As a fighter, *Tekken's* game flow was simple, but there was a lot of data for all the techniques, so compared to a regular project, the management style was different off the bat. The original *Tekken* was also the very first 3D fighting game to be made at Namco. There was the increase in employees halfway into production, which meant the culture of other companies got mixed in. I think our development speed seemed very slow to the new team members, and our trains of thought were more restrained. We weren't very assertive either, so the new guys couldn't tell what we were thinking. Of the newcomers, some were brought in specifically to work on *Tekken*, some for other reasons. Namco's culture was unique, and I could see these newcomers struggling. Some of them liked to row with everybody, but those people didn't stay at the company long. The *Tekken* project was like a storm; for varying

## TICK, TOCK, TEKKEN TIME BOMB

THE ADDITION OF eight new characters brought *Tekken 2*'s crew of brawlers up to a meaty 25. Such a bustling roster could have been overwhelming to *Tekken* newbies, so Kounoe devised a clever bit of technical trickery to resolve the issue and keep punters coming back for more: "I drew up and implemented a plan to prolong the game's life. In the *Tekken* series we have enemy characters called sub-bosses who match up with the character you have selected, but it would look too complicated if you could choose from so many fighters right from the off, so I employed a system that would release them steadily – that way, players could learn the game gradually. The problem was that if the characters made calendar-based debuts it would have infringed on another company's patent! That's why I had to design our own proprietary system, which measured how many hours the cab had been on for."

This also ensured continued interest in Namco's machine at a time when new fighting games were popping up all over the place. To complement the time-release system, a number of characters could also be unlocked by entering codes that the players were left to figure out for themselves.

reasons, many talented developers quit the company."

Understandably, there was a growing pile of discarded ideas – victims of the inter-developer battles and the ensuing delays. "In the original, the development ran over schedule, so we couldn't include sideways rolls when characters got up from the ground," Kounoe recalls. "For *Tekken 2*, Yoshimitsu's designer came up with a penguin fighter. At that time we were trying to think of animals that walked on two feet that we could base on the pre-existing human animation patterns. At any rate, the designer quit the company before he could complete the character model and I don't think many people in

**Kuma was going to wield a frozen fish. You would have been able to control the salmon, just flopping about on the ground**

the team even knew about the penguin idea. These kinds of problems carried over into *Tekken 3* – I wanted to incorporate more strategic play into air combos by introducing safe-falling techniques, but I couldn't complete it because other staff members failed to understand it. That wasn't all. Stances, damage animations, pinning techniques – all these elements got canned because people vetoed them based on their personal preferences.

"Now that I think of it, I remember there were also plans for a playable salmon in *Tekken 3*, but it was rejected. Kuma



» [Arcade] Kuma (Japanese for bear) was one of the more popular secret characters.

was going to wield a frozen fish, like Yoshimitsu's sword. After a timed release, you would have been able to control the salmon on its own, just flopping about on the ground. The plan was for a weak character with a jump and tail-spin attack. I don't remember exactly why it was cancelled. Probably some know-nothing dev obstructed its progress. What a pity. If we'd added the salmon, it would have made people burst out laughing and it would have become a talking point among high-level players because it would be so difficult to win with."

The freedom to act alone was something of a double-edged sword, also working in the game's favour on occasion: "Almost everything that was added was also decided by individuals working alone. Nina's throw combo was added by someone working on motion. I handled the motion for Devil, and a programmer later added his wings and laser beam. The ten-hit combo was overpowered and could lead to players shaving their

opponent's health down to nothing in an instant, so my tuning team stepped in and made some minute adjustments and saved it from being scrapped."

"*Tekken* was designed with the aim of creating a game that was different to *Virtua Fighter*. We focused on unrealistic characters like Devil Kazuya and Kuma. So long as it was flashy and seemed possible, we would try anything. The whole team put in their best efforts to make a fun game, even with the low-performance hardware we had. The problem was that *Tekken 1* and *2* had large portions



created by staff from outside Namco, so we couldn't control the project. This is why it turned into such a weird and flashy game. I think its strangeness makes it fun, though. In other words, the first two games were created as an experiment; even the developers couldn't predict how it would turn out. That's the appeal of *Tekken*. The third game, which I was in charge of, was a more calculated production. It was systematically planned and controlled, which meant it was more subdued, but I think it turned out well."

So does Kounoe like the recent effort between Capcom and Namco? "I have no interest in the *Street Fighter/Tekken* crossover. I haven't played it. The *Tekken* that emerged after I left has fallen below my expectations. It's a lot easier to create 'arrangements' of old games than to make something new. To still be relying on *Tekken* even now is proof that Namco's real strength has disappeared, and I'm shocked by the decline in creativity and development ability. It's shameful to call yourself a developer or a creator if you can't design new games. Relying only on collaborations that will sell well shows a lack of imagination, and it's not going to set the world on fire."



» [Arcade] I fought the Law and the Law won...



» [Arcade] Good old-fashioned girl-on-girl action.





zinio™



Apple Newsstand

Great digital magazines on ✓ iPad ✓ iPhone



### METROID PRIME

Developer: Retro Studios Year: 2002

Retro Studios' Metroid game had an extremely turbulent back story, nearly getting canned in the process. Nintendo intervened, a reinvigorated Retro went back to work, and the end result was one of the GameCube's best titles. While it looks like a first-person shooter, *Metroid Prime* is actually more of an adventure game, effortlessly recapturing the feel of earlier instalments but re-creating them in a beautifully realised 3D world. Coupled with cutting-edge visuals, extremely clever puzzles and a genuinely engaging story, it's one of the best examples of a 2D series making the leap to 3D and cemented Retro Studios' reputation as one of Nintendo's most important Western developers.

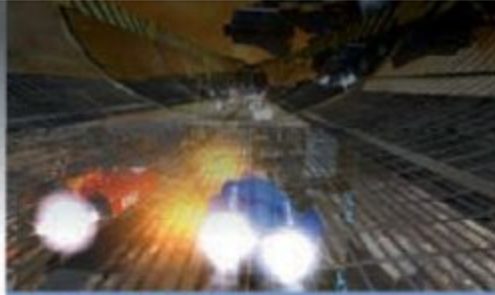

### F-ZERO GX

Developer: Amusement Vision Year: 2003

*F-Zero GX* might not be as good as its Nintendo 64 predecessor, but it's nevertheless the best racer on the GameCube and is still one of the best in the series. Polished to perfection in collaboration with Sega and running at an eye-melting 60 frames per second, it's an amazingly challenging racer, with some of the toughest, most unforgiving AI around. In fact, its formidable opponents are extremely off-putting initially, but stick with it and you'll be rewarded thanks to *F-Zero GX*'s lengthy story mode, rich variety of vehicles and clever track design. Add in some beautiful visuals and an excellent multiplayer mode and *F-Zero GX* becomes an essential racer, fit for any GameCube collection.



### RESIDENT EVIL 4

Developer: Capcom Year: 2005

Like *Metroid Prime*, *Resident Evil 4* suffered a bumpy development in its attempts to overhaul a classic formula, with the final product being a world away from what Capcom had first hinted at during the game's announcement in December 1999. The lengthy wait was worth it, however, as *Resident Evil 4* revolutionised not only the survival horror genre, but also the third-person shooter – both the *Gears Of War* and *Dead Space* series are clearly indebted to it – with its exceptional use of cut-scenes, dynamic set pieces and brilliant pacing. It's the best *Resident Evil* game Capcom has ever produced, not to mention easily one of the most important games of the last decade. *Resident Evil 6* has a lot to live up to...

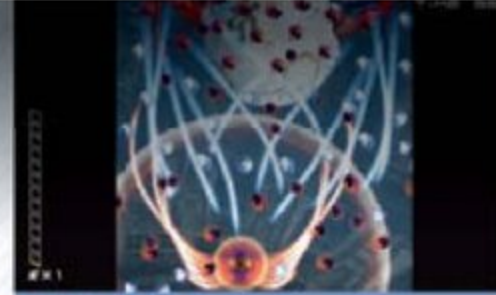

### IKARUGA

Developer: Treasure Year: 2002

We nearly didn't include *Ikaruga* as it made its console debut on Sega's Dreamcast. It's such an exceptionally good shooter, though, that we just had to highlight it here. Created by Treasure and regarded as a spiritual successor to *Radiant Silvergun*, *Ikaruga* is quite simply the best shooter on Nintendo's machine. As intricately designed as it is beautiful to look at, *Ikaruga*'s gameplay revolves around chaining enemies of the same polarity to boost your score. Your own craft can switch between black and white at will and can absorb bullets of the same colour but will be destroyed by opposite ones. It's an excellent mechanic, first hinted at in *Radiant Silvergun*, that gives Treasure's game an almost puzzle-like feel.



### BATEN KAITOS

Developer: n-Corpus/Macsoft/Sega Year: 2003

It was a tough decision between this and *Stargate* due to its exclusivity. *Baten Kaitos: Eternal Wings And The Lost Ocean*, to give it its full title, works because it's so different to many other JRPGs. Its lead character slowly matures over the course of the genuinely interesting storyline, and it boasts a unique combat system that revolves around the use and collecting of cards called Magnis. Epic in scope – like *Resident Evil*, it's spread across two discs – and featuring a magnificent score and sensational graphics, it's an essential RPG that doesn't stick to traditional conventions. It's just a pity that its equally good sequel, *Baten Kaitos Origins*, never made it to Europe.



## Go digital today

- Fully interactive editions
- Download direct to your device
- Save up to 40% off the regular price
- On-sale worldwide the same day as the print version

✓ Android phone ✓ Android tablet ✓ Apple Mac ✓ Windows PC

Save up to 40% off regular print prices



Download and enjoy over 20 great magazines on your favourite topics...

- Technology • Creativity
- Videogames • Sci-fi
- Science & knowledge
- Digital Photography

# Enjoy great magazines on every device from one amazing website

Get your digital copies now at

[www.greatdigitalmags.com](http://www.greatdigitalmags.com)

# KICK OFF

## A Football Legacy 1989-1998

When the time came to delve through the history of one of the most iconic football games ever made, we could think of one man ideally suited for the job. Unfortunately he wasn't in, so we had to get Stuart Campbell to do it. Uh-oh...

When you're writing a retro-focused videogames magazine, games don't have to be either good or successful to be significant or interesting – look at *Rise Of The Robots*, *Duke Nukem Forever* or *E.T. for the Atari 2600*. And so it is with Dino Dini's *Kick Off* series. Its commercial success was modest and brief, its critical praise largely due to being a pioneer in its field, but in any event comprehensively and universally eclipsed by a vastly superior successor.

It's widely misremembered that the *KO* games were ecstatically praised to the skies by reviewers on release. In fact, the first game scored a very respectable but hardly earth-shattering 88% review in *The One*, and the sequel notched a modest 81% in *Amiga Computing*, a magazine whose pass mark was the 50% score it gave *Rise Of The Robots*.

Chart success was short-lived too. *Kick Off 2* was the biggest hit in the franchise, but even propped up by a stream of data disk releases, it lasted less than 18 months in the Amiga top 100 listings, at a time when there were barely 100 games in total that had been created for the machine. By comparison, *Sensible Soccer* – of which this will be the only mention in the feature – went two and a half years

in the top TEN, despite far greater competition, and was only displaced by its own sequel, *Sensible World Of Soccer*, which was still at number two 24 months later, when Amiga charts stopped being published.

But *Kick Off* is still worth discussing for a variety of reasons. Its family tree is wide, splitting off into several branches, and considering how much bitterness and wrangling has been associated with the series, its sheer longevity is remarkable, with new releases in the series still appearing 15 years and more after the original game, despite ever-diminishing returns. Its influence was inarguable, bringing a completely new style to home computer football games, which would become the dominant form for half a decade until the arrival of EA's *FIFA* line, as well as inventing the player-manager sub-genre.

But most of all, *Kick Off* is a noteworthy series because of the incredible hold the games still exert over a tiny but vocal band of fanatical supporters, who furiously defend it to the death as the greatest football game ever made, despite a crushing mountain of evidence of every possible kind to the contrary.

And now they've probably already set off with flaming torches. We might not have much time, let's get on with the story.

### 1989

## Kick Off

(Amiga, ST, PC)

Throughout the Eighties, home computer football games had mostly followed the blueprint set up by *International Soccer* on the C64. They were generally sluggish affairs viewed from a side-on pseudo-3D perspective, and often with reduced numbers of players on each team – the Spectrum favourite *Match Day* having just seven-a-side, for example.

The first game to experiment with the overhead view style was *MicroProse Soccer*, a cartoonish game created by Sensible Software in 1988 and inspired by the superb 1985 coin-op hit *Tehkan World Cup*. Much faster-paced than any previous footy game, it was a minor success, thanks to innovative features like variable weather, a brilliant TV-style action replay of goals and the ability to pull off swerving banana shots.

But it was still very much an arcade title, with shortened sides, the ball sticking like glue to players' feet and each half lasting just 75

» [Amiga] The single-player mode was slight, but *Kick Off* shone for many in multiplayer.



“ You could play a one-off game with generic blue and red teams, or enter an incomprehensible eight-team league mode ”

# 1989

## Kick Off Extra Time

(Amiga, ST)

■ *Kick Off's* extremely spartan menus were soon padded out with this ten-quid add-on, which expanded the options menu. Four new team formations were now available, including extreme defence and extreme attack, as well as the ability to set wind and pitch types, along with goal kick control and a shot power

meter. Still, the expansion disk got a relatively mixed reception, with some reviews even proclaiming 'The best just got better!'

*Amiga Format*, on the other hand, strongly disagreed, lamenting, "What a great idea all these variations are. What a shame they're a total waste of time," and awarding *Extra Time* 45%.



» [Amiga] Surely ALL these pitches are artificial?

# 1989

## Kick Off

(Spectrum, C64)

■ The 8-bit ports of *Kick Off* need a separate entry, because they're both radically different games to their famous parent, and indeed, to each other. The Speccy game is slower, with a new control system – the ball is more inclined to stick to players' feet, and the trapping that was central to the 16-bit gameplay is now absent. In the league mode the teams play in purple and white, whichever ones you pick. You can dribble from a free kick, and you can be awarded a direct free kick in the penalty area that isn't a penalty. The pitch has unmarked borders, so players can suddenly appear in what looks like the middle of the field out of thin air, and you can't see where the

goal is until you're ten yards out. It is, beyond any rational argument, almost hypnotically terrible.

The C64 version at first seems identical to the Speccy one, with the exact same menus, but there's a surprise lurking – when you actually start a game, the action runs horizontally rather than vertically. Otherwise it plays much the same, including the dribble-able free kicks. Teams do play in different colours and penalties work properly, but on the other hand it's also possible to stand still in possession and let the clock run down until full time. It's incredibly sloppy but still kind of fun, in a rubbish sort of way.



» [Amiga] When we let the computer play out the tournament, Scotland got to the semi-final. Nuff said.

# 1990

## Franco Baresi World Cup Kick Off

(Amiga)

■ For some reason, anywhere you look lists this game as having come out in 1988, which would actually make it the first game in the series. That would be an impressive feat of foresight, as it accurately predicts not only all 24 qualifiers for the 1990 World Cup finals in Italy, but also the groups they'd be drawn in. (The actual draw in real life having taken place on 9 December 1989, trivia fans.)

Despite the departure from the regular *Kick Off* name, it's still

basically your bog-standard *Kick Off*, except that the only tournament you can play is the World Cup, which operates in an even more incomprehensible way than the original game's league. You go through the entire tournament, playing or not playing as either team in whichever games you fancy, which we suppose is quite handy if you've got 23 mates round and want to take a team each, but otherwise seems rather superfluous.



» [C64] The key to making a bad footy game still be enjoyable on some level is to let goals be scored.

## 1990

### Kick Off 2

(Amiga, ST, PC, Spectrum, C64, CPC)

■ The sequel raced out hot on the heels of the original, just 12 months later. In truth, it's more like another data disk, adding a few tweaks borrowed from *MicroProse Soccer* (action replays and aftertouch), wiring in the features from *Extra Time* and offering a couple of new cup tournaments, but essentially was the same game that had already been released four times in the space of a year – including *Player Manager*, which had appeared three months before *KO2* (see boxout). They really made the most of the brand while it was still being adored by gamers, even though the biggest technical advance was that the ball now had spots on it.

The most notable change to the gameplay, meanwhile, was a dramatic improvement in the quality of the goalkeepers, which instantly rendered the game roughly 96 per cent less fun. At least in *Kick Off*, if you somehow blundered your way into the opposition's penalty area and got a shot off, there was a moderately decent chance it would go in. But in

*Kick Off 2* the super-goalies closed the skill gap between good and bad players almost entirely.

We, who still can't play the game to save our lives, once challenged the staff of *Amiga Format* – who'd been obsessed with *Kick Off* for a year, playing it incessantly – to a series of challenge matches to make that very point. Utterly bereft of any ability, we just walloped the ball whichever way we were facing and fouled every chance we got. Of eight ten-minute games, we lost one 2-0 and got seven 0-0 draws.

This time the 8-bit ports were much more like the Amiga version but with a quarter of the frame-rate, and both are majestically unplayable and still let you take free kicks to yourself. The absurdly fast C64 game is basically *Kick Off On Ice*, best played by copying the CPU tactics of running in a straight line up the middle of the pitch. It announces a 'goal kick' any time the keeper has the ball in his hands, but actual goal kicks are taken from the centre of the six-yard box, two yards in front of the goal line.

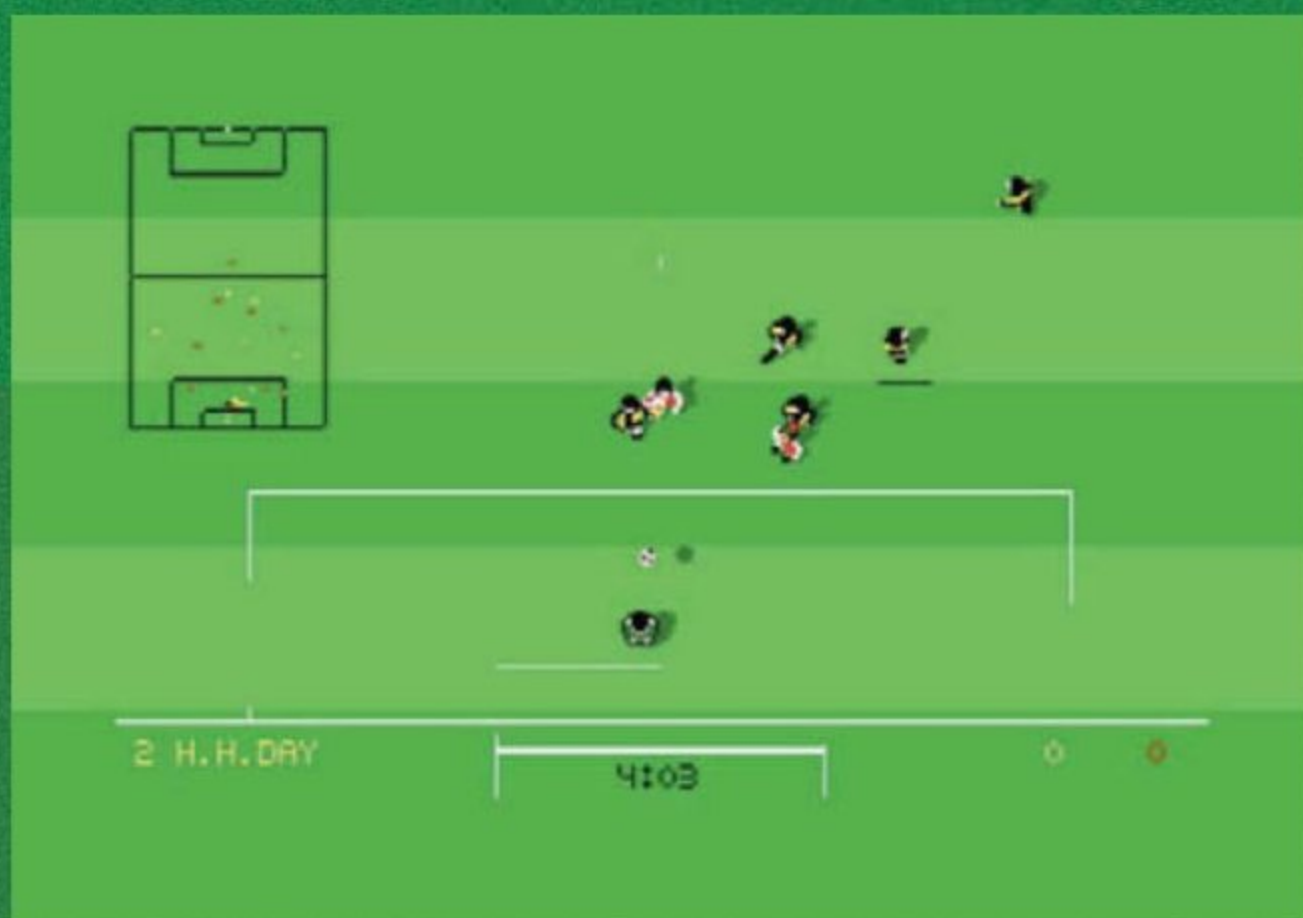

» [ST] This image isn't doctored. With more than four players on screen, the Atari ST port couldn't cope with drawing all the lines, resulting in massive flickering.

“Improvement in the quality of the goalkeepers rendered the game 96 per cent less fun”



10

## 1990

### Kick Off Collection

(Spectrum, Amiga?)

■ Here's a little oddity for you. An exclusive compilation for dodgy box-shifter the Home Computer Club, *Kick Off Collection* comprised *Player Manager*, *Kick Off 2* and *Kick Off World Cup Edition*, which was essentially the same game as *Franco Baresi World Cup Kick Off* – standard *Kick Off* with different-

coloured menus and the baffling World Cup '90 mode added. While the compilation allegedly existed for the Amiga and other formats, the only version we've ever found solid evidence for is the Spectrum one, which would make the Speccy version of *World Cup Edition* the only English-language one to exist.



» [Spectrum] Do you have a non Spectrum version of *Kick Off Collection*? If so we'd love to see it.

## 1991

### Pro Soccer aka Kick Off

(SNES, Game Boy)

■ Never actually available for those of us in the West as far as we can gather, *Pro Soccer* on the SNES was a Japanese port of the original *Kick Off*, with graphics barely above the level of the NES version, and a completely different game to the *Super Kick Off* that was released in the UK a year later. The Game Boy's *Pro Soccer*, on the other hand, was the same as the UK *Kick Off* release, and is mostly notable for some epically bad goalkeepers, who helpfully look identical to opposition players.



» [SNES] Cheer up – if you look at the screen the other way round, you're 10-0 ahead!



2





# Kick Off Stats

## PROCESSING DATA

*Kick Off 2* normally sold for £20, or £25 for a version with the World Cup '90 tournament included. But after testing the water with the original game's *Extra Time* add-on, it also had a whole range of booster packs that, if you bought them all, bumped the price of the complete game up to a staggering £62.

## RETURN TO EUROPE

There were two types of supplementary disk for *Kick Off 2*. 'Expansion disks' affected the on-field gameplay in some way, while 'data disks', as their name suggests, merely added data that altered names or tournament structures. For £10, *Return To Europe* provided the UEFA Cup, Cup Winners' Cup and European Cup tournaments.

## WINNING TACTICS

A collection of 20 or so extra formations for seven quid. In today's money, that's £34.99 (plus VAT).

## THE FINAL WHISTLE

For 13 quid, *The Final Whistle* was by far the most content-heavy expansion, adding a co-op mode, player stats, new corners, penalties, throw-ins and tricks, the offside rule, four new pitches and two new kits. The unusual co-op mode saw one player playing normally while the other was stuck in goal, like the fat kid at school.

## GIANTS OF EUROPE

Another data disk, which gave players 32 of what it described as the "best teams of Europe" to play with for an extra £7. It was the last add-on to be released since *Kick Off 2 Super League*, which was supposed to provide a mammoth setup of four 24-team divisions for another £13, was never completed. You had to buy *The Final Whistle* or *Return To Europe* to use it – or, as the back of the box helpfully warns, 'CAN ONLY BE LOADED BY OTHER DISKS IN KICK OFF 2 SERIES, BUT NOT BY KICK OFF 2'.



» The artist of this picture revealed that all the characters were based on real players, can you work out who they all are? Answers on a postcard please.

# 1992

## Super Kick Off aka Kick Off

(NES, Master System, SNES, Mega Drive)

■ The naming didn't get any less confusing the following year. All these console versions are called *Super Kick Off*, with the exception of the NES release, which is plain old *Kick Off* – although we've found a SNES version under that name too, seemingly identical to the *Super Kick Off* version – but all of them, including the NES game, are essentially based on *Kick Off 2*. That's despite the fact that the NES and Master System games are largely identical to each other and similar to the Amiga original, whereas the SNES and Mega

Drive ones are very different in look and play, boasting greatly updated graphics but running at an insane, unplayable – even by *Kick Off* standards – speed that's like watching an entire match on fast-forward.

The cutest feature is found on the Master System version, where the teams have generic footbally sorts of names – United, Wanderers, Palace, et cetera – which at least lends it a bit of a retro, *Roy Of The Rovers* vibe.

» [SNES] It's much too late for warnings now.





» [Mega Drive] A viewpoint where you can actually see where you're aiming your corner kicks? How very sensible.

## 1993

### Goal! aka Dino Dini's Soccer

(Amiga, ST, Mega Drive, SNES)

Originally developed under the title *90 Minutes*, Dino Dini having lost the rights to the *Kick Off* name when he split from publisher Anco, *Goal!* was the last *Kick Off*-related game to involve the series' creator. At least, we think it was – in somewhat of a curious manner, the box advertised it as 'a game by Dino Dini', whereas the Mega Drive version's title screen instead claimed it was 'based on a game by Dino Dini', despite it being released on the Sega format as *Dino Dini's Soccer*. Either way, magazine adverts cunningly highlighted certain letters of the blurb to spell out the words 'KICK OFF THREE'.

*Goal!* moved much closer to a certain other successful football game than to the original *Kick Off*.

The viewpoint could be zoomed out considerably to show much more of the pitch, the

speed was toned down and the generic teams were replaced by real ones with nearly real player names. Terrible goalkeepers and dodgy AI – the CPU is happy to punt the ball into its own net from 25 yards – make for plenty of nine-goal thrillers, and while still a pale shadow of its main rival, it's easily the most fun of all the games in the series.

One of the most remarkable things about *Goal!* was its hyper-strict refereeing standard, as a result of which the 'tackle' button might as well simply have been labelled 'straight red card'. When we went to play the game on the Mega Drive for this feature, we had a quick match at the default settings. While it ended with seven players against five, at one point it was ten against five and we still couldn't get a shot on target. And we only managed to get our last three sent off during the aptly named injury time.

“ While still a pale shadow of its main rival, *Goal!* is easily the most fun of all the games in the series ”

## 1994

### Kick Off 3

(Amiga)

Steve Screech, who'd provided the graphics for the original *Kick Off*, had stayed with Anco when Dini split, and took over the name. All subsequent games under the *Kick Off* name were his work, and they're not too hard to identify – eschewing even Dini's limited attempts to modernise the formula, they all play a lot like 1989 *Kick Off*, even though the first one adopted an old-style sideways viewpoint.

*Kick Off 3* took almost two years to develop, first previewed in games mags in autumn of 1992 but not released until summer of 1994, but it was hard to see why. Despite Anco boss Anil Gupta

claiming that it was the easiest *Kick Off* to play ever, if anything it was even less friendly than its predecessors, with the trap function missing and the ball ricocheting wildly off players' shins like a Scottish Premier League exhibition match played at 11 in the morning on New Year's Day.

Partly this was due to the bizarre decision to map the passing control to the second fire button on the joystick, when the vast majority of Amiga joysticks were only capable of addressing a single one, but mostly it was because it just wasn't a very good game in the first place.

» [Amiga] *Kick Off 3* was a massive disappointment to fans of *Kick Off 2*, adding little of note to the series.



» [Amiga] You may not be able to make it out, but here the ball has gone past the post while its shadow has scored the goal.



H. HATTELEY

2.39

1995

European Challenge

(Amiga, PC, Mega Drive, SNES)

■ Having taken a bit of a shoeing in the press, six months later Anco shoved out a new version of the game, which addressed some of the original's faults, generously giving purchasers the chance to spend another 30 quid – a mooted upgrade disk didn't materialise –

and hope this one was better. The control options were improved, the crowd had a range of chants, including *Auld Lang Syne* for some reason, and cheered when you scored a goal – in *KO3* they'd fallen totally silent – and there were a bunch of new tournaments, extra

leagues and the like. The Mega Drive version was the best-looking and most playable one, but by this time *FIFA* had been out for a year and a half and *European Challenge* looked like a mid-table Isthmian League North side lining up against Real Madrid.



» [Mega Drive] A consistent feature of every single *Kick Off* game has been their total lack of interest in getting kits right. This isn't a Manchester derby, but QPR vs Arsenal.



1996

Kick Off 96 (Amiga)

■ For the next release, the side-on view was swiftly abandoned again, in favour of a back-to-basics approach with a viewpoint and graphics almost identical to the first *Kick Off*. The only concession to modernity was a slightly 3D view, which put such a strain on the poor old Amiga that it wasn't possible to draw the centre circle or penalty box arcs, sending nostalgic players back to the days of the Atari ST port. The PC version, to be fair, was a lot prettier.

That was the least of *Kick Off 96's* problems, though. Comically, if you're leading and you get a set-piece, you can simply stand back and wait for the clock to run down. But, worse still, an inconceivably gigantic bug meant that in the majority of games, first-half injury time went on forever, rendering it impossible to finish a match. Which means that there's very little point in telling you anything else about it, which is lucky as we're getting near our word count already and there's still quite a way to go.



» [Amiga] You can really see the generational advance in nine years, can't you?

1997

Kick Off 97 (PC)

■ By this point, as far as we can tell, they were pretty much only releasing the *Kick Off* games in Germany, possibly on account of some obscure punishment clause in the Treaty of Versailles that nobody ever got round to repealing.

One of the most remarkable things about the series is while the graphics have improved in leaps and bounds – the camera in *Kick Off 97* swoops around like nobody's business – and the scope of the structure has grown and grown, the game seems to have been created using exactly the same primitive AI algorithms since 1991. All the console ports, and

all versions since *Kick Off 2*, have noticeably stupider AI than the first two games, and those weren't exactly bright to start with.

*Kick Off 97's* CPU players, like those before and after them, run around like hyperactive cockroaches full of Red Bull and Special Brew, broadly homing in on goal but happy to suddenly turn 180 degrees with nobody anywhere near them and run the ball out for a throw-in. We've passed many a happy idle hour starting games then just putting the joystick down and watching their comedy Keystone Kops antics. It's a lot less frustrating than trying to play, certainly.



» [PC] By way of illustration, Leverkusen's zonal marking at this corner needs some work.

## 1997

### Kick Off 98 (PC)

■ *Kick Off 98* came out in 1997, the same year as *Kick Off 97*. And in all honesty, that probably tells you as much about the series' ethics, care and attention to detail as anything we've written in these pages. The most – and, by 'most', we mean 'only' – interesting thing we can think of to say about it is that it uses a side-on perspective again. Oh, and that the Italian version of *Kick Off 98* was endorsed by Fabio Capello. To be honest, we're getting pretty

comprehensively sick of *Kick Off* at this point in the feature, not least because this one just laughed at our attempts to run it in Windows 7, even through compatibility mode, and made us dig out our emergency backup PC, but then spitefully disabled the Print Screen button so we couldn't get any better pictures. We REALLY hate game developers sometimes. Don't rush to eBay, is what we're saying here.

“ We really hate game developers. Don't rush to eBay is what we're saying here ”



» We always wonder when people put their signatures on stuff. Is it their real one, do you think? Could you use it to forge a credit card?



» [PC] We don't know of another *Extra Time* release in the series. Is Anco still advertising the 1989 add-on disk?

## 1998

### Kick Off World (PlayStation)

■ *Kick Off World* has, rather impressively, almost entirely evaded the gaming universe's radar. Google its name and you'll get a page of results for things like 'Charice to kick off world tour in March' (nope, us neither), 'Kick off World Vegetarian Month with author/activist Terry Walters' (we'd rather not) and 'Iran to kick off World War 3' (yikes!). Eventually, after hours and hours, we manage to find a single poor-quality YouTube video, which as far as the internet is concerned might as well be the last living record of *Kick Off World* on earth.

Except, that is, until we found a Greek copy of the game in an obscure – well, let's call it an 'online software shop'. Loading it up excitedly, we momentarily forgot that we can't read Greek, so we can't tell you much except

that stabbing our way randomly through some menus we learned that it features a wide range of national and club teams, made up of real players with their names spelled correctly and everything. We were shocked, too.

There's an almost-overhead mode and a rather nice-looking 3D perspective, but in terms of gameplay it's still somehow barely distinguishable from the original *Kick Off* of almost a decade earlier. It's a dreadful, uncontrollable heap of junk with stupendously bad AI that couldn't find its way to goal with landing lights and a GPS homing beacon. We weren't impressed, if you haven't gathered.

» [PSone] We swear this guy walked it round the keeper then smashed it off the top of the bar from five yards. As we live and breathe.



# 1998

## Kick Off 2002 (PC, Mac, PS2)

■ *Kick Off 2002* sold a whopping 5,000 copies across three formats, and the only review of it on the internet is the one on GamersHell, which said: "I have never played any of the previous games in this long-running series. But, if they all suck as bad as this one I have no idea what would drive them to make more." They still gave it 40%, obviously. Injured players in *Kick Off 2002* get taken off in an ambulance. We know how they feel. Can we stop now, please?



» Nothing for a decade now. Fingers crossed.



» [PSone] "Christ, he's got a gun! LEG IT!"

# Managing your life

## SPIN-OFF CITY

We'd need an entire separate feature to document the history of the *Player Manager* spin-off series. Spanning at least 13 years – the first *Player Manager* was released in 1990, and the last one we know of was *Alex Ferguson's Player Manager 2003* on the PC – and over a dozen games, the *Player Manager* titles have ploughed a lonely furrow of their own. From the 1990 original through 1996's atrocious *Player Manager 2 Extra* on the Amiga (32% in *Amiga Power*) to the

actually rather fabulous *Total Soccer Manager 2002* (aka *Alex Ferguson's Player Manager 2002*) on the Game Boy Advance, which, for our money, is still the best football game ever made for a handheld. Its predecessor, *Steven Gerrard's Total Soccer*, admirably kept up the family trait of casual disregard for the rules of the game by awarding 0 points for a draw in its league mode.



» A unifying feature of *Kick Off* games is absurdly incomprehensible menu screens full of abstract icons. See if you can figure out what the hell these ones represent. Also, why does Kevin Keegan look like Graham Taylor?

## KICK OFF WIKI

We'd like to take a moment out to salute the truly special 1993 incarnation. *Kevin Keegan's Player Manager* on the SNES (or *Karl-Heinz Rummenigge's Player Manager* for readers in Germany) featured a zoomed-out view with smaller players, tiny goals, incomprehensible menus and a ref who appears to be wearing a vest and socks and no shorts. But to describe its most spectacular feature, we'll hand you over to its entry in the Encyclopaedia Gamia: "When the game began, the 'Kevin Keegan' character is 28. When he becomes 35 years old at the end of the 2000 season and declares his retirement, it's not possible to control the players during a match from that point onwards. Controlling the players was impossible if he missed a game to injury or being put in reserves. However, after a few more seasons you could sign his nephew or other family member and you are again able to control the players." Beat that, Sports Interactive.



» We can't help feeling that this is less a football match, more a 'specialist' sex club.



» No Keegan on your team? No control over the players.





# Pitfall: The Mayan Adventure

DON'T CALL ME JUNIOR!

» RETROREVIVAL



- » SUPER NINTENDO
- » ACTIVISION/REDLINE GAMES
- » 1994

Created and programmed by Activision co-founder David Crane, *Pitfall!*'s arcade action and impressive visuals wowed an entire generation of 2600 owners. It also introduced and made a superstar of green-clad croc-dodging adventurer Pitfall Harry, the closest Activision had come to a mascot like Mario and Sonic.

With the platform genre rapidly growing in popularity on 16-bit systems, it thus made perfect sense for Activision to revisit and rejuvenate the franchise for a new generation of gamers. The jungles of the 2600 might have been long deforested, but Activision was confident that its adventurer could adapt to any environment.

This colourful 16-bit update, which Activision co-developed with Redline Games, was the result. It appeared on an impressive number of systems, from the Jaguar to the 32X. Like the classic *Pitfall!*, it boasts rich graphics and animation. It sees a wildly animated Harry Jr, the son of the original adventurer, jumping and

swinging through jungles, caves and temples with such enthusiasm that he makes it feel as if Bear Grylls phones it in.

Of course, snazzy visuals do not maketh the game, and though polished, *The Mayan Adventure* isn't without a few annoying niggles. Though the stages look vibrant, their design can be confusing – alarm bells ring in the form of little Mayan statues littering the stages that point Harry in the direction he needs to go. They're also loaded with some pretty predictable and thus unexciting enemies – snakes, bats and monkeys – that can be real blighters to hit.

There are a few standout moments, though. An enjoyable take on the requisite minecart level is one such example, which sees Harry using the wheels of a broken cart as a skateboard in true Marty McFly fashion. Its amusing ending is also guaranteed to raise a smile from Pitfans, as will the fact that the full original 2600 game is tucked away in there – there's a secret portal on level 4 that warps you back in time to the year 2600.

*The Mayan Adventure* is a polished platformer, a respectful update, and despite a few flaws, it's a must for *Pitfall!* and platformer fans alike. ★



retro gamer  
rules

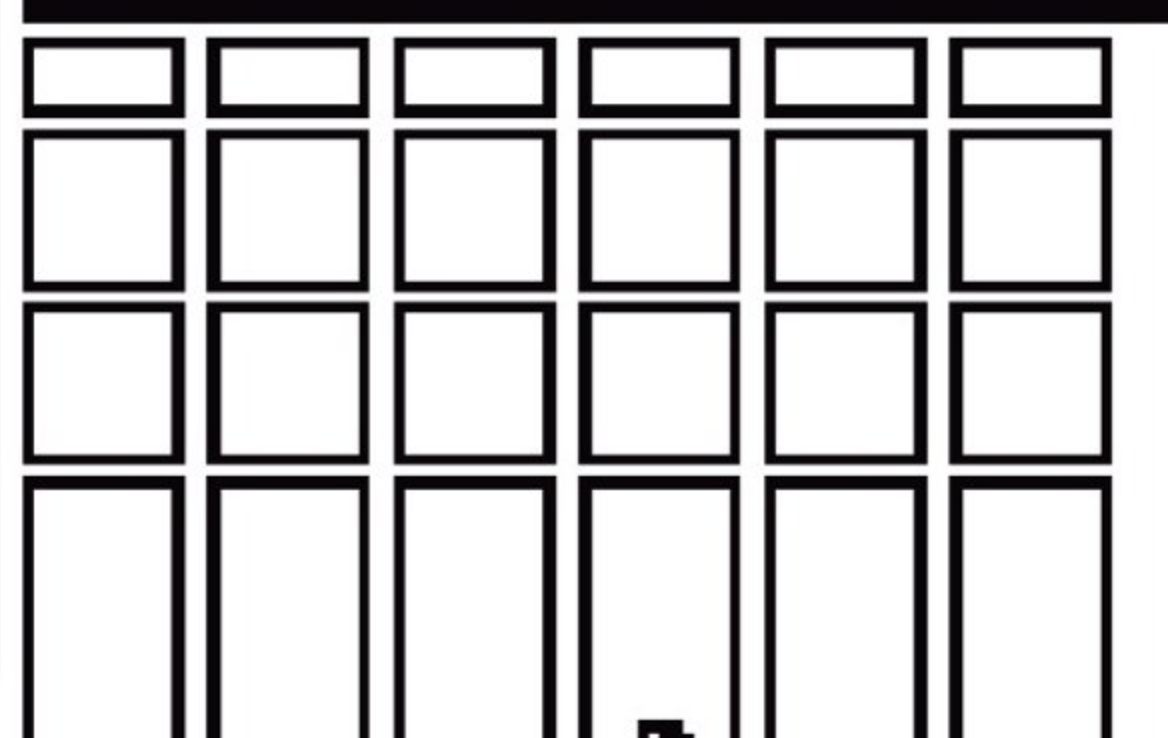
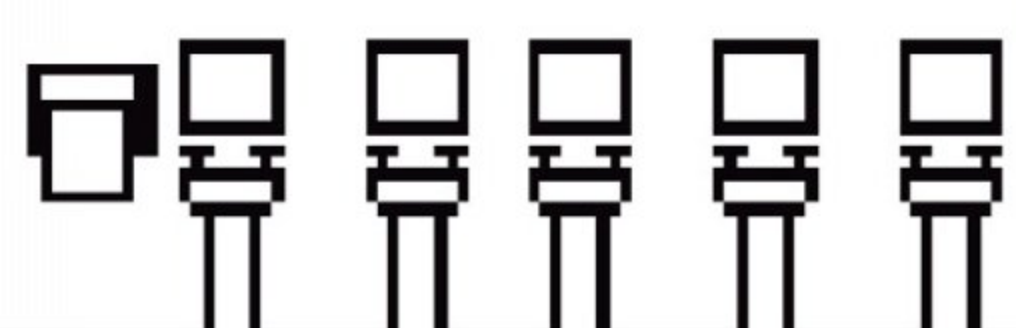

700 LINES  
ERIC







# BACK TO

# SKOOL DAZE

AS BACK TO SKOOL CELEBRATES ITS 25TH ANNIVERSARY, WE SWOT UP ON THE HISTORY OF IT AND ITS INNOVATIVE FREE-ROAMING PREDECESSOR AND LOOK BACK TO A TIME WHEN SKOOL WAS COOL

**W**ithout rules and objectives, the game of *Monopoly* would quickly descend into aimless playing around with a carbonite-encased terrier and worthless play money, while *Football* would just be hanging out with a leather spherical object and 21 mates in a field. In fact, it would be fair to say that rules are what define and differentiate all games, and any feelings of winning, losing or accomplishment come from following them. However, when a game offers the opportunity to break the rules and inject a bit of player-induced anarchy, things often become more interesting.

*Skool Daze* is a great example of this. Breaking moulds on its release by refusing to fall quietly into any specific game genre, it offered a unique and well-observed portrayal of school life through the colourful prism of a Spectrum. Set inside the boisterous walls of an all-boys' school, it thrust players into the shorts of Eric, a young scallywag embarking on a desperate mission to save his skin. Fearing the hot white wrath of his parents when the dreaded report day rolls around, Eric hopes he can keep the natural colour of his backside by frantically dashing around the school to hit a series of shields that will 'hypnotise' his teachers into giving up the combination to the school safe where his report card is kept. If Eric

is caught misbehaving or being somewhere he shouldn't then he receives lines as punishment, and if he accumulates a staggering 10,000 through repeated misdemeanours he is instantly expelled from school and the game ends. But it isn't all stress and gloom for our young hero, as his fellow school chums are on hand to enliven the school day, offsetting the actions of a faculty of four school masters who try their best to pacify and control it.

Through a combination of their individual characteristics and believable behaviour routines, both factions played a big role in bringing *Back To Skool's* gameplay to life. Some teachers were friendly towards the boys, while others, like the school's headmaster Mr Wacker, hated their sweetie-stuffed guts. However, all would act like teachers generally do: taking the kids for lessons and telling them off breaking the rules. Eric's schoolmates, 14 in total, also had individual personalities. Led by a trio of standout pupils inspired by stereotypical school staples, they included the troublesome Boy Wander, who loved seeking out the attention of his peers by writing on blackboards, firing his catapult at teachers and generally acting the twit, the walking line magnet Angelface, the school bully, and finally Einstein, the tale-telling swot who served as Wacker's eyes and ears on the ground. The school environment was equally well observed, containing all the amenities and



areas you'd expect to see in a scholastic institution circa 1984 – with the exception of toilets. It had a library, history, geography and science rooms, and even a staff room (which Eric had to be careful not to get caught sneaking around in).

Of course, for a virtual school to really feel believable there needed to be routine and order, and this came from Eric having to be seen to be abiding to a timetable comprising lessons, revision and playtime. When the nerve-shattering school bell rang to signal the end of break time, Eric had to dash to the relevant classroom and take his seat before class began. And with the school's budget clearly stretched, the seat-to-boy ratio didn't always add up. Thus it was common for Eric to have to fight with his rambunctious school chums to keep his seat and prevent himself from receiving more lines from teachers.

Of course, Eric could always choose to escape the curriculum and continue with his shield-smashing mission during lesson time, and it's here we come to the real meat of *Skool Daze's* brilliance: you could play it how and at whatever pace you liked. You could stray off the task and spend time exploring and causing havoc, but while running down empty corridors was fun it was always done at the risk of getting caught by a teacher. Thus good behaviour in front of the masters was crucial, especially as Eric could get told off for all manner of petty school crimes, from jumping and brandishing his catapult to writing on the blackboards and loitering

on the stairs. And it wasn't just the faculty that Eric had to be wary of, either; his classmates were a pretty troublesome bunch too. Indeed, Eric would often hear rumblings around school that someone was trying to make life difficult for him, be it Boy Wander planting a catapult with Eric's name on for a teacher to discover, or that grovelling little snitch Einstein telling tales to Mr Wacker.

One other genius aspect of *Skool Daze* was that it enabled players to name the teachers and students. Something so brilliantly simple, this clever touch offered players the opportunity to personalise the *Skool Daze* experience at the start of the game. After all, everyone had an Angelface, an Einstein and a Boy Wander at their school, a teacher they thought cool and a few they didn't dare to cross, and here was a game that let you plonk all of them into a videogame and act the anarchist without reprisal.

### A BRIEF HISTORY LESSON

*Skool Daze* was the brainchild of programmer Dave Reidy. In 1981 Dave was working as a systems analyst before he started writing business programs for the ZX81. The following year he set up his own company, Microsphere, and after noticing the swift popularity of the ZX Spectrum he decided to enter into the burgeoning games market. Using local illustrator Keith Warrington to create promotional artwork and packaging, Dave and Microsphere kicked things off

with the delightful *Crevasse/Hotfoot*: a Speccy compilation pack comprising two delightfully simple titles: one saw players steer a crosshair (meant to represent a buggy) across treacherous cracking ice, and another involved helping a weight-increasing rabbit scarf down block-shaped carrots. The games were well received and so Dave was persuaded to continue on dabbling with game-making. *Evolution* and *The Train Game* quickly followed, but it was Dave's next title that brought him and Microsphere to wider attention: *Wheelie*, which spliced together the racing and platform game genres in fantastic fashion and garnered solid reviews.

*Skool Daze*, which was released in the same year, became another hit, and was inspired by a combination of Helen Reidy's experiences working as a school teacher and amusing comic strips like *The Bash Street Kids* about mischievous school kids making life miserable for their teachers. As is clear in retrospect, comics had a big influence on *Skool Daze's* colourful design, from the various classrooms and overall layout of the school resembling comic book panels to the teachers and kids communicating via speech bubbles. Realising then that pulling off a project of this visual scale – an animated comic book – would be a little beyond his artistic talents, Dave asked Keith to design and draw the graphics for the game, which Keith sketched on graph and tracing paper before handing the wads to Dave to then reconstruct in machine code.



# The Skool Daze Yearbook 1984/1985

Industry figures leave their recollections, thoughts and opinions on Dave Reidy's classic franchise

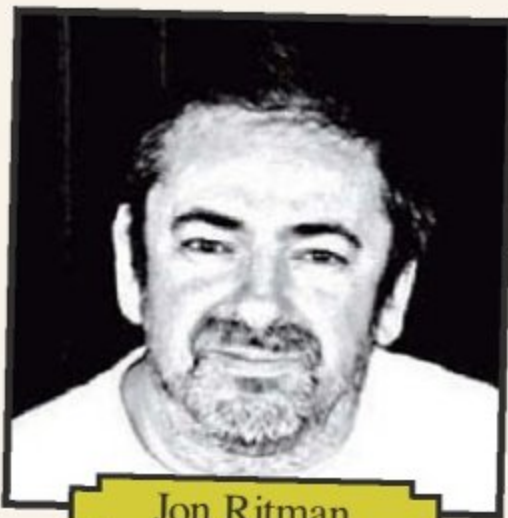

Jon Ritman

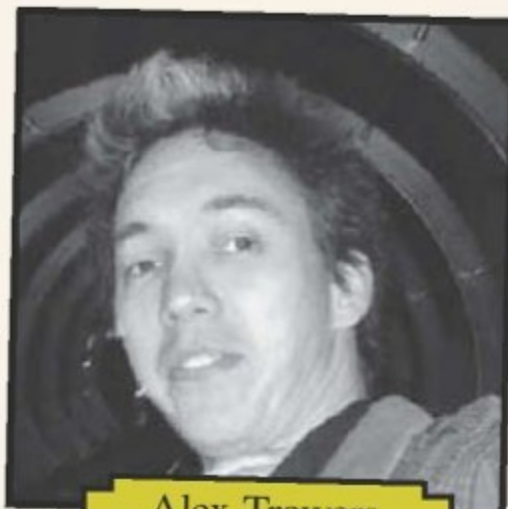

Alex Trowers

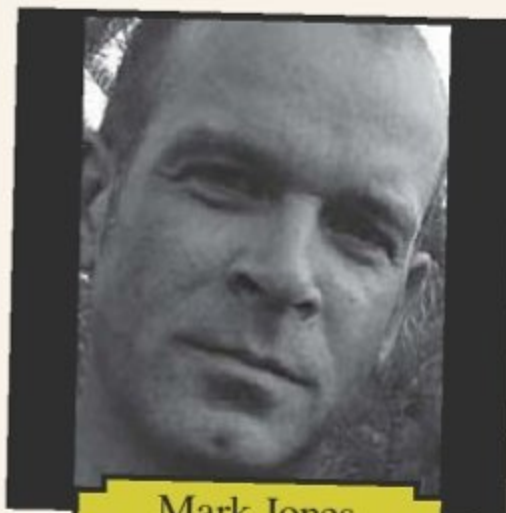

Mark Jones

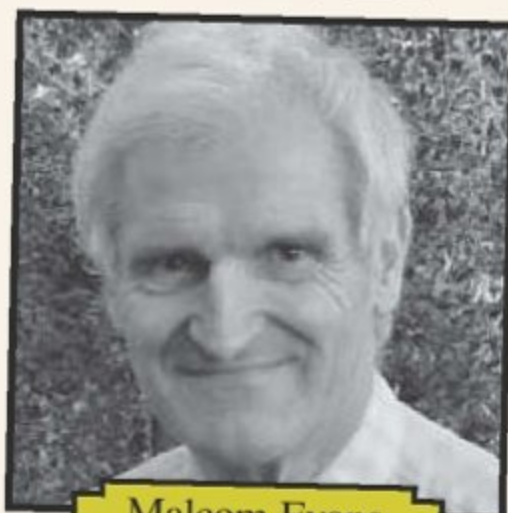

Malcom Evans



Jonathan Evans

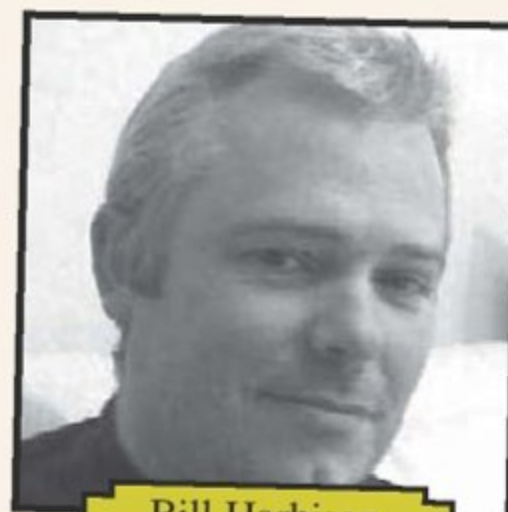

Bill Harbison

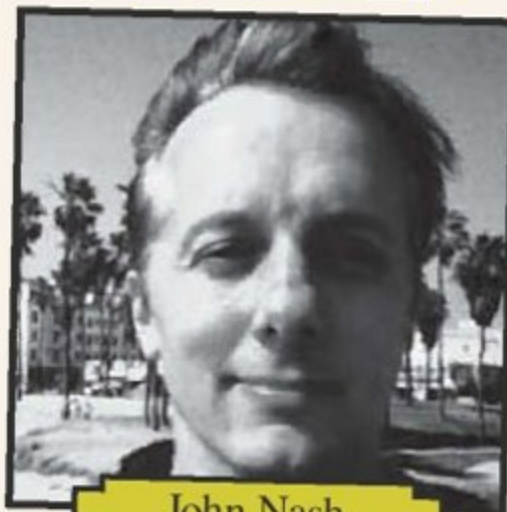

John Nash

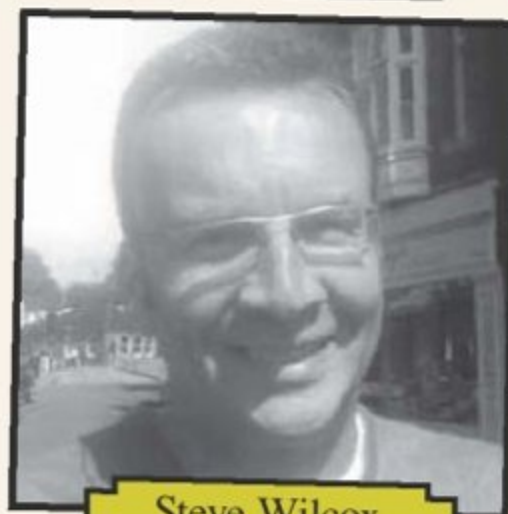

Steve Wilcox

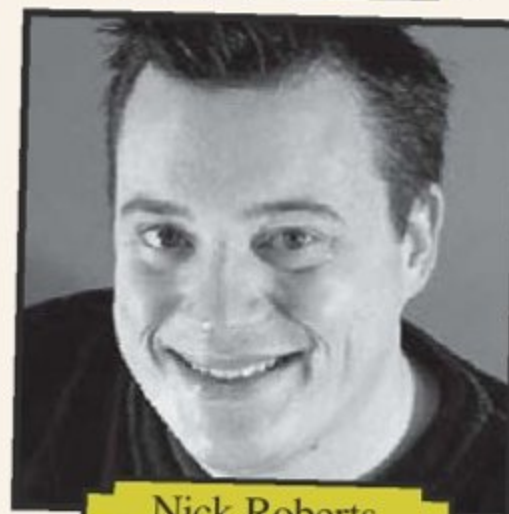

Nick Roberts

**Jon Ritman**, co-creator of *Batman* and *Head Over Heels*

"I played *Skool Daze* for a while, mostly because I thought it was a lovely idea that would appeal to those players still at school (school was a distant memory to me at the time, thank God). It had some great touches and was fun, even if it wasn't the deepest game in the world."

**Alex Trowers**, Bullfrog Productions

"I thought *Skool Daze* and *Back To Skool* were great games. It was the closest you could get to being in an actual episode of *Grange Hill* – all that was missing was the flying sausage/fork combo."

**Mark Jones**, Ocean Software

Me and my schoolmates used to play both games quite a lot when they had just come out. I have more recollection of playing the first one, probably because it was so unlike anything that had come out before. Like everyone who was at school and played either of these games, I had great fun renaming all the characters to teachers and mates from the school I was attending at the time, which for me was the Northampton School for Boys. I didn't even really play it properly. I'd go to a few lessons, then try causing a bit of trouble and see how long it would take for me to get some lines. It was the first game I think that I'd ever played that made going to school seem fun! It was quite clever too. David Reidy had made a game that would appeal to virtually everyone who had a Spectrum.

**Malcolm Evans**, creator of *3D Monster Maze*

I never had a wish to return to school in the Eighties. Though I think I must have spent most of the Sixties in a daze for I remember little of that either.

**Jonathan Evans**, Design Manager, Blitz Games Studios

"As much as people loved the idea of *Skool Daze* with all its glorious, violent anarchy, the best thing wasn't the gameplay itself. No, the best thing about *Skool Daze* was the half hour spent at the beginning of every single game typing in the names of all your actual teachers, so when you gave them grief in the game you were actually grieving your real teachers. That was amazing – just about the best thing I'd ever done in a game. Also, it didn't mind if you used swear words. Yet another reason why it was better than *Grange Hill*."

**Bill Harbison**, Ocean Software

"*Skool Daze* caused a bit of a stir at my secondary school. Not only was it a great game, but the characters bore striking resemblances to the teachers and kids in our class. Every time I played it I had to begin by renaming all the characters to the people I knew, and it was so much fun to live out my violent school fantasies in the game rather than the playground. The graphics were spot-on; they were stereotypes, of course, but abstract enough for you to recognise them as people you knew. *Back To Skool* was even better, and added an extra dimension to the game with the introduction of girls. Even more fantasies were played out in that game."

**John Nash** Studio Design Director, Blitz Games Studios

"Looking back with magenta-tinted glasses, I can recall the endless hours my brother and I spent hunched over our beloved Speccy revelling in the delight of a new kind of game experience – sandbox play. The heady mixture of *Skool Daze*'s self-directed play and being able to live the prankster dream in a parallel school was a revelation, a breath of fresh air in a market saturated with hardcore pixel platformers. Like so many other aficionados of the diminutive dead flesh slab, for me *Skool Daze* = happy days."

**Steve Wilcox**, founder of Elite Systems

"The principal reason for including *Skool Daze* (and indeed *Back To Skool*) in our ZX range of apps is that both games were among the 'ten-most-requested' by the thousands of people who acquired our iOS app *ZX Spectrum: Elite Collection* back in October 2010. Also, *Skool Daze* was a genuinely unique title in its day and (*Back To Skool* aside) remains so today."

**Nick Roberts**, Crash reviewer

"*Skool Daze* and *Back To Skool* are all-time Spectrum classics, without a doubt. We take the fact that you can go anywhere and do anything in games for granted these days, but in 1985 being able to roam the school corridors in lesson time, pick up mice and drop them in the girl's school and go joy-riding on the caretaker's bike was groundbreaking stuff alright! Replaying the games recently with my six-year-old, you can still see the spark and thrill of playing a game based in a school in the eyes of a current schoolboy. Trying to explain colour clash to him was tricky though..."

» Keith Warrington's art perfectly captures the anarchic vibe of both of Dave Reidy's *Skool Dave* games.

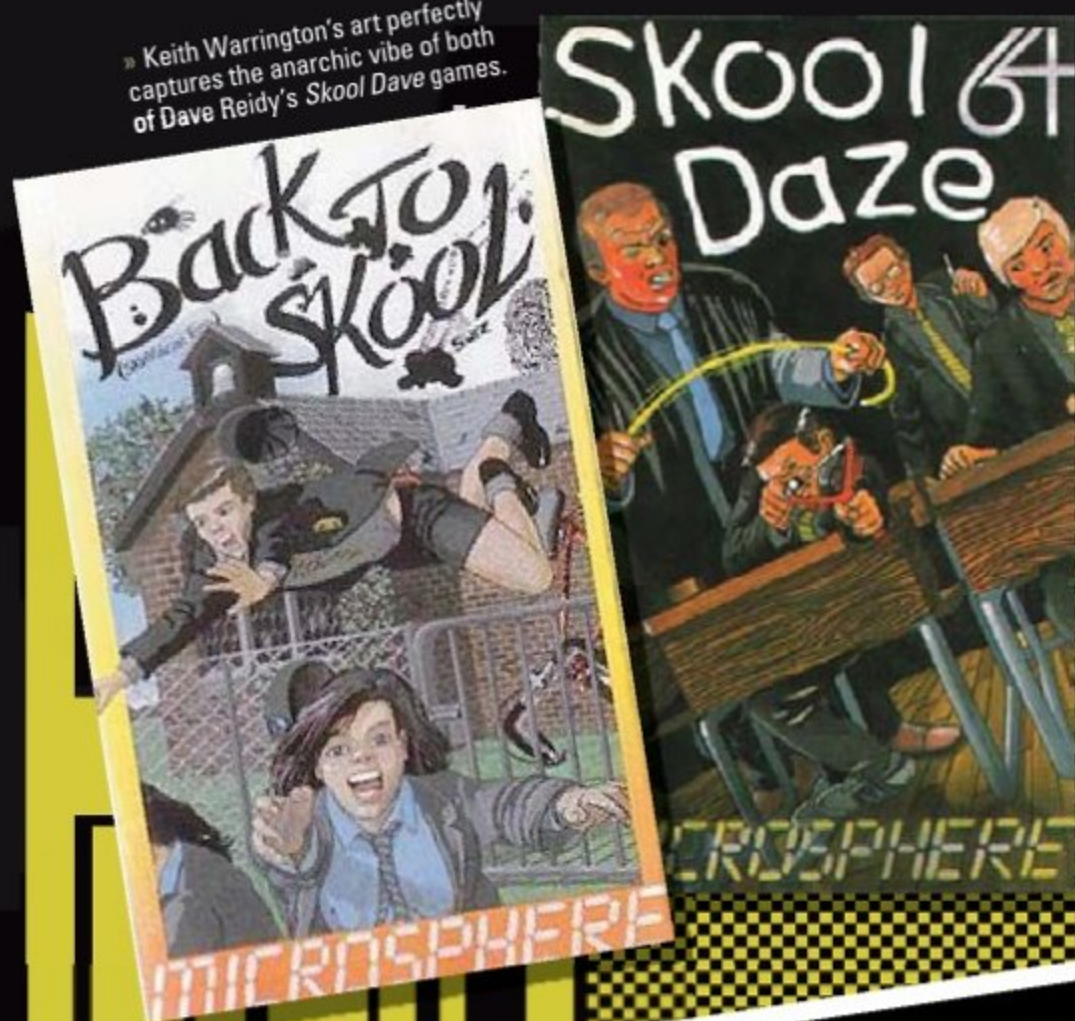

SKOOL DAZE HEADMASTER MR WACKER TAKES US THROUGH THE POTTED HISTORY OF HIS CREATOR

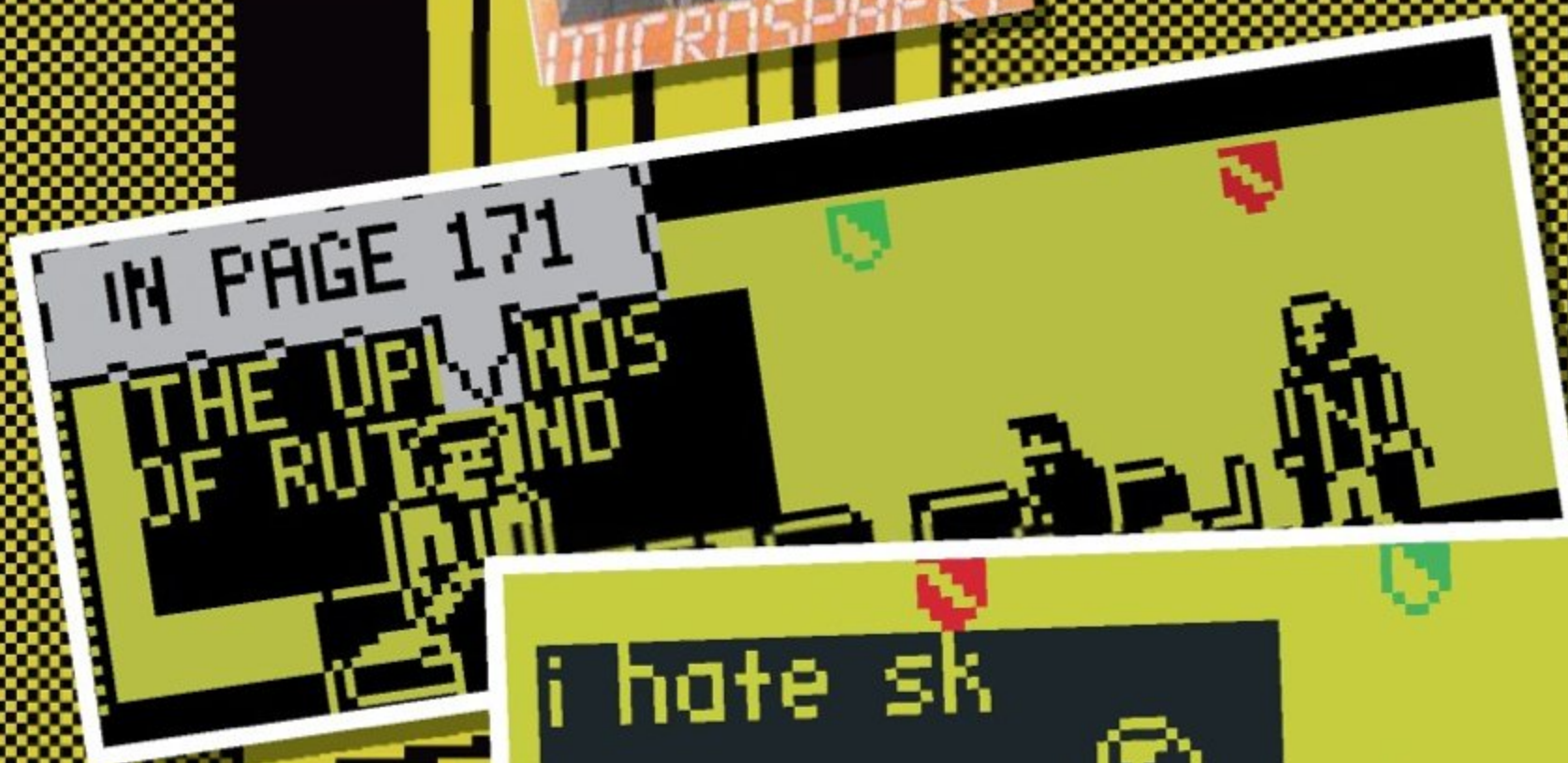

### BACK TO SKOOL WITH DAVE REIDY

Dave Reidy's contribution to the Speccy was incredibly important, so we were keen to speak to him again. Sadly, Mr Reidy wasn't free to talk to us in time for this issue, so we've included excerpts from his interview that first appeared in *Retro Gamer* 17, in case you missed it. You can read a full transcription of the original article at Mark Green's website – <http://pixelatron.com/blog/skool-daze-feature-retrogamer/>

"What I remember best are the things between lessons. Kicking balls around corridors, playing conkers, firing a catapult. Making fun of teachers. Making fun of other kids. And that was basically how I wanted *Skool Daze* to be. There'd be a major task to perform – but if you wanted to spend all your time beating people up, you could. Just like school."

- Dave recalls the other parts of going to school

"Going into 1984, people were copying so much. Somebody at the time estimated that for every game actually sold, there were seven copies made. That's probably about right. We used to get games returned as faulty from WHSmiths and Boots. Most of them played fine; they'd just been bought, copied, and taken back. Some of them had even been tampered with so people could 'prove' the game wouldn't load – recording a few seconds of silence, say. But there was nothing we could do about it."

- Dave on piracy

## 1981

DAVE REIDY IS WORKING AS A SYSTEMS ANALYST. HE PURCHASES A ZX81 AND STARTS WRITING BUSINESS PROGRAMS.

## 1982

SINCLAIR RESEARCH LTD. RELEASES THE ZX SPECTRUM. IT BECOMES A BIG SELLER FOR THE COMPANY. DAVE SETS UP MICROSPHERE COMPUTER SERVICES, OPERATING FROM HIS HOME IN LONDON.

## 1983

MICROSPHERE RELEASES ITS FIRST GAME, *CREVASSE/HOTFOOT*, THE SPREADSHEET PROGRAM *ONMICALC* SERIES AND PRINTING APPLICATION *ZX-SIDEPRINT*, AND THEN *EVOLUTION* AND PUZZLER *THE TRAIN GAME*. *WHEELIE*, RELEASED LATE IN THE YEAR, BECOMES THE COMPANY'S MOST SUCCESSFUL GAME.

## 1984

*SKOOL DAZE* IS RELEASED AND BECOMES ANOTHER HIT THANKS TO ITS FREE-ROAMING GAMEPLAY. THE COMPANY ALSO RELEASES 'COPTER SHOOTER *SKY RANGER*. ITS 3D GRAPHICS ARE REGARDED AN IMPRESSIVE VISUAL SHOWCASE FOR THE SPECTRUM, BUT THE GAMEPLAY IS MEDIOCRE.

## 1985

MICROSPHERE RELEASES *BACK TO SKOOL*; IT'S ANOTHER HIT AND THE DEVELOPER'S ONLY SEQUEL.

## 1986

COLOURFUL DETECTIVE NOIR CAPER *CONTACT* SAM CRUISE MARKS MICROSPHERE'S VERY LAST TITLE.

## A NEW YEAR BEGINS

Garnering glowing reports from the gaming press, *Skool Daze*'s unique free-roaming gameplay, colourful cartoon graphics and unusual setting helped it to instantly stand out from the racers, shooters and platformers that frequently saw release. Test scores saw it awarded 93 per cent in *Crash*, with one impressed reviewer stating that "from the moment you see *Skool Daze*, you fall in love with it", and an equally impressed *Sinclair User* writer remarking that "*Skool Daze* explodes into the imagination with a cloud of chalk dust and a hail of catapult bullets". So with *Skool Daze* helping to make school cool in the eyes of many kids across Britain, and sales of around 50,000 copies, Dave decided that it would be a good idea to stick at school for just a little while longer and released a sequel, *Back To Skool*, the following year.

*Back To Skool* might seem extremely similar to the original but it expanded on the formula brilliantly. Reuniting fans with Eric, the school had received something

of a refurbishment between releases. The builders had given it an entirely fresh new layout and a fresh lick of paint too. New classrooms were kitted out with new equipment, the school was larger than before, and there were even more seats too. A Human Rights group had also done an inspection of the facilities and ordered that the school install a toilet (though you couldn't perform a spot of bog-washing on Einstein, sadly), and girls arrived on the scene thanks to a neighbouring girls' school that was cordoned off by a tall (but easily circumvented) fence during lesson time and open to explore during playtime.

While the *Skool Daze* faculty returned to make Eric's life a misery, *Back To Skool* introduced a selection of new characters. During the summer holidays Eric had gotten a girlfriend, Hayley, who attended the girls' school, and Eric could butter her up and palm off a few lines onto her. If he did this too often, however, she quickly grew wise to his using ways and promptly showed him the door. Furthermore, as well as Hayley and

the usual school masters, Eric now had to contend with a grumpy headmistress, Miss Take, as well as a caretaker named Albert who patrolled the sports field and was often a target for abuse from the kids – Wacker would often use assembly as an opportunity to weed out who was responsible for terrorising the groundsman during playtime.

The level of interaction and hijinks Eric could perform was also expanded upon. In addition to using his trademark catapult, Eric could now find and use a water pistol, steal and ride a pedal bike, and open desks and take their contents. The mission also made better use of the school environment and the characters too. Running around bashing shields in the pursuit of unlocking codes from teachers' brains was amusing, but it was the mischief that the game allowed you to get up to away from the main mission that people loved most about *Skool Daze*. While a spot of shield bashing still had to be done in the sequel, progress now required Eric to set into motion all kinds of amusing action sequences, from frog and



"All the characters are those comic book stereotypes, because by and large all schools are the same... There's always you. There's always the popular people — who you hate, of course. There's always a bully. There's always a swot. And *Skool Daze* was about giving people characters they would recognise. And making it funny, and enjoyable to play. Which, of course, meant making it a little bit evil."

- Dave on the inspiration for *Skool Daze*'s cast

"I just left Keith to it. What he came up with was really very good. The swot had an egghead, the bully was a little bit broad-shouldered and butch, Boy Wonder was blond and attractive and flowed around the place – don't you just hate people like that? Where Keith got his inspiration from, I don't know. He was heading off to be a teacher then, so he probably modelled it on people he knew."

- Dave on creating the character design

"We sold around 50,000 copies of *Skool Daze*. Ten years later, we were thinking that we could have made a lot more money at the time, if we'd been clued up and actually done some proper marketing and merchandising. But I'm not going to cry at the opportunities we lost. We made a decent living out of *Skool Daze* – it paid for its development, a few times over. Keith bought a second-hand motorbike on the proceeds."

- Dave on the success of *Skool Daze*

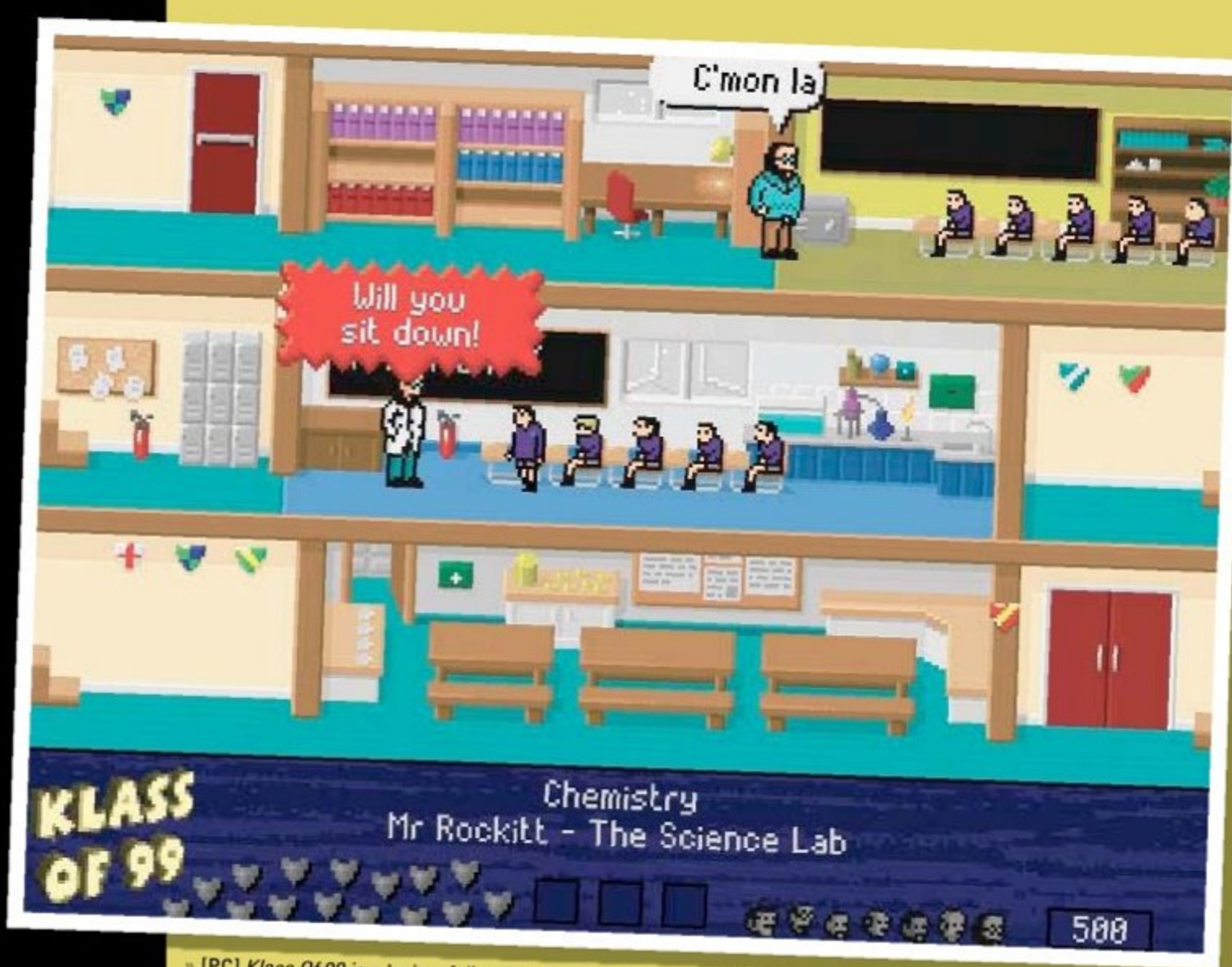

» [PC] *Klass Of 99* is a loving, full-colour homage to the *Skool Daze* series.



Hope you've been paying attention, cherubs – we're about to see if what we've taught has stuck...

1. In *Skool Daze*, how many lines could Eric receive before he was expelled from school?
2. Which company developed *Skool Daze*?
3. What are the names of the four main kids in *Skool Daze*?
4. Fill in the missing words: \_ And \_ Decathlon.
5. How many sporting events were there going to be in the unreleased second *Skool Daze* sequel?
6. What is the name of the school's headmaster?
7. Which year was *Skool Daze* released, and what other innovative 'sandbox' game was released that year?
8. An important amenity was missing from *Skool Daze* but added to *Back To Skool* – what was it?
9. Name three games that *Skool Daze* could plausibly have inspired.
10. Solve this simple sum: *Skool Daze* + *GTA* =?

Answers overleaf

mice drops at the girls' school to letting off a stink bomb to cause a teacher to open a window. With smoother scrolling, improved visuals and a greater level of depth, *Back To Skool* was a great follow-up, and reviews reflected that, with the series upholding its 93% in *Crash*, and receiving nine out of ten in *Your Sinclair*. Top marks.

### SPORTS DAY'S CANCELLED

As reported in magazines at the time, Dave had planned to make a third game in the series. With the working title of *Eric And Hayley's Decathlon*, it was planned to be a school-themed send-up of *Daley Thompson's Decathlon*, comprising ten sporting events stapled together with 'interactive scenes'. Gelling *Skool Daze* with *Daley Thompson* sounds like a winning formula, and package art for the game was even drawn by Keith. But sadly the sequel

never got past first base and the final bell ultimately sounded for the series.

In an early **Retro Gamer** interview in issue 17, David placed much of the blame for the school shutdown on something that commonly irks teachers – copying. With piracy rife and budget games starting to dominate the market, after the release of *Contact Sam Cruise*, a colourful 1930's detective noir action-adventure game that shares a similar look to *Skool Daze*, David decided to abandon games, concluding that profits were becoming too stretched by piracy, and fed up with working and damaged games being returned to retailers by cheeky little Boy Wander types.

Of course, play close attention to the games industry and you'll see *Skool Daze's* legacy endures. Though *Ant Attack* predated its release by a year

and seminal BBC classic *Elite* shares its birthday, *Skool Daze* is arguably the first example of the modern 'sandbox' game. Its free-roaming gameplay and real-world setting made it unique, and its influence can be seen in everything from *Shenmue* and *GTA* to the *Sims* series and, of course, *Bully* (aka *Canis Canem Edit*) – which took many of the ideas and themes of *Skool Daze* and then let them lark about in a three-dimensional playground. Like a teacher imparting some lasting wisdom, the series has certainly had a profound effect on the games industry, and is still fondly remembered by many gamers today. And so ends this lesson about the *Skool Daze* series. We hope you've been paying attention as you're going to be tested on what you've learnt. So, when you're ready, turn over the page and begin answering.

## A MOMENT WITH KEITH WARRINGTON

We speak to the *Microsphere* graphic designer and cover artist about his time working on the *Skool Daze* series...

How did your collaboration with Dave Reidy come about?

Dave married a girl called Helen who was my next door neighbour when I was a kid. Our mums had kept in touch, and so when I moved to London to be an illustrator and Dave needed some cassette inserts designing they got in touch. By coincidence they lived in Muswell Hill and I lived in Hornsey, so I could walk to their house across the grounds of the Ali Pali (which at the time was pretty derelict).

What was it like working for *Microsphere*? Was it on a contract basis or full time?

I was paid for each job. I kept a record of the hours and gave Dave a bill. He was extremely good, and when I gave him the first one he informed me that he thought I was underselling myself and that I should charge a lot more. You don't get clients like that these days (and you didn't much then either).

Why did you decide to leave the games industry?

I didn't – Dave found that after releasing the first couple of *Skool Daze* games he was hardly making any money because of all the copying and deliberate damage to cassettes to get a refund, so he decided to give it up. I think I just carried on working for whoever wanted a graphic designer/illustrator for a while, but I was also doing teacher training and eventually got a job teaching.

What are you currently up to?

I did 25 years of teaching, got fed up with the way the system was being used as a political gimmick at the expense of teachers and students, gave that up, and I am now a portrait artist who fills in with custom paint work and illustration as well. I've been constructing a website for about two years now, but paid work keeps getting in the way.

Did you work on any games outside of the *Skool Daze* games and *Contact Sam Cruise*?

I did inserts for *The Train Game*, a motocross game I've forgotten the name of, an application called ZX-Sideprint, a 3D helicopter game that was way ahead of its time, and I think I did the cockpit instruments for *Crevasse*, and maybe a couple of others. But the Eric games were the only ones I did all the graphics for.

Were the teachers and children modelled on real-life people?

Some were – the cool, 'with-it' teacher was modelled on my favourite junior school teacher, Mr Sykes.

How long did it take to create the graphics for the *Back To Skool* games, and what art packages did you use?

It took a few weeks to do the original, but the second was a lot quicker as I knew what I was doing by then. I wasn't into games at the time and had to get a Sinclair Spectrum (which I recently found in the loft) to see my own graphics in action, so to speak. There were no art packages that I knew of. I designed all the characters and buildings by filling in squares on graph paper to represent the pixels, and just had to keep standing back to get an idea what they'd look like on screen. I then took them round to Dave and Helen's and he programmed them in.

You're credited as the artist on the C64 version of the game. What was your involvement exactly?

Nil. They just reused my graphics I think.

What can you tell us about *Skool Daze 3*?

It was called *Eric And Hayley's Decathlon* – a pun on Daley Thompson's



*Decathlon* – and was going to feature the school sports day. I designed the insert card which featured Eric and his girlfriend hurdling the school wall at high speed, but Dave went off round the world with Helen for a long holiday, and when he got back he never did any more work on it. I had the insert kicking around for years as Dave had paid me for it in advance before he went away and, as technically it was his property, I couldn't bring myself to throw it away. However, after the last time I moved house I've not been able to locate it.

Are you surprised that there is still so much interest in these games you were involved with after all this time?

In some ways yes, but Dave Reidy was a genius in my opinion. Those games were far more intelligent and witty than most, but times have moved on a great deal since and games are massively more sophisticated now. Those kids who pissed Dave off so much he quit the business will have grown up and become nostalgic for their misspent youth like most of us do. It wasn't part of my youth really, though, and I wasn't particularly happy in London, so while I'm pleased people are interested and can still enjoy them, I was glad to move on. When I look at the covers now I think they're pretty poor.

» These days, Keith applies his art to three-dimensional real-world objects rather than imaginary videogame worlds.



Donty No work undertaken on thermoplastic helmets no matter who says it's ok!

# SKOOL TIMETABLE

Ever imagined what school would be like if the National Curriculum was taught using the medium of videogames? You can stop imagining...



## DOUBLE HISTORY

### Mr North and Mr South

Based on a Belgian comic books series, *North & South* is fun, entertaining and loosely educational. Set during the American Civil War, you choose a side and then battle to win control of the various states and regions of the US.



## BIOLOGY

### Mr Mike Rowe-Surgeon

This Intellivision title has a clear *Ultimate Voyage* vibe. *Microsurgeon* let kids to explore the inside of the human form and protect it from infections using a tiny submersible that has been super-miniaturised to the size of a flea's kneecap.



## PHYSICAL EDUCATION

### Mr Jack Enfield

Don't forget your PE kit or you'll be forced to play in your underpants, or the school's regulation punishment kit – someone else's found in a dustbin. *Track & Field* features six events to master, including Hammer, Javelin and Hurdles.



## BUSINESS STUDIES

### Mr Ade Stand

*Lemonade Stand* puts players in charge of a fledgling lemonade drinks enterprise. After considering a daily weather report, they had to determine how much to spend on ingredients and advertising and then set how much to charge to turn a profit.



LEMONSVILLE WEATHER REPORT  
C...UDY



**MATHS**

**Miss Donna Key**

If Nintendo is unable to make maths interesting for kids then no one can. The worst-selling launch title for the NES, *Donkey Kong Jr. Math* saw Jr. creating formulas that equated to the number shown by his pops. An admirable idea, but ultimately it's still maths.



**ENGLISH**

**Mr Grue**

*Zork* is an adventure classic that would have no doubt become an essential play had text adventures formed part of the National Curriculum. You play a nameless adventurer hunting for treasure in a dangerous ancient underground city.

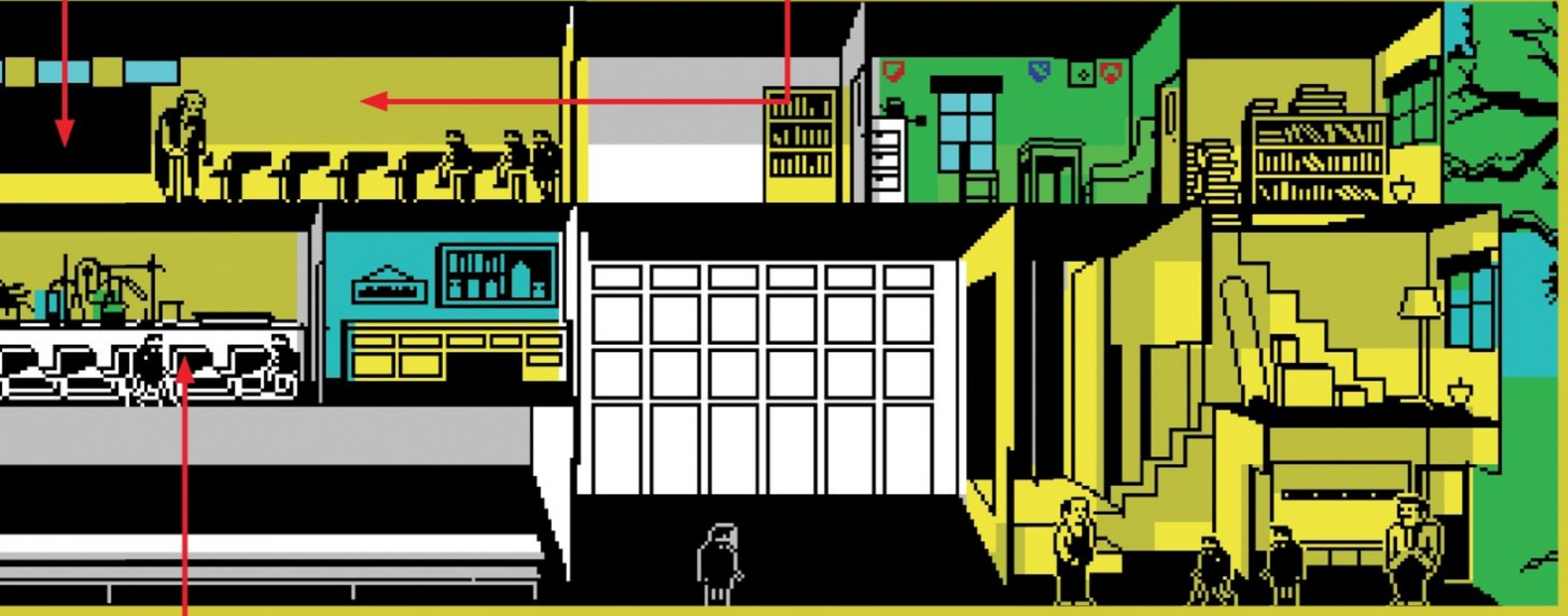

**PHYSICS**

**Mr R Goldberg**

*The Incredible Machines* tasks you with completing a series of simple and sometimes inane tasks – from popping a balloon to blowing up a fish tank – by constructing elaborate contraptions using various everyday objects and considering physics.



**RELIGIOUS STUDIES**

**Mr Christian Lord**

*Bible Adventures* takes three famous bible tales – Baby Moses, Noah's Ark and David and Goliath – and realises each as a mediocre side-scrolling platformer. It's probably sacrilege... but hey, had your teacher let you play it in lessons you wouldn't have complained.



**HOME ECONOMICS**

**Mr Sims**

A life simulator that covers everything from house and baby making to working and socialising, *The Sims*, a hugely successful *Sim City* spin-off, is the perfect application to help prepare you for life in the real world.



**Test Answers:**

10,000 / Microsphere / Eric, Boy Wander, Angelface, Einstein / Eric And Hayley's Decathlon / Ten / Mr Wacker / 1984, Elite / Toilets / Bully (Canis Canem Edit), The Sims, Bonanza Bros., The Great Escape, Where Time Stood Still, GTAIII / Bully (Canis Canem Edit)



# THE CLASSIC GAME

# Contact

# SAM CRUISE



The life of a gumshoe has provided the basis for a number of videogames over the years, from *Movie to LA Noire*, and will surely continue to do so for generations to come.

The private eye goes against the archetypal gaming hero: sword and gun-wielding muscle-mounds that go about their heroics with the same level of subtlety and considered thought as a team of squirrels constructing a 700-foot inflatable Ultimate Warrior-shaped hot air balloon to circumnavigate the sun with. Therefore, if you're holding out for a hero who favours brains over brawn then Sam's your man. He's on the hunt for a bird – no, not that kind of bird; something called the Bali Budgie – and trying to solve a murder.

## 1 Disguises

Sam has a number of disguises, and some prove more effective in certain situations.

## 2 Lights and Blinds

Sam can shut the blinds or turn off the lights to hide his actions, making moving slightly trickier.

## 3 Snipers

Watch for snipers positioned on the streets. Sam can't fight back, but he can dodge.

## 4 Police

The police patrol the streets and have no qualms with throwing Sam in the slammer if he's caught being somewhere he shouldn't be.

## 5 Mobsters

Sam must be wary of mobsters too. Upset them and he gets carried up to the roof of the nearest building and booted off. The fall doesn't kill him, but it does leave him temporarily out of it.

## 6 First Aid Kits

Pretty obvious what these are. You start the game with ten and taking a bullet costs one kit.

## 7 Fuses

Each building has a fuse which can be removed to cause a blackout and make escaping easier.

## 8 Keys

To complete the game you must locate four keys to grant Sam safe access to crucial buildings.

## 9 Telephone

Each phone has its own telephone number. The numbers are gradually revealed during the course of the game.

## 10 Money

The game ends if Sam runs out of health packs or money. His savings diminish during the game, so to keep in the black, Sam must collect client fees or somersault onto bank notes.

# MEMORABLE MOMENTS



## Skool's Out

While many rightly associate Dave Reidy and Microsphere with the *Skool* series, this, the last game to come from the developer is a great parting shot. Taking the free-roaming gameplay of *Skool Daze*, but tying it to a more story-led adventure, when you scratch beneath the surface *Contact Sam Cruise* is an altogether different feeling game to *Skool Daze*, one that feels slightly more linear than in some areas, the way in which you progress for instance, but still has that trademark Reidy flair for feeling open, organic, humorous and immersive. Fans of the *Skool* series should certainly investigate it.



## Fan of Sam

*Skool Daze* and its sequel were full of memorable characters, but in *Contact Sam Cruise* there's little chatter and messing around to be had with the NPCs in the game. Sam becomes the most memorable character by default, though not for good reason. For a guy who spends most of his time sat behind a desk, he's a pretty agile chap, capable of rolling and somersaulting to avoid bullets fired by snipers. He's also a master of disguise, able to change his appearance and disguise himself as a policeman, a nun and a Hasidic Jew, to name just a few of his costume swaps.



## Office Space

There are a few standout locations in the game. There's a police station with a cell, which Sam is forced to spend time in if his wanted level is red and he's caught by the plod, and of course the aforementioned Royale hotel, where the case kicks off. Of course, no gumshoe would be complete without a base of operations, a place he can drink scotch, ponder clues, practice speaking in metaphors, and learn the violin. And Sam is no exception. Not only does he have a second floor office with a working telephone, lights and blackout blinds, but an assistant too.



## The Budgieguard

The opening scene sets up the story brilliantly. Sam receives a telephone call from a mysterious woman, who tells him to meet her on the top floor of a nearby hotel. Curious, he leaves his office and makes his way towards the rendezvous point. Arriving at the hotel entrance, he walks inside and takes the stairs to the top floor. However, instead of the woman, he finds the body of a dead man. A phone rings, a cryptic message is heard – your first clue – and the police are seen running up the stairwell towards the murder scene. Framed for murder and with no means of escape, so begins the case of the Bali Budgie.



## Avenue IQ

The world of *Sam Cruise* is impressive. It's one big lengthy stage, a sleazy street, where Sam has to follow the clues that lead him to certain areas that will progress the case. But whereas the action in *Skool Daze* was viewed internally, in *Sam Cruise* the camera is always positioned on the mean streets. This means any actions that occur inside buildings are obscured by their bricks and mortar, and visible only through windows. While we suspect this perspective certainly won't be to everyone's liking, it's another aspect that helps *Contact Sam Cruise* feel distinctive from the *Skool* games.



## Case closed

There are a number of standout moments in the adventure, from the discovery of the dead man on the top floor or the hotel to Sam getting thrown into the slammer and having to meet bail to get released, and simply evading capture from the police using a wily disguise. But the standout moment is probably the finale. In typical detective story fashion, *Sam Cruise* ends with a twist, and it's certainly worth cracking the case to see it play out. Without wanting to spoil the ending, know that it wraps up everything brilliantly and even leaves the door ajar for a possible sequel.



## IN THE KNOW

- PLATFORM: ZX SPECTRUM
- PUBLISHER: MICROSPHERE
- DEVELOPER: IN-HOUSE, DAVE REIDY
- RELEASED: 1986
- GENRE: ADVENTURE
- EXPECT TO PAY: A FEW QUID

## What the press said... ages ago

**Crash - 93%**

"The Chandleresque flavour is just about perfect, best played in a trilby with a packet of Lucky Strike and a glass of bourbon by your side, this is the next best thing to being Bogart."



**Your Sinclair - 8/10**

The graphics do get a bit difficult to sort out sometimes – especially when you've got dollar bills, passers-by and cops all vying for the same spot on-screen – but if you're looking for a bit of private eyeing, take my advice, kid – contact Sam Cruise.

## What we think

While we suspect that the perspective won't be to everyone's liking, *Contact Sam Cruise* is an atmospheric adventure game that brilliantly captures the seedy world of the film noir private dick. It's also humorous, looks great and tells a well-woven story.



# The Collector's Guide



# VECT



» **Manufacturer:** Smith Engineering » **Model:** Vectrex » **Launched:** 1982 » **Country of Origin:** US

# REX

In our continuing series, Mat Allen explains why the Vectrex holds so much appeal in today's market and why it is a great niche format to collect for

# The Collector's Guide



► [Above] Even the promo materials are hard to find, and go for decent money.

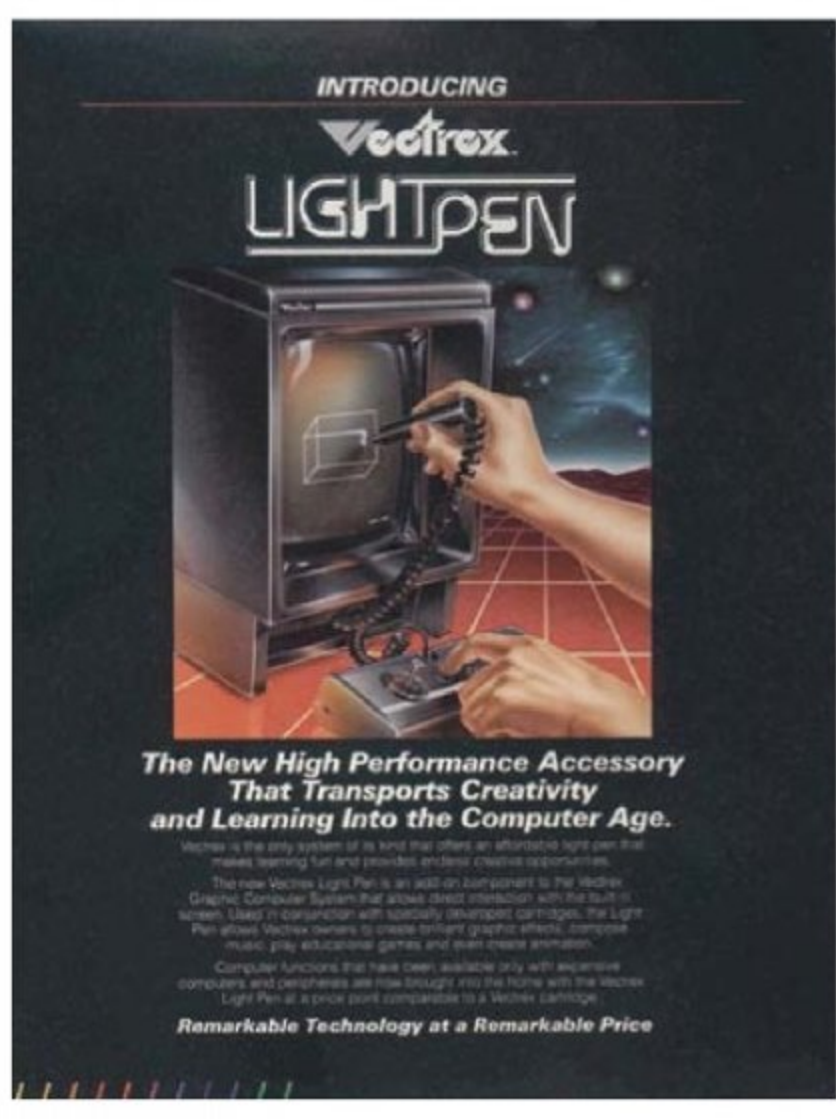

► [Left] The Lightpen was another example of how innovative the Vectrex was.



► [Above] A boxed Vectrex now sells for a pretty penny on the likes of eBay.

## WHY IT'S COLLECTABLE

The GCE/MB Vectrex is arguably the home console counterpart to the Commodore VIC-20. Not only were both machines released in the same era, but they are more powerful than people realise, were very good value for what was on offer, and home to a significantly sized set of more than decent games. They were also unfairly cut off in their prime. For the VIC-20 it was due to its big brother, the Commodore 64, being released; in the Vectrex's case, it was another victim of the videogame market's crash in 1983.

Vector graphics at the time were a small yet staggeringly successful part of the arcade scene, having been popularised by titles such as *Asteroids*, *Tempest*, *Battlezone* and, soon after the Vectrex launched, Atari's *Star Wars*. The arcade manufacturer Cinematronics, however, is the one company permanently tied to the lure of the vector phosphor,

having released games such as *Starhawk* and *Space Wars* way back in 1977, to be followed by *Tail Gunner*, *Rip Off*, *Star Castle* and *Warrior*, the first one-on-one fighting game.

In turn, GCE licensed a number of Cinematronics games for home release, and even traded *Cosmic Chasm* back in return for arcade distribution, although the coin-op version is slightly easier to play compared to its console counterpart. Additionally, GCE managed to acquire licences to convert some popular standard arcade machines such as *Scramble* and *Pole Position* to the Vectrex. Some might conclude this to be misguided, but if truth be told, there isn't a single bad arcade conversion on the format.

So vector games were popular back then, and continue to be so today via efforts in the vector style such as *Geometry Wars*. Perhaps one reason is that they look more timeless and haven't immediately aged in appearance like many other types. Given that the Vectrex is the only home machine that can offer a dedicated vector monitor, it occupies a unique niche

in the games market enhanced by the potential of its hardware, even though the graphics are limited to black and white only.

One other point in the Vectrex's favour is that, like many of its contemporaries, there is no region coding on the cartridges, meaning you can play a game from the US, Europe or Japan on any console. With the display unit being an integral part of the console, there is also no worry regarding PAL/NTSC issues that affect machines such as the Atari 2600 and 7800. Every game will always play in exactly the same way.

Additionally, unlike the majority of other classic systems, the Vectrex is perhaps unique in the fact that all of the original games released by GCE/MB are freely and legally available. It was a decision Jay Smith made when regaining the rights to the programs in the early Nineties, as long as the ROMs were not used for financial gain. A few programmers, such as Jeff Minter, have made their works readily downloadable, but this is probably the only example of a console's entire catalogue being available free of charge.

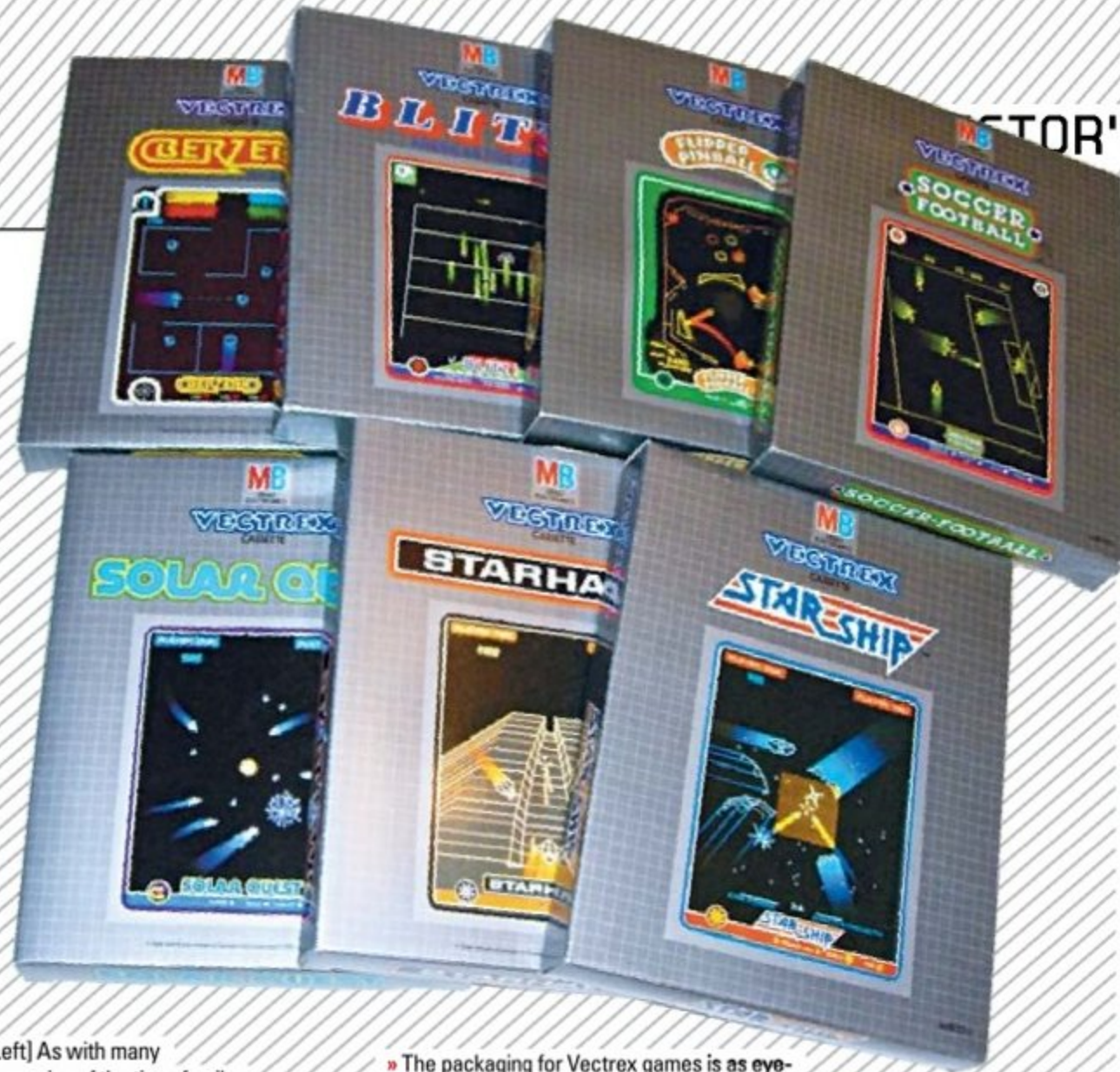

**DID YOU KNOW?**  
 ■ *Minestorm* is arguably one of the finest pack-in games for a console ever, challenging and merciless. So much so, programmer John Hall only designed 13 levels for it, expecting no one to be able to get that far. After the console's release, he was proven wrong. To placate anyone who wrote to GCE regarding this 'issue', an updated version with a rumoured 255 levels was sent out on cartridge. Technically this is the rarest official cartridge out there. This version of *Minestorm* was also installed in the last runs of the hardware.



» [Left] As with many companies of the time, family focus was paramount.

» The packaging for Vectrex games is as eye-catching as the machine's distinctive visuals.



» Two-page spread from the sole issue sent to registered Vectrex owners.

As a result, one of the first developments for Vectrex enthusiasts during the Nineties was the multicart, of which there are a number of examples from various sources, usually with different sets of games on them. Many of the early cartridges were controlled by DIP switches, and only later were on-screen menu systems incorporated into the logic. In today's Vectrex scene, the flash cartridge is the best solution for housing all the games you could want.

Alongside the prevalence of multicarts and general availability of the original ROMs online is the thriving homebrew scene. In fact, there have been more homebrew games produced by fans and devotees to the system than there were original releases. Some of these have become notable in their own right, such as *Protector* by Alex Herbert, *Thrust* by Ville Krumlinde, and *Vector Pilot* by Kristof Tuts. The overall result is that the Vectrex is becoming better-known, no longer just a cult console, and those who get into the machine via homebrew are going on to purchase the original games as well.

Those games also packed a bit more into the box than many other products did. Aside from the usual cartridge and manual, there was a plastic tray to hold the cartridge, and an overlay with paper sleeve for most games. For the 3D titles, there was also a colour disc for use in the Imager. Perhaps it is because plastic is more resilient than paper, but the overlays tend to turn up more often than the manuals do. The complete product is undeniably a thing of beauty. When collecting, it's also easy to see where your particular game has come from. In the US, even after the deal with MB, all the games still retain the GCE logo, while European releases are all labelled MB, and the Japanese games are from Bandai.

So if you wish to start collecting for the Vectrex, what facets should you pay attention to? Due to the relatively short lifespan of the console, the overall library is quite small – only 27 retail titles in total. In absolute terms, it isn't the hardest or most difficult set of programs to acquire, although the value of complete titles is very gradually heading upwards, and the

original peripherals are becoming a lot more valuable. The advice may be that now would be a better time to start than later but, conversely, some of the items being sold on places such as eBay are overpriced. As always, it's wise to shop around, and in respect to the console itself, you should try to test it thoroughly before purchase.

Understandably, the last three games that were released – *Pole Position*, *Star Castle* and *Polar Rescue*, all only made available in the US – are the most expensive three of the set, but even then the values have come down a little, and complete versions of all three should not set you back more than \$100-150 each, which is roughly the maximum price any of the Japanese releases sell for. The European MB releases tend to be a little easier to find than the American GCE releases, but there usually isn't much difference in rarity between the two sets. It really depends on your budget, and loose cartridges of any variety can be quite cheap. So if you fancy collecting for the Vectrex, dive in. It won't end up costing you an arm and a leg.

# The Collector's Guide

## THE PERIPHERALS



» The 3D Imager is extremely cool and extremely expensive to buy.



### 3D IMAGER

The most iconic peripheral for the Vectrex has to be the 3D Imager, released in early 1984 only in the US, and the first home attempt to give consumers a 3D gaming experience. Sega mistakenly believed it was the first to get there with the Master System's 3D glasses a few years later, before having the fact pointed out to it, at which point the promotional materials were hastily withdrawn.

The technology that Sega developed was a mile away from the earlier engineering incorporated by GCE in its 3D Imager, however. In today's light it may appear a little crude in comparison, but it most certainly worked, and worked quite well indeed. A colour disc was included with every game that slotted into the headset mechanism in front of the eyes. Each disc was divided into segments of colour or solid black and powered via the 5V pin on the joystick port,

causing it to spin upon turning on the Vectrex with a supporting cartridge present.

The calculations required to conceive the 3D effect were rather impressive. The in-game display would be rendered twice at slightly different on-screen positions, and timed so that the black half of the disc would be obstructing the vision of one eye per individual render. However, all the vector lines were also timed to be drawn at a particular moment in order to appear in red, blue or green depending on which coloured section of the disc was in front of the eye.

Not only were players getting a 3D image, but they were seeing vectors in colour, which the Vectrex was unable to achieve by itself. Sadly, the planned colour version of the console was canned, so this is the only method available to play coloured vector games with the hardware. The headset is fairly sturdy, but inevitably the weakest point that quite often breaks is the part where the colour disc is attached, as it takes little tugging to remove it.

Three games officially supported the 3D Imager during its original lifespan. An thankfully updated version of *Minestorm* was included in the box, and available separately were *3D Crazy Coaster*, a lacklustre attempt to simulate and make a game out of riding a rollercoaster, and *3D Narrow Escape*, a tunnel shooter. Since then, George Pelonis has released two homebrew titles that support the hardware: an improved version of *War Of The Robots* with similar gameplay named *3D Lord Of The Robots*, and *3D Sector-X*.

Unsurprisingly, given the fragility of the original hardware and the rise in value over the years, there have been attempts to produce modern replicas that operate in exactly the same fashion. John Maccallan manufactured and sold a reproduction with better adjustment for head sizes, much larger colour discs, and far more reliable technology. But ironically, due to various circumstances, this updated version is harder to find today than the original on which it was based.

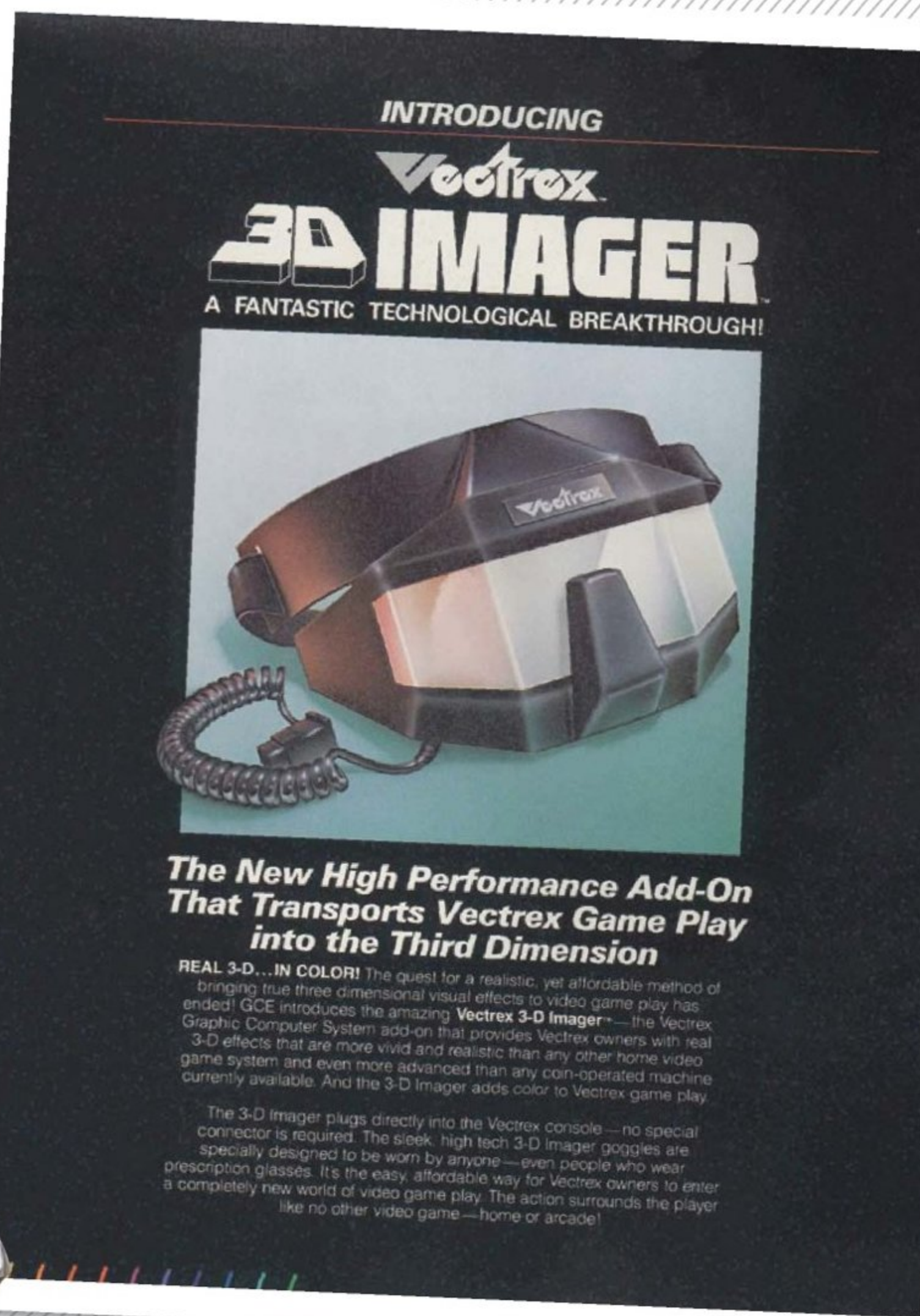



...AND THE REST



**01. Lightpen**

Originally bundled with the Art Master cartridge, and supported by Melody Master and Animation, the lightpen was a bit of a surprise compared to lots of other peripheral equipment at the time in that it actually worked really well. Unfortunately, like the 3D Imager, it was released only in the US, and only towards the end of the Vectrex's lifespan, and supporting games, such as *Mail Plane*, were not completed.

**02. Vectorcade**

Originally sold for \$120 in 2001, the Vectorcade was a professionally made arcade-style digital joystick offered in a range of colours, with the same quality of components found in retail units. Sadly only 27 were made before creator Brett Walach halted production, meaning it's going to be very hard to find one around these days.

**03. Controller**

If you can't locate a Vectorcade, and it's very unlikely that you actually would be able to, the next best solution is to purchase an extra official controller. A number of games support two-player simultaneous action, and the only issue is that even these controllers are a little bit pricey due to high demand.

**04. VecMulti**

The latest iteration of Richard Hutchinson's flash-based multicart technology, the VecMulti allows ROM images to be loaded onto a microSD card and booted via a self-created menu system. With support for onboard RAM and bank-switching to 64K, the VecMulti can play any game produced for the Vectrex to date.

**05. VecVox**

Another modern hardware development, the VecVox has seen a number of versions over the years, thankfully getting smaller in the process. Plugging into joystick port two, it allows supporting programs to directly output speech and samples independently of the sound chip inside the Vectrex.

**06. Carry case**

Despite its many positives, even we at *Retro Gamer* freely admit that the Vectrex is not exactly the easiest thing to move about, even taking into account the quite useful handhold at the top of the unit. For those times when it has been taken with you, there was the carry case, available in both GCE (US) and MB (Europe) varieties.

**07. Dust cover**

You have to understand that there weren't a lot of peripherals released for the Vectrex, hence the inclusion of this item. But should you not be playing your console for some reason, this dust cover would keep it well protected while occupied with your 360 or PS3 instead.



# The Collector's Guide

## TOP 5 GAMES TO PLAY



### 01. Star Castle

■ If you have an iconic vector-based arcade machine, then it's going to be given the most justice by being converted to a vector-based home system. *Star Castle* does not disappoint. Shoot the rings, avoid the fire, and destroy the enemy. This release was US-only, so you'll have to import.



### 02. Scramble

■ Somewhat peculiarly, the Vectrex was the only host of a licensed home version of *Scramble* at the time. Fortunately it was an excellent conversion, retaining all the playability of the original machine, despite the compromises made with the graphics and the screen being vertical instead.

### 03. 3D Narrow Escape

■ Not just a pretty face, this separately available 3D Imager game was actually worth playing. The 3D effect enhances the experience, and the simple yet compelling gameplay of flying into the screen, shooting enemies and flying through gaps, comes off really well.



### 04. Fortress Of Narzod

■ A static-screen vertical shooter made somewhat different by virtue of having a distorted playfield and that your shots can rebound back and kill you just as easily as the enemies you're trying to destroy. Like many Vectrex games, it's not a pushover either, encouraging you to come back to it.



### 05. Armor Attack

■ A conversion of the Cinematronics arcade coin-op, it has fairly simple game mechanics, made better by the challenge on offer and the fact that it can be played in two-player co-operative mode. Drive your jeep around the city, defending it against the attacking tanks and helicopters.



## PLAY THESE NEXT



### Minestorm

■ In line with popular belief for once, *Minestorm* was indeed conceived as an *Asteroids* clone. However, it evolved the play mechanics and in the process produced a far more challenging and intense game. In fact, the programmer John Hall honestly thought no one would get past level 13 (see "Did You Know?").



### Web Wars/Web Warp

■ It looks a bit like *Tempest* and plays a bit like *Tempest*, but that's where the similarities end. Control the Hawk King down the web, shooting down the attack drones and capturing 20 different kinds of creatures. The ability to control your speed and the fact that missed enemies circle around to attack again make this a tricky title to master.



### Bedlam

■ This game, however, plays more than a bit like *Tempest*. It plays quite a lot like *Tempest*, and other titles of that ilk. Control your central gun to rotate and shoot the incoming hostiles, who exhibit varying attack patterns. An occasionally relentless pace means *Bedlam* can provide a stiff challenge to many.



### Cosmic Chasm

■ This was the first ever home videogame translated to the arcade, albeit in slightly simplified form. For that, the original Vectrex version is better and more involving. Fight your way through a complex of rooms, defeating the alien ships to plant a bomb in the middle, and then escape in time before it blows up.

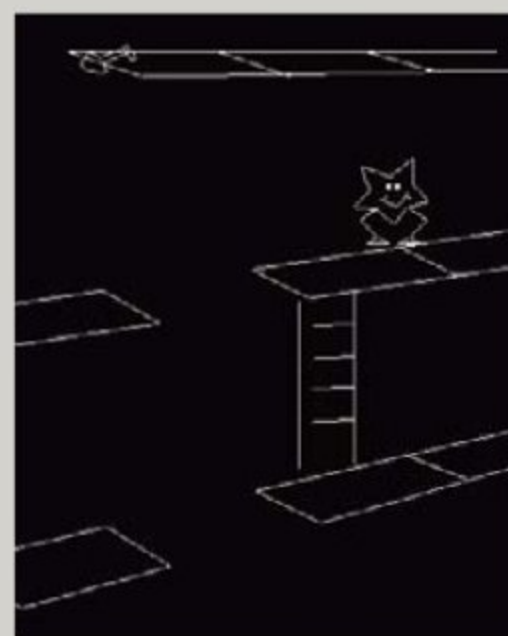

### Spike

■ Eek! Help! Spike! Oh no! Molly! Such were the words heard over the speakers when firing up every game of *Spike*. It is notable not just because of the speech, but also for being the only platform game for the system. Thankfully, it's got a great innovative style, and is a fun little game to boot.

# THE JEWEL IN THE CROWN

Every system has a game that all collectors would love to own no matter its cost. This month, we examine the incredibly rare Mr. Boston Clean Sweep

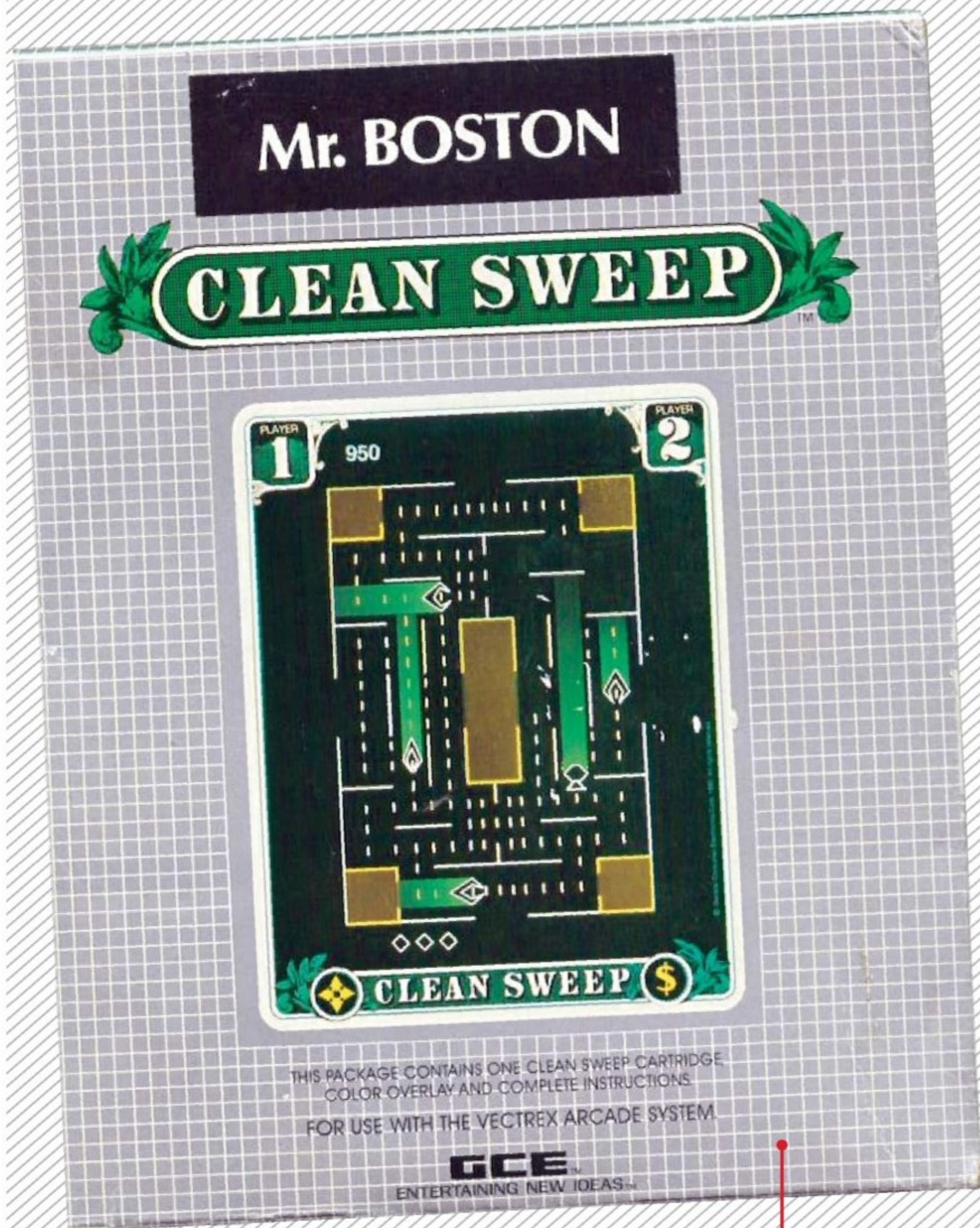

### What makes it hard to find?

■ One of the rarest promotional items on any format, *Mr. Boston* was an obscure curio of a tie-in. Only a handful are known to exist today, of which two are complete copies.

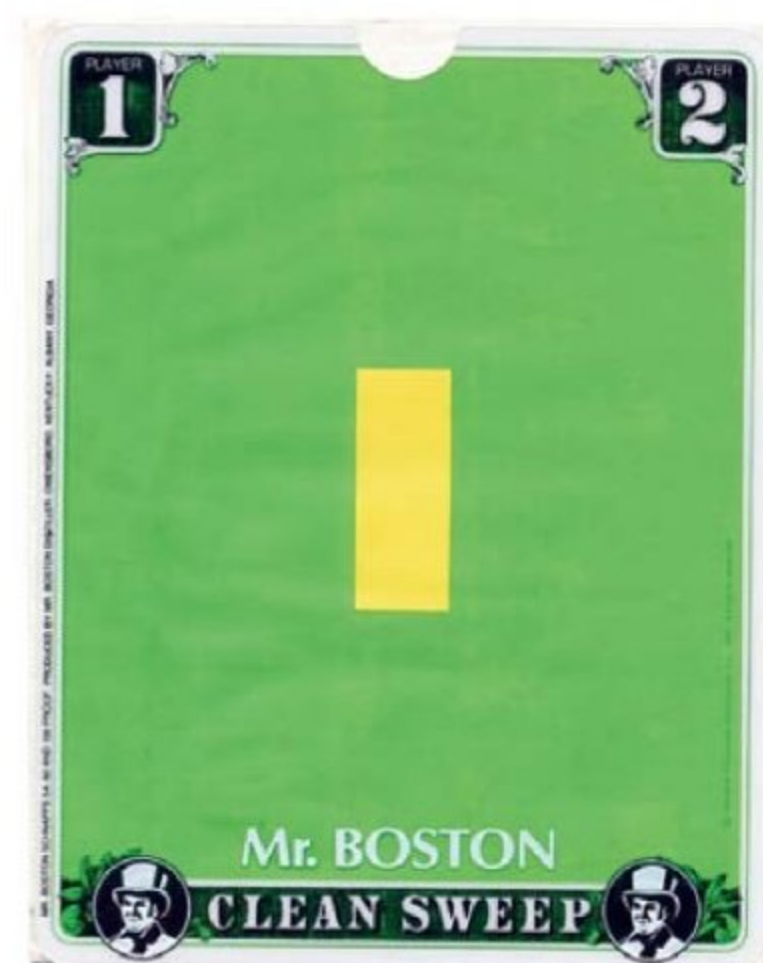

### Why is it so expensive?

■ While the box and manual differ from the regular *Clean Sweep* only in the sticker across the top, the overlay was altered to include the *Mr. Boston* logo in the corners. The cartridge label is not the same quality as official Vectrex labels, being merely a printed white piece of paper.



### What makes it so special?

■ The differences were the addition of an advertising splash screen on boot for *Mr. Boston* products, and changing the main character from a vacuum cleaner to a top hat.



# The Collector's Guide

## ✓ THE COMPLETE CHECKLIST OF ORIGINAL VECTREX GAMES\*

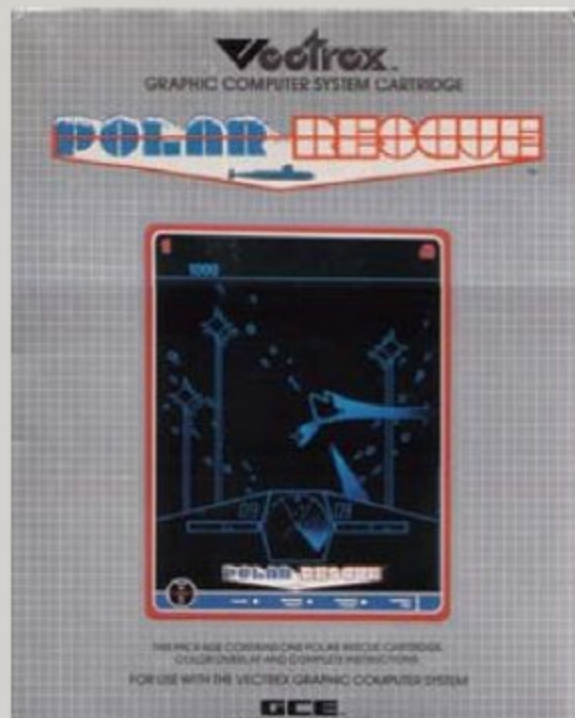

### POLAR RESCUE

Underwater first-person adventure that was the last game to be released on the console.

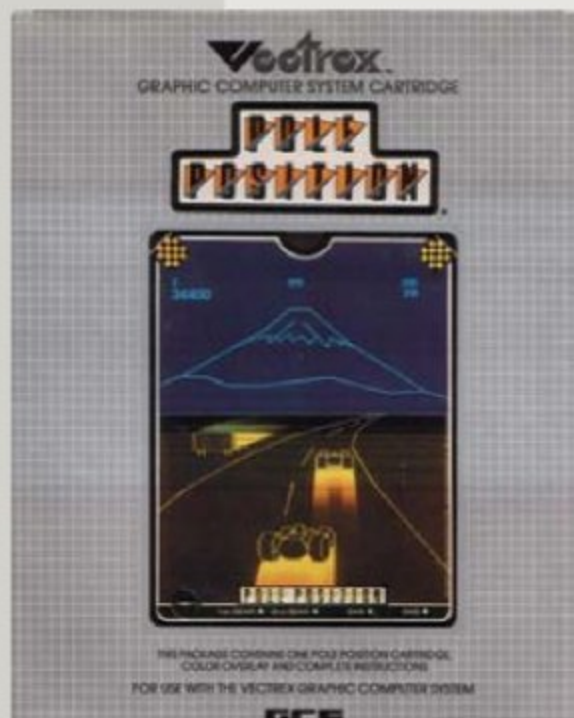

### POLE POSITION

Conversion of the classic Namco racer that, rather surprisingly, actually turned out to be quite good.

### 3D CRAZY COASTER

Arms up, arms down, left, right, flееееew! Not a great game by any means, but a good idea.

### 3D MINESTORM

It's *Minestorm*... but now in the glory and wonder of 3D!

### 3D NARROW ESCAPE

Fly through the tricky corridors, destroy ships and avoid obstacles in this entertaining shooter.

### STAR CASTLE

This is probably Cinematronics' most famous game, brought home to the perfect format.

### MINE STORM

Terrific *Asteroids*-inspired rotation shooter that every Vectrex owner got to enjoy.

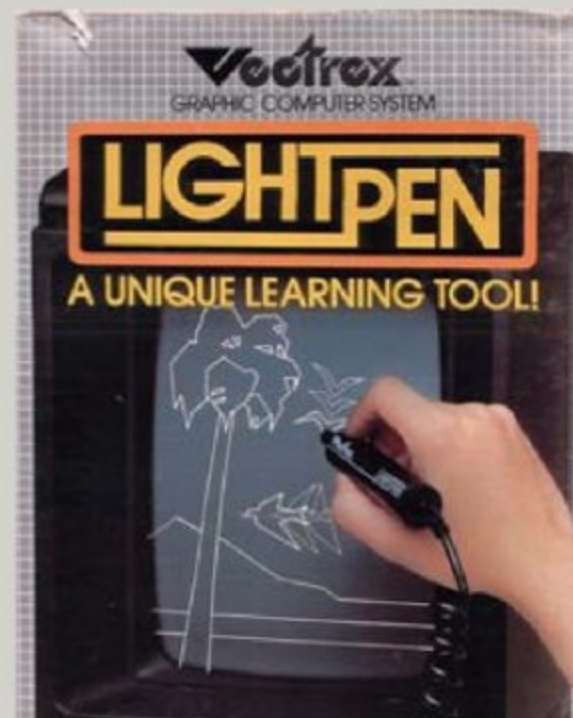

### ARTMASTER

Drawing cartridge packaged with the lightpen that allowed you to sketch and animate simple objects.

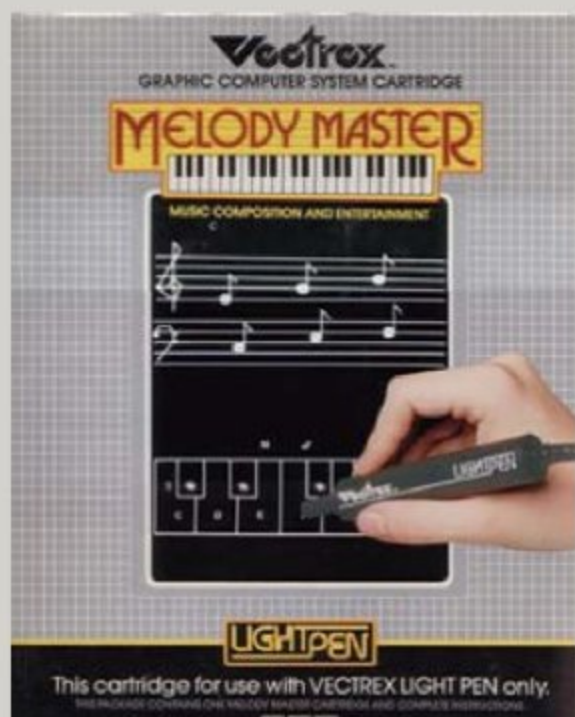

### MELODY MASTER

Create music or play a *Simon*-like music recall game using the lightpen. Way ahead of its time.

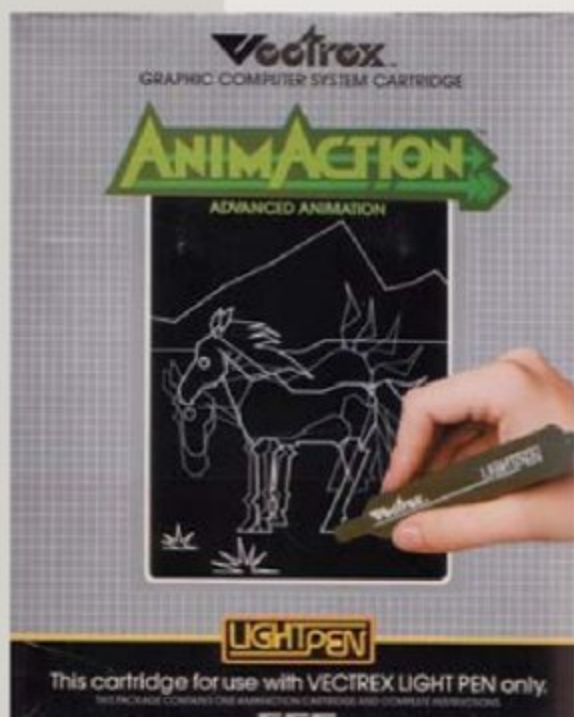

### ANIMATION

Explore your creativity; create sprites and animated scenes using the only cartridge with onboard RAM.

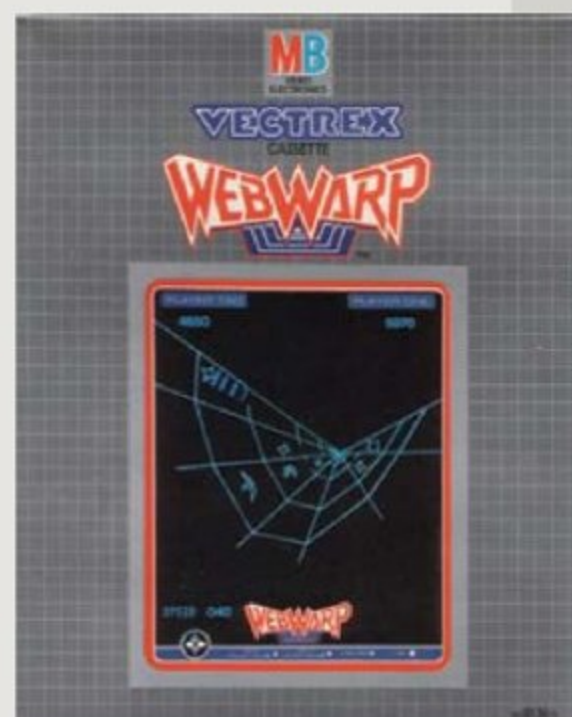

### WEB WARP/WEB WARS (US)

Ride down the web, defeating the enemy saucers and capturing the floating creatures.

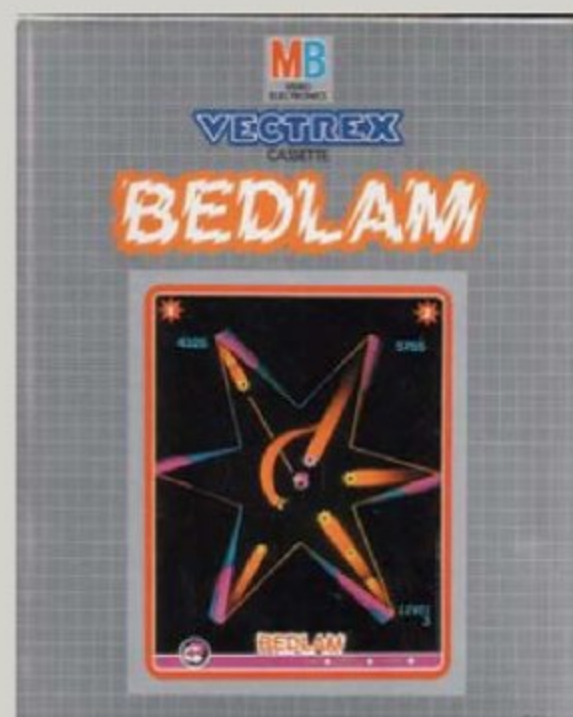

### BEDLAM

Engaging static rotation-based shooter akin to *Tempest*, with similar challenge and variation.

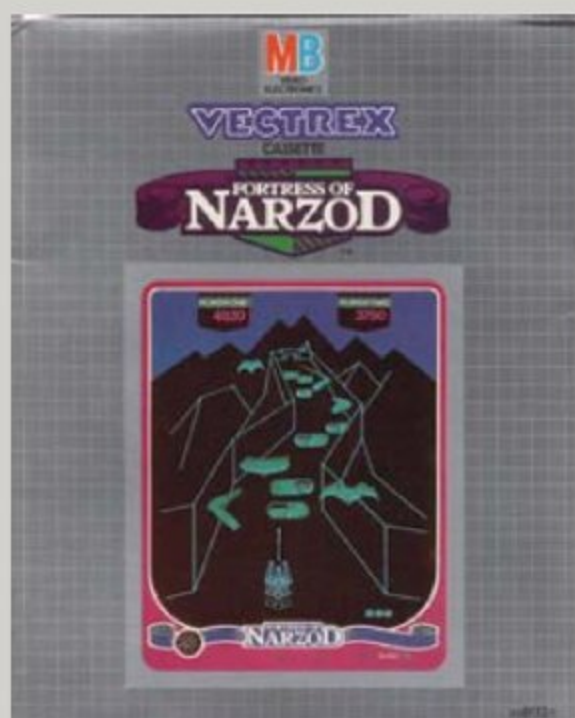

### FORTRESS OF NARZOD

Entertaining vertical shooter with the risk of dying from your own shots.

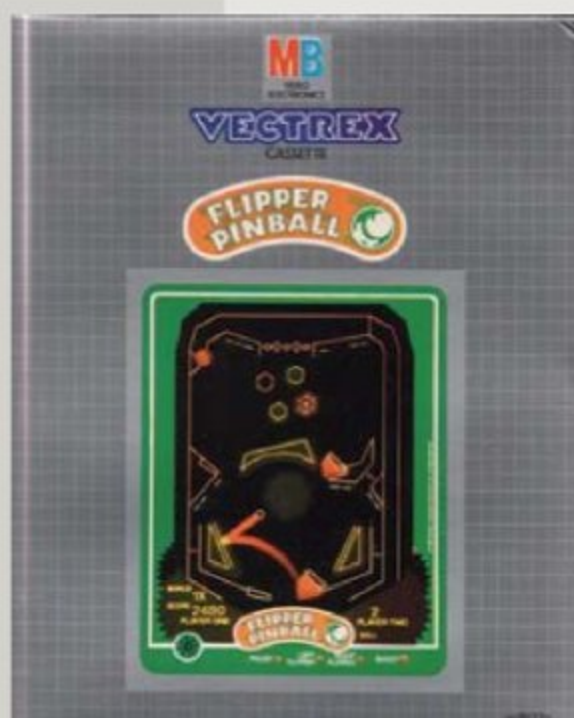

### FLIPPER PINBALL/SPINBALL (US)

It's football, but suffers the same flaws as most other interpretations of the era.

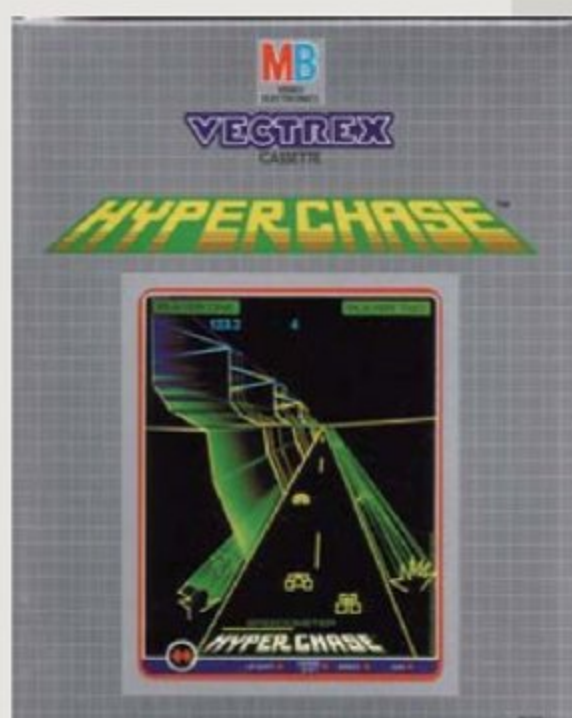

### HYPERCHASE

Turbo-inspired driving game that uses the analogue stick properly.

### SPACE WARS

A Vectrex version of one of the earliest ever videogames, and not bad at all. Only playable with a friend, though we're sure you can find someone to play *Space Wars* with.

### FOOTBALL SOCCER/HEADS UP

### ACTION SOCCER (US)

It's football, but suffers the same flaws as most other interpretations of the era.

### ARMOR ATTACK

Co-op overhead shooter converted from the Cinematronics arcade title makes for a compelling game.

### BERZERK

Conversion of the Stern arcade maze game shooter, whose only flaw is occasional slowdown.

**EXTREMELY RARE**

Games that have less than a few dozen known copies available.

**VERY RARE**

Very hard to come by. Expect to see only a couple of copies per year.

**RARE**

You should be able to source these in a reasonable amount of time.

**UNCOMMON**

You won't find them straight away, but you will after a search.

**COMMON**

Always just a click away for the average collector.

**VERY COMMON**

So common you'll find them in most bundles of games you'll buy.

**Collector Q&A**

We grill French collector Rudy Dobrzeński regarding his Vectrex habits...



■ **What drew you to start collecting for the Vectrex?**  
When I was young, my cousin had an Atari 2600. We spent a lot of time playing on it, and for a while she wanted to give it to me, but my parents would not allow it. They were worried it would somehow break the TV. My godfather found a solution. He read about the Vectrex in a magazine and found one for sale in Brussels, which he bought for me. So I've been playing for a long time.

■ **How long have you been collecting so far?**  
I've collected for the Vectrex since 2005, as I wanted to get one again. The console I bought was just loose without box or guides.

■ **Do you have any advice for potential collectors?**  
Early on, don't buy on eBay because the prices tend to be inflated. Ask around in online communities or forums instead. The control panels can be fairly pricey, so make sure the unit you purchase has one in working condition. Purchase a multicart in the beginning to play the games, before deciding which ones to collect.

■ **What item is the shining light of your collection?**  
I own one of the known copies of *Mr. Boston*, albeit a loose cartridge. There are only a handful of copies known out there, and I was fortunate to acquire it as it was in an auction for a group of Vectrex cartridges with poor photos and descriptions. I only paid around \$150 in total for the lot!

■ **What would you say is the hardest game to find that you've bought?**  
The hardest game to find that I own would be *VeCaves*. I was searching for five years before a copy turned up on eBay that I could buy. By comparison, *Mr. Boston* was easier to find.

■ **What is the most you've spent on any one title?**  
Game-wise, it was the *VeCaves* title mentioned in the previous question. I've spent over €250 on a group of prototypes in the past. The most expensive Vectrex-related item I've bought would be the US display stand.

■ **What's the one item you are still missing that you'd like to acquire?**  
I'm still missing some homebrew limited editions and prototypes, but I don't know if I will ever get them because many of them are rare and go for a lot of money. I would also like to acquire a Vectorcade controller and a Minicade.

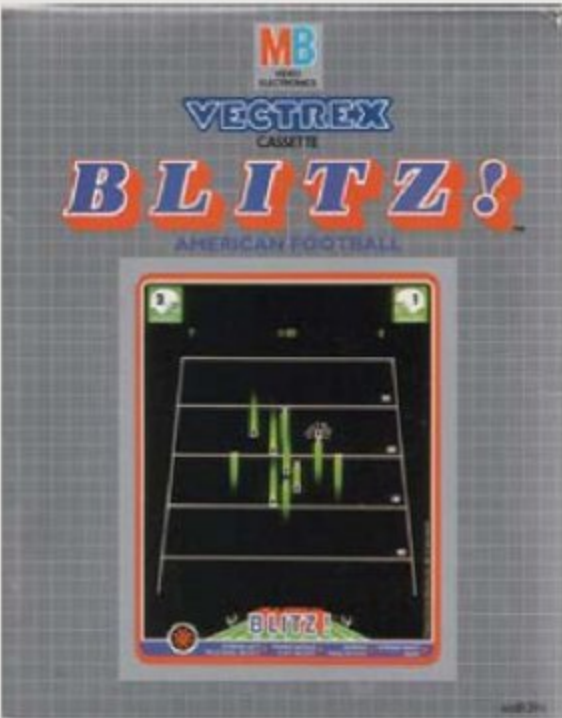

**BLITZ**  
A version of American football that over-reaches somewhat and has to rely on basic graphics.

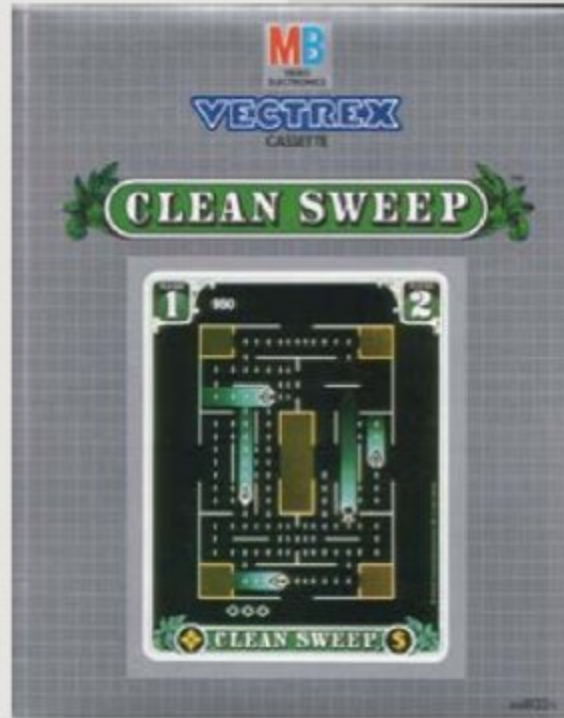

**CLEAN SWEEP**  
*Pac-Man* clone with significant changes, and the twist that you must drop off in the middle every so often.

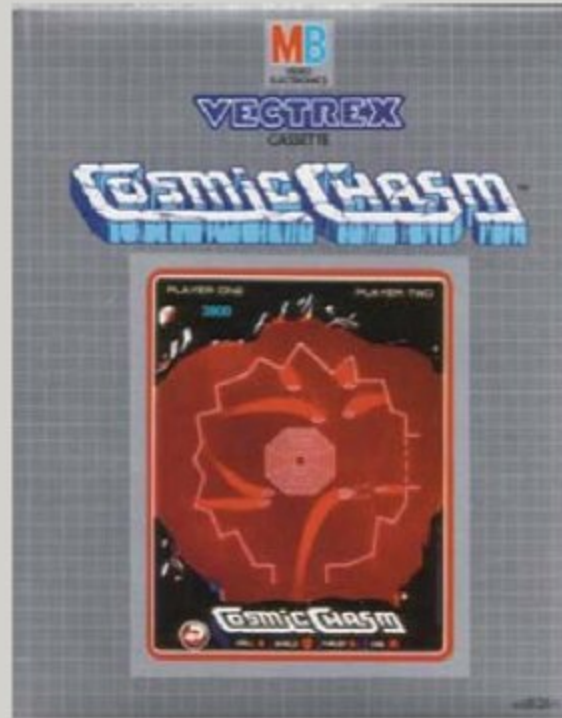

**COSMIC CHASM**  
Infiltrate the caverns, drill the barriers and plant a bomb at the centre before frantically escaping.

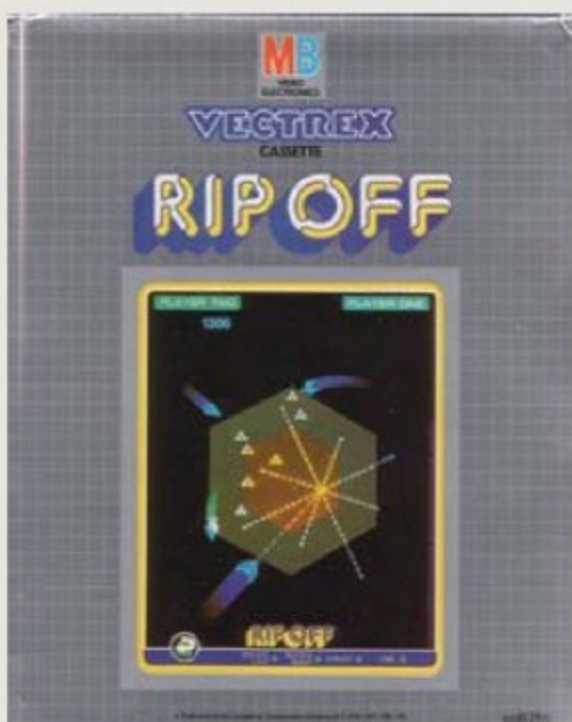

**RIPOFF**  
Another co-op Cinematronics conversion with the emphasis on protecting your supplies.

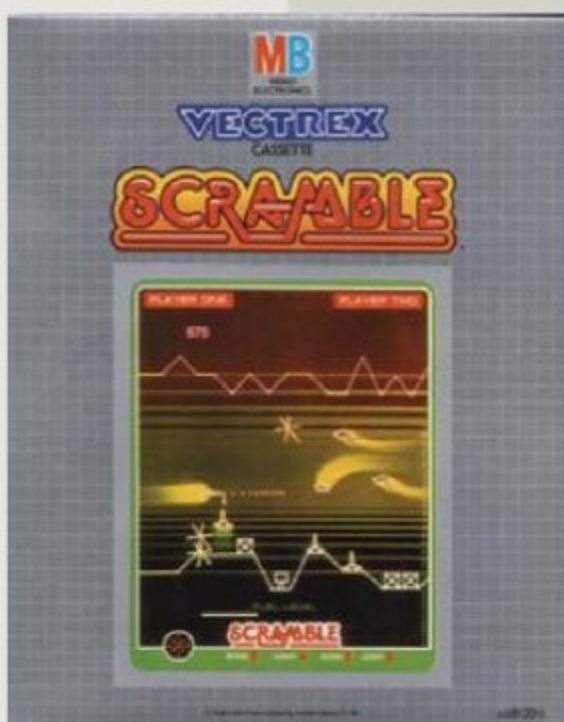

**SCRAMBLE**  
Excellent conversion of the Konami coin-op with all the same addictive qualities. Easy to find, a very good buy.

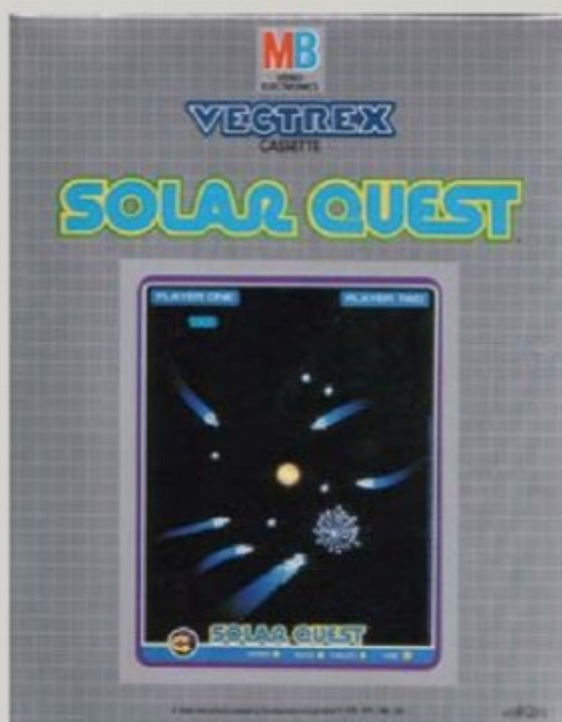

**SOLAR QUEST**  
Like a single-player *Space Wars* where you can choose to capture or destroy the survivors.

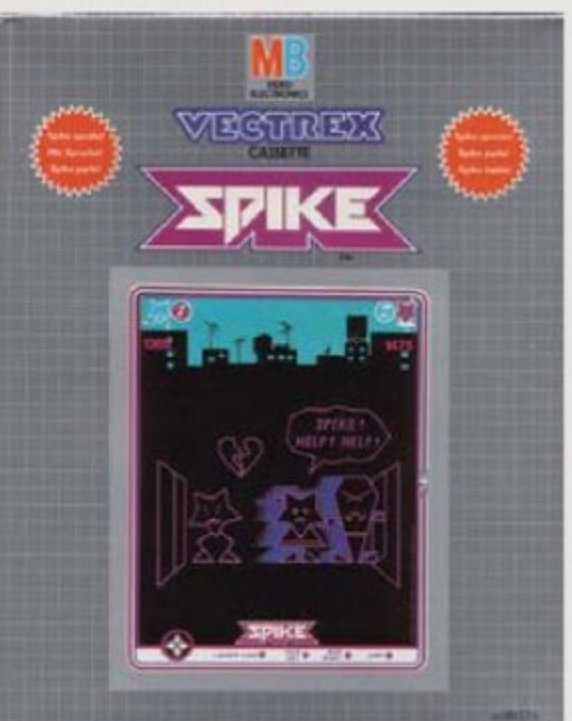

**SPIKE**  
The only platform game on the console that gradually gets harder each round. Absolutely addictive.

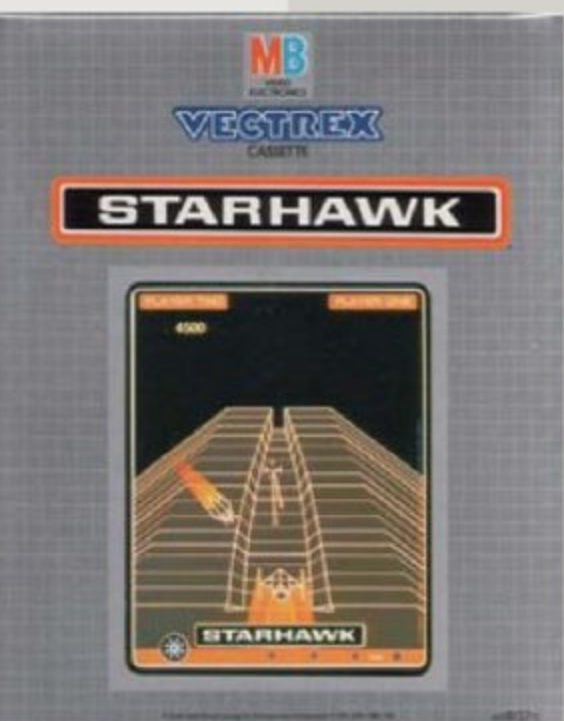

**STARHAWK**  
Crosshair shooter played against the clock, based upon the Death Star trench run in *Star Wars*.

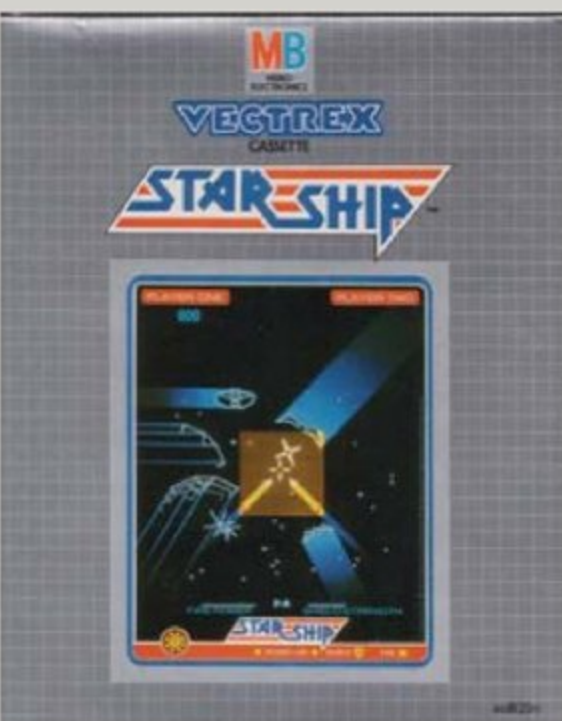

**STARSHIP/STAR TREK (US)**  
Space shooter based upon the first *Star Trek* film, given different names outside the US.



# GameCube

Nintendo's GameCube recently turned ten years old in Europe. To celebrate this special anniversary, we've highlighted ten titles that we feel should be in every GameCube collection



## RESIDENT EVIL

Developer: Capcom Year: 2002

High-definition makeovers are appearing more and more often, and while we enjoy them, they're rarely put together with the same care and attention that Capcom lavished on *Resident Evil's* remake. Released relatively early in the GameCube's life, it's a stunning reproduction of the hit PlayStation game, with around 70 per cent of its content rejigged and numerous gameplay mechanics from later games to ensure it feels like a fresh experience. Graphically it's an absolute masterpiece, with redrawn enemies and environments, stunning lighting effects, and the sort of intricate detail that escapes most high-definition ports. It also introduced the super-scary Crimson Head zombies, maintaining the ability to scare, some six years after its original PlayStation release.



## THE LEGEND OF ZELDA: THE WIND WAKER

Developer: Nintendo Year: 2002

Forget *Heavy Rain* and any other cutting-edge technology-based game that professes to act as a bridge between the medium of film and games, because Eiji Aonuma already achieved it with his excellent *Zelda* game. *The Wind Waker* was initially met with criticism because its gorgeous cel-shaded visuals were a world away from the realistic styling that Nintendo had first hinted at during the GameCube's reveal, but the cel-shading proved to be a masterstroke. The large, anime-styled faces allowed Aonuma to fill his characters with the sort of emotion that's rarely seen, before or since, and we defy anyone not to get personally involved as Link's quest meets its dramatic conclusion.



## ETERNAL DARKNESS: SANITY'S REQUIEM

Developer: Silicon Knights Year: 2002

It's a testament to the willpower of Silicon Knights that *Eternal Darkness* ever received a release, as it was in development hell for years. First pitched as an N64 game – the roughness in its many cut-scenes attests to these origins – *Eternal Darkness* is an interesting take on the survival horror genre and a fitting tribute to the work of HP Lovecraft. Filled with genuinely innovative play mechanics, including its imaginative sanity effects, and featuring an epic story that spans 2,000 years, it places you in the shoes of 12 unique characters, ranging from a Roman centurion to a Persian swordsman, as you try to unravel the mysterious death of Alexandra Roivas's grandfather in the present day.



## METROID PRIME

Developer: Retro Studios Year: 2002

Retro Studios' *Metroid* game had an extremely turbulent back story, nearly getting canned in the process. Nintendo intervened, a reinvigorated Retro went back to work, and the end result was one of the GameCube's best titles. While it looks like a first-person shooter, *Metroid Prime* is actually more of an adventure game, effortlessly recapturing the feel of earlier instalments but re-creating them in a beautifully realised 3D world. Coupled with cutting-edge visuals, extremely clever puzzles and a genuinely engaging story, it's one of the best examples of a 2D series making the leap to 3D and cemented Retro Studios' reputation as one of Nintendo's most important Western developers.



## F-ZERO GX

Developer: Amusement Vision Year: 2003

*F-Zero GX* might not be as good as its Nintendo 64 predecessor, but it's nevertheless the best racer on the GameCube and is still one of the best in the series. Polished to perfection in collaboration with Sega and running at an eye-melting 60 frames per second, it's an amazingly challenging racer, with some of the toughest, most unforgiving AI around. In fact, its formidable opponents are extremely off-putting initially, but stick with it and you'll be rewarded thanks to *F-Zero GX's* lengthy story mode, rich variety of vehicles and clever track design. Add in some beautiful visuals and an excellent multiplayer mode and *F-Zero GX* becomes an essential racer, fit for any GameCube collection.



## RESIDENT EVIL 4

Developer: Capcom Year: 2005

Like *Metroid Prime*, *Resident Evil 4* suffered a bumpy development in its attempts to overhaul a classic formula, with the final product being a world away from what Capcom had first hinted at during the game's announcement in December 1999. The lengthy wait was worth it, however, as *Resident Evil 4* revolutionised not only the survival horror genre, but also the third-person shooter – both the *Gears Of War* and *Dead Space* series are clearly indebted to it – with its exceptional use of cut-scenes, dynamic set pieces and brilliant pacing. It's the best *Resident Evil* game Capcom has ever produced, not to mention easily one of the most important games of the last decade. *Resident Evil 6* has a lot to live up to...

# Gems

10  
YEAR  
ANNIVERSARY



## SUPER MONKEY BALL

Developer: Amusement Vision Year: 2001

After failing to secure a port on the failing Dreamcast, Sega's quirky arcade game instead made its home console debut as a GameCube launch title. Brilliantly playable thanks to the GameCube's excellent analogue stick, *Super Monkey Ball* was a superb puzzle game that had you negotiating tricky mazes as quickly as possible. In addition to an excellent single-player game, *Super Monkey Ball* features some fantastic multiplayer modes, including the insanely addictive Monkey Target, which sees you roll a bubble-encased simian down a hill as quickly as possible, before launching it into the ether to land on a tiny target. While it boasts many sequels, none of them have managed to capture the sheer variety and accessibility of the original game.



## IKARUGA

Developer: Treasure Year: 2003

We nearly didn't include *Ikaruga* as it made its console debut on Sega's Dreamcast. It's such an exceptionally good shooter, though, that we just had to highlight it here. Created by Treasure and regarded as a spiritual successor to *Radiant Silvergun*, *Ikaruga* is quite simply the best shooter on Nintendo's machine. As intricately designed as it is beautiful to look at, *Ikaruga*'s gameplay revolves around chaining enemies of the same polarity to boost your score. Your own craft can switch between black and white at will and can absorb bullets of the same colour but will be destroyed by opposite ones. It's an excellent mechanic, first hinted at in *Radiant Silvergun*, that gives Treasure's game an almost puzzle-like feel.



## BATEN KAITOS

Developer: tri-Crescendo/Monolith Soft Year: 2003

It was a tough decision between this and *Skies Of Arcadia*, but we eventually sided with *Baten Kaitos* due to its exclusivity. *Baten Kaitos: Eternal Wings And The Lost Ocean*, to give it its full title, works because it's so different to many other JRPGs. Its lead character slowly matures over the course of the genuinely interesting storyline, and it boasts a unique combat system that revolves around the use and collecting of cards called Magnus. Epic in scope – like *Resident Evil*, it's spread across two discs – and featuring a magnificent score and sensational graphics, it's an essential RPG that doesn't stick to traditional conventions. It's just a pity that its equally good sequel, *Baten Kaitos Origins*, never made it to Europe.



## PIKMIN 2

Developer: Nintendo Year: 2004

Nintendo's sequel is a marvellous one, sorting out all the niggly elements found in the 2001 original. Players now control Captain Olimar and his companion, Louie, which allows them to manage multiple tasks at once and also introduces a new multiplayer element to the game. The strict time limit from the original is also missing, allowing you to fully enjoy and explore the beautiful and well-designed levels, while delving into caves is nowhere near as dangerous as it once was. Two new Pikmin also appear: the slow but strong Purple Pikmin and the speedy, poisonous White Pikmin, which again adds to the ways you can approach stages. A truly magnificent sequel that shows how to do a follow-up.



Budweiser.





# WORKING CLASS HEROES



**Workers of the videogame world, unite! No, not you overworked coders and oppressed artists; we mean the 8-bit game characters that put in a hard day's work so you could have a good day's play. Paul Drury talks to the men who made heroes of Miner Willy, Monty Mole, Wally Week and many more of their working-class brethren...**

**I**n the early Eighties, as home computers were being dragged up by the bootlaces, a select band of coders chose to eschew space pilots and trigger-happy mercenaries to instead base their games on ordinary folk doing their jobs in extraordinary circumstances. What inspired these pioneers to place the working man centre stage, we wonder? Was it a barbed commentary on the political machinations of the Thatcher years prompted by a detailed analysis of socio-economic forces?

"Actually, I was sat on the toilet," says Malcolm Evans, the creator of *Trashman*. We stand corrected.

"My brother Rod had been at a meeting with our advertising agents. I joined them when it was breaking up, just in time to hear the phrase – not from my brother, I might add – 'All the kids want today is crap!' My brother turned to me and said, 'There you are. We need some crap from you.' There was only one thing to do with a command like that. I went to the crapper."

Sat on the throne, the king of New Generation Software began squeezing out some ideas for his company's next release. He first thought about reworking an old ZX81 game called *Bag Of Worms*, but decided it would be too disgusting in 3D. His mind then drifted to his pre-coding days working in the space industry and to the growing problem of space rubbish, but struggled to picture how the game might play.

"My thoughts came back down to earth and 'crap' became respectable as 'rubbish'," Malcolm explains. "It was then the idea of a dustman came into my mind and started to take off once I had visualised it. By the time I stood up, the idea was almost fully formed."

We decide not to ask if anything else was fully formed. Released in 1984 on the C64, Spectrum and Amstrad, *Trashman* starred a brave binman battling against vicious dogs, pushy barmaids and reckless drivers in a bid to keep Britain tidy. We wonder aloud why the game wasn't named *Dustman*. Surely this 'trash' talk is rather American?

"That was the working title, but then we heard some other company had released a game called *Dustman*, so to be safe, we changed ours to *Trashman*. Rod thought it would be better for the American market, but when Virgin sold it in the States, they changed the title to *Garbage Gobbler*. Apparently, the Americans didn't have any concept of what a trashman was!"

Ah, the US and the UK, divided by our common English tongue once more. There was no such confusion when mining was the trade in question of our gaming hero, and indeed Britain's most notorious underground man, Miner Willy, was inspired in part by the US-born Bounty Bob of *Miner 2049er* fame and partly by the Sinclair machine on which he made his name.

"On the Spectrum, platform games were the obvious things to do," explains Willy's father, the enigmatic and elusive Matthew Smith. "With platformers, you've basically got two options: have them in a building or underground. Once I decided we were heading downwards, you could have a miner or an archaeologist, and a miner seemed more British! Then Alan Maton [Matthew's future business partner at Software Projects] came up with the 'Manic' prefix and it was such a good name, that was it."



» [Spectrum] From rags to riches and back again... Miner Willy's life was a very circular one.



» [Spectrum] Wanted: Monty Mole wasn't afraid of including a little bit of politics in its play...



» The actual piece of coal presented to Tony Crowther's grandfather by NUM chief Arthur Scargill.

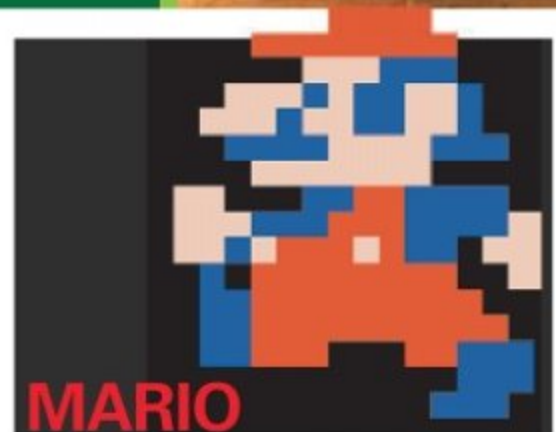

MARIO

**Previous employment:** Carpenter (*Donkey Kong*), plumber (*Mario Bros*)  
**Working-class credentials:** He defied Kong, a huge beast symbolising corporate consumerist America (probably) that paid scant regard to employee safety. Clearly, those barrels should have been stacked properly and kept away from naked flames. He retrained as a plumber but became obsessed with rescuing princesses, which sadly demonstrates a profound lack of class consciousness. Wake up, Mario; Peach will be first up against the wall come the revolution.  
**Hero rating:** 7

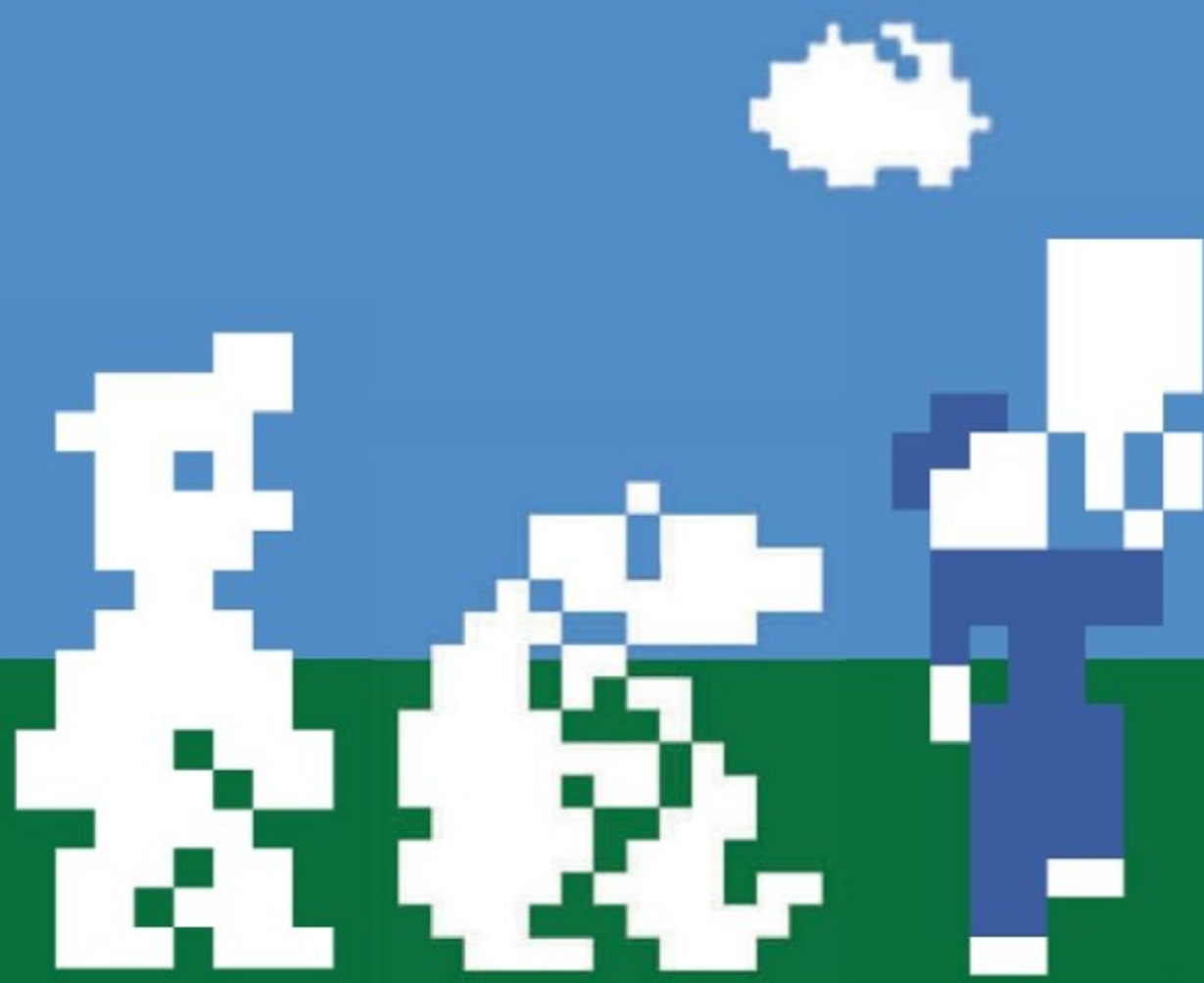

### GOING UNDERGROUND

Matthew programmed like a man possessed and six weeks later, *Manic Miner* was complete. Released in early 1983 by Bug Byte, it brought instant fame and considerable cash to the teenage programmer. This good fortune was shared by an upwardly mobile *Miner Willy*, whose next outing would see him filthy rich and living in a huge mansion, far from his working-class roots. Yet look deeper and you'll see *Jet Set Willy* is a sad tale of a bon vivant deserted by fickle friends, left to clear up the detritus of an evening's decadence alone. It's *The Great Gatsby* with giant penguins and clearly has similarities to Matthew's own slide from wealth and recognition to penniless obscurity. "I am not *Jet Set Willy*, even if the Daily Mail thought so," protests Matthew. "It's a cautionary tale of human life and the ephemeral nature of it all. When I wrote *Jet Set Willy*, I hadn't any money. It's a tale of what could happen later if I wasn't careful.

"My dad was a miner who never got the chance to vote, something the National Union of Mineworkers had never done in the past," he says. "The reasons for the strike were completely justified, but Scargill didn't trust the miners. It was irresponsible leadership. Why else would I have him defeated by a ballot paper?"

The climax of the C64 version of *Wanted: Monty Mole* similarly sees little Monty storming Arthur's castle, which had a personal poignancy for programmer Tony Crowther. "My late granddad was an important figure in the coal board and knew Arthur Scargill," explains Tony, a Sheffield lad, born and bred. "I still have a piece of coal that was presented to him, the first lump from a new pit!"

Tony would hide such lumps throughout the expansive caverns he created for Monty's coal-collecting quest, opting for a multi-directional scrolling platform game rather than the Spectrum's flick-screen approach.

## "IT'S A TALE OF HUMAN LIFE AND THE EPHEMERAL NATURE OF IT ALL" MATTHEW SMITH MUSING ON JET SET WILLY

And I'm sure it did come true in some people's minds..."

We wish Matthew well and leave him to return to his latest project, a 3D printer, but stay at the coalface to investigate another underground phenomenon, *Monty Mole*. Released in 1984 during the bitter miners' strike, which raged that year and the next, the first of Monty's adventures saw the velvety protagonist collecting coal in defiance of industrial action. With union boss Arthur Scargill cast as the final enemy to overcome, there seems little doubt as to which side Peter Harrap, the creator of the Spectrum version, was taking in the dispute.

"I wanted to do a follow up to *Son Of Bigger*," he notes. "I'd learned some new tricks by then and could scroll faster with a larger area. I added conveyor belts, ladders, plungers and a randomly created maze, which is different every time you play. It was a challenging puzzle game!"

### WORKERS' PLAYTIME

Monty's task was indeed an arduous one, but then that was a common experience for our working-class heroes. We recall the tough working conditions imposed on two employees that put in many a shift on the VIC-20 back at the start of the Eighties. *Wacky*

» [VIC-20] Spilt drinks and broken necks were all part of a typical shift in *Wacky Waiters*.

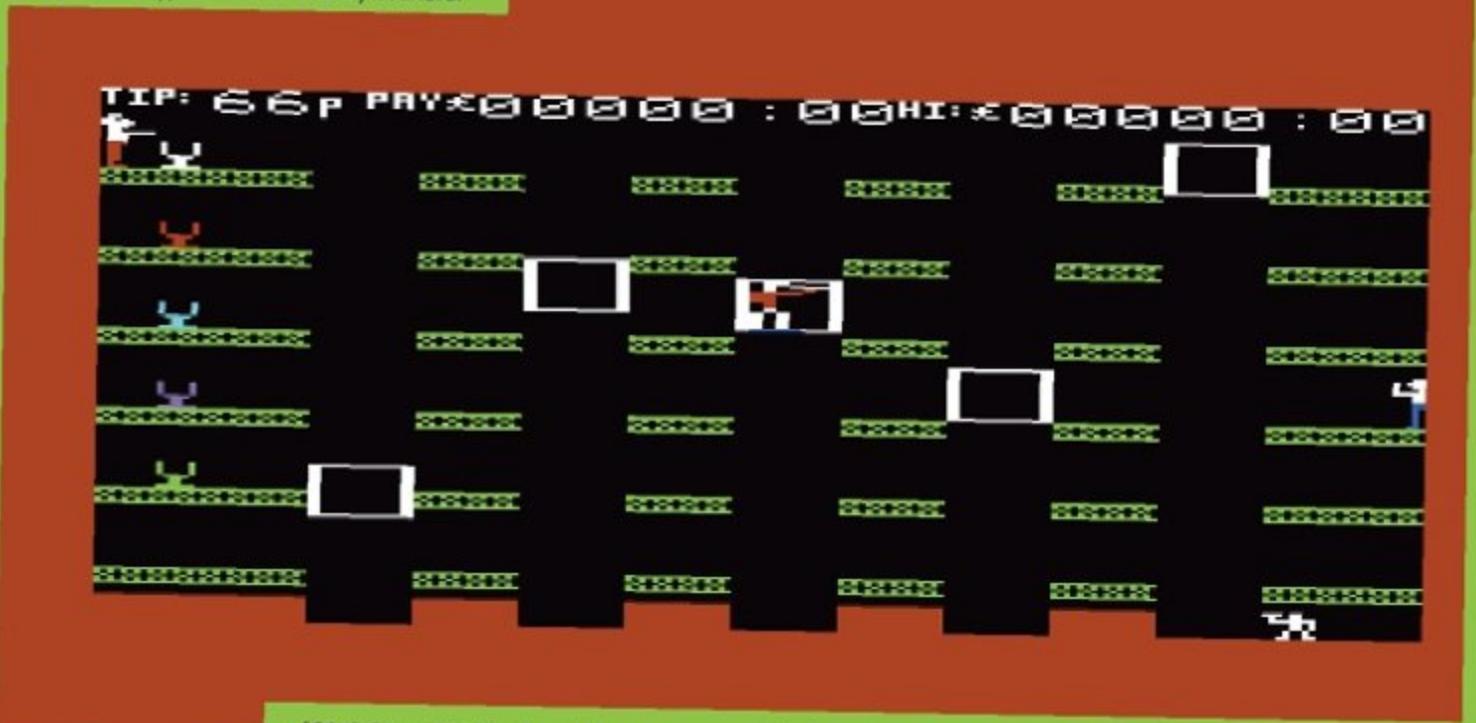

» [C64] *Super Pipeline 2* could be seen as a meditation on the ethical complexities inherent in the relationship between foreman and labourer... or just as one of the C64's finest games.

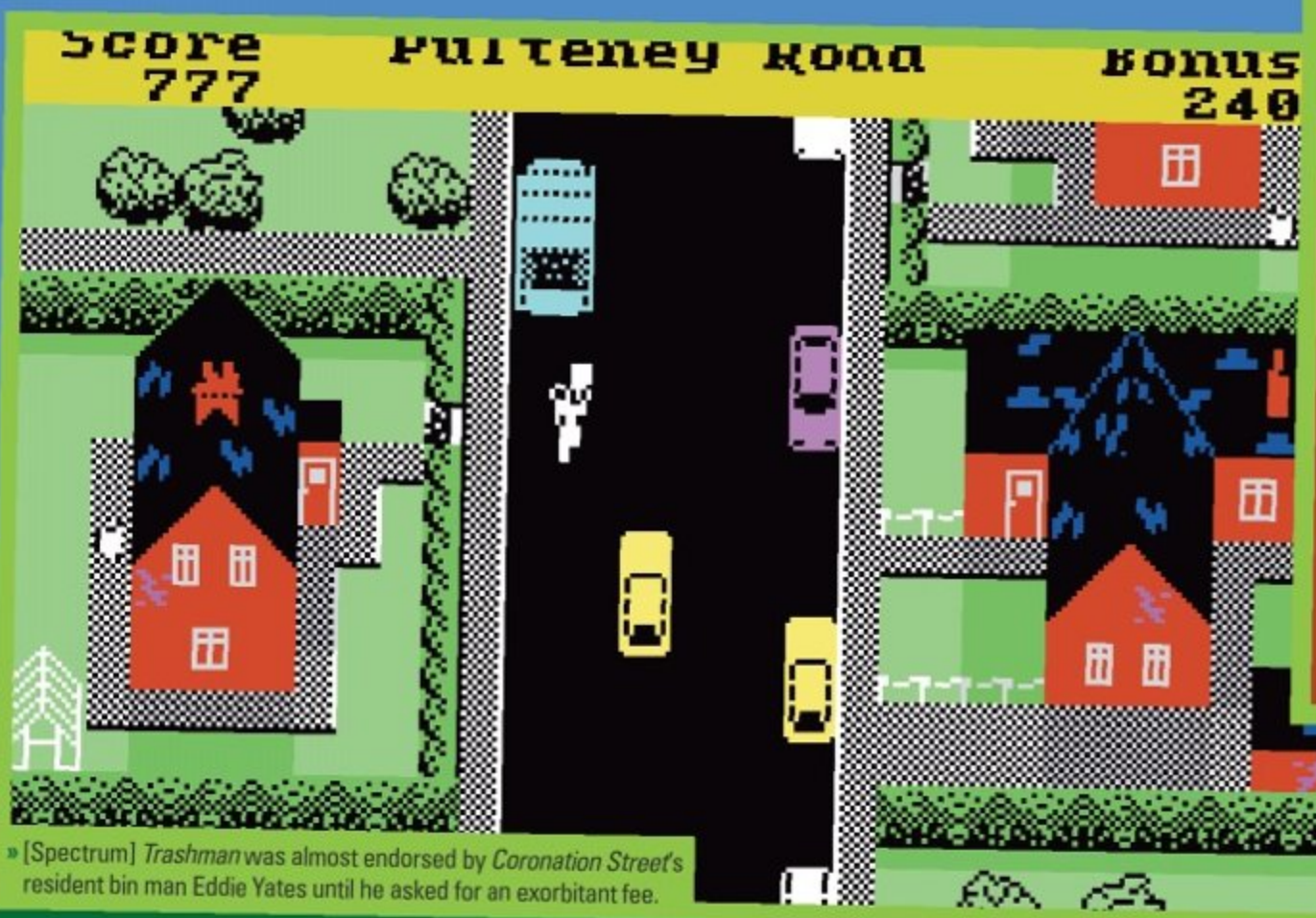

» [Spectrum] *Trashman* was almost endorsed by *Coronation Street*'s resident bin man Eddie Yates until he asked for an exorbitant fee.

*Waiters* was set in a restaurant where the management had made the frankly inexplicable decision to install fast-moving doorless lifts between the kitchen and dining areas, forcing the harassed head waiter to negotiate these deathtraps as he struggled to serve impatient customers. In *Catcha Snatcha*, he had swapped his drinks tray for the crumpled mac of a store detective, but his days were still filled with the stress-inducing realities of thieving customers, lost children and regular bomb threats. Both games were written by Eugene Evans, a coder at Imagine Software, who was also given the daunting brief of creating megagame *Psyclapse* as his C64 debut and later witnessed the bailiffs storming his office during the company's financial meltdown. We asked him whether his games reflected the harsh conditions he experienced during those turbulent times.

"This isn't something I want to highlight," comes Eugene's blunt reply. "I'm too busy right now."

Had we unwittingly stirred painful memories of the impossible demands placed on him by a cruel and exploitative management team? Was this a case of art imitating life?

"We bought Eugene a Lotus Esprit, so I don't think so," interjects a familiar voice, dashing our theory. It's Bruce Everiss, former operations manager at Imagine and the man largely responsible for the epic levels of hype that emanated from the Liverpool-based software house. "Anyway, I have a problem with this whole concept of class. Judging people by their birth, or what they do for a living, or their wealth or how much education they've had is utterly wrong. It's also an artifice created by politicians to create envy. And envy's a sin, isn't it?"

Suitably chastised, we try to steer Bruce onto a subject he was always very comfortable with: the hard sell. We wonder if marketing games based on everyday jobs was a tricky challenge, given that the playing public was more used to space and fantasy

themes? "Not at all," he assures us. "For games back then, you needed a very simple task. I mean you weren't going to be able to emulate brain surgery! So, say, Pedro planting his garden – it was simple because we hadn't got the horsepower in the machines to make the characters do much more than that!"

It's an interesting theory. Jobs that involved simple, repetitive tasks were a good fit for those early home computers – simple machines that could only handle small, repetitive tasks themselves. But what happened when our working-class heroes got promoted to the cutting-edge arcade technology of the day?

### WORKING FOR THE YANKEE DOLLAR

"We'd say 'blue collar', rather than 'working class'," says Steve Meyer, ensuring we know we're in America now. Whichever term you use, Steve was undoubtedly a champion of the working man in videogames. For Bally Midway, he created the moustached Domino Man, who after a spell stacking giant dominoes in his titular debut at the start of 1983, found gainful employment later that year as a bartender in *Tapper*. We assume this project must have required important fieldwork in numerous blue-collar bars, then, Steve?

"Yes, we did quite a bit of research," he burps. "I remember location testing at a Chicago Rush Street bar late into the evening. We got some good focus testing in, although we were a bit out of focus by the end of the night..."

*Tapper* not only put an overworked, underpaid employee in the spotlight – why else would he be scrabbling around for the measly tips left by customers? – but it did an excellent job of making the player feel like they were actually putting in a shift behind that busy bar. Considerable time was spent getting the feel of the controls just right, so as you pulled down the Budweiser beer taps that adorned the original

cabinet, you could really imagine you were filling up those tankards with foaming ale. Atari's *Paperboy* went further by placing hulking handlebars on the front of its arcade machine, so players could actually feel like they were cycling down the mean streets of their paper route.

"They were huge," laughs John Salwitz, who created the game together with Dave Ralston. "Milt Loper's mechanical design for the handlebars was fantastic. There are very few examples of a custom controller having a larger influence on the moment-to-moment gameplay in a videogame. They were a strong hook and a big draw to first-time players. We were certainly trying to make the game as responsive as possible so you could 'feel' the bike."

John and Dave drew extensively on their own experiences of delivering papers when they were boys to create the surprise hit of 1984. Our intrepid paperboy had to steer past construction workers, breakdancers and skateboarders, and though we acknowledge that our own paper rounds didn't conclude with an obstacle course and cheering crowd, the game certainly stirs memories of what was the first taste of paid employment for many.

"We were trying to create a theme that people could relate to," agrees John, "and by incorporating commonplace things, it made this

### TRASHMAN

**Previous employment:** Dustman (*Trashman*), international recycler (*Travel With Trashman*)  
**Working-class credentials:** We can't quite tell if he wore 'cor-blimey trousers', but he was definitely a dustman and quite probably lived in a council flat. Battling to empty those bins in difficult, often life-threatening, situations was heroic, yet he never lost the common touch, enjoying much earthy banter with local residents. His work abroad in *Travel With Trashman* shows solidarity with his international refuse-collecting comrades, too.  
**Hero Rating: 9**

### MINER WILLY

**Previous employment:** Miner (*Manic Miner*), socialite (*Jet Set Willy*)  
**Working-class credentials:** From a solid working-class background, he struggled to escape his humble roots through gold mining, a notoriously dangerous occupation. He then invested his wealth in property, but his attempt to join the moneyed classes ended in a descent to drunken destitution. His unfinished third adventure was to involve an unpleasant meeting with the taxmen, a sobering reminder of Leona Helmsley's assertion that "only the little people pay taxes".  
**Hero Rating: 5**

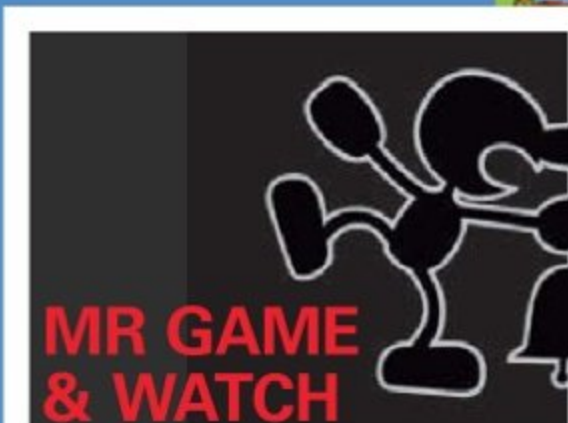

**MR GAME & WATCH**

**Previous employment:** Builder (*Mario's Cement Factory*), road worker (*Manhole*), exterminator (*Vermin*)

**Working-class credentials:** He's been a signalman, a fireman, a chef, a sailor. He's laboured in an oil refinery, ran an outside laundry in *Rain Shower*, endured blatant health and safety violations in *Helmet* and ran away to join the circus in *Lion*. He has put in more shifts, struggled against harsher working conditions and suffered more indignities than all our other heroes combined, yet we don't even know his real name. He is our everyman and we salute him.

**Hero Rating:** 10

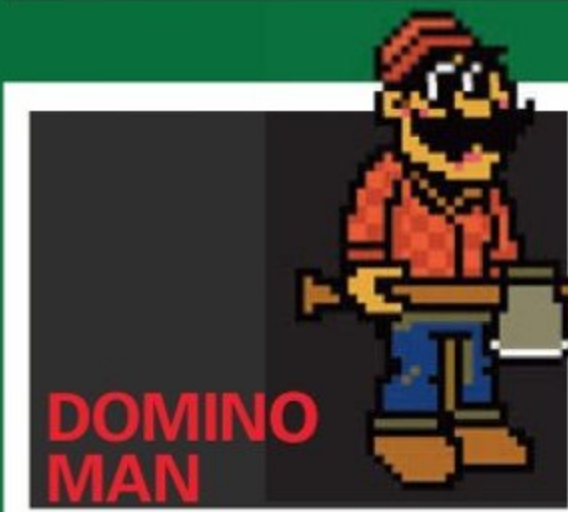

**DOMINO MAN**

**Previous employment:** Barman (*Tapper*), lumberjack (*Timber*)

**Working-class credentials:** Though we aren't sure whether stacking giant dominoes is actually a working-class trade, tending a busy bar and felling trees certainly qualify. A versatile worker, equally at home in the city or the country, he loses points for being a little too friendly with his boss in *Timber* – no one shakes hands that enthusiastically unless they are on the take – but regains them for keeping his brothers refreshed in *Tapper*. This Bud's for you, Domino Man!

**Hero Rating:** 8



» [Arcade] *Paperboy* was an excellent introduction to the painful realities of being a working Joe in videogames.



» [Arcade] With an axe that size at hand, surely Domino Man should have demanded better working conditions from his cigar-smoking boss?

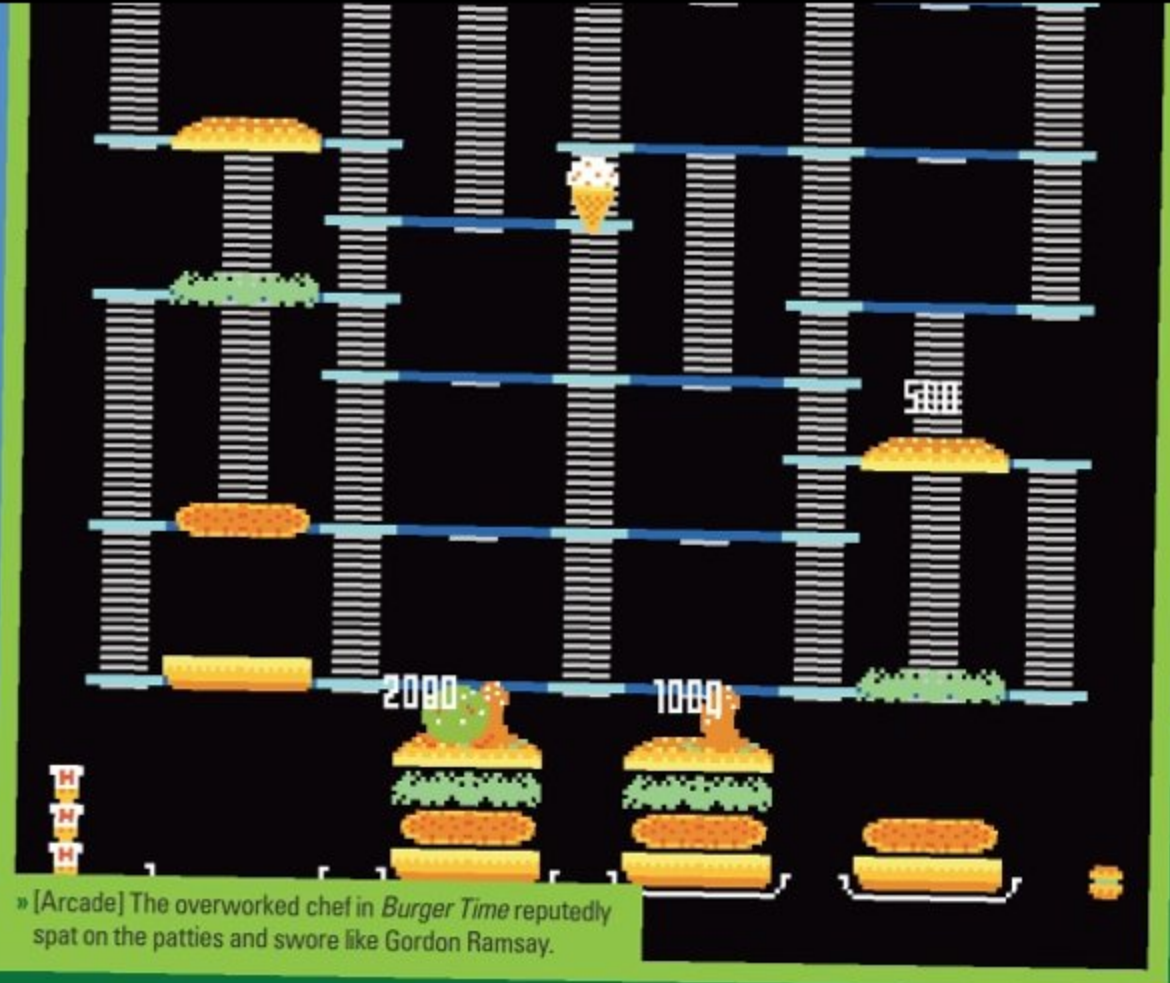

» [Arcade] The overworked chef in *Burger Time* reputedly spat on the patties and swore like Gordon Ramsay.

possible. But to justify this rather deadly game of delivering papers, we needed fantasy elements, like the Grim Reaper. Sometimes the kid doesn't dodge the cars..."

Blatant breaches of health and safety legislation seem to be the bane of our heroes' working lives. Just look at what happened to Domino Man when he left bar work behind and landed a job as a tree-felling fella in 1984's hectic chop-'em-down, *Timber*. He may have been a lumberjack, but he was not okay, tasked as he was with demolishing a fast-growing forest of trees with just an axe and his two strong arms. A cigar-smoking boss looked on from the safety of his log cabin, heartlessly ignoring the twin perils of tumbling trees and beehive-hurling bears faced by our hero, yet swift to punish him with a swift slapping if he failed to complete the job within a brutal time limit. Could this be an analogy of how programmers were treated by managers desperate for the next arcade money-spinner?

"Nope, we had great bosses, who nudged us in the right direction and supported our hard work," notes Steve Meyer. "My games were about ordinary working-class heroes in the midst of insurmountable odds but with the opportunity to overcome those odds."

**IF I HAD A HAMMER**

We've started to notice something about our band of hard-working brothers. They were frequently vulnerable. Trashman, Miner Willy, Tapper and Monty Mole all had to rely on their wits, not weapons.

If game designers did deign to arm their heroes, it was often with distinctly odd armaments: see *Paperboy's* take on 'hard-hitting news' and the equally literal 'pepper spray' brandished by the chef in *Burger Time*. Admittedly, Mario had his Fire Flower, but armed workers in the 8-bit era were not the norm. That is, until another plumber reached for his wrench and pulled out a rather more effective revolver instead.

had to put in that dilemma, but you are in control, so if Plumber Pete takes one for the team, don't you dare put that on Foreman Fred!"

"Don't forget the other plumbers, Sid and Vic," adds Taskset coding stalwart Paul Hodgson. "Good solid workers' names that just happened to have a direct 'inside link' to the C64!"

Paul and Andy focused on another unlikely occupation for their 1984 release, *Poster Paster*. A cloth-capped Bill Stickers struggled to put up adverts on large outdoor hoardings, while numerous foes tried to interfere with his trade and dilute his paste. "I remember being sat in the Taskset offices in Bridlington High Street and suddenly a head would appear at the window," chuckles Paul. "We were on the first floor, so it was rather startling. It seemed like a fun thing to put in a game. It changed from keeping windows clean as nasties gobbled on them to putting up posters when Bill's name came along, and it let us add some great in-jokes. One of the posters

**"A MAN NEEDS SOMETHING WHEN COMING UP AGAINST SIX-LEGGED VENUSIAN PIPE-SPIDERS"  
ANDY WALKER, FOUNDER OF TASKSET SOFTWARE, JUSTIFIES USING GUNS**

"A man needs something when coming up against six-legged Venusian pipe-spiders," says Andy Walker, founder of Taskset Software, defending his decision to give the star of the C64's *Super Pipeline* games a gun. Foreman Fred had to use it to fight off an array of enemies determined to puncture the increasingly convoluted pipework that made up each level. Hang on, though; the actual leak-fixing was left to the diminutive and dispensable team of plumber's mates. Far from being working-class, was Fred actually one of the bourgeoisie, willing to sacrifice his subordinates to save himself?

"He's in a white coat but he'll never be middle class," insists Andy. "He's got his job to do, they've got theirs and only as a team can they succeed. Yes, we

featured 'Tony's Jacuzzi' in homage to a well-known games journalist of the time, and Bill's 'Paste Consistency Gauge', or PCG, was named after the popular mag *Personal Computer Games*. All in the hope of a good review, of course!"

Leaving behind Bill and Fred's excellent adventures, we note that Taskset's dynamic duo are not only solidly working class; they are also quintessentially British, with their overalls, flat caps and wobbling, gin-blossomed noses. It's a look we recognise in our final hero, Mikro-Gen's Wally Week.

"Flat caps and whippets are a good thing!" roars Yorkshireman Chris Hinsley, the proud programmer of Wally's Spectrum escapades. "To quote

# RETRO'S RICHEST

The upper classes have occasionally deigned to make appearances in our vulgar plebeian pastime. Here are some posh protagonists...

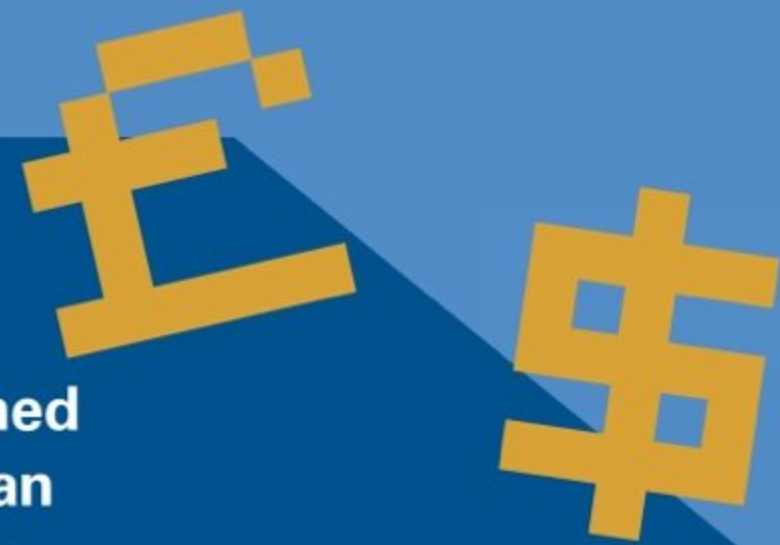

## SABREMAN

With his jaunty pith helmet and impressive handlebar moustache, Sabreman clearly represents the archetypal British colonialist. The Wulf of the game's title clearly symbolises the oppressed native people he tramples under foot, and *Sabre Wulf's* amulet represents the natural resources, which are mercilessly plundered by imperialism for the pleasure of the other rich toffs still lounging it up back home in glorious England. The bounder.

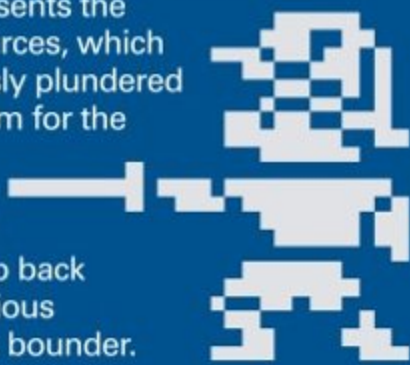

## CHARLIE FROM NODES OF YESOD

Beneath the veneer of that pristine spacesuit hides top hat-wearing posh boy Charlemagne Fotheringham-Grunes. With a double-barrelled surname of great pedigree and a first name shared with the French emperor who conquered Italy and was crowned Emperor of the Romans, we expect his knowledge of moles was acquired when the little blighters ruined his prize-winning croquet lawn and he had them all exterminated by the help.



## LARA CROFT

Hush your objections – the good lady Lara's appearance on the 8-bit Game Boy Color means she qualifies for this retro rundown. And anyway, how could we not include the quintessential videogame toff? She had a butler and lived in mansion – a mansion full of priceless antiques she would use as target practice on bored Sunday afternoons. Also, she's a professional killer of endangered species.



## THE LORDS OF MIDNIGHT

These aristocratic warmongers were quite happy to ride arrogantly across huge swathes of land, trampling peasants and other undesirables under hoof, as if they owned the place. Which they probably did. In fact, their descendants are probably still sitting in the House of Lords, resisting reform and watching their dogs tear foxes apart on weekends.



## JOHNNY CAGE

Johnny Cage was a successful movie star before he started appearing in the Mortal Kombat tournament, earning millions and courting the most beautiful starlets around. As arrogant as he is athletic, he takes great pride in wearing his sunglasses and punching other fighters in the nuts with his signature 'Ballcracker' move.



## SCROOGE MCDUCK

It's quite possible that Scrooge is the richest character to ever appear in sprite form. While he prefers to live a life of aristocratic leisure, spending much of his spare time smugly diving into huge pools of coins and swimming around (we can only imagine the damage that causes to his bill), he's never afraid to jump on his trusty pogo stick whenever his nephews need rescuing – as long as they don't expect a cash hand-out to go with it.



## DUDLEY

*Street Fighter's* spiv pugilist Dudley was born into a wealthy English family and always dreamed of being a fighter while tending the roses on the estate and greasing his hair while staring lovingly into the mirror. After his father lost the family business, Dudley went into training to become a professional boxer and earn back his family's fortune. We can only imagine the montage that would have gone along with that.



## WARIO

Wario is different to the other heroes featured here. He wasn't born into wealth and never worked hard to achieve it. No, Wario simply stole bag after bag of shiny swag to fund his egomaniacal lifestyle and overpowered motorbike collection. A professional thief, and the evil doppelganger of Mario, Wario has recently found success with his own videogame company, as depicted in the *Wario Inc* game series.



Bill Oddie from an episode of *The Goodies*, 'Like all northern folk, Wally knew the art of Ecky Thump!'

Though later retraining as a builder for *Everyone's A Wally*, Wally began his working life as a mechanic in *Automania*, a role that portrayed him as more hapless than heroic. "The 'Week' surname was a bit of a piss-take of Mike Meek, the managing director at the time," whispers Chris. "We never had aspirations for the game to get into political issues or revolutionary thoughts. It was just a good character design that we knew would connect with people..."

## WORKING MAN'S DEAD

Perhaps we remember these labouring lads of the 8-bit era with such fondness precisely because they made an emotional connection with us as players. We could relate to their ordinary lives, made extraordinary in the pixelated playfields of those groundbreaking titles, just as our childhoods were illuminated by the

wondrous new world of videogames. Yet with the rise of the 16-bit machines, working-class heroes in games were largely replaced by anthropomorphic animals, from dolphins to hedgehogs, and then by anonymous super soldiers in the Nineties. Of course, Mario keeps the spirit alive, though it's been a while since he checked a u-bend, and you'll find a proliferation of chefs and farmers in casual gaming circles, but when it comes to major videogame stars, where have all the ordinary folk gone? We decided to ask our interviewees for their ideas for a new working-class game hero.

"You could have great fun with an undertaker," offers Malcolm Evans, rather morbidly.

"How about a master brewer?" suggest Bruce Everiss. "It could get increasingly fuzzy as you progressed."

"It seems we've lost a lot of our traditional heavy industry to IT over the years," notes Chris Hinsley, "so how about a hard-working IT guy, trying to keep his office network up and running,

installing the latest patches, turning the odd machine on and off?"

"A web designer could be a modern equivalent," muses Andy Walker before dismissing the idea. "Nah, you really need to get your hands dirty."

"You can find a decent game concept wherever someone's wielding a spanner," agrees Paul Hodgson.

"An astronaut!" blurts out Matthew Smith, before we gently suggest that may not actually count as a working-class trade. "That's tricky, then," he continues. "You could have bankers, but only as the antagonists, bagging other people's money!"

"A bunch of bankers plus a few corrupt politicians," agrees Peter Harrap. "A student taking on the financial institutions, using their skills to find and redistribute the bonus payments to hard-working families. A 21st Century *Robin Hood* meets *Ocean's Eleven*, with George Clooney doing the voiceovers."

We want to play them all, boys. Arise, ye workers, from your slumber!



**Previous employment:** Miner (*Wanted: Monty Mole*), property speculator (*Auf Wiedersehen Monty*)

**Working-class credentials:** On the one hand, he was a rank and file miner, jailed in *Monty Is Innocent* by a brutal legal system that cared more about theft of private property than the wellbeing of an honest working mole. On the other, he became a yuppie intent on buying his own island in *Auf Wiedersehen Monty*, had delusions of grandeur in *Impossamole* and was a strike-breaker in his first union-busting outing.

**Hero Rating:** SCAB!

# THE MAKING OF

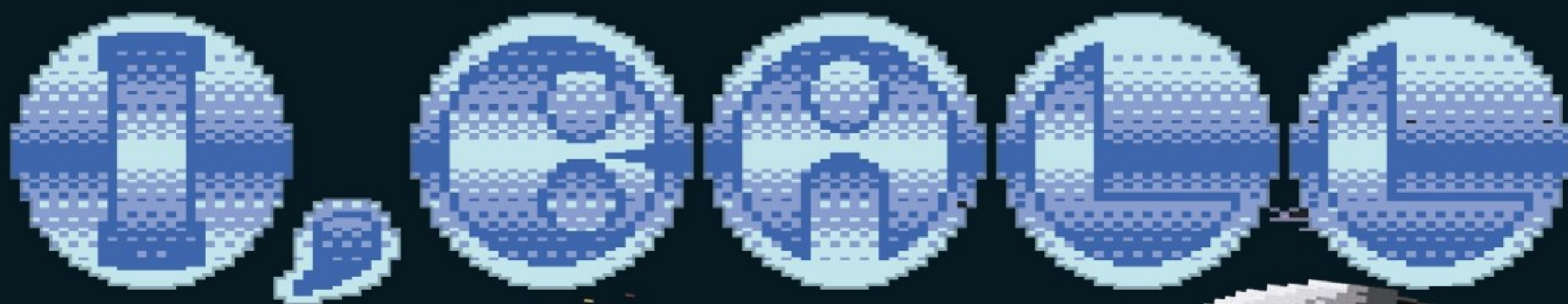

The Eighties gave rise to a plethora of original gaming concepts from young bedroom programmers, and abstract shoot-'em-up *I, Ball* is a prime example. Mike Bevan talks to Tim Closs, former schoolboy creator of a budget classic



## IN THE KNOW

» PUBLISHER: FIREBIRD

» RELEASED: 1987

» PLATFORM: SPECTRUM, C64, AMSTRAD CPC, ATARI ST

» GENRE: SHOOT-'EM-UP

### How did the surreal concept for *I, Ball* come about?

I wanted to build an arcade game with a physics element, so a ball was an obvious choice of character. In terms of character design, there was a lot of 'homage' going on to other popular games.

I'd spend a fair amount of time poring over computer games magazines, staring at screenshots and picking up ideas for graphics and gameplay. I dare say the actual character design of *I, Ball* is a mish-mash of things picked up from other games at the time.

Having the other character names as cheesy puns was a way of keeping my dad happy – he was and still is an appalling punster. My first game, *Bomber Bob*, had 50 different levels, each of which was titled with a terribly painful play on words, most of which were constructed by my dad. I suspect I wanted to pre-empt any involvement in *I, Ball*, so I stuck some puns in there to ward him off!

What was the *I, Ball* sprite supposed to be, by the way? To us

### it always looked like a little *Death Star* with a light on the top...

You're spot-on! Yes, the eye always reminded me of that concave section in the *Death Star*. A lot of artwork in those 8-bit games looked the way it did simply because of the size constraints – you'd concentrate on pushing pixels to make good use of the space, rather than doing concept design sketches first. Isn't that why *Mario* is a plumber – because the pixel artist found that dungarees were the best way of colouring the character within the tiny sprite size?

### From your game design notes we notice that you originally titled the game *Orb*. What made you decide to change the name?

I seem to remember I always conceived *Orb* as a working title only. I've no idea where the *I, Ball* name actually came from. As indicated earlier, I probably suffer from my dad's appalling punitis...

With *Firebird*, was it simply a case of sending the games in on cassette to gain interest? Did you

### have it in mind as publisher when you started working on *I, Ball*?

No, I didn't have anyone in mind. To be honest I was probably just looking for the biggest advance! I think I sent the game to US Gold first in an attempt to get another £6,000, but sadly they'd wised up! I can't remember who showed interest in *I, Ball*, but *Firebird* picked it up for a £3,000 advance plus the standard royalty. I think I got something like 12p per copy for the original version, and 7p for a conversion that *Firebird* had paid for. But if the game sells 50,000 across all platforms, that still works out at around £5,000 for the original author, which is a lot more than you'd get for six weeks of paper rounds!

Actually *Firebird* got really involved with tweaks to the gameplay and the final polish phase. As I remember it, the game I sent to them only had about four weapons, and they weren't shown as icons down the right-hand side of the screen. *Firebird* suggested that the weapons and power-up mechanism should be more of a feature, and after some discussion we agreed on a total number of weapons, together with the icon block at bottom right. They also wanted each weapon to be introduced with a dialogue box when it was collected, so I added that at their request.

*Firebird* thought the game might be a cut above the usual £1.99 fare, and they were thinking of putting it into the imminent *Rainbird* range, as a 'double A-side' offering with another game called *Empire*. I was flattered

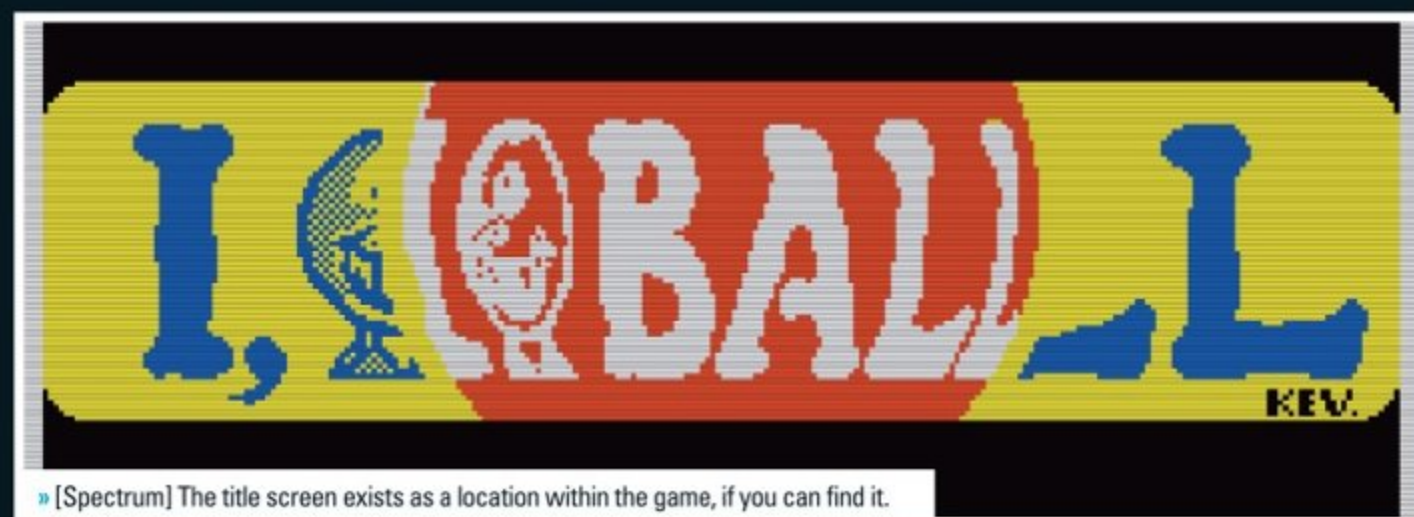

» [Spectrum] The title screen exists as a location within the game, if you can find it.



» [Spectrum] Although it made the game into a RAM hog, the benefits of the eight-colour graphics mode are obvious.



### THE MAGIC NUMBER?

☒ ONE OF THE few people who managed to 'complete' *I, Ball* was **RG** reader Keith Bayliss. "If I remember rightly it said congratulations and gave you the 'magic number'," recalls Keith. "For the hell of it I rang it, and said I'd just completed *I, Ball*. Tim said there was no prize and asked me if I'd cheated, I said no, even though I'd used a poke. I feel bad about that!"

"It was the phone number of my childhood house in Shepperton," explains Tim. "It seemed like a good idea at the time, and I think I was just curious to see if anyone would reach the end of the game! *I, Ball* gets rock hard at the end, so I'm not surprised he needed a poke to complete it. No hard feelings!"

Firebird picked it up for a £3000 advance plus the standard royalty. I think I got something like 12p per copy



and chuffed at the prospect that the higher price point might mean more pocket money. In the end, Firebird changed their minds again and the game went out at the usual price point, which in retrospect was probably the right decision.

**Would we be right in thinking there's a bit of a *Gradius/Nemesis* vibe with the weapon pick-up system and *Robotron/Defender* with the visual style of some of the weapons going on in *I, Ball*?** Completely... As before, there was a lot of borrowing of other ideas going on! *Nemesis* was a particular favourite in the amusement arcades. *I, Ball* was written entirely during my school summer holiday, and that would have included various trips to seaside resorts and frequent games of *Nemesis*!

**Was it fun coming up with and programming the various weapons? And why did you make it so hard to get the Rainbow Ripple 'ultimate weapon'?** Yes, it was fun. Firebird was the one who drove me to make more of the power-up element to the game, but I think I came up with all the power-up designs myself. The Rainbow Ripple effect was pretty crude as it simply used the Spectrum's colour-attribute system to paint eight-by-eight blocks of colour – but the animation was fast enough to get away with it. I guess that given it was the ultimate power-up in the game it was fair enough to make it challenging.

**A lot of people will remember the funny voice effects in *I, Ball*, particularly the 'Oh no!' death accompaniment. Was it fun doing those samples?**

Yes, I was heavily into making music at the time. I had a four-track tape recorder and used to mess around making songs with my brother. Experimenting with the Spectrum's microphone in was a natural thing to do. You basically put your cassette deck into record and pause mode, hit record on your machine-code sampling app, then shouted something into the cassette deck.

The problem with speech on the Spectrum was that it took up a lot of memory. The main reason for the 'scratching' speech sample – "*I, Ball... I-I-I, Ball...*" – was so you could get a longer section of audio out of the same sample data. *I, Ball* didn't have enough memory spare to keep the sample data alongside the game. Instead, I hit upon the idea of storing the sample data in the loading screen. So the *I, Ball* loading screen only takes up the middle third of the display, and the top and bottom third is actually audio sample data, drawn as black-on-black so it can't be seen.

**Were you pleased with how the games were received? It must have been nice to get such good scores in magazine reviews such as 90% in *Crash* and 80% in *Zzap!64*...**

I was very pleased. There were half a dozen kids in my school class who were also obsessive home computer

geeks, so walking into the classroom with my *Crash Smash* review was a nice moment. *I, Ball* was the best-reviewed and bestselling game out of the five games I had published in my school days; I later wrote a game called *Kid Gloves* for Atari ST and Amiga that did pretty well, but by that point I'd started at university.

**How do you feel now about the *I, Ball* games? Are you fond of them?** Yes, very fond of that whole era, which for me was '82-'88, and the *I, Ball* games in particular. When getting to know new colleagues today, I still come across people who remember the games, which is nice. I guess I should jailbreak my iPhone and get them on there!

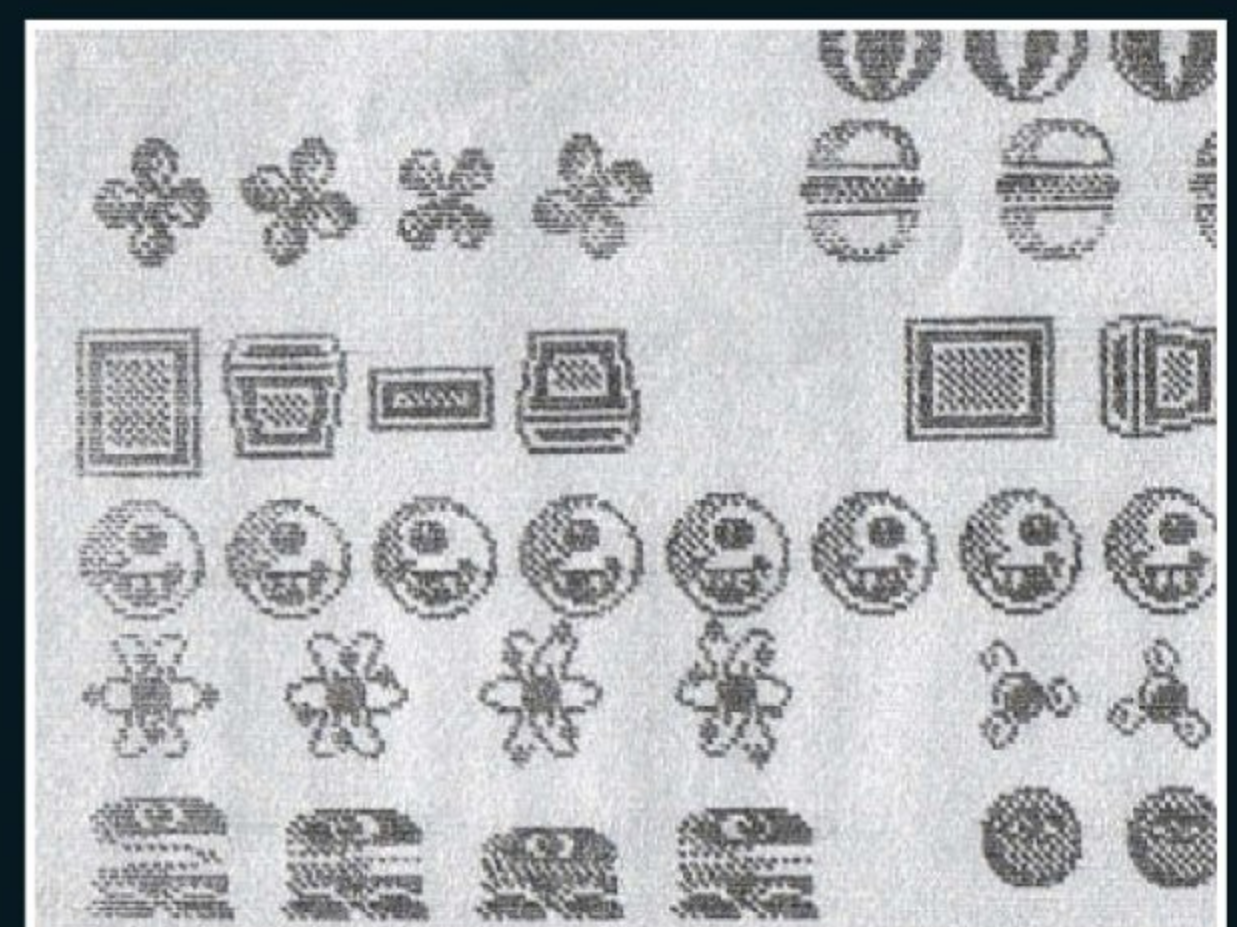



# FROM THE ARCHIVES

RETRO GAMER DIGS UP THE FILES OF THE CLASSIC COMPANIES OF OLD

# Electric Dreams

Forged from a band of Quicksilva alumni by US publishing giant Activision, it was responsible for some of the finest 8-bit arcade conversions and movie licences of the Eighties. Join Graeme Mason as we discover Electric Dreams...

**R**od Cousens CBE may not be a name that immediately springs to mind from the history of videogames, but as the letters after his name confirm, the current Codemasters CEO has overseen the development of some of the best-loved games of the last 30 years.

Yet his career did not begin at Electric Dreams. Rod began work at Quicksilva in 1981, quickly becoming managing director of the Southampton-based company. "A close friend had introduced me to Nick Lambert," begins Rod, "who had started the company with John Hollis, Mark Eyles and Caroline Hayon. I met Nick in manic circumstances, with schoolchildren coming into their office at 4pm to put ZX81 RAM packs into Jiffy packs to meet mail-order demand." Quicksilva was one of the early adopters of the new Sinclair Research

computers, and it wasn't long before it began to develop its own software for both the ZX81 and its popular follow-up, the ZX Spectrum. "It was organised chaos to begin with and the energy vibe was magnetic," smiles Rod, "and I was intrigued. I got on well with the team and felt I could bring something to the party, so it went on from there."

"I certainly can't program, but games and creativity were then, as they are now, compelling forces to me," says Rod, explaining what he brought to the company. This, coupled with his astute business brain, meant he was soon an integral part of the famous software house.

## Leaving Quicksilva

The story of Quicksilva is one for another day; Rod left the company in 1984, a short time after overseeing its sale to the

## INSTANT EXPERT

**Rod Cousens' love** of videogames began in the Seventies with the early coin-ops and, slightly later, the Atari 2600.

**Electric Dreams' first** office was situated on the top floor at 31 Carlton Crescent in Southampton, above Rod's insurance brokerage firm.

**As the company** expanded, it moved to a renovated building at the old Terminus Terrace railway station near Southampton Docks. Today it is home to a casino.

**The Commodore 64** game by Martin Walker, *Chameleon*, was planned for a ZX Spectrum and Amstrad release, but Rod felt the game didn't quite realise its potential so it remained on the 64 only.

**An Electric Dreams** budget range was never considered. "We were a premium publisher of content," explains Rod.

**The similarity between** the Electric Dreams (mark 2) and Disney's *Captain EO* logos – as pointed out by a sharp-eyed *Crash* reader back in 1988 – was apparently entirely coincidental.

**Development team** Software Studios worked on behalf of Activision as well, producing several more arcade conversions such as *After Burner* and *Power Drift*, as well as a game based on the ill-fated movie *Howard The Duck*.

Argus Press Group. "There was a strong rumour going around that Argus wanted to relocate Quicksilva's office to London," he explains, "and I opposed this as I thought it went against the culture of the company." Fortunately, Rod had a get-out clause in his contract that enabled him to leave Quicksilva under such circumstances, not that this was an easy thing to do. "Leaving Quicksilva was an emotional wrench; it was more of a way of life than a job and I was very close to the people who worked there," he says. In addition to Rod's mixed feelings upon leaving Quicksilva, the get-out clause didn't come without a price: non-competition conditions meant he was essentially in exile until the period of his contract expired. Of course, being Rod Cousens, he did not rest on his laurels during this time.

"Quicksilva's games were distributed by CBS Records, who handled a few other publishers, and I got a tip-off that they would be exiting the videogame business shortly after I left Quicksilva," Rod explains. "One of the other publishers they worked for was Epyx, so I was about to fly to San Francisco and pitch to Epyx for European rights for a new company I was planning." One fateful phone call the day before Rod was due to leave for the US changed his path immeasurably. "A head-hunter called me about a job for a leading multinational





## “Greg called me the day after and said: ‘How would you like to be funded?’”

ROD COUSENS ON THE CREATION OF ELECTRIC DREAMS

software house who wanted to establish a presence in the UK. I pretty much knew who it was, as there was only one company of that ilk at the time: Activision.”

With several high-profile Activision personnel already known to Rod from his Quicksilver days, he boarded his plane the next day to California with this key change to his US agenda. In a meeting with Activision’s Greg Fischbach, Rod explained his new venture, a software publishing house based in Southampton in the UK. “Greg called me the day after our meeting,”

### □ BY THE NUMBERS

**2:** Electric Dreams games based on the movie *Aliens*.

**6:** Years between the release of the arcade and home versions of *Tempest*.

**32:** The number of universes for the player to explore in *I, Of The Mask*.

**360:** Degree wraparound background for *Aliens*.

**£350,000:** The amount raised by Rod’s charity compilation, *Soft Aid*, a precursor to Electric Dreams’ *Off The Hook*.

**40,000,000,000:** Number of locations in *Explorer*.

remembers Rod, “and said: ‘How would you like to be funded?’ And that was the start of Electric Dreams.” Rod never got to Epyx, and later that year it signed a deal with rival publisher US Gold.

### The first wave

With an office established on the top floor above Rod’s other business interest, an insurance brokerage, and with the backing of the US giant in place, Electric Dreams began to develop games, aiming for a strong line-up at the 1985 Olympia Computer Games Show. Joining Rod at the new software house were former Quicksilver colleague Paul Cooper (product development), Clare Hirsch (marketing) and ex-Atari employee Jon Dean, with the sales, distribution and finance departments all handled by Activision. Electric Dreams was in the enviable position of being able to concentrate solely on acquiring and developing its products.

This first wave of games, like the majority of Electric Dreams’ output, would be focused on the European market and its popular computers, as Rod explains. “Electric Dreams was geared to European platforms whilst Activision’s development was US-centric, and on Commodore 64 for the most part. Our role was essentially a local market imprint for Activision to gain a market share in this region.”

In 1985, the main local rival to the Commodore machine was the ZX Spectrum, and Electric Dreams initially concentrated on this computer. “I was a huge fan of Sandy White and Angela Sutherland’s work,” continues Rod, “and had built a close relationship with them over the years, so they followed me to Electric Dreams where we published the brilliant *I, Of The Mask*.” The developers of the massively influential Spectrum game *Ant Attack* appreciated Electric Dreams’ support, creating a special piece of artwork depicting Rod’s face in place of the iconic mask. “I hold both of them in deep affection,” he says with obvious emotion, “and it was a privilege to work with such technically and creatively gifted people.”

Despite the innovative *I, Of The Mask* and the well-received maze game *Riddler’s Den*, it was Electric Dreams’ initial move into the world of movie licences that would first bring its name to attention. The hot hit movie of 1985 had been the Michael J Fox time-travel extravaganza *Back To The Future*, and Electric Dreams successfully secured the licence to produce a videogame adaptation on the 8-bit computers. Yet despite a faithful re-creation of the film’s plot, the game failed to spark much excitement with the press and public alike. “Licensed properties of those times were often very constrained by artistic controls

## ARE YOU THE BRIGHT SPARK WE ARE LOOKING FOR?

Electric Dreams Software is a publisher of original programs for Amstrad, Atan, Commodore and Sinclair home computers. We are interested in hearing from authors conversant in machine code on the Z80 series, 68000 series and 6502 processors who are involved in recreational software development. If you are seeking full international exposure and promotional support for your programs and wish to enjoy the rewards your efforts merit, please contact Paul Cooper for an informal discussion.

**SOFTWARE HOUSES**  
Allow Electric Dreams Software to market and distribute your titles, leaving you to concentrate on product design and development. To take advantage of this opportunity and gain financial security, please do not hesitate to telephone Rod Couzens. All enquiries will be treated in strictest confidence.

Contact: Rod Couzens or Paul Cooper at Electric Dreams Software, 31 Carlton Crescent, Southampton SO9 2EW. Tel: Southampton (0703) 225482.

**Electric Dreams SOFTWARE**

» An early recruitment ad for programmers.

## WHERE ARE THEY NOW?



### Rod Couzens

At Electric Dreams, love blossomed and in 1988, Clare and Rod married. Rod became international president of Activision before moving to Acclaim in 1991, where in 2003 he was appointed CEO, succeeding Gregory

Fischbach, with whom Rod had struck the Electric Dreams deal several years earlier. In May 2005, Rod was appointed CEO of Codemasters, and he was awarded a CBE in recognition of services to the videogame industry in 2010.

### Mark Eyles

After Quicksilver, Mark set up his own holography studio while designing games for Electric Dreams on a freelance basis. After a four-year stint as head of design at Rebellion, he now teaches game design at the University of Portsmouth.

moving into interior design. She married Rod Couzens and nowadays shares her time between their four sons, two horses, cats and dogs!

### Jon Dean

Jon works at EA's Tiburon studios, where he is executive producer on the *Tiger Woods* franchise, among others.



### Paul Cooper

Went on to join Thalamus, Newsfield's renowned game-publishing company, as well as enjoying stints at Activision and Acclaim.

### Clare Hirsch

After leaving Activision, Clare worked freelance in marketing with developers such as System 3 before setting up her own company called In The Pink and

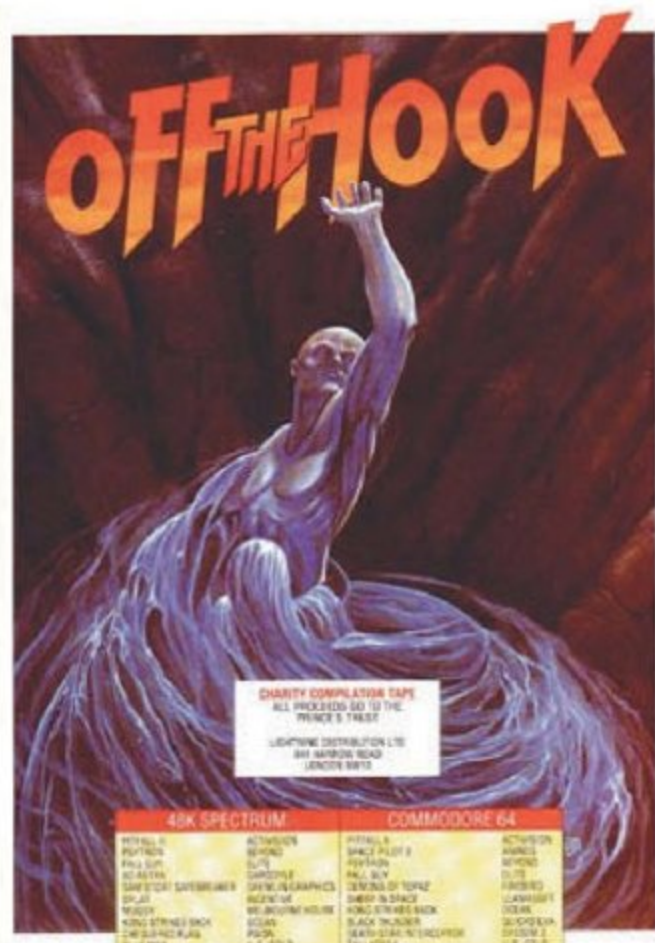

» Striking imagery for Electric Dreams' charity compilation, *Off The Hook*.

and had little interest in the game side, which invariably came after the release of the film," says Rod. "We liked the concept but felt we were too constrained and were unable to overcome the shackles."

Another former Quicksilver worker, Mark Eyles, worked freelance as lead designer for *Back To The Future*. "It was one of those absurd rush jobs where everything had to get done within a couple of months," he recalls with a grimace, "but, in my opinion, although the game was not great, it was still fun to play thanks to the tight feedback

## In some ways, Electric Dreams was a continuation of Quicksilver

MARK EYLES

loop we generated as you tried to rebuild the photo of Marty."

Notwithstanding this inauspicious start to licensing, Electric Dreams and Mark Eyles would soon acquire and develop another movie licence with considerably more pleasing results.

### Good causes

Before then, more original games would appear, with varying degrees of success. Paul Shirley's excellent *Marble Madness* clone, *Spindizzy*; the intriguing action-management game *Hijack*, which was again designed by Mark Eyles; and The RamJam Corporation's commendable *Gauntlet* clone, *Dandy*, were all released in 1986 to generally positive reviews. In the same year, Rod had the idea of releasing another charity compilation of games after having previously enjoyed success in organising Quicksilver's *Soft Aid* in support of the starving in Africa. "Having started the fundraising, it seemed to me important that we continue," says Rod, "and as computer games had a largely male teenage

### TIMELINE

- 1981 ROD COUZENS IS INVITED TO JOIN QUICKSILVER, BEGINNING A CAREER SPANNING OVER 30 YEARS IN VIDEOGAMES
- 1984 ROD LEAVES QUICKSILVER AS RUMOURS OF A RELOCATION TO LONDON AROUND
- 1985 ELECTRIC DREAMS IS FORMED BY ROD AND PAUL COOPER. THEIR FIRST GAMES INCLUDE *BACK TO THE FUTURE* AND SANDY WHITE'S *I, OF THE MASK*

demographic, I believed we should give back to the young, disadvantaged people. Therefore the area we targeted was those who needed help to kick drug habits."

The result was *Off The Hook*, a compilation of ten games from several software houses that supported various charitable organisations. "We had all been stirred by the Ethiopian famine appeal and the efforts of the music industry via Band Aid," says Rod. "We were the coming industry and I felt we should contribute, and continue to do so." A strong cover image was the final element. "We were very fortunate in that we had Dave Rowe do the artwork, as he came up with a cover that really helped to sell the compilation, and we were all passionate about the cause because we wanted to make a difference. Fortunately so were the retailers and wholesalers, who all got behind *Off The Hook* to make it an outstanding success."



» [Spectrum] *Dandy* from The RamJam Corporation was an accomplished *Gauntlet* clone.

## FROM THE ARCHIVES: ELECTRIC DREAMS

IN-HOUSE DEVELOPMENT TEAM SOFTWARE STUDIOS IS SET UP BY ROD IN ORDER TO GAIN MORE CONTROL OF ELECTRIC DREAMS AND ACTIVISION PROJECTS

THE YEAR THE ARCADE CONVERSIONS BEGAN FOR ELECTRIC DREAMS, WITH FIRETRAP, TEMPEST AND SUPER SPRINT ALL SEEING RELEASE

ELECTRIC DREAMS, THE SOFTWARE HOUSE AND LABEL, IS QUIETLY RETIRED, ITS WORK DONE. ROD COUSENS CONTINUES HIS CAREER AT ACTIVISION

1986

1987

1989

being made soon instigated a change within Electric Dreams.

"The market was moving on," Rod explains, "and the idea that you could simply place an advert in a magazine and attract programmers was not valid any more. Development costs were rising and the teams were getting bigger. We were wary of the risks, so wanted to have ownership ourselves of the IP." As a result, Rod formed Software Studios, a development team that, as part of his desire to merge Electric Dreams' and Activision Europe's game production, reflected the globalisation that was beginning to take place in the gaming market. The team was initially led by Jon Dean and then later by Charles Cecil and would go on to produce numerous arcade conversions for both Electric Dreams and Activision.

### Shift to licensing

As 1987 dawned, Electric Dreams stepped up a gear with its licensed material; it was clear a shift in focus had occurred.

"It was a reflection on market conditions at the time," states Rod, "and we all wanted the marketing muscle as we tried to establish computer games as a form of mainstream entertainment." With the marketing emphasis still on print magazines rather than expensive TV advertising, licences expanded the reach of videogames as they benefited through attachment to global properties such as movies, TV

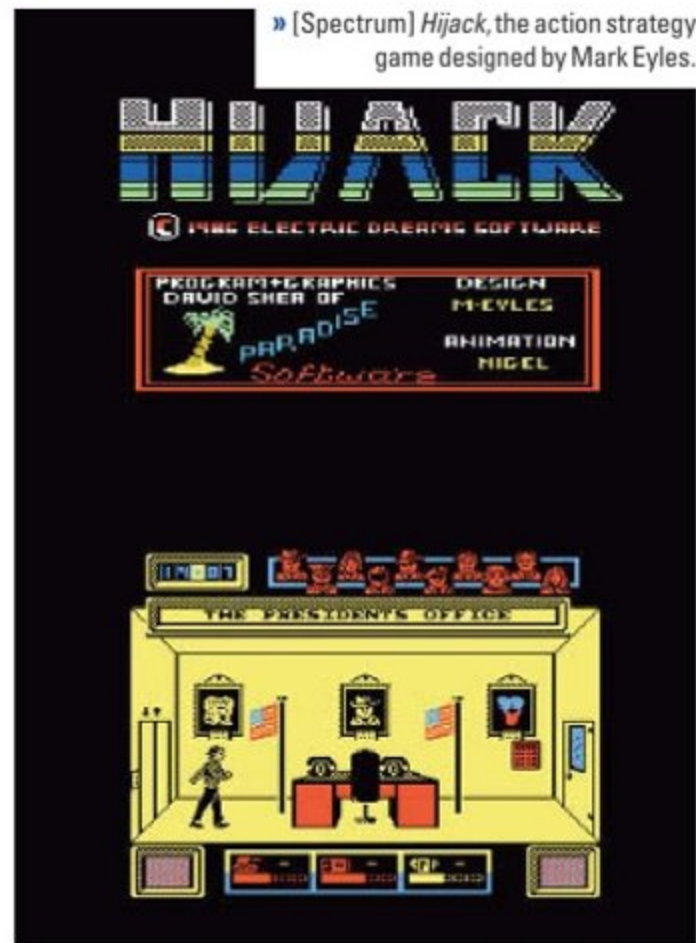

» [Spectrum] *Hijack*, the action strategy game designed by Mark Eyles.

shows, books and arcade machines. "I used to liaise with licensing agents such as Copyright Promotions, IDG, coin-op companies and book publishers," Rod explains, "as we explored rights for anything we considered suitable."

Of course, Electric Dreams wasn't the only software house on the hunt for third-party material on which to base its games. "Ocean were doing great things with licences, as were US Gold," remarks Rod, "and they were formidable competitors. But although you always looked at the ones that got away, we got our fair share. We won some and lost some." With the backing of Activision, which had been the trailblazer of movie licensing with the outstanding success of *Ghostbusters* three years earlier, Electric Dreams was in an enviable position when it came to acquiring film properties, and one of its finest would soon see gamers trembling in fear.

In 1986, James Cameron cemented his place at the Hollywood top table by directing one of the biggest cinematic hits of the decade. The sequel to the 1979 sci-fi horror *Alien*, cleverly titled *Aliens*, was, like *Back To The Future* before it, a

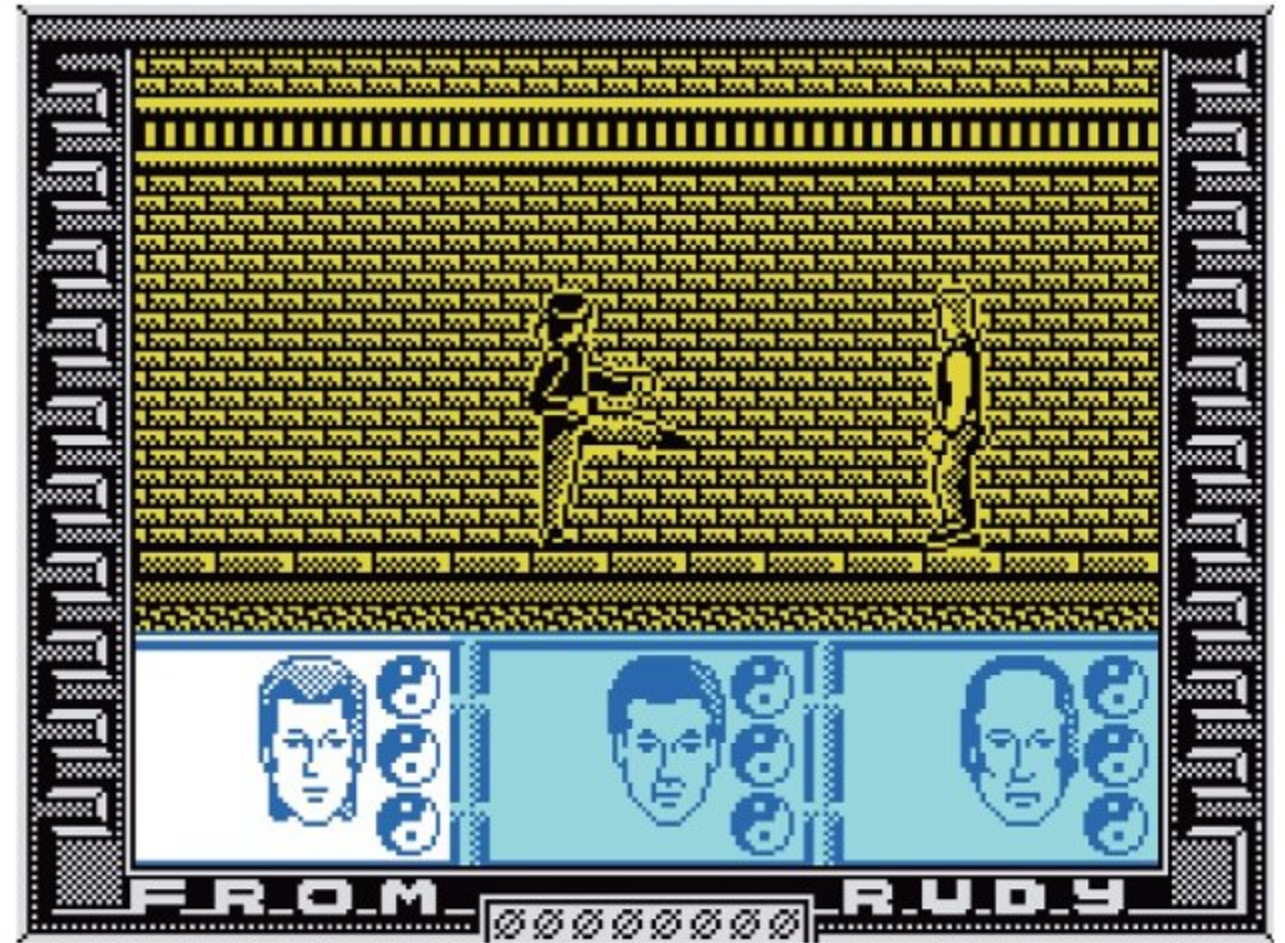

» [Spectrum] *Big Trouble In Little China* was a poor seller for Electric Dreams.

worldwide smash and, not for the last time, Electric Dreams' relationship with Activision proved to be a significant advantage. "The film was a Fox franchise and John Dolgen of Fox had previously worked at Columbia – who had released *Ghostbusters*," divulges Rod. With Activision already enjoying a working relationship with the Fox executive via Greg Fischbach, the licence for a game adaptation of *Aliens* on the 8-bit computers was duly secured for Electric Dreams.

» Effusive claims abound with the *Explorer* advert.

### □ HOLD THE ICE

When David Pringle of Oxford Digital Enterprises bought a copy of *National Geographic* as he travelled to the 1985 PCW show, he could not have conceived what the magazine would lead to.

"There was a great article in it about the Titanic, specifically Robert Ballard who had recently discovered the ship on the sea floor," says David, who was visiting the show to pitch a game idea to Ocean Software. "I bumped into Rod Cousens, who asked me if I had any good concepts for a game. I pitched to him an idea based on the Titanic, and it went from there. I reckon three hours from conception



to pitch! The game, *RMS Titanic*, took five months to develop, with David researching the archives for material, Rik Yapp leading the coding teams, and three artists – including future Sensible Software founder Jon Hare – designing the look of the game. "We had

free rein and were basically allowed to do the game as we wanted," continues David, "and we were pretty happy with the finished game, although some of the sonar effects look awful by today's standards!"

Ultimately the game was released on just the C64, scoring a credible 88% in *Zzap!64*.

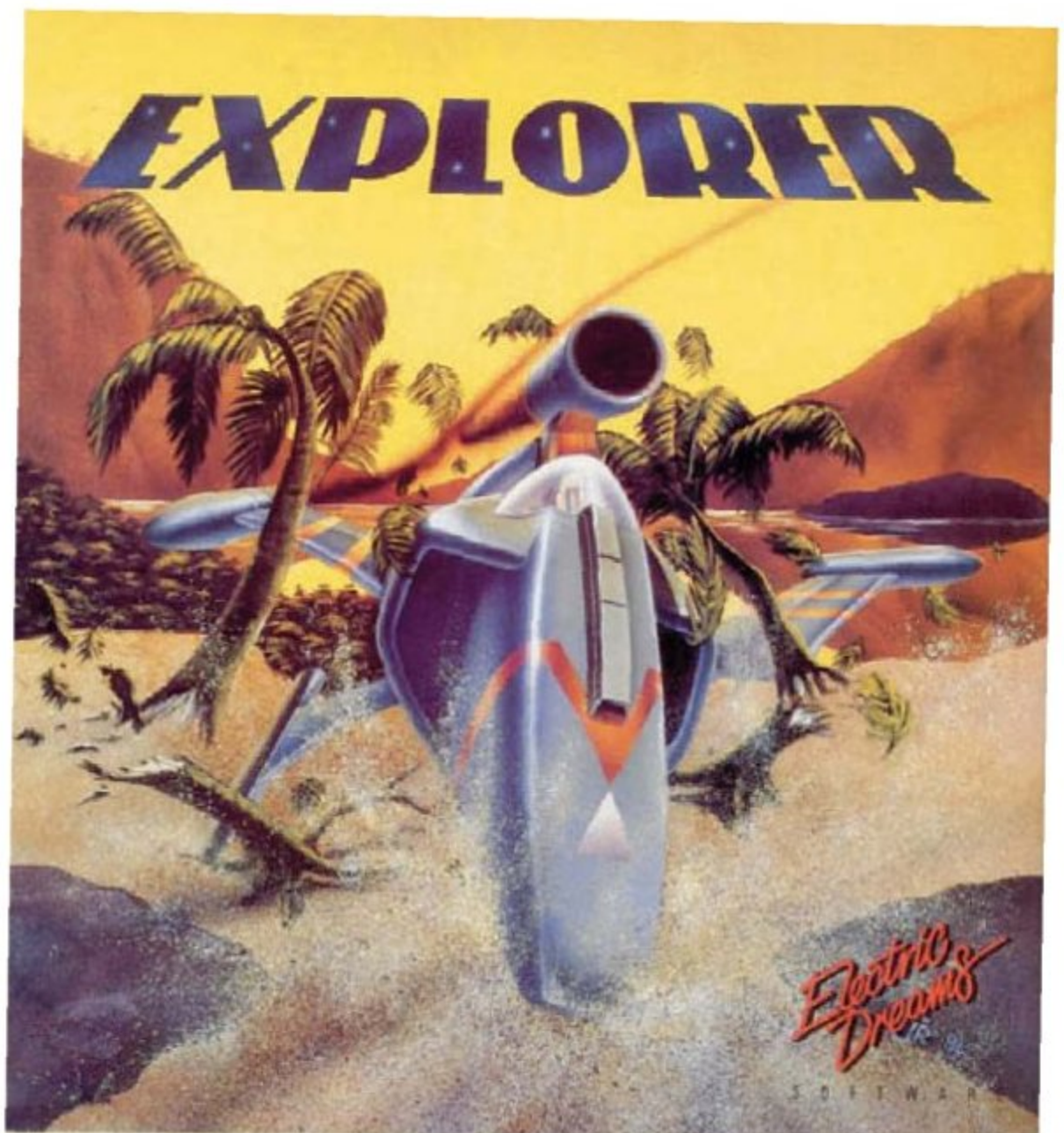

Asargh. Something just woke you from a cryogenic sleep right in the middle of your favourite dream.

Your ship has dropped out of warp and you are forced to make a glide-in landing on a very strange looking jungle planet. Equipped with jet pack for flying, navigation and weapons systems, fight your way through the jungle taking on it's strange and none-too-pleasant inhabitants. Only by finding vital parts stripped in your ship's unscheduled descent can you ever hope to escape.

*Explorer* is huge. There are literally billions of views and an enormous scrolling map.

If you ever wanted to get lost in a simulation this is the one to do it in.

#### FEATURES

- 4 way scrolling landscape
- 40 billion graphic locations
- Inertial navigation system
- Rotovision™ animated landscape
- 360 degree views

#### AVAILABLE ON:

ZX Spectrum 48K/128K + ...£7.99  
Coming soon for Amstrad and Commodore home computers

ELECTRIC DREAMS SOFTWARE, 31 CARLTON CRESCENT, SOUTHAMPTON SO1 2EW TEL: (0703) 229694  
Mail Order: Electric Dreams Software, 23 Pond Street, Hampstead, London NW3 2PN



Rod in his office circa 1987.

## SIX OF THE BEST



**I, Of The Mask (Spectrum) (1985)**  
Sandy White and Angela Sutherland teamed with Rod Couzens for a third time and the result was this. Your task was to negotiate the maze, collecting robot parts and finally the mask itself for your creation.



**Spindizzy (Amstrad CPC) (1985)**  
Paul Shirley's *Marble Madness* clone was an intensely devious and addictive game. *Spindizzy's* only enemy was yourself as you explored the nefariously designed maze.



**Aliens (Amstrad CPC) (1987)**  
Mark Eyles' treatment of the sci-fi action movie not only resulted in an entertaining and fast-paced game, but also a tense and nerve-racking atmosphere that evoked the feel of James Cameron's cinematic masterpiece perfectly.



**Firetrack (C64) (1987)**  
By 1987, the Commodore 64 had seen more than its fair share of vertically scrolling shoot-'em-ups, yet *Firetrack* boasted such manically enjoyable gameplay that it was impossible not to have a blast with it.



**R-Type (Spectrum) (1988)**  
The Software Studios team did a superb job of converting Irem's famous horizontally scrolling shooter, with particular kudos going to the impressive ZX Spectrum version, which was programmed by Bob Pape.



**Millennium 2.2 (Amiga) (1989)**  
Ian Bird's expansive space strategy adventure game certainly didn't lack for atmosphere and also delivered thrills aplenty. Bird improved even further on the template with its sequel, *Deuteros*, published by Activision.

## THREE TO AVOID



**Explorer (Spectrum) (1986)**  
There's no doubting The RamJam Corporation's ambition, with the advertising for *Explorer* boasting over 40 billion graphical locations to explore. In reality, however, the game was an empty experience and poorly received, not living up to its promise.



**Super Hang-On (C64) (1988)**  
The Spectrum version of the motorbike racing arcade machine was a qualified success and hailed as a worthy rival to Activision's own *Enduro Racer*. On the Commodore 64, however, it was a massive disappointment, hamstrung by the machine's poor sprite performance.



**Championship Sprint (Spectrum) (1988)**  
The Electric Dreams conversion of *Super Sprint* had hardly been a classic, yet sequel *Championship Sprint* was even worse, with *Zzap!64* being particularly savage on the C64 version, awarding it a lowly 24%. The other formats fared little better.

The appeal of the movie to software houses was clear: the stark and futuristic scenario coupled with an abundance of guns and aliens to shoot at had massive potential to produce a fantastic game, even on the 8-bit computers.

Mark Eyles was fortunate enough to once again be working as lead designer on a huge licence. "The design process began when I received a script for the film, and I was very excited," he remembers fondly. "I was already a big fan of *Alien*, and when I read the script for *Aliens* I could see it was going to be a worthy successor, and if I recall correctly, much of the initial design work on the game was done before the film was even released."

The treatment for the game created by Mark was indeed something special, and regarded by many as a bridge between the 2D shooters of the time and the shift

the action, the game's brilliant use of the film's motion trackers and other audio cues cranked up the tension and delivered a powerfully intense experience. Yet with *Aliens* released in 1986 to universally positive reviews, Electric Dreams had already decided to go one better.

### Aliens x 2

"We had two great design treatments of the material," says Rod proudly, "so rather than choose between the two, we made the decision to give the go-ahead on both versions and rely on the strength of the licence to make them both bestsellers."

The result was another *Aliens* game, the 'US' version, based on the same movie but offering an alternative style of gameplay. "The US version took a very different approach," says Mark Eyles, "where rather than providing a world in which the player

## Electric Dreams enabled Activision to maintain relevance in the European market

ROD COUSENS ON THE CREATION OF ELECTRIC DREAMS

towards the now-ubiquitous first-person format. He agrees: "We saw it as a way to involve the player more emotionally with the action. The big issue, however, was that the computers of the time really struggled with 3D, so the approach we used had to give the illusion of being in a 3D world." Mark and the development team created this effect by scrolling the 2D background – essentially the walls of the rooms – and this, coupled with other gameplay elements, made *Aliens* an exceptional success.

"The squad-based action was another innovation for the time," continues Mark, "as you could freely switch between the six characters as they moved throughout the base. We combined this with elements from the film – for instance, if a Facehugger got to one of your characters, you lost control of them and had a limited amount of time to go and rescue them." With the squad tactics and shooting providing

could replay their own version of the film, it followed the movie via a series of episodes that re-created key plot events." Released a few months later, the US version proved to be less successful than its forebear, but as many remarked at the time, it was at least a bit easier to play with the lights off!

With the exception of Spectrum *Paradroid* clone *Nihilist* and C64 vertical shooter *Firetrack*, 1987 also saw Electric Dreams begin its assault on the arcade conversion market. "We'd seen what other companies had done and knew there was a big market in converting arcade games to home computers," says Rod. First up, released early in the year, was *Tempest*, an arcade machine that was as legendary as it was ancient. Lost somehow among the rash of *Space Invaders* and *Frogger* clones in the early years of the 8-bit computers, *Tempest* echoed Domark's official *Star Wars* arcade conversion (also released in

## FROM THE ARCHIVES: ELECTRIC DREAMS



» [Amstrad CPC] This was the first of the *Alien*-inspired, and the most successful.



» Mark Eyles in 1986, the year of *Alien* and *Hijack*'s releases.



» [Amstrad CPC] This was a poor alternative to the excellent Spectrum conversion.

» [C64] *Chameleon* on the C64 didn't turn out as Rod had hoped.



» Russian hi-jinks with the conversion of *Karnov*.

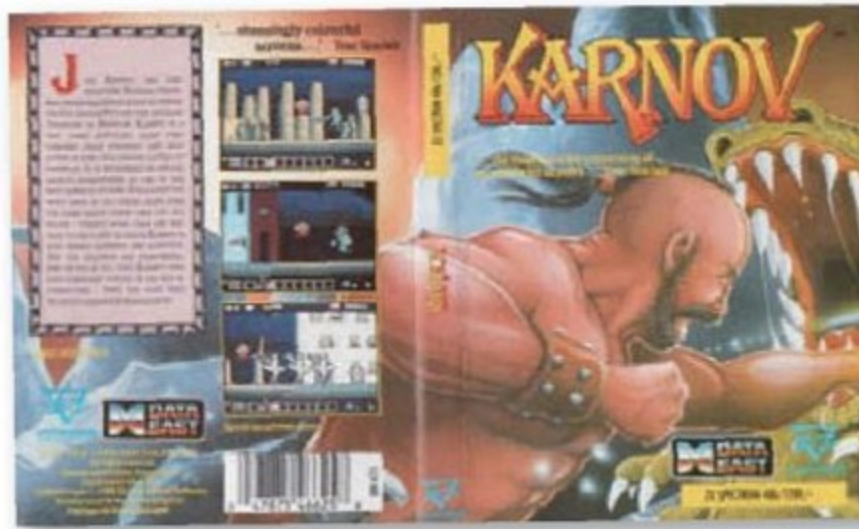

1987) by reaching homes many years after the release of its arcade parent.

Further arcade licences would be swiftly procured by Rod with mixed results. The odd isometric firefighting game *Firetrap* was a moderate success, thanks mainly to its novel subject, but *Super Hang-On* proved to be as dreadful on the Commodore 64 as it was accomplished on the ZX Spectrum. In addition, the popular multiplayer arcade racer *Super Sprint* translated adequately to the 8-bits, yet its sequel, *Championship Sprint*, was roundly panned despite the inclusion of a track designer. Arcade conversions, as for most software houses, were proving tricky for Electric Dreams.

### Blast off

Late in 1987, however, Rod returned from Japan with a licence he considered

something of a coup. "It took a lot of work and persistence, but eventually I managed to get the rights to the Irem shooter *R-Type*," he says proudly, "and I felt the conversions we carried out were excellent." Magazine reviews of the time would bear his feelings out, with the Spectrum version especially attractive and playable considering the limitations of the machine. A conversion of Data East's *Karnov* followed later in 1988 to somewhat lesser acclaim, with Commodore 64 owners in particular feeling short-changed, this time thanks to a virtually identical port of the Spectrum version – something that Julian Rignall and his fellow reviewers in *Zzap!64* magazine took particular exception to, awarding the game a measly 13%.

There's not much information available on how the end came for Electric Dreams,

### FROM THE FORUM: THE BATTLE OF THE ALIENS



**Matt\_B:** I'd definitely go with the UK version; it's like a precursor to the FPS genre.

**Sunny:** I used to play it in a dark room, and picking your shot as it was running along was hairy, and if you missed – causing it to run straight at the screen – it really was brown trousers time.

**Merman:** The US version was interesting. The dropship level echoes *Master Of The Lamps*, the infirmary lock-in sequence, even the weapon identification intro. But the varying quality of the graphics let the atmosphere down.

**Necronom:** I like them both, but for different reasons. The UK one looks much better and is very atmospheric, though is far too hard. The US one follows the film and has more variety. It's easier and has level codes, and I can finish it, so have probably had more fun from it.

**ToxieDogg:** They complement each other quite well. It's worth playing both of them.

**Greenberet79:** UK for me. Loved it – one of my favourite ever games. An early survival horror and an early FPS.

probably because of the way the brand was assimilated into Activision, thinks Rod: "Electric Dreams never really took hold in the US; I had been appointed as international head of Activision, so we merged the resources and concentrated on the main brand, which was obviously Activision itself. The regional markets had begun to converge with common platforms, so the necessity to establish and maintain local imprints was greatly reduced."

With the Commodore Amiga and Atari ST 16-bit computers being chiefly US platforms, although they found some success in Europe, it made sense for the development of global franchises to be routed via the main company. Electric Dreams, without fuss or fanfare, quietly disappeared late in 1989.

### Closing thoughts

"In some ways, Electric Dreams was a continuation of Quicksilver," says Mark Eyles, "and Rod was the key to its success. At the time, the games industry was just getting established in the UK and moving onto a much more business-like footing. Without the business acumen of people like Rod, it would not have succeeded the way it did."

Rod adds: "Electric Dreams enabled Activision, who had a US-skewed product slate, to maintain relevance in the European market, as this was a growing part of their business and, in addition, it crucially allowed the creation of a local development talent pool, which then had access to a powerful global distribution force." It's clear the legacy of Electric Dreams is not just some damn fine videogames; Rod sees its role as a pivotal part of Activision's subsequent success and strength, as well as providing a range of talented people the springboard to careers that continue to this day.

» [C64] *Star Raiders II* was a popular follow-up to the Atari classic. Electric Dreams handled the Spectrum, CPC and C64 versions.



# THE CLASSIC GAME

# LOADS OF CHAOS!

This cult follow-up to Julian Gollop's highly regarded *Chaos* is actually something of a hybrid, taking aspects of his equally well considered *Laser Squad* and merging them with its predecessor. This potentially risky move pays off, with the end result delivering arguably deeper, richer gaming than either of the earlier games. *Lords Of Chaos'* straightforward menu-driven controls make it relatively easy to get into, but behind this concession to accessibility lies sophisticated gameplay built on layers of complexity. Crucially, the title's RPG elements work seamlessly with its underlying focus on strategic combat, and its aesthetics are equally accomplished.



### Vampires

Vampires can take flight to avoid ground attacks but must fight on terra firma.



### Your Wizard

You can choose spells, attributes, and a name for your character using the Wizard Designer.



### Opposing Wizards

The three mages you battle are named Torquemada, Elbo Smogg, and Ragaril.



### Giant Spiders

These are one of the most powerful land-bound creatures.



### Pixies

Pixies are invisible to enemies, making them the perfect spy.



### Unicorns

Unicorns are a good choice to ride into battle, as they have great stamina.



### Gryphons

Gryphons will capably fly you across the battlefield.



### Golden Dragon

These mythical beasts can breathe fire but are difficult to conjure up.



### Magic Fire

This is a powerful spell but can spread out of control.



### Goopy Blob

These spread like magic fire and harm undead creatures.



### Cauldrons

These are used to mix magical potions.



### Vials

Vials hold beneficial potions, such as speed or strength.



### Keys

Keys open doors and treasure chests.



### Treasure Chests

Aside from treasure, these chests can contain powerful weaponry.



### Scrolls

Scrolls can reveal vital, though cryptic, clues.



# MEMORABLE MOMENTS



WHY IT'S A CLASSIC

## A winning strategy

Gaming classics often transcend their genre to become celebrated as a great game, rather than just a great game of their type. *Lords Of Chaos* is a fine example of this; a title hard to pigeonhole in any conventional genre, which is also just accessible enough to attract attention beyond that of its natural audience. That being said, it caters equally well to devotees of strategy-based gaming by providing satisfying, slow-burn gameplay. Additionally, the game's clean design and attractive visuals make it one of the best-looking strategy titles on the Spectrum.

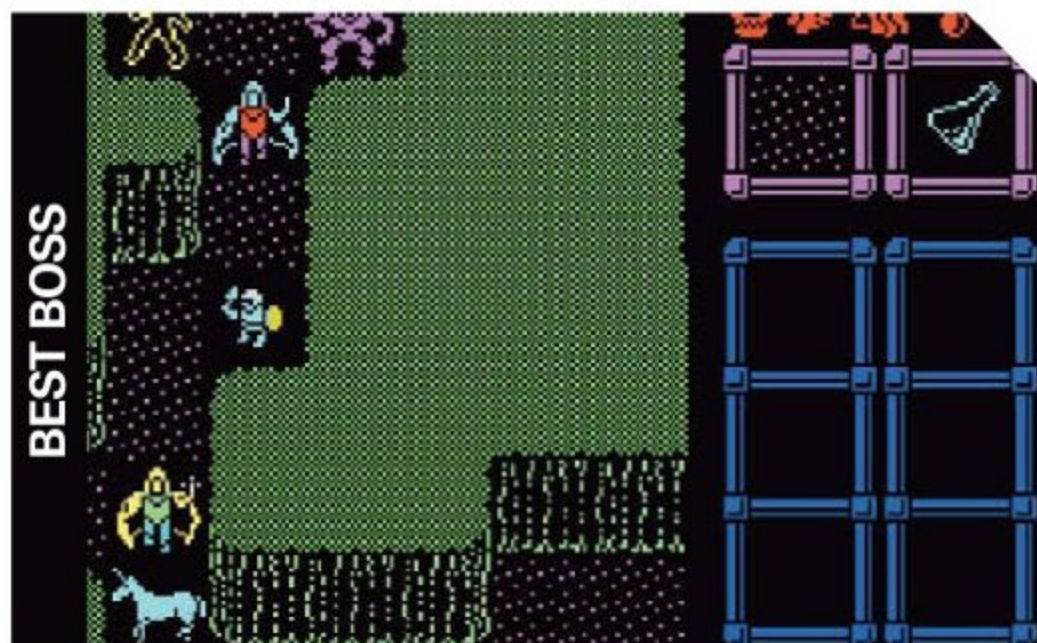

BEST BOSS

## No wizard wheeze

Of the three wizards you do battle with, Elbo Smogg, the ruler of the Slayer's Dungeon, is the most challenging to defeat in hand-to-hand combat, and therefore the most memorable mage. Granted, the wizard Ragaril is technically harder to get the better of, but this is more down to the many puzzles and traps he sets within his domain, rather than his prowess in armed spell-casting. Smogg's tactics are to conjure up a veritable army of creatures, capable of tackling any you might have managed to summon yourself, before tossing a barrage of his favourite spells in your direction.



BEST STAGE

## Mind like a steel trap

The game's first scenario, The Many Coloured Land, allows you to hone your skills, while its second, Slayer's Dungeon, is a stern test of everything you've learned. However, the third scenario, Ragaril's Domain, holds challenges of a slightly different type. The wizard Ragaril, unlike his predecessors, rules his domain through guile rather than brute magical force, and sends creatures to fight his battles for him. This would make reaching Ragaril and defeating him before he escapes hard enough, but while negotiating the maze to his lair you also have to avoid his traps and solve his devious puzzles.



BEST CREATURE

## Attack with a 50-foot spider

There's no shortage of candidates for this category, as the game features an extensive, eclectic mix of creatures sourced from myths, legends and the natural world. And while riding an elephant into battle, flying a harpy over the playfield, or setting a vampire on your opposite number are all high points of the game, the most practical and reliable choice would have to be the giant spider. Admittedly, large arachnids lack wow factor, but since they can hold their own against almost any other creature, they should be your first choice when conjuring up soldiers, or guards for weaker creatures.



BEST SPELL

## Beam me out, quickly!

Of the game's spells that aren't used to summon creatures, you would imagine the most useful would be one used to attack the enemy or defend yourself and your forces. In actual fact, the one piece of magic that no wizard should be without is the teleportation spell. Let's face it: even the most brilliant tactician can get it wrong, and the most reliable of attacks can go awry, leaving you on the losing side with little energy left in reserve. In this unenviable position, the safety net of your teleportation spell is the one you want to have left in your armoury.

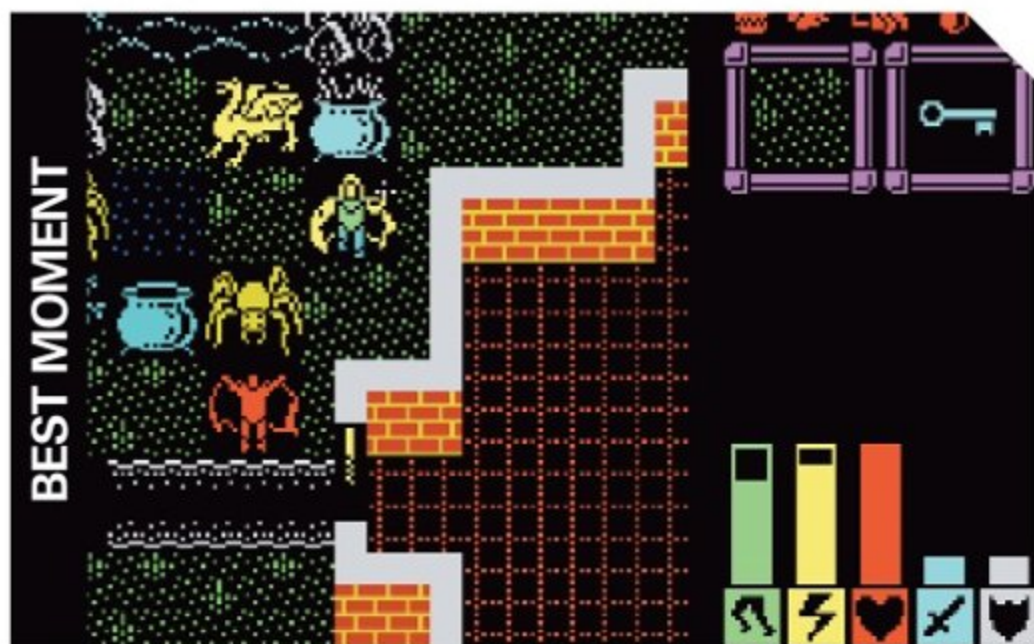

BEST MOMENT

## Outstanding achievements

It's hard to pick one moment in a game of incremental progression, where you can lose yourself for hours at a time; instead, it's probably more useful to highlight a couple of achievements that provide great satisfaction. One early memorable moment is vanquishing the wizard Torquemada for the first time in the game's opening scenario, having first endured what seems like endless defeats at his hands. A much later milestone, reached after extensive play, is conjuring up the legendary golden dragon, a feat requiring healthy reserves of magical energy, a cauldron, and some extremely rare dragon herb.

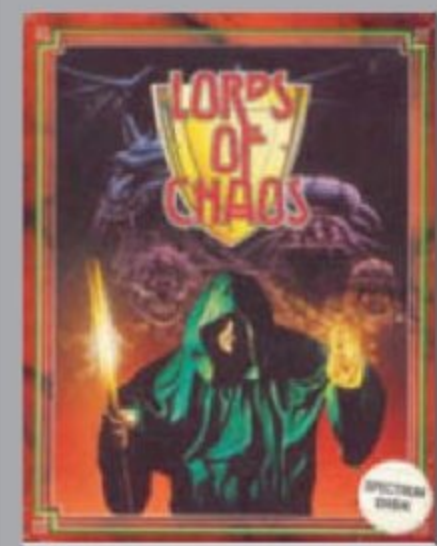

## IN THE KNOW

- PLATFORM: VARIOUS
- PUBLISHER: BLADE SOFTWARE
- DEVELOPER: MYTHOS GAMES
- RELEASED: 1990
- GENRE: TURN-BASED TACTICS
- EXPECT TO PAY: £10+

## What the press said... ages ago



### Your Sinclair

"Perhaps not the kind of fodder to keep die-hard arcadesters happy, but *D&D* fans, sword and sorcery nuts and strategy enthusiasts will lap it up. If you fall into any of these categories then you'll certainly want to check out *Lords Of Chaos*."

## What we think

Time is kindest to those games with challenging gameplay or generous quantities of replay value. As *Lords Of Chaos* exhibits both of these qualities, it's unsurprising to find that the positive comments made on its release still hold true – it might even convert a few "die-hard arcadesters"!



## In the chair with...

# NICK JONES

Once a vital cog of Shiny Entertainment, programmer Nick Jones reveals how seeing aliens in a classroom changed his opinion of computers and ultimately led him down a path to an impressive career in programming

AFTER CUTTING HIS teeth on Herbert Week's dummy and honing his craft at Mikro-Gen, Nick Jones became a programmer for hire. During this time he helped the Commodore 64 keep up with Raffaele Cecco and *Alien 3* win quite a few Super Nintendo fans. Arguably, though, Nick has become most recognised for his work in helping a robot-suited annelid become a Nineties gaming icon, when he left rain-beaten Britain to join David Perry at the start of his Shiny Entertainment venture. Nick speaks to Stuart Hunt about his enduring career in videogames, which spans an impressive 29 years and counting. Just nobody mention Queen.

**\* Tell us about your first experience with computers.**

Initially I wanted to be a civil engineer because my best friend's father was one. I didn't really know what the job entailed. And then somebody told me that computers were a good thing and that I should probably do something around that, so I took a course and hated it. Then one day I went into my classroom and on this really crappy school computer I saw somebody playing a *Space Invaders*-style game, and it had a real profound effect on me. It was terrible, there was no sound, no colour, but it was clearly recognisable as *Space Invaders*. After seeing that,

I bugged every single person I could about anything related to computers. I wanted to know how someone could make something so cool on this computer that I thought was a bit rubbish really. That was probably the driving force, the moment I went from being disinterested in the classroom to having the real strong interest in computers.

***Space Invaders* sparked your interest in computers, but when did you realise you wanted to make a living from videogames?**

At my sixth form there was this guy who was really interested in the BBC Micro and was writing stuff for a computer magazine and making a bit of money. He wasn't making much, but the fact that he was making money from an entertainment means was shocking to me, and without actually admitting it to anyone I knew then that what I wanted to do was make videogames. At that point I knew I needed to buy a machine and I ended up settling for an Oric-1, which was probably a really bad idea. I bought this thing and didn't know anything about what was in the heart of it. It was a 6502 machine, and luckily this proved to be very beneficial for me in the long run. But I got this machine and decided I would create a computer game. It took me 15 months to write it because everything

I wanted to learn about the machine I had to figure out for myself. When it was finished I sold it to a company called Tansoft, who offered me £450 worth of computer equipment for it, including a hard drive. Unfortunately, before my hard drive arrived the company went bankrupt.

**Clearly that didn't discourage your plans, so how did you land your first job in the industry working for Mikro-Gen?**

Well, what I did do with that Oric-1 game I wrote was send it off to Mikro-Gen. I was hoping they'd look at it, but I really wasn't hopeful. Anyway, they phoned me up, invited me to London, and offered me a job on the spot. I couldn't believe it. My foot was in the door and I was getting paid to write videogames. £5,000 a year was what I was getting paid and I just couldn't believe people were paying me to write videogames.

**What was your first project when you started working for Mikro-Gen?**

Well, I lied to them when I got my job. I said I could program in every assembly language known to man, but the reality was I didn't know Z80 all that well. So the first thing they did was give me *Herbert's Dummy Run* to do on the Amstrad, which is a Z80-based machine. I had three







## SELECTED TIMELINE

- Herbert's Dummy Run (CPC) 1985
- Frost Byte 1986
- Cyberoid (C64) 1988
- Vixen (C64) 1988
- Beyond The Ice Palace (C64) 1988
- Dan Dare III: The Escape (C64) 1990
- Smash TV (C64) 1991
- Supremacy (C64) 1991
- Alien 3 1993
- Earthworm Jim (SNES) 1994
- Earthworm Jim 2 1995
- Floigan Bros Episode 1 2001
- NFL 2K series 1999 – present
- NBA 2K series 1999 – present

**“Dave grabbed my back, and I grabbed him by the throat and everybody just ran out of the office”**



In the chair with...

months to do it in and it was kind of my probation project. I sensed that if I didn't pull that off then I was out the door, so for those first three months I really felt a pressure to just knuckle down and learn this Amstrad machine. One thing they realised quickly when I got there was that I had music experience. So as well as doing this Amstrad version of the game they also had me doing the music for their games. They had this little device that could play very basic notes, and I had been playing the piano since I was a kid, so I just went away and wrote the music for them. From then I was lumped into writing all sound effects and music for their games. It wasn't my forte at all, but I didn't mind. In those days you had to do everything; you were doing the graphics, the programming, the level design, the product testing.

**It was during your time at Mikro-Gen that you met and worked alongside some prominent developers like David Perry, Chris Hinsley and Raffaele Cecco. Did you all get along?**

I remember Raffaele specifically. He was a really interesting guy. He was very creative and really into his programming, and I remember his machine code routine for drawing sprites on the screen. And he never did anything except kept looking at this one little bit of code every day and just optimising it. And I basically said to him that he needed to buckle down otherwise he was going to get fired. After that he did and produced *Equinox*, which was a great game. He had a really good eye for visuals and after Mikro-Gen he and I worked together and ended up becoming really good friends.

I remember Dave and Raf would play Queen all day long. They'd put it on full volume until the walls were shaking. And by the end I couldn't stand it. I hated Queen for the longest time. I couldn't stand them. In fact, Dave and I almost ended up in a fist fight over it. We didn't actually get to striking blows but I remember one day he turned it on and I turned it off because I couldn't concentrate. And this went on backwards and forwards until eventually he turned round to me and said something like: 'If you turn that off again I'm going to put my fist in your face!' [laughs]

So I went over and turned it off and he grabbed my back, and I grabbed him by the throat and everybody just ran out of the office. We came to our senses before we ended up hitting each other.

# \* FIVE TO PLAY

## EARTHWORM JIM



EVEN 18 YEARS after the game caused jaws to soundly drop, Nick still receives plenty of interest about his time working on *Earthworm Jim*. He's incredibly proud of the series, as it shows what can happen when talent from all areas of game development is brought together. With David Perry uniting the likes of Doug TenNapel, Nick Bruty, Stephen Crow, musician Tommy Tallarico and Nick, among many other talented individuals, through Shiny Entertainment, Jim had one of the best teams in the business backing him up. Nick was responsible for programming the Super Nintendo version, which he developed by getting David Perry's renowned Mega Drive animation engine to work on the machine. *Earthworm Jim* was praised for its humour, slick visuals, smooth animation and imagination. It scooped awards, made Jim a gaming superstar and put Shiny on the map, making it a studio to watch. With its first game becoming a hot property, Shiny set to work on creating a sequel, which was released the following year. Containing falling grannies, more bizarre foes to battle, some amusing videogame parodies and a level where Jim inexplicably becomes a blind cave salamander, it's possibly the most surreal platformer ever created.

## CYBERNOID: THE FIGHTING MACHINE



A CASUAL PARTNERSHIP with Raffaele Cecco after Mikro-Gen saw Nick porting the *Cybernoid* series to the Commodore 64. Both were solid conversions, but it's the first game we're recommending. An 8-bit tour de force, you pilot the titular Cybernoid, a ship sent to retrieve valuable weapons and cargo from intergalactic pickpockets. With time to complete your objective short, the mission is incredibly tense and challenging, but its quality will always have you returning to it like a lovesick bard looking for new inspiration for a sonnet. *Cybernoid* has everything you could want from a shooter. It looks stunning, has great music and a ton of weaponry, plays smoothly, oozes atmosphere and is very challenging.

## ALIEN 3

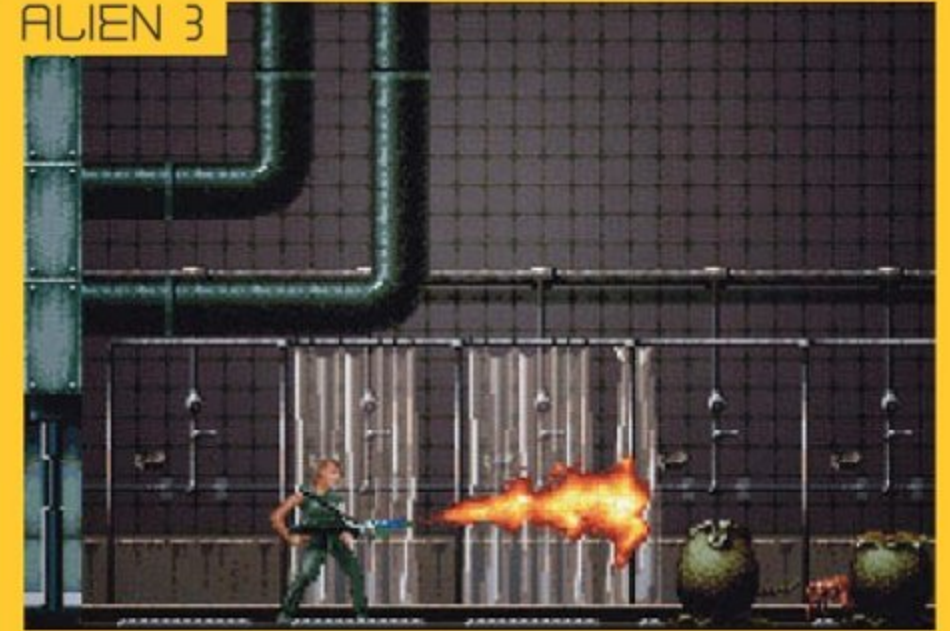

NICK TEAMED UP with graphic artist and good friend Nick Bruty (*Trantor: The Last Stormtrooper*) to create the Super Nintendo version of *Alien 3*. It was a deep, challenging and atmospheric run-and-gun game further enhanced with stunning graphics and a diverse range of missions, which elevates it above the very different Mega Drive version for many gamers. Each mission is divided up into multiple objectives, from flaming eggs to rescuing prisoners, and the Alien menace was pretty relentless too. Some great music, inspired by James Horner's *Aliens* score, finishes off the package nicely. This was the first ever Super Nintendo game Nick worked on and is a testament to his versatility and talent as a programmer.

## HERBERT'S DUMMY RUN



PROGRAMMING THE AMSTRAD version of *Herbert's Dummy Run* was Nick's first ever project for Mikro-Gen. After fibbing his way through his interview with false claims that he was fluent in various flavours of assembler, he was forced to hit the books and learn the intricacies of the machine from scratch. Thankfully, with a proven history of fast learning, in three months Nick delivered a solid version of the *Wally Week* spin-off for the computer. *Herbert's Dummy Run* saw the tenacious tot of *Wally Week* having to negotiate a department store full of colourful furniture, deadly objects and send-ups of popular videogames to get reunited with his poor, worried-sick pops.

## NFL 2K



NICK CURRENTLY WORKS at Visual Concepts, a subsidiary of Take-Two Interactive. Based in California, the developer is best known for handling Take-Two's popular *2K* series of US-centric sports titles. Having worked at the studio for around 14 years, Nick has worked on a lot of games, but it's the first *NFL 2K* that had the most profound effect on him. Developed at a time when polygonal graphics were still relatively new, Nick was amazed by their authenticity and also the fact that at one point he didn't even recognise his own game due to the scale of the project. It's the moment when Nick realised the intimate, do-it-all process of making games had come to an end.

**Tell us what you know about the ill-fated Mikro-Plus add-on from Mikro-Gen, and the infamous *Shadow Of The Unicorn*.**

The idea behind it was simple. It was a 16K game-dedicated ROM chip that came with a cassette game. It basically allowed us to write 64K games that couldn't be pirated. However, the way it was brought to market was absolutely disastrous. The guy who did *Shadow Of The Unicorn* kind of half did it and then left, and we found all these massive design issues with the game. Well, we looked at what he'd left us with and it was terrible. Eventually they put out *Shadow Of The Unicorn* and it just killed the Mikro-Plus. The reality was they should have just canned the game. Dave was doing *Three Weeks In Paradise* at that point and was writing it for the Mikro-Plus. It was a really great game, and in the last second we realised the Mikro-Plus was dead, so we had to take the game and rip it to pieces to get it down to a regular 48K. Ultimately, I think that was the beginning of the end for Mikro-Gen.

**Who was the first one to leave?**

I think Dave was the first one to abandon ship, and then Raf and then Chris. I think I was one of the last engineers to leave. But before that we'd all seen that the writing was on the wall. So what we did is buy our own development systems, and basically just started doing the same thing at home. I actually wrote a couple of budget games in my spare time and sold them to Bubble Bus. When Mikro-Gen closed, I took advantage of a scheme set up by Margaret Thatcher whereby anyone who was unemployed and wanted to set up a business for a year could take themselves off the unemployment register and be given £2,000 to start up their own business. They paid me £40 a week, which covered my rent and everything. I was literally living for nothing while I was making my games, and it really helped get me on my feet. I think the first thing I did was *Cyberoid* with Raffaele

“The SNES was stunning. It was such a big jump from the Commodore 64 days”

for Hewson. It was an informal agreement between us. Raffaele was the creative genius behind it and I would just go over to his house and help him out with technical things on the Spectrum, as I was always thinking about how we could push the hardware, but ultimately I was doing the Commodore variants.

**So you were a freelance programmer. Who else did you write games for at that time?**

Well, at one point I got myself in real trouble. When I started my deal with Hewson they said they were going to do this budget series of games. They knew I had done those budget games for Bubble Bus, and asked me if I could knock them out a budget game on the Amstrad and Speccy. So I did. I worked on it for a few months and it was fairly complete but then they changed their mind. Well, having written this damn thing for three months I was pretty cheesed off, but I put it on the shelf, forgot about it and started work on *Cyberoid*. Then, when *Cyberoid* was approaching completion, Dave Perry contacted me and said he wanted me to work on *Beyond The Ice Palace* for Elite Systems. At the time it was codenamed *ThunderCats*

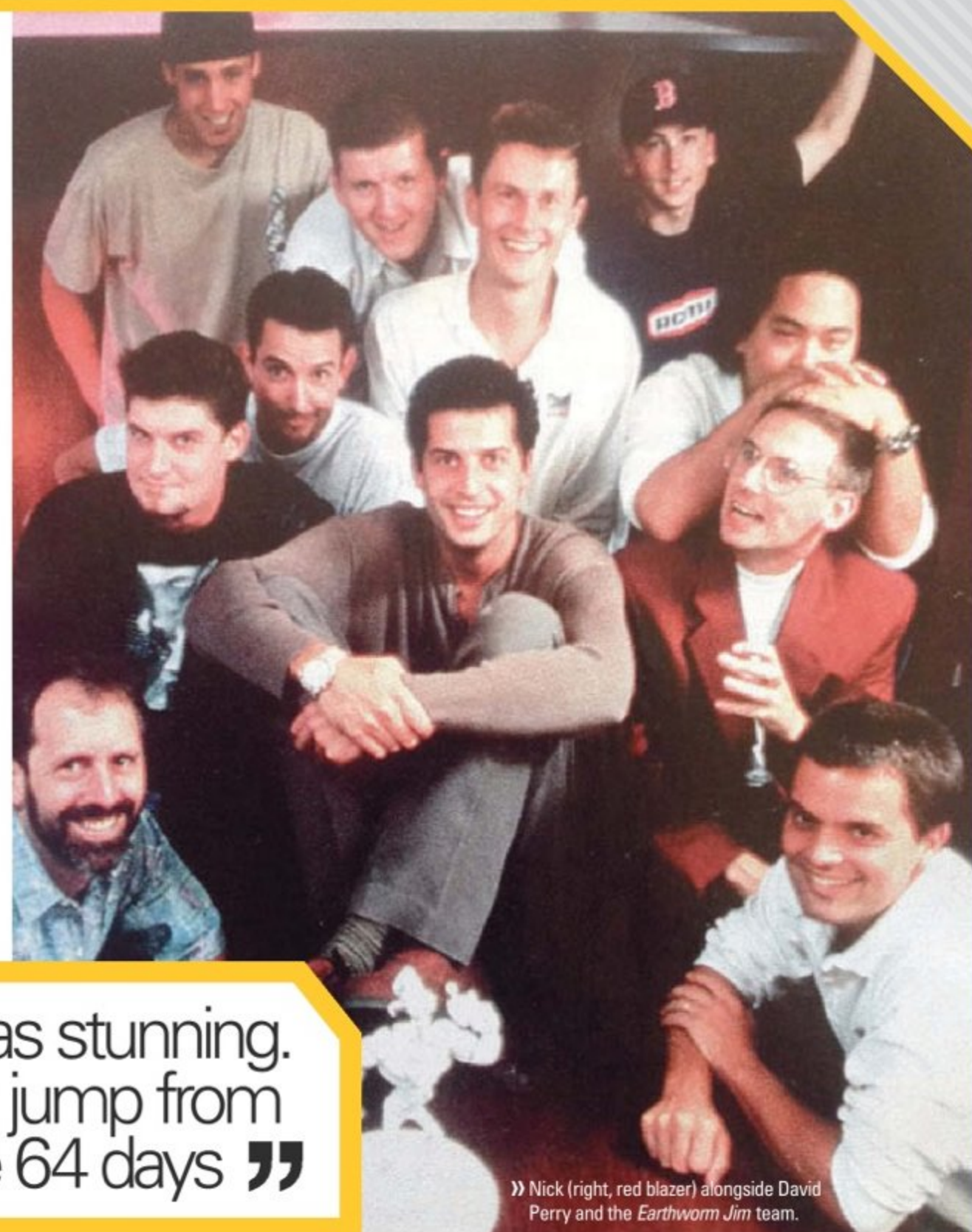

» Nick (right, red blazer) alongside David Perry and the *Earthworm Jim* team.

because it was going to be based on the TV show. Well, Dave negotiated a package deal to do five versions of the game for a lot of money. So I took that deal and then a company called Martech Games phoned me and said they wanted me to do this game called *Vixen*. After taking that on I then got contacted by Fergus McGovern at Probe Software, and I met with him to sell this game I had sat on my shelf for three months. It was pretty sweet at the time because the money was rolling in.

But the reason I'm telling you this story is because I ended up doing five games simultaneously, and I just about had a nervous breakdown. I couldn't deal with it. That was the first time I ever contracted out something. I took this budget game I was doing for Probe and gave it to one of my friends. I paid him £1,000 and asked him to finish it off, which he did. That was my first project for Probe and then I ended up doing a number of games on the Commodore for them, like *Smash TV*, and as I worked with Dave Perry so well I was really comfortable with his code, so I also converted his games *Supremacy* and *Dan Dare III* on the Commodore. But that was how I got connected to Probe and asked to do *Alien 3* for the

Super Nintendo. It was on that game I got to work with Nick Bruty, who's a really good friend of mine, even today.

**How did you find the transition from programming games for the Commodore 64 to the 16-bit Super Nintendo?**

Nick Bruty would come over to my house and we would work together just exploring this Super Nintendo machine and finding out what it could do visually. And it was stunning. It was such a big jump from the Commodore 64 days, but the reason why it made sense for me to move to that machine is that at the heart of the Super Nintendo was a chip called the 65816. It was basically the 16-bit big brother to the 6502, which was in the Commodore and the Oric-1. So that really helped me.

**What was working with Nick Bruty like?**

The art that Nick was creating was unbelievable. He was just hand-drawing Ripley, the character from *Alien 3*, and she looked stunning. I would say to him I needed art for a walk cycle of eight frames, and he'd always come back to me and just blow it out, so instead of doing eight frames he'd give me an animation



## \*NUMBER CRUNCHING

Nick's first computers were a ZX81 and an Oric-1

**£5,000** a year was how much Nick was paid by Mikro-Gen, which gave him his first job in the games industry

**£2,500** was how much Nick was paid for programming the C64 version of *Cybernoid: The Fighting Machine*

Nick was originally going to be paid **£25,000** for *Alien 3*. Following the game's success, he managed to negotiate a further **£6,000**

*NBA 2K12* has sold around **5 million** copies to date

Nick has been playing the piano since the age of **8**

In **2005**, *NFL 2K5* won the Academy of Interactive Arts & Sciences Interactive Achievement Award for Sports Simulation Game of the Year

*MLB 2K10* had a contest open to all gamers that awarded the winner **\$1 million**. Nick wanted to try to win it himself, but his game-writing skills do not translate to his game-playing skills. Oh, and the competition wasn't open to Take-Two employees

that was 20 frames. So he ended up blowing my budget on the memory way out, but visually I couldn't compromise because what he was giving me looked incredible. So *Alien 3* was a very stressful time for me. I was on my own and didn't have that support network of other people who had worked on the machine and who I could ask when problems arose.

*Alien 3* took me about 15 months to write, and it was really successful for Probe. From then, I made a deal with Vivid Image to do a *Mario Kart*-style racer. I was provisionally starting work on that when Dave, who had already left for America to work for Virgin Interactive by this point, phoned me up out of the blue one night and said he needed someone to come over and work with him and be programming director of this new startup company called Shiny Entertainment he was forming. And I was so excited because I was going

Beach. It was like *Baywatch*. He was basically just playing to my wife to show these beautiful aspects of sunny California, and it worked. And it was definitely the right move for us, for sure. I remember the day I started Nick Bruty picked me up from the airport in another limo and we went straight to the beach. He took me into a surf shop and bought me a wetsuit and we were out on the ocean just ripping around on the waves on jet bikes. I just remember how surreal it all was, coming from rainy Britain and as soon as I landed being in this really beautiful, sunny environment, flying around on a jet bike. It was really bizarre.

**Tell us about the team at Shiny at that time.**

It worked really well with Dave. He worked literally about eight feet away from me and he and I were the engineers at Shiny. Nick Bruty

“I remember how surreal it was, coming from Britain and being in this sunny environment, flying around on a jet bike”

to be working with him, and I knew Nick Bruty was on board. I remember I put down the phone, ran into our bedroom and woke up my wife. I was like, 'We're going to America!' She just burst out crying; she couldn't deal with it at all.

**We guess you convinced your wife that a move to America was the best thing...**

When we got over there, David just laid it all on completely. We got off the plane at the airport and we had a limo waiting that took us to this crazy, crazy hotel in Laguna

was the background artist, and Doug TenNapel was the creative guy. We also had a couple of animators, a guy called Ed Schofield and Mike Dietz, and they were really good animators. A guy called Tom Tanaka, who was a great level designer, and then Steve Crow was brought in. They kept offering him a job and he was just sitting on the fence for the longest time because he had a nice comfy job at Virgin, working with the guy he'd worked with for a long time and partnered up with a guy called Mark Kelly, who I both met previously at Probe. I really liked Mark and Steve, and I really got on with Steve. So for him to break from Mark and come and work with us was a scary thing for him, and I was just praying Stephen was going to accept. And when he did I was so happy.

**What was it like during those early days at Shiny, when you were creating *Earthworm Jim*?**

I thought I'd worked hard in England, working on all these Commodore 64 games and that point where I was working on five games simultaneously, but it was nothing like working on *Earthworm Jim*. It was an incredible time but so tiring. I ended

up moving a couch bed between mine and Dave's office and ended up sleeping on it many, many times, and sometimes my wife would sleep on it as well. It was a really rough time and we obviously didn't know if *Earthworm Jim* was going to be a success, but everything was relying on it.

**You were responsible for programming the Super Nintendo version of *Earthworm Jim*, is that correct?**

I did the Super Nintendo one and Dave did the Sega Genesis version. We developed them both at the same time but the Sega Genesis one was always slightly ahead in development, mainly because Dave was using an engine that he had written for his previous games like *Cool Spot* and *Aladdin*, whereas for me the first task I had to do was to get this engine working on a Super Nintendo. So the first thing I did was I took his *Aladdin* game and got that working on a Super Nintendo. There were a few frame rate issues and it would crash now and then, but fundamentally it was a Sega Genesis game running on a Super Nintendo. It was really, really fun to see. And so I spent the first couple of months doing that and we even thought at one point, 'Can we sell this?', but we couldn't because



» Nick ported *Beyond The Ice Palace* and *Supremacy* (aka *Overlord*) to the C64.



» [SNES] Nick also worked on *Earthworm Jim 2*. Subsequent sequels, such as *Earthworm Jim 3D*, were from other studios.



» Receiving an award for *Earthworm Jim*.

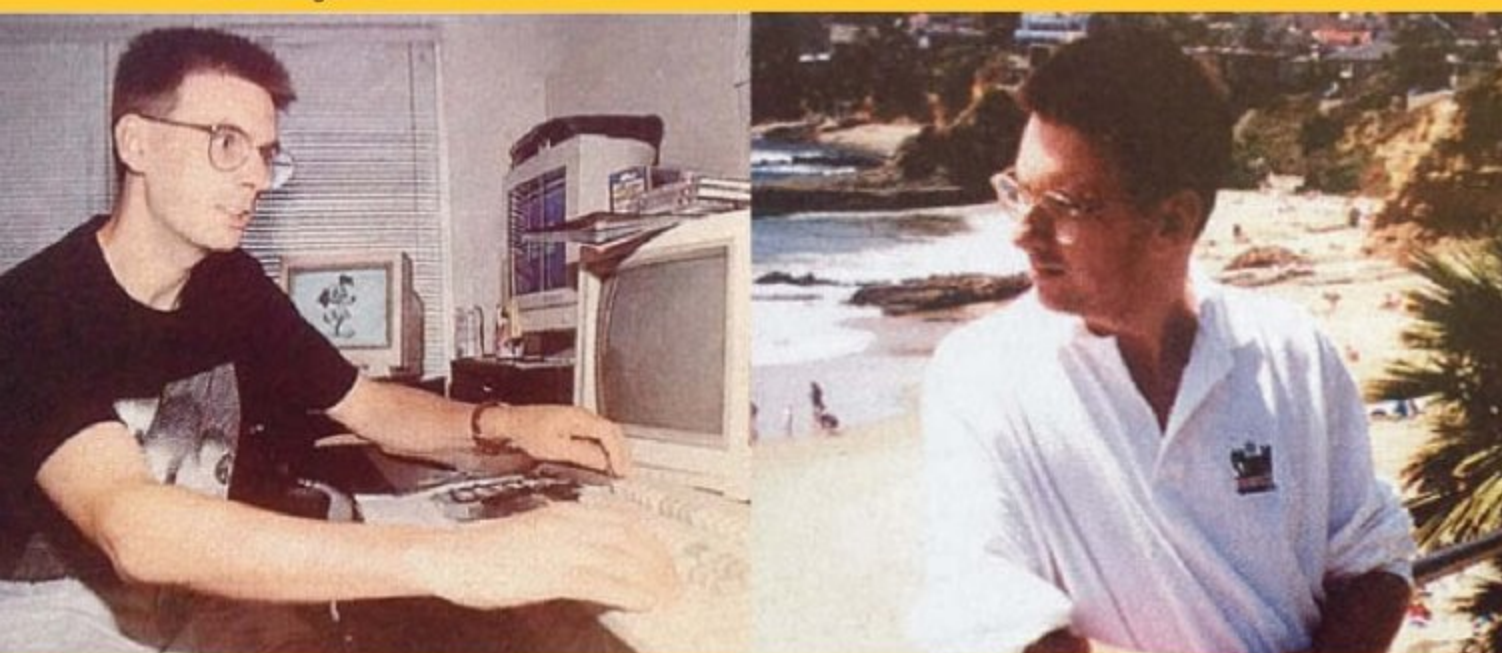

» Nick enjoying the California lifestyle and working on *Earthworm Jim 2*.

somebody else had acquired the licence. I used that engine to make *Earthworm Jim*; all the map editors and things like that were instantly compatible with the game, so there was very little programming involved.

#### Was the end of your time at Shiny a difficult period?

David sold the company and the first person I heard this news from was somebody from the press. I felt so let down and I just couldn't believe it. Then I just saw lawyers coming in, and I thought they were there to negotiate the sale of the company, but they were actually hired to fire and disgruntled employees. And it was then I realised it was the beginning of the end. My worry at that time was I didn't have a Green Card, so I worked really hard to get that, and then started looking around at other options. I was actually given a chance to work with Insomniac Games. They offered me a stake in their company and wanted me to work on *Spyro The Dragon*. I started meeting with them but I turned them down. I look back now and think maybe I shouldn't have. It was fear, I think, more than anything else. What I ended up doing was picking the company I'm at now, which was Visual Concepts, since acquired by Take-Two. We make sports games and I've been there for about 14 years. I've been there for almost as long as my entire career before that. But life is a bit more stable now, I can tell you that.

#### Many ex-Shiny employees went to work at Doug TenNapel's company, The Neverhood. Were you ever tempted to join them?

Of all the people at Shiny, the one person I had the biggest clash with was probably Doug. Doug and I were always fighting with each other, and so I don't think it would've worked out. I'm sure I caused his blood pressure to always go up when we worked at Shiny, but I think because we were always fighting with each other ultimately it made the games better as well. I think he ended up respecting me a bit more once he'd set up his own company and was trying to do what Dave had done himself.

I did work very, very briefly for them, but not in a paid position. It was on the game *Skullmonkeys*. I'm not trying to take any credit away from the programmer because he did

99.99 per cent of the game, but he had a problem with getting the frame rate up. And I think it was Steve who phoned me up and said he needed some help. So I went in and all I did was ask him about a few things, take some of his source code away and then rewrite it in assembler. I went back to him and explained what I'd done and that's all it took to solve the issue. If I remember rightly, the backgrounds were all made of clay and they built all the sets in their warehouse. Anyway, when the game was finished they literally just hacked it all up and threw all this stuff that they'd designed in the bin. It seems crazy when you look back, but what Steve did was he went and hacked off a big chunk of it and put it on a little plaque, which he gave to me for Christmas one year. I've still got it now.

#### Of all the games you worked on, what's been your highlight?

*Earthworm Jim* was a big one for me. That's the game that everyone knows me for. I'm like the old man in the office, and it's kind of embarrassing that some of my workmates were playing it when they were about eight years old. It had everything. It had creativeness, great gameplay, great visuals, and you never really knew what was coming at you at any time on any level. The first *NFL 2K* on Dreamcast was also pretty exciting. I remember we were working on the game and one day I was walking past a conference room and I looked inside and saw a TV showing a live NFL game. When I looked more closely, though, I realised that it wasn't live TV at all; it was our videogame. I couldn't believe it. And as I stood there and watched the game progress slowly, this crowd of people accumulated around me and everyone was just looking at it. That was when we all realised we had something special and could actually convince people, even if it's just for a short period of time, that they were watching the real sport on TV.

#### Finally, what do you miss most about the early days?

I just miss being involved in the whole aspect of it. When I started I did everything. I did the graphics, the music, the programming, and had an interest in every aspect of computer games. But for the last 20 years I've been focused on being specifically a programmer. Just being able to dabble and come up with ideas, working with many, many people, working on different things and being able to have a lot of input in any one of those things as well. That's what I miss. 

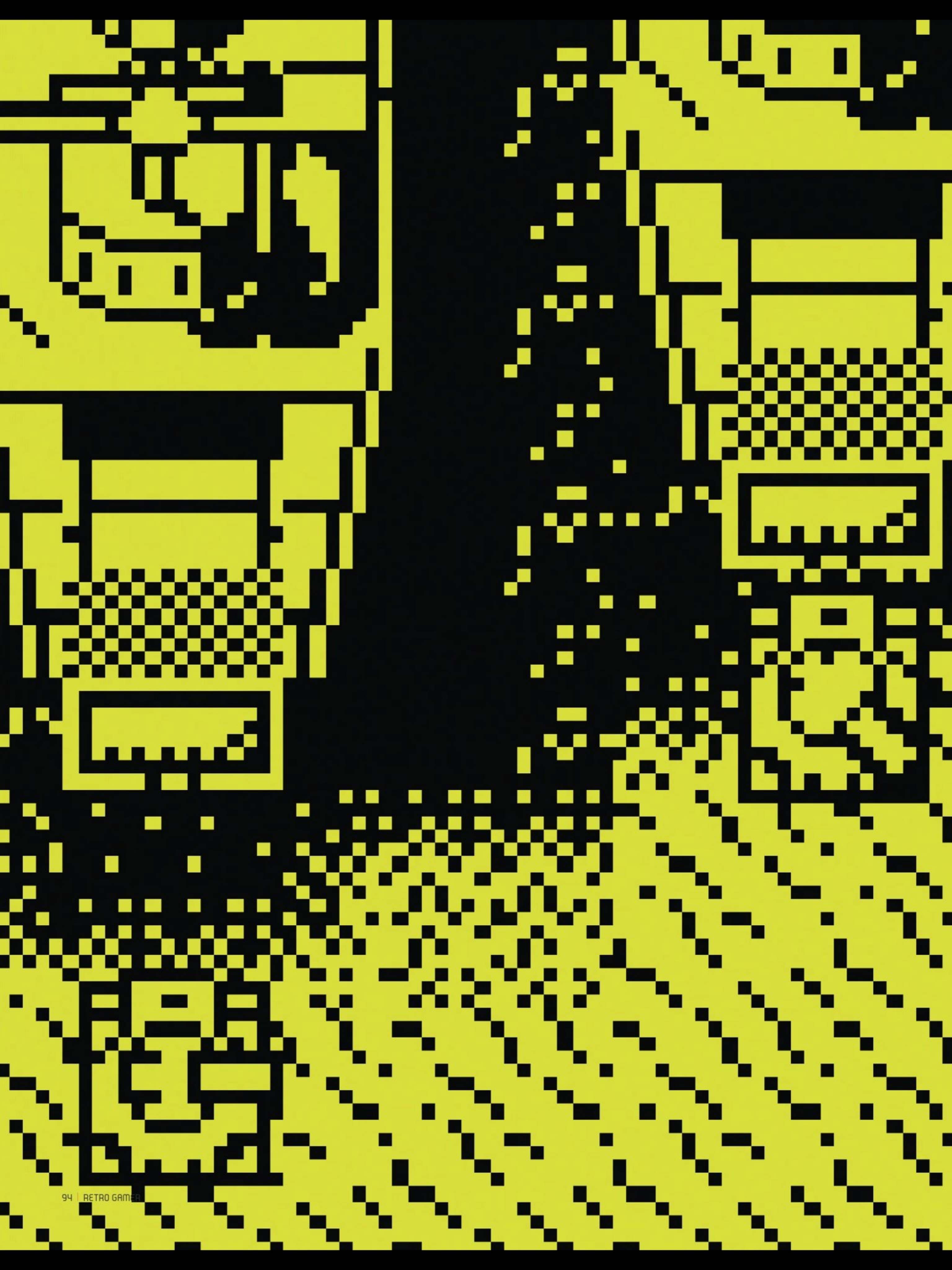

# Flying Shark

...VERSUS MEGA OCTOPUS

» RETROREIVAL



- » ZX SPECTRUM
- » GRAFTGOLD
- » 1987

As Spectrum arcade conversions go, there were few that managed to duplicate their arcade

counterpart as successfully as *Flying Shark*. Often when good-quality shooters become the topic of discussion in the RG office, the conversation touches on the impressive number of them on the C64. However, the likes of *R-Type* and *Flying Shark* proved that Sir Clive's rubber-keyed wonder could deliver Speccy owners from evil – that being the likes of its *Nemesis*, *Kung-Fu Master* and *S.T.U.N. Runner* conversions.

Developed by Graftgold, it's no surprise that *Flying Shark* was a top-notch port. While the original version was a decent gunner, it was nothing particularly groundbreaking. But, like a large number of arcade games, many of us Brits discovered it through some matchmaking set up by our 8-bit home computers. And on those machines, simplicity done well was far better than ambitious done badly.

Essentially a 1942-alike, *Flying Shark* saw two brightly coloured biplanes taking on the combined might of enemy air, sea and ground forces. It was obviously a grossly unfair campaign, as most shoot-'em-up missions are, but this one was made fun through a combination of simple controls, smooth gameplay and a simple power-up system. Probably the one thing most people remember about *Flying Shark*, though, was its runways. The biplanes would take off and land between its action-packed levels, which might sound lame today but back then was actually quite cool to see.

This port is a success, though, because it's so wonderfully done. With intricate visuals that oozed detail, silky smooth scrolling and fun, challenging gameplay, it had everything you wanted from a shooter. Most importantly, though, if you died, you felt you had nobody to blame but that face staring back at you when you're brushing your teeth. Well, perhaps a portion of the blame could be placed on its monochromatic visuals causing the odd bullet to evade your notice.

In any case, if you're looking for an addictive, well-crafted Spectrum shooter, fly first class with Graftgold. You won't be disappointed. ✨

# RETROGRAVED



» It's a good month for sequels. *Diablo III* finally gets a release, *Max Payne* leaps onto our screen in dramatic slow motion, and the second episode of *Sonic 4* makes a long overdue appearance

## \* PICKS OF THE MONTH



### DARRAN

**Diablo III**  
It appears to be more of the same, but *Diablo III* is a massive improvement on its award-winning predecessor.



### DAVID

**Sonic The Hedgehog 4: Episode II**  
It still lacks the impact of the Mega Drive sequels, but it shows Sega is willing to learn from past mistakes.



### STUART

**Max Payne 3**  
Max's third outing may not have evolved much, but it remains a satisfying shooter that's great fun to play.

# Diablo III

BLIZZARD'S KILLER FRANCHISE RETURNS WITH A BANG

## INFORMATION

- » FEATURED SYSTEM: PC
- » ALSO AVAILABLE ON: MAC
- » RELEASED: OUT NOW
- » PRICE: £49.99
- » PUBLISHER: BLIZZARD ENTERTAINMENT
- » DEVELOPER: IN-HOUSE
- » PLAYERS: 1-4

## BRIEF HISTORY

» The original *Diablo* appeared on the PC in 1996 and quickly breathed fresh new life into the stale RPG genre. It received an expansion pack in 1997 and was eventually superseded by its superior sequel four years later, which was still receiving support from Blizzard as late as 2011.



Dungeon crawlers, eh? You wait forever for a decent one to appear, then two come along at once. While last month's *Legend Of Grimrock* was a fitting tribute to classic PC RPGs like *Eye Of The Beholder* and *Dungeon Keeper*, *Diablo III* is an all-out sequel, which proves that no one knows the loot drop RPG genre like Blizzard does.

*Diablo III* begins with a falling star that spurs a truly epic quest. While speed runs have already shown the game being completed in around 12 hours, the average gamer is going to get a lot more out of their first playthrough, particularly if you pursue the many, many side quests. Indeed, it took us nearly eight hours to complete the first act of four, and that's before you even consider playing as the other four classes or tackling the brutally tough Hardcore mode, which spells the end of your character should you die in it.

*Diablo III*'s story, aside from a few neat twists, is rather predictable, but a well-told one nonetheless, with a great range of Ye Olde English voice acting and some epic clashes between Heaven and Hell. It will certainly feel familiar to anyone who's ever played a *Diablo* game in the past, or any other RPG for that matter, but as with other Blizzard titles, it's all in the polish and presentation.

*Diablo III* offers a large number of customisable options that never feels daunting due to the clever way in which Blizzard slowly introduces everything to you. You're barely a couple of hours into the game before you know how to pick skills, place equipment, sell items, use artisans,



assign runes, manage a handy storage trunk for sharing items between different characters, and much more. *Diablo III* offers huge amounts of flexibility both in its new approach to skills and in the way players handle each class.

The Witch Doctor allows you to summon monsters and cast nasty curses on enemies; the Barbarian has received numerous revamped skills and is an absolute tank that can devastate swarms of enemies at close range; while the Demon Hunter is a clever combination of the last game's Assassin and Amazon classes and, like the new Wizard, which itself is a variant of *Diablo II*'s Sorcerer, is great for ranged players. The final character is the Monk, another vicious fighter, but one that,

## \* WHY NOT TRY

### ▼ SOMETHING OLD

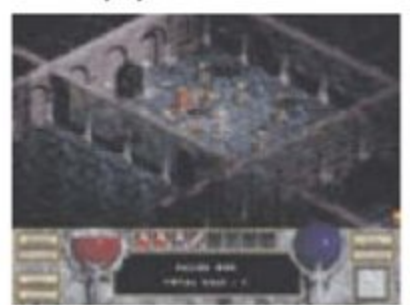

### ▼ SOMETHING NEW

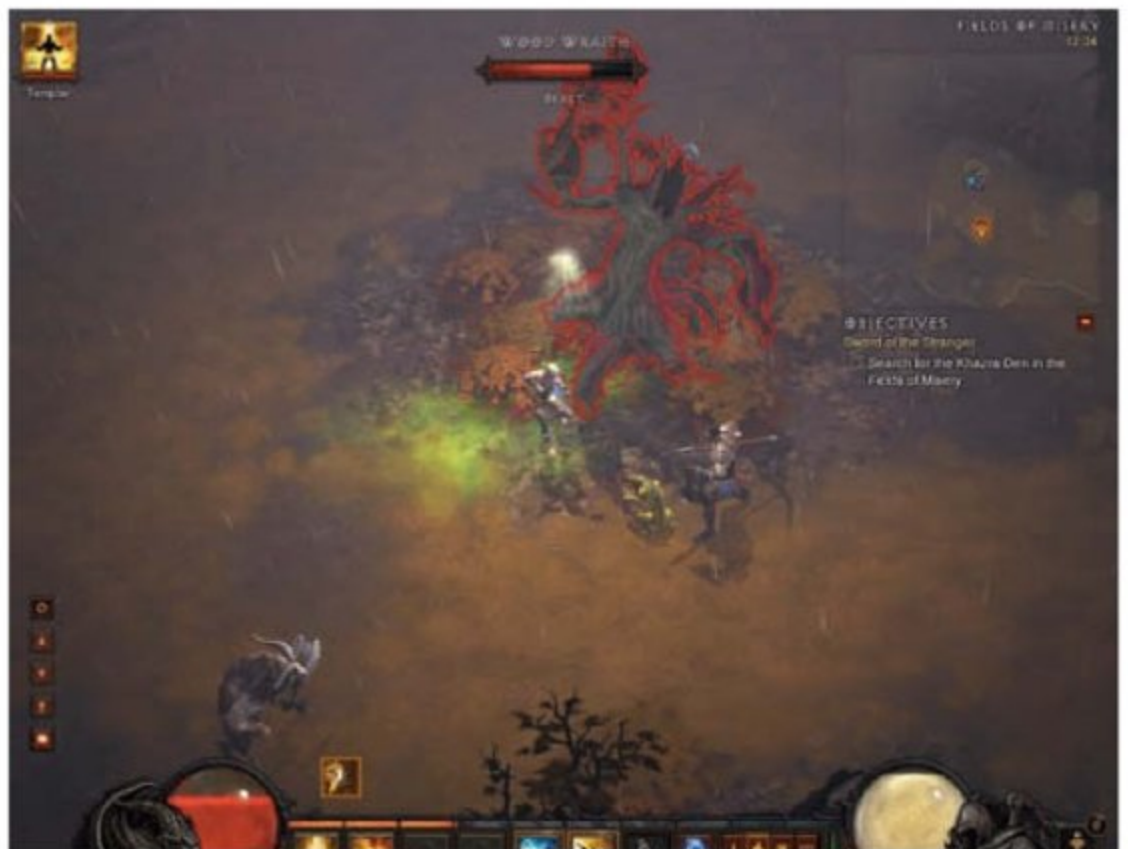
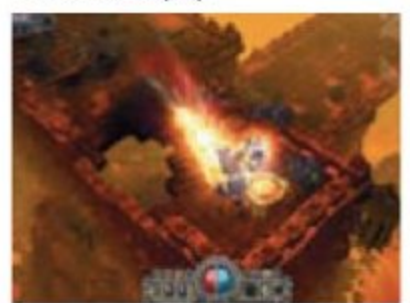





» [PC] There are many large bosses found throughout Sanctuary, and all of them require solid tactics to beat.



**\*GO DEEPER**

- >> Work on *Diablo III* originally started in 2001. It was officially announced in 2008.
- >> Unlike previous games in the series, you can now select the gender for each class.
- >> *Diablo III*'s online auction house will eventually allow gamers to sell magical items for real money. Blizzard will take a small cut of the profits.



» [PC] The Butcher is the first main boss you encounter and guards the end of Act I. Needless to say, he's extremely tough to beat.

satisfying when you're able to take down each chapter's brutal boss. It's also worth noting that *Diablo III* gets very tough, very quickly, so playing with friends is highly recommended, and the drop-in/drop-out play style that Blizzard has adopted makes it extremely flexible. Bear in mind, though, that you may want to enjoy the story on your own first, as you can potentially join a game that's further along than yours.

Ultimately, it's the little touches that make *Diablo III*. The ability to pick up gold as you walk over it, the way the relevant menus open and close on their own when you approach merchants and artisans, the conveniently placed teleports that stop you needlessly trawling through empty dungeons, the greatly improved customisable followers you can pick up. Blizzard has done an amazing amount of work beneath *Diablo III*'s shiny surface to

ensure that your time spent in the world of Sanctuary is as enjoyable as possible. And that's the real key to *Diablo III*: even with Blizzard's insistence that you must always be online to play – something that has resulted in occasional lag and lost progress for some players – it's still the best incarnation of *Diablo* yet, and certainly the best loot drop RPG currently available. Miss it at your peril.

**In a nutshell**

**Yes, it has niggling online-related issues, but there's no denying the quality of Blizzard's game. *Diablo III* is an intense, satisfying dungeon crawler that's as epic to play as it is beautiful to look at.**

>> **Score 95%**



**Arts and craft**

ONE OF THE most enjoyable additions to *Diablo* is the artisans that have been introduced. They'll not only repair existing items for you, but will also trash any magical weapons and equipment you've picked up and turn them into useful materials. These in turn can be used to create new items, and the more you train your artisans through the spending of precious gold, the more powerful items they can create. Initially you'll have access to just a blacksmith, but as *Diablo III* progresses you'll be able to enlist the help of a mystic and jeweller as well. Needless to say, their useful talents mean you'll never walk past a dropped piece of loot again.

unlike the Barbarian, relies on speed and skill instead of simple brute force to cripple enemies. All five characters have their own skill trees and class-specific quests, meaning any group of four is going to feature a lot of diversity. The large number of additional skill sets means it's also going to be a very long time before you see everything that *Diablo III* has to offer.

And you'll want to see it all, because *Diablo III* is an incredibly addictive game and highly satisfying to play. Take the combat, for example. You're effectively just tapping a mouse button, and yet Blizzard has somehow transformed this monotonous task into epic battles that are genuinely exciting to watch unfold. It helps that a new combo system exists that rewards you additional experience points for killing a large number of enemies in quick succession or all at once, but it's the core combat mechanics that ultimately make *Diablo III* so satisfying to play.

Then, of course, there's the ability to team up with friends – or strangers, should you so wish – and tackle the hordes together. It's admittedly not as stable as single-player mode, and some will balk at the lack of PVP – although it is coming – but it remains tremendous fun and immensely



» [PC] You will die many times in *Diablo III*. Reviving decreases the effectiveness of your equipment by 10 per cent.

# RETRO RATED

>> SONIC THE HEDGEHOG 4: EPISODE II / AKAI KATANA

## Sonic The Hedgehog 4: Episode II

TWO SPINS FORWARD, ONE SPIN BACK

» FEATURED SYSTEM: XBOX LIVE ARCADE » ALSO AVAILABLE ON: iOS, PSN, PC » RELEASED: OUT NOW  
 » PRICE: 1,200 POINTS (£10.60) » PUBLISHER: SEGA » DEVELOPER: SONIC TEAM » PLAYERS: 1-2



While the original episode of *Sonic The Hedgehog 4* was fun, it wasn't without its

problems. Knowing this, Sonic Team has gone back to the drawing board and although it has eradicated many of the original complaints, it's also created several new ones.

The physics feel far better than the first, and while they're not a match for those in the Mega Drive originals, they're still decent, making Sonic feel suitably old-school as he whizzes through the four included zones.

The levels are more imaginative as well, and while there's more focus on the speed side of things – fewer enemies and more stretches of open track – there are plenty of fun bits, including outrunning snowballs, escaping filling silos and negotiating the moving parts of a rollercoaster.

*Episode II* is also a step up graphically, with some absolutely

» [360] The foes are inventive but can be frustratingly long-winded to beat.



beautiful vistas ranging from snowy zones to a huge oil rig, complete with dangerous sandstorms. It's something of a pity, then, that the music isn't quite up to the same standard, with some rather screechy tunes that don't always manage to pay tribute to those found in the excellent *Sonic 2*.

The biggest addition to *Episode II* is Tails, but he's a double-edged sword. The ability to team him up with Sonic to overcome obstacles is a nice touch, but there are too many fiddly sections that become a chore to negotiate. It makes certain levels such as a pig to get through that you'll rarely want to return to them. Bosses also disappoint, with most being overly long and cumbersome to battle.

There's still fun to be found in *Episode II* – the homage to *Sonic 2*'s special stage is fantastic – but it's let down by an overreliance on puzzles and complicated bosses that feel at odds with *Sonic*'s core gameplay.



### OPINION

I think Darran is being a bit harsh. The core mode is much better than *Episode I*, while the ability to play as Metal Sonic if you have both episodes adds another level to the gameplay. It's still not a patch on the Mega Drive originals, but it's definitely heading in the right direction.

Stuart Hunt

>> Score **70%**



» [360] It's a complicated scoring system, but so satisfying when you finally crack it.

## Akai Katana

CAVE CREATES BULLET HEAVEN AND HELL

» FEATURED SYSTEM: XBOX 360 » ALSO AVAILABLE ON: N/A » RELEASED: OUT NOW  
 » PRICE: £29.99 » PUBLISHER: RISING STAR GAMES » DEVELOPER: CAVE » PLAYERS: 1-2



Cave's latest shooter arrives courtesy of Rising Star Games and it's another dazzling effort, with yet another clever, if rather convoluted, scoring system to back it up.

The main crux of *Akai Katana* revolves around its attack and defence modes – defence mode happens when you tap the fire button; attack mode engages when you hold it down – which vary depending on which three included versions of the game you play: Origin, Climax or Slash. Shooting enemies in defence mode in Origin and Climax causes them to drop green energy orbs, while doing the same thing in Slash causes them to drop steel. All three modes drop energy while the player is in attack mode. Collecting energy unsurprisingly fills an energy bar, whereas collecting steel fills orbs on the front of your ship.

Tapping the X button transforms your ship and option into a powerful Phantom, which is invincible while it is in defence mode. In Origin and



Climax modes you can repel bullets into nearby enemies, which in turn will generate huge amounts of gold. In Steel mode, meanwhile, activating the Phantom will make a number of orbs appear, which can be launched at enemies to net you katanas, which can be launched for precious gold.

It's a scoring system that's far tougher to learn than the usual efforts from Cave, but Rising Star has included some excellent tutorials, which make things a lot easier. Once mastered, you can sit back and appreciate one of the finest score-chasers currently available on Microsoft's console.

And *Akai Katana* really is a fine game – or games, really, as all three modes play so differently. Slash is the most satisfying, but Climax is excellent for those wanting to weave through insane bullet patterns. Replays can be saved and uploaded for others to view, the graphics are beautifully detailed, and the soundtrack is epic and perfectly paced to the action. It's not as accessible as *Deathsmites*, but high-score junkies are going to love it.



### OPINION

Like many Cave games, the scoring system is extremely intricate and will be off-putting for some. It's certainly worth persevering with, though, as the interplay between the different ship modes is extremely good, and the visuals and sound are excellent. Another great shooter from Cave. It's just a pity it's not as accessible as *Deathsmites*.

Stuart Hunt

>> Score **92%**



## Trials Evolution

» FEATURED SYSTEM: XBOX LIVE ARCADE » ALSO AVAILABLE ON: N/A » RELEASED: OUT NOW  
 » PRICE: 1,200 POINTS (£10.60) » PUBLISHER: UBISOFT » DEVELOPER: REDLYNX » PLAYERS: 1-4

>> **The spiritual successor** to *Kikstart* is back and it's better than ever. Developer RedLynx has listened carefully to the feedback for *Trials HD* and has created a game that fixes virtually every niggle found in the original 2009 smash hit.

The structure of the game is far better, constantly rewarding you with unlocks in order to fuel progression. Having to take the increasingly difficult licences becomes rather irksome, but

they're the only difficulty spikes in an otherwise balanced game. Level design is also massively improved, as taking the series outside has really allowed RedLynx to flex its creative muscles. Add in a spectacular online mode that caters for four-player racing and effortlessly improves on the competitive play of the original, and *Trials Evolution* becomes an essential download.

>> **Score 93%**

## Max Payne 3

» FEATURED SYSTEM: PS3 » ALSO AVAILABLE ON: XBOX 360, PC » RELEASED: OUT NOW  
 » PRICE: £49.99 » PUBLISHER: ROCKSTAR » DEVELOPER: IN-HOUSE » PLAYERS: 1-16



>> **Max Payne 3** may look modern, with its state-of-the-art visuals and cinematic narrative, but beneath its glossy exterior is the same old gameplay that we first enjoyed 11 years ago. This pleases us greatly, as leaping around in slow motion while shooting bad guys in the face remains immense fun, regardless of the graphical fidelity and realistic physics engine that surround it.

Interestingly, the sprawling realism that Rockstar is aiming for – and

admittedly pulls off in impressive style – often clashes with its old-school gameplay, and it's rather telling that *Max Payne 3* works best when you're simply playing the included arcade and multiplayer modes. Lengthy gaps between checkpoints also annoy. Stick with it, though, as the gripping, well-told story is one of the best we've seen in a third-person shooter.

>> **Score 78%**



## Mortal Kombat

» SYSTEM: PS VITA » ALSO ON: XBOX 360, PS3  
 » PRICE: £39.99 » PLAYERS: 1-2

>> **NetherRealm Studios' fun** reboot of *Mortal Kombat* gets shrunk down to the Vita and benefits massively from the move to a portable format. Its rough-and-tumble gameplay is perfectly suited to playing on the go, and the decision to focus on a silky-smooth 60FPS was a sound one. There was already a huge number of gameplay modes in the original game, but it has been enhanced with an all-new Tower, full of additional challenges. It might not be the most technical fighter on the Vita, but it's certainly the most fun.

>> **Score 84%**

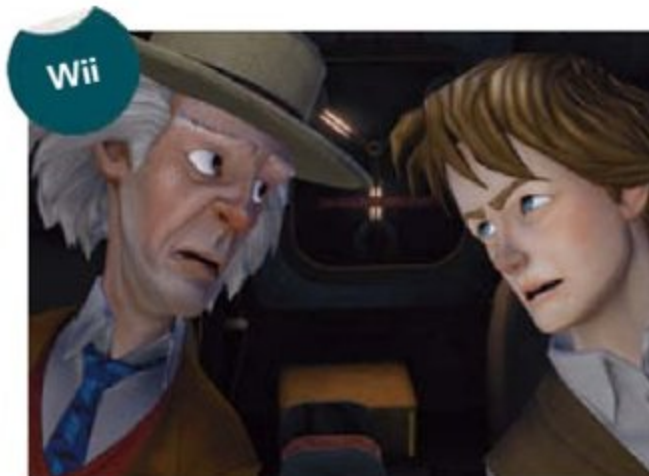

## Back To The Future: The Game

» SYSTEM: WII » ALSO ON: PS3, PC  
 » PRICE: £19.99 » PLAYERS: 1

>> **After debuting digitally** some time ago, Telltale Games' loving point-and-click tribute to the continuing adventures of Marty McFly finally appears in retail form. Sadly, the Wii version falls short, with a jerky frame rate, dull textures, jarring load times and clunky controls that all combine to create an extremely loveless port. Our advice is to seek out the PC and PS3 versions, as this is a highly disappointing effort that doesn't do the game justice.

>> **Score 62%**



## Mario Tennis Open

» SYSTEM: 3DS » ALSO ON: N/A  
 » PRICE: £39.99 » PLAYERS: 1-4

>> **Mario Tennis Open** feels surprisingly slight compared to past iterations. While the tennis itself is fairly robust, with plenty of fun gameplay mechanics and 16 characters to choose from, there aren't many game modes. The core single-player lacks the RPG elements of past instalments, while the slick customisation only applies to imported Mii characters. The included mini-games are also fairly standard, lacking the series' wackiness. It's decent enough, with convincing 3D, but not as expansive as we were hoping for.

>> **Score 66%**



## VVVVVV

» SYSTEM: 3DS » ALSO ON: PC  
 » PRICE: £7.20 » PLAYERS: 1

>> **Terry Cavanagh's quirky,** gravity-flipping platformer finally arrives on the 3DS, and it's every bit as enjoyable and frustrating as his original game. Charged with seeking out his lost crew-mates, Captain Viridian must negotiate the levels to retrieve his friends and seek out missing trinkets. Beautifully styled – it's highly reminiscent of an old C64 game in terms of its distinct look – and featuring a fantastic chiptune soundtrack, *VVVVVV* is only let down by some crushing difficulty. It's a good job it has plenty of save points. You'll certainly need them.

>> **Score 88%**

# RETRO ROUND-UP

>> Every month we take a look at the latest classics that have been re-released for a new generation of gamers

## \* DOWNLOAD OF THE MONTH

# Monster World IV

### INFORMATION

- » System: Virtual Console
- » Buy it for: 900 Points
- » Score: ★★★★★☆



Sega's digital department continues to impress us. First released for the Mega Drive in 1994, *Monster World IV* was an excellent platform-cum-RPG adventure from Westone that never received a release outside of its homeland. That's now changed, though, as Sega has not only released it on Virtual Console in its native 60Hz form, but amazingly, has actually given it an official English translation.

While we're used to this sort of fan service from small companies like Super Fighter Team, it's virtually unheard of from a company like Sega, and it's further testament to the publisher's current commitment to releasing back catalogue classics on current digital services.

*Monster World IV*'s story revolves around a young female warrior called Asha, who aims to save Monster World by restoring its four elemental spirits. Asha's quest is made easier thanks to a cute 'pepelougoo' named Pepe, who can be used to float across large chasms, or let Asha use a handy double jump. Otherwise *Monster World IV* is mechanically very similar to previous games in the *Wonder Boy* series, with Asha able to upgrade weapons and armour, interact with often-humorous NPCs and despatch enemies with a quick slash of her sword.

Graphically, *Monster World IV* is a thing of beauty. Released late in the Mega Drive's life, it features some truly beautiful sprite design, with large, chunky characters that are quite reminiscent of numerous SNES titles. They're also full of humour, with lovely little touches like the giant pigs that collapse in exhaustion after a deadly spinning attack, or the way Asha panics



» [Mega Drive] The sprite design is excellent, showing what could be achieved on the console.



and takes cover from a bomb before it detonates. There's some excellent parallax scrolling on display, and each temple Asha explores is intricately detailed and distinctly different to the next, while the denizens of *Monster World* are big, cute and exceptionally well animated.

The translation is also very impressive, as it must have taken Sega a lot of effort to complete with so much incidental text, as well as plot exposition to wade through. While it's not quite as slick as in the days of Working Designs, the translation is still decent, with a lot of humour and most of the original Japanese quirks intact. In fact, we're still amazed that Sega was even prepared to put so much effort in.

It's effort that's appreciated, though, as *Monster World IV* really is a fantastic adventure that should now hopefully reach a far bigger audience. While the game itself is relatively easy due to the powerful weapons that are available, it's worth noting that nothing is readily signposted, so there can be occasional instances where you're unsure what to do next. For the most part, though, progress is swift, with puzzles to solve, large bosses to fight and some massive areas to explore.

Some might be dismayed with the more structured approach that *Monster World IV* takes – it lacks the free-roaming exploration of *The Dragon's Trap*, for example – and there aren't as many hidden secrets to discover as in past games, but these are extremely minor niggles. *Monster World IV* is an utter joy to play through and proves beyond a shadow of a doubt that the best things really do come to those who wait.

### VIRTUAL CONSOLE

A pretty decent month for the Virtual Console, but it's mainly down to some great digital releases from Sega.

#### Kirby's Dream Land 2

- » System: Game Boy
- » Buy it for: £3.60
- » Score: ★★★★★☆

#### Game & Watch Gallery 2

- » System: Game Boy Color
- » Buy it for: £3.60
- » Score: ★★★★★☆

#### Super Hang-On

- » System: Arcade
- » Buy it for: 900 Points
- » Score: ★★★★★☆

#### Wonder Boy In Monster Land

- » System: Arcade
- » Buy it for: 900 Points
- » Score: ★★★★★☆

### PSN

More Sega love as it releases an insane number of good games. Honestly, we don't know where to start.

#### Alex Kidd In Miracle World

- » System: Master System
- » Buy it for: £3.69
- » Score: ★★★★★☆

#### The Revenge Of Shinobi

- » System: Mega Drive
- » Buy it for: £3.69
- » Score: ★★★★★☆

#### Super Hang-On

- » System: Arcade
- » Buy it for: £3.69
- » Score: ★★★★★☆

#### Wonder Boy In Monster World

- » System: Mega Drive
- » Buy it for: £3.69
- » Score: ★★★★★☆

#### Wonder Boy In Monster Land

- » System: Arcade
- » Buy it for: £3.69
- » Score: ★★★★★☆



### PC SERVICES

The online retro services keep up the stream of classic games updated to work on modern PCs.

#### Torin's Passage

- » Buy it for: \$5.99
- » Buy it from: [www.gog.com](http://www.gog.com)
- » Score: ★★★★★☆

#### Silver

- » Buy it for: \$5.99
- » Buy it from: [www.gog.com](http://www.gog.com)
- » Score: ★★★★★☆

#### Thief: Deadly Shadows

- » Buy it for: \$9.99
- » Buy it from: [www.gog.com](http://www.gog.com)
- » Score: ★★★★★☆

#### Little Big Adventure

- » Buy it for: €4.99
- » Buy it from: [www.dotemu.net](http://www.dotemu.net)
- » Score: ★★★★★☆

#### Little Big Adventure 2

- » Buy it for: €4.99
- » Buy it from: [www.dotemu.net](http://www.dotemu.net)
- » Score: ★★★★★☆



# Special Offers for classic gaming fans...

Complete your retro collection with books, DVDs and mugs that no retro gamer should be without!

## Mugs



£9.99  
now from  
**£4.99**

**Retro Gamer Mugs**  
Retro Gamer has developed a range of mugs based around the iconic games and imagery that makes our computing history so great. We have only produced 250 of each limited edition mug so hurry they won't hang around for long!  
**£4.99**

## Binders

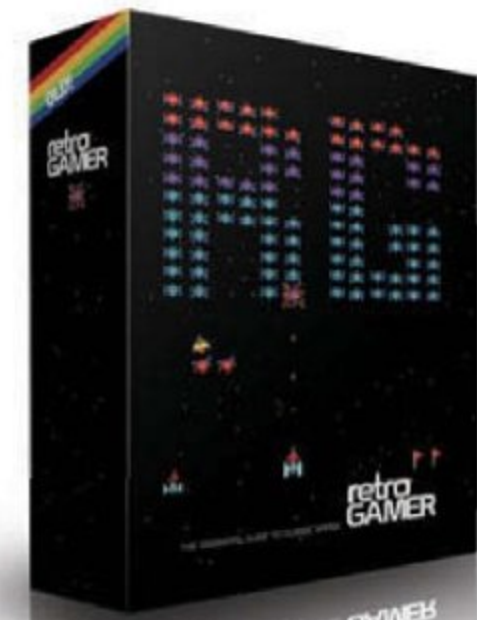

**Retro Gamer Binder**  
The perfect way to keep your retro gaming magazines in tip-top condition.  
**£9.99**

## DVDs



**Retro Gamer DVD eMag Load 3**  
The latest and greatest edition of the ever-popular Retro Gamer DVD eMag series. This DVD-ROM includes issues 56 to 80 and will play on a PC or Mac - you can even transfer pages to an iPad.  
**£19.99**

## Bookazines

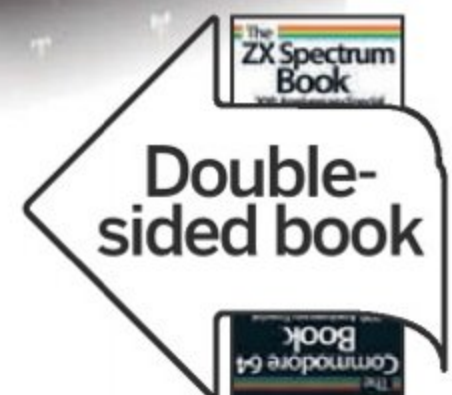
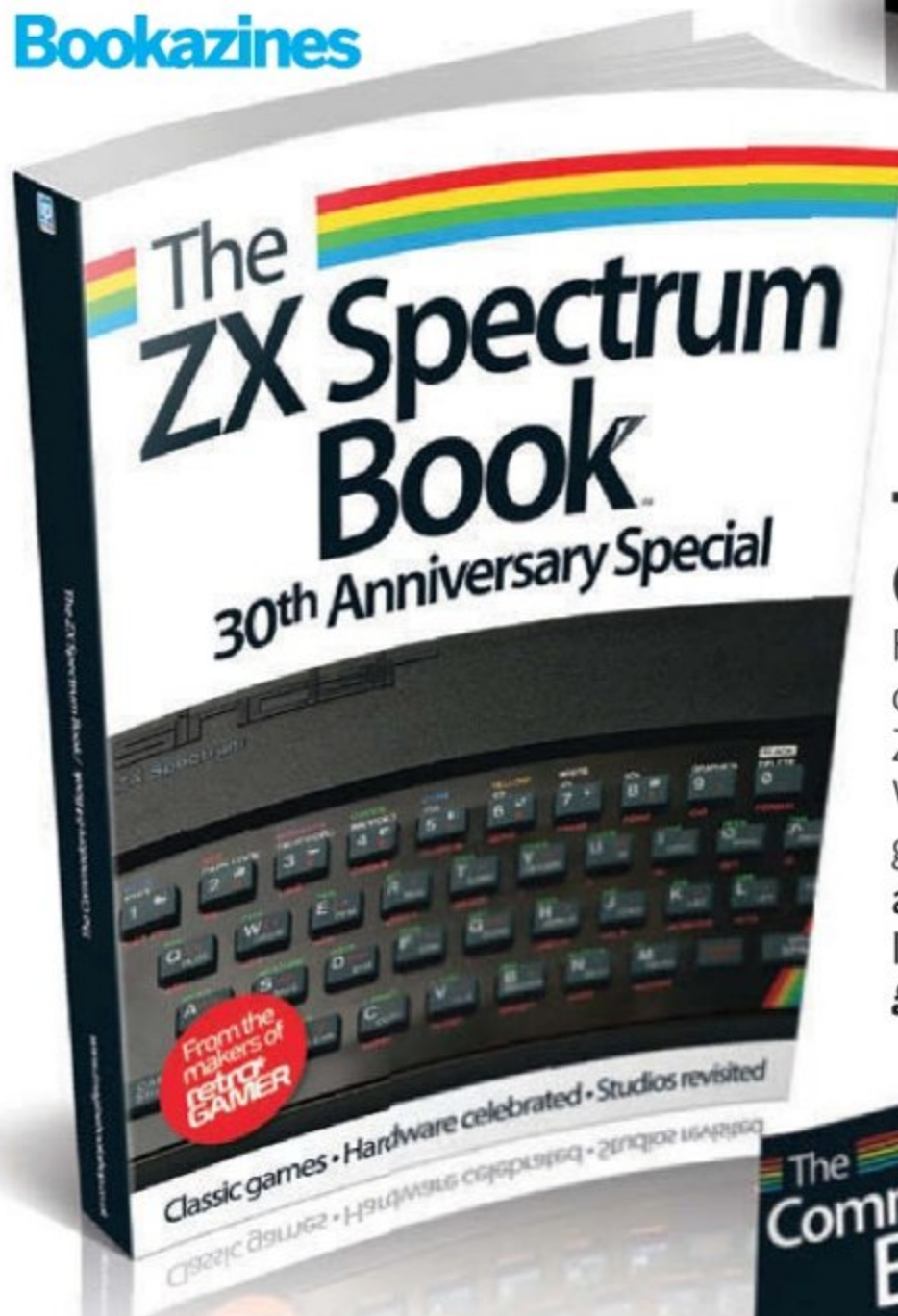

## The ZX Spectrum / Commodore 64 Book

From the makers of Retro Gamer comes the ultimate guides to the ZX Spectrum and Commodore 64. With over 250 pages full of amazing games and in-depth features, this 30th anniversary special is a must for anyone looking for a trip down memory lane.  
**£9.99**

**Only  
£9.99**

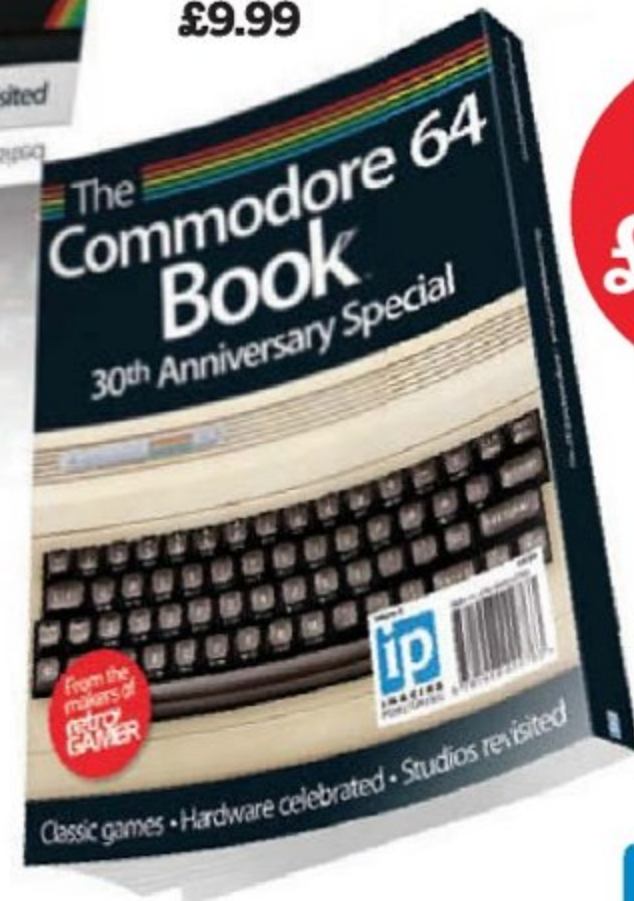

Become an ImagineShop customer and leave reviews of your favourite products.

Hurry, stock is limited!

Order online

**imagineshop.co.uk**



Email [eshop@imagine-publishing.co.uk](mailto:eshop@imagine-publishing.co.uk)  
Twitter @imagineshopuk

MAGAZINES

BOOKS

DVDS

DOWNLOADS

GIFTS

Prices correct at time of going to press.

# HOMEBREW

>> The scene's latest news and reviews



We've been asking you what you want from the homebrew section, and you were quick to tell us your thoughts. By far the most common request was a greater variety of platforms, so I've jumped the gun and delved into a couple of new territories. Meanwhile, if you know about a new game on any classic platform that you think we'd be interested in, get in touch!



FORMAT: ZX EVOLUTION  
DEVELOPED BY: SHIRU  
LINK: KIKSTART.EU/XNX-EVO  
RELEASE DATE: 2012  
PRICE: FREE  
REVIEWED BY: JASON KELK

DARWIN WOULD BE SO PROUD!

## XNX



[ZX Evolution] Here, kitty kitty.

The ZX Evolution is a recently developed Spectrum clone. Recent enough, in fact, that, along with supporting classic Spectrum games, beeper or AY sound, and cassette loading, it ships as a standard Mini-ITX form factor board, and has a VGA connector and PS/2 ports for a keyboard and mouse. In other words, it's pretty much a homebrew version of the Spectrum on steroids and, because all computers need software, this is where XNX comes into play, since it's a cat-themed version of the coin-op Qix that takes advantage of the ZX Evolution's expanded capabilities.

The objective of XNX is to fill a given percentage of the play area by drawing lines across it to box unoccupied areas off, fill them in with pictures of cats and force the spinning enemies into an ever-decreasing free space. The player's weapon of choice is a square, which, when over an already revealed part of a picture, is indestructible, but once it's set in motion across the



[ZX Evolution] Paint me like one of your French girls.

dangerous open spaces inhabited by the nasties, it becomes vulnerable to attacks either on itself or the line currently being drawn. Until it reaches safety again it can't be stopped either, the controls only allowing its flight to be steered.

Taking a knock from the enemy and being blown up isn't fatal, however. Instead it drains ten points off the power gauge, and the game is only over when the bar is totally depleted; more power can be earned by filling an area of the screen above a certain size, with the amount dished out governed by the quantity of cat revealed. There are ten levels in the game to work through, with each being tougher than the previous and featuring its own background image to



[ZX Evolution] This took absolutely AGES!

uncover, although without a time limit or other element to hurry players along, the challenge isn't so much about completing the game as it is trying to do so with the best possible score.

So it's quite simple and perhaps a little flawed as a game, so why should you go through the process of getting it running? We'd say it's worth a look because the game is still pretty fun despite the hiccups in the design. That build process isn't too bad after the first go, and this is a new game for what is essentially a new 8-bit computer, so it's worth a punt to see what the ZX Evolution is like. And, hopefully, it's a sign of great things to come as well.

Because the archive we're linking to next to this review contains the development toolkit that XNX comes included with as an example, to get things up and running you'll need to download and extract that archive, then run the compile.bat located in the game's directory in order to build and start it. And for anybody who might be interested in the hardware itself, have a look at [kikstart.eu/zx-evo](http://kikstart.eu/zx-evo) for more information.

67%



[ZX Evolution] Not one Mrs Slocombe reference.

## NEW GAMES NEEDED

If you have a homebrew project you would like to see featured then please contact us at: [retrogamer@imagine-publishing.co.uk](mailto:retrogamer@imagine-publishing.co.uk)

## DARC

» **FORMAT:** MASTER SYSTEM » **DEVELOPER:** RICHARD CORNELISSE  
» **DOWNLOAD:** KIKSTART.EU/DARC-SMS » **PRICE:** FREE

*DARC* is a flick-screen exploration and shooting game similar to *Air Fortress* on the NES or the classic *H.E.R.O.* and written for SMS Power's 15th anniversary coding competition. The player controls a cool-looking robot that fires in either direction with the two pad buttons and must avoid or destroy the defences on each screen while locating the heavily armed cores. Destroying a core shuts down a force field, opening up further challenges as you progress.

This makes some good use of the Master System's graphical abilities and is well thought out, offering some nice touches like the map screen showing visited areas when the game is paused. And that attention to detail has rubbed off onto the gameplay, which is fast-paced and entertaining, with some particularly absorbing moments when battling cores. The only real problem *DARC* has is that it doesn't have an ending; instead it simply runs out of map data! A more complete game is apparently under way, but this is still worth your attention in the meantime.

70%

» [Master System] Shoot the core!



» [Amiga] A Boing Ball!



## DOWNFALL

» **FORMAT:** AMIGA » **DEVELOPER:** GRAHAM HUMPHREY  
» **DOWNLOAD:** KIKSTART.EU/DOWNFALL-AMIGA » **PRICE:** FREE

The keyword for *Downfall* is survival; the playfield is constantly scrolling new platforms upwards, and one or two players have to avoid getting their avatars either pushed out of play at the top of the screen or falling to their doom at the bottom. Dotted randomly among the platforms are collectable items; some are fruit, which are there as a score bonus, but others either have a positive or negative effect on the player's movement for a few seconds.

*Downfall*, which started life as an Atari 2600 homebrew game called *Man Goes Down*, is a tidily executed, simple and addictive little game, and players will find that 'a quick go' can easily translate into an hour or more of trying and failing to beat a previous score. For Amiga owners with AGA machines, a version of the game with more graphical bells and whistles is currently in progress, which promises to add things like the parallax scrolling of the Atari Jaguar version.

86%

## WHAT'S BREWING?

All the latest news from the homebrew community



» [Amstrad CPC] Use the Force.

### >> Still just our type

To start with, we've excellent news for Amstrad CPC gamers: the bug fix to Easter Egg's *R-Type* has been released and the crashing issues we had when reviewing it all appear to have been blasted with the Force! So as promised, now that all the hard work can be enjoyed properly, we're going to revise our score to 94%. Download it from behind [kikstart.eu/rtype-cpc](http://kikstart.eu/rtype-cpc) and give the Bydo a serious kicking!

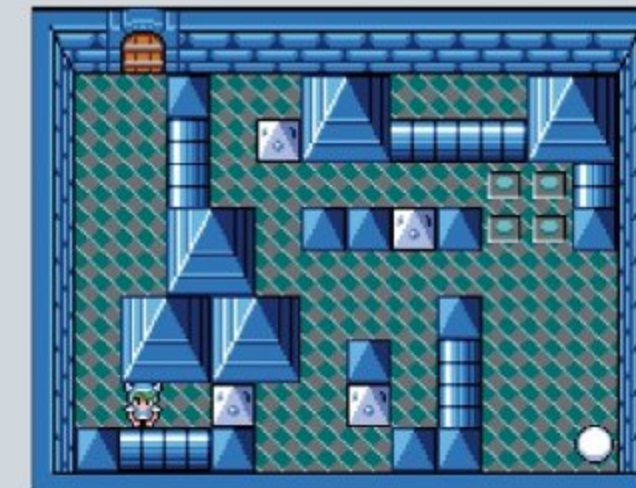

» [Master System] Push it real good.

### >> Raw power!

*DARC* may have won SMS Power's development competition, but let's not forget the five other games that were released! Some of them are flagged as incomplete, though, so while they can be played and are fun, those entries should probably be treated as playable previews. [kikstart.eu/sms-coding-2012](http://kikstart.eu/sms-coding-2012)



» [360] Take us to your leader.

### >> For great justice

Recently released XBLIG shoot-'em-up *League Of Planets* seems attuned to casual players. We've given it a quick test run; it has some very pretty backgrounds but seems to suffer from a slightly fiddly control system and overly sensitive collisions. We'll need to give it some more attention before we make a decision on it, but in the meantime why not fire up the demo behind [kikstart.eu/league-xblig](http://kikstart.eu/league-xblig)?

## NU, PAGADI!

» **FORMAT:** C64 » **DEVELOPER:** FALCON SOFT  
» **DOWNLOAD:** KIKSTART.EU/PAGADI-C64 » **PRICE:** FREE

*Nu, Pagadi!* is based on a Russian Game & Watch clone called *Nu Pogodi*, which was in turn based on an old Soviet cartoon series of the same name. Here, one of the lead characters, a wolf, is tasked with catching freshly laid eggs in his basket.

The game itself is simple. Catching an egg by positioning the wolf's basket at the end of the egg chute as it rolls off will score a point and missing loses one of three lives – unless the hare, another character from the cartoon, is watching, in which case only half a life is lost.

Despite being a little lacking compared to some Game & Watch titles converted to consoles and computers recently – particularly on the sound front, since there's no music at all – it looks good and is fun to play. There aren't any alternative game modes to choose from, though, so *Nu, Pagadi!* will probably not entertain most players for very long.

63%



» [C64] This should bring him out of his shell.

# HOMEBREW

>> The scene's latest news and reviews

## WHAT'S BREWING?

All the latest news from the homebrew community

### >> Cut and thrust

The Amiga appears to be getting quite a bit of homebrew love of late. The most recent outing is *Gravity Beam*, a *Thrust*-like inspired by popular homebrew releases *Gravity Force 2* and *Tractor Beam*. Each mission involves navigating a treacherous cave system, picking up a box with the ship's towrope, and getting it to safety without bouncing anything off a wall. Operatives should report immediately to [kikstart.eu/gravity-beam-amiga](http://kikstart.eu/gravity-beam-amiga)



[Amiga] More fun than a caravan.

### >> Magnificent avatars

The title *Avatar Air Wars* probably tells you everything you need to know about this one, but we might as well flesh the details out while we're here. It's a third-person air combat game for one to eight human players where their avatars fly a selection of aircraft into battle and everything is cannon fodder, including much of the ground detail. [kikstart.eu/air-wars-xblig](http://kikstart.eu/air-wars-xblig) has radioed the tower for further information.



## FLASH BOREDOM

Want to know how to while away those boring office hours? Then don't miss out on Retro Gamer's Flash game of the month. This month we look at *Pongs*

SOME OF THE 36 variations of *Pong* included in *Pongs* are more jokes than actual playable versions, but there are some novel twists on the original to choose from like *Snake Pong*, where the ball gets longer with each hit, or *Laser Pong*, where the bats are armed. [kikstart.eu/pongs-flash](http://kikstart.eu/pongs-flash)

## XBOX LIVE INDIE GAMES ROUND-UP

### UNNECESSARY VIOLENCE

» DOWNLOAD: [KIKSTART.EU/UV-XBLIG](http://KIKSTART.EU/UV-XBLIG)



Sporting a *Blues Brothers* reference as a title and a plotline about road-going terrorists with stolen nuclear devices that even the game itself doesn't appear to take entirely seriously, *Unnecessary Violence* is all about heavily armed cars and wanton destruction. The aforementioned anarchists are racing towards the triggers for bombs around the city and urgently need to be taken down in *Chase HQ* style. Officers such as yourself have been authorised to blast them, anyone who appears to be a supporter, or even slow-moving traffic in the fast lane into smithereens, even if that means using a nuke yourself.

The only downside to using heavy ordnance to clear a path is that it takes precious ammo and, in the case of the machine gun, can cause overheating – but restocking the weapons and fixing damage is possible while rolling and, pleasantly, involves shooting the innocent civilians with power-up icons above their vehicles.

We alluded to *Chase HQ* previously and there are some similarities here, but *Unnecessary Violence* has more in common with *RoadBlasters* and simplifies the action by removing all the corners, leaving a straight ribbon of asphalt to tear up in every sense of the word. As a driving game this is pretty limited, but for 80 Points it's a good way to get rid of road rage after a few hours of motorway driving.

### HONEY BADGER

» DOWNLOAD: [KIKSTART.EU/BADGER-XBLIG](http://KIKSTART.EU/BADGER-XBLIG)



The interweb is taking over the sport of boxing. Under its newly imposed rules, rather than formidable-looking fighters competing to knock the stuffing out of each other, the main contenders are suddenly the cosplaying, Britney-loving 'stars' of those videos that end up being forwarded to everyone by the office joker.

The result of this outlandish mash-up plays like a rough but reasonable copy of the original *Punch-Out!!* but with the boxers replaced by caricatures of internet celebrities drawn in a style similar to *South Park*. We've no doubt that *Punch-Out!!* fans will almost certainly prefer the original, but if you've ever fancied a couple of rounds with that guy who made his own *Tron* outfit, try it out.

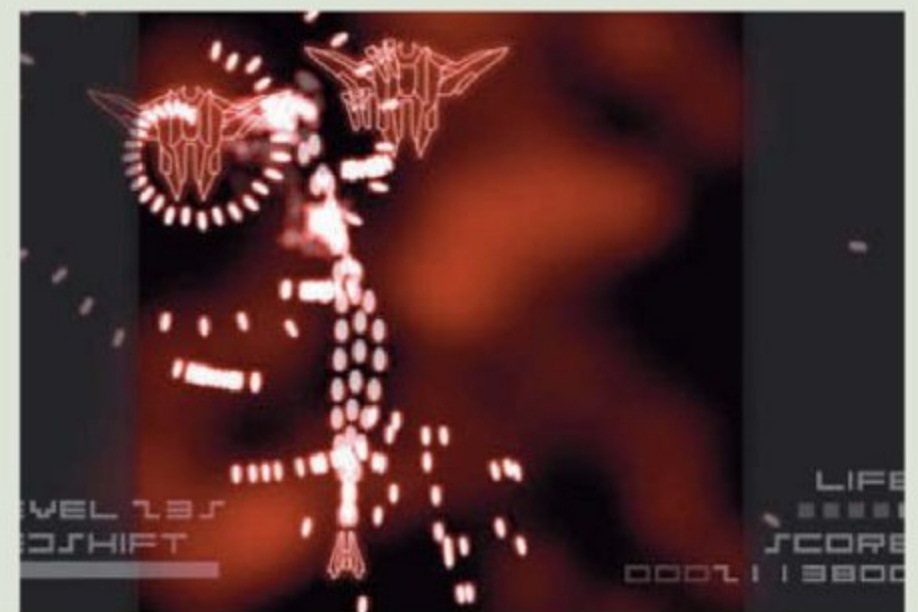

### REDSHIFT

» DOWNLOAD: [KIKSTART.EU/REDSHIFT-XBLIG](http://KIKSTART.EU/REDSHIFT-XBLIG)



*Redshift* is a bullet-hell-style blaster with glowing red graphics. The ship has two firing modes on the A and B buttons. As long as there is energy in the gauge on the status bar, holding the right bumper temporarily slows time down so shots can be piled up to slam into a target in a hugely satisfying manner, and enemy bullet patterns can be weaved around more easily. Redshift power can also be used in one smartbomb-like blast.

More casual fans of the genre will possibly find *Redshift* an overwhelming experience – especially once it really gets into its stride – but it's worth at least giving the demo a blast, and fans of bullet hell action should find it enjoyable.





# THE MAKING OF MORE TEA, VICAR?

MORE TEA, VICAR? HAS BEEN THROUGH ONE OF THE LONGEST DEVELOPMENT CYCLES A SPECTRUM GAME HAS EVER SEEN BUT, NOW IT'S FINISHED, WE GRABBED JONATHAN CAULDWELL FOR A BIT OF A BREW AND A CHAT ABOUT HIS LONG-TERM PROJECT



» [Spectrum] Come at me, bro.



» [Spectrum] Say hello to my little friend.



» [Spectrum] Water's too powerful to conquer or curb.



» [Spectrum] Where the magic happens.

## Q&A

**Retro Gamer:** Well that was quick. Did you not want some more time on it?

**Jonathan Caldwell:** Nine and a bit years is long enough to spend on one project. I didn't want to stretch it out any longer or people would start to think I worked for

Imagine. I mean, how long have they been working on *Psychapse* and *Bandersnatch* now? Honestly, if they don't hurry up and release those games, people will start to wonder if we'll ever see them...

Seriously, though, there were times when I felt the game would never see the light of day.

**RG:** Homebrew scrolling shoot-'em-ups aren't common on the Spectrum. What made you decide to try one?

**JC:** They're not common for a very good reason! The Spectrum doesn't have hardware scrolling, so if you want to scroll the screen you need to do it by hand, pixel by pixel. Doing that and still having enough CPU time to include a decent game as well can be tricky. So in opting to write a scrolling shooter I probably wanted a bit of a challenge. Although I had written scrolling shoot-'em-ups back in the Nineties, they were simpler efforts written with magazine covertapes in mind. This time I wanted a game with proper alien attack patterns, like the ones in games such as *Menace* and *R-Type*. I also had an idea how to improve upon those earlier Spectrum scrolling techniques. As it turned out, all those fine ideas about coding methods ended up counting for nothing in the end, as the code had to be rewritten in order to fit everything in. Still, that's the way it goes sometimes.

**RG:** And where did the name *More Tea, Vicar?* originate?

**JC:** Just about every shoot-'em-up has some sort of heroic, macho name, summoning up the usual mental imagery of bravado and derring-do, one man's fight against alien hordes and impossible odds and all that tripe. So I thought it would be fun to go with something more genteel, which is in complete contrast to the gameplay. Moreover, it has little to do with discussing

parish affairs over a pot of Earl Grey, and more to do with the consumption of ale. You see, whenever I'm down the pub with the lads, the first to down his pint usually asks, "More tea, vicar?" It's a prompt for somebody else to go to the bar and get their round in quickly so the drinking can continue with all haste. That's a totally different kind of bravado altogether.

**RG:** Did you have any outstanding good or bad moments during development?

**JC:** Yes, a few of both, and usually just after I'd received any batch of graphics or level layouts from Javier, or the music from Yerzmyey. The joy of seeing the excellent work they had produced was often tempered slightly by a sinking feeling minutes later when I discovered how much precious memory the latest submission would take, and the slow realisation that we would be lucky to get it all fitting together and working on a 128K machine, never mind 48K. I kept these concerns to myself, though, and in the final months of the project bit the bullet, making compromises in the code. Gone are all the different scrolling routines I started with, replaced with just one routine. Some code runs in slower, contended areas of memory, and the way the buffer is dumped to the screen isn't as fast as it might be either. Still, it was worth these small sacrifices just to get it all in, and to hear Yerzmyey's music playing continuously throughout the game rather than just on the intro screens.

**RG:** And now the game is finished, how do you feel about it in hindsight?

**JC:** Very glad the project is over after an inordinate development period, but also pleased with the way it turned out, given the restrictions. I squeezed as much as I could into the 48K version, even to the extent of storing sprite data in two hidden columns down the sides of the screen. The 128K version also does a few peculiar things, but it all appears to work seamlessly and the resulting game is pleasing enough.

**RG:** And finally, is there any chance of a sequel at all?

**JC:** Well, I won't be starting anything soon, but never say never.

# MAILBAG

HAVE YOUR SAY... SEND US A LETTER OR MAKE YOURSELF HEARD ON THE ONLINE FORUM – [WWW.RETROGAMER.NET](http://WWW.RETROGAMER.NET)

## STAR LETTER

### ARE YOU GAME?

Hi Darran and Retro Gamer,

I thought you would be interested to see the game I have been making for the best part of a year. It's called *Harry Salt And His Quest For Pepper*: [www.youtube.com/watch?v=vvKHxdaz4YU](http://www.youtube.com/watch?v=vvKHxdaz4YU)

Pepper is Pepper Milo – a famous actress and also Harry Salt's girlfriend. She has apparently been abducted by aliens, but all is not what it seems.

It's an old-style platform game for the PC, which is very heavily inspired by *Jet Set Willy* and has a touch of *Mario* in there too. It's not the best-looking game in the world, but I hope you like it. I have included some screenshots and a link to a YouTube video so you can see it in action. The game is unfinished and

the plot hasn't really been worked into the game yet, but I will keep working on it until I finish it. I think it would be great if other

**Retro Gamer** readers also attempted to make their own games. Who didn't have a great idea for a game back in the day? It's always a bit of a disappointment for me when people make remakes of existing games rather than put their own imaginative ideas into pixel reality.

Richard Patrick

**We really like the imagination and Matthew Smith-esque humour in**

**your game, Richard, and the tributes to classic games are also a nice touch. Let us know when it's finally finished so we can take it for a spin. We love seeing what our readers have made, and we've been considering running some kind of indie game competition for a while now. With a revamp of the homebrew section on the cards it could tie in quite nicely...**

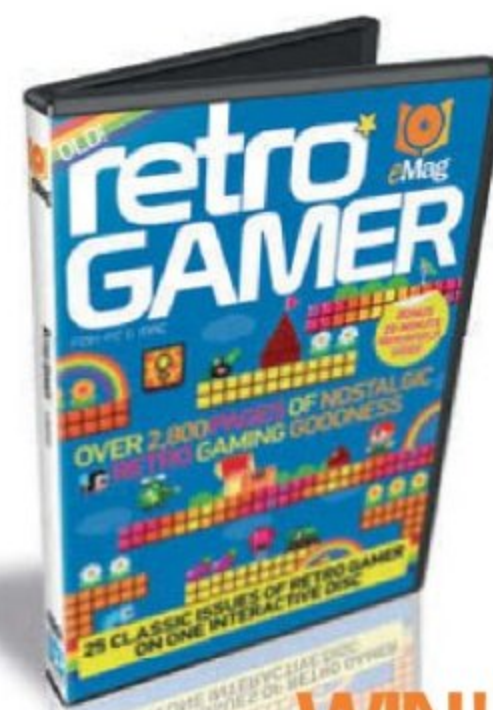

**WIN!**

Every month, one lucky reader will receive a copy of our latest eMag, **Retro Gamer Load 3**, a bargain if ever there was one. All you have to do is present a lucid, thought-provoking piece of literature that melts our souls. Failing that, something funny with swear words, or something *Strider*-related will go down just as well...

### GUY WITH THE SEGA TATTOO

Hey RG guys!

What do you think of my Mega Drive-inspired tattoo? It's hurting more than a Hadouken in the face, but you know what they say – no pain, no game!

Stef Kozakiewicz

**Stef, yours is certainly a tattoo you don't see every day. We are a bit curious as to what area of your body you got inked. The office has been taking bets and currently there are pretty good odds on it being the back of your neck. Or maybe a leg. Let us know so we can get on with our lives.**

### COVER UN-LOVER

Dear RG,

Okay, I had to write in and tell you just how much I loved your classic Atari cover last month. I will admit that your recent covers have left me cold. I loved issue 100 but have to say, that cover. Oh my. I liked the thinking behind doing the whole *Sgt Pepper's* thing with gaming sprites, but it could have been better executed.

I'm looking at it right now as I type this email, in fact. What game is that ugly-looking Sonic sprite taken from? *Sonic Drift* on the Game Gear? Why does Wizball's face look like the finger-insertion area of a bowling ball? And why oh why do so many beat-'em-up



>> Stef showing off his Sega tattoo. He originally planned to have Sony Computer Entertainment Europe, but then saw the price.



>> Craig wasn't a fan of our issue 100 cover, but many have told us they really liked it. Perhaps they were just being kind and didn't want to hurt our feelings.

characters feature? As I said, this month's cover was superb, simple and stylish, and the content wasn't bad either. Keep up the good work, and remember that sometimes less is more.

Craig R

**We wanted issue 100 to really stand out and we felt the best way for it to do that was to pack it with as many iconic characters from as many different game franchises as possible. We tried a version using character art but it didn't really work too well – it looked too modern and lacked nostalgia. Glad that last month's cover was more to your liking.**

### WE'RE LIST-ENING

Hello Retro Gamer,

I just want to say how much I've really enjoyed the Virtual Boy and Atari features you ran recently. I love features that I can dip in and out of, so please, please do more. You will make me one very happy

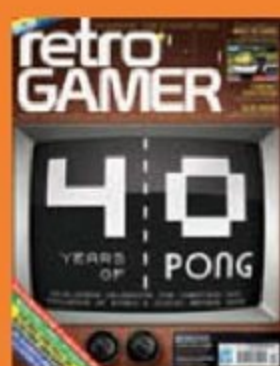

CONTACT US

**Snail Mail:** Retro Gamer, Imagine Publishing, Richmond House, 33 Richmond Hill, Bournemouth, Dorset, BH2 6EZ

**Email:** [retrogamer@imagine-publishing.co.uk](mailto:retrogamer@imagine-publishing.co.uk)



WE RECENTLY HAD a young 13-year old reader named Jacob asking if we had reviewed Kirby's Epic Yarn for the Wii. We did, but Darran has also placed a review on his YouTube channel. Search RetroGamerDaz on YouTube for more information about it.

chappy indeed. How 'bout a top 25 bossiest bosses, or a list of best-ever launch titles for a machine. Heck, even a list of rubbish videogame character jump animations. Anything, I couldn't care – just list features and more of them, please.  
Stephen Oakley

**You'll be pleased to hear that we that we do have more list features in the pipeline, so watch this space. We have to ask, though: what's with the scary obsession with list features? Do you have a very short attention span?**

BEST PALS

Dear Retro Gamer,

I'd like to first of all congratulate you on having passed the big 100 issues mark, for being excellent in general, and for strongly fuelling my interest in retro games and hardware for the last few years. I enjoyed the article on *Super Mario RPG* in issue 102, but there was something that got me thinking. The game was never officially released in PAL territories until 2008 via the Wii's Virtual Console and I was a bit surprised at the line in the first paragraph of the article saying: "The mere mention of the likes of *Final Fantasy VI*, *Chrono Trigger* and *Super Mario World* are enough to send most gamers into paroxysms of nostalgia."

Both *Final Fantasy VI* and *Chrono Trigger* were games that didn't reach PAL territories save through imports. A small percentage of people in the know could find these games on import and play through a converter or relevant NTSC hardware, but otherwise these utter gems took years to be officially

released in Europe. *Final Fantasy VI* finally arrived in Europe and Australia in 2002 on the PlayStation, and it took until 2009 for *Chrono Trigger* to at last arrive through its DS release.

It still baffles me how incredible games like these were not officially released in PAL territories until many years later. Perhaps it might be an idea to do an article that looks into why PAL territories often got such a bum deal when it came to exports in comparison to North America.

Anyway, keep up the great work!  
Steven Warner

**Our guess is that it was purely down to the buying behaviour in those markets persuading publishers that certain games would have little commercial success in those regions. It's telling that those three games mentioned are all RPGs. *Final Fantasy VII* – which, incidentally, was the first *Final Fantasy* game to get a European release – helped the genre take off more in Europe. Following its success, many more RPGs started to see release on PAL consoles. That's our belief anyway.**

NES GAME APPEAL

Hello,

I was wondering if I could make a request for a review of a certain game. The game is called *Air Fortress* for the NES. It is a game that I grew up with and still holds a very important part of my childhood growing up. I have never seen anyone write a review of this game yet.

After purchasing four issues, I am really hooked! I enjoy your content very much! That is why I was asking if you could do this

“ I booted up PSO and cried a little bit when I saw my character for the first time in eight years ”

**RETROBATE PROFILE**

	<b>Name:</b>	Lewis Cox
	<b>Joined:</b>	15th Jan 2012
	<b>Location:</b>	United Kingdom
	<b>Occupation:</b>	Student
	<b>Website:</b>	<a href="http://www.altmaguk.net/">http://www.altmaguk.net/</a>
	<b>Fave Games System:</b>	Dreamcast
	<b>Bio:</b>	My name is Lewis. I love music, nostalgia and Japanese stuff

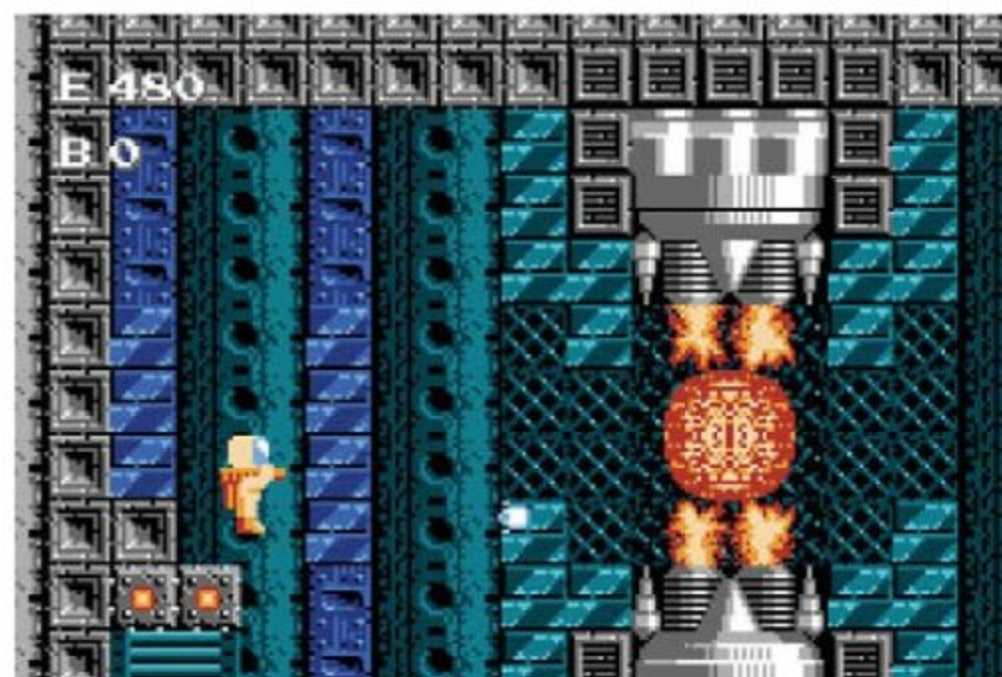

»» [NES] Stuart had a quick bash on *Air Fortress* and liked what he played. He said it was like a NES version of *Major Havoc* and to look out for a write-up.

\* CURRENTLY PLAYING



**DARRAN**

**Diablo III**

Blizzard's game is absolutely epic in scope and the way it constantly generates new dungeons means I'll most likely be playing it forever. If anyone is interested in going on a quest with me then feel free to add my Battle.net tag of DazTM#2510



**STUART**

**Back To Skool**

This month's feature on the *Skool* series reminded me how great the sequel was, which expanded on the original's formula brilliantly and made a great game greater. It still looks the part and, like British bulldog, has lost none of its charm over the years.



**PAUL**

**Halo: Reach**

I've gone back to *Halo: Reach* after months of solid *MW3* and dabbling with *Battlefield 3*. Returning with a fresh perspective highlighted even more of the detail. It also reminded me how the agility focus transforms each multiplayer map into a mind-bending versus arena.

# From the forum

» To have your say visit [www.retrogamer.net/forum](http://www.retrogamer.net/forum)

Every month, **Retro Gamer** asks a question on the forum and prints the best replies. This month we wanted to know...

## What's your favourite Microsphere game?

**Jagfest UK**  
Obviously it has to be the amazing *Back To Skool*. This was as close as anyone came to gaming perfection in the early days of the Spectrum. My childhood would not have been the same without this wonderful title.

**jdanddi**  
As much as I tinkered around with the *Skool* games, the most fun and time I had was with *Wheelie*, a great racing game.

**Morkin**  
*Wheelie*, as I used to spend hours playing this with my best friend. We both loved building ramps and launching ourselves off them – on a ten-speed racer no less – so this game was a perfect match, as we could jump over cars on a motorbike! My love of my Evel Knievel figure and bike also made this a favourite game of mine.

**Sputryk**  
*Wheelie*. Although the *Skool* games were certainly entertaining, they were too taxing for me at the time. *Wheelie*, though frustrating, offered more longevity; just a pity it was a very difficult memory game when racing back to the finish.

**pantal00ns**  
*Contact Sam Cruise*.

Love the *Skool* games but the detective setting just edges it for me. Possibly linked to *Movie* being one of my favourite Speccy games as well.

**merman**  
As a C64 fan, we did not get many of the Microsphere games, so it has to be the one I played the most. *Skool Daze* acted as therapy when I wasn't enjoying school. Change the names to teachers and fellow pupils I did not like and then misbehave a lot.

**Smurph**  
Has to be *Skool Daze* for me. I remember it being the first game I played on a 48K+. Good times.

**r0jaws**  
I genuinely couldn't remember any Microsphere games apart from *Skool Daze* so had to look them up... Not a lot there, and I didn't really like *Skool Daze*, so that's a bust for me.

**stvd**  
Really liked both *Skool* games but preferred the detective theme of *Contact Sam Cruise*.

*Wheelie* along with *Jetpac* were the first games I ever played on the Spectrum and the reason I got one.

**slacey1070**  
Likewise. Tried *Wheelie*

out last night, didn't like it. *Skool Daze* had a bit of 'wow' factor back then... That's about it.

**psj3809**  
*Skool Daze* and *Back To Skool* were amazing, but for me it was their first major hit, which was *Wheelie*.

One of those 'had to be there' moments when it first came out, excellent game, get to the end of the level and then race back against the ghost rider. Had to write a map of the directions of where to go.

Great game for its time, has aged quite badly but does give you some great memories if you played it back in the early Eighties.

**Matt\_B**  
The *Skool* games, *Wheelie* and *The Train Game* are too good not to mention. However, I'll go for the easily overlooked *Sky Ranger* instead. It's an oddball cross between helicopter simulator and shoot-'em-up, but Microsphere never made an conventional games.

I suspect a lot of people gave up on it fairly early as there's a bit of steep learning curve; not least, every little bump you make results in another crack on the windshield, and you've soon got so many that you're left peering through the gaps to make out what's ahead of you.

**paranoid marvin**  
*Sam Cruise* was a great-

looking game that I never got into – one of those I must go back to one day – and the *Skool* games were interesting but way too hard, but *Wheelie* was pitched at just the right learning curve.

Great animation, especially when turning, but flickery as anything – strange how I didn't notice that back in the day! Has to be *Wheelie* – the graphics may have diminished, but the gameplay's still there in bucketloads.

**Antriad2097**  
*Wheelie* was the first of their games I have vivid memories of, not so much for the gameplay as the incredibly detailed deaths.

Having the motorcycle rider crashing, thrown over the bars, was both shocking and satisfying, so much so you almost didn't mind losing a life.

It had that blend of risk and reward that works so well, where turning on the speed made the jumps easier but also offered much greater peril from other hazards.

**kiwimike**  
The *Skool* games by a country mile, head and shoulders above their other titles. So original, so British in many ways, and most I know edited it to mirror their own school and take their frustrations out on it – very cathartic!

YOUR OPINION PLEASE

## INTERESTING GAMING FACTS

**paranoid marvin** 99 per cent of FPS games feature lavatories, but only 1 per cent let you use them.

**krusty40** Most of the street names in *Silent Hill* have famous horror directors' surnames.

**liveinabin** *Dracula* by CRL (Spectrum/C64) was the first game to be given a rating by the BBFC.

**Space\_turnip** If every FPS made does not feature at least five crates, John Romero will explode.

**koopa42** An earlier version of *Street Fighter* had a pressure pad control system that you had to 'hit' to make your character punch.

**Mootown** Awesome arcade racer *Burnout* is an anagram of *OutRun B*.

## ROBOCOP VERSUS THE TERMINATOR

**rocky1980** I love them both. *T2* is a SUPER film but *RoboCop* is amazing, it really is.

**RetroBob** I cannot pick and won't vote in protest at their awesomeness. It's a dirty protest too.

**Katzkatz** *The Terminator*. Good as *RoboCop* is – and I suppose you have to appreciate the satire in the film – *Terminator* is a bleak, unrelenting sci-fi story.

**necronom** I like them both a lot, but *The Terminator* is just amazing. It's probably my second favourite film ever after *Aliens*.

**Treguard** *RoboCop* all the way. I loved it when ITV used to show it and dubbed out all the swearing. Me and my mate still refer to each other as 'mothercrushers' and 'crumbags'.

## BARCODE BATTLER

**woody.cool** I still have one, somewhere in the garage at the bottom of a box. Not sure it still works! Not sure why I bothered really. They are really crap.

**rocky1980** I picked one up in a charity shop last year. I think ashens' YouTube review sums it up well. It did not work back in the day and does not work now.

**Rayne** They functioned pretty well and certainly kept me amused for every supermarket trip. I do remember the back of the pack came with a healing code that revived your monsters. I eventually lost the packaging and, as such, couldn't revive the little critters.

**scunny** I had a Barcode Battler, was really into it for a while. Most items were usually crap but I remember a tin of sausages made a brilliant hero. There is a sentence I didn't think I'd ever write.

## OLD vs NEW

We find out if the classics are better than their successors. This month, *Sonic The Hedgehog 4: Episode II* vs *Sonic The Hedgehog*

**Sonic The Hedgehog**



100%

**ShadowMan**  
*Sonic The Hedgehog*, easily. I much preferred the game's flow and level design.

**Sonic The Hedgehog 4: Episode II**



0%

**Samhain81**  
It's funny how a game can be more colourful and vivid than a game made 20 years later

## HOT TOPIC

Favourite Working-Class Hero

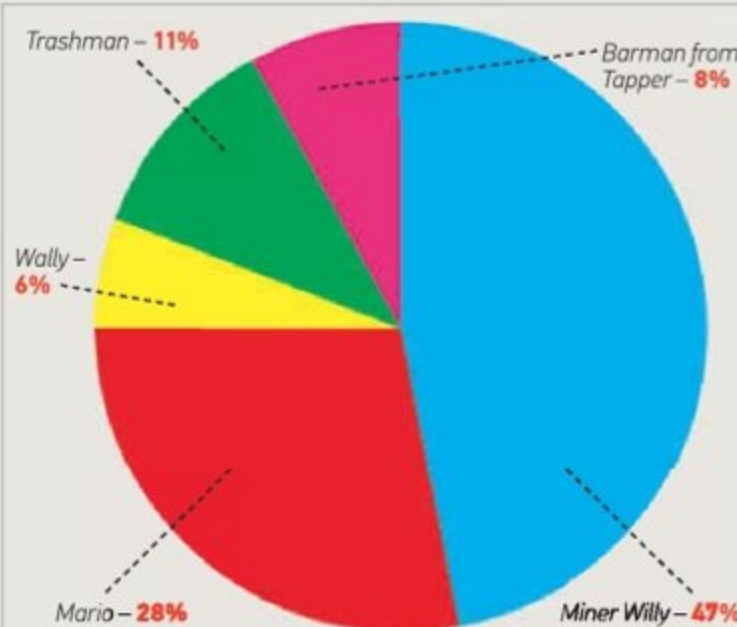

"Trashman, always Trashman. Anyone who empties bins, especially on hot days, gets my vote." **Morkin**

"Miner Willy FTW. The best gaming icon ever. And ever. Amen!" **markopoloman**

"I voted Mario, although I'm not sure he's still working class. After all, he must be loaded after collecting all those giant gold coins!" **theantmeister**

"Has to be the Tapper dude. I worked in a bar once, so he is the closest working-class hero that I can associate with." **IronMaidenRule**

Don't forget to follow us online for all the latest retro updates



RetroGamerUK



@RetroGamer\_Mag

>> for me. Thank you for taking the time to read through this email.  
Jon aka Synical Enigma

We'll see what we can do, John. If it's any good then perhaps we'll do a little Retro Revival write-up about it. Of course, you could always write a few hundred words about it yourself and upload your review on to the Retro Gamer website. It might even get selected to appear in the magazine.

## ALTERED BEATS

Hi Darran,

It's not often I write to magazines – in fact this is my very first time – but I'm glad that my first time is with **Retro Gamer**, which I've been reading since issue 1. I recently made, in the form of a music video for the dance band Slyde, an ode to the experience of waiting for a C64 to load. I thought of all people you guys would enjoy it, so here it is: [www.youtube.com/watch?v=MU7A2fdn3MQ](http://www.youtube.com/watch?v=MU7A2fdn3MQ)  
Martin Shearman-Brettle

We like the video and the song was pretty catchy too. It caused Darran to kick off his flip-flops, expose his matching big toe blisters and start dancing around the Retro Gamer pod like a modern-day jester, sans jester hat... and footwear.

“Why does Wizball's face look like the finger-insertion area of a bowling ball?”

## DISCUSSED THIS MONTH

Steve Version 2.0

This month we welcomed a new designer to the team. As the header implies, he's another Steve. What the header doesn't tell you is that he's a keen surfer, and on three separate occasions has been mistaken for Daniel Craig protecting a surfboard, Tommy Lee Jones holding a large skateboard, and Jeremy Irons carrying a floral ironing board. Steve's favourite videogame is *Surf Champ* on the Spectrum. Probably. Darran and Stuart are too shy to actually ask him. Actually, turns out it's *Defender*.

## PHANTASTIC NEWS

Hi guys,

I am a Dreamcast fanatic and consider it in my opinion, to be the best console ever released. More to the point, I am also a *Phantasy Star Online* addict, although I was until around 2003 when unfortunately the incessant cheating and hacking forced me to retire from Ragol and banish my Dreamcast to the loft. Fast forward to 2012 when I decided to get the Dreamcast back down from the loft. It was a wonderful experience to revisit some of Sega's finest. Then I booted up *PSO* and cried a little bit when I saw my character for the first time in eight years – how good are the VMUs? I tried to go online via dial-up and no joy. It transpired that Sega closed the servers in 2007.

However, after a chance Google search I realised that there are, amazingly, private and free servers available – and after following some very simple instructions I was back online with players from around the world! I really had to pinch myself to make sure I wasn't dreaming. There I was, back in the Forest, like it was 2001 again.

I want to take this opportunity to make **Retro Gamer** readers aware of the server that I've been using. It is called Sylverant and for DC users it is very easy to log on – all that is needed is a patch disc. If you adored *PSO*, please boot up those DCs once again and log on to Sylverant. You will love it. I promise.  
Sanshiro, M 97 FOMar

Maybe because it was Sega's last games console, or simply because it was a fantastic machine with some great exclusive titles. Whatever the reason, there's plenty of lasting love towards the Dreamcast. Hopefully your tip-off will inspire some *PSO* fans to dust off their copies of the game and join you on Ragol.



>> [Dreamcast] Though Sega has long since shut its *Phantasy Star Online* servers, open servers and dedicated fans keep the game alive today.

## \* THE ONES THAT GOT AWAY. . . This issue's covers that nearly happened



### DARRAN

We knew that we wanted *Pong* on the cover, but the question was how to make it look good. Its look is extremely minimal and getting that across was proving to be quite a difficult process. We nailed it eventually, but here's one that just wasn't working for us.



### STUART

We were really keen on doing this because everyone on the mag loves Dave Reidy's games. It was working fairly well, but it was proving to be too similar to the cover used for *gamesTM*'s 100th issue. We stuck with *Pong*.



# retro GAMER

Imagine Publishing Ltd  
Richmond House, 33 Richmond Hill,  
Bournemouth, Dorset, BH2 6EZ  
☎ +44 (0) 1202 586200  
Web: [www.imagine-publishing.co.uk](http://www.imagine-publishing.co.uk)  
[www.retrogamer.net](http://www.retrogamer.net)

## Magazine team

Editor Darran Jones

[retrogamer@imagine-publishing.co.uk](mailto:retrogamer@imagine-publishing.co.uk)  
☎ 01202 586237

Editor in Chief Rick Porter

Art Editor Steven Mathews

Features Editor Stuart Hunt

Senior Sub Editor Mat Hoddy

Sub Editor Ollie Dean, Rebecca Richards

Senior Art Editor Greg Whitaker

Head of Publishing Aaron Asadi

Head of Design Ross Andrews

## Contributors

Mat Allen, Carly Barrett, Mike Bevan, Richard Burton, Stuart Campbell, David Crookes, Paul Davies, Paul Drury, Marty Goldberg, Jason Kelk, Iain Lee, Graeme Mason, Rory Milne, Will Shum, Lora Sykes, Sorell Tilley

## Photo Studio

Studio equipment courtesy of Lastolite ([www.lastolite.co.uk](http://www.lastolite.co.uk))

## Advertising

Digital or printed media packs are available on request

Advertising Director James Willmott

☎ 01202 586432

[james.willmott@imagine-publishing.co.uk](mailto:james.willmott@imagine-publishing.co.uk)

Head of Sales Hang Deretz

☎ 01202 586442

[hang.deretz@imagine-publishing.co.uk](mailto:hang.deretz@imagine-publishing.co.uk)

Account Manager Emma Tyrer

☎ 01202 586420

[greg.reed@imagine-publishing.co.uk](mailto:greg.reed@imagine-publishing.co.uk)

Advertising Sales Executive Richard Rust

☎ 01202 586436

[richard.rust@imagine-publishing.co.uk](mailto:richard.rust@imagine-publishing.co.uk)

## International

Retro Gamer is available for licensing. Contact the International department to discuss partnership opportunities.

Head of International Licensing Cathy Blackman

☎ +44 (0) 1202 586401

[licensing@imagine-publishing.co.uk](mailto:licensing@imagine-publishing.co.uk)

## Subscriptions

Head of Subscriptions Lucy Nash

[subscriptions@imagine-publishing.co.uk](mailto:subscriptions@imagine-publishing.co.uk)

For all subscription enquiries

email [retrogamer@servicehelpline.co.uk](mailto:retrogamer@servicehelpline.co.uk)

☎ (UK) 0844 848 8412

☎ (Overseas) +44 1795 592 872

13 issue subscription UK – £51.90

13 issue subscription Europe – £70

13 issue subscription ROW – £80

## Circulation

Head of Circulation Darren Pearce

☎ 01202 586200

## Production

Production Director Jane Hawkins

☎ 01202 586200

## Founders

Group Managing Director Damian Butt

Group Finance & Commercial Director Steven Boyd

Group Creative Director Mark Kendrick

## Printing & Distribution

Printed by Wyndeham Heron Ltd, Bentalls Complex,  
Colchester Road, Heybridge, Maldon, Essex, CM9 4NW  
☎ 01621 877 777

Distributed in the UK & Eire by: Seymour Distribution, 2 East  
Poultry Avenue, London, EC1A 9PT

☎ 020 7429 4000

Distributed in Australia by: Gordon & Gotch, Equinox Centre,

18 Rodborough Road, Frenchs Forest, NSW 2086

☎ +61 2 9972 8800

Distributed in the Rest of the World by: Marketforce, Blue Fin

Building, 110 Southwark Street, London, SE1 0SU

☎ 0203 148 8105

## Disclaimer

The publisher cannot accept responsibility for any unsolicited material lost or damaged in the post. All text and layout is the copyright of Imagine Publishing Ltd. Nothing in this magazine may be reproduced in whole or part without the written permission of the publisher. All copyrights are recognised and used specifically for the purpose of criticism and review. Although the magazine has endeavoured to ensure all information is correct at time of print, prices and availability may change. This magazine is fully independent and not affiliated in any way with the companies mentioned herein.

© Imagine Publishing Ltd 2012

ISSN 1742-3155



When you have finished with this magazine please recycle it.



# THE MULTI AWARD-WINNING MULTIFORMAT GAMES MAGAZINE



■ Written by gamers for gamers

■ The UK's most respected videogame magazine

■ Massive section dedicated to retro games

games™  
ISSUE 123  
ON SALE NOW!

Get your copy today

✓ Print ✓ iPad  
✓ iPhone ✓ Android



Quality print edition on sale at [imagineshop.co.uk](http://imagineshop.co.uk)  
Interactive digital edition on all platforms on sale at  
[www.greatdigitalmags.com](http://www.greatdigitalmags.com)

Also available at all good newsagents

retro  
GAMER

» LOAD 105

# nextmonth

ON SALE 19 JULY 2012

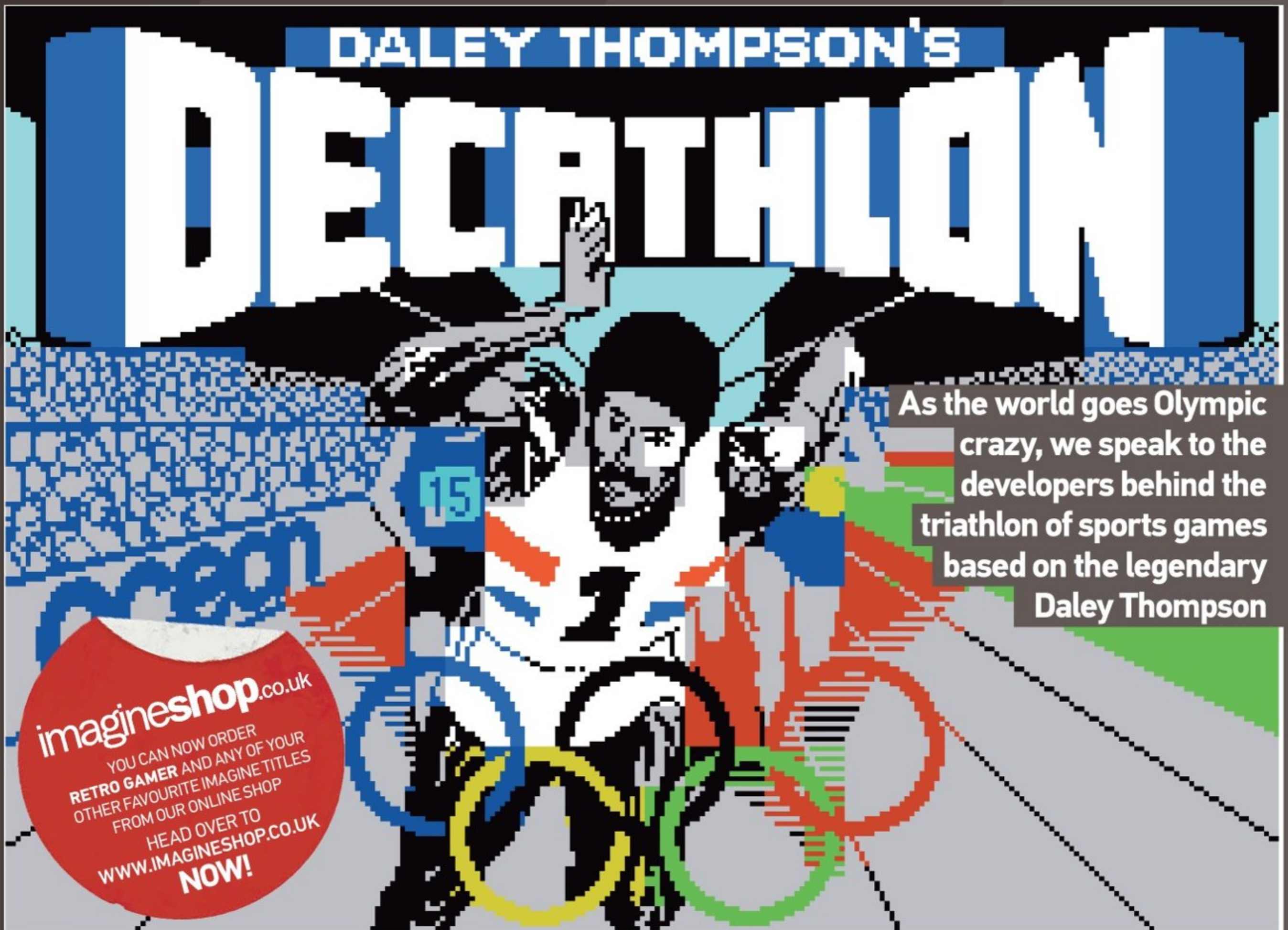

**DALEY THOMPSON'S**  
**DECATHLON**

As the world goes Olympic crazy, we speak to the developers behind the triathlon of sports games based on the legendary Daley Thompson

**imagineshop.co.uk**  
YOU CAN NOW ORDER  
RETRO GAMER AND ANY OF YOUR  
OTHER FAVOURITE IMAGINE TITLES  
FROM OUR ONLINE SHOP  
HEAD OVER TO  
[WWW.IMAGINESHOP.CO.UK](http://WWW.IMAGINESHOP.CO.UK)  
**NOW!**

## MORE EXCITING FEATURES TO LOOK FORWARD TO NEXT ISSUE

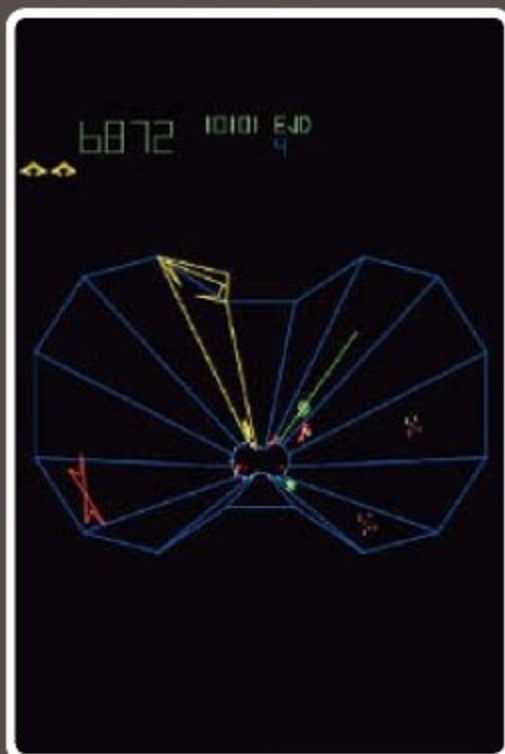

### Tempest

■ In a rare new interview, arcade whizz Dave Theurer reveals the ins and outs of his classic 1980 shooter, while Jeff Minter revisits *Tempest 2000*

### Carmageddon

■ We go behind the scenes of Stainless Games' controversial driving franchise; a game so shocking the BBFC tried to ban it

### XBLIG

■ We highlight the great clones of classic games on Xbox Live's indie service and speak to the developers behind them

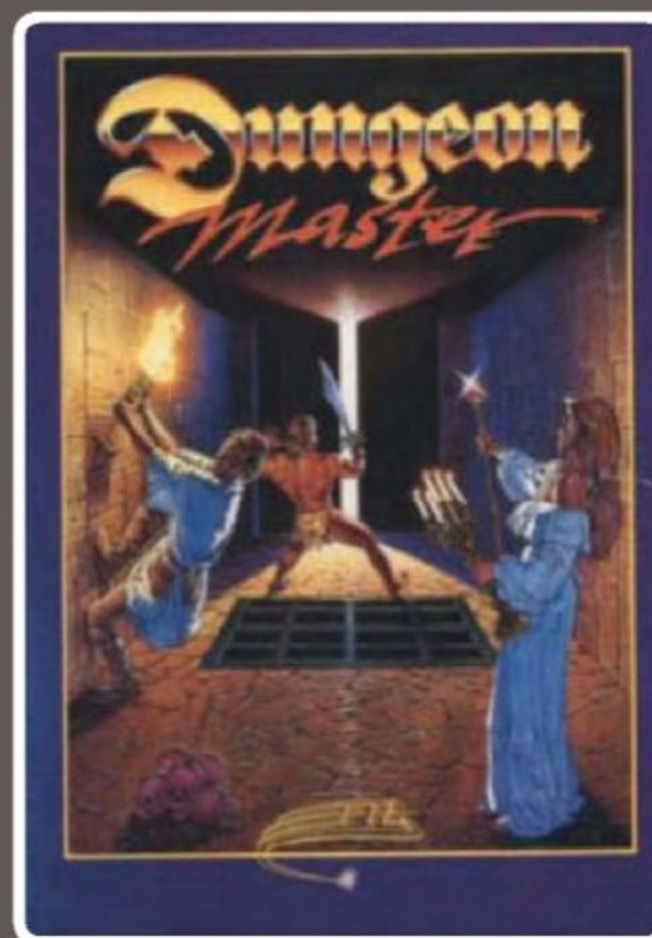

### Dungeon Master

■ In an exclusive round-table interview, the developers of the hit Atari ST game get back together to celebrate 25 years of delving in dungeons

### Mire Mare

■ After years of speculation, Martyn Carroll puts on a deerstalker and attempts to find out the real truth behind one of gaming's holiest grails

# Read anything good lately?

Shop for quality magazines, books and DVDs from Imagine Publishing

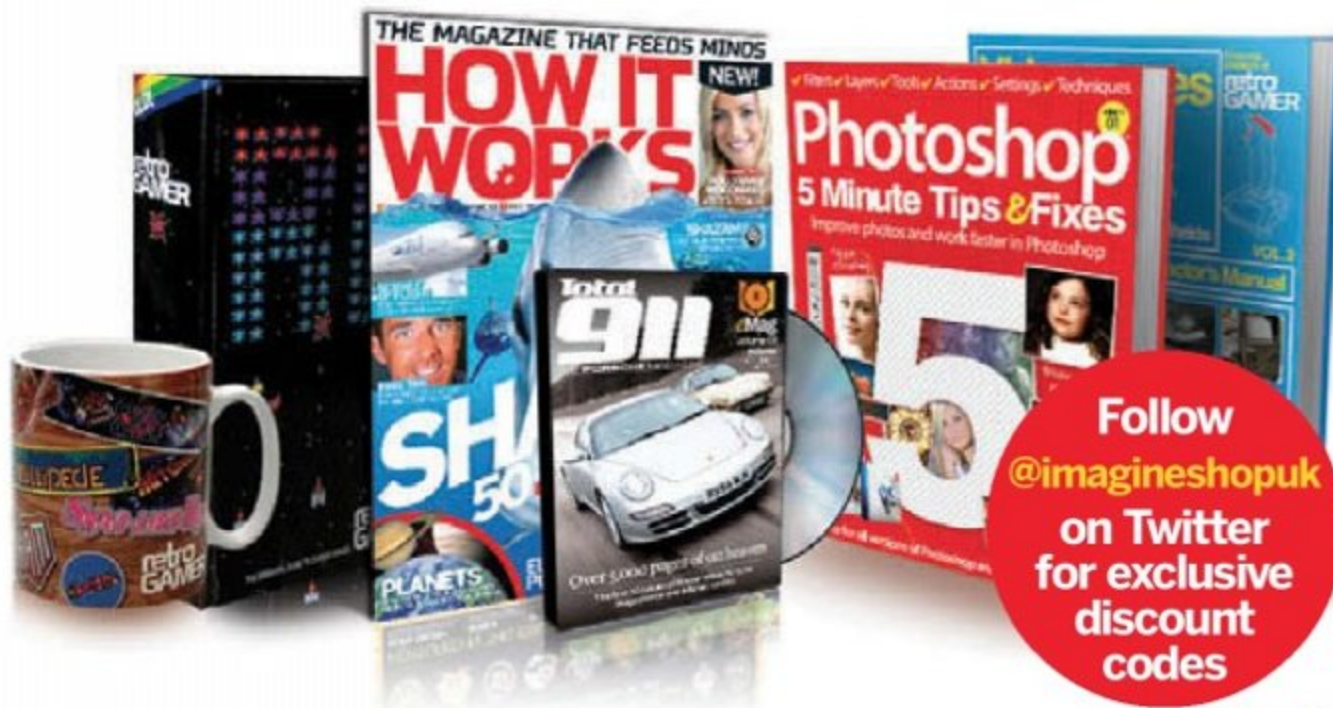

imagineshop.co.uk 

MAGAZINES BOOKS DVDS DOWNLOADS GIFTS

# To Advertise In retro GAMER

Contact Greg Reed on  
01202 586434

greg.reed@Imagine-publishing.co.uk

# CONSOLE PASSION

WWW.CONSOLEPASSION.CO.UK

Serving the  
Retro Gaming  
Community  
for more than



**ONLINE ORDERING AND WORLDWIDE SHIPPING OF THOUSANDS OF GAMES AND CONSOLES.**

**MOST GAMES AND CONSOLES ARE COMPLETE WITH THEIR ORIGINAL BOXES AND INSTRUCTIONS.**

**GAMES COLLECTIONS AND CONSOLES BOUGHT OR PART EXCHANGED.**

**MANY RARE JAPANESE GAMES STOCKED.**

**THE UK'S PREMIER MODIFIED CONSOLE SUPPLIER.**



Find us on  
Facebook  
and Twitter 



# RETRO GT

CLOTHING & MERCHANDISE  
INSPIRED BY VIDEO GAMES



## RetroGT.com

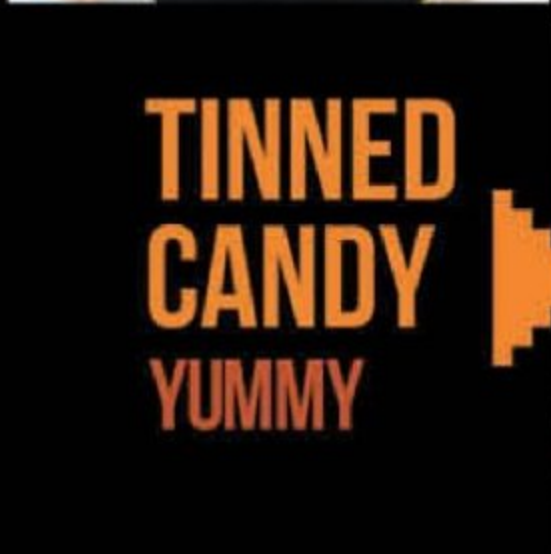

Exclusive Retro Gamer discount code:

# RGBIGFSH

# 10%<sup>off</sup>

enter code at checkout  
expires 31<sup>st</sup> July 2012.

Follow us on Twitter for the chance to win free stuff.

 @RetroGT

# ENDGAME



## ZOMBIES ATE MY NEIGHBORS

» When their neighbourhood turns into a very real version of Halloween night, plucky teenagers Zeke and Julie decide to rescue its survivors, which rather oddly seem to comprise mostly babies and cheerleaders. 48 levels, and many grateful concerned parents and high school jocks later, the duo trace the source of the weirdness to an insane doctor who likes the odd transmuting tippie. Now for the final confrontation...

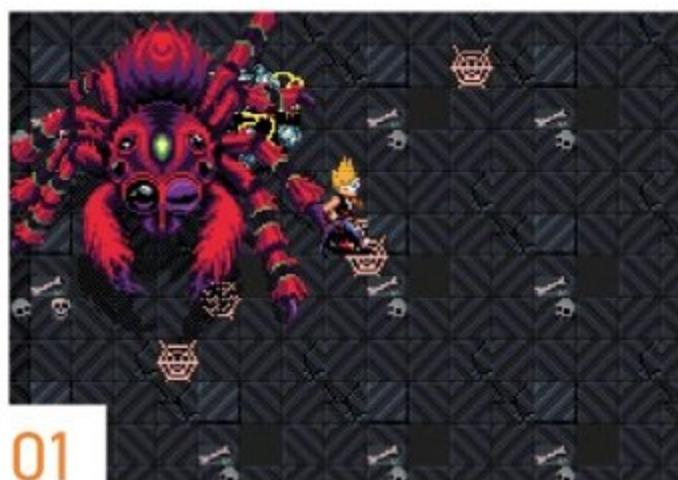

01

» Zeke confronts the deranged Dr Tongue, but before he can save the world from zombitus, the doctor drinks some peculiar potion and transforms into a tarantula. Following this initial battle, the doc gets all big-headed – literally.



02

» With the bad doc defeated, the mission appears to be over. Or is it? Well, not quite. You see, *Zombies Ate My Neighbors* likes a joke, and its creators have created an amusing epilogue level to play during the credits. And guess where it takes place...



03

» Yep, at LucasArts. Zeke completed the entire mission during a work skive, and a certain big boss isn't pleased. George has more pressing issues, though. No, not getting the ball rolling on *The Phantom Menace*; zombies are eating his staff.



04

» As Zeke fights his way through the corridors, he bumps into some of the staff on the game. Look! Here's 2D artist Harrison Ford. No, wait, it's actually Steve Purcell holding a bullwhip and dressed in a leather jacket. An easy mistake to make.



05

» And here's a nameless guy discussing a giant robot game – a clue to a future LucasArts game project, perhaps? Exactly that, we reckon, as the studio released *Metal Warriors* two years later, and it ran on the same 'ZAMN' engine as *Zombies*.



# Oil Rush

naval strategy game

Oil Rush is a real-time naval strategy game that combines the strategic challenge of a classic RTS with the sheer fun of Tower Defence, while featuring state-of-the-art visuals. The game is based on group control: the player doesn't have to micro-manage every unit but has control over all important aspects of tactics, strategy and economy. Capture, upgrade and defend floating production platforms and oil rigs. Discover new technologies and send groups of naval and air units into battle to capture enemy platforms and oil rigs.

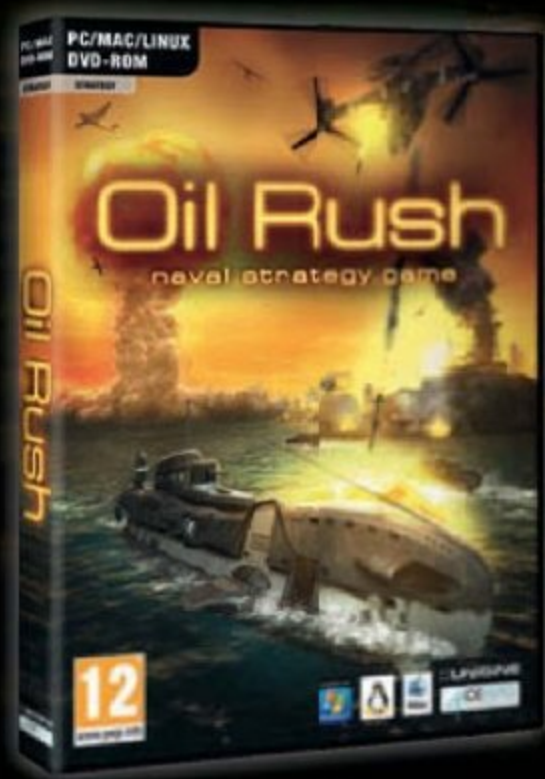

**OUT NOW**

**Destructoid:**

"Once you get into the mode of play that Oil Rush expects from you, it's one of the freshest takes on the strategy genre in a while."



PURCHASE OIL RUSH NAVAL STRATEGY GAME AND OTHER EXCITING GAMES AT: [WWW.ICEBERG-SHOP.COM](http://WWW.ICEBERG-SHOP.COM)

AVAILABLE AT:

Oil Rush © 2012 UNIGINE Corp. Licensed exclusively to and published by Iceberg Interactive B.V. for The United Kingdom, Ireland, Germany, Switzerland, Austria, France, Benelux, Scandinavia, Australia, New Zealand, South Africa. Iceberg Interactive design and mark are registered trademarks of Iceberg Interactive B.V. Developed by UNIGINE Corp. Microsoft®, Windows® and DirectX® are registered trademarks of Microsoft Corporation. Powered by Unigine Engine. All other brands, product names, and logos are trademarks or registered trademarks of their respective owners. All rights reserved. Made in EU.

**Rock, Paper, Shotgun:**  
 "...this is an exceptionally pretty strategy game."



EXCLUSIVE CONTENT  
DOWNLOAD THE BLIPPAR APP AND  
BLIPP THIS ADVERT



# DARKSIDERS II

## DEATH LIVES

Pre-order now to receive the  
LIMITED EDITION Pack,  
including Argul's Tomb DLC\*

SEARCH: DARKSIDERS



AVAILABLE  
AUGUST 21<sup>ST</sup> 2012

WWW.DARKSIDERS.COM



© 2012 THQ Inc. Developed by Vigil Games. Darksiders, Vigil Games, THQ and their respective logos are trademarks and/or registered trademarks of THQ Inc. All rights reserved. All other trademarks, logos and copyrights are property of their respective owners. \*B\*, "PlayStation", "PS3" and "PS" are trademarks or registered trademarks of Sony Computer Entertainment Inc. KINECT, Xbox, Xbox 360, Xbox LIVE, and the Xbox logos are trademarks of the Microsoft group of companies and are used under license from Microsoft. \*Argul's Tomb DLC available for download post release of Darksiders II, exact date TBC.