

fig: 1

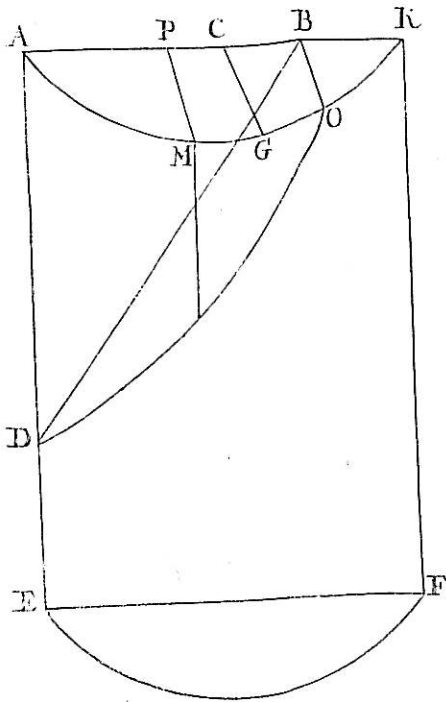


fig: 2

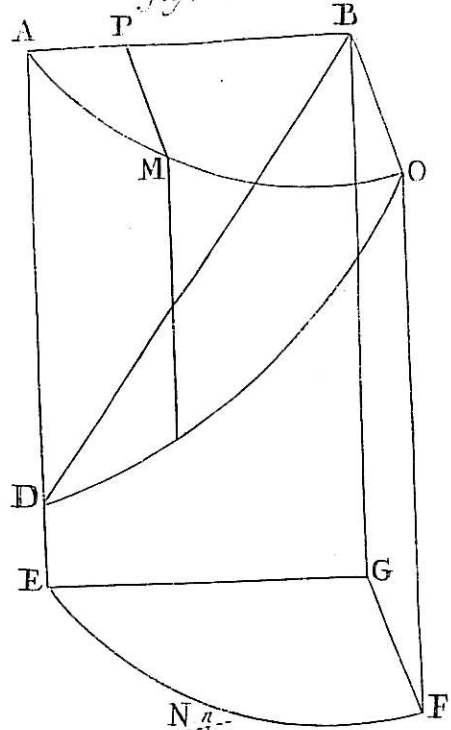


fig: 3

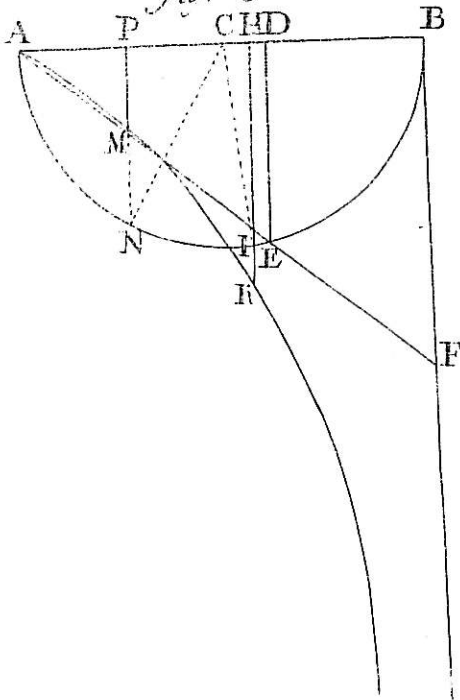
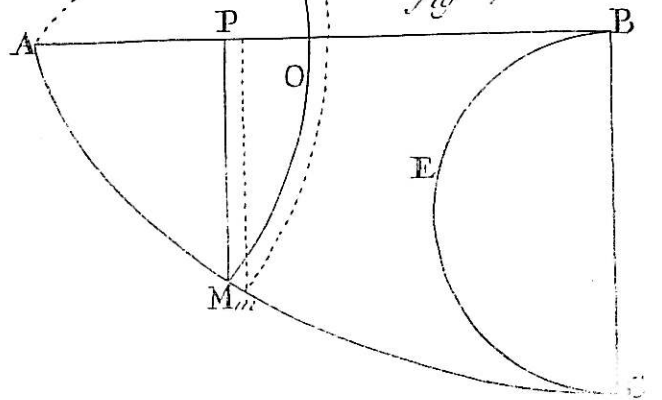
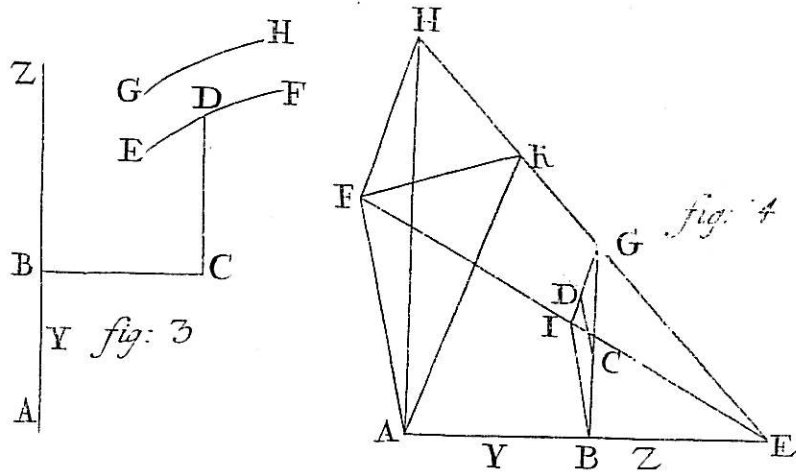
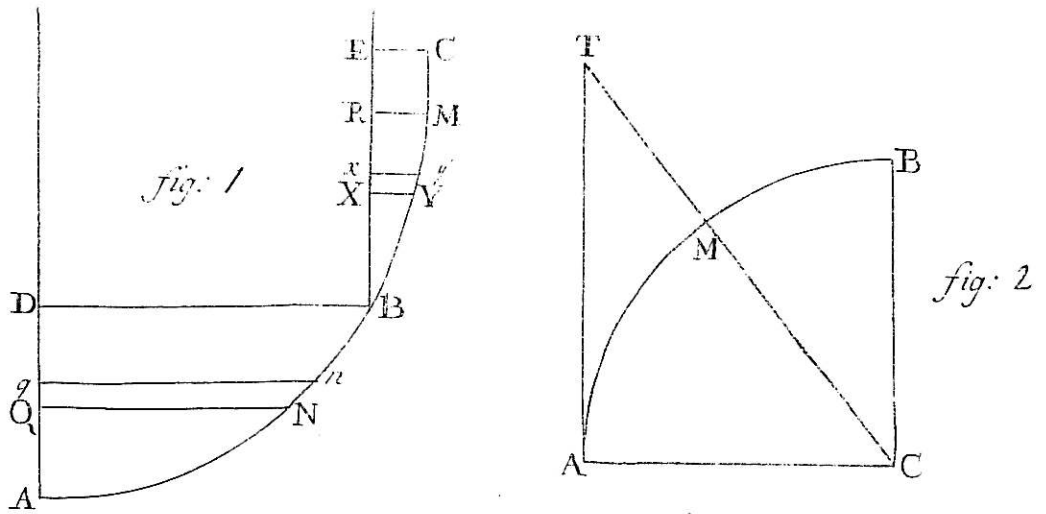
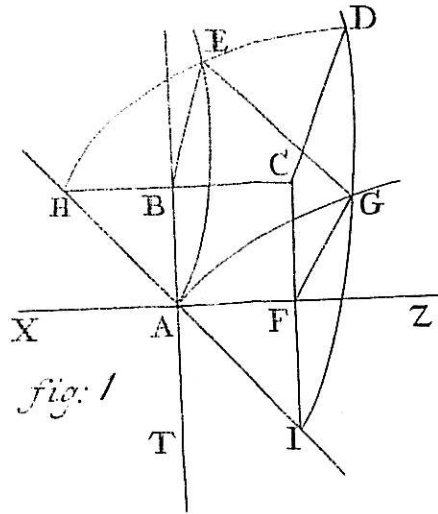


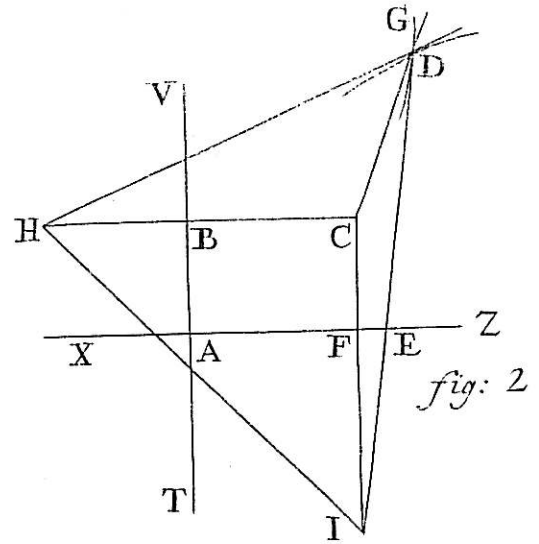
fig: 4



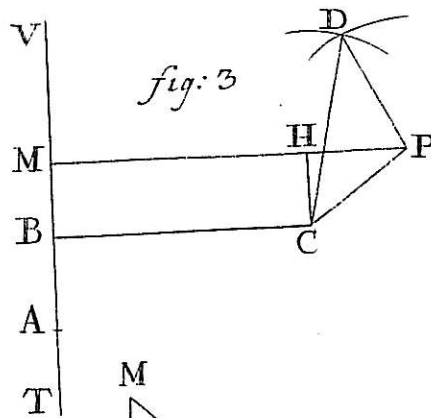




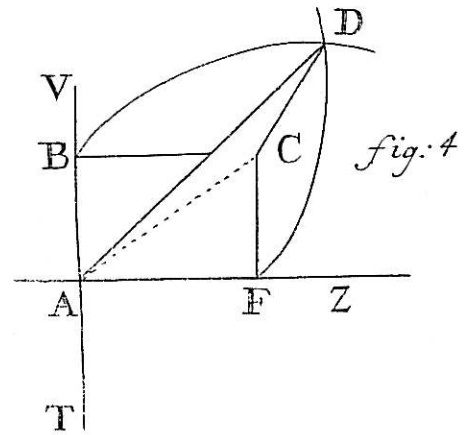
*fig: 1*



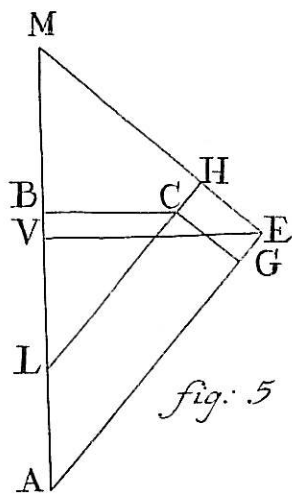
*fig: 2*



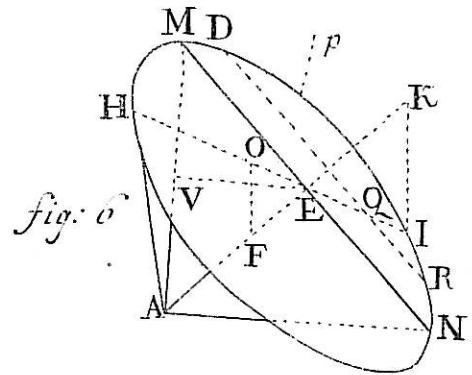
*fig: 3*



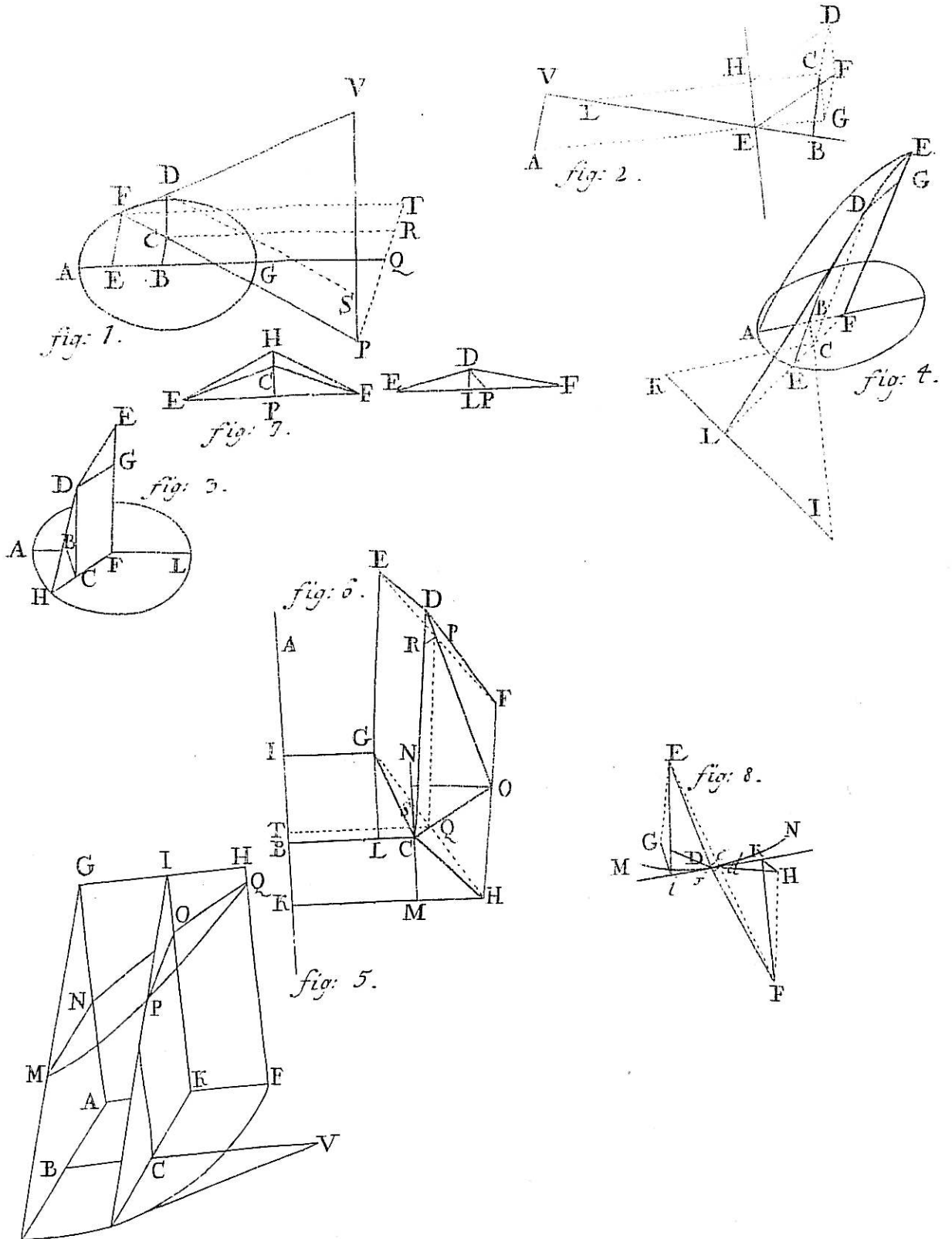
*fig: 4*

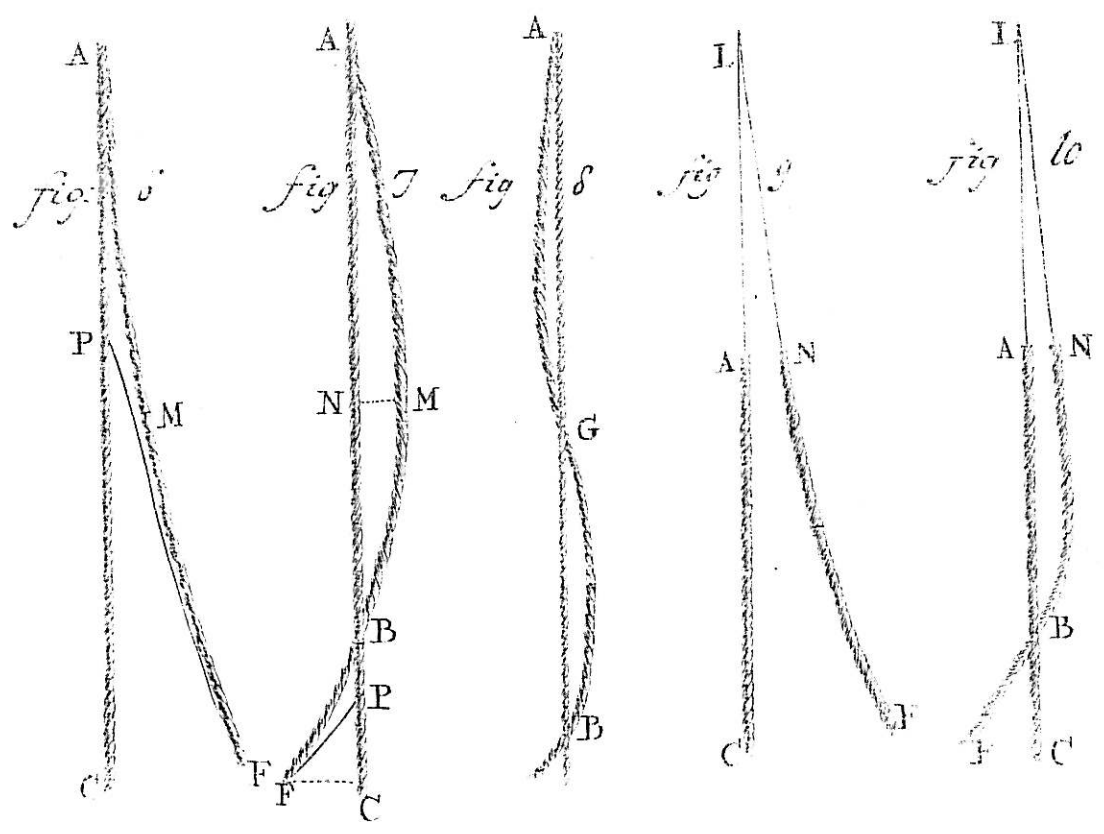
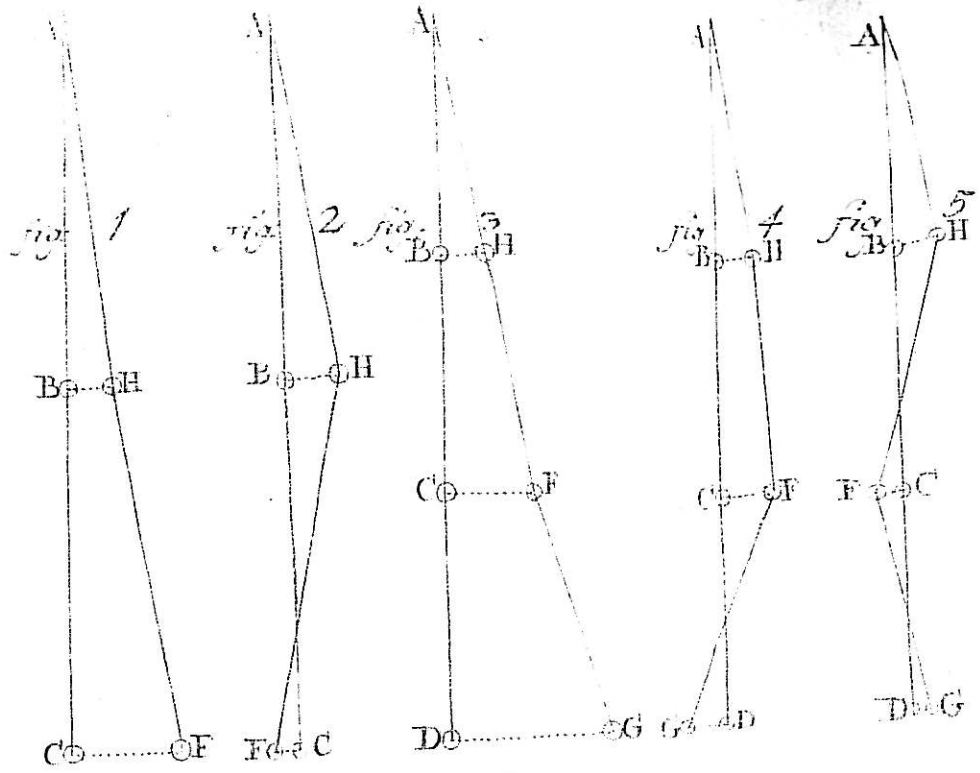


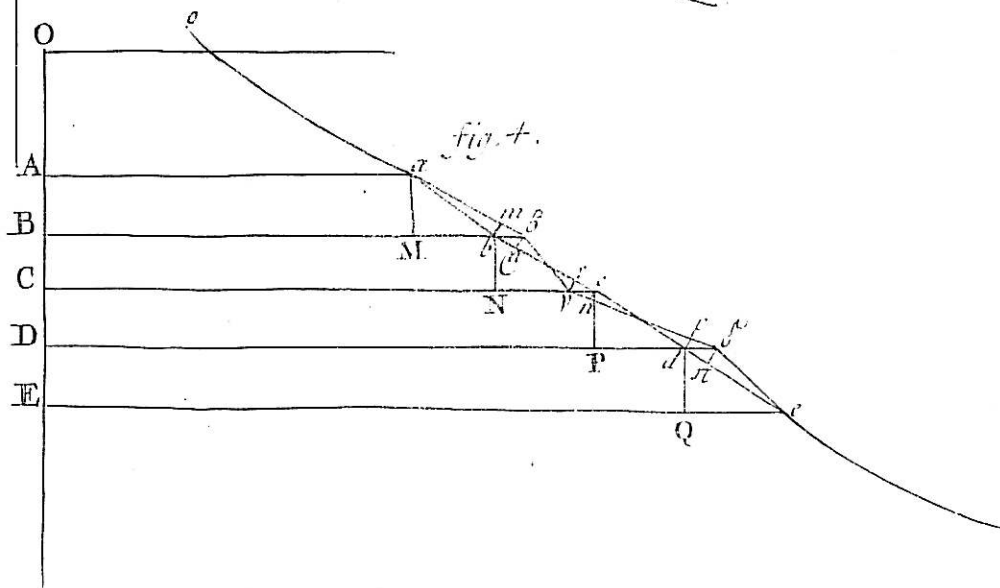
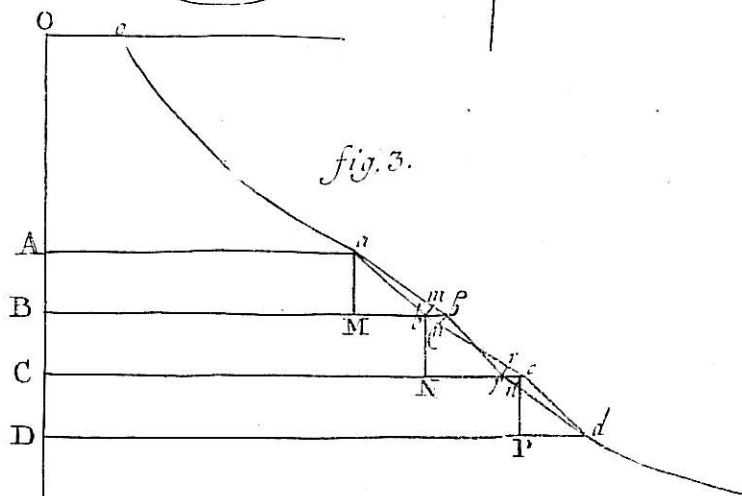
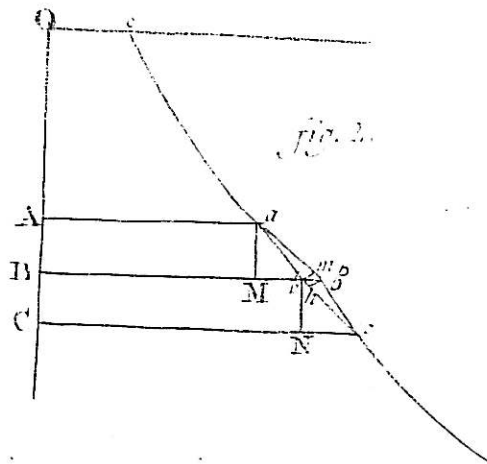
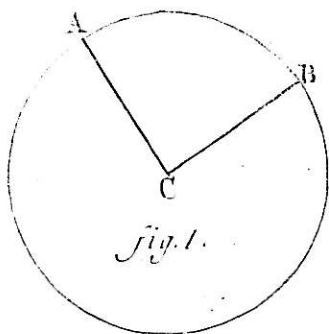
*fig: 5*



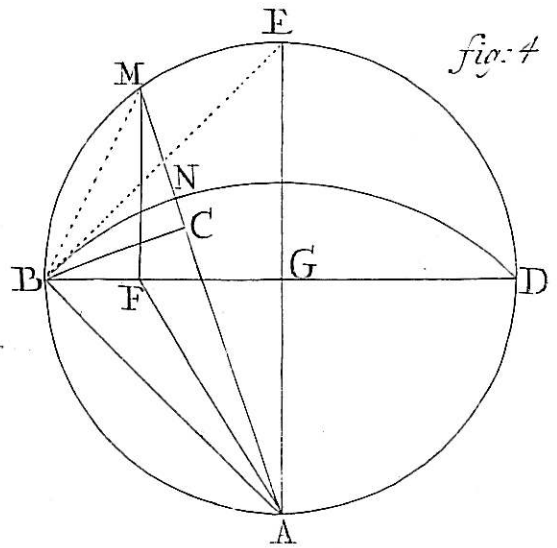
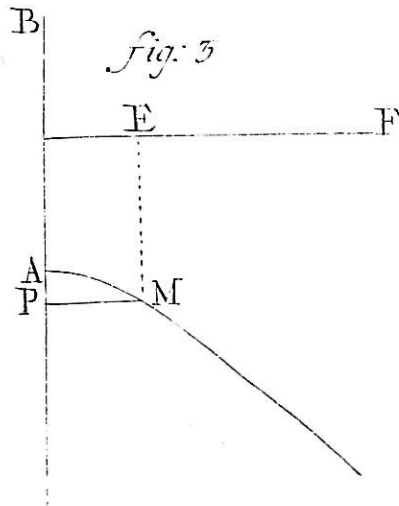
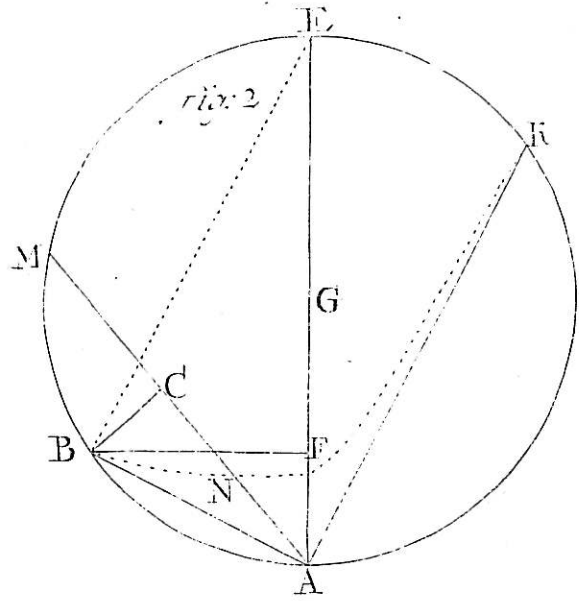
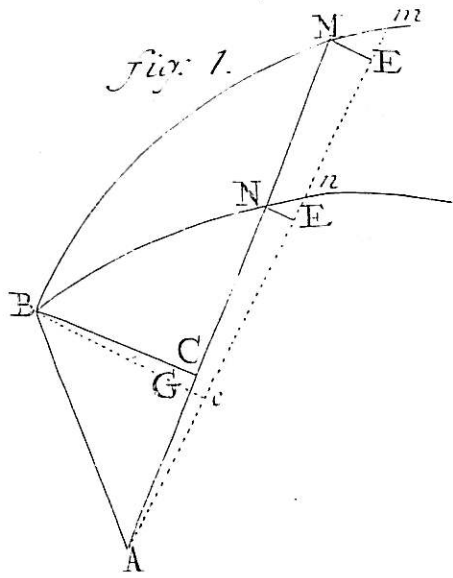
*fig: 6*

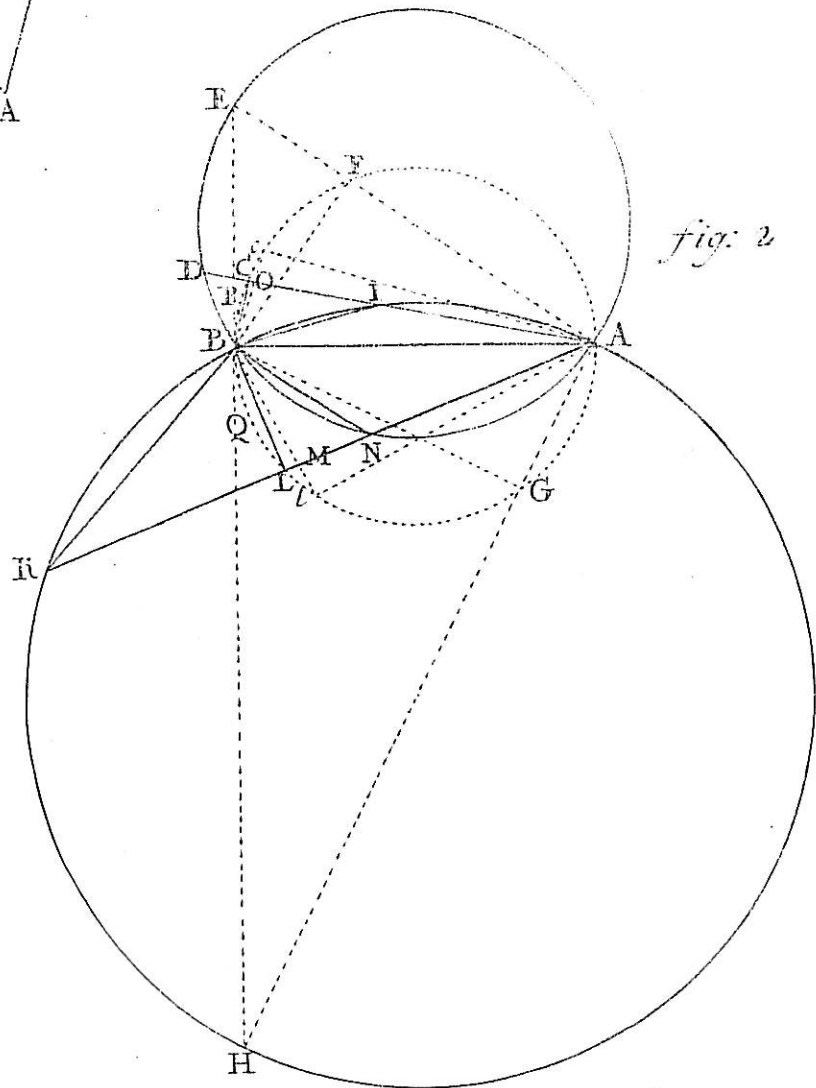
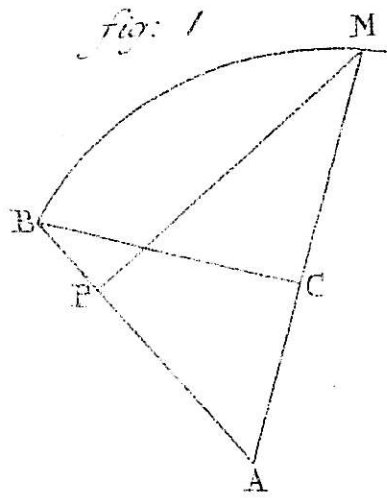












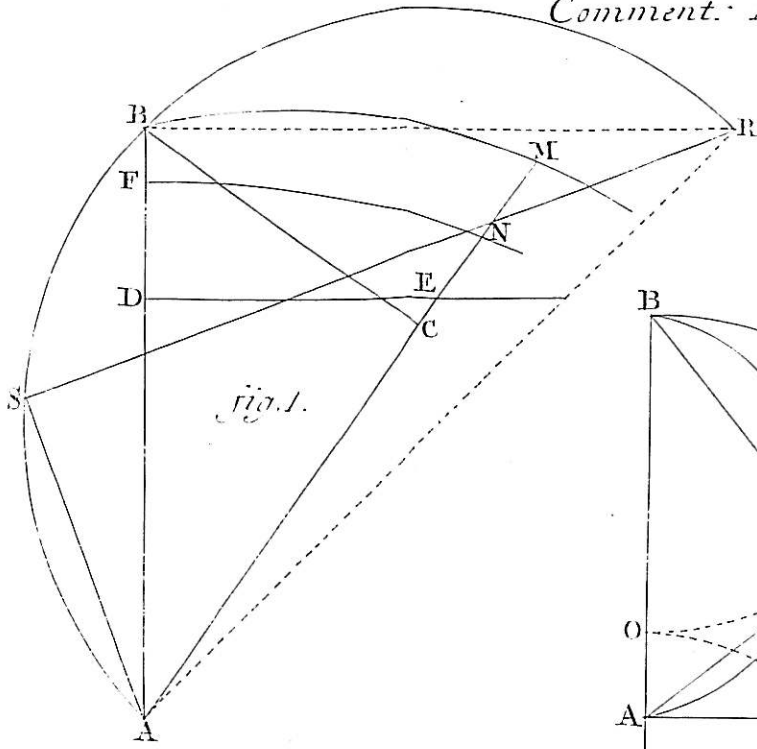


fig. 1.

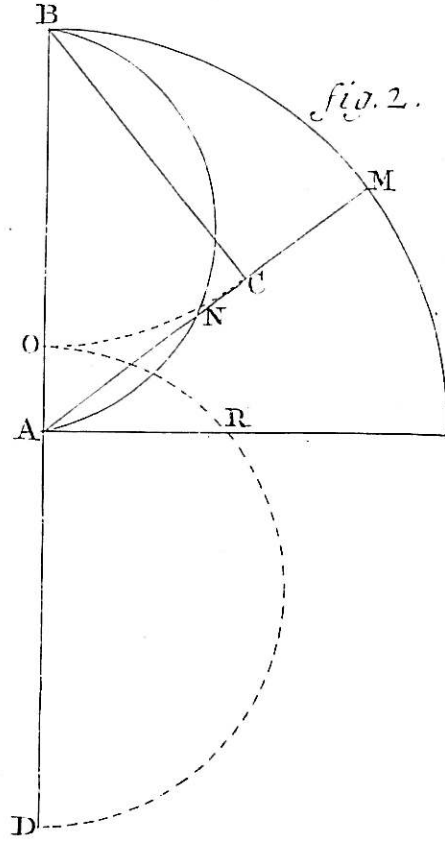


fig. 2.

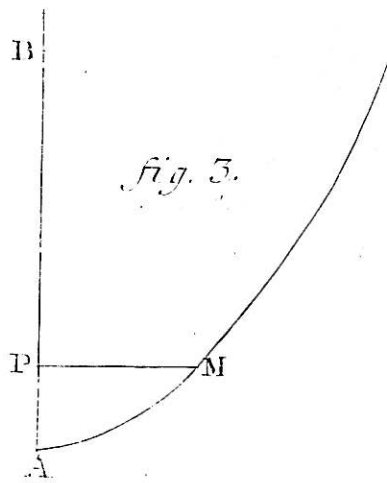


fig. 3.

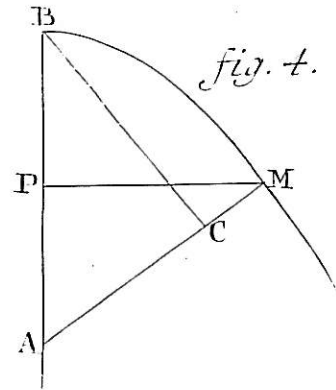
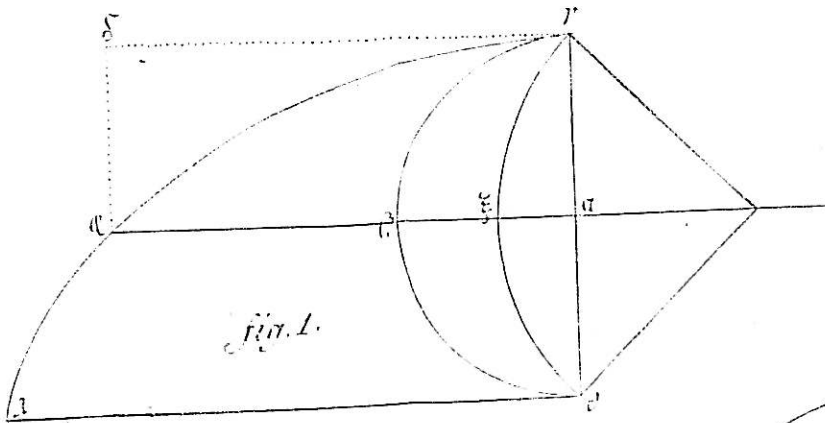
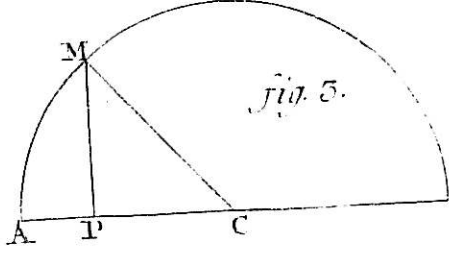


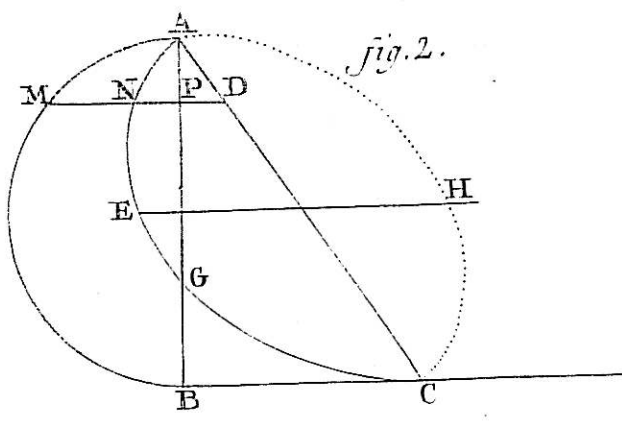
fig. 4.



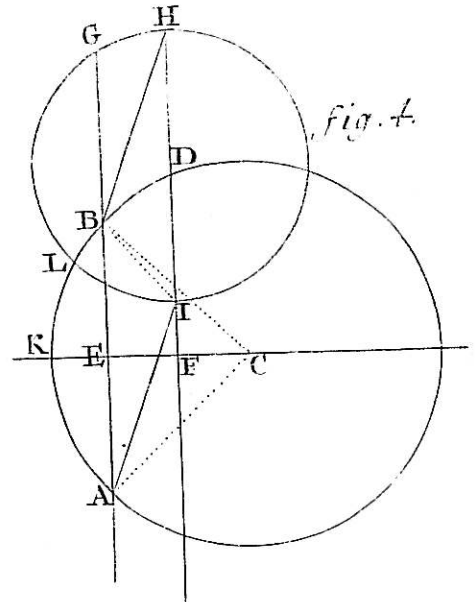
*fig. 1.*



*fig. 5.*

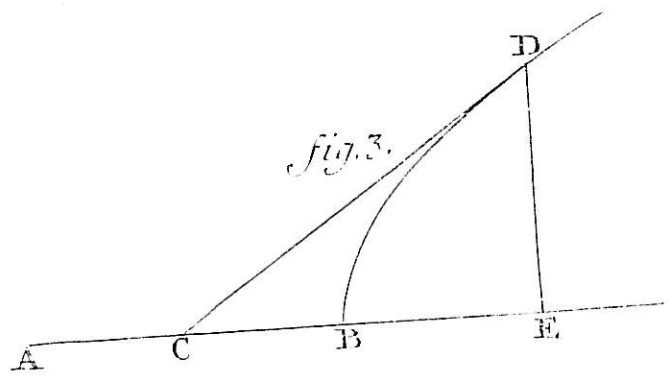
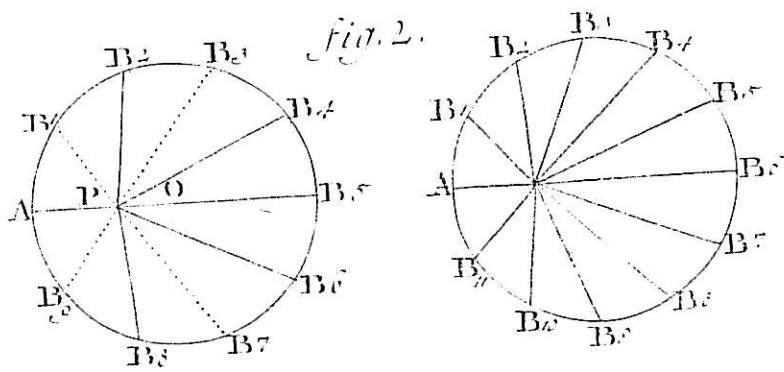
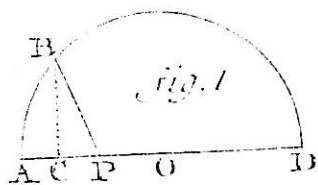


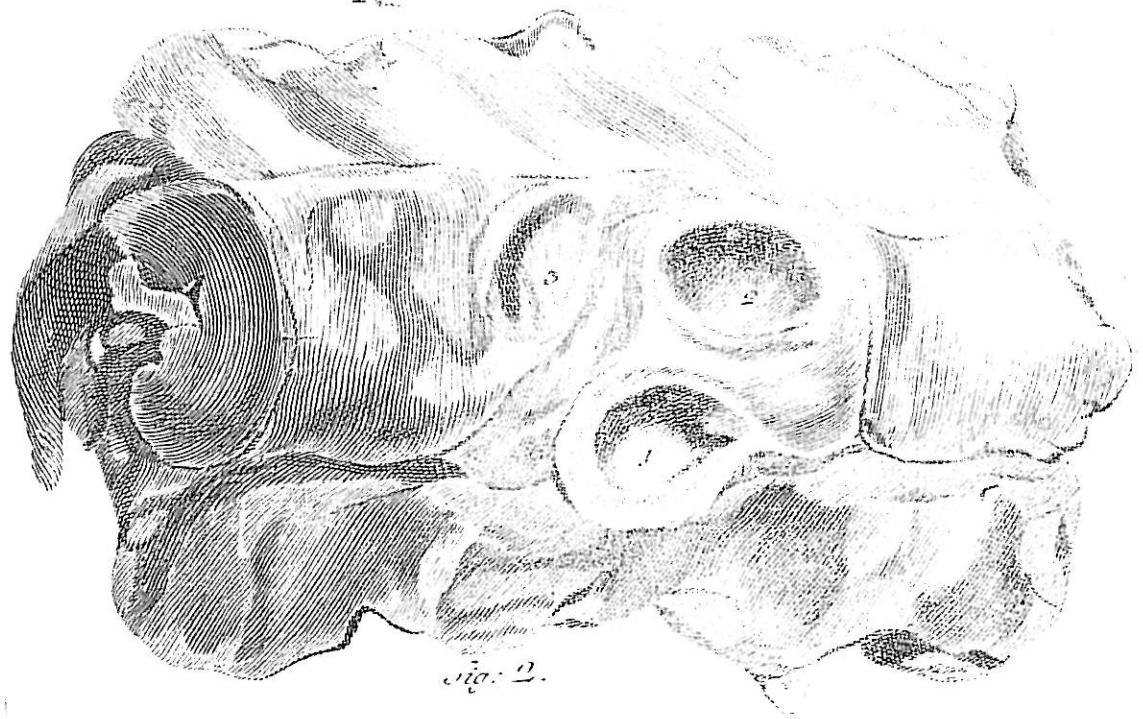
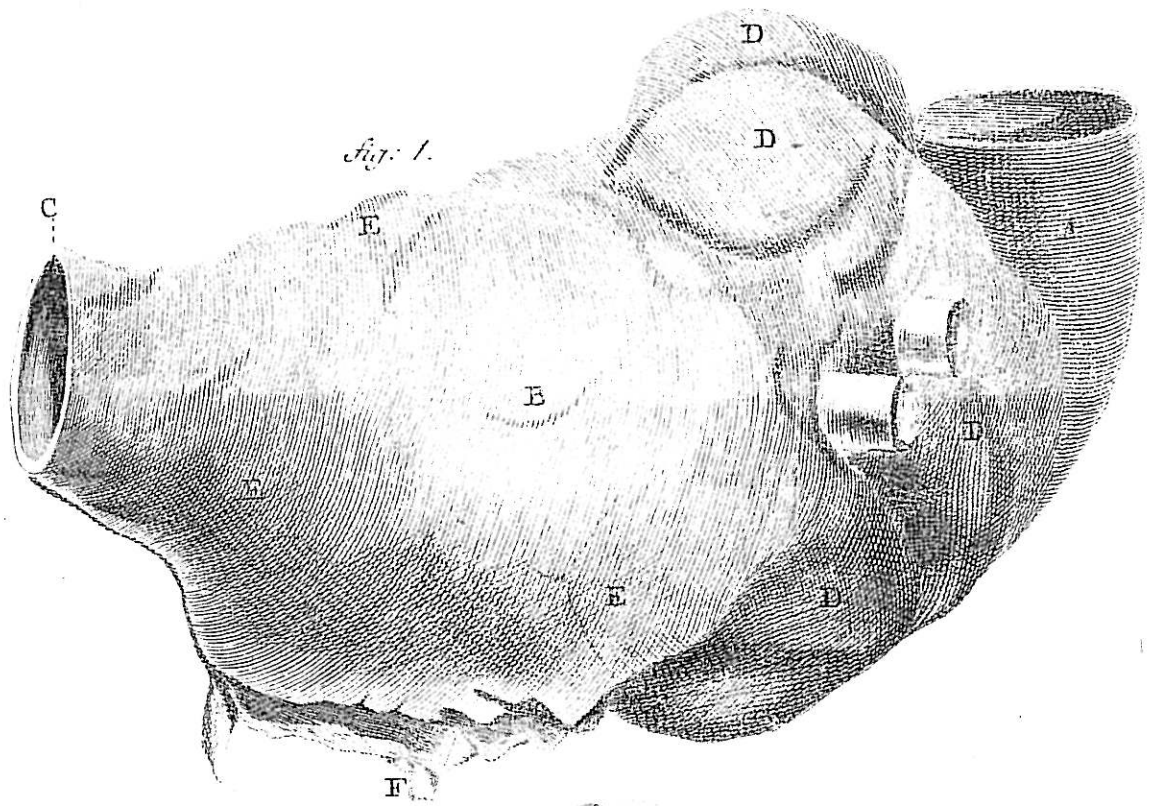
*fig. 2.*



*fig. 4.*







		VOCALES (7)								
		In Initio	In Medio	In Fine						
(1)	あ	あ	い	う	あ	い	う	あ	い	う
		あ	い	う	あ	い	う	あ	い	う
		あ	い	う	あ	い	う	あ	い	う
		あ	い	う	あ	い	う	あ	い	う
(2)	え	え	い	う	え	い	う	え	い	う
		え	い	う	え	い	う	え	い	う
		え	い	う	え	い	う	え	い	う
(3)	お	お	い	う	お	い	う	お	い	う
		お	い	う	お	い	う	お	い	う
(4)	清書金集頭	DIPHTHONGI in i (8)			CONSONANTES sine Vocalibus (10)					
					Initio Medio Initio Medio					
		あ	い	う	あ	い	う	あ	い	う
		あ	い	う	あ	い	う	あ	い	う
		あ	い	う	あ	い	う	あ	い	う
		あ	い	う	あ	い	う	あ	い	う
		あ	い	う	あ	い	う	あ	い	う
		あ	い	う	あ	い	う	あ	い	う
		あ	い	う	あ	い	う	あ	い	う
		あ	い	う	あ	い	う	あ	い	う
(5)	は	DIPHTHONGI in o et u (9)								
(6)	ふ	あ	い	う	あ	い	う	あ	い	う
		あ	い	う	あ	い	う	あ	い	う



Caput. I. Consonantes Vocales terminatae (11)						
a	i	e	o	u	ö	oo
1. <i>na</i>	<i>ni</i>	<i>ni</i>	<i>no</i>	<i>nu</i>	<i>nö</i> <i>noo</i>	13. <i>ku</i>
2. <i>ka</i>	caret		<i>ko</i>	caret	<i>kö</i> <i>koo</i>	<i>ghu</i>
3. <i>ga</i>	caret		<i>go</i>	caret	<i>gö</i> <i>goo</i>	<i>gehe</i>
4. <i>cha</i>	caret		<i>cho</i>	caret	<i>chö</i> <i>choo</i>	<i>ki</i>
5. <i>ba</i>	<i>be</i>	<i>bi</i>	<i>bo</i>	<i>bu</i>	<i>bö</i> <i>boo</i>	<i>gi</i>
6. <i>pa</i>	<i>pe</i>	<i>pi</i>	<i>po</i>	<i>pu</i>	<i>pö</i> <i>poo</i>	<i>ghi</i>
7. <i>sie</i>	<i>se</i>	<i>si</i>	<i>so</i>	<i>su</i>	<i>sö</i> <i>soo</i>	<i>ku</i>
8. <i>scha</i>	<i>sche</i>	<i>schi</i>	<i>scho</i>	<i>schu</i>	<i>schö</i> <i>schoo</i>	<i>au</i>
9. <i>ta</i>	<i>te</i>	<i>ti</i>	<i>to</i>	<i>tu</i>	caret	<i>gchö</i>
10. <i>da</i>	<i>de</i>	<i>di</i>	<i>do</i>	<i>du</i>	caret	14. <i>ka</i>
11. <i>la</i>	<i>le</i>	<i>li</i>	<i>lo</i>	<i>lu</i>	<i>lö</i> <i>loo</i>	<i>ga</i>
12. <i>ma</i>	<i>me</i>	<i>mi</i>	<i>mo</i>	<i>mu</i>	<i>mö</i> <i>moo</i>	<i>cha</i>
13. <i>tscha</i>	<i>tsche</i>	<i>tschi</i>	<i>tscho</i>	<i>tschu</i>	<i>tschö</i> <i>tschoo</i>	<i>ko</i>
14. <i>daja</i>	<i>daje</i>	<i>daji</i>	<i>daje</i>	<i>daju</i>	<i>dajö</i> <i>dajoo</i>	<i>go</i>
15. <i>ja</i>	<i>je</i>	caret	<i>je</i>	<i>ju</i>	<i>jö</i> <i>joo</i>	<i>chö</i>

	a	e	i	o	u	ö oo	
15	ra	re	ri	ro	ru	rö roo	Syllabae anomalae (12)
16	fa	fe	fi	fo	fu	fö föo	
	wa	we	caret				3 <sup>o</sup> si
17	zha	zhe	zhi	zho	zhu	caret	4 <sup>o</sup> tichi
18	ja	je	ji	jo	ju	caret	1 <sup>o</sup> daji
19	gja	gje	gji	gjo	gju	gjö gjoo	
Cap. II. Syllabae terminatae Diphthongis in i (13)							
	nai	nei	nii	noi	nui	nöi	
	bai	bei	bii	boi	bui	böi	
	caret	kai	kii	caret	kui	caret	Sed sequentes x kai xui xoi xüi
	caret	gai	gii		gui		
	chai	chei		caret	chöi		Sed sequentes x kai xui xoi xüi
Cap. III. Syllabae terminatae in r (14)							
	nar	ner	nir	nor	nur	noir	scribitur etiam
	bar	ber	bir	bor	bur	boir	nar etc.
	jar	jer	caret	jer	jur	joir	

Cap. IV. Syllabae terminatae in n (15)

an	en	in	en	un	ön	
kan caret	caret	caret	ken caret	caret	kön	
gan caret	caret	caret	gen caret	caret	gön	
chan caret	caret	caret	chen caret	caret	chön	
ban	ben	bin	ben	bun	bön	Sic etiam pan etc. Nam ba et pa
san	sen	sin	sen	sun	son	Scribuntur } }

Cap. V. Syllabae terminatae in ng (16)

ang	eng	ing	ong	ung	öng	
schang	scheng	caret	schong	schung	schöng	
lang	leng	ling	long	lung	löng	
rang	reng	ring	rong	rung	röng	

Cap. VI. Syllabae terminatae in k (17)

ak	ek	ik	ok	uk	ök	
mak	mek	mik	mok	muk	mök	
tschak	tschek	tschik	tschok	tschuk	tschök	
dajak	dajek	dajik	dajok	dajuk	dajök	

		caret				
			caret		At	
			caret		conso- nans	
			caret		viguens	

Cap: VII Syllabae terminatae in s (18)

						<i>in quoque in perigrinis</i> 

Cap: VIII. Syllabae terminatae in t (19)

	caret			caret		
	caret			caret		
	caret			caret		

*Syllabae in media voce terminatae in t (20)*

at	et	it	ot	ut	öt			
tichat	tichet	tichit	tichot	tichut	tichöt			
jat	jet	caret	jot	jut	jöt			
kat	caret	caret	kot	caret	köt			
gat	caret	caret	got	caret	göt			
chat	caret	caret	chot	caret	chöt			
rat	ret	rit	rot	rut	röt			

*Cap. IX. Syllabae terminatae in b (21)*

ab	eb	ib	ob	ub	öb	
nab	neb	nib	nob	nub	nöb	
dgiab	dgi <b>e</b> b	dgi <b>i</b> b	dgi <b>o</b> b	dgi <b>u</b> b	dgi <b>ö</b> b	
jab	job	caret	job	jub	jöb	

*Cap. X. Syllabae terminatae in diphthongis e et u (22)*

näö	nëö	niü	nöö	nöü	nöü	
bäö	bëö	bii	böö	böü	böü	
fäö	fëö	fii	föö	föü	föü	

Cap. XI. Syllabae terminatae in l (25)

al	el	il	ol	ul	äl
nal	nel	nil	nel	nul	nöl
bal	bel	bil	bol	bul	böl
mal	mel	mil	mol	mul	möl
tal	tel	til	tol	tul	töl

Cap. XII. Syllabae terminatae in m (24)

am	em	im	om	um	öm	
nam	nam	nim	nem	num	nöm	<sup>ken</sup> <sup>pen</sup> <sup>shen</sup>
kam	caret	caret	kem	caret	köm	<sup>ken</sup> <sup>pen</sup> <sup>shen</sup>
gam	caret	caret	gem	caret	göm	<sup>ken</sup> <sup>pen</sup> <sup>shen</sup>
cham	caret	caret	chem	caret	chöm	<sup>ken</sup> <sup>pen</sup> <sup>shen</sup>
bam	bem	bim	bom	bum	böm	<sup>ken</sup> <sup>pen</sup> <sup>shen</sup>
sham	shem	shim	shom	shum	shöm	
ficham	fichem	caret	fichem	fichum	fichöm	
tam	tem	tim	tom	tum	caret	
dam	dem	dim	dom	dum	caret	